



Motorcycle Art



MV AGUSTA F4 BRUTALE 910 S

Owner's Manual

910
BRUTALE



California 65 Proposition Warning:

WARNING

This vehicle contains or emits chemicals known to the State of California to cause cancer and birth defects or other reproductive harm.

Information



MV Agusta S.p.A. is committed to a policy of constant improvement; therefore, you may find slight differences between the information provided in this document and the vehicle you purchased. MV Agusta motorcycles are exported in several countries, in which different rules and regulations (concerning both the Highway Code and the homologation procedures) are in force. Relying on your understanding, MV Agusta S.p.A. deems it necessary to reserve the right to change its products and the related documentation at any time and without notice.

Respect and defend natural environment



Everything we do affects the whole planet as well as its resources. MV Agusta, in order to protect the interests of the community, awakens the Customers and the Technical Assistance operators to use the vehicle and dispose of its replaced parts respecting the laws in force concerning environmental pollution and waste disposal and recycling.

© 2005

This document may not, in whole or in part, be reproduced without prior consent, in writing, from MV Agusta S.p.A.

Part No. 8000A5272 - Edition No. 1

Printed in June 2005

MV AGUSTA

**SP10
BRUTALE**



Owner's Manual

Il presente Manuale di uso e manutenzione è disponibile nelle edizioni in lingua sotto specificate:

This Manual is available in the languages listed below:

Le présent livret d'utilisation et d'entretien est disponible dans les éditions rédigées dans les langues spécifiées ci-dessous:

Die vorliegende Bedienungs- und Wartungsanleitung ist in folgenden Sprachen erhältlich:

Las ediciones del presente manual de uso y mantenimiento están disponibles en los siguientes idiomas:

Codice/Code/Code
Bestell-Nr./Código

Edizione Italiana	<i>Italian Edition</i>	Edition Italienne	<i>Italienische Ausgabe</i>	Edición en Italiano	8000A5271
Edizione Inglese	<i>English Edition</i>	Edition Anglaise	<i>Englische Ausgabe</i>	Edición en Inglés	8A00A5271
Edizione Francese	<i>French Edition</i>	Edition Française	<i>Französische Ausgabe</i>	Edición en Francés	8B00A5271
Edizione Tedesca	<i>German Edition</i>	Edition Allemande	<i>Deutsche Ausgabe</i>	Edición en Alemán	8C00A5271
Edizione Spagnola	<i>Spanish Edition</i>	Edition Espagnole	<i>Spanische Ausgabe</i>	Edición en Español	8D00A5271
Edizione USA	<i>USA Edition</i>	Edition USA	<i>USA Ausgabe</i>	Edición USA	8000A5272

Dear Customer,

We wish to thank you for your preference and congratulate you on purchasing your new F4 Brutale 910. MV Agusta, thanks to the passionate effort of its technicians, offers to its customers a motorcycle with a new aesthetic design combined with a refined framework: these are the elements which have distinguished every vehicle created by MV Agusta throughout its glorious history.

The result of this effort is an exclusive motorcycle with functional and aesthetic characteristics that place it above the finest motorcycles currently available on the market, making it an exclusive and sought-after item.

In fact, the technologies and solutions applied give to the F4 Brutale 910 unique characteristics common to all the MV Agusta models, strenghtening a design phylosophy that involves continuous research, technological innovation and love for detail. This way, MV Agusta gives to all the bikers who freely live their passion the chance to possess a unique object, which surely represents a strong reference worldwide.

This manual has been drawn up with a view to providing you with a clear and practical guide to operating and maintaining your new motorcycle while safeguarding your warranty rights.

The indications contained in the manual will help you make the most of your motorcycle in terms of both performance and operating life. The manual provides useful information on how to take care of your vehicle, and also describes some routine maintenance operations. Fundamental units such as the engine and the transmission are covered in the Workshop Manuals. Operations involving these parts require specific equipment and are reserved for skilled personnel. Your dealer possesses the skills, the equipment and the spare parts that are needed to keep your motorcycle in perfect working order. This manual is to be considered as an integral part of the vehicle, and must be transferred to any new owner together with the vehicle.

Have a good time!

*Claudio Castiglioni
MV Agusta
President*



CONTENTS

<i>chap.</i>	<i>Subject covered</i>	<i>page</i>
1	GENERAL INFORMATION	10
1.1.	Purpose of the manual	10
1.2.	Symbols	11
1.3.	Warranty Booklet and Service Coupons	12
1.4.	Identification data	13
2	SAFETY INFORMATION	22
2.1.	Safety	22
2.1.1.	How to report a safety-related defect	22
2.1.2.	Noise emission warranty	22
2.1.3.	Note on tampering	22
2.1.4.	Information on the emission control system	24
2.1.5.	Safety rules	25
2.1.6.	Precautions for children	28
2.1.7.	Installing accessories	29
2.1.8.	Vehicle load	30
2.1.9.	Modifications	32
2.1.10.	Competitions	32
2.1.11.	Recommendations for safe riding	33
2.1.12.	Protective clothing	36

<i>chap.</i>	<i>Subject covered</i>	<i>page</i>
2.1.13.	Suggestions against theft	37
2.2.	Safety labels - Location	38
2.3.	Safety - Visual and acoustic signals	46
3	CONTROLS AND INSTRUMENTS	47
3.1.	Location of controls and instruments	47
3.2.	Sidestand	49
3.3.	Handlebar controls, left side	50
3.4.	Handlebar controls, right side	52
3.5.	Ignition switch and steering lock	55
3.6.	Gear lever	59
3.7.	Instruments and warning lights	60
3.7.1.	Warning lights	61
3.7.2.	Multifunction display	62
4	OPERATION	63
4.1.	Using the motorcycle	63
4.2.	Running-in	64
4.3.	Starting the engine	66
4.4.	Selecting and setting the display functions	68
4.4.1.	Selecting the display functions	69
4.4.2.	Setting the measurement units	70



CONTENTS

<i>chap.</i>	<i>Subject covered</i>	<i>page</i>	<i>chap.</i>	<i>Subject covered</i>	<i>page</i>
4.4.3.	Resetting the trip mileage counters	73	5.7.3.	Low speed compression damper (rear suspension)	99
4.4.4.	Setting the clock	76	5.8.	Headlight adjustment	100
4.5.	Refuelling	78	6	MAINTENANCE	102
4.6.	Glove compartment	80	6.1.	Tables of scheduled maintenance and checks	102
4.7.	Parking the motorcycle	82	6.2.	Tools and accessories supplied	112
4.8.	Preriding checks	85	6.3.	Table of lubricants and fluids	113
4.9	Riding	87	6.4.	Checking the engine oil level	114
5	ADJUSTMENTS	88	6.4.1.	Topping up the engine oil level	115
5.1.	List of adjustments	88	6.5.	Checking the coolant level	117
5.2.	Table of adjustments	91	6.5.1.	Topping up the coolant level	118
5.3.	Adjusting the front brake lever	92	6.6.	Checking the wear of the brake pads	120
5.4.	Adjusting the clutch lever	92	6.7.	Checking the brake fluid level	121
5.5.	Adjusting the rearview mirrors	93	6.8.	Checking the clutch fluid level	123
5.6.	Adjusting the front suspension	94	6.9.	Checking and replacing the tires	124
5.6.1.	Spring preload	95	6.10.	Checking and lubricating the drive chain	130
5.6.2.	Rebound damper (front suspension)	95	6.11.	Checking the idle speed	134
5.6.3.	Compression damper (front suspension)	96	6.12.	Periodic emission check	135
5.7.	Adjusting the rear suspension	97	6.13.	Evaporative emission control system	136
5.7.1.	Rebound damper (rear suspension)	98			
5.7.2.	High speed compression damper (rear suspension)	99			



CONTENTS

<i>chap.</i>	<i>Subject covered</i>	<i>page</i>	<i>chap.</i>	<i>Subject covered</i>	<i>page</i>
6.14.	Emission control system warranty obligations	137	6.17.	Battery	155
6.14.1	Your warranty rights and obligations	137	6.18.	Cleaning the motorcycle	157
6.14.2	Manufacturer's warranty coverage	137	6.19.	Prolonged inactivity	160
6.14.3	Owner's warranty responsibilities	138	7	TROUBLESHOOTING FLOW CHART	161
6.15.	Limited warranty on emission control system	139	7.1.	Engine problems	161
6.15.1	Coverage	139	7.2.	Electrical equipment problems	166
6.15.2	Limitations	140	8	TECHNICAL INFORMATION	169
6.15.3	Limited liability	141	8.1.	Motorcycle overview	169
6.15.4	Legal rights	142	8.1.1.	Front brake circuit	171
6.15.5	Additional information	142	8.1.2.	Rear brake circuit	172
6.16.	Replacing parts - General information	143	8.1.3.	Clutch circuit	173
6.16.1.	Replacing the fuses	143	8.1.4.	Engine lubrication	174
6.16.2.	Replacing the low beam bulb	146	8.1.5.	Coolant circuit	175
6.16.3.	Replacing the high beam bulb	148	8.1.6.	Fuel system	176
6.16.4	Replacing the front parking light bulb	149	8.2.	Specifications	177
6.16.5.	Replacing the front turn indicator bulbs	150	8.3.	Accessories	184
6.16.6.	Replacing the rear turn indicator bulbs	151	8.4.	Clothing	185
6.16.7.	Replacing the rear light and brake light bulb	152	8.5.	Measure equivalence tables for American and metric systems	186
6.16.8.	Replacing the license plate light bulb	153			



INDEX

A	
Accessories	184
– installation	29
Adjustments	
– clutch lever	92
– front brake lever	92
– front suspension	94
– headlight	100
– list	88
– rear suspension	97
– rearview mirrors	93
– table	91
B	
Battery	155
Brakes	
– fluid level, check	121
– front brake circuit	171
– front brake lever, adjustment	92
– pads, wear check	120
– rear brake circuit	172
Bulbs, replacement of	
– front turn indicators	150
– high beam	148
– license plate light	153
– low beam	146
– parking light	149
– rear light and brake light	152
– rear turn indicators	151
C	
Chain	
– check	130
– lubrication	132
Cleaning the motorcycle	157
Clutch	
– circuit	173
– fluid level, check	123
– lever, adjustment	92
Competitions	32
Controls and instruments, location	47
Coolant	
– level, check	117
– circuit	175
– topping up	118
D	
Damper	
– compression (front suspension)	96
– compression (rear suspension)	99
– rebound (front suspension)	95
– rebound (rear suspension)	98



INDEX

Display, multifunction	62	Headlight, adjustment	100
– selecting functions	69	– high beam, bulb replacement	148
– setting functions	70	– low beam, bulb replacement	146
E		I	
Electrical equipment, troubleshooting	166	Identification data	13
Emissions		Idle speed, check	134
– control system	24	Ignition switch and steering lock	55
– control system warranty	137	Instruments and warning lights	60
– periodic check	135		
Engine		L	
– lubrication	174	Levels	
– oil level, check	114	– brake fluid	121
– oil level, topping up	115	– clutch fluid	123
– serial number	13	– coolant	117
– starting	66	– engine oil	114
– troubleshooting	161	License plate light, bulb replacement	153
		Location of controls and instruments	47
F		Lubricants and fluids, table	113
Fuel system	176		
Fuses, replacement	143	M	
G		Maintenance and checks, tables	102
Gear lever	59	Motorcycle color combination	20
Glove compartment	80	Motorcycle overview	169
H		P	
Handlebar controls		Parking	82
– left side	50	Parking light, bulb replacement	149
– right side	52		



INDEX

Precautions for children	28
Preriding checks	85
Prolonged inactivity	160
Purpose of manual	10
R	
Rear light and brake light, bulb replacement	152
Rearview mirrors, adjustment	93
Refuelling	78
Replacing parts, general information	143
Running-in	64
S	
Safety	22
– labels, location	38
– recommendations for safe riding	33
– rules	25
– visual and acoustic signals	46
Scheduled maintenance tables	102
Sidestand	49
Specifications	177
Spring preload	95
Suspensions	
– front, adjustment	94
– rear, adjustment	97
Symbols	11
T	
Tampering, note	22
Tires, check	124
– puncturing	125
– replacement	126
Tools and accessories supplied	112
Topping up	
– coolant	118
– engine oil	115
Troubleshooting flow chart	
– electrical equipment	166
– engine	161
Turn indicators	
– front, bulb replacement	150
– rear, bulb replacement	151
V	
Vehicle	
– identification number	13
– load	30
– modifications	32
W	
Warning lights	61
Warranty	
– Booklet, Service Coupons and Dealers' Guide	12
– emission control system	137



1

1.1. Purpose of the manual

In addition to providing directions on operation and maintenance, this manual contains important information about general safety: **READ THE MANUAL OVER CAREFULLY BEFORE FIRST USING THE MOTORCYCLE.**

The manual describes the model with the maximum equipment at print time.

This manual must be considered as a part of your motorcycle. It must always be kept inside it, and it must be included with the vehicle even if this one is sold back to another owner.

The manual must be kept in the glove compartment placed under the passenger's seat.

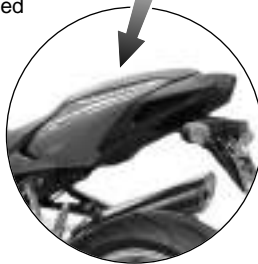



1.2. Symbols

Sections of text that are particularly important in terms of personal safety or possible damage to the motorcycle are marked with the following symbols:



WARNING: Failure to observe the instructions, precautions or procedures accompanied by this symbol, even in part, raises a distinct possibility of a serious hazard, which may result in serious injury, or even death.



CAUTION: Failure to observe instructions or procedures that accompany this symbol, even in part, may result in serious or irreparable damage to the motorcycle, or personal injury to the user, mechanic or other person.

The following symbols give an indication of who is supposed to perform the different adjustments and/or maintenance operations:



Information on operations that can be carried out by the user.



Information on operations that ***must*** be carried out ***only*** by authorized personnel.

The following symbols are used to provide further information:



The “” symbol points out the requirement to use a tool or a special equipment in order to correctly perform the described operation.



The “” symbol refers the reader to the chapter identified by the number that follows.



1.3. Warranty Booklet and Service Coupons

Besides this Owner's Manual, the vehicle is accompanied by the following documents: a Warranty Booklet containing a Warranty and Pre-Delivery Certificate and recommended service coupons, and the MV Agusta Dealers' Guide.

IMPORTANT

The copy of the Warranty and Pre-Delivery Certificate to be sent to MV Agusta must be filled in by the dealer and returned to Cagiva USA within 10 days from the date of registration.

Every time the vehicle is serviced by a dealer, the user must produce the Warranty Booklet so that the dealer can fill in the service coupon and return it to Cagiva USA within 10 days from the date of the servicing.



1.4. Identification data

- 1) vehicle identification number
- 2) engine serial number

► Motorcycle identification

The motorcycle is identified by the vehicle identification number. When placing orders for spare parts, in addition to this number, you may be required to provide the engine serial number, the color code and the key identification.

We recommend writing down the main numbers in the spaces provided below.

VEHICLE No.: _____

ENGINE No.: _____



1

Here below you can find a description of a vehicle identification number:

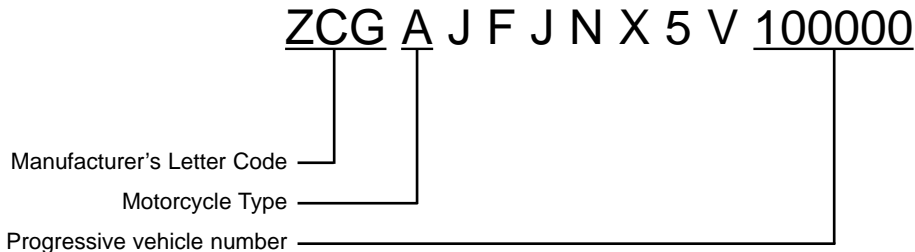

The vehicle identification number must be provided each time you need to contact the MV Agusta Technical Assistance Service, in order to guarantee the traceability of your motorcycle.



► **Motorcycle key identification**

A key is supplied in duplicate for both the ignition and all the locks. Keep the duplicate in a safe place.

It is essential to provide the key identification number if you place an order for a spare motorcycle key. We recommend writing down this number in the space provided below:

KEY No.:

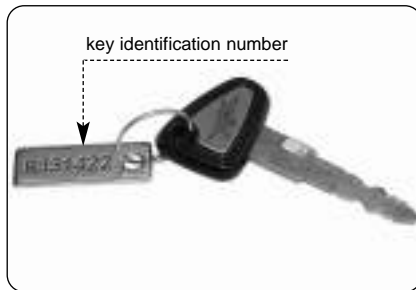



GENERAL INFORMATION

1

1



**► Bodywork parts reference colors**

Bodywork parts are painted with the following reference colors, according to the corresponding motorcycle color combination (see page 20):

1

1. - Rear side fairing, right-hand;
2. - Rear side fairing, left-hand;
3. - Front mudguard:

Color combinations A-D:

CRC B4 Red Painting
(Code Palinal 926XH348D)

Color combination B:

Brutale Metal Matt Black Painting
(Code Palinal 925XH982)

Color combination C:

F4 AGO Silver Painting
(Code Palinal 928XV025)

4. - Fuel tank:

Color combination A:

CRC B4 Red (Code Palinal 926XH348D)

Color combination B:

Brutale Metal Matt Black Painting
(Code Palinal 925XH982)

Color combination C:

F4 AGO Silver (Code Palinal 928XV025) +
CRC B4 Red (Code Palinal 926XH348D)

Color combination D:

CRC Intense Black Painting
(Code Palinal 929R486)

5. - Tail piece;
6. - Air box side fairings;
7. - Ignition switch cover;
8. - Dashboard cover:

“Senna” Metal Matt Black Painting (Code
Palinal 925XV414 + Palinal 923MAT.3)

9. - Fuel tank left-hand side fairing;
10. - Fuel tank right-hand side fairing;
11. - Right-hand rearview mirror;
12. - Left-hand rearview mirror:

“Senna” Metal Matt Black Painting (Code
Palinal 925XV414 + Palinal 923MAT.3)



1





► Frame parts reference colors

Frame parts are painted with the following reference colors:

1. - Frame:

Color combinations A-B:

Brutale Metal Anthracite Grey Painting
(Code Palinal 211XH893)

Color combinations C-D:

F4 AGO Frame Red Painting
(Code Palinal 211XH987)

4. - Front wheel rim;

5. - Rear wheel rim:

Aluminium Grey Painting
(Code Sebino 35204189) +
Transparent Painting
(Code Sebino 35209052)

2. - Rear frame;

3. - Silencers clamp:

Brutale Metal Anthracite Grey Painting
(Code Palinal 211XH893)

6. - Engine:

MV Tamburini Metal Grey Painting
(Code Palinal 211.R129)



1

► Identification of motorcycle color combination

The color code must be mentioned when ordering body spares. It can be read on the lower left side of the fuel tank.

In order to get to the color code label, it is necessary to remove the fuel tank left-hand side fairing.

Pull out the rear part of the fuel tank left-hand side fairing as shown in the figure.

Remove the fuel tank left-hand side fairing by pulling it towards the rear part of the motorcycle.

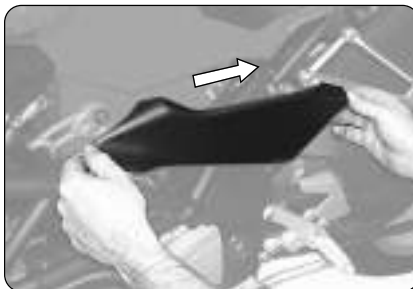
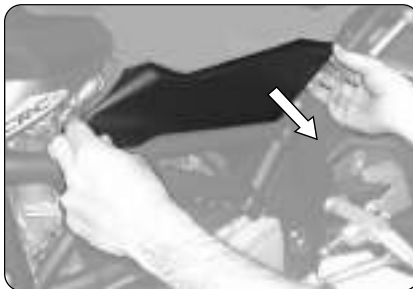



After removing the fuel tank left-hand side fairing, it is possible to get to the color code label. On this label you can read the motorcycle color combination, which determines the painting of the bodywork parts.

We recommend writing down the color code in the space provided below:

COLOR CODE :

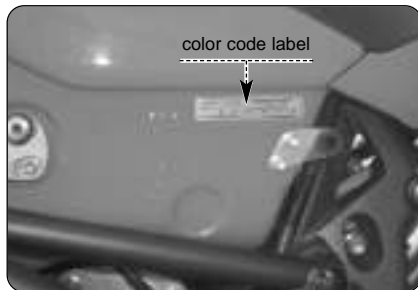



2.1. Safety

2.1.1. HOW TO REPORT A SAFETY-RELATED DEFECT

If you believe that your vehicle has a defect which could cause a crash or could cause injury or death, you should immediately inform the National Highway Traffic Safety Administration (NHTSA) in addition to notifying MV Agusta S.p.A. If NHTSA receives similar complaints, it may open an investigation, and if it finds that a safety defect exists in a group of vehicles, it may order a recall and remedy campaign. However, NHTSA cannot become involved in individual problems between you, your dealer, or MV Agusta S.p.A. To contact NHTSA, you may either call the Auto Safety Hotline toll-free at 1-800-424-9393 (or 366-0123 in Washington, D.C. area) or write to: NHTSA, U.S. Department of Transportation, Washington, D.C. 20590. You can also obtain other information about motor vehicle safety from the Hotline.

2.1.2. NOISE EMISSION WARRANTY

MV Agusta S.p.A. warrants that, at the time of sale, the exhaust system conformed to all applicable U.S. EPA (Environmental Protection Agency) noise control regulations. The warranty applies to the first retail purchaser of the exhaust system and to all subsequent buyers. Any warranty claims must be addressed to: Cagiva U.S.A. Incorporated, 2300 Maryland Road, Willow Grove, PA 19090-4139.

2.1.3. NOTE ON TAMPERING

Tampering with the noise control system is prohibited. In particular, the law prohibits the following acts:

1. The removal or rendering inoperative, other than for purposes of maintenance, repair, or replacement, of any device or element of design incorporated into any new vehicle for the purpose of noise control prior to its sale or delivery to the ultimate purchaser or while it is in use.



2. The use of the vehicle after such device or element of design has been removed or rendered inoperative.

Acts presumed to constitute tampering include:

1. The removal or piercing of the exhaust silencer, the diaphragm, the manifolds, or any other components involved in the transmission of exhaust gases.
2. The removal or piercing of any part of the intake system.
3. Poor maintenance.
4. The replacement of any movable parts of the vehicle or of any intake or exhaust components with parts or components other than those prescribed by the manufacturer.

NOTE

Never ride your motorcycle with a defective muffler. This will effect not only the motorcycle's sound level, but its performance as well. Riding with a defective muffler can also subject you to arrest and imposition of fines.

The rules of the road vary from country to country. Be sure that you understand local regulations before riding your motorcycle.



2.1.4. INFORMATION ON THE EMISSION CONTROL SYSTEM

2 The combustion process produces carbon monoxide and hydrocarbons. Hydrocarbon control is particularly important in that, under certain conditions and when exposed to direct sunlight, hydrocarbons undergo reactions which lead to the formation of photochemical smog. Carbon monoxide does not react in the same way, but it is highly toxic. **MV Agusta** uses a sequential multi-point electronic injection system and other methods designed to cut carbon monoxide and hydrocarbon emissions.

Exhaust emission control system

The exhaust emission control system is made up of the sequential multipoint injection (SMPI) system, which requires no adjustment. The exhaust emission control system is distinct from the crankcase emission control system.

Crankcase emission control system

The engine is equipped with a closed-crankcase

system designed to prevent the release of crankcase emissions into the atmosphere. Blow-by gases return to the combustion chamber via the air filter and the injection system.

Evaporative emission control system

California motorcycles are equipped with an evaporative emission control system, which consists of a charcoal canister and associated plumbing. This system prevents the escape of fuel vapors from the fuel tank.

Problems relating to the vehicle's emissions

Should the vehicle show any of the following symptoms, contact your **MV Agusta** dealer to have it checked and if necessary repaired:

- 1) Engine is difficult to start or stalls after starting.
- 2) Idle speed is erratic.
- 3) Misfiring or backfiring during acceleration.
- 4) Afterburning.
- 5) Poor performance (driveability) and excessive consumption.



2.1.5. SAFETY RULES



IMPORTANT: READ BEFORE USE

► **Before riding**, carefully read this manual so as to familiarize yourself with the controls, characteristics, working and limits of the motorcycle. The manual is aimed at providing information on some of all the possible techniques and methods required for safe riding.

► **Do not attach a sidecar, a trailer or any other accessory to the motorcycle.** Failure to observe this warning may make the vehicle unstable and cause serious accidents.

► **To ensure maximum reliability and maintain the vehicle in perfect working order**, it is essential to perform the servicing detailed in the Scheduled Maintenance Table and to follow all the instructions provided in this manual. For further information, speak with your dealer, who will have the necessary technical skills and information to assist you.

► **MV Agusta** continually strives to improve the quality of all of its motorcycles. Therefore, modifications that improve the performance of the bike are made as soon as they are developed. Therefore, your motorcycle may not be described exactly by the illustrations and text contained in this manual.

► **If you find difficulties in understanding any picture or information contained in this manual**, contact your MV Agusta dealer to obtain the necessary explanations.

► **If you find difficulties in reading any information contained in this manual**, contact your MV Agusta dealer.

► **In order to avoid compromising handling and stability of your motorcycle**, you should obey the following warnings:

- do not attach any object to the vehicle;
- do not remove any part and/or component;
- do not modify the vehicle in any way;
- do not wear garments that could adversely affect control and handling of the motorcycle.



2

- ▶ **Do not ride this motorcycle if you do not possess a regular driving licence.** Failure to heed this warning violates the law and increases the risk of accidents, which may lead to personal serious injury or even death.
- ▶ **Do not try to service or repair this motorcycle if you do not possess the necessary skills.**
- ▶ **Motorcycle riding demands your complete attention.** Do not ride if you are ill, in poor physical condition, or because of worry, etc., unable to concentrate on the task at hand.
- ▶ **Always wear a helmet, even on short rides.**
- ▶ **Always wear suitable clothes, especially when travelling by night (e.g. garments with fluorescent bands).**
- ▶ **When refuelling, switch off the engine and refrain from smoking.**
- ▶ **When refuelling, avoid spilling the fuel onto the tank and the exhaust pipes.** Petrol is highly flammable and it may light if it comes in touch with any hot part of your motorcycle, with subsequent serious burns or even death.

- ▶ **When refuelling, stay away from the vehicle to avoid inhaling harmful fumes.** Should the fuel come into contact with the skin or clothes, immediately wash with water and change the contaminated garments.
- ▶ **Do not start the engine in closed places.** Exhaust gases are toxic and can quickly saturate the air and cause fainting or even death.
- ▶ **Before starting the engine in a closed place, ensure that the area is well ventilated.**
- ▶ **When travelling during the day, use the low beam.**
- ▶ **While the vehicle is in motion, always rest the feet on the specially designed supports.**
- ▶ **While riding, always keep both hands on the handlebars.**

**WARNING**

Driving with your hands and/or feet away from their designed supports can cause loss of control, upset, and subsequent serious injury or even death.



► If your motorcycle has been involved in an accident, check all levers, wires, hoses, brake calipers and other main parts for damage. Do not use the vehicle if you detect a damage that could adversely affect safety. Have all the main parts checked by an authorized MV Agusta dealer, in order to verify the absence of defects and/or damages that the owner could not be able to detect.

**WARNING**

Failure to heed this warning can lead to loss of control of the vehicle, with subsequent serious injury or even death.

**WARNING**

The “warnings”, “dangers” and “cautions” contained in this manual are designed and intended to protect you, the user, from harm. Failure to observe these can lead to serious injury or even death. Always obey the suggestions and instructions in the warning, as well as the accompanying text.

**WARNING**

Observe all of the warnings, dangers and cautions related to the maintenance procedures as listed throughout this manual. Failure to observe this warning can not only destroy your motorcycle, but can lead to serious injury or even death.



2.1.6. PRECAUTIONS FOR CHILDREN



WARNING

- Park the vehicle where it is unlikely to be bumped into or damaged. Even slight or involuntary bumps can cause the vehicle to topple over, with subsequent risk of serious harm to people or children.
- To prevent the vehicle from tipping over, never park it on soft or uneven ground, nor on asphalt strongly heated by the sun.
- Engine and exhaust pipes become very hot during riding. Always park your motorcycle where people or children can not easily reach these parts, in order to avoid serious burns.
- Do not cover your motorcycle with a canvas soon afterwards riding. Before covering your motorcycle, wait until the engine and the exhaust pipes have thoroughly cooled, in order to avoid the risk of a fire with subsequent danger for people and children, as well as damage to the motorcycle.

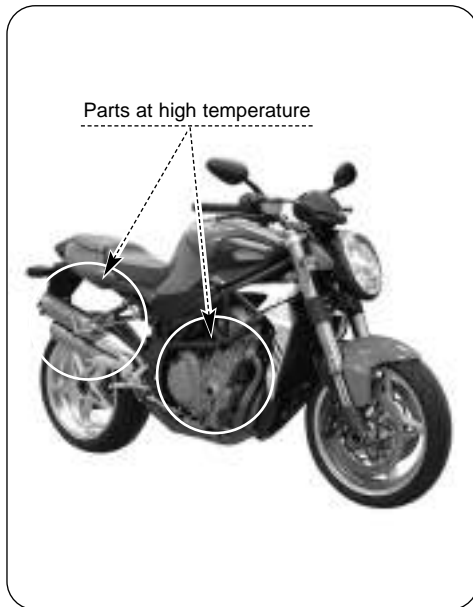



2.1.7. INSTALLING ACCESSORIES

MV Agusta provides a range of accessories specially designed for your vehicle. It is essential that these accessories are installed by an MV Agusta dealer.



WARNING

Use only MV Agusta original accessories. The use of non-genuine accessories can make the vehicle unsafe by reducing its handling, stability and the effectiveness of the braking system. For this reason, the installation of any non-genuine accessory makes the warranty null and void and relieves MV Agusta of all responsibility.

► Every time you apply accessories that affect the weight and/or the aerodynamic characteristics of your motorcycle, they must be assembled on its lower side and near to its center, as much as it is

possible. The brackets and the anchor bolts must be carefully checked after the assembling, to ensure a stable framework and an unmovable support for the accessory. In fact, an eventual breaking of these stands could cause dangerous situations during riding.

► Verify that the assembling of the accessories does not cause a reduction of the minimum ground clearance and of the inclination of your motorcycle. Moreover, verify that the assembling of the accessories does not cause any interference with the handling of the steering system, with the travel of the suspensions and/or with the movement of any other component involved in driving.

► Any accessory positioned on the handlebar or on the front fork can reduce the handling and adversely affect the stability of the vehicle. Therefore, the choice of the accessories should be accurate and restricted to components of light weight and small dimensions only.

► Your motorcycle could undergo lightening or other instability effects in case of wind blowing



2

sideways and transversely; this may also happen when your motorcycle runs into or it is overtaken by vehicles of great dimensions. Under these conditions, the accessories adversely affect your driving safety, especially if they are incorrectly assembled or of the wrong type. It is therefore necessary to pay great attention in choosing and assembling any accessory.

► **Some accessories force the rider to drive in an unnatural position. This may obviously restrict your freedom of movement and cause loss of control of the vehicle, upset, and subsequent serious injury or even death.**

► **Additional electric accessories can cause an overload of the electrical system of your motorcycle; this could damage the wires, causing danger of short circuit and electric shock, with subsequent serious harm or even death.**

2.1.8. VEHICLE LOAD

Your motorcycle is designed for use by the rider and it can also seat a passenger. To use the vehicle in complete safety, it is essential that the following maximum load conditions are never exceeded:

BRUTALE 910 S 425 kg (937 lbs)

This value comes out from the sum of the following weights:

- weight of the motorcycle;
- weight of the driver;
- weight of the passenger;
- weight of the load and all the accessories.

**WARNING**

Since the load can strongly affect handling, braking, performance and safety characteristics of your motorcycle, you should always keep in mind the following warnings.

- **NEVER OVERLOAD YOUR MOTORCYCLE!** Driving an overloaded motorcycle can cause damage to the tires and loss of control of the vehicle, with upset, subsequent serious injury or even death. Verify that the total weight (including the weight of the motorcycle, the driver, the passenger, the load and all the accessories) does not exceed the maximum load values specified for your vehicle.

- Never carry any incorrectly fastened object on your motorcycle, for it might fall away during riding.
- Steadily fasten the heaviest objects near the center of the motorcycle, and equally divide the load on both sides of the vehicle.
- Do not insert any object or accessory in the spaces on the frame trellis, in order to avoid interfering with the movable parts of the motorcycle.
- Before riding, always check the wear and the pressure of the tires.
- Adjust the suspensions according to the load.
- Even if the motorcycle is correctly loaded, drive with caution and never exceed 130 km/h (80 mph) when you carry a load.



2.1.9. MODIFICATIONS

MV Agusta suggests neither to remove any original device, nor to modify the motorcycle in any way that could change its shape or its working.



WARNING

Any modifications made to the vehicle (e.g. alteration and/or removal of components) can make the vehicle unsafe or unlawful. **MV Agusta** cannot be held responsible for any damage to people and objects subsequent to eventual modifications made to the original conditions of your motorcycle. Modifying the vehicle immediately voids the warranty and relieves **MV Agusta** of all responsibility.

2.1.10. COMPETITIONS



WARNING

Riding the vehicle in competitions requires considerable skill and experience as well as an accurate setup of the motorcycle.



CAUTION: The high temperatures caused by the use of the vehicle on race circuits could compromise the efficiency of the catalytic converter and of the exhaust system; therefore, we suggest assembling a special exhaust system when using the vehicle on race circuits.

MV Agusta has designed a number of special components for use in competitions and/or sporting events. The use of such components is strictly limited to areas closed to traffic. Failure to observe this warning violates the law.



2.1.11. RECOMMENDATIONS FOR SAFE RIDING

Besides being a means of transport, your motorcycle is a source of recreation and excitement. However, the configuration of the vehicle does not exclude a certain amount of risk. To ensure maximum safety, in addition to scrupulously observing the warnings and instructions provided in the previous paragraphs, it is essential to take a few additional precautions. In particular:

Before starting off

Follow all the directions given in the section “PRE-RIDING CHECKS”. Conduct an overall check of all safety-related aspects of the motorcycle.

Familiarizing with the vehicle

The rider's ability and his mechanical skills form the basis of riding safety. It is advisable to practise riding in areas without traffic until you have become familiar with the vehicle and its controls. Moreover, **MV Agusta** recommends all riders to take a certified course approved by the

Motorcycle Safety Foundation (MSF), which can provide useful information both to new and experienced riders. For information about MSF training courses, call the toll-free number: (800) 446-9227.

Being aware of one's limits

When riding, never exceed your limits nor those imposed by law. Being aware of your limits and acting accordingly will help you avoid accidents.

Adverse weather conditions

Be very careful when riding in adverse weather conditions. On wet roads, for example, the braking distance increases as a result of reduced tire traction. It is therefore necessary to travel at moderate speed and avoid abrupt braking and acceleration. Pay particular attention when riding on slippery surfaces such as road markings, manholes, level crossings, bridges, gratings, etc. Considering that a motorcycle cannot provide the same degree of shock protection as a motor vehicle, it is essential to adopt a “defensive” riding attitude, particularly in the adverse weather conditions described above.



▶ **Use** the rearview mirror to see the vehicles running at your back before changing lane.

Failure to observe this warning may lead to a collision, with subsequent serious injury or even death.

▶ **Keeping** even one foot or hand away from their designed supports could cause loss of control of the vehicle, with upset, subsequent serious injury and even death. Always keep both hands on the handlebars and both feet on the footrests during riding.

▶ **Change** gears as necessary to ensure that the proper gear ratio is chosen in all riding conditions, allowing the engine to run at optimum speed at all times.

Avoid high gear ratios when travelling at reduced speed (excessively low rpm) as well as low gear ratios when travelling at high speed (excessively high rpm).

▶ **Always** operate the clutch system when you change gear, in order to avoid damage of the engine, of the gearbox and of the transmission.

These components have not been designed to take the shocking stress caused by the forced coupling of a gear.

▶ **Do not** keep the clutch disengaged for a long time during riding, unless you have to change gear. Failure to heed this warning may lead to the overheating and to the abnormal wear of the clutch components.

▶ **When** rapid acceleration is required (e.g. when passing), select a lower gear to obtain better acceleration.

▶ **When** the motorcycle is being ridden at high speed, gearing down several times in rapid succession can cause the engine to overspeed. As a result, the rear wheel may lock, leading to an upset, serious accident, and subsequent injury or even death, as well as damage to the engine and transmission. Never gear down more than one gear at a time without allowing the engine RPM to stabilize.

▶ **When** riding down long hills, reduce the speed of your motorcycle by closing the throttle and



using a low gear ratio to take advantage of engine braking. Use the front and rear brakes as little as possible to maintain your speed, in order to prevent brake overheating and fade.

► **Special attention should be given to the braking system, which plays a key role in ensuring safety. When braking, always take account of the speed of the vehicle and the condition of the road surface.**

The braking action should always be applied gently and gradually to both wheels.

Performing this operation and, more in general, riding the vehicle always requires the utmost care. Therefore, caution should be exercised by all users, and in particular by inexperienced riders.

► **When you make a turn, avoid sudden braking. Failure to observe this warning could lead to the sliding of the wheels and the loss of control of the vehicle, with upset, subsequent serious injury or even death. Always operate the brakes before starting a turn.**

► **When you are laterally blown by a sudden gust of wind (as it may happen when you're overtaken by a vehicle of great dimensions, when you come out of a tunnel or when you're driving in a hilly zone), you could lose control of the vehicle, increasing the risk of accidents with subsequent serious injury or even death. While driving under the above mentioned conditions, reduce your speed and be careful to avoid sideways gusts of wind.**

► **Maintain a safe distance behind vehicles in front of you and adjust your speed to the weather and traffic conditions. Remember that, as your bike picks up speed, stopping distances increase and the motorcycle becomes more difficult to control. Never exceed posted speed limits.**

► **It is strictly forbidden to drink alcoholic beverages or take drugs before riding. Even very small amounts of these substances adversely affect the rider's ability to control the vehicle.**



2.1.12. PROTECTIVE CLOTHING

Always wear a helmet. In many states, it is mandatory. Helmet is the most important part in the biker's protective clothing, because it protects him from head injury in the event of an accident. Always fasten your helmet properly and securely. If you wear an open-face helmet, also wear goggles. Without a protective shield, in fact, wind racing on your face during driving could reduce your visual capacity, increasing the risk of accidents.



WARNING

Failure to wear a helmet increases the risk of serious injury or even death in the event of an accident. Make sure that you and your passenger always wear an approved helmet during driving, by verifying that it bears the corresponding DOT (Department of Transportation) sticker. If you wear an open-face helmet, also wear protective glasses.

Always wear suitable protective clothing. In particular, the following items should be worn:

- ▶ A close fitting jacket, made of tough material and easy to fasten.
- ▶ Supple, reinforced gloves providing both sensitivity and protection.
- ▶ Strong, close-fitting trousers covering the legs completely.
- ▶ Soft, reinforced boots providing both sensitivity and protection.

The items mentioned above are available from any specialized shop.

We recommend buying brightly colored clothes, as they make the rider easier to see at night and in the fog.

In any case, the clothes must allow complete freedom of movement and not hamper the rider in any way. In addition, they must have no loose parts



capable of catching in the control levers, the footrests, the wheels, the drive chain, etc., in order to avoid dangerous situations.

**WARNING**

No helmet or other protective clothing can provide complete protection against the risk of serious personal injury or even death in the event of an accident. Do not be deceived by the false sense of security that you might perceive by wearing even the most excellent protective clothing. Always ride safely.

2.1.13. SUGGESTIONS AGAINST THEFT

1. Every time you park your motorcycle, operate the steering lock and remove the ignition key (see § 3.5.).
2. Park your motorcycle in a closed garage every time it is possible.

3. Install a good quality anti-theft device on your vehicle.
4. Always keep up to date the registration data of your motorcycle.
5. Write down your name, address and phone number in the spaces provided down below, and always keep this owner's manual inside the glove compartment of your motorcycle (see § 4.6.). This is very important, because a stolen motorcycle can be subsequently identified by reading the informations written in the manual found inside it.

NAME: _____

ADDRESS: _____

PHONE NUMBER: _____



2.2. Safety Labels - Location

- 1 - Unleaded petrol
- 2 - Battery warning
- 3 - Chain adjustment
- 4 - Information on gas emissions (Upper and lower silencers)
- 5 - Information on emission control
- 6 - Emission control
- 7 - Certification-Tire Information
- 8 - Rearview mirrors
- 9 - Rear shock absorber
- 10 - Rear wheel hub warning

NOTE

The labels in the following pages do not appear in their real size. If you find difficulties in understanding any of these labels, contact an authorized MV Agusta dealer.

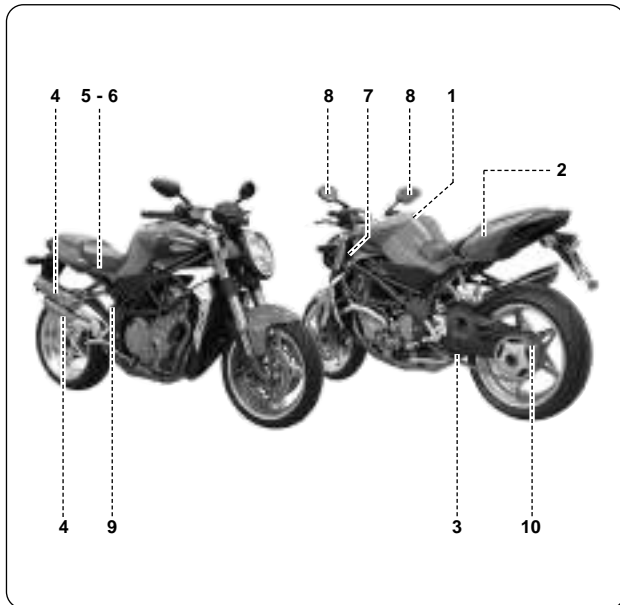



1. ADHESIVE LABEL –
UNLEADED PETROL

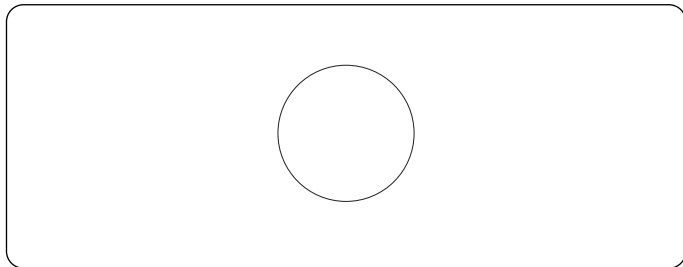

2

2. ADHESIVE LABEL –
BATTERY WARNING





3. ADHESIVE LABEL – CHAIN ADJUSTMENT

2

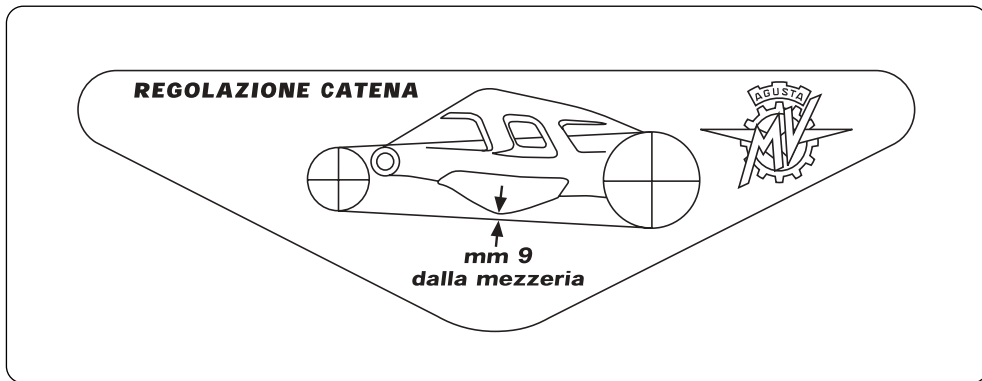

**4.A. STAMPING ON UPPER
SILENCER –****INFORMATION ON GAS
EMISSIONS**

MOTORCYCLE EXHAUST SYSTEM NOISE EMISSION CONTROL INFORMATION
THIS MV AGUSTA EXHAUST SYSTEM, 800097881 MEETS US EPA NOISE EMISSION
REQUIREMENT OF 80 dBA FOR THE FOLLOWING
MOTORCYCLES: CAG44F0750. INSTALLATION OF THIS EXHAUST SYSTEM ON
MOTORCYCLE MODELS NOT SPECIFIED MAY VIOLATE FEDERAL LAW

2**4.B. STAMPING ON LOWER
SILENCER –****INFORMATION ON GAS
EMISSIONS**

MOTORCYCLE EXHAUST SYSTEM NOISE EMISSION CONTROL INFORMATION
THIS MV AGUSTA EXHAUST SYSTEM, 800097880 MEETS US EPA NOISE EMISSION
REQUIREMENT OF 80 dBA FOR THE FOLLOWING
MOTORCYCLES: CAG44F0750. INSTALLATION OF THIS EXHAUST SYSTEM ON
MOTORCYCLE MODELS NOT SPECIFIED MAY VIOLATE FEDERAL LAW



5. ADHESIVE LABEL –

INFORMATION ON EMIS-
SION CONTROL

2

VEHICLE EMISSION CONTROL INFORMATION

ENGINE DISPLACEMENT : 909 cc

ENGINE FAMILY : 5CGXC.998 MV4

ENGINE EXHAUST CONTROL SYSTEM : S.M.P.I.

THIS VEHICLE CONFORMS TO US EPA AND CALIFORNIA REGULATIONS APPLICABLE TO 2005 MODEL YEAR NEW MOTORCYCLES AND IS CERTIFIED TO 1.4 HC + NOx GKM ENGINE FAMILY EXHAUST EMISSION STANDARD IN CALIFORNIA

ENGINE TUNE-UP SPECIFICATIONS AND ADJUSTMENT

ITEM	SPECIFICATIONS	INSTRUCTIONS
IGNITION TIMING :	3° bTDC at idle speed	No Adjustment
IDLE SPEED (RPM) :	1200 ± 50	No Adjustment
IDLE MIXTURE :		No Adjustment

VALVE CLEARANCE (mm) : $\begin{matrix} \text{IN} & 0,15 \pm 0,24 \\ \text{EX} & 0,20 \pm 0,29 \end{matrix}$ See Service Manual

SPARK PLUG : NGK CR9 EB GAP (mm) : 0,7 ± 0,8

FUEL SPECIFICATIONS

UNLEADED OCTANE OIL : SAE 10 W 60
90 R + M/2 TYPE : SYNTHETIC A.P.I. SJ

EVAPORATIVE FAMILY: 5CGXE0018MV4

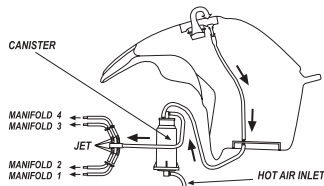

8000A5288

AGUSTA Motorcycles s.p.a. VARESE - ITALY
CAGIVA USA, Inc. WILLOW GROVE, PA



6. ADHESIVE LABEL – EMISSION CONTROL

MOTORCYCLE NOISE EMISSION CONTROL INFORMATION

THIS 2005 CAG44F0900 MOTORCYCLE, 800097880 - 800097881 MEETS US EPA NOISE EMISSION REQUIREMENT OF 80 dBA AT 6050 RPM BY THE FEDERAL TEST PROCEDURE. MODIFICATIONS WHICH CAUSE THIS MOTORCYCLE TO EXCEED FEDERAL NOISE STANDARDS ARE PROHIBITED BY FEDERAL LAW. SEE OWNER'S MANUAL.

 **AGUSTA** Motorcycles S.p.A. VARESE - ITALY

8000A5289

2

7. ADHESIVE LABEL – CERTIFICATION-TIRE INFORMATION

MANUFACTURED BY :  **AGUSTA** Motorcycles S.p.A. DATE :

TYPE OF VEHICLE: MOTORCYCLE

GVWR 937 lbs 425 kg

VIN:

GAWR		TIRE - DIMENSION - RIM		COLD INFL. PRESS	
lbs	Kg			psi	kPa
F 353	160	120/65-/70 17" (56W-58W)	3.50 x 17"	33.0	230
R 584	265	190/50 17" (73W) 190/55 17" (75W)	6.00 x 17" / 5.75 x 17"	33.0	230

THIS VEHICLE CONFORMS TO ALL APPLICABLE FEDERAL MOTOR VEHICLE SAFETY STANDARDS IN EFFECT ON THE DATE OF MANUFACTURE SHOWN ABOVE.

8000A5287



8. ADHESIVE LABEL –
REARVIEW MIRRORS

***OBJECTS IN MIRROR ARE CLOSER
THAN THEY APPEAR***

9. ADHESIVE LABEL –
REAR SHOCK ABSORBER

WARNING
CONTAINS HIGHLY COMPRESSED GAS
USE ONLY PERFECTLY DRY NITROGEN GAS
OTHER GASES MAY CAUSE EXPLOSION
DO NOT INCINERATE REFER TO OWNER'S
MANUAL FOR REGULATING GAS

SACHS



10. ADHESIVE LABEL –
REAR WHEEL HUB
WARNING

ATTENZIONE - WARNING

DURANTE L'OPERAZIONE DI SERRAGGIO DELLE VITI
DEL MOZZO FORCELLONE, ATTENERSI SCRUPolosAMENTE
ALLE SPECIFICHE DI SEGUITO RIPORTATE:

WHEN TIGHTENING THE SWINGARM HUB SCREWS,
CAREFULLY APPLY THE FOLLOWING SPECIFICATIONS:

28 ÷ 32 Nm

2



2.3. Safety - Visual and acoustic signals

Before each ride, it is essential to verify the operation of the visual and acoustic signals.

2

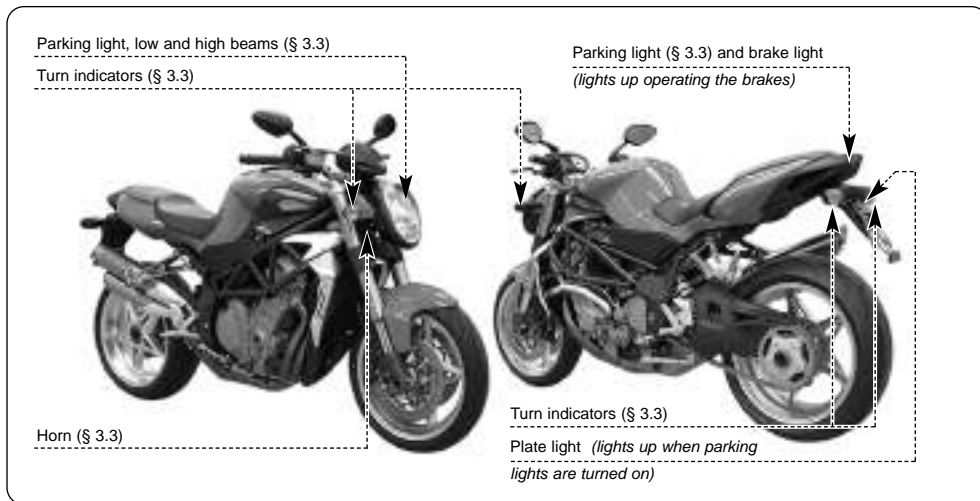



3.1. Location of controls and instruments

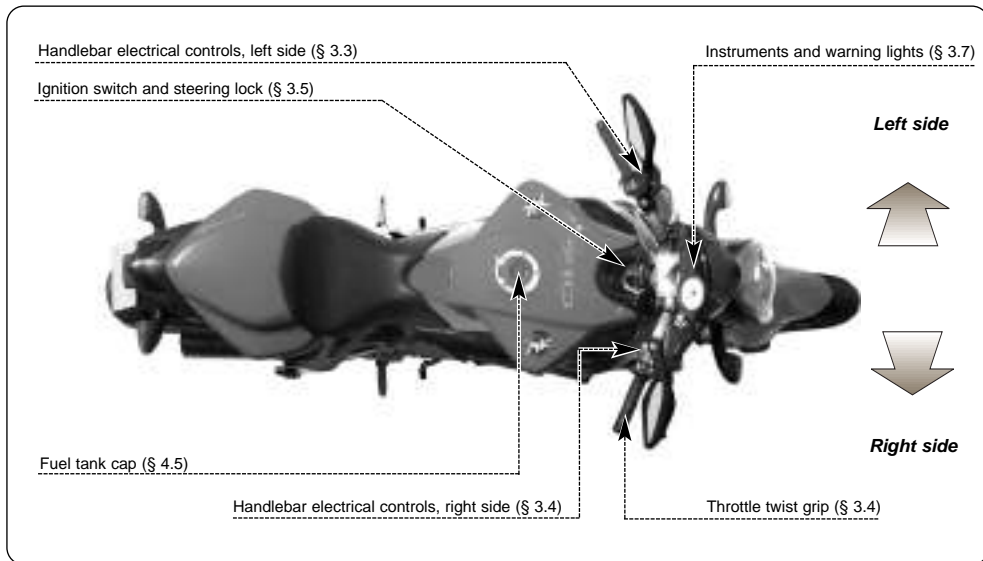

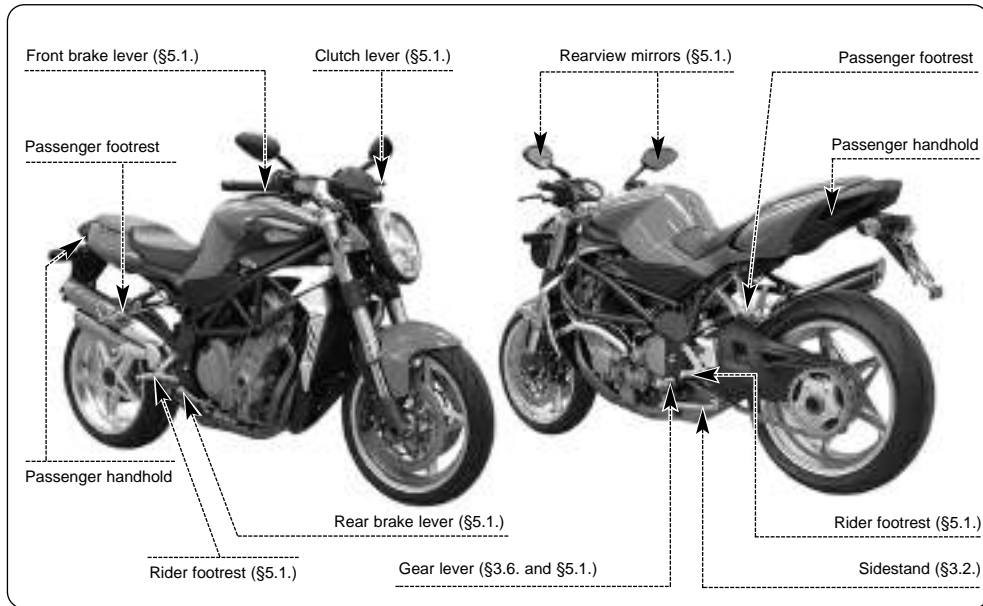



3.2. Sidestand

The sidestand is equipped with a safety switch that prevents the motorcycle from moving off while the stand is down.

If the rider attempts to engage the gears while the engine is running and the stand is down, the switch automatically turns off the engine by cutting the current supply.

If the motorcycle is parked (sidestand down) and the gears are engaged, the switch prevents the engine from being started, thereby avoiding the risk of accidentally toppling the vehicle.

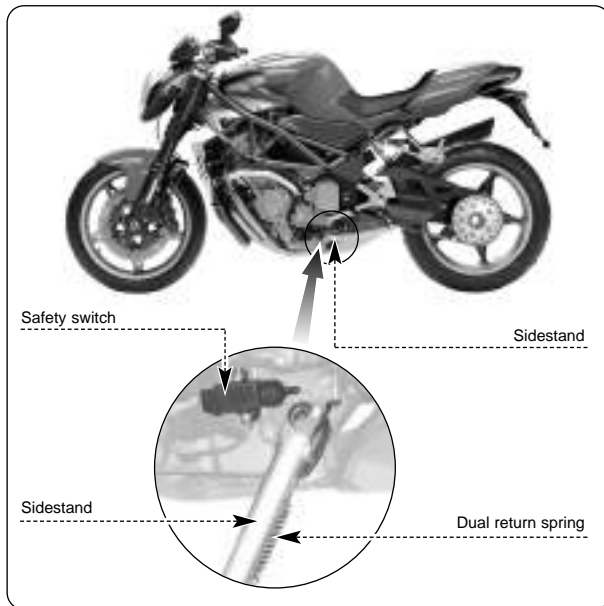



3.3. Handlebar controls, left side



Clutch lever

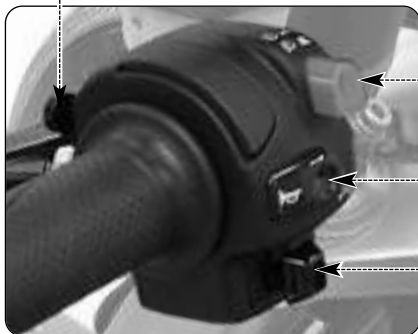

Move towards/away from the handgrip to release/engage the clutch.



High beam flasher button

Press the button repeatedly.

Low/high beam button

Button not pressed in  : low beam 

Button pressed in  : high beam 

Horn button

Press to operate the warning horn.

Turn indicator switch

Shifting the lever to the left or right switches on the left or right turn indicators. The switch then returns to the central position. Press to turn off the indicators.

**High beam flasher button**

It is used to attract the attention of other road users in case of danger. When the high beam is on, the function is inactive.

Low/high beam button

Under normal conditions, the low beam is on. The high beam can be switched on by pressing the button when allowed by the traffic and road conditions.

Turn indicator switch

It is used to show the rider's intention to change direction or lane.

**WARNING**

Always use your turn indicators correctly. Use them to signal your attention before you start a turn, and stop them when you have completed the turn. Failure to observe this warning could lead other users of the road to draw incorrect conclusions about your intentions and the motion of your motorcycle. This could lead to a collision, with subsequent serious injury or even death.

Horn button

It is used to attract the attention of other road users in case of danger.

Clutch lever

It engages/disengages the clutch through a hydraulically controlled device.



3.4. Handlebar controls, right side

3

Front brake lever

Pull to the lever to apply the front brake.

Throttle twist grip

Rotate counterclockwise to increase engine speed.

Cold start (choke) lever

Rotate clockwise when cold starting. After the engine has run for a few seconds, return the lever to its original position.

Engine stop switch

Stops the engine and prevents it from being restarted.

Engine start button

Starts the engine. To be released as soon as the engine starts. When the engine is running, pressing the button selects the display functions.

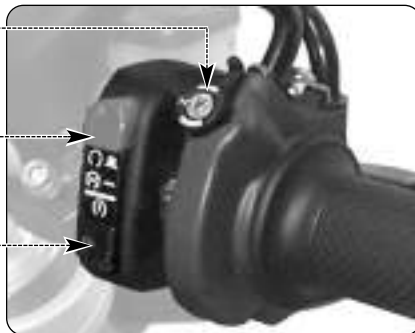
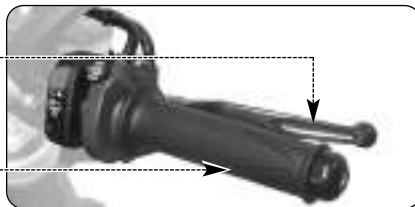



Engine stop switch

It is used to switch off the engine in an emergency. The ignition circuit is disabled, preventing the engine from being restarted. To be able to restart the engine, return the switch to its original position.



WARNING

If the throttle of your motorcycle sticks, and you do not use the engine stop switch to stop the motorcycle, there is a possibility of accident, with subsequent serious injury or even death. Therefore, it is essential that you be familiar with the engine stop switch operation. Should you experience a stuck throttle, stop the engine using the engine stop switch and pull quickly and safely to the side of the road. Do not attempt to start the engine until you are absolutely positive that the problem has been resolved. Failure to observe this warning can lead to an accident with subsequent serious injury or even death.

NOTE

Under normal conditions, do not use this switch to shut off the engine.

Engine start button

It is used to start the engine and, when the engine is running, to select the different functions of the display installed on the instrument panel.

**CAUTION**

To avoid damaging the electrical equipment, be sure not to hold down the button for longer than 5 consecutive seconds.

If, after some attempts, the engine does not start, refer to the chapter “TROUBLESHOOTING” later in this manual.

3**Cold start (choke) lever**

It facilitates cold starting by slightly enriching the fuel-air mixture during start-up.

NOTE

Apply the choke lever for as short a period as possible. Once the engine will idle normally, return the lever to its original position.

Throttle twist grip

It controls the fuel-air mixture supplied to the engine, which regulates engine speed. To increase engine speed, rotate the hand grip from its idle position counterclockwise.

When cold starting (choke on), rotating the throttle twist grip clockwise fully causes the choke lever to return to its original position.

Front brake lever

It controls a hydraulic circuit that operates the front wheel braking system.



3.5. Ignition switch and steering lock

 **WARNING:** Do not attach a ring or any other object to the ignition key as they may hinder the steering action. Failure to observe this warning can lead to loss of control, with upset, subsequent serious injury or even death.

 **WARNING:** Never attempt to change the switch functions while riding. This could cause loss of control with upset, subsequent serious injury or even death.

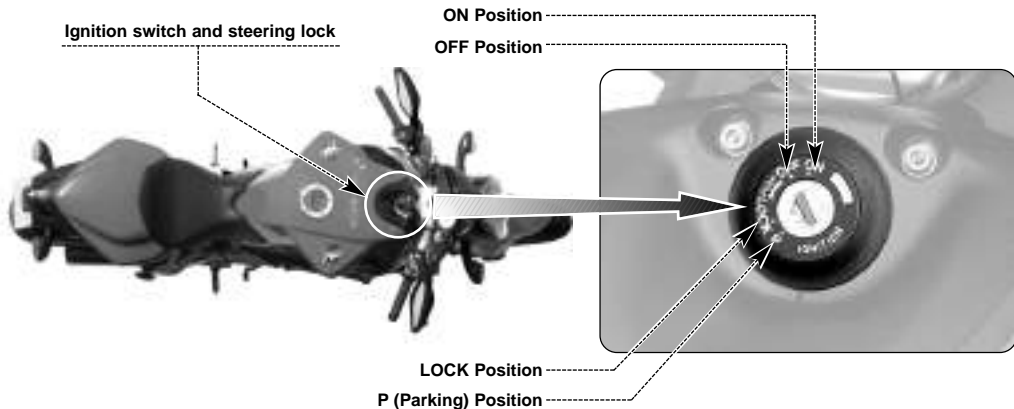



The ignition switch enables and disables the electrical circuit and the steering lock. The four positions of the switch are described below.

OFF position

All electrical circuits are deactivated. The key can be removed.

ON position

All electrical circuits are activated. The instruments and warning lights perform the self-diagnostic cycle. The engine can be started. The key cannot be removed.

3



CAUTION: Do not leave the key on the ON position for a long time when the engine is not running, in order to avoid damage to the electrical parts of the motorcycle.



LOCK position

Turn the handlebar to the left. Press the key in gently while rotating it to the LOCK position. All electrical circuits are deactivated and the steering is locked. The key can be removed.

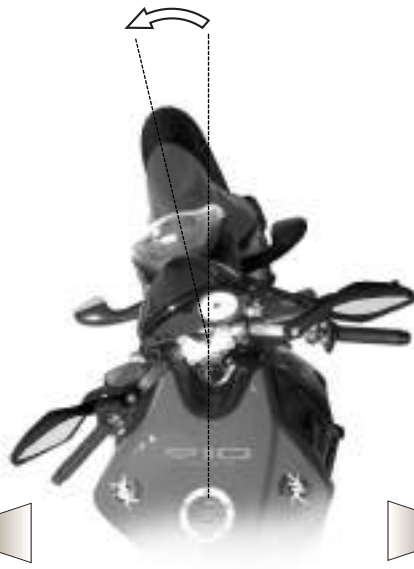

3



Left side



Right side



P (PARKING) position

Turn the key from the LOCK position to the P position. All electrical circuits are deactivated except the parking lights. The steering is locked. The key can be removed.



CAUTION

Do not leave the key on the P position for a long time, in order to avoid discharging the battery of your motorcycle.

3





3.6. Gear lever

The **N** (neutral) position is indicated by the warning light on the instrument panel.

To change into first gear, push the lever down.

To change into second gear, lift the lever up. Lifting the lever up repeatedly engages all the other gears in succession up to the sixth speed.



Gear lever

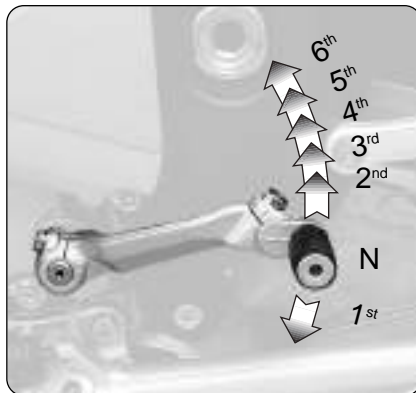



3.7. Instruments and warning lights

The instruments and warning lights are activated by turning the ignition switch to the ON position. After a preliminary check (approx. 7 seconds) the displayed information reflects the current general condition of the motorcycle.

3

Warning lights
(§3.7.1.)

SET button (§3.7.2.)

Warning light
(§3.7.1.)

Multifunction display (§3.7.2.)

Tachometer

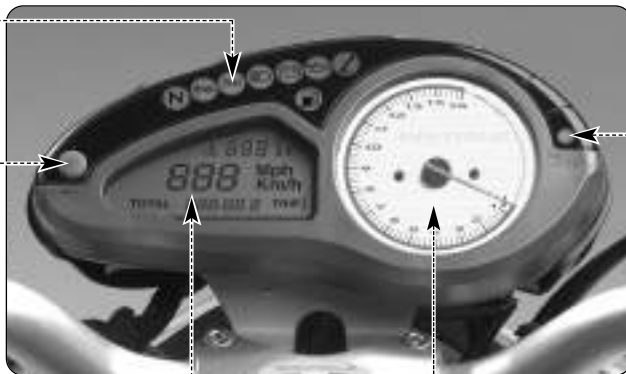



3.7.1. Warning lights

High beam warning light (blue)

Lights up when the high beam is activated.

Low beam warning light (green)

Comes on when the low beam is activated.

Neutral indicator (green)

Lights up when the gears are in neutral.

Turn indicator light (green)

Lights up when the turn indicators are activated.

Reserve fuel indicator (amber)

Comes on when approximately 4 litres (1.05 U.S. gal) of fuel are left.

Battery charge indicator (red)

Lights up when the alternator does not supply enough current to charge the battery.

If the indicator comes on while riding, contact an authorized MV Agusta dealer.

Sidestand down warning light (red)

Lights up when the sidestand is down.

Rev limiter warning light (red)

Lights up when the engine speed exceeds 11,300 rpm. The rev limiter limits the rpm to 12,000.

Engine oil pressure warning light (red)

Lights up when the oil pressure is insufficient.



WARNING: If the warning light comes on while riding, stop the motorcycle immediately. Check and if necessary restore the oil level. If the warning light comes on even if the oil level is correct, do not resume riding and contact an MV Agusta dealer. Failure to observe this warning could lead to an engine seizure with subsequent upset, serious injury or even death.

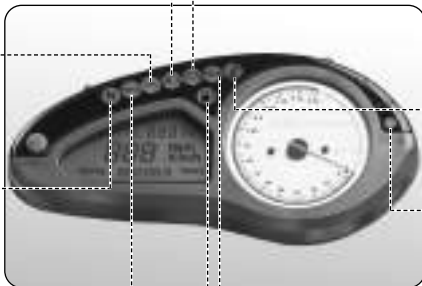



3.7.2. Multifunction display

Speedometer

Measures the speed of the vehicle. The speed can be displayed in kilometres per hour (km/h) or miles per hour (mph). The full-scale value is 299 km/h (186 mph).

Thermometer

Displays the coolant temperature in degrees centigrade (°C) or Fahrenheit (°F).

The display range is 40° to 140° C (104° to 284° F):

- Below 40° C (104° F) no temperature is displayed but three blinking lines denote a very low temperature.
- Between 40° and 49° C (104° and 120° F) the temperature reading blinks to indicate a low temperature.
- Between 50° and 111° C (122° and 232° F) the temperature reading is fixed.
- Between 112° and 140° C (234° and 284° F) the temperature reading blinks to indicate a high temperature.

SET button

Pressing the button allows the setting of the different display functions. Pressing the button again confirms the entered values.

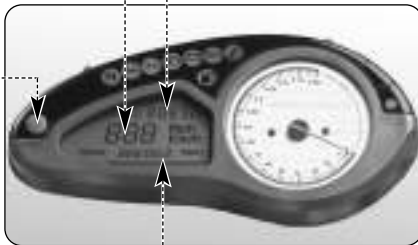

TOTAL mileage counter

Displays the total distance covered: from 0 to 99,999.9 (km or mi)

TRIP 1 mileage counter

Displays a first trip mileage count: from 0 to 9,999.9 (km or mi)

TRIP 2 mileage counter

Displays a second trip mileage count: from 0 to 9,999.9 (km or mi)

Clock

Displays the time (0-24)



WARNING: If the temperature exceeds 120° C (248° F), stop the motorcycle immediately. Check the coolant level (see § 6.6). If the coolant level is correct, do not ride the motorcycle. Contact your MV Agusta dealer for assistance. Observe the WARNING with regard to checking the coolant level given at § 6.6. If the coolant level is low, carefully top up the coolant, after you have allowed the engine to thoroughly cool (see chapter 7 "Troubleshooting"). If the engine overheats again, do not ride the motorcycle. Have it checked by your MV Agusta dealer. Failure to observe this warning can result in engine seizure with subsequent serious injury or even death.



4.1. Using the motorcycle

This section provides the basic information needed to correctly operate the motorcycle:

- Running-in (§ 4.2)
- Starting the engine (§ 4.3)
- Selecting and setting the display functions (§ 4.4)
- Refuelling (§ 4.5)
- Glove compartment (§ 4.6)
- Parking the motorcycle (§ 4.7)
- Pre-riding checks (§ 4.8)
- Riding (§ 4.9)



WARNING: The F4 BRUTALE 910 motorcycle shows high power and performance characteristics; therefore, its use requires an adequate level of knowledge of the vehicle. When you use this motorcycle for the first time, it is essential to adopt a cautious attitude. An aggressive or reckless riding attitude can lead to accidents, with subsequent serious injury or even death.



CAUTION: The high temperatures caused by the use of the vehicle on race circuits could compromise the efficiency of the catalytic converter and of the exhaust system; therefore, we suggest assembling a special exhaust system when using the vehicle on race circuits.



Respect and defend natural environment

Everything we do affects the whole planet as well as its resources.

MV Agusta, in order to protect the interests of the community, awakens the Customers and the Technical Assistance operators to use the vehicle and dispose of its replaced parts respecting the laws in force concerning environmental pollution and waste disposal and recycling.



4.2 Running-in



CAUTION

Failure to observe the indications provided below can reduce performance and shorten the life of the motorcycle.

Running-in is generally considered to apply only to the engine. In fact, it should be regarded as an essential phase for other important parts such as the tires, the brakes and the drive chain. During the very first miles, adopt a relaxed riding style.

□ 0 to 500 km (0 to 300 mi) (A)

Frequently change the engine speed. If possible, prefer hilly routes with gentle slopes and many bends. Avoid long straight stretches.



WARNING

New tires must undergo a proper running-in period to reach their complete efficiency. Avoid abrupt acceleration, turning and braking during the first 100 km (62 miles). Failure to observe these prescriptions can lead to the sliding of the wheels and the loss of control of the vehicle, with upset, subsequent serious injury and even death.



❑ 500 to 1000 km (300 to 600 mi)

Avoid lugging or overspeeding the engine, and vary your speed frequently.



4

❑ 1000 to 2500 km (600 to 1600 mi)

Higher engine performance can be demanded, but it is advisable not to exceed the engine speed shown in the figure.

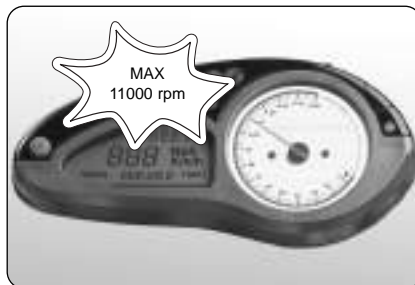



4.3. Starting the engine



WARNING

Starting the engine in a closed place can be dangerous. Exhaust emissions contain carbon monoxide, a colorless and odorless gas that can lead to serious harm or even death when inhaled.

Only start the engine outdoor, in the open air.

4

► As you turn the ignition switch to the ON position, the instruments and the warning lights will go through the self-diagnostic cycle; during this phase, make sure that all the warning lights on the dashboard come on. One of the following conditions must be verified, in order that the ignition switch system allows engine starting:

- The gears are in neutral.
- The gears are engaged, the clutch lever is pulled and the side stand is up.

❑ Cold starting

► Rotate the CHOKE lever without turning the throttle twist grip and then press the start button.





▶ As soon as the engine starts, release the button and, after warming up the engine for a short time, return the CHOKE lever to its original position.

☐ Hot starting

- ▶ Press the start button without turning the throttle twist grip.
- ▶ As soon as the engine starts, release the button.



CAUTION

- Do not press the start button for longer than 5 consecutive seconds, in order to avoid damage to the electrical equipment.
- Avoid warming up the engine while the vehicle is stationary. The subsequent engine overheating can cause damage to the internal parts of the engine. It is advisable to bring the engine to the working temperature by riding at reduced speed.
- To ensure the maximum life of the engine, never speed up at full throttle when the engine is cold.



4





4.4. Selecting and setting the display functions

The display functions allow to change some of the main measuring parameters.

The possible operations are listed as follows:

- Selecting the functions:

TOTAL	Mileage	Counter
TRIP 1	Mileage	Counter
TRIP 2	Mileage	Counter
	Clock	
- Setting the following measurement units:

Speed
Mileage
Temperature
- Resetting the trip mileage counters:

TRIP 1	Mileage	Counter
TRIP 2	Mileage	Counter
- Setting the clock.





4.4.1. Selecting the display functions

You can select the following functions:

- TOTAL Mileage Counter
- TRIP 1 Mileage Counter
- TRIP 2 Mileage Counter
- Clock

► The TOTAL, TRIP 1 and TRIP 2 functions can be displayed by pressing the engine start button. Pressing the button repeatedly cycles through the different functions. Select the desired function.



WARNING

The operation must be performed while the engine is running, the gears are in neutral, the motorcycle is stationary, and with the feet on the ground. Do not set the display functions while riding as it may cause loss of control, upset, and subsequent serious injury or even death.



4.4.2. Setting the measurement units

It is possible to set the measurement units of the displayed quantities.



WARNING

The operation must be performed while the engine is running, the gears are in neutral, the motorcycle is stationary, and with the feet on the ground. Do not set the display functions while riding as it may cause loss of control, upset, and subsequent serious injury or even death.

□ Speedometer (Km/h - Mph)

- ▶ Repeatedly press the engine start button until the TOTAL mileage counter is displayed.
- ▶ Press the SET button; the speedometer unit starts blinking.





- ▶ Press the engine start button to toggle between Km/h and Mph. Changing the speedometer unit also changes the units for the total and trip mileage counters.

Remember that: 1 mi = 1,609 Km



- ▶ Press the SET button to confirm the speedometer unit. The thermometer unit will start blinking, indicating that the display is ready for the next setting.





❑ Thermometer (° C - ° F)

- ▶ Press the engine start button to toggle between ° C and ° F.

Remember that: $T (^{\circ}\text{F}) = 1.8 \cdot t (^{\circ}\text{C}) + 32$



4

- ▶ Press SET to confirm the temperature unit.





4.4.3. Resetting the trip mileage counters

The TRIP 1 and TRIP 2 counters can be reset as follows:



WARNING

The operation must be performed while the engine is running, the gears are in neutral, the motorcycle is stationary, and with the feet on the ground. Do not set the display functions while riding as it may cause loss of control, upset, and subsequent serious injury or even death.

- ▶ Select the TRIP 1 function by pressing the engine start button.
- ▶ Press the button for longer than four seconds. The TRIP 1 mileage will start blinking.





► Pressing the button for less than four seconds sets the mileage to zero. If, on the other hand, the button is pressed for longer than four seconds the entire resetting procedure is cancelled.

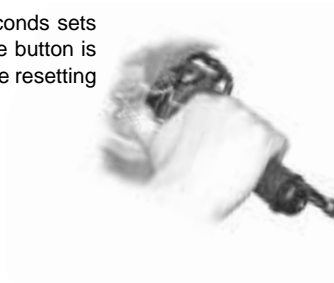

4

► Select the TRIP 2 function by pressing the engine start button.





► Press the engine start button for longer than four seconds; the TRIP 2 mileage will start blinking.



4

► Pressing the button for less than four seconds sets the mileage to zero. If, on the other hand, the button is pressed for longer than four seconds the entire resetting procedure is cancelled.





4.4.4. Setting the clock

It is possible to set the clock function.



WARNING

The operation must be performed while the engine is running, the gears are in neutral, the motorcycle is stationary, and with the feet on the ground. Do not set the display functions while riding as it may cause loss of control, upset, and subsequent serious injury or even death.

4

- ▶ Repeatedly press the engine start button until the time is displayed.
- ▶ Press the SET button – the first hour digit will start blinking.





- ▶ Hold down the engine start button and release it as soon as the desired figure is displayed.

NOTE

To quickly cycle through the selected digit, hold the start button depressed for longer than two seconds.

- ▶ Press SET to confirm the first hour digit and to be able to set the following digit.
- ▶ Repeat the procedure to set the second hour digit and the first and second minute digits.
- ▶ Press SET to confirm the time and exit the set (blinking) mode.

NOTE

The instrument panel has an integrated memory which retains all the parameters even when the engine is not running. Except for the clock, which is reset, all the parameters are retained even when the battery is disconnected.



4





4.5. Refuelling



WARNING

When refuelling, switch off the engine, avoid smoking, and keep away from flames, sparks and heat sources. Failure to observe this warning can lead to a fire with subsequent serious personal injury or even death.



WARNING

Petrol and its fumes are highly toxic. Avoid contact and inhalation and perform refuelling in a well ventilated area. Failure to observe this warning can result in serious hazard to your health.



CAUTION

Only use unleaded fuel with a R.O.N. octane rating of 95 or higher. The green dot on the lower side of the tank cap serve as a reminder of this.

- ▶ Lift the dust cover.
- ▶ Insert the key into the lock and rotate it clockwise.

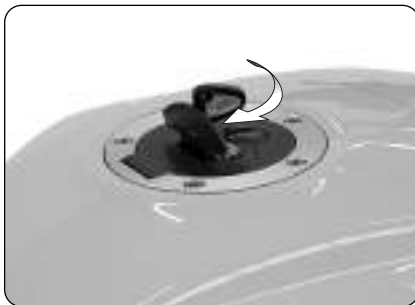



- ▶ Lift the tank cap and operate the refuelling.

**WARNING**

Overfilling the tank may cause the fuel to overflow as a result of the expansion due to the heat from the engine or to exposure to sunlight. Fuel spills can catch fire. The level of the fuel in the tank must never be higher than the base of the filler. Failure to observe this warning can lead to a fire or other damage, with subsequent serious injury or even death.

- ▶ After refuelling, press down the tank cap while rotating the key clockwise to facilitate the locking. Then release the key and remove it.

**CAUTION**

Immediately wipe the overflowed fuel with a clean cloth, to avoid damage to the painted or plastic surfaces.

**WARNING**

Verify that the tank filler cap is correctly closed before using the motorcycle.

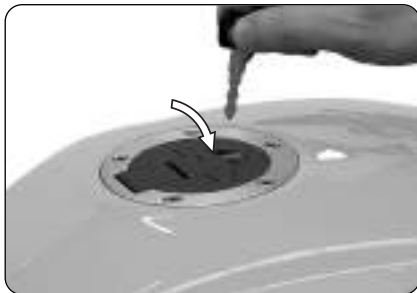



4.6. Glove compartment

▶ Insert the key into the lock.



▶ Press down the pillion while turning the key clockwise. Lift the pillion.

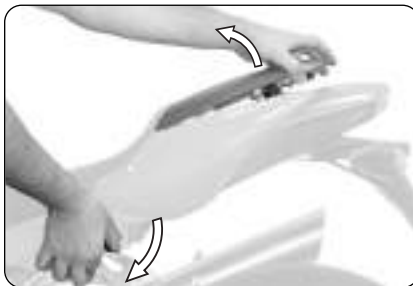



- Remove the pillion.

In order to reassemble the above mentioned part, you must perform the following operations:

- Rotate the key into the lock
- Press down the pillion
- Release the key
- Press down the pillion once more, so to make sure of its firm coupling to the frame.



4

**WARNING**

Every time you lift or remove the pillion and every time the vehicle is used, make sure that the above mentioned part is correctly placed and that it is firmly secured to the motorcycle framework. Failure to heed this warning can lead to loss of control, upset, and subsequent serious injury or even death.



4.7. Parking the motorcycle

□ Using the sidestand



CAUTION

- Park your motorcycle only on firm, level ground. Parking the bike on soft ground can allow the sidestand to dig in, and the motorcycle can fall over.
- If you must park the bike on a slope, engage first gear and park with the motorcycle facing uphill. Remember to return the gear lever to neutral before restarting the engine.
- Never leave your motorcycle unattended without removing the key.

► Using your foot, lower the sidestand as far as it will go, and then slowly tip the motorcycle toward you to bring the stand supporting foot into contact with the ground's surface.



**CAUTION**

Never sit on your bike when it is parked on the sidestand. This can damage the stand, and could cause the bike to fall over, with both damage to the motorcycle and possible injury to you.

**WARNING**

Before riding off, ensure that the sidestand is fully retracted, and that the sidestand warning light on the instrument panel is extinguished. Failure to observe this warning can result in the stand contacting the ground as you are riding, which can upset the motorcycle, with subsequent serious injury or even death. If you notice a malfunction of the side stand switch, have it controlled by your MV Agusta dealer before using the motorcycle.



□ Using the rear stand

Insert the stand pin into the rear wheel axle hole on the left side of the motorcycle. Rest the stand on the ground and, pressing down on the stand, lift the vehicle until it reaches a stable condition.



CAUTION

This operation is best carried out with two people, one to steady the motorcycle and one to manipulate the rear stand.

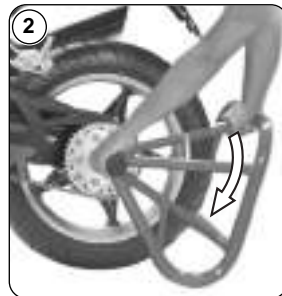
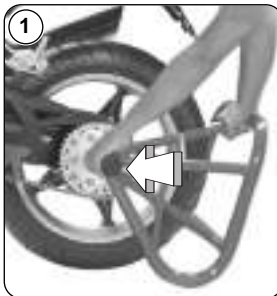



4.8. Preriding checks



WARNING

A motorcycle can be in good running order and then become unexpectedly unreliable even if unused (e.g. deflation of the tires). It is therefore important to carry out the checks described in the table below before each ride. A few moments taken to carry out these checks will help you maintain your motorcycle safe and in perfect working order.

Brakes

Check fluid level (§6.7).

Check for fluid leakage.

Pull lever and press pedal to check brake operation.

Lubricate the lever joint, if necessary.

Check pads for wear (§6.6).

Gear lever

Press pedal to check gear operation.

Lubricate the lever joint, if necessary.

Clutch lever

Check fluid level (§6.8).

Check for fluid leakage.

Pull lever and check that it moves smoothly and gradually.
Lubricate the lever joint, if necessary.

Engine start button / stop switch

Check operation (§3.4).

Throttle twist grip

Check that grip rotates smoothly and returns to closed position when released.

Steering system

Verify that the operation is smooth and uniform.

Check for play and loosening.

Lights, visual and acoustic signals

Check operation.

Tires

Check inflating pressure and wear (§6.9).

Suspensions

Verify that the operation is smooth and uniform.

Check adjustment (§5.6 and 5.7).

Frame fasteners

Check tightening of all screws and nuts.

Tighten them, if necessary.

Drive chain

Check adjustment and lubrication (§6.10).

Coolant

Check level (§6.5).

Check for leakage.

**Fuel**

Check level.

Refuel, if necessary (§4.5).

Check for fuel leakage.

Engine oil

Check level (§6.4).

Check for leakage.

Sidestand

Check return to stowed position.

Verify that the safety switch is working.

Pillion

Verify that the pillion is firmly secured to the framework.

**WARNING**

If any of the above-mentioned parts shows a failure during its operation, have it controlled and repaired before using the motorcycle.



4.9. Riding

Riding a motorcycle well and safely requires training, experience and concentration.

Inexperienced riders should attend a formal training session, such as the Motorcycle Industry Council's introductory training, which consists of both classroom work and practical riding sessions. Moreover, every rider should take a certified course approved by the Motorcycle Safety Foundation (MSF), including basic training lessons for new riders and advanced courses for experienced riders. You can get further information about MSF training courses by calling the toll-free number: (800) 446-9227.

A big advantage to attending a class is that the instructor will be familiar with your motorcycle, and able to provide you with a number of tips and ideas on how to safely use your motorcycle.

Relying on the advice of people other than a qualified riding instructor, even if they are excellent motorcyclists, can be misleading and dangerous.

It is important to learn to ride in an area remote from traffic. Riding a motorcycle, especially if you are improperly trained, can be dangerous or even fatal.

Always observe the safety rules described in paragraph 2.1.11. of this manual. You may wish to refer to them now.



5.1. List of adjustments

There are many adjustments that can significantly improve the ergonomics, geometry and safety of the motorcycle.

Some of these can only be performed by skilled personnel at authorized service centres.



WARNING

To avoid losing control of the motorcycle while riding, be sure to always keep both hands on the handlebars. Do not attempt to perform any of the adjustments listed here while you are riding, unless the text specifically instructs you to do so. Failure to heed this warning can lead to an upset with subsequent serious injury or even death.



(F) Rearview mirror adjustment (§5.5.)

(A) Front brake lever adjustment (§5.3.)

(C) Right-hand footrest adjustment (§5.2.)

(H) Rear suspension adjustment (§5.7.)

(E) Rear brake lever adjustment (§5.2.)

(G) Front suspension adjustment (§5.6.)

(M) Headlight adjustment (§5.8.)



(G) Front suspension adjustment (§5.6.)



(F) Rearview mirror adjustment (§5.5.)

(H) Rear suspension adjustment (§5.7.)

(B) Clutch lever adjustment (§5.4.)

(D) Gear lever adjustment (§5.2.)













(C) Left-hand footrest adjustment (§5.2.)

(L) Drive chain adjustment (§6.10.)





5.2. Table of adjustments

	A - Front brake lever adjustment: Optimizes the grip to suit the rider's needs (§5.3).	
	B - Clutch lever adjustment: Optimizes the grip to suit the rider's needs (§5.4).	
	C - LH and RH footrest adjustment: Optimizes the position of the feet to suit the rider's needs.	
	D - Gear lever adjustment: Optimizes the position of the lever to suit the rider's needs.	
	E - Rear brake lever adjustment: Optimizes the position of the lever to suit the rider's needs.	
	F - Rearview mirror adjustment: Optimizes the orientation of the rearview mirrors (§5.5).  WARNING: Do not operate the screw fixing the rearview mirror to the handlebar. If this screw needs to be tightened, contact your MV Agusta dealer.	
	G - Front suspension adjustment: The following can be adjusted to adapt the response of the suspension to the rider's preference: <ul style="list-style-type: none">- spring preload (§5.6.1.)- rebound damper (§5.6.2.)- compression damper (§5.6.3.)	
	H - Rear suspension adjustment: The following can be adjusted to adapt the response of the suspension to the rider's preference: <ul style="list-style-type: none">- spring preload- geometry height	
	<ul style="list-style-type: none">- rebound damper (§5.7.1.)- high speed compression damper (§5.7.2.)- low speed compression damper (§5.7.3.)	
	L - Drive chain adjustment: To ensure safe and effective transmission of power.	
	M - Headlight adjustment: To adjust the range of the light beam to the geometry of the motorcycle (§5.8).	



5.3. Adjusting the front brake lever



WARNING

Never perform the adjustment while riding. Failure to observe this warning can lead to loss of control with subsequent upset, serious injury, or even death.

While gently pulling the lever against the spring, turn the adjusting ring clockwise or counterclockwise to move the lever away or toward the hand grip.



5.4. Adjusting the clutch lever



WARNING

Never perform the adjustment while riding. Failure to observe this warning can lead to loss of control with subsequent upset, serious injury, or even death.

While gently pulling the lever against the spring, turn the adjusting ring clockwise or counterclockwise to move the lever away or toward the hand grip.





5.5. Adjusting the rearview mirrors

**WARNING**

Never perform the adjustment while riding.

Press the mirror at the points shown in the figure to adjust its position in the four directions.

Perform the adjustment on both the rearview mirrors. It is recommended to sit on the vehicle in order to optimize the rearview mirrors adjustment.



WARNING: Check the rearview mirrors adjustment every time you use your motorcycle.



5



5.6. Adjusting the front suspension

NOTE: It is essential that the adjusters of both fork rods are adjusted to the same position.

Rebound damper

Spring preload

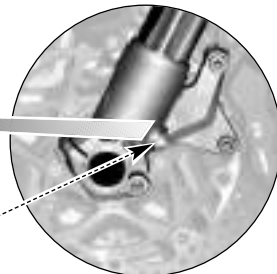
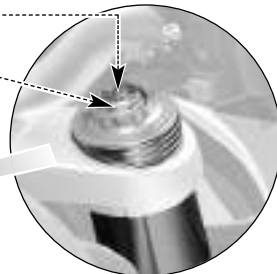

5



5.6.1. Spring preload

See the table in the enclosed sheet for spring preload adjustment. Refer to the number of turns from the fully counterclockwise position.

NOTE: Do not force the adjusting nut past its fully counterclockwise position. Rotate the adjusting screw counterclockwise to decrease preload, clockwise to increase preload.



5.6.2. Rebound damper (front suspension)

See the table in the enclosed sheet for rebound damping adjustment. Refer to the number of clicks from the fully clockwise position.

NOTE: Do not force the adjusting screw past its fully clockwise position. Rotate the adjusting screw counterclockwise to decrease damping, clockwise to increase damping.





5.6.3. Compression damper (front suspension)

See the table in the enclosed sheet for compression damping adjustment. Refer to the number of clicks from the fully clockwise position.

NOTE: Do not force the adjusting screw past its fully clockwise position. Rotate the adjusting screw counterclockwise to decrease damping, clockwise to increase damping.

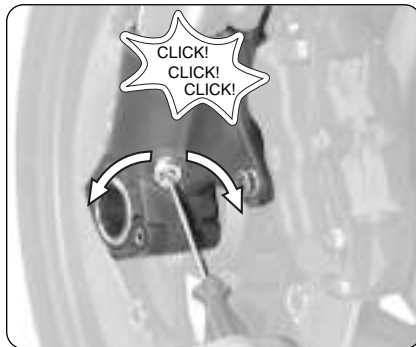



5.7. Adjusting the rear suspension



WARNING

The high temperature of the exhaust pipes can cause burns. Before adjusting the rear suspension, shut off the engine and wait until the exhaust pipes have thoroughly cooled.

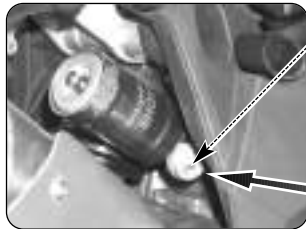

High and Low speed
compression damper

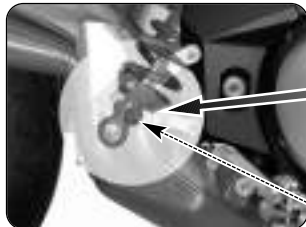

Rebound damper





5.7.1. Rebound damper (rear suspension)

See the table in the enclosed sheet for rebound damping adjustment. Refer to the number of clicks from the fully clockwise position.

NOTE: Do not force the adjusting screw past its fully clockwise position. Rotate the adjusting screw counterclockwise to decrease damping, clockwise to increase damping.



WARNING: The rear shock absorber contains highly compressed gas. Do not try to open or disassemble it in any way. Failure to heed this warning may lead to an explosion, with personal serious injury or even death.





5.7.2. High speed compression damper (rear suspension)

See the table in the enclosed sheet for high speed compression damping adjustment. Refer to the number of clicks from the fully counterclockwise position.

NOTE: Do not force the adjusting screw past its fully counterclockwise position. Rotate the adjusting screw counterclockwise to decrease damping, clockwise to increase damping.



5.7.3. Low speed compression damper (rear suspension)

See the table in the enclosed sheet for low speed compression damping adjustment. Refer to the number of clicks from the fully clockwise position.

NOTE: Do not force the adjusting screw past its fully clockwise position. Rotate the adjusting screw counterclockwise to decrease damping, clockwise to increase damping.





5.8. Headlight adjustment

Place the vehicle at a distance of 10 m (32.8 ft) from a vertical wall.

Make sure that the motorcycle is placed on an even horizontal surface, and that the headlight's optical axis is perpendicular to the wall.

The vehicle must be held in an upright position. Measure the "X" distance between the headlight center and the ground surface, then trace a small cross on the wall at the same height.

When you turn the headlight on, the upper boundary line between the dark area and the lighted area must be at an height equal or lower than the 9/10 of the headlight center height (X).

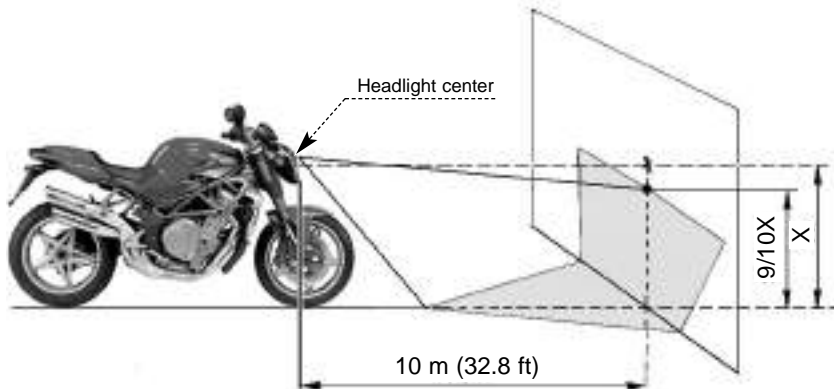





The headlight adjustment can be performed by rotating the screw shown in the picture. Rotate clockwise to incline the headlight downwards, counterclockwise to incline it upwards. The possible adjustment range is equal to $\pm 4^\circ$ from the standard position.





6.1. Tables of scheduled maintenance and checks

The periodic checks and maintenance operations that are required to keep your motorcycle safe and in perfect running order are shown in the following tables.

Some of these operations, indicated with , can be carried out by the owner, provided he or she possesses the required skills. Your MV Agusta dealer will be happy to perform these operations, if you do not desire to do so yourself. Other operations, indicated with , must be performed only by an authorized MV Agusta dealer.

Any damage to your motorcycle which is the result of improperity or lack of maintenance is not covered by the warranty.

6

Most motorcycle maintenance operations must be performed while the bike is on the rear stand, the engine is dead, and the start switch is set to OFF. This does not apply to the checking of fluid levels.

Use only lubricants and fluids listed in this manual (see § 6.3). If your motorcycle is damaged by the use of improper lubricants, fluids, or other such products, this damage is not covered under the warranty.



After the first 36,000 Km (22,400 miles) have elapsed, perform the maintenance operations at the same intervals as those shown in the table.



WARNING

Observe all the warnings, dangers and cautions related to the maintenance procedures as listed throughout this manual. Failure to observe this warning can not only destroy your motorcycle, but can lead to serious injury or even death.



WARNING

Using low quality spare parts can accelerate the wear of your motorcycle and shorten its life. Always use genuine MV Agusta spare parts. Any damage to your motorcycle which is the result of the use of non-genuine spare parts is not covered by the warranty.



WARNING

If your motorcycle is involved in an accident, have all its main parts controlled by an authorized MV Agusta dealer. If necessary, you can make some provisional repairs by yourself.



Respect and defend natural environment

Everything we do affects the whole planet as well as its resources.

MV Agusta, in order to protect the interests of the community, awakens the Customers and the Technical Assistance operators to use the vehicle and dispose of its replaced parts respecting the laws in force concerning environmental pollution and waste disposal and recycling.











Tables of scheduled maintenance

km (mi) covered		0	1000 (600)	6000 (3800)	12000 (7500)	18000 (11200)	24000 (14900)	30000 (18600)	36000 (22400)
Service coupon		Pre-delivery	A	B	C	D	E	F	G
DESCRIPTION		OPERATION							
Engine oil		Check level	Every time vehicle is used						
		Renew	●	●	●	●	●	●	●
Engine oil filter		Replace (Use only MV Agusta genuine spare oil filters)	●	●	●	●	●	●	●
			Every time engine oil is changed						
Coolant		Check / Restore level	Every time vehicle is used						
		Check / Restore level	●	●	●	●	●	●	●
		Renew	At least every two years						
Cooling system		Check for leakage	●	●	●	●	●	●	●
Electric fans		Check operation	●	●	●	●	●	●	●
Valves		Check / Adjust	●		●		●		●
Timing chain		Check	●		●		●		
		Replace							●



Tables of scheduled maintenance

km (mi) covered		0	1000 (600)	6000 (3800)	12000 (7500)	18000 (11200)	24000 (14900)	30000 (18600)	36000 (22400)	
Service coupon		Pre-delivery	A	B	C	D	E	F	G	
DESCRIPTION		OPERATION								
Timing movable shoe		Check / Replace	●		●		●			
		Replace							●	
Every time timing chain is replaced										
Timing chain stretcher		Check / Replace			●		●		●	
Spark plugs		Check / Replace	●	●		●		●		
		Replace			●		●		●	
Fuel filter		Check / Replace			●		●		●	
Throttle body 		Check and Adjust	●	●	●	●	●	●	●	
Air filter		Check / Replace		●	●	●	●	●	●	
Brakes / Clutch fluid		Check level	Every time vehicle is used							
		Check level	●	●	●	●	●		●	●
		Renew						●		
At least every two years										



Tables of scheduled maintenance

km (mi) covered		0	1000 (600)	6000 (3800)	12000 (7500)	18000 (11200)	24000 (14900)	30000 (18600)	36000 (22400)	
Service coupon		Pre-delivery	A	B	C	D	E	F	G	
DESCRIPTION		OPERATION								
Brakes / Clutch		Check operation	Every time vehicle is used							
		Clean lever / master cyl. piston contact area	Every 500 ÷ 1000 km (300 ÷ 600 mi)							
		Check operation	●	●	●	●	●	●	●	●
		Check lines for leakage	●	●	●	●	●	●	●	●
Brake pads (front and rear)		Clean lever / master cyl. piston contact area	●	●	●	●	●	●	●	
		Check wear	Every 1000 Km (600 mi)							
		Check / Replace		●	●	●	●	●	●	●
Fuel lines and connections		Check for leakage		●	●	●	●	●	●	
		Replace	At least every 3 years							
Evaporative emission control system		Check / Adjust				●		●		
Throttle control		Check operation	Every time vehicle is used							
		Check operation	●	●	●	●	●	●	●	
		Check / Adjust play	●	●	●	●	●	●	●	



Tables of scheduled maintenance

km (mi) covered		0	1000 (600)	6000 (3800)	12000 (7500)	18000 (11200)	24000 (14900)	30000 (18600)	36000 (22400)	
Service coupon		Pre-delivery	A	B	C	D	E	F	G	
DESCRIPTION		OPERATION								
Choke control		Check operation	●	●	●	●	●	●	●	
Flexible controls and transmissions		Check / Adjust	●	●	●	●	●	●	●	
Drive chain		Check	Every 1000 Km (600 mi)							
		Lubricate	Every 1000 Km (600 mi) and after riding under the rain							
		Check / Adjust	●	●	●	●	●	●	●	●
		Lubricate		●	●		●		●	
		Replace				●		●		●
Front sprocket / Tab washer		Check		●	●		●		●	
		Replace				●		●		●
			Every time drive chain is replaced							
Rear sprocket		Check		●	●		●		●	
		Replace				●		●		●
			Every time drive chain is replaced							



Tables of scheduled maintenance

km (mi) covered		0	1000 (600)	6000 (3800)	12000 (7500)	18000 (11200)	24000 (14900)	30000 (18600)	36000 (22400)	
Service coupon		Pre-delivery	A	B	C	D	E	F	G	
DESCRIPTION		OPERATION								
Rear sprocket spring drive		Check			●		●		●	
Steering head tube ring		Check / Adjust	●		●		●		●	
Steering bearings		Check / Adjust	●		●		●		●	
		Lubricate					●			
Tires		Check pressure	Every time vehicle is used; at least every 10 days							
		Check wear	Every time vehicle is used; at least every 500 Km (300 mi)							
		Check pressure	●	●	●	●	●	●	●	●
		Check wear		●	●	●	●	●	●	●
Wheel rims		Inspect visually	●	●	●	●	●	●	●	
			Every time tire is replaced							
Front wheel bearings		Check		●	●	●	●	●		
		Every time tire is replaced								
		Replace							●	



Tables of scheduled maintenance

km (mi) covered		0	1000 (600)	6000 (3800)	12000 (7500)	18000 (11200)	24000 (14900)	30000 (18600)	36000 (22400)
Service coupon		Pre-delivery	A	B	C	D	E	F	G
DESCRIPTION		OPERATION							
Sidestand		Check operation							
		Every time vehicle is used							
Side stand switch		Check operation							
		Clean contact area with sidestand							
		Every 500 ÷ 1000 km (300 ÷ 600 mi)							
		Clean contact area with sidestand							
Rear wheel hub		Check / Lubricate needle bearing							
		Replace / Lubricate needle bearing							
Swingarm bearings		Check / Lubricate							
Drive chain pads on swingarm		Check / Replace							
Drive chain pads on frame plate		Check / Replace							
Rear shock absorber		Check / Adjust							
Front fork oil		Renew							



Tables of scheduled maintenance

km (mi) covered		0	1000 (600)	6000 (3800)	12000 (7500)	18000 (11200)	24000 (14900)	30000 (18600)	36000 (22400)
Service coupon		Pre-delivery	A	B	C	D	E	F	G
DESCRIPTION		OPERATION							
Battery connections		Check and clean		●	●	●	●	●	●
Electrical equipment		Check operation	●	●	●	●	●	●	●
Instrument panel		Check operation	Every time vehicle is used						
		Check operation	●	●	●	●	●	●	●
Lights / Visual signals		Check operation	Every time vehicle is used						
		Check operation	●	●	●	●	●	●	●
Horn		Check operation	Every time vehicle is used						
		Check operation	●	●	●	●	●	●	●
Headlight		Check operation	Every time vehicle is used						
		Adjust	Every time geometry is changed						
Ignition switch		Check operation	Every time vehicle is used						
		Check operation	●	●	●	●	●	●	●



Tables of scheduled maintenance

km (mi) covered		0	1000 (600)	6000 (3800)	12000 (7500)	18000 (11200)	24000 (14900)	30000 (18600)	36000 (22400)
Service coupon		Pre-delivery	A	B	C	D	E	F	G
DESCRIPTION		OPERATION							
Locks		Check operation	Every time vehicle is used						
		Check operation	●	●	●	●	●	●	●
Screws and nuts		Check / Tighten	●	●	●	●	●	●	●
Hose clamps		Check / Tighten	●	●	●	●	●	●	●
General lubrication			●	●	●	●	●	●	●
General test			●	●	●	●	●	●	●

In order to highlight symbols importance, remember the following information (already provided at § 1.2 of this manual):



Information on operations that can be carried out by the user.



Information on operations that **must** be performed **only** by your authorized MV Agusta dealer.



The “ ” symbol points out the requirement to use a tool or a special equipment in order to correctly perform the described operation.



The “ § ” symbol refers the reader to the chapter identified by the number that follows.



6.2. Tools and accessories supplied

A bag in the glove compartment contains the following tools:

- 1 hexagonal bar with 10 mm (0.4 inch) hexagon;
- 6 Allen keys with 2,5 - 3 - 4 - 5 - 6 - 8 mm (0.10 - 0.12 - 0.16 - 0.20 - 0.24 - 0.32 inch) hexagons;
- 1 spanner for rear wheel eccentric with extension;
- 2 fuses (7.5 A and 15 A).

The following accessories are also supplied:

- 1 spark plug wrench with 16 mm (0.63 inch) hexagon;
- 1 document holder.





6.3. Table of lubricants and fluids

<i>Description</i>	<i>Recommended product</i>	<i>Specifications</i>
Engine lubrication oil	AGIP RACING 4T 10W/60 (*)	SAE 10W/60 - API SJ
Coolant	AGIP ECO - PERMANENT	Ethylene glycol diluted with 50 percent distilled water
Brake and clutch fluid	AGIP BRAKE FLUID DOT4	DOT4
Drive chain lubrication oil	MOTUL CHAIN LUBE ROAD	–

* : MV Agusta suggests to refer directly to its authorized dealers in order to purchase the recommended product. The AGIP Racing 4T 10W/60 engine oil has been expressly produced for the F4 motorcycle engine. If the above described lubricant is not available, MV Agusta suggests to use a fully synthetic engine oil having characteristics equal or better than the ones prescribed in the following standards:

- Consistent with: API SJ
- Consistent with: ACEA A3
- Consistent with: JASO MA
- SAE Rating: SAE 20 W-50 or 10 W-60

NOTE

The above standard denominations must be written, alone or together, on the engine oil container label.





6.4. Checking the engine oil level

Check the oil level while the engine is not running, and has been allowed to cool down for at least ten minutes after a ride.

The check must be performed after placing the motorcycle in an upright position on a horizontal surface.

The level must be between the MAX and MIN marks on the crankcase.

If the oil level is below the MIN mark, top up as described in § 6.4.1. Never exceed the MAX level.

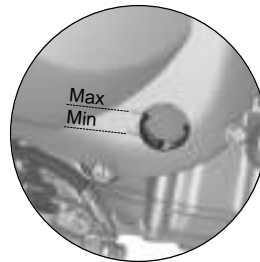

6



WARNING

Never run your motorcycle if the oil level is below the minimum mark. This could cause seizure with subsequent upset and serious injury or even death.



6.4.1. Topping up the engine oil level

To top up the engine oil level, remove the oil filler plug by using the 10 mm hexagonal bar supplied, assembled on a proper key (see figure). Pour an appropriate amount of engine oil of the recommended type (see § 6.3). Never exceed the MAX level mark. At the end of the operation, place back the oil filler plug.



WARNING

Before reassembling the oil filler plug, grease its O-Ring by using AGIP Grease 30.

At last, perform the tightening of the oil filler plug at the tightening torque of 35 Nm, by using a dynamometric key.

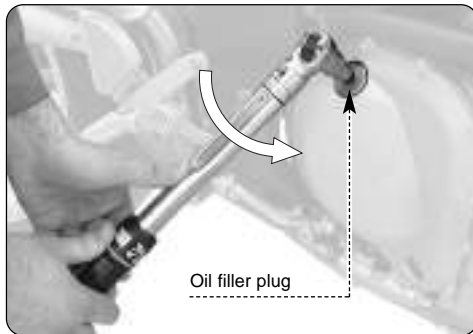

CAUTION

To avoid clutch sliding and damage to the engine, never add chemical additives to the engine oil, nor use an engine oil different from the one specified in the table at § 6.3. Make sure that no foreign body gets in the crankcase while topping up the engine oil.

**WARNING**

New or exhaust engine oil can be dangerous. Engine oil is highly toxic for people and domestic animals. Avoid ingestion and contact. It has been proved that prolonged contact with engine oil can cause skin cancer on guinea pigs. Even a brief contact with engine oil can cause skin irritation.

- In the event of an engine oil ingestion, immediately call a doctor and do not cause vomiting, in order to avoid inhalation of engine oil in lungs.

- Keep new or exhaust engine oil out of reach of children and domestic animals.
- While topping up the engine oil, wear a long-sleeved shirt and a pair of water-proof gloves to protect your skin.
- If the engine oil comes in touch with your skin, wash it away with soap and water.
- Correctly recycle or dispose of the exhaust engine oil, in order to avoid environmental pollution.



6.5. Checking the coolant level

Check the coolant level after the engine has been shut off for at least fifteen minutes after riding. If you attempt to check the coolant level while the engine is still warm, you will get an erroneous level indication.

The motorcycle must be positioned upright on a horizontal surface to make this check.

Ensure that the coolant level is between the MIN mark and the lower side of the frame tube as shown in the figure.

If the coolant level is below the MIN mark, top up the coolant as described at paragraph 6.5.1.



WARNING

Never run your motorcycle if the coolant level is below the minimum mark. This could cause seizure with subsequent upset and serious injury or even death.

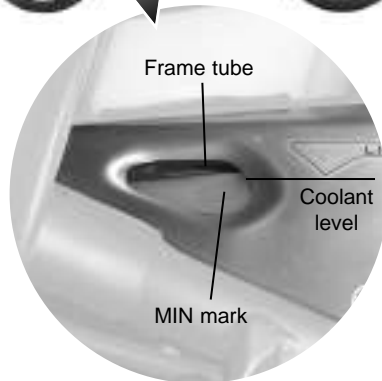



6.5.1. Topping up the coolant level

To gain access to the coolant filler cap, extract the cover after removing its fixing screws. Remove the coolant filler cap and top up with the recommended coolant (see §6.3).

Coolant filler cap

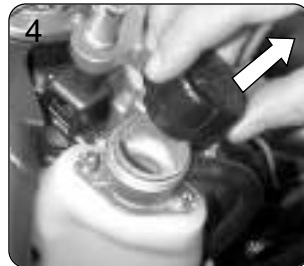
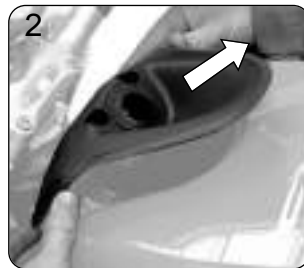

After topping up, carefully replace the previously removed parts.

**WARNING**

The cooling system is under pressure. Always very carefully remove the coolant filler cap. Never attempt to remove the coolant filler cap until the motorcycle has completely cooled to room temperature. Failure to observe this warning will result in coolant being splashed on you with subsequent serious burns and serious personal injury. If you have the slightest doubt that the motorcycle has completely cooled, do not remove the cap, but allow the motorcycle to completely cool.

**WARNING**

Under certain conditions, ethylene glycol contained in the coolant can become flammable. When it is lighted, it produces an invisible flame. Avoid spilling coolant on hot parts of the motorcycle, because the subsequent combustion of ethylene glycol could cause serious burns and serious personal injury.



WARNING: Coolant is a highly toxic fluid. Avoid ingestion and contact with your skin or eyes. Keep coolant out of reach of children and domestic animals. In the event of a coolant ingestion, immediately call a doctor and do not cause vomiting, in order to avoid inhalation of coolant in lungs. If the coolant comes in touch with your skin or eyes, immediately wash it away with water.



CAUTION: Use only the coolant specified in the table in section 6.3. Do not mix nor dilute the coolant with additives or different fluids. If the coolant specified in section 6.3. is not available, use a coolant having technical characteristics consistent with the prescribed product. See your MV Agusta dealer.



CAUTION: Do not spill coolant on any part of the motorcycle. It will damage painted and plastic parts. If you do spill coolant on your motorcycle, carefully flush the coolant away with cool clear water.

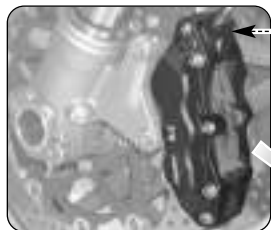

Front brake caliper

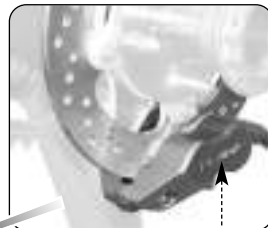

Rear brake caliper

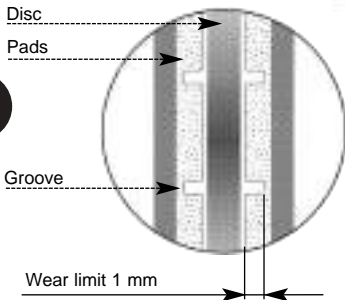

6.6. Checking the wear of the brake pads

The brake pads have grooves that provide an indication of the wear condition. Periodically check the width of the grooves, making sure it never falls below the wear limit (1 mm).



WARNING: If the brake pads are excessively worn out, the effectiveness of the braking system decreases, increasing the risk of accidents with subsequent serious injury or even death. If the pads have worn to near the wear limit, have both pads replaced by your MV Agusta dealer. Never replace just one pad, the pads must always be replaced in pairs. Ensure that the new pads are suitably broken in, see § 4.2.



6.7. Checking the brake fluid level



WARNING

Lack of maintenance of the braking system can increase the risk of accidents, with subsequent serious injury or even death.

Before riding, always check the braking system according to the instructions provided at § 4.9. of this manual.

The level of the brake fluid decreases as the brake pads wear down. Ensure that the fluid level is always between the MAX and MIN marks. If the level falls below the MIN mark, contact your MV Agusta dealer and have the brake system repaired.

**WARNING**

Never use your motorcycle if the fluid level is below the MIN mark. The brakes may fail to properly operate which could lead to an accident with subsequent serious injury or even death. If the brake fluid level is below the MIN mark, you must have it topped up by an authorized MV Agusta dealer.

**WARNING**

Have the topping up of the brake fluid performed only by skilled personnel. Brake fluid is highly toxic. Avoid ingestion and contact with your skin or eyes. Keep brake fluid out of reach of children and domestic animals. In the event of a brake fluid ingestion, immediately call a doctor and do not cause vomiting, in order to avoid inhalation of brake fluid in lungs. If the brake fluid comes in touch with your skin or eyes, immediately wash with water.

**WARNING**

Use only the brake fluid specified at paragraph 6.3. of this manual. Mixing different brake fluids can cause a dangerous chemical reaction, as well as the decrease of the braking efficiency. This could increase the risk of accidents, with subsequent serious injury or even death.

**WARNING**

An insufficient amount of brake fluid may allow the introduction of air in the braking system. This could compromise the effectiveness of the braking system, with subsequent increase of the risk of accidents. Presence of air in the braking system can be identified in the moment you feel a characteristic “spongy effect” while pushing the brake pedal. In this case, have a braking system bleeding performed by an authorized MV Agusta dealer before riding your motorcycle again.



6.8. Checking the clutch fluid level

The fluid level must be between the MAX and MIN marks.

If the level falls below the MIN mark, contact your MV Agusta dealer and have the clutch control system repaired.



WARNING

Never use your motorcycle if the fluid level is below the MIN mark. The clutch may fail to properly operate which could lead to an accident with subsequent serious injury or even death. If the clutch fluid level is below the MIN mark, have it topped up by an authorized MV Agusta dealer.



WARNING

Use only the clutch fluid specified in the paragraph 6.3. of this manual.





6.9. Checking and replacing the tires



WARNING

Before using the motorcycle, always check the pressure and wear of the tires.

Checking the inflating pressure of the tires is an essential requirement to ensure driving safety. Insufficiently inflated tires can reduce the handling of the motorcycle and wear themselves out very quickly. On the other hand, an excessively high inflating pressure reduces the wideness of the surface in contact with the ground, and it can compromise the grip of the vehicle.

Before riding your motorcycle, it is therefore necessary to measure the tire pressure at room temperature. The vehicle must be parked since three hours at least.



WARNING: An incorrect inflating pressure can lead to dangerous situations during riding. An insufficiently inflated tire can cause the sliding of the tire on the wheel rim or its detachment; this may lead to the deflation of the tire and loss of control of the vehicle, with subsequent upset, serious injury or even death.



In fact, by checking the pressure soon afterwards using the motorcycle, you would obtain a higher value than the actual one. This could cause an incorrect adjustment of the tire pressure.

Refer to the pressures given in § 8.2. and/or on the label applied to the steering head tube. In the event of long travels, you can increase the face value of the tire pressure of 0.2 bar.

Moreover, it is extremely important to check the wear of the tires before riding. In fact, a worn out tire can be punctured more easily than a new one, and it can adversely affect handling and stability of the motorcycle.

Always check the depth of the tire tread. The tread depth must always be at least 1/8 inch (3 mm).

Verify the absence of crevices at the bottom of the tread design and fissures on the tire sidewall. Moreover, verify the absence of nails and glass splinters in the tire. If these conditions are not verified, have the tire replaced by an authorized MV Agusta dealer.

**WARNING**

• **Never ride your motorcycle if the tires are cut, checked, or leaking. Never ride your motorcycle if the tires are not properly inflated. Failure to obey these warnings can lead to loss of control and subsequent accident with serious injury or even death. If the tires of your motorcycle are worn out, have it replaced by your MV Agusta dealer.**

• **If a tire is punctured it must be replaced, not repaired. A repaired tire provides a restricted performance and lower safety levels than a new one. If you make a provisional or emergency repair to a tire, you must ride at very low speed until you reach the nearest MV Agusta dealer and have the tire replaced. With a provisionally repaired tire, never exceed 60 km/h (37 mph). Tire repairing must never be performed if the tire is punctured on its sidewall, or if the**



diameter of the puncture on the tread is greater than 6 mm. Failure to obey this warning can lead to loss of control and subsequent accident with serious injury or even death.

- **MV Agusta recommends not to use sealing fluids to repair a punctured tire. These products can adversely affect the material of the tire layers, as well as hide the minor damages caused by objects penetrated in the tire.**
- **When it is necessary to replace the tires, use only the type specified in paragraph 8.2. Moreover, avoid using tires of a different brand or type on the front and on the rear wheel at the same time. Using tires different from those specified can adversely affect the handling and stability of the motorcycle, increasing the risk of accidents with subsequent serious injury or even death.**

- **Have the tires replaced according to their direction of spin, which is highlighted by a small arrow on the tire sidewall.**
- **The wheel rims of your motorcycle have been designed for use with tubeless tires only. Do not assemble an air tube tire on rims designed for tubeless tires. Otherwise, the tire bead could not properly settle down on the wheel rim, leading to the deflation of the tire and the loss of control of the vehicle.**
- **Do not assemble an air tube on a tubeless tire. The overheating of the tire could cause the explosion of the air tube, leading to the deflation of the tire and the loss of control of the vehicle. Failure to heed these warnings can lead to upset, with subsequent serious injury and even death.**

**WARNING**

New tires should be run in for a short period before demanding their full performance. New tires are sometimes coated with a mold release agent which makes them slippery. We suggest to ride at reduced speed and exercise extreme caution during the first 100 km (62 miles) after the replacement of a tire. Failure to obey this warning can lead to loss of control and subsequent accident with serious injury or even death.



❑ Rear wheel disassembling



CAUTION

If you have the rear wheel tire replaced by a tire-dealer, make sure that the following tools are used in the rear wheel disassembling and reassembling:

- 55 mm polygonal socket wrench
- Torque wrench

If the above mentioned operations are performed with tools other than those indicated, the rear wheel parts can be seriously damaged. Therefore, we strongly recommend not to have the tires replaced by an improperly equipped workshop. Always have the tires replaced by an authorized MV Agusta dealer.

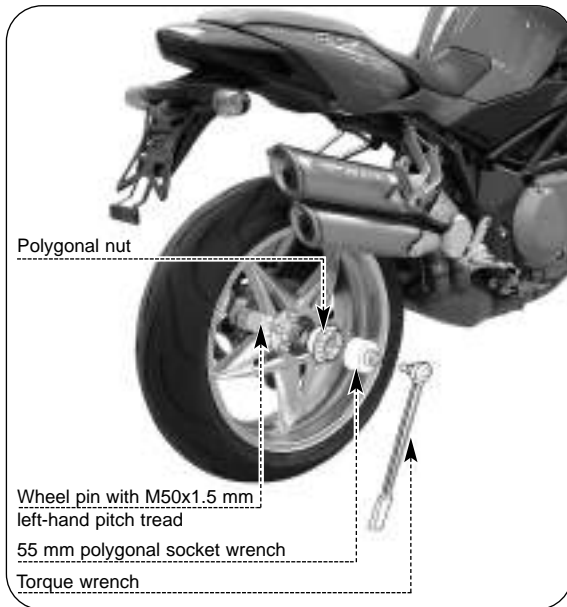



□ Checking the wheel rims

Before riding, always verify the absence of cracks, bending or buckling on the wheel rims.



WARNING

If you find that the wheel rim is damaged, have it replaced by an authorized MV Agusta dealer. Never attempt to repair the wheel rim, even in case of slight damage.

Every time you replace a tire or a rim, you must have a wheel balancing performed by an authorized MV Agusta dealer. Wheel unbalance can adversely affect performance and handling of the motorcycle, as well as shorten the life of the tires. This may increase the risk of accidents, with subsequent serious injury or even death.



WARNING

When you have a wheel balancing performed, make sure to assemble only approved counterweights on the wheel rim. MV Agusta recommends not to use balancing or balancing/sealing fluids.



WARNING

Do not attempt to have a tubeless tire removed without using the proper tools and protections for the wheel rim. Otherwise, you could damage the sealing surface of the rim, leading to the deflation of the tire and the loss of control of the vehicle, with upset, subsequent serious injury or even death.



6.10. Checking and lubricating the drive chain

To perform these operations, you must put the motorcycle on the rear stand, upright on a horizontal surface and with the gear in neutral.



WARNING: When servicing the chain, if your hand is pinched between the chain and the sprocket you will certainly be seriously injured. Always wear heavy gloves and use extreme caution to avoid pinching your fingers between the chain and the sprocket.

□ Checking the chain adjustment

The axis of the chain lower portion must be **9 mm (0.35 inch)** from the lower chain guard. Manually turn the rear wheel and carry out the check at several points along the chain. The distance between the chain and the lower chain guard must remain constant as the wheel turns. If the chain is only partially loosened, it means that some chain links are flattened or seized. If the distance is greater than 9 mm (0.35 inch), have the chain adjusted by your local MV Agusta dealer.

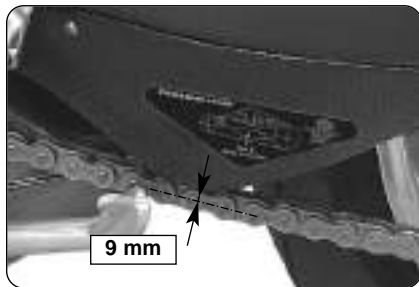

NOTE: On request, it is possible to order to the MV Agusta Spare Parts Service a special elongated upper chain cover. The assembly of this component on your motorcycle gives a better protection than a standard component.





WARNING: Never ride your motorcycle when the drive chain is in poor condition or improperly adjusted. Failure to heed this warning can lead to, among other things, rear wheel lockup with subsequent upset and serious injury or even death. Before riding, always check the chain adjustment according to the procedures shown in this paragraph. If necessary, have the chain adjusted by your MV Agusta dealer.



WARNING: If any chain link is flattened or seized, you must correctly lubricate the chain according to the procedures shown in the following paragraph. Failure to heed this warning can lead to, among other things, rear wheel lockup with subsequent upset and serious injury or even death.



WARNING: If you notice damage or excessive wear of the chain and the related sprockets, have them replaced by an authorized MV Agusta dealer. Every time the chain is replaced, you

must always replace the front and rear sprockets too. Failure to heed this warning can lead to, among other things, rear wheel lockup with subsequent upset and serious injury or even death. **WARNING:** Never use a chain with a fake link. An uncompletely riveted or fake link can accidentally split open and cause accidents, with subsequent serious injury or even death, as well as damage to the engine.



WARNING: Every time it is requested to operate the rear wheel hub screws, contact an authorized MV Agusta dealer. In order to tighten the screws, apply a tightening torque equal to the value shown in the label placed on the swingarm (see paragraph §2.2.). Applying a torque higher than the indicated value can cause the fast decay of the rear wheel hub, compromising the reliability of the vehicle and the safety of the pilot and the passenger, with subsequent risk of serious injury or even death.





❑ Lubrication

To ensure proper operation, the drive chain needs to be properly lubricated.

▶ Preliminary cleaning - Before lubrication, the dirt accumulated on the chain must be dissolved using kerosene. The dirt must then be removed with a clean rag and/or an air jet.



CAUTION

The chain is of the O-ring type. To prevent it from damaging, never clean the chain with a steam or high pressure water jet, nor using gasoline or other solvents. The chain must be cleaned using kerosene only.

6



WARNING

Kerosene is highly toxic and flammable. Avoid contact and inhalation. Keep kerosene away from sparks and flames. Keep kerosene out of reach of children and domestic animals. Correctly dispose of exhaust kerosene, in order to avoid environmental pollution.





► Lubrication - Apply a slight and uniform film of lubricant over the whole length of the drive chain, taking care not to smear the surrounding parts, and in particular the tires.



CAUTION: Only use the lubricant specified in the paragraph 6.3. of this manual, in order to protect the drive chain and avoid oil spurts when the vehicle is in motion.



WARNING: Chain lubrication must be performed according to the intervals specified in the tables of scheduled maintenance (see § 6.1.). It is also necessary to perform this operation after riding under the rain and after cleaning the motorcycle. Never ride your motorcycle when the drive chain is in poor condition or improperly adjusted. Failure to heed this warning can lead to, among other things, rear wheel lockup with subsequent upset and serious injury or even death.





6.11. Checking the idle speed

Check the idle speed when the engine has reached the operating temperature. Ensure that the choke control has not been activated.

The idle speed should range from 1,150 to 1,250 rpm.

If a tune-up is necessary, contact your MV Agusta dealer.





6.12. Periodic emission check

To ensure that your new **MV Agusta Brutale 910** maintains compliance with emission regulations, have the following operations performed by your MV Agusta dealer at the specified intervals.

☐ *1,000 km (600 mi)*

- **Check and if necessary adjust:**

- Idle speed
- Injection system throttle body
- Valve play
- Timing chain
- Timing chain slide
- Spark plugs

- **Renew:**

- Engine oil
- Oil filter

☐ *6,000 km (3,800 mi)*

- **Check and if necessary adjust (or renew):**

- Injection system throttle body
- Air filter
- Spark plugs

- **Renew:**

- Engine oil
- Oil filter

☐ *12,000 km (7,500 mi)*

- **Check and if necessary adjust (or renew):**

- Idle speed
- Injection system throttle body
- Valve play
- Timing chain
- Timing chain slide
- Timing chain tension adjuster

- **Renew:**

- Engine oil
- Oil filter
- Fuel filter
- Spark plugs

The operations mentioned for 6,000 km (3,800 mi) and 12,000 km (7,500 mi) should then be performed every 12,000 km (7,500 mi).



6.13. Evaporative emission control system

MV Agusta F4 Brutale 910 motorcycles are equipped with an evaporative emission control system which prevents the escape of fuel vapors from the fuel tank. In order to keep efficiency and reliability of this device, have the following operations performed by an authorized service centre.

Check (and replace if necessary)

Hoses and connections

Canister

Check (and clean if necessary)

Hot air inlet

These operations should be performed for the first time at 18,000 km (11,200 mi), then they should be repeated every 12,000 km (7,500 mi).

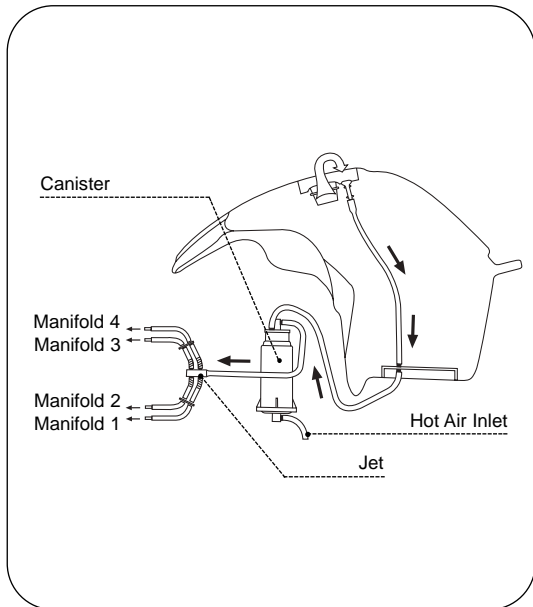



6.14. EMISSION CONTROL SYSTEM WARRANTY OBLIGATIONS

6.14.1.YOUR WARRANTY RIGHTS AND OBLIGATIONS

The *California Air Resources Board* and MV Agusta S.p.A., (hereinafter "MV Agusta"); are pleased to explain the emission control system warranty on your 2000 and later motorcycle. In California new motor vehicles must be designed, built and equipped to meet the State's stringent anti-smog standards. MV Agusta must warrant the emission control system on your motorcycle for the periods of time listed below provided there has been no abuse, neglect or improper maintenance of your motorcycle.

Your emission control system may include parts such as the carburetor or fuel-injection system, the ignition system, catalytic converter and engine computer. Also included may be hoses, belts, connectors and other emission-related assemblies.

Where a warrantable condition exists, MV Agusta will repair your motorcycle at no cost to you, including diagnosis, parts and labour.

6.14.2. MANUFACTURER'S WARRANTY COVERAGE

Class I motorcycles (50-169 cc): for a period of use of five (5) years or 12,000 kilometers (7,456 miles), whichever first occurs.

Class II motorcycles (170 to 279 cc): for a period of use of five (5) years or 18,000 kilometers (11,185 miles), whichever first occurs.

Class III motorcycles (280 cc and larger): for a period of use of five (5) years or 30,000 kilometers (18,641 miles), whichever first occurs.

If an emission-related part on your motorcycle is defective, the part will be repaired or replaced by MV Agusta. This is your emission control system DEFECTS WARRANTY.



6.14.3. OWNER'S WARRANTY RESPONSIBILITIES

As the motorcycle owner, you are responsible for the performance of the required maintenance listed in your owner's manual. MV Agusta recommends that you retain all receipts covering maintenance on your motorcycle, but MV Agusta cannot deny warranty solely for the lack of receipts or for your failure to ensure the performance of all scheduled maintenance.

You are responsible for presenting your motorcycle to an MV Agusta dealer as soon as a problem exists. The warranty repairs should be completed in a reasonable amount of time, not to exceed 30 days.

As the motorcycle owner, you should be aware that MV Agusta may deny your warranty coverage if your motorcycle or a part has failed due to abuse, neglect, improper maintenance or unapproved modifications.

If you have any question regarding your warranty rights and responsibilities, you should contact Cagiva U.S.A. Incorporated, 2300 Maryland Road, Willow Grove, PA 19090-4193 (215) 830-3300, or the California Air Resources Board at P.O. Box 8001, 9528 Telstar Avenue, El Monte, CA 91734-8001.



6.15. LIMITED WARRANTY ON EMISSION CONTROL SYSTEM

MV Agusta S.p.A. Via G. Macchi 144 - 21100 Varese, Italy (hereinafter MV Agusta) warrants that each new 2000 and later MV Agusta motorcycle, which includes as standard equipment a headlight, taillight and stoplight, and is street legal:

- A. is designed, built and equipped so as to conform at the time of initial retail purchase with all applicable regulations of the United States Environmental Protection Agency, and the California Air Resources Board; and
- B. is free from defects in material and workmanship which cause such motorcycle to fail to conform with applicable regulations of the United States Environmental Protection Agency or the California Air Resources Board for a period of use, depending on the engine displacement, of 12,000 kilometers (7,456 miles), if the motorcycle's engine displacement is less than 170 cubic centimeters; of 18,000 kilometers (11,185 miles), if the motorcycle's engine displacement is equal to or greater than 170 cubic centimeters but less than 280 cubic centimeters; or of 30,000 kilometers (18,641 miles), if the motorcycle's engine displacement is 280 cubic centimeters or greater; or 5 (five) years from the date of initial retail delivery, whichever first occurs.

6.15.1. COVERAGE

Warranty defects shall be remedied during customary business hours at any authorized MV Agusta motorcycle dealer located within the United States of America in compliance with the Clean Air Act and applicable regulations of the United States Environmental Protection Agency and the California Air Resources Board. Any part or parts replaced under this warranty shall become the property of MV Agusta.



In the State of California only, emission related warranted parts are specifically defined by the state's Emission Warranty Parts List. These warranted parts are: carburetor and internal parts; intake manifold; fuel tank; fuel injection system; spark advance mechanism; crankcase breather; air cutoff valves; fuel tank cap for evaporative emission controlled vehicles; oil filler cap; pressure control valve; fuel/vapour separator; canister; igniters; breaker governors; ignition coils; ignition wires; ignition points; condensers, and spark plugs if failure occurs prior to the first scheduled replacement; and hoses, clamps, fittings and tubing used directly in these parts. Since emission related parts may vary from model to model, certain models may not contain all of these parts and certain models may contain functionally equivalent parts. In the State of California only, Emission Control System emergency repairs, as provided for in the California Administrative Code, may be performed by other than an authorized MV Agusta dealer. An emergency situation occurs when authorized MV Agusta dealer is not reasonably available, a part is not available within 30 days, or a repair is not complete within 30 days. Any replacement part can be used in an emergency repair. MV Agusta will reimburse the owner for the expenses, including diagnosis, not exceeding MV Agusta's suggested retail price for all warranted parts replaced and labour charges based on MV Agusta's recommended time allowance for the warranty repair and the geographically appropriate hourly labour rate. The owner may be required to keep receipts and failed parts in order to receive compensation.

6.15.2. LIMITATIONS

This Emission Control System warranty shall not cover any of the following:

- A. Repair or replacement required as a result of
 - (1) accident
 - (2) misuse,



- (3) repairs improperly performed or replacements improperly installed
 - (4) use of replacement parts or accessories not conforming to MV Agusta specifications which adversely affect performance and/or
 - (5) use in competitive racing or related events.
- B. Inspections, replacement of parts and other services and adjustments needed for required maintenance.
- C. Any motorcycle on which the odometer mileage has been changed so that actual mileage cannot be readily determined.

6.15.3. LIMITED LIABILITY

- A. The liability of MV Agusta under this Emission Control System Warranty is limited solely to the remedying of defects in material or workmanship by an authorized MV Agusta motorcycle dealer at its place of business during customary business hours. This warranty does not cover inconvenience or loss of use of the motorcycle or transportation of the motorcycle to or from the MV Agusta dealer. MV Agusta shall not be liable for any other expenses, loss or damage, whether direct, incidental, consequential or exemplary arising in connection with the sale or use of or inability to use the MV Agusta motorcycle for any purpose. Some states do not allow the exclusion or limitation of any incidental or consequential damages, so the above limitations may not apply to you.
- B. No express emission control system warranty is given by MV Agusta except as specifically set forth herein. Any emission control system warranty implied by law, including any warranty of merchantability or fitness for a particular purpose, is limited to the express emission control system warranty terms stated in this warranty.



The foregoing statements of warranty are exclusive and in lieu of all other remedies. Some states do not allow limitations on how long an implied warranty lasts so the above limitations may not apply to you.

C. No dealer is authorized to modify this MV Agusta Limited Emission Control System Warranty.

6.15.4. LEGAL RIGHTS

This warranty gives you specific legal rights, and you may also have other rights which vary from state to state.

This warranty is in addition to the MV Agusta limited motorcycle warranty.

6.15.5. ADDITIONAL INFORMATION

Any replacement part that is equivalent in performance and durability may be used in the performance of any maintenance or repairs. However, MV Agusta is not liable for these parts. The owner is responsible for the performance of all required maintenance. Such maintenance may be performed at a service establishment or by any individual. The warranty period begins on the date the motorcycle is delivered to an ultimate purchaser.

MV Agusta S.p.A.
Via G. Macchi, 144
21100 Varese, Italy

Cagiva U.S.A. Incorporated
2300 Maryland Road
Willow Grove, PA 19090-4193



6.16. Replacing parts - General information

The replacement of the fuses (except for the battery recharge fuse) and the light bulbs can be carried out by the owner according to the indications provided below.

	Battery recharge fuse - Replacement (§6.16.1.)
	Service fuses - Replacement (§6.16.1.)
	Low beam bulb - Replacement (§6.16.2.)
	High beam bulb - Replacement (§6.16.3.)
	Front parking light bulb - Replacement (§6.16.4.)
	Front turn indicator bulbs - Replacement (§6.16.5.)
	Rear turn indicator bulbs - Replacement (§6.16.6.)
	Rear light and brake light bulb - Replacement (§6.16.7.)
	License plate light bulb - Replacement (§6.16.8.)

6.16.1. Replacing the fuses

► The recharge fuse is located under the driver's saddle, in the position shown in the figure.

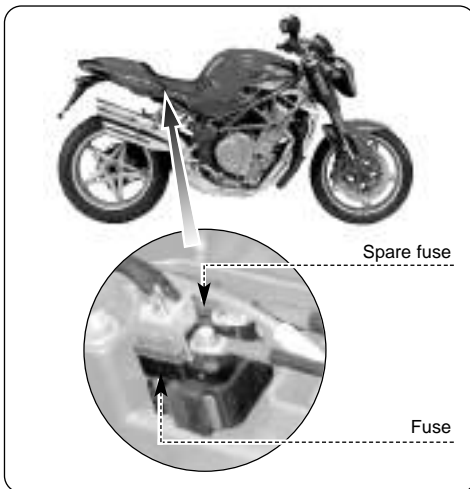



► The service fuses are located on the right side. To expose them, remove the right hand fuel tank side fairing.



► Remove the cover.

6



CAUTION

Turn the ignition key on the “OFF” position before checking or replacing the fuses, in order to avoid a short circuit with subsequent damage to other electric parts of the motorcycle.





► To identify the position and function of the fuses, refer to the information shown on the adhesive label and in the enclosed electrical diagram. The reference letters in the figure correspond to those shown in the diagram.

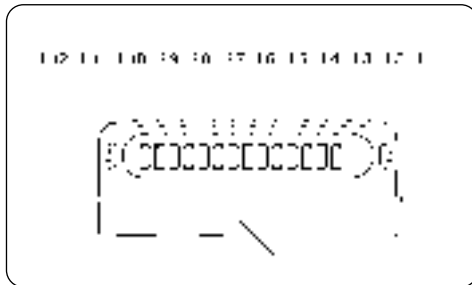

► Replace the blown fuse and refit the cover. Remember that the tool bag contains two spare fuses.



WARNING

Never replace a fuse with a rating other than that prescribed, in order to avoid damage to the electrical equipment of the motorcycle. This could lead to a fire with subsequent risk of serious burns, as well as damage to the motorcycle.





6.16.2. Replacing the low beam bulb

▶ Remove the headlight lateral fixing screws. Pay attention in slipping off the adjuster from its seat when the headlight is being removed from its support.



▶ Before removing the headlight from its support, detach the connector on the rear side of the headlight.

▶ Lay down the headlight on a table, in order to perform the following operations.





- ▶ Remove the headlight rear screw.
- ▶ Remove the front part of the headlight from its supporting shell.
- ▶ Detach the low beam bulb connector.
- ▶ Remove the protective cap.
- ▶ Release the retaining spring.
- ▶ Extract the burnt-out low beam bulb.



CAUTION: Do not touch the bulb glass with bare hands. If you do, clean the bulb with an oil-free solvent.

- ▶ Insert the new bulb.
- ▶ Reattach the spring.
- ▶ Replace the bulb protective cap.
- ▶ Reattach the low beam bulb connector.
- ▶ Replace the front part of the headlight on its supporting shell.
- ▶ Replace the headlight rear screw.
- ▶ Reattach the headlight connector.
- ▶ Replace the headlight on its support and insert the two lateral fixing screws, making sure to insert the adjuster in its proper seat on the headlight.





6.16.3. Replacing the high beam bulb

- ▶ Remove the headlight from its support as described in paragraph 6.16.2.
- ▶ Extract the high beam bulb by rotating it counter-clockwise.
- ▶ Detach the connector from the burnt-out bulb.



CAUTION: Do not touch the bulb glass with bare hands. If you do, clean the bulb with an oil-free solvent.

- ▶ Insert the connector in the new bulb.
- ▶ Insert and lock the bulb holder in place by rotating clockwise.
- ▶ Replace the headlight on its support, following the instructions described in paragraph 6.16.2.





6.16.4. Replacing the front parking light bulb

- ▶ Remove the headlight from its support as described in paragraph 6.16.2.
- ▶ Extract the front parking light bulb holder by rotating it counterclockwise.
- ▶ Pull out the burnt-out bulb.



CAUTION: Do not touch the bulb glass with bare hands. If you do, clean the bulb with an oil-free solvent.

- ▶ Insert the new bulb.
- ▶ Insert and lock the bulb holder in place by rotating clockwise.
- ▶ Replace the headlight on its support, following the instructions described in paragraph 6.16.2.





6.16.5. Replacing the front turn indicator bulbs

- ▶ Remove the fixing screw.
- ▶ Remove the lens.



- ▶ To remove the burnt-out bulb, press it and rotate it counterclockwise.
- ▶ To fit the new bulb, press it and rotate it clockwise.
- ▶ Replace the lens and insert the fixing screw.





6.16.6. Replacing the rear turn indicator bulbs

- ▶ Remove the fixing screw.
 - ▶ Remove the lens.
-
- ▶ To remove the burnt-out bulb, press it and rotate it counterclockwise.
 - ▶ To fit the new bulb, press it and rotate it clockwise.
 - ▶ Replace the lens and insert the fixing screw.





6.16.7. Replacing the rear light and brake light bulb

- ▶ Lift the pillion (§4.6.).
- ▶ Remove the bulb holder by turning it counterclockwise.



- ▶ To remove the bulb, press it and rotate it counterclockwise.
- ▶ To fit the new bulb, press it and rotate it clockwise.
- ▶ Replace the bulb holder and lock it in place by rotating it clockwise.





6.16.8. Replacing the license plate light bulb

- ▶ Remove the cable rail fixing screws.

- ▶ Pull down the cable rail and detach it from the upper surface, operating as described in the picture.





- ▶ Pull out the license plate light bulb holder.
- ▶ Extract the burnt-out bulb.
- ▶ Fit the new bulb.
- ▶ Replace the bulb holder.
- ▶ Push back the cable rail in touch with the upper surface.
- ▶ Replace the cable rail fixing screws.





6.17. Battery

The battery is of the maintenance-free type and is installed under the tail section. This battery does not require checking of the fluid level or adding of distilled water.

If the battery seems to be run-down (causing electrical problems or a difficult starting), have it recharged by an authorized MV Agusta dealer as soon as possible. Remember that the battery runs down more quickly if your motorcycle is equipped with additive electrical accessories.



WARNING

If the battery casing is damaged, there may be a leakage of sulphuric acid, a **HIGHLY TOXIC AND CORROSIVE** substance. Avoid any contact with your eyes, skin and clothes. Always wear protective glasses when you have to work near the battery.

In the event of a contact with sulphuric acid, give the **FIRST AID** as described below:

- **CONTACT WITH EYES:** Wash away with water for about 15 minutes, and immediately call a doctor.
- **CONTACT WITH SKIN:** Wash away with a great amount of water.
- **INGESTION:** Drink great amounts of water or milk, and immediately call a doctor.

Furthermore, leakage of sulphuric acid can result in the formation of hydrogen gas which, if ignited by a spark or a flame, would cause an explosion. Always have the battery replaced by your local MV Agusta dealer.



Prolonged inactivity

If the motorcycle is to remain unused for a long time (a month or longer), it is advisable to disconnect the battery cables or have the battery removed by an authorized MV Agusta dealer. In case of prolonged inactivity, to avoid shortening the life of the battery, it is essential to have it recharged by your MV Agusta dealer every 4-5 months.



WARNING: The inversion of the battery wires can damage the battery and the recharging system, causing an electric shock with subsequent serious harm and even death. The red wires must be connected to the positive terminal (+), while the black wires must be connected to the negative terminal (-). When removing the battery, disconnect the negative terminal **FIRST** and then the positive terminal. When reinstalling the battery, use the reverse procedure.





6.18. Cleaning the motorcycle

Periodic careful cleaning is a key factor in preserving the value of the motorcycle, protecting its surface finish and checking for damages, wear and leakage of corrosive fluids.



CAUTION

Before washing the vehicle, stop up the exhaust pipes and protect the electrical parts.



WARNING

Do not wash your motorcycle soon afterwards riding. Attend a few minutes to allow the engine and the exhaust pipes to thoroughly cool, in order to avoid the risk of serious burns.



CAUTION: Never use washing systems involving steam or high pressure water jets. These systems could cause water infiltration and damage the internal parts of your motorcycle.



INFORMATION: Spilling detergent can cause environmental pollution. Therefore, you should clean your motorcycle in an area equipped for collection and disposal of washing fluids.



Wash the motorcycle with water, a mild detergent and a sponge. Wipe the vehicle with a soft cloth. Use an air jet to dry difficult-to-reach areas.

**CAUTION**

- **Avoid using clothes or sponges that have been in contact with strong or abrasive detergents, solvents or gasoline.**
- **To avoid irreparable damage to the bodywork parts, never use alkaline or strongly acid detergents, petrol, brake fluid or other solvents.**

Periodically treat the paintwork with high quality wax. After riding on roads treated with corrosive substances (salt), wash the vehicle as soon as possible with cold water. Do not use hot water as it enhances the corrosive action.

**WARNING**

Avoid smearing brakes or tires with oil or wax. If necessary, clean the brake discs with a brake disc detergent or with acetone, and wash the tires with warm water and a neutral detergent.

After completing the washing, run the engine for a few minutes and start off at reduced speed. Carefully apply the brakes a few times so as to dry the brake pads and discs. Failure to heed this warning can cause reduction of braking efficiency and risk of accidents, with subsequent serious injury and even death.

**WARNING**

The drive chain must be correctly lubricated after washing the motorcycle, following the instructions provided at § 6.11. of this manual. Failure to heed this warning can lead to, among other things, rear wheel lockup with subsequent upset and serious injury or even death.

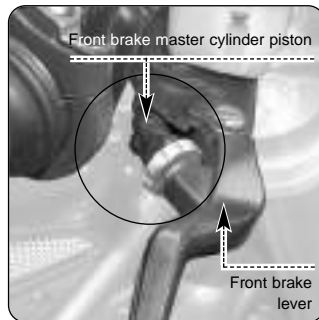
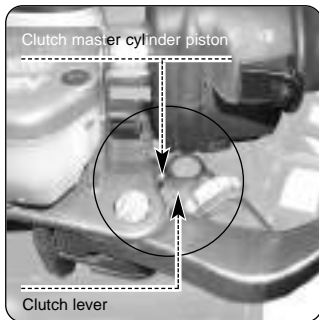
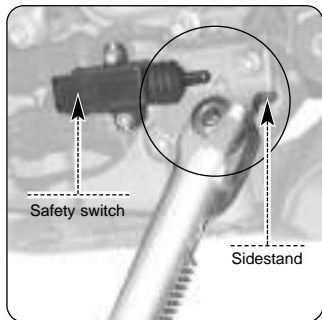
**CAUTION**

Make sure to always keep clean the contact areas between the following components, as shown in the above figures:

- Side stand and safety switch
- Clutch lever and clutch master cylinder piston
- Front brake lever and front brake master cylinder piston

Clean these areas every 500 ÷ 1000 km, as prescribed in the Scheduled Maintenance Table. In any case, we suggest to verify the cleanliness of the above areas every time you use the vehicle, in order to maintain the related parts in good working order.

**6.19. Prolonged inactivity**

If the motorcycle is to remain unused for a long time, it is advisable to carry out the following operations:

	Empty the fuel tank.
	Remove the battery and store it in a suitable place.
	Remove the spark plug caps and the spark plugs. Pour a teaspoonful of engine oil in every spark plug hole, then place back the spark plugs and the corresponding caps. Make the engine run idle for a few times.
	Lubricate all control cables and the joints of all pedals and levers.
	Clean the motorcycle and treat the paintwork with high quality wax (§6.18.).
	In order to ensure integrity and performance of the tires, park your motorcycle in a fresh, dry and dark place, with a temperature relatively constant and lower than 25° C (77° F). Avoid direct contact of the tires with heating pipes or radiators, and prolonged contact with oil or gasoline. Avoid parking with the tires near to electrical motors or devices capable to produce sparks or electric discharge. During the period of inactivity, place your motorcycle on the rear stand (§4.7).
	Cover the vehicle with an adequate canvas cover.

When the motorcycle is first put back into service, remember to carry out a comprehensive check (§4.8.) and, if necessary, to have the vehicle serviced (§6.1.).



7.1. Engine problems: **ENGINE DOES NOT START**

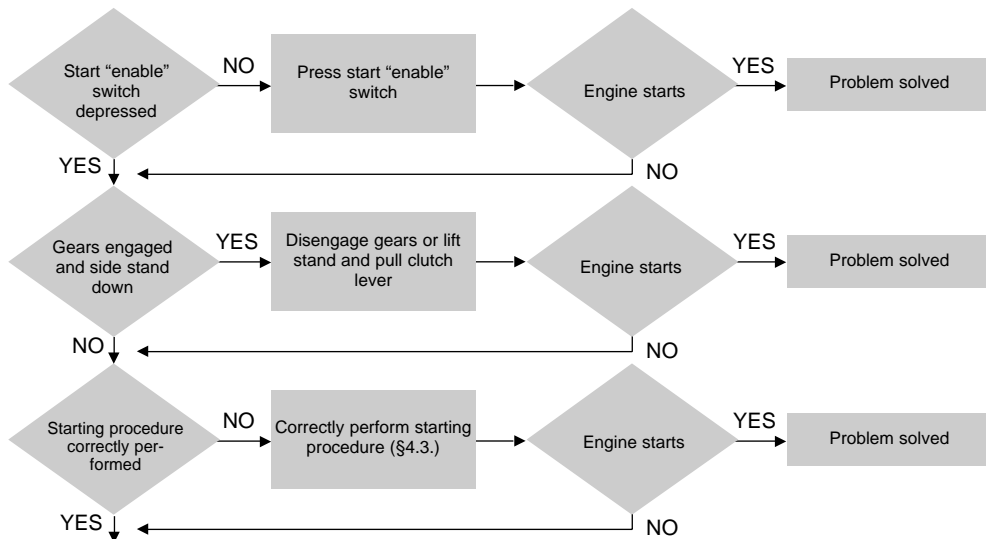

continued on next page



continued from previous page

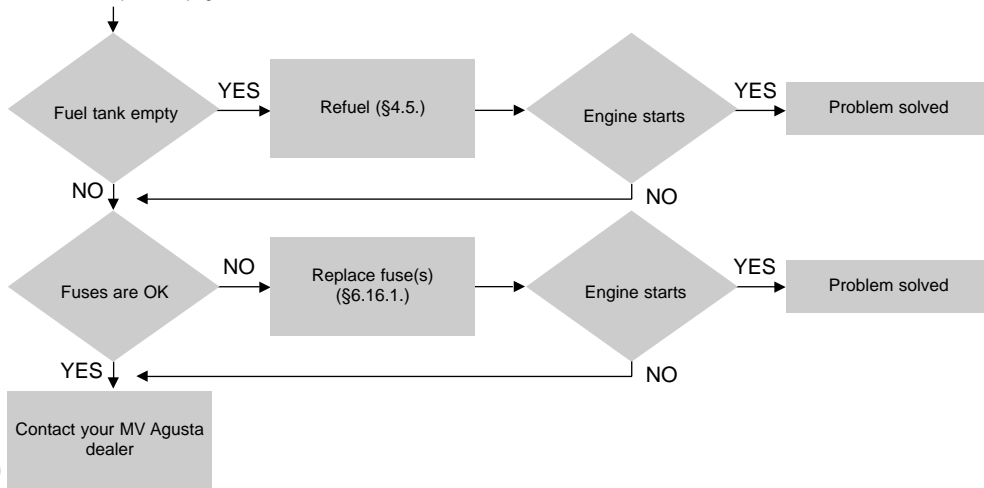



ENGINE IS DIFFICULT TO START

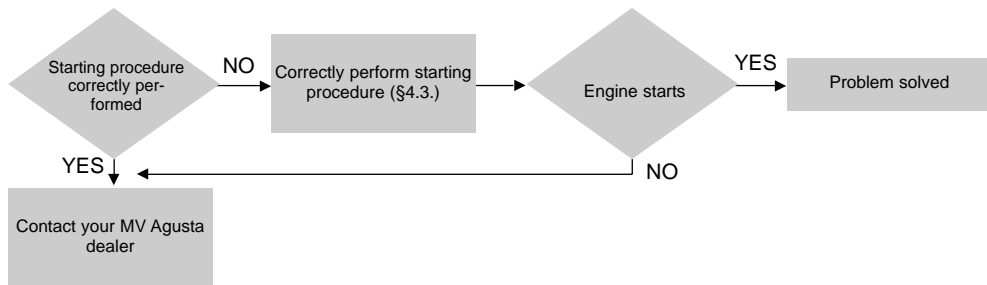



ENGINE OVERHEATS

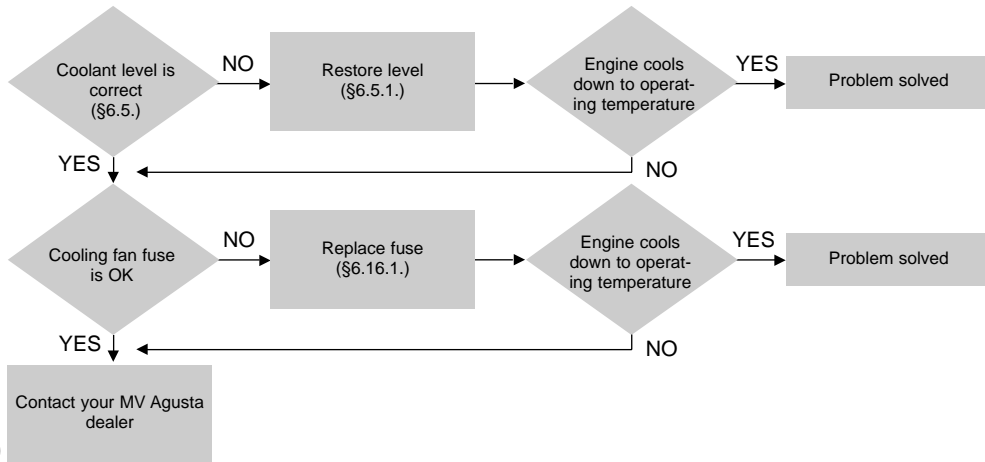



OIL PRESSURE IS TOO LOW

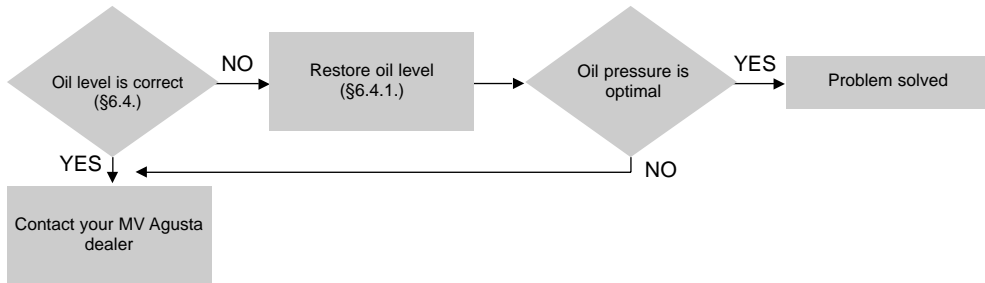



7.2. Electrical equipment problems: **LIGHTS DO NOT WORK**

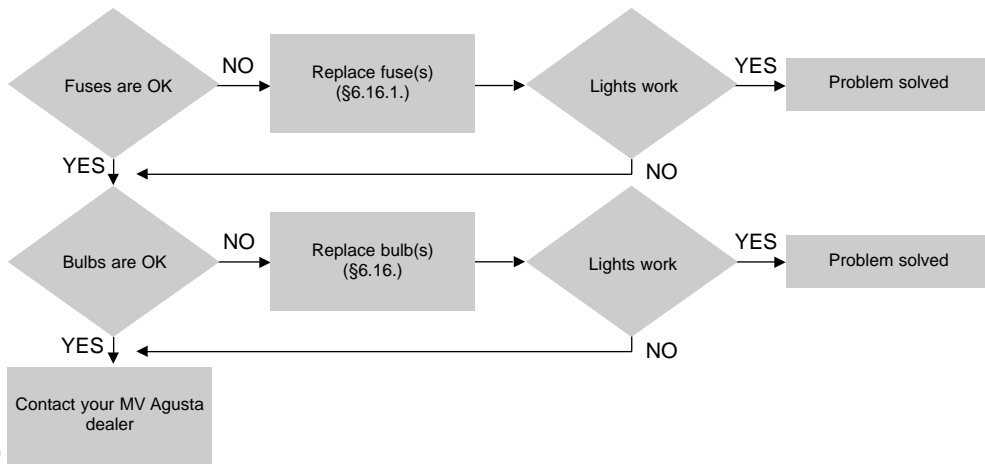



HORN DOES NOT WORK

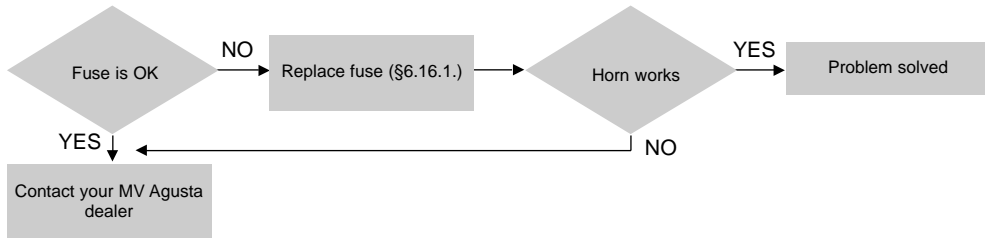

SPEEDOMETER DOES NOT WORK

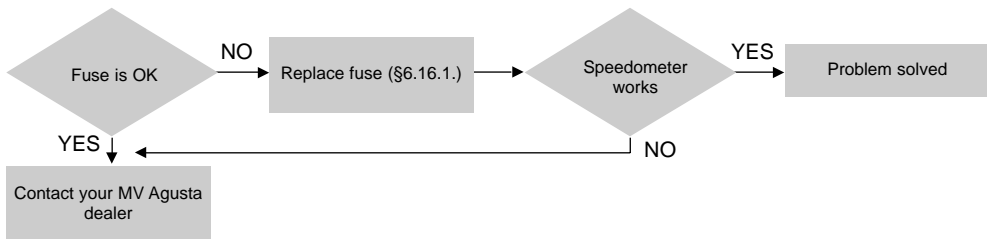



RESERVE FUEL WARNING LIGHT DOES NOT WORK

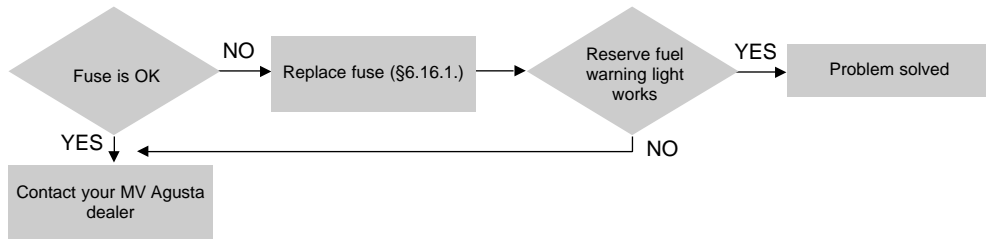

ALTERNATOR DOES NOT CHARGE BATTERY

Contact your MV Agusta dealer



8.1. Motorcycle overview

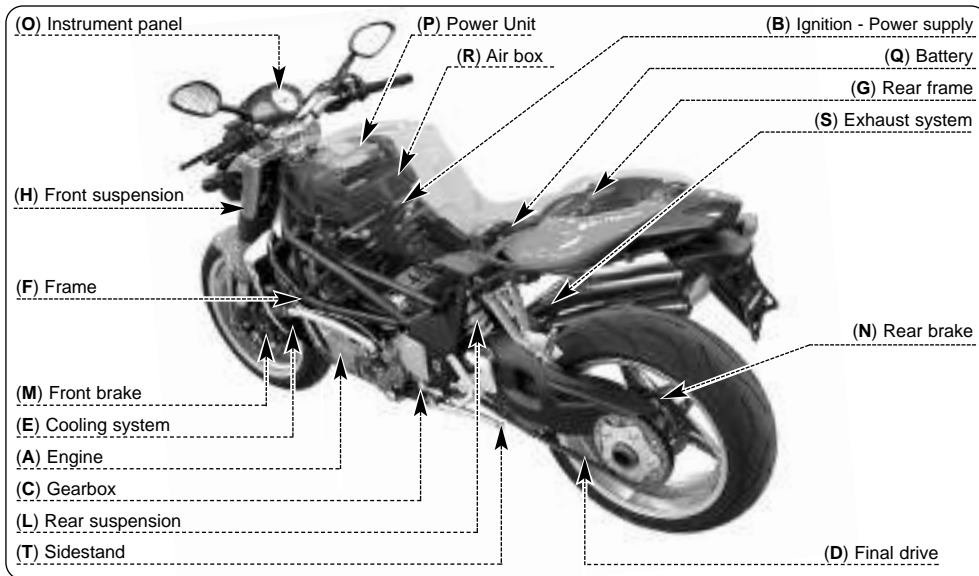



- A - Engine:** four-stroke, inline four-cylinder. Double-overhead camshaft valve train with radial valves. Wet sump lubrication.
- B - Ignition - Power supply:** integrated ignition-injection system. Inductive-discharge electronic ignition. "Multipoint" electronic injection.
- C - Gearbox:** removable, six-speed, with constant-mesh gears.
- D - Final drive:** consisting of drive sprocket, rear sprocket and chain.
- E - Cooling system:** liquid cooling with water-oil heat exchanger.
- F - Frame:** tubular steel trellis with aluminium side plates.
- G - Rear frame:** tubular steel trellis.
- H - Front suspension:** upside-down hydraulic fork with external adjusting system.
- L - Rear suspension:** progressive, with single-sided swingarm and single shock absorber with external adjusting system.
- M - Front brake:** dual semi-floating disc with six-piston calipers.
- N - Rear brake:** single disc with four-piston caliper.
- O - Instrument panel:** with warning lights and analogue and digital instruments.
- P - Power unit:** equipped with EPROM for the electronic control of the integrated ignition-injection system.
- Q - Battery:** sealed and maintenance-free.
- R - Air box:** equipped with filtering system of the engine intake air flow.
- S - Exhaust system:** equipped with catalytic converter for exhaust emission reduction.
- T - Sidestand:** equipped with safety switch and dual return spring.



8.1.1 Front brake circuit

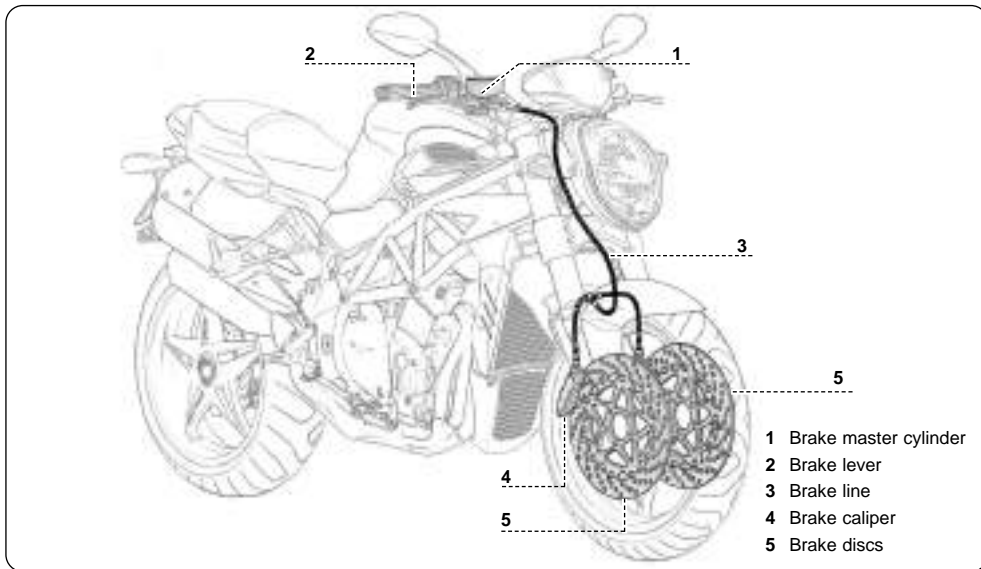



8.1.2. Rear brake circuit

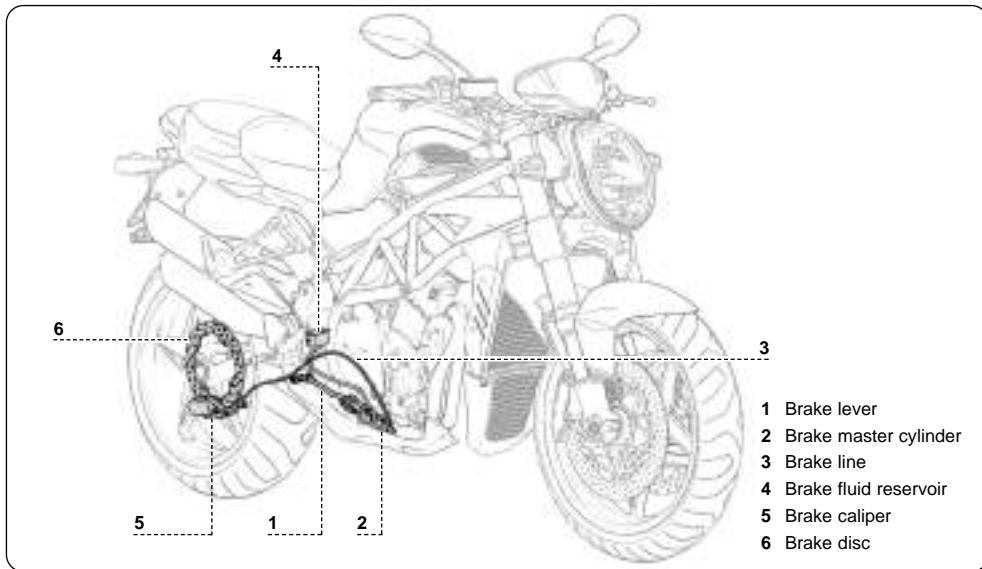



8.1.3. Clutch circuit

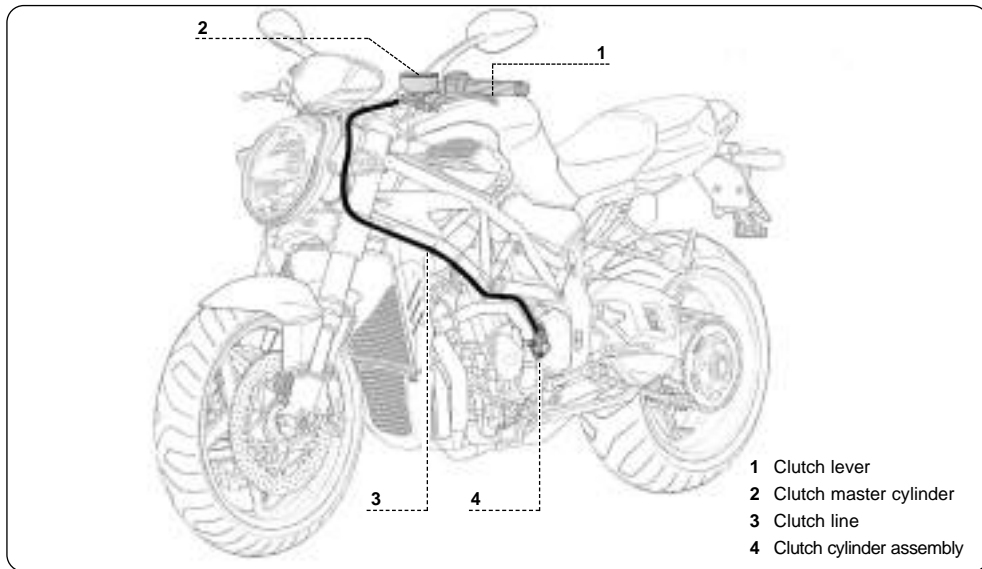



8.1.4. Engine lubrication

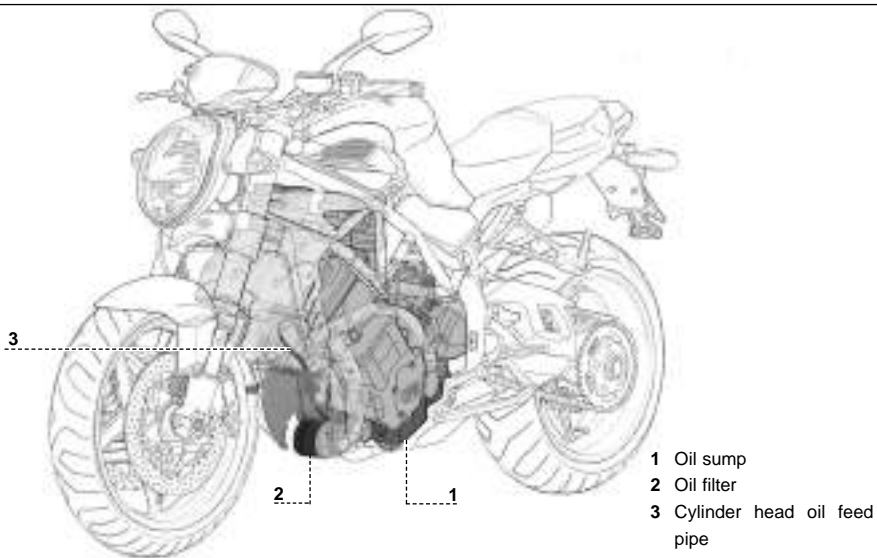



8.1.5. Coolant circuit

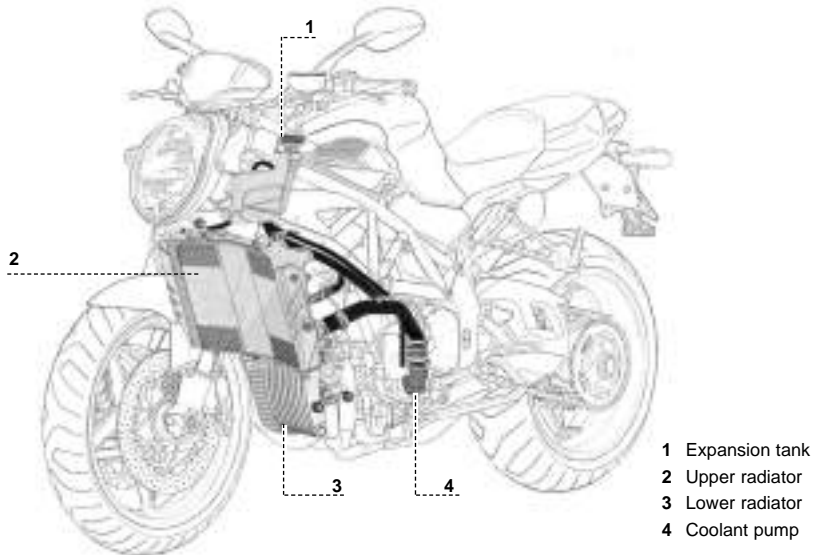



8.1.6. Fuel system

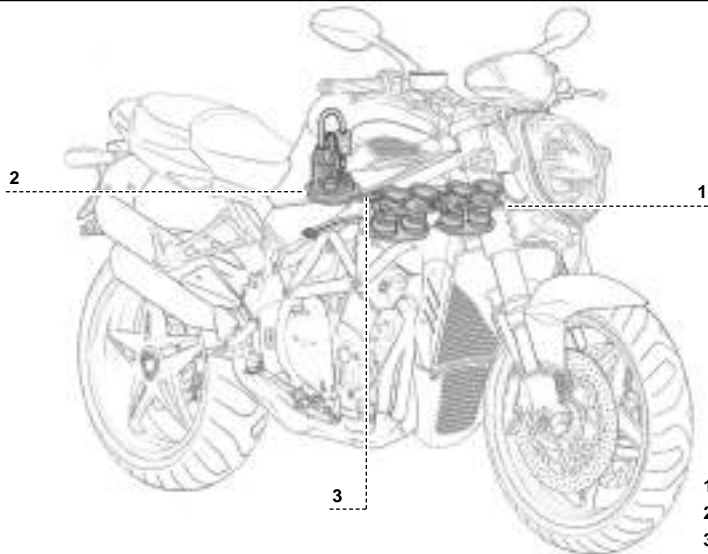

- 1 Throttle bodies
- 2 Fuel pump
- 3 Fuel line

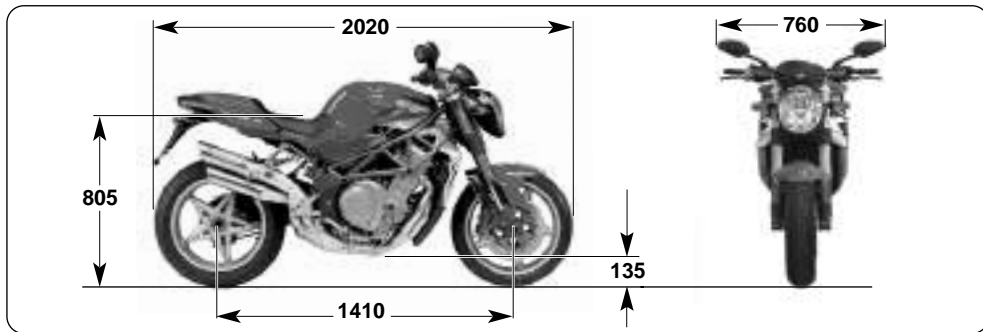

8.2. Specifications

Description	BRUTALE 910 S
SPECIFICATIONS	
Wheelbase (*)	1410 mm (55.55 in)
Overall length (*)	2020 mm (79.59 in)
Max. width	760 mm (29.94 in)
Seat height (*)	805 mm (31.72 in)
Min. ground clearance (*)	135 mm (5.32 in)
Trail (*)	101.5 mm (4 in)

* : The indicated values must not be intended as binding informations. They can change according to the vehicle setup.



Specifications

Description	BRUTALE 910 S
Dry weight	185 kg (407.9 lbs)
Fuel tank capacity (*)	19 lt (5.02 U.S. gal)
Reserve fuel (*)	4 lt (1.06 U.S. gal)
Oil in crankcase	3.5 kg (7.7 lbs)
ENGINE	
Type	Four-cylinder, four-stroke, 16 valves
Bore	76,0 mm (2.99 in)
Stroke	50,1 mm (1.97 in)
Total displacement	909,1 cm ³ (55.4 cu.in)
Compression ratio	13 : 1
Starting	Electric starter
Cooling system	Liquid cooling with water-oil heat exchanger
Crankcase and covers	Die-cast
Head and cylinders	Chill-cast
Valves	Bimetal / single-metal
VALVE TRAIN	
Type	Double-overhead camshaft, radial valves

* : The indicated data must not be intended as binding informations. They can change according to the environmental temperature, the engine temperature and the evaporation point of the gasoline.



Specifications

Description	BRUTALE 910 S
LUBRICATION	
Type	Wet sump
IGNITION - POWER SUPPLY	
Type	"Weber-Marelli" 1.6 M integrated ignition-injection system Inductive discharge electronic ignition, "Multipoint" electronic injection
Spark plugs	NGK CR9 EB
Spark gap	0.7 ÷ 0.8 mm (0.027 ÷ 0.031 in)
CLUTCH	
Type	Multiple-disc in oil bath
PRIMARY DRIVE	
Number of teeth on crankshaft gear	Z = 50
Number of teeth on clutch gear	Z = 79
Transmission ratio	1.58
SECONDARY DRIVE	
Number of teeth on front sprocket	Z = 15
Number of teeth on rear sprocket	Z = 43
Transmission ratio	2.87
TRANSMISSION	
Type	Removable, six-speed gearbox with constant-mesh gears



Specifications

Description	BRUTALE 910 S
Gear ratio (overall ratios)	
First gear	2.92 (13.23)
Second gear	2.12 (9.64)
Third gear	1.78 (8.06)
Fourth gear	1.50 (6.79)
Fifth gear	1.32 (5.98)
Sixth gear	1.21 (5.48)
FRAME	
Type	CrMo steel tubular trellis (TIG welded)
Swingarm pivot plates	Aluminium alloy
FRONT SUSPENSION	
Type	"Upside down" telescopic hydraulic fork with external adjustment of rebound and compression damping and of spring preload
Rod diameter	50 mm (1.97 in)
Travel on leg axis	126 mm (4.96 in)
REAR SUSPENSION	
Type	Progressive, single shock absorber with rebound and compression (High speed / Low speed) damping and spring preload adjustment
Swingarm	Aluminium alloy
Wheel travel	120 mm (4.73 in)



Specifications

Description	BRUTALE 910 S
FRONT BRAKE	
Type	Dual floating disc with steel braking band
Disc diameter	310 mm (12.21 in)
Disc flange	Steel
Calipers, piston diameters	6-piston, Ø 22.65; Ø 25.4; Ø 30.23 mm (Ø 0.89; Ø 1.00; Ø 1.19 in)
REAR BRAKE	
Type	Single steel disc
Disc diameter	210 mm (8.27 in)
Caliper, piston diameter	4-piston, Ø 25.4 mm (Ø 1.00 in)
FRONT RIM	
Material	Aluminium alloy
Dimensions	3.50" x 17"
REAR RIM	
Material	Aluminium alloy
Dimensions	6.00" x 17"
TIRES	
Front	120/65-ZR 17 (56 W) or 120/70-ZR 17 (56 W-58 W) (*)
Rear	190/50-ZR 17 (73 W) or 190/55-ZR 17 (75 W)

* : If you use a 120/70 front tire, it is necessary to displace the front mudguard by assembling it on the upper bores placed on the front fork feet.



Specifications

Description	BRUTALE 910 S
Brand and type	PIRELLI - Dragon Supercorsa Pro MICHELIN - Pilot Power DUNLOP - Sport Max D 208 Race Replica
Inflating pressure (*):	
Front	2.3 bar (33 psi)
Rear	2.3 bar (33 psi)
ELECTRICAL EQUIPMENT	
Equipment voltage	12V
Low beam	12V 55W
High beam	12V 60W
Front parking light	12V 5W
Rear light	12V 5W
Brake light	12V 21W
Turn indicators	12V 10W
Battery	12V - 9Ah
Alternator	650W at 5000 rpm
BODYWORK	
Fuel tank	Thermoplastic material
Air scoops	Thermoplastic material

* : If you use tires of a brand different from the ones recommended, refer to the inflating pressure values marked by the manufacturer on the tire sidewall.



Specifications

Description	BRUTALE 910 S
Fuel tank side panels	Thermoplastic material
Tail piece side panels	Thermoplastic material
Tail piece	Thermoplastic material
Dashboard cover	Thermoplastic material
Ignition switch cover	Thermoplastic material
Front mudguard	Thermoplastic material
Chain guards	Thermoplastic material
Oil cooler guard	Thermoplastic material
License-plate holder	Thermoplastic material
Rearview mirrors	Thermoplastic material
Exhaust pipe guard	Aluminium



8.3. Accessories

MV Agusta, through **MV AGUSTA Corse**, has designed a wide range of accessories, kit and special parts to customize or increase the performances of your motorcycle. This way, **MV Agusta** provides you the chance to develop your motorcycle, taking advantage of the excellence and the exclusiveness of innovatory technical solutions with the quality warranty provided by CRC technical department of research and development. Both frame and bodywork spare parts designed by Cagiva Research Center for MV Agusta Corse have undergone severe tests and rigorous checks, in order to offer to the Customers the same official warranty as all MV Agusta products.

In order to request these components or consult the MV Agusta Corse Catalogue, we suggest to refer to:



MV Agusta Corse S.r.l. - Sales and Technical Assistance Service

Via Ovella 41 - 47893 Borgo Maggiore - Republic of San Marino (R.S.M.)

Phone number: (00378) 0549 907.749 - Fax number: (00378) 0549 907.746

e-mail: info@mvagustacorse.com - <http://www.mvagustacorse.com>

MV Agusta strongly recommends not to use non-genuine components, since they cannot offer the same safety, vehicle performance and life duration as original and certified spare parts.



8.4. Clothing

MV AGUSTA Corse has designed a wide range of wear products and accessories providing high aesthetical and qualitative standards, helping to strenghten and consolidate the prestige of the MV Agusta trademark and, at the same time, making an exclusive experience out of riding an already unique vehicle.





8.5. Measure equivalence tables for American and metric systems

The following conversion factors have been used in accordance with the current international standards.

A. From metric to American system

1. Length

$$1 \text{ mm} = 0.1 \text{ cm} = 0.0394 \text{ in}$$

$$1 \text{ m} = 3.2808 \text{ ft}$$

$$1 \text{ km} = 0.621 \text{ mi}$$

2. Displacement

$$1 \text{ cm}^3 = 0.061 \text{ cu. in}$$

3. Speed

$$1 \text{ km/h} = 0.621 \text{ mph}$$

4. Weight

$$1 \text{ kg} = 2.2046 \text{ lb}$$

5. Capacity

$$1 \text{ lt} = 0.264 \text{ U.S. gal}$$

6. Temperature

$$t \text{ (}^\circ\text{C)} = 0.556 \cdot (T \text{ (}^\circ\text{F)} - 32)$$

7. Pressure

$$1 \text{ bar} = 14.504 \text{ p.s.i.}$$

8. Torque

$$1 \text{ Nm} = 0.102 \text{ kgm} = 0.738 \text{ ft lb}$$

9. Power

$$1 \text{ kW} = 1.3596 \text{ HP}$$

B. From American to metric system

1. Length

$$1 \text{ in} = 25,4 \text{ mm} = 2,54 \text{ cm}$$

$$1 \text{ ft} = 30.48 \text{ cm} = 0.3048 \text{ m}$$

$$1 \text{ mi} = 1.609 \text{ km}$$

2. Displacement

$$1 \text{ cu. in} = 16.387 \text{ cm}^3$$

3. Speed

$$1 \text{ mph} = 1.609 \text{ km/h}$$

4. Weight

$$1 \text{ lb} = 0.454 \text{ kg}$$

5. Capacity

$$1 \text{ U.S. gal} = 3.785 \text{ lt}$$

6. Temperature

$$T \text{ (}^\circ\text{F)} = 1.8 \cdot t \text{ (}^\circ\text{C)} + 32$$

7. Pressure

$$1 \text{ p.s.i.} = 0.06894 \text{ bar}$$

8. Torque

$$1 \text{ ft lb} = 1.3558 \text{ Nm} = 0.138 \text{ kgm}$$

9. Power

$$1 \text{ HP} = 0.7355 \text{ kW}$$

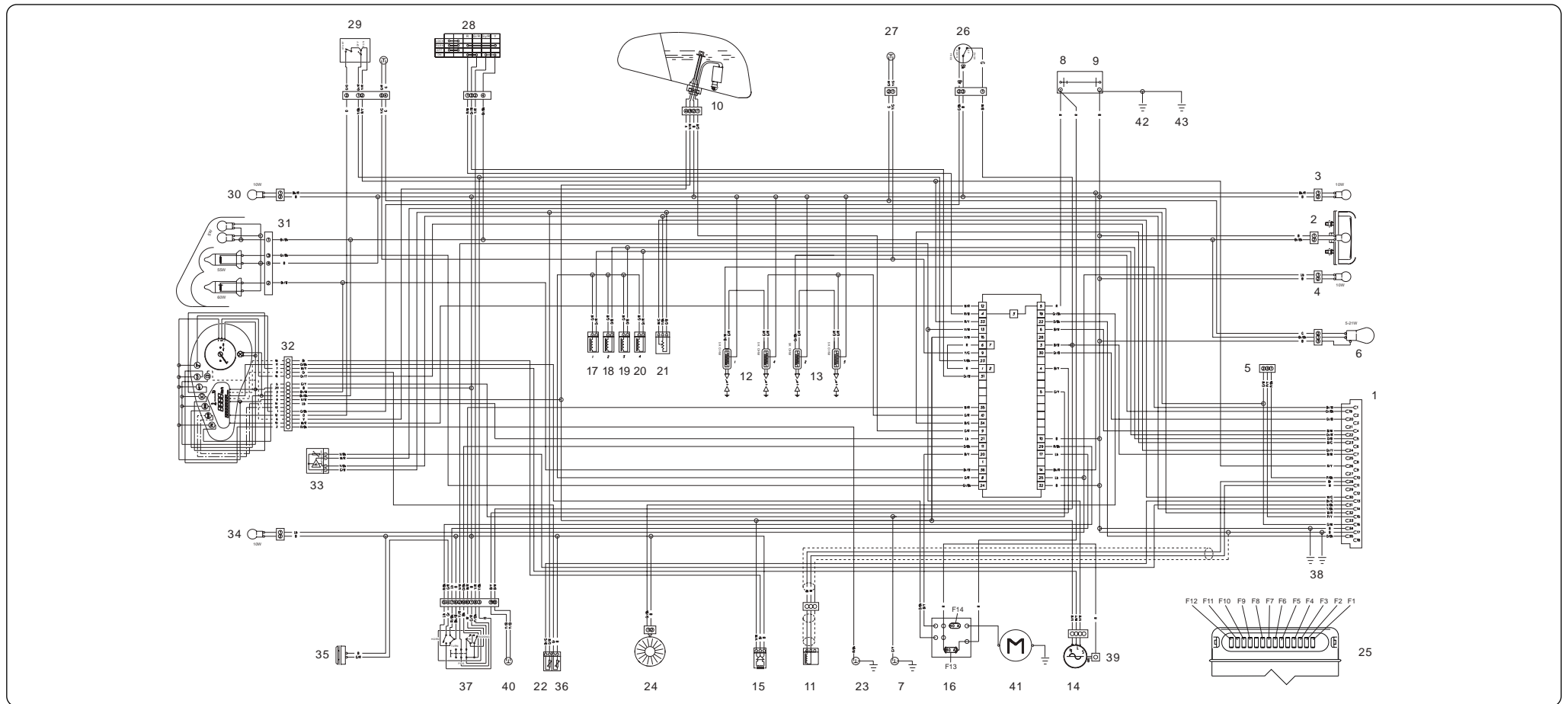

Parts list	
Ref.	Description
1	Power unit
2	Plate light
3	Turn indicator, right hand
4	Turn indicator, left hand
5	Diagnosis connector
6	Brake light
7	Neutral switch
8-9	Battery
10	Pump - Low fuel probe
11	Engine rpm sensor
12	Coil
13	Coil
14	Alternator
15	Speed sensor

Parts list	
Ref.	Description
16	Solenoid starter
17-18	Injectors
19-20	Injectors
21	Throttle potentiometer
22	Water temperature sensor for power unit
23	Oil switch
24	Heater fan
25	Fuses
26	Side stand switch
27	Rear brake switch
28	Key switch
29	Safety and front brake switch
30	Turn indicator, right hand
31	Front light

Parts list	
Ref.	Description
32	Display
33	Air pressure/temperature sensor
34	Turn indicator, left hand
35	Horn
36	Water temperature sensor for display thermometer
37	Light switch
38	Frame - power unit ground
39	Battery recharge
40	Clutch switch
41	Starter
42	Frame ground
43	Engine ground

Wires colors list	
Letter(s)	Color
R	Red
Y	Yellow
B	Blue
G	Green
W	White
Bk	Black
P	Pink
V	Violet
Sb	Sky blue
Gr	Grey
O	Orange
Br	Brown

In combined colors, background and marking colors have been pointed out. E.g. : Br/Bk.

Fuses list		
Ref.	Amperage (A)	Application
F1	5	Position light
F2	5	Speed sensor
F3	5	Turn indicator light, right hand
F4	5	Turn indicator light, left hand
F5	15	Heater fan
F6	5	Brake light
F7	15	"LATCH" relay
F8	7.5	Starter switch
F9	15	Low beam
F10	5	Dashboard clock
F11	15	High beam
F12	15	Injectors - Fuel pump - Coils
F13	40	Battery recharge
F14	40	Battery recharge supply



Phase 1
Initial battery charging
Perform the initial charge of the battery according to the instruction sheet enclosed in its package.

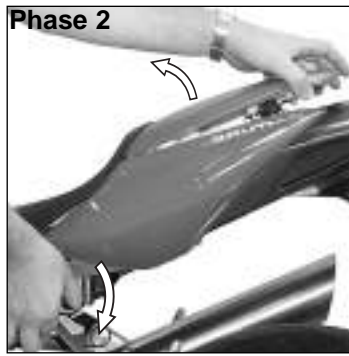

Phase 2
Assembling the battery
Insert the motorcycle key in the rear lock. Rotate the key clockwise while lifting the pillion.

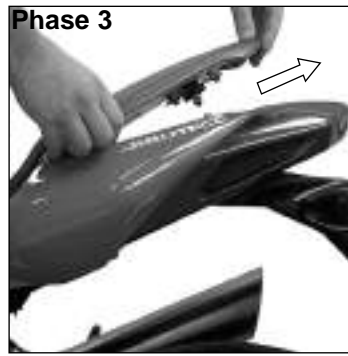

Phase 3
Remove the pillion as shown in the figure.

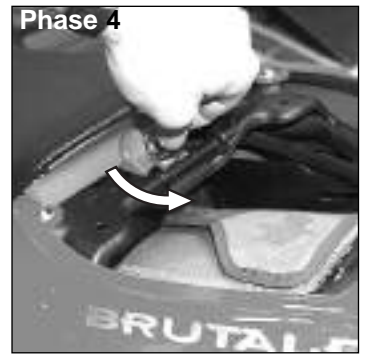

Phase 4
Rotate the driver's saddle catch as shown in the figure.

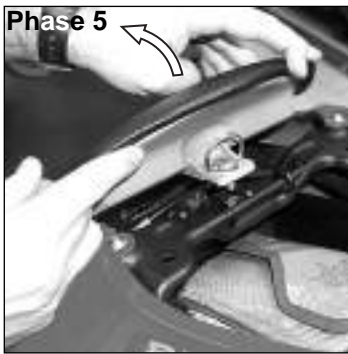

Phase 5
Lift the driver's saddle and remove it.



Phase 6
Insert the battery in its proper compartment.
⚠ WARNING
The initial battery charging must be performed before assembling the battery on the vehicle.



Phase 7
Assembling the battery terminals
Fit the 2 positive terminals (+) on the corresponding battery pole, respecting their disposition as shown in the figure. Pay attention to the colours of the cables in order to correctly place them.

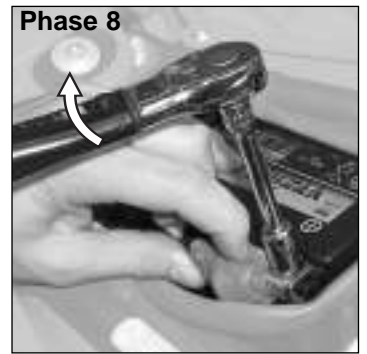

Phase 8
Rotate the positive terminals screw and tighten it at the prescribed torque by using a dynamometric key.
Tightening torque: 7 ÷ 8 Nm



Phase 9
Afterwards, fit the **protective cap** on the positive pole (see figure).



Phase 10
Fit the 2 negative terminals (-) on the corresponding battery pole, respecting their disposition as shown in the figure.

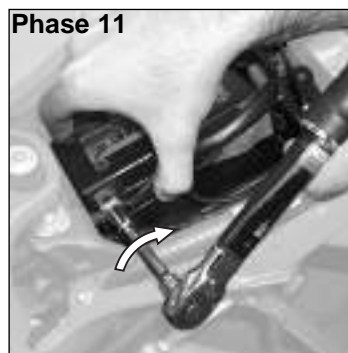

Phase 11
Rotate the negative terminals screw and tighten it at the prescribed torque by using a dynamometric key.
Tightening torque: 7 ÷ 8 Nm
⚠ CAUTION: Before tightening the screw, make sure that the cables are correctly placed (see figure on the reverse side of this sheet).



Phase 12
⚠ WARNING: When the assembly operations have been completed, make sure that the positive terminal cable is placed within the rear frame (see figure).
Replace the driver's saddle and the pillion by inversely performing the operations described in the phases from 2 to 5.

NEGATIVE CABLE (-)

NEGATIVE POLE (-)

NEGATIVE CABLE (-)

 **CAUTION:** Before tightening the screw, make sure that the cables are correctly placed (see figure).

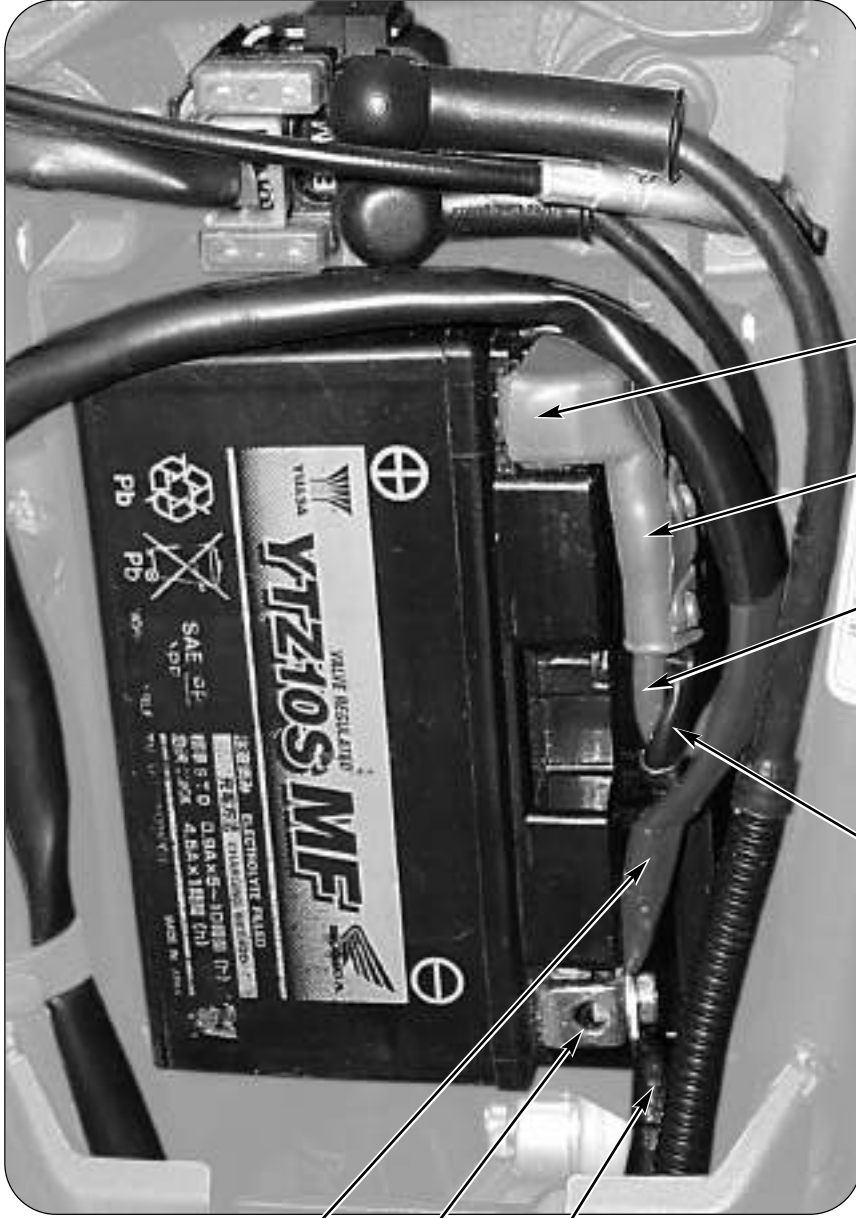

POSITIVE POLE (+)

PROTECTIVE CAP

POSITIVE CABLE (+)

POSITIVE CABLE (+)

 **WARNING:** When the assembly operations have been completed, make sure that the positive terminal cable is placed within the rear frame (see figure).

- Dispositivo idraulico di frenatura in compressione (Bassa velocità)
- Compression damping hydraulic device (Low speed)
- Dispositif hydraulique de freinage en compression (Vitesse basse)
- Hydraulische Kompressionsbremse (Niedrige Gänge)
- Dispositivo hidráulico de frenado en compresión (Baja velocidad)

- Dispositivo idraulico di frenatura in compressione (Alta velocità)
- Compression damping hydraulic device (High speed)
- Dispositif hydraulique de freinage en compression (Vitesse élevée)
- Hydraulische Kompressionsbremse (Hohe Gänge)
- Dispositivo hidráulico de frenado en compresión (alta velocidad)

- Dispositivo idraulico di frenatura in estensione
- Rebound damping hydraulic device
- Dispositif hydraulique de freinage en détente
- Hydraulische Ausdehnungsbremse
- Dispositivo hidráulico de frenado en extensión

- Dispositivo idraulico di frenatura in estensione
- Rebound damping hydraulic device
- Dispositif hydraulique de freinage en détente
- Hydraulische Ausdehnungsbremse
- Dispositivo hidráulico de frenado en extensión

- Dispositivo idraulico di frenatura in compressione
- Compression damping hydraulic device
- Dispositif hydraulique de freinage en compression
- Hydraulische Kompressionsbremse
- Dispositivo hidráulico de frenado en compresión

- Dispositivo idraulico di frenatura in compressione
- Compression damping hydraulic device
- Dispositif hydraulique de freinage en détente
- Hydraulische Ausdehnungsbremse
- Dispositivo hidráulico de frenado en extensión

910 BRUTALE			
Brutale 910 S			
<i>Tipi di assetto - Type of geometry - Type d'assiette - Einstellungsart - Tipo de equilibrado</i>			
Sospensione anteriore <i>Front suspension</i> <i>Suspension avant</i> <i>Vordere Federung</i> <i>Suspensión delantera</i>		Standard	
Soffice <i>Soft</i> <i>Souple</i> <i>Weich</i> <i>Suave</i>		Rigido <i>Stiff</i> <i>Rigide</i> <i>Hart</i> <i>Duro</i>	
1	giri turns tours Drehzahl revoluciones	2	giri turns tours Drehzahl revoluciones
16	scatti clicks emboîtements Rasten disparos	14	scatti clicks emboîtements Rasten disparos
12	scatti clicks emboîtements Rasten disparos	10	scatti clicks emboîtements Rasten disparos
Precarico molla <i>Spring preload</i> <i>Précharge du ressort</i> <i>Federvorspannung</i> <i>Precarga muelle</i>			
Freno in estensione <i>Rebound damping</i> <i>Frein en détente</i> <i>Ausdehnungsbremse</i> <i>Freno en extensión</i>			
Freno in compressione <i>Compression damping</i> <i>Frein en compression</i> <i>Kompressionsbremse</i> <i>Freno en compresión</i>			
Sospensione posteriore <i>Rear suspension</i> <i>Suspension arrière</i> <i>Hintere Federung</i> <i>Suspensión trasera</i>		Standard	
Soffice <i>Soft</i> <i>Souple</i> <i>Weich</i> <i>Suave</i>		Rigido <i>Stiff</i> <i>Rigide</i> <i>Hart</i> <i>Duro</i>	
12		8	
scatti clicks emboîtements Rasten disparos		scatti clicks emboîtements Rasten disparos	
0		6	
scatti clicks emboîtements Rasten disparos		scatti clicks emboîtements Rasten disparos	
15		12	
scatti clicks emboîtements Rasten disparos		scatti clicks emboîtements Rasten disparos	
8		8	
scatti clicks emboîtements Rasten disparos		scatti clicks emboîtements Rasten disparos	
18		18	
scatti clicks emboîtements Rasten disparos		scatti clicks emboîtements Rasten disparos	
12		12	
scatti clicks emboîtements Rasten disparos		scatti clicks emboîtements Rasten disparos	

(*) : Per l'utilizzo del veicolo con passeggero si consiglia di aumentare il precarico molla dell'ammortizzatore posteriore di 2 giri. Questa operazione deve essere tassativamente eseguita da un concessionario MV Agusta. - *To use the vehicle with passenger, we suggest to increase the rear suspension spring preload of 2 turns. This operation must be performed only by a MV Agusta authorized dealer.* - Pour utiliser le véhicule avec le passager, nous suggérons d'augmenter la précharge de ressort de la suspension arrière de 2 tours. Cette intervention doit être impérativement effectuée par un concessionnaire officiel MV Agusta. - *Für das Verwenden des Trägers mit dem Beifahrer, schlaglen wir vor, um die hintere Federungsfedervorspannung von 2 Umdrehungen zu erhöhen. Änderungen an der Trimmlage dürfen ausschließlich von MV Agusta Vertragshändlern vorgenommen werden.* - Para usar el vehículo con el pasajero, sugerimos el aumento de la precarga del resorte de la suspensión posterior de 2 vueltas. Dicha intervención debe ser realizada por un concesionario oficial MV Agusta.

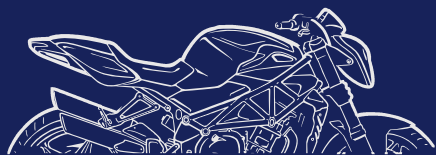

Motorcycle Art



MV AGUSTA S.p.A. - *Via Nino Bixio, 8*
21024 - Cassinetta di Biandronno (VA) - ITALY
www.mvagusta.it Part No. 8000A5272 Edition No. 1

