

## **MINICROSS R107 cc 10/12"**

BETAMOTOR S.p.A. congratulates you on choosing one of its products. This manual contains all the information, advice and remarks which our technicians considered useful to properly operate your motorcycle. It also contains directions about periodical maintenance operation, in order that your motorcycle may always be kept in perfect working order.



Every vehicle is supplied with a copy of the manual.

BETAMOTOR S.p.A. reserves the right to change the data and features described in this manual and to modify its products at any time.



**BETAMOTOR S.p.A.**  
Pian dell'isola, 72  
50067 Rignano Sull'Arno (Firenze) Italy  
Tel. +39-055-8348741 Fax +39-055-8348984  
[www.betamotor.com](http://www.betamotor.com) - [info@betamotor.com](mailto:info@betamotor.com)

## INFORMATIONS

### **ATTENTION**

After the first training hour, check all the tightenings and in particular manner:

- Footboard supports
- Shock absorber cover
- Wheel rims
- Shock absorber
- Engine bolts and nuts
- Crown

### REMEMBER THAT

The means you own is not a toy, you must use it with competence, attention and respect towards the others and towards yourself.

Please always wear the advised apparels, the helmet (well closed), the suitable glasses, gloves and shoes.

Do not try to show to yourself and to the others your driving capabilities.



### WARNING

The vehicle must be in the proportions of the driver's sizes, the person must be able to comfortably lay his feet on the round when he's sitting on the saddle.

The vehicle was designed for a driver with a weight not higher than 75 kg.

The vehicle, if used in a non correct

way without paying attention to the I manual's indication can cause you serious hurts, permanent and/or even mortal ones.

### THE MANUAL

First, this must be carefully read by an adult who afterwards must inform and train the minor to correctly use the Minicross. The minor, if he can, must anyway read the manual to feel responsible.

This manual contains useful information for the use and maintenance of the Minicross and the indications in order to keep it always at the top of its efficiency, so it is important to read this manual and learn the advise and suggestions that we feel are important for you to have.

## INFORMATIONS

BETAMOTOR S.p.A. reserves the right to change the data and features described in this manual and to modify its products at any time.

## INFORMATIONS

Symbols .....	6
Description .....	6
Safety, advice and recommendations .....	7
Ecologic drive.....	12

### SECTION 1: GENERAL INFORMATION

Main parts .....	14
Vehicle identification data .....	15
Plates on the vehicle .....	16
Hand drive controls.....	17
Technical data .....	18
Electrical diagram .....	19

### SECTION 2: OPERATION AND USE

Checks and maintenance before and after use .....	22
How to fuel up into the Minicross .....	23
How to stock and manage fuel .....	25
Recommended lubricants and liquids .....	26
Breaking in .....	27
Startup .....	28

### SECTION 3: MAINTENANCE AND CHECKS

Maintenance, description .....	30
Maintenance and checking to perform .....	31
Gearbox oil .....	32
Air filter .....	33
Spark plug .....	34
Brakes .....	35
Checks after cleaning .....	36
Maintenance and schedule .....	37
How to transport the vehicle .....	38
How to dispose the vehicle .....	38
Suitable apparels .....	38

### SECTION 4: ADJUSTMENTS

Adjustment of brakes.....	42
Adjustment of clutch .....	43
Adjustment of gas clearance.....	43
Adjustment of idling speed .....	44
Check and adjustment of steering gear .....	45
Tightening the chain .....	46
Adjustment of rear shock absorber .....	47

### SECTION 5: WHAT TO DO IN AN EMERGENCY

Troubleshooting .....	50
-----------------------	----

### ALPHABETICAL INDEX

Index .....	53
-------------	----



### WARNING

The guarantee is considered null and the manufacturer is released of all responsibility in the case of any intervention carried out by unauthorized personnel, technical modifications and/or tampering carried out on the Minicross during the guarantee period, or if non original spare parts are used.



**Always wear your crash helmet, the suitable suit, shoes and glasses for a motorbiker and don't go over your capabilities. Being careful means being intelligent.**

### SYMBOLS



#### SAFETY/WARNING

If the parts indicated with this symbol are not respected this could lead to danger for the driver.



#### VEHICLE INTEGRITY

If the parts indicated by this symbol are not respected, this can lead to serious damage to the vehicle and to the guarantee being null.



#### SAFEGUARDING THE ENVIRONMENT

Behaviour to be adopted in order not to damage nature.



#### PROTECTION DEVICES

Use the protection devices shown.



#### BE INFORMED

Important information for the safety of both owner and vehicle

### DESCRIPTION

- This manual is Your guide to the use and simple maintenance of the Minicross.
- We suggest that you follow very closely the advise herewith contained because the good working order and durability in time of the Minicross depend on its correct use and on the methodical application of the maintenance rules mentioned.
- We recommend that You read this "MANUAL" carefully in all its parts before carrying out any USE operation or small MAINTENANCE, **to be carried out always and in any case with the help of an adult and under adult supervision.**
- In case of loss or deterioration of this manual it is necessary to ask your dealer directly for a new copy.



### WARNING

Other operations that are not described in this manual require the use of special equipment and technical know-how. Therefore we recommend that you go to a specialized garage.

### SAFETY, ADVICE AND RECOMMANDATIONS

- Make an adult teach you how to correctly use your Minicross:
  - A. Progressive speeding up modalities.
  - B. Deceleration.
  - C. Braking.
  - D. How to behave correctly during the use of the means.
  - E. Read this manual along with an adult.
  - F. Proper use of gears.



Do not let aliens approach to the means driving when this is stopped on the stand. Danger of burning and falls of the means.

- Do not seat and make nobody seat on the cross-bike when this is stopped and is laid on the stand.

- If you wear sight glasses let an adult inspect they are clean and suitable to be used when driving the means.



**This Minicross has been designed to carry a maximum weight of 75 Kg. It is forbidden to carry passengers.**

- Always keep your motorcycle in perfect working order. This will help you to keep it for a longer time, at its top efficiency and ready to satisfy your desire for fun.



Please remember to always use the helmet, suitable gloves, sunglasses and garments to drive the means. The apparel must be in leather with support patches on knees and elbows.

**Never drive with naked feet.**

## INFORMATIONS



Always tell an adult if you notice anything strange while riding; for your safety, and to keep your Minicross in good condition, it is important to have even the smallest noise checked out.

The vehicle must always be used in the presence of a responsible adult.



Before starting up always check the brakes and the state and pressure of the tyres, the functioning of the gas throttle and of the fuel pipe integrity.



Any alteration or modification of the Minicross made to the original purchase makes the vehicle dangerous because it will no longer be in conformity.

- In case small part should detach from the saddle or metal parts or plastic ones do not swallow and do not bite and in any case call for an adult to repair it.
  - When you start, make sure that no people are nearby and that the children that are present, are kept at the right distance and under the control of an adult.
  - Always follow the indications by an adult that is super-visioning how you are using the means.
- Minicross is not equipped with a stationing stand so please make sure that you have stopped it in a suitable area (in flat and not in a slant).
  - To park the vehicle (when getting off) turn off the engine, pull out the kickstand, and make sure it is firmly resting on the ground. Before riding away, always make sure that the kickstand is all the way up (or down, depending on the model).
  - If the Minicross is stopped on the stand the motor must be switched off.

### WHERE TO USE THE MINICROSS

- Remember that the use of this motorcycle is allowed only in private areas. Where however the ordinary circulation is not allowed



## INFORMATIONS

This vehicle is not authorized for use on public roads.

### **Do not make races or competitions.**



Don't start the engine in closed places.

- Do not drive close to rivers and do not cross water even if not too deep.

### **HOW TO BEHAVE DURING THE DRIVING**

- Do not speak on the mobile phone when driving, even if you wear an earphone.

- Only drive with sufficient light for your safety and the other's one.

### **Do not drive at night.**



Always drive gripping tightly the handles at the side of the handlebars, and drive according to your capabilities and with care, to avoid danger both to yourself and to others.

- Do not wander: always look in front of you. During the driving, your feet must always be comfortably laid on the special pedal cranks.
- On dirt roads or on the wet don't brake completely and in any case use both brakes in order to spread the braking action on two wheels.

### **Never lock the front wheel.**

- Do not start driving if you do not feel in perfect health conditions, this might cause a reduction in the reflex promptness and/or a decrease in the physical capabilities this causing danger situations for yourself and for the others.
- Always proceed at speeds that are suitable for any kind of ground and for your capabilities.
- Always proceed at speeds that can permit to you to stop in safety conditions on every round and road conditions.
- Start braking with sufficient distance from obstacles so that you must not make any sudden operations that may prejudice the means control.
- Remember to release the gas before braking and if the vehicle stops, use the clutch first.

## INFORMATIONS

- Goslow before facing and closing the curves and variations of the kind of round.
- If you use the Minicross along with other friends that are also driving a Minicross please remember to:
  - ALL go in the same direction.
  - Do not make competitions
  - Never proceed side by side.
  - Never talk to other drivers during the driving.
  - Drive carefully.
  - Keep safety distance > 5 m from the Minicross you have in front of you and from the others that you have in front of you or that accidentally should find on your sides.

### **ON MINICROSS YOU CANNOT TAKE**

- **Do not wear flying garments, scarves, necklaces or other objects with chains and/long laces. Do not wear slippers or clogs.**
- Do not drive with objects in your pocket or hanged on your neck.
- Do not drive by holding in your hand or mouth any kind o object.
- Do not take the mobile phone or other electronic tools.
- Passengers or small things.

### **HOW TO PARK THE MINICROSS**

After having used the Minicross please remember:

- **To park it in a safe way, on a flat surface and with the stand well entered.**

- When you stop or you must park the Minicross, **before** getting off, turn the motor off.
- Park it in safe places with no high or dried grass, far from inflammable material that might touch the warm parts of the mufflers.
- Do not leave it unattended if nearby there may be some small children.
- When you move the Minicross by hand please remember to well catch the handlebar throttles; incline towards you the means and go on carefully. Remember to handle by hand the Minicross only when the motor is cold and off.
- Before putting it in the garage make all the warm parts get cold and make sure that the fuel cock and the tank plug are closed.

## INFORMATIONS

- Do not rest the vehicle on its side, and be sure to use the kickstand only on firm ground (not sand or mud).

### HOW TO CORRECTLY USE THE VEHICLE

#### During the driving it is absolutely forbidden to:

- Lay feet on the ground during the running, even at slow speeds.
- Get off from the vehicle when moving.
- Get off from the vehicle when moving.
- Consume foodstuff or drinks during the driving.
- Read or write.
- Use the mobile phone or earphones to listen to music.
- Drive on grounds or roads that are excessively loose or stony or with deep holes.
- Drive in the presence of dangerous differences in the ground height (gorges, slopes and descents with high slant).
- Enter grounds of which you do not know the features.
- Drive under drunk condition or however under the effect of drugs or medicines that may reduce the reaction speed, change the state of conscience, the capability of judging or reduce the physical force.
- Drive in non perfect physical and/or conditions.
- Say hallo to anyone or distract to look around so loosing of sight of your way.
- Drive if you feel asleep.

- Drive in a non neat way or in strange positions or laid on the motorbike during the driving.
- Use your feet to break.
- Use the vehicle to make jokes and do not make jokes during the driving.
- Do not make sudden steering.

#### Use the Minicross only:

- When a responsible adult has suitably informed you on the use of the means and on the norms of behavior and safety.
- When a responsible adult has checked and esteemed your capability at driving and managing the vehicle.

## INFORMATIONS

- If you have the full control of the means even when this is stopped and you can steadily put both feet on round while staying comfortably seated on the saddle.
- After having worn the suitable garments (motor-biker shoes and suit with leather reinforcement patches) and the protection devices (glasses, helmet, motor-biker leather gloves).
- If you can easily action the brake levers and the gas throttle and you have well understood which lever operates the front brake and which one the rear brake.
- If you can easily use the gas throttle and you have well understood its working. If you rotate the motor towards yourself it accelerates, if you release it, this decelerates.
- In absence of persons and animals, the position of which you cannot keep under control or that may suddenly come out from bushes and/or things hiding them.
- From a person at a time, **you cannot transport passengers, animals or things on board.**
- Carefully execute the checking operations before departure see "maintenance section".

## ECOLOGIC DRIVE



The noise and the pollution of every vehicle depends on how it is driven.

We strongly recommend you to drive steadily, without strong acceleration and deceleration.

During off road use do not damage the environment, avoid noise and everything that can disturb persons and animals.

Use a sport drive only on race circuits.

## **SECTION 1: GENERAL INFORMATION**

**INDEX**

**MAIN PARTS**

**VEHICLE IDENTIFICATION DATA**

**PLATES ON THE VEHICLE**

**HAND DRIVE CONTROLS**

**TECHNICAL SPECIFICATIONS**

**ELECTRICAL DIAGRAM**

## SECTION 1: GENERAL INFORMATION

### MAIN PARTS

- 1 Gasoline tank plug
- 2 Air filter
- 3 Stand
- 4 Fuel tap
- 5 Fuel tank
- 6 Kick-starter
- 7 Silencer
- 8 Rear brake pedal
- 9 Fork
- 10 Saddle
- 11 Rear mudguard
- 12 Front mudguard
- 13 Big fork
- 14 Muffler



## SECTION 1: GENERAL INFORMATION

### VEHICLE IDENTIFICATION DATA

#### Frame identification

The identification data **A** are stamped on the steering tube r.h. side.

#### Motor identification

Motor identification data **B** are stamped on the rear part of the engine assembly.



## SECTION 1: GENERAL INFORMATION

### PLATES ON THE VEHICLE

- 1 Danger of burning
- 2 Obligation to use gloves
- 3 Obligation to use the helmet
- 4 Obligation to use motor-biker shoes
- 5 Obligation to use motor-biker glasses
- 6 Obligation to use the motor-biker suit
- 7 Danger of organs in movement
- 8 Danger of fuel tanking with warm motor or motor on.
- 9 Max admissible load
- 10 CE Plate

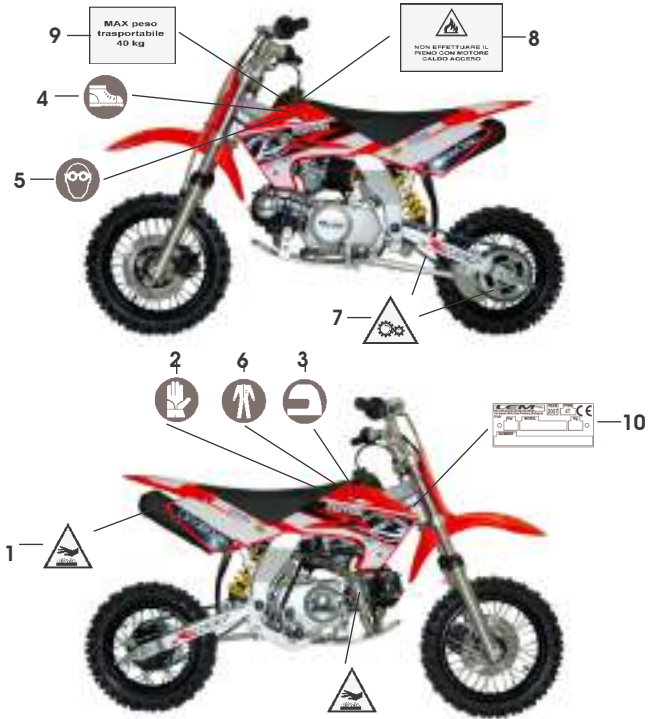



## SECTION 1: GENERAL INFORMATION

### HAND DRIVE CONTROLS

- 1 Front brake lever
- 2 Gas throttle
- 3 Clutch lever
- 4 Engine stop push button
- 5 Rear brake pedal



## SECTION 1: GENERAL INFORMATION

### TECHNICAL DATA

#### Vehicle weight

- ready to operate (unfueled) ..... 61 (kg)
- allowed load ..... 75 (kg)

#### Dimensions

- total length ..... 1425 mm
- total width ..... 740 mm
- total height ..... 980 mm
- pitch ..... 1030 mm
- saddle height ..... 680 mm
- clearance from ground ..... 220 mm

#### Filling capacity

- fuel tank ..... 2 lt
- including reserve of ..... 0,300 lt
- crank case transmission oil ..... 900 gr

#### Front Suspension

- hydraulic fork with 33 mm  $\varnothing$  rods run 100 mm

#### Rear Suspension

- hydraulic mono shock absorber  
- spring fixed length ..... 185 mm

#### Rims

- front ..... 12" x 2.50
- rear ..... 10" x 2.75

#### Brake

- front ..... disk-type with hydraulic control  $\varnothing$  200 mm
- rear ..... mechanically operated drum

#### Engine

- type mono cylinder 4 stroke
- number of cylinders ..... 1
- bore x stroke .....  $\varnothing$  52,4 x 49,5 mm
- displacement ..... 107cc
- cooling ..... air
- transmission ..... 4 speed
- ignition ..... electronic
- kick-starter
- spark plug ..... NGK C7HSA

#### Noise dB

- Vibrations on the arms .....  $\leq 2,04$  m/s<sup>2</sup>
- Vibrations on the seated part .....  $\leq 2,04$  m/s<sup>2</sup>

#### Fuel system

- carburetor ..... Mikuni  $\varnothing$  19
- jet ..... 98 max
- fuel ..... running of unleaded petrol

## SECTION 1: GENERAL INFORMATION

### ELECTRICAL DIAGRAM

#### Legend

- 1 Generator
- 2 High Voltage coil
- 3 Spark plug
- 4 Engine stop push button

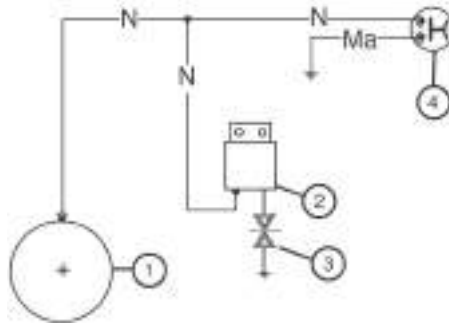

**Ma** Brown  
**N** Black

## **SECTION 2: OPERATION AND USE**

### **INDEX**

#### **CHECKS AND MAINTENANCE BEFORE AND AFTER USE**

#### **REFUELING AND MANAGEMENT OF THE FUEL**

#### **HOW TO STOCK AND MANAGE FUEL**

#### **RECOMMENDED LUBRICANTS AND LIQUIDS**

#### **BREAKING IN**

#### **STARTUP**

### CHECKS AND MAINTENANCE BEFORE AND AFTER USE

In order to avoid problems connected to the operation of the vehicle, it is advisable to perform a number of checks and maintenance operations before and after use. Just a few minutes given to these procedures will save you time and money, and will make riding much safer.

Proceed as follows:

- Check pressure, general condition and thickness of tread.
- On cold days, warm up the engine by running it at minimum for a few minutes before starting off.
- Wash the vehicle carefully after every off-road use.
- Before cleaning wait until the Minicross has cooled down.
- Do not spray water into the exhaust pipe.

## SECTION 2: OPERATION AND USE

### HOW TO FUEL UP INTO THE MINICROSS

Remove cap **A**.

The fuel tank will hold approximately 2 liters, 0.300 liters of which is reserve.

Only refuel with fuel unleaded petrol.

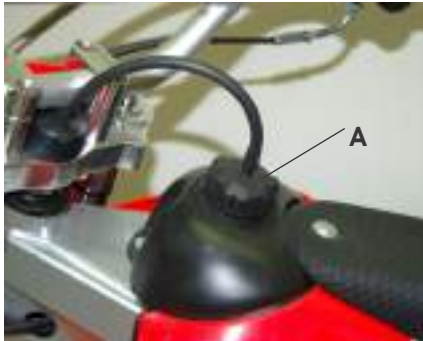

## SECTION 2: OPERATION AND USE

Take all the precautions to avoid dispersions of fuel in the environment.

Always have handy a dust extinguisher or a CO<sub>2</sub> one.

During the preparation/fueling up operations it is forbidden to smoke or use free flames.

To empty the tank it is advised to address to a skilled workshop or to execute the following operations (only if sufficiently expert or in the presence of an expert's supervision; anyway these operations must never be performed by a minor, neither under the supervision of an adult):

- See to a sufficiently long gasoline pipe, and an empty can suitable to contain fuel for more than 5 liters.
- Place in an open and well-aired place, far from free flames and equipped with tested extinguishers or with suitable devices against fire.
- Do not smoke or light free flames during the emptying operation.
- Make children go far away: gasoline and its vapors contain aromatic hydrocarbons that may cause serious illnesses.
- The vehicle must be stopped and cold in all its parts.
- Place the vehicle in a raised and vertical and stable position.
- Put the can in a position lower than the vehicle, in a steady way and so to prevent accidental falls.
- Put one end of the gasoline pipe in the can in a quantity so to avoid exits in quantities that might accidentally cause the same to go out.
- Close the gasoline cock, detach the pipe leading to the carburetor and enter the pipe leading to the tank.
- Open the cock in the position emergency fuel and wait until the tank is empty.
- When the tank is completely empty, detach the pipe leading to the tank, connect again the pipe leading to the carburetor.
- Remove the pipe in the tank by letting it drop inside the tank and dry it with the social absorbing supports.

## SECTION 2: OPERATION AND USE

- Close the tank and put it in a suitable environment.
- Open the gasoline cock in the emergency fuel position and use the vehicle by following the indications contained in this manual until the fuel container in the carburetor has run out.
- Make the vehicle become cold before stowing or transport it
- Keep the containers far from the sunshine
- Keep the containers in places closed and aired and equipped with tested extinguishers or with suitable devices against fire.
- Keep the containers far from the children's reach
- Place under the containers systems to collect some liquid in case of breaking of the carburetor container.

### HOW TO STOCK AND MANAGE FUEL

- Do not keep more than 25 liter gasoline or mixture.
- Only use containers that are suitable to that aim.
- DO NOT use glass containers
- Keep the fuel far from any heat source.
- Execute the fuel pouring off operation possibly in an open place, well-aired one and equipped with tested extinguishers or with suitable devices against-fire.
- Make children go far away: gasoline and its vapors contain aromatic hydrocarbons that may cause serious illnesses.



## SECTION 2: OPERATION AND USE

### RECOMMENDED LUBRICANTS AND LIQUIDS

For better operation and longer vehicle life, we advise you to use the products listed in the following chart:

<b>TYPE OF PRODUCT</b>	<b>TECHNICAL SPECIFICATION</b>
TRANSMISSION OIL	SAE 10W/50
GREASE FOR JOINTS AND RODS	BARDAHL MPG2

### **BREAKING IN**

Run in the vehicle over about 500 km or No. 10 refuelings;

During this time:

- Avoid travel at high speeds
- Change speed often so that the parts will break in uniformly and in a shorter time
- Avoid turning the throttle more than 3/4 of the way.

#### **Warning:**

- Change the gearbox oil after 500 km
- After the first off-road use, check all of the nuts and bolts.

### STARTUP

#### Kick-starter

- Open fuel tank valve **A**

OFF = closed

ON = open

RES = reserve

- Check that the gears are in neutral.
- Depress the kick-starter with a sharp movement of the foot and slightly turn the gas control.
- Always close the fuel tank valve when the engine is off.

#### Note:

When the engine is cold, use choke **B**. Pull and turn the lever wait a few second, and then return the lever to its starting position.

**A**



**B**



## **SECTION 3: MAINTENANCE AND CHECKS**

**INDEX**

**MAINTENANCE, DESCRIPTION**

**MAINTENANCE AND CHECKING TO  
PERFORM**

**GEARBOX OIL**

**AIR FILTER**

**SPARK PLUG**

**BRAKES**

**CHECKS AFTER CLEANING**

**MAINTENANCE SCHEDULE**

**HOW TO TRANSPORT THE VEHICLE**

**HOW TO DISPOSE THE VEHICLE**

**SUITABLE APPARELS**

## SECTION 3: MAINTENANCE AND CHECKS

### MAINTENANCE, DESCRIPTION



In order to have an efficient minicross we advise you to carry out some ordinary maintenance operations before and after use.

It is important to remember some warnings:

- **Maintenance must be always carried out by authorized personnel**
- **Always use original spare parts**
- **Maintenance must be carried out with the Minicross on its service stand and WITH THE ENGINE SWITCHED OFF.**

- In case of breakage and/or lost of the stand do not replace it with means of fortune, ask for the original part from the dealer's.
- Warning, on the Minicross there are some parts that when the motor is switched off may reach high temperature.



**Keep children at a safe distance.**

- **Do not get on the Minicross when it is on its stand.**
- After repairs or maintenance, wash your hands and any parts of your body which have been soiled with oil, grease, etc.

## SECTION 3: MAINTENANCE AND CHECKS

### MAINTENANCE AND CHECKING TO PERFORM

Before using the Minicross and after a fall, with motor off and sufficiently cold you must:

- Verify the correct functioning of the gas throttle when the motor is off: accelerates and decelerates twice and check that the system replies with no jams.
- Verify the correct working of the brakes: handle the Minicross by hand with the motor off and execute sudden braking, check that the two brakes reply.
- Check if there are oil or fuel leaking.

- Check that all the parts of the mini-cross are at their seat and well fixed.

Warning, if you have fallen, first of all check if **YOUR HEALTH** and afterwards the Minicross. In case of fall always tell an adult what has happened. Remember that also a small pain or a small injury must be checked and disinfected.

In case of malfunctioning and/or breakages on the Minicross **IMMEDIATELY ADVISE** a skilled person.

- Check the correct tightening of the screws and the chain tension

- Check the tires wear and tear condition and their pressure.
- Check the wear and tear condition of the brake cables and of gas.
- Check the clearance on the brake cables and of the gas, and if necessary carry out the required adjustments.
- Check the presence of some fuel in the tank.
- Check the oil level when the motor is off.

## SECTION 3: MAINTENANCE AND CHECKS

### GEARBOX OIL

#### Check

- Start the engine and run it for about three minutes.
- Turn off the engine and wait for about a minute.
- Remove inspection cap A from the oil filter.
- Using a clean rag, remove all traces of oil from the dipstick.
- While keeping the vehicle in on upright position, reinsert the dipstick and push it down to the filler thread without screwing the cap on.
- Pull out the dipstick again and check that the oil level is between the **MAX** and **MIN** mark. If the oil level is below the **MIN** mark, pour in fresh oil through the filter hole until the lever reaches the **MAX** mark.

#### Note:

Change the gear box oil after the first 500 km or after No. 10 refuelings. For subsequent oil changes, follow the instructions given on the chart on page 37, using the lubricants recommended on page 26.

#### Warning:



The used oil must be taken to authorized collection centres.

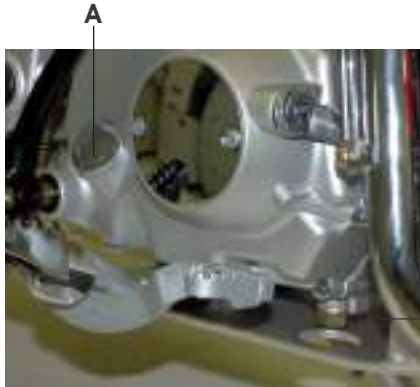

#### Oil change

- Always renew the oil while the engine is hot, taking care not to touch the engine and the oil
- Place a container under the engine
- Unscrew the filler cap **A** and oil drain plug **B**
- Empty the crank case completely
- Refit drain plug **B**
- Put in 900 gr. of oil
- Close the filler cap **A**.
- Arrange all the containment systems and/or oil collection that might go out during the filling up (rags, sawdust, etc.).

### AIR FILTER

Clean the filter every time the vehicle is used cross-country.

To remove the filter, is necessary unscrewing screws **C** and then proceed as follow:

- Remove filter
- Wash the filter with petrol
- Dry the filter
- Wet the filter with filter oil, removing any excess oil so that there is no dripping
- Reassemble the saddle following the disassembly procedure in the reverse order.

**Note:**

- If the filter is very dirty, wash it first with gasoline and then with water and shampoo.
- If the filter is damaged, replace it immediately.



**C**



## SECTION 3: MAINTENANCE AND CHECKS

### SPARK PLUG

Keeping the spark plug in good condition will reduce fuel consumption and increase engine performance.

To perform the check, simply slide off the electrical connection tube and unscrew the spark plug. Examine the distance between the electrodes with a feeler. This distance should be from 0.5 to 0.6 mm. If it is not, it may be corrected by bending the earth electrode.

Check as well that there are no cracks in the insulation or corroded electrodes. If so, replace immediately.

**Observe the chart on page 37 when performing the check.**

When replacing the spark plug, screw it in by hand until it stops, then tighten with a wrench.



Do not start the motor if the spark plug or the pipes are out of their relevant housings. Danger of electrical shock.

#### **Note:.**

- Always use NGK C7HSA spark plugs.



## SECTION 3: MAINTENANCE AND CHECKS



### BRAKES

#### Check Front Brake

To check the front brake for wear, simply observe the caliper from the front, where it is possible to see the ends of the two pads.

These pads should have at least a 2 mm. layer of lining.

If this layer is thinner than 2 mm. replace the pads immediately.

#### Check Rear Brake

The shoes wear can be verified after having checked the brake adjustment, page 42.

When the brake register **A** reach the stop, replace the shoes immediately.

**We suggest to contact your dealer to replace the pads (Front brake), the shoes (Rear brake).**

### CHECKS AFTER CLEANING

After cleaning the motorcycle, it is good practice to:

- Disassemble the flywheel cover and dry the water if necessary
- In case of disassembly/assembly of the ignition system, check the tightening torque of the fixing screws.
- Lubricate the articulated joints **A** on the rear suspension.
- Carefully clean and dry the chain-gear-pinion assembly and then apply grease thoroughly in order to keep these parts in good condition as long as possible.
- Dry well any metal parts subject to corrosion, oxidation, etc.

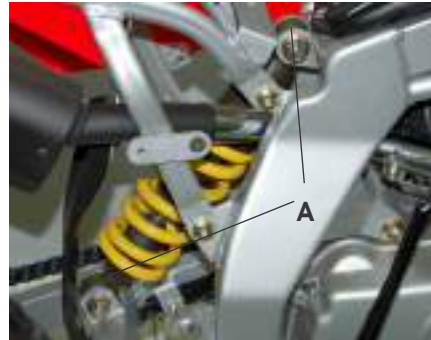

## SECTION 3: MAINTENANCE AND CHECKS

### MAINTENANCE SCHEDULE

MINICROSS 107		100 hours (1 year)	200 hours (2 years)	300 hours (3 years)	400 hours (4 years)	500 hours (5 years)	600 hours (6 years)	700 hours (7 years)	800 hours (8 years)	900 hours (9 years)	1000 hours (10 years)	
<b>Engine</b>	Ignition	C	P	C	S	C	S	C	S	C	S	
	Compression	C	C									
	Fluctuation	C		C		C		C		C		
	Exhaust air	C		S		S		S		S		
	Carburettor			P		P		P		P		
<b>Cycle parts</b>	Clutch	C	C	C	C	C	C	C	C	C	C	
	Transmission, saddle and counter	C		C		C						
	Final drive	C	C									
	Mounting of driving / driving pin	C		C		C		C		C		
	Chain and sprocket	C		C		C		C		C		
	Air filter	C	P	P	S	P	S	P	S	P	S	
	Fuel	C		C		C		C		C		
	Air filter element	C		C		C		C		C		
	Valve gear	Check valve gear every year										
	Clutch fork and pin	C	C	C	C	C	C	C	C	C	C	
	Clutch release	C		C		C		C		C		
	Intermediate shaft	C	C	C		C		C		C		
	Shaft and pinion	C		C		C		C		C		
	Secondary shaft	C		C		C		C		C		
	Secondary sprocket	C		C		C		C		C		
	Secondary sprocket for 1st drive	C	C			C		C		C		
	Secondary sprocket for 2nd drive	C		C		C		C		C		

**Key**

- C - Check (clean, adjust, lubricate or replace/renew as necessary)
- S - Replace/renew
- P - Adjust
- W - Clean
- T - Tighten

## SECTION 3: MAINTENANCE AND CHECKS

### HOW TO TRANSPORT THE VEHICLE

To transport the Minicross you must:

- Empty the mixture tank.
- Put the Minicross in the vertical position and tight it well through some slings and/or ropes to the vehicle platform.
- The Minicross frame shows some natural hooking points, handlebar, saddle and motor.
- When lifting up the Minicross, be careful not to bend your back: keep your back straight and lift with your legs. The vehicle must be lifted by two people.

### HOW TO DISPOSE THE VEHICLE



Remember that the mini-cross is made with material that can be partially recycled and uses some liquids that, if dispersed in the environment, may pollute the ground.

When you have to get rid of some parts of the Minicross, in case this cannot be repaired you must take it to the special waste disposal centers.

For the means disposal or some of its parts you must:

- Empty the tank of the mixture.
- Take it to a disposal or recycling center.

### SUITABLE APPARELS

- Only after having worn long sleeve apparels and with a certain thickness (better if in leather and with knee and elbow padding) that offer a suitable protection to the body.
- Only after a responsible adult has checked that an helmet is worn (possibly entire, or with face protection, but certainly homologated DOT, ANSI z90.1. Snell), well tightened.
- Only after having worn a pair of homologated glasses (VEESC8) with unbreakable lenses and aired ones so to protect the eyes from any eventual stones coming from the vehicles going before or from insects.

## SECTION 3: MAINTENANCE AND CHECKS

- Only after having worn a pair of good gloves that may avoid scratches on the hands, stiffening, tiredness, and that protect them in case of fall or of means upsetting.
- Only after having worn suitable footwear, better if boots over the ankle or special off-road boots , (they offer better protection to the foot and leg).

## **SECTION 4: ADJUSTMENTS**

### **INDEX**

**ADJUSTMENT OF BRAKES**

**ADJUSTMENT OF CLUTCH**

**ADJUSTMENT OF IDLING SPEED**

**ADJUSTMENT OF GAS CLEARANCE**

**CHECK AND ADJUSTMENT OF  
STEERING GEAR**

**TIGHTENING THE CHAIN**

**ADJUSTMENT OF REAR SHOCK  
ABSORBER**

### ADJUSTMENT OF BRAKES

#### Front brake

The front brake is disk type with hydraulic control, and therefore requires no adjustment.



#### Rear brake

The rear brake is provided with mechanically operated shoes. Adjust the brake levers **A** play must be 10-12 mm. as shown in the figure





## SECTION 4: ADJUSTMENTS

### ADJUSTMENT OF CLUTCH

Generally, the only operation that is performed on the clutch is adjustment of the position of lever **A**.

To perform the adjustment, lift rubber dust cover **C** and turn adjuster **B**.

The lever must have 5 mm. of idle stroke.

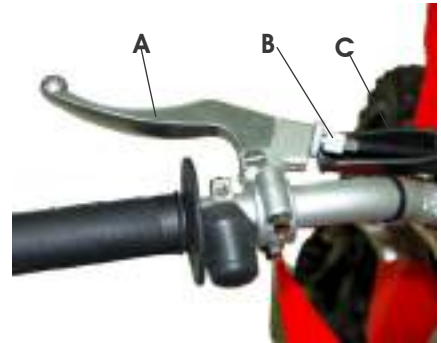

### ADJUSTMENT OF GAS CLEARANCE

Whenever the accelerator shows unloaded travel exceeding 3 mm, measured from the edge of the handle, you should adjust it by means of carburetor register, or throttle control register **D**, after having removed the rubber protection **E**.

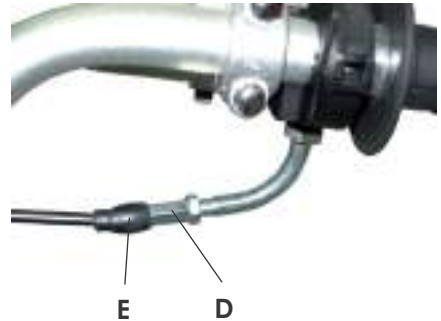

### ADJUSTMENT OF IDLING SPEED

In order to perform this operation correctly, we advise you to do it when the engine is hot, connecting an electric revolution counter to the spark plug wire. Then use a screwdriver on register screw **A** to calibrate the minimum.

Given the condition of motor on, the Minicross must however be laid on the stand (in this case only), and all the persons that are not to make the adjustment are to be kept at distance.

#### WARNING



When the engine is hot there is danger of burns

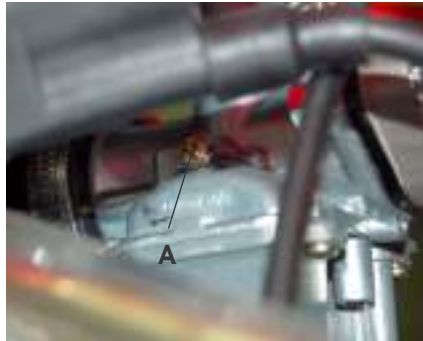



## CHECK AND ADJUSTMENT OF STEERING GEAR

Periodically check the play in the steering sleeve by moving the fork back and forth as shown in the figure. Whenever you feel play, adjust as described below:

- unscrew the 4 screw **A**
- remove handlebar paying particular attention to supports **B**.
- unscrew the screw **C**.
- remove the rubber protection **D** and loosen the nut.
- take up the play by means of ring nut **E**.

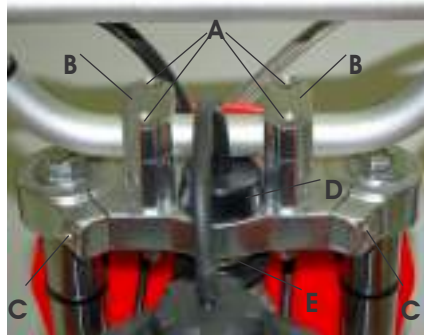
For reassembly, proceed in the reverse order.



 **Note:** Correct adjustment, in addition to not leaving any play, should not cause difficulty or irregularity in turning the handlebar.

**For this operation consult one of our authorized dealers.**

## TIGHTENING THE CHAIN

Checking the drive chain periodically to ensure longer chain life.

Always keep it lubricated and clean of deposited dirt.

Check the chain tightener roller position as shown in the figure.

If the roller position is not correct, tighten the chain as follows:

- Loosen nut **A**
- Loosen nut **B**
- Act on the screw **C** to tighten the chain.
- Act on the same screw on the opposite side by moving it to the same position.
- Check the wheel alignment.
- Block nut **B** and nut **A**.

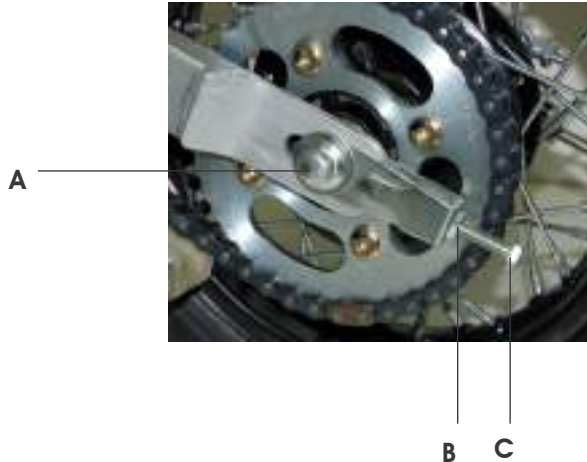

## SECTION 4: ADJUSTMENTS

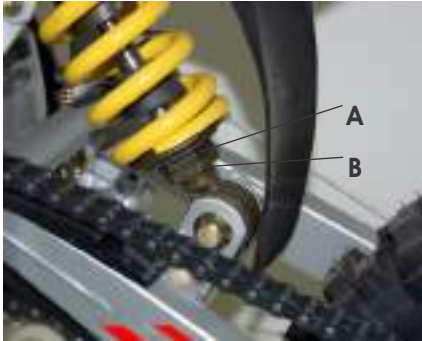

### ADJUSTMENT OF REAR SHOCK ABSORBER

#### Adjustment of spring load

For increase the spring resistance loosen the nut **B** and turning nut **A** clockwise.

Block the nut **B**.

For decreases the spring resistance loosen the nut **B** and turning nut **A** anticlockwise.

Block the nut **B**.

In the event of any malfunction, contact our authorized customer service network.

## **SECTION 5: WHAT TO DO IN AN EMERGENCY**

**INDEX**

**TROUBLESHOOTING**

## SECTION 5: WHAT TO DO IN AN EMERGENCY

### TROUBLESHOOTING

PROBLEM	CAUSE	REMEDY
<b>The engine doesn't start</b>	Fuel system (tubes, fuel tank, valve) is blocked	Clean the system
	Air filter is very dirty	Proceed as indicated on pages 33
	No current arriving at spark plug	Clean or replace spark plug. If the problem persists, consult one of our Authorized Dealers
	Engine is flooded	With gas completely open, continue trying to start engine for a few moments. If engine still doesn't start, remove the spark plug and dry it off
<b>Engine misfires</b>	Spark plug has irregular electrode distance	Restore correct distance
	Spark plug is dirty	Clean or replace

## SECTION 5: WHAT TO DO IN AN EMERGENCY

<b>PROBLEM</b>	<b>CAUSE</b>	<b>REMEDY</b>
<i>Piston knocks</i>	Ignition too early	Check phases
	Carbon deposits inside cylinder or on spark plug	Consult one of our Authorized Dealers
<b>Engine overheats and loses power</b>	Silencer partially obstructed	Consult one of our Authorized Dealers
	Exhaust clearance partially obstructed	Consult one of our Authorized Dealers
	Gasoline too lean	Jet may be partially obstructed
	Delayed ignition	Consult one of our Authorized Dealers
<i>Weak brake</i>	Worn shoes/ Worn pads	Consult one of our Authorized Dealers
	Excessive play on brakes transmission	Consult one of our Authorized Dealers



## SECTION 5: WHAT TO DO IN AN EMERGENCY

<b>PROBLEM</b>	<b>CAUSE</b>	<b>REMEDY</b>
<b>Brakes or throttle are jammed, or do not go back into place after being used and released</b>	Steel cables are blocked.  Rotation points of levers or throttle are dirty or damaged.	Clean or replace the cables.  Clean the rotation points or replace the damaged parts.

## ALPHABETICAL INDEX

- A** Adjustment of brakes.....42  
Adjustment of clutch .....43  
Adjustment of gas clearance ... 43  
Adjustment of idling speed ..... 44  
Adjustment of rear  
    shock absorber.....47  
Air filter.....33
- B** Brakes .....35  
Breaking in .....27
- C** Checks after cleaning .....36  
Check and adjustment  
    of steering gear .....45  
Checks and maintenance  
    before and after use .....22  
Description .....6
- E** cologic drive.....12  
Electrical diagram.....19
- G**earbox oil .....32
- H**and drive controls.....17  
How to dispose the vehicle ....38  
How to fuel up into  
    the Minicross .....23  
How to stock  
    and manage fuel.....25  
How to transport the vehicle ..38
- M**ain parts .....14  
Maintenance schedule.....37  
Maintenance, description .....30  
Maintenance and  
    checking to perform.....31
- P**lates on the vehicle .....16
- R**ecommended lubricants  
    and liquids.....26
- S**afety, advice and  
    recommandations .....7  
Symbols .....6  
**S**park plug .....34  
Startup .....28  
Suitable apparels .....38
- T**echnical data .....18  
Tightening the chain.....46  
Troubleshooting .....50
- V**ehicle identification data.....15

Edition March 2007

LEM MOTOR s.r.l.