

**can-am**™



**2010**

Roadster  
**Operator's  
Guide**

Includes  
**Safety, Vehicle  
and Maintenance Information**

**SPYDER™ RS**

**⚠ WARNING**

**Learn how the Spyder roadster is different.**

**Read** this operator's guide and watch the safety DVD.

**Complete** a training course (if available), practice and become proficient with the controls.

**Consult** local laws - license requirements vary by location.

**Keep** this guide in the front storage compartment.

2 1 9 0 0 0 6 1 9

CALIFORNIA PROPOSITION 65 WARNING

 **WARNING**

This product contains or emits chemicals known to the state of California to cause cancer and birth defects or other reproductive harm.

---

# HOW TO USE THIS OPERATOR'S GUIDE

Congratulations on your purchase of a new CAN-AM™ Roadster. It is backed by the Bombardier Recreational Products Inc. (BRP) warranty and a network of authorized dealers ready to provide the parts, service or accessories you may require.

Your dealer is committed to your satisfaction. He has taken training to perform the initial set-up and inspection of your roadster before you took possession.

At delivery, you were informed of the warranty coverage and signed the *PREDELIVERY CHECK LIST* to ensure your new vehicle was prepared to your entire satisfaction.

## Know Before you Go

For your safety and the safety of passengers and bystanders, read the following sections before you operate the Spyder roadster:

- *GENERAL PRECAUTIONS* (p. 7)
- *VEHICLE INFORMATION* (p. 9)
- *SAFE OPERATING INSTRUCTIONS* (p. 31)
- *PRE-RIDE INSPECTION* (p. 77).

Experienced motorcyclists should pay special attention to *WHAT'S DIFFERENT ABOUT THE SPYDER ROADSTER* (p. 32).

## Safety Messages

The types of safety messages, what they look like and how they are used in this guide are explained as follows:

### **WARNING**

Indicates a potential hazard, if not avoided, could result in serious injury or death.

 **CAUTION** Indicates a hazard situation which, if not avoided, could result in minor or moderate injury.

**NOTICE** Indicates an instruction which, if not followed, could severely damage vehicle components or other property.

## About this Operator's Guide

This Operator's Guide was written in North America in a right-lane driving environment. Please adapt your application of these maneuvers to your jurisdiction and rules of the road.

In this Operator's Guide, the word motorcycle typically refers to a two-wheeled motorcycle.

This Operator's Guide is for both the SM5 (manual transmission) and the SE5 (semi-automatic transmission) Spyder roadster models. All text applies to both except for those items specified as "SM5 Model" or "SE5 Model".

Keep this Operator's Guide in the front storage compartment so that you can refer to it for things such as maintenance, troubleshooting and instructing others.

If you want to view and/or print an extra copy of your Operator's Guide, simply visit the following website [www.operatorsguide.brp.com](http://www.operatorsguide.brp.com).

The informations contained in this document are correct at the time of publication. BRP, however, maintains a policy of continuous improvement of its products without imposing upon itself any obligation to install them on products previously manufactured. Due to late changes, some differences between the manufactured product and the descriptions and/or specifications in this guide may occur. BRP reserves the right at any time to discontinue or change specifications, designs, features, models or equipment without incurring any obligation upon itself.

This Operator's Guide and the *SAFETY DVD* should remain with the vehicle when it's sold.

## **Refer to Other Sources of Information**

In addition to reading this Operator's Guide, you should read the Safety Card on the vehicle; see also and watch the *SAFETY DVD*.

If possible, take a training course that is specifically designed for the Spyder roadster. Check our website at [www.can-am.brp.com](http://www.can-am.brp.com) for more information about upcoming training course availability. If you cannot take a training course specifically designed for the Spyder roadster, it is a good idea to take a motorcycle training course, since some of the skills required are similar and information about managing risk on the road is taught and similarly applies to riding your Spyder roadster.

## **Acknowledgment**

BRP wishes to thank the Motorcycle Safety Foundation (MSF) for giving permission to BRP to use some of MSF's material related to street motorcycle safety found in this Operator's Guide.

The MSF is an internationally recognized not for profit foundation and is supported by motorcycle manufacturers. It provides training, tools and partnerships to the motorcycle safety community. Visit its website at [www.msf-usa.org](http://www.msf-usa.org).

---

# TABLE OF CONTENTS

<b>HOW TO USE THIS OPERATOR'S GUIDE</b> .....	<b>1</b>
Know Before you Go .....	1
Safety Messages.....	1
About this Operator's Guide .....	1
Refer to Other Sources of Information .....	2
Acknowledgment .....	2
<b>GENERAL PRECAUTIONS</b> .....	<b>7</b>
Avoid Carbon Monoxide Poisoning .....	7
Avoid Gasoline Fires and Other Hazards .....	7
Avoid Burns from Hot Parts .....	7
Accessories and Modifications .....	7

## ***VEHICLE INFORMATION***

<b>CONTROLS/INSTRUMENTS</b> .....	<b>10</b>
Primary Controls .....	10
Secondary Controls .....	15
Multifunction Gauge Cluster .....	18
<b>BASIC PROCEDURES</b> .....	<b>22</b>
License Plate Installation .....	22
Adjusting Mirrors.....	22
Locking the Handlebar .....	22
Opening the Front Storage Compartment .....	23
Opening the Seat.....	23
Starting and Stopping the Engine .....	24
Operating in Reverse .....	26
Operating During Break-In.....	26
Fueling .....	27
Adjusting Suspension.....	27

## ***SAFE OPERATING INSTRUCTIONS***

<b>WHAT'S DIFFERENT ABOUT THE SPYDER ROADSTER</b> .....	<b>32</b>
Stability .....	32
Response to Road Conditions.....	32
Brake Pedal .....	32
Parking Brake.....	32
Steering .....	32
Width.....	33
Reverse .....	33
Driver's License and Local Laws.....	33
<b>DRIVING AID TECHNOLOGIES</b> .....	<b>34</b>
Vehicle Stability System (VSS) .....	34
Dynamic Power Steering (DPS).....	35

<b>UNDERSTANDING RISK ON THE ROAD .....</b>	<b>36</b>
Type of Vehicle .....	36
Operator Skills and Judgment.....	36
Rider Condition .....	36
Vehicle Condition.....	37
Road and Weather Conditions .....	37
<b>RIDING GEAR .....</b>	<b>38</b>
Helmets.....	38
Other Riding Gear .....	38
<b>REQUIRED RIDING SKILLS AND PRACTICE EXERCISES .....</b>	<b>41</b>
Choosing a Practice Area .....	41
Preparing to Ride .....	42
Riding Posture .....	42
Practice Exercises (SM5 Model) .....	42
Practice Exercises (SE5 Model) .....	51
Developing Advanced Riding Skills .....	58
<b>STREET STRATEGIES .....</b>	<b>59</b>
Plan your Trip .....	59
Defensive Riding .....	59
Being Visible .....	60
Lane Position .....	61
Common Riding Situations .....	61
Road Conditions and Hazards .....	64
On-Road Emergencies .....	65
Tire Failure .....	65
<b>CARRYING A PASSENGER OR CARGO .....</b>	<b>67</b>
Weight Limits.....	67
Operating with Extra Weight .....	67
Carrying a Passenger .....	67
Where to Store Cargo.....	68
No Towing .....	68
<b>KNOWLEDGE SELF-TEST .....</b>	<b>69</b>
Questionnaire .....	69
Answers .....	71
<b>SAFETY INFORMATION ON THE VEHICLE .....</b>	<b>72</b>
Hang Tag .....	72
Safety Card .....	72
Safety Labels.....	74
<b>REPORTING SAFETY DEFECTS .....</b>	<b>76</b>

***PRE-RIDE INSPECTION***

<b>PRE-RIDE CHECKLIST.....</b>	<b>78</b>
--------------------------------	-----------

**TRANSPORTING AND STORING**

<b>TRANSPORTING THE SPYDER ROADSTER .....</b>	<b>80</b>
<b>STORING THE SPYDER ROADSTER .....</b>	<b>82</b>

**MAINTENANCE**

<b>MAINTENANCE SCHEDULE .....</b>	<b>84</b>
<b>INITIAL INSPECTION .....</b>	<b>87</b>
<b>MAINTENANCE PROCEDURES .....</b>	<b>88</b>
Tool Kit .....	88
Body Panels .....	88
Tires .....	91
Drive Belt .....	92
Engine Oil .....	94
Engine Oil Filter .....	96
HCM Oil Filter (SE5 Model) .....	97
Engine Coolant .....	98
Brakes .....	99
Battery .....	100
Clutch Fluid (SM5 Model) .....	101
Headlights Aiming .....	102
Vehicle Care .....	102

**ROAD SIDE REPAIRS**

<b>PROBLEMS .....</b>	<b>106</b>
Will not Shift into First Gear (SM5 Model) .....	106
Will not Shift into Neutral (SE5 Model) .....	106
Will not Shift (SE5 Model) .....	106
Lost Keys .....	107
Flat Tire .....	107
Dead Battery .....	107
Electrical Accessories Failure .....	108
Light Failure .....	110
Engine will not Start .....	116
<b>MESSAGES IN MULTIFUNCTION GAUGE CLUSTER .....</b>	<b>117</b>

**TECHNICAL INFORMATION**

<b>VEHICLE IDENTIFICATION .....</b>	<b>120</b>
Vehicle Identification Number .....	120
Engine Identification Number .....	120
EPA Compliance Label (USA) .....	120

**SPECIFICATIONS ..... 121**

***WARRANTY***

**BRP LIMITED WARRANTY — USA AND CANADA: 2010 CAN-AM™  
SPYDER™ ROADSTER ..... 128**

**BRP LIMITED WARRANTY OUTSIDE USA AND CANADA: 2010 CAN-AM™  
SPYDER™ ROADSTER ..... 133**

***CUSTOMER INFORMATION***

**PRIVACY INFORMATION ..... 140**

**CHANGE OF ADDRESS/OWNERSHIP ..... 141**



---

# GENERAL PRECAUTIONS

## Avoid Carbon Monoxide Poisoning

All engine exhaust contains carbon monoxide, a deadly gas. Breathing carbon monoxide can cause headaches, dizziness, drowsiness, nausea, confusion and eventually death.

Carbon monoxide is a colorless, odorless, tasteless gas that may be present even if you do not see or smell any engine exhaust. Deadly levels of carbon monoxide can collect rapidly, and you can quickly be overcome and unable to save yourself. Also, deadly levels of carbon monoxide can linger for hours or days in enclosed or poorly ventilated areas. If you experience any symptoms of carbon monoxide poisoning, leave the area immediately, get fresh air and seek medical treatment.

To prevent serious injury or death from carbon monoxide:

- Never run the vehicle in poorly ventilated or partially enclosed areas such as garages, carports or barns. Even if you try to ventilate engine exhaust with fans or open windows and doors, carbon monoxide can rapidly reach dangerous levels.
- Never run the vehicle outdoors where engine exhaust can be drawn into a building through openings such as windows and doors.

## Avoid Gasoline Fires and Other Hazards

Gasoline is extremely flammable and highly explosive. Fuel vapors can spread and be ignited by a spark or flame many feet away from the engine. To reduce the risk of fire or explosion, follow these instructions:

- Refuel outdoors in a well ventilated area away from flames, sparks, anyone smoking and other sources of ignition.
- Never add fuel with engine running.

- Never top off the fuel tank. Leave some room for the fuel to expand with temperature changes.
- Wipe up any spilled fuel.
- Never start or operate the engine with the fuel cap removed.
- Use only an approved red gasoline container to store fuel.
- Do not carry gasoline containers in the front storage compartment or anywhere else on the vehicle.

Gasoline is poisonous and can cause injury or death.

- Never siphon gasoline by mouth.
- If you swallow gasoline, get any in your eye or inhale gasoline vapor, see your doctor immediately.

If gasoline spills on you, wash with soap and water and change your clothes.

## Avoid Burns from Hot Parts

The exhaust system and engine become hot during operation. Avoid contact during and shortly after operation to avoid burns.

## Accessories and Modifications

Do not make unauthorized modifications, or use attachments or accessories that are not approved by BRP. Since these changes have not been tested by BRP, they may increase the risk of crashes on the road or injuries, and they can make the vehicle illegal for use on the road.

Unlike most motorcycles, the Spyder roadster is equipped with a Vehicle Stability System (VSS), which is calibrated for the vehicle normal configuration. VSS may not function properly if the vehicle is modified, such as changing weight distribution, wheelbase, tires, suspension or steering.

See your authorized Can-Am roadster dealer for available accessories for your vehicle.



# ***VEHICLE INFORMATION***

# CONTROLS/INSTRUMENTS

Many controls are similar to the controls of a motorcycle, but some controls are different. It is important to know the location and operation of all controls, and to develop and practice smooth and coordinated use of them. See *REQUIRED RIDING SKILLS AND PRACTICE EXERCISES* (p. 41).

## Primary Controls

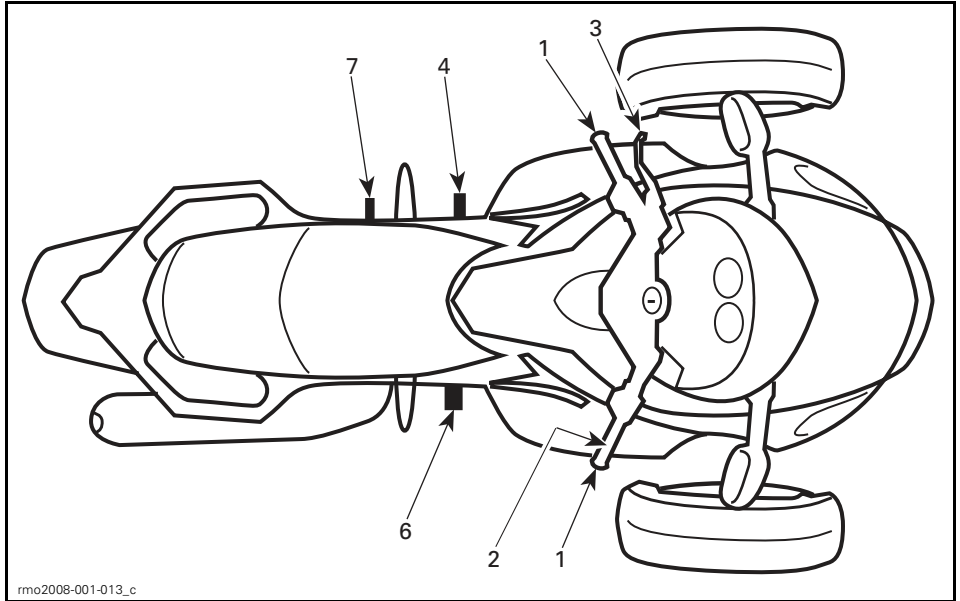

rmo2008-001-013\_c

### SM5 MODEL

1	Handlebar
2	Throttle
3	Clutch Lever
4	Gearshift Lever
6	Brake Pedal
7	Parking Brake Pedal

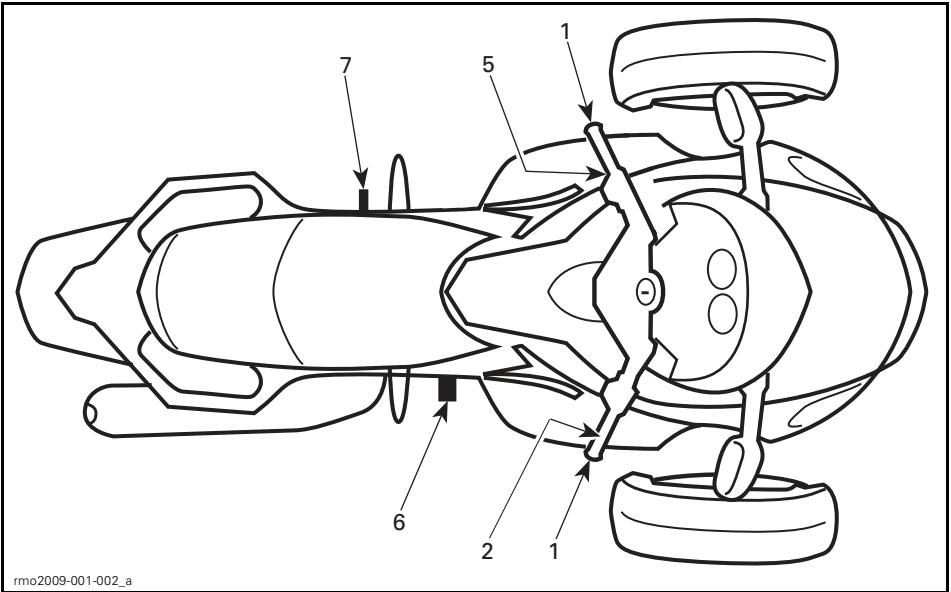

rmo2009-001-002\_a

**SE5 MODEL**

1	Handlebar
2	Throttle
5	Gearshift Selector
6	Brake Pedal
7	Parking Brake Pedal

**1) Handlebar**

Grip the handlebar with both hands. Steer the handlebar in the direction you want to go.

**2) Throttle**

The throttle is the right handgrip, and it controls engine speed. To increase engine speed, roll the throttle as shown (lower your wrist).



rmo2008-001-007\_a

**TO INCREASE SPEED**

To decrease engine speed, roll the throttle as shown (raise your wrist).



TO DECREASE SPEED

The throttle is spring loaded and should return to idle when you release your grip.

### 3) Clutch Lever (SM5 Model)

The clutch lever is in front of the left handgrip. The clutch controls the transmission of power from the engine to the rear wheel. The lever is squeezed in to disengage power and eased out to engage power.

Refer to 2) *LEARNING THE FRICTION ZONE AND BASIC HANDLING* (p. 43) for detailed instructions.

#### Clutch Lever Position Adjustment

The distance between the clutch lever and handgrip can be adjusted. Adjust clutch lever position as follows:

1. Hold the clutch lever forward.
2. Turn the adjuster dial to the desired position.



CLUTCH LEVER ADJUSTMENT

1. Clutch lever
2. Adjuster dial

### 4) Gearshift Lever (SM5 Model)

The gearshift lever is in front of the left footrest.

The gear pattern is Reverse-1-Neutral-2-3-4-5.

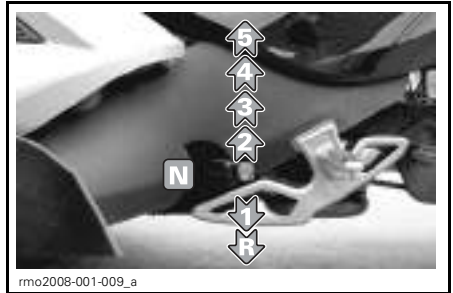

Lift up or press down fully to move sequentially from one gear to the next. When the lever is released, it returns to center where the mechanism resets for the next shift up or down. Neutral (N) is selected by either a half lift from first gear or a half press from second gear. Refer to 8) *SHIFTING* (p. 47) for detailed instructions.

To shift into reverse, refer to 10) *OPERATING IN REVERSE* (p. 50) for detailed instructions.

### 5) Gearshift Selector (SE5 Model)

The gearshift selector is below the left handgrip.

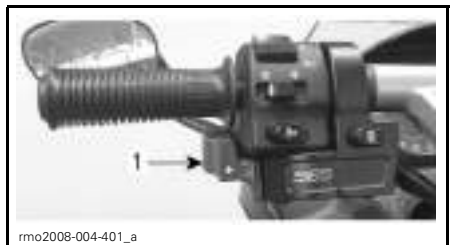

1. Gearshift selector

Press selector forward to upshift. Pull selector toward you to downshift.



1. *Upshift*
2. *Downshift*

This shifts sequentially from one gear to the next. Release the selector after shifting.

To shift through multiple gears, use the selector multiple times.

To shift into neutral from first gear or reverse, briefly press or pull the gear selector. A longer activation will shift over neutral. Refer to 7) *SHIFTING* (p. 55) for detailed instructions.

When the gearshift selector is released, the mechanism resets for the next shift up or down.

If operator does not downshift when slowing down and engine RPM drops below a threshold value, the gearbox will automatically downshift to the next available gear.

If the engine is started with the gearbox in gear, it will automatically shift to neutral position.

## 6) Brake Pedal

The brake pedal is in front of the right footrest. Press it down to operate. This pedal brakes all three wheels.

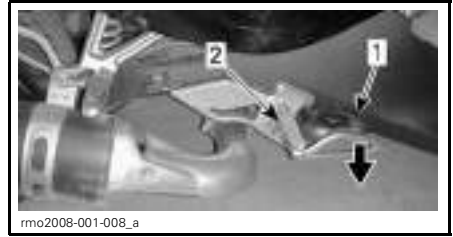

1. *Brake pedal*
2. *Footpeg*

## 7) Parking Brake Pedal

The parking brake pedal is behind the operator's left footpeg.



1. *Parking brake pedal*

With the vehicle stopped, press it down firmly until it locks to apply the parking brake. Firmly press the pedal down a second time to release the parking brake.



1. *Engaging/disengaging parking brake pedal*

 **WARNING**

Do not use the parking brake to slow or stop the vehicle; you could lose control, spin, tip or roll over. Warn passenger not to touch it with their left foot.

Operate the parking brake pedal only while seated on the stopped vehicle.



## Secondary Controls

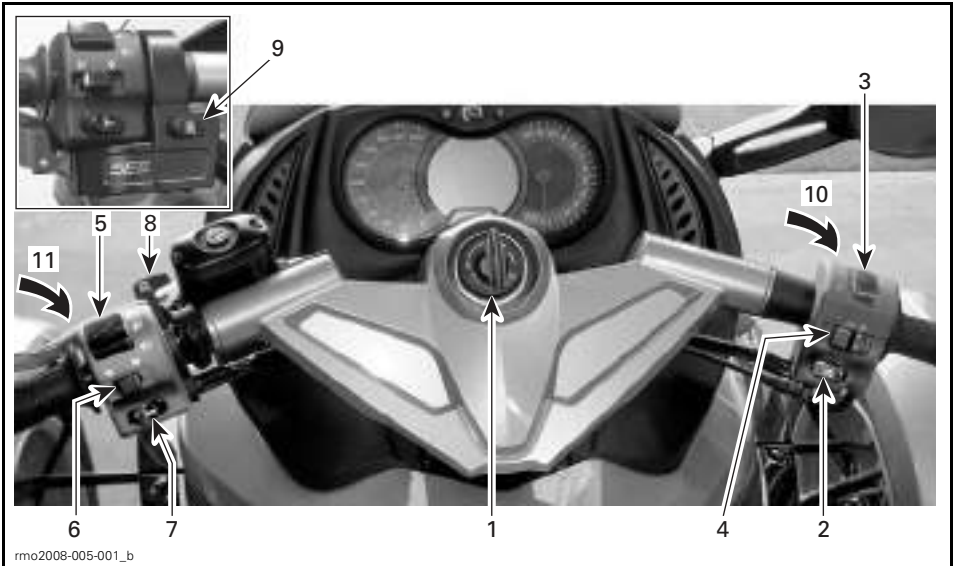

1	Ignition switch	7	Horn button
2	Engine start button	8	Reverse interlock lever (SM5 model)
3	Engine stop switch	9	Reverse button (SE5 model)
4	Hazard warning switch	10	Headlights override button
5	Headlights switch	11	Mode (M) button
6	Turn signal button		

### 1) Ignition Switch

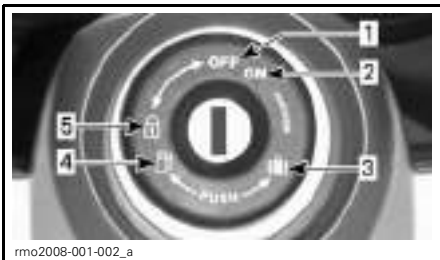

#### IGNITION SWITCH

1. OFF
2. ON
3. Front storage compartment opening
4. Seat opening/fuel tank access
5. Steering lock position

The ignition switch is located in the center of the handlebar. It controls:

- Engine ignition
- Seat opening mechanism to access:
  - Fuel tank cap
  - Fuses
  - Brake fluid reservoirs
  - Battery terminals.
- Front storage compartment opening mechanism
- Steering-lock mechanism.

**NOTICE** If the key does not turn easily, do not force it. Pull it out and reinsert.

**⚠ WARNING**

If you turn the ignition switch to OFF, it shuts off the engine and all the electrical systems including the VSS p.34, EBD and DPS p.35. If you do this while the vehicle is moving, you could lose control and crash.

**NOTE:** You should receive two keys with your vehicle. Each key contains a computer chip specifically pre-programmed to allow starting the engine. Store the spare key in a safe place because you **must** have your spare key to have another one made by an authorized Can-Am roadster dealer.

**2) Engine Start Button**

The engine start button is near the right handgrip. When depressed and held, it starts the engine.

Refer to *STARTING AND STOPPING THE ENGINE* (p.24) for detailed instructions.

**3) Engine Stop Switch**

The engine stop switch is near the right handgrip. It has two positions and must be set to the run position before you can start the engine. It allows you to stop the engine anytime without removing your hand from the handlebar.

Refer to *STARTING AND STOPPING THE ENGINE* (p.24) for detailed instructions.

**4) Hazard Warning Switch**

The hazard warning switch is near the right handgrip. Push the button to the left to turn on the hazard warning lights.

**5) Headlights Switch**

The switch is near the left handgrip, and is used to select high or low beam for the headlight. The headlights automatically turn on when the engine reaches 800 RPM.

To select high beams, push the switch to the front position. To select low beams, push the switch to the down position.

To flash the high beams, push the switch down, then release it. The high beams will stay on as long as the switch is held.

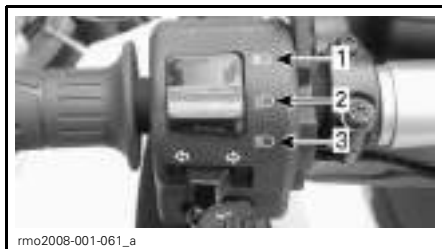

1. High beams
2. Low beams
3. Flash high beams

**6) Turn Signal Button**

The turn signal button is located near the left handgrip. It turns off automatically after a normal turn, but you may have to turn it off manually after a shallow turn or lane change.

To turn the signal off, press the button in.

Turn signals will automatically turn off after 30 seconds while the vehicle is moving.

**7) Horn Button**

The horn button is located near the left handgrip.

**8) Reverse Interlock Lever (SM5 Model)**

The reverse interlock lever is located in front of the left handgrip. Pull it toward you with your right hand to allow shifting into reverse. Refer to *SHIFTING INTO REVERSE (SM5 MODEL)* (p.26) for detailed instructions.

**⚠ WARNING**

Do not use the reverse interlock lever while riding forward. You could lose control.

The hazard warning lights flash when the vehicle is in reverse.

**9) Reverse Button (SE5 Model)**

The reverse button is located near the left handgrip.



1. Reverse button

Push and hold the reverse button to allow shifting into reverse. Refer to *SHIFTING INTO REVERSE (SE5 MODEL)* (p.26) for detailed instructions.

The hazard warning lights flash when the vehicle is in reverse.

**10) Headlight Override**

There is a headlight override button on the front of the right handgrip. Push and hold the headlight override button to operate the selected headlights (low or high beams). This button will light the high beams even if the ignition switch is in the OFF position.

The button can be used to illuminate the inside the front storage compartment. The high beams will reflect on the inside of compartment lid when it is opened.

**11) Mode (M) Button**

A MODE (M) button is located on the front of left multifunction switch for driver convenience and safety. It al-

lows the driver the same functions as the button on the multifunction gauge, but without taking his hand off the handgrip. Refer to *MULTIFUNCTION GAUGE CLUSTER* (p. 18) for a detailed explanation.



MODE (M) BUTTON

## Multifunction Gauge Cluster

The multifunction gauge cluster includes gauges (speedometer, tachometer, engine temperature, fuel level), indicator lamps and a user selectable digital display.

### Description

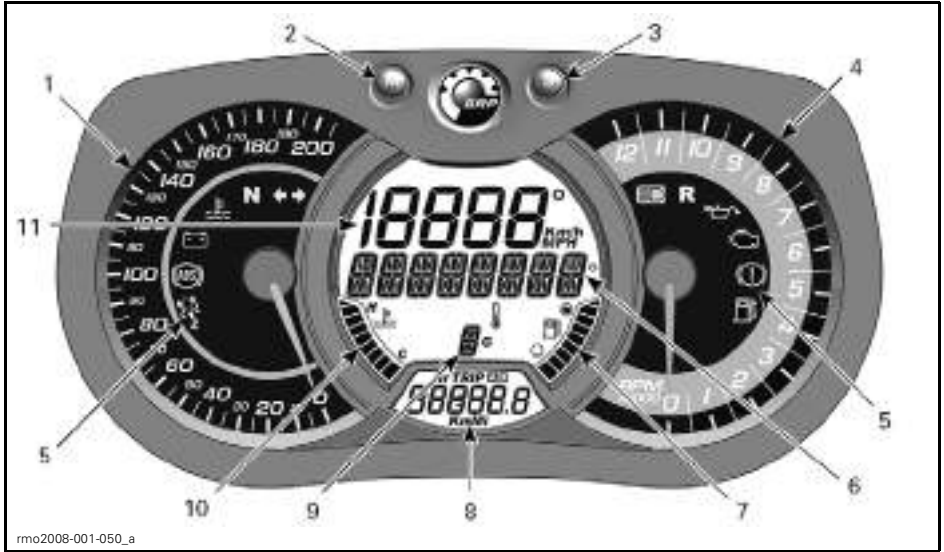

#### 1) Analog Speedometer

Measures vehicle speed in kilometers or miles per hour. To change units, refer to *SETTING METRIC/IMPERIAL UNITS* (p. 21).

#### 2) MODE (M) Button

Pressing the MODE (M) button will scroll through the functions of the secondary digital display.

**NOTE:** A second MODE (M) button is located on the front of left multifunction switch. Refer to *11) MODE (M) BUTTON* (p. 17)

#### 3) SET (S) Button

Pressing the SET (S) button will scroll through the functions of the main digital display.

#### 4) Analog Tachometer (RPM)

Measures engine revolutions per minute (RPM). Multiply by 1000 to obtain actual revolutions.







#### 5) Indicator Lamps

Indicator lamps will inform you of various conditions or problems.

An indicator lamp can flash alone or in combination with another lamp.

The digital display provides a brief description for some of the conditions or problems indicated by lamps.

The following table lists the indicator lamps during normal operation. For problematic conditions, refer to *MESSAGES IN MULTIFUNCTION GAUGE CLUSTER* (p. 117).

INDICATOR LAMP(S)		MAIN DIGITAL DISPLAY	DESCRIPTION
All indicator lamps	On	None	All indicator lamps are activated when ignition switch is ON and the engine is not started
	On	PARK BRAKE	Parking brake engaged
	Flashing + Buzzer	None	SE5 model: The ignition switch is OFF and the parking brake is not engaged. Always engage the parking brake when parking the vehicle
	On	None	Gearbox in neutral position
	Flashing	None	Gearbox in reverse position
	On	None	Headlights in the HIGH beam position
	Flashing	None	VSS intervention occurs
	Flashing	None	Turn signal or hazard warning lights flashing

## 6) Main Digital Display

Displays useful real-time information to the rider.

For display function informations, refer to *MAIN DISPLAY FUNCTIONS* (p. 20).

Important information messages can also be displayed. Refer to *MESSAGES IN MULTIFUNCTION GAUGE CLUSTER* (p. 117).

## 7) Fuel Level

Bar gauge that continuously indicates the amount of fuel left in the fuel tank.

## 8) Secondary Digital Display

Displays useful real time information to the rider. For display function informations, refer to *SECONDARY DISPLAY FUNCTIONS* (p. 20).

## 9) Gearbox Positions

Displays the selected gearbox position.

## 10) Engine Temperature

Bar gauge that continuously indicates the engine coolant temperature.

## 11) Digital Speedometer

In addition of the analog type speedometer, vehicle speed can also be indicated via this display.

Speed can be displayed in kilometers (Km/h) or miles (MPH) per hour. To change units, refer to *SETTING METRIC/IMPERIAL UNITS* (p. 21).

## Startup and Shutdown

Any time the ignition switch is set to ON after having been in the OFF position for five minutes or more, the main digital display will scroll the following message:

- BEFORE OPERATING READ THE SAFETY CARD ABOVE THEN PRESS \_M\_ BUTTON.

**NOTE:** Acknowledge this message to allow engine starting.

## Digital Display Information

### WARNING

Do not adjust the display while riding. You could lose control.

## Main Display Functions

Pressing the SET (S) button will scroll through the different functions.

FUNCTION SEQUENCE	INFORMATION DISPLAYED
Outside temperature	XX °C (Celsius) XX °F (Fahrenheit)
Tachometer (revolutions per minutes)	XXXX RPM

## Secondary Display Functions

Pressing the MODE (M) button will scroll through the different functions.

FUNCTION SEQUENCE	INFORMATION DISPLAYED
Clock	XX:XX (24:00 time base) XX:XX A or P (12:00 AM/PM time base)
Cumulative distance odometer	XXXXX.X Km or mi
Trip distance — odometer A (TRIP A)	XXXXX.X Km or mi
Trip distance — odometer B (TRIP B)	XXXXX.X Km or mi
Trip time chronometer (HrTRIP)	XXXXX.X
Engine time chronometer (Hr)	XXXXX.X

To reset any trip functions, push and hold the MODE (M) button for three seconds.

---

## Display Settings

### Setting Metric/Imperial Units

1. Push and hold SET (S) button for three seconds.
2. Main digital displays scrolling message: PUSH \_M\_ TO SELECT KM, \_S\_ TO SELECT MI
3. Push MODE (M) button to select metric units or SET (S) button to select imperial units.

### Setting Clock

1. Press MODE (M) button to select clock display.
2. Push and hold MODE (M) button for three seconds.
3. Press MODE (M) button to select 12:00 AM PM or 24:00 time base.
4. If 12:00 AM PM time base is selected, A or P flashes. Press MODE (M) button to select A (AM) or P (PM).
5. Press SET (S) button to change hours.
6. Press MODE (M) button to switch to minutes (minutes flash).
7. Press SET (S) button to change minutes.
8. Press MODE (M) button.

### Setting Language

For display language setting, refer to an authorized Can-Am roadster dealer.

# BASIC PROCEDURES

## License Plate Installation

When a license plate needs to be installed or replaced, ensure to install two new damping pads (P/N 293 740 028) on plate to be installed.

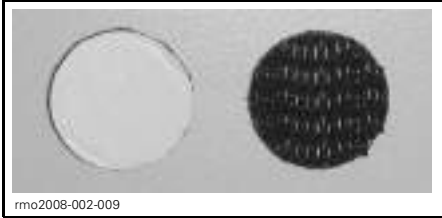

*DAMPING PAD (P/N 293 740 028)*

1. Remove existing plate on vehicle (if applicable).
2. Position new damping pads over existing pads on vehicle plate support.

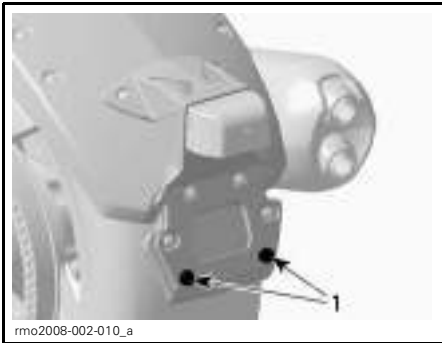

*1. Existing pads on plate support*

3. Peel off backing of new damping pads.

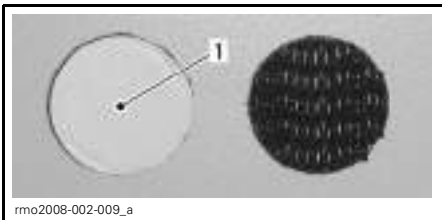

*1. Backing*

4. Secure upper portion of license plate using existing hardware on vehicle plate support.

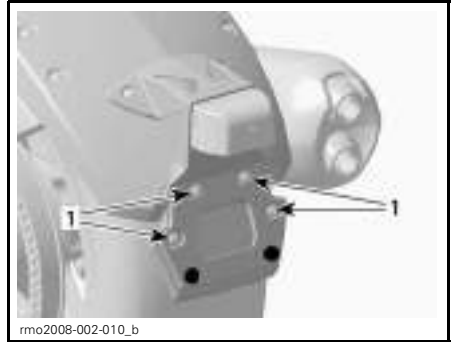

*1. Existing hardware*

5. Squeeze license plate and support together at each lower corner.

## Adjusting Mirrors

Press the mirror at the points shown below to adjust its position in the four directions.

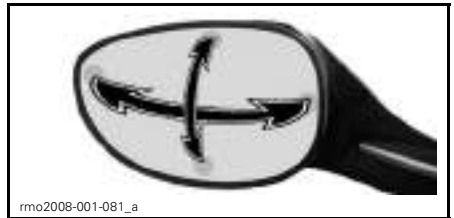

*MIRROR ADJUSTMENT POINTS*

## Locking the Handlebar

To lock the steering mechanism:

1. Insert key in ignition switch.
2. Rotate the handlebar all the way to the right or to the left.
3. Turn the key 1/4 turn counterclockwise to the steering lock position then remove key.





rmo2008-001-074\_a

**KEY POSITION TO LOCK HANDLEBAR**

1. Turn key 1/4 turn

**Opening the Front Storage Compartment**

1. Insert key in ignition switch.
2. Push and turn the key 1/4 turn counterclockwise to the front storage compartment position and hold while lifting cover.

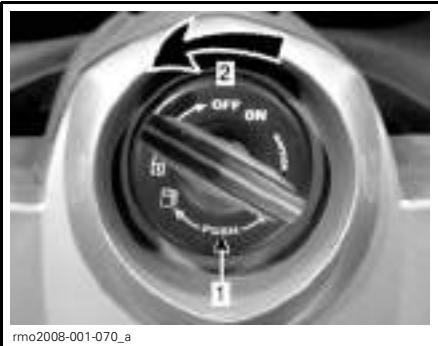

rmo2008-001-070\_a

**KEY POSITION TO OPEN FRONT STORAGE COMPARTMENT**

1. Push key
2. Turn key 1/4 turn



rmo2008-001-010

**FRONT STORAGE COMPARTMENT OPENED****Opening the Seat**

1. Insert key in ignition switch.
2. Push and turn the key 1/4 turn clockwise to the seat opening position and hold while lifting seat.



rmo2008-001-071\_a

**KEY POSITION TO OPEN SEAT**

1. Push key
2. Turn key 1/4 turn

**NOTICE** Do not force the seat past the maximum opening angle or it may break.



rmo2008-001-011\_a

1. Maximum opening of seat

## Starting and Stopping the Engine

### Starting the Engine

#### WARNING

Exhaust gas contains poisonous carbon monoxide that can rapidly accumulate in an enclosed or poorly ventilated area. If inhaled, it can cause serious injury or death.

Only run the engine in an unenclosed, well ventilated area. See *AVOID CARBON MONOXIDE POISONING* (p. 7).

#### *SM5 Model*

1. Push down and hold the brake pedal.
2. Turn the key to ON.

**NOTICE** Do not apply throttle while electrical system is initializing.

3. Refer to the Safety Card as needed to prepare yourself, your passenger and the vehicle, then press the MODE (M) button to enable the starter.
4. Watch the multifunction gauge cluster. If any indicator lights identify a problem, consult *PROBLEMS* (p. 106) before riding. The oil light should be on because the engine has not been started. Pay attention to any scrolling messages on the display.
5. Set the engine stop switch to the RUN/ON position.
6. Pull in and hold the clutch lever.
7. Shift into NEUTRAL. Check the multifunction gauge cluster to be sure you are in neutral.
8. Press and hold the engine start button until the engine starts. Do not hold the start button for more than 15 seconds. If it does not start, re-

lease the button and wait 30 seconds to let the starter cool down before trying again.

**NOTICE** Do not apply throttle while starting the engine.

9. Check the display for problems and to ensure that the oil light turns off.
10. Release the parking brake. Make sure the parking brake indicator on the multifunction gauge cluster is off.

**NOTICE** If the parking brake is not fully released before operating the vehicle, brake pads will drag while you are moving. This can damage the brake system.

#### *SE5 Model*

**NOTE:** The SE5 model can be started in any gear with the brake pedal depressed. The transmission automatically shifts to neutral when the engine started.

1. Push down and hold the brake pedal.
2. Turn the key to ON.

**NOTICE** Do not apply throttle while electrical system is initializing.

3. Refer to the Safety Card as needed to prepare yourself, your passenger and the vehicle, then press the MODE (M) button to enable the starter.
4. Watch the multifunction gauge cluster. If any indicator lights identify a problem, consult *PROBLEMS* (p. 106) before riding. The oil light should be on because the engine has not been started. Pay attention to any scrolling messages on the display.
5. Set the engine stop switch to the RUN/ON position.

6. Press and hold the engine start button until the engine starts. Do not hold the start button for more than 15 seconds. If it does not start, release the button and wait 30 seconds to let the starter cool down before trying again.

**NOTICE** Do not apply throttle while starting the engine.

7. Check the display for problems and to ensure that the oil light turns off.
8. Release the parking brake. Make sure the parking brake indicator on the multifunction gauge cluster is off.

**NOTICE** If the parking brake is not fully released before operating the vehicle, brake pads will drag while you are moving. This can damage the brake system.

## Stopping the Engine

### SM5 Model

1. Shift into first gear.
2. Set the engine stop switch to OFF.
3. Engage the parking brake. The brake locks in the depressed position, and a scrolling message PARK BRAKE will appear on the display.
4. Turn the key to OFF.
5. Before dismounting, check that the parking brake is fully engaged. Hold the clutch and rock the vehicle back and forth.

**NOTE:** As the brake pads wear, you may need to push the parking brake lever farther to engage the brake.

### WARNING

Always fully engage the parking brake. The vehicle can roll if the parking brake is not fully engaged and the transmission is in neutral.

### SE5 Model

1. Shift into neutral.
2. Set the engine stop switch to OFF.
3. Engage the parking brake. The brake locks in the depressed position, and a scrolling message PARK BRAKE will appear on the display.
4. Turn the key to OFF.

**NOTE:** If the parking brake is not engaged while the key is OFF, the park brake indicator light will flash and a buzzer will sound.

5. Before dismounting, check that the parking brake is fully engaged. Rock the vehicle back and forth.

**NOTE:** As the brake pads wear, you may need to push the parking brake lever farther to engage the brake.

### WARNING

Always fully engage the parking brake. The vehicle can roll if the parking brake is not fully engaged, regardless of what gear it is in. The centrifugal clutch is always disengaged when the vehicle is stopped, so the transmission will not hold the vehicle in place.

## Pushing the Vehicle

** CAUTION** Avoid pushing the vehicle on a slope. If you must push the vehicle on a slope, take extra care to stay within reach of the brake pedal in case the vehicle starts to roll.

To move the vehicle a short distance without starting the engine:

1. While seated on the vehicle, push down and hold the brake pedal.
2. Shift the transmission into NEUTRAL (SM5 model).
3. Disengage the parking brake.

4. Dismount on the right side of the vehicle, keeping your foot on the brake pedal.
5. Push the vehicle, using the brake as needed.

**⚠ CAUTION** Only push from the right side, so you can reach the brake pedal. Stay clear of the hot exhaust pipe.

When pulling the vehicle backward, be careful that the front wheel does not roll over your feet.

6. Remount the vehicle and park as specified above.

## Operating in Reverse

See *REVERSE* (p. 33) for more information about safe operation in reverse.

### Shifting Into Reverse (SM5 Model)

1. With engine running, shift into first gear.
2. Hold in the clutch lever.
3. With your right hand, pull the reverse interlock lever (marked "R") towards you and hold it.
4. Step down on the shift lever one stroke.
5. Release the reverse interlock lever and check that the letter "R" flashes on the multifunction gauge cluster and the hazard warning lights flash.

### Shifting Into Reverse (SE5 Model)

1. With engine running, the roadster stopped, and the brake depressed, shift into first gear or neutral.
2. Press and hold the reverse button.
3. Pull the gearshift selector toward you to downshift to reverse.

## Driving in Reverse

Check that the area behind you is clear and continue to look backwards while you operate in reverse. Keep your speed low and do not back up for long distances.

## Shifting Out of Reverse

### SM5 Model

To shift out of reverse, hold in the clutch and lift the shift lever once to shift into first. You do not need to use the reverse interlock lever — it resets automatically.

### SE5 Model

To shift out of reverse, stop vehicle and push on upshift selector quickly to shift into neutral and more longer to shift in first gear.

## Operating During Break-In

A break-in period of 1 000 km (600 mi) is required for the vehicle.

During the first 300 km (200 mi), avoid hard braking.

## **⚠ WARNING**

New brakes and tires do not operate at their maximum efficiency until their break-in is completed. Braking, steering and VSS (p.34) performance may be reduced, so use extra caution.

Brakes and tires take about 300 km (200 mi) of riding with frequent braking and steering to break-in. For riding with infrequent braking and steering, allow extra time to break-in the brakes and tires.

During the first 1 000 km (600 mi):

- Avoid full throttle acceleration.

- Avoid prolonged riding.
- If the cooling fan operates continuously during stop and go traffic, pull over and shut off the engine to let it cool off or speed up to let air cool off the engine.

After the break-in period, your vehicle should be inspected by an authorized Can-Am roadster dealer as per the *MAINTENANCE SCHEDULE* (p. 84).

**NOTE:** The break-in inspection is performed at the expense of the vehicle owner.

## Fueling

### Fuel Recommendation

Use unleaded gasoline or oxygenated fuel containing no more than 10% ethanol or methanol. The gasoline used must have the following **minimum** octane number:

MINIMUM OCTANE NUMBER	
Inside North America	87 ((R+M)/2)
Outside North America	92 RON

**NOTICE** Other fuel can degrade vehicle performance and damage critical parts in the fuel system and engine.

### WARNING

Do not carry gasoline containers in the front storage compartment or anywhere else on the vehicle. Gasoline may spill and ignite, particularly in a crash.

### Refueling Procedure

### WARNING

Gasoline is extremely flammable and highly explosive. Follow the refueling procedure to reduce the risk of fire or explosion. See *AVOID GASOLINE FIRES AND OTHER HAZARDS* (p. 7).

To refuel the vehicle:

1. Park outdoors in a well ventilated area away from flames, sparks, anyone smoking and other sources of ignition.
2. Stop the engine.
3. Unlatch and lift seat (p. 23). The fuel cap is located on the left side.
4. Slowly rotate cap counterclockwise and remove it.



**FUEL CAP ON LEFT SIDE UNDERNEATH SEAT**

5. Fill the tank until the fuel nozzle automatically clicks and shuts off.

**NOTE:** Do not try to top off the fuel tank. Leave some room for the fuel to expand with temperature changes.

6. Wipe up any spilled fuel. If fuel spills on you, wash with soap and water and change your clothes.
7. Put cap on and fully tighten clockwise until you hear a click. Never start or operate the engine with the fuel cap removed.
8. Close seat.

## Adjusting Suspension

The front and rear suspension can be adjusted according to the load on the vehicle or the type of ride you want to experience.

Lower spring preload provides a softer ride and is preferred for light loads and smooth roads. Higher spring preload provides a firmer ride and is recom-

mended for heavy loads, rough road conditions and more challenging riding.

### Front Suspension

#### **⚠ WARNING**

Adjust both springs to the same load. Uneven adjustment can cause poor handling, loss of stability and loss of control.

**NOTICE** Before adjusting suspension, manually raise the front of vehicle to extend the suspension. This will ease turning the adjustment cam and will prevent a potential breakage of the adjustment plate.

1. Place the vehicle on a level surface.
2. Engage the parking brake.
3. Adjust the spring preload by turning the cam with the adjusting wrench (stored in the tool kit).



FRONT SUSPENSION ADJUSTING WRENCH



FRONT SUSPENSION CAM ADJUSTMENT

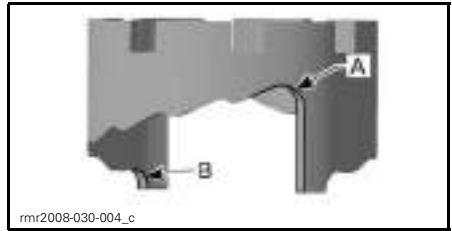

- A. Smooth adjustment (position 1)  
 B. Hard adjustment (position 5)

#### RECOMMENDED FRONT SHOCK ADJUSTMENT

LOAD	CAM POSITION
68 kg (150 lb) rider	1, 2
91 kg (200 lb) rider	3
68 kg (150 lb) rider with cargo	3
91 kg (200 lb) rider with cargo	4
Rider with passenger and cargo	5

### Rear Suspension

1. Place the vehicle on a level surface.
2. Block the front wheels.
3. Install a jack under the rear portion of frame.

**NOTICE** Do not jack the vehicle under the rear shock.

4. Lift the rear of vehicle until the shock absorber is fully extended.
5. Using XPS LUBE (P/N 293 600 016) or an equivalent product, lubricate all around the shock absorber cam. Lubricate especially near the protrusions.

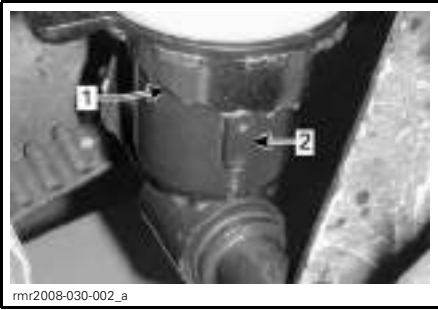

- 1. Cam
- 2. Protrusion

6. With a ratchet and an extension, turn the cam adjuster to change the position of the shock absorber cam.

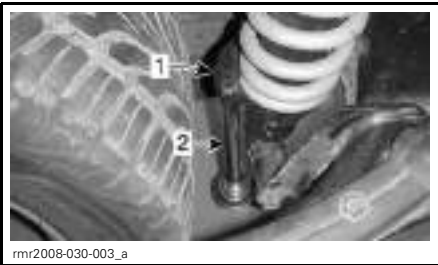

- 1. Cam adjuster
- 2. Ratchet with extension

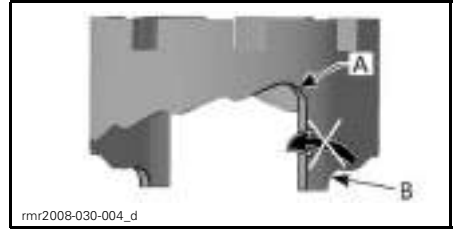

**AVOID ADJUSTING CAM POSITION 7 DIRECTLY TO POSITION 1**

- A. Position 1
- B. Position 7

<b>RECOMMENDED REAR SHOCK ADJUSTMENT</b>	
LOAD	CAM POSITION
68 kg (150 lb) rider	1, 2
91 kg (200 lb) rider	3 - 5
Rider with passenger	6, 7

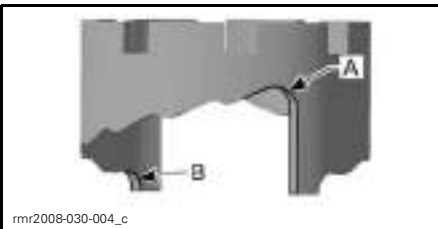

- A. Smooth adjustment (position 1)
- B. Hard adjustment (position 7)

**NOTE:** Never adjust the rear shock absorber cam from position 7 directly to position 1 as it will restrain access to adjustment holes and prevent you adjusting the suspension.





# ***SAFE OPERATING INSTRUCTIONS***

---

# WHAT'S DIFFERENT ABOUT THE SPYDER ROADSTER

The Spyder roadster is a different type of road vehicle. This section will help you understand some of the vehicle's distinctive features and operating characteristics.

## Stability

The three-wheeled "Y" configuration provides greater low-speed stability than a motorcycle. However, it is not as stable as a four-wheeled vehicle such as an automobile. Driving aid technologies, like the electronic Vehicle Stability System (VSS), help maintain stability during maneuvers, but you can still lose control, tip or roll the vehicle due to extreme maneuvers (such as hard turns at high speeds) or striking uneven surfaces or objects. In addition, the operator or passenger can fall off due to hard turns, acceleration, braking or impacts.

## Response to Road Conditions

The Spyder roadster responds differently than other vehicles to certain road conditions.

- Do not ride off-road or on ice or snow.
- Avoid puddles and running water. The vehicle hydroplanes more easily than a car. If you must go through water, slow down.
- Slow down on gravel, dirt or sand covered roads.

See *ROAD CONDITIONS AND HAZARDS* (p. 64).

## Brake Pedal

One pedal brakes all three wheels. There is no hand-operated brake, and there is no way to brake front and rear wheels separately. The Spyder roadster is better able to brake and steer at the same time than a motorcycle. The

vehicle can stop quickly — be aware of vehicles behind you that may not be able to stop as quickly.

## Antilock Braking System (ABS)

The vehicle is equipped with an Antilock Braking System (ABS) as part of the Vehicle Stability System (VSS). For hard braking, press and hold the brake pedal. ABS will prevent wheels from locking.

## Parking Brake

The parking brake mechanically brakes the rear wheel only, and it locks in place when engaged. It is not controlled by driving aid technologies (e.g., ABS, Electronic Brake Distribution). Do not use it to slow or stop the vehicle — you could lose control, spin, tip or roll over. Warn passengers not to touch it with their left foot.

## Steering

### Direct Steering

To steer your Spyder roadster, always steer in the direction of the turn.

Motorcyclists — Do not countersteer as it is done on a motorcycle. Unlike a motorcycle, your Spyder roadster cannot lean while turning. If you are a motorcyclist, you must relearn how to turn. Practice steering in the direction of the turn at all speeds until you are proficient.

### Sideways Forces in Turns

Unlike a motorcycle, the Spyder roadster does not lean in turns. You will feel sideways forces pushing you to the outside of the turn. To maintain balance, the operator and passenger must hold on with both hands and keep both feet firmly planted on the footpegs. In hard turns, it may help to lean your upper body forward and toward the inside of the turn.

## Width

Because the Spyder roadster is wider than a typical motorcycle:

- Keep the front wheels in your lane during turns. Be particularly aware of where your front wheels are in curves and when passing. If you take a path that would put a motorcycle front wheel near the edge of the lane, the Spyder roadster front wheel may be out of the lane.
- Do not share lanes or split lanes (ride between two lanes of traffic). Group riding should proceed in a single file, even with motorcycles.
- Be prepared to swerve farther to avoid obstacles.

## Reverse

The Spyder roadster operates in reverse like a car. However, there are some important differences:

- The hazard warning lights flash when it is in reverse, but there are no backup lights. Be aware that other motorists might not know that you are about to back up.
- If necessary, have the passenger dismount if your visibility is limited.
- Remember that the front is wider than the rear. Do not back up too close to objects or you may hit them with the front tires.
- Keep your speed low and do not back up for long distances.
- When possible, park so that you do not have to back out of the parking space.
- SM5 model: Shift back into first gear before shutting off the engine.

**⚠ CAUTION** Always keep both feet on the pegs while operating in reverse. Never put your feet on the ground while backing-up.

## Driver's License and Local Laws

Driver's license requirements for operating the Spyder roadster vary by location. Depending on local laws, you may need a motorcycle endorsement, three-wheeled vehicle endorsement, or just a standard automobile driver's license.

Check with local authorities to make sure you have the proper license before operating the vehicle on public roads.

---

# DRIVING AID TECHNOLOGIES

## Vehicle Stability System (VSS)

The Spyder roadster is equipped with a Vehicle Stability System (VSS). VSS can help you control the direction of the vehicle and reduce the risk of tipping or rolling over in some situations. VSS consists of:

- An **Antilock Braking System (ABS)** that helps maintain steering control during hard braking by preventing the wheels from locking.
- An **Electronic Brake Distribution (EBD)** system that automatically adjusts the brake balance between all three wheels. With the ABS, EBD helps maintain directional control and maximize the braking force depending on the traction available.
- A **Traction Control System (TCS)** that helps prevent the rear wheel from slipping. The TCS will limit rear wheel spin only if you turn the handlebar (steer out of straight line) or if vehicle speed exceeds 50 km/h (31 MPH).
- A **Stability Control System (SCS)** is designed to limit the power driving the rear tire and to brake individual wheels, which reduces the risk of losing control of the vehicle or rolling over.

### Limitations

VSS cannot help you maintain control in all situations.

### Surfaces With Poor Traction

The grip of tires on the road surface limits the maximum braking. Even with ABS and EBD, your stopping distance will be longer on surfaces with poor traction or if you do not maintain tire pressure and tread condition.

If your tires lose traction with the road surface you may lose control of the vehicle, even with VSS.

If the paved road surface is covered or partially covered with ice, snow or slush, there is not enough traction available to maintain control of the vehicle, even with VSS. Do not operate on snow, ice or slush.

Like other on-road vehicles, this vehicle can hydroplane on water (lose traction on a layer of water). If you ride too fast into a layer of water, such as a large puddle or flowing water on the road, the vehicle can lose traction and spin out, and the VSS cannot keep you in control. Avoid large water puddles or water streams, and slow down or pull off the road during heavy rains. If you must pass through water, slow down as much as possible before you reach it.

Reduce speed on surfaces with poor traction, like mud, sand, gravel or wet pavement. The Spyder roadster is not for off-road operation. Always operate the vehicle on maintained roadways. Do not use the vehicle on any other terrain.

### Tires

The VSS on the vehicle has been calibrated to perform best with a tire of a specific size, material and tread pattern. Replacing your tires with ones not approved by BRP can cause the VSS to be ineffective.

Use only BRP recommended tires, which can be ordered only from an authorized Can-Am roadster dealer.

Proper tire inflation pressure and tread condition are important for maintaining traction, especially on loose or wet surfaces.

See *TIRES* (p.91).

### Hard Turns

The VSS does not control or limit steering input — it cannot keep you from turning too sharply. Large and rapid

steering handlebar movements can cause the vehicle to go out of control, spin, tip or roll over.

### **Engine Braking**

The VSS does not control engine braking (slowing the vehicle by downshifting). If you shift into too low a gear when you are at high speed, the rear tire can skid and you can lose control, spin, tip or roll over, particularly in a curve.

### **Excess Speed**

The VSS does not control the vehicle speed, except when SCS intervenes during a turn. VSS does not prevent the vehicle from entering a turn too fast. If you drive too fast for conditions, you can lose control, even with VSS.

### **Dynamic Power Steering (DPS)**

The DPS (Dynamic Power Steering) provides a computer controlled, variable power assist, achieved by an electric motor to optimize the amount of steering effort required by the rider.

The steering assist level is dependent of the handlebar effort, the steering angle and the vehicle speed.

When vehicle is in the reverse gear, power steering assist will decrease as vehicle speed increases.

---

# UNDERSTANDING RISK ON THE ROAD

Before you operate the Spyder roadster, consider your risk of being hurt or killed in a crash, how you can reduce the risk and whether you are willing to take the risk. There are many factors that contribute to the risk that you face. You can control some of these factors, but others, like the behavior of other drivers, are beyond your control. Here are some of the factors that affect your risk:

## Type of Vehicle

Different types of vehicles vary in terms of size, visibility and maneuverability and provide different degrees of protection.

The Spyder roadster is small and maneuverable. Maneuverability can help avoid crashes. However, smaller vehicles are harder to see, which increases the chance that other motorists will cause a crash. In some situations, the Spyder roadster is less likely to be in a crash than a motorcycle. For example, you are less likely to tip over at low speeds while operating the vehicle. However, in other situations, the vehicle is more likely to be in a crash. For example, because the vehicle is wider, it will not fit through as small an opening as many motorcycles.

In cars and trucks, the structure of the vehicle provides protection in crashes and from other road hazards. In addition, passengers can protect themselves by wearing seat belts. You should expect that riding the Spyder roadster is riskier than riding in a car and that the risk of injury is more like riding a motorcycle.

As when riding a motorcycle, you can reduce the risk of injuries by wearing a helmet and riding gear.

## Operator Skills and Judgment

Every driver has some control over their own risk on the road. Drivers who develop good skills will have better control of their vehicle. Do not rely on your experience with motorcycles, automobiles, ATVs, snowmobiles or any other kind of vehicle to prepare you to operate the Spyder roadster. Learn how this vehicle is different. Read this Operator's Guide, watch the *SAFETY VIDEO*, and if available, take a training course. Become proficient with the controls and be able to do the practice exercises accurately and with confidence before going on the road.

When you begin riding on the road, start with less challenging situations (e.g., light traffic, lower speeds, good weather, no passenger) and gradually move on to more challenging riding situations as you develop your skills. Plan ahead to avoid situations that are too difficult for your skill level, or that present more risk than you want to take on.

Even skilled drivers cause crashes. For example, if you use your skills to do extreme maneuvers or stunts, you increase your risk. The smart driver uses good judgment along with skills to increase the margin of safety and minimize risk. Learn the defensive driving techniques in *STREET STRATEGIES* (p. 59).

## Rider Condition

A driver needs to be alert, sober, and physically ready to ride. Riding when intoxicated, tired or otherwise impaired increases the risk of a crash.

Alcohol, drugs, medications, fatigue, drowsiness and emotions can all inhibit your ability to ride safely. Like riding a motorcycle, riding the Spyder roadster is a challenging activity — being in good physical and mental condition is even more important than for a car. The safest policy is to never oper-

ate the vehicle unless you are alert and completely sober. Even if your blood alcohol level is not over the legal limit, your judgment and skills are impaired by any alcohol consumption.

You must be physically able to operate all controls, turn the handlebar through the full range of steering, mount and dismount, and monitor your surroundings to operate the vehicle.

Passengers also need to be alert, sober and physically able to maintain their posture, hold on and react appropriately to curves, bumps, acceleration and stops.

## **Vehicle Condition**

Keep your vehicle in good condition.

Do pre-operation checks and perform regular maintenance. Watch for any messages on the multifunction gauge cluster when you start the vehicle, and address any problems before you ride.

## **Road and Weather Conditions**

Roads with heavy traffic, poor visibility or poor traction surfaces increase your risk. Choose routes that are appropriate for your skill level and the level of risk you are willing to accept.

# RIDING GEAR

Riding three-wheeled, open-air vehicles like the Spyder roadster requires the same protective gear as motorcycling. Even though the vehicle is more stable at low speeds than a motorcycle, you can still be thrown off.

This section is based on guidance for motorcyclists given by the Motorcycle Safety Foundation (MSF).

In the event of a crash, protective gear may prevent or reduce injuries. Protective gear also helps you stay comfortable and can help provide protection against the elements.

Recommended basic protective gear for riders and passenger includes sturdy over-the-ankle footwear with non-slip soles, long pants, a jacket, full-fingered gloves and, above all, an approved helmet with proper eye protection.

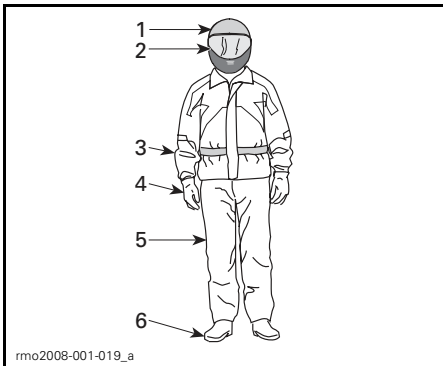

## RIDING GEAR

1. Approved helmet
2. Eye and face protection
3. Jacket with long sleeves
4. Gloves
5. Long pants
6. Over-the-ankle footwear

Proper apparel can reduce the severity of injury in case of a crash for both operators and passengers.

## Helmets

Helmets protect the head and brain from injury. A helmet can also protect the passenger's face from impact

with the back of the operator's helmet. Even the best helmet is no guarantee against injury, but statistics indicate that helmet use significantly reduces the risk of brain injury. So, be safe and always wear a helmet while riding.

## Choosing a Helmet

Helmets should be manufactured to meet the appropriate standard in your state, province or country.

A full-face helmet gives the most protection against impacts since it covers all of the head and face. It can also protect against debris, stones, insects, etc.

A three-quarter or open-face helmet can also offer protection. It is constructed with the same basic components but does not offer the face and chin protection of full-face helmets. If you wear an open-face helmet, you should use a snap-on face shield or a pair of goggles.

**NOTE:** Ordinary glasses or sunglasses are not sufficient eye protection for a motorcyclist. They can shatter or fly off, and they allow wind and airborne objects to reach the eyes.

Use tinted face shields, goggles or glasses in the daytime only; do not use them at night or in poor illumination. Do not use them if they impair your ability to discern color.

## Other Riding Gear

### Footwear

Always wear closed toe footwear. Sturdy over-the-ankle boots protect against a variety of riding hazards, such as stones that get thrown up from the roadway and burns from the hot exhaust pipe.

Avoid long shoelaces that can be tangled in the gearshift lever, brake pedal or other parts. Rubber soles and low heels are a good idea to help keep feet on the footrests.



## Gloves

Full-fingered gloves protect hands from the wind, sun, heat, cold and flying objects. Gloves that fit snugly will improve grip on the handlebar and help reduce hand fatigue. Sturdy, reinforced motorcycle gloves help protect hands in the event of a fall. Gloves made specifically for motorcyclists have seams on the outside to prevent irritation, and are curved to provide a natural grip when curled around the handgrips. If gloves are too bulky, it may be difficult to operate the controls. Gauntlets keep cold air from going up sleeves and protect the wrists.

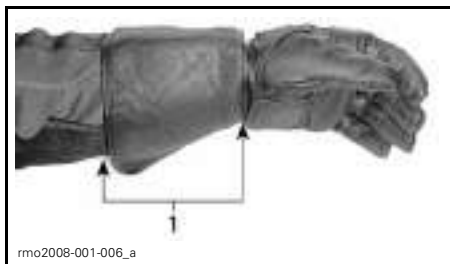

1. Glove gauntlet

## Jackets, Pants and Riding Suits

Wear a jacket and long pants, or a full riding suit. Quality motorcycle-type protective gear will provide comfort, and it can help you avoid being distracted by adverse environmental elements. In case of a crash, good quality protective gear made of sturdy material may prevent or reduce injury. Some gear includes padding or hard armor that may further reduce the risk of injury in a crash. Pants also help protect against burns from hot parts.

Protective gear sold for motorcycling will often provide the best combination of fit and protection. These garments are designed to fit while sitting in a riding position. They are cut longer in the sleeves and legs and are fuller across the shoulders. Riding suits are available in both one-piece and two-piece sets.

Leather is a good choice because it is durable and wind-resistant and provides protection against injury. Other abrasive-resistant protective gear made of synthetic fabrics are good choices, too. Do not wear loose or long clothing or scarves that can become tangled in the moving parts.

Flaps and fasteners seal out the wind. A jacket with a zippered front will be more wind resistant than a jacket with buttons or snaps. A flap of material over the zipper of a jacket gives additional protection against the wind. Jackets with snug cuffs and waist are recommended to keep wind from blowing in. A large, loose collar can flap when riding and may irritate skin or be a distraction.

In cool-weather riding, protect yourself against hypothermia. Hypothermia, a condition of low body temperature, can cause loss of concentration, slowed reactions and loss of smooth, precise muscle movement. In cool conditions, proper protective gear like a windproof jacket and insulated layers of clothing are essential. Even at moderate temperatures, you can feel very cold due to the wind while riding.

Protective gear that is appropriate for cold-weather riding may be too hot when stopped. Dress in layers so that clothing can be removed as desired. Topping the protective gear with a windproof outer layer can prevent cold air from reaching the skin.

Riding gear can also help a rider be more visible. Wearing bright colors is a wise choice. If a dark jacket is worn, an inexpensive reflective vest can be worn over it. It is a good idea to put extra reflective tape on garments worn regularly while riding.

## Rain Gear

If you must ride in wet weather, a rain suit or a waterproof riding suit is recommended. On long rides, it is a good

idea to carry rain gear. A dry rider will be much more comfortable and alert than a rider who is wet and cold.

One or two-piece styles are available, and those designed specifically for motorcycling are best. High-visibility orange or yellow colors are good choices. A feature to look for is elastic in the waist, pant legs and sleeves. The jacket should have a high collar and zip up with wide flaps across the opening. When purchasing a rain suit, consider adding waterproof gloves and footwear.

Remember, if the weather is wet, it is best to avoid riding. If you do ride in wet weather, you may need to stop if water starts to accumulate on the road.

### **Hearing Protection**

Long-term exposure to wind and motor noise when riding can cause permanent hearing loss. Properly worn hearing protective devices such as earplugs can help prevent hearing loss. Check local laws before using any hearing protective devices.

---

# REQUIRED RIDING SKILLS AND PRACTICE EXERCISES

Before you take the Spyder roadster on the road, you need to develop riding skills and strategies for managing risk on the road. The following exercises will familiarize you with the basic operation of the vehicle. If you have experience with motorcycles or other motor vehicles, pay particular attention to how the Spyder roadster operation and performance are different from vehicles you are used to. Practice each exercise until you can perform it proficiently before moving on to the next. This section includes the following exercises:

## ***SM5 Model***

1. Revving the engine and using the engine stop switch (p. 42)
2. Learning the friction zone and basic handling (p. 43)
3. Engine stop while in motion (p. 44)
4. Using the throttle and clutch (p. 44)
5. Basic turns (p. 45)
6. Quick stops (p. 46)
7. Weaves (p. 47)
8. Shifting (p. 47)
9. Swerve (p. 49)
10. Operating in reverse (p. 50).

## ***SE5 Model***

1. Revving the engine and using the engine stop switch (p. 51)
2. Starting, stopping, and basic handling (p. 51)
3. Engine stop while in motion (p. 52)
4. Basic turns (p. 52)
5. Quick stops (p. 54)
6. Weaves (p. 54)
7. Shifting (p. 55)
8. Swerve (p. 57)
9. Operating in reverse (p. 57).

## **Choosing a Practice Area**

Perform these exercises in a paved area at least 76 m - 30 m (250 ft - 100 ft) that is not open to traffic. A closed, well marked parking lot without obstacles (light poles, curbs, etc.) makes a good practice area. Be aware of oil left by parked cars. Look for parking lots that are empty during off hours, such as at schools, churches, community centers or shopping centers. Do not trespass on private property.

Once you have selected a suitable location, get permission to use it from the owner. If there are obstructions, such as light poles or islands, be sure that they do not interfere with the required open paths shown in the diagram below.

Keep this basic parking lot diagram in mind when setting up the exercises. 3 m (10 ft) wide parking lot spaces are indicated in the diagrams for convenience, but the size of the spaces in the lot you use may be different. If the parking lot you choose does not have lines or if the parking spaces are sized much larger or smaller than the ones in the diagrams, use the dimensions shown below. Mark them using a tape measure and chalk or markers such as cones or milk containers weighted with water or sand.

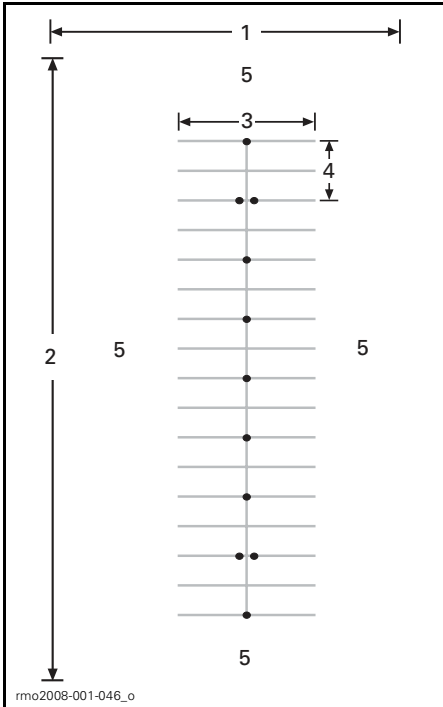

**TYPICAL PARKING LOT**

1. At least 30 m (100 ft)
2. At least 76 m (250 ft)
3. 12 m (40 ft)
4. 6 m (20 ft)
5. Open area

Even in a closed lot, be aware of potential traffic. Check to the front, sides and rear before doing an exercise. Also, watch out for children and animals.

**Preparing to Ride**

Know the location and operation of all the vehicle controls (p. 10).

Perform the pre-ride inspection; see *PRE-RIDE CHECKLIST* (p. 78) before beginning.

Always start and stop the engine according to the instructions on *BASIC PROCEDURES* (p. 22).

**Riding Posture**

Good posture helps you maneuver the vehicle more easily. Always keep both hands and both feet in position so that you can operate the controls easily. The wrist should typically be aligned straight with the arm (this position helps you apply the amount of throttle you want). Arms should be relaxed and bent. Keep your back straight and your head and eyes up. Keep both feet on the pegs near the controls.

Never operate the vehicle, even for a short distance, unless you are in the proper riding posture.



RIDING POSTURE

**Practice Exercises (SM5 Model)**

**1) Revving the Engine and Using the Engine Stop Switch**

**Purpose**

- Become familiar with the sound of the engine revving so you will not be surprised during the exercises.
- Become familiar with using the engine stop switch.

## Directions

- With the vehicle in NEUTRAL, the parking brake engaged, and your right foot pressing the brake pedal, pull in and hold the clutch lever. Watch the tachometer and apply throttle (twist lowering your wrist) a few times to raise the RPM to no more than 4000. As long as the clutch is fully pulled in the power will not transfer to the rear wheel.
- Use the engine stop switch to cut all power to the vehicle. Press the switch with your right thumb while keeping your hand on the handgrip.

## Tips for Additional Practice

- Practice pressing the engine stop switch without looking at it.

## 2) Learning the Friction Zone and Basic Handling

Pulling in the clutch disengages power to the rear wheel — if you feel like you are losing control while doing these exercises, you can pull in the clutch to stop accelerating and apply the brake as needed to slow down. You can also use the engine stop switch to cut power entirely.

The friction zone is the area in the travel of the clutch lever that begins where the clutch starts to transmit power to the rear wheel and ends just before the clutch becomes fully engaged. While the clutch is partially engaged, it allows you to precisely control engine power transmitted to the rear wheel. Proper use of the friction zone helps you get moving smoothly from a stop.

## Purpose

- Become familiar with the clutch and operating within the friction zone.
- Become familiar with low speed deceleration and braking.

## Directions

For this exercise, do **NOT** use any throttle. You will be controlling your movement using only the clutch in the friction zone and brake.

Begin by stopping every 6 m (20 ft) (every marker/every second line).

- Start the engine and release the parking brake.
- With the brake pedal depressed and the clutch lever pulled in, shift the transmission into first gear by firmly pushing down on the shift lever.
- Release the foot brake.
- **Slowly** let out the clutch lever until the vehicle starts to creep forward. Hold the clutch lever at this point. This is the friction zone. If you release the clutch too quickly, the engine may stall or the vehicle may jump forward. **If the vehicle stalls**, restart the engine and try again, releasing the clutch more gradually.
- As you approach the stopping point, pull the clutch lever all the way in and press the brake pedal to stop. Pulling the clutch in does not have to be gradual — you can do this quickly.
- When you reach the end of the straightaway, stop, turn the handlebar all the way to the right, and turn around. Be careful not to apply throttle as you turn. Stop when you are in line with the straightaway in the opposite direction.
- Repeat this exercise until you feel comfortable.

## Tips for Additional Practice

- As you become more comfortable with the friction zone, try stopping every 12 m (40 ft) (every other cone) so that you can fully release the clutch.

### 3) Engine Stop while in Motion

#### Purpose

- Become familiar with using the engine stop switch when in motion so you know how the vehicle will react if you need to use it later.

#### Directions

- Partway down the straightaway, while operating in the friction zone, turn the engine stop switch to OFF and coast to a stop.
- Restart the engine and repeat the exercise. Try releasing the clutch farther and moving a little faster before using the engine stop switch.

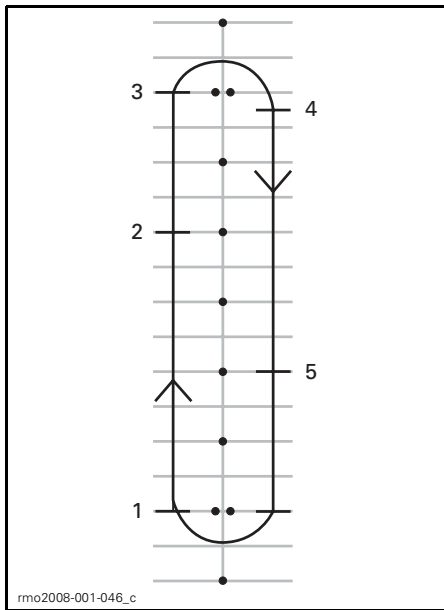

1. Start
2. Press engine stop switch
3. Proceed to end of straightaway, stop and turn as before
4. Stop
5. Press engine stop switch

Restart the engine and proceed to the next exercise.

### 4) Using the Throttle and Clutch

#### Purpose

- Become familiar with operating the throttle.
- Learn to balance throttle and clutch.

#### Directions

This exercise is similar to the friction zone exercise, except this time you will be using some throttle. You will use the entire straightaway, stopping only at the ends.

- Start this exercise stopped in first gear at the beginning of a straightaway.
- With the clutch lever pulled in, gently apply throttle until the tachometer reads between 1500 and 2000 RPM. Practice holding it within this range.
- Hold the throttle at this position while gently releasing the clutch lever as before. Try not to let the RPMs exceed 2500.
- The more quickly you release the clutch lever, the more quickly you will accelerate. If you release the clutch too quickly, the engine may stall or the vehicle may jump forward.
- Applying too much throttle can cause the rear wheel to spin and can result in rapid acceleration.
- When the clutch lever is fully released, the throttle controls your speed.
- As you approach the end of the straightaway, release the throttle, pull in the clutch lever and apply the brakes to come to a stop.
- Without using throttle, turn around and head down the opposite straightaway.

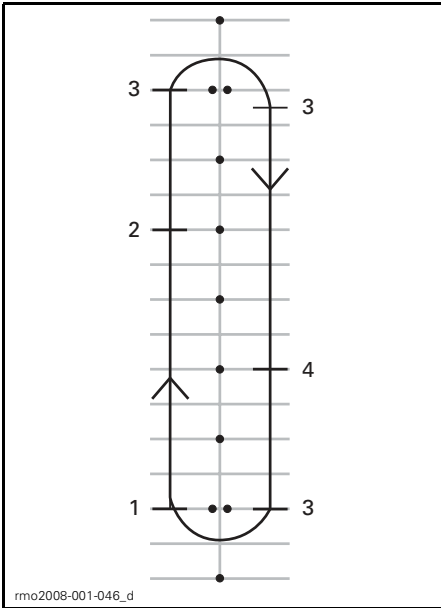

1. Start
2. Roll off throttle
3. Stop
4. Roll off throttle

### Tips for Additional Practice

- Coordinate releasing the clutch lever and applying the throttle to start smoothly and to control your acceleration.

### 5) Basic Turns

#### Purpose

- Get comfortable turning in a controlled manner.

#### Directions

This exercise is similar to what you did before, except that now instead of stopping for each turn, you will make the turn in the friction zone.

- Proceed down the straight away in first gear. Ride a little farther from the cones so you can make a wide arcing turn at the end of the straight-away.

- As you approach the curve, slow down to no more than 8 km/h (5 MPH) by pulling in the clutch lever and applying brake if needed.
- Hold the clutch lever in the friction zone to maintain your low speed.
- Look in the direction of the curve.
- Turn the handlebar in the direction of the curve, pulling on the inside hand-grip and pushing on the outside. Be careful not to change your hand position on the throttle.
- Leaning forward and into the curve may help you turn the handlebar more easily.
- Straighten your handlebar after the turn and proceed down the straight-away.



RIDING POSTURE WHEN TURNING

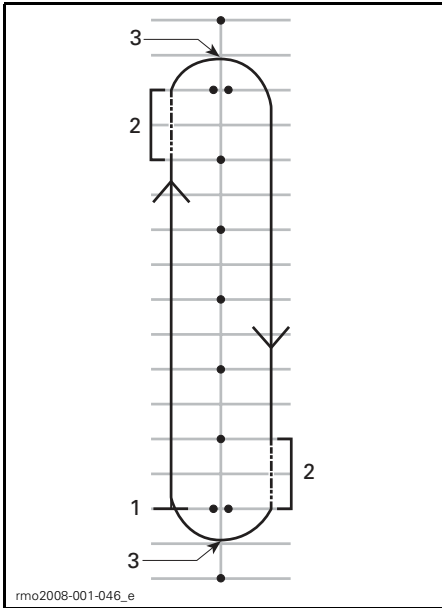

1. Start
2. Friction zone
3. Apex

**NOTE:** Motorcyclists - Riding through turns and curves with your Spyder roadster is different than on a motorcycle. The vehicle does not lean in a turn, so you may need to shift your body weight to the inside of the turn to keep a comfortable posture on the vehicle. You will need to exert more force to turn the handlebar of your vehicle than is needed to turn a motorcycle. However, it is easier to stop while turning than with a motorcycle.

**Tips for Additional Practice**

- After you are comfortable turning in one direction, try going around the course the other way. Be careful not to apply more throttle than you intend when turning left.
- Stop at the apex of the turn to see what it's like to use your brakes in a curve or turn.

**6) Quick Stops**

**Purpose**

- Become familiar with the vehicle braking ability.
- Learn to apply brakes with maximum force.

**Directions**

This exercise is similar to what you did before, except you'll be applying the brake more firmly, working up to braking as hard as possible.

- Start at one end of the straight away and accelerate to 8 km/h (5 MPH).
- Partway down the straightaway, release the throttle completely and brake quickly and firmly.
- Keep head and eyes up and keep handlebar straight.
- Repeat, increasing your speed and braking harder.

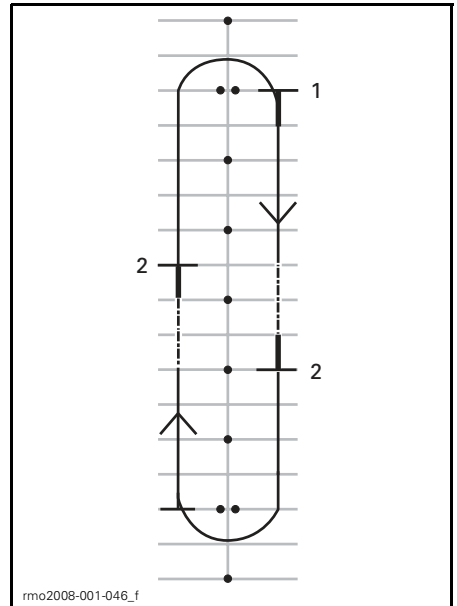

1. Start
2. Stop



**Tips for Additional Practice**

- Practice checking your mirrors before braking hard.

**7) Weaves**

**Purpose**

- Get more experience with the vehicle handling and rider position.

**Directions**

**6 m (20 ft) Weave**

1. Weave between every marker/ intersection of every other parking spot. Do not use throttle — stay in the friction zone.
2. Lean into each turn and turn the handlebar in the direction you want to go by pulling and pushing the grips.

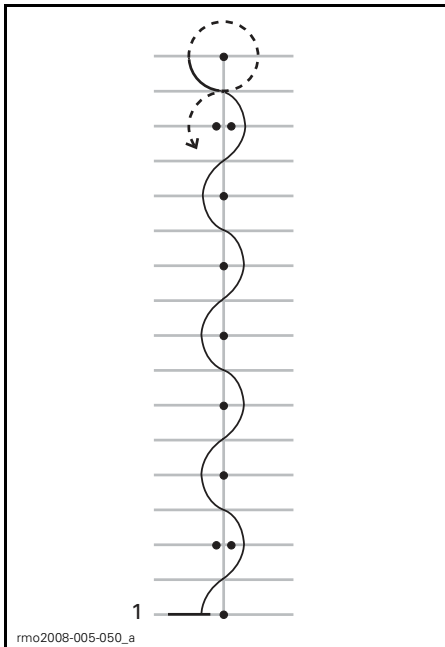

1. Start

**12 m (40 ft) Weave**

Once you're comfortable, try doing 12 m (40 ft) weaves between every other cone/every fourth parking space.

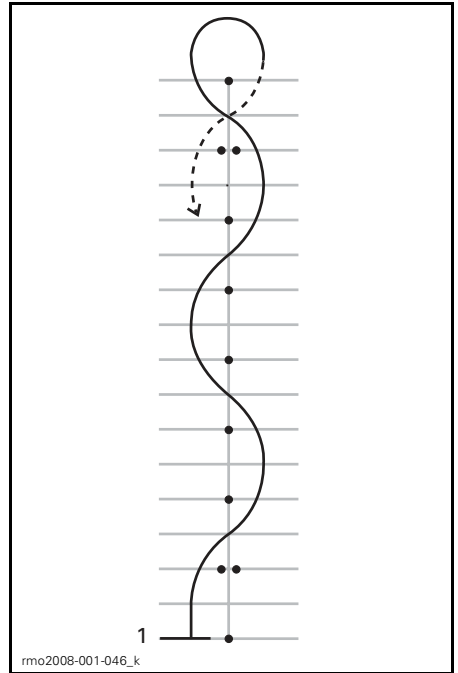

1. Start

**Tips for Additional Practice**

- You can gradually increase speed as you get comfortable to 16 km/h - 19 km/h (10 MPH - 12 MPH) for the weaves, but slow down for the U-turns at the ends.

**8) Shifting**

When riding, you must change gears to match the engine speed with road speed.

**Purpose**

- Become familiar with the foot motions needed to shift gears.
- Learn to upshift and downshift.

**Directions**

This exercise is similar to what you did before, except now you will be upshifting on the straightaways, then coming to a stop at the end of each straight-

away. You may want to use the parking lot aisles for this exercise rather than riding in the spaces.

### 8a) Practice Using the Shift Lever at a Stop

First, while stopped, practice the left foot motion for shifting between first and second gears.

- At a stop in first gear, pull in the clutch lever.
- Slide the tip of your left foot under the shift lever and lift it as far as it will go, one firm stroke up to shift into second gear.
- Step on the shift lever and press it as far as it will go, one firm stroke down to shift into first gear.
- Repeat until you are comfortable with the foot motions required.

### 8b) Upshifting from First into Second Gear

In the straightaway, accelerate to approximately 16 km/h (10 MPH) in first gear.

To upshift:

- Roll off the throttle.
- Pull in the clutch lever. (If you pull in the clutch before releasing throttle, the engine may rev — just release the throttle if this happens.)
- Slide the tip of your left foot under the shift lever and lift it as far as it will go, one firm stroke up to shift into second gear.
- Smoothly ease out the clutch.
- You do not need to apply throttle, but once you are comfortable, if space allows, you can apply the throttle to increase speed in second gear.

As you approach the end of the straightaway, come to a stop:

- Release the throttle.
- Pull the clutch lever all the way in.

- Apply brake.
- After stopping, downshift into first gear by stepping on the shift lever and pressing it as far as it will go, one firm stroke down. Once you are more comfortable, downshift into first as you come to a stop.

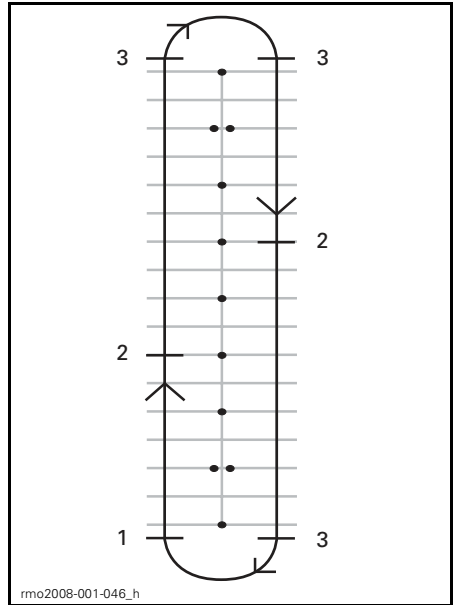

1. Start
2. Shift into second at 16 km/h (10 MPH)
3. Stop

### 8c) Downshifting from Second to First Gear

If space allows, practice downshifting into from second to first gear.

In the straightaway, slow to approximately 16 km/h (10 MPH).

- Release the throttle and pull in the clutch lever.
- Step on the shift lever to shift into first gear.
- Smoothly ease out the clutch.
- Put your foot back on the peg.

### 8d) Other Gears

If space allows, you can try shifting into and out of higher gears as well. Follow the same process and shift up or down one gear at a time.

#### Tips for Additional Practice

As you gain more experience, you can refine your shifting skills and use them to better control the vehicle.

- When downshifting, rolling on the throttle slightly while smoothly easing out the clutch can help the engine rev up to match vehicle speed more quickly and make the downshift smoother, preventing skidding of the rear wheel.
- Shifting to a lower gear slows the vehicle if you do not apply throttle. This is known as engine braking. To use engine braking, shift down one gear at a time and ease out the clutch between each downshift. Keep the clutch in the friction zone until the engine speed stabilizes, then ease out the lever fully until ready for the next downshift.
- Usually you shift gears one at a time, but it is possible to shift through more than one gear while the clutch is squeezed by repeating the up or down stroke as many times as you want gear changes.

Remember that VSS does not control engine braking. If you shift into too low a gear when you are at high speed, the rear tire can skid and you can lose control, spin out, tip or roll over, particularly in a curve.

### 9) Swerve

#### Purpose

- Become familiar with the vehicle's handling for quick maneuvers.
- Try different variations of braking and swerving.

#### Directions

Set up your markers as shown in the diagram below. Do not use any fixed or hard, heavy objects as markers for this exercise.

- Enter between the double cones at about 8 km/h (5 MPH) and maintain that speed throughout.
- Steer around the line of cones.
- Exit through the second set of double cones.
- Repeat the exercise multiple times, swerving in both directions.

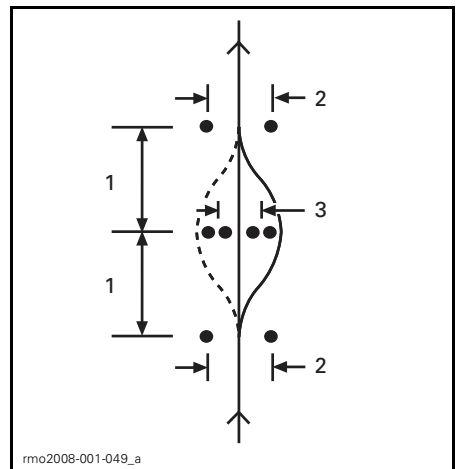

1. 6 m (20 ft)
2. 3 m (10 ft)
3. 2.5 m (8 ft)

#### Tips for Additional Practice

- You can gradually increase your entry speed (to no more than 13 km/h to 19 km/h (8 MPH to 12 MPH)) and try some variations. For example, approach faster and slow before entering the exercise, pull in the clutch and apply brakes during the swerve, etc.

- A helper can add an element of surprise to the exercise by deciding which direction you should swerve, or if you should come to a stop instead. Have your helper stand at a safe distance away (e.g., beyond the end of your practice area). As you reach the first set of cones, the helper can use hand signals to indicate which direction to swerve or for you to stop.
- Practice checking your mirrors and blind spot before you swerve.

### 10) Operating in Reverse

#### Purpose

- Become familiar with the vehicle's handling and turning radius in reverse.

#### Directions

Shift into reverse. See *SHIFTING INTO REVERSE (SM5 MODEL)* (p. 26).

Check that the area behind you is clear and continue to look backwards while you ease out the clutch. Be careful not to strike anything with your front wheels as you back up. Slow and stop using clutch and brake, just like when operating normally.

Back for a few feet at a time, stopping in between.

Keep your speed low and do not back up for long distances.

After you are comfortable with reverse, back into a parking space as shown in the diagram below.

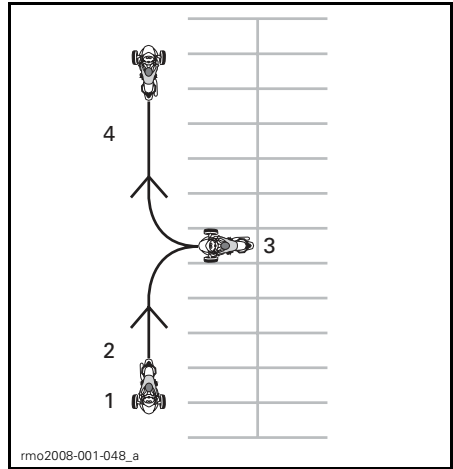

1. Start
2. Reverse
3. Stop
4. Forward

#### Additional Practice in Controlled Environments

Once you are comfortable with all of the above exercises, you can try a few other things as space and conditions allow. This might be in the parking lot or at a later time in a place where you have the opportunity without putting yourself at risk.

- **Quick starts:** Try quickly getting up to speed and upshifting through the gears.
- **Quick stop from higher speed:** Similar to the quick stop exercise, but performed from higher speeds to get a feel for emergency stops.
- **Starting up an incline:** To do this, keep holding the brake pedal as you release the clutch lever until you are in the friction zone. This will keep you from rolling backwards.

## Practice Exercises (SE5 Model)

### 1) Revving the Engine and Using the Engine Stop Switch

#### Purpose

- Become familiar with the operation of the twist throttle.
- Become familiar with the sound of the engine at different RPMs. This will help you to know when to up-shift and downshift based on the engine sound.
- Become familiar with using the engine stop switch.

#### Directions

- Start with the vehicle in NEUTRAL, the parking brake engaged, and your right foot on the brake pedal. Check the multifunction gauge cluster to be sure you are in NEUTRAL — if you are in first gear, the roadster will try to start moving when you apply the throttle.
- Watch the tachometer and apply throttle (twist by lowering your wrist) a few times to raise the RPM to no more than 4000. Practice applying the throttle gently and smoothly, holding it steady at about 3000 RPM, and releasing it. As long as the transmission is in neutral the power will not transfer to the rear wheel.
- Use the engine stop switch to cut all power to the vehicle. Press the switch with your right thumb while keeping your hand on the handgrip.

#### Tips for Additional Practice

- Practice pressing the engine stop switch without looking at it.

### 2) Starting, Stopping and Basic Handling

#### Purpose

If you feel like you are losing control while doing these exercises, release the throttle to stop accelerating and apply the brake as needed to slow down. You can also use the engine stop switch to cut power entirely.

- Learn throttle control and how to get the vehicle moving.
- Become familiar with low speed deceleration and braking.

#### 2a) Apply and Immediately Release Throttle

#### Directions

At first, you will only use the throttle for a moment at a time, then release it and coast.

- Start the engine and release the parking brake.
- With the brake pedal depressed, shift the transmission into first gear by pressing the gear selector forward.
- Release the brake.
- Slowly apply throttle until the vehicle starts to creep forward. As soon as you start moving release the throttle and coast, then press the brake to stop. Repeat to the end of the straightaway.
- To turn around at the end of the straightaway, stop, turn the handlebar all the way to the right, then briefly apply and release the throttle, and coast through the turn. You may need to briefly apply the throttle more than once to complete the turn. Stop when you are in line with the straightaway in the opposite direction.
- Continue with this part of the exercise until you are comfortable with applying and releasing the throttle.

## 2b) Hold Throttle, Release and Stop Every 12 m (40 ft)

Next, you will be holding the throttle a little longer, then stopping every 12 m (40 ft) (every other marker/every fourth line).

- Again, slowly apply throttle until the vehicle starts to creep forward. This time, hold the throttle at this point.
- As you approach the stopping point, release the throttle and press the brake to stop.
- Turn around at the end of the straightaway as before, except now you do not need to release the throttle during the turn. Pay attention to maintaining a steady throttle position as you turn. Stop when you are in line with the straightaway in the opposite direction.

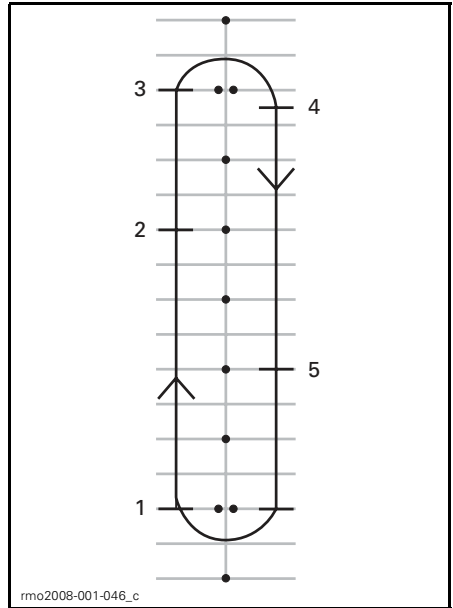

## 2c) Hold Throttle, Release and Stop at Ends

Next, use the entire straightaway, stopping only at the ends. Keep the throttle moderate.

## 3) Engine Stop while in Motion

### Purpose

- Become familiar with using the engine stop switch when in motion so you know how the vehicle will react if you need to use it later.

### Directions

- Partway down the straightaway, while operating at 8 km/h (5 MPH), turn the engine stop switch to OFF and coast to a stop.
- Restart the engine and repeat the exercise. Try increasing your speed (to a maximum of 20 km/h (12 MPH) before using the engine stop switch.

**NOTE:** SE5 model will not start in gear without brake pedal depressed.

1. Start
2. Press engine stop switch
3. Proceed to end of straightaway, stop and turn as before
4. Stop
5. Press engine stop switch

Restart the engine and proceed to the next exercise.

## 4) Basic Turns

### Purpose

- Get comfortable turning in a controlled manner.

### Directions

This exercise is similar to what you did before, except that now instead of stopping for each turn, you will make the turn at low speed.

- Proceed down the straight away in first gear. Ride a little farther from the cones so you can make a wide arcing turn at the end of the straightaway.
- As you approach the curve, slow down to no more than 8 km/h (5 MPH) by releasing the throttle and apply brake if needed.

- Hold the throttle to maintain your low speed.
- Look in the direction of the curve.
- Turn the handlebar in the direction of the curve, pulling on the inside handgrip and pushing on the outside, being careful not to apply throttle.
- Leaning forward and into the curve may help you turn the handlebar more easily.
- Straighten your handlebar after the turn and proceed down the straight-away.



rmo2008-001-064

**RIDING POSTURE WHEN TURNING**

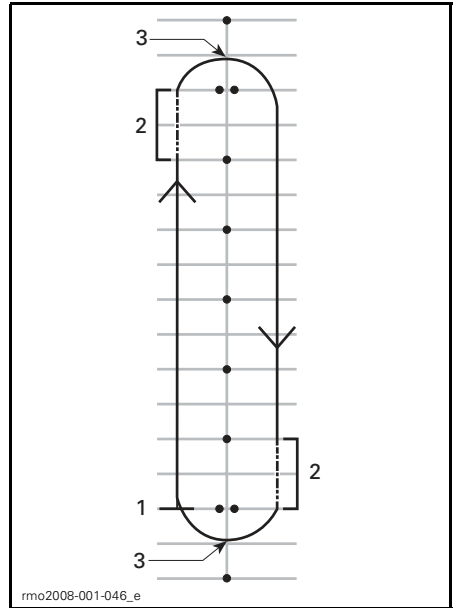

1. Start
2. Friction zone
3. Apex

**NOTE:** Motorcyclists - Riding through turns and curves with your Spyder roadster is different than on a motorcycle. The vehicle does not lean in a turn, so you may need to shift your body weight to the inside of the turn to keep a comfortable posture on the vehicle. You will need to exert more force to turn the handlebar of your vehicle than is needed to turn a motorcycle. However, it is easier to stop while turning than with a motorcycle.

**Tips for Additional Practice**

- After you are comfortable turning in one direction, try going around the course the other way. Be careful not to apply more throttle than you intend when turning left.
- Stop at the apex of the turn to see what it's like to use your brakes in a curve or turn.

## 5) Quick Stops

### Purpose

- Become familiar with the vehicle braking ability.
- Learn to apply brakes with maximum force.

### Directions

This exercise is similar to what you did before, except you'll be applying the brake more firmly, working up to braking as hard as possible. The Antilock Braking System (ABS) will prevent the wheels from locking and help you maintain steering control while applying maximum braking force. Always roll off the throttle completely for quick stops with the SE5. If you apply throttle and brake at the same time, your stopping distance will be longer.

- Start at one end of the straightaway and accelerate to 8 km/h (5 MPH). Partway down the straightaway, roll off the throttle completely and brake quickly. Never pump the brake as the ABS will prevent wheel lock.
- Keep head and eyes up, keep handlebar straight, and do not release the brake until fully stopped.
- Repeat, increasing your speed and braking harder.

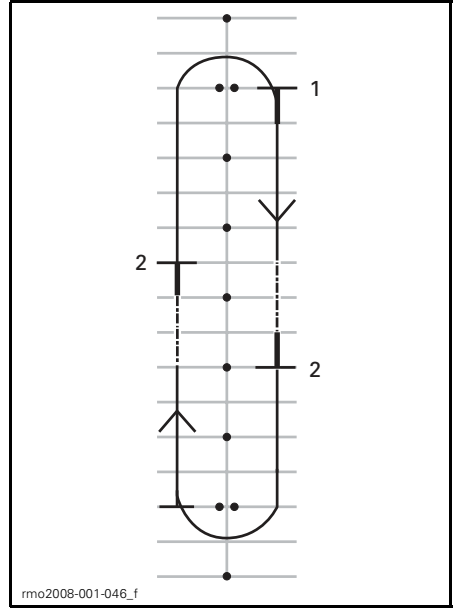

1. Start
2. Stop

### Tips for Additional Practice

- Practice checking your mirrors before braking hard.

## 6) Weaves

### Purpose

- Get more experience with the vehicle handling and rider position.

### Directions

#### 6 m (20 ft) Weave

1. Weave between every marker/intersection of every other parking spot. Keep your speed low initially as you get used to making the changes of direction.
2. Lean into each turn and turn the handlebar in the direction you want to go by pulling and pushing the grips.



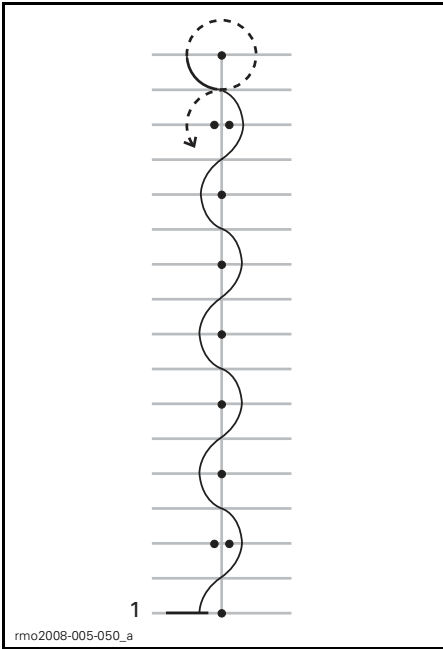

1. Start

### 12 m (40 ft) Weave

Once you're comfortable, try doing 12 m (40 ft) weaves between every other cone/every fourth parking space.

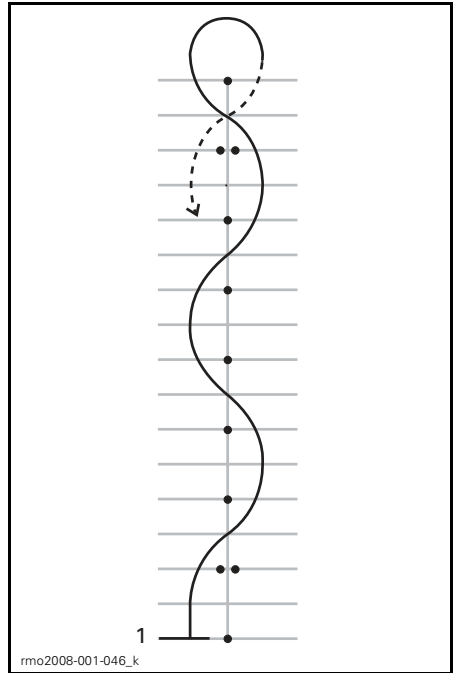

1. Start

### Tips for Additional Practice

- You can gradually increase speed as you get comfortable to 16 km/h - 19 km/h (10 MPH - 12 MPH) for the weaves, but slow down for the U-turns at the ends.

### 7) Shifting

When riding, you must change gears to match the engine speed with road speed. Lower gears are used for lower speeds and higher gears are used for higher speeds, just like on a manual transmission car or truck.

The SE5 will not allow you to upshift if the engine speed is too low. The SE5 will automatically downshift if the engine speed drops under 1800 RPM.

### Purpose

- Learn to upshift and downshift.

## Directions

This exercise is similar to what you did before, except now you will be upshifting on the straightaways, then coming to a stop at the end of each straightaway. You may want to use the parking lot aisles for this exercise rather than riding in the spaces.

### 7a) Practice Using the Gear Selector at a Stop

First, while stopped, practice to single shift between reverse, neutral and first gear. Then practice to:

- Double shift from reverse to first gear
- Double shift from first to reverse gear
- Repeat until you are comfortable.

### 7b) Upshifting from First into Second Gear

- In the straightaway, accelerate until the engine speed reaches 3000 RPM.
- Press the gear selector forward to shift into second gear. You do not have to release the throttle while shifting with the SE5.
- Once you are comfortable, if space allows, you can adjust the throttle to increase speed in second gear.

As you approach the end of the straightaway, come to a stop:

- Roll off the throttle.
- Apply brake.
- The SE5 will downshift automatically as the roadster slows. You can also manually downshift by pulling the gear selector towards you.

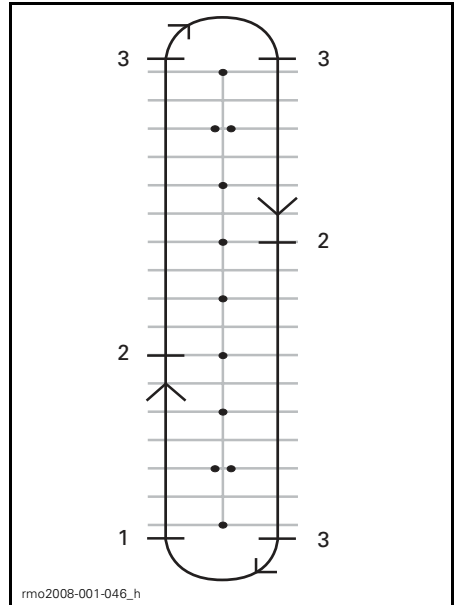

1. Start
2. Shift into second at 25 km/h (16 MPH)
3. Stop

### 7c) If Space Allows, Practice Downshifting into First While Moving

In the straightaway:

- Pull the gear selector toward you without releasing throttle.
- You will feel more engine braking when you downshift without throttle.

### 7d) Other Gears

If space allows, you can try shifting into and out of higher gears as well. Follow the same process and shift up or down one gear at a time.

**NOTE:** Applying slightly more throttle while downshifting can help the engine rev up to match vehicle speed more quickly and make the downshift smoother. When you do not apply throttle while downshifting, engine braking will slow the vehicle. This can help you decrease speed, but remember that VSS does not control engine braking. If you shift into too low a gear when you are at high speed, the rear tire can skid and you can lose control, spin out, tip or roll over, particularly in a curve.

### 8) Swerve

#### Purpose

- Become familiar with the vehicle’s handling for quick maneuvers.
- Try different variations of braking and swerving.

#### Directions

At this point you will need to change your course. Set up your markers as shown in the diagram below. Do not use any fixed or hard, heavy objects as markers for this exercise.

- Enter between the double cones at about 8 km/h (5 MPH) and maintain that speed throughout.
- Steer around the line of cones.
- Exit through the second set of double cones.
- Repeat the exercise multiple times, swerving in both directions.

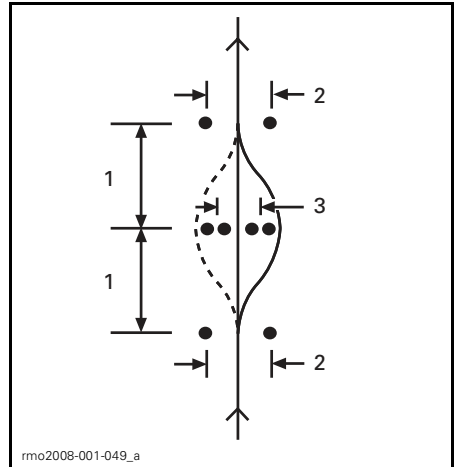

1. 6 m (20 ft)
2. 3 m (10 ft)
3. 2.5 m (8 ft)

#### Tips for Additional Practice

- You can gradually increase your entry speed (to no more than 13 km/h to 19 km/h (8 MPH to 12 MPH) and try some variations. For example, approach faster and slow before entering the exercise, apply brakes during the swerve, etc.
- A helper can add an element of surprise to the exercise by deciding which direction you should swerve, or if you should come to a stop instead. Have your helper stand at a safe distance away (e.g., beyond the end of your practice area). As you reach the first set of cones, the helper can use hand signals to indicate which direction to swerve or for you to stop.
- Practice checking your mirrors and blind spot before you swerve.

### 9) Operating in Reverse

#### Purpose

- Become familiar with the vehicle handling and turning radius in reverse.

**Directions**

- Shift into reverse. See *SHIFTING INTO REVERSE (SE5 MODEL)* (p. 26)
- Check that the area behind you is clear. Continue to look backwards. Be careful not to strike anything with your front wheels as you back up. Slow and stop by releasing throttle and using brake, just like when operating normally.
- Back for a few feet at time, stopping in between.
- Keep your speed low and do not back up for long distances.
- After you are comfortable with reverse, back into a parking space as shown in the diagram below.

Start by riding in less challenging situations:

- Short distances
- Good weather
- Low traffic
- Daytime
- Lower speeds
- No passenger.

You can gradually move on to more challenging riding situations as you develop your skills.

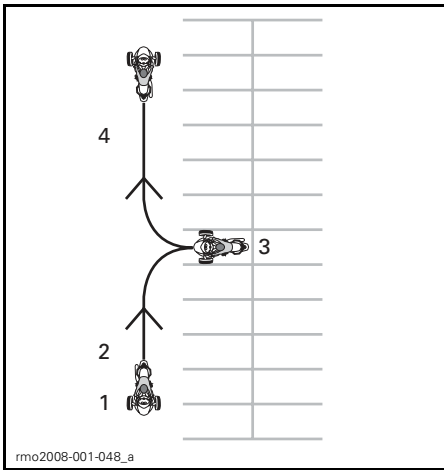

1. Start
2. Reverse
3. Stop
4. Forward

**Developing Advanced Riding Skills**

Once you have mastered basic riding skills, you can begin developing more advanced skills. First, learn the "Street Strategies" covered in the next section. Then you can take the vehicle on the road in relatively low-risk situations.

# STREET STRATEGIES

This section provides some strategies to reduce your risk on the road. Many of these strategies are similar to those used for motorcycles.

This section is based on guidance for motorcyclists given by the Motorcycle Safety Foundation (MSF). However, even experienced motorcyclists should read this section, as some strategies are different for the Spyder roadster.

## Plan your Trip

Always check weather conditions before riding the vehicle. Take appropriate gear for any weather you might encounter.

Plan a route and ride in conditions that are appropriate for your skill level.

The vehicle has a 25 L (6.6 U.S. gal.) fuel tank. When the low fuel indicator light flashes, fill fuel tank as soon as possible. Plan your refueling stops, particularly in unpopulated areas.

## Defensive Riding

As with a motorcycle, defensive riding can help you avoid crashes. You need to stay alert at all times. Never stop watching your surroundings, including the area behind you. Always scan for potential hazards, plan ahead, and leave space and time to avoid trouble. Do not assume other motorists will see you or follow the rules of the road.

## Following Distance

Always leave at least a two-second following distance between you and the vehicle in front of you when operating under ideal riding conditions. This means that you should pass any fixed point on the road at least two full seconds after the vehicle in front of you.

When conditions make braking distance longer, or visibility is limited, use a longer following distance for a greater margin of safety. For example, braking distance is longer on slippery

road surfaces, down hills, or when carrying more weight, and visibility may be limited in fog, in curves or at night.

## Scanning Ahead

In addition to leaving adequate following distance to the next vehicle, scan ahead and plan your path even farther in advance.

Plan your immediate path at least four seconds ahead. Watch this path for hazards, such as anything in the road or anything entering the road.

Scan ahead 12 seconds along your anticipated path to identify potential hazardous situations before they happen. For example, look for intersections where other vehicles may appear or places where pedestrians might enter the road. Be prepared to respond if a hazardous situation develops.

## Watch Behind and to the Sides

Vehicles and other hazards can approach from all directions. Constantly be aware of your surroundings. Check your mirrors frequently to see directly behind you. Also do frequent head checks (turn your head to look) to monitor your blind spot.

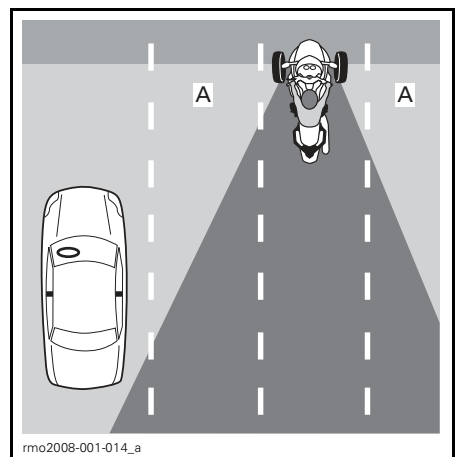

A. Operator's blind spots

When braking, be particularly aware of vehicles behind you that may not be able to stop as quickly as the Spyder roadster.

### Keep your Eyes Moving

To stay aware of your surroundings, do not fixate on any one thing. Move your eyes constantly to monitor the road, traffic control markings and devices and other vehicles. Look near and far, in all directions.

### Anticipate Trouble

Whenever you notice a potential hazard, plan a way to avoid it. This might mean adjusting your speed or lane position, or changing lanes. You should be ready for evasive maneuvers such as swerving and/or braking if something enters your path. Always leave time and space to react to trouble.

### Being Visible

Motorists tend not to see smaller vehicles like motorcycles. Therefore you should use strategies to become more visible.

### To Be More Visible to Other Motorists

#### Lighting and Reflectors

Make sure that the headlights, running lights and tail lights on your vehicle work properly. Your vehicle is equipped with reflectors on the fenders, sides, and back. Make sure that all reflectors are clean and not broken or missing.

Use your high beams whenever possible, both day and night. Use low beams to avoid blinding other motorists at night or when too much light reflects back, such as in fog.

#### Signals

Use your turn signals to inform others of your intentions. The Spyder roadster has automatic canceling turn

signals, but they may not cancel after shallow turns. Make sure turn signals are off after you have completed your maneuver; leaving them on may confuse other motorists.

When possible, flash your brake lights before slowing and when waiting at intersections, to alert motorists behind you.

Use your emergency flashers to make yourself visible when needed.

You can also use your horn to attempt to alert other motorists of your presence.

Do not assume that other motorists will notice your lights, signals or horn.

### Blind Spots

Avoid riding in the blind spots of other vehicles. Position yourself so that drivers ahead can see you in their mirrors. In some cases, such as when you are following a truck or a bus, you must be farther behind the vehicle in front of you.

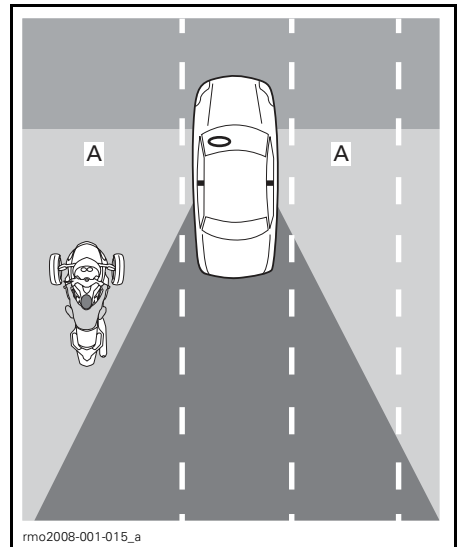

A. Blind spots of other vehicles

## Time of Day and Weather

In dim light, such as at night, at dawn or dusk, or in poor weather such as rain or fog, you may be harder to see. Glare at dawn and dusk or very bright sunlight can also make it harder for other motorists to see you.

## Clothing

Bright colors or reflective clothing can increase your visibility.

## Be Careful Even When Motorists See You

Even when motorists seem to notice you, they may still drive in a way that puts you at risk of a crash. Drive defensively, and don't rely on other motorists to operate their vehicles safely.

## Lane Position

Normally, position the Spyder roadster in the center of the lane. This position keeps the front tires in the lane. It also provides distance from vehicles in other lanes, reducing wind from large vehicles and reducing the risk of being struck by vehicles that leave their lane. This position also keeps your front wheels out of the slippery area in the middle of the lane, helping maintain braking and steering ability. If you are used to driving a car, remember that you are centered on the Spyder roadster, rather than seated to the side, so your perspective is different.

You can move to the left or right part of the lane, to avoid hazards, keep distance from other vehicles, or handle curves. You can also move to the left or right part of the lane to get a better view or to be seen by other vehicles. Because of the Spyder roadster center seat position and width, it may be harder to see around traffic, even when you are near the edge of the lane. You may need a greater following distance behind wide or tall vehicles. Avoid putting your wheel outside of the lane to see around traffic. In order

for drivers ahead to see you, you must be able to see their mirrors. When you are being followed by a large vehicle, passing vehicles may not be able to see you easily if you are not in the left part of the lane.

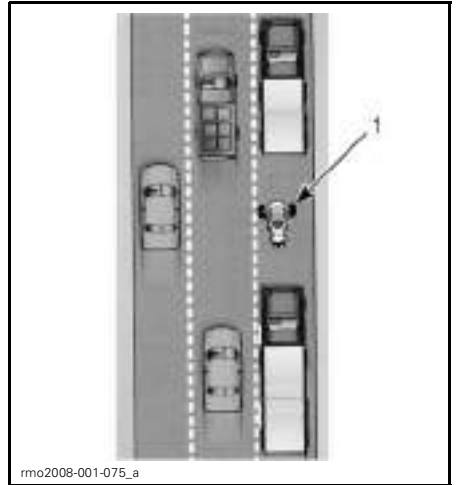

1. Vehicle in left portion of lane

Because the Spyder roadster is wider than a motorcycle, the range of lane positions is smaller. When riding in the left or right part of the lane be sure that the front wheels stay in the lane.

On multilane roads, choose a lane that is appropriate for your speed in the flow of traffic, and also consider your ability to see and be seen, and possible paths for evasive maneuvers (such as swerving into other lanes or onto the shoulder).

## Common Riding Situations

### Intersections

Intersections, including small intersections with alleys and driveways, present an additional risk due to the cross traffic. Always watch for traffic in all directions: behind, in front and to the left and right.

When stopping at an intersection, stop in the middle of the lane, even if you are preparing to turn. This can make you more visible and discourage other motorists from trying to drive around you. Watch for vehicles approaching from behind. Flash your brake lights as they approach. Be in first gear and be prepared to move if necessary to avoid a collision.

### Lane Changes and Passing

Remember that the Spyder roadster is wider than a motorcycle and needs more lateral space to pass another vehicle. Also remember that the vehicle is less visible than a car, so it is particularly important to signal your lane change well in advance and check your mirrors and blind spots. Be sure to turn off your turn signal after changing lanes; a lane change will not turn the handlebar far enough to automatically cancel the signal.

Never drive on the line between two lanes of traffic (split lanes). The vehicle is too wide.

Never drive on the shoulder to pass vehicles. If you put one wheel off the road, you can lose control.

### Turns

Remember to slow, look, and steer through turns.

- **Slow:** Reduce speed as needed before entering a turn by rolling off the throttle, using the brakes, and/or downshifting to a lower gear. Enter the turn at a speed that you can maintain throughout the turn.

Although the Spyder roadster is better able to brake while turning than a motorcycle, it is still important to slow down before you enter a turn or curve rather than braking in the turn. Braking and turning both require traction. The more traction you use for braking, the less there is available for turning at the same time.

When you take a turn or curve too fast, you may notice the inside front wheel lifting off the pavement and feel and hear VSS cutting back engine power. While VSS can help you maintain control, it is still possible to spin or roll over if you turn too hard and fast.

- **Look:** Search through the entire turn and keep your eyes moving. Evaluate the entire turn as soon as possible — surface characteristics, sharpness of the turn, and overall traffic conditions — so you have time to make decisions about speed and position. Sometimes turning your head in the direction of the turn helps to keep a good visual picture.
- **Steer:** Turn the handlebar to steer the vehicle in the direction of the turn. The Spyder roadster is not like a motorcycle, so it does not countersteer, and the vehicle does not lean. Remember, you will experience the lateral force generated by turning, so you may need to shift your body weight to the inside of the turn to keep a comfortable posture on the vehicle. You will need to exert more force to turn the handlebar of your vehicle than is needed to turn a motorcycle.



## SM5 Model

When shifting gears while turning, be careful not to release the clutch lever too fast. Adjust throttle as you release the clutch lever to match engine and vehicle speed in a smooth shift. Releasing the clutch too quickly or using too much throttle may cause the rear wheel to lose traction and start skidding, potentially causing loss of control. The Traction Control System (TCS) will detect the onset of wheel spin and reduce the power transmitted to the rear wheel. This intervention is intended to allow the rear wheel to regain traction and allow you to correct the unwanted oversteering to keep your vehicle on the intended turning radius.

## Curves

Because the Spyder roadster is narrower than a car, you can move from side to side in the lane in curves to straighten your path of travel. But the Spyder roadster is wider than a motorcycle, so less lateral movement is possible, and it is important to make sure that your front tires do not leave the lane.

For typical curves, an outside, inside, outside path is best.

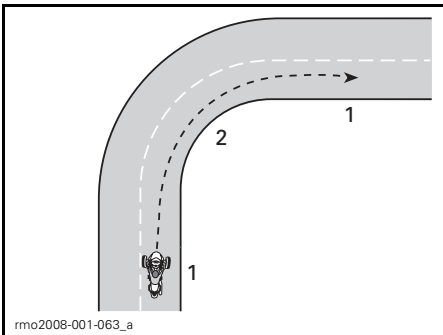

### PATH FOR TYPICAL CURVES

1. Outside
2. Inside (at the apex)

## Hills

Select an appropriate gear for the incline. Going up hills, a lower gear can help maintain enough power. Going down hills, a lower gear can provide engine braking to control your speed.

### SM5 Model

To start while on an incline, hold the vehicle in place with the brake until you move the clutch lever into the friction zone. Then smoothly release the brake as you release the clutch lever and apply throttle.

### SE5 Model

When stopped, the SE5 model can roll regardless of what gear it is in. The SE5 model centrifugal clutch is always disengaged when the vehicle is stopped, so the transmission will not hold the vehicle in place. Hold the brake pedal when stopped on an incline. To start while on an incline, hold the brake pedal as you increase throttle. Release the brake pedal as you feel the clutch engage (at about 1800 RPM).

## Night Riding

In addition to using your lights and signals to be seen by other motorists, consider your own ability to see at night. Use high beams when appropriate. Avoid overriding your headlight (riding so fast that you can't see as far as your stopping distance). You can also use other vehicles headlights to see the road ahead.

Do not use tinted or colored visors or lenses at night, and be particularly careful that your visor does not have scratches or smudges.

## Group Riding

Ride single file only. Never share lanes, even with a motorcycle.

When riding with motorcycles, maintain proper following distance from the motorcycle in front of you, even

if they are riding to one side of the lane. In curves, do not try to follow the path of motorcycles. Motorcycles can move farther to the edges of the lane in curves — if you follow them exactly, your front wheel can leave the lane. Motorcycles may be able to take curves faster than the Spyder roadster. Do not try to match their speed.

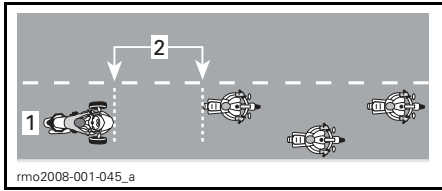

#### GROUP RIDING POSITION

1. Center of lane
2. Distance of 2 sec.

Particularly on curvy roads, Spyder roadster riders might become tired sooner than motorcyclists. Do not push yourself to keep up with motorcycles; stop if you are tired.

## Road Conditions and Hazards

### Ice, Snow and Slush

Do not ride on ice, snow or slush. Even with VSS, there will not be enough traction to maintain control on these slippery surfaces. The Spyder roadster is more likely than a car to spin out of control in slippery surfaces.

### Gravel, Dirt and Sand

On gravel, dirt, or sand-covered roads, use extra caution and reduce your speed, particularly for curves. These surfaces do not provide as much traction as paved surfaces and you can lose control, even with VSS.

### Wet Pavement and Puddles

There is normally enough traction to maintain control on pavement that is moist or wet, as long as there is not a layer of water on top of the pave-

ment (like a puddle or flowing water on the road). As with other vehicles, the Spyder roadster can hydroplane if you drive too fast over water that has accumulated on the road, but hydroplaning occurs at lower speeds than with most cars or motorcycles. You are more likely to hydroplane in deeper water. Watch for splashing or spraying when other vehicles go through water as an indicator of depth.

When hydroplaning occurs, one or more wheels rise up on a layer of water, losing contact with the road. If this happens to the rear wheel, you may feel it slide sideways. Hydroplaning wheels do not have the traction necessary to control the vehicle. You can lose control and spin out, and the VSS cannot keep you in control.

Avoid large water puddles or water streams, and slow down or pull off the road during heavy rains. If you must pass through water, slow down as much as possible before you reach it.

After passing through water, test your brakes. Apply them several times if necessary to let friction dry the brake pads.

Properly maintained tires reduce the risk of hydroplaning. Always maintain recommended tire pressure:

- **Front:**  
Nominal.: 103 kPa (15 PSI)  
Min.: 89 kPa (13 PSI)  
Max.: 117 kPa (17 PSI).
- **Rear:**  
Nominal.: 193 kPa (28 PSI)  
Min.: 179 kPa (26 PSI)  
Max.: 207 kPa (30 PSI).

**NOTE:** The pressure difference between the left and right side tire should not exceed 3.4 kPa (.5 PSI).

Immediately replace any tire that shows the maximum tread wear indicator (p.91) to minimize risk of hydroplaning.

The middle of a lane can be particularly slick in the first few minutes of rain, as oil and dirt combine with the water. After more rain, water can accumulate in ruts in worn pavement. Avoid both of these low traction areas. When possible, keep your front tires in areas with the best traction.

### **Off-Road Use**

Do not use the Spyder roadster off road. The vehicle cannot handle the rough, low-traction, uneven surfaces that you may encounter in off-road riding. You could easily get stuck, lose control or roll over. Also, it may be illegal for off-road use in certain areas.

### **Obstacles, Holes and Bumps**

Whenever possible, avoid riding over obstacles, holes and bumps. If you must ride over them, slow down as much as possible before you get there, then release the brake as you go over. For wide obstacles or bumps, approach straight on if possible, so that both front tires go over at the same time. When going over an obstacle, bump or hole with both front wheels, riders should stand up slightly on the pegs and use legs to absorb the shock. Be prepared for the rear wheel to strike the obstacle. For narrower obstacles, bumps or holes, it is better to ride over it with the rear tire. If you ride over them with a front tire, maintain a firm grip on the handlebar, take care not to accidentally applying the throttle and be prepared to correct your trajectory if necessary.

If you strike a large enough obstacle, bump or hole, the impact can make the vehicle jump and strike you, eject riders, make you lose control, spin or roll over.

If you can't come to a complete stop in time to avoid an obstacle, you can swerve to avoid it. You can swerve and brake at the same time if necessary.

If you encounter a large animal in the road, like a deer, it is best to stop before reaching it and wait until the animal leaves, or go past slowly. If a dog chases you, a good strategy is to slow down and downshift as the dog approaches, then accelerate away as you get closer to where the dog would intercept you.

### **On-Road Emergencies**

A vehicle malfunction or an unexpected situation can occur any time during a ride. A well-maintained vehicle can help reduce the risk of malfunction, but you should still be prepared for an emergency.

- Always have the Operator's Guide and tool kit in the vehicle.
- When stopping on the road, follow these precautions:
  - If the road has paved shoulders, signal your intention to pull off the highway, pull off at near traffic speed, then slow down to a complete stop.
  - If the shoulder is unpaved, signal a right turn and slow down to a safe speed before pulling off the paved roadway.
  - To increase your visibility, turn on the hazard warning lights.
- If you have cellular phone or other communication device, fully charge it before long rides.
- If you are involved in a crash, BRP strongly recommends that you have your vehicle transported (p.80) to the nearest Can-Am roadster dealer to have it thoroughly inspected for safety before riding again.
- Fill in the BRP accident/incident report.

### **Tire Failure**

If a tire failure or a blowout suddenly occurs, firmly grip the handlebar, gradually slow down and carefully steer to a safe place to stop. Avoid hard braking,

downshifting, or sharp steering. If a front tire fails, the vehicle may tend to pull in the direction of the failed tire, so you will need to maintain a firm grip on the handlebar to control your direction. See *FLAT TIRE* (p. 107) for instructions on tire repair.

# CARRYING A PASSENGER OR CARGO

## Weight Limits

Do not exceed the weight limits for riders and cargo.

WEIGHT LIMITS	
Vehicle load limit (including operator, passenger, cargo and added accessories)	200 kg (441 lb)
Front storage compartment	16 kg (35 lb)

Excess weight will:

- Reduce your ability to accelerate, brake and turn.
- Reduce the effectiveness of the VSS.
- Increase the risk of rolling over if the weight is high or toward the rear.
- Reduce ground clearance, increasing the risk of striking low obstacles or uneven road surfaces.
- Increase the risk of tire failure.

## Operating with Extra Weight

Carrying a passenger or heavy cargo affects the way the vehicle handles because of the greater weight, and because the weight distribution will be different.

1. You will not be able to accelerate as quickly. Allow more time and space for passing.
2. You will not be able to stop as quickly. Use a longer following distance from the vehicle in front of you, at least three seconds. Use an even longer distance if riding conditions are not ideal (e.g., low visibility, poor road surface).

3. You will not be able to turn as sharply or at as high a speed. Slow down more than usual before turning and avoid sharp turns.
4. The Spyder roadster may be less stable. There is a greater risk of tipping or rolling during extreme maneuvers with weight that is higher or farther to the rear (like a passenger).

## Carrying a Passenger

The Spyder roadster is designed for only one passenger, seated behind the operator. Never carry multiple passengers.

Do not carry a passenger until you have experience riding alone in a variety of conditions and can proficiently handle the vehicle.

The passenger must be sober, alert, able to reach the passenger footpegs and handholds, maintain balance and hold on in sudden maneuvers, and not distract the operator.

Be sure the passenger is wearing appropriate protective gear. The passenger should wear all of the protective gear recommended for the operator, particularly a helmet. A full-face helmet is recommended; in a sudden stop, the passenger's face can strike the back of the operator's helmet.

Keep the brakes applied and the transmission in neutral until the passenger is in riding position.

Instruct the passenger on how to ride before starting out. Have the passenger follow these rules:

1. Maintain proper riding position. Hold the passenger handholds and keep feet on the passenger footpegs at all times, even with the accessory backrest. The passenger should not hold on to the operator as the operator may not be able to withstand the lateral force generated by both. Different gripping positions on the

handholds may be more comfortable for different maneuvers. (e.g., one hand at the front corner of and one hand at the opposite back corner for turns, both hands further forward or back for other situations).

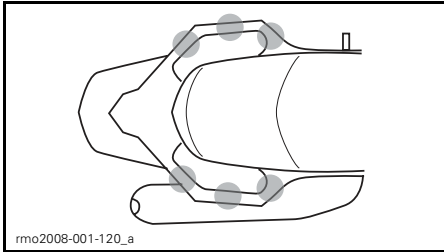

**DIFFERENT GRIPPING POSITIONS ON THE HANDHOLDS**

- Never touch the parking brake pedal with your left foot. Engaging the parking brake while the vehicle is moving can cause a crash.
- Stay clear of the exhaust pipe, the rear wheel and the drive belt.
- Avoid turning around or leaning except to keep balance in a turn. In an unexpected maneuver, a passenger who is not in the normal riding position is more likely to fall off.
- Watch the road and respond to upcoming road conditions. Lean into curves as needed to resist any sideways force. When crossing an obstacle, hole or bump, rise slightly off the seat without locking your elbows.

Avoid abrupt acceleration, braking and turns, especially with inexperienced passengers. Sudden, unexpected maneuvers can make the passenger fall off.

## Where to Store Cargo

You can carry cargo in the front storage compartment. Do not carry cargo in any other location unless the vehicle is equipped with approved BRP accessories.

## Front Storage Compartment

The front storage compartment has room to store light objects, such as two helmets. Do not put more than 16 kg (35 lb) in the front storage compartment, even if the items fit. Never store flammable items, such as fuel, in the front storage compartment. A front storage compartment liner is available. The front storage compartment includes a designated space for this Operator's Guide and a tool kit.



- Tool kit
- Operator's guide

Make sure the front storage compartment latch is secure before riding.

## No Towing

Do not tow anything with the vehicle. The VSS will not be effective, and you will be more likely to lose control.

---

# KNOWLEDGE SELF-TEST

The following provides a sample of information that you should have learned by reading this guide. It does not include all of the important information, but should give you an idea of whether you have a general understanding of the vehicle and its operation.

See p. 71 for answers.

## Questionnaire

1. If you need to stop quickly, press both the brake pedal and the parking brake.

True                      False

2. A pre-ride inspection should be performed once a week.

True                      False

3. VSS allows you to use the vehicle in any kind of weather.

True                      False

4. You should only replace the tires with those approved by BRP obtained from an authorized Can-Am roadster dealer.

True                      False

5. It is important for the passenger to be alert and sober.

True                      False

6. Name six items of protective gear that can reduce your risk of injury.

- 1) \_\_\_\_\_
- 2) \_\_\_\_\_
- 3) \_\_\_\_\_
- 4) \_\_\_\_\_
- 5) \_\_\_\_\_
- 6) \_\_\_\_\_

7. Protective gear is important for preventing and reducing injuries, keeping you comfortable, and providing protection against the elements.

True                      False

8. Which of the following is not one of the vehicle driving controls?

- a. Handlebar
- b. Twist throttle
- c. Front brake lever

9. You should leave your low beam lights on during the day for added visibility.

True                      False

10. You should normally position the vehicle in the center of the lane.

True                      False

11. Unlike a typical motorcycle, you should make it common practice to brake and turn at the same time.

True                      False

12. Under normal conditions, following distance should be at least \_\_\_\_\_.

- a. 1 second
- b. 2 seconds
- c. 3 seconds

13. You should not store flammable liquids such as gasoline in the front storage compartment, even if they are in approved containers.

True                      False

14. List 5 ways of being more noticeable to other drivers.
- 1) \_\_\_\_\_
  - 2) \_\_\_\_\_
  - 3) \_\_\_\_\_
  - 4) \_\_\_\_\_
  - 5) \_\_\_\_\_
15. When braking on surfaces with less than ideal traction, you should pump the brakes to help maintain control of the vehicle.
- True                      False
16. The vehicle's maximum load including riders, cargo and accessories is 200 kg (441 lb).
- True                      False
17. The vehicle can safely tow a trailer as long as the tongue weight does not cause the overall load to exceed 200 kg (441 lb).
- True                      False
18. A passenger should hold onto the operator.
- True                      False
19. Riding the Spyder roadster is as safe as riding in a car.
- True                      False
20. ABS allows you to press the brake pedal hard without locking the brakes.
- True                      False



## Answers

1. **False**  
To stop quickly, press the brake pedal only. Never use the parking brake while the vehicle is moving.
2. **False**  
You should do a pre-ride inspection every time you ride.
3. **False**  
If there is ice, snow, slush or enough water on the road to cause hydroplaning, VSS can not help you maintain control.
4. **True**
5. **True**
6.
  - 1) Helmet
  - 2) Eye and face protection
  - 3) Jacket with long sleeves
  - 4) Gloves
  - 5) Long pants
  - 6) Closed-toe footwear, preferably over the ankle.
7. **True**
8. **c. Front brake lever**  
The vehicle does not have a front brake lever.
9. **False**  
You should use your high beams during the day.
10. **True**
11. **False**  
You can brake and turn at the same time if you need to, but generally it is better to brake before the turn.
12. **b. 2 seconds**  
Under normal conditions, following distance should be at least two seconds.
13. **True**
14.
  - 1) Make sure your lights and reflectors are clean.
  - 2) Use your high beams whenever possible.
  - 3) Use your turn signals.
  - 4) Flash your brake lights before slowing.
  - 5) Use your emergency flashers as needed.
  - 6) Use your horn to alert others of your presence.
  - 7) Avoid riding in blind spots.
  - 8) Wear bright colors and reflective clothing.
15. **False**  
You should press and hold the brake pedal, not pump. The vehicle is equipped with ABS, which keeps the wheels from locking.
16. **True**
17. **False**  
You should never tow a trailer with the vehicle.
18. **False**  
The passenger should always hold on to the handholds.
19. **False**  
In cars and trucks, the structure of the vehicle provides protection. In addition, passengers can protect themselves by wearing seat belts. You should expect that riding the Spyder roadster is much riskier than riding in a car and that the risk of injury is more like the risk of injury when riding a motorcycle.
20. **True**

---

# SAFETY INFORMATION ON THE VEHICLE

This vehicle comes with a hang tag and labels containing important safety information.

Any person who rides this vehicle should read and understand this information on the vehicle before riding.

## Hang Tag

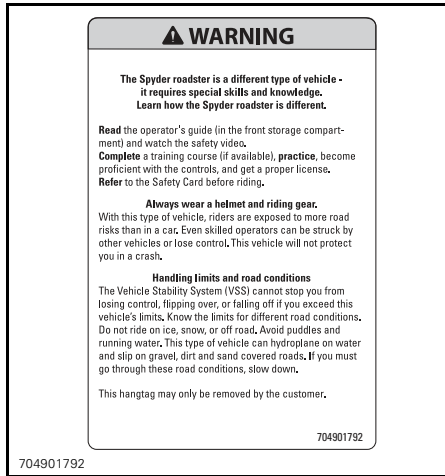

## Safety Card

The Safety Card is found at the top of the multifunction gauge cluster. Pull it out to read it, and be sure to securely put it back before riding.

Use the Safety Card to review key information and when you are teaching new operators and passengers how to ride the vehicle. It also includes frequently referenced information, such as tire pressure, weight limits and a pre-ride inspection checklist.

**NOTE:** The following illustration used in this Operator's Guide is a general representation only. Your model may differ.

**⚠ WARNING**

The Spyder roadster is a different type of vehicle - it requires special skills and knowledge.

Learn how the Spyder roadster is different. Read the operator's guide (in front storage compartment) and watch the safety video.

Complete a training course (if available), practice, become proficient with the controls, and get a proper license. Do the following procedures before each ride.

**Check road conditions.**

The Vehicle Stability System (VSS) cannot stop you from losing control, flipping over, or falling off if you exceed this vehicle's limits.

Know the limits for different road conditions.

- Do not ride on ice, snow, or off road.
- Avoid puddles and running water. This type of vehicle can hydroplane on water and slip on gravel, dirt and sand covered roads. If you must go through these road conditions, slow down.

**Wear a helmet and riding gear.**

With this type of vehicle, riders are exposed to more road risks than in a car. Even skilled operators can be struck by other vehicles or lose control. This vehicle will not protect you in a crash.

**Instruct the passenger.**

- Always hold handholds and keep feet on pegs.
- Watch the road. Lean into curves. Brace for bumps.
- Never touch the parking brake.

**Always keep in mind:**

- Brake with the foot pedal. Never apply parking brake while moving - you could lose control and crash.
- Steer in the direction of a turn; do not countersteer.
- Keep all wheels in your lane, ride always in single file, and don't split lanes.

**Pre-ride Inspection**

- ✓ Tires and wheels (no damage, recommended pressure front 15 psi, rear 28 psi, tread, lugnuts)
- ✓ Drive belt (aligned, no damage)
- ✓ Leaks (under vehicle)
- ✓ Lights and reflectors (clean, no damage, working)
- ✓ Cargo and latches (secured)
- ✓ Weight max. 440 lbs (200 kg) = operator + 1 passenger + cargo + accessories
- ✓ Mirrors (clean and adjust)
- ✓ Gauge cluster (gauges, indicators, messages)
- ✓ Fuel level
- ✓ Controls (brake, throttle, clutch, switches, steering)

704901347C

704901347

**SAFETY CARD**

rmo2008-001-112\_a



rmo2008-001-113

**SAFETY CARD PULLED OUT**

1. Safety card tab location

## Safety Labels

The following labels are on your vehicle, and they should be considered permanent parts of the vehicle. If missing or damaged, they can be replaced free of charge. See an authorized Can-Am roadster dealer.

**NOTE:** The following illustrations used in this Operator's Guide are a general representation only. Your model may differ.

### Label 1

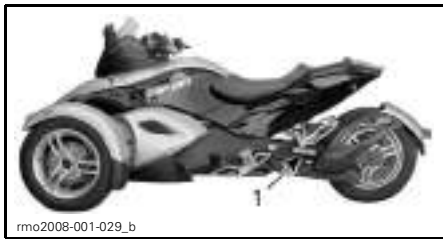
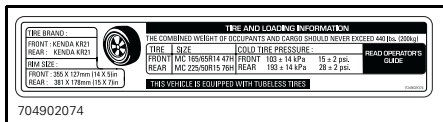

TYPICAL

1. Label 1 location

### Label 2

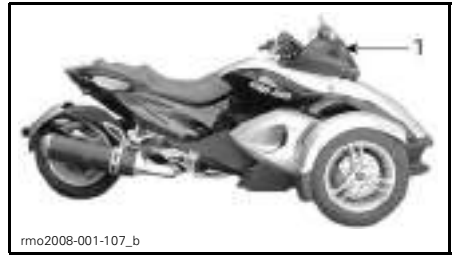
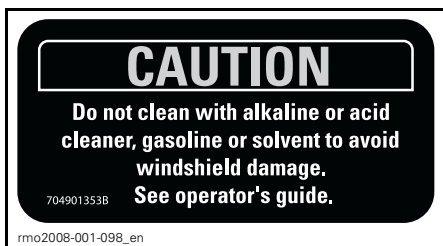

1. Label 2 location

### Label 3

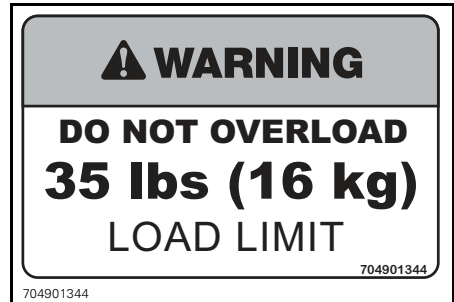

1. Label 3 located in the front storage compartment

**Label 4****CAUTION**Checking Engine Oil Level

- Make sure engine is at operating temperature.
- Roadster must be on a level surface.
- Let engine running at idle for at least 30 seconds.
- Stop engine & wipe the dipstick.
- Dipstick must be screwed in completely before checking oil level.
- Use XPS synthetic blend oil (summer grade) or an equivalent motorcycle oil.

704902096

704902096



rmo2008-003-004\_a

1. Label 5 located underneath service cover

**Label 6****⚠ WARNING**

Clean filler cap before removing.  
Use only DOT 4 brake fluid from  
a sealed container.

704901803

704901803

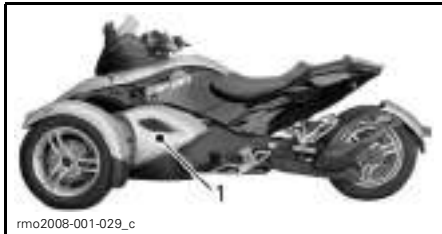

rmo2008-001-029\_c

1. Label 4 located on the oil tank behind the left middle side panel

**Label 5**

rmo2008-003-003

COOLANT RESERVOIR CAP



rmo2008-001-040\_b

1. Label 6 located underneath seat

---

## REPORTING SAFETY DEFECTS

Your safety is very important to Bombardier Recreational Products Inc. (BRP). If you have any concerns you should immediately contact BRP's customer service.

In the USA, if you believe that your vehicle has a defect which could cause a crash or could cause injury or death, you should immediately inform the National Highway Traffic Safety Administration (NHTSA) in addition to notifying Bombardier Recreational Products Inc.

If NHTSA receives similar complaints, it may open an investigation, and if it finds that a safety defect exists in a group of vehicles, it may order a recall and remedy campaign. However, NHTSA cannot become involved in any individual problems between you, your dealer or Bombardier Recreational Products Inc.

To contact NHTSA you may either call the Vehicle Safety Hotline toll-free at 888-327-4236 (TTY: 1 800-424-9153) or go to our website: **[www.safercar.gov](http://www.safercar.gov)** or write to:

Administrator  
NHTSA  
400 7<sup>th</sup> Street SW  
Washington, DC 20590

You can also obtain other information about motor vehicle safety from the the website **[www.safercar.gov](http://www.safercar.gov)**.

# ***PRE-RIDE INSPECTION***

# PRE-RIDE CHECKLIST

## WARNING

Perform a pre-ride inspection before each ride to detect potential problems during operation. The pre-ride inspection can help you monitor wear and deterioration before they become a problem. Correct any problems that you discover to reduce the risk of a breakdown or crash. See an authorized Can-Am roadster dealer as necessary.

There is a pre-ride inspection checklist on the Safety Card.

### Inspect:

- **Tires:** Look for damage, incorrect inflation and excessive tread wear. Refer to *TIRES* (p. 91).
- **Wheels and lugnuts:** Look for damage. Twist each front wheel lugnut by hand to be sure it is not loose. Be sure the rear wheel axle nut is in place.
- **Drive belt:** Look for fraying, cuts, punctures and missing teeth. Verify alignment. For additional information, refer to *DRIVE BELT* (p. 92).
- **Leaks:** Look under the vehicle for any leaks.
- **Front storage compartment cover:** Pull to check that it is properly latched.
- Ensure seat is properly latched.
- **Mirrors:** Clean and adjust (p. 22).
- **Brake pedal:** Press and make sure you feel firm resistance. Pedal must fully return when released.
- **Throttle handle:** Twist several times. Be sure it operates freely and returns to idle position when released.
- **Clutch lever:** (SM5 model): Adjust to your convenience (p. 12). Squeeze to be sure it operates normally and fully returns when released.

- **Gearshift selector (SE5 model):** Be sure gearshift selector operates normally in both directions and returns to center when released.
- **Weight:** Ensure that total load on the vehicle (including operator, passenger, cargo and added accessories) does not exceed 200 kg (441 lb).

### Turn Ignition Key to the ON Position:

- **Multifunction gauge cluster:** Check the gauges, indicators, messages and the fuel level.
- **Lights:** Check operation of headlights, tail light, brake light, turn signals and hazard warning lights.
- **Horn:** Check operation.
- **Steering:** Start engine and verify that steering operates freely.
- **Engine stop switch:** Check that the engine stop switch is working properly.
- **Parking brake:** Start engine, release parking brake and ensure parking brake indicator is off on the multifunction gauge cluster.
- **Brake:** Drive forward slowly a few feet then apply brake to test.

Always lock Safety Card back into position.



# ***TRANSPORTING AND STORING***

# TRANSPORTING THE SPYDER ROADSTER

If your vehicle needs to be transported, it should be carried on a flatbed trailer of the proper size and capacity.

**CAUTION** If you need to push the vehicle, do it from the right-hand side to be able to reach the brake pedal.

When pulling the vehicle backwards, be careful that the front wheel does not roll over your feet.

**NOTICE** Do not tow the Spyder roadster — towing can seriously damage the vehicle's drive system.

When contacting a towing or transporting service, be sure to ask if they have a flatbed trailer, loading ramp or power ramp to safely lift the vehicle and tie-down straps. Ensure the vehicle is properly transported as specified in this section.

**NOTICE** Avoid using chains to tie the vehicle — they may damage the surface finish or plastic components.

To load the vehicle for transport, proceed as follows:

1. Shift the vehicle into NEUTRAL (N).
2. Remove the key from the ignition switch.
3. Put a strap around the lower arm of each front suspension.



1. Strap
2. Lower suspension arm

4. Attach the straps to the winch cable. If possible, use chains or additional straps to attach the straps to the winch cable as indicated below to avoid damaging the bumper cover.

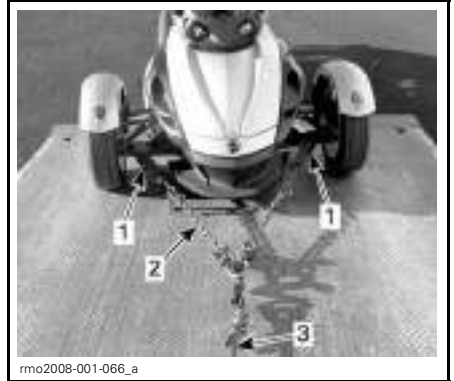

1. Strap around front suspension lower arms
2. Chains to avoid damaging the bumper cover
3. Winch cable

5. Ensure that the parking brake is released.
6. Pull the vehicle on the flatbed trailer with the winch.
7. Engage the parking brake.
8. Ensure that the vehicle's gear is in NEUTRAL (N).
9. Strap the front tires by using one of the following methods indicated below.



## FRONT WHEELS ATTACHMENT — METHOD 1

1. Strap around the rim of each front wheel and attached to the front of trailer



#### FRONT WHEELS ATTACHMENT — METHOD 2

1. Strap around each wheel and fixed to the front and rear of trailer
10. Pass a tie-down strap inside the rear wheel rim only. Do not pass the tie-down strap inside the rear sprocket.

**NOTICE** Passing the tie-down strap inside the rear sprocket may seriously damage the drive system.

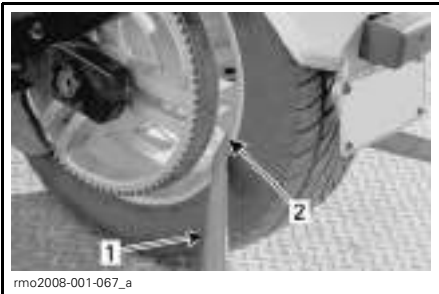

#### REAR WHEEL ATTACHMENT

1. Tie-down strap
  2. Inside rear wheel rim ONLY
11. Firmly attach the rear wheel tie-down strap to the rear of the trailer with a ratchet.
  12. Ensure that both the front and rear wheels are firmly attached to the trailer.



1. Front and rear wheel firmly attached to trailer

---

## STORING THE SPYDER ROADSTER

If the vehicle will not be ridden for at least four months, such as during the winter, proper storage is necessary to keep the vehicle in good condition.

BRP recommends you have your authorized Can-Am roadster dealer fully prepare your vehicle for storage. Or, at your convenience, you can follow the basic procedures below.

### **To Prepare the Vehicle for Storage:**

1. Inspect vehicle and have your authorized Can-Am roadster dealer repair any problems if necessary.
2. Change the engine oil and filter (p. 99). Go to an authorized Can-Am roadster dealer if necessary.
3. Check engine coolant (p. 99), brake fluid (p. 99) and clutch fluid (p. 101) levels.
4. Fill the fuel tank, add fuel stabilizer and run the engine to prevent the tank from rusting and the fuel from deteriorating. Strictly follow instructions on fuel stabilizer container.
5. Inflate all tires to their recommended pressure (p. 91).
6. Clean the vehicle (p. 102).
7. Lubricate all control cables and latches, pivoting points of all levers and lubrication points of front suspensions.
8. Close and latch all storage compartments.
9. Cover the vehicle with a permeable materials (e.g., tarpaulin). Avoid using plastic or similar non-breathing, coated materials that restrict air flow and allow heat and moisture to accumulate.
10. Store the vehicle in a dry area, away from sunlight, with a small amount of daily temperature variation.
11. Slow charge the battery once a month (p. 100) at the recommended charging rate of 2 A. It is not necessary to remove the battery.

### **To Remove the Vehicle from Storage:**

1. Uncover and clean the vehicle (p. 102).
2. Charge the battery if needed (p. 100).
3. Perform a pre-ride inspection (p. 78), then test-ride the vehicle at low speed.

# ***MAINTENANCE***

# MAINTENANCE SCHEDULE

Maintenance is very important for keeping your vehicle in safe operating condition. Proper maintenance is the owner's responsibility. Perform periodic checks and follow the maintenance schedule. The maintenance schedule does not exempt the pre-ride inspection.

## WARNING

Failure to properly maintain the vehicle according to the maintenance schedule and procedures can make it unsafe to operate.

### PERIODIC MAINTENANCE SCHEDULE

A: Adjust C: Clean I: Inspect L: Lubricate R: Replace	Initial inspection 1 000 km (600 mi)					
	Every 5 000 km (3,000 mi)					
	Every 10 000 km (6,000 mi) or 1 year					
	Every 20 000 20 000 km (12,000 mi) or 2 years					
	To be performed by			Note		
<b>ENGINE</b>						
Engine oil and oil filter	R	R			Customer	Check oil level every 500 km (300 mi)
Oil tank strainer	I, C			I, C	Dealer	Inspect and clean if necessary
Transmission oil filter (SE5 model)	R			R	Customer	
Valve clearance				A	Dealer	Inspect first at 10 000 km (6,000 mi)
Air filter				I R	Dealer	
Air filter housing				C	Customer	Wipe off any oil in housing
Clutch fluid (SM5 model)				I R	I: Customer R: Dealer	
Engine coolant	I	I		R	Dealer	
Radiator, hoses and water pump				I	Dealer	Condition, leak and cleanliness
Radiator cap/cooling system pressure test				I	Dealer	
Exhaust "Y" pipe front gaskets				R	Dealer	
Reverse mechanism (SM5 model)				A	Dealer	

PERIODIC MAINTENANCE SCHEDULE						
A: Adjust C: Clean I: Inspect L: Lubricate R: Replace	Initial inspection 1 000 km (600 mi)					
	Every 5 000 km (3,000 mi)					
	Every 10 000 km (6,000 mi) or 1 year					
	Every 20 000 20 000 km (12,000 mi) or 2 years					
	To be performed by			Note		
<b>ELECTRONIC MANAGEMENT SYSTEMS</b>						
Fault codes	I		I		Dealer	
Wheel speed sensor			I		Dealer	Adjust every time rear wheel is loosened
Passenger switch			I		Dealer	
<b>FUEL SYSTEM</b>						
Throttle body			I, C, A		Dealer	
Throttle cable			L		Dealer	
Fuel hoses			I		Dealer	
Fuel filter	Replace every 5 years or 30 000 km (19,000 mi)				Dealer	
<b>ELECTRICAL SYSTEM</b>						
Spark plugs	I		I	R	Dealer	
Battery connections			I, C		Dealer	
Lighting system (Brake light, hazard warning lights, turn signal lights, position lights, license plate light)			I		Customer	
<b>DRIVE SYSTEM</b>						
Drive belt	I, A		I, A		Dealer Customer	Inspect wear, alignment and tension (p. 93)
Rear sprocket bearing				I	Dealer	Replace every 50 000 km (31,000 mi)
Rear axle bearings				I	Dealer	
Bearing seals, O-rings and wear sleeves of rear axle				R	Dealer	

**PERIODIC MAINTENANCE SCHEDULE**

A: Adjust C: Clean I: Inspect L: Lubricate R: Replace	<b>Initial inspection 1 000 km (600 mi)</b>					
	<b>Every 5 000 km (3,000 mi)</b>					
	<b>Every 10 000 km (6,000 mi) or 1 year</b>					
	<b>Every 20 000 20 000 km (12,000 mi) or 2 years</b>					
	<b>To be performed by</b>			<b>Note</b>		

**TIRES/WHEELS**

Tires	Inspect tread wear and pressure before each ride (p.91)				Customer	
Wheel bearings				I	Dealer	
Front wheel nuts		I			Dealer	
Rear wheel nut			I		Dealer	

**STEERING**

Steering play				I	Dealer	
Tie rod				I	Dealer	
Front wheel alignment				I	Dealer	

**SUSPENSION**

Shock absorbers				I	Dealer	
Front suspension arms	L			L	Dealer	
Ball joints				I	Dealer	

**BRAKES**

Brake fluid			I	R	I: Customer R: Dealer	
Brake pads and discs		I			Customer	
Brake hoses			I		Dealer	
Parking brake	I, A	I, C, A			Dealer	

**BODY/FRAME**

Passenger handholds		I			Customer	Check solidness
Footpegs			L		Customer	Use multi-purpose lubricant
Plastic parts fasteners			I		Customer	Check solidness
Storage compartment latch	I		I, L		Customer	Use CABLE LUBRICANT (P/N 293 600 041) or the equivalent.



---

# INITIAL INSPECTION

We recommend that after the first 1 000 km (600 mi) of operation, your vehicle be inspected by an authorized Can-Am dealer. The initial maintenance is very important and must not be neglected.

**NOTE:** The initial inspection is at the expense of the vehicle owner.

We recommend that this inspection be signed by an authorized Can-Am dealer.

---

Date of initial inspection

---

Authorized dealer signature

---

Dealer name

# MAINTENANCE PROCEDURES

This section includes instructions for basic maintenance procedures. If you have the necessary mechanical skills and the required tools, you can perform these procedures. If not, see your authorized Can-Am roadster dealer.

Other important items in the maintenance schedule that are more difficult and require special tools are best performed by your authorized Can-Am roadster dealer.

## WARNING

Turn off the engine and follow these maintenance procedures when performing maintenance. If you do not follow proper maintenance procedures you can be injured by hot parts, moving parts, electricity, chemicals or other hazards.

## Tool Kit

The tool kit is located inside the front storage compartment, on the left-hand side of the vehicle.



1. Tool kit located in the front storage compartment

It contains the tools for the basic maintenance in this Operator's Guide.

## Body Panels

The body panels on the left side of the vehicle can be removed for maintenance.

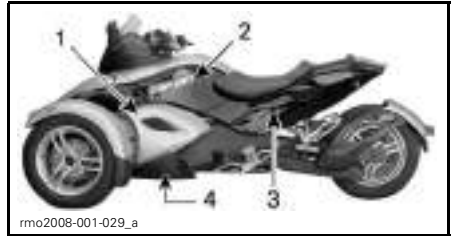

### LEFT HAND SIDE PANELS

1. Middle side panel
2. Top side panel
3. Rear side panel
4. Bottom side panel

### 1) Middle Side Panel



1. Middle side panel

### Removal

1. Unscrew 3 clips.



1. Middle side panel clips

2. Press down panel's top edge with both hands and pull out.



- Step 1: Press down top edge*  
*Step 2: Push top edge under top side panel's edge*

3. Lift panel.

### Installation

1. Insert the middle side panel tabs into the lower side panel slots.

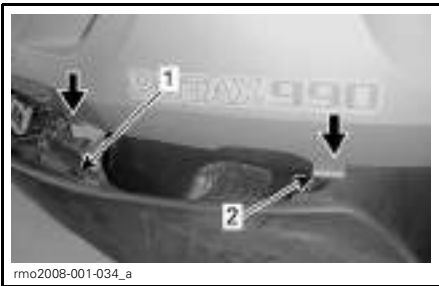

1. Lower side panel's slot
2. Middle side panel tab

2. Press down panel's top edge with both hands and push in. While pressing, ensure that the lower tabs remain in the slots.

3. Secure panel by pushing and turning each clip clockwise (1/4 turn) to its maximum rotation.

Clip is properly fixed when a small amount of force is required while turning clip.  
 Clip is not properly fixed when clip is loose while turning.



### 2) Top Side Panel

#### Removal

1. Unlatch and lift seat.
2. Unscrew 4 Torx screws.



1. Top side panel Torx screws

## Installation

1. Screw 4 Torx screws.

**NOTICE** Do not overtorque. Any deformation on the panel around the screw is an indication that it is too tight. You may damage the panel.

### 3) Rear Side Panel

#### Removal

1. Unlatch and lift seat.
2. Remove top side panel.
3. Unscrew Torx screws.



1. Torx screws
2. Plastic rivets

4. Remove plastic rivets as indicated below.

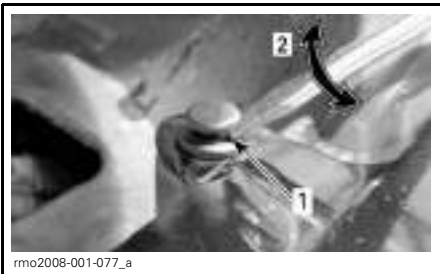

1. Flat head screwdriver under rivet head
2. Turn screwdriver 1/4 turn

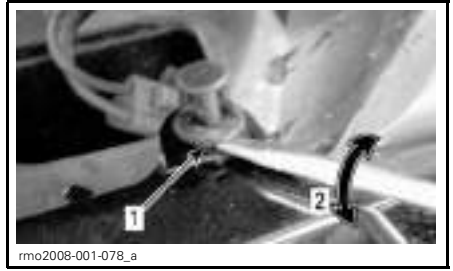

1. Flat head screwdriver under rivet
2. Turn screwdriver 1/4 turn

5. Disconnect left turn signal housing connectors.

#### Installation

1. Connect left turn signal housing connectors by matching the correct wire color.
2. Install plastic rivets and screw in Torx screws.

**NOTICE** Do not overtorque. Any deformation on the panel around the screw is an indication that it is too tight. You may damage the panel.

### 4) Lower Side Panel

#### Removal

1. Remove middle side panel (p. 88).
2. Remove top side panel (p. 89).
3. Remove rear side panel (p. 90).
4. Unscrew 3 Torx screws.



1. Bottom panel Torx screws
2. Screw located at the front of bottom panel

#### Installation

1. Screw 3 Torx screws.

**NOTICE** Do not overtorque. Any deformation on the panel around the screw is an indication that it is too tight. You may damage the panel.

## Tires

### WARNING

Tires that are not the recommended type, damaged, worn down below the minimum tread wear limit indicator or improperly inflated can cause loss of control. New tires will not operate at their maximum efficiency until their break-in is completed. Braking, steering and VSS performance may be reduced, so use extra caution. Tires take about 300 km (200 mi) of riding with frequent braking to break-in. For riding with infrequent braking, allow extra time to break-in the tires.

The tires have been specifically designed for the Spyder roadster. Use only the BRP recommended tires, which can be ordered only from an authorized Can-Am roadster dealer.

### Tire Pressure

Check pressure when tires are cold before using the vehicle. Tire pressure changes with the air temperature. Recheck pressure if temperature has changed (e.g., significant weather change, driving in the mountains).

COLD TIRE PRESSURE RECOMMENDATION	
FRONT	
Nominal	103 kPa (15 PSI)
Minimum	89 kPa (13 PSI)
Maximum	117 kPa (17 PSI)
REAR	
Nominal	193 kPa (28 PSI)
Minimum	179 kPa (26 PSI)
Maximum	207 kPa (30 PSI)

**NOTE:** The pressure difference between the left and right side tire should not exceed 3.4 kPa (.5 PSI).

For your convenience, an electronic pressure gauge is supplied in the tool kit.

### Tire Damage

Check all tires for:

- Cuts, slits and cracks in the tires.
- Bumps or bulges in the side of the tire or the tread.
- Nails or other foreign objects in the side of the tire or tread.
- Air leaks (hissing sound) caused by an ill-fitting rim or a faulty tire valve.

If any of the above occurs, have the tire repaired or replaced as soon as possible by an authorized Can-Am roadster dealer.

### Tire Tread Wear

Check minimum tread depth by using the tread-wear indicators (hard rubber bars molded at the base of the tread; 1 in figure below). Check in three locations across the tire tread:

- Outer edge
- Center
- Inside edge.

The tread-wear indicators will appear across the treads that have been worn down to the minimum tread depth. When at least one tread-wear indicator appears across the tread, have the tire replaced as soon as possible by an authorized Can-Am roadster dealer.

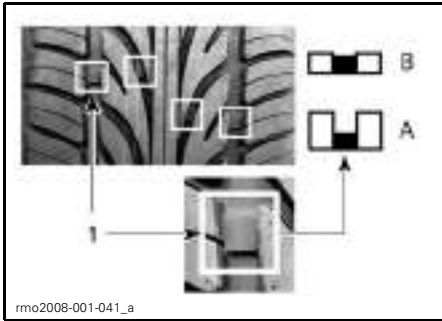

**TIRE TREAD WEAR**

1. Tread-wear limit indicator

A. Appropriate tread depth

B. Minimum tread depth, replace tire

It is normal to see uneven wear on tires depending on how the vehicle is driven and road conditions. The front tires external or internal edges and the rear tire center tread will wear unevenly depending on if the vehicle is driven smoothly or aggressively.

**⚠ WARNING**

The tires are designed to rotate only in one direction. Do not switch the left and right front wheels. If a tire is mounted on the incorrect side, you will have less traction and could lose control.

**⚠ WARNING**

Do not hold the front wheel spoke while attempting to spin the front wheel as your fingers may be caught between the wheel and the brake caliper.

**Tire Registration Form**

In the event of a tire recall, we can only contact you if we have your name and address. As a vehicle manufacturer, BRP keeps a record of the Tire Identification Number (T.I.N.) associated with the Vehicle Identification Number (V.I.N.) (p.120) and its current owner information.

If you replace any tire on your vehicle, a "Tire Registration Form" must be completed and sent to the tire manufacturer consumer service group. The "Tire Registration Form" is available at an authorized Can-Am roadster dealer.

**Drive Belt**

Visually inspect belt alignment and condition before each ride. Refer to *MAINTENANCE SCHEDULE* (p. 84) for scheduled maintenance intervals.

Belt alignment and deflection adjustment should always be performed by an authorized Can-Am roadster dealer.

**Drive Belt Alignment**

The gap between the belt (2) and the sprocket internal flange (3) should be a minimum of 1 mm (1/32 in). If belt goes beyond the outside edge of sprocket (5), have the belt properly aligned by an authorized Can-Am roadster dealer as soon as possible.

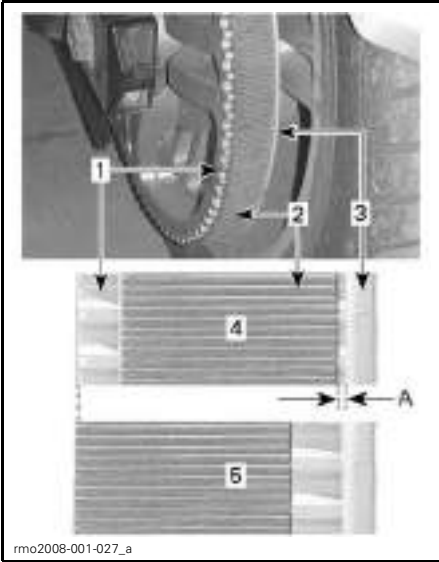

**BELT ALIGNMENT**

1. Rear sprocket teeth
2. Belt
3. Sprocket internal flange
4. Proper belt alignment
5. Belt exceeding external edge — have aligned

A. MIN. 1 mm (1/32 in)

**Drive Belt Wear**

Inspect the drive belt with the vehicle in neutral, engine off, on a level surface with plenty of room — you will have to roll the vehicle forward or backward to see the full length of the belt.

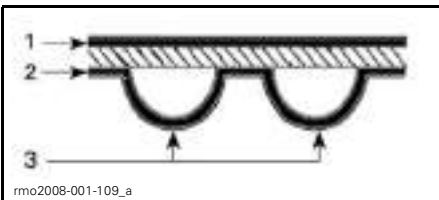

**DRIVE BELT SURFACES**

1. Outer surface
2. Teeth side surface
3. Tooth

Inspect for the following conditions:

WEAR CONDITION	REQUIRED ACTION
Good condition 	None
Hairline cracks 	Monitor condition
Minor chipping 	Monitor condition
Opened cracks 	Replace belt
Hook wear 	Replace belt
Missing teeth 	Replace belt
Belt fabric worn, exposing internal components 	Replace belt
Stone damage 	Replace belt

**NOTE:** Hairline cracks do not require the replacement of the belt, but must be monitored closely — they may lead to opened cracks or missing teeth, requiring belt replacement. Damage to the center of the belt will eventually require belt replacement, but when cracks extend to the edge of the belt, belt failure is imminent.

When a drive belt is replaced, also replace the sprockets to increase the longevity of the new drive belt.

### Drive Belt Tension

While riding, if you feel vibrations in the belt or if the belt is skipping sprocket teeth, have the belt tension adjusted as soon as possible by an authorized Can-Am roadster dealer.

### Engine Oil

**NOTICE** The procedures for checking the Spyder roadster oil level and replacing oil are different from most of the motor vehicles today. Properly follow instructions provided in this section.

#### Recommended Engine Oil

The same oil is used for the engine, gearbox, clutch, and the HCM in the SE5 models.

Use the XPS SYNTHETIC BLEND OIL (SUMMER GRADE) (P/N 293 600 121) or a 5W 40 semi-synthetic (minimum) or synthetic motorcycle oil meeting the requirements for API service SL, SJ, SH or SG classification. Always check the API service label on the oil container.

**NOTICE** To avoid damaging the clutch, do not use a motor oil meeting the API service SM or ILSAC GF-4 classification. Clutch slippage will occur.

#### Engine Oil Level Verification

**NOTICE** To obtain a precise reading of the engine oil level, follow this procedure and make sure engine is at normal operating temperature.

1. Park the vehicle on a level surface.
2. Remove the LH middle side panel. Refer to *BODY* section.

3. With the engine already at normal operating temperature, start engine and let it run for at least 30 seconds.

**NOTE:** Running engine for at least 30 seconds allows the suction oil pump to drain the oil from the engine crankcase back into the oil tank. Not carrying out this step could result in overfilling the engine oil.

4. Stop engine.
5. Unscrew and remove the oil dipstick.



1. Oil dipstick
2. Oil tank

6. Wipe off the dipstick.
7. Reinsert and **completely screw in** the dipstick to assure an accurate reading.
8. Unscrew and remove the dipstick again.
9. Check the oil level on the dipstick. It should be near or equal to the upper mark.

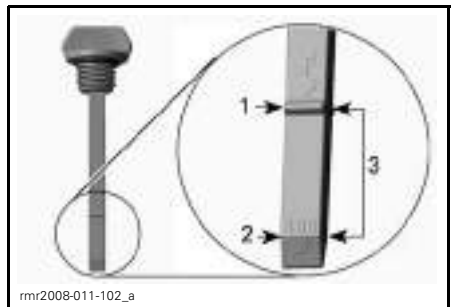

1. Full
2. Add
3. Operating range



**Oil Level is at or Near Upper Mark:**

1. Properly insert and tighten dipstick.
2. Install the LH middle side panel. Refer to *BODY* section.

**Oil Level Under Operating Range:**

1. Add a small amount of recommended oil.
2. Repeat the above steps until oil level reaches the dipsticks upper (F) mark. **Do not overfill.**
3. Properly insert and tighten dipstick.
4. Install the LH middle side panel. Refer to *BODY* section.

**Engine Oil Change**

Prior to changing the oil, ensure vehicle is on a level surface.

**NOTICE** Oil and oil filter must be replaced at the same time. Oil change should be carried out with a warm engine.

**CAUTION** Engine oil can be very hot.

1. Remove the following LH body panels. Refer to *BODY* section:
  - Middle side panel
  - Upper side panel
  - Rear panel
  - Lower side panel.
2. Remove the bottom plate under oil tank.

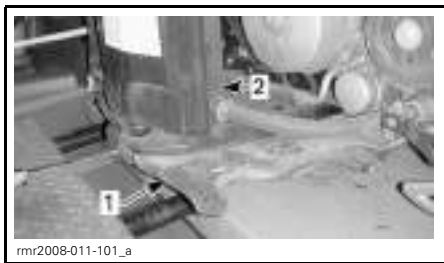

1. Bottom plate  
2. Oil tank

3. Clean area around drain plug under oil tank.
4. Place an appropriate drain pan under oil tank.
5. Remove the tank drain plug and discard the sealing washer.



1. Reservoir drain plug  
2. Oil tank

6. Remove the dipstick.
7. Allow sufficient time for oil to completely drain out of tank.
8. Clean area around engine drain plug.
9. Place an appropriate drain pan under the engine.
10. Remove the engine oil drain plug and discard the sealing washer.



1. Engine oil drain plug  
2. Oil filter cover

11. Allow sufficient time for oil to completely drain from crankcase.
12. Clean the magnet on the engine drain plug.
13. Using **NEW** sealing washers, install engine and oil tank drain plugs.

**NOTICE** Never reuse the drain plug sealing washer. Always replace it with a new one.

14. Torque drain plugs (engine and oil tank) 20 N•m (15 lbf•ft).
15. Replace engine oil filter. Refer to *ENGINE OIL FILTER REPLACEMENT* further in this section.
16. Replace HCM oil filter if necessary (SE5 model). Refer to *HCM OIL FILTER REPLACEMENT* further in this section.
17. Pour 3 L (3 qt (U.S. liq.)) of the recommended oil into oil tank.
18. Start engine and let idle for two minutes.

**NOTICE** Do not rev up engine during idling period as this may cause permanent engine damage.

**NOTICE** Ensure oil pressure warning lamp goes out within 5 seconds from engine start. If oil pressure warning lamp stays ON for more than 5 seconds, STOP ENGINE and recheck oil level.

19. Ensure oil filter cover, engine drain plug and oil tank drain plug are not leaking.
20. Stop engine.

**NOTE:** The oil level dipstick is accurate when the oil temperature is at 80°C (176°F). If the oil level is checked when the oil is at room temperature 20°C (68°F), the proper oil level indication is half way between the lower (ADD) and upper (F) marks on the dipstick. This must be considered to prevent overfilling the oil tank.

### SM5 Models

21. Add 0.9 L (1 qt (U.S. liq.)) of the recommended oil in the oil tank (3.9 L (4.1 qt (U.S. liq.)) total quantity).
22. Check oil level immediately and adjust if required.

23. Reinstall all removed body panels.
24. Dispose of used oil as per your local environmental regulations.

### SE5 Models

25. Add 1.2 L (1.3 qt (U.S. liq.)) of the recommended oil in the oil tank (4.2 L (4.4 qt (U.S. liq.)) total quantity).
  26. Check oil level immediately and adjust if required.
- NOTE:** If both the engine oil filter and the HCM oil filter are replaced, the total oil quantity to add will be 4.3 L (4.5 qt (U.S. liq.)).
27. Reinstall all removed body panels.
  28. Dispose of used oil as per your local environmental regulations.

## Engine Oil Filter

### Oil Filter Removal

1. Refer to *ENGINE OIL CHANGE* (p. 95) to remove the required body panels.
2. Remove oil filter cover screws.

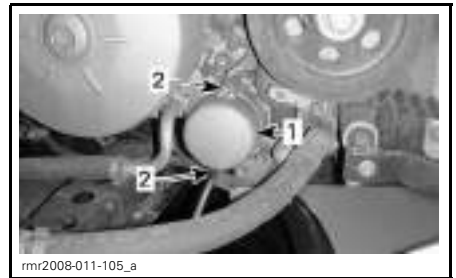

#### TYPICAL

1. Oil filter cover
2. Cover screws
3. Remove oil filter cover with O-ring. Discard O-ring.
4. Remove oil filter.
5. Dispose filter as per your local environmental regulations.

### Oil Filter Installation

Installation is the reverse of the removal procedure. However, pay attention to the following.

1. Check and clean the oil inlet and outlet orifices in crankcase for dirt and contaminants.

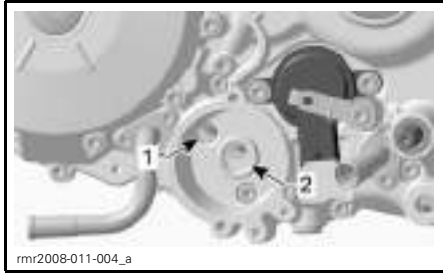

**TYPICAL**

1. Oil inlet orifice from oil pressure pump
2. Oil outlet orifice to engine lubrication system

2. Install a **NEW** O-ring on the oil filter cover.

To ease assembly and prevent displacement of the O-ring during installation, slightly oil filter and O-ring. Refer to following illustration.



1. Apply oil here

### HCM Oil Filter (SE5 Model)

**NOTE:** The HCM (Hydraulic Control Module) uses the same oil as the engine, but has its own oil filter.

### HCM Oil Filter Removal

Refer to *MAINTENANCE SCHEDULE (p. 84)* for replacement frequency.

1. Drain engine oil. Refer to *ENGINE OIL CHANGE (p. 95)* section.
2. Remove oil filter cover screws.

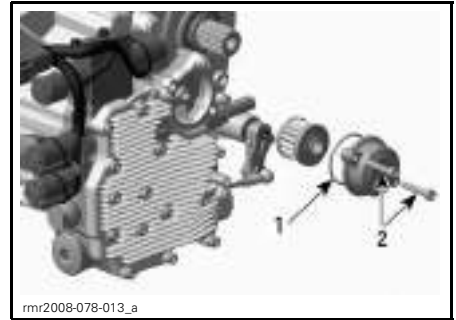

1. Oil filter cover
2. Cover screws

3. Remove oil filter cover with O-ring. Discard O-ring.
4. Remove oil filter.
5. Dispose filter as per your local environmental regulations.

### HCM Oil Filter Installation

The installation is the reverse of the removal procedure. Pay attention to the following.

1. Check and clean the oil inlet and outlet orifices in hydraulic control module for dirt and contaminations.

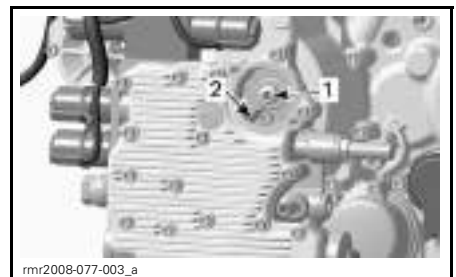

1. Oil outlet orifice to the hydraulic control module lubrication system
2. Oil inlet orifice to the oil pump

2. Install a **NEW** O-ring on oil filter cover.

To ease assembly and prevent displacement of the O-ring during installation, slightly oil filter and O-ring. Refer to following illustration.



1. Apply oil here

## Engine Coolant

### Engine Coolant Level Verification

#### **⚠ WARNING**

When opening the reservoir, the coolant can be very hot and spray out if the engine is hot. In order to avoid getting burned, check the coolant level when the engine is cold.

The cooling system must be filled with distilled water and antifreeze solution (50% distilled water, 50% antifreeze).

For best performance, use BRP's pre-mixed coolant (P/N 219 700 362).

With the engine cold, check the coolant level as follows:

1. Park the vehicle on a firm, level surface.
2. Open the front storage compartment.
3. Pull out the service cover extremities with both hands.

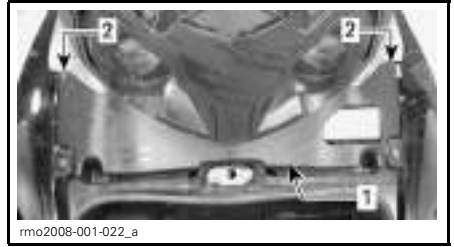

1. Service cover
2. Service cover extremities

4. Check the coolant level on the right hand side. Coolant must be visible without exceeding the MAX. level mark.

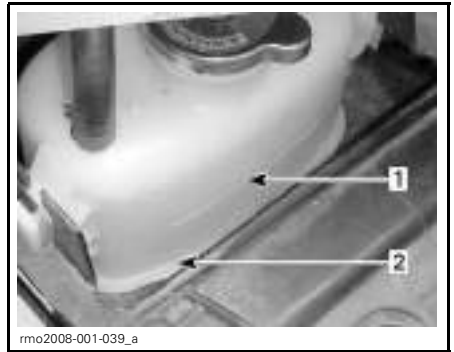

1. Coolant MAX. level mark
2. Coolant must be visible

5. If required, add coolant until it is visible in the reservoir without exceeding the MAX. level mark. Use a funnel to avoid spillage.  
**Do not overfill.**

6. Reinstall the service cover.

**NOTE:** A coolant system that frequently requires coolant indicates leaks or engine problems. See an authorized Can-Am roadster dealer.

## Brakes

### **⚠ WARNING**

New brakes will not operate at their maximum efficiency until their break-in is completed. Braking performance may be reduced, so use extra caution. Brakes take about 300 km (200 mi) of riding with frequent braking to break-in. For riding with infrequent braking, allow extra time to break-in the brakes.

### Brake Fluid Level Verification

### **⚠ WARNING**

Clean filler cap before removing. Use only DOT 4 brake fluid from a sealed container.

Use only DOT 4 brake fluid from a sealed container. An opened container may be contaminated or may have absorbed moisture from the air.

**NOTICE** To avoid serious damage to the braking system, do not use non-recommended fluids. Brake fluid can damage plastic and painted surface. Handle with care.

### **⚠ WARNING**

Avoid getting brake fluid on skin or in eyes — it may cause severe burns. In case of contact with the skin, wash thoroughly. In case of contact with the eyes, immediately rinse with plenty of water for at least 10 minutes and then consult a doctor immediately.

Check the brake fluid level as follows:

1. Park the vehicle on a firm, level surface.
2. Unlatch and lift the seat p. 23.

3. Check the brake fluid level in both reservoirs, near the back of the seat. They should both be above the MIN. mark.



1. Brake fluid reservoir

4. Clean the filler caps before removing.
5. Add fluid as required. Do not overfill.



1. Brake fluid MAX. level mark  
2. Brake fluid MIN. level mark



A. Operating range

6. Immediately wipe up spills if necessary.
7. Reinstall both caps of the reservoir.

8. Close the seat and ensure it is fully latched.

**NOTE:** Low brake fluid may indicate leaks or worn brake pads. See an authorized Can-Am roadster dealer.

### Brake System Verification

The front and rear brakes are hydraulic disc types. These brakes are self-adjusting and do not require adjustment.

The brake pedal also requires no adjustment.

To keep brakes in good condition, check the following as per the *MAINTENANCE SCHEDULE* (p. 84):

1. Entire brake system for fluid leaks
2. Brake pedal for spongy feel
3. Brake discs for excessive wear and surface condition
4. Brake pads for wear, damage or looseness.

See an authorized Can-Am roadster dealer if there are any problems with the brake system.

## Battery

### Battery Location

The battery is located behind the rear left side panel under the seat on the rear. To access the battery, remove the rear side panel (p.90).



1. Battery located behind the rear left side panel

### Battery Charging

The vehicle is equipped with a maintenance-free type battery and is completely sealed; there is no need to add water to adjust the electrolyte level. The battery may need to be charged if the vehicle has not been ridden for at least one month.

Always have the battery replaced by an authorized Can-Am roadster dealer.

### **⚠ WARNING**

Do not use conventional lead-acid type batteries as the battery is installed sideways on the vehicle. Acid may leak out through the battery vent of a conventional lead-acid type battery. Acid may also leak if the battery case is cracked or damaged, which can cause severe burns.

The battery can be charged while it is installed on the vehicle. The battery terminals are located under the seat.

**NOTICE** Follow the instructions provided with your battery charger. Improper charging may damage the battery.

To charge the battery, proceed as follows:

1. Unlatch and lift the seat.
2. First connect the POSITIVE (+) cable to the corresponding terminal.
3. Connect the NEGATIVE (-) cable to the corresponding terminal.

**NOTICE** Always connect the POSITIVE (+) cable first to avoid damaging the electrical system of the vehicle.



1. NEGATIVE (-) terminal
2. POSITIVE (+) terminal

4. Start the battery charger. Charging time will depend on the charging rate.

When the battery is charged:

5. First disconnect the NEGATIVE (-) cable.
6. Disconnect the POSITIVE (+) cable.

**NOTICE** Always disconnect the NEGATIVE (-) cable first to avoid damaging the electrical system of the vehicle.

7. Close the seat and ensure that it is latched.

A standard battery charger can be used. The recommended charge rate is 2 A. If the battery is dead, it can be jump started with a car battery (p. 107).

For home charging, a "trickle" charger can be used to slow charge the battery. This type of charger can be left connected for a long period of time without damaging the battery. Always follow the charging time as recommended in the charger's instructions.

## Clutch Fluid (SM5 Model)

Check the clutch fluid level when the clutch does not operate normally or when it is difficult to shift gears with the gearshift lever.

The clutch fluid reservoir is near the reverse interlock lever on the left handlebar.

Check the clutch fluid level as follows:

1. Park the vehicle on a firm, level surface.
2. Look inside the window on top of the reservoir to see whether the fluid is visible. If necessary, use a flashlight or shake the handlebar.



1. Clutch fluid reservoir window

3. If the fluid is not visible, add fluid to the reservoir. Use only DOT 4 brake fluid.

Add clutch fluid as follows:

4. Open the cap of the reservoir by unscrewing the 2 screws on top of the reservoir.



1. Screw on top of the reservoir

5. Add fluid as required. Do not over-fill.

**⚠ WARNING**

Avoid getting brake fluid on skin or in eyes — it may cause severe burns. In case of contact with the skin, wash thoroughly. In case of contact with the eyes, immediately rinse with plenty of water for at least 10 minutes and then consult a doctor immediately.

6. Immediately wipe up spills if necessary.
7. Reinstall the cap of the reservoir.

**Headlights Aiming**

1. Position the vehicle 10 m (33 ft) in front of a test surface (wall or screen).

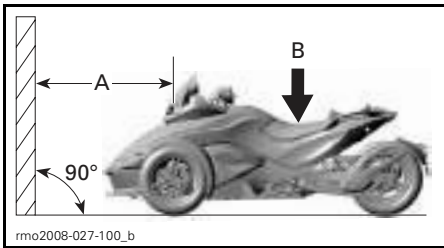

- A. 10 m (33 ft)  
B. 91 kg (200 lb)



2. On the test surface, trace a mark at 700 mm (27-1/2 in) above ground then another at 610 mm (24 in).
3. Have someone weighing at least 91 kg (200 lb) sit on the operator's position.
4. Select low intensity.

5. Beam aiming is correct when the focus point (brightest spot) of the headlight reflection is between the marks.

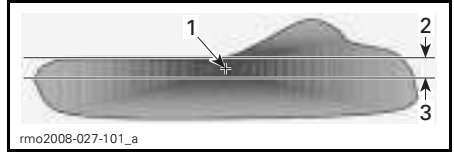

**TYPICAL HEADLIGHT REFLECTION ON SURFACE TEST**

1. Focus point
2. Mark at 700 mm (27-1/2 in) above ground
3. Mark at 610 mm (24 in) above ground

6. Each headlight can be adjusted by turning the adjustment screws located in the front of the lower console with a Phillips screwdriver. Adjust both headlights evenly.



**ADJUSTMENT SCREWS**

**Vehicle Care**

**Cleaning**

To clean the vehicle, do not use high-pressure washers (like the ones found in car washes) as they may damage certain parts of the vehicle.

**NOTICE** Do not clean the windshield with alkaline or acid cleaner, gasoline or solvent to avoid windshield damage.

To clean the vehicle:

1. Rinse the vehicle thoroughly with water to remove loose dirt.



2. Using a soft, clean cloth, wash the vehicle with water mixed with a mild detergent, such as soap specially formulated for motorcycles or automobiles.

**NOTE:** Using warm water works well to remove bugs in the windshield and front panels.

3. While washing the vehicle, check for grease or oil. You can use BRP's vinyl and plastic cleaner (P/N 413 711 200) or a mild automotive degreaser. Thoroughly follow the manufacturer's instructions.
4. Dry the vehicle with a chamois or a soft towel.

### **Waxing**

Apply only nonabrasive wax safe for clearcoat paints on glossy finishes.

Avoid applying wax on matte surfaces.

Windshield can be polished with a plastic cleaner/polisher.

**NOTICE** Do not use water repellent products on windshield.

### **WARNING**

Do not apply a vinyl or plastic protector on the seat as the surface will become slippery and the operator or the passenger may slip off the vehicle.



# ***ROAD SIDE REPAIRS***

# PROBLEMS

**NOTICE** If the vehicle must be transported, do not have it towed — towing can seriously damage the vehicle. Refer to *TRANSPORTING THE SPYDER ROADSTER* (p. 80) for detailed instructions.

## Will not Shift into First Gear (SM5 Model)

If the gearbox cannot shift into first gear when vehicle is not moving:

1. Slowly release the clutch lever while maintaining a light pressure down on the shift lever.
2. When you feel the shift lever engaging into first gear, pull in the clutch lever.

## Will not Shift into Neutral (SE5 Model)

If the gearbox cannot shift into neutral when vehicle is not moving:

1. The engine speed will be automatically increased to approximately 1800 RPM then it will be brought back to idle speed.
2. Up to 3 attempts will be done.
3. If it does not work, retry pressing up-shift or downshift button.

## Will not Shift (SE5 Model)

If a transmission control failure occurs, you can manually move the transmission in gear.

1. Stop the engine.

**NOTICE** The engine must be stopped before you manually move the transmission.

2. From underneath the vehicle on the left side of engine, place the 13 mm open wrench (from toolkit) on the shifting shaft cam as shown. The shifting shaft cam can be seen between the upper side panel and the middle side panel.

The flat surfaces on the end of the shaft are designed to enable the wrench to rotate the shaft.



LEFT SIDE OF ENGINE

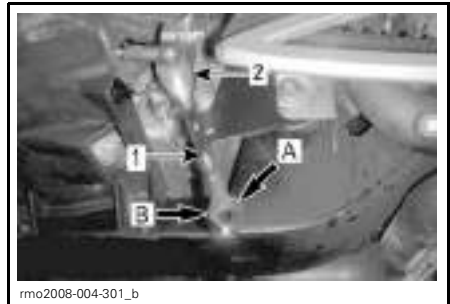

UNDERNEATH VEHICLE

1. 13 mm wrench
2. Shifting shaft cam
- A. Upshift
- B. Downshift

3. Rotate the wrench clockwise to downshift. Rotate the wrench counterclockwise to upshift.

**NOTICE** Do not force shifting mechanism. If unable to shift, rock the vehicle back and forth to move the gears in the transmission and try again.

## **⚠ WARNING**

When you will restart the vehicle, it will be in gear. Do not apply throttle unless you are ready to go.

**NOTE:** SE5 model will not start in gear without brake pedal depressed.

## Lost Keys

Use your spare key to have another one made by an authorized Can-Am roadster dealer as soon as possible. **If both keys are lost**, the ignition switch and the D.E.S.S. electronic module will need to be replaced at the expense of the vehicle owner.

## Flat Tire

If a tire has a **major** puncture or cut in the tread and is completely deflated, have the vehicle transported to the nearest Can-Am Spyder dealer. Refer to *TRANSPORTING THE SPYDER ROADSTER* (p. 80) for transporting instructions.

If a tire has a **minor** nail or stone puncture and is not completely deflated, the tire can be temporarily repaired. To temporarily repair a tire, a self-inflating tire sealer or tire plug repair kit can be used. Follow the manufacturer's instructions that come with the tire sealer or repair kit and have the tire repaired or replaced by an authorized Can-Am roadster dealer **as soon as possible**.

When a tire is temporarily repaired, ride slowly and carefully, and frequently check tire pressure until it is replaced or permanently repaired.

## Dead Battery

If the battery is dead or too low to crank the engine, it can be jump started.

### WARNING

Connect the jumper cables as specified in the jump start procedure.

Batteries can emit explosive gas that can ignite if jumper cables are not properly connected.

To jump start the battery, proceed as follows:

1. Move the other vehicle as close as possible and preferably on the left side of the Spyder roadster. Make sure the vehicles are not touching.
2. Shift the Spyder roadster into NEUTRAL (N) and engage the parking brake.
3. Turn off the engine of the other vehicle and all electrical accessories.
4. Open the hood of the other vehicle.
5. Unlatch and lift the seat of the Spyder roadster p.23.
6. Make sure the ignition switch is set to OFF.
7. Connect one end of the red POSITIVE (+) jumper cable to the POSITIVE (+) terminal under the seat of the Spyder roadster.
8. Connect the other end of the red POSITIVE (+) jumper cable to the POSITIVE (+) terminal of the booster battery.
9. Connect one end of the black NEGATIVE (-) jumper cable to the NEGATIVE (-) terminal of the booster battery.
10. Connect the other end of the black NEGATIVE (-) jumper cable to the NEGATIVE (-) terminal under the seat of the Spyder roadster.



1. NEGATIVE (-) terminal
2. POSITIVE (+) terminal

11. Start the vehicle with the booster battery and run the engine at an idle of 1200 to 1500 RPM for a couple of minutes.
12. Stand on the right side of the Spyder roadster, apply brakes and start the engine. If it does not crank or it cranks slowly, wiggle the jumper cables to make sure they are making good contact and try again.  
If it still does not start, there might be a problem with the starting system. Have the vehicle transported (p.80) and repaired by the nearest authorized Can-Am roadster dealer.
13. As soon as the engine starts, disconnect both jumper cables in the reverse connection order, starting with the NEGATIVE (-) cable connected to the Spyder roadster.
14. Have the battery fully recharged with a battery charger (p.100) or by a qualified service station as soon as possible.

If the engine dies shortly after it has been jump started or when the jumper cables are disconnected, there might be a problem with the charging system. Have the vehicle transported (p.80) and repaired by the nearest authorized Can-Am roadster dealer.

After recharging battery, have the vehicle inspected by an authorized Can-Am roadster dealer.

## Electrical Accessories Failure

If any electrical accessories stop working on the vehicle, check for blown fuses and replace if necessary.

If an electrical failure still occurs, have the vehicle serviced by an authorized Can-Am roadster dealer.

## Fuses

### Fuse Locations

Fuses are located:

- Under the service cover behind the front storage compartment on the front left side of the vehicle
- Under the seat on the right side of the vehicle.



1. Fuse box located under the seat



1. Fuse box located under the service cover behind the front storage compartment

### Fuse Description

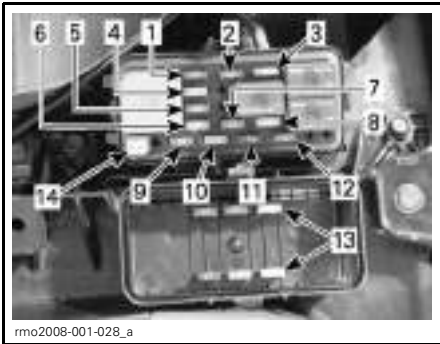

FUSES LOCATED UNDER THE SERVICE COVER

NO.	DESCRIPTION	
1	Main relays control ECM control Pillion rider switch (PRS) Vehicle control module (VCM) Steering angle sensor (SAS) Yaw rate sensor (YRS)	10 A
2	Clutch valve (SM5 model) Horn Service connector	10 A
3	Accessories	3 A
4	Dynamic Power Steering control (DPS) Transmission Control Module (TCM) (SE5 model)	5 A
5	Camshaft position sensor (CAPS) Engine control module (ECM) Fuel pump Q <sup>2</sup> heater Purge valve Starter solenoid	10 A
6	Accessories	3 A
7	D.E.S.S. License plate light Position light Tail lights Service connector	10 A
8	Ignition coil Fuel injectors	15 A

NO.	DESCRIPTION	
9	Clock Hazard warning lights Turn signal lights	10 A
10	Fan	15 A
11	Multifunction gauge cluster	5 A
12	Fog lights (optional)	10 A
13	Spare fuses	-
14	Fuse removal tool	-

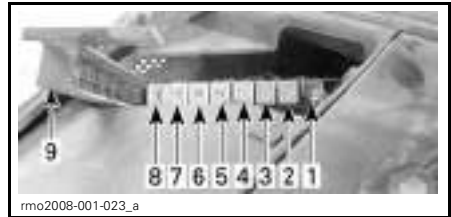

FUSES LOCATED UNDER THE SEAT

NO.	DESCRIPTION	
1	Empty	-
2	Blipper (SE5 model) TCM valves (SE5 model)	20 A
3	Rectifier	60 A
4	Main fuse	40 A
5	Dynamic Power Steering (DPS) motor	40 A
6	VSS pump	40 A
7	Headlights	30 A
8	VSS valves	25 A
9	Fuse box cover	-

### Fuse Replacement

1. Remove either the service cover or lift seat to access the relevant fuse box.
2. Set the ignition switch to OFF.
3. To open the fuse box under the seat, push down on the tab and pull off the cover.



**OPENING FUSE BOX UNDER SEAT**  
 Step 1: Push tab  
 Step 2: Pull cover

4. Pull the fuse out. A fuse removal tool is available in the fuse box located behind the front storage compartment under the service cover.
5. Check whether the filament is melted.

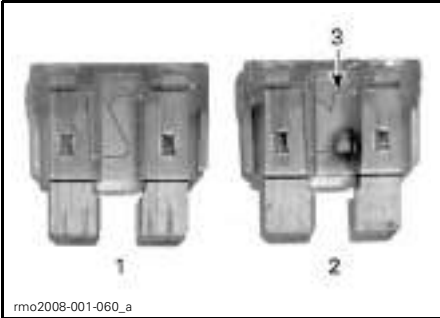

**FUSE UNDER THE SERVICE COVER**  
 1. Good fuse  
 2. Blown fuse  
 3. Melted filament

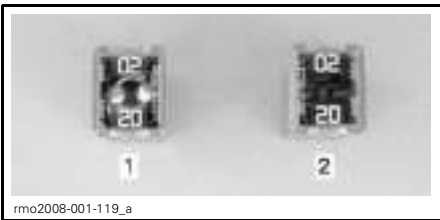

**FUSE UNDER THE SEAT**  
 1. Good fuse  
 2. Blown fuse

6. Replace the fuse with one with the same rating. Spare fuses are located in the front fuse box.

**NOTICE** Using a higher-rated fuse can cause severe damage.

7. Install or close the fuse box cover.
8. Close the service cover and front storage compartment or seat.

## Light Failure

If any light stop working on the vehicle, replace bulb of defective light.

If the light failure still occurs, have the vehicle serviced by an authorized Can-Am roadster dealer.

**⚠ WARNING**  
 Always turn the ignition switch to the OFF position before replacing a bulb to avoid electric shock.

Always check light operation after replacement.

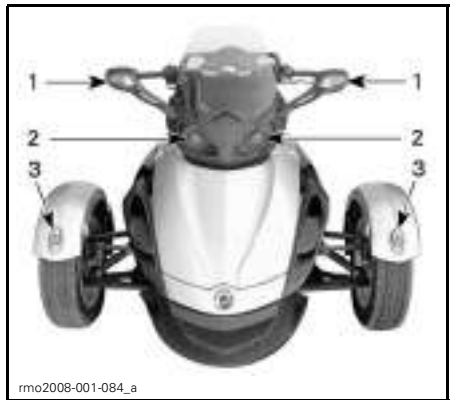

**LIGHTS LOCATION — FRONT OF VEHICLE**  
 1. Turn signal light (p. 112)  
 2. Headlight (p. 111)  
 3. Position light (p. 114)



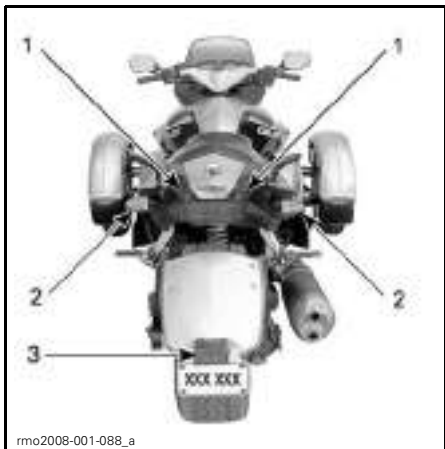

**LIGHTS LOCATION — REAR OF VEHICLE**

1. Tail light/brake light (p. 113)
2. Turn signal light (p. 112)
3. License plate light (p. 114)

**Headlight**

1. Insert a small flat head screwdriver in one of the two holes on the upper console.
2. Press on the screwdriver and gently pry out the upper corner of the cluster.
3. Insert a finger to maintain the opening of the upper corner.

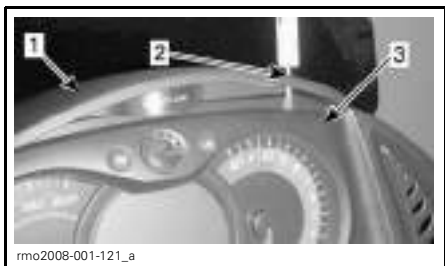

1. Upper console
2. Press on the screwdriver inside hole
3. Insert finger in opening

4. With the other hand, insert the screwdriver in the other hole on the upper console.

5. Press on the screwdriver and gently pry out the other corner of the cluster.  
The upper edge of the cluster will tilt backward.

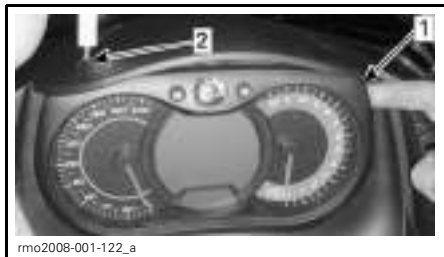

1. Insert a finger to maintain the opening of the upper corner
2. Press on the screwdriver inside the opposite hole

6. Pull out the housing cap as indicated below.



1. Housing cap
7. Turn the connector in the housing counterclockwise to remove.
8. Remove the bulb by releasing both clips with a small flat head screwdriver.

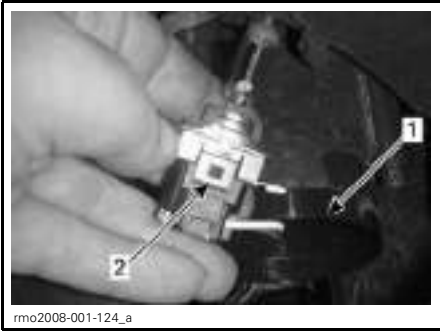

1. Bulb housing
2. Bulb retaining clip

9. Install the new bulb by clipping it to the connector.
10. Install the connector in the bulb housing and put the housing cap on.
11. Install the cluster by first inserting the bottom edge and then firmly pushing the upper edge with both hands.

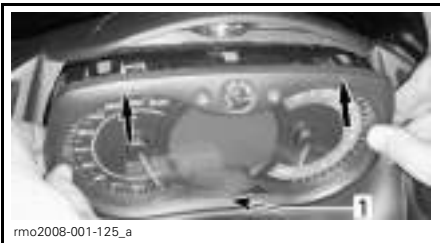

**INSTALLING CLUSTER**

1. Inserting bottom edge of cluster first and then pushing the upper edge
12. Ensure the cluster is properly installed. Repeat step 11 if necessary.

**Turn Signal Light — Front**

1. Remove the lens with a Phillips head screwdriver.



1. Front turn signal lens screw

2. Turn the connector counterclockwise as indicated below and remove lens.



1. Front turn signal light connector

3. Remove the bulb by pushing it in and turning counterclockwise.
4. Install the new bulb by pushing it in and turning clockwise.
5. Properly reinstall the parts in the reverse order of their removal.

**Turn Signal Light — Rear**

1. Remove the lens with a Phillips head screwdriver.



1. Rear turn signal lens screw

2. Remove the bulb by pushing it in and turning counterclockwise.
3. Install the new bulb by pushing it in and turning clockwise.
4. Reinstall the lens.

### Tail Light/Brake Light

1. Remove the panel under the passenger seat by unscrewing 7 Torx screws as indicated below.



**PANEL UNDER PASSENGER SEAT**  
1. 7 Torx screws location

2. Partially remove right rear side panel by removing the 2 plastic rivets under the seat as indicated below.

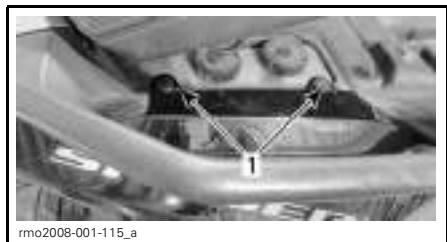

1. 2 plastic rivets under the seat

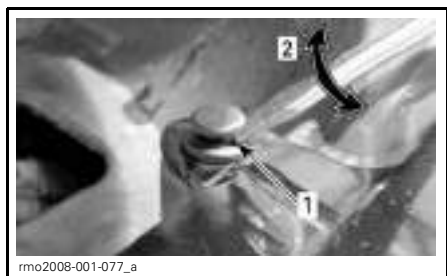

1. Flat head screwdriver under rivet head  
2. Turn screwdriver 1/4 turn

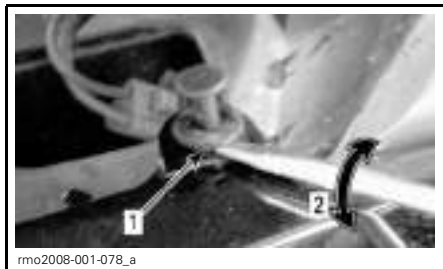

1. Flat head screwdriver under rivet  
2. Turn screwdriver 1/4 turn

3. Disconnect right turn signal housing connectors.
4. Remove the Torx screw behind the lens as indicated below.



1. Removing Torx screw behind lens

5. Remove the Torx screw beside the lens under the rear tip as indicated below.



1. Removing Torx screw beside the lens

6. Turn the connector counterclockwise and remove from the lens.



1. Connector

7. Remove the bulb by pushing it in and turning counterclockwise.
8. Install the new bulb by pushing it in and turning clockwise.
9. Properly reinstall the parts in the reverse order of their removal.

**NOTE:** When installing right rear side panel, connect the turn signal housing connectors by matching the correct wire color and insert by hand the plastic rivets.

**Position Light**

1. Push then hold lens towards rear of fender.



2. Lift front portion of lens with your thumb or a small screwdriver to release.



3. Turn the bulb holder clockwise and remove it from the connector.



1. Turn clockwise

4. Pull out the bulb from the holder as indicated below.



1. Pull out bulb

5. Insert a new bulb in the holder.
6. Properly reinstall the parts in the reverse order of their removal.

**License Plate Light**

1. Remove the lens with a Phillips head screwdriver.

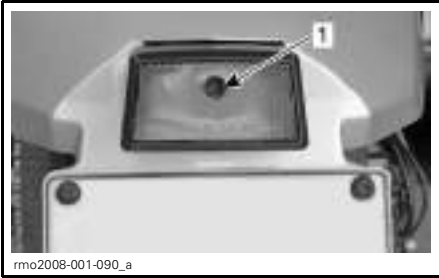

1. *License plate lens screw*
2. Remove the bulb by pushing it in and turning counterclockwise.
3. Install the new bulb by pushing it in and turning clockwise.
4. Reinstall the lens.

## **Engine will not Start**

### **ENGINE DOES NOT TURN OVER**

---

1. **Scrolling safety message on the multifunction gauge cluster not acknowledged.**
  - *Press the MODE (M) to acknowledge the safety message.*
2. **Engine stop switch in the OFF position.**
  - *Make sure that the engine stop switch is in the ON position.*
3. **Clutch lever not engaged (SM5 model).**
  - *Pull in and hold the clutch lever.*
4. **Ignition switch in the OFF position.**
  - *Turn the ignition to the ON position.*
5. **Battery dead or poor battery connections.**
  - *Check the battery charge. Recharge if necessary (p. 100).*
  - *Check the battery connections under the seat and on the battery terminals (p. 100).*
6. **Blown fuse.**
  - *Check fuse condition (p. 108).*
7. **Transmission is in gear (SE5 model).**
  - *Depress brake pedal if transmission is in gear.*

### **ENGINE TURNS OVER, BUT DOES NOT START**

---





1. **Low fuel.**
  - *Fill the fuel tank (p. 27).*
2. **Weak battery.**
  - *Check battery charge. Recharge if necessary (p. 100).*
  - *Check the battery connections under the seat and on the battery terminals (p. 100).*
3. **Engine management problem.**
  - *Check to see whether the engine indicator lamp is ON while starting. See an authorized Can-Am roadster dealer.*





# MESSAGES IN MULTIFUNCTION GAUGE CLUSTER

Important information about vehicle condition is displayed on the multifunction gauge cluster. When starting the engine, always look at the gauge cluster for any special messages.

If a fault is displayed, press the MODE button to skip the error message.

If a problem persists, go to an authorized Can-Am roadster dealer.

INDICATOR LAMP(S)		MAIN DIGITAL DISPLAY	CAUSE	WHAT TO DO
E displayed instead of selected gear		None	Gearbox position sensor malfunction	Have the vehicle repaired by an authorized Can-Am roadster dealer.
		N + R flashing quickly	Undetermined gear position	Stop vehicle and allow to reach neutral.
None		BAD KEY	Wrong or defective key	Use the right key for the vehicle or contact an authorized Can-Am roadster dealer.
	On	HI TEMP	Engine is overheating	<ul style="list-style-type: none"> <li>- Stop and wait for engine to cool off.</li> <li>- Check for leaks.</li> <li>- Check coolant level and adjust (p.98).</li> </ul>
	On	HI TEMP LIMP HOME	Engine is overheating	* Have the vehicle transported to the nearest authorized Can-Am roadster dealer.
	On	LO BATT VOLT	Low battery voltage	<ul style="list-style-type: none"> <li>- Recharge battery (p. 100).</li> <li>- Check battery connections.</li> </ul>
	On	HI BATT VOLT	High battery voltage	Have the vehicle transported to the nearest authorized Can-Am roadster dealer.
	On	ABS FAULT	ABS malfunction. No ABS operation	Have the vehicle transported to the nearest authorized Can-Am roadster dealer.
	On	VSS FAULT LIMP HOME	VSS malfunction	* Have the vehicle transported to the nearest authorized Can-Am roadster dealer.
	On	SEAT SWITCH DEFECTIVE	Defective pillion rider seat switch	Check fuse (p. 108).

INDICATOR LAMP(S)		MAIN DIGITAL DISPLAY	CAUSE	WHAT TO DO
	On	EBD FAULT	VSS malfunction	Have the vehicle transported to the nearest authorized Can-Am roadster dealer.
	On	BRAKE FAILURE	Low brake fluid level or faulty sensor	<ul style="list-style-type: none"> <li>- Check for brake fluid leaks.</li> <li>- Check brake fluid level and adjust (p.99).</li> </ul>
	On	CHECK ENGINE	Engine management component malfunction	<ul style="list-style-type: none"> <li>- Remove and reinsert key.</li> </ul>
	On	CHECK DPS	Dynamic power steering component malfunction	Have the vehicle repaired by an authorized Can-Am roadster dealer.
	On	CHECK TCM	Transmission Control Module component malfunction	<ul style="list-style-type: none"> <li>- Remove and reinsert key.</li> <li>- Have the vehicle repaired by an authorized Can-Am roadster dealer.</li> </ul>
	Flashing	LIMP HOME	Important engine management component or VSS malfunction	* Have the vehicle transported to the nearest authorized Can-Am roadster dealer.
	On	None	Low oil pressure	<ul style="list-style-type: none"> <li>- Check for oil leaks.</li> <li>- Check oil level and adjust (p.94).</li> </ul>
	On	None	Low fuel level	Fill fuel tank (p.27).

\* BRP recommends having the vehicle transported when in LIMP HOME. If you operate the vehicle in LIMP HOME, avoid abrupt maneuvers and immediately go to the nearest authorized Can-Am roadster dealer to have your vehicle serviced before riding again. In LIMP HOME, the engine RPM is limited and therefore the vehicle maximum speed is reduced.



# ***TECHNICAL INFORMATION***

# VEHICLE IDENTIFICATION

The main components of your vehicle (engine and frame) are identified by different serial numbers. It may sometimes become necessary to locate these numbers for warranty purposes or to trace your vehicle in the event of loss. These numbers are required by the authorized Can-Am roadster dealer to complete warranty claims properly. No warranty will be allowed by Bombardier Recreational Products Inc. if the engine identification number (E.I.N.) or vehicle identification number (V.I.N.) is removed or mutilated in any way. We strongly recommend that you take note of all the serial numbers on your vehicle and supply them to your insurance company.

## Vehicle Identification Number

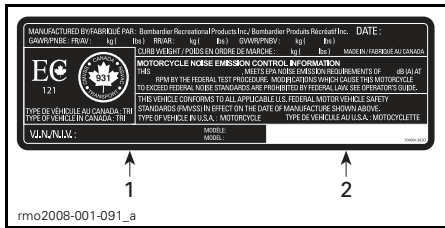

### VEHICLE SERIAL NUMBER LABEL

1. V.I.N. (Vehicle Identification Number)
2. Model number



### LOCATION OF V.I.N.

1. Swing arm (V.I.N. label)
2. Lower frame (V.I.N. stamped on left side)

## Engine Identification Number

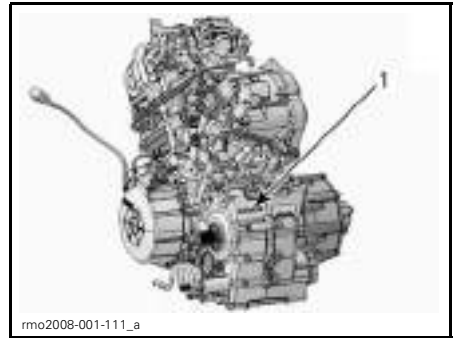

### TYPICAL

1. E.I.N. (Engine Identification Number) location

## EPA Compliance Label (USA)

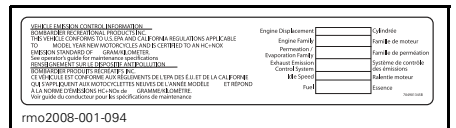

1. EPA exhaust emission label located under seat

# SPECIFICATIONS

MODEL			SPYDER RS	
<b>ENGINE</b>				
Engine type		ROTAX 991 60° V-Twin		
		4-stroke, Dual Over Head Camshaft (DOHC), liquid cooled		
Number of cylinders		2		
Number of valves		8 valves		
Bore		97 mm (3.82 in)		
Stroke		68 mm (2.68 in)		
Displacement		998 cm <sup>3</sup> (60.9 in <sup>3</sup> )		
Compression ratio		10.8:1		
Lubrication	Type		Dry sump with separate oil tank and oil cooler	
	Oil filter	Engine		BRP Rotax paper type, replaceable
		Transmission (SE5)		BRP Rotax paper type, replaceable
	Engine oil Capacity	Oil change with new engine filter	SM5	3.9 L (4.1 qt (U.S. liq.))
		Oil change with new engine filter	SE5	4.2 L (4.4 qt (U.S. liq.))
		Oil change with new engine and HCM filters		4.3 L (4.5 qt (U.S. liq.))
	Recommended Engine Oil			Use XPS SYNTHETIC BLEND OIL (SUMMER GRADE) (P/N 293 600 121) or a 5W 40 semi-synthetic (minimum) or synthetic motorcycle oil meeting the requirements for API service SL, SJ, SH or SG classification.
Clutch	SM5 model	Type	Wet, multi-plate, manual operation through a hydraulic piston, vacuum assist	
		Fluid	DOT 4	
	SE5 model	Type	Centrifugal clutch + wet multi-plate clutch automatically controlled by TCM	
		Engage-ment	2000 +/- 200 RPM (centrifugal)	
		Stall	3200 +/- 200 RPM (centrifugal)	
Exhaust system			2 into 1 with catalytic converter	
Air filter			Paper element	

**SPECIFICATIONS**

<b>MODEL</b>		<b>SPYDER RS</b>
<b>GEARBOX</b>		
Type	SM5	Sequential Manual 5-speed (SM5) with reverse
	SE5	Sequential Electronic 5-speed (SE5) with reverse
<b>COOLING SYSTEM</b>		
Type		Liquid cooled, single radiator with cooling fan
Coolant	Type	Ethyl glycol/water mix (50% coolant, 50% water). Use premixed coolant sold by BRP (P/N 219 700 362) or coolant specifically designed for aluminum engines
	Capacity	3.2 L (3.4 qt (U.S. liq.))
<b>ELECTRICAL SYSTEM</b>		
Magneto generator output		500 W
Ignition system type		Electronic ignition with dual output coil
Ignition timing		Not adjustable
Spark plug	Quantity	2
	Make and type	NGK DCPR9E (apply heat-sink paste P12 (P/N 420 897 186) on spark plug thread)
	Gap	0.7 mm - 0.8 mm (.028 in - .031 in)
Engine RPM limiter setting	Forward	10 000 RPM
Battery	Type	Maintenance free
	Voltage	12 volts
	Nominal rating	21 A•h
	Recommended charging rate	2 A
Headlight		2 x 55 W
Tail light/brake light		2 x 5/21 W
Turn signal lights	Front	21 W
	Rear	10 W
Position lights		2 x 5 W
License plate light		10 W

MODEL	SPYDER RS	
<b>ELECTRICAL SYSTEM (cont'd)</b>		
Fuses under service cover	Main relays control ECM control Pillion rider switch (PRS) Vehicle control module (VCM) Steering angle sensor (SAS) Yaw rate sensor (YRS)	10 A
	Clutch valve Horn Service connector	10 A
	Accessories	2 x 3 A
	Dynamic Power Steering control (DPS) Transmission control Module (TCM) (SE5 model)	5 A
Fuses under service cover	Camshaft position sensor (CAPS) Engine control module (ECM) Fuel pump O <sup>2</sup> heater Purge valve Starter solenoid	10 A
	D.E.S.S. License plate light Position light Tail lights Service connector	10 A
	Ignition coil Fuel injectors	15 A
	Clock Hazard warning lights Turn signal lights	10 A
	Fan	15 A
	Multifunction gauge cluster	5 A
	Fog lights (optional)	10 A
Fuses under seat	Blipper (SE5 model) TCM valves (SE5 model)	20 A
	Rectifier	60 A
	Main fuse	40 A
	Dynamic Power Steering (DPS) motor	40 A
	VSS pump	40 A
	Headlights	30 A
	VSS valves	25 A

**SPECIFICATIONS**

<b>MODEL</b>		<b>SPYDER RS</b>	
<b>FUEL SYSTEM</b>			
Fuel delivery	Type	Multi-point Electronic Fuel Injection (EFI) with dual 57 mm throttle body	
Fuel pump	Type	Electrical module in fuel tank	
Idle speed		1400 ± 100 RPM (not adjustable)	
Fuel	Type	Regular unleaded gasoline	
	Octane no.	Inside North America	87 (R+M)/2 or higher
		Outside North America	92 RON or higher
Fuel tank capacity		25 L (6.6 U.S. gal.)	
<b>DRIVE SYSTEM</b>			
Final drive type		Carbon reinforced drive belt	
Final drive ratio		28/79	
<b>STEERING</b>			
Type		Dynamic Power Steering (DPS)	
<b>FRONT SUSPENSION</b>			
Suspension type		Double A-arm with anti-roll bar	
Suspension travel		144 mm (5.7 in)	
Shock absorber	Qty	2	
	Type	Oil damper	
Spring preload adjustment		5 position cam adjustment	
<b>REAR SUSPENSION</b>			
Suspension type		Swing arm with monoshock	
Suspension travel		145 mm (5.7 in)	
Shock absorber	Qty	1	
	Type	Oil damper	
Spring preload adjustment		7 position cam adjustment	

MODEL		SPYDER RS
<b>BRAKES</b>		
Type		Foot-actuated, fully integrated hydraulic 3-wheel braking system with ABS and EBD
Front brake		Dual discs (260 mm x 6 mm) (10.2 in x 0.25 in) with 4 piston calipers
Rear brake		Single disc (260 mm x 6 mm) (10.2 in x 0.25 in) with 1 piston caliper
Brake fluid	Capacity	545 ml - 570 ml (18.4 U.S. oz - 19.3 U.S. oz)
	Type	DOT 4
Parking brake		Mechanical, left foot pedal actuated to the rear caliper
Minimum brake pad thickness		1 mm (.04 in)
Minimum brake disc thickness		5.33 mm (.21 in)
Maximum brake disc warp		0.12 mm (.005 in)
<b>TIRES</b>		
Type (use only tires recommended by BRP)	Front	MC 165/65R14 47H (special motorcycle type)
	Rear	MC 225/50R15 68H (special motorcycle type) OR MC 225/50R15 76H (special motorcycle type)
Pressure	Front	Nominal.: 103 kPa (15 PSI) Min.: 89 kPa (13 PSI) Max.: 117 kPa (17 PSI) <b>NOTE:</b> The pressure difference between the left and right side tire should not exceed 3.4 kPa (.5 PSI).
	Rear	Nominal.: 193 kPa (28 PSI) Min.: 179 kPa (26 PSI) Max.: 207 kPa (30 PSI)
Minimum tire tread depth	Front	1.7 mm (1/16 in)
	Rear	4.0 mm (5/32 in)
<b>WHEELS</b>		
Size (diameter X width)	Front	355 mm x 127 mm (14 in x 5 in)
	Rear	381 mm x 178 mm (15 in x 7 in)
Front wheel nuts torque		105 N•m (77 lbf•ft)
Rear drive axle nut torque		130 N•m (96 lbf•ft)

**SPECIFICATIONS**

<b>MODEL</b>		<b>SPYDER RS</b>
<b>DIMENSIONS</b>		
Overall length		2 667 mm (105 in)
Overall width		1 506 mm (59.3 in)
Overall height		1 145 mm (45.1 in)
Seat (top) height		737 mm (29 in)
Wheel base		1 727 mm (68 in)
Front wheel track		1 308 mm (51.5 in)
Ground clearance, front and under engine		115 mm (4.5 in)
<b>WEIGHT AND LOADING CAPACITY</b>		
Dry weight		317 kg (699 lb)
Front storage compartment	Capacity	44 L (11.6 U.S. gal.)
	Maximum load	16 kg (35 lb)
Total vehicle load allowed (including operator, all other loads and added accessories)		200 kg (440 lb)
Gross vehicle weight rating (GVWR)		540 kg (1,188 lb)

Because of our ongoing commitment to product quality and innovation, BRP reserves the right, at any time, to make changes in design and specifications and/or to make additions to, or improvements in its products without imposing any obligation upon itself to install them on its previously manufactured products.



# ***WARRANTY***

---

# **BRP LIMITED WARRANTY — USA AND CANADA: 2010 CAN-AM™ SPYDER™ ROADSTER**

## **1. SCOPE OF THE LIMITED WARRANTY**

Bombardier Recreational Products Inc. ("BRP")\* warrants its 2010 Can-Am Spyder roadsters sold by authorized Spyder Dealers (as defined below) in the fifty United States and in Canada from defects in material or workmanship for the period and under the conditions described below. This limited warranty will become null and void if: (1) the Spyder roadster was used for racing or any other competitive activity, at any point, even by a previous owner; (2) the odometer was removed or has been tampered with; (3) the Spyder roadster was used off-road; or (4) the Spyder roadster has been altered or modified in such a way so as to adversely affect its operation, performance or durability, or has been altered or modified to change its intended use.

All genuine Spyder parts and accessories installed on the roadster by an authorized Spyder Dealer at the time of delivery of the roadster carry the same warranty as that of the roadster.

## **2. LIMITATIONS OF LIABILITY**

THIS WARRANTY IS EXPRESSLY GIVEN AND ACCEPTED IN LIEU OF ANY AND ALL OTHER WARRANTIES, EXPRESSED OR IMPLIED, INCLUDING WITHOUT LIMITATION ANY WARRANTY OF MERCHANTABILITY OR FITNESS FOR A PARTICULAR PURPOSE. TO THE EXTENT THAT THEY CANNOT BE DISCLAIMED, THE IMPLIED WARRANTIES ARE LIMITED IN DURATION TO THE LIFE OF THE EXPRESS WARRANTY. INCIDENTAL AND CONSEQUENTIAL DAMAGES ARE EXCLUDED FROM COVERAGE UNDER THIS WARRANTY. SOME STATES/PROVINCES DO NOT ALLOW FOR THE DISCLAIMERS, LIMITATIONS AND EXCLUSIONS IDENTIFIED ABOVE, AS A RESULT, THEY MAY NOT APPLY TO YOU. THIS WARRANTY GIVES YOU SPECIFIC RIGHTS, AND YOU MAY ALSO HAVE OTHER LEGAL RIGHTS WHICH MAY VARY FROM STATE TO STATE, OR PROVINCE TO PROVINCE.

Neither the distributor, any Spyder Dealer nor any other person has been authorized to make any affirmation, representation or warranty regarding the roadster, other than those contained in this limited warranty, and if made, shall not be enforceable against BRP.

BRP reserves the right to modify this warranty at any time, being understood that such modification will not alter the warranty conditions applicable to the roadsters sold while this warranty is in effect.

## **3. EXCLUSIONS — ARE NOT WARRANTED**

The following are not warranted under any circumstances:

- Replacement of routine maintenance items such as, without limitation, oil, lubricants, fluids, filters and spark plugs.
- Normal wear and tear, such as, without limitation, wear and tear of the tires, battery, generator brushes, sealed beams and light bulbs, clutch plates and facings, drive belt, brake pads, brake linings and rotors and sprockets.
- Tune ups and adjustments including without limitation adjustments of belt, alignment and wheel balance.
- Damages related to the appearance of the roadster, including without limitation scratches, dents, fading, flaking, peeling and damages to seat cover material.

- Damage caused by failure to provide proper maintenance or storage, as described in the Operator's Guide.
- Damage resulting from removal of parts, improper repairs, improper service or improper maintenance, modifications, alterations that are outside of the original specifications of the roadster, or damage resulting from repairs done by a person that is not an authorized servicing Spyder Dealer.
- Damage resulting from the installation of parts with specifications that differ from the original Spyder parts, such as, without limitation, different tires, exhaust system, wheels or brakes.
- Damage resulting from abuse, abnormal use, neglect or operation of the Spyder roadster in a manner inconsistent with the recommendations of the Operator's Guide.
- Damage resulting from water ingestion, accident, road hazards, submersion, fire, theft, vandalism or any act of God.
- Damage resulting from operation with fuels, oils or fluids with specifications different than as recommended in the Operator's Guide.
- Damage resulting from corrosion from road salts, battery acid, environmental influences or treatment contrary to the Operator's Guide.
- Incidental or consequential damages, including without limitation towing, storage, telephone, rental, taxi, inconvenience, insurance coverage, loan payments, loss of time, loss of income.

#### **4. WARRANTY COVERAGE PERIOD**

This warranty will be in effect from the date of delivery to the first retail consumer or the date the roadster is first put into use, whichever occurs first and for the following periods:

1. for private, recreational use, **TWENTY FOUR (24) CONSECUTIVE MONTHS**, except for the items covered in points (2) to (5) below; and for commercial use **TWELVE (12) CONSECUTIVE MONTHS**, except for the items covered in points (2) to (5) below.  
A roadster is used commercially when it is used in connection with any work or employment that generates income, during any part of the warranty period. A roadster is also used commercially when, at any point during the warranty period, it is licensed for commercial use;
2. for the battery, **SIX (6) CONSECUTIVE MONTHS**;
3. for the tires, **6 CONSECUTIVE MONTHS** or until tires are worn to the last three thirty-seconds of an inch (3/32 inch) (2.38 millimeters) for the front tires and the last five thirty-seconds of an inch (5/32 inch) (3.97 millimeters) for the rear tire, whichever occurs first;
4. for Spyder roadsters sold to residents of the United States, **FIVE (5) YEARS or THIRTY THOUSAND (30 000) KILOMETERS (18,641 MILES)**, whichever occurs first, on the emission related components included in the chart below:

## WARRANTY EMISSION PART LIST

Oxygen sensor	Oil filler cap
Intake manifold	Catalytic converter
Ignition coil	Rear exhaust manifold
Spark plug wire (front cylinder)	Front exhaust manifold
Spark plug wire (rear cylinder)	Fuel return hose
Fuel tank	Evaporative Emission Control System (EVAP)
Fuel tank cap	Engine Control Module (ECM)

5. for Spyder roadsters produced for sale in the state of California, that are originally sold to residents or subsequently warranty registered to residents in the state of California, please also refer to the applicable California Emissions Control Warranty Statement.

The repair or replacement of parts or the performance of service under this warranty does not extend the life of this warranty beyond its original expiration date.

## 5. CONDITIONS TO HAVE WARRANTY COVERAGE

This warranty coverage is available **only** if **each** of the following conditions has been fulfilled:

- The Spyder roadster must be purchased as new and unused by its first owner from a Spyder dealer authorized to distribute Spyder roadsters in the country in which the sale occurred (“Spyder Dealer”).
- The BRP-specified pre-delivery inspection process must be completed, documented and signed by the purchaser.
- The Spyder roadster must have undergone proper warranty registration by an authorized Spyder Dealer.
- The Spyder roadster must be purchased in the country in which the purchaser resides.
- Routine maintenance must be performed as indicated in the Operator’s Guide. BRP reserves the right to make warranty coverage contingent upon proof of proper maintenance.

BRP will not honour this limited warranty to any private use owner or commercial use owner if the preceding conditions have not been met. Such limitations are necessary in order to allow BRP to preserve both the safety of its products, and also that of its consumers and the general public.

## 6. WHAT TO DO TO OBTAIN WARRANTY COVERAGE

The customer must cease using the Spyder roadster upon the appearance of an anomaly. The customer must notify a servicing Spyder Dealer within two (2) days of the appearance of a defect, and provide it with reasonable access to the product and reasonable opportunity to repair it. The customer must also present to the authorized Spyder Dealer proof of purchase of the product and must sign the repair/work order prior to starting the repair in order to validate the warranty repair. All parts replaced under this limited warranty become the property of BRP.

## **7. WHAT BRP WILL DO**

BRP's obligations under this warranty are limited to, at its sole discretion, repairing parts found defective under normal use, maintenance and service, or replacing such parts with new genuine Spyder parts without charge for parts and labor, at any authorized Spyder Dealer during the warranty coverage period. BRP's responsibility is limited to making the required repairs or replacements of parts. No claim of breach of warranty shall be cause for cancellation or rescission of the sale of the Spyder roadster to the owner.

In the event that service is required outside of the country of original sale, the owner will bear responsibility for any additional charges due to local practices and conditions, such as, but not limited to, freight, insurance, taxes, license fees, import duties, and any and all other financial charges, including those levied by governments, states, territories and their respective agencies.

BRP reserves the right to improve or modify products from time to time without assuming any obligation to modify any products manufactured.

## **8. TRANSFER**

If the ownership of a Spyder roadster is transferred during the warranty coverage period, this warranty shall also be transferred and be valid for the remaining coverage period provided that BRP is notified of such transfer of ownership in the following way:

1. The former owner contacts BRP (at the phone number provided below) or an authorized Spyder Dealer and gives the coordinates of the new owner; or
2. BRP or an authorized Spyder Dealer receives a proof that the former owner agreed to the transfer of ownership, in addition to the coordinates of the new owner.

## **9. CONSUMER ASSISTANCE**

In the event of a controversy or a dispute in connection with this limited warranty, BRP suggests that you try to resolve the issue at the dealership level. We recommend discussing the issue with the authorized Spyder Dealer's service manager or owner.

If the issue has not yet been resolved, please submit your complaint in writing or call the appropriate number below:

### **In Canada:**

**BOMBARDIER RECREATIONAL  
PRODUCTS INC.**  
SPYDER ROADSTER  
Customer Assistance Center  
75 J.-A. Bombardier Street  
Sherbrooke QC J1L 1W3  
Tel.: 819 566-3366

### **In USA:**

**BRP US INC.**  
SPYDER ROADSTER  
Customer Assistance Center  
7575 Bombardier Court  
Wausau WI 54401  
Tel.: 715 848-4957

# **CALIFORNIA EMISSION CONTROL WARRANTY STATEMENT**

## **YOUR WARRANTY RIGHTS AND OBLIGATIONS:**

The California Air Resources Board and BRP US Inc. ("BRP")\*, on behalf of Bombardier Recreational Products Inc., are pleased to explain the emission control system warranty on your 2010 Can-Am Spyder roadster. In California, new motor vehicles must be designated, built and equipped to meet the State's stringent anti-smog standards. BRP must warrant the emission control system on your Spyder roadster for the periods of time listed below provided there has been no abuse, neglect or improper maintenance of your roadster.

Your emission control system may include parts such as the fuel-injection system, ignition system, catalytic converter and engine computer. Also included may be hoses, connectors and other emission-related assemblies. Where a warrantable condition exists, BRP will repair your roadster at no cost to you including diagnosis, parts and labor.

## **MANUFACTURER'S WARRANTY COVERAGE**

– For 5 years or 30 000 kilometers (19,000 miles), whichever occurs first.

## **OWNER'S WARRANTY RESPONSIBILITIES:**

As the Spyder roadster owner, you are responsible for the performance of the required maintenance listed in your Operator's Guide. BRP recommends that you retain all receipts covering maintenance on your roadster, but BRP cannot deny warranty solely for the lack of receipts or for your failure to ensure the performance of all scheduled maintenance.

You are responsible for presenting your Spyder roadster to a Spyder dealer as soon as a problem exists. The warranty repairs should be completed in a reasonable amount of time, not to exceed 30 days.

As the Spyder roadster owner, you should also be aware that BRP may deny you warranty coverage if your roadster or a part has failed due to abuse, neglect, improper maintenance or unapproved modifications.

If you have any questions regarding your warranty rights and responsibilities, you should contact BRP's customer assistance center at 1 715 848-4957 or the California Air Resource Board at 9528 Telstar Avenue, El Monte, CA 91731.

\* In the USA, products are distributed and serviced by BRP US Inc.

© 2009 Bombardier Recreational Products Inc. All rights reserved.

™ trademarks of Bombardier Recreational Products Inc. or its affiliates.

---

# **BRP LIMITED WARRANTY OUTSIDE USA AND CANADA: 2010 CAN-AM™ SPYDER™ ROADSTER**

## **1. SCOPE OF THE LIMITED WARRANTY**

Bombardier Recreational Products Inc. ("BRP")\* warrants its 2010 Can-Am Spyder roadsters (the "Products") sold by authorized Can-Am Spyder roadster distributors and dealers located in the EEA (the "EEA" or "European Economic Area" shall mean the countries member of the European Union plus Norway, Iceland and Liechtenstein) or elsewhere, except in the USA and Canada\*\* (the "Distributors/Dealers") from defects in material or workmanship for the period and under the conditions described below. This limited warranty will become null and void if: (1) the Product was used for racing or any other competitive activity, at any point, even by a previous owner; or (2) the odometer was removed or has been tampered with; (3) the Product was used off-road; or (4) the Product has been altered or modified in such a way so as to adversely affect its operation, performance or durability, or has been altered or modified to change its intended use.

All genuine parts and accessories related to the Product and installed on the Product by an authorized Distributor/Dealer at the time of delivery of the Product carry the same warranty as that of the Product.

## **2. LIMITATIONS OF LIABILITY**

THIS WARRANTY IS EXPRESSLY GIVEN AND ACCEPTED IN LIEU OF ANY AND ALL OTHER WARRANTIES, EXPRESSED OR IMPLIED, INCLUDING WITHOUT LIMITATION ANY WARRANTY OF MERCHANTABILITY OR FITNESS FOR A PARTICULAR PURPOSE. TO THE EXTENT THAT THEY CANNOT BE DISCLAIMED, THE IMPLIED WARRANTIES ARE LIMITED IN DURATION TO THE LIFE OF THE EXPRESS WARRANTY. ALL INCIDENTAL, CONSEQUENTIAL, DIRECT, INDIRECT OR OTHER DAMAGES OF ANY KIND ARE EXCLUDED FROM COVERAGE UNDER THIS WARRANTY. SOME COUNTRIES OR JURISDICTIONS DO NOT ALLOW FOR THE DISCLAIMERS, LIMITATIONS OF INCIDENTAL OR CONSEQUENTIAL DAMAGES OR OTHER EXCLUSIONS IDENTIFIED ABOVE. AS A RESULT, THEY MAY NOT APPLY TO YOU. THIS WARRANTY GIVES YOU SPECIFIC RIGHTS, AND YOU MAY ALSO HAVE OTHER LEGAL RIGHTS WHICH MAY VARY FROM COUNTRY TO COUNTRY, OR JURISDICTION TO JURISDICTION.

Neither the authorized Distributors/Dealers nor any other person have been authorized to make any affirmation, representation or warranty regarding the Product, other than those contained in this limited warranty, and if made, shall not be enforceable against BRP. BRP reserves the right to modify this warranty at any time, being understood that such modification will not alter the warranty conditions applicable to the Products sold while this warranty is in effect.

### **3. EXCLUSIONS — ARE NOT WARRANTED**

The following are not warranted under any circumstances:

- Replacement of routine maintenance items such as, without limitation, oil and lubricants, filters and spark plugs.
- Normal wear and tear, such as, without limitation, wear and tear of the tires, battery, generator brushes, sealed beams and light bulbs, clutch plates and facings, drive belt, brake pads, brake linings and rotors and sprockets.
- Tune ups and adjustments including without limitation adjustments of belt, alignment and wheel balance.
- Damages related to the appearance of the Product, including without limitation scratches, dents, fading, flaking, peeling and damages to seat cover material.
- Damage caused by failure to provide proper maintenance or storage, as described in the Operator's Guide.
- Damage resulting from removal of parts, improper repairs, improper service or improper maintenance, modifications, alterations that are outside of the original specifications of the Product, or damage resulting from repairs done by a person that is not an authorized servicing Distributor/Dealer.
- Damage resulting from the installation of parts with specifications that differ from the original Product parts, such as, without limitation, different tires, exhaust system, wheels or brakes.
- Damage resulting from abuse, abnormal use, neglect or operation of the Product in a manner inconsistent with the recommendations of the Operator's Guide.
- Damage resulting from water ingestion, accident, road hazards, submersion, fire, theft, vandalism or any act of God.
- Damage resulting from operation with fuels, oils or lubricants with specifications different than as recommended in the Operator's Guide.
- Damage resulting from corrosion from road salts, battery acid, environmental influences or treatment contrary to the Operator's Guide.
- Incidental or consequential damages, including without limitation, expense for gasoline, expense for transporting the Product to and from the authorized Distributor/Dealer, mechanic's travel time, trailering or towing, storage, telephone, cell phone, fax or telegram charges, rental of a like or replacement Product during warranty services or down time, taxi, travel, lodging, loss of or damage to personal property, inconvenience, cost of insurance coverage, loan payments, loss of time, loss of income, revenue or profits, or loss of enjoyment or use of Product.



## 4. WARRANTY COVERAGE PERIOD

This warranty will be in effect from the date of delivery to the first retail consumer or the date the Product is first put into use, whichever occurs first and for the following periods:

1. for private, recreational use, TWENTY-FOUR (24) CONSECUTIVE MONTHS, except for the items covered in points (2) and (3) below; and for commercial use TWELVE (12) CONSECUTIVE MONTHS, except for the items covered in points (2) and (3) below.

The Product is used commercially when it is used in connection with any work or employment that generates income, during any part of the warranty period. The Product is also used commercially when, at any point during the warranty period, it is licensed for commercial use;

2. for the battery, SIX (6) CONSECUTIVE MONTHS;
3. for the tires, 6 CONSECUTIVE MONTHS or until tires are worn to the last three thirty-second of an inch (3/32 inch) (2.38 millimeters) for the front tires and the last five thirty-second of an inch (5/32 inch) (3.97 millimeters) for the rear tire, whichever occurs first.

The repair or replacement of parts or the performance of service under this warranty does not extend the life of this warranty beyond its original expiration date. Note that the duration and any other modalities of the warranty coverage are subject to the applicable national or local legislation in the customer's country.

## 5. CONDITIONS TO HAVE WARRANTY COVERAGE

This warranty coverage is available only if each of the following conditions has been fulfilled:

- The Product must be purchased as new and unused by its first owner from a Distributor/Dealer authorized to distribute the Product in the country in which the sale occurred;
- The BRP specified predelivery inspection process has been completed and documented by the purchaser and the authorized Distributor/Dealer and signed by the purchaser;
- The Product must have undergone proper warranty registration by an authorized Distributor/Dealer;
- The Product must be purchased in the country in which the purchaser resides. However, for residents of the EEA, they must purchase the Products within the EEA, irrespective of which country within the EEA.
- Routine maintenance as outlined in the Operator's Guide must be performed in a timely manner. BRP reserves the right to make warranty coverage contingent upon proof of proper maintenance.

BRP will not honour this limited warranty to any private use owner or commercial use owner if the preceding conditions have not been met. Such limitations are necessary in order to allow BRP to protect the safety of its products, its consumers, and the general public.

## **6. WHAT TO DO TO OBTAIN WARRANTY COVERAGE**

The customer must cease using the Product upon the appearance of an anomaly. The customer must notify an authorized servicing Distributor/Dealer within two (2) months of the appearance of a defect, and provide it with reasonable access to the Product and reasonable opportunity to repair it. The customer must also present to the authorized Distributor/Dealer, proof of purchase of the Product and must sign the repair/work order prior to starting the repair in order to validate the warranty repair. All parts replaced under this limited warranty become the property of BRP. Note that the notification period is subject to the applicable national or local legislation in customer's country.

## **7. WHAT BRP WILL DO**

BRP's obligations under this warranty are limited to, at its sole discretion, repairing parts found defective under normal use, maintenance and service, or replacing such parts with new genuine Product parts without charge for parts and labour, at any authorized Distributor/Dealer during the warranty coverage period under the conditions described above. BRP's responsibility is limited to making the required repairs or replacements of parts. No claim of breach of warranty shall be cause for cancellation or rescission of the sale of the Product to the owner.

In the event that service is required outside of the country of original sale, or for EEA residents, if service is required outside of the EEA, the owner will bear responsibility for any additional charges due to local practices and conditions, such as, but not limited to, freight, insurance, taxes, license fees, import duties, and any and all other financial charges, including those levied by governments, states, territories and their respective agencies.

BRP reserves the right to modify products from time to time without assuming any obligation to modify all products manufactured.

## **8. TRANSFER**

If the ownership of a Product is transferred during the warranty coverage period, this warranty shall also be transferred and be valid for the remaining coverage period provided that BRP is notified of such transfer of ownership in the following way:

1. The former owner contacts BRP (at the phone number provided below) or an authorized Distributor/Dealer and gives the coordinates of the new owner; or
2. BRP or an authorized Distributor/Dealer receive a proof that the former owner agreed to the transfer of ownership, in addition to the coordinates of the new owner.

## **9. CONSUMER ASSISTANCE**

In the event of a controversy or a dispute in connection with this limited warranty, BRP suggests that you try to resolve the issue at the dealership level. We recommend discussing the issue with the authorized Distributor/Dealer's service manager or owner. In countries where there are authorized distributors, their coordinates may be found on [www.brp.com](http://www.brp.com).

If the issue is not resolved with the help of your authorized Distributor/Dealer, complaints may be submitted in writing or by calling BRP or one of its subsidiaries as follows.

### **For Countries within Europe, Middle East, Africa, Russia & CIS, Please Contact our European Office:**

BRP EUROPE N.V.  
Customer Assistance Center  
Skaldenstraat 125  
9042 Gent  
Belgium  
Tel.: + 32-9-218-26-00

### **For Scandinavian Countries, Please Contact our Finland Office:**

BRP FINLAND OY  
Service Department  
Isoaavantie 7  
Fin-96320 Rovaniemi  
Finland  
Tel.: + 358 16 3208 111

### **For All Other Countries, Please Contact your Local Distributor or our Canadian Office:**

BOMBARDIER RECREATIONAL PRODUCTS INC.  
Customer Assistance Center  
75 J.-A. Bombardier Street  
Sherbrooke, QC J1L 1W3  
Tel.: +1 819 566-3366

You will find your distributors, coordinates on [www.brp.com](http://www.brp.com).

\* In the European Economic Area and elsewhere, Products are distributed and serviced by BRP European Distribution S.A. and other subsidiaries of BRP.

\*\* The BRP limited warranty offered on Products sold in the USA and Canada is different than the one offered in the EEA and elsewhere.

© 2009 Bombardier Recreational Products Inc. All rights reserved.

™ trademarks of Bombardier Recreational Products Inc. or its affiliates.



# ***CUSTOMER INFORMATION***

---

## PRIVACY INFORMATION

BRP wishes to inform you that your coordinates will be used for safety and warranty related purposes. Furthermore, BRP and its affiliates may use its customer list to distribute marketing and promotional information about BRP and related products.

To exercise your right to consult or correct your data, or to be removed from the addressee-list for direct marketing, please contact BRP.

By E-mail: [privacyofficer@brp.com](mailto:privacyofficer@brp.com)

By mail: BRP  
Senior Legal Counsel-Privacy Officer  
726 St-Joseph  
Valcourt, Quebec  
Canada,  
J0E 2L0

---

## CHANGE OF ADDRESS/OWNERSHIP

If your address has changed or if you are the new owner of the vehicle, be sure to notify BRP by either:

- Mailing one of the following card below;
- **North America Only:** calling at 715 848-4957 (USA) or 819 566-3366 (Canada);
- Notifying an authorized Can-Am roadster dealer.

In case of change of ownership, please join a proof that the former owner agreed to the transfer.

Notifying BRP, even after the expiration of the limited warranty, is very important as it enables BRP to reach the vehicle owner if necessary, like when safety recalls are initiated. It is the owner's responsibility to notify BRP.

**STOLEN UNITS:** If your personal vehicle is stolen, you should notify BRP or an authorized Can-Am roadster dealer. We will ask you to provide your name, address, phone number, the vehicle identification number and the date it was stolen.

### In North America

#### BOMBARDIER RECREATIONAL PRODUCTS INC.

Warranty Department  
75 J.-A. Bombardier Street  
Sherbrooke, QC J1L 1W3  
Canada

### In Other Countries in the World

#### BRP EUROPEAN DISTRIBUTION

Warranty Department  
Chemin de Messidor 5-7  
1006 Lausanne  
Switzerland

### In Scandinavian Countries

#### BRP FINLAND OY

Service Department  
Isoaavantie 7  
Fin-96320 Rovaniemi  
Finland  
Tel.: + 358 16 3208 111





CHANGE OF ADDRESS CHANGE OF OWNERSHIP 

VEHICLE IDENTIFICATION NUMBER

Model Number

Vehicle Identification Number (V.I.N.)

OLD ADDRESS  
OR PREVIOUS OWNER:

NAME

NO.

STREET

APT

CITY

STATE/PROVINCE

ZIP/POSTAL CODE

COUNTRY

TELEPHONE

NEW ADDRESS  
OR NEW OWNER:

NAME

NO.

STREET

APT

CITY

STATE/PROVINCE

ZIP/POSTAL CODE

COUNTRY

TELEPHONE

E-MAIL ADDRESS

V00A2F

CHANGE OF ADDRESS CHANGE OF OWNERSHIP 

VEHICLE IDENTIFICATION NUMBER

Model Number

Vehicle Identification Number (V.I.N.)

OLD ADDRESS  
OR PREVIOUS OWNER:

NAME

NO.

STREET

APT

CITY

STATE/PROVINCE

ZIP/POSTAL CODE

COUNTRY

TELEPHONE

NEW ADDRESS  
OR NEW OWNER:

NAME

NO.

STREET

APT

CITY

STATE/PROVINCE

ZIP/POSTAL CODE

COUNTRY

TELEPHONE

E-MAIL ADDRESS

V00A2F



 **WARNING**

**The Spyder roadster is a different type of vehicle - it requires special skills and knowledge. Learn how the Spyder roadster is different.**

**Read** this operator's guide and watch the safety DVD.

**Complete** a training course (if available), **practice**, become proficient with the controls, and get a proper license.

**Refer** to the Safety Card before riding.

**Always wear a helmet and riding gear.**

With this type of vehicle, riders are exposed to more road risks than in a car. Even skilled operators can be struck by other vehicles or lose control. This vehicle will not protect you in a crash.

**Handling limits and road Conditions.**

The Vehicle Stability System (VSS) cannot stop you from losing control, flipping over, or falling off if you exceed this vehicle's limits. Know the limits for different road conditions. Do not ride on ice, snow, or off road. Avoid puddles and running water. This type of vehicle can hydroplane on water and slip on gravel, dirt and sand covered roads. If you must go through these road conditions, slow down.

219 000 619

CA

OPERATOR'S GUIDE, SPYDER RS / ENGLISH  
GUIDE DU CONDUCTEUR, SPYDER RS / ANGLAIS

FAIT AU / MADE IN CANADA

U/M-P.C.