

OWNER'S MANUAL 2012

690 Enduro R USA

Art. no. 3211802en



KTM

DEAR KTM CUSTOMER

Congratulations on your decision to purchase a KTM motorcycle. You are now the owner of a state-of-the-art sports motorcycle that will give you enormous pleasure if you service and maintain it accordingly.

We wish you a lot of enjoyment in riding this vehicle.

Enter the serial numbers of your vehicle below.

Chassis number (☛ p. 26)	Dealer's stamp
Engine number (☛ p. 27)	
Key number (☛ p. 27)	

The Owner's Manual contained the latest information for this model at the time of going to print. Minor differences due to developments in design cannot be ruled out completely.

All specifications are non-binding. KTM Sportmotorcycle AG specifically reserves the right to modify or delete technical specifications, prices, colors, forms, materials, services, designs, equipment, etc., without prior notice and without specifying reasons, to adapt these to local conditions, as well as to stop production of a particular model without prior notice. KTM accepts no liability for delivery options, deviations from illustrations and descriptions, as well as misprints and other errors. The models portrayed partly contain special equipment that does not belong to the regular scope of delivery.

© 2012 KTM-Sportmotorcycle AG, Mattighofen Austria

All rights reserved

Reproduction, even in part, as well as copying of all kinds, is permitted only with the express written permission of the copyright owner.















ISO 9001(12 100 6061)

According to the international quality management standard ISO 9001, KTM uses quality assurance processes that lead to the maximum possible quality of the products.

Issued by: TÜV Management Service

KTM-Sportmotorcycle AG
5230 Mattighofen, Austria

MEANS OF REPRESENTATION	7	Combination instrument - time	37
IMPORTANT INFORMATION	8	Setting the clock	37
Overview of warning labels.....	12	Combination instrument - display ODO	38
VIEW OF VEHICLE.....	22	Combination instrument - setting/resetting TRIP 1.....	38
View of vehicle, front left (example).....	22	Combination instrument - setting/resetting TRIP 2.....	39
View of vehicle, rear right (example).....	24	Combination instrument - TRIP F display.....	40
SERIAL NUMBERS.....	26	Combination instrument - coolant temperature indicator	40
Chassis number.....	26	Opening the filler cap	41
Type label.....	26	Closing filler cap	42
Engine number.....	27	Seat release.....	42
Key number	27	Handrails.....	43
Fork part number.....	28	Passenger footrests.....	43
Shock absorber part number.....	28	Shift lever.....	44
CONTROLS	29	Foot brake lever.....	45
Clutch lever	29	Side stand	45
Hand brake lever	29	PREPARING FOR USE.....	46
Throttle grip.....	30	Advice on first use.....	46
Light switch	30	Running in the engine.....	47
Turn signal switch	31	Loading the vehicle	48
Horn button	31	RIDING INSTRUCTIONS	50
Emergency OFF switch.....	32	Performing checks and vehicle care when preparing for	
Electric starter button	32	use	50
Ignition/steering lock	33	Starting.....	51
Combination instrument.....	33	Starting off	52
Combination instrument - function buttons	34	Shifting, riding.....	52
Combination instrument - indicator lamps.....	34	Braking	56
Combination instrument - display.....	35	Stopping, parking	57
Combination instrument - speedometer.....	36	Refueling.....	58
Setting kilometers or miles.....	36		

SERVICE SCHEDULE.....	61	Mounting the seat	82
Service schedule	61	Removing the air filter 	83
TUNING THE CHASSIS.....	64	Installing the air filter 	84
Fork/shock absorber	64	Checking the chain for dirt	85
Adjusting the compression damping of the fork	64	Cleaning the chain.....	85
Adjusting the rebound damping of the fork.....	65	Checking the chain tension	86
Compression damping of the shock absorber	66	Adjusting the chain tension	87
Adjusting the low-speed compression damping of the shock absorber	66	Check the chain, rear sprocket, engine sprocket and chain guide.....	89
Adjusting the high-speed compression damping of the shock absorber	67	Adjusting chain guide 	94
Adjusting the rebound damping of the shock absorber.....	68	Adjusting basic position of clutch lever.....	95
Measuring the unloaded rear wheel sag.....	69	Checking/rectifying the fluid level of the hydraulic clutch	95
Checking the static sag of the shock absorber	70	Removing the engine guard	96
Checking the riding sag of the shock absorber	71	Installing the engine guard	97
Adjusting the spring preload of the shock absorber 	71	BRAKES	98
Adjusting the riding sag 	73	Checking the free travel of the hand brake lever	98
Handlebar position	74	Adjusting the free travel of the hand brake lever	98
Adjusting handlebar position 	74	Checking the brake discs.....	99
SERVICE WORK ON THE CHASSIS.....	76	Checking the front brake fluid level	100
Raising the motorcycle with the lift stand	76	Adding front brake fluid 	101
Removing the motorcycle from the lift stand	76	Checking the front brake linings.....	102
Bleeding the fork legs	77	Changing the front brake linings 	103
Cleaning the dust boots of the fork legs	77	Checking the free travel of foot brake lever.....	107
Loosening the fork protection.....	78	Adjusting the basic position of the foot brake lever 	107
Positioning the fork protection	79	Checking rear brake fluid level	108
Checking the steering head bearing play	79	Adding rear brake fluid 	109
Adjusting the play of the steering head bearing 	80	Checking the rear brake linings.....	111
Removing the seat.....	82	Changing the rear brake linings 	111



















WHEELS, TIRES	115	TUNING THE ENGINE	152
Removing the front wheel 	115	Checking the play in the throttle cable.....	152
Installing the front wheel 	116	Adjusting the play in the throttle cable 	153
Removing rear wheel 	118	Adjusting the engine characteristic.....	153
Installing the rear wheel 	119	Checking the basic position of the shift lever.....	155
Checking the rear hub rubber dampers 	120	Adjusting the basic position of the shift lever 	155
Checking the tire condition.....	122	SERVICE WORK ON THE ENGINE	157
Checking the tire air pressure	123	Checking the engine oil level	157
Checking the spoke tension	124	Changing the engine oil and filter, cleaning the oil screens 	158
ELECTRICAL SYSTEM	126	Draining the engine oil 	158
Removing the battery 	126	Removing the oil filter 	159
Installing the battery 	127	Cleaning the oil screens 	161
Recharging the battery 	128	Installing the oil filter 	163
Changing the main fuse	131	Filling up with engine oil 	163
Changing fuses of individual power consumers	132	Adding engine oil	164
Removing the headlight mask with the headlight	134	CLEANING, CARE	166
Installing the headlight mask with the headlight	136	Cleaning the motorcycle	166
Changing the headlight bulb	137	Checks and maintenance steps for winter operation	168
Changing the parking light bulb	138	STORAGE	169
Changing the turn signal bulb	140	Storage.....	169
Changing the tail light.....	141	Preparing for use after storage	170
Checking the headlight setting.....	142	TROUBLESHOOTING.....	171
Adjusting the headlight range	142	BLINK CODE	174
COOLING SYSTEM	144	TECHNICAL DATA - ENGINE	179
Cooling system	144	Capacity - engine oil	180
Checking the antifreeze and coolant level	144	Capacity - coolant.....	180
Checking the coolant level.....	146	TECHNICAL DATA - ENGINE TIGHTENING TORQUES.....	181
Draining the coolant 	148		
Filling the cooling system 	149		

TABLE OF CONTENTS

TECHNICAL DATA - CHASSIS	184
Lighting equipment	185
Tires	186
Capacity - fuel.....	186
TECHNICAL DATA - FORK.....	187
TECHNICAL DATA - SHOCK ABSORBER	188
TECHNICAL DATA - CHASSIS TIGHTENING TORQUES	190
SUBSTANCES.....	194
AUXILIARY SUBSTANCES.....	198
STANDARDS.....	200
INDEX	201

Symbols used

The meaning of specific symbols is described below.



Indicates an expected reaction (e.g. of a work step or a function).



Indicates an unexpected reaction (e.g. of a work step or a function).



All work marked with this symbol requires specialist knowledge and technical understanding. In the interest of your own safety, have these jobs performed by an authorized KTM workshop! There, your motorcycle will be serviced optimally by specially trained experts using the specialist tools required.



Indicates a page reference (more information is provided on the specified page).

Formats used

The typographical formats used in this document are explained below.

Specific name

Identifies a proprietary name.

Name[®]

Identifies a protected name.

Brand[™]

Identifies a brand available on the open market.

Use definition

KTM sport motorcycles are designed and constructed to meet the normal demands of regular road and light offroad operation (dirt roads), but not for use on race courses.



Info

The motorcycle is authorized for public road traffic in the homologous version only.

Service

A prerequisite for fault-free operation and avoiding premature wear is compliance with the instructions for maintenance, care and tuning of the engine and suspension provided in the owner's manual. Poor adjustment and tuning of the engine and chassis can lead to damage and breakage of components.

Using the motorcycle in extreme conditions such as very dirty or wet roads can lead to above-average wear of components such as the transmission train or the brakes. For this reason, it may be necessary to service or replace worn parts before the limit specified in the service schedule is reached.

It is imperative that you adhere to the stipulated run-in times and service intervals. If you observe these exactly, you will ensure a much longer service life for your motorcycle.

Warranty

The work prescribed in the service schedule must be carried out by an authorized KTM workshop only and confirmed in the customer's service record and in the **KTM dealer.net**; otherwise, all warranty claims will be void. No warranty claims can be considered for damage resulting from manipulations and/or alterations to the vehicle.

Fuel, oils, etc.

Use the fuels and operating fluids as specified in the Owner's Manual.

Spare parts, accessories

For your own safety, only use spare parts and accessory products that have been approved and/or recommended by KTM and have them installed by an authorized KTM workshop. KTM accepts no liability for other products and any resulting damage.

Some spare parts and accessory products are specified in parentheses in the descriptions. Your KTM dealer will be glad to advise you.

You will find the current **KTM PowerParts** for your vehicle on the KTM website.

International KTM Website: <http://www.ktm.com>

Work rules

Special tools are necessary for certain tasks. The tools are not contained in the vehicle but can be ordered under the number in parentheses. Example: valve spring mounter (59029019000)

During assembly, non-reusable parts (e.g. self-locking screws and nuts, seals and seal rings, O-rings, pins, lock washers) must be replaced by new parts.

If a thread lock (e.g. **Loctite**®) is used for screw connections, be sure to comply with the manufacturer's specific instructions on its usage. Parts that you want to reuse following repairs and servicing should be cleaned and checked for damage and wear. Change damaged or worn parts.

Ensure that the vehicle is roadworthy after completing repair and maintenance work.

Transport

Note

Danger of damage The parked vehicle may roll away or fall over.

- Always place the vehicle on a firm and even surface.

Note

Fire hazard Some vehicle components become very hot when the vehicle is operated.

- Do not park the vehicle near flammable or explosive substances. Do not place objects on the vehicle while it is still warm from being run. Always let the vehicle cool first.

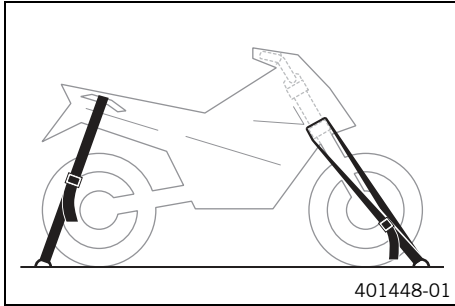

- Switch off the engine and remove the ignition key.
- Use straps or other suitable devices to secure the motorcycle against accidents or falling over.

Environment

Offroad motorcycling is a wonderful sport and we naturally hope that you will be able to enjoy it to the fullest. However, it is a potential problem for the environment and can lead to conflicts with other persons. But if you use your motorcycle responsibly, you can ensure that such problems and conflicts do not have to occur. To protect the future of motorcycle sport, make sure that you use your motorcycle legally, display environmental consciousness, and respect the rights of others.

Overview of warning labels

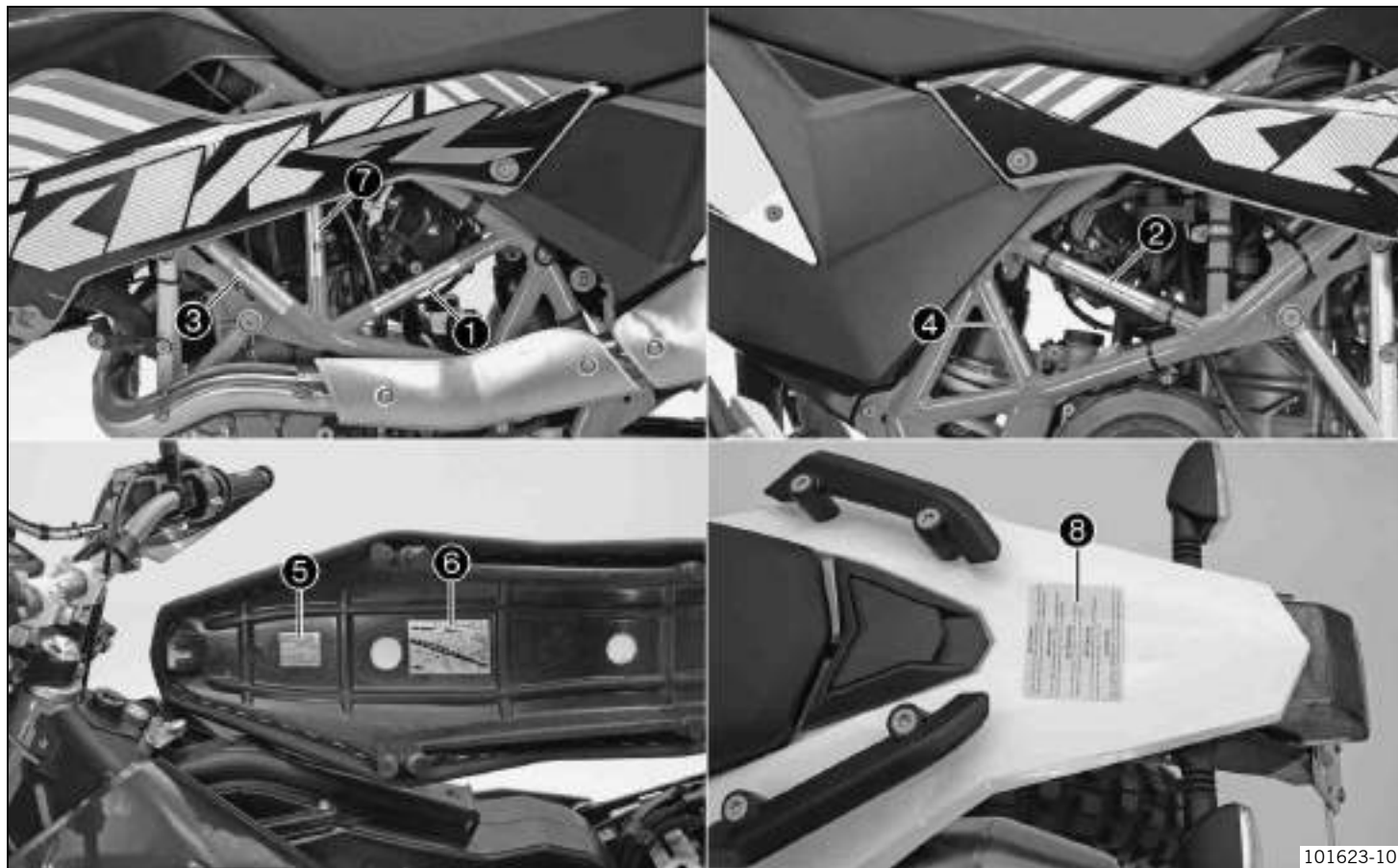

IMPORTANT INFORMATION

	MFD. BY KTM SPORTMOTORCYCLE AG AUSTRIA		
	MOTORCYCLE		DATE
GAWR	771 lbs	350 kg	
GAWR FRONT	331 lbs	150 kg	WITH 90/80-21 TIRE, 54S TYPE, 1.85-21 RIM, AT 30 psi 2.1 bar COLD
GAWR REAR	441 lbs	200 kg	WITH 140/80-18 TIRE, 70S TYPE, 2.50-18 RIM, AT 30 psi 2.1 bar COLD
THIS VEHICLE CONFORMS TO ALL APPLICABLE U.S. FEDERAL MOTOR VEHICLE SAFETY STANDARDS IN EFFECT ON THE DATE OF MANUFACTURE SHOWN ABOVE.			
VBKxxxxxxMxxxxxx			

101616-01

Type label, USA

VEHICLE EMISSIONS INFORMATION	
 MANUFACTURER - KTM SPORTMOTORCYCLE AG - <i>Waldgraben, Austria</i> IMPORTER - KTM NORTH AMERICA, INC. - 1115 Main Ave. - <i>Lehens, OH 44021</i>	
ENGINE DISPLACEMENT	660 cc ENGINE EXHAUST EMISSION CONTROL SYSTEM
ENGINE MODEL	0200088PM TWO, FOUR, 70, 4228 part 1 of 2
ASSEMBLY DATE	OCTOBER 2017 MODEL YEAR 2018 800826000 6
THIS ENGINE CONFORMS WITH U.S. AND CALIFORNIA REGULATIONS APPLICABLE TO 2012 MODEL YEAR NEW MOTORCYCLES AND IS CERTIFIED TO SAE J1335-1102, 12-2011 TO EXHAUST EMISSION STANDARDS IN CALIFORNIA.	
ENGINE LABEL SPECIFICATIONS:	
CONTROL TECHNIQUE	NON-ADJUSTABLE
EGR SYSTEM	NO EGR IN NEUTRAL
EGR METER	NON-ADJUSTABLE
VALVE CLEARANCE	0.01 - 0.15mm INTAKE & EXHAUST
SPARK PLUG	NON-ADJUSTABLE
SPARK PLUG GAP	0.8 mm
FUEL	UNLEADED GASOLINE ONLY AT 30MM OCTANE OR HIGHER
OR	SAE 10/88
VIN: VBKxxxxxxMxxxxxx	DATE OF MANUFACTURE

101617-01

Information, emission control

MOTORCYCLE NOISE EMISSION CONTROL INFORMATION KTM SPORTMOTORCYCLE AG, AUSTRIA		
THIS 2012 KTMC639625 MOTORCYCLE 765.05.082.100 MEETS U.S. EPA NOISE EMISSION REQUIREMENTS OF 80 dBA AT 3850 RPM BY THE U.S. FEDERAL TEST PROCEDURE. MODIFICATIONS WHICH CAUSE THIS MOTORCYCLE TO EXCEED FEDERAL NOISE STANDARDS ARE PROHIBITED BY U.S. FEDERAL LAW. SEE OWNER'S MANUAL.		
Motorcycle Type : 680 Enduro R	Date manufactured :	VIN. : VBK000M0XW000000

101618-01

Information, noise emission

765 01 680 100	FORK		SHOCK			
SETTING	Compression (clicks)	Rebound (clicks)	Collar (low speed (clicks))	Collar (high speed (clicks))	Minusval	Stroke preload (mm)
	Correct	20	20	25	20	20
Basic setting	18	15	15	1,5	16	10
Soft	10	10	15	1,0	10	18
Max. payload	10	10	18	1,0	10	13

101619-01

Information, suspension setting

Information, chain tension

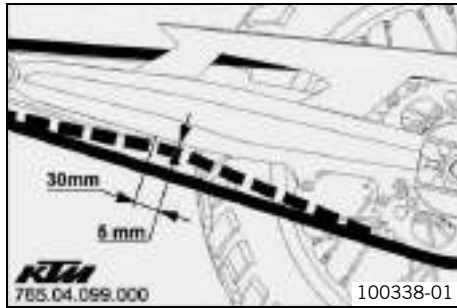

Information, fuel evaporation system



Information, putting into operation

Notes/warnings

Pay close attention to the notes/warnings.

Info

Various information and warning labels are affixed to the vehicle. Do not remove information/warning labels. If they are missing, you or others may not recognize potential hazards and may therefore be injured.

Grades of risks



Danger

Identifies a danger that will immediately and invariably lead to fatal or serious permanent injury if the appropriate measures are not taken.



Warning

Identifies a danger that is likely to lead to fatal or serious injury if the appropriate measures are not taken.



Caution

Identifies a danger that may lead to minor injuries if the appropriate measures are not taken.

Note

Identifies a danger that will lead to considerable machine and material damage if the appropriate measures are not taken.



Warning

Identifies a danger that will lead to environmental damage if the appropriate measures are not taken.

Owner's manual

- It is important that you read this owner's manual carefully and completely before making your first trip. It contains useful information and tips to help you operate and handle your motorcycle. Only then will you find out how to customize the motorcycle ideally for your own use and how you can protect yourself from injury. The owner's manual also contains important information on servicing the motorcycle.
- The owner's manual is an important component of the motorcycle and should be handed over to the new owner if the vehicle is sold.

Reporting safety defects

If you believe that your vehicle has a defect which could cause an accident resulting in injury or death, you should immediately inform the National Highway Traffic Safety Administration (NHTSA) in addition to notifying KTM North America, Inc.

If NHTSA receives similar complaints, it may open an investigation, and if it finds that a safety defect exists in a group of vehicles, it may order a recall and remedy campaign. However, NHTSA cannot become involved in individual problems between you, your dealer, or KTM North America, Inc.

To contact NHTSA, you may either call the Auto Safety Hotline toll-free at 1-888-327-4236 or visit the website www.nhtsa.dot.gov, or write to: NHTSA Headquarters, 1200 New Jersey Avenue, SE, West Building, Washington, DC 20590. You can also obtain other information about motor vehicle safety from the Hotline.

Noise emission warranty

KTM Sportmotorcycle AG warrants that this exhaust system, at the time of sale, meets all applicable U.S. EPA Federal noise standards. This warranty extends to the first person who buys this exhaust system for purposes other than resale, and to all subsequent buyers.

Warranty claims should be directed to:

KTM North America, Inc., Customer Support, 1119 Milan Ave., Amherst, OH 44001, USA

Phone: (440) 985-3553

www.ktmusa.com

KTM Canada, Inc., Customer Support, 1375-1 Marie-Victorin, Saint-Bruno, QC J3V 6B7

Phone: (450) 441-4451 x 4250

www.ktmcanada.com

Tampering warning

Tampering with noise control system prohibited. Federal law prohibits the following acts or causing thereof:

- 1 The removal or rendering inoperative by any person other than for purposes of maintenance, repair, or replacement, of any device or element of design incorporated into any new vehicle for the purpose of noise control prior to its sale or delivery to the ultimate purchaser or while it is in use, or
- 2 the use of the vehicle after such device or element of design has been removed or rendered inoperative by any person.

Among those acts presumed to constitute tampering are the acts listed below.

- 1 Removal of, or puncturing the muffler, baffles, header pipes or any other components which conducts exhaust gases.
- 2 Removal or puncturing of any part of the intake system.
- 3 Lack of proper maintenance.
- 4 Replacing any moving part of the vehicle, or parts of the exhaust or intake system, with parts other than those specified by the manufacturer.

Warning, operating noise

This product should be checked for repair or replacement if the motorcycle noise has increased significantly through use. Otherwise, the owner may become subject to penalties under state and local ordinances.

Consumer rights

Warranty claims should be directed to an authorized KTM workshop. If you are not satisfied, please contact:

KTM North America, Inc., Customer Support, 1119 Milan Ave., Amherst, OH 44001, USA

Phone: (440) 985-3553

www.ktmusa.com

KTM Canada, Inc., Customer Support, 1375-1 Marie-Victorin, Saint-Bruno, QC J3V 6B7

Phone: (450) 441-4451 x 4250

www.ktmcanada.com

Your rights may vary depending on national and regional laws.

View of vehicle, front left (example)



1	Hand brake lever (☛ p. 29)
2	Clutch lever (☛ p. 29)
3	Handrails (☛ p. 43)
4	Filler cap
5	Engine number (☛ p. 27)
6	Shift lever (☛ p. 44)
7	Side stand (☛ p. 45)
8	Seat release (☛ p. 42)
8	Compression damping of the shock absorber (☛ p. 66)

View of vehicle, rear right (example)

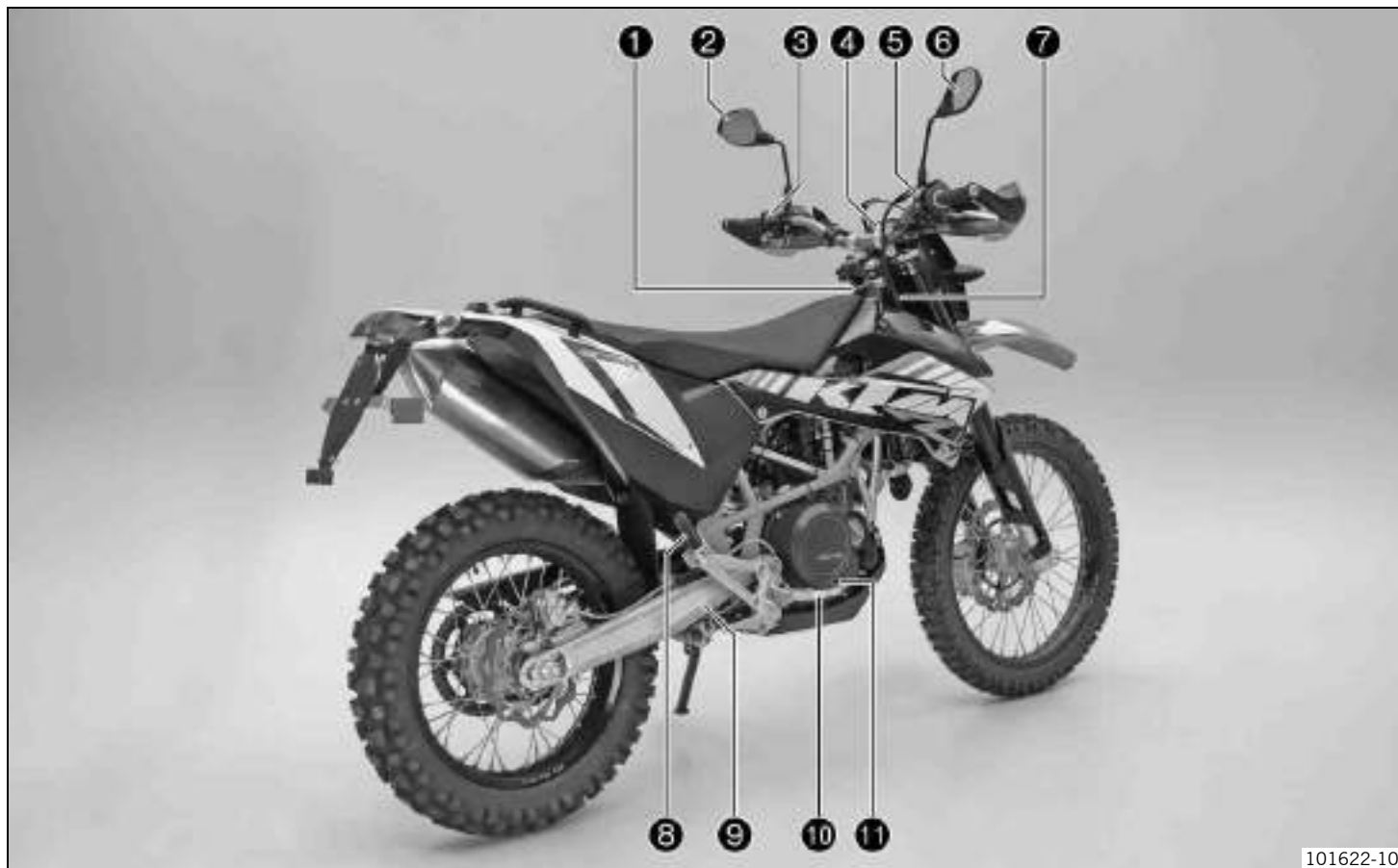

1	Light switch (☛ p. 30)
1	Turn signal switch (☛ p. 31)
1	Horn button (☛ p. 31)
2	Ignition/steering lock (☛ p. 33)
3	Combination instrument (☛ p. 33)
4	Emergency OFF switch (☛ p. 32)
4	Electric starter button (☛ p. 32)
5	Throttle grip (☛ p. 30)
6	Shock absorber, rebound adjustment
7	Foot brake lever (☛ p. 45)
8	Level viewer, engine oil
9	Type label (☛ p. 26)
10	Chassis number (☛ p. 26)

Chassis number

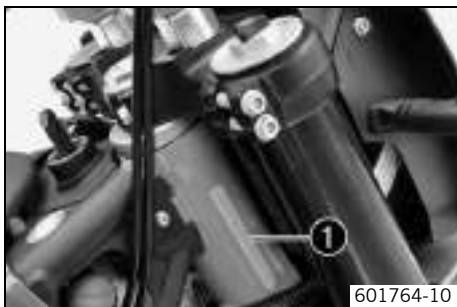

The chassis number ❶ is stamped on the steering head on the right.

Type label



The type label ❶ is located on the right side of the frame.

Engine number



The engine number ❶ is stamped on the left side of the engine under the engine sprocket.

Key number



The key number ❶ can be found on the **KEYCODECARD**.



Info

You need the key number to order a spare key. Keep the **KEYCODECARD** in a safe place.

Fork part number



The fork part number ❶ is stamped on the inner side of the fork stub.

Shock absorber part number



The shock absorber part number ❶ is on the left of the shock absorber.

Clutch lever



The clutch lever ❶ is fitted on the left side of the handlebar.
The clutch is hydraulically operated and self-adjusting.

Hand brake lever



The hand brake lever ❶ is fitted on the right side of the handlebar.
The hand brake lever operates the front brake.

Throttle grip





The throttle grip ❶ is fitted on the right side of the handlebar.

Light switch



The light switch ❶ is fitted on the left side of the handlebar.

Possible states

	Low beam on – Light switch is turned downwards. In this position, the low beam and tail light are switched on.
	High beam on – Light switch is turned upwards. In this position, the high beam and the tail light are switched on.

Turn signal switch



The turn signal switch ❶ is fitted on the left side of the handlebar.

Possible states

	Turn signal off
←	Turn signal light, left, on – Turn signal switch pressed to the left. The turn signal switch returns automatically to the central position after use.
→	Turn signal light, right, on – Turn signal switch pressed to the right. The turn signal switch returns automatically to the central position after use.

To switch off the turn signal light, press the turn signal switch towards the switch case.

Horn button



The horn button ❶ is fitted on the left side of the handlebar.

Possible states

- Horn button ❶ in neutral position
- Horn button ❶ pressed – The horn is operated in this position.

Emergency OFF switch



The emergency OFF switch ❶ is fitted on the right side of the handlebar.

Possible states

	<p>Emergency OFF switch off – In this position, the ignition circuit is interrupted, a running engine stops, and the engine cannot be started.</p>
	<p>Emergency OFF switch on – This position is necessary for operation as the ignition circuit is closed.</p>

Electric starter button



The electric starter button ❶ is fitted on the right side of the handlebar.

Possible states

- Electric starter button ❸ in basic position
- Electric starter button ❸ pressed – In this position, the electric starter is actuated.

Ignition/steering lock



The ignition/steering lock ❶ is located in front of the seat.

Possible states

	<p>Ignition OFF – In this position, the ignition circuit is interrupted, a running engine stops, and a non-running engine will not start. The ignition key can be removed.</p>
	<p>Ignition ON – In this position, the ignition circuit is closed and the engine can be started.</p>
	<p>Steering locked – In this position, the ignition circuit is interrupted and the steering locked. The ignition key can be removed.</p>

Combination instrument



The combination instrument is installed in front of the handlebar.

The combination instrument is divided into 4 function areas.

- ❶ Function buttons
- ❷ Tachometer
- ❸ Indicator lights
- ❹ Display

Combination instrument - function buttons

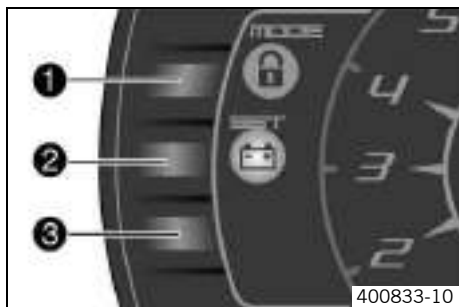

You can change the display mode with the **MODE** button ❶.

Possible display modes are distance traveled (**ODO**), trip master 1 (**TRIP 1**) and trip master 2 (**TRIP 2**).

Press the **SET** button ❷ to reset the trip master 1 function (**TRIP 1**) and trip master 2 function (**TRIP 2**) to **0.0**.

Button ❸ has no function.



Combination instrument - indicator lamps



The indicator lamps offer additional information about the operating state of the motorcycle.

Possible states

	The turn signal indicator light flashes green simultaneously with the turn signals – Turn signal light is switched on.
	The idling speed indicator lamp lights up green – The transmission is switched to idle.
	High beam indicator lamp lights up blue – High beam is switched on.
	Temperature warning lamp lights up red – Coolant temperature has reached a critical value.
	Low fuel warning lamp lights up orange – Fuel level has reached the reserve mark. Display switched to TRIP F .

	<p>The oil pressure warning lamp lights up red – The oil pressure is too low.</p>
	<p>FI warning lamp (MIL) lights up/flashes orange – The OBD (onboard diagnosis) has identified an emissions- or safety-critical fault.</p>
	<p>The battery warning lamp lights up red – The voltage in the vehicle system is too low.</p>

Combination instrument - display



When you switch on the ignition, all display segments light up for one second as a function test.



LEnGth

Following the display function test, the wheel circumference **LEnGth** is shown for one second.



Info

2205 mm equals the circumference of the 21" front wheel with a series production tire.

The display then changes to the last selected mode.

Combination instrument - speedometer



400838-10

The speed ❶ is shown in kilometers per hour **km/h** or in miles per hour **mph**.

Setting kilometers or miles



Info

If you change the unit, the value is retained and converted accordingly.
Making the setting according to the country.

Condition

The motorcycle is stationary.



400839-01

- Switch on the ignition by turning the ignition key to position **ON** .
- Press the **MODE** button repeatedly until the **ODO** mode is active.
- Keep the **MODE** button pressed until the display mode changes from **km/h** to **mph** or from **mph** to **km/h**.

Guideline

Activation duration of MODE button	10 s
---	------

Combination instrument - time



400838-11

The time is shown in area **1** of the display.



Info

After reconnecting the battery or changing the fuse, the time must be reset.

Setting the clock

Condition

The motorcycle is stationary.



- Switch on the ignition by turning the ignition key to position **ON** .
- Press the **MODE** button repeatedly until the **ODO** mode is active.
- Keep the **MODE** button and the **SET** button pressed simultaneously.
 - ✓ The time display begins to flash.
- Press the **MODE** button to set the hour.
- Press the **SET** button to set the minute.
- Keep the **MODE** button and the **SET** button pressed simultaneously.
 - ✓ The time is set.

Combination instrument - display ODO



In the **ODO** display mode, the total distance traveled is shown in kilometers or miles.



Info

This value is retained, even if the battery is disconnected and/or the fuse blows.

Combination instrument - setting/resetting TRIP 1



Info

The **TRIP 1** trip counter runs constantly and counts up to **999.9**.

The trip counter can be used to measure the distance covered during trips or between two refueling stops. After the value **999.9** is reached, the trip counter starts at **0.0** again.



- Switch on the ignition by turning the ignition key to position **ON** .
- Press the **MODE** button repeatedly until the **TRIP 1** mode is active.
- Keep the **SET** button pressed.
- ✓ The **TRIP 1** display is set to **0.0**.

Combination instrument - setting/resetting TRIP 2

Info

The **TRIP 2** trip counter runs constantly and counts up to **999.9**.

The trip counter can be used to measure the distance covered during trips or between two refueling stops. After the value **999.9** is reached, the trip counter starts at **0.0** again.



- Switch on the ignition by turning the ignition key to position **ON** .
- Press the **MODE** button repeatedly until the **TRIP 2** mode is active.
- Keep the **SET** button pressed.
- ✓ The **TRIP 2** display is set to **0.0**.

Combination instrument - TRIP F display



If the fuel level drops to the reserve mark, the display automatically changes to **TRIP F** and starts to count from **0.0**, regardless of the previous display mode.



Info

The low fuel warning lamp lights up in parallel to the **TRIP F** display.

Combination instrument - coolant temperature indicator

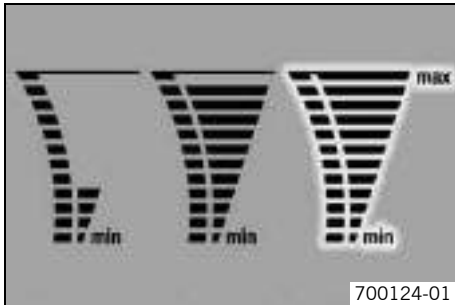

The temperature display consists of 12 bars. The more bars that light up, the hotter the coolant. When the upper bar lights up, all bars in the display begin to flash and the temperature warning lamp lights up.

Possible states

- Engine cold – Up to four bars light up.
- Engine warm – Five to eleven bars light up.
- Engine hot – All twelve bars flash.

Opening the filler cap



Danger

Fire hazard Fuel is highly flammable.

- Never refuel the vehicle near open flames or burning cigarettes, and always switch off the engine first. Be careful that no fuel is spilled, especially on hot vehicle components. Clean up spilled fuel immediately.
- Fuel in the fuel tank expands when warm and can escape if the tank is overfilled. See the notes on refueling.



Warning

Danger of poisoning Fuel is poisonous and a health hazard.

- Avoid contact between fuel and skin, eyes and clothing. Do not inhale fuel vapors. If fuel gets into your eyes, rinse immediately with water and contact a doctor. Wash affected skin areas immediately with soap and water. If fuel is swallowed, contact a doctor immediately. Change clothing that has come into contact with fuel. Store fuel in a suitable canister according to regulations and keep it out of the reach of children.



Warning

Environmental hazard Improper handling of fuel is a danger to the environment.

- Do not allow fuel to get into the ground water, the ground, or the sewage system.



601770-10

- Lift the cover of filler cap ❶ and insert the ignition key.
- Turn the ignition key 90° counterclockwise and remove the filler cap.



Info

The filler cap has a tank air vent system.

Closing filler cap



- Put the filler cap back on and turn the ignition key 90° clockwise.
- Remove the ignition key and fold down the cover.

Seat release



The seat can be released using strap ❶.

Handrails

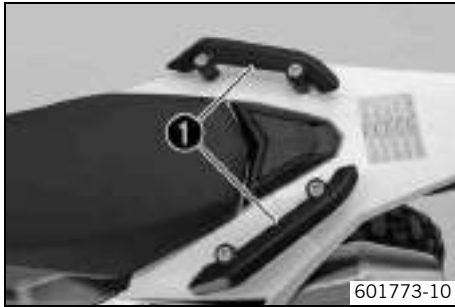

The handrails ❶ are used for moving the motorcycle around.
When you have a passenger, the passenger can hold on the handrails during the journey.

Passenger footrests



The passenger footrests can be folded up and down.

Possible states

- Passenger footrests folded up – For operation without a passenger.
- Passenger footrests folded down – For operation with a passenger.

Shift lever

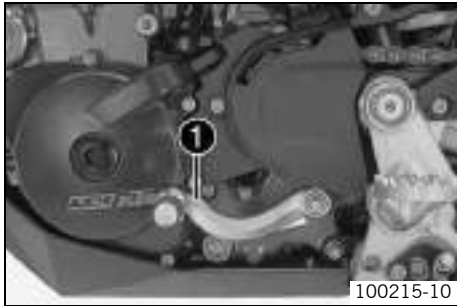

The shift lever ❶ is mounted on the left side of the engine.

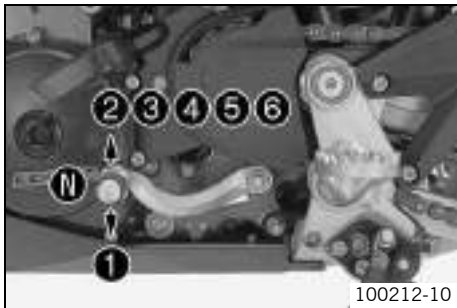

The gear positions can be seen in the photograph.
The neutral or idle position is between the first and second gears.

Foot brake lever



Foot brake lever ❶ is located in front of the right footrest.
The rear brake is engaged with the foot brake lever.

Side stand

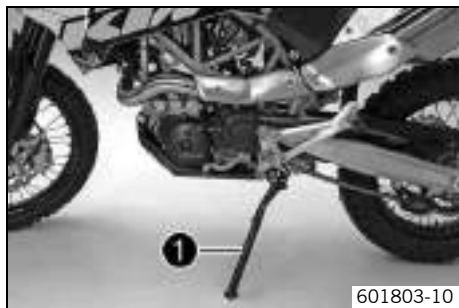

The side stand ❶ is located on the left side of the vehicle.
The side stand is used for parking the motorcycle.



Info

The side stand must be folded up during motorcycle use.
The side stand is coupled with the safety electric starter system - see the riding instructions.

Possible states

- Side stand folded out – The vehicle can be supported on the side stand. The safety electric starter system is active.
- Side stand folded in – This position is mandatory when riding the motorcycle. The safety electric starter system is inactive.

Advice on first use



Danger

Danger of accidents Danger arising from the rider's judgement being impaired.

- Do not operate the vehicle while under the influence of alcohol, drugs and certain medications or physically or mentally impaired.



Warning

Risk of injury Missing or poor protective clothing present an increased safety risk.

- Wear protective clothing (helmet, boots, gloves, pants and jacket with protectors) every time you ride the vehicle. Always wear protective clothing, which must be undamaged and meet legal requirements.



Warning

Danger of crashing Poor vehicle handling due to different tire tread patterns on front and rear wheels.

- The front and rear wheels must be fitted with tires with similar tread patterns to prevent loss of control over the vehicle.



Warning

Danger of accidents Uncontrollable handling characteristic due to non-approved and/or non-recommended tires/wheels.

- Only tires/wheels approved by KTM and with the corresponding speed index should be used.



Warning

Danger of accidents Reduced road grip with new tires.

- New tires have a smooth rolling surface and therefore cannot provide full road grip. The entire rolling surface must be roughened in the first 200 kilometers (124.3 miles) by moderate riding at alternating angles. The full grip levels are not achieved until the tires have been run in.



Warning

Danger of accidents Failure of brake system.

- If the foot brake lever is not released, the brake linings drag continuously. The rear brake may fail due to overheating. Take your foot off the foot brake lever when you are not braking.
-
-



Info

When using your vehicle, remember that others may feel disturbed by excessive noise.

- Make sure that the pre-delivery inspection work has been carried out by an authorized KTM workshop. You receive a delivery certificate and the service record at vehicle handover.
- Before your first trip, read the entire operating instructions carefully.
- Get to know the controls.
- Adjust the basic position of clutch lever. (☞ p. 95)
- Adjust the free travel of the hand brake lever. (☞ p. 98)
- Adjust the basic position of the foot brake lever. ☞ (☞ p. 107)
- Get used to handling the motorcycle on a suitable piece of land before making a longer trip. Try also to ride as slowly as possible and in a standing position to get a better feeling for the vehicle.
- Do not make any offroad trips that over-stress your ability and experience.
- Hold the handlebar firmly with both hands and keep your feet on the footrests when riding.
- Run the engine in. (☞ p. 47)

Running in the engine

- During the running-in phase, do not exceed the specified engine speed.

Guideline

Maximum engine speed	
During the first: 1,000 km (621.4 mi)	6,000 rpm
After the first: 1,000 km (621.4 mi)	7,800 rpm

- Avoid fully opening the throttle!

Loading the vehicle



Warning

Danger of accidents Unstable handling characteristics.

- Do not exceed the maximum permitted weight and axle loads. The overall weight consists of: motorcycle operational and with a full tank, driver and passenger with protective clothing and helmet, baggage.



Warning

Danger of accidents Unstable handling characteristics due to incorrect mounting of suitcase and/or tank rucksack.

- Mount and secure suitcase and tank rucksack according to the manufacturer's instructions.



Warning

Danger of accidents Unstable handling characteristics at high speed.

- Adapt your speed according to your payload. Ride more slowly if your motorcycle is loaded with cases or other baggage.
Maximum speed with baggage 130 km/h (80.8 mph)



Warning

Danger of accidents Risk of breakage of suitcase system.

- If you have fitted suitcases on your motorcycle, read the manufacturer's specifications concerning the maximum payload.

**Warning**

Danger of accidents Poor visibility for other road users due to slipped baggage.

- If the tail light is covered, you are less visible to traffic behind you, especially in the dark. Check that your baggage is fixed properly at regular intervals.

**Warning**

Danger of accidents Changed handling characteristics and longer stopping distance with excessive payload.

- Adapt your speed according to your payload.

**Warning**

Danger of accidents Unstable handling characteristics due to slipped baggage.

- Check the way your baggage is fixed regularly.

**Warning**

Danger of burns A hot exhaust system can burn baggage.

- Fasten your baggage in such a way that it cannot be burned or singed by the hot exhaust system.

-
- If you carry any baggage, make sure it is fixed firmly as close as possible to the center of the vehicle and ensure even weight distribution between the front and rear wheels.
 - Do not exceed the overall maximum permitted weight and the axle loads.

Guideline

Maximum permissible overall weight	350 kg (772 lb.)
Maximum permissible front axle load	150 kg (331 lb.)
Maximum permissible rear axle load	200 kg (441 lb.)

Performing checks and vehicle care when preparing for use



Info

Before each use, check the state and roadworthiness of the vehicle.
Make sure that the vehicle is in perfect technical condition before use.

- Check the engine oil level. (☛ p. 157)
- Check the front brake fluid level. (☛ p. 100)
- Check the rear brake fluid level. (☛ p. 108)
- Check the front brake linings. (☛ p. 102)
- Check the rear brake linings. (☛ p. 111)
- Check the brake system function.
- Check the coolant level. (☛ p. 146)
- Check the chain for dirt. (☛ p. 85)
- Check the chain tension. (☛ p. 86)
- Check the tire condition. (☛ p. 122)
- Check the tire air pressure. (☛ p. 123)
- Check the settings of all controls and ensure that they can be operated smoothly.
- Check that the electrical equipment is functioning correctly.
- Check that baggage is correctly secured.
- Sit on the motorcycle and check the rear mirror setting.
- Check the fuel level.

Starting



Danger

Danger of poisoning Exhaust gases are poisonous and inhaling them may result in unconsciousness and/or death.

- When running the engine, always make sure there is sufficient ventilation, and do not start or run the engine in an enclosed space without an effective exhaust extraction system.



Caution

Danger of accidents If the vehicle is operated with a discharged battery or without a battery, electronic components and safety equipment may be damaged.

- Never operate the vehicle with a discharged battery or without a battery.

Note

Engine failure High engine speeds in cold engines have a negative effect on the service life of the engine.

- Always warm up the engine at low engine speeds.

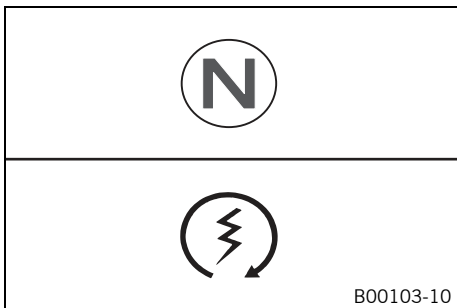

- Turn the emergency OFF switch to the position
- Switch on the ignition by turning the ignition key to position **ON**
- ✓ After you switch on the ignition, you can hear the fuel pump working for about 2 seconds. At the same time, the function test of the combination instrument is run.
- Shift gear to neutral.
- ✓ The green idling speed indicator lamp **N** lights up.
- Press the electric starter button

**Info**

Do not press the electric starter button until the function test of the combination instrument is finished.

When starting, **DO NOT** open the throttle. If you open the throttle during the starting procedure, fuel is not injected by the engine management system and the engine cannot start.

Press the starter for a maximum of 5 seconds. Wait for at least 5 seconds before trying again.

This motorcycle is equipped with a safety start system. You can only start the engine if the gearbox is in neutral or if the clutch is pulled when a gear is engaged. If the side stand is folded out and you shift into gear and release the clutch, the engine stops.

- Take the weight off the side stand and swing it back up with your foot as far as it will go.

Starting off

- Pull the clutch lever, engage 1st gear, release the clutch lever slowly and simultaneously open the throttle carefully.

Shifting, riding**Warning**

Danger of accidents Abrupt load alterations can cause the vehicle to get out of control.

- Avoid abrupt load alterations and sudden braking actions, and adapt your speed to the road conditions.

**Warning**

Danger of accidents If you change down at high engine speed, the rear wheel can lock up.

- Do not change into a low gear at high engine speed. The engine races and the rear wheel can lock up.



Warning

Danger of accidents Malfunctions caused by incorrect ignition key position.

- Do not change the ignition key position during a journey.



Warning

Danger of accidents Distraction from traffic activity by adjustments to the vehicle.

- Make all adjustments when the vehicle is at a standstill.



Warning

Risk of injury Falling off of the passenger.

- The passenger must be capable of properly holding onto the driver or the grab handles and of keeping his or her feet on the passenger footrests. Note the regulations governing the minimum age of passengers in your country.



Warning

Danger of accidents Danger of accidents caused by dangerous driving.

- Comply with traffic regulations and ride defensively and foresightedly to detect sources of danger early on.



Warning

Danger of accidents Reduced road grip with cold tires.

- On every journey, take the first miles carefully at moderate speed until the tires reach operating temperature and optimal road grip is ensured.



Warning

Danger of accidents Reduced road grip with new tires.

- New tires have a smooth rolling surface and therefore cannot provide full road grip. The entire rolling surface must be roughened in the first 200 kilometers (124.3 miles) by moderate riding at alternating angles. The full grip levels are not achieved until the tires have been run in.



Warning

Danger of accidents Unstable handling characteristics.

- Do not exceed the maximum permitted weight and axle loads. The overall weight consists of: motorcycle operational and with a full tank, driver and passenger with protective clothing and helmet, baggage.



Warning

Danger of accidents Unstable handling characteristics due to slipped baggage.

- Check the way your baggage is fixed regularly.



Warning

Danger of accidents Lack of roadworthiness.

- After a fall, check the vehicle as usual before preparing for use.

Note

Engine failure Unfiltered intake air has a negative effect on the service life of the engine.

- Never ride the vehicle without an air filter since dust and dirt can get into the engine and result in increased wear.

Note

Engine failure Overheating of engine.

- If the coolant temperature warning lamp lights up, stop and switch off the engine. Allow the engine to cool down and check the coolant level in the radiator, and top up if necessary. If you continue with the coolant temperature warning lamp alight, you may have engine failure.



Info

If unusual noises arise during operation, stop immediately, park the vehicle properly and contact an authorized KTM workshop.

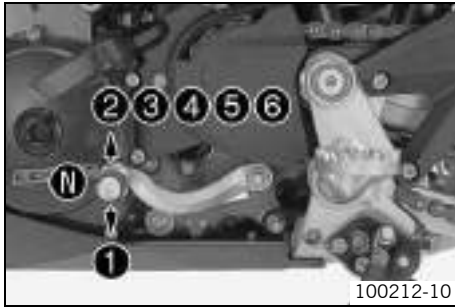

- When conditions allow (incline, road situation, etc.), you can shift into a higher gear.
- Release the throttle while simultaneously pulling the clutch lever, shift into the next gear, release the clutch and open the throttle.

i Info

You can see the positions of the 6 forward gears in the figure. The neutral or idle position is between the first and second gears. First gear is used for starting off or for steep inclines.

The operating temperature is reached when 5 bars of the temperature indicator light up.

-
- After reaching maximum speed by fully opening the throttle grip, turn the throttle back so it is $\frac{3}{4}$ open. This will barely reduce the speed but fuel consumption will be considerably lower.
 - Accelerate only up to a speed suitable for the road surface and weather conditions. When traveling in bends, do not shift, and accelerate very carefully.
 - To shift down, brake if necessary and close the throttle at the same time.
 - Pull the clutch lever and shift into a lower gear, release the clutch lever slowly and open the throttle or shift again.
 - If the engine stalls (e.g. at a crossroads), just pull the clutch lever and press the starter button. You do not have to shift into neutral.
 - Switch off the engine if you expect to be standing for a long time.
 - Avoid frequent and longer slipping of the clutch. This heats the engine oil, the engine and the cooling system.
 - Ride with a lower engine speed instead of with a high engine speed and a slipping clutch.
 - If the **FI** warning lamp (**MIL**) lights up during a trip, stop immediately. When you shift to neutral, the **FI** warning lamp (**MIL**) starts to flash.



Info

From the flashing rhythm, you can derive a two-digit number, the so-called blink code. The blink code tells you which component has a fault.

Braking



Warning

Danger of accidents If you brake too hard, the wheels can lock.

- Adapt your braking to the traffic situation and the road conditions.



Warning

Danger of accidents Reduced braking efficiency due to wet or dirty brakes.

- Clean or dry dirty or wet brakes by riding and braking gently.



Warning

Danger of accidents Reduced braking efficiency caused by spongy pressure point of front or rear brake.

- Check the brake system and do not continue riding. (Your authorized KTM workshop will be glad to help.)



Warning

Danger of accidents Failure of brake system.

- If the foot brake lever is not released, the brake linings drag continuously. The rear brake may fail due to overheating. Take your foot off the foot brake lever when you are not braking.



Warning

Danger of accidents Longer stopping distance due to higher overall weight.

- Take the longer stopping distance into account when carrying a passenger and baggage.



Warning

Danger of accidents Delayed brake action on salted roads.

- There may be salt deposits on the brake discs. In order to restore the normal braking efficiency, you will need to remove the deposits from the discs by carefully applying the brakes.

-
- To brake, release the throttle and operate the front and rear brakes simultaneously.
 - On sandy, wet or slippery surfaces, use the rear brake.
 - Braking should always be completed before you go into a bend. Change down to a lower gear appropriate to your road speed.
 - On long downhill stretches, use the braking effect of the engine. Change down one or two gears, but do not overstress the engine. In this way, you have to brake far less and the brakes do not overheat.

Stopping, parking



Warning

Risk of misappropriation Usage by unauthorized persons.

- Never leave the vehicle while the engine is running. Secure the vehicle against use by unauthorized persons. If you leave the vehicle, lock the steering and remove the ignition key.



Warning

Danger of burns Some vehicle components become very hot when the vehicle is operated.

- Do not touch hot components such as exhaust system, radiator, engine, shock absorber and brakes. Allow these components to cool down before starting work on them.

Note

Danger of damage The parked vehicle may roll away or fall over.

- Always place the vehicle on a firm and even surface.

Note

Fire hazard Some vehicle components become very hot when the vehicle is operated.

- Do not park the vehicle near flammable or explosive substances. Do not place objects on the vehicle while it is still warm from being run. Always let the vehicle cool first.

Note

Material damage Damage and destruction of components by excessive load.

- The side stand is designed for the weight of the motorcycle only. Do not sit on the motorcycle when it is supported by the side stand only. The side stand and/or the frame could be damaged and the motorcycle could fall over.

-
- Brake the motorcycle.
 - Shift gear to neutral.
 - Switch off the ignition by turning the ignition key to position **OFF** ☒.



Info

If the engine is switched off with the emergency OFF switch and the ignition remains switched on at the ignition lock, power continues to flow to most power consumers and the battery will discharge. You should therefore always switch off the engine with the ignition key - the emergency OFF switch is intended for emergencies only.

-
- Park the motorcycle on a firm surface.
 - Swing the side stand forward with your foot as far as it will go and lean the vehicle on it.
 - Lock the steering by turning the handlebar fully to the left, pressing down the ignition key to position ☒ and turning it to position ☒. To make the steering lock engage more easily, move the handlebar a little to the left and right. Remove the ignition key.

Refueling



Danger

Fire hazard Fuel is highly flammable.

- Never refuel the vehicle near open flames or burning cigarettes, and always switch off the engine first. Be careful that no fuel is spilt, especially on hot vehicle components. Clean up spilt fuel immediately.
- Fuel in the fuel tank expands when warm and can escape if the tank is overfilled. See the notes on refueling.



Warning

Danger of poisoning Fuel is poisonous and a health hazard.

- Avoid contact of the fuel with skin, eyes and clothing. Do not inhale fuel vapors. If fuel gets into your eyes, rinse immediately with water and contact a doctor. Wash affected skin areas immediately with soap and water. If fuel is swallowed, contact a doctor immediately. Change clothing that has come into contact with fuel.

Note

Material damage Premature clogging of the fuel filter.

- In some countries and regions, the available fuel quality and cleanliness may not be sufficient. This will result in problems with the fuel system. (Your authorized KTM workshop will be glad to help.)
- Only refuel with clean fuel that meets the specified standards.



Warning

Environmental hazard Improper handling of fuel is a danger to the environment.

- Do not allow fuel to get into the ground water, the ground, or the sewage system.



- Switch off the engine.
- Open the filler cap. (☛ p. 41)
- Fill the fuel tank with fuel up to measurement **A**.

Guideline

Measurement A	20 mm (0.79 in)	
Total fuel tank capacity, approx.	12 l (3.2 US gal)	Super unleaded (ROZ 95/RON 95/PON 91) (☛ p. 197)

- Close the filler cap. (☛ p. 42)



- Press the **SET** button ② for two seconds.
 - ✓ The fuel level warning lamp ① switches off. **TRIP F** is set to **0.0** and the display returns to the previous display mode.

i **Info**

If you do not press the **SET** button ②, the reset takes place automatically after about three minutes.

Service schedule

	K10N	K100A	K200A
Check that the electrical equipment is functioning correctly.	•	•	•
Read out the fault memory using the KTM diagnostics tool. 🛠️	•	•	•
Check the measured service values with the KTM diagnostics tool. 🛠️		•	•
Change the engine oil and filter, clean the oil screens. 🛠️ (📖 p. 158)	•	•	•
Check the front brake linings. (📖 p. 102)	•	•	•
Check the rear brake linings. (📖 p. 111)	•	•	•
Check the brake discs. (📖 p. 99)	•	•	•
Check the brake lines for damage and leakage.	•	•	•
Check the rear brake fluid level. (📖 p. 108)	•	•	•
Check the free travel of the foot brake lever. (📖 p. 107)	•	•	•
Check that the shock absorber and fork are leak tight. If necessary and depending on use, service the fork and shock absorber.	•	•	•
Check the swingarm bearing. 🛠️		•	•
Check the wheel bearing for play. 🛠️		•	•
Check the tire condition. (📖 p. 122)	•	•	•
Check the tire air pressure. (📖 p. 123)	•	•	•
Check the spoke tension. (📖 p. 124)	•	•	•
Check for rim run-out. 🛠️	•	•	•
Check the chain, rear sprocket, engine sprocket and chain guide. (📖 p. 89)		•	•
Check the chain tension. (📖 p. 86)	•	•	•
Grease all moving parts (e.g. side stand, hand lever, chain, ...) and check for smooth operation. 🛠️	•	•	•
Clean the dust boots of the fork legs. (📖 p. 77)		•	•

	K10N	K100A	K200A
Check the front brake fluid level. (☞ p. 100)	•	•	•
Bleed the fork legs. (☞ p. 77)		•	•
Check the steering head bearing play. (☞ p. 79)	•	•	•
Change the spark plug.			•
Check the valve clearance. 🛠️		•	•
Check all hoses (e.g. fuel, cooling, bleeder, drainage, etc.) and sleeves for cracking, leaks, and incorrect routing. 🛠️			•
Check the antifreeze and coolant level. (☞ p. 144)	•	•	•
Check the cables for damage and routing without sharp bends. 🛠️		•	•
Check that the throttle cables are undamaged, routed without sharp bends and set correctly.	•	•	•
Change the air filter. Clean the air filter box. 🛠️		•	•
Check the fuel pressure. 🛠️		•	•
Check the CO adjustment with the KTM diagnostics tool. 🛠️		•	•
Check/rectify the fluid level of the hydraulic clutch. (☞ p. 95)		•	•
Check the screws and nuts for tightness. 🛠️	•	•	•
Change the front brake fluid. 🛠️			•
Change the rear brake fluid. 🛠️			•
Check the clutch. 🛠️			•
Check the headlight setting. (☞ p. 142)	•	•	•
Check that the radiator fan is functioning properly. 🛠️	•	•	•
Final check: Check the vehicle for roadworthiness and take a test ride.	•	•	•
Read out the fault memory using the KTM diagnostics tool after a test ride. 🛠️	•	•	•
Make the service entry in KTM DEALER.NET and in the service record. 🛠️	•	•	•

K10N: Once after 1,000 km (621.4 mi)

K100A: Every 10,000 km (6,214 mi) or annually or after every sporting use

K200A: Every 20,000 km (12,428 mi) or every 2 years

Fork/shock absorber

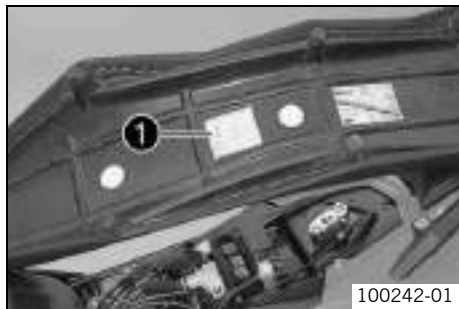

The fork and the shock absorber offer many options of adapting the chassis to your riding style and the payload.



Info

To help you adapt the vehicle, we have summarized our findings in Table 1. You can find the table on the underside of the seat.

These adjustments should be understood as a guideline and should always be the basis of your own personal chassis adaptation. Do not change the adjustments at random or by more than $\pm 40\%$, since otherwise the riding characteristics could deteriorate, particularly at high speeds.

Adjusting the compression damping of the fork



Info

The hydraulic compression damping determines the fork suspension behavior.



- Turn adjusting screws 1 clockwise all the way.



Info

The adjusting screws are located at the bottom end of the fork legs. Make the same adjustment on both fork legs.

- Turn back counterclockwise by the number of clicks corresponding to the fork type.

Guideline

Compression damping	
Comfort	20 clicks
Standard	15 clicks
Sport	10 clicks
Full payload	10 clicks

i Info Turn clockwise to increase damping; turn counterclockwise to reduce damping.

Adjusting the rebound damping of the fork

i Info The hydraulic rebound damping determines the fork rebound behavior.



- Turn adjusting screws ❶ clockwise all the way.

i Info The adjusting screws are located at the top end of the fork legs. Make the same adjustment on both fork legs.

- Turn back counterclockwise by the number of clicks corresponding to the fork type.

Guideline

Rebound damping	
Comfort	20 clicks
Standard	15 clicks
Sport	10 clicks
Full payload	10 clicks



Info

Turn clockwise to increase damping; turn counterclockwise to reduce damping.

Compression damping of the shock absorber

The compression damping of the shock absorber is divided into two ranges: high-speed and low-speed.

High-speed and low-speed refer to the compression speed of the rear wheel suspension and not to the vehicle speed.

The high-speed setting, for example, has an effect on the landing after a jump: the rear wheel suspension compresses more quickly.

The low-speed setting, for example, has an effect when riding over long ground swells: the rear wheel suspension compresses more slowly.

These two ranges can be adjusted separately, although the transition between high-speed and low-speed is gradual. Thus, changes in the high-speed range affect the compression damping in the low-speed range and vice versa.

Adjusting the low-speed compression damping of the shock absorber



Caution

Danger of accidents Disassembly of pressurized parts can lead to injury.

- The shock absorber is filled with high density nitrogen. Adhere to the description provided. (Your authorized KTM workshop will be glad to help.)



Info

The low-speed setting takes effect during the slow to normal compression of the shock absorber.



- Turn adjusting screw ❶ clockwise with a screwdriver up to the last perceptible click.



Info

Do not loosen fitting ❷!

- Turn back counterclockwise by the number of clicks corresponding to the shock absorber type.

Guideline

Compression damping, low-speed	
Comfort	20 clicks
Standard	15 clicks
Sport	10 clicks
Full payload	10 clicks



Info

Turn clockwise to increase damping; turn counterclockwise to reduce damping.

Adjusting the high-speed compression damping of the shock absorber



Caution

Danger of accidents Disassembly of pressurized parts can lead to injury.

- The shock absorber is filled with high density nitrogen. Adhere to the description provided. (Your authorized KTM workshop will be glad to help.)



Info

The high-speed setting takes effect during the fast compression of the shock absorber.



- Turn adjusting screw ❶ clockwise all the way using a socket wrench.



Info

Do not loosen fitting ❷!

- Turn back counterclockwise by the number of turns corresponding to the shock absorber type.

Guideline

Compression damping, high-speed	
Comfort	2 turns
Standard	1.5 turns
Sport	1 turn
Full payload	1 turn



Info

Turn clockwise to increase damping; turn counterclockwise to reduce damping.

Adjusting the rebound damping of the shock absorber



Caution

Danger of accidents Disassembly of pressurized parts can lead to injury.

- The shock absorber is filled with high density nitrogen. Adhere to the description provided. (Your authorized KTM workshop will be glad to help.)

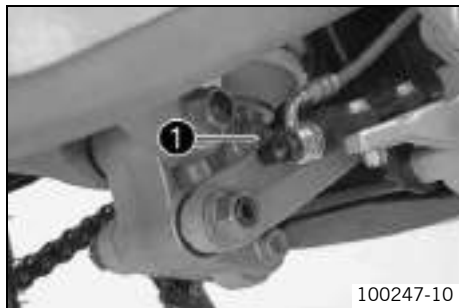

- Turn adjusting screw ❶ clockwise up to the last perceptible click.
- Turn back counterclockwise by the number of clicks corresponding to the shock absorber type.

Guideline

Rebound damping	
Comfort	20 clicks
Standard	15 clicks
Sport	10 clicks
Full payload	10 clicks

i Info Turn clockwise to increase damping; turn counterclockwise to reduce damping.

Measuring the unloaded rear wheel sag

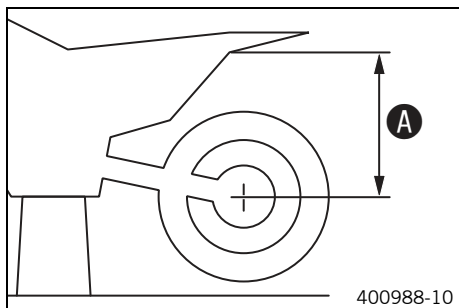

Preliminary work

- Raise the motorcycle with the lift stand. (☛ p. 76)

Main work

- Measure the vertical distance between the rear axle and a fixed point such as a marking on the side cover.
- Note down the value as dimension A.

Follow-up work

- Remove the motorcycle from the lift stand. (☛ p. 76)

Checking the static sag of the shock absorber

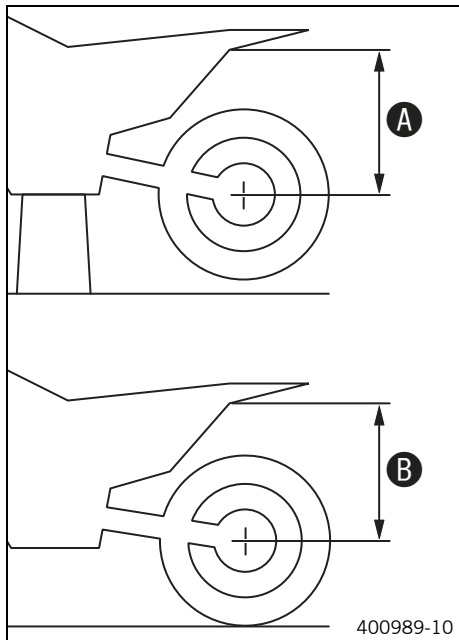

- Measure distance **A** of rear wheel unloaded. (🔧 p. 69)
- Hold the motorcycle upright with the aid of an assistant.
- Measure the distance between the rear axle and the fixed point again.
- Note down the value as dimension **B**.

i Info

The static sag is the difference between measurements **A** and **B**.

- Check the static sag.
 - » If the static sag is less or more than the specified value:
 - Adjust the spring preload of the shock absorber. 🛠️ (🔧 p. 71)

Checking the riding sag of the shock absorber

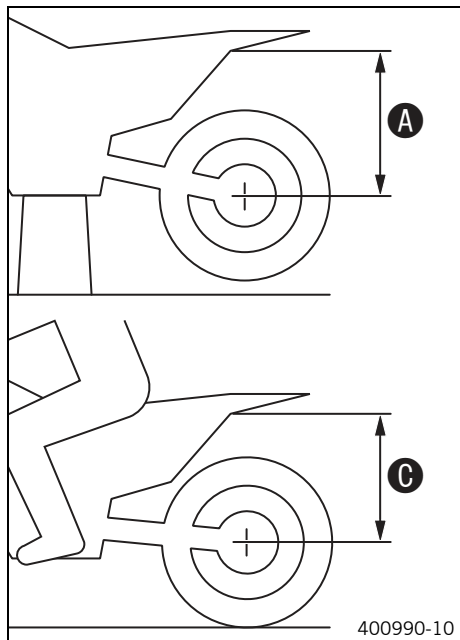

- Measure distance **A** of rear wheel unloaded. (🔧 p. 69)
- With another person holding the motorcycle, the rider, wearing full protective clothing, sits on the seat in a normal sitting position (feet on footrests) and bounces up and down a few times.
 - ✓ The rear wheel suspension levels out.
- Another person now measures the distance between the rear axle and a fixed point.
- Note down the value as dimension **C**.

i Info

The riding sag is the difference between measurements **A** and **C**.

- Check the riding sag.
 - » If the riding sag differs from the specified measurement:
 - Adjust the riding sag. 🛠️ (🔧 p. 73)

Adjusting the spring preload of the shock absorber 🛠️



Caution

Danger of accidents Disassembly of pressurized parts can lead to injury.

- The shock absorber is filled with high density nitrogen. Adhere to the description provided. (Your authorized KTM workshop will be glad to help.)

i **Info**

Before changing the spring preload, make a note of the present setting, e.g., by measuring the length of the spring.

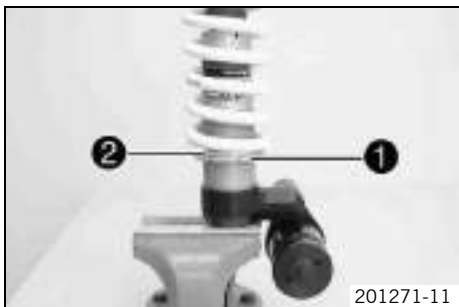

Preliminary work

- Raise the motorcycle with the work stand.
- Remove the shock absorber. 
- After removing the shock absorber, clean it thoroughly.

Main work

- Release retaining ring **1**.
- Turn adjusting ring **2** until the spring is fully relaxed.

Hook wrench (T106S)

- Measure the overall spring length without a load.
- Tighten the spring by turning adjusting ring **2** to the specified measurement.

Guideline



Spring preload	20 mm (0.79 in)
----------------	-----------------

i **Info**

Depending on the static sag and/or the riding sag, it may be necessary to increase or decrease the spring preload.

- Tighten retaining ring **1**.

Subsequent work

- Install the shock absorber. 
- Mount the side cover.
- Mount the seat. ( p. 82)
- Remove the motorcycle from the work stand.

Adjusting the riding sag



Preliminary work

- Raise the motorcycle with the work stand.
- Remove the shock absorber. 
- After removing the shock absorber, clean it thoroughly.

Main work

- Choose and mount a suitable spring.





Guideline

Spring rate	
Medium (standard)	80 N/mm (457 lb/in)
Hard	85 N/mm (485 lb/in)

Info

The spring rate is shown on the outside of the spring.

Subsequent work

- Install the shock absorber. 
- Mount the side cover.
- Mount the seat. ( p. 82)
- Remove the motorcycle from the work stand.
- Check the static sag of the shock absorber. ( p. 70)
- Adjust the rebound damping of the shock absorber. ( p. 68)

Handlebar position

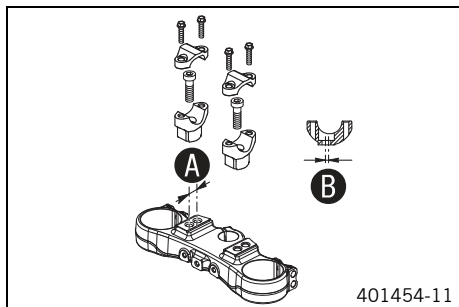

On the upper triple clamp, there are 2 holes at a distance **A** to each other.

Distance A between holes	15 mm (0.59 in)
---------------------------------	-----------------

The holes on the handlebar support are placed at a distance **B** from the center.

Distance B between holes	3.5 mm (0.138 in)
---------------------------------	-------------------

The handlebar can be mounted in 4 different positions. In this way, the handlebar can be installed in the position most comfortable for the rider.

Adjusting handlebar position

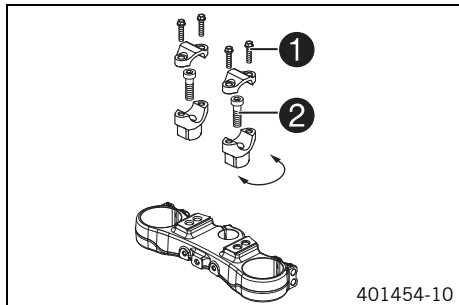

- Remove the four screws **1**. Remove the handlebar clamp. Remove the handlebar and lay it to one side.

Info

Protect the motorcycle and its attachments from damage by covering them.
Do not bend the cables and lines.

- Remove the two screws **2**. Remove the handlebar support.
- Place the handlebar support in the required position. Fit and tighten the two screws **2**.

Guideline

Screw, handlebar support	M10	40 Nm (29.5 lbf ft)	Loctite® 243™
--------------------------	-----	------------------------	----------------------

Info

Position the left and right handlebar supports evenly.

- Position the handlebar.

**Info**

Make sure cables and wiring are positioned correctly.

- Position the handlebar clamp. Fit and evenly tighten the four screws .

Guideline

Screw, handlebar clamp	M8	20 Nm (14.8 lbf ft)
------------------------	----	------------------------

Raising the motorcycle with the lift stand

Note

Danger of damage The parked vehicle may roll away or fall over.

- Always place the vehicle on a firm and even surface.

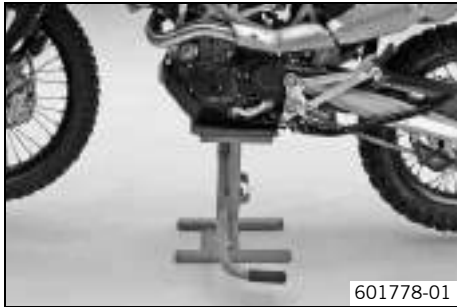

- Raise the motorcycle using the underride guard under the motorcycle.
 - ✓ The wheels must no longer touch the ground.
- Secure the motorcycle against falling over.

Removing the motorcycle from the lift stand

Note

Danger of damage The parked vehicle may roll away or fall over.

- Always place the vehicle on a firm and even surface.
- Remove the motorcycle from the lift stand and rest it on its side stand.
- Remove the lift stand.

Bleeding the fork legs



Preliminary work

- Lean the motorcycle on the side stand.

Main work

- Remove bleeder screws ❶ briefly.
 - ✓ Any excess pressure escapes from the interior of the fork.
- Mount and tighten bleeder screws.



Info

Carry out this action on both fork legs.

Cleaning the dust boots of the fork legs



Preliminary work

- Raise the motorcycle with the lift stand. (☛ p. 76)
- Loosen the fork protection. (☛ p. 78)

Main work

- Push dust boot ❶ of both fork legs downwards.



Info

The dust boots should remove dust and coarse dirt particles from the fork tubes. Over time, dirt can penetrate behind the dust boots. If this dirt is not removed, the oil seals behind can start to leak.



Warning

Danger of accidents Reduced braking efficiency due to oil or grease on the brake discs.

- Always keep the brake discs free of oil and grease, and clean them with brake cleaner when necessary.

- Clean and oil the dust boots and inner fork tube of both fork legs.

Universal oil spray (☛ p. 199)

- Press the dust boots back into their normal position.
- Remove excess oil.

Follow-up work

- Position the fork protection. (☛ p. 79)
- Remove the motorcycle from the lift stand. (☛ p. 76)

Loosening the fork protection



- Remove screws ❶ and take off clamp.
- Remove screws ❷ on left fork leg. Push the fork protection downwards.
- Remove the screws on the right fork leg. Push the fork protection downwards.

Positioning the fork protection



- Position the fork protection on the left fork leg. Mount and tighten screws ❶.

Guideline

Remaining screws, chassis	M6	10 Nm (7.4 lbf ft)
---------------------------	----	--------------------

- Position the brake line and wiring harness. Put the clamp on, mount and tighten screws ❷.

- Position the fork protection on the right fork leg. Mount and tighten the screws.

Guideline

Remaining screws, chassis	M6	10 Nm (7.4 lbf ft)
---------------------------	----	--------------------

Checking the steering head bearing play



Warning

Danger of accidents Unstable vehicle handling from incorrect steering head bearing play.

- Adjust the steering head bearing play without delay. (Your authorized KTM workshop will be glad to help.)



Info

If the bike is ridden with play in the steering head bearing, the bearing and the bearing seats in the frame can become damaged over time.

Preliminary work

- Raise the motorcycle with the lift stand. (👉 p. 76)

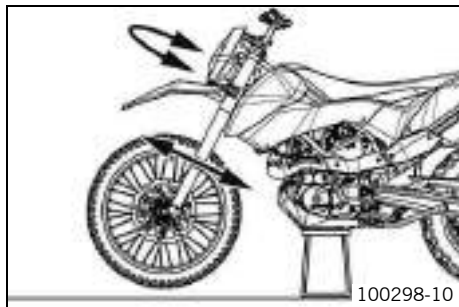

Main work

- Move the handlebar to the straight-ahead position. Move the fork legs to and fro in the direction of travel.

No play should be noticeable in the steering head bearing.

- » If there is noticeable play present:
 - Adjust the play of the steering head bearing. 🛠️ (📖 p. 80)
- Move the handlebar to and fro over the entire steering range.

The handlebar must be able to move easily over the entire steering range. No resting locations should be noticeable.

- » If click positions are noticeable:
 - Adjust the play of the steering head bearing. 🛠️ (📖 p. 80)
 - Check the steering head bearing and change if necessary.

Subsequent work

- Remove the motorcycle from the lift stand. (📖 p. 76)

Adjusting the play of the steering head bearing 🛠️

Preliminary work

- Raise the motorcycle with the lift stand. (📖 p. 76)



Main work

- Loosen screw ❶. Remove screw ❷.
- Loosen and retighten screw ❸.

Guideline

Screw, top steering head	M20x1.5	12 Nm (8.9 lbf ft)
--------------------------	---------	--------------------

- Using a plastic hammer, tap lightly on the upper triple clamp to avoid strains.
- Fully tighten screws ❶.

Guideline

Screw, top triple clamp	M8	17 Nm (12.5 lbf ft)
-------------------------	----	------------------------

- Mount and tighten screw ❷.

Guideline

Screw, steering stem	M8	20 Nm (14.8 lbf ft)
----------------------	----	------------------------

Subsequent work

- Check the steering head bearing play. (☛ p. 79)
- Remove the motorcycle from the lift stand. (☛ p. 76)

Removing the seat



- Pull on strap **1** and raise the rear of the seat at the same time.
- Pull back the seat and lift it off.

Mounting the seat



- Hook slot **1** of the seat onto screw **2**, press the rear downward and at the same time push it forward.
- Push locking pin **3** into lock housing **4** and push the back of the seat down until the locking pin locks in place with an audible click.
- Finally, check that the seat is correctly mounted.

Removing the air filter



Preliminary work

- Remove the seat. ( p. 82)

Main work

- Remove screws ①. Remove filter box top ②.

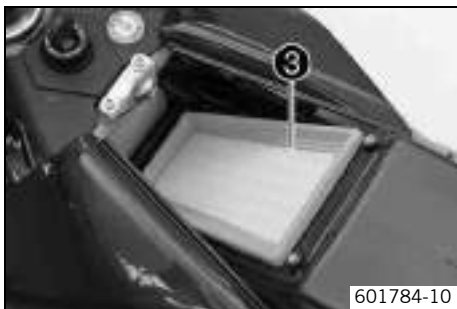

Note

Engine failure Unfiltered intake air has a negative effect on the service life of the engine.

- Never ride the vehicle without an air filter since dust and dirt can get into the engine and result in increased wear.
-
- Remove air filter ③.

Installing the air filter



Main work

- Clean the air filter box.
- Mount air filter ①.

Info

The air filter must lie flush against the air filter box along the entire sealing surface A.

If the air filter is not correctly mounted, dust and dirt can enter the engine and cause damage.

- Hook filter box top ② into the front of the air filter box and swing down.
- Mount and tighten screws ③.

Guideline

Screw, air filter box top	M6	2 Nm (1.5 lbf ft)
---------------------------	----	-------------------



Subsequent work

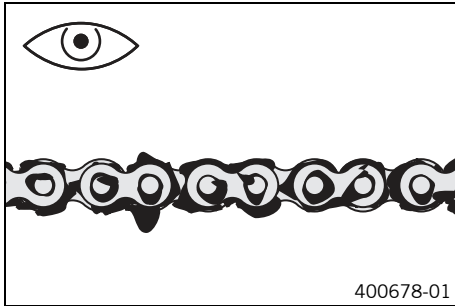

- Mount the seat. ( p. 82)

Checking the chain for dirt



- Check the chain for heavy soiling.
 - » If the chain is very dirty:
 - Clean the chain. (☛ p. 85)

Cleaning the chain

-  **Warning**
Danger of accidents Oil or grease on the tires reduces their grip.
 - Remove oil and grease with a suitable cleaning material.
-  **Warning**
Danger of accidents Reduced braking efficiency due to oil or grease on the brake discs.
 - Always keep the brake discs free of oil and grease, and clean them with brake cleaner when necessary.
-  **Warning**
Environmental hazard Hazardous substances cause environmental damage.
 - Oil, grease, filters, fuel, cleaners, brake fluid, etc., should be disposed of as stipulated in applicable regulations.



Info

The service life of the chain depends largely on its maintenance.

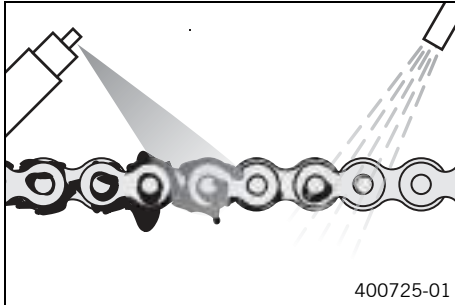

- Clean the chain regularly.
- Rinse off loose dirt with a soft jet of water.
- Remove old grease remains with chain cleaner.

Chain cleaner (☛ p. 198)

- After drying, apply chain spray.

Off-road chain spray (☛ p. 199)

Checking the chain tension



Warning

Danger of accidents Danger caused by incorrect chain tension.

- If the chain tension is too high, the components of the secondary power train (chain, engine sprocket, rear sprocket, bearings in transmission and rear wheel) are under additional load. Apart from premature wear, in extreme cases the chain can rupture or the countershaft of the transmission can break. On the other hand, if the chain is loose, it can fall off the engine sprocket or the rear sprocket and block the rear wheel or damage the engine. Check the chain tension and correct if necessary.

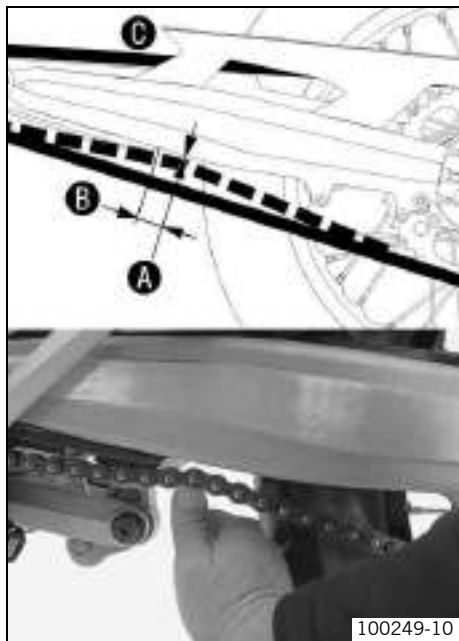

- Lean the motorcycle on the side stand.
- Shift gear to neutral.
- Push the chain upward at a distance **B** from the chain sliding guard and determine the chain tension **A**.



Info

The upper chain section **C** must be taut.
Chain wear is not always even. Repeat this measurement at different chain positions.

Chain tension	5 mm (0.2 in)
Distance to chain sliding guard	30 mm (1.18 in)

- » If the chain tension does not meet specifications:
 - Adjust the chain tension. (🔧 p. 87)

Adjusting the chain tension



Warning

Danger of accidents Danger caused by incorrect chain tension.

- If the chain tension is too high, the components of the secondary power train (chain, engine sprocket, rear sprocket, bearings in transmission and rear wheel) are under additional load. Apart from premature wear, in extreme cases the chain can rupture or the countershaft of the transmission can break. On the other hand, if the chain is loose, it can fall off the engine sprocket or the rear sprocket and block the rear wheel or damage the engine. Check the chain tension and correct if necessary.

Preliminary work

- Check the chain tension. (🔧 p. 86)

Main work

- Loosen nut ❶.
- Loosen nuts ❷.
- Adjust the chain tension by turning adjusting screws ❸ on the left and right.

Guideline

Chain tension	5 mm (0.2 in)
Turn the left and right adjusting screws ❸ so that the markings on the left and right chain adjusters ❹ are in the same position relative to the reference marks ❺. The rear wheel is then correctly aligned.	

i Info

The upper chain section must be taut.

Chain wear is not always even. Repeat this measurement at different chain positions.

- Tighten nuts ❷.
- Make sure that the chain adjusters ❹ are installed correctly on adjusting screws ❸.
- Tighten nut ❶.

Guideline

Nut, rear wheel spindle	M25x1.5	90 Nm (66.4 lbf ft)
-------------------------	---------	------------------------

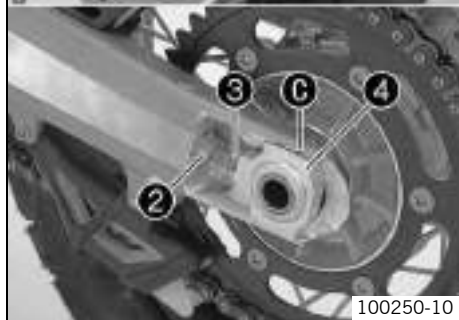
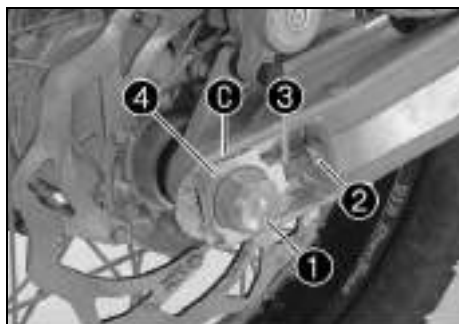

100250-10

Check the chain, rear sprocket, engine sprocket and chain guide

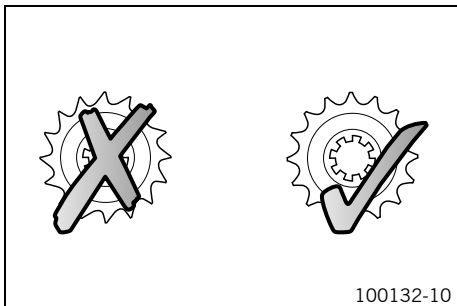

Preliminary work

- Raise the motorcycle with the lift stand. (🔧 p. 76)

Main work

- Shift gear to neutral.
- Check the rear sprocket and engine sprocket for wear.
 - » If the rear sprocket and engine sprocket are worn:
 - Replace the rear sprocket or engine sprocket. 🛠️



Info

The engine sprocket, rear sprocket and chain should always be replaced together.

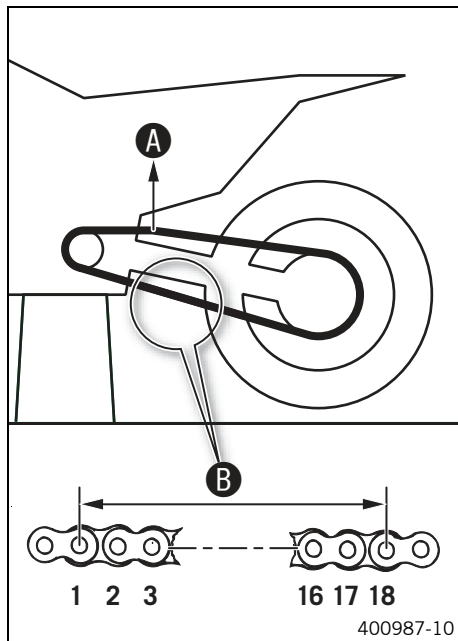

- Pull on the upper section of the chain with the specified weight **A**.

Guideline

Weight of chain wear measurement	15 kg (33 lb.)
----------------------------------	----------------

- Measure distance **B** of 18 chain links in the lower chain section.

i **Info**

Chain wear is not always even, so you should repeat this measurement at different chain positions.

Maximum distance B at the longest chain section	272 mm (10.71 in)
--	-------------------

- » If the distance **B** is greater than the specified measurement:

- Replace the chain. 🛠️

i **Info**

When the chain is replaced, the rear sprocket and engine sprocket should also be changed.

New chains wear out faster on old, worn sprockets.

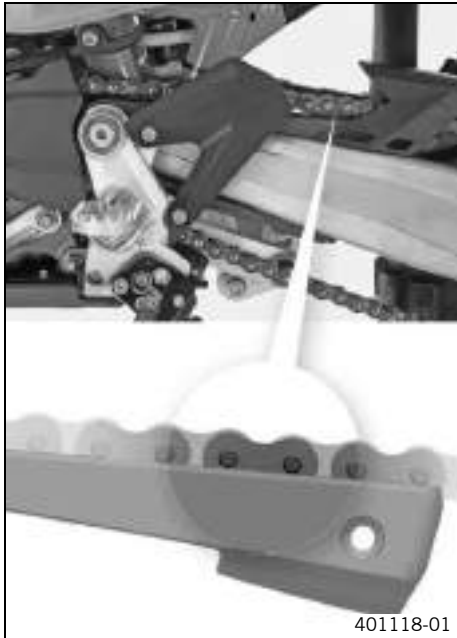

401118-01

- Check the chain sliding guard for wear.
 - » If the lower edge of the chain pins is in line with or below the chain sliding guard:
 - Replace the chain sliding guard. 
- Check that the chain sliding guard is firmly seated.
 - » If the chain sliding guard is loose:
 - Tighten the chain sliding guard.

Guideline

Screw, chain sliding guard	M6	8 Nm (5.9 lbf ft)	Loctite® 243™
----------------------------	----	----------------------	----------------------



401119-01

- Check the chain sliding piece for wear.
 - » If the lower edge of the chain pins is in line with or below the chain sliding piece:
 - Change the chain sliding piece. 🛠️
- Check that the chain sliding piece is firmly seated.
 - » If the chain sliding piece is loose:
 - Tighten the chain sliding piece.

Guideline

Screw, chain sliding piece	M8	15 Nm (11.1 lbf ft)
----------------------------	----	------------------------

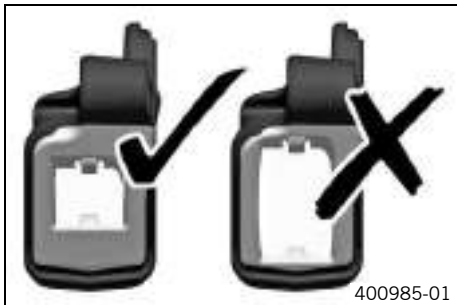

400985-01

- Check the chain guide for wear.



Info

Wear is visible on the front of the chain guide.

- » If the light part of the chain guide is worn:
 - Change the chain guide. 🛠️

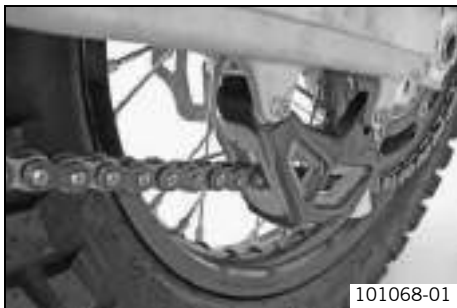

- Check that the chain guide is firmly seated.
 - » If the chain guide is loose:
 - Tighten the chain guide.

Guideline

Remaining screws, chassis	M6	10 Nm (7.4 lbf ft)
---------------------------	----	-----------------------

Subsequent work

- Remove the motorcycle from the lift stand. (🔧 p. 76)

Adjusting chain guide ↩

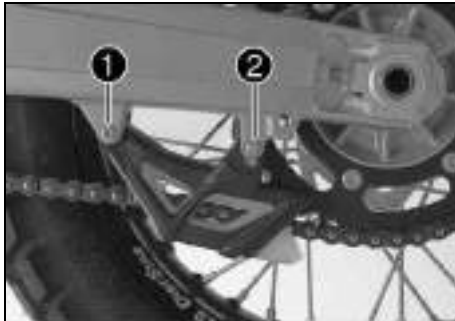

- Remove screws ❶ and ❷. Take off the chain guide.

Condition

Number of teeth: ≤ 44 teeth

- Insert nut ❸ in hole ❹. Position the chain guide.
- Mount and tighten screws ❶ and ❷.

Guideline

Screw, chain guide	M6	8 Nm (5.9 lbf ft)
--------------------	----	-------------------

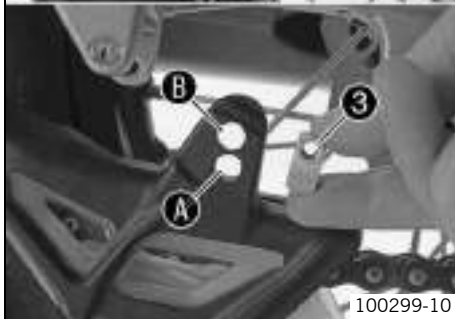

Condition

Number of teeth: ≥ 45 teeth

- Insert nut ❸ in hole ❹. Position the chain guide.
- Mount and tighten screws ❶ and ❷.

Guideline

Screw, chain guide	M6	8 Nm (5.9 lbf ft)
--------------------	----	-------------------

100299-10

Adjusting basic position of clutch lever

i Info

Turn the adjusting screw clockwise to increase the distance between the clutch lever and the handlebar.
Turn the adjusting screw counterclockwise to decrease the distance between the clutch lever and the handlebar.
The range of adjustment is limited.
Turn the adjusting screw by hand only, and do not apply any force.
Do not make any adjustments while riding!

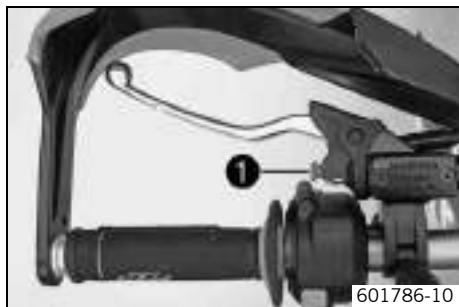

- Adjust the basic setting of the clutch lever to your hand size by turning adjusting screw ❶.
- When adjusting the clutch lever, make sure to leave a minimum clearance to other parts of the vehicle.

Guideline

Minimum clearance	5 mm (0.2 in)
-------------------	---------------

Checking/rectifying the fluid level of the hydraulic clutch

i Info

The fluid level rises with increasing wear of the clutch lining disc.
Do not use brake fluid.

- Move the clutch fluid reservoir mounted on the handlebar to a horizontal position.

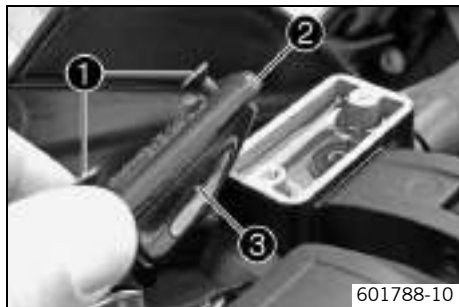

- Remove screws ❶.
- Remove cover ❷ with membrane ❸.
- Check the fluid level.

Fluid level under top level of container	4 mm (0.16 in)
--	----------------

- » If the level of the coolant does not meet specifications:
 - Correct the fluid level of the hydraulic clutch.

Hydraulic fluid (15) (☛ p. 196)

- Position the cover with the membrane. Mount and tighten the screws.

Removing the engine guard

Preliminary work

- Stand the motorcycle on its side stand on a horizontal surface.

Main work

- Remove screws ❶ on the left and right.
- Pull the engine guard forward out of the holders and set it down.



Installing the engine guard



- Slide the engine guard into holders ❶ at the rear.
- Position the engine guard. Mount and tighten screws.

Guideline

Remaining screws, chassis	M6	10 Nm (7.4 lbf ft)
---------------------------	----	--------------------

Checking the free travel of the hand brake lever



Warning

Danger of accidents Brake system failure.

- If there is no free travel on the hand brake lever, pressure builds up in the front brake circuit. The front brake can fail due to overheating. Adjust free travel on hand brake lever according to specifications.



- Push the hand brake to the handlebar and check free travel **A**.

Free travel of hand brake lever	$\geq 3 \text{ mm } (\geq 0.12 \text{ in})$
---------------------------------	---

» If the free travel does not meet specifications:

- Adjust the free travel of the hand brake lever. (☛ p. 98)

Adjusting the free travel of the hand brake lever



- Check the free travel of the hand brake lever. (☛ p. 98)
- Adjust the free travel of the hand brake lever with adjusting screw **1**.



Info

Turn the adjusting screw clockwise to reduce free travel. The pressure point moves away from the handlebar.
 Turn the adjusting screw counterclockwise to increase free travel. The pressure point moves towards the handlebar.
 The range of adjustment is limited.
 Turn the adjusting screw by hand only, and do not apply any force.
 Do not make adjustments while riding.

Checking the brake discs



Warning

Danger of accidents Reduced braking efficiency due to worn brake disc(s).

- Change the worn brake disc(s) without delay. (Your authorized KTM workshop will be glad to help.)

- Check the thickness of the front and rear brake discs in several places to ensure that it conforms to measurement ④.



Info

Wear reduces the thickness of the brake disc at the contact surface ① of the brake disc.

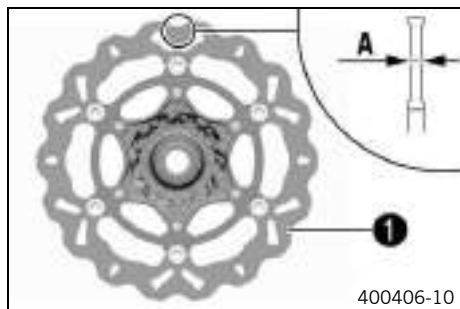

Brake discs - wear limit	
Front	4.5 mm (0.177 in)
Rear	3.5 mm (0.138 in)

- » If the brake disc thickness is less than the specified value:
 - Replace the brake disc.

- Check the front and rear brake discs for damage, cracks, and deformation.
 - » If damage, cracks, or deformation are visible on the brake disc:
 - Replace the brake disc.

Checking the front brake fluid level



Warning

Danger of accidents Failure of the brake system.

- If the brake fluid level falls below the **MIN** mark, this indicates a leakage in the brake system or worn-out brake linings. Check the brake system and do not continue riding. (Your authorized KTM workshop will be glad to help.)



Warning

Danger of accidents Reduced braking efficiency due to old brake fluid.

- Change the brake fluid of the front and rear brake according to the service schedule. (Your authorized KTM workshop will be glad to help.)



601789-10

- Move the brake fluid reservoir mounted on the handlebar to a horizontal position.
- Check the brake fluid level in the viewer ❶.
 - » If the brake fluid level is below the **MIN** mark:
 - Add front brake fluid. 🛠️ (👉 p. 101)

Adding front brake fluid



Warning

Danger of accidents Failure of the brake system.

- If the brake fluid level falls below the **MIN** mark, this indicates a leakage in the brake system or worn-out brake linings. Check the brake system and do not continue riding. (Your authorized KTM workshop will be glad to help.)



Warning

Skin irritation Brake fluid can cause skin irritation on contact.

- Avoid contact with skin and eyes, and keep out of the reach of children.
- Wear suitable protective clothing and goggles.
- If brake fluid comes into contact with the eyes, flush the eyes thoroughly with water and consult a physician immediately.



Warning

Danger of accidents Reduced braking efficiency due to old brake fluid.

- Change the brake fluid of the front and rear brake according to the service schedule. (Your authorized KTM workshop will be glad to help.)



Warning

Environmental hazard Hazardous substances cause environmental damage.

- Oil, grease, filters, fuel, cleaners, brake fluid, etc., should be disposed of as stipulated in applicable regulations.



Info

Never use DOT 5 brake fluid! It is silicone-based and purple in color. Oil seals and brake lines are not designed for DOT 5 brake fluid.

Avoid contact between brake fluid and painted parts. Brake fluid attacks paint!

Use only clean brake fluid from a sealed container.

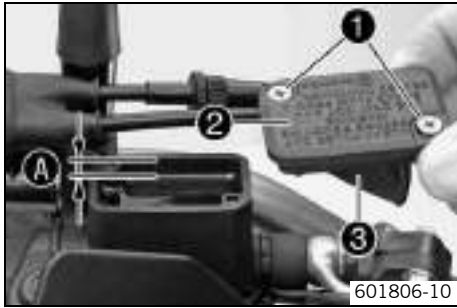

- Move the brake fluid reservoir mounted on the handlebar to a horizontal position.
- Remove screws ①.
- Remove cover ② with membrane ③.
- Add brake fluid to level ④.

Guideline

Measurement of ④	5 mm (0.2 in)
------------------	---------------

Brake fluid DOT 4 / DOT 5.1 (☛ p. 194)
--

- Position the cover with the membrane. Mount and tighten the screws.



Info

Clean up overflowed or spilt brake fluid immediately with water.

Checking the front brake linings



Warning

Danger of accidents Reduced braking efficiency caused by worn brake linings.

- Change worn brake linings immediately. (Your authorized KTM workshop will be glad to help.)

Note

Danger of accidents Reduced braking efficiency caused by damaged brake discs.

- If the brake linings are not changed in time, the steel brake lining carriers grind on the brake disc. The braking effect is greatly reduced and the brake discs are rendered unserviceable. Check the brake linings regularly.

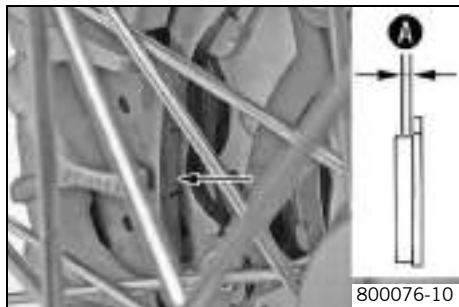

- Check the brake linings for minimum thickness **A**.

Minimum thickness A	$\geq 1 \text{ mm } (\geq 0.04 \text{ in})$
----------------------------	---

- » If the minimum thickness is less than specified:
 - Change the front brake linings. 🛠️ (📄 p. 103)
- Check the brake linings for damage and cracking.
 - » If there is wear or tearing:
 - Change the front brake linings. 🛠️ (📄 p. 103)

Changing the front brake linings 🛠️



Warning

Danger of accident Brake system failure.

- Maintenance work and repairs must be carried out professionally. (Your authorized KTM workshop will be glad to help.)



Warning

Skin irritation Brake fluid can cause skin irritation on contact.

- Avoid contact with skin and eyes, and keep out of the reach of children.
- Wear suitable protective clothing and goggles.
- If brake fluid comes into contact with the eyes, flush the eyes thoroughly with water and consult a physician immediately.



Warning

Danger of accidents Reduced braking efficiency due to old brake fluid.

- Change the brake fluid of the front and rear brake according to the service schedule. (Your authorized KTM workshop will be glad to help.)



Warning

Danger of accidents Reduced braking efficiency due to oil or grease on the brake discs.

- Always keep the brake discs free of oil and grease, and clean them with brake cleaner when necessary.



Warning

Danger of accidents Reduced braking efficiency due to use of non-approved brake linings.

- Brake linings available from accessory suppliers are often not tested and approved for use on KTM vehicles. The construction and friction factor of the brake linings and therefore the brake power can differ considerably from the original KTM brake linings. If brake linings are used that differ from the originals, there is no guarantee that they comply with the original license. The vehicle no longer corresponds to the condition at delivery, and the warranty is no longer valid.



Warning

Environmental hazard Hazardous substances cause environmental damage.

- Oil, grease, filters, fuel, cleaners, brake fluid, etc., should be disposed of as stipulated in applicable regulations.



Info

Never use DOT 5 brake fluid! It is silicone-based and purple in color. Oil seals and brake lines are not designed for DOT 5 brake fluid.

Avoid contact between brake fluid and painted parts. Brake fluid attacks paint!

Use only clean brake fluid from a sealed container.

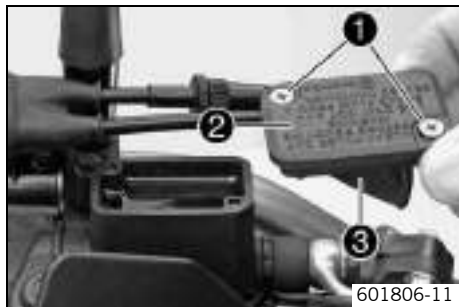

- Move the brake fluid reservoir mounted on the handlebar to a horizontal position.
- Remove screws ①.
- Remove cover ② with membrane ③.
- Press the brake caliper onto the brake disc by hand in order to push back the brake pistons. Make sure that no brake fluid escapes from the brake fluid reservoir. If it does, clean it up.



Info

Make sure when pushing back the brake pistons that you do not press the brake caliper against the spokes.

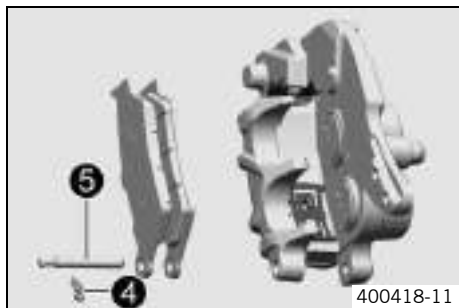

- Remove cotter pin ④, remove bolt ⑤ toward the right by striking it and remove the brake linings.
- Clean brake caliper and brake caliper support.

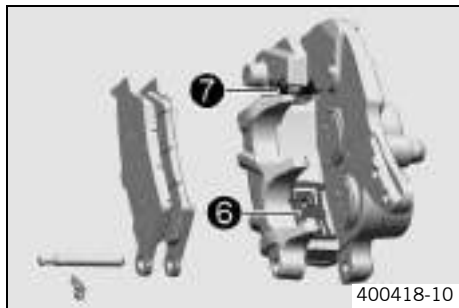

- Check that leaf spring ⑥ in the brake caliper and sliding plate ⑦ in the brake caliper support are seated correctly.

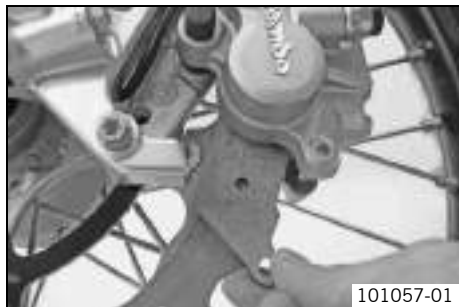

- Insert the brake linings, insert the bolt and mount the cotter pin.
- Operate the hand brake lever repeatedly until the brake linings are in contact with the brake disc and there is a pressure point.



- Adjust the brake fluid level to level ④.

Guideline

Measurement ④	5 mm (0.2 in)
---------------	---------------

Brake fluid DOT 4 / DOT 5.1 (☛ p. 194)
--

- Position the cover with the membrane. Mount and tighten the screws.

i Info

Clean up overflowed or spilt brake fluid immediately with water.

Checking the free travel of foot brake lever



Warning

Danger of accidents Brake system failure.

- If there is no free travel on the foot brake lever, pressure builds up on the rear brake circuit. The rear brake can fail due to over-heating. Adjust free travel on foot brake lever according to specifications.



- Move the foot brake lever back and forth between the end stop and the contact to the foot brake cylinder piston and check free travel **A**.

Guideline

Free travel at foot brake lever	3... 5 mm (0.12... 0.2 in)
---------------------------------	----------------------------



Info

You will know that contact has been made with the foot brake cylinder piston when there is increased resistance when you activate the foot brake lever.

- » If the free travel does not meet specifications:
 - Adjust the basic position of the foot brake lever. 🛠️ (📄 p. 107)

Adjusting the basic position of the foot brake lever 🛠️



Warning

Danger of accidents Brake system failure.

- If there is no free travel on the foot brake lever, pressure builds up on the rear brake circuit. The rear brake can fail due to over-heating. Adjust free travel on foot brake lever according to specifications.

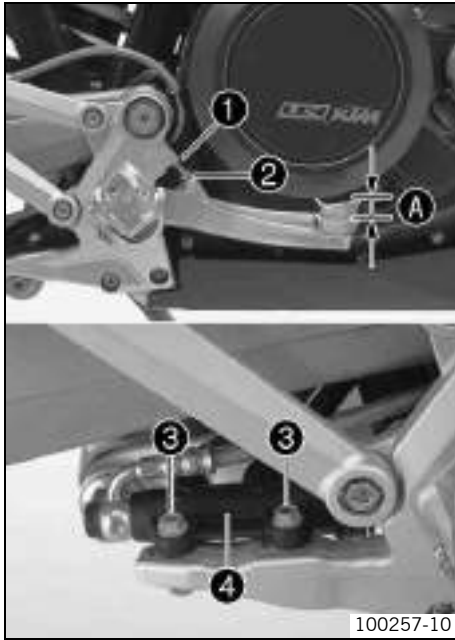

- Remove screws ③ on foot brake cylinder ④.
- To adjust the basic position of the foot brake lever individually, loosen nut ① and turn screw ② accordingly.

i Info

The range of adjustment is limited. The screw must be screwed into the footrest bracket by at least four turns.

- Position foot brake cylinder ④ so that the foot brake lever has the necessary free travel. Hold screws ③ in place and tighten the nuts.

Guideline

Screw connection, foot brake cylinder	M6	10 Nm (7.4 lbf ft)
---------------------------------------	----	--------------------

- Check the free travel of the foot brake lever. (☛ p. 107)
- Tighten nut ①.

Checking rear brake fluid level



Warning

Danger of accidents Failure of the brake system.

- If the brake fluid level falls below the **MIN** mark, this indicates a leakage in the brake system or worn-out brake linings. Check the brake system and do not continue riding. (Your authorized KTM workshop will be glad to help.)



Warning

Danger of accidents Reduced braking efficiency due to old brake fluid.

- Change the brake fluid of the front and rear brake according to the service schedule. (Your authorized KTM workshop will be glad to help.)



- Stand the vehicle upright.
- Check the brake fluid level in the brake fluid reservoir.
 - » If the fluid level reaches the **MIN** marking ❶:
 - Add rear brake fluid. 🛠️ (📖 p. 109)

Adding rear brake fluid 🛠️



Warning

Danger of accidents Failure of the brake system.

- If the brake fluid level falls below the **MIN** mark, this indicates a leakage in the brake system or worn-out brake linings. Check the brake system and do not continue riding. (Your authorized KTM workshop will be glad to help.)



Warning

Skin irritation Brake fluid can cause skin irritation on contact.

- Avoid contact with skin and eyes, and keep out of the reach of children.
- Wear suitable protective clothing and goggles.
- If brake fluid comes into contact with the eyes, flush the eyes thoroughly with water and consult a physician immediately.



Warning

Danger of accidents Reduced braking efficiency due to old brake fluid.

- Change the brake fluid of the front and rear brake according to the service schedule. (Your authorized KTM workshop will be glad to help.)



Warning

Environmental hazard Hazardous substances cause environmental damage.

- Oil, grease, filters, fuel, cleaners, brake fluid, etc., should be disposed of as stipulated in applicable regulations.



Info

Never use DOT 5 brake fluid! It is silicone-based and purple in color. Oil seals and brake lines are not designed for DOT 5 brake fluid.

Avoid contact between brake fluid and painted parts. Brake fluid attacks paint!

Use only clean brake fluid from a sealed container.

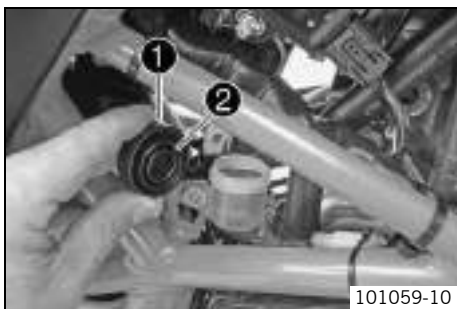

- Stand the vehicle upright.
- Remove screw cap ❶ with the washer and membrane ❷.
- Add brake fluid to the **MAX** mark.

Brake fluid DOT 4 / DOT 5.1 (☛ p. 194)

- Mount the screw cap with the washer and membrane.



Info

Clean up overflowed or spilt brake fluid immediately with water.

Checking the rear brake linings



Warning

Danger of accidents Reduced braking efficiency caused by worn brake linings.

- Change worn brake linings immediately. (Your authorized KTM workshop will be glad to help.)

Note

Danger of accidents Reduced braking efficiency caused by damaged brake discs.

- If the brake linings are not changed in time, the steel brake lining carriers grind on the brake disc. The braking effect is greatly reduced and the brake discs are rendered unserviceable. Check the brake linings regularly.

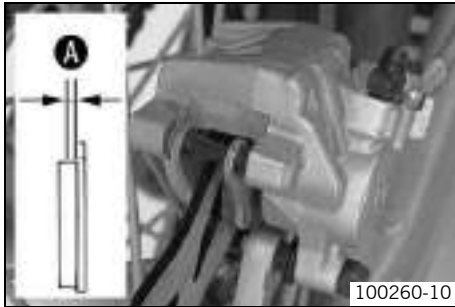

- Check the brake linings for minimum thickness **A**.

Minimum thickness A	$\geq 1 \text{ mm } (\geq 0.04 \text{ in})$
----------------------------	---

- » If the minimum thickness is less than specified:
 - Change the rear brake linings. 🛠️ (👉 p. 111)
- Check the brake linings for damage and cracking.
 - » If there is wear or tearing:
 - Change the rear brake linings. 🛠️ (👉 p. 111)

Changing the rear brake linings 🛠️



Warning

Danger of accident Brake system failure.

- Maintenance work and repairs must be carried out professionally. (Your authorized KTM workshop will be glad to help.)



Warning

Skin irritation Brake fluid can cause skin irritation on contact.

- Avoid contact with skin and eyes, and keep out of the reach of children.
- Wear suitable protective clothing and goggles.
- If brake fluid comes into contact with the eyes, flush the eyes thoroughly with water and consult a physician immediately.



Warning

Danger of accidents Reduced braking efficiency due to old brake fluid.

- Change the brake fluid of the front and rear brake according to the service schedule. (Your authorized KTM workshop will be glad to help.)



Warning

Danger of accidents Reduced braking efficiency due to oil or grease on the brake discs.

- Always keep the brake discs free of oil and grease, and clean them with brake cleaner when necessary.



Warning

Danger of accidents Reduced braking efficiency due to use of non-approved brake linings.

- Brake linings available from accessory suppliers are often not tested and approved for use on KTM vehicles. The construction and friction factor of the brake linings and therefore the brake power can differ considerably from the original KTM brake linings. If brake linings are used that differ from the originals, there is no guarantee that they comply with the original license. The vehicle no longer corresponds to the condition at delivery, and the warranty is no longer valid.



Warning

Environmental hazard Hazardous substances cause environmental damage.

- Oil, grease, filters, fuel, cleaners, brake fluid, etc., should be disposed of as stipulated in applicable regulations.
-

i Info

Never use DOT 5 brake fluid! It is silicone-based and purple in color. Oil seals and brake lines are not designed for DOT 5 brake fluid.

Avoid contact between brake fluid and painted parts. Brake fluid attacks paint!

Use only clean brake fluid from a sealed container.

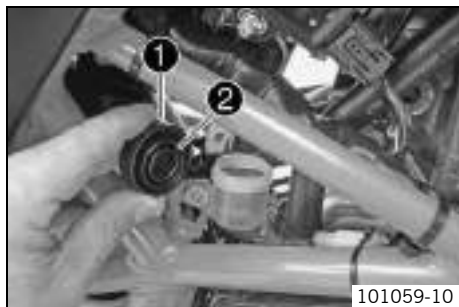

- Stand the vehicle upright.
- Remove screw cap ① with membrane ②.
- Press the brake caliper onto the brake disc by hand in order to push back the brake piston. Make sure that no brake fluid escapes from the brake fluid reservoir. If it does, clean it up.

i Info

Make sure when pushing back the brake piston that you do not press the brake caliper against the spokes.

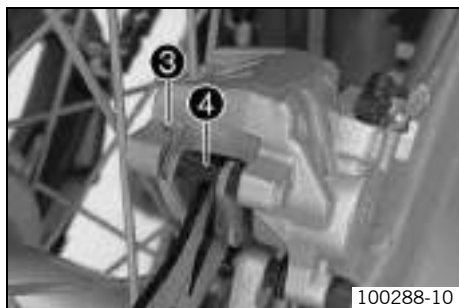

- Remove cotter pin ③, remove bolt ④ toward the left by striking it and remove the brake linings.
- Clean brake caliper and brake caliper support.

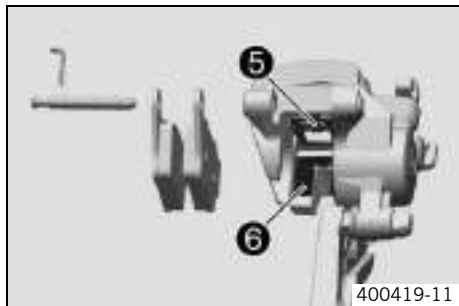

- Check that leaf spring ⑤ in the brake caliper and sliding plate ⑥ in the brake caliper support are seated correctly.



- Insert the brake linings, insert the bolt and mount the cotter pin.
- Operate the foot brake lever repeatedly until the brake linings are in contact with the brake disc and there is a pressure point.
- Add brake fluid to the **MAX** mark.

Brake fluid DOT 4 / DOT 5.1 (☛ p. 194)

- Mount the screw cap with the membrane.

i Info

Clean up overflowed or spilt brake fluid immediately with water.

Removing the front wheel



Preliminary work

- Raise the motorcycle with the lift stand. ( p. 76)

Main work

- Press the brake caliper by hand on to the brake disc in order to press back the brake pistons.



- Remove screw **1**.
- Loosen screw **2**.

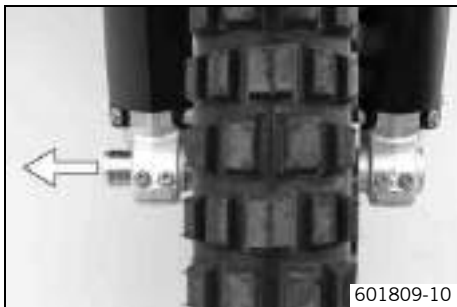

- Holding the front wheel, withdraw the wheel spindle. Take the front wheel out of the fork.

Info

Do not pull the hand brake lever when the front wheel is removed.
Always lay the wheel down in such a way that the brake disc is not damaged.

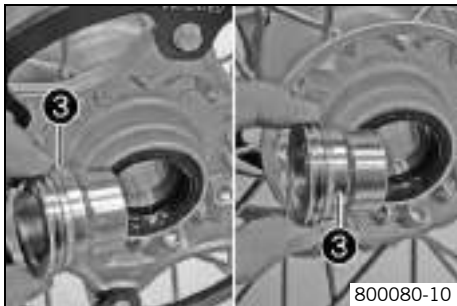

- Remove distance bushings ③.

Installing the front wheel



Warning

Danger of accidents Reduced braking efficiency due to oil or grease on the brake discs.

- Always keep the brake discs free of oil and grease, and clean them with brake cleaner when necessary.

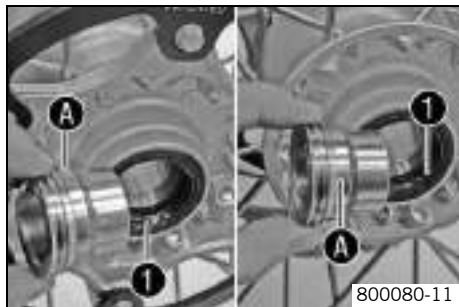

- Check the wheel bearing for damage and wear.
 - » If the wheel bearing is damaged or worn:
 - Replace the wheel bearing. 🛠️
- Clean and grease the shaft seal rings ❶ and bearing surface ❷ of the distance bushings.

Long-life grease (🛠️ p. 198)

- Insert the spacers.

- Lift the front wheel into the fork, position it, and insert the wheel spindle.
- Mount and tighten screw ❷.

Guideline

Screw, front wheel spindle	M24x1.5	40 Nm (29.5 lbf ft)
----------------------------	---------	------------------------

- Activate the hand brake lever multiple times until the brake linings are in contact with the brake disc.
- Remove the motorcycle from the lift stand. (🛠️ p. 76)
- Pull the front wheel brake and push down hard on the fork several times to align the fork legs.
- Tighten screws ❸.

Guideline

Screw, fork stub	M8	15 Nm (11.1 lbf ft)
------------------	----	------------------------



Removing rear wheel

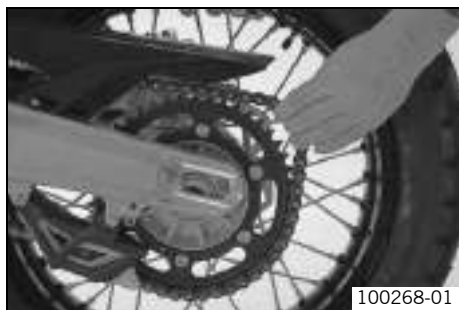
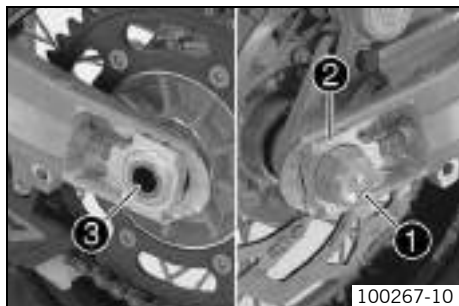

Preliminary work

- Raise the motorcycle with the lift stand. ( p. 76)

Main work

- Press the brake caliper by hand on to the brake disc in order to press back the brake piston.
- Remove nut **1**. Remove chain adjuster **2**.
- Holding the rear wheel, withdraw the wheel spindle **3**.

- Push the rear wheel forwards as far as possible and take the chain off the rear sprocket.



Warning

Danger of accidents Reduced braking effect caused by damaged brake discs.

- Always lay the wheel down in such a way that the brake discs are not damaged.
-
- Take the rear wheel out of the swing arm.



Info

Do not operate the foot brake when the rear wheel is removed.

Installing the rear wheel



Warning

Danger of accidents Reduced braking efficiency due to oil or grease on the brake discs.

- Always keep the brake discs free of oil and grease, and clean them with brake cleaner when necessary.







Warning

Danger of accidents No braking effect when operating the rear brake.

- After installing the rear wheel, always operate the foot brake until the pressure point is reached.

Preliminary work

- Raise the motorcycle with the lift stand. ( p. 76)
- Remove the rear wheel.  ( p. 118)
- Check the rear hub rubber dampers.  ( p. 120)

Main work

- Check the wheel bearing for damage and wear.
 - » If the wheel bearing is damaged or worn:
 - Replace the wheel bearing. 
- Remove bushing **1**. Clean and grease the working surfaces of the bushing and shaft seal ring **2**.

Long-life grease ( p. 198)

- Clean and grease the thread of the wheel spindle and nut **3**.

Long-life grease ( p. 198)

- Install the rubber damper and rear sprocket carrier in the rear wheel.
- Place the rear wheel in the swingarm and bring the brake disc on the brake caliper into contact.



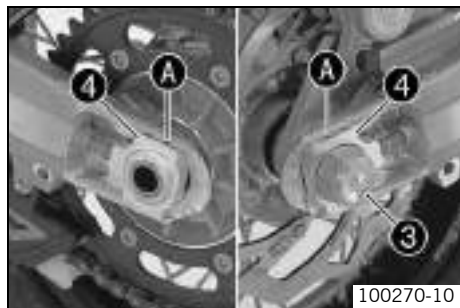

- Push the rear wheel forward as far as possible and lay the chain on the rear sprocket.
- Install the wheel spindle, the chain adjusters and the nut.

Guideline

In order that the rear wheel is correctly aligned, the markings on the left and right chain adjusters must be in the same position relative to the reference marks **A**.

i Info

Mount the left and right chain adjusters **4** in the same position.

- Tighten nut **3**.

Guideline

Nut, rear wheel spindle	M25x1.5	90 Nm (66.4 lbf ft)
-------------------------	---------	------------------------

- Operate the foot brake lever repeatedly until the brake linings are in contact with the brake disc and there is a pressure point.

Subsequent work

- Remove the motorcycle from the lift stand. (👉 p. 76)

Checking the rear hub rubber dampers 🛠️

i Info

The engine power is transmitted from the rear sprocket to the rear wheel via 6 rubber dampers. They eventually wear out during operation. If the rubber dampers are not changed in time, the rear sprocket carrier and the rear hub will be damaged.

Preliminary work

- Raise the motorcycle with the lift stand. (👉 p. 76)
- Remove the rear wheel. 🛠️ (👉 p. 118)

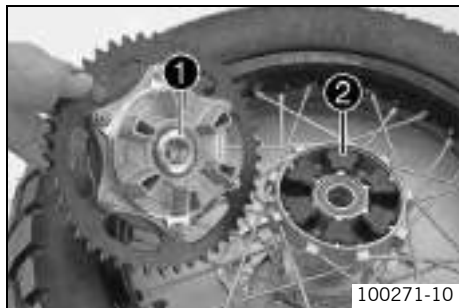

Main work

- Check bearing ❶.
 - » If the bearing is damaged or worn:
 - Replace the bearings. 🛠️
- Check rubber dampers ❷ of the rear hub for damage and wear.
 - » If the rubber dampers of the rear hub are damaged or worn:
 - Change all rubber dampers in the rear hub.

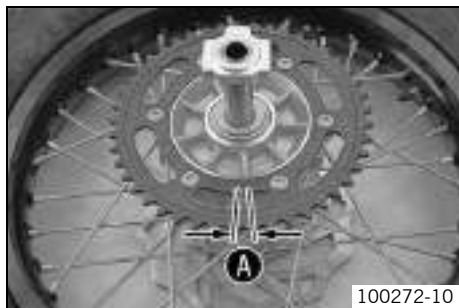

- Lay the rear wheel on a workbench with the rear sprocket facing upwards and insert the wheel spindle in the hub.
- To check play ❸, hold the rear wheel tight and try to rotate the rear sprocket.

Info

Measure the play on the outside of the rear sprocket.

Play in rubber dampers, rear wheel	≤ 5 mm (≤ 0.2 in)
------------------------------------	-------------------

- » If play ❸ is larger than the specified value:
 - Change all rubber dampers in the rear hub.

Subsequent work

- Install the rear wheel. 🛠️ (📖 p. 119)
- Remove the motorcycle from the lift stand. (📖 p. 76)

Checking the tire condition



Warning

Danger of accidents Uncontrollable vehicle handling in the event of a flat tire.

- In the interest of safety, replace damaged or worn tires immediately. (Your authorized KTM workshop will be glad to help.)



Warning

Danger of crashing Poor vehicle handling due to different tire tread patterns on front and rear wheels.

- The front and rear wheels must be fitted with tires with similar tread patterns to prevent loss of control over the vehicle.



Warning

Danger of accidents Uncontrollable handling characteristic due to non-approved and/or non-recommended tires/wheels.

- Only tires/wheels approved by KTM and with the corresponding speed index should be used.



Warning

Danger of accidents Reduced road grip with new tires.

- New tires have a smooth rolling surface and therefore cannot provide full road grip. The entire rolling surface must be roughened in the first 200 kilometers (124.3 miles) by moderate riding at alternating angles. The full grip levels are not achieved until the tires have been run in.



Info

The type, condition and air pressure of the tires all have a major impact on the riding behavior of the motorcycle. Worn tires have a negative effect on riding behavior, especially on wet surfaces.

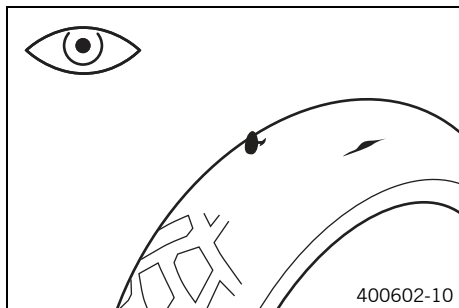

- Check the front and rear tires for cuts, run-in objects and other damage.
 - » If the tires exhibit cuts, run-in objects or other damage:
 - Change the tires.
- Check the depth of the tread.

i **Info**

Note local national regulations concerning the minimum tread depth.

Minimum tread depth	$\geq 2 \text{ mm } (\geq 0.08 \text{ in})$
---------------------	---

- » If the tread depth is less than the minimum permissible depth:
 - Change the tires.
- Check the age of the tires.

i **Info**

The tire's date of manufacture is usually part of the tire markings and is indicated by the last four digits of the **DOT** marking. The first two digits refer to the week of manufacture and last two digits refer to the year of manufacture. KTM recommends that the tires are changed regardless of the actual wear, at the latest after 5 years.

- » If a tire is more than 5 years old:
 - Change the tires.

Checking the tire air pressure

i **Info**

Low tire air pressure leads to abnormal wear and overheating of the tire. Correct tire air pressure ensures optimal riding comfort and maximum tire service life.

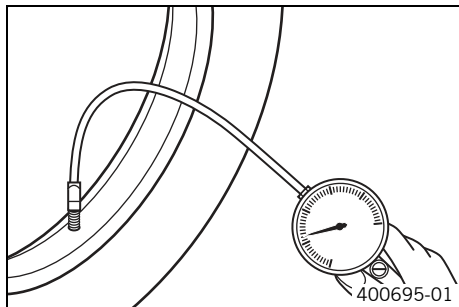

- Remove the dust cap.
- Check the tire air pressure when the tires are cold.

Tire air pressure, offroad, single rider	
Front	1.5 bar (22 psi)
Rear	1.5 bar (22 psi)

Tire air pressure, road, solo	
Front	1.8 bar (26 psi)
Rear	1.8 bar (26 psi)

Tire air pressure with passenger / fully loaded	
Front	2.0 bar (29 psi)
Rear	2.2 bar (32 psi)

- » If the tire pressure does not meet specifications:
 - Correct the tire pressure.
- Mount the dust cap.

Checking the spoke tension



Warning

Danger of accidents Instable handling due to incorrect spoke tension.

- Ensure that the spoke tension is correct. (Your authorized KTM workshop will be glad to help.)

i Info

A loose spoke causes wheel imbalance and rapidly leads to more loose spokes.
If the spokes are too tight, they can break due to local overload.
Check the spoke tension regularly, especially on a new motorcycle.

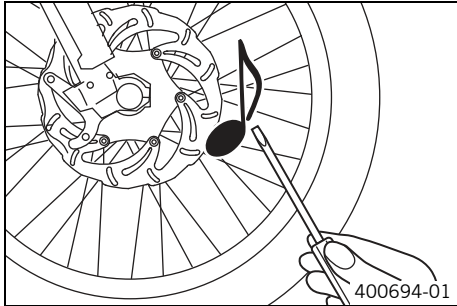

- Briefly strike each spoke with a screwdriver blade.

i Info

The frequency of the tone is a function of the spoke length and spoke diameter.
If you hear different tone frequencies from individual spokes of the same length and thickness, this is an indication of different spoke tensions.

You should hear a high note.

- » If the spoke tensions differ:
 - Correct the spoke tension. 🛠️

Removing the battery



Warning

Risk of injury Battery acid and battery gases cause serious chemical burns.

- Keep batteries out of the reach of children.
- Wear suitable protective clothing and goggles.
- Avoid contact with battery acid and battery gases.
- Keep the battery away from sparks or open flames. Charge only in well-ventilated areas.
- In the event of skin contact, rinse with large amounts of water. If battery acid gets in the eyes, rinse with water for at least 15 minutes and contact a physician.

Preliminary work

- Switch off all power consumers and switch off the engine.
- Remove the seat. ( p. 82)

Main work

- Disconnect the negative (minus) cable of the battery.
- Pull off the plug connector **1** upwards.
- Remove screws **2**.
- Pull the retaining bracket **3** of the battery forward and remove it.
- Take off the positive pole cover **4**.
- Disconnect the positive (plus) cable of the battery.
- Push the wiring harness to the side and pull the battery out of the battery rack.



Info

Never operate the motorcycle with a discharged battery or without a battery. In both cases, electrical components and safety devices can be damaged. The vehicle is therefore no longer roadworthy.

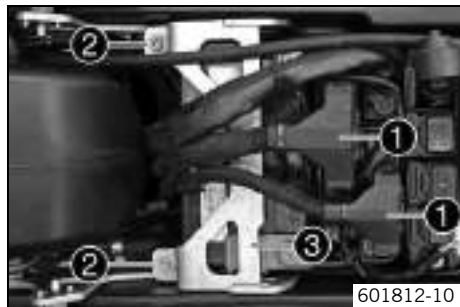

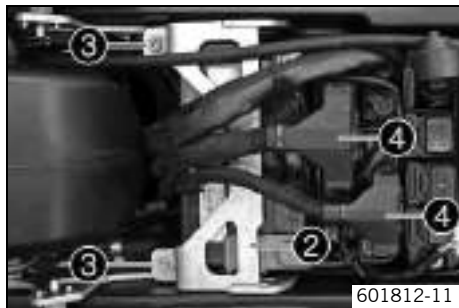
Installing the battery **Main work**

- Slide the battery into the battery rack.

**Info**

The battery terminals must be at the rear.



- Attach the positive cable and mount positive terminal cover ❶.
- Position retaining bracket ❷.
- Mount and tighten screws ❸.

Guideline

Remaining screws, chassis	M6	10 Nm (7.4 lbf ft)
---------------------------	----	--------------------

- Plug in connector ❹.
- Attach the minus cable .

Subsequent work

- Mount the seat. ( p. 82)
- Set the clock. ( p. 37)

Recharging the battery



Warning

Risk of injury Battery acid and battery gases cause serious chemical burns.

- Keep batteries out of the reach of children.
- Wear suitable protective clothing and goggles.
- Avoid contact with battery acid and battery gases.
- Keep the battery away from sparks or open flames. Charge only in well-ventilated areas.
- In the event of skin contact, rinse with large amounts of water. If battery acid gets in the eyes, rinse with water for at least 15 minutes and contact a physician.



Warning

Environmental hazard The battery contains elements that are harmful to the environment.

- Do not discard batteries with the household trash. Dispose of a defective battery in an environmentally compatible manner. Give the battery to your KTM dealer or to a recycling center that accepts used batteries.



Warning

Environmental hazard Hazardous substances cause environmental damage.

- Oil, grease, filters, fuel, cleaners, brake fluid, etc., should be disposed of as stipulated in applicable regulations.



Info

Even when there is no load on the battery, it still loses power steadily.

The charge state and the type of charge are very important for the service life of the battery.

Rapid recharging with a high charging current shortens the battery's service life.

If the charging current, charging voltage and charging time are exceeded, electrolyte escapes through the safety valves. This reduces the battery capacity.

If the battery is depleted from starting the vehicle repeatedly, the battery must be charged immediately.

If the battery is left in a discharged state for an extended period, it will become over-discharged and sulfate, destroying the battery.

The battery is maintenance-free, which means that the acid level does not need to be checked.

Preliminary work

- Switch off all power consumers and switch off the engine.
- Remove the seat. (🔧 p. 82)
- Remove the battery. 🛠️ (🔧 p. 126)



Main work

- Connect the battery charger to the battery. Switch on the battery charger.

Battery charger (58429074000)

You can also use the battery charger to test rest potential and start potential of the battery, and to test the alternator. With this device, you cannot overcharge the battery.



Info

Never remove lid ①.

Charge the battery with a maximum of 10% of the capacity specified on the battery housing ②.

- Switch off and disconnect the charger after charging.

Guideline

The charge current, charge voltage and charge time must not be exceeded.	
Charge the battery regularly when the motorcycle is not in use	3 months

Subsequent work

- Install the battery. (🔧 (👉 p. 127)
- Mount the seat. (👉 p. 82)
- Set the clock. (👉 p. 37)

Changing the main fuse



Warning

Fire hazard The electrical system can be overloaded if the wrong fuses are used.

- Use only fuses with the prescribed amperage. Never by-pass or repair fuses.



Info

The main fuse protects all power consumers in the vehicle. It is in the housing of the starter relay next to the battery.

Preliminary work

- Switch off all power consumers and switch off the engine.
- Remove the seat. (👉 p. 82)

Main work

- Remove protection covers ❶.



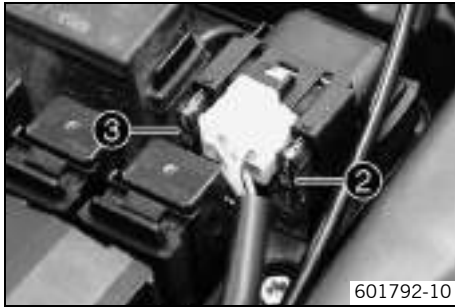

- Remove a defective main fuse ② with needle nose pliers.
- Install a new main fuse.

Fuse (58011109130) (👉 p. 185)

i Info

A reserve fuse ③ is located in the starter relay.

- Check that the electrical equipment is functioning properly.
- Mount the protection covers.

Follow-up work

- Mount the seat. (👉 p. 82)
- Set the clock. (👉 p. 37)

Changing fuses of individual power consumers

i Info

The fuse box containing the fuses of individual power consumers is located under the seat.

Preliminary work

- Switch off all power consumers and switch off the engine.
- Remove the seat. (👉 p. 82)



Main work

- Open fuse box cover ①.

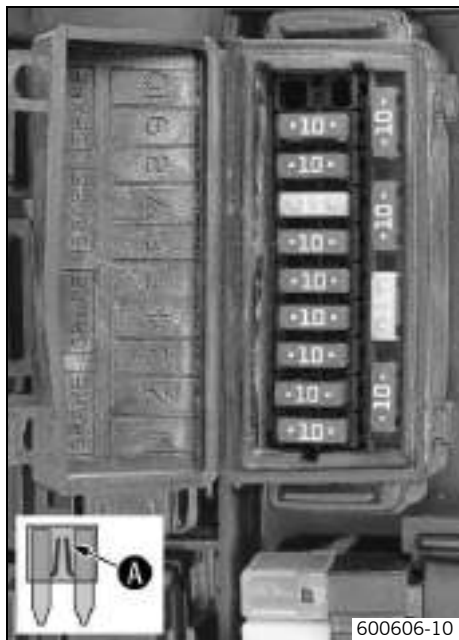

- Remove the defective fuse.

Guideline

Fuse 1 - 10 A - ignition, combination instrument
Fuse 2 - 10 A - clock, ignition (EFI control unit)
Fuse 3 - 10 A - throttle valve control unit
Fuse 4 - 10 A - fuel pump
Fuse 5 - 10 A - radiator fan
Fuse 6 - 10 A - horn, brake light, turn signal
Fuse 7 - 15 A - high beam, low beam, parking light, tail light, license plate lamp
Fuse 8 - 10 A - for supplementary equipment (accessories connected with ignition switch)
Fuse 9 - 10 A - for accessories (permanent positive)
Fuse 10 - not used
Fuse SPARE - 10 A/15 A - spare fuses



Info

A defective fuse is indicated by a burned-out fuse wire ①.



Warning

Fire hazard The electrical system can be overloaded if the wrong fuses are used.

- Use only fuses with the prescribed amperage. Never by-pass or repair fuses.

- Replace with a spare fuse of the right rating.

Fuse (75011088010) (☛ p. 185)

Fuse (75011088015) (☛ p. 185)



Tip

Put a new spare fuse in the fuse box for future use if needed.

- Check the function of power consumers.
- Close the fuse box cover.

Follow-up work

- Mount the seat. (☛ p. 82)

Removing the headlight mask with the headlight

Preliminary work

- Switch off all power consumers and switch off the engine.



Main work

- Cover the fender with a cloth to protect it from damage.
- Remove screws ❶ on the left and right.
- Tip the headlight mask forward and pull it off in an upward direction.

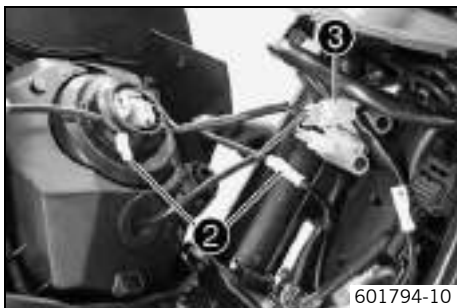

- Disconnect the connectors of turn signals ❷ and headlight ❸.
- Put down the headlight mask.

Installing the headlight mask with the headlight

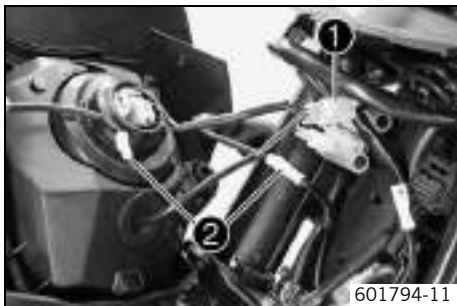

- Connect the connectors of headlight ❶ and turn signal lights ❷.
- Check lighting function.



- Remove the cloth from the fender, attach the headlight mask to points ❸ on the fender and swing it up to the steering head.

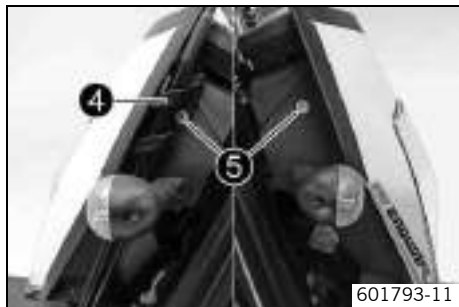

- Position brake-hose guide ④. Mount and tighten screws ⑤.

Guideline

Screw, headlight mask	M5	5 Nm (3.7 lbf ft)
-----------------------	----	-------------------

Changing the headlight bulb

Note

Damage to reflector Reduced luminance.

- Grease on the lamp will evaporate due to the heat and be deposited on the reflector. Clean the lamp and keep it free of grease before mounting.

Preliminary work

- Switch off all power consumers and switch off the engine.
- Remove the headlight mask with the headlight. (☛ p. 134)

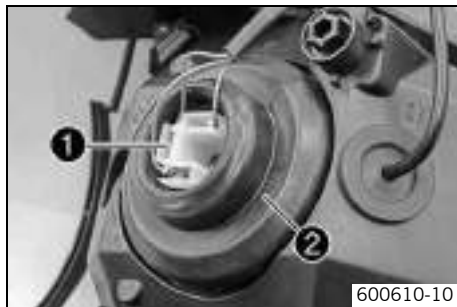

Main work

- Pull off connector ❶.
- Take off rubber cap ❷ of the headlight bulb.



- Detach spring bar ❸.
- Remove headlight bulb ❹.
- Insert a new headlight bulb into the headlight housing.

Headlight (H4 / socket P43t) (☛ p. 185)

- Fix the headlight bulb in the headlight using the spring bar.
- Replace the rubber cap. Attach the connector.

Follow-up work

- Install the headlight mask with the headlight. (☛ p. 136)

Changing the parking light bulb

Note

Damage to reflector Reduced luminance.

- Grease on the lamp will evaporate due to the heat and be deposited on the reflector. Clean the lamp and keep it free of grease before mounting.

Preliminary work

- Switch off all power consumers and switch off the engine.
- Remove the headlight mask with the headlight. (☞ p. 134)

Main work

- Remove rubber cap ❶.



- Pull bulb socket ❷ out of the reflector.
- Pull parking light bulb ❸ out of the bulb socket.
- Insert a new parking light bulb in the bulb socket.

Parking light (W5W / socket W2.1x9.5d) (☞ p. 185)

- Insert the bulb socket in the reflector.
- Insert the rubber cap.

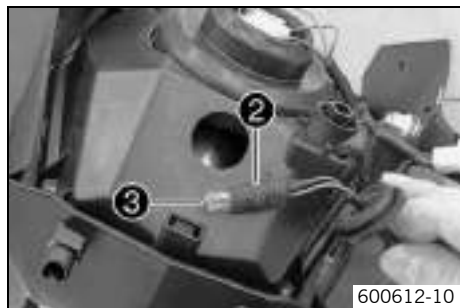

Follow-up work

- Install the headlight mask with the headlight. (☞ p. 136)

Changing the turn signal bulb

Note

Damage to reflector Reduced luminance.

- Grease on the lamp will evaporate due to the heat and be deposited on the reflector. Clean the lamp and keep it free of grease before mounting.

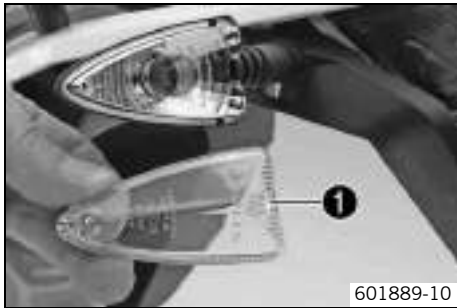

Main work

- Remove the screw on the rear of the turn signal housing.
- Tilt headlamp diffuser ❶ forward carefully and take it off.
- Press the turn signal bulb carefully into the socket, turn it counterclockwise by about 30°, and take it out of the socket.

Info

Do not touch the reflector with your fingers, and keep it free from grease.

- Press the new turn signal bulb carefully into the socket and turn it clockwise until it stops.

Turn signal (RY10W / socket BAU15s) (☛ p. 185)

- Position the diffuser.
- Insert the screw and turn it counterclockwise first until it engages in the thread. Tighten the screw slightly.

Follow-up work

- Check that the turn signal system is functioning properly.

Changing the tail light

Note

Damage to reflector Reduced luminance.

- Grease on the lamp will evaporate due to the heat and be deposited on the reflector. Clean the lamp and keep it free of grease before mounting.

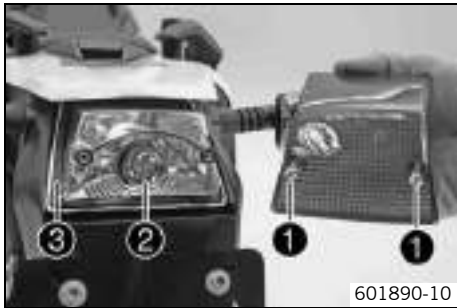

- Remove screws ❶ and take off the lens.
- Press bulb ❷ carefully into the socket, turn it counterclockwise by about 30°, and take it out of the socket.

i Info

Do not touch the reflector with your fingers and keep it free from grease.

- Insert the new bulb and turn it clockwise as far as it will go.

Brake/tail light (P21/5W / socket BAY15d) (🔧 p. 186)

- Check that the tail light and brake light are functioning properly.
- Check that gasket ❸ is properly seated. Position the lens.
- Insert the screws and first turn them counterclockwise until they engage in the thread with a slight jerk. Tighten the screws lightly.

Checking the headlight setting

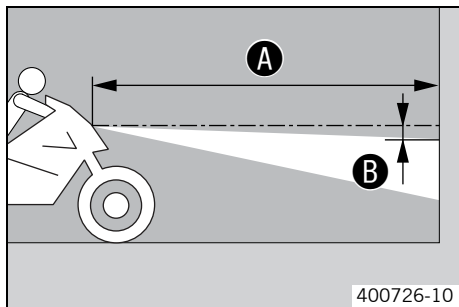

- Stand the vehicle upright on a horizontal surface in front of a light wall and make a mark at the height of the center of the low beam headlight.
- Make another mark at a distance **B** under the first mark.

Guideline

Distance B	5 cm (2 in)
-------------------	-------------

- Position the vehicle vertically at a distance **A** in front of the wall.

Guideline

Distance A	5 m (16 ft)
-------------------	-------------

- The rider, with luggage and a passenger if applicable, now sits down on the motorcycle.
- Switch on the low beam.
- Check the headlight setting.

For a ready-to-operate motorcycle with a rider, and with luggage and a passenger if applicable, the light-dark boundary must lie exactly on the lower mark.

- » If the boundary between light and dark does not meet specifications:
 - Adjust the headlight range. (☛ p. 142)

Adjusting the headlight range

Preliminary work

- Check the headlight setting. (☛ p. 142)



Main work

- Turn adjusting screw ❶ to adjust the headlight range.

Guideline

For a motorcycle with rider, the light/dark boundary must be exactly on the lower mark (made in: Checking headlight adjustment).



Info

Turn clockwise to increase the headlight range; turn counterclockwise to reduce the headlight range.

If you have a heavy payload, you will need to correct the headlight range.

Cooling system



The water pump ❶ in the engine forces the coolant to flow.

The pressure in the cooling system resulting from heat is regulated by a valve in the radiator cap ❷. The heat expansion causes the surplus coolant to flow into the compensating tank ❸. When the temperature falls, this surplus coolant is sucked back into the cooling system. This permits the specified coolant temperature without causing any malfunctions.

125 °C (257 °F)

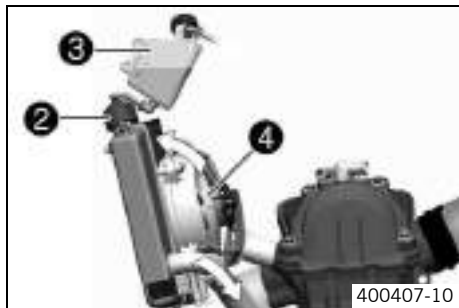

Cooling takes place by means of the air stream and a radiator fan ❹, which is controlled by a thermostwitch.

The lower the speed, the less the cooling effect. Dirty cooling fins also reduce the cooling effect.

Checking the antifreeze and coolant level



Warning

Danger of scalding During motorcycle operation, the coolant gets very hot and is under pressure.

- Do not remove the radiator cap, radiator hoses or other cooling system components when the engine is hot. Allow the engine and cooling system to cool down. In case of scalding, rinse immediately with lukewarm water.



Warning

Danger of poisoning Coolant is poisonous and a health hazard.

- Avoid contact between coolant and skin, eyes and clothing. If it gets into your eyes, rinse immediately with water and contact a doctor. Wash affected skin areas immediately with soap and water. If coolant is swallowed, contact a doctor immediately. Change clothes that have come into contact with coolants. Keep coolant out of the reach of children.

Condition

Engine is cold.

- Stand the motorcycle on its side stand on a horizontal surface.
- Remove the cap of the compensating tank ❶.
- Check antifreeze of coolant.

-25... -45 °C (-13... -49 °F)

- » If the antifreeze of the coolant does not meet specifications:
 - Correct the antifreeze of the coolant.

- Check the coolant level in the compensating tank.

The coolant level must be within the range shown in the figure.

- » If the coolant level does not meet specifications:
 - Correct the coolant level.

Alternative 1

Coolant (☛ p. 194)

Alternative 2

Coolant (mixed ready to use) (☛ p. 194)

- Mount the cap of the compensating tank.





- Screw off the radiator cap ②.
- Check antifreeze of coolant.

-25... -45 °C (-13... -49 °F)

- » If the antifreeze of the coolant does not meet specifications:
 - Correct the antifreeze of the coolant.

- Check the coolant level in the radiator.

The radiator must be completely filled.

- » If the coolant level does not meet specifications:
 - Correct the coolant level and find out the cause of the loss.

Alternative 1

Coolant (☛ p. 194)

Alternative 2

Coolant (mixed ready to use) (☛ p. 194)

- Mount the radiator cap.

Checking the coolant level



Warning

Danger of scalding During motorcycle operation, the coolant gets very hot and is under pressure.

- Do not remove the radiator cap, radiator hoses or other cooling system components when the engine is hot. Allow the engine and cooling system to cool down. In case of scalding, rinse immediately with lukewarm water.



Warning

Danger of poisoning Coolant is poisonous and a health hazard.

- Avoid contact between coolant and skin, eyes and clothing. If it gets into your eyes, rinse immediately with water and contact a doctor. Wash affected skin areas immediately with soap and water. If coolant is swallowed, contact a doctor immediately. Change clothes that have come into contact with coolants. Keep coolant out of the reach of children.

Condition

Engine is cold.

- Stand the motorcycle on its side stand on a horizontal surface.
- Check the coolant level in the compensating tank ❶.

The coolant level must be within the range shown in the figure.

- » If the coolant level does not meet specifications:
 - Correct the coolant level.

Alternative 1

Coolant (☞ p. 194)

Alternative 2

Coolant (mixed ready to use) (☞ p. 194)

- Screw off the radiator cap ❷ and check the coolant level in the radiator.

The radiator must be completely filled.

- » If the coolant level does not meet specifications:
 - Correct the coolant level and find out the cause of the loss.

Alternative 1

Coolant (☞ p. 194)



Alternative 2

Coolant (mixed ready to use) (☞ p. 194)

- Mount the radiator cap.

Draining the coolant



Warning

Danger of scalding During motorcycle operation, the coolant gets very hot and is under pressure.

- Do not remove the radiator cap, radiator hoses or other cooling system components when the engine is hot. Allow the engine and cooling system to cool down. In case of scalding, rinse immediately with lukewarm water.



Warning

Danger of poisoning Coolant is poisonous and a health hazard.

- Avoid contact between coolant and skin, eyes and clothing. If it gets into your eyes, rinse immediately with water and contact a doctor. Wash affected skin areas immediately with soap and water. If coolant is swallowed, contact a doctor immediately. Change clothes that have come into contact with coolants. Keep coolant out of the reach of children.

Preliminary work

- Stand the motorcycle on its side stand on a horizontal surface.
- Remove the engine guard. (☞ p. 96)



Main work

- Stand the motorcycle upright.
- Place a suitable container under the engine.
- Remove screw ❶. Take off the radiator cap.
- Completely drain the coolant.
- Mount screw ❶ with a new seal ring and tighten it.

Guideline

Plug, drain hole of water pump	M10x1	15 Nm (11.1 lbf ft)
--------------------------------	-------	------------------------

Follow-up work

- Install the engine guard. (🔧 p. 97)

Filling the cooling system 🛠️



Warning

Danger of poisoning Coolant is poisonous and a health hazard.

- Avoid contact between coolant and skin, eyes and clothing. If it gets into your eyes, rinse immediately with water and contact a doctor. Wash affected skin areas immediately with soap and water. If coolant is swallowed, contact a doctor immediately. Change clothes that have come into contact with coolants. Keep coolant out of the reach of children.



- Stand the motorcycle on its side stand on a horizontal surface.
- Remove radiator cap ❶.



- Refill the coolant.

Alternative 1

Coolant (☛ p. 194)

Alternative 2

Coolant (mixed ready to use) (☛ p. 194)

- Fill the radiator completely with coolant. Mount radiator cap ❶.



- Remove the cap from compensating tank ❷ and add coolant to the level shown in the figure.
- Mount the cap of the compensating tank.



Danger

Danger of poisoning Exhaust gases are poisonous and inhaling them may result in unconsciousness and/or death.

- When running the engine, always make sure there is sufficient ventilation, and do not start or run the engine in an enclosed space without an effective exhaust extraction system.

- Start the engine and run it until the 5th bar of the temperature indicator lights up.
- Switch off the engine and allow it to cool down.
- After the engine has cooled down, check the coolant level in the radiator and in the compensating tank again and add more coolant if necessary.

Checking the play in the throttle cable

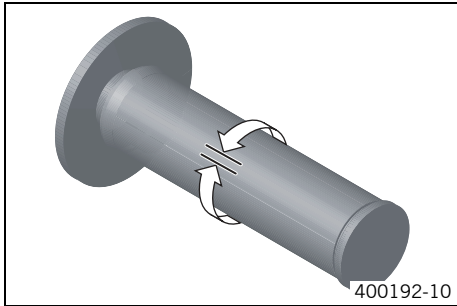

- Check the throttle grip for smooth operation.
- Move the handlebar to the straight-ahead position. Move the throttle grip backwards and forwards to ascertain the play in the throttle cable.

Throttle cable play	3... 5 mm (0.12... 0.2 in)
---------------------	----------------------------

- » If the throttle cable play does not meet specifications:
 - Adjust the play in the throttle cable. 🛠️ (📖 p. 153)



Danger

Danger of poisoning Exhaust gases are poisonous and inhaling them may result in unconsciousness and/or death.

- When running the engine, always make sure there is sufficient ventilation, and do not start or run the engine in an enclosed space without an effective exhaust extraction system.
-
- Start the engine and let it run idle. Move the handlebar to and fro over the entire steering range.

The idle speed must not change.

- » If the idle speed changes:
 - Adjust the play in the throttle cable. 🛠️ (📖 p. 153)

Adjusting the play in the throttle cable

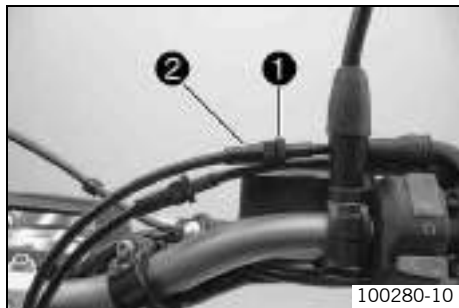

100280-10

- Move the handlebar to the straight-ahead position.
- Use the KTM diagnostics tool to set the motor drive to the basic position.
- Loosen counter nut ❶.
- Set the play in the throttle cable by turning the adjusting screw ❷.



Guideline

Throttle cable play	3... 5 mm (0.12... 0.2 in)
---------------------	----------------------------

- Tighten counter nut ❶.

Adjusting the engine characteristic

Preliminary work

- Switch off the ignition by turning the ignition key to position **OFF** .
- Remove the seat. ( p. 82)

Main work

- Pull the **Map-Select** switch and holder ❶ upward off of the retaining bracket.
- Pull the **Map-Select** switch out of the holder.

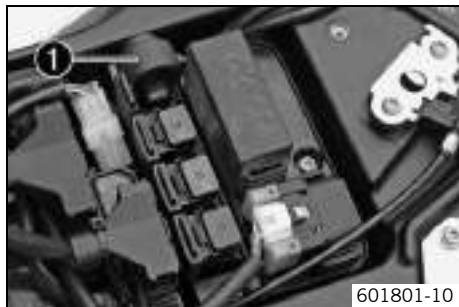

601801-10



601802-10

- Turn the adjusting wheel until the desired digit is next to marking ②.

Set the Map-Select switch to Soft.

- Set the adjusting wheel to position 1.
 - ✓ Soft – reduced homologated peak performance for better driveability.

Set the Map-Select switch to Advanced.

- Set the adjusting wheel to position 2.
 - ✓ Advanced – homologated performance with extremely direct responsiveness.

Set the Map-Select switch to Standard.

- Set the adjusting wheel to position 3, 4, 5, 6, 7, 8 or 9.
 - ✓ Standard – homologated performance with balanced responsiveness.

Set the Map-Select switch to poor fuel quality.

- Set the adjusting wheel to position 0.
 - ✓ Poor fuel quality – homologated performance is reduced in accordance with the fuel quality, use for no more than 1 tank of fuel

- Position the **Map-Select** switch in the holder.
- Slide the **Map-Select** switch with the holder downward onto the retaining bracket.

Subsequent work

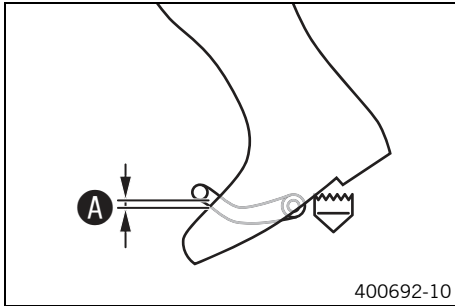

- Mount the seat. (🔧 p. 82)

Checking the basic position of the shift lever



- Sit on the vehicle in the riding position and determine distance **A** between the upper edge of your boot and the shift lever.

Distance between shift lever and upper edge of boot	10... 20 mm (0.39... 0.79 in)
---	-------------------------------

- » If the distance does not meet specifications:
 - Adjust the basic position of the shift lever.  ( p. 155)

Adjusting the basic position of the shift lever

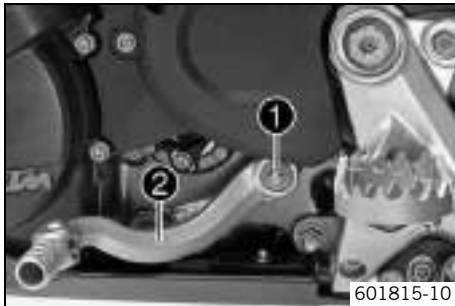

- Remove screw **1** and take off shift lever **2**.

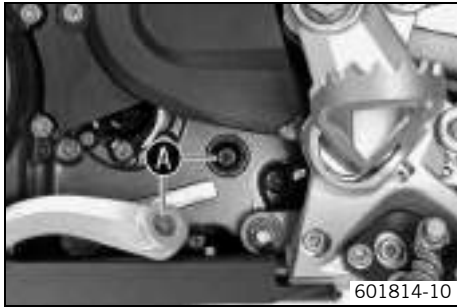

601814-10

- Clean gear teeth **A** of the shift lever and shift shaft.
- Mount the shift lever **2** on the shift shaft in the required position and engage the gearing.

i **Info**

The range of adjustment is limited.
The shift lever must not come into contact with any other vehicle components during the shift procedure.

- Mount and tighten screw **1**.

Guideline

Screw, shift lever	M6	14 Nm (10.3 lbf ft)	Loctite® 222
--------------------	----	------------------------	---------------------

Checking the engine oil level



Info

The engine oil level must be checked when the engine is warm.

Condition

The engine is at operating temperature.

Preliminary work

- Stand the motorcycle upright on a horizontal surface.

Main work

- Check the engine oil level.



Info

After switching off the engine, wait one minute before checking the level.





The engine oil must be between the lower and upper edge of the oil level viewer.

- » If the engine oil level is not at the specified level:
 - Add the engine oil. (👉 p. 164)





Changing the engine oil and filter, cleaning the oil screens



- Drain the engine oil.  (🔧 p. 158)
- Remove the oil filter.  (🔧 p. 159)
- Clean the oil screens.  (🔧 p. 161)
- Install the oil filter.  (🔧 p. 163)
- Fill up with engine oil.  (🔧 p. 163)

Draining the engine oil

-  **Warning**
Danger of scalding Engine oil and gear oil get very hot when the motorcycle is ridden.
- Wear appropriate protective clothing and safety gloves. In case of burns, rinse immediately with lukewarm water.

-  **Warning**
Environmental hazard Hazardous substances cause environmental damage.
- Oil, grease, filters, fuel, cleaners, brake fluid, etc., should be disposed of as stipulated in applicable regulations.

-  **Info**
Drain the engine oil only when the engine is warm.

Preliminary work

- Stand the motorcycle on its side stand on a horizontal surface.
- Remove the engine guard. (🔧 p. 96)

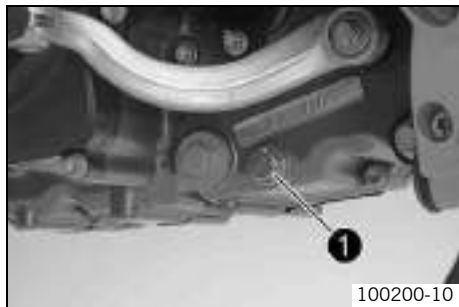

Main work

- Place a suitable container under the engine.
- Remove the oil drain plug ❶ with the magnet and seal ring.
- Completely drain the engine oil.



- Thoroughly clean the oil drain plug with a magnet.
- Mount the oil drain plug with the magnet and seal ring and tighten it.

Guideline

Oil drain plug with magnet	M12x1.5	20 Nm (14.8 lbf ft)
----------------------------	---------	------------------------

Removing the oil filter



Warning

Danger of scalding Engine oil and gear oil get very hot when the motorcycle is ridden.

- Wear appropriate protective clothing and safety gloves. In case of burns, rinse immediately with lukewarm water.



Warning

Environmental hazard Hazardous substances cause environmental damage.

- Oil, grease, filters, fuel, cleaners, brake fluid, etc., should be disposed of as stipulated in applicable regulations.

Preliminary work

- Place a suitable container under the engine.

Main work

- Remove screws ❶. Remove the oil filter cover ❷ with the O-ring.
- Pull oil filter ❸ out of the oil filter housing.

Circlip pliers reverse (51012011000)

- Remove screws ❹. Remove oil filter ❺ with the O-ring.
- Pull oil filter ❻ out of the oil filter housing.

Circlip pliers reverse (51012011000)

- Completely drain the engine oil.
- Thoroughly clean the parts and sealing area.

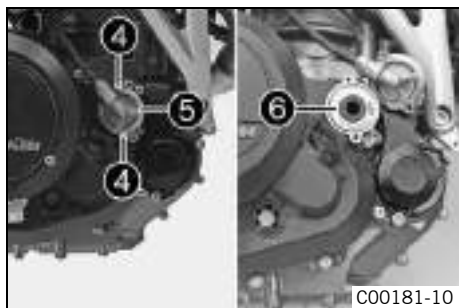
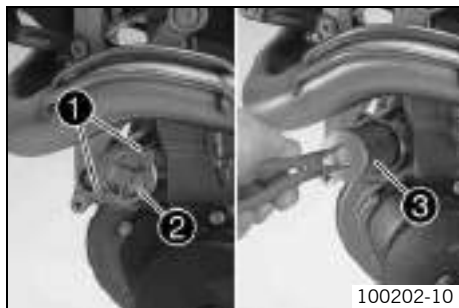

Cleaning the oil screens

-  **Warning**
Danger of scalding Engine oil and gear oil get very hot when the motorcycle is ridden.
- Wear appropriate protective clothing and safety gloves. In case of burns, rinse immediately with lukewarm water.

-  **Warning**
Environmental hazard Hazardous substances cause environmental damage.
- Oil, grease, filters, fuel, cleaners, brake fluid, etc., should be disposed of as stipulated in applicable regulations.

Preliminary work

- Place a suitable container under the engine.

Main work

- Remove plug **1** with oil screen **2** and the O-rings.

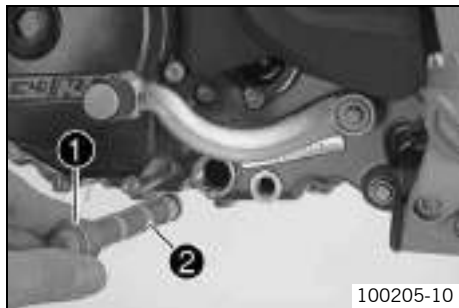

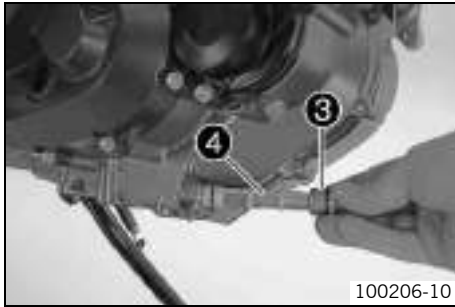

- Remove plug ③ with oil screen ④ and the O-rings.
- Completely drain the remaining engine oil.
- Thoroughly clean the parts and sealing area.

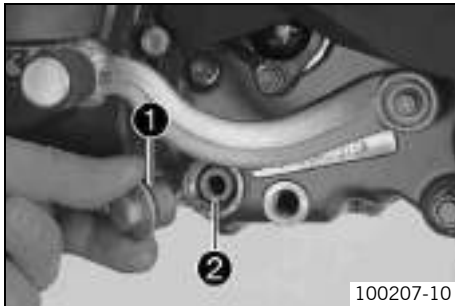

- Position oil screen ② with the O-rings.
- Mount and tighten screw plug ① with the O-ring.

Guideline

Plug, oil screen	M20x1.5	15 Nm (11.1 lbf ft)
------------------	---------	------------------------

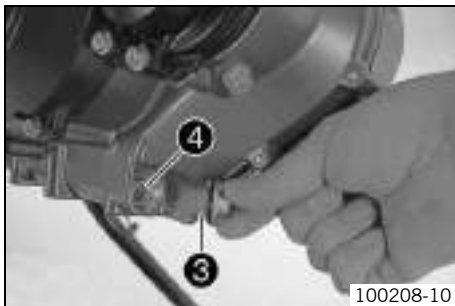

- Position oil screen ④ with the O-rings.
- Mount and tighten screw plug ③ with the O-ring.

Guideline

Plug, oil screen	M20x1.5	15 Nm (11.1 lbf ft)
------------------	---------	------------------------

Installing the oil filter ↩

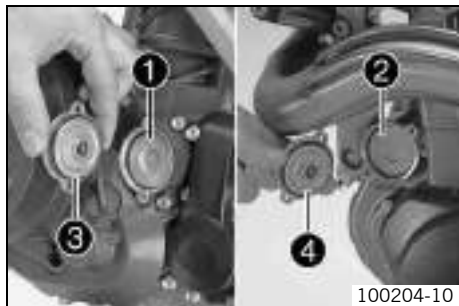

- Insert oil filters ❶ and ❷.
- Oil the O-rings of the oil filter covers. Mount oil filter covers ❸ and ❹.
- Mount and tighten the screws.

Guideline

Screw, oil filter cover	M5	6 Nm (4.4 lbf ft)
-------------------------	----	-------------------

Filling up with engine oil ↩

- i Info**
 Too little engine oil or poor-quality engine oil results in premature wear to the engine.



Main work

- Remove filler plug with O-ring ❶ from the clutch cover and add engine oil.

Engine oil	1.70 l (1.8 qt.)	Engine oil (SAE 10W/60) (00062010035) (↖ p. 195)
		Alternative engine oil Engine oil (SAE 10W/50) (↖ p. 195)

- Refit plug with O-ring ❶ and tighten it.



Danger

Danger of poisoning Exhaust gases are poisonous and inhaling them may result in unconsciousness and/or death.

- When running the engine, always make sure there is sufficient ventilation, and do not start or run the engine in an enclosed space without an effective exhaust extraction system.

- Start the engine and check that it is oil-tight.

Subsequent work

- Install the engine guard. (🔧 p. 97)
- Check the engine oil level. (🔧 p. 157)

Adding engine oil



Info

Too little engine oil or poor-quality engine oil results in premature wear to the engine.



Main work

- Remove the oil filler plug ❶ with the O-ring from the clutch cover and fill up with engine oil.

Engine oil (SAE 10W/60) (00062010035) (🔧 p. 195)
Engine oil (SAE 10W/50) (🔧 p. 195)



Info

For optimal performance of the engine oil, do not mix different types of engine oil.

If appropriate, change the engine oil.

- Install and tighten the oil filler plug ❶ with the O-ring.
-

**Danger**

Danger of poisoning Exhaust gases are poisonous and inhaling them may result in unconsciousness and/or death.

- When running the engine, always make sure there is sufficient ventilation, and do not start or run the engine in an enclosed space without an effective exhaust extraction system.
-
- Start the engine and check that it is oil-tight.

Subsequent work

- Check the engine oil level. (👉 p. 157)

Cleaning the motorcycle

Note

Material damage Damage and destruction of components by high-pressure cleaning equipment.

- Never clean the vehicle with high-pressure cleaning equipment or a strong water-jet. The excessive pressure can penetrate electrical components, socket connects, throttle cables, and bearings, etc., and can damage or destroy these parts.



Warning

Environmental hazard Hazardous substances cause environmental damage.

- Oil, grease, filters, fuel, cleaners, brake fluid, etc., should be disposed of as stipulated in applicable regulations.



Info

If you clean the motorcycle regularly, its value and appearance will be maintained over a long period.
Avoid direct sunshine on the motorcycle during cleaning.

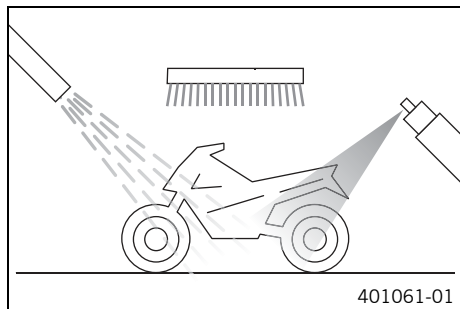

- Seal the exhaust system to keep water out.
- First remove coarse dirt particles with a gentle spray of water.
- Spray very dirty areas with a normal motorcycle cleaner and then clean with a brush.

Motorcycle cleaner (☛ p. 199)



Info

Clean the vehicle using a soft sponge and warm water containing normal motorcycle cleaner.

If the vehicle was operated in road salt, clean it with cold water. Warm water enhances the corrosive effects of salt.

- After rinsing the motorcycle with a gentle spray of water, allow it to dry thoroughly.



Warning

Danger of accidents Reduced braking efficiency due to wet or dirty brakes.

- Clean or dry dirty or wet brakes by riding and braking gently.

- After cleaning, ride the vehicle a short distance until the engine is warm, applying the brakes occasionally.



Info

The heat produced causes water at inaccessible locations in the engine and the brakes to evaporate.

- Push back the protection covers of the handlebar controls to allow any water that has penetrated to evaporate.
- After the motorcycle has cooled off, lubricate all moving parts and bearings.
- Clean the chain. (🔧 p. 85)
- Treat bare metal parts (except for brake discs and exhaust system) with anti-corrosion materials.

Cleaning and preserving materials for metal, rubber and plastic (🔧 p. 198)

- Treat all painted parts with a mild paint polish.

High-luster polish for paint (🔧 p. 198)

- Treat all plastic parts and powder-coated parts with a mild cleaning and care agent.

Paint cleaner and polish for high-gloss and matte finishes, bare metal and plastic surfaces (🔧 p. 199)

- Oil the ignition/steering lock.

Universal oil spray (🔧 p. 199)

Checks and maintenance steps for winter operation

i Info

If you use the motorcycle in winter, you must expect salt on the roads. You should therefore take precautions against aggressive road salt.

If the vehicle was operated in road salt, clean it with cold water after riding. Warm water would enhance the corrosive effects of salt.

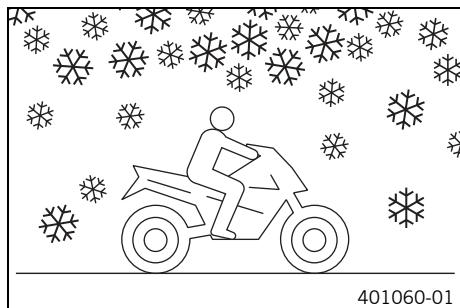

- Clean the motorcycle. (🔧 p. 166)
- Clean the brakes.

i Info

After **EVERY** trip on salted roads, thoroughly wash the brake calipers and brake linings with cold water and dry carefully. This should be done after the parts are cooled down and while they are installed.

After use on salted roads, clean the motorcycle thoroughly with cold water and dry it properly.

- Treat the engine, the swingarm, and all other bare or galvanized parts (except brake discs) with a wax-based anti-corrosion substance.

i Info

To prevent serious reduction of the braking efficiency, make sure no anti-corrosion substance gets on to the brake discs.

- Clean the chain. (🔧 p. 85)

Storage

i Info

If you want to garage the motorcycle for a longer period, take the following actions.

Before storing the motorcycle, check all parts for function and wear. If service, repairs, or replacements are necessary, you should do this during the storage period (less workshop overload). In this way, you can avoid long workshop waiting times at the start of the new season.

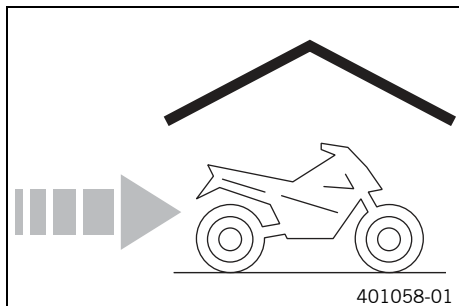

- Make sure the tank is as empty as possible so that you can fill up with fresh fuel when you put the motorcycle back into operation.
- Clean the motorcycle. (☞ p. 166)
- Change the engine oil and filter, clean the oil screens. 🛠️ (☞ p. 158)
- Check the antifreeze and coolant level. (☞ p. 144)
- Check the tire air pressure. (☞ p. 123)
- Remove the battery. 🛠️ (☞ p. 126)
- Recharge the battery. 🛠️ (☞ p. 128)

Guideline

Storage temperature of battery without direct sunshine	0... 35 °C (32... 95 °F)
--	--------------------------

- Store the vehicle in a dry location that is not subject to large fluctuations in temperature.

i Info

KTM recommends jacking up the motorcycle.

- Raise the motorcycle with the lift stand. (☞ p. 76)
- Cover the motorcycle with a tarp or similar cover that is permeable to air.



Info

Do not use non-porous materials since they prevent humidity from escaping, thus causing corrosion.

Avoid running the engine for a short time only. Since the engine cannot warm up properly, the water vapor produced during combustion condenses and causes valves and exhaust system to rust.

Preparing for use after storage

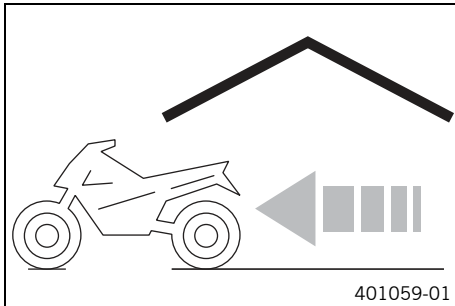











- Remove the motorcycle from the lift stand. (🔧 p. 76)
- Recharge the battery. 🔌 (🔧 p. 128)
- Install the battery. 🔌 (🔧 p. 127)
- Set the clock. (🔧 p. 37)
- Refuel. (🔧 p. 58)
- Perform checks and vehicle care when preparing for use. (🔧 p. 50)
- Take a test ride.





Faults	Possible cause	Action
The engine does not turn when the starter button is pressed	Operating error	– Carry out the start procedure. (☞ p. 51)
	Battery is discharged	– Recharge the battery. 🛠️ (☞ p. 128)
	Fuse 1 , 2 , 3 or 4 is blown	– Change the fuses of individual power consumers. (☞ p. 132)
	Main fuse burned out	– Change the main fuse. (☞ p. 131)
	No ground connection present.	– Check the ground connection.
Engine turns only if the clutch lever is drawn	The vehicle is in gear	– Shift gear to neutral.
	The vehicle is in gear and the side stand is folded out	– Shift gear to neutral.
Engine turns but does not start.	Operating error	– Carry out the start procedure. (☞ p. 51)
	Fuse 4 blown	– Change the fuses of individual power consumers. (☞ p. 132)
	Coupling of fuel hose connection not connected	– Reconnect coupling of fuel hose connection.
	Socket connector of wiring harness is oxidized	– Clean the socket connector and treat it with contact spray.
	Defect in fuel injection system	– Read out the fault memory using the KTM diagnostics tool. 🛠️
Engine has too little power.	Air filter is very dirty	– Remove the air filter. 🛠️ (☞ p. 83) – Install the air filter. 🛠️ (☞ p. 84)
	Fuel filter is very dirty	– Check the fuel pressure. 🛠️
	Defect in fuel injection system	– Read out the fault memory using the KTM diagnostics tool. 🛠️
Engine overheats.	Too little coolant in cooling system	– Check the cooling system for leakage. – Check the coolant level. (☞ p. 146)





Faults	Possible cause	Action
Engine overheats.	Radiator fins very dirty	– Clean radiator fins.
	Foam formation in cooling system	– Drain the coolant. 🛠️ (📖 p. 148) – Fill the cooling system. 🛠️ (📖 p. 149)
	Buckled or damaged radiator hose	– Change the radiator hose. 🛠️
	Thermostat is faulty	– Check the thermostat. 🛠️
	Fuse 5 blown	– Change the fuses of individual power consumers. (📖 p. 132)
	Defect in radiator fan system	– Check the radiator fan system. 🛠️
	Air in cooling system	– Fill the cooling system. 🛠️ (📖 p. 149)
FI warning lamp (MIL) lights/flashes	Defect in fuel injection system	– Read out the fault memory using the KTM diagnostics tool. 🛠️
Engine dies during the journey	Lack of fuel	– Refuel. (📖 p. 58)
	Fuse 1 , 2 or 4 blown	– Change the fuses of individual power consumers. (📖 p. 132)
High oil consumption	Engine vent hose bent	– Route the vent hose without bends or change it if necessary.
	Engine oil level too high	– Check the engine oil level. (📖 p. 157)
	Engine oil too thin (low viscosity)	– Change the engine oil and filter, clean the oil screens. 🛠️ (📖 p. 158)
Headlight and parking light not functioning	Fuse 7 blown	– Change the fuses of individual power consumers. (📖 p. 132)
Turn signal, brake light and horn not functioning	Fuse 6 blown	– Change the fuses of individual power consumers. (📖 p. 132)

Faults	Possible cause	Action
Time is not (correctly) displayed	Fuse 2 blown	<ul style="list-style-type: none"> – Change the fuses of individual power consumers. (☛ p. 132) – Set the clock. (☛ p. 37)
Battery discharged	Ignition not switched off when vehicle was parked	<ul style="list-style-type: none"> – Recharge the battery. 🛠️ (☛ p. 128)
	Battery is not charged by alternator	<ul style="list-style-type: none"> – Check the charging voltage. 🛠️ – Check the quiescent current. 🛠️
Combination instrument shows nothing in the display	Fuse 1 blown	<ul style="list-style-type: none"> – Change the fuses of individual power consumers. (☛ p. 132) – Set the clock. (☛ p. 37)
Speedometer in combination instrument not functioning	Speedometer wiring harness is damaged or plug-in connection is oxidized	<ul style="list-style-type: none"> – Check the wiring harness and plug-in connection.

Blink code FI of warning lamp (MIL)	
	02 FI warning lamp (MIL) flashes briefly 2x
Error level condition	Crankshaft position sensor - circuit fault
Blink code FI of warning lamp (MIL)	
	06 FI warning lamp (MIL) flashes briefly 6x
Error level condition	Throttle position sensor circuit A - input signal too low
Blink code FI of warning lamp (MIL)	
	09 FI warning lamp (MIL) flashes briefly 9x
Error level condition	Manifold absolute pressure sensor cylinder 1 - input signal too low
	Manifold absolute pressure sensor cylinder 1 - input signal too high
Blink code FI of warning lamp (MIL)	
	12 FI warning lamp (MIL) flashes 1x long, 2x short
Error level condition	Engine coolant temperature sensor - input signal too low
	Engine coolant temperature sensor - input signal too high
Blink code FI of warning lamp (MIL)	
	13 FI warning lamp (MIL) flashes 1x long, 3x short
Error level condition	Intake air temperature sensor - input signal too low
	Intake air temperature sensor - input signal too high

Blink code FI of warning lamp (MIL)	
	14 FI warning lamp (MIL) flashes 1x long, 4x short
Error level condition	Ambient air pressure sensor - input signal too low Ambient air pressure sensor - input signal too high
Blink code FI of warning lamp (MIL)	
	15 FI warning lamp (MIL) flashes 1x long, 5x short
Error level condition	Rollover sensor - input signal too low Rollover sensor - input signal too high
Blink code FI of warning lamp (MIL)	
	17 FI warning lamp (MIL) flashes 1x long, 7x short
Error level condition	Lambda sensor cylinder 1, sensor 1 - circuit fault
Blink code FI of warning lamp (MIL)	
	24 FI warning lamp (MIL) flashes 2x long, 4x short
Error level condition	System voltage - circuit fault
Blink code FI of warning lamp (MIL)	
	25 FI warning lamp (MIL) flashes 2x long, 5x short
Error level condition	Side stand switch - circuit fault

Blink code FI of warning lamp (MIL)	 26 FI warning lamp (MIL) flashes 2x long, 6x short
Error level condition	Motor drive hall sensor - circuit fault
Blink code FI of warning lamp (MIL)	 37 FI warning lamp (MIL) flashes 3x long, 7x short
Error level condition	Ignition coil 1, cylinder 1 - circuit fault
Blink code FI of warning lamp (MIL)	 41 FI warning lamp (MIL) flashes 4x long, 1x short
Error level condition	Fuel pump controller - short circuit to ground or open circuit
	Fuel pump controller - input signal too high
Blink code FI of warning lamp (MIL)	 45 FI warning lamp (MIL) flashes 4x long, 5x short
Error level condition	Lambda sensor heater cylinder 1, sensor 1 - short circuit to ground or open circuit
	Lambda sensor heater cylinder 1, sensor 1 - input signal too high
Blink code FI of warning lamp (MIL)	 53 FI warning lamp (MIL) flashes 5x long, 3x short
Error level condition	Fuel evaporation valve - short circuit to ground or open circuit
	Fuel evaporation valve - input signal too high

Blink code FI of warning lamp (MIL)	 54 FI warning lamp (MIL) flashes 5x long, 4x short
Error level condition	Secondary air valve - short circuit to ground or open circuit
Blink code FI of warning lamp (MIL)	 58 FI warning lamp (MIL) flashes 5x long, 8x short
Error level condition	EPT motor drive relay permission - signal fault
Blink code FI of warning lamp (MIL)	 60 FI warning lamp (MIL) flashes 6x long
Error level condition	Motor drive - circuit fault
Blink code FI of warning lamp (MIL)	 90 FI warning lamp (MIL) flashes 9x long
Error level condition	Throttle position - circuit fault
Blink code FI of warning lamp (MIL)	 91 FI warning lamp (MIL) flashes 9x long, 1x short
Error level condition	CAN bus communication error

Blink code FI of warning lamp (MIL)	 92 FI warning lamp (MIL) flashes 9x long, 2x short
Error level condition	Motor drive voltage (internal) - circuit fault

Design	1-cylinder 4-stroke engine, water-cooled
Displacement	690 cm ³ (42.11 cu in)
Stroke	84.5 mm (3.327 in)
Bore	102 mm (4.02 in)
Compression ratio	12.5:1
Idle speed	
Coolant temperature: ≥ 70 °C (≥ 158 °F)	1,550... 1,650 rpm
Control	OHC, 4 valves controlled via rocker arm, chain drive
Valve diameter, intake	40 mm (1.57 in)
Valve diameter, exhaust	34 mm (1.34 in)
Valve play, cold	0.07... 0.13 mm (0.0028... 0.0051 in)
Crankshaft bearing	2 roller bearings
Conrod bearing	Needle bearing
Piston pin bearing	Piston pin with DLC coating
Pistons	Forged light alloy
Piston rings	1 L-ring, 1 tapered compression piston ring, 1 oil scraper ring
Engine lubrication	Semi-dry sump lubrication with two rotor pumps
Primary transmission	36:79
Clutch	APTC™ Antihopping clutch in oil bath / hydraulically operated
Gearbox	6-gears, claw-shifted
Transmission ratio	
1st gear	14:35
2nd gear	16:28
3rd gear	21:28
4th gear	21:23

5th gear	23:22
6th gear	23:20
Mixture preparation	Electronic fuel injection
Ignition	Contactless controlled fully electronic ignition with digital ignition adjustment
Alternator	12 V, 224 W
Spark plug	NGK LKAR 8AI - 9
Spark plug electrode gap	0.9 mm (0.035 in)
Cooling	Water cooling, permanent circulation of coolant by water pump
Starting aid	Electric starter, automatic decompressor

Capacity - engine oil

Engine oil	1.70 l (1.8 qt.)	Engine oil (SAE 10W/60) (00062010035) (☛ p. 195)	
		Alternative engine oil	Engine oil (SAE 10W/50) (☛ p. 195)

Capacity - coolant

Coolant	1.20 l (1.27 qt.)	Coolant (☛ p. 194)
		Coolant (mixed ready to use) (☛ p. 194)

TECHNICAL DATA - ENGINE TIGHTENING TORQUES

Oil hole plug	EJOT	9 Nm (6.6 lbf ft)	Loctite® 243™
Screw, membrane fixation	M3	2.5 Nm (1.84 lbf ft)	Loctite® 243™
Hose clamp, intake flange	M4	1.5 Nm (1.11 lbf ft)	–
Oil nozzle for conrod bearing lubrication	M4	2 Nm (1.5 lbf ft)	Loctite® 243™
Locking screw for bearing	M5	6 Nm (4.4 lbf ft)	Loctite® 243™
Screw, breather cover on valve cover	M5	3 Nm (2.2 lbf ft)	Loctite® 243™
Screw, clutch spring	M5	6 Nm (4.4 lbf ft)	–
Screw, cover plate for oil return line	M5	6 Nm (4.4 lbf ft)	–
Screw, gear sensor	M5	5 Nm (3.7 lbf ft)	Loctite® 243™
Screw, oil filter cover	M5	6 Nm (4.4 lbf ft)	–
Screw, oil pump cover	M5	6 Nm (4.4 lbf ft)	Loctite® 243™
Plug, vacuum connection	M6	10 Nm (7.4 lbf ft)	Loctite® 243™
Screw in alternator cover	M6	10 Nm (7.4 lbf ft)	–
Screw, alternator cover (chain shaft through-hole)	M6	10 Nm (7.4 lbf ft)	Loctite® 243™
Screw, autodecompression	M6	3... 4 Nm (2.2... 3 lbf ft)	Loctite® 243™
Screw, axial lock of camshaft	M6	10 Nm (7.4 lbf ft)	Loctite® 243™
Screw, clutch cover	M6	10 Nm (7.4 lbf ft)	–
Screw, clutch slave cylinder	M6x20	10 Nm (7.4 lbf ft)	Loctite® 243™
Screw, clutch slave cylinder	M6x35	10 Nm (7.4 lbf ft)	–
Screw, cylinder	M6	10 Nm (7.4 lbf ft)	Loctite® 243™
Screw, cylinder head	M6	10 Nm (7.4 lbf ft)	Loctite® 243™
Screw, engine case	M6	10 Nm (7.4 lbf ft)	–
Screw, ignition pulse generator	M6	10 Nm (7.4 lbf ft)	Loctite® 243™

TECHNICAL DATA - ENGINE TIGHTENING TORQUES

Screw, locking lever	M6	10 Nm (7.4 lbf ft)	Loctite® 243™
Screw, rocker arm shaft	M6	12 Nm (8.9 lbf ft)	–
Screw, shift drum locating	M6	10 Nm (7.4 lbf ft)	Loctite® 243™
Screw, shift lever	M6	14 Nm (10.3 lbf ft)	Loctite® 222
Screw, starter motor	M6	10 Nm (7.4 lbf ft)	Loctite® 243™
Screw, stator	M6	10 Nm (7.4 lbf ft)	Loctite® 243™
Screw, thermostat housing	M6	10 Nm (7.4 lbf ft)	Loctite® 243™
Screw, timing chain guide rail	M6	10 Nm (7.4 lbf ft)	Loctite® 243™
Screw, timing chain tensioning rail	M6	10 Nm (7.4 lbf ft)	Loctite® 243™
Screw, valve cover	M6	10 Nm (7.4 lbf ft)	–
Screw, water pump cover	M6	10 Nm (7.4 lbf ft)	–
Screw, water pump wheel	M6	10 Nm (7.4 lbf ft)	Loctite® 243™
Oil jet, piston cooling	M6x0.75	4 Nm (3 lbf ft)	Loctite® 243™
Plug, crankshaft location	M8	20 Nm (14.8 lbf ft)	–
Stud, exhaust flange	M8	10 Nm (7.4 lbf ft)	Loctite® 243™
Cylinder head screw	M10	Tightening sequence: Tighten diagonally, beginning with the rear screw on the chain shaft. Step 1 15 Nm (11.1 lbf ft) Step 2 30 Nm (22.1 lbf ft) Step 3 45 Nm (33.2 lbf ft) Step 4 60 Nm (44.3 lbf ft)	Lubricated with engine oil

TECHNICAL DATA - ENGINE TIGHTENING TORQUES

Oil hole plug	M10x1	15 Nm (11.1 lbf ft)	Loctite® 243™
Plug, drain hole of water pump	M10x1	15 Nm (11.1 lbf ft)	–
Plug, oil bore for oil radiator	M10x1	15 Nm (11.1 lbf ft)	–
Screw, unlocking of timing chain tensioner	M10x1	10 Nm (7.4 lbf ft)	–
Spark plug	M12x1.25	17 Nm (12.5 lbf ft)	–
Coolant temperature sensor on cylinder head	M12x1.5	12 Nm (8.9 lbf ft)	–
Oil drain plug with magnet	M12x1.5	20 Nm (14.8 lbf ft)	–
Oil pressure regulator valve plug	M12x1.5	20 Nm (14.8 lbf ft)	–
Plug, oil bore	M14x1.5	15 Nm (11.1 lbf ft)	Loctite® 243™
Engine case stud	M16x1.5	25 Nm (18.4 lbf ft)	Loctite® 243™
Rotor nut	M18x1.5	100 Nm (73.8 lbf ft)	–
Nut, engine sprocket	M20x1.5	80 Nm (59 lbf ft)	Loctite® 243™
Nut, inner clutch hub	M20x1.5	100 Nm (73.8 lbf ft)	Loctite® 243™
Nut, primary gear	M20LHx1.5	90 Nm (66.4 lbf ft)	Loctite® 243™
Plug, oil screen	M20x1.5	15 Nm (11.1 lbf ft)	–
Plug, timing chain tensioner	M20x1.5	25 Nm (18.4 lbf ft)	–
Plug, oil thermostat	M24x1.5	15 Nm (11.1 lbf ft)	–
Screw in alternator cover	M24x1.5	8 Nm (5.9 lbf ft)	–

Frame	Lattice frame made of chrome molybdenum steel tubing, powder-coated
Fork	WP Suspension 4860 MXMA
Shock absorber	WP Suspension 4618 with Pro-Lever deflector
Suspension travel	
Front	250 mm (9.84 in)
Rear	250 mm (9.84 in)
Brake system	
Front	Disc brake with dual-piston brake caliper, floating
Rear	Disc brake with single-piston brake caliper, floating
Brake discs - diameter	
Front	300 mm (11.81 in)
Rear	240 mm (9.45 in)
Brake discs - wear limit	
Front	4.5 mm (0.177 in)
Rear	3.5 mm (0.138 in)
Tire air pressure, road, solo	
Front	1.8 bar (26 psi)
Rear	1.8 bar (26 psi)
Tire air pressure with passenger / fully loaded	
Front	2.0 bar (29 psi)
Rear	2.2 bar (32 psi)
Tire air pressure, offroad, single rider	
Front	1.5 bar (22 psi)
Rear	1.5 bar (22 psi)

Secondary drive ratio	15:45
Chain	5/8 x 1/4" X-ring
Steering head angle	63°
Wheelbase	1,504±15 mm (59.21±0.59 in)
Seat height unloaded	935 mm (36.81 in)
Ground clearance unloaded	280 mm (11.02 in)
Weight without fuel, approx.	142 kg (313 lb.)
Maximum permissible front axle load	150 kg (331 lb.)
Maximum permissible rear axle load	200 kg (441 lb.)
Maximum permissible overall weight	350 kg (772 lb.)

Battery	YTZ10S	Battery voltage: 12 V Nominal capacity: 8.6 Ah maintenance-free
Fuse	58011109130	30 A
Fuse	75011088015	15 A
Fuse	75011088010	10 A

Lighting equipment

Headlight	H4 / socket P43t	12 V 60/55 W
Parking light	W5W / socket W2.1x9.5d	12 V 5 W
Instrument lights and indicator lamps	LED	
Turn signal	RY10W / socket BAU15s	12 V 10 W

Brake/tail light	P21/5W / socket BAY15d	12 V 21/5 W
License plate lamp	W5W / socket W2.1x9.5d	12 V 5 W

Tires

Front tire	Rear tire
90/90 - 21 M/C 54R TT Pirelli MT 21 RALLYCROSS	140/80 - 18 M/C 70R TT Pirelli MT 21 RALLYCROSS
Additional information is available in the Service section under: http://www.ktm.com	

Capacity - fuel

Total fuel tank capacity, approx.	12 l (3.2 US gal)	Super unleaded (ROZ 95/RON 95/PON 91) (☛ p. 197)
Fuel reserve, approx.	2.5 l (2.6 qt.)	

Fork part number	14.18.7L.10	
Fork	WP Suspension 4860 MXMA	
Compression damping		
Comfort	20 clicks	
Standard	15 clicks	
Sport	10 clicks	
Full payload	10 clicks	
Rebound damping		
Comfort	20 clicks	
Standard	15 clicks	
Sport	10 clicks	
Full payload	10 clicks	
Spring length with preload spacer(s)	472 mm (18.58 in)	
Spring rate		
Soft	5.2 N/mm (29.7 lb/in)	
Medium (standard)	5.4 N/mm (30.8 lb/in)	
Hard	5.6 N/mm (32 lb/in)	
Air chamber length	120±20 mm (4.72±0.79 in)	
Fork length	890 mm (35.04 in)	
Fork oil per fork leg	615 ml (20.79 fl. oz.)	Fork oil (SAE 5) (☛ p. 196)

Shock absorber part number	15.18.7L.10
Shock absorber	WP Suspension 4618 with Pro-Lever deflector
Compression damping, high-speed	
Comfort	2 turns
Standard	1.5 turns
Sport	1 turn
Full payload	1 turn
Compression damping, low-speed	
Comfort	20 clicks
Standard	15 clicks
Sport	10 clicks
Full payload	10 clicks
Rebound damping	
Comfort	20 clicks
Standard	15 clicks
Sport	10 clicks
Full payload	10 clicks
Spring preload	20 mm (0.79 in)
Spring rate	
Medium (standard)	80 N/mm (457 lb/in)
Hard	85 N/mm (485 lb/in)
Spring length	220 mm (8.66 in)
Gas pressure	10 bar (145 psi)
Static sag	18 mm (0.71 in)
Riding sag	70... 80 mm (2.76... 3.15 in)

TECHNICAL DATA - SHOCK ABSORBER

Fitted length	395 mm (15.55 in)
Shock absorber oil (☛ p. 196)	SAE 2.5

TECHNICAL DATA - CHASSIS TIGHTENING TORQUES

Screw, chain guard	EJOT	2 Nm (1.5 lbf ft)	–
Screw, combination instrument	EJOT	1 Nm (0.7 lbf ft)	–
Screw, license plate holder, bottom	EJOT	3 Nm (2.2 lbf ft)	–
Screw, side cover on spoiler	EJOT	1 Nm (0.7 lbf ft)	–
Screw, side stand switch	EJOT	2 Nm (1.5 lbf ft)	–
Screw, SLS valve	EJOT	2 Nm (1.5 lbf ft)	–
Fitting, side stand switch	M4	2 Nm (1.5 lbf ft)	–
Screw, fuel hose clamp on fuel tank	M4	2 Nm (1.5 lbf ft)	–
Screw, wheel speed sensor	M4	2 Nm (1.5 lbf ft)	Loctite® 243™
Spoke nipple, front wheel	M4.5	3... 6 Nm (2.2... 4.4 lbf ft)	–
Bolt, foot brake lever stub	M5	6 Nm (4.4 lbf ft)	Loctite® 243™
Remaining nuts, chassis	M5	4 Nm (3 lbf ft)	–
Remaining screws, chassis	M5	4 Nm (3 lbf ft)	–
Screw, brake line holder on swingarm	M5	Initial screw connection 8 Nm (5.9 lbf ft) Subsequent screw connection 4 Nm (3 lbf ft)	–
Screw, cable on starter motor	M5	3 Nm (2.2 lbf ft)	–
Screw, electrical holder	M5	3 Nm (2.2 lbf ft)	–
Screw, exhaust heat shield	M5	8 Nm (5.9 lbf ft)	Loctite® 243™
Screw, fuel level sensor	M5	3 Nm (2.2 lbf ft)	–
Screw, fuel pump	M5	4 Nm (3 lbf ft)	–
Screw, fuel tank closure flange	M5	2.5 Nm (1.84 lbf ft)	–
Screw, headlight mask	M5	5 Nm (3.7 lbf ft)	–

TECHNICAL DATA - CHASSIS TIGHTENING TORQUES

Screw, pressure regulator	M5	4 Nm (3 lbf ft)	–
Spoke nipple, rear wheel	M5	3... 6 Nm (2.2... 4.4 lbf ft)	–
Remaining nuts, chassis	M6	10 Nm (7.4 lbf ft)	–
Remaining screws on fuel tank	M6	5 Nm (3.7 lbf ft)	–
Remaining screws, chassis	M6	10 Nm (7.4 lbf ft)	–
Screw connection, foot brake cylinder	M6	10 Nm (7.4 lbf ft)	–
Screw, air filter box top	M6	2 Nm (1.5 lbf ft)	–
Screw, ball joint of push rod on foot brake cylinder	M6	10 Nm (7.4 lbf ft)	Loctite® 243™
Screw, brake fluid reservoir of rear brake	M6	5 Nm (3.7 lbf ft)	–
Screw, chain guard	M6	2 Nm (1.5 lbf ft)	Loctite® 243™
Screw, chain guide	M6	8 Nm (5.9 lbf ft)	–
Screw, chain sliding guard	M6	8 Nm (5.9 lbf ft)	Loctite® 243™
Screw, fan hood	M6	4 Nm (3 lbf ft)	–
Screw, front brake disc	M6	14 Nm (10.3 lbf ft)	Loctite® 243™
Screw, ignition lock	M6	10 Nm (7.4 lbf ft)	Loctite® 243™
Screw, lower radiator bracket	M6	8 Nm (5.9 lbf ft)	–
Screw, magnetic holder on side stand	M6	6 Nm (4.4 lbf ft)	Loctite® 243™
Screw, radiator guard	M6	8 Nm (5.9 lbf ft)	–
Screw, rear brake disc	M6	14 Nm (10.3 lbf ft)	Loctite® 243™
Screw, seat lock	M6	5 Nm (3.7 lbf ft)	–
Screw, side cover	M6	5 Nm (3.7 lbf ft)	–
Screw, upper radiator bracket	M6	10 Nm (7.4 lbf ft)	–
Screw, voltage regulator	M6	8 Nm (5.9 lbf ft)	–
Nut, manifold on cylinder head	M8	20 Nm (14.8 lbf ft)	Copper paste

TECHNICAL DATA - CHASSIS TIGHTENING TORQUES

Nut, rear sprocket screw	M8	35 Nm (25.8 lbf ft)	Loctite® 2701
Remaining nuts, chassis	M8	25 Nm (18.4 lbf ft)	–
Remaining screws, chassis	M8	25 Nm (18.4 lbf ft)	–
Screw, bottom triple clamp	M8	12 Nm (8.9 lbf ft)	–
Screw, chain sliding piece	M8	15 Nm (11.1 lbf ft)	–
Screw, connection lever on frame	M8	30 Nm (22.1 lbf ft)	Loctite® 243™
Screw, exhaust clamp on main silencer	M8	12 Nm (8.9 lbf ft)	–
Screw, foot brake lever	M8	25 Nm (18.4 lbf ft)	Loctite® 243™
Screw, fork stub	M8	15 Nm (11.1 lbf ft)	–
Screw, front brake caliper	M8	25 Nm (18.4 lbf ft)	Loctite® 243™
Screw, front footrest bracket	M8	25 Nm (18.4 lbf ft)	–
Screw, fuel tank bracket	M8	15 Nm (11.1 lbf ft)	–
Screw, fuel tank, bottom	M8	25 Nm (18.4 lbf ft)	Loctite® 243™
Screw, fuel tank, top	M8	25 Nm (18.4 lbf ft)	Loctite® 243™
Screw, handlebar clamp	M8	20 Nm (14.8 lbf ft)	–
Screw, handrail	M8	20 Nm (14.8 lbf ft)	–
Screw, heel protector	M8x12	8 Nm (5.9 lbf ft)	–
Screw, license plate holder, top	M8	20 Nm (14.8 lbf ft)	–
Screw, main silencer holder	M8	25 Nm (18.4 lbf ft)	–
Screw, main silencer holder on fuel tank	M8	25 Nm (18.4 lbf ft)	–
Screw, rear footrest bracket	M8x16	25 Nm (18.4 lbf ft)	–
Screw, side stand bracket	M8	25 Nm (18.4 lbf ft)	Loctite® 243™
Screw, spring holder on side stand bracket	M8	25 Nm (18.4 lbf ft)	Loctite® 243™

TECHNICAL DATA - CHASSIS TIGHTENING TORQUES

Screw, steering stem	M8	20 Nm (14.8 lbf ft)	–
Screw, top triple clamp	M8	17 Nm (12.5 lbf ft)	–
Engine carrying screw	M10	45 Nm (33.2 lbf ft)	Loctite® 243™
Remaining nuts, chassis	M10	45 Nm (33.2 lbf ft)	–
Remaining screws, chassis	M10	45 Nm (33.2 lbf ft)	–
Screw, bottom shock absorber	M10	45 Nm (33.2 lbf ft)	Loctite® 243™
Screw, engine bearer on frame	M10	45 Nm (33.2 lbf ft)	–
Screw, handlebar support	M10	40 Nm (29.5 lbf ft)	Loctite® 243™
Screw, side stand	M10	35 Nm (25.8 lbf ft)	Loctite® 243™
Screw, top shock absorber	M10	45 Nm (33.2 lbf ft)	Loctite® 243™
Screw, swingarm pivot	M12	80 Nm (59 lbf ft)	–
Lambda sensor	M12x1.25	25 Nm (18.4 lbf ft)	Copper paste
Nut, linkage lever on swingarm	M14x1.5	100 Nm (73.8 lbf ft)	–
Nut, linkage lever to rocker arm	M14x1.5	100 Nm (73.8 lbf ft)	–
Screw, bottom steering head	M20x1.5	60 Nm (44.3 lbf ft)	Loctite® 243™
Screw, top steering head	M20x1.5	12 Nm (8.9 lbf ft)	–
Screw, front wheel spindle	M24x1.5	40 Nm (29.5 lbf ft)	–
Nut, rear wheel spindle	M25x1.5	90 Nm (66.4 lbf ft)	–

Brake fluid DOT 4 / DOT 5.1

According to

- DOT

Guideline

- Use only brake fluid that complies with the specified standard (see specifications on the container) and that possesses the corresponding properties. KTM recommends **Castrol** and **Motorex®** products.

Supplier

Castrol

- **RESPONSE BRAKE FLUID SUPER DOT 4**

Motorex®

- **Brake Fluid DOT 5.1**

Coolant

Guideline

- Use only suitable coolant (also in countries with high temperatures). Use of low-quality antifreeze can lead to corrosion and foaming. KTM recommends **Motorex®** products.

Mixture ratio

Antifreeze protection: -25... -45 °C (-13... -49 °F)	50 % corrosion inhibitor/antifreeze 50 % distilled water
--	---

Coolant (mixed ready to use)

Antifreeze	-40 °C (-40 °F)
------------	-----------------

Supplier

Motorex®

- **COOLANT G48**

Engine oil (SAE 10W/60) (00062010035)

According to

- JASO T903 MA (☛ p. 200)
- SAE (☛ p. 200) (SAE 10W/60)
- KTM LC4 2007+

Guideline

- Use only engine oils that comply with the specified standards (see specifications on the container) and that possess the corresponding properties. KTM recommends **Motorex®** products.

Synthetic engine oil

Supplier

Motorex®

- **Motorex® KTM Cross Power 4T**

Engine oil (SAE 10W/50)

According to

- JASO T903 MA (☛ p. 200)
- SAE (☛ p. 200) (SAE 10W/50)

Guideline

- Use only engine oils that comply with the specified standards (see specifications on the container) and that possess the corresponding properties. KTM recommends **Motorex®** products.

Fully synthetic engine oil

Supplier

Motorex®

- **Power Synt 4T**

Fork oil (SAE 5)

According to

- SAE (☛ p. 200) (SAE 5)

Guideline

- Use only oils that comply with the specified standards (see specifications on the container) and that possess the corresponding properties. KTM recommends **Motorex**[®] products.

Supplier

Motorex[®]

- **Racing Fork Oil**

Hydraulic fluid (15)

According to

- ISO VG (15)

Guideline

- Use only hydraulic oil that complies with the specified standard (see specifications on the container) and that possesses the corresponding properties. KTM recommends **Motorex**[®] products.

Supplier

Motorex[®]

- **Hydraulic Fluid 75**

Shock absorber oil (SAE 2.5) (50180342S1)

According to

- SAE (☛ p. 200) (SAE 2.5)

Guideline

- Use only oils that comply with the specified standards (see specifications on the container) and that possess the corresponding properties.

Super unleaded (ROZ 95/RON 95/PON 91)

According to

- DIN EN 228 (ROZ 95/RON 95/PON 91)

Guideline

- Only use unleaded super fuel that matches or is equivalent to the specified fuel grade.
- Fuel with an ethanol content of up to 10 % (E10 fuel) is safe to use.



Info

Do **not** use fuel containing methanol (e. g. M15, M85, M100) or more than 10 % ethanol (e. g. E15, E25, E85, E100).

Chain cleaner

Guideline

- KTM recommends **Motorex®** products.

Supplier

Motorex®

- **Chain Clean**

Cleaning and preserving materials for metal, rubber and plastic

Guideline

- KTM recommends **Motorex®** products.

Supplier

Motorex®

- **Protect & Shine**

High-luster polish for paint

Guideline

- KTM recommends **Motorex®** products.

Supplier

Motorex®

- **Moto Polish**

Long-life grease

Guideline

- KTM recommends **Motorex®** products.

Supplier

Motorex®

- **Bike Grease 2000**

Motorcycle cleaner

Guideline

- KTM recommends **Motorex®** products.

Supplier

Motorex®

- **Moto Clean 900**

Off-road chain spray

Guideline

- KTM recommends **Motorex®** products.

Supplier

Motorex®

- **Chainlube Offroad**

Paint cleaner and polish for high-gloss and matte finishes, bare metal and plastic surfaces

Guideline

- KTM recommends **Motorex®** products.

Supplier

Motorex®

- **Clean & Polish**

Universal oil spray

Guideline

- KTM recommends **Motorex®** products.

Supplier

Motorex®

- **Joker 440 Synthetic**

JASO T903 MA

Different technical development directions required a new specification for 4-stroke motorcycles – the JASO T903 MA Standard. Earlier, engine oils from the automobile industry were used for 4-stroke motorcycles because there was no separate motorcycle specification. Whereas long service intervals are demanded for automobile engines, high performance at high engine speeds are in the foreground for motorcycle engines. With most motorcycles, the gearbox and the clutch are lubricated with the same oil as the engine. The JASO MA Standard meets these special requirements.

SAE

The SAE viscosity classes were defined by the Society of Automotive Engineers and are used for classifying oils according to their viscosity. The viscosity describes only one property of oil and says nothing about quality.

A

Accessories 9

Air filter

 installing 84

 removing 83

Antifreeze

 checking 144

B

Baggage 48

Battery

 fitting 127

 recharging 128

 removing 126

Blink code 174-178

Brake discs

 checking 99

Brake fluid

 front brake, adding 101

 rear brake, adding 109

Brake fluid level

 front brake, checking 100

 rear brake, checking 108

Brake linings

 front brake, changing 103

 front brake, checking 102

 rear brake, changing 111

 rear brake, checking 111

Brakes 56

Braking 56

C

Chain

 checking 89

 cleaning 85

 dirt, checking for 85

Chain guide

 adjusting 94

 checking 89

Chain tension

 adjusting 87

 checking 86

Chassis number 26

Clutch

 checking/correcting fluid level 95

Clutch lever **29**

 basic position, adjusting 95

Combination instrument **33**

 clock, setting 37

 coolant temperature indicator 40

 display 35

 function buttons 34

 indicator lamps 34

ODO display 38

- setting kilometers or miles 36
- speed display 36
- time 37
- TRIP 1** display, setting/resetting 38
- TRIP 2** display, setting/resetting 39
- TRIP F** display 40
- Coolant**
 - draining 148
- Coolant level**
 - checking 144, 146
- Cooling system** **144**
 - filling 149
- D**
- Display** 35
- E**
- Electric starter button** 32
- Emergency OFF switch** 32
- Engine**
 - running in 47
- Engine characteristic**
 - adjusting 153
- Engine guard**
 - installing 97
 - removing 96
- Engine number** 27
- Engine oil**
 - adding 164
 - changing 158
 - draining 158
 - refilling 163
- Engine oil level**
 - checking 157
- Engine sprocket**
 - checking 89
- Environment** 10
- F**
- Filler cap**
 - closing 42
 - opening 41
- Filling up**
 - fuel 58
- Foot brake lever** **45**
 - basic position, adjusting 107
 - free travel, checking 107
- Fork** **64**
 - compression damping, adjusting 64
 - dust boots, cleaning 77
 - fork legs, bleeding 77
 - rebound, adjusting 65
- Fork part number** 28

Fork protector	
positioning	79
remove	78
Front wheel	
installing	116
removing	115
Fuel, oils, etc.	8
Fuse	
of individual power consumer, changing	132
H	
Hand brake lever	29
free travel, adjusting	98
free travel, checking	98
Handlebar position	74
adjusting	74
Handrails	43
Headlight	
light range, adjusting	142
Headlight bulb, changing	137
Headlight mask with headlight	
installing	136
removing	134
Headlight setting, checking	142
Horn button	31

I	
Ignition lock	33
Indicator lamps	34
K	
Key number	27
L	
Light switch	30
Loading the vehicle	48
M	
Main fuse	
changing	131
Motorcycle	
cleaning	166
raising with lift stand	76
removing from lift stand	76
O	
Oil filter	
changing	158
installing	163
removing	159
Oil screens	158, 161
Owner's manual	18
P	
Parking	57

- Parking light bulb**
 - changing 138
- Passenger footrests** 43
- Play in throttle cable**
 - adjusting 153
 - checking 152
- Preparing for use**
 - after storage 170
 - checks and vehicle care when preparing for use 50
- Putting into operation**
 - advice on first use 46
- R**
- Rear hub rubber dampers**
 - checking 120
- Rear sprocket**
 - checking 89
- Rear wheel**
 - installing 119
 - removing 118
- Riding** 52
 - starting off 52
- Riding sag**
 - adjusting 73
- S**
- Seat**
 - mounting 82
 - removing 82
- Seat release** 42
- Service** 8
- Service schedule** 61-63
- Shift lever** 44
 - basic position, adjusting 155
 - basic position, checking 155
- Shifting** 52
- Shock absorber** 64
 - compression damping, general 66
 - compression damping, high-speed, adjusting 67
 - compression damping, low-speed, adjusting 66
 - rebound damping, adjusting 68
 - riding sag, checking 71
 - spring preload, adjusting 71
 - static sag, checking 70
- Shock absorber part number** 28
- Side stand** 45
- Spare parts** 9
- Spoke tension**
 - checking 124
- Starting** 51
- Steering head bearing play**
 - adjusting 80
 - checking 79
- Steering lock** 33
- Stopping** 57

Storage 169

T

Tail light

changing 141

Technical data

chassis 184-186

chassis tightening torques 190-193

engine 179-180

engine tightening torques 181-183

fork 187

shock absorber 188-189

Throttle grip 30

Tire air pressure

checking 123

Tire condition

checking 122

Transport 9

Troubleshooting 171-173

Turn signal bulb

changing 140

Turn signal switch 31

Type label 26

U

Use definition 8

V

View of vehicle

front left 22

rear right 24

W

Warranty 8

Winter operation

checks and maintenance steps 168

Work rules 9



3211802en



02/2012 Photo: Mitterbauer



KTM-Sportmotorcycle AG
5230 Mattighofen/Austria
<http://www.ktm.com>