



⚠ Read this manual carefully before operating this vehicle.

OWNER'S MANUAL

**CRYPTON**

**T110C**

40B-F8199-E2

 **Read this manual carefully before operating this vehicle. This manual should stay with this vehicle if it is sold.**

Welcome to the Yamaha world of motorcycling!

As the owner of the T110C, you are benefiting from Yamaha's vast experience and newest technology regarding the design and manufacture of high-quality products, which have earned Yamaha a reputation for dependability.

Please take the time to read this manual thoroughly, so as to enjoy all advantages of your T110C. The Owner's Manual does not only instruct you in how to operate, inspect and maintain your motorcycle, but also in how to safeguard yourself and others from trouble and injury.

In addition, the many tips given in this manual will help keep your motorcycle in the best possible condition. If you have any further questions, do not hesitate to contact your Yamaha dealer.

The Yamaha team wishes you many safe and pleasant rides. So, remember to put safety first!

Yamaha continually seeks advancements in product design and quality. Therefore, while this manual contains the most current product information available at the time of printing, there may be minor discrepancies between your motorcycle and this manual. If there is any question concerning this manual, please consult a Yamaha dealer.



---

**Please read this manual carefully and completely before operating this motorcycle.**

---





# IMPORTANT MANUAL INFORMATION

---

---

EAU10133

Particularly important information is distinguished in this manual by the following notations:

	<b>This is the safety alert symbol. It is used to alert you to potential personal injury hazards. Obey all safety messages that follow this symbol to avoid possible injury or death.</b>
	<b>A WARNING indicates a hazardous situation which, if not avoided, could result in death or serious injury.</b>
	<b>A NOTICE indicates special precautions that must be taken to avoid damage to the vehicle or other property.</b>
	<b>A TIP provides key information to make procedures easier or clearer.</b>

\*Product and specifications are subject to change without notice.

# IMPORTANT MANUAL INFORMATION

---

---

EAU37230

**T110C  
OWNER'S MANUAL  
©2012 by Yamaha Motor Co., Ltd.  
1st edition, September 2012  
All rights reserved.  
Any reprinting or unauthorized use  
without the written permission of  
Yamaha Motor Co., Ltd.  
is expressly prohibited.  
Printed in China.**

# TABLE OF CONTENTS

---

---

<b>SAFETY INFORMATION</b> .....	1-1	<b>FOR YOUR SAFETY – PRE-OPERATION CHECKS</b> .....	4-1	Valve clearance .....	6-13
<b>DESCRIPTION</b> .....	2-1	<b>OPERATION AND IMPORTANT RIDING POINTS</b> .....	5-1	Tires .....	6-14
Left view .....	2-1	Starting and warming up a cold engine .....	5-1	Cast wheels .....	6-16
Right view .....	2-2	Starting a warm engine .....	5-2	Checking the brake lever free play .....	6-16
Controls and instruments.....	2-3	Shifting .....	5-2	Adjusting the brake pedal free play .....	6-17
<b>INSTRUMENT AND CONTROL FUNCTIONS</b> .....	3-1	Tips for reducing fuel consumption .....	5-3	Checking the shift pedal .....	6-17
Main switch/steering lock .....	3-1	Engine break-in .....	5-3	Brake light switches .....	6-18
Indicator lights .....	3-2	Parking .....	5-4	Checking the front brake pads and rear brake shoes .....	6-18
Speedometer unit .....	3-3	<b>PERIODIC MAINTENANCE AND ADJUSTMENT</b> .....	6-1	Checking the brake fluid level .....	6-19
Fuel gauge .....	3-3	Owner's tool kit .....	6-2	Changing the brake fluid .....	6-20
Handlebar switches .....	3-3	Periodic maintenance chart for the emission control system .....	6-3	Drive chain slack .....	6-20
Shift pedal .....	3-4	General maintenance and lubrication chart .....	6-4	Cleaning and lubricating the drive chain .....	6-22
Brake lever .....	3-4	Removing and installing the cowling and panel .....	6-7	Checking and lubricating the cables .....	6-23
Brake pedal .....	3-5	Checking the spark plug .....	6-8	Checking and lubricating the throttle grip and cable .....	6-23
Fuel tank cap .....	3-5	Engine oil .....	6-9	Checking and lubricating the brake lever .....	6-23
Fuel .....	3-6	Cleaning the air filter element .....	6-11	Checking and lubricating the brake pedal .....	6-24
Catalytic converters .....	3-7	Adjusting the carburetor .....	6-12	Checking and lubricating the centerstand and sidestand (for sidestand-equipped models) .....	6-24
Starter (choke) lever .....	3-7	Adjusting the engine idling speed .....	6-12	Lubricating the swingarm pivots .....	6-25
Kickstarter .....	3-8	Checking the throttle grip free play .....	6-13	Checking the front fork .....	6-25
Seat .....	3-8				
Helmet holders .....	3-8				
Storage compartment .....	3-9				
Carrier .....	3-10				
Sidestand (for sidestand-equipped models) .....	3-10				

# TABLE OF CONTENTS

---

---

Checking the steering .....	6-26
Checking the wheel bearings .....	6-26
Battery .....	6-26
Replacing the fuse .....	6-28
Replacing the headlight bulb .....	6-28
Replacing the tail/brake light bulb .....	6-29
Replacing a front turn signal light bulb .....	6-30
Replacing a rear turn signal light bulb .....	6-31
Replacing the license plate light bulb .....	6-31
Replacing an auxiliary light bulb ...	6-32
Front wheel .....	6-33
Rear wheel .....	6-35
Troubleshooting .....	6-37
Troubleshooting chart .....	6-38

## **MOTORCYCLE CARE AND**

<b>STORAGE</b> .....	7-1
Matte color caution .....	7-1
Care .....	7-1
Storage .....	7-3

<b>SPECIFICATIONS</b> .....	8-1
-----------------------------	-----

<b>CONSUMER INFORMATION</b> .....	9-1
Identification numbers .....	9-1

## Be a Responsible Owner

As the vehicle's owner, you are responsible for the safe and proper operation of your motorcycle.

Motorcycles are single-track vehicles. Their safe use and operation are dependent upon the use of proper riding techniques as well as the expertise of the operator. Every operator should know the following requirements before riding this motorcycle.

He or she should:

- Obtain thorough instructions from a competent source on all aspects of motorcycle operation.
- Observe the warnings and maintenance requirements in this Owner's Manual.
- Obtain qualified training in safe and proper riding techniques.
- Obtain professional technical service as indicated in this Owner's Manual and/or when made necessary by mechanical conditions.

- Never operate a motorcycle without proper training or instruction. Take a training course. Beginners should receive training from a certified instructor. Contact an authorized motorcycle dealer to find out about the training courses nearest you.

## Safe Riding

Perform the pre-operation checks each time you use the vehicle to make sure it is in safe operating condition. Failure to inspect or maintain the vehicle properly increases the possibility of an accident or equipment damage. See page 4-1 for a list of pre-operation checks.

- This motorcycle is designed to carry the operator and a passenger.
- The failure of motorists to detect and recognize motorcycles in traffic is the predominating cause of automobile/motorcycle accidents. Many accidents have been caused by an automobile driver who did not see the motorcycle. Making

yourself conspicuous appears to be very effective in reducing the chance of this type of accident.

### Therefore:

- Wear a brightly colored jacket.
- Use extra caution when you are approaching and passing through intersections, since intersections are the most likely places for motorcycle accidents to occur.
- Ride where other motorists can see you. Avoid riding in another motorist's blind spot.
- Never maintain a motorcycle without proper knowledge. Contact an authorized motorcycle dealer to inform you on basic motorcycle maintenance. Certain maintenance can only be carried out by certified staff.



- Many accidents involve inexperienced operators. In fact, many operators who have been involved in accidents do not even have a current motorcycle license.
  - Make sure that you are qualified and that you only lend your motorcycle to other qualified operators.
  - Know your skills and limits. Staying within your limits may help you to avoid an accident.
  - We recommend that you practice riding your motorcycle where there is no traffic until you have become thoroughly familiar with the motorcycle and all of its controls.
- Many accidents have been caused by error of the motorcycle operator. A typical error made by the operator is veering wide on a turn due to excessive speed or undercornering (insufficient lean angle for the speed).
  - Always obey the speed limit and never travel faster than warranted by road and traffic conditions.
- Always signal before turning or changing lanes. Make sure that other motorists can see you.
- The posture of the operator and passenger is important for proper control.
  - The operator should keep both hands on the handlebar and both feet on the operator footrests during operation to maintain control of the motorcycle.
  - The passenger should always hold onto the operator, the seat strap or grab bar, if equipped, with both hands and keep both feet on the passenger footrests. Never carry a passenger unless he or she can firmly place both feet on the passenger footrests.
- Never ride under the influence of alcohol or other drugs.
- This motorcycle is designed for on-road use only. It is not suitable for off-road use.

### **Protective Apparel**

The majority of fatalities from motorcycle accidents are the result of head injuries. The use of a safety helmet is the single most critical factor in the prevention or reduction of head injuries.

- Always wear an approved helmet.
- Wear a face shield or goggles. Wind in your unprotected eyes could contribute to an impairment of vision that could delay seeing a hazard.
- The use of a jacket, heavy boots, trousers, gloves, etc., is effective in preventing or reducing abrasions or lacerations.
- Never wear loose-fitting clothes, otherwise they could catch on the control levers, footrests, or wheels and cause injury or an accident.
- Always wear protective clothing that covers your legs, ankles, and feet. The engine or exhaust system become very hot during or after operation and can cause burns.
- A passenger should also observe the above precautions.

# SAFETY INFORMATION

1

## **Avoid Carbon Monoxide Poisoning**

All engine exhaust contains carbon monoxide, a deadly gas. Breathing carbon monoxide can cause headaches, dizziness, drowsiness, nausea, confusion, and eventually death.

Carbon Monoxide is a colorless, odorless, tasteless gas which may be present even if you do not see or smell any engine exhaust. Deadly levels of carbon monoxide can collect rapidly and you can quickly be overcome and unable to save yourself. Also, deadly levels of carbon monoxide can linger for hours or days in enclosed or poorly ventilated areas. If you experience any symptoms of carbon monoxide poisoning, leave the area immediately, get fresh air, and **SEEK MEDICAL TREATMENT**.

- Do not run engine indoors. Even if you try to ventilate engine exhaust with fans or open windows and doors, carbon monoxide can rapidly reach dangerous levels.
- Do not run engine in poorly ventilated or partially enclosed areas such as barns, garages, or carports.

- Do not run engine outdoors where engine exhaust can be drawn into a building through openings such as windows and doors.

## **Loading**

Adding accessories or cargo to your motorcycle can adversely affect stability and handling if the weight distribution of the motorcycle is changed. To avoid the possibility of an accident, use extreme caution when adding cargo or accessories to your motorcycle. Use extra care when riding a motorcycle that has added cargo or accessories. Here, along with the information about accessories below, are some general guidelines to follow if loading cargo to your motorcycle:

The total weight of the operator, passenger, accessories and cargo must not exceed the maximum load limit.

**Operation of an overloaded vehicle could cause an accident.**

<p><b>Maximum load:</b> 167 kg (368 lb)</p>
-------------------------------------------------

When loading within this weight limit, keep the following in mind:

- Cargo and accessory weight should be kept as low and close to the motorcycle as possible. Securely pack your heaviest items as close to the center of the vehicle as possible and make sure to distribute the weight as evenly as possible on both sides of the motorcycle to minimize imbalance or instability.
- Shifting weights can create a sudden imbalance. Make sure that accessories and cargo are securely attached to the motorcycle before riding. Check accessory mounts and cargo restraints frequently.
  - Properly adjust the suspension for your load (suspension-adjustable models only), and check the condition and pressure of your tires.
  - Never attach any large or heavy items to the handlebar, front fork, or front fender. These items, including such cargo as sleeping bags, duffel bags, or

tents, can create unstable handling or a slow steering response.

- **This vehicle is not designed to pull a trailer or to be attached to a sidecar.**

### **Genuine Yamaha Accessories**

Choosing accessories for your vehicle is an important decision. Genuine Yamaha accessories, which are available only from a Yamaha dealer, have been designed, tested, and approved by Yamaha for use on your vehicle.

Many companies with no connection to Yamaha manufacture parts and accessories or offer other modifications for Yamaha vehicles. Yamaha is not in a position to test the products that these aftermarket companies produce. Therefore, Yamaha can neither endorse nor recommend the use of accessories not sold by Yamaha or modifications not specifically recommended by Yamaha, even if sold and installed by a Yamaha dealer.

### **Aftermarket Parts, Accessories, and Modifications**

While you may find aftermarket products similar in design and quality to genuine Yamaha accessories, recognize that some aftermarket accessories or modifications are not suitable because of potential safety hazards to you or others. Installing aftermarket products or having other modifications performed to your vehicle that change any of the vehicle's design or operation characteristics can put you and others at greater risk of serious injury or death. You are responsible for injuries related to changes in the vehicle.

Keep the following guidelines in mind, as well as those provided under "Loading" when mounting accessories.

- Never install accessories or carry cargo that would impair the performance of your motorcycle. Carefully inspect the accessory before using it to make sure that it does not in any way reduce ground clearance or cornering clearance,

limit suspension travel, steering travel or control operation, or obscure lights or reflectors.

- Accessories fitted to the handlebar or the front fork area can create instability due to improper weight distribution or aerodynamic changes. If accessories are added to the handlebar or front fork area, they must be as lightweight as possible and should be kept to a minimum.
- Bulky or large accessories may seriously affect the stability of the motorcycle due to aerodynamic effects. Wind may attempt to lift the motorcycle, or the motorcycle may become unstable in cross winds. These accessories may also cause instability when passing or being passed by large vehicles.
- Certain accessories can displace the operator from his or her normal riding position. This improper position limits the freedom of movement of the opera-

# SAFETY INFORMATION

---

1

tor and may limit control ability, therefore, such accessories are not recommended.

- Use caution when adding electrical accessories. If electrical accessories exceed the capacity of the motorcycle's electrical system, an electric failure could result, which could cause a dangerous loss of lights or engine power.

## **Aftermarket Tires and Rims**

The tires and rims that came with your motorcycle were designed to match the performance capabilities and to provide the best combination of handling, braking, and comfort. Other tires, rims, sizes, and combinations may not be appropriate. Refer to page 6-14 for tire specifications and more information on replacing your tires.

## **Transporting the Motorcycle**

Be sure to observe following instructions before transporting the motorcycle in another vehicle.

- Remove all loose items from the motorcycle.

- Check that the fuel cock (if equipped) is in the "OFF" position and that there are no fuel leaks.
- Point the front wheel straight ahead on the trailer or in the truck bed, and choke it in a rail to prevent movement.
- Shift the transmission in gear (for models with a manual transmission).
- Secure the motorcycle with tie-downs or suitable straps that are attached to solid parts of the motorcycle, such as the frame or upper front fork triple clamp (and not, for example, to rubber-mounted handlebars or turn signals, or parts that could break). Choose the location for the straps carefully so the straps will not rub against painted surfaces during transport.
- The suspension should be compressed somewhat by the tie-downs, if possible, so that the motorcycle will not bounce excessively during transport.

## Left view

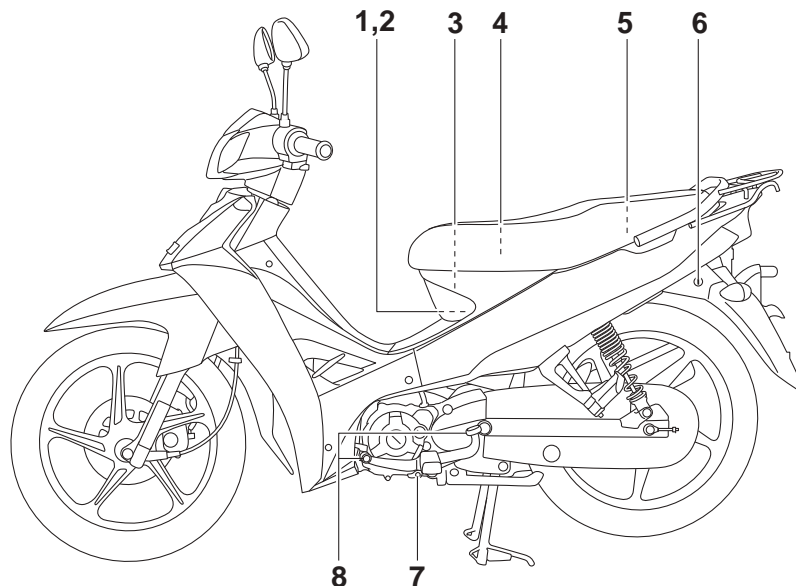

1. Battery (page 6-26)
2. Fuse (page 6-28)
3. Storage compartment (page 3-9)
4. Owner's tool kit (page 6-2)
5. Fuel tank cap (page 3-5)
6. Seat lock (page 3-8)
7. Engine oil drain bolt (page 6-9)
8. Shift pedal (page 3-4)

# DESCRIPTION

EAU10420

## Right view

2

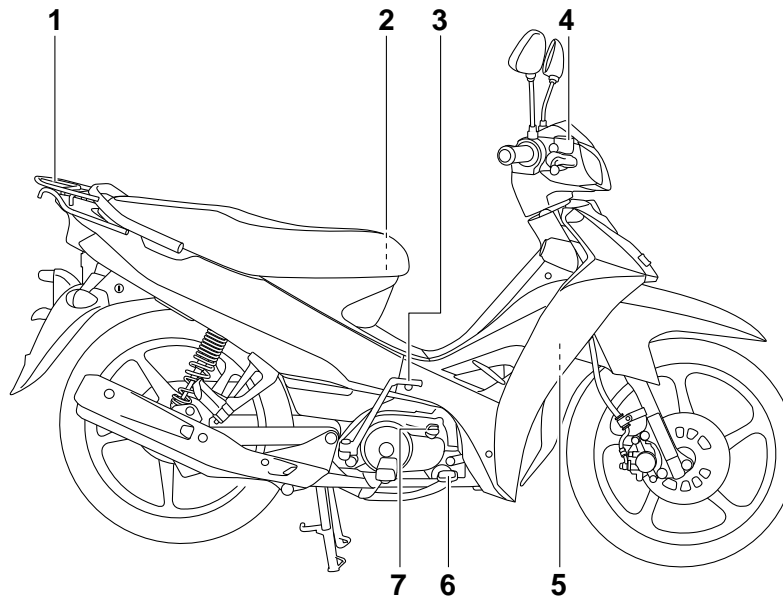

1. Carrier (page 3-10)
2. Helmet holder (page 3-8)
3. Kickstarter (page 3-8)
4. Front brake fluid reservoir (page 6-19)
5. Air filter element (page 6-11)
6. Brake pedal (page 3-5)
7. Engine oil filler cap (page 6-9)

## Controls and instruments

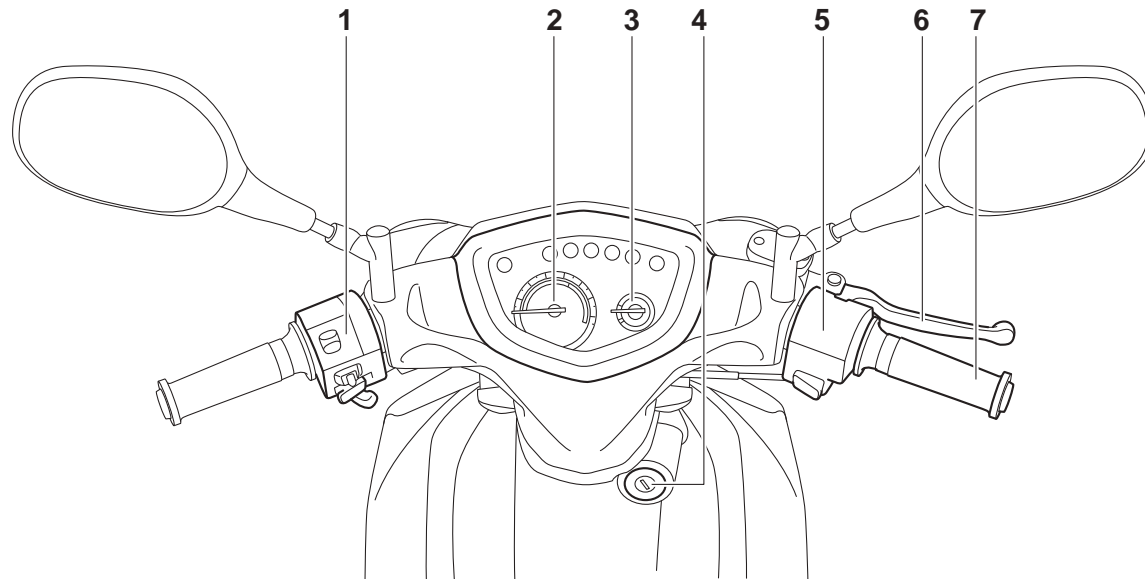

1. Left handlebar switches (page 3-3)
2. Speedometer unit (page 3-3)
3. Fuel gauge (page 3-3)
4. Main switch/steering lock (page 3-1)
5. Right handlebar switch (page 3-3)
6. Brake lever (page 3-4)
7. Throttle grip (page 6-13)

# INSTRUMENT AND CONTROL FUNCTIONS

## Main switch/steering lock

EAU10461

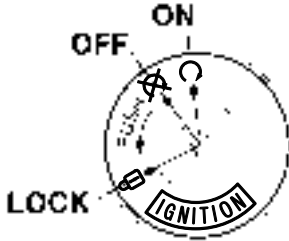

3

The main switch/steering lock controls the ignition and lighting systems, and is used to lock the steering. The various positions are described below.

### ○ (on)

EAU47821

All electrical circuits are supplied with power, the meter lighting, taillight, license plate light and auxiliary lights come on, and the engine can be started. The key cannot be removed.

### TIP

The headlight comes on automatically when the engine is started and stays on until the key is turned to “”.



### (off)

EAU47791

All electrical systems are off. The key can be removed.

### **WARNING**

EWA15350

Never turn the key to “” or “” while the vehicle is moving. Otherwise the electrical systems will be switched off, which may result in loss of control or an accident.

### (lock)



EAU47801

The steering is locked, and all electrical systems are off. The key can be removed.

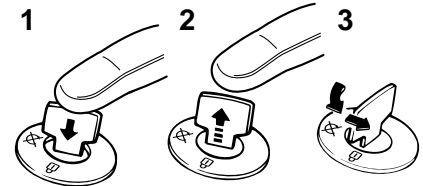
## To lock the steering



1. Push.
2. Release.
3. Turn.

1. Turn the handlebars all the way to the left.
2. Push the key in from the “” position, release it, and then turn it to “”.
3. Remove the key.



# INSTRUMENT AND CONTROL FUNCTIONS

## To unlock the steering

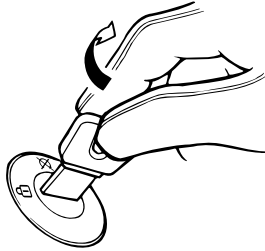



Insert the key and turn it to “”.

## Indicator lights

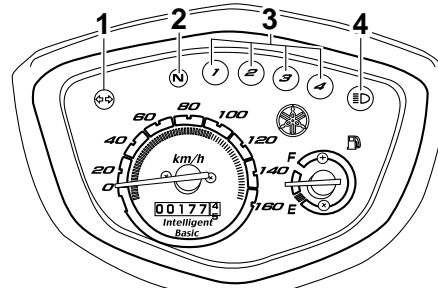
EAU10981



1. Turn signal indicator light “”
2. Neutral indicator light “**N**”
3. Gear position indicator light “1” “2” “3” “4”
4. High beam indicator light “”

## Turn signal indicator light “”

EAU11020

This indicator light flashes when the turn signal switch is pushed to the left or right.

## Neutral indicator light “**N**”

EAU11060

This indicator light comes on when the transmission is in the neutral position.

## Gear position indicator lights “1” “2” “3”, and “4”

EAU37611

The respective indicator light comes on when the transmission is in the 1st, 2nd, 3rd or 4th gear position.

## High beam indicator light “”

EAU11080

This indicator light comes on when the high beam of the headlight is switched on.

# INSTRUMENT AND CONTROL FUNCTIONS

## Speedometer unit

EAU1821

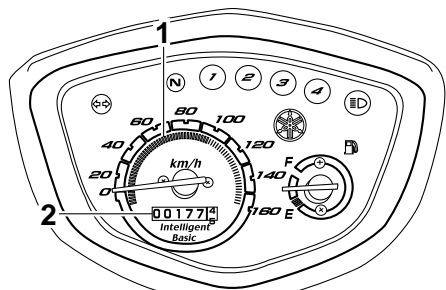

1. Speedometer
2. Odometer

The speedometer unit is equipped with a speedometer and an odometer. The speedometer shows the riding speed. The odometer shows the total distance traveled.

## Fuel gauge

EAU47830

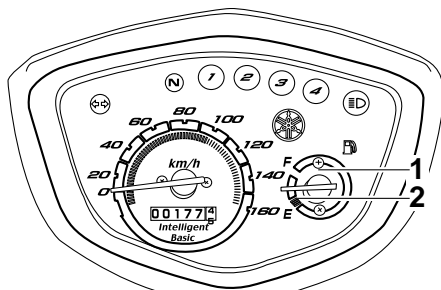

1. Fuel gauge
2. Red zone

The fuel gauge indicates the amount of fuel in the fuel tank. The needle moves towards "E" (Empty) as the fuel level decreases. When the needle reaches the red zone, approximately 1.0 L (0.26 US gal, 0.22 Imp.gal) remain in the fuel tank. If this occurs, refuel as soon as possible.

### TIP

The main switch must be turned to "O" for the fuel gauge to display an accurate fuel level reading.

## Handlebar switches

EAU1234B

### Left

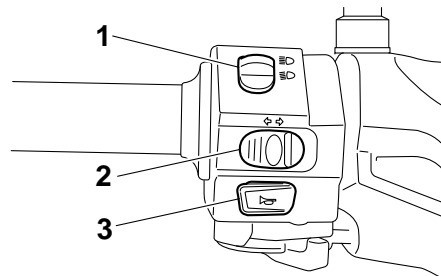

1. Dimmer switch "☰/☷"
2. Turn signal switch "←/→"
3. Horn switch "🔊"

### Right

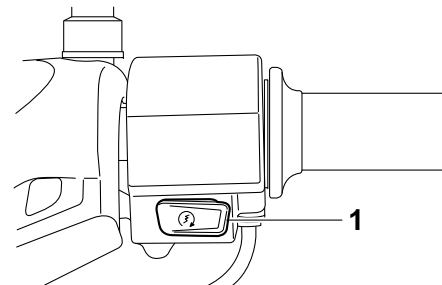



1. Start switch "⚡"

# INSTRUMENT AND CONTROL FUNCTIONS



## Dimmer switch “/”

EAU12400

Set this switch to “” for the high beam and to “” for the low beam.

## Turn signal switch “/”

EAU12460

To signal a right-hand turn, push this switch to “”. To signal a left-hand turn, push this switch to “”. When released, the switch returns to the center position. To cancel the turn signal lights, push the switch in after it has returned to the center position.

## Horn switch “”

EAU12500

Press this switch to sound the horn.

## Start switch “”

EAU12711

Push this switch to crank the engine with the starter. See page 5-1 for starting instructions prior to starting the engine.

## Shift pedal

EAU37461

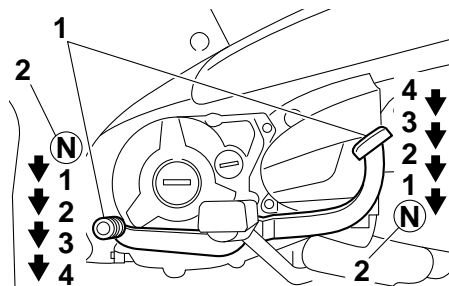

1. Shift pedal
2. Neutral position

The shift pedal is located on the left side of the motorcycle. This motorcycle is equipped with a constant-mesh 4 speed transmission.

### TIP

Use your toes to shift up and your heel to shift down.

## Brake lever

EAU12891

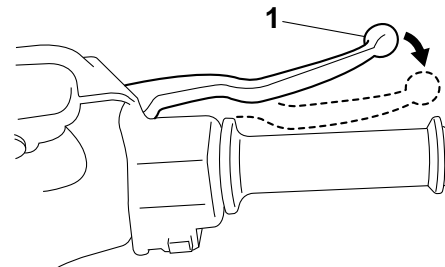

1. Brake lever

The brake lever is located on the right side of the handlebar. To apply the front brake, pull the lever toward the throttle grip.

# INSTRUMENT AND CONTROL FUNCTIONS

## Brake pedal

EAU12941

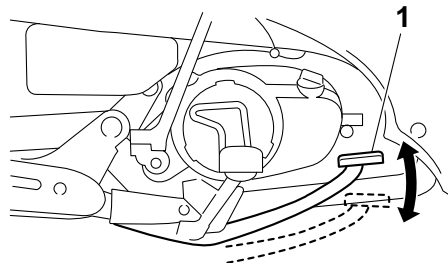

1. Brake pedal

The brake pedal is on the right side of the motorcycle. To apply the rear brake, press down on the brake pedal.

## Fuel tank cap

EAU37471

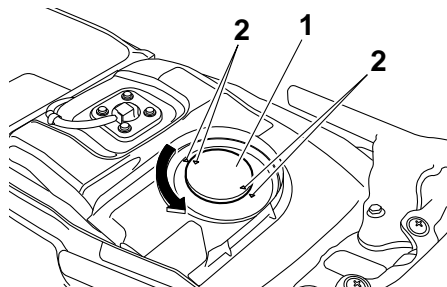

1. Fuel tank cap
2. "△" mark

### To remove the fuel tank cap

1. Open the seat. (See page 3-8.)
2. Turn the fuel tank cap counter-clockwise and pull it off.

### To install the fuel tank cap

1. Insert the fuel tank cap into the tank opening and turn it clockwise until the "△" marks on the cap and tank are aligned.
2. Close the seat.



**Make sure that the fuel tank cap is properly closed after filling fuel. Leaking fuel is a fire hazard.**

EWA11091

# INSTRUMENT AND CONTROL FUNCTIONS

## Fuel

EAU13212

Make sure there is sufficient gasoline in the tank.

EWA10881

### **WARNING**

Gasoline and gasoline vapors are extremely flammable. To avoid fires and explosions and to reduce the risk of injury when refueling, follow these instructions.

1. Before refueling, turn off the engine and be sure that no one is sitting on the vehicle. Never refuel while smoking, or while in the vicinity of sparks, open flames, or other sources of ignition such as the pilot lights of water heaters and clothes dryers.
2. Do not overfill the fuel tank. Stop filling when the fuel reaches the bottom of the filler tube. Because fuel expands when it heats up, heat from the engine or the sun can cause fuel to spill out of the fuel tank.

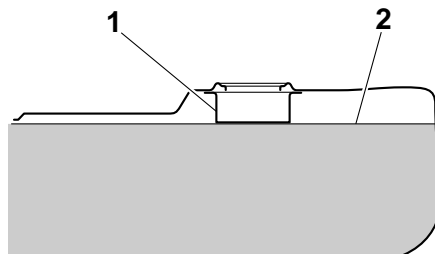

1. Fuel tank filler tube
2. Maximum fuel level

3. Wipe up any spilled fuel immediately. **NOTICE: Immediately wipe off spilled fuel with a clean, dry, soft cloth, since fuel may deteriorate painted surfaces or plastic parts.** [ECA10071]
4. Be sure to securely close the fuel tank cap.

EWA15151

### **WARNING**

Gasoline is poisonous and can cause injury or death. Handle gasoline with care. Never siphon gasoline by mouth. If you should swallow some gasoline or inhale a lot of gasoline vapor, or get some gasoline in your eyes, see your doctor immedi-

ately. If gasoline spills on your skin, wash with soap and water. If gasoline spills on your clothing, change your clothes.

EAU51901

### Recommended fuel:

Regular gasoline

### Fuel tank capacity:

4.2 L (1.11 US gal, 0.92 Imp.gal)

ECA11400

### **NOTICE**

Use only unleaded gasoline. The use of leaded gasoline will cause severe damage to internal engine parts, such as the valves and piston rings, as well as to the exhaust system.

Your Yamaha engine has been designed to use unleaded gasoline with a research octane number of 91 or higher. If knocking (or pinging) occurs, use a gasoline of a different brand or premium unleaded fuel. Use of unleaded fuel will extend spark plug life and reduce maintenance costs.

# INSTRUMENT AND CONTROL FUNCTIONS

## Catalytic converters

EAU13445

This vehicle is equipped with catalytic converters in the exhaust system.

EWA10862

### WARNING

The exhaust system is hot after operation. To prevent a fire hazard or burns:

- Do not park the vehicle near possible fire hazards such as grass or other materials that easily burn.
- Park the vehicle in a place where pedestrians or children are not likely to touch the hot exhaust system.
- Make sure that the exhaust system has cooled down before doing any maintenance work.
- Do not allow the engine to idle more than a few minutes. Long idling can cause a build-up of heat.

### NOTICE

ECA10701

Use only unleaded gasoline. The use of leaded gasoline will cause unreparable damage to the catalytic converter.

## Starter (choke) lever “”

EAU13590

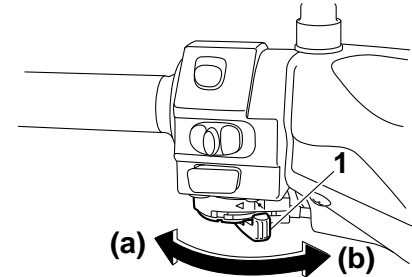

1. Starter (choke) lever “”

Starting a cold engine requires a richer air-fuel mixture, which is supplied by the starter (choke).

Move the lever in direction (a) to turn on the starter (choke).

Move the lever in direction (b) to turn off the starter (choke).

## Kickstarter

EAU47860

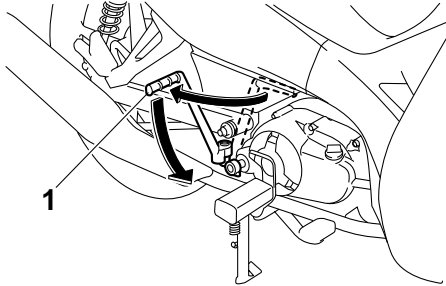

1. Kickstarter

If the engine fails to start by pushing the start switch, try to start it by using the kickstarter. With the transmission in neutral, fold out the kickstarter lever, move it down lightly with your foot until the gears engage, and then push it down smoothly but forcefully.

## Seat

EAU13891

### To open the seat

1. Insert the key in the lock, and then turn it as shown.
2. Fold the seat up.

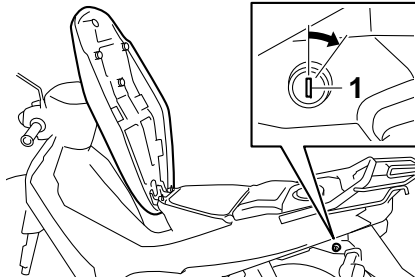

1. Seat lock

### To close the seat

1. Fold the seat down, and then push it down to lock it in place.
2. Remove the key.

### TIP

Make sure that the seat is properly secured before riding.

## Helmet holders

EAU37481

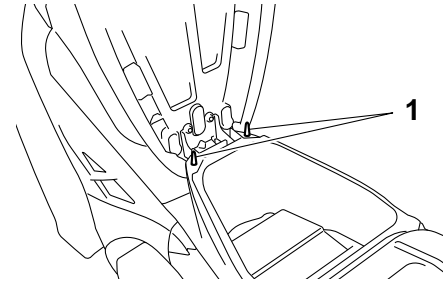

1. Helmet holder

The helmet holders are located under the seat.

### To secure a helmet to a helmet holder

1. Open the seat. (See page 3-8.)
2. Attach a helmet to a helmet holder, and then securely close the seat.

**WARNING! Never ride with a helmet attached to the helmet holder, since the helmet may hit objects, causing loss of control and possibly an accident.** [EWA10161]

# INSTRUMENT AND CONTROL FUNCTIONS

## To release a helmet from a helmet holder

Open the seat, remove the helmet from the helmet holder, and then close the seat.

3

## Storage compartment

EAU14453

- Do not exceed the maximum load of 167 kg (368 lb) for the vehicle.

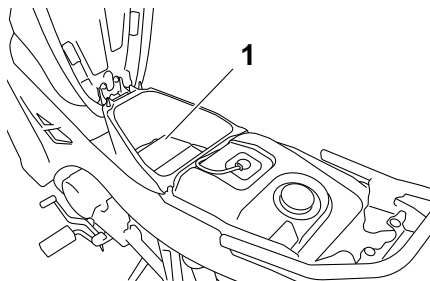

1. Storage compartment

The storage compartment is located under the seat. (See page 3-8.)

When storing the Owner's Manual or other documents in the storage compartment, be sure to wrap them in a plastic bag so that they will not get wet. When washing the vehicle, be careful not to let any water enter the storage compartment.

EWA10961

### **WARNING**

- Do not exceed the load limit of 1.0 kg (2.2 lb) for the storage compartment.



## Carrier

EAU15112

EWA10171

### **WARNING**

- Do not exceed the load limit of 3.0 kg (6.6 lb) for the carrier.
- Do not exceed the maximum load of 167 kg (368 lb) for the vehicle.

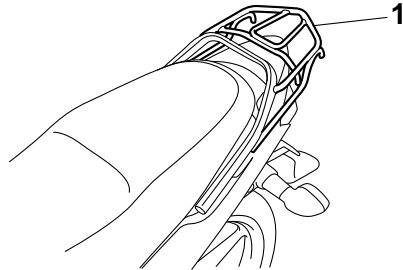

1. Carrier

## Sidestand (for sidestand-equipped models)

EAU55180

The sidestand is located on the left side of the frame. Raise the sidestand or lower it with your foot while holding the vehicle upright.

EWA14190

### **WARNING**

The vehicle must not be ridden with the sidestand down, or if the sidestand cannot be properly moved up (or does not stay up), otherwise the sidestand could contact the ground and distract the operator, resulting in a possible loss of control.

# FOR YOUR SAFETY – PRE-OPERATION CHECKS

EAU15597

Inspect your vehicle each time you use it to make sure the vehicle is in safe operating condition. Always follow the inspection and maintenance procedures and schedules described in the Owner's Manual.

EWA11151

## **WARNING**

**Failure to inspect or maintain the vehicle properly increases the possibility of an accident or equipment damage. Do not operate the vehicle if you find any problem. If a problem cannot be corrected by the procedures provided in this manual, have the vehicle inspected by a Yamaha dealer.**

Before using this vehicle, check the following points:

ITEM	CHECKS	PAGE
Fuel	<ul style="list-style-type: none"><li>• Check fuel level in fuel tank.</li><li>• Refuel if necessary.</li><li>• Check fuel line for leakage.</li></ul>	3-6
Engine oil	<ul style="list-style-type: none"><li>• Check oil level in engine.</li><li>• If necessary, add recommended oil to specified level.</li><li>• Check vehicle for oil leakage.</li></ul>	6-9
Front brake	<ul style="list-style-type: none"><li>• Check operation.</li><li>• If soft or spongy, have Yamaha dealer bleed hydraulic system.</li><li>• Check brake pads for wear.</li><li>• Replace if necessary.</li><li>• Check fluid level in reservoir.</li><li>• If necessary, add specified brake fluid to specified level.</li><li>• Check hydraulic system for leakage.</li></ul>	6-18, 6-19
Rear brake	<ul style="list-style-type: none"><li>• Check operation.</li><li>• Check pedal free play.</li><li>• Adjust if necessary.</li></ul>	6-17, 6-18
Throttle grip	<ul style="list-style-type: none"><li>• Make sure that operation is smooth.</li><li>• Check throttle grip free play.</li><li>• If necessary, have Yamaha dealer adjust throttle grip free play and lubricate cable and grip housing.</li></ul>	6-13, 6-23

# FOR YOUR SAFETY – PRE-OPERATION CHECKS

ITEM	CHECKS	PAGE
<b>Control cables</b>	<ul style="list-style-type: none"> <li>• Make sure that operation is smooth.</li> <li>• Lubricate if necessary.</li> </ul>	6-23
<b>Drive chain</b>	<ul style="list-style-type: none"> <li>• Check chain slack.</li> <li>• Adjust if necessary.</li> <li>• Check chain condition.</li> <li>• Lubricate if necessary.</li> </ul>	6-20, 6-22
<b>Wheels and tires</b>	<ul style="list-style-type: none"> <li>• Check for damage.</li> <li>• Check tire condition and tread depth.</li> <li>• Check air pressure.</li> <li>• Correct if necessary.</li> </ul>	6-14, 6-16
<b>Shift pedal</b>	<ul style="list-style-type: none"> <li>• Make sure that operation is smooth.</li> <li>• Correct if necessary.</li> </ul>	6-17
<b>Brake pedal</b>	<ul style="list-style-type: none"> <li>• Make sure that operation is smooth.</li> <li>• Lubricate pedal pivoting point if necessary.</li> </ul>	6-24
<b>Brake lever</b>	<ul style="list-style-type: none"> <li>• Make sure that operation is smooth.</li> <li>• Lubricate lever pivoting point if necessary.</li> </ul>	6-23
<b>Centerstand, sidestand (for sidestand-equipped models)</b>	<ul style="list-style-type: none"> <li>• Make sure that operation is smooth.</li> <li>• Lubricate pivots if necessary.</li> </ul>	6-24
<b>Chassis fasteners</b>	<ul style="list-style-type: none"> <li>• Make sure that all nuts, bolts and screws are properly tightened.</li> <li>• Tighten if necessary.</li> </ul>	—
<b>Instruments, lights, signals and switches</b>	<ul style="list-style-type: none"> <li>• Check operation.</li> <li>• Correct if necessary.</li> </ul>	—

# OPERATION AND IMPORTANT RIDING POINTS

---

---

EAU15951

Read the Owner's Manual carefully to become familiar with all controls. If there is a control or function you do not understand, ask your Yamaha dealer.

EWA10271

## **WARNING**

**Failure to familiarize yourself with the controls can lead to loss of control, which could cause an accident or injury.**

---

5

## **Starting and warming up a cold engine**

EAU47852

1. Turn the key to “○”.
2. Shift the transmission into the neutral position. The neutral indicator light should come on. If not, ask a Yamaha dealer to check the electrical circuit.
3. Place the vehicle on the centerstand.

EWA14200

## **WARNING**

**Before starting the engine, make sure the transmission is in neutral and that the vehicle is placed on the centerstand.**

---

4. Turn the starter (choke) on and completely close the throttle. (See page 3-7.)
5. Start the engine by pushing the start switch or by pushing the kick-starter lever down.

If the engine fails to start by pushing the start switch, release the switch, wait a few seconds, and then try again. Each starting attempt should be as short as possi-

ble to preserve the battery. Do not crank the engine more than 10 seconds on any one attempt. If the engine does not start with the starter motor, try using the kick-starter.

6. After starting the engine, move the starter (choke) back halfway.
7. When the engine is warm, turn the starter (choke) off.

## **TIP**

The engine is warm when it responds quickly to the throttle with the starter (choke) turned off.

---

ECA11042

## **NOTICE**

**For maximum engine life, never accelerate hard when the engine is cold!**

---

# OPERATION AND IMPORTANT RIDING POINTS

## Starting a warm engine

EAU16640

Follow the same procedure as for starting a cold engine with the exception that the starter (choke) is not required when the engine is warm.

## Shifting

EAU47840

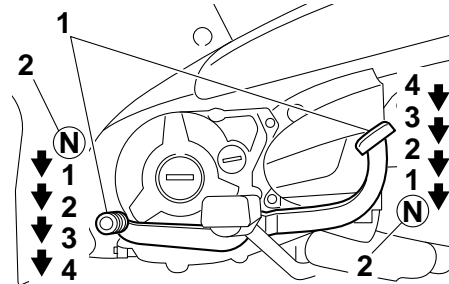

1. Shift pedal
2. Neutral position

Shifting gears lets you control the amount of engine power available for starting off, accelerating, climbing hills, etc. When shifting gears, fully return the throttle grip. The use of the shift pedal is shown in the illustration.

ECA15180

### NOTICE

- Make sure that the transmission is completely shifted into gear.
- Be sure to fully close the throttle grip when shifting.

- Make sure the neutral indicator light comes on when the transmission is in the neutral position.

# OPERATION AND IMPORTANT RIDING POINTS

---

5

## Tips for reducing fuel consumption

EAU16800

Fuel consumption depends largely on your riding style. Consider the following tips to reduce fuel consumption:

- Turn the starter (choke) off as soon as possible.
- Shift up swiftly, and avoid high engine speeds during acceleration.
- Do not rev the engine while shifting down, and avoid high engine speeds with no load on the engine.
- Turn the engine off instead of letting it idle for an extended length of time (e.g., in traffic jams, at traffic lights or at railroad crossings).

## Engine break-in

EAU16830

There is never a more important period in the life of your engine than the period between 0 and 1000 km (600 mi). For this reason, you should read the following material carefully.

Since the engine is brand new, do not put an excessive load on it for the first 1000 km (600 mi). The various parts in the engine wear and polish themselves to the correct operating clearances. During this period, prolonged full-throttle operation or any condition that might result in engine overheating must be avoided.

EAU16863

### 0–150 km (0–90 mi)

Avoid prolonged operation above 1/3 throttle.

After every hour of operation, stop the engine, and then let it cool for five to ten minutes.

Vary the engine speed from time to time. Do not operate the engine at one set throttle position.

### 150–500 km (90–300 mi)

Avoid prolonged operation above 1/2 throttle.

### 500–1000 km (300–600 mi)

Avoid prolonged operation above 3/4 throttle. **NOTICE: After 1000 km (600 mi) of operation, the engine oil must be changed.** [ECA10281]

### 1000 km (600 mi) and beyond

The vehicle can now be operated normally.

ECA10270

## **NOTICE**

---

**If any engine trouble should occur during the engine break-in period, immediately have a Yamaha dealer check the vehicle.**

---

EAU17213

## Parking

When parking, stop the engine, and then remove the key from the main switch.

EWA10311

### **WARNING**

- Since the engine and exhaust system can become very hot, park in a place where pedestrians or children are not likely to touch them and be burned.
  - Do not park on a slope or on soft ground, otherwise the vehicle may overturn, increasing the risk of a fuel leak and fire.
  - Do not park near grass or other flammable materials which might catch fire.
-

# PERIODIC MAINTENANCE AND ADJUSTMENT

---

EAU17244

EWA15122

EAU17302

Periodic inspection, adjustment, and lubrication will keep your vehicle in the safest and most efficient condition possible. Safety is an obligation of the vehicle owner/operator. The most important points of vehicle inspection, adjustment, and lubrication are explained on the following pages.

The intervals given in the periodic maintenance charts should be simply considered as a general guide under normal riding conditions. However, depending on the weather, terrain, geographical location, and individual use, the maintenance intervals may need to be shortened.

6

## WARNING

EWA10321

**Failure to properly maintain the vehicle or performing maintenance activities incorrectly may increase your risk of injury or death during service or while using the vehicle. If you are not familiar with vehicle service, have a Yamaha dealer perform service.**

---

## WARNING

**Turn off the engine when performing maintenance unless otherwise specified.**

- **A running engine has moving parts that can catch on body parts or clothing and electrical parts that can cause shocks or fires.**
- **Running the engine while servicing can lead to eye injury, burns, fire, or carbon monoxide poisoning – possibly leading to death. See page 1-3 for more information about carbon monoxide.**

EWA15460

## WARNING

**Brake discs, calipers, drums, and linings can become very hot during use. To avoid possible burns, let brake components cool before touching them.**

---

Emission controls not only function to ensure cleaner air, but are also vital to proper engine operation and maximum performance. In the following periodic maintenance charts, the services related to emissions control are grouped separately. These services require specialized data, knowledge, and equipment. Maintenance, replacement, or repair of the emission control devices and systems may be performed by any repair establishment or individual that is certified (if applicable). Yamaha dealers are trained and equipped to perform these particular services.



EAU39691

## Owner's tool kit

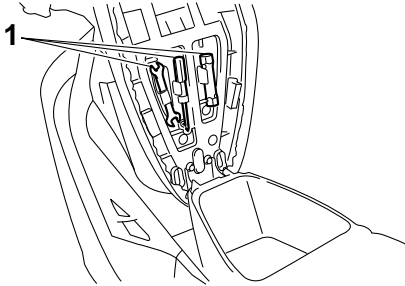

### 1. Owner's tool kit

The owner's tool kit is located on the bottom of the seat. (See page 3-8.)

The service information included in this manual and the tools provided in the owner's tool kit are intended to assist you in the performance of preventive maintenance and minor repairs. However, additional tools such as a torque wrench may be necessary to perform certain maintenance work correctly.

### **TIP** \_\_\_\_\_

If you do not have the tools or experience required for a particular job, have a Yamaha dealer perform it for you.

---

# PERIODIC MAINTENANCE AND ADJUSTMENT

EAU46871

## TIP

- The annual checks must be performed every year, except if a kilometer-based maintenance, or for the UK, a mileage-based maintenance, is performed instead.
- From 30000 km (17500 mi), repeat the maintenance intervals starting from 6000 km (3500 mi).
- Items marked with an asterisk should be performed by a Yamaha dealer as they require special tools, data and technical skills.

EAU46920

## Periodic maintenance chart for the emission control system

NO.	ITEM	CHECK OR MAINTENANCE JOB	ODOMETER READING					ANNUAL CHECK
			1000 km (600 mi)	6000 km (3500 mi)	12000 km (7000 mi)	18000 km (10500 mi)	24000 km (14000 mi)	
1	* Fuel line	<ul style="list-style-type: none"> <li>• Check fuel and vacuum hoses for cracks or damage.</li> </ul>		√	√	√	√	√
2	Spark plug	<ul style="list-style-type: none"> <li>• Check condition.</li> <li>• Clean and regap.</li> </ul>		√		√		
		<ul style="list-style-type: none"> <li>• Replace.</li> </ul>			√		√	
3	* Valves	<ul style="list-style-type: none"> <li>• Check valve clearance.</li> <li>• Adjust.</li> </ul>		√	√	√	√	
4	* Carburetor	<ul style="list-style-type: none"> <li>• Check starter (choke) operation.</li> <li>• Adjust engine idling speed.</li> </ul>	√	√	√	√	√	√
5	* Air induction system	<ul style="list-style-type: none"> <li>• Check the air cut-off valve, reed valve, and hose for damage.</li> <li>• Replace any damaged parts if necessary.</li> </ul>		√	√	√	√	√

# PERIODIC MAINTENANCE AND ADJUSTMENT

EAU17718

## General maintenance and lubrication chart

NO.	ITEM	CHECK OR MAINTENANCE JOB	ODOMETER READING					ANNUAL CHECK
			1000 km (600 mi)	6000 km (3500 mi)	12000 km (7000 mi)	18000 km (10500 mi)	24000 km (14000 mi)	
1	Air filter element	• Clean.		√		√		
		• Replace.			√		√	
2	* Front brake	• Check operation, fluid level and vehicle for fluid leakage.	√	√	√	√	√	√
		• Replace brake pads.	Whenever worn to the limit					
3	* Rear brake	• Check operation and adjust brake pedal free play.	√	√	√	√	√	√
		• Replace brake shoes.	Whenever worn to the limit					
4	* Brake hose	• Check for cracks or damage. • Check for correct routing and clamping.		√	√	√	√	√
		• Replace.	Every 4 years					
5	* Brake fluid	• Replace.	Every 2 years					
6	* Wheels	• Check runout and for damage.		√	√	√	√	
7	* Tires	• Check tread depth and for damage. • Replace if necessary. • Check air pressure. • Correct if necessary.		√	√	√	√	√
8	* Wheel bearings	• Check bearing for looseness or damage.		√	√	√	√	

6

# PERIODIC MAINTENANCE AND ADJUSTMENT

NO.	ITEM	CHECK OR MAINTENANCE JOB	ODOMETER READING					ANNUAL CHECK
			1000 km (600 mi)	6000 km (3500 mi)	12000 km (7000 mi)	18000 km (10500 mi)	24000 km (14000 mi)	
9	* Swingarm	• Check operation and for excessive play.		√	√	√	√	
		• Lubricate with lithium-soap-based grease.	Every 24000 km (14000 mi)					
10	Drive chain	• Check chain slack, alignment and condition. • Adjust and thoroughly lubricate chain with engine oil.	Every 500 km (300 mi) and after washing the motorcycle, riding in the rain or riding in wet areas					
11	* Steering bearings	• Check bearing play and steering for roughness.	√	√	√	√	√	
		• Lubricate with lithium-soap-based grease.	Every 24000 km (14000 mi)					
12	* Chassis fasteners	• Make sure that all nuts, bolts and screws are properly tightened.		√	√	√	√	√
13	Brake lever pivot shaft	• Lubricate with silicone grease.		√	√	√	√	√
14	Brake pedal pivot shaft	• Lubricate with lithium-soap-based grease.		√	√	√	√	√
15	Centerstand, side-stand (for side-stand-equipped models)	• Check operation. • Lubricate with lithium-soap-based grease.		√	√	√	√	√
16	* Front fork	• Check operation and for oil leakage.		√	√	√	√	
17	* Shock absorber assemblies	• Check operation and shock absorbers for oil leakage.		√	√	√	√	

# PERIODIC MAINTENANCE AND ADJUSTMENT

NO.	ITEM	CHECK OR MAINTENANCE JOB	ODOMETER READING					ANNUAL CHECK
			1000 km (600 mi)	6000 km (3500 mi)	12000 km (7000 mi)	18000 km (10500 mi)	24000 km (14000 mi)	
18	Engine oil	<ul style="list-style-type: none"> <li>Change. (See page 6-9.)</li> <li>Check oil level and vehicle for oil leakage.</li> </ul>	√	Every 3000 km (1800 mi)				
19	* Front and rear brake switches	<ul style="list-style-type: none"> <li>Check operation.</li> </ul>	√	√	√	√	√	√
20	Moving parts and cables	<ul style="list-style-type: none"> <li>Lubricate.</li> </ul>		√	√	√	√	√
21	* Throttle grip	<ul style="list-style-type: none"> <li>Check operation.</li> <li>Check throttle grip free play, and adjust if necessary.</li> <li>Lubricate cable and grip housing.</li> </ul>		√	√	√	√	√
22	* Lights, signals and switches	<ul style="list-style-type: none"> <li>Check operation.</li> <li>Adjust headlight beam.</li> </ul>	√	√	√	√	√	√

## TIP

- The air filter needs more frequent service if you are riding in unusually wet or dusty areas.
- Hydraulic brake service
  - Regularly check and, if necessary, correct the brake fluid level.
  - Every two years replace the internal components of the brake master cylinder and caliper, and change the brake fluid.
  - Replace the brake hoses every four years and if cracked or damaged.

# PERIODIC MAINTENANCE AND ADJUSTMENT

## Removing and installing the cowling and panel

EAU18741

The cowling and panel shown need to be removed to perform some of the maintenance jobs described in this chapter. Refer to this section each time the cowling or panel needs to be removed and installed.

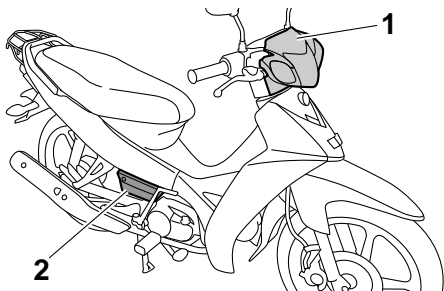

1. Cowling A
2. Panel A

### Cowling A

EAU18853

#### To remove the cowling

Remove the screws, and then pull the cowling off as shown.

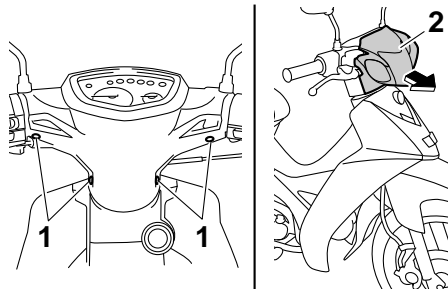

1. Screw
2. Cowling A

#### To install the cowling

Place the cowling in the original position, and then install the screws.

### Panel A

#### To remove the panel

1. Remove the screw.

EAU47650

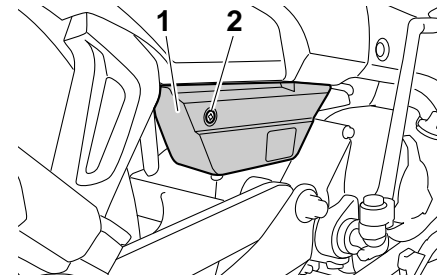

1. Panel A
2. Screw

2. Slide the panel backward to unhook its projection from the slot, and then pull the panel off.

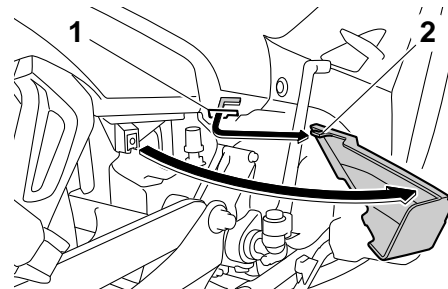

1. Slot
2. Projection

# PERIODIC MAINTENANCE AND ADJUSTMENT

## To install the panel

1. Insert the projection into the slot, and then slide the panel forward.

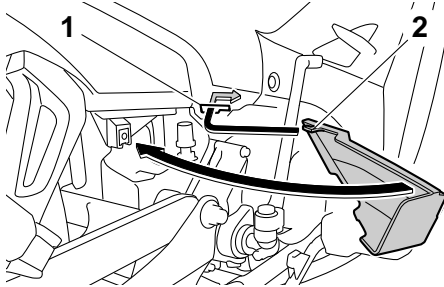

1. Slot
2. Projection

2. Place the panel in its original position, and then install the screw.

EAU19604

## Checking the spark plug

The spark plug is an important engine component, which is easy to check. Since heat and deposits will cause any spark plug to slowly erode, the spark plug should be removed and checked in accordance with the periodic maintenance and lubrication chart. In addition, the condition of the spark plug can reveal the condition of the engine.

## To remove the spark plug

1. Remove the spark plug cap.

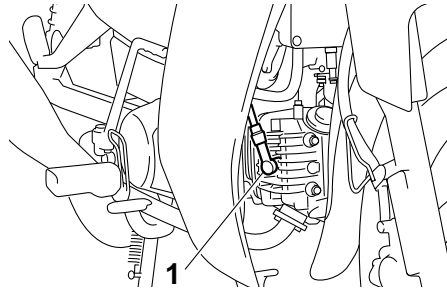

1. Spark plug cap

2. Remove the spark plug as shown, with the spark plug wrench included in the owner's tool kit.

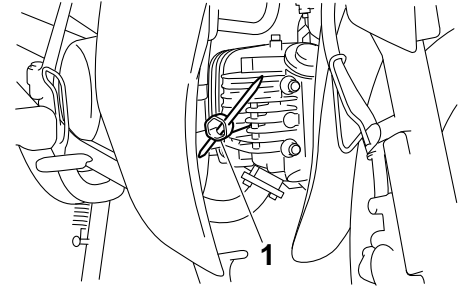

1. Spark plug wrench

## To check the spark plug

1. Check that the porcelain insulator around the center electrode of the spark plug is a medium-to-light tan (the ideal color when the vehicle is ridden normally).

## TIP

If the spark plug shows a distinctly different color, the engine could be operating improperly. Do not attempt to diagnose such problems yourself. Instead, have a Yamaha dealer check the vehicle.

# PERIODIC MAINTENANCE AND ADJUSTMENT

EAU47692

2. Check the spark plug for electrode erosion and excessive carbon or other deposits, and replace it if necessary.

**Specified spark plug:**  
NGK/CR6HSA

3. Measure the spark plug gap with a wire thickness gauge and, if necessary, adjust the gap to specification.

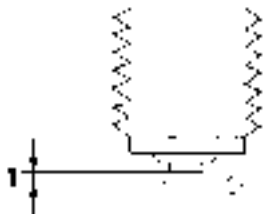

1. Spark plug gap

**Spark plug gap:**  
0.6–0.7 mm (0.024–0.028 in)

## To install the spark plug

1. Clean the surface of the spark plug gasket and its mating surface, and then wipe off any grime from the spark plug threads.
2. Install the spark plug with the spark plug wrench, and then tighten it to the specified torque.

**Tightening torque:**  
Spark plug:  
13 Nm (1.3 m·kgf, 9.4 ft·lbf)

## TIP

If a torque wrench is not available when installing a spark plug, a good estimate of the correct torque is 1/4–1/2 turn past finger tight. However, the spark plug should be tightened to the specified torque as soon as possible.

3. Install the spark plug cap.

## Engine oil

The engine oil level should be checked before each ride. In addition, the oil must be changed at the intervals specified in the periodic maintenance and lubrication chart.

## To check the engine oil level

1. Place the vehicle on the center-stand. A slight tilt to the side can result in a false reading.
2. Start the engine, warm it up for several minutes, and then turn it off.
3. Wait a few minutes until the oil settles, remove the engine oil filler cap, wipe the engine oil dipstick clean, insert it back into the oil filler hole (without screwing it in), and then remove it again to check the oil level.



# PERIODIC MAINTENANCE AND ADJUSTMENT

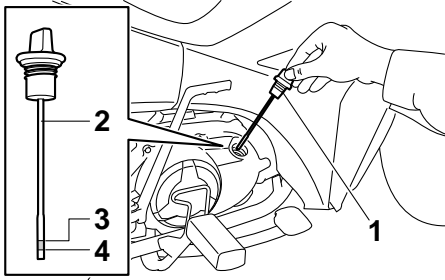

1. Engine oil filler cap
2. Engine oil dipstick
3. Maximum level mark
4. Minimum level mark

## TIP

The engine oil should be between the minimum and maximum level marks.

4. If the engine oil is at or below the minimum level mark, add sufficient oil of the recommended type to raise it to the correct level.
5. Insert the dipstick into the oil filler hole, and then tighten the oil filler cap.

## To change the engine oil

1. Start the engine, warm it up for several minutes, and then turn it off.
2. Place an oil pan under the engine to collect the used oil.
3. Remove the engine oil filler cap, the engine oil drain bolt and its gasket to drain the oil from the crankcase.

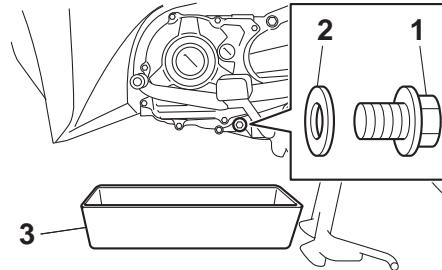

1. Engine oil drain bolt
2. Gasket
3. Oil pan
4. Install the drain bolt and its new gasket, and then tighten it to the specified torque.

## Tightening torque:

Engine oil drain bolt:  
20 Nm (2.0 m·kgf, 14 ft·lbf)

5. Refill with the specified amount of the recommended engine oil, and then install and tighten the oil filler cap.

## Recommended engine oil:

See page 8-1.

## Oil quantity:

0.80 L (0.85 US qt, 0.70 Imp.qt)

## TIP

Be sure to wipe off spilled oil on any parts after the engine and exhaust system have cooled down.

## NOTICE

- In order to prevent clutch slippage (since the engine oil also lubricates the clutch), do not mix any chemical additives. Do not use oils with a diesel specification of "CD" or oils of a higher quality than specified. In

# PERIODIC MAINTENANCE AND ADJUSTMENT

addition, do not use oils labeled “ENERGY CONSERVING II” or higher.

- **Make sure that no foreign material enters the crankcase.**

6. Start the engine, and then let it idle for several minutes while checking it for oil leakage. If oil is leaking, immediately turn the engine off and check for the cause.
7. Turn the engine off, and then check the oil level and correct it if necessary.

## Cleaning the air filter element EAU47771

The air filter element should be cleaned or replaced at the intervals specified in the periodic maintenance and lubrication chart. Clean or, if necessary, replace the air filter element more frequently if you are riding in unusually wet or dusty areas.

1. Remove the air filter case cover by removing the screws.

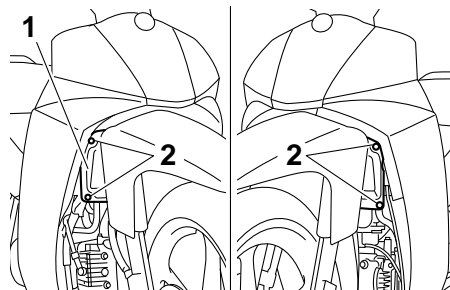

1. Air filter case cover
2. Screw

2. Pull the air filter element out.

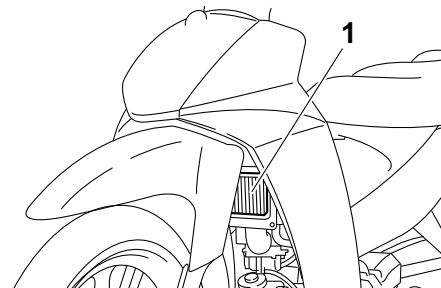

1. Air filter element

3. Lightly tap the air filter element to remove most of the dust and dirt, and then blow the remaining dirt out with compressed air as shown. If the air filter element is damaged, replace it.



1. Air filter element

# PERIODIC MAINTENANCE AND ADJUSTMENT

4. Insert the air filter element into the air filter case. **NOTICE: Make sure that the air filter element is properly seated in the air filter case. The engine should never be operated without the air filter element installed, otherwise the piston(s) and/or cylinder(s) may become excessively worn.**

[ECA10481]

5. Install the air filter case cover by installing the screws.

## Adjusting the carburetor

EAU21280

The carburetor is an important part of the engine and requires very sophisticated adjustment. Therefore, most carburetor adjustments should be left to a Yamaha dealer, who has the necessary professional knowledge and experience. The adjustment described in the following section, however, may be serviced by the owner as part of routine maintenance.

### **NOTICE**

**The carburetor has been set and extensively tested at the Yamaha factory. Changing these settings without sufficient technical knowledge may result in poor performance of or damage to the engine.**

ECA10550

## Adjusting the engine idling speed

EAU21340

The engine idling speed must be checked and, if necessary, adjusted as follows at the intervals specified in the periodic maintenance and lubrication chart.

The engine should be warm before making this adjustment.

### **TIP**

- The engine is warm when it quickly responds to the throttle.
- A diagnostic tachometer is needed to make this adjustment.

1. Attach the tachometer to the spark plug lead.
2. Check the engine idling speed and, if necessary, adjust it to specification by turning the throttle stop screw. To increase the engine idling speed, turn the screw in direction (a). To decrease the engine idling speed, turn the screw in direction (b).

# PERIODIC MAINTENANCE AND ADJUSTMENT

EAU21384

EAU21401

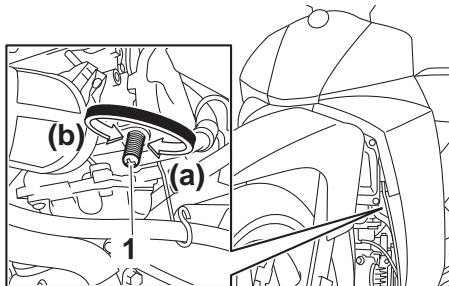

1. Throttle stop screw

**Engine idling speed:**  
1400–1600 r/min

6

**TIP** \_\_\_\_\_  
If the specified idling speed cannot be obtained as described above, have a Yamaha dealer make the adjustment.

## Checking the throttle grip free play

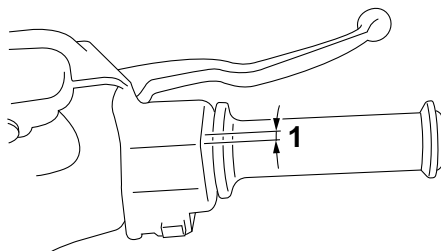

1. Throttle grip free play

The throttle grip free play should measure 3.0–7.0 mm (0.12–0.28 in) at the inner edge of the throttle grip. Periodically check the throttle grip free play and, if necessary, have a Yamaha dealer adjust it.

## Valve clearance

The valve clearance changes with use, resulting in improper air-fuel mixture and/or engine noise. To prevent this from occurring, the valve clearance must be adjusted by a Yamaha dealer at the intervals specified in the periodic maintenance and lubrication chart.

# PERIODIC MAINTENANCE AND ADJUSTMENT

## Tires

EAU21576

Tires are the only contact between the vehicle and the road. Safety in all conditions of riding depends on a relatively small area of road contact. Therefore, it is essential to maintain the tires in good condition at all times and replace them at the appropriate time with the specified tires.

### Tire air pressure

The tire air pressure should be checked and, if necessary, adjusted before each ride.

EWA10503



**WARNING**

Operation of this vehicle with improper tire pressure may cause severe injury or death from loss of control.

- The tire air pressure must be checked and adjusted on cold tires (i.e., when the temperature of the tires equals the ambient temperature).
- The tire air pressure must be adjusted in accordance with the riding speed and with the total

weight of rider, passenger, cargo, and accessories approved for this model.

**Tire air pressure (measured on cold tires):**

**0–90 kg (0–198 lb):**

Front:  
200 kPa (2.00 kgf/cm<sup>2</sup>, 29 psi)

Rear:  
225 kPa (2.25 kgf/cm<sup>2</sup>, 33 psi)

**90–167 kg (198–368 lb):**

Front:  
200 kPa (2.00 kgf/cm<sup>2</sup>, 29 psi)

Rear:  
280 kPa (2.80 kgf/cm<sup>2</sup>, 41 psi)

**Maximum load\*:**

167 kg (368 lb)

\* Total weight of rider, passenger, cargo and accessories

EWA10511



**WARNING**

Never overload your vehicle. Operation of an overloaded vehicle could cause an accident.

### Tire inspection

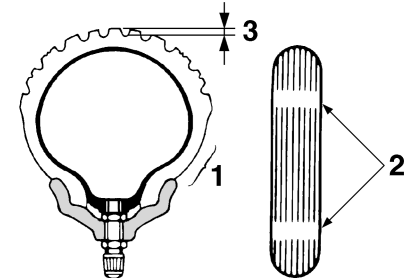

1. Tire sidewall
2. Tire wear indicator
3. Tire tread depth

The tires must be checked before each ride. If the tire shows crosswise lines (minimum tread depth), if the tire has a nail or glass fragments in it, or if the sidewall is cracked, have a Yamaha dealer replace the tire immediately.

**Minimum tire tread depth (front and rear):**

1.0 mm (0.04 in)

### TIP

The tire tread depth limits may differ from country to country. Always comply with the local regulations.

# PERIODIC MAINTENANCE AND ADJUSTMENT

## Tire information

This motorcycle is equipped with tube tires.

Tires age, even if they have not been used or have only been used occasionally. Cracking of the tread and sidewall rubber, sometimes accompanied by carcass deformation, is an evidence of ageing. Old and aged tires shall be checked by tire specialists to ascertain their suitability for further use.

EWA10461



**WARNING**

The front and rear tires should be of the same make and design, otherwise the handling characteristics of the vehicle may be different, which could lead to an accident.

After extensive tests, only the tires listed below have been approved for this model by Yamaha Motor Co., Ltd.

### Front tire:

Size:

70/90-17M/C 38P

Manufacturer/model:

DURO/HF314A

DUNLOP/D104FM (KOR)

### Rear tire:

Size:

80/90-17M/C 50P

Manufacturer/model:

DURO/HF314A

DUNLOP/T900AL (KOR)

very carefully and replace it as soon as possible with a high-quality product.

- Ride at moderate speeds after changing a tire since the tire surface must first be “broken in” for it to develop its optimal characteristics.

EWA10562



**WARNING**

- It is dangerous to ride with a worn-out tire. When a tire tread begins to show crosswise lines, have a Yamaha dealer replace the tire immediately.
- The replacement of all wheel and brake-related parts, including the tires, should be left to a Yamaha dealer, who has the necessary professional knowledge and experience.
- It is not recommended to patch a punctured tube. If unavoidable, however, patch the tube

# PERIODIC MAINTENANCE AND ADJUSTMENT

## Cast wheels

EAU22003

EWA10610

### **WARNING**

The wheels on this model are not designed for use with tubeless tires. Do not attempt to use tubeless tires on this model.

To maximize the performance, durability, and safe operation of your vehicle, note the following points regarding the specified wheels.

- The wheel rims should be checked for cracks, bends, warpage or other damage before each ride. If any damage is found, have a Yamaha dealer replace the wheel. Do not attempt even the smallest repair to the wheel. A deformed or cracked wheel must be replaced.
- The wheel should be balanced whenever either the tire or wheel has been changed or replaced. An unbalanced wheel can result in poor performance, adverse handling characteristics, and a shortened tire life.

## Checking the brake lever free play

EAU37913

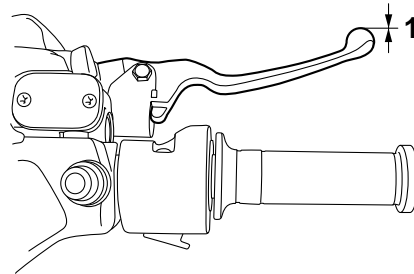

### 1. No brake lever free play

There should be no free play at the brake lever end. If there is free play, have a Yamaha dealer inspect the brake system.

EWA14211

### **WARNING**

A soft or spongy feeling in the brake lever can indicate the presence of air in the hydraulic system. If there is air in the hydraulic system, have a Yamaha dealer bleed the system before operating the vehicle. Air in the hydraulic system will diminish the

braking performance, which may result in loss of control and an accident.

# PERIODIC MAINTENANCE AND ADJUSTMENT

## Adjusting the brake pedal free play

EAU39813

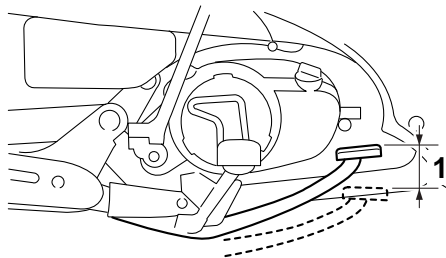

1. Brake pedal free play

The brake pedal free play should measure 20.0–30.0 mm (0.79–1.18 in) at the brake pedal end as shown. Periodically check the brake pedal free play and, if necessary, adjust it as follows. To increase the brake pedal free play, turn the brake pedal free play adjusting nut at the brake rod in direction (a). To decrease the brake pedal free play, turn the adjusting nut in direction (b).

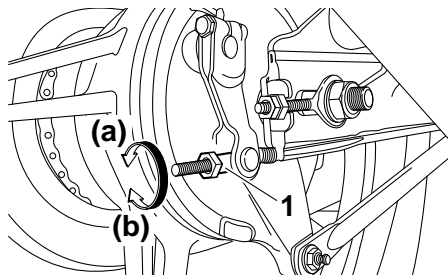

1. Brake pedal free play adjusting nut

EWA10680

### **WARNING**

- After adjusting the drive chain slack or removing and installing the rear wheel, always check the brake pedal free play.
- If proper adjustment cannot be obtained as described, have a Yamaha dealer make this adjustment.
- After adjusting the brake pedal free play, check the operation of the brake light.

## Checking the shift pedal

EAU44820

The operation of the shift pedal should be checked before each ride. If operation is not smooth, have a Yamaha dealer check the vehicle.



# PERIODIC MAINTENANCE AND ADJUSTMENT

## Brake light switches

EAU22294

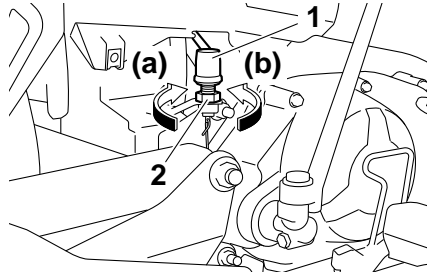

1. Rear brake light switch
2. Rear brake light switch adjusting nut

The brake light, which is activated by the brake pedal and brake lever, should come on just before braking takes effect. If necessary, adjust the rear brake light switch as follows, but the front brake light switch should be adjusted by a Yamaha dealer.

1. Remove panel A. (See page 6-7.)
2. Turn the rear brake light switch adjusting nut while holding the rear brake light switch in place. To make the brake light come on earlier, turn the adjusting nut in direc-

tion (a). To make the brake light come on later, turn the adjusting nut in direction (b).

3. Install the panel.

## Checking the front brake pads and rear brake shoes

EAU22380

The front brake pads and the rear brake shoes must be checked for wear at the intervals specified in the periodic maintenance and lubrication chart.

### Front brake pads

EAU22430

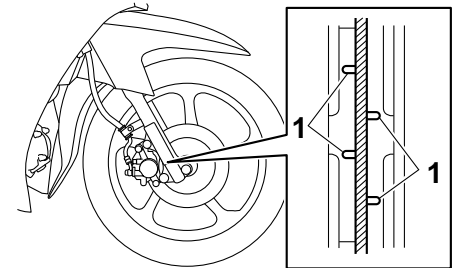

1. Brake pad wear indicator groove

Each front brake pad is provided with wear indicator grooves, which allow you to check the brake pad wear without having to disassemble the brake. To check the brake pad wear, check the wear indicator grooves. If a brake pad has worn to the point that the wear

# PERIODIC MAINTENANCE AND ADJUSTMENT

indicator grooves have almost disappeared, have a Yamaha dealer replace the brake pads as a set.

## Rear brake shoes

EAU22540

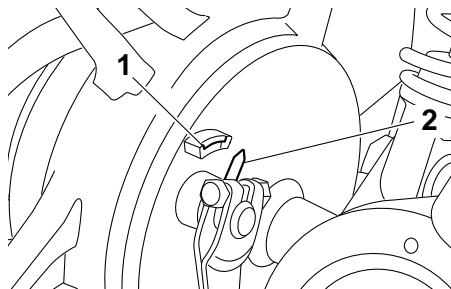

1. Brake shoe wear limit line
2. Brake shoe wear indicator

The rear brake is provided with a wear indicator, which allows you to check the brake shoe wear without having to disassemble the brake. To check the brake shoe wear, check the position of the wear indicator while applying the brake. If a brake shoe has worn to the point that the wear indicator reaches the wear limit line, have a Yamaha dealer replace the brake shoes as a set.

## Checking the brake fluid level

EAU37002

Before riding, check that the brake fluid is above the minimum level mark. Check the brake fluid level with the top of the reservoir level. Replenish the brake fluid if necessary.

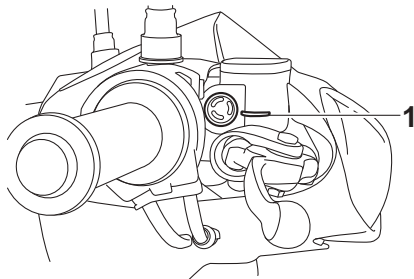

1. Minimum level mark

**Specified brake fluid:**  
DOT 3 or DOT 4

EWA15980

### **WARNING**

**Improper maintenance can result in loss of braking ability. Observe these precautions:**

- Insufficient brake fluid may allow air to enter the brake system, reducing braking performance.
- Clean the filler cap before removing. Use only DOT 3 or DOT 4 brake fluid from a sealed container.
- Use only the specified brake fluid; otherwise, the rubber seals may deteriorate, causing leakage.
- Refill with the same type of brake fluid. Adding a brake fluid other than DOT 3 or DOT 4 may result in a harmful chemical reaction.
- Be careful that water does not enter the brake fluid reservoir when refilling. Water will significantly lower the boiling point of the fluid and may result in vapor lock.

ECA17640

### **NOTICE**

**Brake fluid may damage painted surfaces or plastic parts. Always clean up spilled fluid immediately.**

# PERIODIC MAINTENANCE AND ADJUSTMENT

As the brake pads wear, it is normal for the brake fluid level to gradually go down. A low brake fluid level may indicate worn brake pads and/or brake system leakage; therefore, be sure to check the brake pads for wear and the brake system for leakage. If the brake fluid level goes down suddenly, have a Yamaha dealer check the cause before further riding.

## Changing the brake fluid

EAU22722

Have a Yamaha dealer change the brake fluid at the intervals specified in the periodic maintenance and lubrication chart. In addition, have the oil seals of the brake master cylinder and caliper as well as the brake hose replaced at the intervals listed below or whenever they are damaged or leaking.

- Oil seals: Replace every two years.
- Brake hose: Replace every four years.

## Drive chain slack

EAU22760

The drive chain slack should be checked before each ride and adjusted if necessary.

### To check the drive chain slack

EAU47681

1. Place the motorcycle on the centerstand.
2. Shift the transmission into the neutral position.
3. Remove the drive chain slack check hole cap.

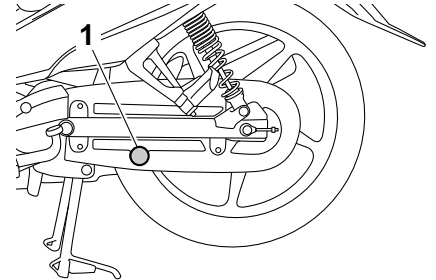

1. Drive chain slack check hole cap

4. Measure the drive chain slack as shown.

# PERIODIC MAINTENANCE AND ADJUSTMENT

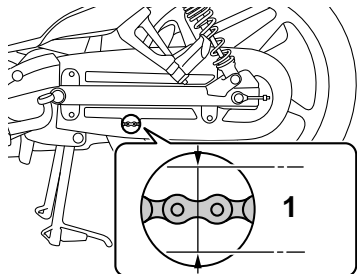

1. Drive chain slack

**Drive chain slack:**  
25.0–35.0 mm (0.98–1.38 in)

5. Install the check hole cap.
6. If the drive chain slack is incorrect, adjust it as follows.

## To adjust the drive chain slack

EAU55190

Consult a Yamaha dealer before adjusting the drive chain slack.

1. Place the motorcycle on the centerstand.
2. Loosen the brake pedal free play adjusting nut and the brake torque rod nut.

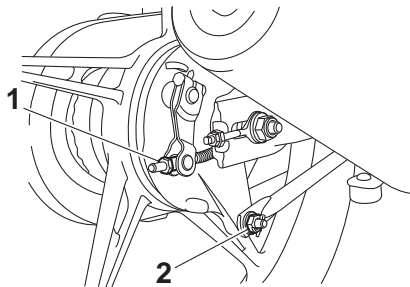

1. Brake pedal free play adjusting nut
2. Brake torque rod nut
3. Loosen the axle nut, then loosen the locknut at each end of the swingarm.

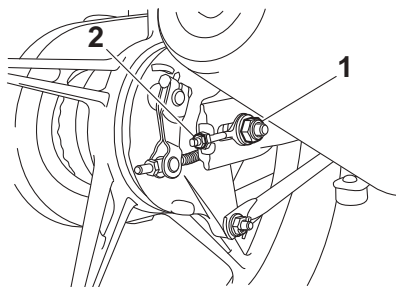

1. Axle nut
2. Locknut

4. To tighten the drive chain, turn the drive chain slack adjusting nut at each end of the swingarm in direction (a). To loosen the drive chain, turn the adjusting nut at each end of the swingarm in direction (b), and then push the rear wheel forward. **NOTICE: Improper drive chain slack will overload the engine as well as other vital parts of the motorcycle and can lead to chain slippage or breakage. To prevent this from occurring, keep the drive chain slack within the specified limits.** [ECA10571]

## TIP

Using the alignment marks on each side of the swingarm, make sure that both drive chain pullers are in the same position for proper wheel alignment.

# PERIODIC MAINTENANCE AND ADJUSTMENT

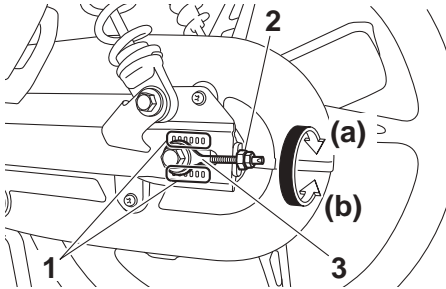

1. Alignment marks
2. Drive chain slack adjusting nut
3. Drive chain puller

5. Tighten both locknuts, and then tighten the axle nut and brake torque rod nut to their specified torques.

## Tightening torques:

Locknut:

7 Nm (0.7 m·kgf, 5.1 ft·lbf)

Axle nut:

60 Nm (6.0 m·kgf, 43 ft·lbf)

Brake torque rod nut:

19 Nm (1.9 m·kgf, 14 ft·lbf)

**TIP** \_\_\_\_\_  
When tightening the axle nut, hold the wheel axle with a wrench to keep it from turning.

6. Adjust the brake pedal free play. (See page 6-17.) **WARNING! After adjusting the brake pedal free play, check the operation of the brake light.** [EWA16080]
7. Make sure that the drive chain pullers are in the same position, the drive chain slack is correct, and the drive chain moves smoothly.

## Cleaning and lubricating the drive chain

EAU23016

The drive chain must be cleaned and lubricated at the intervals specified in the periodic maintenance and lubrication chart, otherwise it will quickly wear out, especially when riding in dusty or wet areas. Service the drive chain as follows.

ECA10583

## NOTICE

**The drive chain must be lubricated after washing the motorcycle, riding in the rain or riding in wet areas.**

1. Remove all dirt and mud from the drive chain with a brush or cloth.

**TIP** \_\_\_\_\_  
For a thorough cleaning, have a Yamaha dealer remove the drive chain and soak it in solvent.

2. Spray Yamaha Chain and Cable Lube or a high-quality spray-type drive chain lubricant on the entire chain, making sure that all side plates and rollers have been sufficiently oiled.

# PERIODIC MAINTENANCE AND ADJUSTMENT

6

## Checking and lubricating the cables

EAU23095

The operation of all control cables and the condition of the cables should be checked before each ride, and the cables and cable ends should be lubricated if necessary. If a cable is damaged or does not move smoothly, have a Yamaha dealer check or replace it. **WARNING! Damage to the outer housing of cables may result in internal rusting and cause interference with cable movement. Replace damaged cables as soon as possible to prevent unsafe conditions.**

[EWA10711]

### Recommended lubricant:

Yamaha Chain and Cable Lube or engine oil

## Checking and lubricating the throttle grip and cable

EAU49920

The operation of the throttle grip should be checked before each ride. In addition, the cable should be lubricated by a Yamaha dealer at the intervals specified in the periodic maintenance chart.

## Checking and lubricating the brake lever

EAU23154

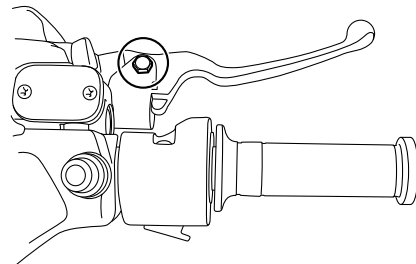

The operation of the brake lever should be checked before each ride, and the lever pivot should be lubricated if necessary.

### Recommended lubricant:

Silicone grease

# PERIODIC MAINTENANCE AND ADJUSTMENT

## Checking and lubricating the brake pedal

EAU23183

The operation of the brake pedal should be checked before each ride, and the pedal pivot should be lubricated if necessary.

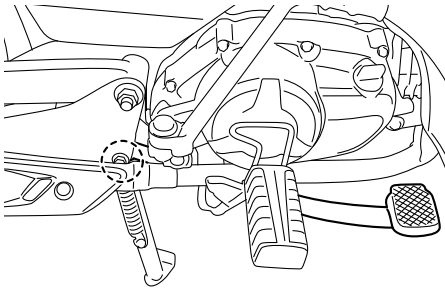

**Recommended lubricant:**  
Lithium-soap-based grease

## Checking and lubricating the centerstand and sidestand (for sidestand-equipped models)

EAU55170

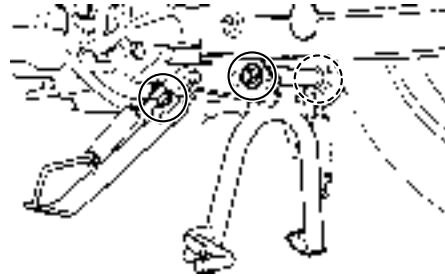

The operation of the centerstand and sidestand should be checked before each ride, and the pivots and metal-to-metal contact surfaces should be lubricated if necessary.

EWA10741

### **⚠ WARNING**

If the centerstand or sidestand does not move up and down smoothly, have a Yamaha dealer check or repair it. Otherwise, the centerstand or

sidestand could contact the ground and distract the operator, resulting in a possible loss of control.

**Recommended lubricant:**  
Lithium-soap-based grease

# PERIODIC MAINTENANCE AND ADJUSTMENT

## Lubricating the swingarm pivots

EAUM1652

The swingarm pivots must be lubricated by a Yamaha dealer at the intervals specified in the periodic maintenance and lubrication chart.

**Recommended lubricant:**  
Lithium-soap-based grease

## Checking the front fork

EAU23272

The condition and operation of the front fork must be checked as follows at the intervals specified in the periodic maintenance and lubrication chart.

### To check the condition

Check the inner tubes for scratches, damage and excessive oil leakage.

### To check the operation

1. Place the vehicle on a level surface and hold it in an upright position. **WARNING! To avoid injury, securely support the vehicle so there is no danger of it falling over.** [EWA10751]
2. While applying the front brake, push down hard on the handlebars several times to check if the front fork compresses and rebounds smoothly.

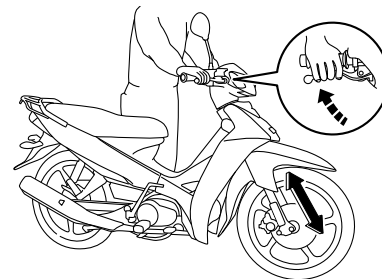

ECA10590

### **NOTICE**

**If any damage is found or the front fork does not operate smoothly, have a Yamaha dealer check or repair it.**



# PERIODIC MAINTENANCE AND ADJUSTMENT

## Checking the steering

EAU45511

Worn or loose steering bearings may cause danger. Therefore, the operation of the steering must be checked as follows at the intervals specified in the periodic maintenance and lubrication chart.

1. Place the vehicle on the centerstand. **WARNING! To avoid injury, securely support the vehicle so there is no danger of it falling over.** (EWA10751)
2. Hold the lower ends of the front fork legs and try to move them forward and backward. If any free play can be felt, have a Yamaha dealer check or repair the steering.

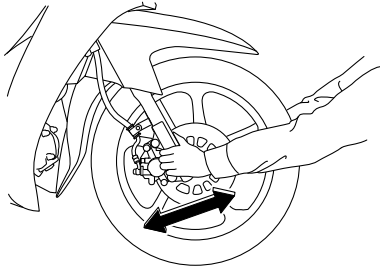

## Checking the wheel bearings

EAU23291

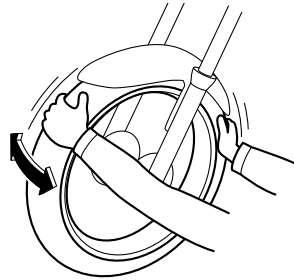

The front and rear wheel bearings must be checked at the intervals specified in the periodic maintenance and lubrication chart. If there is play in the wheel hub or if the wheel does not turn smoothly, have a Yamaha dealer check the wheel bearings.

## Battery

EAU47812

The battery is located under the seat. (See page 3-8.)

This model is equipped with a VRLA (Valve Regulated Lead Acid) battery. There is no need to check the electrolyte or to add distilled water. However, the battery lead connections need to be checked and, if necessary, tightened.

EWA10760

### **! WARNING**

- **Electrolyte is poisonous and dangerous since it contains sulfuric acid, which causes severe burns. Avoid any contact with skin, eyes or clothing and always shield your eyes when working near batteries. In case of contact, administer the following FIRST AID.**
  - **EXTERNAL:** Flush with plenty of water.
  - **INTERNAL:** Drink large quantities of water or milk and immediately call a physician.
  - **EYES:** Flush with water for 15 minutes and seek prompt medical attention.

# PERIODIC MAINTENANCE AND ADJUSTMENT

---

- Batteries produce explosive hydrogen gas. Therefore, keep sparks, flames, cigarettes, etc., away from the battery and provide sufficient ventilation when charging it in an enclosed space.
- **KEEP THIS AND ALL BATTERIES OUT OF THE REACH OF CHILDREN.**

ECA10620

## **NOTICE**

Never attempt to remove the battery cell seals, as this would permanently damage the battery.

6

## **To charge the battery**

Have a Yamaha dealer charge the battery as soon as possible if it seems to have discharged. Keep in mind that the battery tends to discharge more quickly if the vehicle is equipped with optional electrical accessories.

ECA16521

## **NOTICE**

To charge a VRLA (Valve Regulated Lead Acid) battery, a special (constant-voltage) battery charger is required. Using a conventional battery charger will damage the battery.

## **To store the battery**

1. If the vehicle will not be used for more than one month, remove the battery, fully charge it, and then place it in a cool, dry place. **NOTICE: When removing the battery, be sure the key is turned to “⊗”, then disconnect the negative lead before disconnecting the positive lead.** [ECA17710]
2. If the battery will be stored for more than two months, check it at least once a month and fully charge it if necessary.
3. Fully charge the battery before installation. **NOTICE: When installing the battery, be sure the key is turned to “⊗”, then connect the positive lead before connecting the negative lead.** [ECA17720]

4. After installation, make sure that the battery leads are properly connected to the battery terminals.

ECA16530

## **NOTICE**

Always keep the battery charged. Storing a discharged battery can cause permanent battery damage.

# PERIODIC MAINTENANCE AND ADJUSTMENT

EAU47672

## Replacing the fuse

The fuse holder is located under the battery box cover.

If the fuse is blown, replace it as follows.

1. Turn the key to “ $\times$ ” and turn off all electrical circuits.
2. Open the seat. (See page 3-8.)
3. Remove the battery box cover by removing the screw.

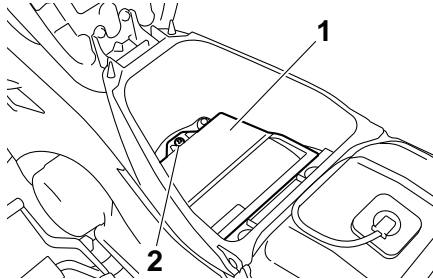

1. Battery box cover
2. Screw

4. Remove the blown fuse, and then install a new fuse of the specified amperage. **WARNING! Do not use a fuse of a higher amperage rating than recommended to**

avoid causing extensive damage to the electrical system and possibly a fire. [EWA15131]

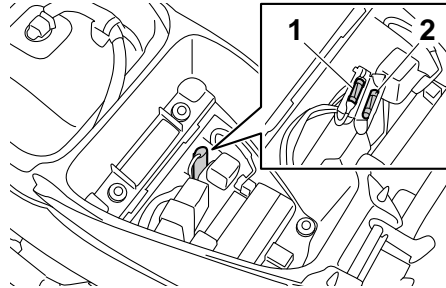

1. Fuse
2. Spare fuse

### Specified fuse:

10.0 A

5. Turn the key to “ $\circ$ ” and turn on the electrical circuits to check if the devices operate.
6. If the fuse immediately blows again, have a Yamaha dealer check the electrical system.
7. Install the battery box cover by installing the screw.
8. Close the seat.

EAU47761

## Replacing the headlight bulb

If the headlight bulb burns out, replace it as follows.

ECA10650

### NOTICE

Take care not to damage the following parts:

- Headlight bulb

Do not touch the glass part of the headlight bulb to keep it free from oil, otherwise the transparency of the glass, the luminosity of the bulb, and the bulb life will be adversely affected. Thoroughly clean off any dirt and fingerprints on the headlight bulb using a cloth moistened with alcohol or thinner.

- Headlight lens

Do not affix any type of tinted film or stickers to the headlight lens.

Do not use a headlight bulb of a wattage higher than specified.

# PERIODIC MAINTENANCE AND ADJUSTMENT

EAU47660

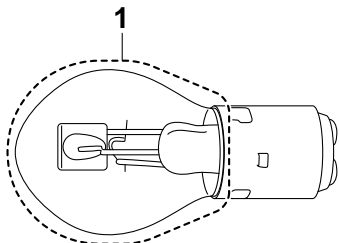

1. Do not touch the glass part of the bulb.

1. Remove cowling A. (See page 6-7.)
2. Remove the headlight bulb cover.

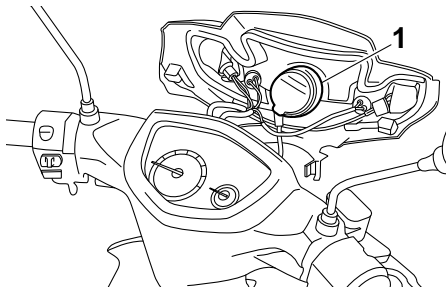

1. Headlight bulb cover

3. Remove the headlight bulb holder (together with the bulb) by turning it counterclockwise.

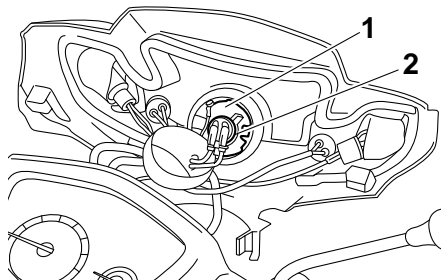

1. Headlight bulb holder
2. Headlight bulb

4. Remove the burnt-out bulb by pushing it in and turning it counterclockwise.
5. Place a new bulb into the holder, push it in, and then turn it clockwise until it stops.
6. Install the bulb holder (together with the bulb) by turning it clockwise.
7. Install the headlight bulb cover.
8. Install the cowling.
9. Have a Yamaha dealer adjust the headlight beam if necessary.

## Replacing the tail/brake light bulb

1. Remove the tail/brake light outer lens by removing the screws.

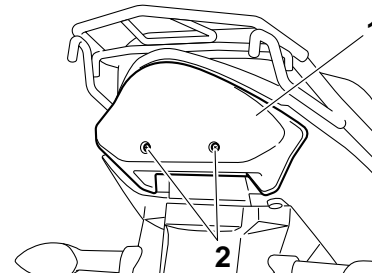

1. Outer lens
2. Screw

2. Remove the inner lens by pulling it out.

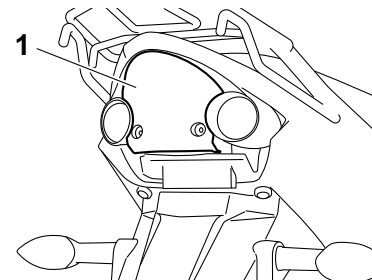

1. Inner lens

# PERIODIC MAINTENANCE AND ADJUSTMENT

3. Remove the burnt-out bulb by pushing it in and turning it counterclockwise.

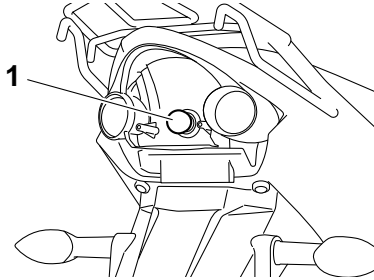

1. Tail/brake light bulb

4. Insert a new bulb into the socket, push it in, and then turn it clockwise until it stops.
5. Place the inner lens in the original position, and then install the outer lens by installing the screws.  
**NOTICE: Do not overtighten the screws, otherwise the lens may break.** [ECA10681]

## Replacing a front turn signal light bulb EAU47741

1. Remove cowling A. (See page 6-7.)
2. Remove the turn signal light bulb socket (together with the bulb) by turning it counterclockwise.

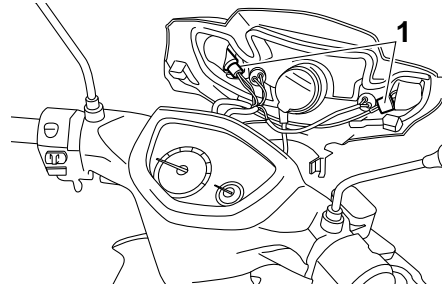

1. Turn signal light bulb socket

3. Remove the burnt-out bulb by pushing it in and turning it counterclockwise.

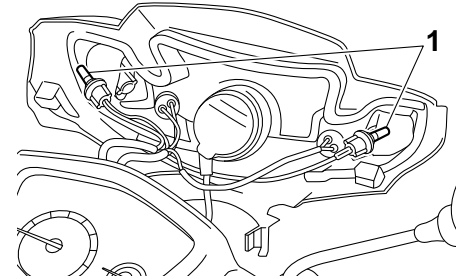

1. Turn signal light bulb

4. Insert a new bulb into the socket, push it in, and then turn it clockwise until it stops.
5. Install the socket (together with the bulb) by turning it clockwise.
6. Install the cowling.

# PERIODIC MAINTENANCE AND ADJUSTMENT

## Replacing a rear turn signal light bulb

EAUS1611

1. Remove the turn signal light lens by removing the screw.

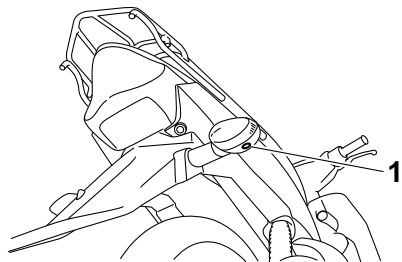

1. Screw

2. Remove the burnt-out bulb by pushing it in and turning it counter-clockwise.

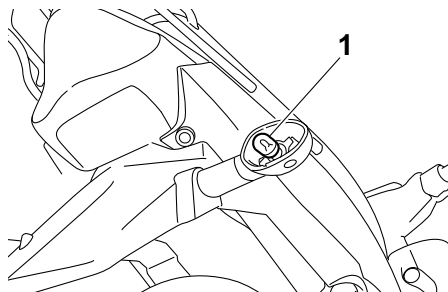

1. Turn signal light bulb
3. Insert a new bulb into the socket, push it in, and then turn it clockwise until it stops.
4. Install the lens by installing the screw. **NOTICE: Do not over-tighten the screw, otherwise the lens may break.** [ECA11191]

## Replacing the license plate light bulb

EAU47910

1. Remove the license plate light cover by removing the screw.

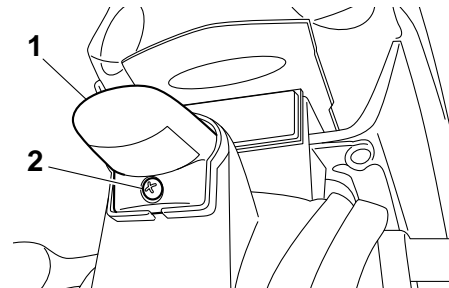

1. License plate light cover
2. Screw

2. Remove the burnt-out bulb by pulling it out from the socket.

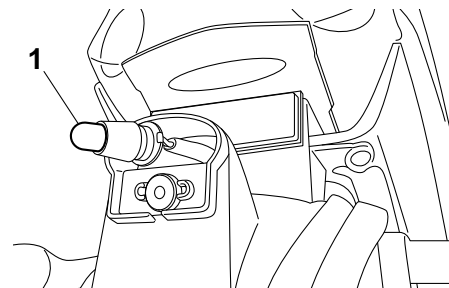

1. License plate light bulb

# PERIODIC MAINTENANCE AND ADJUSTMENT

3. Insert a new bulb into the socket.
4. Install the license plate light cover by installing the screw.

## Replacing an auxiliary light bulb

EAUW0343

This model is equipped with two auxiliary lights. If an auxiliary light bulb burns out, replace it as follows.

1. Remove cowling A. (See page 6-7.)
2. Remove the auxiliary light bulb socket (together with the bulb) by pulling it out.

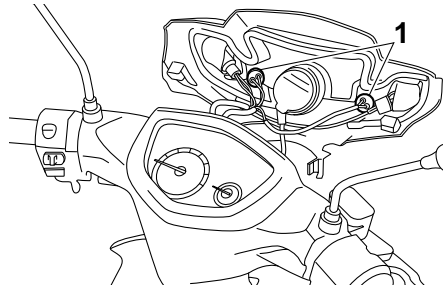

1. Auxiliary light bulb socket

3. Remove the burnt-out bulb by pulling it out.

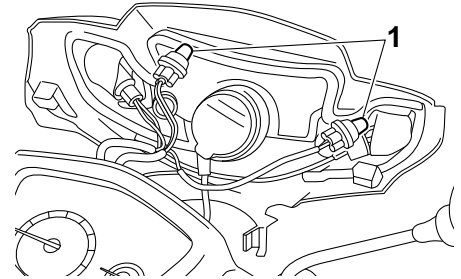

1. Auxiliary light bulb

4. Insert a new bulb into the socket.
5. Install the auxiliary light bulb socket (together with the bulb) by pushing it in.
6. Install the cowling.

# PERIODIC MAINTENANCE AND ADJUSTMENT

## Front wheel

EAU24360

EAU55220

EWA10821

### To remove the front wheel

#### **WARNING**

To avoid injury, securely support the vehicle so there is no danger of it falling over.

1. Place the motorcycle on the centerstand.
2. Remove the rubber cap, and then loosen the wheel axle nut.

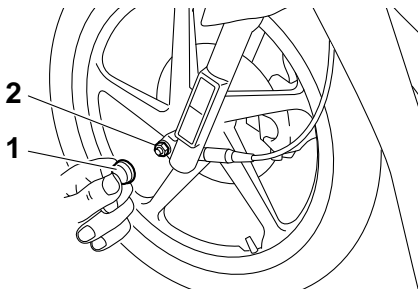

1. Rubber cap
2. Wheel axle nut

3. Disconnect the speedometer cable from the front wheel.

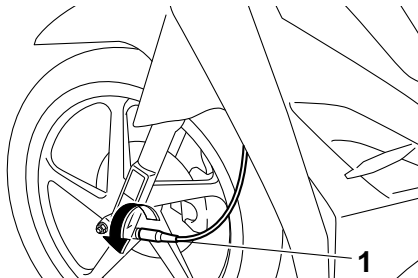

1. Speedometer cable

4. Remove the wheel axle nut and the washer.

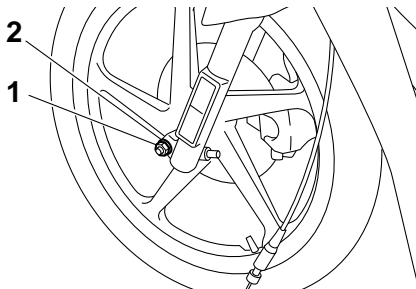

1. Wheel axle nut
2. Washer

5. Pull the wheel axle out, and then remove the wheel. **NOTICE: Do not apply the brake after the wheel has been removed to-**

gether with the brake disc, otherwise the brake pads will be forced shut. [ECA11071]

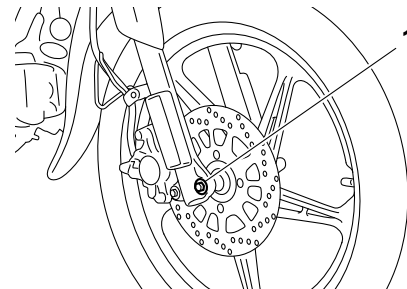

1. Wheel axle

### To install the front wheel

EAU55200

1. Install the speedometer gear unit into the wheel hub so that the projection on the wheel hub fits in either slot of the speedometer gear unit.



# PERIODIC MAINTENANCE AND ADJUSTMENT

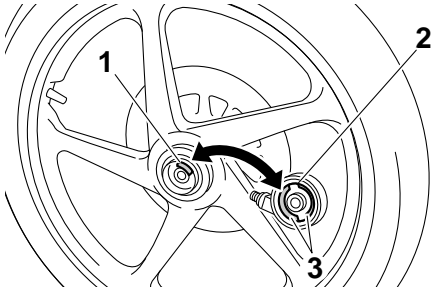

1. Projection
2. Speedometer gear unit
3. Slot

2. Lift the wheel up between the fork legs.

## TIP

Make sure that there is enough space between the brake pads before inserting the brake disc and that the retainer in the speedometer gear unit fits over the slot on the fork leg.

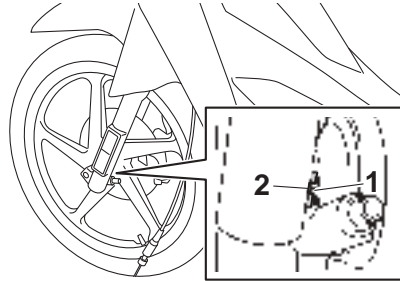

1. Retainer
2. Slot

3. Insert the wheel axle, and then install the washer and the axle nut.
4. Tighten the axle nut to the specified torque.

## Tightening torque:

Axle nut:  
39 Nm (3.9 m·kgf, 28 ft·lbf)

## TIP

When tightening the axle nut, hold the wheel axle with a wrench to keep it from turning.

5. Take the motorcycle off the centerstand.

6. While applying the front brake, push down hard on the handlebars several times to check if the front fork compresses and rebounds smoothly.
7. Place the motorcycle on the centerstand.
8. Install the rubber cap.
9. Connect the speedometer cable.

# PERIODIC MAINTENANCE AND ADJUSTMENT

## Rear wheel

EAU25080

### To remove the rear wheel

EAU55240

EWA10821

#### **⚠ WARNING**

To avoid injury, securely support the vehicle so there is no danger of it falling over.

1. Place the motorcycle on the centerstand.
2. Loosen the wheel axle nut.

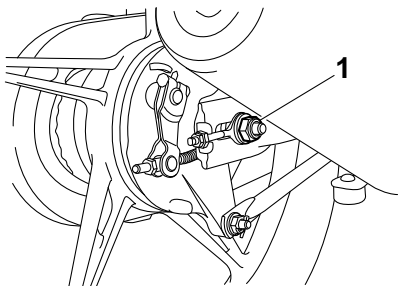

1. Wheel axle nut

3. Remove the drive chain case by removing the bolts.

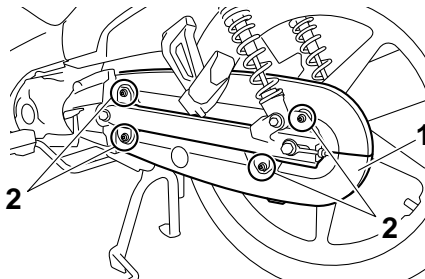

1. Drive chain case
2. Bolt

4. Loosen the locknut and the drive chain slack adjusting nut on both ends of the swingarm.

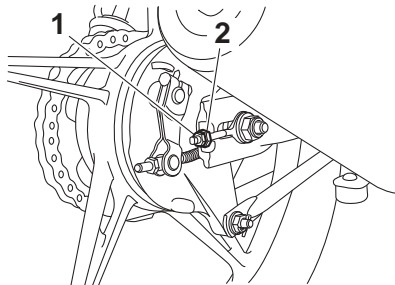

1. Locknut
2. Drive chain slack adjusting nut

5. Disconnect the brake torque rod from the brake shoe plate by removing the cotter pin, the nut, the washer and the bolt.

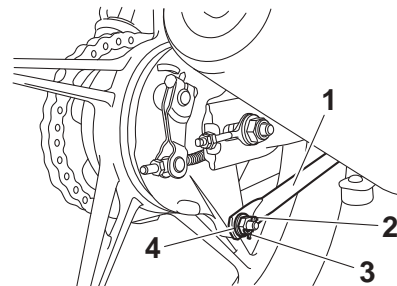

1. Brake torque rod
2. Cotter pin
3. Brake torque rod nut and bolt
4. Washer

6. Remove the brake pedal free play adjusting nut, and then disconnect the brake rod from the brake camshaft lever.

# PERIODIC MAINTENANCE AND ADJUSTMENT

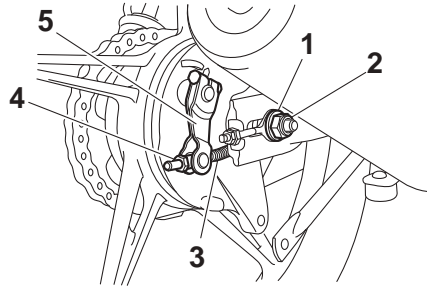

1. Washer
2. Axle nut
3. Brake rod
4. Brake pedal free play adjusting nut
5. Brake camshaft lever

7. Remove the axle nut and the washer, and then pull the wheel axle out.

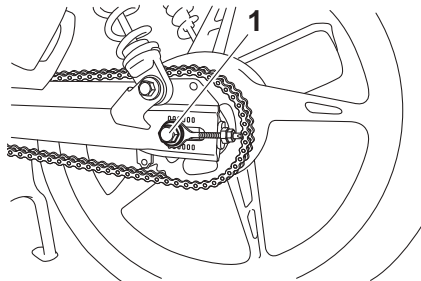

1. Wheel axle

8. Push the wheel forward, and then remove the drive chain from the rear sprocket.

**TIP** \_\_\_\_\_  
The drive chain does not need to be disassembled in order to remove and install the wheel.

9. Remove the wheel.

EAU47702

## To install the rear wheel

1. Install the wheel by inserting the wheel axle from the left-hand side.
2. Install the drive chain onto the rear sprocket.
3. Install the washer and the axle nut.
4. Install the brake rod onto the brake camshaft lever, and then install the brake pedal free play adjusting nut onto the brake rod.
5. Connect the brake torque rod to the brake shoe plate by installing the bolt, the washer and the nut.
6. Adjust the drive chain slack. (See page 6-20.)
7. Tighten the brake torque rod nut and axle nut to the specified torques.

**TIP** \_\_\_\_\_  
When tightening the axle nut, hold the wheel axle with a wrench to keep it from turning.

### Tightening torques:

Brake torque rod nut:

19 Nm (1.9 m·kgf, 14 ft·lbf)

Axle nut:

60 Nm (6.0 m·kgf, 43 ft·lbf)

8. Insert a new cotter pin.
9. Adjust the brake pedal free play. (See page 6-17.) **WARNING! After adjusting the brake pedal free play, check the operation of the brake light.** [EWA16080]
10. Install the drive chain case by installing the bolts.

# PERIODIC MAINTENANCE AND ADJUSTMENT

---

EAU25851

## Troubleshooting

Although Yamaha motorcycles receive a thorough inspection before shipment from the factory, trouble may occur during operation. Any problem in the fuel, compression, or ignition systems, for example, can cause poor starting and loss of power.

The following troubleshooting chart represents a quick and easy procedure for checking these vital systems yourself. However, should your motorcycle require any repair, take it to a Yamaha dealer, whose skilled technicians have the necessary tools, experience, and know-how to service the motorcycle properly.

Use only genuine Yamaha replacement parts. Imitation parts may look like Yamaha parts, but they are often inferior, have a shorter service life and can lead to expensive repair bills.

EWA15141

### **WARNING**

---

**When checking the fuel system, do not smoke, and make sure there are no open flames or sparks in the area, including pilot lights from water**

**heaters or furnaces. Gasoline or gasoline vapors can ignite or explode, causing severe injury or property damage.**

---

# PERIODIC MAINTENANCE AND ADJUSTMENT

EAU25904

## Troubleshooting chart

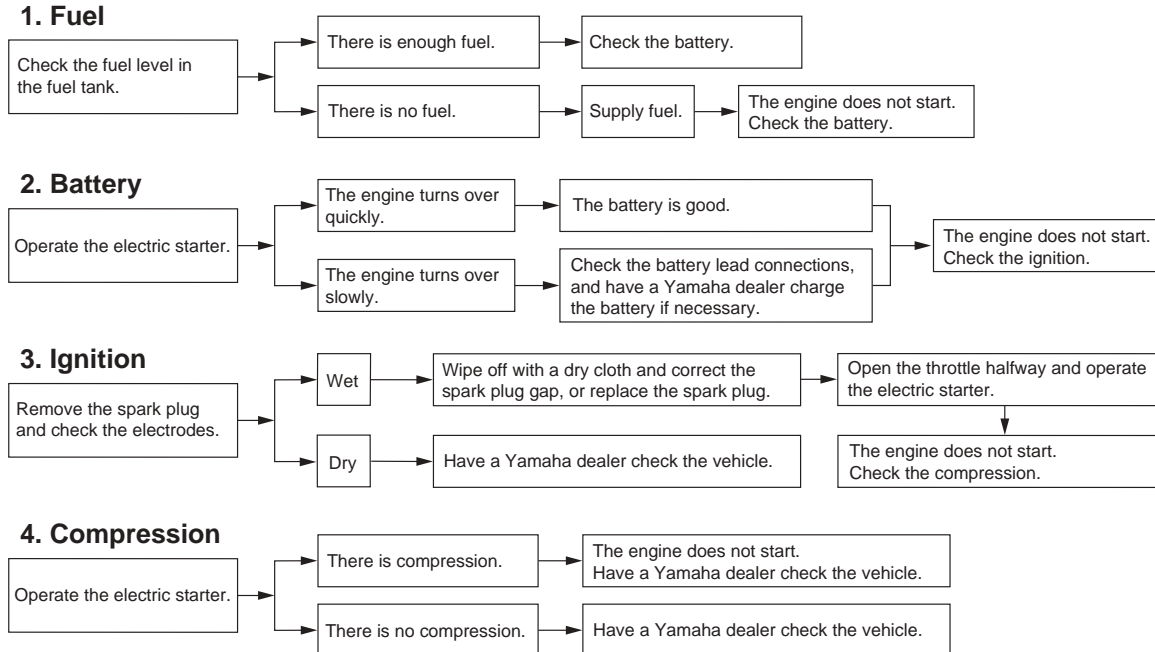

# MOTORCYCLE CARE AND STORAGE

---

## Matte color caution

EAU37833

ECA15192

### **NOTICE**

---

Some models are equipped with matte colored finished parts. Be sure to consult a Yamaha dealer for advice on what products to use before cleaning the vehicle. Using a brush, harsh chemical products or cleaning compounds when cleaning these parts will scratch or damage their surface. Wax also should not be applied to any matte colored finished parts.

---

## Care

EAU26004

While the open design of a motorcycle reveals the attractiveness of the technology, it also makes it more vulnerable. Rust and corrosion can develop even if high-quality components are used. A rusty exhaust pipe may go unnoticed on a car, however, it detracts from the overall appearance of a motorcycle. Frequent and proper care does not only comply with the terms of the warranty, but it will also keep your motorcycle looking good, extend its life and optimize its performance.

## Before cleaning

1. Cover the muffler outlet with a plastic bag after the engine has cooled down.
2. Make sure that all caps and covers as well as all electrical couplers and connectors, including the spark plug cap, are tightly installed.
3. Remove extremely stubborn dirt, like oil burnt onto the crankcase, with a degreasing agent and a brush, but never apply such prod-

ucts onto seals, gaskets, sprockets, the drive chain and wheel axles. Always rinse the dirt and degreaser off with water.

## Cleaning

ECA10772

### **NOTICE**

---

- **Avoid using strong acidic wheel cleaners, especially on spoked wheels. If such products are used on hard-to-remove dirt, do not leave the cleaner on the affected area any longer than instructed. Also, thoroughly rinse the area off with water, immediately dry it, and then apply a corrosion protection spray.**
- **Improper cleaning can damage plastic parts (such as cowlings, panels, windshields, headlight lenses, meter lenses, etc.) and the mufflers. Use only a soft, clean cloth or sponge with water to clean plastic. However, if the plastic parts cannot be thoroughly cleaned with water, diluted mild detergent with water may be used. Be sure to rinse**

# MOTORCYCLE CARE AND STORAGE

off any detergent residue using plenty of water, as it is harmful to plastic parts.

- Do not use any harsh chemical products on plastic parts. Be sure to avoid using cloths or sponges which have been in contact with strong or abrasive cleaning products, solvent or thinner, fuel (gasoline), rust removers or inhibitors, brake fluid, antifreeze or electrolyte.
- Do not use high-pressure washers or steam-jet cleaners since they cause water seepage and deterioration in the following areas: seals (of wheel and swing-arm bearings, fork and brakes), electric components (couplers, connectors, instruments, switches and lights), breather hoses and vents.
- For motorcycles equipped with a windshield: Do not use strong cleaners or hard sponges as they will cause dulling or scratching. Some cleaning compounds for plastic may leave scratches on the windshield.

Test the product on a small hidden part of the windshield to make sure that it does not leave any marks. If the windshield is scratched, use a quality plastic polishing compound after washing.

## After normal use

Remove dirt with warm water, a mild detergent, and a soft, clean sponge, and then rinse thoroughly with clean water. Use a toothbrush or bottlebrush for hard-to-reach areas. Stubborn dirt and insects will come off more easily if the area is covered with a wet cloth for a few minutes before cleaning.

## After riding in the rain, near the sea or on salt-sprayed roads

Since sea salt or salt sprayed on roads during winter are extremely corrosive in combination with water, carry out the following steps after each ride in the rain, near the sea or on salt-sprayed roads.

## TIP

Salt sprayed on roads in the winter may remain well into spring.

1. Clean the motorcycle with cold water and a mild detergent, after the engine has cooled down.  
**NOTICE: Do not use warm water since it increases the corrosive action of the salt.** [ECA10791]
2. Apply a corrosion protection spray on all metal, including chrome- and nickel-plated, surfaces to prevent corrosion.

## After cleaning

1. Dry the motorcycle with a chamois or an absorbing cloth.
2. Immediately dry the drive chain and lubricate it to prevent it from rusting.
3. Use a chrome polish to shine chrome, aluminum and stainless-steel parts, including the exhaust system. (Even the thermally induced discoloring of stainless-steel exhaust systems can be removed through polishing.)

# MOTORCYCLE CARE AND STORAGE

---

ECA10800

4. To prevent corrosion, it is recommended to apply a corrosion protection spray on all metal, including chrome- and nickel-plated, surfaces.
5. Use spray oil as a universal cleaner to remove any remaining dirt.
6. Touch up minor paint damage caused by stones, etc.
7. Wax all painted surfaces.
8. Let the motorcycle dry completely before storing or covering it.

EWA1131

## WARNING

**Contaminants on the brakes or tires can cause loss of control.**

- **Make sure that there is no oil or wax on the brakes or tires.**
- **If necessary, clean the brake discs and brake linings with a regular brake disc cleaner or acetone, and wash the tires with warm water and a mild detergent. Before riding at higher speeds, test the motorcycle's braking performance and cornering behavior.**

## NOTICE

- **Apply spray oil and wax sparingly and make sure to wipe off any excess.**
- **Never apply oil or wax to any rubber and plastic parts, but treat them with a suitable care product.**
- **Avoid using abrasive polishing compounds as they will wear away the paint.**

## TIP

- Consult a Yamaha dealer for advice on what products to use.
- Washing, rainy weather or humid climates can cause the headlight lens to fog. Turning the headlight on for a short period of time will help remove the moisture from the lens.

EAU26152

## Storage

### Short-term

Always store your motorcycle in a cool, dry place and, if necessary, protect it against dust with a porous cover. Be sure the engine and the exhaust system are cool before covering the motorcycle.

ECA10810

## NOTICE

- **Storing the motorcycle in a poorly ventilated room or covering it with a tarp, while it is still wet, will allow water and humidity to seep in and cause rust.**
- **To prevent corrosion, avoid damp cellars, stables (because of the presence of ammonia) and areas where strong chemicals are stored.**

### Long-term

Before storing your motorcycle for several months:

1. Follow all the instructions in the "Care" section of this chapter.



# MOTORCYCLE CARE AND STORAGE

2. For motorcycles equipped with a fuel cock that has an “OFF” position: Turn the fuel cock lever to “OFF”.
3. Drain the carburetor float chamber by loosening the drain bolt; this will prevent fuel deposits from building up. Pour the drained fuel into the fuel tank.
4. Fill up the fuel tank and add fuel stabilizer (if available) to prevent the fuel tank from rusting and the fuel from deteriorating.
5. Perform the following steps to protect the cylinder, piston rings, etc. from corrosion.
  - a. Remove the spark plug cap and spark plug.
  - b. Pour a teaspoonful of engine oil into the spark plug bore.
  - c. Install the spark plug cap onto the spark plug, and then place the spark plug on the cylinder head so that the electrodes are grounded. (This will limit sparking during the next step.)
  - d. Turn the engine over several times with the starter. (This will coat the cylinder wall with oil.)

**WARNING! To prevent damage or injury from sparking, make sure to ground the spark plug electrodes while turning the engine over.**

[EWA10951]

- e. Remove the spark plug cap from the spark plug, and then install the spark plug and the spark plug cap.
6. Lubricate all control cables and the pivoting points of all levers and pedals as well as of the side-stand/centerstand.
7. Check and, if necessary, correct the tire air pressure, and then lift the motorcycle so that both of its wheels are off the ground. Alternatively, turn the wheels a little every month in order to prevent the tires from becoming degraded in one spot.
8. Cover the muffler outlet with a plastic bag to prevent moisture from entering it.
9. Remove the battery and fully charge it. Store it in a cool, dry place and charge it once a month. Do not store the battery in an ex-

cessively cold or warm place [less than 0 °C (30 °F) or more than 30 °C (90 °F)]. For more information on storing the battery, see page 6-26.

## TIP

Make any necessary repairs before storing the motorcycle.

# SPECIFICATIONS

## Dimensions:

Overall length:  
1870 mm (73.6 in)  
Overall width:  
675 mm (26.6 in)  
Overall height:  
1040 mm (40.9 in)  
Seat height:  
770 mm (30.3 in)  
Wheelbase:  
1205 mm (47.4 in)  
Ground clearance:  
130 mm (5.12 in)  
Minimum turning radius:  
1900 mm (74.8 in)

## Weight:

Curb weight:  
102 kg (225 lb)

## Engine:

Engine type:  
Air cooled 4-stroke, SOHC  
Cylinder arrangement:  
Single cylinder  
Displacement:  
110 cm<sup>3</sup>  
Bore × stroke:  
51.0 × 54.0 mm (2.01 × 2.13 in)  
Compression ratio:  
9.30 : 1  
Starting system:  
Electric starter and kickstarter  
Lubrication system:  
Wet sump

## Engine oil:

Recommended brand:  
YAMALUBE  
Type:  
SAE 10W-30, 10W-40, 10W-50, 15W-40,  
20W-40 or 20W-50

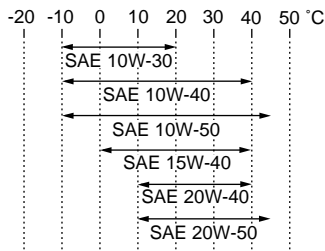

Recommended engine oil grade:  
API service SG type or higher, JASO  
standard MA  
Engine oil quantity:  
Periodic oil change:  
0.80 L (0.85 US qt, 0.70 Imp.qt)

## Air filter:

Air filter element:  
Dry element

## Fuel:

Recommended fuel:  
Regular gasoline  
Fuel tank capacity:  
4.2 L (1.11 US gal, 0.92 Imp.gal)  
Fuel reserve amount:  
1.0 L (0.26 US gal, 0.22 Imp.gal)

## Carburetor:

Type × quantity:  
MP17 x 1

## Spark plug(s):

Manufacturer/model:  
NGK/CR6HSA  
Spark plug gap:  
0.6–0.7 mm (0.024–0.028 in)

## Clutch:

Clutch type:  
Wet, multiple-disc and centrifugal  
automatic

## Transmission:

Primary reduction ratio:  
3.722 (67/18)  
Final drive:  
Chain  
Secondary reduction ratio:  
2.400 (36/15)  
Transmission type:  
Constant mesh 4-speed  
Operation:  
Left foot operation  
Gear ratio:  
1st:  
3.166 (38/12)  
2nd:  
1.941 (33/17)  
3rd:  
1.380 (29/21)  
4th:  
1.095 (23/21)

## Chassis:

Frame type:  
Backbone  
Caster angle:  
27.00 °  
Trail:  
79 mm (3.1 in)

## Front tire:

Type:  
With tube  
Size:  
70/90-17M/C 38P  
Manufacturer/model:  
DURO/HF314A  
Manufacturer/model:  
DUNLOP/D104FM (KOR)

## Rear tire:

Type:  
With tube  
Size:  
80/90-17M/C 50P  
Manufacturer/model:  
DURO/HF314A  
Manufacturer/model:  
DUNLOP/T900AL (KOR)

## Loading:

Maximum load:  
167 kg (368 lb)  
(Total weight of rider, passenger, cargo and accessories)

## Tire air pressure (measured on cold tires):

Loading condition:  
0–90 kg (0–198 lb)

Front:  
200 kPa (2.00 kgf/cm<sup>2</sup>, 29 psi)  
Rear:  
225 kPa (2.25 kgf/cm<sup>2</sup>, 33 psi)  
Loading condition:  
90–167 kg (198–368 lb)  
Front:  
200 kPa (2.00 kgf/cm<sup>2</sup>, 29 psi)  
Rear:  
280 kPa (2.80 kgf/cm<sup>2</sup>, 41 psi)

## Front wheel:

Wheel type:  
Cast wheel  
Rim size:  
17x1.40

## Rear wheel:

Wheel type:  
Cast wheel  
Rim size:  
17x1.60

## Front brake:

Type:  
Single disc brake  
Operation:  
Right hand operation  
Specified brake fluid:  
DOT 3 or 4

## Rear brake:

Type:  
Drum brake  
Operation:  
Right foot operation

## Front suspension:

Type:  
Telescopic fork  
Spring/shock absorber type:  
Coil spring/oil damper  
Wheel travel:  
95.0 mm (3.74 in)

## Rear suspension:

Type:  
Swingarm  
Spring/shock absorber type:  
Coil spring/oil damper  
Wheel travel:  
76.0 mm (2.99 in)

## Electrical system:

Ignition system:  
DC CDI  
Charging system:  
AC magneto

## Battery:

Model:  
MTX7L-BS  
Voltage, capacity:  
12 V, 6.0 Ah

## Headlight:

Bulb type:  
Incandescence

## Bulb voltage, wattage × quantity:

Headlight:  
12 V, 35.0 W/35.0 W × 1  
Tail/brake light:  
12 V, 5.0 W/21.0 W × 1  
Front turn signal light:  
12 V, 21.0 W × 2

# SPECIFICATIONS

---

Rear turn signal light:

12 V, 10.0 W × 2

Auxiliary light:

12 V, 3.0 W × 2

License plate light:

12 V, 5.0 W × 1

Meter lighting:

12 V, 1.7 W × 1

Neutral indicator light:

12 V, 1.7 W × 1

Gear position indicator light:

12 V, 3.0 W × 4

High beam indicator light:

12 V, 1.7 W × 1

Turn signal indicator light:

12 V, 1.7 W × 1

## Fuse:

Fuse:

10.0 A

## Identification numbers

EAU26372

Record the frame serial number and engine serial number in the spaces provided below for assistance when ordering spare parts from a Yamaha dealer or for reference in case the vehicle is stolen.

FRAME SERIAL NUMBER:

ENGINE SERIAL NUMBER:

## Frame serial number

EAU26431

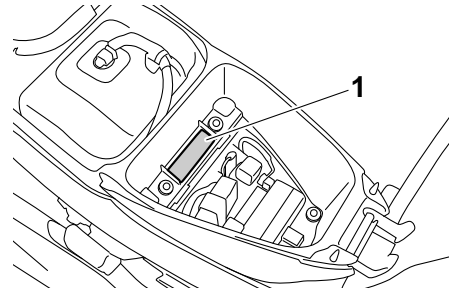

1. Frame serial number

The frame serial number is stamped into the frame.

**TIP** \_\_\_\_\_  
The frame serial number is used to identify your vehicle and may be used to register your vehicle with the licensing authority in your area.

## Engine serial number

EAU26440

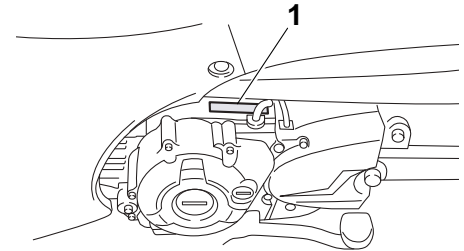

1. Engine serial number

The engine serial number is stamped into the crankcase.

# INDEX

---

## A

- Air filter element, cleaning..... 6-11
- Auxiliary light bulb, replacing ..... 6-32

## B

- Battery..... 6-26
- Brake fluid, changing ..... 6-20
- Brake fluid level, checking ..... 6-19
- Brake lever..... 3-4
- Brake lever, checking and lubricating ... 6-23
- Brake lever free play, checking..... 6-16
- Brake light switches ..... 6-18
- Brake pads and shoes, checking ..... 6-18
- Brake pedal..... 3-5
- Brake pedal,
  - checking and lubricating ..... 6-24
  - Brake pedal free play, adjusting..... 6-17

## C

- Cables, checking and lubricating ..... 6-23
- Carburetor, adjusting ..... 6-12
- Care ..... 7-1
- Carrier ..... 3-10
- Catalytic converters ..... 3-7
- Centerstand and sidestand  
(for sidestand-equipped models),
  - checking and lubricating..... 6-24
- Cowling and panel,
  - removing and installing..... 6-7

## D

- Dimmer switch ..... 3-4
- Drive chain, cleaning and lubricating .... 6-22
- Drive chain slack..... 6-20

## E

- Engine break-in..... 5-3
- Engine idling speed..... 6-12

- Engine oil..... 6-9
- Engine serial number..... 9-1
- Engine, starting a warm..... 5-2

## F

- Frame serial number ..... 9-1
- Front fork, checking..... 6-25
- Fuel..... 3-6
- Fuel consumption, tips for reducing..... 5-3
- Fuel gauge..... 3-3
- Fuel tank cap..... 3-5
- Fuse, replacing..... 6-28

## G

- Gear position indicator lights ..... 3-2

## H

- Handlebar switches ..... 3-3
- Headlight bulb, replacing..... 6-28
- Helmet holders ..... 3-8
- High beam indicator light..... 3-2
- Horn switch..... 3-4

## I

- Identification numbers ..... 9-1
- Indicator lights ..... 3-2

## K

- Kickstarter..... 3-8

## L

- License plate light bulb, replacing ..... 6-31

## M

- Main switch/steering lock..... 3-1
- Maintenance and lubrication, periodic.... 6-4
- Maintenance, emission control system... 6-3
- Matte color, caution ..... 7-1

## N

- Neutral indicator light..... 3-2

## P

- Parking ..... 5-4
- Part locations ..... 2-1

## S

- Safety information ..... 1-1
- Seat..... 3-8
- Shifting ..... 5-2
- Shift pedal ..... 3-4
- Shift pedal, checking..... 6-17
- Sidestand  
(for sidestand-equipped models) ..... 3-10
- Spark plug, checking..... 6-8
- Specifications ..... 8-1
- Speedometer unit..... 3-3
- Starter (choke) lever..... 3-7
- Starting and warming up a cold engine... 5-1
- Start switch..... 3-4
- Steering, checking..... 6-26
- Storage..... 7-3
- Storage compartment..... 3-9
- Swingarm pivots, lubricating ..... 6-25

## T

- Tail/brake light bulb, replacing ..... 6-29
- Throttle grip and cable,
  - checking and lubricating ..... 6-23
- Throttle grip free play, checking ..... 6-13
- Tires ..... 6-14
- Tool kit..... 6-2
- Troubleshooting ..... 6-37
- Troubleshooting chart ..... 6-38
- Turn signal indicator light ..... 3-2
- Turn signal light bulb (front),
  - replacing ..... 6-30

Turn signal light bulb (rear),  
  replacing..... 6-31  
Turn signal switch..... 3-4

## **V**

Valve clearance ..... 6-13

## **W**

Wheel bearings, checking ..... 6-26  
Wheel (front)..... 6-33  
Wheel (rear)..... 6-35  
Wheels..... 6-16









PRINTED IN CHINA  
2012.10-0.3x1 CR  
(E)