



⚠ Read this manual carefully before operating this vehicle.

OWNER'S MANUAL

SCR
950

XVS950XR-A

BL3-28199-E0

 **Read this manual carefully before operating this vehicle. This manual should stay with this vehicle if it is sold.**



YAMAHA MOTOR ELECTRONICS CO., LTD.

1450-6, Mori, Mori-machi, Shuchi-gun, Shizuoka-ken, 437-0292 Japan

DECLARATION of CONFORMITY

For



Product: IMMOBILIZER
Model: 1XC-00

Supplied by

YAMAHA MOTOR ELECTRONICS
CO.,LTD.
1450-6 Mori, Mori-machi Shuchi-gun
Shizuoka 437-0292 Japan

Technical Construction File held by

YAMAHA MOTOR ELECTRONICS
CO.,LTD.
1450-6 Mori, Mori-machi Shuchi-gun
Shizuoka 437-0292 Japan

Standard used for comply

R&TTE Directive
(Article 3.1(a) Safety)
EN 60950-1: 2006 + Amd.11:2009 + Amd.1:2010 +
Amd.12: 2011 + Amd.2:2013
EN 62479: 2010

R&TTE Directive
(Article 3.1(b) EMC)
97/24/EC from 17.06.1997

R&TTE Directive
(Article 3.2 Spectrum)
EN 300 330-1 V1.8.1
EN 300 330-2 V1.6.1

Means of Conformity

We declare under our sole responsibility that the Product (s) is conformity with the essential requirements and other relevant requirements of the
Radio and Telecommunication Terminal Equipment (R&TTE) Directive (1999/5/EC).

Date of issue: April 28, 2016

Signature of Responsible Person:

Hiroshi Kamiizaka
GENERAL MANAGER
QUALITY ASSURANCE DIV.

Welcome to the Yamaha world of motorcycling!

As the owner of the XVS950XR-A, you are benefiting from Yamaha's vast experience and newest technology regarding the design and manufacture of high-quality products, which have earned Yamaha a reputation for dependability.

Please take the time to read this manual thoroughly, so as to enjoy all advantages of your XVS950XR-A. The Owner's Manual does not only instruct you in how to operate, inspect and maintain your motorcycle, but also in how to safeguard yourself and others from trouble and injury.

In addition, the many tips given in this manual will help keep your motorcycle in the best possible condition. If you have any further questions, do not hesitate to contact your Yamaha dealer.

The Yamaha team wishes you many safe and pleasant rides. So, remember to put safety first!

Yamaha continually seeks advancements in product design and quality. Therefore, while this manual contains the most current product information available at the time of printing, there may be minor discrepancies between your motorcycle and this manual. If there is any question concerning this manual, please consult a Yamaha dealer.





Please read this manual carefully and completely before operating this motorcycle.

Important manual information

EAU10134

Particularly important information is distinguished in this manual by the following notations:

	This is the safety alert symbol. It is used to alert you to potential personal injury hazards. Obey all safety messages that follow this symbol to avoid possible injury or death.
 WARNING	A WARNING indicates a hazardous situation which, if not avoided, could result in death or serious injury.
NOTICE	A NOTICE indicates special precautions that must be taken to avoid damage to the vehicle or other property.
TIP	A TIP provides key information to make procedures easier or clearer.

*Product and specifications are subject to change without notice.

EAU10201

**XVS950XR-A
OWNER'S MANUAL**
©2016 by Yamaha Motor Co., Ltd.
1st edition, October 2016
All rights reserved.
Any reprinting or unauthorized use
without the written permission of
Yamaha Motor Co., Ltd.
is expressly prohibited.
Printed in Japan.

Table of contents

Safety information	1-1	For your safety – pre-operation checks	4-1	Checking the brake lever free play.....	6-19
Description	2-1	Operation and important riding points	5-1	Brake light switches	6-20
Left view	2-1	Starting the engine.....	5-1	Checking the front and rear brake pads	6-20
Right view.....	2-2	Shifting	5-2	Checking the brake fluid level	6-21
Controls and instruments	2-3	Tips for reducing fuel consumption	5-3	Changing the brake fluid	6-22
Instrument and control functions ...	3-1	Engine break-in	5-3	Drive belt slack	6-23
Immobilizer system.....	3-1	Parking	5-4	Checking and lubricating the cables.....	6-23
Main switch	3-2	Periodic maintenance and adjustment	6-1	Checking and lubricating the throttle grip and cable.....	6-24
Indicator lights and warning lights.....	3-3	Owner’s tool kit.....	6-2	Checking and lubricating the brake and shift pedals.....	6-24
Multi-function meter unit	3-5	Periodic maintenance chart for the emission control system	6-3	Checking and lubricating the brake and clutch levers.....	6-25
Handlebar switches.....	3-7	General maintenance and lubrication chart.....	6-5	Checking and lubricating the sidestand.....	6-25
Clutch lever	3-8	Removing and installing panels	6-9	Checking the front fork.....	6-26
Shift pedal	3-9	Checking the spark plugs	6-11	Checking the steering.....	6-26
Brake lever.....	3-9	Canister.....	6-12	Checking the wheel bearings	6-27
Brake pedal	3-9	Engine oil and oil filter cartridge....	6-12	Battery	6-27
ABS	3-10	Replacing the air filter element	6-15	Replacing the fuses	6-28
Fuel tank cap.....	3-11	Checking the throttle grip free play	6-16	Replacing the headlight bulb.....	6-30
Fuel.....	3-11	Valve clearance	6-16	Replacing the auxiliary light bulb	6-31
Fuel tank breather/overflow hose	3-13	Tires	6-16	Brake/tail light.....	6-32
Catalytic converter	3-13	Spoke wheels.....	6-18	Replacing a turn signal light bulb	6-32
Steering lock.....	3-14	Adjusting the clutch lever free play	6-19	Replacing the license plate light bulb	6-33
Adjusting the shock absorber assemblies	3-15				
Sidestand	3-16				
Ignition circuit cut-off system.....	3-16				

Table of contents

Supporting the motorcycle.....	6-33
Troubleshooting	6-34
Troubleshooting chart	6-35
Motorcycle care and storage	7-1
Matte color caution	7-1
Care.....	7-1
Storage.....	7-3
Specifications	8-1
Consumer information	9-1
Identification numbers.....	9-1
Diagnostic connector	9-2
Vehicle data recording	9-2
Index	10-1

Be a Responsible Owner

As the vehicle's owner, you are responsible for the safe and proper operation of your motorcycle.

Motorcycles are single-track vehicles. Their safe use and operation are dependent upon the use of proper riding techniques as well as the expertise of the operator. Every operator should know the following requirements before riding this motorcycle.

He or she should:

- Obtain thorough instructions from a competent source on all aspects of motorcycle operation.
- Observe the warnings and maintenance requirements in this Owner's Manual.
- Obtain qualified training in safe and proper riding techniques.
- Obtain professional technical service as indicated in this Owner's Manual and/or when made necessary by mechanical conditions.

- Never operate a motorcycle without proper training or instruction. Take a training course. Beginners should receive training from a certified instructor. Contact an authorized motorcycle dealer to find out about the training courses nearest you.

Safe Riding

Perform the pre-operation checks each time you use the vehicle to make sure it is in safe operating condition. Failure to inspect or maintain the vehicle properly increases the possibility of an accident or equipment damage. See page 4-1 for a list of pre-operation checks.

- This motorcycle is designed to carry the operator and a passenger.
- The failure of motorists to detect and recognize motorcycles in traffic is the predominating cause of automobile/motorcycle accidents. Many accidents have been caused by an automobile driver who did not see the motorcycle. Making yourself conspicuous ap-

pears to be very effective in reducing the chance of this type of accident.

Therefore:

- Wear a brightly colored jacket.
- Use extra caution when you are approaching and passing through intersections, since intersections are the most likely places for motorcycle accidents to occur.
- Ride where other motorists can see you. Avoid riding in another motorist's blind spot.
- Never maintain a motorcycle without proper knowledge. Contact an authorized motorcycle dealer to inform you on basic motorcycle maintenance. Certain maintenance can only be carried out by certified staff.

- Many accidents involve inexperienced operators. In fact, many operators who have been involved in accidents do not even have a current motorcycle license.
 - Make sure that you are qualified and that you only lend your motorcycle to other qualified operators.
 - Know your skills and limits. Staying within your limits may help you to avoid an accident.
 - We recommend that you practice riding your motorcycle where there is no traffic until you have become thoroughly familiar with the motorcycle and all of its controls.
- Many accidents have been caused by error of the motorcycle operator. A typical error made by the operator is veering wide on a turn due to excessive speed or undercornering (insufficient lean angle for the speed).
 - Always obey the speed limit and never travel faster than warranted by road and traffic conditions.
- Always signal before turning or changing lanes. Make sure that other motorists can see you.
- The posture of the operator and passenger is important for proper control.
 - The operator should keep both hands on the handlebar and both feet on the operator footrests during operation to maintain control of the motorcycle.
 - The passenger should always hold onto the operator, the seat strap or grab bar, if equipped, with both hands and keep both feet on the passenger footrests. Never carry a passenger unless he or she can firmly place both feet on the passenger footrests.
- Never ride under the influence of alcohol or other drugs.
- This motorcycle is designed for on-road use only. It is not suitable for off-road use.

Protective Apparel

The majority of fatalities from motorcycle accidents are the result of head injuries. The use of a safety helmet is the single most critical factor in the prevention or reduction of head injuries.

- Always wear an approved helmet.
- Wear a face shield or goggles. Wind in your unprotected eyes could contribute to an impairment of vision that could delay seeing a hazard.
- The use of a jacket, heavy boots, trousers, gloves, etc., is effective in preventing or reducing abrasions or lacerations.
- Never wear loose-fitting clothes, otherwise they could catch on the control levers, footrests, or wheels and cause injury or an accident.
- Always wear protective clothing that covers your legs, ankles, and feet. The engine or exhaust system become very hot during or after operation and can cause burns.
- A passenger should also observe the above precautions.

Safety information

1

Avoid Carbon Monoxide Poisoning

All engine exhaust contains carbon monoxide, a deadly gas. Breathing carbon monoxide can cause headaches, dizziness, drowsiness, nausea, confusion, and eventually death.

Carbon Monoxide is a colorless, odorless, tasteless gas which may be present even if you do not see or smell any engine exhaust. Deadly levels of carbon monoxide can collect rapidly and you can quickly be overcome and unable to save yourself. Also, deadly levels of carbon monoxide can linger for hours or days in enclosed or poorly ventilated areas. If you experience any symptoms of carbon monoxide poisoning, leave the area immediately, get fresh air, and SEEK MEDICAL TREATMENT.

- Do not run engine indoors. Even if you try to ventilate engine exhaust with fans or open windows and doors, carbon monoxide can rapidly reach dangerous levels.
- Do not run engine in poorly ventilated or partially enclosed areas such as barns, garages, or carports.

- Do not run engine outdoors where engine exhaust can be drawn into a building through openings such as windows and doors.

Loading

Adding accessories or cargo to your motorcycle can adversely affect stability and handling if the weight distribution of the motorcycle is changed. To avoid the possibility of an accident, use extreme caution when adding cargo or accessories to your motorcycle. Use extra care when riding a motorcycle that has added cargo or accessories. Here, along with the information about accessories below, are some general guidelines to follow if loading cargo to your motorcycle:

The total weight of the operator, passenger, accessories and cargo must not exceed the maximum load limit.

Operation of an overloaded vehicle could cause an accident.

Maximum load:
205 kg (452 lb)

When loading within this weight limit, keep the following in mind:

- Cargo and accessory weight should be kept as low and close to the motorcycle as possible. Securely pack your heaviest items as close to the center of the vehicle as possible and make sure to distribute the weight as evenly as possible on both sides of the motorcycle to minimize imbalance or instability.
- Shifting weights can create a sudden imbalance. Make sure that accessories and cargo are securely attached to the motorcycle before riding. Check accessory mounts and cargo restraints frequently.
- Properly adjust the suspension for your load (suspension-adjustable models only), and check the condition and pressure of your tires.
- Never attach any large or heavy items to the handlebar, front fork, or front fender. These items, including such cargo as sleeping bags, duffel bags, or

tents, can create unstable handling or a slow steering response.

- **This vehicle is not designed to pull a trailer or to be attached to a sidecar.**

Genuine Yamaha Accessories

Choosing accessories for your vehicle is an important decision. Genuine Yamaha accessories, which are available only from a Yamaha dealer, have been designed, tested, and approved by Yamaha for use on your vehicle.

Many companies with no connection to Yamaha manufacture parts and accessories or offer other modifications for Yamaha vehicles. Yamaha is not in a position to test the products that these aftermarket companies produce. Therefore, Yamaha can neither endorse nor recommend the use of accessories not sold by Yamaha or modifications not specifically recommended by Yamaha, even if sold and installed by a Yamaha dealer.

Aftermarket Parts, Accessories, and Modifications

While you may find aftermarket products similar in design and quality to genuine Yamaha accessories, recognize that some aftermarket accessories or modifications are not suitable because of potential safety hazards to you or others. Installing aftermarket products or having other modifications performed to your vehicle that change any of the vehicle's design or operation characteristics can put you and others at greater risk of serious injury or death. You are responsible for injuries related to changes in the vehicle.

Keep the following guidelines in mind, as well as those provided under "Loading" when mounting accessories.

- Never install accessories or carry cargo that would impair the performance of your motorcycle. Carefully inspect the accessory before using it to make sure that it does not in any way reduce ground clearance or cornering clearance, limit suspension travel,

steering travel or control operation, or obscure lights or reflectors.

- Accessories fitted to the handlebar or the front fork area can create instability due to improper weight distribution or aerodynamic changes. If accessories are added to the handlebar or front fork area, they must be as lightweight as possible and should be kept to a minimum.
- Bulky or large accessories may seriously affect the stability of the motorcycle due to aerodynamic effects. Wind may attempt to lift the motorcycle, or the motorcycle may become unstable in cross winds. These accessories may also cause instability when passing or being passed by large vehicles.
- Certain accessories can displace the operator from his or her normal riding position. This improper position limits the freedom of movement of the

Safety information

1

operator and may limit control ability, therefore, such accessories are not recommended.

- Use caution when adding electrical accessories. If electrical accessories exceed the capacity of the motorcycle's electrical system, an electric failure could result, which could cause a dangerous loss of lights or engine power.

Aftermarket Tires and Rims

The tires and rims that came with your motorcycle were designed to match the performance capabilities and to provide the best combination of handling, braking, and comfort. Other tires, rims, sizes, and combinations may not be appropriate. Refer to page 6-16 for tire specifications and more information on replacing your tires.

Transporting the Motorcycle

Be sure to observe following instructions before transporting the motorcycle in another vehicle.

- Remove all loose items from the motorcycle.

- Check that the fuel cock (if equipped) is in the "OFF" position and that there are no fuel leaks.
- Point the front wheel straight ahead on the trailer or in the truck bed, and choke it in a rail to prevent movement.
- Shift the transmission in gear (for models with a manual transmission).
- Secure the motorcycle with tie-downs or suitable straps that are attached to solid parts of the motorcycle, such as the frame or upper front fork triple clamp (and not, for example, to rubber-mounted handlebars or turn signals, or parts that could break). Choose the location for the straps carefully so the straps will not rub against painted surfaces during transport.
- The suspension should be compressed somewhat by the tie-downs, if possible, so that the motorcycle will not bounce excessively during transport.

Left view

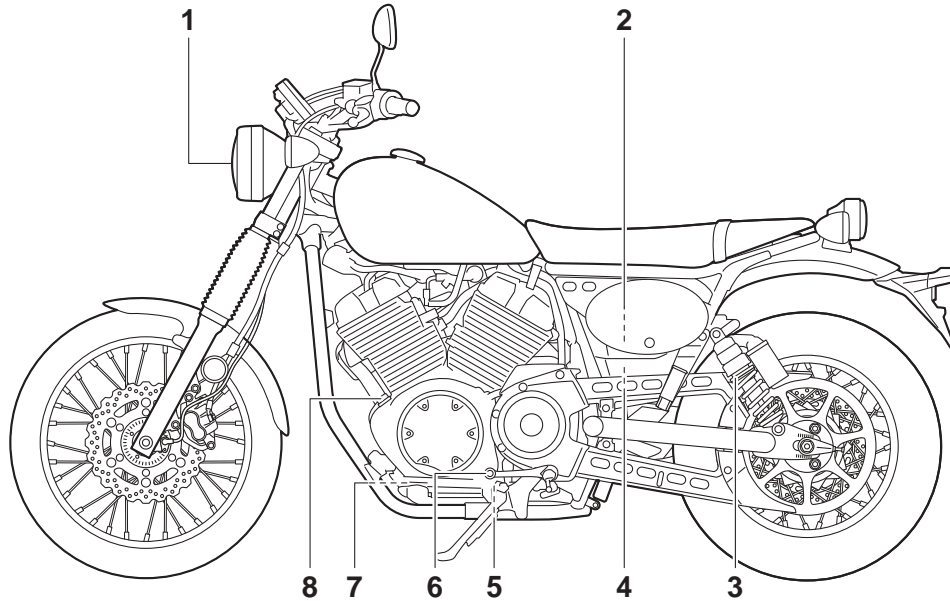

1. Headlight (page 6-30)
2. Owner's tool kit (page 6-2)
3. Shock absorber assembly spring preload adjusting ring (page 3-15)
4. Fuses (page 6-28)
5. Engine oil drain bolt (page 6-12)
6. Shift pedal (page 3-9)
7. Engine oil filter cartridge (page 6-12)
8. Engine oil filler cap (page 6-12)

Description

EAU10421

Right view

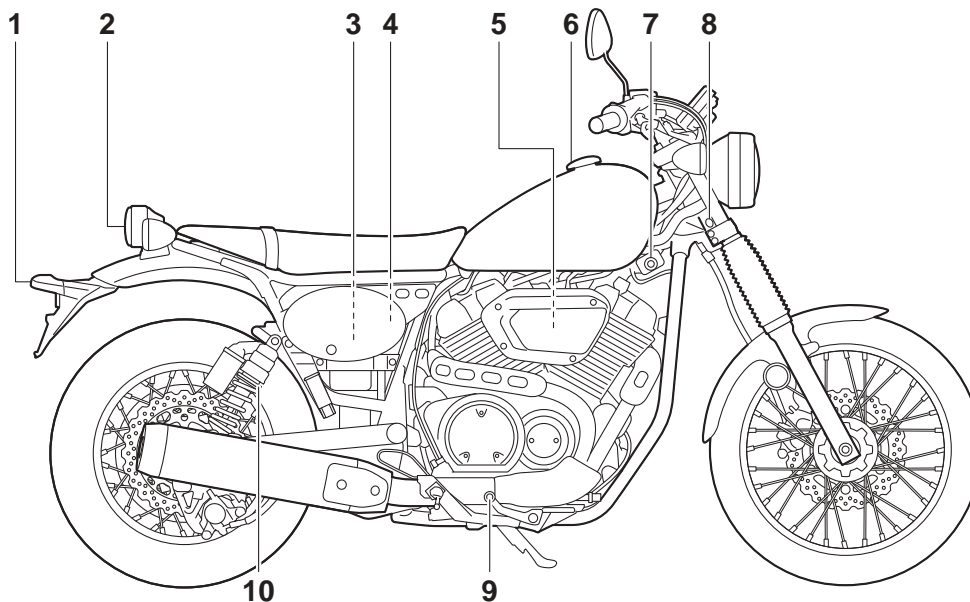

1. License plate light (page 6-33)

2. Brake/tail light (page 6-32)

3. Battery (page 6-27)

4. Rear brake fluid reservoir (page 6-21)

5. Air filter element (page 6-15)

6. Fuel tank cap (page 3-11)

7. Main switch (page 3-2)

8. Steering lock (page 3-14)

9. Brake pedal (page 3-9)

10. Shock absorber assembly spring preload adjusting ring (page 3-15)

Controls and instruments

2

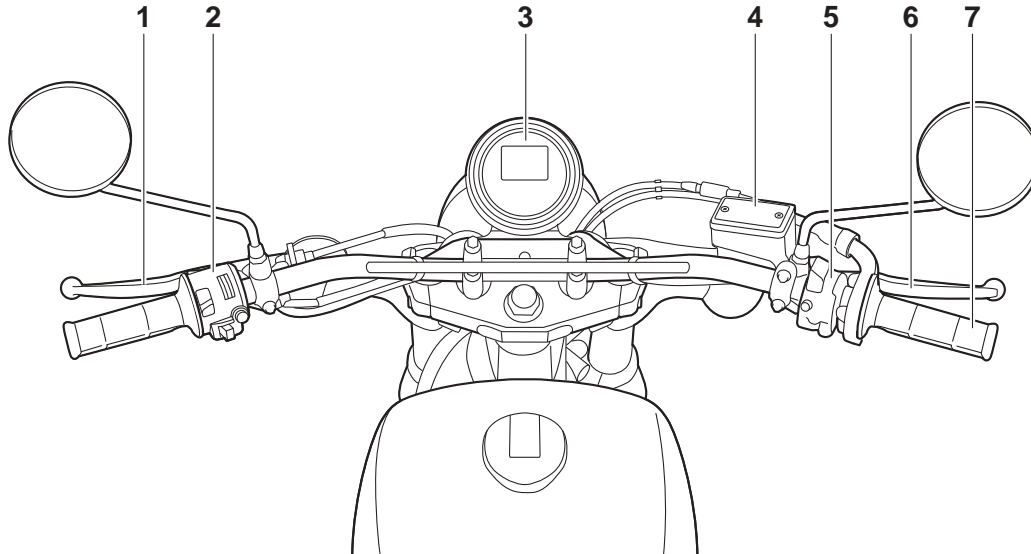

1. Clutch lever (page 3-8)
2. Left handlebar switches (page 3-7)
3. Multi-function meter unit (page 3-5)
4. Front brake fluid reservoir (page 6-21)
5. Right handlebar switches (page 3-7)
6. Brake lever (page 3-9)
7. Throttle grip (page 6-16)

Instrument and control functions

Immobilizer system

EAU10978

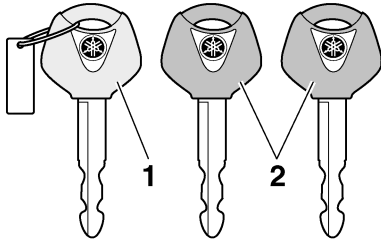

1. Code re-registering key (red bow)
2. Standard keys (black bow)

This vehicle is equipped with an immobilizer system to help prevent theft by re-registering codes in the standard keys. This system consists of the following:

- a code re-registering key (with a red bow)
- two standard keys (with a black bow) that can be re-registered with new codes
- a transponder (which is installed in the code re-registering key)
- an immobilizer unit
- an ECU

- an immobilizer system indicator light (See page 3-5.)

The key with the red bow is used to register codes in each standard key. Since re-registering is a difficult process, take the vehicle along with all three keys to a Yamaha dealer to have them re-registered. Do not use the key with the red bow for driving. It should only be used for re-registering the standard keys. Always use a standard key for driving.

ECA11822

NOTICE

- **DO NOT LOSE THE CODE RE-REGISTERING KEY! CONTACT YOUR DEALER IMMEDIATELY IF IT IS LOST!** If the code re-registering key is lost, registering new codes in the standard keys is impossible. The standard keys can still be used to start the vehicle, however if code re-registering is required (i.e., if a new standard key is made or all keys are lost) the entire immobilizer system must be replaced. Therefore, it is highly recom-

mended to use either standard key and keep the code re-registering key in a safe place.

- Do not submerge any key in water.
- Do not expose any key to excessively high temperatures.
- Do not place any key close to magnets (this includes, but not limited to, products such as speakers, etc.).
- Do not place items that transmit electrical signals close to any key.
- Do not place heavy items on any key.
- Do not grind any key or alter its shape.
- Do not disassemble the plastic part of any key.
- Do not put two keys of any immobilizer system on the same key ring.
- Keep the standard keys as well as keys of other immobilizer systems away from this vehicle's code re-registering key.

Instrument and control functions

- Keep other immobilizer system keys away from the main switch as they may cause signal interference.

Main switch

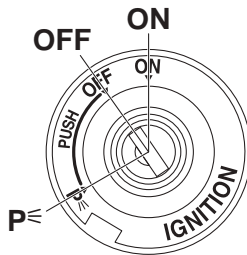

EAU57670

The main switch controls the ignition and lighting systems. The various main switch positions are described below.

ECA17961

NOTICE

Do not use metal key chains or keep more than one key on the same key ring. While the vehicle is in motion, a metal key chain, metallic key rings, or additional keys could contact surrounding components and scratch them. Therefore, it is recommended to use a cloth or leather key chain.

TIP

Be sure to use the standard key (black bow) for regular use of the vehicle. To minimize the risk of losing the code re-registering key (red bow), keep it in a safe place and only use it for code re-registering.

EAU38531

ON

All electrical circuits are supplied with power; the meter lighting, taillight, license plate light and auxiliary light come on, and the engine can be started. The key cannot be removed.

TIP

The headlight comes on automatically when the engine is started and stays on until the key is turned to "OFF", even if the engine stalls.

EAU45752

OFF

All electrical systems are off. The key can be removed.

Instrument and control functions

3

WARNING

EWA10073

Never turn the key to “OFF” while the vehicle is moving, otherwise the electrical systems will be switched off, which may result in loss of control or an accident.

P_⊆ (Parking)

EAU62271

The hazard lights and turn signal lights can be turned on, but all other electrical systems are off. The key can be removed.

The key must be pushed in from the “OFF” position to be turned to “P_⊆”.

ECA20760

NOTICE

Using the hazard or turn signal lights for an extended length of time may cause the battery to discharge.

Indicator lights and warning lights

EAU4939C

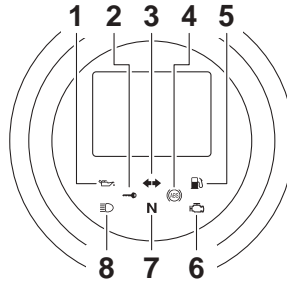

1. Oil level warning light “”
2. Immobilizer system indicator light “”
3. Turn signal indicator light “ ”
4. Anti-lock Brake System (ABS) warning light “”
5. Fuel level warning light “”
6. Engine trouble warning light “”
7. Neutral indicator light “**N**”
8. High beam indicator light “”

Turn signal indicator light “ ”

EAU11022

This indicator light flashes when a turn signal light is flashing.

Neutral indicator light “**N**”

EAU11061

This indicator light comes on when the transmission is in the neutral position.

High beam indicator light “”

EAU11081

This indicator light comes on when the high beam of the headlight is switched on.

Oil level warning light “”

EAU11256

This warning light comes on if the engine oil level is low.

The electrical circuit of the warning light can be checked by turning the key to “ON”. The warning light should come on for a few seconds and then go off.

If the warning light does not come on initially when the key is turned to “ON”, or if the warning light remains on after confirming that the oil level is correct (see page 6-12), have a Yamaha dealer check the vehicle.

TIP

- Even if the oil level is sufficient, the warning light may flicker when riding on a slope or during sudden acceleration or deceleration, but this is not a malfunction.
- This model is equipped with a self-diagnosis device for the oil level detection circuit. If a problem is detected in the oil level detection circuit, the oil level warning light will flash repeatedly. If this occurs, have a Yamaha dealer check the vehicle.

Fuel level warning light “”

EAU11368

This warning light comes on when the fuel level drops below approximately 2.8 L (0.74 US gal, 0.62 Imp.gal). When this occurs, refuel as soon as possible. The electrical circuit of the warning light can be checked by turning the key to “ON”. The warning light should come on for a few seconds and then go off.

If the warning light does not come on initially when the key is turned to “ON”, or if the warning light remains on after refueling, have a Yamaha dealer check the vehicle.

TIP

This model is equipped with a self-diagnosis device for the fuel level detection circuit. If a problem is detected in the fuel level detection circuit, the fuel level warning light will flash repeatedly. If this occurs, have a Yamaha dealer check the vehicle.

Engine trouble warning light “”

EAU73171

This warning light comes on if a problem is detected in the engine or other vehicle control system. If this occurs, have a Yamaha dealer check the on-board diagnostic system.

The electrical circuit of the warning light can be checked by turning the key to “ON”. The warning light should come on for a few seconds, and then go off.

If the warning light does not come on initially when the key is turned to “ON”, or if the warning light remains on, have a Yamaha dealer check the vehicle.

ABS warning light “”

EAU69891

In normal operation, this warning light comes on when the key is turned to “ON”, and goes off after traveling at a speed of 10 km/h (6 mi/h) or higher.

If the ABS warning light:

- does not come on when the key is turned to “ON”
- comes on or flashes while riding
- does not go off after traveling at a speed of 10 km/h (6 mi/h) or higher

The ABS may not work correctly. If any of the above occurs, have a Yamaha dealer check the system as soon as possible. (See page 3-10 for an explanation of the ABS.)

WARNING

EWA16041

If the ABS warning light does not go off after traveling at a speed of 10 km/h (6 mi/h) or higher, or if the warning light comes on or flashes

Instrument and control functions

3

while riding, the brake system reverts to conventional braking. If either of the above occurs, or if the warning light does not come on at all, use extra caution to avoid possible wheel lock during emergency braking. Have a Yamaha dealer check the brake system and electrical circuits as soon as possible.

Immobilizer system indicator light “ When the key is turned to “OFF” and 30 seconds have passed, the indicator light will flash steadily to indicate the immobilizer system is enabled. After 24 hours have passed, the indicator light will stop flashing, however the immobilizer system is still enabled.

The electrical circuit of the indicator light can be checked by turning the key to “ON”. The indicator light should come on for a few seconds, and then go off.

If the indicator light does not come on initially when the key is turned to “ON”, if the indicator light remains on, or if the indicator light flashes in a pattern (if a

problem is detected in the immobilizer system, the immobilizer system indicator light will flash in a pattern), have a Yamaha dealer check the vehicle.

TIP

If the immobilizer system indicator light flashes in the pattern, slowly 5 times then quickly 2 times, this could be caused by transponder interference. If this occurs, try the following.

1. Make sure there are no other immobilizer keys close to the main switch. Other immobilizer system keys may cause signal interference and prevent the engine from starting.
2. Use the code re-registering key to start the engine.
3. If the engine starts, turn it off, and try starting the engine with the standard keys.
4. If one or both of the standard keys do not start the engine, take the vehicle and all 3 keys to a Yamaha dealer to have the standard keys re-registered.

EAU73120

Multi-function meter unit

EAU78680

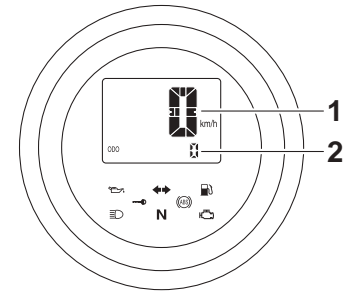

1. Speedometer
2. Odometer/tripmeter/fuel reserve tripmeter/clock

WARNING

EWA12423

Be sure to stop the vehicle before making any setting changes to the multi-function meter unit. Changing settings while riding can distract the operator and increase the risk of an accident.

The multi-function meter unit is equipped with the following:

- a speedometer
- an odometer
- two tripmeters
- a fuel reserve tripmeter

Instrument and control functions

- a clock

TIP

- Be sure to turn the key to “ON” before using the “SELECT” switch.
- For the UK: To switch the speedometer and odometer/tripmeter displays between kilometers and miles, select the odometer mode, and then push the “SELECT” switch for 5 seconds.

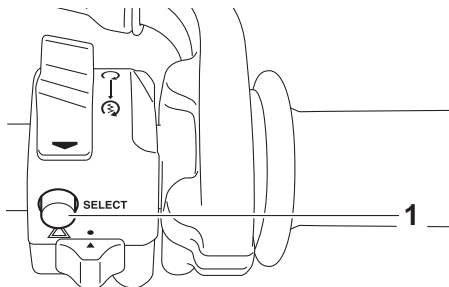

1. “SELECT” switch

Speedometer

The speedometer shows the vehicle’s traveling speed.

Odometer, tripmeters, fuel reserve tripmeter and clock

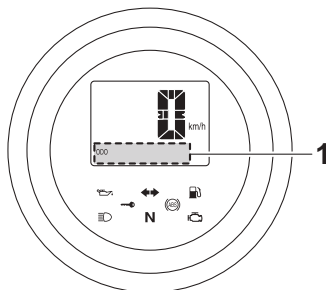

1. Odometer/tripmeter/fuel reserve tripmeter/clock

The odometer shows the total distance traveled.

The tripmeters show the distance traveled since they last reset.

The fuel reserve tripmeter shows the distance traveled since the fuel level warning light came on.

The clock displays time in 12-hour format.

TIP

- The odometer will lock at 999999.
- The tripmeters will reset and continue counting after 999.9 is reached.

In normal operation, use the “SELECT” switch to change the display between the odometer “ODO”, tripmeters “TRIP 1” and “TRIP 2”, and the clock in the following order:

ODO → TRIP 1 → TRIP 2 → clock → ODO

If the fuel level warning light comes on (see page 3-3), the display automatically changes to the fuel reserve tripmeter “TRIP F” and starts counting the distance traveled from that point. In this case, use the “SELECT” switch to change the display between the various tripmeters and the odometer in the following order:

TRIP F → TRIP 1 → TRIP 2 → clock → ODO → TRIP F

To reset a tripmeter, select it by using the “SELECT” switch, and then push the “SELECT” switch for one second. If you do not reset the fuel reserve tripmeter manually, after refueling and traveling 5 km (3 mi) it will reset automatically and disappear from the display.

Instrument and control functions

To set the clock

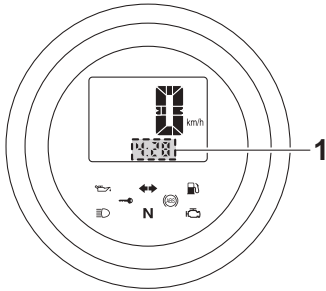

1. Clock

1. Use the “SELECT” switch to change the display to the clock mode.
2. Push the “SELECT” switch for 5 seconds. The hour digits will start flashing.
3. Use the “SELECT” switch to set the hours.
4. Push the “SELECT” switch for one second and the minute digits will start flashing.
5. Use the “SELECT” switch to set the minutes.
6. Push the “SELECT” switch for one second to start the clock.

Handlebar switches

EAU1234M

Left

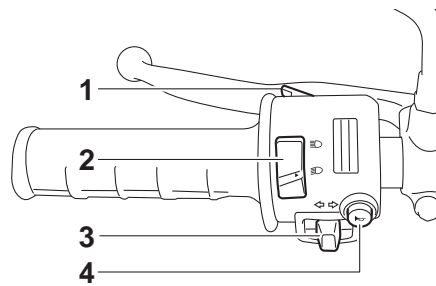

1. Pass switch “
2. Dimmer switch “
3. Turn signal switch “
4. Horn switch “

Right

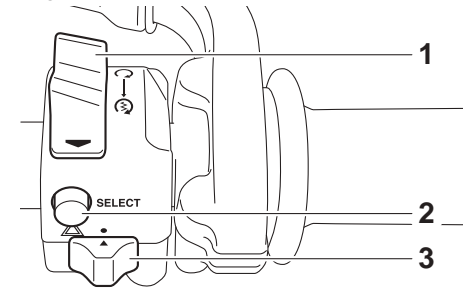

1. Start/Engine stop switch “
2. “SELECT” switch
3. Hazard switch “

Pass switch “

EAU12352

Press this switch to flash the headlight.

TIP

When the dimmer switch is set to “

Dimmer switch “

EAU12401

Set this switch to “

Turn signal switch “↵/↶”

EAU12461

To signal a right-hand turn, push this switch to “↶”. To signal a left-hand turn, push this switch to “↵”. When released, the switch returns to the center position. To cancel the turn signal lights, push the switch in after it has returned to the center position.

Horn switch “📢”

EAU12501

Press this switch to sound the horn.

Start/Engine stop switch “🔌/🔌/🔌”

EAU68270

To crank the engine with the starter, set this switch to “🔌”, and then slide the switch toward “🔌”. See page 5-1 for starting instructions prior to starting the engine.

Set this switch to “🔌” to stop the engine in case of an emergency, such as when the vehicle overturns or when the throttle cable is stuck.

Hazard switch “⚠️”

EAU12735

With the key in the “ON” or “P” position, use this switch to turn on the hazard lights (simultaneous flashing of all turn signal lights).

The hazard lights are used in case of an emergency or to warn other drivers when your vehicle is stopped where it might be a traffic hazard.

NOTICE

Do not use the hazard lights for an extended length of time with the engine not running, otherwise the battery may discharge.

ECA10062

“SELECT” switch

EAU55701

This switch is used to perform selections in the odometer and tripmeters and to set the clock of the multi-function meter unit.

See “Multi-function meter unit” on page 3-5 for detailed information.

Clutch lever

EAU12822

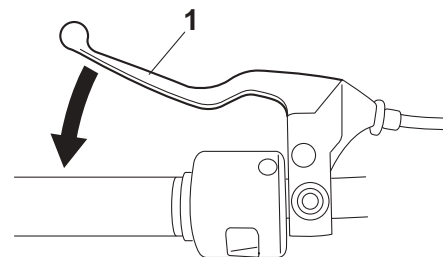

1. Clutch lever

The clutch lever is located on the left side of the handlebar. To disengage the clutch, pull the lever toward the handlebar grip. To engage the clutch, release the lever. The lever should be pulled rapidly and released slowly for smooth clutch operation.

The clutch lever is equipped with a clutch switch, which is part of the ignition circuit cut-off system. (See page 3-16.)

Instrument and control functions

Shift pedal

EAU12872

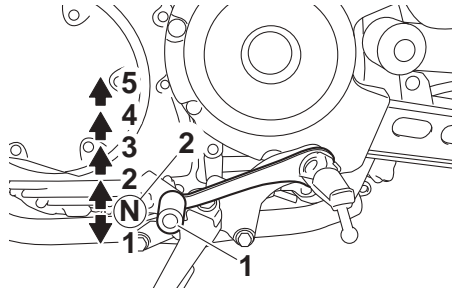

1. Shift pedal
2. Neutral position

The shift pedal is located on the left side of the motorcycle and is used in combination with the clutch lever when shifting the gears of the 5-speed constant-mesh transmission equipped on this motorcycle.

Brake lever

EAU12892

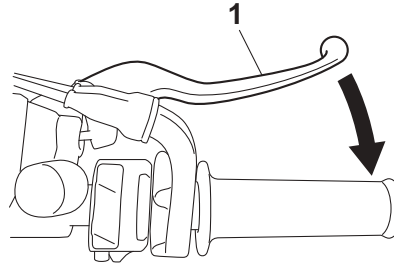

1. Brake lever

The brake lever is located on the right side of the handlebar. To apply the front brake, pull the lever toward the throttle grip.

Brake pedal

EAU12944

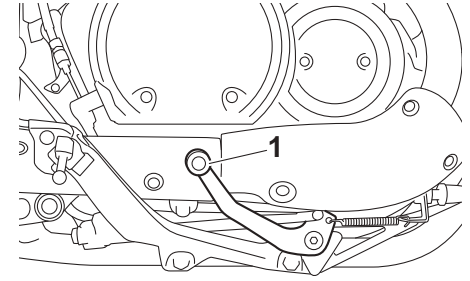

1. Brake pedal

The brake pedal is located on the right side of the motorcycle. To apply the rear brake, press down on the brake pedal.

ABS

EAU63040

The Yamaha ABS (Anti-lock Brake System) features a dual electronic control system, which acts on the front and rear brakes independently.

Operate the brakes with ABS as you would conventional brakes. If the ABS is activated, a pulsating sensation may be felt at the brake lever or brake pedal. In this situation, continue to apply the brakes and let the ABS work; do not “pump” the brakes as this will reduce braking effectiveness.

EWA16051

WARNING

Always keep a sufficient distance from the vehicle ahead to match the riding speed even with ABS.

- **The ABS performs best with long braking distances.**
- **On certain surfaces, such as rough or gravel roads, the braking distance may be longer with the ABS than without.**

The ABS is monitored by an ECU, which will revert the system to conventional braking if a malfunction occurs.

TIP

- The ABS performs a self-diagnosis test each time the vehicle first starts off after the key is turned to “ON” and the vehicle has traveled at a speed of 10 km/h (6 mi/h) or higher. During this test, a “clicking” noise can be heard from the hydraulic control unit, and if the brake lever or brake pedal is even slightly applied, a vibration can be felt at the lever and pedal, but these do not indicate a malfunction.
- This ABS has a test mode which allows the owner to experience the pulsation at the brake lever or brake pedal when the ABS is operating. However, special tools are required, so please consult your Yamaha dealer.

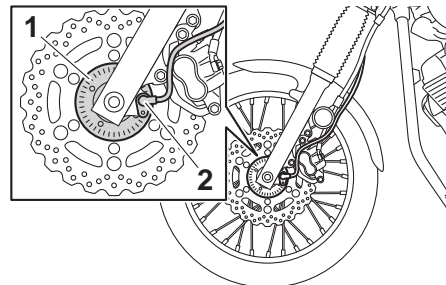

1. Front wheel sensor rotor
2. Front wheel sensor

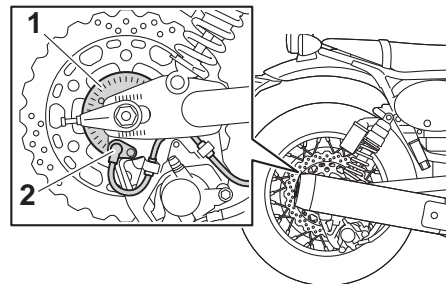

1. Rear wheel sensor rotor
2. Rear wheel sensor

NOTICE

ECA20100

Be careful not to damage the wheel sensor or wheel sensor rotor; otherwise, improper performance of the ABS will result.

Instrument and control functions

Fuel tank cap

EAUM1794

EAU13222

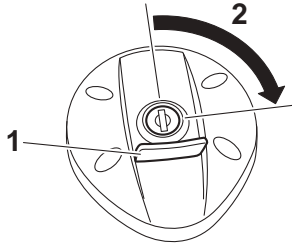

1. Fuel tank cap lock cover
2. Unlock.

To remove the fuel tank cap

1. Open the fuel tank cap lock cover.
2. Insert the key into the lock and turn it 1/4 turn clockwise. The lock will be released and the fuel tank cap can be removed.

To install the fuel tank cap

1. Push and install the fuel tank cap into position with the key inserted in the lock.
2. Turn the key counterclockwise to the original position, and then remove it.

TIP _____

The fuel tank cap cannot be installed unless the key is in the lock. In addition, the key cannot be removed if the cap is not properly installed and locked.

3. Close the lock cover.

EWA11142

WARNING _____

Make sure that the fuel tank cap is properly installed before riding. Leaking fuel is a fire hazard.

Fuel

Make sure there is sufficient gasoline in the tank.

EWA10882

WARNING _____

Gasoline and gasoline vapors are extremely flammable. To avoid fires and explosions and to reduce the risk of injury when refueling, follow these instructions.

1. Before refueling, turn off the engine and be sure that no one is sitting on the vehicle. Never refuel while smoking, or while in the vicinity of sparks, open flames, or other sources of ignition such as the pilot lights of water heaters and clothes dryers.
2. Do not overfill the fuel tank. When refueling, be sure to insert the pump nozzle into the fuel tank filler hole. Stop filling when the fuel reaches the bottom of the filler tube. Because fuel expands when it heats up, heat from the engine or the sun can cause fuel to spill out of the fuel tank.

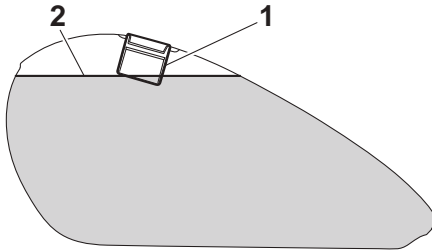

1. Fuel tank filler tube
2. Maximum fuel level

3. Wipe up any spilled fuel immediately. **NOTICE: Immediately wipe off spilled fuel with a clean, dry, soft cloth, since fuel may deteriorate painted surfaces or plastic parts.** [ECA10072]
4. Be sure to securely close the fuel tank cap.

EWA15152

WARNING

Gasoline is poisonous and can cause injury or death. Handle gasoline with care. Never siphon gasoline by mouth. If you should swallow some gasoline or inhale a lot of gasoline vapor, or get some gasoline in your eyes, see your doctor immediately. If

gasoline spills on your skin, wash with soap and water. If gasoline spills on your clothing, change your clothes.

EAU57692

Recommended fuel:

Regular unleaded gasoline (Gasohol [E10] acceptable)

Fuel tank capacity:

13 L (3.4 US gal, 2.9 Imp.gal)

Fuel reserve amount (when the fuel level warning light comes on):

2.8 L (0.74 US gal, 0.62 Imp.gal)

ECA11401

NOTICE

Use only unleaded gasoline. The use of leaded gasoline will cause severe damage to internal engine parts, such as the valves and piston rings, as well as to the exhaust system.



TIP

- This mark identifies the recommended fuel for this vehicle as specified by European regulation (EN228).
- Check that gasoline nozzle has the same identifier when fueling.

Your Yamaha engine has been designed to use regular unleaded gasoline with a research octane number of 95 or higher. If knocking (or pinging) occurs, use a gasoline of a different brand or premium unleaded fuel. Use of unleaded fuel will extend spark plug life and reduce maintenance costs.

Instrument and control functions

3

Gasohol

There are two types of gasohol: gasohol containing ethanol and that containing methanol. Gasohol containing ethanol can be used if the ethanol content does not exceed 10% (E10). Gasohol containing methanol is not recommended by Yamaha because it can cause damage to the fuel system or vehicle performance problems.

Fuel tank breather/overflow hose

EAU77630

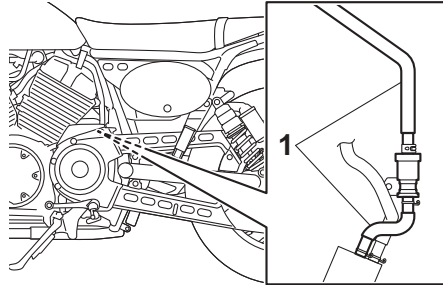

1. Fuel tank breather/overflow hose

Before operating the motorcycle:

- Check the fuel tank breather/overflow hose connections.
- Check the hose for cracks or damage, and replace it if necessary.
- Make sure that the canister breather is not blocked, and clean it if necessary.

TIP

See page 6-12 for canister information.

EAU13434

Catalytic converter

This model is equipped with a catalytic converter in the exhaust system.

EWA10863

⚠ WARNING

The exhaust system is hot after operation. To prevent a fire hazard or burns:

- Do not park the vehicle near possible fire hazards such as grass or other materials that easily burn.
- Park the vehicle in a place where pedestrians or children are not likely to touch the hot exhaust system.
- Make sure that the exhaust system has cooled down before doing any maintenance work.
- Do not allow the engine to idle more than a few minutes. Long idling can cause a build-up of heat.

NOTICE

Use only unleaded gasoline. The use of leaded gasoline will cause unreparable damage to the catalytic converter.

ECA10702

Steering lock

The steering lock is located on the right side of the vehicle between the upper and lower steering brackets.

To lock the steering

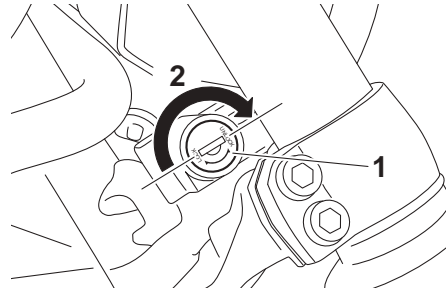

1. Steering lock
2. Lock.

1. Turn the handlebar all the way to the left.
2. Insert the key into the steering lock and turn it 1/2 turn clockwise.
3. Remove the key from the lock.

TIP

If the steering lock is difficult to engage, try turning the handlebars back to the right slightly.

EAU55663

To unlock the steering

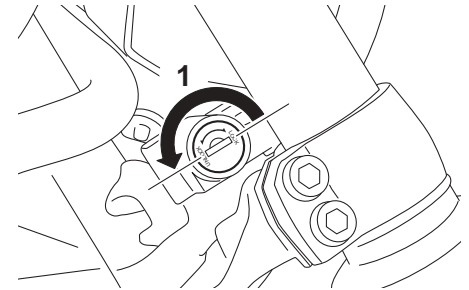

1. Unlock.

1. Insert the key into the steering lock.
2. Turn the key 1/2 turn counter-clockwise.
3. Remove the key.

Instrument and control functions

Adjusting the shock absorber assemblies

EAU66951

EWA10211

WARNING

Always adjust both shock absorber assemblies equally, otherwise poor handling and loss of stability may result.

Each shock absorber assembly is equipped with a spring preload adjusting ring.

It is recommended to have a Yamaha dealer adjust the spring preload. However, if you choose to make this adjustment yourself, obtain the special wrench necessary at a Yamaha dealer.

ECA10102

NOTICE

To avoid damaging the mechanism, do not attempt to turn beyond the maximum or minimum settings.

Adjust the spring preload as follows. To increase the spring preload and thereby harden the suspension, turn the adjusting ring on each shock absorber assembly in direction (a). To decrease the spring preload and thereby

soften the suspension, turn the adjusting ring on each shock absorber assembly in direction (b).

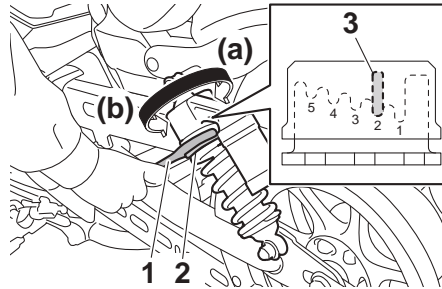

1. Special wrench
2. Spring preload adjusting ring
3. Stopper

Spring preload setting:

Minimum (soft):

1

Standard:

2

Maximum (hard):

5

EWA10232

WARNING

These shock absorber assemblies contain highly pressurized nitrogen gas. Read and understand the following information before handling the shock absorber assemblies.

- Do not tamper with or attempt to open the cylinder assemblies.
- Do not subject the shock absorber assemblies to an open flame or other high heat source. This may cause the unit to explode due to excessive gas pressure.
- Do not deform or damage the cylinders in any way. Cylinder damage will result in poor damping performance.
- Do not dispose of a damaged or worn-out shock absorber assembly yourself. Take the shock absorber assembly to a Yamaha dealer for any service.

Sidestand

EAU15306

The sidestand is located on the left side of the frame. Raise the sidestand or lower it with your foot while holding the vehicle upright.

TIP

The built-in sidestand switch is part of the ignition circuit cut-off system, which cuts the ignition in certain situations. (See the following section for an explanation of the ignition circuit cut-off system.)

EWA10242

WARNING

The vehicle must not be ridden with the sidestand down, or if the sidestand cannot be properly moved up (or does not stay up), otherwise the sidestand could contact the ground and distract the operator, resulting in a possible loss of control. Yamaha's ignition circuit cut-off system has been designed to assist the operator in fulfilling the responsibility of raising the sidestand before starting off. Therefore, check

this system regularly and have a Yamaha dealer repair it if it does not function properly.

Ignition circuit cut-off system

EAU68280

The ignition circuit cut-off system (comprising the sidestand switch, clutch switch and neutral switch) has the following functions.

- It prevents starting when the transmission is in gear and the sidestand is up, but the clutch lever is not pulled.
- It prevents starting when the transmission is in gear and the clutch lever is pulled, but the sidestand is still down.
- It cuts the running engine when the transmission is in gear and the sidestand is moved down.

Periodically check the operation of the ignition circuit cut-off system according to the following procedure.

Instrument and control functions

3

With the engine turned off:
1. Move the sidestand down.
2. Make sure that the start/engine stop switch is set to “O”.
3. Turn the key on.
4. Shift the transmission into the neutral position.
5. Slide the switch toward “(N)”.
Does the engine start?

YES NO

With the engine still running:
6. Move the sidestand up.
7. Keep the clutch lever pulled.
8. Shift the transmission into gear.
9. Move the sidestand down.
Does the engine stall?

YES NO

After the engine has stalled:
10. Move the sidestand up.
11. Keep the clutch lever pulled.
12. Slide the switch toward “(N)”.
Does the engine start?

YES NO

The system is OK. **The motorcycle can be ridden.**



WARNING
If a malfunction is noted, have a Yamaha dealer check the system before riding.

The neutral switch may not be working correctly.
The motorcycle should not be ridden until checked by a Yamaha dealer.

The sidestand switch may not be working correctly.
The motorcycle should not be ridden until checked by a Yamaha dealer.

The clutch switch may not be working correctly.
The motorcycle should not be ridden until checked by a Yamaha dealer.

For your safety – pre-operation checks

EAU15599

Inspect your vehicle each time you use it to make sure the vehicle is in safe operating condition. Always follow the inspection and maintenance procedures and schedules described in the Owner's Manual.

EWA11152

WARNING

Failure to inspect or maintain the vehicle properly increases the possibility of an accident or equipment damage. Do not operate the vehicle if you find any problem. If a problem cannot be corrected by the procedures provided in this manual, have the vehicle inspected by a Yamaha dealer.

4

Before using this vehicle, check the following points:

ITEM	CHECKS	PAGE
Fuel	<ul style="list-style-type: none">• Check fuel level in fuel tank.• Refuel if necessary.• Check fuel line for leakage.• Check fuel tank breather/overflow hose for obstructions, cracks or damage, and check hose connection.	3-11, 3-13
Engine oil	<ul style="list-style-type: none">• Check oil level in engine.• If necessary, add recommended oil to specified level.• Check vehicle for oil leakage.	6-12
Front brake	<ul style="list-style-type: none">• Check operation.• If soft or spongy, have Yamaha dealer bleed hydraulic system.• Check brake pads for wear.• Replace if necessary.• Check fluid level in reservoir.• If necessary, add specified brake fluid to specified level.• Check hydraulic system for leakage.	6-20, 6-21

For your safety – pre-operation checks

ITEM	CHECKS	PAGE
Rear brake	<ul style="list-style-type: none"> • Check operation. • If soft or spongy, have Yamaha dealer bleed hydraulic system. • Check brake pads for wear. • Replace if necessary. • Check fluid level in reservoir. • If necessary, add specified brake fluid to specified level. • Check hydraulic system for leakage. 	6-20, 6-21
Clutch	<ul style="list-style-type: none"> • Check operation. • Lubricate cable if necessary. • Check lever free play. • Adjust if necessary. 	6-19
Throttle grip	<ul style="list-style-type: none"> • Make sure that operation is smooth. • Check throttle grip free play. • If necessary, have Yamaha dealer adjust throttle grip free play and lubricate cable and grip housing. 	6-16, 6-24
Control cables	<ul style="list-style-type: none"> • Make sure that operation is smooth. • Lubricate if necessary. 	6-23
Wheels and tires	<ul style="list-style-type: none"> • Check for damage. • Check tire condition and tread depth. • Check air pressure. • Correct if necessary. 	6-16, 6-18
Brake and shift pedals	<ul style="list-style-type: none"> • Make sure that operation is smooth. • Lubricate pedal pivoting points if necessary. 	6-24
Brake and clutch levers	<ul style="list-style-type: none"> • Make sure that operation is smooth. • Lubricate lever pivoting points if necessary. 	6-25
Sidestand	<ul style="list-style-type: none"> • Make sure that operation is smooth. • Lubricate pivot if necessary. 	6-25
Chassis fasteners	<ul style="list-style-type: none"> • Make sure that all nuts, bolts and screws are properly tightened. • Tighten if necessary. 	—
Instruments, lights, signals and switches	<ul style="list-style-type: none"> • Check operation. • Correct if necessary. 	—

For your safety – pre-operation checks

ITEM	CHECKS	PAGE
Sidestand switch	<ul style="list-style-type: none">• Check operation of ignition circuit cut-off system.• If system is not working correctly, have Yamaha dealer check vehicle.	3-16

Operation and important riding points

EAU15952

EAU73450

EAU69830

Read the Owner's Manual carefully to become familiar with all controls. If there is a control or function you do not understand, ask your Yamaha dealer.

EWA10272

WARNING

Failure to familiarize yourself with the controls can lead to loss of control, which could cause an accident or injury.

5

TIP

This model is equipped with:

- a lean angle sensor to stop the engine in case of turnover. In this case, turn the key "OFF" and then to "ON" before attempting to restart the engine. Failing to do so will prevent the engine from starting even though the engine will crank when the start switch is pushed.
- an engine auto-stop system. The engine stops automatically if left idling for 20 minutes. In this case, simply push the start switch to restart the engine.

Starting the engine

In order for the ignition circuit cut-off system to enable starting, one of the following conditions must be met:

- The transmission is in the neutral position.
- The transmission is in gear with the clutch lever pulled and the sidestand up.

See page 3-16 for more information.

1. Turn the key to "ON" and make sure that the start/engine stop switch is set to "○".

The following warning lights and indicator light should come on for a few seconds, then go off.

- Oil level warning light
- Fuel level warning light
- Engine trouble warning light
- Immobilizer system indicator light

ECA11834

NOTICE

If a warning or indicator light does not come on initially when the key is turned to "ON", or if a warning or indicator light remains on, see page

3-3 for the corresponding warning and indicator light circuit check.

The ABS warning light should come on when the key is turned to “ON” and then go off after traveling at a speed of 10 km/h (6 mi/h) or higher.

ECA17682

NOTICE

If the ABS warning light does not come on and then go off as explained above, see page 3-3 for the warning light circuit check.

2. Shift the transmission into the neutral position. The neutral indicator light should come on. If not, ask a Yamaha dealer to check the electrical circuit.
3. Start the engine by sliding the switch toward “”.

If the engine fails to start, release the start/engine stop switch, wait a few seconds, and then try again. Each starting attempt should be as short as possible to preserve the battery. Do not crank the engine more than 10 seconds on any one attempt.

ECA11043

NOTICE

For maximum engine life, never accelerate hard when the engine is cold!

EAU16673

Shifting

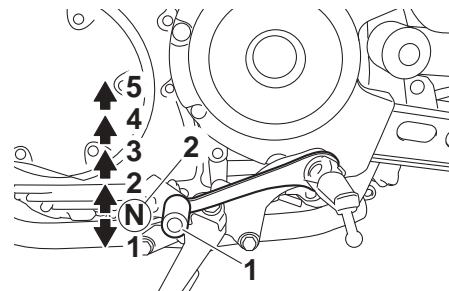

1. Shift pedal
2. Neutral position

Shifting gears lets you control the amount of engine power available for starting off, accelerating, climbing hills, etc.

The gear positions are shown in the illustration.

TIP

To shift the transmission into the neutral position, press the shift pedal down repeatedly until it reaches the end of its travel, and then slightly raise it.

Operation and important riding points

NOTICE

ECA10261

- Even with the transmission in the neutral position, do not coast for long periods of time with the engine off, and do not tow the motorcycle for long distances. The transmission is properly lubricated only when the engine is running. Inadequate lubrication may damage the transmission.
 - Always use the clutch while changing gears to avoid damaging the engine, transmission, and drive train, which are not designed to withstand the shock of forced shifting.
-

Tips for reducing fuel consumption

EAU16811

Fuel consumption depends largely on your riding style. Consider the following tips to reduce fuel consumption:

- Shift up swiftly, and avoid high engine speeds during acceleration.
- Do not rev the engine while shifting down, and avoid high engine speeds with no load on the engine.
- Turn the engine off instead of letting it idle for an extended length of time (e.g., in traffic jams, at traffic lights or at railroad crossings).

Engine break-in

EAU16842

There is never a more important period in the life of your engine than the period between 0 and 1600 km (1000 mi). For this reason, you should read the following material carefully.

Since the engine is brand new, do not put an excessive load on it for the first 1600 km (1000 mi). The various parts in the engine wear and polish themselves to the correct operating clearances. During this period, prolonged full-throttle operation or any condition that might result in engine overheating must be avoided.

EAU17024

0–1000 km (0–600 mi)

Avoid prolonged operation above 1/3 throttle. **NOTICE: After 1000 km (600 mi) of operation, the engine oil must be changed, and the oil filter cartridge or element replaced.** [ECA11283]

1000–1600 km (600–1000 mi)

Avoid prolonged operation above 1/2 throttle.

1600 km (1000 mi) and beyond

The vehicle can now be operated normally.

ECA10271

NOTICE

If any engine trouble should occur during the engine break-in period, immediately have a Yamaha dealer check the vehicle.

EAU17214

Parking

When parking, stop the engine, and then remove the key from the main switch.

EWA10312

⚠ WARNING

- Since the engine and exhaust system can become very hot, park in a place where pedestrians or children are not likely to touch them and be burned.
 - Do not park on a slope or on soft ground, otherwise the vehicle may overturn, increasing the risk of a fuel leak and fire.
 - Do not park near grass or other flammable materials which might catch fire.
-

Periodic maintenance and adjustment

EAU17246

EWA15123

EAU17303

Periodic inspection, adjustment, and lubrication will keep your vehicle in the safest and most efficient condition possible. Safety is an obligation of the vehicle owner/operator. The most important points of vehicle inspection, adjustment, and lubrication are explained on the following pages.

The intervals given in the periodic maintenance charts should be simply considered as a general guide under normal riding conditions. However, depending on the weather, terrain, geographical location, and individual use, the maintenance intervals may need to be shortened.

WARNING

EWA10322

Failure to properly maintain the vehicle or performing maintenance activities incorrectly may increase your risk of injury or death during service or while using the vehicle. If you are not familiar with vehicle service, have a Yamaha dealer perform service.

WARNING

Turn off the engine when performing maintenance unless otherwise specified.

- **A running engine has moving parts that can catch on body parts or clothing and electrical parts that can cause shocks or fires.**
- **Running the engine while servicing can lead to eye injury, burns, fire, or carbon monoxide poisoning – possibly leading to death. See page 1-3 for more information about carbon monoxide.**

Emission controls not only function to ensure cleaner air, but are also vital to proper engine operation and maximum performance. In the following periodic maintenance charts, the services related to emissions control are grouped separately. These services require specialized data, knowledge, and equipment. Maintenance, replacement, or repair of the emission control devices and systems may be performed by any repair establishment or individual that is certified (if applicable). Yamaha dealers are trained and equipped to perform these particular services.

WARNING

EWA15461

Brake discs, calipers, drums, and linings can become very hot during use. To avoid possible burns, let brake components cool before touching them.

Owner's tool kit

EAU55631

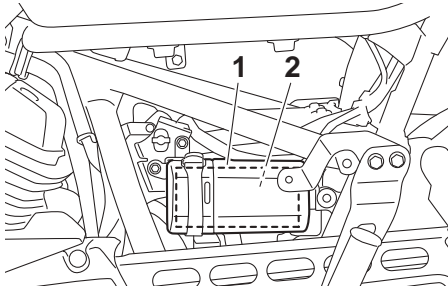

1. Owner's tool box
2. Owner's tool kit

The owner's tool kit is located inside the owner's tool box behind panel C. (See page 6-9.)

The service information included in this manual and the tools provided in the owner's tool kit are intended to assist you in the performance of preventive maintenance and minor repairs. However, additional tools such as a torque wrench may be necessary to perform certain maintenance work correctly.

TIP

- If you do not have the tools or experience required for a particular job, have a Yamaha dealer perform it for you.
- Install the owner's tool box with the "INSIDE" mark facing inward.

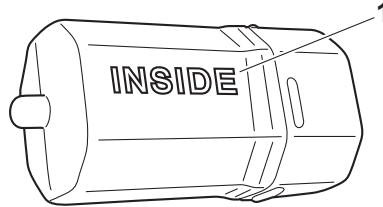

1. "INSIDE" mark

Periodic maintenance and adjustment

EAU71030

TIP

- The annual checks must be performed every year, except if a kilometer-based maintenance, or for the UK, a mileage-based maintenance, is performed instead.
- From 50000 km (30000 mi), repeat the maintenance intervals starting from 10000 km (6000 mi).
- Items marked with an asterisk should be performed by a Yamaha dealer as they require special tools, data and technical skills.

EAU71051

Periodic maintenance chart for the emission control system

NO.	ITEM	CHECK OR MAINTENANCE JOB	ODOMETER READING					ANNUAL CHECK
			1000 km (600 mi)	10000 km (6000 mi)	20000 km (12000 mi)	30000 km (18000 mi)	40000 km (24000 mi)	
1	* Fuel line	<ul style="list-style-type: none"> • Check fuel hoses for cracks or damage. • Replace if necessary. 		√	√	√	√	√
2	* Spark plugs	<ul style="list-style-type: none"> • Check condition. • Adjust gap and clean. 		√		√		
		<ul style="list-style-type: none"> • Replace. 			√		√	
3	* Valve clearance	<ul style="list-style-type: none"> • Check and adjust. 	Every 20000 km (12000 mi)					
4	* Fuel injection	<ul style="list-style-type: none"> • Check engine idle speed. 	√	√	√	√	√	√
		<ul style="list-style-type: none"> • Check and adjust synchronization. 		√	√	√	√	√
5	* Exhaust system	<ul style="list-style-type: none"> • Check for leakage. • Tighten if necessary. • Replace gaskets if necessary. 	√	√	√	√	√	

Periodic maintenance and adjustment

NO.	ITEM	CHECK OR MAINTENANCE JOB	ODOMETER READING					ANNUAL CHECK
			1000 km (600 mi)	10000 km (6000 mi)	20000 km (12000 mi)	30000 km (18000 mi)	40000 km (24000 mi)	
6	*	Evaporative emission control system			√		√	

Periodic maintenance and adjustment

EAU71351

General maintenance and lubrication chart

NO.	ITEM	CHECK OR MAINTENANCE JOB	ODOMETER READING					ANNUAL CHECK
			1000 km (600 mi)	10000 km (6000 mi)	20000 km (12000 mi)	30000 km (18000 mi)	40000 km (24000 mi)	
1	* Diagnostic system check	<ul style="list-style-type: none"> Perform dynamic inspection using Yamaha diagnostic tool. Check the error codes. 	√	√	√	√	√	√
2	* Air filter element	<ul style="list-style-type: none"> Replace. 	Every 40000 km (24000 mi)					
3	Clutch	<ul style="list-style-type: none"> Check operation. Adjust. 	√	√	√	√	√	
4	* Front brake	<ul style="list-style-type: none"> Check operation, fluid level, and for fluid leakage. Replace brake pads if necessary. 	√	√	√	√	√	√
5	* Rear brake	<ul style="list-style-type: none"> Check operation, fluid level, and for fluid leakage. Replace brake pads if necessary. 	√	√	√	√	√	√
6	* Brake hoses	<ul style="list-style-type: none"> Check for cracks or damage. Replace. 		√	√	√	√	√
7	* Brake fluid	<ul style="list-style-type: none"> Change. 	Every 2 years					
8	* Wheels	<ul style="list-style-type: none"> Check runout, spoke tightness and for damage. Tighten spokes if necessary. 	√	√	√	√	√	
9	* Tires	<ul style="list-style-type: none"> Check tread depth and for damage. Replace if necessary. Check air pressure. Correct if necessary. 		√	√	√	√	√
10	* Wheel bearings	<ul style="list-style-type: none"> Check bearing for looseness or damage. 		√	√	√	√	

6

Periodic maintenance and adjustment

NO.	ITEM	CHECK OR MAINTENANCE JOB	ODOMETER READING					ANNUAL CHECK
			1000 km (600 mi)	10000 km (6000 mi)	20000 km (12000 mi)	30000 km (18000 mi)	40000 km (24000 mi)	
11	* Swingarm pivot bearings	<ul style="list-style-type: none"> • Check operation and for excessive play. 		√	√	√	√	
12	* Drive belt	<ul style="list-style-type: none"> • Check belt condition. • Replace if damaged. • Check belt tension. • Adjust if necessary. 	At the initial interval and every 4000 km (2500 mi) thereafter.					
13	* Steering bearings	<ul style="list-style-type: none"> • Check bearing assemblies for looseness. 	√	√		√		
		<ul style="list-style-type: none"> • Moderately repack with lithium-soap-based grease. 			√		√	
14	* Chassis fasteners	<ul style="list-style-type: none"> • Make sure that all nuts, bolts and screws are properly tightened. 		√	√	√	√	√
15	Brake lever pivot shaft	<ul style="list-style-type: none"> • Lubricate with silicone grease. 		√	√	√	√	√
16	Brake pedal pivot shaft	<ul style="list-style-type: none"> • Lubricate with lithium-soap-based grease. 		√	√	√	√	√
17	Clutch lever pivot shaft	<ul style="list-style-type: none"> • Lubricate with lithium-soap-based grease. 		√	√	√	√	√
18	Shift pedal pivot shaft	<ul style="list-style-type: none"> • Lubricate with lithium-soap-based grease. 		√	√	√	√	√
19	Sidestand	<ul style="list-style-type: none"> • Check operation. • Lubricate with lithium-soap-based grease. 		√	√	√	√	√
20	* Sidestand switch	<ul style="list-style-type: none"> • Check operation and replace if necessary. 	√	√	√	√	√	√

Periodic maintenance and adjustment

NO.	ITEM	CHECK OR MAINTENANCE JOB	ODOMETER READING					ANNUAL CHECK
			1000 km (600 mi)	10000 km (6000 mi)	20000 km (12000 mi)	30000 km (18000 mi)	40000 km (24000 mi)	
21	* Front fork	<ul style="list-style-type: none"> • Check operation and for oil leakage. • Replace if necessary. 		√	√	√	√	
22	* Shock absorber assemblies	<ul style="list-style-type: none"> • Check operation and for oil leakage. • Replace if necessary. 		√	√	√	√	
23	Engine oil	<ul style="list-style-type: none"> • Change (warm engine before draining). • Check oil level and vehicle for oil leakage. 	√	√	√	√	√	√
24	Engine oil filter cartridge	<ul style="list-style-type: none"> • Replace. 	√		√		√	
25	* Front and rear brake switches	<ul style="list-style-type: none"> • Check operation. 	√	√	√	√	√	√
26	* Moving parts and cables	<ul style="list-style-type: none"> • Lubricate. 		√	√	√	√	√
27	* Throttle grip housing and cable	<ul style="list-style-type: none"> • Check operation and free play. • Adjust the throttle cable free play if necessary. • Lubricate the throttle grip housing and cable. 		√	√	√	√	√
28	* Lights, signals and switches	<ul style="list-style-type: none"> • Check operation. • Adjust headlight beam. 	√	√	√	√	√	√

TIP

- Air filter
 - This model's air filter is equipped with a disposable oil-coated paper element, which must not be cleaned with compressed air to avoid damaging it.
 - The air filter element needs to be replaced more frequently when riding in unusually wet or dusty areas.
 - Hydraulic brake service
 - Regularly check and, if necessary, correct the brake fluid level.
 - Every two years replace the internal components of the brake master cylinders and calipers, and change the brake fluid.
 - Replace the brake hoses every four years and if cracked or damaged.
-

Periodic maintenance and adjustment

Removing and installing panels

EAU18773

The panels shown need to be removed to perform some of the maintenance jobs described in this chapter. Refer to this section each time a panel needs to be removed and installed.

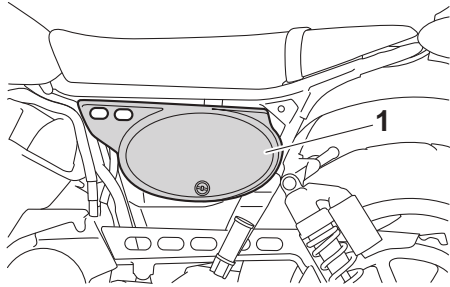

1. Panel A

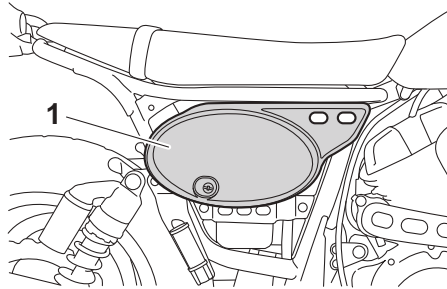

1. Panel B

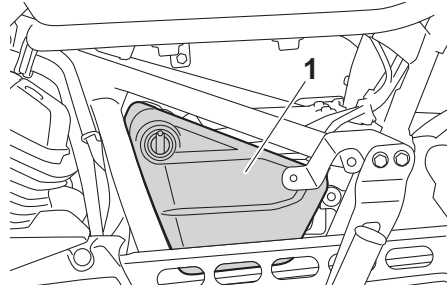

1. Panel C

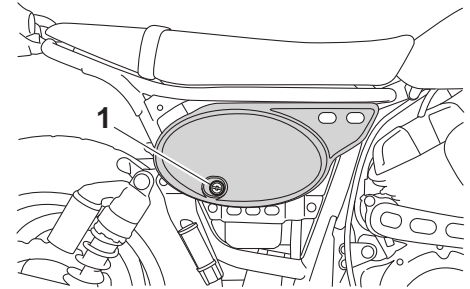

1. Screw

2. Pull the panel off as shown.

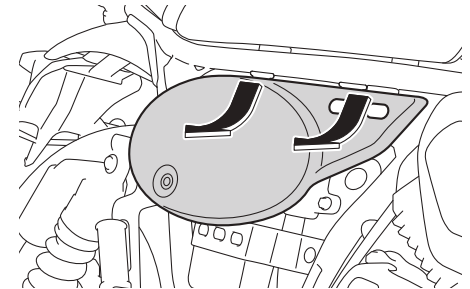

EAU74860

To install a panel

Place the panel in its original position, and then install the screw.

Panels A and B

To remove a panel

1. Remove the screw.

Periodic maintenance and adjustment

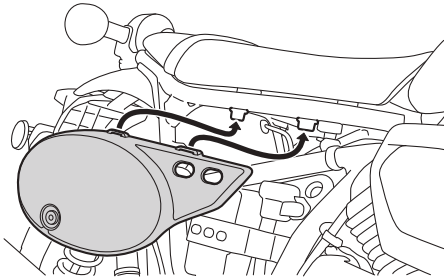

Panel C

To remove the panel

1. Remove the panel A.
2. Slide the panel lock cover open, insert the key into the lock, and then turn it 1/4 turn clockwise.

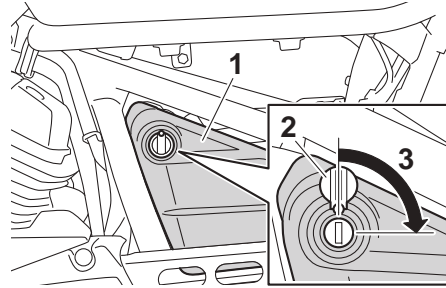

1. Panel C
 2. Panel lock cover
 3. Unlock.
3. Pull the panel off as shown.

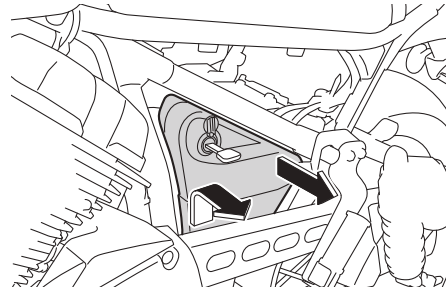

To install the panel

1. Place the panel in the original position.

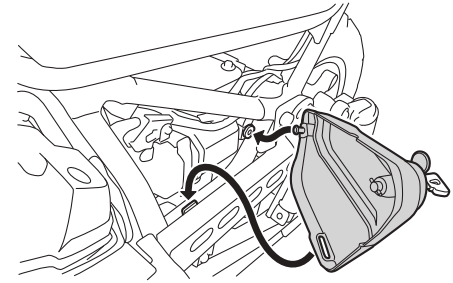

2. Turn the key 1/4 turn counter-clockwise, remove it, and then slide the panel lock cover closed.
3. Install the panel A.

Periodic maintenance and adjustment

EAU19643

Checking the spark plugs

The spark plugs are important engine components, which should be checked periodically, preferably by a Yamaha dealer. Since heat and deposits will cause any spark plug to slowly erode, they should be removed and checked in accordance with the periodic maintenance and lubrication chart. In addition, the condition of the spark plugs can reveal the condition of the engine.

6

The porcelain insulator around the center electrode of each spark plug should be a medium-to-light tan (the ideal color when the vehicle is ridden normally), and all spark plugs installed in the engine should have the same color. If any spark plug shows a distinctly different color, the engine could be operating improperly. Do not attempt to diagnose such problems yourself. Instead, have a Yamaha dealer check the vehicle.

If a spark plug shows signs of electrode erosion and excessive carbon or other deposits, it should be replaced.

Specified spark plug:
NGK/CPR7EA-9

Before installing a spark plug, the spark plug gap should be measured with a wire thickness gauge and, if necessary, adjusted to specification.

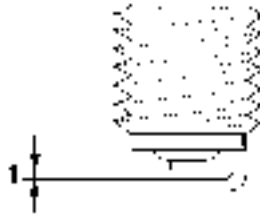

1. Spark plug gap

Spark plug gap:
0.8–0.9 mm (0.031–0.035 in)

Clean the surface of the spark plug gasket and its mating surface, and then wipe off any grime from the spark plug threads.

Tightening torque:
Spark plug:
13 N·m (1.3 kgf·m, 9.4 lb·ft)

TIP

If a torque wrench is not available when installing a spark plug, a good estimate of the correct torque is 1/4–1/2 turn past finger tight. However, the spark plug should be tightened to the specified torque as soon as possible.

Canister

EAU36112

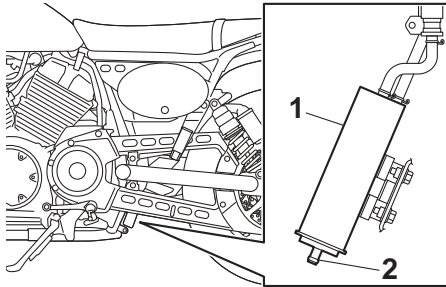

1. Canister
2. Canister breather

This model is equipped with a canister to prevent the discharging of fuel vapor into the atmosphere. Before operating this vehicle, make sure to check the following:

- Check each hose connection.
- Check each hose and canister for cracks or damage. Replace if damaged.
- Make sure that the canister breather is not blocked, and if necessary, clean it.

Engine oil and oil filter cartridge

EAU47115

The engine oil level should be checked before each ride. In addition, the oil must be changed and the oil filter cartridge replaced at the intervals specified in the periodic maintenance and lubrication chart.

To check the engine oil level

1. Place the vehicle on a level surface and hold it in an upright position. A slight tilt to the side can result in a false reading.
2. Start the engine, warm it up for several minutes, and then turn it off.
3. Wait a few minutes until the oil settles.
4. Remove the engine oil filler cap, wipe the engine oil dipstick clean, insert it back into the oil filler hole (without screwing it in), and then remove it again to check the oil level.

TIP

The engine oil should be between the minimum and maximum level marks.

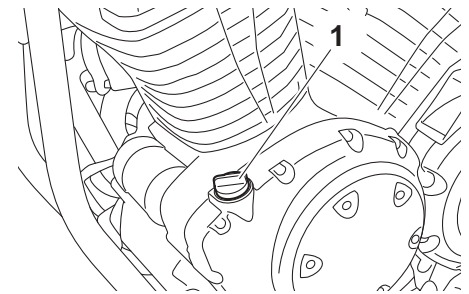

1. Engine oil filler cap

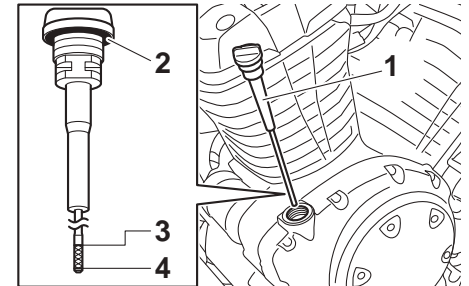

1. Engine oil dipstick
2. O-ring
3. Maximum level mark
4. Minimum level mark

Periodic maintenance and adjustment

5. If the engine oil is at or below the minimum level mark, add sufficient oil of the recommended type to raise it to the correct level.
6. Check the O-ring for damage, and replace it if necessary.
7. Insert the dipstick into the oil filler hole, and then tighten the oil filler cap.

To change the engine oil (with or without oil filter cartridge replacement)

1. Start the engine, warm it up for several minutes, and then turn it off.
2. Place an oil pan under the engine to collect the used oil.
3. Remove the engine oil filler cap, the engine oil drain bolt and its gasket to drain the oil from the crankcase.

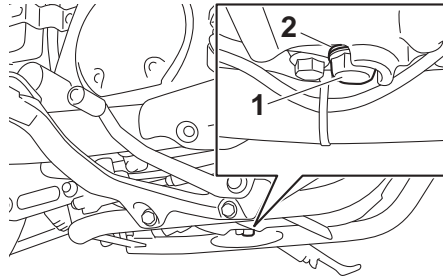

1. Engine oil drain bolt
2. Gasket

TIP

Skip steps 4–6 if the oil filter cartridge is not being replaced.

4. Remove the oil filter cartridge with an oil filter wrench.

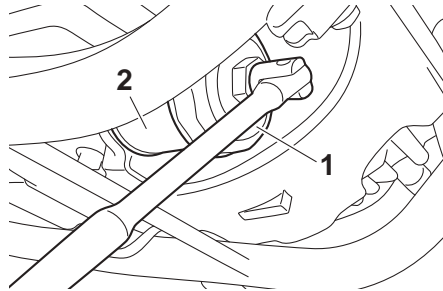

1. Oil filter wrench
2. Oil filter cartridge

TIP

An oil filter wrench is available at a Yamaha dealer.

5. Apply a thin coat of clean engine oil to the O-ring of the new oil filter cartridge.

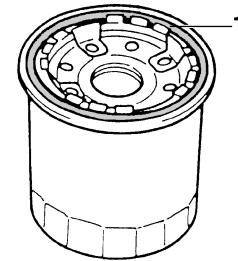

1. O-ring

TIP

Make sure that the O-ring is properly seated.

6. Install the new oil filter cartridge with an oil filter wrench, and then tighten it to the specified torque with a torque wrench.

Periodic maintenance and adjustment

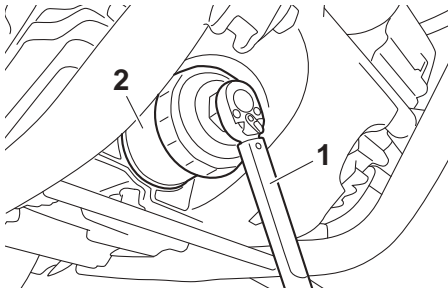

1. Torque wrench
2. Oil filter cartridge

Tightening torque:

Oil filter cartridge:
17 N·m (1.7 kgf·m, 12 lb·ft)

7. Install the engine oil drain bolt and its new gasket, and then tighten the bolt to the specified torque.

Tightening torque:

Engine oil drain bolt:
43 N·m (4.3 kgf·m, 31 lb·ft)

8. Refill with the specified amount of the recommended engine oil.

Recommended engine oil:

See page 8-1.

Oil quantity:

Oil change:

3.70 L (3.91 US qt, 3.26 Imp.qt)

With oil filter removal:

4.00 L (4.23 US qt, 3.52 Imp.qt)

TIP

Be sure to wipe off spilled oil on any parts after the engine and exhaust system have cooled down.

ECA11621

NOTICE

- In order to prevent clutch slippage (since the engine oil also lubricates the clutch), do not mix any chemical additives. Do not use oils with a diesel specification of “CD” or oils of a higher quality than specified. In addition, do not use oils labeled “ENERGY CONSERVING II” or higher.
- Make sure that no foreign material enters the crankcase.

9. Check the O-ring for damage, and replace it if necessary.

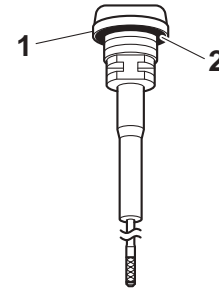

1. Engine oil filler cap
2. O-ring

10. Install and tighten the engine oil filler cap.
11. Start the engine, and then let it idle for several minutes while checking it for oil leakage. If oil is leaking, immediately turn the engine off and check for the cause.

TIP

After the engine is started, the engine oil level warning light should go off if the oil level is sufficient.

Periodic maintenance and adjustment

ECA10402

NOTICE

If the oil level warning light flickers or remains on even if the oil level is correct, immediately turn the engine off and have a Yamaha dealer check the vehicle.

12. Turn the engine off, wait a few minutes until the oil settles, and then check the oil level and correct it if necessary.

Replacing the air filter element

The air filter element should be replaced at the intervals specified in the periodic maintenance and lubrication chart. Replace the air filter element more frequently if you are riding in unusually wet or dusty areas.

To replace the air filter element

1. Remove the air filter case cover by removing the bolts.

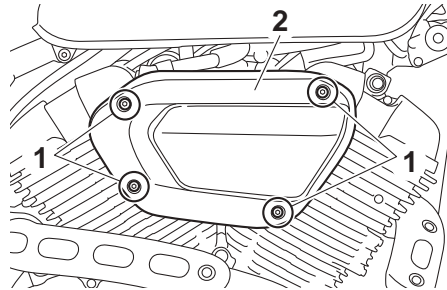

1. Bolt
2. Air filter case cover

2. Pull the air filter element out.

EAU47081

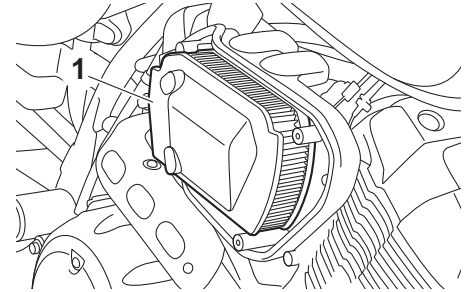

1. Air filter element

3. Insert a new air filter element into the air filter case. **NOTICE: Make sure that the air filter element is properly seated in the air filter case. The engine should never be operated without the air filter element installed, otherwise the piston(s) and/or cylinder(s) may become excessively worn.**

[ECA10482]

4. Install the air filter case cover by installing the bolts.

Checking the throttle grip free play

EAU21386

Measure the throttle grip free play as shown.

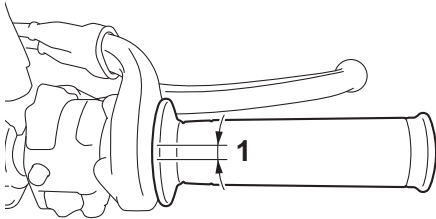

1. Throttle grip free play

Throttle grip free play:
4.0–6.0 mm (0.16–0.24 in)

Periodically check the throttle grip free play and, if necessary, have a Yamaha dealer adjust it.

Valve clearance

EAU21402

The valve clearance changes with use, resulting in improper air-fuel mixture and/or engine noise. To prevent this from occurring, the valve clearance must be adjusted by a Yamaha dealer at the intervals specified in the periodic maintenance and lubrication chart.

Tires

EAU73600

Tires are the only contact between the vehicle and the road. Safety in all conditions of riding depends on a relatively small area of road contact. Therefore, it is essential to maintain the tires in good condition at all times and replace them at the appropriate time with the specified tires.

Tire air pressure

The tire air pressure should be checked and, if necessary, adjusted before each ride.

EWA10504

⚠ WARNING

Operation of this vehicle with improper tire pressure may cause severe injury or death from loss of control.

- The tire air pressure must be checked and adjusted on cold tires (i.e., when the temperature of the tires equals the ambient temperature).
- The tire air pressure must be adjusted in accordance with the riding speed and with the total

Periodic maintenance and adjustment

EWA17960

weight of rider, passenger, cargo, and accessories approved for this model.

Tire air pressure (measured on cold tires):

1 person:

Front:

280 kPa (2.80 kgf/cm², 41 psi)

Rear:

280 kPa (2.80 kgf/cm², 41 psi)

2 persons:

Front:

280 kPa (2.80 kgf/cm², 41 psi)

Rear:

280 kPa (2.80 kgf/cm², 41 psi)

Maximum load*:

205 kg (452 lb)

* Total weight of rider, passenger, cargo and accessories

EWA10512

WARNING

Never overload your vehicle. Operation of an overloaded vehicle could cause an accident.

Tire inspection

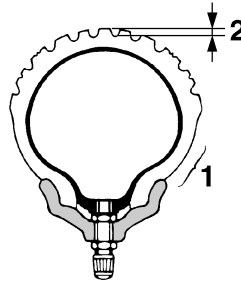

1. Tire sidewall
2. Tire tread depth

The tires must be checked before each ride. If the center tread depth reaches the specified limit, if the tire has a nail or glass fragments in it, or if the sidewall is cracked, have a Yamaha dealer replace the tire immediately.

Minimum tire tread depth (front and rear):

1.6 mm (0.06 in)

TIP

The tire tread depth limits may differ from country to country. Always comply with the local regulations.

WARNING

- It is dangerous to ride with a worn-out tire. When a tire tread depth reaches the specified limit, have a Yamaha dealer replace the tire immediately.
- The replacement of all wheel and brake-related parts, including the tires, should be left to a Yamaha dealer, who has the necessary professional knowledge and experience.
- It is not recommended to patch a punctured tube. If unavoidable, however, patch the tube very carefully and replace it as soon as possible with a high-quality product.
- Ride at moderate speeds after changing a tire since the tire surface must first be “broken in” for it to develop its optimal characteristics.

Tire information

This model is equipped with tube tires.

Periodic maintenance and adjustment

Tires age, even if they have not been used or have only been used occasionally. Cracking of the tread and sidewall rubber, sometimes accompanied by carcass deformation, is an evidence of ageing. Old and aged tires shall be checked by tire specialists to ascertain their suitability for further use.

EWA10462



The front and rear tires should be of the same make and design, otherwise the handling characteristics of the vehicle may be different, which could lead to an accident.

After extensive tests, only the tires listed below have been approved for this model by Yamaha.

Front tire:

Size:

100/90-19M/C 57H

Manufacturer/model:

BRIDGESTONE/TRAIL WING 101
E

Rear tire:

Size:

140/80R17M/C 69H

Manufacturer/model:

BRIDGESTONE/TRAIL WING 152
E

Spoke wheels

EAU21944

EWA10611



The wheels on this model are not designed for use with tubeless tires. Do not attempt to use tubeless tires on this model.

To maximize the performance, durability, and safe operation of your motorcycle, note the following points regarding the specified wheels.

- The wheel rims should be checked for cracks, bends, warpage or other damage, and the spokes for looseness or damage before each ride. If any damage is found, have a Yamaha dealer replace the wheel. Do not attempt even the smallest repair to the wheel. A deformed or cracked wheel must be replaced.
- The wheel should be balanced whenever either the tire or wheel has been changed or replaced. An unbalanced wheel can result in poor performance, adverse handling characteristics, and a shortened tire life.

Periodic maintenance and adjustment

Adjusting the clutch lever free play

EAU33893

Measure the clutch lever free play as shown.

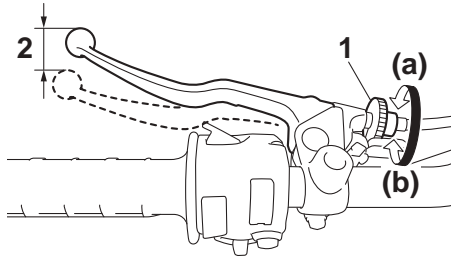

1. Clutch lever free play adjusting bolt
2. Clutch lever free play

Clutch lever free play:
5.0–10.0 mm (0.20–0.39 in)

Periodically check the clutch lever free play and, if necessary, adjust it as follows.

To increase the clutch lever free play, turn the clutch lever free play adjusting bolt at the clutch lever in direction (a). To decrease the clutch lever free play, turn the adjusting bolt in direction (b).

TIP

If the specified clutch lever free play cannot be obtained as described above, proceed as follows.

1. Fully turn the adjusting bolt at the clutch lever in direction (a) to loosen the clutch cable.
2. Loosen the locknut at the crankcase.

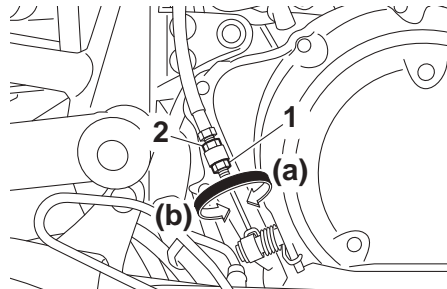

1. Locknut
2. Clutch lever free play adjusting nut
3. To increase the clutch lever free play, turn the clutch lever free play adjusting nut in direction (a). To decrease the clutch lever free play, turn the adjusting nut in direction (b).
4. Tighten the locknut.

Checking the brake lever free play

EAU37914

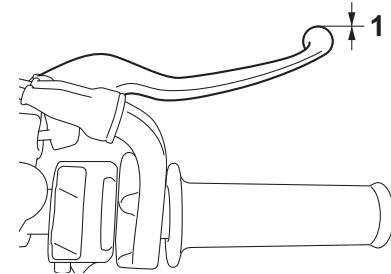

1. No brake lever free play

There should be no free play at the brake lever end. If there is free play, have a Yamaha dealer inspect the brake system.

WARNING

A soft or spongy feeling in the brake lever can indicate the presence of air in the hydraulic system. If there is air in the hydraulic system, have a Yamaha dealer bleed the system before operating the vehicle. Air in the hydraulic system will diminish the

EWA14212

Periodic maintenance and adjustment

braking performance, which may result in loss of control and an accident.

Brake light switches

EAU36504

The brake light, which is activated by the brake pedal and brake lever, should come on just before braking takes effect. If necessary, have a Yamaha dealer adjust the brake light switches.

Checking the front and rear brake pads

EAU22393

The front and rear brake pads must be checked for wear at the intervals specified in the periodic maintenance and lubrication chart.

Front brake pads

EAU22432

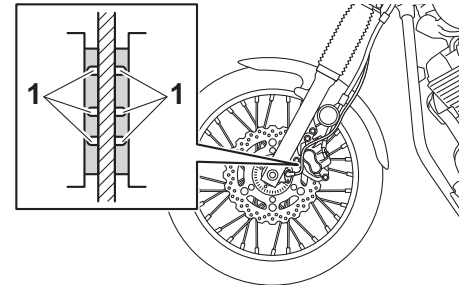

1. Brake pad wear indicator groove

Each front brake pad is provided with wear indicator grooves, which allow you to check the brake pad wear without having to disassemble the brake. To check the brake pad wear, check the wear indicator grooves. If a brake pad has worn to the point that the wear

Periodic maintenance and adjustment

indicator grooves have almost disappeared, have a Yamaha dealer replace the brake pads as a set.

Rear brake pads

EAU22501

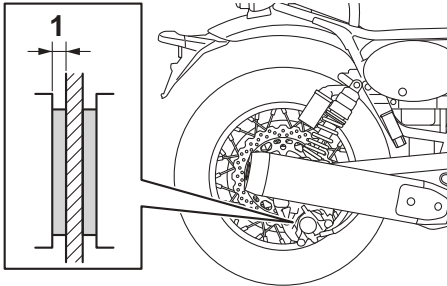

1. Lining thickness

Check each rear brake pad for damage and measure the lining thickness. If a brake pad is damaged or if the lining thickness is less than 0.8 mm (0.03 in), have a Yamaha dealer replace the brake pads as a set.

Checking the brake fluid level

EAU43113

Before riding, check that the brake fluid is above the minimum level mark. Check the brake fluid level with the top of the reservoir level. Replenish the brake fluid if necessary.

Front brake

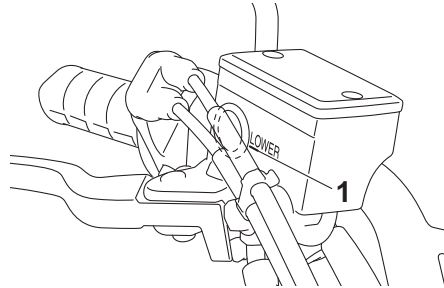

1. Minimum level mark

Rear brake

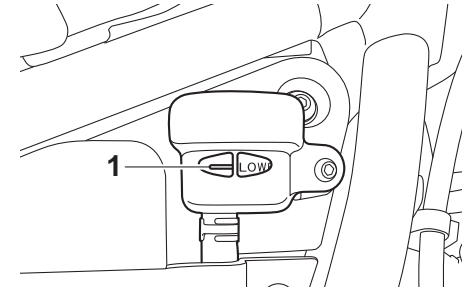

1. Minimum level mark

TIP

The rear brake fluid reservoir is located behind panel B. (See page 6-9.)

Specified brake fluid:
DOT 4

EWA16011

WARNING

Improper maintenance can result in loss of braking ability. Observe these precautions:

- Insufficient brake fluid may allow air to enter the brake system, reducing braking performance.

- **Clean the filler cap before removing. Use only DOT 4 brake fluid from a sealed container.**
- **Use only the specified brake fluid; otherwise, the rubber seals may deteriorate, causing leakage.**
- **Refill with the same type of brake fluid. Adding a brake fluid other than DOT 4 may result in a harmful chemical reaction.**
- **Be careful that water or dust does not enter the brake fluid reservoir when refilling. Water will significantly lower the boiling point of the fluid and may result in vapor lock, and dirt may clog the ABS hydraulic unit valves.**

ECA17641

NOTICE

Brake fluid may damage painted surfaces or plastic parts. Always clean up spilled fluid immediately.

As the brake pads wear, it is normal for the brake fluid level to gradually go down. A low brake fluid level may indicate worn brake pads and/or brake

system leakage; therefore, be sure to check the brake pads for wear and the brake system for leakage. If the brake fluid level goes down suddenly, have a Yamaha dealer check the cause before further riding.

Changing the brake fluid

EAU22733

Have a Yamaha dealer change the brake fluid at the intervals specified in the periodic maintenance and lubrication chart. In addition, have the oil seals of the master cylinders and calipers as well as the brake hoses replaced at the intervals listed below or whenever they are damaged or leaking.

- Oil seals: Replace every two years.
- Brake hoses: Replace every four years.

Periodic maintenance and adjustment

Drive belt slack

EAU23041

The drive belt slack should be checked and adjusted at the intervals specified in the periodic maintenance and lubrication chart.

To check the drive belt slack

EAU55773

1. Place the vehicle on the side-stand.
2. Note the current position of the drive belt using the marks near the drive belt check hole.

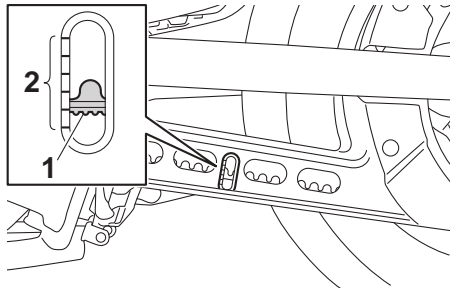

1. Drive belt
2. Marks

3. Note the position of the drive belt with a force of 45 N (4.5 kgf, 10 lbf) applied to the belt with a belt tension gauge as shown.

TIP

A belt tension gauge is available at a Yamaha dealer.

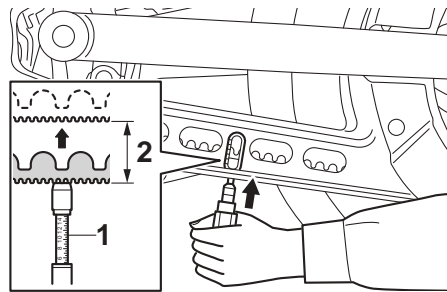

1. Belt tension gauge
2. Drive belt slack

4. Calculate the drive belt slack by subtracting the measurement noted in step 2 from the measurement noted in step 3.

Drive belt slack:

6.0–8.0 mm (0.24–0.31 in)

5. If the drive belt slack is incorrect, have a Yamaha dealer adjust it.

Checking and lubricating the cables

EAU23098

The operation of all control cables and the condition of the cables should be checked before each ride, and the cables and cable ends should be lubricated if necessary. If a cable is damaged or does not move smoothly, have a Yamaha dealer check or replace it. **WARNING! Damage to the outer housing of cables may result in internal rusting and cause interference with cable movement. Replace damaged cables as soon as possible to prevent unsafe conditions.** [EWA10712]

Recommended lubricant:

Yamaha cable lubricant or other suitable cable lubricant

Checking and lubricating the throttle grip and cable

EAU23115

The operation of the throttle grip should be checked before each ride. In addition, the cable should be lubricated by a Yamaha dealer at the intervals specified in the periodic maintenance chart.

The throttle cable is equipped with a rubber cover. Make sure that the cover is securely installed. Even though the cover is installed correctly, it does not completely protect the cable from water entry. Therefore, use care not to pour water directly onto the cover or cable when washing the vehicle. If the cable or cover becomes dirty, wipe clean with a moist cloth.

Checking and lubricating the brake and shift pedals

EAU44276

The operation of the brake and shift pedals should be checked before each ride, and the pedal pivots should be lubricated if necessary.

Brake pedal

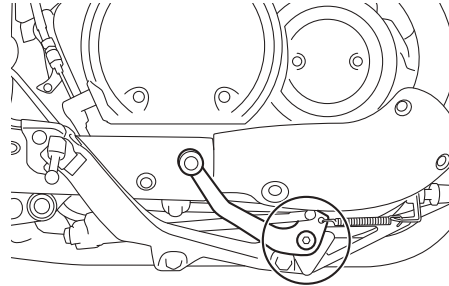

Shift pedal

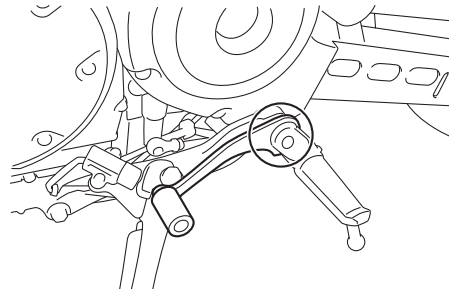

Recommended lubricant:
Lithium-soap-based grease

Periodic maintenance and adjustment

Checking and lubricating the brake and clutch levers

EAU23144

The operation of the brake and clutch levers should be checked before each ride, and the lever pivots should be lubricated if necessary.

Brake lever

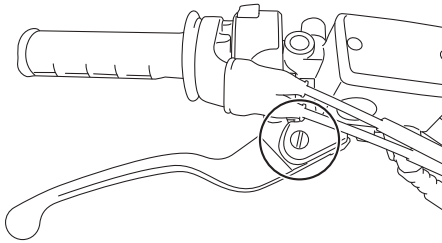

Clutch lever

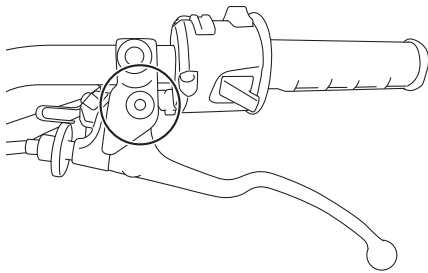

Recommended lubricants:

Brake lever:

Silicone grease

Clutch lever:

Lithium-soap-based grease

Checking and lubricating the sidestand

EAU23203

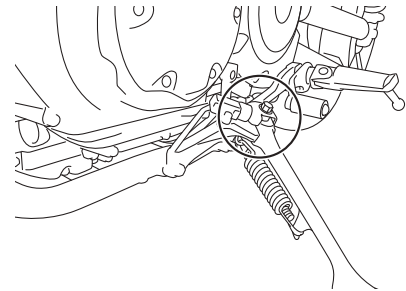

The operation of the sidestand should be checked before each ride, and the sidestand pivot and metal-to-metal contact surfaces should be lubricated if necessary.

EWA10732

! WARNING

If the sidestand does not move up and down smoothly, have a Yamaha dealer check or repair it. Otherwise, the sidestand could contact the ground and distract the operator, resulting in a possible loss of control.

Recommended lubricant:

Lithium-soap-based grease

EAU51951

Checking the front fork

The condition and operation of the front fork must be checked as follows at the intervals specified in the periodic maintenance and lubrication chart.

To check the condition

Check the front fork for damage and excessive oil leakage.

To check the operation

1. Place the vehicle on a level surface and hold it in an upright position. **WARNING! To avoid injury, securely support the vehicle so there is no danger of it falling over.** [EWA10752]
2. While applying the front brake, push down hard on the handlebars several times to check if the front fork compresses and rebounds smoothly.

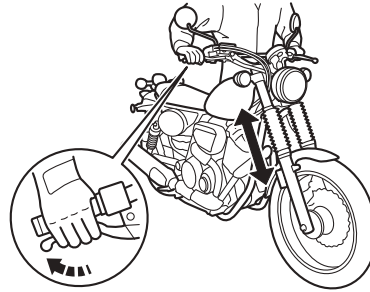

ECA10591

NOTICE

If any damage is found or the front fork does not operate smoothly, have a Yamaha dealer check or repair it.

EAU23285

Checking the steering

Worn or loose steering bearings may cause danger. Therefore, the operation of the steering must be checked as follows at the intervals specified in the periodic maintenance and lubrication chart.

1. Raise the front wheel off the ground. (See page 6-33.) **WARNING! To avoid injury, securely support the vehicle so there is no danger of it falling over.** [EWA10752]
2. Hold the lower ends of the front fork legs and try to move them forward and backward. If any free play can be felt, have a Yamaha dealer check or repair the steering.

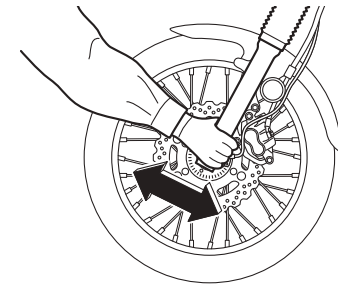

Periodic maintenance and adjustment

Checking the wheel bearings

EAU23292

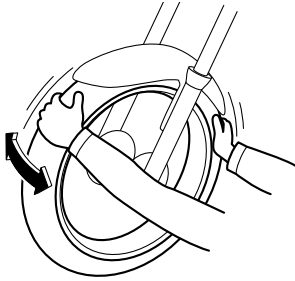

6

The front and rear wheel bearings must be checked at the intervals specified in the periodic maintenance and lubrication chart. If there is play in the wheel hub or if the wheel does not turn smoothly, have a Yamaha dealer check the wheel bearings.

Battery

EAU60691

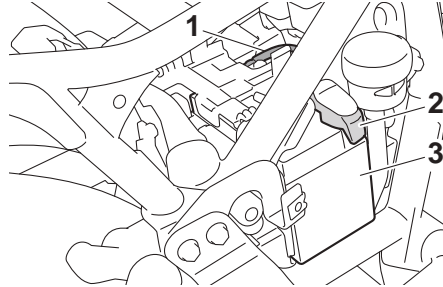

1. Negative battery lead (black)
2. Positive battery lead (red)
3. Battery

The battery is located behind panel B. (See page 6-9.)

This model is equipped with a VRLA (Valve Regulated Lead Acid) battery. There is no need to check the electrolyte or to add distilled water. However, the battery lead connections need to be checked and, if necessary, tightened.

EWA10761

WARNING

- **Electrolyte is poisonous and dangerous since it contains sulfuric acid, which causes severe**

burns. Avoid any contact with skin, eyes or clothing and always shield your eyes when working near batteries. In case of contact, administer the following **FIRST AID**.

- **EXTERNAL:** Flush with plenty of water.
- **INTERNAL:** Drink large quantities of water or milk and immediately call a physician.
- **EYES:** Flush with water for 15 minutes and seek prompt medical attention.
- **Batteries produce explosive hydrogen gas. Therefore, keep sparks, flames, cigarettes, etc., away from the battery and provide sufficient ventilation when charging it in an enclosed space.**
- **KEEP THIS AND ALL BATTERIES OUT OF THE REACH OF CHILDREN.**

To charge the battery

Have a Yamaha dealer charge the battery as soon as possible if it seems to have discharged. Keep in mind that the

battery tends to discharge more quickly if the vehicle is equipped with optional electrical accessories.

ECA16522

NOTICE

To charge a VRLA (Valve Regulated Lead Acid) battery, a special (constant-voltage) battery charger is required. Using a conventional battery charger will damage the battery.

To store the battery

1. If the vehicle will not be used for more than one month, remove the battery, fully charge it, and then place it in a cool, dry place.
NOTICE: When removing the battery, be sure to turn the main switch off, then disconnect the negative lead before disconnecting the positive lead. [ECA16304]
2. If the battery will be stored for more than two months, check it at least once a month and fully charge it if necessary.
3. Fully charge the battery before installation. **NOTICE: When installing the battery, be sure to turn the main switch off, then**

connect the positive lead before connecting the negative lead.

[ECA16842]

4. After installation, make sure that the battery leads are properly connected to the battery terminals.

ECA16531

NOTICE

Always keep the battery charged. Storing a discharged battery can cause permanent battery damage.

Replacing the fuses

The main fuse, the ABS motor fuse, and the fuse boxes, which contain the fuses for the individual circuits, are located under the owner's tool box behind panel C. (See page 6-9.)

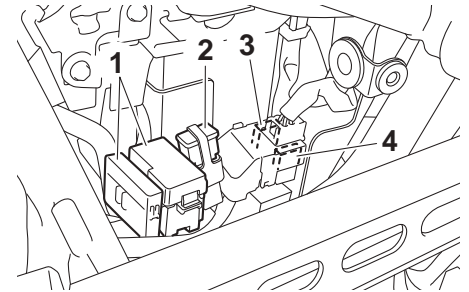

1. Fuse box
2. Main fuse
3. ABS motor fuse
4. ABS motor spare fuse

Periodic maintenance and adjustment

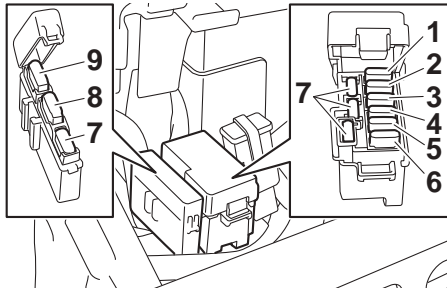

1. Ignition fuse
2. ABS control unit fuse
3. Signaling system fuse
4. Parking lighting fuse
5. Backup fuse (for clock and immobilizer system)
6. Headlight fuse
7. Spare fuse
8. Fuel injection system fuse
9. ABS solenoid fuse

TIP

To access the ABS motor fuse, remove the starter relay cover by pulling it upward.

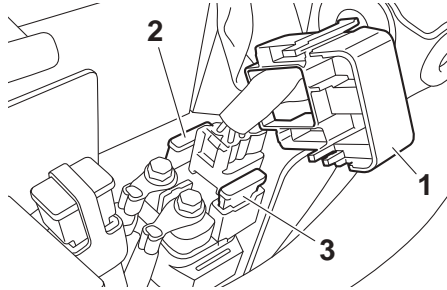

1. Starter relay cover
2. ABS motor fuse
3. ABS motor spare fuse

If a fuse is blown, replace it as follows.

1. Turn the key to "OFF" and turn off the electrical circuit in question.
2. Remove the blown fuse, and then install a new fuse of the specified amperage. **WARNING! Do not use a fuse of a higher amperage rating than recommended to avoid causing extensive damage to the electrical system and possibly a fire.** [EWA15132]

Specified fuses:

- Main fuse:
40.0 A
- Headlight fuse:
20.0 A
- Signaling system fuse:
7.5 A
- Ignition fuse:
15.0 A
- Parking lighting fuse:
15.0 A
- ABS motor fuse:
30.0 A
- Fuel injection system fuse:
10.0 A
- ABS solenoid fuse:
15.0 A
- ABS control unit fuse:
7.5 A
- Backup fuse:
7.5 A

3. Turn the key to "ON" and turn on the electrical circuit in question to check if the device operates.
4. If the fuse immediately blows again, have a Yamaha dealer check the electrical system.

Periodic maintenance and adjustment

Replacing the headlight bulb EAU63180

This model is equipped with a halogen bulb headlight. If the headlight bulb burns out, replace it as follows.

ECA10661

NOTICE

Do not touch the glass part of the headlight bulb to keep it free from oil, otherwise the transparency of the glass, the luminosity of the bulb, and the bulb life will be adversely affected. Thoroughly clean off any dirt and fingerprints on the headlight bulb using a cloth moistened with alcohol or thinner.

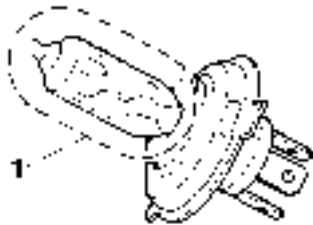

1. Do not touch the glass part of the bulb.

1. Remove the headlight unit by removing the screws.

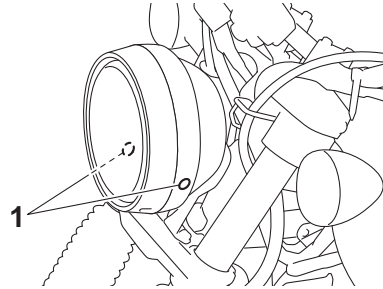

1. Screw

2. Disconnect the headlight coupler, and then remove the headlight bulb cover.

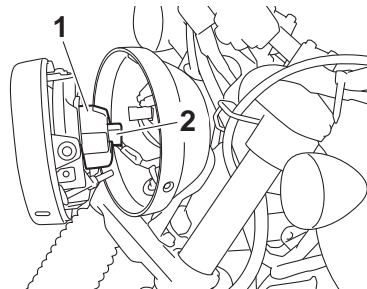

1. Headlight bulb cover

2. Headlight coupler

3. Unhook the headlight bulb holder, and then remove the burnt-out bulb.

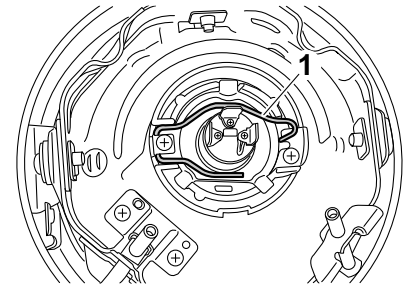

1. Headlight bulb holder

4. Place a new headlight bulb into position, and then secure it with the bulb holder.
5. Install the bulb cover, and then connect the coupler.

TIP

When installing the headlight bulb cover, make sure the "TOP" mark faces upwards.

Periodic maintenance and adjustment

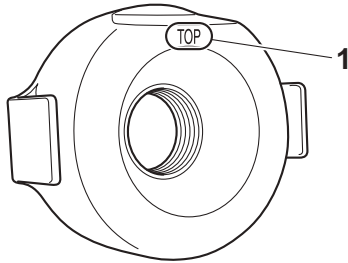

1. "TOP" mark

6. Install the headlight unit by installing the screws.
7. Have a Yamaha dealer adjust the headlight beam if necessary.

Replacing the auxiliary light bulb EAU45226

If the auxiliary light bulb burns out, replace it as follows.

1. Remove the headlight unit. (See page 6-30.)
2. Remove the auxiliary light bulb socket (together with the bulb) by pulling it out.

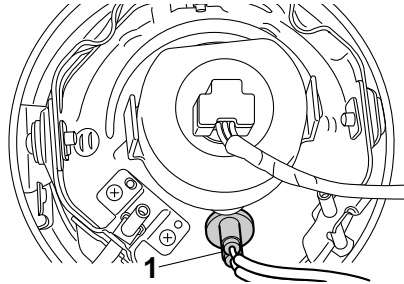

1. Auxiliary light bulb socket

3. Remove the burnt-out bulb by pulling it out.

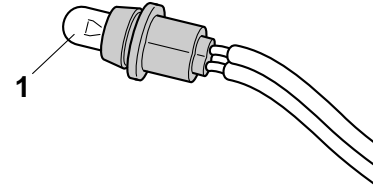

1. Auxiliary light bulb

4. Insert a new bulb into the socket.
5. Install the socket (together with the bulb) by pushing it in.
6. Install the headlight unit.

Brake/tail light

This model is equipped with an LED-type brake/tail light. If the brake/tail light does not come on, have a Yamaha dealer check it.

EAU70540

Replacing a turn signal light bulb

EAU24215

1. Remove the turn signal light lens by removing the screws.

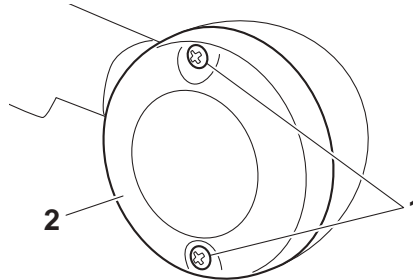

1. Screw
2. Turn signal light lens

2. Remove the burnt-out bulb by pushing it in and turning it counterclockwise.

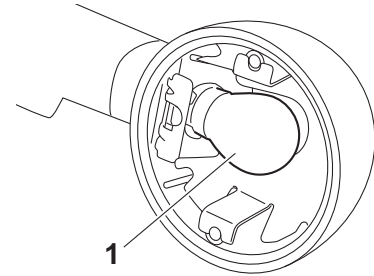

1. Turn signal light bulb
3. Insert a new bulb into the socket, push it in, and then turn it clockwise until it stops.
4. Install the lens by installing the screws. **NOTICE: Do not overtighten the screws, otherwise the lens may break.** [ECA10682]

Periodic maintenance and adjustment

Replacing the license plate light bulb

EAU24314

1. Remove the license plate light unit by removing the screws.

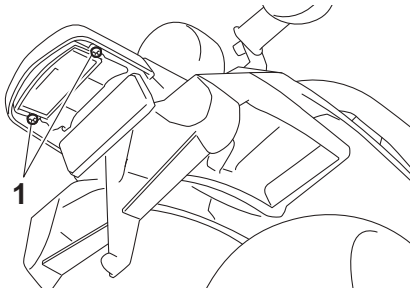

1. Screw

2. Remove the license plate light bulb socket (together with the bulb) by pulling it out.

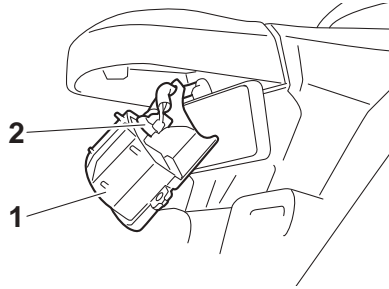

1. License plate light unit
2. License plate light bulb socket

3. Remove the burnt-out bulb by pulling it out.
4. Insert a new bulb into the socket.
5. Install the socket (together with the bulb) by pushing it in.
6. Install the license plate light unit by installing the screws.

Supporting the motorcycle

EAU24351

Since this model is not equipped with a centerstand, follow these precautions when removing the front and rear wheel or performing other maintenance requiring the motorcycle to stand upright. Check that the motorcycle is in a stable and level position before starting any maintenance. A strong wooden box can be placed under the engine for added stability.

To service the front wheel

1. Stabilize the rear of the motorcycle by using a motorcycle stand or, if an additional motorcycle stand is not available, by placing a jack under the frame in front of the rear wheel.
2. Raise the front wheel off the ground by using a motorcycle stand.

To service the rear wheel

Raise the rear wheel off the ground by using a motorcycle stand or, if a motorcycle stand is not available, by placing

a jack either under each side of the frame in front of the rear wheel or under each side of the swingarm.

Troubleshooting

EAU25853

Although Yamaha motorcycles receive a thorough inspection before shipment from the factory, trouble may occur during operation. Any problem in the fuel, compression, or ignition systems, for example, can cause poor starting and loss of power.

The following troubleshooting chart represents a quick and easy procedure for checking these vital systems yourself. However, should your motorcycle require any repair, take it to a Yamaha dealer, whose skilled technicians have the necessary tools, experience, and know-how to service the motorcycle properly.

Use only genuine Yamaha replacement parts. Imitation parts may look like Yamaha parts, but they are often inferior, have a shorter service life and can lead to expensive repair bills.

EWA15142

WARNING

When checking the fuel system, do not smoke, and make sure there are no open flames or sparks in the area, including pilot lights from water

heaters or furnaces. Gasoline or gasoline vapors can ignite or explode, causing severe injury or property damage.

Periodic maintenance and adjustment

EAU42604

Troubleshooting chart

1. Fuel

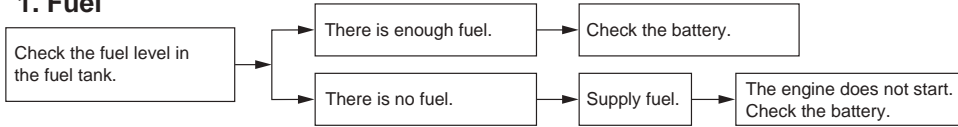

2. Battery

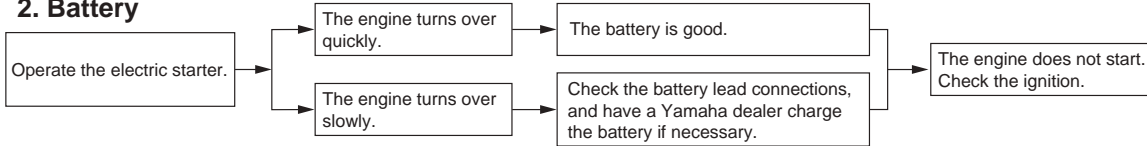

3. Ignition

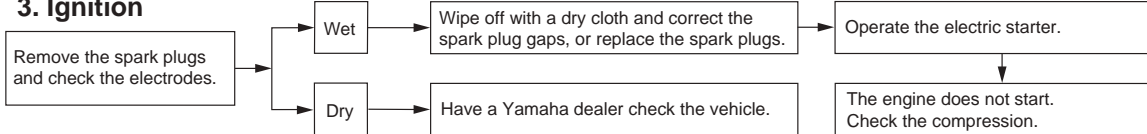

4. Compression

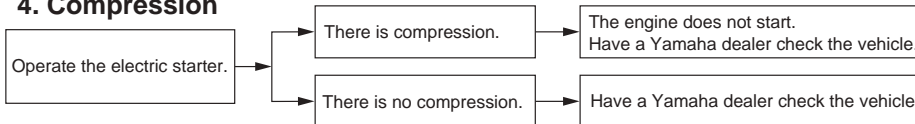

Matte color caution

EAU37834

NOTICE

Some models are equipped with matte colored finished parts. Be sure to consult a Yamaha dealer for advice on what products to use before cleaning the vehicle. Using a brush, harsh chemical products or cleaning compounds when cleaning these parts will scratch or damage their surface. Wax also should not be applied to any matte colored finished parts.

ECA15193

Care

EAU26075

While the open design of a motorcycle reveals the attractiveness of the technology, it also makes it more vulnerable. Rust and corrosion can develop even if high-quality components are used. A rusty exhaust pipe may go unnoticed on a car, however, it detracts from the overall appearance of a motorcycle. Frequent and proper care does not only comply with the terms of the warranty, but it will also keep your motorcycle looking good, extend its life and optimize its performance.

Before cleaning

1. Cover the muffler outlet with a plastic bag after the engine has cooled down.
2. Make sure that all caps and covers as well as all electrical couplers and connectors, including the spark plug caps, are tightly installed.
3. Remove extremely stubborn dirt, like oil burnt onto the crankcase, with a degreasing agent and a brush, but never apply such prod-

ucts onto seals, gaskets, the drive belt and wheel axles. Always rinse the dirt and degreaser off with water.

Cleaning

ECA10773

NOTICE

- Avoid using strong acidic wheel cleaners, especially on spoked wheels. If such products are used on hard-to-remove dirt, do not leave the cleaner on the affected area any longer than instructed. Also, thoroughly rinse the area off with water, immediately dry it, and then apply a corrosion protection spray.
- Improper cleaning can damage plastic parts (such as cowlings, panels, windshields, headlight lenses, meter lenses, etc.) and the mufflers. Use only a soft, clean cloth or sponge with water to clean plastic. However, if the plastic parts cannot be thoroughly cleaned with water, diluted mild detergent with water may be used. Be sure to rinse

Motorcycle care and storage

off any detergent residue using plenty of water, as it is harmful to plastic parts.

- Do not use any harsh chemical products on plastic parts. Be sure to avoid using cloths or sponges which have been in contact with strong or abrasive cleaning products, solvent or thinner, fuel (gasoline), rust removers or inhibitors, brake fluid, antifreeze or electrolyte.
- Do not use high-pressure washers or steam-jet cleaners since they cause water seepage and deterioration in the following areas: seals (of wheel and swing-arm bearings, fork and brakes), electric components (couplers, connectors, instruments, switches and lights), breather hoses and vents.
- For motorcycles equipped with a windshield: Do not use strong cleaners or hard sponges as they will cause dulling or scratching. Some cleaning compounds for plastic may leave scratches on the wind-

shield. Test the product on a small hidden part of the windshield to make sure that it does not leave any marks. If the windshield is scratched, use a quality plastic polishing compound after washing.

After normal use

Remove dirt with warm water, a mild detergent, and a soft, clean sponge, and then rinse thoroughly with clean water. Use a toothbrush or bottlebrush for hard-to-reach areas. Stubborn dirt and insects will come off more easily if the area is covered with a wet cloth for a few minutes before cleaning.

After riding in the rain, near the sea or on salt-sprayed roads

Since sea salt or salt sprayed on roads during winter are extremely corrosive in combination with water, carry out the following steps after each ride in the rain, near the sea or on salt-sprayed roads.

TIP

Salt sprayed on roads in the winter may remain well into spring.

1. Clean the motorcycle with cold water and a mild detergent, after the engine has cooled down. **NOTICE: Do not use warm water since it increases the corrosive action of the salt.** [ECA10792]
2. After drying the motorcycle, apply a corrosion protection spray on all metal, including chrome- and nickel-plated, surfaces to prevent corrosion.

After cleaning

1. Dry the motorcycle with a chamois or an absorbing cloth.
2. Use a chrome polish to shine chrome, aluminum and stainless-steel parts, including the exhaust system. (Even the thermally induced discoloring of stainless-steel exhaust systems can be removed through polishing.)

3. To prevent corrosion, it is recommended to apply a corrosion protection spray on all metal, including chrome- and nickel-plated, surfaces.
4. Use spray oil as a universal cleaner to remove any remaining dirt.
5. Touch up minor paint damage caused by stones, etc.
6. Wax all painted and chrome-plated surfaces. Avoid combination cleaner waxes, many of which contain abrasives that may mar the paint or protective finish.
7. Let the motorcycle dry completely before storing or covering it.

EWA11132

WARNING

Contaminants on the brakes or tires can cause loss of control.

- **Make sure that there is no oil or wax on the brakes or tires.**
- **If necessary, clean the brake discs and brake linings with a regular brake disc cleaner or acetone, and wash the tires with warm water and a mild detergent. Before riding at higher**

speeds, test the motorcycle's braking performance and cornering behavior.

ECA10951

NOTICE

- **Apply spray oil and wax sparingly and make sure to wipe off any excess.**
- **Never apply oil or wax to the drive belt.**
- **Never apply oil or wax to any rubber and plastic parts, but treat them with a suitable care product.**
- **Avoid using abrasive polishing compounds as they will wear away the paint.**

TIP

- Consult a Yamaha dealer for advice on what products to use.
- Washing, rainy weather or humid climates can cause the headlight lens to fog. Turning the headlight on for a short period of time will help remove the moisture from the lens.

Storage

Short-term

Always store your motorcycle in a cool, dry place and, if necessary, protect it against dust with a porous cover. Be sure the engine and the exhaust system are cool before covering the motorcycle.

ECA10811

NOTICE

- **Storing the motorcycle in a poorly ventilated room or covering it with a tarp, while it is still wet, will allow water and humidity to seep in and cause rust.**
- **To prevent corrosion, avoid damp cellars, stables (because of the presence of ammonia) and areas where strong chemicals are stored.**

Long-term

Before storing your motorcycle for several months:

1. Follow all the instructions in the "Care" section of this chapter.

Motorcycle care and storage

2. Fill up the fuel tank and add fuel stabilizer (if available) to prevent the fuel tank from rusting and the fuel from deteriorating.
3. Perform the following steps to protect the cylinders, piston rings, etc. from corrosion.
 - a. Remove the spark plug caps and spark plugs.
 - b. Pour a teaspoonful of engine oil into each spark plug bore.
 - c. Install the spark plug caps onto the spark plugs, and then place the spark plugs on the cylinder head so that the electrodes are grounded. (This will limit sparking during the next step.)
 - d. Turn the engine over several times with the starter. (This will coat the cylinder walls with oil.)
- e. Remove the spark plug caps from the spark plugs, and then install the spark plugs and the spark plug caps.
4. Lubricate all control cables and the pivoting points of all levers and pedals as well as of the side-stand/centerstand.
5. Check and, if necessary, correct the tire air pressure, and then lift the motorcycle so that both of its wheels are off the ground. Alternatively, turn the wheels a little every month in order to prevent the tires from becoming degraded in one spot.
6. Cover the muffler outlet with a plastic bag to prevent moisture from entering it.
7. Remove the battery and fully charge it. Store it in a cool, dry place and charge it once a month. Do not store the battery in an excessively cold or warm place [less than 0 °C (30°F) or more than 30 °C (90°F)]. For more information on storing the battery, see page 6-27.

[EWA10952]

TIP

Make any necessary repairs before storing the motorcycle.

Dimensions:

- Overall length:
2255 mm (88.8 in)
- Overall width:
895 mm (35.2 in)
- Overall height:
1170 mm (46.1 in)
- Seat height:
830 mm (32.7 in)
- Wheelbase:
1575 mm (62.0 in)
- Ground clearance:
145 mm (5.71 in)
- Minimum turning radius:
3.3 m (10.83 ft)

Weight:

- Curb weight:
252 kg (556 lb)

Engine:

- Combustion cycle:
4-stroke
- Cooling system:
Air cooled
- Valve train:
SOHC
- Cylinder arrangement:
V-type
- Number of cylinders:
2-cylinder
- Displacement:
942 cm³
- Bore × stroke:
85.0 × 83.0 mm (3.35 × 3.27 in)

Compression ratio:

9.0 : 1

Starting system:

Electric starter

Lubrication system:

Wet sump

Engine oil:

Recommended brand:

YAMALUBE

SAE viscosity grades:

10W-40

Recommended engine oil grade:

API service SG type or higher, JASO standard MA

Engine oil quantity:

Oil change:

3.70 L (3.91 US qt, 3.26 Imp.qt)

With oil filter removal:

4.00 L (4.23 US qt, 3.52 Imp.qt)

Air filter:

Air filter element:

Oil-coated paper element

Fuel:

Recommended fuel:

Regular unleaded gasoline (Gasohol [E10] acceptable)

Fuel tank capacity:

13 L (3.4 US gal, 2.9 Imp.gal)

Fuel reserve amount:

2.8 L (0.74 US gal, 0.62 Imp.gal)

Fuel injection:

Throttle body:

ID mark:

BS54 00

Spark plug(s):

Manufacturer/model:

NGK/CPR7EA-9

Spark plug gap:

0.8–0.9 mm (0.031–0.035 in)

Clutch:

Clutch type:

Wet, multiple-disc

Drivetrain:

Primary reduction ratio:

1.674 (72/43)

Final drive:

Belt

Secondary reduction ratio:

2.333 (70/30)

Transmission type:

Constant mesh 5-speed

Gear ratio:

1st:

3.067 (46/15)

2nd:

2.063 (33/16)

3rd:

1.579 (30/19)

4th:

1.259 (34/27)

5th:

1.042 (25/24)

Chassis:

Frame type:

Double cradle

Caster angle:

29.0 °

Specifications

Trail:
130 mm (5.1 in)

Front tire:

Type:
With tube
Size:
100/90-19M/C 57H
Manufacturer/model:
BRIDGESTONE/TRAIL WING 101 E

Rear tire:

Type:
With tube
Size:
140/80R17M/C 69H
Manufacturer/model:
BRIDGESTONE/TRAIL WING 152 E

Loading:

Maximum load:
205 kg (452 lb)
(Total weight of rider, passenger, cargo
and accessories)

Tire air pressure (measured on cold tires):

1 person:
Front:
280 kPa (2.80 kgf/cm², 41 psi)
Rear:
280 kPa (2.80 kgf/cm², 41 psi)
2 persons:
Front:
280 kPa (2.80 kgf/cm², 41 psi)
Rear:
280 kPa (2.80 kgf/cm², 41 psi)

Front wheel:

Wheel type:
Spoke wheel
Rim size:
19 x 2.50

Rear wheel:

Wheel type:
Spoke wheel
Rim size:
17M/C x MT3.50

Front brake:

Type:
Hydraulic single disc brake
Specified brake fluid:
DOT 4

Rear brake:

Type:
Hydraulic single disc brake
Specified brake fluid:
DOT 4

Front suspension:

Type:
Telescopic fork
Spring:
Coil spring
Shock absorber:
Hydraulic damper
Wheel travel:
120 mm (4.7 in)

Rear suspension:

Type:
Swingarm
Spring:
Coil spring

Shock absorber:
Gas-hydraulic damper
Wheel travel:
70 mm (2.8 in)

Electrical system:

System voltage:
12 V
Ignition system:
TCI
Charging system:
AC magneto

Battery:

Model:
YTZ14S
Voltage, capacity:
12 V, 11.2 Ah (10 HR)

Headlight:

Bulb type:
Halogen bulb

Bulb wattage:

Headlight:
H4, 60.0 W/55.0 W
Brake/tail light:
LED
Front turn signal light:
21.0 W
Rear turn signal light:
21.0 W
Auxiliary light:
5.0 W
License plate light:
5.0 W
Meter lighting:
EL (Electroluminescent)

Neutral indicator light:

LED

High beam indicator light:

LED

Oil level warning light:

LED

Turn signal indicator light:

LED

Fuel level warning light:

LED

Engine trouble warning light:

LED

ABS warning light:

LED

Immobilizer system indicator light:

LED

Fuse(s):

Main fuse:

40.0 A

Headlight fuse:

20.0 A

Signaling system fuse:

7.5 A

Ignition fuse:

15.0 A

Parking lighting fuse:

15.0 A

Fuel injection system fuse:

10.0 A

ABS control unit fuse:

7.5 A

ABS motor fuse:

30.0 A

ABS solenoid fuse:

15.0 A

Backup fuse:

7.5 A

Consumer information

Identification numbers

EAU53562

Record the vehicle identification number, engine serial number, and the model label information in the spaces provided below. These identification numbers are needed when registering the vehicle with the authorities in your area and when ordering spare parts from a Yamaha dealer.

VEHICLE IDENTIFICATION NUMBER:

ENGINE SERIAL NUMBER:

MODEL LABEL INFORMATION:

Vehicle identification number

EAU26401

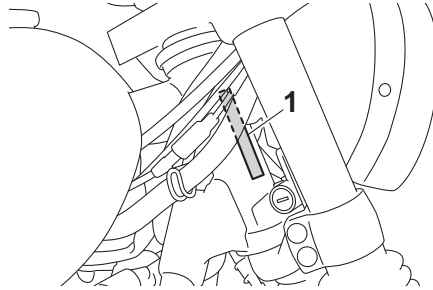

1. Vehicle identification number

The vehicle identification number is stamped into the steering head pipe. Record this number in the space provided.

TIP

The vehicle identification number is used to identify your motorcycle and may be used to register your motorcycle with the licensing authority in your area.

Engine serial number

EAU26442

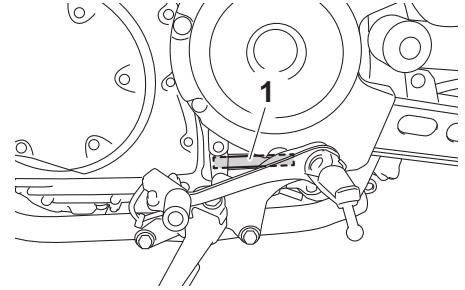

1. Engine serial number

The engine serial number is stamped into the crankcase.

Model label

EAU36981

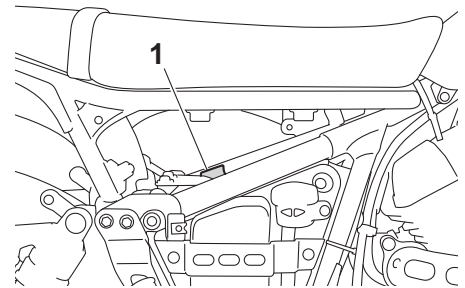

1. Model label

The model label is affixed to the frame behind panel B. (See page 6-9.) Record the information on this label in the space provided. This information will be needed when ordering spare parts from a Yamaha dealer.

Diagnostic connector

EAU69910

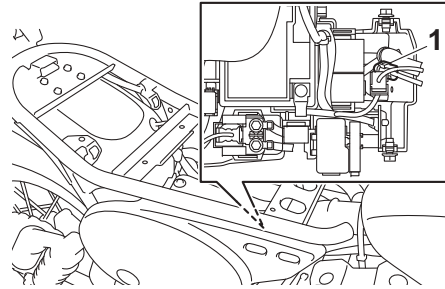

1. Diagnostic connector

The diagnostic connector is located as shown.

Vehicle data recording

EAU74701

This model's ECU stores certain vehicle data to assist in the diagnosis of malfunctions and for research and development purposes. This data will be uploaded only when a special Yamaha diagnostic tool is attached to the vehicle, such as when maintenance checks or service procedures are performed.

Although the sensors and recorded data will vary by model, the main data points are:

- Vehicle status and engine performance data
- Fuel-injection and emission-related data

Yamaha will not disclose this data to a third party except:

- With the consent of the vehicle owner
- Where obligated by law
- For use by Yamaha in litigation
- For general Yamaha-conducted research purposes when the data is not related to an individual vehicle nor owner

Index

A

- ABS3-10
- ABS warning light3-4
- Air filter element, replacing6-15
- Auxiliary light bulb, replacing6-31

B

- Battery6-27
- Brake and clutch levers, checking and lubricating6-25
- Brake and shift pedals, checking and lubricating6-24
- Brake fluid, changing6-22
- Brake fluid level, checking6-21
- Brake lever3-9
- Brake lever free play, checking6-19
- Brake light switches6-20
- Brake pedal3-9
- Brake/tail light6-32

C

- Cables, checking and lubricating6-23
- Canister6-12
- Care7-1
- Catalytic converter3-13
- Clutch lever3-8
- Clutch lever free play, adjusting6-19

D

- Data recording, vehicle9-2
- Diagnostic connector9-2
- Dimmer switch3-7
- Drive belt slack6-23

E

- Engine break-in5-3
- Engine oil and oil filter cartridge6-12
- Engine serial number9-1

- Engine trouble warning light3-4

F

- Front and rear brake pads, checking ... 6-20
- Front fork, checking6-26
- Fuel3-11
- Fuel consumption, tips for reducing5-3
- Fuel level warning light3-4
- Fuel tank breather/overflow hose3-13
- Fuel tank cap3-11
- Fuses, replacing6-28

H

- Handlebar switches3-7
- Hazard switch3-8
- Headlight bulb, replacing6-30
- High beam indicator light3-3
- Horn switch3-8

I

- Identification numbers9-1
- Ignition circuit cut-off system3-16
- Immobilizer system3-1
- Immobilizer system indicator light3-5
- Indicator lights and warning lights3-3

L

- License plate light bulb, replacing6-33

M

- Main switch3-2
- Maintenance and lubrication, periodic ... 6-5
- Maintenance, emission control system6-3
- Matte color, caution7-1
- Model label9-1
- Multi-function meter unit3-5

N

- Neutral indicator light3-3

O

- Oil level warning light3-3

P

- Panels, removing and installing6-9
- Parking5-4
- Part locations2-1
- Pass switch3-7

S

- Safety information1-1
- SELECT switch3-8
- Shifting5-2
- Shift pedal3-9
- Shock absorber assemblies, adjusting3-15
- Sidestand3-16
- Sidestand, checking and lubricating6-25
- Spark plugs, checking6-11
- Specifications8-1
- Start/Engine stop switch3-8
- Starting the engine5-1
- Steering, checking6-26
- Steering lock3-14
- Storage7-3
- Supporting the motorcycle6-33

T

- Throttle grip and cable, checking and lubricating6-24
- Throttle grip free play, checking6-16
- Tires6-16
- Tool kit6-2
- Troubleshooting6-34
- Troubleshooting chart6-35
- Turn signal indicator light3-3
- Turn signal light bulb, replacing6-32

Turn signal switch..... 3-8

V

Valve clearance 6-16

Vehicle identification number 9-1

W

Wheel bearings, checking 6-27

Wheels..... 6-18

