



⚠ Read this manual carefully before operating this vehicle.

OWNER'S MANUAL

YS125

YS125-5C

BT4-F8199-E0

 **Read this manual carefully before operating this vehicle. This manual should stay with this vehicle if it is sold.**

Welcome to the Yamaha world of motorcycling!

As the owner of the YS125-5C, you are benefiting from Yamaha's vast experience and newest technology regarding the design and manufacture of high-quality products, which have earned Yamaha a reputation for dependability.

Please take the time to read this manual thoroughly, so as to enjoy all advantages of your YS125-5C. The Owner's Manual does not only instruct you in how to operate, inspect and maintain your motorcycle, but also in how to safeguard yourself and others from trouble and injury.

In addition, the many tips given in this manual will help keep your motorcycle in the best possible condition. If you have any further questions, do not hesitate to contact your Yamaha dealer.

The Yamaha team wishes you many safe and pleasant rides. So, remember to put safety first!

Yamaha continually seeks advancements in product design and quality. Therefore, while this manual contains the most current product information available at the time of printing, there may be minor discrepancies between your motorcycle and this manual. If there is any question concerning this manual, please consult a Yamaha dealer.





Please read this manual carefully and completely before operating this motorcycle.

Important manual information

EAU10134

Particularly important information is distinguished in this manual by the following notations:

	This is the safety alert symbol. It is used to alert you to potential personal injury hazards. Obey all safety messages that follow this symbol to avoid possible injury or death.
 WARNING	A WARNING indicates a hazardous situation which, if not avoided, could result in death or serious injury.
NOTICE	A NOTICE indicates special precautions that must be taken to avoid damage to the vehicle or other property.
TIP	A TIP provides key information to make procedures easier or clearer.

*Product and specifications are subject to change without notice.

EAU37231

**YS125-5C
OWNER'S MANUAL
©2016 by Yamaha Motor Co., Ltd.
1st edition, November 2016
All rights reserved.
Any reprinting or unauthorized use
without the written permission of
Yamaha Motor Co., Ltd.
is expressly prohibited.
Printed in China.**

Table of contents

Safety information	1-1	For your safety – pre-operation checks	4-1	Cast wheels	6-19
Description	2-1	Operation and important riding points	5-1	Adjusting the clutch lever free play.....	6-19
Left view	2-1	Starting the engine.....	5-1	Checking the brake lever free play.....	6-20
Right view.....	2-2	Shifting	5-2	Adjusting the brake pedal free play.....	6-21
Controls and instruments	2-3	Tips for reducing fuel consumption	5-3	Brake light switches	6-21
Instrument and control functions ...	3-1	Engine break-in	5-3	Checking the front brake pads and rear brake shoes	6-22
Main switch/steering lock.....	3-1	Parking	5-4	Checking the brake fluid level	6-22
Indicator lights and warning light	3-2	Periodic maintenance and adjustment	6-1	Changing the brake fluid	6-23
Multi-function meter unit	3-3	Owner’s tool kit.....	6-2	Drive chain slack.....	6-24
Handlebar switches.....	3-5	Periodic maintenance chart for the emission control system.....	6-3	Cleaning and lubricating the drive chain.....	6-25
Clutch lever	3-6	General maintenance and lubrication chart.....	6-4	Checking and lubricating the cables.....	6-26
Shift pedal	3-6	Removing and installing the cowling and panels.....	6-8	Checking and lubricating the throttle grip and cable.....	6-26
Brake lever.....	3-7	Checking the spark plug.....	6-10	Checking and lubricating the brake and shift pedals.....	6-26
Brake pedal	3-7	Engine oil and oil filter element	6-11	Checking and lubricating the brake and clutch levers.....	6-27
Fuel tank cap.....	3-8	Cleaning the air filter element and cleaning the check hose.....	6-14	Checking and lubricating the centerstand and sidestand.....	6-28
Fuel.....	3-8	Adjusting the engine idling speed.....	6-16	Lubricating the swingarm pivots.....	6-28
Catalytic converters	3-10	Checking the throttle grip free play	6-16	Checking the front fork.....	6-29
Seat	3-11	Valve clearance.....	6-17	Checking the steering.....	6-29
Adjusting the shock absorber assemblies	3-11	Tires	6-17	Checking the wheel bearings	6-30
Sidestand	3-12			Battery	6-30
Ignition circuit cut-off system.....	3-13				

Table of contents

Replacing the fuse.....	6-31
Replacing the headlight bulb.....	6-33
Replacing the auxiliary light bulb	6-34
Replacing the brake/tail light bulb	6-35
Replacing a turn signal light bulb	6-35
Replacing the license plate light bulb	6-36
Front wheel.....	6-36
Rear wheel.....	6-37
Troubleshooting	6-39
Troubleshooting chart	6-41
Motorcycle care and storage	7-1
Matte color caution	7-1
Care.....	7-1
Storage.....	7-3
Specifications	8-1
Consumer information	9-1
Identification numbers.....	9-1
Diagnostic connector	9-2
Vehicle data recording	9-2
Index	10-1

Be a Responsible Owner

As the vehicle's owner, you are responsible for the safe and proper operation of your motorcycle.

Motorcycles are single-track vehicles. Their safe use and operation are dependent upon the use of proper riding techniques as well as the expertise of the operator. Every operator should know the following requirements before riding this motorcycle.

He or she should:

- Obtain thorough instructions from a competent source on all aspects of motorcycle operation.
- Observe the warnings and maintenance requirements in this Owner's Manual.
- Obtain qualified training in safe and proper riding techniques.
- Obtain professional technical service as indicated in this Owner's Manual and/or when made necessary by mechanical conditions.

- Never operate a motorcycle without proper training or instruction. Take a training course. Beginners should receive training from a certified instructor. Contact an authorized motorcycle dealer to find out about the training courses nearest you.

Safe Riding

Perform the pre-operation checks each time you use the vehicle to make sure it is in safe operating condition. Failure to inspect or maintain the vehicle properly increases the possibility of an accident or equipment damage. See page 4-1 for a list of pre-operation checks.

- This motorcycle is designed to carry the operator and a passenger.
- The failure of motorists to detect and recognize motorcycles in traffic is the predominating cause of automobile/motorcycle accidents. Many accidents have been caused by an automobile driver who did not see the motorcycle. Making yourself conspicuous ap-

pears to be very effective in reducing the chance of this type of accident.

Therefore:

- Wear a brightly colored jacket.
- Use extra caution when you are approaching and passing through intersections, since intersections are the most likely places for motorcycle accidents to occur.
- Ride where other motorists can see you. Avoid riding in another motorist's blind spot.
- Never maintain a motorcycle without proper knowledge. Contact an authorized motorcycle dealer to inform you on basic motorcycle maintenance. Certain maintenance can only be carried out by certified staff.

- Many accidents involve inexperienced operators. In fact, many operators who have been involved in accidents do not even have a current motorcycle license.
 - Make sure that you are qualified and that you only lend your motorcycle to other qualified operators.
 - Know your skills and limits. Staying within your limits may help you to avoid an accident.
 - We recommend that you practice riding your motorcycle where there is no traffic until you have become thoroughly familiar with the motorcycle and all of its controls.
- Many accidents have been caused by error of the motorcycle operator. A typical error made by the operator is veering wide on a turn due to excessive speed or undercornering (insufficient lean angle for the speed).
 - Always obey the speed limit and never travel faster than warranted by road and traffic conditions.
- Always signal before turning or changing lanes. Make sure that other motorists can see you.
- The posture of the operator and passenger is important for proper control.
 - The operator should keep both hands on the handlebar and both feet on the operator footrests during operation to maintain control of the motorcycle.
 - The passenger should always hold onto the operator, the seat strap or grab bar, if equipped, with both hands and keep both feet on the passenger footrests. Never carry a passenger unless he or she can firmly place both feet on the passenger footrests.
- Never ride under the influence of alcohol or other drugs.
- This motorcycle is designed for on-road use only. It is not suitable for off-road use.

Protective Apparel

The majority of fatalities from motorcycle accidents are the result of head injuries. The use of a safety helmet is the single most critical factor in the prevention or reduction of head injuries.

- Always wear an approved helmet.
- Wear a face shield or goggles. Wind in your unprotected eyes could contribute to an impairment of vision that could delay seeing a hazard.
- The use of a jacket, heavy boots, trousers, gloves, etc., is effective in preventing or reducing abrasions or lacerations.
- Never wear loose-fitting clothes, otherwise they could catch on the control levers, footrests, or wheels and cause injury or an accident.
- Always wear protective clothing that covers your legs, ankles, and feet. The engine or exhaust system become very hot during or after operation and can cause burns.
- A passenger should also observe the above precautions.

Safety information

1

Avoid Carbon Monoxide Poisoning

All engine exhaust contains carbon monoxide, a deadly gas. Breathing carbon monoxide can cause headaches, dizziness, drowsiness, nausea, confusion, and eventually death.

Carbon Monoxide is a colorless, odorless, tasteless gas which may be present even if you do not see or smell any engine exhaust. Deadly levels of carbon monoxide can collect rapidly and you can quickly be overcome and unable to save yourself. Also, deadly levels of carbon monoxide can linger for hours or days in enclosed or poorly ventilated areas. If you experience any symptoms of carbon monoxide poisoning, leave the area immediately, get fresh air, and SEEK MEDICAL TREATMENT.

- Do not run engine indoors. Even if you try to ventilate engine exhaust with fans or open windows and doors, carbon monoxide can rapidly reach dangerous levels.
- Do not run engine in poorly ventilated or partially enclosed areas such as barns, garages, or carports.

- Do not run engine outdoors where engine exhaust can be drawn into a building through openings such as windows and doors.

Loading

Adding accessories or cargo to your motorcycle can adversely affect stability and handling if the weight distribution of the motorcycle is changed. To avoid the possibility of an accident, use extreme caution when adding cargo or accessories to your motorcycle. Use extra care when riding a motorcycle that has added cargo or accessories. Here, along with the information about accessories below, are some general guidelines to follow if loading cargo to your motorcycle:

The total weight of the operator, passenger, accessories and cargo must not exceed the maximum load limit.

Operation of an overloaded vehicle could cause an accident.

Maximum load:
171 kg (377 lb)

When loading within this weight limit, keep the following in mind:

- Cargo and accessory weight should be kept as low and close to the motorcycle as possible. Securely pack your heaviest items as close to the center of the vehicle as possible and make sure to distribute the weight as evenly as possible on both sides of the motorcycle to minimize imbalance or instability.
- Shifting weights can create a sudden imbalance. Make sure that accessories and cargo are securely attached to the motorcycle before riding. Check accessory mounts and cargo restraints frequently.
- Properly adjust the suspension for your load (suspension-adjustable models only), and check the condition and pressure of your tires.
- Never attach any large or heavy items to the handlebar, front fork, or front fender. These items, including such cargo as sleeping bags, duffel bags, or

tents, can create unstable handling or a slow steering response.

- **This vehicle is not designed to pull a trailer or to be attached to a sidecar.**

Genuine Yamaha Accessories

Choosing accessories for your vehicle is an important decision. Genuine Yamaha accessories, which are available only from a Yamaha dealer, have been designed, tested, and approved by Yamaha for use on your vehicle.

Many companies with no connection to Yamaha manufacture parts and accessories or offer other modifications for Yamaha vehicles. Yamaha is not in a position to test the products that these aftermarket companies produce. Therefore, Yamaha can neither endorse nor recommend the use of accessories not sold by Yamaha or modifications not specifically recommended by Yamaha, even if sold and installed by a Yamaha dealer.

Aftermarket Parts, Accessories, and Modifications

While you may find aftermarket products similar in design and quality to genuine Yamaha accessories, recognize that some aftermarket accessories or modifications are not suitable because of potential safety hazards to you or others. Installing aftermarket products or having other modifications performed to your vehicle that change any of the vehicle's design or operation characteristics can put you and others at greater risk of serious injury or death. You are responsible for injuries related to changes in the vehicle.

Keep the following guidelines in mind, as well as those provided under "Loading" when mounting accessories.

- Never install accessories or carry cargo that would impair the performance of your motorcycle. Carefully inspect the accessory before using it to make sure that it does not in any way reduce ground clearance or cornering clearance, limit suspension travel,

steering travel or control operation, or obscure lights or reflectors.

- Accessories fitted to the handlebar or the front fork area can create instability due to improper weight distribution or aerodynamic changes. If accessories are added to the handlebar or front fork area, they must be as lightweight as possible and should be kept to a minimum.
- Bulky or large accessories may seriously affect the stability of the motorcycle due to aerodynamic effects. Wind may attempt to lift the motorcycle, or the motorcycle may become unstable in cross winds. These accessories may also cause instability when passing or being passed by large vehicles.
- Certain accessories can displace the operator from his or her normal riding position. This improper position limits the freedom of movement of the

Safety information

1

operator and may limit control ability, therefore, such accessories are not recommended.

- Use caution when adding electrical accessories. If electrical accessories exceed the capacity of the motorcycle's electrical system, an electric failure could result, which could cause a dangerous loss of lights or engine power.

Aftermarket Tires and Rims

The tires and rims that came with your motorcycle were designed to match the performance capabilities and to provide the best combination of handling, braking, and comfort. Other tires, rims, sizes, and combinations may not be appropriate. Refer to page 6-17 for tire specifications and more information on replacing your tires.

Transporting the Motorcycle

Be sure to observe following instructions before transporting the motorcycle in another vehicle.

- Remove all loose items from the motorcycle.

- Check that the fuel cock (if equipped) is in the "OFF" position and that there are no fuel leaks.
- Point the front wheel straight ahead on the trailer or in the truck bed, and choke it in a rail to prevent movement.
- Shift the transmission in gear (for models with a manual transmission).
- Secure the motorcycle with tie-downs or suitable straps that are attached to solid parts of the motorcycle, such as the frame or upper front fork triple clamp (and not, for example, to rubber-mounted handlebars or turn signals, or parts that could break). Choose the location for the straps carefully so the straps will not rub against painted surfaces during transport.
- The suspension should be compressed somewhat by the tie-downs, if possible, so that the motorcycle will not bounce excessively during transport.

Left view

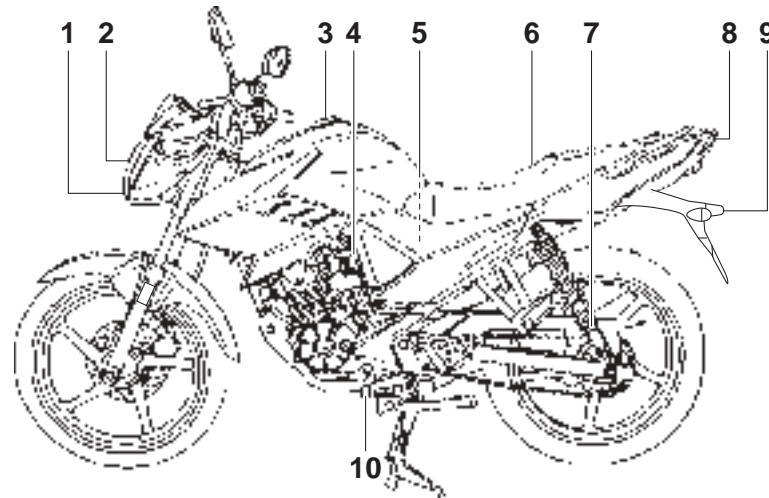

- | | |
|--|------------------------------------|
| 1. Auxiliary light (page 6-34) | 9. License plate light (page 6-36) |
| 2. Headlight (page 6-33) | 10. Shift pedal (page 3-6) |
| 3. Fuel tank cap (page 3-8) | |
| 4. Idle adjusting screw (page 6-16) | |
| 5. Air filter element (page 6-14) | |
| 6. Seat (page 3-11) | |
| 7. Shock absorber assembly spring preload adjusting ring (page 3-11) | |
| 8. Brake/tail light (page 6-35) | |

Description

EAU10421

Right view

2

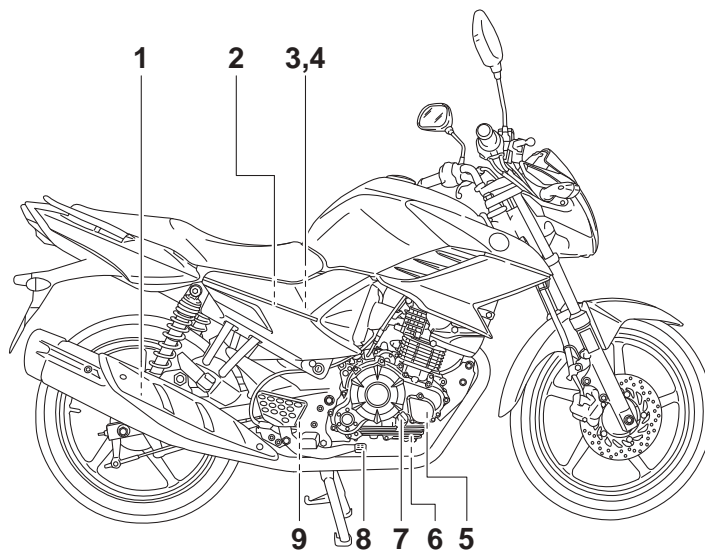

1. Shock absorber assembly spring preload adjusting ring (page 3-11)
2. Owner's tool kit (page 6-2)
3. Battery (page 6-30)
4. Fuses (page 6-31)
5. Engine oil filter element (page 6-11)
6. Engine oil drain bolt (page 6-11)
7. Engine oil filler cap (page 6-11)
8. Brake pedal (page 3-7)
9. Rear brake light switch (page 6-21)

Controls and instruments

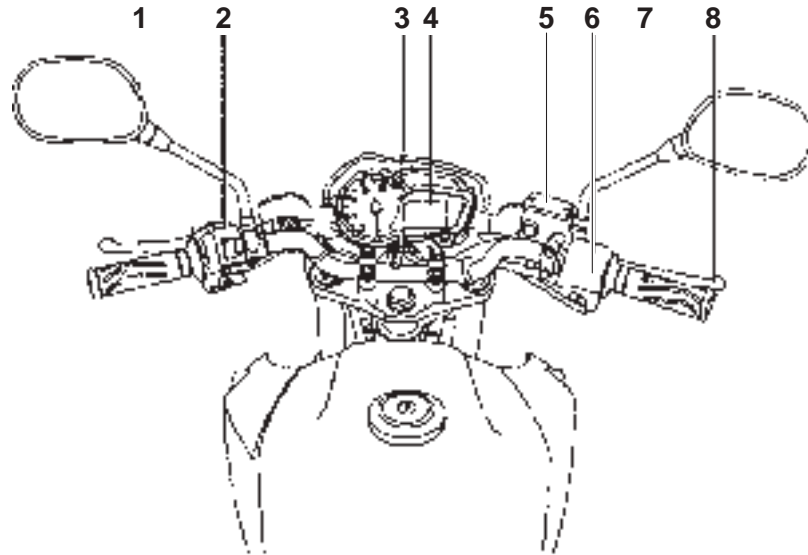

1. Clutch lever (page 3-6)
2. Left handlebar switches (page 3-5)
3. Main switch/steering lock (page 3-1)
4. Multi-function meter unit (page 3-3)
5. Front brake fluid reservoir (page 6-22)
6. Right handlebar switch (page 3-5)
7. Throttle grip (page 6-16)
8. Brake lever (page 3-7)

Instrument and control functions

3

Main switch/steering lock

EAU10462

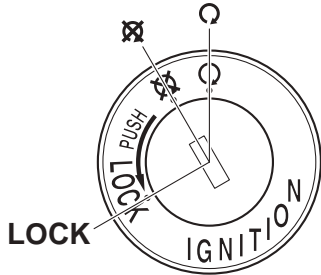

The main switch/steering lock controls the ignition and lighting systems, and is used to lock the steering. The various positions are described below.

○ (on)

EAU78890

All electrical circuits are supplied with power and the vehicle lights are turned on. The engine can be started. The key cannot be removed.

TIP

To prevent draining the battery, do not leave the key in the on position for an extended time without the engine running.

⊗ (off)

EAU54301

All electrical systems are off. The key can be removed.

⚠ WARNING

EWA16371

Never turn the key to “⊗” or “LOCK” while the vehicle is moving. Otherwise the electrical systems will be switched off, which may result in loss of control or an accident.

LOCK

EAU73820

The steering is locked, and all electrical systems are off. The key can be removed.

To lock the steering

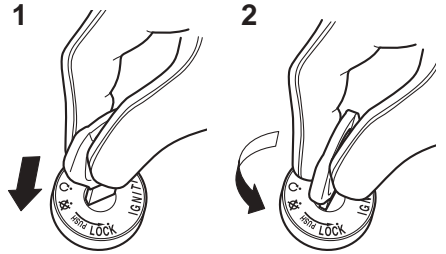

1. Push.
2. Turn.

1. Turn the handlebars all the way to the left or right.
2. With the key in the “⊗” position, push the key in and turn it to “LOCK”.
3. Remove the key.

TIP

If the steering will not lock, try turning the handlebars back to the right or left slightly.

To unlock the steering

1

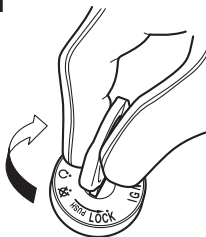

1. Turn.

Insert the key and turn it to “”.

Indicator lights and warning light

EAU1100D

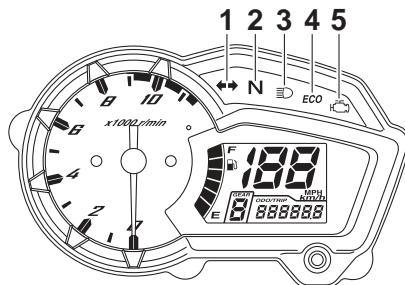

1. Turn signal indicator light “ ”
2. Neutral indicator light “**N**”
3. High beam indicator light “”
4. Eco indicator light “ECO”
5. Engine trouble warning light “”

Turn signal indicator light “ ”

EAU11022

This indicator light flashes when a turn signal light is flashing.

Neutral indicator light “**N**”

EAU11061

This indicator light comes on when the transmission is in the neutral position.

High beam indicator light “”

EAU11081

This indicator light comes on when the high beam of the headlight is switched on.

Engine trouble warning light “”

EAU78310

This warning light comes on if a problem is detected in the engine or other vehicle control system. If this occurs, have a Yamaha dealer check the on-board diagnostic system.

The electrical circuit of the warning light can be checked by turning the key to “”. The warning light should come on for a few seconds, and then go off. If the warning light does not come on initially when the key is turned to “”, or if the warning light remains on, have a Yamaha dealer check the vehicle.

Eco indicator light “ECO”

EAUE2572

This indicator light comes on when the vehicle is being operated in an environmentally friendly, fuel-efficient manner. The indicator light goes off when the vehicle is stopped.

Instrument and control functions

TIP _____

Consider the following tips to reduce fuel consumption:

- Avoid high engine speeds during acceleration.
- Travel at a constant speed.
- Select the transmission gear that is appropriate for the vehicle speed.

3

Multi-function meter unit

EAU78331

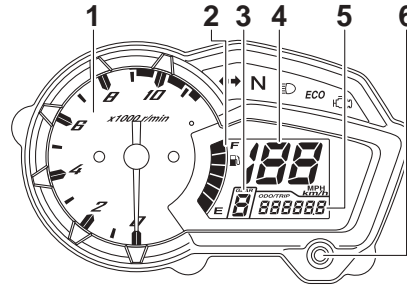

1. Tachometer
2. Fuel meter
3. Transmission gear display
4. Speedometer
5. Odometer/tripmeter
6. "RESET/SELECT" button

EWA12423

WARNING

Be sure to stop the vehicle before making any setting changes to the multi-function meter unit. Changing settings while riding can distract the operator and increase the risk of an accident.

The multi-function meter unit is equipped with the following:

- speedometer

- odometer
- tripmeter
- tachometer
- fuel meter
- transmission gear display

TIP _____

- Be sure to turn the key to "O" before using the "RESET/SELECT" button.
- For the UK: To switch the speedometer and odometer/tripmeter displays between kilometers and miles, push the "RESET/SELECT" button for two seconds. However, the display units can be switched only while the odometer is displayed.

Speedometer

The speedometer shows the vehicle's traveling speed.

Instrument and control functions

Odometer and tripmeter

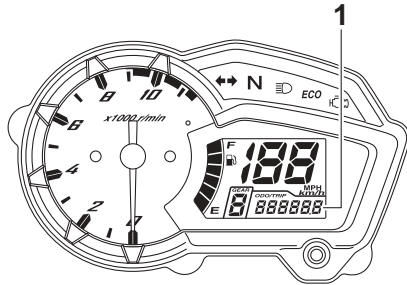

1. Odometer/tripmeter

The odometer shows the total distance traveled by the vehicle.

The tripmeter shows the distance traveled since it was last reset.

TIP

- The odometer will lock at 999999.
- The tripmeter will reset and continue counting after 9999.9 is reached.

Pushing the “RESET/SELECT” button switches the display between the odometer “ODO” and the tripmeter “TRIP”.

To reset the tripmeter, select it by pushing the “RESET/SELECT” button, and then push the “RESET/SELECT” button for one second.

Tachometer

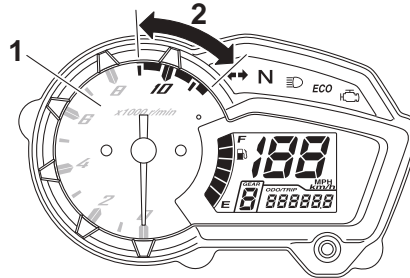

1. Tachometer
2. Tachometer red zone

The tachometer allows the rider to monitor the engine speed and keep it within the ideal power range.

ECA10032

NOTICE

Do not operate the engine in the tachometer red zone.

Red zone: 9000 r/min and above

Fuel meter

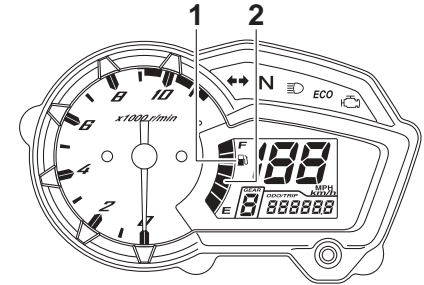

1. Fuel level warning indicator “”
2. Fuel meter

The fuel meter indicates the amount of fuel in the fuel tank. The display segments of the fuel meter disappear from “F” (full) towards “E” (empty) as the fuel level decreases. When the last segment of the fuel meter and the fuel level warning indicator “” start flashing, refuel as soon as possible.

TIP

If a problem is detected in the fuel meter electrical circuit, all the display segments and the fuel level warning indicator “” start flashing. If this occurs, have a Yamaha dealer check the electrical circuit.

Instrument and control functions

Transmission gear display

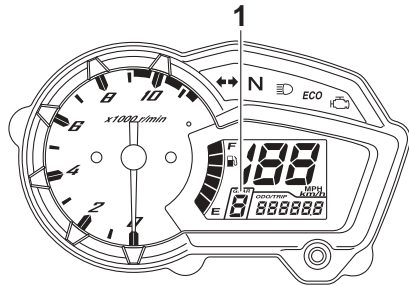

1. Transmission gear display





This display shows the selected gear. The neutral position, however, is not displayed, it is indicated by the neutral indicator light.

Handlebar switches

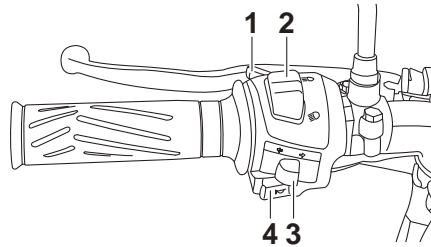
EAU1234M

Left



1. Pass switch “ ”
2. Dimmer switch “ ”
3. Turn signal switch “ ”
4. Horn switch “ ”

Right

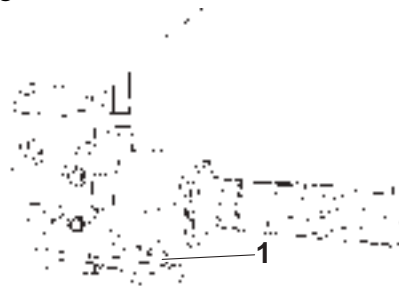

1. Start switch “ ”

Pass switch “ ”

EAU12352



Press this switch to flash the headlight.

TIP

When the dimmer switch is set to “ ”, the passing switch has no effect.



Dimmer switch “ / ”

EAU12401

Set this switch to “ ” for the high beam and to “ ” for the low beam.

Turn signal switch “ / ”

EAU12461

To signal a right-hand turn, push this switch to “ ”. To signal a left-hand turn, push this switch to “ ”. When released, the switch returns to the center position. To cancel the turn signal lights, push the switch in after it has returned to the center position.

Horn switch “ ”

EAU12501

Press this switch to sound the horn.

Start switch “”

EAU12713

Push this switch to crank the engine with the starter. See page 5-1 for starting instructions prior to starting the engine.

Clutch lever

EAU12822

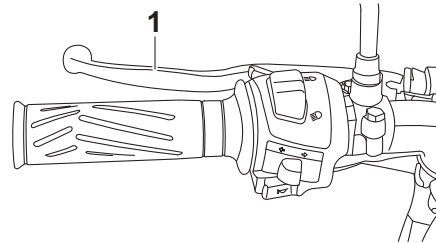

1. Clutch lever

The clutch lever is located on the left side of the handlebar. To disengage the clutch, pull the lever toward the handlebar grip. To engage the clutch, release the lever. The lever should be pulled rapidly and released slowly for smooth clutch operation.

The clutch lever is equipped with a clutch switch, which is part of the ignition circuit cut-off system. (See page 3-13.)

Shift pedal

EAU12872

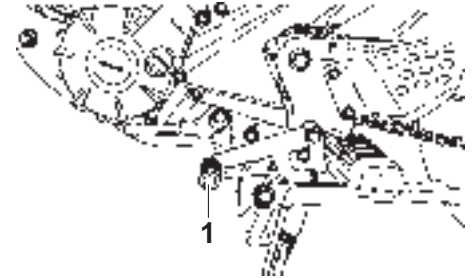

1. Shift pedal

The shift pedal is located on the left side of the motorcycle and is used in combination with the clutch lever when shifting the gears of the 5-speed constant-mesh transmission equipped on this motorcycle.

Instrument and control functions

Brake lever

EAU78900

3

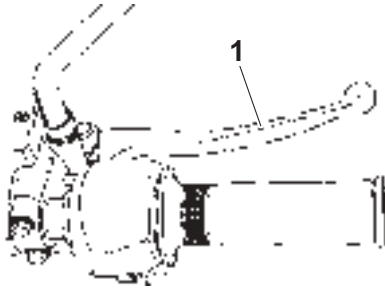

1. Brake lever

The brake lever is located on the right side of the handlebar. To apply the front brake, pull the lever toward the throttle grip.

This model is equipped with a unified brake system.

When the brake lever is pulled, the rear brake is also applied proportionally to the front brake. For full braking performance, operate the brake lever and brake pedal simultaneously.

TIP

- Because the unified brake system is mechanical, additional free play can be felt in the brake pedal

when the brake lever is being pulled, but this does not indicate a malfunction.

- The unified brake system does not operate when the brake pedal is pressed down directly.

Brake pedal

EAU78910

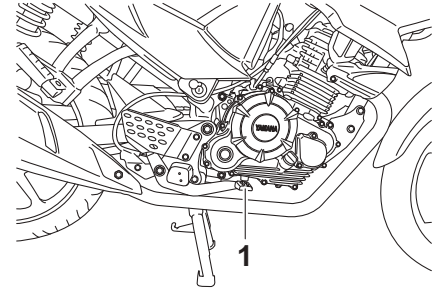

1. Brake pedal

The brake pedal is located on the right side of the motorcycle. To apply the rear brake, press down on the brake pedal.

TIP

Because the unified brake system is mechanical, additional free play can be felt in the brake pedal when the brake lever is being pulled, but this does not indicate a malfunction.

Fuel tank cap

EAU13003

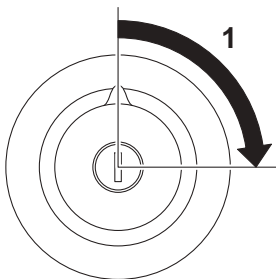

1. Unlock.

To remove the fuel tank cap

Insert the key into the lock and turn it 1/4 turn clockwise. The lock will be released and the fuel tank cap can be removed.

To install the fuel tank cap

1. Push the fuel tank cap into position with the key inserted in the lock.
2. Turn the key counterclockwise to the original position, and then remove it.

TIP _____

The fuel tank cap cannot be installed unless the key is in the lock. In addition, the key cannot be removed if the cap is not properly installed and locked.

⚠ WARNING _____

EWA11142

Make sure that the fuel tank cap is properly installed before riding. Leaking fuel is a fire hazard.

Fuel

EAU13213

Make sure there is sufficient gasoline in the tank.

EWA10882

⚠ WARNING _____

Gasoline and gasoline vapors are extremely flammable. To avoid fires and explosions and to reduce the risk of injury when refueling, follow these instructions.

1. Before refueling, turn off the engine and be sure that no one is sitting on the vehicle. Never refuel while smoking, or while in the vicinity of sparks, open flames, or other sources of ignition such as the pilot lights of water heaters and clothes dryers.
2. Do not overfill the fuel tank. Stop filling when the fuel reaches the bottom of the filler tube. Because fuel expands when it heats up, heat from the engine or the sun can cause fuel to spill out of the fuel tank.

Instrument and control functions

3

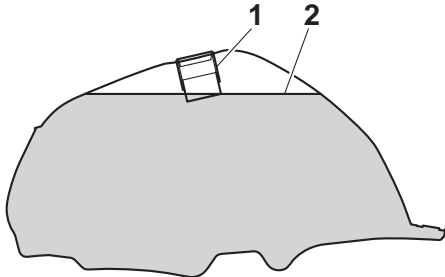

1. Fuel tank filler tube
2. Maximum fuel level
3. Wipe up any spilled fuel immediately. **NOTICE: Immediately wipe off spilled fuel with a clean, dry, soft cloth, since fuel may deteriorate painted surfaces or plastic parts.** [ECA10072]
4. Be sure to securely close the fuel tank cap.

EWA15152

WARNING

Gasoline is poisonous and can cause injury or death. Handle gasoline with care. Never siphon gasoline by mouth. If you should swallow some gasoline or inhale a lot of gasoline vapor, or get some gasoline in your eyes, see your doctor immediately. If

gasoline spills on your skin, wash with soap and water. If gasoline spills on your clothing, change your clothes.

EAU76860

Recommended fuel:

Regular unleaded gasoline (Gasohol [E10] acceptable)

Fuel tank capacity:

14 L (3.7 US gal, 3.1 Imp.gal)

Fuel reserve amount:

2.2 L (0.58 US gal, 0.48 Imp.gal)

ECA11401

NOTICE

Use only unleaded gasoline. The use of leaded gasoline will cause severe damage to internal engine parts, such as the valves and piston rings, as well as to the exhaust system.



TIP

- This mark identifies the recommended fuel for this vehicle as specified by European regulation (EN228).
- Check that gasoline nozzle has the same identifier when fueling.

Your Yamaha engine has been designed to use regular unleaded gasoline with a research octane number of 95 or higher. If knocking (or pinging) occurs, use a gasoline of a different brand or premium unleaded fuel. Use of unleaded fuel will extend spark plug life and reduce maintenance costs.

Gasohol

There are two types of gasohol: gasohol containing ethanol and that containing methanol. Gasohol containing ethanol can be used if the ethanol content does not exceed 10% (E10). Gasohol containing methanol is not recommended by Yamaha because it can cause damage to the fuel system or vehicle performance problems.

EAU13447

Catalytic converters

This vehicle is equipped with catalytic converters in the exhaust system.

EWA10863

WARNING

The exhaust system is hot after operation. To prevent a fire hazard or burns:

- Do not park the vehicle near possible fire hazards such as grass or other materials that easily burn.
- Park the vehicle in a place where pedestrians or children are not likely to touch the hot exhaust system.
- Make sure that the exhaust system has cooled down before doing any maintenance work.
- Do not allow the engine to idle more than a few minutes. Long idling can cause a build-up of heat.

ECA10702

NOTICE

Use only unleaded gasoline. The use of leaded gasoline will cause unreparable damage to the catalytic converter.

Instrument and control functions

Seat

EAU78851

3. Lift the front of the seat and pull it forward.

To remove the seat

1. Remove panels A and B. (See page 6-8.)
2. Remove the bolts.



1. Bolt

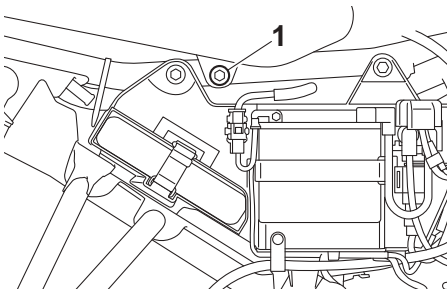

1. Bolt

To install the seat

1. Insert the projection on the rear of the seat into the seat holder as shown.

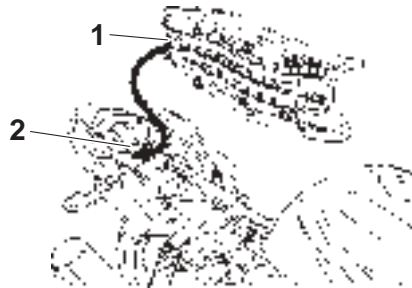

1. Projection
2. Seat holder

2. Place the seat in the original position, and then tighten the bolts.
3. Install the panels.

TIP

Make sure that the seat is properly secured before riding.

Adjusting the shock absorber assemblies

EUA68420

EUA10211

⚠ WARNING

Always adjust both shock absorber assemblies equally, otherwise poor handling and loss of stability may result.

Each shock absorber assembly is equipped with a spring preload adjusting ring.

ECA10102

NOTICE

To avoid damaging the mechanism, do not attempt to turn beyond the maximum or minimum settings.

Adjust the spring preload as follows.

To increase the spring preload and thereby harden the suspension, turn the adjusting ring on each shock absorber assembly in direction (a). To decrease the spring preload and thereby soften the suspension, turn the adjusting ring on each shock absorber assembly in direction (b).

- Align the appropriate notch in the adjusting ring with the position indicator on the shock absorber.
- Use the screwdriver included in the owner's tool kit to make this adjustment.



1. Spring preload adjusting ring
2. Position indicator
3. Screwdriver

Spring preload setting:

- Minimum (soft):
1
- Standard:
2
- Maximum (hard):
5

Sidestand

EAU15306

The sidestand is located on the left side of the frame. Raise the sidestand or lower it with your foot while holding the vehicle upright.

this system regularly and have a Yamaha dealer repair it if it does not function properly.

TIP

The built-in sidestand switch is part of the ignition circuit cut-off system, which cuts the ignition in certain situations. (See the following section for an explanation of the ignition circuit cut-off system.)

EWA10242

! WARNING

The vehicle must not be ridden with the sidestand down, or if the sidestand cannot be properly moved up (or does not stay up), otherwise the sidestand could contact the ground and distract the operator, resulting in a possible loss of control. Yamaha's ignition circuit cut-off system has been designed to assist the operator in fulfilling the responsibility of raising the sidestand before starting off. Therefore, check

Instrument and control functions

EAU78340

Ignition circuit cut-off system

The ignition circuit cut-off system (comprising the sidestand switch, clutch switch and neutral switch) has the following functions.

3

- It prevents starting when the transmission is in gear and the sidestand is up, but the clutch lever is not pulled.
- It prevents starting when the transmission is in gear and the clutch lever is pulled, but the sidestand is still down.
- It cuts the running engine when the transmission is in gear and the sidestand is moved down.

Periodically check the operation of the ignition circuit cut-off system according to the following procedure.

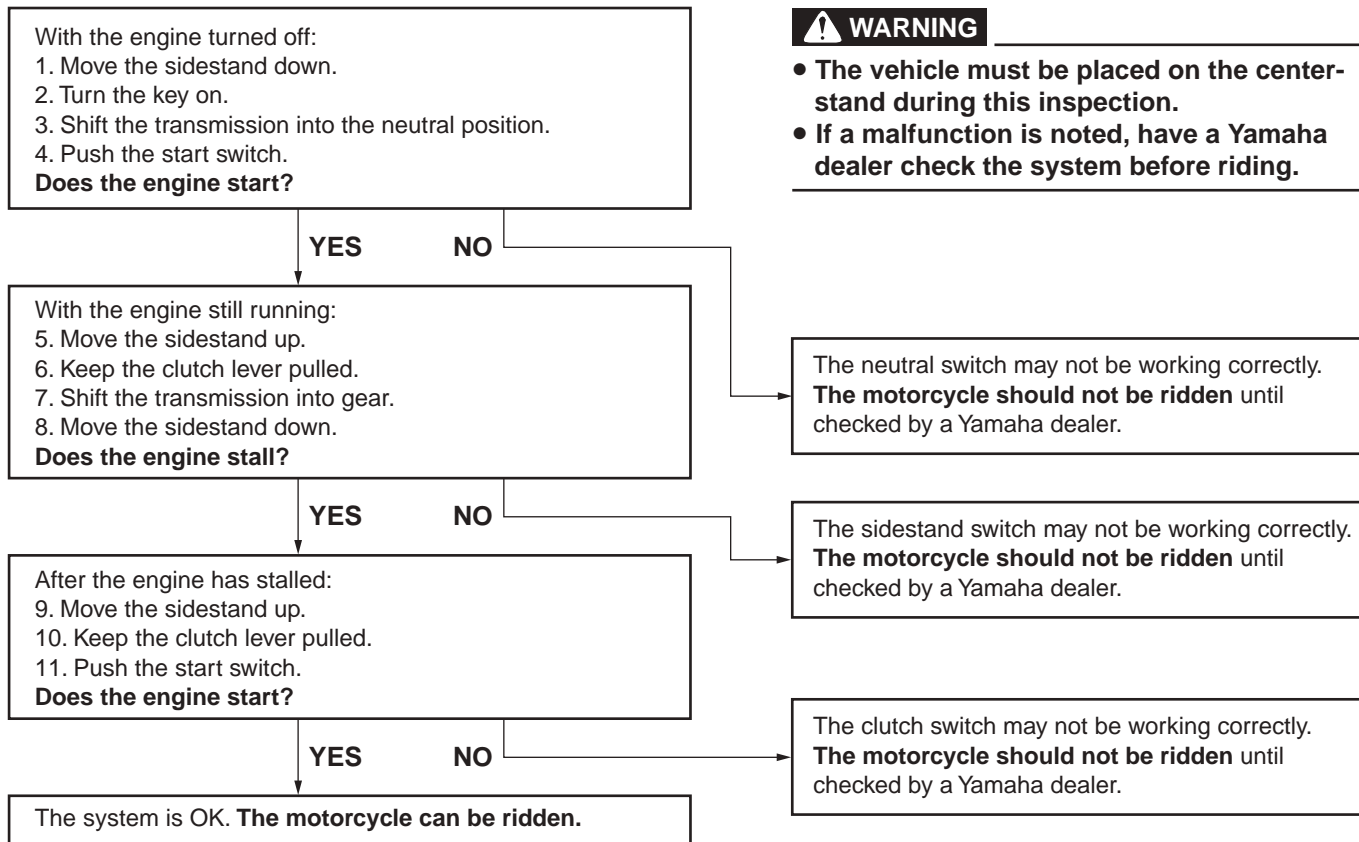

For your safety – pre-operation checks

EAU15599

Inspect your vehicle each time you use it to make sure the vehicle is in safe operating condition. Always follow the inspection and maintenance procedures and schedules described in the Owner's Manual.

EWA11152

WARNING

Failure to inspect or maintain the vehicle properly increases the possibility of an accident or equipment damage. Do not operate the vehicle if you find any problem. If a problem cannot be corrected by the procedures provided in this manual, have the vehicle inspected by a Yamaha dealer.

4

Before using this vehicle, check the following points:

ITEM	CHECKS	PAGE
Fuel	<ul style="list-style-type: none">• Check fuel level in fuel tank.• Refuel if necessary.• Check fuel line for leakage.	3-8
Engine oil	<ul style="list-style-type: none">• Check oil level in engine.• If necessary, add recommended oil to specified level.• Check vehicle for oil leakage.	6-11
Front brake	<ul style="list-style-type: none">• Check operation.• If soft or spongy, have Yamaha dealer bleed hydraulic system.• Check brake pads for wear.• Replace if necessary.• Check fluid level in reservoir.• If necessary, add specified brake fluid to specified level.• Check hydraulic system for leakage.	6-22, 6-22
Rear brake	<ul style="list-style-type: none">• Check operation.• Check pedal free play.• Adjust if necessary.	6-21, 6-22
Clutch	<ul style="list-style-type: none">• Check operation.• Lubricate cable if necessary.• Check lever free play.• Adjust if necessary.	6-19

For your safety – pre-operation checks

ITEM	CHECKS	PAGE
Throttle grip	<ul style="list-style-type: none"> • Make sure that operation is smooth. • Check throttle grip free play. • If necessary, have Yamaha dealer adjust throttle grip free play and lubricate cable and grip housing. 	6-16, 6-26
Control cables	<ul style="list-style-type: none"> • Make sure that operation is smooth. • Lubricate if necessary. 	6-26
Drive chain	<ul style="list-style-type: none"> • Check chain slack. • Adjust if necessary. • Check chain condition. • Lubricate if necessary. 	6-24, 6-25
Wheels and tires	<ul style="list-style-type: none"> • Check for damage. • Check tire condition and tread depth. • Check air pressure. • Correct if necessary. 	6-17, 6-19
Brake and shift pedals	<ul style="list-style-type: none"> • Make sure that operation is smooth. • Lubricate pedal pivoting points if necessary. 	6-26
Brake and clutch levers	<ul style="list-style-type: none"> • Make sure that operation is smooth. • Lubricate lever pivoting points if necessary. 	6-27
Centerstand, sidestand	<ul style="list-style-type: none"> • Make sure that operation is smooth. • Lubricate pivots if necessary. 	6-28
Chassis fasteners	<ul style="list-style-type: none"> • Make sure that all nuts, bolts and screws are properly tightened. • Tighten if necessary. 	—
Instruments, lights, signals and switches	<ul style="list-style-type: none"> • Check operation. • Correct if necessary. 	—
Sidestand switch	<ul style="list-style-type: none"> • Check operation of ignition circuit cut-off system. • If system is not working correctly, have Yamaha dealer check vehicle. 	3-12

Operation and important riding points

EAU15952

Read the Owner's Manual carefully to become familiar with all controls. If there is a control or function you do not understand, ask your Yamaha dealer.

EWA10272



WARNING

Failure to familiarize yourself with the controls can lead to loss of control, which could cause an accident or injury.

5

EAUM3150

TIP

This model is equipped with a lean angle sensor to stop the engine in case of a turnover. To start the engine after a turnover, be sure to turn the main switch to “” and then to “”. Failing to do so will prevent the engine from starting even though the engine will crank when pushing the start switch.

EAU78350

Starting the engine

In order for the ignition circuit cut-off system to enable starting, one of the following conditions must be met:

- The transmission is in the neutral position.
- The transmission is in gear with the clutch lever pulled and the sidestand up.

See page 3-13 for more information.

1. Turn the key to “”.
The engine trouble warning light should come on for a few seconds, then go off.

ECA23970

NOTICE

If the warning light does not come on initially when the key is turned to “”, or if the warning light remains on, see page 3-2 for the warning light circuit check.

2. Shift the transmission into the neutral position. The neutral indicator light should come on. If not, ask a Yamaha dealer to check the electrical circuit.

3. Start the engine by pushing the start switch.

If the engine fails to start when using the start switch, release it, wait a few seconds, and then try again. Each starting attempt should be as short as possible to preserve the battery. Do not crank the engine more than 10 seconds on any one attempt.

ECA11043

NOTICE

For maximum engine life, never accelerate hard when the engine is cold!

Shifting



EAU16673

ECA10261

NOTICE

- Even with the transmission in the neutral position, do not coast for long periods of time with the engine off, and do not tow the motorcycle for long distances. The transmission is properly lubricated only when the engine is running. Inadequate lubrication may damage the transmission.
- Always use the clutch while changing gears to avoid damaging the engine, transmission, and drive train, which are not designed to withstand the shock of forced shifting.

5

1. Shift pedal
2. Neutral position

Shifting gears lets you control the amount of engine power available for starting off, accelerating, climbing hills, etc.

The gear positions are shown in the illustration.

TIP

To shift the transmission into the neutral position, press the shift pedal down repeatedly until it reaches the end of its travel, and then slightly raise it.

Operation and important riding points

Tips for reducing fuel consumption

EAU16811

Fuel consumption depends largely on your riding style. Consider the following tips to reduce fuel consumption:

- Shift up swiftly, and avoid high engine speeds during acceleration.
- Do not rev the engine while shifting down, and avoid high engine speeds with no load on the engine.
- Turn the engine off instead of letting it idle for an extended length of time (e.g., in traffic jams, at traffic lights or at railroad crossings).

Engine break-in

EAU16831

There is never a more important period in the life of your engine than the period between 0 and 1000 km (600 mi). For this reason, you should read the following material carefully.

Since the engine is brand new, do not put an excessive load on it for the first 1000 km (600 mi). The various parts in the engine wear and polish themselves to the correct operating clearances. During this period, prolonged full-throttle operation or any condition that might result in engine overheating must be avoided.

EAU16883

0–150 km (0–90 mi)

Avoid prolonged operation above 4500 r/min.

After every hour of operation, stop the engine, and then let it cool for five to ten minutes.

Vary the engine speed from time to time. Do not operate the engine at one set throttle position.

150–500 km (90–300 mi)

Avoid prolonged operation above 5400 r/min.

Rev the engine freely through the gears, but do not use full throttle at any time.

500–1000 km (300–600 mi)

Avoid prolonged full-throttle operation. Avoid prolonged operation above 7000 r/min. **NOTICE: After 1000 km (600 mi) of operation, the engine oil must be changed and the oil filter cartridge or element replaced.** [ECA10303]

1000 km (600 mi) and beyond

The vehicle can now be operated normally.

ECA10311

NOTICE

- Keep the engine speed out of the tachometer red zone.
 - If any engine trouble should occur during the engine break-in period, immediately have a Yamaha dealer check the vehicle.
-

EAU17214

Parking

When parking, stop the engine, and then remove the key from the main switch.

EWA10312

WARNING

- **Since the engine and exhaust system can become very hot, park in a place where pedestrians or children are not likely to touch them and be burned.**
 - **Do not park on a slope or on soft ground, otherwise the vehicle may overturn, increasing the risk of a fuel leak and fire.**
 - **Do not park near grass or other flammable materials which might catch fire.**
-

Periodic maintenance and adjustment

EAU17246

EWA15123

EAU17303

Periodic inspection, adjustment, and lubrication will keep your vehicle in the safest and most efficient condition possible. Safety is an obligation of the vehicle owner/operator. The most important points of vehicle inspection, adjustment, and lubrication are explained on the following pages.

The intervals given in the periodic maintenance charts should be simply considered as a general guide under normal riding conditions. However, depending on the weather, terrain, geographical location, and individual use, the maintenance intervals may need to be shortened.

WARNING

EWA10322

Failure to properly maintain the vehicle or performing maintenance activities incorrectly may increase your risk of injury or death during service or while using the vehicle. If you are not familiar with vehicle service, have a Yamaha dealer perform service.

WARNING

Turn off the engine when performing maintenance unless otherwise specified.

- **A running engine has moving parts that can catch on body parts or clothing and electrical parts that can cause shocks or fires.**
- **Running the engine while servicing can lead to eye injury, burns, fire, or carbon monoxide poisoning – possibly leading to death. See page 1-3 for more information about carbon monoxide.**

Emission controls not only function to ensure cleaner air, but are also vital to proper engine operation and maximum performance. In the following periodic maintenance charts, the services related to emissions control are grouped separately. These services require specialized data, knowledge, and equipment. Maintenance, replacement, or repair of the emission control devices and systems may be performed by any repair establishment or individual that is certified (if applicable). Yamaha dealers are trained and equipped to perform these particular services.

WARNING

EWA15461

Brake discs, calipers, drums, and linings can become very hot during use. To avoid possible burns, let brake components cool before touching them.

EAU17342

Owner's tool kit

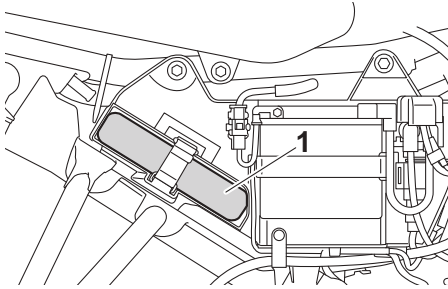

1. Owner's tool kit

The owner's tool kit is located behind panel B. (See page 6-8.)

The service information included in this manual and the tools provided in the owner's tool kit are intended to assist you in the performance of preventive maintenance and minor repairs. However, additional tools such as a torque wrench may be necessary to perform certain maintenance work correctly.

TIP _____

If you do not have the tools or experience required for a particular job, have a Yamaha dealer perform it for you.

Periodic maintenance and adjustment

EAU71020

TIP

- The annual checks must be performed every year, except if a kilometer-based maintenance, or for the UK, a mileage-based maintenance, is performed instead.
- From 30000 km (17500 mi), repeat the maintenance intervals starting from 6000 km (3500 mi).
- Items marked with an asterisk should be performed by a Yamaha dealer as they require special tools, data and technical skills.

EAU71040

Periodic maintenance chart for the emission control system

NO.	ITEM	CHECK OR MAINTENANCE JOB	ODOMETER READING					ANNUAL CHECK
			1000 km (600 mi)	6000 km (3500 mi)	12000 km (7000 mi)	18000 km (10500 mi)	24000 km (14000 mi)	
1	* Fuel line	<ul style="list-style-type: none"> • Check fuel hoses for cracks or damage. • Replace if necessary. 		√	√	√	√	√
2	* Spark plug	<ul style="list-style-type: none"> • Check condition. • Adjust gap and clean. 		√		√		
		<ul style="list-style-type: none"> • Replace. 			√		√	
3	* Valve clearance	<ul style="list-style-type: none"> • Check and adjust. 		√	√	√	√	
4	* Fuel injection	<ul style="list-style-type: none"> • Check and adjust engine idle speed. 	√	√	√	√	√	√
5	* Exhaust system	<ul style="list-style-type: none"> • Check for leakage. • Tighten if necessary. • Replace gasket if necessary. 	√	√	√	√	√	

Periodic maintenance and adjustment

EAU71342

General maintenance and lubrication chart

NO.	ITEM	CHECK OR MAINTENANCE JOB	ODOMETER READING					ANNUAL CHECK
			1000 km (600 mi)	6000 km (3500 mi)	12000 km (7000 mi)	18000 km (10500 mi)	24000 km (14000 mi)	
1	* Diagnostic system check	<ul style="list-style-type: none"> Perform dynamic inspection using Yamaha diagnostic tool. Check the error codes. 	√	√	√	√	√	√
2	* Air filter element	• Clean.		√		√		
		• Replace.			√		√	
3	Air filter case check hose	• Clean.	√	√	√	√	√	
4	Clutch	<ul style="list-style-type: none"> Check operation. Adjust. 	√	√	√	√	√	
5	* Front brake	<ul style="list-style-type: none"> Check operation, fluid level, and for fluid leakage. Replace brake pads if necessary. 	√	√	√	√	√	√
6	* Rear brake	<ul style="list-style-type: none"> Check operation. Adjust brake pedal free play. Replace brake shoes if necessary. 	√	√	√	√	√	√
7	* Brake hose	• Check for cracks or damage.		√	√	√	√	√
		• Replace.	Every 4 years					
8	* Brake fluid	• Change.	Every 2 years					
9	* Wheels	<ul style="list-style-type: none"> Check runout and for damage. Replace if necessary. 		√	√	√	√	

Periodic maintenance and adjustment

NO.	ITEM	CHECK OR MAINTENANCE JOB	ODOMETER READING					ANNUAL CHECK
			1000 km (600 mi)	6000 km (3500 mi)	12000 km (7000 mi)	18000 km (10500 mi)	24000 km (14000 mi)	
10	* Tires	<ul style="list-style-type: none"> • Check tread depth and for damage. • Replace if necessary. • Check air pressure. • Correct if necessary. 		√	√	√	√	√
11	* Wheel bearings	<ul style="list-style-type: none"> • Check bearing for looseness or damage. 		√	√	√	√	
12	* Swingarm pivot bushes	<ul style="list-style-type: none"> • Check bush assemblies for looseness. 		√	√	√	√	
		<ul style="list-style-type: none"> • Lubricate with lithium-soap-based grease. 			√		√	
13	Drive chain	<ul style="list-style-type: none"> • Check chain slack, alignment and condition. • Adjust and lubricate chain with a special O-ring chain lubricant thoroughly. 	Every 1000 km (600 mi) and after washing the motorcycle, riding in the rain or riding in wet areas					
14	* Steering bearings	<ul style="list-style-type: none"> • Check bearing assemblies for looseness. 	√	√	√	√		
		<ul style="list-style-type: none"> • Moderately repack with lithium-soap-based grease. 					√	
15	* Chassis fasteners	<ul style="list-style-type: none"> • Make sure that all nuts, bolts and screws are properly tightened. 		√	√	√	√	√
16	Brake lever pivot shaft	<ul style="list-style-type: none"> • Lubricate with silicone grease. 		√	√	√	√	√
17	Brake pedal pivot shaft	<ul style="list-style-type: none"> • Lubricate with lithium-soap-based grease. 		√	√	√	√	√
18	Clutch lever pivot shaft	<ul style="list-style-type: none"> • Lubricate with lithium-soap-based grease. 		√	√	√	√	√

Periodic maintenance and adjustment

NO.	ITEM	CHECK OR MAINTENANCE JOB	ODOMETER READING					ANNUAL CHECK
			1000 km (600 mi)	6000 km (3500 mi)	12000 km (7000 mi)	18000 km (10500 mi)	24000 km (14000 mi)	
19	Shift pedal pivot shaft	<ul style="list-style-type: none"> Lubricate with lithium-soap-based grease. 		√	√	√	√	√
20	* Unified brake system	<ul style="list-style-type: none"> Check cable free play, and adjust if necessary. 	√	√	√	√	√	√
		<ul style="list-style-type: none"> Lubricate link pivot of brake pedal with lithium-soap-based grease. 		√	√	√	√	√
21	Sidestand, center-stand	<ul style="list-style-type: none"> Check operation. Lubricate with lithium-soap-based grease. 		√	√	√	√	√
22	* Sidestand switch	<ul style="list-style-type: none"> Check operation and replace if necessary. 	√	√	√	√	√	√
23	* Front fork	<ul style="list-style-type: none"> Check operation and for oil leakage. Replace if necessary. 		√	√	√	√	
24	* Shock absorber assemblies	<ul style="list-style-type: none"> Check operation and for oil leakage. Replace if necessary. 		√	√	√	√	
25	Engine oil	<ul style="list-style-type: none"> Change (warm engine before draining). Check oil level and vehicle for oil leakage. 	√	√	√	√	√	√
26	Engine oil filter element	<ul style="list-style-type: none"> Replace. 	√		√		√	
27	* Front and rear brake switches	<ul style="list-style-type: none"> Check operation. 	√	√	√	√	√	√
28	* Moving parts and cables	<ul style="list-style-type: none"> Lubricate. 		√	√	√	√	√

Periodic maintenance and adjustment

NO.	ITEM	CHECK OR MAINTENANCE JOB	ODOMETER READING					ANNUAL CHECK
			1000 km (600 mi)	6000 km (3500 mi)	12000 km (7000 mi)	18000 km (10500 mi)	24000 km (14000 mi)	
29 *	Throttle grip housing and cable	<ul style="list-style-type: none"> • Check operation and free play. • Adjust the throttle cable free play if necessary. • Lubricate the throttle grip housing and cable. 		√	√	√	√	√
30 *	Lights, signals and switches	<ul style="list-style-type: none"> • Check operation. • Adjust headlight beam. 	√	√	√	√	√	√

EAU72690

6

TIP

- The air filter needs more frequent service if you are riding in unusually wet or dusty areas.
- Hydraulic brake service
 - Regularly check and, if necessary, correct the brake fluid level.
 - Every two years replace the internal components of the brake master cylinder and caliper, and change the brake fluid.
 - Replace the brake hoses every four years and if cracked or damaged.

Removing and installing the cowling and panels

EAU18724

The cowling and panels shown need to be removed to perform some of the maintenance jobs described in this chapter. Refer to this section each time the cowling or a panel needs to be removed and installed.

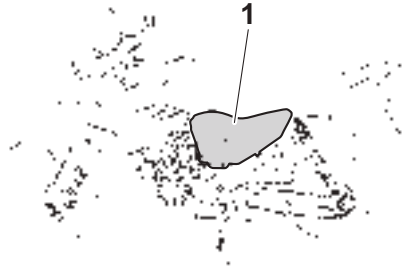

1. Panel A

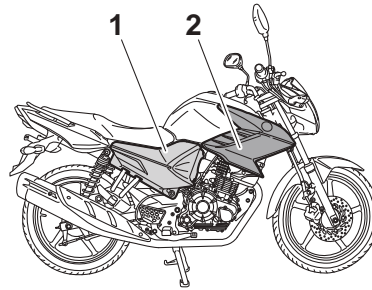

1. Panel B
2. Cowling A

Cowling A

EAU78741

To remove the cowling

Remove the bolt, and then take the cowling off.

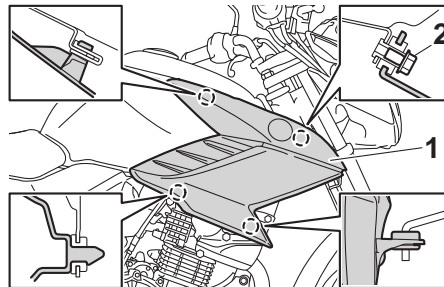

1. Cowling A
2. Bolt

To install the cowling

Place the cowling in the original position, and then install the bolt.



Panel A

To remove the panel

1. Remove the screw.

EAU56050

Periodic maintenance and adjustment

6

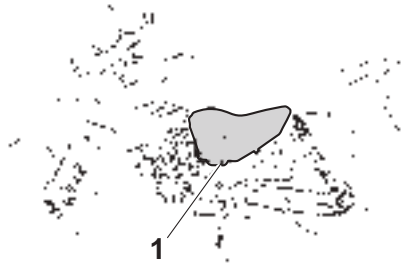

1. Screw

2. Pull the front of the panel out, and then slide the panel forward to release it in the rear.



To install the panel

1. Secure the rear of the panel, and then push the front of the panel in.
2. Install the screw.

Panel B

To remove the panel

1. Slide the panel lock cover open, insert the key into the lock, and then turn it 1/4 turn clockwise.

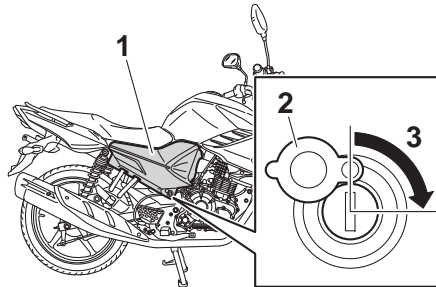

1. Panel B
2. Panel lock cover
3. Unlock.

2. Pull the front of the panel out with the key inserted in the lock, and then slide the panel forward to release it in the rear.

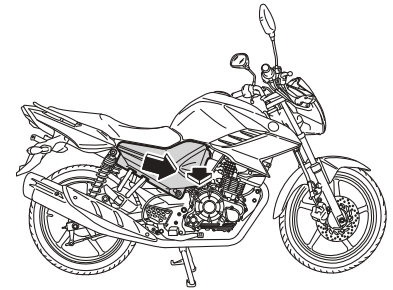

To install the panel

1. Secure the rear of the panel, and then push the front of the panel in with the key inserted in the lock.
2. While pushing the panel inward, turn the key counterclockwise to the original position, remove it, and then close the panel lock cover.

EAU78710

Checking the spark plug

The spark plug is an important engine component, which is easy to check. Since heat and deposits will cause any spark plug to slowly erode, the spark plug should be removed and checked in accordance with the periodic maintenance and lubrication chart. In addition, the condition of the spark plug can reveal the condition of the engine.

To remove the spark plug

1. Remove cowlings A. (See page 6-8.)
2. Remove the Y.R.C.S. (Yamaha Ram-Air Cooling System) cap by removing the bolts and then, remove the spark plug cap.



1. Cowlings A
2. Y.R.C.S (Yamaha Ram-Air Cooling System) cap
3. Bolt
4. Spark plug cap

3. Remove the spark plug as shown, with the spark plug wrench included in the owner's tool kit.

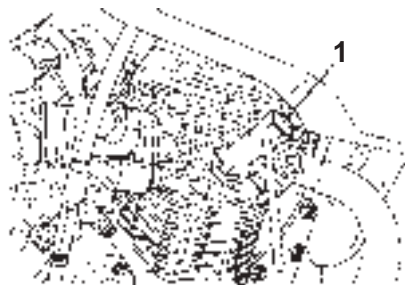

1. Spark plug wrench

To check the spark plug

1. Check that the porcelain insulator around the center electrode of the spark plug is a medium-to-light tan (the ideal color when the vehicle is ridden normally).

TIP

If the spark plug shows a distinctly different color, the engine could be operating improperly. Do not attempt to diagnose such problems yourself. Instead, have a Yamaha dealer check the vehicle.

2. Check the spark plug for electrode erosion and excessive carbon or other deposits, and replace it if necessary.

Specified spark plug:

NGK/CPR8EA-9

3. Measure the spark plug gap with a wire thickness gauge and, if necessary, adjust the gap to specification.

Periodic maintenance and adjustment

EAU78803

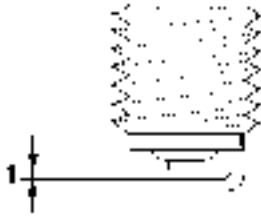

1. Spark plug gap

Spark plug gap:

0.8–0.9 mm (0.031–0.035 in)

6

To install the spark plug

1. Clean the surface of the spark plug gasket and its mating surface, and then wipe off any grime from the spark plug threads.
2. Install the spark plug with the spark plug wrench, and then tighten it to the specified torque.

Tightening torque:

Spark plug:

13 N·m (1.3 kgf·m, 9.4 lb·ft)

TIP

If a torque wrench is not available when installing a spark plug, a good estimate of the correct torque is 1/4–1/2 turn past finger tight. However, the spark plug should be tightened to the specified torque as soon as possible.

3. Install the spark plug cap.
4. Install the Y.R.C.S. (Yamaha Ram-Air Cooling System) cap by installing the bolts.
5. Install the cowling.

Engine oil and oil filter element

The engine oil level should be checked before each ride. In addition, the oil must be changed and the oil filter element replaced at the intervals specified in the periodic maintenance and lubrication chart.

To check the engine oil level

1. Place the vehicle on the centerstand. A slight tilt to the side can result in a false reading.
2. Start the engine, warm it up for several minutes, and then turn it off.
3. Wait a few minutes until the oil settles, remove the engine oil filler cap, wipe the dipstick clean, insert it back into the oil filler hole (without screwing it in), and then remove it again to check the oil level.

WARNING! Never remove the engine oil filler cap after high-speed operation, otherwise hot engine oil could spout out and cause damage or injury. Always let the engine oil cool down suf-

Periodic maintenance and adjustment

efficiently before removing the oil filler cap. [EWA17640] **NOTICE:** Do not operate the vehicle until you know that the engine oil level is sufficient. [ECA10012]



1. Engine oil filler cap

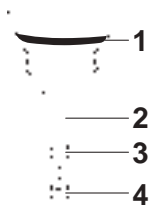

1. O-ring
2. Engine oil dipstick
3. Maximum level mark
4. Minimum level mark

TIP

The engine oil should be between the minimum and maximum level marks.

4. If the engine oil is below the minimum level mark, add sufficient oil of the recommended type to raise it to the correct level.
5. Check the O-ring for damage, and replace it if necessary.
6. Install and tighten the engine oil filler cap.

To change the engine oil (with or without oil filter element replacement)

1. Start the engine, warm it up for several minutes, and then turn it off.
2. Place an oil pan under the engine to collect the used oil.
3. Remove the engine oil filler cap, the engine oil drain bolt and its gasket to drain the oil from the crankcase.

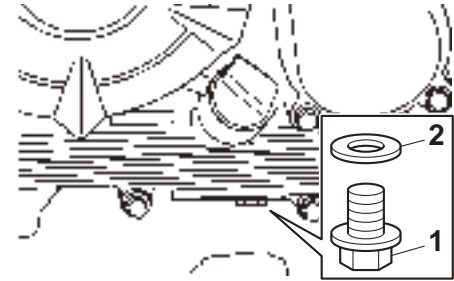

1. Engine oil drain bolt
2. Gasket

TIP

Skip steps 4–6 if the oil filter element is not being replaced.

4. Remove the oil filter element cover by removing the bolts.

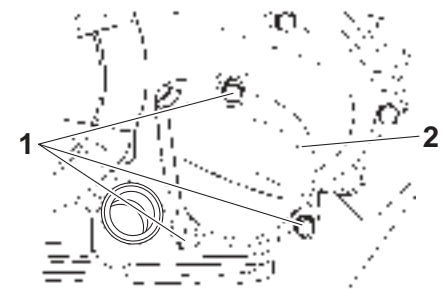

1. Bolt
2. Oil filter element cover

Periodic maintenance and adjustment

- Remove and replace the oil filter element and O-ring.

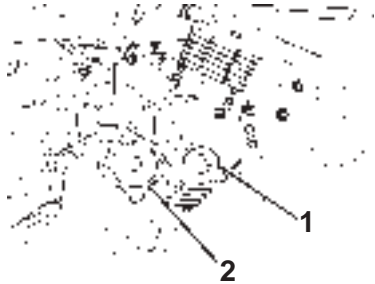

- Oil filter element
- O-ring

- Install the oil filter element cover by installing the bolts, then tightening them to the specified torque.

Tightening torque:

Oil filter element cover bolt:
10 N·m (1.0 kgf·m, 7.2 lb·ft)

TIP _____
Make sure that the O-ring is properly seated.

- Install the engine oil drain bolt and its new gasket, and then tighten the bolt to the specified torque.

Tightening torque:

Engine oil drain bolt:
20 N·m (2.0 kgf·m, 14 lb·ft)

- Refill with the specified amount of the recommended engine oil.

Recommended engine oil:

See page 8-1.

Oil quantity:

Oil change:
1.00 L (1.06 US qt, 0.88 Imp.qt)
With oil filter removal:
1.10 L (1.16 US qt, 0.97 Imp.qt)

ECA11621

NOTICE

- In order to prevent clutch slippage (since the engine oil also lubricates the clutch), do not mix any chemical additives. Do not use oils with a diesel specification of “CD” or oils of a higher quality than specified. In addition, do not use oils labeled “ENERGY CONSERVING II” or higher.**
- Make sure that no foreign material enters the crankcase.**

- Check the O-ring for damage, and replace it if necessary.



- Engine oil filler cap
- O-ring

- Install and tighten the engine oil filler cap.

ECA10441

NOTICE

After changing the engine oil, be sure to check the oil pressure as described below.

To check the oil pressure

- Remove cowling A. (See page 6-8.)
- Remove the Y.R.C.S. (Yamaha Ram-Air Cooling System) cap. (See page 6-10.)

Periodic maintenance and adjustment

- Loosen the bleed bolt, start the engine and keep it idling until oil flows out. If no oil comes out after several minutes, turn the engine off immediately and consult a Yamaha dealer for inspection.



1. Bleed bolt

- After checking the oil pressure, tighten the bleed bolt with the specified torque.

Tightening torque:

Bleed bolt:
7 N·m (0.7 kgf·m, 5.1 lb·ft)

- Install the Y.R.C.S. (Yamaha Ram-Air Cooling System) cap.
- Install the cowling.

- Start the engine, and then let it idle for several minutes while checking it for oil leakage. If oil is leaking, immediately turn the engine off and check for the cause.
- Turn the engine off, check the oil level and correct it if necessary.

Cleaning the air filter element and cleaning the check hose

EAUW3321

The air filter element should be cleaned at the intervals specified in the periodic maintenance and lubrication chart. Clean the air filter element more frequently if you are riding in unusually wet or dusty areas. In addition, the air filter check hose must be frequently checked and cleaned if necessary.

To clean the air filter element

- Remove panel A. (See page 6-8.)
- Remove the air filter case cover by removing the screws, and then pull the air filter element out.

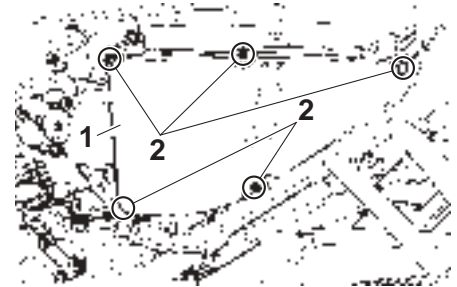

- Air filter case cover
- Screw

Periodic maintenance and adjustment

3. Lightly tap the air filter element to remove most of the dust and dirt, and then blow the remaining dirt out with compressed air as shown.

TIP

Replace the air filter element if it is excessively worn or damaged.

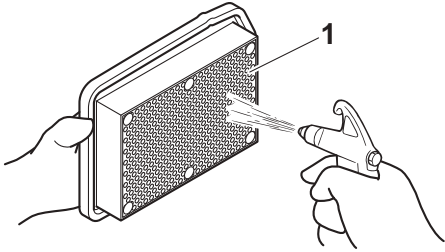

1. Air filter element

4. Insert the air filter element into the air filter case. **NOTICE: Make sure that the air filter element is properly seated in the air filter case. The engine should never be operated without the air filter element installed, otherwise the**

piston(s) and/or cylinder(s) may become excessively worn.

[ECA10482]

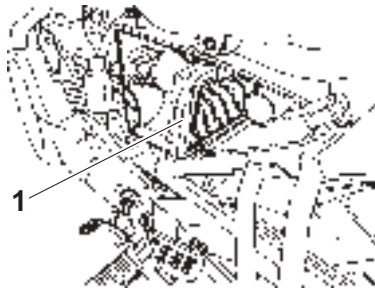

1. Air filter element

5. Install the air filter case cover by installing the screws.
6. Install the panel.

To clean the air filter check hose

1. Remove panel A. (See page 6-8.)
2. Check the hose shown for accumulated dirt, water or oil.

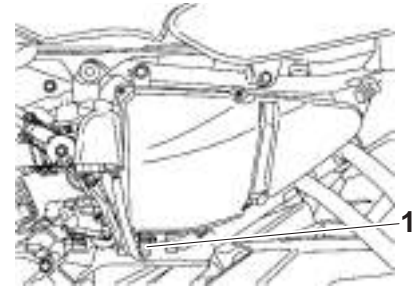

1. Air filter check hose

3. If dirt, water or oil is visible, remove the hose, clean it, and then install it in its original position.
4. Install the panel.

Adjusting the engine idling speed

EAU34302

The engine idling speed must be checked and, if necessary, adjusted as follows at the intervals specified in the periodic maintenance and lubrication chart.

The engine should be warm before making this adjustment.

Check the engine idling speed and, if necessary, adjust it to specification by turning the idle adjusting screw. To increase the engine idling speed, turn the screw in direction (a). To decrease the engine idling speed, turn the screw in direction (b).

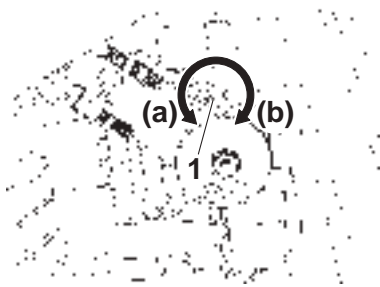

1. Idle adjusting screw

Engine idling speed:
1300–1500 r/min

TIP

If the specified idling speed cannot be obtained as described above, have a Yamaha dealer make the adjustment.

Checking the throttle grip free play

EAU21386

Measure the throttle grip free play as shown.

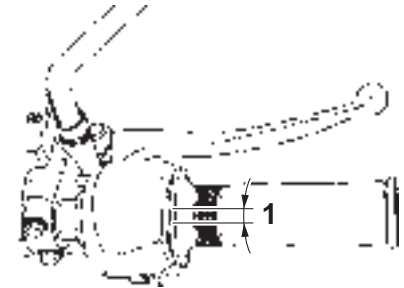

1. Throttle grip free play

Throttle grip free play:
3.0–7.0 mm (0.12–0.28 in)

Periodically check the throttle grip free play and, if necessary, have a Yamaha dealer adjust it.

Periodic maintenance and adjustment

EAU21402

Valve clearance

The valve clearance changes with use, resulting in improper air-fuel mixture and/or engine noise. To prevent this from occurring, the valve clearance must be adjusted by a Yamaha dealer at the intervals specified in the periodic maintenance and lubrication chart.

EAU69760

Tires

Tires are the only contact between the vehicle and the road. Safety in all conditions of riding depends on a relatively small area of road contact. Therefore, it is essential to maintain the tires in good condition at all times and replace them at the appropriate time with the specified tires.

Tire air pressure

The tire air pressure should be checked and, if necessary, adjusted before each ride.

EWA10504



Operation of this vehicle with improper tire pressure may cause severe injury or death from loss of control.

- The tire air pressure must be checked and adjusted on cold tires (i.e., when the temperature of the tires equals the ambient temperature).
- The tire air pressure must be adjusted in accordance with the riding speed and with the total

weight of rider, passenger, cargo, and accessories approved for this model.

Tire air pressure (measured on cold tires):

1 person:

Front:

175 kPa (1.75 kgf/cm², 25 psi)

Rear:

200 kPa (2.00 kgf/cm², 29 psi)

2 persons:

Front:

175 kPa (1.75 kgf/cm², 25 psi)

Rear:

225 kPa (2.25 kgf/cm², 33 psi)

Maximum load:

Front:

175 kPa (1.75 kgf/cm², 25 psi)

Rear:

250 kPa (2.50 kgf/cm², 36 psi)

Maximum load*:

171 kg (377 lb)

* Total weight of rider, passenger, cargo and accessories

EWA10512



Never overload your vehicle. Operation of an overloaded vehicle could cause an accident.

Periodic maintenance and adjustment

Tire inspection

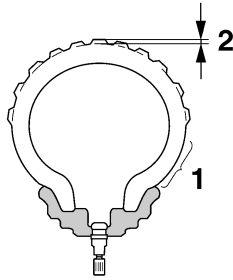

1. Tire sidewall
2. Tire tread depth

The tires must be checked before each ride. If the center tread depth reaches the specified limit, if the tire has a nail or glass fragments in it, or if the sidewall is cracked, have a Yamaha dealer replace the tire immediately.

Minimum tire tread depth (front and rear):
1.6 mm (0.06 in)

TIP

The tire tread depth limits may differ from country to country. Always comply with the local regulations.

! WARNING

EWA10472

- **Have a Yamaha dealer replace excessively worn tires. Besides being illegal, operating the vehicle with excessively worn tires decreases riding stability and can lead to loss of control.**
- **The replacement of all wheel and brake-related parts, including the tires, should be left to a Yamaha dealer, who has the necessary professional knowledge and experience to do so.**
- **Ride at moderate speeds after changing a tire since the tire surface must first be “broken in” for it to develop its optimal characteristics.**

Tire information

This model is equipped with tubeless tires and rubber tire air valves.

Tires age, even if they have not been used or have only been used occasionally. Cracking of the tread and sidewall rubber, sometimes accompanied by carcass deformation, is an evidence of

ageing. Old and aged tires shall be checked by tire specialists to ascertain their suitability for further use.

EWA10462

! WARNING

The front and rear tires should be of the same make and design, otherwise the handling characteristics of the vehicle may be different, which could lead to an accident.

After extensive tests, only the tires listed below have been approved for this model by Yamaha.

Front tire:

Size:
2.75-18M/C 42P
Manufacturer/model:
CHENG SHIN/C910

Rear tire:

Size:
100/80-18M/C 59P
Manufacturer/model:
CHENG SHIN/C905

Periodic maintenance and adjustment

6

Cast wheels

EAU21963

To maximize the performance, durability, and safe operation of your vehicle, note the following points regarding the specified wheels.

- The wheel rims should be checked for cracks, bends, warp-age or other damage before each ride. If any damage is found, have a Yamaha dealer replace the wheel. Do not attempt even the smallest repair to the wheel. A deformed or cracked wheel must be replaced.
- The wheel should be balanced whenever either the tire or wheel has been changed or replaced. An unbalanced wheel can result in poor performance, adverse handling characteristics, and a shortened tire life.

Adjusting the clutch lever free play

EAU51253

Measure the clutch lever free play as shown.

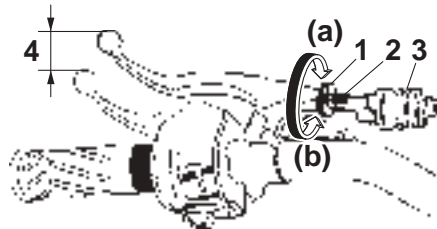

1. Locknut
2. Clutch lever free play adjusting bolt
3. Rubber cover
4. Clutch lever free play

Clutch lever free play:
10.0–15.0 mm (0.39–0.59 in)

Periodically check the clutch lever free play and, if necessary, adjust it as follows.

1. Slide back the rubber cover at the clutch lever.
2. Loosen the locknut.

3. To increase the clutch lever free play, turn the clutch lever free play adjusting bolt in direction (a). To decrease the clutch lever free play, turn the adjusting bolt in direction (b).

TIP

If the specified clutch lever free play could be obtained as described above, skip steps 4–7.

4. Fully turn the adjusting bolt at the clutch lever in direction (a) to loosen the clutch cable.
5. Slide back the rubber cover that is located further down the clutch cable, and then loosen the locknut.

Periodic maintenance and adjustment

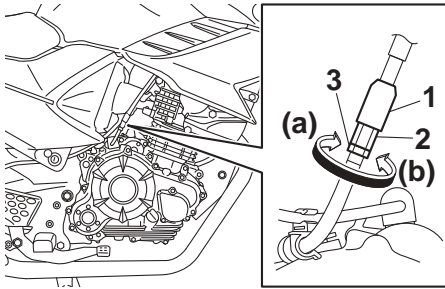

1. Rubber cover
2. Clutch lever free play adjusting nut
3. Locknut

6. To increase the clutch lever free play, turn the clutch lever free play adjusting nut in direction (a). To decrease the clutch lever free play, turn the adjusting nut in direction (b).
7. Tighten the locknut at the clutch cable, and then slide the rubber cover to its original position.
8. Tighten the locknut at the clutch lever, and then slide the rubber cover to its original position.

Checking the brake lever free play ^{EAU37914}



1. No brake lever free play

There should be no free play at the brake lever end. If there is free play, have a Yamaha dealer inspect the brake system.

EWA14212

⚠ WARNING

A soft or spongy feeling in the brake lever can indicate the presence of air in the hydraulic system. If there is air in the hydraulic system, have a Yamaha dealer bleed the system before operating the vehicle. Air in the hydraulic system will diminish the

Periodic maintenance and adjustment

EAU39815

Adjusting the brake pedal free play

Measure the brake pedal free play at the brake pedal end as shown.

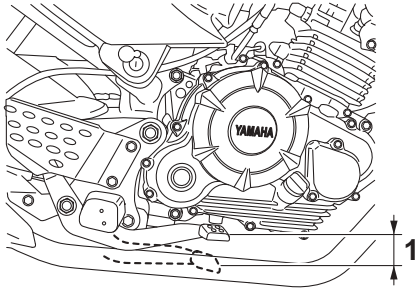

1. Brake pedal free play

Brake pedal free play:
10.0–20.0 mm (0.39–0.79 in)

Periodically check the brake pedal free play and, if necessary, adjust it as follows.

To increase the brake pedal free play, turn the brake pedal free play adjusting nut at the brake rod in direction (a). To decrease the brake pedal free play, turn the adjusting nut in direction (b).

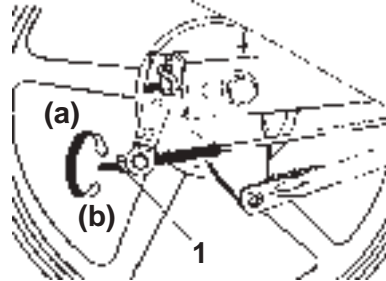

1. Brake pedal free play adjusting nut

EWA10681

WARNING

- After adjusting the drive chain slack or removing and installing the rear wheel, always check the brake pedal free play.
- If proper adjustment cannot be obtained as described, have a Yamaha dealer make this adjustment.
- After adjusting the brake pedal free play, check the operation of the brake light.

EAU22274

Brake light switches

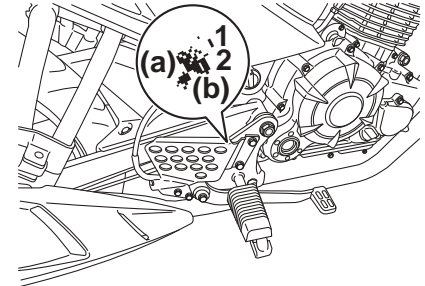

1. Rear brake light switch
2. Rear brake light switch adjusting nut

The brake light, which is activated by the brake pedal and brake lever, should come on just before braking takes effect. If necessary, adjust the rear brake light switch as follows, but the front brake light switch should be adjusted by a Yamaha dealer. Turn the rear brake light switch adjusting nut while holding the rear brake light switch in place. To make the brake light come on earlier, turn the adjusting nut in direction (a). To make the brake light come on later, turn the adjusting nut in direction (b).

Checking the front brake pads and rear brake shoes

EAU22382

The front brake pads and the rear brake shoes must be checked for wear at the intervals specified in the periodic maintenance and lubrication chart.

Front brake pads

EAU22432

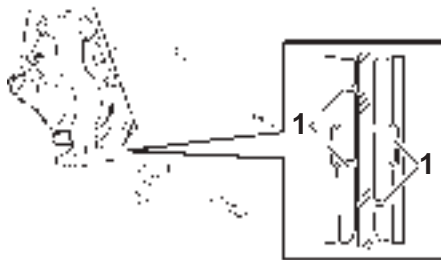

1. Brake pad wear indicator groove

Each front brake pad is provided with wear indicator grooves, which allow you to check the brake pad wear without having to disassemble the brake. To check the brake pad wear, check the wear indicator grooves. If a brake pad has worn to the point that the wear

indicator grooves have almost disappeared, have a Yamaha dealer replace the brake pads as a set.

Rear brake shoes

EAU43171

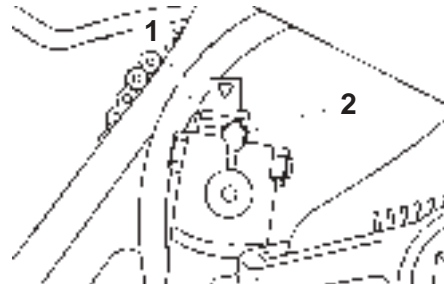

1. Brake shoe wear limit mark
2. Brake shoe wear indicator

The rear brake is provided with a wear indicator, which allows you to check the brake shoe wear without having to disassemble the brake. To check the brake shoe wear, check the position of the wear indicator while applying the brake. If a brake shoe has worn to the point that the wear indicator reaches the wear limit mark, have a Yamaha dealer replace the brake shoes as a set.

Checking the brake fluid level

EAU32346

Before riding, check that the brake fluid is above the minimum level mark. Check the brake fluid level with the top of the reservoir level. Replenish the brake fluid if necessary.

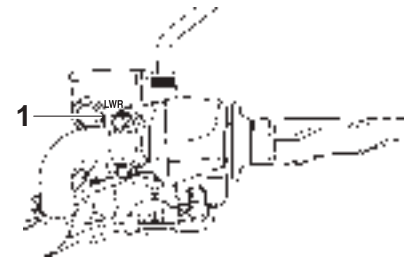

1. Minimum level mark

Specified brake fluid:
DOT 4

⚠ WARNING

Improper maintenance can result in loss of braking ability. Observe these precautions:

EWA15991

Periodic maintenance and adjustment

6

- **Insufficient brake fluid may allow air to enter the brake system, reducing braking performance.**
- **Clean the filler cap before removing. Use only DOT 4 brake fluid from a sealed container.**
- **Use only the specified brake fluid; otherwise, the rubber seals may deteriorate, causing leakage.**
- **Refill with the same type of brake fluid. Adding a brake fluid other than DOT 4 may result in a harmful chemical reaction.**
- **Be careful that water does not enter the brake fluid reservoir when refilling. Water will significantly lower the boiling point of the fluid and may result in vapor lock.**

ECA17641

NOTICE

Brake fluid may damage painted surfaces or plastic parts. Always clean up spilled fluid immediately.

As the brake pads wear, it is normal for the brake fluid level to gradually go down. A low brake fluid level may indicate worn brake pads and/or brake system leakage; therefore, be sure to check the brake pads for wear and the brake system for leakage. If the brake fluid level goes down suddenly, have a Yamaha dealer check the cause before further riding.

EAU22724

Changing the brake fluid

Have a Yamaha dealer change the brake fluid at the intervals specified in the periodic maintenance and lubrication chart. In addition, have the oil seals of the brake master cylinder and caliper as well as the brake hose replaced at the intervals listed below or whenever they are damaged or leaking.

- **Oil seals:** Replace every two years.
- **Brake hose:** Replace every four years.

Periodic maintenance and adjustment

Drive chain slack

EAU22762

The drive chain slack should be checked before each ride and adjusted if necessary.

To check the drive chain slack

EAU22799

1. Place the motorcycle on the centerstand.
2. Shift the transmission into the neutral position.
3. Measure the drive chain slack as shown.

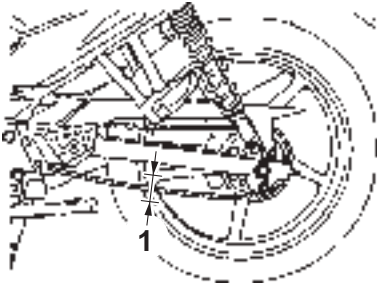

1. Drive chain slack

Drive chain slack:

40.0–50.0 mm (1.57–1.97 in)

4. If the drive chain slack is incorrect, adjust it as follows. **NOTICE: Improper drive chain slack will overload the engine as well as other vital parts of the motorcycle and can lead to chain slippage or breakage. To prevent this from occurring, keep the drive chain slack within the specified limits.** [ECA10572]

EAU78831

To adjust the drive chain slack

Consult a Yamaha dealer before adjusting the drive chain slack.

1. Take the motorcycle off the centerstand, and then put the side-stand down.
2. Loosen the brake pedal free play adjusting nut, brake torque rod nut, and axle nut.

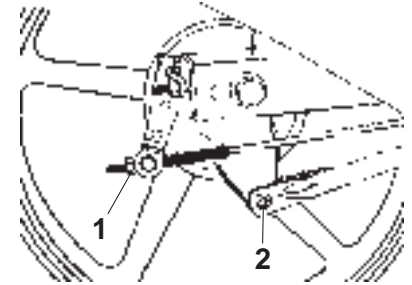

1. Brake pedal free play adjusting nut
2. Brake torque rod nut

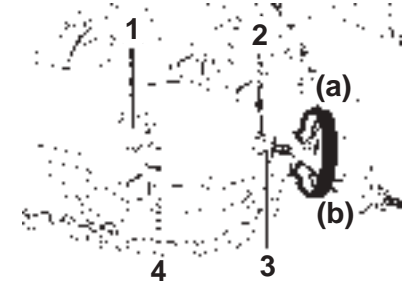

1. Axle nut
2. Drive chain slack adjusting nut
3. Drive chain puller locknut
4. Drive chain puller

3. Loosen the drive chain puller locknut at each end of the swingarm.

Periodic maintenance and adjustment

- Place the motorcycle on the centerstand.
- To tighten the drive chain, turn the drive chain slack adjusting nut at each end of the swingarm in direction (a). To loosen the drive chain, turn the adjusting nut at each end of the swingarm in direction (b), and then push the rear wheel forward.

TIP

Using the alignment marks on each drive chain puller, make sure that both drive chain pullers are in the same position for proper wheel alignment.

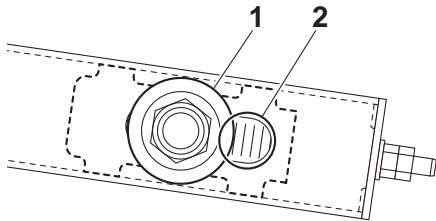

- Washer
- Alignment marks

- Take the motorcycle off the centerstand, and then put the sidestand down.
- Tighten both locknuts, and then tighten the axle nut and brake torque rod nut to their specified torques.

Tightening torques:

Locknut:

7 N·m (0.7 kgf·m, 5.1 lb·ft)

Axle nut:

90 N·m (9.0 kgf·m, 65 lb·ft)

Brake torque rod nut:

18 N·m (1.8 kgf·m, 13 lb·ft)

- Adjust the brake pedal free play. (See page 6-21.)

EWA10661

WARNING

After adjusting the brake pedal free play, check the operation of the brake light.

- Make sure that the drive chain pullers are in the same position, the drive chain slack is correct, and the drive chain moves smoothly.

Cleaning and lubricating the drive chain

EAU23018

The drive chain must be cleaned and lubricated at the intervals specified in the periodic maintenance and lubrication chart, otherwise it will quickly wear out, especially when riding in dusty or wet areas. Service the drive chain as follows.

ECA10584

NOTICE

The drive chain must be lubricated after washing the motorcycle, riding in the rain or riding in wet areas.

- Remove all dirt and mud from the drive chain with a brush or cloth.

TIP

For a thorough cleaning, have a Yamaha dealer remove the drive chain and soak it in solvent.

- Spray Yamaha chain lubricant or other suitable chain lubricant on the entire chain, making sure that all side plates and rollers have been sufficiently oiled.

Checking and lubricating the cables

EAU23098

The operation of all control cables and the condition of the cables should be checked before each ride, and the cables and cable ends should be lubricated if necessary. If a cable is damaged or does not move smoothly, have a Yamaha dealer check or replace it. **WARNING! Damage to the outer housing of cables may result in internal rusting and cause interference with cable movement. Replace damaged cables as soon as possible to prevent unsafe conditions.** [EWA10712]

Recommended lubricant:

Yamaha cable lubricant or other suitable cable lubricant

Checking and lubricating the throttle grip and cable

EAU49921

The operation of the throttle grip should be checked before each ride. In addition, the cable should be lubricated by a Yamaha dealer at the intervals specified in the periodic maintenance chart.

Checking and lubricating the brake and shift pedals

EAU44276

The operation of the brake and shift pedals should be checked before each ride, and the pedal pivots should be lubricated if necessary.

Brake pedal

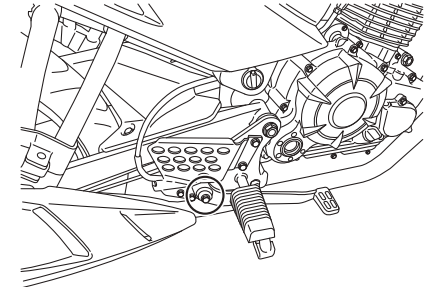

Shift pedal

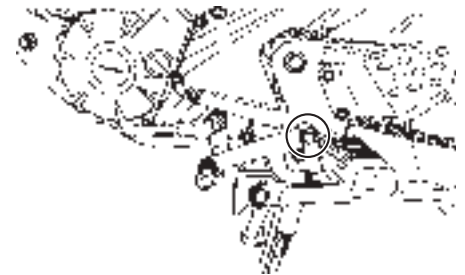

Periodic maintenance and adjustment

Recommended lubricant:
Lithium-soap-based grease

Checking and lubricating the brake and clutch levers

EAU23144

The operation of the brake and clutch levers should be checked before each ride, and the lever pivots should be lubricated if necessary.

Recommended lubricants:

Brake lever:
Silicone grease
Clutch lever:
Lithium-soap-based grease

Brake lever



Clutch lever



Checking and lubricating the centerstand and sidestand

EAU23215



The operation of the centerstand and sidestand should be checked before each ride, and the pivots and metal-to-metal contact surfaces should be lubricated if necessary.

EWA10742

WARNING

If the centerstand or sidestand does not move up and down smoothly, have a Yamaha dealer check or repair it. Otherwise, the centerstand or sidestand could contact the ground and distract the operator, resulting in a possible loss of control.

Recommended lubricant:
Lithium-soap-based grease

Lubricating the swingarm pivots

EAM1653

The swingarm pivots must be lubricated by a Yamaha dealer at the intervals specified in the periodic maintenance and lubrication chart.

Recommended lubricant:
Lithium-soap-based grease

Periodic maintenance and adjustment

EAU23273

Checking the front fork

The condition and operation of the front fork must be checked as follows at the intervals specified in the periodic maintenance and lubrication chart.

To check the condition

Check the inner tubes for scratches, damage and excessive oil leakage.

To check the operation

1. Place the vehicle on a level surface and hold it in an upright position. **WARNING! To avoid injury, securely support the vehicle so there is no danger of it falling over.** [EWA10752]
2. While applying the front brake, push down hard on the handlebars several times to check if the front fork compresses and rebounds smoothly.



ECA10591

NOTICE

If any damage is found or the front fork does not operate smoothly, have a Yamaha dealer check or repair it.

EAU45512

Checking the steering

Worn or loose steering bearings may cause danger. Therefore, the operation of the steering must be checked as follows at the intervals specified in the periodic maintenance and lubrication chart.

1. Place the vehicle on the centerstand. **WARNING! To avoid injury, securely support the vehicle so there is no danger of it falling over.** [EWA10752]
2. Hold the lower ends of the front fork legs and try to move them forward and backward. If any free play can be felt, have a Yamaha dealer check or repair the steering.



Checking the wheel bearings

EAU23292

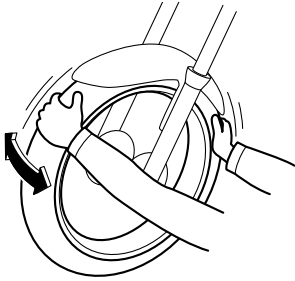

The front and rear wheel bearings must be checked at the intervals specified in the periodic maintenance and lubrication chart. If there is play in the wheel hub or if the wheel does not turn smoothly, have a Yamaha dealer check the wheel bearings.

Battery

EAU2338A

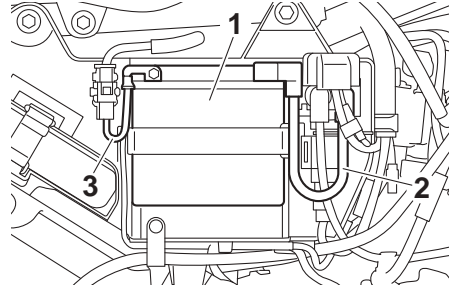

1. Battery
2. Positive battery lead (red)
3. Negative battery lead (black)

The battery is located behind panel B. (See page 6-8.)

This model is equipped with a VRLA (Valve Regulated Lead Acid) battery. There is no need to check the electrolyte or to add distilled water. However, the battery lead connections need to be checked and, if necessary, tightened.

EWA10761

WARNING

- Electrolyte is poisonous and dangerous since it contains sulfuric acid, which causes severe

burns. Avoid any contact with skin, eyes or clothing and always shield your eyes when working near batteries. In case of contact, administer the following **FIRST AID**.

- **EXTERNAL:** Flush with plenty of water.
- **INTERNAL:** Drink large quantities of water or milk and immediately call a physician.
- **EYES:** Flush with water for 15 minutes and seek prompt medical attention.
- Batteries produce explosive hydrogen gas. Therefore, keep sparks, flames, cigarettes, etc., away from the battery and provide sufficient ventilation when charging it in an enclosed space.
- **KEEP THIS AND ALL BATTERIES OUT OF THE REACH OF CHILDREN.**

Periodic maintenance and adjustment

ECA10621

NOTICE

Never attempt to remove the battery cell seals, as this would permanently damage the battery.

To charge the battery

Have a Yamaha dealer charge the battery as soon as possible if it seems to have discharged. Keep in mind that the battery tends to discharge more quickly if the vehicle is equipped with optional electrical accessories.

ECA16522

NOTICE

To charge a VRLA (Valve Regulated Lead Acid) battery, a special (constant-voltage) battery charger is required. Using a conventional battery charger will damage the battery.

To store the battery

1. If the vehicle will not be used for more than one month, remove the battery, fully charge it, and then place it in a cool, dry place. **NOTICE:** When removing the battery, be sure to turn the main

switch off, then disconnect the negative lead before disconnecting the positive lead. [ECA16304]

2. If the battery will be stored for more than two months, check it at least once a month and fully charge it if necessary.
3. Fully charge the battery before installation. **NOTICE:** When installing the battery, be sure to turn the main switch off, then connect the positive lead before connecting the negative lead. [ECA16842]
4. After installation, make sure that the battery leads are properly connected to the battery terminals.

ECA16531

NOTICE

Always keep the battery charged. Storing a discharged battery can cause permanent battery damage.

EAU78861

Replacing the fuse

The fuse is located behind panel B. (See page 6-8.)

To access the fuse, remove the starter relay cover, and then disconnect the starter relay coupler.

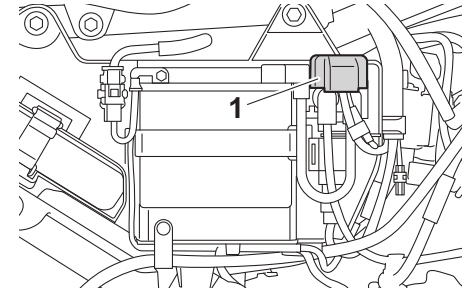

1. Starter relay cover

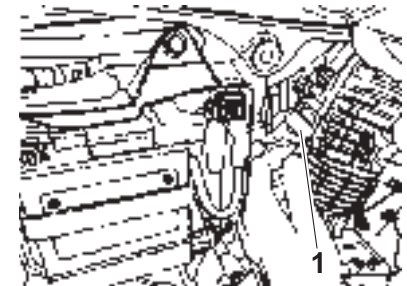

1. Starter relay coupler

Periodic maintenance and adjustment

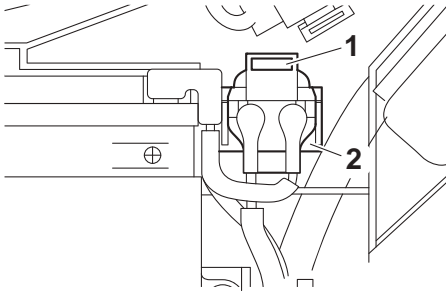

1. Fuse
2. Starter relay holder

The spare fuse is located on the rear of the starter relay holder.

To access the spare fuse, remove the starter relay (together with its holder) by pulling it out, then turn the starter relay over.

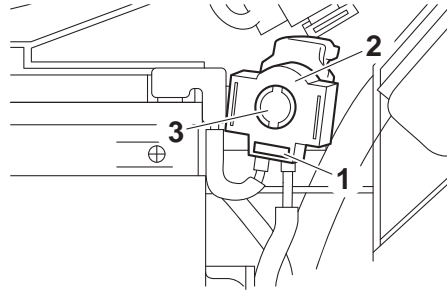

1. Spare fuse
2. Starter relay holder
3. Starter relay

If the fuse is blown, replace it as follows.

1. Turn the key to “ \otimes ” and turn off all electrical circuits.
2. Remove the blown fuse, and then install a new fuse of the specified amperage. **WARNING! Do not use a fuse of a higher amperage rating than recommended to avoid causing extensive damage to the electrical system and possibly a fire.** [EWA15132]

Specified fuse:
15.0 A

3. Turn the key to “ \odot ” and turn on the electrical circuits to check if the devices operate.
4. If the fuse immediately blows again, have a Yamaha dealer check the electrical system.

Periodic maintenance and adjustment

Replacing the headlight bulb

EAU78872

This model is equipped with a halogen bulb headlight. If the headlight bulb burns out, replace it as follows.

ECA10651

NOTICE

Take care not to damage the following parts:

- **Headlight bulb**

Do not touch the glass part of the headlight bulb to keep it free from oil, otherwise the transparency of the glass, the luminosity of the bulb, and the bulb life will be adversely affected. Thoroughly clean off any dirt and fingerprints on the headlight bulb using a cloth moistened with alcohol or thinner.

- **Headlight lens**

Do not affix any type of tinted film or stickers to the headlight lens.

Do not use a headlight bulb of a wattage higher than specified.

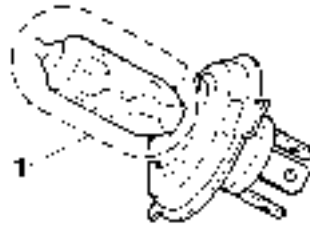

1. Do not touch the glass part of the bulb.

1. Remove the headlight unit side covers by removing the screw on each side.

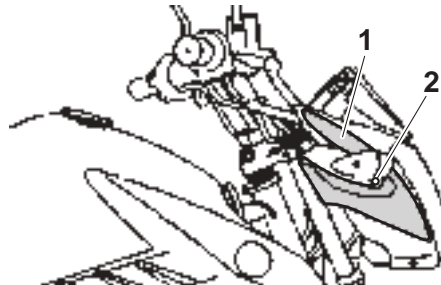

1. Headlight unit side cover
2. Screw

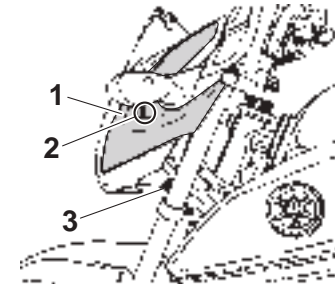

1. Headlight unit side cover
2. Screw
3. Headlight unit stay bolt

2. Remove the bolt on each side.

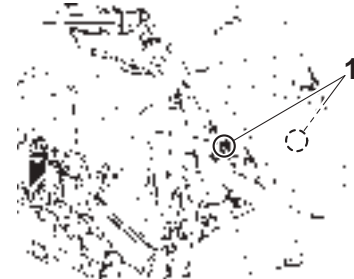

1. Bolt

3. Loosen the headlight unit stay bolt, and then tilt the headlight unit forward.

4. Disconnect the headlight coupler, then remove the headlight bulb cover.

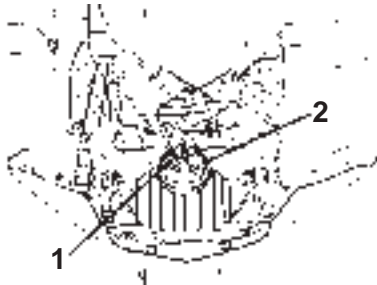

1. Headlight coupler
2. Headlight bulb holder

5. Unhook the headlight bulb holder, then remove the burnt-out bulb.

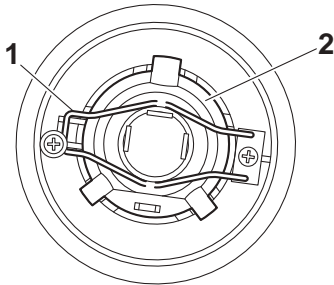

1. Headlight bulb holder
2. Headlight bulb

6. Place a new headlight bulb into position, then secure it with the bulb holder.
7. Install the headlight bulb cover, then connect the headlight coupler.
8. Place the headlight unit in its original position, and then tighten the headlight unit stay bolt to the specified torque.

Tightening torque:

Headlight unit stay bolt:
7 N·m (0.7 kgf·m, 5.1 lb·ft)

9. Install the bolt on each side.
10. Place the headlight unit side covers in their original position, and then install the screw on each side.
11. Have a Yamaha dealer adjust the headlight beam if necessary.

Replacing the auxiliary light bulb

EAU45226

If the auxiliary light bulb burns out, replace it as follows.

1. Remove the headlight unit. (See page 6-33.)
2. Remove the auxiliary light bulb socket (together with the bulb) by pulling it out.

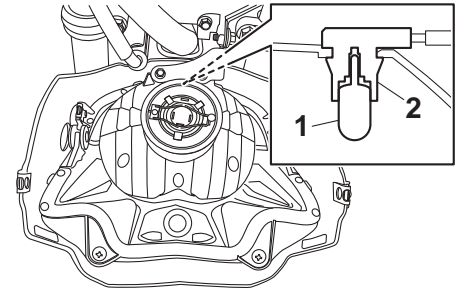

1. Auxiliary light bulb
2. Auxiliary light bulb socket

3. Remove the burnt-out bulb by pulling it out.
4. Insert a new bulb into the socket.
5. Install the socket (together with the bulb) by pushing it in.
6. Install the headlight unit.

Periodic maintenance and adjustment

Replacing the brake/tail light bulb

EAU78920

1. Remove the seat. (See page 3-11.)
2. Remove the brake/tail light bulb socket (together with the bulb) by turning it counterclockwise.

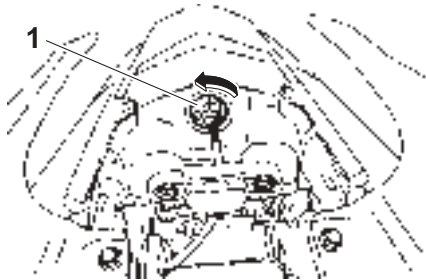

1. Brake/tail light bulb socket

3. Remove the burnt-out bulb by pushing it in and turning it counterclockwise.



1. Brake/tail light bulb

4. Insert a new bulb into the socket, push it in, and then turn it clockwise until it stops.
5. Install the socket (together with the bulb) by turning it clockwise.
6. Install the seat.

Replacing a turn signal light bulb

EAU24205

1. Remove the turn signal light lens by removing the screw.

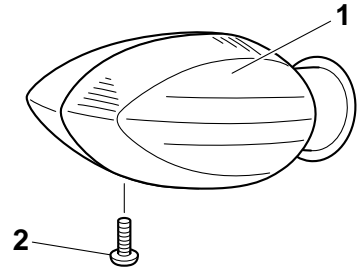

1. Turn signal light lens
2. Screw

2. Remove the burnt-out bulb by pushing it in and turning it counterclockwise.

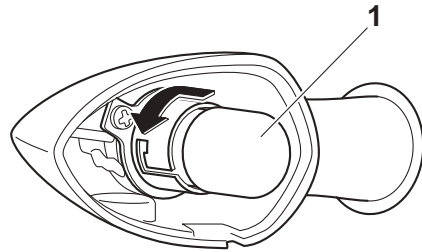

1. Turn signal light bulb
3. Insert a new bulb into the socket, push it in, and then turn it clockwise until it stops.
4. Install the lens by installing the screw. **NOTICE: Do not over-tighten the screw, otherwise the lens may break.** [ECA11192]

Replacing the license plate light bulb

EAU78970

1. Remove the license plate light unit by removing the nuts.

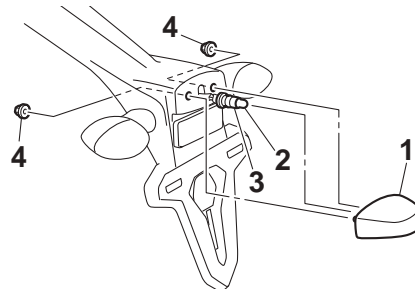

1. License plate light unit
2. License plate light bulb
3. License plate light bulb socket
4. Nut
2. Remove the license plate light bulb socket (together with the bulb) by pulling it out.
3. Remove the burnt-out bulb by pulling it out.
4. Insert a new bulb into the socket.
5. Install the socket (together with the bulb) by pushing it in.
6. Install the license plate light unit by installing the nuts.

Front wheel

EAU24361

EAUW3361

To remove the front wheel

EWA10822



WARNING
To avoid injury, securely support the vehicle so there is no danger of it falling over.

1. Take the vehicle off the center-stand so that the front wheel is on the ground, and then put the side-stand down.
2. Loosen the front wheel axle nut.

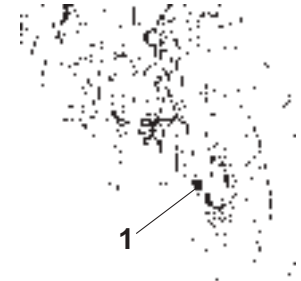

1. Axle nut

Periodic maintenance and adjustment

3. Place the vehicle on the centerstand, and then remove the axle nut.
4. Pull the wheel axle out, and then remove the wheel. **NOTICE: Do not apply the brake after the wheel and brake disc have been removed, otherwise the brake pads will be forced shut.** [ECA11073]

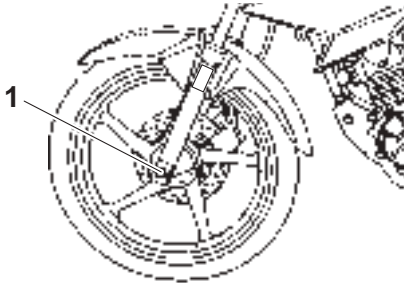

1. Wheel axle

To install the front wheel

1. Lift the wheel up between the fork legs.

TIP

Make sure that there is enough space between the brake pads before inserting the brake disc into the caliper.

2. Insert the wheel axle, and then install the axle nut.
3. Take the vehicle off the centerstand so that the front wheel is on the ground, and then put the sidestand down.
4. Tighten the axle nut to the specified torque.

Tightening torque:

Axle nut:
59 N·m (5.9 kgf·m, 43 lb·ft)

5. Push down hard on the handlebar several times to check for proper fork operation.

Rear wheel

EAU25081

EAU78751

To remove the rear wheel

EWA10822

WARNING

To avoid injury, securely support the vehicle so there is no danger of it falling over.

1. Take the motorcycle off the centerstand so that the rear wheel is on the ground, and then put the sidestand down.
2. Loosen the axle nut.
3. Disconnect the brake torque rod from the brake shoe plate by removing the nut and the bolt.

Periodic maintenance and adjustment



1. Axle nut

4. Remove the brake pedal free play adjusting nut, and then disconnect the brake rod from the brake camshaft lever.

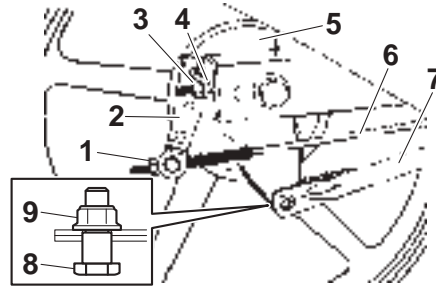

1. Brake pedal free play adjusting nut
2. Brake camshaft lever
3. Drive chain puller locknut
4. Drive chain slack adjusting nut
5. Brake shoe plate
6. Brake rod
7. Brake torque rod
8. Brake torque rod bolt
9. Brake torque rod nut

5. Loosen the drive chain puller locknut and the drive chain slack adjusting nut on both ends of the swingarm.
6. Place the motorcycle on the centerstand.
7. Remove the axle nut and the washer, then pull the wheel axle together with the washer out from the right side, and then remove the collars.

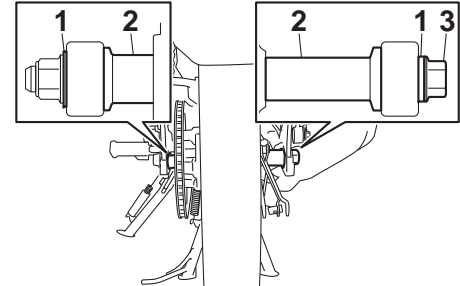

1. Washer
2. Collar
3. Wheel axle

TIP

A rubber mallet may be useful to tap the wheel axle out.

8. Push the wheel forward, and then remove the drive chain from the rear sprocket.



Periodic maintenance and adjustment

TIP _____
The drive chain does not need to be disassembled in order to remove and install the wheel.

9. Remove the wheel.

To install the rear wheel

1. Install the drive chain onto the rear sprocket.
2. Install the wheel by installing the collars on both sides and installing the washer and the wheel axle from the right side.
3. Install the washer and the axle nut.
4. Connect the brake rod to the brake camshaft lever, and then install the brake pedal free play adjusting nut onto the brake rod.
5. Connect the brake torque rod to the brake shoe plate by installing the bolt and the nut.
6. Adjust the drive chain slack. (See page 6-24.)
7. Take the motorcycle off the centerstand so that the rear wheel is on the ground, and then put the sidestand down.

8. Adjust the brake pedal free play. (See page 6-21.)

EWA10661



After adjusting the brake pedal free play, check the operation of the brake light.

EAU25853

Troubleshooting

Although Yamaha motorcycles receive a thorough inspection before shipment from the factory, trouble may occur during operation. Any problem in the fuel, compression, or ignition systems, for example, can cause poor starting and loss of power.

The following troubleshooting chart represents a quick and easy procedure for checking these vital systems yourself. However, should your motorcycle require any repair, take it to a Yamaha dealer, whose skilled technicians have the necessary tools, experience, and know-how to service the motorcycle properly.

Use only genuine Yamaha replacement parts. Imitation parts may look like Yamaha parts, but they are often inferior, have a shorter service life and can lead to expensive repair bills.

EWA15142



When checking the fuel system, do not smoke, and make sure there are no open flames or sparks in the area, including pilot lights from water

Periodic maintenance and adjustment

heaters or furnaces. Gasoline or gasoline vapors can ignite or explode, causing severe injury or property damage.

Periodic maintenance and adjustment

EAUT1985

Troubleshooting chart

1. Fuel

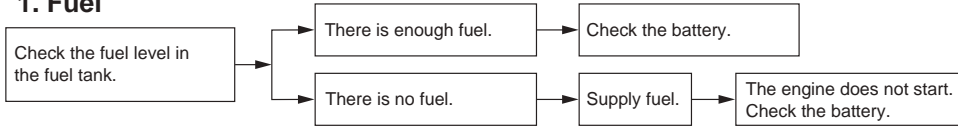

2. Battery

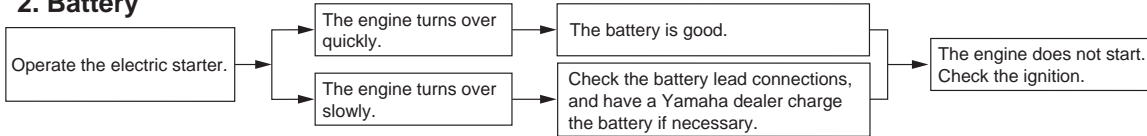

3. Ignition

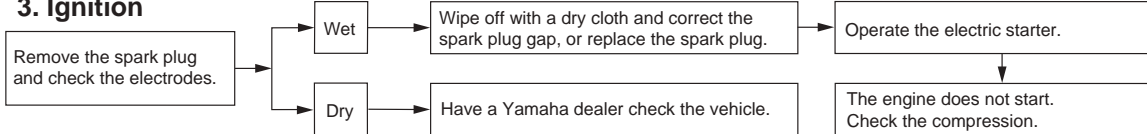

4. Compression

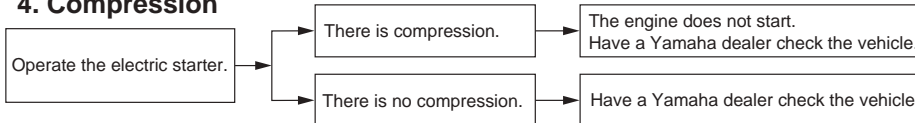

Matte color caution

EAU37834

NOTICE

Some models are equipped with matte colored finished parts. Be sure to consult a Yamaha dealer for advice on what products to use before cleaning the vehicle. Using a brush, harsh chemical products or cleaning compounds when cleaning these parts will scratch or damage their surface. Wax also should not be applied to any matte colored finished parts.

ECA15193

Care

EAU26005

While the open design of a motorcycle reveals the attractiveness of the technology, it also makes it more vulnerable. Rust and corrosion can develop even if high-quality components are used. A rusty exhaust pipe may go unnoticed on a car, however, it detracts from the overall appearance of a motorcycle. Frequent and proper care does not only comply with the terms of the warranty, but it will also keep your motorcycle looking good, extend its life and optimize its performance.

Before cleaning

1. Cover the muffler outlet with a plastic bag after the engine has cooled down.
2. Make sure that all caps and covers as well as all electrical couplers and connectors, including the spark plug cap, are tightly installed.
3. Remove extremely stubborn dirt, like oil burnt onto the crankcase, with a degreasing agent and a brush, but never apply such prod-

ucts onto seals, gaskets, sprockets, the drive chain and wheel axles. Always rinse the dirt and degreaser off with water.

Cleaning

ECA10773

NOTICE

- Avoid using strong acidic wheel cleaners, especially on spoked wheels. If such products are used on hard-to-remove dirt, do not leave the cleaner on the affected area any longer than instructed. Also, thoroughly rinse the area off with water, immediately dry it, and then apply a corrosion protection spray.
- Improper cleaning can damage plastic parts (such as cowlings, panels, windshields, headlight lenses, meter lenses, etc.) and the mufflers. Use only a soft, clean cloth or sponge with water to clean plastic. However, if the plastic parts cannot be thoroughly cleaned with water, diluted mild detergent with water may be used. Be sure to rinse

Motorcycle care and storage

off any detergent residue using plenty of water, as it is harmful to plastic parts.

- Do not use any harsh chemical products on plastic parts. Be sure to avoid using cloths or sponges which have been in contact with strong or abrasive cleaning products, solvent or thinner, fuel (gasoline), rust removers or inhibitors, brake fluid, antifreeze or electrolyte.
- Do not use high-pressure washers or steam-jet cleaners since they cause water seepage and deterioration in the following areas: seals (of wheel and swing-arm bearings, fork and brakes), electric components (couplers, connectors, instruments, switches and lights), breather hoses and vents.
- For motorcycles equipped with a windshield: Do not use strong cleaners or hard sponges as they will cause dulling or scratching. Some cleaning compounds for plastic may leave scratches on the wind-

shield. Test the product on a small hidden part of the windshield to make sure that it does not leave any marks. If the windshield is scratched, use a quality plastic polishing compound after washing.

After normal use

Remove dirt with warm water, a mild detergent, and a soft, clean sponge, and then rinse thoroughly with clean water. Use a toothbrush or bottlebrush for hard-to-reach areas. Stubborn dirt and insects will come off more easily if the area is covered with a wet cloth for a few minutes before cleaning.

After riding in the rain, near the sea or on salt-sprayed roads

Since sea salt or salt sprayed on roads during winter are extremely corrosive in combination with water, carry out the following steps after each ride in the rain, near the sea or on salt-sprayed roads.

TIP

Salt sprayed on roads in the winter may remain well into spring.

1. Clean the motorcycle with cold water and a mild detergent, after the engine has cooled down. **NOTICE: Do not use warm water since it increases the corrosive action of the salt.** [ECA10792]
2. Apply a corrosion protection spray on all metal, including chrome- and nickel-plated, surfaces to prevent corrosion.

After cleaning

1. Dry the motorcycle with a chamois or an absorbing cloth.
2. Immediately dry the drive chain and lubricate it to prevent it from rusting.
3. Use a chrome polish to shine chrome, aluminum and stainless-steel parts, including the exhaust system. (Even the thermally induced discoloring of stainless-steel exhaust systems can be removed through polishing.)

4. To prevent corrosion, it is recommended to apply a corrosion protection spray on all metal, including chrome- and nickel-plated, surfaces.
5. Use spray oil as a universal cleaner to remove any remaining dirt.
6. Touch up minor paint damage caused by stones, etc.
7. Wax all painted surfaces.
8. Let the motorcycle dry completely before storing or covering it.

EWA11132

WARNING

Contaminants on the brakes or tires can cause loss of control.

- **Make sure that there is no oil or wax on the brakes or tires.**
- **If necessary, clean the brake discs and brake linings with a regular brake disc cleaner or acetone, and wash the tires with warm water and a mild detergent. Before riding at higher speeds, test the motorcycle's braking performance and cornering behavior.**

ECA10801

NOTICE

- **Apply spray oil and wax sparingly and make sure to wipe off any excess.**
- **Never apply oil or wax to any rubber and plastic parts, but treat them with a suitable care product.**
- **Avoid using abrasive polishing compounds as they will wear away the paint.**

TIP

- Consult a Yamaha dealer for advice on what products to use.
- Washing, rainy weather or humid climates can cause the headlight lens to fog. Turning the headlight on for a short period of time will help remove the moisture from the lens.

EAU43204

Storage

Short-term

Always store your motorcycle in a cool, dry place and, if necessary, protect it against dust with a porous cover. Be sure the engine and the exhaust system are cool before covering the motorcycle.

ECA10811

NOTICE

- **Storing the motorcycle in a poorly ventilated room or covering it with a tarp, while it is still wet, will allow water and humidity to seep in and cause rust.**
- **To prevent corrosion, avoid damp cellars, stables (because of the presence of ammonia) and areas where strong chemicals are stored.**

Long-term

Before storing your motorcycle for several months:

1. Follow all the instructions in the "Care" section of this chapter.

Motorcycle care and storage

2. Fill up the fuel tank and add fuel stabilizer (if available) to prevent the fuel tank from rusting and the fuel from deteriorating.
3. Perform the following steps to protect the cylinder, piston rings, etc. from corrosion.
 - a. Remove the spark plug cap and spark plug.
 - b. Pour a teaspoonful of engine oil into the spark plug bore.
 - c. Install the spark plug cap onto the spark plug, and then place the spark plug on the cylinder head so that the electrodes are grounded. (This will limit sparking during the next step.)
 - d. Turn the engine over several times with the starter. (This will coat the cylinder wall with oil.)
WARNING! To prevent damage or injury from sparking, make sure to ground the spark plug electrodes while turning the engine over.
 - e. Remove the spark plug cap from the spark plug, and then install the spark plug and the spark plug cap.
4. Lubricate all control cables and the pivoting points of all levers and pedals as well as of the side-stand/centerstand.
5. Check and, if necessary, correct the tire air pressure, and then lift the motorcycle so that both of its wheels are off the ground. Alternatively, turn the wheels a little every month in order to prevent the tires from becoming degraded in one spot.
6. Cover the muffler outlet with a plastic bag to prevent moisture from entering it.
7. Remove the battery and fully charge it. Store it in a cool, dry place and charge it once a month. Do not store the battery in an excessively cold or warm place [less than 0 °C (30 °F) or more than 30 °C (90 °F)]. For more information on storing the battery, see page 6-30.

TIP

Make any necessary repairs before storing the motorcycle.

[EWA10952]

Dimensions:

- Overall length:
2005 mm (78.9 in)
- Overall width:
735 mm (28.9 in)
- Overall height:
1050 mm (41.3 in)
- Seat height:
795 mm (31.3 in)
- Wheelbase:
1320 mm (52.0 in)
- Ground clearance:
150 mm (5.91 in)
- Minimum turning radius:
2.2 m (7.22 ft)

Weight:

- Curb weight:
129 kg (284 lb)

Engine:

- Combustion cycle:
4-stroke
- Cooling system:
Air cooled
- Valve train:
SOHC
- Number of cylinders:
Single cylinder
- Displacement:
125 cm³
- Bore × stroke:
52.4 × 57.9 mm (2.06 × 2.28 in)
- Compression ratio:
10.0 : 1

Starting system:

- Electric starter
- Lubrication system:
Wet sump

Engine oil:

- Recommended brand:
YAMALUBE
- SAE viscosity grades:
10W-40, 20W-40

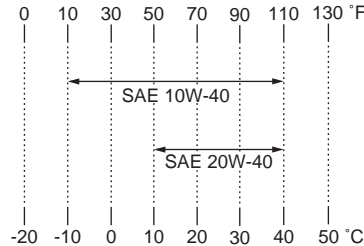

Recommended engine oil grade:

- API service SG type or higher, JASO standard MA
- Engine oil quantity:
Oil change:
1.00 L (1.06 US qt, 0.88 Imp.qt)
With oil filter removal:
1.10 L (1.16 US qt, 0.97 Imp.qt)

Air filter:

- Air filter element:
Dry element

Fuel:

- Recommended fuel:
Regular unleaded gasoline (Gasohol [E10] acceptable)
- Fuel tank capacity:
14 L (3.7 US gal, 3.1 Imp.gal)
- Fuel reserve amount:
2.2 L (0.58 US gal, 0.48 Imp.gal)

Fuel injection:

- Throttle body:
ID mark:
BT41 00

Spark plug(s):

- Manufacturer/model:
NGK/CPR8EA-9
- Spark plug gap:
0.8–0.9 mm (0.031–0.035 in)

Clutch:

- Clutch type:
Wet, multiple-disc

Drivetrain:

- Primary reduction ratio:
3.409 (75/22)
- Final drive:
Chain
- Secondary reduction ratio:
3.071 (43/14)
- Transmission type:
Constant mesh 5-speed
- Gear ratio:
1st:
2.714 (38/14)
2nd:
1.789 (34/19)

Specifications

3rd:
1.318 (29/22)
4th:
1.045 (23/22)
5th:
0.875 (21/24)

Chassis:

Frame type:
Diamond
Caster angle:
25.0 °
Trail:
82 mm (3.2 in)

Front tire:

Type:
Tubeless
Size:
2.75-18M/C 42P
Manufacturer/model:
CHENG SHIN/C910

Rear tire:

Type:
Tubeless
Size:
100/80-18M/C 59P
Manufacturer/model:
CHENG SHIN/C905

Loading:

Maximum load:
171 kg (377 lb)
(Total weight of rider, passenger, cargo
and accessories)

Tire air pressure (measured on cold tires):

1 person:
Front:
175 kPa (1.75 kgf/cm², 25 psi)
Rear:
200 kPa (2.00 kgf/cm², 29 psi)
2 persons:
Front:
175 kPa (1.75 kgf/cm², 25 psi)
Rear:
225 kPa (2.25 kgf/cm², 33 psi)
Maximum load:
Front:
175 kPa (1.75 kgf/cm², 25 psi)
Rear:
250 kPa (2.50 kgf/cm², 36 psi)

Front wheel:

Wheel type:
Cast wheel
Rim size:
18M/C x MT1.85

Rear wheel:

Wheel type:
Cast wheel
Rim size:
18M/C x MT2.15

Unified brake system:

Operation:
Activated by front brake

Front brake:

Type:
Hydraulic single disc brake

Specified brake fluid:
DOT 3 or 4

Front brake:

Type:
Mechanical leading trailing drum brake

Front suspension:

Type:
Telescopic fork
Spring:
Coil spring
Shock absorber:
Hydraulic damper
Wheel travel:
120 mm (4.7 in)

Rear suspension:

Type:
Swingarm
Spring:
Coil spring
Shock absorber:
Hydraulic damper
Wheel travel:
112 mm (4.4 in)

Electrical system:

System voltage:
12 V
Ignition system:
TCI
Charging system:
AC magneto

Battery:

Model:
YTX5L-BS

Voltage, capacity:
12 V, 4.0 Ah (10 HR)

Headlight:

Bulb type:
Halogen bulb

Bulb wattage:

Headlight:
HS1, 35.0 W/35.0 W

Front turn signal light:
10.0 W

Rear turn signal light:
10.0 W

Auxiliary light:
3.0 W

Meter lighting:
LED

Neutral indicator light:
LED

High beam indicator light:
LED

Turn signal indicator light:
LED

Engine trouble warning light:
LED

ECO indicator light:
LED

Fuse(s):

Main fuse:
15.0 A

Consumer information

Identification numbers

EAU53562

Record the vehicle identification number, engine serial number, and the model label information in the spaces provided below. These identification numbers are needed when registering the vehicle with the authorities in your area and when ordering spare parts from a Yamaha dealer.

VEHICLE IDENTIFICATION NUMBER:

ENGINE SERIAL NUMBER:

MODEL LABEL INFORMATION:

Vehicle identification number

EAU26401

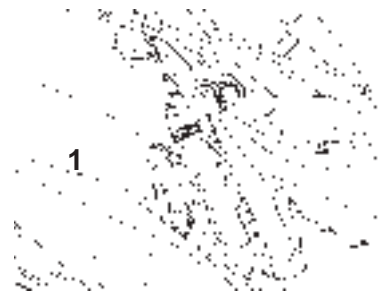

1. Vehicle identification number

The vehicle identification number is stamped into the steering head pipe. Record this number in the space provided.

TIP

The vehicle identification number is used to identify your motorcycle and may be used to register your motorcycle with the licensing authority in your area.

Engine serial number

EAU26442

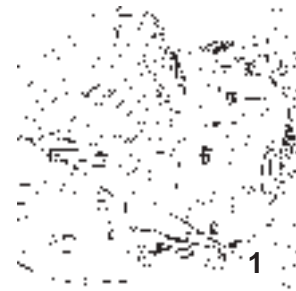

1. Engine serial number

The engine serial number is stamped into the crankcase.

Model label

EAU36981



1. Model label

The model label is affixed to the frame behind panel A. (See page 6-8.) Record the information on this label in the space provided. This information will be needed when ordering spare parts from a Yamaha dealer.

Diagnostic connector

EAU69910

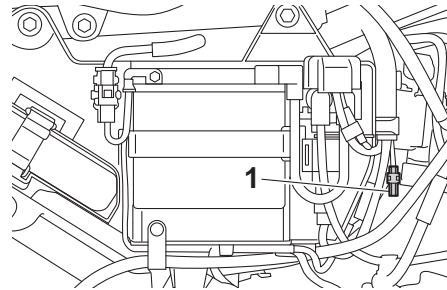

1. Diagnostic connector

The diagnostic connector is located as shown.

Vehicle data recording

EAU74701

This model's ECU stores certain vehicle data to assist in the diagnosis of malfunctions and for research and development purposes. This data will be uploaded only when a special Yamaha diagnostic tool is attached to the vehicle, such as when maintenance checks or service procedures are performed.

Although the sensors and recorded data will vary by model, the main data points are:

- Vehicle status and engine performance data
- Fuel-injection and emission-related data

Yamaha will not disclose this data to a third party except:

- With the consent of the vehicle owner
- Where obligated by law
- For use by Yamaha in litigation
- For general Yamaha-conducted research purposes when the data is not related to an individual vehicle nor owner

Index

A

- Air filter element and check hose, cleaning6-14
- Auxiliary light bulb, replacing.....6-34

B

- Battery6-30
- Brake and clutch levers, checking and lubricating.....6-27
- Brake and shift pedals, checking and lubricating.....6-26
- Brake fluid, changing6-23
- Brake fluid level, checking6-22
- Brake lever3-7
- Brake lever free play, checking.....6-20
- Brake light switches.....6-21
- Brake pads and shoes, checking6-22
- Brake pedal.....3-7
- Brake pedal free play, adjusting6-21
- Brake/tail light bulb, replacing6-35

C

- Cables, checking and lubricating6-26
- Care7-1
- Catalytic converters.....3-10
- Centerstand and sidestand, checking and lubricating.....6-28
- Clutch lever.....3-6
- Clutch lever free play, adjusting6-19
- Cowling and panels, removing and installing.....6-8

D

- Data recording, vehicle9-2
- Diagnostic connector.....9-2
- Dimmer switch3-5
- Drive chain, cleaning and lubricating....6-25

- Drive chain slack 6-24

E

- Eco indicator light..... 3-2
- Engine break-in 5-3
- Engine idling speed 6-16
- Engine oil and oil filter element 6-11
- Engine serial number..... 9-1
- Engine trouble warning light..... 3-2

F

- Front fork, checking 6-29
- Fuel..... 3-8
- Fuel consumption, tips for reducing 5-3
- Fuel tank cap..... 3-8
- Fuse, replacing 6-31

H

- Handlebar switches..... 3-5
- Headlight bulb, replacing 6-33
- High beam indicator light 3-2
- Horn switch 3-5

I

- Identification numbers..... 9-1
- Ignition circuit cut-off system..... 3-13
- Indicator lights and warning light 3-2

L

- License plate light bulb, replacing..... 6-36

M

- Main switch/steering lock..... 3-1
- Maintenance and lubrication, periodic... 6-4
- Maintenance, emission control system..... 6-3
- Matte color, caution 7-1
- Model label..... 9-1
- Multi-function meter unit 3-3

N

- Neutral indicator light.....3-2

P

- Parking5-4
- Part locations2-1
- Pass switch3-5

S

- Safety information 1-1
- Seat.....3-11
- Shifting.....5-2
- Shift pedal.....3-6
- Shock absorber assemblies, adjusting3-11
- Sidestand3-12
- Spark plug, checking6-10
- Specifications8-1
- Starting the engine.....5-1
- Start switch3-6
- Steering, checking6-29
- Storage7-3
- Swingarm pivots, lubricating6-28

T

- Throttle grip and cable, checking and lubricating6-26
- Throttle grip free play, checking6-16
- Tires6-17
- Tool kit6-2
- Troubleshooting6-39
- Troubleshooting chart.....6-41
- Turn signal indicator light.....3-2
- Turn signal light bulb, replacing6-35
- Turn signal switch3-5

V

- Valve clearance.....6-17

Vehicle identification number 9-1

W

Wheel bearings, checking 6-30

Wheel (front) 6-36

Wheel (rear)..... 6-37

Wheels..... 6-19

