

OWNER'S MANUAL 2020

READY TO RACE
in every situation

1290 Super Adventure R

Art. no. 3214096en



KTM

Congratulations on your decision to purchase a KTM motorcycle. You are now the owner of a state-of-the-art sports vehicle that will continue giving you pleasure for a long time if you maintain it properly.

We wish you good and safe riding at all times!

Please enter the serial numbers of your vehicle below.

| | |
|---|----------------|
| Vehicle identification number (📖 p. 26) | Dealer's stamp |
| Engine number (📖 p. 27) | |
| Key number (📖 p. 27) | |

The Owner's Manual contained the latest information for this model series at the time of going to print. However, minor differences due to further developments in design cannot be ruled out completely.

All specifications contained herein are non-binding. KTM Sportmotorcycle GmbH specifically reserves the right to modify or delete technical specifications, prices, colors, forms, materials, services, designs, equipment, etc., without prior notice and without specifying reasons, to adapt these to local conditions, as well as to stop production of a particular model without prior notice. KTM accepts no liability for delivery options, deviations from figures and descriptions, misprints, and other errors. The models portrayed partly contain special equipment that does not belong to the regular scope of supply.

© 2019 KTM Sportmotorcycle GmbH, Mattighofen Austria
All rights reserved



3214096en

09/2019

DEAR KTM CUSTOMER

Reproduction, even in part, as well as copying of all kinds, is permitted only with the express written permission of the copyright owner.



ISO 9001(12 100 6061)

KTM applies quality assurance processes that lead to the highest possible product quality as defined in the ISO 9001 international quality management standard.

Issued by: TÜV Management Service

KTM Sportmotorcycle GmbH
Stallhofnerstraße 3
5230 Mattighofen, Austria

This document is valid for the following models:

1290 Super Adventure R EU (F9903T6)

1290 Super Adventure R TKC EU (F9903T7)

1290 Super Adventure R TKC CN (F9987T7)





| | | | | | |
|---|---|----|------|---|----|
| 1 | MEANS OF REPRESENTATION | 11 | 4 | VIEW OF VEHICLE | 22 |
| | 1.1 Symbols used | 11 | 4.1 | View of vehicle, front left (example) ... | 22 |
| | 1.2 Formats used..... | 12 | 4.2 | View of vehicle, rear right (example)..... | 24 |
| 2 | SAFETY ADVICE..... | 13 | 5 | SERIAL NUMBERS | 26 |
| | 2.1 Use definition – intended use..... | 13 | 5.1 | Vehicle identification number..... | 26 |
| | 2.2 Misuse..... | 13 | 5.2 | Type label | 26 |
| | 2.3 Safety advice..... | 13 | 5.3 | Key number..... | 27 |
| | 2.4 Degrees of risk and symbols | 14 | 5.4 | Engine number | 27 |
| | 2.5 Tampering warning..... | 15 | 5.5 | Fork part number | 28 |
| | 2.6 Safe operation | 15 | 5.6 | Shock absorber article number | 28 |
| | 2.7 Protective clothing | 17 | 5.7 | Steering damper article number | 29 |
| | 2.8 Work rules..... | 17 | 6 | CONTROLS..... | 30 |
| | 2.9 Environment..... | 18 | 6.1 | Clutch lever..... | 30 |
| | 2.10 Owner's Manual | 18 | 6.2 | Hand brake lever..... | 30 |
| 3 | IMPORTANT NOTES..... | 19 | 6.3 | Throttle grip | 31 |
| | 3.1 Manufacturer and implied warranty.... | 19 | 6.4 | Combination switch, left side | 31 |
| | 3.2 Fuel, auxiliary substances | 19 | 6.5 | Light switch | 32 |
| | 3.3 Spare parts, accessories | 19 | 6.6 | Cruise control system tip switch | 33 |
| | 3.4 Service | 20 | 6.7 | Menu buttons..... | 36 |
| | 3.5 Figures | 20 | 6.8 | Turn signal switch..... | 36 |
| | 3.6 Customer service..... | 20 | 6.9 | Horn button..... | 38 |
| | | | 6.10 | Combination switch, right | 38 |

TABLE OF CONTENTS

| | | | | | |
|------|---|----|--------|---|----|
| 6.11 | Hazard warning flasher switch | 39 | 7.2 | Activation and test | 57 |
| 6.12 | Emergency OFF switch/electric starter button | 40 | 7.3 | Day-Night mode | 59 |
| 6.13 | Race-on button | 41 | 7.4 | Warnings | 60 |
| 6.14 | Steering lock (antenna)..... | 42 | 7.5 | Ice warning | 61 |
| 6.15 | Immobilizer | 43 | 7.6 | Indicator lamps..... | 62 |
| 6.16 | Race-on key | 43 | 7.7 | Display | 66 |
| 6.17 | Socket for electrical accessories | 44 | 7.8 | Speed | 68 |
| 6.18 | USB socket | 45 | 7.9 | Shift warning light | 69 |
| 6.19 | Opening fuel tank filler cap..... | 45 | 7.10 | Cruise control indicator..... | 70 |
| 6.20 | Closing the fuel tank filler cap..... | 47 | 7.11 | Speed | 71 |
| 6.21 | Fuel cocks..... | 48 | 7.12 | ABS display..... | 71 |
| 6.22 | Opening storage compartment | 48 | 7.13 | MTC display | 72 |
| 6.23 | Closing storage compartment | 49 | 7.14 | Ride display | 72 |
| 6.24 | Seat lock..... | 49 | 7.15 | Heated grip (optional)..... | 73 |
| 6.25 | Grab handles | 50 | 7.16 | Seat heater (optional)..... | 73 |
| 6.26 | Luggage rack plate..... | 50 | 7.17 | Coolant temperature indicator | 74 |
| 6.27 | Case holders..... | 51 | 7.18 | Fuel level display | 74 |
| 6.28 | Passenger foot pegs | 52 | 7.19 | Ambient air temperature indicator | 75 |
| 6.29 | Shift lever | 52 | 7.20 | Time..... | 76 |
| 6.30 | Foot brake lever | 53 | 7.21 | Favourites display | 76 |
| 6.31 | Side stand..... | 54 | 7.22 | Quick Selector 1 display | 77 |
| 6.32 | Center stand..... | 55 | 7.23 | Quick Selector 2 display | 77 |
| 7 | COMBINATION INSTRUMENT | 56 | 7.24 | Navigation display (optional) | 78 |
| 7.1 | Combination instrument | 56 | 7.25 | Menu | 79 |
| | | | 7.25.1 | KTM MY RIDE (optional) | 79 |
| | | | 7.25.2 | Audio (optional)..... | 80 |

| | | | | | |
|---------|--|-----|---------|----------------------------------|-----|
| 7.25.3 | Navigation (optional)..... | 82 | 7.25.28 | ABS..... | 109 |
| 7.25.4 | Navigation Setup (optional)..... | 83 | 7.25.29 | HHC (optional) | 111 |
| 7.25.5 | Navigation information (optional) | 85 | 7.25.30 | Settings | 111 |
| 7.25.6 | Volume (optional) | 86 | 7.25.31 | Favourites | 112 |
| 7.25.7 | Setup (optional)..... | 87 | 7.25.32 | Navi Info Screen..... | 112 |
| 7.25.8 | Bluetooth (optional) | 88 | 7.25.33 | Quick Selector 1 | 113 |
| 7.25.9 | Phone (optional) | 89 | 7.25.34 | Quick Selector 2..... | 114 |
| 7.25.10 | Headset Rider (optional)..... | 91 | 7.25.35 | Preferences | 115 |
| 7.25.11 | Headset Pass. (optional)..... | 93 | 7.25.36 | Units | 115 |
| 7.25.12 | Wireless Interface | 95 | 7.25.37 | Distance | 116 |
| 7.25.13 | Telephony (optional) | 96 | 7.25.38 | Temperature..... | 116 |
| 7.25.14 | Info | 97 | 7.25.39 | Pressure | 117 |
| 7.25.15 | Trip 1 | 98 | 7.25.40 | Consumption | 118 |
| 7.25.16 | Trip 2 | 99 | 7.25.41 | Language | 118 |
| 7.25.17 | General Info | 100 | 7.25.42 | Shift Light | 119 |
| 7.25.18 | TPMS | 100 | 7.25.43 | Setting the time and date | 120 |
| 7.25.19 | Warnings..... | 102 | 7.25.44 | DRL | 122 |
| 7.25.20 | Service | 102 | 7.25.45 | Quickshifter + (optional)..... | 123 |
| 7.25.21 | Extra Functions | 103 | 7.25.46 | Heated Grips (optional) | 124 |
| 7.25.22 | Motorcycle | 104 | 7.25.47 | Heated Seat Rid (optional)..... | 124 |
| 7.25.23 | Heated Grips (optional) | 104 | 7.25.48 | Heated Seat Pas (optional) | 125 |
| 7.25.24 | Heated Seat (optional) | 105 | 7.25.49 | Cornering Light Test..... | 125 |
| 7.25.25 | Ride Mode | 106 | 8 | ERGONOMICS | 127 |
| 7.25.26 | MTC | 107 | 8.1 | Handlebar position..... | 127 |
| 7.25.27 | MTC+MSR (optional)..... | 108 | | | |

TABLE OF CONTENTS

| | | | | | |
|------|--|-----|-------|--|-----|
| 8.2 | Adjusting the handlebar position  | 127 | 10 | RIDING INSTRUCTIONS..... | 148 |
| 8.3 | Adjusting the windshield | 130 | 10.1 | Checks and maintenance measures when preparing for use | 148 |
| 8.4 | Adjusting the basic position of the clutch lever | 131 | 10.2 | Starting..... | 149 |
| 8.5 | Adjusting the basic position of the hand brake lever | 132 | 10.3 | Starting off..... | 152 |
| 8.6 | Rider footrests | 132 | 10.4 | Quickshifter + (optional)..... | 153 |
| 8.7 | Adjusting the footrests  | 133 | 10.5 | Starting off with HHC (optional) | 154 |
| 8.8 | Checking the basic position of the shift lever..... | 136 | 10.6 | Shifting, riding | 155 |
| 8.9 | Adjusting the basic position of the shift lever  | 137 | 10.7 | MSR (optional) | 161 |
| 8.10 | Setting the shift lever stub..... | 139 | 10.8 | Applying the brakes..... | 161 |
| 8.11 | Adjusting the basic position of the foot brake lever  | 140 | 10.9 | Stopping, parking..... | 164 |
| 8.12 | Adjusting the tilt of the combination instrument..... | 141 | 10.10 | Transporting..... | 166 |
| 9 | PREPARING FOR USE..... | 143 | 10.11 | Refueling | 167 |
| 9.1 | Advice on preparing for first use | 143 | 11 | SERVICE SCHEDULE | 170 |
| 9.2 | Running in the engine | 145 | 11.1 | Additional information | 170 |
| 9.3 | Loading the vehicle | 145 | 11.2 | Required work | 170 |
| | | | 11.3 | Recommended work | 173 |
| | | | 12 | SUSPENSION SETTING..... | 174 |
| | | | 12.1 | Fork/shock absorber | 174 |
| | | | 12.2 | Adjusting the compression damping of the fork..... | 174 |
| | | | 12.3 | Adjusting the rebound damping of the fork..... | 176 |

| | | | | | |
|------|---|-----|-------|--|-----|
| 12.4 | Adjusting the spring pretension of the fork..... | 177 | 13.9 | Checking the chain, rear sprocket, and engine sprocket | 192 |
| 12.5 | Compression damping of the shock absorber..... | 178 | 13.10 | Checking/correcting the fluid level of the hydraulic clutch..... | 195 |
| 12.6 | Adjusting the low-speed compression damping of the shock absorber..... | 179 | 13.11 | Checking steering head bearing play | 197 |
| 12.7 | Adjusting the high-speed compression damping of the shock absorber..... | 180 | 13.12 | Removing the bottom triple clamp cover | 199 |
| 12.8 | Adjusting the rebound damping of the shock absorber..... | 182 | 13.13 | Installing the bottom triple clamp cover | 200 |
| 12.9 | Adjusting the spring pretension of the shock absorber..... | 183 | 13.14 | Removing the front side cover | 201 |
| 13 | SERVICE WORK ON THE CHASSIS..... | 184 | 13.15 | Installing the front side cover..... | 201 |
| 13.1 | Raising the vehicle with the center stand | 184 | 13.16 | Removing the mask spoiler 🖐..... | 202 |
| 13.2 | Removing the vehicle from the center stand | 185 | 13.17 | Installing the mask spoiler 🖐..... | 206 |
| 13.3 | Removing the seat | 186 | 13.18 | Removing front fender | 209 |
| 13.4 | Mounting the seat | 186 | 13.19 | Installing front fender..... | 210 |
| 13.5 | Checking for chain dirt | 187 | 13.20 | Cleaning the dust boots of the fork legs 🖐..... | 211 |
| 13.6 | Cleaning the chain | 187 | 13.21 | Removing the fuel tank cover | 213 |
| 13.7 | Checking the chain tension | 189 | 13.22 | Installing the fuel tank cover..... | 216 |
| 13.8 | Adjusting the chain tension..... | 190 | 13.23 | Removing the windshield | 218 |
| | | | 13.24 | Installing the windshield..... | 218 |
| | | | 13.25 | Removing the engine guard..... | 219 |
| | | | 13.26 | Installing the engine guard | 219 |
| | | | 13.27 | Removing the crash bar 🖐..... | 220 |
| | | | 13.28 | Installing the crash bar 🖐..... | 221 |

TABLE OF CONTENTS

| | | | | | |
|-------|--|-----|-------|--|-----|
| 14 | BRAKE SYSTEM | 224 | 16 | ELECTRICAL SYSTEM | 259 |
| 14.1 | Anti-lock braking system (ABS) | 224 | 16.1 | Daytime running light (DRL)..... | 259 |
| 14.2 | Checking the brake discs | 227 | 16.2 | Cornering light..... | 260 |
| 14.3 | Checking the front brake fluid level | 228 | 16.3 | Removing the 12-V battery 🛠..... | 261 |
| 14.4 | Adding front brake fluid 🛠..... | 229 | 16.4 | Installing the 12-V battery 🛠..... | 263 |
| 14.5 | Checking the front brake linings | 232 | 16.5 | Charging the 12-V battery 🛠..... | 266 |
| 14.6 | Checking the rear brake fluid level | 233 | 16.6 | Changing the Race-on key battery.... | 271 |
| 14.7 | Adding rear brake fluid 🛠..... | 234 | 16.7 | Changing the main fuse..... | 272 |
| 14.8 | Checking the rear brake linings | 237 | 16.8 | Changing the fuses in the fuse box..... | 275 |
| 15 | WHEELS, TIRES | 238 | 16.9 | Checking the headlight setting | 278 |
| 15.1 | Removing the front wheel 🛠..... | 238 | 16.10 | Adjusting the headlight range..... | 279 |
| 15.2 | Installing the front wheel 🛠..... | 240 | 16.11 | Diagnostics connector | 280 |
| 15.3 | Removing the rear wheel 🛠..... | 244 | 16.12 | Front ACC1 and ACC2 | 280 |
| 15.4 | Installing the rear wheel 🛠..... | 247 | 16.13 | ACC1 and ACC2 rear | 281 |
| 15.5 | Checking the rear hub damping rubber pieces 🛠..... | 250 | 17 | COOLING SYSTEM | 282 |
| 15.6 | Checking the tire condition | 252 | 17.1 | Checking the coolant level in the compensating tank..... | 282 |
| 15.7 | Checking tire pressure | 255 | 17.2 | Correcting the coolant level in the compensating tank..... | 284 |
| 15.8 | Checking spoke tension | 256 | 18 | TUNING THE ENGINE | 287 |
| 15.9 | Tubeless tire system..... | 257 | 18.1 | Ride Mode | 287 |
| 15.10 | Using tire repair spray | 258 | 18.2 | Motorcycle traction control (MTC).... | 288 |

| | | | | | |
|--------|---|-----|------|---|-----|
| 19 | SERVICE WORK ON THE ENGINE | 289 | 23.6 | Tires | 323 |
| 19.1 | Checking the engine oil level..... | 289 | 23.7 | Fork..... | 323 |
| 19.2 | Changing the engine oil and oil filter, cleaning the oil screens  | 290 | 23.8 | Shock absorber | 324 |
| 19.3 | Adding engine oil | 297 | 23.9 | Chassis tightening torques | 326 |
| 20 | CLEANING, CARE | 300 | 24 | DECLARATIONS OF CONFORMITY | 332 |
| 20.1 | Cleaning the motorcycle | 300 | 24.1 | Declarations of conformity | 332 |
| 20.2 | Checks and maintenance steps for winter operation..... | 303 | 24.2 | Country-specific declarations of conformity..... | 334 |
| 21 | STORAGE..... | 305 | 25 | OPEN SOURCE | 335 |
| 21.1 | Storage | 305 | 25.1 | Information on open source software | 335 |
| 21.2 | Preparing for use after storage..... | 307 | 26 | SUBSTANCES | 336 |
| 22 | TROUBLESHOOTING | 308 | 27 | AUXILIARY SUBSTANCES | 340 |
| 23 | TECHNICAL DATA..... | 312 | 28 | STANDARDS | 342 |
| 23.1 | Engine | 312 | 29 | INDEX OF SPECIAL TERMS | 343 |
| 23.2 | Engine tightening torques | 314 | 30 | LIST OF ABBREVIATIONS..... | 345 |
| 23.3 | Capacities | 319 | 31 | LIST OF SYMBOLS..... | 346 |
| 23.3.1 | Engine oil | 319 | 31.1 | Red symbols..... | 346 |
| 23.3.2 | Coolant | 319 | 31.2 | Yellow and orange symbols..... | 346 |
| 23.3.3 | Fuel | 319 | 31.3 | Green and blue symbols..... | 347 |
| 23.4 | Chassis | 320 | | | |
| 23.5 | Electrical system..... | 321 | | | |

TABLE OF CONTENTS

| | |
|------------|-----|
| INDEX..... | 348 |
|------------|-----|

1.1 Symbols used

The meaning of specific symbols is described below.



Indicates an expected reaction (e.g. of a work step or a function).



Indicates an unexpected reaction (e.g. of a work step or a function).



All work marked with this symbol requires specialist knowledge and technical understanding. In the interest of your own safety, have these jobs performed by an authorized KTM workshop! Your motorcycle will be optimally cared for there by specially trained experts using the auxiliary tools required.



Indicates a page reference (more information is provided on the specified page).



Indicates information with more details or tips.



Indicates the result of a testing step.

1 MEANS OF REPRESENTATION

V

Indicates a voltage measurement.

A

Indicates a current measurement.



Indicates the end of an activity, including potential rework.

1.2 Formats used

The typographical formats used in this document are explained below.

Proprietary name

Indicates a proprietary name.

Name®

Indicates a protected name.

Brand™

Indicates a brand available on the open market.

Underlined terms

Refer to technical details of the vehicle or indicate technical terms, which are explained in the glossary.

2.1 Use definition – intended use

The vehicle is designed and constructed to withstand the usual demands of regular traffic and use on gentle terrain (unpaved roads). This vehicle is not suitable for use on race tracks.



Info

This vehicle is only authorized for operation on public roads in its homologated version. When used in a dusty environment, it may be necessary to use air filter protection. Your authorized KTM dealer will be happy to advise you.

2.2 Misuse

The vehicle must only be used as intended.

Dangers can arise for people, property and the environment through use not as intended.

Any use of the vehicle beyond the intended and defined use constitutes misuse.

Misuse also includes the use of operating and auxiliary fluids which do not meet the required specification for the respective use.

2.3 Safety advice

A number of safety instructions need to be followed to operate the product described safely. Therefore read this instruction and all further instructions included carefully. The safety instructions are highlighted in the text and are referred to at the relevant passages.



Info

Various information and warning labels are attached in prominent locations on the product described. Do not remove any information or warning labels. If they are missing, you or others may not recognize dangers and may therefore be injured.

2.4 Degrees of risk and symbols



Danger

Identifies a danger that will immediately and invariably lead to fatal or serious permanent injury if the appropriate measures are not taken.



Warning

Identifies a danger that is likely to lead to fatal or serious injury if the appropriate measures are not taken.



Caution

Identifies a danger that may lead to minor injuries if the appropriate measures are not taken.

Note

Identifies a danger that will lead to considerable machine and material damage if the appropriate measures are not taken.



Note

Indicates a danger that will lead to environmental damage if the appropriate measures are not taken.

2.5 Tampering warning

Tampering with the noise control system is prohibited. Federal law prohibits the following acts or the causing thereof:

- 1 The removal or rendering inoperative by any person other than for purposes of servicing, repair, or replacement, of any device or element of design incorporated into any new vehicle for the purpose of noise control prior to its sale or delivery to the ultimate purchaser or while it is in use, or
- 2 the use of the vehicle after such device or element of design has been removed or rendered inoperative by any person.

Among those acts presumed to constitute tampering are the acts listed below:

- 1 Removal or puncturing of the main silencers, baffles, header pipes or any other components which conduct exhaust gases.
- 2 Removal or puncturing of parts of the intake system.
- 3 Lack of proper maintenance.
- 4 Replacing moving parts of the vehicle, or parts of the exhaust system or intake system, with parts other than those specified by the manufacturer.

2.6 Safe operation



Danger

Danger of accidents A rider who is not fit to ride poses a danger to him or herself and others.

- Do not operate the vehicle if you are not fit to ride due to alcohol, drugs or medication.
- Do not operate the vehicle if you are physically or mentally impaired.

2 SAFETY ADVICE



Danger

Danger of poisoning Exhaust gases are toxic and inhaling them may result in unconsciousness and death.

- Always make sure there is sufficient ventilation when running the engine.
- Use effective exhaust extraction when starting or running the engine in an enclosed space.



Warning

Danger of burns Some vehicle components become very hot when the vehicle is operated.

- Do not touch any parts such as the exhaust system, radiator, engine, shock absorber, or brake system before the vehicle parts have cooled down.
- Let the vehicle parts cool down before you perform any work on the vehicle.

Only operate the vehicle when it is in perfect technical condition, in accordance with its intended use, and in a safe and environmentally compatible manner.

The vehicle should only be used by trained persons. An appropriate driver's license is needed to ride the vehicle on public roads.

Have malfunctions that impair safety promptly eliminated by an authorized KTM workshop.

Adhere to the information and warning labels on the vehicle.

2.7 Protective clothing



Warning

Risk of injury Missing or poor protective clothing presents an increased safety risk.

- Wear appropriate protective clothing such as helmet, boots, gloves as well as trousers and a jacket with protectors on all rides.
- Always wear protective clothing that is in good condition and meets the legal regulations.

In the interest of your own safety, KTM recommends that you only operate the vehicle while wearing protective clothing.

2.8 Work rules

Unless specified otherwise, the ignition must be turned off during all work (models with ignition lock, models with remote key) or the engine must be at a standstill (models without ignition lock or remote key).

Special tools are necessary for certain tasks. The tools are not a component of the vehicle, but can be ordered using the number in parentheses. Example: bearing puller (15112017000)

During assembly, use new parts to replace parts which cannot be reused (e.g. self-locking screws and nuts, seals, sealing rings, O-rings, pins, and lock washers).

In the case of certain screws, a screw adhesive (e.g. **Loctite**®) is required. Observe the manufacturer's instructions.

If thread locker (e.g., **Precote**®) has already been applied to a new part, do not apply any additional thread locker. After disassembly, clean the parts that are to be reused and check them for damage and wear. Change damaged or worn parts.

After completing a repair or service work, check the operating safety of the vehicle.

2.9 Environment

If you use your motorcycle responsibly, you can ensure that problems and conflicts do not occur. To protect the future of the motorcycle sport, make sure that you use your motorcycle legally, display environmental consciousness, and respect the rights of others.

When disposing of used oil, other operating and auxiliary fluids, and used components, comply with the laws and regulations of the respective country.

Because motorcycles are not subject to the EU regulations governing the disposal of used vehicles, there are no legal regulations that pertain to the disposal of an end-of-life motorcycle. Your authorized KTM dealer will be glad to advise you.

2.10 Owner's Manual

It is important that you read this Owner's Manual carefully and completely before making your first trip. The Owner's Manual contains useful information and many tips on how to operate, handle, and service your motorcycle. Only then will you find out how to customize the vehicle ideally for your own use and how you can protect yourself from injury.

Keep the Owner's Manual in an accessible place to enable you to refer to it as needed.

If you would like to know more about the vehicle or have questions on the material you read, please contact an authorized KTM dealer.

The Owner's Manual is an important component of the vehicle and must be handed over to the new owner if the vehicle is sold.

The Owner's Manual is also available for download from your authorized KTM dealer and on the KTM website. International KTM Website: <http://www.ktm.com>

3.1 Manufacturer and implied warranty

The work prescribed in the service schedule must only be carried out in an authorized KTM workshop and confirmed in the **KTM Dealer.net**, as otherwise all warranty claims will be void. Damage or secondary damage caused by tampering with and/or conversions on the vehicle are not covered by the manufacturer warranty.

3.2 Fuel, auxiliary substances



Note

Environmental hazard Improper handling of fuel is a danger to the environment.

- Do not allow fuel to enter the groundwater, the soil, or the sewage system.

Use fuels and auxiliary substances in accordance with the Owner's Manual and specification.

3.3 Spare parts, accessories

For your own safety, only use spare parts and accessory products that are approved and/or recommended by KTM and have them installed by an authorized KTM workshop. KTM accepts no liability for other products and any resulting damage or loss.

Certain spare parts and accessory products are specified in parentheses in the descriptions. Your authorized KTM dealer will be glad to advise you.

The current **KTM PowerParts** for your vehicle can be found on the KTM website.
International KTM Website: <http://www.ktm.com>

3 IMPORTANT NOTES

3.4 Service

A prerequisite for perfect operation and the prevention of premature wear is that the service, care, and tuning work on the engine and chassis are properly carried out as described in the Owner's Manual. Poor suspension settings can result in damage to the components.

Using the motorcycle in extreme operating conditions, e.g. on very muddy and wet roads or in a dusty and dry environment, can lead to above-average wear of components, such as the drive train, brakes or air filter. For this reasons, it may be necessary to service or replace worn parts before the interval listed in the service schedule is reached.

It is imperative that you adhere to the stipulated run-in times and service intervals. If you observe these exactly, you will ensure a much longer service life for your motorcycle.

3.5 Figures

The figures contained in the manual may depict special equipment.

In the interest of clarity, some components may be shown disassembled or may not be shown at all. It is not always necessary to disassemble the component to perform the activity in question. Please follow the instructions in the text.

3.6 Customer service

Your authorized KTM dealer will be happy to answer any questions you may have on your vehicle and KTM.

A list of authorized KTM dealers can be found on the KTM website.

International KTM Website: <http://www.ktm.com>

4 VIEW OF VEHICLE

4.1 View of vehicle, front left (example)



- ❶ Socket for electrical accessories (📖 p. 44)
- ❷ Clutch lever (📖 p. 30)
- ❸ Seat lock (📖 p. 49)
- ❹ Grab handles (📖 p. 50)
- ❺ Luggage rack plate (📖 p. 50)
- ❻ Passenger foot pegs (📖 p. 52)
- ❼ Center stand (📖 p. 55)
- ❽ Rider footrests (📖 p. 132)
- ❾ Shift lever (📖 p. 52)
- ❿ Side stand (📖 p. 54)
- ⓫ Engine oil level viewer
- ⓬ Fuel cocks (📖 p. 48)

4 VIEW OF VEHICLE

4.2 View of vehicle, rear right (example)



- ① Fuel tank filler cap
- ② Combination switch, left side (📖 p. 31)
- ③ Fork compression adjuster
- ④ Combination switch, right (📖 p. 38)
- ⑤ Fork rebound adjustment
- ⑥ Hand brake lever (📖 p. 30)
- ⑦ Storage compartment
- ⑧ Cooling system compensating tank
- ⑨ Foot brake lever (📖 p. 53)
- ⑩ Shock absorber compression adjustment
- ⑪ Shock absorber rebound adjustment

5 SERIAL NUMBERS

5.1 Vehicle identification number

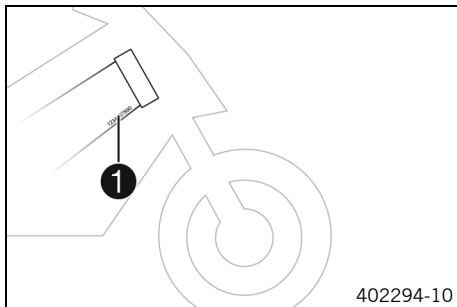

The vehicle identification number **1** is stamped on the bottom right of the frame behind the steering head.
The vehicle identification number is also shown on the type label.

5.2 Type label

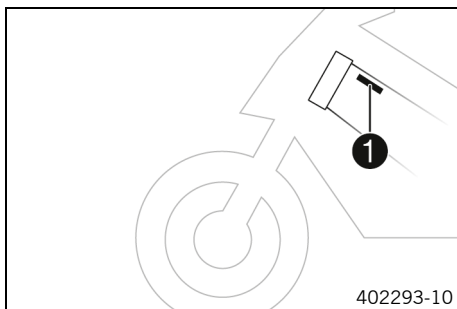

Type label **1** is affixed to the top left of the frame behind the steering head.

5.3 Key number

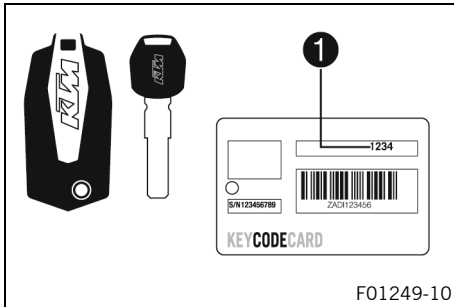

The key number **Code number 1** can be found on the **KEYCODECARD**.

i Info

You need the key number to order a spare key. Keep the **KEYCODECARD** in a safe place.

5.4 Engine number

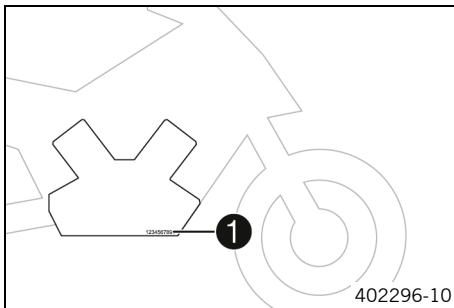

The engine number **1** is stamped on the right side of the engine.

5 SERIAL NUMBERS

5.5 Fork part number

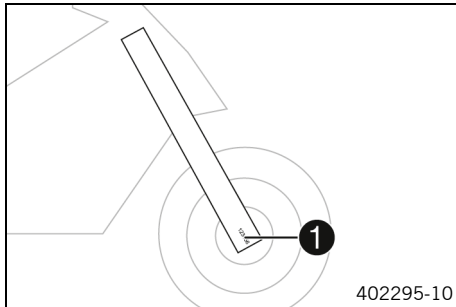

The fork part number **1** is stamped on the inner side of the fork stub.

5.6 Shock absorber article number

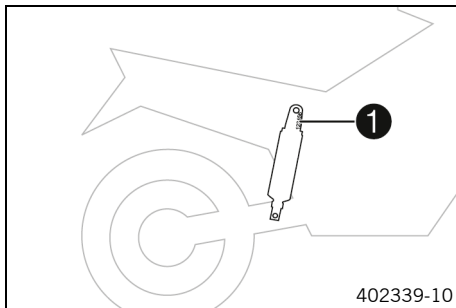

The shock absorber article number **1** is stamped on the top of the shock absorber.

5.7 Steering damper article number

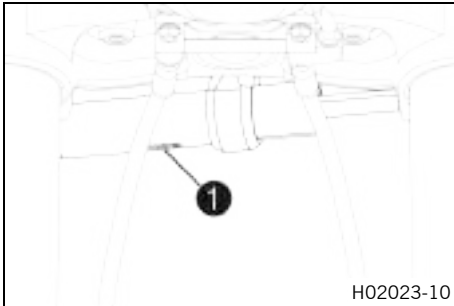

Steering damper article number ❶ is embossed on the underside of the steering damper.

H02023-10

6 CONTROLS

6.1 Clutch lever



The clutch lever **1** is fitted on the left side of the handlebar. The clutch is hydraulically operated and self-adjusting.

6.2 Hand brake lever



The hand brake lever **1** is located on the right side of the handlebar. The hand brake lever is used to activate both the front brake and rear brake at the same time.

i Info

When the **Offroad ABS** mode is switched on, only the front brake is activated.
When ABS is switched off, only the front brake is activated.

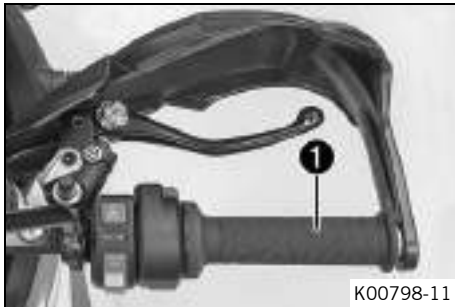
6.3 Throttle grip

The throttle grip **1** is fitted on the right side of the handlebar.

6.4 Combination switch, left side

The left combination switch is fitted on the left side of the handlebar.



Overview of the left combination switch

- ❶ Light switch (📖 p. 32)
- ❷ Cruise control system tip switch (📖 p. 33)
- ❸ Menu buttons (📖 p. 36)
- ❹ Turn signal switch (📖 p. 36)
- ❺ Horn button (📖 p. 38)

6.5 Light switch



The light switch ❶ is fitted on the combination switch on the left.

Possible states







| | |
|--|---|
| | Low beam on – Light switch in position ❶. In this position, the low beam and tail light are switched on. |
| | High beam on – Push the light switch to position ❷. In this position, the high beam and the tail light are switched on. |
| | Headlight flasher. – Push the light switch into position ❸. |

6.6 Cruise control system tip switch



The cruise control system tip switch **1** is fitted on the left side of the combination switch.

Possible states

- Cruise control system tip switch  in the basic position.
- Cruise control system tip switch  pressed to the left. – In this position, the cruise control system function is switched on and off. The operating mode is displayed in the combination instrument.
- Briefly press cruise control system tip switch  at the top. – The last saved speed is reached and maintained. Every subsequent brief pressing increases the target speed by 1 km/h or 1 mph.
- Press and hold cruise control system tip switch  at the top. – The target speed increases in increments of 5 km/h or 5 mph.
- Briefly press cruise control system tip switch  at the bottom. – The cruise control system function is activated and the current speed is maintained. Every subsequent brief pressing reduces the target speed by 1 km/h or 1 mph.
- Press and hold cruise control system tip switch  at the bottom. – The target speed decreases in increments of 5 km/h or 5 mph.



Info

After activation of the cruise control system function, the throttle grip can be turned back to the home position. The selected speed will be maintained.

If the target speed is exceeded for less than 30 seconds when turning the throttle grip, the cruise control system remains activated.

To switch off the cruise control system function, press the cruise control system tip switch  to the left.

In addition, the cruise control system function is deactivated when one of the following events occurs:

- Operating the hand brake lever
- Operating the foot brake lever
- Operating the clutch lever
- Shifting gears
- Turning the throttle grip beyond the home position
- Control of the motorcycle traction control (**MTC**  p. 288)
- Slip at the rear wheel or lifting front wheel
- A fault occurring, which impairs the cruise control system function
- Exceeding the target speed for more than 30 seconds when overtaking

**Warning**

Danger of accidents The cruise control system function is not suitable for all driving situations.

The selected target speed will not be reached, if the engine power is not sufficient for a gradient.

The selected target speed will be exceeded if the engine braking effect is not sufficient on a decline.

- Do not use the cruise control systems function on winding roads.
- Do not use the cruise control systems on slippery road surfaces (e.g. rain, ice or snow) or unpaved surfaces (e.g. sand, stones or gravel).
- Do not use the cruise control systems function if the traffic does not permit a constant speed.

The cruise control system function is only available when motorcycle traction control (**MTC** (📖 p. 288)) is activated.

When motorcycle traction control (**MTC** (📖 p. 288)) is switched off, the cruise control system function is also switched off.

The cruise control system function cannot be activated during rapid acceleration.

The cruise control system function can only be activated in 3rd, 4th, 5th and 6th gear.

The control range is from 40 to 200 km/h or from 25 to 125 mph.

6 CONTROLS

6.7 Menu buttons

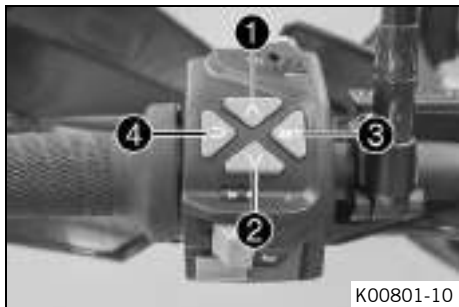

The menu buttons are fitted in the middle of the left combination switch.

The menu buttons are used to control the matrix display on the combination instrument.

Button **1** is the **UP** button.

Button **2** is the **DOWN** button.

Button **3** is the **SET** button.

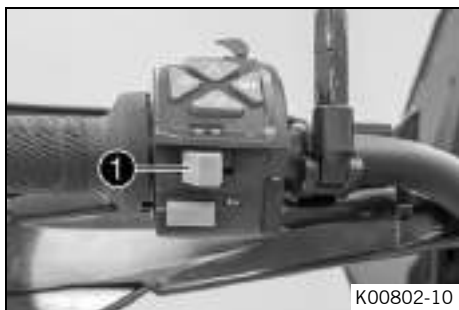

Button **4** is the **BACK** button.

6.8 Turn signal switch



Turn signal switch **1** is fitted on the combination switch on the left.

Possible states

| | |
|---|--|
|  | Turn signal off – Push the turn signal switch toward the switch housing. |
|  | Left turn signal, on – Turn signal switch pressed to the left. The turn signal switch returns automatically to the central position after use. |



Right turn signal, on – Turn signal switch pressed to the right. The turn signal switch returns automatically to the central position after use.



Info

An automatic turn signal switch-off function (**ATIR**) is available as a software feature.

The **ATIR** function uses a time and distance counter.

If the turn signal has been on for at least 10 seconds and 150 meters of riding distance, the turn signal is switched off.

If the vehicle is stationary, both counters are stopped.

If the turn signal switch is reactivated, both counters are reset.

6.9 Horn button

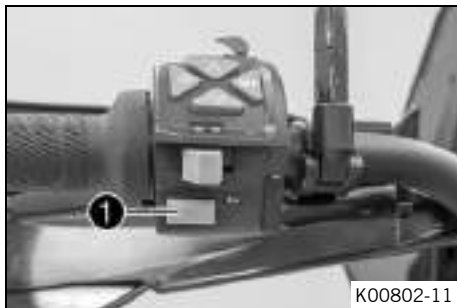

Horn button ❶ is fitted on the left side of the handlebar.

Possible states

- The horn button is in the basic position
- The horn button is pressed – The horn is operated in this position.

6.10 Combination switch, right

The right combination switch is fitted on the right side of the handlebar.



Overview of the right combination switch

- ① Hazard warning flasher switch (📖 p. 39)
- ② Emergency OFF switch/electric starter button (📖 p. 40)
- ③ Race-on button (📖 p. 41)

6.11 Hazard warning flasher switch



The hazard warning flasher switch ① is fitted on the right side of the combination switch. The hazard warning flasher is used to indicate emergency situations.

i Info

The hazard warning flasher can be activated or deactivated while the ignition is switched on or up to 60 seconds after the ignition is switched off. Only keep the hazard warning flasher activated as long as necessary as it depletes the 12-V battery.

Possible states



Hazard warning flasher on – All four turn signals and the green turn signal indicator lights in the combination instrument flash.

6.12 Emergency OFF switch/electric starter button



The emergency OFF switch/electric starter button ① is fitted on the right side of the combination switch.

Possible states



Emergency OFF switch/electric starter button off (top position) – In this position, the ignition circuit is interrupted, a running engine stops, and a non-running engine cannot be started. A message appears on the display.



Emergency OFF switch/electric starter button on (middle position) – This position is required for operation; the ignition circuit is closed.



Starter motor on (lower position) – In this position, the starter motor is actuated.

6.13 Race-on button





The Race-on button ① is fitted on the right side of the combination switch.

i Info

The Race-on button performs the ignition lock function on this vehicle.

The steering can only be locked if the handlebar is turned fully to the left.

Possible states

- Race-on button  in the basic position.
- Race-on button  pressed briefly – Pressing briefly switches the ignition on and unlocks the steering lock or switches the ignition off. The Race-on indicator lamp lights up briefly once for confirmation.
- Race-on button  pressed and held – Pressing and holding switches the ignition off and locks the steering lock.

6.14 Steering lock (antenna)

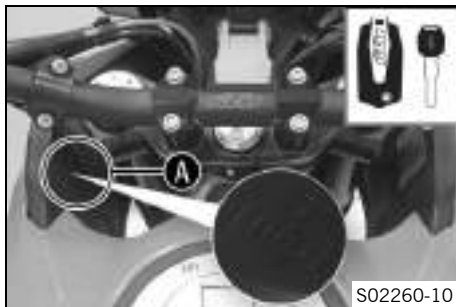

On this vehicle, the ignition/steering lock is replaced by a remote key with transponder (Race-on key (📖 p. 43)).

In order to activate the steering lock, the handlebar must be turned fully to the left.

The steering is locked and unlocked electromechanically via the Race-on button (📖 p. 41).

If the battery voltage of the Race-on key is too low, hold the Race-on key or the black ignition key in area **A** on the motorcycle and repeat starting.

i Info

As soon as the engine has been started, safely stow away the Race-on key or the black ignition key again.

Possible states

- Ignition off, steering locked – In this operating mode, the ignition circuit is interrupted and the steering locked.
- Ignition off, steering unlocked – In this operating mode, the ignition circuit is interrupted and the steering unlocked.
- Ignition on, steering unlocked – In this operating mode, the ignition circuit is closed and the steering unlocked.

6.15 Immobilizer



The electronic immobilizer secures the vehicle against unauthorized use.

The immobilizer is activated and the engine electronics are locked as soon as the ignition is switched off via the Race-on button (📖 p. 41).

The Race-on indicator lamp ❶ can indicate errors by flashing. If the optional alarm system is installed, the Race-on indicator lamp ❶ flashes when the alarm system is switched on.

6.16 Race-on key

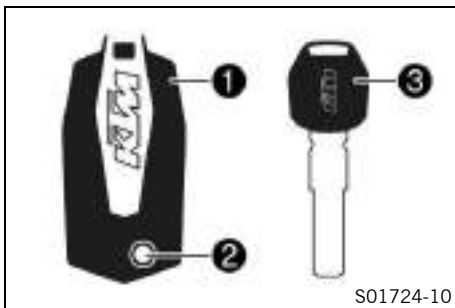

In this vehicle, the Race-on key ❶ performs all the functions of the conventional ignition key.

Press the ❷ button to fold out the key bit. The key bit is only used for unlocking the seat lock and for opening the cases (optional).

The black ignition key ❸ is only intended for situations in which the Race-on key is not available or is not functional.

The black Race-on spare key can be used to start the vehicle if the Race-on key battery voltage is too low and the transponder is not recognized by the vehicle. The black Race-on key can also be used to unlock the seat lock and open the cases (optional).



Info

The ignition keys contain electronic components. Always maintain a distance of several centimeters to other devices with electronic components.

A lost ignition key must be deactivated by an authorized KTM workshop to prevent unauthorized persons from operating the vehicle.

The ignition keys supplied are activated when delivered.

Up to four ignition keys in total can be activated by an authorized KTM workshop. The key number must be provided in each case.

6.17 Socket for electrical accessories



Socket **1** for electrical accessories is fitted in front of the upper triple clamp.

It is connected to the permanent positive and is fuse-protected.

| Socket for electrical accessories | |
|-----------------------------------|------|
| Voltage | 12 V |
| Maximum current consumption | 10 A |

6.18 USB socket



A USB socket **1** is located in the storage compartment for supplying power to external devices. The USB socket is activated when the ignition is switched on.

| USB socket | |
|-----------------------------|-------|
| Voltage | 5 V |
| Maximum current consumption | 2.1 A |

6.19 Opening fuel tank filler cap



Danger

Fire hazard Fuel is highly flammable.

The fuel in the fuel tank expands when warm and can escape if overfilled.

- Do not refuel the vehicle in the vicinity of open flames or lit cigarettes.
- Switch off the engine for refueling.
- Make sure that no fuel is spilled; particularly not on hot parts of the vehicle.
- If any fuel is spilled, wipe it off immediately.
- Observe the specifications for refueling.



Warning

Danger of poisoning Fuel is poisonous and a health hazard.

- Avoid skin, eye and clothing contact with fuel.
- Immediately consult a doctor if you swallow fuel.
- Do not inhale fuel vapors.
- In case of skin contact, rinse the affected area with plenty of water.
- Rinse the eyes thoroughly with water, and consult a doctor in case of fuel contact with the eyes.
- Change your clothing in case of fuel spills on them.
- Keep fuels correctly in a suitable canister, and out of the reach of children.



Note

Environmental hazard Improper handling of fuel is a danger to the environment.

- Do not allow fuel to enter the groundwater, the soil, or the sewage system.

Condition

The motorcycle is stationary.

The engine is off.

The ignition has been switched on or off for less than 1 minute.

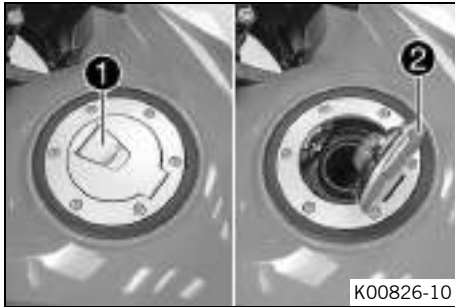

- Fold up cover ① slowly.
- ✓ The fuel tank filler cap is unlocked.
- Fold up fuel tank filler cap ②.

6.20 Closing the fuel tank filler cap

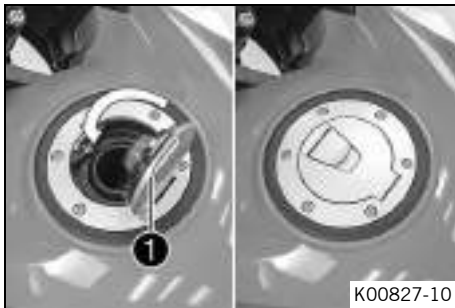

Warning

Fire hazard Fuel is highly flammable, toxic and a health hazard.

- Check that the fuel tank filler cap is locked correctly after closing.
- Change your clothing if fuel spills on them.
- Rinse the affected area immediately with plenty of water in the event of contact with the skin.

- Fold down fuel tank filler cap ① and push it down.
- ✓ The fuel tank filler cap locks audibly in place.

6.21 Fuel cocks



A fuel cock **1** is located on each side of the fuel tank.

i Info

The fuel cocks must always be open during operation.
The fuel cocks are only closed to remove the fuel tank.

Possible states

- Fuel cocks are closed – Level equalization cannot take place and the fuel supply to the throttle valve body is shut off.
- Fuel cocks are open – Level equalization can take place and the fuel supply to the throttle valve body is open.

6.22 Opening storage compartment



- Lift the lock **1** and detach in area **A**.
- Open storage compartment.

i Info

A USB socket (📖 p. 45) **2** is located in the storage compartment for supplying power to external devices.

6.23 Closing storage compartment

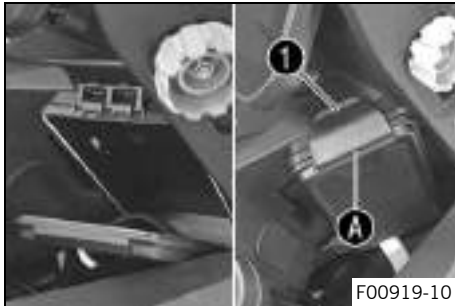

- Close storage compartment.
- Attach lock ① in area ① and press down.

6.24 Seat lock



Seat lock ① is located on the left side of the vehicle under the seat.
It can be unlocked using the Race-on key or the black Race-on key.

6 CONTROLS

6.25 Grab handles

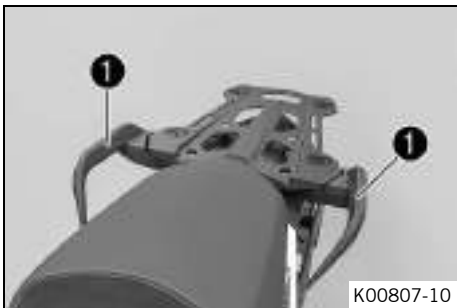

The passenger can hold onto the grab handles **1** during the trip.

6.26 Luggage rack plate



The luggage rack plate **1** is located behind the seat. The base plate of a luggage system (optional) can be attached to the luggage rack plate. The luggage rack plate may not be loaded with more than the specified weight.

| | |
|--|---------------|
| Maximum permissible load on luggage rack plate | 8 kg (18 lb.) |
|--|---------------|



Info

Note the information provided by the luggage manufacturer.

6.27 Case holders

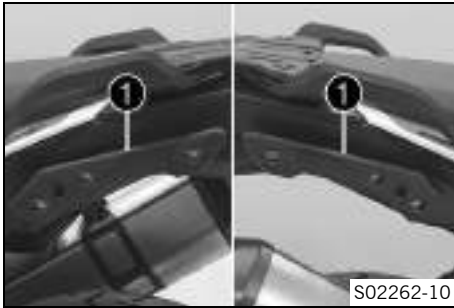

Case holders ① are located on each side of the passenger seat. A case system (optional) can be attached on the case holders. Use case systems approved and/or recommended by KTM. Observe the specifications in the enclosed **KTM PowerParts** fitting instructions.



Info

The use of other case systems is not recommended. Do not exceed the maximum load of the case holders if using other case systems.

| | |
|--|----------------------|
| <p>Maximum permissible load of the case holders per side if using other case systems</p> | <p>7 kg (15 lb.)</p> |
|--|----------------------|

6.28 Passenger foot pegs

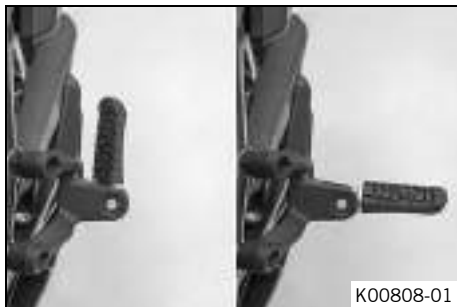

The passenger foot pegs can be folded up and down.

Possible states

- Passenger foot pegs folded up – For operation without a passenger.
- Passenger foot pegs folded down – For operation with a passenger.

6.29 Shift lever

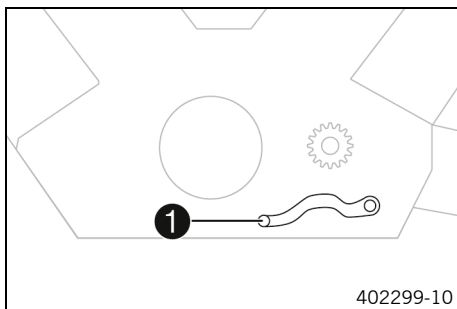

The shift lever **1** is fitted on the left side of the engine.

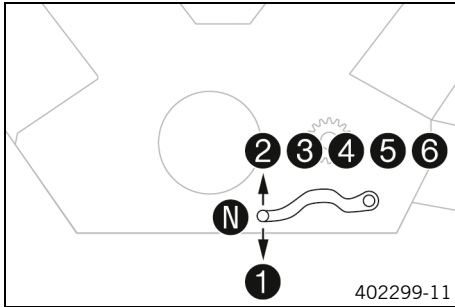

The gear positions can be seen in the figure.
The idle position is between first and second gears.

6.30 Foot brake lever

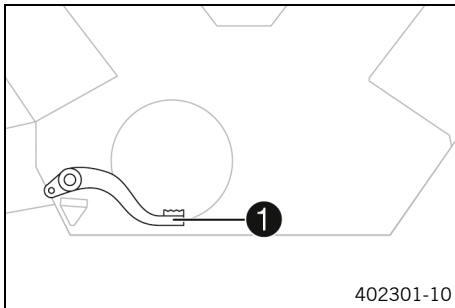

Foot brake lever ① is located in front of the right footrest.
The rear brake is activated using the foot brake lever.

6.31 Side stand

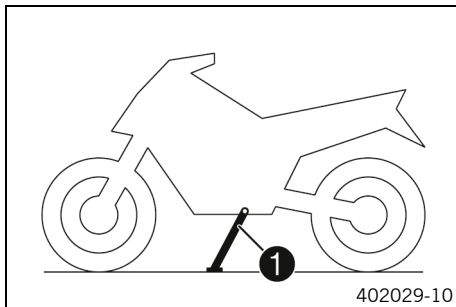

The side stand **1** is located on the left of the vehicle.
The side stand is used for parking the motorcycle.



Info

The side stand must be folded up during motorcycle use.
The side stand is coupled with the safety starting system.
See the instructions in the section on “Stopping, parking”.

Possible states

- Side stand folded out – The vehicle can be supported on the side stand. The safety starting system is active.
- Side stand folded in – This position is mandatory when riding the motorcycle. The safety starting system is inactive.

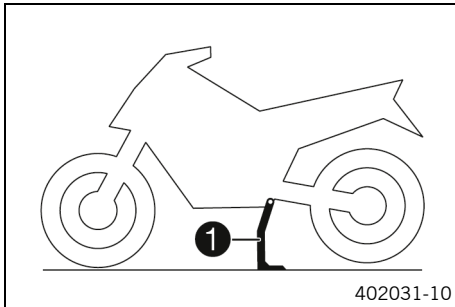
6.32 Center stand

In addition to the side stand, the vehicle is equipped with a center stand **1**.

7 COMBINATION INSTRUMENT

7.1 Combination instrument



The combination instrument is attached in front of the handlebar. The combination instrument is divided into two function areas.

① indicator lamps (📖 p. 62)

Display ②



Warning

Danger of burns Parts of the combination instrument become very hot in certain situations.

In particular, the display gets hot in ambient temperatures above 55 °C (131 °F), during extended stationary periods, e.g. at a traffic light, or in direct sunlight.

- Do not touch the combination instrument with bare hands in the situations referred to.
- Where appropriate protective clothing.
- If you have been burned, hold the area affected under lukewarm water immediately.

7.2 Activation and test



Activation

The combination instrument is activated when the ignition is switched on.

Info

The brightness of the displays is controlled by an ambient light sensor in the combination instrument.

Test

The welcome text appears on the display and the indicator lamps are briefly activated for a function check.



Info

The malfunction indicator lamp always lights up as long as the engine is not running. If the engine is running and the malfunction indicator lamp lights up, stop (taking care not to endanger yourself or other road users in the process) and contact an authorized KTM workshop.

The oil pressure warning lamp always lights up as long as the engine is not running. If the engine is running and the oil pressure warning lamp lights up, stop immediately (taking care not to endanger yourself or other road users in the process) and switch off the engine.

The ABS warning lamp and TC indicator lamp light up until a speed of approx. 6 km/h (approx. 4 mph) or more has been reached.

7.3 Day-Night mode



Day mode is shown in a bright color.



Night mode is shown in a dark color.

i Info

The ambient light sensor in the combination instrument measures the brightness of the environment and automatically switches the display to day or night mode. The display is brightened, darkened or switched to the other mode depending on the brightness measured by the ambient light sensor.

The display mode cannot be changed manually.

7 COMBINATION INSTRUMENT

7.4 Warnings

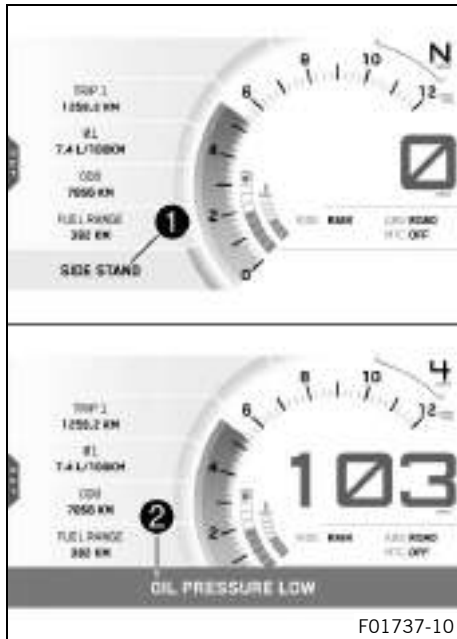

F01737-10

Warnings appear on the bottom edge of the display; these are marked yellow or red depending on their relevance.

Yellow warnings **1** indicate errors or information which require prompt intervention or an adjustment to the riding style.

Red warnings **2** indicate errors or information which require immediate intervention.

i Info

Warnings can be hidden by pressing any button.

All the existing warnings are displayed in the **Warnings** menu until they are no longer active.

7.5 Ice warning

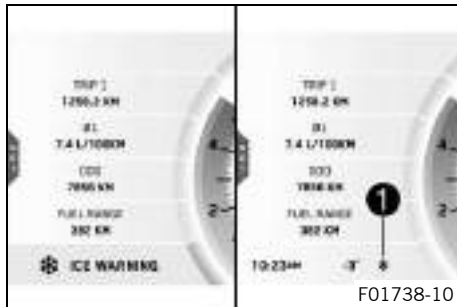

The ice warning ❄ goes on when there is an increased risk of ice on the roads.

The ice warning ❄ is shown in area ❶ of the display.

The ice warning ❄ appears on the display when the ambient temperature drops below the specified value.

| | |
|-------------|--|
| Temperature | $\leq 4\text{ }^{\circ}\text{C}$ ($\leq 39\text{ }^{\circ}\text{F}$) |
|-------------|--|

The ice warning ❄ goes out on the display when the ambient temperature rises above the specified value.

| | |
|-------------|--|
| Temperature | $\geq 6\text{ }^{\circ}\text{C}$ ($\geq 43\text{ }^{\circ}\text{F}$) |
|-------------|--|

i Info

When the ice warning ❄ lights up, the warning **ICE WARNING** also appears.

7 COMBINATION INSTRUMENT

7.6 Indicator lamps



The indicator lamps offer additional information about the operating state of the motorcycle.
When the ignition is switched on, all indicator lamps light up briefly.





Info

The malfunction indicator lamp always lights up as long as the engine is not running. If the engine is running and the malfunction indicator lamp lights up, stop (taking care not to endanger yourself or other road users in the process) and contact an authorized KTM workshop.







The oil pressure warning lamp always lights up as long as the engine is not running. If the engine is running and the oil pressure warning lamp lights up, stop immediately (taking care not to endanger yourself or other road users in the process) and switch off the engine.

The ABS warning lamp and TC indicator lamp light up until a speed of approx. 6 km/h (approx. 4 mph) or more has been reached.

Possible states

| | |
|---|---|
|  | Race-on indicator lamp lights up/flashes yellow/orange/red – Status or error messages relating to Race-on system/alarm system. |
|  | The left turn signal indicator lamp flashes green with a steady rhythmic flash – The left turn signal is switched on. |
|  | The high beam indicator lamp lights up blue – The high beam is switched on. |
|  | The general warning lamp lights up yellow – A note/warning note on operating safety has been detected. This is also shown in the display. |
|  | The ABS warning lamp lights up yellow – Status or error messages relating to <u>ABS</u> . The ABS warning lamp flashes if the ABS mode Offroad is enabled. |

7 COMBINATION INSTRUMENT

| | |
|---|--|
|  | TC indicator lamp lights up/flashes yellow – The MTC (📖 p. 288) is not enabled or is currently intervening. The TC indicator lamp also lights up if an error is detected. Contact an authorized KTM workshop. The TC indicator lamp flashes if TC actively engages or if the HHC (📖 p. 154) (optional) is activated. |
|  | The idle indicator lamp lights up green – The transmission is in neutral. |
|  | The oil pressure warning lamp lights up red – The oil pressure is too low. Stop immediately, taking care not to endanger yourself or other road users in the process, and switch off the engine. |
|  | The cruise control system indicator lamp lights up yellow – The cruise control system function is switched on, but the speed control is not active. |
|  | The cruise control system indicator lamp lights up green – The cruise control system function is switched on and the speed control is active. |
|  | Malfunction indicator lamp lights up yellow – The OBD has detected an emission- or safety-critical fault. |
|  | The right turn signal indicator lamp flashes green with a steady rhythmic flash – The right turn signal is switched on. |

7 COMBINATION INSTRUMENT

7.7 Display

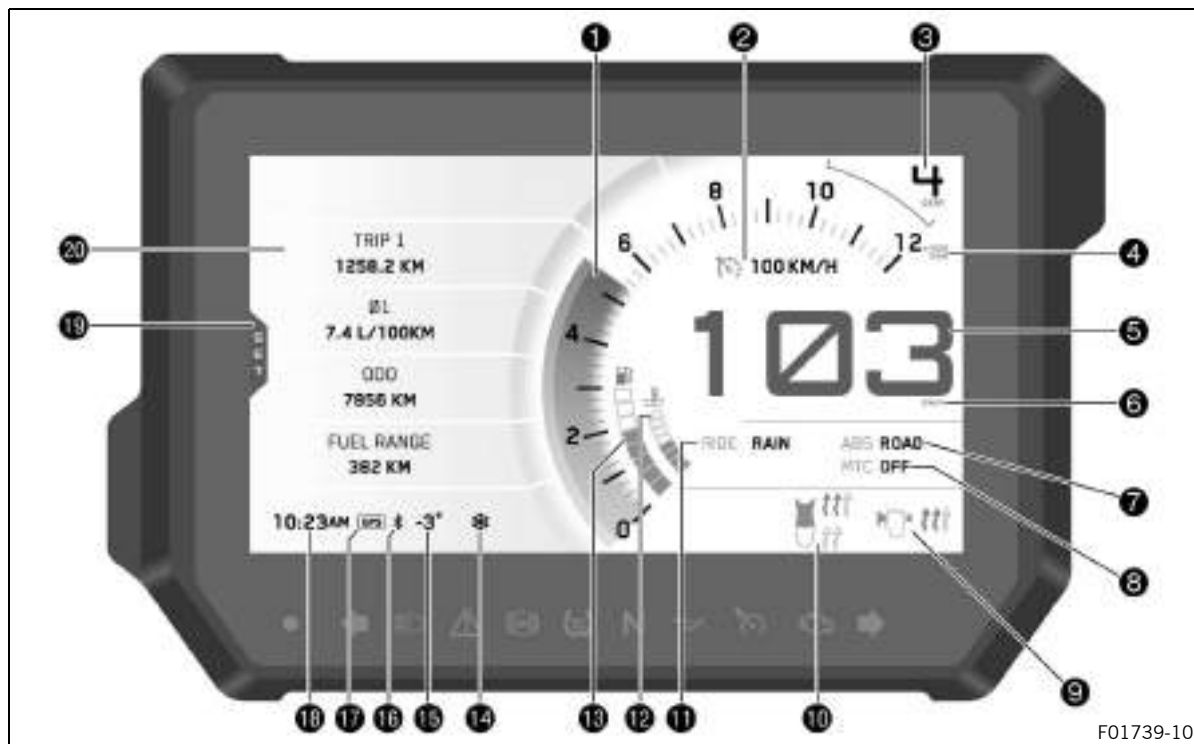

**Info**

The figure shows the start screen of the combination instrument. If the menu is opened, the speed is still displayed.

- ① Speed (📖 p. 68)
- ① Shift warning light (📖 p. 69)
The shift warning light is integrated in the tachometer display.
- ② Cruise control indicator (📖 p. 70)
- ③ Gear display
- ④ Unit for the speed display
- ⑤ Speed (📖 p. 71)
- ⑥ Unit for the speedometer
- ⑦ **ABS** display (📖 p. 71)
- ⑧ **MTC** display (📖 p. 72)
- ⑨ Heated grip (optional) (📖 p. 73)
- ⑩ Seat heater (optional) (📖 p. 73)
- ⑪ **Ride** display (📖 p. 72)
- ⑫ Coolant temperature indicator (📖 p. 74)
- ⑬ Fuel level display (📖 p. 74)
- ⑭ Ice warning (📖 p. 61)
Only shown when there is an increased risk of ice on the roads.
- ⑮ Ambient air temperature indicator (📖 p. 75)

7 COMBINATION INSTRUMENT

- 16 **Bluetooth®** (optional)
- 17 **GPS** (optional)
- 18 **Time** (📖 p. 76)
- 19 **SET**
Only shown where the menu overview is closed.
- 20 **Favourites** display (📖 p. 76)

7.8 Speed

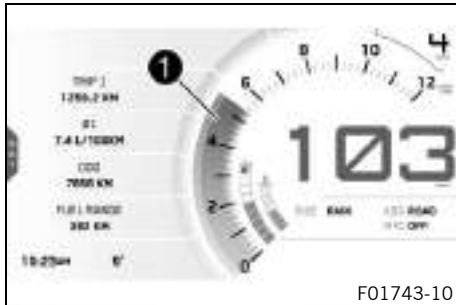

The speed is shown in area **1** of the display.
The speed is measured in revolutions per minute.

7.9 Shift warning light

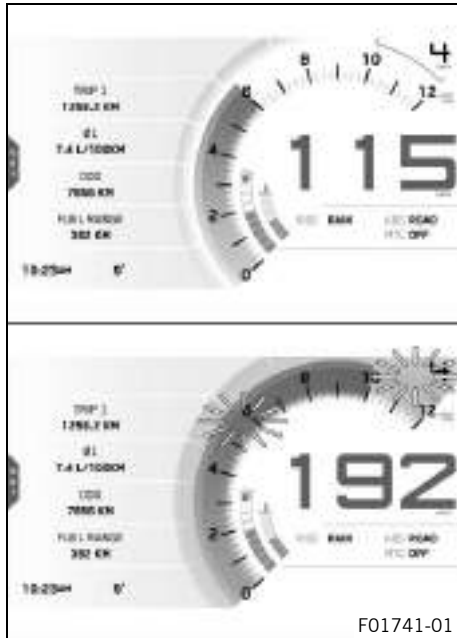

F01741-01

The shift warning light is integrated in the tachometer display. In the **Shift Light** menu, the engine speed for the shift warning light can be set. The shift warning light is always active during the running-in phase (up to 1,000 km / 621 mi). The shift warning light can only be deactivated, and the values for **RPM1** and **RPM2** can only be adjusted after this. The shift warning light lights up red at **RPM1** and flashes red at **RPM2**.



Info

In sixth-gear, the shift warning light is deactivated when the engine is warm after the first service.

| | |
|---|---|
| Coolant temperature | $\leq 35\text{ }^{\circ}\text{C}$ ($\leq 95\text{ }^{\circ}\text{F}$) |
| ODO | < 1,000 km (< 620 mi) |
| The shift warning light always lights up at | 6,500 rpm |
| Coolant temperature | $> 35\text{ }^{\circ}\text{C}$ ($> 95\text{ }^{\circ}\text{F}$) |
| ODO | > 1,000 km (> 620 mi) |
| RPM1 shift warning light | lights up |

7 COMBINATION INSTRUMENT

| | |
|--------------------------|---------|
| RPM2 shift warning light | flashes |
|--------------------------|---------|

7.10 Cruise control indicator

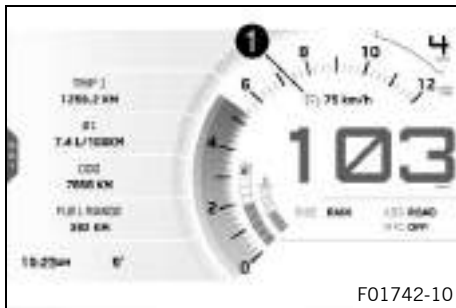

The operating state and active cruise control are shown in the ① area of the display.

Cruise control is operated using the cruise control tip switch (p. 33).

7.11 Speed

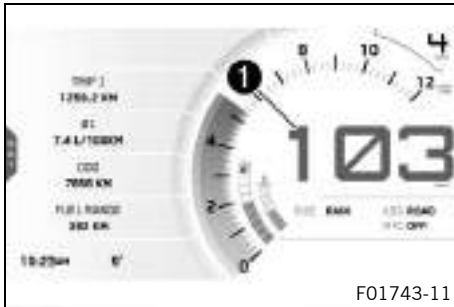

The speed is shown in area ❶ of the display.
 The unit of speed can be configured in the **Distance** menu.
 Speed is shown in kilometers per hour **km/h** or in miles per hour **mph**.

i Info

From 160 km/h (100 mph), the font size of the indicator increases with the speed.
 At 200 km/h (124 mph), the maximum font size is reached; afterwards, the contrast of the background is reduced.

7.12 ABS display

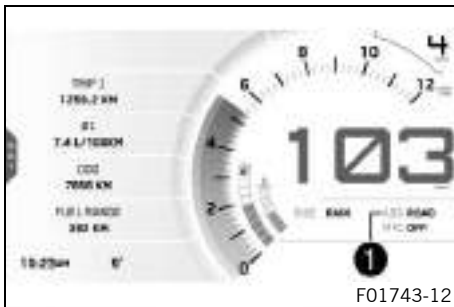

The ABS mode setting is shown in the ❶ area of the display.
 The **ABS** can be configured in the **ABS** menu.

7 COMBINATION INSTRUMENT

7.13 MTC display

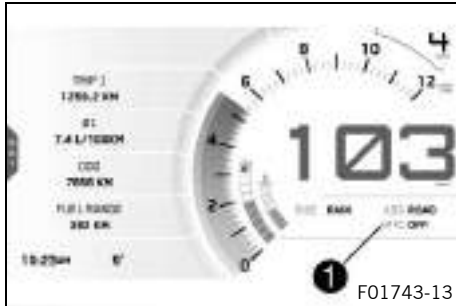

The **1** area of the display indicates whether **MTC** the system is switched on or off.

The motorcycle traction control can be switched on or off in the **MTC** menu.

7.14 Ride display

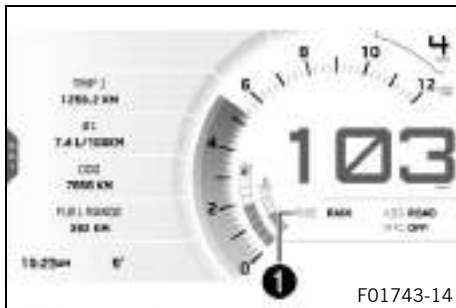

The **Ride Mode** setting is shown in area **1** of the display. The drive mode can be configured in the **Ride Mode** menu.

7.15 Heated grip (optional)

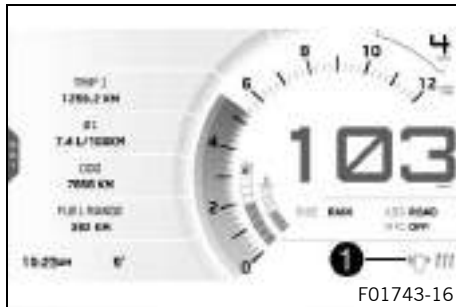

When the heated grip is switched on, the **Heated Grips** symbol appears in the **1** area of the display. The heated grip can be configured in the **Heated Grips** menu.

7.16 Seat heater (optional)

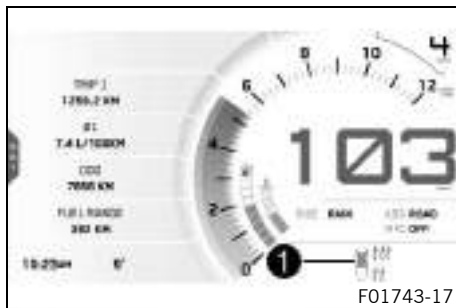

When the seat heating is switched on, the **Heated Seat** symbol appears in area **1** of the display. The seat heating can be configured in the **Heated Seat** menu.

i Info

The heating level for the passenger seat heating can be controlled by a switch next to the right grab handle.

7 COMBINATION INSTRUMENT

7.17 Coolant temperature indicator

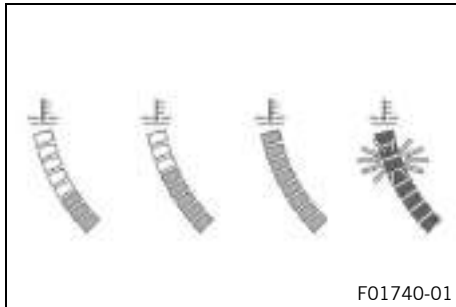

The coolant temperature indicator consists of bars. The more bars that light up, the hotter the coolant.



Info

When all the bars flash, the warning **ENGINE TEMP HIGH** also appears.

Possible states

- The engine is cold – Up to three bars light up.
- Engine warm – Four bars light up.
- Engine hot – Five to eight bars light up.
- Engine very hot – all eight bars flash red.

7.18 Fuel level display

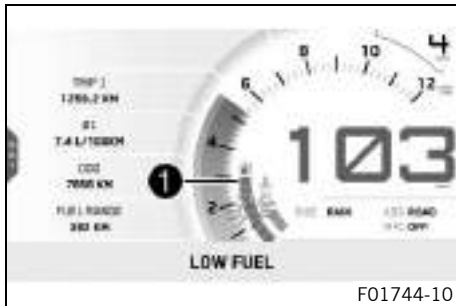

The fuel tank contents are shown in area ❶ of the display. The fuel level indicator consists of bars. The more bars are lit, the more fuel is in the fuel tank.

i Info

If the fuel level is getting low, all eight segments flash red and the following warning also appears **LOW FUEL**. The fuel level is displayed with a slight delay to prevent the indicator from constantly moving while riding. The fuel level display is not updated while the side stand is folded out or the emergency off switch is switched off. Once the side stand is folded up and the emergency OFF switch is switched on, the fuel level display is next updated after 2 minutes. The fuel level display flashes if the combination instrument does not receive a signal from the fuel level sensor.

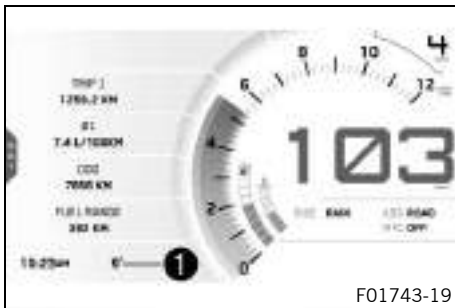
7.19 Ambient air temperature indicator

The ambient air temperature is displayed in the ① area. The unit of ambient air temperature can be configured in the **Temperature** menu. The ambient air temperature is displayed in **°C** or **°F**.

7 COMBINATION INSTRUMENT

7.20 Time

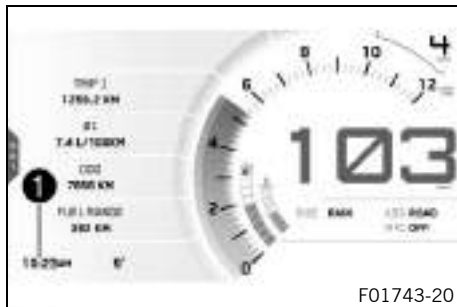

F01743-20

The time is shown in area ❶ of the display.

The time is displayed in 24 hour format in all languages except for EN-US. The time is displayed in 12 hour format if the language is set to EN-US.

The time can be configured in the **Time/Date** menu.

i Info

The time must be reset if the 12-V battery was disconnected from the vehicle or the fuse was removed.

7.21 Favourites display



F01746-01

Up to eight items of information are shown in the **Favourites** display.

The **Favourites** display can be freely configured in the **Favourites** menu.

i Info

One to four items of information selected are displayed on two lines. Five to eight items of information selected are displayed on a single line.

7.22 Quick Selector 1 display



When the menu is closed, the **Quick Selector 1** menu is opened by pressing the **UP** button.
Press the **BACK** button to close **Quick Selector 1**.



Info

The **Quick Selector 1** can be configured in the **Quick Selector 1** menu. Any information can be selected.

7.23 Quick Selector 2 display



When the menu is closed, the **Quick Selector 2** menu is opened by pressing the **DOWN** button.
Press the **BACK** button to close **Quick Selector 2**.



Info

The **Quick Selector 2** can be configured in the **Quick Selector 2** menu. Any information can be selected.

7 COMBINATION INSTRUMENT

7.24 Navigation display (optional)



The **Navigation** display appears when the navigation function is active.

The **Navigation** display shows the direction arrow, the distance to the next waypoint, the road name as well as up to four sets of information.

The **Navigation** display can be freely configured in the **Navi Info Screen** menu.



Info

One to two sets of information selected are displayed on two lines. Three to four sets of information selected are displayed on one line.

7.25 Menu

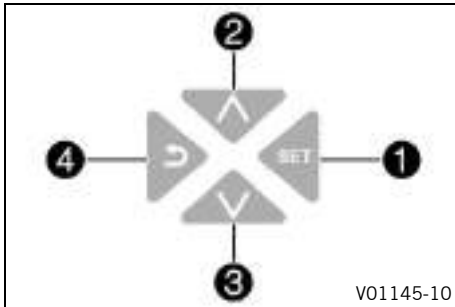

i Info

Press the **SET** button ① in the start screen to open the menu.

Navigate through the menu using the **UP** button ② or the **DOWN** button ③.

Press the **BACK** button ④ to close the current menu or the menu overview.

If no button on the left combination switch is pressed when the menu is open, the menu closes automatically after about 20 seconds. Pressing the **SET** button again opens the last menu opened.

7.25.1 KTM MY RIDE (optional)



Condition

- The motorcycle is stationary.
- Function **KTM MY RIDE** (optional) activated.
 - Press the **SET** button when the menu is closed.
 - Press the **UP** or **DOWN** button until **KTM MY RIDE** is marked. Press the **SET** button to open the menu.

In **KTM MY RIDE** an appropriate cellphone or headset can be paired with the combination instrument via **Bluetooth®** and the navigation function can be configured.



Info

Not every cellphone and headset is suitable for pairing with the combination instrument.

The standard **Bluetooth**® 2.1 must be supported.

7.25.2 Audio (optional)



Condition

- Function **KTM MY RIDE** (optional) activated.
 - Function **Wireless Interface** (optional) activated.
 - The combination instrument is connected to a suitable cellphone.
 - The combination instrument is connected to a suitable headset.
- Press the **SET** button when the menu is closed.
 - Press the **UP** or **DOWN** button until **KTM MY RIDE** is marked. Press the **SET** button to open the menu.



Warning

Danger of accidents Headphone volume which is too high distracts attention from traffic activity.

- Always select headphone volume which is low enough for you to still clearly hear acoustic signals.

- Press the **UP** or **DOWN** button until **Audio** is marked. Press the **SET** button to open the menu.
 - Press and hold the **UP** button to increase the audio volume.
 - Press and hold the **DOWN** button to reduce the audio volume.
 - Press the **UP** button briefly to change to the next audio track.
 - Briefly pressing the **DOWN** button twice changes to the previous audio title or plays the current audio title, depending on the cellphone model.
 - Press the **SET** button to play or pause the audio track.
-



Tip

With some cellphones, the audio player needs to be started before playback is possible.

The **Audio** function can be added to **Quick Selector 1** or **Quick Selector 2** for easier operation.

7.25.3 Navigation (optional)



Condition

- Function **KTM MY RIDE** (optional) activated.
- The **KTM MY RIDE** app (optional) is installed and opened on a suitable cellphone (**Android**® devices Version 6.0 and higher, iOS devices Version 10 and higher).
- The combination instrument is connected to a suitable cellphone.
- The GPS function is activated on the connected cellphone.
- For voice navigation: The combination instrument is connected to a suitable headset and an appropriate language package has been downloaded in the **KTM MY RIDE** app.
 - Press **SET** button when the menu is closed.
 - Press **UP** or **DOWN** button until **KTM MY RIDE** is marked. Press the **SET** button to open the menu.
 - Press the **UP** or **DOWN** button until **Navigation** is marked. Press the **SET** button to open the menu.

The **Navigation** menu allows various settings to be made and general information on the navigation to be called up.

**Info**

The **Audio** function can be used with the navigation function at the same time.

An incoming call is visualized in a small window at the top of the combination instrument display when the navigation function is active. You cannot navigate in the **Navigation** menu during an active phone conversation.

When the navigation function is switched on and the device is connected, the **GPS** symbol appears in the display of the combination instrument.

7.25.4 Navigation Setup (optional)

**Condition**

- Function **KTM MY RIDE** activated (optional).
 - The **KTM MY RIDE** app (optional) is installed and opened on a suitable cellphone (**Android**® devices Version 6.0 and higher, iOS devices Version 10 and higher).
 - The combination instrument is connected to a suitable cellphone.
 - The GPS function is activated on the connected cellphone.
- Press **SET** button when the menu is closed.
 - Press **UP** or **DOWN** button until **KTM MY RIDE** is marked. Press the **SET** button to open the menu.

- Press the **UP** or **DOWN** button until **Navigation** is marked. Press the **SET** button to open the menu.
- Press the **UP** or **DOWN** button until **Navigation Setup** is marked. Press the **SET** button to open the menu.
- Press the **UP** or **DOWN** button until the desired menu item **Navigation Off** or **Turn by Turn** is marked. Press the **SET** button to switch the submenu item on or off.



Info

The visual navigation can be switched on or off with the **Navigation Off**. Voice navigation remains switched on if it has been activated.

The visual navigation can be changed to direction arrows with **Turn by Turn**.

Navigation mode can be set in the **Navigation Setup** submenu.

7.25.5 Navigation information (optional)



Condition

- Function **KTM MY RIDE** (optional) activated.
- The **KTM MY RIDE** app (optional) is installed and opened on a suitable cellphone (**Android**® devices Version 6.0 and higher, iOS devices Version 10 and higher).
- The combination instrument is connected to a suitable cellphone.
- The GPS function is activated on the connected cellphone.
 - Press **SET** button when the menu is closed.
 - Press **UP** or **DOWN** button until **KTM MY RIDE** is marked. Press the **SET** button to open the menu.
 - Press the **UP** or **DOWN** button until **Navigation** is marked. Press the **SET** button to open the menu.
 - Press the **UP** or **DOWN** button until **Navigation Information** is marked. Press the **SET** button to open the menu.



Info

Distance to Target shows the distance to the destination.
Arrival Time shows the arrival time of the cellphone.

Information on the current navigation can be viewed in the **Navigation Information** submenu.

7.25.6 Volume (optional)



Condition

- Function **KTM MY RIDE** (optional) activated.
- The **KTM MY RIDE** app (optional) is installed and opened on a suitable cellphone (**Android**® devices Version 6.0 and higher, iOS devices Version 10 and higher).
- The combination instrument is connected to a suitable cellphone.
- The GPS function is activated on the connected cellphone.
- For voice navigation: The combination instrument is connected to a suitable headset and an appropriate language package has been downloaded in the **KTM MY RIDE** app.
 - Press **SET** button when the menu is closed.
 - Press **UP** or **DOWN** button until **KTM MY RIDE** is marked. Press the **SET** button to open the menu.
 - Press the **UP** or **DOWN** button until **Navigation** is marked. Press the **SET** button to open the menu.



Warning

- Danger of accidents** Headphone volume which is too high distracts attention from traffic activity.
- Always select headphone volume which is low enough for you to still clearly hear acoustic signals.

- Press the **UP** or **DOWN** button until **Volume** is marked.

**Info**

Press and hold **UP** button to increase the audio volume.
Press and hold **DOWN** button to reduce the audio volume.

The volume of the navigation can be set in the **Volume** submenu.

7.25.7 Setup (optional)

**Condition**

- The motorcycle is stationary.
- Function **KTM MY RIDE** (optional) activated.
 - Press the **SET** button when the menu is closed.
 - Press the **UP** or **DOWN** button until **KTM MY RIDE** is marked. Press the **SET** button to open the menu.
 - Press the **UP** or **DOWN** button until **Setup** is marked. Press the **SET** button to open the menu.

Setup allows you to configure **Wireless Interface**, via which the **Bluetooth** menu can be activated or deactivated.



Info

The **Bluetooth®** function can only be used in conjunction with **KTM MY RIDE** (optional).
When the **Bluetooth®** function is switched on and the device is connected, the **Bluetooth®** symbol appears in the display of the combination instrument.
Not every cellphone and headset is suitable for pairing with the combination instrument.

7.25.8 Bluetooth (optional)



Condition

- The motorcycle is stationary.
- Function **KTM MY RIDE** (optional) activated.
- Function **Wireless Interface** (optional) activated.
- Press the **SET** button when the menu is closed.
- Press the **UP** or **DOWN** button until **KTM MY RIDE** is marked. Press the **SET** button to open the menu.
- Press the **UP** or **DOWN** button until **Setup** is marked. Press the **SET** button to open the menu.
- Press the **UP** or **DOWN** button until **Bluetooth** is marked. Press the **SET** button to open the menu.

In **Bluetooth**, an appropriate cellphone or headset can be paired with the combination instrument via **Bluetooth®**.

**Info**

The **Bluetooth®** function can only be used in conjunction with **KTM MY RIDE** (optional).
 When the **Bluetooth®** function is switched on and the device is connected, the **Bluetooth®** symbol appears in the display of the combination instrument.
 Not every cellphone and headset is suitable for pairing with the combination instrument.

7.25.9 Phone (optional)

**Condition**

- The motorcycle is stationary.
 - Function **KTM MY RIDE** (optional) activated.
 - Function **Wireless Interface** (optional) activated.
 - The **Bluetooth®** function should also be activated in the device to be paired.
- Press the **SET** button when the menu is closed.
 - Press the **UP** or **DOWN** button until **KTM MY RIDE** is marked. Press the **SET** button to open the menu.
 - Press the **UP** or **DOWN** button until **Setup** is marked. Press the **SET** button to open the menu.
 - Press the **UP** or **DOWN** button until **Bluetooth** is marked. Press the **SET** button to open the menu.

- Press the **UP** or **DOWN** button until the desired menu item **Phone** is marked. Press the **SET** button to open the menu.



Info

Two cellphones can never be paired simultaneously with the combination instrument.

- Press the **SET** button again to confirm the **Pairing** submenu item.
- A message appears on the combination instrument indicating that this is now ready for pairing. The pairing is completed successfully by confirming the **Passkey** on the cellphone and on the combination instrument.



Info

Once the pairing is completed, the registered trademark of the paired cellphone is displayed in the **Phone** menu. Press the **UP** or **DOWN** button until the paired device is marked. The paired device can be deleted by pressing the **SET** button.

Not every cellphone is suitable for pairing with the combination instrument.

- Move the device already paired into the range of the combination instrument while the **Bluetooth®** function is active.
 - ✓ The device is automatically paired with the combination instrument.

- ✘ If the device is not automatically paired with the combination instrument after approx. 30 seconds:
 - Restart combination instrument or **Pairing** repeat procedure.

A suitable cellphone can be paired with the combination instrument in the **Phone** submenu.

7.25.10 Headset Rider (optional)



Condition

- The motorcycle is stationary.
- Function **KTM MY RIDE** (optional) activated.
- Function **Wireless Interface** (optional) activated.
- The **Bluetooth®** function should also be activated in the device to be paired.
 - Press the **SET** button when the menu is closed.
 - Press the **UP** or **DOWN** button until **KTM MY RIDE** is marked. Press the **SET** button to open the menu.
 - Press the **UP** or **DOWN** button until **Setup** is marked. Press the **SET** button to open the menu.
 - Press the **UP** or **DOWN** button until **Bluetooth** is marked. Press the **SET** button to open the menu.
 - Press the **UP** or **DOWN** button until **Headset Rider** is marked. Press the **SET** button to open the menu.

- Press the **SET** button again to confirm the **Pairing** submenu item.
- The registered trademark of the rider headset appears on the combination instrument. Press the **SET** button to select the device. Press the **SET** button again to confirm the **Confirm** submenu item. The pairing of a rider headset with the combination instrument is now completed at this point.



Info

Once the pairing is completed, the registered trademark of the paired headset is displayed in the **Headset Rider** menu.

Press the **UP** or **DOWN** button until the paired device is marked. The paired device can be deleted by pressing the **SET** button.

Not every headset is suitable for pairing with the combination instrument.

-
- Move the device already paired into the range of the combination instrument while the **Bluetooth®** function is active.
 - ✓ The device is automatically paired with the combination instrument.
 - ✗ If the device is not automatically paired with the combination instrument after approx. 30 seconds:
 - Restart combination instrument or **Pairing** repeat procedure.

A suitable rider headset can be paired with the combination instrument in the **Headset Rider** submenu.

7.25.11 Headset Pass. (optional)



Condition

- The motorcycle is stationary.
 - Function **KTM MY RIDE** (optional) activated.
 - Function **Wireless Interface** (optional) activated.
 - The **Bluetooth®** function should also be activated in the device to be paired.
- Press the **SET** button when the menu is closed.
 - Press the **UP** or **DOWN** button until **KTM MY RIDE** is marked. Press the **SET** button to open the menu.
 - Press the **UP** or **DOWN** button until **Setup** is marked. Press the **SET** button to open the menu.
 - Press the **UP** or **DOWN** button until **Bluetooth** is marked. Press the **SET** button to open the menu.
 - Press the **UP** or **DOWN** button until **Headset Pass.** is marked. Press the **SET** button to open the menu.
 - Press the **SET** button again to confirm the **Pairing** submenu item.
 - The registered trademark of the passenger headset appears on the combination instrument. Press the **SET** button to select the device. Press the **SET** button again to confirm the **Confirm**

submenu item. The pairing of a passenger headset with the combination instrument is now successfully completed.



Info

Once the pairing is completed, the registered trademark of the paired headset is displayed in the **Headset Pass.** menu.

Press the **UP** or **DOWN** button until the paired device is marked. The paired device can be deleted by pressing the **SET** button.

Not every headset is suitable for pairing with the combination instrument.

- Move the device already paired into the range of the combination instrument while the **Bluetooth®** function is active.
 - ✓ The device is automatically paired with the combination instrument.
 - ✗ If the device is not automatically paired with the combination instrument after approx. 30 seconds:
 - Restart combination instrument or **Pairing** repeat procedure.

A suitable passenger headset can be paired with the combination instrument in the **Headset Pass.** submenu.

7.25.12 Wireless Interface



Condition

- The motorcycle is stationary.
- Function **KTM MY RIDE** (optional) activated.
 - Press the **SET** button when the menu is closed.
 - Press the **UP** or **DOWN** button until **KTM MY RIDE** is marked. Press the **SET** button to open the menu.
 - Press the **UP** or **DOWN** button until **Setup** is marked. Press the **SET** button to open the menu.
 - Press the **UP** or **DOWN** button until **Wireless Interface** is marked. Switch the **Wireless Interface** on or off by pressing the **SET** button.

Wireless Interface allows the **Bluetooth®** menu to be activated or deactivated.

i Info

The **Bluetooth®** function can only be used in conjunction with **KTM MY RIDE** (optional). When the **Bluetooth®** function is switched on and the device is connected, the **Bluetooth®** symbol appears in the display of the combination instrument. Not every cellphone and headset is suitable for pairing with the combination instrument.

7 COMBINATION INSTRUMENT

7.25.13 Telephony (optional)

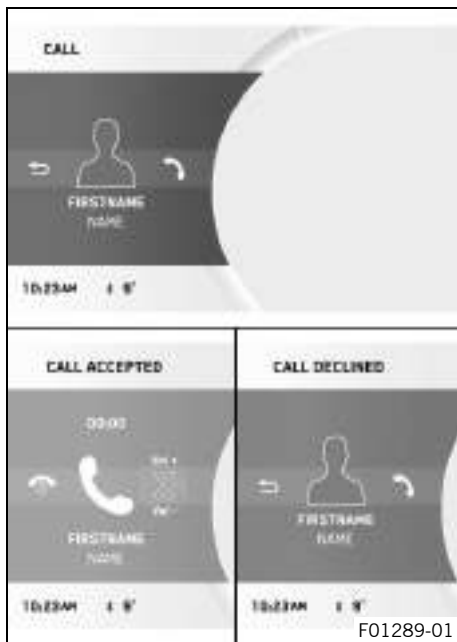

Condition

- Function **KTM MY RIDE** (optional) activated.
- Function **Wireless Interface** (optional) activated.
- The combination instrument is connected to a suitable cell-phone.
- The combination instrument is connected to a suitable head-set.



Warning

Danger of accidents Headphone volume which is too high distracts attention from traffic activity.

- Always select headphone volume which is low enough for you to still clearly hear acoustic signals.

- Press the **SET** button to accept an incoming call.
- Press and hold down the **BACK** button to reject an incoming call.
- Press and hold the **UP** button to increase the audio volume.
- Press and hold the **DOWN** button to reduce the audio volume.

**Info**

The call duration and contact are displayed. Depending on the cellphone settings, the contact is displayed with a picture and a name.

An incoming call is visualized in a small window at the top of the combination instrument display when the navigation function is active.

7.25.14 Info



- Press the **SET** button when the menu is closed.
- Press the **UP** or **DOWN** button until **Info** is marked. Press the **SET** button to open the menu.

General information can be accessed in **Info**.

7 COMBINATION INSTRUMENT

7.25.15 Trip 1

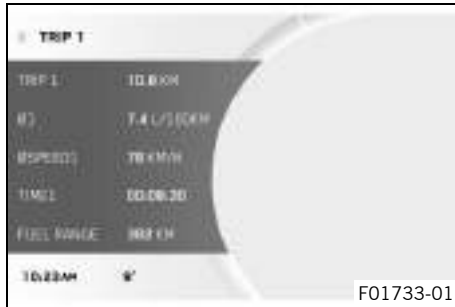

- Press the **SET** button when the menu is closed.
- Press the **UP** or **DOWN** button until **Info** is marked. Press the **SET** button to open the menu.
- Press the **UP** or **DOWN** button until **Trip 1** is marked. Press the **SET** button to open the menu.

Trip 1 shows the distance since the last reset, such as between two refueling stops. **Trip 1** is running and counts up to **9999**.

Ø1 indicates the average fuel consumption based on **Trip 1**.

ØSpeed1 indicates the average speed based on **Trip 1** and **Time1**.

Time1 shows the journey time on the basis of **Trip 1** and runs as soon as a speed signal is received.

Fuel Range indicates the possible distance you can cover with the fuel reserve.

Press and hold the **SET** button for 3 - 5 seconds.

All entries in the **Trip 1** menu are reset.

7.25.16 Trip 2



- Press the **SET** button when the menu is closed.
- Press the **UP** or **DOWN** button until **Info** is marked. Press the **SET** button to open the menu.
- Press the **UP** or **DOWN** button until **Trip 2** is marked. Press the **SET** button to open the menu.

Trip 2 shows the distance since the last reset, such as between two refueling stops. **Trip 2** is running and counts up to **9999**.

Ø2 indicates the average fuel consumption based on **Trip 2**.

ØSpeed2 indicates the average speed based on **Trip 2** and **Time2**.

Time2 shows the journey time on the basis of **Trip 2** and runs as soon as a speed signal is received.

Fuel Range indicates the possible distance you can cover with the fuel reserve.

| | |
|---|--|
| Press and hold the SET button for 3 - 5 seconds. | All entries in the Trip 2 menu are reset. |
|---|--|

7 COMBINATION INSTRUMENT

7.25.17 General Info



- Press the **SET** button when the menu is closed.
- Press the **UP** or **DOWN** button until **Info** is marked. Press the **SET** button to open the menu.
- Press the **UP** or **DOWN** button until **General Info** is marked. Press the **SET** button to open the menu.

Date shows the date.

ODO shows the total distance covered.

Battery indicates the battery voltage.

Oil Temp indicates the engine oil temperature.

7.25.18 TPMS



Condition

- Model with **TPMS**.
- Press the **SET** button when the menu is closed.
- Press the **UP** or **DOWN** button until **Info** is marked. Press the **SET** button to open the menu.

**Warning**

Danger of accidents The tire pressure monitoring system does not eliminate the necessity to check the tires before going on a ride.

To avoid false alarms, the tire pressure values are evaluated over a period of several minutes.

- Check the tire pressure before every ride.
- Correct the tire pressure if the tire pressure deviates from the specified value.
- Even if the tire pressure values are correct, stop the vehicle immediately if its behavior indicates a loss of pressure in the tires.

- Press the **UP** or **DOWN** button until **TPMS** is marked. Press the **SET** button to open the menu.

Guideline

| | |
|---|------------------|
| Tire pressure, solo / with passenger / full payload | |
| front: with cold tires | 2.6 bar (38 psi) |
| rear: with cold tires | 2.9 bar (42 psi) |

The **TPMS** menu displays the tire pressure of the front and rear tires.

Press Front indicates the tire pressure at the front.

Press Rear indicates the tire pressure at the rear.

7 COMBINATION INSTRUMENT

7.25.19 Warnings



Condition

- Message or warning is present.
 - Press the **SET** button when the menu is closed.
 - Press the **UP** or **DOWN** button until **Info** is marked. Press the **SET** button to open the menu.
 - Press the **UP** or **DOWN** button until **Warnings** is marked. Press the **SET** button to open the menu.
 - Use the **UP** or **DOWN** button to navigate through the warnings.

All the warnings that have occurred are displayed and stored in the **Warnings** menu.

7.25.20 Service



Condition

- The motorcycle is stationary.
 - Press the **SET** button when the menu is closed.
 - Press the **UP** or **DOWN** button until **Info** is marked. Press the **SET** button to open the menu.
 - Press the **UP** or **DOWN** button until **Service** is marked. Press the **SET** button to open the menu.

The next service due is shown in the **Service** menu.

7.25.21 Extra Functions



Condition

- The motorcycle is stationary.
- Motorcycle with optional supplementary function.
 - Press the **SET** button when the menu is closed.
 - Press the **UP** or **DOWN** button until **Info** is marked. Press the **SET** button to open the menu.
 - Press the **UP** or **DOWN** button until **Extra Functions** is marked. Press the **SET** button to open the menu.
 - Use the **UP** or **DOWN** button to navigate through the extra functions.

The optional extra functions are listed in **Extra Functions**.

Info

The current **KTM PowerParts** and the available software for your vehicle can be found on the KTM website.

7 COMBINATION INSTRUMENT

7.25.22 Motorcycle



Condition

- The motorcycle is stationary.
 - Press the **SET** button when the menu is closed.
 - Press the **UP** or **DOWN** button until **Motorcycle** is marked. Press the **SET** button to open the menu.

The vehicle drive mode can be configured in **Motorcycle**.

7.25.23 Heated Grips (optional)



Condition

- The motorcycle is stationary.
- Menu **Heated Grips** activated.
 - Press **SET** button when the menu is closed.
 - Press **UP** or **DOWN** button until **Motorcycle** is marked. Press the **SET** button to open the menu.
 - Press the **UP** or **DOWN** button until **Heated Grips** is marked. Press the **SET** button to open the menu.
 - Activate menu item using the **UP** or **DOWN** button.
 - Press the **SET** button to select the heating level or to switch the heated grip on or off.

7.25.24 Heated Seat (optional)

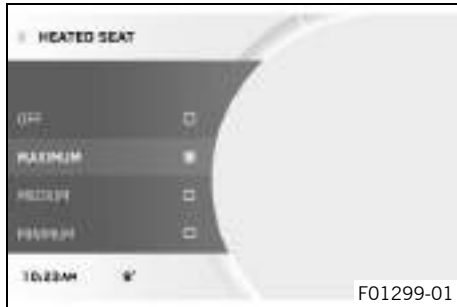
**Condition**

- The motorcycle is stationary.
- Menu **Heated Seat Ride** activated.
- Menu **Heated Seat Pas** activated.
 - Press **SET** button when the menu is closed.
 - Press **UP** or **DOWN** button until **Motorcycle** is marked. Press the **SET** button to open the menu.
 - Press the **UP** or **DOWN** button until **Heated Seat** is marked. Press the **SET** button to open the menu.
 - Activate menu item using the **UP** or **DOWN** button.
 - Press the **SET** button to select the heating level or to switch the seat heating on or off.

**Info**

The heating level for the passenger seat heating is selected using the switch next to the right grab handle.

7.25.25 Ride Mode



Condition

- Emergency OFF switch/electric starter button on (middle position) – This position is required for operation; the ignition circuit is closed. (📖 p. 40)
- Cruise control system function deactivated
 - Press **SET** button when the menu is closed.
 - Press **UP** or **DOWN** button until **Motorcycle** is marked. Press the **SET** button to open the menu.
 - Press the **UP** or **DOWN** button until **Ride Mode** is marked. Press the **SET** button to open the menu.
 - Press the **UP** or **DOWN** button to activate the menu item and select it with the **SET** button. Press the **SET** button to select the engine and motorcycle traction control settings that are coordinated with each other.
 - ✓ **SPORT** – homologated performance with very direct response; the motorcycle traction control allows greater slip on the rear wheel.
 - ✓ **STREET** – homologated performance with balanced response; the motorcycle traction control allows normal slip on the rear wheel.
 - ✓ **RAIN** – reduced homologated performance for better rideability; the motorcycle traction control allows normal slip on the rear wheel.

- ✓ OFFROAD – reduced homologated performance for better ridability; the motorcycle traction control allows high slip on the rear wheel.

**Info**

Do not open the throttle during the selection.

7.25.26 MTC

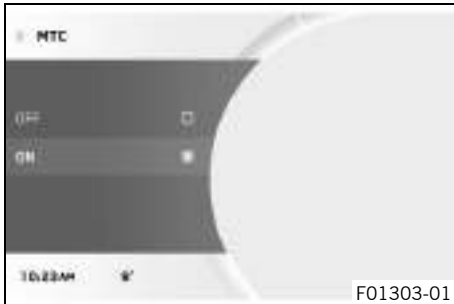
**Condition**

- The motorcycle is stationary.
- Cruise control system function deactivated
- Press **SET** button when the menu is closed.
- Press **UP** or **DOWN** button until **Motorcycle** is marked. Press the **SET** button to open the menu.
- Press the **UP** or **DOWN** button until **MTC** is marked. Press the **SET** button to open the menu.
- Activate menu item using the **UP** or **DOWN** button.
- Switch **MTC** on or off by pressing the **SET** button.

**Info**

Do not open the throttle when switching on or off. After the ignition is switched on, motorcycle traction control is enabled again.

7 COMBINATION INSTRUMENT

Press and hold the **SET** button for 3 - 5 seconds.

Activation of the motorcycle traction control.

7.25.27 MTC+MSR (optional)



Condition

- The motorcycle is stationary.
- Cruise control system function deactivated
- Press **SET** button when the menu is closed.
- Press **UP** or **DOWN** button until **Motorcycle** is marked. Press the **SET** button to open the menu.
- Press the **UP** or **DOWN** button until **MTC+MSR** is marked. Press the **SET** button to open the menu.
- Activate menu item using the **UP** or **DOWN** button.
- Switch **MTC+MSR** on or off by pressing the **SET** button.



Info

Do not open the throttle when switching on or off.
When the ABS is switched off or the **Offroad** ride mode is active, the **MSR** is not active.
After the ignition is switched on, the motorcycle traction control and engine traction torque control are enabled again.

Press and hold the **SET** button for 3 - 5 seconds.

Activation of the motorcycle traction control and the engine traction torque control.

7.25.28 ABS



Condition

- The motorcycle is stationary.
- Press **SET** button when the menu is closed.
- Press **UP** or **DOWN** button until **Motorcycle** is marked. Press the **SET** button to open the menu.

Note

Voiding of the government approval for road use and the insurance coverage If the ABS is switched off completely, the vehicle's approval for road use is invalidated.

- Only operate the vehicle in closed-off areas remote from public road traffic if the ABS is switched off completely.
- Press the **UP** or **DOWN** button until **ABS** is marked. Press the **SET** button to open the menu.
- Activate menu item using the **UP** or **DOWN** button.
- Press the **SET** button to switch off **ABS** or to select between ABS modes.



Info

Do not open the throttle during the selection.

The ABS can only be reactivated by switching on the ignition again.

When the **Road** ABS mode is active, ABS controls both wheels.

When the **Offroad** ABS mode is active, ABS only controls the front wheel. The rear wheel is not controlled by ABS and may lock during braking maneuvers.

| | |
|---|--|
| Press and hold the SET button for 3 - 5 seconds. | Activation of the different ABS modes. |
|---|--|

7.25.29 HHC (optional)



Condition

- The motorcycle is stationary.
 - Press **SET** button when the menu is closed.
 - Press **UP** or **DOWN** button until **Motorcycle** is marked. Press the **SET** button to open the menu.
 - Press the **UP** or **DOWN** button until **HHC** is marked. Press the **SET** button to open the menu.
 - Activate menu item using the **UP** or **DOWN** button.
 - Switch **HHC** on or off by pressing the **SET** button.

7.25.30 Settings



Condition

- The motorcycle is stationary.
 - Press the **SET** button when the menu is closed.
 - Press the **UP** or **DOWN** button until **Settings** is marked. Press the **SET** button to open the menu.

Favorites and quick selection can be configured in **Settings**.

7 COMBINATION INSTRUMENT

7.25.31 Favourites



Condition

- The motorcycle is stationary.
 - Press the **SET** button when the menu is closed.
 - Press the **UP** or **DOWN** button until **Settings** is marked. Press the **SET** button to open the menu.
 - Press the **UP** or **DOWN** button until **Favourites** is marked. Press the **SET** button to open the menu.
 - Press the **UP** or **DOWN** button to activate the menu item and select it with the **SET** button.

Up to eight items of information can be selected in the **Favourites** menu.

7.25.32 Navi Info Screen



Condition

- The motorcycle is stationary.
 - Press the **SET** button when the menu is closed.
 - Press the **UP** or **DOWN** button until **Settings** is marked. Press the **SET** button to open the menu.
 - Press the **UP** or **DOWN** button until **Navi Info Screen** is marked. Press the **SET** button to open the menu.
 - Press the **UP** or **DOWN** button to activate the menu item and select it with the **SET** button.

Up to four sets of information can be selected in the **Navi Info Screen** menu.

7.25.33 Quick Selector 1



Condition

- The motorcycle is stationary.
 - Press the **SET** button when the menu is closed.
 - Press the **UP** or **DOWN** button until **Settings** is marked. Press the **SET** button to open the menu.
 - Press the **UP** or **DOWN** button until **Quick Selector 1** is marked. Press the **SET** button to open the menu.
 - Press the **UP** or **DOWN** button to activate the menu item and select it with the **SET** button.

A menu can be defined for direct selection in the **Quick Selector 1** menu.

When the menu is closed, the menu defined in **Quick Selector 1** is opened by pressing the **UP** button.

7.25.34 Quick Selector 2



Condition

- The motorcycle is stationary.
 - Press the **SET** button when the menu is closed.
 - Press the **UP** or **DOWN** button until **Settings** is marked. Press the **SET** button to open the menu.
 - Press the **UP** or **DOWN** button until **Quick Selector 2** is marked. Press the **SET** button to open the menu.
 - Press the **UP** or **DOWN** button to activate the menu item and select it with the **SET** button.

A menu can be defined for direct selection in the **Quick Selector 2** menu.

When the menu is closed, the menu defined in **Quick Selector 2** is opened by pressing the **DOWN** button.

7.25.35 Preferences



Condition

- The motorcycle is stationary.
 - Press the **SET** button when the menu is closed.
 - Press the **UP** or **DOWN** button until **Preferences** is marked. Press the **SET** button to open the menu.

The combination instrument display can be configured in **Preferences**. Settings can be made for units or various values. Several functions can be enabled or disabled.

7.25.36 Units



Condition

- The vehicle is stationary.
 - Press the **SET** button when the menu is closed.
 - Press the **UP** or **DOWN** button until **Preferences** is marked. Press the **SET** button to open the menu.
 - Press the **UP** or **DOWN** button until **Units** is marked.
 - Press the **SET** button to open the menu.

Units allows settings to be made for units or various values.

7 COMBINATION INSTRUMENT

7.25.37 Distance



Condition

- The motorcycle is stationary.
 - Press the **SET** button when the menu is closed.
 - Press the **UP** or **DOWN** button until **Preferences** is marked. Press the **SET** button to open the menu.
 - Press the **UP** or **DOWN** button until **Units** is marked.
 - Press the **SET** button to open the menu.
 - Press the **UP** or **DOWN** button until **Distance** is marked. Press the **SET** button to open the menu.
 - Activate the menu item using the **UP** or **DOWN** button.
 - Press the **SET** button to confirm the desired unit.

7.25.38 Temperature

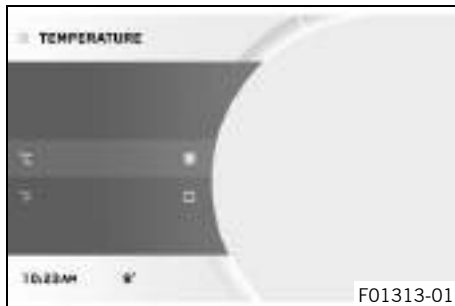

Condition

- The motorcycle is stationary.
 - Press the **SET** button when the menu is closed.
 - Press the **UP** or **DOWN** button until **Preferences** is marked. Press the **SET** button to open the menu.
 - Press the **UP** or **DOWN** button until **Units** is marked.
 - Press the **SET** button to open the menu.
 - Press the **UP** or **DOWN** button until **Temperature** is marked. Press the **SET** button to open the menu.

- Activate the menu item using the **UP** or **DOWN** button.
- Press the **SET** button to confirm the desired unit.

7.25.39 Pressure



Condition

- The motorcycle is stationary.
- Press the **SET** button when the menu is closed.
- Press the **UP** or **DOWN** button until **Preferences** is marked. Press the **SET** button to open the menu.
- Press the **UP** or **DOWN** button until **Units** is marked.
- Press the **SET** button to open the menu.
- Press the **UP** or **DOWN** button until **Pressure** is marked. Press the **SET** button to open the menu.
- Activate the menu item using the **UP** or **DOWN** button.
- Press the **SET** button to confirm the desired unit.

7 COMBINATION INSTRUMENT

7.25.40 Consumption



Condition

- The motorcycle is stationary.
 - Press the **SET** button when the menu is closed.
 - Press the **UP** or **DOWN** button until **Preferences** is marked. Press the **SET** button to open the menu.
 - Press the **UP** or **DOWN** button until **Units** is marked.
 - Press the **SET** button to open the menu.
 - Press the **UP** or **DOWN** button until **Consumption** is marked. Press the **SET** button to open the menu.
 - Activate the menu item using the **UP** or **DOWN** button.
 - Press the **SET** button to confirm the desired unit.

7.25.41 Language



Condition

- The motorcycle is stationary.
 - Press the **SET** button when the menu is closed.
 - Press the **UP** or **DOWN** button until **Preferences** is marked. Press the **SET** button to open the menu.
 - Press the **UP** or **DOWN** button until **Language** is marked. Press the **SET** button to open the menu.
 - Press the **UP** or **DOWN** button to activate the menu item and select it with the **SET** button.

The menu languages are US English, UK English, German, Italian, French, and Spanish.

7.25.42 Shift Light

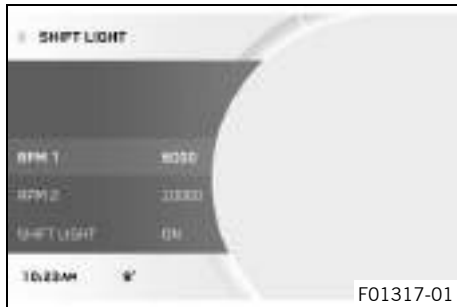

Condition

- The motorcycle is stationary.
- **ODO** > 1000 km (621 mi).
- Press the **SET** button when the menu is closed.
- Press the **UP** or **DOWN** button until **Preferences** is marked. Press the **SET** button to open the menu.
- Press the **UP** or **DOWN** button until **Shift Light** is marked. Press the **SET** button to open the menu.
- Activate the menu item using the **UP** or **DOWN** button.
- Switch the shift warning light on or off or set the engine speed for the gear shift recommendation by pressing the **SET** button.



Info

When the engine speed reaches **RPM 1**, the speed display lights up red.

When the engine speed reaches **RPM 2**, the speed display flashes red.

7.25.43 Setting the time and date



Condition

The motorcycle is stationary.

- Press the **SET** button when the menu is closed.
- Press the **UP** or **DOWN** button until **Preferences** appears. Press the **SET** button to open the menu.
- Press the **UP** or **DOWN** button until **Time/Date** is marked. Press the **SET** button to open the menu.

Setting the clock

- Press the **UP** or **DOWN** button until the time is marked.
- Press the **SET** button.
 - ✓ The hour next to **Clock** flashes.
- Press the **UP** or **DOWN** button until the current hour is set.
- Press the **SET** button.
 - ✓ The minute next to **Clock** flashes.
- Press the **UP** or **DOWN** button until the current minute is set.
- Press the **SET** button.
 - ✓ The time is stored.



Setting the date



Info

The date format may differ depending on the language set.

- Press the **UP** or **DOWN** button until the date is marked.
- Press the **SET** button.
 - ✓ The month next to **Date** flashes.
- Press the **UP** or **DOWN** button until the current month is set.
- Press the **SET** button.
 - ✓ The day next to **Date** flashes.
- Press the **UP** or **DOWN** button until the current day is set.
- Press the **SET** button.
 - ✓ The year next to **Date** flashes.
- Press the **UP** or **DOWN** button until the current year is set.
- Press the **SET** button.
 - ✓ The date is stored.



7.25.44 DRL



Condition

- The motorcycle is stationary.
- Press the **SET** button when the menu is closed.
- Press the **UP** or **DOWN** button until **Preferences** is marked. Press the **SET** button to open the menu.



Warning

Danger of accidents When visibility is poor, the daytime running light is not a substitute for the low beam. Automatic switching between the daytime running light and low beam may only be partially available when visibility is significantly impaired due to fog, snow or rain.

- Ensure that the appropriate type of lighting is always selected.
- If necessary switch off the daytime running lights using the menu before going on a ride or when stopped so that the low beam is switched on permanently.
- Note the legal regulations regarding the daytime running light.

- Press the **UP** or **DOWN** button until **DRL** is marked. Press the **SET** button to open the menu.
- Activate the menu item using the **UP** or **DOWN** button.
- Press the **SET** button to switch the daytime running light on or off.

7.25.45 Quickshifter + (optional)



Condition

- The motorcycle is stationary.
- Press the **SET** button when the menu is closed.
- Press the **UP** or **DOWN** button until **Preferences** is marked. Press the **SET** button to open the menu.
- Press the **UP** or **DOWN** button until **Quickshifter +** is marked. Press the **SET** button to open the menu.
- Activate the menu item using the **UP** or **DOWN** button.
- Press the **SET** button to switch the quickshifter + on or off.

7 COMBINATION INSTRUMENT

7.25.46 Heated Grips (optional)

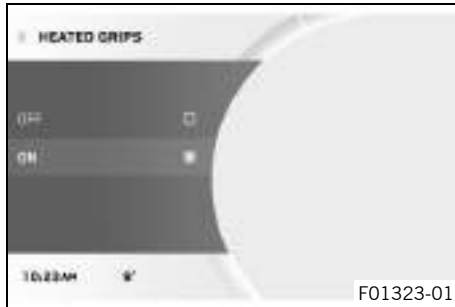

Condition

- The motorcycle is stationary.
 - Press the **SET** button when the menu is closed.
 - Press the **UP** or **DOWN** button until **Preferences** is marked. Press the **SET** button to open the menu.
 - Press the **UP** or **DOWN** button until **Heated Grips** is marked. Press the **SET** button to open the menu.
 - Activate the menu item using the **UP** or **DOWN** button.
 - Switch the **Heated Grips** on or off by pressing the **SET** button.

7.25.47 Heated Seat Rid (optional)

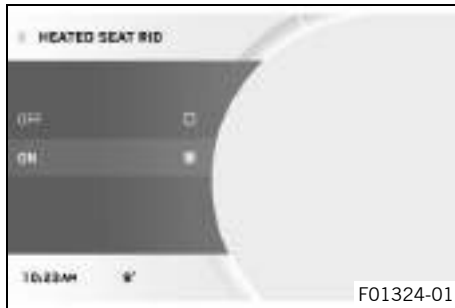

Condition

- The motorcycle is stationary.
 - Press the **SET** button when the menu is closed.
 - Press the **UP** or **DOWN** button until **Preferences** is marked. Press the **SET** button to open the menu.
 - Press the **UP** or **DOWN** button until **Heated Seat Rid** is marked. Press the **SET** button to open the menu.
 - Activate the menu item using the **UP** or **DOWN** button.
 - Switch the **Heated Seat Rid** on or off by pressing the **SET** button.

7.25.48 Heated Seat Pas (optional)

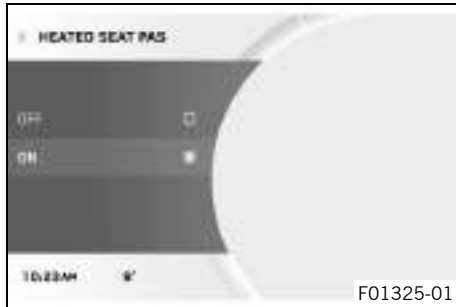

Condition

- The motorcycle is stationary.
- Press the **SET** button when the menu is closed.
- Press the **UP** or **DOWN** button until **Preferences** is marked. Press the **SET** button to open the menu.
- Press the **UP** or **DOWN** button until **Heated Seat Pas** is marked. Press the **SET** button to open the menu.
- Activate the menu item using the **UP** or **DOWN** button.
- Switch the **Heated Seat Pas** on or off by pressing the **SET** button.

7.25.49 Cornering Light Test

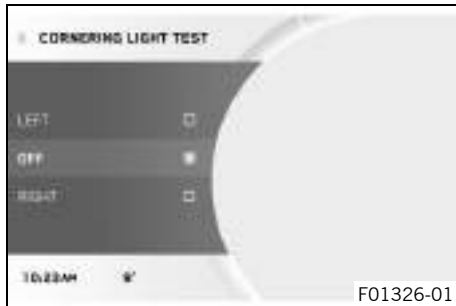

Condition

- The motorcycle is stationary.
- Press the **SET** button when the menu is closed.
- Press the **UP** or **DOWN** button until **Preferences** is marked. Press the **SET** button to open the menu.
- Press the **UP** or **DOWN** button until **Cornering Light Test** is marked. Press the **SET** button to open the menu.
- Activate the menu item using the **UP** or **DOWN** button.



Info

The **Cornering Light Test** is performed on the left cornering light in the **Left** submenu.

The **Cornering Light Test** is performed on the right cornering light in the **Right** submenu.

The **Cornering Light Test** is completed in the **Off** submenu.

- Press the **SET** button in order to perform or switch off the desired **Cornering Light Test**.
-



Info

The respective cornering light segments light up in succession, starting with the lower segment.

When the test of the respective cornering light is complete, the upper segment lights up continuously.

8.1 Handlebar position

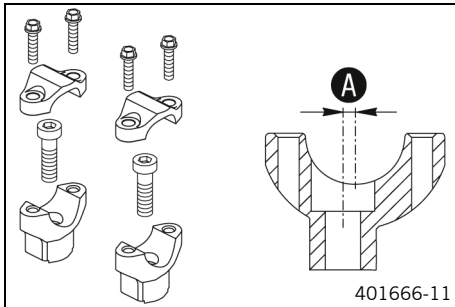

The holes on the handlebar support are placed at a distance of **A** from the center.

| | |
|------------------------|-------------------|
| Hole distance A | 3.5 mm (0.138 in) |
|------------------------|-------------------|

The handlebar can be mounted in two different positions. In this way, the handlebar can be mounted in the position that is most comfortable for the rider.

8.2 Adjusting the handlebar position ↩



Warning

Danger of accidents A repaired handlebar poses a safety risk.

If the handlebar is bent or straightened, the material becomes fatigued. The handlebar may break as a result.

- Change the handlebar if the handlebar is damaged or bent.

8 ERGONOMICS

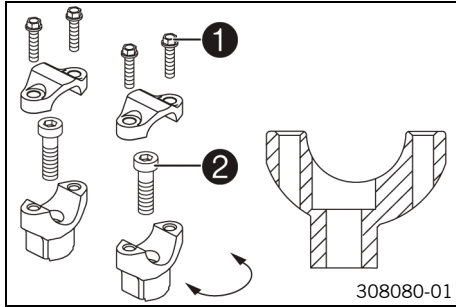

- Remove screws ①. Take off the handlebar clamps. Remove the handlebar and lay it to one side.



Info

Cover the components to protect them against damage. Do not kink the cables and lines.

- Remove screws ②. Take off the handlebar supports.
- Place the handlebar supports in the required position. Mount and tighten screws ②.

Guideline

| | | |
|--------------------------|-----|--|
| Screw, handlebar support | M10 | 40 Nm (29.5 lbf ft) Loctite®243™ |
|--------------------------|-----|--|



Info

Position the left and right handlebar supports evenly.

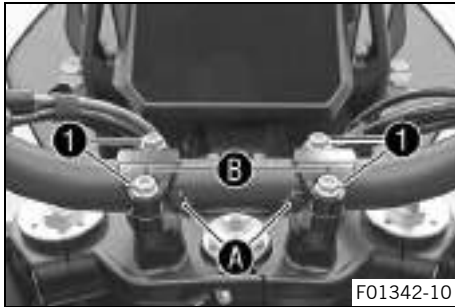

- Position the handlebar.

i Info
Make sure the cables and wiring are positioned correctly.

- Position the handlebar clamps. Mount screws **1** and tighten evenly.

Guideline

| | | |
|------------------------|----|---------------------|
| Screw, handlebar clamp | M8 | 20 Nm (14.8 lbf ft) |
|------------------------|----|---------------------|

- ✓ Handlebar scale markings **A** are located centrally between the handlebar clamps.
- ✓ Markings **B** face backwards.

i Info
Make sure the gap widths are even.



8.3 Adjusting the windshield

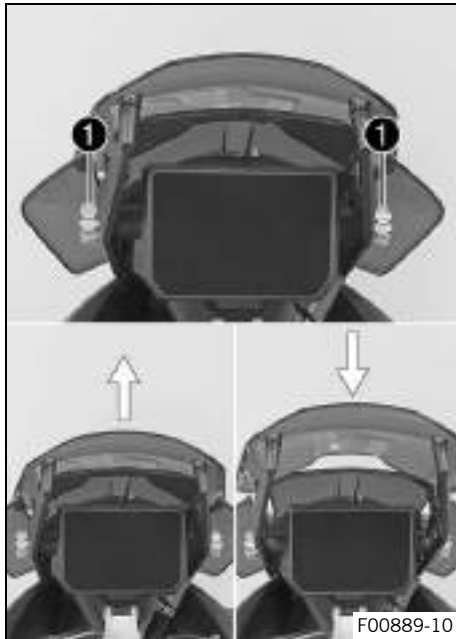

- Turn the adjusting wheel **1** to bring the windshield in the required position.

8.4 Adjusting the basic position of the clutch lever



- Adjust the basic position of the clutch lever to your hand size by turning adjusting screw ①.



Info

When the adjusting screw is turned clockwise, the clutch lever moves closer to the handlebar. When the adjusting screw is turned counterclockwise, the clutch lever moves away from the handlebar. The range of adjustment is limited. Only turn the adjusting screw by hand, and do not use force. Do not make any adjustments while riding.



8.5 Adjusting the basic position of the hand brake lever



- Adjust the basic position of the hand brake lever to your hand size by turning adjusting wheel ①.



Info

Push the hand brake lever forward and turn the adjusting wheel.

Do not make any adjustments while riding.

8.6 Rider footrests

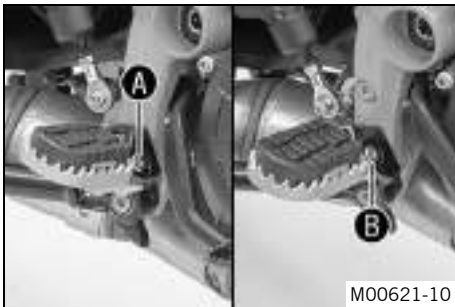

The rider footrests can be mounted in one of two positions.

Possible states

- Rider footrests, low ①
- Rider footrests, high ②

8.7 Adjusting the footrests ↘



Info

The operations on the footrest brackets are the same for the left and right sides.

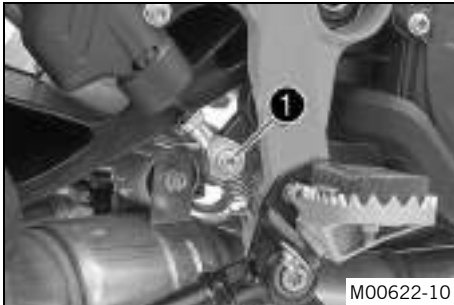

- Remove screw ①.
- ✓ The foot brake lever swings up to the stop.

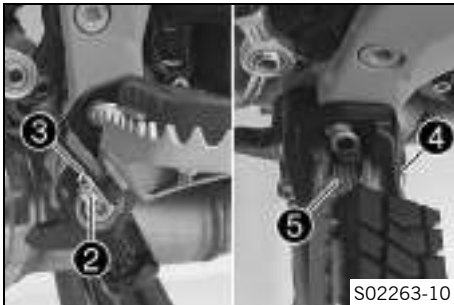

- Remove pin ② with washer ③.
- Carefully remove the pin ④ of the rider footrest.



Info

The spring is under high tension and can pop out when the pin is removed.

- Take off the rider footrest ⑤ with the spring.

8 ERGONOMICS

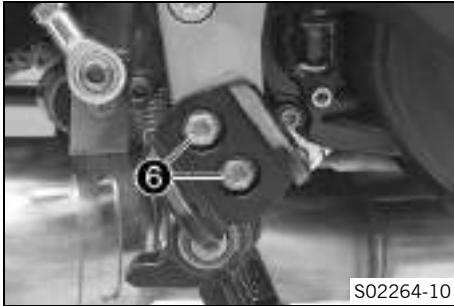

- Remove screws ⑥.



- Adjust the footrest bracket to the desired position.

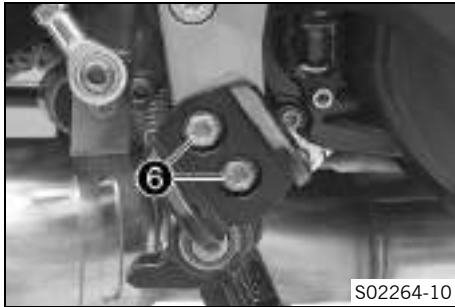

S02264-10

- Mount and tighten screws ⑥.

Guideline

| | | |
|----------------------------------|----|--|
| Screw, front footrest bracket | M8 | 25 Nm (18.4 lbf ft) Loctite®243™ |
|----------------------------------|----|--|

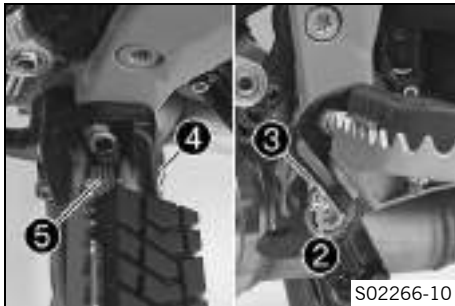

S02266-10

- Mount the rider footrest with spring ⑤ and pin ④.

| |
|-------------------------------------|
| Footrest spring plier (58429083000) |
|-------------------------------------|

- Mount the washer ③ and pin ②.

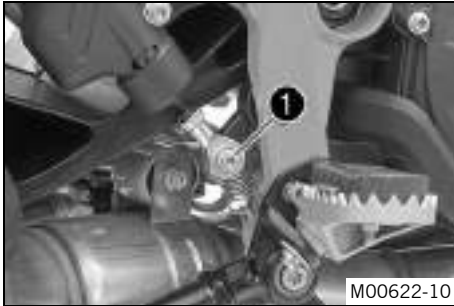

- Position the foot brake lever.
- Mount and tighten screw ①.

Guideline

| | | |
|--|----|---|
| Screw, ball joint of push rod on foot brake cylinder | M6 | 10 Nm (7.4 lbf ft) Loctite®243™ |
|--|----|---|

8.8 Checking the basic position of the shift lever

i Info

When driving, the shift lever must not touch the rider's boot when in the basic position. If the shift lever is permanently touching the boot, the transmission will be subject to excessive load; this can cause a malfunction of the quickshifter.

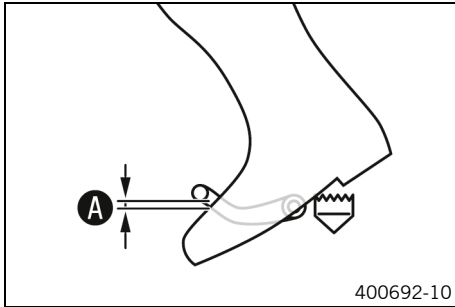

- Sit on the vehicle in the riding position and determine distance **A** between the upper edge of your boot and the shift lever.

| | |
|---|---------------------------------|
| Distance between shift lever and upper edge of boot | 10 ... 20 mm (0.39 ... 0.79 in) |
|---|---------------------------------|

- » If the distance does not meet specifications:
 - Adjust the basic position of the shift lever. 🛠️ (📖 p. 137)

8.9 Adjusting the basic position of the shift lever 🛠️

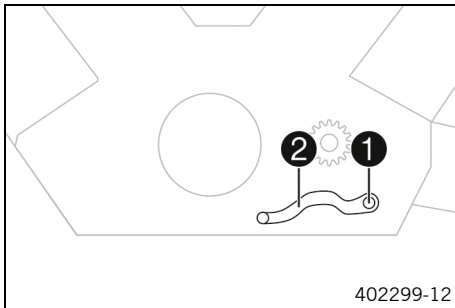

- Remove screw **1** with the washers and take off shift lever **2**.

8 ERGONOMICS

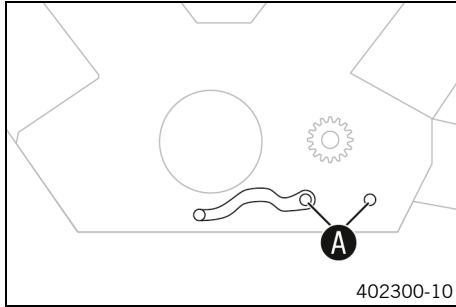

- Clean gear teeth **A** of the shift lever and shift shaft.
- Mount the shift lever on the shift shaft in the required position and engage gearing.



Info

The range of adjustment is limited.
The shift lever must not come into contact with any other vehicle components during the shift procedure.

- Mount and tighten screw **1** with the washers.

Guideline

| | | |
|--------------------|----|--|
| Screw, shift lever | M6 | 18 Nm (13.3 lbf ft) Loctite®243™ |
|--------------------|----|--|

8.10 Setting the shift lever stub

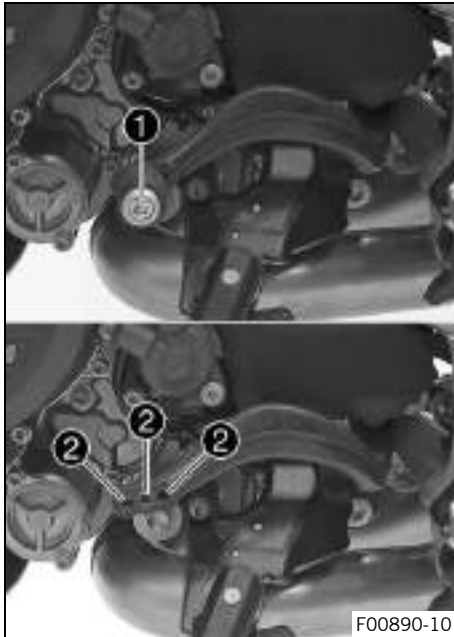

- Remove screw **1** along with the shift lever stub.
- Position the shift lever stub with the screw in one of drilled holes **2** depending on the desired lever length.

Guideline

| | |
|----------|-------------|
| Standard | Middle hole |
|----------|-------------|

- Tighten the screw.

Guideline

| | | |
|------------------------------|----|--------------------|
| Remaining screws, chassis | M6 | 10 Nm (7.4 lbf ft) |
|------------------------------|----|--------------------|



8.11 Adjusting the basic position of the foot brake lever ↴

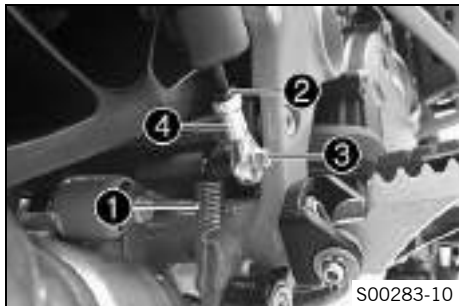

- Detach spring ❶.
- Loosen nut ❷.
- Remove screw ❸.
- To adjust the basic position of the foot brake lever to individual requirements, turn ball joint ❹ accordingly.

i Info

The range of adjustment is limited.
The screw must be screwed into the ball joint by at least 5 turns.

- Hold ball joint ❹ and tighten nut ❷.

Guideline

| | | |
|-------------------------|----|--------------------|
| Remaining nuts, chassis | M6 | 10 Nm (7.4 lbf ft) |
|-------------------------|----|--------------------|

- Mount and tighten screw ❸.

Guideline

| | | |
|--|----|---|
| Screw, ball joint of push rod on foot brake cylinder | M6 | 10 Nm (7.4 lbf ft) Loctite®243™ |
|--|----|---|

- Attach spring ❶.

8.12 Adjusting the tilt of the combination instrument



- Pull clamping lever ① in the direction of the arrow.
- ✓ The combination instrument is unlocked.

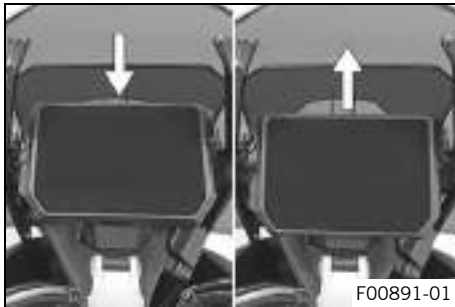

- To move the combination instrument to the desired position, press the combination instrument upward or downward.

8 ERGONOMICS



- Pull clamping lever ① in the direction of the arrow.
- ✓ The combination instrument is locked.

9.1 Advice on preparing for first use



Danger

Danger of accidents A rider who is not fit to ride poses a danger to him or herself and others.

- Do not operate the vehicle if you are not fit to ride due to alcohol, drugs or medication.
- Do not operate the vehicle if you are physically or mentally impaired.



Warning

Risk of injury Missing or poor protective clothing presents an increased safety risk.

- Wear appropriate protective clothing such as helmet, boots, gloves as well as trousers and a jacket with protectors on all rides.
- Always wear protective clothing that is in good condition and meets the legal regulations.



Warning

Danger of crashing Different tire tread patterns on the front and rear wheel impair the handling characteristic.

Different tire tread patterns can make the vehicle significantly more difficult to control.

- Make sure that only tires with a similar tire tread pattern are fitted to the front and rear wheel.



Warning

Danger of accidents Non-approved or non-recommended tires and wheels impact the handling characteristic.

- Only use tires/wheels approved by KTM with the corresponding speed index.



Warning

Danger of accidents New tires have reduced road grip.

The contact surface on new tires is not yet roughened.

- Run in new tires with moderate riding at alternating angles.
Running-in phase 200 km (124 mi)



Warning

Danger of accidents The brake system fails in the event of overheating.

If the foot brake lever is not released, the brake linings drag continuously.

- Take your foot off the foot brake lever when you are not braking.



Info

When using your vehicle, remember that others may feel disturbed by excessive noise.

- Make sure that the pre-sales inspection work has been carried out by an authorized KTM workshop.
✓ You will receive a delivery certificate when the vehicle is handed over.
- Before riding for the first time, read the entire Owner's Manual carefully.
- Get to know the controls.
- Adjust the motorcycle to your requirements, as described in the "Ergonomics" chapter.
- Get used to the handling characteristic of the motorcycle in a suitable area before making a longer trip. Try also to ride as slowly as possible and in a standing position to get a better feel for the motorcycle.
- Hold the handlebar firmly with both hands and keep your feet on the footrests when riding.

- Run the engine in. (📖 p. 145)



9.2 Running in the engine

- During the running-in phase, do not exceed the specified engine speed.

Guideline

| | |
|-------------------------------------|------------|
| Maximum engine speed | |
| During the first: 1,000 km (620 mi) | 6,500 rpm |
| After the first: 1,000 km (620 mi) | 10,250 rpm |

- Avoid fully opening the throttle!



Info

If the maximum engine speed is exceeded before the first service, the shift warning light flashes.



9.3 Loading the vehicle



Warning

Danger of accidents Total weight and axle loads influence the handling characteristic.

The total weight consists of: motorcycle ready for operation and with a full tank, driver and passenger with protective clothing and helmet, and luggage.

- Do not exceed the maximum permissible overall weight or the axle loads.



Warning

Danger of accidents Improper mounting of cases or the tank rucksack impairs the handling characteristic.

- Mount and secure cases and tank rucksack according to the manufacturer's instructions.



Warning

Danger of accidents Unstable handling characteristics at high speed.

- Adapt your speed according to your payload. Ride more slowly if your motorcycle is loaded with cases or other baggage.

Maximum speed with luggage

150 km/h (93.2 mph)



Warning

Danger of accidents The luggage system will be damaged if it is overloaded.

- Read the manufacturer information on maximum payload when mounting cases.



Warning

Danger of accidents Luggage which has slipped impairs visibility.

If the tail light is covered, you are less visible to traffic behind you, especially when it is dark.

- Check that your luggage is fixed properly at regular intervals.



Warning

Danger of accidents A high payload alters the handling characteristic and increases the stopping distance.

- Adapt your speed to your payload.



Warning

Danger of accidents Pieces of luggage which have slipped impair the handling characteristic.

- Check that your luggage is fixed properly at regular intervals.



Warning

Fire hazard The hot exhaust system may burn luggage.

- Fasten your luggage in such a way that it cannot be burned or singed by the hot exhaust system.

-
- If luggage is carried, ensure it is fixed firmly as close as possible to the center of the vehicle and ensure even weight distribution between the front and rear wheels.
 - Do not exceed maximum permissible weight and maximum permissible axle loads.

Guideline

| | |
|-------------------------------------|------------------|
| Maximum permissible total weight | 450 kg (992 lb.) |
| Maximum permissible front axle load | 165 kg (364 lb.) |
| Maximum permissible rear axle load | 285 kg (628 lb.) |



10.1 Checks and maintenance measures when preparing for use



Info

Before every trip, check the condition of the vehicle and ensure that it is roadworthy. The vehicle must be in perfect technical condition when it is being operated.

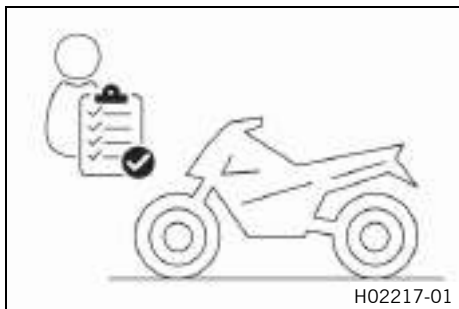

- Check the engine oil level. (📖 p. 289)
- Check the front brake fluid level. (📖 p. 228)
- Check the rear brake fluid level. (📖 p. 233)
- Check the front brake linings. (📖 p. 232)
- Check the rear brake linings. (📖 p. 237)
- Check that the brake system is functioning properly.
- Check the coolant level in the compensating tank. (📖 p. 282)
- Check the chain for dirt. (📖 p. 187)
- Check the chain tension. (📖 p. 189)
- Check the tire condition. (📖 p. 252)
- Check tire pressure. (📖 p. 255)
- Check the spoke tension. (📖 p. 256)
- Check the settings of all controls and ensure that they can be operated smoothly.
- Check that the electrical system is functioning properly.
- Check that luggage is properly secured.
- Check the setting of the rear mirror.

- Check the fuel level.



10.2 Starting



Danger

- Danger of poisoning** Exhaust gases are toxic and inhaling them may result in unconsciousness and death.
- Always make sure there is sufficient ventilation when running the engine.
 - Use effective exhaust extraction when starting or running the engine in an enclosed space.



Caution

- Danger of accidents** Electronic components and safety devices will be damaged if the 12-V battery is discharged or missing.
- Never operate the vehicle with a discharged 12-V battery or without a 12-V battery.

Note

- Engine damage** High revving speed with a cold engine negatively impacts the lifespan of the engine.
- Always run the engine warm at a low speed.

10 RIDING INSTRUCTIONS



- Take the motorcycle off side stand and sit in the motorcycle.
- Bring the Race-on key within range of the antenna.
- Ensure that the Race-on key stays in range while riding.

Guideline

| | |
|---|----------------|
| Maximum range of the Race-on key around the antenna | 1.5 m (4.9 ft) |
|---|----------------|



Info

The range may be reduced by decreases in battery voltage of the Race-on key and interfering radio waves. If the battery voltage of the Race-on key is too low, one of the ignition keys must be held in the area of the antenna (🗨 p. 42) and must be safely stored again after starting.

- Make sure that the emergency OFF switch/electric starter button is in the middle position ○.
- Switch on ignition; to do this, briefly press the Race-on button Ⓜ (maximum of 1 second).
 - ✓ The steering is unlocked.
 - ✓ The function check of the combination instrument is run.
 - ✓ The ABS warning lamp goes out when starting off.

**Info**

If the handlebar does not unlock, move the handlebar slightly.

- Shift the transmission into neutral **N**.
- ✓ The green idle indicator lamp **N** lights up.
- Turn emergency OFF switch/electric starter button to the lower position ③.

**Info**

Do not press the emergency off switch/electric starter button into the lower position ③ until the combination instrument function check has been completed.

When starting, **DO NOT** open the throttle. If you open the throttle during the starting procedure, fuel is not injected by the engine management system and the engine cannot start.

Press the emergency OFF switch/electric starter button into the lower position ③ for a maximum of 5 seconds. Wait for a least 5 seconds before trying again.

This motorcycle is equipped with a safety starting system. You can only start the engine if the transmission is in neutral or if the clutch lever is pulled when a gear is engaged. If the side stand is folded out and you shift into gear, the engine stops.



10 RIDING INSTRUCTIONS

10.3 Starting off

- Pull the clutch lever, engage 1st gear, release the clutch lever slowly and simultaneously open the throttle carefully.



10.4 Quickshifter + (optional)

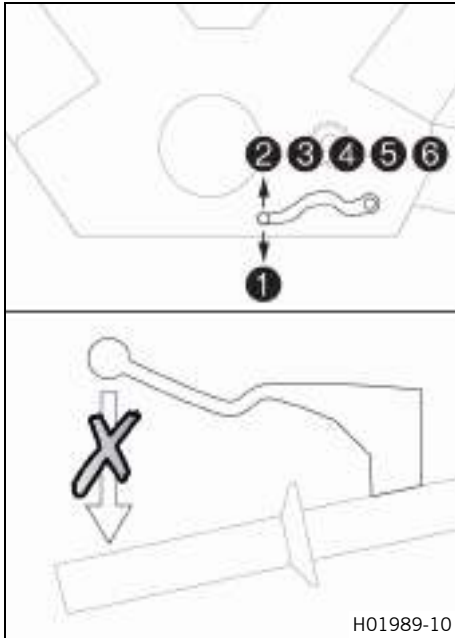

If the quickshifter + (optional) is activated, you can shift up and down without actuating the clutch. Because there is no need to close the throttle grip, uninterrupted gear shifts are possible. The quickshifter + uses the shifter shaft position to check whether or not a shift should be initiated, and sends a corresponding signal to the engine control. If the quickshifter + is disabled in the combination instrument, the clutch needs to be actuated in the normal way for each shift.

10.5 Starting off with HHC (optional)

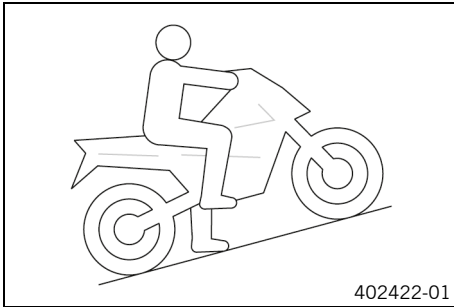

The **HHC** is an optional auxiliary function of the brake system. The **HHC** prevents accidental rolling back of the motorcycle on hills.

The **HHC** recognizes stopping on hills and operates the rear brake. After releasing the brake lever, the brake force is maintained for a maximum of 5 seconds as long as the motorcycle is not moving forward.

When driving off the **HHC** releases the rear brake automatically.

i Info

When the **HHC** is active, the TC indicator lamp  flashes. When the ignition is switched on, the **HHC** can still be active even if the engine is stopped.

To roll back with active **HHC**, wait 5 seconds, shift to neutral, or switch off the ignition.

If the **HHC** does not detect a start off after 5 seconds, the braking force is automatically reduced gently.

When a brake lever is actuated, the **HHC** is re-activated.

10.6 Shifting, riding



Warning

Danger of accidents Abrupt load alterations can cause the vehicle to get out of control.

- Avoid abrupt load alterations and sudden braking actions.
- Adapt your speed to the road conditions.



Warning

Danger of accidents If you change down at high engine speed, the rear wheel blocks and the engine races.

- Do not change into a low gear at high engine speed.



Warning

Danger of accidents Adjustments to the vehicle distract attention from traffic activity.

- Make all adjustments when the vehicle is at a standstill.



Warning

Risk of injury The passenger may fall from the motorcycle if they conduct themselves incorrectly.

- Ensure that the passenger sits correctly on the passenger seat, places his or her feet on the passenger foot pegs and holds on to the rider or the grab handles.
- Note the regulations governing the minimum age of passengers in your country.

10 RIDING INSTRUCTIONS



Warning

Danger of accidents A risky riding style constitutes a major risk.

- Comply with traffic regulations and ride defensively and with foresight to detect sources of danger as early as possible.



Warning

Danger of accidents Cold tires have reduced road grip.

- Ride the first miles carefully on every journey at moderate speed until the tires reach operating temperature.



Warning

Danger of accidents New tires have reduced road grip.

The contact surface on new tires is not yet roughened.

- Run in new tires with moderate riding at alternating angles.
Running-in phase 200 km (124 mi)



Warning

Danger of accidents Total weight and axle loads influence the handling characteristic.

The total weight consists of: motorcycle ready for operation and with a full tank, driver and passenger with protective clothing and helmet, and luggage.

- Do not exceed the maximum permissible overall weight or the axle loads.

**Warning**

Danger of accidents Pieces of luggage which have slipped impair the handling characteristic.

- Check that your luggage is fixed properly at regular intervals.

**Warning**

Danger of accidents A fall can damage the vehicle more seriously than it may first appear.

- Check the vehicle after a fall as you do when preparing for use.

Note

Engine damage Unfiltered intake air has a negative effect on the service life of the engine.

Dust and dirt will enter the engine without an air filter.

- Never start to use the vehicle without an air filter.

Note

Engine failure Overheating damages the engine.

- If the coolant temperature warning is displayed, stop immediately and take care not to endanger yourself or other traffic participants in the process.
- Allow the engine and cooling system to cool down.
- Check and, if necessary, correct the coolant level on the cooling system while it is in a cooled state.

Note

Transmission damage Incorrect use of the quickshifter+ will damage the transmission.

The quickshifter+ can only be used if the function is enabled in the combination instrument.

The quickshifter+ is not active if you pull the clutch lever.

- Only use the quickshifter+ in the permitted speed range shown.

i Info

If you hear unusual noises while riding, stop immediately, switch off the engine, and contact an authorized KTM workshop.

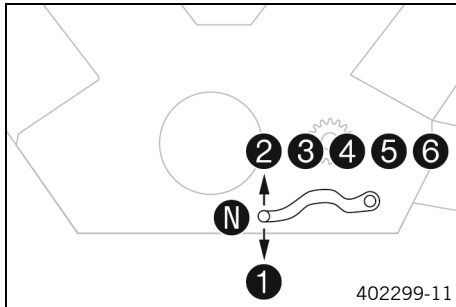



- Shift into a higher gear when conditions allow (incline, road situation, etc.).
- Release throttle while simultaneously pulling the clutch lever, shift into the next gear, release the clutch lever, and open the throttle.

i Info

The gear positions can be seen in the figure. The idle position is between the first and second gears. First gear is used for starting off or for steep inclines.

- After reaching maximum speed by fully opening the throttle grip, turn the throttle back so it is $\frac{3}{4}$ open. This will barely reduce the speed, but fuel consumption will be considerably lower.

- Accelerate only up to a speed suitable for the road surface and weather conditions. Particularly in bends, do not shift, and accelerate very carefully.
- Brake if necessary and close the throttle at the same time in order to shift down.
- Pull clutch lever and shift into a lower gear, release the clutch lever slowly, and open the throttle or shift again.
- If the engine stalls (e.g. at an intersection), just pull the clutch lever and press the start button. The transmission must not be shifted into neutral.
- Switch off the engine if you are likely to be running at idle speed or stationary for a long time.
- If the oil pressure warning lamp  lights up during a trip, stop as soon as it is safe to do so and switch off the engine. Contact an authorized KTM workshop.
- If the malfunction indicator lamp  lights up during a trip, please contact an authorized KTM workshop as soon as possible.
- If the general warning lamp  lights up during a trip, the display shows a message for 10 seconds.

**Info**

Very important messages are stored in the **Warning** menu.

10 RIDING INSTRUCTIONS

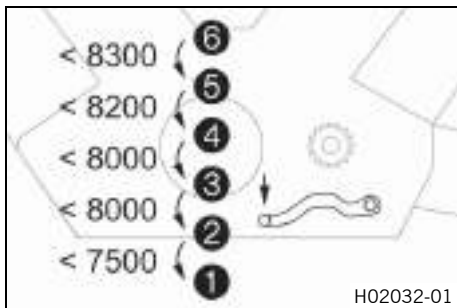
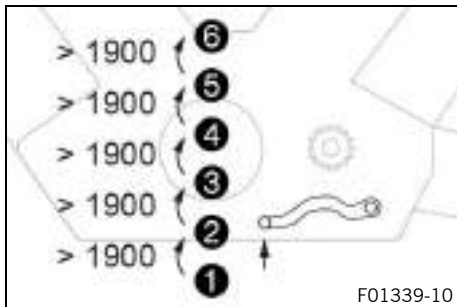

- If the ice warning ❄ appears on the combination instrument, there may be black ice on the road surface. Adjust your speed to the road conditions.

Condition

The quickshifter + (optional) is enabled.

- If the quickshifter + is enabled in the combination instrument, one can shift up in the engine speed range shown without pulling the clutch lever.

i Info

The minimum engine speed before shifting up in revolutions per minute is shown in the figure. Pull the shift lever to the stop quickly without changing the throttle twist grip position.

- If the quickshifter + is enabled in the combination instrument, one can shift down in the engine speed range shown without pulling the clutch lever.

i Info

The maximum engine speed before shifting down in revolutions per minute is shown in the figure. Depress the shift lever to the stop quickly without changing the throttle twist grip position.

10.7 MSR (optional)

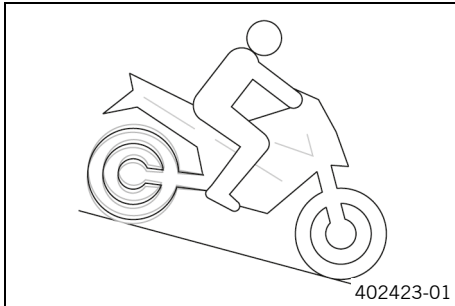

The **MSR** is an optional auxiliary function of the engine control. If the engine braking effect is too great, the **MSR** prevents the rear wheel from locking or sliding away on a sloping position.

To avoid slip of the rear wheel, the **MSR** only opens the throttle valve as far as absolutely necessary.

The **MSR** is applied on surfaces, where the friction is too low to open the slipper clutch.

To further increase ride safety, the **MSR** is slope dependent.

i Info

If **ABS** is disabled, **MTC** is disabled or ABS Mode **Offroad** is enabled, the **MSR** is not active.

10.8 Applying the brakes



Warning

Danger of accidents Moisture and dirt impair the brake system.

- Brake carefully several times to dry out and remove dirt from the brake linings and the brake discs.



Warning

Danger of accidents A spongy pressure point on the front or rear brake reduces braking efficiency.

- Check the brake system and do not continue riding until the problem is eliminated. (Your authorized KTM workshop will be glad to help.)



Warning

Danger of accidents The brake system fails in the event of overheating.

If the foot brake lever is not released, the brake linings drag continuously.

- Take your foot off the foot brake lever when you are not braking.



Warning

Danger of accidents Higher total weight increases the stopping distance.

- Take the longer stopping distance into account when carrying a passenger or luggage with you.



Warning

Danger of accidents Salt on the roads impairs the brake system.

- Brake carefully several times to remove salt from the brake linings and the brake discs.



Warning

Danger of accidents ABS may increase the stopping distance in certain situations.

- Adjust application of the brakes to the respective riding situation and riding surface conditions.



Warning

Danger of accidents Excessively forceful application of the brakes blocks the wheels.

The ABS effectiveness is only ensured if it is switched on.

- Leave the ABS switched on in order to benefit from the protective effect.

**Warning**

Danger of accidents Driving aids can only prevent a rollover within the physical limitations.

It is not always possible to compensate for extreme riding situations, for example with luggage loaded with a high center of gravity, varying road surfaces, steep descents or full braking without disengaging the gear.

- Adapt your riding style to the road conditions and your driving ability.

-
- When braking, release the throttle and apply the front and rear brakes at the same time.

**Info**

When the ABS is enabled, maximum braking power can be achieved even with low road grip surfaces such as sandy, wet, or slippery terrain without locking the wheels.

**Warning**

Danger of accidents The rear wheel can lock due to the engine braking effect.

- Pull in the clutch, if you perform emergency or full braking, or if you brake on a slippery ground.

**Warning**

Danger of accidents Banked or laterally sloping ground reduces the maximum possible delay.

- If possible finish braking before going into a bend.

-
- Always finish braking before you go into a bend. Shift down to a lower gear appropriate to your speed.

- Use the braking effect of the engine on long downhill stretches. To do so, shift back one or two gears, but do not overrev the engine. This means that significantly less braking is required and the brake system does not overheat.

10.9 Stopping, parking



Warning

Risk of injury People who act without authorization endanger themselves and others.

If a valid transponder is in range, the vehicle can be started.

- Do not leave the vehicle unattended if the engine is running.
- Never leave the vehicle unattended if the Race-on key or the black Race-on key are close to the vehicle.
- Protect the vehicle against access by unauthorized persons.
- Lock the steering if you leave the vehicle unattended.



Warning

Danger of burns Some vehicle components become very hot when the vehicle is operated.

- Do not touch any parts such as the exhaust system, radiator, engine, shock absorber, or brake system before the vehicle parts have cooled down.
- Let the vehicle parts cool down before you perform any work on the vehicle.

Note

Fire hazard Hot vehicle components pose a fire hazard and explosion risk.

- Do not park the vehicle near to materials which are highly flammable or explosive.
- Allow the vehicle to cool down before covering it.

Note

Material damage The vehicle may be damaged by incorrect procedure when parking.

Significant damage may be caused if the vehicle rolls away or falls over.

The components for parking the vehicle are designed only for the weight of the vehicle.

- Park the vehicle on a firm and level surface.
 - Ensure that nobody sits on the vehicle when the vehicle is parked on a stand.
-

- Apply the brakes on the motorcycle.
 - Shift the transmission into neutral **N**.
 - Switch off ignition - to do this, briefly press the Race-on button  (maximum of 1 second) with the ignition switched on.
-



Info

If the engine is switched off with the emergency OFF switch and the ignition remains switched on using the Race-on button, the power supply to most power consumers remains unbroken. This discharges the 12-V battery. You should therefore always switch off the engine with the Race-on button – the emergency OFF switch is intended for emergencies only.

- Park motorcycle on a firm surface.

Alternative 1

- Swing side stand forward with your foot as far as it will go and lean the vehicle on it.
-

10 RIDING INSTRUCTIONS

Alternative 2

- Raise the vehicle with the center stand. (📖 p. 184)
- Move the handlebar fully to the left and press and hold the Race-on button  (for at least 2 seconds).
- ✓ The steering is locked.



Info

If the steering lock does not engage, move the handlebar slightly.

10.10 Transporting

Note

Danger of damage The parked vehicle can roll away or fall over.

- Park the vehicle on a firm and level surface.

Note

Fire hazard Hot vehicle components pose a fire hazard and explosion risk.

- Do not park the vehicle near to materials which are highly flammable or explosive.
 - Allow the vehicle to cool down before covering it.
-

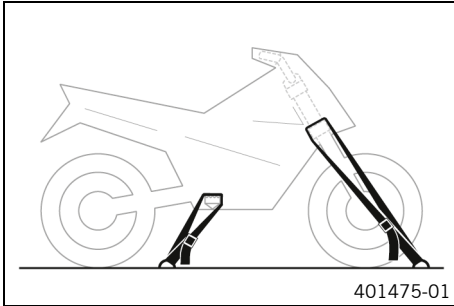

- Switch off the engine.
- Use tension belts or other suitable devices to secure the motorcycle against falling over or rolling away.

10.11 Refueling



Danger

Fire hazard Fuel is highly flammable.

The fuel in the fuel tank expands when warm and can escape if overfilled.

- Do not refuel the vehicle in the vicinity of open flames or lit cigarettes.
- Switch off the engine for refueling.
- Make sure that no fuel is spilled; particularly not on hot parts of the vehicle.
- If any fuel is spilled, wipe it off immediately.
- Observe the specifications for refueling.



Warning

Danger of poisoning Fuel is poisonous and a health hazard.

- Avoid skin, eye and clothing contact with fuel.
- Immediately consult a doctor if you swallow fuel.
- Do not inhale fuel vapors.
- In case of skin contact, rinse the affected area with plenty of water.
- Rinse the eyes thoroughly with water, and consult a doctor in case of fuel contact with the eyes.
- Change your clothing in case of fuel spills on them.

Note

Material damage Inadequate fuel quality causes the fuel filter to quickly become clogged.

In some countries and regions, the available fuel quality and cleanliness may not be sufficient. This will result in problems with the fuel system.

- Refuel only with clean fuel that meets the specified standards. (Your authorized KTM workshop will be glad to help.)



Note

Environmental hazard Improper handling of fuel is a danger to the environment.

- Do not allow fuel to enter the groundwater, the soil, or the sewage system.
-



- Switch off the engine.
- Open the fuel tank filler cap. (📖 p. 45)
- Fill the fuel tank with fuel up to the lower edge **A** of the filler neck.

| | | |
|-----------------------------------|----------------------|---|
| Total fuel tank capacity, approx. | 23 l (6.1 US gal) | Super unleaded (ROZ 95/RON 95/PON 91) (📖 p. 339) |
|-----------------------------------|----------------------|---|

- Close the fuel tank filler cap. (📖 p. 47)

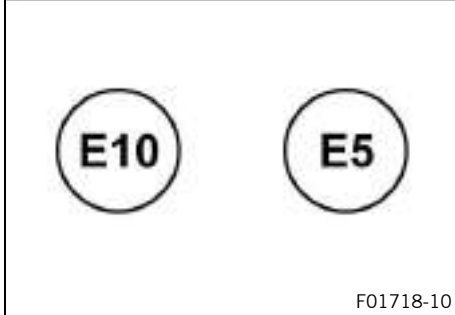

F01718-10

11 SERVICE SCHEDULE

11.1 Additional information

Any further work that results from the compulsory work or from the recommended work must be ordered separately and invoiced separately.

Different service intervals may apply in your country, depending on the local operating conditions.

Individual service intervals and scopes may change in the course of technical developments. The most up-to-date service schedule can always be found on KTM Dealer.net. Your authorized KTM dealer will be happy to advise you.

11.2 Required work

| | every 24 months | | | | |
|--|-----------------------------|---|---|---|---|
| | every 12 months | | | | |
| | every 30,000 km (18,600 mi) | | | | |
| | every 15,000 km (9,300 mi) | | | | |
| | after 1,000 km (620 mi) | | | | |
| Read out the trouble code memory using the KTM diagnostics tool. 🛠️ | ○ | ● | ● | ● | ● |
| Check that the electrical system is functioning properly. 🛠️ | ○ | ● | ● | ● | ● |
| Change the engine oil and the oil filter, clean the oil screens. 🛠️ (📖 p. 290) | ○ | ● | ● | ● | ● |
| Check the front brake linings. (📖 p. 232) | ○ | ● | ● | ● | ● |
| Check the rear brake linings. (📖 p. 237) | ○ | ● | ● | ● | ● |
| Check the brake discs. (📖 p. 227) | ○ | ● | ● | ● | ● |
| Check the brake lines for damage and leakage. 🛠️ | ○ | ● | ● | ● | ● |
| Change the front brake fluid. 🛠️ | | | | | ● |

| | every 24 months | | | |
|---|-----------------------------|---|---|---|
| | every 12 months | | | |
| | every 30,000 km (18,600 mi) | | | |
| | every 15,000 km (9,300 mi) | | | |
| | after 1,000 km (620 mi) | | | |
| Change the rear brake fluid. 🛠️ | | | | • |
| Change the hydraulic clutch fluid. 🛠️ | | | | • |
| Check the front brake fluid level. (📖 p. 228) | ○ | • | • | • |
| Check the rear brake fluid level. (📖 p. 233) | ○ | • | • | • |
| Check/correct the fluid level of the hydraulic clutch. (📖 p. 195) | | • | • | • |
| Check the shock absorber and fork for leaks. Perform service as needed and depending on how the vehicle is used. 🛠️ | ○ | • | • | • |
| Clean the dust boots of the fork legs. 🛠️ (📖 p. 211) | | • | • | |
| Check steering head bearing play. (📖 p. 197) | ○ | • | • | • |
| Check the tire condition. (📖 p. 252) | ○ | • | • | • |
| Check tire pressure. (📖 p. 255) | ○ | • | • | • |
| Retighten the spokes. 🛠️ | ○ | | | |
| Check the spoke tension. (📖 p. 256) | | • | • | • |
| Check the rim run-out. 🛠️ | ○ | • | • | • |
| Check the chain, rear sprocket, and engine sprocket. (📖 p. 192) | | • | • | • |
| Check the chain tension. (📖 p. 189) | ○ | • | • | • |
| Change the spark plugs (air filter removed). 🛠️ | | | • | |

11 SERVICE SCHEDULE

| | | every 24 months | | | |
|---|---|-----------------------------|---|---|---|
| | | every 12 months | | | |
| | | every 30,000 km (18,600 mi) | | | |
| | | every 15,000 km (9,300 mi) | | | |
| | | after 1,000 km (620 mi) | | | |
| Check the valve clearance (air filter and spark plugs removed). 🛠️ | | | ● | | |
| Change the SAS diaphragm valves. 🛠️ | | | ● | | |
| Check the cables for damage and routing without sharp bends. (fuel tank removed) 🛠️ | | | ● | ● | ● |
| Check the coolant level in the compensating tank. (📖 p. 282) | ○ | ● | ● | ● | ● |
| Change the air filter, clean the air filter box. 🛠️ | | | ● | ● | |
| Check the fuel pressure. 🛠️ | | | ● | ● | ● |
| Check the headlight setting. (📖 p. 278) | ○ | ● | ● | | |
| Check that the radiator fan is functioning properly. 🛠️ | ○ | ● | ● | ● | ● |
| Final check: Check the vehicle is roadworthy and take a test ride. 🛠️ | ○ | ● | ● | ● | ● |
| Read out the error memory after the test ride using the KTM diagnostics tool. 🛠️ | ○ | ● | ● | ● | ● |
| Set the service interval display. 🛠️ | ○ | ● | ● | ● | ● |
| Make a service entry in KTM Dealer.net . 🛠️ | ○ | ● | ● | ● | ● |

- One-time interval
- Periodic interval

11.3 Recommended work

| | every 48 months | | | | |
|--|-----------------------------|---|---|---|---|
| | every 12 months | | | | |
| | every 30,000 km (18,600 mi) | | | | |
| | every 15,000 km (9,300 mi) | | | | |
| | after 1,000 km (620 mi) | | | | |
| Check the frame. 🛠️ | | | | • | |
| Check the link fork. 🛠️ | | | | • | |
| Check/clean the oil nozzle for clutch lubrication. 🛠️ | ○ | • | • | | |
| Check the fork bearing for play. 🛠️ | | • | • | | |
| Check the wheel bearing for play. 🛠️ | | • | • | | |
| Grease all moving parts (e.g., side stand, hand lever, chain, ...) and check for smooth operation. 🛠️ | ○ | • | • | • | • |
| Empty the drainage hoses. 🛠️ | ○ | • | • | • | • |
| Check all hoses (e.g. fuel, cooling, bleeder, drainage, etc.) and sleeves for cracking, leaks, and incorrect routing. 🛠️ | | • | • | • | • |
| Check the tightness of the safety-relevant screws and nuts which are easily accessible. 🛠️ | ○ | • | • | • | • |
| Check the antifreeze. 🛠️ | ○ | • | • | • | |
| Change the coolant. 🛠️ | | | | | • |

- One-time interval
- Periodic interval

12 SUSPENSION SETTING

12.1 Fork/shock absorber



The fork and the shock absorber offer many options of adapting the suspension to the riding style and the payload.

i Info

The recommendations for the suspension setting are shown in table ❶. The table is found on the left inside cover.

These adjustments are guidelines and should always be the basis for a suspension setting. If the guidelines are not adhered to, the riding characteristics could deteriorate, particularly at high speeds.

12.2 Adjusting the compression damping of the fork

i Info

The hydraulic compression damping determines the fork suspension behavior.



- Turn white adjusting screw ① clockwise as far as it will go.



Info

Adjusting screw ① is located at the upper end of the left fork leg. The compression damping is located in left fork leg **COMP** (white adjusting screw). The rebound damping is located in right fork leg **REB** (red adjusting screw).

- Turn counterclockwise by the number of clicks corresponding to the fork type.

Guideline

| Compression damping | |
|---------------------|-----------|
| Comfort | 17 clicks |
| Standard | 12 clicks |
| Sport | 7 clicks |
| Full payload | 7 clicks |



Info

Turn clockwise to increase damping; turn counterclockwise to reduce damping.



12.3 Adjusting the rebound damping of the fork



Info

The hydraulic rebound damping determines the fork suspension behavior.



- Turn red adjusting screw ① clockwise as far as it will go.



Info

Adjusting screw ① is located at the upper end of the right fork leg.

The rebound damping is located in right fork leg **REB** (red adjusting screw). The compression damping is located in left fork leg **COMP** (white adjusting screw).

- Turn counterclockwise by the number of clicks corresponding to the fork type.

Guideline

| Rebound damping | |
|-----------------|-----------|
| Comfort | 17 clicks |
| Standard | 12 clicks |
| Sport | 7 clicks |
| Full payload | 7 clicks |



Info

Turn clockwise to increase damping; turn counterclockwise to reduce damping.



12.4 Adjusting the spring pretension of the fork

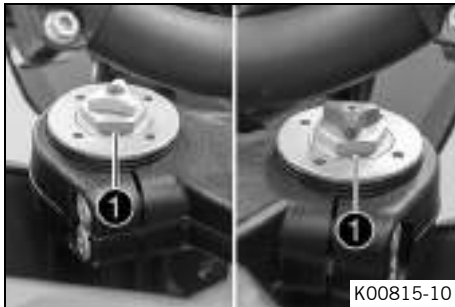

- Turn adjusting screws ① counterclockwise all the way.



Info

Make the same adjustment on both fork legs.

- Turn clockwise by the number of turns corresponding to the fork type.

Guideline

| Spring preload - Preload Adjuster | |
|--|---------|
| Comfort | 2 turns |
| Standard | 5 turns |
| Sport | 5 turns |
| Full payload | 8 turns |



Info

Turn clockwise to increase the spring pretension; turn counterclockwise to reduce the spring preload. Adjusting the spring pretension has no influence on the absorption setting of the rebound damping. Basically, however, you should set the rebound damping higher with a higher spring pretension.

12.5 Compression damping of the shock absorber

The compression damping of the shock absorber is divided into two ranges: high-speed and low-speed. High-speed and low-speed refer to the compression speed of the rear wheel suspension and not to the vehicle speed.

The high-speed compression adjuster, for example, has an effect when riding over an asphalt edge: the rear wheel suspension compresses quickly.

The low-speed compression adjuster has an effect, for example, when riding over long ground swells: the rear wheel suspension compresses slowly.

These two ranges can be adjusted separately, although the transition between high-speed and low-speed is gradual. Thus, modifications in the high-speed range affect the compression damping in the low-speed range and vice versa.

12.6 Adjusting the low-speed compression damping of the shock absorber



Caution

Risk of injury Parts of the shock absorber will move around if the shock absorber is detached incorrectly. The shock absorber is filled with highly compressed nitrogen.

- Please follow the description provided. (Your authorized KTM workshop will be glad to help.)



Info

The low-speed compression adjuster takes effect during slow to normal compression of the shock absorber.



- Turn adjusting screw ① clockwise with a screwdriver as far as the last perceptible click.



Info

Do not loosen fitting ②!

- Turn counterclockwise by the number of clicks corresponding to the shock absorber type.

Guideline

| Low-speed compression damping | |
|-------------------------------|-----------|
| Comfort | 20 clicks |
| Standard | 15 clicks |
| Sport | 10 clicks |
| Full payload | 10 clicks |



Info

Turn clockwise to increase damping; turn counterclockwise to reduce damping.

12.7 Adjusting the high-speed compression damping of the shock absorber



Caution

Risk of injury Parts of the shock absorber will move around if the shock absorber is detached incorrectly. The shock absorber is filled with highly compressed nitrogen.

- Please follow the description provided. (Your authorized KTM workshop will be glad to help.)



Info

The high-speed compression adjuster takes effect during fast compression of the shock absorber.



- Turn adjusting screw **1** all the way clockwise with a socket wrench.

i **Info**
Do not loosen fitting **2**!

- Turn counterclockwise by the number of turns corresponding to the shock absorber type.

Guideline

| High-speed compression damping | |
|--------------------------------|-----------|
| Comfort | 1.5 turns |
| Standard | 1.5 turns |
| Sport | 1 turn |
| Full payload | 1 turn |

i **Info**
Turn clockwise to increase damping; turn counterclockwise to reduce damping.

12.8 Adjusting the rebound damping of the shock absorber



Caution

Risk of injury Parts of the shock absorber will move around if the shock absorber is detached incorrectly. The shock absorber is filled with highly compressed nitrogen.

- Please follow the description provided. (Your authorized KTM workshop will be glad to help.)

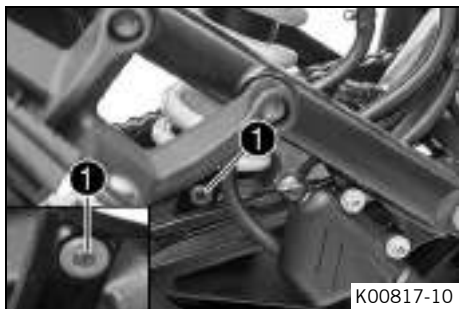

- Turn adjusting screw ❶ clockwise up to the last perceptible click.
- Turn counterclockwise by the number of clicks corresponding to the shock absorber type.

Guideline

| Rebound damping | |
|-----------------|-----------|
| Comfort | 20 clicks |
| Standard | 15 clicks |
| Sport | 10 clicks |
| Full payload | 10 clicks |



Info

Turn clockwise to increase damping; turn counterclockwise to reduce damping.

12.9 Adjusting the spring pretension of the shock absorber



- Turn handwheel ① counterclockwise as far as it will go.
- Turn it clockwise by the number of turns corresponding to the shock absorber type and use.

Guideline

| Spring preload | |
|----------------|----------|
| Comfort | 2 turns |
| Standard | 2 turns |
| Sport | 2 turns |
| Full payload | 18 turns |



Info

Turn clockwise to increase the spring pretension; turn counterclockwise to reduce the spring pretension.



13 SERVICE WORK ON THE CHASSIS

13.1 Raising the vehicle with the center stand

Note

Material damage The vehicle may be damaged by incorrect procedure when parking.

Significant damage may be caused if the vehicle rolls away or falls over.

The components for parking the vehicle are designed only for the weight of the vehicle.

- Park the vehicle on a firm and level surface.
- Ensure that nobody sits on the vehicle when the vehicle is parked on a stand.

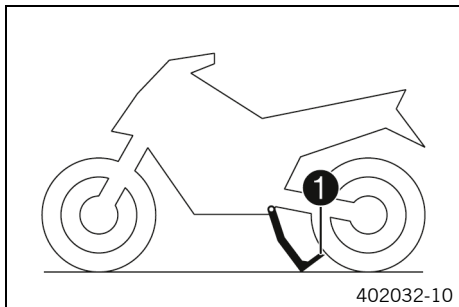

- Stand to the left of the vehicle.
- Hold the handlebar with your left hand and push the center stand onto the ground with your right foot.
- Put your entire weight on arm ① of the center stand while pulling the vehicle up at the left grab handle.
- ✓ The center stand is folded out to the stop.

13.2 Removing the vehicle from the center stand

Note

Danger of damage The parked vehicle can roll away or fall over.

- Park the vehicle on a firm and level surface.

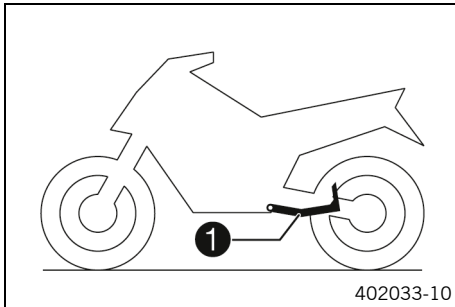

- Make sure that the steering is unlocked.
- Move the vehicle forward with both hands on the handlebar.
- While the vehicle tips off the center stand, actuate the front brake to stop the vehicle from rolling away.
- Check that the center stand ① is folded all the way up.



13 SERVICE WORK ON THE CHASSIS

13.3 Removing the seat

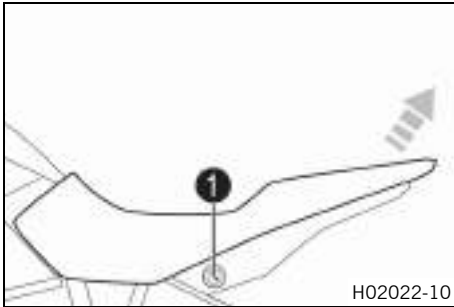

- Insert the Race-on key or the black ignition key into the seat lock **1** and turn clockwise.
- Raise the rear of the seat, pull the seat back, and lift it off.
- Remove the ignition key.

13.4 Mounting the seat

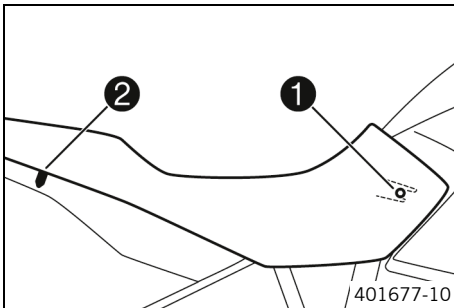

- Hook holding lug **1** of the seat onto the fuel tank, lower the rear and push it forward.
- Insert locking pin **2** into the lock housing and push down the rear of the seat until the locking pin engages with a click.
- Check that the seat is correctly mounted.

13.5 Checking for chain dirt

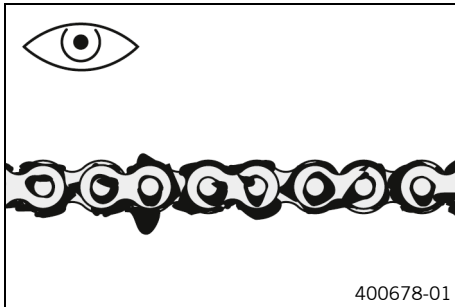

- Check the chain for coarse dirt accumulation.
 - » If the chain is very dirty:
 - Clean the chain. (📖 p. 187)



13.6 Cleaning the chain



Warning

Danger of accidents Lubricants on the tires reduces the road grip.

- Remove lubricants from the tires using a suitable cleaning agent.



Warning

Danger of accidents Oil or grease on the brake discs reduces the braking effect.

- Always keep the brake discs free of oil and grease.
- Clean the brake discs with brake cleaner when necessary.

13 SERVICE WORK ON THE CHASSIS



Note

Environmental hazard Hazardous substances cause environmental damage.

- Dispose of oils, grease, filters, fuel, cleaning agents, brake fluid, etc., correctly and in compliance with the applicable regulations.



Info

The service life of the chain depends largely on its maintenance.

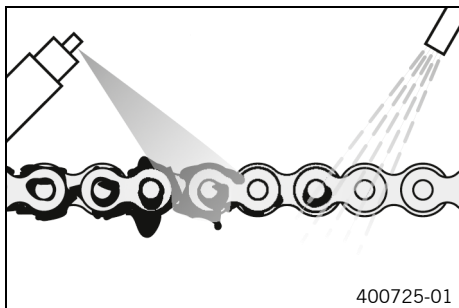

Preparatory work

- Raise the vehicle with the center stand. (📖 p. 184)

Main work

- Rinse off loose dirt with a soft jet of water.
- Remove old grease residue with chain cleaner.

Chain cleaner (📖 p. 340)

- After drying, apply chain spray.

Street chain spray (📖 p. 341)

Finishing work

- Remove the vehicle from the center stand. (📖 p. 185)

13.7 Checking the chain tension



Warning

Danger of accidents Incorrect chain tension damages components and results in accidents.

If the chain is tensioned too much, the chain, engine sprocket, rear sprocket, transmission and rear wheel bearings wear more quickly. Some components may break if overloaded.

If the chain is too loose, the chain may fall off the engine sprocket or the rear sprocket. As a result, the rear wheel locks or the engine will be damaged.

- Check the chain tension regularly.
- Set the chain tension in accordance with the specification.

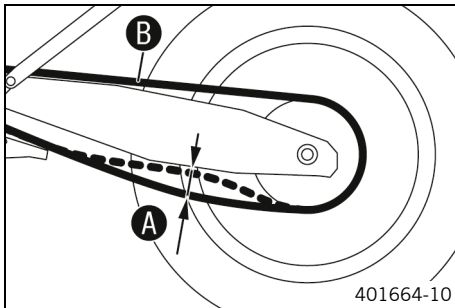

Preparatory work

- Raise the vehicle with the center stand. (📖 p. 184)

Main work

- Shift the transmission into neutral **N**.
- In the area in front of the chain guide, push the chain up and determine the chain tension **A**.



Info

Top chain section **B** must be taut.
Chain wear is not always even, so you should repeat this measurement at different chain positions.

| | |
|---------------|---------------------------------|
| Chain tension | 40 ... 45 mm (1.57 ... 1.77 in) |
|---------------|---------------------------------|

- » If the chain tension does not meet the specification:
 - Adjust the chain tension. (📖 p. 190)

Finishing work

- Remove the vehicle from the center stand. (📖 p. 185)

13.8 Adjusting the chain tension



Warning

Danger of accidents Incorrect chain tension damages components and results in accidents.

If the chain is tensioned too much, the chain, engine sprocket, rear sprocket, transmission and rear wheel bearings wear more quickly. Some components may break if overloaded.

If the chain is too loose, the chain may fall off the engine sprocket or the rear sprocket. As a result, the rear wheel locks or the engine will be damaged.

- Check the chain tension regularly.
- Set the chain tension in accordance with the specification.

Preparatory work

- Raise the vehicle with the center stand. (📖 p. 184)
- Check the chain tension. (📖 p. 189)

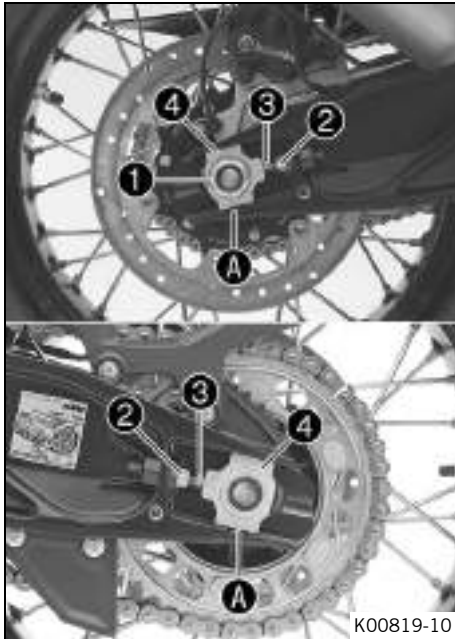

K00819-10

Main work

- Loosen nut ①.
- Loosen nuts ②.
- Adjust the chain tension by turning adjusting screws ③ left and right.

Guideline

| | |
|--|---------------------------------|
| Chain tension | 40 ... 45 mm (1.57 ... 1.77 in) |
| Turn the adjusting screws ③ on the left and right so that the markings on the left and right chain adjusters ④ are in the same position relative to the reference marks A. The rear wheel is then correctly aligned. | |

i Info

The top chain section must be taut.

Chain wear is not always even, so you should check the setting at different chain positions.

- Tighten nuts ②.
- Make sure that chain adjusters ④ are fitted correctly on adjusting screws ③.
- Tighten nut ①.

13 SERVICE WORK ON THE CHASSIS

Guideline

| | | |
|-------------------------|---------|---------------------------------------|
| Nut, rear wheel spindle | M25x1.5 | 90 Nm (66.4 lbf ft) Thread greased |
|-------------------------|---------|---------------------------------------|



Info

Chain adjusters ④ can be turned by 180°.

Finishing work

- Remove the vehicle from the center stand. (📖 p. 185)

13.9 Checking the chain, rear sprocket, and engine sprocket

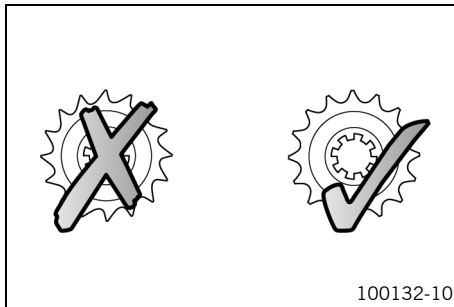

Preparatory work

- Raise the vehicle with the center stand. (📖 p. 184)

Main work

- Check the chain, rear sprocket, and engine sprocket for wear.
 - » If the chain, rear sprocket or engine sprocket is worn:
 - Change the drivetrain kit. 🔧



Info

The engine sprocket, rear sprocket, and chain should always be replaced together.

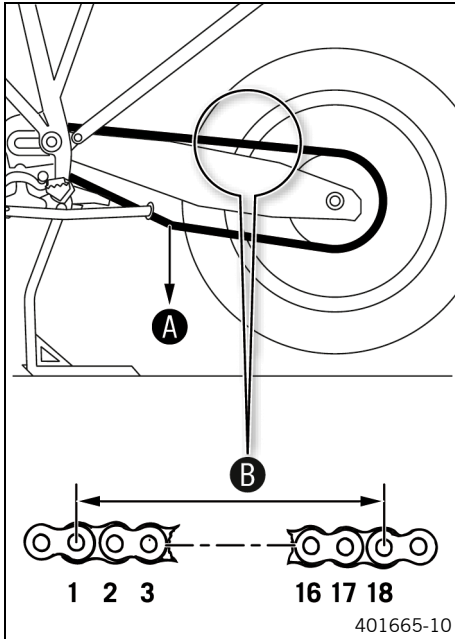

- Shift the transmission into neutral **N**.
- Pull on the lower chain section with the specified weight **A**.

Guideline

| | |
|--------------------------------|----------------|
| Weight, chain wear measurement | 15 kg (33 lb.) |
|--------------------------------|----------------|

- Measure distance **B** of 18 chain rollers in the upper chain section.



Info

Chain wear is not always even, so you should repeat this measurement at different chain positions.

| | |
|--|-------------------|
| Maximum distance B from 18 chain rollers at the longest chain section | 272 mm (10.71 in) |
|--|-------------------|

- » If distance **B** is greater than the specified measurement:
 - Change the drivetrain kit. 🛠️



Info

When a new chain is mounted, the rear sprocket and engine sprocket should also be changed. New chains wear out faster on old, worn sprockets. For safety reasons, the chain has no chain joint.

13 SERVICE WORK ON THE CHASSIS

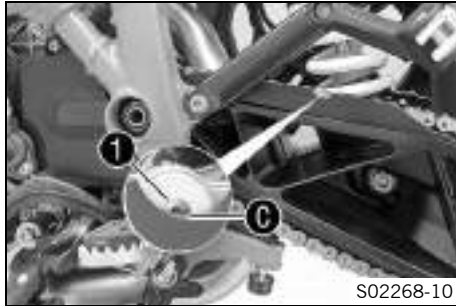

S02268-10

- Check the chain sliding guard for wear at the recess.

i Info

When the chain sliding guard is new, the rivets **1** are half visible at the bottom edge **C** of the recess.

- » When the rivets of the chain are no longer visible at the bottom edge of the recess of the chain sliding guard:
 - Change the chain sliding guard. 🛠️
- Check that the chain sliding guard is firmly seated.
 - » If the chain sliding guard is loose:
 - Tighten the screws on the chain sliding guard.

Guideline

| | | |
|----------------------------|----|-------------------|
| Screw, chain sliding guard | M5 | 5 Nm (3.7 lbf ft) |
|----------------------------|----|-------------------|



401670-01

- Check the chain guide for wear.
 - » If the chain guide is worn:
 - Change the chain guide. 🛠️
- Check that the chain guide is firmly seated.
 - » If the chain guide is loose:
 - Tighten the screws on the chain guide.

Guideline

| | | |
|-----------------------|----|-------------------|
| Screw, chain guide | M6 | 5 Nm (3.7 lbf ft) |
|-----------------------|----|-------------------|

Finishing work

- Remove the vehicle from the center stand. (📖 p. 185)



13.10 Checking/correcting the fluid level of the hydraulic clutch

**Warning**

Skin irritation Brake fluid causes skin irritation.

- Keep brake fluid out of the reach of children.
- Wear suitable protective clothing and safety glasses.
- Do not allow brake fluid to come into contact with the skin, the eyes or clothing.
- Consult a doctor immediately if brake fluid has been swallowed.
- Rinse the affected area with plenty of water in the event of contact with the skin.
- Rinse eyes thoroughly with water immediately and consult a doctor if brake fluid comes into contact with the eyes.
- If brake fluid spills on to your clothing, change the clothing.

13 SERVICE WORK ON THE CHASSIS



Note

Environmental hazard Hazardous substances cause environmental damage.

- Dispose of oils, grease, filters, fuel, cleaning agents, brake fluid, etc., correctly and in compliance with the applicable regulations.



Info

The fluid level rises with increasing wear of the clutch facing discs.

Never use DOT 5 brake fluid. It is silicone-based and purple in color. Oil seals and clutch lines are not designed for DOT 5 brake fluid.

Avoid contact between brake fluid and painted parts. Brake fluid attacks paint.

Only use clean brake fluid from a sealed container.

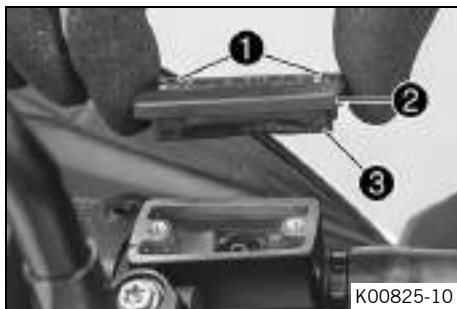

- Move the clutch fluid reservoir mounted on the handlebar to a horizontal position.
- Remove screws ❶.
- Take off cover ❷ with membrane ❸.
- Check the fluid level.

| | |
|---------------------------------|----------------|
| Fluid level below container rim | 4 mm (0.16 in) |
|---------------------------------|----------------|

- » If the fluid level does not meet specifications:
 - Correct the fluid level of the hydraulic clutch.

Brake fluid DOT 4 / DOT 5.1 (📖 p. 336)

- Position the cover with the membrane. Mount and tighten the screws.

**Info**

Clean up overflowed or spilled brake fluid immediately with water.



13.11 Checking steering head bearing play

**Warning**

Danger of accidents Incorrect steering head bearing play impairs the handling characteristic and damages components.

- Correct incorrect steering head bearing play immediately. (Your authorized KTM workshop will be glad to help.)

**Info**

If the vehicle is operated for a lengthy period with play in the steering head bearing, the bearings and the bearing seats in the frame can become damaged over time.

Preparatory work

- Raise the vehicle with the center stand. (📖 p. 184)

13 SERVICE WORK ON THE CHASSIS

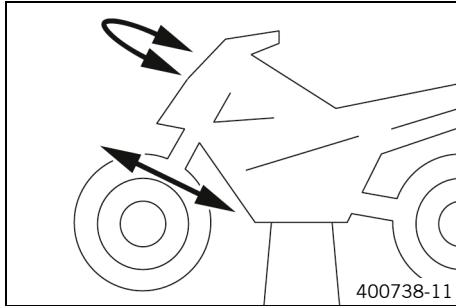

Main work

- Place a load on the rear of the vehicle.
 - ✓ The front wheel is not in contact with the ground.
- Move the handlebar to the straight-ahead position. Move the fork legs back and forth in the direction of travel.

Play should not be detectable on the steering head bearing.

- » If there is detectable play:
 - Adjust steering head bearing play. 🛠️
- Move the handlebar back and forth over the entire steering range.

It must be possible to move the handlebar easily over the entire steering range. There should be no detectable detent positions.

- » If detent positions are detected:
 - Adjust steering head bearing play. 🛠️
 - Check the steering head bearing and adjust if necessary.

Finishing work

- Remove the vehicle from the center stand. (📖 p. 185)

13.12 Removing the bottom triple clamp cover

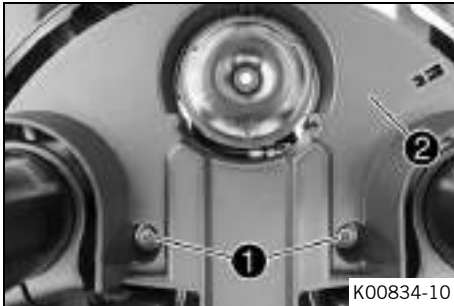

- Remove screws ①.
- Lower triple clamp cover ② slightly.

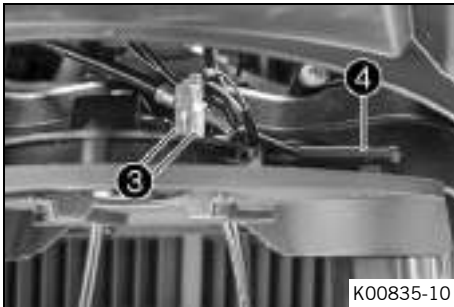

- Disconnect plugs ③ of the horn.
- Detach temperature sensor ④.
- Remove the triple clamp cover.



13 SERVICE WORK ON THE CHASSIS

13.13 Installing the bottom triple clamp cover

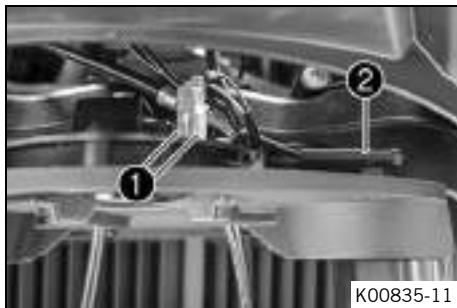

- Plug in connectors **1** of the horn.
- Attach temperature sensor **2**.

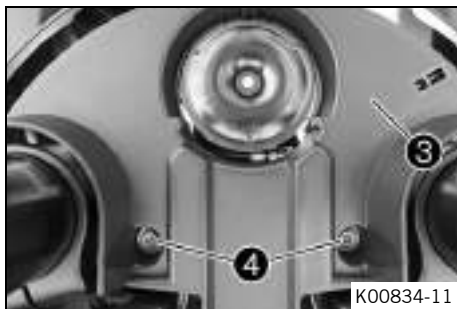

- Position the triple clamp cover **3**.
- Mount and tighten screws **4**.

Guideline

| | | |
|------------------------------|----|--------------------|
| Remaining screws, chassis | M6 | 10 Nm (7.4 lbf ft) |
|------------------------------|----|--------------------|

13.14 Removing the front side cover



- Remove screws ①.
- Remove side cover ②.
- Repeat these steps on the opposite side.



13.15 Installing the front side cover



- Position the side cover in area ① under the fuel tank cover.

13 SERVICE WORK ON THE CHASSIS

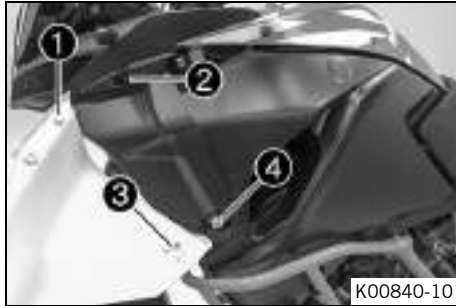

- Attach side cover to bracket ② using holding lug ①.
- Attach side cover to bracket ③ using holding lug ④ and position on the fuel tank.



- Mount and tighten screws ⑤.

Guideline

| | | |
|-------------------|-------|-------------------------|
| Screw, cover part | M5x12 | 3.5 Nm (2.58 lbf ft) |
|-------------------|-------|-------------------------|

- Repeat these steps on the opposite side.

13.16 Removing the mask spoiler ↗

Preparatory work

- Remove the seat. (📖 p. 186)
- Remove the front side cover. (📖 p. 201)
- Remove the fuel tank cover. (📖 p. 213)

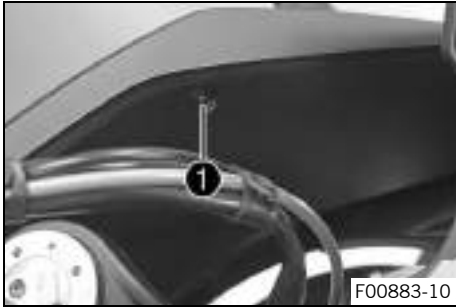

Main work

- Remove screw ①.



- Remove screw ②.

13 SERVICE WORK ON THE CHASSIS

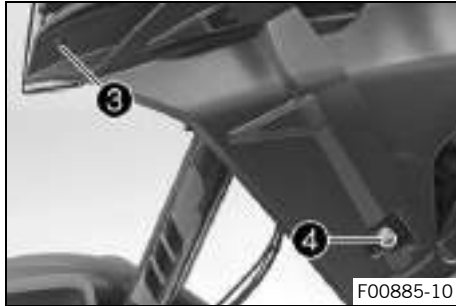

- Remove screw ③.
- Remove screw ④ with the bushing.

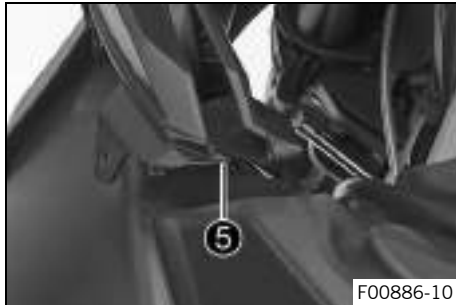

- Loosen holding lug ⑤ from the inside cover.



- Remove the mask spoiler laterally from the supports.



Info

Pay attention to the turn signal cable.



- Disconnect plug-in connector **6**.
- Remove the mask spoiler with the turn signal.
- Repeat these steps on the opposite side.



13 SERVICE WORK ON THE CHASSIS

13.17 Installing the mask spoiler ↘



Main work

- Connect plug-in connector ①.



- Position the mask spoiler and press laterally into the supports.



Info

Ensure that the turn signal cable is placed correctly.



- Position holding lug **2** in the drill hole.

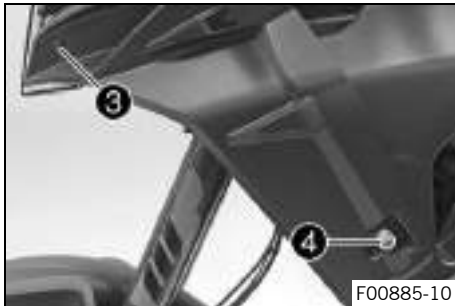

- Mount and tighten screw **3**.

Guideline

| | | |
|---------------------|-------|-------------------------|
| Screw, mask spoiler | M5x12 | 3.5 Nm (2.58 lbf ft) |
|---------------------|-------|-------------------------|

- Mount and tighten screw **4** with the bushing.

Guideline

| | | |
|----------------|----|-----------------|
| Screw, bushing | M6 | 4 Nm (3 lbf ft) |
|----------------|----|-----------------|

13 SERVICE WORK ON THE CHASSIS

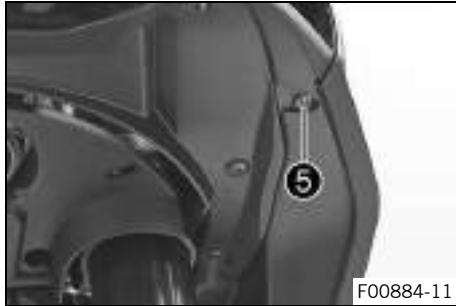

- Mount and tighten screw ⑤.

Guideline

| | | |
|---------------------|-------|-------------------------|
| Screw, mask spoiler | M5x12 | 3.5 Nm (2.58 lbf ft) |
|---------------------|-------|-------------------------|

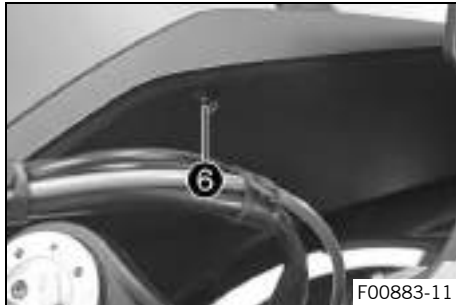

- Mount and tighten screw ⑥.

Guideline

| | | |
|---------------------|-------|-------------------------|
| Screw, mask spoiler | M5x12 | 3.5 Nm (2.58 lbf ft) |
|---------------------|-------|-------------------------|

- Repeat these steps on the opposite side.

Finishing work

- Install the fuel tank cover. (📖 p. 216)
- Install the front side cover. (📖 p. 201)
- Mount the seat. (📖 p. 186)

13.18 Removing front fender

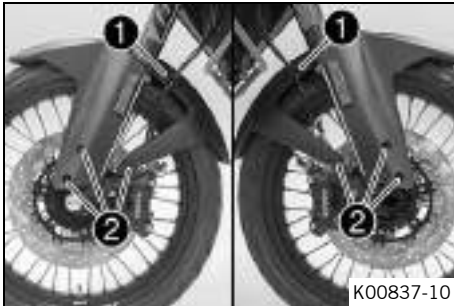

(Super Adventure R EU)

- Open holder ① and detach the brake lines and cable.
- Remove screws ②.
- Take the fender off to the front.



Info

Pay attention to the brake lines and the cable.

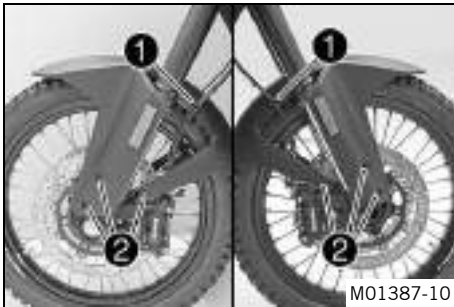

(1290 Super Adventure R TKC EU, 1290 Super Adventure R TKC CN)

- Open holder ① and detach the brake lines and cable.
- Remove screws ②.
- Take the fender off to the front.



Info

Pay attention to the brake lines and the cable.

13 SERVICE WORK ON THE CHASSIS

13.19 Installing front fender

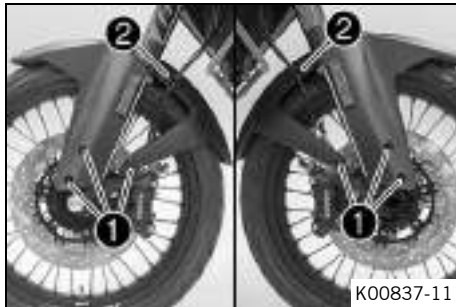

(Super Adventure R EU)

- Position the fender.



Info

Pay attention to the routing of the brake lines and the cable.

- Mount and tighten screws ①.

Guideline

| | | |
|---------------|-------|-------------------------|
| Screw, fender | M5x12 | 3.5 Nm (2.58 lbf ft) |
|---------------|-------|-------------------------|

- Insert the brake lines and cable in brackets ② and close the holder.

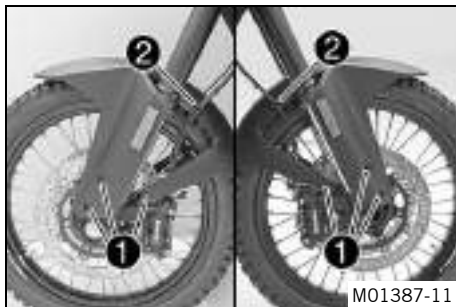

(1290 Super Adventure R TKC EU, 1290 Super Adventure R TKC CN)

- Position the fender.



Info

Pay attention to the routing of the brake lines and the cable.

- Mount and tighten screws ①.

Guideline

| | | |
|---------------|-------|-------------------------|
| Screw, fender | M5x12 | 3.5 Nm (2.58 lbf ft) |
|---------------|-------|-------------------------|

- Insert the brake lines and cable in brackets ② and close the holder.



13.20 Cleaning the dust boots of the fork legs 🛠️

Preparatory work

- Raise the vehicle with the center stand. (📖 p. 184)
- Remove front fender. (📖 p. 209)

Main work

(Super Adventure R EU)

- Push dust boots ① of both fork legs downward.



Info

The dust boots remove dust and coarse dirt particles from the inside fork tubes. Over time, dirt can accumulate behind the dust boots. If this dirt is not removed, the oil seals behind can start to leak.

13 SERVICE WORK ON THE CHASSIS



Warning

Danger of accidents Oil or grease on the brake discs reduces the braking effect.

- Always keep the brake discs free of oil and grease.
- Clean the brake discs with brake cleaner when necessary.

- Clean and oil the dust boots and inner fork tubes of both fork legs.

Universal oil spray (📖 p. 341)

- Press dust boots ❶ back into their installation position.
- Remove excess oil.

(1290 Super Adventure R TKC EU, 1290 Super Adventure R TKC CN)

- Push dust boots ❶ of both fork legs downward.



Info

The dust boots remove dust and coarse dirt particles from the inside fork tubes. Over time, dirt can accumulate behind the dust boots. If this dirt is not removed, the oil seals behind can start to leak.

**Warning**

Danger of accidents Oil or grease on the brake discs reduces the braking effect.

- Always keep the brake discs free of oil and grease.
- Clean the brake discs with brake cleaner when necessary.

- Clean and oil the dust boots and inner fork tubes of both fork legs.

Universal oil spray (📖 p. 341)

- Press dust boots **1** back into their installation position.
- Remove excess oil.

Finishing work

- Install front fender. (📖 p. 210)
- Remove the vehicle from the center stand. (📖 p. 185)

**13.21 Removing the fuel tank cover****Preparatory work**

- Remove the seat. (📖 p. 186)
- Remove the front side cover. (📖 p. 201)

13 SERVICE WORK ON THE CHASSIS

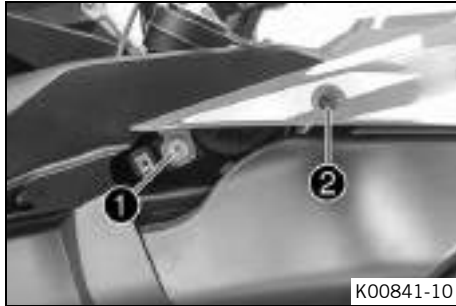

Main work

- Remove screw ①.
- Remove screw ②.

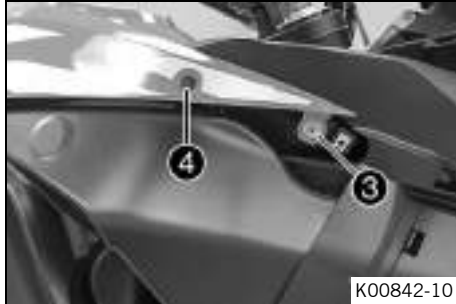

- Remove screw ③.
- Remove screw ④.

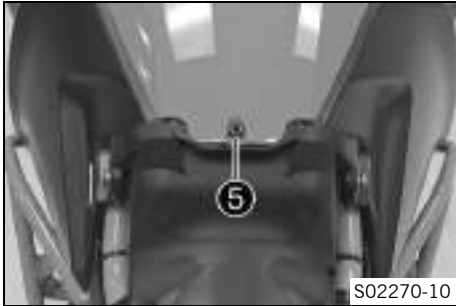

- Remove screw ⑤.



- Raise the fuel tank cover at the rear and take it off in a forward direction.



13 SERVICE WORK ON THE CHASSIS

13.22 Installing the fuel tank cover

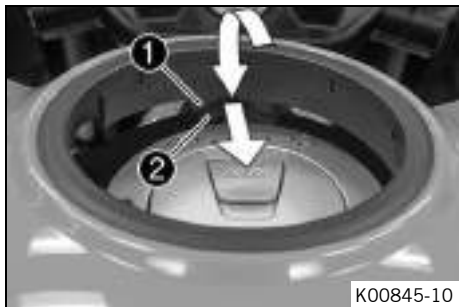

Main work

- Position the fuel tank cover.
- ✓ Holding lug ① engages under the fuel tank ②.



Info

Pay attention to the sealing lip and the bleeder hose.

- Mount and tighten screw ③.

Guideline

| | | |
|-------------------|-------|-------------------------|
| Screw, cover part | M5x12 | 3.5 Nm (2.58 lbf ft) |
|-------------------|-------|-------------------------|

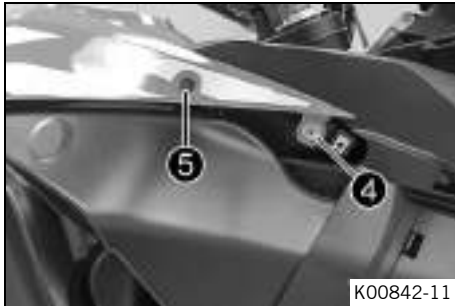

- Mount and tighten screw ④.

Guideline

| | | |
|-------------------|----|-------------------|
| Screw, cover part | M6 | 6 Nm (4.4 lbf ft) |
|-------------------|----|-------------------|

- Mount and tighten screw ⑤.

Guideline

| | | |
|-------------------|-------|-------------------------|
| Screw, cover part | M5x12 | 3.5 Nm (2.58 lbf ft) |
|-------------------|-------|-------------------------|

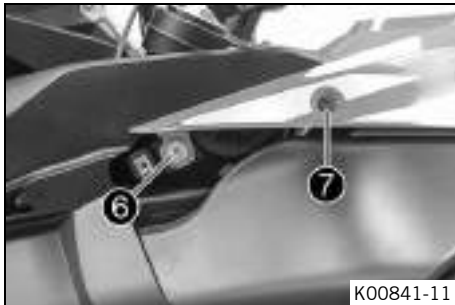

- Mount and tighten screw ⑥.

Guideline

| | | |
|-------------------|----|-------------------|
| Screw, cover part | M6 | 6 Nm (4.4 lbf ft) |
|-------------------|----|-------------------|

- Mount and tighten screw ⑦.

Guideline

| | | |
|-------------------|-------|-------------------------|
| Screw, cover part | M5x12 | 3.5 Nm (2.58 lbf ft) |
|-------------------|-------|-------------------------|

Finishing work

- Install the front side cover. (📖 p. 201)
- Mount the seat. (📖 p. 186)



13 SERVICE WORK ON THE CHASSIS

13.23 Removing the windshield

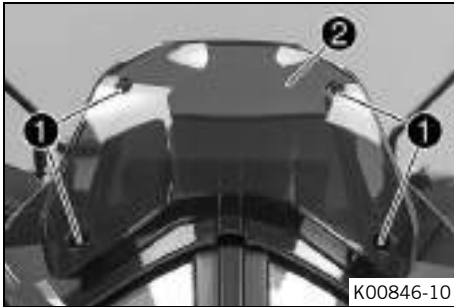

- Remove screws ① with rubber bushing and windshield ②.

13.24 Installing the windshield

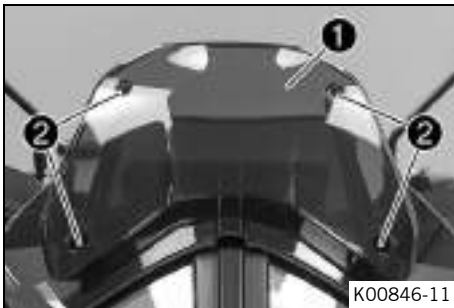

- Position windshield ①.
- Mount and tighten screws ② with the rubber bushings.

Guideline

| | | |
|--------------------|----|-------------------------|
| Screw, wind shield | M5 | 3.5 Nm (2.58 lbf ft) |
|--------------------|----|-------------------------|

13.25 Removing the engine guard

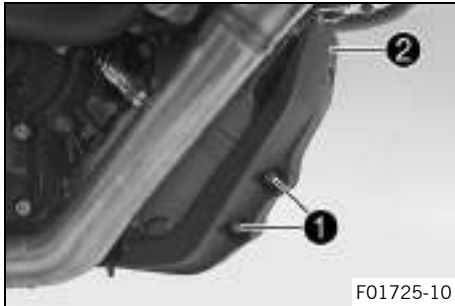

- Remove screws **1** with bushings and engine guard **2**.

13.26 Installing the engine guard

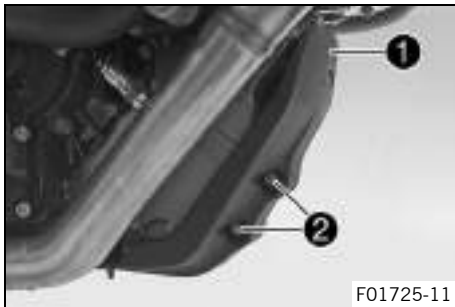

- Position engine guard **1**, mount screws **2** with bushings and tighten.

Guideline

| | | |
|---------------------|----|--------------------|
| Screw, engine guard | M6 | 10 Nm (7.4 lbf ft) |
|---------------------|----|--------------------|

13 SERVICE WORK ON THE CHASSIS

13.27 Removing the crash bar ↴

Preparatory work

- Raise the vehicle with the center stand. (📖 p. 184)

Main work

- Remove fittings ❶.

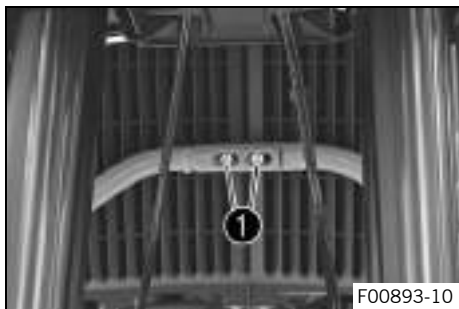

- Remove screws ❷ and take off the clamp halves.
- Remove screw ❸.
- Remove screw ❹ and take off right crash bar.

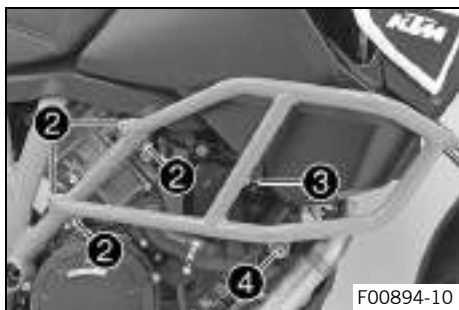

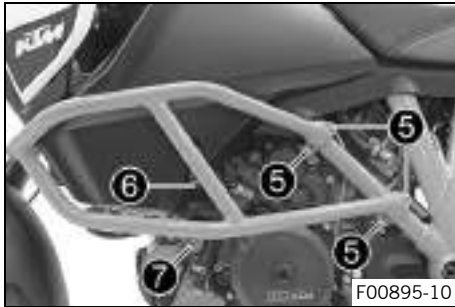

- Remove screws **5** and take off the clamp halves.
- Remove screw **6**.
- Remove screw **7** and take off left crash bar.

13.28 Installing the crash bar

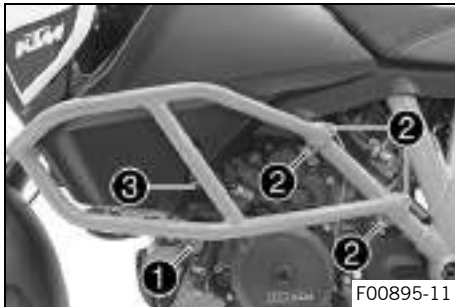

- Position the left crash bar with frame protector and attach the clamp to the frame tube.



Info

Cover the components to protect them against damage.

- Mount screw **1** but do not tighten yet.

Guideline

| | | |
|---------------------------|-----|---------------------|
| Remaining screws, chassis | M10 | 45 Nm (33.2 lbf ft) |
|---------------------------|-----|---------------------|

- Mount screws **2** but do not tighten yet.

13 SERVICE WORK ON THE CHASSIS

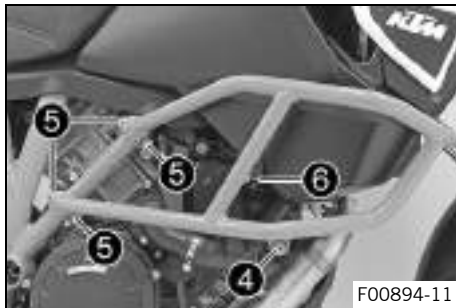

Guideline

| | | |
|---------------------------|----|--------------------|
| Remaining screws, chassis | M6 | 10 Nm (7.4 lbf ft) |
|---------------------------|----|--------------------|

- Mount screw ③ but do not tighten yet.

Guideline

| | | |
|---------------------------|----|--------------------|
| Remaining screws, chassis | M6 | 10 Nm (7.4 lbf ft) |
|---------------------------|----|--------------------|

- Position the right crash bar with frame protector and attach the clamp to the frame tube.



Info

Cover the components to protect them against damage.

- Mount screw ④ but do not tighten yet.

Guideline

| | | |
|---------------------------|-----|---------------------|
| Remaining screws, chassis | M10 | 45 Nm (33.2 lbf ft) |
|---------------------------|-----|---------------------|

- Mount screws ⑤ but do not tighten yet.

Guideline

| | | |
|---------------------------|----|--------------------|
| Remaining screws, chassis | M6 | 10 Nm (7.4 lbf ft) |
|---------------------------|----|--------------------|

- Mount screw ⑥ but do not tighten yet.

Guideline

| | | |
|---------------------------|----|--------------------|
| Remaining screws, chassis | M6 | 10 Nm (7.4 lbf ft) |
|---------------------------|----|--------------------|

- Mount and tighten fittings ⑦.

Guideline

| | | |
|---------------------------|----|--------------------|
| Remaining screws, chassis | M6 | 10 Nm (7.4 lbf ft) |
|---------------------------|----|--------------------|

✓ The crash bars are equally aligned with each other.

- Tighten all the screws of the crash bar.

Guideline

| | | |
|---------------------------|-----|---------------------|
| Remaining screws, chassis | M6 | 10 Nm (7.4 lbf ft) |
| Remaining screws, chassis | M10 | 45 Nm (33.2 lbf ft) |

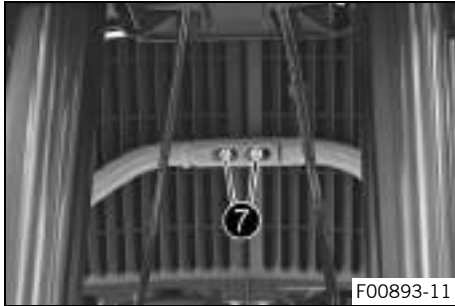

14.1 Anti-lock braking system (ABS)

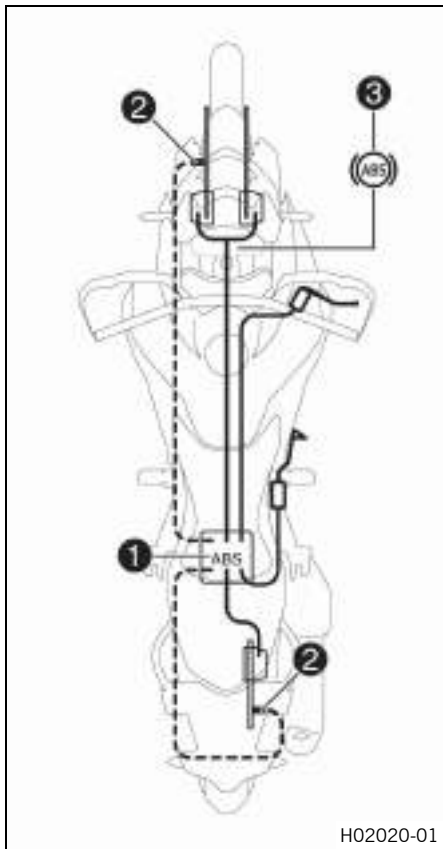

The ABS module **1**, consisting of a hydraulic unit, an ABS control unit, and a return pump, is located under the seat. One wheel speed sensor **2** is located in each case on the front and the rear wheel.



Warning

Danger of accidents Changes to the vehicle impair the function of the ABS.

- Only allow the rear wheel to spin with the front brake applied away from public road traffic if the ABS is switched off.
- Do not make any changes to the suspension travel.
- Only use spare parts on the brake system which have been approved and recommended by KTM.
- Only use tires/wheels approved by KTM with the corresponding speed index.
- Maintain specified tire pressure.
- Ensure that service work and repairs are performed professionally. (Your authorized KTM workshop will be glad to help.)

ABS is a safety system that prevents locking of the wheels when driving straight ahead without the influence of lateral forces.

**Warning**

Danger of accidents Driving aids can only prevent a rollover within the physical limitations.

It is not always possible to compensate for extreme riding situations, for example with luggage loaded with a high center of gravity, varying road surfaces, steep descents or full braking without disengaging the gear.

- Adapt your riding style to the road conditions and your driving ability.

ABS has two operating modes: the **Road** and **Offroad** ABS modes. In the **Road** ABS mode, the brakes are also applied to the rear wheel when the front brake is applied. ABS can intervene on both wheels.

In the **Offroad** ABS mode, the front brake slows the front wheel. The rear brake slows the rear wheel. There is no ABS intervention on the rear wheel. The ABS warning lamp  flashes slowly to remind you that the **Offroad** ABS mode is enabled.

**Info**

In the **Offroad** ABS mode, the rear wheel may lock and there is a risk of falling.

The ABS operates with two independent brake circuits (front and rear brakes). When the ABS control unit detects a locking ten-

dency in a wheel, ABS begins regulating the brake pressure. The control function causes a slight pulsing of the hand and foot brake levers.

The ABS warning lamp **3** must light up after the ignition is switched on and go out after starting off. If it does not go out after starting off or if it is lit while riding, this indicates a fault in the ABS. In this case, the ABS is no longer enabled and the wheels may lock during braking. The brake system itself stays functional; only ABS control is not available.

The ABS warning lamp may also light up if the rotating speeds of the front and rear wheels differ greatly under extreme riding conditions, for example when making "wheelies" or if the rear wheel spins. This causes the ABS to switch off.

To reactivate the ABS, stop the vehicle and switch off the ignition. The ABS is reactivated when the vehicle is switched on again. The ABS warning lamp goes out after starting off.

MSC

The **MSC** is a supplementary function for the ABS that can prevent blocking and slipping of the wheels during braking when the vehicle is inclined (riding in curves) within the physical limitations. By means of the 5-D sensor, the ABS control is now dependent on the inclination and pitch angle.

ABS control that is dependent on the inclination and pitch angle improves the riding stability and braking effect in all riding situations. The **MSC** also reduces the righting moment during hard braking in curves. This prevents the motorcycle from righting itself from an inclined angle and moving along a larger curve radius.

Due to the additional electronic control of the brake force distribution between the two wheels, the braking force is optimally distributed and the motorcycle is additionally stabilized.



Info

The **MSC** is only active in **Road** ABS mode.

14.2 Checking the brake discs



Warning

Danger of accidents Worn-out brake discs reduce the braking effect.

- Make sure that worn-out brake discs are replaced immediately. (Your authorized KTM workshop will be glad to help.)

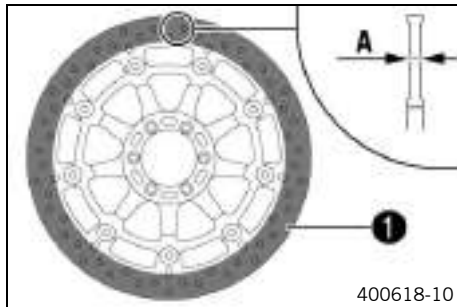

- Check the front and rear brake disc thickness at multiple points for the dimension **A**.



Info

Wear will reduce the thickness of the brake disc at contact surface **1** of the brake linings.

| Brake discs - wear limit | |
|--------------------------|-------------------|
| front | 4 mm (0.16 in) |
| rear | 4.5 mm (0.177 in) |

- » If the brake disc thickness is less than the specified value.
 - Change the front brake discs. 🛠️
 - Change the rear brake disc. 🛠️
- Check the front and rear brake discs for damage, cracking, and deformation.
 - » If the brake disc exhibits damage, cracking, or deformation:
 - Change the front brake discs. 🛠️
 - Change the rear brake disc. 🛠️

14.3 Checking the front brake fluid level



Warning

Danger of accidents An insufficient brake fluid level will cause the brake system to fail.

If the brake fluid level drops below the **MIN** marking, the brake system is leaking or the brake linings are worn down.

- Check the brake system and do not continue riding until the problem is eliminated. (Your authorized KTM workshop will be glad to help.)



Warning

Danger of accidents Old brake fluid reduces the braking effect.

- Make sure that brake fluid for the front and rear brake is changed in accordance with the service schedule. (Your authorized KTM workshop will be glad to help.)

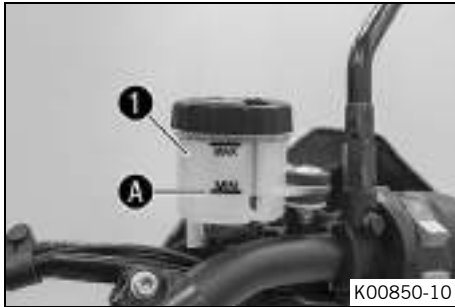

- Move the brake reservoir mounted on the handlebar to a horizontal position.
- Check the brake fluid level in brake fluid reservoir ①.
 - » If the brake fluid level has dropped below **MIN** marking A:
 - Add front brake fluid. 🛠️ (📖 p. 229)



14.4 Adding front brake fluid 🛠️



Warning

Danger of accidents An insufficient brake fluid level will cause the brake system to fail.

If the brake fluid level drops below the **MIN** marking, the brake system is leaking or the brake linings are worn down.

- Check the brake system and do not continue riding until the problem is eliminated. (Your authorized KTM workshop will be glad to help.)



Warning

Skin irritation Brake fluid causes skin irritation.

- Keep brake fluid out of the reach of children.
- Wear suitable protective clothing and safety glasses.
- Do not allow brake fluid to come into contact with the skin, the eyes or clothing.
- Consult a doctor immediately if brake fluid has been swallowed.
- Rinse the affected area with plenty of water in the event of contact with the skin.
- Rinse eyes thoroughly with water immediately and consult a doctor if brake fluid comes into contact with the eyes.
- If brake fluid spills on to your clothing, change the clothing.



Warning

Danger of accidents Old brake fluid reduces the braking effect.

- Make sure that brake fluid for the front and rear brake is changed in accordance with the service schedule. (Your authorized KTM workshop will be glad to help.)



Note

Environmental hazard Hazardous substances cause environmental damage.

- Dispose of oils, grease, filters, fuel, cleaning agents, brake fluid, etc., correctly and in compliance with the applicable regulations.

**Info**

Never use DOT 5 brake fluid. It is silicone-based and purple in color. Oil seals and brake lines are not designed for DOT 5 brake fluid.

Avoid contact between brake fluid and painted parts. Brake fluid attacks paint.

Only use clean brake fluid from a sealed container.

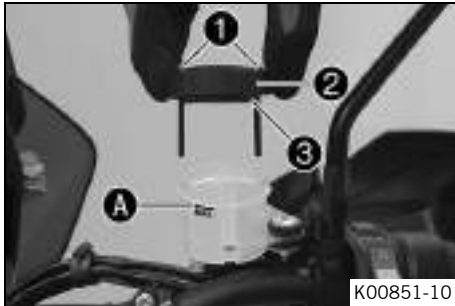
**Preparatory work**

- Check the front brake linings. (📖 p. 232)

Main work

- Move the brake reservoir mounted on the handlebar to a horizontal position.
- Remove screws ❶.
- Take off cover ❷ with membrane ❸.
- Add brake fluid up to **MAX** marking ❸.

Brake fluid DOT 4 / DOT 5.1 (📖 p. 336)

- Position cover ❷ with membrane ❸.
- Mount and tighten screws ❶.

**Info**

Clean up overflowed or spilled brake fluid immediately with water.

14.5 Checking the front brake linings



Warning

Danger of accidents Worn-out brake linings reduce the braking effect.

- Ensure that worn-out brake linings are replaced immediately. (Your authorized KTM workshop will be glad to help.)



Warning

Danger of accidents Damaged brake discs reduce the braking effect.

If the brake linings are not changed in time, the brake lining carriers grind against the brake disc. As a consequence, the braking effect is greatly reduced and the brake discs are destroyed.

- Check the brake linings regularly.

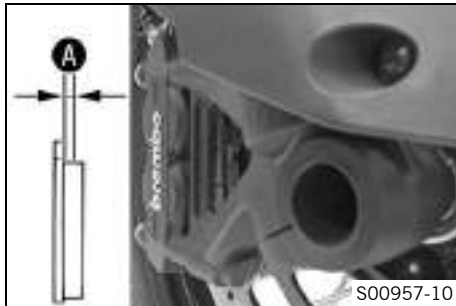

- Check all brake linings on both brake calipers to ensure they have the minimum thickness **A**.

| | |
|----------------------------|---|
| Minimum thickness A | $\geq 1 \text{ mm } (\geq 0.04 \text{ in})$ |
|----------------------------|---|

- » If the minimum thickness is less than specified:
 - Change the front brake linings. 🛠️
- Check all brake linings on both brake calipers for damage and cracking.
 - » If there is damage or cracking:
 - Change the front brake linings. 🛠️

14.6 Checking the rear brake fluid level



Warning

Danger of accidents An insufficient brake fluid level will cause the brake system to fail.

If the brake fluid level drops below the **MIN** marking, the brake system is leaking or the brake linings are worn down.

- Check the brake system and do not continue riding until the problem is eliminated. (Your authorized KTM workshop will be glad to help.)



Warning

Danger of accidents Old brake fluid reduces the braking effect.

- Make sure that brake fluid for the front and rear brake is changed in accordance with the service schedule. (Your authorized KTM workshop will be glad to help.)

Preparatory work

- Raise the vehicle with the center stand. (📖 p. 184)

14 BRAKE SYSTEM

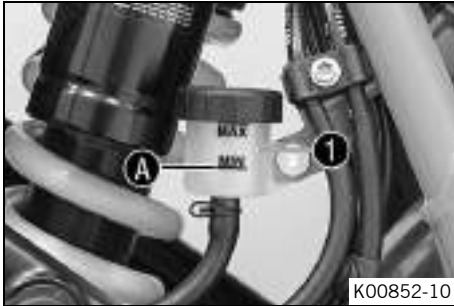

Main work

- Check the brake fluid level in brake fluid reservoir ①.
 - » If the fluid level reaches the **MIN** marking A:
 - Add rear brake fluid. 🛠️ 📖 p. 234

14.7 Adding rear brake fluid 🛠️



Warning

Danger of accidents An insufficient brake fluid level will cause the brake system to fail.

If the brake fluid level drops below the **MIN** marking, the brake system is leaking or the brake linings are worn down.

- Check the brake system and do not continue riding until the problem is eliminated. (Your authorized KTM workshop will be glad to help.)

**Warning**

Skin irritation Brake fluid causes skin irritation.

- Keep brake fluid out of the reach of children.
- Wear suitable protective clothing and safety glasses.
- Do not allow brake fluid to come into contact with the skin, the eyes or clothing.
- Consult a doctor immediately if brake fluid has been swallowed.
- Rinse the affected area with plenty of water in the event of contact with the skin.
- Rinse eyes thoroughly with water immediately and consult a doctor if brake fluid comes into contact with the eyes.
- If brake fluid spills on to your clothing, change the clothing.

**Warning**

Danger of accidents Old brake fluid reduces the braking effect.

- Make sure that brake fluid for the front and rear brake is changed in accordance with the service schedule. (Your authorized KTM workshop will be glad to help.)

**Note**

Environmental hazard Hazardous substances cause environmental damage.

- Dispose of oils, grease, filters, fuel, cleaning agents, brake fluid, etc., correctly and in compliance with the applicable regulations.
-

i Info

Never use DOT 5 brake fluid. It is silicone-based and purple in color. Oil seals and brake lines are not designed for DOT 5 brake fluid.

Avoid contact between brake fluid and painted parts. Brake fluid attacks paint.

Only use clean brake fluid from a sealed container.

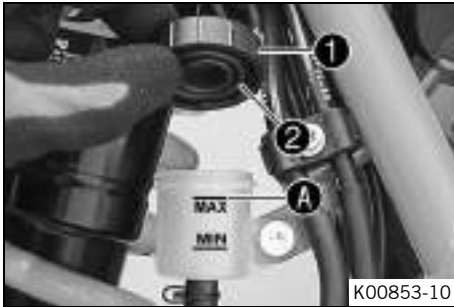

Preparatory work

- Raise the vehicle with the center stand. (📖 p. 184)
- Check the rear brake linings. (📖 p. 237)

Main work

- Remove screw cap ① with membrane ②.
- Add brake fluid up to **MAX** marking **A**.

Brake fluid DOT 4 / DOT 5.1 (📖 p. 336)

- Mount and tighten screw cap ① with membrane ②.

i Info

Clean up overflowed or spilled brake fluid immediately with water.

14.8 Checking the rear brake linings



Warning

Danger of accidents Worn-out brake linings reduce the braking effect.

- Ensure that worn-out brake linings are replaced immediately. (Your authorized KTM workshop will be glad to help.)



Warning

Danger of accidents Damaged brake discs reduce the braking effect.

If the brake linings are not changed in time, the brake lining carriers grind against the brake disc. As a consequence, the braking effect is greatly reduced and the brake discs are destroyed.

- Check the brake linings regularly.

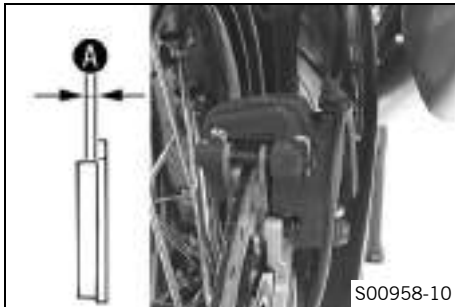

- Check the brake linings for minimum thickness **A**.

| | |
|----------------------------|---|
| Minimum thickness A | $\geq 1 \text{ mm } (\geq 0.04 \text{ in})$ |
|----------------------------|---|

- » If the minimum thickness is less than specified:
 - Change the rear brake linings. 🛠️
- Check the brake linings for damage and cracking.
 - » If there is wear or tearing:
 - Change the rear brake linings. 🛠️

15.1 Removing the front wheel ↘

Preparatory work

- Raise the vehicle with the center stand. (📖 p. 184)

Main work

- Place a load on the rear of the vehicle.
 - ✓ The front wheel is not in contact with the ground.
- Remove screw ❶ and pull wheel speed sensor ❷ out of the hole.

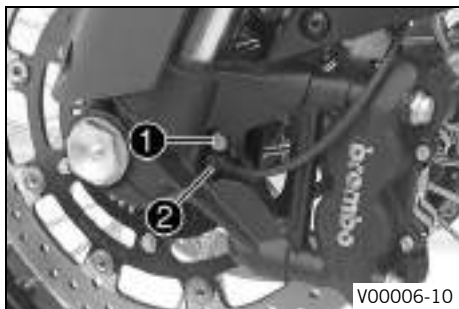

- Remove screws ❸ from both brake calipers.
- Press back the brake linings by slightly tilting the brake calipers laterally on the brake disc.
- Pull the brake calipers carefully back from the brake discs and hang to the side loosely.

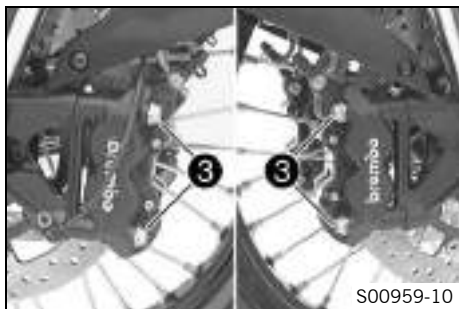

Info

Do not operate the hand brake lever if the brake calipers have been removed.

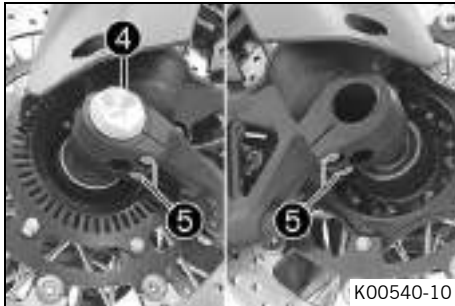

- Loosen screw ④ by several rotations.
- Loosen screws ⑤.
- Press on screw ④ to push the wheel spindle out of the axle clamp.
- Remove screw ④.



Warning

Danger of accidents Damaged brake discs reduce the braking effect.

- Always lay the wheel down in such a way that the brake discs are not damaged.

- Hold the front wheel and remove the wheel spindle. Take the front wheel out of the fork.



Info

Do not actuate the hand brake lever when the front wheel is removed.

15 WHEELS, TIRES

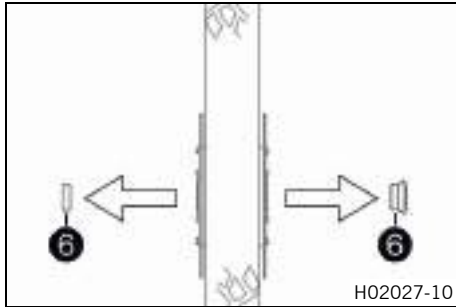

- Remove spacers ⑥.

15.2 Installing the front wheel ↩



Warning

Danger of accidents Oil or grease on the brake discs reduces the braking effect.

- Always keep the brake discs free of oil and grease.
- Clean the brake discs with brake cleaner when necessary.

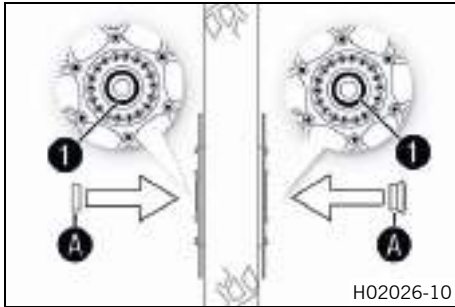

- Check the wheel bearing for damage and wear.
 - » If the wheel bearing is damaged or worn:
 - Change front wheel bearing. 🛠️
- Clean and grease shaft seal rings **1** and contact surfaces **A** of the spacers.

Long-life grease (📖 p. 340)

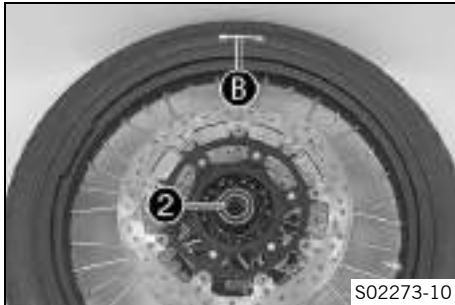

(Super Adventure R EU)

- Insert narrow spacer **2** on the right in the direction of travel.



Info

Arrow **B** indicates the direction of travel of the front wheel.

The wheel speed sensor wheel is on the left viewed in the direction of travel.

- Insert the wide spacer on the left in the direction of travel.

15 WHEELS, TIRES

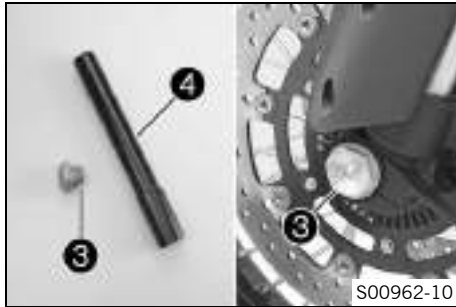
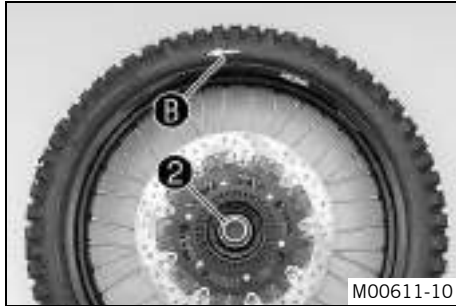

(1290 Super Adventure R TKC EU, 1290 Super Adventure R TKC CN)

- Insert wide spacer **2** on the left in the direction of travel.

i Info

Arrow **B** indicates the direction of travel of the front wheel.

The wheel speed sensor wheel is on the left viewed in the direction of travel.

- Insert the narrow spacer on the right in the direction of travel.



Warning

Danger of accidents Oil or grease on the brake discs reduces the braking effect.

- Always keep the brake discs free of oil and grease.
- Clean the brake discs with brake cleaner when necessary.

- Clean and grease screw **3** and wheel spindle **4**.

Long-life grease (📖 p. 340)

- Jack up the front wheel into the fork, position it, and insert the wheel spindle.
- Mount and tighten screw **3**.

Guideline

| | | |
|----------------------------|---------|---------------------------------------|
| Screw, front wheel spindle | M25x1.5 | 45 Nm (33.2 lbf ft) Thread greased |
|----------------------------|---------|---------------------------------------|

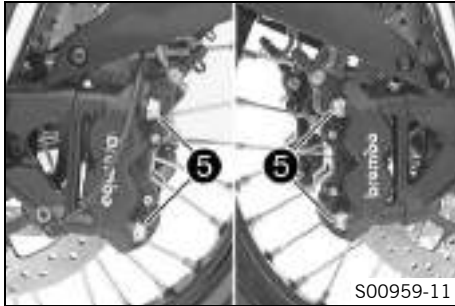

- Position brake calipers.
 - ✓ The brake linings are correctly positioned.
- Mount screws ⑤ on both brake calipers, but do not tighten yet.
- Operate the hand brake lever repeatedly until the brake linings are in contact with the brake disc and there is a pressure point. Secure the hand brake lever in the activated position.
 - ✓ The brake calipers straighten.
- Tighten screws ⑤ on both brake calipers.

Guideline

| | | |
|----------------------------|-----|--|
| Screw, front brake caliper | M10 | 45 Nm (33.2 lbf ft) Loctite®243™ |
|----------------------------|-----|--|

- Remove locking piece of the hand brake lever.

15 WHEELS, TIRES

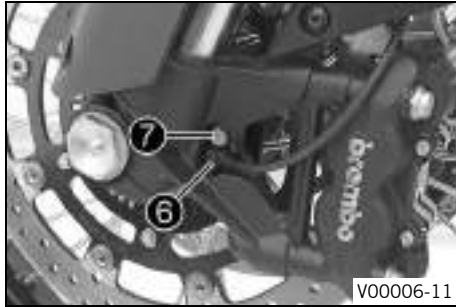

- Position wheel speed sensor **6** in the hole.
- Mount and tighten screw **7**.

Guideline

| | | |
|---------------------------|----|--------------------|
| Remaining screws, chassis | M6 | 10 Nm (7.4 lbf ft) |
|---------------------------|----|--------------------|

- Remove the vehicle from the center stand. (📖 p. 185)



- Operate the front brake and compress the fork a few times firmly.

✓ The fork legs straighten.

- Tighten screws **8**.

Guideline

| | | |
|------------------|----|---------------------|
| Screw, fork stub | M8 | 15 Nm (11.1 lbf ft) |
|------------------|----|---------------------|

15.3 Removing the rear wheel 🛠️

Preparatory work

- Raise the vehicle with the center stand. (📖 p. 184)

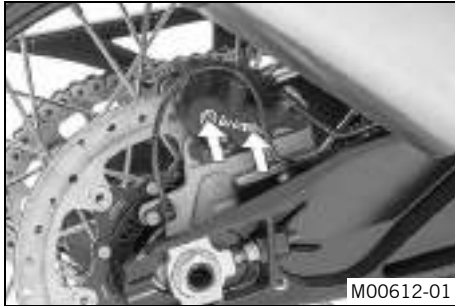

Main work

- Manually press the brake caliper toward the brake disc to push back the brake pistons.

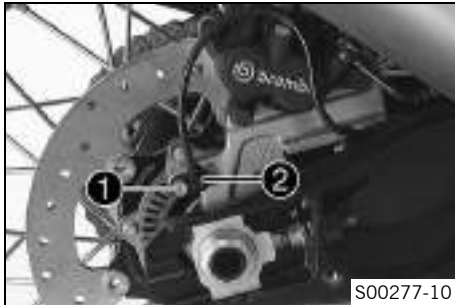

- Remove screw ① and pull wheel speed sensor ② out of the hole.

15 WHEELS, TIRES

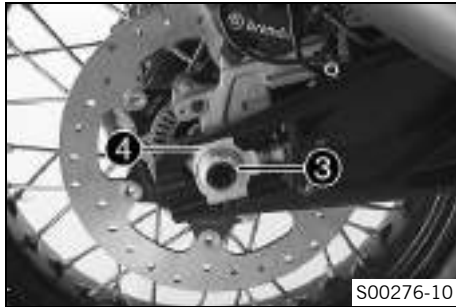

- Remove nut ③. Take off chain adjuster ④.

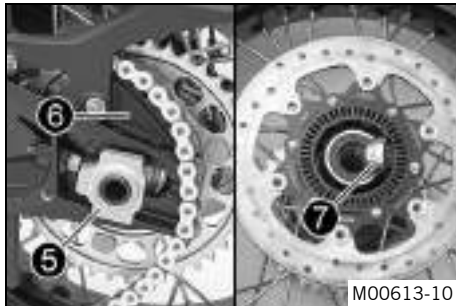

- Pull out wheel spindle ⑤ far enough to allow the rear wheel to be pushed forward.
- Push the rear wheel forward as far as possible. Take the chain off the rear sprocket and place it on chain sprocket guard ⑥.



Warning

Danger of accidents Damaged brake discs reduce the braking effect.

- Always lay the wheel down in such a way that the brake disc is not damaged.

- Hold the rear wheel and remove the wheel spindle. Take the rear wheel out of the link fork.

**Info**

Do not operate the foot brake when the rear wheel is removed.

- Remove spacer .



15.4 Installing the rear wheel

**Warning**

Danger of accidents Oil or grease on the brake discs reduces the braking effect.

- Always keep the brake discs free of oil and grease.
- Clean the brake discs with brake cleaner when necessary.

**Warning**

Danger of accidents There is no braking effect to start with at the rear brake after installing the rear wheel.

- Actuate the foot brake several times before going on a ride until you can feel a firm pressure point.

- Check the rear hub damping rubber pieces.   p. 250

15 WHEELS, TIRES

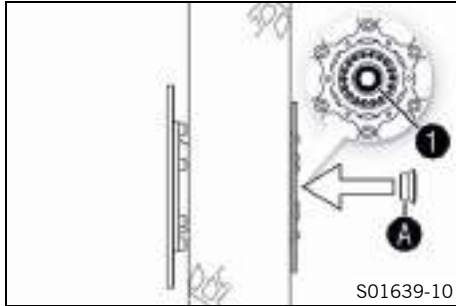

- Check the wheel bearing for damage and wear.
 - » If the wheel bearing is damaged or worn:
 - Change the rear wheel bearing. 🛠️
- Clean and grease shaft seal ring **1** and contact surface **A** of the spacer.

Long-life grease (📖 p. 340)

- Insert a spacer.
- Clean and grease the thread of the wheel spindle and nut.

Long-life grease (📖 p. 340)

- Mount the damping rubber pieces and rear sprocket carrier on the rear wheel.
- Place the rear wheel in the link fork and engage the brake disc in the brake caliper.
- Mount wheel spindle **2**, but do not push it in all the way.
- Push the rear wheel forward as far as possible and lay the chain on the rear sprocket.

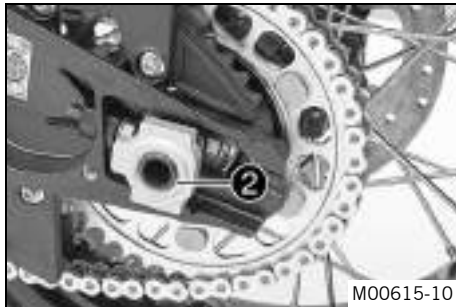

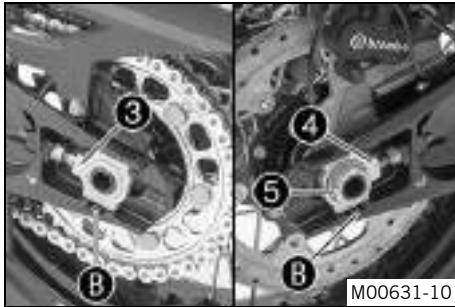

- Push wheel spindle in all the way and mount chain adjuster **4** and nut **5**.



Info

Mount chain adjusters **3** and **4** in the same position.

- Make sure that the chain adjusters are fitted correctly on the adjusting screws.

Guideline

In order for the rear wheel to be correctly aligned, the markings on the left and right chain adjusters must be in the same position relative to reference markings **B**.

- Tighten nut **5**.

Guideline

| | | |
|-------------------------|---------|---------------------------------------|
| Nut, rear wheel spindle | M25x1.5 | 90 Nm (66.4 lbf ft) Thread greased |
|-------------------------|---------|---------------------------------------|

15 WHEELS, TIRES

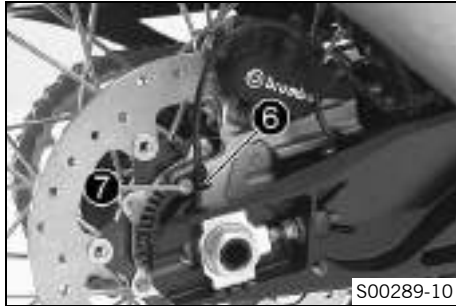

- Position wheel speed sensor ⑥ in the hole.
- Mount and tighten screw ⑦.

Guideline

| | | |
|---------------------------|----|--------------------|
| Remaining screws, chassis | M6 | 10 Nm (7.4 lbf ft) |
|---------------------------|----|--------------------|

- Operate the foot brake lever repeatedly until the brake linings are in contact with the brake disc and there is a pressure point.

15.5 Checking the rear hub damping rubber pieces 🛠️

i Info

The engine power is transmitted from the rear sprocket to the rear wheel via the 6 damping rubber pieces. The damping rubber pieces wear out during operation. If the damping rubber pieces are not changed in time, the rear sprocket carrier and the rear hub will be damaged.

Preparatory work

- Raise the vehicle with the center stand. (🛠️ p. 184)
- Remove the rear wheel. 🛠️ (🛠️ p. 244)

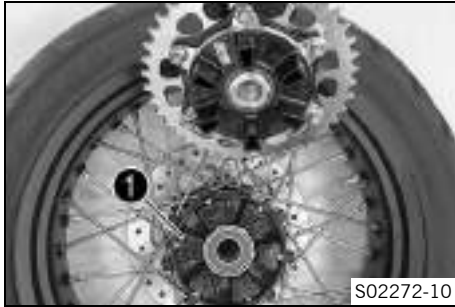

Main work (Super Adventure R EU)

- Check the damping rubber pieces ❶ of the rear hub for damage and wear.
 - » If the damping rubber pieces of the rear hub are damaged or worn:
 - Change all the damping rubber pieces of the rear hub. 🛠️



(1290 Super Adventure R TKC EU, 1290 Super Adventure R TKC CN)

- Check the damping rubber pieces ❶ of the rear hub for damage and wear.
 - » If the damping rubber pieces of the rear hub are damaged or worn:
 - Change all the damping rubber pieces of the rear hub. 🛠️

15 WHEELS, TIRES



- Lay the rear wheel on a workbench with the rear sprocket facing upward and insert the wheel spindle in the hub.
- Check the rear sprocket play **A**.



Info

Measure the play on the outside of the rear sprocket.

| | |
|---|--|
| Play of damping rubber pieces on rear wheel | $\leq 5 \text{ mm } (\leq 0.2 \text{ in})$ |
|---|--|

- » If clearance **A** is larger than the specified value:
 - Change all the damping rubber pieces of the rear hub. 🛠️

Finishing work

- Install the rear wheel. 🛠️ (📖 p. 247)

15.6 Checking the tire condition



Warning

Danger of accidents If a tire bursts while riding, the vehicle becomes uncontrollable.

- Ensure that damaged or worn tires are replaced immediately. (Your authorized KTM workshop will be glad to help.)



Warning

Danger of crashing Different tire tread patterns on the front and rear wheel impair the handling characteristic.

Different tire tread patterns can make the vehicle significantly more difficult to control.

- Make sure that only tires with a similar tire tread pattern are fitted to the front and rear wheel.



Warning

Danger of accidents Non-approved or non-recommended tires and wheels impact the handling characteristic.

- Only use tires/wheels approved by KTM with the corresponding speed index.



Warning

Danger of accidents New tires have reduced road grip.

The contact surface on new tires is not yet roughened.

- Run in new tires with moderate riding at alternating angles.
Running-in phase 200 km (124 mi)



Info

Tire type, tire condition, and tire pressure influence the braking and handling characteristics of the vehicle.

Worn tires are particularly unfavorable on wet surfaces.

15 WHEELS, TIRES

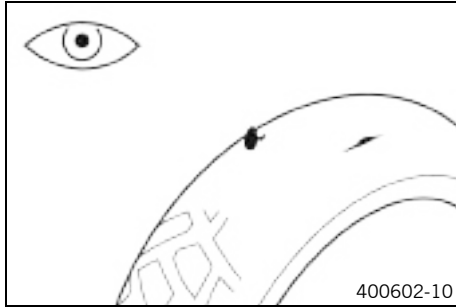

- Check the front and rear tires for cuts, run-in objects, and other damage.
 - » If the tires have cuts, run-in objects, or other damage:
 - Change the tires. 🛠️
- Check the tread depth.



Info

Adhere to the legally required minimum tread depth.

| | |
|---------------------|---|
| Minimum tread depth | $\geq 2 \text{ mm } (\geq 0.08 \text{ in})$ |
|---------------------|---|

- » If the tread depth is less than the minimum tread depth:
 - Change the tires. 🛠️

- Check the tire age.



Info

The tire date of manufacture is usually contained in the tire label and is indicated by the last four digits of the **DOT** number. The first two digits indicate the week of manufacture and the last two digits the year of manufacture.

KTM recommends that the tires be changed after 5 years at the latest, regardless of the actual state of wear.

- » If the tires are more than 5 years old:

- Change the tires. ↩



15.7 Checking tire pressure



Info

Low tire pressure leads to abnormal wear and overheating of the tire.
Correct tire pressure ensures optimal riding comfort and maximum tire service life.

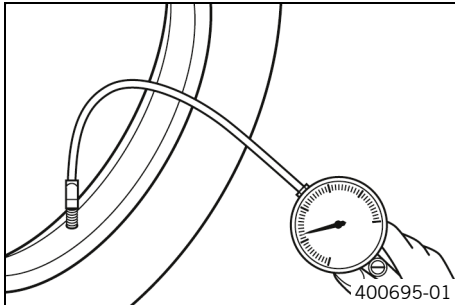

- Remove the protection cap.
- Check the tire pressure when the tires are cold.

| Tire pressure, solo / with passenger / full payload | |
|---|------------------|
| front: with cold tires | 2.6 bar (38 psi) |
| rear: with cold tires | 2.9 bar (42 psi) |

- » If the tire pressure does not meet specifications:
 - Correct the tire pressure.
- Mount the protection cap.



15.8 Checking spoke tension



Warning

Danger of accidents Incorrectly tensioned spokes impair the handling characteristic and result in secondary damage.

The spokes break due to being overloaded if they are too tightly tensioned. If the tension in the spokes is too low, then lateral and radial run-out will form in the wheel. Other spokes will become looser as a result.

- Check spoke tension regularly, and in particular on a new vehicle. (Your authorized KTM workshop will be glad to help.)

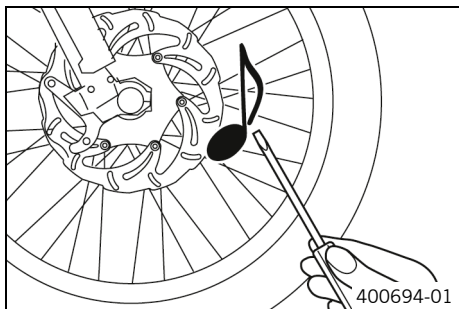

- Strike each spoke briefly using a screwdriver blade.



Info

The frequency of the sound depends on the spoke length and spoke diameter. If spokes of the same length and diameter vibrate with a different tone, this is an indication that the spoke tensions differ.

You should hear a high note.

- » If the spoke tension differs:
 - Correct the spoke tension. 🛠️

15.9 Tubeless tire system

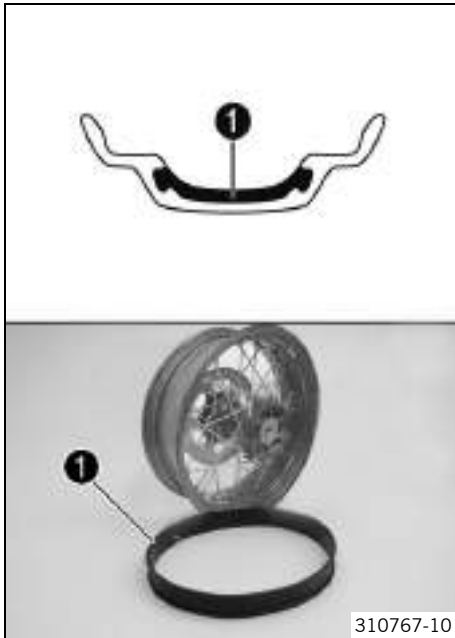

This vehicle uses a tubeless tire system in which a rim seal band ❶ is used instead of the conventional tube.

The advantages of the tubeless system lie in the absence of danger from a faulty tube. This greatly reduces the risk of a sudden loss in pressure.

The masses and moments of inertia of these wheels are smaller than on conventional wire spoke wheels with a tube. This results in better handling and riding comfort.

The rigid rim design results in a wire spoke wheel that is almost entirely maintenance-free.

KTM recommends that the rim seal band be changed after 5 years at the latest, regardless of the actual state of wear.

15.10 Using tire repair spray

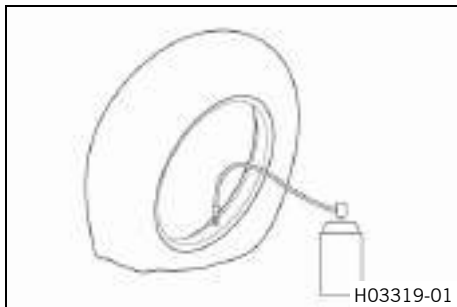

Warning

Danger of accidents Incorrect use of tire repair spray will result in the repaired tire losing pressure.

Tire repair spray cannot be used for all types of damage.

- Observe the instructions and specifications of the manufacturer of the tire repair spray.
- After repairing a tire with tire repair spray, ride slowly and carefully.
- Ride no further than to the nearest workshop and have the tire changed.

Tire repair spray should only be used in an emergency. We recommend transporting the broken down vehicle to the nearest workshop instead of using tire repair spray.

Note

Material damage Tire repair spray damages the tire pressure sensor.

- Note that after using tire repair spray, the tire pressure sensor may need to be replaced.

16.1 Daytime running light (DRL)



Warning

Danger of accidents When visibility is poor, the daytime running light is not a substitute for the low beam.

Automatic switching between the daytime running light and low beam may only be partially available when visibility is significantly impaired due to fog, snow or rain.

- Ensure that the appropriate type of lighting is always selected.
- If necessary switch off the daytime running lights using the menu before going on a ride or when stopped so that the low beam is switched on permanently.
- Note the legal regulations regarding the daytime running light.

The daytime running (DRL)/position light is integrated in the main headlight. The daytime running light is brighter than the position light.

The daytime running light must only be switched on when visibility conditions are good.

This is controlled by the ambient light sensor in the combination instrument. When visibility conditions are good, the low beam

with position light is switched off and the daytime running light is switched on.
When the daytime running light is switched off, the low beam with position light lights up.
On high beam or headlight flasher, the daytime running light changes automatically to the position light.

16.2 Cornering light



The cornering light is integrated into the main headlight.

i Info

To activate the cornering light, the low beam must be switched on and the daytime running light switched off.

The cornering light is activated.

| | |
|-------------------------------|---------------------------------|
| Lean angle for the lower LED | $\geq 12^\circ$ |
| Lean angle for the middle LED | $\geq 20^\circ$ |
| Lean angle for the upper LED | $\geq 28^\circ$ |
| Speed | ≥ 6 km/h (≥ 3.7 mph) |

16.3 Removing the 12-V battery ↴



Warning

Risk of injury Battery acid and battery gases cause serious chemical burns.

- Keep 12 V batteries out of the reach of children.
- Wear suitable protective clothing and safety glasses.
- Avoid contact with battery acid and battery gases.
- Keep sparks or open flames away from the 12 V battery.
- Only charge 12 V batteries in well-ventilated rooms.
- Rinse the affected area immediately with plenty of water in the event of contact with the skin.
- Rinse eyes with water for at least 15 minutes and consult a doctor immediately if battery acid and battery gases get into the eyes.



Caution

Danger of accidents Electronic components and safety devices will be damaged if the 12-V battery is discharged or missing.

- Never operate the vehicle with a discharged 12-V battery or without a 12-V battery.

Preparatory work

- Remove the seat. (📖 p. 186)

16 ELECTRICAL SYSTEM

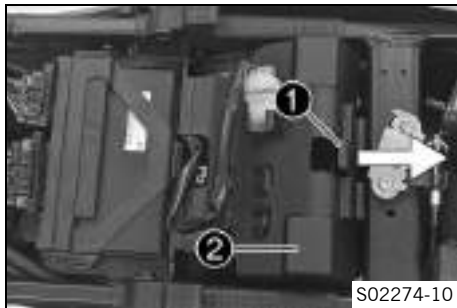

Main work

- Pull locking mechanism ① in the direction of the arrow.
- Fold open cover ②.

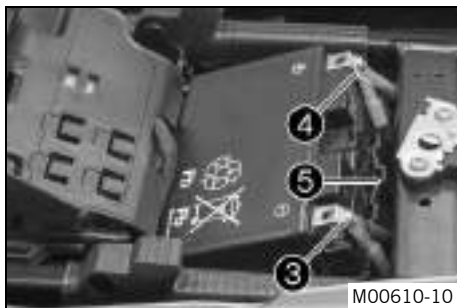

- Disconnect both negative cables ③ from the 12-V battery.
- Disconnect both positive cables ④ from the 12-V battery.
- Take the 12-V battery and battery case ⑤ out of the battery compartment.

16.4 Installing the 12-V battery ↻



Warning

Risk of injury Battery acid and battery gases cause serious chemical burns.

- Keep 12 V batteries out of the reach of children.
- Wear suitable protective clothing and safety glasses.
- Avoid contact with battery acid and battery gases.
- Keep sparks or open flames away from the 12 V battery.
- Only charge 12 V batteries in well-ventilated rooms.
- Rinse the affected area immediately with plenty of water in the event of contact with the skin.
- Rinse eyes with water for at least 15 minutes and consult a doctor immediately if battery acid and battery gases get into the eyes.



Caution

Danger of accidents Electronic components and safety devices will be damaged if the 12-V battery is discharged or missing.

- Never operate the vehicle with a discharged 12-V battery or without a 12-V battery.

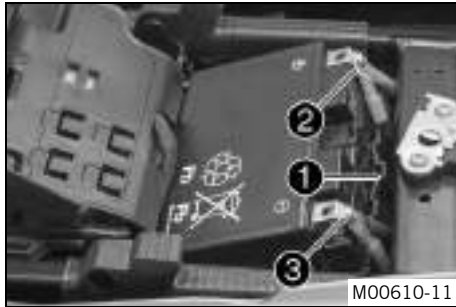

Main work

- Position the 12-V battery in battery case ❶.

Guideline

The even side of the battery case must be opposite the poles.

- Position the 12-V battery with the battery case in the battery compartment.
- Position both positive cables ❷ and mount and tighten the screw.

Guideline

| | | |
|-------------------------|----|-------------------------|
| Screw, battery terminal | M6 | 4.5 Nm (3.32 lbf ft) |
|-------------------------|----|-------------------------|

- Position the negative cable ❸ and mount and tighten the screw.

Guideline

| | | |
|-------------------------|----|-------------------------|
| Screw, battery terminal | M6 | 4.5 Nm (3.32 lbf ft) |
|-------------------------|----|-------------------------|

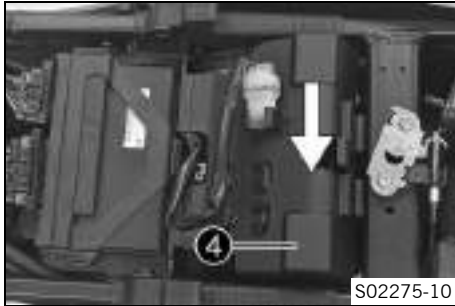

- Close cover ④ and gently push down.
- ✓ The cover engages with an audible click.

Finishing work

- Mount the seat. (📖 p. 186)
- Set the time and date.



16.5 Charging the 12-V battery ↴



Warning

Risk of injury Battery acid and battery gases cause serious chemical burns.

- Keep 12 V batteries out of the reach of children.
- Wear suitable protective clothing and safety glasses.
- Avoid contact with battery acid and battery gases.
- Keep sparks or open flames away from the 12 V battery.
- Only charge 12 V batteries in well-ventilated rooms.
- Rinse the affected area immediately with plenty of water in the event of contact with the skin.
- Rinse eyes with water for at least 15 minutes and consult a doctor immediately if battery acid and battery gases get into the eyes.



Note

Environmental hazard 12 V batteries contain environmentally hazardous materials.

- Do not dispose of 12 V batteries as household waste.
- Dispose of 12 V batteries at a collection point for used batteries.



Note

Environmental hazard Hazardous substances cause environmental damage.

- Dispose of oils, grease, filters, fuel, cleaning agents, brake fluid, etc., correctly and in compliance with the applicable regulations.

**Info**

Even when there is no load on the 12-V battery, it discharges steadily each day.

The charging level and the method of charging are very important for the service life of the 12-V battery.

Rapid recharging with a high charging current shortens the service life of the battery.

If the charging current, charging voltage, and charging time are exceeded, electrolyte escapes through the safety valves. This reduces the capacity of the 12-V battery.

If the 12-V battery is depleted from starting the vehicle repeatedly, the battery must be charged immediately.

If the 12-V battery is left in a discharged state for an extended period, it will become deeply discharged and sulfating occurs, destroying the battery.

The 12-V battery is maintenance-free. The acid level does not have to be checked.

If the 12-V battery is not charged by the KTM battery charger, the 12-V battery must be removed for charging. Otherwise, overvoltage may damage electronic components. Charge the 12-V battery according to the instructions on the battery housing.

Preparatory work

- Remove the seat. (📖 p. 186)

16 ELECTRICAL SYSTEM

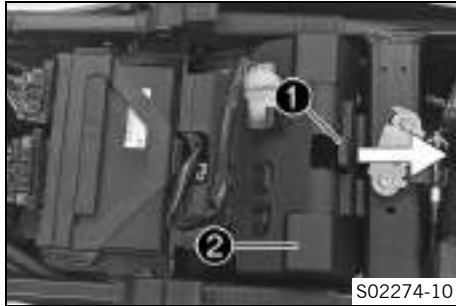

Main work

- Pull locking mechanism **1** in the direction of the arrow.
- Fold open cover **2**.



- Disconnect both negative cables **3** from the 12-V battery to avoid damaging the onboard electronics.



- Connect a battery charger to the 12-V battery. Switch on the battery charger.

Battery charger (58429074000)



Info

You can also use the battery charger to test the open-circuit voltage and starting ability of the 12-V battery, and to test the alternator. In addition, you cannot overcharge the 12-V battery with this device.

Charge the 12-V battery to a maximum of 10 % of the capacity specified on the battery housing.

- Switch off the battery charger after charging and disconnect from the 12-V battery.

Guideline

The charging current, charging voltage, and charging time must not be exceeded.

Recharge the 12-V battery regularly when the motorcycle is not being used

3 months

16 ELECTRICAL SYSTEM

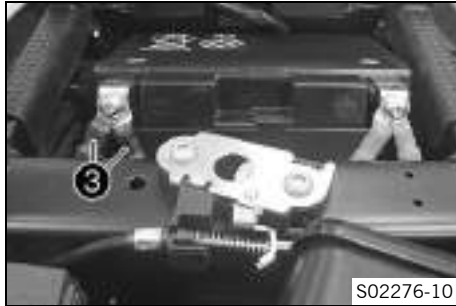

- Connect both negative cables ③ to the 12-V battery.

Guideline

| | | |
|-------------------------|----|-------------------------|
| Screw, battery terminal | M6 | 4.5 Nm (3.32 lbf ft) |
|-------------------------|----|-------------------------|

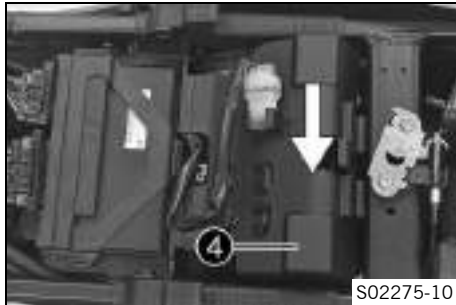

- Close cover ④ and gently push down.
✓ The cover engages with an audible click.

Finishing work

- Mount the seat. (📖 p. 186)
- Set time and date.

16.6 Changing the Race-on key battery

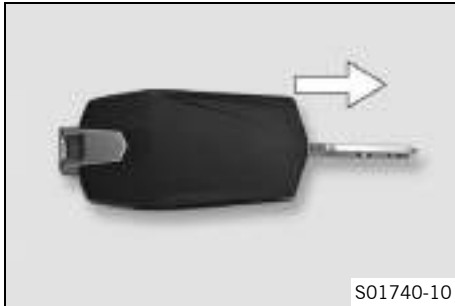

- Fold out the key bit of the Race-on key.
- Push the lower half of the Race-on key in the direction of the arrow and take off.

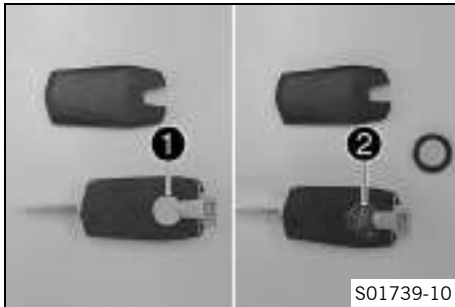

- Remove battery cover ①.
- Remove the Race-on key battery ②.
- Insert a new Race-on key battery with the label facing upward.

Race-on key battery (CR 2032) (📖 p. 321)

- Mount battery cover ①.

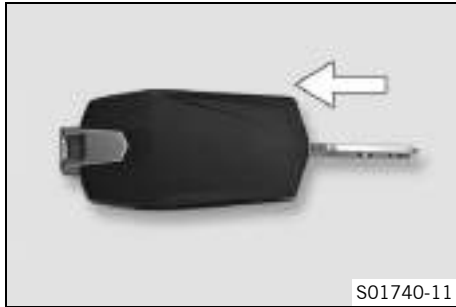

- Fit lower half of the Race-on key and snap into place in the direction of the arrow.

16.7 Changing the main fuse



Warning

Fire hazard Incorrect fuses overload the electrical system.

- Only use fuses with the required ampere value.
- Do not bypass or repair fuses.

Preparatory work

- Remove the seat. (📖 p. 186)

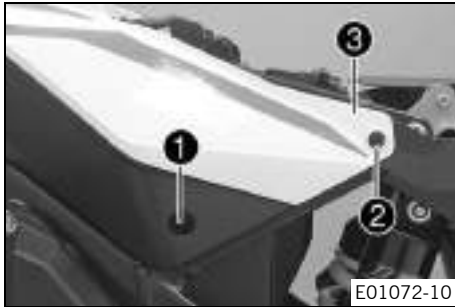

Main work

- Remove screw ❶ and screw ❷.
- Carefully raise rear fairing ❸ slightly.



- Take off protection caps ❹.

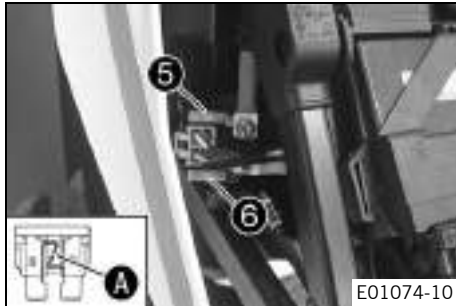

- Remove faulty main fuse **5**.

i Info

A faulty fuse has a burned-out fuse wire **A**.
A spare fuse **6** is located in the starter relay.
The main fuse protects all power consumers of the vehicle.

-
- Insert a new main fuse.

Fuse (58011109130) (📖 p. 322)

- Check that the electrical system is functioning properly.
- Mount the protection caps.

i Tip

Insert a new spare fuse into the starter relay to have it available when needed.

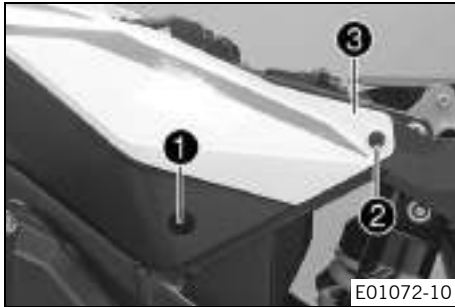

- Position rear fairing ③.
- Mount and tighten screw ②.

Guideline

| | | |
|-------------------|-------|-------------------------|
| Screw, cover part | M5x17 | 3.5 Nm (2.58 lbf ft) |
|-------------------|-------|-------------------------|

- Mount and tighten screw ①.

Guideline

| | | |
|-------------------|-------|-------------------------|
| Screw, cover part | M5x12 | 3.5 Nm (2.58 lbf ft) |
|-------------------|-------|-------------------------|

Finishing work

- Mount the seat. (🛠️ p. 186)
- Set time and date.



16.8 Changing the fuses in the fuse box



Warning

Fire hazard Incorrect fuses overload the electrical system.

- Only use fuses with the required ampere value.
- Do not bypass or repair fuses.



Info

The fuse box containing the fuses of individual power consumers is located under the seat.



Preparatory work

- Remove the seat. (📖 p. 186)

Main work

- Open fuse box cover ❶.

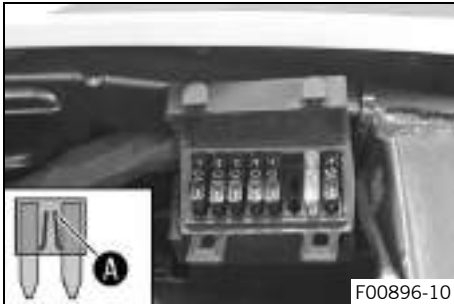

- Check the fuses.



Info

A faulty fuse has a burned-out fuse wire ❸.

- Remove the faulty fuse.

Guideline

| |
|--|
| Fuse 1 - 10 A - power supply for control units and components |
| Fuse 2 - 10 A - permanent positive for auxiliary equipment (ACC1), ignition positive for auxiliary equipment (ACC2) |
| Fuse 3 - 10 A - headlight control unit |
| Fuse 4 - 10 A - headlight control unit |
| Fuse 5 - 10 A - engine electronics control unit |
| Fuse 6 - not assigned |
| Fuse 7 - 25 A - ABS return pump |
| Fuse 8 - 15 A - ABS hydraulic unit |

- Insert the spare fuse with the correct rating.

| |
|-------------------------------|
| Fuse (58011109110) (📖 p. 322) |
| Fuse (58011109115) (📖 p. 322) |
| Fuse (58011109125) (📖 p. 322) |



Tip

Insert a spare fuse so that it is available if needed.

- Check that the power consumer is functioning properly.
- Close the fuse box cover.

Finishing work

- Mount the seat. (📖 p. 186)



16.9 Checking the headlight setting

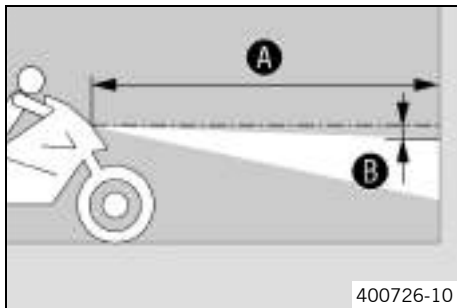

- Park the vehicle on a horizontal surface in front of a light-colored wall and make a mark at the height of the center of the low beam headlight.
 - Make another mark at a distance **B** under the first marking.
- Guideline

| | |
|-------------------|-------------|
| Distance B | 5 cm (2 in) |
|-------------------|-------------|

- Position the vehicle perpendicular to the wall at a distance **A** from the wall and switch on the low beam.

Guideline

| | |
|-------------------|-------------|
| Distance A | 5 m (16 ft) |
|-------------------|-------------|

- The rider now mounts the motorcycle with luggage and passenger if applicable.
- Check the headlight setting.

The light-dark boundary must be exactly on the lower marking when the motorcycle is ready to be operated with the rider mounted along with any luggage and a passenger if applicable.

- » If the boundary between light and dark does not meet specifications:
 - Adjust the headlight range. (📖 p. 279)

16.10 Adjusting the headlight range

Preparatory work

- Check the headlight setting. (📖 p. 278)



Main work

- Turn adjusting wheel ❶ to adjust the headlight range.



Info

Turn counterclockwise to increase the headlight range; turn clockwise to reduce the headlight range. If you have a payload, you may have to correct the headlight range.

- Set the headlight to marking ❷.

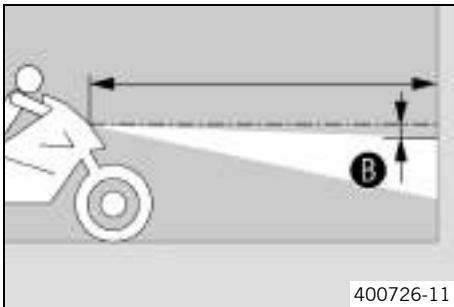

Guideline

The light-dark boundary must lie exactly on lower marking ❷ when the motorcycle is ready to operate with the rider mounted along with any luggage and a passenger if applicable.

16.11 Diagnostics connector

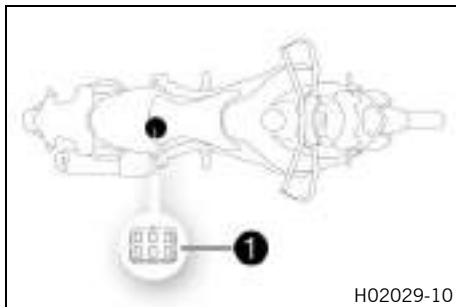

Diagnostics connector **1** is located under the front rider's seat.

(1290 Super Adventure R TKC CN)

In the factory, a diagnostics adapter has been plugged in for connection with a diagnostics interface which applies to all manufacturers.



Info

Unplug the diagnostics adapter to use the KTM diagnostics tool.

Following completion of the diagnosis, plug the diagnostics adapter back in.

16.12 Front ACC1 and ACC2



Installation location

- The front power supplies ACC1 **1** and ACC2 **2** are located behind the headlight.



Info

The power supplies are protected by a fuse, however this fuse also protects other power consumers.

The maximum continuous load is therefore significantly lower than the value of the fuse.

Do not use a stronger fuse.

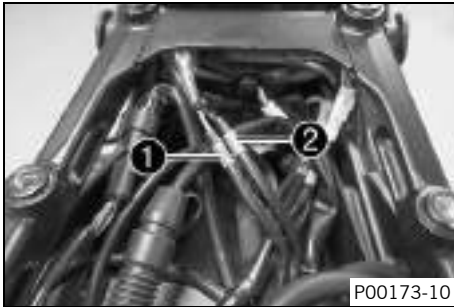
16.13 ACC1 and ACC2 rear**Installation location**

- The rear power supplies ACC1 ① and ACC2 ② are located under the luggage rack plate.

i Info

The power supplies are protected by a fuse, however this fuse also protects other power consumers. The maximum continuous load is therefore significantly lower than the value of the fuse. Do not use a stronger fuse.

17.1 Checking the coolant level in the compensating tank



Warning

Danger of scalding During motorcycle operation, the coolant gets very hot and is under pressure.

- Do not open the radiator, the radiator hoses or other cooling system components if the engine or the cooling system are at operating temperature.
- Allow the cooling system and the engine to cool down before you open the radiator, the radiator hoses or other components of the cooling system.
- In the event of scalding, rinse the area affected immediately with lukewarm water.



Warning

Danger of poisoning Coolant is toxic and a health hazard.

- Keep coolant out of the reach of children.
- Do not allow coolant to come into contact with the skin, the eyes and clothing.
- Consult a doctor immediately if coolant is swallowed.
- Rinse the affected area immediately with plenty of water in the event of contact with the skin.
- Rinse eyes thoroughly with water and consult a doctor immediately if coolant gets into the eyes.
- Change clothing if coolant spills onto your clothing.

Condition

The engine is cold.

The radiator is completely full.

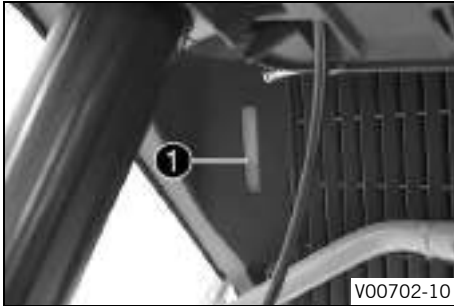

- Park the motorcycle on a horizontal surface.
- Check the coolant level in the compensating tank ①.

The coolant level must be between **MIN** and **MAX**.

- » If there is no coolant in the compensating tank:
 - Check the cooling system for leaks. 🛠️



Info

Do not start up the motorcycle!

-
- Add coolant/bleed cooling system. 🛠️
 - » If the coolant in the compensating tank is not at the required level, but the tank is not empty:
 - Correct the coolant level in the compensating tank. (📖 p. 284)



17.2 Correcting the coolant level in the compensating tank



Warning

Danger of scalding During motorcycle operation, the coolant gets very hot and is under pressure.

- Do not open the radiator, the radiator hoses or other cooling system components if the engine or the cooling system are at operating temperature.
- Allow the cooling system and the engine to cool down before you open the radiator, the radiator hoses or other components of the cooling system.
- In the event of scalding, rinse the area affected immediately with lukewarm water.



Warning

Danger of poisoning Coolant is toxic and a health hazard.

- Keep coolant out of the reach of children.
- Do not allow coolant to come into contact with the skin, the eyes and clothing.
- Consult a doctor immediately if coolant is swallowed.
- Rinse the affected area immediately with plenty of water in the event of contact with the skin.
- Rinse eyes thoroughly with water and consult a doctor immediately if coolant gets into the eyes.
- Change clothing if coolant spills onto your clothing.

Condition

The engine is cold.

The radiator is completely full.

Preparatory work

- Check the coolant level in the compensating tank. (📖 p. 282)
- Remove the front side cover. (📖 p. 201)



Info

Only disassemble the right-hand side.



Main work

- Remove cover ①.



- Remove cover ② of the compensating tank.

17 COOLING SYSTEM



- Add coolant until the coolant reaches the specified level.

Guideline

The coolant level must be between **MIN** and **MAX**.

Coolant (📖 p. 336)

- Mount cover ② of the compensating tank.
- Mount cover ①.

Finishing work

- Install the front side cover. (📖 p. 201)



18.1 Ride Mode



Possible states

- **SPORT** – Homologated performance with very direct response; the traction control allows greater slip on the rear wheel.
- **STREET** – Homologated performance with balanced response; the traction control allows normal slip on the rear wheel.
- **RAIN** – Reduced homologated performance for better rideability; the traction control allows normal slip on the rear wheel.
- **OFFROAD** – Reduced homologated performance for better rideability; the traction control allows high slip on the rear wheel.

Various vehicle tunings can be selected in the **Ride Mode** menu.

SPORT, **STREET**, **RAIN** and **OFFROAD** are available.

The drive mode selected last is displayed in the combination instrument.

The drive mode can also be changed while riding with a closed throttle grip and deactivated speed sensor.

18.2 Motorcycle traction control (MTC)





The motorcycle traction control (MTC) lowers the engine torque in case of loss of traction in the rear wheel. Depending on the motorcycle traction control setting, a slight slip on the rear wheel may be desirable. Example: offroad.

i Info

When motorcycle traction control is switched off, the rear wheel may spin during strong acceleration and on surfaces with low grip, resulting in a risk of crashing. After the ignition is switched back on, motorcycle traction control is enabled again.

The motorcycle traction control is controlled via the **Motorcycle** menu on the combination instrument. The motorcycle traction control can be switched off in the **MTC** menu.

i Info

When the motorcycle traction control is active, the TC indicator lamp  flashes. When motorcycle traction control is switched off, the TC indicator lamp  lights up.

19.1 Checking the engine oil level



Info

Oil consumption depends on the riding style and the operating conditions.

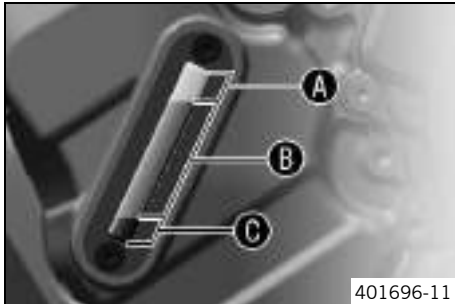

Condition

The engine is at operating temperature.

Preparatory work

- Stand the motorcycle upright on a horizontal surface.

Main work

- Check the engine oil level in the engine oil level viewer.



Info

After switching off the engine, wait one minute before checking the level.

The engine oil level should be in the upper part of the range **B** of the engine oil level viewer.

- » When the engine oil level is in area **A** of the engine oil level viewer:
 - Do not add engine oil.
- » When the engine oil level is in area **B** of the engine oil level viewer:
 - Engine oil can be added.

- » When the engine oil level is in area **C** of the engine oil level viewer:
 - Add engine oil. (🛠️ p. 297)

19.2 Changing the engine oil and oil filter, cleaning the oil screens 🛠️



Warning

Danger of scalding Engine and gear oil get very hot when the motorcycle is ridden.

- Wear suitable protective clothing and safety gloves.
- In the event of scalding, rinse the area affected immediately with lukewarm water.



Note

Environmental hazard Hazardous substances cause environmental damage.

- Dispose of oils, grease, filters, fuel, cleaning agents, brake fluid, etc., correctly and in compliance with the applicable regulations.

Preparatory work

- Remove the engine guard. (🛠️ p. 219)

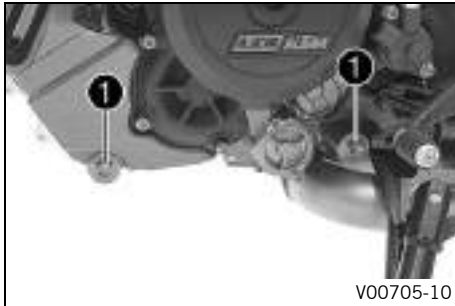

Main work

- Place the motorcycle on a horizontal surface using the side stand.
- Place an appropriate container under the engine.
- Remove oil drain plugs ① with the magnets, O-rings, and oil screens.

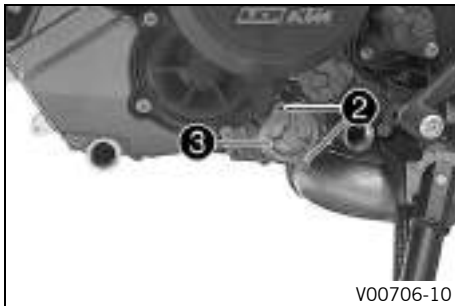

- Remove screws ②. Take off oil filter cover ③ with the O-ring.

19 SERVICE WORK ON THE ENGINE



- Pull oil filter ④ out of the oil filter housing.

Lock ring plier (51012011000)

- Allow the engine oil to drain completely.
- Thoroughly clean the parts and the sealing surface.

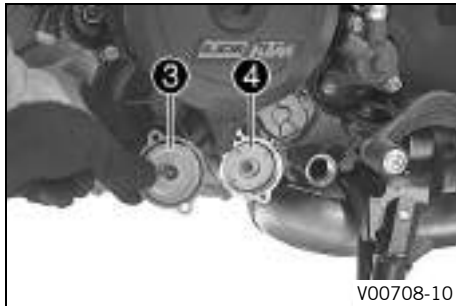

- Insert new oil filter ④.

i Info

Only insert the oil filter by hand.

- Lubricate the O-ring of the oil filter cover. Mount oil filter cover ③.

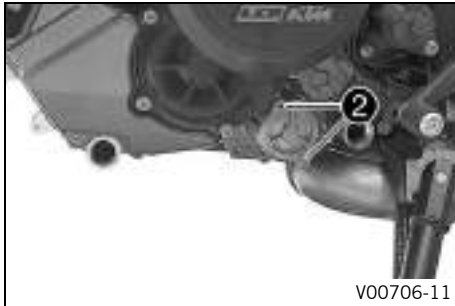

- Mount and tighten screws **2**.

Guideline

| | | |
|-------------------------|----|-------------------|
| Remaining engine screws | M5 | 6 Nm (4.4 lbf ft) |
|-------------------------|----|-------------------|

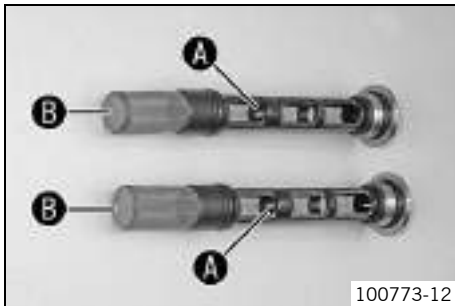

- Thoroughly clean magnets **A** and oil screens **B** of the oil drain plugs.

19 SERVICE WORK ON THE ENGINE

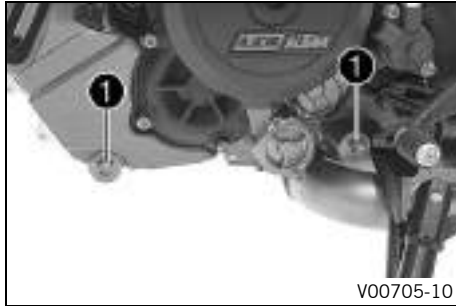

- Mount and tighten oil drain plugs ① with the magnets, O-rings, and oil screens.

Guideline

| | | |
|----------------|---------|---------------------|
| Oil drain plug | M20x1.5 | 20 Nm (14.8 lbf ft) |
|----------------|---------|---------------------|

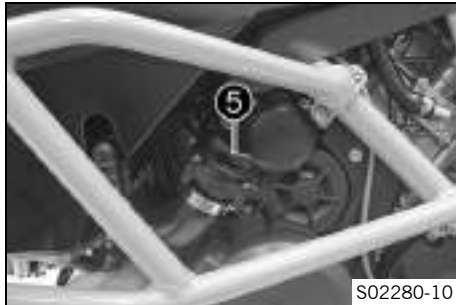

- Have the entire filling quantity available.

| | | |
|---|---------------------|--|
| Engine oil Ambient temperature: $\geq 0\text{ }^{\circ}\text{C}$ ($\geq 32\text{ }^{\circ}\text{F}$) | 3.60 l (3.8 qt.) | Engine oil (SAE 10W/50) (📖 p. 337) |
| Engine oil Ambient temperature: $< 0\text{ }^{\circ}\text{C}$ ($< 32\text{ }^{\circ}\text{F}$) | | Engine oil (SAE 5W/40) (📖 p. 338) |

- Add the oil quantity in two steps.
- Remove filler plug ⑤ with the O-ring, and fill up with the first partial quantity.

| | | |
|---|-----------------|------------------------------------|
| Engine oil (1st partial quantity) approx. Ambient temperature: $\geq 0\text{ }^{\circ}\text{C}$ ($\geq 32\text{ }^{\circ}\text{F}$) | 3.0 l (3.2 qt.) | Engine oil (SAE 10W/50) (📖 p. 337) |
| Engine oil (1st partial quantity) approx. Ambient temperature: $< 0\text{ }^{\circ}\text{C}$ ($< 32\text{ }^{\circ}\text{F}$) | | Engine oil (SAE 5W/40) (📖 p. 338) |

- Mount filler plug **5** with the O-ring.



Danger

Danger of poisoning Exhaust gases are toxic and inhaling them may result in unconsciousness and death.

- Always make sure there is sufficient ventilation when running the engine.
- Use effective exhaust extraction when starting or running the engine in an enclosed space.

- Start the engine and check for tightness.
- Switch off the engine.

19 SERVICE WORK ON THE ENGINE



- Remove the filler plug with the O-ring and add the second partial quantity up to the upper marking **C** on the engine oil level viewer.

| | | |
|---|----------------------|---------------------------------------|
| Engine oil (2nd partial quantity) approx. Ambient temperature: $\geq 0\text{ }^{\circ}\text{C}$ ($\geq 32\text{ }^{\circ}\text{F}$) | 0.60 l (0.63 qt.) | Engine oil (SAE 10W/50) (📖 p. 337) |
| Engine oil (2nd partial quantity) approx. Ambient temperature: $< 0\text{ }^{\circ}\text{C}$ ($< 32\text{ }^{\circ}\text{F}$) | | Engine oil (SAE 5W/40) (📖 p. 338) |

- Mount the filler plug with the O-ring.



Danger

Danger of poisoning Exhaust gases are toxic and inhaling them may result in unconsciousness and death.

- Always make sure there is sufficient ventilation when running the engine.
- Use effective exhaust extraction when starting or running the engine in an enclosed space.

- Start the engine and check for tightness.

Finishing work

- Check the engine oil level. (🔧 p. 289)
- Install the engine guard. (🔧 p. 219)



19.3 Adding engine oil

**Info**

Too little engine oil or poor-quality engine oil results in premature wear to the engine. The engine may be damaged if the engine oil level is too high.

Condition

The engine is at operating temperature.

Preparatory work

- Stand the motorcycle upright on a horizontal surface.
- Check the engine oil level. (🔧 p. 289)

19 SERVICE WORK ON THE ENGINE

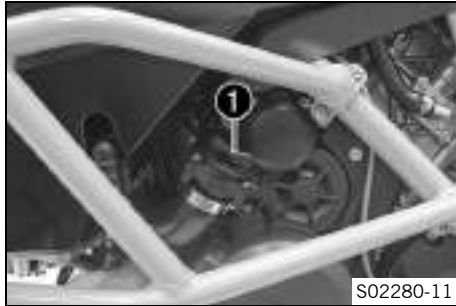

Main work

- Remove filler plug **1** with the O-ring.

- Add engine oil to upper marking **A** on the engine oil level viewer.

Condition

Ambient temperature: $\geq 0\text{ }^{\circ}\text{C}$ ($\geq 32\text{ }^{\circ}\text{F}$)

Engine oil (SAE 10W/50) (📖 p. 337)

Condition

Ambient temperature: $< 0\text{ }^{\circ}\text{C}$ ($< 32\text{ }^{\circ}\text{F}$)

Engine oil (SAE 5W/40) (📖 p. 338)

i Info

In order to achieve optimal engine oil performance, it is not advisable to mix different engine oils.
KTM recommends changing the engine oil.

- Mount the filler plug with the O-ring.



Danger

Danger of poisoning Exhaust gases are toxic and inhaling them may result in unconsciousness and death.

- Always make sure there is sufficient ventilation when running the engine.
- Use effective exhaust extraction when starting or running the engine in an enclosed space.

- Start the engine and check for tightness.

Finishing work

- Check the engine oil level. (📖 p. 289)



20.1 Cleaning the motorcycle

Note

Material damage Components become damaged or destroyed if a pressure cleaner is used incorrectly. The high pressure forces water into the electrical components, connectors, throttle cables, and bearings, etc. Pressure which is too high causes malfunctions and destroys components.

- Do not direct the water jet directly on to electrical components, connectors, throttle cables or bearings.
- Maintain a minimum distance between the nozzle of the pressure cleaner and the component.

Minimum clearance

60 cm (23.6 in)



Note

Environmental hazard Hazardous substances cause environmental damage.

- Dispose of oils, grease, filters, fuel, cleaning agents, brake fluid, etc., correctly and in compliance with the applicable regulations.
-



Info

To maintain the value and appearance of the motorcycle over a long period, clean it regularly. Avoid direct sunshine when cleaning the motorcycle.

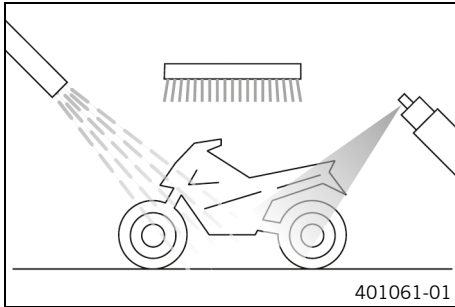

- Close off the exhaust system to keep water from entering.
- Remove loose dirt first with a soft jet of water.
- Spray heavily soiled parts with a normal commercial motorcycle cleaner and then brush off with a soft brush.

Motorcycle cleaner (🗉 p. 340)



Info

Use warm water containing normal motorcycle cleaner and a soft sponge.
 Never apply motorcycle cleaner to a dry vehicle; always rinse the vehicle with water first.
 If the vehicle was operated in road salt, clean it with cold water. Warm water would enhance the corrosive effects of salt.

- After rinsing the motorcycle with a gentle spray of water, allow it to dry thoroughly.
- Remove the closure of the exhaust system.



Warning

Danger of accidents Moisture and dirt impair the brake system.

- Brake carefully several times to dry out and remove dirt from the brake linings and the brake discs.

- After cleaning, ride the vehicle a short distance until the engine warms up.



Info

The heat produced causes water at inaccessible locations in the engine and on the brake system to evaporate.

-
- Push back the protection caps of the handlebar controls to allow any water that has penetrated to evaporate.
 - After the motorcycle has cooled down, lubricate all moving parts and pivot points.
 - Clean the chain. (📖 p. 187)
 - Treat bare metal (except for brake discs and the exhaust system) with a corrosion inhibitor.

Preserving materials for paints, metal and rubber
(📖 p. 341)

- Treat the painted parts with a mild paint polish.

Perfect finish and high gloss polish for paints (📖 p. 340)



Info

Do not polish parts that were matte when delivered as this would strongly impair the material quality.

- Treat the plastic parts and powder-coated parts with a mild cleaning and care product.

Special cleaner for glossy and matte paint finishes, metal and plastic surfaces (📖 p. 341)

- Oil the ignition and steering lock, tank lock, and seat lock.

Universal oil spray (📖 p. 341)



20.2 Checks and maintenance steps for winter operation



Info

If you use the motorcycle in winter, you must expect salt on the roads. You should therefore take precautions against aggressive road salt.

If the vehicle has been used on salted roads, use cold water for cleaning after riding. Warm water enhances the corrosive effects of salt.

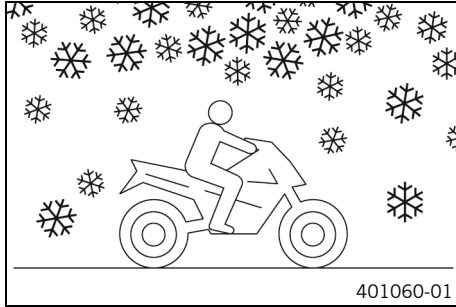

- Clean the motorcycle. (📖 p. 300)
- Clean the brakes.



Info

After **EVERY** trip on salted roads, thoroughly clean the brake calipers and brake linings, after they have cooled down and without removing them, with cold water and dry them carefully.

After riding on salted roads, thoroughly clean the motorcycle with cold water and dry it well.

- Treat the engine, the link fork, and all other bare or zinc-plated parts (except the brake discs) with a wax-based corrosion inhibitor.



Info

Corrosion inhibitor must not come into contact with the brake discs. This would severely lower the braking effect.

- Clean the chain. (📖 p. 187)

21.1 Storage



Info

If you plan to garage the motorcycle for a longer period, perform the following steps or have them performed.

Before storing the motorcycle, check all parts for function and wear. If service, repairs, or replacements are necessary, you should do this during the storage period (less workshop overload). In this way, you can avoid long workshop waiting times at the start of the new season.

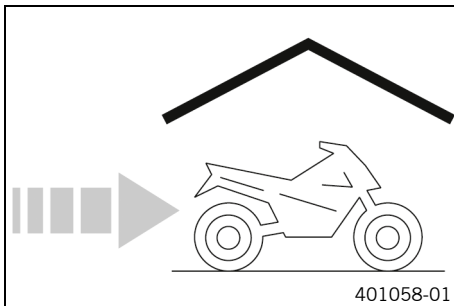

- When refueling for the last time before taking the motorcycle out of service, add fuel additive.

| |
|--------------------------|
| Fuel additive (📖 p. 340) |
|--------------------------|

- Refuel. (📖 p. 167)
- Clean the motorcycle. (📖 p. 300)
- Change the engine oil and the oil filter, clean the oil screens. 🛠️ (📖 p. 290)
- Check the coolant fill level and antifreeze. 🛠️
- Check tire pressure. (📖 p. 255)
- Remove the 12-V battery. 🛠️ (📖 p. 261)

Guideline

| | |
|---|----------------------------|
| Storage temperature of the 12-V battery without direct sunlight | 0 ... 35 °C (32 ... 95 °F) |
|---|----------------------------|

- Charge the 12-V battery. 🛠️ (📖 p. 266)

- Store the vehicle in a dry location that is not subject to large fluctuations in temperature.
- Raise the vehicle with the center stand. (📖 p. 184)
- Cover the motorcycle with a tarp or cover that is permeable to air.



Info

Do not use non-porous materials since they prevent humidity from escaping, thus causing corrosion. Avoid running the engine for a short time only. Since the engine cannot warm up properly, the water vapor produced during combustion condenses and causes valves and the exhaust system to rust.

21.2 Preparing for use after storage

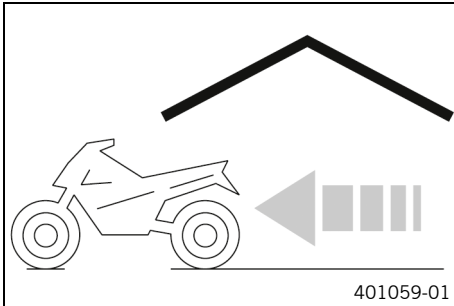

- Remove the vehicle from the center stand. (📖 p. 185)
- Install the 12-V battery. 🛠️ (📖 p. 263)



Info

If the 12-V battery was removed, the time and date must be set.

- Perform checks and maintenance measures when preparing for use. (📖 p. 148)
- Take a test ride.





The Race-on indicator lamp ❶ can indicate errors by flashing. These are indicated up to five seconds after the Race-on button is actuated.



Info

Blink codes referring to **KTM RACE ON** are only displayed once and not repeated.

| Faults | Possible cause | Action |
|--|-----------------------|---|
| No response if the Race-on button is pressed | Race-on button faulty | <ul style="list-style-type: none">– Check Race-on button for damage.– Check cable and plug of Race-on button for damage. |

| Faults | Possible cause | Action |
|---|---|--|
| Race-on indicator lamp flashes twice | No response signal from the Race-on key | <ul style="list-style-type: none"> – Ensure that the Race-on key is in range. – Remove other electronic devices from the vicinity of the Race-on antenna. – Check battery compartment in the Race-on key for correct locking. – Check the battery compartment of the Race-on key for corrosion. – Change the Race-on key battery. (📖 p. 271) – Use black ignition key. |
| Race-on indicator lamp flashes three times | 12-V battery discharged | <ul style="list-style-type: none"> – Charge the 12-V battery. 🛡️ (📖 p. 266) – Check the open-circuit current. 🛡️ |
| Race-on indicator lamp flashes four times | Steering lock bolt locked or tense | <ul style="list-style-type: none"> – Move handlebar slightly. |
| Race-on indicator lamp flashes five times | Race-on antenna faulty | <ul style="list-style-type: none"> – Check Race-on antenna for damage. |
| The combination instrument shows nothing on the display | Fuse 1 blown | <ul style="list-style-type: none"> – Change the fuses in the fuse box. (📖 p. 275) |
| | Main fuse burned out | <ul style="list-style-type: none"> – Change the main fuse. (📖 p. 272) |
| | 12-V battery discharged | <ul style="list-style-type: none"> – Charge the 12-V battery. 🛡️ (📖 p. 266) – Check the open-circuit current. 🛡️ |

22 TROUBLESHOOTING

| Faults | Possible cause | Action |
|---|--|--|
| The engine does not turn if the emergency OFF switch/electric starter button is pressed into the lower position | Operating error | – Carry out the start procedure. (📖 p. 149) |
| | 12-V battery discharged | – Charge the 12-V battery. 🛠️ (📖 p. 266) – Check the open-circuit current. 🛠️ |
| | Faulty safety starting system | – Read out the fault memory using the KTM diagnostics tool. 🛠️ |
| | Electronic fault | – Read out the fault memory using the KTM diagnostics tool. 🛠️ |
| Engine turns only if the clutch lever is drawn | The vehicle is in gear | – Shift the transmission into neutral N . |
| | Faulty safety starting system | – Read out the fault memory using the KTM diagnostics tool. 🛠️ |
| Engine turns although a gear is engaged | Faulty safety starting system | – Read out the fault memory using the KTM diagnostics tool. 🛠️ |
| Engine turns but does not start | Quick release coupling not joined | – Join quick release coupling. |
| | Error in the electronic fuel injection | – Read out the fault memory using the KTM diagnostics tool. 🛠️ |
| | Fuel quality is insufficient | – Add suitable fuel. |
| Engine dies during the trip | Lack of fuel | – Refuel. (📖 p. 167) |
| | Error in the electronic fuel injection | – Read out the fault memory using the KTM diagnostics tool. 🛠️ |

| Faults | Possible cause | Action |
|--------------------------------------|---|---|
| Malfunction indicator lamp lights up | Error in the electronic fuel injection | – Read out the fault memory using the KTM diagnostics tool. 🛠️ |
| The ABS warning lamp lights up | ABS fuse is blown | – Change the fuses in the fuse box. (📖 p. 275) |
| | Wheel speeds of front and rear wheels differ greatly | – Stop, switch off the ignition, start again. |
| | Malfunction in ABS | – Read out the fault memory using the KTM diagnostics tool. 🛠️ |
| High oil consumption | Engine oil level too high | – Check the engine oil level. (📖 p. 289) |
| | Engine oil too thin (low viscosity) | – Change the engine oil and the oil filter, clean the oil screens. 🛠️ (📖 p. 290) |
| 12-V battery discharged | A power consumer is connected to the socket/ACC1. | – Disconnect the power consumer from the socket/ACC1. – Charge the 12-V battery. 🛠️ (📖 p. 266) |
| | The hazard warning flasher is switched on | – Switch off the hazard warning flasher. – Charge the 12-V battery. 🛠️ (📖 p. 266) |
| | The 12-V battery is not being charged by the alternator | – Check the charging voltage. 🛠️ |
| | Ignition was not switched off when vehicle was parked | – Charge the 12-V battery. 🛠️ (📖 p. 266) |

23.1 Engine

| | |
|------------------------------|--|
| Design | 2-cylinder 4-stroke Otto engine, 75° V arrangement, water-cooled |
| Displacement | 1,301 cm ³ (79.39 cu in) |
| Stroke | 71 mm (2.8 in) |
| Bore | 108 mm (4.25 in) |
| Compression ratio | 13.1:1 |
| Idle speed | 1,280 ... 1,480 rpm |
| Control | DOHC, 4 valves per cylinder, chain-driven |
| Valve - valve plate diameter | |
| Intake | 42 mm (1.65 in) |
| Exhaust | 34 mm (1.34 in) |
| Valve clearance | |
| Exhaust at: 20 °C (68 °F) | 0.25 ... 0.30 mm (0.0098 ... 0.0118 in) |
| Intake at: 20 °C (68 °F) | 0.10 ... 0.15 mm (0.0039 ... 0.0059 in) |
| Crankshaft bearing | Sleeve bearing |
| Conrod bearing | Sleeve bearing |
| Piston | Forged light alloy |
| Piston ring | 1 upper compression (rectangular) ring, 1 lower compression ring, 1 oil scraper ring |

| | |
|---------------------------|---|
| Engine lubrication | Pressure circulation lubrication with three rotary pumps |
| Primary transmission | 40:76 |
| Clutch | Antihopping clutch in oil bath/hydraulically operated |
| Transmission | 6-gear transmission, claw shifted |
| Transmission ratio | |
| 1st gear | 12:35 |
| 2nd gear | 15:32 |
| 3rd gear | 18:30 |
| 4th gear | 20:27 |
| 5th gear | 24:27 |
| 6th gear | 35:32 |
| Mixture preparation | Electronic fuel injection |
| Ignition system | Contactless controlled fully electronic ignition with digital ignition adjustment |
| Alternator | 12 V, 450 W |
| Spark plug | |
| Inside spark plug | NGK LKAR9BI-10 |
| Outside spark plug | NGK LMAR7DI-10 |
| Electrode gap, spark plug | 1.0 mm (0.039 in) |
| Cooling | Water cooling, permanent circulation of coolant by water pump |

| | |
|-------------------|---------------|
| Cold start device | Starter motor |
|-------------------|---------------|

23.2 Engine tightening torques

| | | |
|---|----------------------------|---|
| Screw, damping plate | EJOT ALtracs® M6x14 | 10 Nm (7.4 lbf ft) Loctite®243™ |
| Screw, retaining bracket, valve cover, rear | EJOT ALtracs® M6x12 | 10 Nm (7.4 lbf ft) |
| Hose clip, intake flange | M4 | 1.5 Nm (1.11 lbf ft) |
| Oil nozzle | M5 | 2 Nm (1.5 lbf ft) Loctite®243™ |
| Remaining engine screws | M5 | 6 Nm (4.4 lbf ft) |
| Screw, bearing retainer | M5 | 5 Nm (3.7 lbf ft) Loctite®243™ |
| Screw, bearing shells retaining bracket | M5 | 6 Nm (4.4 lbf ft) Loctite®243™ |
| Screw, crankshaft speed sensor | M5 | 6 Nm (4.4 lbf ft) Loctite®243™ |
| Screw, engine oil level viewer | M5 | 4 Nm (3 lbf ft) |
| Screw, gear position sensor | M5 | 5 Nm (3.7 lbf ft) Loctite®243™ |
| Screw, resonator | M5 | 8 Nm (5.9 lbf ft) |
| Swing angle sensor screw | M5 | 5 Nm (3.7 lbf ft) Loctite®243™ |

| | | | |
|--|-----------|---------------------|---------------------|
| Nut, cylinder head | M6 | 9 Nm (6.6 lbf ft) | |
| Remaining engine screws | M6 | 10 Nm (7.4 lbf ft) | |
| Screw, alternator cover | M6 | 10 Nm (7.4 lbf ft) | |
| Screw, camshaft bearing support | M6 – 10.9 | 10 Nm (7.4 lbf ft) | |
| Screw, clutch cover | M6 | 10 Nm (7.4 lbf ft) | |
| Screw, clutch spring | M6 | 12 Nm (8.9 lbf ft) | |
| Screw, coolant connection on the cylinder head | M6 | 8 Nm (5.9 lbf ft) | |
| Screw, engine case | M6x60 | 10 Nm (7.4 lbf ft) | |
| Screw, engine case | M6x80 | 10 Nm (7.4 lbf ft) | |
| Screw, engine case | M6x90 | 10 Nm (7.4 lbf ft) | |
| Screw, freewheel ring | M6 – 10.9 | 15 Nm (11.1 lbf ft) | |
| Screw, locking lever | M6 | 10 Nm (7.4 lbf ft) | Loctite®243™ |
| Screw, oil pump cover | M6 | 10 Nm (7.4 lbf ft) | Loctite®243™ |
| Screw, shift drum locating | M6 – 12.9 | 15 Nm (11.1 lbf ft) | Loctite®243™ |
| Screw, shift lever | M6 | 18 Nm (13.3 lbf ft) | Loctite®243™ |
| Screw, starter motor | M6 | 10 Nm (7.4 lbf ft) | |
| Screw, starter wheel guide | M6 | 10 Nm (7.4 lbf ft) | Loctite®243™ |

23 TECHNICAL DATA

| | | |
|---------------------------------|--------------------|---|
| Screw, stator | M6 | 10 Nm (7.4 lbf ft) Loctite®243™ |
| Screw, valve cover | M6 | 10 Nm (7.4 lbf ft) |
| Screw, water pump cover | M6 | 10 Nm (7.4 lbf ft) |
| Screw, water pump wheel | M6 | 10 Nm (7.4 lbf ft) Loctite®243™ |
| Stud, timing chain shaft | M6 | 8 Nm (5.9 lbf ft) |
| Vacuum connection | M6 | 5 Nm (3.7 lbf ft) Loctite®243™ |
| Nozzle 100 | M6x0.75 | 3 Nm (2.2 lbf ft) Loctite®243™ |
| Plug, crankshaft retainer | M8 | 15 Nm (11.1 lbf ft) |
| Screw, camshaft bearing support | M8 – 10.9 | Step 1 10 Nm (7.4 lbf ft) Step 2 18 Nm (13.3 lbf ft) |
| Screw, engine bearer | M8 | 20 Nm (14.8 lbf ft) |
| Screw, engine case | Expansion screw M8 | 18 Nm (13.3 lbf ft) |
| Screw, guide rail | M8 | 15 Nm (11.1 lbf ft) Loctite®243™ |
| Screw, heat exchanger | M8 | 15 Nm (11.1 lbf ft) |
| Screw, tensioning rail | M8 | 15 Nm (11.1 lbf ft) Loctite®243™ |

| | | |
|--|-------|---|
| Stud, exhaust flange | M8 | 10 Nm (7.4 lbf ft) |
| Screw, engine bearer | M10 | 45 Nm (33.2 lbf ft) |
| Oil channel screw plug | M10x1 | 12 Nm (8.9 lbf ft) |
| Oil pressure sensor | M10x1 | 10 Nm (7.4 lbf ft) |
| Plug, clutch lubrication | M10x1 | 10 Nm (7.4 lbf ft) |
| Screw plug, cam lever axis | M10x1 | 12 Nm (8.9 lbf ft) |
| Screw plug, spreading transmission lock | M10x1 | 12 Nm (8.9 lbf ft) |
| Screw, conrod bearing | M10x1 | Step 1 25 Nm (18.4 lbf ft) Step 2 30 Nm (22.1 lbf ft) Step 3 90° |
| Screw, unlocking of timing chain tensioner | M10x1 | 8 Nm (5.9 lbf ft) |
| Spark plug | M10x1 | 11 Nm (8.1 lbf ft) |

23 TECHNICAL DATA

| | | |
|------------------------------|-------------------------|--|
| Cylinder head screw | M11x1.5 | Tightening sequence: Using a crisscross pattern Step 1 15 Nm (11.1 lbf ft) Step 2 30 Nm (22.1 lbf ft) Step 3 90° Step 4 90° Lubricated with engine oil |
| Coolant temperature sensor | M12x1.5 | 12 Nm (8.9 lbf ft) |
| Screw, rotor | Expansion screw M12x1.5 | 115 Nm (84.8 lbf ft) |
| Spark plug | M12x1.5 | 18 Nm (13.3 lbf ft) |
| Nut of engine sprocket | M20x1.5 | 100 Nm (73.8 lbf ft) Loctite®243™ |
| Oil drain plug | M20x1.5 | 20 Nm (14.8 lbf ft) |
| Nut, inner clutch hub | M22x1.5 | 130 Nm (95.9 lbf ft) Loctite®243™ |
| Plug, timing-chain tensioner | M24x1.5 | 25 Nm (18.4 lbf ft) |
| Screw plug, alternator cover | M24x1.5 | 8 Nm (5.9 lbf ft) |
| Nut, primary gear wheel | M33LHx1.5 | 130 Nm (95.9 lbf ft) Loctite®243™ |

23.3 Capacities

23.3.1 Engine oil

| | | |
|---|------------------|---------------------------------------|
| Engine oil Ambient temperature: ≥ 0 °C (≥ 32 °F) | 3.60 l (3.8 qt.) | Engine oil (SAE 10W/50) (📖 p. 337) |
| Engine oil Ambient temperature: < 0 °C (< 32 °F) | | Engine oil (SAE 5W/40) (📖 p. 338) |

23.3.2 Coolant

| | | |
|---------|-------------------|--------------------|
| Coolant | 2.40 l (2.54 qt.) | Coolant (📖 p. 336) |
|---------|-------------------|--------------------|

23.3.3 Fuel

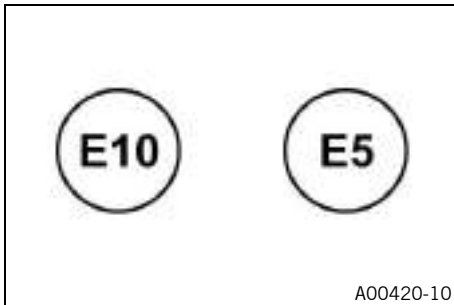

Please observe the labels on EU fuel pumps.

23 TECHNICAL DATA

| | | |
|-----------------------------------|-------------------|--|
| Total fuel tank capacity, approx. | 23 l (6.1 US gal) | Super unleaded (ROZ 95/RON 95/PON 91) (📖 p. 339) |
|-----------------------------------|-------------------|--|

| | |
|-----------------------|-----------------|
| Fuel reserve, approx. | 3.5 l (3.7 qt.) |
|-----------------------|-----------------|

23.4 Chassis

| | |
|--------------------------|--|
| Frame | Lattice frame made of chrome molybdenum steel tubing, powder-coated |
| Fork | WP Suspension 4860 ROTA SPLIT |
| Shock absorber | WP Suspension 4618 DCC PA |
| Suspension travel | |
| front | 220 mm (8.66 in) |
| rear | 220 mm (8.66 in) |
| Brake system | |
| front | Double disc brake with radially mounted four-piston brake calipers, floating brake discs |
| rear | Single disc brake with dual-piston brake caliper, floating brake disc |
| Brake discs - diameter | |
| front | 320 mm (12.6 in) |
| rear | 267 mm (10.51 in) |
| Brake discs - wear limit | |

| | |
|---|--------------------------------|
| front | 4 mm (0.16 in) |
| rear | 4.5 mm (0.177 in) |
| Tire pressure, solo / with passenger / full payload | |
| front: with cold tires | 2.6 bar (38 psi) |
| rear: with cold tires | 2.9 bar (42 psi) |
| Secondary drive ratio | 17:42 |
| Chain | 5/8 x 5/16" (525) X-ring |
| Steering head angle | 64° |
| Wheelbase | 1,580 ± 15 mm (62.2 ± 0.59 in) |
| Seat height, unloaded | 890 mm (35.04 in) |
| Ground clearance, unloaded | 250 mm (9.84 in) |
| Weight without fuel, approx. | 229.3 kg (505.5 lb.) |
| Maximum permissible front axle load | 165 kg (364 lb.) |
| Maximum permissible rear axle load | 285 kg (628 lb.) |
| Maximum permissible total weight | 450 kg (992 lb.) |

23.5 Electrical system

| | | |
|---------------------|---------|--|
| 12-V battery | YTZ14S | Battery voltage: 12 V Nominal capacity: 11.2 Ah Maintenance-free |
| Race-on key battery | CR 2032 | 3 V |

23 TECHNICAL DATA

| | | |
|------|-------------|------|
| Fuse | 58011109110 | 10 A |
| Fuse | 58011109115 | 15 A |
| Fuse | 58011109125 | 25 A |
| Fuse | 58011109130 | 30 A |

| | |
|---|-----|
| Low beam | LED |
| High beam | LED |
| Position light | LED |
| Cornering light | LED |
| Combination instrument lighting and indicator lamps | LED |
| Turn signal | LED |
| Tail light | LED |
| Brake light | LED |
| License plate lamp | LED |

23.6 Tires

| Validity | Front tire | Rear tire |
|---|---|--|
| (Super Adventure R EU) | 90/90 - 21 M/C 54V TL Pirelli SCORPION TRAIL II | 150/70 R 18 M/C 70V TL Pirelli SCORPION TRAIL II |
| (1290 Super Adventure R TKC EU, 1290 Super Adventure R TKC CN) | 90/90 - 21 M/C 54T M+S TL Continental TKC 80 Twinduro | 150/70 B 18 M/C 70Q M+S TL Continental TKC 80 Twinduro |
| The tires specified represent one of the possible series production tires. Additional information is available in the Service section under: http://www.ktm.com | | |

23.7 Fork

| | |
|---------------------|--------------------------------------|
| Fork article number | 14.18.8Q.25 |
| Fork | WP Suspension 4860 ROTA SPLIT |
| Compression damping | |
| Comfort | 17 clicks |
| Standard | 12 clicks |
| Sport | 7 clicks |
| Full payload | 7 clicks |
| Rebound damping | |
| Comfort | 17 clicks |
| Standard | 12 clicks |

23 TECHNICAL DATA

| | | |
|--|---|--|
| Sport | 7 clicks | |
| Full payload | 7 clicks | |
| Spring preload - Preload Adjuster | | |
| Comfort | 2 turns | |
| Standard | 5 turns | |
| Sport | 5 turns | |
| Full payload | 8 turns | |
| Spring length with preload spacer(s) | 577 mm (22.72 in) | |
| Spring rate | | |
| Soft | 5.9 N/mm (33.7 lb/in) | |
| Medium (standard) | 6.5 N/mm (37.1 lb/in) | |
| Hard | 7.0 N/mm (40 lb/in) | |
| Fork length | 920 mm (36.22 in) | |
| Air chamber length | 85 \pm $_{0}^{35}$ mm (3.35 \pm $_{0}^{1.38}$ in) | |
| Fork oil per fork leg | 715 ml (24.17 fl. oz.) | Fork oil (SAE 4) (48601166S1) ( p. 338) |

23.8 Shock absorber

| | |
|-------------------------------|----------------------------------|
| Shock absorber article number | 15.18.7Q.25 |
| Shock absorber | WP Suspension 4618 DCC PA |
| Low-speed compression damping | |

| | |
|--------------------------------|----------------------|
| Comfort | 20 clicks |
| Standard | 15 clicks |
| Sport | 10 clicks |
| Full payload | 10 clicks |
| High-speed compression damping | |
| Comfort | 1.5 turns |
| Standard | 1.5 turns |
| Sport | 1 turn |
| Full payload | 1 turn |
| Rebound damping | |
| Comfort | 20 clicks |
| Standard | 15 clicks |
| Sport | 10 clicks |
| Full payload | 10 clicks |
| Spring preload | |
| Comfort | 2 turns |
| Standard | 2 turns |
| Sport | 2 turns |
| Full payload | 18 turns |
| Spring rate | |
| Soft | 170 N/mm (971 lb/in) |

23 TECHNICAL DATA

| | |
|---------------------------------|------------------------|
| Medium (standard) | 180 N/mm (1,028 lb/in) |
| Hard | 190 N/mm (1,085 lb/in) |
| Spring length | 205 mm (8.07 in) |
| Gas pressure | 10 bar (145 psi) |
| Static sag | 25 mm (0.98 in) |
| Riding sag | 55 mm (2.17 in) |
| Fitted length | 408 mm (16.06 in) |
| Shock absorber fluid (📖 p. 338) | SAE 2.5 |

23.9 Chassis tightening torques

| | | |
|-----------------------------------|----------------------------|--|
| Nut, tire pressure sensor | ISO 10V2 | 12 Nm (8.9 lbf ft) Loctite®2701™ |
| Screw, combination switch, left | | 5 Nm (3.7 lbf ft) |
| Screw, headlight | EJOT ALtracs® 60x20 | 8 Nm (5.9 lbf ft) |
| Screw, headlight bracket | EJOT ALtracs® 50x12 | 7 Nm (5.2 lbf ft) |
| Screw, fixed grip, left | M4 | 2 Nm (1.5 lbf ft) |
| Screw, side stand sensor | M4 | 2 Nm (1.5 lbf ft) |
| Remaining nuts, chassis | M5 | 5 Nm (3.7 lbf ft) |
| Remaining screws, chassis | M5 | 5 Nm (3.7 lbf ft) |
| Screw for throttle grip | M5 | 3.5 Nm (2.58 lbf ft) |
| Screw, brake line holder on frame | M5 | 2 Nm (1.5 lbf ft) |

| | | |
|--|-------|--|
| Screw, brake line holder on link fork | M5 | 5 Nm (3.7 lbf ft) |
| Screw, cable channel | M5 | 5 Nm (3.7 lbf ft) |
| Screw, chain sliding guard | M5 | 5 Nm (3.7 lbf ft) |
| Screw, combination instrument | M5 | 4.5 Nm (3.32 lbf ft) |
| Screw, combination switch, right | M5 | 3.5 Nm (2.58 lbf ft) |
| Screw, cover part | M5x12 | 3.5 Nm (2.58 lbf ft) |
| Screw, cover part | M5x17 | 3.5 Nm (2.58 lbf ft) |
| Screw, foot brake lever stub | M5 | 6 Nm (4.4 lbf ft) Loctite®243™ |
| Screw, fuel level sensor | M5 | 3 Nm (2.2 lbf ft) |
| Screw, fuel tank filler cap | M5 | 3 Nm (2.2 lbf ft) |
| Screw, heat guard on main silencer | M5 | 4 Nm (3 lbf ft) |
| Screw, mask spoiler | M5x12 | 3.5 Nm (2.58 lbf ft) |
| Screw, rear wheel speed sensor cable guide | M5 | 3 Nm (2.2 lbf ft) |
| Screw, wind shield | M5 | 3.5 Nm (2.58 lbf ft) |
| Spoke nipple | M5 | 5 Nm (3.7 lbf ft) |
| Ground fitting on frame | M6 | 6 Nm (4.4 lbf ft) |
| Nut, ABS module fastening | M6 | 8 Nm (5.9 lbf ft) |
| Remaining nuts, chassis | M6 | 10 Nm (7.4 lbf ft) |
| Remaining screws, chassis | M6 | 10 Nm (7.4 lbf ft) |

23 TECHNICAL DATA

| | | |
|--|----|--|
| Screw, angle sensor | M6 | 6 Nm (4.4 lbf ft) Loctite®243™ |
| Screw, ball joint of push rod on foot brake cylinder | M6 | 10 Nm (7.4 lbf ft) Loctite®243™ |
| Screw, battery terminal | M6 | 4.5 Nm (3.32 lbf ft) |
| Screw, bushing | M6 | 4 Nm (3 lbf ft) |
| Screw, cable channel | M6 | 5 Nm (3.7 lbf ft) |
| Screw, chain guide | M6 | 5 Nm (3.7 lbf ft) |
| Screw, clutch assembly | M6 | 5 Nm (3.7 lbf ft) |
| Screw, cooler retaining bracket | M6 | 7 Nm (5.2 lbf ft) |
| Screw, cover part | M6 | 6 Nm (4.4 lbf ft) |
| Screw, engine guard | M6 | 10 Nm (7.4 lbf ft) |
| Screw, exhaust clamp | M6 | 8 Nm (5.9 lbf ft) |
| Screw, foot brake cylinder | M6 | 10 Nm (7.4 lbf ft) Loctite®243™ |
| Screw, front brake disc | M6 | 14 Nm (10.3 lbf ft) Loctite®243™ |
| Screw, front wheel speed sensor | M6 | 10 Nm (7.4 lbf ft) |
| Screw, fuel pump | M6 | 6 Nm (4.4 lbf ft) |
| Screw, fuel tank | M6 | 10 Nm (7.4 lbf ft) |
| Screw, fuel tap | M6 | 6 Nm (4.4 lbf ft) |
| Screw, hand guard clamping | M6 | 5 Nm (3.7 lbf ft) |

| | | |
|---|----|--|
| Screw, lower rear panel | M6 | 6 Nm (4.4 lbf ft) |
| Screw, magnetic holder on side stand | M6 | 6 Nm (4.4 lbf ft) Loctite®243™ |
| Screw, rear brake disc | M6 | 14 Nm (10.3 lbf ft) Loctite®243™ |
| Screw, rear wheel speed sensor | M6 | 10 Nm (7.4 lbf ft) |
| Screw, retaining bracket, angle sensor | M6 | 10 Nm (7.4 lbf ft) |
| Screw, voltage regulator | M6 | 6 Nm (4.4 lbf ft) |
| Remaining nuts, chassis | M8 | 25 Nm (18.4 lbf ft) |
| Remaining screws, chassis | M8 | 25 Nm (18.4 lbf ft) |
| Screw, bottom triple clamp | M8 | 12 Nm (8.9 lbf ft) |
| Screw, exhaust clamp | M8 | 25 Nm (18.4 lbf ft) |
| Screw, foot brake lever | M8 | 25 Nm (18.4 lbf ft) Loctite®243™ |
| Screw, fork stub | M8 | 15 Nm (11.1 lbf ft) |
| Screw, front footrest bracket | M8 | 25 Nm (18.4 lbf ft) Loctite®243™ |
| Screw, handle bar end hand guard | M8 | 25 Nm (18.4 lbf ft) |
| Screw, handlebar clamp | M8 | 20 Nm (14.8 lbf ft) |
| Screw, ignition lock (tamper-proof screw) | M8 | 25 Nm (18.4 lbf ft) Loctite®243™ |

23 TECHNICAL DATA

| | | | |
|------------------------------|----------|---------------------|---------------------|
| Screw, rear footrest bracket | M8 | 25 Nm (18.4 lbf ft) | Loctite®243™ |
| Screw, steering damper | M8 | 25 Nm (18.4 lbf ft) | Loctite®243™ |
| Screw, steering damper clamp | M8 | 12 Nm (8.9 lbf ft) | |
| Screw, steering stem | M8 | 20 Nm (14.8 lbf ft) | |
| Screw, suitcase hook | M8 | 20 Nm (14.8 lbf ft) | Loctite®243™ |
| Screw, top triple clamp | M8 | 20 Nm (14.8 lbf ft) | |
| Remaining nuts, chassis | M10 | 45 Nm (33.2 lbf ft) | |
| Remaining screws, chassis | M10 | 45 Nm (33.2 lbf ft) | |
| Screw, front brake caliper | M10 | 45 Nm (33.2 lbf ft) | Loctite®243™ |
| Screw, handlebar support | M10 | 40 Nm (29.5 lbf ft) | Loctite®243™ |
| Screw, side stand | M10 | 35 Nm (25.8 lbf ft) | Loctite®243™ |
| Screw, side stand bracket | M10 | 45 Nm (33.2 lbf ft) | Loctite®243™ |
| Banjo bolt, brake line | M10x1 | 25 Nm (18.4 lbf ft) | |
| Nut, rear sprocket screw | M10x1.25 | 50 Nm (36.9 lbf ft) | Loctite®243™ |
| Lambda sensor | M12x1.25 | 25 Nm (18.4 lbf ft) | |

| | | |
|------------------------------|---------|--|
| Screw, bottom shock absorber | M14x1.5 | 80 Nm (59 lbf ft) Thread greased |
| Screw, top shock absorber | M14x1.5 | 80 Nm (59 lbf ft) Thread greased |
| Nut, socket | M18x1 | 4 Nm (3 lbf ft) |
| Nut, fork pivot | M19x1.5 | 130 Nm (95.9 lbf ft) Thread greased |
| Nut, seat lock | M22x1.5 | 4 Nm (3 lbf ft) |
| Screw, steering head, top | M22x1.5 | 18 Nm (13.3 lbf ft) |
| Nut, rear wheel spindle | M25x1.5 | 90 Nm (66.4 lbf ft) Thread greased |
| Screw, front wheel spindle | M25x1.5 | 45 Nm (33.2 lbf ft) Thread greased |

24.1 Declarations of conformity



Info

The functional and equipment scope is model-dependent and may not include all wireless systems and application areas referred to.

KTM AG hereby declares that the **KTM RACE ON system** wireless system conforms with the relevant guidelines. The full text of the Declaration of Conformity is available at the following Internet address.

Certification website: <http://www.ktm.com/ktm-race-on-system>

KTM AG hereby declares that the **LC8 DASHBOARD** wireless system conforms with the relevant guidelines. The full text of the Declaration of Conformity is available at the following Internet address.

Certification website: <http://www.ktm.com/lc8-dashboard>

Schrader Electronics Ltd hereby declares that the **Tyre Pressure Monitoring System** wireless system conforms with the relevant guidelines. The full text of the Declaration of Conformity is available at the following Internet address.

Certification website: <http://www.ktm.com/tpms>

24.2 Country-specific declarations of conformity

KTM RACE ON system

Advertencia de FETEL
 La operación de este equipo está sujeta a las siguientes dos condiciones:
 1) El usuario que este equipo y dispositivo no debe interferir con cualquier otro sistema de comunicación inalámbrica que opere en el mismo espacio de frecuencias.
 2) Este equipo debe ser utilizado solo para su propósito previsto, no para cualquier otro uso que no sea el que se indica en el manual de usuario.
Modelo XC80305 (antena central) K0349-0 (base sitting)
 Certificado Homologación Número: **RLVZAXC17-1532**



R 001 - A10834

CNC COMISIÓN NACIONAL DE COMUNICACIONES
H-20232



MCMC
 HD0F17000192

Model: K0349-0



06880-17-08714

ICASA TA-2017/1409

ADRESSE PAR L'AMRT MAROC
 Numéro d'agrément: MR 1408 AMRT 2017
 Date d'agrément: 31/05/2017

ADRESSE PAR L'AMRT MAROC
 Numéro d'agrément: MR 1098 AMRT 2017
 Date d'agrément: 31/05/2017

Este equipamento opera em caráter secundário, ou seja, não deve interferir com qualquer sistema primário, e deve ser tolerante em relação aos sistemas de comunicação de rádio primários, a fim de evitar a interferência, a qualquer momento em qualquer condição.

هذا الجهاز يعمل في نطاق الترددات الثانوي، ولا ينبغي ان يتداخل مع اي نظام اتصالات لاسلكي يعمل في النطاق الترددي نفسه، كما يجب ان يتحمل الاثر من اي نظام اتصالات لاسلكي يعمل في النطاق الترددي نفسه، لكي يتجنب التداخل في اي وقت.

Model: XC80305





07025-17-08714

NOTICE
 This equipment has been registered with the Telecommunications Regulatory Authority for use in the UAE.
TRA REGISTERED No: ER6352818
DEALER No: DA7572118

NOTICE
 This equipment has been registered with the Telecommunications Regulatory Authority for use in the UAE.
TRA REGISTERED No: ER6353118
DEALER No: DA7572118

هذا الجهاز يعمل في نطاق الترددات الثانوي، ولا ينبغي ان يتداخل مع اي نظام اتصالات لاسلكي يعمل في النطاق الترددي نفسه، كما يجب ان يتحمل الاثر من اي نظام اتصالات لاسلكي يعمل في النطاق الترددي نفسه، لكي يتجنب التداخل في اي وقت.





U.A. TR. 109.0199-17

U.A. TR. 109.0198-17



Company name: ZADI S.p.A.
 Equipment Name: Keyless System
 Base Model Name: XC80305
 Series Model Name: XC80305
 Manufacture Date: New / Year
 Manufacture / Country: ZADI S.p.A./ ITALY



Company name: ZADI S.p.A.
 Equipment Name: RPS Remote control key
 Model Name: K0349-0
 Manufacture Date: New / Year
 Manufacture / Country: ZADI S.p.A./ ITALY

Complies with
EMDA Standards
04337982



F01726-01

25.1 Information on open source software

Some vehicle components use open source software.

The source code of the software used and other information are available online.

Overview: <http://www.ktm.com/ktm-oss>



Info

Due to the file size, the download may take a long time.

Depending on the Internet provider, costs may arise due to the data volume.

Brake fluid DOT 4 / DOT 5.1

Standard/classification

- DOT

Guideline

- Use only brake fluid that complies with the specified standard (see specifications on the container) and that exhibits the corresponding properties.

Recommended supplier

Castrol

- **REACT PERFORMANCE DOT 4**

MOTOREX®

- **Brake Fluid DOT 5.1**

Coolant

Guideline

- Only use high-grade, silicate-free coolant with corrosion inhibitor additive for aluminum motors. Low grade and unsuitable antifreeze causes corrosion, deposits and frothing.
- Do not use pure water as only coolant is able to meet the requirements needed in terms of corrosion protection and lubrication properties.
- Only use coolant that complies with the requirements stated (see specifications on the container) and that has the relevant properties.

| | |
|-----------------------------------|-----------------|
| Antifreeze protection to at least | -25 °C (-13 °F) |
|-----------------------------------|-----------------|

The mixture ratio must be adjusted to the necessary antifreeze protection. Use distilled water if the coolant needs to be diluted.

The use of premixed coolant is recommended.

Observe the coolant manufacturer specifications for antifreeze protection, dilution and miscibility (compatibility) with other coolants.

Recommended supplier**MOTOREX®**

- COOLANT M3.0

Engine oil (SAE 10W/50)**Standard/classification**

- JASO T903 MA2 (📖 p. 342)
- SAE (📖 p. 342) (SAE 10W/50)

Guideline

- Use only engine oils that comply with the specified standards (see specifications on the container) and that possess the corresponding properties.

| |
|----------------------------|
| Fully synthetic engine oil |
|----------------------------|

Recommended supplier**MOTOREX®**

- Power Synt 4T

Engine oil (SAE 5W/40)

Standard/classification

- JASO T903 MA2 (📖 p. 342)
- SAE (📖 p. 342) (SAE 5W/40)

Guideline

- Use only engine oils that comply with the specified standards (see specifications on the container) and that possess the corresponding properties.

Fully synthetic engine oil

Recommended supplier

MOTOREX®

- Power Synt 4T

Fork oil (SAE 4) (48601166S1)

Standard/classification

- SAE (📖 p. 342) (SAE 4)

Guideline

- Use only oils that comply with the specified standards (see specifications on the container) and that exhibit the corresponding properties.

Shock absorber fluid (SAE 2.5) (50180751S1)

Standard/classification

- SAE (📖 p. 342) (SAE 2.5)

Guideline

- Use only oils that comply with the specified standards (see specifications on the container) and that exhibit the corresponding properties.

Super unleaded (ROZ 95/RON 95/PON 91)**Standard/classification**

- DIN EN 228 (ROZ 95/RON 95/PON 91)

Guideline

- Only use unleaded super fuel that matches or is equivalent to the specified fuel grade.
- Fuel with an ethanol content of up to 10 % (E10 fuel) is safe to use.

**Info**

Do **not** use fuel containing methanol (e. g. M15, M85, M100) or more than 10 % ethanol (e. g. E15, E25, E85, E100).

Chain cleaner

Recommended supplier

MOTOREX®

- Chain Clean

Fuel additive

Recommended supplier

MOTOREX®

- Fuel Stabilizer

Long-life grease

Recommended supplier

MOTOREX®

- Bike Grease 2000

Motorcycle cleaner

Recommended supplier

MOTOREX®

- Moto Clean

Perfect finish and high gloss polish for paints

Recommended supplier

MOTOREX®

- Moto Shine

Preserving materials for paints, metal and rubber

Recommended supplier

MOTOREX®

- Moto Protect

Special cleaner for glossy and matte paint finishes, metal and plastic surfaces

Recommended supplier

MOTOREX®

- Quick Cleaner

Street chain spray

Guideline

Recommended supplier

MOTOREX®

- Chainlube Road Strong

Universal oil spray

Recommended supplier

MOTOREX®

- Joker 440 Synthetic

JASO T903 MA2

Different technical development directions required a separate specification for motorcycles – the **JASO T903 MA2** standard.

Earlier, engine oils from the automobile industry were used for motorcycles because there was no separate motorcycle specification.

Whereas long service intervals are demanded for automobile engines, the focus for motorcycle engines is on high performance at high engine speeds.

In most motorcycle engines, the transmission and clutch are lubricated with the same oil.

The **JASO T903 MA2** standard meets these special requirements.

SAE

The SAE viscosity classes were defined by the Society of Automotive Engineers and are used for classifying oils according to their viscosity. The viscosity describes only one property of oil and says nothing about quality.

| | | |
|------|--------------------------------|---|
| ABS | Anti-lock braking system | Safety system that prevents locking of the wheels when driving straight ahead without the influence of lateral forces |
| ATIR | Automatic Turn Indicator Reset | Software, which automatically switches the indicator off according to a time or travel distance counter |
| DRL | Daytime Running Light | Light, which enhances the visibility of the vehicle during the day but is not focused, and in contrast to low beam does not illuminate the road surface |
| ETTC | Engine traction torque control | Auxiliary function of the engine control, which prevents rear wheel locking with excessive engine braking effect, by lightly opening the throttle valve |
| HHC | Hill Hold Control | Assist, which prevents the vehicle from rolling backwards on an incline |
| - | KTM RACE ON | System that releases the ignition, steering lock, and fuel tank filler cap via a remote key with a transponder |
| MSC | Motorcycle Stability Control | The is an auxiliary function for the ABS, which can prevent blocking and slipping of the wheels during braking on an inclined position, within the physical limitations |
| MTC | Motorcycle Traction Control | Auxiliary function of the motor control that reduces engine torque with spinning rear wheel |
| OBD | On-board diagnosis | Vehicle system, which monitors the specified parameters of the vehicle electronics |

29 INDEX OF SPECIAL TERMS

| | | |
|------|---------------------------------|--|
| - | Quickshifter + | Engine electronics function for shifting up and down without clutch actuation |
| TPMS | Tire pressure monitoring system | A safety system that monitors the tire pressure with the assistance of sensors in the tires and displays it to the rider |

| | |
|----------|----------------|
| Art. no. | Article number |
| ca. | circa |
| cf. | compare |
| e.g. | for example |
| etc. | et cetera |
| i.a. | inter alia |
| no. | number |
| poss. | possibly |





31.1 Red symbols

Red symbols indicate an error condition that requires immediate intervention.

| | |
|---|--|
|  | The oil pressure warning lamp lights up red – The oil pressure is too low. Stop immediately, taking care not to endanger yourself or other road users in the process, and switch off the engine. |
|---|--|

31.2 Yellow and orange symbols





Yellow and orange symbols indicate an error condition that requires prompt intervention. Active driving aids are also represented by yellow or orange symbols.

| | |
|---|--|
|  | Race-on indicator lamp lights up/flashes yellow/orange/red – Status or error messages relating to Race-on system/alarm system. |
|  | The general warning lamp lights up yellow – A note/warning note on operating safety has been detected. This is also shown in the display. |
|  | The ABS warning lamp lights up yellow – Status or error messages relating to ABS. The ABS warning lamp flashes if the ABS mode Offroad is enabled. |
|  | TC indicator lamp lights up/flashes yellow – The MTC (📖 p. 288) is not enabled or is currently intervening. The TC indicator lamp also lights up if an error is detected. Contact an authorized KTM workshop. The TC indicator lamp flashes if TC actively engages or if the HHC (📖 p. 154) (optional) is activated. |
|  | The cruise control system indicator lamp lights up yellow – The cruise control system function is switched on, but the speed control is not active. |

| | |
|---|---|
|  | Malfunction indicator lamp lights up yellow – The OBD has detected an emission- or safety-critical fault. |
|---|---|

31.3 Green and blue symbols

Green and blue symbols reflect information.

| | |
|---|---|
|  | The left turn signal indicator lamp flashes green with a steady rhythmic flash – The left turn signal is switched on. |
|  | The high beam indicator lamp lights up blue – The high beam is switched on. |
|  | The idle indicator lamp lights up green – The transmission is in neutral. |
|  | The cruise control system indicator lamp lights up green – The cruise control system function is switched on and the speed control is active. |
|  | The right turn signal indicator lamp flashes green with a steady rhythmic flash – The right turn signal is switched on. |

1

12-V battery

- charging 266
- installing 263
- removing 261

A

ABS 224

ACC1

- front 280
- rear 281

ACC2

- front 280
- rear 281

Accessories 19

Anti-lock braking system 224

Applying the brakes 161

Auxiliary substances 19

B

Brake discs

- checking 227

Brake fluid

- front brake, adding 229

- rear brake, adding 234

Brake fluid level

- front brake, checking 228
- rear brake, checking 233

Brake linings

- front brake, checking 232
- rear brake, checking 237

Brake system 224-237

Brakes 161

C

Capacity

- coolant 319
- engine oil 294, 319
- fuel 169, 320

Case holders 51

Center stand 55

Chain

- checking 192
- checking for dirt 187
- cleaning 187

Chain tension

- adjusting 190
- checking 189

| | |
|-----------------------------------|---------------|
| Clutch | |
| fluid level, checking/correcting | 195 |
| Clutch lever | 30 |
| basic position, adjusting | 131 |
| Combination instrument | 56-126 |
| ABS | 109 |
| ABS display | 71 |
| activation and test | 57 |
| adjusting tilt | 141 |
| ambient air temperature indicator | 75 |
| Audio | 80 |
| Bluetooth | 88 |
| Consumption | 118 |
| coolant temperature indicator | 74 |
| Cornering Light Test | 125 |
| cruise control indicator | 70 |
| Day-Night mode | 59 |
| display | 66 |
| Distance | 116 |
| DRL | 122 |
| Extra Functions | 103 |
| Favourites | 112 |
| Favourites display | 76 |
| fuel level display | 74 |
| General Info | 100 |
| Headset Pass. | 93 |
| Headset Rider | 91 |
| heated grip (optional) | 73 |
| Heated Grips (optional) | 104, 124 |
| Heated Seat (optional) | 105 |
| Heated Seat Pas (optional) | 125 |
| Heated Seat Rid (optional) | 124 |
| HHC (optional) | 111 |
| ice warning | 61 |
| indicator lamps | 62 |
| Info | 97 |
| KTM MY RIDE | 79 |
| Language | 118 |
| menu | 79 |
| Motorcycle | 104 |
| MTC | 107 |
| MTC display | 72 |
| MTC+MSR (optional) | 108 |
| Navi Info Screen | 112 |
| navigation | 82 |
| navigation information | 85 |
| Navigation setup | 83 |
| Navigation display | 78 |
| overview | 56 |
| Phone | 89 |

| | | | |
|--|----------|---|----------------|
| Preferences | 115 | Combination switch | |
| Pressure | 117 | left side | 31 |
| Quick Selector 1 | 113 | overview left side | 32 |
| Quick Selector 1 display | 77 | overview right | 39 |
| Quick Selector 2 | 114 | right | 38 |
| Quick Selector 2 display | 77 | Coolant level | |
| Quickshifter + (optional) | 123 | compensating tank, checking | 282 |
| Ride display | 72 | correcting in the compensating tank | 284 |
| Ride Mode | 106, 287 | Cornering light | 260 |
| seat heater (optional) | 73 | Crash bar | |
| Service | 102 | installing | 221 |
| Settings | 111 | removing | 220 |
| Setup | 87 | Cruise control system | |
| shift warning light | 69 | operation | 33 |
| speed | 68, 71 | Customer service | 20 |
| telephony | 96 | D | |
| Temperature | 116 | Date | |
| time | 76 | adjusting | 120 |
| TPMS | 100 | Daytime running light | 259 |
| Trip 1 | 98 | Declarations of conformity | 332-334 |
| Trip 2 | 99 | country-specific | 334 |
| Units | 115 | Diagnostics connector | 280 |
| volume | 86 | DRL | 259 |
| warnings | 60, 102 | | |
| Wireless Interface | 95 | | |

| | |
|---|-----------|
| E | |
| Emergency OFF switch | 40 |
| Engine | |
| running in | 145 |
| Engine guard | |
| installing | 219 |
| removing | 219 |
| Engine number | 27 |
| Engine oil | |
| adding | 297 |
| changing | 290 |
| Engine oil level | |
| checking | 289 |
| Engine sprocket | |
| checking | 192 |
| Engine traction torque control | 161 |
| Environment | 18 |
| F | |
| Figures | 20 |
| Foot brake lever | 53 |
| basic position, adjusting | 140 |

| | |
|--------------------------------------|------------|
| Footrests | |
| adjusting | 133 |
| Fork | 174 |
| compression damping, adjusting | 174 |
| dust boots, cleaning | 211 |
| rebound, adjusting | 176 |
| Spring pretension, adjusting | 177 |
| Fork part number | 28 |
| Front fender | |
| installing | 210 |
| removing | 209 |
| Front side cover | |
| installing | 201 |
| removing | 201 |
| Front wheel | |
| installing | 240 |
| removing | 238 |
| Fuel cocks | 48 |
| Fuel tank cover | |
| installing | 216 |
| removing | 213 |
| Fuel tank filler cap | |
| closing | 47 |

| | | | |
|--|-----|--|-----|
| opening | 45 | Implied warranty | 19 |
| Fuel, oils, etc. | 19 | Indicator lamps | 62 |
| Fuses | | Intended use | 13 |
| in fuse box, changing | 275 | K | |
| G | | Key number | 27 |
| Grab handles | 50 | L | |
| H | | Light switch | 32 |
| Hand brake lever | 30 | Luggage | 145 |
| basic position, adjusting | 132 | Luggage rack plate | 50 |
| Handlebar position | 127 | M | |
| adjusting | 127 | Main fuse | |
| Hazard warning flasher | 39 | changing | 272 |
| Hazard warning flasher switch | 39 | Manufacturer warranty | 19 |
| Headlight | | Mask spoiler | |
| daytime running light | 259 | installing | 206 |
| range, adjusting | 279 | removing | 202 |
| Headlight setting | | Misuse | 13 |
| checking | 278 | Motorcycle | |
| Horn button | 38 | cleaning | 300 |
| I | | Motorcycle traction control | 288 |
| Ice warning | 61 | MSR | 161 |
| Immobilizer | 43 | MTC | 288 |

O

| | |
|-----------------------|-----|
| Oil filter | |
| changing | 290 |
| Oil screens | |
| cleaning | 290 |
| Open source | |
| information | 335 |
| Open source | |
| information | 335 |
| Owner's Manual | 18 |

P

| | |
|--------------------------------------|-----|
| Parking | 164 |
| Passenger foot pegs | 52 |
| Preparing for use | |
| advice on preparing for first use | 143 |
| after storage | 307 |
| checks and maintenance measures when | |
| preparing for use | 148 |
| Protective clothing | 17 |

Q

| | |
|-----------------------|-----|
| Quickshifter + | 153 |
|-----------------------|-----|

R

| | |
|---|------------|
| Race-on button | 41 |
| Race-on key | 43 |
| Race-on key battery, changing | 271 |
| Rear hub damping rubber pieces | |
| checking | 250 |
| Rear sprocket | |
| checking | 192 |
| Rear wheel | |
| installing | 247 |
| removing | 244 |
| Refueling | |
| fuel | 167 |
| Rider footrests | 132 |
| Riding | 155 |
| starting off | 152 |
| starting off with HHC (optional) | 154 |

S

| | |
|-----------------------|-----|
| Safe operation | 15 |
| Seat | |
| mounting | 186 |
| removing | 186 |

| | | | |
|--|------------|---|---------|
| Seat lock | 49 | Steering damper article number | 29 |
| Service | 20 | Steering head bearing play | |
| Service schedule | 170-173 | checking | 197 |
| Shift lever | 52 | Steering lock | 42 |
| basic position, adjusting | 137 | Stopping | 164 |
| basic position, checking | 136 | Storage | 305 |
| Shift lever stub | | Storage compartment | |
| adjusting | 139 | closing | 49 |
| Shifting | 155 | opening | 48 |
| Shock absorber | 174 | USB socket | 45 |
| Compression damping | 178 | Suspension setting | 174-183 |
| high-speed compression damping, adjusting . | 180 | | |
| low-speed compression damping, adjusting . | 179 | T | |
| rebound damping, adjusting | 182 | Technical data | |
| spring pretension, adjusting | 183 | capacities | 319 |
| Shock absorber article number | 28 | chassis | 320 |
| Side stand | 54 | chassis tightening torques | 326 |
| Socket for electrical accessories | 44 | electrical system | 321 |
| Spare parts | 19 | engine | 312-331 |
| Spoke tension | | engine tightening torques | 314 |
| checking | 256 | fork | 323 |
| Start button | 40 | shock absorber | 324 |
| Starting | 149 | tires | 323 |
| | | Throttle grip | 31 |

Time
 adjusting 120

Tire condition
 checking 252

Tire pressure
 checking 255

Tire repair spray
 using 258

Transporting 166

Triple clamp cover, bottom
 installing 200
 removing 199

Troubleshooting 308-311

Tubeless tire system 257

Turn signal switch 36

Type label 26

U

USB socket 45

Use definition 13

V

Vehicle
 loading 145
 raising with the center stand 184

removing from the center stand 185

Vehicle identification number 26

View of vehicle
 front left 22
 rear right 24

W

Windshield
 adjusting 130
 installing 218
 removing 218

Winter operation
 checks and maintenance steps 303

Work rules 17

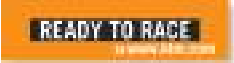

3214096en

09/2019



KTM Sportmotorcycle GmbH
3230 Mattighofen/Austria
<http://www.ktm.com>



Photo:
Mitterbauer/KISKA/KTM