



OWNER'S MANUAL

MT-03

MOTORCYCLE

 Read this manual carefully before operating this vehicle.

MTN320-A

B6W-F8199-E0 ●

 **Read this manual carefully before operating this vehicle. This manual should stay with this vehicle if it is sold.**

Welcome to the Yamaha world of motorcycling!

As the owner of the MTN320-A, you are benefiting from Yamaha's vast experience and newest technology regarding the design and manufacture of high-quality products, which have earned Yamaha a reputation for dependability.

Please take the time to read this manual thoroughly, so as to enjoy all advantages of your MTN320-A. The Owner's Manual does not only instruct you in how to operate, inspect and maintain your motorcycle, but also in how to safeguard yourself and others from trouble and injury.

In addition, the many tips given in this manual will help keep your motorcycle in the best possible condition. If you have any further questions, do not hesitate to contact your Yamaha dealer.

The Yamaha team wishes you many safe and pleasant rides. So, remember to put safety first!

Yamaha continually seeks advancements in product design and quality. Therefore, while this manual contains the most current product information available at the time of printing, there may be minor discrepancies between your motorcycle and this manual. If there is any question concerning this manual, please consult a Yamaha dealer.







Please read this manual carefully and completely before operating this motorcycle.

Important manual information

EAU63350

Particularly important information is distinguished in this manual by the following notations:

	This is the safety alert symbol. It is used to alert you to potential personal injury hazards. Obey all safety messages that follow this symbol to avoid possible injury or death.
	A WARNING indicates a hazardous situation which, if not avoided, could result in death or serious injury.
	A NOTICE indicates special precautions that must be taken to avoid damage to the vehicle or other property.
	A TIP provides key information to make procedures easier or clearer.

*Product and specifications are subject to change without notice.

EAUN0430

**MTN320-A
OWNER'S MANUAL
©2020 PT Yamaha Indonesia Motor
Manufacturing
1st edition, October 2019
All rights reserved.
Any reprinting or unauthorized use
without the written permission of
PT Yamaha Indonesia Motor Manufac-
turing
is expressly prohibited.
Printed in Indonesia.**

Table of contents

Safety information	1-1	Periodic maintenance charts	6-3
Description	2-1	Periodic maintenance chart for the emission control system.....	6-3
Left view	2-1	General maintenance and lubrication chart.....	6-4
Right view.....	2-2	Checking the spark plugs	6-7
Controls and instruments.....	2-3	Canister.....	6-8
Instrument and control functions	3-1	Engine oil and oil filter cartridge	6-8
Main switch/steering lock	3-1	Why Yamalube.....	6-11
Indicator lights and warning lights	3-2	Coolant	6-12
Multi-function meter unit.....	3-4	Replacing the air filter element and cleaning the check hose.....	6-13
Handlebar switches.....	3-10	Checking the throttle grip free play.....	6-15
Clutch lever	3-11	Valve clearance.....	6-15
Shift pedal	3-12	Tires	6-16
Brake lever	3-12	Cast wheels	6-18
Brake pedal	3-13	Adjusting the clutch lever free play.....	6-18
ABS	3-13	Checking the brake lever free play.....	6-19
Fuel tank cap.....	3-14	Brake light switches.....	6-20
Fuel.....	3-15	Checking the front and rear brake pads.....	6-20
Fuel tank overflow hose	3-16	Checking the brake fluid level.....	6-21
Catalytic converter	3-17	Changing the brake fluid.....	6-22
Seats	3-17	Drive chain slack.....	6-23
Helmet holders	3-19	Cleaning and lubricating the drive chain	6-24
Storage compartment	3-20	Checking and lubricating the cables	6-25
Adjusting the shock absorber assembly.....	3-20	Checking and lubricating the throttle grip and cable	6-25
Luggage strap holders	3-21	Checking and lubricating the brake and shift pedals.....	6-26
Sidestand	3-22	Checking and lubricating the brake and clutch levers	6-26
Ignition circuit cut-off system.....	3-22	Checking and lubricating the sidestand	6-27
For your safety – pre-operation checks	4-1	Lubricating the swingarm pivots...	6-27
Operation and important riding points	5-1	Checking the front fork	6-28
Engine break-in	5-1	Checking the steering	6-28
Starting the engine	5-2	Checking the wheel bearings	6-29
Shifting	5-3	Battery	6-29
Tips for reducing fuel consumption	5-4	Replacing the fuses	6-31
Parking	5-5	Vehicle lights.....	6-33
Periodic maintenance and adjustment	6-1		
Tool kit.....	6-2		

Table of contents

Replacing the license plate	
light bulb	6-33
Supporting the motorcycle.....	6-34
Troubleshooting.....	6-35
Troubleshooting chart	6-36
Motorcycle care and storage.....	7-1
Matte color caution	7-1
Care.....	7-1
Storage.....	7-4
Specifications.....	8-1
Consumer information.....	9-1
Identification numbers.....	9-1
Diagnostic connector	9-2
Vehicle data recording.....	9-2
Index.....	10-1

EAU1028C

Be a Responsible Owner

As the vehicle's owner, you are responsible for the safe and proper operation of your motorcycle.

Motorcycles are single-track vehicles. Their safe use and operation are dependent upon the use of proper riding techniques as well as the expertise of the operator. Every operator should know the following requirements before riding this motorcycle.

He or she should:

- Obtain thorough instructions from a competent source on all aspects of motorcycle operation.
- Observe the warnings and maintenance requirements in this Owner's Manual.
- Obtain qualified training in safe and proper riding techniques.
- Obtain professional technical service as indicated in this Owner's Manual and/or when made necessary by mechanical conditions.
- Never operate a motorcycle without proper training or instruction. Take a training course. Beginners should receive training from a certified instructor. Contact an authorized motorcycle dealer to find out about the training courses nearest you.

Safe Riding

Perform the pre-operation checks each time you use the vehicle to make sure it is in safe operating condition. Failure to inspect or maintain the vehicle properly increases the possibility of

an accident or equipment damage. See page 4-1 for a list of pre-operation checks.

- This motorcycle is designed to carry the operator and a passenger.
- The failure of motorists to detect and recognize motorcycles in traffic is the predominating cause of automobile/motorcycle accidents. Many accidents have been caused by an automobile driver who did not see the motorcycle. Making yourself conspicuous appears to be very effective in reducing the chance of this type of accident.

Therefore:

- Wear a brightly colored jacket.
- Use extra caution when you are approaching and passing through intersections, since intersections are the most likely places for motorcycle accidents to occur.
- Ride where other motorists can see you. Avoid riding in another motorist's blind spot.
- Never maintain a motorcycle without proper knowledge. Contact an authorized motorcycle dealer to inform you on basic motorcycle maintenance. Certain maintenance can only be carried out by certified staff.

Safety information

1

- Many accidents involve inexperienced operators. In fact, many operators who have been involved in accidents do not even have a current motorcycle license.
- Make sure that you are qualified and that you only lend your motorcycle to other qualified operators.
- Know your skills and limits. Staying within your limits may help you to avoid an accident.
- We recommend that you practice riding your motorcycle where there is no traffic until you have become thoroughly familiar with the motorcycle and all of its controls.
- Many accidents have been caused by error of the motorcycle operator. A typical error made by the operator is veering wide on a turn due to excessive speed or undercornering (insufficient lean angle for the speed).
 - Always obey the speed limit and never travel faster than warranted by road and traffic conditions.
 - Always signal before turning or changing lanes. Make sure that other motorists can see you.
- The posture of the operator and passenger is important for proper control.
 - The operator should keep both hands on the handlebar and both feet on the operator footrests during operation to maintain control of the motorcycle.
 - The passenger should always hold onto the operator, the seat strap or grab bar, if equipped, with both hands and keep both feet on the passenger footrests. Never carry a passenger unless he or she can firmly place both feet on the passenger footrests.
- Never ride under the influence of alcohol or other drugs.
- This motorcycle is designed for on-road use only. It is not suitable for off-road use.

Protective Apparel

The majority of fatalities from motorcycle accidents are the result of head injuries. The use of a safety helmet is the single most critical factor in the prevention or reduction of head injuries.

- Always wear an approved helmet.
- Wear a face shield or goggles. Wind in your unprotected eyes could contribute to an impairment of vision that could delay seeing a hazard.
- The use of a jacket, heavy boots, trousers, gloves, etc., is effective in preventing or reducing abrasions or lacerations.
- Never wear loose-fitting clothes, otherwise they could catch on the control levers, footrests, or wheels and cause injury or an accident.
- Always wear protective clothing that covers your legs, ankles, and feet. The engine or exhaust system become very hot during or after operation and can cause burns.
- A passenger should also observe the above precautions.

Avoid Carbon Monoxide Poisoning

All engine exhaust contains carbon monoxide, a deadly gas. Breathing carbon monoxide can cause headaches, dizziness, drowsiness, nausea, confusion, and eventually death.

Carbon Monoxide is a colorless, odorless, tasteless gas which may be present even if you do not see or smell any engine exhaust. Deadly levels of carbon monoxide can collect rapidly and you can quickly be overcome and unable to save yourself. Also, deadly levels of carbon monoxide can linger for hours or days in enclosed or poorly ventilated areas. If you experience any symptoms of carbon monoxide poisoning, leave the area immediately, get fresh air, and **SEEK MEDICAL TREATMENT**.

- Do not run engine indoors. Even if you try to ventilate engine exhaust with fans or open windows and doors, carbon monoxide can rapidly reach dangerous levels.
- Do not run engine in poorly ventilated or partially enclosed areas such as barns, garages, or carports.
- Do not run engine outdoors where engine exhaust can be drawn into a building through openings such as windows and doors.

Loading

Adding accessories or cargo to your motorcycle can adversely affect stability and handling if the weight distribution of the motorcycle is changed. To avoid the possibility of an accident, use extreme caution when adding cargo or accessories to your motorcycle. Use

extra care when riding a motorcycle that has added cargo or accessories. Here, along with the information about accessories below, are some general guidelines to follow if loading cargo to your motorcycle:

The total weight of the operator, passenger, accessories and cargo must not exceed the maximum load limit.

Operation of an overloaded vehicle could cause an accident.

Maximum load: 160 kg (353 lb)

When loading within this weight limit, keep the following in mind:

- Cargo and accessory weight should be kept as low and close to the motorcycle as possible. Securely pack your heaviest items as close to the center of the vehicle as possible and make sure to distribute the weight as evenly as possible on both sides of the motorcycle to minimize imbalance or instability.
- Shifting weights can create a sudden imbalance. Make sure that accessories and cargo are securely attached to the motorcycle before riding. Check accessory mounts and cargo restraints frequently.
- Properly adjust the suspension for your load (suspension-adjustable models only), and check the condition and pressure of your tires.
- Never attach any large or heavy items to the handlebar, front fork, or front fender. These items, including such cargo as

Safety information

sleeping bags, duffel bags, or tents, can create unstable handling or a slow steering response.

- **This vehicle is not designed to pull a trailer or to be attached to a sidecar.**

Genuine Yamaha Accessories

Choosing accessories for your vehicle is an important decision. Genuine Yamaha accessories, which are available only from a Yamaha dealer, have been designed, tested, and approved by Yamaha for use on your vehicle.

Many companies with no connection to Yamaha manufacture parts and accessories or offer other modifications for Yamaha vehicles. Yamaha is not in a position to test the products that these aftermarket companies produce. Therefore, Yamaha can neither endorse nor recommend the use of accessories not sold by Yamaha or modifications not specifically recommended by Yamaha, even if sold and installed by a Yamaha dealer.

Aftermarket Parts, Accessories, and Modifications

While you may find aftermarket products similar in design and quality to genuine Yamaha accessories, recognize that some aftermarket accessories or modifications are not suitable because of potential safety hazards to you or others. Installing aftermarket products or having other modifications performed to your vehicle that change any of the vehicle's design or operation characteristics can put you and others

at greater risk of serious injury or death. You are responsible for injuries related to changes in the vehicle.

Keep the following guidelines in mind, as well as those provided under "Loading" when mounting accessories.

- Never install accessories or carry cargo that would impair the performance of your motorcycle. Carefully inspect the accessory before using it to make sure that it does not in any way reduce ground clearance or cornering clearance, limit suspension travel, steering travel or control operation, or obscure lights or reflectors.
- Accessories fitted to the handlebar or the front fork area can create instability due to improper weight distribution or aerodynamic changes. If accessories are added to the handlebar or front fork area, they must be as lightweight as possible and should be kept to a minimum.
- Bulky or large accessories may seriously affect the stability of the motorcycle due to aerodynamic effects. Wind may attempt to lift the motorcycle, or the motorcycle may become unstable in cross winds. These accessories may also cause instability when passing or being passed by large vehicles.
- Certain accessories can displace the operator from his or her normal riding position. This improper position limits the freedom of movement of the

operator and may limit control ability, therefore, such accessories are not recommended.

- Use caution when adding electrical accessories. If electrical accessories exceed the capacity of the motorcycle's electrical system, an electric failure could result, which could cause a dangerous loss of lights or engine power.

Aftermarket Tires and Rims

The tires and rims that came with your motorcycle were designed to match the performance capabilities and to provide the best combination of handling, braking, and comfort. Other tires, rims, sizes, and combinations may not be appropriate. See page 6-16 for tire specifications and for information on servicing and replacing your tires.

Transporting the Motorcycle

Be sure to observe following instructions before transporting the motorcycle in another vehicle.

- Remove all loose items from the motorcycle.
- Check that the fuel cock (if equipped) is in the off position and that there are no fuel leaks.
- Shift the transmission into gear (for models with a manual transmission).
- Secure the motorcycle with tie-downs or suitable straps that are attached to solid parts of the motorcycle, such as the frame or upper front fork triple clamp (and not, for example, to rubber-mounted

handlebars or turn signals, or parts that could break). Choose the location for the straps carefully so the straps will not rub against painted surfaces during transport.

- The suspension should be compressed somewhat by the tie-downs, if possible, so that the motorcycle will not bounce excessively during transport.

Description

EAU63371

Left view

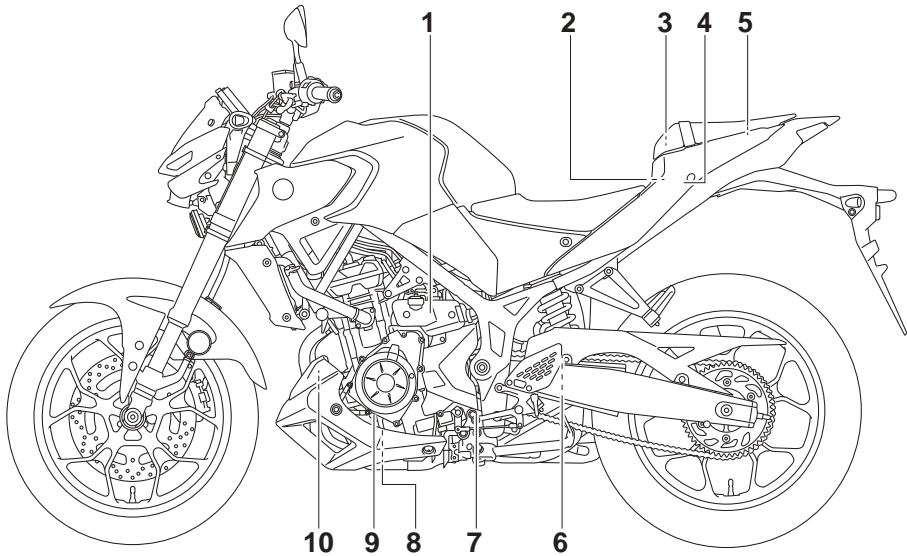

1. Coolant reservoir (page 6-12)
2. Main fuse (page 6-31)
3. Tool kit (page 6-2)
4. Passenger seat lock (page 3-17)
5. Storage compartment (page 3-20)
6. Shock absorber assembly spring preload adjusting ring (page 3-20)
7. Shift pedal (page 3-12)
8. Engine oil drain bolt (page 6-8)
9. Engine oil filter cartridge (page 6-8)
10. Canister (page 6-8)

Right view

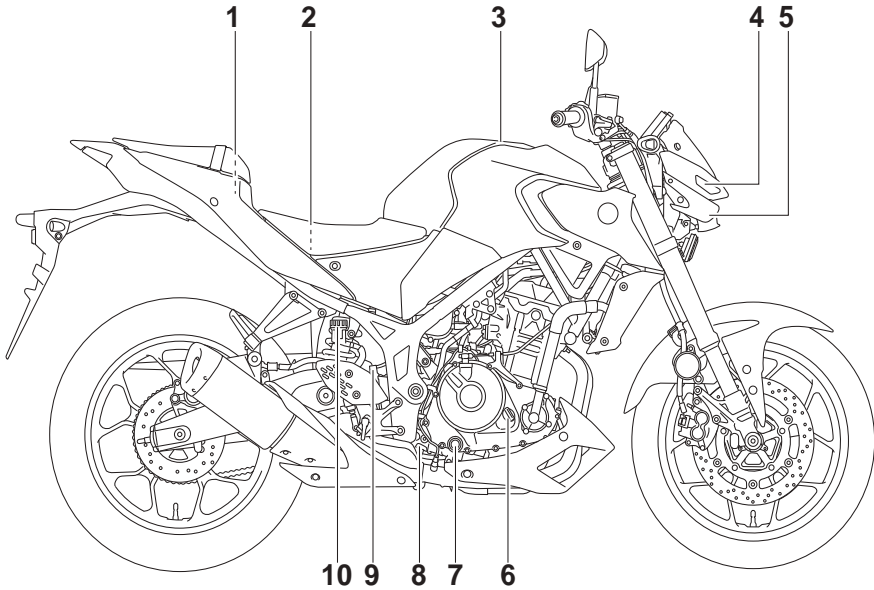

1. Fuse box (page 6-31)
2. Battery (page 6-29)
3. Fuel tank cap (page 3-14)
4. Auxiliary light
5. Headlight (page 6-33)
6. Engine oil filler cap (page 6-8)
7. Engine oil level check window (page 6-8)
8. Brake pedal (page 3-13)
9. Rear brake light switch (page 6-20)
10. Rear brake fluid reservoir (page 6-21)

Controls and instruments

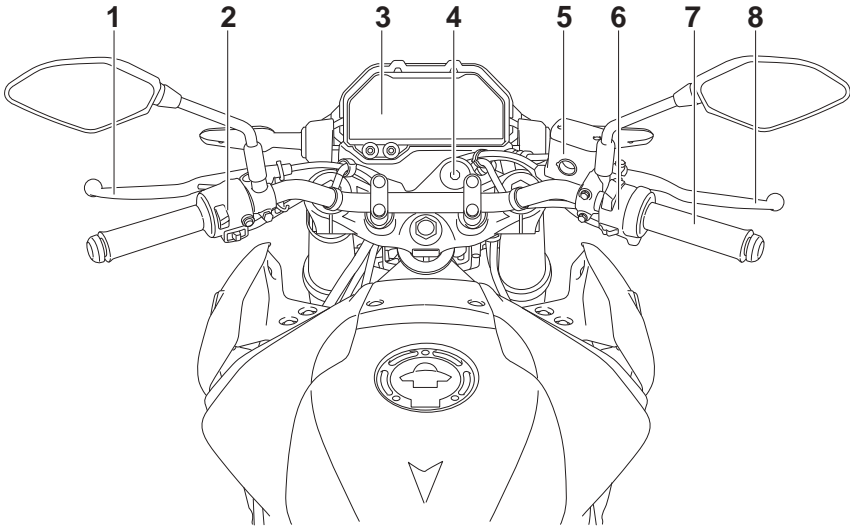

1. Clutch lever (page 3-11)
2. Left handlebar switches (page 3-10)
3. Multi-function meter unit (page 3-4)
4. Main switch/steering lock (page 3-1)
5. Front brake fluid reservoir (page 6-21)
6. Right handlebar switches (page 3-10)
7. Throttle grip (page 6-15)
8. Brake lever (page 3-12)

Instrument and control functions

Main switch/steering lock

EAU10462

EAU1068B

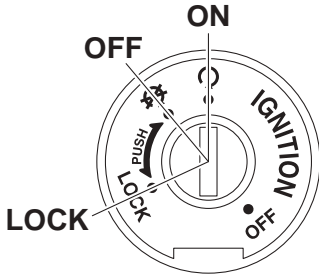

The main switch/steering lock controls the ignition and lighting systems, and is used to lock the steering. The various positions are described below.

ON

EAU85040

All electrical circuits are supplied with power and the vehicle lights are turned on. The engine can be started. The key cannot be removed.

TIP

- To prevent battery discharge, do not leave the key in the on position without the engine running.
- The headlight comes on automatically when the engine is started.

OFF

EAU10662

All electrical systems are off. The key can be removed.

EWA10062

⚠ WARNING

Never turn the key to “OFF” or “LOCK” while the vehicle is moving. Otherwise the electrical systems will be switched off, which may result in loss of control or an accident.

LOCK

The steering is locked and all electrical systems are off. The key can be removed.

To lock the steering

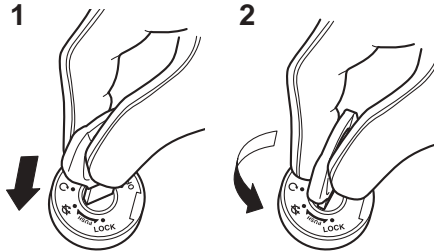

1. Push.
2. Turn.

1. Turn the handlebars all the way to the left.
2. With the key in the “OFF” position, push the key in and turn it to “LOCK”.
3. Remove the key.

TIP

If the steering will not lock, try turning the handlebars back to the right slightly.

To unlock the steering

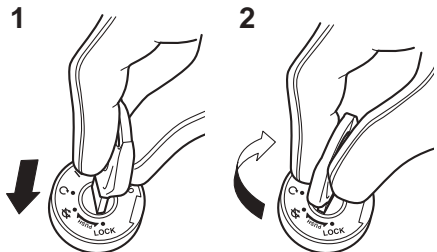

1. Push.
2. Turn.





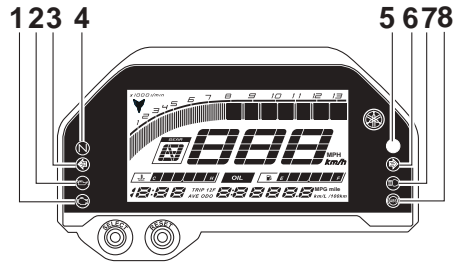

Instrument and control functions

From the “LOCK” position, push the key in and turn it to “OFF”.

Indicator lights and warning lights

EAU4939H



1. Engine trouble warning light “”
2. Oil pressure warning light “”
3. Left turn signal indicator light “”
4. Neutral indicator light “**N**”
5. Shift indicator light “”
6. Right turn signal indicator light “”
7. High beam indicator light “”
8. Anti-lock Brake System (ABS) warning light “”

Turn signal indicator lights “” and “”

EAU11032

Each indicator light will flash when its corresponding turn signal lights are flashing.

Neutral indicator light “**N**”

EAU11061

This indicator light comes on when the transmission is in the neutral position.

High beam indicator light “”

EAU11081

This indicator light comes on when the high beam of the headlight is switched on.

Oil pressure warning light “”

EAU85091

This warning light comes on when the engine oil pressure is low.

Instrument and control functions

TIP

When the vehicle is turned on, the light should come on and remain on until the engine is started. Otherwise, have a Yamaha dealer check the vehicle.

NOTICE

If the warning light comes on when the engine is running, stop the engine and check the oil level. If the oil level is low, add sufficient oil of the recommended type. If the warning light remains on after adding oil, stop the engine and have a Yamaha dealer check the vehicle.

Engine trouble warning light “”

This warning light comes on if a problem is detected in the engine. If this occurs, have a Yamaha dealer check the on-board diagnostic system.

TIP

When the vehicle is turned on, this light should come on for a few seconds and then go off. Otherwise, have a Yamaha dealer check the vehicle.

ABS warning light “”

This warning light comes on when the vehicle is first turned on, and goes off after starting riding. If the warning light comes on while riding, the anti-lock brake system may not work correctly.

WARNING

If the ABS warning light does not turn off after reaching 10 km/h (6 mi/h), or if the warning light comes on while riding:

- Use extra caution to avoid possible wheel lock during emergency braking.
- Have a Yamaha dealer check the vehicle as soon as possible.

Shift indicator light “○”

This indicator light comes on when it is time to shift to the next higher gear. The engine speeds at which it comes on or goes off can be adjusted.

TIP

When the vehicle is turned on, this light should come on for a few seconds and then go off. If the light does not come on, or if the light remains on, have a Yamaha dealer check the vehicle.

3

Instrument and control functions

Multi-function meter unit

EAU87090

EAU86831

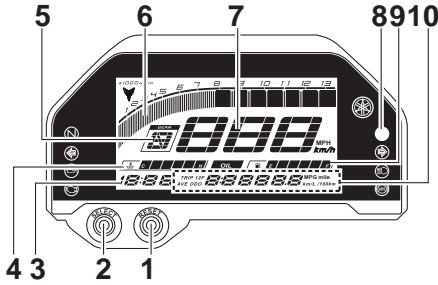

1. "RESET" button
2. "SELECT" button
3. Clock
4. Coolant temperature meter
5. Transmission gear display
6. Tachometer
7. Speedometer
8. Shift indicator light "O"
9. Fuel meter
10. Multi-function display

The multi-function meter unit is also equipped with a shift timing indicator light control mode.

EWA12423

WARNING

Be sure to stop the vehicle before making any setting changes to the multi-function meter unit. Changing settings while riding can distract the operator and increase the risk of an accident.

EAU87140

Switching the display units

The display units can be switched between kilometers and miles. To switch the display units, push the "SELECT" button until the display units change.

Speedometer

The speedometer shows the vehicle's traveling speed.

Tachometer

EAU87170

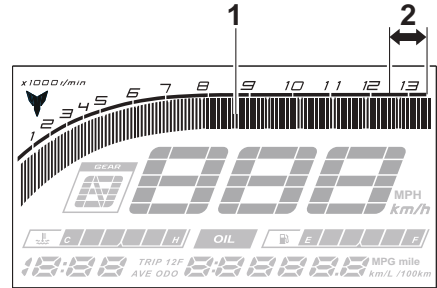

1. Tachometer
2. Tachometer red zone

The tachometer allows the rider to monitor the engine speed and keep it within the ideal power range.

ECA10032

NOTICE

Do not operate the engine in the tachometer red zone.

Red zone: 12500 r/min and above

Fuel meter

EAU86841

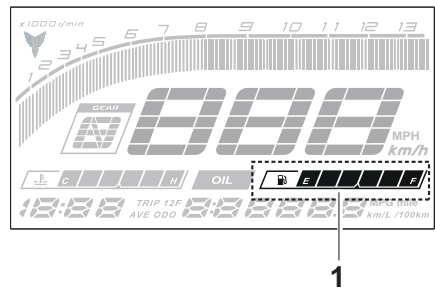

1. Fuel meter

The fuel meter indicates the amount of fuel in the fuel tank. The display segments of the fuel meter disappear from

Instrument and control functions

EAU87350

“F” (full) towards “E” (empty) as the fuel level decreases. When approximately 3.0 L (0.79 US gal, 0.66 Imp.gal) of fuel remains, the last segment starts flashing. Refuel as soon as possible.

TIP

If a problem is detected in the electrical circuit, the fuel level segments will flash repeatedly. If this occurs, have a Yamaha dealer check the vehicle.

Coolant temperature meter

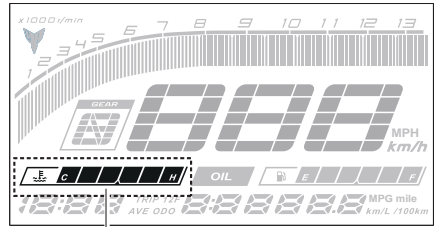

1

1. Coolant temperature meter

This meter shows the temperature of the coolant, and thereby the condition of the engine. The segments come on from “C” (cold) to “H” (hot) as the engine temperature increases. If the hot segment flashes, stop the engine as soon as possible, and let the engine cool. (See page 6-37.)

Clock

EAU87290

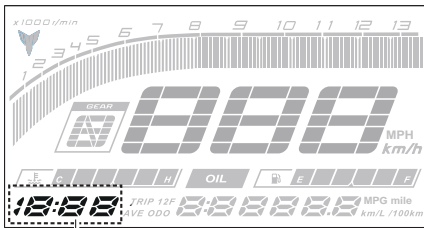

1

1. Clock

The clock uses a 12-hour time system.

To set the clock

1. Push both the “SELECT” button and “RESET” button until the hour digits start flashing.
2. Use the “RESET” button to set the hours.
3. Push the “SELECT” button and the minute digits start flashing.
4. Use the “RESET” button to set the minutes.
5. Push the “SELECT” button to confirm the settings.

EAU87400

Transmission gear display

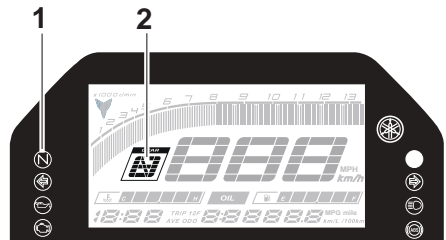

1. Neutral indicator light “N”
2. Transmission gear display

This display shows the selected gear. The neutral position is indicated by “N” and by the neutral indicator light.

Instrument and control functions

EAU87580

Multi-function display

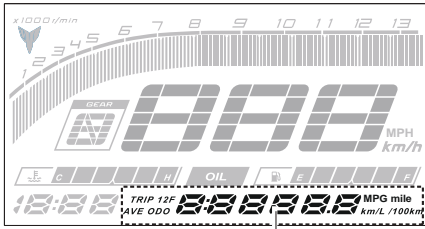

3

1. Multi-function display

The multi-function display is equipped with the following:

- an odometer (ODO)
- two tripmeters (TRIP 1 and TRIP 2)
- a fuel reserve tripmeter (TRIP F)
- an oil change tripmeter (OIL TRIP)
- an oil change indicator
- an instantaneous fuel consumption display (km/L, L/100 km, or MPG)
- an average fuel consumption display (AVE_ _ km/L, AVE_ _ L/100 km, or AVE_ _ MPG)

Push the “SELECT” button to change the display in the following order:

ODO → TRIP 1 → TRIP 2 → TRIP F → km/L, L/100 km or MPG → AVE_ _ km/L, AVE_ _ L/100 km or AVE_ _ MPG → OIL TRIP → ODO

TIP

The fuel reserve tripmeter appears only when you are low on fuel.

EAU86890

Odometer

The odometer shows the total distance traveled by the vehicle.

TIP

The odometer will lock at 999999 and cannot be reset.

EAU88050

Tripmeters

The tripmeters show the distance traveled since they were last reset.

To reset a tripmeter, change the display to the tripmeter you want to reset, and then push the “RESET” button until it is reset.

TIP

The tripmeters will reset and continue counting after 9999.9 is reached.

EAU87600

Fuel reserve tripmeter

If the last segment of the fuel meter starts flashing, the display automatically changes to the fuel reserve tripmeter “TRIP F” and starts counting the distance traveled from that point.

To reset the fuel reserve tripmeter, push the “RESET” button until it is reset.

TIP

If you do not reset the fuel reserve tripmeter manually, it will reset automatically and disappear from the display after refueling and traveling 5 km (3 mi).

Oil change tripmeter

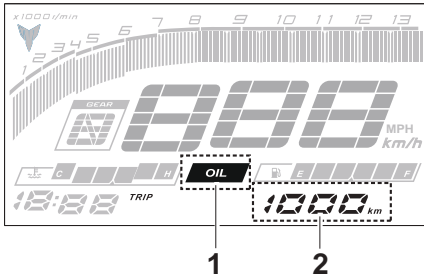

1. Oil change indicator “OIL”
2. Oil change tripmeter

This tripmeter shows the distance traveled since the last engine oil change. The oil change indicator “OIL” will flash at the initial 1000 km (600 mi), the next 4000 km (2500 mi), and then every 5000 km (3000 mi) thereafter.

To reset the oil change tripmeter and oil change indicator, select the oil change tripmeter, and then push the “RESET” button until “OIL” and the tripmeter start flashing. While “OIL” and the tripmeter are flashing, push the “RESET” button until the tripmeter is reset.

TIP

When the engine oil has been changed, the oil change tripmeter and the oil change indicator must be reset. Otherwise, the oil change indicator will not come on at the correct time.

Instantaneous fuel consumption display

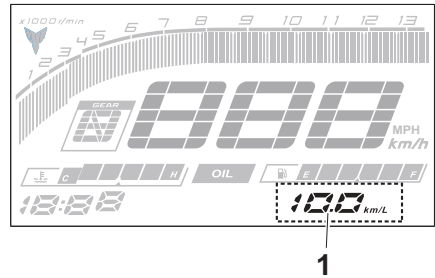

1. Instantaneous fuel consumption display

This display shows the fuel consumption under the current riding conditions. It can be set to either “km/L” or “L/100 km”, or “MPG” when using miles. To switch the fuel consumption measurement units, push the “SELECT” button until the measurement units change.

- “km/L”: the distance that can be traveled on 1.0 L of fuel.
- “L/100 km”: the amount of fuel necessary to travel 100 km.
- “MPG”: the distance that can be traveled on 1.0 Imp.gal of fuel.

TIP

When traveling under 10 km/h (6 mi/h), “_ _ _” is displayed.

Instrument and control functions

EAU87860

Average fuel consumption display

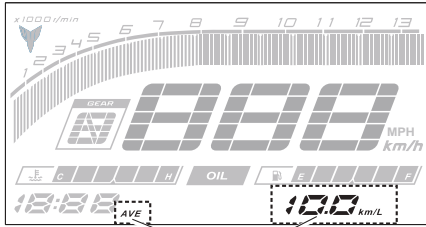

1

1. Average fuel consumption display

This display shows the average fuel consumption since it was last reset. The average fuel consumption display can be set to either “AVE_ _ _ km/L” or “AVE_ _ _ L/100 km”, or “AVE_ _ _ MPG” when using miles. To switch the fuel consumption measurement units, push the “SELECT” button until the measurement units change.

- “AVE_ _ _ km/L”: the average distance that can be traveled on 1.0 L of fuel.
- “AVE_ _ _ L/100 km”: the average amount of fuel necessary to travel 100 km.
- “AVE_ _ _ MPG”: the average distance that can be traveled on 1.0 Imp.gal of fuel.

TIP

- To reset the display, push the “RESET” button until it resets.
- After resetting, “_ _ _” is shown until the vehicle has traveled some distance.

EAU87960

Shift indicator light control mode

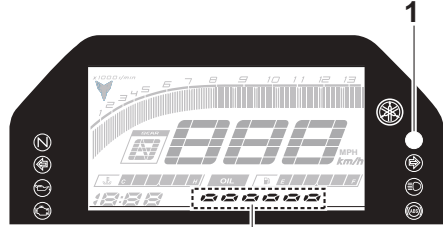

2

1. Shift indicator light “○”
2. Brightness level display

This mode cycles through 4 control functions in the order listed below.

- Shift indicator light on / flash / off
- Shift indicator light on r/min
- Shift indicator light off r/min
- Shift indicator light brightness

To set the shift indicator light on / flash / off

1. Turn the vehicle off.
2. Push and hold the “SELECT” button.
3. Turn the vehicle on, and then release the “SELECT” button after 5 seconds.
4. Push the “RESET” button to select one of the following flashing pattern settings:
 - On setting: the shift indicator light will come on when the set engine speed is reached. This setting is selected when the shift indicator light stays on.
 - Flash setting: the shift indicator light will flash when the set engine speed is reached. This

Instrument and control functions

setting is selected when the shift indicator light flashes 4 times per second.

- Off setting: the shift indicator light is deactivated. This setting is selected when the shift indicator light flashes once every 2 seconds.
5. Push the “SELECT” button to confirm the setting. The control mode changes to the shift indicator light on r/min setting function.

To set the shift indicator light on r/min

The shift indicator light can be set between 7000 r/min and 13500 r/min. From 7000 r/min to 12000 r/min, the indicator light can be set in increments of 500 r/min. From 12000 r/min to 13500 r/min, the indicator light can be set in increments of 200 r/min.

1. Push the “RESET” button to select the desired engine speed for activating the shift indicator light.
2. Push the “SELECT” button to confirm the selected engine speed. The control mode changes to the shift indicator light off r/min setting function.

To set the shift indicator light off r/min

The shift indicator light can be set between 7000 r/min and 13500 r/min. From 7000 r/min to 12000 r/min, the indicator light can be set in increments of 500 r/min. From 12000 r/min to 13500 r/min, the indicator light can be set in increments of 200 r/min.

Be sure to set the off r/min to a higher engine speed than the on r/min setting, otherwise the shift indicator light will not come on.

1. Push the “RESET” button to select the desired engine speed for deactivating the shift indicator light.
2. Push the “SELECT” button to confirm the selected engine speed. The control mode changes to the shift indicator light brightness setting function.

To adjust the shift indicator light brightness

1. Push the “RESET” button to select the desired shift indicator light brightness level.
2. Push the “SELECT” button to confirm the selected brightness level and exit the control mode.

Instrument and control functions

Handlebar switches

EAU1234M

EAU12461

Left

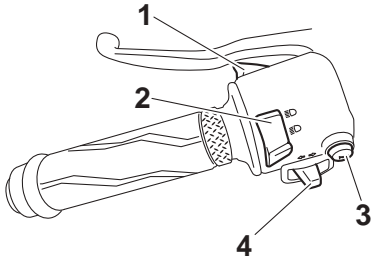

1. Pass switch “PASS”
2. Dimmer switch “ $\equiv\text{O}/\equiv\text{O}$ ”
3. Horn switch “ H ”
4. Turn signal switch “ \leftarrow/\rightarrow ”

Right

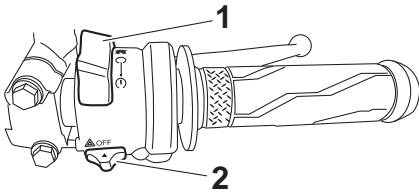

1. Start/Engine stop switch “ $(\text{M})/\text{O}/\text{X}$ ”
2. Hazard switch “ Δ/OFF ”

Pass switch “PASS”

EAU12362

Press this switch to flash the headlight.

TIP

When the dimmer switch is set to “ $\equiv\text{O}$ ”, the passing switch has no effect.

EAU12402

Dimmer switch “ $\equiv\text{O}/\equiv\text{O}$ ”

Set this switch to “ $\equiv\text{O}$ ” for the high beam and to “ $\equiv\text{O}$ ” for the low beam.

Turn signal switch “ \leftarrow/\rightarrow ”

To signal a right-hand turn, push this switch to “ \rightarrow ”. To signal a left-hand turn, push this switch to “ \leftarrow ”. When released, the switch returns to the center position. To cancel the turn signal lights, push the switch in after it has returned to the center position.

Horn switch “ H ”

EAU12501

Press this switch to sound the horn.

Start/Engine stop switch “ $(\text{M})/\text{O}/\text{X}$ ”

EAU68270

To crank the engine with the starter, set this switch to “ O ”, and then slide the switch toward “ (M) ”. See page 5-2 for starting instructions prior to starting the engine.

Set this switch to “ X ” to stop the engine in case of an emergency, such as when the vehicle overturns or when the throttle cable is stuck.

Hazard switch “ OFF/Δ ”

EAU88272

Use this switch to turn on the hazard lights (simultaneous flashing of all turn signal lights). The hazard lights are used in case of an emergency or to warn other drivers when your vehicle is stopped where it might be a traffic hazard.

The hazard lights can be turned on or off only when the key is in the “ON” position. You can turn the main switch to the “OFF” or “LOCK” position, and the hazard lights will continue to flash. To turn off the hazard lights, turn the main switch to the “ON” position and operate the hazard switch again.

NOTICE

Do not use the hazard lights for an extended length of time with the engine not running, otherwise the battery may discharge.

Clutch lever

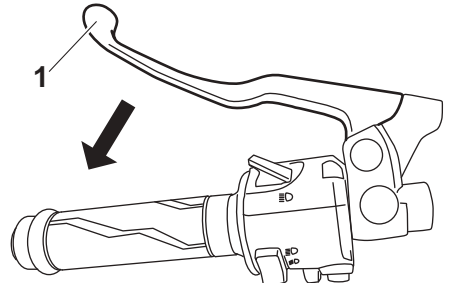

1. Clutch lever

To disengage the drivetrain from the engine, such as when shifting gears, pull the clutch lever toward to the handlebar. Release the lever to engage the clutch and transmit power to the rear wheel.

TIP

The lever should be pulled rapidly and released slowly for smooth shifting. (See page 5-3.)

Instrument and control functions

Shift pedal

EAU12876

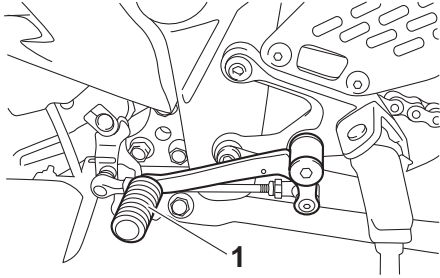

1. Shift pedal

The shift pedal is located on the left side of the motorcycle. To shift the transmission to a higher gear, move the shift pedal up. To shift the transmission to a lower gear, move the shift pedal down. (See page 5-3.)

Brake lever

EAU12892

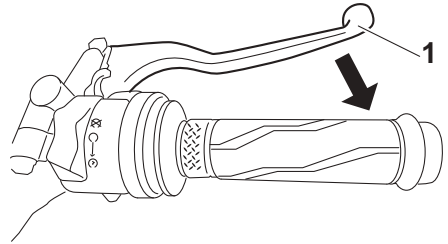

1. Brake lever

The brake lever is located on the right side of the handlebar. To apply the front brake, pull the lever toward the throttle grip.

Brake pedal

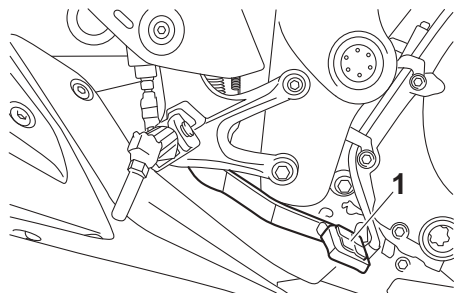

1. Brake pedal

The brake pedal is located on the right side of the motorcycle. To apply the rear brake, press down on the brake pedal.

ABS

The Yamaha ABS (Anti-lock Brake System) features a dual electronic control system, which acts on the front and rear brakes independently.

Operate the brakes with ABS as you would conventional brakes. If the ABS is activated, a pulsating sensation may be felt at the brake lever or brake pedal. In this situation, continue to apply the brakes and let the ABS work; do not “pump” the brakes as this will reduce braking effectiveness.

EWA16051

WARNING

Always keep a sufficient distance from the vehicle ahead to match the riding speed even with ABS.

- **The ABS performs best with long braking distances.**
- **On certain surfaces, such as rough or gravel roads, the braking distance may be longer with the ABS than without.**

The ABS is monitored by an ECU, which will revert the system to conventional braking if a malfunction occurs.

TIP

- The ABS performs a self-diagnosis test each time the vehicle first starts off after the key is turned to “ON” and the vehicle has traveled at a speed of 10 km/h (6 mi/h) or higher. During this test, a “clicking” noise can be heard from the hydraulic control unit, and if the brake lever or brake pedal is even slightly applied, a vibration can be felt at the lever and pedal, but these do not indicate a malfunction.

Instrument and control functions

EAU13076

- This ABS has a test mode which allows the owner to experience the pulsation at the brake lever or brake pedal when the ABS is operating. However, special tools are required, so please consult your Yamaha dealer.

ECA20100

NOTICE

- 3** Be careful not to damage the wheel sensor or wheel sensor rotor; otherwise, improper performance of the ABS will result.

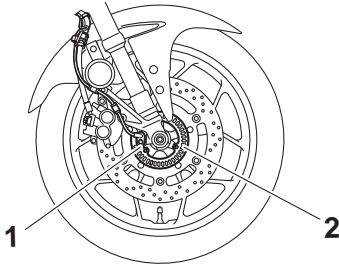

1. Front wheel sensor
2. Front wheel sensor rotor

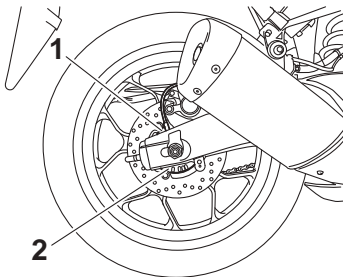

1. Rear wheel sensor
2. Rear wheel sensor rotor

Fuel tank cap

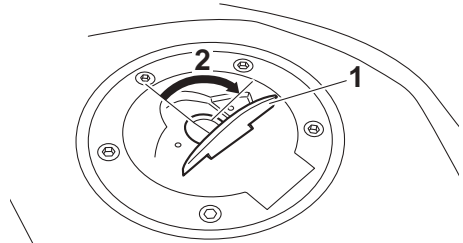

1. Fuel tank cap lock cover
2. Unlock.

To open the fuel tank cap

Open the fuel tank cap lock cover, insert the key into the lock, and then turn it 1/4 turn clockwise. The lock will be released and the fuel tank cap can be opened.

To close the fuel tank cap

With the key still inserted in the lock, push down the fuel tank cap. Turn the key 1/4 turn counterclockwise, remove it, and then close the lock cover.

TIP

The fuel tank cap cannot be closed unless the key is in the lock. In addition, the key cannot be removed if the cap is not properly closed and locked.

EWA11092

WARNING

Make sure that the fuel tank cap is properly closed after filling fuel. Leaking fuel is a fire hazard.

Instrument and control functions

Fuel

Make sure there is sufficient gasoline in the tank.

EAU13222

EWA10882

WARNING

Gasoline and gasoline vapors are extremely flammable. To avoid fires and explosions and to reduce the risk of injury when refueling, follow these instructions.

1. Before refueling, turn off the engine and be sure that no one is sitting on the vehicle. Never refuel while smoking, or while in the vicinity of sparks, open flames, or other sources of ignition such as the pilot lights of water heaters and clothes dryers.
2. Do not overfill the fuel tank. When refueling, be sure to insert the pump nozzle into the fuel tank filler hole. Stop filling when the fuel reaches the bottom of the filler tube. Because fuel expands when it heats up, heat from the engine or the sun can cause fuel to spill out of the fuel tank.

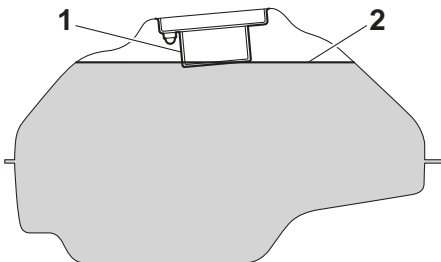

1. Fuel tank filler tube
2. Maximum fuel level

3. Wipe up any spilled fuel immediately. **NOTICE: Immediately wipe off spilled fuel with a clean, dry, soft cloth, since fuel may deteriorate painted surfaces or plastic parts.** [ECA10072]
4. Be sure to securely close the fuel tank cap.

EWA15152

WARNING

Gasoline is poisonous and can cause injury or death. Handle gasoline with care. Never siphon gasoline by mouth. If you should swallow some gasoline or inhale a lot of gasoline vapor, or get some gasoline in your eyes, see your doctor immediately. If gasoline spills on your skin, wash with soap and water. If gasoline spills on your clothing, change your clothes.

EAU86071

Your Yamaha engine was designed to use unleaded gasoline with a research octane number of 90 or higher. If engine knocking or pinging occurs, use a gasoline of a different brand or higher octane rating.

Recommended fuel:

Unleaded gasoline (E10 acceptable)

Octane number (RON):

90

Fuel tank capacity:

14 L (3.7 US gal, 3.1 Imp.gal)

Fuel tank reserve:

3.0 L (0.79 US gal, 0.66 Imp.gal)

Instrument and control functions

EAU80200



3

TIP

- This mark identifies the recommended fuel for this vehicle as specified by European regulation (EN228).
- Confirm the gasoline pump nozzle has the same same fuel identification mark.

Gasohol

There are two types of gasohol: gasohol containing ethanol and that containing methanol. Gasohol containing ethanol can be used if the ethanol content does not exceed 10% (E10). Gasohol containing methanol is not recommended by Yamaha because it can cause damage to the fuel system or vehicle performance problems.

ECA11401

NOTICE

Use only unleaded gasoline. The use of leaded gasoline will cause severe damage to internal engine parts, such as the valves and piston rings, as well as to the exhaust system.

Fuel tank overflow hose

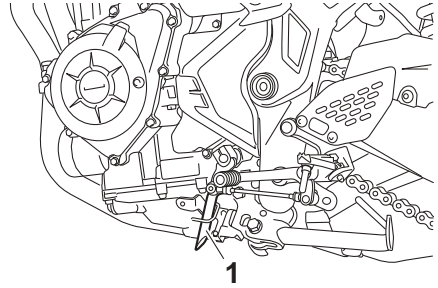

1. Fuel tank overflow hose

Before operating the vehicle:

- Check the fuel tank overflow hose connection.
- Check the fuel tank overflow hose for cracks or damage, and replace it if necessary.
- Make sure that the end of the fuel tank overflow hose is not blocked, and clean it if necessary.
- Make sure that the end of the fuel tank overflow hose is positioned as shown.

TIP

See page 6-8 for canister information.

Catalytic converter

The exhaust system contains catalytic converter(s) to reduce harmful exhaust emissions.

EWA10863

WARNING

The exhaust system is hot after operation. To prevent a fire hazard or burns:

- Do not park the vehicle near possible fire hazards such as grass or other materials that easily burn.
- Park the vehicle in a place where pedestrians or children are not likely to touch the hot exhaust system.
- Make sure that the exhaust system has cooled down before doing any maintenance work.
- Do not allow the engine to idle more than a few minutes. Long idling can cause a build-up of heat.

Seats

Passenger seat

To remove the passenger seat

1. Insert the key into the seat lock, and then turn it clockwise.

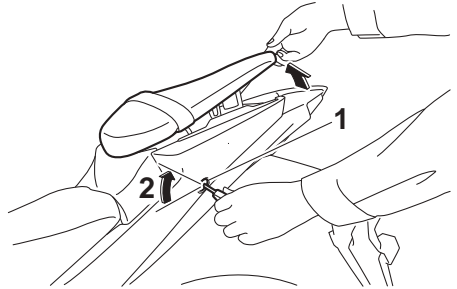

1. Passenger seat lock
2. Unlock.

2. While holding the key in that position, lift the rear of the passenger seat and pull it backward.

To install the passenger seat

1. Insert the projections on the front of the passenger seat into the seat holders as shown, and then push the rear of the seat down to lock it in place.

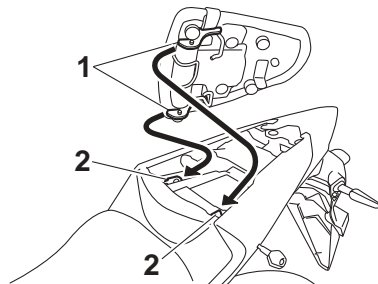

1. Projection
2. Seat holder

2. Remove the key.

Instrument and control functions

Rider seat

To remove the rider seat

1. Remove the passenger seat.
2. Remove the center cover by removing the screws.

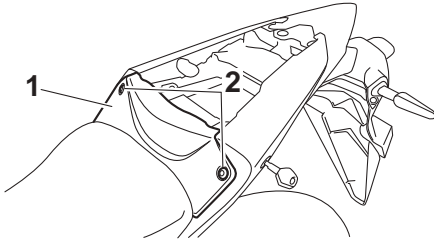

1. Center cover
2. Screw

3. Remove the rider seat by removing the bolts. Lift the rear of the rider seat and pull it backward.

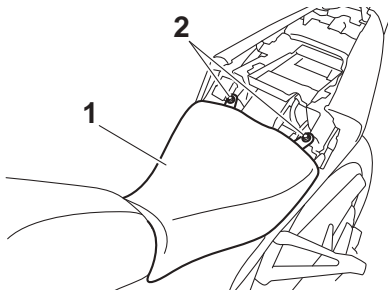

1. Rider seat
2. Bolt

To install the rider seat

1. Insert the projection on the front of the rider seat into the seat holder as shown, and then place the seat in the original position.

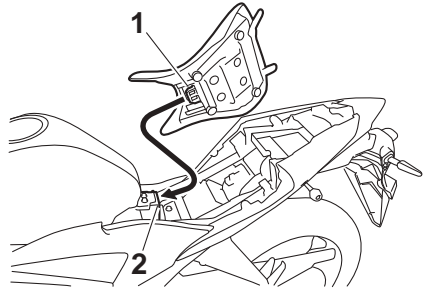

1. Projection
2. Seat holder

2. Install the rider seat bolts.
3. Install the center cover by installing the screws.
4. Install the passenger seat.

TIP

Make sure that the seats are properly secured before riding.

EAU62930

Helmet holders

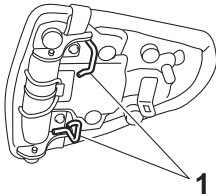

1. Helmet holder

The helmet holders are located on the bottom of the passenger seat.

To secure a helmet to a helmet holder

1. Remove the passenger seat. (See page 3-17.)
2. Attach a helmet to a helmet holder, and then securely install the passenger seat. **WARNING! Never ride with a helmet attached to the helmet holder, since the helmet may hit objects, causing loss of control and possibly an accident.** [EWA10162]

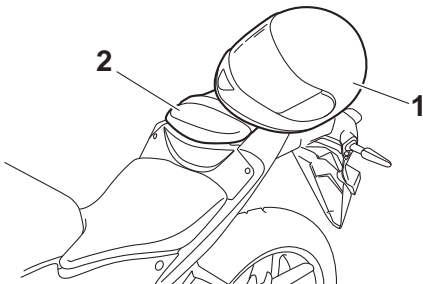

1. Helmet
2. Passenger seat

Instrument and control functions

Storage compartment

EAU62550

EAU68143

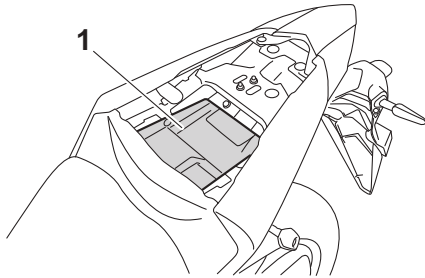

1. Storage compartment

The storage compartment is located under the passenger seat. (See page 3-17.)

When storing documents or other items in the storage compartment, be sure to wrap them in a plastic bag so that they will not get wet. When washing the vehicle, be careful not to let any water enter the storage compartment.

EWA15401

⚠ WARNING

Do not exceed the maximum load of 160 kg (353 lb) for the vehicle.

Adjusting the shock absorber assembly

This shock absorber assembly is equipped with a spring preload adjusting ring.

ECA10102

NOTICE

To avoid damaging the mechanism, do not attempt to turn beyond the maximum or minimum settings.

Adjust the spring preload as follows.

TIP

For ABS models, remove the drive chain guard by removing the bolts and collars.

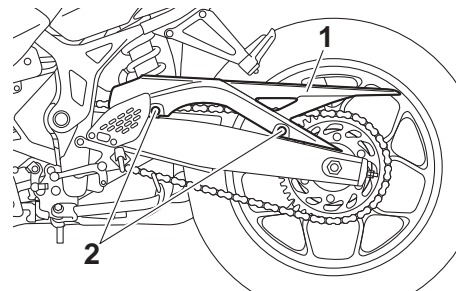

1. Drive chain guard
2. Bolt and collar

Turn the adjusting ring in direction (a) to increase the spring preload.

Turn the adjusting ring in direction (b) to decrease the spring preload.

- Align the appropriate notch in the adjusting ring with the position indicator on the shock absorber.
- Use the special wrench and the extension bar included in the tool kit to make the adjustment.

Instrument and control functions

EAU84680

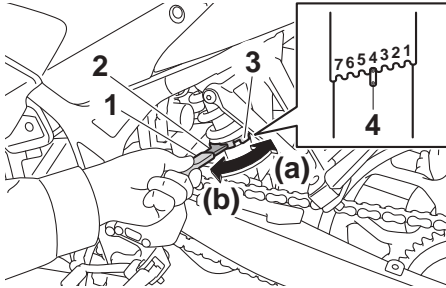

1. Extension bar
2. Special wrench
3. Spring preload adjusting ring
4. Position indicator

Spring preload setting:

Minimum (soft):

1

Standard:

4

Maximum (hard):

7

Luggage strap holders

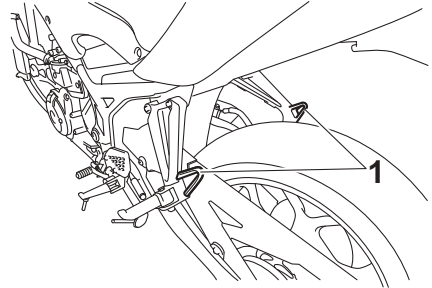

1. Luggage strap holder

Use the indicated strap points to secure luggage ties to the vehicle.

TIP

For ABS models, be sure to install the drive chain guard by installing the collars and bolts, and then tighten the bolts to the specified torque.

Tightening torque:

Drive chain guard bolt:

10 N·m (1.0 kgf·m, 7.4 lb·ft)

Instrument and control functions

EAU15306

EAU64051

Sidestand

The sidestand is located on the left side of the frame. Raise the sidestand or lower it with your foot while holding the vehicle upright.

TIP

The built-in sidestand switch is part of the ignition circuit cut-off system, which cuts the ignition in certain situations. (See the following section for an explanation of the ignition circuit cut-off system.)

EWA10242

WARNING

The vehicle must not be ridden with the sidestand down, or if the sidestand cannot be properly moved up (or does not stay up), otherwise the sidestand could contact the ground and distract the operator, resulting in a possible loss of control. Yamaha's ignition circuit cut-off system has been designed to assist the operator in fulfilling the responsibility of raising the sidestand before starting off. Therefore, check this system regularly and have a Yamaha dealer repair it if it does not function properly.

Ignition circuit cut-off system

This system prevents in-gear engine starts unless the clutch lever is pulled and the sidestand is up. Also, it will stop the running engine should the sidestand be lowered while the transmission is in gear.

Periodically check the system via the following procedure.

TIP

- This check is most reliable if performed with a warmed-up engine.
 - See pages 3-1 for switch operation information.
-

Instrument and control functions

With the engine turned off:
1. Move the sidestand down.
2. Set engine stop switch to run position.
3. Turn main switch to on position.
4. Shift transmission into neutral.
5. Push the start switch.
Does the engine start?



If a malfunction is found, have the vehicle inspected before riding.

YES

NO

The neutral switch may not be working.
The motorcycle should not be ridden until checked by a Yamaha dealer.

3

With the engine still running:
6. Move the sidestand up.
7. Pull the clutch lever.
8. Shift transmission into gear.
9. Move the sidestand down.
Does the engine stall?

YES

NO

The sidestand switch may not be working.
The motorcycle should not be ridden until checked by a Yamaha dealer.

After the engine has stalled:
10. Move the sidestand up.
11. Pull the clutch lever.
12. Push the start switch.
Does the engine start?

YES

NO

The clutch switch may not be working.
The motorcycle should not be ridden until checked by a Yamaha dealer.

The system is OK. **The motorcycle can be ridden.**

For your safety – pre-operation checks

EAU63441

Inspect your vehicle each time you use it to make sure the vehicle is in safe operating condition. Always follow the inspection and maintenance procedures and schedules described in the Owner's Manual.

EWA11152

WARNING

Failure to inspect or maintain the vehicle properly increases the possibility of an accident or equipment damage. Do not operate the vehicle if you find any problem. If a problem cannot be corrected by the procedures provided in this manual, have the vehicle inspected by a Yamaha dealer.

Before using this vehicle, check the following points:

ITEM	CHECKS	PAGE
Fuel	<ul style="list-style-type: none">• Check fuel level in fuel tank.• Refuel if necessary.• Check fuel line for leakage.• Check fuel tank breather hose and overflow hose for obstructions, cracks or damage, and check hose connections.	3-15, 3-16
Engine oil	<ul style="list-style-type: none">• Check oil level in engine.• If necessary, add recommended oil to specified level.• Check vehicle for oil leakage.	6-8
Coolant	<ul style="list-style-type: none">• Check coolant level in reservoir.• If necessary, add recommended coolant to specified level.• Check cooling system for leakage.	6-12
Front brake	<ul style="list-style-type: none">• Check operation.• If soft or spongy, have Yamaha dealer bleed hydraulic system.• Check brake pads for wear.• Replace if necessary.• Check fluid level in reservoir.• If necessary, add specified brake fluid to specified level.• Check hydraulic system for leakage.	6-20, 6-21
Rear brake	<ul style="list-style-type: none">• Check operation.• If soft or spongy, have Yamaha dealer bleed hydraulic system.• Check brake pads for wear.• Replace if necessary.• Check fluid level in reservoir.• If necessary, add specified brake fluid to specified level.• Check hydraulic system for leakage.	6-20, 6-21
Clutch	<ul style="list-style-type: none">• Check operation.• Lubricate cable if necessary.• Check lever free play.• Adjust if necessary.	6-18

For your safety – pre-operation checks

ITEM	CHECKS	PAGE
Throttle grip	<ul style="list-style-type: none"> • Make sure that operation is smooth. • Check throttle grip free play. • If necessary, have Yamaha dealer adjust throttle grip free play and lubricate cable and grip housing. 	6-15, 6-25
Control cables	<ul style="list-style-type: none"> • Make sure that operation is smooth. • Lubricate if necessary. 	6-25
Drive chain	<ul style="list-style-type: none"> • Check chain slack. • Adjust if necessary. • Check chain condition. • Lubricate if necessary. 	6-23, 6-24
Wheels and tires	<ul style="list-style-type: none"> • Check for damage. • Check tire condition and tread depth. • Check air pressure. • Correct if necessary. 	6-16, 6-18
Brake and shift pedals	<ul style="list-style-type: none"> • Make sure that operation is smooth. • Lubricate pedal pivoting points if necessary. 	6-26
Brake and clutch levers	<ul style="list-style-type: none"> • Make sure that operation is smooth. • Lubricate lever pivoting points if necessary. 	6-26
Sidestand	<ul style="list-style-type: none"> • Make sure that operation is smooth. • Lubricate pivot if necessary. 	6-27
Chassis fasteners	<ul style="list-style-type: none"> • Make sure that all nuts, bolts and screws are properly tightened. • Tighten if necessary. 	—
Instruments, lights, signals and switches	<ul style="list-style-type: none"> • Check operation. • Correct if necessary. 	—
Sidestand switch	<ul style="list-style-type: none"> • Check operation of ignition circuit cut-off system. • If system is not working correctly, have Yamaha dealer check vehicle. 	3-22

Operation and important riding points

EAU15952

Read the Owner's Manual carefully to become familiar with all controls. If there is a control or function you do not understand, ask your Yamaha dealer.

EWA10272

WARNING

Failure to familiarize yourself with the controls can lead to loss of control, which could cause an accident or injury.

EAU16842

Engine break-in

There is never a more important period in the life of your engine than the period between 0 and 1600 km (1000 mi). For this reason, you should read the following material carefully.

Since the engine is brand new, do not put an excessive load on it for the first 1600 km (1000 mi). The various parts in the engine wear and polish themselves to the correct operating clearances. During this period, prolonged full-throttle operation or any condition that might result in engine overheating must be avoided.

EAU17094

0–1000 km (0–600 mi)

Avoid prolonged operation above 7000 r/min. **NOTICE: After 1000 km (600 mi) of operation, the engine oil must be changed and the oil filter cartridge or element replaced.** [ECA10303]

1000–1600 km (600–1000 mi)

Avoid prolonged operation above 8400 r/min.

1600 km (1000 mi) and beyond

The vehicle can now be operated normally.

ECA10311

NOTICE

- Keep the engine speed out of the tachometer red zone.
 - If any engine trouble should occur during the engine break-in period, immediately have a Yamaha dealer check the vehicle.
-

Operation and important riding points

Starting the engine

EAU86620

The ignition circuit cut-off system will enable starting when:

- the transmission is in the neutral position or
- the transmission is in gear, the sidestand is up, and the clutch lever is pulled.

To start the engine

1. Turn the main switch on and set the engine stop switch to the run position.
2. Confirm the indicator and warning light(s) come on for a few seconds, and the go off. (See page 3-2.)

TIP

- Do not start the engine if the engine trouble warning light remains on.
- The oil pressure warning light should come on and stay on until the engine is started.
- The ABS warning light should come on and stay on until the vehicle reaches a speed of 10 km/h (6 mi/h).

ECA24110

NOTICE

If a warning or indicator light does not work as described above, have a Yamaha dealer check the vehicle.

3. Shift the transmission into the neutral position.
4. Start the engine by pushing the start switch.

5. Release the start switch when the engine starts, or after 5 seconds. Wait 10 seconds before pressing the switch again to allow battery voltage to restore.

ECA11043

NOTICE

For maximum engine life, never accelerate hard when the engine is cold!

Operation and important riding points

EAUM3632

EAU16674

TIP

This model is equipped with:

- a lean angle sensor. This sensor stops the engine in case of a vehicle turnover. If this happens, the engine trouble warning light will come on, but this is not a malfunction. Turn the vehicle power off and then back on again to cancel the warning light. Failing to do so will prevent the engine from starting even though the engine will crank when pushing the start switch.
- an engine auto-stop system. The engine stops automatically if left idling for 20 minutes. If the engine stops, simply push the start switch to restart the engine.

Shifting

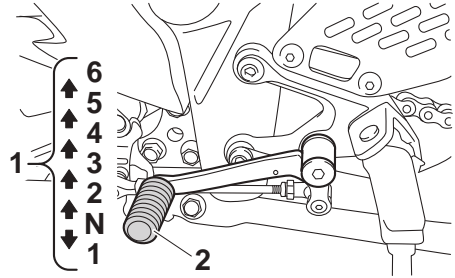

1. Gear positions
2. Shift pedal

Shifting gears lets you control the amount of engine power available for starting off, accelerating, climbing hills, etc.

The gear positions are shown in the illustration.

TIP

To shift the transmission into the neutral position (**N**), press the shift pedal down repeatedly until it reaches the end of its travel, and then slightly raise it.

ECA10261

NOTICE

- Even with the transmission in the neutral position, do not coast for long periods of time with the engine off, and do not tow the motorcycle for long distances. The transmission is properly lubricated only when the engine is running. Inadequate lubrication may damage the transmission.
- Always use the clutch while changing gears to avoid damaging the engine, transmission,

Operation and important riding points

and drive train, which are not designed to withstand the shock of forced shifting.

EAU16811

Tips for reducing fuel consumption

Fuel consumption depends largely on your riding style. Consider the following tips to reduce fuel consumption:

- Shift up swiftly, and avoid high engine speeds during acceleration.
- Do not rev the engine while shifting down, and avoid high engine speeds with no load on the engine.
- Turn the engine off instead of letting it idle for an extended length of time (e.g., in traffic jams, at traffic lights or at railroad crossings).

Operation and important riding points

EAU17214

Parking

When parking, stop the engine, and then remove the key from the main switch.

EWA10312

WARNING

- Since the engine and exhaust system can become very hot, park in a place where pedestrians or children are not likely to touch them and be burned.
 - Do not park on a slope or on soft ground, otherwise the vehicle may overturn, increasing the risk of a fuel leak and fire.
 - Do not park near grass or other flammable materials which might catch fire.
-

Periodic maintenance and adjustment

EAU17246

Periodic inspection, adjustment, and lubrication will keep your vehicle in the safest and most efficient condition possible. Safety is an obligation of the vehicle owner/operator. The most important points of vehicle inspection, adjustment, and lubrication are explained on the following pages.

The intervals given in the periodic maintenance charts should be simply considered as a general guide under normal riding conditions. However, depending on the weather, terrain, geographical location, and individual use, the maintenance intervals may need to be shortened.

EWA10322

WARNING

Failure to properly maintain the vehicle or performing maintenance activities incorrectly may increase your risk of injury or death during service or while using the vehicle. If you are not familiar with vehicle service, have a Yamaha dealer perform service.

EWA15123

WARNING

Turn off the engine when performing maintenance unless otherwise specified.

- **A running engine has moving parts that can catch on body parts or clothing and electrical parts that can cause shocks or fires.**
- **Running the engine while servicing can lead to eye injury, burns, fire, or carbon monoxide poisoning – possibly leading to**

death. See page 1-3 for more information about carbon monoxide.

EWA15461

WARNING

Brake discs, calipers, drums, and linings can become very hot during use. To avoid possible burns, let brake components cool before touching them.

Periodic maintenance and adjustment

EAU85230

Tool kit

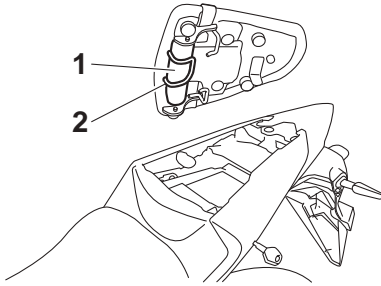

1. Tool kit
2. O-ring

The tool kit is in the location shown. The information included in this manual and the tools provided in the tool kit are intended to assist you in the performance of preventive maintenance and minor repairs. However, a torque wrench and other tools are necessary to perform certain maintenance work correctly.

TIP _____

If you do not have the tools or experience required for a particular job, have your Yamaha dealer perform it for you.

Periodic maintenance and adjustment

EAU71033

Periodic maintenance charts

TIP

- Items marked with an asterisk should be performed by your Yamaha dealer because these items require special tools, data, and technical skills.
- From 50000 km (30000 mi), repeat the maintenance intervals starting from 10000 km (6000 mi).
- **The annual checks must be performed every year, except if a distance-based maintenance is performed instead.**

EAU71071

Periodic maintenance chart for the emission control system

NO.	ITEM	CHECK OR MAINTENANCE JOB	ODOMETER READINGS					ANNUAL CHECK		
			X 1000 km							
			1	10	20	30	40			
X 1000 mi					0.6	6	12	18	24	
1	* Fuel line	<ul style="list-style-type: none"> • Check fuel hoses for cracks or damage. • Replace if necessary. 		√	√	√	√	√		√
2	* Spark plugs	<ul style="list-style-type: none"> • Check condition. • Adjust gap and clean. 		√		√				
		<ul style="list-style-type: none"> • Replace. 			√		√			
3	* Valve clearance	<ul style="list-style-type: none"> • Check and adjust. 	Every 40000 km (24000 mi)							
4	* Fuel injection	<ul style="list-style-type: none"> • Check engine idle speed. 	√	√	√	√	√	√	√	
		<ul style="list-style-type: none"> • Check and adjust synchronization. 		√	√	√	√	√	√	
5	* Exhaust system	<ul style="list-style-type: none"> • Check for leakage. • Tighten if necessary. • Replace gaskets if necessary. 	√	√	√	√	√			
6	* Evaporative emission control system	<ul style="list-style-type: none"> • Check control system for damage. • Replace if necessary. 			√			√		
7	* Air induction system	<ul style="list-style-type: none"> • Check the air cut-off valve, reed valve, and hose for damage. • Replace any damaged parts if necessary. 		√	√	√	√	√	√	

Periodic maintenance and adjustment

EAU71372

General maintenance and lubrication chart

NO.	ITEM	CHECK OR MAINTENANCE JOB	ODOMETER READINGS					ANNUAL CHECK		
			X 1000 km							
			1	10	20	30	40			
X 1000 mi					0.6	6	12	18	24	
1	* Diagnostic system check	<ul style="list-style-type: none"> Perform dynamic inspection using Yamaha diagnostic tool. Check the error codes. 	√	√	√	√	√	√	√	√
2	* Air filter element	<ul style="list-style-type: none"> Replace. 			√			√		
3	Air filter case check hose	<ul style="list-style-type: none"> Clean. 	√	√	√	√	√	√	√	
4	Clutch	<ul style="list-style-type: none"> Check operation. Adjust. 	√	√	√	√	√	√	√	
5	* Front brake	<ul style="list-style-type: none"> Check operation, fluid level, and for fluid leakage. Replace brake pads if necessary. 	√	√	√	√	√	√	√	√
6	* Rear brake	<ul style="list-style-type: none"> Check operation, fluid level, and for fluid leakage. Replace brake pads if necessary. 	√	√	√	√	√	√	√	√
7	* Brake hoses	<ul style="list-style-type: none"> Check for cracks or damage. 		√	√	√	√	√	√	√
		<ul style="list-style-type: none"> Replace. 	Every 4 years							
8	* Brake fluid	<ul style="list-style-type: none"> Change. 	Every 2 years							
9	* Wheels	<ul style="list-style-type: none"> Check runout and for damage. Replace if necessary. 		√	√	√	√	√		
10	* Tires	<ul style="list-style-type: none"> Check tread depth and for damage. Replace if necessary. Check air pressure. Correct if necessary. 		√	√	√	√	√	√	
11	* Wheel bearings	<ul style="list-style-type: none"> Check bearing for looseness or damage. 		√	√	√	√	√		
12	* Swingarm pivot bearings	<ul style="list-style-type: none"> Check operation and for excessive play. 		√	√	√	√	√		
13	Drive chain	<ul style="list-style-type: none"> Check chain slack, alignment and condition. Adjust and lubricate chain with a special O-ring chain lubricant thoroughly. 	Every 800 km (500 mi) and after washing the motorcycle, riding in the rain or riding in wet areas							

Periodic maintenance and adjustment

NO.	ITEM	CHECK OR MAINTENANCE JOB	ODOMETER READINGS					ANNUAL CHECK		
			X 1000 km							
			1	10	20	30	40			
X 1000 mi					0.6	6	12	18	24	
14	*	Steering bearings	• Check bearing assemblies for looseness.	√	√		√			
			• Moderately repack with lithium-soap-based grease.			√		√		
15	*	Chassis fasteners	• Make sure that all nuts, bolts and screws are properly tightened.		√	√	√	√	√	
16		Brake lever pivot shaft	• Lubricate with silicone grease.		√	√	√	√	√	
17		Brake pedal pivot shaft	• Lubricate with lithium-soap-based grease.		√	√	√	√	√	
18		Clutch lever pivot shaft	• Lubricate with lithium-soap-based grease.		√	√	√	√	√	
19		Shift pedal pivot shaft	• Lubricate with lithium-soap-based grease.		√	√	√	√	√	
20		Sidestand	• Check operation. • Lubricate with lithium-soap-based grease.		√	√	√	√	√	
21	*	Sidestand switch	• Check operation and replace if necessary.	√	√	√	√	√	√	
22	*	Front fork	• Check operation and for oil leakage. • Replace if necessary.		√	√	√	√		
23	*	Shock absorber assembly	• Check operation and for oil leakage. • Replace if necessary.		√	√	√	√		
24		Engine oil	• Change (warm engine before draining). • Check oil level and vehicle for oil leakage.	At the initial interval and when the oil change indicator flashes or comes on.					√	
25		Engine oil filter cartridge	• Replace.	√		√		√		
26	*	Cooling system	• Check coolant level and vehicle for coolant leakage.		√	√	√	√	√	
			• Change.	Every 3 years						
27	*	Front and rear brake switches	• Check operation.	√	√	√	√	√	√	

Periodic maintenance and adjustment

NO.	ITEM	CHECK OR MAINTENANCE JOB	ODOMETER READINGS					ANNUAL CHECK		
			X 1000 km							
			1	10	20	30	40			
X 1000 mi					0.6	6	12	18	24	
28	* Moving parts and cables	• Lubricate.		√	√	√	√	√	√	√
29	* Throttle grip housing and cable	• Check operation and free play. • Adjust the throttle cable free play if necessary. • Lubricate the throttle grip housing and cable.		√	√	√	√	√	√	√
30	* Lights, signals and switches	• Check operation. • Adjust headlight beam.	√	√	√	√	√	√	√	√

EAU72710

6

TIP

- Air filter
 - This model's air intake system is equipped with a disposable oil-coated paper element. The air filter element cannot be cleaned with compressed air, it must be replaced.
 - The air filter element needs to be replaced more frequently when riding in unusually wet or dusty areas.
- Hydraulic brake service
 - After disassembling the brake master cylinder and caliper, always change the fluid. Regularly check the brake fluid level and fill the reservoir as required.
 - Every two years replace the internal components of the brake master cylinder and caliper, and change the brake fluid.
 - Replace the brake hose every four years and if cracked or damaged.

Periodic maintenance and adjustment

EAU19643

Checking the spark plugs

The spark plugs are important engine components, which should be checked periodically, preferably by a Yamaha dealer. Since heat and deposits will cause any spark plug to slowly erode, they should be removed and checked in accordance with the periodic maintenance and lubrication chart. In addition, the condition of the spark plugs can reveal the condition of the engine.

The porcelain insulator around the center electrode of each spark plug should be a medium-to-light tan (the ideal color when the vehicle is ridden normally), and all spark plugs installed in the engine should have the same color. If any spark plug shows a distinctly different color, the engine could be operating improperly. Do not attempt to diagnose such problems yourself. Instead, have a Yamaha dealer check the vehicle.

If a spark plug shows signs of electrode erosion and excessive carbon or other deposits, it should be replaced.

Specified spark plug:
NGK/LMAR8A-9

Before installing a spark plug, the spark plug gap should be measured with a wire thickness gauge and, if necessary, adjusted to specification.

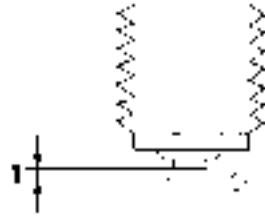

1. Spark plug gap

Spark plug gap:
0.8–0.9 mm (0.031–0.035 in)

Clean the surface of the spark plug gasket and its mating surface, and then wipe off any grime from the spark plug threads.

Tightening torque:
Spark plug:
13 N·m (1.3 kgf·m, 9.6 lb·ft)

TIP _____
If a torque wrench is not available when installing a spark plug, a good estimate of the correct torque is 1/4–1/2 turn past finger tight. However, the spark plug should be tightened to the specified torque as soon as possible.

Periodic maintenance and adjustment

EAU36112

EAUN1150

Canister

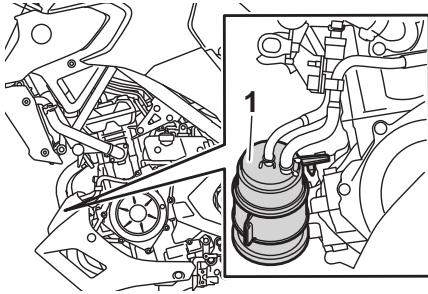

1. Canister

This model is equipped with a canister to prevent the discharging of fuel vapor into the atmosphere. Before operating this vehicle, make sure to check the following:

- Check each hose connection.
- Check each hose and canister for cracks or damage. Replace if damaged.
- Make sure that the canister breather is not blocked, and if necessary, clean it.

Engine oil and oil filter cartridge

The engine oil level should be checked before each ride. In addition, the oil must be changed and the oil filter cartridge replaced at the intervals specified in the periodic maintenance and lubrication chart.

To check the engine oil level

1. Place the vehicle on a level surface and hold it in an upright position. A slight tilt to the side can result in a false reading.
2. Start the engine, warm it up for several minutes, and then turn it off.
3. Wait a few minutes until the oil settles, and then check the oil level through the engine oil level check window located at the bottom-right side of the crankcase.

TIP

The engine oil should be between the minimum and maximum level marks.

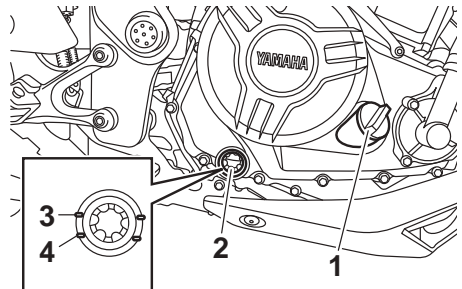

1. Engine oil filler cap
2. Engine oil level check window
3. Maximum level mark
4. Minimum level mark

Periodic maintenance and adjustment

4. If the engine oil is below the minimum level mark, add sufficient oil of the recommended type to raise it to the correct level.

To change the engine oil (with or without oil filter cartridge replacement)

1. Place the vehicle on a level surface.
2. Start the engine, warm it up for several minutes, and then turn it off.
3. Place an oil pan under the engine to collect the used oil.
4. Remove the cowling by removing the bolts.

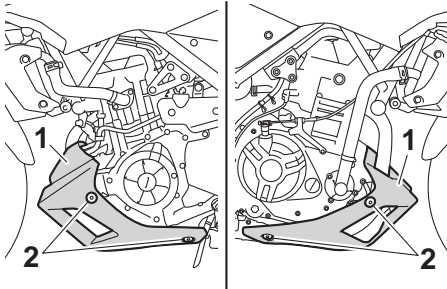

1. Cowling
2. Bolt

5. Remove the engine oil filler cap, the engine oil drain bolt and its gasket to drain the oil from the crankcase.

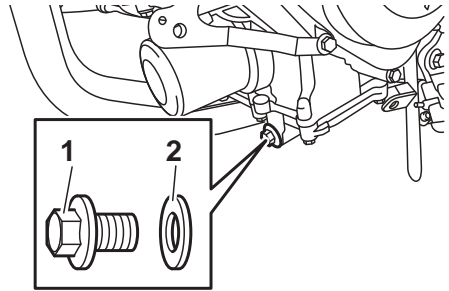

1. Engine oil drain bolt
2. Gasket

TIP

Skip steps 6–8 if the oil filter cartridge is not being replaced.

6. Remove the oil filter cartridge with an oil filter wrench.

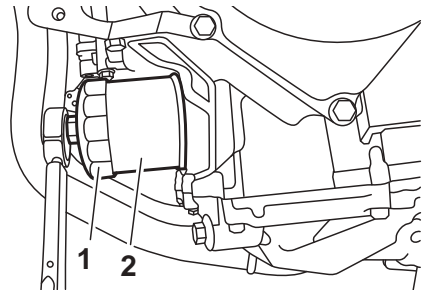

1. Oil filter wrench
2. Oil filter cartridge

TIP

An oil filter wrench is available at a Yamaha dealer.

7. Apply a thin coat of clean engine oil to the O-ring of the new oil filter cartridge.

Periodic maintenance and adjustment

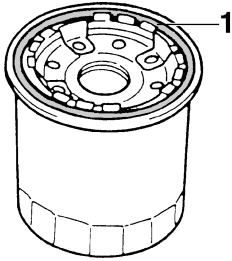

1. O-ring

TIP

Make sure that the O-ring is properly seated.

8. Install the new oil filter cartridge with an oil filter wrench, and then tighten it to the specified torque with a torque wrench.

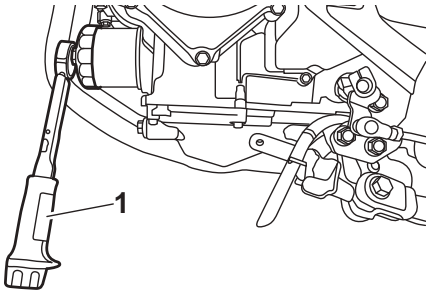

1. Torque wrench

Tightening torque:

Oil filter cartridge:
17 N·m (1.7 kgf·m, 13 lb·ft)

9. Install the engine oil drain bolt and its new gasket, and then tighten the bolt to the specified torque.

TIP

Install the new gasket as shown.

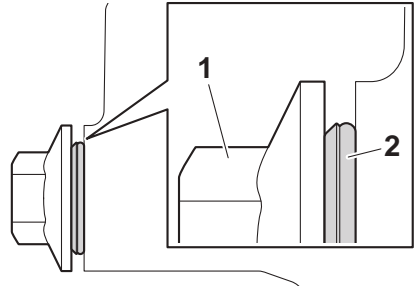

1. Engine oil drain bolt
2. Gasket

Tightening torque:

Engine oil drain bolt:
20 N·m (2.0 kgf·m, 15 lb·ft)

10. Refill with the specified amount of the recommended engine oil, and then install and tighten the oil filler cap.

Recommended engine oil:

See page 8-1.

Oil quantity:

Oil change:

1.80 L (1.90 US qt, 1.58 Imp.qt)

With oil filter removal:

2.10 L (2.22 US qt, 1.85 Imp.qt)

TIP

Be sure to wipe off spilled oil on any parts after the engine and exhaust system have cooled down.

ECA11621

NOTICE

- In order to prevent clutch slippage (since the engine oil also lubricates the clutch), do not mix any chemical additives. Do not use oils with a diesel specification of "CD" or oils of a higher quality than specified. In

Periodic maintenance and adjustment

EAU85450

addition, do not use oils labeled “ENERGY CONSERVING II” or higher.

- **Make sure that no foreign material enters the crankcase.**

11. Install the cowling by installing the bolts.
12. Start the engine, and then let it idle for several minutes while checking it for oil leakage. If oil is leaking, immediately turn the engine off and check for the cause.

TIP

After the engine is started, the engine oil pressure warning light should go off.

ECA20860

NOTICE

If the oil pressure warning light flickers or remains on even if the oil level is correct, immediately turn the engine off and have a Yamaha dealer check the vehicle.

13. Turn the engine off, wait a few minutes until the oil settles, and then check the oil level and correct it if necessary.

Why Yamalube

YAMALUBE oil is a Genuine YAMAHA Part born of the engineers' passion and belief that engine oil is an important liquid engine component. We form teams of specialists in the fields of mechanical engineering, chemistry, electronics and track testing, and have them develop the engine together with the oil it will use. Yamalube oils take full advantage of the base oil's qualities and blend in the ideal balance of additives to make sure the final oil clears our performance standards. Thus, Yamalube mineral, semisynthetic and synthetic oils have their own distinct characters and value. Yamaha's experience gained over many years of research and development into oil since the 1960's helps make Yamalube the best choice for your Yamaha engine.



YAMALUBE®

Periodic maintenance and adjustment

Coolant

EAU20071

The coolant level should be checked before each ride. In addition, the coolant must be changed at the intervals specified in the periodic maintenance and lubrication chart.

EAU38176

To check the coolant level

1. Place the vehicle on a level surface and hold it in an upright position.

TIP

- The coolant level must be checked on a cold engine since the level varies with engine temperature.
- Make sure that the vehicle is positioned straight up when checking the coolant level. A slight tilt to the side can result in a false reading.

2. Check the coolant level in the coolant reservoir.

TIP

The coolant should be between the minimum and maximum level marks.

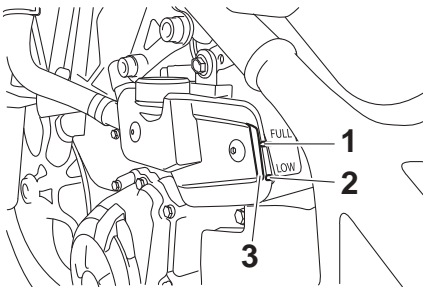

1. Maximum level mark
2. Minimum level mark
3. Coolant reservoir

3. If the coolant is at or below the minimum level mark, remove the coolant reservoir cover by removing the bolts, remove the coolant reservoir cap, and then add coolant to the maximum level mark. **WARNING! Remove only the coolant reservoir cap. Never attempt to remove the radiator cap when the engine is hot.**

[EWA15162] **NOTICE:** If coolant is not available, use distilled water or soft tap water instead. Do not use hard water or salt water since it is harmful to the engine. If water has been used instead of coolant, replace it with coolant as soon as possible, otherwise the cooling system will not be protected against frost and corrosion. If water has been added to the coolant, have a Yamaha dealer check the anti-freeze content of the coolant as soon as possible, otherwise the effectiveness of the coolant will be reduced. [ECA10473]

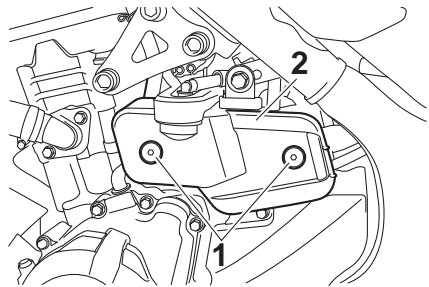

1. Bolt
2. Coolant reservoir cover

Periodic maintenance and adjustment

EAUN1172

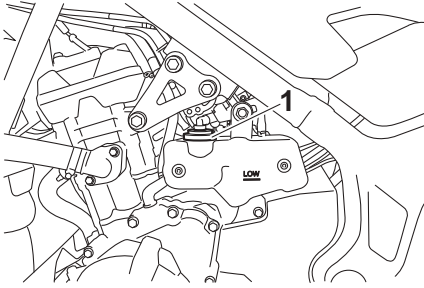

1. Coolant reservoir cap

Coolant reservoir capacity (up to the maximum level mark):
0.25 L (0.26 US qt, 0.22 Imp.qt)

4. Install the reservoir cap, and then install the coolant reservoir cover by installing the bolts.

Changing the coolant

EAU33032

The coolant must be changed at the intervals specified in the periodic maintenance and lubrication chart. Have a Yamaha dealer change the coolant. **WARNING! Never attempt to remove the radiator cap when the engine is hot.** [EWA10382]

Replacing the air filter element and cleaning the check hose

The air filter element should be replaced at the intervals specified in the periodic maintenance and lubrication chart. Replace the air filter element more frequently if you are riding in unusually wet or dusty areas. In addition, the air filter check hose must be frequently checked and cleaned if necessary.

To replace the air filter element

1. Remove the rider seat. (See page 3-17.)
2. Remove the left side panel bolts.

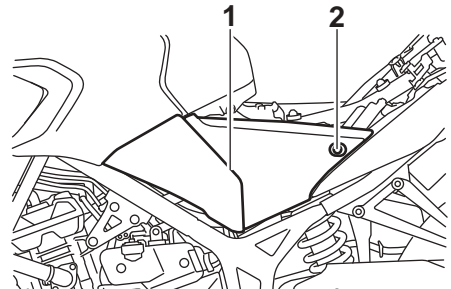

1. Left side panel
2. Bolt

3. Remove the left side panel by removing the lower projection on the panel from the slot, and then removing the upper projection as shown.

Periodic maintenance and adjustment

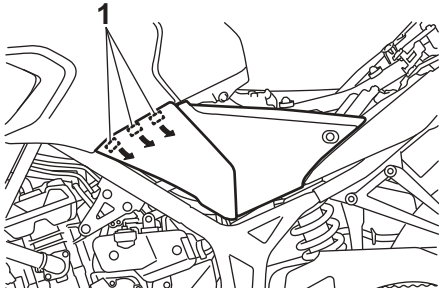

1. Projection

4. Lift up the rubber covers, and then remove the air filter case cover by removing the screws.

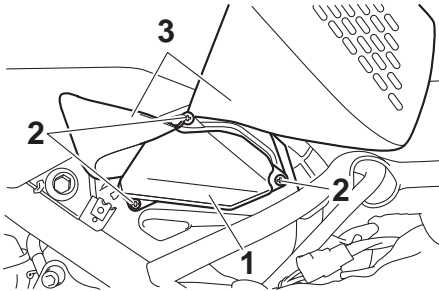

1. Air filter case cover
2. Screw
3. Rubber cover

5. Pull the air filter element out.

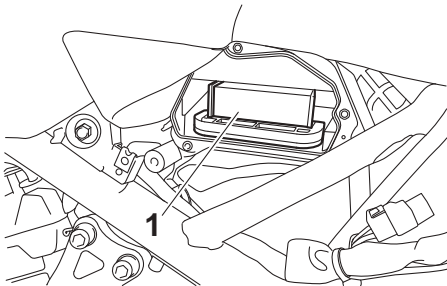

1. Air filter element

6. Insert a new air filter element into the air filter case. **NOTICE: Make sure that the air filter element is properly seated in the air filter**

case. The engine should never be operated without the air filter element installed, otherwise the piston(s) and/or cylinder(s) may become excessively worn.

[ECA10482]

7. Install the air filter case cover by installing the screws, and then place the rubber covers in their original positions.
8. Place the left side panel in the original position, and then install the bolts.
9. Install the rider seat.

To clean the air filter check hose

1. Check the hose on the front of the air filter case for accumulated dirt or water.

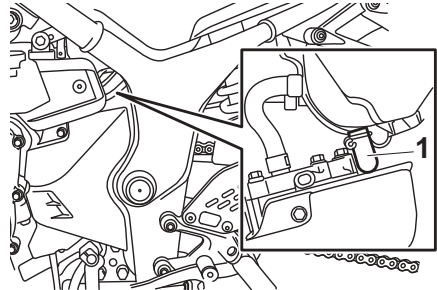

1. Air filter check hose

2. If dirt or water is visible, remove the hose, clean it, and then install it.

Periodic maintenance and adjustment

EAU21386

EAU21403

Checking the throttle grip free play

Measure the throttle grip free play as shown.

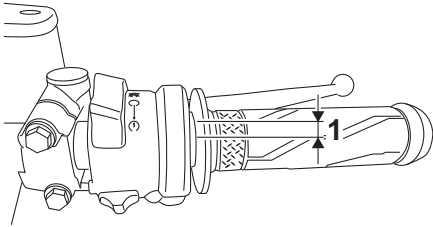

1. Throttle grip free play

Throttle grip free play:
3.0–5.0 mm (0.12–0.20 in)

Periodically check the throttle grip free play and, if necessary, have a Yamaha dealer adjust it.

Valve clearance

The valves are an important engine component, and since valve clearance changes with use, they must be checked and adjusted at the intervals specified in the periodic maintenance chart. Unadjusted valves can result in improper air-fuel mixture, engine noise, and eventually engine damage. To prevent this from occurring, have your Yamaha dealer check and adjust the valve clearance at regular intervals.

TIP

This service must be performed when the engine is cold.

Periodic maintenance and adjustment

EAU69761

Tires

Tires are the only contact between the vehicle and the road. Safety in all conditions of riding depends on a relatively small area of road contact. Therefore, it is essential to maintain the tires in good condition at all times and replace them at the appropriate time with the specified tires.

Tire air pressure

The tire air pressure should be checked and, if necessary, adjusted before each ride.

EWA10504

WARNING

Operation of this vehicle with improper tire pressure may cause severe injury or death from loss of control.

- The tire air pressure must be checked and adjusted on cold tires (i.e., when the temperature of the tires equals the ambient temperature).
- The tire air pressure must be adjusted in accordance with the riding speed and with the total weight of rider, passenger, cargo, and accessories approved for this model.

Cold tire air pressure:

1 person:

Front:

200 kPa (2.00 kgf/cm², 29 psi)

Rear:

250 kPa (2.50 kgf/cm², 36 psi)

2 persons:

Front:

200 kPa (2.00 kgf/cm², 29 psi)

Rear:

250 kPa (2.50 kgf/cm², 36 psi)

Maximum load:

Vehicle:

160 kg (353 lb)

The vehicle's maximum load is the combined weight of the rider, passenger, cargo, and any accessories.

EWA10512

WARNING

Never overload your vehicle. Operation of an overloaded vehicle could cause an accident.

Tire inspection

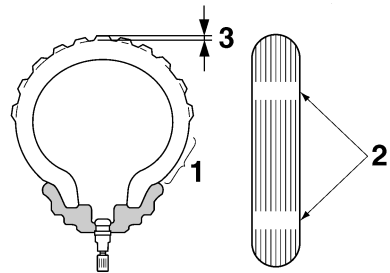

1. Tire sidewall
2. Tire wear indicator
3. Tire tread depth

The tires must be checked before each ride. If the center tread depth reaches the specified limit, if the tire has a nail or glass fragments in it, or if the sidewall is cracked, have a Yamaha dealer replace the tire immediately.

Periodic maintenance and adjustment

EWA10462

Minimum tire tread depth (front and rear):

1.6 mm (0.06 in)

TIP

The tire tread depth limits may differ from country to country. Always comply with the local regulations.

EWA10472

! WARNING

- **Have a Yamaha dealer replace excessively worn tires. Besides being illegal, operating the vehicle with excessively worn tires decreases riding stability and can lead to loss of control.**
- **The replacement of all wheel and brake-related parts, including the tires, should be left to a Yamaha dealer, who has the necessary professional knowledge and experience to do so.**
- **Ride at moderate speeds after changing a tire since the tire surface must first be “broken in” for it to develop its optimal characteristics.**

! WARNING

The front and rear tires should be of the same make and design, otherwise the handling characteristics of the vehicle may be different, which could lead to an accident.

After extensive tests, only the tires listed below have been approved for this model by Yamaha.

Front tire:

Size:

110/70R-17M/C 54H

Manufacturer/model:

DUNLOP/GPR-300F

Rear tire:

Size:

140/70R-17M/C 66H

Manufacturer/model:

DUNLOP/GPR-300

6

Tire information

This model is equipped with tubeless tires and rubber tire air valves.

Tires age, even if they have not been used or have only been used occasionally. Cracking of the tread and sidewall rubber, sometimes accompanied by carcass deformation, is an evidence of ageing. Old and aged tires shall be checked by tire specialists to ascertain their suitability for further use.

Periodic maintenance and adjustment

EAU21963

EAU33893

Cast wheels

To maximize the performance, durability, and safe operation of your vehicle, note the following points regarding the specified wheels.

- The wheel rims should be checked for cracks, bends, warpage or other damage before each ride. If any damage is found, have a Yamaha dealer replace the wheel. Do not attempt even the smallest repair to the wheel. A deformed or cracked wheel must be replaced.
- The wheel should be balanced whenever either the tire or wheel has been changed or replaced. An unbalanced wheel can result in poor performance, adverse handling characteristics, and a shortened tire life.

Adjusting the clutch lever free play

Measure the clutch lever free play as shown.

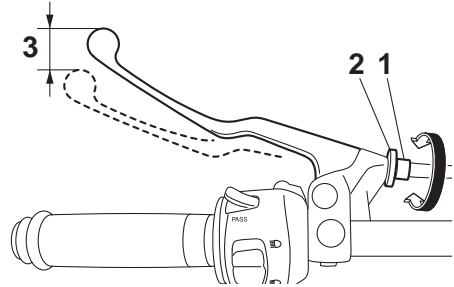

1. Clutch lever free play adjusting bolt
2. Locknut
3. Clutch lever free play

Clutch lever free play:

10.0–15.0 mm (0.39–0.59 in)

Periodically check the clutch lever free play and, if necessary, adjust it as follows.

To increase the clutch lever free play, turn the clutch lever free play adjusting bolt at the clutch lever in direction (a). To decrease the clutch lever free play, turn the adjusting bolt in direction (b).

TIP

If the specified clutch lever free play cannot be obtained as described above, proceed as follows.

1. Fully turn the adjusting bolt at the clutch lever in direction (a) to loosen the clutch cable.
2. Loosen the locknut at the crankcase.

Periodic maintenance and adjustment

EAU37914

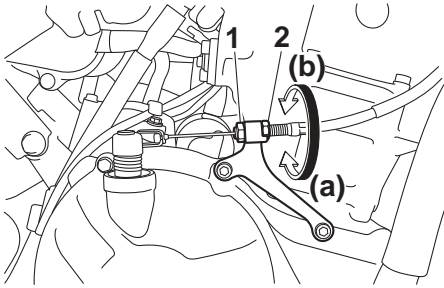

1. Locknut
2. Clutch lever free play adjusting nut
3. To increase the clutch lever free play, turn the clutch lever free play adjusting nut in direction (a). To decrease the clutch lever free play, turn the adjusting nut in direction (b).
4. Tighten the locknut.

Checking the brake lever free play

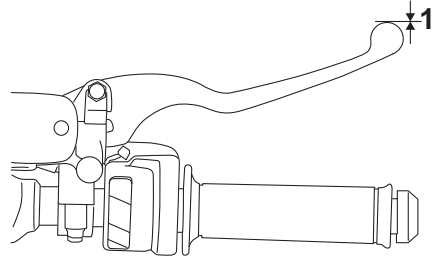

1. No brake lever free play

There should be no free play at the brake lever end. If there is free play, have a Yamaha dealer inspect the brake system.

EWA14212

WARNING

A soft or spongy feeling in the brake lever can indicate the presence of air in the hydraulic system. If there is air in the hydraulic system, have a Yamaha dealer bleed the system before operating the vehicle. Air in the hydraulic system will diminish the braking performance, which may result in loss of control and an accident.

Periodic maintenance and adjustment

Brake light switches

EAU36505

The brake light should come on just before braking takes effect. The brake light is activated by switches connected to the brake lever and brake pedal. Since the brake light switches are components of the anti-lock brake system, they should only be serviced by a Yamaha dealer.

Checking the front and rear brake pads

EAU22393

The front and rear brake pads must be checked for wear at the intervals specified in the periodic maintenance and lubrication chart.

Front brake pads

EAU22433

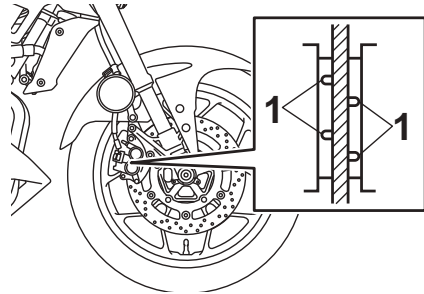

1. Brake pad wear indicator groove

Each front brake pad is provided with wear indicator grooves, which allow you to check the brake pad wear without having to disassemble the brake. To check the brake pad wear, check the wear indicator grooves. If a brake pad has worn to the point that the wear indicator grooves have almost disappeared, have a Yamaha dealer replace the brake pads as a set.

Periodic maintenance and adjustment

Rear brake pads

EAU36721

EAU22583

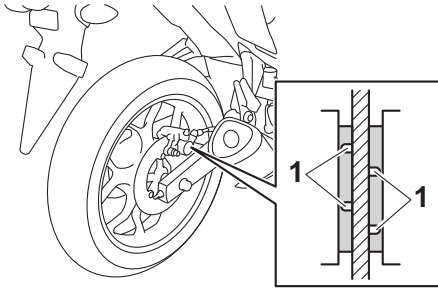

1. Brake pad wear indicator groove

Each rear brake pad is provided with wear indicator grooves, which allow you to check the brake pad wear without having to disassemble the brake. To check the brake pad wear, check the wear indicator grooves. If a brake pad has worn to the point that the wear indicator grooves have almost disappeared, have a Yamaha dealer replace the brake pads as a set.

Checking the brake fluid level

Before riding, check that the brake fluid is above the minimum level mark. Check the brake fluid level with the reservoir in an upright position. Replenish the brake fluid if necessary.

Specified brake fluid:
DOT 4

ECA17641

NOTICE

Brake fluid may damage painted surfaces or plastic parts. Always clean up spilled fluid immediately.

Front brake

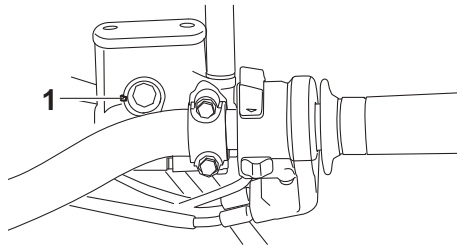

1. Minimum level mark

Rear brake

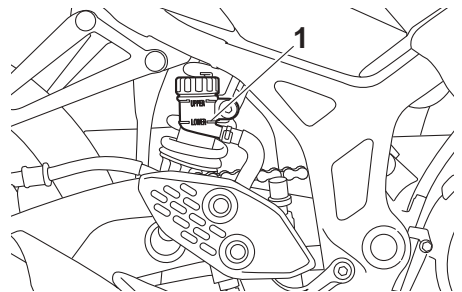

1. Minimum level mark

As the brake pads wear, it is normal for the brake fluid level to gradually go down.

Periodic maintenance and adjustment

EAU22734

- A low brake fluid level may indicate worn brake pads or brake system leakage; therefore, be sure to check the brake pads for wear and the brake system for leakage.
- If the brake fluid level goes down suddenly, have a Yamaha dealer check the cause before further riding.

EWA15991

WARNING

Improper maintenance can result in loss of braking ability. Observe these precautions:

- **Insufficient brake fluid may allow air to enter the brake system, reducing braking performance.**
- **Clean the filler cap before removing. Use only DOT 4 brake fluid from a sealed container.**
- **Use only the specified brake fluid; otherwise, the rubber seals may deteriorate, causing leakage.**
- **Refill with the same type of brake fluid. Adding a brake fluid other than DOT 4 may result in a harmful chemical reaction.**
- **Be careful that water does not enter the brake fluid reservoir when refilling. Water will significantly lower the boiling point of the fluid and may result in vapor lock.**

Changing the brake fluid

Have a Yamaha dealer change the brake fluid every 2 years. In addition, have the seals of the master cylinders and brake calipers, as well as the brake hoses replaced at the intervals listed below or sooner if they are damaged or leaking.

- Brake seals: every 2 years
- Brake hoses: every 4 years

Periodic maintenance and adjustment

EAU22762

EAU62983

Drive chain slack

The drive chain slack should be checked before each ride and adjusted if necessary.

EAU74253

To check the drive chain slack

1. Place the motorcycle on the side-stand.

TIP

When checking and adjusting the drive chain slack, there should be no weight on the motorcycle.

2. Shift the transmission into the neutral position.
3. Measure the drive chain slack as shown.

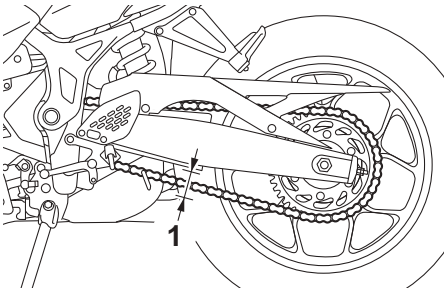

1. Drive chain slack

Drive chain slack:

35.0–45.0 mm (1.38–1.77 in)

4. If the drive chain slack is incorrect, adjust it as follows. **NOTICE: Improper drive chain slack will overload the engine as well as other vital parts of the motorcycle and can lead to chain slippage or breakage. To prevent this from occurring, keep the drive chain slack within the specified limits.** [ECA10572]

To adjust the drive chain slack

Consult a Yamaha dealer before adjusting the drive chain slack.

1. Remove the drive chain puller cap, and then loosen the axle nut and the locknut on each side of the swingarm.

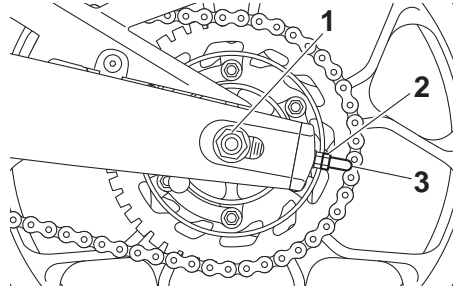

1. Axle nut
2. Locknut
3. Drive chain puller cap

2. To tighten the drive chain, turn the drive chain slack adjusting nut on each side of the swingarm in direction (a). To loosen the drive chain, turn the adjusting nut on each side of the swingarm in direction (b), and then push the rear wheel forward.

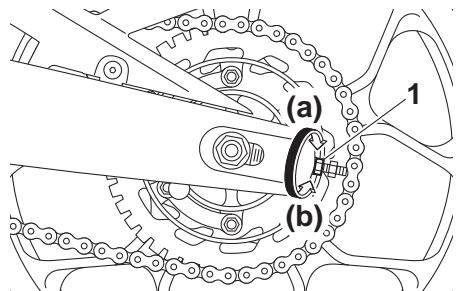

1. Drive chain slack adjusting nut

Periodic maintenance and adjustment

EAU23026

TIP

Using the alignment marks on each side of the swingarm, make sure that both drive chain pullers are in the same position for proper wheel alignment.

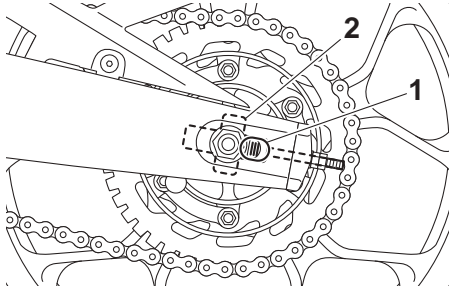

1. Alignment marks
2. Drive chain puller
3. Tighten the axle nut, then the locknuts to their specified torques.

Tightening torques:

Axle nut:

57 N·m (5.7 kgf·m, 42 lb·ft)

Locknut:

16 N·m (1.6 kgf·m, 12 lb·ft)

4. Make sure that the drive chain pullers are in the same position, the drive chain slack is correct, and the drive chain moves smoothly.
5. Install the drive chain puller caps.

Cleaning and lubricating the drive chain

The drive chain must be cleaned and lubricated at the intervals specified in the periodic maintenance and lubrication chart, otherwise it will quickly wear out, especially when riding in dusty or wet areas. Service the drive chain as follows.

ECA10584

NOTICE

The drive chain must be lubricated after washing the motorcycle, riding in the rain or riding in wet areas.

1. Clean the drive chain with kerosene and a small soft brush. **NOTICE: To prevent damaging the O-rings, do not clean the drive chain with steam cleaners, high-pressure washers or inappropriate solvents.** [ECA11122]
2. Wipe the drive chain dry.
3. Thoroughly lubricate the drive chain with a special O-ring chain lubricant. **NOTICE: Do not use engine oil or any other lubricants for the drive chain, as they may contain substances that could damage the O-rings.**

[ECA11112]

Periodic maintenance and adjustment

EAU23098

Checking and lubricating the cables

The operation of all control cables and the condition of the cables should be checked before each ride, and the cables and cable ends should be lubricated if necessary. If a cable is damaged or does not move smoothly, have a Yamaha dealer check or replace it. **WARNING! Damage to the outer housing of cables may result in internal rusting and cause interference with cable movement. Replace damaged cables as soon as possible to prevent unsafe conditions.** [EWA10712]

Recommended lubricant:

Yamaha cable lubricant or other suitable cable lubricant

EAU49921

Checking and lubricating the throttle grip and cable

The operation of the throttle grip should be checked before each ride. In addition, the cable should be lubricated by a Yamaha dealer at the intervals specified in the periodic maintenance chart.

Periodic maintenance and adjustment

EAU44276

Checking and lubricating the brake and shift pedals

The operation of the brake and shift pedals should be checked before each ride, and the pedal pivots should be lubricated if necessary.

Brake pedal

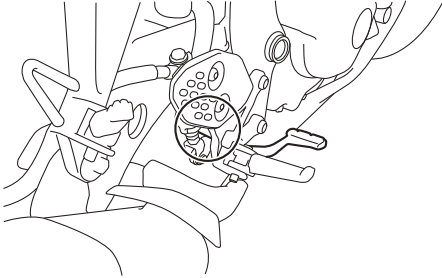

EAU23144

Checking and lubricating the brake and clutch levers

The operation of the brake and clutch levers should be checked before each ride, and the lever pivots should be lubricated if necessary.

Brake lever

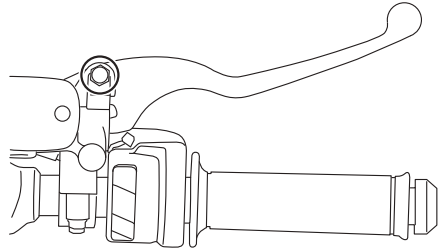

6

Shift pedal

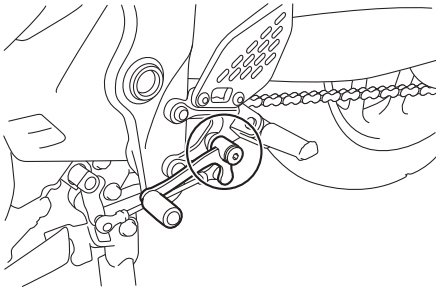

Clutch lever

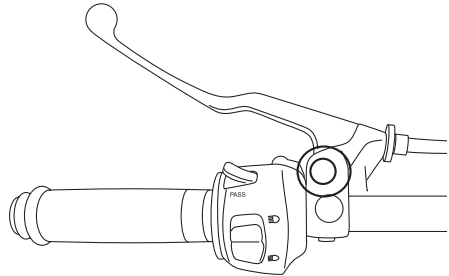

Recommended lubricant:
Lithium-soap-based grease

Recommended lubricants:

Brake lever:
Silicone grease
Clutch lever:
Lithium-soap-based grease

Periodic maintenance and adjustment

Checking and lubricating the sidestand

EAU23203

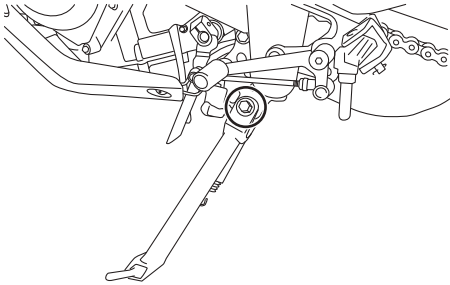

The operation of the sidestand should be checked before each ride, and the sidestand pivot and metal-to-metal contact surfaces should be lubricated if necessary.

EWA10732

WARNING

If the sidestand does not move up and down smoothly, have a Yamaha dealer check or repair it. Otherwise, the sidestand could contact the ground and distract the operator, resulting in a possible loss of control.

Recommended lubricant:
Lithium-soap-based grease

Lubricating the swingarm pivots

EAUM1653

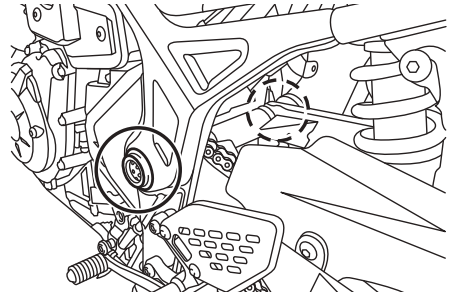

The swingarm pivots must be lubricated by a Yamaha dealer at the intervals specified in the periodic maintenance and lubrication chart.

Recommended lubricant:
Lithium-soap-based grease

Periodic maintenance and adjustment

EAU23273

EAU23285

Checking the front fork

The condition and operation of the front fork must be checked as follows at the intervals specified in the periodic maintenance and lubrication chart.

To check the condition

Check the inner tubes for scratches, damage and excessive oil leakage.

To check the operation

1. Place the vehicle on a level surface and hold it in an upright position. **WARNING! To avoid injury, securely support the vehicle so there is no danger of it falling over.** [EWA10752]
2. While applying the front brake, push down hard on the handlebars several times to check if the front fork compresses and rebounds smoothly.

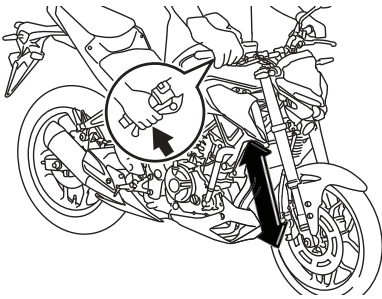

ECA10591

NOTICE

If any damage is found or the front fork does not operate smoothly, have a Yamaha dealer check or repair it.

Checking the steering

Worn or loose steering bearings may cause danger. Therefore, the operation of the steering must be checked as follows at the intervals specified in the periodic maintenance and lubrication chart.

1. Raise the front wheel off the ground. (See page 6-34.) **WARNING! To avoid injury, securely support the vehicle so there is no danger of it falling over.** [EWA10752]
2. Hold the lower ends of the front fork legs and try to move them forward and backward. If any free play can be felt, have a Yamaha dealer check or repair the steering.

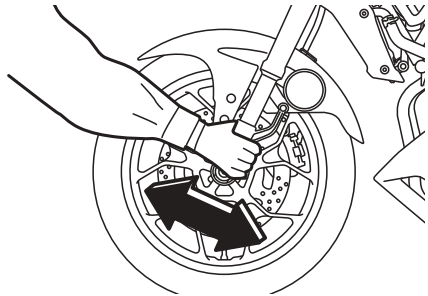

Periodic maintenance and adjustment

Checking the wheel bearings

EAU23292

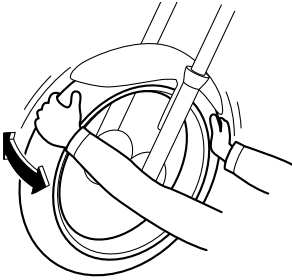

The front and rear wheel bearings must be checked at the intervals specified in the periodic maintenance and lubrication chart. If there is play in the wheel hub or if the wheel does not turn smoothly, have a Yamaha dealer check the wheel bearings.

Battery

EAU50583

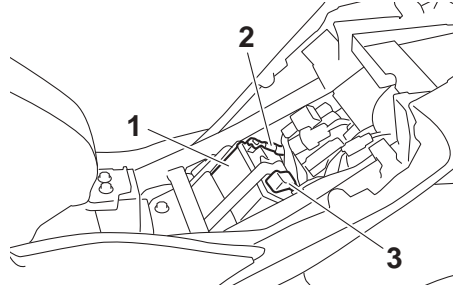

1. Battery
2. Negative battery lead (black)
3. Positive battery lead (red)

The battery is located under the rider seat. It is a VRLA (valve-regulated lead-acid) battery. There is no need to check the electrolyte or to add distilled water. However, the battery lead connections need to be checked, and tightened if necessary.

EWA10761

WARNING

- **Electrolyte is poisonous and dangerous since it contains sulfuric acid, which causes severe burns. Avoid any contact with skin, eyes or clothing and always shield your eyes when working near batteries. In case of contact, administer the following FIRST AID.**
 - **EXTERNAL:** Flush with plenty of water.
 - **INTERNAL:** Drink large quantities of water or milk and immediately call a physician.
 - **EYES:** Flush with water for 15 minutes and seek prompt medical attention.

Periodic maintenance and adjustment

- **Batteries produce explosive hydrogen gas. Therefore, keep sparks, flames, cigarettes, etc., away from the battery and provide sufficient ventilation when charging it in an enclosed space.**
- **KEEP THIS AND ALL BATTERIES OUT OF THE REACH OF CHILDREN.**

ECA10621

NOTICE

Never attempt to remove the battery cell seals, as this would permanently damage the battery.

To charge the battery

Have your Yamaha dealer charge the battery if it seems to have discharged. Keep in mind that the battery tends to discharge more quickly if the vehicle is equipped with optional electrical accessories.

ECA16522

NOTICE

To charge a VRLA (Valve Regulated Lead Acid) battery, a special (constant-voltage) battery charger is required. Using a conventional battery charger will damage the battery.

To store the battery

1. If the vehicle will not be used for more than one month, remove the battery, fully charge it, and then place it in a cool, dry place.
NOTICE: When removing the battery, be sure to turn the main switch off, then disconnect the negative lead before disconnecting the positive lead. [ECA16304]

2. If the battery will be stored for more than two months, check it at least once a month and fully charge it if necessary.
3. Fully charge the battery before installation. **NOTICE: When installing the battery, be sure to turn the main switch off, then connect the positive lead before connecting the negative lead.**

[ECA16842]

4. After installation, make sure that the battery leads are properly connected to the battery terminals.

ECA16531

NOTICE

Always keep the battery charged. Storing a discharged battery can cause permanent battery damage.

Periodic maintenance and adjustment

EAU62776

Replacing the fuses

The main fuse is located under the passenger seat. The fuse box, which contains the fuses for the individual circuits, is located behind the center panel.

To access the main fuse, proceed as follows.

1. Remove the passenger seat. (See page 3-17.)
2. Remove the tray by removing the quick fasteners.

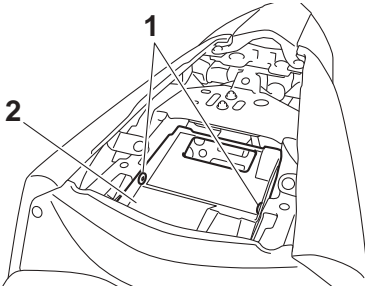

1. Quick fastener
2. Tray

3. Pull back the starter relay cover.

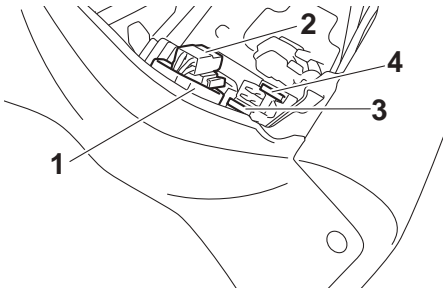

1. Starter relay cover
2. Starter relay coupler
3. Main fuse
4. Spare main fuse

4. Disconnect the starter relay coupler by pressing from both sides.

5. Connect the starter relay coupler, and then slide the cover to its original position.
6. Place the tray in its original position, and then install the quick fasteners.
7. Install the passenger seat.

TIP

To access the fuse box, remove the center cover. (See page 3-17.)

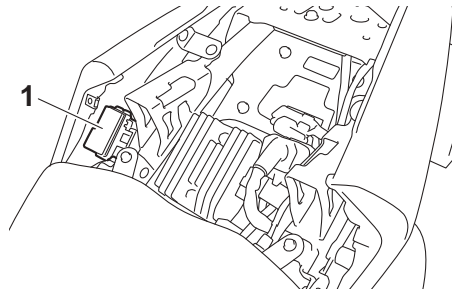

1. Fuse box

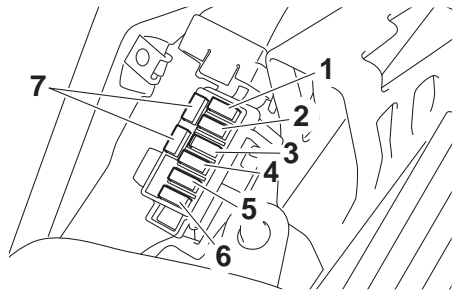

1. Ignition fuse
2. Signaling system fuse
3. ABS control unit fuse
4. Headlight fuse
5. Backup fuse (for clock)
6. Radiator fan motor fuse
7. Spare fuse

Periodic maintenance and adjustment

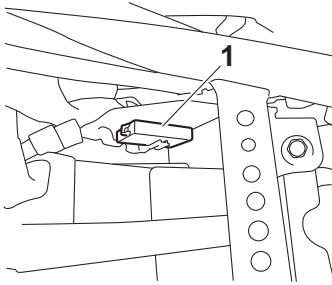

1. Fuse box 2

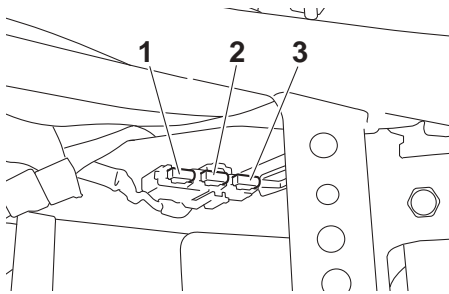

1. Spare fuse
2. ABS solenoid fuse
3. ABS motor fuse

If a fuse is blown, replace it as follows.

1. Turn the main switch off and turn off the electrical circuit in question.
2. Remove the blown fuse, and then install a new fuse of the specified amperage. **WARNING! Do not use a fuse of a higher amperage rating than recommended to avoid causing extensive damage to the electrical system and possibly a fire.** [EWA15132]

Specified fuses:

- Main fuse:
30.0 A
- Headlight fuse:
7.5 A
- Signaling system fuse:
15.0 A
- Ignition fuse:
15.0 A
- Radiator fan motor fuse:
7.5 A
- ABS motor fuse:
30.0 A
- ABS solenoid fuse:
15.0 A
- ABS control unit fuse:
7.5 A
- Backup fuse:
7.5 A

3. Turn the main switch on and turn on the electrical circuit in question to check if the device operates.
4. If the fuse immediately blows again, have a Yamaha dealer check the electrical system.

Periodic maintenance and adjustment

Vehicle lights

EAU80380

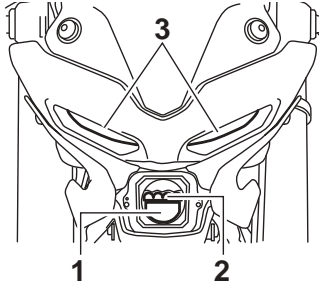

1. Headlight (high beam)
2. Headlight (low beam)
3. Auxiliary light

Except for the license plate light bulb, this model's lights are all LED.

If an LED light does not come on, check the fuses and then have a Yamaha dealer check the vehicle. If the license plate light does not come on, check and replace the bulb. (See page 6-33.)

ECA16581

NOTICE

Do not affix any type of tinted film or stickers to the headlight lens.

EAU62670

Replacing the license plate light bulb

1. Remove the mudguard by removing the quick fasteners.

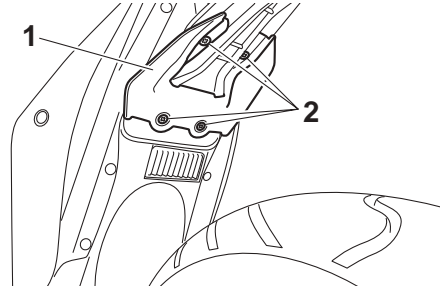

1. Mudguard
2. Quick fastener

2. Remove the rear fender lower panel by removing the bolts and screws.

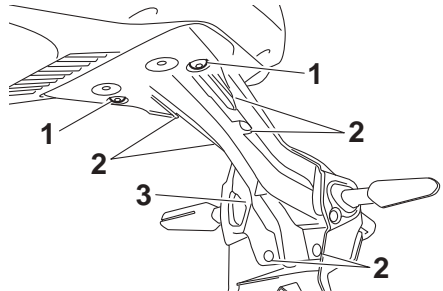

1. Bolt
2. Screw
3. Rear fender lower panel

3. Remove the license plate light bulb socket (together with the bulb) by pulling it out.
4. Remove the burnt-out bulb by pulling it out.

Periodic maintenance and adjustment

EAU24351

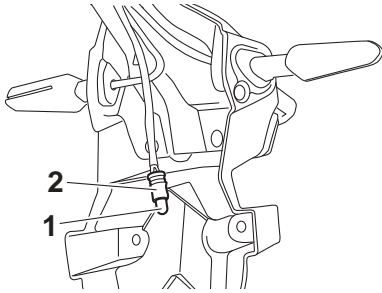

1. License plate light bulb
2. License plate light bulb socket

5. Insert a new bulb into the socket.
6. Install the socket (together with the bulb) by pushing it in.
7. Install the rear fender lower panel by installing the bolts and screws.
8. Install the mudguard by installing the quick fasteners.

Supporting the motorcycle

Since this model is not equipped with a centerstand, follow these precautions when removing the front and rear wheel or performing other maintenance requiring the motorcycle to stand upright. Check that the motorcycle is in a stable and level position before starting any maintenance. A strong wooden box can be placed under the engine for added stability.

To service the front wheel

1. Stabilize the rear of the motorcycle by using a motorcycle stand or, if an additional motorcycle stand is not available, by placing a jack under the frame in front of the rear wheel.
2. Raise the front wheel off the ground by using a motorcycle stand.

To service the rear wheel

Raise the rear wheel off the ground by using a motorcycle stand or, if a motorcycle stand is not available, by placing a jack either under each side of the frame in front of the rear wheel or under each side of the swingarm.

EAU25872

Troubleshooting

Although Yamaha motorcycles receive a thorough inspection before shipment from the factory, trouble may occur during operation. Any problem in the fuel, compression, or ignition systems, for example, can cause poor starting and loss of power.

The following troubleshooting charts represent quick and easy procedures for checking these vital systems yourself. However, should your motorcycle require any repair, take it to a Yamaha dealer, whose skilled technicians have the necessary tools, experience, and know-how to service the motorcycle properly.

Use only genuine Yamaha replacement parts. Imitation parts may look like Yamaha parts, but they are often inferior, have a shorter service life and can lead to expensive repair bills.

EWA15142

WARNING

When checking the fuel system, do not smoke, and make sure there are no open flames or sparks in the area, including pilot lights from water heaters or furnaces. Gasoline or gasoline vapors can ignite or explode, causing severe injury or property damage.

Periodic maintenance and adjustment

EAU86390

Troubleshooting chart

1. Fuel

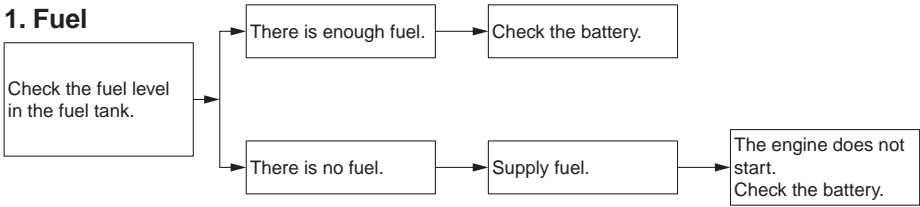

2. Battery

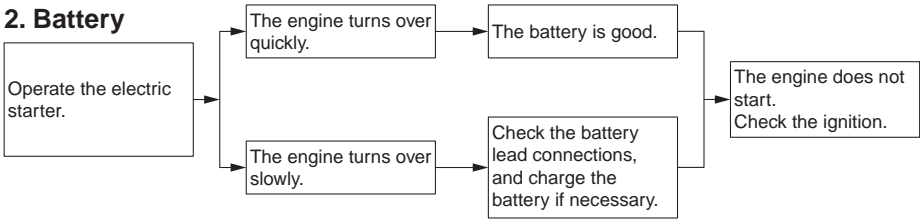

3. Ignition

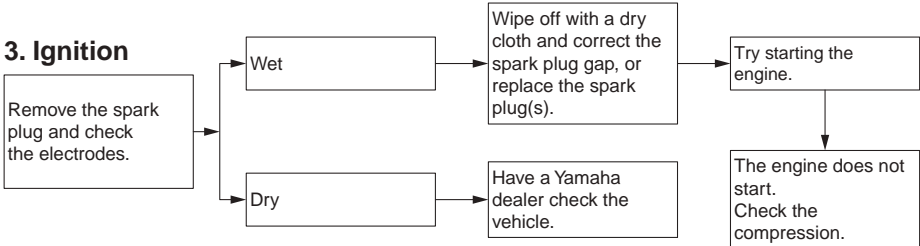

4. Compression

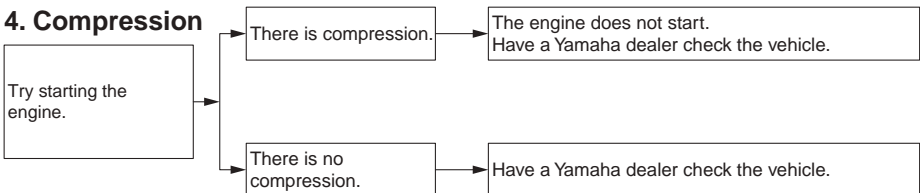

Periodic maintenance and adjustment

EAU86430

EWAT1041

Engine overheating

! WARNING

- Do not remove the radiator cap when the engine and radiator are hot. Scalding hot fluid and steam may be blown out under pressure, which could cause serious injury. Be sure to wait until the engine has cooled.
- Place a thick rag, like a towel, over the radiator cap, and then slowly rotate the cap counterclockwise to the detent to allow any residual pressure to escape. When the hissing sound has stopped, press down on the cap while turning it counterclockwise, and then remove the cap.

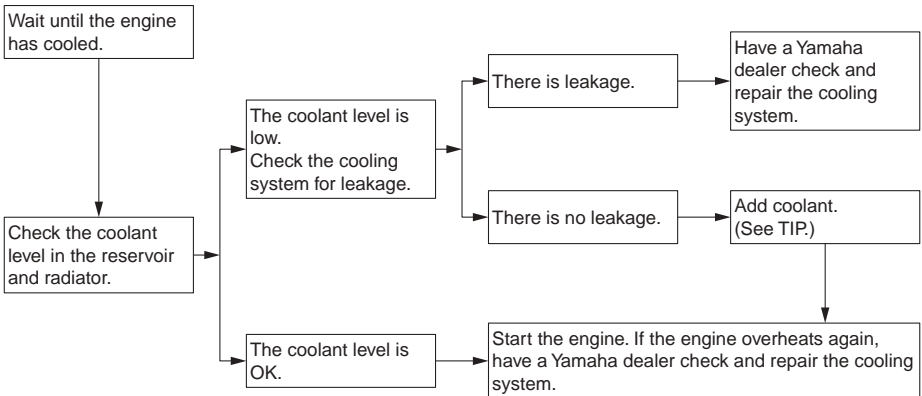

6

TIP

If coolant is not available, tap water can be temporarily used instead, provided that it is changed to the recommended coolant as soon as possible.

Motorcycle care and storage

Matte color caution

EAU37834

EAU83443

NOTICE

ECA15193

Some models are equipped with matte colored finished parts. Be sure to consult a Yamaha dealer for advice on what products to use before cleaning the vehicle. Using a brush, harsh chemical products or cleaning compounds when cleaning these parts will scratch or damage their surface. Wax also should not be applied to any matte colored finished parts.

Care

Frequent, thorough cleaning of the vehicle will not only enhance its appearance but also will improve its general performance and extend the useful life of many components. Washing, cleaning, and polishing will also give you a chance to inspect the condition of the vehicle more frequently. Be sure to wash the vehicle after riding in the rain or near the sea, because salt is corrosive to metals.

TIP

- The roads of heavy snowfall areas may be sprayed with salt as a de-icing method. This salt can stay on the roads well into spring, so be sure to wash the underside and chassis parts after riding in such areas.
 - Genuine Yamaha care and maintenance products are sold under the YAMALUBE brand in many markets worldwide.
 - See your Yamaha dealer for additional cleaning tips.
-

ECA26280

NOTICE

Improper cleaning can cause cosmetic and mechanical damage. Do not use:

- **high-pressure washers or steam-jet cleaners. Excessive water pressure may cause water seepage and deterioration of wheel bearings, brakes, transmission seals and electrical devices. Avoid high-pressure detergent applications such as those available in coin-operated car washers.**

Motorcycle care and storage

- harsh chemicals, including strong acidic wheel cleaners, especially on spoke or magnesium wheels.
- harsh chemicals, abrasive cleaning compounds, or wax on matte-finished parts. Brushes can scratch and damage the matte-finish, use soft sponge or towel only.
- towels, sponges, or brushes contaminated with abrasive cleaning products or strong chemicals such as, solvents, gasoline, rust removers, brake fluid, or antifreeze, etc.

Before washing

1. Park the vehicle out of direct sunlight and allow it to cool. This will help avoid water spots.
2. Make sure all caps, covers, electrical couplers and connectors are tightly installed.
3. Cover the muffler end with a plastic bag and a strong rubber band.
4. Pre-soak stubborn stains like insects or bird droppings with a wet towel for a few minutes.
5. Remove road grime and oil stains with a quality degreasing agent and a plastic-bristle brush or sponge. **NOTICE: Do not use degreasing agent on areas requiring lubrication such as seals, gaskets, and wheel axles. Follow product instructions.**

[ECA26290]

Washing

1. Rinse off any degreaser and spray down the vehicle with a garden hose. Use only enough pressure to do the job. Avoid spraying water directly into the muffler, instrument panel, air inlet, or other inner areas such as underseat storage compartments.
2. Wash the vehicle with a quality automotive-type detergent mixed with cool water and a soft, clean towel or sponge. Use an old toothbrush or plastic-bristle brush for hard-to-reach places. **NOTICE: Use cold water if the vehicle has been exposed to salt. Warm water will increase salt's corrosive properties.** [ECA26301]
3. For windshield-equipped vehicles: Clean the windshield with a soft towel or sponge dampened with water and a pH neutral detergent. If necessary, use a high-quality windshield cleaner or polish for motorcycles. **NOTICE: Never use any strong chemicals to clean the windshield. Additionally, some cleaning compounds for plastic may scratch the windshield, so be sure to test all cleaning products before general application.** [ECA26310]
4. Rinse off thoroughly with clean water. Be sure to remove all detergent residues, as they can be harmful to plastic parts.

After washing

1. Dry the vehicle with a chamois or absorbent towel, preferably microfiber terrycloth.

Motorcycle care and storage

ECA26320

2. For drive chain-equipped models: Dry and then lubricate the drive chain to prevent rust.
3. Use a chrome polish to shine chrome, aluminum, and stainless steel parts. Often the thermally induced discoloring of stainless steel exhaust systems can be removed through polishing.
4. Apply a corrosion protection spray on all metal parts including chrome or nickel-plated surfaces.
WARNING! Do not apply silicone or oil spray to seats, hand grips, rubber foot pegs or tire treads. Otherwise these parts will become slippery, which could cause loss of control. Thoroughly clean the surfaces of these parts before operating the vehicle. [EWA20650]
5. Treat rubber, vinyl, and unpainted plastic parts with a suitable care product.
6. Touch up minor paint damage caused by stones, etc.
7. Wax all painted surfaces using a non-abrasive wax or use a detail spray for motorcycles.
8. When finished cleaning, start the engine and let it idle for several minutes to help dry any remaining moisture.
9. If the headlight lens has fogged up, start the engine and turn on the headlight to help remove the moisture.
10. Let the vehicle dry completely before storing or covering it.

NOTICE

- Do not apply wax to rubber or unpainted plastic parts.
 - Do not use abrasive polishing compounds as they will wear away the paint.
 - Apply sprays and wax sparingly. Wipe off excess afterwards.
-

EWA20660

WARNING

Contaminants left on the brakes or tires can cause loss of control.

- Make sure there is no lubricant or wax on the brakes or tires.
 - If necessary, wash the tires with warm water and a mild detergent.
 - If necessary, clean the brake discs and pads with brake cleaner or acetone.
 - Before riding at higher speeds, test the vehicle's braking performance and cornering behavior.
-

EAU83472

Storage

Always store the vehicle in a cool, dry place. If necessary, protect it against dust with a porous cover. Be sure the engine and the exhaust system are cool before covering the vehicle. If the vehicle often sits for weeks at a time between uses, the use of a quality fuel stabilizer is recommended after each fill-up.

ECA21170

NOTICE

- **Storing the vehicle in a poorly ventilated room or covering it with a tarp, while it is still wet, will allow water and humidity to seep in and cause rust.**
- **To prevent corrosion, avoid damp cellars, stables (because of the presence of ammonia) and areas where strong chemicals are stored.**

Long term storage

Before storing the vehicle long term (60 days or more):

1. Make all necessary repairs and perform any outstanding maintenance.
2. Follow all instructions in the Care section of this chapter.
3. Fill up the fuel tank, adding fuel stabilizer according to product instructions. Run the engine for 5 minutes to distribute treated fuel through the fuel system.
4. For vehicles equipped with a fuel cock: Turn the fuel cock lever to the off position.

5. For vehicles with a carburetor: To prevent fuel deposits from building up, drain the fuel in the carburetor float chamber into a clean container. Retighten the drain bolt and pour the fuel back into the fuel tank.

6. Use a quality engine fogging oil according to product instructions to protect internal engine components from corrosion. If engine fogging oil is not available, perform the following steps for each cylinder:

- a. Remove the spark plug cap and spark plug.
- b. Pour a teaspoonful of engine oil into the spark plug bore.
- c. Install the spark plug cap onto the spark plug, and then place the spark plug on the cylinder head so that the electrodes are grounded. (This will limit sparking during the next step.)
- d. Turn the engine over several times with the starter. (This will coat the cylinder wall with oil.)

WARNING! To prevent damage or injury from sparking, make sure to ground the spark plug electrodes while turning the engine over.

[EWA10952]

- e. Remove the spark plug cap from the spark plug, and then install the spark plug and the spark plug cap.
7. Lubricate all control cables, pivots, levers and pedals, as well as the sidestand and centerstand (if equipped).

Motorcycle care and storage

8. Check and correct the tire air pressure, and then lift the vehicle so that all wheels are off the ground. Otherwise, turn the wheels a little once a month in order to prevent the tires from becoming degraded in one spot.
9. Cover the muffler outlet with a plastic bag to prevent moisture from entering it.
10. Remove the battery and fully charge it, or attach a maintenance charger to keep the battery optimally charged. **NOTICE: Confirm that the battery and its charger are compatible. Do not charge a VRLA battery with a conventional charger.** [ECA26330]

TIP

- If the battery will be removed, charge it once a month and store it in a temperate location between 0-30 °C (32-90 °F).
 - See page 6-29 for more information on charging and storing the battery.
-

***Dimensions:**

Overall length:
2090 mm (82.3 in)
Overall width:
755 mm (29.7 in)
Overall height:
1070 mm (42.1 in)
Seat height:
780 mm (30.7 in)
Wheelbase:
1380 mm (54.3 in)
Ground clearance:
160 mm (6.30 in)
Minimum turning radius:
2.9 m (9.51 ft)

***Weight:**

Curb weight:
169 kg (373 lb)

***Engine:**

Combustion cycle:
4-stroke
Cooling system:
Liquid cooled
Valve train:
DOHC
Cylinder arrangement:
Inline
Number of cylinders:
2-cylinder
Displacement:
321 cm³
Bore × stroke:
68.0 × 44.1 mm (2.68 × 1.74 in)
Starting system:
Electric starter

***Engine oil:**

Recommended brand:



SAE viscosity grades:
10W-40

Recommended engine oil grade:
API service SG type or higher, JASO
standard MA

***Engine oil quantity:**

Oil change:
1.80 L (1.90 US qt, 1.58 Imp.qt)

With oil filter removal:
2.10 L (2.22 US qt, 1.85 Imp.qt)

***Coolant quantity:**

Coolant reservoir (up to the maximum level
mark):
0.25 L (0.26 US qt, 0.22 Imp.qt)
Radiator (including all routes):
0.81 L (0.86 US qt, 0.72 Imp.qt)

***Fuel:**

Recommended fuel:
Unleaded gasoline (E10 acceptable)
Octane number (RON):
90
Fuel tank capacity:
14 L (3.7 US gal, 3.1 Imp.gal)
Fuel reserve amount:
3.0 L (0.79 US gal, 0.66 Imp.gal)

***Fuel injection:**

*Throttle body:
ID mark:
BR51

***Drivetrain:**

*Gear ratio:
1st:
2.500 (35/14)
2nd:
1.824 (31/17)
3rd:
1.348 (31/23)
4th:
1.087 (25/23)
5th:
0.920 (23/25)
6th:
0.800 (24/30)

***Front tire:**

Type:
Tubeless
Size:
110/70R-17M/C 54H
Manufacturer/model:
DUNLOP/GPR-300F

***Rear tire:**

Type:
Tubeless
Size:
140/70R-17M/C 66H
Manufacturer/model:
DUNLOP/GPR-300

Specifications

*Loading:

Maximum load:

160 kg (353 lb)

(Total weight of rider, passenger, cargo and accessories)

*Front brake:

Type:

Hydraulic single disc brake

*Rear brake:

Type:

Hydraulic single disc brake

*Front suspension:

Type:

Telescopic fork

*Rear suspension:

Type:

Swingarm

*Electrical system:

System voltage:

12 V

*Battery:

Model:

GTZ8V

Voltage, capacity:

12 V, 7.0 Ah (10 HR)

*Bulb wattage:

Headlight:

LED

Brake/tail light:

LED

Front turn signal light:

LED

Rear turn signal light:

LED

Auxiliary light:

LED

License plate light:

5.0 W

Identification numbers

EAU26366

Record the vehicle identification number and the engine serial number in the spaces provided below for assistance when ordering spare parts from a Yamaha dealer or for reference in case the vehicle is stolen.

VEHICLE IDENTIFICATION NUMBER:

ENGINE SERIAL NUMBER:

Vehicle identification number

EAU62971

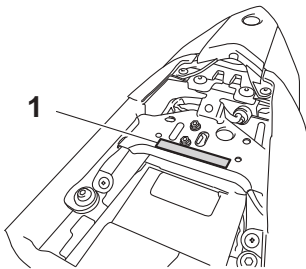

1. Vehicle identification number

The vehicle identification number is stamped into the frame under the passenger seat. (See page 3-17.)

TIP

The vehicle identification number is used to identify your vehicle and may be used to register it with the licensing authority in your area.

Engine serial number

EAU26442

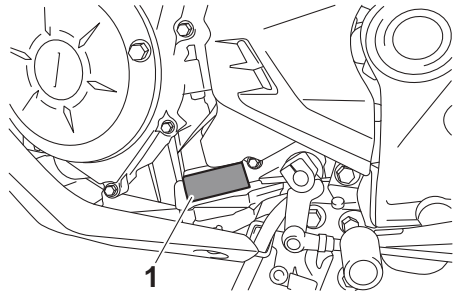

1. Engine serial number

The engine serial number is stamped into the crankcase.

Model label

EAU26521

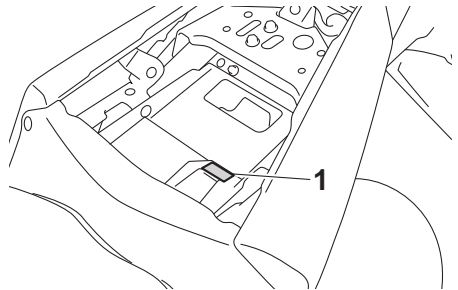

1. Model label

The model label is affixed to the frame under the passenger seat. (See page 3-17.) Record the information on this label in the space provided. This information will be needed when ordering spare parts from a Yamaha dealer.

Diagnostic connector

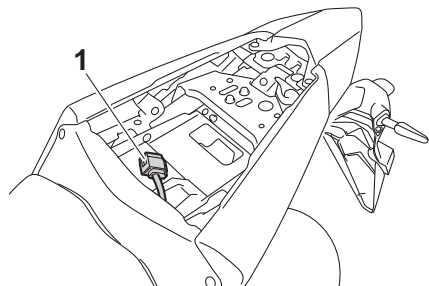

1. FI diagnostic connector

The diagnostic connector is located as shown.

Vehicle data recording

This model's ECU stores certain vehicle data to assist in the diagnosis of malfunctions and for research, statistical analysis and development purposes.

Although the sensors and recorded data will vary by model, the main data points are:

- Vehicle status and engine performance data
- Fuel-injection and emission-related data

This data will be uploaded only when a special Yamaha diagnostic tool is attached to the vehicle, such as when maintenance checks or service procedures are performed.

Vehicle data uploaded will be handled appropriately according to the following Privacy Policy.

Privacy Policy

<https://www.yamaha-motor.eu/eu/privacy/privacy-policy.aspx>

Yamaha will not disclose this data to a third party except in the following cases. In addition, Yamaha may provide vehicle data to a contractor in order to outsource services related to the handling of vehicle data. Even in this case, Yamaha will require the contractor to properly handle the vehicle data we provided and Yamaha will appropriately manage the data.

- With the consent of the vehicle owner
- Where obligated by law
- For use by Yamaha in litigation
- When the data is not related to an individual vehicle nor owner

- A**
- ABS 3-13
 - ABS warning light..... 3-3
 - Air filter element and check hose,
replacing and cleaning..... 6-13
- B**
- Battery 6-29
 - Brake and clutch levers,
checking and lubricating..... 6-26
 - Brake and shift pedals,
checking and lubricating..... 6-26
 - Brake fluid, changing 6-22
 - Brake fluid level, checking 6-21
 - Brake lever 3-12
 - Brake lever free play, checking 6-19
 - Brake light switches 6-20
 - Brake pedal 3-13
- C**
- Cables, checking and lubricating..... 6-25
 - Canister 6-8
 - Care..... 7-1
 - Catalytic converter 3-17
 - Clock 3-5
 - Clutch lever 3-11
 - Clutch lever free play, adjusting..... 6-18
 - Coolant..... 6-12
 - Coolant temperature meter 3-5
- D**
- Data recording, vehicle 9-2
 - Diagnostic connector 9-2
 - Dimmer switch 3-10
 - Display units, switching..... 3-4
 - Drive chain, cleaning and lubricating ... 6-24
 - Drive chain slack 6-23
- E**
- Engine break-in 5-1
 - Engine oil and oil filter cartridge..... 6-8
 - Engine overheating..... 6-37
 - Engine serial number..... 9-1
 - Engine trouble warning light..... 3-3
- F**
- Front and rear brake pads, checking ... 6-20
 - Front fork, checking 6-28
 - Fuel..... 3-15
 - Fuel consumption, tips for reducing 5-4
 - Fuel meter 3-4
 - Fuel tank cap..... 3-14
 - Fuel tank overflow hose 3-16
 - Fuses, replacing 6-31
- H**
- Handlebar switches 3-10
 - Hazard switch 3-10
 - Helmet holders..... 3-19
 - High beam indicator light..... 3-2
 - Horn switch..... 3-10
- I**
- Identification numbers 9-1
 - Ignition circuit cut-off system 3-22
 - Indicator lights and warning lights 3-2
- L**
- License plate light bulb, replacing 6-33
 - Luggage strap holders..... 3-21
- M**
- Main switch/steering lock 3-1
 - Maintenance and lubrication, periodic ... 6-4
 - Maintenance, emission control
system 6-3
 - Matte color, caution..... 7-1
 - Model label 9-1
 - Multi-function display 3-6
 - Multi-function meter unit 3-4
- N**
- Neutral indicator light..... 3-2
- O**
- Oil pressure warning light 3-2
- P**
- Parking..... 5-5
 - Part locations..... 2-1
 - Pass switch..... 3-10
- S**
- Safety information..... 1-1
 - Seats 3-17
 - Shift indicator light 3-3
 - Shift indicator light control mode 3-8
 - Shifting 5-3
 - Shift pedal..... 3-12
 - Shock absorber assembly, adjusting ... 3-20
 - Sidestand..... 3-22
 - Sidestand, checking and lubricating ... 6-27
 - Spark plugs, checking 6-7
 - Specifications 8-1
 - Speedometer 3-4
 - Start/Engine stop switch 3-10
 - Starting the engine..... 5-2
 - Steering, checking 6-28
 - Storage 7-4
 - Storage compartment..... 3-20
 - Supporting the motorcycle 6-34
 - Swingarm pivots, lubricating 6-27

Index

T

Tachometer.....	3-4
Throttle grip and cable, checking and lubricating	6-25
Throttle grip free play, checking	6-15
Tires	6-16
Tool kit	6-2
Transmission gear display	3-5
Troubleshooting	6-35
Troubleshooting chart.....	6-36
Turn signal indicator lights.....	3-2
Turn signal switch	3-10

V

Valve clearance.....	6-15
Vehicle identification number	9-1
Vehicle lights.....	6-33

W

Wheel bearings, checking.....	6-29
Wheels	6-18

Y

Yamalube.....	6-11
---------------	------



PRINTED IN INDONESIA
2019.10