

can-am

RYKER® Series

OPERATOR'S GUIDE

Includes
Safety, Vehicle and
Maintenance Information

**2
0
2
1**

⚠ WARNING

Learn how the vehicle is different.

Read this operator's guide and watch the safety video on:

<https://can-am.brp.com/spyder/owners/safety/safety-information.html>

Complete a training course (if available), practice and become proficient with the controls.

Consult local laws - license requirements vary by location.

Keep this guide in the front storage compartment.

2 1 9 0 0 2 1 4 8

Original Instructions

WARNING

Disregarding any of the safety precautions and instructions contained in this Operator's Guide, the Safety video and on-product safety labels could cause injury including the possibility of death!

CALIFORNIA PROPOSITION 65 WARNING

 **WARNING:** Operating, servicing and maintaining a passenger vehicle can expose you to chemicals including engine exhaust, carbon monoxide, phthalates, and lead, which are known to the State of California to cause cancer and birth defects or other reproductive harm. To minimize exposure, avoid breathing exhaust, do not idle the engine except as necessary, service your vehicle in a well-ventilated area and wear gloves or wash your hands frequently when servicing your vehicle. For more information go to www.p65warnings.ca.gov/products/passenger-vehicle.



In Canada, products are distributed by Bombardier Recreational Products Inc.
In USA, products are distributed by BRP US Inc.

This is a non-exhaustive list of trademarks that are the property of Bombardier Recreational Products Inc. or its affiliates:

ACE™	Can-Am®
Rally™	Rotax®
Ryker®	XPS™

OPERATOR'S GUIDE 2021

Ryker 600

Ryker 900

Ryker 900 Rally Edition

FOREWORD

Deutsch	Dieses Handbuch ist möglicherweise in Ihrer Landessprache verfügbar. Bitte wenden Sie sich an Ihren Händler oder besuchen Sie: www.operatorsguides.brp.com
English	This guide may be available in your language. Check with your dealer or go to: www.operatorsguides.brp.com
Español	Es posible que este manual esté disponible en su idioma. Consulte a su distribuidor o visite: www.operatorsguides.brp.com
Français	Ce guide peut être disponible dans votre langue. Vérifier avec votre concessionnaire ou aller à: www.operatorsguides.brp.com
Italiano	Questa guida potrebbe essere disponibile nella propria lingua. Contattare il concessionario o consultare: www.operatorsguides.brp.com
中文	本手册可能有您的语种的翻译版本。请向经销商询问，或者登录 www.operatorsguides.brp.com 查询。
日本語	このガイドは、言語によって翻訳版が用意されています。ディーラーに問い合わせるか、次のアドレスでご確認ください： www.operatorsguides.brp.com
Nederlands	Deze handleiding kan beschikbaar zijn in uw taal. Vraag het aan uw dealer of ga naar: www.operatorsguides.brp.com
Norsk	Denne boken kan finnes tilgjengelig på ditt eget språk. Kontakt din forhandler eller gå til: www.operatorsguides.brp.com
Português	Este manual pode estar disponível em seu idioma. Fale com sua concessionária ou visite o site: www.operatorsguides.brp.com
Русский	Воспользуйтесь руководством на вашем языке. Узнайте о его наличии у дилера или на странице по адресу www.operatorsguides.brp.com
Suomi	Käyttöohjekirja voi olla saatavissa omalla kielelläsi. Tarkista jälleenmyyjältä tai käy osoitteessa: www.operatorsguides.brp.com
Svenska	Denna bok kan finnas tillgänglig på ditt språk. Kontakta din återförsäljare eller gå till: www.operatorsguides.brp.com

Congratulations on your purchase of a new Can-Am® Ryker™ model. It is backed by the Bombardier Recreational Products Inc. (BRP) warranty and a large network of authorized dealers ready to provide the parts, service or accessories you may require.

Your dealer is committed to your satisfaction. He has taken training to prepare, inspect and performed the final adjustment of your new vehicle before you took possession of it.

If you need more information concerning the servicing of your vehicle, please ask your dealer.

At delivery, you were informed about the warranty coverage and also, you signed the *PREDELIVERY CHECK LIST* to ensure your new vehicle was prepared to your entire satisfaction.

Know Before you Go

For your safety and the safety of passengers and bystanders, read the following sections before you operate this vehicle:

- GENERAL PRECAUTIONS
- VEHICLE INFORMATION
- SAFE OPERATING INSTRUCTIONS
- PRE-RIDE INSPECTION.

Experienced motorcyclists should pay special attention to *WHAT'S DIFFERENT FROM OTHER VEHICLES*.

Safety Messages

The types of safety messages, what they look like and how they are used in this guide are explained as follows:

The safety alert symbol  indicates a potential injury hazard.

WARNING

Indicates a potential hazard, if not avoided, could result in serious injury or death.

 **CAUTION** Indicates a hazard situation which, if not avoided, could result in minor or moderate injury.

 **NOTICE** Indicates an instruction which, if not followed, could severely damage vehicle components or other property.

About this Operator's Guide

This Operator's Guide was written in North America in a right-lane driving environment. Please adapt your application of these maneuvers to your jurisdiction and rules of the road.

In this Operator's Guide, the word motorcycle typically refers to a two-wheeled motorcycle.

Keep this Operator's Guide in the vehicle at all time so that you can refer to it for things such as maintenance, road side repairs and instructing others.

If you want to view and/or print an extra copy of your Operator's Guide, simply visit the following web site:

www.operatorsguides.brp.com

The informations contained in this document are correct at the time of publication. BRP, however, maintains a policy of continuous improvement of its products without imposing upon itself any obligation to install them on products previously manufactured.

Due to late changes, some differences between the manufactured product and the descriptions and/or specifications in this guide may occur. BRP reserves the right at any time to discontinue or change specifications, designs, features, models or equipment without incurring any obligation upon itself.

This Operator's Guide should remain with the vehicle when it is sold.

Refer to Other Sources of Information

In addition to reading this Operator's Guide, you should read the Safety Card, all on-product safety labels and watch the *SAFETY VIDEO* located at:

<https://can-am.brp.com/spyder/owners/safety/safety-information.html>
or use the following QR code.



If possible, take a training course that is specifically designed for a 3-wheel vehicle.

For more information about upcoming training course availability, visit our web site at:

www.can-am.brp.com

If a training course specifically designed for a 3-wheel vehicle is not available in your area, it could be a good idea to take a training course for motorcycles.

Many of the skills required are similar and also, the received information about managing the risk on the road are suitable for a 3-wheel vehicle.

Acknowledgment

BRP wishes to thank the Motorcycle Safety Foundation (MSF) for giving permission to BRP to use their material related to street motorcycle safety found in this Operator's Guide.

The MSF is an internationally recognized not for profit foundation and is supported by motorcycle manufacturers. It provides training, tools and partnerships to the motorcycle safety community. Visit its website at:

www.msf-usa.org

TABLE OF CONTENTS

FOREWORD	1
Know Before you Go	2
Safety Messages	2
About this Operator's Guide	2
Refer to Other Sources of Information	3
Acknowledgment	3
GENERAL PRECAUTIONS	9
Avoid Carbon Monoxide Poisoning	9
Avoid Gasoline Fires and Other Hazards	9
Avoid Burns from Hot Parts	9
Accessories and Modifications	9
 VEHICLE INFORMATION	
PRIMARY CONTROLS	12
1) Handlebar	13
2) Throttle	13
3) Brake Pedal	13
4) Park Lever	13
5) Shift Lever	14
SECONDARY CONTROLS	16
1) Radio Frequency Digitally Encoded Security System (RF D.E.S.S.)	16
2) Engine Start Button	17
3) Engine Stop Switch	17
4) Headlights Switch	17
5) Turn Signal Button	18
6) Horn Button	18
7) Hazard Warning Flasher Button	19
4.5" DIGITAL DISPLAY	20
Multifunction Display	20
Warning Lamps and Indicators	22
Settings	23
EQUIPMENT	25
Control Components Adjustment	25
Passenger's Seat	27
Lights	28
Mirrors	30
Glove Box	31
Service Covers	31
BASIC PROCEDURES	34
Starting and Stopping the Engine	34
Starting In a Slope	35
Hill Hold Control	35
Pushing the Vehicle	36
Operating in Reverse	36

BASIC PROCEDURES (cont'd)	
Operating During Break-In.....	36
Fueling	37
Adjusting Suspension.....	39
SAFE OPERATING INSTRUCTIONS	
WHAT'S DIFFERENT FROM OTHER VEHICLES	44
Stability	44
Response to Road Conditions.....	44
Driving Modes.....	44
Brake Pedal	45
Park Position.....	45
Steering	45
Width.....	45
Reverse	45
Driver's License and Local Laws.....	46
DRIVING AID TECHNOLOGIES	47
Vehicle Stability System (VSS)	47
UNDERSTANDING RISK ON THE ROAD	49
Type of Vehicle	49
Operator Skills and Judgment.....	49
Rider Condition	50
Vehicle Condition.....	50
Road and Weather Conditions	50
RIDING GEAR	51
Helmets.....	51
Other Riding Gear	51
REQUIRED RIDING SKILLS AND PRACTICE EXERCISES	54
Choosing a Practice Area	54
Preparing to Ride.....	55
Riding Posture.....	55
Practice Exercises	55
Developing Advanced Riding Skills.....	61
STREET STRATEGIES.....	62
Plan your Trip	62
Defensive Riding.....	62
Being Visible	63
Lane Position	64
Common Riding Situations	64
Road Conditions and Hazards	66
On-Road Emergencies	68
Tire Failure	68
CARRYING A PASSENGER OR CARGO	69
Weight Limits.....	69
Operating with Extra Weight.....	69

CARRYING A PASSENGER OR CARGO (cont'd)	
Carrying a Passenger	69
Where to Store Cargo	70
Towing a Trailer	70
KNOWLEDGE SELF-TEST	71
Questionnaire	71
Answers	73
SAFETY INFORMATION ON THE VEHICLE	75
Hang Tag	75
Safety Card	76
Safety Labels	77
REPORTING SAFETY DEFECTS	82
 PRE-RIDE INSPECTION 	
PRE-RIDE CHECKLIST	86
Before Starting the Vehicle, Inspect the Following:	86
Start the Vehicle and Check the Following:	87
 MAINTENANCE 	
MAINTENANCE SCHEDULE	90
Severe Dusty Conditions	90
Maintenance Schedule	91
MAINTENANCE PROCEDURES	93
Tires	93
Wheel	94
Engine Oil	98
Engine Air Filter	102
CVT Air Filter	102
CVT Drive Belt	103
Engine Coolant	103
Final Drive	104
Gearbox	106
Brakes	108
Battery	110
On Board Diagnostic (OBD) Connector Location	111
Exhaust System	111
Headlights	111
Radiator	115
Steering System	117
VEHICLE CARE	119
Cleaning the Vehicle	119
Vehicle Protection	119

STORAGE AND PRESEASON PREPARATION	120
Storage	120
Preseason Preparation	120

ROAD SIDE REPAIRS

DIAGNOSTIC GUIDELINES	122
MESSAGES IN MULTIFUNCTION GAUGE	124
WHAT TO DO IN THE FOLLOWING CIRCUMSTANCES	126
Lost RF D.E.S.S. Keys	126
Flat Tire	126
Dead Battery	126
REPLACING A FUSE	128
Fuse Locations	128
Fuse Box Items Description	128
Replacing a Fuse	129
CHANGING A BULB	130
Hi/Low Beam Headlight Bulbs (Inside North America)	130
Hi Beam Headlight Bulbs (Outside North America)	131
Low Beam Headlight Projectors (Outside North America)	132
TRANSPORTING THE VEHICLE	133
To Load the Vehicle Manually	133
To Load the Vehicle Using a Winch	134

TECHNICAL INFORMATION

VEHICLE IDENTIFICATION	136
Vehicle Identification Number	136
Engine Identification Number	136
VEHICLE COMPLIANCE LABELS	138
EPA Compliance Label (North American Models)	138
Compliance Labels (Australian Models)	138
NOISE EMISSION CONTROL SYSTEM REGULATION	139
RADIO FREQUENCY DIGITALLY ENCODED SECURITY SYSTEM (RF D.E.S.S. KEY)	140
EAC DECLARATION OF CONFORMITY	141
SPECIFICATIONS	142

WARRANTY

BRP LIMITED WARRANTY — CANADA AND USA: 2021 Can-Am® RYKER® SERIES	150
--	------------

BRP INTERNATIONAL LIMITED WARRANTY : 2021 Can-Am® RYKER® SERIES 157

BRP LIMITED WARRANTY FOR THE EUROPEAN ECONOMIC AREA, THE COMMONWEALTH OF THE INDEPENDENT STATES AND TURKEY: 2021 Can-Am® RYKER® SERIES 161

MAINTENANCE RECORDS 167

CUSTOMER INFORMATION

PRIVACY INFORMATION 172

CONTACT US..... 173

 Asia..... 173

 Europe 173

 North America 173

 Oceania 173

 South America..... 173

CHANGE OF ADDRESS/OWNERSHIP..... 174

GENERAL PRECAUTIONS

Avoid Carbon Monoxide Poisoning

All engine exhaust contains carbon monoxide, a deadly gas. Breathing carbon monoxide can cause headaches, dizziness, drowsiness, nausea, confusion and eventually death.

Carbon monoxide is a colorless, odorless, tasteless gas that may be present even if you do not see or smell any engine exhaust. Deadly levels of carbon monoxide can collect rapidly, and you can quickly be overcome and unable to save yourself. Also, deadly levels of carbon monoxide can linger for hours or days in enclosed or poorly ventilated areas. If you experience any symptoms of carbon monoxide poisoning, leave the area immediately, get fresh air and seek medical treatment.

To prevent serious injury or death from carbon monoxide:

- Never run the vehicle in poorly ventilated or partially enclosed areas such as garages, carports or barns. Even if you try to ventilate engine exhaust with fans or open windows and doors, carbon monoxide can rapidly reach dangerous levels.
- Never run the vehicle outdoors where engine exhaust can be drawn into a building through openings such as windows and doors.

Avoid Gasoline Fires and Other Hazards

Gasoline is extremely flammable and highly explosive. Fuel vapors can spread and be ignited by a spark or flame many feet away from the engine. To reduce the risk of fire or explosion, follow these instructions:

- Refuel outdoors in a well ventilated area away from flames, sparks, lit cigarettes and other sources of ignition.
- Never add fuel with engine running.

- Never top off the fuel tank. Leave some room for the fuel to expand with temperature changes.
- Wipe up any spilled fuel.
- Never start or operate the engine with the fuel filler door opened.
- Use only an approved red gasoline container to store fuel.
- Do not carry gasoline containers on the vehicle.

Gasoline is poisonous and can cause injury or death.

- Never siphon gasoline by mouth.
- If you swallow gasoline, get any in your eye or inhale gasoline vapor, see your doctor immediately.

If gasoline spills on you, wash with soap and water and change your clothes.

Avoid Burns from Hot Parts

The exhaust, oil, and cooling systems as well the engine become hot during operation. Other vehicle parts, such as multifunction gauge glass, can also be hot if exposed to sunlight. Temperature higher than 60°C (140°F) can be reached. Avoid contact during and shortly after operation to avoid burns.

Accessories and Modifications

Do not make unauthorized modifications, or use attachments or accessories that are not approved by BRP. Since these changes have not been tested by BRP, they may increase the risk of crashes on the road or injuries, and they can make the vehicle illegal for use on the road.

Unlike most motorcycles, this vehicle is equipped with a Vehicle Stability System (VSS), which is calibrated for the vehicle normal configuration. VSS may not function properly if the vehicle is modified, such as changing weight distribution, wheelbase, tires, suspension, brakes or steering.

See your authorized Can-Am On-Road dealer for available BRP accessories for your vehicle.

VEHICLE INFORMATION

PRIMARY CONTROLS

It is important to know the location and operation of all controls, and to develop and practice smooth and coordinated use of them.

! WARNING

The handlebar, the driver's footpegs and the brake pedal can be easily adjusted to meet each driver needs. It is important that all controls must be fully accessible and easily usable by the person driving the vehicle and this at all times. Take time to adjust the vehicle to the driver before riding.

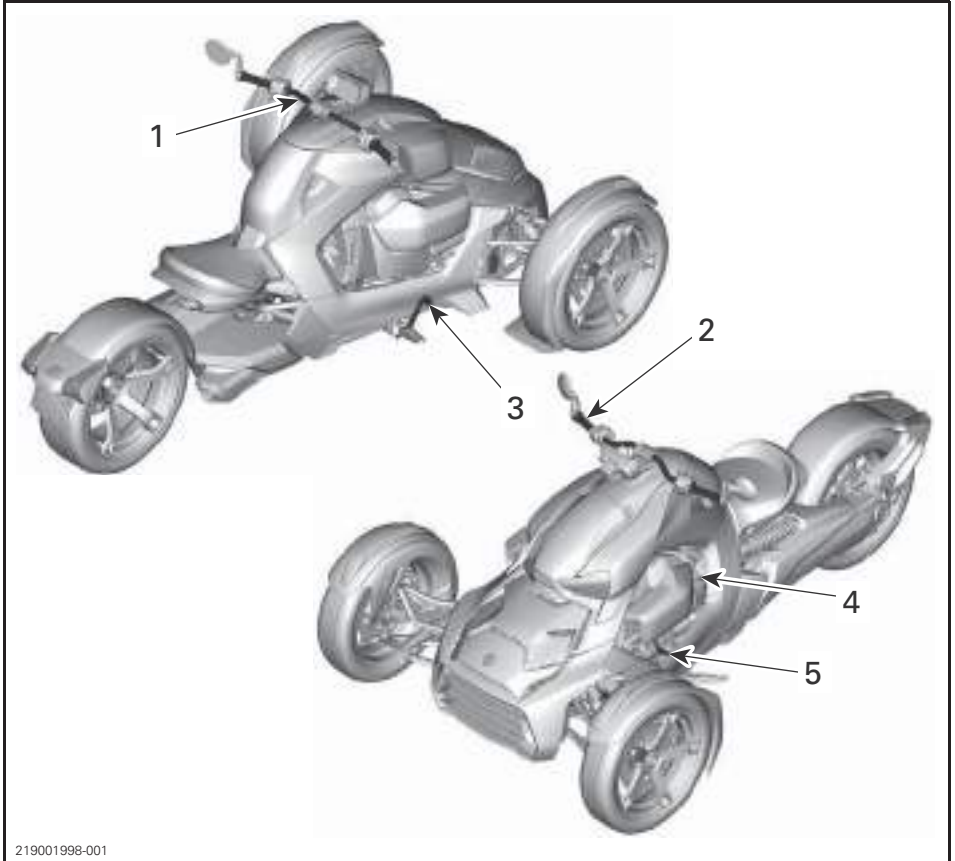

219001998-001

1. *Handlebar*
2. *Throttle*
3. *Brake pedal*
4. *Park position lever*
5. *Transmission lever*

1) Handlebar

Grip the handlebar with both hands. Steer the handlebar in the direction you want to go.

2) Throttle

Twist the right handgrip to operate the throttle. This controls the vehicle's speed by controlling the flow of fuel to the engine.

To speed up, twist the throttle toward you (lower your wrist).

To slow down, twist it away from you (raise your wrist).

The throttle should spring back completely to the idle position when you release the grip.



219001998-002

1. To speed up
2. To slow down

This vehicle is equipped with an Electronic Throttle Control (ETC). The throttle plates in the throttle body are controlled electronically and can be opened or closed irrespective of the throttle twist grip position when necessary.

It may happen that when you accelerate, the Vehicle Stability System (VSS) prevents engine acceleration in order to maintain vehicle stability. Then, when the vehicle is stabilized, the engine RPM would increase as requested if the throttle was maintained. This would be felt as a "delayed" acceleration.

The VSS can never accelerate the vehicle. All it can do is to open the throttle slightly to decrease the amount of engine braking on slippery surfaces. This prevents the rear tire from slipping because of engine braking.

3) Brake Pedal

The brake lever is located in front of the right footpeg.

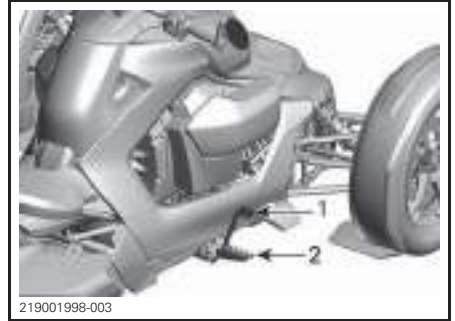

219001998-003

1. Brake pedal
2. Right footpeg

Press the lever with your foot to apply the brake to all three wheels.

Always apply your brakes as a signal to others that you are slowing down.

NOTICE When riding, make sure not to lay your foot on brake pedal. Otherwise, the engine management will activate the limp home mode to protect the braking system.

4) Park Lever

Located on the left side of the vehicle, the park position blocks the gearbox to prevent the rear wheel to turn.

⚠ WARNING

Always use the PARK (P) position when the vehicle is not in operation. The vehicle can roll if the park lever is not engaged.

NOTICE Never pull the park lever to stop the vehicle. The vehicle must be stopped prior to engaging the park lever.

When the lever is pointed towards the ground, the P position is disengaged.

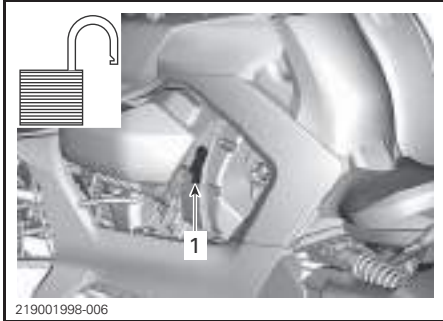

1. PARK lever in unlock position (disengaged)

Fully pull the lever upwards to engage and lock the P position.

Rock the vehicle back and forth to confirm that the park position lever is fully engaged.

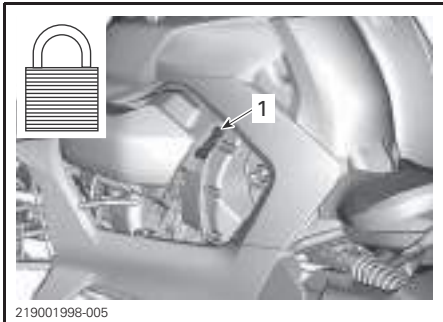

1. PARK lever in lock position (engaged)

A P will be indicated in the Selected Gear Display when the park position lever is fully engaged.

Park Position Lever Lock

Outside North America

The park position lever can be locked when it is engaged to the P position.

Turn the key clockwise to lock the park position lever.

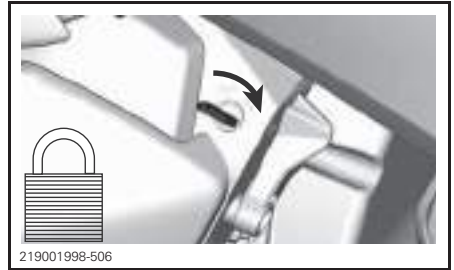

To unlock the park position lever, turn key counterclockwise.



5) Shift Lever

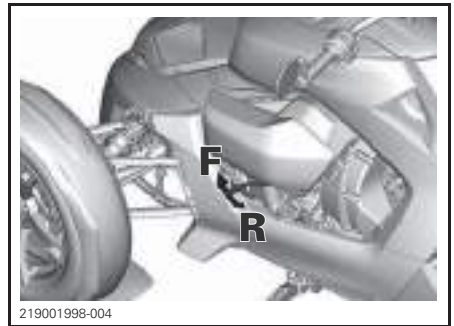

F = Forward
R = Reverse

Located on the left side of the vehicle, under the LH service cover, the shift lever is used to change the gearbox from Forward to Reverse position.

NOTICE Never move the shift lever from forward to reverse or reverse to forward if the vehicle is not fully stopped

Forward

Normal driving position. This position allows the vehicle to move forward and accelerate through a continuous range of gear ratio.

Reverse

The reverse position allows the vehicle to go backwards.

In reverse operation, the engine's RPM is limited, thus limiting the vehicle reverse speed.

WARNING

When driving downhill in reverse, gravity can increase the vehicle speed above the set limited reverse speed.

All Countries except Australia

The turn indicator lights flash when the vehicle is in reverse.

Australia

The reverse light, located on the rear fender, is turned on when the vehicle is in reverse.

SECONDARY CONTROLS

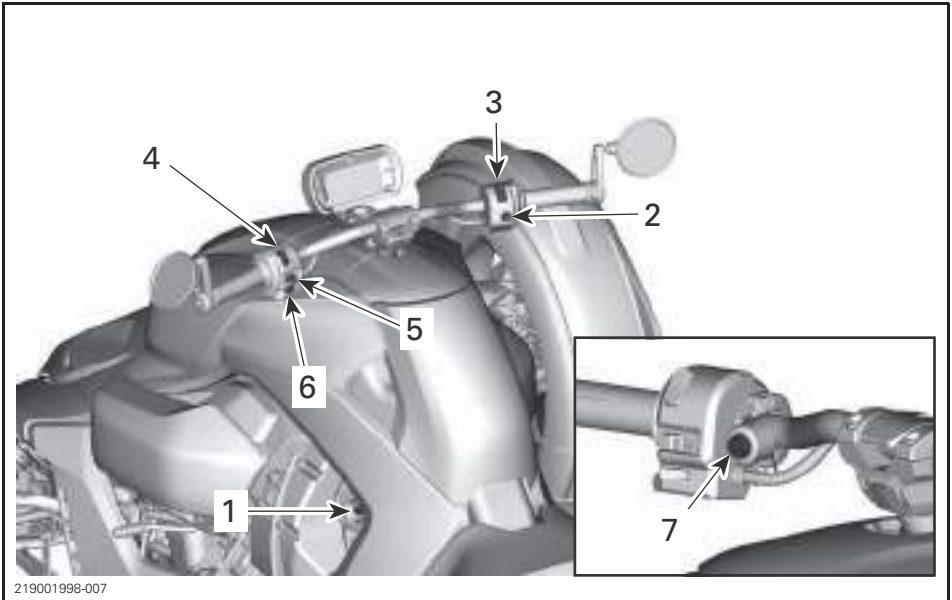

1. RF D.E.S.S. Post
2. Engine start button
3. Engine stop switch
4. Headlights switch
5. Turn signal button
6. Horn button
7. Hazard warning flasher button (Australia and Russia)

1) Radio Frequency Digitally Encoded Security System (RF D.E.S.S.)

RF D.E.S.S. Post

The post of the Radio Frequency Digitally Encoded Security System (RF D.E.S.S.) is located on the left side of the vehicle, between the seat and the LH service cover.



1. RF D.E.S.S. post

RF D.E.S.S. Key

Two RF D.E.S.S. keys are delivered with the vehicle.

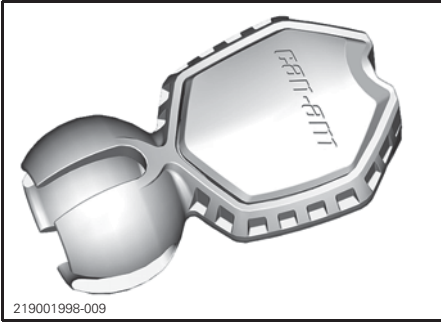

Each key contains an electronic circuit including a specifically pre-programmed chip that is read via radio frequency by the immobilizer system to allow starting the engine.

These keys do not contain batteries.

Learning Key

The Can-Am On-Road learning key limits the speed of the vehicle therefore enabling first time users and less experienced operators to learn how to operate the vehicle while gaining the necessary confidence and control.

The D.E.S.S. of your vehicle can be programmed by your authorized Can-Am On-Road dealer to accept up to 8 different keys.

2) Engine Start Button

The engine start button is located at the bottom of the right side multifunction switch.



3) Engine Stop Switch

The engine stop switch is located at the top of the right side multifunction switch.



To start the engine, toggle the engine stop switch on the RUN position.

To stop the engine, set the engine stop switch to the STOP position.

NOTE: The engine can only be stopped by using the engine stop switch. Removing the RF D.E.S.S. key from its post will not stop the engine, the key is required only to start the vehicle.

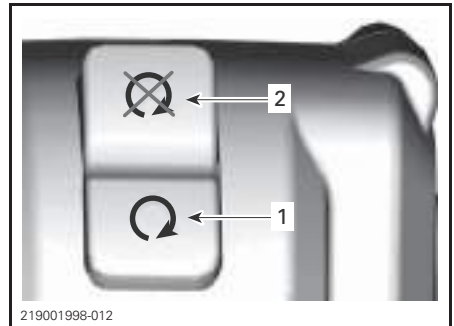

1. RUN position
2. STOP position

4) Headlights Switch

The headlights switch is located at the top of the left side multifunction switch.



This switch is used to select either the headlights low or high beams

Toggle this switch to select the high beams or the low beams.



1. High beam position
2. Low beam position

5) Turn Signal Button

The turn signal button is located in the middle of the left side multifunction switch.

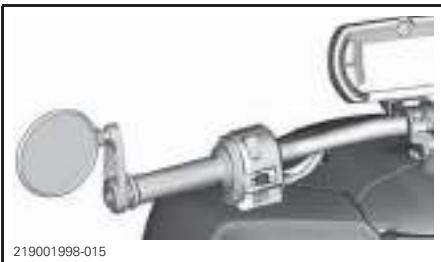

It turns off automatically after a normal turn, but you may have to turn it off manually after a shallow turn or lane change.

To turn the signal off, press the button in.

Turn signals will automatically turn off after 30 seconds while the vehicle is moving.

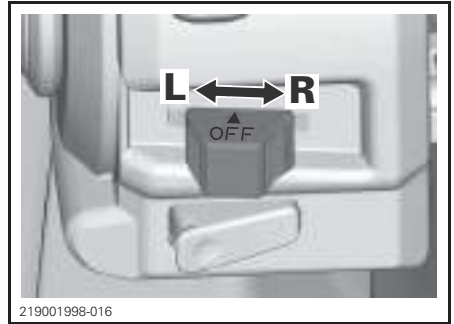

- L = Left turn signal
R = Right turn signal

6) Horn Button

The horn button is located at the bottom of the left side multifunction switch.



Press the button to activate the horn.



7) Hazard Warning Flasher Button

Australian and Russian Models

The hazard warning flasher button is located on the right side of the left side multifunction switch.

Press the button to activate or deactivate the hazard warning flashers.



The hazard warning flashers may be activated any time even if the engine is not running. The flashers will drain the battery if they are used for an extended time.

4.5" DIGITAL DISPLAY

Multifunction Display

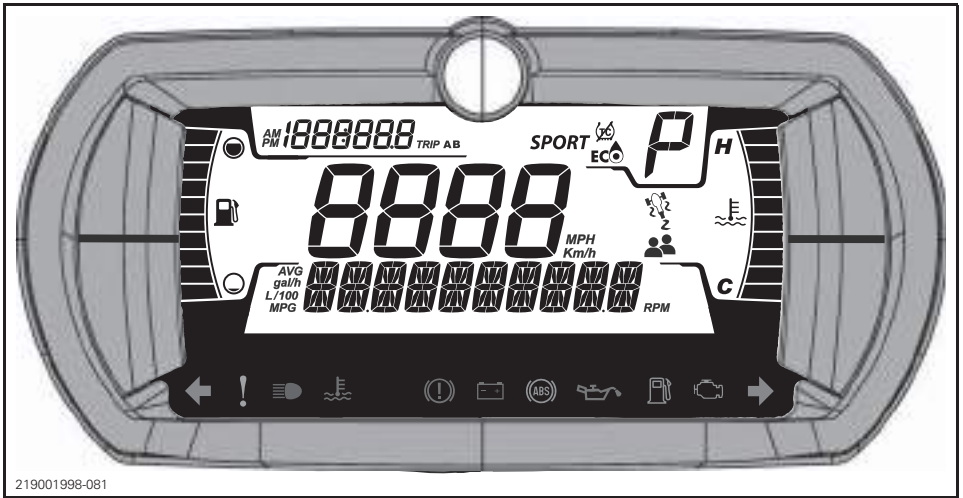

219001998-081

⚠ WARNING

Reading or tampering with the multifunction gauge can distract you from the operation of the vehicle, particularly from constantly scanning the environment. Always pay attention to road conditions, ensure your environment is clear and free from obstacles. Furthermore, when riding, only glance at the multifunction gauge briefly to maintain awareness of road conditions.

The multifunction gauge includes digital gauges (temperature and tachometer), telltale lights, icons and a digital screen to see important information (speed, RPM, etc.).

Lower Display

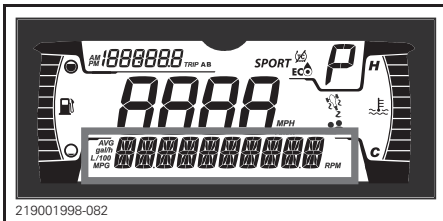

219001998-082

May display the following:

- RPM
- AVG - Average Fuel Consumption
- Distance to Empty

- Settings
- Messages

Left Lateral Display

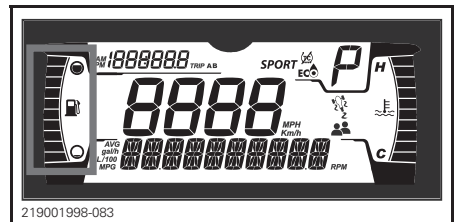

219001998-083

The left lateral display includes:

- Fuel level indicator

NOTE: Use this information as a reference only. Due to the fuel tank configuration, the fuel level indicator will indicate a full tank during a long period before showing a lower level of the indicators. The "Distance To Empty" information is more accurate to determine if you have enough gasoline to reach your destination.

Right Lateral Display

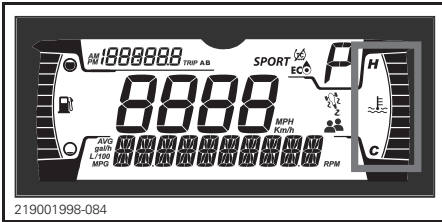

The right lateral display includes:

- Engine Temperature
- VSS icon
- Passenger icon

Central Display

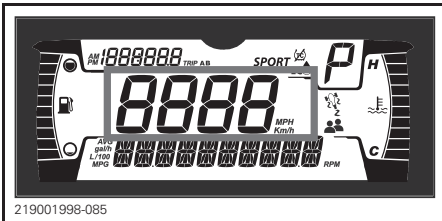

Display the vehicle speed in Km/h or MPH.

Selected Gear Display

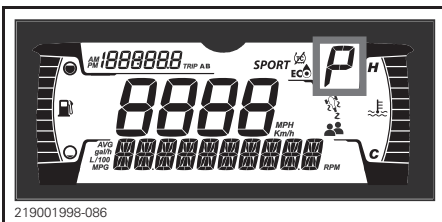

This display indicates the gear position of the gearbox:

- F (forward)
- R (reverse)

Also, it will indicate a P when the park position lever is in the locked position.

Trip Display

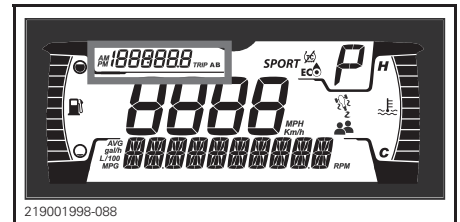

This display shows trip informations:

- Cumulative distance odometer
- Trip A
- Trip B
- Clock

MODE Display

Available on Models with a 900 ACE Engine only

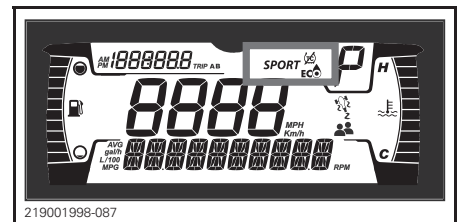





The MODE display indicates the selected driving mode:

- ECO
- SPORT
- RALLY (on Rally Edition only)

On the Ryker 900 Rally™ Edition model, the RALLY mode must be used when the vehicle is used on a non-paved road.

When a mode is selected, a message is displayed in the lower display. At the same time one or more icons will turn on to confirm your choice.

When in STANDARD mode, no information is displayed.

DRIVING MODE	ICONS
STANDARD	No icon
ECO	
SPORT	SPORT and  and 
RALLY (Rally edition only)	 and 







Warning Lamps and Indicators

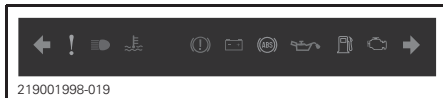

The following indicator lamps will alert you to a vehicle condition that may become serious. Some lamps will illuminate when starting the vehicle to make sure they work. If any lamps remain on after starting the vehicle, refer to the respective system warning lamp for further information.

NOTE: Some warning indicators appear in the display of the multifunction gauge and function the same as an indicator lamp but do not display when starting the vehicle.





Telltale Lights - Lower Bar





LIGHTS	DESCRIPTION
	GREEN - Left or right turn signal is turned on,
	Hazard Warning Flasher (if equipped) - All front and rear turn signals will flash
	ORANGE - Vehicle malfunction
	BLUE - The high beam are selected
	RED - The engine temperature is too high.
	RED - Park position lever is engaged or malfunction of the brake system
	RED - If illuminate while driving, it indicates a malfunction. Turn off all unnecessary electrical equipment and have the electrical and charging systems checked.
	ORANGE - Malfunction of the ABS system

LIGHTS	DESCRIPTION
	RED - If illuminate while the engine running or while driving, this indicates a malfunction. Stop the vehicle as soon as it is safe to do so and turn the engine off. Check the engine oil level. Have the lubrication system checked as soon as possible, even if the level being correct.
	ORANGE - Illuminate when the fuel level is low or when the fuel tank is near empty. Refuel as soon as possible.
	ORANGE Turn on: Malfunction of the vehicle emissions control system Blink: Engine limitation, the limp home mode is activated. Have the vehicle serviced immediately.

Icons and Indicators - Multifunction Display

ICONS	
	Fuel indicator
	Temperature indicator
	Passenger icon - this icon turns on when the LH passenger footpeg is deployed
	VSS icon Turn on: When the VSS is activated or when there is a malfunction Blink: If the VSS is doing an intervention.

ICONS	
	Indicates that the Traction Control system is partially deactivated. The system allows to have all engine power, but with reduced driving stability. It is therefore necessary to drive with appropriate caution.
	Denote ECO mode is selected.
SPORT	Denote SPORT mode is selected.

Settings

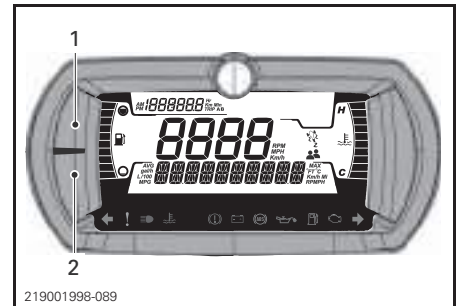

1. UPPER button
2. LOWER button

Display Brightness

The brightness of the display is factory setup by default at the medium level. The brightness may be modified by an authorized Can-Am On-Road dealer.

Setting Language

The language of the display is factory setup by default in English. See an authorized Can-Am On-Road dealer for available languages and change the setup at your convenience.

Menu Buttons

Upper Button

The following informations may be displayed by pressing the UPPER button:

- Odometer - Cumulative distance
- Trip A
- Trip B
- Clock.

Lower Button

The following informations may be displayed by pressing the LOWER button:

- RPM
- Fuel Statistic (average)
- Autonomy (km or M)
- Settings.
 - Reset Maintenance
 - Fault codes
 - Units
 - Reset Statistics
 - Clock settings
 - Exit

The LOWER button may also be used to select a driving mode.

Choosing, Resetting or Changing a Value

Upper Menu

Press on the UPPER button until the information to display are selected.

To Reset Trip A or B

Select trip A or B.

Press and hold the UPPER button until the value is reset.

Lower Menu

To Select Specific Information

Press the LOWER button until the name of the desired information is displayed.

Except for SETTINGS, wait 2-3 seconds to select and view the information.

To enter in the SETTINGS menu, hold the LOWER button 2-3 seconds.

NOTE: If no selection is done within 10 seconds, the cluster go out of the SETTINGS menu

To Reset a Value (AVG)

Select the value to be reset.

Press and hold the LOWER button until the value is reset.

To Modify a Value (Clock)

Press the LOWER button to select the information to be modified.

When selected, hold the LOWER button to enter in the modification mode.

Press LOWER button until the new value is displayed.

Wait 2-3 second to accept the change.

Selecting or Changing the Driving Mode

Available on Models with a 900 ACE only

Press and hold the LOWER button until the message in the lower display changes.

Press the LOWER button to scroll all available driving modes.

Wait 2-3 seconds to select and view the new information.

To return to the STANDARD mode, select ECO OFF.

EQUIPMENT

Control Components Adjustment

⚠ WARNING

The handlebar, the driver's footpegs and the brake pedal can be easily adjusted to meet each driver needs. It is important that all controls must be fully accessible and easily usable by the person driving the vehicle and this at all times. Take time to adjust the vehicle to the driver before riding.

As an example, the brake pedal activation should be easily accessible, workable and must go all the way through its operating travel.

Handlebar

⚠ WARNING

Make sure the engine is turned off and the engine stop switch is on the STOP position before performing any control components adjustments.

Sitting on the vehicle, engine off, lift the locking lever to unlock the handlebar.

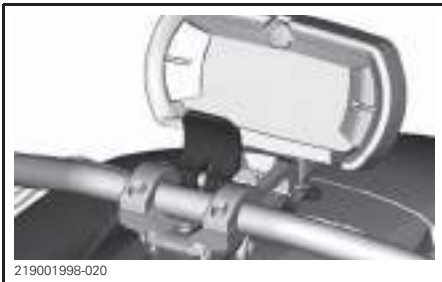

Move the handlebar back and forth until a comfortable position is obtained.

When done, reposition the locking lever in its original position to lock the handlebar in place.

⚠ WARNING

Be sure that the locking lever is well positioned. It should be equal with the handlebar retaining clamps.

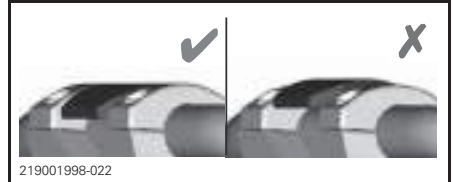

Adjusting the Locking Lever Clamping Strength

Turn the locking lever screw counter-clockwise to increase the clamping strength and clockwise to decrease it.

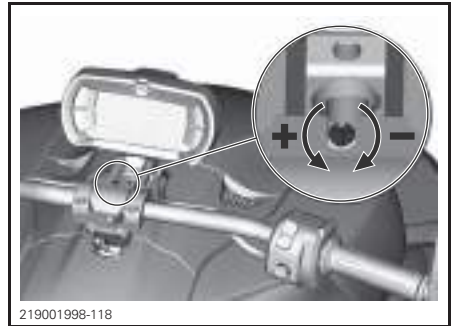

Driver's Footpegs and Brake Pedal

⚠ WARNING

Each time the right footpeg is moved, the brake pedal **MUST** also be repositioned.

⚠ WARNING

It is also recommended to position the footpegs equally on both sides. To help you, use the reference marks molded on the rocker panels.

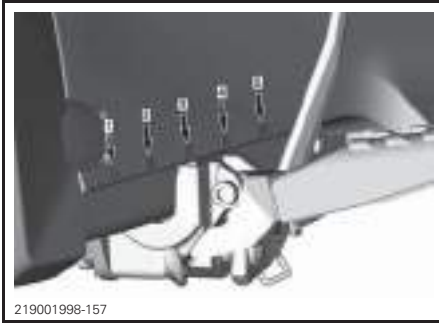

After the adjustment of the footpegs and the brake pedal, BRP recommends that the driver seats on the vehicle in driving position to determine if the position is the most adequate and the most comfortable. The driver must also check if the brake pedal goes all the way through its operating travel.

Left Side Footpeg

⚠ WARNING

Make sure the engine is turned off and the engine stop switch is on the STOP position before performing an adjustment on a control component.

1. With the engine off, lift the footpeg completely.

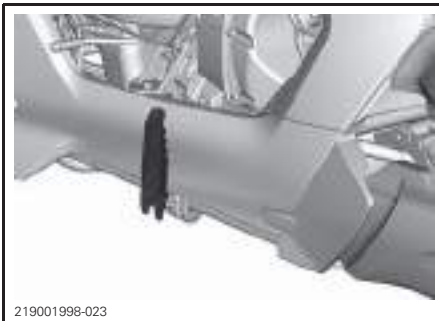

2. Slide the footpeg forward or rearward to the desired position.



3. Lower the footpeg in its position for the driving.

Right Side Footpeg and Brake Pedal

⚠ WARNING

Make sure the engine is turned off and the engine stop switch is on the STOP position before performing an adjustment on a control component.

1. Lift the footpeg completely.



2. Slide the footpeg and the brake pedal forward or rearward to the desired position.



3. Pull the brake pedal and position it in a functional position.



4. Lower the footpeg and validate that the driver is able to apply the full stroke of the brake pedal.

⚠ WARNING

Always ensure the driver can easily press the brake pedal and reach the end of the stroke, before confirming the final position.

5. Repeat steps 3 and 4 until perfect adjustment of the brake pedal is done.

Passenger's Seat

This vehicle is factory manufactured for an operator only, no passenger. However, you can change this by adding a BRP passenger's seat kit.

The BRP passenger's seat kit was designed to transport one passenger securely and it includes some safety features required for a safe ride.

The first and most important feature is two retractable footpegs that include a magnetic switch into the left footpeg that change the VSS calibration.

- The greater weight and the different distribution of this weight when carrying a passenger affects the vehicle compartment.
- The center of the gravity is modified and the vehicle compartment is no more the same. Therefore, the VSS calibration must be modified to reflect the new situation. Just need to lower the footpegs to activate the VSS calibration to ride with a passenger.
- It is also recommended to fold back the footpegs when riding without passenger, in order for the VSS to use the right calibration.

The passenger icon  will appear in the cluster gauge to indicate that the VSS is now in passenger mode

⚠ WARNING

Never carry a passenger if the footpegs are not lowered or not installed. Loss of control may occur in some situations.

Another safety feature are the integrated passenger's handholds. Refer to *CARRYING A PASSENGER* section for more information on how to use the handholds.

Lights

Canadian and USA Models

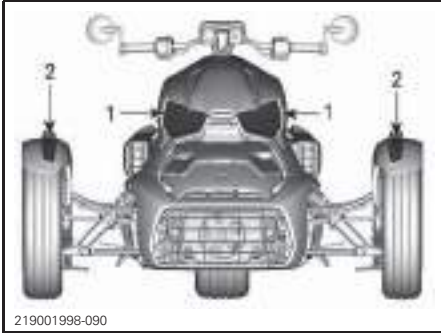

219001998-090

FRONT OF VEHICLE

1. Headlight - high and low beams
2. Turn signal lights/position lights



219001998-091

REAR OF VEHICLE

1. License plate light
2. Brake lights/Turn signal lights/tail lights

Australian Models

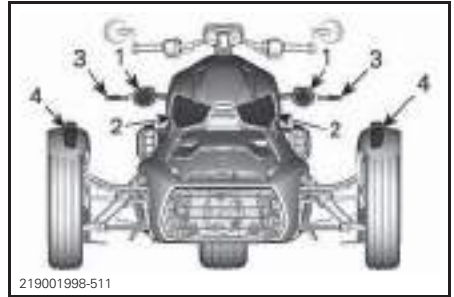

219001998-511

FRONT OF VEHICLE

1. Headlight - low beam
2. Headlight - high beam
3. Turn signal lights/Hazard warning lights
4. Position lights

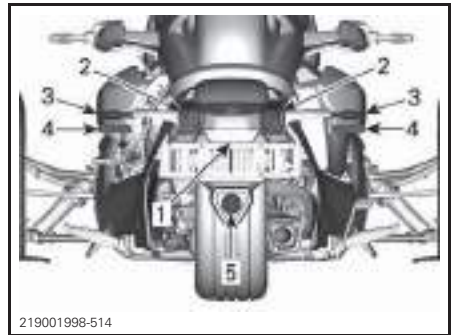

219001998-514

REAR OF VEHICLE

1. License plate light
2. Brake lights
3. Turn signal lights/tail lights/Hazard warning lights
4. RED reflectors
5. Reverse light

Japanese Models

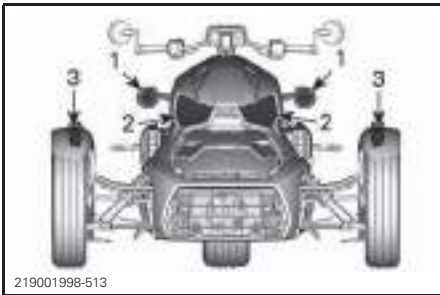

219001998-513

FRONT OF VEHICLE

1. Headlight - low beam
2. Headlight - high beam
3. Turn signal lights/position lights

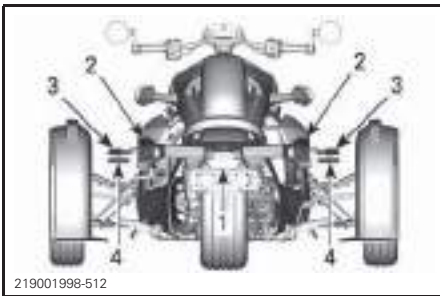

219001998-512

REAR OF VEHICLE

1. License plate light
2. Brake lights
3. Turn signal lights/tail lights
4. RED reflectors

Russian Models

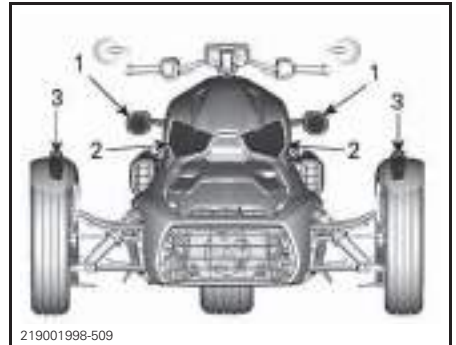

219001998-509

FRONT OF VEHICLE

1. Headlight - low beam
2. Headlight - high beam
3. Turn signal lights/position lights/Hazard warning lights



219001998-510

REAR OF VEHICLE

1. License plate light
2. Brake lights
3. Turn signal lights/tail lights/Hazard warning lights
4. RED reflectors

All Other Countries

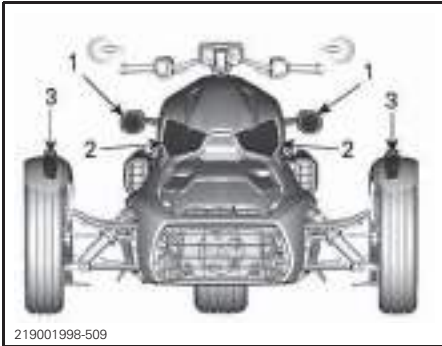

FRONT OF VEHICLE

1. Headlight - low beam
2. Headlight - high beam
3. Turn signal lights/position lights



REAR OF VEHICLE

1. License plate light
2. Brake lights
3. Turn signal lights/tail lights
4. RED reflectors

Mirrors

Each mirror can be adjusted to suit driver's preference by gently rotating it.

NOTICE Do not try to turn the mirror arm. It must remain oriented vertically (upwards).

⚠ WARNING

Do not adjust the mirrors while the vehicle is in motion.



Repositioning the Mirror Support

It may happen that the support becomes loose and lower during the use of the vehicle. Do the following to reposition and secure the support correctly.

1. Loosen the mirror support screw about 10 mm to 13 mm (3/8 in to 1/2 in).

NOTICE To avoid losing parts, do not remove the screw completely.



- A. 10 mm to 13 mm (3/8 in to 1/2 in)

2. Hit the screw to push it inward and release the support retainer mechanism.
3. Fully push the support against the handlebar.
4. Position the mark on the support perpendicularly with the ground.

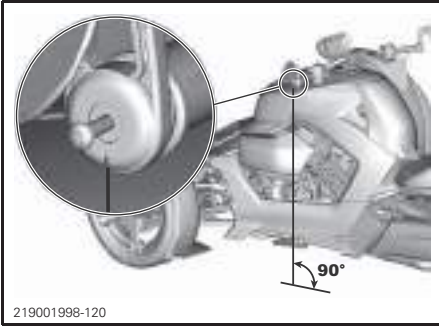

5. Hold the support and tighten the screw.

TIGHTENING TORQUE	
Mirror support screw	5 N•m ± 0.5 N•m (44 lbf•in ± 4 lbf•in)

6. Adjust the mirrors.

Glove Box

This model comes equipped with a glove box to carry small personal items and store the operator's guide.

Press on the rear portion of the glove box cover to open.

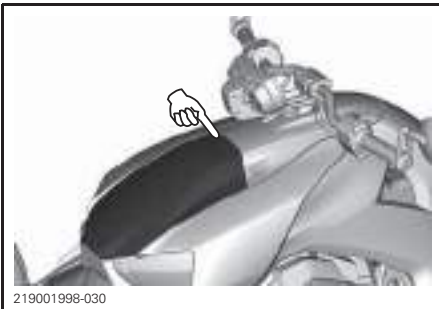

A double USB connector is also located inside the glove box. Each USB plug can charge with current up to 2.1A at 5V.



1. Double USB connector

Service Covers

Front Service Cover



The front service cover must be removed to reach the following items:

- Battery
- Fuse box
- Coolant reservoir
- Diagnostic connector
- Engine oil filter.

Removing the Front Service Cover

1. On each side of the service cover, insert a finger into the front lateral opening and lift the retaining tab to unlock the cover.

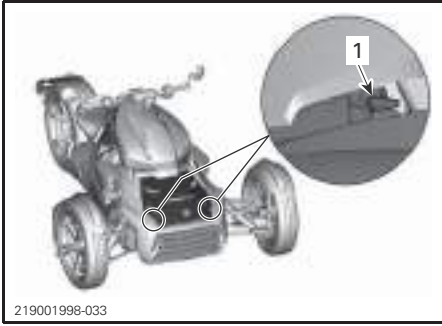

1. Locking tab

2. Hold the tabs and slide the cover forward.
3. Remove service cover from vehicle

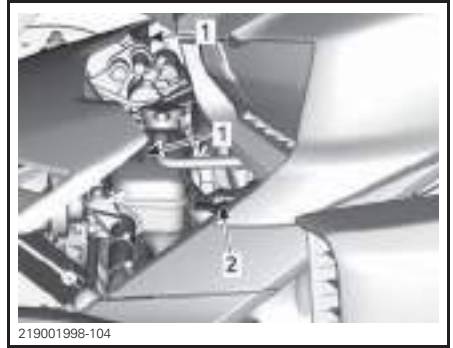

1. Rear tabs of the front service cover
2. LH vehicle support

3. Clip the front of the service cover
4. Pull on the cover to make sure it is properly latched.

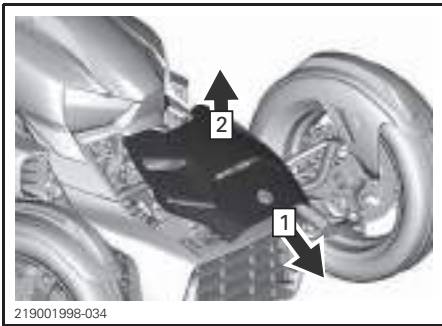

1. Slide forward
2. Lift up

Installing the Front Service Cover

1. Slide front service cover back in place.
2. Insert service cover rear tabs into vehicle supports slots.

Right Service Cover



The right service cover gives access to:

- Safety card
- CVT air filter
- Engine oil dipstick
- Refuelling funnel.

Opening the Right Service Cover

1. Turn the quarter-turn screw counter-clockwise.



2. Tilt the service cover.

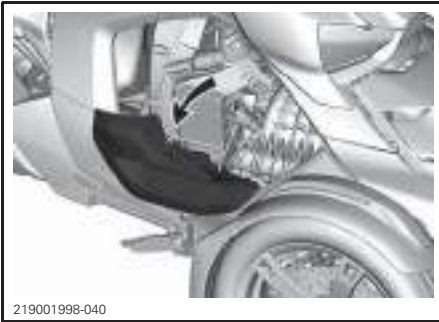

Closing the Right Service Cover

Close the cover and lock it using the quarter-turn screw.

Left Service Cover



The left service cover must be removed to servicing the engine air filter.

Removing the Left Service Cover

1. Release both clips, located underneath the left service cover, that retain it in place.

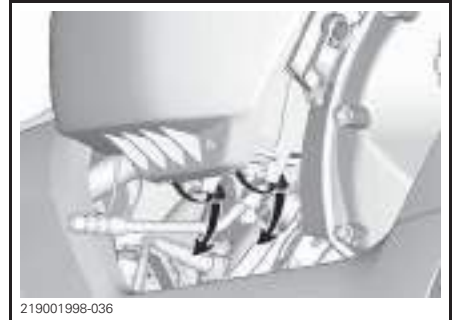

2. Remove the cover from the vehicle.



Installing the Left Service Cover

The installation is the reverse of the removal procedure.

BASIC PROCEDURES

Starting and Stopping the Engine

Starting the Engine

IMPORTANT: At start-up, engine RPM will slightly increase by itself before running its normal rotation.

⚠ WARNING

Exhaust gas contains poisonous carbon monoxide that can rapidly accumulate in an enclosed or poorly ventilated area. If inhaled, it can cause serious injury or death.

Only run the engine in an unenclosed, well ventilated area. See **AVOID CARBON MONOXIDE POISONING**.

1. Open the right side service cover and read the Safety Card as needed to prepare yourself, your passenger and the vehicle, before starting the vehicle.
2. Install the RF D.E.S.S. key on the D.E.S.S. post.

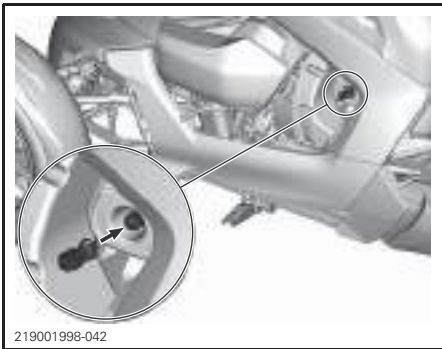

3. Briefly, press the start button to wake-up the electrical system.
4. Set the engine stop switch to the RUN position.

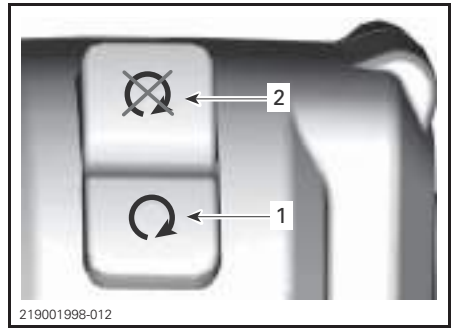

1. *RUN* position
2. *STOP* position

5. Twist gently the throttle handle away from you (raise your wrist) to activate the starting system. A beeping sound will be heard.
 - Once this motion is done, release the throttle handle.
 - The engine can be started in the next 30 seconds without doing this motion again.
 - Each time the engine is stopped, this motion must be performed to start the engine.



6. Push down and hold the brake pedal.
 7. Press the start button, no need to hold it to start the engine.
- NOTE:** If the engine does not start, press the start button again.
8. Check the display for problems and to ensure that the oil light turns off.

- Release the park position lever. Make sure the indicator on the multifunction gauge cluster is off.

IMPORTANT: If the park position lever is not released before operating the vehicle, the engine power will be limited in order to prevent transmission damages. The buzzer will sound and the telltale  will flash in order to inform the driver to release the park position lever.

Stopping the Engine

- Stop the vehicle.
- Set the engine stop switch to the OFF position.

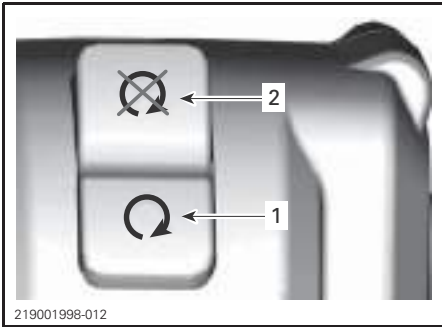

- RUN position*
- STOP position*

NOTE: The engine can only be stopped by using the engine stop switch. Removing the RF D.E.S.S. key from its post will not stop the engine, the key is required only to start the vehicle.

- Remove the RF D.E.S.S. key.
- Engage and lock the park position lever.

The telltale  and a P will appear in the display.

- Rock the vehicle back and forth to be sure that the park position lever is fully engaged

WARNING

Always engage the park position lever. The vehicle can roll if the park position lever is not locked. The clutch is always disengaged when the vehicle is stopped, so the transmission will not hold the vehicle in place.

- Get down of the vehicle.

Automatic Engine Shut Down

This vehicle is equipped with a feature that stops the engine 3 minutes after the engine operating temperature is reached.

A shutdown message will appear in the display, along with beep to prevent that shutdown will occur shortly.

The engine will be stopping unless one of the following conditions occurs.

- The brakes are applied.
- The throttle handle is activated.

Starting In a Slope

If the vehicle is parked in a slope and the park position lever is hard to release, select F or R position (in the direction of the top of the slope) then, gently turn the throttle handle while releasing the park position lever.

Hill Hold Control

Slope over 5% will cause the vehicle to be stationary after you release the brake pedal. This feature prevents the vehicle from moving forward or backward for one second.

The brakes are released automatically once the throttle is applied.

This is an advantage when you need restarting in a slope, (for example traffic lights, driveway or a parking).

This feature is activated automatically when the F or R position is selected to go upward the slope and this, in any slope that can result in significant vehicle rollback.

Pushing the Vehicle

⚠ CAUTION Avoid pushing the vehicle on a slope. If you must push the vehicle on a slope, take extra care to stay within reach of the brake pedal in case the vehicle starts to roll.

To move the vehicle a short distance without starting the engine:

1. While seated on the vehicle, push down and hold the brake pedal.
2. Disengage the park position lever.
3. Get down from the right side of the vehicle, keeping your foot on the brake pedal.
4. Push the vehicle, using the brake as needed.

⚠ CAUTION Only push from the right side, so you can reach the brake pedal. Stay clear of the hot exhaust pipe. When pulling the vehicle backward, be careful that the front wheel does not roll over your feet.

5. Seat down on the vehicle and park it as specified above.

Operating in Reverse

For safe operation in reverse, refer to *SAFE OPERATING INSTRUCTIONS* section.

Shifting Into Reverse

1. Stop the vehicle and let the engine running at idle.
2. Keep the foot on the brake pedal.
3. With the other foot or your left hand, pull the shift lever rearward to engage the reverse.

A double beep is heard to warn that reverse is engaged.

Driving in Reverse

Check that the area behind you is clear and continue to look backwards while you operate in reverse. Keep your speed low and do not back up for long distances.

Shifting Out of Reverse

1. Stop the vehicle and let the engine running.
2. Keep the foot on the brake pedal.
3. With the other foot or your left hand, push the shift lever forward to disengage the reverse.

Operating During Break-In

A break-in period of 300 km (200 mi) is required for the vehicle.

After the break-in period, the vehicle should be inspected as per the *MAINTENANCE SCHEDULE*.

Engine

During the break-in period:

- Avoid full throttle acceleration.
- Avoid maintaining constant RPM.
- Avoid sustained accelerations.
- Avoid prolonged cruising speeds.
- If the cooling fan operates continuously during stop and go traffic, pull over and shut off the engine to let it cool down or speed up to let air cool off the engine.

However, brief acceleration and speed variations contribute to a good break-in.

Brakes and Tires

During the break-in period, avoid hard braking.

⚠ WARNING

New brakes and tires do not operate at their maximum efficiency until their break-in is completed. Braking, steering and VSS performance may be reduced, so use extra caution.

Brakes and tires take about 300 km (200 mi) of riding with frequent braking and steering to break-in. For riding with infrequent braking and steering, allow extra time to break-in the brakes and tires.

Drive belt

A new drive belt requires a break-in period of 50 km (30 mi).

During this period:

- Avoid strong acceleration and deceleration.
- Avoid high speed cruising.

Fueling**Fuel Requirements**

NOTICE Always use fresh gasoline. Gasoline will oxidize; the result is loss of octane, volatile compounds, and the production of gum and varnish deposits which can damage the fuel system.

Alcohol fuel blending varies by country and region. This engine was designed to operate using the recommended fuels. However, be aware of the following:

- Use of fuel containing alcohol above the percentage specified by government regulations is not recommended and can result in the following problems in the fuel system components:
 - Starting and operating difficulties.
 - Deterioration of rubber or plastic parts.
 - Corrosion of metal parts.
 - Damage to internal engine parts.
- Inspect frequently for the presence of fuel leaks or other fuel system abnormalities if you suspect the presence of alcohol in gasoline exceeds the current government regulations.
- Alcohol blended fuels attract and hold moisture which may lead to fuel phase separation and can result in engine performance problems or engine damage.

Recommended Fuel

Use regular unleaded gasoline with a minimum AKI (RON+MON)/2 octane rating of 87, or an RON octane rating of 92.

For optimal performance, use premium unleaded gasoline with an AKI (RON+MON)/2 octane rating of 91, or an RON octane rating of 95.

NOTICE Never experiment with other fuels. Engine or fuel system damages may occur with the use of an inadequate fuel.

NOTICE Do NOT use fuel from fuel pumps labeled E85.

United States of America

Use of fuel labeled E15 is prohibited by U.S. EPA Regulations.

Refueling Procedure

⚠ WARNING

Gasoline is extremely flammable and highly explosive. Follow the refueling procedure to reduce the risk of fire or explosion. See *AVOID GASOLINE FIRES AND OTHER HAZARDS*.

To refuel the vehicle:

1. Park outdoors, on a level surface and in a well ventilated area away from flames, sparks, anyone smoking and other sources of ignition.
2. Stop the engine.
3. Slide the fuel filler door backward.

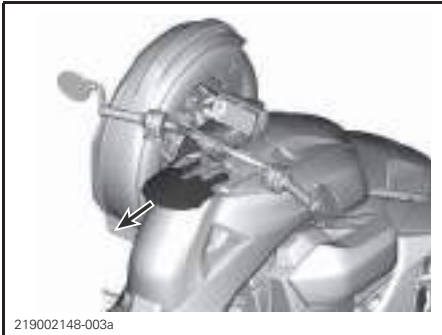

4. Unscrew slowly the fuel reservoir cap counterclockwise to remove it.

⚠ WARNING

If a differential pressure condition is noticed (whistling sound heard when loosening fuel reservoir cap) have vehicle inspected and/or repaired before further operation.

5. Insert the spout into the filler neck.
6. Pour fuel slowly so that air can escape from the tank and prevent fuel flow back. Be careful not to spill fuel.

7. Stop filling when the fuel reaches the bottom of filler neck. Do not overflow.

⚠ WARNING

Never top up the fuel tank before placing the vehicle in a warm area. As temperature increases, fuel expands and may overflow.

8. Fully tighten fuel reservoir cap clockwise.

⚠ WARNING

Always wipe off any fuel spillage from the vehicle.

9. Screw the fuel cap in position.
10. Fully push the fuel filler door forwards to close it.
11. Wipe up any spilled fuel. If fuel spills on you, wash with soap and water and change your clothes.

Refueling Procedure With a Portable Fuel Container

⚠ WARNING

Do not insert the nozzle of a portable fuel container or after-market funnel directly into the capless fuel filler neck. This could damage the capless fuel filler neck and compromise its tightness. If the capless fuel filler neck is damaged, the fuel could flow onto the fuel tank and maybe on the engine instead of filling the tank, which could result in fire.

NOTICE Do not try to pry open or push open the capless fuel filler neck with foreign objects. This could damage the capless fuel filler neck and compromise its tightness.

When filling the vehicle's fuel tank from a portable fuel container, always use the funnel included with the vehicle.

1. Stop the engine and move the park position lever in the locked position.
2. Tilt the right service cover to access the plastic funnel.



3. Slide the fuel filler door backward.

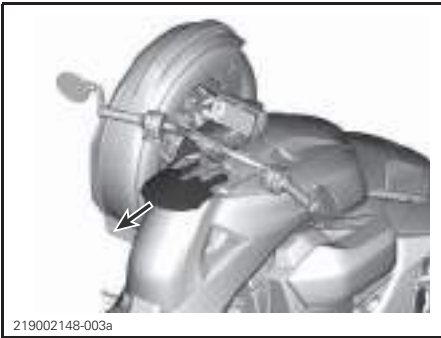

4. Unscrew slowly the fuel reservoir cap counterclockwise to remove it.
5. Carefully, insert the funnel into the fuel filler neck.

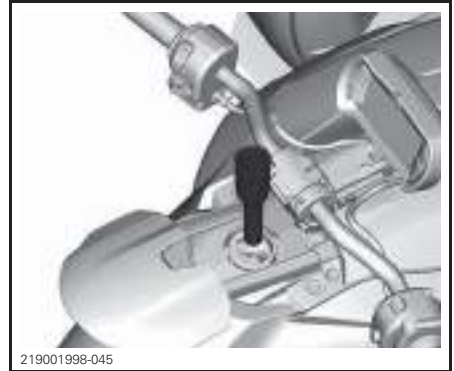

6. Fill vehicle.

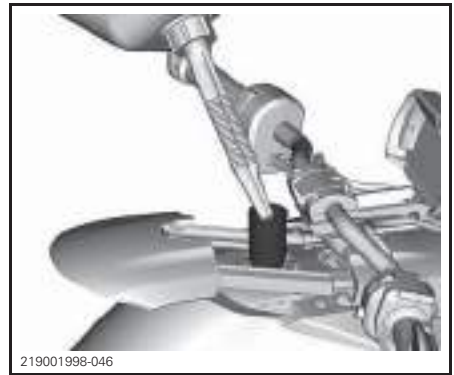

7. When completed, remove and clean the funnel before replacing it on its support.
8. Screw the fuel cap in position.
9. Close and lock the service cover.
10. Fully push the fuel filler door forwards to close it.

Adjusting Suspension

Suspension adjustment and loading can have an effect on your vehicle handling and comfort.

Choice of suspension adjustments vary with driver's weight, personal preference, riding speed and field condition.

Front Suspension

⚠ WARNING

Suspension adjustment could affect vehicle handling. Always take time to familiarize yourself with the vehicle's behavior after any suspension adjustment have been made.

⚠ WARNING

The left and right shock absorber must always be adjusted to the same position. Never adjust only one side. Uneven adjustment can cause poor steering control and loss of stability, which could lead to an accident.

Spring Preload Adjustment

Ryker 600 and Ryker 900

There is no adjustment on front shock absorbers.

Ryker 900 Rally Edition

Shorten the springs for a firmer ride and rough conditions.

Lengthen the springs for a softer ride and smooth conditions.

Adjust by turning the adjustment ring.



219001998-092

1. Adjustment ring

Rear Suspension

Spring Preload Adjustment

Use the following information to adjust the rear suspension of your vehicle.

Ryker 600 and Ryker 900

WEIGHT	CAM POSITION
Up to 100 kg (220 lb) - driver alone (Factory setting)	1
More than 100 kg (220 lb) - including driver and cargo	3
With a passenger	5

If you ride often with a passenger, talk with your Can-Am On-Road dealer to determine if the purchase of a rear spring specially designed for riding with a passenger could be a good option for you.



CAM POSITIONS

Ryker 900 Rally Edition

WEIGHT	ADJUSTMENT RING DISTANCE (A)
Driver alone and/or cargo (Factory setting)	6 mm (1/4 in)
Occasionally with a passenger	11 mm (7/16 in)
Often or always with a passenger	16 mm (5/8 in)

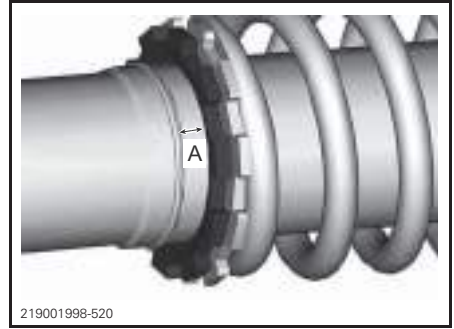

Compression Damping Adjustment

Ryker 900 Rally Edition

High speed compression damping controls how the shock absorber reacts to a high suspension velocity (quick compression strokes, in most cases when riding at higher speeds).

To adjust, turn the adjuster knob located on the reservoir.

WEIGHT	KNOB POSITION*	
	SMOOTH ROAD	ROUGH ROAD
Driver alone (Factory setting)	1	2
With a passenger	2	4

* ± 1 click for personal preference

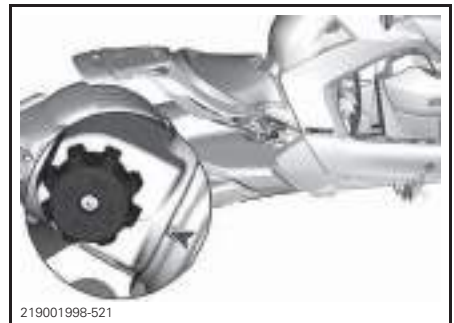

***This page is
intentionally blank***

SAFE OPERATING INSTRUCTIONS

WHAT'S DIFFERENT FROM OTHER VEHICLES

This section will help you to understand some distinctive and operating features of this vehicle

Stability

The “Y” configuration of this 3-wheel vehicle provides greater low-speed stability than a motorcycle.

However, it is not as stable as a four-wheeled vehicle such as an automobile. Driving aid technologies, like the electronic Vehicle Stability System (VSS), help maintain stability during maneuvers, but you can still lose control, tip or roll the vehicle due to extreme maneuvers (such as hard turns), overloading the vehicle or striking uneven surfaces or objects. In addition, the operator or passenger can fall off due to hard turns, acceleration, braking or impacts.

Response to Road Conditions

The road behavior of this vehicle may be different from other vehicles on the road. Follow these recommendations.

- Do not ride off-road or on ice or snow.
- Avoid puddles and running water. The vehicle hydroplanes more easily than a car. If you must go through water, slow down.
- Slow down on gravel, dirt or sand covered roads.
- Driving at temperature lower than 5°C (41°F) will result in reduced adherence.

Refer to *STREET STRATEGIES* for detailed instructions.

Driving Modes

ECO Mode

The ECO (fuel economy mode) setting reduces fuel consumption by limiting throttle response and maximum throttle opening to maintain an optimal cruising setting.

SPORT Mode

When the SPORT mode is activated, the VSS will allow significantly more rear wheel spinning and higher vehicle slip angle, thus requiring countersteering. Moreover, when this mode is activated, traction control is reduced, meaning that rear wheel skidding is less supported even on lower friction surfaces. This mode is most effective on dry or wet asphalt. When this mode is activated, the driver should be even more careful than when normally driving the vehicle.

This mode can only be activated when the driver is alone on the vehicle (no passenger) and if no VSS fault is active.

WARNING

You should familiarize yourself with the basic operation of the vehicle as well as vehicle handling with the VSS before using the sport mode. When using the sport mode, always be aware of your surroundings and of the vehicle handling.

RALLY Mode

The RALLY mode was designed to improve the riding experience on loose gravel road and other unpaved roads. VSS interventions are adapted to loose surface roads. This mode must only be used when riding on unpaved roads. When this mode is activated, the driver should be even more careful than when normally driving the vehicle.

This mode can only be activated when the driver is alone on the vehicle (no passenger) and if no VSS fault is active.

⚠ WARNING

You should familiarize yourself with the basic operation of the vehicle as well as vehicle handling with the VSS before using the RALLY mode. When using the RALLY mode, always be aware of your surroundings and of the vehicle handling.

Brake Pedal

One pedal applies brakes on all three wheels. There is no hand-operated brake, and there is no way to brake front and rear wheels separately.

This vehicle is able to brake and steer at the same time, much better than a motorcycle and can stop very quickly. Be aware of vehicles behind you, they may not be able to stop or react as quickly.

Anti-lock Braking System (ABS)

The vehicle is equipped with an Anti-lock Braking System (ABS) as part of the Vehicle Stability System (VSS).

This system helps to maintain the steering control during an emergency braking situation by keeping the brakes from locking.

Park Position

The park position lever is a mechanical device that locks the drive shaft when engaged.

NOTICE Never try to slow or stop vehicle by moving the park position lever. The drive shaft and the gearbox will be damaged.

Also, the selected gear display will indicate a P when the park position lever is in the locked position.

Steering

Direct Steering

To take a turn, always steer the handlebar in the direction of the turn.

Motorcyclists - Do not countersteer as you do with a motorcycle. Unlike a motorcycle, this 3-wheel vehicle cannot lean while turning. You must relearn how to turn. Practice the turns at different speeds until you are proficient.

Sideways Forces in Turns

Unlike a motorcycle, this vehicle cannot lean while turning. You will feel sideways forces pushing you to the outside of the turn.

To maintain balance, the operator and passenger must hold back with their both hands and keep their feet firmly planted on the footpegs.

In tight turns, it may help to lean your upper body forward and toward the inside of the turn.

Width

Because this vehicle is wider than a typical motorcycle:

- Always keep the front wheels in your lane. Be particular aware of the front wheels location when entering in a curve or during an overtaking.
- Do not share lanes or split lanes (ride between two lanes of traffic). Group riding should proceed in a single file, even with motorcycles.
- Be prepared to swerve farther to avoid obstacles.

NOTE: Clearing an obstacle with the front wheels does not guarantee clearing the obstacle with the rear wheel.

Reverse

The Reverse icon  appears into the selected gear display when the reverse position is selected.

This vehicle may back in reverse like a car. However, there are some important differences:

- If necessary, have the passenger dismount if your visibility is limited.
- Remember that the front is wider than the rear. Do not back up too close to objects or you may hit them with the front tires.
- Keep your speed low and do not back up for long distances.
- When possible, park so that you do not have to back out of the parking space.

 **CAUTION** Always keep both feet on the footpegs while operating in reverse. Never put your feet on the ground while backing-up.

Driver's License and Local Laws

Driver's license requirements for operating this vehicle vary by location. Depending on local laws, you may need an automobile driver's license, a motorcycle's license, or a specific endorsement for a 3-wheel vehicle.

Check with local authorities to make sure you have the proper license before operating the vehicle on public roads.

DRIVING AID TECHNOLOGIES

Vehicle Stability System (VSS)

This vehicle is equipped with a Vehicle Stability System (VSS).

This system helps to keeping the control of the direction and reduce the risk of tipping or rolling over in some situations.

The VSS is composed of:

- An **Anti-lock Braking System (ABS)** that helps maintain steering control during an emergency braking situation by keeping the brakes from locking.
- An **Electronic Brake Distribution (EBD)** system that automatically adjusts the brake balance between all three wheels. With the ABS, EBD helps maintain directional control and maximize the braking force depending on the traction available.
- A **Traction Control System (TCS)** that helps prevent the rear wheel from slipping. The TCS will limit rear wheel spin only if you turn the handlebar (steer out of straight line) or if traction conditions or vehicle stability require engine torque to be reduced. The system allows more slipping when SPORT or RALLY modes are selected.
- A **Stability Control System (SCS)** is designed to limit the power driving the rear tire and to brake individual wheels, which reduces the risk of losing control of the vehicle or rolling over.

Limitations

VSS cannot help you maintain control in all situations.

Surfaces with Poor Traction

The grip of tires on the road surface limits the maximum braking. Even with ABS and EBD, your stopping distance will be longer on surfaces with

poor traction, if you do not maintain recommended tire pressure or if tire tread condition is degraded.

If your tires lose traction with the road surface you may lose control of the vehicle, even with VSS.

If the paved road surface is covered or partially covered with ice, snow or slush, there is not enough traction available to maintain control of the vehicle, even with VSS. Do not operate on snow, ice or slush.

NOTE: The grip of the vehicle tires starts to decrease below 5°C (41°F).

Like other on-road vehicles, this vehicle can hydroplane on water (lose traction on a layer of water). If you ride too fast into a layer of water, such as a large puddle or flowing water on the road, the vehicle can lose traction and spin out, and the VSS cannot keep you in control. Avoid large water puddles or water streams, and slow down or pull off the road during heavy rains. If you must pass through water, slow down as much as possible before you reach it.

Ryker 600 and Ryker 900

Reduce speed on surfaces with poor traction, like mud, sand, gravel or wet pavement. This vehicle is not for off-road operation. Always operate the vehicle on maintained roadways. Do not use the vehicle on any other terrain.

Ryker 900 Rally Edition

This model is specially designed to be used on multiples rolling surfaces. Even if it can used on surfaces with reduced traction, IT IS NOT AN OFF-ROAD VEHICLES.

Be aware when driving on slippery surfaces that the vehicle systems cannot compensate for all dangerous driving situations. USE YOUR COMMON SENSE.

Always select the *RALLY MODE* when driving under these conditions. Refer to *SETTINGS* in the 4.5" *DIGITAL DISPLAY* section.

Tires

The VSS on the vehicle has been calibrated to perform best with a tire of a specific size, material and tread pattern. Replacing your tires with ones not approved by BRP can cause the VSS to be less effective.

Use only BRP recommended tires, which can be ordered only from an authorized Can-Am On-Road dealer.

Proper tire inflation pressure and tread condition are important for maintaining traction, especially on loose or wet surfaces. Tire pressure that is too low may result in hydroplaning and excessive tire heat build up, while a tire pressure that is too high can reduce VSS effectiveness.

Hard Turns

The VSS does not control or limit steering input — it cannot keep you from turning too sharply. Large and rapid steering handlebar movements can cause the vehicle to go out of control, spin, tip or roll over.

Excess Speed

The VSS does not control the vehicle speed, except when SCS intervenes during a turn. The VSS does not prevent the vehicle from entering a turn too fast. If you drive too fast for conditions, you can lose control, even with VSS.

Excess Weight

Never load vehicle above specified values.

Ryker 600 and Ryker 900

WEIGHT LIMITS	
Vehicle load limit (including operator, passenger*, cargo and added accessories)	204 kg (449 lb)
Glove box compartment	2 kg (4.4 lb)
* No passenger allowed without the installation of an approved passenger's seat kit	

Ryker 900 Rally Edition

WEIGHT LIMITS	
Vehicle load limit (including operator, passenger*, cargo and added accessories)	199 kg (438 lb)
Glove box compartment	2 kg (4.4 lb)
* No passenger allowed without the installation of an approved passenger's seat kit	

UNDERSTANDING RISK ON THE ROAD

Before operating this 3-wheel vehicle, watch the safety video, read the safety card and all on-product safety labels.

Consider your risk of being hurt or killed in a crash, think how you can reduce this risk and whether, you are willing to take this risk.

There are many factors that contribute to the risk that you face. You can control some of these factors, but others, like the behavior of other drivers, are beyond your control.

Here are some of the factors that affect your risk:

Type of Vehicle

Different types of vehicles vary in terms of size, visibility and maneuverability and provide different degrees of protection.

This vehicle is small and maneuverable. Maneuverability can help avoid crashes. However, smaller vehicles are harder to see, which increases the chance that other motorists will cause a crash. In some situations, the Ryker is less likely to be in a crash than a motorcycle. For example, you are less likely to tip over at low speeds while operating the vehicle. However, in other situations, the vehicle is more likely to be in a crash. For example, because the vehicle is wider, it will not fit through as small an opening as many motorcycles.

In cars and trucks, the structure of the vehicle provides protection in crashes and from other road hazards. In addition, passengers can protect themselves by wearing seat belts. You should expect that the riding of this vehicle is riskier than riding in a car and that the risk of injury is more like riding a motorcycle.

As when riding a motorcycle, you can reduce the risk of injuries by wearing a helmet and riding gear.

Operator Skills and Judgment

Every driver has some control over their own risk on the road. Drivers who develop good skills will have better control of their vehicle. Do not rely on your experience with motorcycles, automobiles, ATVs, snowmobiles or any other kind of vehicle to prepare you to operate the vehicle. Learn how this vehicle is different. Read this Operator's Guide, watch the *SAFETY VIDEO* located at:

<https://can-am.brp.com/spyder/owners/safety/safety-information.html> and if available, take a training course. Become proficient with the controls and be able to do the practice exercises accurately and with confidence before going on the road.



When you begin riding on the road, start with less challenging situations (e.g., light traffic, lower speeds, good weather, no passenger) and gradually move on to more challenging riding situations as you develop your skills. Plan ahead to avoid situations that are too difficult for your skill level, or that present more risk than you want to take on.

Even skilled drivers cause crashes. For example, if you use your skills to do extreme maneuvers or stunts, you increase your risk. The smart driver uses good judgment along with skills to increase the margin of safety and minimize risk. Learn the defensive driving techniques in *STREET STRATEGIES*.

Rider Condition

A driver needs to be alert, sober, and physically ready to ride. Never use this vehicle with drugs or alcohol. Riding when intoxicated, tired or otherwise impaired increases the risk of a crash.

Alcohol, drugs, medications, fatigue, drowsiness and emotions can all inhibit your ability to ride safely. Like riding a motorcycle, riding this vehicle is a challenging activity — being in good physical and mental condition is even more important than for a car. The safest policy is to never operate the vehicle unless you are alert and completely sober. Even if your blood alcohol level is not over the legal limit, your judgment and skills are impaired by any alcohol consumption.

You must be physically able to operate all controls, turn the handlebar through the full range of steering, mount and dismount, and monitor your surroundings to operate the vehicle.

Passengers also need to be alert, sober and physically able to maintain their posture, hold on and react appropriately to curves, bumps, acceleration and stops.

Vehicle Condition

Keep your vehicle in good condition.

Do pre-operation checks and perform regular maintenance. Watch for any messages on the multifunction gauge cluster when you start the vehicle, and address any problems before you ride.

Always use the multifunction gauge with extreme caution. Prolonged attention to the display while riding significantly increases the risk of a crash.

Road and Weather Conditions

Roads with heavy traffic, poor visibility or poor traction surfaces increase your risk. Choose routes that are appropriate for your skill level and the level of risk you are willing to accept.

RIDING GEAR

Riding this vehicle requires the same protective gear as motorcycling. Even though the vehicle is more stable at low speeds than a motorcycle, you can still be thrown off.

This section is based on guidance for motorcyclists given by the Motorcycle Safety Foundation (MSF).

In the event of a crash, protective gear may prevent or reduce injuries. Protective gear also helps you stay comfortable and can help provide protection against the elements.

Recommended basic protective gear for riders and passenger includes sturdy over-the-ankle footwear with non-slip soles, long pants, a jacket, full-fingered gloves and, above all, an approved helmet with proper eye protection.

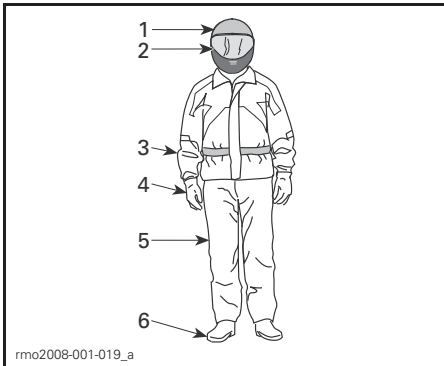

RIDING GEAR

1. Approved helmet
2. Eye and face protection
3. Jacket with long sleeves
4. Gloves
5. Long pants
6. Over-the-ankle footwear

Proper apparel can reduce the severity of injuries in case of a crash, either for the operator or the passenger.

Helmets

Helmets protect the head and brain from injury. A helmet can also protect the passenger's face from impact with the back of the operator's helmet.

Even the best helmet is no guarantee against injury, but statistics indicate that helmet use significantly reduces the risk of brain injury. So, be safe and always wear a helmet while riding.

Choosing a Helmet

Helmets should be manufactured to meet the appropriate standard in your state, province or country.

A full-face helmet gives the most protection against impacts since it covers all of the head and face. It can also protect against debris, stones, insects, etc.

A three-quarter or open-face helmet can also offer protection. It is constructed with the same basic components but does not offer the face and chin protection of full-face helmets. If you wear an open-face helmet, you should use a snap-on face shield or a pair of goggles.

NOTE: Ordinary glasses or sunglasses are not sufficient eye protection for a motorcyclist. They can shatter or fly off, and they allow wind and airborne objects to reach the eyes.

Use tinted face shields, goggles or glasses in the daytime only; do not use them at night or in poor illumination. Do not use them if they impair your ability to discern color.

Other Riding Gear

Footwear

Always wear closed toe footwear. Sturdy over-the-ankle boots protect against a variety of riding hazards, such as stones that get thrown up from the roadway and burns from the hot exhaust pipe.

Avoid long shoelaces that can be tangled in the gearshift lever, brake pedal or other parts. Rubber soles and low heels are a good idea to help keep feet on the footrests.

Gloves

Full-fingered gloves protect hands from the wind, sun, heat, cold and flying objects. Gloves that fit snugly will improve grip on the handlebar and help reduce hand fatigue. Sturdy, reinforced motorcycle gloves help protect hands in the event of a fall. Gloves made specifically for motorcyclists have seams on the outside to prevent irritation, and are curved to provide a natural grip when curled around the handgrips. If gloves are too bulky, it may be difficult to operate the controls. Gauntlets keep cold air from going up sleeves and protect the wrists.

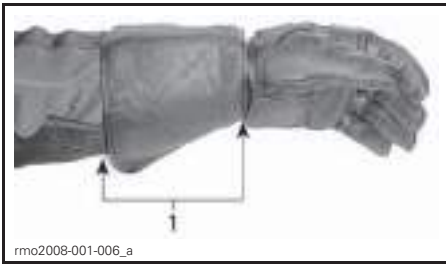

1. *Glove gauntlet*

Jackets, Pants and Riding Suits

Wear a jacket and long pants, or a full riding suit. Quality motorcycle-type protective gear will provide comfort, and it can help you avoid being distracted by adverse environmental elements. In case of a crash, good quality protective gear made of sturdy material may prevent or reduce injury. Some gear includes padding or hard armor that may further reduce the risk of injury in a crash. Pants also help protect against burns from hot parts.

Protective gear sold for motorcycling will often provide the best combination of fit and protection. These garments are designed to fit while sitting in a riding position. They are cut longer in the sleeves and legs and are fuller across the shoulders. Riding suits are available in both one-piece and two-piece sets.

Leather is a good choice because it is durable and wind-resistant and provides protection against injury. Other abrasive-resistant protective gear made of synthetic fabrics are good choices, too. Do not wear loose or long clothing or scarves that can become tangled in the moving parts.

Flaps and fasteners seal out the wind. A jacket with a zippered front will be more wind resistant than a jacket with buttons or snaps. A flap of material over the zipper of a jacket gives additional protection against the wind. Jackets with snug cuffs and waist are recommended to keep wind from blowing in. A large, loose collar can flap when riding and may irritate skin or be a distraction.

In cool-weather riding, protect yourself against hypothermia. Hypothermia, a condition of low body temperature, can cause loss of concentration, slowed reactions and loss of smooth, precise muscle movement. In cool conditions, proper protective gear like a windproof jacket and insulated layers of clothing are essential. Even at moderate temperatures, you can feel very cold due to the wind while riding.

Protective gear that is appropriate for cold-weather riding may be too hot when stopped. Dress in layers so that clothing can be removed as desired. Topping the protective gear with a windproof outer layer can prevent cold air from reaching the skin.

Riding gear can also help a rider be more visible. Wearing bright colors is a wise choice. If a dark jacket is worn, an inexpensive reflective vest can be worn over it. It is a good idea to put extra reflective tape on garments worn regularly while riding.

Rain Gear

If you must ride in wet weather, a rain suit or a waterproof riding suit is recommended. On long rides, it is a good

idea to carry rain gear. A dry rider will be much more comfortable and alert than a rider who is wet and cold.

One or two-piece styles are available, and those designed specifically for motorcycling are best. High-visibility orange or yellow colors are good choices. A feature to look for is elastic in the waist, pant legs and sleeves. The jacket should have a high collar and zip up with wide flaps across the opening. When purchasing a rain suit, consider adding waterproof gloves and footwear.

Remember, if the weather is wet, it is best to avoid riding. If you do ride in wet weather, you may need to stop if water starts to accumulate on the road.

Hearing Protection

Long-term exposure to wind and motor noise when riding can cause permanent hearing loss. Properly worn hearing protective devices such as earplugs can help prevent hearing loss. Check local laws before using any hearing protective devices.

REQUIRED RIDING SKILLS AND PRACTICE EXERCISES

Before riding this vehicle on the road, you need to develop riding skills and strategies for managing the risks on the road.

If you have experience with motorcycles or other motor vehicles, pay particular attention to how the operation and performance of this vehicle are different from vehicles you are used to.

The following exercises will familiarize you with the basic operation of the vehicle. Practice each exercise until you can perform it proficiently before moving on to the next.

This section includes the following exercises:

1. Revving the engine and using the engine stop switch
2. Starting, stopping, and basic handling
3. Engine stop while in motion
4. Basic turns
5. Quick stops
6. Weaves
7. Swerve
8. Operating in reverse.

Choosing a Practice Area

Perform these exercises in a paved area at least 76 m - 30 m (250 ft - 100 ft) that is not open to traffic. A closed, well marked parking lot without obstacles (light poles, curbs, etc.) makes a good practice area. Be aware of oil left by parked cars. Look for parking lots that are empty during off hours, such as schools, churches, community centers or shopping centers. Do not trespass on private property.

Once you have selected a suitable location, get permission to use it from the owner. If there are obstructions, such as light poles or islands, be sure that they do not interfere with the required open paths shown in the diagram below.

Keep this basic parking lot diagram in mind when setting up the exercises. 3 m (10 ft) wide parking lot spaces are indicated in the diagrams for convenience, but the size of the spaces in the lot you use may be different. If the parking lot you choose does not have lines or if the parking spaces are sized much larger or smaller than the ones in the diagrams, use the dimensions shown below. Mark them using a tape measure and chalk or markers such as cones or milk containers weighted with water or sand.

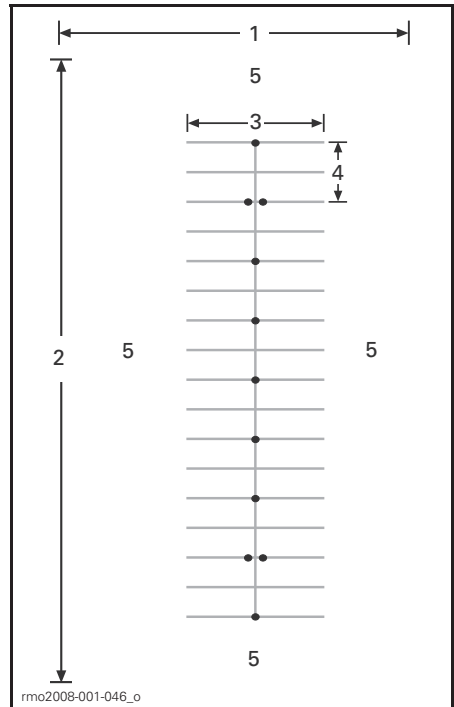

TYPICAL PARKING LOT

1. At least 30 m (100 ft)
2. At least 75 m (250 ft)
3. 12 m (40 ft)
4. 6 m (20 ft)
5. Open area

Even in a closed lot, be aware of potential traffic. Check to the front, sides and rear before doing an exercise. Also, watch out for children and animals.

Preparing to Ride

Know the location and operation of all the vehicle controls. Refer to *VEHICLE INFORMATION* section.

Adjust handlebar, footpegs and brake pedal to meet driver needs. Refer to *CONTROL COMPONENTS ADJUSTMENT* in *EQUIPMENT* section.

Perform the pre-ride inspection. Refer to *PRE-RIDE INSPECTION* section.

Always start and stop the engine according to the instructions in *STARTING AND STOPPING THE ENGINE* in *BASIC PROCEDURES*.

Riding Posture

Good posture helps you maneuver the vehicle more easily. Always keep both hands and both feet in position so that you can operate the controls easily. The wrist should typically be aligned straight with the arm (this position helps you apply the amount of throttle you want). Arms should be relaxed and bent. Keep your back straight and your head and eyes up. Keep both feet on the pegs near the controls.

Never operate the vehicle, even for a short distance, unless you are in the proper riding posture.



219001998-160

RIDING POSTURE

Practice Exercises

1) Revving the Engine and Using the Engine Stop Switch

Purpose

- Become familiar with the operation of the twist throttle.
- Become familiar with using the engine stop switch.

Directions

- Start with your right foot on the brake pedal and the park position lever locked.
- Use the engine stop switch to cut all power to the vehicle. Press the switch with your right thumb while keeping your hand on the handgrip.

Tips for Additional Practice

- Practice pressing the engine stop switch without looking at it.

2) Starting, Stopping and Basic Handling

Purpose

- Learn throttle control and how to get the vehicle moving.
- Become familiar with low speed deceleration and braking.

Directions

If you feel like you are losing control while doing these exercises, release the throttle to stop accelerating and apply the brake as needed to slow down. You can also use the engine stop switch to cut power entirely.

2a) Apply and Immediately Release Throttle

Directions

At first, you will only use the throttle for a moment at a time, then release it and coast.

- Start the engine and release the park position lever.

- With the brake pedal depressed, push on the shift lever to ensure the forward position is selected.
- Release the brake.
- Slowly apply throttle until the vehicle starts to creep forward. As soon as you start moving release the throttle and coast, then press the brake to stop. Repeat to the end of the straightaway.
- To turn around at the end of the straightaway, stop, turn the handlebar all the way to the right, then briefly apply and release the throttle, and coast through the turn. You may need to briefly apply the throttle more than once to complete the turn. Stop when you are in line with the straightaway in the opposite direction.
- Continue with this part of the exercise until you are comfortable with applying and releasing the throttle.

2b) Hold Throttle, Release and Stop Every 12 m (40 ft)

Next, you will be holding the throttle a little longer, then stopping every 12 m (40 ft) (every other marker/every fourth line).

- Again, slowly apply throttle until the vehicle starts to creep forward. This time, hold the throttle at this point.
- As you approach the stopping point, release the throttle and press the brake to stop.
- Turn around at the end of the straightaway as before, except now you do not need to release the throttle during the turn. Pay attention to maintaining a steady throttle position as you turn. Stop when you are in line with the straightaway in the opposite direction.

2c) Hold Throttle, Release and Stop at Ends

Next, use the entire straightaway, stopping only at the ends. Keep the throttle moderate.

3) Engine Stop while in Motion

Purpose

- Become familiar with using the engine stop switch when in motion so you know how the vehicle will react if you need to use it later.

Directions

- Partway down the straightaway, while operating at 8 km/h (5 MPH), toggle the engine stop switch to OFF position and coast to a stop.
- Restart the engine and repeat the exercise. Try increasing your speed (to a maximum of 20 km/h (12 MPH) before using the engine stop switch.

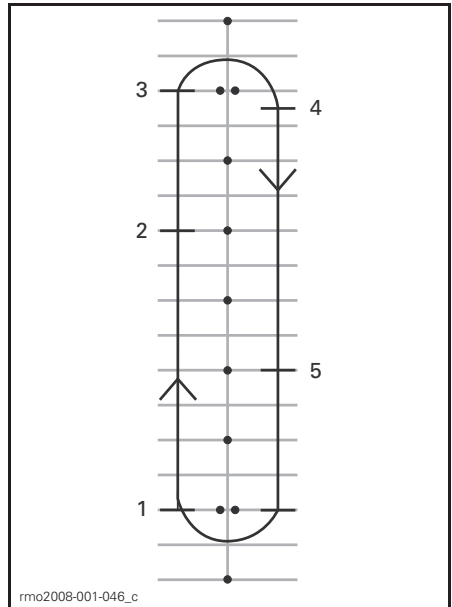

1. Start
2. Press engine stop switch
3. Proceed to end of straightaway, stop and turn as before
4. Stop
5. Press engine stop switch

Restart the engine and proceed to the next exercise.

4) Basic Turns

Purpose

- Get comfortable turning in a controlled manner.

Directions

This exercise is similar to what you did before, except that now instead of stopping for each turn, you will make the turn at low speed.

- Roll in a straight line. Ride a little farther from the cones so you can make a wide arcing turn at the end of the straightaway.
- As you approach the curve, slow down to no more than 8 km/h (5 MPH) by releasing the throttle and apply brake if needed.
- Hold the throttle to maintain your low speed.
- Look in the direction of the curve.
- Turn the handlebar in the direction of the curve, pulling on the inside handgrip and pushing on the outside, being careful not to apply throttle.
- Leaning forward and into the curve may help you turn the handlebar more easily.
- Straighten your handlebar after the turn and proceed down the straightaway.

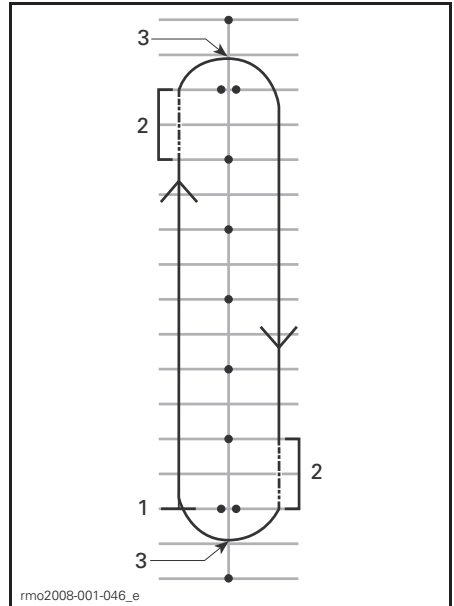

1. Start
2. Friction zone
3. Apex

NOTE: Motorcyclists - Riding through turns and curves with this vehicle is different than on a motorcycle. The vehicle does not lean during a turn, so you may need to shift your body weight towards the inside of the turn to keep a comfortable posture on the vehicle. You will need to exert more force to turn the handlebar of your vehicle than is needed to turn a motorcycle. However, it is easier to stop while turning than with a motorcycle.

Tips for Additional Practice

- After you are comfortable turning in one direction, try going around the course the other way. Be careful not to apply more throttle than you intend when turning left.
- Stop at the apex of the turn to see what it is like to use your brakes in a curve or turn.



RIDING POSTURE WHEN TURNING

5) Quick Stops

Purpose

- Become familiar with the vehicle braking ability.
- Learn to apply brakes with maximum force.

Directions

This exercise is similar to what you did before, except you'll be applying the brake more firmly, working up to braking as hard as possible. The Anti-lock Braking System (ABS) will prevent the wheels from locking and help you maintain steering control while applying maximum braking force. Always release the throttle completely for quick stops. If you apply throttle and brake at the same time, your stopping distance will be longer.

- Start at one end of the straightaway and accelerate to 8 km/h (5 MPH). Partway down the straightaway, release the throttle completely and brake quickly. Never pump the brake as the ABS will prevent wheel lock.
- Keep head and eyes up, keep handlebar straight, and do not release the brake until fully stopped.
- Repeat, increasing your speed and braking harder.

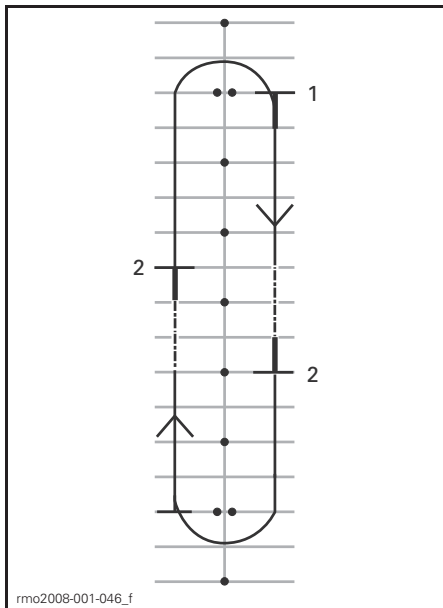

1. Start
2. Stop

Tips for Additional Practice

- Practice checking your mirrors before braking hard.

6) Weaves

Purpose

- Get more experience with the vehicle handling and rider position.

Directions

6 m (20 ft) Weave

1. Weave between every marker/intersection of every other parking spot. Keep your speed low initially as you get used to making the changes of direction.
2. Lean into each turn and turn the handlebar in the direction you want to go by pulling and pushing the grips.

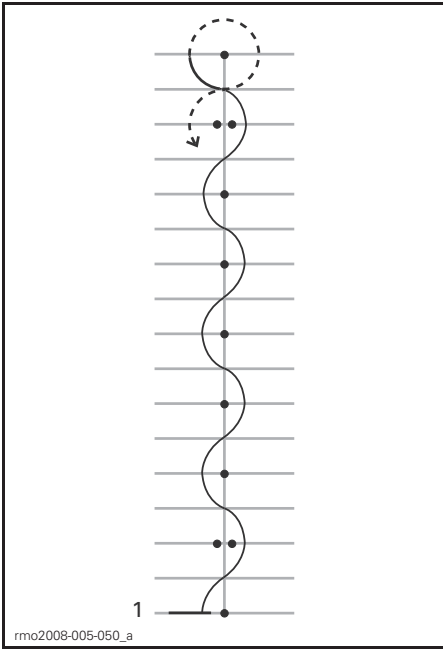

1. Start

12 m (40 ft) Weave

Once you're comfortable, try doing 12 m (40 ft) weaves between every other cone/every fourth parking space.

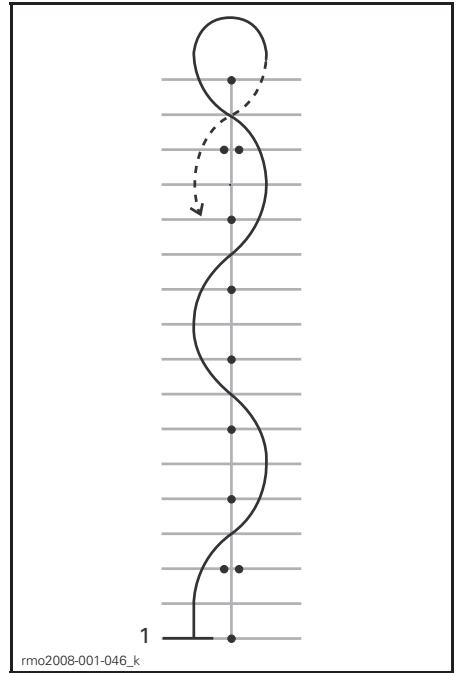

1. Start

Tips for Additional Practice

- You can gradually increase speed as you get comfortable to 16 km/h - 19 km/h (10 MPH - 12 MPH) for the weaves, but slow down for the U-turns at the ends.

7) Swerve

Purpose

- Become familiar with the vehicle's handling for quick maneuvers.
- Try different variations of braking and swerving.

Directions

At this point you will need to change your course. Set up your markers as shown in the diagram below. Do not use any fixed or hard, heavy objects as markers for this exercise.

- Enter between the double cones at about 8 km/h (5 MPH) and maintain that speed throughout.

- Steer around the line of cones.
- Exit through the second set of double cones.
- Repeat the exercise multiple times, swerving in both directions.

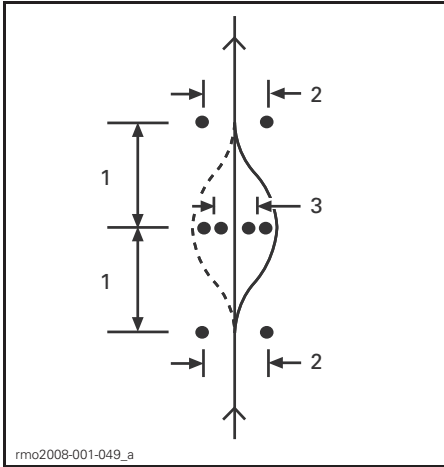

1. 6 m (20 ft)
2. 3 m (10 ft)
3. 2.5 m (8 ft)

Tips for Additional Practice

- You can gradually increase your entry speed (to no more than 13 km/h to 19 km/h (8 MPH to 12 MPH) and try some variations. For example, approach faster and slow before entering the exercise, apply brakes during the swerve, etc.
- A helper can add an element of surprise to the exercise by deciding which direction you should swerve, or if you should come to a stop instead. Have your helper stand at a safe distance (e.g., beyond the end of your practice area). As you reach the first set of cones, the helper can use hand signals to indicate which direction to swerve or for you to stop.
- Practice checking your mirrors and blind spot before you swerve.

8) Operating in Reverse

Purpose

- Become familiar with the vehicle handling and turning radius in reverse.

Directions

- Shift into reverse. See *OPERATING IN REVERSE* in *BASIC PROCEDURES*.
- Check that the area behind you is clear. Continue to look backwards. Be careful not to strike anything with your front wheels as you back up. Slow and stop by releasing throttle and using brake, just like when operating normally.
- Back for a few feet at a time, stopping in between.
- Keep your speed low and do not back up for long distances.
- After you are comfortable with reverse, back into a parking space as shown in the diagram below.

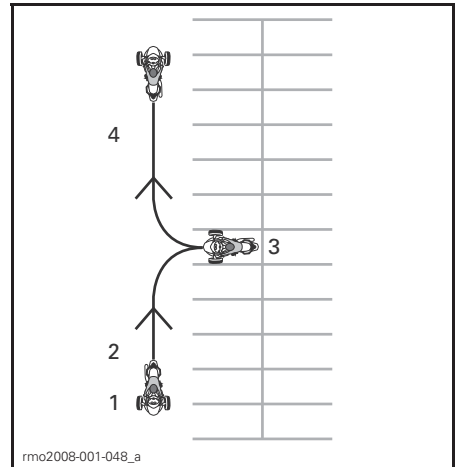

1. Start
2. Reverse
3. Stop
4. Forward

Developing Advanced Riding Skills

Once you have mastered basic riding skills, you can begin developing more advanced skills. First, learn the *STREET STRATEGIES* covered in the next section. Then you can take the vehicle on the road in relatively low-risk situations.

Start by riding in less challenging situations:

- Short distances
- Good weather
- Low traffic
- Daytime
- Lower speeds
- No passenger.

You can gradually move on to more challenging riding situations as you develop your skills.

STREET STRATEGIES

This section provides some strategies to reduce your risk on the road. Many of these strategies are similar to those used for motorcycles.

This section is based on guidance for motorcyclists given by the Motorcycle Safety Foundation (MSF). However, even experienced motorcyclists should read this section, as some strategies are different for a 3-wheel vehicle.

Plan your Trip

Always check weather conditions before riding the vehicle. Take appropriate gear for any weather you might encounter.

Plan a route and ride in conditions that are appropriate for your skill level.

The vehicle has a 20 L (5.3 U.S. gal.) fuel tank. When the low fuel indicator light flashes, fill fuel tank as soon as possible. Plan your refueling stops, particularly in unpopulated areas.

Defensive Riding

As with a motorcycle, defensive riding can help you avoid crashes. You need to stay alert at all times. Never stop watching your surroundings, including the area behind you. Always scan for potential hazards, plan ahead, and leave space and time to avoid trouble. Do not assume other motorists will see you or follow the rules of the road.

Following Distance

Always leave at least a two-second following distance between you and the vehicle in front of you when operating under ideal riding conditions. This means that you should pass any fixed point on the road at least two full seconds after the vehicle in front of you.

When conditions make braking distance longer, or visibility is limited, use a longer following distance for a greater margin of safety. For example, braking distance is longer on slippery

road surfaces, down hills, or when carrying more weight, and visibility may be limited in fog, in curves or at night.

Scanning Ahead

In addition to leaving adequate following distance to the next vehicle, scan ahead and plan your path even farther in advance.

Plan your immediate path at least four seconds ahead. Watch this path for hazards, such as anything in the road or anything entering the road.

Scan ahead 12 seconds along your anticipated path to identify potential hazardous situations before they happen. For example, look for intersections where other vehicles may appear or places where pedestrians might enter the road. Be prepared to respond if a hazardous situation develops.

Watch Behind and to the Sides

Vehicles and other hazards can approach from all directions. Constantly be aware of your surroundings. Check your mirrors frequently to see directly behind you. Also do frequent head checks (turn your head to look) to monitor your blind spot.

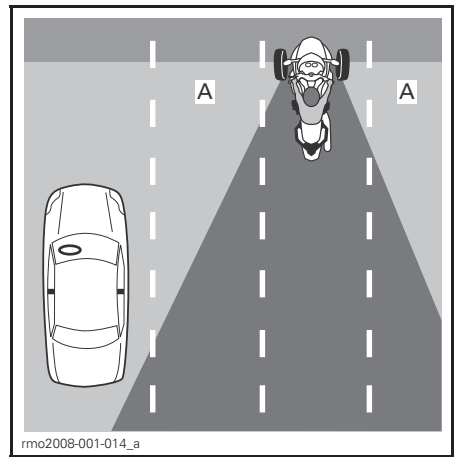

A. Operator's blind spots

When braking, be particularly aware of vehicles behind you that may not be able to stop as quickly than you.

Keep your Eyes Moving

To stay aware of your surroundings, do not fixate on any one thing. Move your eyes constantly to monitor the road, traffic control markings and devices and other vehicles. Look near and far, in all directions.

Anticipate Trouble

Whenever you notice a potential hazard, plan a way to avoid it. This might mean adjusting your speed or lane position, or changing lanes. You should be ready for evasive maneuvers such as swerving and/or braking if something enters your path. Always leave time and space to react to trouble.

Being Visible

Motorists tend not to see smaller vehicles like motorcycles. Therefore you should use strategies to become more visible.

To Be More Visible to Other Motorists

Lighting and Reflectors

Make sure that the headlights, running lights and taillights on your vehicle work properly. Your vehicle is equipped with reflectors on the fenders, sides, and back. Make sure that all reflectors are clean and not broken or missing.

Use your high beams whenever possible, both day and night. Use low beams to avoid blinding other motorists at night or when too much light reflects back, such as in fog.

Signals

Use your turn signals to inform others of your intentions. The vehicle has automatic canceling turn signals, but they may not cancel after shallow

turns. Make sure turn signals are off after you have completed your maneuver; leaving them on may confuse other motorists.

When possible, flash your brake lights before slowing and when waiting at intersections, to alert motorists behind you.

You can also use your horn to attempt to alert other motorists of your presence.

Do not assume that other motorists will notice your lights, signals or horn.

Australian and Russian Models

Use your hazard warning lights to make yourself visible when needed.

Blind Spots

Avoid riding in the blind spots of other vehicles. Position yourself so that drivers ahead can see you in their mirrors. In some cases, such as when you are following a truck or a bus, you must be farther behind the vehicle in front of you.

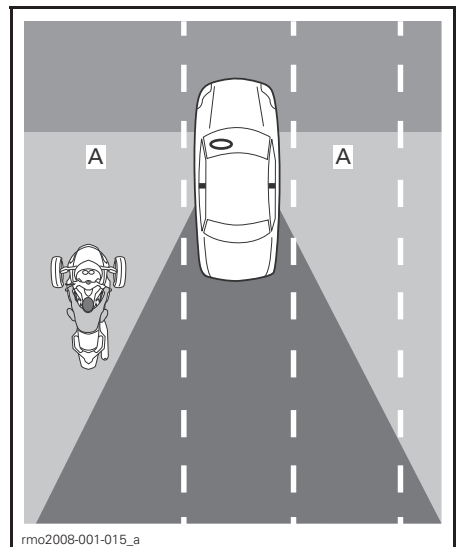

A. Blind spots of other vehicles

Time of Day and Weather

In dim light, such as at night, at dawn or dusk, or in poor weather such as rain or fog, you may be harder to see. Glare at dawn and dusk or very bright sunlight can also make it harder for other motorists to see you.

Clothing

Bright colors or reflective clothing can increase your visibility.

Be Careful Even When Motorists See You

Even when motorists seem to notice you, they may still drive in a way that puts you at risk of a crash. Drive defensively, and do not rely on other motorists to operate their vehicles safely.

Lane Position

Normally, position the vehicle in the center of the lane. This position keeps the front tires in the lane. It also provides distance from vehicles in other lanes, reducing wind from large vehicles and reducing the risk of being struck by vehicles that leave their lane. This position also keeps your front wheels out of the slippery area in the middle of the lane, helping maintain braking and steering ability. If you are used to driving a car, remember that you are sitting in the center of the vehicle, your perspective is different.

You can move to the left or right part of the lane, to avoid hazards, keep distance from other vehicles, or handle curves. You can also move to the left or right part of the lane to get a better view or to be seen by other vehicles. Because of the central seat position and the width of the vehicle, it may be harder to see around traffic, even when you are near the edge of the lane. You may need a greater following distance behind wide or tall vehicles. Avoid putting your wheel outside of the lane to see around traffic. In order for drivers ahead to see you, you must

be able to see their mirrors. When you are being followed by a large vehicle, passing vehicles may not be able to see you easily if you are not in the left part of the lane.

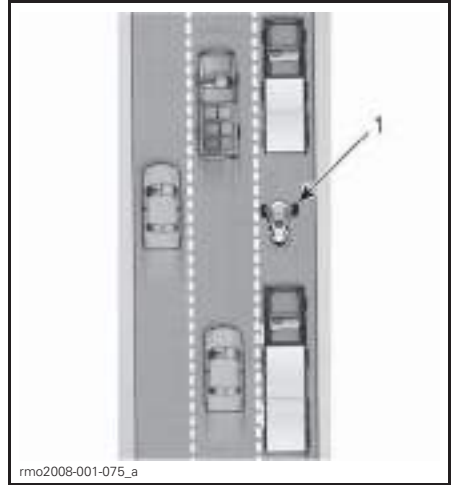

1. Vehicle in left portion of lane

Because the vehicle is wider than a motorcycle, the range of lane positions is smaller. When riding in the left or right part of the lane be sure that the front wheels stay in the lane.

On multilane roads, choose a lane that is appropriate for your speed in the flow of traffic, and also consider your ability to see and be seen, and possible paths for evasive maneuvers (such as swerving into other lanes or onto the shoulder).

Common Riding Situations

Intersections

Intersections, including small intersections with alleys and driveways, present an additional risk due to the cross traffic. Always watch for traffic in all directions: behind, in front and to the left and right.

When stopping at an intersection, stop in the middle of the lane, even if you are preparing to turn. This can make

you more visible and discourage other motorists from trying to drive around you. Watch for vehicles approaching from behind. Flash your brake lights as they approach. Be prepared to move if necessary to avoid a collision.

Lane Changes and Passing

Remember that the vehicle is wider than a motorcycle and needs more lateral space to pass another vehicle. Also remember that the vehicle is less visible than a car, so it is particularly important to signal your lane change well in advance and check your mirrors and blind spots. Be sure to turn off your turn signal after changing lanes; a lane change will not turn the handlebar far enough to automatically cancel the signal.

Never drive on the line between two lanes of traffic (split lanes). The vehicle is too wide.

Never drive on the shoulder to pass vehicles. If you put one wheel off the road, you can lose control.

Turns

Remember to slow, look, and steer through turns.

- **Slow:** Reduce speed as needed before entering a turn by rolling off the throttle and/or using the brakes. Enter the turn at a speed that you can maintain throughout the turn. Although the vehicle is better able to brake while turning than a motorcycle, it is still important to slow down before you enter a turn or curve rather than braking in the turn. Braking and turning both require traction. The more traction you use for braking, the less there is available for turning at the same time. When you take a turn or curve too fast, you may notice the inside front wheel lifting off the pavement and feel and hear VSS cutting back engine power. While VSS can help you maintain control, it is still possible to spin or roll over if you turn too hard and fast.
- **Look:** Search through the entire turn and keep your eyes moving. Evaluate the entire turn as soon as possible — surface characteristics, sharpness of the turn, and overall traffic conditions — so you have time to make decisions about speed and position. Sometimes turning your head in the direction of the turn helps to keep a good visual picture.
- **Steer:** Turn the handlebar to steer the vehicle in the direction of the turn. This vehicle is not like a motorcycle, so it does not countersteer, and the vehicle does not lean. Remember, you will experience the lateral force generated by turning, so you may need to shift your body weight to the inside of the turn to keep a comfortable posture on the vehicle. You will need to exert more force to turn the handlebar of your vehicle than is needed to turn a motorcycle.

Curves

Because the vehicle is narrower than a car, you can move from side to side in the lane in curves to straighten your path of travel. But the vehicle is wider than a motorcycle, so less lateral movement is possible, and it is important to make sure that your front tires do not leave the lane.

For typical curves, an outside, inside, outside path is best.

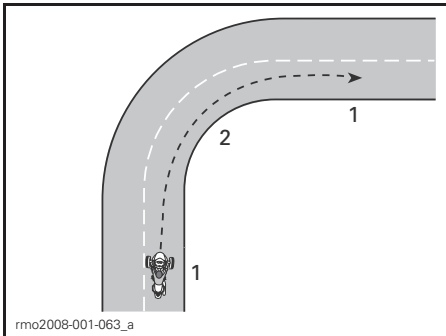

PATH FOR TYPICAL CURVES

1. Outside
2. Inside (at the apex)

Hills

When stopped, the vehicle can roll regardless of what gear it is in. The clutch is always disengaged when the vehicle is stopped, so the transmission will not hold the vehicle in place. Hold the brake pedal when stopped on an incline. To start while on an incline, hold the brake pedal as you increase throttle. Release the brake pedal as you feel the clutch engage.

Night Riding

In addition to using your lights and signals to be seen by other motorists, consider your own ability to see at night. Use high beams when appropriate. Avoid overriding your headlight (riding so fast that you cannot see as far as your stopping distance). You can also use other vehicles headlights to see the road ahead.

Do not use tinted or colored visors or lenses at night, and be particularly careful that your visor does not have scratches or smudges.

Group Riding

Ride single file only. Never share lanes, even with a motorcycle.

When riding with motorcycles, maintain proper following distance from the motorcycle in front of you, even if they are riding to one side of the lane. In curves, do not try to follow the path of motorcycles. Motorcycles can move farther to the edges of the lane in curves — if you follow them exactly, your front wheel can leave the lane. Motorcycles may be able to take curves faster than this vehicle. Do not try to match their speed.

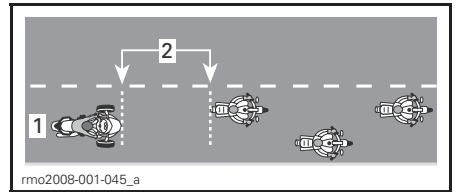

GROUP RIDING POSITION

1. Center of lane
2. Distance of 2 seconds

Particularly on curvy roads, the riders might become tired sooner than motorcyclists. Do not push yourself to keep up with motorcycles; stop if you are tired.

Road Conditions and Hazards

Ice, Snow and Slush

Do not ride on ice, snow or slush. Even with VSS, there will not be enough traction to maintain control on these slippery surfaces. This vehicle is more likely than a car to spin out of control in slippery surfaces.

Gravel, Dirt and Sand

On gravel, dirt, or sand-covered roads, use extra caution and reduce your speed, particularly for curves. These surfaces do not provide as much traction as paved surfaces and you can lose control, even with VSS.

Wet Pavement and Puddles

There is normally enough traction to maintain control on pavement that is moist or wet, as long as there is not a layer of water on top of the pavement (like a puddle or flowing water on the road). As with other vehicles, the vehicle can hydroplane if you drive too fast over water that has accumulated on the road, but hydroplaning occurs at lower speeds than with most cars or motorcycles. You are more likely to hydroplane in deeper water. Watch for splashing or spraying when other vehicles go through water as an indicator of depth.

When hydroplaning occurs, one or more wheels rise up on a layer of water, losing contact with the road. If this happens to the rear wheel, you may feel it slide sideways. Hydroplaning wheels do not have the traction necessary to control the vehicle. You can lose control and spin out, and the VSS cannot keep you in control.

Avoid large water puddles or water streams, and slow down or pull off the road during heavy rains. If you must pass through water, slow down as much as possible before you reach it.

After passing through water, test your brakes. Apply them several times if necessary to let friction dry the brake pads.

Properly maintained tires reduce the risk of hydroplaning. Always maintain recommended tire pressure:

Refer to *TIRE PRESSURE* in *MAINTENANCE PROCEDURES* section

NOTE: The pressure difference between the left and right side tire should not exceed 3.4 kPa (.5 PSI).

Immediately replace any tire that shows the maximum tread wear indicator to minimize risk of hydroplaning.

The middle of a lane can be particularly slick in the first few minutes of rain, as oil and dirt combine with the water. After more rain, water can accumulate in ruts in worn pavement. Avoid both of these low traction areas. When possible, keep your front tires in areas with the best traction.

Off-Road Use

Do not use your vehicle off road. The vehicle cannot handle the rough, low-traction, uneven surfaces that you may encounter in off-road riding. You could easily get stuck, lose control or roll over. Also, it may be illegal for off-road use in certain areas.

Ryker 900 Rally Edition

Even if this vehicle is designated as an all-road vehicle, **it is not an off-road vehicle**. This vehicle was designed to be able to drive on compact non-asphalted roads (gravel, earth, sand). The RALLY mode may be activated to improve the riding experience. This mode must only be used when riding on unpaved roads.

Obstacles, Holes and Bumps

Whenever possible, avoid riding over obstacles, holes and bumps. If you must ride over them, slow down as much as possible before you get there, then release the brake as you go over.

For wide obstacles or bumps, approach straight on if possible, so that both front tires go over at the same time. When going over an obstacle, bump or hole with both front wheels, riders should stand up slightly on the pegs and use legs to absorb the shock. Be prepared for the rear wheel to strike the obstacle.

⚠ CAUTION Due to vehicle design, your heels may scrub on ground in some situations. Think to lift them when crossing an obstacle, a hole or a bump.

For narrower obstacles, bumps or holes, it is better to ride over it with the rear tire. If you ride over them with a front tire, maintain a firm grip on the handlebar, take care not to accidentally applying the throttle and be prepared to correct your trajectory if necessary.

If you strike a large enough obstacle, bump or hole, the impact can make the vehicle jump and strike you, eject riders, make you lose control, spin or roll over.

If you can't come to a complete stop in time to avoid an obstacle, you can swerve to avoid it. You can swerve and brake at the same time if necessary.

If you encounter a large animal in the road, like a deer, it is best to stop before reaching it and wait until the animal leaves, or go past slowly.

If a dog chases you, a good strategy is to slow down and downshift as the dog approaches, then accelerate away as you get closer to where the dog would intercept you.

On-Road Emergencies

A vehicle malfunction or an unexpected situation can occur any time during a ride. A well-maintained vehicle can help reduce the risk of malfunction, but you should still be prepared for an emergency.

- Always have the Operator's Guide in the vehicle.

- When stopping on the road, follow these precautions:
 - If the road has paved shoulders, signal your intention to pull off the highway, pull off at near traffic speed, then slow down to a complete stop.
 - If the shoulder is unpaved, signal your intention to pull off the roadway, slow down to a safe speed before pulling off the paved roadway and stop the vehicle.
 - Let the turn signal activated to increase your visibility.
 - On models equipped with hazard warning lights, activate them to increase your visibility.
- If you have cellular phone or other communication device, fully charge it before long rides.
- If you are involved in an accident, BRP strongly recommends that you have your vehicle transported (see *TRANSPORTING THE VEHICLE*) to the nearest Can-Am On-Road dealer to have it thoroughly inspected for safety before riding again.

Tire Failure

If a tire failure or a blowout suddenly occurs, firmly grip the handlebar, gradually slow down and carefully steer to a safe place to stop. Avoid hard braking, downshifting, or sharp steering. If a front tire fails, the vehicle may tend to pull in the direction of the failed tire, so you will need to maintain a firm grip on the handlebar to control your direction. Refer to *ROAD SIDE REPAIRS* section for instructions on tire repair.

CARRYING A PASSENGER OR CARGO

Weight Limits

Do not exceed the weight limits for riders and cargo.

Ryker 600 and Ryker 900

WEIGHT LIMITS	
Vehicle load limit (including operator, passenger*, cargo and added accessories)	204 kg (449 lb)
Glove box compartment	2 kg (4.4 lb)
* No passenger allowed without the installation of an approved passenger's seat kit	

Ryker 900 Rally Edition

WEIGHT LIMITS	
Vehicle load limit (including operator, passenger*, cargo and added accessories)	199 kg (438 lb)
Glove box compartment	2 kg (4.4 lb)
* No passenger allowed without the installation of an approved passenger's seat kit	

Excess weight will:

- Reduce your ability to accelerate, brake and turn.
- Reduce the effectiveness of the VSS.
- Increase the risk of rolling over if the weight is high or toward the rear.
- Reduce ground clearance, increasing the risk of striking low obstacles or uneven road surfaces.
- Increase the risk of tire failure.

Operating with Extra Weight

Carrying a passenger or heavy cargo affects the way the vehicle handles because of the greater weight, and because the weight distribution will be different.

1. You will not be able to accelerate as quickly. Allow more time and space for passing.
2. You will not be able to stop as quickly. Use a longer following distance from the vehicle in front of you, at least three seconds. Use an even longer distance if riding conditions are not ideal (e.g., low visibility, poor road surface).
3. You will not be able to turn as sharply or at as high a speed. Slow down more than usual before turning and avoid sharp turns.
4. The vehicle may be less stable. There is a greater risk of tipping or rolling during extreme maneuvers with weight that is higher or farther to the rear (like a passenger).

NOTE: VSS effectiveness is decreased when operating above maximum allowed load.

Carrying a Passenger

This vehicle is designed to carry only one passenger behind the operator when equipped with an approved passenger's seat kit. Never try to carry more than one passenger.

WARNING

Never carry a passenger if an approved passenger's seat kit is not installed on vehicle.

Fully deploy both footpegs when carrying a passenger.

The passenger icon  will appear in the cluster gauge to indicate that the VSS is now in passenger mode

Do not carry a passenger until you have experience riding alone in a variety of conditions and can proficiently handle the vehicle.

The passenger must be sober, alert, able to reach the passenger footrests and handholds, maintain balance and hold on in sudden maneuvers, and not distract the operator.

Be sure the passenger is wearing appropriate protective gear. The passenger should wear all of the protective gear recommended for the operator, particularly a helmet. A full-face helmet is recommended; in a sudden stop, the passenger's face can strike the back of the operator's helmet.

Keep the brakes applied until the passenger is in riding position.

Instruct the passenger on how to ride before starting out. Have the passenger follow these rules:

1. Maintain proper riding position.
 - Hold the passenger handholds and keep feet on the passenger footrests at all times, even with an accessory backrest.
 - The passenger should not hold on to the operator as the operator may not be able to withstand the lateral force generated by both.
 - Different gripping positions on the handholds may be more comfortable for different maneuvers. (e.g., one hand at the front corner of and one hand at the opposite back corner for turns, both hands further forward or back for other situations).

NOTICE Never use handholds to tie down, lift or transport vehicle.

2. Stay clear of the exhaust pipe and the rear wheel.
3. Avoid turning around or leaning except to keep balance in a turn. In an unexpected maneuver, a passenger who is not in the normal riding position is more likely to fall off.

4. Watch the road and respond to upcoming road conditions. Lean into curves as needed to resist any sideways force. When crossing an obstacle, hole or bump, rise slightly off the seat without locking your elbows.

Avoid abrupt acceleration, braking and turns, especially with inexperienced passengers. Sudden, unexpected maneuvers can make the passenger fall off.

Where to Store Cargo

You can carry small personal items in the glove box. Do not carry cargo in any other location unless the vehicle is equipped with approved BRP accessories.

Towing a Trailer

Do not tow anything with the vehicle, it is not designed for this application.

In addition, the VSS will not be effective, you will be more likely to lose control.

KNOWLEDGE SELF-TEST

The following provides a sample of information that you should have learned by reading this guide. It does not include all of the important information, but should give you an idea of whether you have a general understanding of the vehicle and its operation.

See the *ANSWERS* on the page following the questionnaire.

Questionnaire

1. If you need to stop quickly, apply the brakes and the parking brake.
True False
2. A pre-ride inspection should be performed once a week.
True False
3. VSS allows you to use the vehicle in any kind of weather.
True False
4. You should only replace the tires with those approved by BRP obtained from an authorized Can-Am On-Road dealer.
True False
5. It is important for the passenger to be alert and sober.
True False
6. Name six items of protective gear that can reduce your risk of injury.
1) _____
2) _____
3) _____
4) _____
5) _____
6) _____
7. Protective gear is important for preventing and reducing injuries, keeping you comfortable, and providing protection against the elements.
True False
8. Which of the following is not one of the vehicle driving controls?
a. Handlebar
b. Twist throttle
c. Front brake lever
9. You should leave your low beam lights on during the day for added visibility.
True False
10. You should normally position the vehicle in the center of the lane.
True False
11. Unlike a typical motorcycle, you should make it common practice to brake and turn at the same time.
True False
12. Under normal conditions, the following distance should be at least _____.
a. 1 second
b. 2 seconds
c. 3 seconds

13. You should never carry flammable liquids such as gasoline on the vehicle or in a storage compartment, even if they are in approved containers.

True False

20. ABS allows you to press the brake pedal hard without locking the wheels.

True False

14. List 5 ways of being more noticeable to other drivers.

1) _____

2) _____

3) _____

4) _____

5) _____

15. When braking on surfaces with less than ideal traction, you should pump the brakes to help maintain control of the vehicle.

True False

16. The vehicle's maximum load includes: the operator, the passenger, the cargo and all accessories

True False

17. The vehicle can safely tow a trailer.

True False

18. When the vehicle configuration allows it, the passenger should hold the operator firmly.

True False

19. Riding a 3-wheel vehicle is as safe as riding in a car.

True False

Answers

1. **False**
To stop quickly, press the brake pedal only. Never use the parking brake while the vehicle is moving.
2. **False**
You should do a pre-ride inspection every time you ride.
3. **False**
The VSS can not help you maintain control if there is ice, snow, slush or enough water to cause hydroplaning. The VSS performance may also be reduced when tires adherence decreases due to cold temperatures or when riding on unpaved road..
4. **True**
5. **True**
6.
 - 1) Helmet
 - 2) Eye and face protection
 - 3) Jacket with long sleeves
 - 4) Gloves
 - 5) Long pants
 - 6) Closed-toe footwear, preferably over the ankle.
7. **True**
8. **c. Front brake lever**
The vehicle does not have a front brake lever.
9. **False**
You should use your high beams during the day.
10. **True**
11. **False**
You can brake and turn at the same time if you need to, but generally it is better to brake before the turn.
12. **b. 2 seconds**
Under normal conditions, following distance should be at least two seconds.
13. **True**
14.
 - 1) Make sure your lights and reflectors are clean.
 - 2) Use your high beams whenever possible.
 - 3) Use your turn signals.
 - 4) Flash your brake lights before slowing.
 - 5) Use your emergency flashers as needed.
 - 6) Use your horn to alert others of your presence.
 - 7) Avoid riding in blind spots.
 - 8) Wear bright colors and reflective clothing.
15. **False**
You should press and hold the brake pedal, not pump. The vehicle is equipped with ABS, which keeps the wheels from locking.
16. **True**
17. **False**
18. **False**
The passenger should always hold on to the handholds.

19. False

In cars and trucks, the structure of the vehicle provides protection. In addition, passengers can protect themselves by wearing seat belts. You should expect that riding a 3-wheel vehicle is much riskier than riding in a car. The risk of injury is more like the one for a motorcycle.

20. True

SAFETY INFORMATION ON THE VEHICLE

This vehicle comes with hang tags and labels containing important safety information.

Any person who rides this vehicle should read and understand this information on the vehicle before riding.

The following illustration used in this Operator's Guide is a general representation only. Your model may differ.

Hang Tag

General Safety Warning

WARNING

This Can-Am On-Road is a different type of vehicle - it requires special skills and knowledge. Learn how this product is different.

Read the operator's guide and watch the safety video using the QR code link or visit Can-Am On-Road web site.

Complete a training course (if available), **practice**, become proficient with the controls, and get a proper licence .

Refer to the Safety Card before riding.



Always wear a helmet and riding gear.

With this type of vehicle, riders are exposed to more road risks than in a car. Even skilled operators can be struck by other vehicles or lose control. This vehicle will not protect you in a crash.

Handling limits and road conditions

The Vehicle Stability System (VSS) cannot stop you from losing control, flipping over, or falling off if you exceed this vehicle's limits. Know the limits for different road conditions. Do not ride on ice, snow, or off road. Avoid puddles and running water. This type of vehicle can hydroplane on water and slip on gravel, dirt and sand covered roads. If you must go through these road conditions, slow down.

This hangtag may only be removed by the customer.



704907629

EN-704907629B_DEC

AVERTISSEMENT

Ce produit routier est différent.

Il nécessite des habiletés et des connaissances spéciales. Sachez ce qui distingue ce produit Can-Am des autres véhicules.

Lisez le guide du conducteur et visionnez la vidéo de sécurité via le lien QR code ou en visitant le site internet Can-Am On-Road .

Suivez une formation (si disponible), **exercez-vous**, apprenez à maîtriser les commandes et obtenez le permis approprié.

Consultez la carte de sécurité avant de conduire le véhicule.



Portez toujours un casque et des vêtements appropriés.

Sur ce type de véhicule, les utilisateurs sont exposés à davantage de risques routiers qu'en automobile. Même un conducteur habile peut être frappé par un autre véhicule ou perdre le contrôle. Ce véhicule ne vous protégera pas en cas de collision.

Limites de manœuvrabilité et conditions routières

Le système de stabilité du véhicule (VSS) ne peut pas vous empêcher de perdre le contrôle, de faire des tonneaux ou de tomber si vous dépassez les limites du véhicule. Apprenez à connaître ces limites dans différentes conditions routières. Ne conduisez pas sur la glace, sur la neige ou hors route. Évitez les flaques et les ruissellements d'eau. Ce type de véhicule peut faire de l'aquaplanage sur les chaussées détrempées et déraiper sur les routes recouvertes de gravier, de terre ou de sable. Si vous devez conduire dans ces conditions, ralentissez. Seul le client doit enlever cette étiquette.

704907629

California Proposition 65 Warning

⚠ WARNING. Operating, servicing and maintaining a passenger Vehicle can expose you to chemicals including engine exhaust, carbon monoxide, phthalates, and lead, which are known to the State of California to cause cancer and birth defects or other reproductive harm.

To minimize exposure, avoid breathing exhaust, do not idle the engine except as necessary, service your vehicle in a well-ventilated area and wear gloves or wash your hands frequently when servicing your vehicle.

For more information go to www.P65Warnings.ca.gov/products/passenger-vehicle



704906973

EN-704906973-DEC

Safety Card

The safety card is located inside the right side service cover.

Use the safety card to review key information and when you are teaching new operators and passengers how to ride the vehicle. It also includes frequently referenced information.



1. Safety card inside right side service cover

⚠ WARNING
This Can-Am On-Road product is a different type of vehicle. It requires special skills and knowledge.

Learn how this product is different. Read the operator's guide and watch the safety video using the QR code link or visiting Can-Am-On-Road.com. Complete training course if available. **Practice** become proficient with the controls, and get a proper license.

- The vehicle Stability System (VSS) cannot stop you from losing control, flipping over, or falling off if you exceed this vehicle's limits.
- Do not ride on ice, snow, or off road.
- Avoid puddles and running water. This type of vehicle can hydroplane on water and also on gravel, dirt and sand covered roads. If you must go through these road conditions, slow down.

Wear a helmet and riding gear.

- With this type of vehicle, riders are exposed to more road risks than in a car. Even skilled operators can be struck by other vehicles or lose control. This vehicle will not protect you in a crash.

Protect the passenger if applicable:

- Always hold hands.
- Always hold handrails.
- Watch the road. Lean into curves. Brace for bumps.

Always keep in mind:

- Brake with the foot pedal.
- Steer in the direction of a turn, do not countersteer.
- Keep all wheels in your lane, always ride in a single file, and do not split lanes.
- Perform Pre-ride inspection.

Turn throttle handle backward to enable starter.

www.can-am.com
info.can-am.com

704908531-DEC

Safety Labels

These labels are affixed to the vehicle for the safety of the operator, passenger or bystanders

The following labels are on your vehicle, and they should be considered permanent parts of the vehicle. If missing or damaged, they can be replaced free of charge. See an authorized Can-Am On-Road dealer.

NOTE: In the event of any discrepancy between this guide and the vehicle, the safety labels on the vehicle have precedence over the labels in this guide.

Tires Pressure and Maximum Load

TIRE AND LOADING INFORMATION /
 RENSEIGNEMENTS SUR LES PNEUS ET LE CHARGEMENT

	SEATING CAPACITY / NOMBRE DE PLACES	TOTAL	2	FRONT AVANT	1	REAR ARRIÈRE	1
---	--	-------	---	----------------	---	-----------------	---

The combined weight of occupants and cargo should never exceed 204 kg or 449 lbs
Le poids total des occupants et du chargement ne doit jamais dépasser 204 kg ou 449 lbs

TIRE / PNEU	SIZE/ DIMENSION	COLD TIRE PRESSURE/ PRESSION PNEUS À FROID	RIM SIZE/ DIMENSION JANTE	
FRONT/AVANT	MC145/60R16 66T	172 kPa / 25 psi	16 x 4.5 in	
REAR/ARRIÈRE	MC205/45R16 77T	193 kPa / 28 psi	16 x 6.5 in	
SPARE/SECOURS	NONE / AUCUN	NONE / AUCUN	NONE/AUCUN	

P-STD

7064

EN-704907064B_DEC

RYKER 600 AND RYKER 900

**TIRE AND LOADING INFORMATION /
RENSEIGNEMENTS SUR LES PNEUS ET LE CHARGEMENT**

SEATING CAPACITY / NOMBRE DE PLACES	TOTAL	2	FRONT AVANT	1	REAR ARRIÈRE	1
--	-------	---	----------------	---	-----------------	---

The combined weight of occupants and cargo should never exceed 199 kg or 438 lbs
Le poids total des occupants et du chargement ne doit jamais dépasser 199 kg ou 438 lbs

TIRE / PNEU	SIZE/ DIMENSION	COLD TIRE PRESSURE/ PRESSION PNEUS À FROID	RIM SIZE/ DIMENSION JANTE	
FRONT/AVANT	MC145/60R16 66T	138 kPa / 20 psi	16 x 4.5 in	
REAR/ARRIÈRE	MC205/55R15 81T	193 kPa / 28 psi	15 x 6.5 in	
SPARE / SECOURS	NONE / AUCUN	NONE / AUCUN	NONE/AUCUN	

P-AR
7396

EN-704907396A_DEC

RYKER 900 RALLY EDITION

1. Tire pressure label inside right side service cover



1. Label located under the fuel filler door

Fueling Procedure

WARNING

- Carefully insert the fuel filler nozzle fully into the capless fuel filler neck.
- After refueling is completed, **wait about five to ten seconds** before removing the fuel filler nozzle.
- When filling the vehicle's fuel tank from a portable fuel container, always use the funnel included with the vehicle.

WARNING

- Always set the engine stop switch to the OFF position before adjust footpegs and brake pedal.

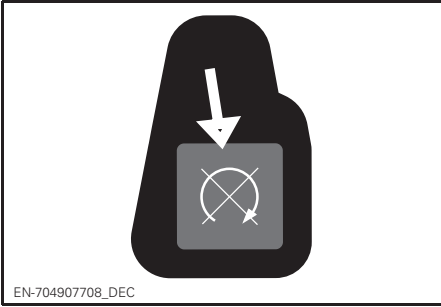

Coolant Hot - Do Not Open



COOLANT RESERVOIR CAP



1. Label located under the right side footpeg

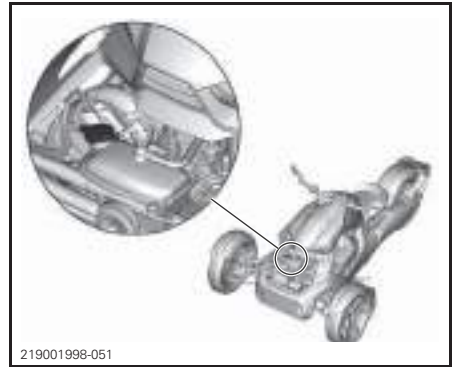

Brake Fluid - Clean and Refill

Checking Engine Oil Level

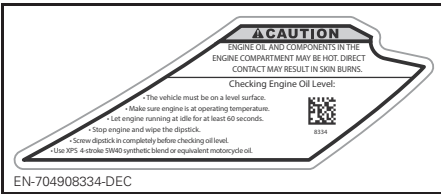

BRAKE FLUID RESERVOIR CAP

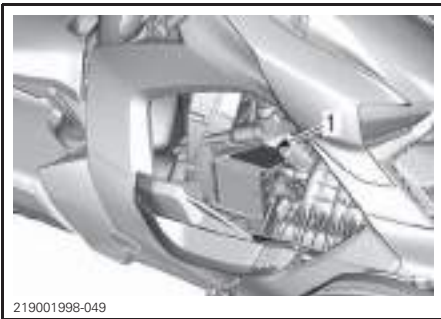

TYPICAL
1. Label located inside the right side service cover



219001998-053

BEHIND THE RH ROCKER PANEL

Passenger and Cargo

⚠ WARNING

TO REDUCE THE RISK OF LOSING CONTROL THAT CAN RESULT IN A CRASH

NEVER carry a passenger without properly installing a complete BRP passenger kit that ensures the activation of the passenger mode.

NEVER exceed 10 kg (22 lb) of cargo. Securely attach cargo on this carrier.

< 10 kg
(22 lb)

7499

EN-704907499E_DEC

RYKER 900 RALLY EDITION



219001998-054

ON THE UPPER REAR FENDER

Vehicle Cleaning

NOTICE

- Matt finish paint needs special care to maintain its appearance. See operator's guide
- PVD chrome wheel should be washed with water and a mild soap. Do not polish, use acid based or abrasive chrome cleaner on the PVD chrome wheel.
- Do not clean windshield with alkaline or acid cleaner, gasoline or solvent to avoid windshield damage. See operator's guide.

704907056

EN-704907056_DEC



219001998-055

INSIDE THE GLOVE BOX COVER

Glove Box Load

⚠ WARNING

DO NOT OVERLOAD

2 kg (4.4 lb)

LOAD LIMIT

7057

EN-704907057A_DEC



219001998-056

INSIDE GLOVE BOX

REPORTING SAFETY DEFECTS

Your safety is very important to Bombardier Recreational Products Inc. (BRP). If you have any concerns you should immediately contact BRP customer service.

In the USA, if you believe that your vehicle has a defect which could cause a crash or could cause injury or death, you should immediately inform the National Highway Traffic Safety Administration (NHTSA) in addition to notifying Bombardier Recreational Products Inc.

If NHTSA receives similar complaints, it may open an investigation, and if it finds that a safety defect exists in a group of vehicles, it may order a recall and remedy campaign. However, NHTSA cannot become involved in any individual problems between you, your dealer or Bombardier Recreational Products Inc.

TO CONTACT NHTSA:



888-327-4236



1 800-424-9153



National Highway Traffic Safety Administration
1200 New Jersey Avenue, SE
Washington, DC 20590



www.safercar.gov

In Canada, if you believe that your vehicle has a defect which could cause a crash or could cause injury or death, you should immediately inform Transport Canada in addition to notifying Bombardier Recreational Products Inc.

If Transport Canada receives similar complaints, it may open an investigation, and if it finds that a safety defect exists in a group of vehicles, it may order a recall and remedy campaign. However, Transport Canada cannot become involved in any individual problems between you, your dealer or Bombardier Recreational Products Inc.

TO CONTACT TRANSPORT CANADA:



819-994-3328 (Gatineau-Ottawa area or internationally)
Toll free : 1 800-333-0510 (in Canada)



Transport Canada - ASFAD
330 Sparks Street
Ottawa, ON
K1A 0N5



<https://www.tc.gc.ca/recalls>

POUR CONTACTER TRANSPORT CANADA:



819-994-3328 (dans la région de Gatineau-Ottawa et à l'extérieur du pays)
Sans frais: 1 800-333-0510 (au Canada)



Transport Canada - ASFAD
330, rue Sparks
Ottawa (Ontario) K1A 0N5



<https://www.tc.gc.ca/rappels>

***This page is
intentionally blank***

PRE-RIDE INSPECTION

PRE-RIDE CHECKLIST

We encourage you to have an Annual Safety Inspection of your vehicle. Please contact an authorized Can-Am On-Road dealer for further details. Though not required, it is recommended that an authorized Can-Am On-Road dealer performs the pre-season preparation of your vehicle. Each visit is a great opportunity for your dealer to verify if your vehicle is included in any warranty campaign. We also urge you to visit your authorized Can-Am On-Road dealer in a timely manner if you become aware of any safety related campaigns.

WARNING

Perform a pre-ride inspection before each ride to detect potential problems during operation. The pre-ride inspection can help you monitor wear and deterioration before they become a problem. Correct any problems that you discover to reduce the risk of a breakdown or crash. See an authorized Can-Am On-Road dealer as necessary.

Before Starting the Vehicle, Inspect the Following:

ITEM	PROCEDURE	
WEIGHT	Ensure that total load on the vehicle (including operator, cargo and added accessories) does not exceed recommended load as indicate in the <i>TECHNICAL SPECIFICATIONS</i> section.	
GLOVE BOX AND ALL SERVICE COVERS	Pull to check that it is properly latched.	
PARK POSITION LEVER	Make sure park position lever is applied and locked.	
HANDLEBAR, FOOTPEGS AND BRAKE PEDAL	Ensure vehicle is configured for the driver. Adjust as required.	
BRAKE PEDAL	Press and make sure you feel firm resistance. Pedal must fully return when released. Validate that the driver is able to apply the full stroke of the brake pedal.	
THROTTLE HANDLE	Twist several times. Be sure it operates freely and returns to idle position when released.	
LEAKS	Look under the vehicle for any leaks.	
LOCKING CLIP OF THE CENTER LOCK WHEEL	Check if all locking clips are properly installed. If not, DO NOT USE THE VEHICLE and have it transport to an authorized BRP dealer.	
WHEEL	Look for damages.	
TIRES	Look for damages. Verify tread wear. Check tire pressure. Refer to <i>MAINTENANCE PROCEDURES</i> .	
MIRRORS	Clean and adjust: (see <i>MIRRORS</i> in <i>EQUIPMENT</i>).	

Start the Vehicle and Check the Following:

ITEM	PROCEDURE	
MULTIFUNCTION GAUGE	Check the indicators, the messages and the fuel level	
LIGHTS	Check operation of headlights, taillights, brake lights, turn signals and, if equipped, the hazard warning lights.	
HORN	Check operation.	
STEERING	Verify that steering operates freely.	
ENGINE STOP SWITCH	Check that the engine stop switch is working properly.	
PARK POSITION LEVER	Press brake pedal and release park position lever. Ensure brake indicator lamp is off in the multifunction gauge.	
BRAKE	Drive a short distance forward slowly then apply brake to test.	

If an approved passenger's seat kit is installed

If a passenger seat kit was installed on the vehicle, the following items must be inspected before riding.

ITEM	PROCEDURE	
WEIGHT	Ensure that total load on the vehicle (including operator, passenger, cargo and added accessories) does not exceed recommended load as indicate in the <i>TECHNICAL SPECIFICATIONS</i> section	
FOOTPEGS	Make sure passenger's footpegs are completely deployed and passenger icon appears in the cluster gauge	
HANDHOLDS	Check solidity of the passenger handholds	

***This page is
intentionally blank***

MAINTENANCE

MAINTENANCE SCHEDULE

Maintenance is very important for keeping your vehicle in safe operating condition. Proper maintenance is the owner's responsibility. A warranty claim may be denied if, among other things, the owner or operator caused the problem through improper maintenance or use.

Perform periodic checks and follow the maintenance schedule. **The maintenance schedule does not exempt the pre-ride inspection.**

Verifying fault codes, as first maintenance step, is a good practice and is highly recommended.

WARNING

Failure to properly maintain the vehicle according to the maintenance schedule and procedures can make it unsafe to operate.

EPA Regulation - Canadian and USA Vehicles

A repair shop or person of the owner's choosing may maintain, replace, or repair emission control devices and systems. These instructions do not require components or service by BRP or authorized Can-Am On-Road dealers.

Although an authorized Can-Am On-Road dealer has an in-depth technical knowledge and tools to service your vehicle, the emission-related warranty is not conditioned on the use of an authorized Can-Am On-Road dealer or any other establishment with which BRP has a commercial relationship.

Proper maintenance is the owner's responsibility. A warranty claim may be denied if, among other things, the owner or operator caused the problem through improper maintenance or use.

For emission-related warranty claims, BRP is limiting the diagnosis and repair of emission-related parts to the authorized Can-Am On-Road dealers. For more information, please refer to the *US EPA EMISSIONS PERFORMANCE WARRANTY* contained in the *WARRANTY* section.

You must follow the instructions for fuel requirements in the fueling section of this manual. Even if gasoline containing greater than ten volume percent ethanol is readily available, the US EPA issued a prohibition against the use of gasoline containing greater than 10 vol% ethanol that applies to this vehicle. The use of gasoline containing greater than 10 vol% ethanol with this engine may harm the emission control system.

Severe Dusty Conditions

Ryker 900 Rally Edition

Engine air filter and CVT air filter maintenance should be adjusted according to riding conditions.

The filters maintenance must be increased in frequency in the following dusty conditions:

- Riding on dry sand
- Riding on dry dirt covered surfaces
- Riding on dry gravel roads or similar conditions.

Riding in a group in these conditions would increase even more the filters maintenance.

Maintenance Schedule

EVERY YEAR OR EVERY 10 000 KM (6,000 MI) (WHICHEVER COMES FIRST)
Perform all items indicated in the <i>PRE-RIDE INSPECTION</i>
Check fault codes
Replace engine oil and oil filter
Check engine coolant level
Remove front fascia and clear all debris from radiator air duct
Visually check radiator, cooling hoses and water pump
Perform a pressure test of cooling system
Check battery connections tightening
Check steering for abnormal play
Check ball joints condition
Check tie-rods condition
Replace CVT air filter
Check brake fluid level
Visually check brake hoses
Check brake pads and discs condition
Check and retighten exhaust pipe, clamping rings, joints, and gaskets condition
Visually check condition of fuel hoses, fuel evaporation lines and canister
Check front and rear wheel bearings condition
Verify park position lever operation and have the cable adjusted as required
Check body panels looseness
The following must be performed every 10 000 km (6,000 mi) (if used in a dusty or sandy environment - regardless of the time elapsed):
Replace the fuel filter
Replace engine air filter and clean the housing

EVERY TWO YEAR OR EVERY 20 000 KM (12,000 MI)
(WHICHEVER COMES FIRST)

Replace gearbox oil

Replace final drive oil

**The following must be performed every two year
(irrespective of the covered distance):**

Replace brake fluid

**The following must be performed every 20 000 km (12,000 mi)
(irrespective of the number of years):**

Replace spark plugs

Replace engine air filter and clean the housing

Replace the fuel filter

**The following must be performed every 20 000 km (12,000 mi) or when
the message TRANSMISSION MAINTENANCE REQUIRED appears
(irrespective of the number of years):**

Replace the CVT drive belt

Clean drive pulley sheaves

EVERY FIVE YEAR OR EVERY 50 000 KM (30,000 MI)
(WHICHEVER COMES FIRST)

Replace engine coolant

Check front suspension arms rubber bushings

MAINTENANCE PROCEDURES

This section includes instructions for basic maintenance procedures.

Due to the complexity of some maintenance procedures, a good mechanical skill is required.

Several procedures must be done by an authorized Can-Am On-Road dealer, repair shop, or person of your own choosing.

If you are not comfortable with the mechanics, do not hesitate to contact an authorized Can-Am On-Road dealer, repair shop, or person of your own choosing.

WARNING

Turn off the engine and follow these maintenance procedures when performing maintenance. If you do not follow proper maintenance procedures you can be injured by hot parts, moving parts, electricity, chemicals or other hazards.

Tires

WARNING

Tires that are not the recommended type, damaged, worn down below the minimum tread wear limit indicator or improperly inflated can cause loss of control. New tires will not operate at their maximum efficiency until their break-in is completed. Braking, steering and VSS performance may be reduced, so use extra caution. Tires take about 300 km (200 mi) of riding with frequent braking to break-in. For riding with infrequent braking, allow extra time to break-in the tires.

The tires have been specifically designed for this vehicle. Use only the BRP recommended radial tires, which can be ordered only from an authorized Can-Am On-Road dealer.

Tire Pressure

Use the recommended cold inflation pressure for optimum tire performance and wear. Under-inflation or over-inflation may cause uneven tread wear patterns.

Recommended tire inflation pressure is found on the Tire Label located inside the right side service cover.

When weather temperature changes occur, tire inflation pressures also change. A drop of 6°C (10°F) can cause a corresponding drop of 1 psi (7 kPa) in inflation pressure. Check your tire pressures frequently and adjust them to the proper pressure

NOTE: The pressure difference between the left and right side tire should not exceed 3.4 kPa (.5 PSI).

Tire Damage

Check all tires for:

- Cuts, slits and cracks in the tires.
- Bumps or bulges in the side of the tire or the tread.
- Nails or other foreign objects in the side of the tire or tread.
- Air leaks (hissing sound) caused by an ill-fitting rim or a faulty tire valve.

If any of the above occurs, have the tire repaired or replaced as soon as possible by an authorized Can-Am On-Road dealer.

Tire Tread Wear

Check minimum tread depth by using the tread-wear indicators (hard rubber bars molded at the base of the tread; 1 in figure below). Check in three locations across the tire tread:

- Outer edge
- Center
- Inside edge.

The tread-wear indicators will appear across the treads that have been worn down to the minimum tread depth. When at least one tread-wear indicator

appears across the tread, have the tire replaced as soon as possible by an authorized Can-Am On-Road dealer.

The rear tire owns 2 types of wear indicator, one for the regular use and another for the use on a wet surface. Regular tread-wear limit indicators are indicated by a triangle symbol and the ones for the wet surface use are indicated by a water droplet symbol.

! WARNING

It is not recommended to use the vehicle on a wet road if the tread-wear limit indicators for wet surface use are reached or near to be reached. Replace the tire for your safety.

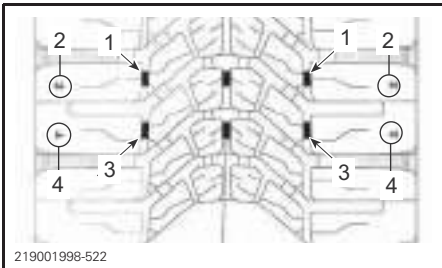

REAR TIRE SHOWN

1. Tread-wear limit indicators for wet surface use
2. Tread-wear limit indicator symbols for wet surface use
3. Regular tread-wear limit indicators
4. Regular tread-wear limit indicator symbols

It is normal to see uneven wear on tires depending on how the vehicle is driven and road conditions. The front tires external or internal edges and the rear tire center tread will wear unevenly depending on if the vehicle is driven smoothly or aggressively.

Tires Rotation

Rotate front tires when tread depth reaches 4 mm (5/32 in). This will maximize tire life.

! CAUTION Do not hold the front wheel spoke while attempting to spin the front wheel as your fingers may be caught between the wheel and the brake caliper.

Tire Registration Form

In the event of a tire recall, we can only contact you if we have your name and address. As a vehicle manufacturer, BRP keeps a record of the Tire Identification Number (T.I.N.) associated with the Vehicle Identification Number (V.I.N.) (see *VEHICLE IDENTIFICATION*) and its current owner information.

If you replace any tire on your vehicle, a "Tire Registration Form" must be completed and sent to the tire manufacturer consumer service group. The "Tire Registration Form" is available at an authorized Can-Am On-Road dealer.

Wheel

Front Wheels

Removing the Front Wheel

1. Place the vehicle on a level surface.
2. Lift and support the front of the vehicle.

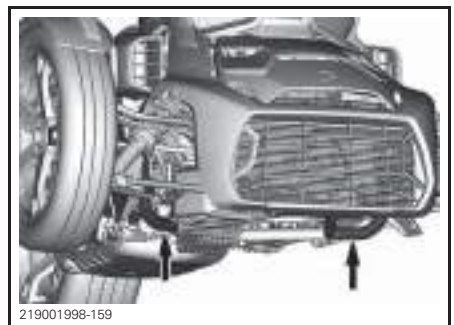

USE THESE TUBES TO LIFT OR SUPPORT THE FRONT OF THE VEHICLE

3. Turn the handlebar and lock the wheel hub with a locking device (such as a long Allen key or a tempered steel rod).

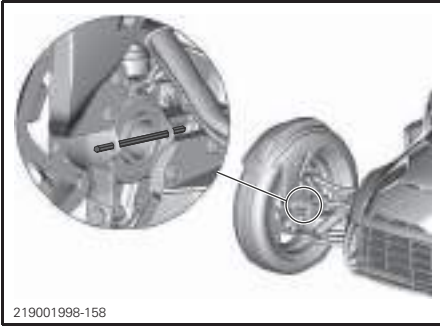

4. Remove the RED locking clip.

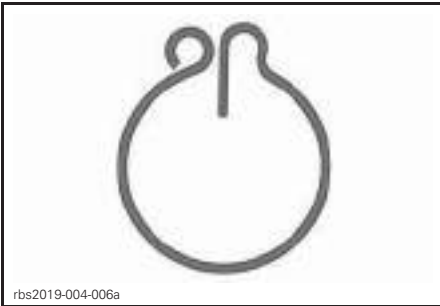

5. Remove the center lock wheel nut and the conical washer.

6. Remove the wheel from the vehicle.

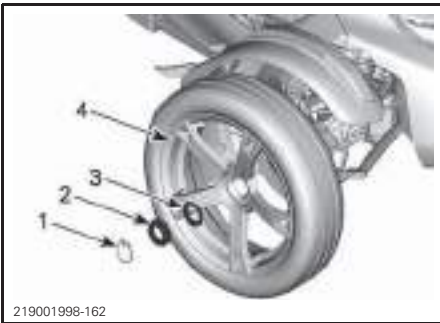

1. RED locking clip
2. Center lock wheel nut
3. Conical washer
4. Wheel

Installing Front Wheels

NOTICE The installation instruction and tightening torque values must be strictly adhered to. Failure to do so can lead to rim damage.

The installation is the reverse of the removal procedure. However, pay attention to the following.

Align the three dowel pins of the rim with the brake disk holes.

NOTICE All contact surfaces of the wheel, wheel hub, brake disc and the thread in the wheel hub must be free of abrasion, sand, dust or chips. Do not use fluids of any kind to wash the surfaces, use only dry soft cloth.



Install the conical washer and the center lock wheel nut.

Tighten the center lock wheel nut to specification.

NOTICE Never use impact tools to tighten wheel nuts.

TIGHTENING TORQUE	
Center lock wheel nut	300 N•m ± 15 N•m (221 lbf•ft ± 11 lbf•ft)

⚠ WARNING
Failure to install the RED locking clip may cause the loss of a wheel if the center lock wheel nut becomes loose.

Install the RED locking clip. The folded end must point inside the drive axle.

NOTICE Never untighten the nut to align the RED locking clip hole. Tighten the nut to the nominal value, then tighten further to align the hole.

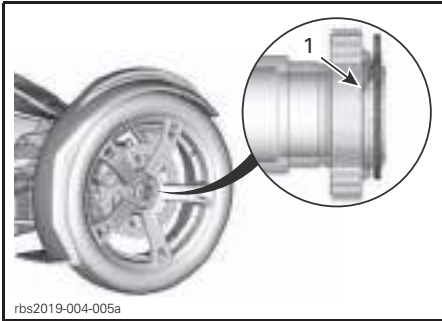

1. *Folded end pointing inside the drive axle*



Remove locking device from the wheel hub.

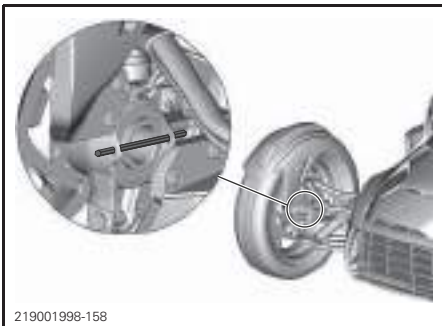

Rear Wheel

Removing the Rear Wheel

1. Place the vehicle on a level surface.
2. Move the park position lever in the locked position.
3. Remove the RED locking clip.

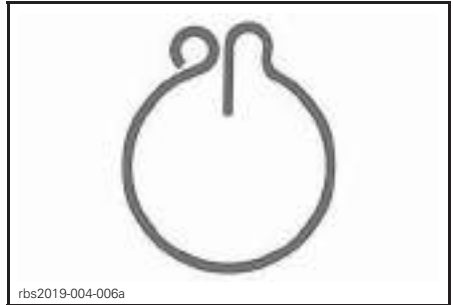

4. Loosen the center lock wheel nut.



1. *RED locking clip*
2. *Center lock wheel nut*

REQUIRED TOOL

65MM SOCKET
(P/N 529 036
457)



5. Lift and support the rear of the vehicle.



219001998-201

USE THESE LOCATIONS TO LIFT OR SUPPORT THE REAR OF THE VEHICLE

6. Unscrew caliper retaining bolts from the LH side and move the caliper aside.

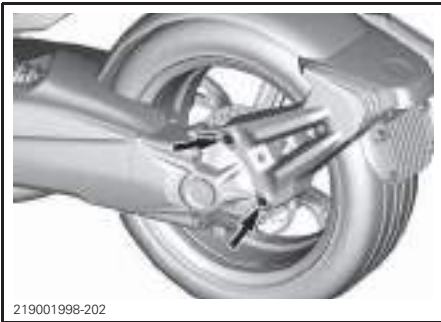

219001998-202

7. Remove the center lock wheel nut and the conical washer.
8. Remove the wheel from the vehicle.

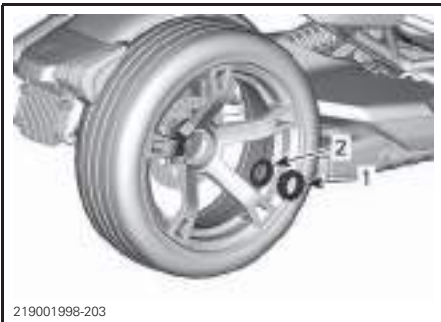

219001998-203

1. Center lock wheel nut
2. Conical washer

Installing the Rear Wheel

NOTICE The installation instruction and tightening torque values must be strictly adhered to. Failure to do so can lead to rim damage.

The installation is the reverse of the removal procedure. However, pay attention to the following.

Each time the rear wheel is removed, apply synthetic grease on brake disc splines.

RECOMMENDED XPS SERVICE PRODUCT
--

XPS synthetic grease

NOTICE All contact surfaces of the wheel, wheel hub, brake disc and the thread in the wheel hub must be free of abrasion, sand, dust or chips. Do not use fluids of any kind to wash the surfaces, use only dry soft cloth.

Install the conical washer and the center lock wheel nut.

Tighten the center lock wheel nut to specification.

NOTICE Never use impact tools to tighten wheel nuts.

TIGHTENING TORQUE	
--------------------------	--

Center lock wheel nut	300 N•m ± 15 N•m (221 lbf•ft ± 11 lbf•ft)
-----------------------	--

⚠ WARNING

Failure to install the RED locking clip may cause the loss of a wheel if the center lock wheel nut becomes loose.

Install the RED locking clip. The folded end must point inside the drive axle.

NOTICE Never untighten the nut to align the RED locking clip hole. Tighten the nut to the nominal value, then tighten further to align the hole.

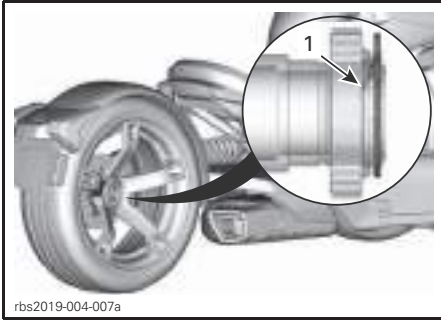

rbs2019-004-007a

1. Folded end pointing inside the drive axle



rbs2019-004-008a

Engine Oil

Recommended Engine Oil

Rotax® engines were developed and validated using the XPS™ oil. BRP recommends the use of its XPS engine oil or an equivalent at all time. Do not add any additives to the recommended engine oil. Damages caused by the use of an oil not suitable for the engine or by adding of an additives may not be covered by the BRP Limited Warranty.

XPS RECOMMENDED ENGINE OIL	
Scandinavia	4T 5W40 SYNTHETIC BLEND OIL (EUR) (P/N 779290)
Other Countries	4T 5W40 SYNTHETIC BLEND OIL (P/N 779133)
IF THE RECOMMENDED XPS ENGINE OIL IS NOT AVAILABLE	
<p>Use a 5W40 4-stroke SAE synthetic engine oil meeting or exceeding the following lubricant industry specifications. Always check the API service label certification on the oil container, it must contain at least one of the indicated standards.</p> <ul style="list-style-type: none"> – API service classification SJ, SL, SM or SN 	

Verifying the Engine Oil Level

NOTICE Operating the engine with an improper oil level may cause severe engine damage. Follow this procedure to obtain a precise reading of the engine oil level.

1. Bring the engine to its normal operating temperature (90°C (194°F) engine oil temperature) and let it idle for **at least 60 seconds**. Place vehicle on a level surface and move parking lock lever to the locked position.

NOTE: The engine is at normal operating temperature when the temperature indicator on the right lateral display shows 5 bars.

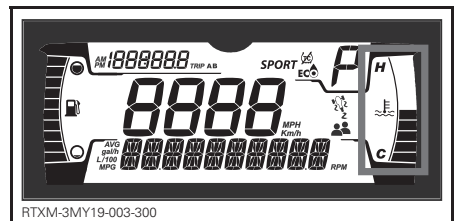

2. Open the RH side service cover while engine is idling.
3. Stop engine and immediately perform following steps.

NOTICE Perform the engine oil level verification **within 10 seconds after engine stop.**

- 3.1 Unscrew the dipstick to remove it and wipe clean.
- 3.2 Insert the dipstick into the filler tube and tighten it

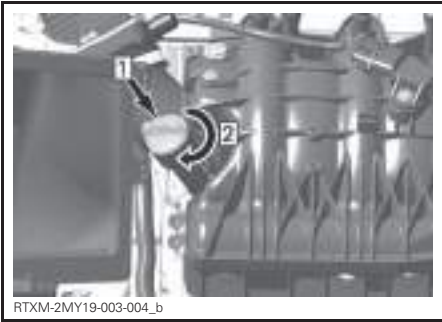

RTXM-2MY19-003-004_b

*Step 1: Insert dipstick
Step 2: Tighten dipstick.*

- 3.3 Remove the dipstick again and check oil level. It should be between MIN and MAX marks.

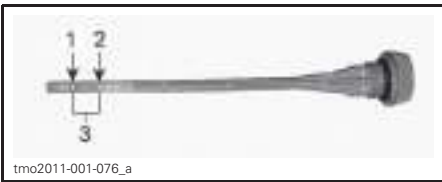

tmo2011-001-076_a

TYPICAL
 1. MIN
 2. MAX
 3. Operating range

Oil Level Between MIN and MAX Marks

1. Reinstall the dipstick and tighten it properly.
2. Wipe off any spillage.
3. Close the RH side service cover.

NOTICE An engine oil level above the MAX mark can lead to severe engine damage.

Oil Level Below MIN Mark

1. Place a funnel into the filler tube and add 400 ml (14 U.S. oz) of recommended engine oil.

NOTE: The oil quantity between MIN and MAX marks is 400 ml (14 U.S. oz).

2. Restart the engine to bring it to its normal operating temperature and let idling for at least 60 seconds.

NOTICE Adjusting the oil level with an engine not at the operating temperature will result in overfilling.

3. Stop engine and immediately perform following steps.

NOTICE Perform the engine oil level verification **within 10 seconds after engine stop.**

- 3.1 Unscrew the dipstick to remove it and wipe clean.
- 3.2 Insert the dipstick into the filler tube and tighten it.
- 3.3 Remove the dipstick again and check oil level. It should be between MIN and MAX marks.
4. Repeat above steps until oil level is between the MIN and MAX marks.

NOTICE Do not overfill.

5. Reinstall the dipstick and tighten it properly.
6. Wipe off any spillage.
7. Close the RH side service cover.

Changing the Engine Oil and Oil Filter

CAUTION The engine oil can be very hot. Wait until engine oil is warm.

NOTICE Engine oil and oil filter must be replaced at the same time.

1. Bring engine to its normal operating temperature (90°C (194°F) at oil tank surface).

NOTE: The engine is at normal operating temperature when the temperature indicator on the right lateral display shows 5 bars.

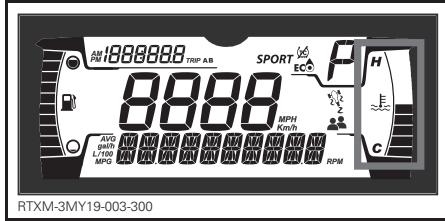

2. Place vehicle on a level surface.
3. Open the right service cover.
4. Remove dipstick.

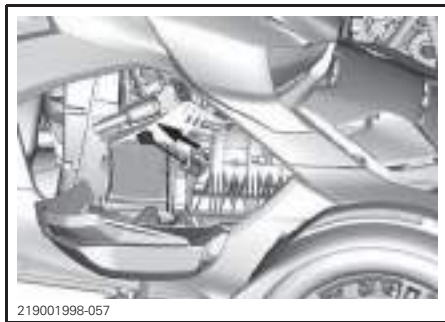

5. Clean drain plug area.
6. Place a drain pan under the engine.
7. Remove engine drain plugs in the following order.
 1. Magnetic drain plug
 2. Secondary drain plug.

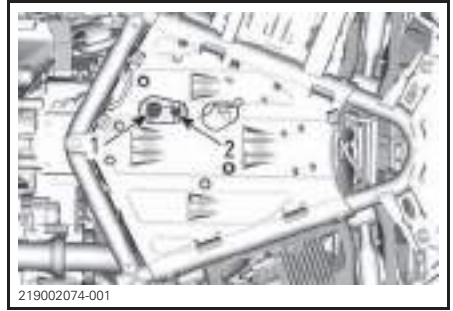

600 ACE ENGINE

1. Magnetic drain plug
2. Secondary drain plug

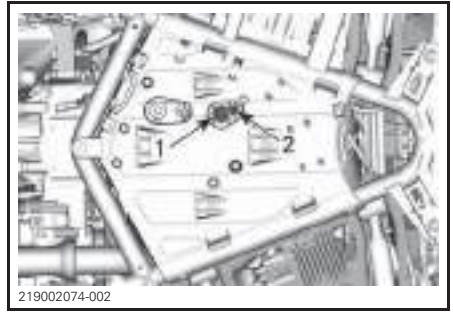

900 ACE ENGINE

1. Magnetic drain plug
2. Secondary drain plug

8. Allow oil to drain completely.

During this time, replace the engine oil filter.

9. Remove the front service cover. Refer to *SERVICE COVERS*.
10. Clean the engine oil filter area.
11. Remove the oil filter cover.



1. Oil filter cover screws
2. Oil filter cover
3. O-ring (discard)
4. Oil filter

12. Check the oil filter inlet and outlet orifices inside oil filter cavity (integrated part of magneto cover) for dirt and contaminations.

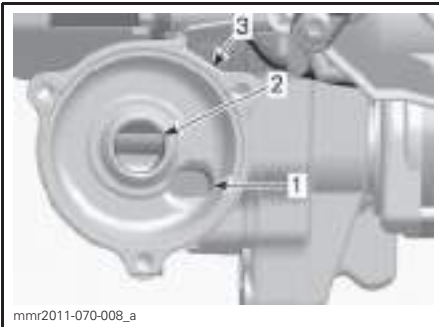

1. Oil inlet orifice from the oil pressure pump
2. Oil outlet orifice to the engine lubrication system
3. Oil filter receptacle

13. Replace the cover O-ring by a **NEW** one.
14. Remove the oil filter
15. Install the **NEW** oil filter into the cover.
16. Apply engine oil on O-ring and on end of filter.
17. Insert the oil filter in its location.

NOTICE Pay attention to avoid pinching the O-ring during filter and cover installation.

18. Tighten oil filter cover to recommended specification.

TIGHTENING TORQUE	
Oil filter cover screws	9 N•m ± 1 N•m (80 lbf•in ± 9 lbf•in)

19. Wipe off any oil spillage on engine.
20. Install **NEW** sealing washers on oil drain plugs.

NOTICE Never use a sealing washer a second time. Always replace with a new one.

21. Install drain plugs and tighten to the specified torque.

TIGHTENING TORQUE	
Magnetic drain plug	30 N•m ± 3 N•m (22 lbf•ft ± 2 lbf•ft)
Secondary drain plug	15 N•m ± 2 N•m (133 lbf•in ± 18 lbf•in)



900 ACE ENGINE SHOWN

1. Magnetic drain plug
2. **NEW** Sealing washer
3. Secondary drain plug
4. **NEW** Sealing washer

22. Refill oil tank at the proper level with the recommended oil.

APPROXIMATE ENGINE OIL CAPACITY (WITH FILTER)	
600 ACE	2.5 L (2.64 qt (U.S. liq.))
900 ACE	2.8 L (2.96 qt (U.S. liq.))

23. Reinstall the dipstick and tighten it properly.
24. Start engine and let it idle for a few minutes.
25. Ensure there are no leaks.
26. Stop engine and check oil level. Refill if necessary.
27. Dispose oil and filter as per your local environmental regulations.

Engine Air Filter

Removing the Engine Air Filter

1. Remove the left service cover. Refer to *SERVICE COVERS* section.
2. Remove the air filter from the cover.



Inspecting the Engine Air Filter

Inspect air filter for cleanliness and damage.

NOTICE It is not recommended to blow compressed air on the paper filter. This could damage the paper fibers and reduce its filtration ability when used in dusty environments.

NOTICE Do not wash the paper filter with any cleaning solution.

NOTICE Inspect air intake silencer and remove any dust or debris taking care not to blow or move anything inside the clean side of the engine air inlet (passed air filter).

NOTICE Remove any dust or debris that may have moved or shifted inside the clean side of the air intake silencer (passed air filter). Clean by pulling on the dust and not pushing it inside.

Replace air filter as necessary according to recommended maintenance schedule and particular use (especially in dusty environments).

Installing the Engine Air Filter

The installation is the reverse of the removal procedure. However, pay attention to the following:

Make sure the ring on which the air filter sits is flat and well positioned before seating the air filter.

CVT Air Filter

Removing the CVT Air Filter

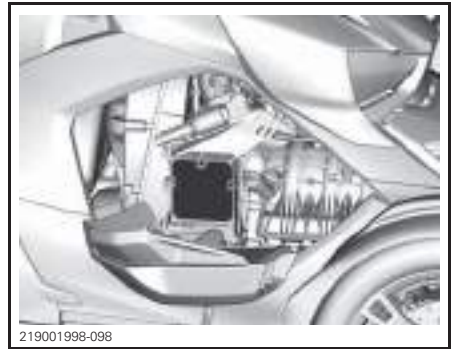

1. Remove the screw retaining the bottom of the CVT air filter housing.

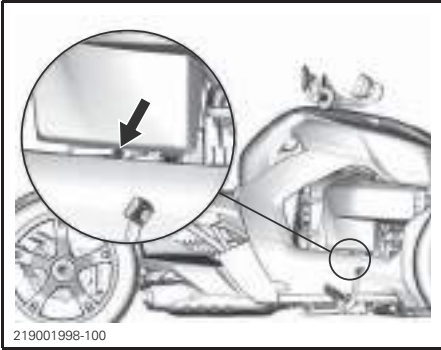

2. Open the right service cover. Refer to *SERVICE COVERS* section.
3. Remove the screws retaining the CVT air filter housing.

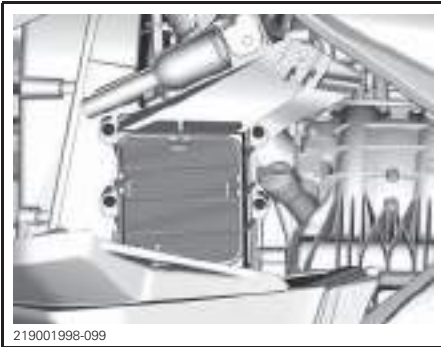

4. Remove the air filter from its housing.

Inspecting the CVT Air Filter

Inspect air filter for cleanliness and damage.

NOTICE It is not recommended to blow compressed air on the paper filter. This could damage the paper fibers and reduce its filtration ability when used in dusty environments.

NOTICE Do not wash the paper filter with any cleaning solution.

NOTICE Inspect air filter housing and remove any dust or debris taking care not to blow or move anything inside the CVT.

NOTICE Remove any dust or debris that may have moved or shifted inside the clean side of the air intake silencer (passed air filter). Clean by pulling on the dust and not pushing it inside.

Replace air filter as necessary according to recommended maintenance schedule and particular use (especially in dusty environments).

Installing the CVT Air Filter

The installation is the reverse of the removal procedure. However, pay attention to the following:

Make sure the ring on which the air filter sits is flat and well positioned before seating the air filter.

CVT Drive Belt

Replacing the CVT Drive Belt

Have the CVT drive belt replaced by an authorized Can-Am On-Road dealer, a repair shop, or a person of your own choosing.

Cleaning the CVT Pulley Sheaves

Have the CVT pulley sheaves cleaned by an authorized Can-Am On-Road dealer, a repair shop, or a person of your own choosing.

Engine Coolant

Recommended Engine Coolant

NOTICE Always use ethylene-glycol antifreeze containing corrosion inhibitors specifically for internal combustion aluminum engines.

To prevent antifreeze deterioration, always use the same brand and grade. Never mix different brands or grades unless cooling system is completely flushed and refilled.

XPS™ RECOMMENDED COOLANT
Extended life pre-mixed coolant
IF THE RECOMMENDED XPS COOLANT IS NOT AVAILABLE
Use a low silicate, extended life ethylene-glycol premixed coolant (50%-50%) specifically formulated for internal combustion aluminum engines.

Verifying the Engine Coolant Level

⚠ WARNING

When opening the reservoir, the coolant can be very hot and spray out if the engine is hot. In order to avoid getting burned, check the coolant level when the engine is cold.

With the engine cold, check the coolant level as follows:

1. Park the vehicle on a firm, level surface.
2. Remove the front service cover. Refer to *SERVICE COVER* section.
3. Check the coolant level on the right hand side. Coolant must be visible slightly above the MIN level mark.

NOTE: If engine is hot, coolant must be visible without exceeding the MAX level mark.

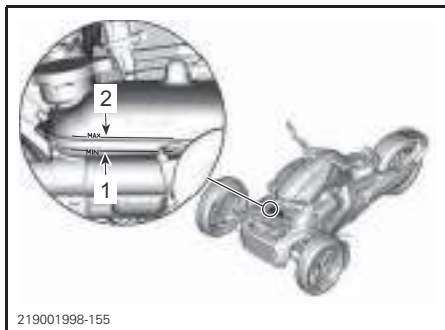

- 219001998-155
1. Coolant MIN. level mark
 2. Coolant MAX level mark

4. If required, add coolant until it is visible in the reservoir slightly above the MIN level mark. Use a funnel to avoid spillage.
Do not overfill.

5. Reinstall the service cover.

NOTE: A coolant system that frequently requires coolant indicates leaks or engine problems. See an authorized Can-Am On-Road dealer.

Replacing the Engine Coolant

Have the engine coolant replaced by an authorized Can-Am On-Road dealer, a repair shop, or a person of your own choosing.

Performing the Cooling System Pressure Test

Have the pressure test of the cooling system performed by an authorized Can-Am On-Road dealer, a repair shop, or a person of your own choosing.

Final Drive

Recommended Final Drive Oil

XPS™ RECOMMENDED FINAL DRIVE OIL
75W90 Synthetic gear oil
IF THE RECOMMENDED XPS FINAL DRIVE OIL IS NOT AVAILABLE
Use a 75W90 gear oil that meets the API GL-5 specification.

Verifying the Final Drive Oil Level

1. Place the vehicle on a level surface.
2. Stop the engine and move the park position lever in the locking position.
3. Remove the final drive fill plug located on the inner side of the final drive housing.
 - 3.1 Turn the rear wheel until the fill plug may be reached through a disc brake opening.

- 3.2 Using a long 8 mm Allen key remove the fill plug.



5. Remove the fill plug.

4. Check oil level. The oil should be level with the bottom of the oil level hole.

NOTICE Operating the final drive with an improper oil level may severely damage it.

5. If required, add recommended final drive oil.
6. Install and tighten the fill plug.

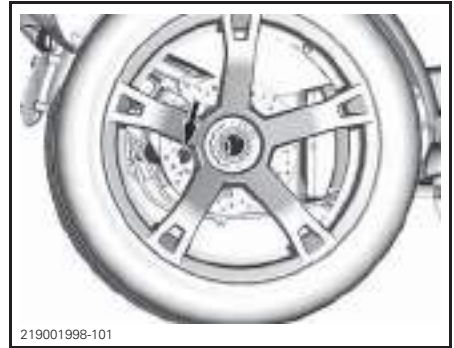

TIGHTENING TORQUE	
Fill plug	16 N•m ± 3 N•m (142 lbf•in ± 27 lbf•in)

Replacing the Final Drive Oil

1. Position vehicle on a level surface.
2. From underneath of the final drive housing, clean magnetic drain plug area.
3. Place a drain pan under the magnetic drain plug area.
4. Remove the final drive oil drain plug and the O-ring. Discard the O-ring.

CAUTION The final drive oil can be hot.

6. Allow oil to completely flow out of the final drive.
7. Clean magnetic drain plug and pay attention to any debris present on drain plug.

NOTE: Presence of excessive debris provides an indication of a final drive problem.

8. Reinstall magnetic drain plug with a **NEW** O-ring and tighten to specification.

TIGHTENING TORQUE	
Magnetic drain plug	16 N•m ± 3 N•m (142 lbf•in ± 27 lbf•in)

9. Fill the final drive through the fill hole until the oil reaches the bottom of the oil level hole.
10. Install and tighten the fill plug.

TIGHTENING TORQUE	
Fill plug	16 N•m ± 3 N•m (142 lbf•in ± 27 lbf•in)

11. Dispose final drive oil as per your local environmental regulations.

Gearbox

Recommended Gearbox Oil

XPS™ RECOMMENDED GEARBOX OIL	
General purpose	4T 5W40 Synthetic blend oil
Warm temperature	4T 10W50 Synthetic or 75W140 Synthetic gear oil

If THE RECOMMENDED XPS GEARBOX OIL IS NOT AVAILABLE

General purpose	Use a 4-stroke SAE engine oil meeting or exceeding the following lubricant industry specifications: API service classification SJ, SL, SM or SN Always check the API service label certification on the oil container, it must contain at least one of the indicated standards.
Warm temperature	Use a 75W140 gear oil that meets the API GL-5 specification.

Gearbox Oil Quantity

GEARBOX OIL MAXIMUM CAPACITY
500 ml (.53 qt (U.S. liq.)) (oil must be level with the bottom of the oil level plug hole)

Verifying the Gearbox Oil Level

1. Place the vehicle on a level surface.
2. Stop the engine and move the park position lever in the locking position.
3. Remove the gearbox oil level plug and discard sealing washer.

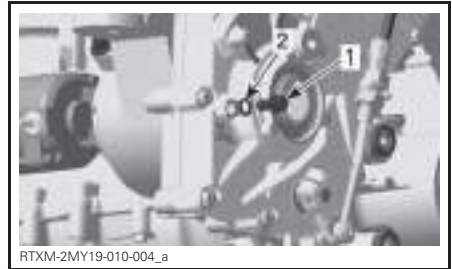

1. Oil level plug
2. Sealing washer

NOTE: The oil level plug is located behind the LH engine support, below the CVT drive belt housing.

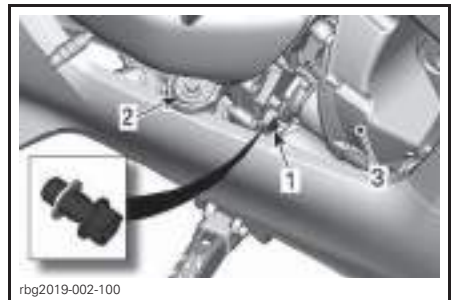

GEARBOX OIL LEVEL PLUG LOCATION

1. Oil level plug
2. LH engine support
3. CVT drive belt housing

4. Check oil level. The oil should be level with the oil level hole.

NOTICE Operating the gearbox with an improper oil level may severely damage gearbox.

5. If required, add gearbox oil.
 - 5.1 Remove the oil filler plug and discard the O-ring.

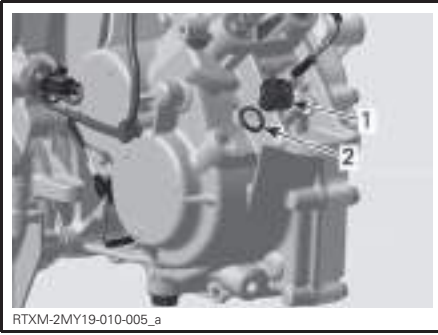

1. Oil filler plug
2. O-ring

NOTE: The oil filler plug is located forwards of the gearbox housing, between the LH engine support and the shift lever.



GEARBOX OIL FILLER PLUG LOCATION

1. Oil filler plug
2. LH engine support
3. Shift lever

- 5.2 Add recommended gearbox oil, in small quantity, until oil comes out by the oil level plug hole.
6. Reinstall the oil level plug and oil filler plug with a **NEW** sealing washer and **NEW** O-ring. Tighten to specification.

Replacing the Gearbox Oil

1. Start engine and operate vehicle to warm-up the gearbox oil.

NOTE: Running engine at idle is not sufficient, vehicle gearbox must be operated.

2. Position vehicle on a level surface.
3. From underneath of the vehicle, clean magnetic drain plug area.

CAUTION The exhaust system can be very hot.

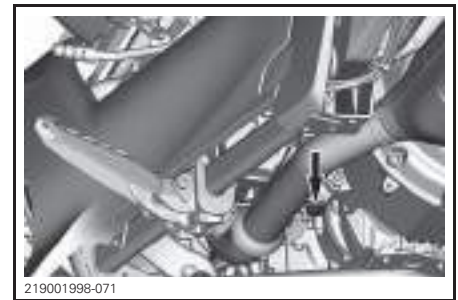

4. Place a drain pan under the gearbox magnetic drain plug area.
5. Remove magnetic drain plug and sealing washer. Discard sealing washer.

CAUTION The gearbox oil can be very hot.

6. Remove gearbox oil level plug. Discard sealing washer.

NOTE: The oil level plug is located behind the LH engine support, below the CVT drive belt housing.

TIGHTENING TORQUE

Oil level plug	15 N•m ± 2 N•m (133 lbf•in ± 18 lbf•in)
Oil filler plug	4.5 N•m ± 0.5 N•m (40 lbf•in ± 4 lbf•in)

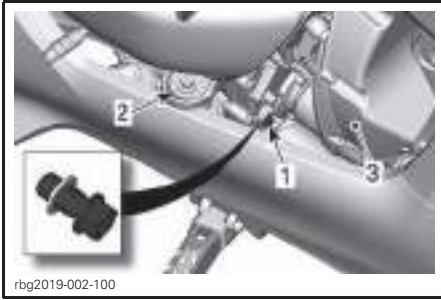

GEARBOX OIL LEVEL PLUG LOCATION

1. Oil level plug
2. LH engine support
3. CVT drive belt housing

7. Allow oil to completely flow out of gearbox.
8. Clean magnetic drain plug and pay attention to any debris present on drain plug.

NOTE: Presence of excessive debris provides an indication of a gearbox problem.

9. Reinstall magnetic drain plug with a **NEW** sealing washer and tighten to specification.

TIGHTENING TORQUE	
Magnetic drain plug	30 N•m ± 3 N•m (22 lbf•ft ± 2 lbf•ft)

10. Remove the oil filler plug and discard the O-ring.

NOTE: The oil filler plug is located forwards of the gearbox housing, between the LH engine support and the shift lever.

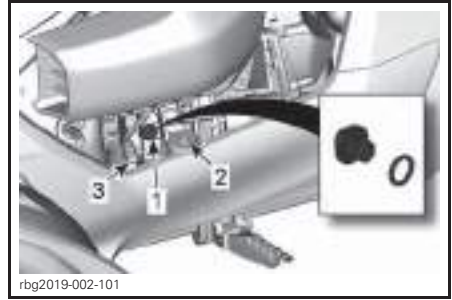

GEARBOX OIL FILLER PLUG LOCATION

1. Oil filler plug
2. LH engine support
3. Shift lever

11. Fill the gearbox through the oil filler hole until oil comes out by the oil level plug hole.
12. Reinstall the oil level plug and oil filler plug with a **NEW** sealing washer and **NEW** O-ring. Tighten to specification.

TIGHTENING TORQUE	
Oil level plug	15 N•m ± 2 N•m (133 lbf•in ± 18 lbf•in)
Oil filler plug	4.5 N•m ± 0.5 N•m (40 lbf•in ± 4 lbf•in)

13. Dispose gearbox oil as per your local environmental regulations.

Brakes

⚠ WARNING

New brakes will not operate at their maximum efficiency until their break-in is completed. Braking performance may be reduced, so use extra caution. Brakes take about 300 km (200 mi) of riding with frequent braking to break-in. For riding with infrequent braking, allow extra time to break-in the brakes.

Verifying the Brake Fluid Level

Use only DOT 4 brake fluid from a sealed container.

Check the brake fluid level as follows:

1. Park the vehicle on a firm, level surface.
2. Slide the RH footpeg in order to be able to see the level marks on the rear of the master cylinder reservoir. Refer to *DRIVER'S FOOTPEGS AND BRAKE PEDAL* section.
3. Check the brake fluid level in the reservoir. In both chambers, the fluid must be above the MIN mark.

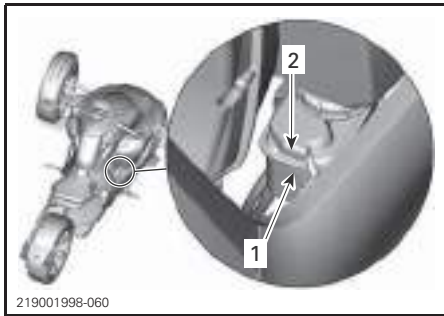

1. Brake fluid MIN. level mark
2. Brake fluid MAX. level mark

4. Add fluid as required. Refer to *ADDING BRAKE FLUID*.

NOTE: Low brake fluid may indicate leaks or worn brake pads. See an authorized Can-Am On-Road dealer.

Adding Brake Fluid

1. Slide the RH footpeg fully rearward.
2. Clean the filler cap and the top of the reservoir.

⚠ WARNING

Clean the filler cap and its surrounding area before removing it in order to avoid brake fluid system contamination.

3. Remove the filler cap, the anti friction washer and the diaphragm.

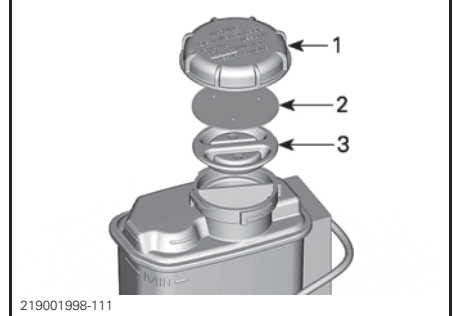

1. Filler cap
2. Anti friction washer
3. Diaphragm

4. Add fluid to MAX level.

NOTE: Replacing brake pads will increase brake fluid level. If replaced when at MAX level, brake fluid spills may occur.

NOTICE Brake fluid can damage painted surfaces or plastic parts. Wipe up any spills.

5. Reinstall the filler cap, the anti friction washer and the diaphragm.
6. Reposition the footpeg and the brake pedal as described in the *DRIVER'S FOOTPEGS AND BRAKE PEDAL* section.

Verifying the Brake System

The front and rear brakes are hydraulic disc types. These brakes are self-adjusting and do not require adjustment.

⚠ WARNING

The brake pedal requires an adjustment each time the RH footpeg is moved.

To keep brakes in good condition, check the following as per the *MAINTENANCE SCHEDULE*:

- Entire brake system for fluid leaks
- Brake pedal for spongy feel
- Brake discs for excessive wear and surface condition
- Brake pads for wear, damage or looseness.

See an authorized Can-Am On-Road dealer if there are any problems with the brake system or for servicing.

Have the brake system servicing by an authorized Can-Am On-Road dealer, a repair shop, or a person of your own choosing.

Battery

Battery Location

The battery is located in the front portion of the vehicle, under the front service cover.



219001998-062

Battery Charging

The vehicle is equipped with a maintenance-free type battery and is completely sealed; there is no need to add water to adjust the electrolyte level.

The battery may need to be charged if the vehicle has not been ridden for at least one month.

⚠ WARNING

Do not use conventional lead-acid type batteries. Acid may leak out through the battery vent of a conventional lead-acid type battery. Acid may also leak if the battery case is cracked or damaged, which can cause severe burns.

The battery can be charged while it is installed on the vehicle.

NOTICE Follow the instructions provided with your battery charger. Improper charging may damage the battery.

To charge the battery, proceed as follows:

1. Remove the front service cover.
2. Remove the rubber insulator from the positive battery terminal.
3. First connect the RED (+) cable to the corresponding terminal.
4. Connect the BLACK (-) cable to the corresponding terminal.

NOTICE Always connect the RED (+) cable first to avoid damaging the electrical system of the vehicle.

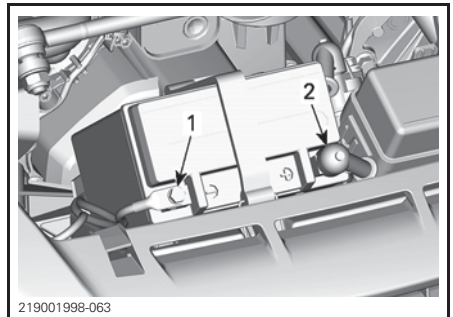

219001998-063

1. BLACK (-) terminal
2. RED (+) terminal

5. Start the battery charger. Charging time will depend on the charging rate.

When the battery is charged:

1. First disconnect the BLACK (-) cable.
2. Disconnect the RED (+) cable.

NOTICE Always disconnect the BLACK (-) cable first to avoid damaging the electrical system of the vehicle.

3. Slide back the rubber insulator over the positive battery terminal.
4. Install the front service cover.

A standard battery charger can be used. The recommended charge rate is 2 A. If the battery is dead, it can be jump started with a car battery (see *ROADSIDE REPAIRS* section).

For home charging, a “trickle” charger can be used to slow charge the battery. This type of charger can be left connected for a long period of time without damaging the battery. Always follow the charging time as recommended in the charger instructions.

On Board Diagnostic (OBD) Connector Location

The on board diagnostic connector is located in the front portion of the vehicle, under the front service cover.

Refer to the OBD manufacturer instructions for connection and diagnostic procedures.

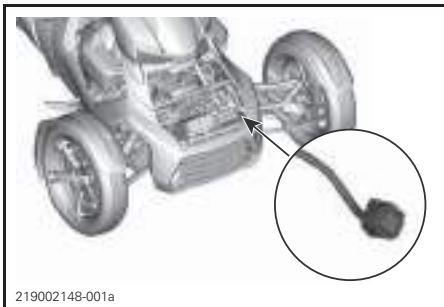

OBD CONNECTOR LOCATION

Exhaust System

See an authorized Can-Am On-Road dealer to verify the exhaust system or for servicing.

Headlights

Verifying the Headlights Aiming

The headlight aiming verification must be performed without weight on the vehicle.

Canada and USA

1. Verify tires are correctly inflated. See the *TIRE LABEL* located inside the right side service cover.
2. Position the vehicle at 10 m (33 ft) from a test surface.

Make sure the vehicle is level and positioned perpendicularly with the test surface.

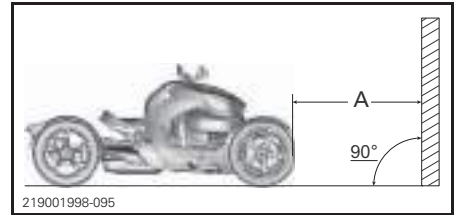

TYPICAL
A. 10 m (33 ft)

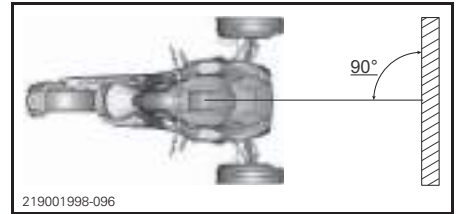

TYPICAL

3. Trace 2 lines parallel with the ground on the test surface as per the follow table:

LINES ON THE TEST SURFACE (ABOVE THE GROUND)		
Ryker 600	Line A	486 mm (19.134 in)
	Line B	449 mm (17.677 in)
Ryker 900	Line A	481 mm (18.937 in)
	Line B	443 mm (17.441 in)
Ryker 900 Rally edition	Line A	466 mm (18.346 in)
	Line B	429 mm (16.89 in)

- Select **HIGH** beam.
- Beam aiming is correct when the focus point (brightest spot) of the headlight reflection is between the marks.

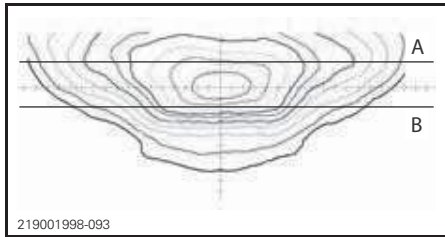

219001998-093
TYPICAL - HEADLIGHT REFLECTION ON TEST SURFACE

- Line A
- Line B

All Other Countries

- Verify tires are correctly inflated. See the **TIRE LABEL** located inside the right side service cover.
- Position the vehicle at 10 m (33 ft) from a test surface.

Make sure the vehicle is level and positioned perpendicularly with the test surface.

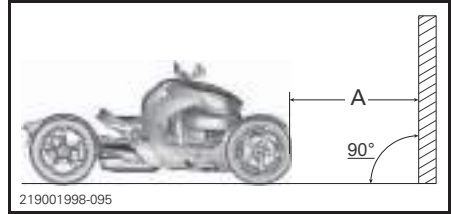

219001998-095
TYPICAL
A. 10 m (33 ft)

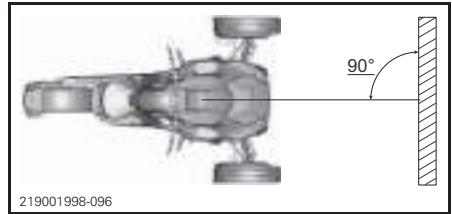

219001998-096
TYPICAL

- Trace 4 lines parallel with the ground on the test surface as per the follow table:

LINES ON THE TEST SURFACE (ABOVE THE GROUND)		
Ryker 600	Line A	486 mm (19.134 in)
	Line B	449 mm (17.677 in)
	Line C	517 mm (20.354 in)
	Line D	466 mm (18.346 in)
Ryker 900	Line A	481 mm (18.937 in)
	Line B	443 mm (17.441 in)
	Line C	511 mm (20.118 in)
	Line D	461 mm (18.15 in)
Ryker 900 Rally edition	Line A	466 mm (18.346 in)
	Line B	429 mm (16.89 in)
	Line C	497 mm (19.567 in)
	Line D	446 mm (17.559 in)

- Select **HIGH** beam.
- Beam aiming is correct when the focus point (brightest spot) of the headlight reflection is between the lines A and B.

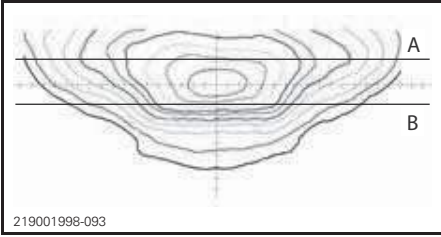

219001998-093
TYPICAL - HEADLIGHT REFLECTION ON TEST SURFACE

Line A
 Line B

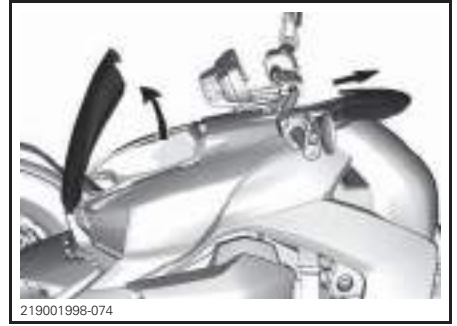

219001998-074

TYPICAL

6. Select **LOW** beam.
7. Beam aiming is correct when the focus point (brightest spot) of the headlight reflection is between the lines C and D.

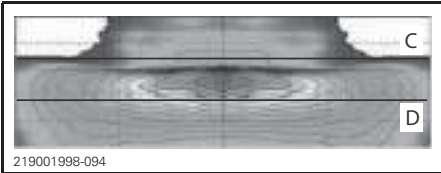

219001998-094
TYPICAL - HEADLIGHT REFLECTION ON TEST SURFACE

Line C
 Line D



219001998-075

TYPICAL

- 1.2 Remove and keep the plastic rivets retaining the side fairing.

- 1.3 Pull the front bottom corner to unlatch the retaining tab.

Headlights Aiming Adjustment

The headlight aiming adjustment must be performed without weight on the vehicle.

Canada and USA

1. Remove the side fairing.
 - 1.1 Open the glove box and slide the fuel filler door backward.

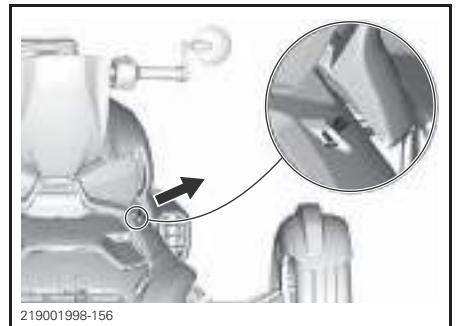

219001998-156

- 1.4 Remove the side fairing.
2. Open the right service cover. Refer to *SERVICE COVERS* section.

3. Using the screwdriver provided with the vehicle, adjust each headlight by turning gently the headlight adjuster located on the headlight housing.

⚠ WARNING
Adjust both headlights evenly.

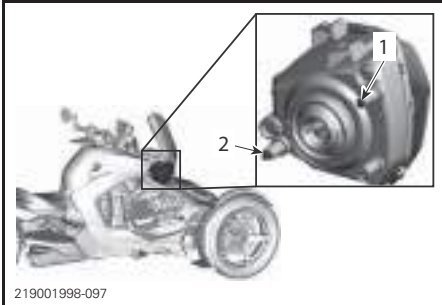

1. Headlight adjuster for the horizontal adjustment (left and right)
2. Headlight adjuster for the vertical adjustment (up and down)

4. When completed, reinstall all removed parts.

All Other Countries

High Beam

1. Remove the side fairing.
 - 1.1 Open the glove box and slide the fuel filler door backward.



TYPICAL

- 1.2 Remove and keep the plastic rivets retaining the side fairing.



TYPICAL

- 1.3 Pull the front bottom corner to unlatch the retaining tab.

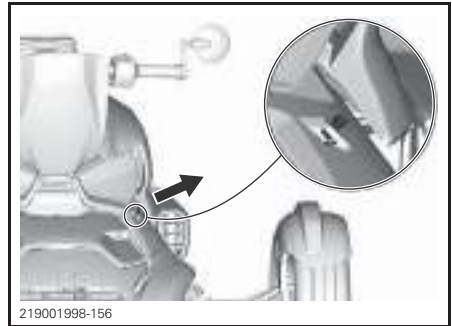

219001998-156

- 1.4 Remove the side fairing.
2. Open the right service cover. Refer to *SERVICE COVERS* section.
3. Using the screwdriver provided with the vehicle, adjust each headlight by turning gently the adjusters located on the headlight housing.

⚠ WARNING
Adjust both headlights evenly.

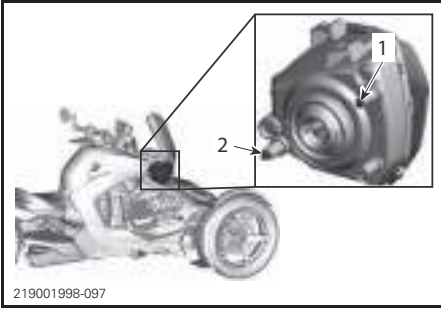

1. Adjuster for the horizontal adjustment (left and right)
 2. Adjuster for the vertical adjustment (up and down)
4. When completed, reinstall all removed parts.

Low Beam

1. Using the screwdriver provided with the vehicle, adjust each projector by turning gently the adjusters located on the projector housing.

⚠ WARNING

Adjust both headlights evenly.

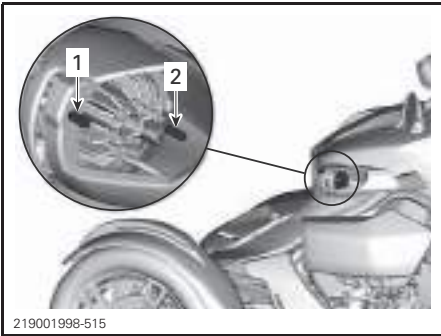

1. Adjuster for the horizontal adjustment (left and right)
2. Adjuster for the vertical adjustment (up and down)

Radiator

Cleaning the Radiator Fins

NOTICE Do not use high-pressure washers (like the ones found in car washes) as they may damage radiator fins.

To access the radiator, remove the front fascia.

1. Remove the front service cover. Refer to *SERVICE COVERS* section.
2. Remove screws located underneath the front fascia.

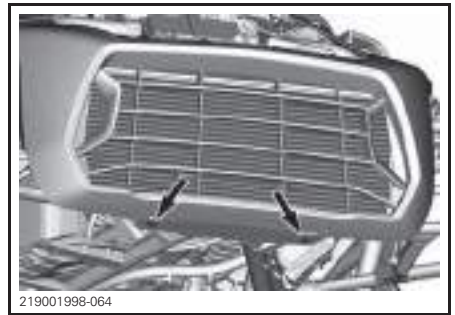

3. Roll up the end of the front fascia extensions to release the rear retaining tabs.



4. Pull the front fascia forward to remove it from vehicle.

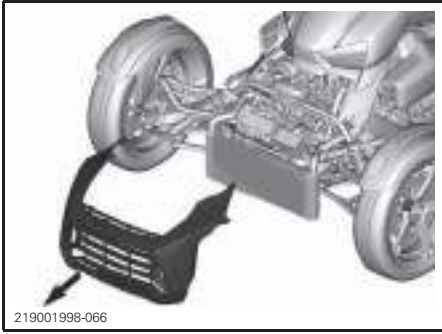

5. Clear debris and dirt.

NOTICE Do not use high-pressure washers (like the ones found in car washes) as they may damage radiator fins.

6. Reinstall the front fascia.

Installing the Front Fascia

1. Place the lower strip of the front fascia against the radiator support.



1. Front fascia lower strip
2. Radiator support

2. Tilt the top of the front fascia against the vehicle.



3. Roll up both ends of the front fascia extensions.



4. Install screws located underneath the front fascia and hand tighten only.

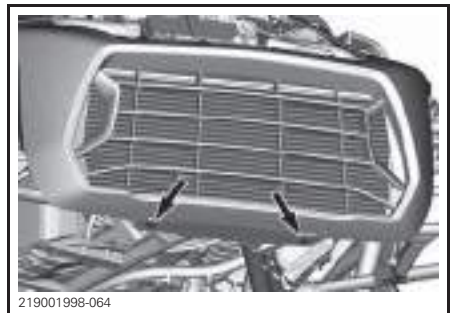

5. Tighten screws located underneath the front fascia to specification.



TIGHTENING TORQUE	
Front fascia screws	3.5 N•m ± 0.5 N•m (31 lb•in ± 4 lb•in)

6. Ensure front posts are properly inserted into rubber grommets.

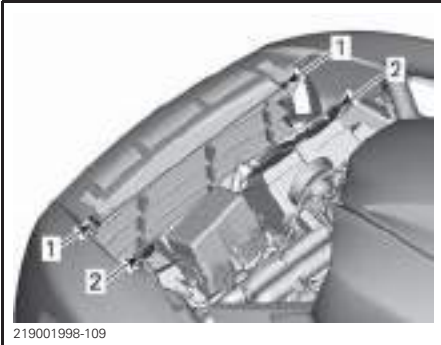

1. Front posts
2. Rubber grommets

7. Push the front fascia in place.
8. Insert the upper alignment posts in upper frame slots.

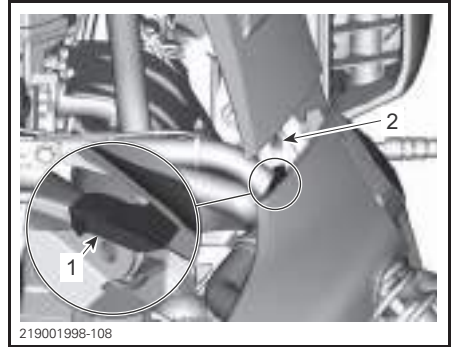

- LH SIDE SHOWN**
1. Upper alignment post
 2. Upper frame slot

9. Ensure front posts are properly inserted into rubber grommets.
10. Release both ends of the front fascia extensions. The retaining tabs should be located under the upper frame.

Steering System

1. Verify if the handlebar adjustment mechanism is well clamp, Adjust clamping strength if required. Refer to *ADJUSTING THE LOCKING LEVER CLAMPING STRENGTH* in the *EQUIPMENT* section.
2. Move handlebar and check for abnormal play.
3. Check if the tie-rods are bent.
4. Check if the tie-rod ends are loose.
 - 4.1 Grip the tie-rod near its end.

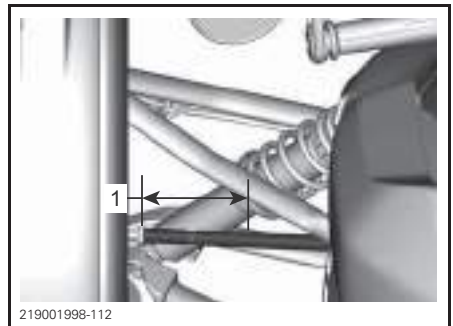

1. Grip tie-rod in this section

- 4.2 Try to move the tie-rod in its axle.

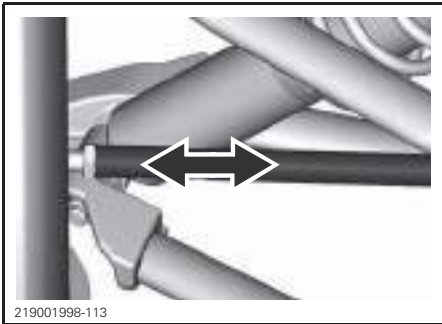

- 4.3 Pay attention for a slight play and/or a sound coming from the ball of the tie-rod.

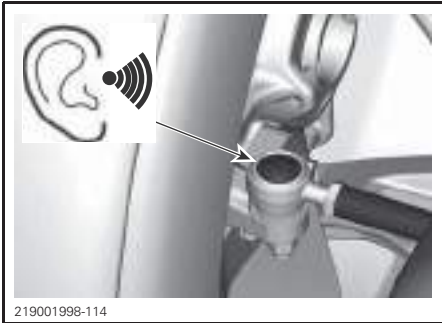

5. Check front and rear wheels for any play.

If a problem with a component of the steering system is detected, see an authorized Can-Am On-Road dealer, a repair shop, or a person of your own choosing to have your vehicle repaired.

VEHICLE CARE

Cleaning the Vehicle

NOTICE Do not use high-pressure washers (like the ones found in car washes) as they may damage certain parts of the vehicle.

To clean the vehicle:

1. Rinse the vehicle thoroughly with water to remove loose dirt.
2. Using a soft, clean cloth, wash the vehicle with water mixed with a mild detergent, such as soap specially formulated for motorcycles or automobiles.

NOTE: Using warm water works well to remove bugs in the windshield and front panels.

3. While washing the vehicle, check for grease or oil. You can use XPS ROADSTER WASH (P/N 219 701 703) or a mild automotive degreaser. Thoroughly follow the manufacturer's instructions.
4. Dry the vehicle with a chamois or a soft towel.

Vehicles with Matte Finishes

NOTICE Do not use wax, detail spray, or other products used on regular paint. Do not wash with abrasive materials. Do not use mechanical cleaners or polishers, and do not rub the surfaces vigorously.

Hand-wash with a soft wash mitt and a mild cleaning product safe for matte paint. To remove foreign substances such as insects, use a soft applicator and a mild solvent. Saturate and soak area before cleaning. Rub lightly.

This paint finish may require more frequent cleaning.

Vehicle Protection

Apply non-abrasive wax to plastic parts.

NOTICE Do not wax or polish matte surfaces (including matte paint finishes).

SURFACE	RECOMMENDATION
Glossy paint finishes	Apply only non-abrasive wax, safe for clear coat paints
Matte paint finishes	Do not apply wax
Matte finishes	

WARNING

Do not apply any protectant for vinyl or plastic on the seat. These products leave the seat slippery, the driver may have problems to stay stable on the seat when riding.

STORAGE AND PRESEASON PREPARATION

Storage

If the vehicle will not be ridden for at least four months, such as during the winter, proper storage is necessary to keep the vehicle in good condition.

BRP recommends you have your authorized Can-Am On-Road dealer, repair shop, or person of your own choosing fully prepare your vehicle for storage. Or, at your convenience, you can follow the basic procedures below.

1. Inspect vehicle and have your authorized Can-Am On-Road dealer, repair shop, or person of your own choosing for maintenance, repair, or replacement if necessary.
 - For US and Canadian citizens, please refer to the US EPA EMISSION PERFORMANCE WARRANTY contained in the *WARRANTY* section for information about warranty claims.
2. Change the engine oil and filter. Seek service from an authorized Can-Am On-Road dealer, repair shop, or person of your own choosing for maintenance, repair, or replacement.
3. Check level of the engine coolant and the brake fluid.
4. Fill the fuel tank, add fuel stabilizer and run the engine. Strictly follow instructions on fuel stabilizer container.
5. Inflate all tires to their recommended pressure.
6. Clean the vehicle.
7. Cover the vehicle with a permeable materials (e.g., tarpaulin). Avoid using plastic or similar non-breathing, coated materials that restrict air flow and allow heat and moisture to accumulate.

8. Store the vehicle in a dry area, away from sunlight, with a small amount of daily temperature variation.
9. Once a month, recharge the battery. Apply a slow charge at the recommended charging rate of 2A. The removal of the battery is not required.

Preseason Preparation

After a storage period, the vehicle must be prepared and inspected before riding. Perform the following:

1. Uncover and clean the vehicle.
2. Charge the battery if needed.
3. Perform a pre-ride inspection, then test-ride the vehicle at low speed.

ROAD SIDE REPAIRS

DIAGNOSTIC GUIDELINES

NOTICE If the vehicle must be transported, do not have it towed — towing can seriously damage the vehicle. Refer to *TRANSPORTING THE VEHICLE* in this section for detailed instructions.

This vehicle is equipped with an *ON BOARD DIAGNOSTIC* (OBD) connector. This allows vehicle self diagnostic and reporting of electronic system faults.

Refer to the OBD manufacturer instructions for connection and diagnostic procedures.

THE VEHICLE BEEPS CONTINUOUSLY AFTER THE ENGINE STOPPING AND THE REMOVAL OF THE RF D.E.S.S. KEY.

1. Park position lever not engaged.
 - Move the lever in the locked position.
2. Shift lever is not engaged in F or R position.
 - Move the shift lever on F or R position.

ENGINE DOES NOT TURN OVER

1. Scrolling safety message on the multifunction gauge cluster not acknowledged. (even if the safety message does not appear anymore).
 - Open the right side service cover and read the Safety Card.
 - Twist the throttle away from you (lift your wrist) to acknowledge the safety message.
2. Engine stop switch in the OFF position.
 - Make sure that the engine stop switch is in the ON position.

ENGINE DOES NOT TURN OVER (cont'd)

3. Battery dead or poor battery connections.
 - Check the battery charge. Recharge if necessary (see *MAINTENANCE PROCEDURES*).
 - Check the battery connections (see *MAINTENANCE PROCEDURES*).
4. Blown fuse.
 - Check fuse condition (see *REPLACING A FUSE*).
5. The RF D.E.S.S. key is not read.
 - Properly reinstall the D.E.S.S. key
 - Try another D.E.S.S. key already programmed for this vehicle

ENGINE TURNS OVER, BUT DOES NOT START

1. Low fuel.
 - Fill the fuel tank (see *BASIC PROCEDURES*).
2. Weak battery.
 - Check battery charge. Recharge if necessary (see *MAINTENANCE PROCEDURES*).
 - Check the battery connections in the front storage compartment.
3. Engine management problem.
 - Check to see whether the engine indicator lamp is ON while starting. Communicate with an authorized Can-Am On-Road dealer, repair shop, or person of your own choosing for an inspection and repair.

ENGINE LACKS ACCELERATION OR POWER

1. Engine break-in period not completed.
 - Complete break-in period.

ENGINE LACKS ACCELERATION OR POWER (cont'd)

- 2. Engine air filter plugged or dirty.**
 - Check air filter and replace if necessary.
 - Check deposits in engine air filter housing.
- 3. Drive and driven pulleys require servicing.**
 - Contact an authorized Can-Am On-Road dealer.
- 4. Engine overheats.**
 - Refer to *ENGINE OVERHEATS* below.
- 5. Drive belt worn too thin.**
 - Replace drive belt. — If the drive belt has lost more than 3 mm (1/8 in) of its original width, it will affect vehicle performance.
- 6. Lack of fuel**
 - Dirty or clogged fuel pump pre-filter. Communicate with an authorized Can-Am On-Road dealer, repair shop, or person of your own choosing for an inspection and repair.
- 7. If a passenger's seat kit is installed and no passenger is present, the left footpeg may be lowered.**
 - Raise and close the left passenger's footpeg.

ENGINE OVERHEATS

- 1. Low coolant level in cooling system.**
 - Check coolant level and refill. See *MAINTENANCE PROCEDURES*. Seek service from an authorized Can-Am On-Road dealer, repair shop, or person of your own choosing for maintenance, repair, or replacement. For US and Canadian citizens, please refer to the US EPA *EMISSION PERFORMANCE WARRANTY* contained in the *WARRANTY* section for information about warranty claims.

ENGINE OVERHEATS (cont'd)





- 2. Cooling fan is not working.**
 - Ensure cooling fan is not jammed and working properly.
 - Check fan fuse. See *FUSE LOCATIONS* in the *ROAD SIDE REPAIRS* section.
- 3. Dirty radiator fins.**
 - Check and clean radiator fins. See *CLEANING THE RADIATOR FINS* in the *MAINTENANCE PROCEDURES* section.







MESSAGES IN MULTIFUNCTION GAUGE

Important information about vehicle condition is displayed on the multifunction gauge. When starting the engine, always look at the gauge for any indicator lamps or special messages.

NOTE: A combination of two different warnings can occur.

BRP recommends having the vehicle transported when in LIMP HOME. If you operate the vehicle in LIMP HOME, avoid abrupt maneuvers and immediately go to the nearest authorized Can-Am On-Road dealer to have your vehicle serviced before riding again. In LIMP HOME, the engine RPM is limited and therefore the vehicle speed.

INDICATOR LAMPS (MALFUNCTIONS)			
INDICATOR LAMP(S)	DIGITAL WARNING	CAUSE	WHAT TO DO
None	BAD KEY	Wrong or defective key	- Use the right key for the vehicle or contact an authorized Can-Am On-Road dealer.
 ON	HIGH ENGINE TEMPERATURE	Engine is overheating	- Stop and wait for engine to cool down. - Check for leaks. - Check coolant level and adjust (see <i>MAINTENANCE PROCEDURES</i>).
 ON	LO BATT VOLT or HI BATT VOLT	Low or high battery voltage	- Recharge battery (see <i>MAINTENANCE PROCEDURES</i>). - Check battery connections. - Have the vehicle transported to the nearest authorized Can-Am On-Road dealer.
 ON	ABS FAULT	ABS malfunction. No ABS operation	- Have the vehicle transported to the nearest authorized Can-Am On-Road dealer.
 ON	VSS FAULT	VSS malfunction	- Have the vehicle transported to the nearest authorized Can-Am On-Road dealer.

INDICATOR LAMPS (MALFUNCTIONS)			
INDICATOR LAMP(S)	DIGITAL WARNING	CAUSE	WHAT TO DO
 ON	EBD FAULT	EBD malfunction	- Have the vehicle transported to the nearest authorized Can-Am On-Road dealer.
	BRAKE FAILURE	Low brake fluid level or faulty sensor	- Check for brake fluid leaks. - Check brake fluid level and adjust (see <i>MAINTENANCE PROCEDURES</i>).
 FLASHING + BEEPING AT KEY OFF	NONE	Park position lever not locked at key off	- Move the park position lever in the locked position.
 ON	CHECK ENGINE	Engine management component malfunction	- Stop the engine. The cluster must be completely shut down.
 FLASHING	LIMP HOME MODE	Important engine management component or VSS malfunction	- Have the vehicle transported to the nearest authorized Can-Am On-Road dealer.
 ON	NONE	Low oil pressure	- Check for oil leaks. - Check oil level and adjust (see <i>MAINTENANCE PROCEDURES</i>).
 ON	Variable messages - The message changes in accordance with the defective component.		

WHAT TO DO IN THE FOLLOWING CIRCUMSTANCES

Lost RF D.E.S.S. Keys

The RF D.E.S.S. key is required to start the vehicle.

If the key is lost during a ride, the engine will continue without cut or misfire and a the message "CHECK KEY" will be displayed. You will be able to stop the engine but you will need the spare key to restart the vehicle.

See your dealer to buy a new key and have it programmed.

Flat Tire

If a tire has a **major** puncture or cut in the tread and is completely deflated, have the vehicle transported to the nearest Can-Am On-Road dealer. Refer to *TRANSPORTING THE VEHICLE* in this section for transporting instructions.

If a tire has a **minor** nail or stone puncture and is not completely deflated, the tire can be temporarily repaired. To temporarily repair a tire, a self-inflating tire sealer or tire plug repair kit can be used. Follow the manufacturer's instructions that come with the tire sealer or repair kit and have the tire repaired or replaced by an authorized Can-Am On-Road dealer **as soon as possible**.

When a tire is temporarily repaired, ride slowly and carefully, and frequently check tire pressure until it is replaced or permanently repaired.

Dead Battery

If the battery is dead or too low to crank the engine, it can be jump started.

! WARNING

Connect the jumper cables as specified in the jump start procedure.

Batteries can emit explosive gas that can ignite if jumper cables are not properly connected.

NOTICE Do not disconnect the discharged battery.

1. Park the booster vehicle closed to the front of your vehicle.
2. Remove the front service cover. Refer to *SERVICE COVERS* section.
3. Remove the positive terminal cover and clean corrosion from battery posts before connecting the jumper cables.

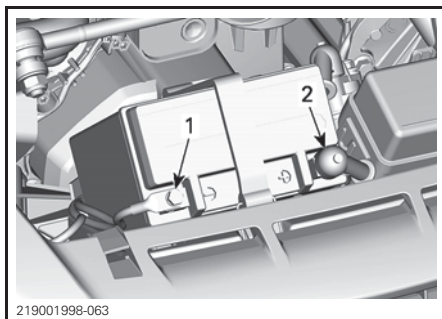

1. *BLACK (-) terminal*
2. *RED (+) terminal*
4. Begin by connecting one end of the RED jump lead to the positive (+) terminal of the discharged battery.
5. Connect the other RED end to the positive (+) terminal of the booster vehicle battery.
6. Connect one end of the BLACK jump lead to the negative (-) terminal of the discharged battery.
7. Connect the other BLACK end to the negative (-) terminal of the booster vehicle battery.

8. Start your vehicle in the usual way; if the engine does not start, wait a few minutes before repeating the attempt in order to protect the starter motor and the booster battery.

NOTE: If it still does not start, there might be a problem with the starting system. Have the vehicle transported (see *TRANSPORTING THE VEHICLE* in this section) and repaired by an authorized Can-Am On-Road dealer.

9. Once the vehicle has been started, let run both engines to idle for a few minutes before disconnecting the jumper cables.
10. Remove the jumper cables in the reverse order that they were connected.

NOTE: If the engine dies shortly after it has been jump started or when the jumper cables are disconnected, there might be a problem with the charging system. Have the vehicle transported (see *TRANSPORTING THE VEHICLE* section) and repaired by the an authorized Can-Am On-Road dealer.

11. Have the battery fully recharged with a battery charger (see *MAINTENANCE PROCEDURES*) or by a qualified service station as soon as possible.

REPLACING A FUSE

If any electrical accessories stop working on the vehicle, check for blown fuses and replace if necessary.

If an electrical failure still occurs, have the vehicle serviced by an authorized Can-Am On-Road dealer.

Fuse Locations

The fuse box is located in front of the vehicle, beside the battery.

To access to the fuse box, remove the front service cover. Refer to *SERVICE COVERS* section.

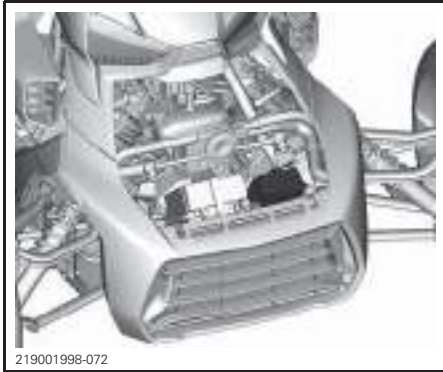

Fuse Box Items Description

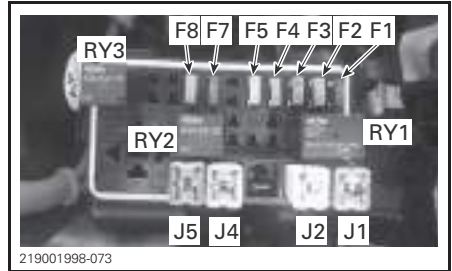

DESCRIPTION		RATING
F1	Horn / Hazard	7.5 A
F2	Headlamps	15 A
F3	USB / ACC	5 A
F4	Cooling fan	15 A
F5	Fuel pump / Engine	20 A
F6	EMPTY	-
F7	Electronic module	10 A
F8	Start button / Cluster	15 A
J1	VCM pump	40 A
J2	VCM valves	25 A
J3	EMPTY	-
J4	Main	30 A
J5	Battery	50 A
RY1	Main relay	
RY2	Cooling fan relay	
RY3	Headlamps relay	

Replacing a Fuse

1. Turn the engine OFF.
2. Pull the fuse out.
3. Check whether the filament is melted.

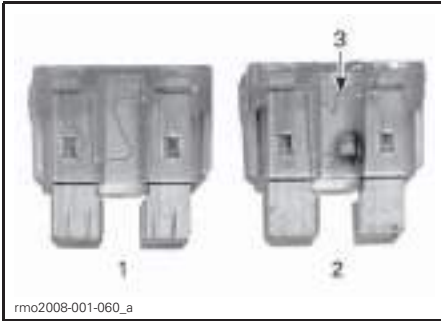

1. *Good fuse*
2. *Blown fuse*
3. *Melted filament*

4. Replace the fuse with one with the same rating. Spare fuses are located in the fuse box cover.

⚠ WARNING

Using a higher-rated fuse can cause severe damage and may cause fires.

5. To close the fuse box cover, position the cover over fuses and carefully push down until they click.
6. To close the fuse service covers, position covers over fuse boxes and push down carefully until the fuse service covers engage.
7. Install basket and close the front storage compartment.

CHANGING A BULB

The following lights are built with LEDs (light emitting diode) and this technology proved to be reliable. In the unlikely event they do not work, have them checked by an authorized Can-Am On-Road dealer.

- Turn indicator lights
- Brake lights
- Position lights
- License plate light
- Reverse light (Australian model only)
- Hazard warning flashers (Australian and Russian models).

Hi/Low Beam Headlight Bulbs (Inside North America)

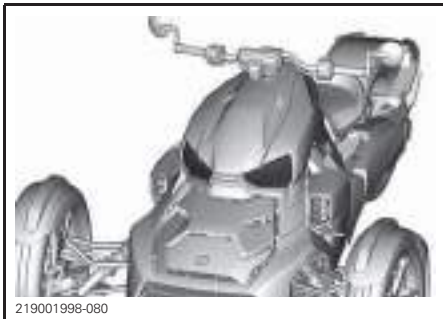

1. Remove the side fairing.
 - 1.1 Open the glove box and slide the fuel filler door backward.



TYPICAL

- 1.2 Remove and keep the plastic rivets retaining the side fairing.



TYPICAL

- 1.3 Pull the front bottom corner to unlatch the retaining tab.
- 1.4 Remove the side fairing.
2. Disconnect the headlight connector.

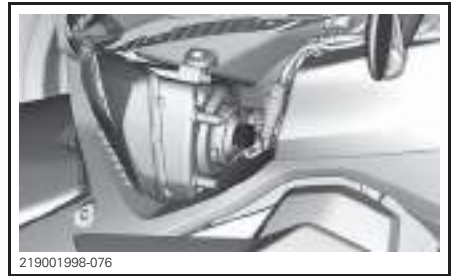

3. Remove the headlight bulb cover.



4. Turn the bulb stopper counterclockwise to unlock it.



TYPICAL

5. Remove the defective bulb.
6. Install the new bulb. Align bulb tabs with housing recesses.

NOTICE Never touch glass portion of a halogen bulb with bare fingers, it shortens its operating life. If glass is touched, clean it with isopropyl alcohol and a clean cloth.

7. Secure the bulb in place by turning the bulb stopper clockwise.
8. Properly reinstall all parts in the reverse order of their removal.

Hi Beam Headlight Bulbs (Outside North America)



TYPICAL

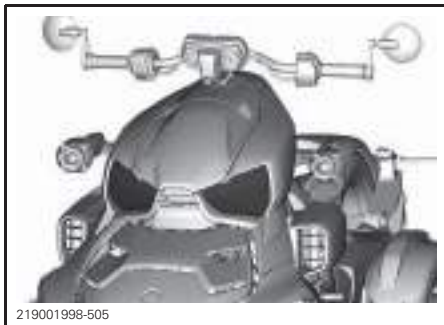

1. Remove the side fairing.
 - 1.1 Open the glove box and slide the fuel filler door backward.



- 1.2 Remove and keep the plastic rivets retaining the side fairing.
- 1.3 Pull the front bottom corner to unlatch the retaining tab.
- 1.4 Remove the side fairing.
2. Disconnect the headlight connector.

3. Remove the headlight bulb cover.



4. Turn the bulb stopper counterclockwise to unlock it.



5. Remove the defective bulb.
6. Install the new bulb. Align bulb tabs with housing recesses.

NOTICE Never touch glass portion of a halogen bulb with bare fingers, it shortens its operating life. If glass is touched, clean it with isopropyl alcohol and a clean cloth.

7. Secure the bulb in place by turning the bulb stopper clockwise.
8. Properly reinstall all parts in the reverse order of their removal.

Low Beam Headlight Projectors (Outside North America)

The bulb in the low beam projectors cannot be replaced. In the unlikely event they do not work, have them checked by an authorized Can-Am On-Road dealer.



TRANSPORTING THE VEHICLE

If your vehicle needs to be transported, it should be carried on a flatbed trailer of the proper size and capacity.

⚠ CAUTION If you need to push the vehicle, do it from the right-hand side to be able to reach the brake pedal.

When pulling the vehicle backwards, be careful that the front wheel does not roll over your feet.

NOTICE Do not tow this vehicle — towing can seriously damage the vehicle drive system.

NOTICE Avoid using chains to tie the vehicle — they may damage the surface finish or plastic components.

NOTICE Always transport the vehicle with the front fascia towards the towing vehicle.

When contacting a towing or transporting service, be sure to ask if they have a flatbed trailer, loading ramp or power ramp to safely lift the vehicle and tie-down straps. Ensure the vehicle is properly transported as specified in this section.

To Load the Vehicle Manually

1. Make sure the transmission lever is in Forward position

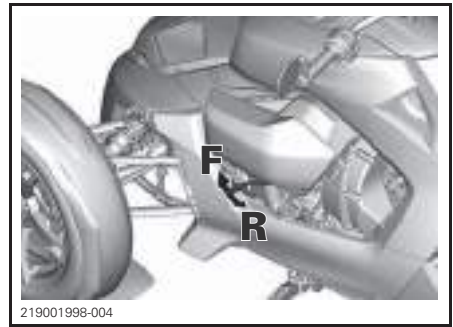

F = Forward
R = Reverse

2. Release the park position lever.
3. Push the vehicle on the trailer or the ramp.
4. Engage the park position lever.
5. For each wheels, insert a strap through the rim and firmly secure it to the trailer or the ramp.

NOTICE To avoid damaging the vehicle, do not use other attachment points to secure the vehicle



FRONT WHEEL



REAR WHEEL

To Load the Vehicle Using a Winch

1. Make sure the transmission lever is in Forward position

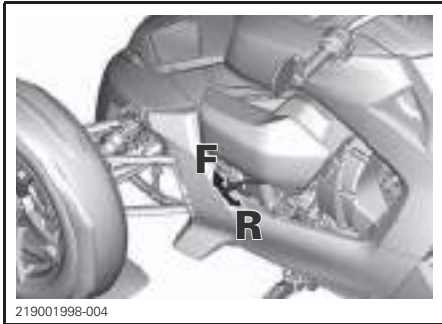

F = Forward
R = Reverse

2. Put a strap around each lower suspension arm.



3. Attach the straps to the winch cable.

NOTICE Make sure using straps long enough to avoid damaging the front of the vehicle.



4. Release the park position lever.
5. Active the winch to pull the vehicle on the trailer or the ramp.

6. Engage the park position lever.
7. Detach the winch and remove straps from lower suspension arms.

WARNING

Never use the winch to secure the vehicle.

8. For each wheels, insert a strap through the rim and firmly secure it to the trailer or the ramp.

NOTICE To avoid damaging the vehicle, do not use other attachment points to secure the vehicle



FRONT WHEEL



REAR WHEEL

TECHNICAL INFORMATION

VEHICLE IDENTIFICATION

The main components of your vehicle (engine and frame) are identified by different serial numbers. It may sometimes become necessary to locate these numbers for warranty purposes or to trace your vehicle in the event of loss. These numbers are required by the dealer to complete warranty claims properly. We strongly recommend that you take note of all the serial numbers on your vehicle and supply them to your insurance company.

Vehicle Identification Number

Canadian and USA Models

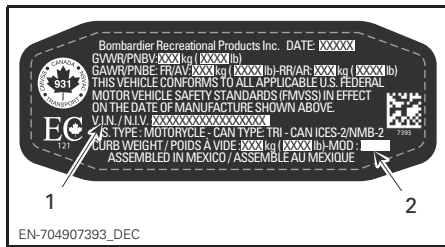

VEHICLE SERIAL NUMBER LABEL

1. VIN (Vehicle Identification Number)
2. Model number

All Other Models



TYPICAL - VEHICLE SERIAL NUMBER LABEL

1. VIN (Vehicle Identification Number)
2. Model number

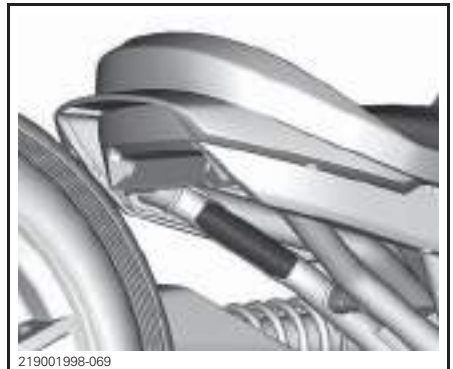

TYPICAL - UNDER THE SEAT, AFFIX ON THE LEFT LOWER REAR TUBE

Engine Identification Number

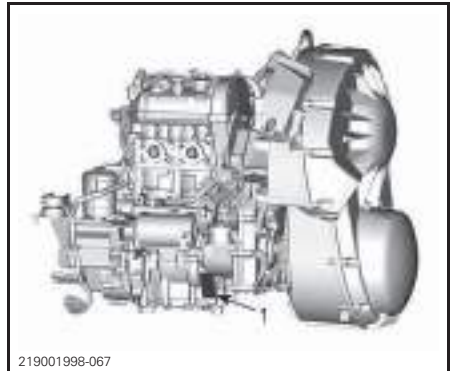

600 ACE ENGINE

1. EIN (Engine Identification Number) location

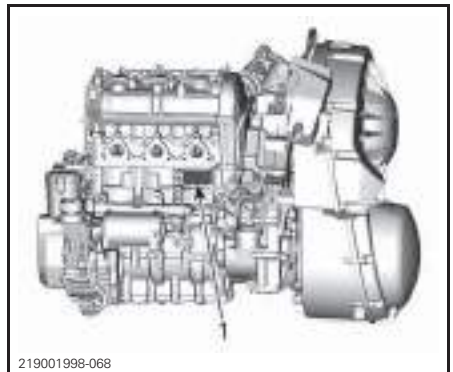

900 ACE ENGINE

1. EIN (Engine Identification Number) location

There is also a second EIN located at the front of the cylinder head.

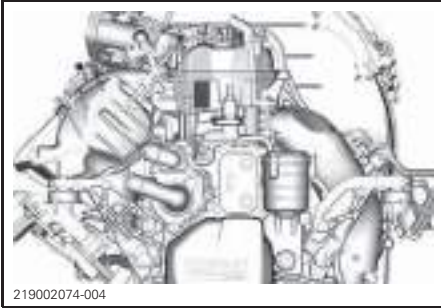

219002074-004

VEHICLE COMPLIANCE LABELS

EPA Compliance Label (North American Models)

This label is located above the air filter.

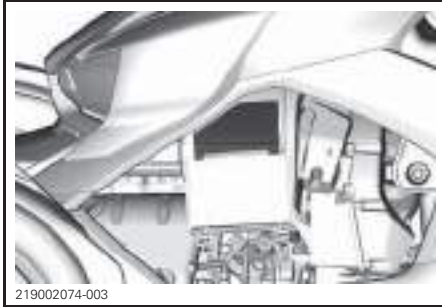

Compliance Labels (Australian Models)

This label is affixed on the right lower rear tube.

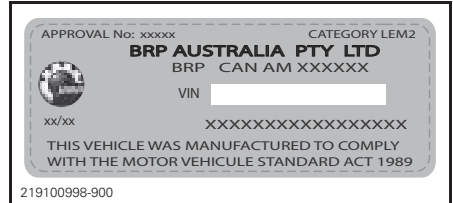

TYPICAL - AUSTRALIA ADR LABEL

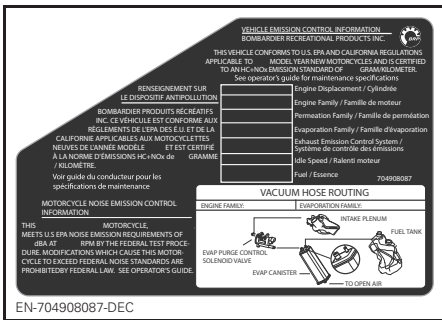

TYPICAL - CANADIAN AND USA MODELS

NOISE EMISSION CONTROL SYSTEM REGULATION

Tampering with Noise Control System Is Prohibited!

U.S. Federal law and Canadian provincial laws may prohibit the following acts or the causing there of:

1. The removal or rendering inoperative by any person other than for purposes of maintenance, repair or replacement of any device or element of design incorporated into any new vehicle for the purpose of noise control prior to its sale or delivery to the ultimate purchaser or while it is in use or
2. The use of the vehicle after such device or element of design has been removed or rendered inoperative by any person.

Among those Acts Presumed to Constitute Tampering Are the Acts Listed Below:

1. Removal or alteration or the puncturing of the muffler or any engine component which conducts removal of engine exhaust gases.
2. Removal or alteration or the puncturing of any part of the intake system.
3. Replacing any moving parts of the vehicle or parts of the exhaust or intake system, with non-compliant part.
4. Lack of proper maintenance.

RADIO FREQUENCY DIGITALLY ENCODED SECURITY SYSTEM (RF D.E.S.S. KEY)

This device complies with FCC Part 15 and Industry Canada license exempt RSS standard(s). Operation is subject to the following two conditions: (1) this device may not cause interference, and (2) this device must accept any interference, including interference that may cause undesired operation of the device.

Le présent appareil est conforme aux CNR d'Industrie Canada applicables aux appareils radio exempts de licence. L'exploitation est autorisée aux deux conditions suivantes: (1) l'appareil ne doit pas produire de brouillage, et (2) l'utilisateur de l'appareil doit accepter tout brouillage radioélectrique subi, même si le brouillage est susceptible d'en compromettre le fonctionnement.

Changes or modifications not expressly approved by the party responsible for compliance could void the user's authority to operate the equipment.

IC: 11538A-246416

FCC ID: 2ABBF-246416

EAC DECLARATION OF CONFORMITY

*Left blank for Eurasian Conformity
mark where applicable*

SPECIFICATIONS

Because of our ongoing commitment to product quality and innovation, BRP reserves the right, at any time, to make changes in design and specifications and/or to make additions to, or improvements in its products without imposing any obligation upon itself to install them on its previously manufactured products.

ENGINE - 600 ACE	
Engine type	ROTAX® 600 ACE, liquid cooled, 4-stroke, Double Over Head Camshaft (DOHC), dry sump
Number of cylinders	2
Number of valves	8 valves (self adjusting hydraulic valve lifters)
Bore	74 mm (2.91 in)
Stroke	69.7 mm (2.74 in)
Displacement	599 cm ³ (36.55 in ³)
Compression ratio	12:1
Maximum HP RPM	6750 RPM
Exhaust system	2 into 1 manifold, muffler with catalytic converter
Air filter	Paper element

ENGINE - 900 ACE	
Engine type	ROTAX 900 ACE, liquid cooled, 4-stroke, Double Over Head Camshaft (DOHC), dry sump
Number of cylinders	3
Number of valves	12 valves (self adjusting hydraulic valve lifters)
Bore	74 mm (2.91 in)
Stroke	69.7 mm (2.74 in)
Displacement	899 cm ³ (54.86 in ³)
Compression ratio	11:1
Maximum HP RPM	7750 RPM
Exhaust system	3 into 1 manifold, muffler with catalytic converter
Air filter	Paper element

LUBRICATION SYSTEM			
Type		Dry sump	
Oil filter		Replaceable cartridge oil filter	
Engine oil tank capacity (engine oil and filter replacement)		Ryker 600	2.5 L (2.64 qt (U.S. liq.))
		Ryker 900	2.8 L (2.96 qt (U.S. liq.))
Engine oil		Refer to <i>RECOMMENDED ENGINE OIL</i> in <i>MAINTENANCE PROCEDURES</i> section	
COOLING SYSTEM			
Coolant type		Refer to <i>RECOMMENDED ENGINE COOLANT</i> in <i>MAINTENANCE PROCEDURES</i> section	
Capacity		Ryker 600	2.2 L (.58 U.S. gal.)
		Ryker 900	2.45 L (.65 U.S. gal.)
FUEL SYSTEM			
Fuel delivery		Multipoint fuel injection, 46mm throttle body	
Fuel pump		Electric (in fuel tank)	
Fuel	Type	Regular unleaded Refer to <i>FUEL REQUIREMENTS</i> in <i>BASIC PROCEDURES</i> section	
	Minimum Octane rating	North America	87 (R+M)/2
		Outside North America	92 RON
	Recommended Octane rating	North America	91 (R+M)/2
Outside North America		95 RON	
Fuel tank capacity		20 L (5.28 U.S. gal.)	
Fuel remaining when low fuel light turns ON		± 3.8 L (1 U.S. gal.)	
Idle speed		Ryker 600	1100 RPM± 50 (not adjustable)
		Ryker 900	850 RPM± 50 (not adjustable)

SPECIFICATIONS

ELECTRICAL SYSTEM		
Magneto output		400 watts @ 7000 RPM
Spark plug	Type	NGK CR8EB or equivalent
	Gap	0.7 mm to 0.8 mm (.028 in to .031 in)
Battery	Type	YTX14L, Maintenance free SLA
	Voltage	12 volts
	Nominal rating	12 A•h
Headlight	CA/US	H4, 12V 55/60W
	Other countries	LOW: projector LED HIGH: H4, 12V 55/60W
Lights (turn indicators, brake, position, license plate)		LED
Reverse light	Australia	LED
Fuses and Relays		Refer to <i>FUSE BOX ITEMS DESCRIPTION</i> in <i>REPLACING A FUSE</i> section

DRIVE SYSTEM		
Transmission		Continuously Variable Transmission (CVT)
Engagement RPM		1800 RPM
Final drive		Shaft drive with bevel gears
Final drive oil	Capacity	335 ml (.35 qt (U.S. liq.))
	Recommended	Refer to <i>RECOMMENDED FINAL DRIVE OIL</i> in <i>MAINTENANCE PROCEDURES</i> section
Rear gear ratio		3.15 : 1
Gearbox		Forward and reverse positions
Gearbox oil	Capacity	500 ml (.53 qt (U.S. liq.))
	Recommended	Refer to <i>RECOMMENDED GEARBOX OIL</i> in <i>MAINTENANCE PROCEDURES</i> section

STEERING			
Type		Pitman arm	
Steering wheel		Adjustable steering	
Turning radius		4 435 mm (174.61 in)	
FRONT SUSPENSION			
Suspension type		Double suspension arm with stabilizer bar	
Suspension travel		Ryker 600 Ryker 900	137 mm (5.39 in)
		Ryker 900 Rally Edition	162 mm (6.38 in)
Shock absorber		QTY	
		2	
		Type	Ryker 600 Ryker 900
Ryker 900 Rally Edition	HPG shocks		
Preload adjustment type		Ryker 600 Ryker 900	No adjustment
		Ryker 900 Rally Edition	Threaded rings

SPECIFICATIONS

REAR SUSPENSION		
Suspension type		Single swinging arm
Suspension travel	Ryker 600 Ryker 900	150 mm (5.91 in)
	Ryker 900 Rally Edition	175 mm (6.89 in)
Shock absorber	QTY	
	1	
	Type	Ryker 600 Ryker 900
	Ryker 900 Rally Edition	HPG shocks with piggyback reservoir.
Preload adjustment type	Ryker 600 Ryker 900	Cam 5 positions
	Ryker 900 Rally Edition	Threaded ring

BRAKES		
Type		Foot actuated, fully integrated hydraulic 3 wheel braking system with ABS and EBD
Front brake		Dual 270 mm (11 in) discs, Nissin floating caliper with 2x 27mm pistons
Rear brake		Single 220 mm (9 in) disc with 1 piston floating caliper
Brake fluid	Type	DOT 4
	Capacity	200 ml (6.8 U.S. oz)
Caliper		Floating
Brake pad material		Organic

BRAKES	
Minimum brake pad thickness	0.5 mm (.02 in)
Minimum brake disc thickness	5 mm (.197 in)
Maximum brake disc warpage	0.2 mm (.01 in)

TIRES			
Type (use only radial tires recommended by BRP)	Front	Ryker 600 Ryker 900	Kenda KR390 145/60R16 M/C 66T
		Ryker 900 Rally Edition	Kenda KR392 145/60R16 M/C 66T
	Rear	Ryker 600 Ryker 900	Kenda KR391 205/45R16 M/C 77T
		Ryker 900 Rally Edition	Kenda KR393 205/55R15 M/C 81T
Pressure			Recommended tire inflation pressure is found on the Tire Label
Minimum tire tread depth	Front	1.6 mm (.063 in)	
	Rear	1.6 mm (.063 in)	

WHEELS			
Type	Ryker 600 Ryker 900		Cast aluminum wheels
	Ryker 900 Rally Edition		Machined aluminum wheels
Rim size	Front		406 mm (16 in) x 114 mm (4.5 in)
	Rear	Ryker 600 Ryker 900	406 mm (16 in) x 165 mm (6.5 in)
		Ryker 900 Rally Edition	381 mm (15 in) x 165 mm (6.5 in)
Center lock wheel nut			300 N•m ± 15 N•m (221 lbf•ft ± 11 lbf•ft)

SPECIFICATIONS

DIMENSIONS		
Overall length		2 352 mm (92.6 in)
Overall width		1 509 mm (59.4 in)
Overall height		1 062 mm (41.8 in)
Seat height	Ryker 600	599 mm (23.6 in)
	Ryker 900	597 mm (23.5 in)
	Ryker 900 Rally Edition	615 mm (24.2 in)
Wheelbase		1 709 mm (67.3 in)
Ground clearance, front and under engine	Ryker 600	104 mm (4.1 in)
	Ryker 900	102 mm (4 in)
	Ryker 900 Rally Edition	112 mm (4.4 in)

WEIGHT AND LOADING CAPACITY			
Dry weight	Ryker 600	270 kg (594 lb)	
	Ryker 900	280 kg (616 lb)	
	Ryker 900 Rally Edition	285 kg (627 lb)	
Glove box		2 kg (4.4 lb)	
Rear structure (MAX mount)	Ryker 900 Rally Edition	10 kg (22 lb)	
Total vehicle load allowed (including driver, passengers, all other loads and added accessories)		207 kg (456 lb)	
Gross vehicle weight rating (GVWR)	Ryker 600	489 kg (1,078 lb)	
	Ryker 900	499 kg (1,100 lb)	
Gross axle weight rating (GAWR)	Front	Ryker 600	239 kg (527 lb)
		Ryker 900	248 kg (547 lb)
	Rear	Ryker 600	250 kg (551 lb)
		Ryker 900	251 kg (553 lb)

WARRANTY

BRP LIMITED WARRANTY — CANADA AND USA: 2021 Can-Am® RYKER® SERIES

1. SCOPE OF THE LIMITED WARRANTY

Bombardier Recreational Products Inc. ("BRP")* warrants its 2021 Can-Am Ryker (the "Product") sold by an authorized Can-Am On-Road Dealers (as defined below) in the United States of America and in Canada from defects in material or workmanship for the period and under the conditions described below. This limited warranty will become null and void if: (1) The Product was used for racing or any other competitive activity, at any point, even by a previous owner; (2) the odometer was removed or has been tampered with; (3) the Product was used off-road; or (4) the Product has been altered or modified in such a way so as to adversely affect its operation, performance or durability, or has been altered or modified to change its intended use.

Non-factory installed parts and accessories are not covered under this limited warranty. Please refer to the applicable parts and accessories limited warranty text.

2. LIMITATIONS OF LIABILITY

THIS WARRANTY IS EXPRESSLY GIVEN AND ACCEPTED IN LIEU OF ANY AND ALL OTHER WARRANTIES, EXPRESSED OR IMPLIED, INCLUDING WITHOUT LIMITATION ANY WARRANTY OF MERCHANTABILITY OR FITNESS FOR A PARTICULAR PURPOSE. TO THE EXTENT THAT THEY CANNOT BE DISCLAIMED, THE IMPLIED WARRANTIES ARE LIMITED IN DURATION TO THE LIFE OF THE EXPRESS WARRANTY. INCIDENTAL AND CONSEQUENTIAL DAMAGES ARE EXCLUDED FROM COVERAGE UNDER THIS WARRANTY. SOME STATES/PROVINCES DO NOT ALLOW FOR THE DISCLAIMERS, LIMITATIONS AND EXCLUSIONS IDENTIFIED ABOVE, AS A RESULT, THEY MAY NOT APPLY TO YOU. THIS WARRANTY GIVES YOU SPECIFIC RIGHTS, AND YOU MAY ALSO HAVE OTHER LEGAL RIGHTS WHICH MAY VARY FROM STATE TO STATE, OR PROVINCE TO PROVINCE.

Neither the distributor, any Dealer nor any other person has been authorized to make any affirmation, representation or warranty regarding the Product, other than those contained in this limited warranty, and if made, shall not be enforceable against BRP. BRP reserves the right to modify this limited warranty at any time, being understood that such modification will not alter the warranty conditions applicable to the Product sold while this limited warranty is in effect.

3. EXCLUSIONS — ARE NOT WARRANTED

The following are not warranted under any circumstances:

- Replacement of routine maintenance items such as, without limitation, oil, lubricants, fluids, filters and spark plugs.
- Normal wear and tear, such as, without limitation, wear and tear of the tires, battery, generator brushes, sealed beams and light bulbs, clutch plates and facings, drive belt, brake pads, brake linings and rotors and sprockets.
- Tune ups and adjustments including without limitation adjustments of belt, alignment and wheel balance.
- Damages related to the appearance of the Product, including without limitation scratches, dents, fading, flaking, peeling and damages to seat cover material.

* In the USA, products are distributed and serviced by BRP US Inc.

- Damage caused by failure to provide proper maintenance or storage, as described in the *OPERATOR'S GUIDE*.
- Damage resulting from removal of parts, improper repairs, improper service or improper maintenance, modifications, alterations that are outside of the original specifications of the Product, or damage resulting from repairs done by a person that is not an authorized servicing Dealer.
- Damage resulting from the installation of parts with specifications that differ from the original Product parts, such as, without limitation, different tires, exhaust system, wheels or brakes.
- Damage resulting from abuse, abnormal use, neglect or operation of the Product in a manner inconsistent with the recommendations of the *OPERATOR'S GUIDE*.
- Damage resulting from water ingestion, accident, road hazards, submersion, fire, theft, vandalism or any act of God.
- Damage resulting from operation with fuels, oils or fluids with specifications different than as recommended in the *OPERATOR'S GUIDE*.
- Damage resulting from corrosion from road salts, battery acid, environmental influences or treatment contrary to the *OPERATOR'S GUIDE*.
- Incidental or consequential damages, including without limitation towing, storage, telephone, rental, taxi, inconvenience, insurance coverage, loan payments, loss of time or loss of income.

4. WARRANTY COVERAGE PERIOD

This limited warranty will be in effect from the date of delivery to the first retail consumer or the date the Product is first put into use, whichever occurs first and for the following periods:

1. **TWELVE (12) CONSECUTIVE MONTHS**, for private, recreational and commercial use owners, except for the items covered in points (2) to (5) below.
2. For the battery, **SIX (6) CONSECUTIVE MONTHS**
3. For the tires, **SIX (6) CONSECUTIVE MONTHS** or until tires are worn to the last three thirty-seconds of an inch (3/32 ") (2.38 millimeters) for the front tires and the last five thirty-seconds of an inch (5/32 ") (3.97 millimeters) for the rear tire, whichever occurs first.
4. For emission-related components; please also refer to the *US EPA EMISSIONS PERFORMANCE WARRANTY* contained herein.
5. For Product produced for sale in the state of California, that are originally sold to residents or subsequently warranty registered to residents in the state of California, please also refer to the applicable California Emissions Control Warranty Statement.

The repair or replacement of parts or the performance of service under this warranty does not extend the life of this warranty beyond its original expiration date.

5. CONDITIONS TO HAVE WARRANTY COVERAGE

This warranty coverage is available **only** if **each** of the following conditions has been fulfilled:

- The Product must be purchased as new and unused by its first owner from a Can-Am On-Road dealer authorized to distribute the Product in the country in which the sale occurred ("Dealer").

- The BRP-specified pre-delivery inspection process must be completed, documented and signed by the purchaser.
- The Product must have undergone proper warranty registration by an authorized Can-Am On-Road dealer.
- The Product must be purchased in the country in which the purchaser resides.
- Routine maintenance must be performed as indicated in the *OPERATOR'S GUIDE*. BRP reserves the right to make warranty coverage contingent upon proof of proper maintenance.

BRP will not honor this limited warranty to any private use owner or commercial use owner if the preceding conditions have not been met. Such limitations are necessary in order to allow BRP to preserve both the safety of its products, and also that of its consumers and the general public.

6. WHAT TO DO TO OBTAIN WARRANTY COVERAGE

The customer must cease using the Product upon the appearance of an anomaly. The customer must notify a servicing Dealer within three (3) days of the appearance of a defect, and provide it with reasonable access to the product and reasonable opportunity to repair it. The customer must also present to the authorized Dealer proof of purchase of the product and must sign the repair/work order prior to starting the repair in order to validate the warranty repair. All parts replaced under this limited warranty become the property of BRP.

7. WHAT BRP WILL DO

BRP's obligations under this warranty are limited to, at its sole discretion, repairing parts found defective under normal use, maintenance and service, or replacing such parts with new genuine parts without charge for parts and labor, at any authorized Dealer during the warranty coverage period. BRP's responsibility is limited to making the required repairs or replacements of parts. No claim of breach of warranty shall be cause for cancellation or rescission of the sale of the Product to the owner.

In the event that service is required outside of the country of original sale, the owner will bear responsibility for any additional charges due to local practices and conditions, such as, but not limited to, freight, insurance, taxes, license fees, import duties, and any and all other financial charges, including those levied by governments, states, territories and their respective agencies.

BRP reserves the right to improve or modify products from time to time without assuming any obligation to modify any products manufactured.

8. TRANSFER

If the ownership of a product is transferred during the warranty coverage period, this limited warranty, subject to its terms and conditions, shall also be transferred and be valid for the remaining coverage period provided BRP or an authorized Distributor/Dealer receives a proof that the former owner agreed to the transfer of ownership, in addition to the coordinates of the new owner.

9. CONSUMER ASSISTANCE

In the event of a controversy or a dispute in connection with this limited warranty, BRP suggests that you try to resolve the issue at the dealership level. We recommend discussing the issue with the authorized Dealer's service manager or owner.

If the matter still remains unresolved, contact BRP by filling out the customer contact form at www.brp.com or contact BRP by mail at one of the addresses listed under the *CONTACT US* section of this guide.

US EPA EMISSIONS PERFORMANCE WARRANTY

Bombardier Recreational Products Inc. ("BRP")* warrants that if:

1. The vehicle is maintained and operated in accordance with the written instructions for proper maintenance and use, and
2. The vehicle fails to conform at any time during its useful life to the applicable emission standards or family emission limits as determined by an EPA-approved emission test, and
3. Such nonconformity results or will result in the vehicle's owner having to bear any penalty or other sanction (including the denial of the right to use the Vehicle) under local, State or Federal law, then BRP shall remedy the nonconformity at no cost to the owner; except that, if the vehicle has been in operation for more than 5 years or 30,000 kilometers (18,641 miles). BRP shall be required to remedy only those nonconformities resulting from the failure of components which have been installed in or on the vehicle for the sole or primary purpose of reducing vehicle's emissions and that were not in general use prior to model year 1968.

The warranty period begins on the date the vehicle is delivered to its ultimate purchase, or if the vehicle is first placed in service as a "demonstrator" or "company" motorcycle prior to delivery, on the date it is first placed in service.

Items which are covered by the Emissions Performance Warranty for the full useful life of the vehicle:

Fuel System and Air Admission Systems

- Fuel Injectors, Fuel Pump Module, Fuel Filter Ass'y, Throttle Body (Including Throttle Position Sensor), Air Intake Manifold

Ignition Components and Sensors

- Engine Control Module (ECM), Engine Wiring Harness, Ignition Coils, Spark Plugs (covered only up to the first maintenance replacement), Noise Sensor (Knock Sensor), Camshaft Position Sensor, Crankshaft Position Sensor, Temperature Sensor (Coolant), Pressure And Temperature Sensor, Oxygen Sensors

Exhaust System

- Primary Muffler (Containing Catalytic Converter), Exhaust Manifolds
- Clamps, Gaskets and Seals (from Engine up to Primary Muffler)

Crankcase Ventilation System

- Crankcase Vent Breather, Crankcase Vent Hose, Oil Filler Cap

* In the USA, products are distributed and serviced by BRP US Inc.

Evaporative Emission Control System

- Fuel Tank, Fuel Cap, Fuel Hose, Vapor Canister, Vapor Canister Mounting Bracket, Bleed Valve (Purge Valve), Check Valve, Filters, Evaporative Components Mounting Brackets
- Clamp, Seal, Gasket and Fitting (associated with fuel system assembly)

See maintenance information section in this operator's guide for proper maintenance. This operator's guide contains information for proper use of the vehicle.

Under the Emissions Performance Warranty, BRP shall be liable for the total cost of the remedy for any vehicle validly presented for repair to any authorized Can-Am On-Road dealer, unless for emergency repairs as required by item 2 of the following list. State or local limitations as to the extent of the penalty or sanction imposed upon an owner of a failed vehicle shall have no bearing on this liability.

In no case may BRP deny an emission performance warranty claim on the basis of:

1. Warranty work or predelivery service performed by any facility authorized by BRP to perform such work or service; or
2. Work performed in an emergency situation to rectify an unsafe condition, including an unsafe driveability condition, attributable to BRP, provided the vehicle's owner has taken steps to put the vehicle back in a conforming condition in a timely manner; or
3. The use of any uncertified part or non-compliance with any written instruction for proper maintenance and use which is not relevant to the reason that the vehicle failed to comply with applicable emission standards; or
4. Any cause attributable to BRP; or
5. The use of any fuel which is commonly available in the geographical area in which the vehicle is located, unless the written instructions for proper maintenance and use specify that the use of that fuel would adversely affect the emission control devices and systems of the vehicle, and there is commonly available information for the owner to identify the proper fuel to be used. See maintenance information section and fuel requirements of fueling section.

Except as stated in the previous items; BRP may deny an emission performance warranty claim on the basis of an uncertified aftermarket part used in the maintenance or repair of a vehicle if the use of the uncertified part caused the vehicle's failure to meet emission standards. The use of parts not equivalent to the original parts or uncertified aftermarket parts may have a negative impact on the effectiveness of the emission control system and results in the vehicle's failure to meet emission standards. The use of certified parts does not affect the emission performance warranty. **Maintenance, replacement, or repair of the emission control devices and systems may be performed by any motorcycle repair establishment or individual using any certified part.**

As soon as you become aware of a defect; you are responsible for presenting your vehicle to an authorized Can-Am On-Road dealer. The authorized Can-Am On-Road dealer will proceed with the warranty claim.

In the case an authorized Can-Am On-Road dealer is unable (for reasons not attributable to the vehicle owner or events beyond the control of BRP or an authorized Can-Am On-Road dealer) to repair a vehicle within 30 days after the initial presentation of the vehicle to an authorized Can-Am On-Road dealer, then the owner shall be entitled to have the warranty remedy performed, at the expense of BRP, by any repair facility of the owner's choosing.

All defective parts replaced under this warranty become the property of BRP.

Contact the Director, Field Operations and Support Division (6406J), Environmental Protection Agency, 401 "M" Street, SW., Washington, DC 20460 (Attention: Warranty Claim) for further information concerning the Emissions Performance Warranty or to report a violations of the terms of the Emissions Performance Warranty.

Bombardier Recreational Products Inc. ("BRP")* also warrants to the ultimate purchaser and each subsequent purchaser that this new vehicle, including all parts of its exhaust emission-control system and its evaporative emission-control system, meets two conditions:

- It is designed, built, and equipped so it conforms at the time of sale to the ultimate purchaser with the requirements of 40 CFR 86 and with the evaporative emission standards of 40 CFR 1051, as applicable to onroad motorcycles.
- It is free from defects in materials and workmanship that may keep it from meeting the requirements of 40 CFR 86 and with the evaporative emission standards of 40 CFR 1051, as applicable to onroad motorcycles.

Where a warrantable condition exists, BRP will repair or replace, as it elects, any part or component with a defect in materials or workmanship that would increase the engine's emissions of any regulated pollutant within the stated warranty period at no cost to the owner, including expenses related to diagnosing and repairing or replacing emission-related parts.

The emission-related warranty is valid for the following period whichever comes first:

	KILOMETERS/MILES	YEARS
Exhaust and Evaporative emission-related components	30,000/18,641	5

US EPA FEDERAL NOISE EMISSION WARRANTY

Bombardier Recreational Products Inc. ("BRP")* warrants to the ultimate purchaser and each subsequent purchaser that this new vehicle, at time of sale, was designed, built and equipped to meets all applicable US EPA Federal noise control standards and is free from defects in materials and workmanship that may keep it, when properly maintained and used, from meeting the requirements of all applicable US EPA Federal noise standards for the following period whichever comes first:

KILOMETERS/MILES	YEAR
6,000/3,730	1

* In the USA, products are distributed and serviced by BRP US Inc.

CALIFORNIA EMISSION CONTROL WARRANTY STATEMENT

YOUR WARRANTY RIGHTS AND OBLIGATIONS:

The California Air Resources Board and BRP US Inc. ("BRP")*, on behalf of Bombardier Recreational Products Inc., are pleased to explain the emission control system warranty on your 2021 Can-Am Ryker. In California, new motor vehicles must be designated, built and equipped to meet the State's stringent anti-smog standards. BRP must warrant the emission control system on your vehicle for the periods of time listed below provided there has been no abuse, neglect or improper maintenance of your vehicle.

Your emission control system may include parts such as the fuel-injection system, ignition system, catalytic converter and engine computer. Also included may be hoses, connectors and other emission-related assemblies. Where a warrantable condition exists, BRP will repair your vehicle at no cost to you including diagnosis, parts and labor.

MANUFACTURER'S WARRANTY COVERAGE

– For 5 years or 30 000 kilometers (18,641 miles), whichever occurs first.

OWNER'S WARRANTY RESPONSIBILITIES:

As the Vehicle's owner, you are responsible for the performance of the required maintenance listed in your *OPERATOR'S GUIDE*. BRP recommends that you retain all receipts covering maintenance on your vehicle, but BRP cannot deny warranty solely for the lack of receipts or for your failure to ensure the performance of all scheduled maintenance.

You are responsible for presenting your vehicle to a Dealer as soon as a problem exists. The warranty repairs should be completed in a reasonable amount of time, not to exceed 30 days.

As the vehicle's owner, you should also be aware that BRP may deny you warranty coverage if your vehicle or a part has failed due to abuse, neglect, improper maintenance or unapproved modifications.

If you have any questions regarding your warranty rights and responsibilities, you should contact BRP's customer assistance center at 1-888-272-9222 or the California Air Resource Board at 9528 Telstar Avenue, El Monte, CA 91731.

* In the USA, products are distributed and serviced by BRP US Inc.

© 2020 Bombardier Recreational Products Inc. All rights reserved.

®™ Trademarks of Bombardier Recreational Products Inc. or its affiliates.

BRP INTERNATIONAL LIMITED WARRANTY : 2021 Can-Am® RYKER® SERIES

1. SCOPE OF THE LIMITED WARRANTY

Bombardier Recreational Products Inc. ("BRP")* warrants its 2021 Can-Am Ryker (the "Products") sold by distributors or dealers authorized by BRP to distribute Can-Am On-Road products ("Can-Am On-Road Distributor/Dealer") outside of the United States of America ("USA"), Canada, member states of the European Economic Area (which is comprised of the states of the European Union plus Norway, Iceland and Liechtenstein) ("EEA"), Turkey and member states of the Commonwealth of the Independent States (including Ukraine and Turkmenistan) ("CIS") from defects in material or workmanship for the period and under the conditions described below. This limited warranty will become null and void if: (1) the Product was used for racing or any other competitive activity, at any point, even by a previous owner; or (2) the odometer was removed or has been tampered with; (3) the Product was used off-road; or (4) the Product has been altered or modified in such a way so as to adversely affect its operation, performance or durability, or has been altered or modified to change its intended use.

Non-factory installed parts and accessories are not covered under this limited warranty. Please refer to the applicable parts and accessories limited warranty text.

2. LIMITATIONS OF LIABILITY

JURISDICTIONS TO THE EXTENT PERMITTED BY LAW. THIS WARRANTY IS EXPRESSLY GIVEN AND ACCEPTED IN LIEU OF ANY AND ALL OTHER WARRANTIES, EXPRESSED OR IMPLIED, INCLUDING WITHOUT LIMITATION ANY WARRANTY OF MERCHANTABILITY OR FITNESS FOR A PARTICULAR PURPOSE. TO THE EXTENT THAT THEY CANNOT BE DISCLAIMED, THE IMPLIED WARRANTIES ARE LIMITED IN DURATION TO THE LIFE OF THE EXPRESS WARRANTY. ALL INCIDENTAL, CONSEQUENTIAL, DIRECT, INDIRECT OR OTHER DAMAGES OF ANY KIND ARE EXCLUDED FROM COVERAGE UNDER THIS WARRANTY. SOME JURISDICTIONS DO NOT ALLOW FOR THE DISCLAIMERS, LIMITATIONS OF INCIDENTAL OR CONSEQUENTIAL DAMAGES OR OTHER EXCLUSIONS IDENTIFIED ABOVE. AS A RESULT, THEY MAY NOT APPLY TO YOU. THIS WARRANTY GIVES YOU SPECIFIC RIGHTS, AND YOU MAY ALSO HAVE OTHER LEGAL RIGHTS WHICH MAY VARY FROM COUNTRY TO COUNTRY, OR JURISDICTION TO JURISDICTION. (FOR PRODUCTS PURCHASED IN AUSTRALIA SEE CLAUSE 4 BELOW).

Neither the authorized Distributors/Dealers nor any other person has been authorized to make any affirmation, representation or warranty regarding the Product, other than those contained in this limited warranty, and if made, shall not be enforceable against BRP. BRP reserves the right to modify this warranty at any time, being understood that such modification will not alter the warranty conditions applicable to the Products sold while this warranty is in effect.

3. EXCLUSIONS — ARE NOT WARRANTED

The following are not warranted under this limited policy under any circumstances:

- Replacement of routine maintenance items such as, without limitation, oil and lubricants, filters and spark plugs.

- Normal wear and tear, such as, without limitation, wear and tear of the tires, battery, generator brushes, sealed beams and light bulbs, clutch plates and facings, drive belt, brake pads, brake linings and rotors and sprockets.
- Tune ups and adjustments including without limitation adjustments of belt, alignment and wheel balance.
- Damages related to the appearance of the Product, including without limitation scratches, dents, fading, flaking, peeling and damages to seat cover material.
- Damage caused by negligence or failure to provide proper maintenance and/or storage, as described in the *OPERATOR'S GUIDE*.
- Damage resulting from removal of parts, improper repairs, improper service or improper maintenance, modifications, alterations that are outside of the original specifications of the Product, or damage resulting from use of parts or accessories not manufactured or approved by BRP which in its reasonable judgement are either incompatible with the product or adversely affect its operation, performance or durability or resulting from repairs done by a person that is not an authorized servicing Distributor/Dealer.
- Damage resulting from the installation of parts with specifications that differ from the original Product parts, such as, without limitation, different tires, exhaust system, wheels or brakes.
- Damage resulting from abuse, abnormal use, neglect, racing or operation of the Product in a manner inconsistent with the recommendations of the *OPERATOR'S GUIDE*.
- Damage resulting from water ingestion, accident, road hazards, submersion, fire, theft, vandalism or any act of God.
- Damage resulting from operation with fuels, oils or lubricants with specifications different than as recommended in the *OPERATOR'S GUIDE*.
- Damage resulting from corrosion from road salts, battery acid, environmental influences or treatment contrary to the *OPERATOR'S GUIDE*.
- Incidental or consequential damages, including without limitation, expense for gasoline, expense for transporting the Product to and from the authorized Distributor/Dealer, mechanic's travel time, trailering or towing, storage, telephone, cell phone, fax or telegram charges, rental of a like or replacement Product during warranty services or down time, taxi, travel, lodging, loss of or damage to personal property, inconvenience, cost of insurance coverage, loan payments, loss of time, loss of income, revenue or profits, or loss of enjoyment or use of Product.

4. WARRANTY COVERAGE PERIOD

This warranty will be in effect from the date of delivery to the first retail consumer or the date the Product is first put into use, whichever occurs first and for the following periods:

1. **TWENTY-FOUR (24) CONSECUTIVE MONTHS**, for private, recreational and commercial use owners, except for the items covered in points (2) and (3) below.
2. For the battery, **SIX (6) CONSECUTIVE MONTHS**
3. For the tires, **SIX (6) CONSECUTIVE MONTHS** or until tires are worn to the last three thirty-second of an inch (3/32") (2.38 millimeters) for the front tires and the last five thirty-second of an inch (5/32 ") (3.97 millimeters) for the rear tire, whichever occurs first.

The repair or replacement of parts or the performance of service under this warranty does not extend the life of this warranty beyond its original expiration date.

Note that the duration and any other modalities of the warranty coverage are subject to the applicable national or local legislation in the customer's country.

FOR PRODUCTS SOLD IN AUSTRALIA ONLY

Nothing in these Warranty terms and conditions should be taken to exclude, restrict or modify the application of any condition, warranty, guarantee, right or remedy conferred or implied under the Competition and Consumer Act 2010 (Cth), including the Australian Consumer Law or any other law, where to do so would contravene that law, or cause any part of these terms and conditions to be void. The benefits given to you under this limited warranty are in addition to other rights and remedies that you have under Australian law.

Our goods come with guarantees that cannot be excluded under the Australian Consumer Law. You are entitled to a replacement or refund for a major failure and for compensation for any other reasonably foreseeable loss or damage. You are also entitled to have the goods repaired or replaced if the goods fail to be of acceptable quality and the failure does not amount to a major failure.

5. CONDITIONS TO HAVE WARRANTY COVERAGE

This warranty coverage is available **only** if **each** of the following conditions has been fulfilled:

- The Product must be purchased as new and unused by its first owner from a Distributor/Dealer authorized to distribute the Product in the country or union of countries in which the sale occurred;
- The BRP specified pre-delivery inspection process has been completed and documented by the purchaser and the authorized Distributor/Dealer and signed by the purchaser;
- The Product must have undergone proper warranty registration by an authorized Distributor/Dealer;
- The Product must be purchased in the country or union of countries in which the purchaser resides.
- Routine maintenance as outlined in the *OPERATOR'S GUIDE* must be performed in a timely manner. BRP reserves the right to make warranty coverage contingent upon proof of proper maintenance.

BRP will not honour this limited warranty to any private use owner or commercial use owner if one of the preceding conditions has not been met. Such limitations are necessary in order to allow BRP to preserve both the safety of its products, and also that of its consumers and the general public.

6. WHAT TO DO TO OBTAIN WARRANTY COVERAGE

The customer must cease using the Product upon the appearance of an anomaly. The customer must notify an authorized servicing Distributor/Dealer within two (2) days of the appearance of a defect, and provide it with reasonable access to the Product and reasonable opportunity to repair it. The customer must also present to the authorized Distributor/Dealer, proof of purchase of the Product and must sign the repair/work order prior to starting the repair in order to validate the war-

ranty repair. All parts replaced under this limited warranty become the property of BRP. Note that the notification period is subject to the applicable national or local legislation in customer's country.

7. WHAT BRP WILL DO

To the extent permitted by law, BRP's obligations under this warranty are limited to, at its sole discretion, repairing parts found defective under normal use, maintenance and service, or replacing such parts with new genuine Product parts without charge for parts and labour, at any authorized Distributor/Dealer during the warranty coverage period under the conditions described herein. BRP's responsibility is limited to making the required repairs or replacements of parts. No claim of breach of warranty shall be cause for cancellation or rescission of the sale of the Product to the owner. You may have other legal rights which may vary from country to country.

In the event that service is required outside of the country of original sale, , the owner will bear responsibility for any additional charges due to local practices and conditions, such as, but not limited to, freight, insurance, taxes, license fees, import duties, and any and all other financial charges, including those levied by governments, states, territories and their respective agencies.

BRP reserves the right to improve or modify products from time to time without assuming any obligation to modify all products previously manufactured.

8. TRANSFER

If the ownership of a Product is transferred during the warranty coverage period, this limited warranty, subject to its terms and conditions, shall also be transferred and be valid for the remaining coverage period provided BRP or an authorized Distributor/Dealer receives a proof that the former owner agreed to the transfer of ownership, in addition to the coordinates of the new owner.

9. CONSUMER ASSISTANCE

In the event of a controversy or a dispute in connection with this limited warranty, BRP suggests that you try to resolve the issue at the Distributor/Dealer level. We recommend discussing the issue with the authorized Distributor/Dealer's service manager or owner.

If the matter still remains unresolved, contact BRP by filling out the customer contact form at www.brp.com or contact BRP by mail at one of the addresses listed under the *CONTACT US* section of this guide.

* For the territory covered by this limited warranty, products are distributed and serviced by Bombardier Recreational Products Inc. or its affiliates.

© 2020 Bombardier Recreational Products Inc. All rights reserved.

®™ Trademarks of Bombardier Recreational Products Inc. or its affiliates.

BRP LIMITED WARRANTY FOR THE EUROPEAN ECONOMIC AREA, THE COMMONWEALTH OF THE INDEPENDENT STATES AND TURKEY: 2021 Can-Am® RYKER® SERIES

1. SCOPE OF THE LIMITED WARRANTY

Bombardier Recreational Products Inc. ("BRP")* warrants its 2021 Can-Am Ryker (the "Products") sold by distributors or dealers authorized by BRP to distribute Can-Am On-Road products ("Can-Am On-Road Distributor/Dealer") in member states of the European Economic Area (which is comprised of the member states of the European Union plus Norway, Iceland and Liechtenstein) ("EEA"), in member states of the Commonwealth of the Independent States (including Ukraine and Turkmenistan) ("CIS") and Turkey (the "Distributors/Dealers") from defects in material or workmanship for the period and under the conditions described below. This limited warranty will become null and void if: (1) the Product was used for racing or any other competitive activity, at any point, even by a previous owner; or (2) the odometer was removed or has been tampered with; (3) the Product was used off-road; or (4) the Product has been altered or modified in such a way so as to adversely affect its operation, performance or durability, or has been altered or modified to change its intended use.

Non-factory installed parts and accessories are not covered under this limited warranty. Please refer to the applicable parts and accessories limited warranty text.

2. LIMITATIONS OF LIABILITY

JURISDICTIONS TO THE EXTENT PERMITTED BY LAW. THIS WARRANTY IS EXPRESSLY GIVEN AND ACCEPTED IN LIEU OF ANY AND ALL OTHER WARRANTIES, EXPRESSED OR IMPLIED, INCLUDING WITHOUT LIMITATION ANY WARRANTY OF MERCHANTABILITY OR FITNESS FOR A PARTICULAR PURPOSE. TO THE EXTENT THAT THEY CANNOT BE DISCLAIMED, THE IMPLIED WARRANTIES ARE LIMITED IN DURATION TO THE LIFE OF THE EXPRESS WARRANTY. ALL INCIDENTAL, CONSEQUENTIAL, DIRECT, INDIRECT OR OTHER DAMAGES OF ANY KIND ARE EXCLUDED FROM COVERAGE UNDER THIS WARRANTY. SOME JURISDICTIONS DO NOT ALLOW FOR THE DISCLAIMERS, LIMITATIONS OF INCIDENTAL OR CONSEQUENTIAL DAMAGES OR OTHER EXCLUSIONS IDENTIFIED ABOVE. AS A RESULT, THEY MAY NOT APPLY TO YOU. THIS WARRANTY GIVES YOU SPECIFIC RIGHTS, AND YOU MAY ALSO HAVE OTHER LEGAL RIGHTS WHICH MAY VARY FROM COUNTRY TO COUNTRY, OR JURISDICTION TO JURISDICTION. (FOR PRODUCTS PURCHASED IN AUSTRALIA SEE CLAUSE 4 BELOW).

Neither the authorized Distributors/Dealers nor any other person has been authorized to make any affirmation, representation or warranty regarding the Product, other than those contained in this limited warranty, and if made, shall not be enforceable against BRP. BRP reserves the right to modify this warranty at any time, being understood that such modification will not alter the warranty conditions applicable to the Products sold while this warranty is in effect.

3. EXCLUSIONS — ARE NOT WARRANTED

The following are not warranted under this limited policy under any circumstances:

- Replacement of routine maintenance items such as, without limitation, oil and lubricants, filters and spark plugs.
- Normal wear and tear, such as, without limitation, wear and tear of the tires, battery, generator brushes, sealed beams and light bulbs, clutch plates and facings, drive belt, brake pads, brake linings and rotors and sprockets.
- Tune ups and adjustments including without limitation adjustments of belt, alignment and wheel balance.
- Damages related to the appearance of the Product, including without limitation scratches, dents, fading, flaking, peeling and damages to seat cover material.
- Damage caused by negligence or failure to provide proper maintenance and/or storage, as described in the *OPERATOR'S GUIDE*.
- Damage resulting from removal of parts, improper repairs, improper service or improper maintenance, modifications, alterations that are outside of the original specifications of the Product, or damage resulting from use of parts or accessories not manufactured or approved by BRP which in its reasonable judgement are either incompatible with the product or adversely affect its operation, performance or durability or resulting from repairs done by a person that is not an authorized servicing Distributor/Dealer.
- Damage resulting from the installation of parts with specifications that differ from the original Product parts, such as, without limitation, different tires, exhaust system, wheels or brakes.
- Damage resulting from abuse, abnormal use, neglect, racing or operation of the Product in a manner inconsistent with the recommendations of the *OPERATOR'S GUIDE*.
- Damage resulting from water ingestion, accident, road hazards, submersion, fire, theft, vandalism or any act of God.
- Damage resulting from operation with fuels, oils or lubricants with specifications different than as recommended in the *OPERATOR'S GUIDE*.
- Damage resulting from corrosion from road salts, battery acid, environmental influences or treatment contrary to the *OPERATOR'S GUIDE*.
- Incidental or consequential damages, including without limitation, expense for gasoline, expense for transporting the Product to and from the authorized Distributor/Dealer, mechanic's travel time, trailering or towing, storage, telephone, cell phone, fax or telegram charges, rental of a like or replacement Product during warranty services or down time, taxi, travel, lodging, loss of or damage to personal property, inconvenience, cost of insurance coverage, loan payments, loss of time, loss of income, revenue or profits, or loss of enjoyment or use of Product.

4. WARRANTY COVERAGE PERIOD

This warranty will be in effect from the date of delivery to the first retail consumer or the date the Product is first put into use, whichever occurs first and for the following periods:

1. **TWENTY-FOUR (24) CONSECUTIVE MONTHS**, for private, recreational use except for the items covered in points (3) and (4) below;

2. **TWELVE (12) CONSECUTIVE MONTHS** for commercial use, except for the items covered in points (3) and (4) below.

The Product is used commercially when it is used in connection with any work or employment that generates income, during any part of the warranty period. The Product is also used commercially when, at any point during the warranty period, it is licensed for commercial use;

3. For the battery, **SIX (6) CONSECUTIVE MONTHS**;
4. For the tires, **SIX (6) CONSECUTIVE MONTHS** or until tires are worn to the last three thirty-second of an inch (3/32 ") (2.38 millimeters) for the front tires and the last five thirty-second of an inch (5/32 ") (3.97 millimeters) for the rear tire, whichever occurs first.

The repair or replacement of parts or the performance of service under this warranty does not extend the life of this warranty beyond its original expiration date.

Note that the duration and any other modalities of the warranty coverage are subject to the applicable national or local legislation in the customer's country.

5. CONDITIONS TO HAVE WARRANTY COVERAGE

This warranty coverage is available **only** if **each** of the following conditions has been fulfilled:

- The Product must be purchased as new and unused by its first owner from a Distributor/Dealer authorized to distribute the Product in the country or union of countries in which the sale occurred;
- The BRP specified pre-delivery inspection process has been completed and documented by the purchaser and the authorized Distributor/Dealer and signed by the purchaser;
- The Product must have undergone proper warranty registration by an authorized Distributor/Dealer;
- The Product must be purchased in the country or union of countries in which the purchaser resides.
- Routine maintenance as outlined in the *OPERATOR'S GUIDE* must be performed in a timely manner. BRP reserves the right to make warranty coverage contingent upon proof of proper maintenance.

BRP will not honour this limited warranty to any private use owner or commercial use owner if one of the preceding conditions has not been met. Such limitations are necessary in order to allow BRP to preserve both the safety of its products, and also that of its consumers and the general public.

6. WHAT TO DO TO OBTAIN WARRANTY COVERAGE

The customer must cease using the Product upon the appearance of an anomaly. The customer must notify an authorized servicing Distributor/Dealer within two (2) months of the appearance of a defect, and provide it with reasonable access to the Product and reasonable opportunity to repair it. The customer must also present to the authorized Distributor/Dealer, proof of purchase of the Product and must sign the repair/work order prior to starting the repair in order to validate the

warranty repair. All parts replaced under this limited warranty become the property of BRP. Note that the notification period is subject to the applicable national or local legislation in customer's country.

7. WHAT BRP WILL DO

To the extent permitted by law, BRP's obligations under this warranty are limited to, at its sole discretion, repairing parts found defective under normal use, maintenance and service, or replacing such parts with new genuine Product parts without charge for parts and labour, at any authorized Distributor/Dealer during the warranty coverage period under the conditions described herein. BRP's responsibility is limited to making the required repairs or replacements of parts. No claim of breach of warranty shall be cause for cancellation or rescission of the sale of the Product to the owner. You may have other legal rights which may vary from country to country.

In the event that service is required outside of the country of original sale, or for EEA residents, if service is required outside of the EEA, the owner will bear responsibility for any additional charges due to local practices and conditions, such as, but not limited to, freight, insurance, taxes, license fees, import duties, and any and all other financial charges, including those levied by governments, states, territories and their respective agencies.

BRP reserves the right to improve or modify products from time to time without assuming any obligation to modify all products previously manufactured.

8. TRANSFER

If the ownership of a Product is transferred during the warranty coverage period, this limited warranty, subject to its terms and conditions, shall also be transferred and be valid for the remaining coverage period provided BRP or an authorized Distributor/Dealer receives a proof that the former owner agreed to the transfer of ownership, in addition to the coordinates of the new owner.

9. CONSUMER ASSISTANCE

In the event of a controversy or a dispute in connection with this limited warranty, BRP suggests that you try to resolve the issue at the Distributor/Dealer level. We recommend discussing the issue with the authorized Distributor/Dealer's service manager or owner.

If the matter still remains unresolved, contact BRP by filling out the customer contact form at www.brp.com or contact BRP by mail at one of the addresses listed under the *CONTACT US* section of this guide.

ADDITIONAL TERMS AND CONDITIONS FOR FRANCE ONLY

The following terms and conditions are applicable to products sold in France only:

* In the European Economic Area and elsewhere, Products are distributed and serviced by BRP European Distribution S.A. and other subsidiaries of BRP.

© 2020 Bombardier Recreational Products Inc. All rights reserved.

®™ Trademarks of Bombardier Recreational Products Inc. or its affiliates.

The seller shall deliver goods that are complying with the contract and shall be responsible for defects existing upon delivery. The seller shall also be responsible for defects resulting from packaging, assembling instructions or the installation when it is its responsibility per the contract or if accomplished under its responsibility. To be compliant with the contract, the good shall:

1. Be fit for normal use for goods similar thereto and, if applicable:
 - 1.1 Correspond to the description provided by the seller and have the qualities presented to the buyer through sample or model;
 - 1.2 Have the qualities that a buyer may legitimately expect considering the public declarations of the seller, the manufacturer or its representative, including in advertising or labeling; or
2. Have the characteristics mutually agreed upon as between the parties or be fit for the specific use intended by the buyer and brought to the attention of the seller and which accepted.

The action for failure to comply is prescribed after two years after delivery of the goods. The seller is responsible for the warranty for hidden defects of the good sold if such hidden defects are rendering the good unfit for the intended use, or if they diminish its use in such a way that the buyer would not have acquired the good or would have given a lesser price, had he known. The action for such hidden defects shall be taken by the buyer within 2 years of the discovery of the defect.

***This page is
intentionally blank***

MAINTENANCE RECORDS

Send photocopy of maintenance record to BRP if needed.

PREDELIVERY	
Serial number: _____ Mileage / km: _____ Hours: _____ Date: _____ Dealer no: _____ Notes: _____ _____	Signature/Print: _____
Refer to vehicle Pre-Delivery Bulletin for detailed installation procedures	

FIRST INSPECTION	
Mileage / km: _____ Hours: _____ Date: _____ Dealer no: _____ Notes: _____ _____	Signature/Print: _____
For maintenance schedule refer to Maintenance Information section of this operator's guide	

SERVICE	
Mileage / km: _____ Hours: _____ Date: _____ Dealer no: _____ Notes: _____ _____	Signature/Print: _____
For maintenance schedule refer to Maintenance Information section of this operator's guide	

SERVICE

Mileage / km: _____

Hours: _____

Date: _____

Dealer no: _____

Notes: _____

Signature/Print: _____

For maintenance schedule refer to Maintenance Information section of this operator's guide

SERVICE

Mileage / km: _____

Hours: _____

Date: _____

Dealer no: _____

Notes: _____

Signature/Print: _____

For maintenance schedule refer to Maintenance Information section of this operator's guide

SERVICE

Mileage / km: _____

Hours: _____

Date: _____

Dealer no: _____

Notes: _____

Signature/Print: _____

For maintenance schedule refer to Maintenance Information section of this operator's guide

SERVICE

Mileage / km:

Hours:

Date:

Dealer no:

Notes:

Signature/Print:

For maintenance schedule refer to Maintenance Information section of this operator's guide

SERVICE

Mileage / km:

Hours:

Date:

Dealer no:

Notes:

Signature/Print:

For maintenance schedule refer to Maintenance Information section of this operator's guide

CUSTOMER INFORMATION

PRIVACY INFORMATION

BRP wishes to inform you that your coordinates will be used for safety and warranty related purposes. Furthermore, BRP and its affiliates may use its customer list to distribute marketing and promotional information about BRP and related products.

To exercise your right to consult or correct your data, or to be removed from the addressee-list for direct marketing, please contact BRP.

By E-mail: privacyofficer@brp.com

By mail:

BRP
Senior Legal Counsel-Privacy Officer
726 St-Joseph
Valcourt QC
Canada,
JOE 2L0

CONTACT US

www.brp.com

Asia

Room 4609, Tower 2,
Grand Gateway 3 Hong Qiao
Road Shanghai,
China 200020

21F Shinagawa East One Tower
2-16-1 Konan, Minatoku-ku,
Tokyo 108-0075
Japan

Europe

Skaldenstraat 125
B-9042 Gent
Belgium

Itterpark 11
D-40724 Hilden
Germany

ARTEPARC Bâtiment B
Route de la côte d'Azur, Le Canet
13590 Meyreuil
France

Ingvald Ystgaardsvei 15
N-7484 Trondheim
Norway

Isoaavantie 7
PL 8040
96101 Rovaniemi

Spinnvägen 15
903 61 Umeå
Sweden

Avenue d'Ouchy 4-6
1006 Lausanne
Switzerland

North America

565 de la Montagne Street
Valcourt (Québec) J0E 2L0
Canada

Sa De Cv, Av. Ferrocarril 202
Parque Ind. Querétaro, Lote2-B
76220

Santa Rosa Jáuregui, Qro., Mexico

Sturtevant, Wisconsin, U.S.A.

10101 Science Drive
Sturtevant, Wisconsin

53177
U.S.A.

Oceania

6 Lord Street
Lakes Business Park
Botany, NSW 2019
Australia

3B Echelon Place, East Tamaki,
Auckland 2013,
New Zealand

South America

Rua James Clerck Maxwell, 230
TechnoPark Campinas SP 13069-380
Brazil

CHANGE OF ADDRESS/OWNERSHIP

If your address has changed or if you are the new owner of the vehicle, be sure to notify BRP by either:

- Notifying an authorized Can-Am On-Road dealer.
- **North America Only:** calling at 1-888-272-9222;
- Mailing one of the change of address cards on the following pages at one of the BRP addresses indicated in the *CONTACT US* section of this guide.

In case of change of ownership, please join a proof that the former owner agreed to the transfer.

Notifying BRP, even after the expiration of the limited warranty, is very important as it enables BRP to reach the vehicle owner if necessary, like when safety recalls are initiated. It is the owner's responsibility to notify BRP.

STOLEN UNITS: If your personal vehicle is stolen, you should notify BRP or an authorized Can-Am On-Road dealer. We will ask you to provide your name, address, phone number, the vehicle identification number and the date it was stolen.

***This page is
intentionally blank***

***This page is
intentionally blank***

NOTES

WARNING

This Can-Am On-road product is a different type of vehicle. It requires special skills and knowledge. Learn how this product is different.

- **BEFORE YOU OPERATE THIS VEHICLE, READ THIS OPERATOR'S GUIDE, ALL ON PRODUCT SAFETY LABELS AND WATCH THE SAFETY VIDEO.**



- **COMPLETE** a training course (if available), practice, become proficient with the controls, and get a proper license.
- **REFER** to the Safety Card before riding.
- **ALWAYS WEAR A HELMET AND RIDING GEAR.** With this type of vehicle, riders are exposed to more road risks than in a car. Even skilled operators can be struck by other vehicles or lose control. This vehicle will not protect you in a crash.
- **HANDLING LIMITS AND ROAD CONDITIONS.** The Vehicle Stability System (VSS) cannot stop you from losing control, flipping over, or falling off if you exceed this vehicle's limits. Know the limits for different road conditions. Do not ride on ice, snow, or off road. Avoid puddles and running water. This type of vehicle can hydroplane on water and slip on gravel, dirt and sand covered roads. If you must go through these road conditions, slow down.

