

2021

OWNER'S MANUAL

CMX1100A/D

rebel
1100



This manual should be considered a permanent part of the vehicle and should remain with the vehicle when it is resold.

This publication includes the latest production information available before printing. Honda Motor Co., Ltd. reserves the right to make changes at any time without notice and without incurring any obligation.

No part of this publication may be reproduced without written permission.

The vehicle pictured in this owner's manual may not match your actual vehicle.

CMX1100A/D Single seat type is USA model only.

CMX1100A/D Double seat type is Canada model only.

Welcome

Congratulations on your purchase of a new Honda vehicle. Your selection of a Honda makes you part of a worldwide family of satisfied customers who appreciate Honda's reputation for building quality into every product.

To ensure your safety and riding pleasure:

- Read this owner's manual carefully.
- Follow all recommendations and procedures contained in this manual.
- Pay close attention to safety messages contained in this manual and on the vehicle.

To protect your investment, we urge you to take responsibility for keeping your vehicle well serviced and maintained. Also, observe the break-in guidelines, and always perform the pre-ride inspection and other periodic checks in this manual.

When service is required, remember that your Honda dealer knows your vehicle best. If you have the required mechanical “know-how” and tools, you can purchase an official Honda Service Manual to help you perform many maintenance and repair tasks. ➔ P. 156

Read the warranty information thoroughly so that you understand the warranty coverage and that you are aware of your rights and responsibilities. ➔ P. 157

You may also want to visit our website at www.powersports.honda.com.

Canada www.honda.ca.

Happy riding!

A Few Words About Safety

Your safety, and the safety of others, is very important. Operating this vehicle safely is an important responsibility.

To help you make informed decisions about safety, we have provided operating procedures and other information on safety labels and in this manual. This information alerts you to potential hazards that could hurt you or others.

Of course, it is not practical or possible to warn you about all hazards associated with operating or maintaining a vehicle. You must use your own good judgment.

You will find important safety information in a variety of forms, including:

- Safety labels on the vehicle
- Safety Messages preceded by a safety alert symbol  and one of three signal words: DANGER, WARNING, or CAUTION. These signal words mean:

DANGER

You **WILL** be **KILLED** or **SERIOUSLY HURT** if you don't follow instructions.

WARNING

You **CAN** be **KILLED** or **SERIOUSLY HURT** if you don't follow instructions.

CAUTION

You **CAN** be **HURT** if you don't follow instructions.

Other important information is provided under the following titles:

NOTICE Information to help you avoid damage to your vehicle, other property, or the environment.

Contents

Vehicle Safety P. 2

Operation Guide P. 22

Maintenance P. 80

Troubleshooting P. 124

Information P. 137

Specifications P. 164

Vehicle Safety

This section contains important information for safe riding of your vehicle.
Please read this section carefully.

Safety Guidelines	P. 3
Safety Labels	P. 8
Safety Precautions	P. 10
Riding Precautions	P. 12
Accessories & Modifications	P. 17
Loading	P. 18

Safety Guidelines

Follow these guidelines to enhance your safety:

- Perform all routine and regular inspections specified in this manual.
- Stop the engine and keep sparks and flame away before filling the fuel tank.
- Do not run the engine in enclosed or partly enclosed areas. Carbon monoxide in exhaust gases is toxic and can kill you.

Always Wear a Helmet

It's a proven fact: helmets and protective apparel significantly reduce the number and severity of head and other injuries. So always wear an approved helmet and protective apparel. ➤ P. 10

Before Riding

USA model (Model not equipped with Optional Passenger Seat Kit)

Make sure that you are physically fit, mentally focused and free of alcohol and drugs. Check that you are wearing an approved helmet and protective apparel.

Canada model and USA model equipped with Optional Passenger Seat Kit

Make sure that you are physically fit, mentally focused and free of alcohol and drugs. Check that you and your passenger are both wearing an approved helmet and protective apparel. Instruct your passenger on holding onto the seat strap or your waist, leaning with you in turns, and keeping their feet on the footpegs, even when the vehicle is stopped.

Take Time to Learn & Practice

Even if you have ridden other vehicles, practice riding in a safe area to become familiar with how this vehicle works and handles, and to become accustomed to the vehicle's size and weight.

We recommend that all riders take a certified course approved by the Motorcycle Safety Foundation (MSF) or a state approved training course. New riders should start with the basic course, and even experienced riders will find the advanced course beneficial.

For information about the MSF training course nearest you, call the national toll-free number: (800) 446-9227.

USA Other riding tips can be found in the You and Your Motorcycle Riding Tips booklet that came with your vehicle.

Ride Defensively

Always pay attention to other vehicles around you, and do not assume that other drivers see you. Be prepared to stop quickly or perform an evasive maneuver.

Make Yourself Easy to See

Make yourself more visible, especially at night, by wearing bright reflective clothing, positioning yourself so other drivers can see you, signaling before turning or changing lanes, and using your horn when necessary.

Ride within Your Limits

Never ride beyond your personal abilities or faster than conditions warrant. Fatigue and inattention can impair your ability to use good judgment and ride safely.

Never Carry a passenger

USA model (Model not equipped with Optional Passenger Seat Kit)

There are no handholds, seat, or footrests to carry a passenger.

Do not carry a passenger unless you have purchased and installed the Honda Genuine Accessory Passenger Seat Kit, or equivalent parts specifically designed for this vehicle, which must include the passenger seat, seat strap, footpegs, and the mounting hardware.

Don't Drink or Use Drugs and Ride

Alcohol or drugs and riding don't mix. Even one alcoholic drink can reduce your ability to respond to changing conditions, and your reaction time gets worse with every additional drink. The same is true for drug use. Don't drink or use and ride, and don't let your friends do it either.

Keep Your Honda in Safe Condition

It's important to keep your vehicle properly maintained and in safe riding condition. Inspect your vehicle before every ride and perform all recommended maintenance. Never exceed load limits (➤ P. 18), and do not modify your vehicle or install accessories that would make your vehicle unsafe (➤ P. 17).

If You are Involved in a Crash

Personal safety is your first priority. If you or anyone else has been injured, take time to assess the severity of the injuries and whether it is safe to continue riding. Call for emergency assistance if needed. Also follow applicable laws and regulations if another person or vehicle is involved in the crash.

Safety Guidelines

If you decide to continue riding, first turn the ignition switch to the OFF position, and evaluate the condition of your vehicle. Inspect for fluid leaks, check the tightness of critical nuts and bolts, and check the handlebar, control levers, brakes, and wheels. Ride slowly and cautiously. Your vehicle may have suffered damage that is not immediately apparent. Have your vehicle thoroughly checked at a qualified service facility as soon as possible.

Emergency Shut-down Procedure for Vehicles Equipped with Dual Clutch Transmission

CMX1100D

Unlike standard motorcycles, or its manual transmission sibling, the CMX1100D with dual-clutch transmission does not have a clutch lever that would provide you with an additional means to control the engine power being transmitted to the rear wheel. Thus, in the unlikely event that you experience a stuck throttle or other unintended application of power to the rear wheel, you should shut down the engine by use of the engine stop switch (P. 46). By moving this switch to the  (Stop) position, you will immediately stop the engine but maintain all electrical system functions, including lights and indicators.

Carbon Monoxide Hazard

Exhaust contains poisonous carbon monoxide, a colorless, odorless gas. Breathing carbon monoxide can cause loss of consciousness and may lead to death.

If you run the engine in confined or even partly enclosed area, the air you breathe could contain a dangerous amount of carbon monoxide.

Never run your vehicle inside a garage or other enclosure.

WARNING

Running the engine of your vehicle while in an enclosed or even partially enclosed area can cause a rapid build-up of toxic carbon monoxide gas.

Breathing this colorless, odorless gas can quickly cause unconsciousness and lead to death.

Only run your vehicle's engine when it is located in a well ventilated area outdoors.

Safety Labels

Safety and information labels on your vehicle provide important safety information and may warn you of potential hazards that could cause

serious injury. Read these labels carefully and don't remove them.

If a label comes off or becomes hard to read, contact your dealer for a replacement.

USA model (Model not equipped with Optional Passenger Seat Kit) shown

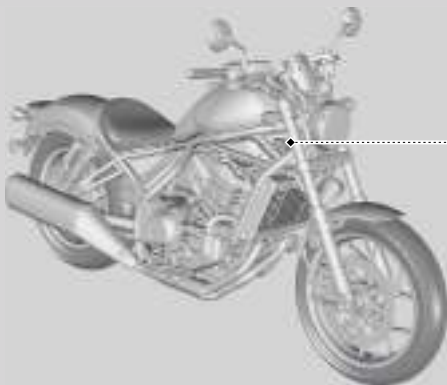

USA model (Model not equipped with Optional Passenger Seat Kit) shown

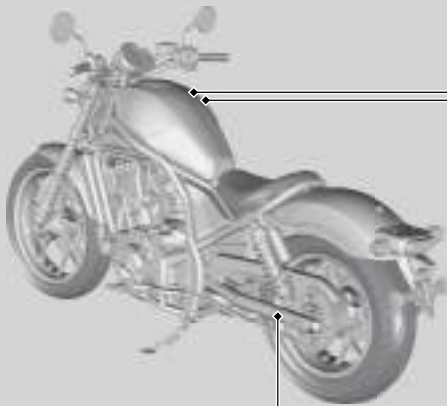

⚠ WARNING

Improper loading can cause a crash and you may be seriously hurt or killed. See "Load Limits and Guidelines" in your Owner's Manual for complete instructions.

For your protection, always wear your helmet while riding. Read the owner's manual carefully.

TIRE INFORMATION				
Cold tire pressures		kPa	kgf/cm ²	psi
Up to maximum weight capacity	Front	225	2.25	33
	Rear	225	2.25	33
Up to 90kg(200lbs) load	Front	225	2.25	33
	Rear	225	2.25	33
Tire size	Front	130/70B 18M/C 63H		
	Rear	180/65B 16M/C 81H		
Min. recommend tire center tread depth,	Front	1.5mm (0.06in.)		
	Rear	2.0mm (0.08in.)		
Maximum weight capacity	158kg(348lbs)			

DRIVE CHAIN

Keep chain adjusted and lubricated, 20 mm (3/4 in.) Freeplay

Freeplay

Read owner's manual.

Safety Precautions

- Ride cautiously and keep your hands on the handlebar and feet on the footpegs.

- **Canada model and USA model equipped with Optional Passenger Seat Kit**

Keep passenger's hands onto the seat strap or your waist, passenger's feet on the footpegs while riding.

- **USA model (Model not equipped with Optional Passenger Seat Kit)**

Always consider the safety of other drivers and riders.

- **Canada model and USA model equipped with Optional Passenger Seat Kit**

Always consider the safety of your passenger, as well as other drivers and riders.

Protective Apparel

USA model (Model not equipped with Optional Passenger Seat Kit)

Make sure that you are wearing an approved helmet, eye protection, and high-visibility protective clothing. Avoid wearing loose clothes that could get caught on any part of the vehicle. Ride defensively in response to weather and road conditions.

Canada model and USA model equipped with Optional Passenger Seat Kit

Make sure that you and any passenger are wearing an approved helmet, eye protection, and high-visibility protective clothing. Avoid wearing loose clothes that could get caught on any part of the vehicle. Ride defensively in response to weather and road conditions.

■ Helmet

Should be safety-standard certified, high-visibility, and correct size for your head

- Must fit comfortably but securely, with the chin strap fastened.
- Face shield with unobstructed field of vision or other approved eye protection

USA Look for a DOT (Department of Transportation) certification label on any helmet you buy.

WARNING

Not wearing a helmet increases the chance of serious injury or death in a crash.

USA model (Model not equipped with Optional Passenger Seat Kit)

Make sure that you always wear an approved helmet and protective apparel.

Canada model and USA model equipped with Optional Passenger Seat Kit

Make sure that you and any passenger always wear an approved helmet and protective apparel.

Riding Precautions

■ Gloves

Full-finger leather gloves with high abrasion resistance

■ Boots or Riding Shoes

Sturdy boots with non-slip soles and ankle protection

■ Jacket and Pants

Protective, highly visible, long-sleeved jacket and durable long pants for riding (or a protective suit)

Riding Precautions

Break-in Period

During the first 300 miles (500 km) of running, follow these guidelines to ensure your vehicle's future reliability and performance.

- Avoid full-throttle starts and rapid acceleration.
- Avoid hard braking and rapid down-shifts.
- Ride conservatively.

Brakes

Observe the following guidelines:

- Avoid excessively hard braking and downshifting.
 - ▶ Sudden braking can reduce the vehicle's stability.
 - ▶ Where possible, reduce speed before turning; otherwise you risk sliding out.

- Exercise caution on low traction surfaces.
 - ▶ The tires slip more easily on such surfaces and braking distances are longer.
- Avoid continuous braking.
 - ▶ Repeated braking, such as when descending long, steep slopes can seriously overheat the brakes, reducing their effectiveness. Use engine braking with intermittent use of the brakes to reduce speed.
- For full braking effectiveness, operate both the front and rear brakes together.

■ Anti-lock Brake System (ABS)

This model is equipped with an Anti-lock Brake System (ABS) designed to help prevent the brakes from locking up during hard braking.

- ABS does not reduce braking distance. In certain circumstances, ABS may result in a longer stopping distance.
- ABS does not function at speeds below 6 mph (10 km/h).
- The brake lever and pedal may recoil slightly when applying the brakes. This is normal.
- Always use the recommended front/rear tires and sprockets to ensure correct ABS operation.

■ Engine Braking

Engine braking helps slow your vehicle down when you release the throttle. For further slowing action, downshift to a lower gear. Use engine braking with intermittent use of the brakes to reduce speed when descending long, steep slopes.

■ Wet or Rainy Conditions

Road surfaces are slippery when wet, and wet brakes further reduce braking efficiency. Exercise extra caution when braking in wet conditions. If the brakes get wet, apply the brakes while riding at low speed to help them dry.

Parking

- Park on a firm, level surface.
- If you must park on a slight incline or loose surface, park so that the vehicle cannot move or fall over.
- Make sure that high-temperature parts cannot come into contact with flammable materials.
- Do not touch the engine, muffler, brakes and other high-temperature parts until they cool down.
- To reduce the likelihood of theft, always lock the handlebar and remove the key when leaving the vehicle unattended. Use of an anti-theft device is also recommended.

■ Parking with the Side Stand

1. Stop the engine.
2. Push the side stand down.
3. Slowly lean the vehicle to the left until its weight rests on the side stand.
4. Turn the handlebar fully to the left.
 - ▶ Turning the handlebar to the right reduces stability and may cause the vehicle to fall.
5. Turn the ignition switch to the OFF position and remove the key.
6. Lock the steering. ➤ P. 51

Refueling and Fuel Guidelines

Follow these guidelines to protect the engine, fuel system and catalytic converter:

- Use only unleaded gasoline.
- Use recommended octane number. Using lower octane gasoline will result in decreased engine performance.
- Do not use fuels containing a high concentration of alcohol. ➤ P. 155
- Do not use stale or contaminated gasoline or an oil/gasoline mixture.
- Avoid getting dirt or water in the fuel tank.

Honda selectable torque control

When the Honda selectable torque control (Torque Control) detects rear wheel spin during acceleration, the system will limit the amount of torque applied to the rear wheel based on the Torque Control level selected.

Additionally, the system eases the rapid motion during a wheelie when accelerating based on the Torque Control level selected.

Torque Control will allow some wheel spin during acceleration at the lower Torque Control levels settings. Select a level that is appropriate for your skill and riding conditions.

Torque Control does not work during deceleration and will not prevent the rear wheel from skidding due to engine braking. Do not close the throttle suddenly, especially when riding on slippery surfaces.

Torque Control may not compensate for rough road conditions or rapid throttle operation.

Always consider road and weather conditions, as well as your skills and condition, when applying throttle.

If your vehicle gets stuck in mud, snow or sand, it may be easier to free it by turning off the Torque Control temporarily.

Temporarily turning off Torque Control also may help you maintain control and balance when riding on off-road terrain.

Always use the recommended tires and sprockets to ensure correct Torque Control operation.

Accessories & Modifications

We strongly advise that you do not add any accessories that were not specifically designed or approved for your vehicle by Honda or make modifications to your vehicle from its original design. Doing so can make it unsafe. Modifying your vehicle may also void your warranty and make your vehicle illegal to operate on public roads. Before deciding to install accessories on your vehicle, be certain the modification is safe and legal.

WARNING

Improper accessories or modifications can cause a crash in which you can be seriously hurt or killed.

Follow all instructions in this owner's manual regarding accessories and modifications.

Do not pull a trailer with, or attach a sidecar to, your vehicle. Your vehicle was not designed for these attachments, and their use can seriously impair your vehicle's handling.

Loading

- **USA model (Model not equipped with Optional Passenger Seat Kit)**
Never carry a passenger. Your vehicle was not designed to carry a passenger.
- Carrying extra weight affects your vehicle's handling, braking and stability.
Always ride at a safe speed for the load you are carrying.
- Avoid carrying an excessive load and keep within specified load limits.
Maximum weight capacity ➤ P. 164
- Tie all luggage securely, evenly balanced and close to the center of the vehicle.
- Do not place objects near the lights or the muffler.

WARNING

USA model (Model not equipped with Optional Passenger Seat Kit)

Overloading, improper loading or carrying a passenger can cause a crash and you can be seriously hurt or killed.

Canada model and USA model equipped with Optional Passenger Seat Kit

Overloading or improper loading can cause a crash and you can be seriously hurt or killed.

Follow all load limits and other loading guidelines in this manual.

USA only

Your vehicle comes from the factory with a single seat for operator only, but ratings capacity (subject to applicable weight ratings) to also carry a passenger with the purchase and installation of the optional Honda Genuine Accessory Passenger Seat Kit, or equivalent parts specifically designed for this vehicle.

Do not carry a passenger unless a passenger seat (with seat strap) and footpegs have been securely installed on your vehicle.

⚠ WARNING

Carrying a passenger without a properly designed and installed passenger seat and footpegs can result in serious injury or death to you and/or the passenger.

Never carry a passenger without first installing a passenger seat (with seat strap) and footpegs specifically designed for this vehicle. Further, never carry more than one passenger.

Loading

USA only

The vehicle GVWR, weight ratings and tire load capacities can be found on the vehicle. Single Seat as produced.

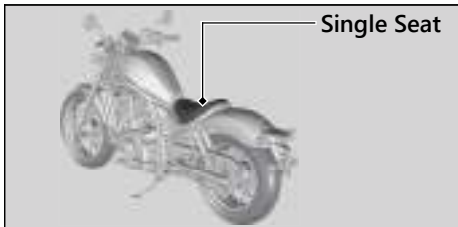

Optional Honda Genuine Accessory Passenger Seat Kit shown.

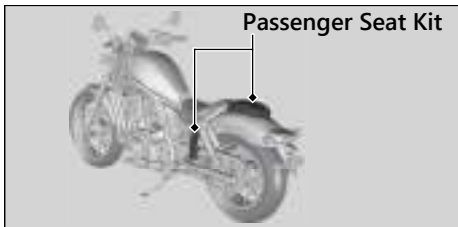

Parts Location

Canada model and USA model equipped with Optional Passenger Seat Kit

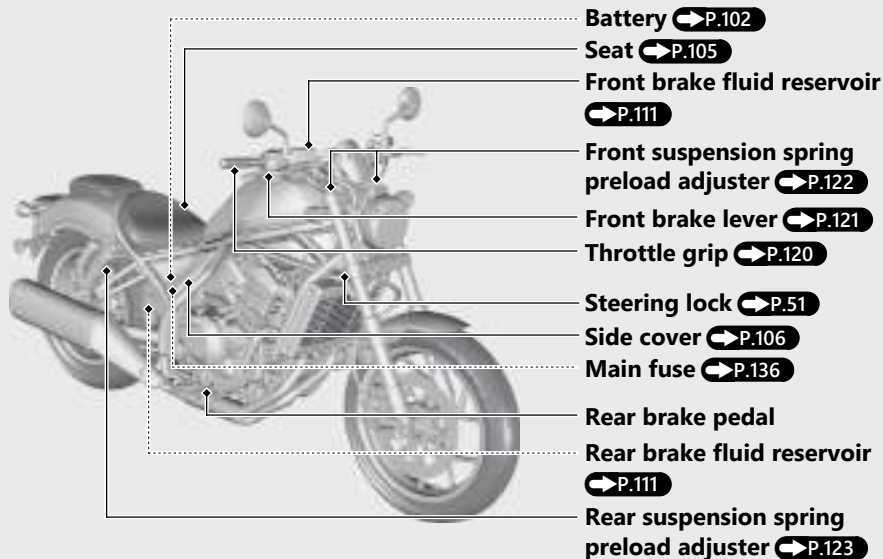

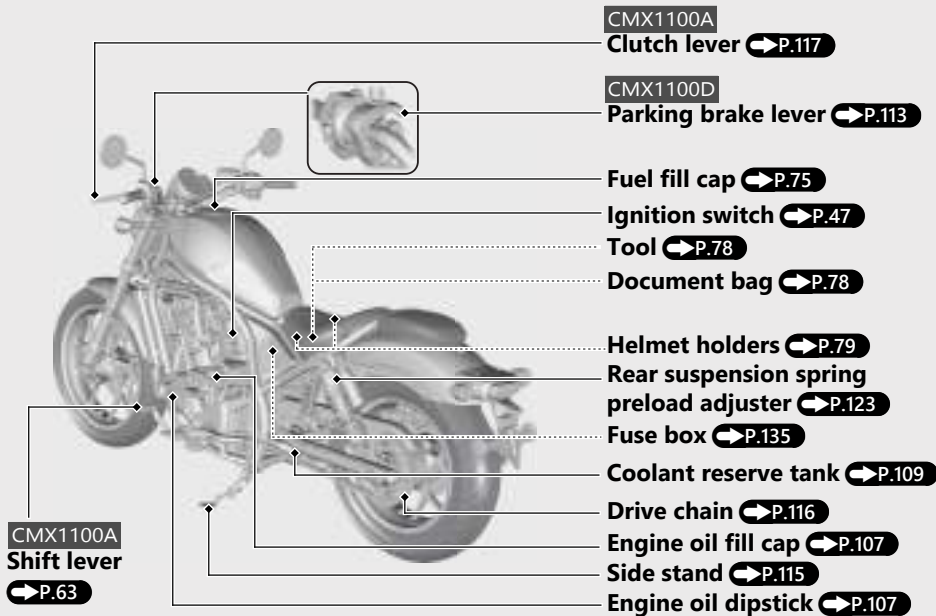

Instruments

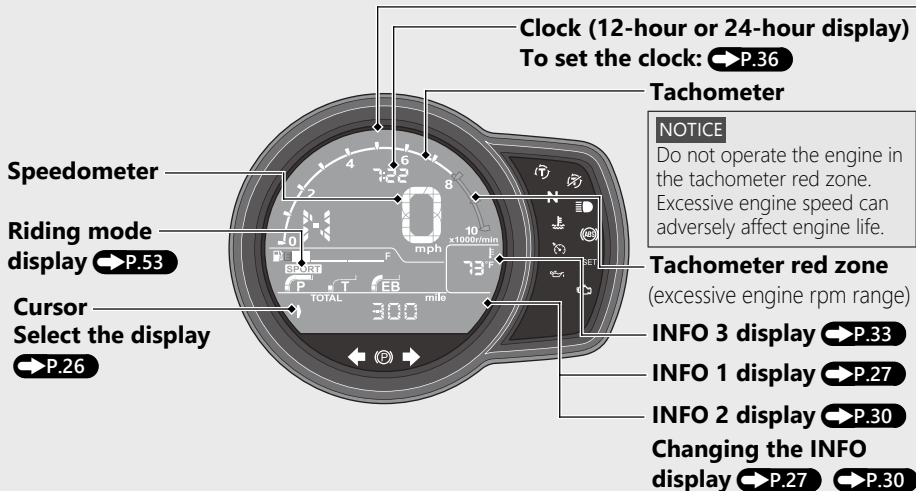

Display Check

When the ignition switch is turned to the ON position, initial animation will show. If any part of these displays does not come on when it should, have your dealer check for problems.

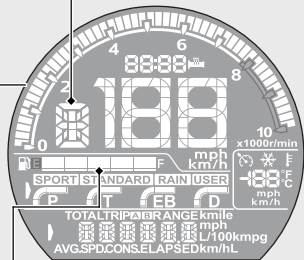

Fuel gauge

Remaining fuel when only 1st (E) segment starts flashing: approximately 1.06 US gal (4.0 L)



If the fuel gauge indicator flashes in a repeat pattern or turns off: **P.131**

Gear position indicator

CMX1100A

The gear position is shown in the gear position indicator.

- ▶ "-" appears when the transmission is not shifted properly.

CMX1100D

The gear position is shown in the gear position indicator when the MT MODE is selected. The indicator may flash if:

- ▶ The front wheel leaves the ground.
- ▶ You turn the wheel while the vehicle is upright on the stand.

This is normal. To operate the system again, turn the ignition switch to the OFF position, and then to the ON position again.

Instruments *(Continued)*

Select the display

Press the **MODE** button to move the cursor and select a display.

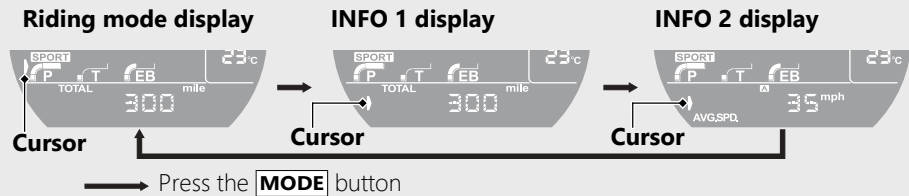

INFO 1 display

You can select the following:

- Odometer [TOTAL]
- Current fuel mileage [CONS.]
- Elapsed time [ELAPSED]
- Available driving distance [RANGE]

Changing the INFO 1 display

- 1 Select the INFO 1 display. **→ P.26**
- 2 Press the **SEL ▲** (up) or the **SEL ▼** (down) button until the desired indication is displayed.
- 3 Press the **MODE** button. The INFO 1 display is set, and then the display moves to the INFO 2 display. **→ P.30**

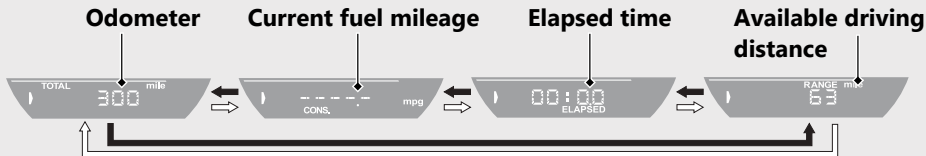

→ Press the **SEL ▲** (up) button

⇨ Press the **SEL ▼** (down) button

Instruments *(Continued)*

Odometer [TOTAL]

Total distance ridden.

When "-----" is displayed, go to your dealer for service.

Current fuel mileage [CONS.]

Displays the current instant fuel mileage.

Display range: 0.0 to 300.0 mpg (L/100km or km/L)

- When your speed is less than 3 mph (5 km/h): "---.-" is displayed.
- **When select the "mpg" or "km/L" for fuel mileage unit**

More than 300.0 mpg (km/L): "300.0" is displayed.

When select the "L/100 km" for fuel mileage unit

More than 300.0 L/100km : "---.-" is displayed.

If the calculated value is less than 0.1 L/100km: "0.0" is displayed.

When "---.-" is displayed except for the above-mentioned cases, go to your dealer for service.

Elapsed time [ELAPSED]

Displays operating time since the engine was started.

Display range: 00:00 to 99:59 (hours:minutes)

- The elapsed time return to 00:00 when the readout exceeds 99:59.

When the ignition switch is turned to the OFF position, the elapsed time is reset.

Available Driving Distance [RANGE]

Displays the estimated distance you can travel on the remaining fuel.

Display range: 999 to 3 mile (999 to 5 km)

- Above 999 mile (km): "999" is displayed.
- Initial display: "---" is displayed.
- When the available driving distance is below 3 mile (5 km) or the amount of remaining fuel is below 0.2 gal (1.0 L), "---" is displayed.

The indicated available driving distance is calculated based on driving conditions, and the indicated figure may not always be the actual allowable distance.

When "---" is displayed except for the above-mentioned cases, go to your dealer for service.

Instruments *(Continued)*

INFO 2 display

You can select the following:

- Trip A [TRIP A]
- Average fuel mileage A [AVG.CON.S. A]
- Average speed A [AVG. SPD. A]
- Trip B [TRIP B]
- Average fuel mileage B [AVG.CON.S. B]
- Average speed B [AVG. SPD. B]

Changing the INFO 2 display

- 1 Select the INFO 2 display. P.26
- 2 Press the **SEL** (up) or the **SEL** (down) button until the desired indication is displayed.
- 3 Press the **MODE** button. The INFO 2 display is set, and then the display moves to the riding mode display.

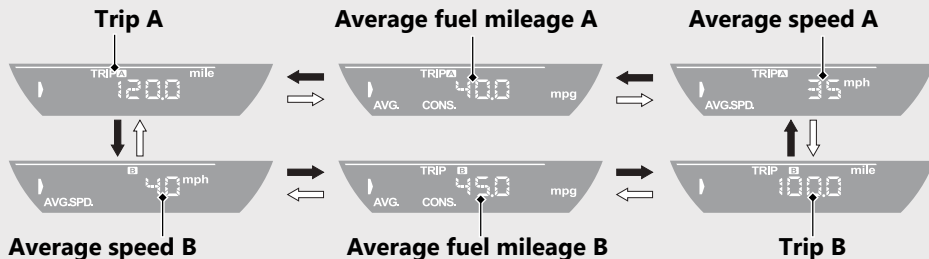

Press the **SEL** (up) button

Press the **SEL** (down) button

Tripmeter A/B [TRIP A/B]

Distance ridden since tripmeter was reset.
When "-----.-" is displayed, go to your dealer for service.

To reset the tripmeter:  **P.34**

Average speed [AVG.SPD.]

Displays the average speed since the average speed was reset.

The average speed will be calculated based on value displayed on the tripmeter (A or B) selected.

- Display range: 0 to 124 mph or 0 to 199 km/h
- When your vehicle has traveled less than 0.2 km since the engine was started: "---" is displayed.
- When your vehicle operating time is less than 16 seconds since the engine was started: "---" is displayed.

To reset the average speed:  **P.34**

Instruments *(Continued)*

Average fuel mileage [AVG.CON.S.]

Displays the average fuel mileage since the average fuel mileage was reset.

The average fuel mileage will be calculated based on value displayed on the tripmeter (A or B) selected.

Display range: 0.0 to 300.0 mpg (km/L or L/100km)

- When select the "mpg" or "km/L" for fuel mileage unit

More than 300.0 mpg (km/L): "300.0" is displayed.

When select the "L/100 km" for fuel mileage unit

More than 300.0 L/100km: "---.-" is displayed.

If the calculated value is less than 0.1 L/100km: "0.0" is displayed.

- When the average fuel mileage is reset: "---.-" is displayed.

When "---.-" is displayed except for the above-mentioned cases, go to your dealer for service.

To reset the average fuel mileage:

➡ P.34

INFO 3 display

The following items are displayed.

- Air temperature gauge
- Cruise Control Set Speed

When not using Cruise Control, air temperature gauge is displayed.

Cruise control set speed is displayed when using cruise control.

Cruise Control Set Speed

The speed set for cruise control is displayed.

To set the cruise control set speed:

➡ P.71

Air temperature gauge

Shows ambient temperature.

Display range: 14 °F to 122 °F or -10 °C to 50 °C

- Below -10 °C (14 °F): "---" is displayed
- Above 122 °F (50 °C): 122°F (50 °C) flashes

❄ Comes on when air temperature is below 3 °C (38 °F), and goes off when air temperature reaches 5 °C (41 °F) after ❄ comes on.

▶ If you use cruise control while ❄ is displayed, ❄ turns off.

Road heat and exhaust from another vehicle can affect the temperature reading when your vehicle speed is less than 19 mph (30 km/h). It may take several minutes for the display to be updated after the temperature reading has stabilized.

Instruments *(Continued)*

To reset the tripmeter A/B, average fuel mileage A/B and average speed A/B

To reset the tripmeter A, average fuel mileage A and average speed A together, press and hold the **MODE** button while the tripmeter A, average fuel mileage A or average speed A is displayed.

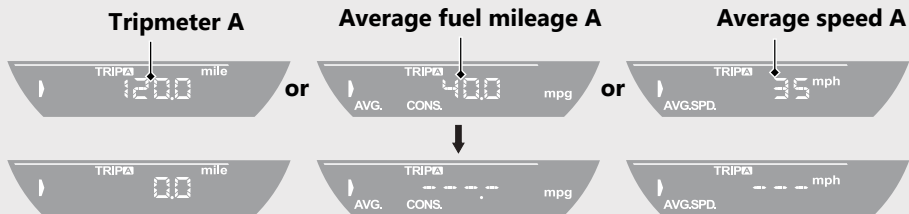

When they are reset, reset display appears at each indication. Then, the display returns to the last selected indication.

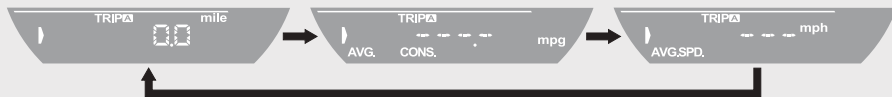

To reset the tripmeter B, average fuel mileage B and average speed B together, press and hold the **MODE** button while the tripmeter B, average fuel mileage B or average speed B is displayed.

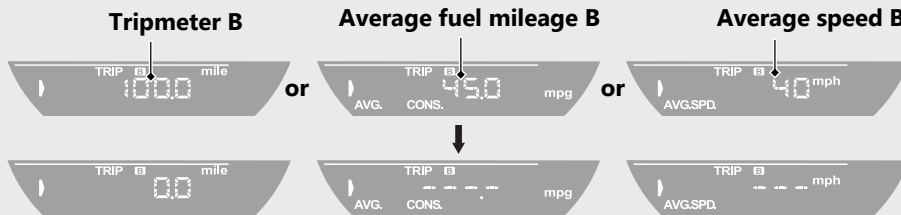

When they are reset, reset display appears at each indication. Then, the display returns to the last selected indication.



Instruments *(Continued)*

Display Setting

Following items can be changed sequentially.

- Time format setting
- Clock setting
- Backlight brightness adjustment
- TRIP A Auto reset
- Changing of speed and mileage unit
- Changing of temperature unit
- Changing of fuel mileage meter unit (only when km unit system is selected)

➡ Press and hold the **SEL**  (up) or the **SEL**  (down) button and the **MODE** button

➡ Press the **MODE** button

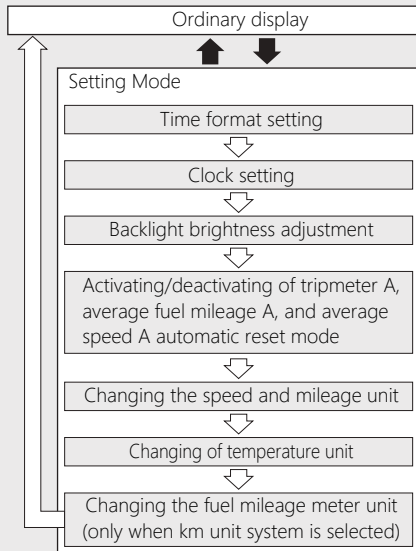

If the ignition switch is turned to the OFF position or none of the **MODE**, **SEL** ▲ (up), **SEL** ▼ (down) buttons are pressed for about 30 seconds, the control is automatically switched from the setting mode to the ordinary display.

If the button is not pressed for about 30 seconds, items in the process of being set will be discarded and only items where settings have been finalized will be applied.

Press and hold the **MODE** button and the **SEL** ▲ (up) button or the **SEL** ▼ (down) button, the display return to the ordinary display.

If the ignition switch is turned to the OFF position, or press and hold the **MODE** button and **SEL** ▲ (up) or **SEL** ▼ (down) button, items in the process of being set and those that are finalized will be applied.

1 Time format setting:

You can switch the time format between 12 hour format or 24 hour format.

- 1 Turn the ignition switch to the ON position.
- 2 Press and hold the **MODE** button and the **SEL** ▲ (up) button or the **SEL** ▼ (down) button, the current time format starts flashing.
- 3 Press the **SEL** ▲ (up) button or the **SEL** ▼ (down) button to select "12hr" or "24hr".

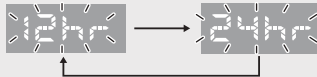

- 4 Press the **MODE** button. The time format is set, and then the display moves to the clock setting.

Instruments *(Continued)*

2 Clock setting:

- 1 Press the **SEL** ▲ (up) button or the **SEL** ▼ (down) button until the desired hour is displayed.
 - ▶ Press and hold the **SEL** ▲ (up) button or the **SEL** ▼ (down) button to advance the hour fast.



- 2 Press the **MODE** button. The minute digits start flashing.





- 3 Press the **SEL** ▲ (up) button or the **SEL** ▼ (down) button until the desired minute is displayed.
 - ▶ Press and hold the **SEL** ▲ (up) button or the **SEL** ▼ (down) button to advance the minute fast.



- 4 Press the **MODE** button. The clock is set, and then the display moves to the backlight brightness adjustment.

3 Backlight brightness adjustment:

You can adjust the brightness to one of five levels.

- 1 Press the **SEL**  (up) button or the **SEL**  (down) button. The brightness is switched.
- 2 Press the **MODE** button. The backlight is set, and then the display moves to the activating/deactivating of tripmeter A, average fuel mileage A, and average speed A automatic reset mode.

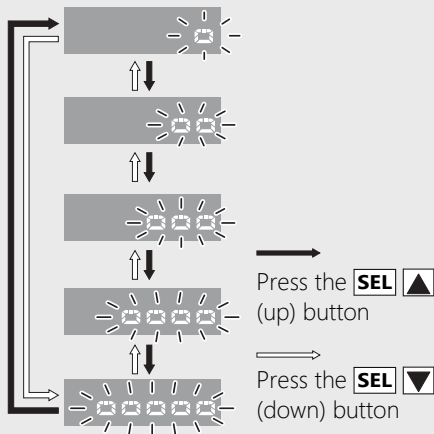



Instruments *(Continued)*

4 Activating/deactivating of tripmeter A, average fuel mileage A and average speed A automatic reset mode:

You can also activate or deactivate the automatic reset mode by increasing two or more fuel gauge segments. Activation is initially set.

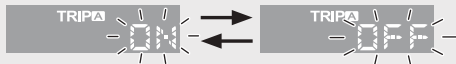

If the automatic reset mode is "ON"(activate), after refueling, tripmeter A, average fuel mileage A, and average speed A will automatically reset when your vehicle travels 0.06 mile (0.1 km) and the ignition switch is turned to the OFF position, and then to the ON position again.

- 1 Press the **SEL**  (up) button or the **SEL**  (down) button to select "On"(activate) or "OFF" (deactivate) in the automatic reset mode.



- 2 Press the **MODE** button. The activation/deactivation of automatic reset mode is set, and then the display moves to the changing of the speed and mileage unit.

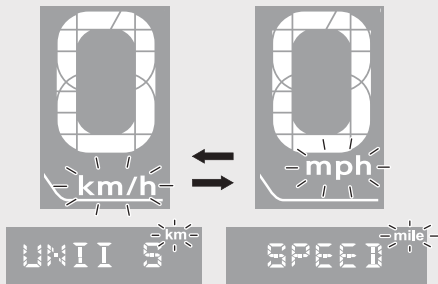

5 Changing the speed and mileage unit:

- 3 Press the **SEL**  (up) button or the **SEL**  (down) button to select either "km/h" & "km" or "mph" & "mile".



- 4 Press the **MODE** button. The speed and mileage unit is set, and then the display moves to the changing of the temperature gauge unit.

6 Changing the temperature gauge unit:

- 1 Press the **SEL**  (up) button or the **SEL**  (down) button to select "°C" (Centigrade) or "°F" (Fahrenheit).

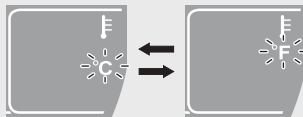

- 2 When the "km/h" for speed and "km" for mileage are selected



Press the **MODE** button. The temperature gauge unit is set, and then the display moves to the changing of the fuel mileage meter unit.

When the "mph" for speed and "mile" for mileage are selected

Press the **MODE** button. The temperature gauge unit is set, and then the display will return to the ordinary display.

Instruments *(Continued)*

7 Changing the fuel mileage meter unit:

- 1 Press the **SEL**  (up) button or the **SEL**  (down) button to select "L/100km" or "km/L".

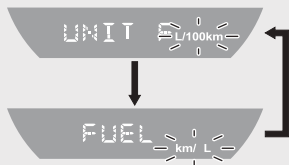

- 2 Press the **MODE** button. The fuel mileage meter unit is set, and then the display will return to the ordinary display.

Indicators

If one of these indicators does not come on when it should, have your dealer check for problems.

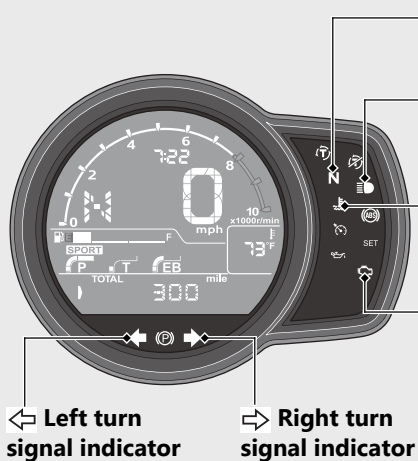

N Neutral indicator

Comes on when the transmission is in Neutral.

High beam indicator

Comes on briefly when the ignition switch is turned to the ON position

High coolant temperature indicator

Comes on briefly when the ignition switch is turned to the ON position

PGM-FI (Programmed Fuel Injection) malfunction indicator lamp (MIL)

Comes on briefly when the ignition switch is turned to the ON position with the engine stop switch in the  (Run) position.

If it comes on while engine is running:

➔ P.127

Indicators (Continued)



Parking brake indicator

CMX1100D

Lights as a reminder that you have not released the parking brake lever.

ABS (Anti-lock Brake System) indicator

Comes on when the electrical system is turned on. Goes off when your speed reaches approximately 10 km/h (6 mph).

If it comes on while riding:  **P.128**

Low oil pressure indicator

Comes on when the ignition switch is turned to the ON position. Goes off when the engine starts.

If it comes on while engine is running:

 **P.127**

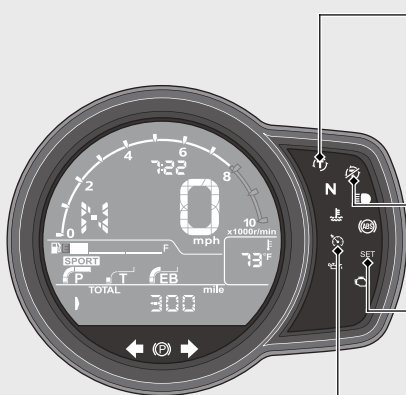

Torque Control indicator

- Comes on when the ignition switch is turned to the ON position. Goes off when your speed reaches approximately 5 km/h (3 mph) to indicate Torque Control is ready to work.
- Blinks when Torque Control is operating.

Torque Control OFF Indicator

Comes on when the Torque Control is turned Off.

SET **Cruise control set indicator**

Comes on if you have set a speed for cruise control.

Cruise control main indicator

Comes on when you press  cruise control main switch.

Cruise Control:  **P.70**

Switches

Left handlebar switch

➡ P.49

➡ P.50

Right handlebar switch ➡ P.48

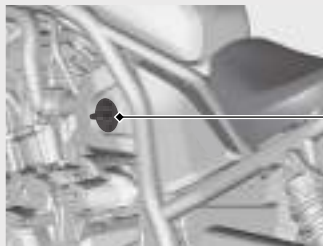

Ignition switch

Switches the electrical system on/off.

- ▶ Key can be removed when in the OFF position.

Steering Lock:  P.51

ON
Turns electrical system on for starting/riding.

SEAT
Open the seat.

OFF
Turns engine off.

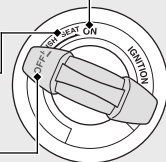

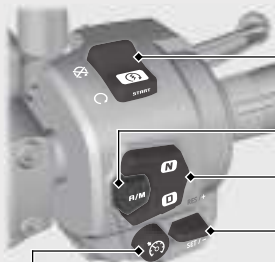

Switches *(Continued)*

Right handlebar switch



Engine stop switch/**START** button

Should normally remain in the  (Run) position.

► In an emergency, switch to the  (Stop) position to stop the engine.

A/M switch

CMX1100D

To shift between the AT MODE and MT MODE.  **P.68**

N-D switch

CMX1100D

To shift between Neutral and AT MODE.

 **P.68**

Cruise control main switch

Press to activate the cruise control system.  **P.70**

Cruise control lever

Push up or down to set the speed or adjust the set speed.

 **P.72**

Left handlebar switches



Shift up switch (+)

CMX1100D

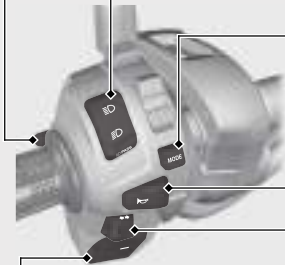
To shift up the gear.  P.69



Headlight dimmer switch/Passing switch

-  : High beam
-  : Low beam
-  **PASS** : Flashes the high beam headlight.

MODE button

Used to operate and set the display.

 P.26  P.36

Also used to set the riding mode.  P.53

Horn button

Turn signal switch

Shift down switch (-)

CMX1100D

To shift down the gear.  P.69

Switches *(Continued)*

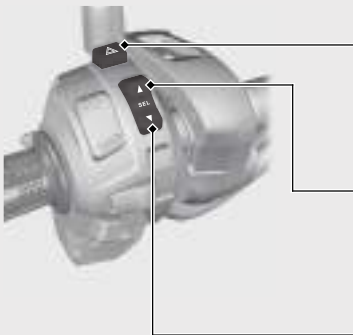

Hazard switch

Switchable when the ignition switch is turned to the ON position.

Sel up switch

Used to operate and set the display.

 **P.36**

Also used to set the riding mode.  **P.36**

Sel down switch

Used to operate and set the display.

 **P.36**

Also used to set the riding mode.  **P.53**

Steering Lock

Lock the steering when parking to help prevent theft.

A U-shaped wheel lock or similar device is also recommended.

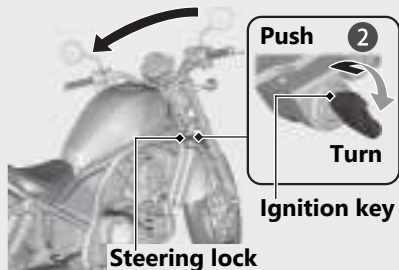

Locking

- 1 Turn the handlebar all the way to the left.
- 2 Insert the ignition key in the steering lock.
- 3 Push the ignition key down, and turn it 180 degrees clockwise.
 - ▶ Jiggle the handlebar if the lock is difficult to engage.
- 4 Remove the ignition key.

Unlocking

Insert the ignition key, push it in, and turn it 180 degrees counterclockwise.

Parking Brake

CMX1100D

Parking brake lever and Release button

Be sure the parking brake is applied while parking and warming up the engine.

- ▶ Make sure the parking brake lever is released before riding.

Parking brake lever

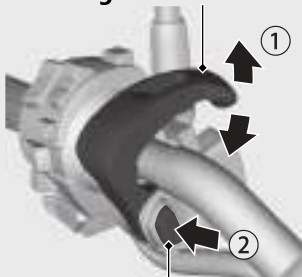

Release button

Locking

Pull the parking brake lever back to lock the rear wheel.

- ▶ Be sure the release button pops out and parking brake lever is not released.
- ▶ The parking brake lock will not function if the parking brake is not adjusted properly.

➔ P.113

Unlocking

Release the parking brake lever by lightly pulling in the lever (1) and pressing the release button (2).

- ▶ Before riding, check that the parking brake indicator is turned off and make sure that the parking brake is fully released so there is no drag on the rear wheel.

Riding mode

You can change the riding mode.
The riding mode consists of the following parameters.
The level of each parameter changes according to the selected riding mode.

P: Engine output level
EB: Engine brake level
T: Torque Control level
D: DCT level

Current riding mode

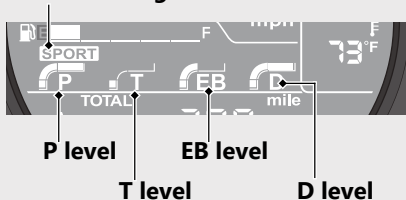

Riding mode has four modes.
Available riding mode: SPORT, STANDARD, RAIN and USER.

SPORT, STANDARD and RAIN

- ▶ **SPORT:** This mode is suitable for sports riding. You can feel the highest engine response.
- ▶ **STANDARD:** Standard, all-around mode for a variety of situations.
- ▶ **RAIN:** Good for stable riding on slippery surfaces such as rainy conditions.

















These levels cannot be changed.

USER

Each value of initial setting can be changed.

Riding mode *(Continued)*

Initial setting

	P level	T level	EB level	D level
SPORT	High 	Low 	Middle 	High 
STANDARD	Middle 	Middle 	Middle 	Middle 
RAIN	Low 	High 	Low 	Low 
USER	Middle* ¹ 	Middle* ^{1, 2} 	Middle* ¹ 	Middle* ¹ 

Notes:

*1 : Level can be changed.

*2 : If off is selected, the level will change to Middle the next time the ignition is turned on.

P level (Engine output level)

P level has three setting levels.

Available setting range: Low to High



Low



Middle



High

- ▶ High has the most power.
- ▶ Low has the least power.

T level (Torque control level)

T level has three setting levels or can be turned off.

Available setting range: Low to High, or Off



Off



Low



Middle



High

- ▶ Low is the minimum Torque Control level
- ▶ High is the maximum Torque Control level.
- ▶ Off deactivates the Torque Control.

EB level (Engine brake level)

EB level has three setting levels.

Available setting range: Low to High



Low



Middle



High

- ▶ High has the strongest engine braking effect.
- ▶ Low has the weakest engine braking effect.

D level (DCT level)

D level has three setting levels.

Available setting range: Low to High



Low



Middle



High

- ▶ Low has the lowest engine revolution.
- ▶ High has the highest engine revolution.

Riding mode *(Continued)*

Selecting the riding mode

- 1 Stop the vehicle.
- 2 Select the riding mode display. P.26
- 3 Press the **SEL ▲** (up) or **SEL ▼** (down) button with the throttle fully closed.

SEL ▲ (up) button

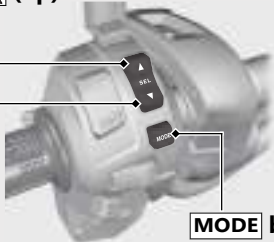

MODE button

SEL ▼ (down) button

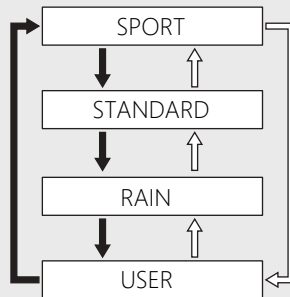

Press the **SEL ▲** (up) button

Press the **SEL ▼** (down) button

Setting the riding mode







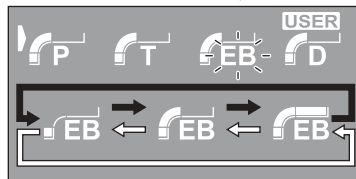
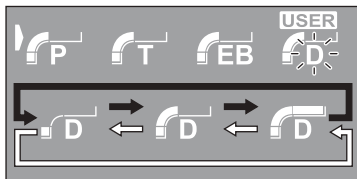
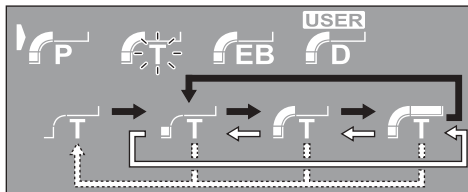
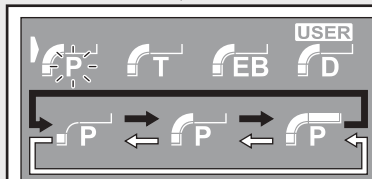

You can change the P, T, EB and D levels on the USER of the riding mode.

- 1 Stop the vehicle.
- 2 Select the USER in the riding mode .
➡ P.56
- 3 Press and hold the **MODE** button until P display is flashed.
- 4 Select the desired parameter and setting level.
 - ▶ To select the parameter, press the **MODE** button.
 - ▶ To select the setting level, press the **SEL** **▲** (up) or **▼** (down) button.
 - ▶ T level can be changed to off by pressing and holding the **SEL** **▼** (down) button while selecting the T parameter.
 - ▶ T level can be changed from Off to Low by pressing the **SEL** **▲** (up) button.

You can stop setting the riding modes at any time by pressing and holding the **MODE** button.

Riding mode *(Continued)*



-  Press and hold the **MODE** button
-  Press the **MODE** button
-  Press the **SEL**  (up) button
-  Press the **SEL**  (down) button
-  Press and hold the **SEL**  (down) button

Starting the Engine

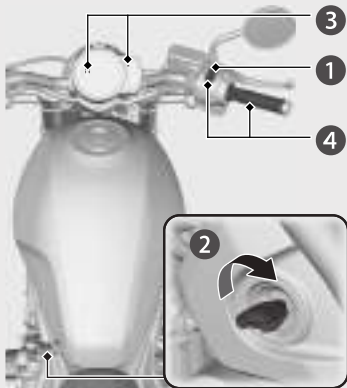

CMX1100A

Start your engine using the following procedure, regardless of whether the engine is cold or warm.



NOTICE

- If the engine does not start within 5 seconds, turn the ignition switch to the OFF position and wait 10 seconds before trying to start the engine again to recover battery voltage.
- Extended fast idling and revving the engine can damage the engine, and the exhaust system.

- 1 Make sure the engine stop switch is in the  (Run) position.
- 2 Turn the ignition switch to the ON position.
- 3 Shift the transmission to Neutral (**N** indicator comes on). Alternatively, pull in the clutch lever to start your vehicle with the transmission is in gear so long as the side stand is raised.
- 4 Press the **START**  button with the throttle completely closed.

Starting the Engine *(Continued)*

If you cannot start the engine:

With the throttle slightly open (about 1/8 in (3 mm), without freeplay), press the start button.

About 1/8 in (3 mm), without freeplay

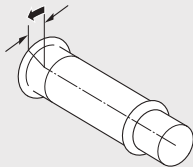

If the engine does not start:

- ① Open the throttle fully and press the **START** button for 5 seconds.
- ② Repeat the normal starting procedure.
- ③ If the engine starts, open the throttle slightly if idling is unstable.
- ④ If the engine does not start, wait 10 seconds before trying steps ① & ② again.



If Engine Will Not Start ➔ P.125

CMX1100D

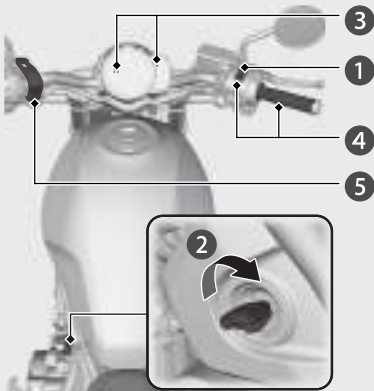
Start your engine using the following procedure, regardless of whether the engine is cold or warm.

**NOTICE**

- If the engine does not start within 5 seconds, turn the ignition switch to the OFF position and wait 10 seconds before trying to start the engine again to recover battery voltage.
- Extended fast idling and revving the engine can damage the engine, and the exhaust system.

- 1 Make sure the engine stop switch is in the  (Run) position.
- 2 Turn the ignition switch to the ON position.
- 3 Check the transmission is in Neutral (**N** indicator come on).
- 4 Press the **START**  button with the throttle completely closed.
- 5 Make sure the parking brake lever is released before riding.  **P.52**

| If Engine Does Not Start  **P.60**

Starting the Engine *(Continued)*

When you stop the engine

- ① To stop the engine, shift the transmission to Neutral (N indicator comes on).
 - ▶ If you turn the ignition switch to the OFF position when the vehicle is in gear, the engine will shut off with the clutch disengaged.
- ② Turn the ignition switch to the OFF position.
- ③ Set the parking brake when you park the vehicle. ➔ **P.52**

Shifting Gears

CMX1100A

Your vehicle transmission has 6 forward gears in a one-down, five-up shift pattern.

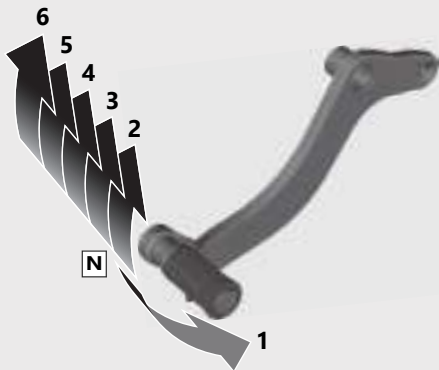

If you put the vehicle in gear with the side stand down, the engine will shut off.

Recommended Shift Points

Shifting Up

From 1st to 2nd	12 mph (20 km/h)
From 2nd to 3rd	19 mph (30 km/h)
From 3rd to 4th	25 mph (40 km/h)
From 4th to 5th	31 mph (50 km/h)
From 5th to 6th	37 mph (60 km/h)

Shifting Down

From 6th to 5th	28 mph (45 km/h)
From 5th to 4th	22 mph (35 km/h)
From 4th to 3rd	16 mph (25 km/h)

NOTICE

Improper shifting can damage the engine, transmission, and drive train. Also, coasting or towing the vehicle for long distances with the engine off can damage the transmission.

Shifting Gears *(Continued)*

CMX1100D

Your vehicle is equipped with an automatically controlled 6-speed transmission. It can be shifted automatically (by AT MODE) or manually (by MT MODE).

Recommended Shift Points

Shifting Up

From 1st to 2nd	12 mph (20 km/h)
From 2nd to 3rd	19 mph (30 km/h)
From 3rd to 4th	25 mph (40 km/h)
From 4th to 5th	31 mph (50 km/h)
From 5th to 6th	37 mph (60 km/h)

Shifting Down

From 6th to 5th	28 mph (45 km/h)
From 5th to 4th	23 mph (37 km/h)
From 4th to 3rd	20 mph (32 km/h)

NOTICE

Improper shifting can damage the engine, transmission, and drive train. Also, coasting or towing the vehicle for long distances with the engine off can damage the transmission.

Dual Clutch Transmission

CMX1100D

In order to respond to rider demands in a broad range of situations, the transmission is equipped with three operating modes, AT MODE (including D mode for regular operation); and MT MODE (MT mode for a 6-speed manual operation), which delivers the same shift feel as a manual transmission.

- ▶ Always use the recommended tires and sprockets to ensure correct Dual Clutch Transmission operation.

The Dual Clutch Transmission system runs a self check immediately after starting the engine.

"—" appears in the gear position indicator window for a few seconds, then goes out. While "—" appears, you cannot shift into gear.

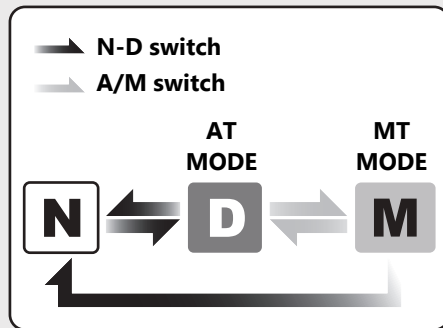

Shifting Gears *(Continued)*

Neutral (N): Neutral is selected automatically when you turn the ignition switch to the ON position.

If neutral is not selected when you turn the ignition switch to the ON position.

- ▶ Turn the ignition switch to the OFF position and then to the ON position again.
- ▶ If neutral is still not selected after turning the ignition switch to the OFF position, and then to the ON position again. ➡ **P.130**
You may hear (click) noises when the transmission shifts to Neutral (N). This is normal.

When you can change between N and D

- ▶ Vehicle is stopped and the engine is idling.
- ▶ Throttle is completely closed. It is not possible to change from Neutral to D mode while the throttle is applied.
- ▶ You cannot change between N and D mode while the wheels are rotating.
- ▶ Side stand is raised.

NOTICE

To prevent clutch damage, do not use the throttle to keep the vehicle stopped uphill.

AT MODE: In this mode the gears are shifted automatically according to your riding conditions.

And also using the shift up switch (+) or shift down switch (-), you can temporarily shift up or down. These switches are convenient when you want to temporarily down-shift in front of a curve, etc. ➡P.69

You can change the D level when you need more power in AT MODE, such as when overtaking, climbing hills, pulling away. Higher engine RPM can be used by increasing the level.

D level can be changed only when riding mode is USER.

To change the D level : ➡P.57

Riding mode : ➡P.53

D mode (AT): This is the standard mode when AT MODE is selected. Select D mode for regular operation and efficient fuel economy.

MT MODE: MT MODE (6-speed manual operation) You can choose between 6 gears in this mode.

Shifting Gears *(Continued)*

Changing between Neutral and AT MODE/MT MODE

Changing from Neutral (N) to AT MODE

Press the D on the N-D switch (①).

The D indicator comes on (②), "1" is shown in the gear position indicator and first gear is selected.

Changing from AT or MT MODE to Neutral

Press **N** on the N-D switch (③).

The D indicator goes out (④) while gear position is in the neutral.

Changing between AT MODE and MT MODE

Press the **A/M** switch (⑤).

The D indicator goes out while MT MODE is selected (⑥).

A/M switch

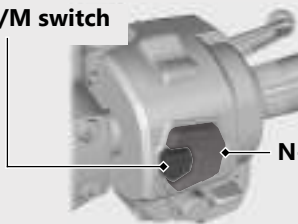

N-D switch

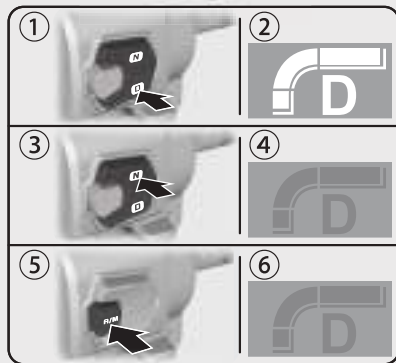

Riding in MT MODE

Shift up and down with the shift up switch (+) and shift down switch (-).

The selected gear is shown on the gear position indicator.

- ▶ If the MT MODE is selected, the transmission does not shift up automatically. Do not allow the engine revs to go into the red zone.
- ▶ The transmission automatically shifts down when you slow down, even in MT MODE.
- ▶ You will start from 1st gear even if MT MODE is selected.

Gear shift operation

Shifting Up:

Press the shift up switch (+) (7).

Shifting Down:

Press the shift down switch (-) (8).

You cannot continue shifting gear by keeping the shift switch pressed.

To continue shifting gear release the switch and press it again.



Shift Limit

You cannot downshift if the engine will exceed the rev limit.

Cruise Control

The cruise control system allows you to maintain a steady speed within a specified range.

The available speed setting range and operating gear are listed below:

CMX1100A

Available Speed setting range	30 - 100 mph (50 – 160 km/h)
Operating gear	From 4th to 6th gear

CMX1100D

Available Speed setting range	30 - 100 mph (50 – 160 km/h)
Operating gear	From 3rd to 6th gear

When cruise control is on, your speed will still vary slightly, particularly going up and down hills.



Cruise control is intended for use only on straight, uncongested highways. Do not use cruise control on city streets, winding roads, during bad weather, or at any other time when you need total control of the throttle.

WARNING

Improper use of the cruise control can lead to a crash in which you could be seriously hurt or killed.

Use the cruise control only when travelling on open highways in good weather.

To Set Cruise Control

- 1 Make sure the travelling speed and operating gear are conformed to the requirements of the system.
 - ▶ Any speed other than the available range will not be memorized.
- 2 Press the  cruise control main switch. (The  cruise control main indicator will come on.)
- 3 Accelerate to the desired speed.
- 4 Push the cruise control lever to **SET / -** side. (The cruise control set indicator will come on.)
 - ▶ Current travelling speed is memorized, and then the set speed is displayed on the INFO 3 display.

INFO 3 display

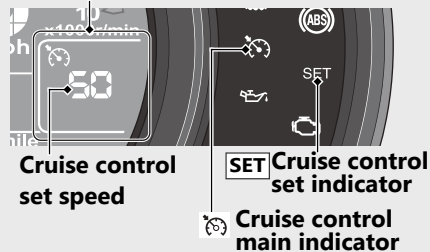

Cruise Control *(Continued)*

To Change the Set Speed

To Fine Tune the Set Speed

- 1 To increase the set speed: tap the cruise control lever to **RES / +** side.
To decrease the set speed: tap the cruise control lever to **SET / -** side.
- 2 The set speed is displayed in the INFO 3 display.

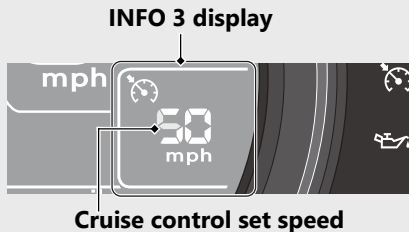

Each quick tap (brief push and release) on either side will change your speed by 1 mph or 1 km/h (depending on mileage meter set unit).

Any speed other than the possible setting range will not be indicated (stops at the upper or lower limit speed).

To Change the Set Speed Continuously

- To increase the set speed: push and hold the cruise control lever to **RES / +** side. The system will accelerate your vehicle automatically. When you reach the desired speed, release the cruise control lever.

If the cruise control lever is pushed and held to **RES / +** side continuously, the set speed indicated in the INFO 3 display stops at the upper limit of the possible setting range.

- To decrease speed: push and hold the cruise control lever to **SET / -** side. The system will automatically slow your vehicle. When you reach the desired speed, release the cruise control lever. If the cruise control lever is pushed and held to **SET / -** side continuously, the set speed indicated in the INFO 3 display stops at the lower limit of the possible setting range.

To Manually Increase the Set Speed

- 1 Use the throttle to accelerate until you reach the desired speed.
- 2 Push and release the cruise control lever to **SET / -** side.
 - ▶ Cruise control set speed is set to the travelling speed when cruise control lever is released.

To Manually Increase Vehicle Speed

- 1 Use the throttle in the normal manner to accelerate.
- 2 To return to the set speed, close the throttle and coast without applying the brakes.
 - ▶ The cruise system will maintain the speed you previously set.

To Cancel Cruise Control

To Disengage the System

- Press the cruise control main switch. (The  cruise control main indicator goes off and the set speed will be erased from memory.)

Cruise Control *(Continued)*

To Temporarily Disengage the System

- 1 Perform one of the following operations to disengage the system temporarily. (SET
Cruise control set indicator temporarily goes off but the set speed remains in memory.)
 - Apply the brake lever or pedal.
 - Rotate the throttle grip past the automatically closed position in the deceleration direction.
 - **CMX1100A**
Disengage the clutch or operate the shift lever.

- 2 To resume cruise control:
 - If you are still over 30 mph (50 km/h), push and release the cruise control lever to RES / + side.
 - If you are under 30 mph (50 km/h), use the throttle to increase road speed above 30 mph (50 km/h) and then push and release the cruise control lever to RES / + side.

Refueling

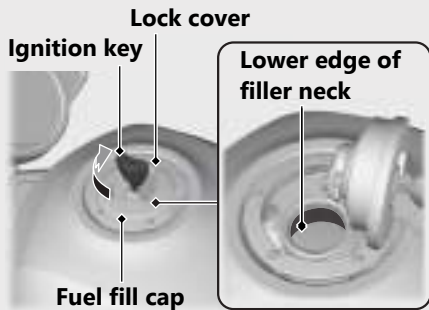

Do not fill with fuel above the lower edge of the filler neck.

Fuel type: Unleaded gasoline only

Recommended fuel octane number:

Pump Octane Number (PON) 86 or higher.

Tank capacity: 3.59 US gal (13.6 L)

Refueling and Fuel Guidelines ➔ P.15

Opening the Fuel Fill Cap

Open the lock cover, insert the ignition key, and turn it clockwise to open the fuel fill cap.

Closing the Fuel Fill Cap

- 1 After refueling, push the fuel fill cap closed until it locks.
- 2 Remove the ignition key and close the lock cover.
 - ▶ The ignition key cannot be removed if the fuel fill cap is not locked.

⚠ WARNING

Gasoline is highly flammable and explosive. You can be burned or seriously injured when handling fuel.

- Stop the engine, and keep heat, sparks, and flame away.
- Handle fuel only outdoors.
- Wipe up spills immediately.

USB Socket

Your vehicle is equipped with the USB socket (for USB Type-C only). The USB socket is located under the seat. ➡P.105

This socket are for battery charge only.

Use USB devices at your own risk.

In no event shall Honda be liable for any damage to your USB device when in use.

Only USB devices within the following specifications can be connected.

USB Type-C rated capacity :

15 W (5 V, 3.0 A)

To connect your USB device

- 1 Remove the seat. ➡P.105
- 2 Remove the cap to access the USB socket.
- 3 Connect a certified USB cable to the USB socket.
 - ▶ To prevent lost the cap, put the USB socket cover through the ring part of the cap, and then connect a certified USB cable to the USB socket.

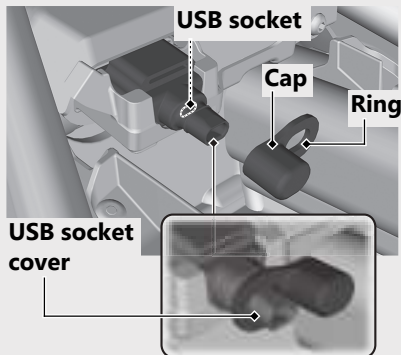

- ▶ To prevent the battery from becoming weak (or dead), keep the engine running while drawing current from the socket.
- ▶ To prevent entry of foreign matter into the socket, be sure to close the cover.
- ▶ Carefully secure all connected devices, as vibration may cause damage to them or they could shift unexpectedly.

NOTICE

- Using any heat-generating USB devices or improperly rated USB devices can damage the socket.
- Do not use the USB socket in wet conditions, when or while washing or any other wet conditions as these will damage the USB socket.
- Do not allow the USB's harness to become pinched or trapped.
- Do not allow the USB's harness to interfere with the steering or controls.

Storage Equipment

Tool/Document Bag

The tool kit and document bag are located under the seat by the rubber strap.

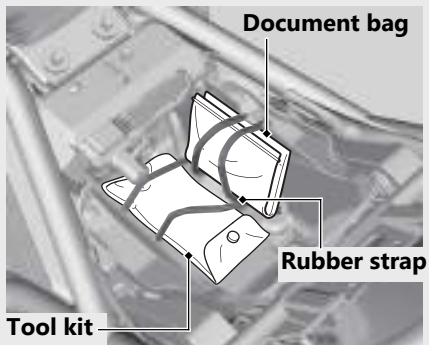

Removing the Seat  P.105

Helmet Holder

The helmet holders are located on the underside of the seat.

- ▶ Use the helmet holder only when parked.

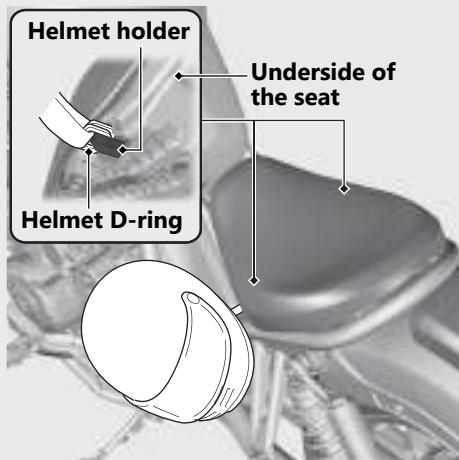

Removing the Seat P.105

WARNING

Riding with a helmet attached to the holder can interfere with your ability to safely operate the vehicle and could lead to a crash in which you can be seriously hurt or killed.

Use the helmet holder only while parked. Do not ride with a helmet secured by the holder.

Maintenance

Please read "Importance of Maintenance" and "Maintenance Fundamentals" carefully before attempting any maintenance. Refer to "Specifications" for service data.

An optional larger tool kit may be available.

Check with your Honda dealer's parts department.

Importance of Maintenance	P. 81	Drive Chain	P. 116
Maintenance Schedule	P. 83	Clutch	P. 117
Maintenance Record	P. 86	Throttle	P. 120
Maintenance Fundamentals	P. 87	Other Adjustments	P. 121
Removing & Installing Body		Adjusting the Brake Lever	P. 121
Components	P. 102	Adjusting the Front Suspension	P. 122
Battery	P. 102	Adjusting the Rear Suspension.....	P. 123
Clip.....	P. 104		
Seat.....	P. 105		
Side Cover.....	P. 106		
Engine Oil	P. 107		
Coolant	P. 109		
Brakes	P. 111		
Side Stand	P. 115		

Importance of Maintenance

Importance of Maintenance

Keeping your vehicle well-maintained is absolutely essential to your safety and to protect your investment, obtain maximum performance, avoid breakdowns, and reduce air pollution. Maintenance is the owner's responsibility. Be sure to inspect your vehicle before each ride, and perform the periodic checks specified in the Maintenance Schedule.

➔ P. 83

⚠ WARNING

Improperly maintaining your vehicle or failing to correct a problem before you ride can cause a crash in which you can be seriously hurt or killed.

Always follow the inspection and maintenance recommendations and schedules in this owner's manual.

For information about the exhaust emission and noise emission requirements of the U.S. Environmental Protection Agency (EPA), the California Air Resources Board (CARB), and the Environment and Climate Change Canada (ECCC). ➔ P. 149

USA

Maintenance, replacement or repair of the emission control devices and systems may be performed by any vehicle repair establishment or individual using parts that are "certified" to EPA standards.

Maintenance Safety

Always read the maintenance instructions before you begin each task, and make sure that you have the tools, parts, and skills required. We cannot warn you of every conceivable hazard that can arise in performing maintenance. Only you can decide whether or not you should perform a given task.

Follow these guidelines when performing maintenance.

- Stop the engine and remove the key.
- Place your vehicle on a firm, level surface using the side stand or a maintenance stand to provide support.
- Allow the engine, muffler, brakes, and other high-temperature parts to cool before servicing as you can get burned.
- Run the engine only when instructed, and do so in a well-ventilated area.

Maintenance Schedule

The maintenance schedule specifies the maintenance requirements necessary to ensure safe, dependable performance, and proper emission control.

Maintenance work should be performed in accordance with Honda's standards and specifications by properly trained and equipped technicians. Your dealer meets all of these requirements. All scheduled maintenance is considered a normal owner operating cost and will be charged to you by your dealer. Keeping an accurate maintenance record will help ensure your vehicle is properly maintained.



➤ P. 86

Make sure whoever performs the scheduled maintenance completes the maintenance record. Retain all service documents. If you sell your vehicle, these service documents should be transferred with the vehicle to the new owner.

Maintenance Schedule























































Items	Frequency*1									Regular Replace	Refer to page
	× 1,000 mi	0.6	4	8	12	16	20	24			
	× 1,000 km	1.0	6.4	12.8	19.2	25.6	32.0	38.4			
Fuel Line				I		I		I			-
Throttle Operation				I		I		I			120
Air Cleaner*2						R		R			-
Crankcase Breather*3			C	C	C	C	C	C			-
Spark Plug	Every 16,000 mi (25,600 km): I Every 32,000 mi (51,200 km): R										-
Valve Clearance						I					-
Engine Oil		R		R		R		R		1 Year	-
Engine Oil Filter		R				R					-
Clutch Oil Filter*6		R				R					-
Engine Idle Speed				I		I		I			-
Radiator Coolant*5				I		I		I		3 Years	109
Cooling System				I		I		I			-
Secondary Air Supply System						I					-
Evaporative Emission Control System*4						I					-

Maintenance Level

-  : Intermediate. We recommend service by your dealer, unless you have the necessary tools and are mechanically skilled. Procedures are provided in an official Honda Service Manual (➔ P. 156).
-  : Technical. In the interest of safety, have your vehicle serviced by your dealer.

Maintenance Legend

- I** : Inspect (clean, adjust, lubricate, or replace, if necessary)
- R** : Replace
- L** : Lubricate
- C** : Clean

Items		Frequency*1								Regular Replace	Refer to page
		× 1,000 mi	0.6	4	8	12	16	20	24		
		× 1,000 km	1.0	6.4	12.8	19.2	25.6	32.0	38.4		
Non-Emission-Related Items	Drive Chain		Every 600 mi (1,000 km): 							116	
	Brake Fluid*5									2 Years	111
	Brake Pads Wear										112
	Brake System										87
	Brake Light Switch										114
	Brake Lock Operation*6										113
	Headlight Aim										–
	Clutch System*7										117
	Side Stand										115
	Suspension										–
	Nuts, Bolts, Fasteners										–
	Wheels/Tires										98
	Steering Head Bearings										–

Notes:

*1 : At higher odometer reading, repeat at the frequency interval established here.

*2 : Service more frequently when riding in unusually wet or dusty areas.

*3 : Service more frequently when riding in rain or at full throttle.

*4 : 50 STATE (meets California).

*5 : Replacement requires mechanical skill.

*6 : CMX1100D only

*7 : CMX1100A only

Maintenance Record

Distance	Odometer	Date	Performed By:	Notes
600 miles (1,000 km)				
4,000 miles (6,400 km)				
8,000 miles (12,800 km)				
12,000 miles (19,200 km)				
16,000 miles (25,600 km)				
20,000 miles (32,000 km)				
24,000 miles (38,400 km)				
28,000 miles (44,800 km)				
32,000 miles (51,200 km)				
36,000 miles (57,600 km)				
40,000 miles (64,000 km)				
44,000 miles (70,400 km)				
48,000 miles (76,800 km)				
52,000 miles (83,200 km)				
56,000 miles (89,600 km)				
60,000 miles (96,000 km)				
64,000 miles (102,400 km)				
68,000 miles (108,800 km)				

Maintenance Fundamentals

Pre-ride Inspection

To ensure safety, it is your responsibility to perform a pre-ride inspection and make sure that any problem you find is corrected. A pre-ride inspection is a must, not only for safety, but because having a breakdown, or even a flat tire, can be a major inconvenience.

Check the following items before you get on your vehicle:

- Tire tread wear and air pressures are within limits. ➔ P. 98
- Lights, horn, and turn signals operate normally.
- Check the condition of the drive chain. Adjust slack and lubricate as needed. ➔ P. 95

USA model (Model not equipped with Optional Passenger Seat Kit)

Check the following items if you are carrying a cargo:

Canada model and USA model equipped with Optional Passenger Seat Kit

Check the following items if you are carrying a passenger or cargo:

- Combined weight is within load limits.
➔ P. 164
- Cargo is secured properly.
- Suspension is adjusted to suit load. ➔ P. 122,
➔ P. 123

Check the following items after you get on your vehicle:

- Throttle action moves smoothly without binding. ➔ P. 120
- Brake lever and pedal operate normally.
- Check the fuel level and refuel when needed. ➔ P. 15, ➔ P. 75
- Engine stop switch functions properly.
➔ P. 46

Maintenance Fundamentals

Check the following items at regular intervals:

- Oil level is between the upper and lower level marks. ➔ P. 107
- Brake fluid level is
Front: above the LOWER level mark. ➔ P. 111
Rear: between the UPPER and LOWER level marks. ➔ P. 111
- Engine coolant level is between the UPPER and LOWER level marks. ➔ P. 109
- Side stand functions properly. ➔ P. 115
- **CMX1100D**
Parking brake works properly. ➔ P. 113

Periodic Checks

You should also perform other periodic maintenance checks at least once a month regardless of how often you ride, or more often if you ride frequently.

Also, check the odometer reading against the Maintenance Schedule and perform all maintenance that is due. ➔ P. 83

Tires and wheels	Check the air pressure (➔ P. 98), examine tread for wear and damage (➔ P. 98), and check the wheels for damage.
Fluid levels	Check the engine oil level (➔ P. 107), engine coolant level (➔ P. 109), and brake fluid level (➔ P. 111).
Lights	Check that the headlight, brake light, taillight, license plate light, turn signals and position lights are working properly.
Controls	Check the freeplay of the clutch lever (CMX1100A only) (➔ P. 117), throttle grip (➔ P. 120), front brake lever (➔ P. 121), rear brake pedal and parking brake (CMX1100D only) (➔ P. 113) operate properly.
Drive chain	Check the slack (➔ P. 116), adjust the slack, and lubricate (➔ P. 96) as needed.
Fuses	Check that you have a full supply of spare fuses.
Nuts & bolts	Check the major nuts and bolts, and tighten as needed.

Replacing Parts

Always use Honda Genuine Parts or their equivalents to ensure reliability and safety. When ordering colored components, specify the model name, color, and code mentioned on the color label.

The color label is attached to the utility box under the seat. ➤ P. 105

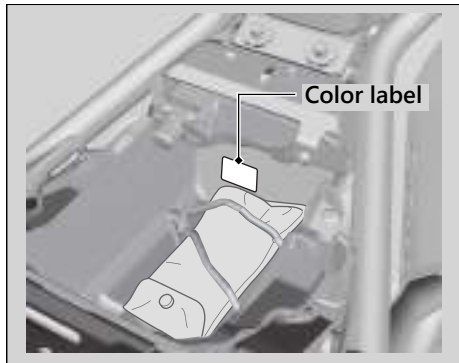

⚠️ WARNING

Installing non-Honda parts may make your vehicle unsafe and cause a crash in which you can be seriously hurt or killed.

Always use Honda Genuine Parts or equivalents that have been designed and approved for your vehicle.

Battery

Your vehicle has a maintenance-free type battery. You do not have to check the battery electrolyte level or add distilled water. Clean the battery terminals if they become dirty or corroded.

Do not remove the battery cap seals. There is no need to remove the cap when charging.

NOTICE

An improperly disposed of battery can be harmful to the environment and human health. Always confirm local regulations for proper battery disposal instruction.

What to do in an emergency

If any of the following occur, immediately see your doctor.

- Electrolyte splashes into your eyes:
 - ▶ Wash your eyes repeatedly with cool water for at least 15 minutes. Using water under pressure can damage your eyes.
- Electrolyte splashes onto your skin:
 - ▶ Remove affected clothing and wash your skin thoroughly using water.
- Electrolyte splashes into your mouth:
 - ▶ Rinse mouth thoroughly with water, and do not swallow.

⚠ WARNING

The battery gives off explosive hydrogen gas during normal operation.

A spark or flame can cause the battery to explode with enough force to kill or seriously hurt you.

Wear protective clothing and a face shield, or have a skilled mechanic do the battery servicing.

WARNING: Battery posts, terminals, and related accessories contain lead and lead compounds.

Wash your hands after handling.

| Cleaning the Battery Terminals

1. Remove the battery. ➤ P. 102
2. If the terminals are starting to corrode and are coated with a white substance, wash with warm water and wipe clean.
3. If the terminals are heavily corroded, clean and polish the terminals with a wire brush or sandpaper. Wear safety glasses.

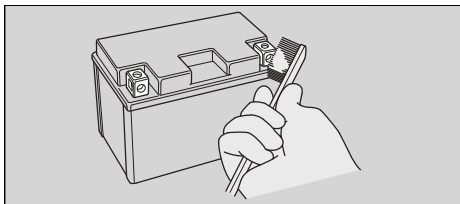

4. After cleaning, reinstall the battery.

The battery has a limited life span. Consult your dealer about when you should replace the battery. Always replace the battery with another maintenance-free battery of the same type.

| Charging

If you use electrical accessories that drain the battery or you do not ride frequently, we recommend that you charge the battery every 30 days using a charger designed specifically for your Honda, which can be purchased from your dealer. Read the information that came with your battery charger and follow the instructions on the battery. Avoid using an automobile-type battery charger, as these can overheat a motorcycle battery and cause permanent damage.

Make sure the ignition switch is in the OFF position before charging the battery.

NOTICE

Improper charging can damage the battery. If you can't charge the battery or it appears unable to hold a charge, contact your dealer.

NOTICE

Jump starting using an automobile battery can damage your vehicle's electrical system and is not recommended. Bump starting is also not recommended.

NOTICE

Installing non-Honda electrical accessories can overload the electrical system, discharging the battery and possibly damaging the system.

Fuses

Fuses protect the electrical circuits on your vehicle. If something electrical on your vehicle stops working, check for and replace any blown fuses. ➤ P. 135

Inspecting and Replacing Fuses

Turn the ignition switch to the OFF position to remove and inspect fuses. If a fuse is blown, replace with a fuse of the same rating. For fuse ratings, see "Specifications." ➤ P. 166

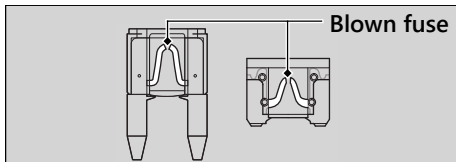
**NOTICE**

Replacing a fuse with one that has a higher rating greatly increases the chance of damage to the electrical system.

If a fuse fails repeatedly, you likely have an electrical fault. Have your vehicle inspected by your dealer.

Engine Oil

Engine oil consumption varies and oil quality deteriorates according to riding conditions and time elapsed.

Check the engine oil level regularly, and add the recommended engine oil if necessary. Dirty oil or old oil should be changed as soon as possible.

Selecting the Engine Oil

For recommended engine oil, see "Specifications." ▣ P. 165

If you use non-Honda engine oil, check the label to make sure that the oil satisfies all of the following standards:

- JASO T 903 standard^{*1}: MA
- SAE standard^{*2}: 10W-30
- API classification^{*3}: SG or higher

- ^{*1}. The JASO T 903 standard is an index for engine oils for 4-stroke motorcycle engines. There are two classes: MA and MB. For example, the following label shows the MA classification.

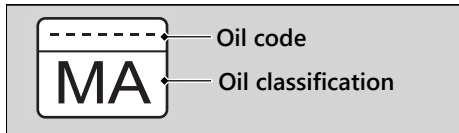

- ^{*2}. The SAE standard grades oils by their viscosity.
- ^{*3}. The API classification specifies the quality and performance rating of engine oils. Use SG or higher oils, excluding oils marked as "Energy Conserving" or "Resource Conserving" on the circular API service symbol.

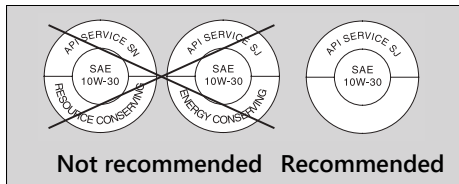

Brake Fluid

Do not add or replace brake fluid, except in an emergency. Use only fresh brake fluid from a sealed container. If you do add fluid, have the brake system serviced by your dealer as soon as possible.

NOTICE

Brake fluid can damage plastic and painted surfaces. Wipe up spills immediately and wash thoroughly.

Recommended brake fluid:

Honda DOT 4 Brake Fluid or equivalent

⚠WARNING

Clean filler cap before removing. Use only DOT 4 fluid from a sealed container.

Drive Chain

The drive chain must be inspected and lubricated regularly. Inspect the chain more frequently if you often ride on bad roads, ride at high speed, or ride with repeated fast acceleration. 📄 P. 116

If the chain does not move smoothly, makes strange noises, has damaged rollers, has loose pins, has missing O-rings, or kinks, have the chain inspected by your dealer.

Also inspect the drive sprocket and driven sprocket. If either has worn or damaged teeth, have the sprocket replaced by your dealer.



**Normal
(GOOD)**



**Worn
(REPLACE)**



**Damaged
(REPLACE)**

NOTICE

Use of a new chain with worn sprockets will cause rapid chain wear.

Cleaning and Lubricating

After inspecting the slack, clean the chain and sprockets while rotating the rear wheel. Use a dry cloth with chain cleaner designed specifically for O-ring chains, or neutral detergent. Use a soft brush if the chain is dirty. After cleaning, wipe dry and lubricate with the recommended lubricant.

Recommended lubricant:

Pro Honda HP Chain Lube or equivalent

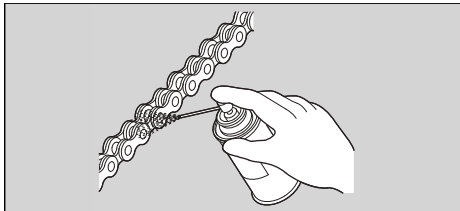

Do not use a steam cleaner, a high pressure cleaner, a wire brush, volatile solvent such as gasoline and benzene, abrasive cleaner, chain cleaner or lubricant NOT designed specifically for O-ring chains as these can damage the rubber O-ring seals.

Avoid getting lubricant on the brakes or tires. Avoid applying excess chain lubricant to prevent spray onto your clothes and the vehicle.

Recommended Coolant

Pro Honda HP Coolant is a pre-mixed solution of antifreeze and distilled water.

Concentration:

50% antifreeze and 50% distilled water

A concentration of antifreeze below 40% will not provide proper corrosion and cold temperature protection.

A concentration of up to 60% will provide better protection in colder climates.

NOTICE

Using coolant not specified for aluminum engines or tap/mineral water can cause corrosion.

Crankcase Breather

Service more frequently when riding in rain, at full throttle, or after the vehicle is washed or overturned. Service if the deposit level can be seen in the transparent section of the drain tube.

If the drain tube overflows, the air filter may become contaminated with engine oil causing poor engine performance.

Tires (Inspecting/Replacing)

Checking the Air Pressure

Visually inspect your tires and use an air pressure gauge to measure the air pressure at least once a month or any time you think the tires look low. Always check air pressure when your tires are cold.

Even if the direction of the valve stem is changed, do not return it to the original position. Have your vehicle inspected by your dealer.

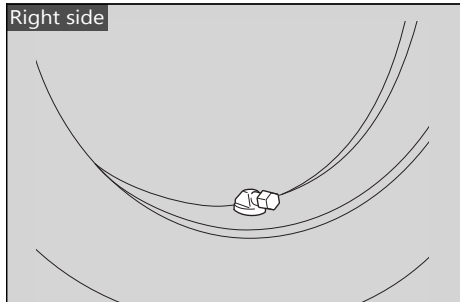

Inspecting for Damage

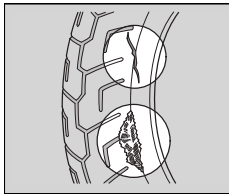

Inspect the tires for cuts, slits, or cracks that exposes fabric or cords, or nails or other foreign objects embedded in the side of the tire or the tread.

Also inspect for any unusual bumps or bulges in the side walls of the tires.

Inspecting for Abnormal Wear

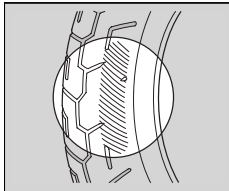

Inspect the tires for signs of abnormal wear on the contact surface.

Inspecting Tread Depth

Inspect the tread wear indicators. If they become visible, replace the tires immediately. For safe riding, you should replace the tires when the minimum tread depth is reached.

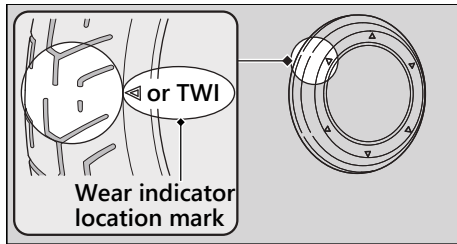

⚠ WARNING

Riding on tires that are excessively worn or improperly inflated can cause a crash in which you can be seriously hurt or killed.

Follow all instructions in this owner's manual regarding tire inflation and maintenance.

Maintenance Fundamentals

Have your tires replaced by your dealer. For recommended tires, air pressure and minimum tread depth, see "Specifications."

➤ P. 165

Follow these guidelines whenever you replace tires.

- Use the recommended tires or equivalents of the same size, construction, speed rating, and load range.
- Have the wheel balanced with Honda Genuine balance weights or equivalent after the tire is installed.
- Do not install a tube inside a tubeless tire on this vehicle. Excessive heat build-up can cause the tube to burst.
- Use only tubeless tires on this vehicle. The rims are designed for tubeless tires, and during hard acceleration or braking, a tube-type tire could slip on the rim and cause the tire to rapidly deflate.

WARNING

Installing improper tires on your vehicle can adversely affect handling and stability, and can cause a crash in which you can be seriously hurt or killed.

Always use the size and type of tires recommended in this owner's manual.

Tire Service Life

The service life of your tires is dependent on many factors, including, but not limited to, riding habits, road conditions, vehicle loading, tire air pressure, maintenance history, speed, and environmental conditions (even when the tires are not in use).

In addition to your regular inspections and maintenance, it is recommended that you have annual inspections performed once the tires reach 5 years old. It is also recommended that all tires be removed from service after 10 years from the date of manufacture, regardless of their condition or state of wear.

The last four digits of the TIN (tire identification number) indicate the date of manufacture.

Tire Identification Number (TIN)

The tire identification number (TIN) is a group of numbers and letters located on the sidewall of the tire.

① ② ③

DOT XXXX XXXX 22 09

DOT: This indicates that the tire meets all requirements of the U.S. Department of Transportation.

- ① XXXX: Factory code
- ② XXXX: Tire type code
- ③ 22 09: Date of manufacture (week & year).
Example: week 22 in year 09.

Tire Labeling Example

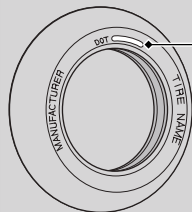

Tire identification number (TIN)

Battery

Removal

Make sure the ignition switch is in the OFF position.

1. Remove the left and right side covers.
➤ P. 106
2. Remove the utility box by removing the screws.

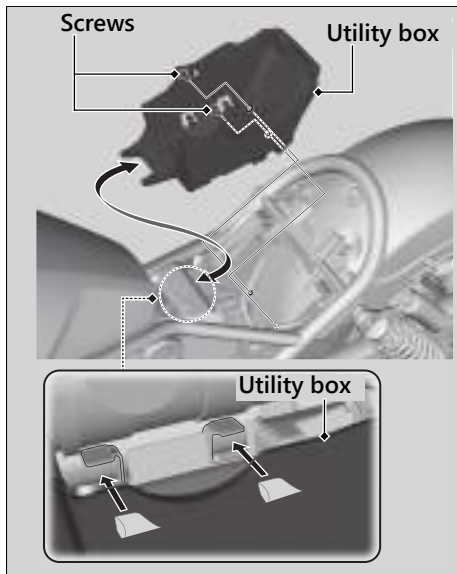

3. Disconnect the negative \ominus terminal from the battery.

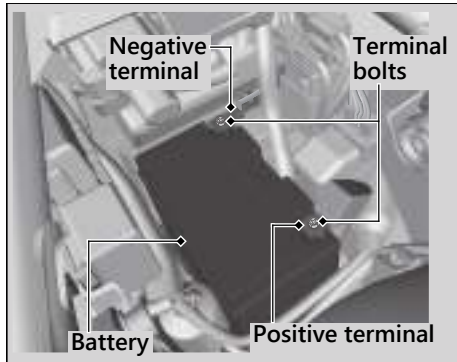

4. Disconnect the positive \oplus terminal from the battery.
5. Remove the battery taking care not to drop the terminal nuts.
 - Temporarily tighten the terminal bolt to the terminal nut when removing the battery.

Installation

Install the parts in the reverse order of removal. Always connect the positive \oplus terminal first. Make sure that bolts and nuts are tight.

Make sure the clock information is correct after the battery is reconnected. ➤ P. 36
 For proper handling of the battery, see "Maintenance Fundamentals." ➤ P. 90
 "Battery Goes Dead." ➤ P. 134

Clip

Removal

1. Remove the pin by a Phillips screwdriver.
2. Pull the clip out of the hole.

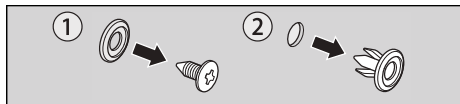

Installation

1. Insert the clip into the hole.
2. Push the pin in.

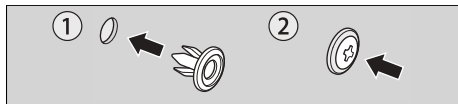

Seat

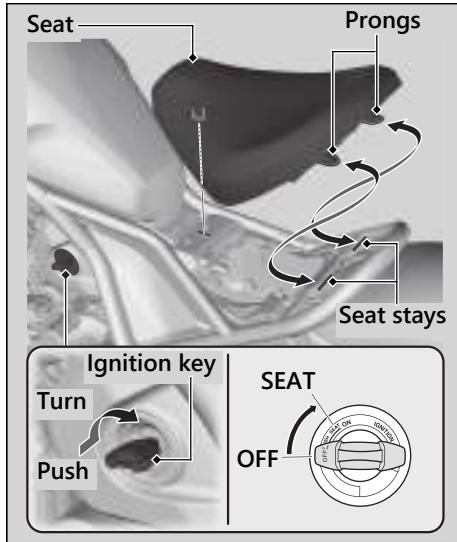

Removal

1. Push the ignition key down, and turn the ignition switch to the SEAT position.
2. Pull the seat up and forward.

Installation

1. Put the prongs under the seat stays.
2. Push the front of the seat backward and lower until it locks.

Make sure that the seat is locked securely in position by pulling it up lightly.

The seat locks automatically when closed. Take care not to lock your key in the compartment under the seat.

Side Cover

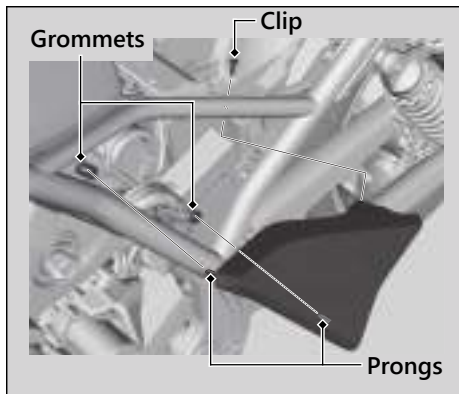

The right and left side covers can be removed in the same way.

Removal

1. Remove the seat. ► P. 105
2. Remove the clip. ► P. 104
3. Remove the prongs from the grommets.
4. Remove the side cover.

Installation

Install the parts in the reverse order of removal.

Checking the Engine Oil

1. If the engine is cold, idle the engine for 3 to 5 minutes.
2. Turn the ignition switch to the OFF position and wait for 2 to 3 minutes.
3. Place your vehicle in an upright position on a firm, level surface.
4. Remove the dipstick and wipe it clean.
5. Insert the dipstick until it seats, but don't screw it in.
6. Check that the oil level is between the upper level and lower level marks on the dipstick.
7. Securely install the dipstick.

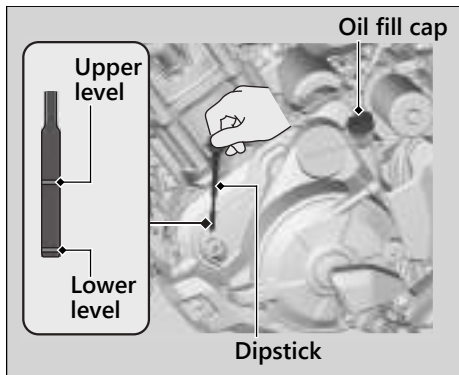

Adding Engine Oil

If the engine oil is below or near the lower level mark, add the recommended engine oil.

► P. 94, ► P. 165

1. Remove the oil fill cap. Add the recommended oil until it reaches the upper level mark.
 - Place your vehicle in an upright position on a firm, level surface when checking the oil level.
 - Do not overfill above the upper level mark.
 - Make sure no foreign objects enter the oil filler opening.
 - Wipe up any spills immediately.
2. Securely reinstall the oil fill cap.

NOTICE

Overfilling with oil or operating with insufficient oil can cause damage to your engine. Do not mix different brands and grades of oil. They may affect lubrication and clutch operation.

For the recommended oil and oil selection guidelines, see “Maintenance Fundamentals.”

► P. 94

Checking the Coolant

Check the coolant level in the reserve tank while the engine is cold.

1. Place your vehicle on a firm, level surface.
2. Hold your vehicle in an upright position.
3. Check that the coolant level is between the UPPER level and LOWER level marks on the reserve tank.

If the coolant level is dropping noticeably or the reserve tank is empty, you likely have a serious leak. Have your vehicle inspected by your dealer.

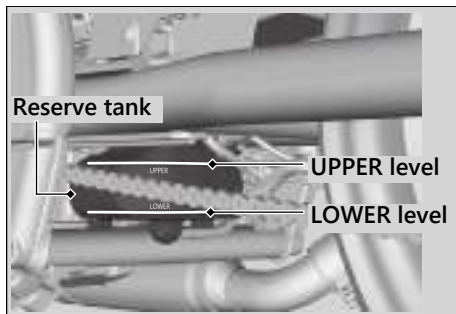

Adding Coolant

If the coolant level is below the LOWER level mark, add the recommended coolant (► P. 97) until the level reaches the UPPER level mark.

Add fluid only from the reserve tank cap and do not remove the radiator cap.

Coolant ► Adding Coolant

1. Remove the reserve tank cap and add fluid while monitoring the coolant level.
 - Do not overfill above the UPPER level mark.
 - Make sure no foreign objects enter the reserve tank opening.
2. Securely reinstall the reserve tank cap.

⚠ WARNING

Removing the radiator cap while the engine is hot can cause the coolant to spray out, potentially scalding you.

Always let the engine and radiator cool down before removing the radiator cap.

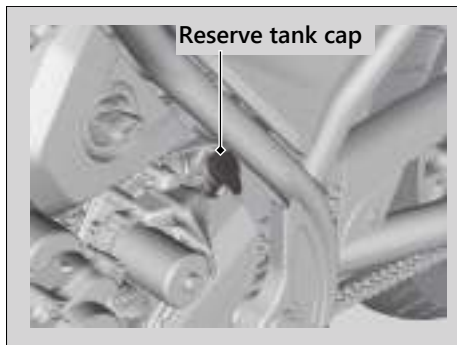

Checking Brake Fluid

1. Place your vehicle in an upright position on a firm, level surface.
2. Check that the brake fluid reservoir is horizontal and that the fluid level is:
Front above the LOWER level mark.
Rear between the LOWER level and UPPER level marks.

If the brake fluid level in either reservoir is below the LOWER level mark or the brake lever and pedal freeplay becomes excessive, inspect the brake pads for wear. If the brake pads are not worn, you most likely have a leak. Have your vehicle inspected by your dealer.

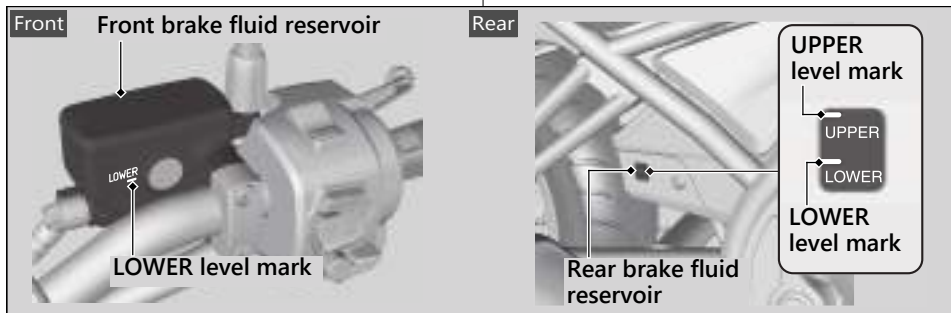

Inspecting the Brake Pads

Check the condition of the brake pad wear indicators.

Front The pads need to be replaced if a brake pad is worn to the bottom of the indicator.

Rear The pads need to be replaced if a brake pad is worn to the indicator.

1. **Front** Inspect the brake pads from below the brake caliper.
2. **Rear** Inspect the brake pads from the rear right of the vehicle.

If necessary have the pads replaced by your dealer.

Always replace both left and right brake pads at the same time.

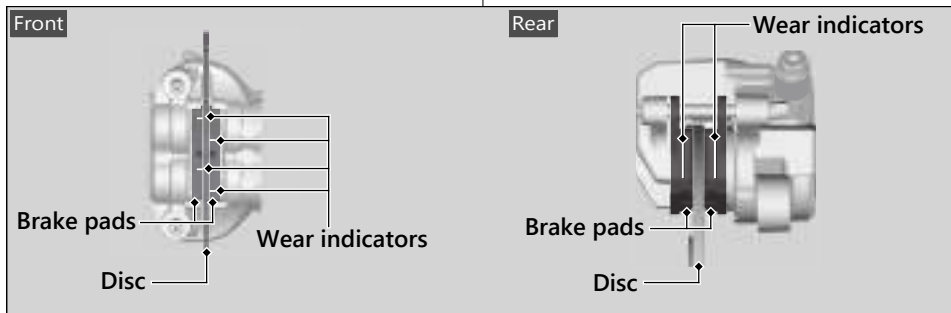

Checking the Parking Brake

CMX1100D

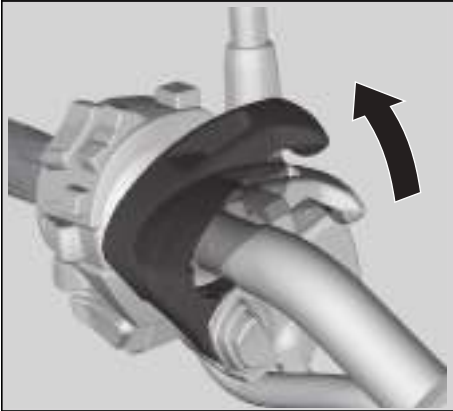

Place your vehicle on a firm, level surface. Stop the engine and push your vehicle while set the parking brake to check the efficacy of the parking brake.

If the efficacy of the parking brake becomes weak, have the brake adjusted by your dealer.

Adjusting the Brake Light Switch

Check the operation of the brake light switch. Hold the brake light switch and turn the adjusting nut in the direction A if the switch operates too late, or turn the nut in the direction B if the switch operates too soon.

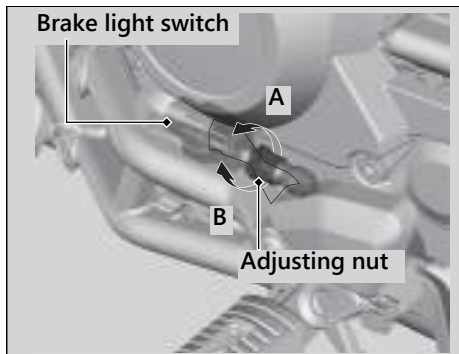

Checking the Side Stand

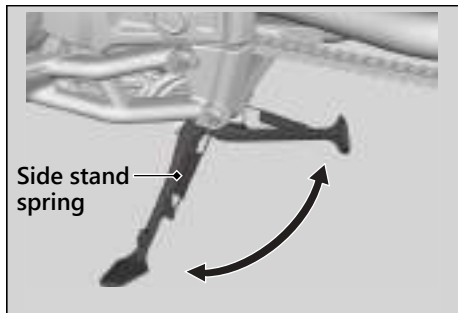

1. Check that the side stand operates smoothly. If the side stand is stiff or squeaky, clean the pivot area and lubricate the pivot bolt with clean grease.
2. Check the spring for damage or loss of tension.

3. **CMX1100A**
Sit on the vehicle, shift the transmission to Neutral, and raise the side stand.
CMX1100D
Sit on the vehicle and raise the side stand.
4. **CMX1100A**
Start the engine, pull the clutch lever in, and shift the transmission into gear.
CMX1100D
Start the engine and press the D side of N-D switch to switch the transmission into D mode.
5. Lower the side stand all the way. The engine should stop as you lower the side stand. If the engine doesn't stop, have your vehicle inspected by your dealer.

Inspecting the Drive Chain Slack

Check the drive chain slack at several points along the chain. If the slack is not constant at all points, some links may be kinked and binding.

Have the chain inspected by your dealer.

1. Shift the transmission to Neutral. Stop the engine.
2. Place your vehicle on its side stand on a firm, level surface.
3. Check the slack in the lower half of the drive chain midway between the sprockets.

Drive chain slack:

9/16 - 1 in (15 - 25 mm)

- ▶ Do not ride your vehicle if the slack exceeds 1 15/16 in (50 mm).

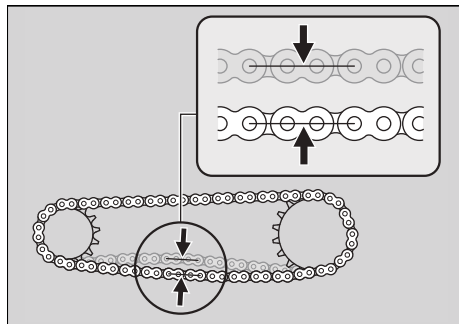

4. Roll the vehicle forward and check that the chain moves smoothly.
5. Inspect the sprockets. ➤ P. 95
6. Clean and lubricate the drive chain. ➤ P. 96

Checking the Clutch

CMX1100A

Checking the Clutch Lever Freeplay

Check the clutch lever freeplay.

Freeplay at the clutch lever:

3/8 - 13/16 in (10 - 20 mm)

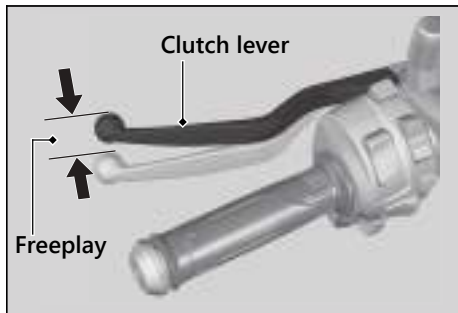

Check the clutch cable for kinks or signs of wear. If necessary have it replaced by your dealer.

Lubricate the clutch cable with a commercially available cable lubricant to prevent premature wear and corrosion.

NOTICE

Improper freeplay adjustment can cause premature clutch wear.

Adjusting the Clutch Lever Freeplay

CMX1100A

Upper Adjustment

Attempt adjustment with the upper clutch cable adjuster first.

1. Loosen the upper lock nut.
2. Turn the upper clutch cable adjuster until the freeplay is $3/8 - 13/16$ in (10 - 20 mm).
3. Tighten the upper lock nut and check the freeplay again.

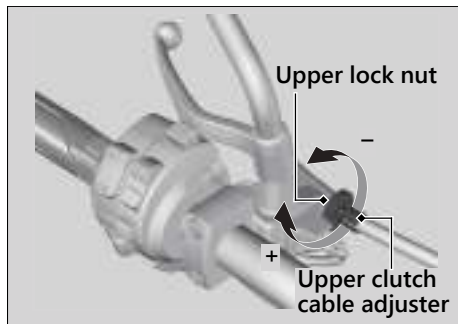

Lower Adjustment

If the upper clutch cable adjuster is threaded out near its limit, or the correct freeplay cannot be obtained, attempt adjustment with the lower clutch cable adjusting nut.

1. Loosen the upper lock nut and turn the upper clutch cable adjuster all the way in (to provide maximum freeplay). Tighten the upper lock nut.
2. Loosen the lower lock nut.
3. Turn the lower adjusting nut until the clutch lever freeplay is $\frac{3}{8}$ - $\frac{13}{16}$ in (10 - 20 mm).
4. Tighten the lower lock nut and check the clutch lever freeplay.
5. Start the engine, pull the clutch lever in, and shift into gear. Make sure the engine does not stall and the vehicle does not creep. Gradually release the clutch lever and open the throttle. Your vehicle should move smoothly and accelerate gradually.

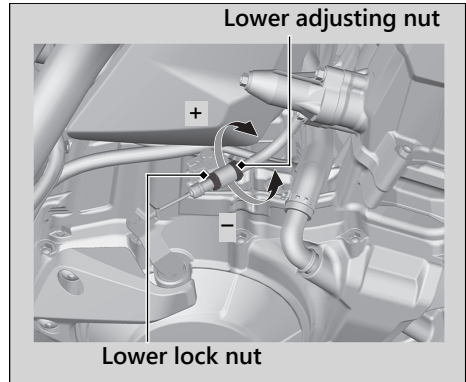

If proper adjustment cannot be obtained or the clutch does not work correctly, see your dealer.

Checking the Throttle

With the engine off, check that the throttle rotates smoothly from fully closed to fully open. If the throttle does not move smoothly, close automatically, have the vehicle inspected by your dealer.

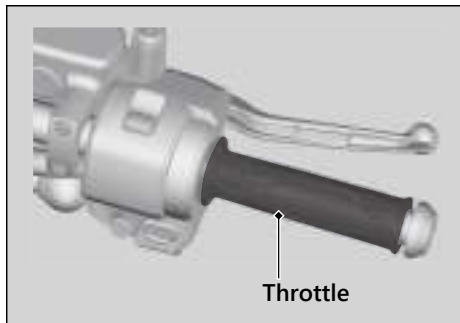

Adjusting the Brake Lever

You can adjust the distance between the tip of the brake lever and handle grip.

Adjustment method

Turn the adjuster until the numbers align with the index mark while pushing the lever forward in the desired position.

After adjustment, check that the lever operates correctly before riding.

NOTICE

Do not turn the adjuster beyond its natural limit.

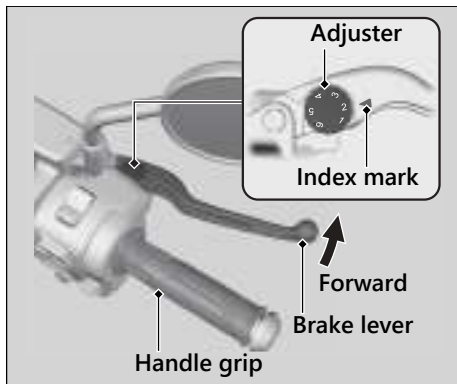

Adjusting the Front Suspension

Spring Preload

You can adjust the spring preload by the adjuster to suit the load or the road surface. Turn clockwise to increase spring preload (hard), or turn counterclockwise to decrease spring preload (soft). The standard position is $\frac{3}{8}$ in (9 mm) from the adjuster top surface to the fork bolt top surface.

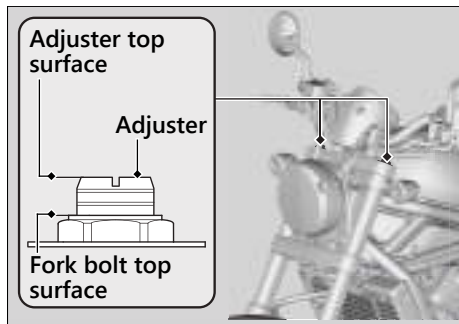

NOTICE

Do not turn the adjuster beyond its limits. Adjust both left and right forks to the same spring preload.

Adjusting the Rear Suspension

Spring Preload

You can adjust the spring preload by the adjuster to suit the load or the road surface. Turn the adjuster using the provided pin spanner.  P. 78

Turn clockwise to increase spring preload (hard), or turn counterclockwise to decrease spring preload (soft).

The standard position is 3 clicks from the minimum setting.

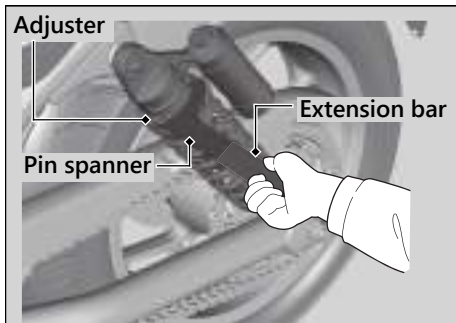

NOTICE

Do not turn the adjuster beyond its limits. Adjust both left and right shock absorbers to the same spring preload.

NOTICE

The rear shock absorber damper unit contains high pressure nitrogen gas. Do not attempt to disassemble, service, or improperly dispose of the damper. See your dealer.

Troubleshooting

Engine Will Not Start	P. 125
Overheating (High coolant temperature indicator is on)	P. 126
Warning Indicators On or Flashing	P. 127
Low Oil Pressure Indicator	P. 127
PGM-FI (Programmed Fuel Injection)	
Malfunction Indicator Lamp (MIL).....	P. 127
ABS (Anti-lock Brake System) Indicator	P. 128
Torque Control Indicator.....	P. 129
If the “-” Indicator is Blinking in the Gear Position Window While Riding	P. 130
Other Warning Indications	P. 131
Fuel Gauge Failure Indication.....	P. 131
Tire Puncture	P. 133

Electrical Trouble	P. 134
Battery Goes Dead.....	P. 134
Burned-out Light Bulb	P. 134
Blown Fuse.....	P. 135

Starter Motor Operates But Engine Does Not Start

Check the following items:

- Check the correct engine starting sequence. ➔ P. 59
- Check that there is gasoline in the fuel tank.
- Check if the PGM-FI malfunction indicator lamp (MIL) is on.
 - ▶ If the indicator lamp is on, contact your dealer as soon as possible.

Starter Motor Does Not Operate

Check the following items:

- Check the correct engine starting sequence. ➔ P. 59
- Make sure engine stop switch is in the  (Run) position. ➔ P. 46
- Check for a blown fuse. ➔ P. 135
- Check for a loose battery connection (➔ P. 102) or battery terminal corrosion (➔ P. 90).
- Check the condition of the battery.
 - ➔ P. 134

If the problem continues, have your vehicle inspected by your dealer.

Overheating (High coolant temperature indicator is on)

The engine is overheating when the following occurs:

- High coolant temperature indicator comes on.
- Acceleration becomes sluggish.
If this occurs, pull safely to the side of the road and perform the following procedure.

Extended fast idling may cause the high coolant temperature indicator to come on.

NOTICE

Continuing to ride with an overheated engine can cause serious damage to the engine.

1. Stop the engine using the ignition switch, and then turn the ignition switch to the ON position.
2. Check that the radiator fan is operating, and then turn the ignition switch to the OFF position.

If the fan is not operating:

Suspect a fault. Do not start the engine. Transport your vehicle to your dealer.

If the fan is operating:

Allow the engine to cool with the ignition switch in the OFF position.

3. After the engine has cooled, inspect the radiator hose and check if there is a leak.

➡ P. 109

If there is a leak:

Do not start the engine. Transport your vehicle to your dealer.

4. Check the coolant level in the reserve tank. ➡ P. 109
▶ Add coolant as necessary.
5. If 1-4 check normal, you may continue riding, but closely monitor the high coolant temperature indicator.

Low Oil Pressure Indicator

If the low oil pressure indicator comes on, pull safely to the side of the road and stop the engine.

NOTICE

Continuing to ride with low oil pressure can cause serious damage to the engine.

1. Check the engine oil level, and add oil as necessary. 📄 P. 107, 📄 P. 108
2. Start the engine.
 - ▶ Only continue riding if the low oil pressure indicator goes off.

Rapid acceleration may momentarily cause the low oil pressure indicator to come on, especially if the oil is at or near the low level. If the low oil pressure indicator stays on when the oil level is at the proper level, stop the engine and contact your dealer.

If the engine oil level goes down rapidly, your vehicle may have a leak or another serious problem. Have your vehicle inspected by your dealer.

PGM-FI (Programmed Fuel Injection) Malfunction Indicator Lamp (MIL)

If the indicator comes on while riding, you may have a serious problem with the PGM-FI system. Reduce speed and have your vehicle inspected by your dealer as soon as possible.

ABS (Anti-lock Brake System) Indicator

If the indicator operates in one of the following ways, you may have a serious problem with the ABS. Reduce your speed and have your vehicle inspected by your dealer as soon as possible.

- Indicator comes on or starts flashing while riding.
- Indicator does not come on when the ignition switch is in the ON position.
- Indicator does not go off at speeds above 6 mph (10 km/h).

If the ABS indicator stays on, your brakes will continue to work as a conventional system, but without the anti-locking function.

The ABS indicator may flash if you turn the rear wheel while the rear wheel is lifted off the ground. In this case, turn the ignition switch to the OFF position, and then to the ON position again. The ABS indicator will go off after your speed reaches 19 mph (30 km/h).

Torque Control Indicator

If the indicator operates in one of the following ways, you may have a serious problem with the Torque Control. Reduce your speed and have your vehicle inspected by your dealer as soon as possible.

- Indicator comes and stays on (solid) while riding.
- Indicator does not come on when the ignition switch is turned to the ON position.
- Indicator does not go off at speeds above 3 mph (5 km/h).

Even when the Torque Control indicator is on, your vehicle will have normal riding ability without Torque Control function.

- When the indicator comes on while the Torque Control is in operation, you will have to completely close the throttle to regain normal riding ability.

The Torque Control indicator may come on if you rotate the rear wheel while your vehicle is lifted off the ground. In this case, turn the ignition switch to the OFF position, and then to the ON position again. The Torque Control indicator will go off after your speed reaches 3 mph (5 km/h).

If the “-” Indicator is Blinking in the Gear Position Window While Riding

CMX1100D

If the “-” indicator is blinking while riding, you may have a serious problem with the Dual Clutch Transmission system.

Park your vehicle in a safe place and have your vehicle inspected by dealer immediately. It may be possible to ride your vehicle by following the steps below.

1. Turn the ignition switch to the OFF position.
2. Turn the ignition switch to the ON position and start the engine.

If you cannot start the engine:

Turn the ignition switch to the OFF position and move the vehicle back and forth slightly (to disengage the gears).

Turn the ignition switch to the ON position again and start the engine.

If you still cannot start the engine:

Start the engine while applying the brake lever or pressing the brake pedal.

If you can shift from N to D mode:

When a gear position is shown in the gear position indicator, you can ride in that gear. Take your vehicle to your dealer riding at a safe speed.

If you can't shift from N to D mode and the “-” indicator is blinking:

Damage is preventing you from riding. Have your vehicle inspected by your dealer immediately.

Fuel Gauge Failure Indication

If the fuel system has an error, the fuel gauge indicators will be displayed as shown in the illustrations.

If this occurs, see your dealer as soon as possible.

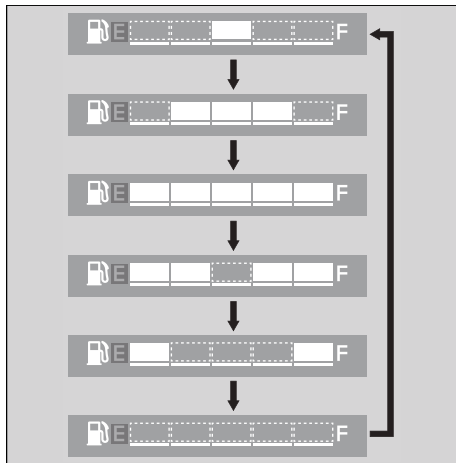
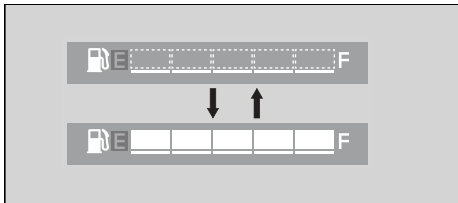

Other Warning Indications ► Fuel Gauge Failure Indication

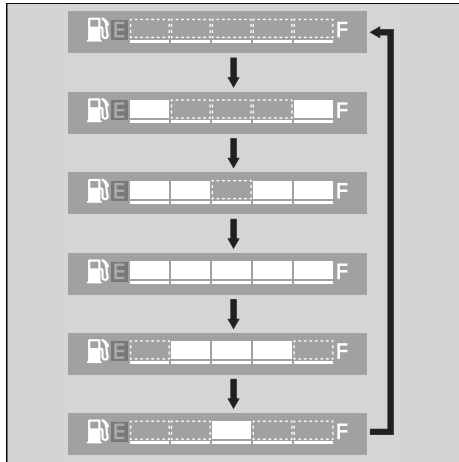

Tire Puncture

Repairing a puncture or removing a wheel requires special tools and technical expertise. We recommend you have this type of service performed by your dealer.

After an emergency repair, always have the tire inspected/replaced by your dealer.

Emergency Repair Using a Tire Repair Kit

If your tire has a minor puncture, you can make an emergency repair using a tubeless tire repair kit.

Follow the instructions provided with the emergency tire repair kit.

Riding your vehicle with a temporary tire repair is very risky. Do not exceed 30 mph (50 km/h). Have the tire replaced by your dealer as soon as possible.

WARNING

Riding your vehicle with a temporary tire repair can be risky. If the temporary repair fails, you can crash and be seriously injured or killed.

If you must ride with a temporary tire repair, ride slowly and carefully and do not exceed 30 mph (50 km/h) until the tire is replaced.

Battery Goes Dead

Charge the battery using a motorcycle battery charger.

Remove the battery from the vehicle before charging.

Do not use an automobile-type battery charger, as these can overheat a motorcycle battery and cause permanent damage. If the battery does not recover after recharging, contact your dealer.

NOTICE

Jump starting using an automobile battery can damage your vehicle's electrical system and is not recommended.

Bump starting is also not recommended.

Burned-out Light Bulb

All light bulbs on the vehicle are LEDs. If there is an LED which is not turned on, see your dealer for servicing.

Blown Fuse

Before handling fuses, see "Inspecting and Replacing Fuses." ► P. 93

Fuse Box Fuses

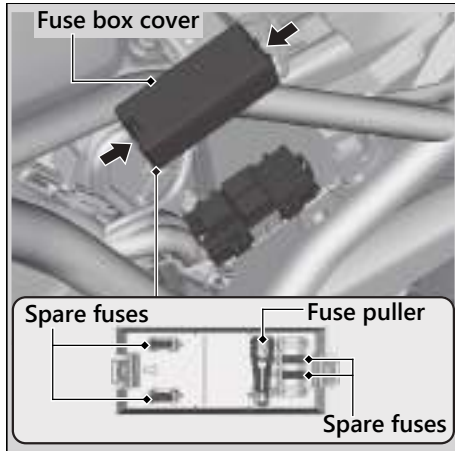

1. Remove the left side cover. ► P. 106
2. Remove the fuse box cover.
3. Pull the fuses out one by one with the fuse puller and check for a blown fuse. Always replace a blown fuse with a spare fuse of the same rating.
 - Fuse puller and spare fuses are provided on back side of the fuse box cover.
4. Reinstall parts in the reverse order of removal.

■ Main Fuse & FI Fuse

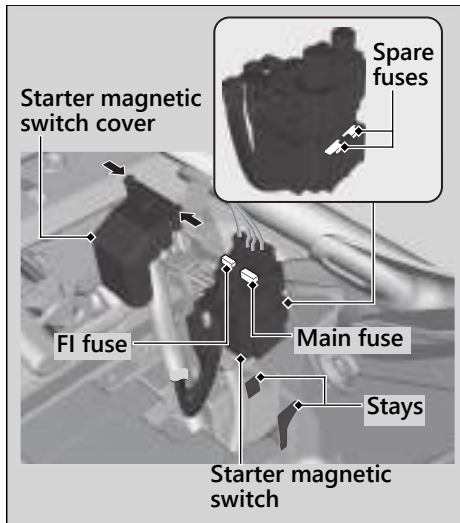

1. Remove the utility box. ► P. 102
2. Remove the starter magnetic switch cover.
3. Remove the starter magnetic switch from the stay.
4. Pull the main fuse and FI fuse out one by one with the fuse puller and check for a blown fuse. Always replace a blown fuse with a spare fuse of the same rating.
 - Spare fuses are provided in the starter magnetic switch.
 - Fuse puller is provided on back side of the fuse box cover. ► P. 135
5. Reinstall parts in the reverse order of removal.

NOTICE

If a fuse fails repeatedly, you likely have an electrical problem. Have your vehicle inspected by your dealer.

Information

Service Diagnostic Recorders.....	P. 138	Reporting Safety Defects	P. 162
Keys.....	P. 139		
Instruments, Controls, & Other Features...	P. 140		
Caring for Your Vehicle.....	P. 142		
Storing Your Vehicle.....	P. 145		
Transporting Your Vehicle	P. 146		
You & the Environment	P. 147		
Vehicle Identification Number.....	P. 148		
Emission Control Systems	P. 149		
Catalytic Converter	P. 154		
Oxygenated Fuels.....	P. 155		
Authorized Manuals	P. 156		
Warranty Coverage and Service	P. 157		
Honda Contacts.....	P. 160		

Service Diagnostic Recorders

Your vehicle is equipped with service-related devices that record information about powertrain performance and riding conditions. The data can be used to help technicians diagnose, repair and maintain the vehicle. This data may not be accessed by anyone else except as legally required or with the permission of the vehicle owner.

However this data may be accessed by Honda, its authorised dealers and authorised repairers, employees, representatives and contractors only for the purpose of the technical diagnosis, research and development of the vehicle.

Keys

Ignition Key/Steering Lock Key

This vehicle has two ignition keys and a key tag with a key number and a bar code. Store the spare key and the key tag in a safe location. To make a duplicate key, take the spare key and the key tag to your dealer or a locksmith. If you lose all ignition keys and the key tag, the ignition switch assembly will probably have to be removed by your dealer to determine the key number.

A metal key holder may cause damage to the area surrounding the ignition switch.

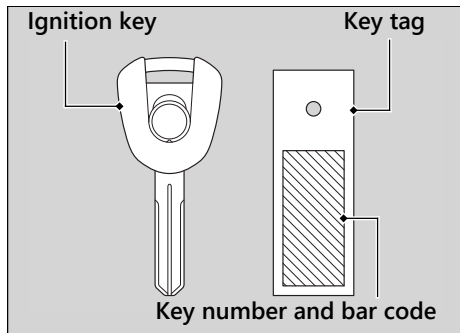

Instruments, Controls, & Other Features

Ignition Switch

Leaving the ignition switch in the ON position with the engine stopped will drain the battery.

Do not turn the key while riding.

Engine Stop Switch

Do not use the engine stop switch except in an emergency. Doing so when riding will cause the engine to suddenly turn off, making riding unsafe.

If you stop the engine using the engine stop switch, turn the ignition switch to the OFF position. Failing to do so will drain the battery.

Odometer

The display locks at 999,999 when the read-out exceeds 999,999.

Tripmeter

The tripmeters return to 0.0 when each read-out exceeds 99,999.9.

Document Bag

The owner's manual, registration, and insurance information can be stored in the plastic document bags located underside of the seat.

Ignition Cut-off System

A banking (lean angle) sensor automatically stops the engine and fuel pump if the vehicle falls over. To reset the sensor, you must turn the ignition switch to the OFF position and back to the ON position before the engine can be restarted.

Assist-slipper Clutch System

CMX1100A

The assist-slipper clutch system helps to prevent the rear tire from locking up when the deceleration of your vehicle produces a strong engine braking effect. It also makes the clutch lever operation feel lighter.

Use only MA classification engine oil for your vehicle. Using engine oil other than MA classification oil could result in damage to the assist-slipper clutch system.

Throttle by Wire System

This model is equipped with a Throttle by Wire System.

Do not put magnetized items or items susceptible to magnetic interference near the right handlebar switches.

Caring for Your Vehicle

Frequent cleaning and polishing is important to ensure the life of your Honda. A clean vehicle makes it easier to spot potential problems. In particular, seawater and salts used to prevent ice on roads promote the formation of corrosion. Always wash your vehicle thoroughly after riding on coastal or treated roads.

Washing

Allow the engine, muffler, brakes, and other high-temperature parts to cool before washing.

1. Rinse your vehicle thoroughly using a low pressure garden hose to remove loose dirt.
2. If necessary, use a sponge or a soft towel with mild cleaner to remove road grime.
 - ▶ Clean the headlight lens, panels, and other plastic components with extra care to avoid scratching them.Avoid directing water into the air cleaner, muffler, and electrical parts.

3. Thoroughly rinse your vehicle with plenty of clean water and dry with a soft, clean cloth.
4. After the vehicle dries, lubricate any moving parts.
 - ▶ Make sure that no lubricant spills onto the brakes or tires. Brake discs, pads, drum or shoes contaminated with oil will suffer greatly reduced braking effectiveness and can lead to a crash.
5. Lubricate the drive chain immediately after washing and drying the vehicle.
6. Apply a coat of wax to prevent corrosion.
 - ▶ Avoid products that contain harsh detergents or chemical solvents. These can damage the metal, paint, and plastic on your vehicle.
 - ▶ Keep the wax clear of the tires and brakes.
 - ▶ If your vehicle has any matte painted parts, do not apply a coat of wax to the matte painted surface.

Washing Precautions

Follow these guidelines when washing:

- Do not use high-pressure washers:
 - ▶ High-pressure water cleaners can damage moving parts and electrical parts, rendering them inoperable.
 - ▶ Water in the air intake can be drawn into the throttle body and/or enter the air cleaner.
 - Do not direct water at the muffler:
 - ▶ Water in the muffler can prevent starting and causes rust in the muffler.
 - Dry the brakes:
 - ▶ Water adversely affects braking effectiveness. After washing, apply the brakes intermittently at low speed to help dry them.
 - Do not direct water under the seat:
 - ▶ Water in the under seat compartment can damage your documents and other belongings.
-
- Do not direct water at the air cleaner:
 - ▶ Water in the air cleaner can prevent the engine from starting.
 - Do not direct water near the headlight:
 - ▶ The headlight's inside lens may fog temporarily after washing or while riding in the rain. This does not impact the headlight function.
However, if you see a large amount of water or ice accumulated inside the lens(es), have your vehicle inspected by your dealer.
 - Do not use wax or polishing compounds on matte painted surface:
 - ▶ Use a soft cloth or sponge, plenty of water, and a mild detergent to clean matte painted surfaces. Dry with a soft clean cloth.

Aluminum Components

Aluminum will corrode from contact with dirt, mud, or road salt. Clean aluminum parts regularly and follow these guidelines to avoid scratches:

- Do not use stiff brushes, steel wool, or cleaners containing abrasives.
- Avoid riding over or scraping against curbs.

Panels

Follow these guidelines to prevent scratches and blemishes:

- Wash gently using a soft sponge and plenty of water.
- To remove stubborn stains, use diluted detergent and rinse thoroughly with plenty of water.
- Avoid getting gasoline, brake fluid, or detergents on the instruments, panels, or headlight.

Exhaust Pipe and Muffler

When the exhaust pipe and muffler are painted, do not use a commercially available abrasive kitchen cleaning compound. Use a neutral detergent to clean the painted surface on the exhaust pipe and muffler. If you are not sure if your exhaust pipe and muffler are painted, contact your dealer.

Storing Your Vehicle

If you store your vehicle outdoors, you should consider using a full-body cover.

If you won't be riding for an extended period, follow these guidelines:

- Wash your vehicle and wax all painted surfaces (except matte painted surfaces).
Coat chrome pieces with rust-inhibiting oil.
- Lubricate the drive chain. ➤ P. 95
- Place your vehicle on a maintenance stand and position a block so that both tires are off the ground.
- After rain, remove the body cover and allow the vehicle to dry.
- Remove the battery (➤ P. 102) to prevent discharge. Fully charge the battery and then place it in a shaded, well-ventilated area.
 - ▶ If you leave the battery in place, disconnect the negative ⊖ terminal to prevent discharge.

After removing your vehicle from storage, inspect all maintenance items required by the Maintenance Schedule.

USA For more information about storage, refer to the *Honda Winter Storage Guide*, available from your dealer.

Canada For more information about storage, visit our website at www.honda.ca and look up "Storage Tips" under the "Honda Warranty" in the Warranty tab for your Model.

Transporting Your Vehicle

If your vehicle needs to be transported, it should be carried on a motorcycle trailer or a flatbed truck or trailer that has a loading ramp or lifting platform, and motorcycle tie-down straps. Never try to tow your vehicle with a wheel or wheels on the ground.

NOTICE

Towing your vehicle with a wheel or wheels on the ground can cause serious damage to the transmission.

You & the Environment

Owning and riding a vehicle can be enjoyable, but you must do your part to protect the environment.

Choose Sensible Cleaners

Use a biodegradable detergent when you wash your vehicle. Avoid aerosol spray cleaners that contain chlorofluorocarbons (CFCs) which damage the atmosphere's protective ozone layer.

Recycle Wastes

Put oil and other toxic wastes in approved containers and take them to a recycling center. Call your local or state office of public works or environmental services to find a recycling center in your area, and to get instructions on how to dispose of non-recyclable wastes. Do not place used engine oil in the trash, or pour it down a drain or on the ground. Used oil, gasoline, coolant, and cleaning solvents contain poisons that can hurt refuse workers and contaminate drinking water, lakes, rivers, and oceans.

Vehicle Identification Number

The VIN and engine serial number uniquely identify your vehicle and are required in order to register your vehicle. They may also be required when ordering replacement parts. You should record these numbers and keep them in a safe place.

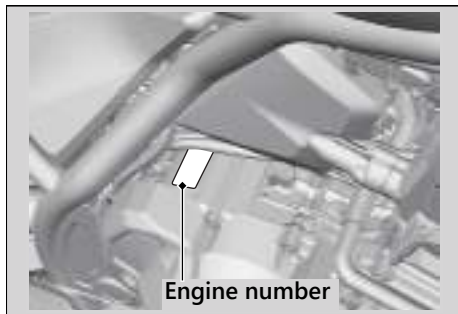
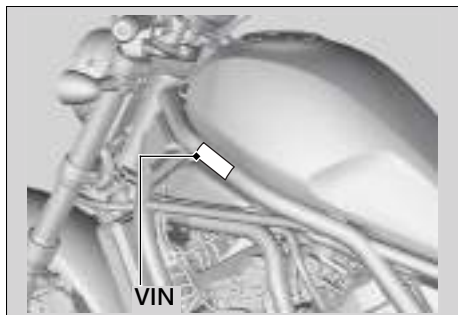
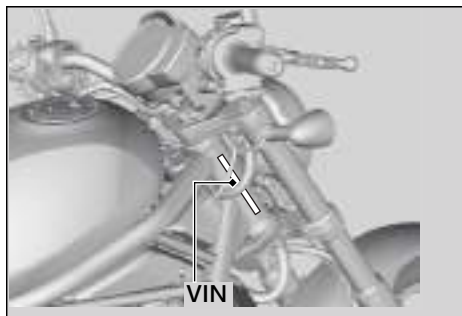

Emission Control Systems

Your vehicle engine emits combustion byproducts, including carbon monoxide (CO), oxides of nitrogen (NO_x), and hydrocarbons (HC). Gasoline evaporation also emits hydrocarbons. Controlling the production of NO_x, CO, and HC is important for the environment.

Exhaust Emission Requirements

The U.S. Environmental Protection Agency (EPA), the California Air Resources Board (CARB), and Environment and Climate Change Canada (ECCC) require that your vehicle comply with applicable exhaust, crankcase, and fuel permeation emission standards during its useful life, when operated and maintained according to the instructions provided.

CARB also requires that your vehicle comply with applicable evaporative emission requirements during its useful life, when

operated and maintained according to the instructions provided.

USA Compliance with the terms of the Distributor's Warranties for Honda Motorcycle Emission Control Systems is necessary in order to maintain a valid emissions system warranty.

The Vehicle Emission Control Information label is located on the right and left side of the swingarm.

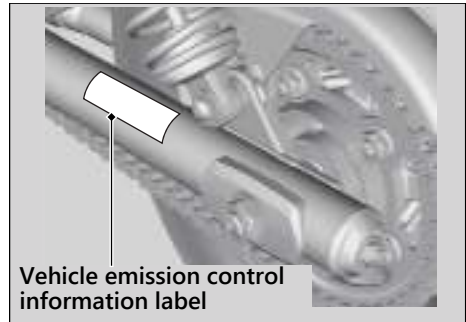



Noise Emission Requirements

The EPA requires that vehicles built after January 1, 1983 comply with applicable noise emission standards for one year or 3,730 miles (6,000 km) after the time of purchase when operated and maintained according to the instructions provided.

Exhaust Emission Control System

The exhaust emission control system includes the following components that should not need adjustment, although periodic inspection by your dealer is recommended.

PGM-FI System

The PGM-FI (programmed fuel injection) system uses sequential multiport fuel injection, and is comprised of air intake, engine control, fuel control, and exhaust control subsystems. The engine control module (ECM) uses sensors to determine how much air enters the engine, and then controls how much fuel to inject.

Ignition Timing Control System

The ignition timing control system adjusts the ignition timing to reduce the amount of HC, CO, and NO_x produced.

Secondary Air Injection System

The secondary air injection system adds filtered air into the exhaust gas to help improve emission control performance.

Catalytic Converters

The exhaust system contains one or more catalytic converters. Catalytic converters use a catalyst to convert most of the harmful exhaust gas compounds into harmless compounds.

Evaporative Emission Control System

50 STATE (meets California)

An evaporative emissions control system uses a canister filled with charcoal to adsorb fuel vapor from the fuel tank while the engine is off. The vapor is drawn into the engine and burned while riding.

Crankcase Emissions Control System

The engine is equipped with a closed crankcase system to prevent discharging crankcase emissions into the atmosphere. Blow-by gas is returned to the combustion chamber through the air cleaner housing and throttle body.

Fuel Permeation Emission Control

The fuel tank, fuel hoses, and fuel vapor charge hoses use fuel permeation control technologies to prevent fuel vapor emissions. Tampering with these components to reduce or defeat the effectiveness of the fuel permeation technologies is prohibited.

Noise Emission Control System

TAMPERING WITH THE NOISE CONTROL SYSTEM IS PROHIBITED:

U. S. federal law prohibits, and Canadian provincial laws may prohibit, the following acts or the causing thereof: (1) The removal or rendering inoperative by any person, other than for purposes of maintenance, repair or replacement, of any device or element of design incorporated into any new vehicle for the purpose of noise control prior to its sale or delivery to the ultimate purchaser or while it is in use; or (2) the use of the vehicle after such device or element of design has been removed or rendered inoperative by any person.

AMONG THOSE ACTS PRESUMED TO CONSTITUTE TAMPERING ARE THE FOLLOWING ACTS:

- Removal of, or puncturing the muffler, baffles, header pipes or any other component which conducts exhaust gases.
- Removal of, or puncturing of any part of the intake system.
- Lack of proper maintenance.
- Removing or disabling any emissions compliance component, or replacing any compliance component with a noncompliant component.

Problems Affecting Vehicle Exhaust Emissions

Have your vehicle inspected and repaired by your dealer if you experience any of the following symptoms:

- Hard starting or stalling after starting
- Rough idling
- Misfiring or backfiring during acceleration
- Poor engine performance and poor fuel economy

Catalytic Converter

This vehicle is equipped with a three-way catalytic converter. The catalytic converter contains precious metals that serve as catalysts in high temperature chemical reactions that convert hydrocarbons (HC), carbon monoxide (CO), and oxides of nitrogen (NOx) in the exhaust gasses into safe compounds.

A defective catalytic converter contributes to air pollution and can impair your engine's performance. A replacement unit must be an original Honda part or equivalent.

Follow these guidelines to protect your vehicle's catalytic converter.

- Always use unleaded gasoline. Leaded gasoline will damage the catalytic converter.
- Keep the engine in good running condition. A poorly running engine can cause the catalytic converter to overheat causing damage to the converter or the vehicle.
- If your engine is misfiring, backfiring, stalling, or otherwise not running properly, stop riding and turn off the engine. Have your vehicle serviced as soon as possible.

Oxygenated Fuels

Some conventional fuels blended with alcohol or an ether compound are available in some locales to help reduce emissions to meet clean air standards. These gasolines are collectively referred to as oxygenated fuels. If you plan to use oxygenated fuel, check that it is unleaded and meets the minimum octane rating and blend requirement.

The following fuel blends have been approved for use in your vehicle:

- Ethanol (ethyl alcohol) up to 10% by volume.
 - ▶ Gasoline containing ethanol may be marketed under the name Gasohol.
- Do not use gasoline containing methanol (methyl alcohol).

If you accidentally fill your fuel tank with an oxygenated fuel containing higher percentages, you may experience performance problems. To resolve the problem, have your dealer drain the fuel tank and replace with the correct fuel. Fuel system or performance problems resulting from the use of an oxygenated fuel containing higher percentages are not covered by your warranty.

NOTICE

Improper use of oxygenated fuels can damage metal, rubber, and plastic parts of your fuel system.

Oxygenated fuel can also damage paint.

Damage caused by spilled fuel is not covered by warranty.

If you notice any undesirable operating symptoms or performance problems, try a different brand of gasoline.

Authorized Manuals

USA The Service Manual used by your authorized dealer is available from your Honda dealer or Helm, Inc.

Canada See your dealer to order authorized manuals.

Also available, but not necessary to service your model, is the Honda Common Service Manual, which explains basic service information for various systems on Honda motorcycles, scooters, ATV, and SxS.

USA The Winter Storage Guide in conjunction with the Owner's Manual and Service Manual can help you prepare your Honda motorcycle, scooter, ATV, and SxS for winter storage.

These Honda manuals are written for the professional technician. However, if you possess the proper tools, observe the safety standards, and are mechanically capable, you should find them easy to use.

Special Honda tools are necessary for some procedures.

USA

Order online: www.helminc.com

Order Toll Free: 1-888-CYCLE93

(1-888-292-5393)

(NOTE: For Credit Card Orders Only)

Monday - Friday 8:00 AM - 6:00 PM EST

Description
2021 CMX1100A/D Service Manual
Common Service Manual (61CSM00)
USA Winter Storage Guide (S9507)
2021 CMX1100A/D Owner's Manual

Warranty Coverage and Service

Coverage

Your new Honda is covered by the following warranties:

- Vehicle Limited Warranty
- Emission Control System Warranty
- **USA** Noise Control Warranty

The responsibilities, restrictions, and exclusions that apply to these warranties are explained in the Warranties Booklet given to you by your Honda dealer at the time of purchase. Always keep your Honda owner's card with your Warranties Booklet.

Canada Please refer to the Warranty Booklet posted on our website at www.honda.ca.

It is important to realize that your warranty applies only to defects in material or workmanship of your Honda. Your warranty coverage does not apply to the normal wear and deterioration associated with use of the vehicle.

Your warranty coverage is not voided if you perform your own maintenance. However, failures that occur due directly to improper maintenance are not covered by these warranties.

USA You can extend almost all of your warranty coverage through the Honda Protection Plan. For more information, see your Honda dealer.

Statement on Warranty Coverage for Aftermarket and Recycled Parts

New Jersey

The Magnuson-Moss Warranty Act, 15 U.S.C. s. 2301 et seq., makes it illegal for motor vehicle manufacturers to void a motor vehicle warranty or deny warranty coverage solely because an aftermarket or recycled part has been used to repair the vehicle or someone other than the authorized service provider performed service on the vehicle. This provision does not apply to a new motor vehicle purchased solely for commercial or industrial use.

Under federal law, a manufacturer may deny warranty coverage and charge for repairs to a vehicle if it is discovered that an aftermarket or recycled part installed on the vehicle is defective or was installed incorrectly and caused damage to another part of the vehicle otherwise covered under warranty. The Federal Trade Commission requires that a manufacturer demonstrate that an aftermarket or recycled part or service

performed by a person other than an authorized service provider caused damage to another part of the vehicle otherwise covered under warranty before denying warranty coverage. Additionally, federal law allows a manufacturer to void a motor vehicle warranty or deny warranty coverage if the manufacturer provides the article or service to consumers free of charge under the warranty or the manufacturer has secured a waiver from the Federal Trade Commission.

Service

Please remember that maintenance recommended in the Maintenance Schedule is not included in your warranty coverage.

If you believe you have a problem with your vehicle, call the service department of your Honda dealer. Make an appointment for an inspection and diagnosis. You will be asked to authorize that inspection, and your dealer will return the results of the inspection. If a problem exists and is covered under warranty, your dealer will perform the warranty repairs. If you have any questions about your warranty coverage or the nature of the repair, talk to the Service Manager of your Honda dealer.

If a misunderstanding occurs and you aren't satisfied with your dealer's handling of the situation, we suggest you discuss your problem with the appropriate member of the dealership's management team. If you are still not satisfied, contact the owner of the dealership or their designated representative.

Honda Contacts

American Honda Motor Co., Inc.

If you wish to contact Honda directly to comment on your experiences with your vehicle or with your dealer, please send your comments to the following address:

Powersports Customer Relations
American Honda Motor Co., Inc.,
P.O. Box 2200, Torrance,
CA 90509-2200
Mailstop: 100-4W-5F,
Telephone: (866) 784-1870
Website: <https://powersports.honda.com/contact-us>

Canada

Honda Canada Inc.
Customer Relations Department,
180 Honda Boulevard
Markham, Ontario
L6C 0H9
Telephone: (888) 946-6329
Fax: (877) 939-0909
E-mail: honda_cr@ch.honda.com

Please include the following information in your letter:

- Name, address, and telephone number
- Product model, year, and VIN
- Date of purchase
- Dealer name and address

We will likely ask your Honda dealer to respond, or possibly acknowledge your comments directly.

Your Honda Dealer

The service department of your Honda dealer offers trained personnel to perform regular maintenance and unexpected repairs. It has the latest available service information from Honda and also handles warranty inspections and repairs.

The parts department offers Honda Genuine Parts, Pro Honda products, Honda Genuine Accessories (USA only), and Honda accessories and products (Canada only) that provide the same quality that went into your vehicle.

USA The sales department offers the Honda Protection Plan to extend almost all of your warranty coverage.

Your Honda dealer can also supply information about, riding events, and information about safety training available in your local area.

Reporting Safety Defects

USA

If you believe that your vehicle has a defect which could cause a crash or could cause injury or death, you should immediately inform the National Highway Traffic Safety Administration (NHTSA) in addition to notifying American Honda Motor Co., Inc.

If NHTSA receives similar complaints, it may open an investigation, and if it finds that a safety defect exists in a group of vehicles, it may order a recall and remedy campaign. However, NHTSA cannot become involved in individual problems between you, your dealer, or American Honda Motor Co., Inc.

To contact NHTSA, you may call the Vehicle Safety Hotline toll-free at:

1-888-327-4236

(TTY: 1-800-424-9153); go to

<http://www.safercar.gov>;

or write to:

Administrator, NHTSA,

1200 New Jersey Avenue, SE.,

Washington, DC 20590.

You can also obtain other information about motor vehicle safety from:

<http://www.safercar.gov>.

Canada

If you believe that your vehicle has a defect which could cause a crash or could cause injury or death, you should immediately inform Honda Canada Inc. and you may also inform Transport Canada.

If Transport Canada receives similar complaints, it may open an investigation, and if it finds that a safety defect exists in a group of vehicles, it may lead to a recall and remedy campaign. However, Transport Canada cannot become involved in individual problems between you, your dealer, or Honda Canada Inc.

To contact Transport Canada's Defect Investigations and Recalls Division, you may call:

1-800-333-0510

For more information on reporting safety defects or about motor vehicle safety, go to

<http://www.tc.gc.ca/roadsafety>.

Specifications

■ Main Components

Overall length	88.2 in (2,240 mm)	
Overall width	CMX1100A	33.6 in (853 mm)
	CMX1100D	32.8 in (834 mm)
Overall height	43.9 in (1,115 mm)	
Wheelbase	59.8 in (1,520 mm)	
Minimum ground clearance	4.7 in (120 mm)	
Caster angle	28°	
Trail	4.3 in (110 mm)	
	CMX1100A	
Curb weight	50 STATE (meets California)	487 lb (221 kg)
	Canada model	492 lb (223 kg)
	CMX1100D	
	50 STATE (meets California)	509 lb (231 kg)
Maximum weight capacity *1	Canada model	514 lb (233 kg)
	USA model	348 lb (158 kg)
Maximum weight capacity *1	Canada model	348 lb (158 kg)
	USA model	348 lb (158 kg)

*1 : Including rider, passenger, all luggage, and accessories

Passenger capacity	USA model (Model not equipped with Optional Passenger Seat Kit)	Rider only (no passenger)
	Canada model and USA model equipped with Optional Passenger Seat Kit	Rider and 1 passenger
Minimum turning radius	9.8 ft (2.99 m)	
Displacement	66.1 cu-in (1,084 cm ³)	
Bore x stroke	3.62 x 3.21 in (92.0 x 81.5 mm)	
Compression ratio	10.1 : 1	
Fuel	Unleaded gasoline	
	Recommended: 86 PON or higher	
Tank capacity	3.59 US gal (13.6 L)	
Battery	YTZ14S	
	12 V-11.2 Ah (10 HR)	

	CMX1100A	
	1st	2.866
	2nd	1.888
	3rd	1.480
	4th	1.230
	5th	1.064
	6th	0.972
	CMX1100D	
	1st	2.562
	2nd	1.761
	3rd	1.375
	4th	1.133
	5th	0.972
	6th	0.882
Reduction ratio	CMX1100A	1.717 / 2.625
(primary / final)	CMX1100D	1.863 / 2.625

Gear ratio

■ Service Data

Tire size	Front	130/70B18M/C 63H
	Rear	180/65B16M/C 81H
Tire type	Bias-ply, tubeless	
Recommended tire	Front	DUNLOP D428F
	Rear	DUNLOP D428
Tire air pressure	Front	33 psi (225 kPa, 2.25 kgf/cm ²)
	Rear	33 psi (225 kPa, 2.25 kgf/cm ²)
Minimum tread depth	Front	0.06 in (1.5 mm)
	Rear	0.08 in (2.0 mm)
Spark plug	(standard)	SILMAR8A9S (NGK)
Spark plug gap	0.031 - 0.035 in (0.80 - 0.90 mm)	
Idle speed	(non-adjustable)	1,250 ± 100 rpm
Recommended engine oil	API Service Classification SG or higher except oils labeled as energy conserving or resource conserving on the circular API service label, SAE 10W-30, JASO T 903 standard MA, Pro Honda GN4 4-stroke oil (USA & Canada) or Honda 4-stroke oil, or an equivalent motorcycle oil	

Specifications

	CMX1100A
	After draining 4.1 US qt (3.9 L)
	After draining & filter change 4.2 US qt (4.0 L)
Engine oil capacity	After disassembly 5.1 US qt (4.8 L)
	CMX1100D
	After draining 4.2 US qt (4.0 L)
	After draining & filter change 4.4 US qt (4.2 L)
	After disassembly 5.5 US qt (5.2 L)
Recommended brake fluid	Honda DOT 4 Brake Fluid
Cooling system capacity	1.84 US qt (1.74 L)
Recommended coolant	Pro Honda HP Coolant
Recommended drive chain lubricant	Pro Honda HP Chain Lube or equivalent
Drive chain slack	9/16 - 1 in (15 - 25 mm)

Standard drive chain	RK BP525MRO
	No. of links 114
Standard sprocket size	Drive sprocket 16T
	Driven sprocket 42T

■ Bulbs

Headlight	LED
Brake light/Taillight	LED
Front turn signal/Position light	LED
Rear turn signal	LED
License plate light	LED

■ Fuses

Main fuse	30 A
Other fuse	30 A, 20 A, 15 A, 10 A, 7.5 A

Information Record

VIN	
Engine No.	
Color Label & Code	
Owner's Name	
Address	
City/State	
Phone	
Dealer's Name	
Address	
City/State	
Phone	
Service Manager	

California Proposition 65 Warning

 **WARNING:** Operating, servicing and maintaining a passenger vehicle or off-highway motor vehicle can expose you to chemicals including engine exhaust, carbon monoxide, phthalates, and lead, which are known to the State of California to cause cancer and birth defects or other reproductive harm. To minimize exposure, avoid breathing exhaust, do not idle the engine except as necessary, service your vehicle in a well-ventilated area and wear gloves or wash your hands frequently when servicing your vehicle. For more information go to www.P65Warnings.ca.gov/passenger-vehicle.

HONDA
The Power of Dreams

**RIDE
RED**

31MLA602
00X31-MLA-6020