

390 DUKE

Art. no. 3214321en



KTM

Congratulations on your decision to purchase a KTM motorcycle. You are now the owner of a state-of-the-art sports vehicle which, with appropriate care, will bring you pleasure for a long time to come.

We wish you good and safe riding at all times!

Enter the serial numbers of your vehicle below.

Vehicle identification number (📖 p. 24)	Dealer's stamp
Engine number (📖 p. 25)	
Key number (📖 p. 26)	

The Owner's Manual contained the latest information for this model series at the time of publication. However, minor differences due to further developments in design cannot be ruled out completely.

All specifications contained herein are non-binding. KTM Sportmotorcycle GmbH specifically reserves the right to modify or delete technical specifications, prices, colors, forms, materials, services, designs, equipment, etc., without prior notice and without specifying reasons, to adapt these to local conditions, as well as to stop production of a particular model without prior notice. KTM accepts no liability for delivery options, deviations from figures and descriptions, misprints, and other errors. The models portrayed partly contain special equipment that does not belong to the regular scope of supply.



3214321en

02/2021

DEAR KTM CUSTOMER

© 2021 KTM Sportmotorcycle GmbH, Mattighofen Austria

All rights reserved

Reproduction, even in part, as well as copying of all kinds, is permitted only with the express written permission of the copyright owner.



REG.NR. 13 100 6061

ISO 9001(12 100 6061)

KTM applies quality assurance processes that lead to the highest possible product quality as defined in the ISO 9001 international quality management standard.

Issued by: TÜV Management Service

KTM Sportmotorcycle GmbH
Stallhofnerstraße 3
5230 Mattighofen, Austria

This document is valid for the following models:

390 DUKE EU (F4303U1, F4303U2)

390 DUKE B.D. EU (F4303U3, F4303U4)

390 DUKE B.D. 2 EU (F4303U3L, F4303U4L)

390 DUKE EU B.D. (F4303U5, F4303U6)

390 DUKE AU (F4360U1, F4360U2)

390 DUKE JP (F4386U1, F4386U2)

390 DUKE AR (F4342U1, F4342U2)

390 DUKE BR (F4340U1, F4340U2)

390 DUKE CN (F4387U1, F4387U2)

390 DUKE CO (F4341U1, F4341U2)

390 DUKE MY (F4389U1, F4389U2)

390 DUKE PH (F4382U1, F4382U2)

390 DUKE TH (F4383U1, F4383U2)

1	MEANS OF REPRESENTATION	9	4	VIEW OF VEHICLE	20
	1.1 Symbols used	9	4.1	View of vehicle, front left (example) ...	20
	1.2 Formats used.....	10	4.2	View of vehicle, rear right (example).....	22
2	SAFETY ADVICE.....	11	5	SERIAL NUMBERS	24
	2.1 Use definition.....	11	5.1	Vehicle identification number.....	24
	2.2 Misuse.....	11	5.2	Type label	24
	2.3 Safety advice.....	11	5.3	Engine number	25
	2.4 Degrees of risk and symbols.....	12	5.4	Key number.....	26
	2.5 Tampering warning.....	13	6	CONTROLS.....	27
	2.6 Safe operation	13	6.1	Clutch lever.....	27
	2.7 Protective clothing	14	6.2	Hand brake lever.....	27
	2.8 Work rules.....	15	6.3	Throttle grip	28
	2.9 Environment.....	15	6.4	Switches on the left side of the handlebar.....	28
	2.10 Owner's Manual	16	6.4.1	Combination switch.....	28
3	IMPORTANT NOTES.....	17	6.4.2	Light switch	29
	3.1 Manufacturer warranty, implied warranty.....	17	6.4.3	Menu buttons	30
	3.2 Fuel, auxiliary substances.....	17	6.4.4	Turn signal switch.....	30
	3.3 Spare parts, accessories	17	6.4.5	Horn button	31
	3.4 Service	18	6.5	Switches on the right side of the handlebar.....	31
	3.5 Figures	18	6.5.1	Emergency OFF switch	31
	3.6 Customer service.....	18			

TABLE OF CONTENTS

6.5.2	Start button	32	7.12	Fuel level display	55
6.6	Ignition and steering lock.....	32	7.13	Time.....	56
6.7	Locking the steering.....	33	7.14	Favourites display	57
6.8	Unlocking the steering.....	34	7.15	Quick Selector 1 display	57
6.9	Opening fuel tank filler cap.....	34	7.16	Quick Selector 2 display	58
6.10	Closing the fuel tank filler cap.....	36	7.17	Menu	58
6.11	Seat lock.....	37	7.17.1	KTM MY RIDE (optional)	59
6.12	Tool set.....	37	7.17.2	Info	60
6.13	Grab handles	38	7.17.3	Motorcycle	60
6.14	Passenger foot pegs	38	7.17.4	Settings	61
6.15	Shift lever	39	7.17.5	Preferences	61
6.16	Foot brake lever	40	7.17.6	Pairing (optional)	62
6.17	Side stand.....	40	7.17.7	Phone (optional)	63
7	COMBINATION INSTRUMENT	42	7.17.8	Headset (optional)	65
7.1	Combination instrument	42	7.17.9	Audio (optional).....	67
7.2	Activation and test	42	7.17.10	Telephony (optional)	69
7.3	Day-Night mode.....	43	7.17.11	General Info	70
7.4	Warnings.....	44	7.17.12	Trip 1	70
7.5	Indicator lamps.....	46	7.17.13	Trip 2	71
7.6	Display	50	7.17.14	Warning	72
7.7	Speed	52	7.17.15	ABS.....	73
7.8	Shift warning light	52	7.17.16	Favourites	74
7.9	Speed	53	7.17.17	Quick Selector 1	74
7.10	ODO display	54	7.17.18	Quick Selector 2	75
7.11	Coolant temperature indicator	54	7.17.19	Bluetooth (optional)	76
			7.17.20	Display Theme.....	77

7.17.21	Shift Light	78	10	SERVICE SCHEDULE	109
7.17.22	Setting the time and date	78	10.1	Additional information	109
7.17.23	DRL	81	10.2	Required work	109
7.17.24	Distance	82	10.3	Recommended work	111
7.17.25	Temperature.....	83	11	TUNING THE CHASSIS	113
7.17.26	Fuel Cons.....	83	11.1	Adjusting the spring preload of the shock absorber 	113
7.17.27	Language	84	11.2	Adjusting the shift lever.....	114
7.17.28	Service	85	12	SERVICE WORK ON THE CHASSIS.....	116
7.17.29	Extra Functions	85	12.1	Raising the motorcycle with rear lifting gear	116
8	PREPARING FOR USE.....	87	12.2	Removing the rear of the motorcycle from the lifting gear.....	116
8.1	Advice on preparing for first use	87	12.3	Lifting the motorcycle with the front lifting gear.....	117
8.2	Running in the engine	89	12.4	Taking the motorcycle off the front lifting gear	119
8.3	Loading the vehicle	89	12.5	Cleaning the dust boots of the fork legs	120
9	RIDING INSTRUCTIONS.....	92	12.6	Removing the passenger seat	122
9.1	Checks and maintenance measures when preparing for use	92	12.7	Mounting the passenger seat.....	123
9.2	Starting.....	93	12.8	Removing the front rider's seat	123
9.3	Starting off.....	95	12.9	Mounting the front rider's seat.....	124
9.4	Shifting, riding	96			
9.5	Applying the brakes.....	100			
9.6	Stopping, parking.....	103			
9.7	Transport	104			
9.8	Refueling	106			

TABLE OF CONTENTS

12.10	Checking for chain dirt accumulation.....	125	13.9	Checking the rear brake fluid level	151
12.11	Cleaning the chain	125	13.10	Adding rear brake fluid 🛠️	152
12.12	Checking the chain tension	127	13.11	Checking the rear brake linings	155
12.13	Adjusting the chain tension.....	128	14	WHEELS, TIRES	157
12.14	Checking the chain, rear sprocket, and engine sprocket	130	14.1	Removing the front wheel 🛠️.....	157
12.15	Adjusting the basic position of the clutch lever	133	14.2	Installing the front wheel 🛠️	158
12.16	Removing the front spoiler	134	14.3	Removing the rear wheel 🛠️.....	160
12.17	Fitting front spoiler	136	14.4	Installing the rear wheel 🛠️.....	162
13	BRAKE SYSTEM	138	14.5	Checking the rear hub damping rubber pieces 🛠️.....	165
13.1	Anti-lock braking system (ABS)	138	14.6	Checking the tire condition	167
13.2	Adjusting the basic position of the hand brake lever	140	14.7	Checking tire pressure	169
13.3	Checking the brake discs	140	15	ELECTRICAL SYSTEM	171
13.4	Checking the front brake fluid level	142	15.1	Daytime running light (DRL).....	171
13.5	Adding the front brake fluid 🛠️.....	143	15.2	Removing the 12-V battery 🛠️.....	172
13.6	Checking the front brake linings	146	15.3	Installing the 12-V battery 🛠️.....	174
13.7	Checking the free travel of foot brake lever	147	15.4	Charging the 12-V battery 🛠️.....	175
13.8	Adjusting the free travel of the foot brake lever 🛠️.....	149	15.5	Changing the main fuse (EU/JP)	178
			15.6	Changing the ABS fuses	180
			15.7	Changing the fuses of individual power consumers	183
			15.8	Checking the headlight setting	187
			15.9	Adjusting the headlight range.....	188

15.10	Diagnostics connector	189	19	CLEANING, CARE	215
15.11	Front ACC1 and ACC2	189	19.1	Cleaning the motorcycle	215
15.12	ACC2 rear	190	19.2	Checks and maintenance steps for winter operation	218
16	COOLING SYSTEM	191	20	STORAGE	220
16.1	Cooling system	191	20.1	Storage	220
16.2	Checking the antifreeze and coolant level	193	20.2	Preparing for use after storage	222
16.3	Checking the coolant level	196	21	TROUBLESHOOTING	223
16.4	Draining the coolant 🛠	198	22	TECHNICAL DATA	226
16.5	Filling/bleeding the cooling system 🛠	199	22.1	Engine	226
16.6	Changing the coolant 🛠	202	22.2	Engine tightening torques	228
17	TUNING THE ENGINE	206	22.3	Capacities	232
17.1	Checking the clutch lever play	206	22.3.1	Engine oil	232
17.2	Adjusting play in the clutch lever 🛠	207	22.3.2	Coolant	232
18	SERVICE WORK ON THE ENGINE	208	22.3.3	Fuel	232
18.1	Checking the engine oil level	208	22.4	Chassis	233
18.2	Changing the engine oil and oil filter, cleaning the oil screens 🛠	209	22.5	Electrical system	235
18.3	Adding engine oil	213	22.6	Tires	236
			22.7	Fork	236
			22.8	Shock absorber	236
			22.9	Chassis tightening torques	237

TABLE OF CONTENTS

23	DECLARATIONS OF CONFORMITY	244
23.1	Declarations of conformity	244
24	SUBSTANCES	245
25	AUXILIARY SUBSTANCES	249
26	STANDARDS	251
27	INDEX OF SPECIAL TERMS	252
28	LIST OF ABBREVIATIONS.....	253
29	LIST OF SYMBOLS.....	254
29.1	Red symbols.....	254
29.2	Yellow and orange symbols.....	254
29.3	Green and blue symbols.....	254
	INDEX	256

1.1 Symbols used

The meaning of specific symbols is described below.



Indicates an expected reaction (e.g. of a work step or a function).



Indicates an unexpected reaction (e.g. of a work step or a function).



All work marked with this symbol requires specialist knowledge and technical understanding. In the interest of your own safety, have these jobs performed by an authorized KTM workshop! Your motorcycle will be optimally cared for there by specially trained experts using the auxiliary tools required.



Indicates a page reference (more information is provided on the specified page).



Indicates information with more details or tips.



Indicates the result of a testing step.

1 MEANS OF REPRESENTATION

V

Indicates a voltage measurement.

A

Indicates a current measurement.



Indicates the end of an activity, including potential rework.

1.2 Formats used

The typographical formats used in this document are explained below.

Proprietary name

Indicates a proprietary name.

Name®

Indicates a protected name.

Brand™

Indicates a brand available on the open market.

Underlined terms

Refer to technical details of the vehicle or indicate technical terms, which are explained in the glossary.

2.1 Use definition

KTM sport motorcycles are designed and constructed to meet the normal demands of regular road operation but not for use on race courses or offroad.



Info

The motorcycle is authorized for public road traffic in the homologous version only.

2.2 Misuse

The vehicle must only be used as intended.

Dangers can arise for people, property and the environment through use not as intended.

Any use of the vehicle beyond the intended and defined use constitutes misuse.

Misuse also includes the use of operating and auxiliary fluids which do not meet the required specification for the respective use.

2.3 Safety advice

A number of safety instructions need to be followed to operate the product described safely. Therefore read this instruction and all further instructions included carefully. The safety instructions are highlighted in the text and are referred to at the relevant passages.



Info

Various information and warning labels are attached in prominent locations on the product described. Do not remove any information or warning labels. If they are missing, you or others may not recognize dangers and may therefore be injured.

2.4 Degrees of risk and symbols



Danger

Identifies a danger that will immediately and invariably lead to fatal or serious permanent injury if the appropriate measures are not taken.



Warning

Identifies a danger that is likely to lead to fatal or serious injury if the appropriate measures are not taken.



Caution

Identifies a danger that may lead to minor injuries if the appropriate measures are not taken.

Note

Identifies a danger that will lead to considerable machine and material damage if the appropriate measures are not taken.



Note

Indicates a danger that will lead to environmental damage if the appropriate measures are not taken.

2.5 Tampering warning

Tampering with the noise control system is prohibited. Federal law prohibits the following acts or the causing thereof:

- 1 The removal or rendering inoperative by any person other than for purposes of servicing, repair, or replacement, of any device or element of design incorporated into any new vehicle for the purpose of noise control prior to its sale or delivery to the ultimate purchaser or while it is in use, or
- 2 the use of the vehicle after such device or element of design has been removed or rendered inoperative by any person.

Among those acts presumed to constitute tampering are the acts listed below:

- 1 Removal or puncturing of the main silencers, baffles, header pipes or any other components which conduct exhaust gases.
- 2 Removal or puncturing of parts of the intake system.
- 3 Lack of proper maintenance.
- 4 Replacing moving parts of the vehicle, or parts of the exhaust system or intake system, with parts other than those specified by the manufacturer.

2.6 Safe operation



Danger

Danger of accidents A rider who is not fit to ride poses a danger to him or herself and others.

- Do not operate the vehicle if you are not fit to ride due to alcohol, drugs or medication.
- Do not operate the vehicle if you are physically or mentally impaired.

2 SAFETY ADVICE



Danger

Danger of poisoning Exhaust gases are toxic and inhaling them may result in unconsciousness and death.

- Always make sure there is sufficient ventilation when running the engine.
- Use effective exhaust extraction when starting or running the engine in an enclosed space.



Warning

Danger of burns Some vehicle components become very hot when the vehicle is operated.

- Do not touch any parts such as the exhaust system, radiator, engine, shock absorber, or brake system before the vehicle parts have cooled down.
- Let the vehicle parts cool down before you perform any work on the vehicle.

Only operate the vehicle when it is in perfect technical condition, in accordance with its intended use, and in a safe and environmentally compatible manner.

An appropriate driver's license is needed to ride the vehicle on public roads.

Have malfunctions that impair safety promptly eliminated by an authorized KTM workshop.

Adhere to the information and warning labels on the vehicle.

2.7 Protective clothing



Warning

Risk of injury Missing or poor protective clothing presents an increased safety risk.

- Wear appropriate protective clothing such as helmet, boots, gloves as well as trousers and a jacket with protectors on all rides.
 - Always wear protective clothing that is in good condition and meets the legal regulations.
-

In the interest of your own safety, KTM recommends that you only operate the vehicle while wearing protective clothing.

2.8 Work rules

Unless specified otherwise, the ignition must be turned off during all work (models with ignition lock, models with remote key) or the engine must be at a standstill (models without ignition lock or remote key).

Special tools are necessary for certain tasks. The tools are not a component of the vehicle, but can be ordered using the number in parentheses. Example: bearing puller (15112017000)

During assembly, use new parts to replace parts which cannot be reused (e.g. self-locking screws and nuts, expansion screws, seals, sealing rings, O-rings, pins, and lock washers).

In the case of certain screws, a screw adhesive (e.g. **Loctite**®) is required. Observe the manufacturer's instructions.

If thread locker (e.g., **Precote**®) has already been applied to a new part, do not apply any additional thread locker. After disassembly, clean the parts that are to be reused and check them for damage and wear. Change damaged or worn parts.

After completing a repair or service work, check the operating safety of the vehicle.

2.9 Environment

If you use your motorcycle responsibly, you can ensure that problems and conflicts do not occur. To protect the future of the motorcycle sport, make sure that you use your motorcycle legally, display environmental consciousness, and respect the rights of others.

When disposing of used oil, other operating and auxiliary fluids, and used components, comply with the laws and regulations of the respective country.

2 SAFETY ADVICE

Because motorcycles are not subject to the EU regulations governing the disposal of used vehicles, there are no legal regulations that pertain to the disposal of an end-of-life motorcycle. Your authorized KTM dealer will be glad to advise you.

2.10 Owner's Manual

Read this owner's manual carefully and completely before making your first trip. The Owner's Manual contains useful information and many tips on how to operate, handle, and service your motorcycle. This is the only way to find out how best to customize the vehicle for your own use and how you can protect yourself from injury.



Tip

Store the Owner's Manual on your terminal device, for example, so that you can read it whenever you need to.

If you would like to know more about the vehicle or have questions on the material you read, please contact an authorized KTM dealer.

The Owner's Manual is an important component of the vehicle. If the vehicle is sold, the Owner's Manual must be downloaded again by the new owner.

The Owner's Manual can be downloaded several times using the QR code or the link on the delivery certificate.

The Owner's Manual is also available for download from your authorized KTM dealer and on the KTM website. A printed copy can also be ordered from your authorized KTM dealer.

International KTM Website: KTM.com

3.1 Manufacturer warranty, implied warranty

The work prescribed in the service schedule must only be carried out in an authorized KTM workshop and confirmed in the **KTM Dealer.net**, as otherwise all warranty claims will be void. Damage or secondary damage caused by tampering with and/or conversions on the vehicle are not covered by the manufacturer warranty.

3.2 Fuel, auxiliary substances



Note

Environmental hazard Improper handling of fuel is a danger to the environment.

- Do not allow fuel to enter the groundwater, the soil, or the sewage system.

Use fuels and auxiliary substances in accordance with the Owner's Manual and specification.

3.3 Spare parts, accessories

For your own safety, only use spare parts and accessory products that are approved and/or recommended by KTM and have them installed by an authorized KTM workshop. KTM accepts no liability for other products and any resulting damage or loss.

Certain spare parts and accessory products are specified in parentheses in the descriptions. Your authorized KTM dealer will be glad to advise you.

The current **KTM PowerParts** for your vehicle can be found on the KTM website.
International KTM Website: KTM.com

3 IMPORTANT NOTES

3.4 Service

A prerequisite for perfect operation and prevention of premature wear is that the service, care, and tuning work on the engine and chassis is properly carried out as described in the Owner's Manual. An incorrect suspension setting can lead to damage and breakage of chassis components.

Use of the vehicle under difficult conditions, such as dusty environments, heavy rain, high heat or with a heavy load, can lead to considerably more rapid wear of components such as the air filter, drive train, brake system, or suspension components. For this reason, it may be necessary to inspect or replace parts before the next scheduled service.

It is imperative that you adhere to the stipulated run-in times and service intervals. If you observe these exactly, you will ensure a much longer service life for your motorcycle.

The relevant mileage or time interval is whichever occurs first.

3.5 Figures

The figures contained in the manual may depict special equipment.

In the interest of clarity, some components may be shown disassembled or may not be shown at all. It is not always necessary to disassemble the component to perform the activity in question. Please follow the instructions in the text.

3.6 Customer service

Your authorized KTM dealer will be happy to answer any questions you may have on your vehicle and KTM.

A list of authorized KTM dealers can be found on the KTM website.

International KTM Website: KTM.com

4 VIEW OF VEHICLE

4.1 View of vehicle, front left (example)



S04740-10

- ① Combination instrument
- ② Clutch lever (📖 p. 27)
- ③ Front rider's seat
- ④ Passenger seat
- ⑤ Grab handles (📖 p. 38)
- ⑥ Seat lock (📖 p. 37)
- ⑦ Side stand (📖 p. 40)
- ⑧ Shift lever (📖 p. 39)

4 VIEW OF VEHICLE

4.2 View of vehicle, rear right (example)



- ① Tool set (📖 p. 37)
- ② Light switch (📖 p. 29)
- ② Menu buttons (📖 p. 30)
- ② Turn signal switch (📖 p. 30)
- ② Horn button (📖 p. 31)
- ③ Ignition and steering lock (📖 p. 32)
- ④ Emergency OFF switch (📖 p. 31)
- ④ Start button (📖 p. 32)
- ⑤ Throttle grip (📖 p. 28)
- ⑥ Hand brake lever (📖 p. 27)
- ⑦ Vehicle identification number (📖 p. 24)
- ⑦ Type label (📖 p. 24)
- ⑧ Foot brake lever (📖 p. 40)
- ⑨ Passenger foot pegs (📖 p. 38)

5 SERIAL NUMBERS

5.1 Vehicle identification number

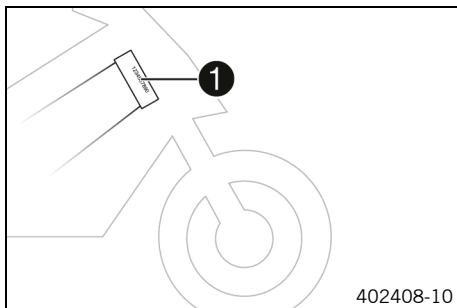

The vehicle identification number ❶ is stamped on the right side of the steering head.

5.2 Type label

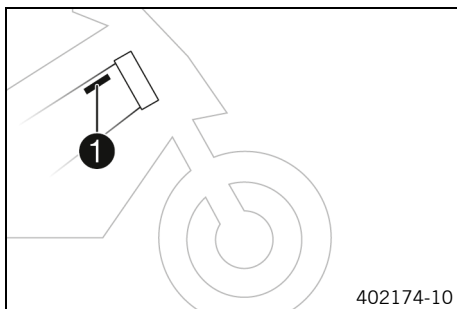

(EU/JP/AR/BR/CN/CO/MY/PH/TH, 390 DUKE EU B.D.)

The type label ❶ is on the right of the frame behind the steering head.

(390 DUKE AU)

The type label **1** is on the left of the frame behind the steering head.

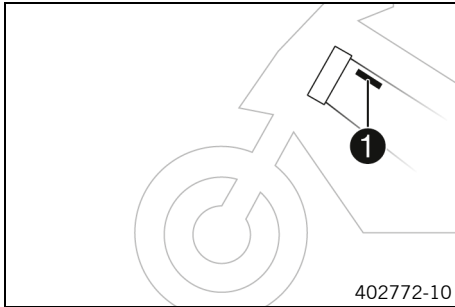

5.3 Engine number

The engine number **1** is stamped on the left side of the engine under the engine sprocket.

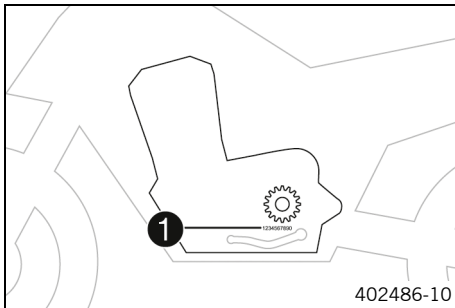

5 SERIAL NUMBERS

5.4 Key number

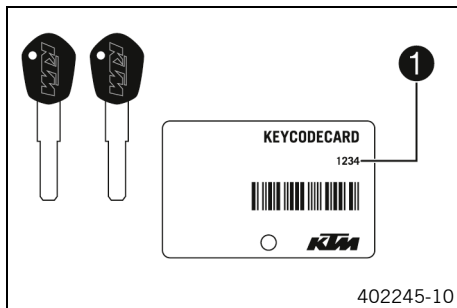

The key number **1** can be found on the **KEYCODECARD**.

i Info

The key number is needed to order a replacement key.

Keep the **KEYCODECARD** in a safe place.

If at least one ignition key is still available, a spare key can be produced. If an ignition key is no longer present, the entire lock system must be replaced.

6.1 Clutch lever

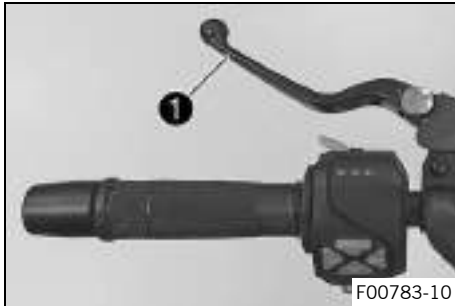

The clutch lever ① is fitted on the left side of the handlebar.

6.2 Hand brake lever



The hand brake lever ① is fitted on the right side of the handlebar.

The front brake is engaged using the hand brake lever.

6 CONTROLS

6.3 Throttle grip



The throttle grip **1** is fitted on the right side of the handlebar.

6.4 Switches on the left side of the handlebar

6.4.1 Combination switch

The combination switch is fitted on the left side of the handlebar.

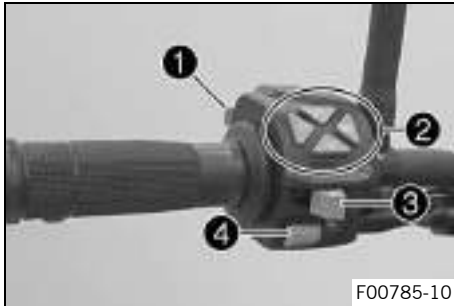

Overview of the left combination switch

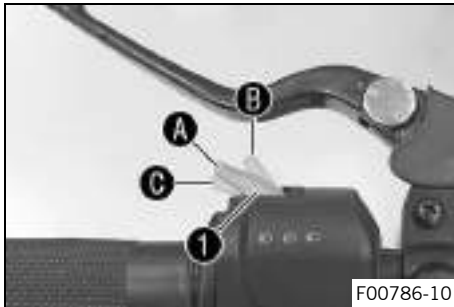

- ① Light switch (📖 p. 29)
- ② Menu buttons (📖 p. 30)
- ③ Turn signal switch (📖 p. 30)
- ④ Horn button (📖 p. 31)

6.4.2 Light switch



Light switch ① is fitted on the left side of the handlebar.

Possible states

	Low beam on – Light switch in position A . In this position, the low beam and the tail light are switched on.
	High beam on – Push the light switch to position B . In this position, the high beam and the tail light are switched on.
	Headlight flasher – Push the light switch into position C .

6 CONTROLS

6.4.3 Menu buttons

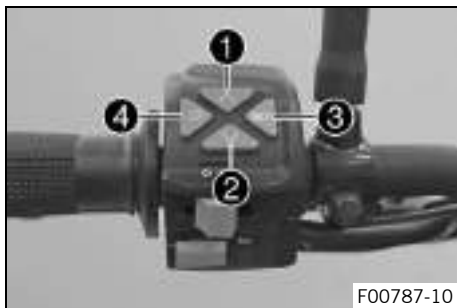

The menu buttons are fitted in the middle of the left combination switch.

The menu buttons are used to control the display on the combination instrument.

Button ① is the **UP** button.

Button ② is the **DOWN** button.

Button ③ is the **SET** button.



Button ④ is the **BACK** button.

6.4.4 Turn signal switch



Turn signal switch ① is fitted on the left side of the handlebar.

Possible states

	Turn signal off – Turn signal switch pushed toward the switch housing.
	Left turn signal, on – Turn signal switch pressed to the left. The turn signal switch returns automatically to the central position after use.
	Right turn signal, on – Turn signal switch pressed to the right. The turn signal switch returns automatically to the central position after use.

6.4.5 Horn button



Horn button ❶ is fitted on the left side of the handlebar.

Possible states

- The horn button is in the basic position
- The horn button is pressed – The horn is operated in this position.

6.5 Switches on the right side of the handlebar

6.5.1 Emergency OFF switch



The emergency OFF switch ❶ is fitted on the right side of the handlebar.

Possible states

	<p>Emergency OFF switch off – In this position, the ignition circuit is interrupted, a running engine stops, and a non-running engine cannot be started.</p>
	<p>Emergency OFF switch on – This position is required for operation; the ignition circuit is closed.</p>

6.5.2 Start button



Start button ❶ is fitted on the right side of the handlebar.

Possible states



- The start button ❷ is in the basic position
- The start button ❷ is pressed – In this position, the starter motor is actuated.

6.6 Ignition and steering lock



The ignition and steering lock is located in front of the upper triple clamp.

Possible states

	Ignition off OFF – In this position, the ignition circuit is interrupted, a running engine stops, and a non-running engine will not start. The ignition key can be removed.
	Ignition on ON – In this position, the ignition circuit is closed and the engine can be started.



Steering locked **LOCK** – In this position, the ignition circuit is interrupted and the steering locked. The ignition key can be removed.

6.7 Locking the steering

Note

Danger of damage The parked vehicle can roll away or fall over.

- Park the vehicle on a firm and level surface.



400732-01

- Park the vehicle.
- Turn the handlebar all the way to the left.
- Insert the ignition key into the ignition and steering lock, press in, and turn to the left. Remove the ignition key.
- ✓ Steering is no longer possible.



6.8 Unlocking the steering

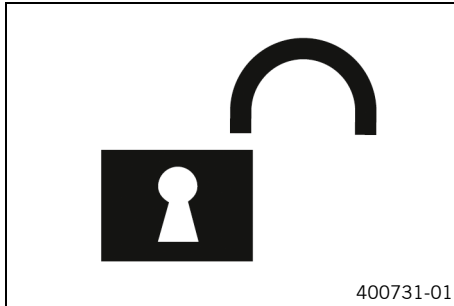

- Insert the ignition key into the ignition and steering lock, press in, and turn to the right. Remove the ignition key.
- ✓ The handlebar can now be moved again.

6.9 Opening fuel tank filler cap



Danger

Fire hazard Fuel is highly flammable.

The fuel in the fuel tank expands when warm and can escape if overfilled.

- Do not fuel the vehicle in the vicinity of open flames or lit cigarettes.
- Switch off the engine for refueling.
- Make sure that no fuel is spilled; particularly not on hot parts of the vehicle.
- If any fuel is spilled, wipe it off immediately.
- Observe the specifications for refueling.



Warning

Danger of poisoning Fuel is poisonous and a health hazard.

- Avoid skin, eye and clothing contact with fuel.
- Immediately consult a doctor if you swallow fuel.
- Do not inhale fuel vapors.
- In case of skin contact, rinse the affected area with plenty of water.
- Rinse the eyes thoroughly with water, and consult a doctor in case of fuel contact with the eyes.
- Change your clothing in case of fuel spills on them.
- Keep fuels correctly in a suitable canister, and out of the reach of children.



Note

Environmental hazard Improper handling of fuel is a danger to the environment.

- Do not allow fuel to enter the groundwater, the soil, or the sewage system.

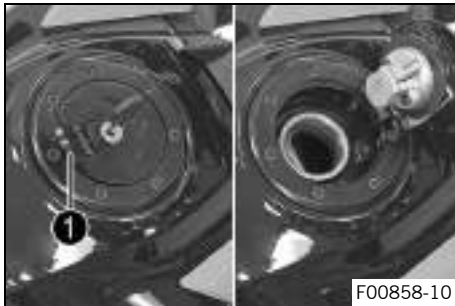

- Lift cover **1** of the fuel tank filler cap and insert the ignition key into the lock.

Note

Danger of damage The ignition key may break if overloaded. Damaged ignition keys must be replaced.

- Push down on the fuel tank filler cap to take pressure off the ignition key.
- Turn the ignition key 90° clockwise.

- Lift the fuel tank filler cap.

6.10 Closing the fuel tank filler cap

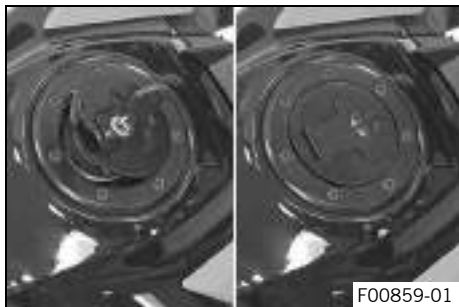

Warning

Fire hazard Fuel is highly flammable, toxic and a health hazard.

- Check that the fuel tank filler cap is locked correctly after closing.
- Change your clothing if fuel spills on them.
- Rinse the affected area immediately with plenty of water in the event of contact with the skin.

- Fold down the fuel tank filler cap.
- Turn the ignition key 90° clockwise.
- Push down the fuel tank filler cap and turn the ignition key counterclockwise until the fuel tank filler cap lock engages.
- Remove the ignition key and close the cover.

6.11 Seat lock



The seat lock **1** is located to the left of the seat.
The seat lock can be unlocked using the ignition key.

6.12 Tool set

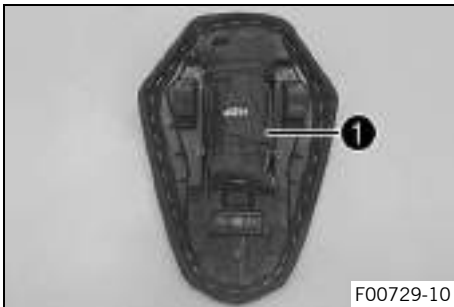

The tool set **1** is located under the passenger seat.

6.13 Grab handles



The grab handles ❶ are used for moving the motorcycle around. If you carry a passenger, the passenger can hold onto the grab handles during the trip.

6.14 Passenger foot pegs

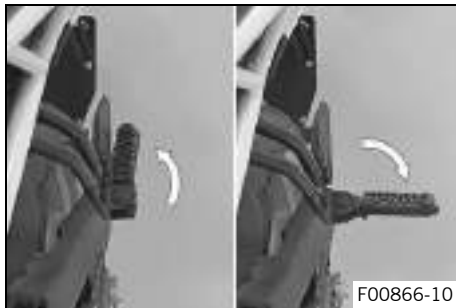

The passenger foot pegs can be folded up and down.

Possible states

- Passenger foot pegs folded up – For operation without a passenger.
- Passenger foot pegs folded down – For operation with a passenger.

6.15 Shift lever

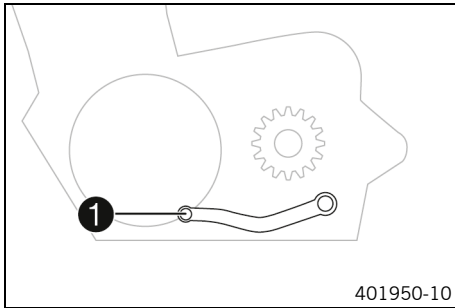

Shift lever ① is mounted on the left side of the engine.

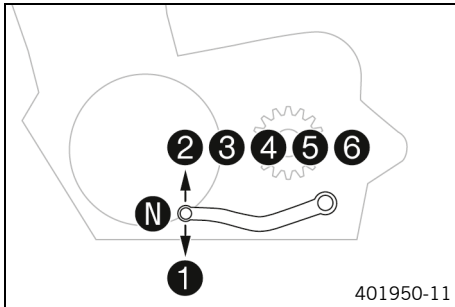

The gear positions can be seen in the photograph.
The neutral or idle position is between the first and second gears.

6.16 Foot brake lever

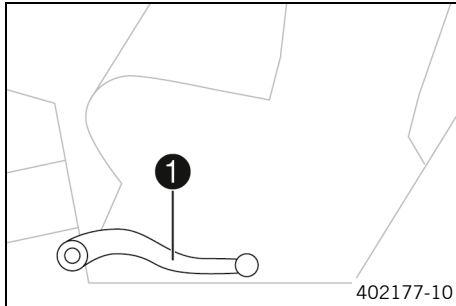

Foot brake lever **1** is located in front of the right footrest. The foot brake lever is used to activate the rear brake.

6.17 Side stand

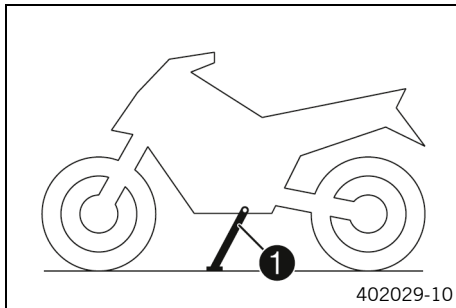

The side stand **1** is located on the left of the vehicle. The side stand is used for parking the motorcycle.

i Info

The side stand must be folded up during motorcycle use. The side stand is coupled with the safety starting system; follow the riding instructions.

Possible states

- Side stand folded out – The vehicle can be supported on the side stand. The safety starting system is active.

- Side stand folded in – This position is mandatory when riding the motorcycle. The safety starting system is inactive.

7 COMBINATION INSTRUMENT

7.1 Combination instrument

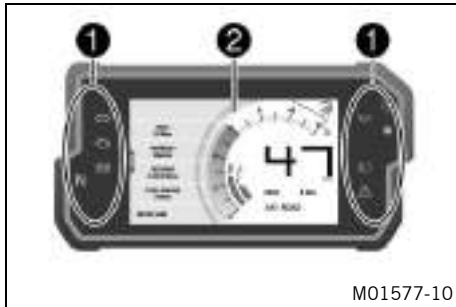

The combination instrument is attached in front of the handlebar. The combination instrument is divided into two function areas.

① indicator lamps (📖 p. 46)

Display ②

7.2 Activation and test



Activation

The combination instrument is activated when the ignition is switched on.

i Info

The brightness of the displays is controlled by an ambient light sensor in the combination instrument.

Test

The welcome text appears on the display and the indicator lamps are briefly activated for a function check.

7.3 Day-Night mode

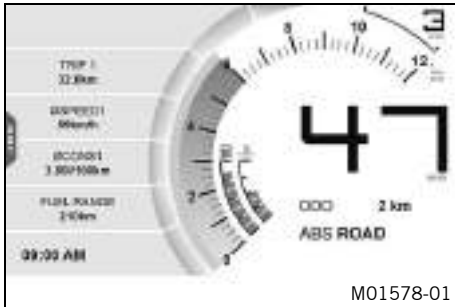

Day mode is shown in a bright color.



Night mode is shown in a dark color.

i Info

The ambient light sensor in the combination instrument detects the brightness of the environment. Depending on the amount of light detected by the ambient light sensor, the display is brightened or dimmed, or switched to the other mode depending on the setting.

The display mode can be configured in the **Display Theme** menu. Here, you can select automatic day-night mode or permanent night mode.

7 COMBINATION INSTRUMENT

7.4 Warnings

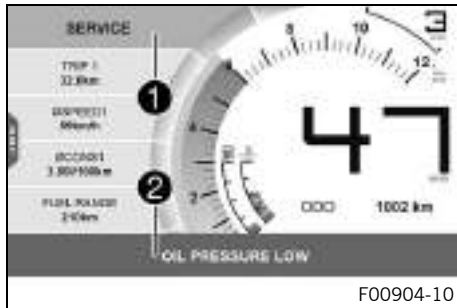

Warnings appear on the top and/or bottom edge of the display; these are marked yellow or red depending on their relevance. Yellow warnings ① indicate malfunctions or information which require prompt intervention or an adjustment to the riding style. Red warnings ② indicate malfunctions or information which require immediate intervention.

i Info

Warnings can be hidden by pressing any button. All the existing warnings are displayed in the **Warning** menu until they are no longer active.

7 COMBINATION INSTRUMENT

7.5 Indicator lamps



F00900-01

The indicator lamps offer additional information about the operating state of the motorcycle. When the ignition is switched on, all indicator lamps light up briefly.





i Info

The malfunction indicator lamp always lights up as long as the engine is not running. If the engine is running and the malfunction indicator lamp lights up, stop (taking care not to endanger yourself or other road users in the process) and contact an authorized KTM workshop.





The oil pressure warning lamp always lights up as long as the engine is not running. If the engine is running and the oil pressure warning lamp lights up, stop immediately (taking care not to endanger yourself or other road users in the process) and switch off the engine.

The ABS warning lamp lights up until a speed of approx. 6 km/h (approx. 4 mph) or more has been reached.

Possible states

	The turn signal indicator lamp flashes green simultaneously with the turn signal – The turn signal is switched on.
	Malfunction indicator light lights up yellow – The <u>OBD</u> has detected a malfunction in the vehicle electronics. Come safely to a halt, and contact an authorized KTM workshop.
	The ABS warning lamp lights up yellow – Status or error messages relating to <u>ABS</u> . The ABS warning lamp flashes if the ABS mode Super Moto is enabled.
	The idle indicator lamp lights up green – The transmission is in neutral.

7 COMBINATION INSTRUMENT

	The oil pressure warning lamp lights up red – The oil pressure is too low. Stop immediately, taking care not to endanger yourself or other road users in the process, and switch off the engine.
	Alarm system indicator lamp flashes red – Status message on the alarm system (optional).
	High beam indicator lamp lights up blue – The high beam is switched on.
	The general warning lamp lights up yellow – A note/warning note on operating safety has been detected. This is shown in addition.

7 COMBINATION INSTRUMENT

7.6 Display

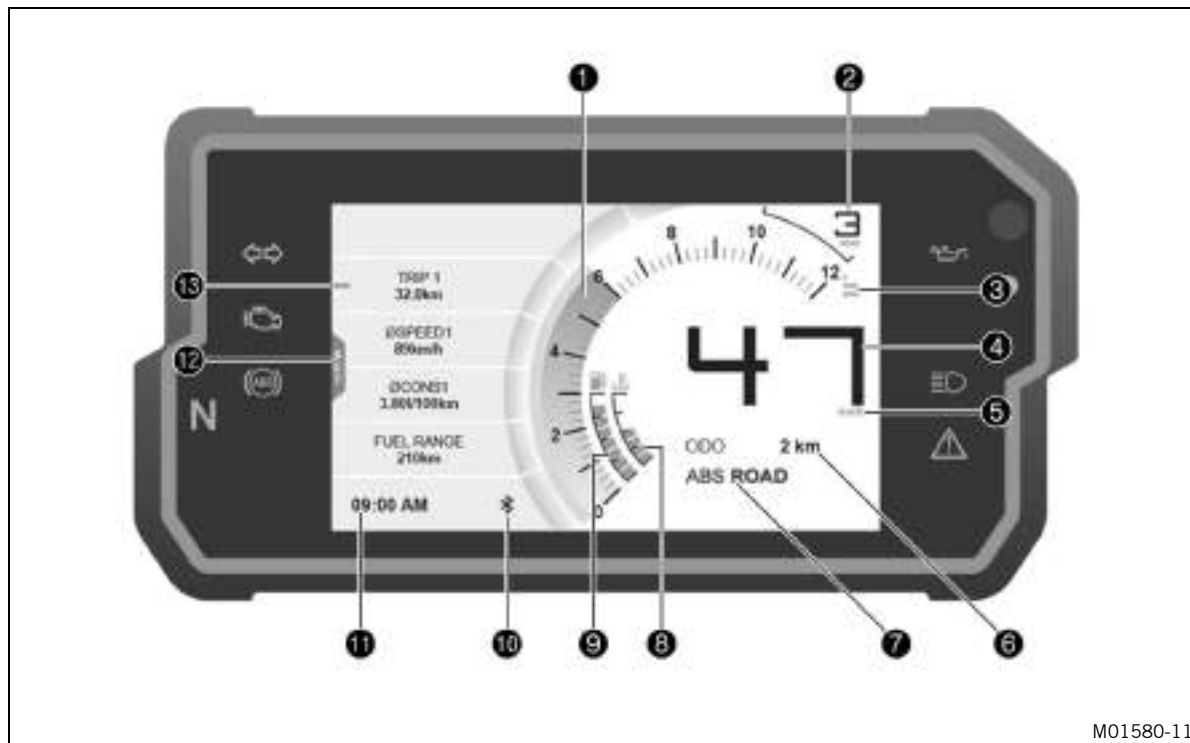

M01580-11

- ① Speed (📖 p. 52)
- ① Shift warning light (📖 p. 52)
The shift warning light is integrated in the tachometer display.
- ② Gear display
- ③ Unit for the speed display
- ④ Speed (📖 p. 53)
- ⑤ Unit for the speedometer
- ⑥ **ODO** display (📖 p. 54)
- ⑦ ABS mode
- ⑧ Coolant temperature indicator (📖 p. 54)
- ⑨ Fuel level display (📖 p. 55)
- ⑩ **Bluetooth®** (optional)
- ⑪ Time (📖 p. 56)
- ⑫ **SET**
Only shown where the menu overview is closed.
- ⑬ **Favourites** display (📖 p. 57)

7 COMBINATION INSTRUMENT

7.7 Speed

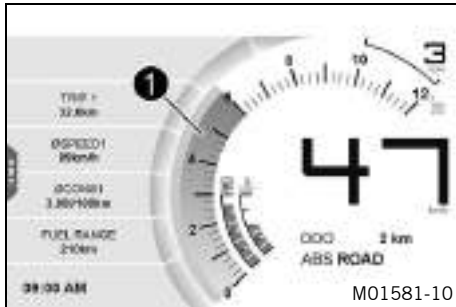

The speed **1** is measured in revolutions per minute.

7.8 Shift warning light

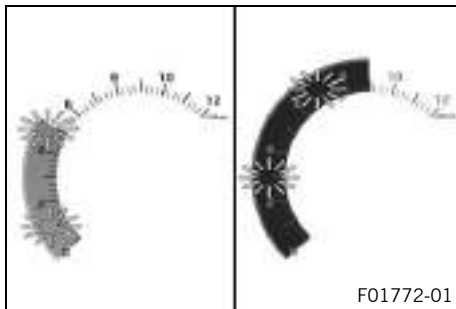

The shift warning light is integrated in the tachometer display. In the **Shift Light** menu, the engine speed for the shift warning light can be set. The shift warning light is always active during the running-in phase (up to 1,000 km / 621 mi). The shift warning light can only be deactivated, and the values for **RPM1** and **RPM2** can only be adjusted after this. In **RPM1** the shift warning light flashes and in **RPM2** it flashes and the color changes.

i Info

In sixth gear, the shift warning light is deactivated when the engine is warm after the first service.

Coolant temperature	$\leq 35\text{ }^{\circ}\text{C}$ ($\leq 95\text{ }^{\circ}\text{F}$)
ODO	< 1,000 km (< 620 mi)
The shift warning light always flashes at	6,500 rpm
Coolant temperature	$> 35\text{ }^{\circ}\text{C}$ ($> 95\text{ }^{\circ}\text{F}$)
ODO	> 1,000 km (> 620 mi)
RPM1 shift warning light	flashes
RPM2 shift warning light	flashes and changes color

7.9 Speed

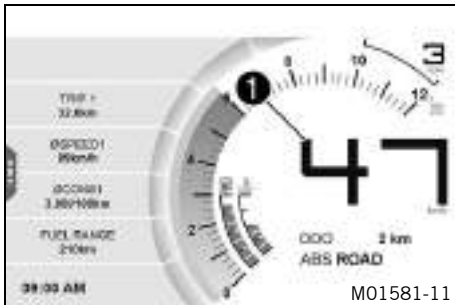

Speed **1** is shown in kilometers per hour **km/h** or in miles per hour **mph**.

7 COMBINATION INSTRUMENT

7.10 ODO display

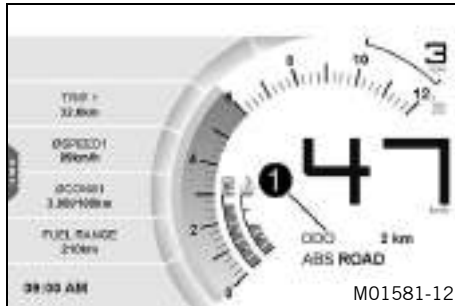

The total distance covered **ODO** is shown in area **1** of the display.

i Info

This value is retained, even if the 12-V battery is disconnected from the vehicle or the fuse blows.

7.11 Coolant temperature indicator

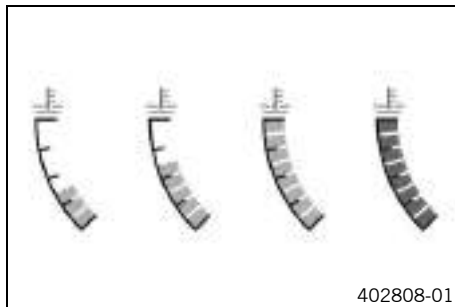

The coolant temperature indicator consists of bars. The more bars that light up, the hotter the coolant.

Note

Engine failure Overheating damages the engine.

- If the coolant temperature warning is displayed, stop immediately and take care not to endanger yourself or other traffic participants in the process.
- Allow the engine and cooling system to cool down.
- Check and, if necessary, correct the coolant level on the cooling system while it is in a cooled state.

**Info**

When all the bars light up, the warning **ENGINE TEMP HIGH** also appears.

If the cooling system overheats, the maximum engine speed is limited.

Possible states

- The engine is cold – Up to three bars light up.
- Engine warm – Four to five bars light up.
- Engine hot – Six to eight bars light up.
- Engine very hot – All eight bars light up red.

7.12 Fuel level display

The fuel tank contents are shown in area ① of the display. The fuel level indicator consists of bars. The more bars are lit, the more fuel is in the fuel tank.

7 COMBINATION INSTRUMENT



Info

If the fuel level is getting low, the last segment flashes red and the following warning also appears **LOW FUEL**. The fuel level is displayed with a slight delay to prevent the indicator from constantly moving while riding. The fuel level display is not updated while the side stand is folded out or the emergency off switch is switched off. Once the side stand is folded up and the emergency OFF switch is switched on, the fuel level display is next updated after 2 minutes. The fuel level display flashes if the combination instrument does not receive a signal from the fuel level sensor.

7.13 Time

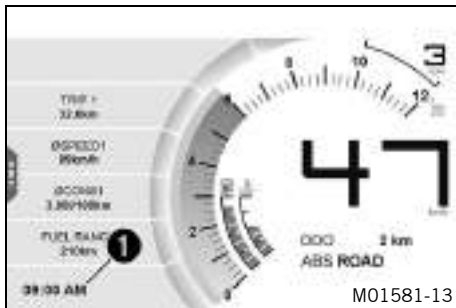

The time is shown in area **1** of the display. The time is displayed in 24 hour format in all languages except for EN-US. The time is displayed in 12 hour format if the language is set to EN-US. The time can be configured in the **Clock/Date** menu.



Info

The time must be reset if the 12-V battery was disconnected from the vehicle or the fuse was removed.

7.14 Favourites display



Up to eight items of information are shown in the **Favourites** display.

The **Favourites** display can be freely configured in the **Favourites** menu.

i Info

One to four items of information selected are displayed on two lines. Five to eight items of information selected are displayed on a single line.

7.15 Quick Selector 1 display

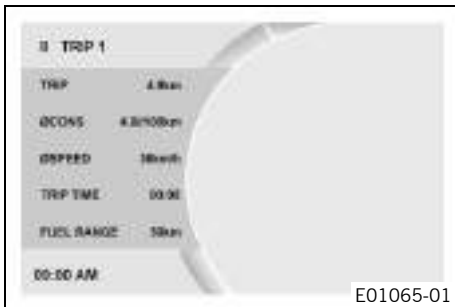

When the menu is closed, the **Quick Selector 1** menu is opened by pressing the **UP** button.

Press the **BACK** button to close **Quick Selector 1**.

i Info

The **Quick Selector 1** can be configured in the **Quick Selector 1** menu. Any information can be selected.

7 COMBINATION INSTRUMENT

7.16 Quick Selector 2 display

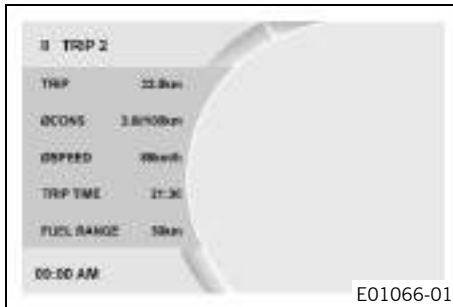

When the menu is closed, the **Quick Selector 2** menu is opened by pressing the **DOWN** button.

Press the **BACK** button to close **Quick Selector 2**.



Info

The **Quick Selector 2** can be configured in the **Quick Selector 2** menu. Any information can be selected.

7.17 Menu

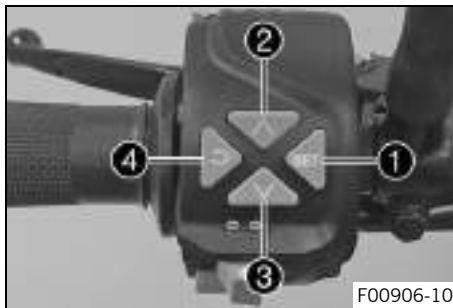

Info

Press the **SET** button **1** in the start screen to open the menu.

Navigate through the menu using the **UP** button **2** or the **DOWN** button **3**.

Press the **BACK** button **4** to close the current menu or the menu overview.

7.17.1 KTM MY RIDE (optional)

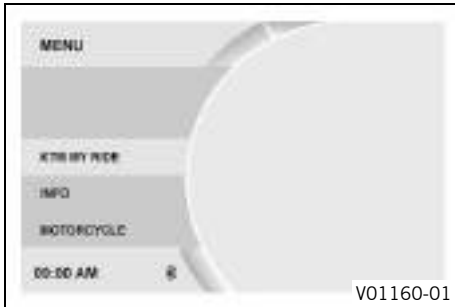
**Condition**

- The motorcycle is stationary.
- Function **KTM MY RIDE** (optional) activated.
- Function **Bluetooth®** (optional) activated.
 - Press the **SET** button when the menu is closed.
 - Press the **UP** or **DOWN** button until **KTM MY RIDE** is marked. Press the **SET** button to open the menu.

In the **KTM MY RIDE** menu, an appropriate cellphone or appropriate headset can be paired with the combination instrument via **Bluetooth®**.

**Info**

Not every cellphone and headset is suitable for pairing with the combination instrument. The standard **Bluetooth®** 2.1 must be supported.

7 COMBINATION INSTRUMENT

7.17.2 Info

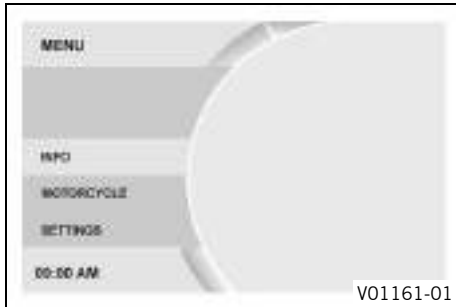

- Press the **SET** button when the menu is closed.
- Press the **UP** or **DOWN** button until **Info** is marked. Press the **SET** button to open the menu.

General information can be accessed in **Info**.

7.17.3 Motorcycle

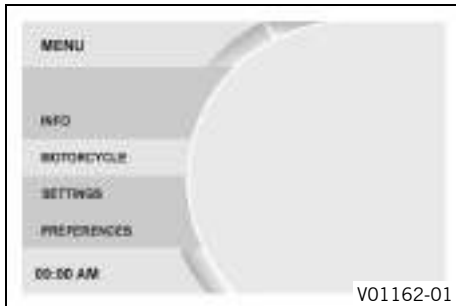

Condition

- The motorcycle is stationary.
- Press the **SET** button when the menu is closed.
- Press the **UP** or **DOWN** button until **Motorcycle** is marked. Press the **SET** button to open the menu.

The vehicle drive mode can be configured in **Motorcycle**.

7.17.4 Settings

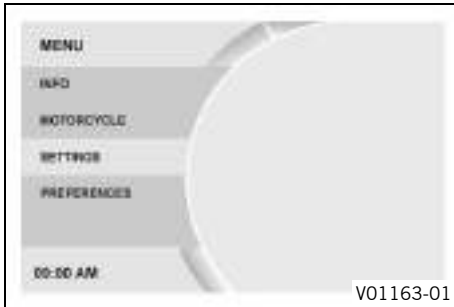

Condition

- The motorcycle is stationary.
 - Press the **SET** button when the menu is closed.
 - Press the **UP** or **DOWN** button until **Settings** is marked. Press the **SET** button to open the menu.

Favorites and quick selection can be configured in **Settings**.

7.17.5 Preferences

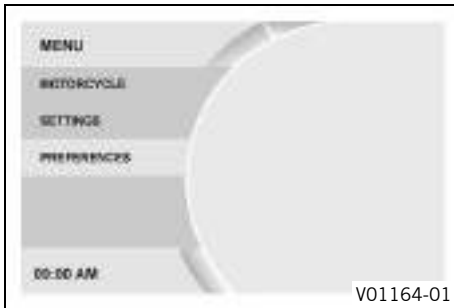

Condition

- The motorcycle is stationary.
 - Press the **SET** button when the menu is closed.
 - Press the **UP** or **DOWN** button until **Preferences** is marked. Press the **SET** button to open the menu.

The combination instrument display can be configured in **Preferences**. Settings can be made for units or various values. Several functions can be enabled or disabled.

7.17.6 Pairing (optional)

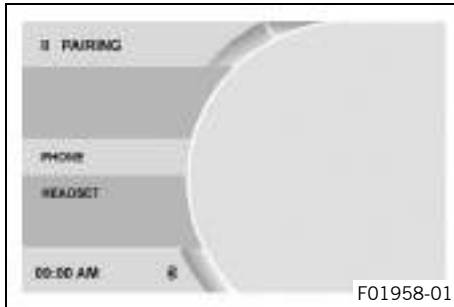

Condition

- The motorcycle is stationary.
 - Function **KTM MY RIDE** (optional) activated.
 - Function **Bluetooth®** (optional) activated.
- Press the **SET** button when the menu is closed.
 - Press the **UP** or **DOWN** button until **KTM MY RIDE** is marked. Press the **SET** button to open the menu.
 - Press the **UP** or **DOWN** button until **Pairing** is marked. Press the **SET** button to open the menu.

A suitable cellphone or headset can be paired with the combination instrument via **Bluetooth®** in the **Pairing** menu.

i Info

The **Bluetooth®** function can only be used in conjunction with **KTM MY RIDE** (optional).
When the **Bluetooth®** function is switched on and the device is connected, the **Bluetooth®** symbol appears in the display of the combination instrument.
Not every cellphone and headset is suitable for pairing with the combination instrument.

7.17.7 Phone (optional)

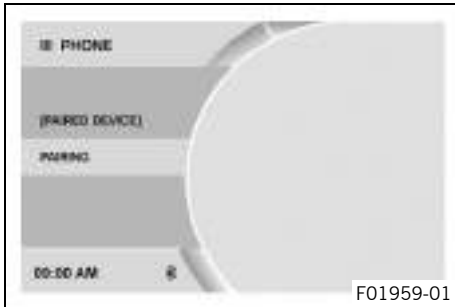
**Condition**

- The motorcycle is stationary.
- Function **KTM MY RIDE** (optional) activated.
- Function **Bluetooth** (optional) activated.
- The **Bluetooth**® function should also be activated in the device to be paired.
 - Press the **SET** button when the menu is closed.
 - Press the **UP** or **DOWN** button until **KTM MY RIDE** is marked. Press the **SET** button to open the menu.
 - Press the **UP** or **DOWN** button until **Pairing** is marked. Press the **SET** button to open the menu.
 - Press the **UP** or **DOWN** button until **Phone** is marked. Press the **SET** button to open the menu.

**Info**

Two cellphones can never be paired simultaneously with the combination instrument.

- Press the **UP** or **DOWN** button until **Pairing** is marked. Press the **SET** button to open the menu.
- The combination instrument starts searching for a suitable cellphone. If the search was successful, the name of the cell-

7 COMBINATION INSTRUMENT

phone is displayed in the **Pairing** menu. Press the **SET** button to start the pairing.



Info

The cellphone must be visible via **Bluetooth®** for the cellphone to be found by the combination instrument.

- A message appears on the combination instrument indicating that this is now ready for pairing. The pairing is completed successfully by confirming the **Passkey** on the cellphone and on the combination instrument.
-



Info

Once the pairing is completed, the registered trademark of the paired cellphone is displayed in the **Phone** menu. Press the **UP** or **DOWN** button until the paired device is marked. The paired device can be deleted by pressing the **SET** button.

Not every cellphone is suitable for pairing with the combination instrument.

- Move the previously paired device into the range of the combination instrument while the **Bluetooth®** function is active.
 - ✓ The device is automatically paired with the combination instrument.

- ✘ If the device is not automatically paired with the combination instrument after approx. 30 seconds:
 - Restart the combination instrument or repeat the **Pairing** procedure.

A suitable cellphone can be paired with the combination instrument in the **Phone** menu.

7.17.8 Headset (optional)

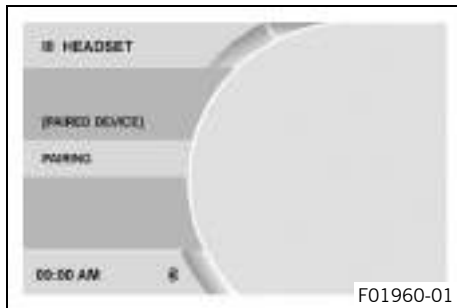

Condition

- The motorcycle is stationary.
- Function **KTM MY RIDE** (optional) activated.
- Function **Bluetooth** (optional) activated.
- The **Bluetooth®** function should also be activated in the device to be paired.
 - Press the **SET** button when the menu is closed.
 - Press the **UP** or **DOWN** button until **KTM MY RIDE** is marked. Press the **SET** button to open the menu.
 - Press the **UP** or **DOWN** button until **Pairing** is marked. Press the **SET** button to open the menu.
 - Press the **UP** or **DOWN** button until **Headset** is marked. Press the **SET** button to open the menu.
 - Press the **UP** or **DOWN** button until **Pairing** is marked. Press the **SET** button to open the menu.

- The combination instrument starts searching for a suitable headset. If the search was successful, the name of the headset is displayed in the **Pairing** menu. Press the **SET** button to select the device. Press the **SET** button again to confirm the **Confirm** menu item. The pairing of the headset with the combination instrument has been successfully completed.



Info

The headset must be in pairing mode for the headset to be found by the combination instrument. Follow the instructions in the Owner's Manual of the headset. Once the pairing is completed, the name of the paired headset is displayed in the **Headset** menu.

Press the **UP** or **DOWN** button until the paired device is marked. The paired device can be deleted by pressing the **SET** button.

Not every headset is suitable for pairing with the combination instrument.

-
- Move the previously paired device into the range of the combination instrument while the **Bluetooth®** function is active.
 - ✓ The device is automatically paired with the combination instrument.

- ✘ If the device is not automatically paired with the combination instrument after approx. 30 seconds:
 - Restart the combination instrument or repeat the **Pairing** procedure.

A suitable headset can be paired with the combination instrument in the **Headset** menu.

7.17.9 Audio (optional)

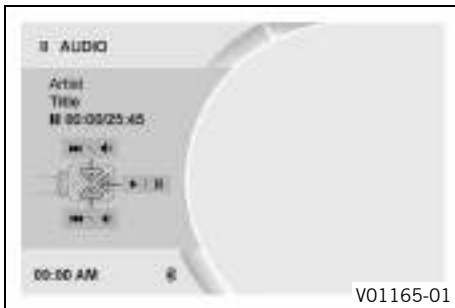

Condition

- Function **KTM MY RIDE** (optional) activated.
 - Function **Bluetooth®** (optional) activated.
 - The **Bluetooth®** function should also be activated in the device to be paired.
- Press the **SET** button when the menu is closed.
 - Press the **UP** or **DOWN** button until **KTM MY RIDE** is marked. Press the **SET** button to open the menu.



Warning

Danger of accidents Headphone volume which is too high distracts attention from traffic activity.

- Always select headphone volume which is low enough for you to still clearly hear acoustic signals.

7 COMBINATION INSTRUMENT

- Press the **UP** or **DOWN** button until **Audio** is marked. Press the **SET** button to open the menu.
 - Press and hold the **UP** button to increase the audio volume.
 - Press and hold the **DOWN** button to reduce the audio volume.
 - Press the **UP** button briefly to change to the next audio track.
 - Press the **DOWN** button briefly to change to the previous audio track.
 - Press the **SET** button to play or pause the audio track.
-



Info

The audio function can be added to **Quick Selector 1** or **Quick Selector 2** for easier operation.

7.17.10 Telephony (optional)

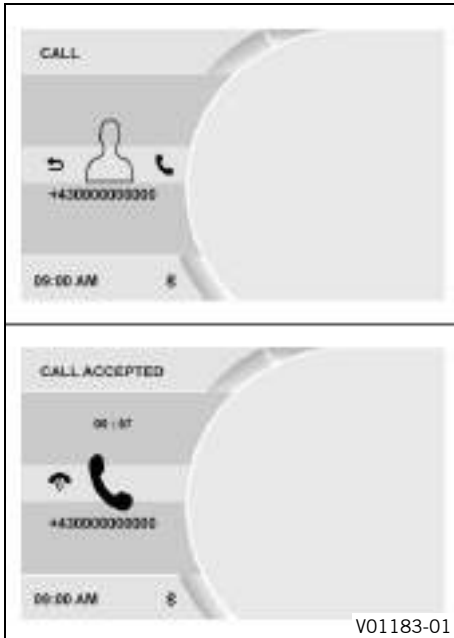
**Condition**

- Function **KTM MY RIDE** activated (optional).
- Function **Bluetooth®** activated.
- The **Bluetooth®** function should also be activated in the device to be paired.
- Headset linked with appropriate cellphone.

**Warning**

Danger of accidents Headphone volume which is too high distracts attention from traffic activity.

- Always select headphone volume which is low enough for you to still clearly hear acoustic signals.

- Press the **SET** button to accept an incoming call.
- Press the **BACK** button to reject an incoming call.
- Press and hold the **UP** button to increase the audio volume.
- Press and hold the **DOWN** button to reduce the audio volume.

**Info**

The call duration and contact are displayed. Depending on the cellphone settings, the contact is shown by name.

7 COMBINATION INSTRUMENT

7.17.11 General Info

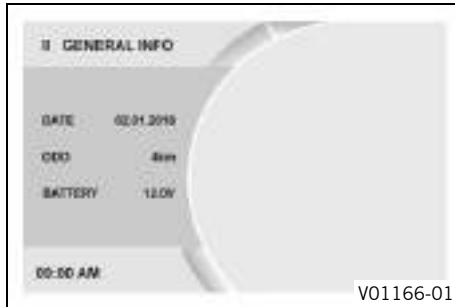

- Press **SET** button when the menu is closed.
- Press the **UP** or **DOWN** button until **Info** is marked. Press the **SET** button to open the menu.
- Press the **UP** or **DOWN** button until **General Info** is marked. Press the **SET** button to open the menu.

Date shows the date.

ODO shows the total distance covered.

Battery indicates the battery voltage.

7.17.12 Trip 1

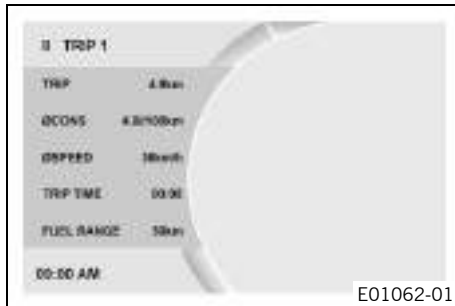

- Press **SET** button when the menu is closed.
- Press the **UP** or **DOWN** button until **Info** is marked. Press the **SET** button to open the menu.
- Press the **UP** or **DOWN** button until **Trip 1** is marked. Press the **SET** button to open the menu.

Trip shows the distance since the last reset, such as between two refueling stops. **Trip** is running and counts up to **9999**.

ØCons indicates the average fuel consumption based on **Trip**.

ØSpeed indicates the average speed based on **Trip** and **Trip Time**.

Trip Time shows the journey time on the basis of **Trip** and runs as soon as a speed signal is received.

Fuel Range indicates the possible distance you can cover with the fuel reserve.

Press and hold the **SET** button for 3-5 seconds.

All the entries in the **Trip 1** menu are reset.

7.17.13 Trip 2

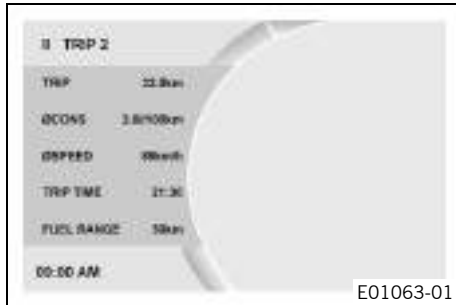

- Press **SET** button when the menu is closed.
- Press the **UP** or **DOWN** button until **Info** is marked. Press the **SET** button to open the menu.
- Press the **UP** or **DOWN** button until **Trip 2** is marked. Press the **SET** button to open the menu.

Trip shows the distance since the last reset, such as between two refueling stops. **Trip** is running and counts up to **9999**.

ØCons indicates the average fuel consumption based on **Trip**.

ØSpeed indicates the average speed based on **Trip** and **Trip Time**.

Trip Time shows the journey time on the basis of **Trip** and runs as soon as a speed signal is received.

Fuel Range indicates the possible distance you can cover with the fuel reserve.

7 COMBINATION INSTRUMENT

Press and hold the **SET** button for 3-5 seconds.

All the entries in the **Trip 2** menu are reset.

7.17.14 Warning

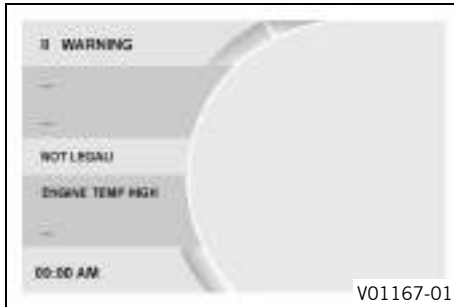

Condition

- Message or warning is present.
 - Press **SET** button when the menu is closed.
 - Press the **UP** or **DOWN** button until **Info** is marked. Press the **SET** button to open the menu.
 - Press the **UP** or **DOWN** button until **Warning** is marked. Press the **SET** button to open the menu.
 - Use the **UP** or **DOWN** button to navigate through the warnings.
- All the warnings that have occurred are displayed and stored in the **Warning** menu.

7.17.15 ABS

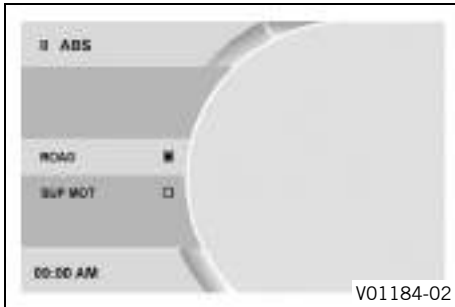
**Condition**

- The motorcycle is stationary.
 - Press **SET** button when the menu is closed.
 - Press the **UP** or **DOWN** button until **Motorcycle** is marked. Press the **SET** button to open the menu.
 - Press the **UP** or **DOWN** button until **ABS** is marked. Press the **SET** button to open the menu.
 - Activate menu item using the **UP** or **DOWN** button.
 - Press the **SET** button to select between ABS modes.

**Info**

If the ABS mode **Road** is enabled, ABS controls both wheels.

If the ABS mode **Super Moto** is enabled, ABS only controls the front wheel. The rear wheel is not controlled by ABS and may lock during braking maneuvers. The ABS warning lamp flashes slowly to remind you that the **Super Moto** ABS mode is enabled.

Press and hold the **SET** button for 3-5 seconds.

Activation of the different ABS modes.

7 COMBINATION INSTRUMENT

7.17.16 Favourites

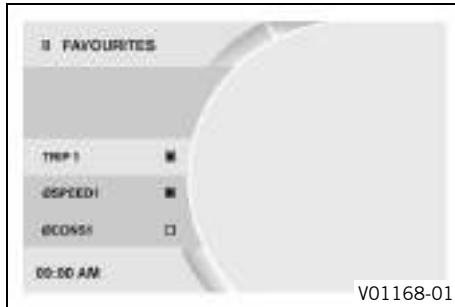

Condition

- The motorcycle is stationary.
 - Press the **SET** button when the menu is closed.
 - Press the **UP** or **DOWN** button until **Settings** is marked. Press the **SET** button to open the menu.
 - Press the **UP** or **DOWN** button until **Favourites** is marked. Press the **SET** button to open the menu.
 - Press the **UP** or **DOWN** button to activate the menu item and select it with the **SET** button.

Up to eight items of information can be selected in the **Favourites** menu.

7.17.17 Quick Selector 1

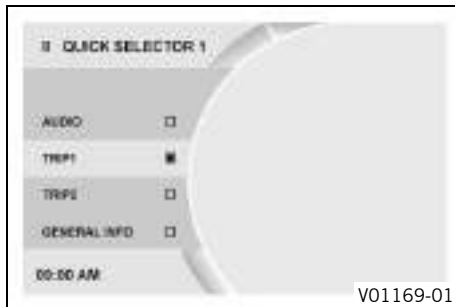

Condition

- The motorcycle is stationary.
 - Press the **SET** button when the menu is closed.
 - Press the **UP** or **DOWN** button until **Settings** is marked. Press the **SET** button to open the menu.
 - Press the **UP** or **DOWN** button until **Quick Selector 1** is marked. Press the **SET** button to open the menu.
 - Press the **UP** or **DOWN** button to activate the menu item and select it with the **SET** button.

Information can be selected in the **Quick Selector 1** menu.

When the menu is closed, the **Quick Selector 1** menu is opened by pressing the **UP** button.

7.17.18 Quick Selector 2

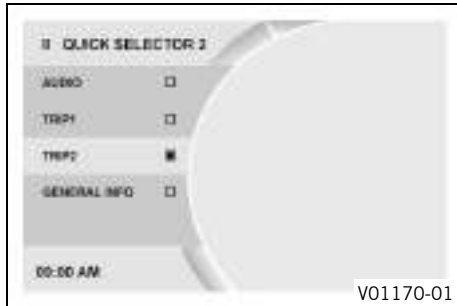

Condition

- The motorcycle is stationary.
- Press the **SET** button when the menu is closed.
- Press the **UP** or **DOWN** button until **Settings** is marked. Press the **SET** button to open the menu.
- Press the **UP** or **DOWN** button until **Quick Selector 2** is marked. Press the **SET** button to open the menu.
- Press the **UP** or **DOWN** button to activate the menu item and select it with the **SET** button.

Information can be selected in the **Quick Selector 2** menu.

When the menu is closed, the **Quick Selector 2** menu is opened by pressing the **DOWN** button.

7.17.19 Bluetooth (optional)

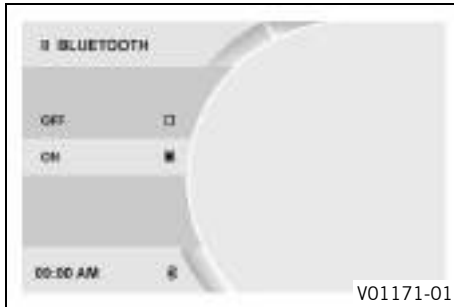

Condition

- The motorcycle is stationary.
 - Press the **SET** button when the menu is closed.
 - Press the **UP** or **DOWN** button until **Preferences** is marked. Press the **SET** button to open the menu.
 - Press the **UP** or **DOWN** button until **Bluetooth** is marked. Press the **SET** button to open the menu.
 - Activate the menu item using the **UP** or **DOWN** button.
 - Press the **SET** button to switch the **Bluetooth**® function on or off.

i Info

The **Bluetooth**® function can only be used in conjunction with **KTM MY RIDE** (optional).
When the **Bluetooth**® function is switched on and the device is connected, the **Bluetooth**® symbol appears in the display of the combination instrument.

7.17.20 Display Theme

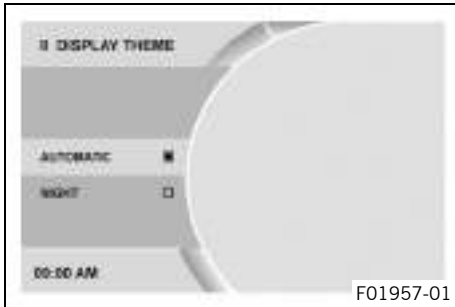
**Condition**

- The motorcycle is stationary.
 - Press the **SET** button when the menu is closed.
 - Press the **UP** or **DOWN** button until **Preferences** is marked. Press the **SET** button to open the menu.
 - Press the **UP** or **DOWN** button until **Display Theme** is marked. Press the **SET** button to open the menu.
 - Activate the menu item using the **UP** or **DOWN** button.
 - Press the **SET** button to set up automatic day-night mode or permanent night mode.

**Info**

In both modes, the display is brightened or dimmed depending on the amount of light that the ambient light sensor detects.

7.17.21 Shift Light



Condition

- The motorcycle is stationary.
- **ODO** > 1000 km (621 miles).
 - Press the **SET** button when the menu is closed.
 - Press the **UP** or **DOWN** button until **Preferences** is marked. Press the **SET** button to open the menu.
 - Press the **UP** or **DOWN** button until **Shift Light** is marked. Press the **SET** button to open the menu.
 - Activate the menu item using the **UP** or **DOWN** button.
 - Switch the shift warning light on or off or set the engine speed for the gear shift recommendation by pressing the **SET** button.



Info

When the engine speed reaches **RPM 1**, the speed display lights up red.
When the engine speed reaches **RPM 2**, the speed display flashes red.

7.17.22 Setting the time and date

Condition

The motorcycle is stationary.

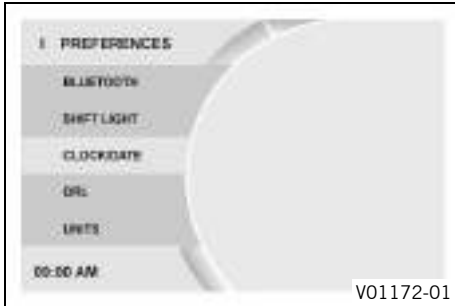

- Press the **SET** button when the menu is closed.
- Press the **UP** or **DOWN** button until **Preferences** appears. Press the **SET** button to open the menu.
- Press the **UP** or **DOWN** button until **Clock/Date** is marked. Press the **SET** button to open the menu.

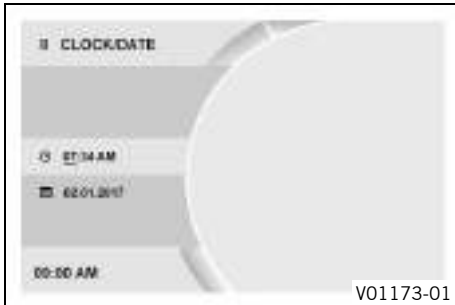

Setting the clock

- Press the **UP** or **DOWN** button until the time is marked.
- Press the **SET** button.
 - ✓ The hour flashes and is underlined.
- Press the **UP** or **DOWN** button until the current hour is set.
- Press the **SET** button.
 - ✓ The minutes flash and are underlined.
- Press the **UP** or **DOWN** button until the current minute is set.
- Press the **SET** button.
 - ✓ The time is stored.

7 COMBINATION INSTRUMENT

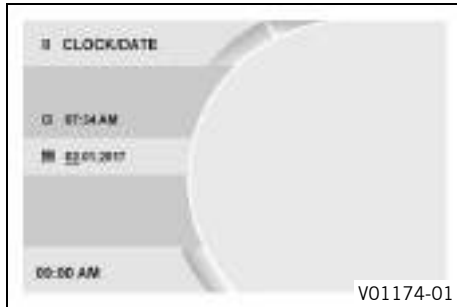

Setting the date

- Press the **UP** or **DOWN** button until the date is marked.
- Press the **SET** button.
 - ✓ The day flashes and is underlined.
- Press the **UP** or **DOWN** button until the current day is set.
- Press the **SET** button.
 - ✓ The month flashes and is underlined.
- Press the **UP** or **DOWN** button until the current month is set.
- Press the **SET** button.
 - ✓ The year flashes and is underlined.
- Press the **UP** or **DOWN** button until the current year is set.
- Press the **SET** button.
 - ✓ The date is stored.

7.17.23 DRL

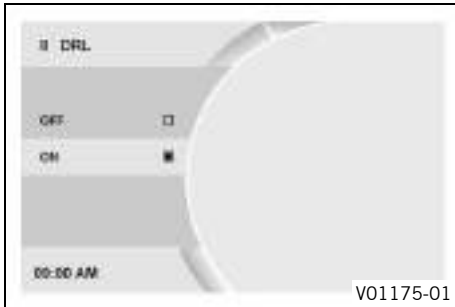
**Condition**

- The motorcycle is stationary.
- Press the **SET** button when the menu is closed.
- Press the **UP** or **DOWN** button until **Preferences** is marked. Press the **SET** button to open the menu.

**Warning**

Danger of accidents When visibility is poor, the daytime running light is not a substitute for the low beam. Automatic switching between the daytime running light and low beam may only be partially available when visibility is significantly impaired due to fog, snow or rain.

- Ensure that the appropriate type of lighting is always selected.
- If necessary switch off the daytime running lights using the menu before going on a ride or when stopped so that the low beam is switched on permanently.
- Note the legal regulations regarding the daytime running light.

7 COMBINATION INSTRUMENT

- Press the **UP** or **DOWN** button until **DRL** is marked. Press the **SET** button to open the menu.
- Activate the menu item using the **UP** or **DOWN** button.
- Press **SET** button to switch the daytime running light on or off.

7.17.24 Distance

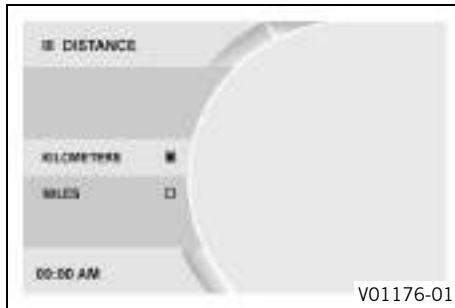

Condition

- The motorcycle is stationary.
- Press the **SET** button when the menu is closed.
- Press the **UP** or **DOWN** button until **Preferences** is marked. Press the **SET** button to open the menu.
- Press the **UP** or **DOWN** button until **Units** is marked. Press the **SET** button to open the menu.
- Press the **UP** or **DOWN** button until **Distance** is marked. Press the **SET** button to open the menu.
- Activate the menu item using the **UP** or **DOWN** button.
- Press the **SET** button to confirm the desired unit.

7.17.25 Temperature

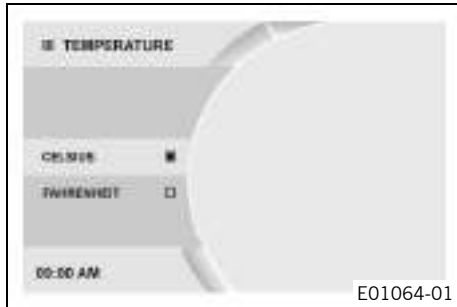

Condition

- The motorcycle is stationary.
 - Press the **SET** button when the menu is closed.
 - Press the **UP** or **DOWN** button until **Preferences** is marked. Press the **SET** button to open the menu.
 - Press the **UP** or **DOWN** button until **Units** is marked. Press the **SET** button to open the menu.
 - Press the **UP** or **DOWN** button until **Temperature** is marked. Press the **SET** button to open the menu.
 - Activate the menu item using the **UP** or **DOWN** button.
 - Press the **SET** button to confirm the desired unit.

7.17.26 Fuel Cons

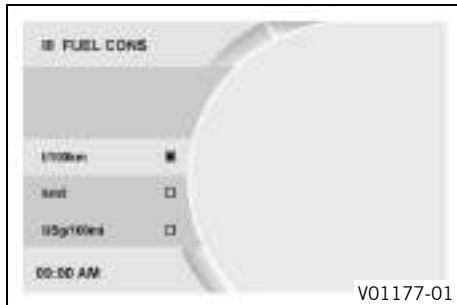

Condition

- The motorcycle is stationary.
 - Press the **SET** button when the menu is closed.
 - Press the **UP** or **DOWN** button until **Preferences** is marked. Press the **SET** button to open the menu.
 - Press the **UP** or **DOWN** button until **Units** is marked. Press the **SET** button to open the menu.
 - Press the **UP** or **DOWN** button until **Fuel Cons** is marked. Press the **SET** button to open the menu.

7 COMBINATION INSTRUMENT

- Activate the menu item using the **UP** or **DOWN** button.
- Press the **SET** button to confirm the desired unit.

7.17.27 Language

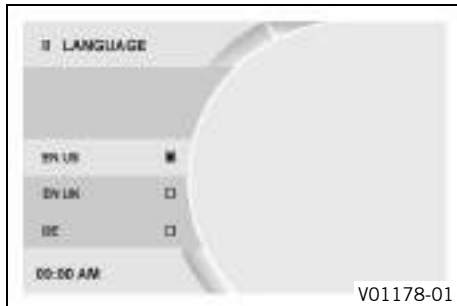

Condition

- The motorcycle is stationary.
- Press the **SET** button when the menu is closed.
- Press the **UP** or **DOWN** button until **Preferences** is marked. Press the **SET** button to open the menu.
- Press the **UP** or **DOWN** button until **Language** is marked. Press the **SET** button to open the menu.
- Press the **UP** or **DOWN** button to activate the menu item and select it with the **SET** button.

The menu languages are US English, UK English, German, Italian, French, and Spanish.

7.17.28 Service

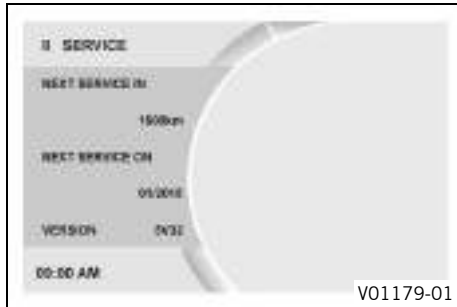

Condition

- The motorcycle is stationary.
 - Press the **SET** button when the menu is closed.
 - Press the **UP** or **DOWN** button until **Preferences** is marked. Press the **SET** button to open the menu.
 - Press the **UP** or **DOWN** button until **Service** is marked. Press the **SET** button to open the menu.

The next service due is shown in the **Service** menu.

7.17.29 Extra Functions

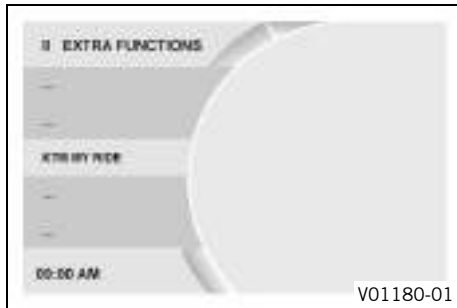

Condition

- The motorcycle is stationary.
- Motorcycle with optional supplementary function.
 - Press the **SET** button when the menu is closed.
 - Press the **UP** or **DOWN** button until **Preferences** is marked. Press the **SET** button to open the menu.
 - Press the **UP** or **DOWN** button until **Extra Functions** is marked. Press the **SET** button to open the menu.
 - Use the **UP** or **DOWN** button to navigate through the extra functions.

The optional extra functions are listed in **Extra Functions**.



Info

The current **KTM PowerParts** and the available software for your vehicle can be found on the KTM website.

8.1 Advice on preparing for first use



Danger

Danger of accidents A rider who is not fit to ride poses a danger to him or herself and others.

- Do not operate the vehicle if you are not fit to ride due to alcohol, drugs or medication.
- Do not operate the vehicle if you are physically or mentally impaired.



Warning

Risk of injury Missing or poor protective clothing presents an increased safety risk.

- Wear appropriate protective clothing such as helmet, boots, gloves as well as trousers and a jacket with protectors on all rides.
- Always wear protective clothing that is in good condition and meets the legal regulations.



Warning

Danger of crashing Different tire tread patterns on the front and rear wheel impair the handling characteristic.

Different tire tread patterns can make the vehicle significantly more difficult to control.

- Make sure that only tires with a similar tire tread pattern are fitted to the front and rear wheel.



Warning

Danger of accidents Non-approved or non-recommended tires and wheels impact the handling characteristic.

- Only use tires/wheels approved by KTM with the corresponding speed index.



Warning

Danger of accidents New tires have reduced road grip.

The contact surface on new tires is not yet roughened.

- Run in new tires with moderate riding at alternating angles.
Running-in phase 200 km (124 mi)



Info

When using the vehicle, remember that others may feel disturbed by excessive noise.

- Ensure that the pre-sales inspection work has been carried out by an authorized KTM workshop.
 - ✓ The delivery certificate is transferred upon vehicle handover.
- Read the entire Owner's Manual before riding for the first time.
- Get to know the controls.
- Get used to the handling characteristic of the motorcycle on suitable terrain before undertaking a more challenging ride. Also, ride as slowly as possible to get a better feeling for the motorcycle.
- Hold the handlebar firmly with both hands and keep your feet on the footrests when riding.
- Run the engine in. (📖 p. 89)

8.2 Running in the engine

- During the running-in phase, do not exceed the specified engine speed.

Guideline

Maximum engine speed	
During the first: 1,000 km (620 mi)	7,500 rpm



Info

During the running-in phase, the shift warning light is set to a specified value and cannot be changed.

- Avoid fully opening the throttle!



8.3 Loading the vehicle



Warning

Danger of accidents Total weight and axle loads influence the handling characteristic.

The total weight consists of: motorcycle ready for operation and with a full tank, driver and passenger with protective clothing and helmet, and luggage.

- Do not exceed the maximum permissible overall weight or the axle loads.



Warning

Danger of accidents Improper mounting of cases or the tank rucksack impairs the handling characteristic.

- Mount and secure cases and tank rucksack according to the manufacturer's instructions.



Warning

Danger of accidents The luggage system will be damaged if it is overloaded.

- Read the manufacturer information on maximum payload when mounting cases.



Warning

Danger of accidents Luggage which has slipped impairs visibility.

If the tail light is covered, you are less visible to traffic behind you, especially when it is dark.

- Check that your luggage is fixed properly at regular intervals.



Warning

Danger of accidents A high payload alters the handling characteristic and increases the stopping distance.

- Adapt your speed to your payload.



Warning

Danger of accidents Pieces of luggage which have slipped impair the handling characteristic.

- Check that your luggage is fixed properly at regular intervals.

- If luggage is carried, ensure it is fixed firmly as close as possible to the center of the vehicle and ensure even weight distribution between the front and rear wheels.
- Do not exceed maximum permissible weight and maximum permissible axle loads.

Guideline

Maximum permissible overall weight	355 kg (783 lb.)
Maximum permissible front axle load	127 kg (280 lb.)
Maximum permissible rear axle load	228 kg (503 lb.)



9.1 Checks and maintenance measures when preparing for use

i Info

Before every trip, check the condition of the vehicle and ensure that it is roadworthy. The vehicle must be in perfect technical condition when it is being operated.

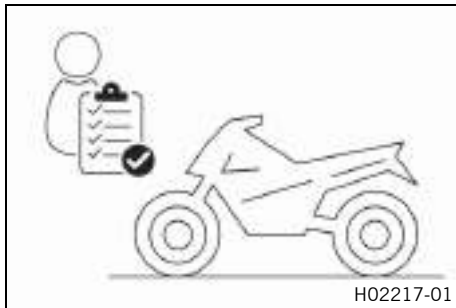

- Check the engine oil level. (📖 p. 208)
- Check the front brake fluid level. (📖 p. 142)
- Check the rear brake fluid level. (📖 p. 151)
- Check the front brake linings. (📖 p. 146)
- Check the rear brake linings. (📖 p. 155)
- Check that the brake system is functioning properly.
- Check the coolant level. (📖 p. 196)
- Check for chain dirt accumulation. (📖 p. 125)
- Check the chain tension. (📖 p. 127)
- Check the tire condition. (📖 p. 167)
- Check tire pressure. (📖 p. 169)
- Check the settings of all controls and ensure that they can be operated smoothly.
- Check that the electrical system is functioning properly.
- Check that luggage is properly secured.
- Sit on the motorcycle and check the rear mirror setting.
- Check the fuel level.

9.2 Starting



Danger

Danger of poisoning Exhaust gases are toxic and inhaling them may result in unconsciousness and death.

- Always make sure there is sufficient ventilation when running the engine.
- Use effective exhaust extraction when starting or running the engine in an enclosed space.



Caution

Danger of accidents Electronic components and safety devices will be damaged if the 12-V battery is discharged or missing.

If the 12-V battery is discharged or defective, malfunctions in the vehicle electronics can occur, especially when starting.

- Never operate the vehicle with a discharged 12-V battery or without a 12-V battery.

Note

Engine damage Unfiltered intake air has a negative effect on the service life of the engine.

Dust and dirt will enter the engine without an air filter.

- Only operate the vehicle if it is equipped with an air filter.

Note

Engine damage High revving speed with a cold engine negatively impacts the lifespan of the engine.

- Always run the engine warm at a low speed.

9 RIDING INSTRUCTIONS

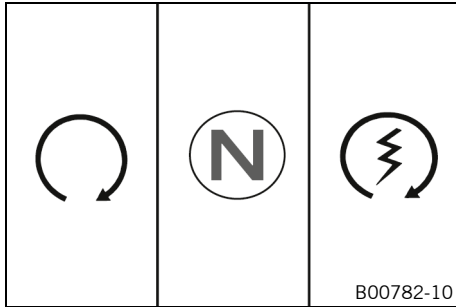

- Unlock the steering. (📖 p. 34)
- Sit on the vehicle, take the weight off of the side stand, and move it all the way up with your foot.
- Turn the emergency OFF switch to the position ○.
- Switch on the ignition by turning the ignition key to the position ○.
 - ✓ After you switch on the ignition, you can hear the fuel pump working for about two seconds. The function check of the combination instrument is run at the same time.
- Shift the transmission into neutral.
 - ✓ The green idle indicator lamp **N** lights up.
 - ✓ The ABS warning light lights up and goes out again after starting off.
- Press start button (🔌).

**Info**

Do not press the start button until the combination instrument function check has finished.

Do not open the throttle to start.

Press the starter for a maximum of five seconds. Wait for a least five seconds before trying again.

This motorcycle is equipped with a safety starting system. You can only start the engine if the transmission is in neutral or if the clutch lever is pulled when a gear is engaged. If the side stand is folded out and you shift into gear and release the clutch lever, the engine stops.



9.3 Starting off

- Pull the clutch lever, engage 1st gear, release the clutch lever slowly, and simultaneously open the throttle carefully.

**Tip**

If the engine dies while starting off, only pull the clutch lever and press the electric starter button. You do not need to shift into neutral.



9.4 Shifting, riding



Warning

Danger of accidents Abrupt load alterations can cause the vehicle to get out of control.

- Avoid abrupt load alterations and sudden braking actions.
- Adapt your speed to the road conditions.



Warning

Danger of accidents If you change down at high engine speed, the rear wheel blocks and the engine races.

- Do not change into a low gear at high engine speed.



Warning

Danger of accidents An incorrect ignition key position causes malfunctions.

- Do not change the ignition key position while driving.



Warning

Danger of accidents Adjustments to the vehicle distract attention from traffic activity.

- Make all adjustments when the vehicle is at a standstill.

**Warning**

Risk of injury The passenger may fall from the motorcycle if they conduct themselves incorrectly.

- Ensure that the passenger sits correctly on the passenger seat, places his or her feet on the passenger foot pegs and holds on to the rider or the grab handles.
- Note the regulations governing the minimum age of passengers in your country.

**Warning**

Danger of accidents A risky riding style constitutes a major risk.

- Comply with traffic regulations and ride defensively and with foresight to detect sources of danger as early as possible.

**Warning**

Danger of accidents Cold tires have reduced road grip.

- Ride the first miles carefully on every journey at moderate speed until the tires reach operating temperature.

**Warning**

Danger of accidents New tires have reduced road grip.

The contact surface on new tires is not yet roughened.

- Run in new tires with moderate riding at alternating angles.
Running-in phase 200 km (124 mi)



Warning

Danger of accidents Pieces of luggage which have slipped impair the handling characteristic.

- Check that your luggage is fixed properly at regular intervals.



Warning

Danger of accidents A fall can damage the vehicle more seriously than it may first appear.

- Check the vehicle after a fall as you do when preparing for use.

Note

Engine failure Overheating damages the engine.

- If the coolant temperature warning is displayed, stop immediately and take care not to endanger yourself or other traffic participants in the process.
 - Allow the engine and cooling system to cool down.
 - Check and, if necessary, correct the coolant level on the cooling system while it is in a cooled state.
-



Info

If unusual noises occur while riding, stop immediately (taking care not to endanger yourself or other road users in the process), switch off the engine and contact an authorized KTM workshop.

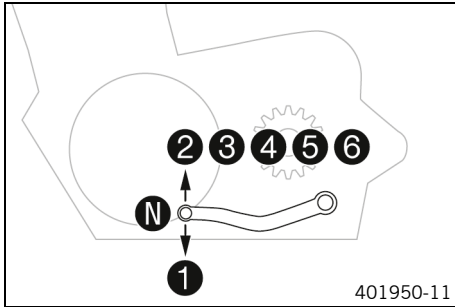



- Shift into a higher gear when conditions allow (incline, road situation, etc.).
- Release the throttle while simultaneously pulling the clutch lever, shift into the next gear, release the clutch lever, and open the throttle.

i Info

The gear positions can be seen in the figure. The idle position is between the first and second gears. First gear is used for starting off or for steep inclines.

- After reaching maximum speed by fully opening the throttle grip, turn the throttle back so it is $\frac{3}{4}$ open. This will barely reduce the speed, but fuel consumption will be considerably lower.
- Accelerate only up to a speed suitable for the road surface and weather conditions. Particularly in bends, do not shift, and accelerate very carefully.
- Brake if necessary and close the throttle at the same time in order to shift down.
- Pull clutch lever and shift into a lower gear, release the clutch lever slowly, and open the throttle or shift again.
- Switch off the engine if you are likely to be running at idle speed or stationary for a long time.

- If the engine stalls (e.g. at an intersection), just pull the clutch lever and actuate the start button. The transmission must not be shifted into neutral.
- If the oil pressure warning lamp  lights up during a trip, stop as soon as it is safe to do so and switch off the engine. Contact an authorized KTM workshop.
- If the malfunction indicator lamp  lights up during a trip, please contact an authorized KTM workshop as soon as possible.
- If the general warning lamp  lights up during a trip, an operating safety (warning) message was detected.



Info

All warnings which have occurred are displayed and stored in the **Warning** menu until these are no longer active.

9.5 Applying the brakes



Warning

Danger of accidents Moisture and dirt impair the brake system.

- Brake carefully several times to dry out and remove dirt from the brake linings and the brake discs.

**Warning**

Danger of accidents A spongy pressure point on the front or rear brake reduces braking efficiency.

- Check the brake system and do not continue riding until the problem is eliminated. (Your authorized KTM workshop will be glad to help.)

**Warning**

Danger of accidents The brake system fails in the event of overheating. If the foot brake lever is not released, the brake linings drag continuously.

- Take your foot off the foot brake lever if you do not want to brake.

**Warning**

Danger of accidents Higher total weight increases the stopping distance.

- Take the longer stopping distance into account when carrying a passenger or luggage with you.

**Warning**

Danger of accidents Salt on the roads impairs the brake system.

- Brake carefully several times to remove salt from the brake linings and the brake discs.

**Warning**

Danger of accidents ABS may increase the stopping distance in certain situations.

- Adjust application of the brakes to the respective riding situation and riding surface conditions.

- When braking, release the throttle and apply the front and rear brakes at the same time.



Info

When the ABS is enabled, maximum braking power can be achieved even with low road grip surfaces such as sandy, wet, or slippery terrain without locking the wheels.



Warning

Danger of accidents The rear wheel can lock due to the engine braking effect.

- Pull in the clutch, if you perform emergency or full braking, or if you brake on a slippery ground.



Warning

Danger of accidents Banked or laterally sloping ground reduces the maximum possible delay.

- If possible finish braking before going into a bend.

- Always finish braking before you go into a bend. Shift down to a lower gear appropriate to your speed.
- Use the braking effect of the engine on long downhill stretches. Shift back one or two gears, but do not over-rev the engine when doing so. This means that significantly less braking is required and the brake system does not overheat.

9.6 Stopping, parking



Warning

Risk of injury People who act without authorization endanger themselves and others.

- Do not leave the vehicle unattended if the engine is running.
- Protect the vehicle against access by unauthorized persons.
- Lock the steering and remove the ignition key if you leave the vehicle unattended.



Warning

Danger of burns Some vehicle components become very hot when the vehicle is operated.

- Do not touch any parts such as the exhaust system, radiator, engine, shock absorber, or brake system before the vehicle parts have cooled down.
- Let the vehicle parts cool down before you perform any work on the vehicle.

Note

Material damage The vehicle may be damaged by incorrect procedure when parking.

Significant damage may be caused if the vehicle rolls away or falls over.

The components for parking the vehicle are designed only for the weight of the vehicle.

- Park the vehicle on a firm and level surface.
- Ensure that nobody sits on the vehicle when the vehicle is parked on a stand.

9 RIDING INSTRUCTIONS

Note

Fire hazard Hot vehicle components pose a fire hazard and explosion risk.

- Do not park the vehicle near to materials which are highly flammable or explosive.
 - Allow the vehicle to cool down before covering it.
-

- Apply the brakes on the motorcycle.
 - Shift the transmission into neutral.
 - Switch off the ignition by turning the ignition key to the position ☒.
-



Info

If the engine is switched off with the emergency OFF switch and the ignition remains switched on in the ignition lock, the power supply to most electrical power consumers remains uninterrupted and this discharges the 12-V battery. You should therefore always switch off the engine with the ignition lock – the emergency OFF switch is intended for emergencies only.

- Park the motorcycle on a firm surface.
 - Swing side stand forward with your foot as far as it will go and lean the vehicle on it.
 - Lock the steering. (🗉 p. 33)
-

9.7 Transport

Note

Danger of damage The parked vehicle can roll away or fall over.

- Park the vehicle on a firm and level surface.
-

Note

Fire hazard Hot vehicle components pose a fire hazard and explosion risk.

- Do not park the vehicle near to materials which are highly flammable or explosive.
 - Allow the vehicle to cool down before covering it.
-

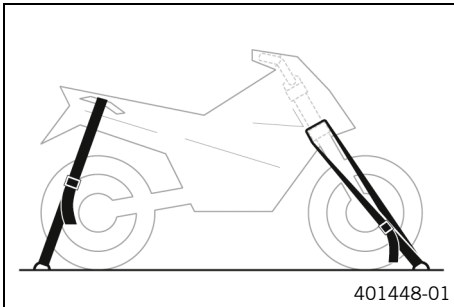

- Switch off the engine and remove the ignition key.
- Use tension belts or other suitable devices to secure the motorcycle against accidents or falling over.

9.8 Refueling



Danger

Fire hazard Fuel is highly flammable.

The fuel in the fuel tank expands when warm and can escape if overfilled.

- Do not fuel the vehicle in the vicinity of open flames or lit cigarettes.
- Switch off the engine for refueling.
- Make sure that no fuel is spilled; particularly not on hot parts of the vehicle.
- If any fuel is spilled, wipe it off immediately.
- Observe the specifications for refueling.



Warning

Danger of poisoning Fuel is poisonous and a health hazard.

- Avoid skin, eye and clothing contact with fuel.
- Immediately consult a doctor if you swallow fuel.
- Do not inhale fuel vapors.
- In case of skin contact, rinse the affected area with plenty of water.
- Rinse the eyes thoroughly with water, and consult a doctor in case of fuel contact with the eyes.
- Change your clothing in case of fuel spills on them.

Note

Material damage Inadequate fuel quality causes the fuel filter to quickly become clogged.

In some countries and regions, the available fuel quality and cleanliness may not be sufficient. This will result in problems with the fuel system.

- Refuel only with clean fuel that meets the specified standards. (Your authorized KTM workshop will be glad to help.)



Note

Environmental hazard Improper handling of fuel is a danger to the environment.

- Do not allow fuel to enter the groundwater, the soil, or the sewage system.
-

9 RIDING INSTRUCTIONS

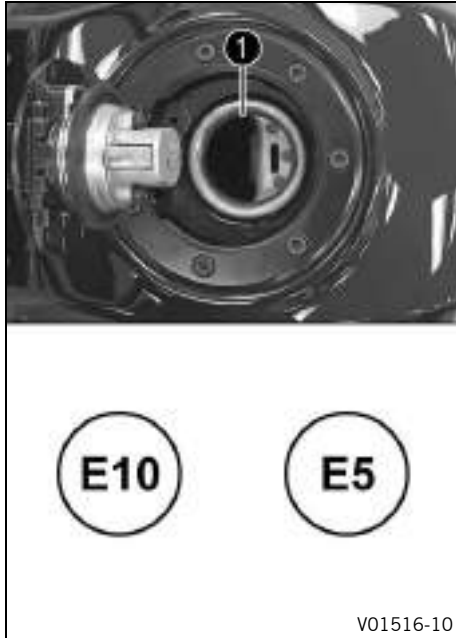

- Switch off the engine.
- Open fuel tank filler cap. (📖 p. 34)
- Fill the fuel tank with fuel up to the lower edge **1** of the fuel filler.

Total fuel tank capacity, approx.	13.5 l (3.57 US gal)	Super unleaded (ROZ 95) (📖 p. 247) (EU/AU/JP/AR/CN/CO/MY/PH)
Total fuel tank capacity, approx.		Gasohol 95 E20 (RON 95) (📖 p. 247) (390 DUKE TH)
Total fuel tank capacity, approx.		Super unleaded, type C (ROZ 95/RON 95/PON 91) (📖 p. 248) (390 DUKE BR)

- Close the fuel tank filler cap. (📖 p. 36)

10.1 Additional information

Any further work that results from the compulsory work or from the recommended work must be ordered separately and invoiced separately.

Different service intervals may apply in your country, depending on the local operating conditions.

Individual service intervals and scopes may change in the course of technical developments. The most up-to-date service schedule can always be found on KTM Dealer.net. Your authorized KTM dealer will be happy to advise you.

10.2 Required work

	every 24 months				
	every 12 months				
	every 15,000 km (9,300 mi)				
	every 7,500 km (4,650 mi)				
	after 1,000 km (620 mi)				
Read out the fault memory using the KTM diagnostics tool. 🛠️	○	●	●	●	●
Program the shift shaft sensor. 🛠️	○		●	●	●
Check that the electrical system is functioning properly. 🛠️	○	●	●	●	●
Change the engine oil and the oil filter, clean the oil screens. 🛠️ (📖 p. 209)	○	●	●	●	●
Check the brake discs. (📖 p. 140)	○	●	●	●	●
Check the front brake linings. (📖 p. 146)	○	●	●	●	●
Check the rear brake linings. (📖 p. 155)	○	●	●	●	●
Check the brake lines for damage and leakage. 🛠️	○	●	●	●	●

10 SERVICE SCHEDULE

	every 24 months				
	every 12 months				
	every 15,000 km (9,300 mi)				
	every 7,500 km (4,650 mi)				
	after 1,000 km (620 mi)				
Check the front brake fluid level. (📖 p. 142)	○	●	●	●	●
Check the rear brake fluid level. (📖 p. 151)	○	●	●	●	●
Check the tire condition. (📖 p. 167)	○	●	●	●	●
Check tire pressure. (📖 p. 169)	○	●	●	●	●
Check the shock absorber and fork for leaks. 🛠️	○	●	●	●	●
Clean the dust boots of the fork legs. (📖 p. 120)		●	●		
Check the chain, rear sprocket, and engine sprocket. (📖 p. 130)		●	●	●	●
Check the chain tension. (📖 p. 127)	○	●	●	●	●
Check the coolant level. (📖 p. 196)	○	●	●	●	●
Check that the radiator fan is functioning properly. 🛠️	○	●	●	●	●
Change the air filter, clean the air filter box. 🛠️		●	●		
Check that the throttle cables are undamaged, routed without sharp bends, and set correctly. 🛠️	○	●	●	●	●
Check the cables for damage and routing without sharp bends. 🛠️	○	●	●	●	●
Check the valve clearance, change the spark plug. 🛠️			●		
Change the front brake fluid. 🛠️					●
Change the rear brake fluid. 🛠️					●

	every 24 months				
	every 12 months				
	every 15,000 km (9,300 mi)				
	every 7,500 km (4,650 mi)				
	after 1,000 km (620 mi)				
Check the steering head bearing play. 🛠️	○	●	●	●	●
Check the headlight setting. (📖 p. 187)	○	●	●		
Final check: Final check: Check the vehicle for safe operation and take a test ride. 🛠️	○	●	●	●	●
Read out the error memory after the test ride using the KTM diagnostics tool. 🛠️	○	●	●	●	●
Set the service interval display. 🛠️	○	●	●	●	●
Make a service entry in KTM Dealer.net . 🛠️	○	●	●	●	●

- One-time interval
- Periodic interval

10.3 Recommended work

	every 48 months				
	every 12 months				
	every 30,000 km (18,600 mi)				
	every 7,500 km (4,650 mi)				
	after 1,000 km (620 mi)				
Check the frame. 🛠️			●		

10 SERVICE SCHEDULE

	every 48 months				
	every 12 months				
	every 30,000 km (18,600 mi)				
	every 7,500 km (4,650 mi)				
	after 1,000 km (620 mi)				
Check the link fork. 🛠️			●		
Check the swingarm bearing for play. 🛠️		●	●		
Check the wheel bearing for play. 🛠️		●	●		
Check the antifreeze. 🛠️	○	●	●	●	
Change the coolant. 🛠️ (📖 p. 202)					●
Empty the drainage hoses. 🛠️	○	●	●	●	●
Check all hoses (e.g. fuel, coolant, bleeder, drainage, etc.) and sleeves for cracking, leaks, and incorrect routing. 🛠️	○	●	●	●	●
Grease all moving parts (e.g., side stand, hand lever, chain, ...) and check for smooth operation. 🛠️	○	●	●	●	●
Check the tightness of the safety-relevant screws and nuts which are easily accessible. 🛠️	○	●	●	●	●

- One-time interval
- Periodic interval

11.1 Adjusting the spring preload of the shock absorber ↩



Warning

Danger of accidents Modifications to the suspension setting may seriously alter the handling characteristic.

- Ride slowly to start with after making adjustments to get the feel of the new handling characteristic.



Info

The spring preload defines the initial status of the spring operation on the shock absorber. The best spring preload setting is achieved when it is set for the weight of the rider and that of any luggage and a passenger, thus ensuring an ideal compromise between handling and stability.



- Adjust the spring preload by turning adjusting ring ①.

Guideline

Spring preload	
Standard	5 clicks
Hook wrench, shock absorber (90529077000)	
Extension for hook wrench (90129099025)	



Info

The spring preload can be set to 10 different positions.



11 TUNING THE CHASSIS

11.2 Adjusting the shift lever



Info

The adjustment range of the shift lever is limited.

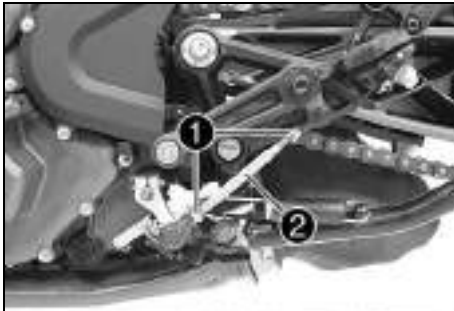

- Loosen nuts **1**.
- Adjust the shift lever by turning shift rod **2**.

Guideline

Shift rod adjustment range A	90 ... 102 mm (3.54 ... 4.02 in)
-------------------------------------	----------------------------------



Info

Make the same adjustments on both sides.
At least five screw threads must be screwed into the seating.

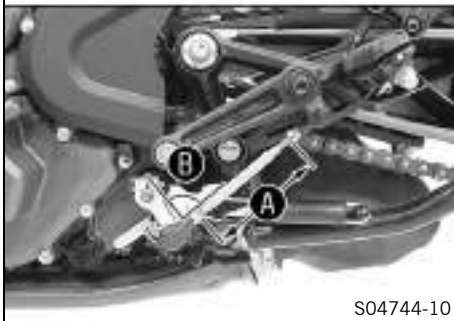

- Check adjusting angle **B**.

Guideline

Adjusting angle B shift rod - bell crank - shift lever	90°
---	-----

- Tighten nuts **1**.

S04744-10



Info

After the nuts have been tightened, the bearings of the shift rod must be central and aligned identically to each other in order to ensure freedom of movement in the bearing shells.

- Check the shift lever to ensure it is functioning properly and can move freely.



12 SERVICE WORK ON THE CHASSIS

12.1 Raising the motorcycle with rear lifting gear

Note

Danger of damage The parked vehicle can roll away or fall over.

- Park the vehicle on a firm and level surface.

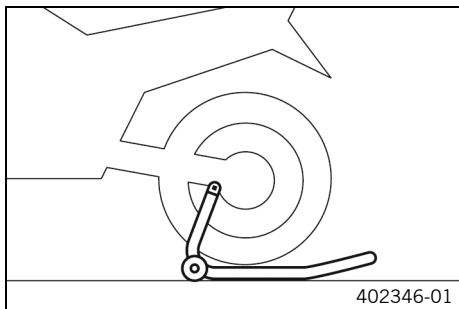

- Mount the supports of the lifting gear.
- Insert the adapter in the rear lifting gear.

Retaining adapter (61029955244)

Rear wheel work stand (69329955000)

- Stand the motorcycle upright, align the lifting gear to the link fork and the adapters, and raise the motorcycle.

12.2 Removing the rear of the motorcycle from the lifting gear

Note

Danger of damage The parked vehicle can roll away or fall over.

- Park the vehicle on a firm and level surface.

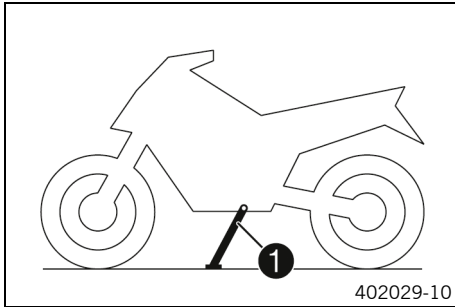

- Secure the motorcycle against falling over.
- Remove the rear lifting gear and lean the vehicle on side stand **1**.
- Remove bushings kit.



12.3 Lifting the motorcycle with the front lifting gear

Note

Danger of damage The parked vehicle can roll away or fall over.

- Park the vehicle on a firm and level surface.

Preparatory work

- Raise the motorcycle with the rear lifting gear. (📖 p. 116)

12 SERVICE WORK ON THE CHASSIS



Condition

- Remove protection cap ❶.

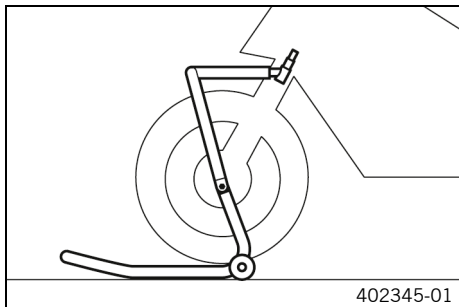

- Move the handlebar to the straight-ahead position. Position the lifting gear.

Mounting pin (69329965030)

Front wheel work stand, large (69329965100)

Info

Always raise the motorcycle at the rear first.

- Lift the motorcycle at the front.

12.4 Taking the motorcycle off the front lifting gear

Note

Danger of damage The parked vehicle can roll away or fall over.

- Park the vehicle on a firm and level surface.

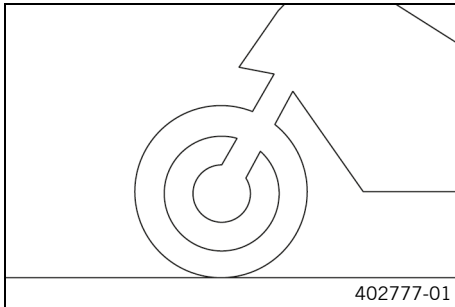

Main work

- Secure the motorcycle against falling over.
- Remove the front lifting gear.

12 SERVICE WORK ON THE CHASSIS

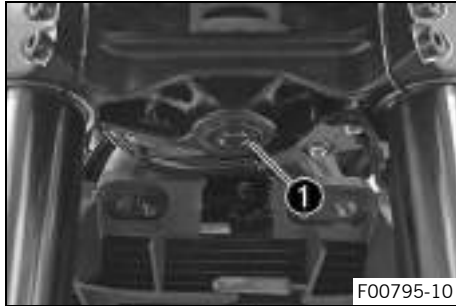

- Mount protection cap ❶.

Finishing work

- Remove the rear of the motorcycle from the lifting gear.
(📖 p. 116)

12.5 Cleaning the dust boots of the fork legs

Preparatory work

- Raise the motorcycle with the rear lifting gear. (📖 p. 116)
- Lift the motorcycle with the front lifting gear. (📖 p. 117)

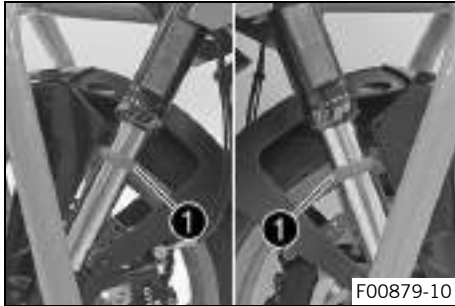

Main work

- Push dust boots ❶ of both fork legs downward.



Info

The dust boots remove dust and coarse dirt particles from the inside fork tubes. Over time, dirt can accumulate behind the dust boots. If this dirt is not removed, the oil seals behind can start to leak.



Warning

Danger of accidents Oil or grease on the brake discs reduces the braking effect.

- Always keep the brake discs free of oil and grease.
- Clean the brake discs with brake cleaner when necessary.

- Clean and oil the dust boots and inside fork tubes of both fork legs.

Universal oil spray (📖 p. 250)

- Press the dust boots back into the installation position.
- Remove the excess oil.

Finishing work

- Take the motorcycle off the front lifting gear. (📖 p. 119)

12 SERVICE WORK ON THE CHASSIS

- Remove the rear of the motorcycle from the lifting gear.
(📖 p. 116)

12.6 Removing the passenger seat

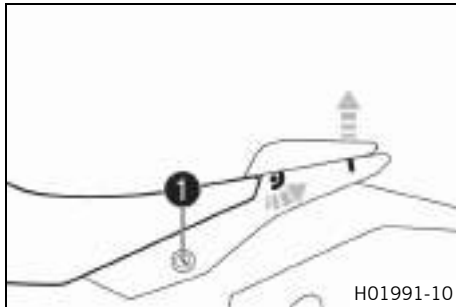

- Insert the ignition key in seat lock ❶ and turn it clockwise.
- Raise the rear of the seat, push it towards the rear, and lift it off.
- Remove the ignition key from the seat lock.

12.7 Mounting the passenger seat

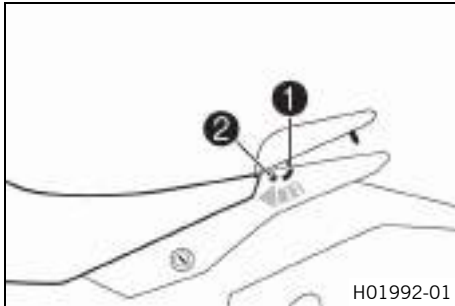

- Attach hooks **1** on the passenger seat to seat mounting **2** on the subframe, and lower it at the rear while pushing forward.
- Press passenger seat downward until it clicks into place.



Warning

Danger of accidents The seat can come loose from the anchoring if it is not mounted correctly.

- After assembly, check whether the seat is correctly locked and cannot be pulled up.
-
- Finally, check that the passenger seat is correctly mounted.



12.8 Removing the front rider's seat

Preparatory work

- Remove the passenger seat. (📖 p. 122)

12 SERVICE WORK ON THE CHASSIS

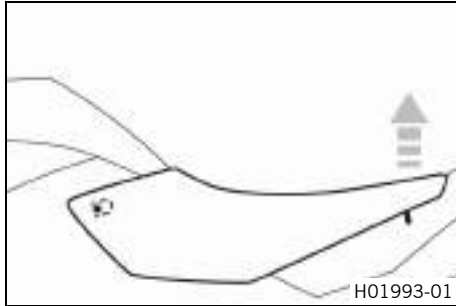

Main work

- Raise the rear of the front rider's seat, pull it towards the rear, and remove it upwards.

12.9 Mounting the front rider's seat

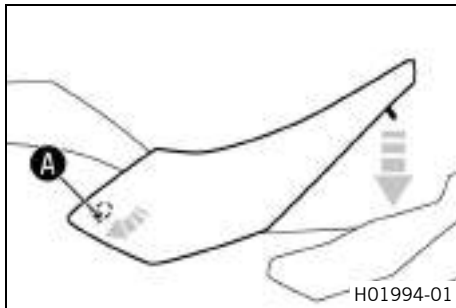

Main work

- Attach the front rider's seat in area **A** and lower at the rear.
- Finally, check that the front rider's seat is correctly mounted.

Finishing work

- Mount the passenger seat. (📖 p. 123)

12.10 Checking for chain dirt accumulation

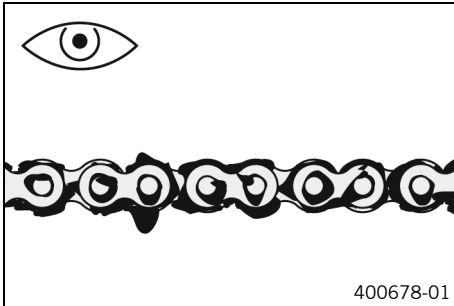

- Check the chain for coarse dirt accumulation.
 - » If the chain is very dirty:
 - Clean the chain. (📖 p. 125)



12.11 Cleaning the chain



Warning

Danger of accidents Lubricants on the tires reduces the road grip.

- Remove lubricants from the tires using a suitable cleaning agent.



Warning

Danger of accidents Oil or grease on the brake discs reduces the braking effect.

- Always keep the brake discs free of oil and grease.
- Clean the brake discs with brake cleaner when necessary.

12 SERVICE WORK ON THE CHASSIS



Note

Environmental hazard Hazardous substances cause environmental damage.

- Dispose of oils, grease, filters, fuel, cleaning agents, brake fluid, etc., correctly and in compliance with the applicable regulations.



Info

The service life of the chain depends largely on its maintenance.

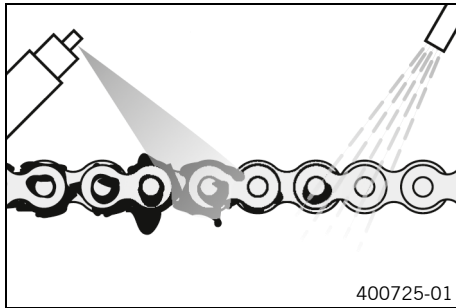

Preparatory work

- Raise the motorcycle with the rear lifting gear. (📖 p. 116)

Main work

- Clean the chain regularly.
- Rinse off loose dirt with a soft jet of water.
- Remove old grease remains with chain cleaner.

Chain cleaner (📖 p. 249)

- After drying, apply chain spray.

Street chain spray (📖 p. 250)

Finishing work

- Remove the rear of the motorcycle from the lifting gear. (📖 p. 116)

12.12 Checking the chain tension



Warning

Danger of accidents Incorrect chain tension damages components and results in accidents.

If the chain is tensioned too much, the chain, engine sprocket, rear sprocket, transmission and rear wheel bearings wear more quickly. Some components may break if overloaded.

If the chain is too loose, the chain may fall off the engine sprocket or the rear sprocket. As a result, the rear wheel locks or the engine will be damaged.

- Check the chain tension regularly.
- Set the chain tension in accordance with the specification.

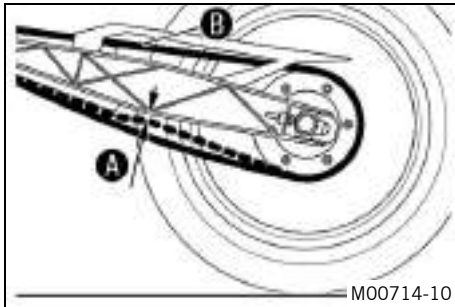

Preparatory work

- Raise the motorcycle with the rear lifting gear. (📖 p. 116)

Main work

- Shift the transmission into neutral.
- In the area after the chain sliding guard, press the chain upward toward the link fork and measure chain tension **A**.



Info

Top chain section **B** must be taut.
Chain wear is not always even, so you should repeat this measurement at different chain positions.

Chain tension	5 ... 7 mm (0.2 ... 0.28 in)
---------------	------------------------------

- » If the chain tension does not meet the specification:
 - Adjust the chain tension. (📖 p. 128)
- Remove the rear of the motorcycle from the lifting gear. (📖 p. 116)

12.13 Adjusting the chain tension



Warning

Danger of accidents Incorrect chain tension damages components and results in accidents.

If the chain is tensioned too much, the chain, engine sprocket, rear sprocket, transmission and rear wheel bearings wear more quickly. Some components may break if overloaded.

If the chain is too loose, the chain may fall off the engine sprocket or the rear sprocket. As a result, the rear wheel locks or the engine will be damaged.

- Check the chain tension regularly.
- Set the chain tension in accordance with the specification.

Preparatory work

- Raise the motorcycle with the rear lifting gear. (📖 p. 116)
- Check the chain tension. (📖 p. 127)

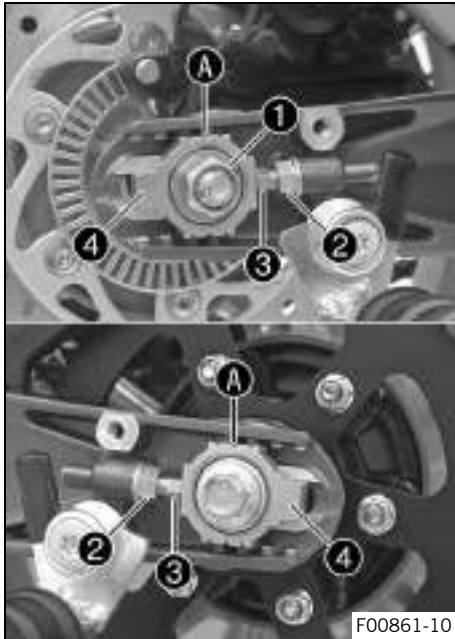

Main work

- Loosen nut ①.
- Loosen nuts ②.
- Adjust the chain tension by turning adjusting screws ③ left and right.

Guideline

Chain tension	5 ... 7 mm (0.2 ... 0.28 in)
Turn the adjusting screws ③ on the left and right so that the markings on the left and right chain adjusters ④ are in the same position relative to the reference marks ①. The rear wheel is then correctly aligned.	



Info

The top chain section must be taut.
Chain wear is not always even, so you should check the setting at different chain positions.

- Tighten nuts ②.
- Make sure that chain adjusters ④ are fitted correctly on adjusting screws ③.
- Tighten nut ①.

Guideline

Nut, rear wheel spindle	M14x1.5	98 Nm (72.3 lbf ft)
-------------------------	---------	---------------------

Finishing work

- Remove the rear of the motorcycle from the lifting gear. (📖 p. 116)

12.14 Checking the chain, rear sprocket, and engine sprocket

Preparatory work

- Raise the motorcycle with the rear lifting gear. (📖 p. 116)

Main work

- Check the rear sprocket and engine sprocket for wear.
 - » If the rear sprocket and engine sprocket are worn:
 - Change the drivetrain kit. 🛠️

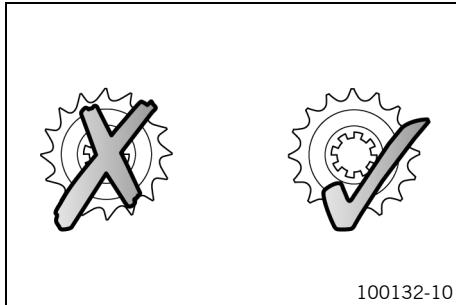

Info

The engine sprocket, rear sprocket, and chain should always be replaced together.

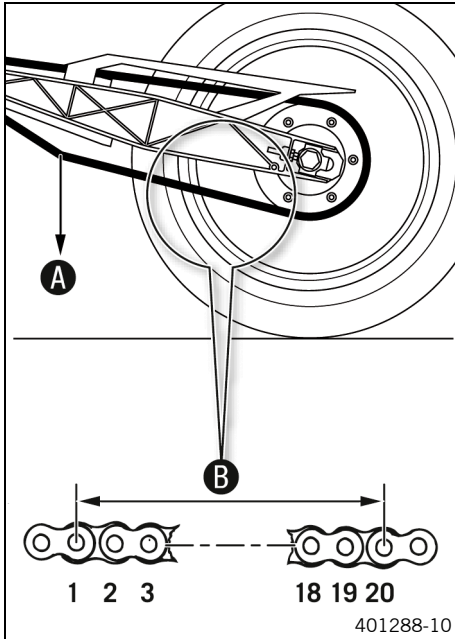

- Shift the transmission into neutral.
- Pull on the lower chain section with the specified weight **A**.

Guideline

Weight, chain wear measurement	15 kg (33 lb.)
--------------------------------	----------------

- Measure distance **B** of 20 chain rollers in the lower chain section.



Info

Chain wear is not always even, so you should repeat this measurement at different chain positions.

Maximum distance B from 20 chain rollers at the longest chain section	301.6 mm (11.874 in)
--	----------------------

- » If distance **B** is greater than the specified measurement:
 - Change the drivetrain kit. 🛠️



Info

When a new chain is mounted, the rear sprocket and engine sprocket should also be changed. New chains wear out faster on old, worn sprockets.

12 SERVICE WORK ON THE CHASSIS

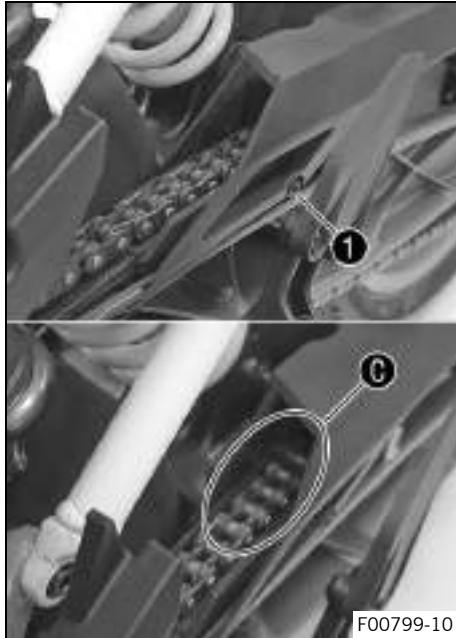

- Check the chain sliding guard for wear.
 - » If screw ① becomes visible in area ② of the chain sliding guard when viewed from above:
 - Change the chain sliding guard. 🛠️
- Check that the chain sliding guard is firmly seated.
 - » If the chain sliding guard is loose:
 - Tighten the screw of the chain sliding guard.

Guideline

Screw, chain guard	M5	7 Nm (5.2 lbf ft) Loctite®243™
--------------------	----	--

Finishing work

- Remove the rear of the motorcycle from the lifting gear.
(📖 p. 116)

12.15 Adjusting the basic position of the clutch lever



- Adjust the basic position of the clutch lever to your hand size by turning adjusting wheel ❶.



Info

Push the clutch lever forward and turn the adjusting wheel.
Do not make any adjustments while riding.



12 SERVICE WORK ON THE CHASSIS

12.16 Removing the front spoiler

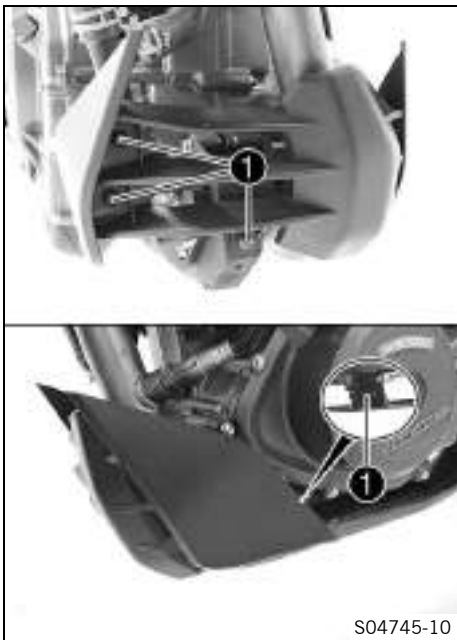

- Remove screws ① and remove the front spoiler.

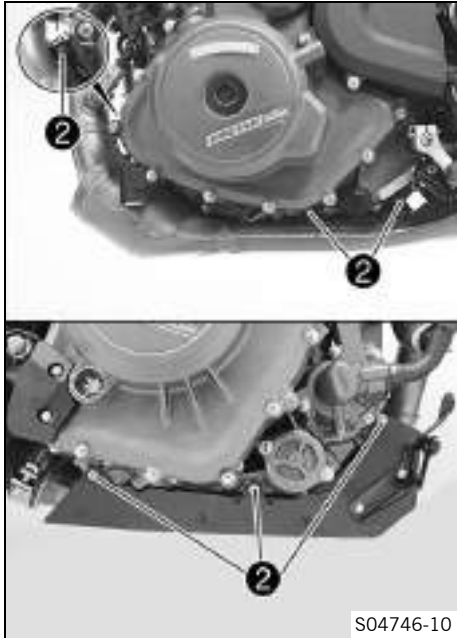

- Remove screws ②.
- Remove lower part of front spoiler.



12 SERVICE WORK ON THE CHASSIS

12.17 Fitting front spoiler

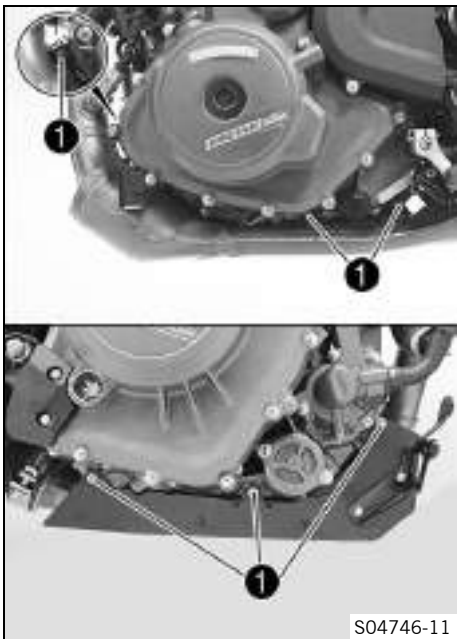

- Position the lower part of front spoiler. Mount and tighten screws **1**.

Guideline

Screw, front spoiler lower part	M6x14	9 Nm (6.6 lbf ft)
---------------------------------	-------	-------------------

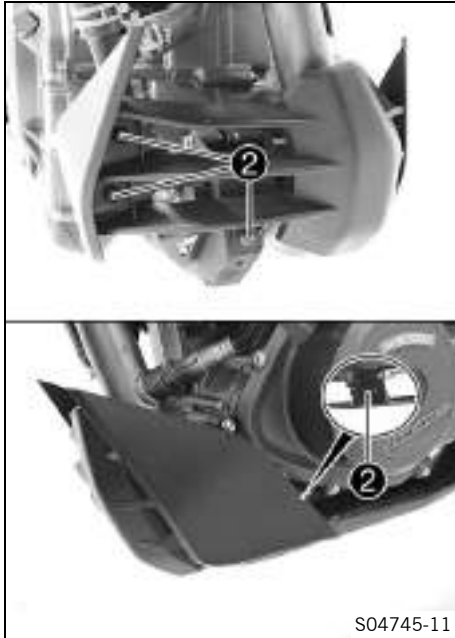

- Position the front spoiler, mount and tighten screws ②.

Guideline

Screw, front spoiler	M6x12	9 Nm (6.6 lbf ft)
----------------------	-------	-------------------



13.1 Anti-lock braking system (ABS)

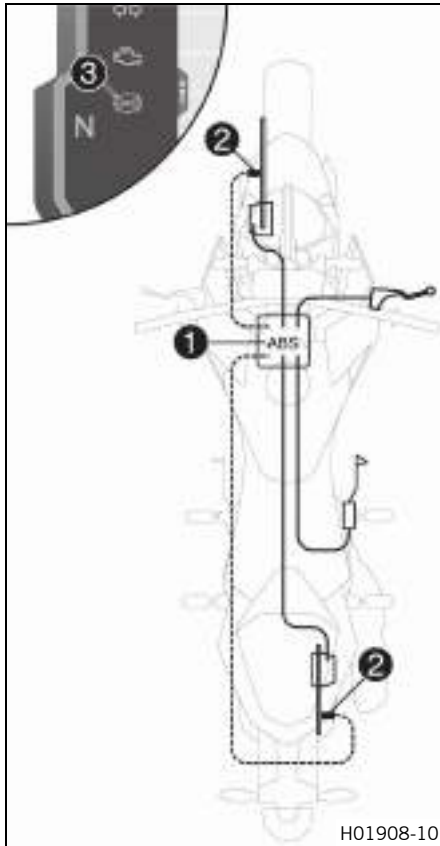

The ABS module ①, which consists of a hydraulic unit, ABS control unit, and return pump, is installed under the fuel tank. One wheel speed sensor ② is located in each case on the front and the rear wheel.



Warning

Danger of accidents Changes to the vehicle impair the function of the ABS.

- Do not make any changes to the suspension travel.
- Only use spare parts on the brake system which have been approved and recommended by KTM.
- Only use tires/wheels approved by KTM with the corresponding speed index.
- Maintain the specified tire pressure.
- Ensure that service work and repairs are performed professionally. (Your authorized KTM workshop will be glad to help.)

The ABS is a safety system that prevents locking of the wheels when driving straight ahead without the influence of lateral forces.

**Warning**

Danger of accidents Driving aids can reduce the probability of a fall only within physical limits.

It is not always possible to compensate for extreme riding situations, for example with luggage loaded with a high center of gravity, varying road surfaces, steep descents or full braking without disengaging the gear.

- Adapt your riding style to the road conditions and your driving ability.

The ABS operates with two independent brake circuits (front and rear brakes). During normal operation, the brake system operates like a conventional brake system without ABS. When the ABS control unit detects a locking tendency in a wheel, ABS begins regulating the brake pressure. The control function causes a slight pulsing of the hand and foot brake levers.

The ABS warning lamp **3** must light up after the ignition is switched on and go out after starting off. If it does not go out after starting off or if it lights up while riding, this indicates a malfunction in the ABS. In this case, the ABS is no longer enabled and the wheels may lock during braking. The brake system itself stays functional; only ABS control is not available.

The ABS warning lamp may also light up if the rotating speeds of the front and rear wheels differ greatly under extreme riding con-

ditions, for example when making "wheelies" or if the rear wheel spins. This causes the ABS to switch off. To reactivate the ABS, stop the vehicle and switch off the ignition. The ABS is reactivated when the vehicle is switched on again. The ABS warning lamp goes out after starting off.

13.2 Adjusting the basic position of the hand brake lever



- Adjust the basic position of the hand brake lever to your hand size by turning adjusting wheel ❶.



Info

Push the hand brake lever forward and turn the adjusting wheel.
Do not make any adjustments while riding.

13.3 Checking the brake discs



Warning

Danger of accidents Worn-out brake discs reduce the braking effect.

- Make sure that worn-out brake discs are replaced immediately. (Your authorized KTM workshop will be glad to help.)

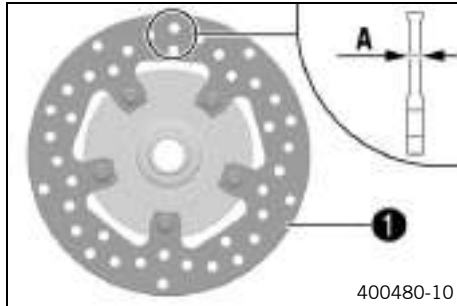

- Check the front and rear brake disc thickness at multiple points for the dimension **A**.



Info

Wear will reduce the thickness of the brake disc at contact surface **1** of the brake linings.

Brake discs - wear limit	
front	4.5 mm (0.177 in)
rear	3.6 mm (0.142 in)

- » If the brake disc thickness is less than the specified value.
 - Change the front brake disc. 🛠️
 - Change the rear brake disc. 🛠️
- Check the front and rear brake discs for damage, cracking, and deformation.
 - » If the brake disc exhibits damage, cracking, or deformation:
 - Change the front brake disc. 🛠️
 - Change the rear brake disc. 🛠️



13.4 Checking the front brake fluid level



Warning

Danger of accidents An insufficient brake fluid level will cause the brake system to fail.

If the brake fluid level drops below the **MIN** marking, the brake system is leaking or the brake linings are worn down.

- Check the brake system and do not continue riding until the problem is eliminated. (Your authorized KTM workshop will be glad to help.)



Warning

Danger of accidents Old brake fluid reduces the braking effect.

- Make sure that brake fluid for the front and rear brake is changed in accordance with the service schedule. (Your authorized KTM workshop will be glad to help.)

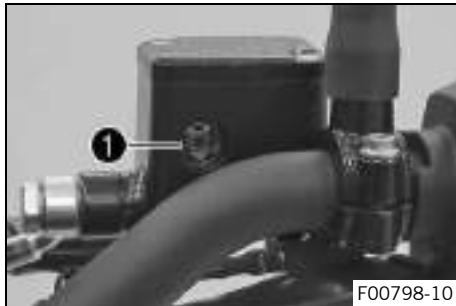

- Move the brake reservoir mounted on the handlebar into a horizontal position.
- Check the brake fluid level in the level viewer **1**.
 - » If the brake fluid level is below the **MIN** marking:
 - Add the front brake fluid. 🛠️ (📖 p. 143)

13.5 Adding the front brake fluid



Warning

Danger of accidents An insufficient brake fluid level will cause the brake system to fail.

If the brake fluid level drops below the **MIN** marking, the brake system is leaking or the brake linings are worn down.

- Check the brake system and do not continue riding until the problem is eliminated. (Your authorized KTM workshop will be glad to help.)



Warning

Skin irritation Brake fluid causes skin irritation.

- Keep brake fluid out of the reach of children.
- Wear suitable protective clothing and safety glasses.
- Do not allow brake fluid to come into contact with the skin, the eyes or clothing.
- Consult a doctor immediately if brake fluid has been swallowed.
- Rinse the affected area with plenty of water in the event of contact with the skin.
- Rinse eyes thoroughly with water immediately and consult a doctor if brake fluid comes into contact with the eyes.
- If brake fluid spills on to your clothing, change the clothing.



Warning

Danger of accidents Old brake fluid reduces the braking effect.

- Make sure that brake fluid for the front and rear brake is changed in accordance with the service schedule. (Your authorized KTM workshop will be glad to help.)



Note

Environmental hazard Hazardous substances cause environmental damage.

- Dispose of oils, grease, filters, fuel, cleaning agents, brake fluid, etc., correctly and in compliance with the applicable regulations.



Info

Never use DOT 5 brake fluid. It is silicone-based and purple in color. Oil seals and brake lines are not designed for DOT 5 brake fluid.

Avoid contact between brake fluid and painted parts. Brake fluid attacks paint.

Only use clean brake fluid from a sealed container.

Preparatory work

- Check the front brake linings. (📖 p. 146)

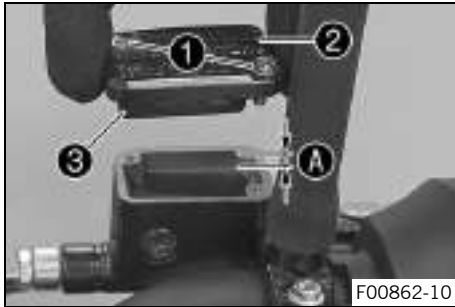

Main work

- Move the brake fluid reservoir mounted on the handlebar to a horizontal position.
- Remove screws ①.
- Take off cover ② with membrane ③.
- Add brake fluid to level A.

Guideline

Dimension A	5 mm (0.2 in)
-------------	---------------

Brake fluid DOT 4 / DOT 5.1 (📖 p. 245)

- Position the cover with the membrane. Mount and tighten the screws.



Info

Immediately clean up any brake fluid that has overflowed or spilled with water.



13.6 Checking the front brake linings



Warning

Danger of accidents Worn-out brake linings reduce the braking effect.

- Ensure that worn-out brake linings are replaced immediately. (Your authorized KTM workshop will be glad to help.)



Warning

Danger of accidents Damaged brake discs reduce the braking effect.

If the brake linings are not changed in time, the brake lining carriers grind against the brake disc. As a consequence, the braking effect is greatly reduced and the brake discs are destroyed.

- Check the brake linings regularly.

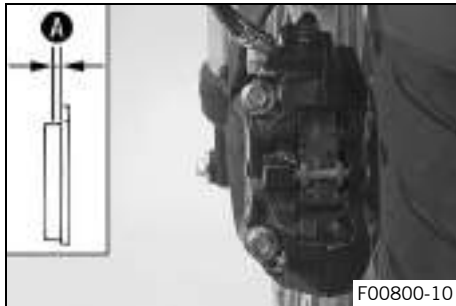

- Check the brake linings for minimum thickness **A**.

Minimum thickness A	$\geq 1 \text{ mm } (\geq 0.04 \text{ in})$
----------------------------	---

- » If the minimum thickness is less than specified:
 - Change the front brake linings. 🛠️
- Check the brake linings for damage and cracking.
 - » If there is wear or tearing:
 - Change the front brake linings. 🛠️

13.7 Checking the free travel of foot brake lever



Warning

Danger of accidents The brake system fails in the event of overheating.

If there is no free travel on the foot brake lever, pressure builds up in the brake system on the rear brake.

- Set the free travel on the foot brake lever in accordance with the specification.

13 BRAKE SYSTEM

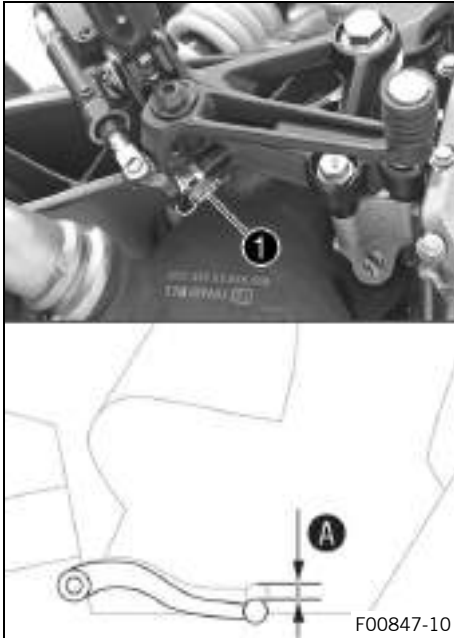

- Disconnect spring ❶.
- Move the foot brake lever back and forth between the end stop and the contact to the foot brake cylinder piston and check free travel ❸.

Guideline

Free travel at foot brake lever	3 ... 5 mm (0.12 ... 0.2 in)
---------------------------------	------------------------------

- » If the free travel does not meet specifications:
 - Adjust the free travel of the foot brake lever. 🛠️
(📖 p. 149)
- Reconnect spring ❶.

13.8 Adjusting the free travel of the foot brake lever ↴



Warning

Danger of accidents The brake system fails in the event of overheating.

If there is no free travel on the foot brake lever, pressure builds up in the brake system on the rear brake.

- Set the free travel on the foot brake lever in accordance with the specification.

13 BRAKE SYSTEM

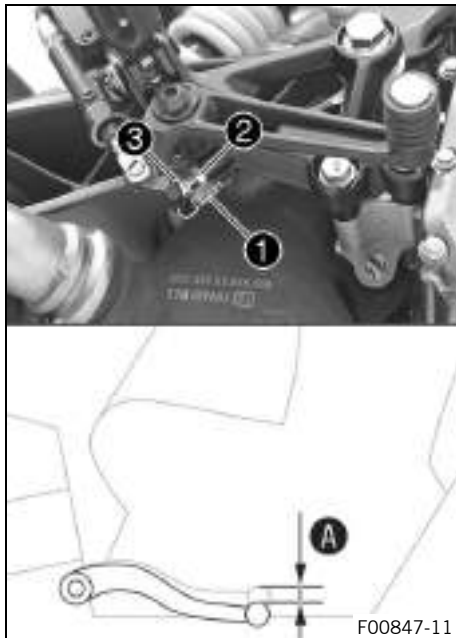

- Detach spring ①.
- Release nut ② and use screw ③ to adjust the specified free travel A.

Guideline

Free travel at foot brake lever	3 ... 5 mm (0.12 ... 0.2 in)
---------------------------------	------------------------------

i **Info**

The range of adjustment is limited.

- Hold screw ③ and tighten nut ②.
- Attach spring ①.

13.9 Checking the rear brake fluid level



Warning

Danger of accidents An insufficient brake fluid level will cause the brake system to fail.

If the brake fluid level drops below the **MIN** marking, the brake system is leaking or the brake linings are worn down.

- Check the brake system and do not continue riding until the problem is eliminated. (Your authorized KTM workshop will be glad to help.)





Warning

Danger of accidents Old brake fluid reduces the braking effect.

- Make sure that brake fluid for the front and rear brake is changed in accordance with the service schedule. (Your authorized KTM workshop will be glad to help.)



- Stand the vehicle upright.
- Check the brake fluid level in the brake fluid reservoir.
 - » If the fluid level reaches the **MIN** marking  - Add rear brake fluid.   p. 152)



13.10 Adding rear brake fluid



Warning

Danger of accidents An insufficient brake fluid level will cause the brake system to fail.

If the brake fluid level drops below the **MIN** marking, the brake system is leaking or the brake linings are worn down.

- Check the brake system and do not continue riding until the problem is eliminated. (Your authorized KTM workshop will be glad to help.)



Warning

Skin irritation Brake fluid causes skin irritation.

- Keep brake fluid out of the reach of children.
- Wear suitable protective clothing and safety glasses.
- Do not allow brake fluid to come into contact with the skin, the eyes or clothing.
- Consult a doctor immediately if brake fluid has been swallowed.
- Rinse the affected area with plenty of water in the event of contact with the skin.
- Rinse eyes thoroughly with water immediately and consult a doctor if brake fluid comes into contact with the eyes.
- If brake fluid spills on to your clothing, change the clothing.

**Warning**

Danger of accidents Old brake fluid reduces the braking effect.

- Make sure that brake fluid for the front and rear brake is changed in accordance with the service schedule. (Your authorized KTM workshop will be glad to help.)

**Note**

Environmental hazard Hazardous substances cause environmental damage.

- Dispose of oils, grease, filters, fuel, cleaning agents, brake fluid, etc., correctly and in compliance with the applicable regulations.

**Info**

Never use DOT 5 brake fluid. It is silicone-based and purple in color. Oil seals and brake lines are not designed for DOT 5 brake fluid.

Avoid contact between brake fluid and painted parts. Brake fluid attacks paint.

Only use clean brake fluid from a sealed container.

Preparatory work

- Check the rear brake linings. (📖 p. 155)

13 BRAKE SYSTEM

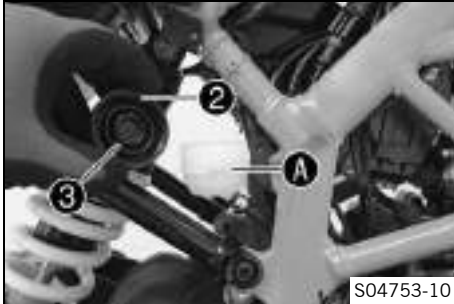
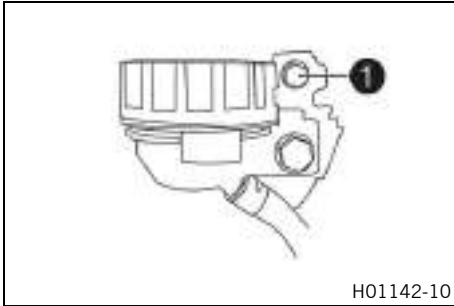

Main work

Condition

The screw cap is locked.

- Remove screw ① and take off the screw cap lock.

- Position the vehicle upright.
- Remove screw cap ② with membrane ③.
- Add brake fluid up to the marking A.

Brake fluid DOT 4 / DOT 5.1 (📖 p. 245)

- Mount the screw cap with the membrane.

i Info

Immediately clean up any brake fluid that has overflowed or spilled with water.

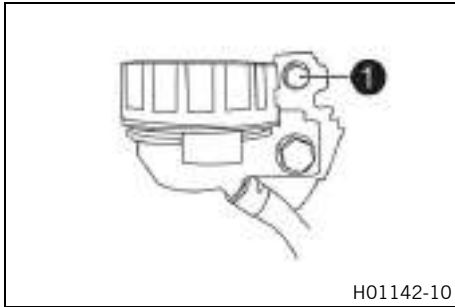

Condition

The screw cap is locked.

- Position the screw cap lock and mount and tighten screw **1**.

Guideline

Screw, compensating tank cap lock, rear brake	M5	9 Nm (6.6 lbf ft)
---	----	-------------------

13.11 Checking the rear brake linings



Warning

Danger of accidents Worn-out brake linings reduce the braking effect.

- Ensure that worn-out brake linings are replaced immediately. (Your authorized KTM workshop will be glad to help.)



Warning

Danger of accidents Damaged brake discs reduce the braking effect.

If the brake linings are not changed in time, the brake lining carriers grind against the brake disc. As a consequence, the braking effect is greatly reduced and the brake discs are destroyed.

- Check the brake linings regularly.

13 BRAKE SYSTEM

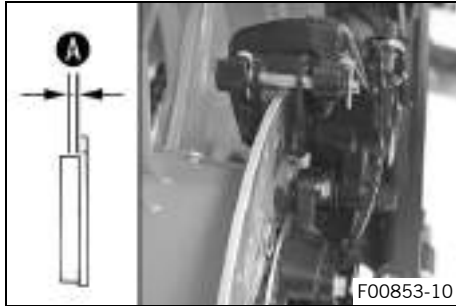

- Check the brake linings for minimum thickness **A**.

Minimum thickness A	$\geq 1 \text{ mm } (\geq 0.04 \text{ in})$
----------------------------	---

- » If the minimum thickness is less than specified:
 - Change the rear brake linings. 🛠️
- Check the brake linings for damage and cracking.
 - » If there is wear or tearing:
 - Change the rear brake linings. 🛠️

14.1 Removing the front wheel ↴

Preparatory work

- Raise the motorcycle with the rear lifting gear. (📖 p. 116)
- Lift the motorcycle with the front lifting gear. (📖 p. 117)

Main work

- Remove screws **1** with washers and push the fender slightly to the side.
- Remove screw **2** and pull wheel speed sensor **3** out of the hole.
- Loosen screw **4** by several rotations.
- Loosen screws **5**.
- Press on screw **4** to push the wheel spindle out of the axle clamp.
- Remove screw **4**.

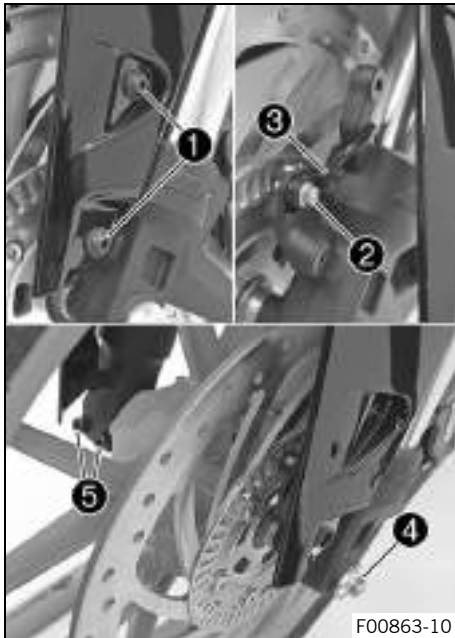

Warning

Danger of accidents Damaged brake discs reduce the braking effect.

- Always lay the wheel down in such a way that the brake disc is not damaged.

- Hold the front wheel and remove the wheel spindle. Take the front wheel out of the fork.



Info

Do not actuate the hand brake lever when the front wheel is removed.

14.2 Installing the front wheel



Warning

Danger of accidents Oil or grease on the brake discs reduces the braking effect.

- Always keep the brake discs free of oil and grease.
- Clean the brake discs with brake cleaner when necessary.

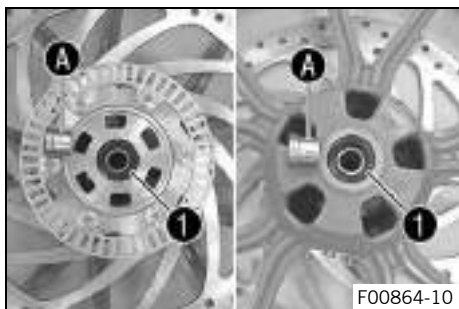

- Check the wheel bearing for damage and wear.
 - » If the wheel bearing is damaged or worn:
 - Change front wheel bearing.
- Remove the spacers.
- Clean and grease shaft seal rings (1) and contact surfaces (A) of the spacers.

Long-life grease (📖 p. 249)
- Insert the spacers.



- Clean the thread of the wheel spindle and screw ②.
- Clean and grease the wheel spindle.

Long-life grease (📖 p. 249)

- Position the front wheel and insert the wheel spindle.
✓ The brake linings are correctly positioned.
- Mount and tighten screw ②.

Guideline

Screw, front wheel spindle	M8	25 Nm (18.4 lbf ft)
----------------------------	----	---------------------

- Position wheel speed sensor ③ in the hole.
- Mount and tighten screw ④.

Guideline

Screw, wheel speed sensor holder	M6	8 Nm (5.9 lbf ft)
----------------------------------	----	-------------------

- Mount and tighten screws ⑤ with the washers.

Guideline

Screw, front fender	M6	7 Nm (5.2 lbf ft)
---------------------	----	-------------------

- Operate the hand brake lever repeatedly until the brake linings are in contact with the brake disc and there is a pressure point.
- Take the motorcycle off the front lifting gear. (📖 p. 119)

14 WHEELS, TIRES

- Remove the rear of the motorcycle from the lifting gear.
(📖 p. 116)
- Operate the front brake and compress the fork a few times firmly.
✓ The fork legs straighten.
- Tighten screws ⑥.

Guideline

Screw, fork stub	M8	15 Nm (11.1 lbf ft)
------------------	----	---------------------

14.3 Removing the rear wheel ↩

Preparatory work

- Raise the motorcycle with the rear lifting gear. (📖 p. 116)

Main work

- Remove screw ①.



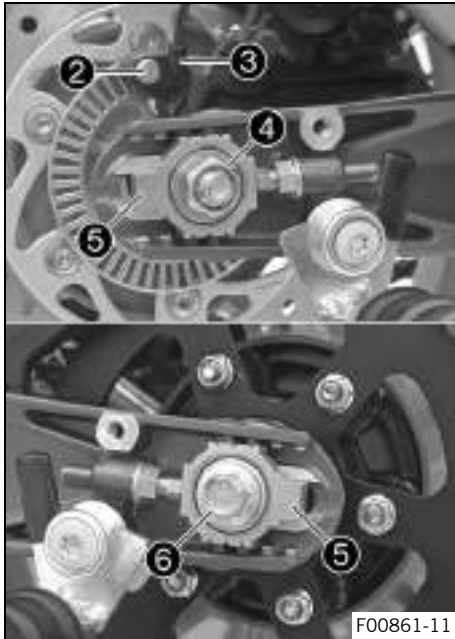

- Remove screw ② and pull wheel speed sensor ③ out of the hole.
- Remove nut ④ and washer.
- Take off chain adjuster ⑤.
- Holding the rear wheel, withdraw wheel spindle ⑥ with the washer and chain adjuster ⑤.
- Push the rear wheel forward as far as possible and take the chain off the rear sprocket.
- Push chain guard to the side.



Warning

Danger of accidents Damaged brake discs reduce the braking effect.

- Always lay the wheel down in such a way that the brake disc is not damaged.

- Pull the rear wheel back and take it out of the link fork.



Info

Do not operate the foot brake lever when the rear wheel is removed.



14.4 Installing the rear wheel ↻



Warning

Danger of accidents Oil or grease on the brake discs reduces the braking effect.

- Always keep the brake discs free of oil and grease.
- Clean the brake discs with brake cleaner when necessary.



Warning

Danger of accidents There is no braking effect to start with at the rear brake after installing the rear wheel.

- Actuate the foot brake several times before going on a ride until you can feel a firm pressure point.

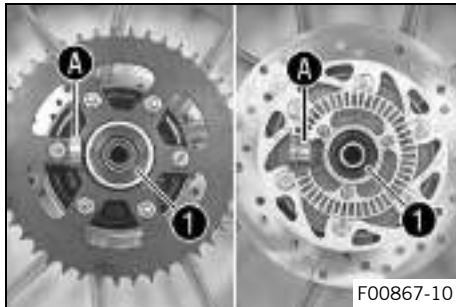

Main work

- Check the wheel bearing for damage and wear.
 - » If the wheel bearing is damaged or worn:
 - Change the rear wheel bearing. ↻
 - Remove the spacers.
 - Clean and grease shaft seal rings **1** and contact surfaces **A** of the spacers.
- Long-life grease (📖 p. 249)
- Clean the thread of the wheel spindle and axle nut.
 - Clean and grease wheel spindle.

Long-life grease (📖 p. 249)

- Clean the contact areas on the brake caliper bracket and link fork.
- Mount the damping rubber and rear sprocket carrier on the rear wheel.
- Insert the spacers.
- Position the rear wheel.
 - ✓ The brake linings are correctly positioned.
- Push the rear wheel forward as far as possible and lay the chain on the rear sprocket.
- Position the chain guard.

14 WHEELS, TIRES

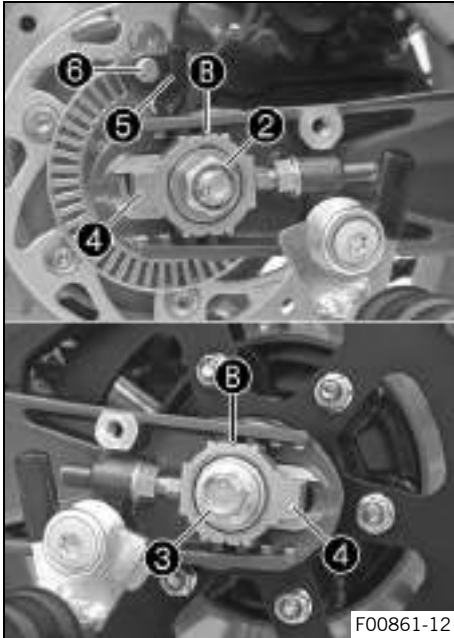

- Pull the rear wheel back and mount wheel spindle **3** with the washer and chain adjuster **4**.

Guideline

Mount left and right chain adjusters **4** in the same position.

- Mount nut **2** and the washer.
- Push the rear wheel forward so that the chain adjusters are in contact with the screws, and tighten nut **2**.

Guideline

In order for the rear wheel to be correctly aligned, the markings on the left and right chain adjusters must be in the same position relative to reference markings **B**.

Nut, rear wheel spindle	M14x1.5	98 Nm (72.3 lbf ft)
-------------------------	---------	---------------------

- Position wheel speed sensor **5** in the hole.
- Mount and tighten screw **6**.

Guideline

Screw, wheel speed sensor holder	M6	8 Nm (5.9 lbf ft)
----------------------------------	----	-------------------



- Mount and tighten screw 7.

Guideline

Screw, chain guard	EJOT PT® K60x30	7 Nm (5.2 lbf ft)
--------------------	---------------------------	-------------------

Finishing work

- Remove the rear of the motorcycle from the lifting gear. (📖 p. 116)
- Check the chain tension. (📖 p. 127)



14.5 Checking the rear hub damping rubber pieces 🛠️



Info

The engine power is transmitted from the rear sprocket to the rear wheel via the six damping rubber pieces. They eventually wear out during operation. If the damping rubber pieces are not changed in time, the rear sprocket carrier and the rear hub will be damaged.

Preparatory work

- Raise the motorcycle with the rear lifting gear. (📖 p. 116)
- Remove the rear wheel. 🛠️ (📖 p. 160)

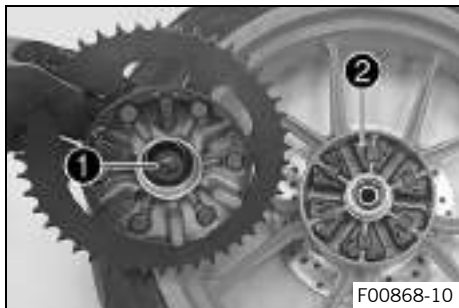

Main work

- Check bearing ①.
 - » If the bearing is damaged or worn:
 - Change the bearing. 🛠️
- Check damping rubber pieces ② of the rear hub for damage and wear.
 - » If the damping rubber pieces of the rear hub are damaged or worn:
 - Change all the damping rubber pieces of the rear hub.
- Lay the rear wheel on a workbench with the rear sprocket facing upward and insert the wheel spindle in the hub.
- To check play A, hold the rear wheel tight and try to rotate the rear sprocket.

Info

Measure the play on the outside of the rear sprocket.

Play of damping rubber pieces on rear wheel	≤ 5 mm (≤ 0.2 in)
---	-------------------

- » If clearance A is larger than the specified value:
 - Change all the damping rubber pieces of the rear hub.

Finishing work

- Install the rear wheel. 🛠️ (📖 p. 162)

- Remove the rear of the motorcycle from the lifting gear. (📖 p. 116)
- Check the chain tension. (📖 p. 127)



14.6 Checking the tire condition



Warning

Danger of accidents If a tire bursts while riding, the vehicle becomes uncontrollable.

- Ensure that damaged or worn tires are replaced immediately. (Your authorized KTM workshop will be glad to help.)



Warning

Danger of crashing Different tire tread patterns on the front and rear wheel impair the handling characteristic.

Different tire tread patterns can make the vehicle significantly more difficult to control.

- Make sure that only tires with a similar tire tread pattern are fitted to the front and rear wheel.



Warning

Danger of accidents Non-approved or non-recommended tires and wheels impact the handling characteristic.

- Only use tires/wheels approved by KTM with the corresponding speed index.

14 WHEELS, TIRES

i Info

The type, condition, and pressure of the tires all have a major impact on the handling characteristic of the motorcycle.

Worn tires have a negative effect on handling characteristics, especially on wet surfaces.

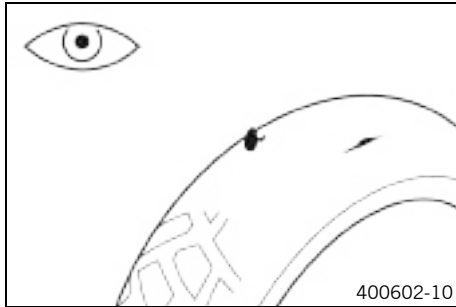

- Check the front and rear tires for cuts, run-in objects, and other damage.
 - » If the tires have cuts, run-in objects, or other damage:
 - Change the tires. 🛠️
- Check the tread depth.

i Info

Observe the minimum tread depth required by national law.

Minimum tread depth	$\geq 2 \text{ mm}$ ($\geq 0.08 \text{ in}$)
---------------------	--

- » If the tread depth is less than the minimum tread depth:
 - Change the tires. 🛠️

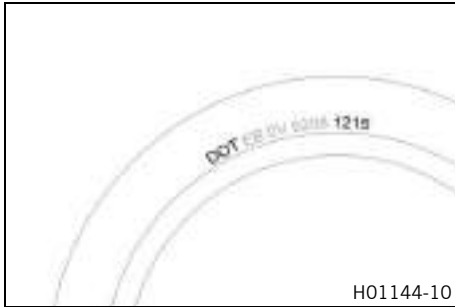

- Check the tire age.



Info

The tire date of manufacture is usually contained in the tire label and is indicated by the last four digits of the **DOT** number. The first two digits indicate the week of manufacture and the last two digits the year of manufacture.

KTM recommends that the tires be changed after 5 years at the latest, regardless of the actual state of wear.

- » If the tires are more than 5 years old:
 - Change the tires. 🛠️



14.7 Checking tire pressure



Info

Low tire pressure leads to abnormal wear and overheating of the tire.

Correct tire pressure ensures optimal riding comfort and maximum tire service life.

14 WHEELS, TIRES

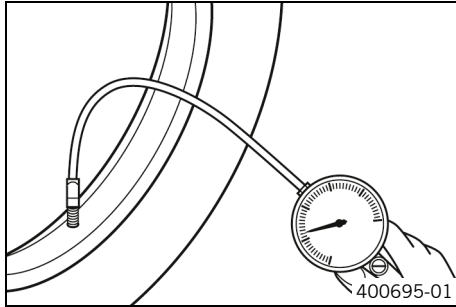

- Remove the protection cap.
- Check the tire pressure when the tires are cold.

Tire pressure when solo	
front	2.0 bar (29 psi)
rear	2.0 bar (29 psi)

Tire pressure with passenger / full payload	
front	2.0 bar (29 psi)
rear	2.2 bar (32 psi)

- » If the tire pressure does not meet specifications:
 - Correct the tire pressure.
- Mount the protection cap.



15.1 Daytime running light (DRL)



Warning

Danger of accidents When visibility is poor, the daytime running light is not a substitute for the low beam.

Automatic switching between the daytime running light and low beam may only be partially available when visibility is significantly impaired due to fog, snow or rain.

- Ensure that the appropriate type of lighting is always selected.
- If necessary switch off the daytime running lights using the menu before going on a ride or when stopped so that the low beam is switched on permanently.
- Note the legal regulations regarding the daytime running light.

The daytime running light (DRL) is integrated in the main headlight.

The daytime running light (DRL) must only be switched on when visibility conditions are good.

Activate the daytime running light (DRL) in the combination instrument.

This is controlled by the ambient light sensor in the combination instrument. When visibility conditions are good, the low beam is switched off and the daytime running light is switched on.



Info

The position light **1** lights up with all types of lighting.

15.2 Removing the 12-V battery





Warning

Risk of injury Battery acid and battery gases cause serious chemical burns.

- Keep 12 V batteries out of the reach of children.
- Wear suitable protective clothing and safety glasses.
- Avoid contact with battery acid and battery gases.
- Keep sparks or open flames away from the 12 V battery.
- Only charge 12 V batteries in well-ventilated rooms.
- Rinse the affected area immediately with plenty of water in the event of contact with the skin.
- Rinse eyes with water for at least 15 minutes and consult a doctor immediately if battery acid and battery gases get into the eyes.

Preparatory work

- Remove the passenger seat. ( p. 122)
- Remove the front rider's seat. ( p. 123)



Main work

- Disconnect negative cable ① from the 12-V battery.

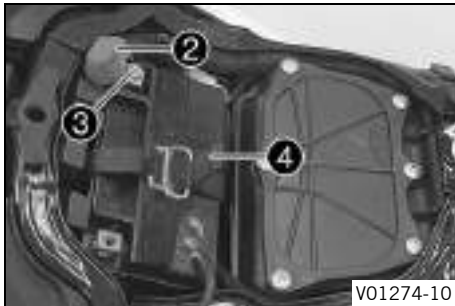

- Pull back positive terminal cover ②.
- Disconnect positive cable ③ from the 12-V battery.
- Detach rubber strap ④.
- Pull the 12-V battery upwards and out of the battery compartment.



Info

Never operate the motorcycle with a discharged 12-V battery or without a 12-V battery. In both cases, electrical components and safety devices can be damaged. The vehicle will therefore no longer be roadworthy.



15.3 Installing the 12-V battery ↘

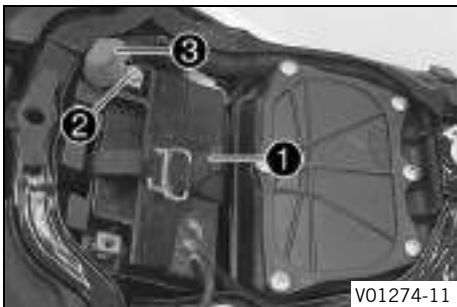

V01274-11



V01273-11

Main work

- Position the 12-V battery in the battery compartment.

12-V battery (ETZ-9-BS) (📖 p. 235)

- Attach rubber strap ①.
- Position positive cable ② and mount and tighten the screw.
- Position positive terminal cover ③.

- Position negative cable ④; mount and tighten the screw.

Finishing work

- Mount the front rider's seat. (📖 p. 124)
- Mount the passenger seat. (📖 p. 123)

- Set the time and date. (📖 p. 78)



15.4 Charging the 12-V battery ↴



Warning

Risk of injury Battery acid and battery gases cause serious chemical burns.

- Keep 12 V batteries out of the reach of children.
- Wear suitable protective clothing and safety glasses.
- Avoid contact with battery acid and battery gases.
- Keep sparks or open flames away from the 12 V battery.
- Only charge 12 V batteries in well-ventilated rooms.
- Rinse the affected area immediately with plenty of water in the event of contact with the skin.
- Rinse eyes with water for at least 15 minutes and consult a doctor immediately if battery acid and battery gases get into the eyes.



Note

Environmental hazard 12 V batteries contain environmentally hazardous materials.

- Do not dispose of 12 V batteries as household waste.
- Dispose of 12 V batteries at a collection point for used batteries.

i Info

Even when there is no load on the 12-V battery, it discharges steadily each day.

The charging level and the method of charging are very important for the service life of the 12-V battery. Rapid recharging with a high charging current shortens the service life of the battery.

If the charging current, charging voltage, or charging time is exceeded, electrolyte escapes through the safety valves. This reduces the capacity of the 12-V battery.

If the 12-V battery is depleted by repeated starting, the 12-V battery must be charged immediately.

If the 12-V battery is left in a discharged state for an extended period, it will become deeply discharged and sulfating occurs, destroying the battery.

The 12-V battery is maintenance-free. The acid level does not have to be checked.

Preparatory work

- Remove the passenger seat. (📖 p. 122)
- Remove the front rider's seat. (📖 p. 123)
- Disconnect the negative cable of the 12-V battery to avoid damage to the onboard electronics.



Main work

- Connect a battery charger to the 12-V battery. Switch on the battery charger.

Battery charger (58429074000)

In addition, this battery charger can be used to test the open-circuit voltage, the starting ability of the 12-V battery, and the alternator. It is impossible to overcharge the 12-V battery using this device.



Info

Never remove cover ❶.

Charge the 12-V battery to a maximum of 10 % of the capacity specified on battery housing ❷.

- Switch off the battery charger after charging and disconnect from the 12-V battery.

Guideline

The charging current, charging voltage, and charging time must not be exceeded.	
---	--

Recharge the 12-V battery regularly when the motorcycle is not being used	3 months
---	----------

- Position the negative cable and mount and tighten the screw.
- Position the negative terminal cover.

Finishing work

- Mount the front rider's seat. (📖 p. 124)
- Mount the passenger seat. (📖 p. 123)
- Set the time and date. (📖 p. 78)

15.5 Changing the main fuse (EU/JP)



Warning

Fire hazard Incorrect fuses overload the electrical system.

- Only use fuses with the required ampere value.
- Do not bypass or repair fuses.



Info

The main fuse protects all electrical power consumers of the vehicle. The main fuse is under the seat.

Preparatory work

- Remove the passenger seat. (📖 p. 122)

**Main work**

- Remove protection cap ①.

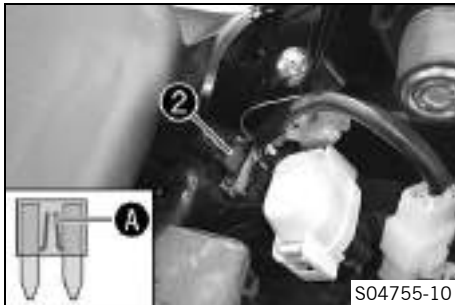

- Remove faulty main fuse ②.

i Info

A faulty fuse has a burned-out fuse wire **A**.
A spare fuse is located in the fuse box.

- Insert a new main fuse.

Fuse (75011088030) (📖 p. 235)

i Tip

Put a spare fuse in the fuse box so that it is available if needed.

15 ELECTRICAL SYSTEM

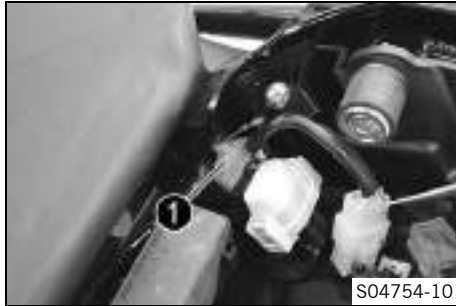

- Mount protection cap ❶.

Finishing work

- Mount the passenger seat. (📖 p. 123)
- Set the time and date. (📖 p. 78)

15.6 Changing the ABS fuses



Warning

Fire hazard Incorrect fuses overload the electrical system.

- Only use fuses with the required ampere value.
- Do not bypass or repair fuses.

**Info**

Two fuses for the ABS are located under the passenger seat. These fuses protect the return pump and the hydraulic unit of the ABS. The third fuse, which protects the ABS control unit, is located in the fuse box.

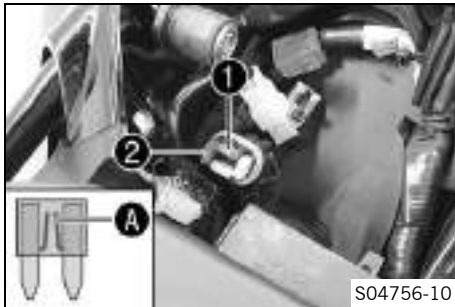
**Preparatory work**

- Switch off all power consumers and the engine.
- Remove the passenger seat. (📖 p. 122)

To change the fuse of the ABS hydraulic unit:

- Take off the protection cap and remove fuse ①.

**Info**

A faulty fuse has a burned-out fuse wire **A**.

**Warning**

Fire hazard Incorrect fuses overload the electrical system.

- Only use fuses with the required ampere value.
- Do not bypass or repair fuses.

- Insert the spare fuse with the correct rating.

Fuse (75011088010) (📖 p. 235)

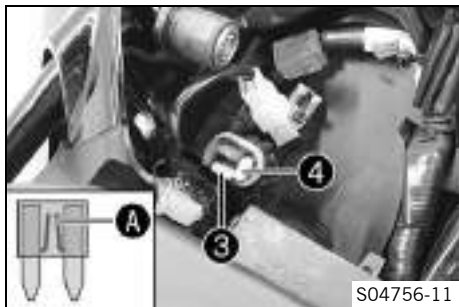

Tip

Insert spare fuse ② in the fuse box so that it is available if needed.

- Mount the protection cap.

To change the fuse of the ABS return pump:

- Take off the protection cap and remove fuse ③.



Info

A faulty fuse has a burned-out fuse wire ①.



Warning

Fire hazard Incorrect fuses overload the electrical system.

- Only use fuses with the required ampere value.
 - Do not bypass or repair fuses.
-
- Insert the spare fuse with the correct rating.

Fuse (90111088025) (📖 p. 235)

**Tip**

Insert spare fuse ④ in the fuse box so that it is available if needed.

- Mount the protection cap.

Finishing work

- Mount the passenger seat. (📖 p. 123)
- 

15.7 Changing the fuses of individual power consumers

**Info**

The fuse box with the main fuse and the fuses of the individual power consumers is located under the passenger seat.

Preparatory work

- Remove the passenger seat. (📖 p. 122)

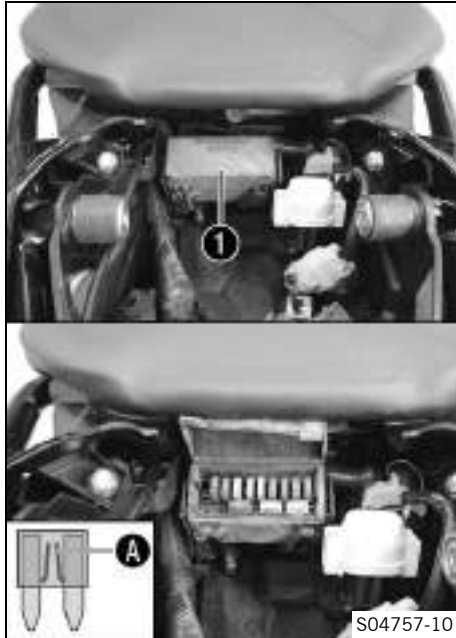

Main work

- Open fuse box cover **1**.

(EU B.D/AU/AR/BR/CN/CO/MY/PH/TH)

- Remove the faulty fuse.

Guideline

Fuse 1 - 30 A - main fuse
Fuse 2 - 10 A - combination instrument
Fuse 3 - 10 A - power relay
Fuse 4 - 15 A - ignition coil, fuel pump, start auxiliary relay, horn
Fuse 5 - 15 A - radiator fan
Fuse 6 - 15 A - brake light, turn signal, high beam, low beam, position light, tail light, license plate lamp
Fuse 7 - 10 A - engine control unit, ABS control unit
Fuse 8 - 10 A - alarm system (optional)
Fuse 9 - 10 A - permanent positive for auxiliary equipment (ACC1)
Fuse 10 - 10 A - ignition positive for auxiliary equipment (ACC2)
Fuse SPARE - 10 A/15 A/30 A - spare fuses



Info

A faulty fuse has a burned-out fuse wire **A**.

(EU/JP)

- Remove the faulty fuse.

Guideline

Fuse 1 - not assigned
Fuse 2 - 10 A - combination instrument
Fuse 3 - 10 A - power relay
Fuse 4 - 15 A - ignition coil, fuel pump, start auxiliary relay, horn
Fuse 5 - 15 A - radiator fan
Fuse 6 - 15 A - brake light, turn signal, high beam, low beam, position light, tail light, license plate lamp
Fuse 7 - 10 A - engine control unit, ABS control unit
Fuse 8 - 10 A - emergency OFF switch
Fuse 9 - 10 A - permanent positive for auxiliary equipment (ACC1)
Fuse 10 - 10 A - ignition positive for auxiliary equipment (ACC2)
Fuse SPARE - 10 A/15 A/30 A - spare fuses

**Info**

A faulty fuse has a burned-out fuse wire .



Warning

Fire hazard Incorrect fuses overload the electrical system.

- Only use fuses with the required ampere value.
- Do not bypass or repair fuses.

- Insert the spare fuse with the correct rating.

Fuse (75011088010) (📖 p. 235)

Fuse (75011088015) (📖 p. 235)

Fuse (75011088030) (📖 p. 235)



Tip

Put a spare fuse in the fuse box so that it is available if needed.

- Check that the power consumer is functioning properly.
- Close the fuse box cover ❶.

Finishing work

- Mount the passenger seat. (📖 p. 123)

15.8 Checking the headlight setting

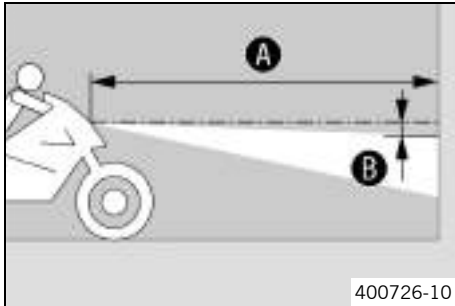

- Park the vehicle on a horizontal surface in front of a light-colored wall and make a mark at the height of the center of the low beam headlight.
- Make another mark at a distance **B** under the first marking.

Guideline

Distance B	5 cm (2 in)
-------------------	-------------

- Position the vehicle vertical to the wall at distance **A** from the wall and switch on the low beam.

Guideline

Distance A	5 m (16 ft)
-------------------	-------------

- The rider now mounts the motorcycle with luggage and passenger if applicable.
- Check the headlight setting.

The light-dark boundary must be exactly on the lower marking when the motorcycle is ready to be operated with the rider mounted along with any luggage and a passenger if applicable.

- » If the boundary between light and dark does not meet specifications:
 - Adjust the headlight range. (📖 p. 188)



15.9 Adjusting the headlight range

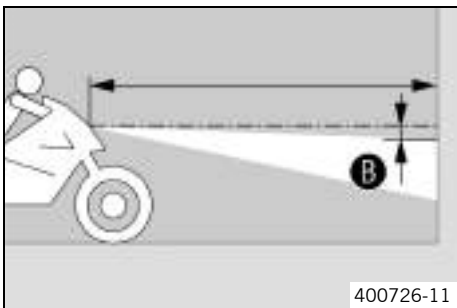

Preparatory work

- Check the headlight setting. (📖 p. 187)

Main work

- Turn adjusting screw ① to adjust the headlight range.

Info

Turn clockwise to increase the headlight range; turn counterclockwise to reduce the headlight range. If you have a payload, you may have to correct the headlight range.

Screw ① also secures the headlight. Ensure the screw is always screwed in far enough.

- Set the headlight to marking ②.

Guideline

The light-dark boundary must lie exactly on lower marking ② when the motorcycle is ready to operate with the rider mounted along with any luggage and a passenger if applicable.

15.10 Diagnostics connector

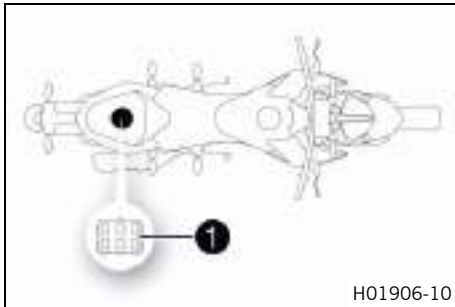

Diagnostics connector ① is located under the passenger seat.

15.11 Front ACC1 and ACC2

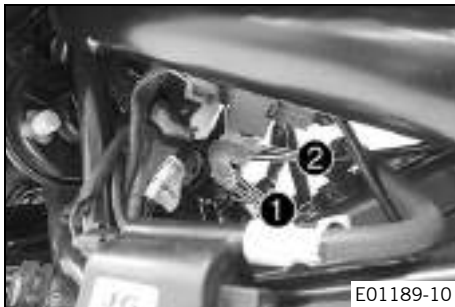

Installation location

- Power supplies ACC1 ① and ACC2 ② front are located on the left of the vehicle, behind the cover under the fuel tank.

15 ELECTRICAL SYSTEM

15.12 ACC2 rear



Installation location

- Rear ACC2 ① power supplies are located under the passenger seat.

16.1 Cooling system



Water pump ① in the engine ensures forced circulation of the coolant.

The pressure resulting from the warming of the cooling system is regulated by a valve in radiator cap ②. Heat expansion causes excess coolant to flow into compensating tank ③. When the temperature falls, this surplus coolant is sucked back into the cooling system. This ensures that operating the vehicle at the specified coolant temperature will not result in a risk of malfunctions.

110 °C (230 °F)

16 COOLING SYSTEM

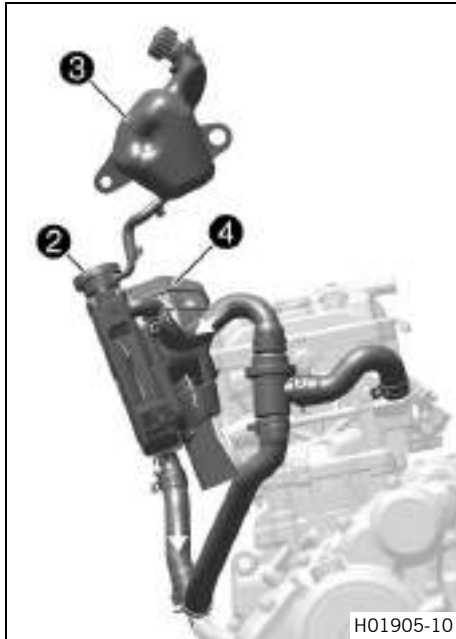

The coolant is cooled by the air stream and a radiator fan **4**, which is activated at high temperature. The lower the speed, the less the cooling effect. Dirty cooling fins also reduce the cooling effect.



Info

If the cooling system overheats, the maximum engine speed is limited.

16.2 Checking the antifreeze and coolant level



Warning

Danger of scalding During motorcycle operation, the coolant gets very hot and is under pressure.

- Do not open the radiator, the radiator hoses or other cooling system components if the engine or the cooling system are at operating temperature.
- Allow the cooling system and the engine to cool down before you open the radiator, the radiator hoses or other components of the cooling system.
- In the event of scalding, rinse the area affected immediately with lukewarm water.



Warning

Danger of poisoning Coolant is toxic and a health hazard.

- Keep coolant out of the reach of children.
- Do not allow coolant to come into contact with the skin, the eyes and clothing.
- Consult a doctor immediately if coolant is swallowed.
- Rinse the affected area immediately with plenty of water in the event of contact with the skin.
- Rinse eyes thoroughly with water and consult a doctor immediately if coolant gets into the eyes.
- Change clothing if coolant spills onto your clothing.

Condition

The engine is cold.

16 COOLING SYSTEM



- Stand the motorcycle upright on a horizontal surface.
- Remove cap ❶ of the compensating tank.
- Check the antifreeze in the coolant.

-25 ... -45 °C (-13 ... -49 °F)

» If the antifreeze in the coolant does not match the specified value:

- Correct the antifreeze in the coolant.

- Check the coolant level in the compensating tank.

The coolant level must be between the two markings.

» If the coolant level does not match the specified value:

- Correct the coolant level.

Coolant (📖 p. 245)

- Mount the cap of the compensating tank.



- Remove radiator cap ②.
- Check the antifreeze in the coolant.

-25 ... -45 °C (-13 ... -49 °F)

- » If the antifreeze in the coolant does not match the specified value:
 - Correct the antifreeze in the coolant.

- Check the coolant level in the radiator.

The radiator must be filled completely.

- » If the coolant level does not match the specified value:
 - Check the coolant level and the reason for the loss.

Coolant (📖 p. 245)

- » If you had to add more coolant than the specified amount:
 - > 0.20 l (> 0.21 qt.)
 - Fill/bleed the cooling system. 🛠️ (📖 p. 199)

- Mount the radiator cap.



16.3 Checking the coolant level



Warning

Danger of scalding During motorcycle operation, the coolant gets very hot and is under pressure.

- Do not open the radiator, the radiator hoses or other cooling system components if the engine or the cooling system are at operating temperature.
- Allow the cooling system and the engine to cool down before you open the radiator, the radiator hoses or other components of the cooling system.
- In the event of scalding, rinse the area affected immediately with lukewarm water.



Warning

Danger of poisoning Coolant is toxic and a health hazard.

- Keep coolant out of the reach of children.
- Do not allow coolant to come into contact with the skin, the eyes and clothing.
- Consult a doctor immediately if coolant is swallowed.
- Rinse the affected area immediately with plenty of water in the event of contact with the skin.
- Rinse eyes thoroughly with water and consult a doctor immediately if coolant gets into the eyes.
- Change clothing if coolant spills onto your clothing.

Condition

The engine is cold.



- Stand the motorcycle upright on a horizontal surface.
- Check the coolant level in compensating tank ①.

The coolant level must be between the two markings.

- » If the coolant level does not match the specified value:
 - Correct the coolant level.

Coolant (📖 p. 245)



- Remove radiator cap ② and check the coolant level in the radiator.

The radiator must be filled completely.

- » If the coolant level does not match the specified value:
 - Check the coolant level and the reason for the loss.
- » If you had to add more coolant than the specified amount:
 - > 0.20 l (> 0.21 qt.)
 - Fill/bleed the cooling system. 🛠️ (📖 p. 199)

- Mount the radiator cap.



16.4 Draining the coolant ↴



Warning

Danger of scalding During motorcycle operation, the coolant gets very hot and is under pressure.

- Do not open the radiator, the radiator hoses or other cooling system components if the engine or the cooling system are at operating temperature.
- Allow the cooling system and the engine to cool down before you open the radiator, the radiator hoses or other components of the cooling system.
- In the event of scalding, rinse the area affected immediately with lukewarm water.



Warning

Danger of poisoning Coolant is toxic and a health hazard.

- Keep coolant out of the reach of children.
- Do not allow coolant to come into contact with the skin, the eyes and clothing.
- Consult a doctor immediately if coolant is swallowed.
- Rinse the affected area immediately with plenty of water in the event of contact with the skin.
- Rinse eyes thoroughly with water and consult a doctor immediately if coolant gets into the eyes.
- Change clothing if coolant spills onto your clothing.

Condition

The engine is cold.

Preparatory work

- Remove the front spoiler. (📖 p. 134)

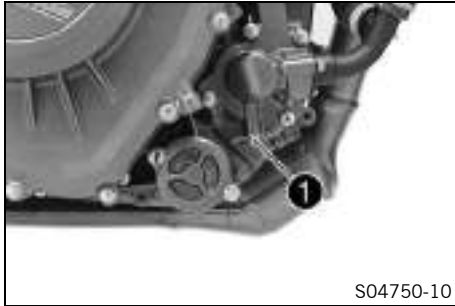

Main work

- Position the motorcycle upright.
- Position an appropriate container under the engine.
- Remove screw ❶ with the seal ring.
- Remove the radiator cap.
- Completely drain the coolant.
- Mount and tighten screw ❶ with a new seal ring.

Guideline

Screw plug, water pump drain hole	M6	10 Nm (7.4 lbf ft)
-----------------------------------	----	--------------------



16.5 Filling/bleeding the cooling system ↩



Warning

Danger of poisoning Coolant is toxic and a health hazard.

- Keep coolant out of the reach of children.
- Do not allow coolant to come into contact with the skin, the eyes and clothing.
- Consult a doctor immediately if coolant is swallowed.
- Rinse the affected area immediately with plenty of water in the event of contact with the skin.
- Rinse eyes thoroughly with water and consult a doctor immediately if coolant gets into the eyes.
- Change clothing if coolant spills onto your clothing.

16 COOLING SYSTEM



Main work

- Remove radiator cap ①.



- Loosen bleeder screw ②.

Guideline

3 turns

- Tilt the vehicle slightly to the right.
- Pour in the coolant until it emerges without bubbles at the bleeder screw, and then mount and tighten the bleeder screw immediately.

Coolant (📖 p. 245)

- Completely fill the radiator with coolant. Mount the radiator cap.
- Rest the vehicle on the side stand.



Danger

Danger of poisoning Exhaust gases are toxic and inhaling them may result in unconsciousness and death.

- Always make sure there is sufficient ventilation when running the engine.
- Use effective exhaust extraction when starting or running the engine in an enclosed space.



- Start the engine and allow it to warm up.
- Stop the engine and allow it to cool down.
- When the engine is cool, check the coolant level in the radiator and, if necessary, add coolant.
- Remove cap ③ of the compensating tank and top up the coolant level to the upper marking.
- Mount the cap of the compensating tank.

Finishing work

- Fit the front spoiler. (📖 p. 136)



16.6 Changing the coolant ↩



Warning

Danger of scalding During motorcycle operation, the coolant gets very hot and is under pressure.

- Do not open the radiator, the radiator hoses or other cooling system components if the engine or the cooling system are at operating temperature.
- Allow the cooling system and the engine to cool down before you open the radiator, the radiator hoses or other components of the cooling system.
- In the event of scalding, rinse the area affected immediately with lukewarm water.



Warning

Danger of poisoning Coolant is toxic and a health hazard.

- Keep coolant out of the reach of children.
- Do not allow coolant to come into contact with the skin, the eyes and clothing.
- Consult a doctor immediately if coolant is swallowed.
- Rinse the affected area immediately with plenty of water in the event of contact with the skin.
- Rinse eyes thoroughly with water and consult a doctor immediately if coolant gets into the eyes.
- Change clothing if coolant spills onto your clothing.

Condition

The engine is cold.

Preparatory work

- Remove the front spoiler. (📖 p. 134)

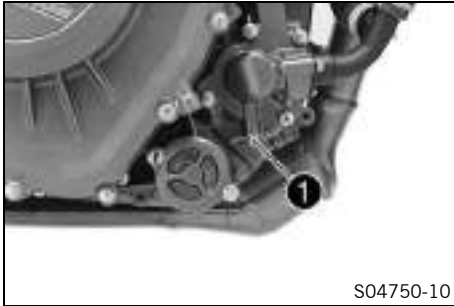

Main work

- Position the motorcycle upright.
- Position an appropriate container under the engine.
- Remove screw **1** with the seal ring.



- Remove radiator cap **2**.
- Completely drain the coolant.
- Mount and tighten screw **1** with a new seal ring.

Guideline

Screw plug, water pump drain hole	M6	10 Nm (7.4 lbf ft)
-----------------------------------	----	--------------------

16 COOLING SYSTEM



- Loosen bleeder screw ③.

Guideline

3 turns

- Tilt the vehicle slightly to the right.
- Pour in the coolant until it emerges without bubbles at the bleeder screw, and then mount and tighten the bleeder screw immediately.

Coolant (📖 p. 245)

- Completely fill the radiator with coolant. Mount the radiator cap.
- Rest the vehicle on the side stand.



Danger

Danger of poisoning Exhaust gases are toxic and inhaling them may result in unconsciousness and death.

- Always make sure there is sufficient ventilation when running the engine.
 - Use effective exhaust extraction when starting or running the engine in an enclosed space.
-
- Start the engine and allow it to warm up.



- Stop the engine and allow it to cool down.
- When the engine is cool, check the coolant level in the radiator and, if necessary, add coolant.
- Remove cap ④ of the compensating tank and top up the coolant level up to the **MAX** marking.
- Mount the cap of the compensating tank.

Finishing work

- Fit the front spoiler. (📖 p. 136)



17.1 Checking the clutch lever play

Note

Clutch damage If there is no free travel by the clutch lever, the clutch will begin to slip.

- Check the free travel of the clutch lever each time before using the motorcycle.
- Adjust the free travel of the clutch lever when necessary in accordance with the specification.

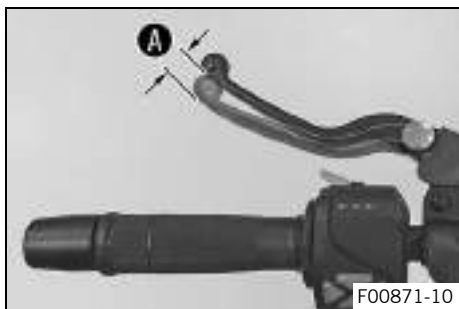

- Check the clutch lever for smooth operation.
- Move the handlebar to the straight-ahead position.
- Pull the clutch lever until resistance is perceptible, and determine the play in the clutch lever **A**.

Clutch lever play A	1 ... 3 mm (0.04 ... 0.12 in)
----------------------------	-------------------------------

- » If the clutch lever play does not meet the specified value:
 - Adjust play in the clutch lever. 🛠️ (📖 p. 207)
- Move the handlebar to and fro over the entire steering range.

The clutch lever play must not change.

- » If the clutch lever play changes:
 - Check the routing of the clutch cable.

17.2 Adjusting play in the clutch lever ↩

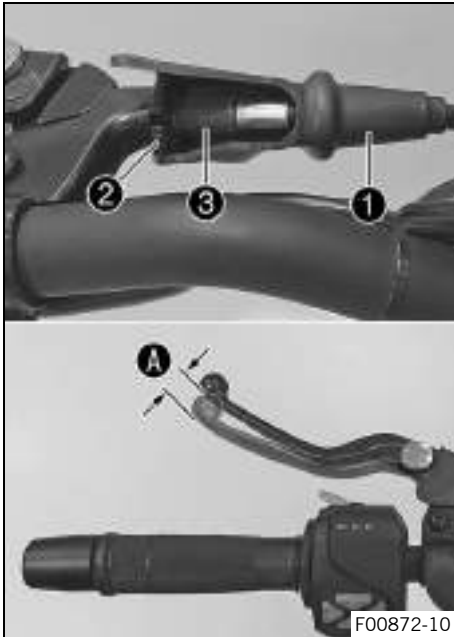

- Move the handlebar to the straight-ahead position.
- Push back sleeve ❶.
- Loosen lock nut ❷.
- Adjust the play in the clutch level A by turning adjusting screw ❸.

Guideline

Clutch lever play A	1 ... 3 mm (0.04 ... 0.12 in)
---------------------	-------------------------------

- Tighten lock nut ❷.
- Position bellows ❶.

18.1 Checking the engine oil level

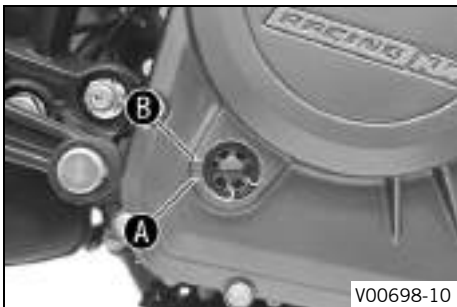

Condition

The engine is at operating temperature.

Preparatory work

- Stand the motorcycle upright on a horizontal surface.

Main work

- Check the engine oil level.

Info

After switching off the engine, wait one minute before checking the level.

The engine oil must be between the **A** and **B** markings .

- » When the engine oil level is below the **A** marking:
 - Add engine oil. (📖 p. 213)
- » When the engine oil level is above the **B** marking:
 - Correct the engine oil level.

18.2 Changing the engine oil and oil filter, cleaning the oil screens ↩



Warning

Danger of scalding Engine and gear oil get very hot when the motorcycle is ridden.

- Wear suitable protective clothing and safety gloves.
- In the event of scalding, rinse the area affected immediately with lukewarm water.



Note

Environmental hazard Hazardous substances cause environmental damage.

- Dispose of oils, grease, filters, fuel, cleaning agents, brake fluid, etc., correctly and in compliance with the applicable regulations.



Info

Drain the engine oil while the engine is at operating temperature.

Preparatory work

- Remove the front spoiler. (📖 p. 134)
- Stand the motorcycle on a level surface using the side stand.

18 SERVICE WORK ON THE ENGINE

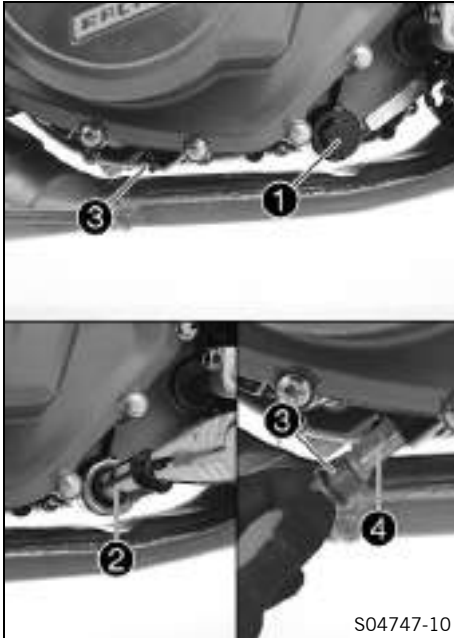

Main work

- Place an appropriate container under the engine.
- Remove oil drain plug ① with the O-ring.
- Remove oil screen ② with the O-ring.
- Remove screw plug ③ with oil screen ④.
- Allow the engine oil to drain completely.
- Thoroughly clean the oil drain plugs and oil screens.
- Position oil screen ② and mount and tighten oil drain plug ① with the O-ring.

Guideline

Oil drain plug	M24x1.5	15 Nm (11.1 lbf ft)
----------------	---------	---------------------

- Mount and tighten screw plug ③ with oil screen ④ and the O-ring.

Guideline

Oil screen screw plug, small	M17x1.5	12 Nm (8.9 lbf ft)
------------------------------	---------	--------------------

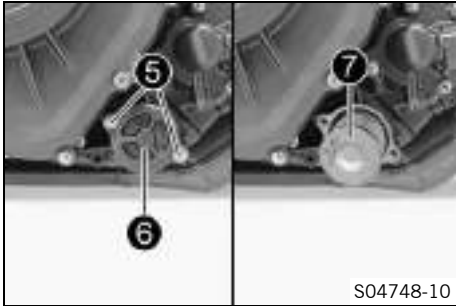

- Remove screws **5**. Take off oil filter cover **6** with the O-ring.
- Pull oil filter **7** out of the oil filter housing.
- Allow the engine oil to drain completely.
- Thoroughly clean the parts and the sealing surface.



- Insert new oil filter **7**.
- Oil the O-ring of the oil filter cover. Mount oil filter cover **6**.
- Mount and tighten the screws.

Guideline

Screw, oil filter cover	M6	10 Nm (7.4 lbf ft)
-------------------------	----	--------------------



Info

Too little engine oil or poor-quality engine oil will result in premature wear of the engine.

18 SERVICE WORK ON THE ENGINE

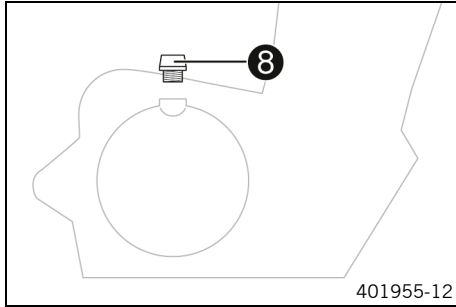

- Remove filler plug ⑧ with the O-ring, and fill up with engine oil.

Engine oil	1.7 l (1.8 qt.)	Engine oil (SAE 15W/50) (📖 p. 246)
------------	-----------------	--

- Mount and tighten the filler plug together with the O-ring.



Danger

Danger of poisoning Exhaust gases are toxic and inhaling them may result in unconsciousness and death.

- Always make sure there is sufficient ventilation when running the engine.
 - Use effective exhaust extraction when starting or running the engine in an enclosed space.
-
- Start the engine and check for leaks.

Finishing work

- Fit the front spoiler. (📖 p. 136)
- Check the engine oil level. (📖 p. 208)

18.3 Adding engine oil



Info

Too little engine oil or poor-quality engine oil will result in premature wear of the engine.

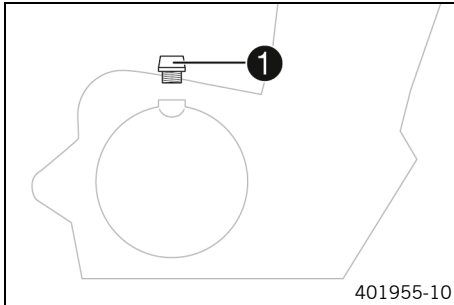

Main work

- Remove filler plug ❶ with the O-ring, and fill up with engine oil.

Engine oil (SAE 15W/50) (📖 p. 246)



Info

In order to achieve optimal engine oil performance, it is not advisable to mix different engine oils. KTM recommends changing the engine oil.

- Mount and tighten the filler plug together with the O-ring.



Danger

Danger of poisoning Exhaust gases are toxic and inhaling them may result in unconsciousness and death.

- Always make sure there is sufficient ventilation when running the engine.
- Use effective exhaust extraction when starting or running the engine in an enclosed space.

- Start the engine and check for leaks.

18 SERVICE WORK ON THE ENGINE

Finishing work

- Check the engine oil level. (📖 p. 208)



19.1 Cleaning the motorcycle

Note

Material damage Components become damaged or destroyed if a pressure cleaner is used incorrectly.

The high pressure forces water into the electrical components, connectors, throttle cables, and bearings, etc. Pressure which is too high causes malfunctions and destroys components.

- Do not direct the water jet directly on to electrical components, connectors, throttle cables or bearings.
- Maintain a minimum distance between the nozzle of the pressure cleaner and the component.

Minimum clearance 60 cm (23.6 in)



Note

Environmental hazard Hazardous substances cause environmental damage.

- Dispose of oils, grease, filters, fuel, cleaning agents, brake fluid, etc., correctly and in compliance with the applicable regulations.
-



Info

Clean the motorcycle regularly to maintain its value and appearance over a long period.
Avoid direct sunshine when cleaning the motorcycle.

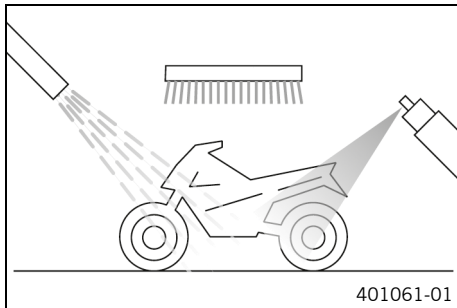

- Close off exhaust system to keep water from entering.
- Remove loose dirt first with a soft jet of water.
- Spray the heavily soiled parts with a normal commercial motorcycle cleaner and clean using a brush.

Motorcycle cleaner (🗉 p. 249)



Info

Use warm water containing normal motorcycle cleaner and a soft sponge.

Never apply motorcycle cleaner to a dry motorcycle; always rinse the vehicle with water first.

Clean the motorcycle with cold water if it has been used on salted roads. Warm water enhances the corrosive effects of salt.

- After rinsing the motorcycle with a gentle spray of water, allow it to dry thoroughly.
- Remove the closure of the exhaust system.



Warning

Danger of accidents Moisture and dirt impair the brake system.

- Brake carefully several times to dry out and remove dirt from the brake linings and the brake discs.

- After cleaning, ride the vehicle a short distance until the engine warms up.



Info

The heat produced causes water at inaccessible locations in the engine and on the brake system to evaporate.

-
- Push back the sleeves of the handlebar controls to allow any water that has penetrated to evaporate.
 - After the motorcycle has cooled down, lubricate all moving parts and pivot points.
 - Clean the chain. (📖 p. 125)
 - Treat bare metal (except for brake discs and the exhaust system) with a corrosion inhibitor.

Preserving materials for paints, metal and rubber
(📖 p. 250)

- Treat all painted parts with a mild paint care product.

Perfect finish and high gloss polish for paints (📖 p. 249)



Info

Do not polish parts that were matte when delivered as this would strongly impair the material quality.

- Treat all plastic parts and powder-coated parts with a mild cleaning and care product.

Special cleaner for glossy and matte paint finishes, metal and plastic surfaces (📖 p. 250)

- Lubricate the ignition and steering lock.

Universal oil spray (📖 p. 250)

19.2 Checks and maintenance steps for winter operation

i Info

If you use the motorcycle in winter, you must expect salt on the roads. You should therefore take precautions against aggressive road salt. Clean the motorcycle with cold water if it has been used on salted roads. Warm water enhances the corrosive effects of salt.

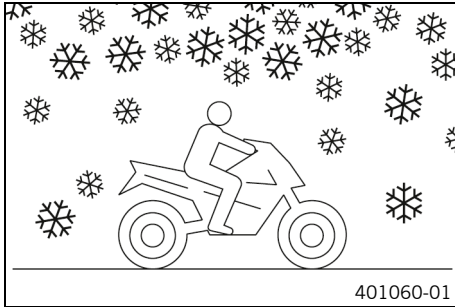

- Clean the motorcycle. (📖 p. 215)
- Clean the brakes.



Info

After **EVERY** trip on salted roads, thoroughly clean the motorcycle and, in particular, the brake calipers and brake linings, after they have cooled down and without removing them, with cold water and dry carefully.

- Treat the engine, the link fork, and all other bare or zinc-plated parts (except the brake discs) with a wax-based corrosion inhibitor.



Info

Corrosion inhibitor must not come in contact with the brake discs as this would greatly reduce the braking force.

- Clean the chain. (📖 p. 125)



20.1 Storage

i Info

If you plan to garage the motorcycle for a longer period, perform the following steps or have them performed.

Before storing the motorcycle, check all parts for function and wear. If service, repairs, or replacements are necessary, you should do this during the storage period (less workshop overload). In this way, you can avoid long workshop waiting times at the start of the new season.

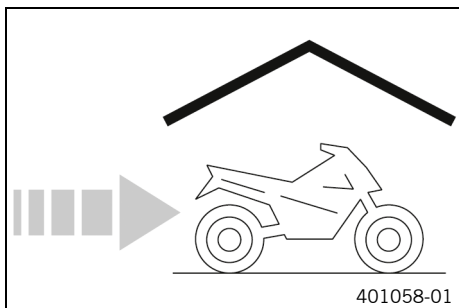

- When refueling for the last time before taking the motorcycle out of service, add fuel additive.

Fuel additive (📖 p. 249)

- Refuel. (📖 p. 106)
- Clean the motorcycle. (📖 p. 215)
- Change the engine oil and the oil filter, clean the oil screens. 🛠️ (📖 p. 209)
- Check the antifreeze and coolant level. (📖 p. 193)
- Check tire pressure. (📖 p. 169)
- Remove the 12-V battery. 🛠️ (📖 p. 172)
- Charge the 12-V battery. 🛠️ (📖 p. 175)

Guideline

Storage temperature of the 12-V battery without direct sunlight	0 ... 35 °C (32 ... 95 °F)
---	----------------------------

- Store vehicle in a dry location that is not subject to large fluctuations in temperature.

**Info**

KTM recommends jacking up the motorcycle.

- Raise the motorcycle with the rear lifting gear. (📖 p. 116)
- Lift the motorcycle with the front lifting gear. (📖 p. 117)
- Cover the motorcycle with a tarp or cover that is permeable to air.

**Info**

Do not use non-porous materials since they prevent humidity from escaping, thus causing corrosion. Avoid running the engine for a short time only. Since the engine cannot warm up properly, the water vapor produced during combustion condenses and causes valves and the exhaust system to rust.



20.2 Preparing for use after storage

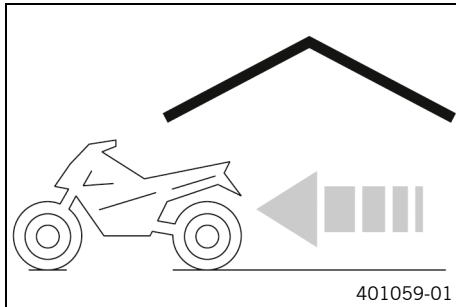

- Take the motorcycle off the front lifting gear. (📖 p. 119)
- Remove the rear of the motorcycle from the lifting gear. (📖 p. 116)
- Install the 12-V battery. 🔧 (📖 p. 174)
- Set the time and date. (📖 p. 78)
- Perform checks and maintenance measures when preparing for use. (📖 p. 92)
- Take a test ride.

Faults	Possible cause	Action
The engine does not turn when the start button is pressed	Operating error	– Carry out start procedure. (📖 p. 93)
	12-V battery discharged	– Charge the 12-V battery. 🛠️ (📖 p. 175)
	Fuse 1 , 3 , 4 , or 7 is blown	– Change the fuses of individual power consumers. (📖 p. 183)
	No ground connection present	– Check the ground connection.
Engine turns only if the clutch lever is drawn	The vehicle is in gear	– Shift the transmission into neutral.
	The vehicle is in gear and the side stand is folded out	– Shift the transmission into neutral.
Engine turns but does not start	Operating error	– Carry out start procedure. (📖 p. 93)
	Malfunction in the electronic fuel injection	– Read out the fault memory using the KTM diagnostics tool. 🛠️
Engine has too little power	Air filter is very dirty	– Change the air filter.
	Fuel filter is very dirty	– Check the fuel pressure. 🛠️
	Malfunction in the electronic fuel injection	– Read out the fault memory using the KTM diagnostics tool. 🛠️
Engine overheats	Too little coolant in cooling system	– Check the cooling system for leakage. – Check the coolant level. (📖 p. 196)
	Radiator fins very dirty	– Clean the radiator fins.
	Foam formation in cooling system	– Drain the coolant. 🛠️ (📖 p. 198) – Fill/bleed the cooling system. 🛠️ (📖 p. 199)

Faults	Possible cause	Action
Engine overheats	Thermostat defective	– Check the thermostat. 🛠️
	Fuse 5 blown	– Change the fuses of individual power consumers. (📖 p. 183)
	Defect in radiator fan system	– Check the radiator fan system. 🛠️
Malfunction indicator lamp lights up yellow	Malfunction in the electronic fuel injection	– Read out the fault memory using the KTM diagnostics tool. 🛠️
Engine dies during the trip	Lack of fuel	– Refuel. (📖 p. 106)
	Fuse 1, 3, 4, or 7 is blown	– Change the fuses of individual power consumers. (📖 p. 183)
The ABS warning lamp lights up	ABS fuse blown	– Change the ABS fuses. (📖 p. 180)
	Large difference in wheel speeds of the front and rear wheels	– Stop the vehicle, switch off the ignition, and start it again.
	Malfunction in ABS	– Read out the fault memory using the KTM diagnostics tool. 🛠️
High oil consumption	Engine vent hose bent	– Route the vent hose without bends or change it if necessary.
	Engine oil level too high	– Check the engine oil level. (📖 p. 208)
	Engine oil too thin (low viscosity)	– Change the engine oil and the oil filter, clean the oil screens. 🛠️ (📖 p. 209)
Headlight and position light are not functioning	Fuse 6 blown	– Change the fuses of individual power consumers. (📖 p. 183)

Faults	Possible cause	Action
Turn signal, brake light, and horn are not functional	Fuse 4 or 6 blown	– Change the fuses of individual power consumers. (📖 p. 183)
Time is not displayed or not correctly displayed	Fuse 2 is blown	– Change the fuses of individual power consumers. (📖 p. 183)
12 V battery discharged	Ignition was not switched off when vehicle was parked	– Charge the 12-V battery. 🔧 (📖 p. 175)
	The 12-V battery is not being charged by the alternator	– Check the charging voltage. 🔧 – Check the open-circuit current. 🔧
The combination instrument shows nothing on the display	Fuse 2 is blown	– Change the fuses of individual power consumers. (📖 p. 183)
Speedometer in combination instrument not functioning	Speedometer wiring harness is damaged or plug-in connector is oxidized	– Check the wiring harness and plug-in connector.

22.1 Engine

Design	1-cylinder 4-stroke engine, water-cooled
Displacement	373 cm ³ (22.76 cu in)
Stroke	60 mm (2.36 in)
Bore	89 mm (3.5 in)
Compression ratio	12.4:1
Control	DOHC, four valves controlled via cam lever, chain drive
Intake valve diameter	36 mm (1.42 in)
Exhaust valve diameter	29 mm (1.14 in)
Valve clearance, intake, cold	0.10 ... 0.15 mm (0.0039 ... 0.0059 in)
Valve clearance, exhaust, cold	0.15 ... 0.20 mm (0.0059 ... 0.0079 in)
Crankshaft bearing	2 slide bearings
Conrod bearing	Sleeve bearing
Pistons	Forged light alloy
Piston rings	1 compression ring, 1 tapered compression piston ring, 1 oil scraper ring
Engine lubrication	Pressure circulation lubrication with 2 trochoidal pumps
Primary transmission	30:80
Clutch	Slipper clutch in oil bath/mechanically operated

Transmission	6-gear transmission, claw shifted
Transmission ratio	
1st gear	12:32
2nd gear	14:26
3rd gear	19:27
4th gear	21:24
5th gear	23:22
6th gear	25:21
Mixture preparation	Electronic fuel injection
Ignition	Contactless controlled fully electronic ignition with digital ignition adjustment
Alternator	12 V, 230 W
Spark plug	BOSCHVR5NEU
Spark plug electrode gap	1 mm (0.04 in)
Cooling	Water cooling, permanent circulation of coolant by water pump
Idle speed	1,680 ± 50 rpm
Starting aid	Starter motor

22.2 Engine tightening torques

Oil nozzle	M5	6 Nm (4.4 lbf ft)	Loctite®243™
Screw, crankshaft speed sensor	M5	6 Nm (4.4 lbf ft)	Loctite®243™
Screw, gear sensor	M5	6 Nm (4.4 lbf ft)	Loctite®243™
Screw, retaining bracket	M5	6 Nm (4.4 lbf ft)	Loctite®243™
Screw, retaining bracket, stator cable	M5	8 Nm (5.9 lbf ft)	Loctite®243™
Screw, stator	M5	8 Nm (5.9 lbf ft)	Loctite®243™
Cylinder head screw	M6	12 Nm (8.9 lbf ft)	
Nut, water pump impeller	M6	10 Nm (7.4 lbf ft)	Loctite®243™
Oil nozzle	M6	6 Nm (4.4 lbf ft)	Loctite®243™
Screw plug, water pump drain hole	M6	10 Nm (7.4 lbf ft)	
Screw, alternator cover	M6	12 Nm (8.9 lbf ft)	
Screw, bearing retainer	M6	12 Nm (8.9 lbf ft)	Loctite®243™
Screw, camshaft bearing support	M6	10 Nm (7.4 lbf ft)	

Screw, camshaft, decompression shaft	M6	10 Nm (7.4 lbf ft)	Loctite®243™
Screw, chain securing guide	M6	10 Nm (7.4 lbf ft)	Loctite®243™
Screw, clutch cable retaining bracket	M6	6 Nm (4.4 lbf ft)	Loctite®243™
Screw, clutch cover	M6	12 Nm (8.9 lbf ft)	
Screw, clutch spring	M6	10 Nm (7.4 lbf ft)	
Screw, engine case	M6x35	12 Nm (8.9 lbf ft)	
Screw, engine case	M6x75	12 Nm (8.9 lbf ft)	Loctite®243™
Screw, engine vent plate	M6	10 Nm (7.4 lbf ft)	Loctite®243™
Screw, freewheel gear retaining bracket	M6	12 Nm (8.9 lbf ft)	Loctite®243™
Screw, lock washer, engine sprocket	M6	12 Nm (8.9 lbf ft)	Loctite®243™
Screw, locking lever	M6	12 Nm (8.9 lbf ft)	Loctite®243™
Screw, oil filter cover	M6	10 Nm (7.4 lbf ft)	
Screw, oil pump	M6	12 Nm (8.9 lbf ft)	Loctite®243™

22 TECHNICAL DATA

Screw, retaining bracket	M6	12 Nm (8.9 lbf ft) Loctite®243™
Screw, retaining bracket, radial shaft seal ring, clutch cover	M6	12 Nm (8.9 lbf ft) Loctite®243™
Screw, shift drum locating	M6	12 Nm (8.9 lbf ft) Loctite®243™
Screw, starter motor	M6	12 Nm (8.9 lbf ft)
Screw, timing chain tensioner	M6	12 Nm (8.9 lbf ft)
Screw, timing chain tensioning rail	M6	12 Nm (8.9 lbf ft) Loctite®243™
Screw, unlocking of timing chain tensioner	M6	6 Nm (4.4 lbf ft)
Screw, valve cover	M6	12 Nm (8.9 lbf ft)
Screw, water pump cover	M6	12 Nm (8.9 lbf ft)
Nut, exhaust flange	M8	8 Nm (5.9 lbf ft)
Screw plug	M8	12 Nm (8.9 lbf ft) Loctite®243™
Screw, balancer shaftgear wheel	M8	40 Nm (29.5 lbf ft) Loctite®243™
Screw, spring thrust bearing of the shift shaft	M8	20 Nm (14.8 lbf ft) Loctite®243™
Stud, exhaust flange	M8	22 Nm (16.2 lbf ft)
Screw, conrod bearing	M8x1	34 Nm (25.1 lbf ft)

Coolant temperature sensor	M10	14 Nm (10.3 lbf ft)
Oil pressure sensor	M10	14 Nm (10.3 lbf ft)
Screw, camshaft gear wheel	M10	36 Nm (26.6 lbf ft) Loctite®243™
Screw, cylinder head	M10	1st stage 30 Nm (22.1 lbf ft) 2nd stage 60 Nm (44.3 lbf ft) Thread is oiled, head flat is greased
Screw, rotor	M10	105 Nm (77.4 lbf ft) Loctite®243™
Screw plug, cam lever axis	M10x1	10 Nm (7.4 lbf ft)
Spark plug	M12	15 Nm (11.1 lbf ft)
Nut, inner clutch hub	M16LHx1.5	120 Nm (88.5 lbf ft) Loctite®243™
Nut, primary gear wheel/timing chain sprocket	M16x1.5	120 Nm (88.5 lbf ft) Loctite®243™
Oil screen screw plug, small	M17x1.5	12 Nm (8.9 lbf ft)
Screw plug, alternator cover	M18x1.5	10 Nm (7.4 lbf ft)
Oil drain plug	M24x1.5	15 Nm (11.1 lbf ft)
Screw plug, alternator cover	M24x1.5	10 Nm (7.4 lbf ft)

22.3 Capacities

22.3.1 Engine oil

Engine oil	1.7 l (1.8 qt.)	Engine oil (SAE 15W/50) (📖 p. 246)
------------	-----------------	---------------------------------------

22.3.2 Coolant

Coolant	1.2 l (1.3 qt.)	Coolant (📖 p. 245)
---------	-----------------	--------------------

22.3.3 Fuel

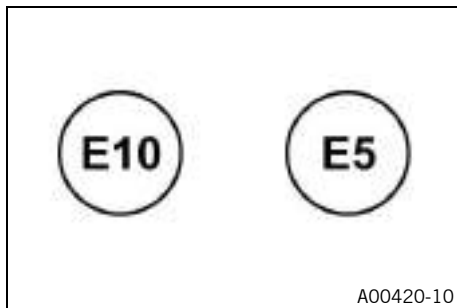

Please observe the labels on EU fuel pumps.

Total fuel tank capacity, approx.	13.5 l (3.57 US gal)	Super unleaded (ROZ 95) (📖 p. 247) (EU/AU/JP/AR/CN/ CO/MY/PH)
-----------------------------------	----------------------	---

Total fuel tank capacity, approx.	13.5 l (3.57 US gal)	Gasohol 95 E20 (RON 95) (📖 p. 247) (390 DUKE TH)
Total fuel tank capacity, approx.		Super unleaded, type C (ROZ 95/RON 95/PON 91) (📖 p. 248) (390 DUKE BR)
Fuel reserve, approx.		1.5 l (1.6 qt.)

22.4 Chassis

Frame	Lattice frame of steel tubes, powder-coated
Fork	WP Suspension
Shock absorber	WP Suspension
Brake system	
front	Disc brake with 4-piston brake caliper
rear	Disc brake with single-pot brake caliper, floating
Suspension travel	
front	142 mm (5.59 in)
rear	150 mm (5.91 in)
Brake discs - diameter	
front	320 mm (12.6 in)
rear	230 mm (9.06 in)
Brake discs - wear limit	

22 TECHNICAL DATA

front	4.5 mm (0.177 in)
rear	3.6 mm (0.142 in)
Tire pressure when solo	
front	2.0 bar (29 psi)
rear	2.0 bar (29 psi)
Tire pressure with passenger / full payload	
front	2.0 bar (29 psi)
rear	2.2 bar (32 psi)
Secondary ratio	15:45
Chain	5/8 x 1/4" (520) X-ring
Steering head angle	65°
Wheelbase	1,357 ± 15.5 mm (53.43 ± 0.61 in)
Seat height, unloaded	830 mm (32.68 in)
Ground clearance, unloaded	175 mm (6.89 in)
Dry weight	149 kg (328 lb.)
Maximum permissible front axle load	127 kg (280 lb.)
Maximum permissible rear axle load	228 kg (503 lb.)
Maximum permissible overall weight	355 kg (783 lb.)

22.5 Electrical system

12-V battery	ETZ-9-BS	Battery voltage: 12 V Nominal capacity: 8 Ah Maintenance-free
Fuse	75011088010	10 A
Fuse	75011088015	15 A
Fuse	90111088025	25 A
Fuse	75011088030	30 A
Headlight	LED	
Position light	LED	
Combination instrument lighting and indicator lamps	LED	
Turn signal	LED	
Brake/tail light	LED	
License plate lamp	LED	

22.6 Tires

Front tire	Rear tire
110/70 R 17 M/C 54H TL Metzeler Sportec M5 Interact	150/60 R 17 M/C 66H TL Metzeler Sportec M5 Interact
110/70 R 17 M/C 54H TL Continental ContiMotion	150/60 R 17 M/C 66H TL Continental ContiMotion
The tires specified represent one of the possible series production tires. Additional information is available in the Service section under: KTM.com	

22.7 Fork

Fork article number	93301000144	
Fork	WP Suspension	
Fork length	744 mm (29.29 in)	
Fork oil	450 ml (15.21 fl. oz.)	Fork oil (SAE 4) (48601166S1) (📖 p. 247)

22.8 Shock absorber

Shock absorber article number	93304010000
Shock absorber	WP Suspension

Spring preload	
Standard	5 clicks
Static sag	14 mm (0.55 in)
Riding sag	47 mm (1.85 in)
Fitted length	304 mm (11.97 in)

22.9 Chassis tightening torques

Screw, chain guard	EJOT PT® K60x30	7 Nm (5.2 lbf ft)
Remaining screws, chassis	M4	4 Nm (3 lbf ft)
Remaining nuts, chassis	M5	5 Nm (3.7 lbf ft)
Remaining screws, chassis	M5	5 Nm (3.7 lbf ft)
Screw, chain guard	M5	7 Nm (5.2 lbf ft) Loctite®243™
Screw, compensating tank cap lock, rear brake	M5	9 Nm (6.6 lbf ft)
Screw, fuel tank cover	M5	4 Nm (3 lbf ft)
Screw, outer clutch cable guide	M5	5 Nm (3.7 lbf ft) Loctite®243™
Screw, side stand sensor	M5	5 Nm (3.7 lbf ft) Loctite®243™
Screw, tail light	M5	5 Nm (3.7 lbf ft)
Nut, foot brake lever adjustment	M6	9 Nm (6.6 lbf ft)

22 TECHNICAL DATA

Remaining nuts, chassis	M6	10 Nm (7.4 lbf ft)	
Remaining screws, chassis	M6	10 Nm (7.4 lbf ft)	
Screw, ABS hose clamp	M6	7 Nm (5.2 lbf ft)	
Screw, ABS module	M6	10 Nm (7.4 lbf ft)	
Screw, ABS module retaining bracket on frame	M6	7 Nm (5.2 lbf ft)	
Screw, air filter box	M6	6 Nm (4.4 lbf ft)	
Screw, brake fluid reservoir for rear brake	M6	8 Nm (5.9 lbf ft)	Loctite®243™
Screw, brake hose clamp	M6	7 Nm (5.2 lbf ft)	
Screw, chain sliding guard	M6	7 Nm (5.2 lbf ft)	
Screw, combination instrument	M6	7 Nm (5.2 lbf ft)	
Screw, compensating tank	M6	5 Nm (3.7 lbf ft)	
Screw, damper block	M6	8 Nm (5.9 lbf ft)	
Screw, engine sprocket cover	M6	8 Nm (5.9 lbf ft)	
Screw, foot brake cylinder	M6	9 Nm (6.6 lbf ft)	Loctite®243™
Screw, front fender	M6	7 Nm (5.2 lbf ft)	
Screw, front seat fixing	M6	6 Nm (4.4 lbf ft)	
Screw, front spoiler	M6x12	9 Nm (6.6 lbf ft)	
Screw, front spoiler lower part	M6x14	9 Nm (6.6 lbf ft)	
Screw, fuel pump	M6	10 Nm (7.4 lbf ft)	

Screw, fuel tank trim	M6	5 Nm (3.7 lbf ft)	
Screw, fuel tank trim	M6	7 Nm (5.2 lbf ft)	
Screw, headlight	M6	8 Nm (5.9 lbf ft)	
Screw, holder of fuel vapor valve	M6	9 Nm (6.6 lbf ft)	
Screw, ignition coil	M6	8 Nm (5.9 lbf ft)	
Screw, ignition lock (tamper-proof screw)	M6	13 Nm (9.6 lbf ft)	
Screw, license plate holder	M6	12 Nm (8.9 lbf ft)	Loctite®243™
Screw, lower rear panel	M6	7 Nm (5.2 lbf ft)	
Screw, magnetic holder on side stand	M6	5 Nm (3.7 lbf ft)	Loctite®243™
Screw, main silencer	M6	12 Nm (8.9 lbf ft)	
Screw, main silencer retaining bracket	M6	9 Nm (6.6 lbf ft)	
Screw, protective plate	M6	8 Nm (5.9 lbf ft)	
Screw, radiator holder	M6	10 Nm (7.4 lbf ft)	
Screw, radiator shield	M6	7 Nm (5.2 lbf ft)	
Screw, rear splash protector	M6	9 Nm (6.6 lbf ft)	
Screw, rear wheel speed sensor	M6	8 Nm (5.9 lbf ft)	Loctite®243™
Screw, shift lever linkage	M6	11 Nm (8.1 lbf ft)	Loctite®243™

22 TECHNICAL DATA

Screw, side stand sensor cable holder	M6	9 Nm (6.6 lbf ft)	Loctite®243™
Screw, tilt sensor	M6	8 Nm (5.9 lbf ft)	Loctite®243™
Screw, wheel speed sensor holder	M6	8 Nm (5.9 lbf ft)	
Nut, rear sprocket	M8	27 Nm (19.9 lbf ft)	
Remaining nuts, chassis	M8	25 Nm (18.4 lbf ft)	
Remaining screws, chassis	M8	25 Nm (18.4 lbf ft)	
Screw, bottom triple clamp	M8	12 Nm (8.9 lbf ft)	
Screw, engine bearer	M8	22 Nm (16.2 lbf ft)	
Screw, foot brake lever	M8	16 Nm (11.8 lbf ft)	Loctite®243™
Screw, fork stub	M8	15 Nm (11.1 lbf ft)	
Screw, front brake disc	M8	30 Nm (22.1 lbf ft)	Loctite®243™
Screw, front seat fixing	M8	25 Nm (18.4 lbf ft)	
Screw, front wheel spindle	M8	25 Nm (18.4 lbf ft)	
Screw, fuel tank	M8	20 Nm (14.8 lbf ft)	
Screw, grab handle	M8	22 Nm (16.2 lbf ft)	
Screw, handlebar clamp	M8	20 Nm (14.8 lbf ft)	Loctite®243™
Screw, horn	M8	12 Nm (8.9 lbf ft)	
Screw, main silencer	M8	23 Nm (17 lbf ft)	

Screw, passenger footrest unit	M8	22 Nm (16.2 lbf ft) Loctite®243™
Screw, rear brake disc	M8	21 Nm (15.5 lbf ft) Loctite®243™
Screw, rear seat fixing	M8	18 Nm (13.3 lbf ft)
Screw, seat support plate	M8	18 Nm (13.3 lbf ft)
Screw, subframe	M8	25 Nm (18.4 lbf ft) Loctite® 620™
Screw, top triple clamp	M8	15 Nm (11.1 lbf ft)
Screw, front brake caliper	M8x1	30 Nm (22.1 lbf ft) Loctite®243™
Banjo bolt, brake line	M10	24 Nm (17.7 lbf ft)
Fitting side stand	M10	35 Nm (25.8 lbf ft) Loctite®243™
Remaining nuts, chassis	M10	45 Nm (33.2 lbf ft)
Remaining screws, chassis	M10	45 Nm (33.2 lbf ft)
Screw, engine bearer	M10	49 Nm (36.1 lbf ft) Loctite®243™
Fitting, handlebar support	M10x1.25	21 Nm (15.5 lbf ft)
Fitting, shock absorber, bottom	M10x1.25	51 Nm (37.6 lbf ft) Loctite®243™
Nut, left rear mirror	M10x1.25	16 Nm (11.8 lbf ft)
Nut, right rear mirror	M10LHx1.25	16 Nm (11.8 lbf ft)

22 TECHNICAL DATA

Nut, side stand bracket	M10x1.25	35 Nm (25.8 lbf ft)
Screw, combination instrument bracket	M10x1.25	21 Nm (15.5 lbf ft)
Screw, front footrest bracket	M10x1.25	44 Nm (32.5 lbf ft) Loctite®243™
Screw, front footrest bracket / engine bearer	M10x1.25	49 Nm (36.1 lbf ft)
Screw, top shock absorber	M10x1.25	51 Nm (37.6 lbf ft) Loctite®243™
Stud, rear sprocket	M10x1.25	50 Nm (36.9 lbf ft)
Nut, rear wheel spindle	M14x1.5	98 Nm (72.3 lbf ft)
Nut, swingarm pivot	M14x1.5	98 Nm (72.3 lbf ft)
Screw, steering head, top	M16x1.5	49 Nm (36.1 lbf ft) Loctite®243™
Lambda sensor	M18x1.5	19 Nm (14 lbf ft)
Adjusting ring, link fork bearing	M22x1	Tighten and ensure that there is no play

Nut, steering head	M30x1	1st stage 45 Nm (33.2 lbf ft) 2nd stage (loosen, counterclock- wise) 2 turns 3rd stage 5 Nm (3.7 lbf ft)
--------------------	-------	--

23.1 Declarations of conformity



Info

The functional and equipment scope is model-dependent and may not include all wireless systems and application areas referred to.

COBO SpA hereby declares that the **BT-ROUTER** wireless system conforms with the relevant guidelines. The full text of the Declaration of Conformity is available at the following Internet address.

Certification website: <http://www.ktm.com/btrouter>

JNS Instruments Ltd. hereby declares that the **210M1100** wireless system conforms with the relevant guidelines.

The full text of the Declaration of Conformity is available at the following Internet address.

Certification website: <http://www.ktm.com/210m1100>

Brake fluid DOT 4 / DOT 5.1

Standard/classification

- DOT

Guideline

- Use only brake fluid that complies with the specified standard (see specifications on the container) and that exhibits the corresponding properties.

Recommended supplier

Castrol

- REACT PERFORMANCE DOT 4

MOTOREX®

- Brake Fluid DOT 5.1

Coolant

Guideline

- Only use high-grade, silicate-free coolant with corrosion inhibitor additive for aluminum motors. Low grade and unsuitable antifreeze causes corrosion, deposits and frothing.
- Do not use pure water as only coolant is able to meet the requirements needed in terms of corrosion protection and lubrication properties.
- Only use coolant that complies with the requirements stated (see specifications on the container) and that has the relevant properties.

Antifreeze protection to at least	-25 °C (-13 °F)
-----------------------------------	-----------------

The mixture ratio must be adjusted to the necessary antifreeze protection. Use distilled water if the coolant needs to be diluted.

The use of premixed coolant is recommended.

Observe the coolant manufacturer specifications for antifreeze protection, dilution and miscibility (compatibility) with other coolants.

Recommended supplier

MOTOREX®

- **COOLANT M3.0**

Engine oil (SAE 15W/50)

Standard/classification

- JASO T903 MA2 (📖 p. 251)
- SAE (📖 p. 251) (SAE 15W/50)

Guideline

- Use only engine oils that comply with the specified standards (see specifications on the container) and that exhibit the corresponding properties.

Partially synthetic engine oil

Recommended supplier

MOTOREX®

- **Formula 4T**

Fork oil (SAE 4) (48601166S1)

Standard/classification

- SAE (📖 p. 251) (SAE 4)

Guideline

- Use only oils that comply with the specified standards (see specifications on the container) and that exhibit the corresponding properties.

Gasohol 95 E20 (RON 95)

Standard/classification

- Gasohol 95 E20 (RON 95)

Guideline

- Only use super unleaded fuel that matches or is equivalent to the specifications.
- Super unleaded fuel with an ethanol content of 19 to 20% is permissible.



Info

Do **not** use fuel made of methanol (e.g., M15, M85, M100).

Do **not** use fuel with less than 19% ethanol (e.g., E10).

Do **not** use fuel with more than 20% ethanol (e.g., E30, E85, E100).

Super unleaded (ROZ 95)

Standard/classification

- DIN EN 228 (ROZ 95)

Guideline

- Only use super unleaded fuel that matches or is equivalent to the specified standard.
-

- Fuel with an ethanol content of up to 10% (E10 fuel) is safe to use.
-



Info

Do **not** use fuel containing methanol (e.g., M15, M85, M100) or more than 10% ethanol (e.g., E15, E25, E85, E100).

Super unleaded, type C (ROZ 95/RON 95/PON 91)

Standard/classification

- ANP (Agência Nacional do Petróleo) #57 (ROZ 95/RON 95/PON 91)

Guideline

- Only use super unleaded fuel that matches or is equivalent to the following specifications.
 - Super unleaded fuel with an ethanol content of 19 to 27% is permissible.
-



Info

Do **not** use fuel made of methanol (e.g., M15, M85, M100).
Do **not** use fuel with less than 19% ethanol (e.g., E10).
Do **not** use fuel with more than 27% ethanol (e.g., E30, E85, E100).

Chain cleaner

Recommended supplier

MOTOREX®

- Chain Clean

Fuel additive

Recommended supplier

MOTOREX®

- Fuel Stabilizer

Long-life grease

Recommended supplier

MOTOREX®

- Bike Grease 2000

Motorcycle cleaner

Recommended supplier

MOTOREX®

- Moto Clean

Perfect finish and high gloss polish for paints

Recommended supplier

MOTOREX®

- Moto Shine

25 AUXILIARY SUBSTANCES

Preserving materials for paints, metal and rubber

Recommended supplier

MOTOREX®

- Moto Protect

Special cleaner for glossy and matte paint finishes, metal and plastic surfaces

Recommended supplier

MOTOREX®

- Quick Cleaner

Street chain spray

Guideline

Recommended supplier

MOTOREX®

- Chainlube Road Strong

Universal oil spray

Recommended supplier

MOTOREX®

- Joker 440 Synthetic

JASO T903 MA2

Different technical development directions required a separate specification for motorcycles – the **JASO T903 MA2** standard.

Earlier, engine oils from the automobile industry were used for motorcycles because there was no separate motorcycle specification.

Whereas long service intervals are demanded for automobile engines, the focus for motorcycle engines is on high performance at high engine speeds.

In most motorcycle engines, the transmission and clutch are lubricated with the same oil.

The **JASO T903 MA2** standard meets these special requirements.

SAE

The SAE viscosity classes were defined by the Society of Automotive Engineers and are used for classifying oils according to their viscosity. The viscosity describes only one property of oil and says nothing about quality.

27 INDEX OF SPECIAL TERMS

ABS	Anti-lock braking system	Safety system that prevents locking of the wheels when driving straight ahead without the influence of lateral forces
DRL	Daytime Running Light	Light, which enhances the visibility of the vehicle during the day but is not focused, and in contrast to low beam does not illuminate the road surface
-	KTM MY RIDE	System for wireless communication with appropriate cellphones and headsets for telephony and audio
OBD	On-board diagnosis	Vehicle system, which monitors the specified parameters of the vehicle electronics

Art. no.	Article number
ca.	circa
cf.	compare
e.g.	for example
etc.	et cetera
i.a.	inter alia
no.	number
poss.	possibly

29 LIST OF SYMBOLS



29.1 Red symbols

Red symbols indicate an error condition that requires immediate intervention.

	The oil pressure warning lamp lights up red – The oil pressure is too low. Stop immediately, taking care not to endanger yourself or other road users in the process, and switch off the engine.
---	--

29.2 Yellow and orange symbols



Yellow and orange symbols indicate an error condition that requires prompt intervention. Active driving aids are also represented by yellow or orange symbols.

	Malfunction indicator light lights up yellow – The OBD has detected a malfunction in the vehicle electronics. Come safely to a halt, and contact an authorized KTM workshop.
	The ABS warning lamp lights up yellow – Status or error messages relating to ABS. The ABS warning lamp flashes if the ABS mode Super Moto is enabled.
	The general warning lamp lights up yellow – A note/warning note on operating safety has been detected. This is shown in addition.

29.3 Green and blue symbols

Green and blue symbols reflect information.

	The turn signal indicator lamp flashes green simultaneously with the turn signal – The turn signal is switched on.
---	--

	The idle indicator lamp lights up green – The transmission is in neutral.
	High beam indicator lamp lights up blue – The high beam is switched on.

1

12-V battery

charging	175
installing	174
removing	172

A

ABS	138
-----	-----

ABS fuses

changing	180
----------	-----

ACC1

front	189
-------	-----

ACC2

front	189
rear	190

Accessories	17
-------------	----

Antifreeze

checking	193
----------	-----

Anti-lock braking system	138
--------------------------	-----

Applying the brakes	100
---------------------	-----

Auxiliary substances	17
----------------------	----

B

Brake discs

checking	140
----------	-----

Brake fluid

of front brake, adding	143
of rear brake, adding	152

Brake fluid level

front brake, checking	142
rear brake, checking	151

Brake linings

front brake, checking	146
rear brake, checking	155

Brakes	100
--------	-----

C

Capacity

coolant	232
engine oil	232
fuel	108, 232-233

Chain

chain dirt accumulation, checking	125
checking	130
cleaning	125

Chain tension	
adjusting	128
checking	127
Clutch lever	27
basic position, adjusting	133
Clutch lever play	
checking	206
Combination instrument	42-86
ABS	73
activation and test	42
Audio	67
Bluetooth (optional)	76
coolant temperature indicator	54
day-night mode	43
display	50
Display Theme	77
Distance	82
DRL	81
Extra Functions	85
Favourites	74
Favourites display	57
fuel level display	55
Fuel Cons	83
General Info	70
Headset	65
indicator lamps	46
Info	60
KTM MY RIDE	59
Language	84
menu	58
Motorcycle	60
ODO display	54
overview	42
Pairing	62
Phone	63
Preferences	61
Quick Selector 1	74
Quick Selector 1 display	57
Quick Selector 2	75
Quick Selector 2 display	58
Service	85
Settings	61
shift warning light	52
speed	52-53
telephony	69
Temperature	83
time	56
Trip 1	70
Trip 2	71
Warning	72

warnings	44	Engine oil level	
Combination switch	28	checking	208
overview	29	Engine sprocket	
Coolant		checking	130
changing	202	Environment	15
draining	198	F	
Coolant level		Figures	18
checking	193, 196	Filling up	
Cooling system	191	fuel	106
filling/bleeding	199	Foot brake lever	40
Customer service	18	free travel, adjusting	149
D		free travel, checking	147
Declarations of conformity	244	Fork legs	
Diagnostics connector	189	dust boots, cleaning	120
E		Front rider's seat	
Emergency OFF switch	31	mounting	124
Engine		Front rider's seat	
running in	89	removing	123
Engine number	25	Front spoiler	
Engine oil		installing	136
adding	213	removing	134
changing	209	Front wheel	
		installing	158

removing	157
Fuel tank filler cap	
closing	36
opening	34
Fuel, oils, etc.	17
Fuse	
of the individual consumers, changing	183
G	
Grab handles	38
H	
Hand brake lever	27
basic position, adjusting	140
Headlight	
daytime running light	171
range, adjusting	188
Headlight setting	
checking	187
Horn button	31
I	
Ignition lock	32
Implied warranty	17
Indicator lamps	46

K	
Key number	26
L	
Light switch	29
Loading the vehicle	89
Luggage	89
M	
Main fuse	
changing	178
Manufacturer warranty	17
Misuse	11
Motorcycle	
cleaning	215
lifting with front lifting gear	117
rear lifting gear, raising with	116
removing the rear from the lifting gear	116
taking off front lifting gear	119
O	
Oil filter	
changing	209
Oil screens	
cleaning	209

Owner's Manual	16	Riding	96
P		starting off	95
Parking	103	S	
Passenger foot pegs	38	Safe operation	13
Passenger seat		Seat lock	37
mounting	123	Service	18
removing	122	Service schedule	109-112
Play in the clutch lever		Shift lever	39
adjusting	207	adjusting	114
Preparing for use		Shifting	96
advice on preparing for first use	87	Shock absorber	
after storage	222	spring preload, adjusting	113
checks and maintenance measures when		Side stand	40
preparing for use	92	Spare parts	17
Protective clothing	14	Start button	32
R		Starting	93
Rear hub damping rubbers		Steering	
checking	165	locking	33
Rear sprocket		unlocking	34
checking	130	Steering lock	32
Rear wheel		Stopping	103
installing	162	Storage	220
removing	160		

Switch	
on the left side of the handlebar	28
on the right side of the handlebar	31
T	
Technical data	
Capacities	232
chassis	233
chassis tightening torques	237
electrical system	235
Engine	226
Engine tightening torques	228
fork	236
shock absorber	236
tires	236
Throttle grip	28
Time	
adjusting	78
Tire condition	
checking	167
Tire pressure	
checking	169
Tool set	37
Transport	104

Troubleshooting	223-225
Turn signal switch	30
Type label	24
U	
Use definition	11
V	
Vehicle identification number	24
View of vehicle	
front left	20
rear right	22
W	
Winter operation	
checks and maintenance steps	218
Work rules	15

READY TO
RACE



3214321en

02/2021



KTM Sportmotorcycle GmbH
5230 Mattighofen/Austria
KTM.com



Photo:
Mitterbauer/KISKA/KTM