

Rider's Manual

G 650 Xcountry



BMW Motorrad



The Ultimate
Riding Machine

Motorcycle data/dealership details

Motorcycle data

Model

Vehicle identification number

Colour code

Date of first registration

Registration number

Dealership details

Person to contact in Service department

Ms/Mr

Phone number

Dealership address/phone number (company stamp)

Welcome to BMW

We congratulate you on your choice of a motorcycle from BMW and welcome you to the community of BMW riders.

Familiarise yourself with your new motorcycle so that you can ride it safely and confidently in all traffic situations.

Please read this Rider's Manual carefully before starting to use your new BMW motorcycle. It contains important information on how to operate the controls and how to make the best possible use of all your BMW's technical features.

In addition, it contains information on maintenance and care to help you maintain your motorcycle's reliability and safety, as well as its value.

If you have questions concerning your motorcycle, your authorised

BMW Motorrad dealer will gladly provide advice and assistance.

We hope that you will enjoy riding your BMW and that all your journeys will be pleasant and safe.

BMW Motorrad.

Table of Contents

You can also consult the index at the end of this Rider's Manual if you want to find a particular topic or item of information.

1 General instructions 5

Overview 6

Abbreviations and symbols 6

Equipment 6

Technical data 7

Currency 7

2 General views 9

General view, left side 11

General view, right side 13

Handlebar fitting, left 14

Handlebar fitting, right 15

Underneath the seat 16

Instrument cluster 17

3 Status indicators 19

Standard status indicators 20

Standard warnings 20

ABS warnings^{OE} 23

4 Operation 27

Ignition switch and steering lock 28

Multifunction display 28

Lights 31

Turn indicators 32

Emergency off switch (kill switch) 32

BMW Motorrad ABS^{OE} 33

Clutch 33

Brakes 34

Mirrors 34

Spring preload 35

Damping 36

Height of suspension 37

Tyres 37

Headlight 38

Seat 38

5 Riding 41

Safety instructions 42

Checklist 44

Starting 44

Running in 46

Brakes 47

Parking your motorcycle 49

Refuelling 50

Securing motorcycle for transportation 50

6 Engineering details 53

Brake system with BMW Motorrad ABS^{OE} 54

7 Accessories 57

General instructions 58

Power socket^{OE} 58

Luggage 59

Topcase^{OA} 60

8 Maintenance 63

Notes 64

Toolkit 64

Engine oil 65

Brake system 67

Brake pads 67

Brake fluid 69

Coolant 71

Clutch 72

Tyres 73

Rims 74

| | | | |
|--|------------|---|------------|
| Chain..... | 74 | Engine oil | 107 |
| Wheels | 76 | Clutch | 108 |
| BMW Motorrad auxiliary stand | 82 | Transmission | 108 |
| BMW Motorrad front-wheel stand | 83 | Rear-wheel drive | 109 |
| Fuses | 85 | Running gear | 109 |
| Bulbs..... | 87 | Brakes | 110 |
| Jump starting | 93 | Wheels and tyres..... | 110 |
| Battery | 94 | Electrics..... | 111 |
| 9 Care | 99 | Frame | 113 |
| Care products | 100 | Dimensions | 113 |
| Washing motorcycle..... | 100 | Weights | 114 |
| Cleaning easily damaged components..... | 100 | Riding specifications | 114 |
| Paint care | 101 | 11 Service | 115 |
| Protective wax coating | 102 | BMW Motorrad service.... | 116 |
| Laying up motorcycle | 102 | BMW Motorrad service quality | 116 |
| Restoring motorcycle to use | 102 | BMW Motorrad Service Card: on-the-spot break- down assistance | 116 |
| 10 Technical data | 103 | BMW Motorrad service network | 117 |
| Troubleshooting chart | 104 | Maintenance work..... | 117 |
| Threaded fasteners | 105 | Confirmation of mainten- ance work | 118 |
| Engine | 106 | Confirmation of service.... | 123 |
| Fuel | 107 | | |

General instructions

| | |
|---------------------------------|---|
| Overview | 6 |
| Abbreviations and symbols | 6 |
| Equipment | 6 |
| Technical data | 7 |
| Currency | 7 |

Overview

Chapter 2 of this Rider's Manual will provide you with an initial overview of your motorcycle. All maintenance and repair work on the motorcycle is documented in Chapter 11. This record of the maintenance work you have had performed on your motorcycle is a precondition for generous treatment of goodwill claims.

When the time comes to sell your BMW, please remember to hand over this Rider's Manual; it is an important part of the motorcycle.

Abbreviations and symbols



Indicates warnings that you must comply with for reasons of your safety and the safety of others, and to protect your motorcycle against damage.



Specific instructions on how to operate, control, adjust or look after items of equipment on the motorcycle.



Indicates the end of an item of information.



Instruction.



Result of an activity.



Reference to a page with more detailed information.



Indicates the end of a passage relating to specific accessories or items of equipment.



Tightening torque.



Item of technical data.

OE Optional extra
The motorcycles are assembled complete with all the BMW optional extras originally ordered.

OA Optional accessory
You can obtain optional accessories through your authorised BMW Motorrad dealer; optional accessories have to be retrofitted to the motorcycle.

ABS Anti-lock brake system

Equipment

When you ordered your BMW motorcycle, you chose various items of custom equipment. This Rider's Manual describes optional extras (OE) offered by BMW and selected optional accessories (OA). This explains why the manual may also contain de-

scriptions of equipment which you have not ordered. Please note, too, that your motorcycle might not be exactly as illustrated in this manual on account of country-specific differences. If your BMW was supplied with equipment not described in this Rider's Manual, you will find these features described in separate manuals.

Technical data

All dimensions, weights and power ratings stated in the Rider's Manual are quoted to the standards and comply with the tolerance requirements of the Deutsches Institut für Normung e.V. (DIN). Versions for individual countries may differ.

Currency

The high safety and quality standards of BMW motorcycles are maintained by constant development work on designs, equipment and accessories. Because of this, your motorcycle may differ from the information supplied in the Rider's Manual. Nor can BMW Motorrad entirely rule out errors and omissions. We hope you will appreciate that no claims can be entertained on the basis of the data, illustrations or descriptions in this manual.

General views

| | |
|--------------------------------|----|
| General view, left side..... | 11 |
| General view, right side | 13 |
| Handlebar fitting, left | 14 |
| Handlebar fitting, right | 15 |
| Underneath the seat | 16 |
| Instrument cluster | 17 |



General view, left side

- 1 Adjuster for spring preload, rear (➡ 35)
- 2 Power socket^{OE} (➡ 58)
- 3 Adjuster for damping characteristic, rear suspension (➡ 36)
- 4 Coolant-level indicator (➡ 71)



General view, right side

- 1 Seat lock (→ 38)
- 2 Fuel filler neck (→ 50)
- 3 Brake-fluid reservoir, front (→ 69)
- 4 ABS fuses, behind the side panel (→ 86)
- 5 Brake-fluid reservoir, rear (→ 70)

Handlebar fitting, left

- 1 Headlight flasher
- 2 Operating the ABS^{OE}
(→ 33)
- 3 Switch for flashing turn indicators (→ 32)
- 4 Horn
- 5 High-beam headlight
(→ 31)

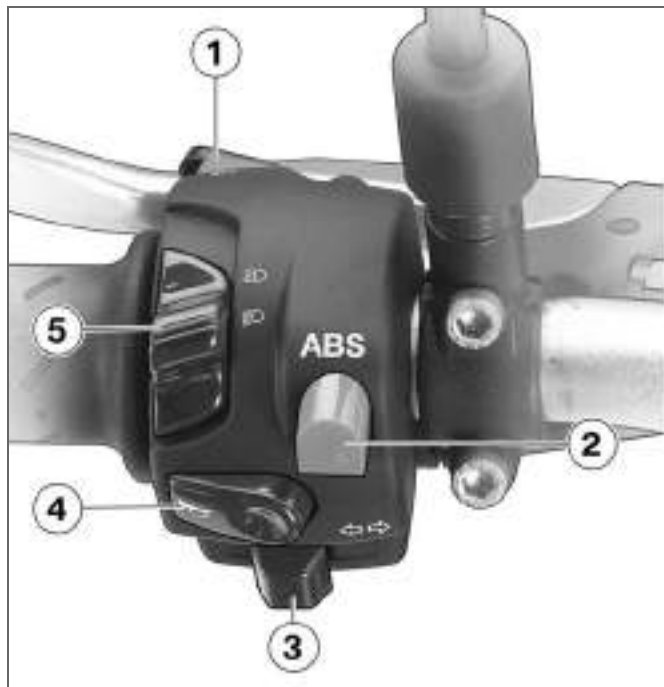

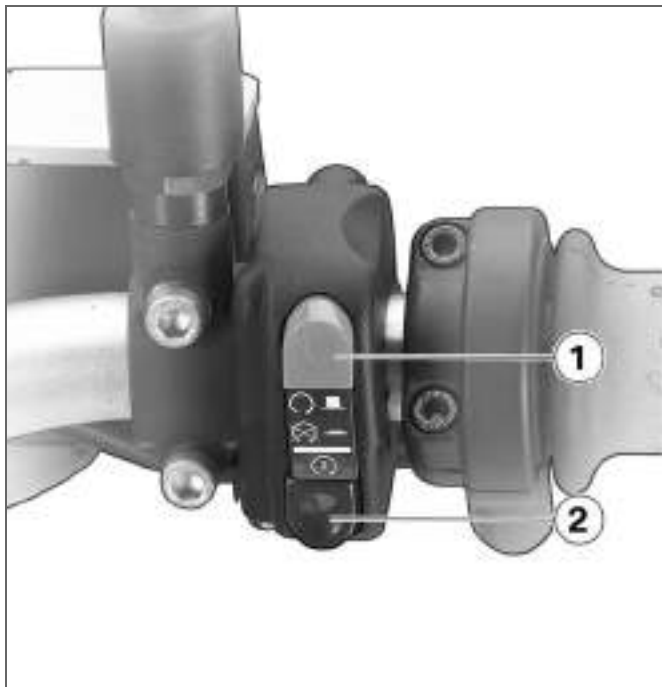

Handlebar fitting, right

- 1 Emergency off switch (kill switch) (→ 32)
- 2 Starter button (→ 44)

Underneath the seat

- 1 Oil dipstick and engine-oil filler neck (→ 65)
- 2 Toolkit
- 3 Fuse box (→ 85)

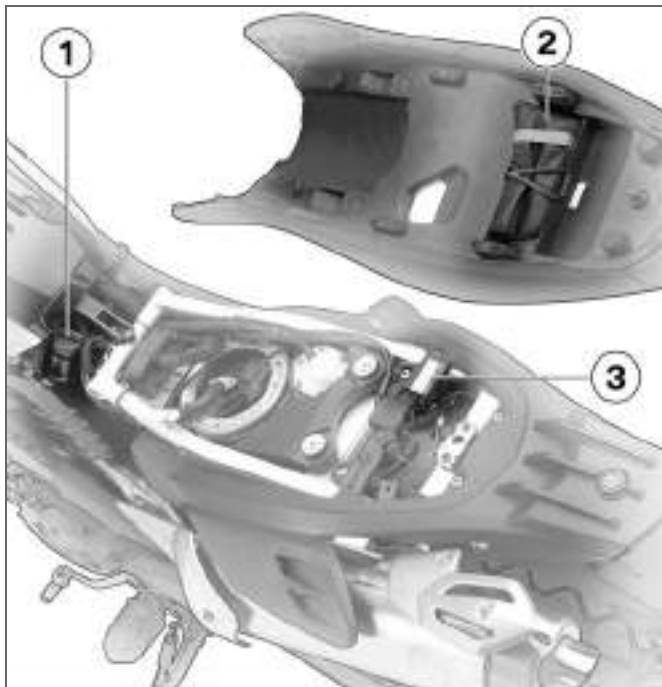

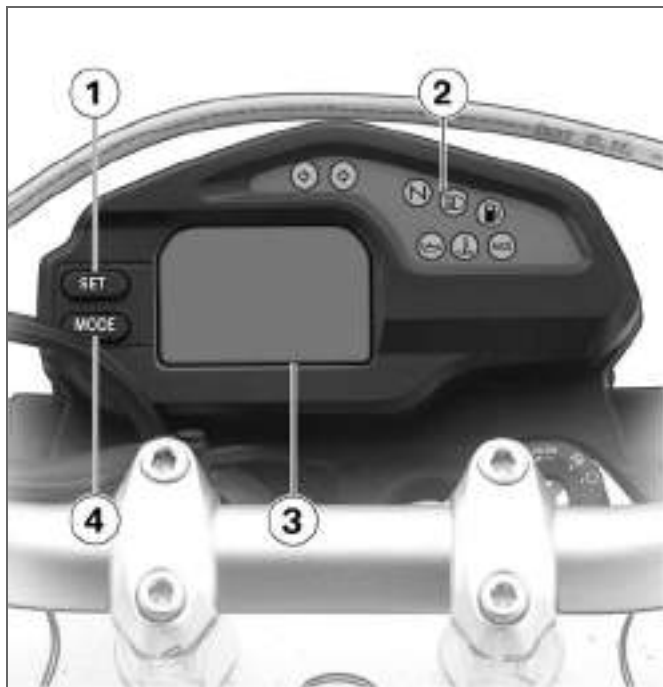

Instrument cluster

- 1 Set the clock (→ 29)
Reset the tripmeter (→ 29)
- 2 Telltale lights (→ 20)
- 3 Multifunction display (→ 20)
- 4 Select the readings (→ 28)

Status indicators

| | |
|----------------------------------|----|
| Standard status indicators | 20 |
| Standard warnings | 20 |
| ABS warnings ^{OE} | 23 |

Standard status indicators

Multifunction display



- 1** Speedometer
- 2** Odometer, clock or battery voltage (☰ 28)

Telltale lights

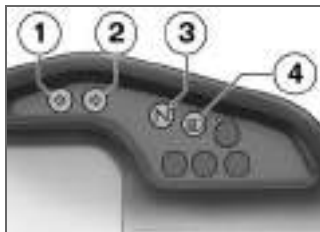

- 1** Flashing turn indicators, left
- 2** Flashing turn indicators, right
- 3** Idle
- 4** High-beam headlight

Standard warnings

Mode of presentation







Warnings are indicated by warning lights **1**.
The possible warnings are listed on the next page.

Warnings, overview

Telltale lights

Status indicators

Meaning

| | | |
|--|-----------|--|
|  | Lights up | Fuel down to reserve ( 22) |
|  | Lights up | Insufficient engine oil pressure ( 22) |
|  | Lights up | Coolant temperature too high ( 22) |

Fuel down to reserve



Warning light for fuel down to reserve lights up.



Lack of fuel can result in the engine misfiring and cutting out unexpectedly. Misfiring can damage the catalytic converter; a hazardous situation can result if the engine cuts out unexpectedly.

Do not run the fuel tank dry.◀

Possible cause:

The fuel tank contains no more than the reserve quantity of fuel.



Reserve fuel

— ≥ 2 l

- Refuelling (➡ 50)

Insufficient engine oil pressure



Warning light for oil pressure shows.

The oil pressure in the lube-oil system is too low. Stop immediately and switch off the engine if the warning light shows.



The insufficient oil pressure warning does not fulfil the function of an oil gauge. The only way of checking whether the oil level is correct is to check with the oil dipstick.◀

Possible cause:

Engine-oil level too low.

- Check the engine oil level (➡ 65)

If the oil level is too low:

- Top up the engine oil (➡ 66)

Possible cause:

If the engine oil level is correct:



Riding when engine-oil pressure is low can result in engine damage.

Do not continue your journey.◀

- Have the fault rectified as quickly as possible by a specialist workshop, preferably an authorised BMW Motorrad dealer.

Coolant temperature too high



Warning light for coolant temperature shows.



Continuing to ride when the engine is overheated could result in engine damage.

You must comply with the instructions below.◀

Possible cause:

Coolant level too low.

- Check the coolant level (➡ 71)

If the coolant level is too low:

- Topping up coolant (➡ 71)

Possible cause:

Radiator fan defective.

If the radiator fan does not start even though the coolant-temperature warning light shows:

- Have the fault rectified as quickly as possible by a specialist workshop, preferably an authorised BMW Motorrad dealer.

Possible cause:

Insufficient cooling.

- If possible, ride in the part-load range to cool down the engine.
- In traffic jams, switch off the engine, but leave the ignition switched on so that the radiator fan continues to operate.

- If the coolant temperature is frequently too high, have the fault rectified as soon as possible by a specialist workshop, preferably an authorised BMW Motorrad dealer.

ABS warnings^{OE}

Mode of presentation



ABS warnings are indicated by ABS warning light **1**.

The detailed descriptions start on page (➡ 54), and you will find an overview listing the possible warnings on the next page.

Warnings, overview**Telltale lights****Status indicators****Meaning**

Flashes

Self-diagnosis not completed (→ 25)



Lights up

ABS deactivated (→ 25)



Lights up

ABS fault (→ 25)

Self-diagnosis not completed



ABS warning light flashes.

Possible cause:

The ABS function is not available, because self-diagnosis did not complete. The motorcycle has to move forward a few metres for the wheel sensors to be tested.

- Pull away slowly. Bear in mind that the ABS function is not available until self-diagnosis has completed.

ABS deactivated



ABS warning light shows.

Possible cause:

The rider has switched off the ABS system.

—with BMW Motorrad ABS^{OE}

- Activate the ABS function (➡ 33)

ABS fault



ABS warning light shows.

Possible cause:

The ABS control unit has detected a fault. The ABS function is not available.

- You can continue to ride. Bear in mind that the ABS function is not available. Bear in mind the more detailed information on situations that can lead to an ABS fault (➡ 55).
- Have the fault rectified as quickly as possible by a specialist workshop, preferably an authorised BMW Motorrad dealer.

Operation

| | |
|---|----|
| Ignition switch and steering lock | 28 |
| Multifunction display | 28 |
| Lights..... | 31 |
| Turn indicators..... | 32 |
| Emergency off switch (kill switch)..... | 32 |
| BMW Motorrad ABS ^{OE} | 33 |
| Clutch | 33 |
| Brakes | 34 |
| Mirrors..... | 34 |
| Spring preload | 35 |
| Damping | 36 |
| Height of suspension | 37 |
| Tyres | 37 |
| Headlight | 38 |

| | |
|------------|----|
| Seat | 38 |
|------------|----|

Ignition switch and steering lock

Keys

You receive one master key and one spare key.

Ignition switch and steering lock, tank filler cap lock and seat lock are all operated with the same key.

Switching on ignition



- Turn the key to position **1**.
- » Side light and all function circuits switched on.
- » Engine can be started.

» Pre-ride check is performed.
(➡ 45)

—with BMW Motorrad ABS^{OE}

- Turn the key to position **1**.
- » ABS self-diagnosis is performed in addition to the checks outlined above.
(➡ 46)◁

Switching off ignition



- Turn the key to position **2**.
- » Lights switched off.
- » Handlebars not locked.
- » Key can be removed.

Locking handlebars



- Turn the handlebars all the way to the left
- Turn the key to position **3**, while moving the handlebars slightly.
- » Ignition, lights and all function circuits switched off.
- » Handlebars locked.
- » Key can be removed.

Multifunction display

Selecting readings

- Switch on the ignition.

▶ If the motorcycle is to remain abroad for a lengthy period, you can have the display readouts changed from miles to kilometres or vice versa, if necessary. Under these circumstances consult a specialist workshop, preferably an authorised BMW Motorrad dealer. ◀



- Press button **1**.



The display starts with the current value and each time the button is pressed it moves one step through the following sequence:

- Odometer (ODO)
- Tripmeter 1 (Trip I)
- Tripmeter 2 (Trip II)
- Clock
- Battery voltage
- Residual range on reserve quantity of fuel (once fuel level is down to reserve)

Resetting tripmeter

- Switch on the ignition.

- Select the desired tripmeter.



- Press and hold down button **1**.
» The tripmeter is reset to zero.

Setting clock

- Switch on the ignition.

▶ You can make this adjustment only when the motorcycle is at a standstill. ◀

- Select the clock.

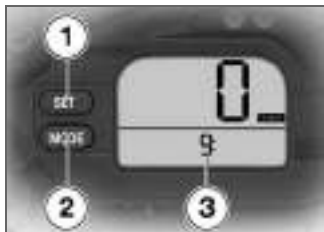

- Press and hold down button **1**.
 - » Hours reading **3** shows.
- Press button **1**.
 - » The hours reading increments by one each time you press the button.
- Press button **2**.
 - » The hours reading decrements by one each time you press the button.



- When the hours reading is correct wait briefly.
 - » Minutes reading **4** shows.
- Press button **1**.
 - » The minutes reading increments by one each time you press the button.
- Press button **2**.
 - » The minutes reading decrements by one each time you press the button.
- When the minutes reading is correct wait briefly.
 - » The clock is now set and the time appears on the display.

» The procedure is also terminated if speed is greater than zero.

Battery voltage



The battery-voltage reading **1** appears together with the battery symbol **2**.

Residual range on reserve quantity of fuel



Reading **1** is the distance covered since the fuel in the tank dropped to the reserve level.

Lights

Side light

The side lights switch on automatically when the ignition is switched on.

▷ The side lights place a strain on the battery. Do not switch the ignition

on for longer than absolutely necessary. ◀

Low-beam headlight

The low-beam headlight switches on automatically when the ignition is switched on.

▷ The low-beam headlight places a strain on the battery. Do not switch the ignition on for longer than absolutely necessary. ◀

High-beam headlight



- Push full-beam headlight switch **1** up.

- » High-beam headlight switched on.
- Push full-beam headlight switch **1** down.
- » High-beam headlight switched off.

Headlight flasher



- Press headlight flasher button **1**.
- » The high-beam headlight is switched on until you release the button.

Turn indicators

Operating flashing turn indicators



- Push turn-indicator button **1** to the left.
 - » Left-hand turn indicators switched on.
 - » Telltale light for left-hand turn indicators flashes.
- Push the turn-indicator button to the right.
 - » Right-hand turn indicators switched on.
 - » Telltale light for right-hand turn indicator flashes.

- Push the turn-indicator button forward.
 - » Flashing turn indicators switched off.
 - » Turn indicator telltale light is off.

Emergency off switch (kill switch)



1 Emergency off switch (kill switch)

 Operating the kill switch when riding can cause the rear wheel to lock and thus cause a fall.

Do not operate the kill switch when riding.◀

The emergency off switch is a kill switch for switching off the engine quickly and easily.

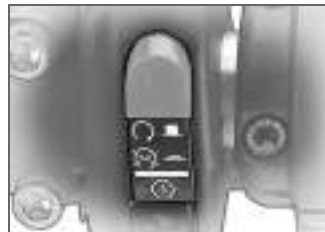

- Switch in normal position: operating position.
- Switch actuated: engine switched off.

 You cannot start the engine unless the kill switch is in the run position.◀

BMW Motorrad ABS^{OE}

Deactivating ABS function

- Switch on the ignition, or bring the motorcycle to a stop.



- Press and hold down ABS button **1**.

 ABS warning light starts to show.

- Release the ABS button within five seconds.

» The ABS function is deactivated.

 ABS warning light remains ON.

Activating ABS function



- Press and hold down ABS button **1**.

 ABS warning light goes out; if self-diagnosis has not completed it starts flashing.

- Release the ABS button within five seconds.

» The ABS warning light remains off or continues to flash.

» The ABS function is activated.

- Instead of pressing the ABS button, you have the option of switching the ignition off and then on again.

 If you switch the ignition off then on again and the ABS light comes back on, there is a fault in the ABS.◀

Clutch

Adjusting clutch lever

 Attempting to adjust the clutch lever while riding the motorcycle can lead to accidents. Do not attempt to adjust the clutch lever unless the motorcycle is at a standstill.◀



- Turn knob **1** to the desired position.

▷ The adjusting screw is easier to turn if you push the clutch lever forward.◀

» Possible positions:

- Position 1 for the widest span between handlebar grip and clutch lever.
- Positions 2 and 3 for intermediate spans.
- Position 4 for the narrowest span between handlebar grip and clutch lever.

Brakes

Adjusting handbrake lever

 Changing the position of the brake-fluid reservoir can allow air to penetrate the brake system.

Do not twist the handlebar fitting or the handlebars.◀

 Attempting to adjust the brake lever while riding the motorcycle can lead to accidents. Do not attempt to adjust the

brake lever unless the motorcycle is at a standstill.◀



- Turn knob **1** to the desired position.

▷ The adjusting screw is easier to turn if you push the handbrake lever forward.◀

» Possible positions:

- Position 1 for the widest span between handlebar grip and handbrake lever.
- Positions 2 to 4 for intermediate spans.

— Position 5 for the narrowest span between handlebar grip and handbrake lever.

Mirrors

Adjusting mirrors



- Turn the mirror to the correct position.

Adjusting mirror arm



- Push up rubber grommet **1**.
- Slacken nut **2**.
- Turn the mirror arm to the appropriate position.
- Tighten the nut to the specified tightening torque, while holding the mirror arm to ensure that it does not move out of position.

 Union nut, mirror

–20 Nm

- Pull the rubber grommet over the threaded fastener.

Spring preload

Adjustment for rear suspension

It is essential to set spring preload of the rear suspension to suit the load carried by the motorcycle. Increase spring preload when the motorcycle is heavily loaded and reduce spring preload accordingly when the motorcycle is lightly loaded.

Adjusting spring preload for rear wheel

- Make sure the ground is level and firm and place the motorcycle on its stand.



 Your motorcycle's handling will suffer if you do not match the spring-preload and damping-characteristic settings. Adjust the damping characteristic to suit spring preload.◀

 Adjusting spring preload while the motorcycle is being ridden can lead to accidents. Do not attempt to adjust spring preload unless the motorcycle is at a standstill.◀

 Note that there is a danger of coming into contact with the hot exhaust silencer when you adjust spring preload.

Allow the silencer to cool.◀

- Adjust spring preload by turning knob **1**.
- If you want to increase spring preload, turn the knob toward **HARD**.
- If you want to reduce spring preload, turn the knob toward **SOFT**.



Basic setting of spring preload, rear

- Turn the knob as far as it will go in the "SOFT" direction and then turn it 10 full turns in the "HARD" direction. (Full load of fuel, with rider 85 kg)

Damping

Adjustment for rear suspension

Damping must be adapted to suit spring preload and the surface on which the motorcycle is ridden. An increase in spring preload requires firmer damping, a reduction in spring preload requires softer damping.

The harder the setting, the more the movement that the spring strut can make to absorb surface irregularities is damped. When you choose a soft setting the spring strut responds all the more rapidly to surface irregularities.

Adjusting damping for rear wheel

- Make sure the ground is level and firm and place the motorcycle on its stand.

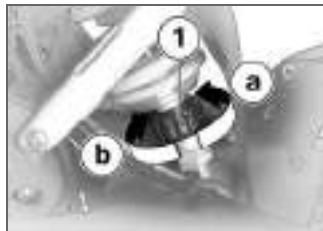

Note that there is a danger of coming into contact with the hot exhaust silencer when you adjust damping.

Allow the silencer to cool.◀

- Adjust damping by turning nut **1**.
- If you want to increase damping, turn nut **1** in direction **a**.
- If you want to reduce damping, turn nut **1** in direction **b**.



 Rebound stage, basic setting, rear

— Turn the bottom knob as far as it will go in the a direction, then back it off 13 clicks in the b direction. (Full load of fuel, with rider 85 kg)

Height of suspension

Adjusting height of suspension

The height of the suspension is adjustable; the motorcycle is delivered with the suspension set low.

If you would like the height of the suspension adjusted consult a specialist workshop, preferably an authorised BMW Motorrad dealer.

Tyres

Checking tyre pressure

- Make sure the ground is level and firm and place the motorcycle on its stand.

 Incorrect tyre pressures impair the motorcycle's handling characteristics and increase the rate of tyre wear.

Always check that the tyre pressures are correct. ◀

 At high road speeds, tyre valves have a tendency to open as a result of centrifugal force.

Fit valve caps with rubber seals and screw them on firmly to prevent sudden deflation. ◀

- Check tyre pressures against the data below.

 Tyre pressure, front

— 1.9 bar (one-up, tyre cold)

— 2 bar (two-up and/or with luggage, tyre cold)

 Tyre pressure, rear

— 2.1 bar (one-up, tyre cold)

— 2.3 bar (two-up and/or with luggage, tyre cold)

If tyre pressure is too low:

- Correct tyre pressure.

Headlight

Adjusting headlight for driving on right/driving on left

If the motorcycle is ridden in a country where the opposite rule of the road applies, its asymmetric low-beam headlight will tend to dazzle oncoming traffic.

Have the headlight set accordingly by a specialist workshop, preferably an authorised BMW Motorrad dealer.

Headlight beam throw and spring preload

Headlight beam throw is generally kept constant when spring preload is adjusted to suit load. Spring preload adjustment might not suffice only if the motorcycle is very heavily loaded. Under

these circumstances, headlight beam throw has to be adjusted to suit the weight carried by the motorcycle.

▶ Consult a specialist workshop, preferably an authorised BMW Motorrad dealer, if you are unsure whether the headlight basic setting is correct. ◀



Screws **1** on left and right allow the height of the headlight to be adjusted. This adjustment should be carried out by a specialist workshop, preferably an

authorised BMW Motorrad dealer.

Seat

Removing seat

- Make sure the ground is level and firm and place the motorcycle on its stand.



- Use the ignition key to turn seat lock **1** counter-clockwise and hold it in this position.



- Lift seat **2** at the rear and release the key.
- Pull the seat to the rear to remove.
- Place the seat, upholstered side down, on a clean surface.

Installing seat



- Position seat **2** in such a way that mounts **3** on left and right are in front of left and right holders **4**.



 If too much pressure is applied in the forward direction, there is a danger that the motorcycle will be pushed off its stand.

Always make sure that the motorcycle is stable and firmly supported.◀

- Lower seat **2** into position and push it forward as far as it will go.
- Firmly press down on the seat at the rear.
- » The seat engages with an audible click.
- Check that the seat is secure.

Riding

| | |
|--|----|
| Safety instructions | 42 |
| Checklist | 44 |
| Starting | 44 |
| Running in | 46 |
| Brakes | 47 |
| Parking your motorcycle | 49 |
| Refuelling | 50 |
| Securing motorcycle for transportation | 50 |

Safety instructions

Rider's equipment

Do not ride without the correct clothing. Always wear:

- Helmet
- Motorcycling jacket and trousers
- Gloves
- Boots

This applies even to short journeys, and to every season of the year. Your authorised BMW Motorrad dealer will be glad to advise you on the correct clothing for every purpose.

Speed

If you ride at high speed, always bear in mind that various boundary conditions can adversely affect the handling of your motorcycle:

- Settings of the spring-strut and shock-absorber system
- Imbalanced load
- Loose clothing
- Insufficient tyre pressure
- Poor tyre tread
- Etc.

Correct loading



Overloading and imbalanced loads can adversely affect the motorcycle's handling. Do not exceed the permissible gross weight and be sure to comply with the instructions on loading.◀

Alcohol and drugs



Even small amounts of alcohol or drugs will adversely affect your perception and your ability to assess situations and make decisions, and slow down your reflexes. Medication can exacerbate these effects.

Do not ride your motorcycle after consuming alcohol, drugs and/or medication.◀

Risk of poisoning

Exhaust fumes contain carbon monoxide, which is colourless and odourless but highly toxic.



Inhaling the exhaust fumes therefore represents a health hazard and can even cause loss of consciousness with fatal consequences.

Do not inhale exhaust fumes. Do not run the engine in an enclosed space.◀

High voltage



Touching live parts of the ignition system with the engine running can cause electric shock.

Do not touch parts of the ignition system when the engine is running.◀

Catalytic converter

If misfiring causes unburned fuel to enter the catalytic converter, there is a danger of overheating and damage.

For this reason, observe the following points:

- Do not run the fuel tank dry.
- Do not attempt to start or run the engine with a spark-plug cap disconnected.
- Stop the engine immediately if it misfires.
- Use only unleaded fuel.
- Comply with all specified maintenance intervals.

 Unburned fuel will destroy the catalytic converter. Note the points listed for protection of the catalytic converter.◀

Risk of fire

Temperatures at the exhaust are high.

 Flammable materials (e.g. hay, leaves, grass, clothing and luggage, etc.) could ignite if allowed to come into contact with the hot exhaust pipe.

Do not permit flammable materials to come into contact with the hot exhaust system.◀

 Cooling would be inadequate if the engine were allowed to idle for a lengthy period with the motorcycle at a standstill: overheating would result. In extreme cases, the motorcycle could catch fire. Do not allow the engine to idle unnecessarily. Ride away immediately after starting the engine.◀

Tampering with the control unit of the electronic engine-management system

 Tampering with the engine control unit can damage the motorcycle and cause accidents.

Do not tamper with the engine control unit.◀

 Tampering with the engine control unit can result in mechanical loads that the motorcycle's components are not designed to withstand. Damage caused in this way is not covered by the warranty. Do not tamper with the engine control unit.◀

Checklist

Use the following checklist to check important functions, settings and wear limits before you ride off.

- Brakes
- Brake-fluid levels, front and rear
- Clutch
- Clutch fluid level
- Shock absorber setting and spring preload
- Tyre-tread depth and tyre pressures
- Cases correctly installed and luggage secured

At regular intervals:

- Engine oil level (every refuelling stop)
- Brake-pad wear (every third refuelling stop)
- Tension and lubrication of the drive chain

Starting

Side stand

You cannot start the motorcycle with the side stand extended and a gear engaged. The engine will switch itself off if you start it with the gearbox in neutral and then engage a gear before retracting the side stand.

Gearbox

You can start the engine when the gearbox is in neutral or if you pull the clutch with a gear engaged.

Starting engine.



- Kill switch in operating position (run).



Gearbox lubrication is ensured only when the engine is running. Inadequate lubrication can result in damage to the gearbox.

Do not allow the motorcycle to roll for a lengthy period of time or push it a long distance with the engine switched off. ◀

- Switch on the ignition.
- » Pre-ride check is performed.
(45)

- with BMW Motorrad ABS^{OE}
 - Switch on the ignition.
 - » Pre-ride check is performed. (➡ 45)
 - » ABS self-diagnosis is performed. (➡ 46)◀
 - Wait until the warning light for the coolant temperature stops flashing.

▷ The idle actuator is positioned after you switch on the ignition. The coolant-temperature warning light flashes if the idle actuator has not correctly positioned before the pre-ride check completes. In order to avoid subsequent problems, wait for this process to complete before proceeding.◀



- Press starter button **1**.

▷ If ambient temperatures are very low, you might find it necessary to open the throttle slightly when starting the engine. At ambient temperatures below 0 °C, disengage the clutch after switching on the ignition.◀

▷ If the engine fails to start even though the starter turns, insufficient battery voltage might be causing the problem. Recharge the battery before you start the engine, or use jump leads and a donor battery to start.◀

- » The engine starts.
- » Consult the troubleshooting chart below if the engine refuses to start. (➡ 104)

Pre-ride check

The instrument cluster runs a test of the instruments and the warning lights and telltale lights and the display when the ignition is switched on. This test is known as the "Pre-Ride-Check".

Phase 1

All the telltale and warning lights are switched on briefly, along with all the segments of the multifunction display.

Phase 2

The tyre parameters stored in the memory of the instrument cluster appear briefly on the display.

The instrument cluster then reverts to its normal operating mode.

If a warning light or telltale light did not show as specified above or if a segment or segments of the multifunction display failed to light up:



Some malfunctions cannot be indicated if one of the warning lights fails to show.

Make sure that all the warning and telltale lights come on in the pre-ride check. ◀

- Have the fault rectified as quickly as possible by a specialist workshop, preferably an authorised BMW Motorrad dealer.

ABS self-diagnosis^{OE}

BMW Motorrad ABS performs self-diagnosis to ensure its operability. Self-diagnosis is performed automatically when you

switch on the ignition. The motorcycle has to move forward a few metres for the wheel sensors to be tested.

Phase 1

» Test of the diagnosis-compatible system components with the motorcycle at a standstill.



ABS warning light flashes.

Phase 2

» Test of the wheel sensors as the motorcycle pulls away from rest.



ABS warning light flashes.

ABS self-diagnosis completed

» The ABS warning light goes out.

If an indicator showing an ABS fault appears when ABS self-diagnosis completes:

- You can continue to ride. Bear in mind that the ABS function is not available.
- Have the fault rectified as quickly as possible by a specialist workshop, preferably an authorised BMW Motorrad dealer.

Running in

The first 1000 km

- While running in the motorcycle, vary the throttle opening and engine-speed range frequently.
- Try to do most of your riding during this initial period on twisting, fairly hilly roads, avoiding high-speed main roads and highways if possible.

 Exceeding the specified engine speeds while running in will lead to increased engine wear.

Keep to the specified engine speeds for running in. ◀

- During the running-in phase, do not exceed the speed limits specified for the various gears.



Maximum speeds during running-in period

— max 35 km/h (1st gear)

— max 55 km/h (2nd gear)

— max 75 km/h (3rd gear)

— max 95 km/h (4th gear)

— max 110 km/h (5th gear)

- No full-load acceleration.
- Avoid low engine speeds at full load.
- Do not omit the first inspection after 500 - 1200 km.

Brake pads

New brake pads must "bed down" and therefore do not achieve their optimum friction levels during the first 500 km. You can compensate for this initial reduction in braking efficiency by exerting greater pressure on the levers.



New brake pads can extend stopping distance by a significant margin.

Apply the brakes in good time. ◀

Tyres

New tyres have a smooth surface. This must be roughened by riding in a restrained manner at various heel angles until the tyres are run in. This running in procedure is essential if the tyres are to achieve maximum grip.



Tyres do not have their full grip when new and there

is a risk of accidents at extreme angles of heel.

Avoid extreme angles of heel. ◀

Brakes

How can stopping distance be minimised?

Each time the brakes are applied, a load distribution shift takes place with the load shifting forward from the rear to the front wheel. The sharper the motorcycle decelerates, the more load is shifted to the front wheel. The higher the wheel load, the more braking force can be transmitted without the wheel locking.

To optimise stopping distance, apply the front brakes rapidly and keep on increasing the force you apply to the brake lever. This makes the best possible use of the dynamic increase in load at the front wheel. Remember to pull the clutch at the same time. In the "panic braking situ-

ations" that are trained so frequently braking force is applied as rapidly as possible and with the rider's full force applied to the brake levers; under these circumstances the dynamic shift in load distribution cannot keep pace with the increase in deceleration and the tyres cannot transmit the full braking force to the surface of the road. ABS has to intervene to keep the front wheel from locking; this increases stopping distance.

Descending mountain passes

 There is a danger of the brakes fading if you use only the rear brakes when descending mountain passes. Under extreme conditions, the brakes could overheat and suffer severe damage.
Use both front and rear brakes,

and make use of the engine's braking effect as well.◀

Wet brakes

 After the motorcycle has been washed, ridden through water or ridden in the rain, the brake discs and pads might be wet and the brakes might not take effect immediately.

Apply the brakes in good time until the brakes have dried out.◀

Salt on brakes

 The brakes may fail to take effect immediately if the motorcycle was ridden on salt-covered roads and the brakes were not applied for some time. Apply the brakes in good time until the salt layer on the brake discs and brake pads has been removed.◀

Oil or grease on brakes

 Oil and grease on the brake discs and pads considerably diminish braking efficiency. Especially after repair and maintenance work, make sure that the brake discs and brake pads are free of oil and grease.◀

Dirt or mud on brakes

 When riding on loose surfaces or muddy roads, the brakes may fail to take effect immediately because of dirt or moisture on the discs or brake pads. Apply the brakes in good time until the brakes have been cleaned.◀

 The brake pads will wear more rapidly if you ride frequently on unsurfaced tracks or poor roads.
Check the thickness of the brake

pads more frequently and replace the brake pads in good time.◀

Parking your motorcycle

Placing motorcycle on side stand

 If the ground is soft or uneven, there is no guarantee that the motorcycle will rest firmly on the stand.

Always check that the ground under the stand is level and firm.◀

- Switch off the engine.
- Pull the handbrake lever.
- Hold the motorcycle upright and balanced.
- Use your left foot to extend the side stand fully.

 The side stand is designed to support only the weight of the motorcycle.

Do not lean or sit on the

motorcycle with the side stand extended.◀

- Slowly lean the motorcycle to the side until its weight is taken by the stand and dismount to the left.

 If the motorcycle is on the side stand, the surface of the ground will determine whether it is better to turn the handlebars to the left or right. However, the motorcycle is more stable on a level surface with the handlebars turned to the left than with the handlebars turned to the right.

On level ground, always turn the handlebars to the left to set the steering lock.◀

- Turn the handlebars to full left or right lock.
- Check that the motorcycle is standing firmly.

 On a gradient, the motorcycle should always face uphill; select 1st gear.◀

- Engage the steering lock (possible only with handlebars turned all the way to the left).

Removing motorcycle from side stand

- Unlock the steering lock.
- From the left, grip the handlebars with both hands.
- Pull the handbrake lever.
- Swing your right leg over the seat and lift the motorcycle to the upright position.
- Hold the motorcycle upright and balanced.

 An extended side stand can catch on the ground when the motorcycle is moving and lead to a fall.

Retract the side stand before moving the motorcycle.◀

- Sit on the motorcycle and use your left foot to retract the side stand.

Refuelling

 Fuel is highly flammable. A naked flame close to the fuel tank can cause a fire or explosion.

Do not smoke. Never bring a naked flame near the fuel tank.◀

 Fuel expands when hot. Fuel escaping from an overfilled tank could make its way onto the rear tyre. This could cause a fall.

Do not fill the tank past the bottom edge of the filler neck.◀



 Fuel attacks plastics, which become dull or unsightly. Wipe off plastic parts immediately if they come into contact with fuel.◀

 Leaded fuel will destroy the catalytic converter. Use only unleaded fuel.◀

- Make sure the ground is level and firm and place the motorcycle on its stand.



- Open fuel tank cap **1** with the ignition key by turning it counter-clockwise.
- Remove the fuel tank cap.
- Refuel with fuel of the grade stated below; do not fill the tank past the bottom edge of the filler neck.

| | |
|---|------------------------------|
|  | Recommended fuel grade |
| | —95 ROZ/RON (Super unleaded) |
|  | Usable fuel capacity |
| | —≤9.5 l |
|  | Reserve fuel |
| | —≥2 l |

- Place the fuel tank cap in position in the filler neck.
- Close the fuel tank cap with the ignition key by turning it clockwise.

Securing motorcycle for transportation

- Make sure that all components that might come into contact with straps used to secure the

motorcycle are adequately protected against scratching. Use adhesive tape or soft cloths, for example, for this purpose.



⚠ The motorcycle can topple and fall on its side.

Make sure that the motorcycle cannot topple sideways.◀

- Push the motorcycle onto the transportation flat and hold it in position: do not place it on the side stand.



⚠ Risk of damaging components.

Take care not to trap components such as brake lines or wires.◀

- At the front, secure the straps to the bottom fork bridge on both sides and tighten the straps.



- At the rear, secure the straps to the rear footrests on both sides and tighten the straps.
- Tighten all the straps uniformly; the motorcycle's suspension should be compressed as tightly as possible front and rear.

Engineering details

| | |
|--------------------------------|----|
| Brake system with BMW Motorrad | |
| ABS ^{OE} | 54 |

Brake system with BMW Motorrad ABS^{OE}

How does ABS work?

The amount of braking force that can be transferred to the road depends on factors that include the coefficient of friction of the road surface. Loose stones, ice and snow or a wet road all have much lower coefficients of friction than a clean, dry asphalt surface. The lower the coefficient of friction, the longer the braking distance.

If the rider increases braking pressure to the extent that braking force exceeds the maximum transferrable limit, the wheels start to lock and the motorcycle loses its directional stability; a fall is imminent. Before this situation can occur, ABS intervenes and adapts braking pressure to the maximum transferrable braking force, so the wheels continue

to turn and directional stability is maintained irrespective of the condition of the road surface.

What are the effects of surface irregularities?

Humps and surface irregularities can cause the wheels to lose contact temporarily with the road surface; if this happens the braking force that can be transmitted to the road can drop to zero. If the brakes are applied under these circumstances the ABS has to reduce braking force to ensure that directional stability is maintained when the wheels regain contact with the road surface. At this instant the BMW Motorrad ABS must assume an extremely low coefficient of friction, so that the wheels will continue to rotate under all imaginable circumstances, because this is the precondition for ensuring directional stability. As soon as

is registers the actual circumstances, the system reacts instantly and adjusts braking force accordingly to achieve optimum braking.

Rear wheel lift

Even under severe braking, a high level of tyre grip can mean that the front wheel does not lock up until very late, if at all. Consequently, ABS does not intervene until very late, if at all. Under these circumstances the rear wheel can lift off the ground, and the outcome can be a high-siding situation in which the motorcycle can flip over.



Severe braking can cause the rear wheel to lift off the ground.

When you brake, bear in mind that ABS control cannot be relied on in all circumstances to prevent the rear wheel from lifting clear of the ground.◀

What is the design baseline for BMW Motorrad ABS?

Within the limits imposed by physics, BMW Motorrad ABS ensures directional stability on any surface. The system is not optimised for special requirements that apply under extreme competitive situations off-road or on the track.

Special situations

The speeds of the front and rear wheels are compared as one means of detecting a wheel's incipient tendency to lock. If the system registers implausible values for a lengthy period the ABS function is deactivated for safety reasons and an ABS fault message is issued. Self-diagnosis has to complete before fault messages can be issued.

In addition to problems with the BMW Motorrad ABS, exceptional

riding conditions can lead to a fault message being issued.

Exceptional riding conditions:

- Riding for a lengthy period with the front wheel lifted off the ground (wheelie).
- Rear wheel rotating with the motorcycle held stationary by applying the front brake (burn-out).
- Heating up with the motorcycle on the centre stand or an auxiliary stand, engine idling or with a gear engaged.
- Rear wheel locked for a lengthy period, for example while descending off-road.

If a fault message is issued on account of exceptional riding conditions as outlined above, you can reactivate the ABS function by switching the ignition off and on again.

What significance devolves on regular maintenance?



Invariably, a technical system cannot perform beyond the abilities dictated by its level of maintenance.

In order to ensure that the BMW Motorrad ABS is always maintained in optimum condition, it is essential for you to comply strictly with the specified inspection intervals.◀

Reserves for safety

The potentially shorter braking distances which BMW Motorrad ABS permits must not be used as an excuse for careless riding. ABS is primarily a means of ensuring a safety margin in genuine emergencies.

Take care when cornering. When you apply the brakes on a corner, the motorcycle's weight and

momentum take over and even BMW Motorrad ABS is unable to counteract their effects.

Accessories

| | |
|----------------------------------|----|
| General instructions..... | 58 |
| Power socket ^{OE} | 58 |
| Luggage | 59 |
| Topcase ^{OA} | 60 |

General instructions

BMW Motorrad recommends the use of parts and accessories for your motorcycle that are approved by BMW for this purpose. Genuine BMW parts and accessories and other products which BMW has approved can be obtained from your authorised BMW Motorrad dealer, together with expert advice on their installation and use.

These parts and products have been tested by BMW for safety, function and suitability. BMW accepts product liability for them. Conversely, BMW is unable to accept any liability whatsoever for parts and accessories which it has not approved.



BMW Motorrad cannot assess each non-BMW product to determine whether it can be used on or in connection with BMW motorcycles

without constituting a safety hazard. Country-specific official authorisation does not suffice as assurance. Tests conducted by these instances cannot make provision for all operating conditions experienced by BMW motorcycles and, consequently, they are not sufficient in some circumstances.

Use only parts and accessories approved by BMW for your motorcycle. ◀

Whenever you are planning modifications, comply with all the legal requirements. Make sure that the motorcycle does not infringe national road-vehicle construction and use regulations.

Power socket^{OE}

Ratings



Do not attempt to connect a load that would exceed the maximum amperage stated in the technical data for on-board socket **1**.

Operating electrical accessories

Electrically powered accessories inevitably place a strain on the battery. It is essential to ensure that the battery retains its ability to start the engine.

Cable routing

The cables from the power socket to the auxiliary device must be routed in such a way that they:

- Do not impede the rider
- Do not restrict or obstruct the steering angle and handling characteristics
- Cannot be trapped



Incorrectly routed cables can impede the rider.

Route the cables as described above. ◀

Luggage

Correct loading



Overloading and imbalanced loads can adversely affect the motorcycle's handling.

Do not exceed the permissible gross weight and be sure to comply with the instructions on loading. ◀

- Set spring preload, damping characteristic and tyre pressures to suit total weight.
- Note the maximum permissible payload of the luggage carrier.



Loading luggage carrier

— with luggage carrier^{OA}

— ≤5 kg◀

- Note the maximum permissible payload of the tank rucksack and the speed limit for riding with a tank rucksack on the motorcycle.



Payload of tank rucksack

— with tank rucksack^{OA}

— ≤5 kg◀



Maximum permissible speed for riding with the tank rucksack fitted to the motorcycle

— with tank rucksack^{OA}

— ≤130 km/h◀

- Note the maximum permissible payload of the topcase and the speed limit for riding with a topcase on the motorcycle.



Payload of topcase

— with topcase^{OA}

— max 5 kg◀



Maximum permissible speed for riding with topcase fitted to the motorcycle

— with topcase^{OA}

— max 130 km/h◀

- Note the maximum permissible payload of the rear softbag and

the speed limit for riding with a rear softbag on the motorcycle.



Payload of rear softbag

—with rear softbag^{OA}

—≤2.5 kg<



Maximum permissible speed for riding with the rear softbag fitted to the motorcycle

—with rear softbag^{OA}

—≤130 km/h<

Topcase^{OA}

Opening topcase



- If applicable, unlock topcase lock **1**.
- Pull locking lever **2** up.
 - » The lid of the topcase can be opened.

Closing topcase



- Close the topcase lid.
- Push locking lever **2** down.
 - » The locking lever engages with an audible click.
- If applicable, lock topcase lock **1**.

Removing topcase



- If applicable, unlock topcase lock **1**.
- Push locking lever **2** down.
- Pull the topcase back and clear of the adapter plate.

Installing topcase



- Push the topcase with guides **3** forward onto the adapter plate until seated.

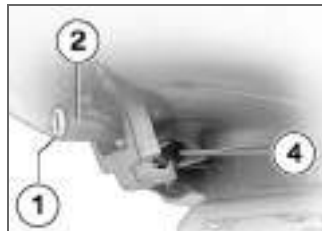

- Push locking lever **2** up, making sure that the lever engages the adapter plate at position **4**.
 - » The locking lever engages with an audible click.
- If applicable, lock topcase lock **1**.

Maintenance

| | | | |
|---|----|---------------------|----|
| Notes | 64 | Fuses | 85 |
| Toolkit | 64 | Bulbs | 87 |
| Engine oil | 65 | Jump starting | 93 |
| Brake system | 67 | Battery | 94 |
| Brake pads | 67 | | |
| Brake fluid | 69 | | |
| Coolant | 71 | | |
| Clutch | 72 | | |
| Tyres | 73 | | |
| Rims | 74 | | |
| Chain | 74 | | |
| Wheels | 76 | | |
| BMW Motorrad auxiliary stand | 82 | | |
| BMW Motorrad front-wheel stand | 83 | | |

Notes

The Maintenance chapter describes straightforward procedures for checking and replacing certain wear parts.

Special tightening torques are listed as applicable. The tightening torques for the threaded fasteners on your motorcycle are listed in the section entitled "Technical data".

You will find information on more extensive maintenance and repair work in the Repair Manual on DVD/CD-ROM (RepROM) for your motorcycle, which is available from your authorised BMW Motorrad dealer.

Some of the work calls for special tools and a thorough knowledge of motorcycles. If you are in doubt consult a specialist workshop, preferably your authorised BMW Motorrad dealer.

Toolkit

Contents I

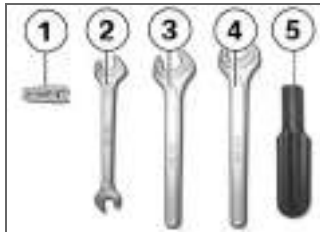

- 1** Fuse puller
- 2** Open-ended spanner
Width across flats 8/10
- 3** Open-ended spanner
Width across flats 14
- 4** Open-ended spanner
Width across flats 15
- 5** Screwdriver handle

Contents II

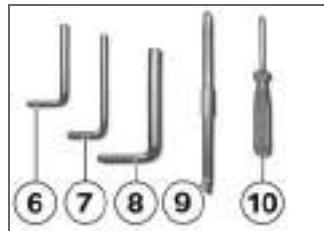

- 6** Allen key
3 mm
- 7** Allen key
4 mm
- 8** Allen key
6 mm
- 9** Reversible screwdriver blade
With star-head and plain-tip ends
- 10** Small screwdriver with star-head tip

On-board toolkit service kit^{OA}

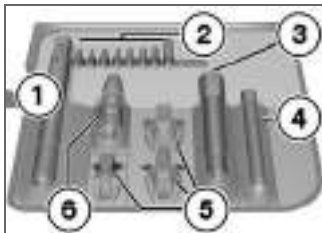

- 1 Extending tool holder holds all tools by means of adapters, and for removing the spark plug
- 2 1/4" bits
Bits of various sizes
- 3 3/8" adapter for socket-head screws, w/f 22 for removing the quick-release axle from the front wheel
- 4 Electric torch

5 Socket
Open-ended spanners of various sizes

6 Adapter
To accommodate the 1/4" bits and the 9x12 mm and the 3/8" universal-joint adapter

Engine oil

Checking engine oil level



The engine can seize if the oil level is low, and this can lead to accidents.

Always make sure that the oil level is correct. ◀



The oil level varies with the temperature of the oil. The higher the temperature, the higher the level of oil in the sump. Checking the oil level with the engine cold or after no more than a short ride will lead to misinterpretation; this in turn, means that

the engine will be operated with the incorrect quantity of oil. In order to ensure that the engine oil level is read correctly, check the oil level only after a lengthy trip. ◀

- Allow the engine to idle until the fan starts up, then allow it to idle one minute longer.
- Make sure the ground is level and firm and hold the motorcycle upright.
- Switch off the engine.
- Wipe the area around the oil filler neck clean.

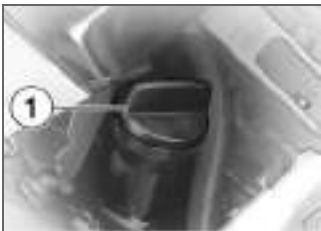

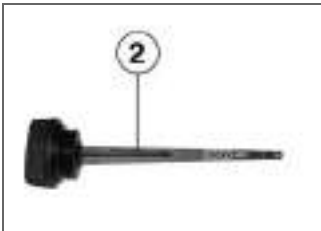

- Remove oil dipstick **1** by turning it counter-clockwise.

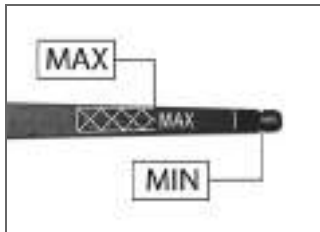

- Wipe the oil off MIN-MAX part of dipstick **2** with a clean, dry cloth.

- Turn the oil dipstick clockwise to install.
- Remove the oil dipstick and check the oil level.



| | |
|---|-----------------------------|
|  | Engine oil, specified level |
| — | Engine oil, 15W-40 |
| — | Between MIN and MAX marks |

If the oil level is below the MIN mark:

- Top up the engine oil (➔ 66)

If the oil level is above the MAX mark:

- Have the oil level corrected by a specialist workshop, preferably an authorised BMW Motorrad dealer.

Topping up engine oil

 Damage to the engine can result if it is operated without enough oil, but the same also applies if the oil level is too high.

Always make sure that the oil level is correct. ◀

- Wipe the area around the filler neck clean.

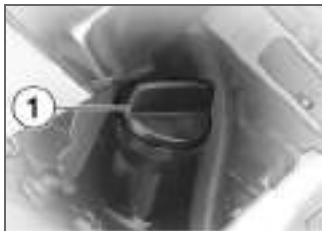

- Remove oil dipstick **1**.

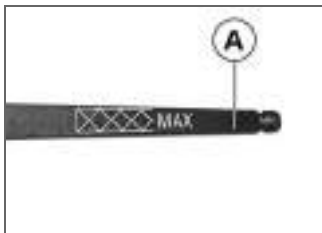

- Top up the engine oil until the level reaches mark **A**.
- Check the engine oil level (→ 65)
- Install the oil dipstick.

Brake system

Dependability of the brake system

A fully functional brake system is a basic requirement for the road safety of your motorcycle.

Do not ride the motorcycle if you have any doubts about the dependability of the brake system. Under these circumstances have the brake system checked by a specialist workshop, preferably an authorised BMW Motorrad dealer.



Incorrect working practices endanger the reliability of the brakes.

Have all work on the brake system performed by a specialist workshop, preferably an authorised BMW Motorrad dealer. ◀

Checking operation of brakes

- Pull the handbrake lever.
 - » The pressure point must be clearly perceptible.
- Press the footbrake lever.
 - » The pressure point must be clearly perceptible.

If pressure points are not clearly perceptible:

- Have the brakes checked by a specialist workshop, preferably an authorised BMW Motorrad dealer.

Brake pads

Checking front brake pad thickness

- Make sure the ground is level and firm and place the motorcycle on its stand.



! Brake pads worn past the minimum permissible thickness can cause a reduction in braking efficiency and under certain circumstances they can cause damage to the brake system.

In order to ensure the dependability of the brake system, do not permit the brake pads to wear past the minimum permissible thickness. ◀

- Visually inspect the brake pads to ascertain their thickness. Viewing direction: Above the wheel axle, between wheel and

fork tube toward the brake caliper.

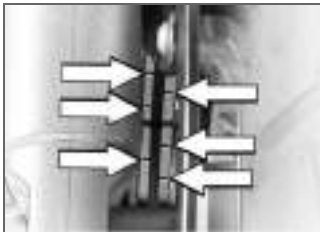

Brake-pad wear limit, front

— min 1.0 mm (Friction pad only, without backing plate. The wear indicators (grooves) must be clearly visible.)

If the wear indicating marks are no longer clearly visible:

- Have the brake pads replaced by a specialist workshop,

preferably an authorised BMW Motorrad dealer.

Checking brake pad thickness, rear brakes

- Make sure the ground is level and firm and place the motorcycle on its stand.



! Brake pads worn past the minimum permissible thickness can cause a reduction in braking efficiency and under certain circumstances they can cause damage to the brake system.

In order to ensure the dependab-

ility of the brake system, do not permit the brake pads to wear past the minimum permissible thickness.◀

- Visually inspect rear brake pads **1** from behind to ascertain their thickness.

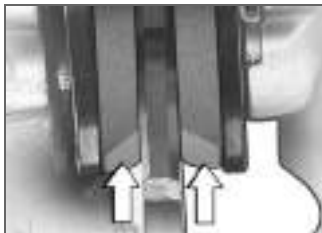

Brake-pad wear limit, rear

—min 1.0 mm (Friction pad only, without backing plate. The wear indicators must be clearly visible.)

If the wear indicating marks are no longer visible:

- Have the brake pads replaced by a specialist workshop, preferably an authorised BMW Motorrad dealer.

Brake fluid

Checking brake-fluid level, front brakes

- Make sure the ground is level and firm and hold the motorcycle upright.
- Move the handlebars to the straight-ahead position.



A low fluid level in the brake reservoir can allow air to penetrate the brake system. This significantly reduces braking efficiency.

Check the brake-fluid level at regular intervals.◀

- Check the brake fluid level in front reservoir **1**.



Wear of the brake pads causes the brake fluid level in the reservoir to sink.◀

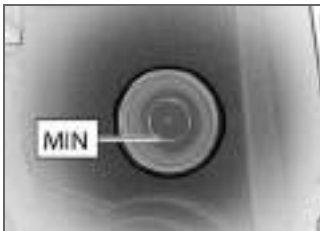

Brake fluid level, front

– DOT4 brake fluid

– Do not permit the brake fluid level to drop below the MIN mark. (Brake-fluid reservoir horizontal)

If the brake fluid level drops below the permitted level:

- Have the defect rectified as quickly as possible by a specialist workshop, preferably an authorised BMW Motorrad dealer.

Checking brake-fluid level, rear brakes

- Make sure the ground is level and firm and hold the motorcycle upright.



! A low fluid level in the brake reservoir can allow air to penetrate the brake system. This significantly reduces braking efficiency.

Check the brake-fluid level at regular intervals.◀

- Check the brake fluid level in rear reservoir **1**.

▶ Wear of the brake pads causes the brake fluid level in the reservoir to sink.◀



Brake fluid level, rear

– DOT4 brake fluid

– Do not permit the brake fluid level to drop below the MIN mark. (Brake-fluid reservoir horizontal)

If the brake fluid level drops below the permitted level:

- Have the defect rectified as quickly as possible by a spe-

cialist workshop, preferably an authorised BMW Motorrad dealer.

Coolant

Checking coolant level

- Make sure the ground is level and firm and hold the motorcycle upright.



- Read off the coolant level on scale **1** on the coolant expansion tank.

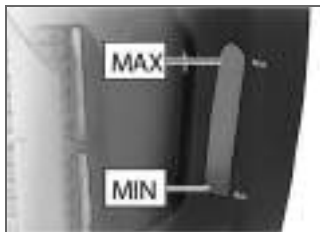

Coolant, specified level

—Between MIN and MAX marks on the expansion tank

If the coolant level is too low:

- Top up the coolant.

If the coolant level is too high:

- Seek the advice of a specialist workshop, preferably an authorised BMW Motorrad dealer.

Topping up coolant

- Remove the seat (→ 38)

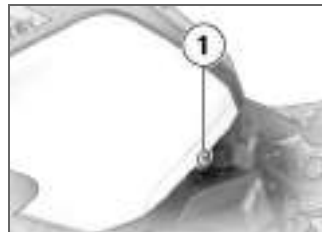

- Remove screw **1**.

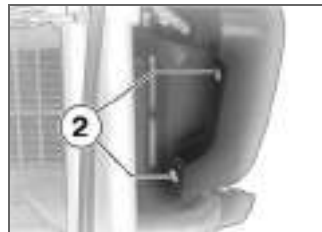

- Remove screws **2**.

- Work the side panel down to remove.



- Open cap of the expansion tank for coolant **1**.
- Top up the coolant to the specified level.
- Close the cap of the expansion tank for coolant.



- Seat the side panel in mounts **3**.

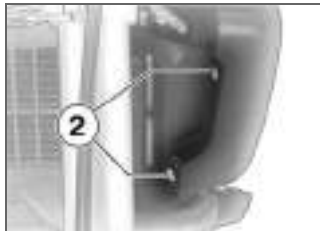

- Install screws **2**.

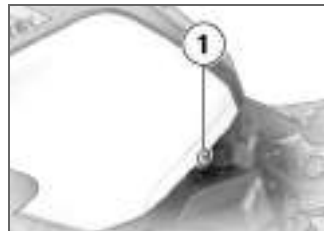

- Install screw **1**.
- Install the seat (➡ 39)

Clutch

Checking operation of clutch

- Pull the clutch lever.
 - » The pressure point must be clearly perceptible.
- If the pressure point is not clearly perceptible:
- Have the clutch checked by a specialist workshop, preferably an authorised BMW Motorrad dealer.

Checking clutch-lever play

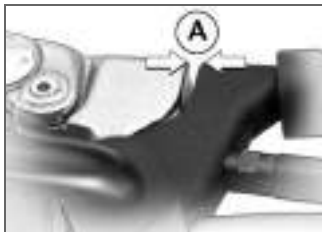

- Pull the clutch lever until resistance is perceptible.
- Measure clutch-lever play **A**.



Clutch-lever play

−2...3 mm (Engine cold)

Clutch-lever play is out of tolerance:

- Adjust the clutch-lever play (→ 73)

Adjusting clutch-lever play



- Push back boot **1**.
- Slacken locknut **2**.
- Set clutch-lever play to specification by turning adjusting screw **3**.
 - » Turning clockwise: increases play.
 - » Turning counter-clockwise: reduces play.
- Check the clutch-lever play (→ 73)
- Tighten locknut **2**.
- Pull boot **1** back over the adjusting screw.

Tyres

Checking tyre tread depth

- Make sure the ground is level and firm and place the motorcycle on its stand.
- Measure the tyre tread depth in the main tread grooves with wear marks.

▶ Tyres have wear indicators integrated into the main tread grooves. The tyre is worn out when the tyre tread has worn down to the level of the marks. The locations of the marks are indicated on the edge of the tyre, e.g. by the letters TI, TWI or by an arrow.◀

If the tyre tread no longer complies with the minimum legally required tread depth:

- Replace tyre.

Rims

Checking rims

- Make sure the ground is level and firm and place the motorcycle on its stand.
- Visually inspect the rims for defects.
- Have damaged rims checked and, if necessary, replaced by a specialist workshop, preferably an authorised BMW Motorrad dealer.

Checking spokes

- Make sure the ground is level and firm and place the motorcycle on its stand.
- Draw the handle of a screwdriver or a similar instrument across the spokes and listen to the notes of the individual spokes.

If the notes vary:

- Have the spokes checked by a specialist workshop, preferably an authorised BMW Motorrad dealer.

Chain

Lubricating chain

- Switch the ignition off and select neutral.



Dirt, dust and inadequate lubrication will result in accelerated wear and significantly shorten the drive chain's useful life.

Clean and lubricate the drive chain at regular intervals.◀

- Lubricate the drive chain every 1000 km at the latest. Lubricate the chain more frequently if the motorcycle is ridden in wet, dusty or dirty conditions.

- Clean the drive chain with a suitable cleaning product, dry it and apply chain lubricant.
- Wipe off excess lubricant.

Checking chain tension

- Make sure the ground is level and firm and place the motorcycle on its stand.

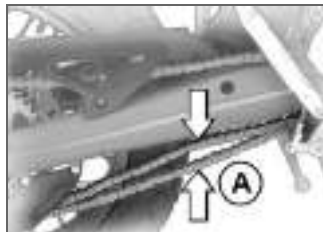

- Use a screwdriver to push the chain up and down and measure difference **A**.



Chain deflection

—25...30 mm (Motorcycle supported on its side stand)

—30...35 mm (Rear suspension extended)

If measured value is outside permitted tolerance:

- Adjust the chain tension (→ 75)

Adjusting chain tension

- Make sure the ground is level and firm and place the motorcycle on its stand.

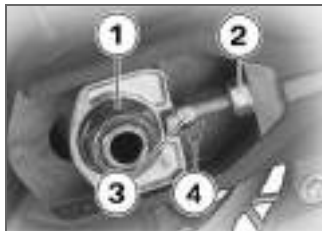

- Slacken quick-release axle nut **1**.
- Slacken locknuts **2** on left and right by turning them counter-clockwise.
- Use adjusting screws **3** on left and right to adjust chain tension.
 - » Turning screws clockwise: reduces chain tension.
 - » Turning screws counter-clockwise: increases chain tension.
- Check the chain tension (→ 74)

- Make sure that scale readings **4** are the same on left and right.
- Tighten locknuts **2** on left and right by turning them clockwise.



Locknut of the final-drive chain tensioning screw

—25 Nm

- Tighten quick-release axle nut **1** to the specified tightening torque.



Nut on quick-release axle, rear

—80 Nm

Checking chain wear

- Make sure the ground is level and firm and place the motorcycle on its stand.

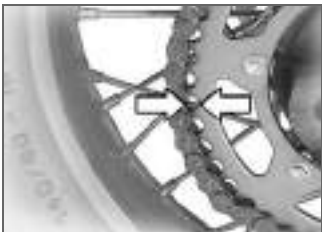

- Pull the chain back at the rear-most point of the sprocket.
- » The tips of the sprocket teeth must remain inside the chain links.

If the chain can be pulled back far enough to expose the tips of the sprocket teeth:

- Consult a specialist workshop, preferably an authorised BMW Motorrad dealer.

Wheels

Recommended tyres

For each size of tyre BMW Motorrad tests and classifies as roadworthy certain makes. BMW Motorrad cannot assess the suitability or provide any guarantee of road safety for other tyres. BMW Motorrad recommends using only tyres tested by BMW Motorrad.

You can obtain detailed information from your authorised BMW Motorrad dealer or on the Internet at www.bmw-motorrad.com.

Effect of wheel size on ABS

Wheel size is very important as a parameter for the ABS. In particular, the diameter and the width of a motorcycle's wheels are programmed into the control unit and are fundamental to all calculations. Any change in these

influencing variables, caused for example by a switch to wheels other than those installed ex-works, can have serious effects on the performance of the control systems.

The sensor rings are essential for correct road-speed calculation, and they too must match the motorcycle's control systems and consequently cannot be changed.

If you decide that you would like to fit non-standard wheels to your motorcycle, it is very important to consult a specialist workshop beforehand, preferably an authorised BMW Motorrad dealer. In some cases, the data programmed into the control units can be changed to suit the new wheel sizes.

Removing front wheel

- Place the motorcycle on a suitable auxiliary stand. BMW Mo-

torrad recommends the BMW Motorrad auxiliary stand.

- Install the auxiliary stand (→ 82)
- with BMW Motorrad ABS^{OE}



- Remove screw **1** of the ABS sensor and remove the ABS sensor from the holder.<
- Use a suitable auxiliary stand to lift the front wheel. BMW Motorrad recommends the BMW Motorrad front wheel stand.
- Install the front wheel stand (→ 83)



- Slacken left axle clamping screws **2**.
- Remove axle screw **3**.



- Slacken right axle clamping screws **4**.

- Use a screwdriver to remove axle **5**.
- Do not remove the grease from the axle.



- Hold left slider tube **6** and turn the front wheel left to push the brake pads apart.

 Once the calipers have been removed, there is a risk of the brake pads being pressed together to the extent that they cannot be slipped back over the brake disc on reassembly.

Do not operate the handbrake

lever when the brake calipers have been removed.◀

- Roll the front wheel clear of the forks.

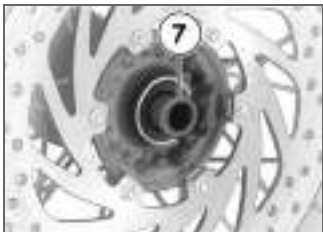

- Remove spacer sleeve 7.

Installing front wheel



- Install spacer sleeve 7.

! The front wheel must be installed right way round to rotate in the correct direction. Note the direction-of-rotation arrows on the tyre or the wheel rim.◀

- Roll the front wheel into position between the forks, making sure that the brake disc passes between the brake pads.



- Install axle 5.



! Threaded fasteners not tightened to the specified torque can work loose or their threads can suffer damage. Always have the security of the fasteners checked by a specialist

workshop, preferably an authorised BMW Motorrad dealer. ◀

- Tighten axle screw **3** to the specified torque; if necessary use a screwdriver to counterhold at the right-hand side.

 Nut on quick-release axle, front

–80 Nm

- Remove the front-wheel stand.
- Without operating the brakes: firmly compress the forks and release; repeat the procedure several times.
- Tighten left axle clamping screws **2** to the specified tightening torque.

 Front-axle retainer

–10 Nm



- Tighten right axle clamping screws **4** to the specified tightening torque.

 Front-axle retainer

–10 Nm

–with BMW Motorrad ABS^{OE}



- Seat the ABS sensor in the holder and install screw **1** of the ABS sensor. ◀
- Remove the auxiliary stand.
- Firmly pull the brake lever several times to seat the brake pads against the brake disc.

Removing rear wheel

- Place the motorcycle on a suitable auxiliary stand. BMW Motorrad recommends the BMW Motorrad auxiliary stand.

- Install the auxiliary stand (→ 82)



- Remove screws **1** and pull cover **2** down slightly.



- Remove screw **3** of the speed sensor and remove the speed sensor from the holder.



- Remove quick-release axle nut **4**.

- Slacken locknuts **5** on left and right by turning them counter-clockwise.
- Back off adjusting screws **6** left and right by turning them clockwise until adjusting plate **7** can be removed.
- Remove quick-release axle **8**.

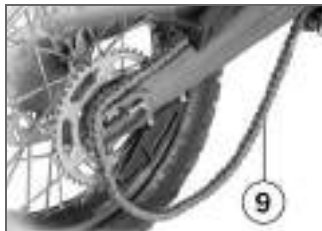

- Roll the rear wheel as far forward as possible and disengage chain **9** from the sprocket.
- Roll the rear wheel back until it is clear of the swinging arm.

▷ The sprocket and the spacer sleeves on left and right are loose fits in the wheel. Make sure that these parts are not damaged or lost on removal.◀

Installing rear wheel

- Roll the rear wheel into the swinging arm, making sure that the brake disc passes between the brake pads.

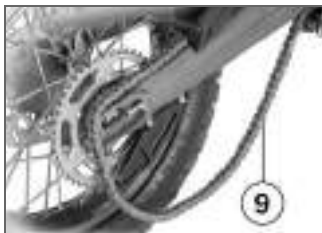

- Roll the rear wheel as far forward as possible and loop chain **9** over the sprocket.

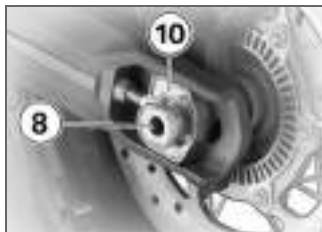

- Seat left adjusting plate **10** in the swinging arm and install quick-release axle **8** in the brake caliper and the rear wheel.
- Make sure that the axle fits into the recess of the adjusting plate.



- Install right adjusting plate **7**.



- Install quick-release axle nut **4**, but do not tighten it at this point.



- Seat the speed sensor in the holder and install screw **3** of the speed sensor.



- Place cover **2** in position.
- Install 2 screws **1**.

- Adjust the chain tension (→ 75)
- Remove the auxiliary stand.

BMW Motorrad auxiliary stand

Installing auxiliary stand

- Make sure the ground is level and firm and place the motorcycle on its stand.
- Use the auxiliary stand with the number (0 401 358) and the H adapter with the number (0 430 385).



- With the lifting lever to the left, slip the auxiliary stand into position underneath the motorcycle, between the side stand and the rear wheel.



- On the left-hand side, slip stud **1** half-way into mount **2**.

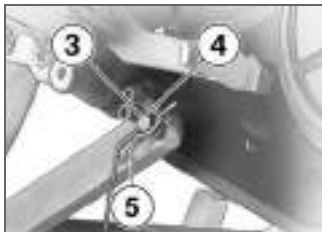

- On the right-hand side, pull stud **3** all the way into mount **4**.
- Push split pin **5** into the hole.



- Bring the motorcycle to the upright position, so that the auxiliary stand is lying flat on the ground.
- Press the lifting lever down to the ground.



- In order to ensure stability, the height of the auxiliary stand can be adjusted by means of scissor-type lifter **6**.

BMW Motorrad front-wheel stand

Installing front wheel stand

 The BMW Motorrad front wheel stand is not designed to support motorcycles not fitted with a centre stand or without other auxiliary stands. A motorcycle resting only on the front

wheel stand and the rear wheel can topple.

Place the motorcycle on its centre stand or another auxiliary stand before lifting the front wheel with the BMW Motorrad front-wheel stand.◀

- Place the motorcycle on an auxiliary stand; BMW Motorrad recommends the BMW Motorrad auxiliary stand.
- Install the auxiliary stand (▶▶ 82)
- Use the front-wheel stand with the number (0 402 240).

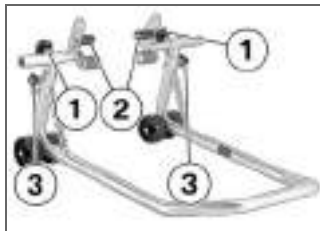

- Slacken adjusting screws **1** of the front-wheel stand.
- Push the two adapters **2** apart until the front forks fit between them.
- Use locating pins **3** to set the front-wheel stand to the desired height.
- Centre the front-wheel stand relative to the front wheel and push it against the front axle.



- Align the two adapters **2** so that the front forks are securely seated.
- Tighten adjusting screws **1**.



! If the front of the motorcycle is raised too far the auxiliary stand will lift clear of the ground and the motorcycle could topple to one side.

When raising the motorcycle, make sure that the auxiliary stand remains on the ground. If necessary, adjust the height of the front-wheel stand or the auxiliary stand. ◀

- Apply uniform pressure to push the front-wheel stand down and raise the motorcycle.

Fuses

Removing fuse

! Risk of fire if an attempt is made to jumper defective fuse.

Always replace defective fuses with new fuses of the correct amperage rating. ◀

- Switch off the ignition.
- Remove the seat (➡ 38)



- Push latching lever **1** and open the fuse cover.
- Check the fuse-assignment diagram and pull the defective

fuse up and out of the fuse box.

▶ If fuse defects recur frequently have the electric circuits checked by a specialist workshop, preferably an authorised BMW Motorrad dealer. ◀

Fuse assignment

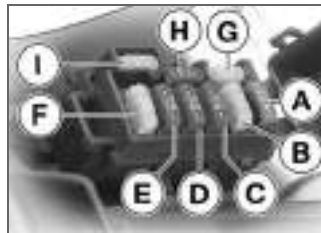

- A** ABS (OE) (10 A)
- B** Engine management control unit (15 A)
- C** Low-beam headlight (7.5 A)
- D** Brake light, horn, instrument cluster, diagnosis plug (7.5 A)

- E** Side light, number-plate light, headlight flasher, high-beam headlight (7.5 A)
- F** Starter relay, flashing turn indicators, diagnosis plug (15 A)
- G** Spare fuse (15 A or 10 A with ABS (OE))
- H** Spare fuse (7.5 A)
- I** Spare fuse (15 A)

Installing fuse

- Remove the defective fuse and replace it with a fuse of the correct amperage rating.
- Close the fuse cover.
- » The latch engages with an audible click.
- Install the seat (➔ 39)

Removing ABS fuse

 Risk of fire if an attempt is made to jumper defective fuse.

Always replace defective fuses

with new fuses of the correct amperage rating.◀

- Switch off the ignition.
- Remove the right side panel (➔ 96)
- Check the fuse-assignment diagram and pull the defective fuse up and out of the fuse box.

 If fuse defects recur frequently have the electric circuits checked by a specialist workshop, preferably an authorised BMW Motorrad dealer.◀

Fuse assignment, ABS^{OE}



- 1** ABS (30 A)
- 2** Spare fuse (30 A)
- 3** Spare fuse (20 A)
- 4** ABS (20 A)

Installing ABS fuse

- Remove the defective fuse and replace it with a fuse of the correct amperage rating.
- Install the right side panel (➔ 97)

Bulbs

Notes



A defective bulb places your safety at risk because it is easier for other users to oversee the motorcycle. Replace defective bulbs as soon as possible; always carry a complete set of spare bulbs if possible.◀



The bulb is pressurised and can cause injury if damaged.

Wear protective goggles and gloves when changing bulbs.◀



The types of bulb fitted to your motorcycle are listed in the section entitled "Technical data".◀



Do not touch the glass of new bulbs with your fingers. Use a clean, dry cloth to hold the bulbs when handling them. Dirt deposits, in particular oil and

grease, interfere with heat radiation from the bulb. This leads to overheating and shortens the bulb's operating life.◀

Replacing low-beam and high-beam headlight bulb

- Remove the headlight (→ 89)



- Remove rubber cap **1**.



- Disengage spring clips **2** from the fastenings and swing them aside.
- Pull high-beam/low-beam bulb **3** out of the headlight housing.
- Replace the defective bulb.



Bulb for low-beam and high-beam headlight

—H4 / 12 V / 55...60 W



- Insert bulb **3** into the headlight housing.
- Close and lock spring clips **2**.



- Position the rubber cap **1** on the headlight housing and push it into place.

- Install the headlight (➡ 90)

Replacing parking-light bulb

- Remove the headlight (➡ 89)



- Remove rubber cap **1**.



- Pull bulb socket **2** out of the headlight housing.

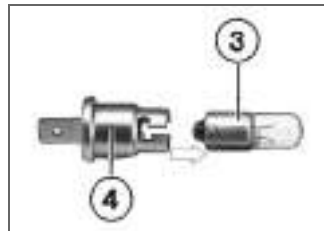

- Press bulb **3** into fitting **4** and remove by turning it counter-clockwise.

- Replace the defective bulb.

 Bulb for parking light

—W5W / 12 V / 5 W

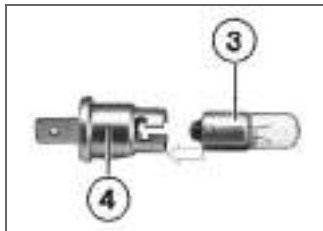

- Press bulb **3** into socket **4** and turn it clockwise to install.



- Insert bulb holder **2** into the headlight housing.



- Position the rubber cap **1** on the headlight housing and push it into place.
- Install the headlight (→ 90)

Removing headlight

 If it is not standing firmly, the motorcycle could topple in the course of the operations described below.

Always make sure that the motorcycle is stable and firmly supported.◀

- Make sure the ground is level and firm and place the motorcycle on its stand.
- Switch off the ignition.



- While holding the headlight, remove three screws **1**.

- Remove cover **2** and lift the headlight out of the housing.



- Disconnect plugs **3**, **4** and **5**.

Installing headlight



- Connect plugs **3**, **4** and **5**.



- Seat the headlight with cover **2** in the headlight housing.
- Install three screws **1**.

Replacing turn indicator bulbs, front and rear

 If it is not standing firmly, the motorcycle could topple in the course of the operations described below.

Always make sure that the motorcycle is stable and firmly supported. ◀

- Make sure the ground is level and firm and place the motorcycle on its stand.

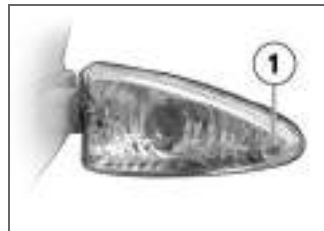

- Remove screw **1**.



- Pull the glass out of the reflector housing at the threaded-fastener side.

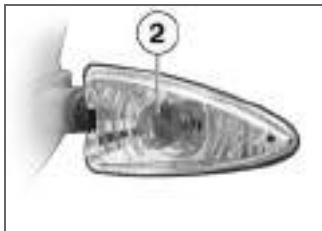

- Turn bulb **2** counter-clockwise and remove it from the bulb housing.
- Replace the defective bulb.

 Bulbs for flashing turn indicators, front

—RY10W / 12 V / 10 W

 Bulbs for flashing turn indicators, rear

—RY10W / 12 V / 10 W

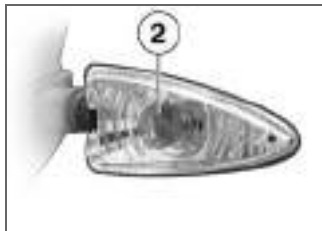

- Turn bulb **2** clockwise to install it in the bulb housing.



- Working from the inboard side, insert the glass into the bulb housing and close the housing.

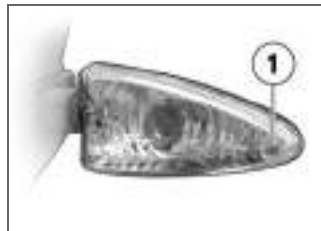

- Install screw **1**.

LED rear light

The rear light has to be replaced if more than three of the LEDs in the array fail. Under these circumstances consult a specialist workshop, preferably an authorised BMW Motorrad dealer.

Replacing number-plate light bulbs

 If it is not standing firmly, the motorcycle could topple in the course of the operations described below.

Always make sure that the

motorcycle is stable and firmly supported. ◀

- Make sure the ground is level and firm and place the motorcycle on its stand.



- Pull bulb holder **1** out of the light carrier.



- Pull bulb **2** out of socket **3**.
- Replace the defective bulb.



Bulb for number-plate light

—W5W / 12 V / 5 W



- Insert bulb **2** into socket **3**.

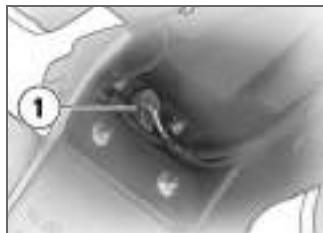

- Seat bulb holder **1** in the light carrier.

Jump starting

 The wires leading to the power socket do not have a load-capacity rating adequate for jump-starting the engine. Excessively high current can lead to a cable fire or damage to the vehicle electronics.

Do not use the on-board socket to jump-start the engine of the motorcycle. ◀

 Touching live parts of the ignition system with the engine running can cause electric shock.

Do not touch parts of the ignition system when the engine is running. ◀

 A short-circuit can result if the crocodile clips of the jump leads are accidentally brought into contact with the motorcycle.

Use only jump leads fitted with

fully insulated crocodile clips at both ends. ◀

 Jump-starting with a donor-battery voltage higher than 12 V can damage the vehicle electronics.

Make sure that the battery of the donor vehicle has a voltage rating of 12 V. ◀

- Make sure the ground is level and firm and place the motorcycle on its stand.
- Remove the right side panel (🔧 96)
- When jump-starting the engine, do not disconnect the battery from the on-board electrical system.



- Disengage rubber retaining strap **1** from the holder at the bottom and pull battery **2** partly out.
- Run the engine of the donor vehicle during jump-starting.



- Begin by connecting one end of the red jump lead to positive terminal **3** of the discharged battery and the other end to the positive terminal of the donor battery.
- Then connect one end of the black jump lead to the negative terminal of the donor battery, and the other end to a suitable grounding point on this motorcycle.
- Start the engine of the vehicle with the discharged battery in the usual way; if the engine does not start, wait a few minutes before repeating the

attempt in order to protect the starter motor and the donor battery.

- Allow both engines to idle for a few minutes before disconnecting the jump leads.
- Disconnect the jump lead from the negative terminal and the ground point first, then disconnect the second jump lead from positive terminal **3**.

 Do not use proprietary start-assist sprays or other products to start the engine.◀

- Slide the battery into the battery compartment and engage the rubber retaining strap in the holder at the bottom.
- Install the right side panel (➡ 97)

Battery

Maintenance instructions

Correct upkeep, recharging and storage will prolong the life of the battery and are essential if warranty claims are to be considered.

Compliance with the points below is important in order to maximise battery life:

- Keep the surface of the battery clean and dry
- Do not open the battery
- Do not top up with water
- Be sure to read and comply with the instructions for charging the battery on the following pages
- Do not turn the battery upside down



If the battery is not disconnected, the on-board electronics (e.g. clock, etc.) gradually drain the battery. This can cause the battery to run flat. If this hap-

pens, warranty claims will not be accepted.

If the motorcycle is to be out of use for more than four weeks, disconnect the battery or connect a suitable trickle charger to the battery.◀

Charging battery when connected

—with power socket^{OA}

 Charging the connected battery directly at the battery terminals can damage the vehicle electronics.

Always disconnect the battery from the on-board circuits before recharging it with a charger connected directly to the battery posts.◀

 If you switch on the ignition and the multifunction display and telltale lights fail to light up, the battery is completely flat. Attempting to charge a com-

pletely flat battery via the on-board socket can cause damage to the motorcycle's electronics. If a battery has discharged to the extent that it is completely flat, it has to be disconnected from the on-board circuits and charged with the charger connected directly to the battery posts.◀

- With the battery connected to the motorcycle's on-board electrical system, charge only via the power socket.
- Comply with the operating instructions of the charger.◀

Charging battery when disconnected

- Charge the battery using a suitable charger.
- Comply with the operating instructions of the charger.
- Once the battery is fully charged and charging is completed, disconnect the

charger's terminal clips from the battery terminals.

 The battery has to be recharged at regular intervals in the course of a lengthy period of disuse. See the instructions for caring for your battery. Always fully recharge the battery before restoring it to use.◀

Removing battery

- Remove the right side panel (→ 96)

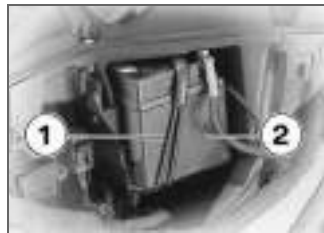

- Disengage rubber retaining strap **1**.

- Remove battery **2**.



⚠ Disconnection in the wrong sequence increases the risk of short-circuits. Always proceed in the correct sequence.◀

- Disconnect negative battery lead **4** first.
- Then disconnect positive battery lead **3**.

Install the battery



⚠ Installation in the wrong sequence increases the risk of short-circuits. Always proceed in the correct sequence.◀

- Connect battery positive lead **3** first.
- Then connect battery negative lead **4**.



- Install battery **2**, negative terminal first.
- Engage rubber retaining strap **1**.
- Install the right side panel (➡ 97)
- Set the clock (➡ 29)

Removing right side panel

- Make sure the ground is level and firm and place the motorcycle on its stand.
- Remove the seat (➡ 38)



- Remove screw **1**.

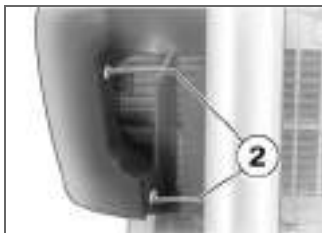

- Remove screws **2**.
- Work the side panel down to remove.

Installing right side panel



- Seat the side panel in mounts **3**.

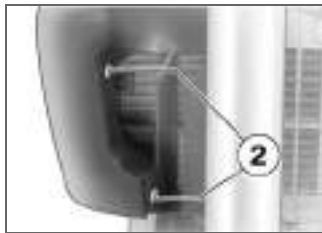

- Install screws **2**.



- Install screw **1**.
- Install the seat (→ 39)

Care

| | |
|---|-----|
| Care products | 100 |
| Washing motorcycle | 100 |
| Cleaning easily damaged components..... | 100 |
| Paint care | 101 |
| Protective wax coating | 102 |
| Laying up motorcycle | 102 |
| Restoring motorcycle to use | 102 |

Care products

BMW Motorrad recommends that you use the cleaning and care products you can obtain from your authorised BMW Motorrad dealer. The substances in BMW Care Products have been tested in laboratories and in practice; they provide optimised care and protection for the materials used in your vehicle.

 The use of unsuitable cleaning and care products can damage vehicle components. Do not use solvents such as cellulose thinners, cold cleaners, fuel or the like, and do not use cleaning products that contain alcohol.◀

Washing motorcycle

BMW Motorrad recommends that you use BMW insect remover to soften and wash off insects and stubborn dirt on

painted parts prior to washing the motorcycle.

To prevent stains, do not wash the motorcycle immediately after it has been exposed to strong sunlight and do not wash it in the sun.

Make sure that the motorcycle is washed frequently, especially during the winter months.

To remove road salt, clean the motorcycle with cold water immediately after every trip.

 After the motorcycle has been washed, ridden through water or ridden in the rain, the brake discs and pads might be wet and the brakes might not take effect immediately.

Apply the brakes in good time until the brakes have dried out.◀

 Warm water intensifies the effect of salt.

Use only cold water to wash off road salt.◀

 The high pressure of steam cleaners can damage seals, the hydraulic brake system, the electrical system, and the seat. Do not use a steam jet or high-pressure cleaning equipment.◀

Cleaning easily damaged components

Plastics

Clean plastic parts with water and BMW plastic care emulsion. This includes in particular:

- Windscreen and slipstream deflectors
- Headlight lens made of plastic
- Glass cover of the instrument cluster
- Black, unpainted parts

 If plastic parts are cleaned using unsuitable cleaning

agents, the surfaces can be damaged.

Do not use cleaning agents that contain alcohol, solvents or abrasives to clean plastic parts.

Even fly-remover pads or cleaning pads with hard surfaces can produce scratches.◀

 Soften stubborn dirt and insects by covering the affected areas with a wet cloth.◀

Chrome

Use plenty of water and BMW shampoo to clean chrome, particularly if it has been exposed to road salt. Use chrome polish for additional treatment.

Radiator

Clean the radiator regularly to prevent overheating of the engine due to inadequate cooling. For example, use a garden hose with low water pressure.



Cooling fins can be bent easily.

Take care not to bend the fins when cleaning the radiator.◀

Rubber

Treat rubber components with water or BMW rubber-care products.



Using silicone sprays for the care of rubber seals can cause damage.

Do not use silicone sprays or other care products that contain silicon.◀

Paint care

Washing the motorcycle regularly will help counteract the long-term effects of substances that damage the paint, especially if your motorcycle is ridden in areas with high air pollution or natural sources of dirt, for example tree resin or pollen.

Remove particularly aggressive substances immediately, however, as otherwise the paint can be affected or become discoloured. Substances of this nature include spilt fuel, oil, grease, brake fluid and bird droppings. We recommend BMW vehicle polish or BMW paint cleaner for this purpose.

Marks on the paintwork are particularly easy to see after the motorcycle has been washed. Remove stains of this kind immediately, using cleaning-grade benzene or petroleum spirit on a clean cloth or ball of cotton wool. BMW Motorrad recommends BMW tar remover for removing specks of tar. Remember to wax the parts treated in this way.

Protective wax coating

BMW Motorrad recommends applying only BMW car wax or products containing carnauba wax or synthetic wax.

It is time to re wax the paint-work when water "puddles" on the surface, instead of forming beads.

Laying up motorcycle

- Clean the motorcycle.
- Remove the battery.
- Spray the brake and clutch lever pivots and the main and side stand pivots with a suitable lubricant.
- Coat bright metal and chrome-plated parts with an acid-free grease (e.g. Vaseline).
- Stand the motorcycle in a dry room in such a way that there is no load on either wheel. Authorised BMW Motorrad deal-

ers can provide suitable auxiliary stands.

▶ Before laying the vehicle up out of use, have the engine oil and the oil filter element changed by a specialist workshop, preferably an authorised BMW Motorrad dealer. Combine work for laying up/restoring to use with a BMW service or inspection.◀

Restoring motorcycle to use

- Remove the protective wax coating.
- Clean the motorcycle.
- Install a charged battery.
- Before starting: work through the checklist.

Technical data

| | |
|-----------------------------|-----|
| Troubleshooting chart | 104 |
| Threaded fasteners | 105 |
| Engine | 106 |
| Fuel..... | 107 |
| Engine oil | 107 |
| Clutch | 108 |
| Transmission | 108 |
| Rear-wheel drive..... | 109 |
| Running gear | 109 |
| Brakes | 110 |
| Wheels and tyres | 110 |
| Electrics | 111 |
| Frame | 113 |
| Dimensions | 113 |
| Weights..... | 114 |

| | |
|-----------------------------|-----|
| Riding specifications | 114 |
|-----------------------------|-----|

Troubleshooting chart

Engine does not start at all or is difficult to start.

| Possible cause | Remedy |
|---|---|
| Emergency off switch (kill switch) | Kill switch in operating position (run). |
| Side stand | Retract the side stand (➡ 44). |
| Gear engaged and clutch not disengaged. | Select neutral or pull clutch lever (➡ 44). |
| No fuel in tank | Refuelling (➡ 50) |
| Battery flat | Charge the battery when connected (➡ 95) |

Threaded fasteners

| Front wheel | Value | Valid |
|--|--------------|--------------|
| Nut on quick-release axle, front | | |
| M20 x 1.25 | 80 Nm | |
| Front-axle retainer | | |
| M6 | 10 Nm | |
| Rear wheel | Value | Valid |
| Nut on quick-release axle, rear | | |
| M20 x 1.25 | 80 Nm | |
| Locknut of the final-drive chain tensioning screw | | |
| M8 | 25 Nm | |
| Mirror arm | Value | Valid |
| Union nut, mirror | | |
| | 20 Nm | |
| Clamping screw, mirror to handlebar fitting | | |
| | 21 Nm | |

Engine

Engine

| | |
|----------------------|---|
| Engine design | Single-cylinder four-stroke, double overhead camshafts driven by roller chain, 4 valves operated by bucket tappets, balancing shaft, liquid-cooled cylinder and cylinder head, integral water pump, 5-speed gearbox and dry sump lubrication. |
| Displacement | 652 cm ³ |
| Cylinder bore | 100 mm |
| Piston stroke | 83 mm |
| Compression ratio | 11.5:1 |
| Nominal output | 39 kW, - at engine speed: 7000 min ⁻¹ |
| Torque | 60 Nm, - at engine speed: 5250 min ⁻¹ |
| Maximum engine speed | max 7500 min ⁻¹ |
| Idle speed | 1480 min ⁻¹ |

Fuel

Fuel

| | |
|------------------------|----------------------------|
| Recommended fuel grade | 95 ROZ/RON, Super unleaded |
| Usable fuel capacity | ≤9.5 l |
| Reserve fuel | ≥2 l |

Engine oil

Engine oil

| | |
|-------------------------------------|---|
| Engine oil, capacity | 2.3 l, with filter change |
| Lubricant | Engine oil, 15W-40 |
| Engine oil, quantity for topping up | 0.25 l, Difference between MIN and MAX |
| Lubricant | Engine oil, 15W-40 |
| Oil grades | Mineral engine oils of API classification SF to SH. BMW Motorrad recommends not using oil additives, because they can have a detrimental effect on clutch operation. BMW Motorrad recommends not using synthetic oils for the first 10000 km. Please do not hesitate to contact your authorised BMW Motorrad dealer if you have any questions relating the choice of a suitable engine oil for your motorcycle. |

Permissible viscosity classes

| | |
|-------------|--|
| SAE 10 W-40 | ≥-20 °C, Operation at low temperatures |
| SAE 15 W-40 | ≥-10 °C |

Clutch

Clutch

| | |
|-------------|---------------------------------------|
| Clutch type | Multiplate clutch running in oil bath |
|-------------|---------------------------------------|

Transmission

Transmission

| | |
|-----------------------------|--|
| Gearbox type | claw-shift 5-speed gearbox |
| Gearbox transmission ratios | 1.946 (37:72 teeth), Primary transmission ratio 2.750 (12:33 teeth), 1st gear 1.750 (16:28 teeth), 2nd gear 1.313 (16:21 teeth), 3rd gear 1.045 (22:23 teeth), 4th gear 0.875 (24:21 teeth), 5th gear |

Rear-wheel drive

Rear-wheel drive

| | |
|------------------------------|-------------------------------------|
| Type of final drive | Chain drive |
| Type of rear suspension | Two-arm cast-aluminium swinging arm |
| Secondary transmission ratio | 2,938 |

Running gear

Running gear

Front wheel

| | |
|--------------------------|-----------------------------|
| Type of front suspension | Upside-down telescopic fork |
| Spring travel, front | 240 mm, At wheel |

Rear wheel

| | |
|-----------------------------|--|
| Type of rear suspension | Directly pivot-mounted central spring strut with coil spring and single-tube gas-filled shock absorber |
| Spring travel at rear wheel | 210 mm, At wheel |

Brakes

Brakes

| | |
|---------------------------|--|
| Type of front brake | Hydraulically operated single-disc brake with 2-piston floating caliper and fixed disc |
| Brake-pad material, front | Organic material |
| Type of rear brake | Hydraulically operated single-disc brake with 1-piston floating caliper and fixed disc |
| Brake-pad material, rear | Organic material |

Wheels and tyres

Wheels and tyres

| | |
|-----------------------|--|
| Recommended tyre sets | You can obtain an up-to-date list of approved tyres from your authorised BMW Motorrad dealer or on the Internet at " www.bmw-motorrad.com ". |
|-----------------------|--|

Front wheel

| | |
|-------------------------|---------------|
| Front wheel, type | Spoked wheel |
| Front wheel rim size | 2.50" x 19" |
| Tyre designation, front | 100 / 90 - 19 |

Rear wheel

| | |
|------------------------|---------------|
| Rear wheel type | Spoked wheel |
| Rear wheel rim size | 3.00" x 17" |
| Tyre designation, rear | 130 / 80 - 17 |

Tyre pressures

| | |
|----------------------|--|
| Tyre pressure, front | 1.9 bar, one-up, tyre cold 2 bar, two-up and/or with luggage, tyre cold |
| Tyre pressure, rear | 2.1 bar, one-up, tyre cold 2.3 bar, two-up and/or with luggage, tyre cold |

Electrics

Electrics

| | |
|--|---|
| Electrical rating of on-board socket | |
| — with BMW Motorrad ABS ^{OE} or — with power socket ^{OA} | 5 A |
| Fuses | Plug-in "Minifuses" with ratings of 7.5 A and 15 A |
| — with BMW Motorrad ABS ^{OE} | Plug-in "Minifuses" with ratings of 10 A, 20 A and 30 A |

Battery

| | |
|---------------------------------------|-----------------------------------|
| Battery, manufacturer and designation | ETZ 10 S |
| Battery type | AGM (Absorbent Glass Mat) battery |
| Battery rated voltage | 12 V |
| Battery rated capacity | 10 Ah |

Spark plugs

| | |
|---|--|
| Spark plugs, manufacturer and designation | NGK DR8 EB |
| Electrode gap of spark plug | 0.6...0.7 mm, When new max 0.9 mm, Wear limit |

Lighting

| | |
|---|-----------------------|
| Bulb for low-beam and high-beam headlight | H4 / 12 V / 55...60 W |
| Bulb for parking light | W5W / 12 V / 5 W |
| Bulbs for flashing turn indicators, front | RY10W / 12 V / 10 W |
| Bulbs for flashing turn indicators, rear | RY10W / 12 V / 10 W |
| Bulb for number-plate light | W5W / 12 V / 5 W |

Frame

Frame

| | |
|---------------------|---|
| Frame type | Bridge-type steel frame, load-bearing drive unit and bolt-on rear frame |
| Type plate location | Front frame, right |
| VIN location | Front frame, right |

Dimensions

Dimensions

| | |
|----------------------|---|
| Length of motorcycle | 2185 mm |
| Height of motorcycle | max 1205 mm, without mirrors max 1440 mm, with mirrors |
| Width of motorcycle | 907 mm, Across mirrors |
| Front-seat height | 840...870 mm, Without rider at unladen weight |

Weights

Weights

| | |
|--------------------------|--|
| Unladen weight | 160 kg, DIN unladen weight, ready for road, 90 % load of fuel, without optional extras |
| Permissible gross weight | 335 kg |
| Maximum payload | 175 kg |

Riding specifications

Riding specifications

| | |
|-----------|----------|
| Top speed | 165 km/h |
|-----------|----------|

Service

| | |
|--|-----|
| BMW Motorrad service | 116 |
| BMW Motorrad service quality | 116 |
| BMW Motorrad Service Card: on-the-spot breakdown assistance | 116 |
| BMW Motorrad service network | 117 |
| Maintenance work | 117 |
| Confirmation of maintenance work | 118 |
| Confirmation of service | 123 |

BMW Motorrad service

Advanced technology requires specially adapted methods of maintenance and repair.



If maintenance and repair work is performed inexpertly, it could result in consequential damage and thus constitute a safety risk.

BMW Motorrad recommends you to have all the associated work on your motorcycle carried out by a specialist workshop, preferably an authorised BMW Motorrad dealer. ◀

Your authorised BMW Motorrad dealer can provide information on BMW services and the work undertaken as part of each service. Have all maintenance and repair work carried out confirmed in the "Service" chapter in this manual. Authorised BMW Motorrad dealers are supplied with the latest technical information and have

the necessary technical know-how. BMW Motorrad recommends that you contact your authorised BMW Motorrad dealer if you have questions regarding your motorcycle.

BMW Motorrad service quality

Along with its reputation for engineering quality and high reliability, BMW Motorrad is a byword for excellent quality of service.

To ensure that your BMW is always in optimum condition, BMW Motorrad recommends that you have the maintenance work required for your motorcycle carried out regularly, preferably by your authorised BMW Motorrad dealer. For generous treatment of claims submitted after the warranty period has expired, evidence of regular maintenance is essential.

Certain signs of wear, moreover, may otherwise not be noticed until it is too late to put them right at moderate cost. Your authorised BMW Motorrad dealer's mechanics know every detail of your motorcycle and can take remedial action if necessary before minor faults develop into serious problems. By having the necessary repairs done properly and in good time, you save time and money in the long run.

BMW Motorrad Service Card: on-the-spot breakdown assistance

In the event of a breakdown, the BMW Motorrad Service Card issued with each new BMW motorcycle enables you to access an extensive range of services such as breakdown assistance, motorcycle transportation etc. (details can differ from country to country). In the event of a break-

down, contact BMW Motorrad's Mobile Service. The specialists will provide the necessary advice and assistance.

You will find important country-specific contact addresses and the after-sales service organisation phone numbers in the "Service Kontakt / Service Contact" brochures, along with information on Mobile Service and the dealership network.

BMW Motorrad service network

BMW Motorrad has an extensive after-sales service network in place to look after you and your motorcycle in more than 100 countries. In Germany alone, you have the best possible access to approximately 200 authorised BMW Motorrad dealers.

All information concerning the international dealership network can be found in the brochure

"Service Contact Europe" or "Service Contact Africa, America, Asia, Australia, Oceania".

Maintenance work

BMW Pre-delivery Check

Your authorised BMW Motorrad dealer conducts the BMW pre-delivery check before handing over the motorcycle to you.

BMW Running-in Check

The BMW running-in check has to be performed when the motorcycle has covered between 500 km and 1,200 km

BMW Service

The BMW Service is carried out once a year; the extent of servicing can vary, depending on the age of the motorcycle and the distance it has covered. Your authorised BMW Motorrad dealer confirms that the service work has been carried out and enters

the date when the next service will be due.

Riders who cover long distances in a year might have to bring in their motorcycles for service before the next scheduled date. It is to allow for these cases that a maximum odometer reading is entered as well in the confirmation of service. Servicing has to be brought forward if this odometer reading is reached before the next scheduled date for the service.

Confirmation of maintenance work

BMW Pre-delivery Check

Completed

on _____

Stamp, signature

BMW Running-in Check

Completed

on _____

Odometer reading _____

Next service
at the latest

on _____

or, if logged beforehand,

Odometer reading _____

Stamp, signature

BMW Service

Completed

on _____

Odometer reading _____

Next service

at the latest

on _____

or, if logged beforehand,

Odometer reading _____

Stamp, signature**BMW Service**

Completed

on _____

Odometer reading _____

Next service

at the latest

on _____

or, if logged beforehand,

Odometer reading _____

Stamp, signature**BMW Service**

Completed

on _____

Odometer reading _____

Next service

at the latest

on _____

or, if logged beforehand,

Odometer reading _____

Stamp, signature

BMW Service

Completed

on _____

Odometer reading _____

Next service
at the latest

on _____

or, if logged beforehand,

Odometer reading _____

Stamp, signature**BMW Service**

Completed

on _____

Odometer reading _____

Next service
at the latest

on _____

or, if logged beforehand,

Odometer reading _____

Stamp, signature**BMW Service**

Completed

on _____

Odometer reading _____

Next service
at the latest

on _____

or, if logged beforehand,

Odometer reading _____

Stamp, signature

BMW Service

Completed

on _____

Odometer reading _____

Next service

at the latest

on _____

or, if logged beforehand,

Odometer reading _____

Stamp, signature**BMW Service**

Completed

on _____

Odometer reading _____

Next service

at the latest

on _____

or, if logged beforehand,

Odometer reading _____

Stamp, signature**BMW Service**

Completed

on _____

Odometer reading _____

Next service

at the latest

on _____

or, if logged beforehand,

Odometer reading _____

Stamp, signature

BMW Service

Completed

on _____

Odometer reading _____

Next service
at the latest

on _____

or, if logged beforehand,

Odometer reading _____

Stamp, signature**BMW Service**

Completed

on _____

Odometer reading _____

Next service
at the latest

on _____

or, if logged beforehand,

Odometer reading _____

Stamp, signature**BMW Service**

Completed

on _____

Odometer reading _____

Next service
at the latest

on _____

or, if logged beforehand,

Odometer reading _____

Stamp, signature

Confirmation of service

The table is intended as a record of maintenance and repair work, the installation of optional accessories and, if appropriate, special campaign (recall) work.

| Item | Odometer reading | Date |
|------|------------------|------|
| | | |
| | | |
| | | |
| | | |
| | | |
| | | |
| | | |
| | | |
| | | |
| | | |

A

Abbreviations and symbols, 6

ABS

- Engineering details, 54
- Fuses, 13
- Operation, 33
- Replacing fuses, 86
- Self-diagnosis, 46
- Switching off and on, 14
- Warnings, 23

Accessories

- Notes, 58

Auxiliary stand

- Installing, 82

B

Battery

- Charging battery when connected, 95
- Charging battery when disconnected, 95
- Installation, 96
- Maintenance instructions, 94
- Removal, 95
- Voltmeter, 20, 30

BMW Motorrad service, 116

BMW Motorrad Service

- Card, 116

Brake fluid

- Checking fluid levels, 69
- Reservoir, front, 13
- Reservoir, rear, 13

Brake pads

- Checking brake-pad thickness, 67
- Running in, 47

Brakes

- Adjusting brake lever, 34
- Checking operation, 67
- Safety instructions, 47
- Technical data, 110

Bulbs

- Notes on replacement, 87
- Replacing high-beam headlight bulb, 87
- Replacing low-beam headlight bulb, 87
- Replacing number-plate light bulbs, 91
- Replacing rear light, 91

Replacing side-light bulb, 88

Replacing turn indicator bulb, 90

Technical data, 112

C

Chain

- Adjusting tension, 75
- Checking tension, 74
- Checking wear, 75
- Lubricating, 74

Checklist, 44

Clock, 20

- Adjusting, 17, 29

Clutch

- Adjusting clutch lever, 33
- Adjusting handlebar-lever play, 73
- Checking operation, 72
- Checking play, 73
- Technical data, 108

Confirmation of maintenance work, 118

- Coolant
 - Checking fluid level, 71
 - Fore-and-aft tilt indicator, 11
 - Topping up, 71
- Coolant temperature
 - Warning, 22

- D**
- Damping
 - Adjusting, 11, 36
- Dimensions
 - Technical data, 113
- Display
 - Selecting readings, 17

- E**
- Electrics
 - Technical data, 111
- Emergency off switch (kill switch), 15, 32
- Engine
 - Starting, 15, 44
 - Technical data, 106

- Engine oil
 - Checking fill level, 65
 - Filler neck, 16
 - Oil dipstick, 16
 - Technical data, 107
 - Topping up, 66
- Engine oil pressure
 - Warning, 22
- Equipment, 6

- F**
- Frame
 - Technical data, 113
- Front-wheel stand
 - Installing, 83
- Fuel
 - Filler neck, 13
 - Refuelling, 50
 - Technical data, 4, 107
 - Warning, 22
- Fuses, 16
 - Replacing, 85
 - Technical data, 111

- G**
- General views
 - Instrument cluster, 17
 - Left handlebar fitting, 14
 - Left side, 11
 - Multifunction display, 20
 - Right handlebar fitting, 15
 - Right side, 13
 - Telltale lights, 20
 - Underneath the seat, 16

- H**
- Handlebar fitting, left
 - Overview, 14
- Handlebar fitting, right
 - Overview, 15
- Headlight
 - Beam throw, 38
 - Driving on right/driving on left, 38
- Headlight flasher, 14, 31
- High-beam headlight
 - Switch, 14
 - Telltale light, 20
- Horn, 14

I

- Idle
 - Telltale light, 20
- Ignition
 - Switching off, 28
 - Switching on, 28
- Instrument cluster
 - Overview, 17

J

- Jump starting, 93

K

- Keys, 28

L

- Laying up, 102
- Lights
 - High-beam headlight, 31
 - Low-beam headlight, 31
 - Side light, 31
- Luggage
 - Correct loading, 59
 - Instructions for loading and securing objects, 59

M

- Maintenance, 117
 - Notes, 64
- Mirrors
 - Adjusting, 34
- Motorcycle
 - Laying up, 102
 - Overview, 11, 13
 - Parking, 49
 - Restoring to use, 102
- Multifunction display
 - Operation, 28
 - Overview, 20
 - See display, 17

O

- Odometer and tripmeters, 20
 - Resetting, 17

P

- Parking, 49
- Power socket, 11, 58
- Pre-ride check, 45

R

- Rear-wheel drive
 - Technical data, 109
- Refuelling, 50
- Restoring to use, 102
- Running gear
 - Adjusting treble setting, 37
 - Technical data, 109
- Running in, 46

S

- Safety instructions, 42
 - Brakes, 47
- Seat
 - Installation, 38
 - Lock, 13
 - Removal, 38
- Service, 116
- Service Card, 116
- Spark plugs
 - Technical data, 112
- Speedometer, 20

Spring preload
 Adjusting, 11, 35
Standards, 7
Starter, 15
Starting, 44
Status indicators
 See also warnings, 20
 Standard status indicators, 20
 Warnings, 20
Steering lock, 28

T

Technical data
 Brakes, 110
 Bulbs, 112
 Clutch, 108
 Dimensions, 113
 Electrics, 111
 Engine, 106
 Engine oil, 107
 Frame, 113
 Fuel, 4, 107
 Rear-wheel drive, 109
 Running gear, 109
 Spark plugs, 112
 Standards, 7
 Transmission, 108
 Weights, 114
 Wheels and tyres, 110
Telltale lights, 17
 Overview, 20
Toolkit, 16
 Contents, 64
Topcase
 Operation, 60
Torques, 105
Transmission
 Technical data, 108
Transportation
 Lashing, 50
Troubleshooting chart, 104
Turn indicators
 Operate, 14
 Operation, 32
 Telltale light, 20
Tyres
 BMW recommendations, 76
 Checking inflation pressure, 37
 Checking tread depth, 73
 Pressures, 4, 111

Running in, 47
 Technical data, 110

W

Warnings, 20
 With ABS, 23
Warnings, overview, 21, 24
Weights
 Technical data, 114
Wheels
 Change of size, 76
 Checking rims, 74
 Install the rear wheel, 81
 Installing front wheel, 78
 Remove the front wheel, 76
 Removing rear wheel, 79
 Technical data, 110

Details described or illustrated in this booklet may differ from the motorcycle's actual specification as purchased, the accessories fitted or the national-market specification. No claims will be entertained as a result of such discrepancies.

Dimensions, weights, fuel consumption and performance data are quoted to the customary tolerances.

The right to modify designs, equipment and accessories is reserved.

Errors and omissions excepted.

© 2008 BMW Motorrad

Not to be reproduced either wholly or in part without written permission from BMW Motorrad, After Sales.

Printed in Germany.

Important data for refuelling

| Fuel | |
|------------------------|---|
| Recommended fuel grade | 95 ROZ/RON, Super unleaded |
| Usable fuel capacity | ≤9.5 l |
| Reserve fuel | ≥2 l |
| Tyre pressures | |
| Tyre pressure, front | 1.9 bar, one-up, tyre cold 2 bar, two-up and/or with luggage, tyre cold |
| Tyre pressure, rear | 2.1 bar, one-up, tyre cold 2.3 bar, two-up and/or with lug- gage, tyre cold |

BMW recommends 

Order No. 01 41 7 714 291
03.2008, 4th edition

