

Rider's Manual

HP2 Sport



BMW Motorrad



The Ultimate Riding
Machine

Motorcycle data/dealership details

Motorcycle data

Model

Vehicle identification number

Colour code

Date of first registration

Registration number

Dealership details

Person to contact in Service department

Ms/Mr

Phone number

Dealership address/phone number (company stamp)

Welcome to BMW

We congratulate you on your choice of a motorcycle from BMW and welcome you to the community of BMW riders. Familiarise yourself with your new motorcycle so that you can ride it safely and confidently in all traffic situations.

Please read this Rider's Manual carefully before starting to use your new BMW motorcycle. It contains important information on how to operate the controls and how to make the best possible use of all your BMW's technical features.

In addition, it contains information on maintenance and care to help you maintain your motorcycle's reliability and safety, as well as its value.

If you have questions concerning your motorcycle, your authorised

BMW Motorrad dealer will gladly provide advice and assistance.

We hope that you will enjoy riding your BMW and that all your journeys will be pleasant and safe.

BMW Motorrad.

Table of Contents

You can also consult the index at the end of this Rider's Manual if you want to find a particular topic or item of information.

1 General instructions 5

Overview	6
Abbreviations and symbols	6
Equipment	6
Technical data	7
Currency	7

2 General views 9

General view, left side	11
General view, right side	13
Underneath the seat	14
Handlebar fitting, left	15
Handlebar fitting, right	16
Instrument panel	17
Headlight	17

3 Status indicators 19

Readings in ROAD mode	20
Warnings	22
ABS warnings ^{OE}	27

4 Instrument panel 31

Diversity	32
Operation	32
Selecting display mode	33
ROAD mode	34
RACE mode	37
INFO mode	46
Settings	50
Infrared receiver ^{OA}	55

5 Operation 57

Ignition switch and steering lock	58
Electronic immobiliser (EWS)	59
Lights	60
Turn indicators	61
Hazard warning flashers	61
Emergency off switch (kill switch)	62
BMW Motorrad ABS ^{OE}	63
Clutch	64
Shift lever	64
Brakes	65
Mirrors	66

Handlebars	66
Footrests	68
Spring preload	68
Damping	74
Height of suspension	77
Tyres	81
Headlight	82
Front seat	82

6 Riding 85

Safety instructions	86
Checklist	87
Starting	88
Running in	90
Shifting gear	91
Brakes	92
Parking your motorcycle	93
Refuelling	94

7 Engineering details 97

Brake system with BMW Motorrad ABS ^{OE}	98
High Performance	102

8 Accessories	111	Jump starting	143	Wheels and tyres.....	164
General instructions	112	Battery	145	Electrics	165
Power socket ^{OA}	112	11 Care	149	Frame	166
Luggage	113	Cleaning carbon compon- ents	150	Dimensions	167
9 For race-circuit use	115	Care products	150	Weights	167
Turn indicators	116	Washing motorcycle.....	150	Riding specifications	168
Mirrors	118	Cleaning easily damaged components.....	151	13 Service	169
Number-plate carrier	119	Paint care	151	BMW Motorrad service.....	170
On public roads	120	Protective wax coating	152	BMW Motorrad service quality.....	170
10 Maintenance	121	Laying up motorcycle	152	BMW Motorrad Service Card: on-the-spot break- down assistance	170
General instructions	122	Restoring motorcycle to use	152	BMW Motorrad service net- work.....	171
Toolkit.....	122	12 Technical data	153	Maintenance work.....	171
Engine oil	123	Troubleshooting chart.....	154	Confirmation of mainten- ance work	172
Brake system	124	Threaded fasteners	155	Confirmation of service.....	177
Brake pads	125	Engine	159		
Brake fluid.....	127	Fuel	160		
Clutch	129	Engine oil	160		
Tyres.....	130	Clutch	161		
Rims	130	Transmission	161		
Wheels	130	Rear-wheel drive	162		
Front-wheel stand.....	136	Running gear.....	162		
Rear-wheel stand	137	Brakes	163		
Middle stand	138				
Bulbs.....	139				

General instructions

Overview	6
Abbreviations and symbols	6
Equipment	6
Technical data	7
Currency	7

Overview

Chapter 2 of this Rider's Manual will provide you with an initial overview of your motorcycle. All maintenance and repair work on the motorcycle is documented in Chapter 13. This record of the maintenance work you have had performed on your motorcycle is a precondition for generous treatment of goodwill claims.

When the time comes to sell your BMW, please remember to hand over this Rider's Manual; it is an important part of the motorcycle.

Abbreviations and symbols

 Indicates warnings that you must comply with for reasons of your safety and the safety of others, and to protect your motorcycle against damage.

 Specific instructions on how to operate, control, adjust or look after items of equipment on the motorcycle.

◀ Indicates the end of an item of information.

• Instruction.

» Result of an activity.

 Reference to a page with more detailed information.

◁ Indicates the end of a passage relating to specific accessories or items of equipment.



Tightening torque.



Item of technical data.

OE Optional extra
The motorcycles are assembled complete with all the BMW optional extras originally ordered.

OA Optional accessory
You can obtain optional accessories through your authorised BMW Motorrad dealer; optional accessories have to be retrofitted to the motorcycle.

EWS Electronic immobiliser (Elektronische Wegfahrsicherung).

ABS Anti-lock brake system

Equipment

When you ordered your BMW motorcycle, you chose various items of custom equipment. This Rider's Manual describes option-

al extras (OE) offered by BMW and selected optional accessories (OA). This explains why the manual may also contain descriptions of equipment which you have not ordered. Please note, too, that your motorcycle might not be exactly as illustrated in this manual on account of country-specific differences. If your BMW was supplied with equipment not described in this Rider's Manual, you will find these features described in separate manuals.

Technical data

All dimensions, weights and power ratings stated in the Rider's Manual are quoted to the standards and comply with the tolerance requirements of the Deutsche Institut für Normung e.V. (DIN). Versions for individual countries may differ.

Currency

The high safety and quality standards of BMW motorcycles are maintained by constant development work on designs, equipment and accessories. Because of this, your motorcycle may differ from the information supplied in the Rider's Manual. Nor can BMW Motorrad entirely rule out errors and omissions. We hope you will appreciate that no claims can be entertained on the basis of the data, illustrations or descriptions in this manual.

General views

General view, left side.....	11
General view, right side	13
Underneath the seat	14
Handlebar fitting, left	15
Handlebar fitting, right	16
Instrument panel.....	17
Headlight	17

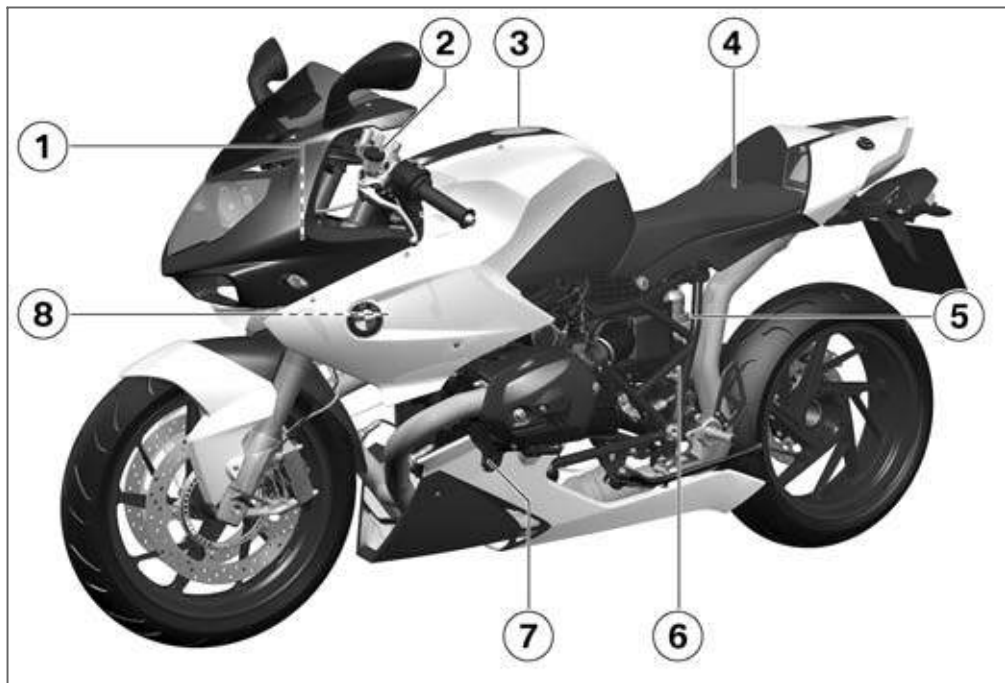

General view, left side

- 1** Adjuster for headlight beam throw (underneath the instrument panel) (⇒ 82)
- 2** Clutch-fluid reservoir (⇒ 129)
- 3** Fuel filler neck (⇒ 94)
- 4** Seat latch (⇒ 82)
- 5** Adjuster for spring preload, rear (⇒ 68)
- 6** Adjuster for damping characteristic, rear suspension (rebound stage) (⇒ 74)
- 7** Oil-level indicator (⇒ 123)
- 8** Adjuster for spring preload, front (behind side panel) (⇒ 68)

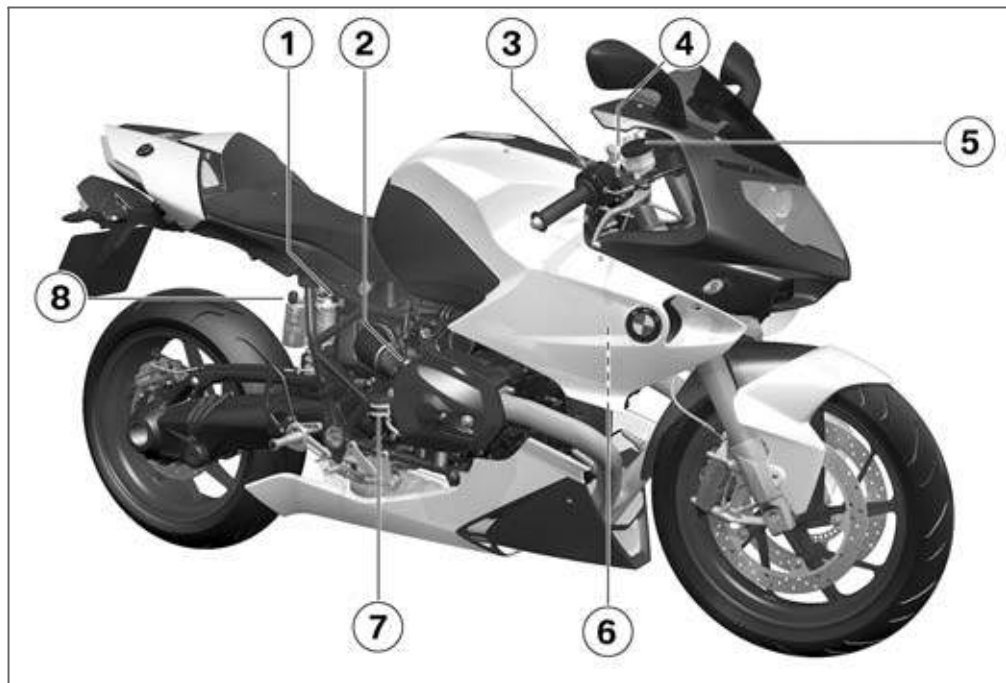

General view, right side

- 1 Power socket^{OA} (➔ 112)
- 2 Engine-oil filler neck
(➔ 124)
- 3 Adjuster for spring damping, front (rebound stage, in front of fuel filler neck)
(➔ 74)
- 4 Vehicle Identification Number (VIN) (underneath top fork bridge)
- 5 Brake-fluid reservoir, front
(➔ 127)
- 6 Adjuster for damping characteristic, front suspension (compression stage)
(➔ 74)
- 7 Brake-fluid reservoir, rear
(➔ 127)
- 8 Adjuster for damping characteristic, rear suspension (compression stage) (➔ 74)

Underneath the seat

- 1 Toolkit
- 2 Type plate
- 3 Table of tyre pressures
- 4 Battery (➔ 145)

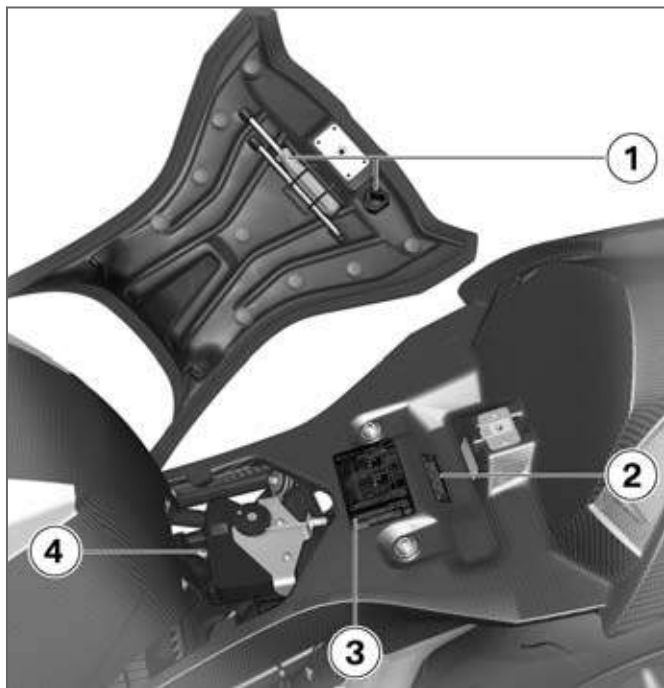



Handlebar fitting, left

- 1 Operation of the instrument panel (→ 32)
- 2 Operating the ABS^{OE} (→ 63)
- 3 Horn
- 4 Flashing turn indicators, left (→ 61), Hazard warning flashers (→ 61)
- 5 Headlight flasher and high-beam headlight (→ 60)

Handlebar fitting, right

- 1 Emergency-off switch (kill switch) (→ 62)
- 2 Starter button (→ 88)
- 3 Flashing turn indicators, right (→ 61), Hazard warning flashers (→ 61)
- 4 Cancel button, flashing turn indicators (→ 61), Pushbutton, cancel hazard warning flashers (→ 62)

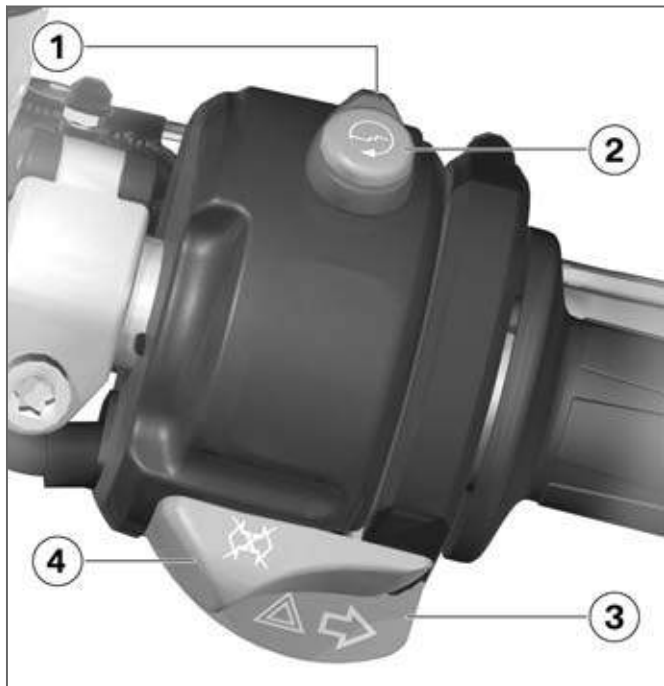

Instrument panel

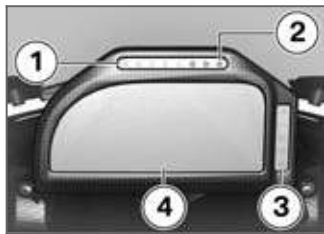

- 1** LED strip: indicator for progress of warm-up phase (⇒ 89), indicator for rpm limit (⇒ 21), Shift light (⇒ 37)
- 2** Sensor for ambient brightness (for adjustment of the brightness of the LEDs and the telltale and warning lights)
- 3** Telltale lights (⇒ 21)
- 4** Multifunction display (⇒ 20)

Headlight

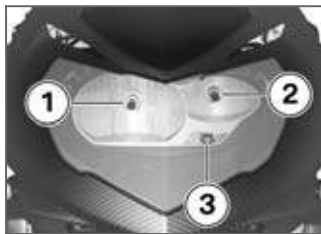

- 1** Low-beam headlight
- 2** High-beam headlight
- 3** Side light

Status indicators

Readings in ROAD mode	20
Warnings	22
ABS warnings ^{OE}	27

Readings in ROAD mode

Multifunction display

- 1 LED strip: indicator for progress of warm-up phase (⇒ 89), indicator for rpm limit (⇒ 21)
- 2 Rev. counter (digital)
- 3 Speedometer
- 4 Gear indicator (⇒ 21)
- 5 Trip meter (⇒ 34)
- 6 Stopwatch (⇒ 35)
- 7 Control panel (⇒ 32)
- 8 Odometer
- 9 Clock (⇒ 50)
- 10 Rev. counter (analog)

▶ The ROAD mode is the default mode for riding on public roads. The other modes are described in the next chapter. ◀

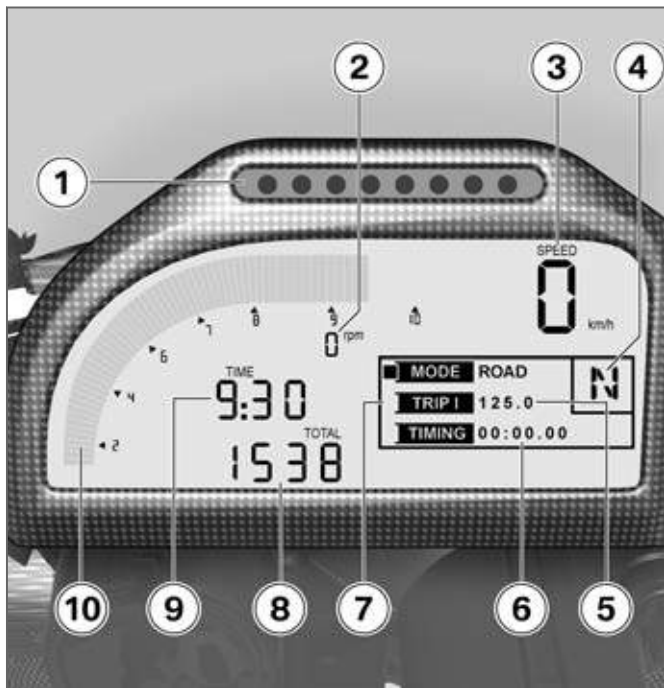

Telltale lights

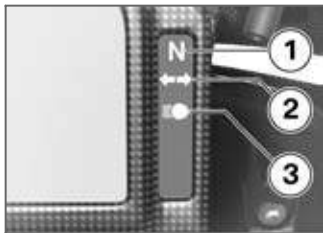

- 1 Idle
- 2 Turn indicators
- 3 High-beam headlight

Gear indicator

N The gear engaged or N for neutral appears on the display.

N If no gear is engaged, the 'neutral' telltale light also lights up.

Redline warning

The four LEDs on the right light up in succession as engine revs approach the rpm limit; if engine speed continues to increase all four LEDs start to flicker.

Warnings

Mode of presentation

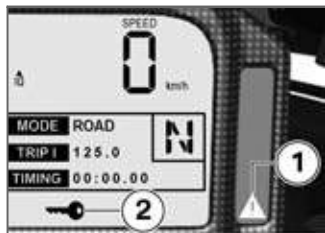

Warnings are indicated by 'General' warning light **1** showing in combination with a warning symbol such as, for example, **2**. The 'General' warning light shows red or yellow, depending on the urgency of the warning. If two or more warnings occur at the same time, all the appropriate warning lights and warning symbols appear.













The possible warnings are listed on the next page.

Warnings, overview

Telltale lights

Status indicators

Meaning

 Lights up yellow	 Appears on the display	Electronic immobiliser active (→ 24)
 Lights up yellow	 Flashes	Fuel down to reserve (→ 24)
 Lights up yellow	 Appears on the display	Engine in emergency-operation mode (→ 24)
 Flashes red	 Appears on the display	Insufficient engine oil pressure (→ 25)
 Lights up red	 Appears on the display	Insufficient battery charge current (→ 25)
	 Appears on the display	Rear light bulb defective (→ 25)
	 Appears on the display	Front light bulb defective (→ 26)
	 Appears on the display	Bulb defective (→ 26)

Electronic immobiliser active



General warning light shows yellow.



Key symbol appears on the display.

Possible cause:

The key being used is not authorised for starting, or communication between key and engine electronics is disrupted.

- Remove all other vehicle keys from the same ring as the ignition key.
- Use the reserve key.
- Have the defective key replaced, preferably by an authorised BMW Motorrad dealer.

Fuel down to reserve



General warning light shows yellow.



Fuel-pump symbol flashes.



Lack of fuel can result in the engine misfiring and cutting out unexpectedly. Misfiring can damage the catalytic converter; a hazardous situation can result if the engine cuts out unexpectedly.

Do not run the fuel tank dry. ◀

Possible cause:

The fuel tank contains no more than the reserve quantity of fuel.

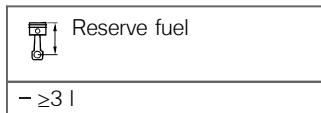

- Refuelling (→ 94)

Engine in emergency-operation mode



General warning light shows yellow.



Engine symbol appears on the display.



The engine is running in emergency operating mode. Engine power might be reduced and this can cause hazardous situations, particularly if you attempt to overtake other road users.

Engine power level might be lower than normal: adapt your style of riding accordingly. ◀

Possible cause:

The engine control unit has diagnosed a fault. In exceptional cases, the engine stops and refuses to start. Otherwise, the engine runs in emergency operating mode.

- You can continue to ride, but bear in mind that the usual engine power might not be available.
- Have the fault rectified as quickly as possible by a

specialist workshop, preferably an authorised BMW Motorrad dealer.

Insufficient engine oil pressure



General warning light flashes red.



Oil-can symbol appears on the display.

The oil pressure in the lube-oil system is too low. Stop immediately and switch off the engine.



The insufficient oil pressure warning does not fulfil the function of an oil gauge. The only way of checking whether the oil level is correct is to check the oil sight glass. ◀

Possible cause:

The engine-oil level is too low.

- Check the engine oil level (➔ 123)

If the oil level is too low:

- Top up the engine oil (➔ 124)

Possible cause:

The engine-oil pressure is insufficient.



Riding when engine-oil pressure is low can result in engine damage.

Do not continue your journey. ◀

- Have the fault rectified as quickly as possible by a specialist workshop, preferably an authorised BMW Motorrad dealer.

Insufficient battery charge current



General warning light shows red.



Battery symbol appears on the display.



A discharged battery can render various systems unavailable, for example the lights,

the engine or the ABS. This can result in dangerous situations.

If possible, do not continue your journey. ◀

Battery is not being charged. If you continue to ride the motorcycle the on-board electronics will drain the battery.

Possible cause:

Alternator or alternator drive belt defective

- Have the fault rectified as quickly as possible by a specialist workshop, preferably an authorised BMW Motorrad dealer.

Rear light bulb defective



Bulb symbol with arrow pointing to the rear appears on the display.



A defective bulb places your safety at risk because it is easier for other users to oversee the motorcycle.

Replace defective bulbs at the earliest possible opportunity.◀

Possible cause:

Rear light or brake light bulb defective.

- The LED rear light can be replaced only as a complete unit. Consult a specialist workshop, preferably an authorised BMW Motorrad dealer.

Front light bulb defective



Bulb symbol with arrow pointing to the front appears on the display.



A defective bulb places your safety at risk because it is easier for other users to oversee the motorcycle.

Replace defective bulbs as soon as possible; always carry a complete set of spare bulbs if possible.◀

Possible cause:

Low-beam headlight, high-beam headlight or side-light bulb defective.

- Replace the low-beam and high-beam headlight bulb (➡ 139)
- Replacing parking-light bulb (➡ 141)

Bulb defective



Bulb symbol with arrows appears on the display.



A defective bulb places your safety at risk because it is easier for other users to oversee the motorcycle.

Replace defective bulbs as soon as possible; always carry a complete set of spare bulbs if possible.◀

Possible cause:

Turn-indicator bulb or several bulbs defective.

- Visually inspect to ascertain which bulb is defective.
- Replace the low-beam and high-beam headlight bulb (➡ 139)
- Replacing parking-light bulb (➡ 141)
- Replacing turn indicator bulbs, front and rear (➡ 142)
- The LED rear light can be replaced only as a complete unit. Consult a specialist workshop, preferably an authorised BMW Motorrad dealer.

ABS warnings^{OE}

Mode of presentation

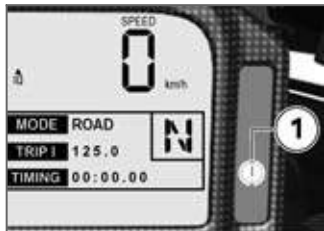

ABS warnings are indicated by ABS warning light **1**.

The detailed descriptions relating to BMW Motorrad ABS start on page (→ 98), and you will find an overview listing the possible warnings on the next page.

Warnings, overview**Telltale lights****Status indicators****Meaning**

Flashes

Self-diagnosis not completed (➔ 29)



Lights up

ABS deactivated (➔ 29)



Lights up

ABS fault (➔ 29)

Self-diagnosis not completed



ABS warning light flashes.

Possible cause:

The ABS function is not available, because self-diagnosis did not complete. The motorcycle has to move forward a few metres for the wheel sensors to be tested.

- Pull away slowly. Bear in mind that the ABS function is not available until self-diagnosis has completed.

ABS deactivated



ABS warning light shows.

Possible cause:

The rider has switched off the ABS system.

– with BMW Motorrad ABS^{OE}

- Activate the ABS function (➡ 63)

ABS fault



ABS warning light shows.

Possible cause:

The ABS control unit has detected a fault. The ABS function is not available.

- You can continue to ride the motorcycle, but make due provision for the fact that the ABS function is not available. Bear in mind the more detailed information on situations that can lead to an ABS fault (➡ 99).
- Have the fault rectified as quickly as possible by a specialist workshop, preferably an authorised BMW Motorrad dealer.

Instrument panel

Diversity	32
Operation	32
Selecting display mode	33
ROAD mode	34
RACE mode	37
INFO mode	46
Settings	50
Infrared receiver ^{OA}	55

Diversity

The instrument panel offers diverse views and customisable settings.

The ROAD mode provides you with all the information necessary for riding on public roads. Information of importance for racing can be viewed in RACE mode, and this mode also enables you to save this information for each lap so that it can subsequently be viewed in INFO mode.

The SETUP mode enables you to configure the instrument-panel readings in line with your personal preferences.



Operation

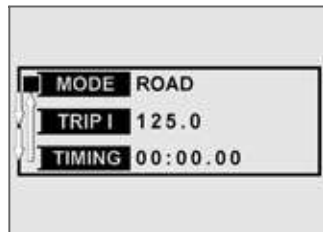

- Press MENU button **2** to position the cursor to the left of the line of your choice in the control panel.



The cursor moves to the next line each time you press the MENU button.

-  The line can be selected if the left end is open.
-  The line cannot be selected if the left end is closed.

Selecting display mode



- Press SET button **1** to activate the function stated in the line you selected.



- Repeatedly press MENU button **2** until the cursor is to the left of the **MODE** field.
- Press SET button **1**.

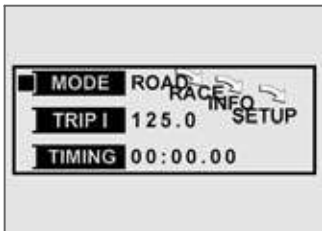

The display cycles to the next option in the list each time you press the SET button.

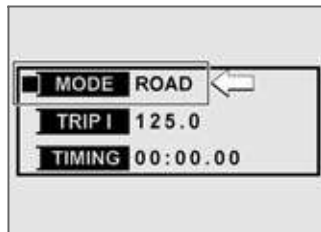

The display starts with the current mode and each time the button is pressed it moves one step through the following sequence:

- On-road riding (**ROAD**)
- On-track riding (**RACE**)
- View race data stored in memory (**INFO**) (only when the motorcycle is at a standstill)
- Basic settings (**SETUP**) (only when the motorcycle is at a standstill)

ROAD mode

Selecting odometer



- Repeatedly press MENU button **2** until the cursor is to the left of the middle field.
- Press SET button **1**.



The display starts with the current value and each time the button is pressed it moves one step through the following sequence:

- Tripmeter 1 (Trip I)
- Tripmeter 2 (Trip II)
- Residual range (RANGE) (when fuel level is down to reserve)

Resetting tripmeter

- Select the desired tripmeter.



- Press and hold down SET button **1**.
- » The tripmeter is reset to zero.

Residual range

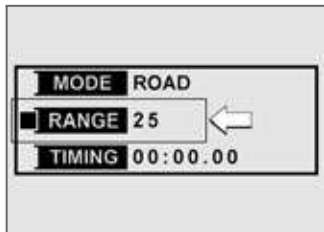

The residual-range reading appears accompanied by the word **RANGE** and indicates how far you can ride with the fuel remaining in the tank. This reading is not displayed until fuel level has dropped to reserve. This distance is calculated on the basis of fuel level and average consumption.

When refuelling after running on reserve, make sure that you top up the tank to a level above reserve, as otherwise the sensor will not be able to register the new level. If the sensor cannot

register the new level neither the fuel-level reading nor the residual-range readout can be updated.

▶ The calculated range is an approximate value. Consequently, BMW Motorrad recommends that you should not try to use the full residual range before refuelling.◀

Operating stopwatch



- Repeatedly press MENU button **2** until the cursor is to the left of the **TIMING** field.

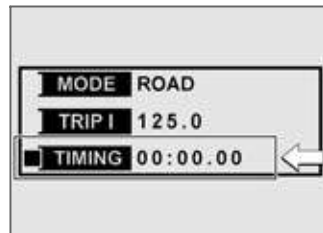

- Press SET button **1** while the stopwatch is not running.
- » The stopwatch begins timing in tenths of a second from the time originally shown.

- » The stopwatch keeps running even if you change the mode or switch off the ignition.
- Press the SET button while the stopwatch is running.
- » The stopwatch shows the stopped time.
- Press and hold down the SET button.
- » The stopwatch is reset to zero.

RACE mode

Display in RACE mode

In RACE mode the display shows information on each lap, and this information is also saved by the instrument. The display is operated by the SET button on the handlebar fitting or by means of an infrared sensor available as an optional accessory. When the motorcycle has been brought to a stop you can select the INFO mode to view the information stored in memory.

In RACE mode the LED strip acts as an upshift indicator. You can set the rpm threshold for each LED.

You can use the display as a LAP monitor or as a SPEED monitor.

Readings of the LAP monitor:

- Time expired on this lap
- Fastest lap time
- Number of laps completed
- Race time expired

Each time you finish a lap the readout indicating your lap time is frozen for an adjustable period of time so that it is easier to read. When this freeze time expires the readout switches back to your current lap time.

Readings of the SPEED monitor:

- Highest speed on this lap
- Lowest speed on this lap
- Number of laps completed
- Race time expired

The scope of information that can be called up in INFO mode depends on the monitor you select. If you switch temporarily to

ROAD mode, all measurements are resumed in RACE mode.

Race-time measurement is automatically interrupted for each period for the duration of which the motorcycle is at a standstill. Measurement resumes as soon as the motorcycle starts to move. Lap timing continues even if the motorcycle stops.

The measured values are retained in memory if the ignition is switched off. The measurements are resumed as soon as the ignition is switched on again.

Display as LAP monitor

- 1 Gear indicator instead of speedometer
- 2 Speedometer instead of gear indicator
- 3 Race time
- 4 Number of laps completed
- 5 Fastest lap
- 6 Time expired on this lap

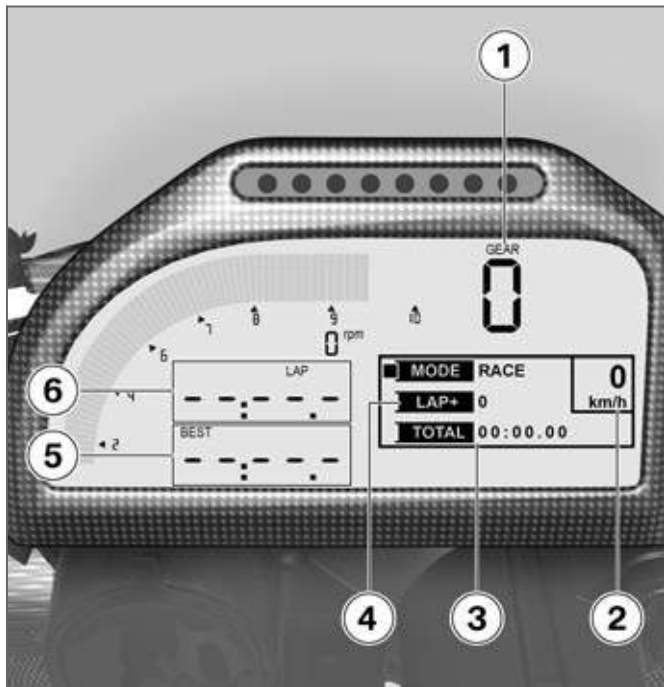

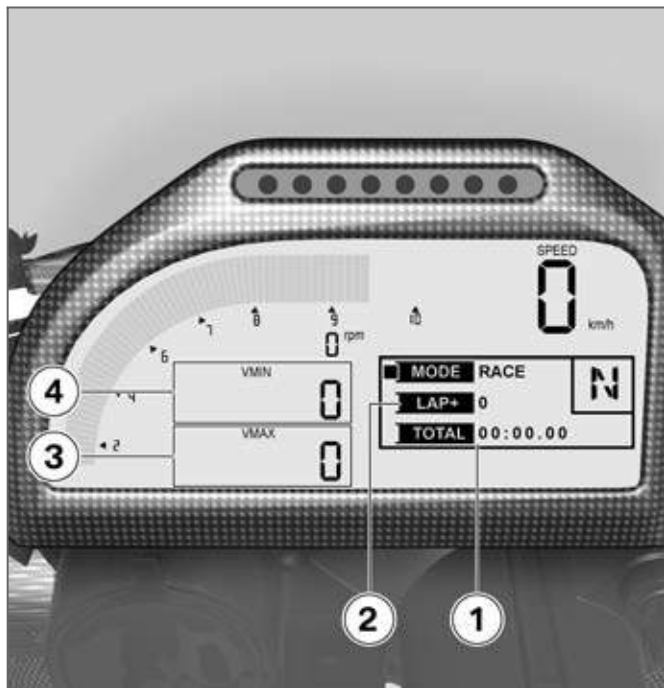

Display as SPEED monitor

- 1 Race time
- 2 Number of laps completed
- 3 Highest speed on this lap
- 4 Lowest speed on this lap

Selecting RACE monitor

- Select SETUP mode.

▶ You can make this adjustment only when the motor-cycle is at a standstill. ◀

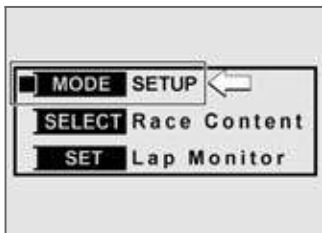

- Press MENU button **2** twice.
 - » The cursor is to the left of the SET field.
- Repeatedly press SET button **1** until the monitor you want to use appears on the display.
 - » possible settings:
 - Lap Monitor
 - Speed Monitor
 - » The monitor you selected appears on the display when you change to RACE mode.

Operating RACE monitor

- Select RACE mode.

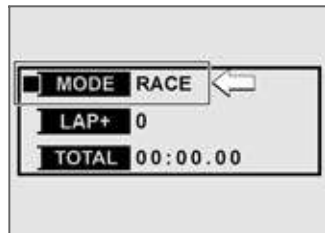

- Press MENU button **2** once.

- » The cursor is to the left of the LAP + field.
 - » The lap counter flashes at 0.
- If the lap counter shows a number other than zero:
- Reset the RACE monitor (→ 41)



- At the start of the race, press SET button **1**.
- » Measurement of race and lap times starts.
- » The number of completed laps is counted.
- » in the LAP monitor:
 - the lap time is shown

- as of the second lap, the fastest lap time is shown
- » in the SPEED monitor:
 - the fastest and slowest speeds of the current lap are shown
- At the end of each lap, press the SET button.
- » Measurements for the next lap are started.
- Press and hold down the SET button.
- » The measurements are paused.
- » The number shown by the lap counter flashes.
- Press the SET button.
- » The measurements are resumed.

Resetting RACE monitor



- Press and hold down SET button **1**.

▶ If you reset the RACE monitor in the next step all the data stored in memory is deleted and can no longer be called up in INFO mode.◀

- » The measurements are paused.
- » The number shown by the lap counter flashes.
- Again press and hold down SET button **1**.

» The readings are reset.

Setting freeze time for lap-time readout in the LAP monitor

- Select SETUP mode.

▶ You can make this adjustment only when the motorcycle is at a standstill. ◀

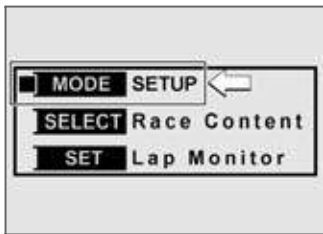

- Press MENU button **2** once.
 - » The cursor is to the left of the **SELECT** field.
- Repeatedly press SET button **1** until **Freeze Time** appears on the display.

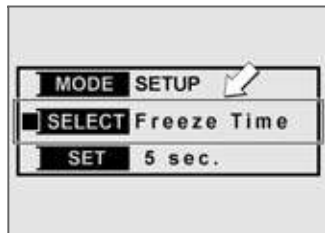

- Press MENU button **2** once.
 - » The cursor is to the left of the **SET** field.
- Repeatedly press SET button **1** until the time you want to use as the freeze time dur-

ing which the readout remains visible appears on the display.

- » Each time you press the button the time increases by five seconds: the range is from 0 to 30 seconds.

Setting upshift indicator

- Select SETUP mode.

▶ You can make this adjustment only when the motor-cycle is at a standstill. ◀

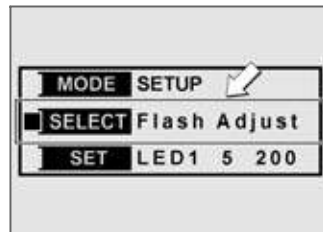

- Press MENU button **2** once.
- » The cursor is to the left of the **SELECT** field.
- Repeatedly press SET button **1** until **Flash Adjust** appears on the display.



- Press MENU button **2** once.
- » The cursor is to the left of the **SET** field.



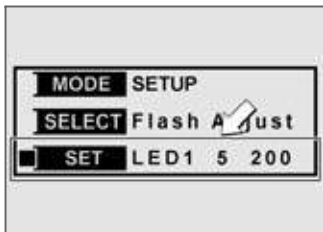

» The first LED lights up and the rpm threshold for upshifting is shown (in this example LED 1 lights up at 5200 rpm).



- Press SET button **1** once for each step.
- » Each time you press the button the next LED lights up and the corresponding rpm threshold for upshifting is shown.

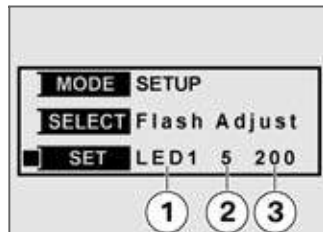

- Repeatedly press the SET button until the LED you want lights up.
- » The number of the active LED is shown at position **1**.
- Press and hold down the SET button until thousands digit **2** flashes.
- Repeatedly press SET button until the number you want is shown.
- Press and hold down the SET button until hundreds number **3** flashes.
- Repeatedly press SET button until the number you want is shown.

- Hold down the SET button until the hundreds number stops flashing.
 - » The time you selected is now set as the duration.

INFO mode

Display in INFO mode

In INFO mode you can call up the information stored beforehand for each race lap in RACE mode.

Readings in INFO mode

- Highest engine rpm
- Average speed
- Number of gearshifts
- Lap time
- Lap shown and number of laps recorded
- Highest speed
- Lowest speed
- Lap length
- Average throttle-valve angle
- Proportion of time ridden with the brakes applied

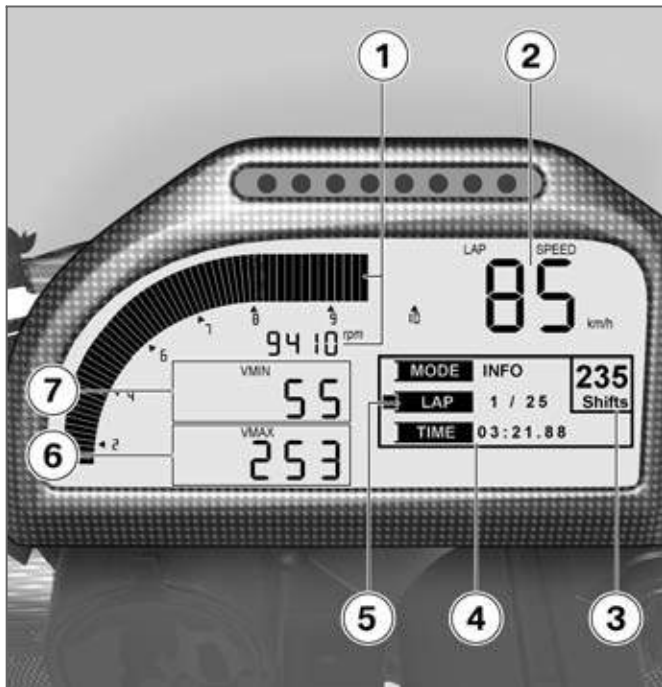

Display in INFO mode

- 1 Highest rpm on the lap currently displayed
- 2 Average speed for the lap currently displayed
- 3 Number of gearshifts on the lap currently displayed
- 4 Lap time for the lap currently displayed
- 5 Lap to which the data currently displayed apply / number of timed laps
- 6 Highest speed on the lap currently displayed
- 7 Lowest speed on the lap currently displayed

Using INFO mode

- Select INFO mode.

▶ You can make this adjustment only when the motor-cycle is at a standstill. ◀

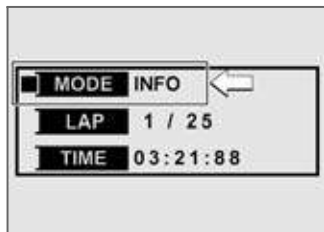

- Press MENU button **2** once.
 - » The cursor is to the left of the LAP field.
- Press SET button **1** once at each step.
 - » Each time you press the button the next in the sequence of parameters for the next lap as described below is shown.
- To view the readings for lap length, average throttle-valve setting and the proportion of the lap ridden with the brakes applied: press MENU button **2** once.

» The cursor is to the left of the TIME field.

- Press SET button **1** once at each step.

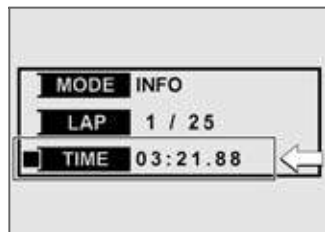

Each time the button is pressed the display cycles to the next step in the following sequence:

- Lap time (TIME)
- Circuit length (DIST.)
- Average throttle-valve aperture (THROT.)
- Proportion of distance ridden with brakes applied (BRAKE)

- » The minimum for each readout is indicated by `min!` and the maximum by `max!`.

Settings

Setting clock

- Select SETUP mode.

▶ You can make this adjustment only when the motor-cycle is at a standstill. ◀



- Press MENU button **2** once.
» The cursor is to the left of the SELECT field.
- Repeatedly press SET button **1** until SELECT Clock appears on the display.



- Press MENU button **2** once.
» The cursor is to the left of the SET field.

- Press and hold down SET button **1** until the hours number flashes.
- Repeatedly press the SET button until the hours number is correct.
- Hold down the SET button until the minutes number flashes.
- Repeatedly press the SET button until the minutes number is correct.
- Hold down the SET button until the minutes number stops flashing.
- » The clock is now set to the time you selected.

Adjusting brightness of the LED strip

- Select **SETUP** mode.

▶ You can make this adjustment only when the motorcycle is at a standstill. ◀

▶ The instrument panel has automatic day/night switchover for the lighting. The brightness of the LEDs is set for daylight riding. This value is then used as the basis for reduced brightness for riding in the dark. ◀



- Press **MENU** button **2** once.
- » The cursor is to the left of the **SELECT** field.
- Repeatedly press **SET** button **1** until **Flash Brightn** appears on the display.

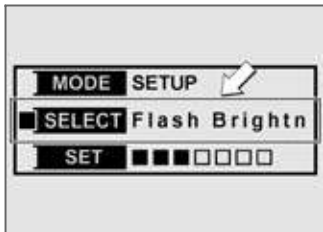

- Press MENU button **2** once.
- » The cursor is to the left of the **SET** field.
- Press SET button **1**.

» Brightness increases each time you press the button, as indicated by the number of filled boxes. The LEDs are off if all the boxes are empty.

Adjusting backlight

- Select **SETUP** mode.

▶ You can make this adjustment only when the motor-cycle is at a standstill.◀



- Press MENU button **2** once.
- » The cursor is to the left of the **SELECT** field.
- Repeatedly press SET button **1** until **Backlight** appears on the display.

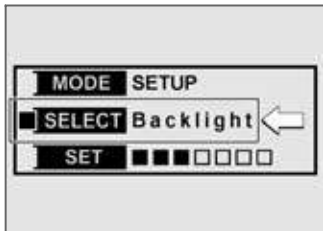

» Brightness increases each time you press the button, as indicated by the number of filled boxes (backlight can be dimmed, but not switched off completely).

Selecting start logo

- Select **SETUP** mode.

▶ You can make this adjustment only when the motor-cycle is at a standstill.◀

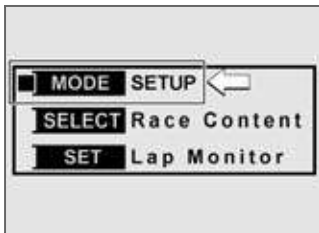

- Press **MENU** button **2** once.
- » The cursor is to the left of the **SET** field.
- Press **SET** button **1**.



- Press **MENU** button **2** once.
- » The cursor is to the left of the **SELECT** field.
- Repeatedly press **SET** button **1** until **Start Logo** appears on the display.



» The start logo toggles between activated (On) and deactivated (Off).

Restoring factory defaults

- Select SETUP mode.

▶ You can make this adjustment only when the motorcycle is at a standstill. ◀



- Press MENU button **2** once.
- » The cursor is to the left of the SET field.
- Press SET button **1**.

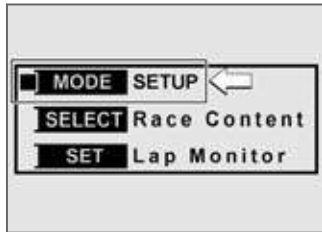

- Press MENU button **2** once.
- » The cursor is to the left of the SELECT field.
- Repeatedly press SET button **1** until Reset Dash appears on the display.



» The words **Factory Res.** flash and all factory default settings are restored.

Infrared receiver^{OA}

Convenient lap timing

An infrared signal provides a convenient way of operating the instrument panel in RACE mode. The instrument panel can be operated in this way only when the infrared receiver available as an optional accessory is connected. The SET button can still be used to operate the instrument panel even when the infrared receiver is installed.

A lap timeout can be defined to stop the receiver from registering completion of a lap prematurely in response to spurious signals. Signals received before this time elapses are ignored. The lap timeout does not apply to operation by means of the SET button.



- Press MENU button **2** once.
- » The cursor is to the left of the SET field.
- Press and hold down SET button **1**.

Setting the lap timeout

- Select SETUP mode.

 You can make this adjustment only when the motor-cycle is at a standstill. ◀

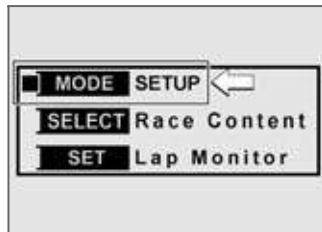



- Press MENU button **2** once.
- » The cursor is to the left of the **SELECT** field.
- Repeatedly press SET button **1** until **Lap Timeout** appears on the display.



- Press MENU button **2** once.
- » The cursor is to the left of the **SET** field.
- » The lap timeout set beforehand appears on the display.

- Press and hold down SET button **1** until the minutes number flashes.
- Repeatedly press the SET button until the minutes number is correct.
- » Time range: 00:00 to 10:59
- Hold down the SET button until the seconds number flashes.
- Repeatedly press the SET button until the seconds number is correct.
- Hold down the SET button until the seconds number stops flashing.
- » The time you selected is now set as the lap timeout.

Operation

Ignition switch and steering lock	58	Height of suspension	77
Electronic immobiliser (EWS)	59	Tyres	81
Lights	60	Headlight	82
Turn indicators	61	Front seat	82
Hazard warning flashers	61		
Emergency off switch (kill switch)	62		
BMW Motorrad ABS ^{OE}	63		
Clutch	64		
Shift lever	64		
Brakes	65		
Mirrors	66		
Handlebars	66		
Footrests	68		
Spring preload	68		
Damping	74		

Ignition switch and steering lock

Keys

You receive one master key and one spare key, plus a key for removing the seat. Please consult the information on the electronic immobiliser (EWS) if a key is lost or mislaid (→ 59).

Ignition switch and steering lock and the tank filler cap lock are all operated with the same key.

Switching on ignition



- Turn the key to position **1**.

- » Side light and all function circuits switched on.
- » Engine can be started.
- » Pre-ride check is performed. (→ 89)
- with BMW Motorrad ABS^{OE}
 - Turn the key to position **1**.
 - » ABS self-diagnosis is performed in addition to the checks outlined above. (→ 90)◁

Switching off ignition



- Turn the key to position **2**.
- » Lights switched off.

- » Handlebars not locked.
- » Key can be removed.
- » Electrically powered accessories remain operational for a limited period of time.
- » The battery can be recharged via the on-board socket.

Locking handlebars



! If the motorcycle is on the side stand, the surface of the ground will determine whether it is better to turn the handlebars to the left or right. However, the motorcycle is more stable on a level surface with the handlebars turned to the left than with

the handlebars turned to the right.

On level ground, always turn the handlebars to the left to set the steering lock.◀

- Turn the handlebars to the full left or right lock position.
- Turn the key to position **3**, while moving the handlebars slightly.
- » Ignition, lights and all function circuits switched off.
- » Handlebars locked.
- » Key can be removed.

Electronic immobiliser (EWS)

Protection against theft

The electronic immobiliser helps protect your BMW motorcycle from theft, and this enhanced security is at your disposal without any need for you to set parameters or activate additional systems. The engine of a motorcycle fit-

ted with this electronic immobiliser can be started only with the keys that belong to the vehicle. You can also have your authorised BMW Motorrad dealer bar individual keys, for example if a particular key goes missing. The engine cannot be started with a key that has been barred.

In-key electronics

The motorcycle's electronics exchange certain continuously changing signals with the electronics in the key; these signals are specific to your motorcycle and they are transmitted via the ring aerial in the ignition lock. The ignition is not enabled for starting until the key has been recognised as "authorised" for your motorcycle.

 A spare key attached to the same ring as the ignition key used to start the engine could "irritate" the electron-

ics, in which case the enabling signal for starting is not issued. The EWS warning appears in the multifunction display. Always keep the spare key separately from the ignition key.◀

Replacement and extra keys

You can obtain replacement/extra keys only through an authorised BMW Motorrad dealer. The keys are part of an integrated security system, so the dealer is under an obligation to check the legitimacy of all applications for replacement/extra keys. If you want to have a lost key barred, you have to bring with you all the other keys that belong to the motorcycle. A key that has been barred can subsequently be cleared and reactivated for use.

Lights

Side light

The side lights switch on automatically when the ignition is switched on.

▶ The side lights place a strain on the battery. Do not switch the ignition on for longer than absolutely necessary. ◀

Low-beam headlight

The low-beam headlight switches on automatically when you start the engine.

▶ When the engine is not running you can switch on the lights by switching on the ignition and either switching on the high-beam headlight or operating the headlight flasher. ◀

High-beam headlight and headlight flasher



- Press the top section of full-beam headlight switch **1**.
 - » High-beam headlight switched on.
- Move full-beam headlight switch **1** to the centre position.
 - » High-beam headlight switched off.
- Press the bottom section of full-beam headlight switch **1**.
 - » The high-beam headlight is switched on until you release the button (headlight flasher).

Switching on parking lights

- Switch off the ignition.



- Immediately after switching off the ignition, press and hold down button **1** for the left turn indicators.
 - » Parking light switches on.

Switching off parking lights

- Switch the ignition on and then off again.
 - » Parking lights switched off.

Turn indicators

Switching on left flashing turn indicators

- Switch on the ignition.

▷ The turn indicators are cancelled automatically after you have ridden for approximately 10 seconds, or covered a distance of about 200 m.◀



- Press button **1** for the left-hand turn indicators.
 - » Left-hand turn indicators switched on.
 - » Turn-indicator telltale light flashes.

Switching on right flashing turn indicators

- Switch on the ignition.

▷ The turn indicators are cancelled automatically after you have ridden for approximately 10 seconds, or covered a distance of about 200 m.◀



- Press button **2** for the right-hand turn indicators.
 - » Right-hand turn indicators switched on.
 - » Turn-indicator telltale light flashes.

Cancelling turn indicators



- Press cancel button **3**.
 - » Flashing turn indicators switched off.
 - » Turn-indicator telltale light is off.

Hazard warning flashers

Switching on hazard warning flashers

- Switch on the ignition.

▷ The hazard warning flashers place a strain on the battery. Do not use the hazard

warning flashers for longer than absolutely necessary. ◀

▶ If you press a turn-indicator button with the ignition switched on, the turn-indicator function is activated instead of the hazard warning flashers, and remains active until you release the button. The hazard warning flashers recommence flashing as soon as the button is released. ◀

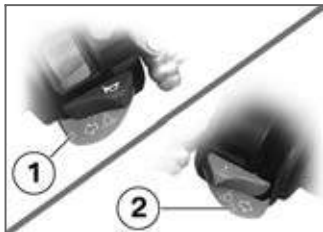

- Simultaneously press button **1** for left turn indicators and button **2** for right turn indicators.

- » The hazard warning flashers are switched on.
- » Turn-indicator telltale light flashes.

⚠ General warning light flashes red.

- Switch off the ignition.
- » The hazard warning flashers continue to operate.
- » Turn-indicator telltale light and 'General' warning light are off.

Switching off hazard warning flashers



- Press cancel button **3**.

- » Hazard warning flashers switched off.

Emergency off switch (kill switch)



- 1** Emergency off switch (kill switch)

⚠ Operating the kill switch when riding can cause the rear wheel to lock and thus cause a fall.

Do not operate the kill switch when riding. ◀

The emergency off switch is a kill switch for switching off the engine quickly and easily.

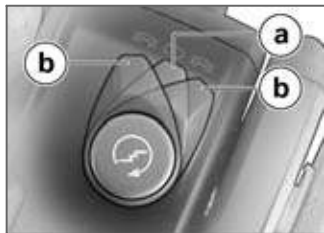

- a** Normal operating position (run)
- b** Engine switched off.

▶ You cannot start the engine unless the kill switch is in the run position.◀

BMW Motorrad ABS^{OE}

Deactivating ABS function

- Bring the motorcycle to a stop or, if the motorcycle is at a

standstill, switch on the ignition.



- Press and hold down button **1** until the ABS warning light changes status.



ABS warning light shows.

- Release the ABS button within two seconds.



ABS warning light remains ON.

- » The ABS function is deactivated.

Activating ABS function



- Press and hold down button **1** until the ABS warning light changes status.



ABS warning light goes out; if self-diagnosis has not completed it starts flashing.

- Release the ABS button within two seconds.



The ABS warning light remains off or continues to flash.

- » The ABS function is activated.
- You also have the option of switching the ignition off and then on again.

▷ If you switch the ignition off then on again and the ABS light comes back on, there is a fault in the ABS. ◀

Clutch

Adjusting clutch lever

⚠ If the position of the clutch fluid reservoir is changed, air can enter the clutch system. Do not twist the handlebar fitting or the handlebars. ◀

⚠ Attempting to adjust the clutch lever while riding the motorcycle can lead to accidents. Do not attempt to adjust the clutch lever unless the motorcycle is at a standstill. ◀



- Turn adjusting screw **1** clockwise.

▷ The adjusting screw is indexed and is easier to turn if you push the clutch lever forward. ◀

- » Span between handlebar grip and clutch lever increases.
- Turn adjusting screw **1** counter-clockwise.
- » Span between handlebar grip and clutch lever decreases.

Shift lever

Adjusting shift lever



- Slacken screw **1**.
- Turn peg **2** to the desired position.

▷ You might experience difficulties with gearshifts if the peg is set either too high or too low. Check the setting of the peg if you experience gearshift difficulties. ◀

⚠ Threaded fasteners not tightened to the specified torque can work loose or their threads can suffer damage.

Always have the security of the fasteners checked by a specialist workshop, preferably an authorised BMW Motorrad dealer. ◀

- Tighten screw **1** to the specified torque.

 Eccentric, peg to shift lever

– Thread-locking compound:
Micro-encapsulated

– 8 Nm



- To restore the factory setting: align the peg with mark **3**.

Brakes

Adjusting handbrake lever

 Changing the position of the brake-fluid reservoir can allow air to penetrate the brake system.

Do not twist the handlebar fitting or the handlebars. ◀

 Attempting to adjust the brake lever while riding the motorcycle can lead to accidents. Do not attempt to adjust the brake lever unless the motorcycle is at a standstill. ◀



- Turn adjusting screw **1** clockwise.

 The adjusting screw is indexed and is easier to turn if you push the handbrake lever forward. ◀

- » Span between handlebar grip and handbrake lever increases.
- Turn adjusting screw **1** counter-clockwise.
- » Span between handlebar grip and handlebar lever decreases.

Adjusting footbrake lever

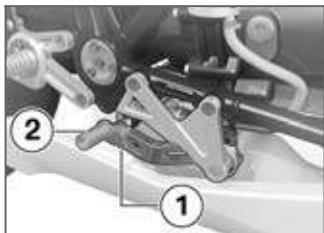

- Slacken screw **1**.
- Turn peg **2** to the desired position.

⚠ Threaded fasteners not tightened to the specified torque can work loose or their threads can suffer damage. Always have the security of the fasteners checked by a specialist workshop, preferably an authorised BMW Motorrad dealer. ◀

- Tighten screw **1** to the specified torque.



Eccentric, peg to footbrake lever

– Thread-locking compound:
Micro-encapsulated

– 8 Nm



- To restore the factory setting: align the peg with mark **3**.

Mirrors

Adjusting mirrors

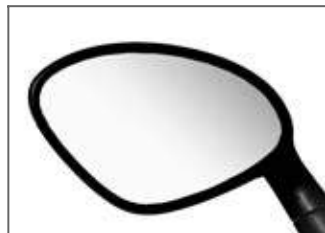

- Pivot the mirror to the correct position by pressing gently at the edge.

Handlebars

Adjusting handlebars

▶ The following descriptions of operations involving the clutch lever fitting and the left stub handlebar apply by analogy to the handbrake fitting and the right stub handlebar. ◀

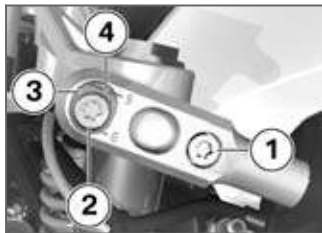

⚠ Pulling the handlebar lever while the reservoir is at an angle can enable air to enter the system.

Do not operate the handlebar lever when the unit has been removed.◀

- Remove screw **1** and remove the clutch lever fitting.

- Slacken screw **1**.
- Remove screw **2**.
- Remove bushing **3** and reinsert it at the desired position.
 - » Marking line **4** up: low position.
 - » Marking line **4** down: high position.

⚠ Threaded fasteners not tightened to the specified torque can work loose or their threads can suffer damage. Always have the security of the fasteners checked by a specialist workshop, preferably an authorised BMW Motorrad dealer.◀

- Install screw **2**, tighten screws **1** and **2** to the specified torque.

 Stub handlebar to handlebar bridge

- | |
|--|
| – Tightening sequence: begin by tightening inboard screw |
| – 10 Nm (Initial torque) |
| – 21 Nm (Final torque) |

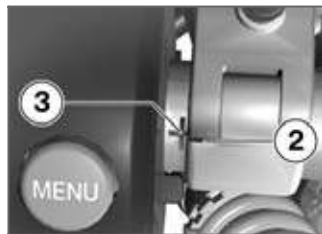

- Hold the clutch lever fitting in position and as shown here, align it with opening **2** at mark **3**.



 Threaded fasteners not tightened to the specified torque can work loose or their threads can suffer damage. Always have the security of the fasteners checked by a specialist workshop, preferably an authorised BMW Motorrad dealer. ◀

- Install screw **1** and tighten to specified torque.

 Handlebar fitting to handlebar

– 5 Nm

- Check the operation of the clutch lever.

Footrests

Adjusting footrests



- Slacken screws **1** on left and right.
- Turn left and right footrests **2** to the desired position.
 - » The footrests engage with an audible click.
- Tighten screws **1** on left and right.

 Clamp, eccentric adjustment, footrests

– Thread-locking compound: Micro-encapsulated

 Clamp, eccentric adjustment, footrests

– 15 Nm

- To restore the factory setting: advance the footrests to the forward position.

Spring preload Setting

Front and rear spring preload has to be adjusted to suit the rider's weight. Spring extension is set by measuring the difference between the heights of the suspension with and without the rider's weight applied.

Adjusting spring preload for front wheel



- Remove screws **1** on left and right.
- Work the cover of the fuel tank to the rear to remove.



- Remove screw **1** from the intake air pipe.



- Disengage both retainers **2** by pressing at rear and remove.
- Remove the intake air pipe.



 Your motorcycle's handling will suffer if you do not match the spring-preload and damping-characteristic settings. Adjust the damping characteristic to suit spring preload.◀

- Use adjusting rings **1** and **2** to adjust spring preload.

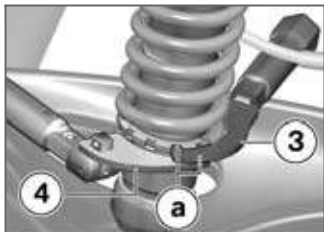

- To turn the adjusting rings: use tool **3** from the on-board toolkit to counter-hold and tool **4** to turn the ring. Make sure that hooks **a** are each securely engaged in a recess.

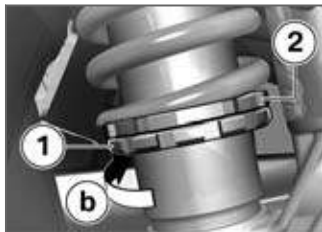

- Slacken the lock by tightening adjusting ring **1** in direction **b** with the tool from the toolkit, while counter-holding adjusting ring **2**.
- Take all weight off the front wheel.



- Measure distance **d** between top edge of top fork bridge **5** and top edge of bottom fork bridge **6**.
- Apply the rider's weight to the motorcycle.
- With the assistance of a second person, measure distance **d** between points **5** and **6** again and calculate the difference between the two readings.

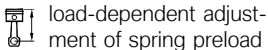

load-dependent adjustment of spring preload

- 33 mm (Negative spring displacement of front wheel under load)

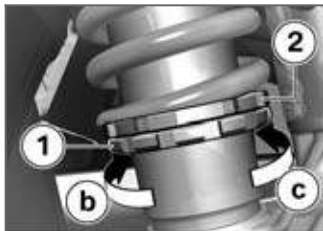

- If you want to reduce the difference (increase spring preload, in other words), turn adjusting ring **1** in direction **c**.
- If you want to increase the difference (reduce spring preload, in other words), turn adjusting ring **2** in direction **b**.

- Tighten the lock by tightening adjusting ring **1** in direction **c** with the tool from the toolkit, while holding adjusting ring **2** with the second tool from the toolkit.



Locknut for spring basic setting to spring retainer

- 5 Nm

- Adjust the damping characteristic to suit spring preload.



- Hold the air intake pipe in position.

- Push in both retainers **2** until they engage with an audible click.



- Check that the throttle-valve cable is seated in guide **3** of the intake and that the throttle valve is seated against the stop.



- Install screw **1** and tighten until hand-tight.



- Ease the cover for the fuel tank forward over the fuel tank.
- Install screws **1** on right and left and tighten until hand-tight.

Adjusting spring preload for rear wheel

- Make sure the ground is level and firm and place the motorcycle on its stand.

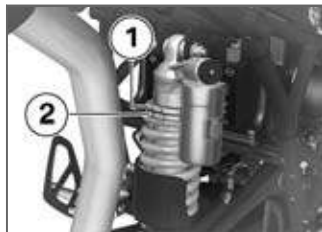

- **!** Your motorcycle's handling will suffer if you do not match the spring-preload and damping-characteristic settings. Adjust the damping characteristic to suit spring preload. ◀

- Use adjusting rings **1** and **2** to adjust spring preload.

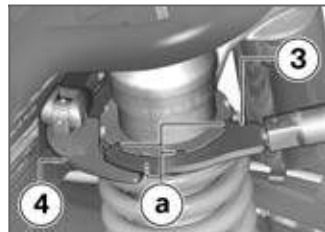

- **!** Risk of short-circuit at the battery's negative terminal. When inserting tools into the tool tray, take care not to touch the negative terminal of the battery. ◀

- To turn the adjusting rings: use tool **4** from the on-board toolkit to counter-hold and tool **3** to turn the ring. Make sure that hooks **a** are each securely engaged in a recess.

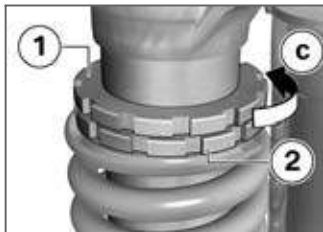

- Release the lock by turning adjusting ring **1** in direction **c** with the tool from the toolkit, while holding adjusting ring **2** with the second tool from the toolkit.

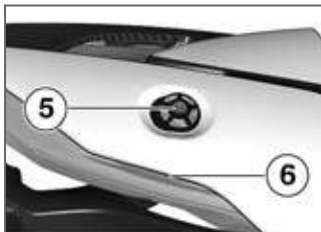

- In order to ensure that the reference point for measurement is correct, always centre the measuring tape over screw **5** and read off the distance at edge **6**.
- Make sure there is no load on the rear wheel; remove all items of luggage, if carried.



- Measure distance **d** between edge **6** of tail section as described above, and top of axle tube **7**.
- Apply the rider's weight to the motorcycle.
- With the assistance of a second person, measure distance **d** between points **6** and **7** again and calculate the difference between the two readings.



load-dependent adjustment of spring preload

- 36 mm (Negative spring displacement of rear wheel under load)

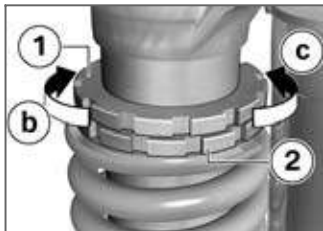

- If you want to reduce the difference (increase spring preload, in other words), turn adjusting ring **2** in direction **b**.
- If you want to increase the difference (reduce spring preload, in other words), turn adjusting ring **2** in direction **c**.

- Tighten the lock by tightening adjusting ring **1** in direction **b** with the tool from the toolkit, while holding adjusting ring **2** with the second tool from the toolkit.



Locknut for spring basic setting at top spring retainer

- 5 Nm

- Adjust the damping characteristic to suit spring preload.

Damping Setting

Damping must be adapted to suit the surface on which the motorcycle is ridden and to suit spring preload.

- An uneven surface requires softer damping than a smooth surface.
- An increase in spring preload requires firmer rebound-

stage damping, a reduction in spring preload requires softer rebound-stage damping.

Adjusting rebound-stage damping for front wheel



 Your motorcycle's handling will suffer if you do not match the spring-preload and damping-characteristic settings. Adjust the damping characteristic to suit spring preload. ◀

- Adjust the damping by turning knob **1**.



- If you want to increase damping, turn knob **1** in direction **H**.
- If you want to reduce damping, turn knob **1** in direction **S**.

 Rebound stage, basic setting, front

- Adjust damping by turning top knob to fully tightened position, then back it off 8 clicks. (Motorcycle with full load of fuel, with rider 85 kg)

Adjusting compression-stage damping for front wheel



 Your motorcycle's handling will suffer if you do not match the spring-preload and damping-characteristic settings. Adjust the damping characteristic to suit spring preload. ◀

- Adjust the damping by turning knob **1**. The knob is behind the side panel and accessible from below.



- If you want to increase damping, turn knob **1** in direction **H**.
- If you want to reduce damping, turn knob **1** in direction **S**.

 Compression stage, basic setting, front

- Adjust damping by turning bottom knob to fully tightened position, then back it off 14 clicks. (Motorcycle with full load of fuel, with rider 85 kg)

Adjusting rebound-stage damping for rear wheel

- Make sure the ground is level and firm and place the motorcycle on its stand.



- Adjust the rebound-stage damping by turning knob **1**.

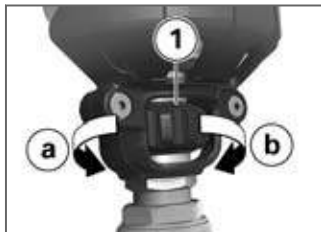

- If you want to reduce rebound-stage damping, turn knob **1** in direction **a**.
- If you want to increase rebound-stage damping, turn knob **1** in direction **b**.



Rebound stage, basic setting, rear

- Adjust damping by turning bottom knob to fully tightened position, then back it off 16 clicks. (Motorcycle with full load of fuel, with rider 85 kg)

Adjusting compression-stage damping for rear wheel

- Make sure the ground is level and firm and place the motorcycle on its stand.



- Adjust the compression-stage damping by turning knob **1**.



- If you want to increase compression-stage damping, turn knob **1** in direction **H**.
- If you want to reduce compression-stage damping, turn knob **1** in direction **S**.

 Compression stage, basic setting, rear

- Adjust damping by turning top knob to fully tightened position, then back it off 14 clicks. (Motorcycle with full load of fuel, with rider 85 kg)

Height of suspension Setting

You can vary the height of the suspension. You do this by changing the position of the front forks in the bottom fork bridge and adjusting the length of the spring strut.

Adjusting height of front forks

- Make sure the ground is level and firm and place the motorcycle on its stand.

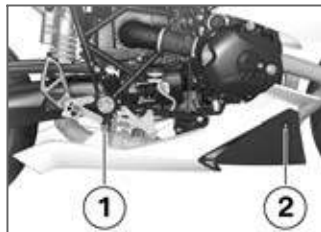

- Remove screw **1** on left and right.
- While supporting the engine spoiler, remove screw **2** on left and right.
- Push the engine spoiler slightly to the rear and work it down to remove.

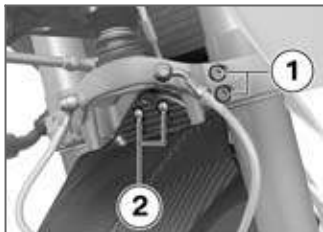

- Slacken screws **1** at left and right sliding tubes.
- Slacken screws **2** at the front mudguard.
- Using a suitable lifter, raise the motorcycle until the front wheel is clear of the ground. BMW Motorrad recommends the BMW Motorrad middle stand.
- Install the middle stand (→ 138)



- Adjust the forks to the desired height by repositioning the sliding tubes in the fork bridge within range of adjustment **a**. Make sure that the tubes are not moved past highest permissible position **3**.



Motorcycle height, front

– max 15 mm (Range of adjustment between bottom edge of fork slider tube bridge and stop on slider tube)

- To restore the factory setting: push the sliding tubes all the way up.



- If the sliding tubes are difficult to move in the fork bridge: slacken axle clamping screw **4**.
- Slacken quick-release axle **5**.
- Adjust the height of the forks as described above.

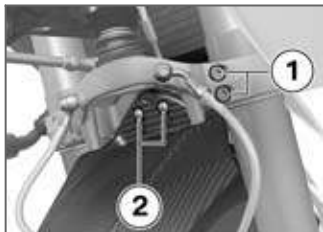

- Tighten screws **2** on the front mudguard until hand-tight.

⚠ Threaded fasteners not tightened to the specified torque can work loose or their threads can suffer damage. Always have the security of the fasteners checked by a specialist workshop, preferably an authorised BMW Motorrad dealer. ◀

- Tighten screws **1** for left and right sliding tubes to the specified torque.

 Fork bridge, bottom, with slider tube

– Tightening sequence: 2x each side, alternately

– 25 Nm



- If applicable, tighten quick-release axle **5** to the specified torque.

 Quick-release axle in axle holder

– 50 Nm

- If applicable, tighten axle clamping screw **4** to the specified torque.

 Quick-release axle clamp screws

– 19 Nm

- Lower the motorcycle to the ground and remove the lifter.



- Work the engine spoiler forward into position until holders **3** on left and right are seated on mounts **4** and support it at the front.

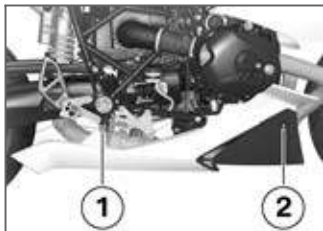

- Install screws **2** on left and right and tighten until hand-tight.
- Install screws **1** on left and right and tighten until hand-tight.

Adjusting spring-strut length

- Make sure the ground is level and firm and place the motor cycle on its stand.
- Remove the rear wheel (→ 135)



- Slacken screws **1** of the spray guard.



- Slacken nut **2** by turning it in direction **b**.

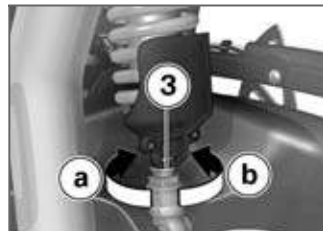

- Turn nut **3** in direction **b**.
 - » Increase spring-strut length.
- Turn nut **3** in direction **a**.
 - » Reduce spring-strut length.
- Adjust the spring strut to the desired length.
- To restore the factory setting: turn nut **3** as far as it will go in direction **a**.



- Tighten nut **2** by turning it in direction **a**.

 Locknut for length adjustment at bottom spring retainer

– 40 Nm



- Tighten screws **1** of the spray guard until hand-tight.
- Install the rear wheel (→ 135)

Tyres

Checking tyre pressure

 Incorrect tyre pressures impair the motorcycle's handling characteristics and increase the rate of tyre wear.

Always check that the tyre pressures are correct. ◀

 At high road speeds, tyre valves installed perpendicular to the wheel rim have a

tendency to open as a result of centrifugal force.

In order to avoid a sudden loss of tyre pressure, fit a valve cap with rubber sealing ring to the rear tyre and make sure that the cap is screwed on firmly. ◀

- Make sure the ground is level and firm and place the motorcycle on its stand.
- Check tyre pressures against the data below.



Tyre pressure, front

– 2.2 bar (Tyre cold)



Tyre pressure, rear

– 2.5 bar (Tyre cold)



Tyre pressure for sport riding

– 2.1±0.2 bar (Tyre cold)

If tyre pressure is too low:

- Correct tyre pressure.

Headlight

Adjusting headlight for driving on left/driving on right

If the motorcycle is ridden in a country where the opposite rule of the road applies, its asymmetric low-beam headlight will tend to dazzle oncoming traffic.

Have the headlight set accordingly by a specialist workshop, preferably an authorised BMW Motorrad dealer.

Headlight beam throw and spring preload

Headlight beam throw is generally kept constant when spring preload is adjusted to suit load. Spring preload adjustment might not suffice only if the motorcycle is very heavily loaded. Under

these circumstances, headlight beam throw has to be adjusted to suit the weight carried by the motorcycle.

 Consult a specialist workshop, preferably an authorised BMW Motorrad dealer, if you are unsure whether the headlight basic setting is correct. ◀

Headlight beam-throw adjustment

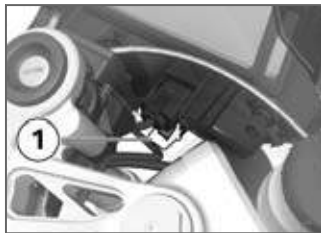

- 1 Headlight beam-throw adjustment

Spring preload adjustment might not suffice if the motorcycle is very heavily loaded. Moving the pivot lever adjusts headlight beam throw so as not to dazzle oncoming traffic.



- a Neutral position
- b Position for heavy load

Front seat

Removing front seat

- Make sure the ground is level and firm and place the motorcycle on its stand.

Installing seat

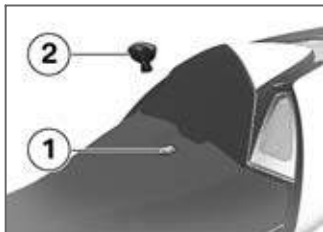

- Remove screw **1** with special key **2** for the seat.



- Engage seat mounts **3** in holders **4**.



- Pull the seat to the rear and up out of the holders.

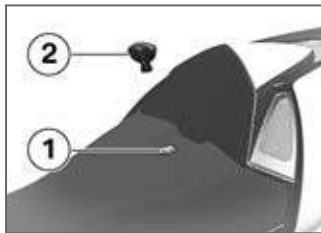

- Tighten screw **1** with special key **2** for the seat until it is hand-tight.

Riding

Safety instructions	86
Checklist	87
Starting	88
Running in	90
Shifting gear	91
Brakes	92
Parking your motorcycle	93
Refuelling	94

Safety instructions

Rider's equipment

Do not ride without the correct clothing. Always wear:

- Helmet
- Motorcycling jacket and trousers
- Gloves
- Boots

This applies even to short journeys, and to every season of the year. Your authorised BMW Motorrad dealer will be glad to advise you on the correct clothing for every purpose.

Speed

If you ride at high speed, always bear in mind that various boundary conditions can adversely affect the handling of your motorcycle:

- Settings of the spring-strut and shock-absorber system
- Imbalanced load
- Loose clothing
- Insufficient tyre pressure
- Poor tyre tread
- Etc.

Correct loading



Overloading and imbalanced loads can adversely affect the motorcycle's handling. Do not exceed the permissible gross weight and be sure to comply with the instructions on loading. ◀

Alcohol and drugs



Even small amounts of alcohol or drugs will adversely affect your perception and your ability to assess situations and make decisions, and slow down your reflexes. Medication can exacerbate these effects.

Do not ride your motorcycle after consuming alcohol, drugs and/or medication. ◀

Risk of poisoning

Exhaust fumes contain carbon monoxide, which is colourless and odourless but highly toxic.



Inhaling the exhaust fumes therefore represents a health hazard and can even cause loss of consciousness with fatal consequences.

Do not inhale exhaust fumes. Do not run the engine in an enclosed space. ◀

High voltage



Touching live parts of the ignition system with the engine running can cause electric shock.

Do not touch parts of the ignition system when the engine is running. ◀

Catalytic converter

If misfiring causes unburned fuel to enter the catalytic converter, there is a danger of overheating and damage.

For this reason, observe the following points:

- Do not run the fuel tank dry.
- Do not attempt to start or run the engine with a spark-plug cap disconnected.
- Stop the engine immediately if it misfires.
- Use only unleaded fuel.
- Comply with all specified maintenance intervals.

 Unburned fuel will destroy the catalytic converter. Note the points listed for protection of the catalytic converter. ◀

Risk of fire

Temperatures at the exhaust are high.

 Flammable materials (e.g. hay, leaves, grass, clothing and luggage, etc.) could ignite if allowed to come into contact with the hot exhaust pipe.

Do not permit flammable materials to come into contact with the hot exhaust system. ◀

 Cooling would be inadequate if the engine were allowed to idle for a lengthy period with the motorcycle at a standstill: overheating would result. In extreme cases, the motorcycle could catch fire. Do not allow the engine to idle unnecessarily. Ride away immediately after starting the engine. ◀

Tampering with the engine control unit

 Tampering with the engine control unit can damage the motorcycle and cause accidents.

Do not tamper with the engine control unit. ◀

 Tampering with the engine control unit can result in mechanical loads that the motorcycle's components are not designed to withstand. Damage caused in this way is not covered by the warranty.

Do not tamper with the engine control unit. ◀

Checklist

Use the following checklist to check important functions, settings and wear limits before you ride off.

- Brakes
- Brake-fluid levels, front and rear
- Clutch
- Clutch fluid level
- Damping-characteristic setting and spring preload
- Tyre-tread depth and tyre pressures
- Security of the luggage

At regular intervals:

- Engine oil level (every refuelling stop)
- Brake-pad wear (every third refuelling stop)

Starting

Side stand

You cannot start the motorcycle with the side stand extended and a gear engaged. The engine will switch itself off if you start it with the gearbox in neutral and then engage a gear before retracting the side stand.

Gearbox

You can start the engine when the gearbox is in neutral or if you pull the clutch with a gear engaged. Do not pull the clutch until after you have switched on the ignition, as otherwise the engine will refuse to start.

Starting engine.



- Kill switch in run position **a**.
- Switch on the ignition.
- » Pre-ride check is performed. (➔ 89)

- with BMW Motorrad ABS^{OE}
- Switch on the ignition.
- » Pre-ride check is performed. (➔ 89)
- » ABS self-diagnosis is performed. (➔ 90)◀



- Press starter button **1**.

▶ If ambient temperatures are very low, you might find it necessary to open the throttle slightly when starting the engine. At ambient temperatures below 0 °C, disengage the clutch after switching on the ignition.◀

▶ The start attempt is automatically interrupted if battery voltage is too low. Recharge the battery before you start the engine, or use jump leads and a donor battery to start. ◀

- » The engine starts.
- » Consult the troubleshooting chart below if the engine refuses to start. (→ 154)

Warm-up phase

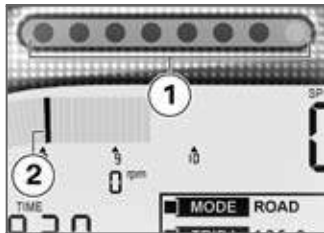

During the warm-up phase, LEDs **1** indicate engine temperature: the colder the engine the more LEDs show. At the same time, vertical

segment **2** in the rev. counter indicates the recommended maximum engine speed. As the engine warms up the LEDs go out and the recommended maximum engine speed increases. Once the engine has reached operating temperature all the LEDs are off and the engine can be revved to maximum speed. The vertical segment still visible in the rev. counter indicates the highest permissible engine speed.

The LEDs will flicker if you rev the engine past this maximum permissible speed as indicated by the rev. counter.

Pre-ride check

The instrument panel runs a test of the 'General' warning light when the ignition is switched on: this is the "Pre-Ride-Check" The 'General' warning light shows first red and then yellow, so that you

can check that it is in working order. The test is aborted if you start the engine before it completes.

The rev. counter is activated if the start-logo status is ON.

Phase 1



General warning light shows red.

Phase 2



General warning light shows yellow.

If the 'General' warning light does not show:



Some malfunctions cannot be indicated if the 'General' warning light cannot be displayed.

Check that the 'General' warning

light comes on, and that it shows red and yellow. ◀

- Have the fault rectified as quickly as possible by a specialist workshop, preferably an authorised BMW Motorrad dealer.

ABS self-diagnosis^{OE}

BMW Motorrad ABS performs self-diagnosis to ensure its operability. Self-diagnosis is performed automatically when you switch on the ignition. The motorcycle has to move forward at a speed above 5 km/h for the wheel sensors to be tested.

Phase 1

- » Test of the diagnosis-compatible system components with the motorcycle at a standstill.



ABS warning light flashes.

Phase 2

- » Test of the wheel sensors as the motorcycle pulls away from rest.



ABS warning light flashes.

ABS self-diagnosis completed

- » The ABS warning light goes out.

If an indicator showing an ABS fault appears when ABS self-diagnosis completes:

- You can continue to ride. Bear in mind that the ABS function is not available.
- Have the fault rectified as quickly as possible by a specialist workshop, preferably an authorised BMW Motorrad dealer.

Running in

The first 1000 km

- While running in the motorcycle, vary the throttle opening and engine-speed range frequently.
- Try to do most of your riding during this initial period on twisting, fairly hilly roads, avoiding high-speed main roads and highways if possible.



Exceeding the specified engine speeds while running in will lead to increased engine wear.

Keep to the specified engine speeds for running in. ◀

- Do not exceed the rpm limits recommended for running in.

	Running-in speed
– <math><5000 \text{ min}^{-1}</math>	

- No full-load acceleration.

- Avoid low engine speeds at full load.
- Do not omit the first inspection after 500 - 1200 km.

Brake pads

New brake pads must "bed down" and therefore do not achieve their optimum friction levels during the first 500 km. You can compensate for this initial reduction in braking efficiency by exerting greater pressure on the levers.

 New brake pads can extend stopping distance by a significant margin. Apply the brakes in good time.◀

Tyres

New tyres have a smooth surface. This must be roughened by riding in a restrained manner at various heel angles until the tyres are run in. This running in pro-

cedure is essential if the tyres are to achieve maximum grip.

 Tyres do not have their full grip when new and there is a risk of accidents at extreme angles of heel. Avoid extreme angles of heel.◀

Shifting gear

Shift assistant

Your motorcycle is equipped with a shift assistant evolved from motorcycle-racing technology; the shift assistant enables you to upshift in virtually all load and engine-rpm ranges without pulling the clutch or changing the throttle-valve angle. The throttle valve remains open to accelerate the motorcycle and upshift time is reduced to a minimum. You select the gear in the usual way by means of the foot-operated shift lever.



Sensor **1** in the shift linkage registers the shift request and triggers shift assistance.

When you are riding at constant speed with the engine revving high in a low gear, upshifting without disengaging the clutch can cause a severe reaction to the load change. BMW Motorrad recommends disengaging the clutch for upshifts in these circumstances. It is advisable to avoid using the shift assistant at engine speeds close to the limits at which the governor cuts in to limit engine rpm.

Shift assistance is not available in the following situations:

- Gearshifts with the clutch disengaged
- Gearshifts with the throttle valve closed (engine overrun)
- Downshifts

Gearshift-pattern reverser^{OA}

The external shift linkage is designed to accommodate a retrofit gearshift-pattern reverser. Note that the gearshift-pattern reverser also requires installation of a modified shift sensor.

If you are considering having a gearshift-pattern reverser installed consult a specialist workshop, preferably your authorised BMW Motorrad dealer.



Riding on public roads with the gearshift-pattern reverser fitted to the motorcycle is prohibited.

Do not use the gearshift-pat-

tern reverser for riding on public roads. ◀

Brakes

How can stopping distance be minimised?

Each time the brakes are applied, a load distribution shift takes place with the load shifting forward from the rear to the front wheel. The sharper the motorcycle decelerates, the more load is shifted to the front wheel. The higher the wheel load, the more braking force can be transmitted without the wheel locking.

To optimise stopping distance, apply the front brakes rapidly and keep on increasing the force you apply to the brake lever. This makes the best possible use of the dynamic increase in load at the front wheel. Remember to pull the clutch at the same time. In the "panic braking situations" that are trained so frequently

braking force is applied as rapidly as possible and with the rider's full force applied to the brake levers; under these circumstances the dynamic shift in load distribution cannot keep pace with the increase in deceleration and the tyres cannot transmit the full braking force to the surface of the road. Under these circumstances the front wheel can lock up.

– with BMW Motorrad ABS^{OE} ABS has to intervene to keep the front wheel from locking; this increases stopping distance. ◀

Descending mountain passes



There is a danger of the brakes fading if you use only the rear brakes when descending mountain passes. Under extreme conditions, the brakes

could overheat and suffer severe damage.

Use both front and rear brakes, and make use of the engine's braking effect as well. ◀

Wet brakes

 After the motorcycle has been washed, ridden through water or ridden in the rain, the brake discs and pads might be wet and the brakes might not take effect immediately.

Apply the brakes in good time until the brakes have dried out. ◀

Salt on brakes

 The brakes may fail to take effect immediately if the motorcycle was ridden on salt-covered roads and the brakes were not applied for some time. Apply the brakes in good time until the salt layer on the brake

discs and brake pads has been removed. ◀

Oil or grease on brakes

 Oil and grease on the brake discs and pads considerably diminish braking efficiency.

Especially after repair and maintenance work, make sure that the brake discs and brake pads are free of oil and grease. ◀

Dirt or mud on brakes

 When riding on loose surfaces or muddy roads, the brakes may fail to take effect immediately because of dirt or moisture on the discs or brake pads.

Apply the brakes in good time until the brakes have been cleaned. ◀

 The brake pads will wear more rapidly if you ride fre-

quently on unsurfaced tracks or poor roads.

Check the thickness of the brake pads more frequently and replace the brake pads in good time. ◀

Parking your motorcycle

Placing motorcycle on side stand

 If the ground is soft or uneven, there is no guarantee that the motorcycle will rest firmly on the stand.

Always check that the ground under the stand is level and firm. ◀

- Switch off the engine.
- Pull the handbrake lever.
- Hold the motorcycle upright and balanced.
- Use your left foot to extend the side stand fully.

 The side stand is designed to support only the weight of the motorcycle.

Do not lean or sit on the motorcycle with the side stand extended. ◀

- Slowly lean the motorcycle to the side until its weight is taken by the stand and dismount to the left.

 If the motorcycle is on the side stand, the surface of the ground will determine whether it is better to turn the handlebars to the left or right. However, the motorcycle is more stable on a level surface with the handlebars turned to the left than with the handlebars turned to the right.

On level ground, always turn the handlebars to the left to set the steering lock. ◀

- Turn the handlebars to full left or right lock.

- Check that the motorcycle is standing firmly.

 On a gradient, the motorcycle should always face uphill; select 1st gear. ◀

- Lock the steering lock.

Removing motorcycle from side stand

- Unlock the steering lock.
- From the left, grip the handlebars with both hands.
- Pull the handbrake lever.
- Swing your right leg over the seat and lift the motorcycle to the upright position.
- Hold the motorcycle upright and balanced.

 An extended side stand can catch on the ground when the motorcycle is moving and lead to a fall.

Retract the side stand before moving the motorcycle. ◀

- Sit on the motorcycle and use your left foot to retract the side stand.

Refuelling

 Fuel is highly flammable. A naked flame close to the fuel tank can cause a fire or explosion.

Do not smoke. Never bring a naked flame near the fuel tank. ◀

 Fuel expands when hot. Fuel escaping from an overfilled tank could make its way onto the rear tyre. This could cause a fall.

Do not fill the tank past the bottom edge of the filler neck. ◀

 Fuel attacks plastics, which become dull or unsightly. Wipe off plastic parts immediately if they come into contact with fuel. ◀

 Fuel can attack the material of the windscreen and the side slipstream deflectors, which become dull or unsightly.

Wipe off the windscreen and slipstream deflectors immediately if they come into contact with fuel. ◀

 Leaded fuel will destroy the catalytic converter. Use only unleaded fuel. ◀

- Make sure the ground is level and firm and place the motorcycle on its stand.

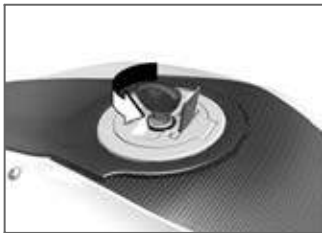

- Open the protective cap.

- Open the fuel tank cap with the ignition key by turning it counter-clockwise.



- Refuel with fuel of the grade stated below; do not fill the tank past the bottom edge of the filler neck.

 Recommended fuel grade

– 98 ROZ/RON (Premium plus unleaded)

 Recommended fuel grade

– 95 ROZ/RON (Premium unleaded (fuel grade, usable with power- and consumption-related restrictions))

 Usable fuel capacity

– approx. 16 l

 Reserve fuel

– ≥ 3 l

- Press the fuel tank cap down firmly to close.
- Remove the key and close the protective cap.

Engineering details

Brake system with BMW Motorrad ABS ^{OE}	98
High Performance	102

Brake system with BMW Motorrad ABS^{OE}

How does ABS work?

The amount of braking force that can be transferred to the road depends on factors that include the coefficient of friction of the road surface. Loose stones, ice and snow or a wet road all have much lower coefficients of friction than a clean, dry asphalt surface. The lower the coefficient of friction, the longer the braking distance.

If the rider increases braking pressure to the extent that braking force exceeds the maximum transferrable limit, the wheels start to lock and the motorcycle loses its directional stability; a fall is imminent. Before this situation can occur, ABS intervenes and adapts braking pressure to the maximum transferrable braking force, so the wheels continue

to turn and directional stability is maintained irrespective of the condition of the road surface.

What are the effects of surface irregularities?

Humps and surface irregularities can cause the wheels to lose contact temporarily with the road surface; if this happens the braking force that can be transmitted to the road can drop to zero. If the brakes are applied under these circumstances the ABS has to reduce braking force to ensure that directional stability is maintained when the wheels regain contact with the road surface. At this instant the BMW Motorrad ABS must assume an extremely low coefficient of friction, so that the wheels will continue to rotate under all imaginable circumstances, because this is the precondition for ensuring directional stability. As soon as

is registers the actual circumstances, the system reacts instantly and adjusts braking force accordingly to achieve optimum braking.

Rear wheel lift

Under very severe and sudden deceleration, however, under certain circumstances it is possible that the BMW Motorrad ABS will be unable to prevent the rear wheel from lifting clear of the ground. If this happens the outcome can be a highside situation in which the motorcycle can flip over.



Severe braking can cause the rear wheel to lift off the ground.

When you brake, bear in mind that ABS control cannot be relied on in all circumstances to prevent the rear wheel from lifting clear of the ground. ◀

What is the design baseline for BMW Motorrad ABS?

Within the limits imposed by physics, BMW Motorrad ABS ensures directional stability on any surface. The system is not optimised for special requirements that apply under extreme competitive situations on the track.

Special situations

The speeds of the front and rear wheels are compared as one means of detecting a wheel's incipient tendency to lock. If the system registers implausible values for a lengthy period the ABS function is deactivated for safety reasons and an ABS fault message is issued. Self-diagnosis has to complete before fault messages can be issued.

In addition to problems with the BMW Motorrad ABS, exceptional

riding conditions can lead to a fault message being issued.

Exceptional riding conditions:

- Riding for a lengthy period with the front wheel lifted off the ground (wheelie).
- Rear wheel rotating with the motorcycle held stationary by applying the front brake (burn-out).
- Heating up with the motorcycle on the centre stand or an auxiliary stand, engine idling or with a gear engaged.
- Rear wheel locked for a lengthy period, for example while descending off-road.

If a fault message is issued on account of exceptional riding conditions as outlined above, you can reactivate the ABS function by switching the ignition off and on again.

What significance devolves on regular maintenance?



Invariably, a technical system cannot perform beyond the abilities dictated by its level of maintenance.

In order to ensure that the BMW Motorrad ABS is always maintained in optimum condition, it is essential for you to comply strictly with the specified inspection intervals. ◀

Reserves for safety

The potentially shorter braking distances which BMW Motorrad ABS permits must not be used as an excuse for careless riding. ABS is primarily a means of ensuring a safety margin in genuine emergencies.

Take care when cornering. When you apply the brakes on a corner, the motorcycle's weight and

momentum take over and even BMW Motorrad ABS is unable to counteract their effects.

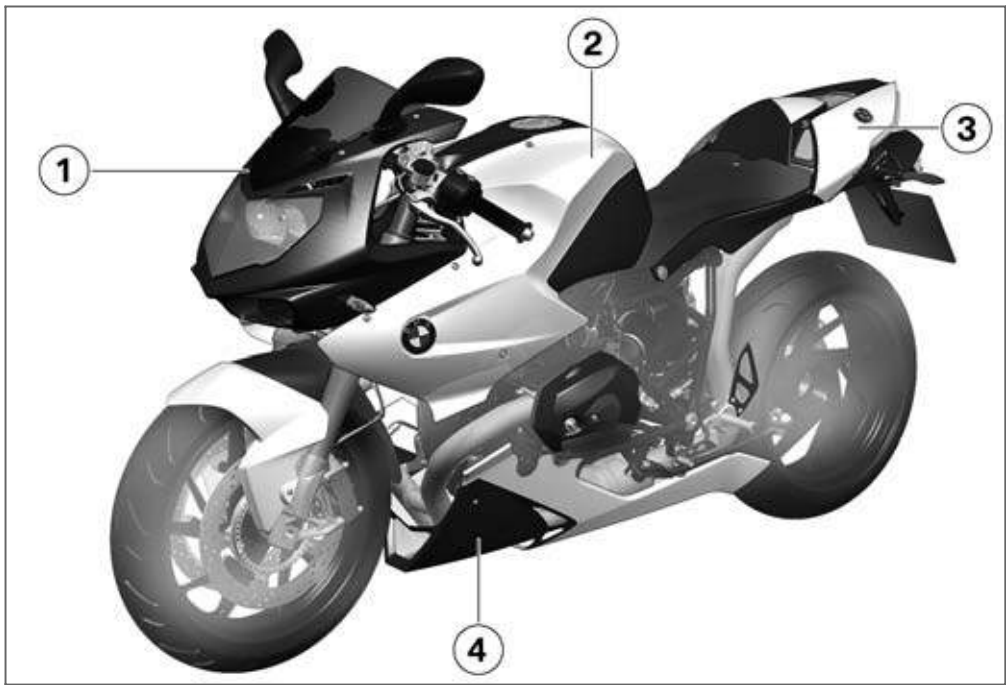

High Performance

Body panels

- 1** The carbon front fairing is self-supporting and is held in place by two screws. Headlight, instrument panel and oil cooler are all mounted directly in the fairing to reduce the number of parts and to save weight.
- 2** The carbon cover for the fuel tank is in one piece. This design combines lightness with easy removability.
- 3** The extremely light, self-supporting carbon tail assembly dispenses with an auxiliary frame. It is both seat and mount for the silencer and also provides the mounting point for the number-plate carrier, which is easily removed for track days.
- 4** The carbon engine spoiler is bolted on at four mounting points and is easily removed and installed. The rear mounts have rests to facilitate installation.

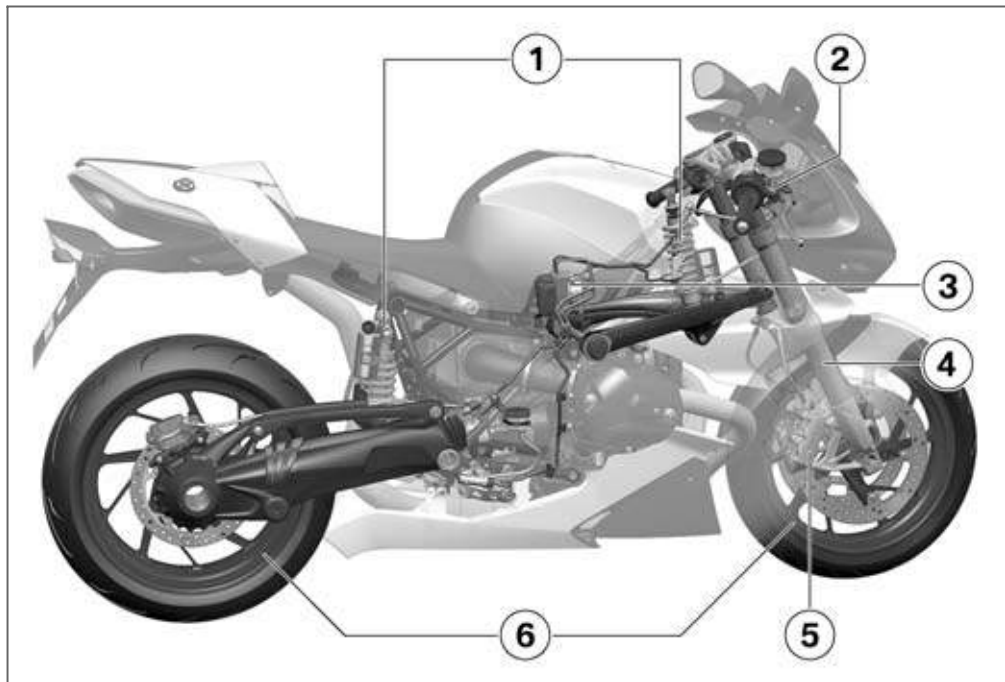

Suspension components

- 1** The front and rear Öhlins spring struts have adjustable compression-stage and rebound-stage damping and spring-preload adjustment. The rear spring strut is also length-adjustable so that steering geometry can be varied and ground clearance maximised to increase the motorcycle's angle of heel.
- 2** The design and leverage of the Magura brake fitting with radially mounted brake actuator provide sensitive control of the powerful brakes. The clutch lever fitting is also of radial design. The stub handlebars are mounted on a milled fork bridge and the drop angle is adjustable.
- 3** BMW Motorrad ABS is available as an optional extra and combined compact design with low weight, and is deactivatable. The integrated pressure sensor enables a high level of braking performance.
- 4** The position of the slider tubes in the bottom fork bridge is adjustable: this is another feature that can be utilised to increase the angle of heel. On-track handling can be maximised by setting the fork bridge as low as possible and the spring strut as high as possible. The heel angle can be maximised for "hanging-off" cornering by setting the fork bridge as high as possible.
- 5** The radially bolted Brembo monoblock brake calipers and the 320 mm brake discs provide the stopping power needed for circuit racing.
- 6** The lightweight and exclusive-look forged wheels are mill-finished to maximise weight saving.

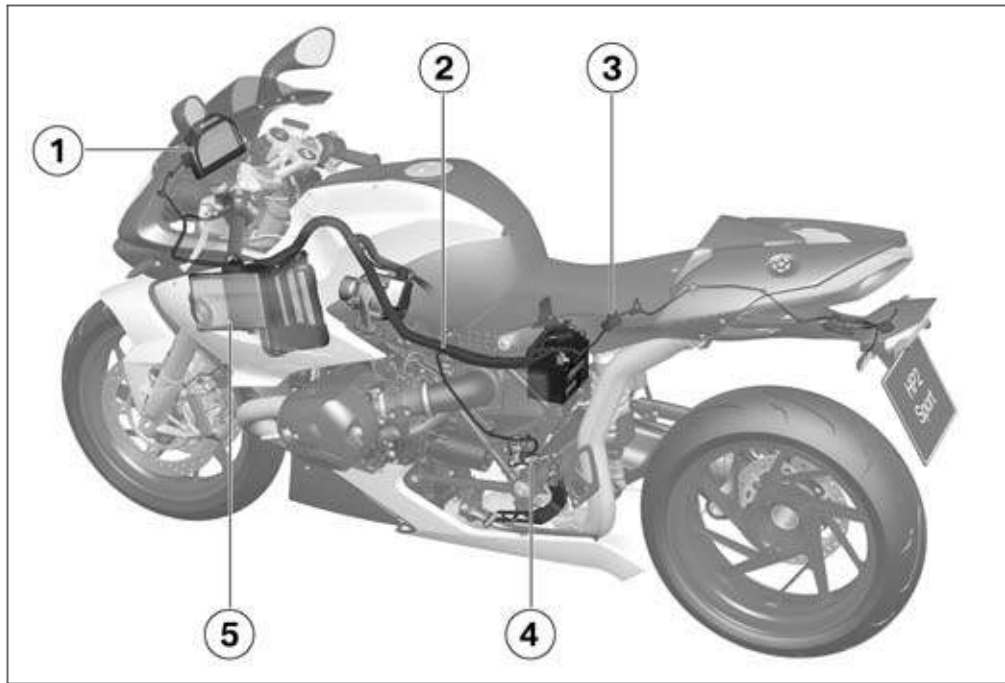

Electrics

- 1** The instrument panel from 2D Systems offers functions for road riding and for racing. On race days the instrument panel can save comprehensive data for each lap ridden, and this information can subsequently be called up for viewing and analysis. An infrared sensor available as an optional accessory can be connected for precision lap timing.
- 2** CAN-bus technology is used for the on-board electrics. This means that the high-end control units can communicate over a wiring harness that consists of a minimal number of wires.
- 3** Removing the number-plate carrier entails disconnecting only one plug in the wiring harness.
- 4** The sensor for the shift assistant is connected to the engine control unit. The software integrated into the control unit ensures extremely short interruptions in tractive power so upshifts are very fast, without the clutch lever being pulled or the throttle twistgrip turned.
- 5** All light functions are controlled centrally by the control unit for the central vehicle electronics (ZFE). Switchable power ICs are used, so there are no conventional fuses.

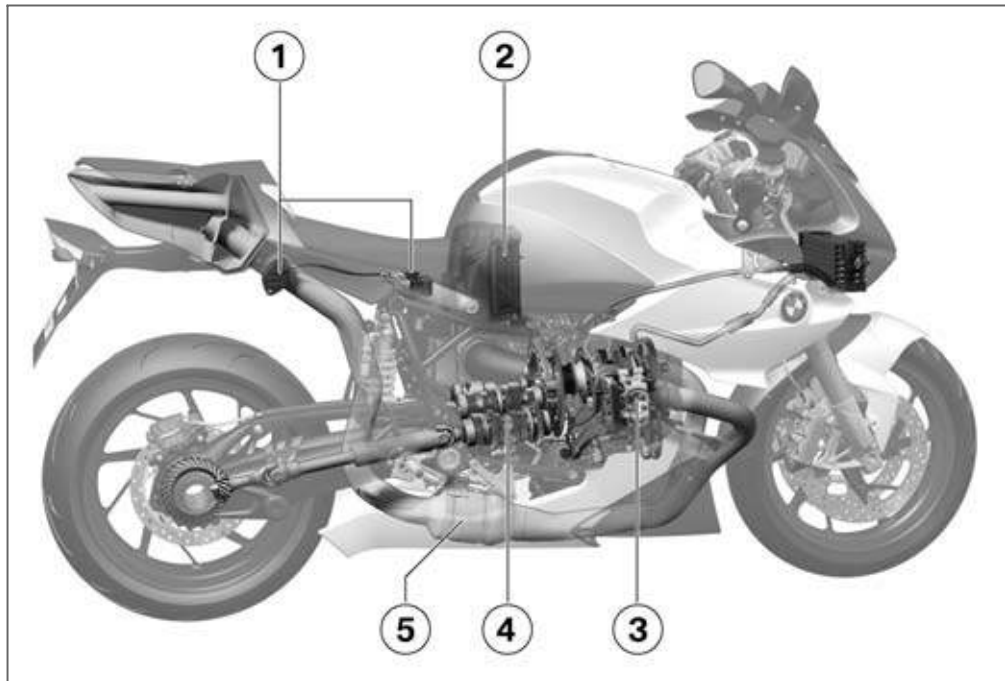

Drive

- 1** Among the modifications implemented to gain more ground clearance for increased angles of heel, the stainless-steel headers come together in front of the engine, so that the exhaust pipe can be kept as close to the underside of the engine as possible. The exhaust-flow control valve actuated by a servomotor influences acoustic emissions as a function of operating condition.
- 2** The airbox is optimised for a high air throughput rate and accommodates a high-grade oil-wetted sport air filter made of metal-reinforced fabric.
- 3** Valve actuation (➔ 110)
- 4** An updated clutch transmits engine power to the six-speed sports gearbox, which has the close-ratio tuning that makes it ideal for track-racing requirements. The combination with the shift assistant that is a standard feature of this model means that maximum use is made of the engine's power output for optimum acceleration.
- 5** The stainless-steel exhaust system incorporates an integral, extra-large metal-body catalytic converter.

Valve actuation



The valves are positioned radially so that the combustion chamber can be compact and contoured for smooth gas flow. The inlet ducts are machine-finished to optimise the inlet flow. Four valves per cylinder are operated by two overhead camshafts with angle-ground cams and short cam followers. Removal of the oil sinks with the cam followers is a service-friendly operation for valve-clearance adjustment. The carbon cylinder-head covers are fitted with replaceable slip pads.

Accessories

General instructions.....	112
Power socket ^{OA}	112
Luggage	113

General instructions

BMW Motorrad recommends the use of parts and accessories for your motorcycle that are approved by BMW for this purpose. Genuine BMW parts and accessories and other products which BMW has approved can be obtained from your authorised BMW Motorrad dealer, together with expert advice on their installation and use.

These parts and products have been tested by BMW for safety, function and suitability. BMW accepts product liability for them. Conversely, BMW is unable to accept any liability whatsoever for parts and accessories which it has not approved.



BMW Motorrad cannot assess each non-BMW product to determine whether it can be used on or in connection with BMW motorcycles

without constituting a safety hazard. Country-specific official authorisation does not suffice as assurance. Tests conducted by these instances cannot make provision for all operating conditions experienced by BMW motorcycles and, consequently, they are not sufficient in some circumstances.

Use only parts and accessories approved by BMW for your motorcycle. ◀

Whenever you are planning modifications, comply with all the legal requirements. Make sure that the motorcycle does not infringe national road-vehicle construction and use regulations.

Power socket^{OA}

Ratings



The supply to socket **1** is cut off automatically if battery voltage is low or the load exceeds the maximum rating.

Operating electrical accessories

You can start using electrical accessories only when the ignition is switched on. The accessory remains operational if the ignition is subsequently switched off. In order to ensure that the drain on the on-board power supply

system is minimised, In order to ensure that the drain on the on-board power supply system is minimised, the supply to the power socket is cut off approximately 15 minutes after the ignition is switched off, and it is also temporarily interrupted during the start procedure.

Cable routing

The cables from the power socket to the auxiliary device must be routed in such a way that they:

- Do not impede the rider
- Do not restrict or obstruct the steering angle and handling characteristics
- Cannot be trapped



Incorrectly routed cables can impede the rider.

Route the cables as described above.◀

Luggage

Stowage



The mesh screens set into the tail section permit air heated by the silencer to escape upward. The application of excessive weight can damage the tail section.

Do not attempt to transport luggage or similar on the tail section.◀

For race-circuit use

Turn indicators.....	116
Mirrors.....	118
Number-plate carrier.....	119
On public roads.....	120

Turn indicators

Removing front right flashing turn indicator

- Make sure the ground is level and firm and place the motorcycle on its stand.

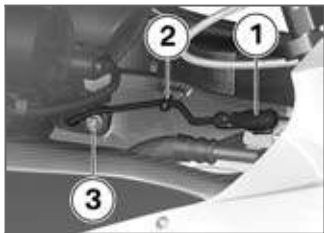

- Disconnect plug **1**.

▶ To disconnect: take a firm grip of the cable close to the front part of the plug, push it in and then pull it forward.◀

- Remove cable tie **2**.
- Counter-hold nut **3** in the next step.



- Remove screw **4**.
- Turn the flashing turn indicator through 90° and remove.
- Thread out the cable.

Removing front left flashing turn indicator

- Make sure the ground is level and firm and place the motorcycle on its stand.



- Disconnect plug **1**.

▶ To disconnect: take a firm grip of the cable close to the bottom part of the plug, push it in and then pull it down.◀

- Remove cable tie **2**.
- Counter-hold nut **3** in the next step.



- Remove screw **4**.
- Turn the flashing turn indicator through 90° and remove.
- Thread out the cable.

Installing front right flashing turn indicator



- Work the cable into position, insert the flashing turn indicator and turn it through 90°.
- Insert bolt **4** and in the next step tighten it with the nut until hand-tight.

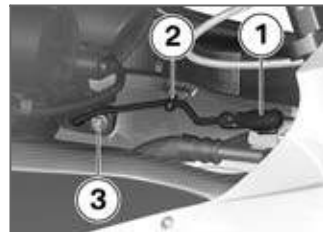

- Counter-hold nut **3** to facilitate insertion of the bolt.
- Connect plug **1**.
- Secure the cable with cable tie **2**.

Installing front left flashing turn indicator



- Work the cable into position, insert the flashing turn indicator and turn it through 90°.
- Insert bolt **4** and in the next step tighten it with the nut until hand-tight.



- Counter-hold nut **3** to facilitate insertion of the bolt.
- Connect plug **1**.
- Secure the cable with cable tie **2**.

Mirrors

Removing mirror

- Make sure the ground is level and firm and place the motorcycle on its stand.



- Remove screws **1**.
- Remove the mirror.

Installing mirrors

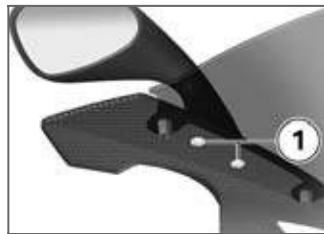

- Hold the mirror in position.
- Install screws **1** and tighten until hand-tight.

Number-plate carrier

Removing number-plate carrier

- Make sure the ground is level and firm and place the motorcycle on its stand.

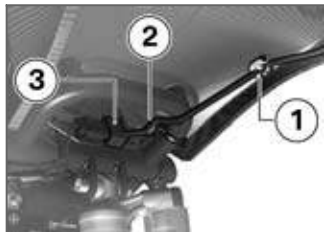

- Remove the cable from holders **1** and **2**.
- Disconnect plug **3**.

▶ To disconnect: squeeze the retainers at the narrow sides of the plug together and pull out the plug.◀

- Protect the plug on the motorcycle to prevent the ingress of foreign matter.



- Remove screws **4** on left and right and remove the number-plate carrier.

Installing number-plate carrier



- Hold the number-plate carrier in position, install screws **4** on left and right and tighten to specified torque.

 Number-plate carrier to tail section

– Thread-locking compound:
Micro-encapsulated

– 8 Nm

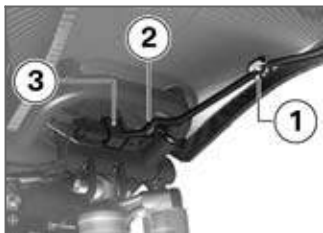

- Connect plug **3**.
- Seat the cable in holders **1** and **2**.

On public roads

Tyre pressure

 Tyre pressures reduced for race-track riding impair the motorcycle's handling characteristics on ordinary public roads and can lead to accidents. Always check that the tyre pressures are correct. ◀

Parts removed

 If the motorcycle is to be used on public roads, note that road-traffic regulations might require the re-installation of components removed beforehand for on-track use.

Be sure to re-install all components necessary for compliance with regulations governing use of the motorcycle on public roads. ◀

Gearshift-pattern reverser^{OA}

 Riding on public roads with the gearshift-pattern reverser fitted to the motorcycle is prohibited.

Do not use the gearshift-pattern reverser for riding on public roads. ◀

Maintenance

General instructions.....	122
Toolkit	122
Engine oil	123
Brake system	124
Brake pads	125
Brake fluid	127
Clutch	129
Tyres	130
Rims.....	130
Wheels	130
Front-wheel stand	136
Rear-wheel stand	137
Middle stand.....	138
Bulbs	139
Jump starting	143

Battery.....	145
--------------	-----

General instructions

The Maintenance chapter describes straightforward procedures for checking and replacing certain wear parts.

Special tightening torques are listed as applicable. The tightening torques for the threaded fasteners on your motorcycle are listed in the section entitled "Technical data".

You will find information on more extensive maintenance and repair work in the Repair Manual on the DVD/CD-ROM that accompanies your motorcycle.

Some of the work calls for special tools and a thorough knowledge of motorcycle technology. If you are in doubt consult a specialist workshop, preferably your authorised BMW Motorrad dealer.

Toolkit

Underneath the seat

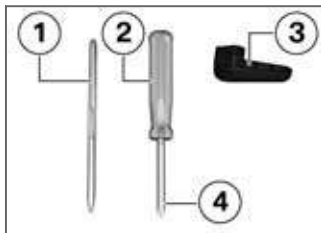

- 1** Reversible screwdriver blade
With star-head and Torx T25
- 2** Screwdriver handle
- 3** Tool for oil cap
For opening the oil filler cap
- 4** Reversible screwdriver blade
With star-head and plain-tip ends

Service kit

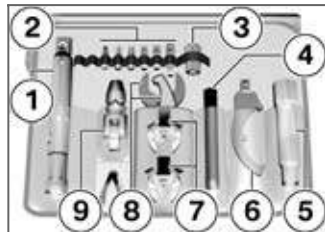



- 1** Extending tool holder
holds all tools by means of adapters, and for removing the spark plug
- 2** 1/4" bits
Bits of various sizes
- 3** Torx socket E12
- 4** Electric torch
- 5** 3/8" adapter for socket-head screws, w/f 22
for removing the quick-release axle from the front wheel
- 6** Large hook wrench
for adjusting spring preload

- 7 Socket
Open-ended spanner, w/ f 10, w/f 13
- 8 Adapter
To accommodate the 1/4" bits and the 9x12 mm and the 3/8" universal-joint adapter
Small hook wrench for adjusting spring preload
- 9 Adapter
To accommodate the 1/4" bits and the 9x12 mm and the 3/8" universal-joint adapter

Engine oil

Checking engine oil level

 The engine can seize if the oil level is low, and this can lead to accidents. Always make sure that the oil level is correct.◀

 The oil level varies with the temperature of the oil. The higher the temperature, the higher the level of oil in the sump. Checking the oil level with the engine cold or after no more than a short ride will lead to misinterpretation; this in turn, means that the engine will be operated with the incorrect quantity of oil. In order to ensure that the engine oil level is read correctly, check the oil level only after a lengthy trip.◀

- Check that the engine is at operating temperature, make sure that the ground is level and firm and place the motorcycle on its stand.
- Wait five minutes after switching off the engine at operating temperature.



- Check the oil level in oil-level indicator **1**.

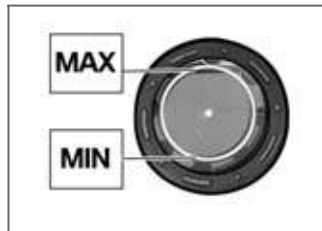

 Engine oil level

– Between MIN and MAX marks



Engine oil level

- max 0.5 l (Difference between MIN and MAX)

If the oil level is below the MIN mark:

- Top up the engine oil (➔ 124)

If the oil level is above the MAX mark:

- Have the oil level corrected by a specialist workshop, preferably an authorised BMW Motorraddealer.

Topping up engine oil

- Make sure the ground is level and firm and place the motorcycle on its stand.

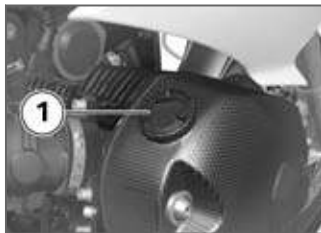

- Wipe the area around the filler neck clean.
- Use the tool from the toolkit to remove cap **1** from the engine-oil filler neck.

 Damage to the engine can result if it is operated without enough oil, but the same also applies if the oil level is too high.

Always make sure that the oil level is correct.◀

- Top up the engine oil to the specified level.
- Check the engine oil level (➔ 123)

- Install the cap of the oil filler neck.

Brake system

Dependability of the brake system

A fully functional brake system is a basic requirement for the road safety of your motorcycle.

Do not ride the motorcycle if you have any doubts about the dependability of the brake system. Under these circumstances have the brake system checked by a specialist workshop, preferably an authorised BMW Motorrad dealer.

 Incorrect working practices endanger the reliability of the brakes.

Have all work on the brake system performed by a specialist workshop, preferably an authorised BMW Motorrad dealer.◀

Checking operation of brakes

- Pull the handbrake lever.
 - » The pressure point must be clearly perceptible.
- Press the footbrake lever.
 - » The pressure point must be clearly perceptible.

If pressure points are not clearly perceptible:

- Have the brakes checked by a specialist workshop, preferably an authorised BMW Motorrad dealer.

Brake pads

Checking front brake pad thickness

 Brake pads worn past the minimum permissible thickness can cause a reduction in braking efficiency and under certain circumstances they can cause damage to the brake system.

In order to ensure the dependability of the brake system, do not permit the brake pads to wear past the minimum permissible thickness. ◀

- Make sure the ground is level and firm and place the motorcycle on its stand.
- Turn the handlebars to the full-lock position.



- Visually inspect left and right brake pads **1** to ascertain their thickness.



Brake-pad wear limit, front

– min 1 mm (Friction pad only, without backing plate)

If the brake pads are worn:

- Have the brake pads replaced by a specialist workshop, preferably an authorised BMW Motorraddealer.

Checking rear brake pad thickness

 Brake pads worn past the minimum permissible thickness can cause a reduction in braking efficiency and under certain circumstances they can cause damage to the brake system.

In order to ensure the dependability of the brake system, do not permit the brake pads to wear past the minimum permissible thickness. ◀

- Make sure the ground is level and firm and place the motorcycle on its stand.



- Visually inspect the brake pads of brake caliper **1** from the left to ascertain their thickness.

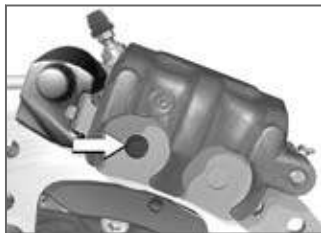

Brake-pad wear limit, rear

- 1 mm (Friction pad only, without backing plate)
- Make sure that the brake disc is not visible through the bore in the inboard brake block.

If the brake disc is visible:

- Have the brake pads replaced by a specialist workshop, preferably an authorised BMW Motorrad dealer.

Brake-pad wear

The rear brake has a brake-pad wear indicator.

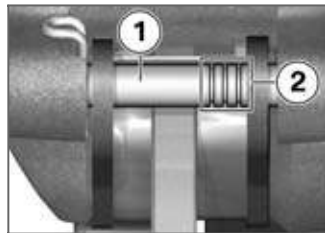

Shaft **1** with three marker rings **2** is between the brake pads.

How to interpret the marks:

- Three rings visible: brake-pad thickness is at least 75 %
- Two rings visible: brake-pad thickness is at least 50 %
- One ring visible: brake-pad thickness is at least 25 %
- No rings visible: brake pads worn to wear limit; check as described above

Brake fluid

Checking brake-fluid level, front brakes



A low fluid level in the brake reservoir can allow air to penetrate the brake system. This significantly reduces braking efficiency.

Check the brake-fluid level at regular intervals.◀

- Make sure the ground is level and firm and place the motorcycle on its side stand.
- Turn the handlebars all the way to the right



- Check the brake fluid level in front reservoir **1**.

▶ The brake fluid level in the brake fluid reservoir drops as the brake pads wear.◀



 Brake fluid level, front (visual inspection)

– DOT4 brake fluid

– It is impermissible for the brake fluid level to drop below the MIN mark. (Brake-fluid reservoir horizontal)

If the brake fluid level drops below the permitted level:

- Have the defect rectified as quickly as possible by a specialist workshop, preferably an authorised BMW Motorrad dealer.

Checking brake-fluid level, rear brakes

! A low fluid level in the brake reservoir can allow air to penetrate the brake system. This significantly reduces braking efficiency.

Check the brake-fluid level at regular intervals. ◀

- Make sure the ground is level and firm and position the motorcycle upright.



- Check the brake fluid level in reservoir **1**.

▶ The brake fluid level in the brake fluid reservoir drops as the brake pads wear. ◀

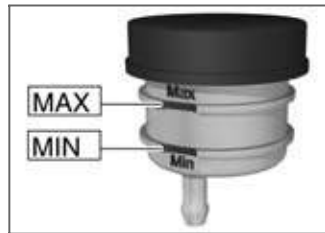

 Brake fluid level, rear

– DOT4 brake fluid

– It is impermissible for the brake fluid level to drop below the MIN mark. (Brake-fluid reservoir horizontal)

If the brake fluid level drops below the permitted level:

- Have the defect rectified as quickly as possible by a specialist workshop, preferably an authorised BMW Motorrad dealer.

Clutch

Checking operation of clutch

- Pull the clutch lever.
 - » The pressure point must be clearly perceptible.

If the pressure point is not clearly perceptible:

- Have the clutch checked by a specialist workshop, preferably an authorised BMW Motorrad dealer.

Checking clutch fluid level

- Make sure the ground is level and firm and position the motorcycle upright.
- Move the handlebars to the straight-ahead position.



- Check the clutch fluid level in reservoir **1**.

▶ Wear of the clutch causes the fluid level in the clutch fluid reservoir to rise.◀



 Clutch-fluid level (visual inspection)

– It is impermissible for the clutch fluid level to drop.

If the fluid level drops:

 Unsuitable hydraulic fluids could cause damage to the clutch system.

Do not attempt to top up the system with fluids of any kind.◀

- Have the defect rectified as quickly as possible by a specialist workshop, preferably

an authorised BMW Motorrad dealer.

 The clutch system is filled with a special hydraulic fluid that does not have to be changed.◀

Tyres

Checking tyre tread depth

 Your motorcycle's handling and grip can be impaired even before the tyres wear to the minimum tyre tread depth permitted by law.

Have the tyres changed in good time before they wear to the minimum permissible tread depth.◀

- Make sure the ground is level and firm and place the motorcycle on its stand.
- Measure the tyre tread depth in the main tread grooves with wear marks.

 Tyres have wear indicators integrated into the main tread grooves. The tyre is worn out when the tyre tread has worn down to the level of the marks. The locations of the marks are indicated on the edge of the tyre, e.g. by the letters TI, TWI or by an arrow.◀

If the tyre tread is worn to minimum:

- Replace tyre or tyres, as applicable.

Rims

Checking rims

- Make sure the ground is level and firm and place the motorcycle on its stand.
- Visually inspect the rims for defects.
- Have damaged rims checked and, if necessary, replaced by a specialist workshop, preferably

an authorised BMW Motorrad dealer.

Wheels

Tyre recommendation

For each size of tyre BMW Motorrad tests and classifies as roadworthy certain makes. BMW Motorrad cannot assess the suitability or provide any guarantee of road safety for other tyres. BMW Motorrad recommends using only tyres tested by BMW Motorrad.

You can obtain detailed information from your authorised BMW Motorrad dealer or on the Internet at www.bmw-motorrad.com.

Effect of wheel size on suspension-control systems

Wheel size is very important as a parameter for the ABS. In particular, the diameter and the width of a motorcycle's wheels are programmed into the control unit and are fundamental to all calculations. Any change in these influencing variables, caused for example by a switch to wheels other than those installed ex-works, can have serious effects on the performance of the control systems.

The sensor rings are essential for correct road-speed calculation, and they too must match the motorcycle's ABS system and consequently cannot be changed.

If you decide that you would like to fit non-standard wheels to your motorcycle, it is very important to consult a specialist work-

shop beforehand, preferably an authorised BMW Motorrad dealer. In some cases, the data programmed into the control units can be changed to suit the new wheel sizes.

Remove the front wheel

- Make sure the ground is level and firm and place the motorcycle on its stand.
- with BMW Motorrad ABS^{OE}



- Unclip the retaining clip of the ABS sensor cable from the brake line.◀

- Mask off the parts of the wheel rim that could be scratched in the process of removing the brake calipers.



 Once the calipers have been removed, there is a risk of the brake pads being pressed together to the extent that they cannot be slipped back over the brake disc on reassembly.

Do not operate the handbrake lever when the brake calipers have been removed.◀

- Remove securing screws **1** of the brake calipers on left and right.

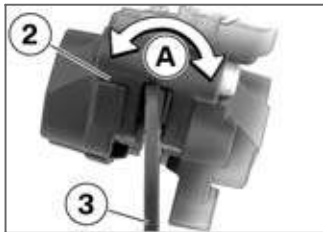

- Force the brake pads slightly apart by rocking brake calipers **2** back and forth **A** against brake discs **3**.
- Carefully pull the brake calipers back and out until clear of the brake discs.

– with BMW Motorrad ABS^{OE}



- Remove screw **1** and remove the ABS sensor from its bore.◁
- Place the motorcycle on an auxiliary stand; BMW Motorrad recommends the BMW Motorrad rear-wheel stand.
- Install the rear-wheel stand (➔ 137)
- Raise front of motorcycle until the front wheel can turn freely. BMW Motorrad recommends the BMW Motorrad front-wheel stand for lifting the motorcycle.

- Install the front-wheel stand (➔ 136)



- Release axle clamping screw **2**.
- Remove quick-release axle **3**, while supporting the wheel.
- Lower the front wheel to the ground between the front forks.
- Roll the front wheel forward to remove.

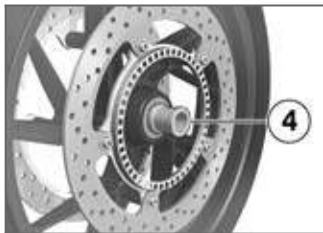

- Remove spacing bushing **4** from the front-wheel hub.

Install the front wheel

 Possible malfunctions when the ABS system intervenes if non-standard wheels are installed.

See the information on the effect of wheel size on the ABS system at the start of this chapter. ◀

 Threaded fasteners not tightened to the specified torque can work loose or their threads can suffer damage.

Always have the security of the

fasteners checked by a specialist workshop, preferably an authorised BMW Motorrad dealer. ◀

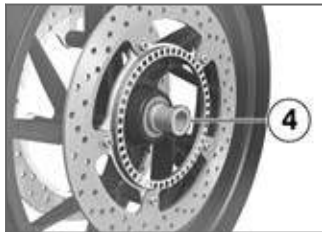

- Install spacing bushing **4** in the wheel hub.

 The front wheel must be installed right way round to rotate in the correct direction. Note the direction-of-rotation arrows on the tyre or the wheel rim. ◀

- Roll the front wheel into position between the front forks.



- Raise the front wheel, insert quick-release axle **3** and tighten to specified torque.

 Quick-release axle in axle holder

– 50 Nm

- Tighten axle clamping screw **2** to the specified torque.

 Quick-release axle clamp screws

– 19 Nm

– with BMW Motorrad ABS^{OE}



- Insert the ABS sensor into its bore and install screw **1**. ◀
- Remove the front-wheel and rear-wheel stands.
- Ease the brake calipers on to the brake discs.



- Install securing screws **1** on left and right and tighten to specified tightening torque.



Radially mounted brake caliper to slider tube

– 30 Nm

- Remove the adhesive tape from the wheel rim.
- !** Braking efficiency is impaired if the brake pads are not correctly bedded against the discs.
Before riding off, always check that the brakes bite as soon as

the brake lever is pulled or the brake pedal depressed. ◀

- Operate the brake several times until the brake pads are bedded.

– with BMW Motorrad ABS^{OE}



- Close the retaining clips holding the ABS sensor cable to the brake line.



The cable of the ABS sensor could chafe through if it comes into contact with the brake disc.

Make sure that the ABS sensor cable is routed correctly. ◀

- Make sure that the ABS sensor cable is routed as shown here. ◀

Removing rear wheel

- Place the motorcycle on an auxiliary stand; BMW Motorrad recommends the BMW Motorrad rear-wheel stand.
- Install the rear-wheel stand (➔ 137)
- Engage first gear.



- ⚠ Risk of burns caused by the hot exhaust system. Do not touch the exhaust system when it is hot; if necessary, allow

the exhaust system ample time to cool before proceeding. ◀

- Remove studs **1** from the rear wheel, while supporting the wheel.
- Lower the rear wheel to the ground and roll it out to the rear.

Installing rear wheel

- ⚠ Possible malfunctions when the ABS system intervenes if non-standard wheels are installed.

See the information on the effect of wheel size on the ABS system at the start of this chapter. ◀

- ⚠ Threaded fasteners not tightened to the specified torque can work loose or their threads can suffer damage. Always have the security of the fasteners checked by a specialist workshop, preferably an authorised BMW Motorrad dealer. ◀

- Seat the rear wheel on the rear-wheel adapter.



- Install wheel studs **1** and tighten to specified torque.

 Rear wheel to wheel carrier

– Tightening sequence: Tighten in diagonally opposite sequence

– 60 Nm

- Remove the rear-wheel stand

Front-wheel stand

Installing front-wheel stand

! The BMW Motorrad front wheel stand is not designed to support motorcycles not fitted with a centre stand or without other auxiliary stands. A motorcycle resting only on the front wheel stand and the rear wheel can topple.

Place the motorcycle on its centre stand or another auxiliary stand before lifting the front wheel with the BMW Motorrad front-wheel stand. ◀

- Place the motorcycle on an auxiliary stand; BMW Motorrad recommends the BMW Motorrad rear-wheel stand.
- Install the rear-wheel stand (➔ 137)
- Use basic stand with tool number (0 402 241) in combina-

tion with front-wheel adapter (0 402 242).

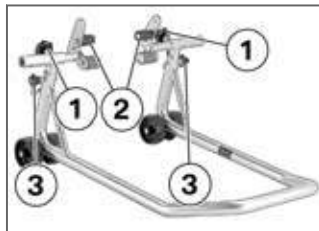

- Slacken adjusting screws **1**.
- Push the two adapters **2** apart until the front forks fit between them.
- Use locating pins **3** to set the front-wheel stand to the desired height.
- Centre the front-wheel stand relative to the front wheel and push it against the front axle.



- Align the two adapters **2** so that the front forks are securely seated.
- Tighten adjusting screws **1**.



- Apply uniform pressure to push the front-wheel stand down and raise the motorcycle.

Rear-wheel stand

Installing rear-wheel stand

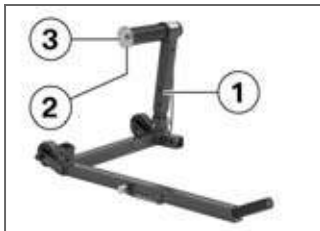

- Use screw **1** to set the rear-wheel stand to the desired height.
- Remove retaining disc **2**. To do so, press release button **3**.

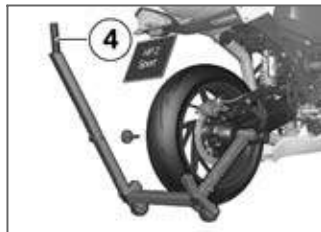

- Push the rear-wheel stand from the right onto the rear axle.
- Push the retaining disc on from the left, while holding the unlock button down.
- Hold the motorcycle with your left hand to keep it upright and use your right hand to grip the lever of the rear-wheel stand **4**.



- Lift the motorcycle upright, simultaneously pressing the lever down until the stand supports the motorcycle in the upright position.
- Press the lever down to the ground.

Middle stand

Installing middle stand

- Make sure the ground is level and firm and place the motorcycle on its stand.
- Use the auxiliary stand with the number (0 401 358) and

the H adapter with the number (0 430 386).

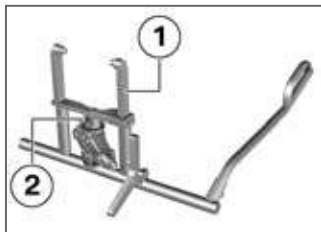

- Release left guide **1** by pulling out pin **2** and pull the guide out.

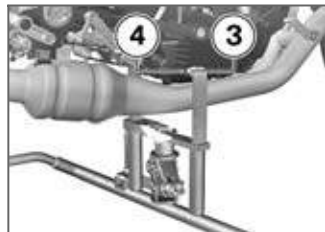

- On the right-hand side, slip stud **3** into mount **4** on the motorcycle.

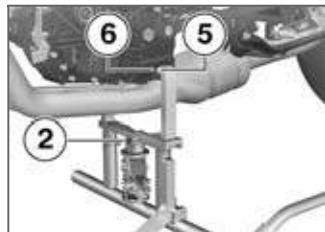

- On the left-hand side, slip stud **5** into mount **6** on the

motorcycle. Make sure that pin **2** latches into position.

- Bring the motorcycle to the upright position, so that the auxiliary stand is lying flat on the ground.
- Press the lifting lever down to the ground.



- In order to ensure stability, the height of the auxiliary stand can be adjusted by means of scissor-type lifter **7**.

Bulbs

General instructions

A warning appears in the multi-function display if a bulb is defective. If the brake or rear light fails, the symbol is accompanied by the 'General' warning light, which lights up yellow.

 A defective bulb places your safety at risk because it is easier for other users to oversee the motorcycle.

Replace defective bulbs as soon as possible; always carry a complete set of spare bulbs if possible.◀

 The bulb is pressurised and can cause injury if damaged.

Wear protective goggles and gloves when changing bulbs.◀

 The types of bulb fitted to your motorcycle are listed

in the section entitled "Technical data".◀

 Do not touch the glass of new bulbs with your fingers. Use a clean, dry cloth to hold the bulbs when handling them. Dirt deposits, in particular oil and grease, interfere with heat radiation from the bulb. This leads to overheating and shortens the bulb's operating life.◀

Replace the low-beam and high-beam headlight bulb

 The plug and the spring clip might face in a direction other than that shown here.◀

 If it is not standing firmly, the motorcycle could topple in the course of the operations described below.

Always make sure that the motorcycle is stable and firmly supported.◀

- Make sure the ground is level and firm and place the motorcycle on its stand.
- Switch off the ignition.
- Turn the handlebars to the full-lock position.

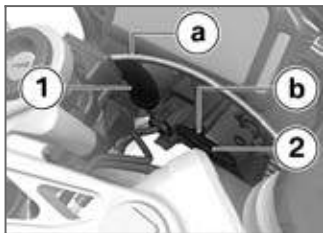

- Unlatch cover **1** for high-beam headlight at position **a** and remove.
- Unlatch cover **2** for low-beam headlight at position **b** and remove.



- Disconnect plug **3**.



- Disengage spring clips **4** from the fastenings and swing them aside.
- Remove bulb **5**.

- Replace the defective bulb.



Bulb for low-beam headlight

– H7 / 12 V / 55 W



Bulb for high-beam headlight

– H7 / 12 V / 55 W

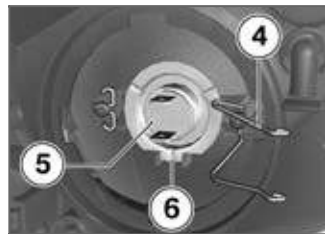

- Install bulb **5**, making sure that tab **6** is correctly positioned.

 The bulb might face in a direction other than that shown here. ◀

- Engage spring clip **4** in the catch.



- Install plug **3**.

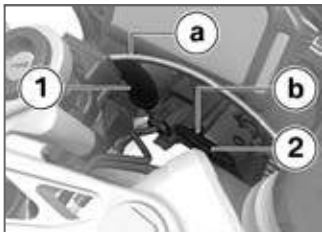

- Install cover **1** for high-beam headlight at position **a** and secure the cover.

- Install cover **2** for low-beam headlight at position **b** and secure the cover.

Replacing parking-light bulb

⚠ If it is not standing firmly, the motorcycle could topple in the course of the operations described below.

Always make sure that the motorcycle is stable and firmly supported.◀

- Make sure the ground is level and firm and place the motorcycle on its stand.
- Switch off the ignition.
- Turn the handlebars all the way to the right



- Pull bulb carrier **1** out of the headlight housing.



- Pull the bulb out of the bulb socket.

- Replace the defective bulb.



Bulb for parking light

– W5W / 12 V / 5 W



- Install the bulb in the bulb socket.



- Install bulb carrier **1** in the headlight housing.

Replacing turn indicator bulbs, front and rear



If it is not standing firmly, the motorcycle could topple in the course of the operations described below.

Always make sure that the motorcycle is stable and firmly supported. ◀

- Make sure the ground is level and firm and place the motorcycle on its stand.



- Remove screw **1**.



- Pull the glass out of the reflector housing at the threaded-fastener side.

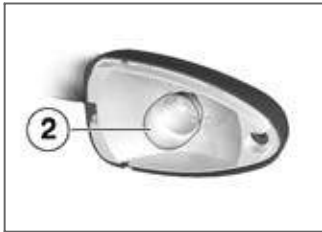

- Turn bulb **2** counter-clockwise and remove it from the bulb housing.
- Replace the defective bulb.

 Bulbs for flashing turn indicators, front

– LED / 12 V

 Bulbs for flashing turn indicators, rear

– LED / 12 V

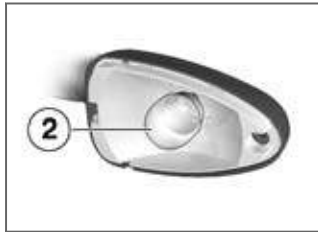

- Turn bulb **2** clockwise to install it in the bulb housing.



- Working from the inboard side, insert the glass into the bulb housing and close the housing.



- Install screw **1**.

Replacing brake light and rear light bulb

- The LED rear light can be replaced only as a complete unit. Consult a specialist workshop, preferably an authorised BMW Motorrad dealer.

Jump starting

-  The wires leading to the power socket do not have a load-capacity rating adequate for jump-starting the engine. Excessively high current can lead

to a cable fire or damage to the vehicle electronics.

Do not use the on-board socket to jump-start the engine of the motorcycle.◀

! Touching live parts of the ignition system with the engine running can cause electric shock.

Do not touch parts of the ignition system when the engine is running.◀

! A short-circuit can result if the crocodile clips of the jump leads are accidentally brought into contact with the motorcycle.

Use only jump leads fitted with fully insulated crocodile clips at both ends.◀

! Jump-starting with a donor-battery voltage higher than 12 V can damage the vehicle electronics.

Make sure that the battery of the

donor vehicle has a voltage rating of 12 V.◀

- Make sure the ground is level and firm and place the motorcycle on its stand.
- When jump-starting the engine, do not disconnect the battery from the on-board electrical system.



! Risk of burns caused by the hot exhaust system.

Do not touch the exhaust system when it is hot; if necessary, allow the exhaust system ample time to cool before proceeding.◀

- Begin by connecting one end of the red jump lead to positive terminal **1** of the motorcycle's battery and the other end to the positive terminal of the donor battery.
- Connect one end of the black jump lead to an earthing point on the motorcycle and the other end to the negative terminal of the donor battery.
- Run the engine of the donor vehicle during jump-starting.
- Start the engine of the vehicle with the discharged battery in the usual way; if the engine does not start, wait a few minutes before repeating the attempt in order to protect the starter motor and the donor battery.
- Allow both engines to idle for a few minutes before disconnecting the jump leads.
- Disconnect the jump lead from the negative terminals first,

then disconnect the second lead from the positive terminals.

 Do not use proprietary start-assist sprays or other products to start the engine. ◀

Battery

Maintenance instructions

Correct upkeep, recharging and storage will prolong the life of the battery and are essential if warranty claims are to be considered.

Compliance with the points below is important in order to maximise battery life:

- Keep the surface of the battery clean and dry
- Do not open the battery
- Do not top up with water
- Be sure to read and comply with the instructions for charging the battery on the following pages

- Do not turn the battery upside down

 If the battery is not disconnected, the on-board electronics (e.g. clock, etc.) gradually drain the battery. This can cause the battery to run flat. If this happens, warranty claims will not be accepted.

If the motorcycle is to be out of use for more than four weeks, disconnect the battery or connect a suitable trickle charger to the battery. ◀

 BMW Motorrad has developed a float charger specially designed for compatibility with the electronics of your motorcycle. Using this charger, you can keep the battery charged during long periods of disuse, without having to disconnect the battery from the motorcycle's on-board systems. You can obtain additional information from

your authorised BMW Motorrad dealer. ◀

Charging battery when connected

 Charging the connected battery directly at the battery terminals can damage the vehicle electronics.

Always disconnect the battery from the on-board circuits before recharging it with a charger connected directly to the battery posts. ◀

 If you switch on the ignition and the multifunction display and telltale lights fail to light up, the battery is completely flat. Attempting to charge a completely flat battery via the on-board socket can cause damage to the motorcycle's electronics. If a battery has discharged to the extent that it is completely flat, it has to be disconnected from the

on-board circuits and charged with the charger connected directly to the battery posts. ◀

! Only chargers suitable for this mode of charging can be used to recharge the battery via the on-board socket. Unsuitable chargers could cause damage to the motorcycle's on-board electrics.

Use BMW chargers with the part numbers 71 60 7 688 864 (220 V) or, as applicable, 71 60 7 688 865 (110 V). If you are in doubt, disconnect the battery from the on-board systems and connect the charger directly to the battery. ◀

- Charge via the power socket, with the battery connected to the motorcycle's on-board electrical system.

▷ The motorcycle's on-board electronics know when the battery is fully charged. The

on-board socket is switched off when this happens. ◀

- Comply with the operating instructions of the charger.

▷ If you are unable to charge the battery through the on-board socket, you may be using a charger that is not compatible with your motorcycle's electronics. If this happens, disconnect the battery from the on-board systems and connect the charger directly to the battery. ◀

Charging battery when disconnected

- Charge the battery using a suitable charger.
- Comply with the operating instructions of the charger.
- Once the battery is fully charged, disconnect the charger's terminal clips from the battery terminals.

▷ The battery has to be recharged at regular intervals in the course of a lengthy period of disuse. See the instructions for caring for your battery. Always fully recharge the battery before restoring it to use. ◀

Removing battery

- Remove the front seat (→ 82)
- Switch off the ignition.

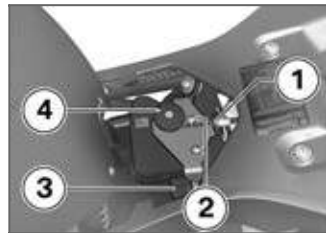

! When withdrawing the Bowden cable from the holder, there is a risk of hitting your hand on the rear trim panel.

Keep your hand clear of the trim panel. ◀

- Pull the Bowden cable out of holder **1**.
- Remove screws **2**.
- Disconnect plug **3**.
- Remove end of Bowden cable **4** from the relay pulley.
- Remove the control unit.

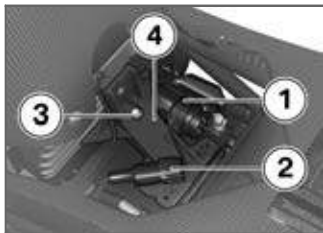

- Remove diagnosis plug **1** from its holder.
- Disconnect plug **2** and remove it from its holder.

- Remove screw **3** and remove battery holder **4**.



! Disconnection in the wrong sequence increases the risk of short-circuits.

Always proceed in the correct sequence. ◀

- Disconnect negative battery lead **5** first.
- Then disconnect positive battery lead **6**.
- Lift the battery up and out.

Installing battery

- Place the battery in the battery compartment, positive terminal on the left in the forward direction of travel.



! Installation in the wrong sequence increases the risk of short-circuits.

Always proceed in the correct sequence.

Never install the battery without the protective cap. ◀

- Connect battery positive lead **6** first.

- Connect battery negative lead **5**.

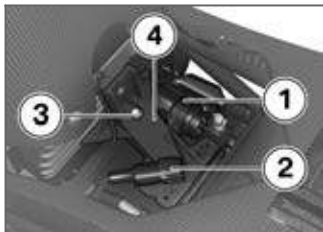

- Route cable of diagnosis plug **1** underneath the battery holder. Hold battery holder **4** in position and install screw **3**.
- Seat plug **2** in its holder and connect it.
- Seat diagnosis plug **1** in the holder.

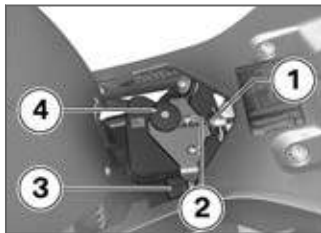

- Engage end of Bowden cable **4** in the relay pulley.
- Connect plug **3**.
- Hold the control unit in position and install screws **2**.
- Press the Bowden cable into holder **1**.
 - » The Bowden cable engages with an audible click.
- Install the seat (➔ 83)
- Set the clock (➔ 50)

Care

Cleaning carbon components.....	150
Care products	150
Washing motorcycle	150
Cleaning easily damaged components.....	151
Paint care.....	151
Protective wax coating	152
Laying up motorcycle	152
Restoring motorcycle to use	152

Cleaning carbon components

The carbon body parts are derived from racing and are produced by a complex process involving a high proportion of craftsmanship.

The descriptions in the sections on care products and looking after the paintwork also apply to carbon parts. Superficial scratches are best removed with the BMW polish set recommended by BMW Motorrad and available from your authorised BMW Motorrad dealer.

Consult your authorised BMW Motorrad dealer if your motorcycle requires attention to more than superficial damage resulting from collisions, drops or other causes.

Care products

BMW Motorrad recommends that you use the cleaning and care products you can obtain from your authorised BMW Motorrad dealer. The substances in BMW Care Products have been tested in laboratories and in practice; they provide optimised care and protection for the materials used in your vehicle.



The use of unsuitable cleaning and care products can damage vehicle components. Do not use solvents such as cellulose thinners, cold cleaners, fuel or the like, and do not use cleaning products that contain alcohol. ◀

Washing motorcycle

BMW Motorrad recommends that you use BMW insect remover to soften and wash off insects and stubborn dirt on

painted parts prior to washing the motorcycle.

To prevent stains, do not wash the motorcycle immediately after it has been exposed to strong sunlight and do not wash it in the sun.

Make sure that the motorcycle is washed frequently, especially during the winter months.

To remove road salt, clean the motorcycle with cold water immediately after every trip.



After the motorcycle has been washed, ridden through water or ridden in the rain, the brake discs and pads might be wet and the brakes might not take effect immediately.

Apply the brakes in good time until the brakes have dried out. ◀



Warm water intensifies the effect of salt.

Use only cold water to wash off road salt.◀

 The high pressure of steam cleaners can damage seals, the hydraulic brake system, the electrical system, and the seat. Do not use a steam jet or high-pressure cleaning equipment.◀

Cleaning easily damaged components

Plastics

Clean plastic parts with water and BMW plastic care emulsion. This includes in particular:

- Windscreen and slipstream deflectors
- Headlight lens made of plastic
- Glass cover of the instrument panel
- Black, unpainted parts

 If plastic parts are cleaned using unsuitable cleaning

agents, the surfaces can be damaged.

Do not use cleaning agents that contain alcohol, solvents or abrasives to clean plastic parts. Even fly-remover pads or cleaning pads with hard surfaces can produce scratches.◀

 Soften stubborn dirt and insects by covering the affected areas with a wet cloth.◀

Windscreen

Clean off dirt and insects with a soft sponge and plenty of water.

 Fuel and chemical solvents attack the material of the windscreen; the windscreen becomes opaque or dull. Do not use cleaning agents.◀

Rubber

Treat rubber components with water or BMW rubber-care products.

 Using silicone sprays for the care of rubber seals can cause damage.

Do not use silicone sprays or other care products that contain silicon.◀

Paint care

Washing the motorcycle regularly will help counteract the long-term effects of substances that damage the paint, especially if your motorcycle is ridden in areas with high air pollution or natural sources of dirt, for example tree resin or pollen.

Remove particularly aggressive substances immediately, however, as otherwise the paint can be affected or become discoloured. Substances of this nature

include spilt fuel, oil, grease, brake fluid and bird droppings. We recommend BMW vehicle polish or BMW paint cleaner for this purpose.

Marks on the paintwork are particularly easy to see after the motorcycle has been washed. Remove stains of this kind immediately, using cleaning-grade benzene or petroleum spirit on a clean cloth or ball of cotton wool. BMW Motorrad recommends BMW tar remover for removing specks of tar. Remember to wax the parts treated in this way.

Protective wax coating

BMW Motorrad recommends applying only BMW car wax or products containing carnauba wax or synthetic wax. It is time to re wax the paintwork when water "puddles" on the surface, instead of forming beads.

Laying up motorcycle

- Clean the motorcycle.
- Remove the battery.
- Spray the brake and clutch lever pivots and the main and side stand pivots with a suitable lubricant.
- Coat bright metal and chrome-plated parts with an acid-free grease (e.g. Vaseline).
- Stand the motorcycle in a dry room in such a way that there is no load on either wheel. Authorised BMW Motorrad dealers can provide suitable auxiliary stands.

▷ Before laying the vehicle up out of use, have the engine oil and the oil filter element changed by a specialist workshop, preferably an authorised BMW Motorrad dealer. Combine work for laying up/restoring to use with a BMW service or inspection.◀

Restoring motorcycle to use

- Remove the protective wax coating.
- Clean the motorcycle.
- Install a charged battery.
- Before starting: work through the checklist.

Technical data

Troubleshooting chart	154	Riding specifications	168
Threaded fasteners	155		
Engine	159		
Fuel.....	160		
Engine oil	160		
Clutch	161		
Transmission	161		
Rear-wheel drive.....	162		
Running gear	162		
Brakes	163		
Wheels and tyres	164		
Electrics	165		
Frame	166		
Dimensions	167		
Weights.....	167		

Troubleshooting chart

Possible cause	Remedy
Emergency off switch (kill switch)	Kill switch in operating position
Side stand	Retract the side stand (➔ 88)
Gear engaged and clutch not disengaged	Select neutral or pull clutch lever (➔ 88)
Clutch pulled before ignition was switched on	Switch on the ignition, then pull the clutch lever
No fuel in tank	Refuelling (➔ 94)
Battery flat	Charge the battery when connected (➔ 145)

Threaded fasteners

Spark plugs	Value	Valid
Spark plug to cylinder head		
NGK MAR9A-J, M10 x 1,00, Thinly coat threads of new spark plugs with Klüber paste HEL 46-450	Initial torque, 12 Nm	
	Back off spark plug 90°	
	Final torque, 12 Nm	
Front wheel	Value	Valid
Radially mounted brake caliper to slider tube		
M8 x 65 - 10.9	30 Nm	
Quick-release axle clamp screws		
M8 x 40	19 Nm	
Quick-release axle in axle holder		
M24 x 1.5	50 Nm	
Front suspension	Value	Valid
Locknut for spring basic setting to spring retainer		
	5 Nm	

Front suspension	Value	Valid
Fork bridge, bottom, with slider tube		
M8 x 25	2x each side, alternately	
	25 Nm	
Rear wheel	Value	Valid
Rear wheel to wheel carrier		
M10 x 40 x 1.25	Tighten in diagonally opposite sequence	
	60 Nm	
Rear suspension	Value	Valid
Locknut for spring basic setting at top spring retainer		
	5 Nm	
Locknut for length adjustment at bottom spring retainer		
	40 Nm	

Tail section	Value	Valid
Number-plate carrier to tail section		
M6 x 30, Replace screw Micro-encapsulated	8 Nm	
Handlebar adjustment	Value	Valid
Stub handlebar to handlebar bridge		
M8 x 25	begin by tightening inboard screw	
	Initial torque, 10 Nm	
	Final torque, 21 Nm	
Handlebar fitting to handlebar		
M6 x 20	5 Nm	
Footrests and foot-operated levers	Value	Valid
Eccentric, peg to shift lever		
M6 x 20 Thread-locking compound acts as anti-corrosion agent, Micro-encapsu- lated	8 Nm	

Footrests and foot-operated levers**Value****Valid**

Eccentric, peg to footbrake lever		
M6 x 20 Thread-locking compound acts as anti-corrosion agent, Micro-encapsulated	8 Nm	
Clamp, eccentric adjustment, footrests		
M8 x 30 Thread-locking compound acts as anti-corrosion agent, Micro-encapsulated	15 Nm	

Engine

Engine design	Four-stroke opposed twin, air-cooled with oil-cooled exhaust ports, installed longitudinally, two overhead camshafts and four radially positioned valves per cylinder, electronic engine management.
Displacement	1170 cm ³
Cylinder bore	101 mm
Piston stroke	73 mm
Compression ratio	12.5:1
Nominal output	98 kW, - at engine speed: 8750 min ⁻¹
Torque	115 Nm, - at engine speed: 6000 min ⁻¹
Maximum engine speed	max 9500 min ⁻¹
Idle speed	1200±50 min ⁻¹

Fuel

Recommended fuel grade	98 ROZ/RON, Premium plus unleaded 95 ROZ/RON, Premium unleaded (fuel grade, usable with power- and consumption-related restrictions)
Usable fuel capacity	approx. 16 l
Reserve fuel	≥3 l

Engine oil

Engine oil, capacity	max 4 l, with filter change
Lubricant	Castrol Power 1 Racing 4T (SAE 10W-50; API SJ)
alternative lubricant	Castrol TWS Motorsport (SAE 10W-60; API SJ/CF)

Clutch

Clutch type	Single-plate dry clutch
-------------	-------------------------

Transmission

Gearbox type	Helical 6-speed gearbox with integral reaction damper, claw-action shift by sliding sleeves
Gearbox transmission ratios	1.734 (19:33 teeth), Primary transmission ratio 2.176 (37:17 teeth), 1st gear 1.625 (39:24 teeth), 2nd gear 1.296 (35:27 teeth), 3rd gear 1.065 (33:31 teeth), 4th gear 0.939 (31:33 teeth), 5th gear 0.848 (28:33 teeth), 6th gear

Rear-wheel drive

Type of final drive	Shaft drive with bevel gears
Number of teeth on rear-wheel drive (gear ratio)	33 : 12, Stamped into underside of final-drive housing

Running gear

Front wheel

Spring strut, front, type	Central spring strut with coil spring and single-tube, gas-filled shock absorber, adjustable spring preload and adjustable rebound and compression stages
Type of front suspension	BMW Telelever, leading link pivot-mounted on engine and telescopic forks, central spring strut supported by pivot mounts in leading link and main frame
Spring travel, front	105 mm, At wheel

Rear wheel

Type of rear suspension	BMW Paralever, consisting of rear wheel swinging arm with central spring strut, reaction link supported by final drive and frame.
Type of rear suspension	Central spring strut with single-tube, gas-filled shock absorber, external expansion tank, adjustable rebound-stage and compression-stage damping, steplessly adjustable spring preload and length adjustment
Spring travel at rear wheel	120 mm, At wheel

Brakes

Type of front brake	Hydraulically operated twin disc brake with radially bolted 4-piston fixed calipers and floating brake discs
Brake-pad material, front	Sintered metal
Type of rear brake	Hydraulically operated disc brake with 2-piston floating caliper and brake disc mounted on final drive
Brake-pad material, rear	Sintered metal

Wheels and tyres

Tyre combinations recommended at time of going to press	You can obtain an up-to-date list of approved tyres from your authorised BMW Motorrad dealer or on the Internet at " www.bmw-motorrad.com ".
---	--

Front wheel

Front wheel, type	Forged wheel with 10 spokes, MT H2
Front wheel rim size	3.50" x 17"
Tyre designation, front	120/70-17

Rear wheel

Rear wheel type	Forged wheel with 10 spokes, MT H2
Rear wheel rim size	6.00" x 17"
Tyre designation, rear	190/55-17

Tyre pressures

Tyre pressure, front	2.2 bar, Tyre cold
Tyre pressure, rear	2.5 bar, Tyre cold
Tyre pressure for sport riding	2.1 ^{±0.2} bar, Tyre cold

Electrics

Electrical rating of on-board socket	
– with power socket ^{OA}	max 5 A
Fuses	Electronic fuses protect the circuits. If an electronic fuse trips and de-energises a circuit, the circuit is active as soon as the ignition is switched on after the fault has been rectified.

Battery

Battery, manufacturer and designation	ETZ 12 BS
Battery type	AGM (Absorbent Glass Mat) battery
Battery rated voltage	12 V
Battery rated capacity	12 Ah

Spark plugs

Spark plugs, manufacturer and designation	NGK MAR9A-J
Electrode gap of spark plug	0.8 \pm 0.1 mm, When new max 1 mm, Wear limit

Lighting

Bulb for high-beam headlight	H7 / 12 V / 55 W
Bulb for low-beam headlight	H7 / 12 V / 55 W
Bulb for parking light	W5W / 12 V / 5 W
Bulb for tail light/brake light	LED / 12 V
Bulbs for flashing turn indicators, front	LED / 12 V
Bulbs for flashing turn indicators, rear	LED / 12 V

Frame

Frame type	Tubular steel spaceframe, carbon-fibre rear frame and load-bearing drive unit
Type plate location	underneath the seat on self-supporting carbon-fibre rear frame
VIN location	on front frame underneath top fork bridge

Dimensions

Length of motorcycle	2135 mm
Height of motorcycle	1163 mm, at DIN unladen weight, across mirrors
Width of motorcycle	750 mm, across touchdown pads for cylinders
Front-seat height	830 mm, At unladen weight
Rider's inside-leg arc, heel to heel	1810 mm

Weights

Unladen weight	199 kg, DIN unladen weight, ready for road 90 % load of fuel, without optional extras
Permissible gross weight	330 kg
Maximum payload	131 kg

Riding specifications

Top speed	>200 km/h
-----------	-----------

Service

BMW Motorrad service	170
BMW Motorrad service quality	170
BMW Motorrad Service Card: on-the-spot breakdown assistance	170
BMW Motorrad service network ...	171
Maintenance work	171
Confirmation of maintenance work	172
Confirmation of service	177

BMW Motorrad service

Advanced technology requires specially adapted methods of maintenance and repair.



If maintenance and repair work is performed inexpertly, it could result in consequential damage and thus constitute a safety risk.

BMW Motorrad recommends you to have all the associated work on your motorcycle carried out by a specialist workshop, preferably an authorised BMW Motorrad dealer. ◀

Your authorised BMW Motorrad dealer can provide information on BMW services and the work undertaken as part of each service. Have all maintenance and repair work carried out confirmed in the "Service" chapter in this manual. Authorised BMW Motorrad dealers are supplied with the latest technical information and have

the necessary technical know-how. BMW Motorrad recommends that you contact your authorised BMW Motorrad dealer if you have questions regarding your motorcycle.

BMW Motorrad service quality

Along with its reputation for engineering quality and high reliability, BMW Motorrad is a byword for excellent quality of service. To ensure that your BMW is always in optimum condition, BMW Motorrad recommends that you have the maintenance work required for your motorcycle carried out regularly, preferably by your authorised BMW Motorrad dealer. For generous treatment of claims submitted after the warranty period has expired, evidence of regular maintenance is essential.

Certain signs of wear, moreover, may otherwise not be noticed until it is too late to put them right at moderate cost. Your authorised BMW Motorrad dealer's mechanics know every detail of your motorcycle and can take remedial action if necessary before minor faults develop into serious problems. By having the necessary repairs done properly and in good time, you save time and money in the long run.

BMW Motorrad Service Card: on-the-spot breakdown assistance

In the event of a breakdown, the BMW Motorrad Service Card issued with each new BMW motorcycle enables you to access an extensive range of services such as breakdown assistance, motorcycle transportation etc. (details can differ from country to country). In the event of a break-

down, contact the Mobile Service organisation of BMW Motorrad. The specialists will provide the necessary advice and assistance. You will find important country-specific contact addresses and the after-sales service organisation phone numbers in the "Service Kontakt / Service Contact" brochures, along with information on Mobile Service and the dealership network.

BMW Motorrad service network

BMW Motorrad has an extensive after-sales service network in place to look after you and your motorcycle in more than 100 countries. In Germany alone, you have the best possible access to approximately 200 authorised BMW Motorrad dealers.

All information concerning the international dealership network can be found in the brochure

"Service Contact Europe" or "Service Contact Africa, America, Asia, Australia, Oceania".

Maintenance work

BMW Pre-delivery Check

Your authorised BMW Motorrad dealer conducts the BMW pre-delivery check before handing over the motorcycle to you.

BMW Running-in Check

The BMW running-in check has to be performed when the motorcycle has covered between 500 km and 1200 km

BMW Service

The BMW Service is carried out once a year; the extent of servicing can vary, depending on the age of the motorcycle and the distance it has covered. Your authorised BMW Motorrad dealer confirms that the service work has been carried out and enters

the date when the next service will be due.

Riders who cover long distances in a year might have to bring in their motorcycles for service before the next scheduled date. It is to allow for these cases that a maximum odometer reading is entered as well in the confirmation of service. Servicing has to be brought forward if this odometer reading is reached before the next scheduled date for the service.

BMW Service, engine

A special engine service has to be undertaken after 50000 km.

Confirmation of maintenance work

BMW Pre-delivery Check

Completed

on _____

Stamp, signature

BMW Running-in Check

Completed

on _____

Odometer reading _____

Next service
at the latest

on _____

or, if logged beforehand,

Odometer reading _____

Stamp, signature

BMW Service

Completed

on _____

Odometer reading _____

Next service
at the latest

on _____

or, if logged beforehand,

Odometer reading _____

Stamp, signature**BMW Service**

Completed

on _____

Odometer reading _____

Next service
at the latest

on _____

or, if logged beforehand,

Odometer reading _____

Stamp, signature**BMW Service**

Completed

on _____

Odometer reading _____

Next service
at the latest

on _____

or, if logged beforehand,

Odometer reading _____

Stamp, signature

BMW Service

Completed

on _____

Odometer reading _____

Next service
at the latest

on _____

or, if logged beforehand,

Odometer reading _____

Stamp, signature**BMW Service**

Completed

on _____

Odometer reading _____

Next service
at the latest

on _____

or, if logged beforehand,

Odometer reading _____

Stamp, signature**BMW Service**

Completed

on _____

Odometer reading _____

Next service
at the latest

on _____

or, if logged beforehand,

Odometer reading _____

Stamp, signature

BMW Service

Completed

on _____

Odometer reading _____

Next service
at the latest

on _____

or, if logged beforehand,

Odometer reading _____

Stamp, signature**BMW Service**

Completed

on _____

Odometer reading _____

Next service
at the latest

on _____

or, if logged beforehand,

Odometer reading _____

Stamp, signature**BMW Service**

Completed

on _____

Odometer reading _____

Next service
at the latest

on _____

or, if logged beforehand,

Odometer reading _____

Stamp, signature

BMW Service

Completed

on _____

Odometer reading _____

Next service

at the latest

on _____

or, if logged beforehand,

Odometer reading _____

Stamp, signature**BMW Service**

Completed

on _____

Odometer reading _____

Next service

at the latest

on _____

or, if logged beforehand,

Odometer reading _____

Stamp, signature**BMW Service**

Completed

on _____

Odometer reading _____

Next service

at the latest

on _____

or, if logged beforehand,

Odometer reading _____

Stamp, signature

A

Abbreviations and symbols, 6

ABS

- Control, 15
- Engineering details, 98
- Operation, 63
- Self-diagnosis, 90
- Warnings, 27

Accessories

- General instructions, 112

B

Battery

- Charging, 145, 146
- Installation, 147
- Maintenance instructions, 145
- Removal, 146
- Stowage, 14
- Warning for charge current, 25

BMW Motorrad service, 170

BMW Motorrad Service

- Card, 170

Brake fluid

- Checking fluid levels, 127
- Reservoir, front, 13
- Reservoir, rear, 13

Brake pads

- Checking brake-pad thickness, 125
- Running in, 91

Brakes

- Adjusting brake lever, 65
- Checking operation, 124
- Safety instructions, 92
- Technical data, 163

Bulbs

- General instructions, 139
- LED rear light, 143
- Overview, headlights, 17
- Replacing high-beam headlight bulb, 139
- Replacing low-beam headlight bulb, 139
- Replacing parking-light bulb, 141
- Replacing turn indicator bulbs, 142
- Technical data, 166
- Warning for bulb failure, 26
- Warning, bulb failure, 25, 26

C

Carbon, 150

Checklist, 87

Clock, 20

- Adjusting, 50

Clutch

- Adjust the clutch lever, 64
- Checking fluid level, 129
- Checking operation, 129
- Fluid reservoir, 11
- Technical data, 161

Confirmation of maintenance work, 172

Currency, 7

D

Damping

- Adjuster, front, 13
- Adjuster, rear, 11, 13
- Adjusting, 74

Dimensions, 167

Display

- See multifunction display, 17

E

- Electrics
 - Technical data, 165
- Emergency off switch (kill switch), 16, 62
- Engine
 - Control, 16
 - Starting, 88
 - Technical data, 159
 - Warning for engine electronics, 24
- Engine oil
 - Checking fill level, 123
 - Fill-level indicator, 11
 - Filler neck, 13
 - Technical data, 160
 - Topping up, 124
 - Warning for engine oil pressure, 25
- Equipment, 6

F

- Footrests
 - Adjusting, 68
- Frame
 - Technical data, 166

- Front-wheel stand
 - Installing, 136

- Fuel
 - Filler neck, 11
 - Refuelling, 94
 - Technical data, 160
 - Warning for fuel down to reserve, 24
- Fuses, 165

G

- Gear indicator, 20, 21
- General views
 - Headlight, 17
 - Instrument panel, 17
 - Left handlebar fitting, 15
 - Left side of motorcycle, 11
 - Right handlebar fitting, 16
 - Right side of motorcycle, 13
 - Underneath the seat, 14

H

- Handlebar fittings
 - General view, left side, 15
 - General view, right side, 16

- Handlebars
 - Adjusting, 66
- Hazard warning flashers
 - Control, 15, 16
 - Operation, 61
- Headlight
 - Beam throw, 82
 - Driving on right/driving on left, 82
 - Headlight beam-throw adjustment, 11
 - Overview, 17
- Headlight flasher, 15
- High Performance
 - Engineering details, 103
- High-beam headlight
 - Control, 15
 - Switching on, 60
 - Telltale light, 21
- Horn, 15

I

- Idle
 - Telltale light, 21

Ignition

Switching off, 58

Switching on, 58

Immobiliser, 59

Warning, 24

INFO mode

Operation, 46

Instrument panel, 32

Control, 15

INFO mode, 46

Overview, 17

RACE mode, 37

Settings, 50

Warm-up phase, 89

J

Jump start, 143

K

Keys, 58, 59

L

LAP monitor, 37

Laying up, 152

Lights

Headlight flasher, 60

Switch on the high-beam

headlight, 60

Switch on the parking lights, 60

Switching on the low-beam

headlight, 60

Switching on the side lights, 60

Low-beam headlight

Switching on, 60

Luggage

Instructions for loading and
securing objects, 113

M

Maintenance intervals, 171

Middle stand, 138

Mirrors

Adjusting, 66

Removal, 118

Motorcycle

Laying up, 152

Parking, 93

Restoring to use, 152

Multifunction display, 17

Status indicators, 20

N

Number-plate carrier

Removal, 119

O

Odometer and tripmeters, 20

Operation, 34

P

Parking, 93

Parking light

Switching on, 60

Power socket, 13, 112

Pre-ride check, 89

R

RACE mode

Operation, 37

Race track

Modifications, 115

public roads, 120

- Rear-wheel drive
 - Technical data, 162
- Rear-wheel stand, 137
- Refuelling, 94
- Reserve volume
 - Warning, 24
- Residual range, 35
- Restoring to use, 152
- Rev. counter, 20
- RPM redline warning, 17, 21
- Running gear
 - Adjusting heights, 77
 - Technical data, 162
- Running in, 90

S

- Safety instructions, 86
 - Brakes, 92
- Seat
 - Installation, 82
 - Lock, 11
 - Removal, 82
- Service, 170
- Service Card, 170

- Shift lever
 - Adjusting, 64
- Shift light, 17
- Shifting gear
 - Gearshift-pattern reverser, 91
 - Shift assistant, 91
- Side light
 - Switching on, 60
- Spark plugs
 - Technical data, 165
- SPEED monitor, 37
- Speedometer, 20
- Spring preload
 - Adjuster, front, 11
 - Adjuster, rear, 11
 - Adjusting, 68
- Starting, 88
- Status indicators
 - See also warnings, 20
 - Standard status indicators, 20
- Steering lock
 - Locking, 58
- Stopwatch
 - Operation, 35

T

- Technical data
 - Brakes, 163
 - Bulbs, 166
 - Clutch, 161
 - Dimensions, 167
 - Electrics, 165
 - Engine, 159
 - Engine oil, 160
 - Frame, 166
 - Fuel, 160
 - Rear-wheel drive, 162
 - Running gear, 162
 - Spark plugs, 165
 - Standards, 7
 - Transmission, 161
 - Weights, 167
 - Wheels and tyres, 164
- Telltale lights, 21
- Toolkit
 - Contents, 122
 - Stowage, 14
- Torques, 155

- Transmission
 - Technical data, 161
- Troubleshooting chart, 154
- Turn indicators
 - Control, left, 15
 - Control, right, 16
 - Operation, 61
 - Removal, 116
 - Telltale light, 21
- Type plate, 14
- Tyres
 - Checking inflation pressure, 81
 - Checking tread depth, 130
 - Pressures, 4, 164
 - Recommendation, 130
 - Running in, 91
 - Table of tyre pressures, 14
 - Technical data, 164
- Warnings
 - Mode of presentation, 22
 - With ABS, 27
- Warnings, overview, 23, 28
- Weights, 167
- Wheels
 - Change of size, 131
 - Checking rims, 130
 - Install the front wheel, 133
 - Installing rear wheel, 135
 - Remove the front wheel, 131
 - Removing rear wheel, 135
 - Technical data, 164

V

- Vehicle identification number, 13

W

- Warm-up phase, 89

Details described or illustrated in this booklet may differ from the motorcycle's actual specification as purchased, the accessories fitted or the national-market specification. No claims will be entertained as a result of such discrepancies.

Dimensions, weights, fuel consumption and performance data are quoted to the customary tolerances.

The right to modify designs, equipment and accessories is reserved.

Errors and omissions excepted.

© 2007 BMW Motorrad

Not to be reproduced either wholly or in part without written permission from BMW Motorrad, After Sales.

Printed in Germany.

The most important data for a filling-station stop can be found in the following chart:

Fuel	
Recommended fuel grade	98 ROZ/RON, Premium plus unleaded 95 ROZ/RON, Premium unleaded (fuel grade, usable with power- and consumption-related restrictions)
Usable fuel capacity	approx. 16 l
Reserve fuel	≥3 l
Tyre pressures	
Tyre pressure, front	2.2 bar, Tyre cold
Tyre pressure, rear	2.5 bar, Tyre cold
Tyre pressure for sport riding	2.1±0.2 bar, Tyre cold

BMW recommends 

Order No. 01 41 7 712 361
12.2007, 1st edition

