

2021 CSC Monterey Owner's Manual



Preface

The Electric Vehicle Maintenance Manual details the ZS1500D-6 motorcycle's basic structure, working principles, disassembly and maintenance, fault diagnosis and exclusion, etc. At the same time, it has also introduced the vehicle's technical specifications, performance parameters and maintenance and adjustment data. The manual is informative, illustrated and practical. It is hoped that this manual can provide support and guidance on the maintenance technology for the customers and aftersales staff.

The technical specifications, performance parameters and maintenance and adjustment data labeled in the manual are based on the latest status. Our company's subsequent improvements for the vehicle model will be done without notice. If there is any difference between the manual and the improved product, please understand. We sincerely wish that you can tell us your ideas and suggestions about the design, manufacture or quality of the motorcycle, so that we can make improvements in time. Thanks for your support.

All information, figures, data and performance indexes shown in the manual were what they were till the time the manual is printed. We have the authority to revise this manual without notice. Please understand. Any part of this manual is copyrighted by Zongshen Industrial Group. No entities or individuals shall be allowed to reproduce the manual without the permission of our company, otherwise, investigations will be conducted for criminal liability according to law.

Due to the limited level of the editor, there may be some faults or careless omissions in the manual. We are looking forward to your criticism and corrections.

Content

Chapter 1 Introduction of the Electric Vehicle	1
Section 1 Composition of Electric Vehicles	1
Section 2 Technical Specifications and Performance Parameters	2
Chapter II Correct Use and Maintenance of the Electric Vehicle	3
Section 1 Correct Use of the Electric Vehicle	3
Section 2 Maintenance of the Electric Vehicle	5
Chapter III Structure and Maintenance of Electric Vehicles	9
Section 1 Motor	9
Section 2 Storage Battery	10
Section 3 Charger	11
Section 4 Controller	12
Section 5 Speed Control Handle and Brake Handle	13
Section 6 Converter	14
Section 7 Instrument	15
Section 8 Structure Principle and Maintenance of Vehicle Part	17
Section 9 Wheels	22
Section 10 Shock Absorber	25
Section 11 Lighting and Signal Lights	29
Chapter 4 Common Fault Diagnosis and Troubleshooting Methods	34
Appendix: ZS1500D-6 Electrical Schematic Diagram	37

Chapter 1 Introduction of the Electric Vehicle

Section 1 Composition of Electric Vehicles

I. The basic composition of electric vehicles

The electric vehicle is mainly composed of a body, an electric drive (motor), a battery, a charger and a control system, and the functions of each component are as follows.

A. Vehicle body

The vehicle body is mainly composed of frame, front fork, wheels, steering handle and seat cushion, which mainly supports and controls the running of electric vehicles.

B. Motor

The motor is a component that converts the electric energy of the vehicle-mounted battery into mechanical energy, thereby driving the hub of the electric vehicle to rotate.

C. Battery

Battery is the energy carrier used by electric vehicles to provide motor rotation, and it is one of the key components to determine the driving range of electric vehicles.

D. Charger

The charger can recharge the electric energy when the battery of the electric vehicle is insufficient.

E. Control components

The control components of electric vehicle include controller, steering handle, brake handle, power sensor, instrument, combination switch, lighting and indicator lamps (eg., headlamps), etc.

a. Controller

The controller of the electric vehicle is used to control the working state of the motor, which is the core component of the electric system of the electric vehicle. It has the functions of undervoltage, current limit and overcurrent protection. The intelligent controller used in the electric vehicle performs self-inspection, constant speed, power assistance and other functions on the electrical components of the whole vehicle.

b. Acceleration handle

The acceleration handle is a component for controlling the running speed of electric vehicles. The electrical signals output to the controller are different according to the rotation angle of the handle. The controller controls the motor speed according to this signal, which plays a role in adjusting the speed of the handle.

c. Brake handle

On the one hand, the brake handle holds the wheel tightly by the mechanical force of steel wire rope and brake shoe, and controls the wheel to rotate; on the other hand, the output signal of internal electronic circuit is transmitted to the controller, which cuts off the power supply circuit of the motor, thus realizing the purpose of braking and power off.

d. Instrument

The instrument can display the working state of the electric vehicle. Its display contents generally include power on/off, battery power, driving speed, etc. The intelligent controller can also display the states of power assistance, electric operation, constant speed, etc., and its display modes generally include pointers, numbers, light-emitting diodes, etc.

e. Lighting, indicator light

Lamps are components that provide illumination and indication, including headlamps, rear taillights, turn indicators, etc.

Section 2 Technical Specifications and Performance Parameters

I. Technical specifications and performance parameters of ZS1500D-6electric vehicle

Items		Technical specification parameters
Outer contour dimension (L× W × H)		1895mm × 680mm × 1020mm
Wheelbase		1235mm
Minimum ground clearance		160mm
Complete vehicle curb mass		82kg
Maximum capacity		150kg
Electricity consumption		≥ 2.69kWh /100 km
Maximum speed		≤ 45km/h
Gradeability		≥ 10 °
Brake		Front brake hand operated/disc Rear brake hand operated/disc
Shock absorber		Undamped mechanical type of front and rear springs
Tyre size and air pressure	Front	70/90-17 , 225kPa
	Rear	80/90-17 , 250kPa
Battery	Type	Lithium battery
	Capacity	60V26Ah
	Standard voltage	60V
Charger	Input voltage	(180 ~ 240)V
	Frequency	50Hz
Drive motor	Rated power	1500W
	Rated speed	442 ± 40 (r/min)
	Rated output torque	32N.m (r/min)
Controller	Overcurrent protection	38 ± 1A
	Undervoltage protection value	52 ± 1V
Other electrical parts	Headlamps	12V/4.5W/4.5W
	Steering lamp	12V/2.8W× 4
	Brake lamp/rear taillight	12V/0.96W/0.24W
	Rear license plate lamp	12V/0.8W

Chapter II Correct Use and Maintenance of the Electric Vehicle

Section 1 Correct Use of the Electric Vehicle

I. Check before starting

Please inspect the electric vehicle carefully before starting to avoid or reduce the occurrence of running faults. The general inspection is as follows:

1. Check whether the connection of the whole vehicle parts is tight and whether there are other abnormal phenomena, so as to avoid accidents caused by looseness, falling off and fracture.
2. Check whether the power is sufficient. If the power is insufficient, please charge first. If the power is insufficient, do not use the electric and electric assist functions.
3. Check whether the control mechanisms such as speed control handle and front and rear brake cables are flexible and reliable.
4. Check whether the front and rear brake handles are flexible and reliable.
5. Check whether the front and rear tire pressures are adequate and consistent, and whether the tire is in good condition.
6. Check whether the functions of various electrical equipment such as lighting, horn and instrument display are normal.
7. Remove the front and rear wheels from the ground, and check whether the wheels can run normally and have abnormal noise.

II. Start correctly

Key points for safe and correct starting of electric vehicles;

1. Make a comprehensive inspection of the electric vehicle in accordance with the regulations before starting the vehicle, and ensure the electric vehicle is in good running condition.
2. Turn the speed control handle backward gradually to improve the continuous mileage of one-time charging.

III. Control the control panel according to the instructions

The electric vehicle is equipped with an instrument display panel that displays speed, power, mileage, voltage and current, etc. The user can master and control the operation of the electric vehicle according to the data on the instrument display panel during driving, and the operation status is clear at a glance.

IV. Start in riding

Electric vehicles will encounter some unexpected situations during riding, so the driver need to know how to slow down, accelerate and stop. The brake power-off function of electric vehicles ensures the driving safety of users, and takes effect immediately as long as the front brake or the rear brake decelerates. In addition, the power supply can be cut off by lightening the speed control handle up and returning the handle.

V. Reasonable braking

On the premise of ensuring safety, the braking times should be reduced as much as possible to avoid frequent starting. However, the following points should be noticed when braking is necessary in some unexpected situations:

1. According to the principle of "stopping with front brake and decelerating with rear brake", the front and rear brakes should be used together when braking.
2. When driving fast or going downhill, please slow down ahead of time, and apply the "cadence braking"; after braking, instead of using the front brake first, so as to avoid the danger of the center of gravity moving forward.

3. In rainy and snowy weather, the road is so muddy and slippery that the braking effect is poor, and the inertia force is large, it is prone to danger. The user should be more careful when driving, and should balance the front and rear braking force to prevent sideslip.

VI. Correct use

To keep the electric vehicle in good condition, you need not only choose an electric vehicle with good quality, but also need user's keep usual maintenance and correct operation. Developing good usage habits and reasonable usage methods plays a vital role in the service life of batteries and motors. Be diligent in maintenance, boosting power and charging.

1. Maintenance

Keep the electric vehicle clean and tidy, and prevent the vehicle body or rotating parts from being corroded by the sun and rain. When using or passing through the pool in rainy season, the water level should not be higher than the center line of the reel shaft, so as to prevent the motor from being damaged by water ingress. Tire inflation should be sufficient to reduce the friction resistance between tire and road. Notice the braking performance of front and rear brakes to ensure driving safety. After driving for about half a year (about 3000km), the special maintenance center should be required to maintain the electric wheel hub and replenish lubricating oil.

When charging, use a matching charger in a cool and ventilated place, avoid high temperature and humidity, and never fill the charger in water to prevent electric shock accidents.

2. Matters needing attention

- ① . The performance of the battery will be affected by the ambient temperature. When the air temperature drops below 0℃ , the battery power may drop significantly. Therefore, in winter or cold areas, it is normal to reduce the driving range after one charge. When the temperature rises to about 20℃ the function of the battery will naturally recover.
- ② . Frequent braking, starting, going uphill, driving against the wind and muddy roads will consume a lot of electric energy and affect the driving range. In order to achieve the best driving range, it is recommended to adopt the following methods when driving:
 - a. Under the premise of ensuring safety, minimize frequent braking and starting.
 - b. When the battery is out of service for a long time, please unload and store it after it is fully charged. It is recommended to replenish electricity every 3 ~ 4 weeks.
- ③ . All batteries will self-discharge, and long-term insufficient storage will affect the life of batteries.
 - a. In rainy and snowy weather, please slow down your riding speed and avoid emergency braking in case of any accident.
- ④ . Please use the specified charger and other accessories.
- ⑤ . It is forbidden to disassemble or modify electric vehicles without authorization. In case of failure, contact the local distributor or the designated repair site.
- ⑥ . After braking, the motor will stop rotating. If the motor cannot rotate when it is started again, it is necessary to hold the front and rear brake handles and release them. At this time, the motor will rotate normally when it is started.
- ⑦ . In the process of driving, there will be a variety of complex road conditions and a variety of electromagnetic interference, because the electric vehicle's circuit by the computer chip control, the crash phenomenon may occur when there is interference. At this time, you can turn off the power supply and then turn it back to normal.
- ⑧ . For electric vehicles that are not ready for use for a long time, please seal them up. First, remove the battery from the vehicle after it is fully charged, and cut off the power supply. The vehicle should be maintained once to remove mud and dust, inflate the tires, and place the whole vehicle in a ventilated, dry and cool place. If the storage time exceeds 20 ~ 30 days, the battery must be recharged once, and the charger should be placed in a dry place to avoid dust. Storage batteries should be stored indoors in winter.

⑨ . Do not drive beyond the maximum load capacity of electric vehicles.

3. Safety instructions

① . Please read the operation and maintenance instructions carefully, and check whether all parts are in good condition. Please do not use electric vehicles until you know the performance of electric vehicles; Don't lend it to someone who can't operate an electric car.

② . In rainy and snowy weather, the road is in poor driving conditions, so pay attention to braking in advance, make cadence braking first and then brake.

③ . Please do not disassemble the parts by yourself. If you want to replace them, please go to our after-sales service and repair site to replace the original parts.

④ . There is a safe power supply in the battery box. Please don't touch the two electrodes when your hands are wet. And the two electrodes are not allowed to contact with metal at the same time, otherwise, a large short-circuit current will be generated and an accident will be caused.

⑤ . Please consciously abide by the traffic rules and drive safely to ensure personal safety. The following persons are strictly prohibited from driving:

- a. Persons with mental illness or history of mental illness are prohibited from driving.
- b. Patients with heart disease are strictly prohibited from driving.
- c. The deaf-mute are forbidden to drive.
- d. The disabled unsuitable for driving are prohibited from driving.
- e. Drunk driving is strictly prohibited.

Section 2 Maintenance of the Electric Vehicle

I. Routine maintenance

See table 2-1 for the parts and methods of daily maintenance of electric vehicles.

Table 2-1 Daily Maintenance Parts

Position	Maintenance methods	Maintenance time
Wheel bearing	Disassemble the front wheel bearings, replenish grease, check the wear of the bearings, and replace the parts if they are worn or damaged.	Once a year
Wheel axle	Remove the wheel shaft and check whether the wheel shaft is bent or deformed; If the wheel shaft is bent and deformed, it should be replaced and corrected.	Once every six months
Wheel	Check the yaw and runout of the front and rear wheels. If the yaw and runout of the front and rear wheels are too large, correct or replace the wheels in time.	The first month of the new vehicle, once every 2 years from now on
Brake handle	Adjust the free stroke of the front and rear brake handles within the specified range: 10mm~ 20mm.	Once every three months
Brake cable	Check the brake cable for interference and wear. Replace the brake cable if it is seriously worn.	Once a month
	Clean the brake cable and apply grease or lubricating oil.	Once every 3 months
Brake shoe	Check the wear of brake shoes. If the wear of brake shoes exceeds the maintenance limit, replace the brake shoes in time.	Once a month in time.
Seat cushion	Check the damage of cushion leather cover and cushion foam. If the cushion leather cover and cushion foam are damaged, replace the cushion in time.	Irregularly
Battery power	Check whether the battery has enough power, and if not, charge it.	Once a day. For battery without using for a long time, once a month.

The daily maintenance of electric vehicles is as follows:

1. Electric vehicles should always be kept clean. Please use clean cotton yarn or cotton cloth to wipe away dust and sludge. Electric vehicles should be wiped clean with dry cloth in time after being drenched, so as to avoid rusting of parts and short circuit of electrical components due to damp. Baked paint should not be wrapped with plastic, because it is not easy to dry after encountering water, and the paint film is easy to fall off. Baking paint parts should not be rubbed with oil, so as not to make surface of the baking paint be glazed. Electroplated parts should be rubbed frequently with neutral engine oil or sewing machine oil to prevent rusting.

2. The air storage capacity of tires should be checked frequently to keep them in normal use.

3. The main transmission components of electric vehicles, such as front wheel (front wheel drive), rear wheel (rear wheel drive), middle axle, front and rear shock absorbers, large and small sprockets, etc., as well as the electric wheel hub, should be checked and adjusted frequently to keep the transmission components flexible and free from impact and noise. The screws and nuts of the whole vehicle should be inspected frequently, and tightened in time if any looseness is found, so as to prevent the parts from increasing wear or causing greater damage due to looseness.

4. The braking parts of electric vehicles should be checked and adjusted frequently to make them in a flexible and good braking state. If the brake shoes are seriously worn, the braking performance will be reduced, and the brake shoes should be replaced. After being used in rainy days, the silt adhered to the brake working face should be removed to avoid affecting the braking performance.

5. Check whether the operating parts and cables are flexible and reliable, and ensure that there is no interference or jamming. Slowly drip lubricating oil from one end of the hose, and pull the wire rope at the same time, feeling that the wire rope slides lightly in the hose.

6. A small amount of lubricating oil should be frequently added to each moving part of the electric vehicle to reduce the wear of each part and keep the electric vehicle sliding well. In particular, lubricating oil should be frequently added to the moving parts of the braking part and the chain of the transmission part to keep the braking and transmission flexible. See table 2-2 for lubrication parts and lubrication cycle.

7. Electric vehicles should be stored in a dry and ventilated shed, and should not be placed in damp and over-high temperature places. The heat source will age the tire rubber.

8. Every 6 months to 1 year, the whole vehicle should be scrubbed, and all transmission (moving) parts should be cleaned, then proper amount of calcium-based grease should be added, and the aluminum wheels (spokes) should be carefully corrected.

9. The electric hub, controller, charger and battery box are not within the scope of routine maintenance, and it is forbidden to disassemble and repair them without permission. If there is any fault, please go to a professional maintenance station for repair by professionals.

Table 2-2

Lubrication Parts and Lubrication Cycle

Lubrication part	Lubricant	Lubrication cycle
Front axle bearing Rear axle bearing	No.3 calcium-based	6 months to 1 year
Direction column upper and lower bearings	No.3 calcium-based	6 months
Brake cable at sliding parts such as brake swing arm shaft and shaft sleeve	No.30 machine oil	3 days to 7 days
Other moving and rotating parts	No.30 machine oil	3 days

Note: The above table is for general reference only. The cycle can be shortened or extended as appropriate according to the working environment, frequency of use, quality of electric vehicles, as well as old and new conditions.

II. Inspection and adjustment beyond 1000km mileage

1000km mileage is the running in mileage of electric vehicles, which is also called “running-in period”. The so-called “running-in period” refers to the running-in process in which all parts of the newly purchased electric vehicle are run-in after a period of riding, so that the cooperation between them is more compact, more consistent and more flexible. Running-in mileage is different for different models and different factory conditions, but it is basically within 1000km. The specific mileage can be inquired from the instruction manual.

After the running-in period, the whole vehicle should be adjusted comprehensively to ensure the normal operation of the whole vehicle in the future, and to make the electric vehicle run faster and more durable. The main adjustment items are as follows:

1. Adjustment of aluminum wheel (spoke) of wheel

After a period of driving, the stress of each aluminum wheel (spoke) becomes more reasonable. Therefore, the aluminum wheel (spoke) should be properly adjusted to make the stress of the aluminum wheel (spoke) more uniform and ensure the roundness of the wheel.

2. Adjustment of bearings

After the running-in period, the raceway surface between the steel ball, the shaft bowl and the shaft stop will be smoother and more consistent under the operation of the stressed load, but the clearance should be properly adjusted.

3. Adjustment of braking system

After a period of use, the coordination of various parts of the brake system is more perfect, especially the brake shoe and the inner diameter surface of the brake drum are more consistent after running-in. In order to drive safely, the free stroke of brake system should be adjusted appropriately.

4. After the adjustment of fasteners runs during the running-in period, some bolts or nuts will inevitably become loose after the electric vehicle is bumped and shaken, so it is necessary to check and tighten them in time to ensure the normal running of the electric vehicle.

III. Regular maintenance self-inspection content

1. Under normal circumstances, aluminum alloy (spoke) wheels should be adjusted once after driving for a period of time, so as to ensure that the aluminum wheels (rims) are aligned, reduce the waggle during riding, and help save electric energy.

2. Check whether the tire pressure is appropriate. The front and rear tire pressures are 225 kPa (2.8 ~ 4.5 kg/cm²).

3. Check whether the rear reflector is in good condition.

4. Check the fastening nuts of front and rear axles frequently to prevent loosening.

5. All fasteners must be fastened in place. Especially, the stopper plate installed on the electric hub shaft of the rear wheel cannot be loosened.

6. Butter or lubricating oil can be filled into the brake cable to reduce friction.

7. The adjustment method of the brake adjusts the free travel of the front and rear brake handles to within 10mm-20mm, which can not only effectively control the wheels, but also prevent the wheels from blocking when the brake handles are released (otherwise, it will cause driving resistance and consume a lot of electric energy).

8. It is suggested that the new vehicle should be inspected and maintained at the designated maintenance station after driving for one month, and that maintenance should be performed once every 1000km.

9. A power-off device is installed at the handle of the electric power-assisted handle, which mainly controls the power-off in the braking state.

10. In daily use and maintenance, if the users find any problems that he/she can solve, please send the vehicle to the designated maintenance site for inspection or repair by professionals.

11. Any failure and damage caused by dismantling parts of this electric vehicle without authorization is not covered by the free warranty.

12. The motor, controller and battery are all maintenance-free. If there are problems during the warranty period, please replace the parts at the dealer. It is forbidden to soak electrical components such as motors and controllers in water during use.

IV. Main points of maintenance

1. Main points of battery maintenance

- ① . Try to use pedal assistance when starting or driving uphill to avoid frequent braking and starting.
- ② . Users should charge when they use it if conditions allow.
- ③ . When accelerating, rotate the speed control handle slowly, do not adjust too frequent.
- ④ . It is strictly forbidden to use the recovery voltage to drive.
- ⑤ . When it is not used for a long time, it should be stored after being fully charged, and it should be recharged regularly, generally once a month or so.
- ⑥ . In winter, when the air temperature is lower than -16°C , place the battery indoors to prevent failure to start.

2. Tire maintenance

- ① . Check the tire pressure frequently to keep it at normal pressure at any time. Generally, use the finger to press, if it can be pressed down a little, the tire is in good condition. If the air pressure is insufficient or too high, it will affect the normal running of electric vehicles.
- ② . Remove foreign matters from the grooves of the outer tire pattern to avoid hard and sharp foreign matters damaging the inner and outer tires.
- ③ . Check the abrasion of the outer tire, and replace it if it exceeds the maintenance limit: 2.00 mm.
- ④ . Check whether the valve is skewed. If the skew is serious, correct it in time.
- ⑤ . It is not allowed to stick engine oil on tires. If engine oil is accidentally splashed on tires, clean them in time to avoid deformation of tires.

3. Maintenance and cleaning instructions

- ① . Please use neutral detergent to gently wipe the dirt on the surface of baking paint parts or plastic parts with a rag, and then wipe it clean with a dry cloth.
- ② . Please wipe the metal parts of the vehicle body with anti-rust oil to prevent rusting.
- ③ . It is forbidden to apply lubricating oil to front and rear brakes, aluminum wheels (rims) and inner and outer tires.
- ④ . Note: If you are unable to troubleshoot or judge the faults by yourself, which mainly include (motor, controller, charger, battery pack) and other components, please send the electric vehicle to the maintenance site for testing, and don't repair the above components without authorization, otherwise, our company won't promise warranty.
- ⑤ . Do not plug and unplug electrical components and connecting plugs on electric vehicles at will, so as to prevent faults such as short circuit.
- ⑥ . Lubrication parts shall be maintained once every 1 ~ 2 months. Recommended lubricating oil for maintenance: 32# engine oil.



Motor bearing Rear brake cable Flat fork bearing Steering mechanism Front wheel bearing

Lubrication parts of ZS1500D-6 electric vehicle

Chapter III Structure and Maintenance of Electric Vehicles

Section 1 Motor

I. Overview of motor:

The motor is a component that converts battery electrical energy into mechanical energy and drives the wheels of electric vehicles to rotate.

Working principle and control method of motor:

Step 1: When the position sensor (Hall) in the motor body is electrified, Hall inputs the position (N-S pole) signal of the rotor magnet steel to the controller;

Step 2: The control circuit of the controller generates drive signals after logic transformation of these signals, and the drive signals control the electronic switch circuit, so that the windings of each phase of the motor are energized in a certain order, and (alternately) energization generates a magnetic field. According to the principle that the same sex repels and the opposite sex attracts, the stator and rotor move relatively, and the wheels are forced to rotate.

Step 3: As soon as the wheel rotates, the output signal of Hall changes, and the controller uses the re-collected change signal to change the energization mode of the winding of the motor; The magnetic field generated by this output just repelled the fixed magnetic field (magnetic steel) again, and attracted the opposite sex, which forced the rotor to continue rotating, and then Hall output signal changed again. . .

. . . Over and over again, the wheel keeps turning in one direction.

Precautions for disassembly and installation of motor:

1. Before disassembling the motor, first unplug the leads of the motor and the controller. At this time, make sure to record the corresponding relationship between the colors of the motor leads and the controller leads.

2. Before opening the motor end cover, clean the working area to prevent foreign materials from being sucked on the magnetic steel in the motor.

3. Mark the relative position between the end cover and the hub.

4. The radial clearance between rotor and stator of motor is called air gap. Generally, the air gap of motor is between 0.25-0.8 mm. After removing the motor fault, the original end cover mark must be assembled, so as to prevent bore sweeping after secondary assembly.

5. Before installation, the impurities on the surface of motor components must be cleaned to avoid affecting the normal operation of the motor, and the hub body must be firmly fixed to avoid the collision and damage of components due to the strong attraction of magnetic steel during installation.

Note:

1. Make sure to screw diagonally during disassembly and installation to avoid deformation of motor shell;

2. In principle, Zongshen Industry Group does not allow users to disassemble the motor end cover by themselves.



Section 2 Storage Battery

Battery is the power source of electric vehicles. There are mainly lead-acid batteries, nickel-cadmium batteries, nickel-hydrogen batteries and lithium-ion batteries. This vehicle adopts lithium ion battery.

I. Storage requirements for lithium ion batteries:

1. Storage site: The battery is required to be stored at ventilated and dry site.
2. Stacking: No more than 3 layers of lithium-ion batteries are stacked, and it is recommended to stack one layer if conditions permit.
3. Lithium-ion batteries shall not be stored together with other metal objects, especially small sharp objects.
4. When the lithium ion battery is stored, the power protection is 40%~60%.
5. For the lithium-ion battery that has not been used for 3 months, it needs to be recharged once. If it needs to be stored continuously, the power will be 60% when charged; If the batteries are not used for 6 months and need to continue to be stored, the power will be 60% when charging; If the battery has not been used for one year, it needs to be completely discharged and then charged to activate the battery.
6. Lithium-ion batteries should be stored separately in the warehouse.
7. Lithium-ion batteries should be stored in a special warehouse with explosion-proof and fire-proof functions.
8. Storage temperature and humidity:
≤ 1 month, -20 ~ 45 °C
≤ 3 months, 0 ~ 30 °C
≤ 6 months, 20 ± 5 °C Humidity: 45-85%.



II. Requirements for lithium-ion battery use:

1. When charging lithium-ion batteries, special chargers must be used. It is strictly forbidden to charge the battery directly with AC220 (household voltage) without a charger; (very dangerous); It is strictly forbidden to use a charger higher than the battery voltage platform to charge the battery, such as using a 72V charger to charge a 60V battery.
2. When charging, each charging connector must be connected reliably without poor contact. In case of poor contact or damaged charging connector, please contact professional maintenance personnel for repair before charging. (More than 90% of battery accidents occur during charging).
3. The charging current is recommended to be charged at 0.2C, but not more than 0.5C at most. Please charge according to the design charging current of the battery.
4. When using lithium-ion batteries, it is recommended that the batteries be charged in time after they have been used to 5% of the electricity. It is strictly prohibited that the battery is not charged in time after the battery charge reaches 0%, which will cause the battery to be damaged by over-discharge.
5. It is strictly forbidden to reverse connect the positive and negative poles of the battery to the charger or electrical equipment.
6. It is strictly forbidden to short-circuit the battery charging and discharging ports with metal objects. When the battery charging and discharging interface is not in use, cover the dust cover in time to prevent personnel from getting an electric shock or children from putting metal objects into the charging and discharging ports to cause short circuit of the battery.
7. It is strictly forbidden to immerse the battery in water or let the battery enter the water. In this case, please stop using it immediately.
8. Service temperature of lithium ion battery: The charging temperature is 0 ~ 45, and the discharging temperature is -20 ~ 55 °C .
9. Based on its characteristics, it is normal for lithium-ion batteries to have certain capacity attenuation below 10 °C . When the temperature is below 0 , its capacity is lower than 70% of the initial capacity. It is suggested that electric vehicles should be used in the environment above 0.
10. It is strictly forbidden to use lithium-ion batteries with different brands, different voltages, different batteries and without balanced management in series and parallel.
11. If the battery emits peculiar smell, fever, deformation, discoloration or any other abnormal phenomenon, it shall not be used; If the battery is being used or charged, it should be taken out of the appliance or charger immediately and stopped!
12. It is forbidden to put the battery on the fire heating or put into the fire.
13. Do not disassemble the battery in any way!

III. Transport requirements for lithium ion batteries:

1. When transporting lithium-ion batteries, the stacking height shall not exceed 3 layers.
2. When transporting lithium-ion batteries, it is forbidden to stack heavy objects on them.
3. When transporting lithium ion batteries, it is strictly prohibited to transport them with other sharp objects or metal objects.
4. When transporting lithium-ion batteries, it is forbidden to drop or collide the batteries.
5. When transporting lithium-ion batteries, it is forbidden to transport the batteries naked and without packaging.

Section 3 Charger

Chargers are an important part of electric vehicles, and the quality of chargers affects the service life of batteries a lot. The charger is mainly composed of rectification filter, high voltage switch, voltage exchange, constant voltage and charging control.

This charger has trickle function, and notice the one-time charging time generally cannot exceed 12 hours, otherwise it will affect the life of the charger. The charger should be in a dry and ventilated environment when charging; Avoid fire sources nearby when charging batteries; The charger cannot be covered with articles to avoid fire.

When charging, first connect the output plug of the charger with the socket on the battery box, and then plug the charger into the ordinary power socket. After charging, the charger should be powered off first, and then the output plug should be unplugged from the battery box socket. Keep the charger properly or put it in the glove box with the vehicle.

Warning

1. Chargers must be waterproof and moisture-proof, and should be used or stored in a dry environment, and should not be dropped again to prevent electric shock accidents.

2. It is forbidden to touch and turn on the charger when charging, because there is high voltage current in the charger, so as to prevent electric shock.

3. When the charger is getting hot during charging, it should be kept in a well-ventilated place, and should not be charged near inflammable and explosive dangerous goods such as carpets and wooden floors to avoid fire or explosion accidents.

4. When charging, the voltage and current of the battery must be consistent with the specifications of the charger, and the polarity of the output plug of the charger should be consistent with that of the battery pack, otherwise the charger and battery will be damaged.

5. When the indicator light of the charger can't change color for a long time (more than 8 hours), it is always in red indicating signal state, so the charger should be stopped immediately and sent to the service department for inspection.

6. When the charger fails, it must be repaired and handled by professionals.

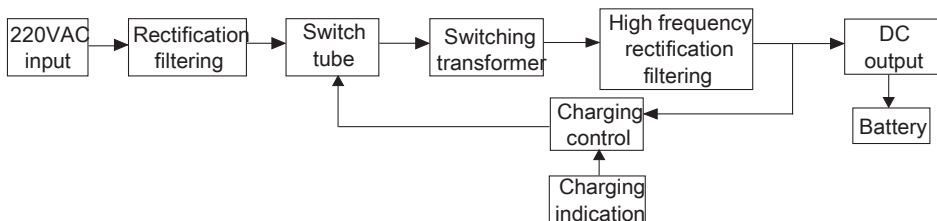

Working principle of charger

Section 4 Controller

Functions and characteristics of brushless controller

1. Function of controller

The main function of the controller is to control the rotation speed of the motor and effectively protect the electrical system of the electric vehicle. According to the different forms of driving motors, the selected controllers are different.

The controller for electric vehicles, whether brushless or not, generally adopts PWM speed regulation mode. Inside the controller are PWM generator circuit, power supply circuit, power device, power device driving circuit, control device driving circuit, signal acquisition unit and processing circuit of control components (rotor, brake, motor Hall, etc.), and protection circuits such as overcurrent and undervoltage.

The main functions of the controller are as follows:

(1) Speed adjustment: The controller should be able to speed the drive motor.

(2) Overcurrent protection: The controller is provided with an automatic current limiting device, which can automatically limit the current output when driving under heavy load, braking or circuit failure.

(3) Brake power failure: When the controller is in braking state, the power supply of the driving motor should be automatically cut off.

(4) Undervoltage protection: When the controller voltage drops to the set undervoltage protection value [48V] for [42V power supply], the motor should be powered off and not work.

2. Characteristics of intelligent controller

The intelligent controller has strong load capacity and stable performance, and can provide driving modes such as shifting and boosting. It also has the functions of battery undervoltage protection, current-limiting protection, braking and power-off and online detection procedures, so as to maximize the efficacy of electric vehicles.

3. Operating environment of the controller

- ① Service temperature: $-25 \sim 60$ °C
- ② Operating humidity: 40% ~ 80%.
- ③ Preservation temperature: $-20 \sim +65$ °C .
- ④ Use occasion: Try to avoid dust, oil mist and corrosive gas.
- ⑤ Cooling mode: Natural cooling.



Section 5 Speed Control Handle and Brake Handle

Brief introduction of speed regulating handle and brake handle;

At present, Hall handles are mostly used in the market, and there are three leads: They are power supply (+5V), ground wire, and handle signal line (the signal size is proportional to the handle rotation amplitude, and usually changes within the range of 1.1V-4.2V). The controller controls the motor speed through the output size of the handle signal. Therefore, the rotating handle is often called the speed regulating handle.

The brake handle is actually a switch, which shorts the high brake line of the controller to the high voltage (12V- power supply voltage) or the low brake line to the ground. The controller receives a braking signal when braking, and then controls the motor to stop rotating, and performs functions such as electronic braking and kinetic energy recovery.



Section 6 Converter

I. Introduction of converter:

A DC step-down DC-DC converter is used in electric vehicles, which reduces the power supply of electric vehicles to a certain DC voltage (12V). It can provide power for other low-voltage devices on electric vehicles, such as various lamps, horns, instruments, etc.

The main parameters of the converter are: Output power (product of output voltage and current), conversion efficiency (the higher the efficiency, the smaller the loss and heat generation under the same output power condition, and the smaller the overall volume), input voltage range (if the range is wide, it can be used for electric vehicles with different voltages), output ripple size, etc.

In addition to converting DC higher than power supply into low-voltage electricity, the converter can also add many functional designs to meet other corresponding functions of the whole electric vehicle, such as adding extended power-off function, which can extend the lamp extinguishing time when the whole vehicle closes the power lock, and achieve the lighting effect at night.

II. Working principle of DC-DC converter

What is DC? It stands for Direct Current, such as dry battery or vehicle battery.

The 100V power supply for home use is alternating current (AC). If a converter can convert a DC voltage of 3.0V into other DC voltages (1.5V or 5.0V), we call this converter a DC-DC converter, or a switching power supply or switching regulator.

A: The DC-DC converter is generally composed of a control chip, an inductor, a diode, a triode and a capacitor. When discussing the performance of DC-DC converter, we can't judge its advantages and disadvantages if we only focus on the control chip. Component characteristics of its peripheral circuit and wiring pattern of the substrate can change the performance of the power supply circuit, so comprehensive judgment should be made.

B: Modulation system

1: PFM (Pulse Frequency Modulation)

The switching pulse width is constant, and the output voltage can be stabilized by changing the pulse output time.

2: PWM (pulse width modulation)

The frequency of switching pulse is constant, and the output voltage can be stabilized by changing the pulse output width.

3: The performance differences between PFM and PWM DC-DC converters are as follows.

Selection method of PWM frequency and PFM duty ratio.

PFM modulation mode

In case of large duty cycle (e.g.: Duty=75%) The duty ratio is small (such as: Duty=58%)

(1) Small load, low efficiency. (1) When the load is small, the efficiency should be improved.

(2) It can output larger current. (2) The output current is small.

Therefore, a larger output current can be obtained by selecting 75% duty cycle. If the duty cycle is 58% when the load is not large, the efficiency will be higher.

Effect of replacing BJT transistor with MOSFET as switching component of peripheral circuit on efficiency.

Efficiency will increase accordingly. Because BJT tube needs to supply driving current to its base, which increases the current consumption of the circuit, while MOSFET is voltage driven, so it does not need to supply current to its gate, which will not increase the current consumption of the circuit. In practical application, please consider whether MOSFET has influence on peripheral components.

Peak noise of DC-DC converter (switching regulator).

DC-DC converter (switching regulator) boosts or reduces voltage through switching action, especially when transistor or FET is in fast switching, it will produce common peak noise and electrical breakdown interference.



Section 7 Instrument

I. Structure of instrument

Instrument lamps are a combination of components that provide illumination and display the status of electric vehicles. Instruments generally provide battery voltage display, vehicle speed display, driving status display, lamp status display, etc. The intelligent instrument can also display the faults of all electrical components of the whole vehicle.

The display of the dashboard and its meaning are shown in the following table:

Display and meaning of instrument

Display conten	Function
Power indicator	Indicates that the vehicle power supply has been turned on
Battery level	Use light-emitting diode or voltmeter head to indicate battery level
Low battery indicator	Indicates whether the battery level is lower than the normal use value
Speed	Indicates the current driving speed of the electric vehicle (km/h)
Lamp indication	Indicates the working status of headlamps, left and right turn signals, tail lights and brake lights
Cumulative mileage	Indicates the cumulative mileage of electric vehicles

Disassembly, installation, overhaul and maintenance of instruments

Open the power switch lock and check whether the indicator light of the instrument is on.

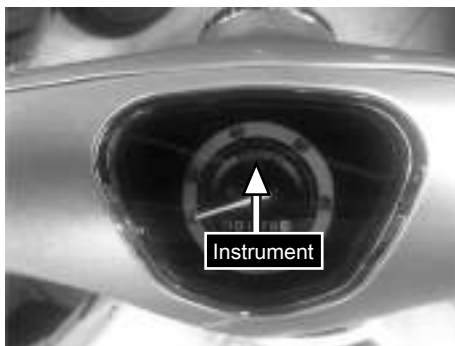

Remove the front panel and check whether the instrument wiring is firm.

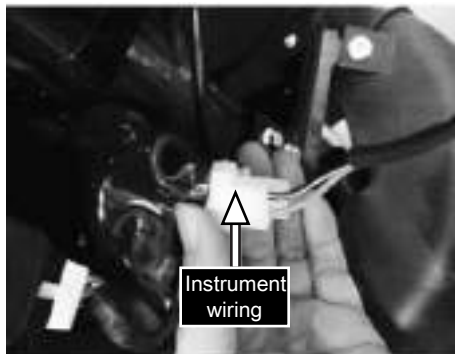

Remove the Instrument cover and instrument screws. Remove the instrument assembly and check the instrument, Check whether the watch is damaged

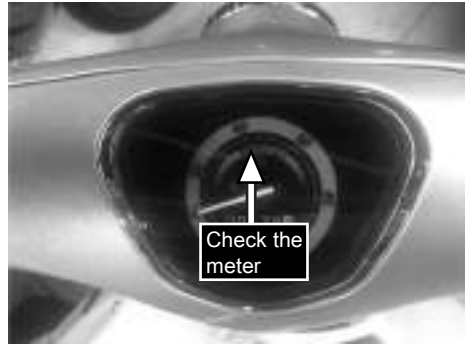

Section 8 Structure Principle and Maintenance of Vehicle Part

I. Structure principle of the frame

The frame is the supporting skeleton of the electric vehicle and the main supporting part of the electric vehicle. Because electric vehicles must be subjected to strong road impact and vibration during driving, they must have high strength and rigidity in terms of material selection and structure, and at the same time, the frame weight must be relatively light, which is beneficial to the driving of electric vehicles. The U-shaped frame adopted by the electric vehicle has the characteristics of high strength, good rigidity and strong applicability, and is mainly made of a head pipe, a tailstock pipe, a rear support pipe, a bent beam pipe and the like by welding and riveting. The frame structure is shown in Figure.

The main function of the frame is to support the battery, steering mechanism, transmission device, traveling system, operating system, braking system and other components, and also provide mounting support points for other subsidiary mechanisms, so that the electric vehicle forms a complete whole.

ZS1500D-6 frame



II. Structure principle of front vibration reduction

The front shock absorber is an elastic connecting part between the front wheels and the car body, and the rear shock absorber mainly bears the axial force of the rear wheels of the motorcycle, which together support the weight of the car body. In that run process of the electric vehicle, the impact and vibration of the front and rear wheel on motorcycle drivers and passengers are effectively and rapidly attenuated, the stress of various parts of the motorcycle is buffer, the service life of the electric vehicle is prolonged, and the comfort, operability and stability of drivers and passengers are improved.

1. Front shock absorber

The motorcycle front shock absorber is a hydraulic spring composite front shock absorber, which mainly consists of a front shock absorber spring, a sealing ring, a dustproof cover, a piston ring, a front shock absorber column, a piston rod, a buffer spring, a one-way valve spring seat, a one-way valve spring, a one-way valve seat, a front shock absorber cylinder, a piston rod seat and the like.



Structure of front and rear shock absorbers

When the front wheels of the electric vehicle are impacted and shaken by the road surface, and the front shock absorber tube goes up, the damping oil in the shock absorber flows upward through the one-way valve and the small holes on the piston rod, and the damping force is not large at this time; When that shock absorb cylinder continues to move upward, the gap between the check valve seat and the conical surface of the piston rod seat become smaller and smaller, which increases the dam and prevents the front shock absorber cylinder from colliding with the front shock absorber. When the front damper tube descends due to the restoring force of the front damper spring, the damping oil can only flow out of the small hole on the piston rod due to the closing of the one-way valve, which forms a large damping and effectively attenuates the vibration of the front damper spring.

2. Rear shock absorber

The motorcycle rear shock absorber is a hydraulic spring composite rear shock absorber, which mainly comprises an upper joint, a buffer rubber sleeve, a bushing, a rear shock absorber spring, a rear shock absorber rod, a piston, a damper, a lower joint and the like.

The rear shock absorber is mainly subjected to the axial force of the rear wheel of the electric vehicle. When the rear wheel of the electric vehicle is impacted and vibrated by the road surface and the rear shock absorber is compressed and extended, the hydraulic oil in the damper is forced to flow through the damping hole, which effectively attenuates the vibration of the rear shock absorber.

III. Disassembly, installation, overhaul and maintenance of rear shock absorber

Remove the connecting bolts on the rear shock absorber and check whether the bushing is worn or damaged.



Remove the lower fastening bolts of the rear shock absorber, take out the rear shock absorber and check whether the bushing is worn or damaged.

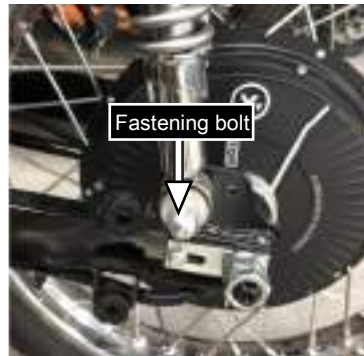

Check whether the spring of the rear shock absorber is soft, and check whether the rear damper leaks oil. Replace rear shock absorber



Damage form, fault phenomenon and maintenance method of rear suspension device

Part name	Damage form	Component failures	Vehicle failures	Maintenance method
Rear shock absorber assembly	The rear shock absorbing spring is broken or its elasticity becomes soft.	The rear shock absorbing spring is broken or its elasticity becomes soft.	The rear shock absorber is too soft or too hard	Replace the rear damping spring
	Oil leakage from rear damper	Oil leakage from rear damper	The rear shock absorber leaks oil and is too soft	Replace the rear damper
	The piston rod on the rear damper is bent, deformed or broken.	The piston rod on the rear damper is bent, deformed or broken.	The rear shock absorber is too hard	Replace the rear damper

V. Structure principle and maintenance of steering mechanism

Steering mechanism is mainly composed of steering handle and steering column, etc. The steering column is connected with the steering handle. With the frame riser as the center, the steering handle riser is inserted into the steering column riser, and the core screw is rotated to tighten the cone-shaped or wedge-shaped core nut. Finally, the steering handle and the steering column are tightly connected into a whole. The steering handle is mainly used to steer the front wheels, so that the electric vehicle runs in a certain direction. When the steering handle rotates left and right, the front wheel is rotated by the steering column to control the driving direction of the electric bicycle.



Structure of direction column and direction handle

1. Directional handlebar

At the right end of the steering handle, a speed regulating handle and a front brake handle for controlling the rotating speed of the driving motor are installed; The left end is provided with a rubber handle sleeve and a rear brake handle; In addition, the left and right ends are also equipped with rearview mirrors and combination switches.

2. Direction column

The steering column is an important component of the steering mechanism of the electric vehicle, which is made of forgings and sleeved in the frame riser. It mainly consists of directional column, lower connecting plate, bearing, bearing retaining ring, etc. The impact load generated when the front wheel is impacted by the road surface is transmitted to the steering column through the front shock absorber, and then transmitted to the vehicle body. Therefore, the directional column should not only bear large impact load, but also ensure flexible rotation during driving.

VI. Structure principle and maintenance of the flat fork

1. Structure principle of flat fork

The flat fork of the electric vehicle connects the rear wheel with the frame, and makes the rear wheel swing up and down around a fixed point on the frame through the rear shock absorber, so as to buffer the impact and vibration borne by the rear wheel. Because the flat fork bears great impact and vibration from the rear wheel, it requires high strength and rigidity in material selection and welding, and then it is connected by welding and riveting. It is mainly composed of a flat fork shaft, a flat fork and the like.

2. Maintenance of flat fork

Support the main bracket, swing the rear wheel left and right, and check whether the horizontal fork swings too much. Check whether the welding of the flat fork falls off or whether the flat fork bends or deforms. If the flat fork is bent or welded off, it must be corrected, welded or replaced. Knock out the flat fork shaft sleeve with a soft rubber hammer, and never knock out the shaft sleeve. When installing, grease must be coated on the fork shaft sleeve.



Section 9 Wheels

The wheel is the running part of the electric vehicle, which supports the quality of the whole vehicle and ensures reliable adhesion with the road surface during driving without slipping. The wheels can alleviate and absorb the vibration and impact caused by road. The front wheels cooperate with the operating parts to determine the driving direction of the electric vehicle. The rear wheels are driven by the driving motor to drive the electric vehicle. Wheels are mainly composed of outer tires, inner tubes, aluminum wheels, hubs, bearings, bushings, oil seals, axles, etc.

1. Tire

The tire of electric vehicle is an important part of the running system. Its function is to directly contact with the road surface, bear the mass of the whole vehicle, use its elasticity, relieve the vibration and impact while driving, and ensure the vehicle running balance with reliable adhesion. Tires include outer tires, inner tubes and lining belts.

The outer tire is composed of tread, carcass, buffer layer and bead. The tread of the outer tire is in direct contact with the road surface, and various tread patterns are made on the tread, so that motorcycles can obtain proper adhesion on different roads. The matrix should have a certain strength, but it should not be too thick to enhance heat dissipation. The bead is wrapped by the edge of the curtain cloth and the traveler, so that the outer tire is reliably fixed on the rim. The small circumference of the bead makes it difficult to disassemble and assemble the outer tire. Excessive circumference makes the outer tire jump out easily. The ply is the skeleton of the outer tire, and the plies in the outer tire cross each other and form an angle (crown angle) with the cross section of the tire. In radial tire, the cords are arranged in the radial direction of the earth, and the crown angle is 0. Radial tire has the advantages of reducing power loss, saving fuel and prolonging service life.

2. Rim

The rim is the framework for supporting and fixing the tire. The rim is a spoke type rim, which is made of steel strip. There are several hole seats on the circumference of the wheel rim. A spoke and a spoke nut are installed in each hole seat, and the other end of the spoke is connected with the wheel hub. It has good shock resistance, adjustable and easy to maintain.

3. Wheel hub

The wheel hub of electric vehicle can be divided into front wheel hub and rear wheel hub. The rear wheel hub driven by single wheel is the driving wheel, and a driving motor is installed on the rear wheel hub to provide power source for electric vehicle.

The front and rear hubs of two-wheel drive are driving wheels, and the driving motors are installed on both hubs to provide better power source for electric vehicles. Bearings, bearing bushings, oil seals and wheel shafts are installed in the front and rear hubs, which is beneficial to the normal movement of the hubs.

4. Maintenance of wheels

1). In case of insufficient air pressure in the front tire during the use of motorcycle, first check whether there is air leakage in the inner tube valve core, and check the wear condition of the front tire casing. The maintenance limit value of the pattern wear of the front tire casing is: 2.00mm. If the inner tube valve core leakage, the valve core must be repaired or replaced. If the inner tube leaks air, the inner tube must be repaired or replace.

2). Put the front and rear wheels on the calibration bench, check the yaw of the front and rear wheels, rotate the wheel hub by hand, measure the deflection value of the front and rear wheels with a dial indicator, and read the indicated deflection value. Maintenance limit: radial 2.0 mm; axial 2.0 mm. If the deflection of front and rear wheels exceeds the above maintenance limit value of 2.0 mm, the front and rear wheels shall be corrected or replaced.



[1] Check whether the tire pressure is kept within the normal pressure range. Remove foreign matters attached to the tread pattern so as to keep the adhesion of tire to the ground and prevent inner and outer tires from being damaged.



Remove the front axle nut, remove the front axle, and check whether the front axle is deformed.



Take off the front wheel and the front axle bushing, and check whether the front axle bushing is worn or damaged.

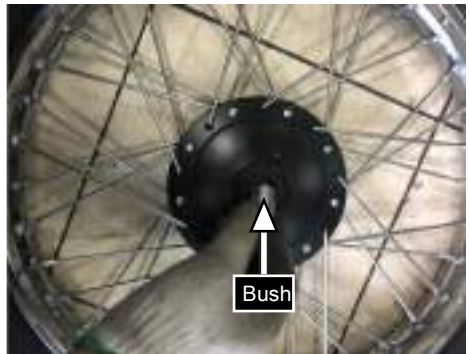

Take out the front wheel oil seal and check whether the cutting edge is worn or damaged.



Remove the motor shaft nut, take out the motor assembly, and check whether the motor shaft is deformed. Check for damaged parts, tread depth and air pressure.



Damage forms, failure phenomena and maintenance methods of front and rear wheels

Part name	Damage form	Component failures	Vehicle failures	Maintenance method
Front wheel	Front wheel distortion	Front wheel distortion	Running deviation, the steering handle shakes or shakes during running	Replace the front wheel rim
	Excessive wear of hub bearing seat hole	The hub bearing seat hole is loose due to the fit with the bearing	Running deviation, the steering handle shakes or shakes during running	Replace the front wheel rim
	Bearing is excessively worn or damaged	The axial and radial clearance between the inner and outer rings of the bearing is too large or the rotation is inflexible	Running deviation, the steering handle shakes or shakes during running	Replace bearing
Front tire		Insufficient front tire pressure	The steering handle is inflexible.	Repair or replace inner tube
	Excessive tire wear (tread depth less than 2mm)		Driving is easy to slip and has poor sideslip prevention capability	Replace outer tire
Rear wheel	Rear wheel distortion		Driving deviation, rear wheel swinging during driving	Replace the rear wheel rim
	Excessive wear of rear brake drum		Rear brake failure	Replace the rear wheel rim
	Excessive wear of hub bearing hole	The hub bearing seat hole is loose due to the fit with the bearing	Driving deviation, rear wheel swinging during driving	Replace the rear wheel rim
	Bearing is excessively worn or damaged	Excessive axial and radial clearance or inflexible rotation	Driving deviation, rear wheel swinging during driving	Replace bearing
Rear tire	Inner tube puncture or rupture	Insufficient rear tire pressure	The steering handle is inflexible and the engine power is insufficient	Repair or replace inner tube
	Excessive tire wear (tread depth less than 2mm)		Driving is easy to slip and has poor sideslip prevention capability	Replace outer tire

Section 10 Shock Absorber

When an electric vehicle needs to decelerate or stop while driving, the brake is required to apply force or torque to the wheels to stop them from rotating, so as to achieve the purpose of deceleration and stop. Generally, the front wheel brakes are operated by the right hand and the rear wheel brakes are operated by the left hand. Electric vehicle brakes can be divided into drum brakes and disc brakes, and this electric vehicle is front and rear drum brakes.



Front brake



Rear brake

2. Inspection and adjustment of brakes

Hold the brake handle and check the braking performance of the brake. Standard free travel of brake handle is: 10mm ~ 20mm. If the brake handle is not within the specified range, the brake must be readjusted. At the same time, check the wear condition of brake disc, and the limit value of brake disc wear is: 3.0mm.

Disassembly, installation, overhaul and maintenance of brake system

Check whether the front and rear brake cables are damaged and replace the cables.



If the free stroke of the front brake grip cannot be adjusted, check whether the pointer on the front brake rocker arm and the tag on the front brake cover are in a straight line. If the pointers on the rocker arm of front brake and the mark on the front brake disc are in a straight line, the front brake shoe should be replaced.



Remove the front axle fastening nuts and the speedometer flexible shaft. Take down the front wheel and front brake. Check whether the front brake and front brake hub are severely braded.



Remove the front brake shoe and measure whether the thickness of the front brake shoe succeed the maintenance value using the calipers. When its thickness is 2mm more than the maintenance limit value, the front brake shoe should be replaced. Check the brake cam is rust or abraded, whether it rotates flexibly and it is greased.



Check whether the pointer on rear brake rocker and tag on rear brake cover are in a straight line, if yes, the rear brake shoe should be replaced.

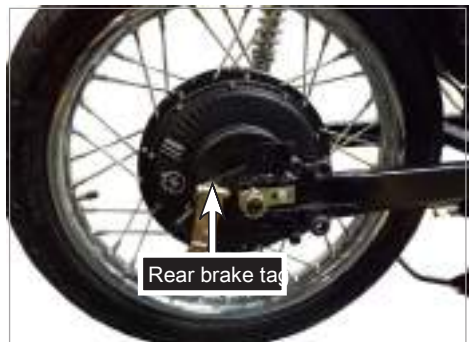

Remove the rear wheel and rear brake assembly. Check whether the rear brake shoe and rear brake hub are abraded, the rear brake shoe should be replaced.



Take the rear brake shoe, rear brake rocker arm and rear brake cam. Check whether the brake cam is rust or abraded and it should be added with the lubricating grease.

Use the caliper to measure whether the thickness of the brake shoe exceeds the repair value, when the thickness is 2mm more than the maintenance limit, the rear brake shoe should be replaced.

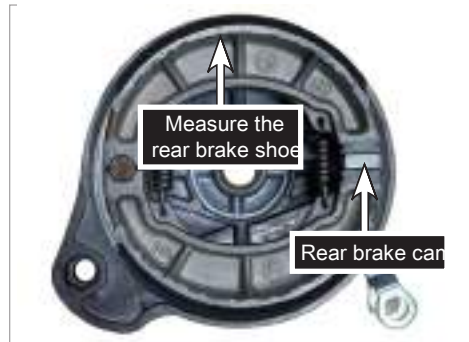

Damage form, fault phenomenon and maintenance method of front and rear brakes

Component Name	Damage Form	Component Fault Phenomenon	Complete Motorcycle Fault Phenomenon	Maintenance Method
Brake shoe	The friction plate is abraded excessively.	—————	The brake fails or the brake shoe fails to return.	Replace a complete set of brake shoe
	The end face of the brake shoe is worn by the brake cam to form a groove, or is excessively worn.	—————	The rear brake fails or makes an abnormal sound.	
	The contact area of brake shoe and the brake drum is too small.	—————	The brake fails.	Repair or replace the friction plate of brake shoe
	The brake shoe spring has insufficient elastic force or breaks off.	—————	The brake shoe fails to return.	Replace the return spring.
Brake cam	The movable part is rusted or has foreign matters.	The brake cam rotates inflexibly.	The brake fails or cannot return.	Clean and lubricate the brake cam.
	The arc surface of the brake cam is abraded.	—————	The brake fails.	Replace the brake cam.

Section 11 Lighting and Signal Lights

Disassembly, installation, overhaul and maintenance of signal system

Turn on the power switch, turn on the switch button of each signal lamp, and check whether each signal indicator is on.

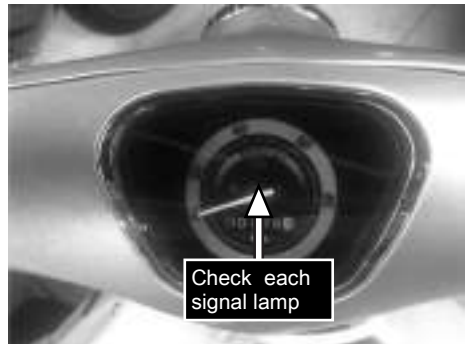
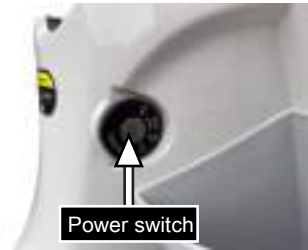

Open the battery cover and check whether the battery connector is loose.



Check whether the DC converter regulates voltage with multimeter.

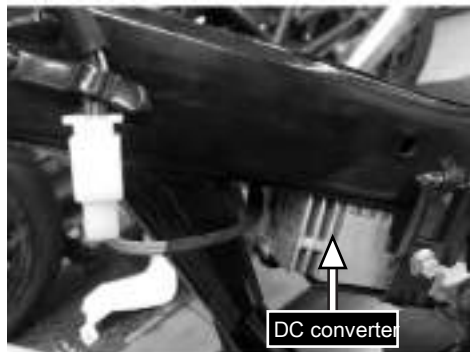

Check whether the flasher is burnt out or the plug is loose.

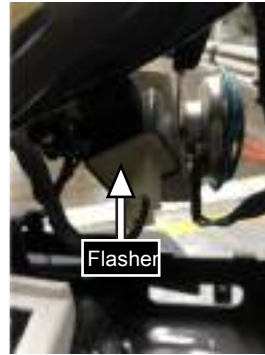

Check whether the instrument wire plug is loose.



Check the turn signal switch for rust or poor contact.



Screw down the taillight screws and check whether the lampholders of taillights and brake lights are in poor contact or whether the bulbs are burnt out.



Remove the bulb of the turn signal lamp, and check whether there is electricity or poor contact.

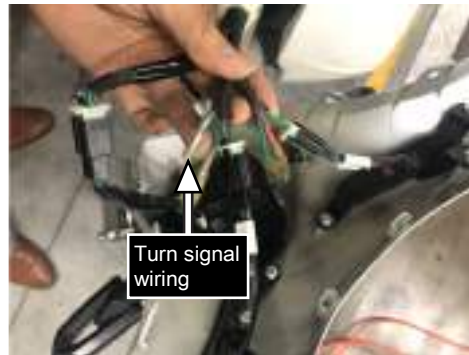

Check whether the horn switch is loose or in poor contact, and check whether the horn is loose or interferes with other components.



Check the electric horn plug for good contact or power supply.



When the sound of the electric horn is hoarse and the electric horn has no sound, adjust the volume of the electric horn according to the actual situation, or replace the electric horn of the same model.

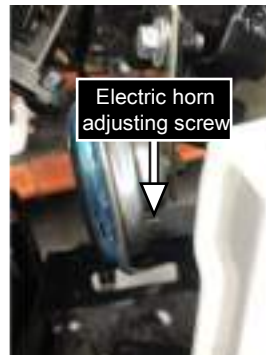

Install the headlamp bulb and lamp holder, and check whether the headlamp is on.



Check whether the headlamp cable socket is loose.



Check whether the headlamp high and low light switches are energized or loose.



Remove the power switch socket and check whether there is current input to the headlamp main switch.



Damage Forms, Fault Phenomena and Maintenance Methods of Signal Lighting System

Part name	Damage form	Component failures	Vehicle failures	Maintenance method
Steering lamp	Filament burnout	Lamp filament of steering lamp is burnt out	The turn signal is not on	Replace the turn signal lamp bulb
Turn signal switch	Poor contact of the internal contact	Poor contact inside the turn signal switch	The turn signal is not on	Repair or replace the turn signal switch
Flasher	Internal burn-out	The flasher burned out inside	The turn signal does not illuminate or flash	Replace flasher
Stop lamp switch	Internal contact does not return or damage	Brake light switch does not return or is damaged	The brake light is on or off for a long time	Repair or replace the brake light switch
Horn button	Poor or damaged internal contacts	Poor or damaged internal contact of horn button	The electric horn does not sound or does not sound normally	Repair or replace horn button
Electric horn	Burned or damaged inside	Burned or damaged inside the electric horn	The electric horn does not sound or does not sound normally	Replace the electric horn
Headlamp assembly	The filament of headlamp is burnt out	The filament of headlamp is burnt out	Headlamps are not on	Adjusting headlamp beam
Taillight/ Brake light	Burnout of taillamp/ brake filament	Burnout of taillamp/ brake filament	Burnout of taillamp/ brake filament	Replace the bulb of tail lamp/brake lamp
Lighting/ Dimming switch	Poor or damaged internal contacts	Poor or damaged internal contacts	Lighting lamp does not work normally or does not work	Repair or replace the lighting/dimming switch

Chapter 4 Common Fault Diagnosis and Troubleshooting Methods

I. Faults: The fault that the motor does not turn.

Trouble causes and solutions:

1. Cause of failure: The power supply fuse of the whole vehicle is blown or tripped in the air, resulting in the power supply circuit being blocked;
Solutions: a. Replace the safety tube; b. Open it again.
2. Cause of failure: The battery voltage is too low, causing the controller to be under-voltage protected;
Solutions: Charge the battery.
3. Cause of failure: The battery voltage is too high, which causes the controller to be in overvoltage protection state;
Solutions: a. Detect the cause of high battery voltage and troubleshoot; b. Replace the battery again.
4. Cause of failure: Malfunction of governor handle;
Solutions: Replace the speed control handle.
5. Cause of failure: Brake failure causes the controller to be in brake protection state;
Solutions: Check whether the brake switch and brake light are short-circuited and replace the corresponding parts.
6. Cause of failure: Burning of motor Hall or mismatch between Hall signal line and phase line;
Solutions: a. Replace Hall (at present, most motors are double Hall. If one Hall is broken, change and connect the other Hall harness. If both are broken, it is recommended to change the whole motor. In principle, the company does not allow customers or businesses to open the motor to replace Hall by themselves); b. Change Hall harness to match phase line (output Hall signal line on motor: green, yellow, blue and controller harness: green, yellow and blue are connected).
7. Cause of failure: Motor phase line short circuit or open circuit, resulting in controller protection;
Solutions: Most of this phenomenon is caused by overload of the motor, and the internal coil is burnt out due to serious heating. The only solution is to replace the motor assembly.

II. Faults: The motor can run normally, but the speed is too slow.

1. Cause of failure: The battery voltage is relatively low;
Solutions: Measure the battery voltage with a multimeter. If the voltage is too low, recharge the battery immediately.
2. Cause of failure: The controller is set to speed limit;
Solutions: Cancel the speed limit command of the controller (if the controller has a speed limit line alone, just disconnect the speed limit connection line).
3. Cause of failure: The gear is in low gear;
Solutions: Shift the gear to high gear.
4. Cause of failure: Turn the handle fault, its signal output voltage is too low;
Solutions: Replace the speed control knob.

III. Faults: The motor can rotate by twisting the speed knob, but it stops again after a few seconds and appears repeatedly.

Cause of failure This fault is mostly caused by low battery voltage of electric vehicles. As we all know, the battery has discharging phenomenon, that is, the battery voltage is relatively high when no load is applied. After loading, the battery voltage drops sharply, which will be lower than the undervoltage protection value, causing the controller to undervoltage protect and stop the motor driving output.

Solutions: Measure the battery voltage with a multimeter. If the voltage is too low, recharge the battery immediately.

IV. Faults: The noise and current of ordinary speed riding motor are relatively large.

1. Cause of failure: Most of these faults are caused by the damage of controller MOS tube.
Solutions: Replace the controller.
2. Cause of failure: Motor damage; Such as turn-to-turn short circuit of motor winding, and large interference of

Hall signal output.

Solutions: This kind of fault is difficult to be measured, detected and processed by multimeter, so replacement method can be used to replace the new motor to see if the problem still exists, and if the problem is solved, the motor is faulty.

3. Cause of failure: The mismatch between the controller and the motor Hall will also cause the motor noise;

Solutions: Replace the matching controller.

V. Faults: Screw the governor handle, and sometimes the motor can rotate, sometimes it can't, the current is large and the motor noise is large when rotating.

1. Cause of failure: Due to the incorrect phase sequence, when the phase sequence of the company T2/T3 models is incorrect, the controller status indicator will flash four times, resulting in "locked rotor protection"; Sometimes it may be caused by poor contact of phase sequence wiring;

Solutions: Connect the phase sequence correctly according to the wiring drawing (Hall wiring); Solve the problem of poor contact.

2. Cause of failure: The phase angle of the controller does not match with the motor. When the phase angle of the motor of model of the company does not match, the controller status indicator will flash five times, resulting in "error" protection.

Solutions: Replace the motor or controller.

VI. Faults: No-load is normal. Screw the governor handle at the place with excessive load or large slope to start the electric car. Sometimes, it will feel that the motor has forward force, but the electric car still does not move forward. After a few seconds, the force disappears. After the handle is reset, add the handle again, which repeatedly produces the above phenomenon.

Cause of failure This phenomenon is often called 'locked-rotor' in electric vehicles. When starting, the load is very large, but the motor does not rotate, so the controller will not produce commutation action. Large current will pass through the same set of MOS tubes on the upper and lower bridges of the controller and the same winding of the motor, which will easily burn down the controller and the motor for a long time. In order to protect the controller and the motor, the motor drive output must be stopped in a safe time period, which is "locked-rotor protection" of the controller.

Solutions: In case of the above situation, it is necessary to reduce the load of the electric vehicle or wait for the electric vehicle to restart at a place with a small slope.

Tips: Do not let low-power electric vehicles run for a long time under heavy load (heavy load or climbing a steep slope), so as not to affect the service life of the motor or controller.

VII. Faults: When an electric vehicle starts, it sometimes needs power assisting.

1. Cause of failure: Controller failure;

Solutions: Replace the controller of the same model.

2. Cause of failure: Poor phase line contact of motor;

Solutions: Reconnect the motor phase line.

VIII. Faults: Stop-and-go during the whole vehicle riding.

1. Cause of failure: Poor contact of power cord, handle cable, motor phase cable and Hall cable;

Solutions: Check the connection of each node to ensure that the contact parts are firmly contacted without poor contact.

2. Cause of failure: Insufficient battery voltage;

Solutions: Check the battery voltage and replenish it in time.

IX. Faults: When the speed control handle is not reset during the whole vehicle riding, the brake will not work.

1. Cause of failure: Brake switch is damaged;

Solutions: Test and replace the brake switch (or brake handle).

2. Cause of failure: Brake switch circuit is not connected or dropped;

Solutions: Check the circuit and eliminate the corresponding faults.

3. Cause of failure: The brake input circuit inside the controller is broken;

Solutions: Replace the controller.

X. Faults: Sometimes speed regulation has no effect after braking when the whole vehicle is riding.

Cause of failure Brake handle fails or is damaged after being used for a long time;

Solutions: Replace the brake switch.

XI. Faults: Short cruising range.

Cause of failure: The short cruising range is related to many factors, and the factors related to the whole vehicle manufacturer: Efficiency characteristics of selected motor, capacity and life characteristics of storage battery; Other factors related to objective conditions: The weight of the rider, the road conditions of frequent riding, whether the

brakes need to be used frequently, the riding habits of the rider, and so on.

1. From the reason of the motor itself:

a. Low efficiency-the amount of electric energy converted into mechanical energy by motor is reduced, while the amount of loss used for heating is increased. This kind of motor does not run for a long time and generally has a high temperature rise;

b. Magnetic steel demagnetization-with the increase of service time, it is certain that magnetic steel demagnetization will occur, but it is only a matter of how much. However, if the quality of the magnetic steel itself is not good and the demagnetization performance is poor, the magnetic steel will be easy to demagnetize, resulting in a significant decline in motor performance, an increase in operating current and a shortening of driving mileage.

2. From other aspects:

a. The quality of the battery has a great relationship, such as whether the capacity of the battery is worthy of the name and whether the temperature characteristics are good;

b. The cooperation of the controller, whether the undervoltage value of the selected controller is too high;

c. Whether the specifications of the selected motor and the matching of the whole vehicle are reasonable.

3. From the objective situation:

a. The weight of the rider, that is, the load of the vehicle;

b. The rolling resistance is not consistent with the road surface when riding frequently.

c. The rider's riding habits, whether they often start strongly, ride fast and brake frequently.

Solutions:

a. Manufacturers select motors with high efficiency;

b. Match the controller and motor parameters and set a reasonable undervoltage value;

c. Choose batteries with high energy density;

d. Without overloading;

e. The rider shall develop good riding habits.

Appendix: ZS1200DT Electrical Schematic Diagram

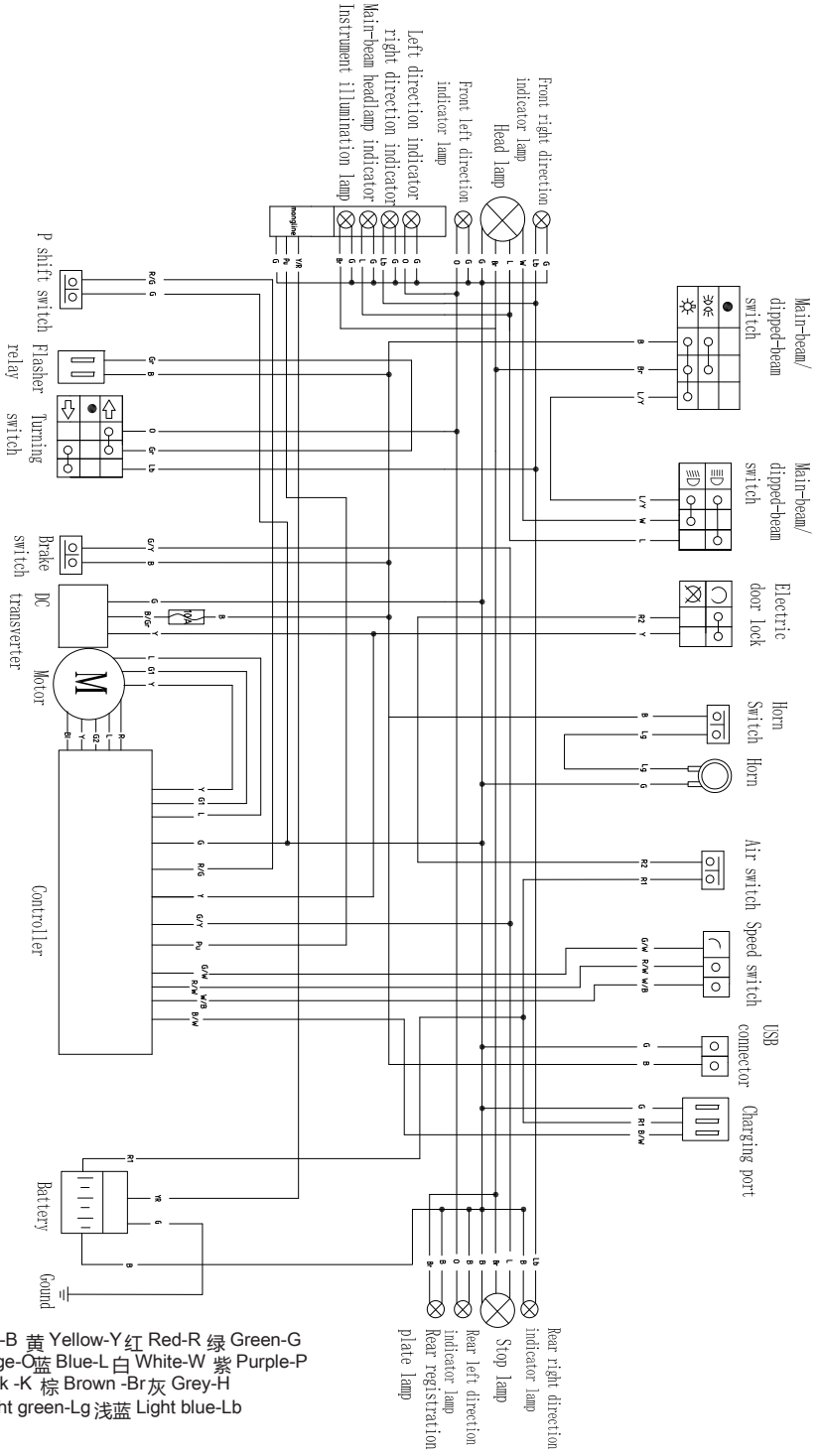

黑 Black-B 黄 Yellow-Y 红 Red-R 绿 Green-G
 橙 Orange-O 蓝 Blue-L 白 White-W 紫 Purple-P
 粉红 Pink-K 棕 Brown-Br 灰 Grey-H
 浅绿 Light green-Lg 浅蓝 Light blue-Lb