

RE3 Owner's Manual

CSIC
MOTORCYCLES



<https://www.motomanuals.net/>

A Word From Steve

Thank you for purchasing this CSC RE3 motorcycle. The RE3 is a great motorcycle and we are proud of it. The RE3 is easy to maintain, it's reliable, and it's fun. You have made a wise purchase decision. I want you to know that we value the trust and confidence you have in CSC. Our guiding principle will always be that our customers come first.

We wish you many miles of safe and enjoyable riding on your new RE3 motorcycle. If there is anything we can do to enhance your ownership experience, please let us know.

Thank you again,

A handwritten signature in cursive script, appearing to read "Steve Seidner".

Steve Seidner

Founder and CEO

CSC Motorcycles, LLC

1331 W. Foothill Boulevard, Azusa, California 91702

909 445 0900

www.CSCMotorcycles.com

<https://www.mqtom manuals.net/>

Contents

Caution and Warning Symbols	4
Section 1: Owner's Manual	5
VIN and Engine Numbers	5
Motorcycle Components	6
Ignition Lock	9
Instruments	10
Left Handlebar Controls	11
Right Handlebar Controls	12
Fuel Tank	13
Motorcycle Controls	14
Tool Kit	16
Motorcycle Load Limits	17
Break-In Procedure	18
EFI System	19
General Motorcycle Safety Guidance	24
Inspections Before Riding	26
Starting Your Motorcycle	28
Riding Your Motorcycle	30
Safe Riding	32
Section 2: Maintenance	35

<https://www.mqtomanuals.net/>

Component Cleaning	36
Parts Inspection	37
Maintenance Adjustments	37
Recommended Tools	38
Adjustment Specifications	39
Maintenance Schedule	40
Cleaning Your Motorcycle	41
Checking Your Oil	42
Changing Your Oil	43
Changing Your Oil Filter	44
Air Cleaner Maintenance	45
Spark Plug Maintenance	46
Throttle Cable Maintenance and Adjustment	47
Front Brake Inspection	48
Rear Brake Inspection	49
Wheel And Tire Inspection	50
Battery Maintenance	51
Fuse Replacement	52
Motorcycle Horn	53
Troubleshooting Guidelines	54
Storing Your Motorcycle	55

<https://www.mqtomanuals.net/>

Motorcycle Specifications	56
Wiring Schematic	57

You should read this Owner's Manual carefully prior to riding your motorcycle. You should have a good understanding of the controls, their use, and how to operate the motorcycle. The data, technical specifications and performance parameters included in this Owner's Manual are based on the latest data available at publication. We reserve the right to modify this Manual at any time without prior notice.

Please purchase parts and consumables for your motorcycle only from CSC Motorcycles. You can reach us at www.CSCMotorcycles.com or 909 445 0900.

Caution and Warning Symbols

Caution and warning symbols in this manual are as follows:

The **Caution!** symbol indicates a condition that may lead to motorcycle damage.

The **Warning!** symbol indicates a condition that may lead to injury or death.

<https://www.mqtomanuals.net/>

Section 1: Owner's Manual

VIN and Engine Numbers

VIN and engine numbers are located as shown below:



The VIN is printed on the right side of the frame.



The vehicle nameplate is attached to the right side of the frame.



The engine number is on the upper left side of the crankcase.

<https://www.motomanuals.net/>

Motorcycle Components

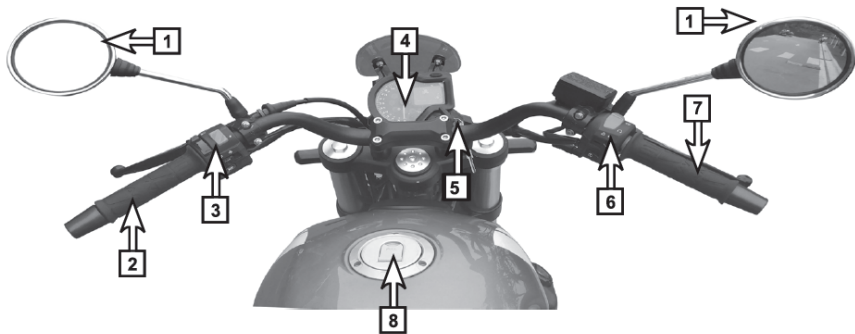

1. Rearview Mirrors
2. Left Handgrip
3. Turn Signals, Horn, Emergency Flashers
4. Instrument Pod

5. Ignition Lock
6. Kill Switch and Starter Button
7. Throttle
8. Fuel Cap and Lock

<https://www.mqtom manuals.net/>

Motorcycle Components (continued)

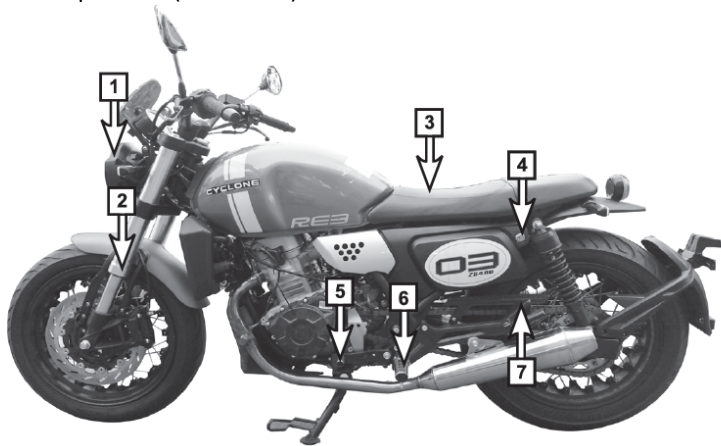

- | | |
|---------------------|------------------------|
| 1. Headlight | 5. Gearshift |
| 2. Front Suspension | 6. Left Front Footrest |
| 3. Seat | 7. Left Rear Footrest |
| 4. Seat Lock | |

<https://www.mqto manuals.net/>

Motorcycle Components (continued)



1. Rear Wheel
2. Muffler
3. Right Rear Footrest
4. Right Front Footrest
5. Rear Brake Lever
6. Front Wheel

<https://www.motomanuals.net/>

Ignition Lock

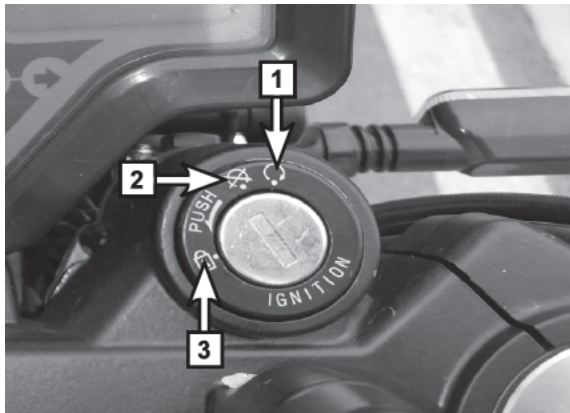

Position 1: Engine run. Turn the key to this position and press the start button to start the motorcycle.

Position 2: Engine off. Turn the key to this position to turn off the motorcycle.

Position 3: Motorcycle fork locked. Turn the forks all the way to the left and push down on the key to lock the front forks.

Caution! Park the motorcycle in a safe place and lock the handlebar to prevent theft.

Instruments



The instrument cluster is located above the headlight as shown above.

Caution! Do not over rev the engine. Doing so will result in engine damage.

Item 1 is the LCD reset button. Press it to cycle between the tripmeter and the odometer. Holding this down for several seconds in the trip mode will reset the trip meter to 0.0. To switch between English and metric units, turn off the ignition, hold the button down, turn on the ignition with button depressed for 5 seconds.

Item 2 is the LCD screen, which shows fuel quantity, speed, water temperature, gear, time, and mileage.

Item 3 are indicator lights showing high beam, low fuel, EFI fault indicator, and neutral.

Left Handlebar Controls

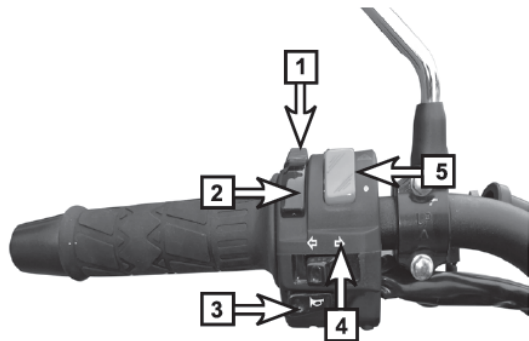

Item 1 is the high beam flash switch.

Item 2 is the high beam/low beam control switch.

Item 3 is the horn switch.

Item 4 is the turn signal switch. The turn signals are not self-cancelling; you should press this switch after making a turn.

Item 5 is the emergency flasher switch. It can be operated with the ignition off.

Right Handlebar Controls

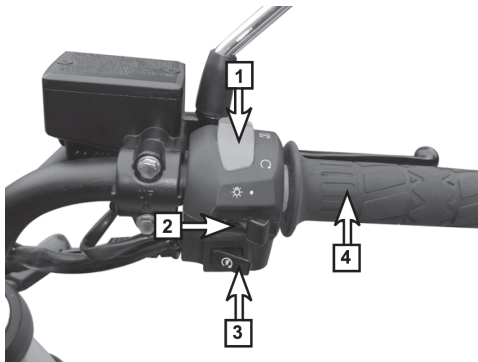

Item 1 is the kill switch. Use it to kill the engine in an emergency.

Caution! Do not use the kill switch to routinely turn off the engine. Use the ignition key instead.

Item 2 is the headlight switch. Use it to turn the headlights on.

Item 3 is the starter button. Press it after turning the ignition lock on to start the engine.

Item 4 is the throttle. Twist it to increase engine rpm.

Caution! Do not crank the engine for more than 5 seconds at a time.

Fuel Tank

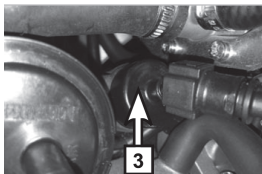
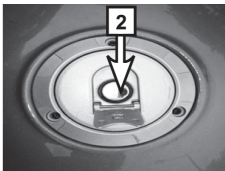
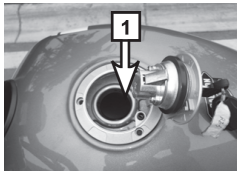

Warning! Do not overfill the fuel tank.

Warning! Do not smoke when refilling.

Warning! Turn off the engine when refilling.

Caution! Do not use fuel with ethanol exceeding 15%.

Caution! Wipe up any fuel that spills outside the fuel tank.

Item 1 is the fuel tank inlet.

Item 2 is the fuel tank lock. It uses the motorcycle's ignition key.

Item 3 is the fuel filter. It is located beneath the fuel tank.

<https://www.motomanuals.net/>

Motorcycle Controls

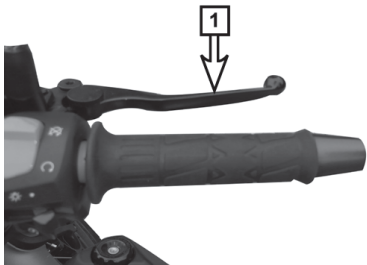

Item 1 is the front brake lever. Its stroke is 10 to 20 mm.

Item 2 is the rear brake lever. Its stroke is 20 to 30mm.

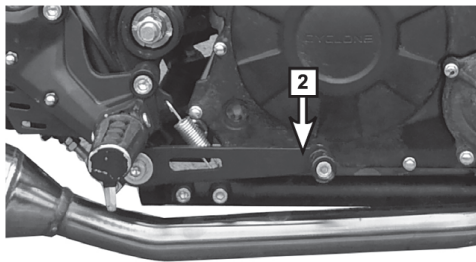

Warning! Check your motorcycle's front and rear brake operation prior to every ride.

Warning! Service the front and rear brakes at the intervals recommended in this Owner's Manual.

Motorcycle Controls (continued)

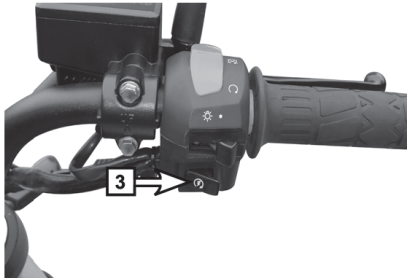

Item 3 is the starter button.

Item 4 is the gear shift lever. Depress it to downshift while actuating the clutch. Raise it to upshift while actuating the clutch. Neutral is between first and second gear.

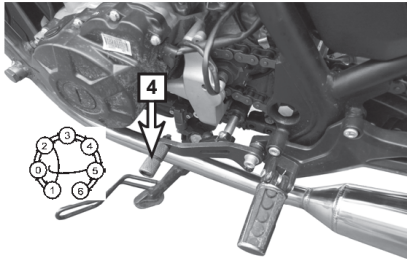

Caution! Do not attempt to shift the motorcycle without using the clutch.

Tool Kit

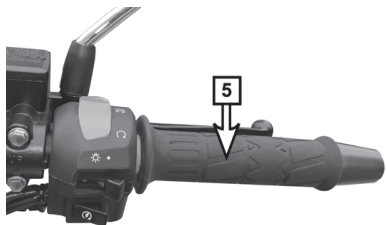

Item 5 is the throttle. Twist it to increase engine rpm, release it to decrease engine rpm.

Item 6 is the motorcycle tool kit. It includes the tools shown for simple motorcycle maintenance. These tools include:

- 4mm, 5mm, and 6mm Allen wrenches
- Spark plug socket
- 8mm and 10mm open end wrenches
- Pliers
- Screwdriver

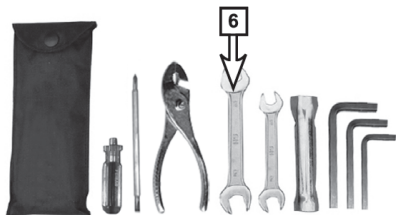

<https://www.motomanuals.net/>

Motorcycle Load Limits



Warning! Do not attempt to operate the motorcycle with more than two people (operator and one passenger).

The motorcycle is designed to carry the rider and one passenger. You should never exceed a total load on the motorcycle in excess of 330 lbs.

Warning! Do not exceed a combined load of 330 lbs.

Warning! Do not load the motorcycle asymmetrically; balance the loads so they are equally distributed on the left and the right.

Break-In Procedure

When an internal combustion engine is new, it should not be subjected to hard acceleration, lugging, overheating, or running for long periods at a constant engine speed. You should avoid these situations during the first 500 miles of service.

Caution! Do not violate the guidance provided here, or you may damage your motorcycle engine.

We recommend the first oil change when the motorcycle reaches between 200 and 500 miles. We recommend a second oil change at 1,000 miles, and every 2,500 miles thereafter. We recommend using only 10-40W motorcycle oil. **Caution!** Never use any oils intended for automotive use, or any oil that contains friction reducing additives (use of these oils will induce clutch slippage not covered by the CSC warranty).

Caution! Use only non-synthetic oils during the first 1000 miles of use. After that, you may wish to change to synthetic motorcycle oil.

EFI System

The motorcycle is fuel injected. The fuel injection system includes the ECU, the nozzle, the throttle, the intake sensor, the pressure sensor, the engine temperature sensor, the ignition coil, the crankshaft position sensor, the fuel pump, and the O2 sensor. The instrument cluster includes an EFI fault indicator. It should turn on when the ignition is turned on and turn off after the engine has started. If there is a fault, the EFI fault indicator will turn on or flash. If the EFI indicator does this, check the electrical connections to the components described above, the fuel lines, and battery voltage.

Caution! Do not operate the motorcycle with less than a quarter tank of fuel. Fuel in the fuel tank is needed to keep the fuel pump cool.

Caution! Do not install accessories that interfere with the fuel injection system. All electrical accessories should be at least 6 inches away from EFI components.

Caution! Clean the air filter element and the throttle valve and replace the fuel filter every 5000 miles.

EFI Schematic

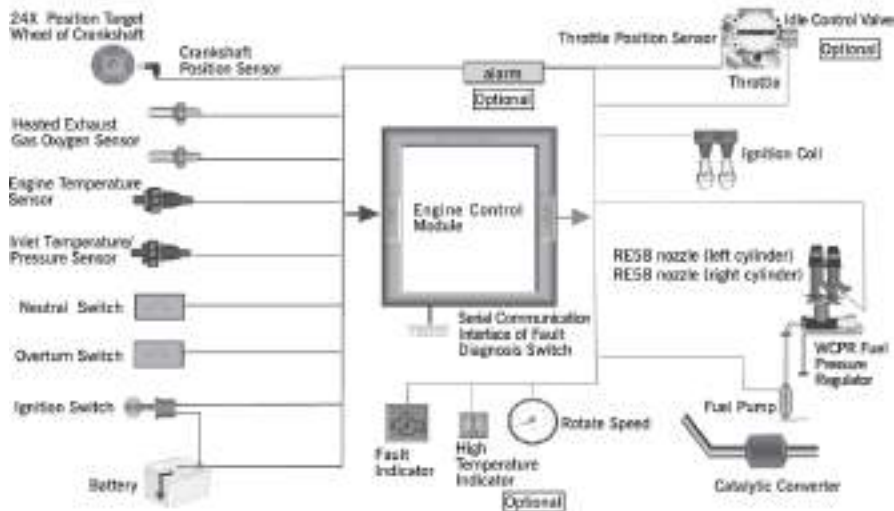

<https://www.motomanuals.net/>

EFI System (continued)

1. Electronic Control Unit (ECU): Collect, process information and issue instruction.



3. Nozzle: Atomize the fuel and import into combustor.



2. Throttle valve assembly: Adjust air inflow, idling and throttle position.



4. Fuel pump: To provide specified oil pressure.



EFI System (continued)

5. Inlet Temperature/Pressure Sensor: Inlet pressure, inlet temperature and barometric pressure test.



7. Oxygen Sensor : oxygen content test



6. Ignition coil: Provide high voltage to spark plug for ignition



8. Crankshaft Position Sensor: Crankshaft position measurement, provide the basis for oil injection and ignition controlling.



EFI System (continued)

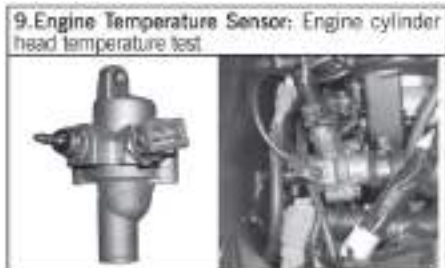

Warning! The fuel system is pressurized. When breaking fuel connections, use a cloth to prevent fuel spray. Eliminate all ignition sources.

Caution! Do not attempt to maintain the EFI system with the ignition on.

Caution! Lubricate EFI components when installing to prevent seal damage.

Caution! Do not apply additional electrical energy to any EFI component.

General Motorcycle Safety Guidance

- **Warning!** Do not attempt to ride this motorcycle on public roads if you do not have a motorcycle license.
- **Warning!** Do not attempt to ride this motorcycle if you do not know how to ride a motorcycle.
- **Warning!** Always wear appropriate motorcycle gear when riding your motorcycle. Never ride your motorcycle without wearing an approved helmet, a motorcycle jacket, eye protection, gloves, motorcycle pants, and boots.
- **Warning!** Always remain alert while operating your motorcycle. Pay attention to traffic conditions and the road surface. Adjust your speed and following distances taking these factors into consideration.
- **Warning!** Never operate your motorcycle while under the influence of drugs or alcohol, or when sleep deprived.
- **Warning!** The motorcycle's cylinder, cylinder head, and exhaust system are hot when the motorcycle is running and after turning it off. Do not touch these items.
- **Warning!** Always maintain appropriate tire pressure. Operating the motorcycle with low tire pressure will adversely affect the motorcycle's handling.

- **Warning!** Replace worn tires promptly.
- **Warning!** Never attempt to lubricate the chain by running the engine, putting the motorcycle in gear, and lifting the rear of the motorcycle. Lubricate the chain with the engine off.
- **Warning!** Do not attempt to reach under the tank to open or close the choke while riding the motorcycle.
- **Warning!** Do not overload the motorcycle or load it unevenly.
- **Warning!** Do not attempt to carry more than one passenger (in addition to the rider).
- **Warning!** Do not attempt to perform “wheelies” or “stoppies.”
- **Caution!** Don't park your motorcycle facing downhill without leaving the motorcycle in gear, or it may roll forward and fall down.
- **Caution!** Never operate your motorcycle without the air filter, the muffler, and all emissions components in place. Doing so will reduce performance, damage the engine, and void your warranty.

Inspections Before Riding

Before riding your motorcycle, you should check the following:

- Both tires are appropriately inflated.
- Neither tire has nails nor other foreign objects embedded in the tread or the sidewall.
- The fuel tank contains adequate fuel.
- The crankcase has oil.
- The turn signals, the front and rear brake lights, the horn, and the headlight all operate when commanded to do so (the ignition switch must be in the ON position).
- The front and rear brake levers have adequate free play.

<https://www.motomanuals.net/>

- The front and rear brakes operate.
- The forks turn freely from side to side.
- The rear-view mirrors are adjusted appropriately.
- The engine kill switch is in the RUN position.
- The chain has appropriate slack.
- Major threaded fasteners are tight. We always hand check the axle nuts, the exhaust header nuts and bolts, the muffler bolts and nuts (grab the muffler and check it for any side-to-side play), the steering stem nut, and the front and rear caliper bolts.

Starting Your Motorcycle

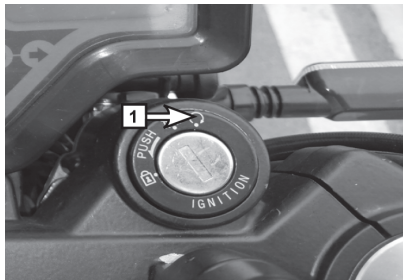

Turn the ignition lock to the run position, as shown in the photo to the left. Wait until you hear the fuel pump pressurize the fuel system.

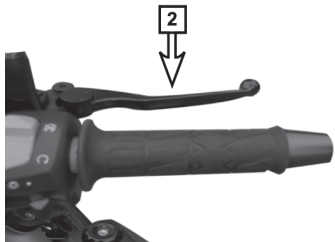

Hold the front brake lever in (denoted by Item 2 in the photo to the left).

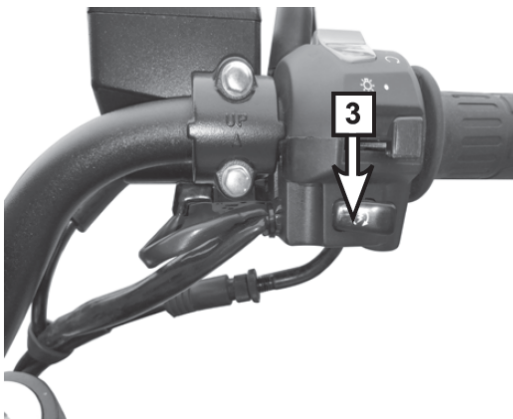

Press the starter button, shown as Item 3 in the photo to the left.

After the engine starts, allow it to warm up at idle for approximately 3 minutes.

Caution! Do not hold the starter button on for more than 5 seconds.

Caution! Do not race the engine while it is warming.

Riding Your Motorcycle

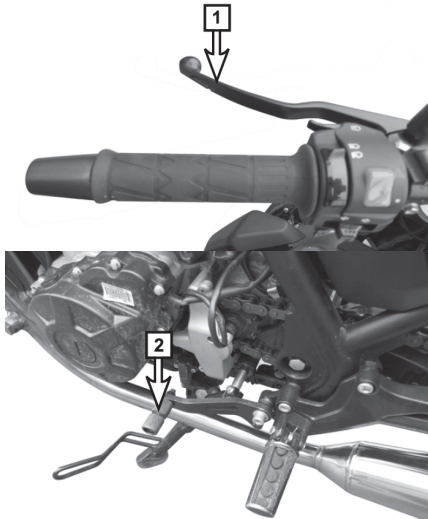

Warning! Wear all required safety gear prior to riding the motorcycle.

After putting on all required safety gear and allowing the engine to warm, straddle the motorcycle, lift it and retract the stand, and pull in the clutch lever (Item 1 in the photo to the left).

Depress the foot shift (Item 2 in the photo to the left) to engage 1st gear. Open the throttle slightly and slowly release the clutch to propel the motorcycle forward.

Shift into higher gears by operating the clutch and pulling the shift left up.

- As the motorcycle accelerates, pull in the clutch, pull up on the gearshift lever, and engage second gear. Repeat the above process to engage third, fourth, and fifth gear.
- When you need to stop, allow the throttle to close and apply both the front and rear brakes. **Warning!** Do not apply the brakes too aggressively, as this can induce a skid. Be cognizant of the road surface and adjust braking force appropriately.
- As the motorcycle slows, pull in the clutch, depress the gear shift lever to shift to a lower gear, and release the clutch. Match your speed as you decelerate to the gear you are downshifting to. **Warning!** If you downshift too aggressively (i.e., you downshift to too low a gear for your speed), you can induce a skid.
- Repeat the above process, using engine braking and the front and rear brakes to slow the motorcycle. Prior to coming to a complete stop, pull in the clutch. Shift the motorcycle to neutral.
- If you wish to park the motorcycle, turn off the ignition key. **Caution!** Do not use the kill switch for routine stops and leave the ignition key in the ON position when the engine is not running. This will run down the battery.
- If you wish to park the motorcycle, turn off the ignition key. **Caution!** Do not use the kill switch for routine stops and leave the ignition key in the ON position

- when the engine is not running. This will run down the battery.
- Deploy the sidestand and lean the motorcycle to the left. Make sure the sidestand is fully forward prior to leaning the motorcycle to the left. **Caution!** Do not park the motorcycle with the front end angled downward; it could roll forward (off the sidestand) and fall.
 - Lock the front forks. **Caution!** Do not leave the ignition key with the motorcycle.

Safe Riding

Operating a motorcycle is much different than driving a car, and a much higher degree of care and attentiveness is required to operate a motorcycle safely. You must pay attention to your vehicle, surrounding vehicles, the road surface, and the weather. With the above in mind, we offer the following guidance:

- Always wear all safety gear, as outlined earlier in this manual.
- Never assume another driver sees you; always assume other vehicles will try to occupy your space.
- Drive defensively, as your safety and the safety of any passengers you take with you depend on it.

- Never race another car or motorcycle on a public road.
- Never exceed the speed limit.
- In conditions of limited visibility, drive below the speed limit. Never drive at a speed such that you cannot stop within the limits of your visibility.
- If the road is wet, reduce your speed.
- If the road is icy, stop riding and get off the road.
- If someone cuts you off, do not make obscene gestures or threaten the other driver. Motorcycles do not win arguments with cars.
- Never overload your motorcycle.
- Never attempt to negotiate a corner at too high a speed.
- If sand or gravel is on the road surface, reduce your speed.
- If cut grass is on the road surface, reduce your speed.
- If oil is on the road surface, greatly reduce your speed.
- If it is legal to split lanes in your state, never exceed the speed limit and never drive more than 5 mph faster than cars in the lanes you are splitting.
- Do not apply the brakes so aggressively that you lose traction.
- Always use the front and rear brake when slowing to a stop.
- At stop lights or stop signs, always check traffic behind you.

- Never attempt to beat a train through an intersection.
- Recognize that as your speed increases, so does your stopping distance, and ride accordingly.
- Never ride your brakes constantly, as they will overheat and lose stopping power.
- Never ride the clutch constantly, as it will wear out.
- Use lower gears when ascending or descending hills.
- Be aware of your surroundings when stopping your motorcycle and in particular, make sure the ground is solid when you put your foot out to support the motorcycle at a stop.
- Always keep your feet on the footpegs when riding the motorcycle.
- Never do wheelies or burnouts.
- Never pass another vehicle unless you are sure it is safe to do so.
- Never allow children to play on or around the motorcycle; it might fall over on them.
- Never allow children near the motorcycle when you finish a ride; the engine components are hot and might burn them.

Section 2: Maintenance

When you maintain or repair the motorcycle, please use original components and parts, accessories, lubricating oil and other materials that are made or recognized by CSC Motorcycles. **Caution!** If you use any parts or components other than those recommended by CSC, it may adversely affect the performance, reliability, stability, or warranty of your motorcycle.

When working on your motorcycle, you should follow this guidance:

- **Warning!** Whenever the motorcycle is to be reassembled after disassembly, washers, seals, and cotter pins need to be replaced.
- When you fasten a series of bolts or nuts, you should do so in a diagonal pattern.
- **Warning!** Do not use flammable cleaning fluid to clean components and parts.
- **Caution!** Before assembly operations, add lubricating oil or lubricating grease to lubricated surfaces.
- **Warning!** After assembly, make sure all parts are properly assembled and tightened.
- **Warning!** Stop the engine when repairing the motorcycle.

- **Warning!** If the maintenance operation needs to be done while the engine is working, make sure the area is well-ventilated.
- **Warning!** Gas is flammable and combustible, so do not smoke or provide ignition sources in the work area.
- **Warning!** The battery can liberate hydrogen, which is flammable. Do not smoke, ignite or make sparks near the battery, especially when it is charging.
- **Warning!** The electrolyte of the battery contains sulfuric acid. If your eyes, skin or clothes are splashed with electrolyte, rinse them thoroughly with water and seek immediate medical attention.
- **Warning!** Disconnect the negative battery terminal when performing any maintenance on the motorcycle engine, drive train, or fuel system.

Component Cleaning

After parts are disassembled, they may need to be cleaned. Cleaning methods vary according to the characteristics of the parts.

- To remove oil or grease contamination, CSC recommends using Simple Green or other similar degreasing agents.

- **Warning!** Never use gasoline as a cleaning agent.
- To remove carbon deposits, use mechanical or chemical methods. The mechanical method uses a wooden or plastic scraper or blade to clear the carbon deposit first, and then rinse the parts with an appropriate cleaning agent. The chemical method is to soak the parts in the cleaning agent first, then clean them with a brush, and then rinse them with hot water.

Parts Inspection

Parts should be inspected after they are cleaned. The purpose of inspection is to check if the parts need to be repaired or replaced.

Maintenance Adjustments

The RE3 motorcycle requires adjustments in the following areas:

- The clutch must be adjusted according to the maintenance instructions included in this manual. The main adjustment feature is the clutch lever free travel ($\frac{1}{4}$ to $\frac{1}{2}$ inch), and the clutch cable adjusting mechanism. This

<https://www.motomanuals.net/>

- Service Manual presents the procedure for clutch adjustment.
- The throttle cable adjustment is performed at the throttle. The throttle should have 2 to 5 degrees of free rotation. This adjustment is presented in this Service Manual.
 - The drive chain is adjusted by positioning and aligning the rear wheel. The drive chain should have 3/5 inch of free play. The drive chain adjustment procedure is explained in this Service Manual.
 - The valves should be adjusted to the specified gap.
 - Tire pressure should be maintained as specified in this manual.

Recommended Tools

The RE3 motorcycle includes a basic tool kit. These tools are suitable for emergency repairs only. CSC sells custom tool kits with professional grade tools; please contact us at 909 445 0900 to order tools.

<https://www.motomanuals.net/>

Adjustment Specifications

Item	Adjustment Limits
Clutch lever free play (at tip)	¼ to ½ inch
Throttle free travel	2-5 degrees
Drive chain	3/5 inch
Valve gap (at TDC)	0.04 to 0.08 mm
Tire pressure (front/rear)	36 psi

Maintenance Schedule

ITEMS \ TIMES	Odometer reading km			Remark
	Break-in period 1000km or 1 month	Primary 2000km or 3 months	Each 2000km or 3 months	
Valve clearance [※]	Inspect/adjust	Inspect/adjust	Inspect/adjust	1. ※※: refers to the middle-weight luboil for wheel. 2. ※: advise you to maintain motorcycle or parts at maintenance center of our company. 3. Shorten maintenance cycle if motorcycle runs at humid or dusty places.
Spark plug [※]	Clean/adjust	Clean/adjust	Clean/adjust	
Air cleaner [※]		Clean/Inspect	Clean/Inspect	
Oil filter ^{※※}	replace once per 8000-10000Km			
Engine oil [※]	replace once 300km	Inspect/replace once	Inspect/replace once	
Oil strainer [※]	Clean/replace	Clean/replace	Clean/replace	
Brake [※]	Inspect/adjust	Inspect/adjust	Inspect/adjust/replace	
Clutch [※]	Inspect/adjust	Inspect/adjust	Inspect/adjust/replace	
Aluminium wheel/spoke wheel [※]	adjust spoke once per 300km			
Wheel bearing ^{※※}	inspect	Clean/lubricate	Clean/replace/lubricate	
Steering bearing ^{※※}	Clean/replace/lubricate	Clean/lubricate	Clean/lubricate	
Absorber [※]	inspect	Inspect/adjust	Inspect/adjust	
Driving chain/sprocket ^{※※}	inspect/adjust	Clean/adjust/lubriacte	Clean/adjust/lubriacte	
Battery [※]	inspect	Charge/add electrolyte	Charge/add electrolyte	
Tightening parts	Inspect/tight	Inspect/tight	Inspect/tight/replace	

Cleaning Your Motorcycle

Clean your motorcycle when it becomes dirty as outlined below:

- Wash the motorcycle with low pressure water to loosen and remove mud, insects, and other debris.
- Wash the motorcycle using soapy water. Rinse the motorcycle. **Caution!** Do not spray water directly into the muffler.
- Clean the chain using a suitable chain cleaner.
- Dry the motorcycle with a towel or a chamois.
- Lubricate the chain with a suitable chain lubricant. **Caution!** Do not spray lubricant directly into the brakes.
- Wax the motorcycle using a suitable wax.
- **Warning!** When riding the motorcycle after cleaning it, actuate the brakes to make sure they have not been degraded as a result of cleaning the motorcycle.

CSC stocks numerous cleaning and lubrication products; please call us at 909 445 0900 to order these items.

<https://www.motomanuals.net/>

Checking Your Oil

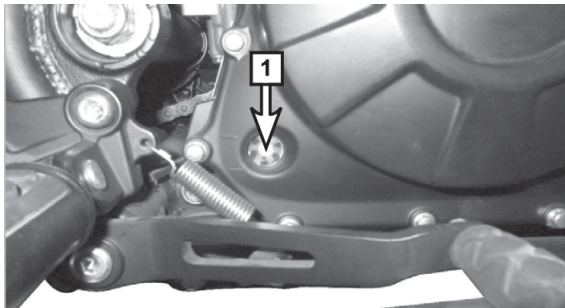

When the engine is warm, hold the motorcycle in the vertical position (off the sidestand). Oil should be visible in the Item 1 viewport. You should check the oil before every ride.

Warning! Take care not to let the motorcycle fall when you are holding it in the vertical position and checking the oil level in the viewport.

Changing Your Oil

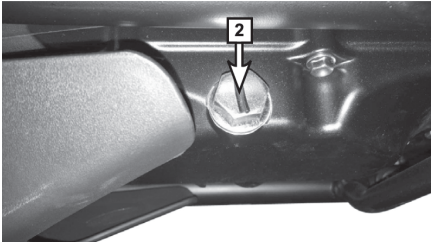

To change your oil, first warm the engine. Place a suitable oil container beneath the motorcycle. Unscrew the oil drain plug (Item 2 in the photo to the left). Allow the old oil to drain completely into the oil tray. Hold the motorcycle vertically to drain all oil.

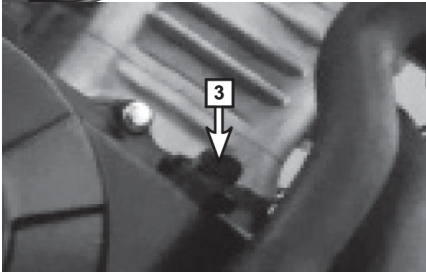

Replace the oil drain plug shown above. Unscrew the oil fill port (Item 3 in the photo to the left). Add new oil of the specified type and quantity. The new oil should be visible in the oil view port.

Changing Your Oil Filter

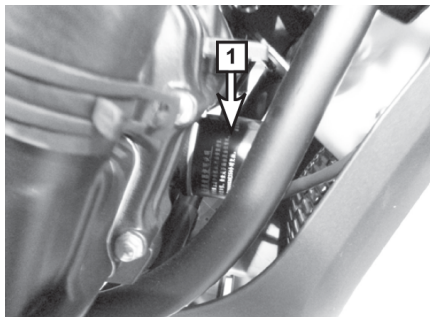

The oil filter is a screw-on unit as shown as Item 1 in the photo to the left. Unscrew the old filter.

Caution! If the engine has been running, the oil filter will be hot.

Replace the oil filter every 10,000 km or 250 hours of operation. Smear a small amount of motor oil on the oil filter gasket. Screw the new oil filter in place, hand tightening it. Start the engine and check for leaks.

Air Cleaner Maintenance

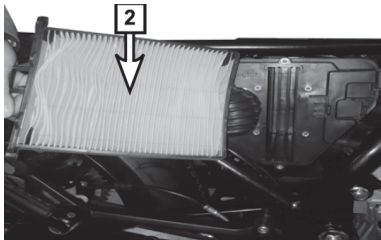
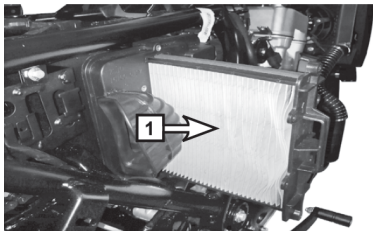

The air cleaner is located on the right side of the motorcycle, as shown in the photo to the left. The air filter should be inspected and cleaned or replaced regularly. You can wipe down the exterior portions with a dry cloth. Use compressed air directed opposite normal air flow to blow out the air cleaner.

Warning! Do not use gasoline or other solvents to clean the air filter.

Caution! If the air cleaner cannot be cleaned satisfactorily, replace it with a new air cleaner.

Caution! Never operate your motorcycle without the air cleaner.

Spark Plug Maintenance

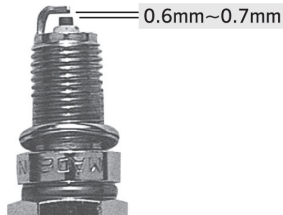

The spark plugs are accessible on the side of the cylinder head. Clean or replace the spark plugs as necessary. Use JH9RC spark plug with a gap of 0.6 to 0.7 mm. Torque the spark plugs to 17.5 Nm.

Caution! If the engine has been running, the spark plugs and the engine will be hot.

Throttle Cable Maintenance and Adjustment

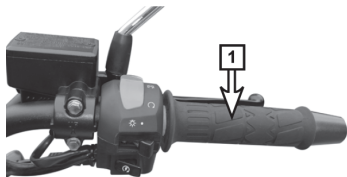

The throttle (Item 1 in the photo to the left) should have 2 to 5 degrees of free play in it.

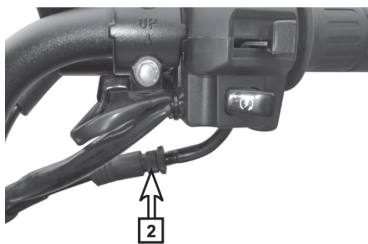

The throttle cable slack can be adjusted with the Item 2 barrel nut and lock shown in the photograph to the left. Adjust these to attain the required throttle free play and then lock the barrel nut and lock.

Front Brake Inspection

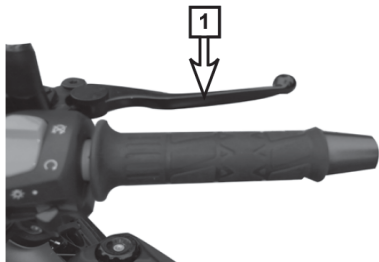

The front brake lever (Item 1) should have a stroke of 10-20mm.

The brake fluid reservoir has a viewport (Item 2 in the photo to the left). It shows the brake fluid level. Use only DOT 3 or DOT 4 brake fluid.

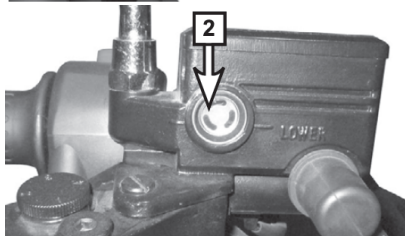

Warning! Do not mix brake fluid with other fluids. Do not re-use brake fluid. Change the brake fluid every two years.

Caution! If the brake fluid spills onto a painted surface, wipe it off immediately.

Rear Brake Inspection

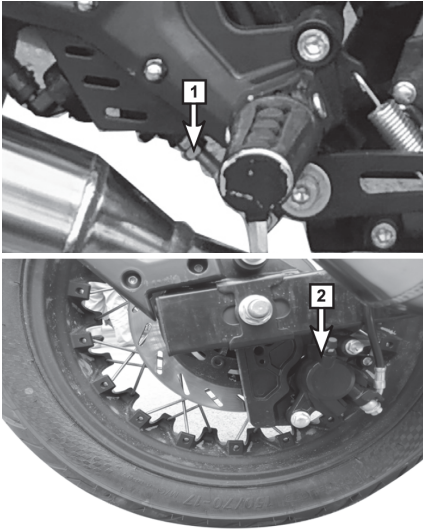

The rear brake pedal has a stroke of 20 to 30mm. Pedal actuation slack can be adjusted with the Item 1 adjustor shown in the photo to the left. The rear brake pad thickness (Item 2 in the photo to the left) should be no less than 2mm. If the rear brake pad is less than 2mm thick, replace the rear brake pads.

Wheel And Tire Inspection



Limit value of outer tyre abrasion

Limit value of outer tyre abrasion	Front wheel	Two scale line
	Rear wheel	Two scale line

The limit value of wheel warp

Limit value	Axial	2.0mm
	Radial	2.0mm

Tyre size and pressure

Size	Front	120/70-17M/C
	Rear	150/70/17M/C
Pressure	Front	250kPa
	Rear	250kPa

Warning! Wheels and tires should be inspected before each ride.

<https://www.motomanuals.net/>

Battery Maintenance

The battery is located beneath the seat.

	Item	standard value	
Battery	The specific gravity of electrolyte	1.280±0.010g/cm ³ (20°C)	
	The voltage of two ends	Daytime	Night
	1500r/min	Above 14.0V	Above 13.5V
	8500r/min	Below 14.6V	Below 14.6V

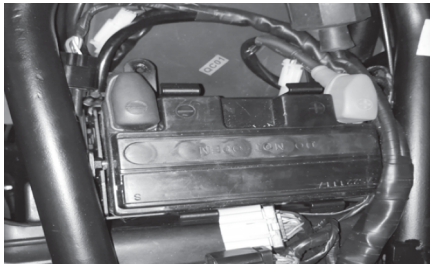

We recommend using a battery tender to keep the battery charged between rides. Please call us at 909 445 0900 if you wish to purchase a battery tender.

Warning! If you spill battery acid on yourself, flush immediately with copious amounts of water.

Warning! Charge the battery in a well-ventilated area.

Warning! Disconnect the battery when performing any work on the motorcycle.

Fuse Replacement

The fuse is located beneath the body panel on the right side of the motorcycle. Your motorcycle uses a 20A fuse.

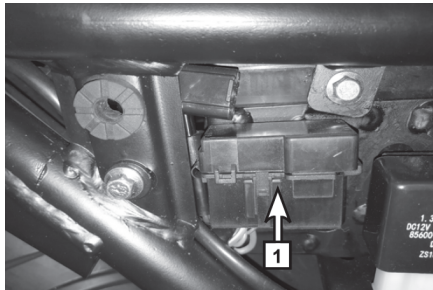

Warning! Never replace the fuse with anything but another fuse.

Warning! Never replace the fuse with a higher amperage fuse.

Caution! If the fuse opens, do not simply replace it. Troubleshoot the electrical system to find out why the fuse blew or it will blow the replacement fuse.

Motorcycle Horn

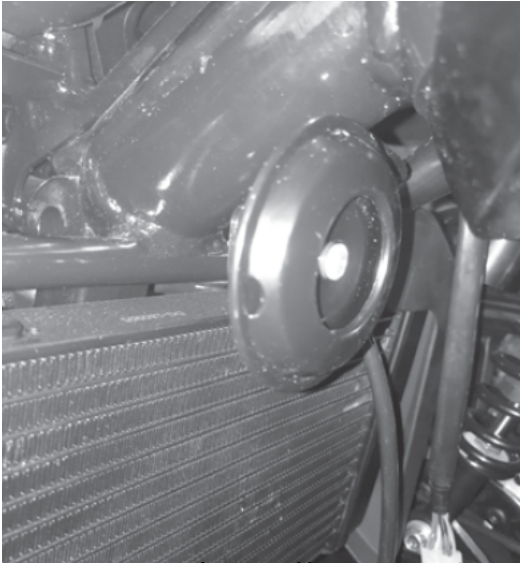

The horn is located in front of the engine. If the mounting screw loosens the horn may rattle. If the horn sound weakens, it may be adjusted using the white adjusting nut shown in the photo to the left. If the horn cannot be adjusted, it must be replaced.

Troubleshooting Guidelines

Item	Trouble description	Cause
1	no electricity	1.Fuses part or loose,2.The connection between wire and the anode or the cathode of the battery are loosening,3.The lock is loosening,4.Ground wire is loosening; 5.The main relay is damaged.
2	Difficult to start	1.Oxygen sensor is broken.The voltage of oxygen sensor is not beat. (fault diagnosis tester-read data streams-voltage of oxygen sensor is 100~800mv); 2.Crankshaft position sensor is broken without any trigger signal.(oscilloscope); 3. Nozzle and ignition coil are broken.No oil ignition pulse(fault diagnosis tester-read data streams-oil injection pulse width); 4.Fuel pipe is extruded; 5.Low battery; 6.The wire is damaged or disconnected; 7.The engine is failure.
3	No idle speed or high idle speed.	1.Oxygen sensor is broken; 2.The step motor is step-out; 3.Throttle position sensor is fault.(fault diagnosis tester-read data streams-throttle position should on 0~100 position); 4.The fuel in tank is too insufficient to submerge pump.
4	Can not accelerate or decelerate	1.Oxygen sensor is fault.2.Throttle position sensor is fault.3.The step motor is step-out; 4.Abnormal pump pressure.5.Intake pressure/temperature is fault.
5	High fuel consumption	1.Oxygen sensor is fault.2.Intake pressure/temperature is fault.

The EFI system should be cleared for troubleshooting by turning the ignition key on for 15 seconds, then turn the key on and off five times at 0.5-second intervals. If the motorcycle does not start after several attempts, to clear away unburnt fuel in the cylinder fully open the throttle and press the start button for 3 to 5 seconds.

Storing Your Motorcycle

For storage longer than 60 days, store the motorcycle as outlined below:

- Drain the fuel from the fuel tank and the fuel lines. Close the fuel tank cap.
- Remove the spark plugs and add 5cc of motor oil into each cylinder. Reinstall the spark plug. With the spark plug wires left off, cycle the engine several times.
- Remove the battery, charge it, and store it in a cool and dry environment.
- Support the motorcycle on blocks to prevent tire damage.
- Cover the motorcycle to protect it from dust, moisture, and other contaminants.
- Add fuel stabilizer to the fuel to prevent gumming in the tank, the fuel injectors, or the fuel lines.
- After storage, charge and reinstall the battery. Add fuel. Replace the engine oil if the motorcycle has been in storage longer than 4 months.

For shorter storage intervals, we recommend attaching the motorcycle to a Battery Tender.

Motorcycle Specifications

ITEM	SPECIFICATION
Dimension(L×W×H)	2065mm ×780mm ×1090mm
Wheelbase	1380mm
Min.ground clearance	145mm
Min. turning diameter	4900mm
Net weight	184kg
Max.load	150kg
Engine model	ZS266MQ-S
Engine type	Double cylinder, four-stroke, water-cooling
Bore×stroke	66mm×55.2mm
Capacity	378ml
Compression ratio	10 :1
ECU	MT05
Lubrication	Pressure and splash
Starter	Electric starting
Max.power/corresponding rev	27/9000 kw/rpm
Max.torque/correspondig rev	33/6500 N.m/rpm
Min.no load speed	1400±140 (r/min)
Economical fuel consumption	3.4L/100km
Max.speed	138km/h
fuel tank capacity and fuel type	19L, 92#
lubricating oil No.and lubrication type	SJ 10W/40, 3.0L
shock absorber	Hydraulic and spring compound
Tyre size/Pressure	Front120/70-17M/C/250kPa/Rear150/70-17M/C/250kPa

<https://www.motomanuals.net/>

Wiring Schematic

CIRCUIT

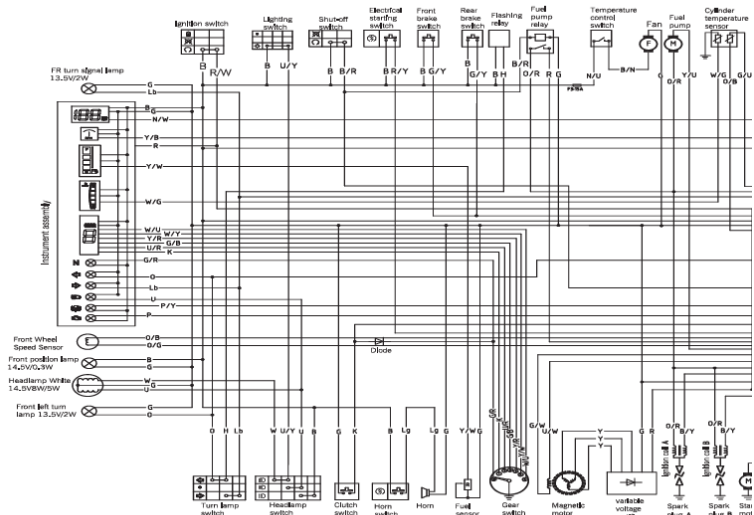

Black-B, Red-R, Green-G, Orange
Grey-H, Pink-K, Brown-N, Light

<https://www.motomanuals.net/>

DIAGRAM

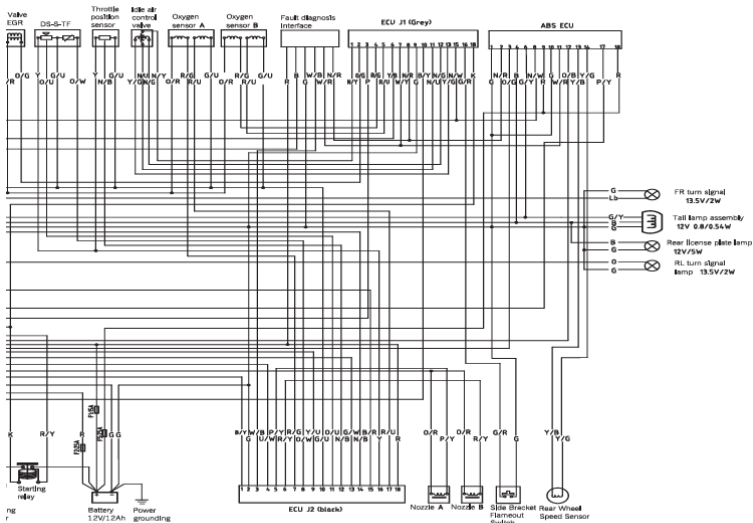

ange-O,Blue-U,Purple-P
: blue-Lb,Light green-Lg

<https://www.motomanuals.net/>