

CSC TT250

Owner's and Service

Manual





Contents

Foreword.....	4
Caution and Warning Symbols.....	4
Section 1: Owner's Manual.....	5
General Motorcycle Safety Guidance	5
Inspections Before Riding	6
Motorcycle Specifications	6
Motorcycle Description.....	8
Controls.....	9
Ignition Lock and Fork Lock.....	9
Instruments.....	9
Left and Right Handlebar Switchgear	10
Fuel, Fuel Tank, Filler Cap, and Petcock.....	10
Choke	11
Helmet Lock	11
Adjustable Front and Rear Suspension	12
Load Limits	12
Tool Kit	13
Engine Break-In Procedure	13
Starting the Motorcycle	13
Operating the Motorcycle.....	14
Cleaning the Motorcycle	14
Storing the Motorcycle	15
Section 2: Service Manual	16
Maintenance Cautions and Warnings.....	16
Component Cleaning.....	16
Parts Inspection	17
Maintenance Adjustments.....	17
Recommended Tools	17
Adjustment Specifications	17
Motorcycle Maintenance Schedule	18
Torque Values	18
Unpacking	19
Inspection.....	19
Frame and Body	19
Brakes.....	20
Master Cylinder Locations	20
Front Brake Pad Inspection and Replacement.....	21
Rear Brake Pad Inspection and Replacement.....	23
Front and Rear Brake Rotor Inspection	24
Flushing and Replacing the Brake Fluid	25
Bleeding the Brakes	25
Brake Troubleshooting.....	26
Power Transmission.....	26



Chain Drive System	26
Chain Lubrication	26
Chain Adjustment	26
Sprocket and Chain Inspection	29
Chain Drive Troubleshooting	30
Clutch Maintenance	30
Clutch Cable Installation and Adjustment	30
Clutch Replacement.....	32
Clutch Troubleshooting.....	41
Suspension	42
Forks.....	42
Adjusting Ride Height.....	42
Changing Fork Oil	43
Replacing Fork Seals and Bushings	48
Swingarm and Rear Suspension.....	50
Swingarm and Rear Suspension Troubleshooting	53
Steering System	54
Steering Stem Bearing Adjustment.....	54
Steering System Troubleshooting	56
Wheels and Tires.....	56
Front Wheel Removal	56
Rear Wheel Removal.....	59
Wheel and Tire Inspection	62
Wheel and Tire Troubleshooting	62
Fixing Flat Tires	62
Engine.....	65
Oil Change	65
Spark Plug Removal and Installation.....	69
Valve Adjustment.....	69
Carburetor.....	78
Air Filter Replacement	89
Exhaust System	91
Engine Troubleshooting	92
Fuel System	94
Fuel System Troubleshooting	95
Control Cables.....	96
Clutch and Throttle Cable Troubleshooting.....	96
Electrical System	96
Battery.....	104
Lighting and Turn Signals	106
Charging System.....	109
Starting System	113
Electrical System Troubleshooting.....	118
Electrical Schematic	120
Appendix A - Service Checklists	121



A Word From Steve

Thank you for purchasing this CSC TT250 motorcycle. The TT250 is a great motorcycle and we are very proud of it. The TT250 is easy to maintain, it's reliable, and it's fun. You've made a wise purchase decision.

I want you to know that we value the trust and confidence you have in CSC. Our guiding principle will always be that our customers come first.

We wish you many miles of safe and enjoyable riding on your new TT250 motorcycle. If there's anything we can do to enhance your ownership experience, please let us know.

Thank you again,

Steve Seidner
Founder and CEO
CSC Motorcycles, LLC
1331 W. Foothill Boulevard
Azusa, California 91702
909 445 0900
www.CSCMotorcycles.com



Foreword

The TT250 Owner's and Service Manual provides information on operating and maintaining the CSC TT250 motorcycle. It includes the motorcycle's technical specifications, performance parameters, and operating, maintenance, and adjustment data. This manual includes both the Owner's Manual and the Service Manual. The Owner's Manual is included in the first section of this document; the Service Manual is included in the second section of this document.

CSC Motorcycles stocks all TT250 motorcycle parts, and we recommend that you use only parts and materials provided by us when servicing or maintaining your motorcycle.

The TT250 Owner's and Service Manual is provided free to all who purchase a new CSC TT250 motorcycle.

Reproduction of the CSC TT250 Owner's and Service Manual or posting it online without CSC's permission is expressly prohibited.

If you have any questions, please contact CSC Motorcycles by calling us at 909 445 0900 or via email at info@CSCMotorcycles.com.

Caution and Warning Symbols

Caution and warning symbols in this manual are as follows:

The **Caution!** symbol indicates a condition that may lead to motorcycle damage.

The **Warning!** symbol indicates a condition that may lead to injury or death.



Section 1: Owner's Manual

General Motorcycle Safety Guidance

Warning! Do not attempt to ride this motorcycle on public roads if you do not have a motorcycle license.

Warning! Do not attempt to ride this motorcycle if you do not know how to ride a motorcycle.

Warning! Always wear appropriate motorcycle gear when riding your motorcycle. Never ride your motorcycle without wearing an approved helmet, a motorcycle jacket, eye protection, gloves, motorcycle pants, and boots.

Warning! Always remain alert while operating your motorcycle. Pay attention to traffic conditions and the road surface. Adjust your speed and following distances taking these factors into consideration.

Warning! Never operate your motorcycle while under the influence of drugs or alcohol, or when sleep deprived.

Warning! The motorcycle's cylinder, cylinder head, and exhaust system are hot when the motorcycle is running and after turning it off. Do not touch these items.

Warning! Always maintain appropriate tire pressure. Operating the motorcycle with low tire pressure will adversely affect the motorcycle's handling.

Warning! Replace worn tires promptly.

Warning! Never attempt to lubricate the chain by running the engine, putting the motorcycle in gear, and lifting the rear of the motorcycle. Lubricate the chain with the engine off.

Warning! Make sure the choke is fully open when riding the motorcycle.

Warning! Do not attempt to reach under the tank to open or close the choke while riding the motorcycle.

Warning! Do not overload the motorcycle or load it unevenly.

Warning! Do not attempt to carry more than one passenger (in addition to the rider).

Warning! Do not attempt to perform "wheelies."

Caution! Don't park your motorcycle facing downhill without leaving the motorcycle in gear, or it may roll forward and fall down.

Caution! Never operate your motorcycle without the air filter, the muffler, and all emissions components in place. Doing so will reduce performance, damage the engine, and void your warranty.



Inspections Before Riding

Before riding your motorcycle, you should check the following:

- Both tires are appropriately inflated.
- Neither tire has nails nor other foreign objects embedded in the tread or the sidewall.
- The fuel tank contains adequate fuel, and the fuel petcock is in the ON position. If the fuel petcock is in the RESERVE position, fill the fuel tank at the next opportunity.
- The crankcase has oil. You can check the oil level using either the dipstick or the crankcase viewing port.
- The turn signals, the front and rear brake lights, the horn, and the headlight all operate when commanded to do so (the ignition switch must be in the ON position).
- The front and rear brake levers have adequate free play.
- The front and rear brakes operate.
- The forks turn freely from side to side.
- The rear view mirrors are adjusted appropriately.
- The engine kill switch is in the RUN position.
- The chain has appropriate slack.
- Major threaded fasteners are tight. We always hand check the axle nuts, the exhaust header nuts and bolts, the muffler bolts and nuts (grab the muffler and check it for any side-to-side play), the steering stem nut, and the front and rear caliper bolts.

Motorcycle Specifications

General	
Type	Dual sport
Designation	CSC TT Special
Colors	Copper, black, white
Fuel	87 octane
Fuel Capacity	2.9 gallons
Top Speed	Dependent on gearing and rider weight; approximately 70 mph with 17T countershaft sprocket and 50T rear sprocket. Other gear ratios available from CSC.
Powertrain	
Engine Configuration	Single cylinder, air cooled, 2 valve, carbureted, counterbalanced, choke



Bore x Stroke	66.5mm x 66.2mm
Displacement	229.9 cc
Compression Ratio	9.6:1
Horsepower	16.1 @ 7000 rpm
Torque	13.5 ft-lb
Oil Type	10W 40, motorcycle type
Oil Capacity	1.3 quart
Starting	Electric and kick
Primary Type	Gear driven
Transmission	5 speed, constant mesh
Front/Rear Sprockets	17T/50T
Chain Type	428
Brakes	
Type	Hydraulic disk front and rear, braided stainless steel brake lines
Front Disk Diameter	10.50 inches
Rear Disk Diameter	8.63 inches
Wheels and Tires	
Wheels	Steel, spoked
Front Tire	3.00 x 21 knobby, DOT approved
Rear Tire	4.60 x 18 knobby, DOT approved
Front & Rear Tire Pressure	32 psi, front and rear
Switchgear/Controls	
Instrumentation	Speedometer, odometer, tripmeter, neutral indicator, turn signal indicator, high beam indicator, fuel gage
Dash Cluster	Keyed ignition switch, lockable cover, lockable forks
Left Handlebar	High/low beam, horn, turn signals, high beam flash, emergency flashers
Right Handlebar	Off/Accessory 1/Accessory 2 , engine kill switch, starter
Chassis and Suspension	
Ground Clearance	11.5 inches
Seat Height	34.0 inches
Handlebar Height	44.5 inches
Footpeg Height (rider)	13.5 inches
Footpeg Height (passenger)	19.0 inches
Helmet Lock	Left rear frame
Tool kit	Left rear frame
Wheelbase	55.0 inches
Weight	309 lbs
Gross Vehicle Weight Rating	639 lbs
Frame	Tubular steel
Rear Suspension Travel	6.5 inches
Front Suspension Type	Inverted telescopic fork, anodized gold, upper fork diameter 49mm, lower fork diameter 37mm.
Front Suspension Travel	6.2 inches
Rake	28 degrees
Rear Suspension	Single shock, adjustable preload and damping

Motorcycle Description

The CSC TT250 motorcycle is a 250cc dual sport motorcycle. The motorcycle has a single-cylinder, 4-stroke, air-cooled engine and a 5-speed transmission. Major components are identified in the photographs below.



TT250 Right Side View



TT250 Left Side View

Vehicle Identification Number and Engine Number

The vehicle identification number is located on the right side of the steering stem, as shown in the photo to the right.

The engine serial number is shown on the lower left side of the engine crankcase (behind the shift lever), as shown in the photo to the right.



Controls

The motorcycle is operated with the ignition switch, the instruments, the throttle, the clutch, the front brake lever, and the rear brake lever. You can start your motorcycle using either the kick starter or the electric starter. Locations for these items are shown in the photos above and below. Operating the motorcycle is explained below.

Ignition Lock and Fork Lock

Your TT250 is equipped with an ignition lock. The motorcycle key operates the basic ignition lock. Insert the key and turn it to the right to turn the ignition on.

The TT250 also has a mechanical cover to prevent access to the ignition switch. It is operated by manually moving the cover to the closed position with the actuator knob located on the right front surface of the ignition switch module. To open the ignition switch cover, insert the side of the plastic key upper segment into the recessed cover, and use the key as a lever to twist the cover mechanism open.

The ignition switch also operates the fork lock. Turn the forks all the way to the left. Push the ignition key into the switch and rotate the key to the left to lock the forks.



Instruments

TT250 instrumentation includes a speedometer, an odometer, a trip meter, a fuel gage, turn signal indicators, a high beam indicator, and a neutral indicator. You can reset the tripmeter to zero by rotating the knob on the left side of the instrument cluster.



Left and Right Handlebar Switchgear

Left handle switchgear includes the passing light, the high beam/low beam switch, the emergency flasher switch, the turn signals, and the horn. The passing light momentarily activates the motorcycle's high beam when the low beam only is on. You can use it to alert a vehicle you are about to pass. The high beam/low beam switch is used to switch between the high beam and low beam. The emergency flasher switch activates the motorcycle's flashers; when it is in the ON position, all four turn signals will flash. The turn signals are activated when the turn signal is pushed either to the right or to the left. The turn signals are not self-cancelling; you might depress the turn signal switch sharply in its center position to turn the turn signal off. The horn button sounds the horn.

Right handlebar switchgear includes the engine kill switch, the accessories switch, and the starter switch. The kill switch is used to shut all electrical power to the motorcycle. Do not routinely use the kill switch to stop the engine (use the ignition switch instead). The accessories switch is used to provide 12V electrical energy to either of the accessory outlets beneath the seat. Power to the accessories outlets is provided only when the ignition is on. The starter switch is used to start the engine after the ignition switch is turned on.

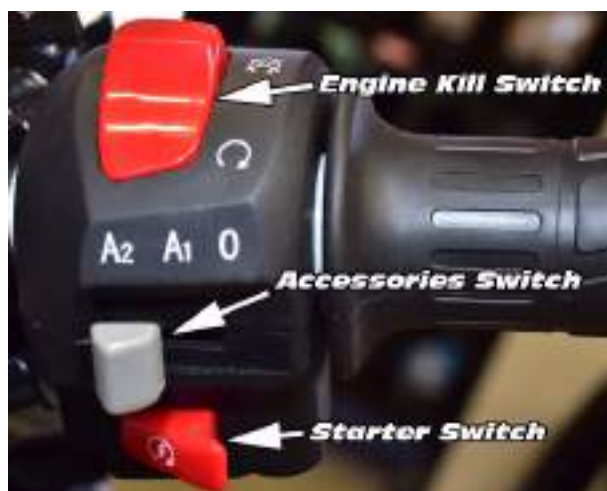
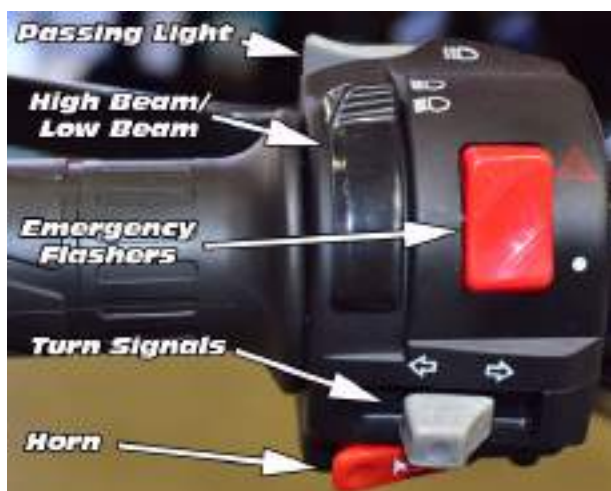

Fuel, Fuel Tank, Filler Cap, and Petcock

The TT250 fuel tank holds 2.9 gallons of fuel. Use 87 octane or higher fuel.

The fuel petcock is located on left side of the tank. Turn the petcock to the OFF position when you are not riding the motorcycle. Turn the petcock to the RUN position prior to operating the motorcycle. If the motorcycle runs out of fuel, turn the petcock to the RESERVE position. Find a fuel station and fill the motorcycle as soon as possible after the fuel petcock switching to the RESERVE position.

The fuel tank filler cap is a locking cap. To open it, insert the ignition key in the fuel tank and turn it clockwise. After filling the fuel tank, push down firmly on the filler cap to lock it.

*Off**Normal Operation**Reserve Operation**Filler Cap*

Choke

The choke is located on the left side of the carburetor underneath the fuel tank. When the choke lever is all the way down, the choke is not engaged. When the choke is all the way up, the choke is fully on. There is an intermediate position halfway between the choke open and fully-choked position.

When starting the motorcycle with a cold engine, push the choke lever all the way up to the fully-choked position. After the engine has warmed slightly, push the choke to the intermediate position. After the engine has warmed, open the choke fully by pushing the choke lever all the way down.

*Choke Fully On**Intermediate Choke**Choke Fully Open*

Do not ride the motorcycle until the engine is fully warmed and the choke lever is in the fully open (all the way down) position.

Warning! Do not attempt to actuate the choke lever while riding the motorcycle.

Helmet Lock

The helmet lock is located on the motorcycle's left rear frame. You can attach the D-ring on your helmet strap to the helmet lock to secure your helmet while you are not riding the motorcycle. To open the helmet lock, insert the ignition key and turn it counterclockwise. To close the helmet lock, push down on the plunger above the helmet lock.

Warning! Do not operate your motorcycle with a helmet held in place by the helmet lock. Always wear your helmet when riding your motorcycle.



Adjustable Front and Rear Suspension

The TT250's front and rear suspension damping can be adjusted by turning the slots located at the top of the forks and on lower portion of the rear shock absorber. Turn the screw slots clockwise for more damping, and counterclockwise for less damping.

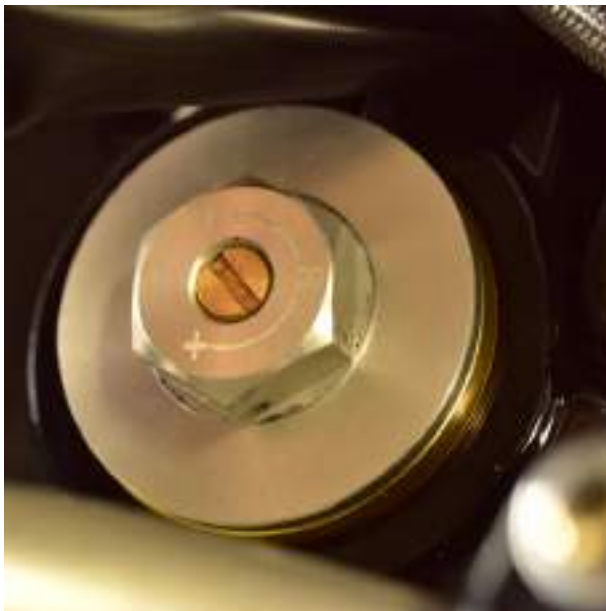

Load Limits

The TT250 motorcycle weighs 309 lbs. The gross vehicle weight rating is 639 lbs.

Warning! Do not overload or unevenly load the motorcycle or the handling will be adversely affected.

Tool Kit

The TT250 includes a tool kit stored in a container on the left rear frame.



Engine Break-In Procedure

When an internal combustion engine is new, it should not be subjected to hard acceleration, lugging, overheating, or running for long periods at a constant engine speed. You should avoid these situations during the first 500 miles of service. **Caution!** Do not violate the guidance provided here, or you may damage your motorcycle engine.

We recommend the first oil change when the motorcycle reaches between 200 and 500 miles. We recommend a second oil change at 1,000 miles, and every 2,500 miles thereafter. We recommend using only 10-40W motorcycle oil. **Caution!** Never use any oils intended for automotive use, or any oil that contains friction reducing additives (use of these oils will induce clutch slippage not covered by the CSC warranty).

Use only non-synthetic oils during the first 1000 miles of use. After that, you may wish to change to synthetic motorcycle oil.

The oil change procedure is outlined in the Oil Change section of this Owner's and Service Manual.

Starting the Motorcycle

After completing the pre-ride inspection, you can start the motorcycle using either the kickstarter or the electric starter. Follow the steps listed below:

- Put the fuel petcock in the RUN position.
- In cool weather, close the choke. This is accomplished by pushing the choke lever (mounted on the carburetor) all the way up.
- Insert the ignition key and turn it to the ON position. Make sure the transmission is in the neutral position. Make sure the engine kill switch is in the RUN position.
- If using the kick starter, vigorously kick the engine through a compression cycle, while opening the throttle slightly.
- If using the electric starter, depress the start button while opening the throttle slightly. Do not crank the engine with the electric starter for more than a few seconds.
- After the engine starts, allow it to warm for at least one minute. As the engine warms, open the choke to the intermediate position (partially down) and then (after the engine has warmed) to the fully open position (the choke lever should be all the way down). **Warning!** Do not attempt to actuate the choke lever while riding the motorcycle.

Operating the Motorcycle

Operate the motorcycle as outlined below:

- After completing the pre-ride inspection in the Inspections Before Riding section and putting on all of your riding gear (helmet, gloves, jacket, eye protection, and other protective riding apparel), mount the motorcycle and stand it upright.
- Start the motorcycle as outlined above.
- Lift the sidestand stand to the retracted position. **Warning!** Do not ride the motorcycle with the sidestand down.
- Pull in the clutch and push the gearshift lever down to put the motorcycle in first gear.
- Open the throttle slightly and engage the clutch.
- As the motorcycle accelerates, pull in the clutch, pull up on the gearshift lever, and engage second gear. Repeat the above process to engage third, fourth, and fifth gear.
- When you need to stop, allow the throttle to close and apply both the front and rear brakes. **Warning!** Do not apply the brakes too aggressively, as this can induce a skid. Be cognizant of the road surface and adjust braking force appropriately.
- As the motorcycle slows, pull in the clutch, depress the gear shift lever to shift to a lower gear, and release the clutch. Match your speed as you decelerate to the gear you are downshifting to. **Warning!** If you downshift too aggressively (i.e., you downshift to too low a gear for your speed), you can induce a skid.
- Repeat the above process, using engine braking and the front and rear brakes to slow the motorcycle. Prior to coming to a complete stop, pull in the clutch. Shift the motorcycle to neutral.
- If you wish to park the motorcycle, turn off the ignition key. **Caution!** Do not use the kill switch for routine stops and leave the ignition key in the ON position when the engine is not running. This will run down the battery.
- Deploy the sidestand and lean the motorcycle to the left. Make the sidestand is fully forward prior to leaning the motorcycle to the left. **Caution!** Do not park the motorcycle with the front end angled downward; it could roll forward (off the sidestand) and fall.
- Lock the front forks. Do not leave the ignition key with the motorcycle.

Cleaning the Motorcycle

Clean your motorcycle when it becomes dirty as outlined below:

- Wash the motorcycle with low pressure water to loosen and remove mud, insects, and other debris.
- Wash the motorcycle using soapy water. Rinse the motorcycle. **Caution!** Do not spray water directly into the muffler.
- Clean the chain using a suitable chain cleaner.
- Dry the motorcycle with a towel or a chamois.
- Lubricate the chain with a suitable chain lubricant.
- Wax the motorcycle using a suitable wax.

CSC stocks a number of cleaning products; please call us at 909 445 0900 to order these items.



Storing the Motorcycle

For storage longer than 60 days, store the motorcycle as outlined below:

- Drain the fuel from the fuel tank, the fuel lines, and the carburetor. Close the fuel tank cap.
- Remove the spark plug and add 5cc of motor oil into the cylinder. Reinstall the spark plug. With the ignition switch in the OFF position, cycle the engine several times with the kick starter.
- Remove the battery, charge it, and store it in a cool and dry environment.
- Support the motorcycle on blocks to prevent tire damage.
- Cover the motorcycle to protect it from dust, moisture, and other contaminants.
- Add fuel stabilizer to the fuel to prevent gumming in the tank, the carburetor, or the fuel lines.
- After storage, charge and reinstall the battery. Add fuel. Replace the engine oil if the motorcycle has been in storage longer than 6 months.

For shorter storage intervals, we recommend attaching the motorcycle to a Battery Tender.

CSC stocks all of the items described above. Please call us at 909 445 0900 to order any of the items described above.



Section 2: Service Manual

Maintenance Cautions and Warnings

When you repair the motorcycle, please use original components and parts, accessories, lubricating oil and other materials that are made or recognized by CSC Motorcycles. **Caution!** If you use any parts or components other than those recommended by CSC, it may adversely affect the performance, reliability, stability, or warranty of your motorcycle.

When working on your motorcycle, you should follow this guidance:

- **Warning!** Whenever the motorcycle is to be reassembled after disassembly, washers, seals, and cotter pins need to be replaced.
- When you fasten a series of bolts or nuts, you should do so in a diagonal pattern.
- **Warning!** Do not use flammable cleaning fluid to clean components and parts.
- **Caution!** Before assembly operations, add lubricating oil or lubricating grease to lubricated surfaces.
- **Warning!** After assembly, make sure all parts are properly assembled and tightened.
- **Warning!** Stop the engine when repairing the motorcycle.
- **Warning!** If the maintenance operation needs to be done while the engine is working, make sure the area is well-ventilated.
- **Warning!** Gas is flammable and combustible, so do not smoke or provide ignition sources in the work area.
- **Warning!** The battery can liberate hydrogen, which is flammable. Do not smoke, ignite or make sparks near the battery, especially when it is charging.
- **Warning!** The electrolyte of the battery contains sulfuric acid. If your eyes, skin or clothes are splashed with electrolyte, rinse them thoroughly with water and seek immediate medical attention.
- **Warning!** Disconnect the negative battery terminal when performing any maintenance on the motorcycle engine, drive train, or fuel system.

Component Cleaning

After parts are disassembled, they may need to be cleaned. Cleaning methods vary according to the characteristics of the parts.

- To remove oil or grease contamination, CSC recommends using Simple Green or other similar degreasing agents.
- **Warning!** Never use gasoline as a cleaning agent.
- To remove carbon deposits, use mechanical or chemical methods. The mechanical method uses a wooden or plastic scraper or blade to clear the carbon deposit first, and then rinse the parts with an appropriate cleaning agent. The chemical method is to soak the parts in the cleaning agent first, then clean them with a brush, and then rinse them with hot water.



Parts Inspection

Parts should be inspected after they are cleaned. The purpose of inspection is to check if the parts need to be repaired or replaced.

Maintenance Adjustments

The TT250 motorcycle requires adjustments in the following areas:

- The clutch must be adjusted according to the maintenance instructions included in this manual. The main adjustment feature is the clutch lever free travel ($\frac{1}{4}$ to $\frac{1}{2}$ inch), and the clutch cable adjusting mechanism. This Service Manual presents the procedure for clutch adjustment.
- The throttle cable adjustment is performed at the throttle. The throttle should have 2 to 5 degrees of free rotation. This adjustment is presented in this Service Manual.
- The drive chain is adjusted by positioning and aligning the rear wheel. The drive chain should have $\frac{3}{5}$ inch of free play. The drive chain adjustment procedure is explained in this Service Manual.
- The valves should be adjusted to a gap of 0.04mm to 0.08mm. This Service Manual presents the procedure for adjusting the motorcycle's valve.
- Tire pressure should be maintained at 32 psi for the front and rear tires for the rear tire.

Recommended Tools

The CSC TT250 motorcycle includes a basic tool kit that is stored under the rear seat. These tools are suitable for emergency repairs only. CSC sells custom tool kits with professional grade tools; please contact us at 909 445 0900 to order tools.

Adjustment Specifications

Item	Adjustment Limits
Clutch lever free play (at tip)	$\frac{1}{4}$ to $\frac{1}{2}$ inch
Throttle free travel	2-5 degrees
Drive chain	$\frac{3}{5}$ inch
Valve gap (at TDC)	0.04 to 0.08 mm
Tire pressure (front/rear)	32 psi



Motorcycle Maintenance Schedule

Maintenance Times Maintenance Item	Odometer (miles)						
	500 miles	2,500 miles	5,000 miles	7,500 miles	10,000 miles	12,500 miles	15,000 miles
Fuel system							
Fuel filter							
Air cleaner element							
Spark plug gap							
Valve lash							
Oil change	I/L	I/L	I/L	I/L	I/L	I/L	I/L
Rear chain	I/L	I/L	I/L	I/L	I/L	I/L	I/L
Battery							
Brake pad wear							
Braking system							
Stop lamp switch							
Headlamp							
Sidestand							
Front and rear suspension							
Nuts/bolts/ fasteners							
Front/rear wheel bearings							

The motorcycle should be maintained according to the schedule above. The symbols are defined below:

- R-rinsing
- L-lubrication
- I-inspection, cleaning, adjustment, lubrication or replacement

If you operate the motorcycle in dusty areas, the maintenance cycle should be shortened.

Torque Values

A table for general torque values follows. In various places in this Service Manual, specific torque values are provided, and you should use those where specified. In all other instances, use the values provided below. The values provided throughout are for clean, dry threads.

Bolt Size (mm)	Torque (ft-lbs)	Bolt Size (mm)	Torque (ft-lbs)
6	3-5	14	60
8	8-12	16	60-94
10	15-22	18	60-130
12	39	20	166-188



Unpacking

When the motorcycle is delivered, check the condition of the delivered crate. If there are any anomalies, stop and call CSC at 909 445 0900. Check the VIN numbers on the exterior of the crate. Compare these numbers to the documentation delivered to you prior to the motorcycle's arrival. If the numbers don't match, stop and call CSC at 909 445 0900.

Inspection

Perform the following inspections when servicing the motorcycle.

- Check to confirm all fasteners are properly tightened and all components are installed correctly and in an operational state.
- Swing the handlebars from side to side to make sure motion is uninhibited.
- Check chain tension and rear wheel alignment in accordance with the requirements of Service Manual.
- Insert the ignition key and turn it on.
- Check horn function, turn signals, headlight high and low beam, brake lights for front and rear brake activation, and instrument panel readout.
- Check oil level and tire pressure.
- Confirm the motorcycle is in neutral.
- Place the clutch in, close the choke, and start motorcycle. Allow engine to warm.
- Check brake and suspension function.
- Test ride motorcycle to confirm operability.

Detailed inspection checklists are included in Appendix A of this Service Manual.

Frame and Body

The frame and body subsystem includes the motorcycle's steel frame, the seat, the body panels, the sidestand, the footpegs, the tool kit, and the fenders.

The tool kit is stored in a container on the left side of the motorcycle.

The seat is held in place by two bolts. The rear seat can be removed to provide access to the battery.

Frame and body maintenance and troubleshooting guidelines are summarized below.

Frame and Body Maintenance and Troubleshooting

Item	Cause	Symptom	Vehicle Effect	Maintenance Action
Frame	Frame is hit or falls over	Frame is curved or deformed	Drift	Correct or replace the frame
	Frame is hit or falls over	Frame is cracked or fractured	Motorcycle cannot drive	Weld or replace the frame
	Frame is impacted and shocked by road	Frame welding detachment	Shake or drift	Weld the frame

Item	Cause	Symptom	Vehicle Effect	Maintenance Action
Sidestand	Deformation or fracture	Sidestand cannot return	Noise and compromised parking	Correct or replace the side support
Left or right rear panel	Impact	Panel damaged	Compromised appearance	Replace or repair the panel
Left or right tank panel	Impact	Panel damaged	Compromised appearance	Replace or repair the panel
Front fender	Impact	Deformation or breakage	Compromised appearance	Replace the front fender
Rear fender	Impact	Deformation or breakage	Compromised appearance	Replace the rear fender
Seat cushion	Impact	Seat cushion damaged	Riding comfort decreases	Replace the seat
Front footpeg	Impact	Deformation or breakage	Compromised driving safety	Replace the footpeg
Rear footpeg	Impact	Deformation or breakage	Compromised driving safety	Replace the footpeg
Rearview mirror	Impact	Deformation or breakage	Compromised driving safety	Replace the rearview mirror
Rear rack	Impact	Deformation	Compromised placement of items	Replace the rear rack

Brakes

This section of the TT250 Owner's and Service Manual covers the following topics:

- Master cylinder locations
- Inspecting and replacing the brake pads
- Inspecting and replacing the brake disks
- Flushing and replacing the brake fluid
- Bleeding the brakes
- Brake troubleshooting

Master Cylinder Locations

The front brake master cylinder is located on the right handlebar. It has a fluid level indicator on the master cylinder that shows the "low" level. When the front master cylinder fluid level is at the low mark, it is an indication that the front brake pads should be replaced. Do not rely only on this indication; you should check the pad thickness regularly and replace them when they are worn below acceptable limits (to be described below).



The rear brake master cylinder is located under the seat and behind the carburetor. It is visible from the right side of the motorcycle, but it is easier to check the brake fluid level if the left rear body panel is removed. The left rear body panel is secured by a screw and two grommet snaps.



The rubber grommets securing the rear panel are shown in the photo to the right.



The upper and lower fluid levels of the rear brake master cylinder are shown in the photo to the right.



Front Brake Pad Inspection and Replacement

It is possible to check the thickness on the front and rear brake pads without removing the caliper from the motorcycle, but you have to get below the brake calipers to do so. It is better to remove the caliper to better see the pads.

The front brake caliper is located on the left side of the motorcycle.



Loosen the front brake caliper's two 5mm Allen pins.



Remove the caliper's two 8mm mounting bolts and then remove the caliper from the front rotor and fork.



You should not remove the hydraulic brake line or loosen it.



Completely remove the caliper's two 5mm Allen pins, and remove the two brake pads.



The front brake's pads are interchangeable left to right (the rear brake's pads are not). Note that the brake pads have wear grooves machined into the pad surface. These are the three vertical slots you see in the photo above. When the pads are worn on either pad such that the wear indicators are no longer visible, replace the pads with new pads. We keep these in stock, so call us at 909 445 0900 if you need to order a pair. Note that it is normal for the front brake pads to wear much more quickly than the rear brake pads.

Push the caliper pistons all the way into the caliper.



Assembly is the reverse of disassembly. Install new front pads, install the two 5mm Allen pins, place the caliper over the rotor, and install the two caliper mounting bolts. The 5mm Allen pins should be torqued to 3 to 5 ft-lbs. The caliper mounting bolts should be torqued to 15 to 18 ft-lbs.

Rear Brake Pad Inspection and Replacement

The rear brake caliper is located on the right side of the swingarm.



Loosen the rear brake caliper's two 5mm Allen pins.



Remove the caliper's two 8mm mounting bolts and then remove the caliper from the swingarm. You should not remove the hydraulic brake line or loosen it.



Completely remove the caliper's two 5mm Allen pins, and remove the two brake pads.



Note that unlike the front brake, the rear brake's calipers are different. The one with the extension on it goes on the inside of the rotor (the side closest to the spokes).



When the pads are worn on either side such that the wear indicators are no longer visible, replace the pads with new pads. We keep these in stock, so call us at 909 445 0900 if you need to order a pair. Note that it is normal for the front brake pads to wear much more quickly than the rear brake pads.

Assembly is the reverse of disassembly. Push the caliper pistons all the way into the caliper. Install new rear brake pads, install the two 5mm Allen pins, place the caliper over the rotor, and install the two caliper mounting bolts. The 5mm Allen pins should be torqued to 3 to 5 ft-lbs. The caliper mounting bolts should be torqued to 15 to 18 ft-lbs.

Front and Rear Brake Rotor Inspection

Both the front brake and rear brake rotors are 4mm thick when new. If either rotor thickness drops below 3mm, the rotor should be replaced.



The front and rear brake rotors are each retained by Allen head bolts that take a 6mm drive. These should be torqued to 22 ft-lbs. Take care when removing these for the first time; they are Loctited in place at the factory and it is easy to strip the Allen drive socket (we recommend heating the head of the bolt first to soften the adhesive). We keep replacement rotors in stock; if you need a new rotor please call us at 909 445 0900.

Flushing and Replacing the Brake Fluid

It is a good idea to bleed the brakes every year, and to flush and replace the brake fluid every two years. Use only DOT4 brake fluid. We sell brake fluid suitable for use in your TT250 motorcycle; if you need brake fluid please call us at 909 445 0900. **Caution!** Brake fluid can damage painted components. Promptly wipe up spilled brake fluid.



To drain the brakes, open the master cylinder. Attach a hose to the caliper bleed port and route it to a suitable container. Open the caliper bleed port with an 8mm wrench and allow the brake fluid to drain. Note that the drain hose is not shown in the photo below to allow clarity in identifying the caliper bleed port.



After draining the brake fluid, add fluid to the master cylinder and bleed the brakes as described below.

Bleeding the Brakes

Caution! Brake fluid can damage painted components. Promptly wipe up spilled brake fluid.

To bleed the brakes, attach a hose to the brake caliper bleed port and route it to a suitable container. Open the master cylinder. The front brake master cylinder cover is removed with a Philips head screwdriver.



On the rear brake master cylinder, it is best to gain access by removing the left rear body panel (as outlined earlier in this maintenance tutorial), unbolting the master cylinder from the frame, and temporarily securing the rear brake master cylinder in a vertical orientation with a zip tie.



Open the caliper bleed port with an 8mm wrench while applying the brake lever, and before releasing the brake lever, close the bleed port with the 8mm wrench. It's important not to allow the bleed port



to remain open while releasing the brake lever or you will suck air into the system. Repeat this open-the-bleed-port, apply-the-brake-lever, close-the-bleed-port, add-brake-fluid process until the master cylinder is full. Reinstall the brake master cylinder cover. For the rear brake master cylinder, reinstall the rear brake master cylinder in its proper location and reinstall the left rear body panel.

Prior to taking the motorcycle on the street, operate it slowly and apply the brakes several times.

Brake Troubleshooting

Brake troubleshooting procedures are summarized below.

Front and Rear Brake Troubleshooting and Maintenance

Item	Symptom	Cause	Vehicle Effect	Maintenance Action
Brake pad	Reduced braking force	Worn brake pad(s)	Longer stopping distance	Replace brake pad
Air in brake lines	Reduced braking force	Air intrusion into brake line	Longer stopping distance	Bleed brakes
Pulsating brakes	Pulsating brake lever	Warped rotor disk	Pulsations; longer stopping distance	Measure disk runout, replace disk rotor

Power Transmission

The TT250 uses a manually-operated wet clutch and a chain drive system.

Chain Drive System

This system consists of the clutch, the countershaft sprocket, the rear sprocket, the rear wheel, and the drive chain.

Chain Lubrication

The drive chain should be lubricated approximately every 500 miles or more often if riding in rainy or dusty conditions. Use only a quality wax-based or petroleum based motorcycle chain lubricant. Ride the motorcycle for at least 15 minutes to warm the chain, and apply the lubricant immediately after stopping. **Warning!** Take care not to spray lubricant onto the tire or the rear brake. Do not use the motorcycle for the next 15 minutes to allow the lubricant to seep into the chain.

Chain Adjustment

This section of the Owner's and Service Manual addresses adjusting the TT250 motorcycle's chain and aligning the rear wheel. You will need 13mm, 18mm, and 19mm wrenches, and a screwdriver for this maintenance activity.

You don't have to get the rear wheel off the ground to adjust the TT250's chain.

Adjusting the chain on a motorcycle consists of two jobs: Adjusting chain tension and aligning the rear wheel.

You can check this adjustment easily, and you should perform this check on a regular basis. A lubricated chain will require adjustment every 500 to 1000 miles once the motorcycle is broken in.

Adjusting the chain involves loosening (but not removing) the rear axle, loosening the adjustor nuts and locknuts, using a screwdriver between the chain and the rear sprocket to remove all kinks, aligning the rear wheel, tightening the rear axle, and tightening the adjustor nuts and locknuts.

You should check the chain adjustment during your motorcycle's first scheduled maintenance and at every scheduled maintenance thereafter. The biggest adjustment will most likely occur at the first service interval, because chains do most of their stretching in their first several hundred miles of use.

When the chain is properly adjusted, it should have about 15mm (or 3/5 of an inch) slack at its midpoint.



The rear axle is loosened by loosening the rear axle bolt and nut. The rear axle bolt head on the right side of the motorcycle takes an 18mm wrench; the rear axle nut on the left side of the motorcycle takes a 19mm wrench.



If your chain requires adjustment, loosen the rear axle.



The left side of the rear axle.



The left side takes a 19mm wrench.



The rear axle adjuster nuts and locknuts are located behind the adjuster plate on both sides of the swingarm. These are 13mm nuts. Loosen both nuts on both sides of the swingarm.



The intent is to position and align the rear wheel such that the chain has $\frac{3}{5}$ of an inch slack at its midpoint. This is the amount of slack the chain should have with the motorcycle on the ground and the rider on the bike. If the bike is on a lift such that the rear wheel is off the ground, you should increase the amount of slack when you adjust the chain such that when you are on the bike, the slack is $\frac{3}{5}$ of an inch. If the rear wheel must move forward to increase chain slack, back off on the adjuster nuts and locknuts and manually push the rear wheel forward. If the rear wheel must move rearward to decrease chain slack, tighten the inner nuts as required on both sides of the swingarm to move the axle to the rear.

After moving the rear wheel, put a screwdriver between the chain and the rear wheel sprocket (as shown below) and sharply rotate the rear wheel. This will remove any kinks in the chain.



Check the alignment of the rear wheel by comparing the scribe marks on the rear axle adjusters with the scribe marks on the swingarm. You can see these in the photos to the right. This photo shows the right side of the motorcycle and the scribe lines.



This photo shows the left side of the motorcycle and the scribe lines.



When we adjust the chain, we don't fully unbolt the rear axle. We just loosen it and use the adjuster nuts to drag the wheel to its required location.

When the rear wheel is aligned and the chain slack is correct, tighten the rear axle to 35 ft-lb. Tighten the rear axle adjusters' 13mm positioning nuts, and then tighten the rear axle adjusters' locknuts (the outer 13mm nuts) to lock the adjusters in place.

We always lube the chain every time we adjust it. You can use either a wax-based or an oil-based chain lube; we stock both types. You can call us at 909 445 0900 if you need chain lube.

Sprocket and Chain Inspection

The TT250 has a 428 chain, a 17 tooth front sprocket, and a 50 tooth rear sprocket. If you keep your chain properly adjusted and lubed, the chain and sprockets will last much longer than they would if you don't maintain these items, but they still won't last forever. You can expect the chain and sprockets to wear more quickly if you ride in dusty environments or off road. Chains and sprockets should be replaced as a set. Do not replace one without replacing the other or rapid wear will result.

Remove the countershaft sprocket cover by removing the bolts that attach it to the engine. You don't have to remove the gear shift lever to remove the countershaft sprocket cover.

If the sprocket teeth are hooked or otherwise excessively worn, replace both sprockets. If the chain has excessive stretch or if it has kinks that you cannot work out by manually rotating the links with respect to each other, it's time for a new chain.

The TT250 motorcycle chain does not have a master link. When you need to replace the original equipment chain on your motorcycle, you have to cut it off.

Please call us at 909 445 0900 to order replacement chains and sprockets.

Chain Drive Troubleshooting

Troubleshooting and maintenance activities for the chain drive system are summarized in the table below.

Chain Drive Troubleshooting and Maintenance

Item	Symptom	Cause	Vehicle Effect	Maintenance Action
Rear sprocket	Excessive wear	Inadequate lubrication, misaligned rear wheel, incorrect chain adjustment	Chain skipping, chain breakage	Replace chain and both sprockets
Counter shaft sprocket	Excessive wear	Inadequate lubrication, misaligned rear wheel, incorrect chain adjustment	Chain skipping, chain breakage	Replace chain and both sprockets
Drive chain	Excessive wear	Inadequate lubrication, misaligned rear wheel, incorrect chain adjustment	Chain skipping, chain breakage	Replace chain and both sprockets
	Excessive tightness	Inadequate lubrication, misaligned rear wheel, incorrect chain adjustment	Chain breakage, loss of power, stiff rear suspension	Adjust chain
	Excessive looseness	Improper adjustment of chain's tension	Chain skipping on sprocket, excessive chain slap	Adjust chain

Clutch Maintenance

This section of the TT250 Owner's and Service Manual addresses clutch cable installation, clutch adjustment, and clutch replacement.

Clutch Cable Installation and Adjustment

Route the cable from the handlebar (without attaching it yet) to the engine. Note that there is a loop welded on the left front frame downtube through which you should route the clutch cable.



Apply a small amount of grease to the lower clutch cable attachment point and attach the lower end of the clutch cable to the engine clutch arm. This is what it will look like looking down at the attach point between the engine and the exhaust pipe.



Route the clutch cable through the adjustment mount on the engine, and adjust the adjustor nuts to give the cable as much slack as possible. The barrel should reach as far back to the rear of the motorcycle as it can.



Pull back the handlebar clutch lever hood.



Screw the clutch lever adjustors into the clutch lever as far as possible. After applying a small amount of grease to the clutch cable barrel, route the clutch cable through the adjustors and connect the clutch cable barrel.



After doing the above, position the handlebar clutch lever adjuster so that the adjuster is in the middle of the adjustment range. Note that there will still be considerable slack in the clutch cable at this point.



Next, adjust the cable slack with the engine-mounted adjusters. Use the adjusters shown here. Adjust these so that there is approximately 3mm of slack on the handlebar clutch lever.



Lock all of the adjuster nuts (on the engine and on the handlebar clutch lever adjuster). Pull the rubber adjuster hood over the adjusters at the handlebar clutch lever. **All future clutch adjustments should be made with the handlebar clutch lever adjusters.** You should not lubricate the clutch cable; it has a Teflon sheath and is self-lubricating.

Clutch Replacement

If you change your oil regularly, if you use the right kind of oil, and if you don't abuse your bike, your clutch will last a long time. If you abuse your clutch it will wear prematurely. If the clutch is grabby or if it slips and you can't fix it by changing the oil or by adjusting the clutch, you need a new clutch.

Drain the engine oil. See the Oil Change section of the Service Manual for instruction on how to do this. Disconnect the rear brake lever from the rear master cylinder by removing the cotter pin and pulling the shaft out. This will allow rotating the rear brake lever out of the way to allow removing the right engine case.



Remove the 13mm bolt securing the kick start lever and remove the kick start lever.



Loosen the handlebar clutch lever cable adjuster by screwing it all the way into the clutch lever casting.



Disconnect the clutch cable at the engine end.



Remove the 13 10mm bolts securing the right engine cover to the engine.



Tap the right engine cover lightly with a soft mallet to loosen it.



Remove the right engine cover.



At this point, you will see the engine internals on the right side of the engine. These components are labeled here for reference during the remainder of this tutorial.

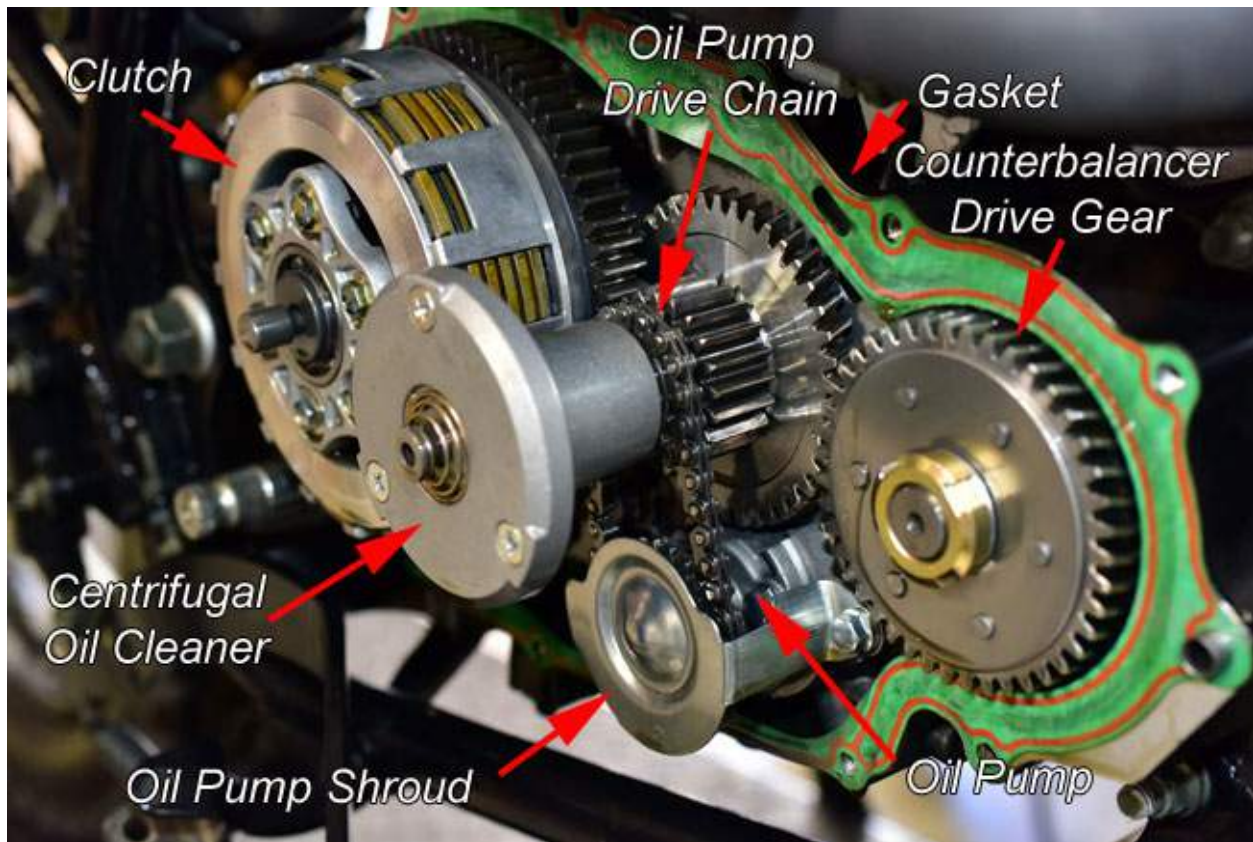

Remove the clutch actuation rod and bushing.



Remove the clutch throwout bearing. If this bearing is worn or does not operate smoothly, replace it with a new bearing.



Remove the six clutch bolts in an even pattern by unscrewing each bolt a few turns at a time. Do this in a criss-cross pattern to allow the clutch hub to back out evenly.



Remove the clutch hub to expose the clutch springs.



We recommend replacing the clutch springs when replacing the clutch. Remove the Circlip that secures the clutch inner basket.



For reference during reassembly, the Circlip has a sharp-cornered edge and a radiused edge on opposite sides. The sharp edge should face away from the motorcycle during reassembly.

This is the sharp edge.



This is the rounded edge.



To remove the rest of the clutch components, it is necessary to remove the centrifugal oil cleaner. Unscrew the three Phillips head screws on the centrifugal oil cleaner.

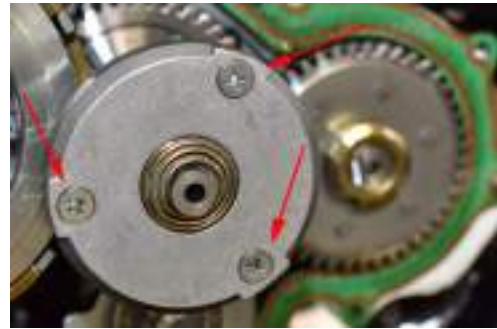

Remove the centrifugal oil cleaner cover.



On a motorcycle with much higher mileage, packed sludge will accumulate around the inner periphery of the centrifugal oil cleaner in the areas shown by the red arrows below. Scrape this sludge out and wipe the interior of the centrifugal oil cleaner clean.



The inner portion of the centrifugal oil cleaner is secured by a castellated nut. This nut is shown by the lower red arrow on the right in the photo.



Use a castellated nut driver like the one shown here to remove the nut.



Remove the castellated nut.



Remove the castellated nut.



There is a washer underneath the castellated nut. This washer is labeled to show which side should face out.



Pull the inner portion of the centrifugal oil cleaner off of its shaft.



At this point (after removing the inner portion of the centrifugal oil cleaner), the clutch inner basket and clutch components can be removed.



The clutch consists of six fiber plates and five steel plates. The fiber plates are the outer plates on both sides of the clutch assembly. The plates alternate (fiber, steel, fiber, steel, etc.).

CSC stocks the clutch plates and the clutch springs. Please call us at 909 445 0900 if you need these components.



Inspect the clutch inner basket for any discontinuities in the notches on which the clutch plates translate. If the clutch inner basket has surface discontinuities or excessive wear, replace it.



Similarly inspect the clutch outer basket for any surface discontinuities or excessive wear. Replace the clutch outer basket if necessary.



The kick starter seal should be replaced if the engine cover is removed.



Inspect the oil viewing port. If any external leakage is evident, replace the oil viewing port seal.



The oil viewing port can be pushed out from the inside of the engine cover.



Before installing the new clutch plates, soak them in motorcycle oil for 24 hours. **Caution!** If you don't soak the clutch plates prior to installation, you may ruin the new clutch.

Assembly is the reverse of disassembly. Use a new engine cover gasket. Torque the clutch derby bolts to 5 ft-lbs. Torque the engine cover bolts to 15 ft-lbs. Torque the kick start lever bolt to 35 ft-lbs. Torque the centrifugal oil cleaner castellated nut to 60 ft-lbs. After installing all components, adjust the clutch as explained in the TT250 Clutch Adjustment section of this manual.

Clutch Troubleshooting

Item	Symptom	Cause	Vehicle Effect	Maintenance Action
Clutch cable	Breaks	Wear, improper adjustment, inadequate lubrication	Clutch will not disengage	Replace clutch cable
Clutch cable	Sticks or grabs	Wear, improper adjustment, inadequate lubrication	Difficult clutch operation	Lubricate or replace clutch cable
Clutch	Slips	Incorrect engine oil, worn clutch plates, improper clutch adjustment	Loss of power transmission, engine over revving	Adjust clutch, check engine oil, replace clutch plates
Clutch lever	Too little or too much play at clutch lever	Incorrect clutch adjustment, worn clutch plates	Clutch engages early, or clutch slips	Adjust clutch
Difficult shifting	Transmission does not shift smoothly	Incorrect clutch adjustment	Difficult shifting	Adjust clutch

Suspension

The suspension subsystem includes the forks, the rear shock absorber, and the swingarm.

Forks

The front forks of this motorcycle are an inverted hydraulic spring design with adjustable damping. When the front wheel receives irregularities in the road and moves up, damping oil inside the forks flows through tiny openings. This provides damping.

Check the performance of the forks and inspect for leaks. Prompt inspection and maintenance should be given to the forks when any abnormalities are found.

If you wish to use a higher viscosity fork oil to stiffen the forks, please call CSC at 909 445 0900 to discuss which oil will best meet your needs.

Adjusting Ride Height

The front forks can be raised and lowered in the fork upper triple tees to adjust the ride height. It is not necessary to remove the front wheel to make this adjustment. It is necessary to support the motorcycle's weight while adjusting the ride height.

Warning! You should support the motorcycle such that no weight is on the front end when you make this adjustment

Loosen the fork upper triple tee pinch bolt with a 10mm socket or wrench.



Loosen the fork lower triple tee pinch bolts with a 10mm socket or wrench.

Caution! Hold the fork tube as you loosen the last lower triple tee pinch bolt, as the tube will now be free to slide up or down in the triple tees.



The fork uppers have circumferential rings. You can move the forks up and down in the triple tees to adjust height. Moving the forks up in the triple tees lowers the motorcycle's height; moving the forks down in the triple tees raises the motorcycle's height.

Warning! Both forks should be adjusted to the same position in the triple tees, or handling will be adversely affected.

Warning! Do not go outside the adjustment range indicated by the fork uppers' circumferential rings.

Once the forks have been adjusted to the desired position, tighten all pinch bolts.



Changing Fork Oil

Remove the front wheel (please see the Front Wheel Removal section of this Owner's and Service Manual for instructions on front wheel removal). Actions shown here are on a motorcycle with the headlight removed (removing the headlight provides easier access to the fork pinch bolts; please see the Lighting and Turn Signals section of this Owner's and Service Manual for instructions on headlight removal).

Screw the adjustable damper all the way into the fork. This is shown being done with the fork removed from the motorcycle; you should do this prior to removing the fork from the upper and lower triple tees.



Loosen, but do not remove, the upper fork cap using either a 22mm wrench or a socket.

Caution! The upper fork cap is aluminum and can be easily marred. We show this being done with the fork leg removed; you should do this after loosening the fork upper triple tee pinch bolt and before you loosen the fork lower triple tee pinch bolts. This will hold the fork leg and make it easier to loosen the fork cap.



As a better approach to loosening the fork cap, you can use a towel or cloth to prevent marring the fork cap and a socket larger than 22mm, as is shown here. Again, we show this operation after the fork leg has been removed. We recommend that you do this after loosening the fork upper triple tee pinch bolt and before the fork lower triple tee pinch bolts have been loosened; this will better secure the fork for this operation.



Remove the speedometer drive cable from the speedometer drive.



Remove the Phillips head screws at the bottom of the fork shroud.



Remove the Phillips head screw at the top of the fork shroud.



Remove the fork shroud from the fork.

Caution! Do not ride the motorcycle with the fork shroud(s) removed. The fork shrouds keep dust and dirt from accumulating on the fork lowers. If the shroud is removed, dust and dirt will accelerate wear of the fork seals.



Loosen the fork upper triple tee pinch bolt with a 10mm socket or wrench.



Loosen the fork lower triple tee pinch bolts with a 10mm socket or wrench.

Caution! Hold the fork tube as you loosen the last pinch bolt, as the tube will now be free to slide out of the triple tees.



Slide the fork tube down through the triple tees.



Remove the fork tube.



Unscrew the fork cap over a suitable oil container. Oil will begin to drain out of the fork leg when you do this.



Drain the oil from the fork leg.



Remove the 6mm Allen bolt at the bottom of the fork lower. You can put the axle in the fork lower casting to prevent the fork from turning as you loosen the 6mm Allen bolt.



Remove the fork lower casting.



Remove the fork lower by lifting it up and out of the fork upper.



Pump the fork lower up and down over a suitable container to remove all oil.



Each fork leg holds approximately 330cc of oil.



After the fork legs have drained, reassemble the forks and install them into the motorcycle without installing the fork cap. Adjust height as described in the preceding section of the Owner's and Service Manual. Tighten only the lower fork pinch bolts at this point. Replace the fork oil with suitable oil. Please call CSC at 909 445 0900 for a discussion on which oil best suits your needs and to order replacement oil.

Warning! Do not operate the motorcycle without fork oil.

Caution! Do not overfill the forks, or you may blow out the fork seals.

Fully screw in the fork caps. Tighten the upper fork pinch bolts. Reinstall the fork shrouds. Reconnect the speedometer drive cable to the speedometer drive. Reinstall the front wheel.

Replacing Fork Seals and Bushings

If a fork seal leaks because it was damaged by grit or some other attributable cause, you need to replace only the leaking seal. If the seal(s) leak due to age-induced degradation, you should to replace the seals on both fork legs.

Remove the affected fork leg(s) as described in the preceding section.

Remove the dust seal using a light touch. Use a fine bladed screwdriver (or something similar) and gently tap the dust seal away from the fork upper tube. Work gently around the periphery of the dust seal.

Caution! Take care not to gouge the fork or damage the dust seal.



Work gently around the periphery of the dust seal.

Caution! Take care not to gouge the fork or damage the dust seal.



The fork seal is secured with a clip, as shown by the red arrow.



Use a screwdriver blade to gently lift the clip out of the groove securing it.

Caution! Take care not to mar the fork upper with the screwdriver when performing this operation.



Remove the 6mm Allen bolt at the bottom of the fork lower.



Remove the fork lower casting.



Remove the fork lower by lifting it up and out of the fork upper.



Examine the fork lower (which is the part that slides through the dust seal and the fork seal). If there are any scratches, gouges, or surface imperfections on the portion of the fork lower that slides through the seals, polish the imperfections out or replace the fork lower.

The fork seal and bushing at the bottom of the fork upper are shown here. The red arrow on the right points to the fork seal. The red arrow on the left points to the bushing. There is an iron washer between the fork seal and bushing.



Gently pry the fork seal out of the fork. You can similarly remove the fork bushing with a pick.

Caution! Take care not to mar the fork upper when performing this operation.

After removing the fork seal, the dust seal, and the bushing, examine these parts carefully for any cuts, tears, or degradation. Replace the defective part(s). CSC stocks these parts; please call us at 909 445 0900 if you need replacement seals or bushing.



Assembly is the reverse of disassembly.

Swingarm and Rear Suspension

This section of the Owner's and Service Manual addresses swingarm and rear suspension maintenance.

The first step is to safely elevate the rear end of the motorcycle. We use a motorcycle jack; any suitable lift method will work.



Remove the rear wheel. Rear wheel removal is covered in the TT250 Wheel Removal section of the Owner's and Service Manual.



Detach the rear brake line keepers from the swingarm.



Remove the nut and bolt that attaches the rear shock absorber to the swingarm.



Rotate the lower portion of the rear shock absorber to clear the swingarm mounting bracket, and remove the bushing from the rear shock absorber.



Unbolt the nuts securing the swingarm pivot axle.



There will be dust caps/washers on the frame between the swingarm axle nuts and the frame. Remove these and set them aside.



Pull the swingarm pivot axle out of the frame.



Remove the swingarm from the motorcycle frame.



Remove the dust caps that fit between the frame and the swingarm.



The next steps involve re-greasing (lubricating) the swingarm pivot points. We use Maxima waterproof grease, which is a great lubricant. We stock the full line of Maxima lubricating oils and greases. Please call us at 909 445 0900 if you need any of these items.



Apply grease to the frame bushings through which the swingarm pivot axle will pass.



Apply grease to the exterior of the swingarm bushings.



Apply grease to the rear shock absorber bushing.



Insert the rear shock absorber bushing and apply grease to the exterior exposed edge of the bushing.



Assembly is the reverse of disassembly. Torque the shock absorber nut and bolt to 25 ft-lbs. There is no torque specification for the swingarm pivot axle nuts. Tighten the swingarm pivot axle nuts equally such that there is no side-to-side play in the swingarm and the swingarm pivots up and down with minimal drag.

Swingarm and Rear Suspension Troubleshooting

Item	Symptom	Cause	Vehicle Effect	Maintenance Action
Swingarm	Deformed swingarm	Impact	Pulls to one side	Replace swingarm
	Fractured swingarm	Impact	Pulls to one side	Replace swingarm
	Sticky swingarm action	Inadequate lubrication, overtightened swingarm pivot axle nuts	Poor rear suspension action	Lubricate and adjust as directed herein
Forks	Spring excessively soft	Fork has poor elastic force or is broken	Poor comfort	Replace fork spring
	Left and right forks are not at same level	Fork distorted	Poor fork action, motorcycle pulls to one side	Adjust fork

Item	Symptom	Cause	Vehicle Effect	Maintenance Action
	Fork has oil leak at the oil seal	Scratches found on surface of fork	Poor fork action	Replace fork or seal
	Oil leak	Oil seal abraded or damaged	Poor fork action, leaking fork	Replace oil seal
	Fork becomes soft	Fork oil low	Poor fork action	Add oil as required
Rear shock absorber	Rear shock absorber soft	Rear shock absorber spring broken or soft spring force	Rear suspension overly soft	Replace rear shock absorber
	Defective rear shock absorber	Rear shock absorber leak	Rear suspension overly soft, leakage	Replace rear shock absorber
	Aging, exposure to contaminants	The rubber sheath abraded or cracked	Rear suspension overly soft or harsh	Replace rear shock absorber

Steering System

The handlebar, fork yoke, and steering components should be inspected and adjusted periodically to check for any abnormal conditions. The front forks should turn evenly from side to side with no interference or looseness. Apply the front brake and rock the motorcycle back and forth. There should be no looseness or clicking in the steering head area.

Steering Stem Bearing Adjustment

This section of the TT250 Owner's and Service Manual addresses steering stem bearing adjustment. You only need to do this if there is free play in the steering stem bearings, or if the bearings are adjusted too tight. Sometimes you can detect this by applying the front brake when coming to a stop, or by rocking the bike back and forth with the front brake applied. If you hear or feel clicking in the front end, it is likely you need to adjust the steering stem bearings.

The best way to test for appropriate steering stem bearing adjustment is to put the bike on a lift to get the front wheel off the ground. Once the wheel is off the ground, grab the front forks near the front axle and pull the front end back and forth. If you feel any play and hear the steering stem bearings clicking, the steering stem bearings are too loose. Next, turn the front wheel from left to right and from right to left. If you feel too much resistance (it's a subjective assessment), the steering stem bearings are too tight.



In the photos here, the fuel tank, the seat, and the rear body panels are removed. You don't need to remove these components for this maintenance activity. We had a TT250 with the panels removed and we left the bike in that configuration for these instructions.

If your assessment indicates the steering stem bearings require adjustment, loosen the upper triple tree pinch bolts on the left and the right side of the motorcycle. You don't need to remove the bolts; you only need to loosen them. The intent is to allow the upper triple tree to move with respect to the fork legs. The upper triple tree pinch bolts take a 10mm wrench.



Loosen both the left and right pinch bolts.



Loosen the steering stem bolt. It takes a 22mm wrench. You don't need to remove the handlebars to do this, but it is a tight fit for the wrench if you do not. In this tutorial, we did not remove the handlebars.



Use a spanner to either tighten or loosen the steering stem adjuster nut. You'll want to tighten it if the steering stem bearings are too loose (as indicated by free play or clicking when moving the forks back and forth).



If the forks have too much resistance when turning them from left to right (and vice versa), you'll want to loosen the steering stem adjuster nut.





After making the adjustment, tighten the steering stem bolt to 50 ft-lbs. Check the front end of the motorcycle again to make sure the adjustment provides no clicking or movement of the forks when pulling the forks back and forth, and that the steering is not restricted when turning the front end from side to side. When you are satisfied with the adjustment, tighten the upper triple tree pinch bolts to 10 ft-lbs.

Steering System Troubleshooting

Item	Symptom	Cause	Vehicle Effect	Maintenance Action
Handlebar	Bent	Impact	Drift	Replace handlebar
Steel ball race	Excessive tightness of adjusting nut	Overtightened	Sticky movement	Adjust using a locking wrench until steering column can rotate freely with no end play between steering column and frame
	Excessive abrasion, pitting, dirt, crack and damage	Contamination	Sticky movement, swing and shaking of handlebar while driving	Replace whole set of steel ball and race
Steering race balls	Abrasion, deformation, damage	Contamination	Sticky movement, swing or shaking of handlebar while driving	Replace whole set of steel ball and race
Steering column	Bent	Impact	Sticky movement	Replace steering column

Wheels and Tires

The TT250 uses a 21x1.85-inch steel rimmed wire wheel on the front of the motorcycle, and an 18x2.15-inch steel rimmed wire wheel on the rear of the motorcycle. Both the front and rear wheels use inner tubes.

The front tire should be inflated to 32 psi. The rear tire should be inflated to 32 psi. **Warning!** Under-inflation or over-inflation of either tire will adversely affect the motorcycle's handling characteristics.

Both the front and rear wheel and tire should be dynamically balanced any time either tire is removed and reinstalled or when a new tire is installed.

Front Wheel Removal

You will need 15mm, 17mm, and 10mm wrenches for this operation.

Start by securing the motorcycle on a lift such that the front wheel is off the ground. Unbolt the front brake caliper by removing the two 10mm bolts that secure it to the front fork.



Allow the caliper to hang by the hydraulic brake line. Do not loosen or remove the hydraulic brake line.



Loosen the front axle by using a 17mm wrench on the axle nut and a 15mm wrench on the axle's bolt head.



This is the right side of the motorcycle showing the 17mm axle nut.



This is the left side of the motorcycle showing the 15mm axle bolt head.



Use a 15mm wrench on the left side of the front wheel axle.



Remove the axle nut.



Pull the axle out of the forks.



Support the front wheel while removing the axle.



There is a bushing between the left side of the front hub and the left fork. There is no bushing on the right side of the motorcycle. The speedometer drive mechanism is on the right side of the motorcycle. It is located between the right fork and the right side of the hub. Front wheel installation is the reverse of front wheel removal.

Prior to installing the speedometer drive mechanism, it is best to disconnect the speedometer cable.



You should apply grease to the inside of the speedometer drive mechanism and the right side of the wheel hub. Note that the speedometer drive mechanism has two tabs. **Caution!** Take care to align the tabs with the front hub slots when installing the front wheel.



Reinstall the front axle, the front axle nut, the front brake caliper, and the speedometer drive cable. The front axle should be torqued to 35 ft-lbs. The caliper bolts should be torqued to 22 ft-lbs. Check the front brake prior to riding to assure proper operation.

Rear Wheel Removal

You'll need a way to get the rear wheel off the ground, and you'll need 18mm and 19mm wrenches, and a 10mm wrench for this operation. In the CSC service area we use a motorcycle jack. You can use a tree stump, a suitable block, or anything that will support and balance the motorcycle with the rear wheel off the ground.

The rear wheel axle has an 18mm bolt head on the right side of the motorcycle.



Use an 18mm wrench on the right side of the motorcycle.



The rear wheel axle has a 19mm self-locking nut on the left side of the motorcycle.



Use a 19mm wrench on the left side of the motorcycle.



Unbolt the nut and withdraw the axle from the right side of the motorcycle.



It's a lot easier to get the rear wheel off the motorcycle with the rear brake caliper removed. Unbolt the rear caliper by removing the two 10mm bolts shown below, and take the caliper off of the rotor.



Push the rear wheel forward and take the chain off the rear wheel sprocket.



As you pull the rear wheel away from the motorcycle, remove the caliper mount.



Note that the rear wheel bushing on the right side is integral to the caliper. There are no other bushings or washers on the right side of the motorcycle.



The left side of the motorcycle has a bushing that fits between the rear wheel and the swingarm. It is orientation insensitive (it can be installed either way).



Rear wheel installation is the reverse of removal. The caliper bolts should be torqued to 22 ft-lbs. The rear axle nut should be torqued to 35 ft-lbs.

When the rear wheel is installed, the chain should be adjusted and the rear wheel should be aligned. These maintenance activities are addressed in the chain adjustment and wheel alignment section of this manual.



Wheel and Tire Inspection

Check if the tire air pressure is at the specified value (32 psi front and psi rear). Inspect the valve stems for lock nut installation, lock nut security, and valve stem condition. Do not operate the motorcycle without the valve stem cap in place. Inspect the tire condition. **Warning!** Replace any tire with tread that is worn down to the tread wear indicator (or if the tread remaining is less than 2mm), if the tire exhibits cupping, or if the tire has any other defects.

Inspect the spokes on both the front and the rear wheel. If any spokes are loose, tighten them and check for wheel trueness. If any spokes are missing, replace them. The entire wheel should be relaced at the next available opportunity.

Check the rims for dents. If the rim is dented, it should be replaced.

When the wheels are removed from the motorcycle, check the grease seals, the wheel bearings, and other components. If the grease seals are cut or torn, they should be replaced. If the wheel bearing inner races are loose, gritty when rotated, or noisy, replace the bearing.

Place the wheels on a truing stand and inspect them for runout and ovality. If either exceeds 1.0mm, true the wheel by adjusting spoke tension.

Balance the wheel and tire on a dynamic balancer.

Wheel and Tire Troubleshooting

Item	Symptom	Cause	Vehicle Effect	Maintenance Action
Wheel and Tire	Vibration	Deformation, out of balance condition, worn tire, wheel trueness or ovality outside of spec limits, worn bearing, motorcycle load	Drift, handlebar shake, vibration	True wheel, check bearings, check inflation pressure, check tire condition, balance tire and wheel, check for proper loading of motorcycle
Tire	Premature wear, cupping	Out of balance, misaligned rear wheel, worn bearing, under or over inflated.	Premature tire wear	True wheel, check bearings, check inflation pressure, balance tire and wheel, check for proper loading of motorcycle

Fixing Flat Tires

If your motorcycle has a flat tire, check for any obvious causes on the outside of the tire (it will make finding the leak in the tube easier).

Prior to lifting the bike to get the wheel with the flat tire off the ground, loosen the axle bolts (just loosen them, do not remove them).

Remove the wheel with the flat tire in accordance with the instructions for doing so in this Owner's and Service Manual. Place the wheel on its side, with the brake disk facing down. Remove the valve cap and

depress the Schrader valve to allow any remaining air in the tube to escape. Loosen the nut around the valve stem, and then unscrew it completely by hand.



Break the bead around the tire. You only need to do this on one side of the tire. Usually, just stepping on the tire (as shown below) will unseat the tire from the rim. After you've broken the bead, spray the area between the bead and the rim with a rubber lubricant designed for tire mounting.



Using a tire iron (you'll need two), insert the tip between the tire and the bead, and pull the bead over the rim. Using the second tire iron, pick a location about 6 inches away (measured circumferentially on the rim) and do the same thing. Remove the first tire iron and repeat the process. You usually only need to do this once and the tire will pop off the rim on the side you're working. You do not need to remove the tire from the rim; you only have to get it off the wheel on one side.



Push the valve stem back into the rim so that it is no longer passes through the rim. Remembering where the puncture occurred on the tire (if you were able to identify the puncture location), pull the tube out of the tire (you'll be pulling it out between the tire and the rim on the side where you separated the tire from the rim).

Carefully inspect the tube in the area adjacent to the tire puncture location and inspect for the source of the leak. If you find it and if it is small (they almost always are), you can most likely patch it as a temporary fix. If the tear is more extensive, you should replace the tube.

If you can't find the leak, partially inflate the tube and listen for hissing. You may have to put the partially inflated tube near your ear and rotate it until you find the leak. If you are near water, you can immerse the tube and look for bubbles to locate the leak. If you hear it but can't see it, you can rub spit around the general area and look for the leak.

Before you reinstall the tube (either one you've patched or a new one), reach in and gingerly feel around the inside of the tire. Look for anything that might damage the tube when you reinstall it. **Warning!** Exercise caution (if there is something sticking into the tire, don't cut yourself on it). If you find anything, remove it.

Gently insert either the patched or a new tube into the tire. Position it so that the valve stem is aligned with the hole in the rim. Push the valve stem through the hole in the rim and then reinstall the 10mm nut on the valve stem to lock the valve stem in place. Gently tuck the tube completely in to the tire.

Reinstall the tire on the rim using tire irons. Take care not to pinch the tube between the tire and the rim (and don't damage the tube with the tire irons) when reseating the tire. Liberal use of spray lubricant will help.

Reinstall the tire and wheel on the motorcycle before you inflate the tube. This is the reverse of the process I described above.

After accomplishing the above, inflate the tire and to seat it on the rim.

CSC advises keeping a patch kit, a tire repair kit, and a source of compressed air with you, especially if you ride in remote locations. If you need these items, please call CSC at 909 445 0900.



Engine

The TT250 engine is an air-cooled, overhead valve, counterbalanced engine.

Oil Change

The following information applies to TT250 oil changes.

- The TT250 takes 1.3 quarts of 10W-40 motorcycle oil.
- The TT250 has two oil cleaning devices. One is the strainer (it is addressed in this section of the Owner's and Service Manual), and it should be removed and cleaned with each oil change. The other cleaning device is the centrifugal oil cleaner, which is located inside the right engine crankcase cover. The centrifugal cleaner does not require regular cleaning; it should only be cleaned when the right engine crankcase cover is removed for other reasons. Gaining access to the centrifugal oil cleaner is explained in the clutch replacement section of the TT250 Owner's and Service Manual.
- The TT250 engine has one oil fill port on the right side of the engine.
- The TT250 engine has an oil viewport on the right side of the engine for assessing engine oil level, and the bike needs to be vertical to use it.
- The TT250 engine has an oil dipstick, which is attached to the oil fill port cap.
- You'll need a 17mm socket to remove the oil drain plug.
- You'll need a 24mm wrench to remove the oil strainer cap.
- You'll need an oil drain pan to put beneath the engine when you drain the oil.
- Use only non-synthetic oil for the first 1000 miles. If you wish to use synthetic motorcycle oil, you may do so after a 1000-mile break-in period.
- You should do the first oil change after 200 miles, and then change the oil every 2500 miles.
- You should change the oil more frequently if the motorcycle is subjected to sustained high speed use or if the motorcycle is operated in dusty environments.

With the above in mind, the procedure for changing the oil follows.

Remove the dipstick from the engine.



Remove the oil drain plug underneath the engine and allow the oil to drain. Hold the bike in the vertical position so all the oil drains.



The oil drain plug takes a 17mm wrench or socket.



Remove the oil strainer cap on the left side of the engine.



The oil strainer cap takes a 24mm wrench.



When the oil strainer cap is removed, there will be a spring inside of it, as shown below.



Usually, the oil strainer remains in the engine when the oil strainer cap and spring are removed. You'll have to reach into the engine with a pick or a screwdriver to get the oil strainer out of the engine.



When you remove the oil strainer for the first couple of oil changes (as the engine is breaking in), you will see more than a few metallic particles and plastic adhesive material (the green stuff) on the strainer. This is normal.

Clean the strainer. WD-40 works well, because you can direct the spray into the strainer from the inside and blow the filtered particles off. If you wipe them off with a shop rag, take care not to deform the strainer.



After all of the oil has drained from the crankcase, insert the cleaned strainer into the spring/cap assembly, as you see below.

Reinstall the strainer, the spring, and the strainer cap. Reinstall the oil drain plug.



Pour 1.2 liters of oil into the oil fill port on the right side of the motorcycle.



1.2 liters is about 1.3 quarts. The best way to get the right amount of oil in the engine is to pour in a quart, and then pour the last 0.3 quarts in at a slow rate keeping an eye on the oil viewing port (on the right side of the engine). When you have 1.2 liters, the oil level will be between the L and H marks when the bike is vertical (off the sidestand), as you see here.



Start the engine, let the bike warm up, and then check the oil again. You can also check the oil with the dipstick. The proper way to do this is to let the engine warm, shut the ignition, remove the dipstick and wipe it clean, wait one minute, hold the bike vertical, and then reinsert the dipstick without screwing it into the engine.



Withdraw the dipstick and check the oil level. It should be at the upper level of the cross-hatched area on the dipstick (the oil should come up to the upper red arrow shown in the photo below).



This is the proper level for the engine oil.

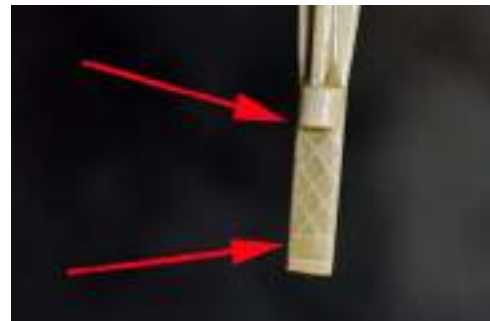

CSC Motorcycles can provide you with everything you need to change your oil, including recommended regular and synthetic oil. Call us at 909 445 0900 to order these items.

Spark Plug Removal and Installation

This portion of the Owner's and Service Manual addresses spark plug removal and replacement. You should replace the spark plug every 10,000 miles or more often if the motorcycle exhibits symptoms consistent with spark plug failure (missing under load, no spark across the electrode, etc.).

Remove the lead from the spark plug. The spark plug is on the right side of the motorcycle.



Unscrew the spark plug from the cylinder head. You can use an 11/16-inch or an 18mm spark plug socket.



The TT250 engine takes a Torch D8TC spark plug. The gap should be 0.028 inch or 0.711mm when the plug is new; if it is not at this gap, adjust the electrode accordingly.



Assembly is the reverse of disassembly.

Valve Adjustment

This section of the Owner's and Service Manual addresses TT250 valve adjustment.

You'll need the following tools for this operation:

- A pair of pliers
- 14mm socket with ratchet and extension
- Spark plug wrench
- 10mm wrench
- Long handled Phillips head screwdriver
- Large bladed flat head screwdriver
- 6mm Allen wrench

The TT250 has a two-valve engine. The intake valve opens to admit the fuel/air mixture, and the exhaust valve opens to expel the exhaust. When the engine is at the top of its compression stroke, we want both valves closed. That's because we want to compress the fuel air mixture, ignite it, and then allow the resulting high combustion pressures to drive the piston down. If any leakage occurs around any of the valves while this is occurring, the engine will lose power and it could "burn" a valve if the combusting fuel/air mix escapes around the valve while it is still burning.

When engineers design an engine, they want it to do the above, but they have to account for the thermal expansion that occurs as engine temperature increases during normal operation. In order to compensate for this thermal expansion, the engineers design in a gap in the rocker arm/valve train. As the engine warms, this gap approaches zero, and everything works the way it is supposed to.

On the TT250, the valve train looks like you see in the photo (the photo shows the exhaust valve, but both the intake and the exhaust valve have similar valve trains). The valve gap (also referred to as the valve clearance) is what the lower red arrow points to in the photo.



As the wear described above increases, it has the effect of reducing the valve gap (i.e., the clearance built into the valve train to account for the thermal expansion as the engine warms up). What happens is that as this wear occurs, the valve actually moves higher into the cylinder head and the valve gap decreases. If this wear goes beyond acceptable limits without adjusting the valves, the valve gap grows smaller and smaller. Ultimately, this wear will result in the valve being held off the seat when combustion occurs. This is bad, because when this condition exists, hot burning gases escape around the valve sealing area. Ultimately, these burning gases will destroy the valve and the seat. That's what happens when we "burn a valve."

The above scenario is also bad because the valve needs to cool, and it is cooled primarily when it is closed against the valve seat. That allows heat to escape from the valve and flow into the cylinder head. If the valve never fully closes, the valve will continue to heat, and the valve stem will expand diametrically so much that it seizes in the valve guide. That's bad, too, because when that happens, the valve will stick, the piston will hit it, and you've just bought yourself a new engine (or you'll have to pay for expensive repairs on the current engine).

We avoid the above conditions by adjusting the valves. All we are really doing is keeping the gap in the valve train within an acceptable range over the life of an engine. As the valve and the valve seat wear, we keep everything adjusted so that when the engine is at operating temperature we still form a good seal around the valve seat.

Different engines use different approaches for adjusting the valves. Your TT250 engine uses the best approach for easy maintenance and high performance: It uses a threaded adjuster shaft with a lock nut to set and lock the valve gap. In the photo above, that's what the upper two arrows point to. These adjusters are located in the ends of the rocker arms that interface directly with the valve stem.

So, with all that theory behind us, let's consider what we're going to do here:

1. We want to gain access to the valve rocker arms and their adjustment screws.
2. We want the engine to be at a point in its rotation such that the rocker arm is on the cam's base circle. This means the cam is not actuating the rocker arm. We want the engine to have the piston at (or very near) top dead center, which means the valves should be closed (which is another way of saying the rocker arm is on the cam's base circle).
3. With the engine in this position, we want to loosen the threaded adjuster lock nuts, we want to set the valve gaps to the specified gap of 0.04mm to 0.07mm, and we want to tighten the lock nuts to lock the threaded adjusters at this gap. We always make the adjustment to the 0.07mm setting. As the valve and the cylinder head wear, the gap will grow smaller. Setting it to the 0.07mm setting allows us to keep the valve adjustment interval (the number of miles you can ride between valve adjustments) at a reasonably high number. Initially, we're establishing this interval to be 500 miles for the first adjustment, and every 2500 miles thereafter.
4. When we've completed the above, we want to put everything back together.

Most of the work in adjusting the valves is associated with just getting access to the adjusters. The adjustment operation (once we have access) takes only a few minutes.

When you adjust the valves, you have to start with a cold engine. Let your TT250 cool down completely.

Remove the rear body panels on the left and right side of the motorcycle.



Remove the rear body panels on the left and right side of the motorcycle.



Remove the seat. It's secured by 10mm bolts on either side.



Once the bolts have been removed, the seat slides to the rear.



Close the fuel petcock and remove the fuel hose from it.



Remove the hose from the right upper hose boss on the carbon canister. The other end of this hose remains attached to the fuel tank.



Remove the 10mm bolt at the base of the fuel tank. You'll see it after you have removed the seat.



Remove the two screws that secure the left and right fuel tank body panels to the frame.



You do not need to remove the body panels from the fuel tank.



Slide the fuel tank to the rear.



After you have lifted it partially off the motorcycle, disconnect the electrical connector that runs from the fuel tank sending unit to the fuel gage.



When you remove the fuel tank from the motorcycle, two hoses will hang down. The longer one is the fuel tank overflow line. It simply hangs down from the fuel tank; the other end is not attached to anything (it vents to atmosphere). The shorter hose is the one that attaches to the carbon canister. You'll have to reinstall the end of it on the carbon canister boss when you reinstall the fuel tank after adjusting the valves.



At this point, we have what we want, and that's access to the valve cover.



The valve cover is attached to the cylinder head by three 10mm bolts. Note that there is a fourth 10mm bolt on top of the valve cover (it's the one in the photo below just beneath and partially behind the hose). Leave that bolt alone (do not remove it from the valve cover).



Do remove the three bolts that attach the valve cover to the cylinder head.



Detach the large diameter hose from the exhaust gas recirculation valve shown below.



Tap the valve cover gently to break the seal between it and the cylinder head.



Remove the valve cover. It will remove to the right side of the motorcycle.



The valve cover seals to the cylinder head with an o-ring type seal. Place the valve cover where this seal will not be contaminated by dirt or debris. Prior to reinstalling the valve cover (after you have adjusted the valves), apply a light coat of motor oil to the rubber seal.



Remove the spark plug.



This will allow you to turn the engine without compression restricting crankshaft rotation.



Remove the left crankcase engine cover port.



The cover port is secured with three Phillips head screws.



After you have removed the cover, you will see a 14mm bolt head. By placing a socket wrench on this bolt head, you will be able to rotate the engine (it's why we removed the spark plug). If you have the bike in the vertical position (straight up and down), only a tiny amount of oil will escape. If the bike is on the sidestand, more oil will escape.



Remove the timing port cover on the left side of the engine with a large blade screwdriver or a coin.



When you remove the timing port cover, take care not to lose the o-ring that seals it. Place the o-ring in an area where it will not become contaminated with dirt or debris.



Rotate the engine by hand by attaching a 14mm drive to the crank bolt.



There are three timing marks on the crank shaft indicator wheel. One is a double scribe line that shows when the ignition is fully advanced. We're not interested in that one for the valve adjustment operation; this information is included here for reference only.



The next mark is a scribe line with an F. This shows when the spark plug fires. We're not interested in that mark, either, for the valve adjustment operation. It's mentioned here for reference only.



Here's the mark we're interested in. It's a scribe line with a T. That shows when the piston is at top dead center, which is where we want it to be for the valve adjustment operation. You should manually rotate the engine so that this T mark and the scribe line are aligned with the slot and both valves are fully closed.



Rotate the engine's crankshaft through the full 360 degrees at least twice to check valve position. On one rotation, you may see that one of the valves is not fully closed. If that's the case, DO NOT adjust the valves with the engine crankshaft in this position. Rotate the engine another 360 degrees to bring the T mark and scribe line into alignment with the slot in the threaded area. Both valves should be



fully closed, which is to say that the rockers should be in the full up position and the valve gap is fully open for the both valves.

Loosen the threaded adjuster enough to allow insertion of a 0.07mm feeler gage into the valve gap, as shown here.



Hand tighten the adjuster so that it is snug against the feeler. You don't want to overtighten the adjuster or you will start to open the valve and your adjustment will be incorrect. Just make it snug so that if you try to pull the feeler out, you feel slight resistance.



Tighten the 10mm adjuster lock nut.

Repeat the above process for the other valve. Manually rotate the engine two complete revolutions, align the T mark and the scribe line again, and check the clearance again.

Assembly is the reverse of disassembly.

CSC recommends inspecting the valve gap at 500 miles, and adjusting the valves every 5000 miles. If the motorcycle is ridden aggressively or at high rpm for extended periods, you may need to increase the valve adjustment frequency.

Carburetor

This section of the TT250 Owner's and Service Manual addresses TT250 carburetor maintenance. If your motorcycle is running rough and the problem is related to the carburetor, or if your motorcycle has not been operated for a long time and you did not treat the fuel prior to storage, the fuel will create gums that can clog the carburetor jets and affect engine performance. This section will show you how to remove, disassemble, clean, reassemble, and reinstall your carburetor.

The TT250 uses a Keima slide carburetor. It will be much easier to gain access to the carburetor if the fuel tank is removed. Removing the fuel tank involves removing the rear body panels and the seat, detaching the tank body panels from the frame (you do not need to remove the body panels from the tank), disconnecting the fuel line from the carburetor, removing the fuel tank, and disconnecting the fuel tank electrical connection to the fuel gage.



Loosen the Phillips head screw securing the airbox inlet to the carburetor.



Detach it from the carburetor.



Unscrew the carburetor slide assembly cap and remove the carburetor slide assembly from the carburetor.



Pull the slide out of the carburetor body.



Remove the two 10mm nuts securing the carburetor to the intake manifold.



It will be easier to access the left side carburetor mounting nut if you first detach the rear brake master cylinder.



Pull the carburetor away from the engine.



Detach the vent hose such that you can move the carburetor to a clean work area.



Remove the carburetor float bowl



Place the float bowl aside.



At this point, when you invert the carburetor you can see the float, the float valve, the main jet, the slow jet, and the idle jet.

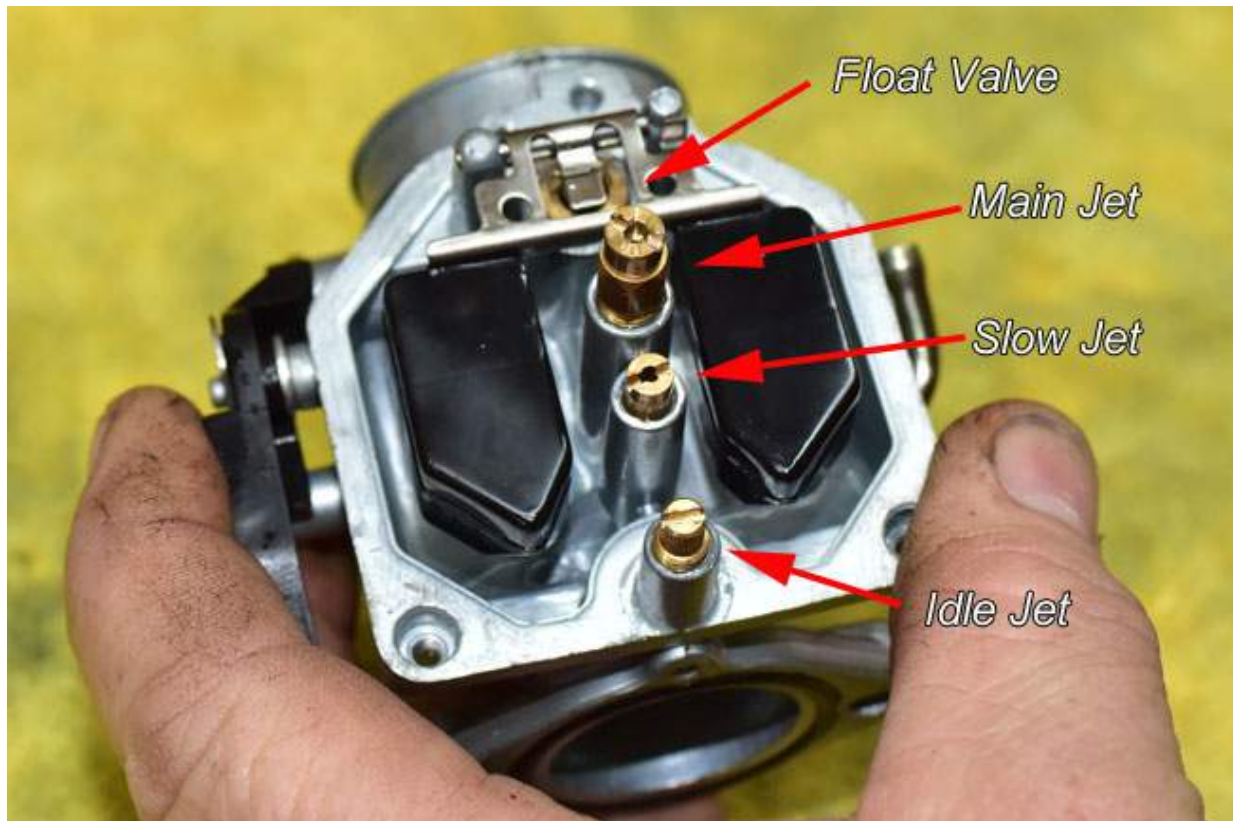

The float pivots on the float pivot shaft to operate the float valve. The float valve is connected to the float by a wire clip.



Gently push the float pivot shaft out of the carburetor body.



Lift the float and the float valve from the carburetor body. Take care not to drop the float valve; it will fall off of the float when the float is tilted.



These arrows identify the float valve and the pivot.



This is the float valve.



Remove the main, slow, and idle jets from the carburetor with a flat head screw driver.



The main jet is in a brass carrier. It's likely the entire carrier will unscrew when you unscrew the main jet. You can then unscrew the main jet if you secure the main jet carrier with an 8mm wrench.



There is a brass bushing that fits in the bottom of the carburetor body. It interfaces with the main jet carrier. Remove the bushing from the carburetor.



Note that this bushing has a beveled end and a square-cut end. The beveled end will interface with the main jet carrier when these parts are reassembled.



Remove the slow jet with a flat head screwdriver.



Pull the slow jet from the carburetor body.



Remove the idle jet.



There will be a spring, a flat metal washer, and an o-ring beneath the idle jet. Carefully remove these from the carburetor body if they do not come out with the idle jet.



The idle jet, the slow jet, and the main jet components are shown below. The idle jet is on the left, the slow jet is in the middle, and the main jet is on the right.



Remove the slide adjustment screw (this is the screw used to adjust idle speed) and spring from the carburetor body.



Pull the idle adjustment screw from the carburetor body.



Clean all three jets using a suitable cleaning solvent and a jet cleaning tool to assure all passageways are open. We stock these items; please call us at 909 445 0900 if you need them.



This is a jet cleaning tool.



Cleaning the jet with the jet cleaning tool.



Clean the central bore and the two radial holes.



Looking through the jet.

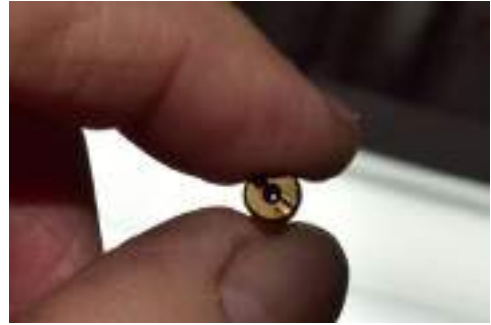

Remove the o-rings from the float bowl and the carburetor body.



Clean the carburetor interior and exterior surfaces using a suitable solvent.

Use a q-tip to clean the interior of the float valve body.



Assembly is the reverse of disassembly.

When reinstalling the jets and the jet carriers, do not overtighten them or you may strip the aluminum carburetor body threads.



When installing the brass bushing that faces the underside of the main jet, make sure the square end faces away from the main jet carrier and the beveled end faces the main jet carrier.



When you insert this piece in the carburetor body, it is not likely to fully seat or go in straight without assistance. We use an Allen wrench to make sure this bushing is properly guided into its seat.



This is what the seat should look like viewed from the carburetor bore.



After the bushing is in place, install the main jet carrier and lightly tighten it.



Do not overtighten it.



Install the main jet and lightly tighten it with a flat head screwdriver.



Put the float valve on the float and guide it over the float valve seat. Take care not to let the clip that connects the float valve to the float come off the float.



Lowering the float valve into the carburetor body.



Guide the float pivot shaft through the carburetor body tangs' drilled pivot points and the float.



Reinstall the O-rings on the float body and the carburetor body. We apply a light coating of grease to the O-rings.



Apply a light coat of grease to the carburetor body O-ring.



Reinstall the carburetor slide assembly. The carburetor slide assembly includes circlip that attaches the needle to the slide, as shown in the photo blow. Positioning the needle higher in the slide will enrichen the air fuel mixture; positioning the needle lower in the slide will cause the engine to run leaner.



Re-installation of the carburetor on the motorcycle is the reverse of installation. After installing the carburetor and reassembling the motorcycle, start the engine and allow the motorcycle to come to operating temperature. Adjust the idle speed with the carburetor slide idle speed adjustment screw to approximately 1500 rpm (the TT250 does not have a tachometer; we make the adjustment by sound).

Air Filter Replacement

This section of the Owner's and Service Manual addresses removal and replacement of the TT250 air filter. The TT250 uses a paper air filter. We stock all parts for the TT250 motorcycle, so when you need a new air filter, please call us at 909 445 0900 and we will ship an air filter to you.

You should check your TT250 air filter every 2500 miles. If it is dirty or clogged, it will reduce the motorcycle's performance and you should replace it. You should check the air filter more often if you ride in dusty or offroad conditions.

Caution! Do not operate your TT250 without the air filter.

Access to the TT250 air filter is gained by removing the rear body panels, the rear seat, and the airbox cover.



The rear body panels are each secured by a single screw and two rubber pop-off retaining posts. Remove both rear body panels.



The seat is secured by a 10mm bolt on either side. Remove both 10mm bolts and slide the seat to the rear of the motorcycle to remove it.



After removing the seat, you will see the airbox cover. It is secured by four Phillips head screws. Remove the screws and the airbox cover.



After removing the airbox cover, the air filter and the air filter retainer will be visible. If the air filter is dirty or clogged, it should be replaced. Please contact us at 909 445 0900 to order replacement air filters.



The air filter retainer is secured by four Phillips head screws. To remove the air filter, remove the four air filter retainer screws.

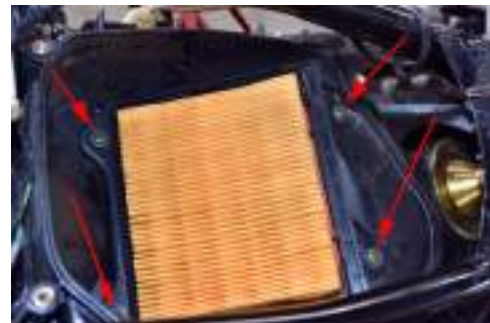

The air filter can be removed from the retainer at this point.



Assembly is the reverse of disassembly.

Exhaust System

This section of the Owner's and Service Manual addresses the TT250 exhaust system.

Caution! Do not operate your TT250 without all exhaust system components in place.

The exhaust header is secured to the cylinder head by two acorn nuts.



Remove the acorn nuts.



Slide the exhaust header flange away from the cylinder head



Loosen the 10mm bolt securing the exhaust header-to-muffler clamp.



Remove the 10mm bolt securing the forward end of the muffler to the motorcycle frame.



Remove the 10mm bolt and nut securing the muffler to the motorcycle frame on the right side of the motorcycle beneath the seat.



Remove the exhaust header crush gasket from the cylinder head.



Remove the mesh gasket between the exhaust header and the muffler.



Assembly is the reverse of disassembly.

CSC stocks all TT250 exhaust system parts. Please call us at 909 445 0900 if you require replacement parts.

Engine Troubleshooting

Item	Symptom	Cause	Vehicle Effect	Maintenance Action
Intake system	Hard starting,	Excessive dust	Poor performance, poor	Clean or replace the air



Item	Symptom	Cause	Vehicle Effect	Maintenance Action
	low power	on the air cleaner element	idling, excessive fuel consumption, dark smoke exhaust	cleaner element
	Excessive intake noise	Cracks or chaps on the air cleaner shell	Poor performance, excessive intake noise	Replace the air cleaner shell
Exhaust system	Excessive exhaust noise	Cracks or openings in exhaust system	Poor performance, excessive noise	Replace defective components
Exhaust system	Smoke emanating from exhaust	Worn rings, worn valve seal, choke in on position, carburetor too rich	Smoke trail	Check choke position, check carburetor, perform compression check (if compression low, isolate cause and correct)
Engine	Poor engine performance	See below	See below	See below
Starter	Difficult starting	Clogged air filter, carburetor not adjusted correctly, valves too tight, battery low	Difficult to start engine	Check air filter, check charging circuit, check valves; adjust/correct as required
Engine	Overheating	Mud or other debris in cooling fins, low oil, running in too high a gear, engine running too lean	Engine overheats	Check for air leaks in intake path, check to make sure all fins are clear, check oil level, check valve adjustment.
Engine	Excessive fuel consumption	Clogged air filter, engine valves not adjusted correctly, carburetor not adjusted correctly; chain too tight, tire pressure low	Poor fuel economy	Check possible causes and correct any departures from required adjustment setting
Engine	Missing or sputters	Defective spark plug, defective coil, defective ignition wiring	Missing	Inspect and replace defective component(s).

Fuel System

The fuel system consists of the fuel tank, fuel mounting hardware, fuel hoses, the fuel filter, the fuel petcock, the carburetor, fuel vapor vent lines, and the fuel level sensor and its associated wiring. Fuel tank removal procedures are included in the valve adjustment section of this Owner's and Service Manual.

The fuel filter is located below the fuel tank on the left side of the motorcycle. The fuel petcock is located on the left side of the fuel tank. You can inspect the fuel filter to see if it is dirty or clogged; if it is, you should replace it. You can remove the sediment bowl on the fuel petcock to remove accumulated sediment.



The fuel tank level sensor connector is accessible beneath the tank when the fuel tank is being removed.



Two hoses are beneath the fuel tank. The longer is routed through the motorcycle as a drain line for overflow. The shorter one attaches to the carbon canister.



The fuel tank mounts with a single bolt at the rear and fits onto two rubber dampers (one on either side of the frame).



The fuel tank level sensor attaches to the underside of the fuel tank.



CSC stocks all fuel system components. Please contact us at 909 445 0900 if you need any parts.

Fuel System Troubleshooting

Item	Symptom	Cause	Vehicle Effect	Maintenance Action
Fuel tank	Rusty tank body	Water intrusion	Fuel leakage, clogged fuel filter	Repair or replace the tank
	Fuel supply impeded	Fuel cap vent clogged	Starting failure, engine stalls	Clean air vent
	Deformed tank	Impact	Poor appearance	Repair or replace tank
Fuel hoses	Fuel supply impeded	Fuel	Starting difficulty, insufficient power, unstable idle speed	Clean filter
	Fuel supply impeded	Fuel hose kinked	Starting difficulty, insufficient power, unstable idle speed	Unkink fuel hose
	Fuel leaking	Fuel hose leaking	Leaking fuel, insufficient power, unstable idle speed	Replace fuel hose, fuel filter, or fuel petcock
Fuel petcock	Fuel leaking	Fuel petcock worn	Leaking fuel, insufficient power, unstable idle speed	Replace fuel petcock
Fuel filter	Fuel leaking	Cracked fuel filter	Leaking fuel, insufficient power, unstable idle speed	Replace fuel filter
	Loss of power	Fuel filter clogged	Difficult starting, loss of power	Replace fuel filter
Fuel tank	Fuel tank rattling	Loose or missing bolt, degraded or missing fuel tank mounting donut	Fuel tank rattling	Replace fuel tank mounting donut, tighten fuel tank mounting bolt
Fuel gage	Fuel gage inoperable	Short or open circuit, defective fuel gage	Incorrect fuel gage reading	Check wiring, replace fuel sending unit, replace fuel gage

Control Cables

The CSC TT250 uses one control cable for the throttle, and one for the clutch.

The throttle cable should be adjusted such that there it has 2 to 5 degrees of free rotation before the throttle is actuated. This accomplished through use of the adjustment mechanism underneath the right handlebar.



Clutch cable adjustment is covered in the Clutch Cable section of the Owner's and Service Manual.

Clutch and Throttle Cable Troubleshooting

Item	Symptom	Cause	Vehicle Effect	Maintenance Action
Clutch cable	See Clutch section of this Service Manual			
Throttle cable	Throttle has no free play, idle speed too high, throttle does not work	Seized or sticking throttle cable, throttle cable adjustment incorrect, throttle cable snaps	Throttle does not operate, throttle sticks open	Replace or adjust throttle cable

Electrical System

This section of the Owner's and Service Manual explains the electrical system's main components, their locations, their functions, and some suggestions in the unlikely event you'll ever need to troubleshoot the system.

The TT250 has an 18-pole, 300-watt stator that puts out plenty of power. Many riders like to run accessories (heated vests, spotlights, heated grips, etc.), and on bikes with smaller electrical outputs, you can run the battery down while riding with all the accessories powered up. Your TT250 won't have this problem.

The TT250 has built-in accessory outlets already wired into the main harness, and the accessories switch is located on the right handlebar (see the Controls section of the Owner's and Service Manual).

Most of the electrical and electronic components on this bike are located under the seat and tank, and behind the headlight.

In this section of the Owner's and Service Manual, we will remove the seat, the fuel tank, and the headlight so you can see everything. The first part of this section focuses on removing these items; the second part identifies various electronic component locations.

Remove the rear body panels on the left and right side of the motorcycle. There's a single bolt in each one.



The panels pop off after you have removed the bolt.



Next, remove the seat. There's a 10mm bolt on either side.



Remove these bolts and pull the seat to the rear to remove it.



Removing the tank involves:

- Closing the fuel petcock.
- Disconnecting the fuel line from the fuel petcock to the carburetor.
- Removing the 10mm bolt at the rear of the tank and the two Phillips head screws under the forward body panels (one on each side of the tank).
- Disconnecting the fuel sending unit connector plug.
- Disconnecting the tank vent line from the carbon canister.

These actions are shown in the steps below.

Remove the 10mm bolt from the rear of the fuel tank.



Disconnect the fairing front the motorcycle frame.



Remove this fastener to disconnect the fairing from the frame. You do not need to remove the fairing from the fuel tank.



Close the petcock and disconnect the fuel line to it.



Disconnect the vent line from the carbon canister.



Slide the fuel tank to the rear to remove it.



Disconnect the fuel gage connector plug.



The headlight is removed by unscrewing two Phillips head screws on either side.



The first component is the ignition switch, located on top of the forks.



The headlight nacelle includes the harness running into the headlight bulb. In this photo, you can also see the wiring for the parking light (not separately operable on the North American bikes).



The horn is located on the right side of the frame near the front of the motorcycle. It is accessible without removing the fuel tank.



The connector from the fuel tank's fuel gage sending unit to the fuel gage is underneath the tank. This is the half of the connector that stays with the motorcycle when the fuel tank is removed.



The battery is located on the left side of the motorcycle. It is accessible by removing the left rear body panel and the seat. It is secured by a rubber strap.

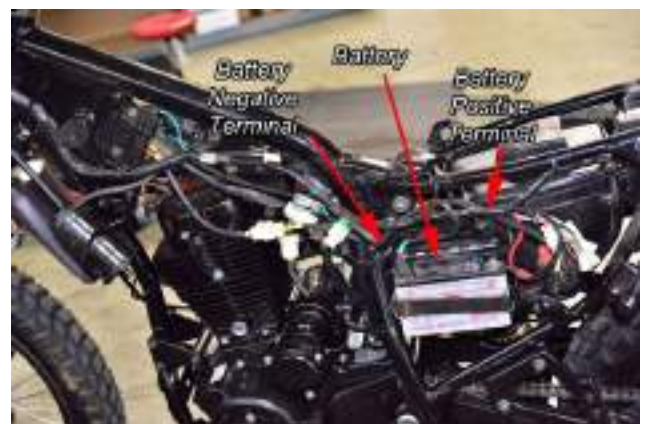

As you can see from the photo, red is positive, and green is ground. Throughout the motorcycle, wires with green insulation are ground wires.



The regulator/rectifier is on the left side of the motorcycle near the front of the bike. It mounts to the frame beneath the fuel tank. If this component is not working, the battery will not charge properly or it may overcharge and boil over. The red and green wires go to the battery to charge it. The yellow wires come from the motorcycle's stator.



The ignition coil is located underneath the fuel tank on the right frame.



The starter relay is located on the left side of the motorcycle just to the rear of the battery. It closes when commanded to do so to send power to the starter motor.



As you can see in the photo, the starter relay is attached to the frame with a rubber carrier that fits over tabs protruding from the frame.

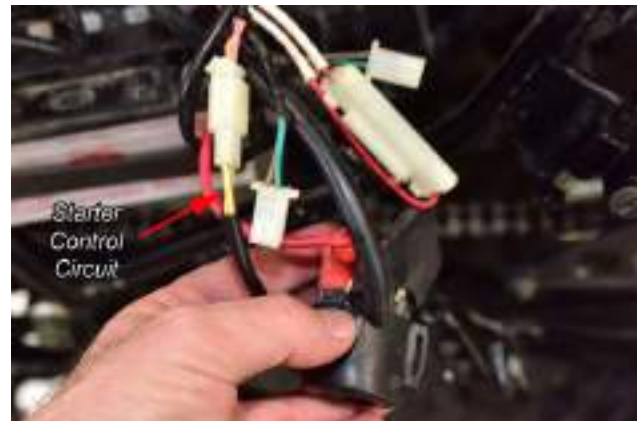

The motorcycle's only electrical fuse is located in a carrier behind the battery. This pops open to provide access to the fuse.



If the motorcycle loses all electrical power, there are several potential causes, but the most likely are that the fuse has opened, or the engine kill switch is in the off position. Several of the connectors and harnesses in the battery area (on the left side of the motorcycle) are identified in these photos.

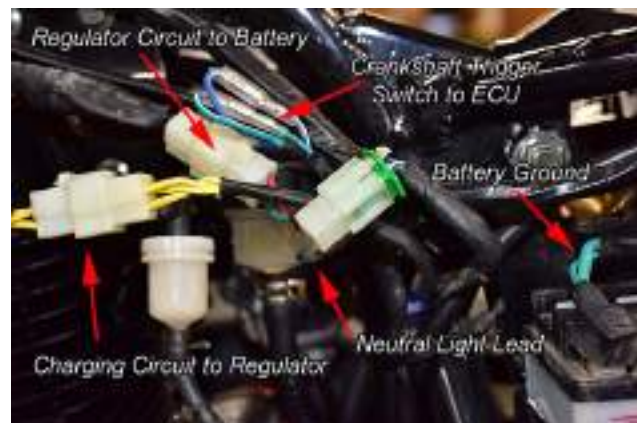

The two 12V underseat accessory outlet connectors are on the left side of the motorcycle. These are controlled by the handlebar-mounted switch and they are provided as a convenient point for connecting accessories, heated vests, etc. When the ignition is off, power is cut to these connectors.



The engine ECU and turn signal controller are located beneath the seat.

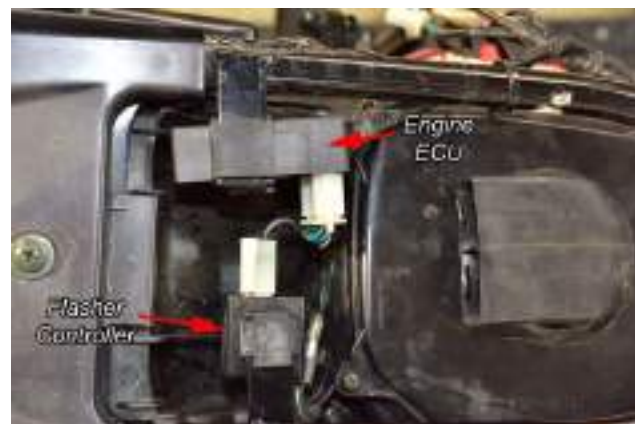

When the headlight has been removed, several connectors and harnesses are visible from the front of the motorcycle. These are identified in the photos to the right.

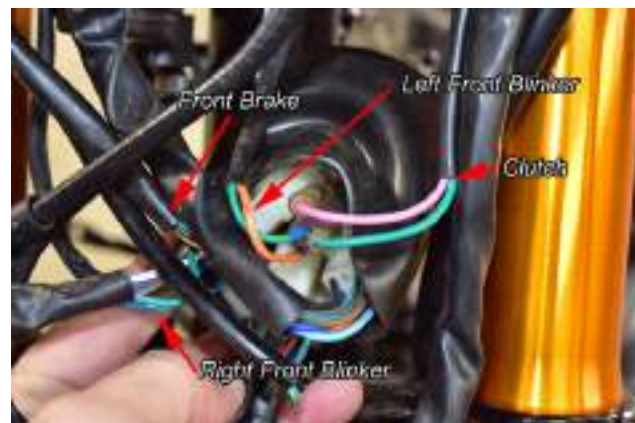

More harness connectors are identified in this photo.

The neutral light diode controls when the neutral light is on. If it is shorted, it will allow the neutral light to come on whenever the clutch lever is pulled in.



Access to the indicator lights and wiring is provided when the headlight nacelle is removed. The photo below shows the underside of the dash cluster.



The TT250 Owner's and Service Manual provides a wiring diagram, which can be used in conjunction with the above photos when troubleshooting any electrical problems.

Battery

This section of the Owner's and Service Manual addresses TT250 battery maintenance. You should keep the terminals clean, keep the acid level within an acceptable range, and replace the battery when it won't hold a charge.

In this section of the Owner's and Service Manual, we're showing everything with the battery removed from the motorcycle (which is the way we prefer to work on the battery), but everything seen in this section can be done with the battery in the bike.

You will need to remove the left rear body panel to gain access to the battery.

Remove the left rear body panel by unscrewing the body panel screw. The body panel will pull off after the screw has been removed.



Inspect the battery terminal area. If oxidation is present around the terminal (it will appear as a white growth around the terminal), pour a water-and-baking-soda solution over the terminal area to eliminate the oxidation. After doing this, flush the area with water.



Disconnect the battery. Disconnect the negative terminal first (the one with the green insulation on the lead) and then disconnect the positive terminal.



Unhook the battery's rubber retention strap and remove the battery.



Check the acid level in the battery. The level should be between the upper and lower red lines on the front of the battery. It's a little difficult to see this in the first photo below, so we tilted the battery so you can see it better.



If any of the cells are below the minimum level, remove the filler cap for each affected cell. Add only distilled water to a cell if it is below the minimum level such that the cell level is within the acceptable range.



We recommend replacing the battery if it is more than 2 years old, or if the battery won't hold a charge.

Evaluate the battery's ability to hold a charge by leaving it on the charger long enough to fully charge, and then measure the voltage. If it's less than 12.8 volts, replace the battery.



If you need a new battery, CSC stocks all of the parts for your TT250. Please call us at 909 445 0900.

We recommend using a trickle charger, and we use the Battery Tender brand. If you want one, please call us at 909 445 0900.



Lighting and Turn Signals

This section of the Owner's and Service Manual addresses the motorcycle's lighting, including the headlight, the taillight and brake light, the instrumentation lights, and the turn signals.

If you experience a lighting failure, the most likely cause of failure is the bulb or, in the case of the turn signals, the LED lights. Check the bulb for the light that is not working first. If the bulb is open or the LED is not operating correctly, you will need to replace this component. If the bulb or the LED is intact and operational, the fault lies elsewhere and you will need to find the source in the circuit leading to the bulb or the LED turn signal.

The taillight and brake light is accessed by removing the red lens on the rear of the motorcycle. It is secured by two Phillips head screws.



Remove the Phillips head screws and remove the red lens.



After the red lens has been removed, you will have access to the taillight and brake light bulb. It is a standard 1157 bulb. Push in and twist the bulb to release it. Replace the bulb if either the brake light or the taillight filament is open. CSC stocks these bulbs; please call us at 909 445 0900 if you need a replacement.



The headlight and instrument lights are accessed by removing the headlight and its nacelle. These items are secured by two Allen bolts (one on either side of the headlight). Remove these Allen bolts.



Tilt the headlight and its nacelle forward.



Remove the rubber insulator that covers the rear of the headlight. Disconnect the connector plug at the rear of the headlight bulb.



Twist and remove the plastic lock for the headlight bulb.



Remove the headlight bulb. Replace the headlight bulb if it has an open filament. The TT250 takes a standard 12V 35/35W bulb. CSC stocks these bulbs; please call us at 909 445 0900 if you need a replacement.



If any of the instrumentation lights or indicators go dark, you can access these bulbs after you have removed the headlight and its nacelle as described above. After removing the headlight and its nacelle, the instrument lights are accessible from beneath the dash cluster. Isolate the defective light and pull it from the dash cluster as shown here.



Pull the bulb from the rubber receptacle. If it is defective, replace it. CSC stocks these bulbs; please call us at 909 445 0900 if you need a replacement.



The turn signals use LED lighting. If the turn signal does not work and the fault is not in the wiring to the turn signal, you will need to remove and replace the affected turn signal.

The front turn signal is removed and replaced by unscrewing its retaining nut, disconnecting the harness, and replacing the turn signal. CSC stocks the turn signals; please call us at 909 445 0900 if you need a replacement.



The rear turn signal is similarly removed and replaced by unscrewing its retaining nut, disconnecting the harness, and replacing the turn signal. CSC stocks the turn signals; please call us at 909 445 0900 if you need a replacement.



Charging System

This section of the Owner's and Service Manual addresses maintenance of the TT250 charging system.

You might have a charging system problem if the battery is dead or the bike is hard to start. It's more likely this is just a battery problem, so the first thing to do is to check the battery (see the TT250 battery maintenance section of this Manual).

If you have ruled out a defective battery, the next thing to check is the charging circuit.

Put a multimeter on the battery and measure the voltage when the engine is revved. It should be between 13.8 and 14.5 VDC. If the voltage is above 14.5 VDC, the regulator is defective and it must be replaced.



The regulator is located beneath the fuel tank on the left side of the motorcycle. You will need to remove the seat and fuel tank to gain access to the regulator; the procedure for removing these components is described in other parts of this Manual. If you need a regulator, please call us at 909 445 0900.



If the battery voltage is below 13.8 volts when the engine is revved, more analysis is required.

The next step is to measure the output of the charging system. Check for charging system AC voltage and resistance. Find the charging circuit harness, and with the engine running, measure the AC voltage between all three leads. At idle, it should be 12 VDC. With the engine at maximum rpm, it should be 60 VDC.



Shut the engine off, disconnect the harness connector shown above, and measure the resistance between all three leads (it should be approximately 0.5 ohms; anything between 0.3 ohms and 0.6 ohms is acceptable). If the resistance is outside the range mentioned above the stator should be replaced.



If the charging system from the engine crankshaft (i.e., at the yellow leads discussed above) has appropriate output and resistance, we should next check the output from the regulator. Find the connector plug as shown in the photo and check the voltage output when the engine is running. If it is below 13.8 VDC or above 14.5 VDC when you blip the throttle, the regulator is defective and it must be replaced.



If the voltage is within the acceptable range (i.e., between 13.8 and 14.5 VDC) but the output at the battery terminals (with the engine running) is outside this range, the problem lies in the circuit between the connector plug and the battery. In this situation, you should check for open circuits, improper connections, or shorts to ground and correct the anomalous condition.

If the engine is not providing the appropriate output AC voltage or the resistance between the stator leads is too high (as measured at the connector shown earlier), there is a problem with the stator, the engine's internal wiring from the stator, or the rotor. It will be necessary to remove the left engine crankcase cover to inspect and correct the anomalous condition.

Place a drip pan beneath the engine, as oil will escape from the engine during this operation, and remove the gear shift lever with a 10mm wrench.

There are several 8mm bolts securing the left engine cover and the countershaft sprocket cover. Remove all of them. Note that the bolts are of different lengths. Take care to note where each bolt is used.

Remove the countershaft sprocket cover.

Disconnect the stator harness.



Unbolt the harness retainer from the crankcase.



Remove the starter motor transfer gear cover.



Remove the starter transfer gears. Note their orientation; the smaller gear is closest to the starter motor. Note that there are small shims on either side of the gear cluster; take care not to lose them.



Unbolt the 8mm bolt securing the starter gear transfer case to the crankcase. Note that this bolt is a fully threaded bolt.



Gently pry the left crankcase engine cover from the engine.



Examine the stator inside the engine cover. If the resistance between the three leads is outside the range specified above, replace the stator. If there is no resistance between any of the leads and ground (this means there is a short to ground), replace the stator. CSC stocks replacement stators; please call us at 909 445 0900 if you need a replacement stator.



Inspect the rotor. If the rotor is damaged in any manner, you will need to replace it. To remove the rotor, remove the bolt securing the rotor.



Use a rotor pulling tool to back the rotor off of the crankshaft. We sell these; please give us a call at 909 445 0900 if you need this tool.



Assembly is the reverse of disassembly. Apply Loctite to the rotor crankcase bolt and torque the rotor crankcase bolt to 60 N-m. Torque the engine cover mounting and countershaft cover bolts to 9 N-m. Apply Loctite to the stator mounting bolts and torque the stator mounting bolts to 9 N-m.

Starting System

The TT250 has both a kickstarter and an electric starter. This section of the Operation and Maintenance Manual addresses the TT250 electric start system.

If your TT250 does not start when you press the starter button, the first thing you should check is the engine kill switch to make sure it is in the run position.

If the kill switch is in the run position and the motorcycle does not crank at all, the next thing to check is the fuse. The fuse is accessible underneath the left body panel.



If the fuse is open (blown), you will need to replace it, but before you do, you should find the reason the fuse blew or it is likely you will just blow the fuse again when you replace it. Our most frequently encountered reason for a blown fuse is the wire cluster behind the headlight. Sometimes the connector boots slide away from the connector and permit a short to ground (it's the first place I'd look). If that is not the problem, examine all of the motorcycle's wiring and use a multimeter to identify any shorts to ground.



If the fuse is intact and the motorcycle does not crank, next check the battery. Please see our battery maintenance tutorial for this.



If the battery output is appropriate and the connections are in good shape, check the starter relay. Use a multimeter to confirm voltage is reaching the relay and the relay closes when the starter button is pressed. If the starter relay does not receive voltage when the starter button is pressed, the problem is in the circuit from the starter button. Use a multimeter to isolate the fault and correct any anomalies. If the starter relay receives electrical energy but it does not close the circuit to the starter, check the starter relay connections. If they are intact and free of corrosion, replace the starter relay. Please call us at 909 445 0900 if you need a starter relay.



If the starter relay closes, use a multimeter and check to see if electrical energy is reaching the starter motor. The connection is on the starter motor just behind the starter motor case on the left side of the motorcycle.



If the starter motor is receiving electrical energy but does not crank, the problem is most likely the starter motor. You will need to remove the exhaust pipe to get access to the starter motor. The starter motor is removed by removing the two bolts retaining it (accessible from the right side of the motorcycle, and the electrical connection. If you need a starter motor, please call us at 909 445 0900.

If the starter motor spins freely but the engine does not turn, either the starter motor output gear is stripped or there is a problem in the starter gear train. Remove the starter motor transfer gear train cover and examine the gears. The starter motor transfer gear train cover is restrained by three 8mm bolts. If the starter motor output gear or the gear train exhibits any anomalies, replace any defective components. Please call us at 909 445 0900 for replacement parts. Note that the gear cluster has thin shims on either side; take care not to lose these. If no defects are apparent, it will be necessary to remove the left engine crankcase cover for further troubleshooting.



Place a drip pan under the engine, as engine oil will escape from the engine during the following steps. Remove the gear shift lever.



The left engine crankcase cover and the countershaft cover are secured by several 8mm bolts. Remove all of them. Note that the bolts are of differing lengths.



Remove the countershaft sprocket cover.



Remove the charging circuit harness retention clip.



Disconnect the charging circuit connector plug.



Unbolt the 8mm bolt inside the starter motor transfer case.



Gently remove the left engine crankcase cover.



Check the two drive gears that interface with the starter motor gear transfer gears and the engine start drive gear. Note that the gear cluster has thin shims on either side; take care not to lose these. If either is damaged, replace the transfer gears. If you need replacement gears, please call us at 909 445 0900.



Check the engine start drive gear behind the rotor. Examine the engine start drive gear for any defects. Check for rotation; the engine start drive gear should rotate in only one direction. If it can be rotated in either direction, the sprag clutch is defective and it must be replaced. If the engine start drive gear is defective, it must be replaced. If you need replacement parts, please call us at 909 445 0900.



If you need to replace the engine start drive gear or the sprag clutch, you will have to remove the rotor. To do so, remove the rotor attach bolt.



Remove the rotor with a gear puller. If you need the gear puller, we sell them. Please call us at 909 445 0900.



After you have removed the rotor, you will see the engine start drive gear sprag clutch. This clutch drives the engine start drive gear in one direction only. After the engine has started, the crankshaft and the engine start drive gear can spin freely in the sprag clutch. Inspect the sprag clutch for any damage. Remove the sprag clutch from the rotor and replace the sprag clutch if it is damaged or if it allows the engine start drive gear to spin in either direction.



After removing the rotor, remove the engine start drive gear if it is damaged. To do so, you must remove the small Woodruff key that indexes the engine start drive gear to the crankshaft. Gently tap the Woodruff key out with a screwdriver and a hammer.



Remove the engine start drive gear. If you need a replacement engine start drive gear, please call us at 909 445 0900.



Assembly is the reverse of disassembly. When assembling the left engine cover to the engine, use a new gasket (please call us at 909 445 0900 if you need a new gasket). Apply Loctite to the rotor crankcase bolt and torque the rotor crankcase bolt to 45 ft-lbs. Torque the engine cover mounting and countershaft cover bolts to 7 ft-lbs.

Electrical System Troubleshooting

Troubleshooting flow charts for electrical system problems are provided below in the following pages.

Item	Symptom	Cause	Vehicle Effect	Maintenance Action
Fuse	No electrical power to vehicle	Short circuit in wiring	Cannot operate motorcycle	Check electrical system, isolate and correct any short circuits to ground, replace fuse after correcting short circuit
Battery	Low or no output	Charging failure	Cannot operate motorcycle	See below
		Battery acid low	Cannot start motorcycle	Add distilled water
		Battery plates sulfated	Cannot start or operate motorcycle	Replace battery
	Does not charge	No regulator output	Cannot start or operate motorcycle	Check regulator output; replace regulator if defective
		Open circuit in charging circuit	Cannot start or operate motorcycle.	Check electrical system, isolate and correct open circuit



Item	Symptom	Cause	Vehicle Effect	Maintenance Action
		Charging system defect	Cannot start or operate motorcycle.	Check charging system output to isolate defective component, replace defective component
	Leaks	Cracked battery case, battery overfilled, overcharging	Leaking battery acid	Check battery case for cracking; replace if necessary, check battery acid level, reduce if necessary; check regulator output, replace regulator if output too high
Starter	Does not start	Defective starter motor	Cannot start motorcycle	Check power to starter; if power present and starter does not crank, replace starter motor
		Open circuit to starter motor	Cannot start motorcycle	Check starter circuit as outlined above, isolate and correct open circuit
		Starter gear train failure	Starter cranks but spins freely	Check starter motor output gear, check starter motor gear train as outlined above, isolate and replace defective component
Bulb or LED	Does not illuminate	Open circuit, no power, or defective bulb/LED	Bulb does not illuminate	Check bulb/LED, replace if necessary; if bulb/LED is not defective, check circuit and all switches in circuit, isolate and replace defective component
	Weak illumination	Low power	Weak lighting	Check battery and charging circuit as outlined above
	Burn out	Excessive charging system output, excessive shock, age	No illumination	Replace bulb/LED; if failures persist, check charging circuit output
Horn	Does not beep	Defective horn, no power to horn	No beep from horn	Check horn with alternative 12V power source; replace if necessary, check circuit for presence of power, if power not present, isolate and correct defective component

Electrical Schematic

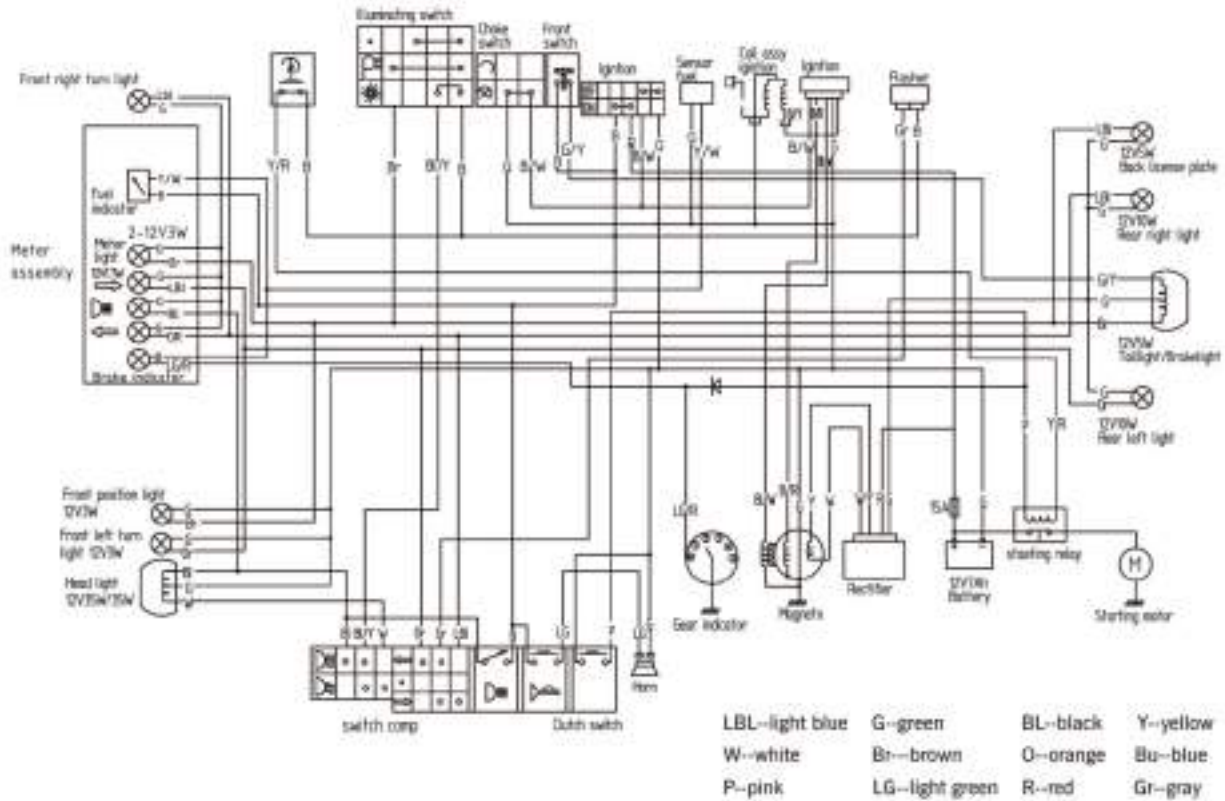



Appendix A - Service Checklists

500-Mile New Motorcycle First Service		
Customer Name:	License:	Odometer;
Repair Order No:	Date:	Technician:
Service Item	Completion	Comments
Change engine oil and filter		
Check/adjust intake and exhaust valves to 0.07mm		
Check/adjust brake fluid levels		
Check throttle operation for free play and smoothness		
Check/adjust clutch operation		
Check/adjust wheel true and spoke tightness		
Check/adjust tire pressure (32 psi front and rear)		
Check lighting and signal systems		
Check/adjust drive chain		
Check all chassis hardware		
Check/adjust steering bearing		
Install Lucas fuel injection treatment		
Test ride		
Notes		
Odometer reading at completion:		



2500-Mile Motorcycle Service		
Customer Name:	License:	Odometer;
Repair Order No:	Date:	Technician:
Service Item	Completion	Comments
Change engine oil and filter, clean screens		
Check engine mounts; tighter as required		
Inspect air filter, clean or replace as necessary		
Check throttle operation for free play and smoothness		
Check/adjust clutch operation		
Check/adjust seat cable operation		
Check high beam		
Check low beam		
Check turn signals		
Check brake light front and rear		
Check tail light		
Check auxiliary lights		
Check/adjust front and rear brake fluid levels		
Check brake pads front and rear		
Check brake rotor wear front and rear		
Check brake hoses and connections		
Check caliper bolts		
Check caliper pins		
Check front and rear tire wear (mm)		
Check/adjust tire pressure (32 psi front and rear)		
Check/adjust front and rear wheel true		
Check/adjust front and rear spokes		
Check/adjust coolant level		
Check hose condition		
Check coolant hose clamp tightness		
Check/adjust drive chain		
Check sprocket wear		
Check all chassis hardware		
Check/adjust steering bearing		
Install Lucas fuel injection treatment		
Test ride		
Notes		
Odometer reading at completion:		



5000-Mile Motorcycle Service		
Customer Name:	License:	Odometer;
Repair Order No:	Date:	Technician:
Service Item	Completion	Comments
Change engine oil and filter, clean screens		
Check engine mounts; tighter as required		
Check intake/exhaust valve timing; adjust gap to 0.07mm		
Replace spark plug		
Inspect air filter, clean or replace as necessary		
Check throttle operation for free play and smoothness		
Check/adjust clutch operation		
Adjust clutch free play		
Lubricate clutch pivot points		
Check/adjust seat cable operation		
Check high beam		
Check low beam		
Check turn signals		
Check brake light front and rear		
Check tail light		
Check auxiliary lights		
Check/adjust front and rear brake fluid levels		
Check brake pads front and rear		
Check brake rotor wear front and rear		
Check brake hoses and connections		
Check brake caliper bolts		
Check caliper pins		
Check front and rear tire wear (mm)		
Check/adjust tire pressure (32 psi front and rear)		
Check/adjust front and rear wheel true		
Check/adjust front and rear spokes		
Check front and rear axle torque		
Check/adjust coolant level; replace if more than 2 years		
Check hose condition		
Check coolant hose clamp tightness		
Check battery connections		
Check battery charge rate		
Check battery condition		
Lube drive chain		
Check/adjust drive chain		
Check sprocket wear		
Check all chassis hardware		
Check/adjust steering bearing		
Install Lucas fuel injection treatment		
Test ride		
Notes		
Odometer reading at completion:		



Annual Motorcycle Service		
Customer Name:	License:	Odometer;
Repair Order No:	Date:	Technician:
Service Item	Completion	Comments
Change engine oil and filter		
Change brake fluid front and rear		
Check throttle cable for smooth operation		
Check/adjust tire pressure (32 psi front and rear)		
Check tire condition and tread depth		
Check lighting and signal systems		
Check drive chain tension		
Check battery condition		
Check coolant level		
Check radiator hose condition		
Check hose clamp tightness		
Check frame bolts for tightness		
Install Lucas fuel injection treatment		
Test ride		
Notes		
Odometer reading at completion:		