

CENTURY 125 i.e E4

Engine Workshop Manual





Engine Workshop Manual

Century 125i.e.

The descriptions and images in this publication are given for illustrative purposes only and are not binding. While the basic characteristics as described and illustrated in this booklet remain unchanged, Rieju S.A. reserves the right, at any time and without being required to update this publication beforehand, to make any changes to components, parts or accessories, which it considers necessary to improve the product or which are required for manufacturing or construction reasons.

Not all versions/models shown in this publication are available in all countries. The availability of each model should be checked at the official RIEJU sales network.

© Copyright 2014 - Rieju S.A. All rights reserved. Reproduction of this publication in whole or in part is prohibited.

Rieju S.A. C/ Borrassà 41 E-17600 Figueres GIRONA-SPAIN
www.riejumoto.com



ENGINE WORKSHOP MANUAL

Century 125/300 i.e.

This manual for service stations was made by Rieju S.A. to be used by the workshops of dealers and sub-agencies RIEJU. It is assumed that users of this publication for the maintenance and repair of Rieju vehicles has a basic knowledge of the principles of mechanics and technique procedures of vehicle repair. Any significant changes to vehicle characteristics or specific repair operations will be communicated by updates to this manual.

N.B. Provides key information to make the procedure easier to understand and carry out.

CAUTION Refers to specific procedures to carry out for preventing damages to the vehicle.

WARNING Refers to specific procedures to carry out to prevent injuries to the repairer.



Personal safety Failure to completely observe these instructions will result in serious risk of personal injury.



Safeguarding the environment Sections marked with this symbol indicate the correct use of the vehicle to prevent damaging the environment.



Vehicle intactness The incomplete or non-observance of these regulations leads to the risk of serious damage to the vehicle and sometimes even the invalidity of the guarantee.



Index

1. GEARBOX	6
2. STARTER MOTOR	8
3. GENERATOR SIDE	9
4. CLUTCH SIDE	14
a. Checking the clutch	19
b. Checking the springs	21
5. CRANKCASE	23
a. Bushing selection	32
6. HEAD AND TIMING	36
a. Checking the overhead camshaft	43
b. Valve check	43
c. Valve clearance	46
c. Checking the piston	52
e. Checking the connecting rod small end	54
9. LUBRICATION	59

Engine



Gearbox

Gearbox shafts

Disassembling the gearbox

- Open the crankcase halves.
- Remove the gaskets from the crankcase.



- Take out both fork rods and the transmission forks (1) (2).
- Take out the desmodromic control (3).
- Take out the secondary axle (4).
- Take out the primary axle (5).

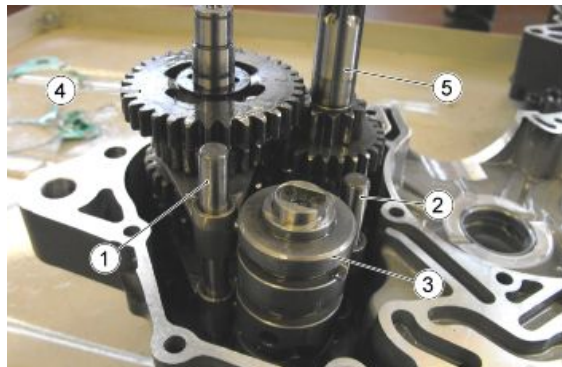

See also

Crankcase opening

Checking the primary shaft

COUPLING CLASSES

The gears of the primary drive are classified according to the coupling with the gear of the clutch housing and with the gear of the balancing countershaft and follow the logic shown in the tables listed below:

COUPLING CLASSES CLUTCH HOUSING - FIRST GEAR SHAFT

Coupling classes on Crankcase	Clutch housing gear	Transmission gear
X	X	X
Y	Y	Y

COUPLING CLASSES FIRST GEAR SHAFT - BALANCING COUNTERSHAFT

Coupling classes on Crankcase	Transmission gear	Balancing countershaft gear
S	S	S
T	T	T

NOTE

Engine

THE CLASS AS WELL AS BEING REPRODUCED ON TWO COUPLING ELEMENTS IS ALSO SHOWN ON THE TWO CRANKCASE HALVES OF THE CRANKCASE.

NOTE

CRANKCASE SPARE PARTS ARE ALWAYS CLASS X.

Checking the desmodromic drum

- Check the contact zone on fork (1) and the driving pin (2) of the forks for wear.
 - Check the desmodromic drum (4) grooves (3) for wear.
 - Make sure that both ball bearings rotate freely and check if there are signs of corrosion.
-
- Check the eccentricity of the transmission shafts.
 - Check the condition of the two springs (5) and (6) of the selector (7).

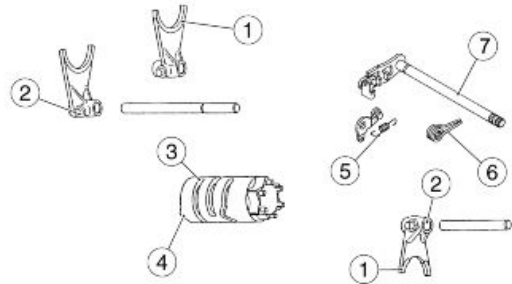

- Check the condition of the gears, replace them if they are blue, if they have cracks or are worn.

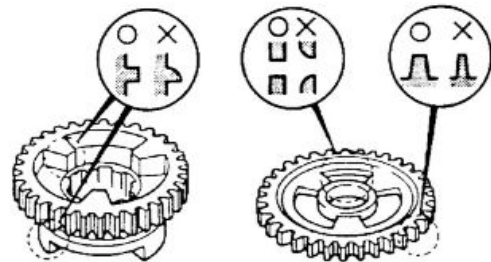

Assembling the gearbox

- Place the specific tool on the secondary shaft to avoid damaging the oil seal.
- Heat up the engine crankcase.
- Apply LOCTITE Anti-Seize on the bearing seats present on the crankcase.
- Fit the bearings in their seats.
- Insert the gears unit (5).
- Apply oil for gears on the grooves of the desmodromic drum.

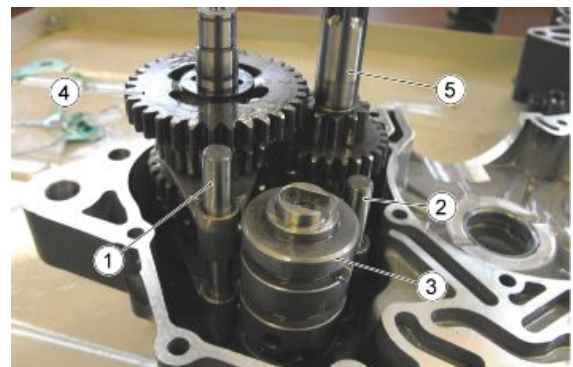

Engine

- Position the desmodromic drum in the crankcase (3).
- Fit the two axles of the transmission forks (1)(2).
- Fit the two transmission forks.
- Finally, fit the crankshaft.

Starter motor

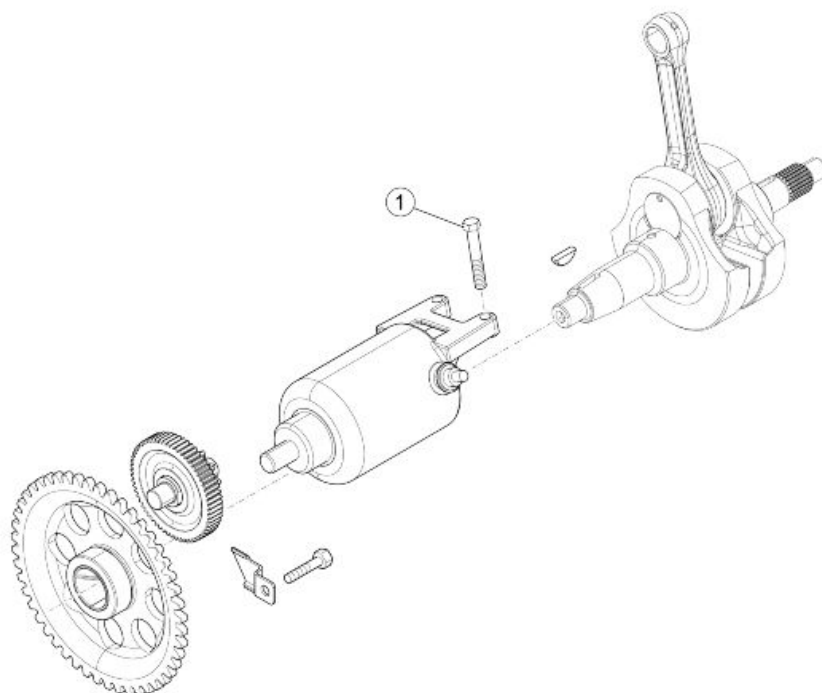

STARTER MOTOR

pos.	Description	Type	Quantity	Torque	Notes
1	Starter motor fixing screw	M6x25	2	11 - 13 Nm (8.11 - 9.58 lbf ft)	-

STARTER MOTOR

- Make sure that the tothing (1) is not deformed or worn.
- Make sure that the O-ring (2) is not damaged or worn.
- The electric starter motor is not fitted for repair. If necessary, replace the whole motor.

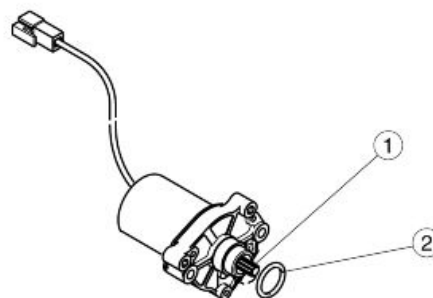

Engine

Removing the starter motor

- Undo and remove the two fixing screws (1).
- Remove the starter motor (2).

NOTE

THE STARTER MOTOR CAN ALSO BE REMOVED IF THE ENGINE IS FITTED TO THE VEHICLE.

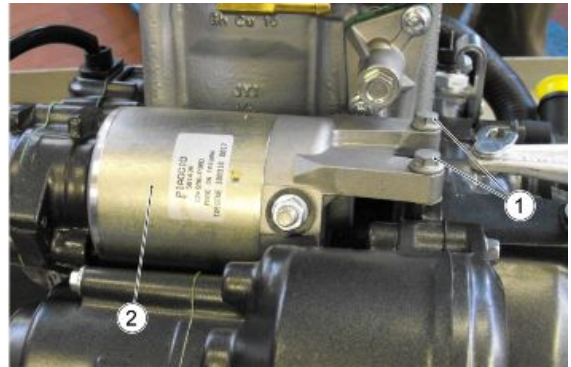

Installing the starter motor

- Place the electric starter motor.
- Apply LOCTITE 221.
- Tighten the starter motor fixing screws.

Generator side

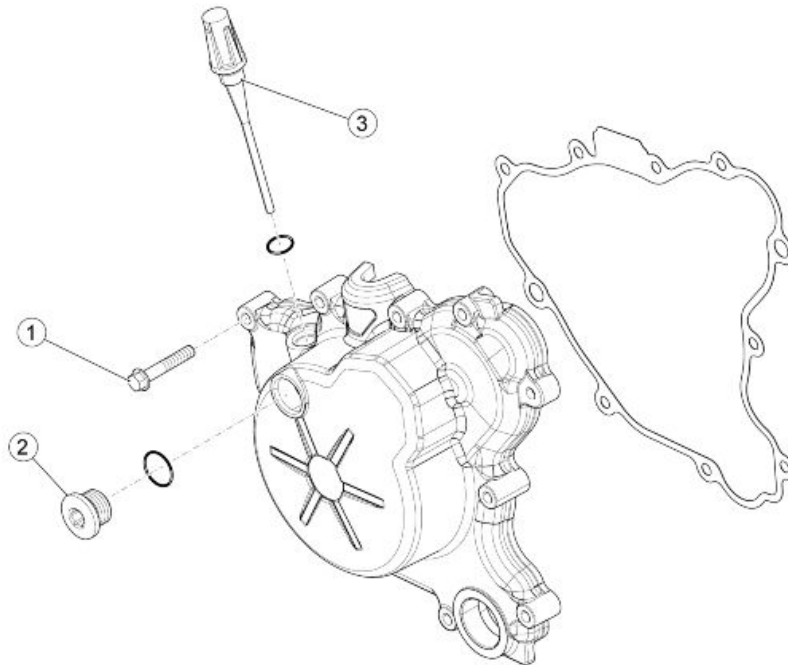

FLYWHEEL COVER

pos.	Description	Type	Quantity	Torque	Notes
1	Flywheel cover fastener screw	M6	10	11 - 13 Nm (8.11 - 9.58 lbf ft)	-



pos.	Description	Type	Quantity	Torque	Notes
2	Timing control cover	M18	2	3.5 - 4.5 Nm (2.58 - 3.31 lbf ft)	-
3	Oil dipstick	M12x1.5	1	4 - 6 Nm (2.95 - 4.42 lbf ft)	-

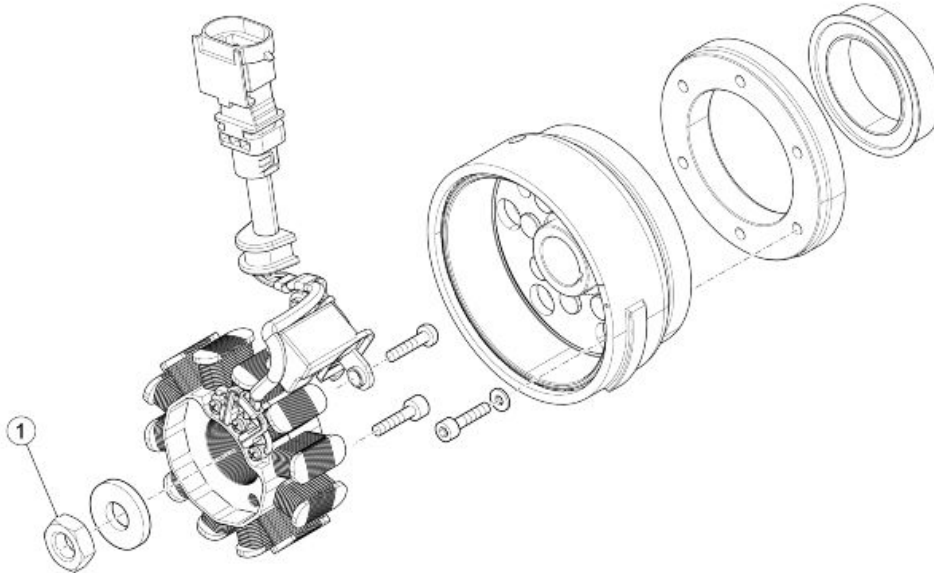

IGNITION UNIT

pos.	Description	Type	Quantity	Torque	Notes
1	Flywheel rotor fixing screw	M14x1.5	1	83 - 90 Nm (61.21 - 66.38 lb ft)	-

Removing the flywheel cover

- Unscrew and remove the two adjustment plugs (1).
- Unscrew and remove the engine oil pre-filter plug (2).
- Remove the engine oil pre-filter.
- Undo and remove the ten screws fixing the flywheel cover.
- Remove the flywheel cover.

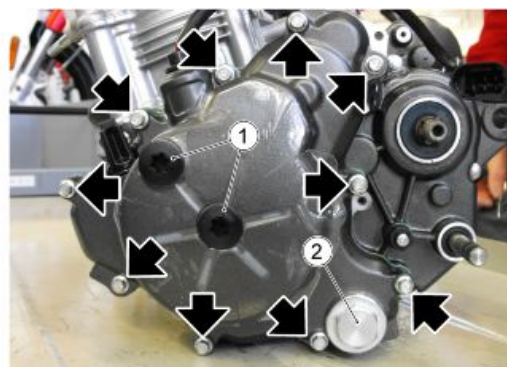

Engine

Magneto flywheel removal

- Remove the starter motor gear.



- Position the locking tool.
- Unscrew and remove the hex head screw and retrieve the washer.



- Position the tool.
- Remove the flywheel and its spline.





-
- Remove the oil filter.



Engine

Freewheel removal

- Undo and remove the screw from the lock.
- Remove the freewheel.

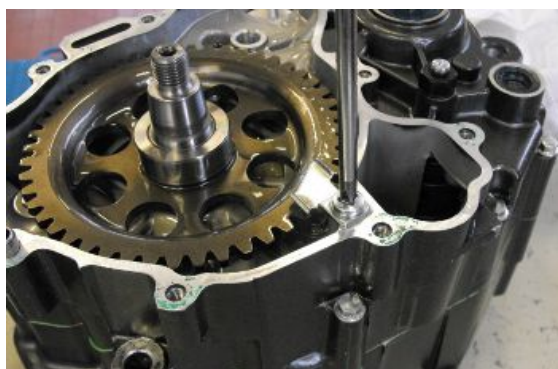

Installing the flywheel

For refitting follow the operations described previously in reverse order.

See also

Magneto flywheel removal

Clutch side

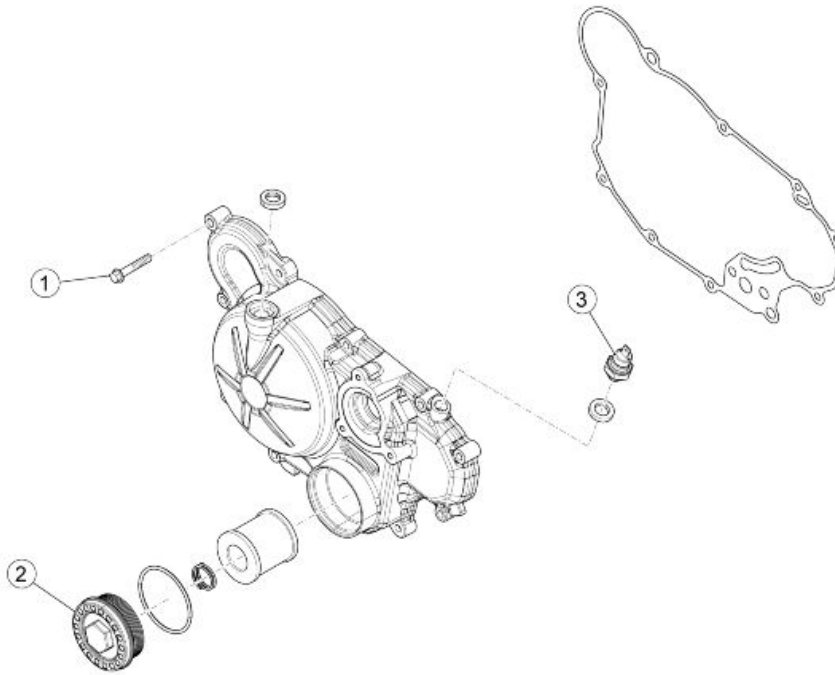

CLUTCH COVER

pos.	Description	Type	Quantity	Torque	Notes
1	Clutch cover fixing screw	M6x35	10	11 - 13 Nm (8.11 - 9.58 lbf ft)	-
2	Oil filter cover	M56x1.5	1	24 - 26 Nm (17.70 - 19.17lbf ft)	-
3	Oil pressure sensor	M10	1	12 - 14 Nm (8.85 - 10.32 lbf ft)	-

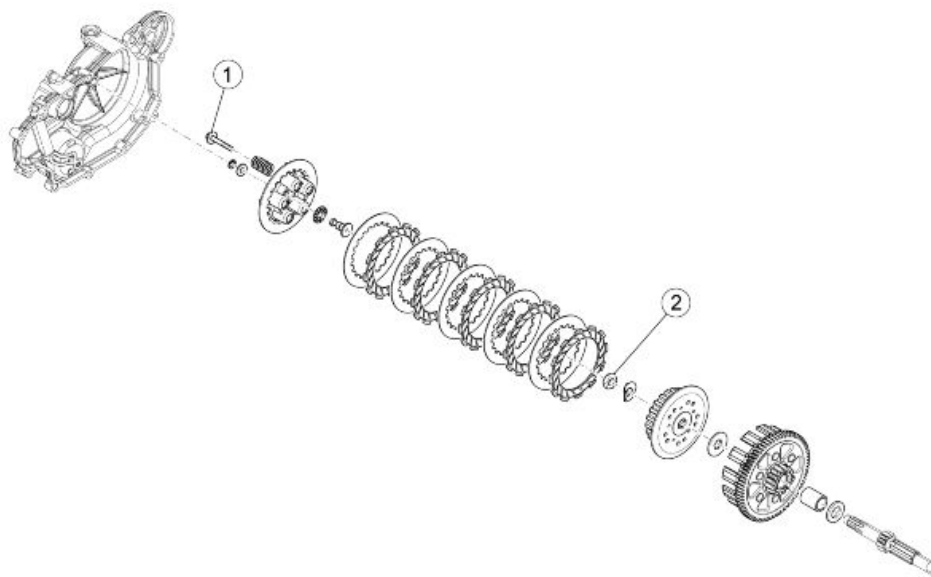

Engine

CLUTCH

pos.	Description	Type	Quantity	Torque	Notes
1	Clutch spring screw	M5	5	3.5 - 4.5 Nm (2.58 - 3.31 lbf ft)	-
2	Clutch housing retainer nut	M12	1	35 - 45 Nm (25.81 - 33.19 lbf ft)	-

Removing the clutch cover

- Unscrew and remove the three water pump cover screws.

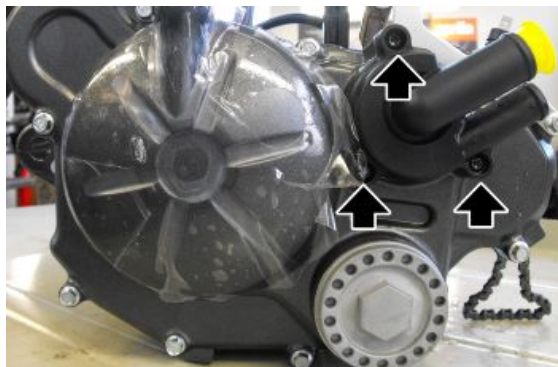

- Remove the water pump cover.



- Unscrew and remove the rotor fixing screw.
- Remove the rotor.



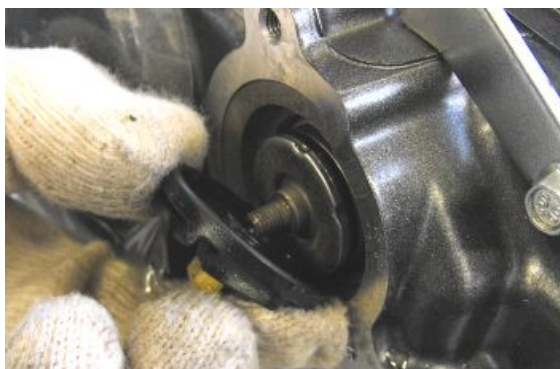

- Unscrew and remove the oil filter plug.



- Remove the spring and oil filter.



Engine

- Unscrew and remove the ten clutch cover screws.
- Remove the clutch cover and the gasket.
- Collect the dowel pins.

WARNING



REPLACE THE GASKET DURING REFITTING.

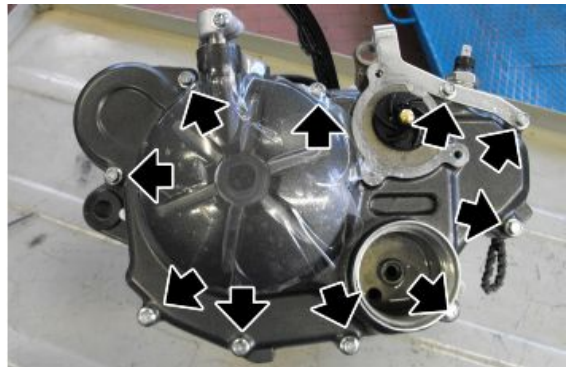

- Remove the lubrication circuit by-pass spring.



Disassembling the clutch

- Unscrew and remove the six screws by loosening them 1/4 of a turn at a time; operate in stages and diagonally, and retrieve the washers and the clutch springs.



- Remove the thrust bearing.
- Remove the discs.



- Release the screw by lowering the lock tab.



- Block clutch bell rotation using the specific tool.
- Unscrew and remove the clutch bell fixing nut.
- Remove the clutch hub.

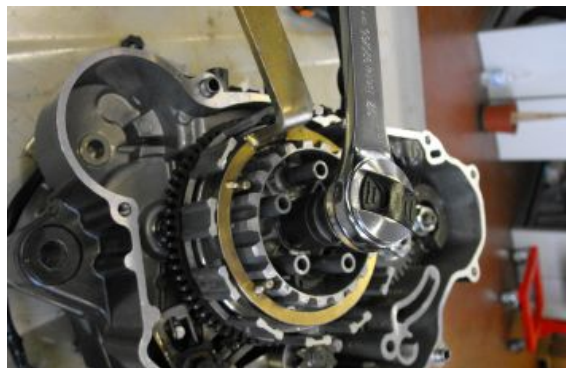

- Remove the shim and the clutch housing.



Engine

- Remove the shim.



Checking the clutch plates

Characteristic

Driving plates thickness

2.85 - 2.95 mm (0.112 - 0.116 in)

Number of driving plates

5

Driven plates thickness

1.46 - 1.53 mm (0.057 - 0.06 in)

Number of driven plates

4

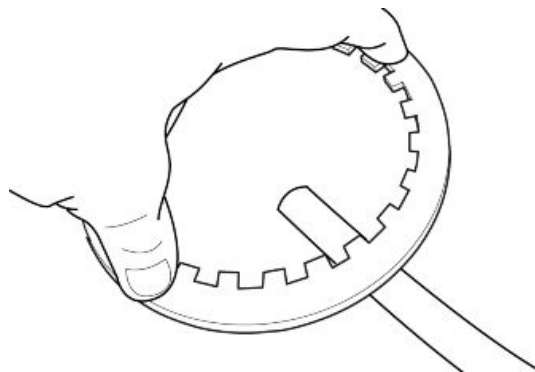
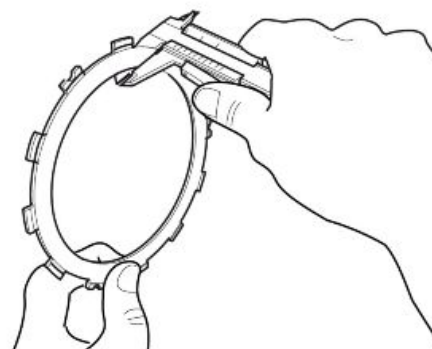

Checking the clutch housing

COUPLING CLASSES

The gears that are coupled to each other: clutch housing, first gear shaft and balancing countershaft, indicate the coupling classes; in this regard, see section "Checking the primary shaft" within the topic "Gearshift".

Engine

Check the primary driven gear for damage and wear and, if necessary, replace the primary driven gear and the clutch bell all together.

Make sure there is not excessive noise during operation; if necessary, replace the primary drive gear and the clutch bell all together.

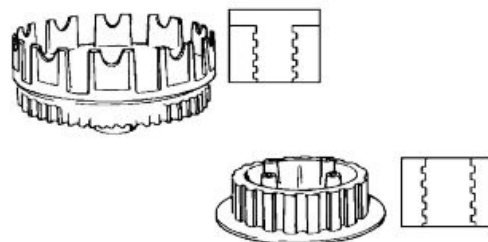

- Check the worn guiding grooves of the clutch bell (1); max. insertion depth (A) = 0.5 mm (0.020 in).

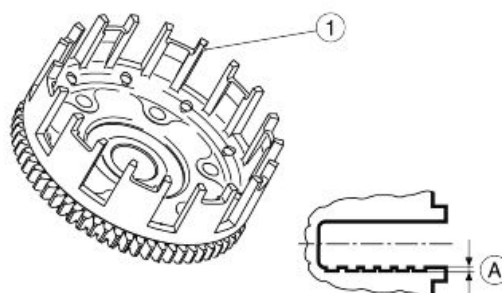

Checking the clutch hub

- When the clutch hub is worn it can create problems with sliding of the housing. The hub should be replaced if the surface of the spring has exceeded the wear limits. Max. wear limit (A) 0.3 mm (0.012 in).

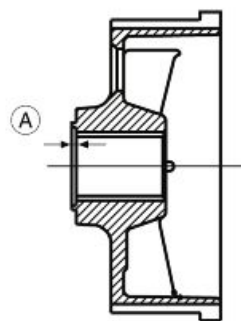

Check the clutch hub for damage and wear that may result in clutch irregular operation. If necessary, replace the hub.

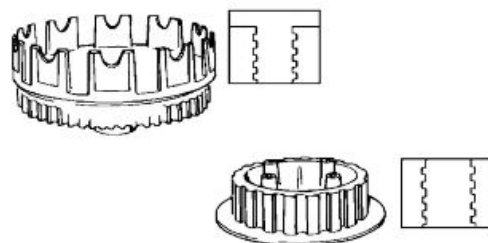

Engine

Checking the springs

- Check the springs for damage and, if necessary, replace the them all together.
- Measure the clutch spring length when unloaded; if necessary, replace the springs all together.

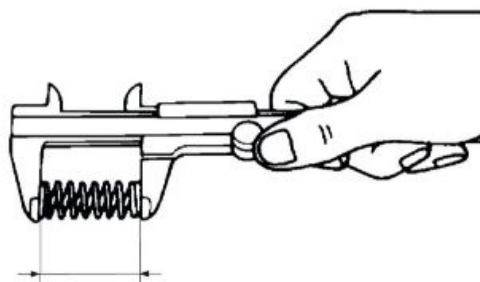

Characteristic

Minimum wear limit in the release position of the individual clutch springs

31.6 mm (1.24 in)

Assembling the clutch

- Insert the shim.



- Fit the clutch housing.
- Fit the shim washer.



Engine

- Insert the clutch hub.
- Screw in the retainer nut locking the rotation of the clutch housing with the specific tool.



- Lift one side of the lock tab.



- Insert the disc covered with the friction material into the bell.
- Continue inserting, alternating a metal disc with one with friction material, finishing with a friction material disc with a black tooth.



- Place the thrust plate.



- Fit the clutch springs.
- Fit the screw washers.
- Tighten the six screws operating in stages and diagonally.

Engine

- Insert a new gasket.
- Position the dowel pins and the cover.
- Position the clutch cable support.
- Screw in the ten screws, tightening diagonally and in stages.
- Refit the water pump.
- Refit the oil filter.
- Add engine oil up to the correct level.

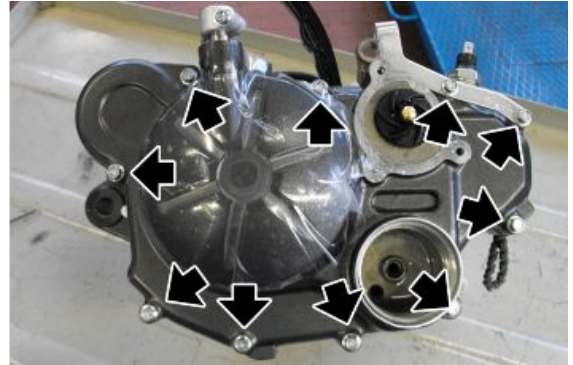

WARNING



TO FACILITATE INSERTION OF THE COVER, ROTATE WATER PUMP THE ROTOR UNTIL THE GEARS ENGAGE.

Crankcase

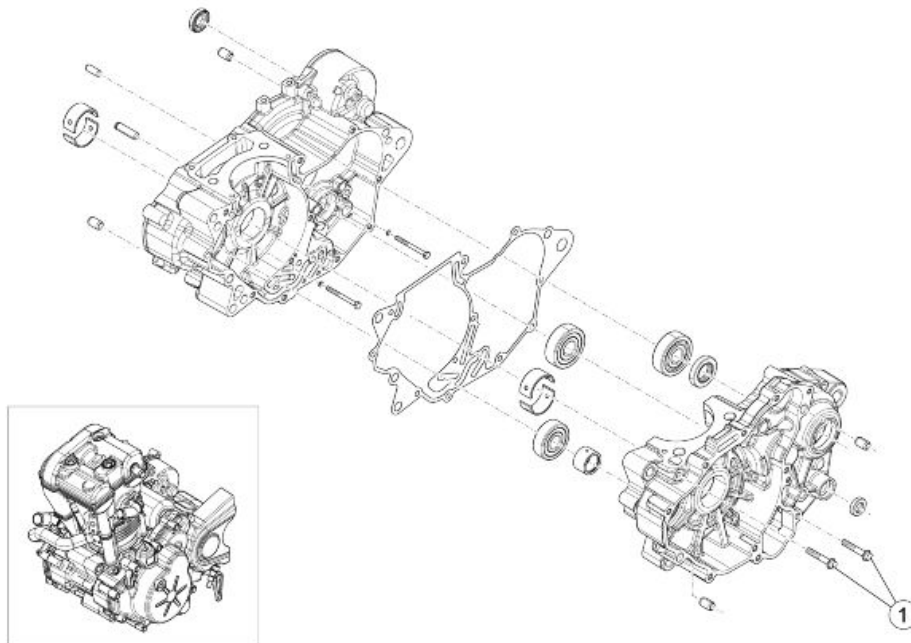

ENGINE CRANKCASE

pos.	Description	Type	Quantity	Torque	Notes
1	Crankcase halves union	M6	12	11 - 13 Nm (8.11 - 9.58 lbf ft)	-



Engine

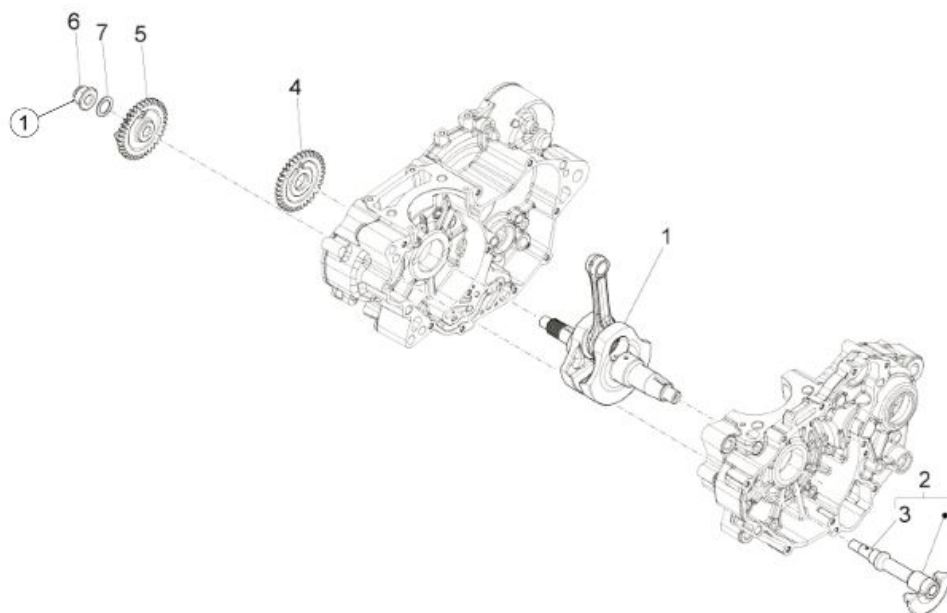

CRANKSHAFT

pos.	Description	Type	Quantity	Torque	Notes
1	Countershaft gear retainer nut	M10	1	35 - 45 Nm (25.81 - 33.19 lbf ft)	-

Balancing countershaft removal

- Before taking out the balancing countershaft the clutch cover and flywheel cover must be removed.
- Lock the countershaft with the specific tool.



- Unscrew and remove the nut and collect the washer



See also

Engine

Removing the clutch cover
Removing the flywheel cover

- Remove the countershaft gear.



- Remove the countershaft from the alternator side.



Balancing countershaft fitting

- Insert the countershaft from the alternator side.



- Insert the gear aligning its reference to the primary gear.
- Using the specific tool, tighten the nut remember first to place the washer.

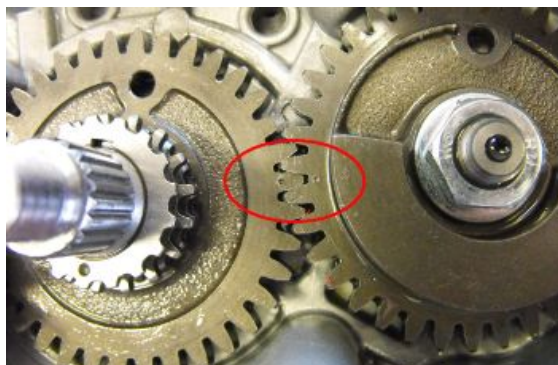

Crankcase opening

- Beforehand remove the clutch cover and the clutch.
- Remove the gear selector.



- Install the countershaft blocking tool.

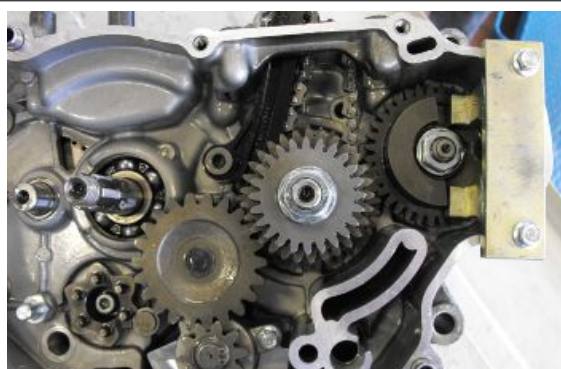

- Remove the primary gear unscrewing and removing the nut.
- Collect the washer.
- Remove the countershaft gear.



- Remove the primary remaining gears.
- Remove the head and cylinder.



See also

Removing the cylinder

Engine

- Remove the chain guide slider, unscrewing and removing the fixing screw.
- Remove the timing chain gear.



- Remove the pump drive gear, removing the seeger and recovering the washer.



- Remove the base gear of the main shaft.
- Remove the cotter.

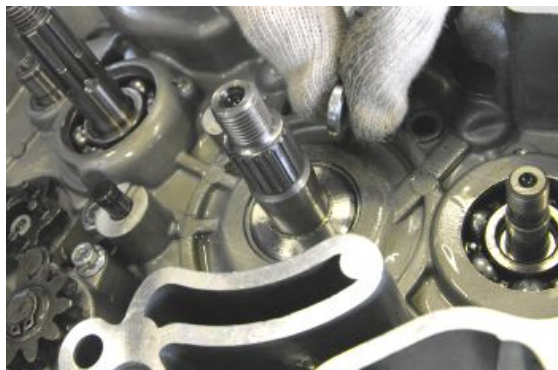

Engine

- Remove the oil pump unscrewing the three fixing screws.
- Collect the gasket.

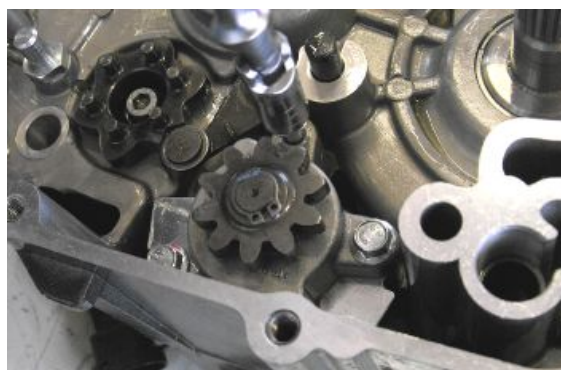

- Remove the gear spider screw, unscrewing and removing the fixing screw.



- Moving from the left side of the engine, remove the flywheel and all of its components beforehand.
- Unscrew and remove the six screws on the outside of the crankcase (1).



See also

Magneto flywheel removal

- Unscrew and remove the longest screw (2).



Engine

- Unscrew and remove the five screws (3).
- Unscrew and remove the short screw (4).



- Remove the left crankcase.



Bearing removal

- Heat the crankcase surface with a heat gun.
- Remove the bearing using the extractor.

Crankcase check

There are two classes of couplings highlighted on the crankcases (X-Y and S-T).

The coupling between the gears of the crankshaft and the first gear shaft has been classified into two classes. These classes are defined according to the interaxial distance that exists between two elements:

COUPLING CLASS INTERVALS CRANKSHAFT - FIRST GEAR SHAFT

Specification	Desc./Quantity
X	86.00 - 86.04 mm (3.386 - 3.388 in)
Y	85.96 - 86.00 mm (3.384 - 3.386 in)

Engine

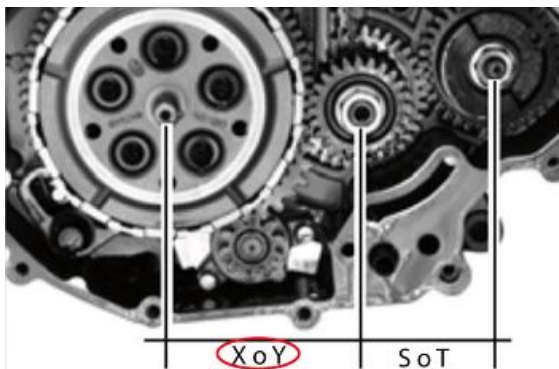

Therefore, the couplings will be:

COUPLING CLASSES CLUTCH HOUSING - FIRST GEAR SHAFT

Coupling classes on Crankcase	Clutch housing gear	Transmission gear
X	X	X
Y	Y	Y

The coupling between the gears of the first gear shaft and gear of the balancing countershaft has been classified into two classes. These classes are defined according to the interaxial distance that exists between two elements:

COUPLING CLASS INTERVALS FIRST GEAR SHAFT - BALANCING COUNTERSHAFT

Specification	Desc./Quantity
S	64.00 - 64.03 mm (2.520 - 2.521 in)
T	63.97 - 64.00 mm (2.519 - 2.520 in)

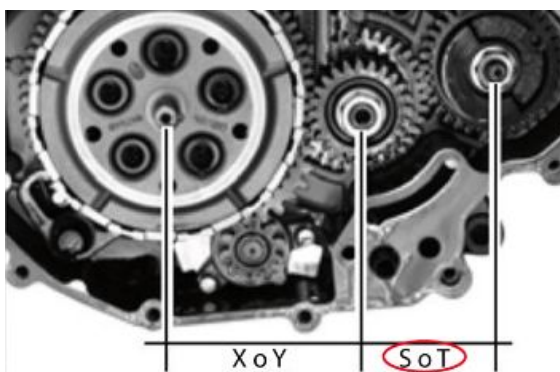

Therefore, the couplings will be:

COUPLING CLASSES FIRST GEAR SHAFT - BALANCING COUNTERSHAFT

Coupling classes on Crankcase	Transmission gear	Balancing countershaft gear
S	S	S
T	T	T

Engine

The classes of the transmission elements are also listed on the two crankcase halves.

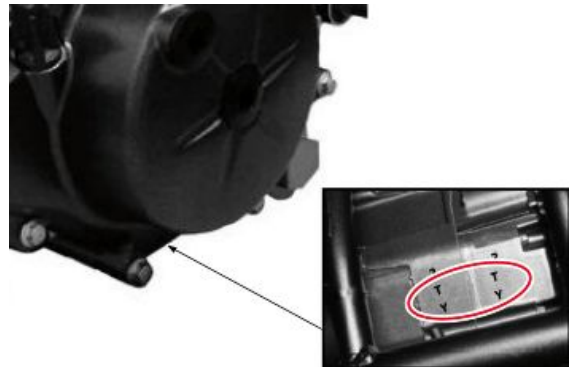

NOTE

CRANKCASE SPARE PARTS ARE ALWAYS CLASS X.

Crankshaft check

- Before checking the crankcase halves, thoroughly clean all the surfaces and the oil pipes.
- For the crankcase half on the transmission side, take particular care when handling the housing and hoses for the oil pump, the duct with the by-pass valve and the main bushings.
- As already described in the lubrication chapter, it is especially important that the by-pass valve housing shows no wear that may impair the proper sealing of the lubrication pressure adjustment ball.
- Check that the surfaces are free from dents or deformations, with special attention to both the crankcase coupling and the cylinder-crankcase surfaces.
- Defects in the crankcase coupling gasket or the surfaces indicated in the figure can cause a drop in the oil pressure and affect the lubrication pressure for the main bushings and the connecting rod.
- Check that the surfaces that limit crankshaft axial clearance show no signs of wear. To measure and check sizes follow the procedure described previously for checking crankshaft axial clearance and dimensions.

Balancing countershaft check

COUPLING CLASSES

The gears that are coupled to each other: clutch housing, first gear shaft and balancing countershaft, indicate the coupling classes; in this regard, see section "Checking the primary shaft" within the topic "Gearshift".

Bushing selection

BUSHING SEAT DIAMETER ON CRANKCASE

Specification	Desc./Quantity
Class 1	MIN 36.500 mm (1.4370 in) MAX 36.508 mm (1.4373 in)
Class 2	MIN 36.508 mm (1.4373 in) MAX 36.516 mm (1.4376 in)

CRANKSHAFT DIAMETER

Specification	Desc./Quantity
Class 1	MIN 32.480 mm (1.2787 in) MAX 32.485 mm (1.2789 in)
Class 2	MIN 32.485 mm (1.2789 in) MAX 32.490 mm (1.2791 in)

BUSHING THICKNESS

Specification	Desc./Quantity
Red	MIN 2.005 mm (0.0789 in) MAX 2.010 mm (0.0791 in)
Blue	MIN 2.010 mm (0.0791 in) MAX 2.015 mm (0.0793 in)

CRANKSHAFT COUPLING/BUSHING SEAT DIAMETER

Specification	Desc./Quantity
Crankshaft type 2	Type 1 crankcase diameter RED + RED Type 2 crankcase diameter RED + BLUE
Crankshaft type 1	Type 1 crankcase diameter RED + BLUE Type 2 crankcase diameter BLUE + BLUE

Bearing fitting

- Heat up the crankcase using the thermal gun.
- Fit the bearing in the seat with the aid of the tool.

NOTE: insertion of the roller bearing cages in line with the crankcase is recommended from the inside to the outside.

Crankcase closing

- After fitting the transmission, fit a new gasket.
- Close the two crankcases using the dowel pins.



Engine

- Position and screw the short screw (4).
- Position and screw the five screws (3).



See also

Assembling the gearbox

- Position and screw the long screw (2).
- Moving from the left side of the crankcase, position and screw the six screws (1).
- Fit the countershaft.

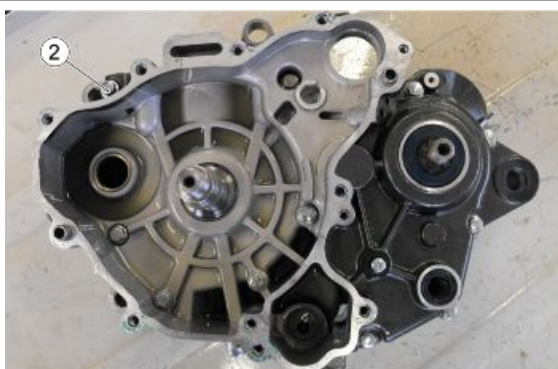

- Position the selection spider screw.
- Position and screw the screw.



See also

Balancing countershaft fitting

- Fit a new oil pump gasket.
- Fit the oil pump, screwing the three screws.

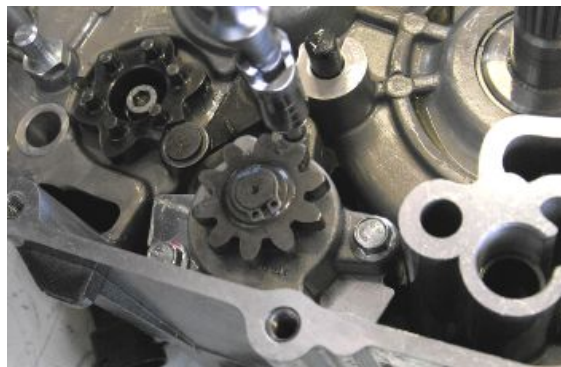

- Insert the countershaft gear and position the washer.
- Use the specific tool to tighten the nut.
- Apply the cotter to the main shaft.
- Position the base gear of the primary, aligning the two references.

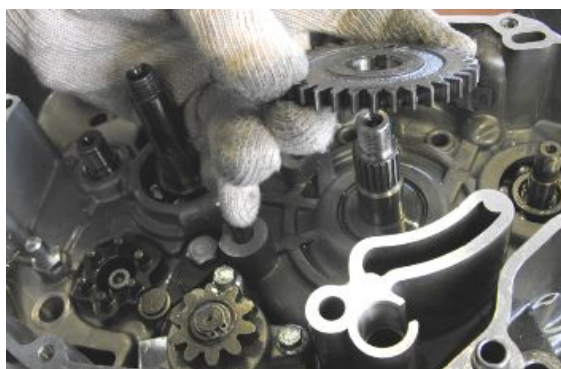
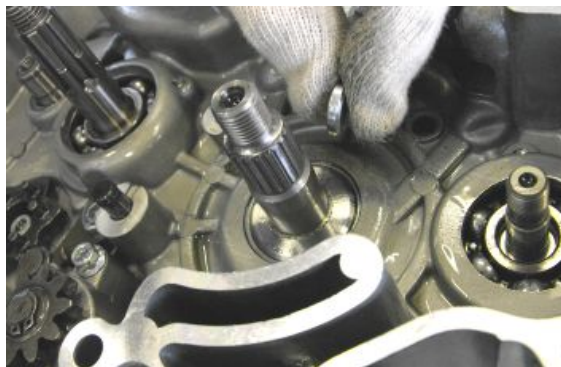
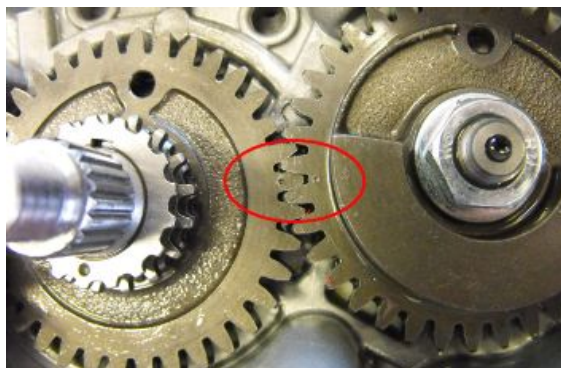

Engine

- Insert the pump drive gear.
- Insert the washer and apply the fixing seeger.



- Insert the timing chain gear, paying attention to the direction. The engraving must face upward.
- Fit the timing chain.

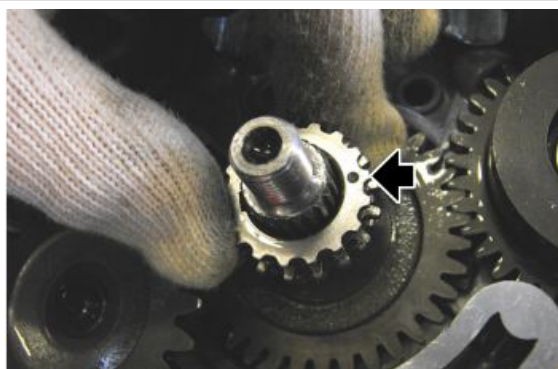

- Position the chain guide slider.
- Position and screw the fixing screw.



- Fit the rest of the primary gears.
- Tighten the fixing nut.
- Remove the countershaft locking tool.



- Fit the gear selector.



Head and timing

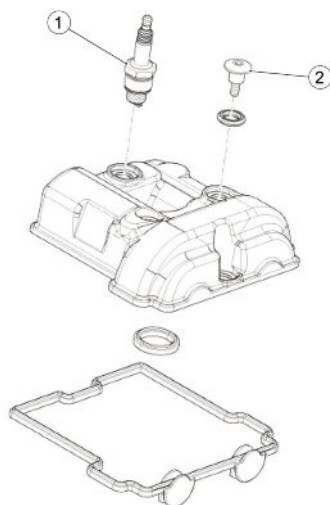

HEAD COVER

pos.	Description	Type	Quantity	Torque	Notes
1	Spark plug	M10	1	12 - 14 Nm (8.85 - 10.32 lbf ft)	-
2	Head cover fixing screw	M6	4	10 - 12 Nm (7.38 - 8.85 lbf ft)	-

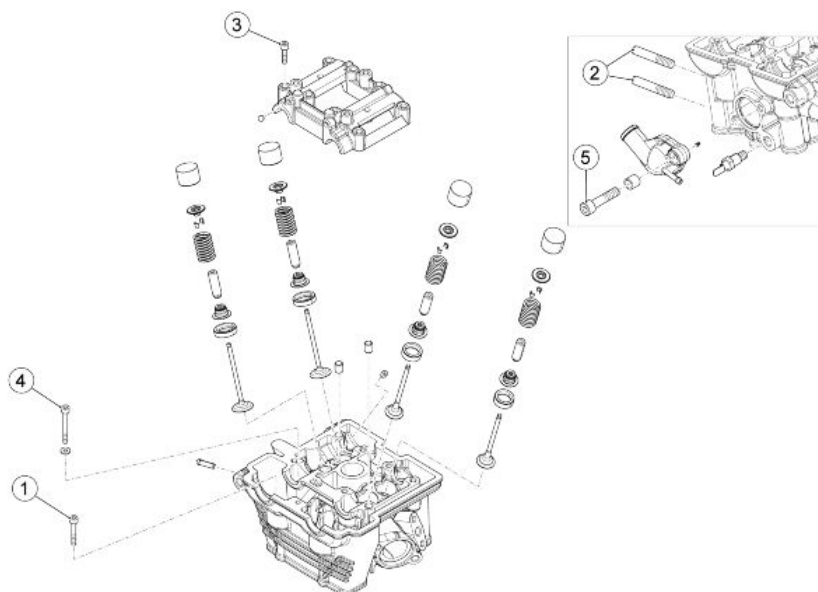

Engine

HEAD - VALVES

pos.	Description	Type	Quantity	Torque	Notes
1	Head fastener screw, chain side	M6x130	2	11 Nm (8.11 lbf ft)	-
2	Exhaust side fixing stud bolt	M8x40	2	12 Nm (8.85 lbf ft)	-
3	Camshaft support fixing screw	M6x40	8	10 Nm (7.38 lbf ft)	-
4	Head fixing screw	M8x166	4	25 Nm + 90° (18.44 lbf ft + 90°)	-
5	Thermostat cover fixing screw	M6x20	2	10 Nm (7.38 lbf ft)	-

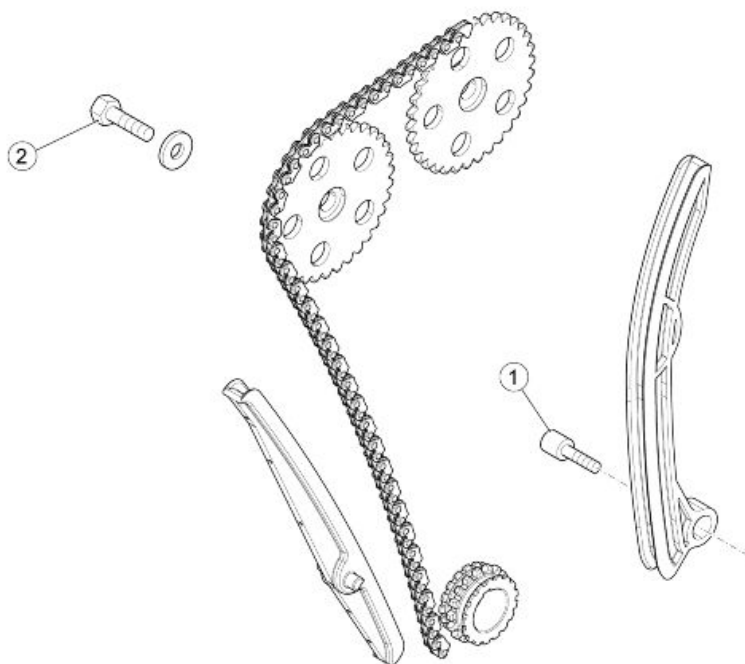

TIMING SYSTEM

pos.	Description	Type	Quantity	Torque	Notes
1	Chain tensioner slider fulcrum fixing screw	M6x16	1	10 Nm (7.38 lbf ft)	Loctite 243
2	Transmission timing gear fixing screw	M8x40	1	27 Nm (19.91 lbf ft)	Loctite 243

Removing the head cover

- Remove the adjuster screw covers (1).



- Unscrew and remove the four cylinder head screws (2).
- Remove the cylinder head (3).



- Remove the gasket (4).

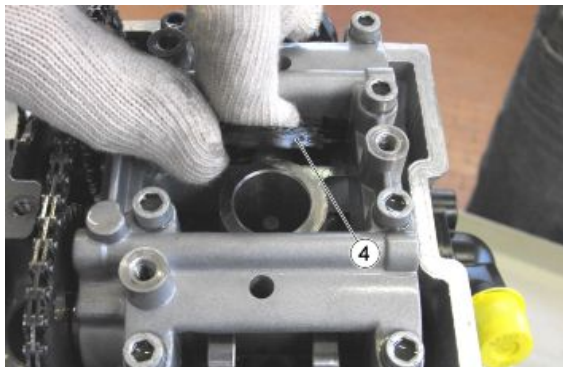

- Remove the spark plug.

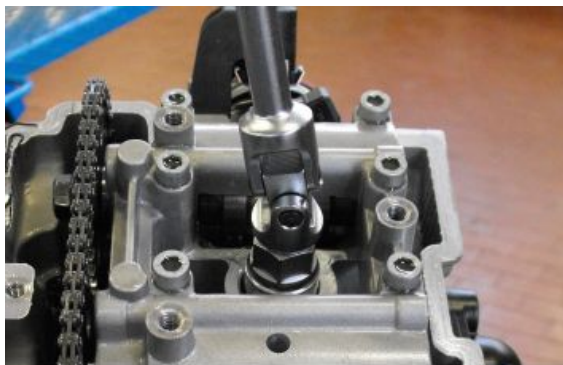

Engine

Removing the timing control

- Turn the crankshaft from the hole on the cover (1)
- Take the piston to TDC.
- The sign (2) must be aligned with the sign (3).

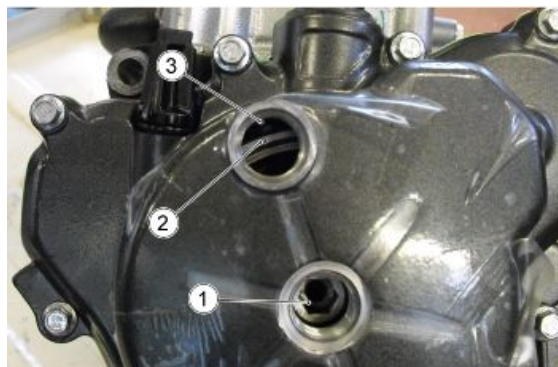

- Insert the specific pins (4) on the valves cam tower.

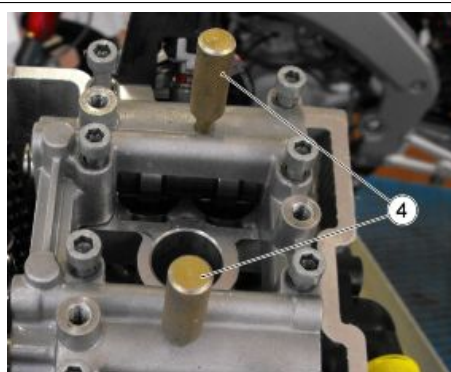

- Remove the starter motor beforehand.
- Loosen and remove the tensioner screw (5).

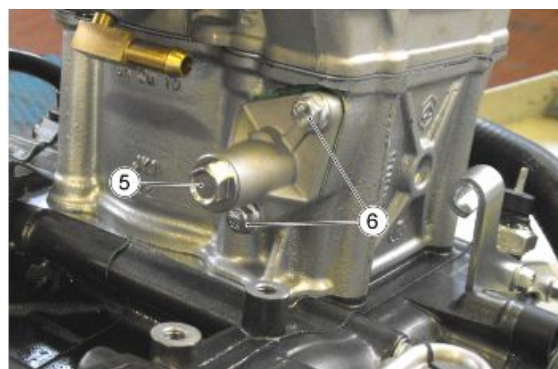

- Remove the spring.
- Unscrew and remove the two screws (6) and remove the entire tension control.



See also

Removing the starter motor

- Lock the timing gear using the tool.

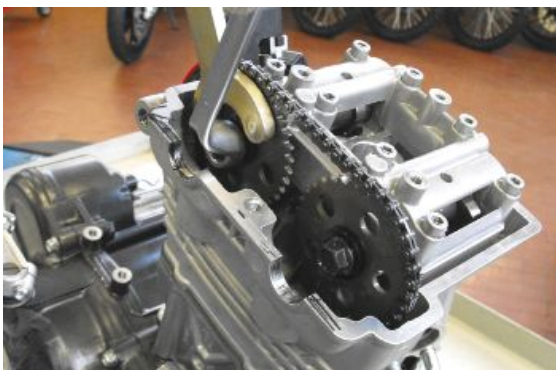

- Unscrew and remove the gear.
- Repeat the operation with the other gear.



Cylinder head

Removing the overhead camshaft

- Unscrew and remove the six screws (1) a
- Remove the cylinder head (3).

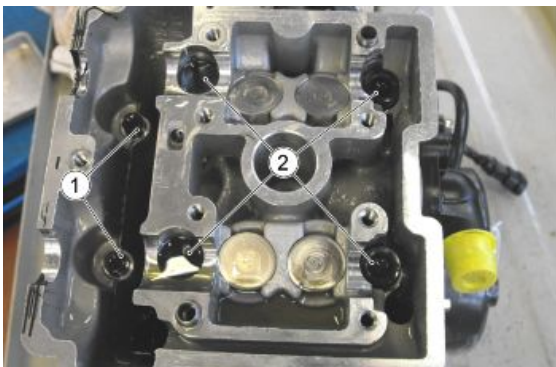

Engine

- Remove the cylinder head (3).



- Remove the two pins from the valves cam tower.
- Remove the eight screws (1).

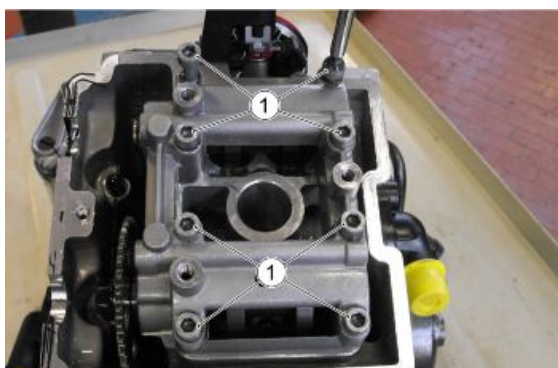

- Remove the valve cam tower (2).

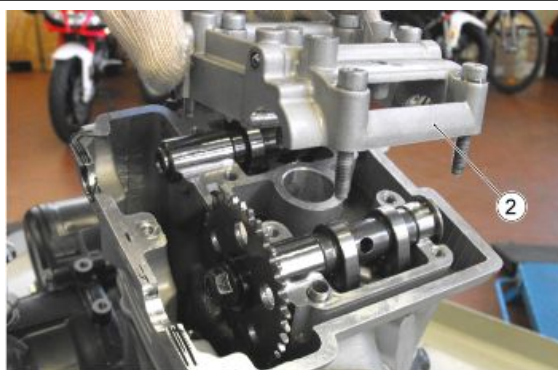

- Remove the two camshafts, intake and exhaust side.

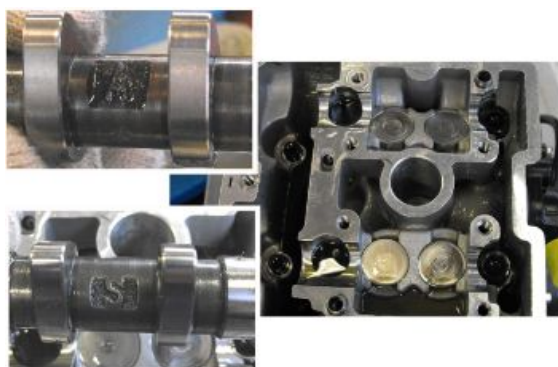

Removing the valves

- Remove the head.
- Place the head on supporting surface.
- Number the valves and their bucket tappets in order to position them correctly upon refitting.



- Remove the valve bucket tappets.



- Compress the valve spring using the tool.



- Remove both cotter pins.



Engine

- Release the valve springs.
- Remove the cap and the valve spring.

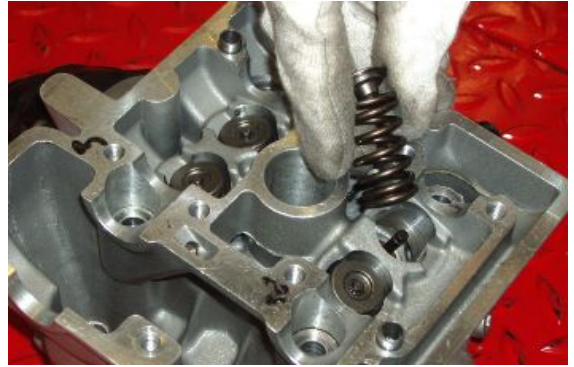

Checking the overhead camshaft

- Check the camshaft bearings for signs of abnormal wear.

Characteristic

Standard diameter - Bearing A

19.980 - 19.959 mm (0.7866 - 0.7858 in)

Minimum diameter allowed - Bearing A

19.95 mm (0.7854 in)

Inlet cam height

31.488 mm (1.23968 in)

Exhaust cam height

30.864 mm (1.21511 in)

- Check that the holes used for timing and their shoulders are not worn.
- If values measured are not within the specified limits or there are signs of wear, replace the defective components with new ones.



Characteristic

Maximum axial clearance allowed:

0.4 mm (0.0157 in)

Valve check

- Measure the width of the sealing surface on the valve seats and on the valves themselves.
- If the sealing surface on the valve is wider than the specified limit, damaged in one or more points or curved, replace the valve with a new one.

CAUTION

DO NOT CHANGE THE VALVE FITTING POSITION (RH - LH).

Characteristic

Minimum diameter allowed - Intake

3.96 mm (0.1559 in)

Minimum diameter allowed - Exhaust:

Engine

3.95 mm (0.1555 in)

Standard clearance - Intake:

0.015/0.042 mm (0.00059/ 0.0016 in)

Standard clearance - Exhaust:

0.025/0.052 mm (0.00098/ 0.00204 in)

Maximum clearance admitted - Intake:

0.060 mm (0.0023 in)

Maximum clearance admitted - Exhaust:

0.070 mm (0.0027 in)

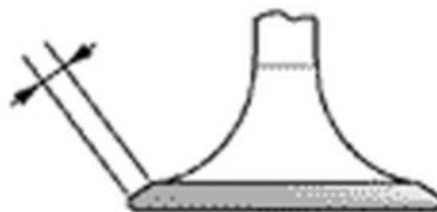
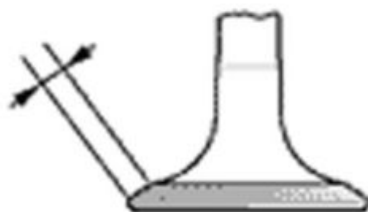

- Remove the head cover.
- Bring the engine to reach the top dead centre and lock it at that position using the tool (4).

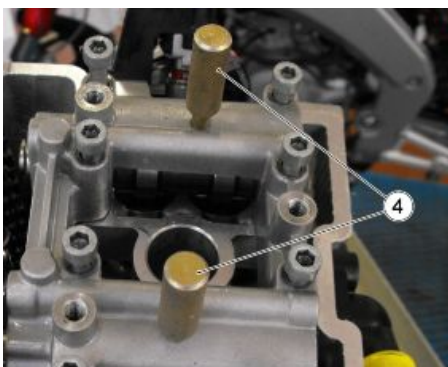

Engine

- Use a feeler gauge to check clearance on the four valves.
- If the values measured differ from the values specified, record the difference between MAXIMUM ALLOWED CLEARANCE e CLEARANCE MEASURED.

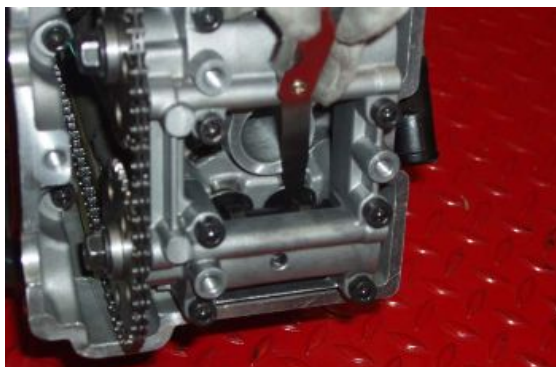

- Remove the chain tensioner.
- Undo and remove the eight screws and remove the cam tower.



- Remove the timing chain and the gears of the camshaft of the valves in question.



Engine

- Remove the bucket tappet of the valve in question and read the calibration value for that bowl, found inside the bucket tappet itself.
- Replace the bucket tappet with new one of a size suitable to restore the correct clearance.



Characteristic

Valve clearance at intake

0.15 mm (0.0059 in)

Exhaust valve clearance

0,25 mm (0.0098 in)



- Fit the camshaft, the gears and the chain in their correct positions, using the references located on the flywheel side of the crankcase.
- Fit the cam tower and tighten the eight screws to the prescribed torque.
- Fit the chain tensioner.
- Check for correct valve clearance.
- Fit the head cover.

Inspecting the valve sealings

- Fit the valves into the cylinder head
- Alternatively test the intake and exhaust valves
- This test should be carried out by filling the manifold with petrol and checking that the head does not excessively ooze through the valves.

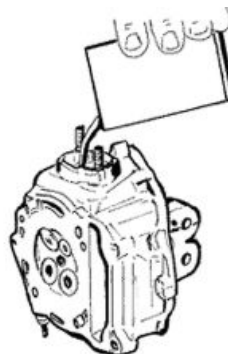

Engine

- Measure the sealing surface width on the valve seats.

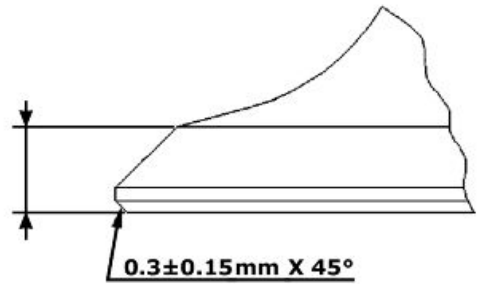

VALVE SEALING SURFACE

Specification	Desc./Quantity
Inlet valve - seal surface	2.30 +/- 0.15 mm (0.0905 +/- 0.0059 in)
Outlet valve - seal surface	2.95 +/- 0.15 mm (0.1161 +/- 0.0059 in)
Valve chamfering	0.2 +/- 0.1 mm x 45° (0.0079 +/- 0.0039 in x 45°)

Inspecting the valve housings

- Remove any carbon deposits from the valve guides.
- Measure the inside diameter of each valve guide.
- Measure according to the thrust direction at three different heights.

Characteristic

Intake guide - standard diameter

4.012 mm (0.1579 in)

Intake guide: Wear limit

4.020 mm (0.1582 in)

Discharge guide - standard diameter

4.012 mm (0.1579 in)

Discharge guide: Wear limit

4.020 mm (0.1582 in)

- Replace the head if the values corresponding to the width of the mark on the valve seat or the valve guide diameter exceed the specified limits.
- Check the width of the mark on the valve seat «V».

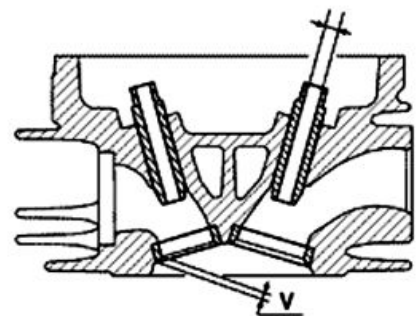

Characteristic

Wear limit for the width of the mark on the valve seat "V"

- Intake: 1.6 mm (0.0630 in)
- Outlet: 1.8 mm (0.0708 in)

Inspecting the springs and half-cones

- Check that the spring upper supporting caps and the cotters show no signs of abnormal wear.
- Check the unloaded spring length.

Characteristic

Valve spring length:

33.24 +/- 0.25 mm (1.3086 +/-0.0098 in)

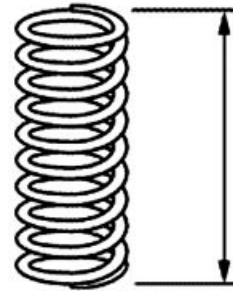

Checking the cylinder head

- Using a trued bar, check that the head surface is not worn or distorted.
- Check that the camshaft bushings are not worn.
- Check that the head cover surface, the intake manifold and the exhaust manifold are not worn.

Installing the valves

- Lubricate the valve guides with engine oil.
- Position the two oil seals on the cylinder head.

- Fit the valves, the springs and the caps. Use the specific tool, compress the springs and fit the cotters in their seats.



Engine

Checking the chain tensioner

CHAIN TENSIONER

- Remove the central screw with the washer and the tensioner spring. Check that the one-way mechanism is not worn.
- Check the condition of the tensioner spring.
- If signs of wear are found, replace the whole assembly.



Checking the chain

- Check that the guide slider and the tensioner pad are not excessively worn.
- Check that the chain assembly, the camshaft driving pulleys and the sprocket wheel are not worn.
- Replace the parts if signs of wear are found.



Cylinder-piston assembly

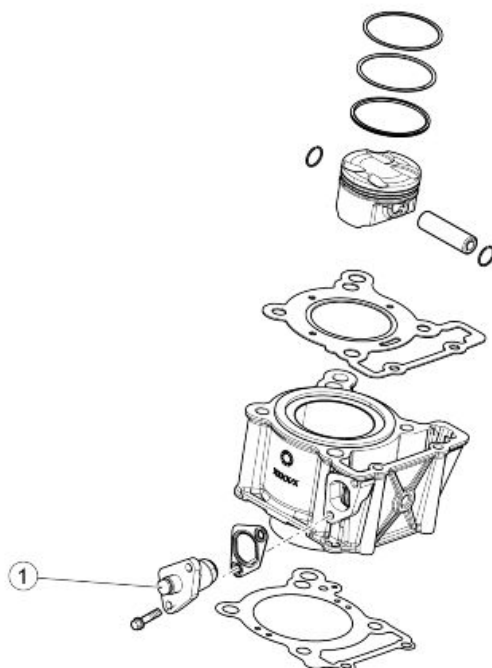

CYLINDER - PISTON

pos.	Description	Type	Quantity	Torque	Notes
1	Chain tensioner screw	M8	1	6 Nm (4.43 lbf ft)	-

Removing the cylinder

CYLINDER REMOVAL

- Remove the cylinder head gasket (1).



- Remove the guide slider (2).

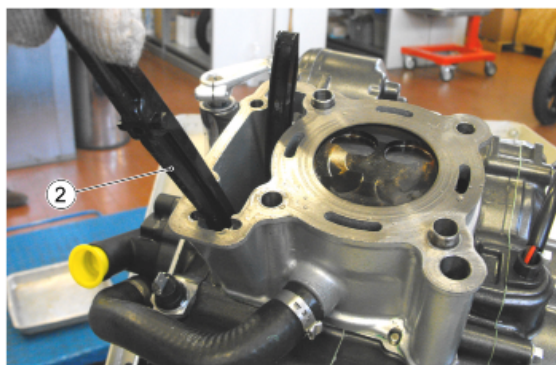

- Remove the water sleeve clamp (3).

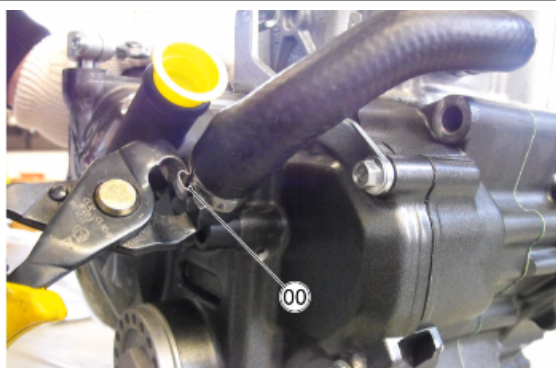

Engine

- Remove the cylinder (4).
- Remove the gasket (5).



Disassembling the piston

- Apply the tool under the piston (1).
- Cover the base of the cylinder with a cloth.

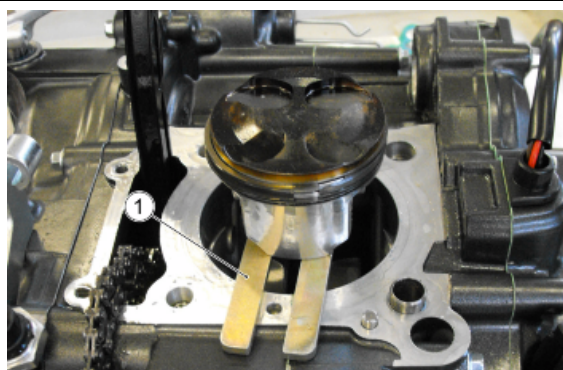

- Remove the retainer ring which locks the pin (2).



- Remove the pin (3).
- Remove the piston (4).



Checking the piston

- Measure the pin seat diameter on the piston.
- Calculate the pin - piston coupling clearance.

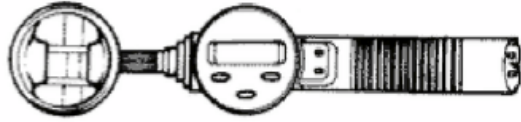

- Measure the piston outside diameter, perpendicular to the pin axis.
- Take the measurement at 6 mm (0.24 in) from the base, at the position shown in the figure.

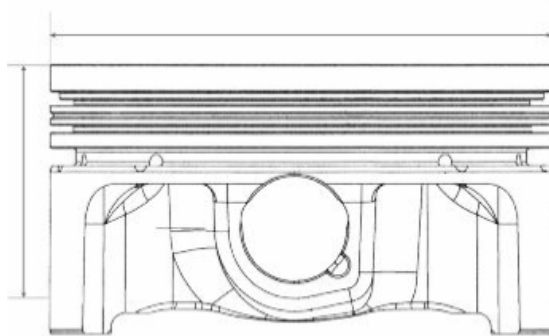

- Carefully clean the sealing rings housings.
- Measure the sealing rings - grooves coupling clearance using suitable sensors, as shown in the diagram
- If clearances measured exceed the limits specified in the table, the piston should be replaced by a new one.



NOTE

MEASURE CLEARANCE BY INSERTING THE BLADE OF THE FEELER GAUGE FROM THE 2nd SEALING RING SIDE.

Characteristic

Piston / cylinder

Piston pin hole - standard: 15.003 - 15.008 mm
(0.5907 - 0.5908 in)

Maximum piston / cylinder coupling clearance after use

- top ring: 0.075 mm (0.0029 in)
- middle ring: 0.065 mm (0.0025 in)
- oil scraper: 0.25 mm (0.0098 in)

Standard piston / cylinder coupling clearance

Engine

- top ring: +0.03 / 0.062 mm (0.0012 / 0.0024 in)
- middle ring: +0.02 / 0.052 mm (0.0008 / 0.0020 in)
- oil scraper: +0.01 / 0.19 mm (0.0004 / 0.007480 in)

cylinder check

- Using a bore meter, measure the cylinder inside diameter at three different points according to the directions shown in the figure.
- Check that the coupling surface with the head is not worn or misshapen.



CAUTION

THE MARKING IS LOCATED ON THE PISTON CROWN.

Characteristic

Maximum run-out allowed:

0.05 mm

CYLINDER - PISTON COUPLING CLEARANCE 125 CM³

Coupling categories with cast-iron cylinder

NAME	ABBREVIATION	CYLINDER		PISTON		FITTING CLEARANCE	
		min	max	min	max	min	max
Cylinder/Piston	M	58.010	58.017	57.963	57.970	0.040	0.054
Cylinder/Piston	N	58.017	58.024	57.970	57.977	0.040	0.054
Cylinder/Piston	O	58.024	58.031	57.977	57.984	0.040	0.054
Cylinder/Piston	P	58.031	58.038	57.984	57.991	0.040	0.054

Inspecting the wrist pin

- Check the pin outside diameter.

Characteristic

Pin

Minimum diameter: 14.995 mm (0.590 in)

Standard diameter: 15.0000 +0/-0.0030 mm (0.00012 in)

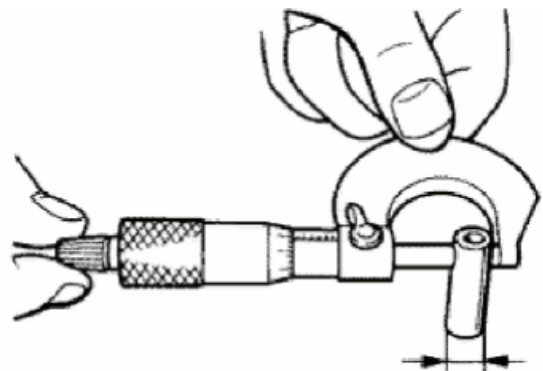

Inspecting the piston rings

ANELLI DI TENUTA

Specification	Desc./Quantity
Compression ring (top)	0.2 / 0.35 mm (0.0079 / 0.014 in)
Compression ring (middle)	0.2 / 0.35 mm (0.0079 / 0.014 in)

Engine

Specification	Desc./Quantity
Oil scraper ring	0.2 / 0.7 mm (0.0079 / 0.027 in)
Top ring maximum value	0.45 mm (0.18 in)
Middle ring maximum value	0.45 mm (0.18 in)

Checking the connecting rod small end

- Measure the inside diameter of the connecting rod small end using a specific micrometer.

NOTE

IF THE CONNECTING ROD SMALL END DIAMETER EXCEEDS THE MAXIMUM DIAMETER ALLOWED, SHOWS SIGNS OF WEAR OR OVERHEATING, REPLACE THE CRANKSHAFT AS DESCRIBED IN THE "CRANKCASE AND CRANKSHAFT" CHAPTER.

Characteristic

Rod small end

Maximum diameter: 15.023 mm (0.591 in)

Standard diameter: 15.010 - 15.018 mm (0.5910 - 0.5912 in)

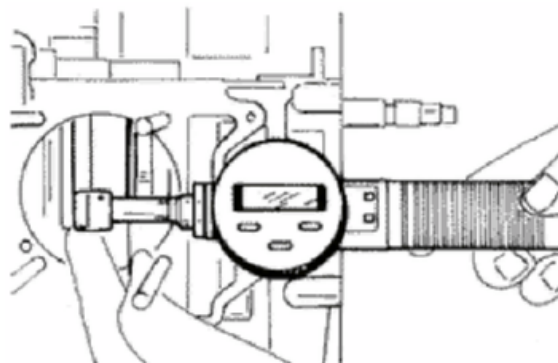

Fitting the piston

- Install piston and pin onto the connecting rod, aligning the piston arrow the arrow facing towards the exhaust.



- Fit the retainer ring.



Engine

- Temporarily install the cylinder on the piston, without the gasket of the cylinder's base.
- Fit a dial gauge on the specific tool.
- Take the piston to TDC.
- Position the dial gauge on one side of the cylinder and fasten it in order to detect the zero position correctly.



- Move the dial gauge diagonally and measure the piston protrusion in relation to the reference surface.
- Calculate the necessary thickness of the gasket, selecting it based on the values shown in the table below.

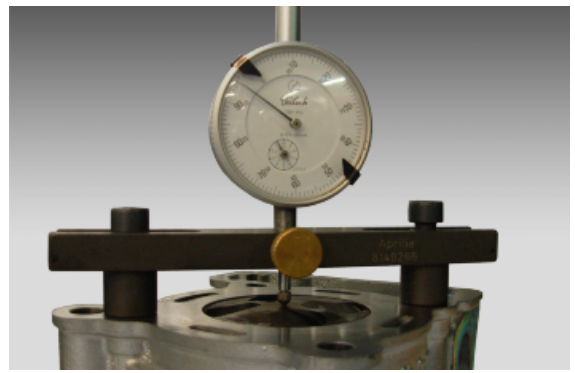

Installing the cylinder

- Fit a new cylinder base gasket of the chosen thickness.
- Refit the cylinder as indicated in the figure using the specific clamp tighten-er tool.

NOTE

BEFORE FITTING THE CYLINDER, CAREFULLY BLOW AIR INTO THE LUBRICATION DUCT AND LUBRICATE THE CYLINDER LINER.

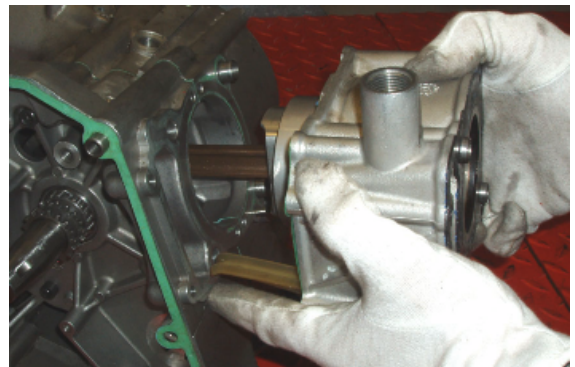

Engine

- Fit a new gasket between the cylinder and the head.
- Place the two dowels.
- Install the head.

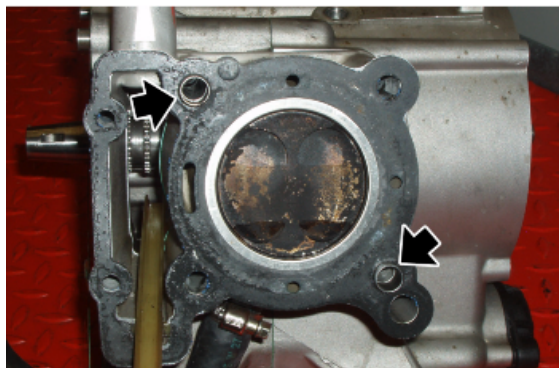

Selecting the base gasket

BASE GASKET SELECTION

Specification	Desc./Quantity
Size measured: 0.95 / 1.09 mm (0.037 - 0.042 in)	Gasket 0.3+/-0.05 mm (0.012+/-0.001 in)
Size measured: 1.1 / 1.25 mm (0.043 - 0.049 in)	Gasket 0.4+/-0.05 mm (0.015+/-0.001 in)
Size measured: 1.26 / 1.45 mm (0.049 - 0.057 in)	Gasket 0.5+/-0.05 mm (0.019+/-0.001 in)

Installing the cylinder head

- Fit the chain guide slider onto the cylinder.
- Fit the head gasket and the alignment dowels
- Fit the head.



- Screw but do not tighten both central long screws (3) and position the washers.
- Screw but do not tighten both central long screws (2) and position the washers.
- Screw but do not tighten the two side short screws (1).

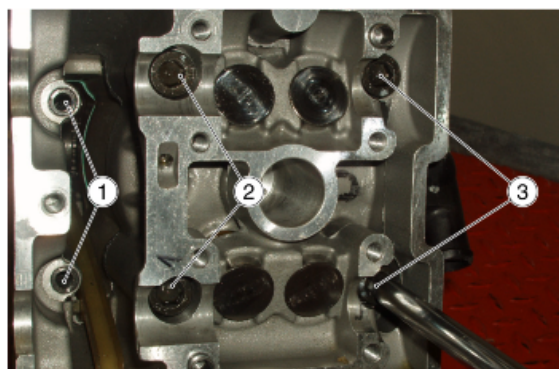

NOTE

BEFORE INSTALLING THE HEAD, MAKE SURE THAT THE LUBRICATION CHANNEL IS GENERALLY CLEAN AND USE A JET OF COMPRESSED AIR FOR CLEANING.

- Tighten the four central screws (2 - 3) crosswise.
- Lastly, tighten the two side screws (1).

Engine

- Insert the timing control chain on the crankshaft.
- Insert the chain tensioner pad of the head and lock it with the fixing screw.



- Insert the camshafts in their seats on the head, remember to position the camshaft marked with the letter (A) on the intake side and the camshaft marked with the letter (S) on the exhaust side.



WARNING

POSITION THE CAMS OF BOTH SHAFTS FACING OUTWARDS.

- Position the cam tower cap.
- Screw but do not and tighten the eight screws.

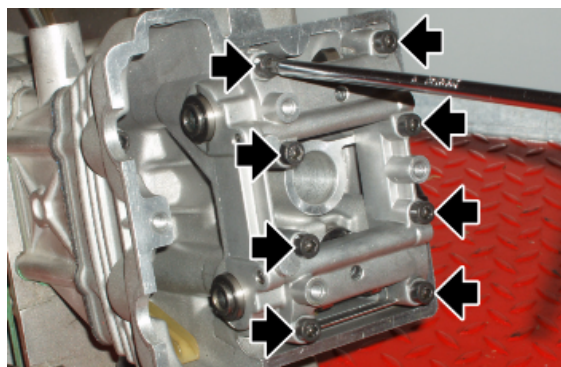

- Place the pins in their positions on the overhead camshafts.

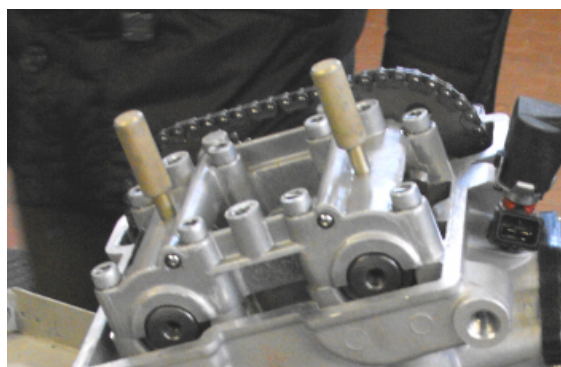

Engine

- Place the camshaft gears on the chain, be careful not to invert the original direction of rotation.
- Keep the camshafts locked with the pins and screw but do not tighten the screws fixing the gears using Loctite 243.



- Fit the chain tensioner on the cylinder using a new gasket, and tighten the two screws (1) to the prescribed torque.
- Insert the spring with the central screw (2) and o-ring, and tighten the cap the prescribed torque.

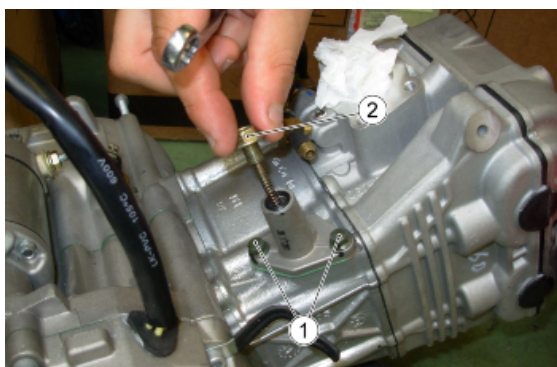

- Tighten the screws fixing the camshaft gears to the prescribed torque.
- Remove the pins on the camshafts.
- Remove the specific crankshaft locking tool.
- Tighten the screw on the crankcase.
- Check the valve clearance and adjust it if required.
- Refit the tappet cover.

Engine

Lubrication

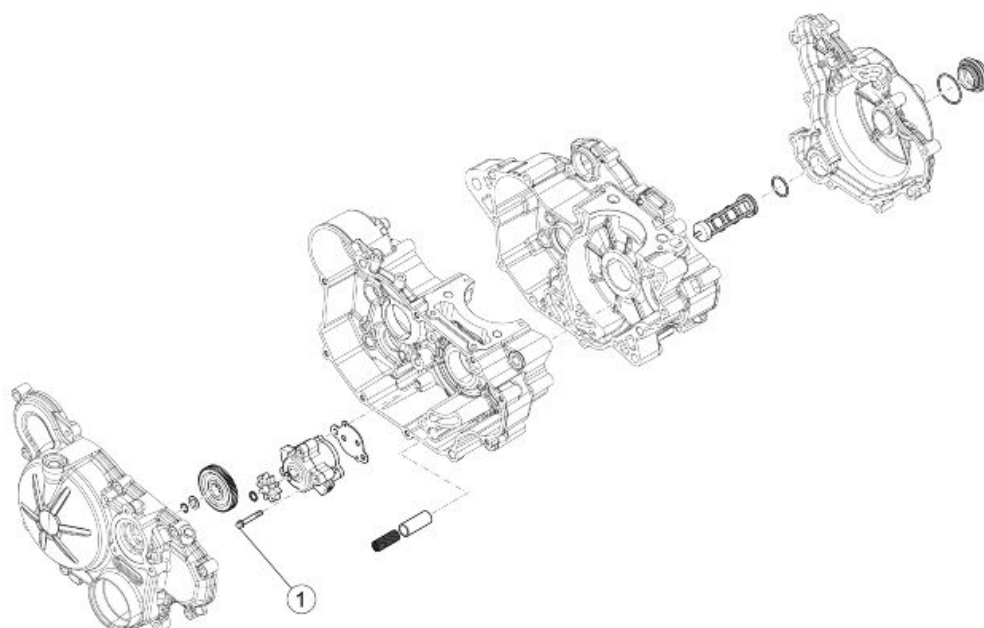

OIL PUMP

pos.	Description	Type	Quantity	Torque	Notes
1	Oil pump fixing screw	M6x25	3	10 Nm (7.38 lbf ft)	Loctite 243

Conceptual diagrams

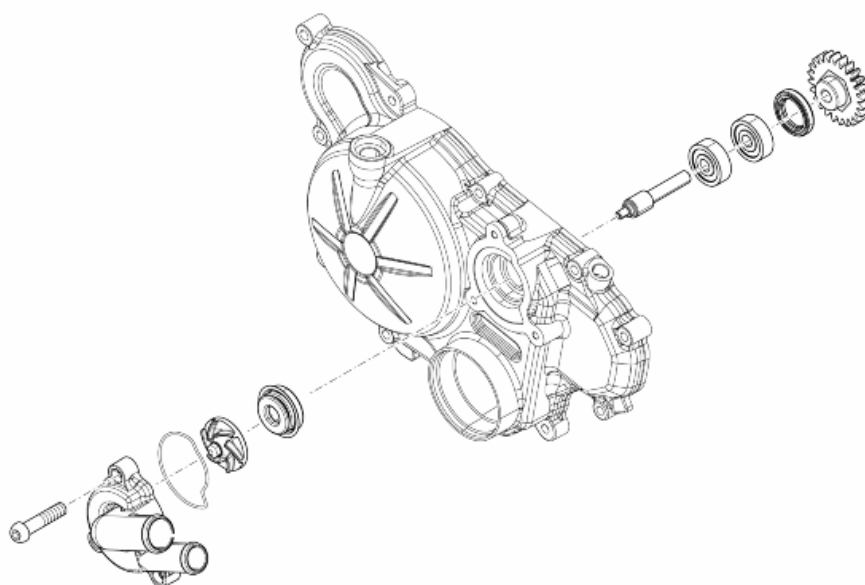

Removing

- Remove the Seeger ring.

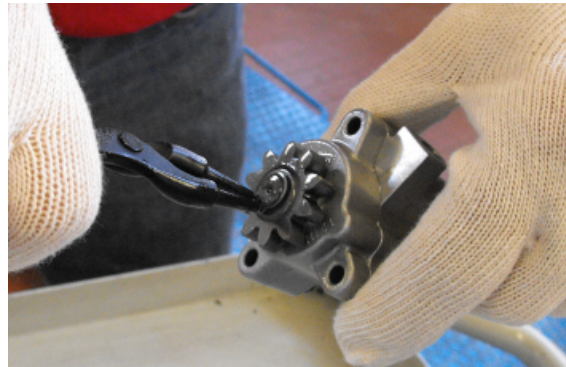

- Remove the pump gear.



- Remove the pump gear.

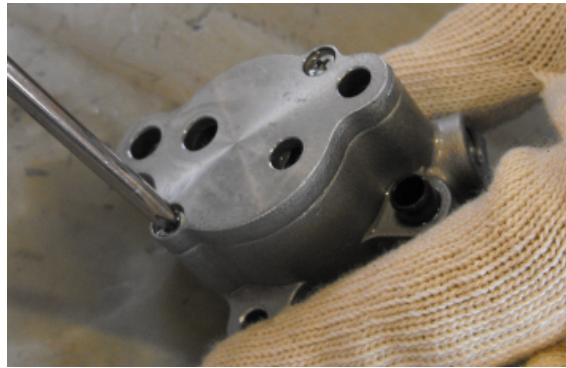

- Separate the components to inspect them.

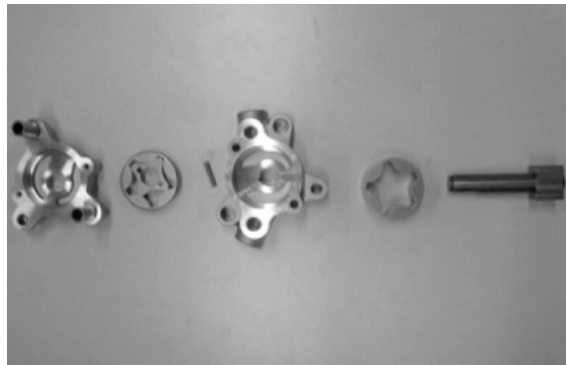

Engine

Inspection

- Measure distance between rotors with a feeler gauge at the positions shown in the picture.

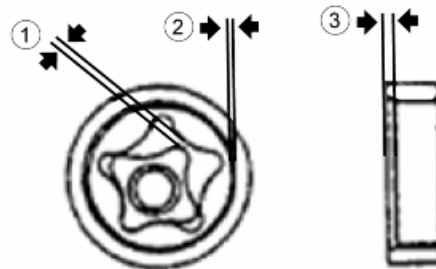

Characteristic

Oil intake rotor

Thickness: 13.5 mm (0.53 in)

Oil supply rotor

Thickness: 8.5 mm (0.33 in)

Standard values

Radial clearance (1) between points of the rotor:

0.04 mm (0.0015 in)

Radial clearance (2) between points of the rotor: 0.08 mm (0.003 in)

Radial clearance (3) between rotor 1 and the pump body: 0.04 mm (0.0015 in)

Radial clearance (3) between rotor 2 and the pump body: 0.05 mm (0.0019 in)

Installing

- Refit the oil pump proceeding in reverse order of disassembly. Pay attention to the direction of the rotor, the dot should stay on the opposite part of the resting face.

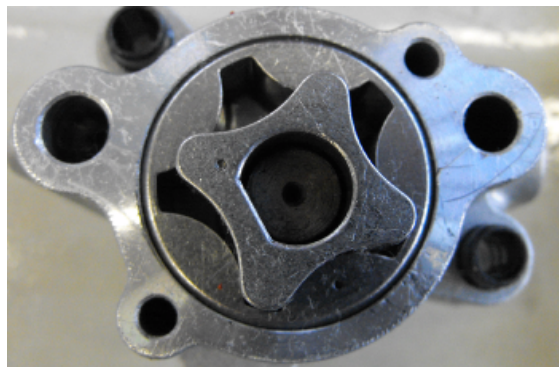



RIEJU

Telf. +34 / 972500850 Fax +34 / 972506950

RIEJU, S.A. c/.Borrassà, 41

E-17600 FIGUERES, GIRONA (SPAIN)

www.riejumoto.com / e-mail rieju@riejumoto.com