

OWNER'S MANUAL

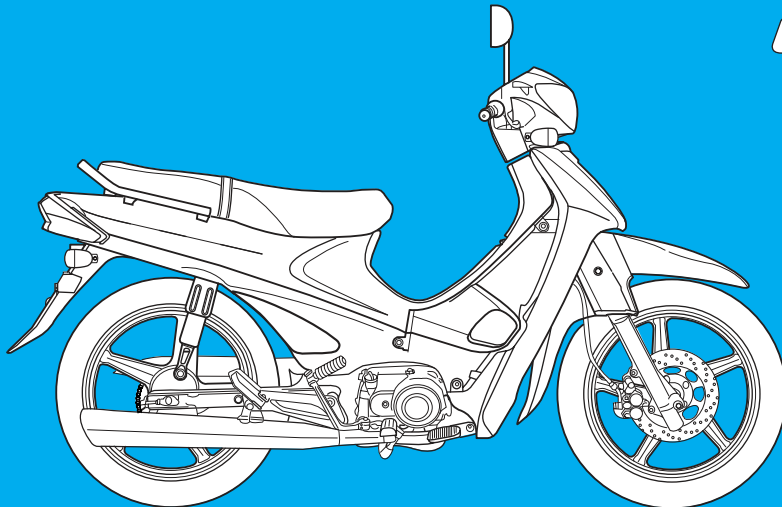

Citi **Ace** ¹¹⁰

IMPORTANT NOTICE

● OPERATOR AND PASSENGER

This vehicle is designed to carry the operator and one passenger.

● ON-ROAD USE

This vehicle is designed to be used only on the road.

● READ THIS OWNER'S MANUAL CAREFULLY

Pay special attention to statements preceded by the following words:

▲ WARNING

Indicates a strong possibility of severe personal injury or death if instructions are not followed.

▲ CAUTION

Indicates a possibility of personal injury or equipment damage if instructions are not followed.

▲ NOTE

Gives helpful information.

This manual should be considered a permanent part of the motorcycle and should remain with the vehicle when resold or otherwise transferred to a new owner or operator.

CONTENTS

SPECIFICATION	3	HORN BUTTON	15
OPERATION INSTRUCTION	4	EQUIPMENT USAGE	16
SAFETY PRECAUTIONS	4	STEERING WHEEL LOCK	16
PRIOR TO STARTING VEHICLE	5	REAR CUSHION ADJUSTMENT	16
CORRECT ATTIRE	5	SELF INSPECTIONS BEFORE OPERATION	17
OPERATION	6	BRAKES	17
CARGO	7	FUEL	20
MODIFICATION	8	TIRES	21
ATTACHMENT	8	ENGINE OIL LEVEL CHECK	22
MUFFLER	8	LIGHTS AND WINKER	22
PARTS LOCATION	9	BACK MIRROR	23
METER READING AND USAGE	12	LICENSE PLATE	23
METER	12	OPERATION	23
FUEL GAUGE	12	PRE-RIDE INSPECTION	23
INDICATOR LAMPS	12	STARTING THE ENGINE	24
SWITCH OPERATION	13	IF ENGINE CANNOT BE STARTED	25
MAIN SWITCH	13	RUNNING-IN	25
STARTER BUTTON	14	RIDING	26
HEADLIGHT AND POSITION LAMP	14	BRAKING	27
WINKER SWITCH	15	PARKING	27

MAINTENANCE	28	SAFE DRIVING	47
MAINTENANCE SCHEDULE	29	PREPARATION BEFORE DRIVING	47
TOOL KIT	31	DRIVING METHOD	48
FRAME AND ENGINE NUMBERS	31	DRIVING POSITION	48
MAINTENANCE PRECAUTIONS	32	PRECAUTION WHEN DRIVING	49
THROTTLE GRIP	32	STARTING	50
AIR CLEANER ELEMENT	33	TURNING METHOD	51
CHANGINE ENGINE OIL	34	PRINCIPLE OF TURN	51
SPARK PLUG	35	EFFECT OF SPEED	51
IDLE SPEED ADJUSTMENT	36	3 POSITIONS OF TURNING	52
CLUTCH ADJUSTMENT	36	TURNING METHOD	53
DRIVE CHAIN	37	PRECAUTION WHEN TURNING	54
WHEEL REMOVAL	39	BRAKING METHOD	55
SIDE STAND	40	BASIC PRINCIPLE OF BRAKE(FRICTION FORCE)	55
BATTERY	41	RESTRAINT OF BRAKING EFFECT (INERTIA)	55
FUSE REPLACEMENT	42	BRAKING METHOD	56
BULB REPLACEMENT	43	COMPARISION OF BRAKING DISTANCE	56
CABLE RUBBER PART	45	IMPACT WHEN COLLISION	56
NOTABLES FOR CAR WASHING	45	WIRING DIAGRAM	57
STORAGE GUIDE	46		

SPECIFICATION

ITEM	DATA	ITEM	DATA
LENGTH × WIDTH × HEIGHT(mm)	1,910 × 700 × 1,080	TIRE SIZE	FR. 2.75-16-4PR
WHEEL BASE(mm)	1,220		RR. 3.00-16-4PR
GROUND CLEARANCE(mm)	125	SUSPENSION	FR. TELESCOPIC
SEAT HEIGHT(mm)	765		RR. SWING ARM
DRY WEIGHT(kgf)	96	BRAKE	FR. HYDRAULIC DISK
PASSENGER	2		RR. DRUM BRAKE
ENGINE TYPE	AIR COOLED 4 STROKE	SPARK PLUG	C7HSA(NGK)
PISTON DISPLACEMENT(cc)	108.9	FUSE(A)	7
BORE AND STROKE(mm)	50 × 55.5	HEADLIGHT BULB	12V 35W/35W
STARTING SYSTEM	START MOTOR / KICK	STOP/TAIL LIGHT BULB	12V 21/5W
TRANSMISSION TYPE	4 STEPS ROTARY	WINKER BULB	12V 10W × 4
IGNITION SYSTEM	C.D.I	SPEEDOMETER LAMP	12V 1.7W
BATTERY CAPACITY	12V 8AH(MF TYPE)	WINKER INDICATOR LAMP	12V 3.4W × 2
FUEL CAPACITY(l)	4.0		

OPERATION INSTRUCTION

This manual describes matters pertaining to correct operation, safe operation and simple maintenance of the vehicle you purchased.

To ensure more comfortable and safer operation, make sure to read this manual carefully prior to operation.

- The photographs and drawings shown in this manual may differ from those of actual vehicles due to changes in vehicle specifications and modifications made.
- This vehicle is designed for 2 riders including the operator.

⚠ CAUTION

- Do not use polluted gasoline.
Using polluted gasoline will cause rust inside the fuel tank, and will close the supply of fuel to the carburetor, leading to an improper engine starting or may cause serious damage to an engine.
- Do not use polluted or low-grade oil.
Always use genuine oil to protect and extend motorcycle performance and its life span.
- If any failure occurs due to the use of polluted gasoline or oil, such failure will be excluded from being eligible for repairs under the warranty.

SAFETY PRECAUTIONS

- Careful driving and the wearing of proper attire and safety equipment are the most important factors in the safe operation of the vehicle. Please obey traffic regulations and do not be hurried and careless.
- Many new vehicle owners operate their newly purchased vehicles with great care and attention to safety factors. However, after becoming accustomed to the operations are often discarded, which can lead to accidents. Please don't let this happen to you and always approach the operation of your vehicle with the safety considerations needed.
When operating the vehicle, always keep in mind and obey the notes of precaution printed on the "Safety Precaution Label" attached to the vehicle.

- Always wear helmet.
- Always put on gloves.
- Observe posted speed limits.
- Park vehicle away from people (especially children) as the muffler can get very hot.
- For safety, do not illegally modify the vehicle.
- Regularly conduct specified maintenance inspections. <Maintenance Inspection Points>
Brakes, Tires, Oil, Lights, Horn, Instruments

PRIOR TO STARTING VEHICLE

- Read user's manual carefully.
- Conduct maintenance checks prior to operation.
- Always maintain vehicle in clean status and carry out specified maintenance checks.
- Make sure to stop engine and stay away from fire when fueling.
- Exhaust gas contains harmful substance such as carbon monoxide. Start engine in well-ventilated places.



CORRECT ATTIRE

- Always make sure to wear helmet for safety. Wear gloves and safety goggles.
- Do not wear uniforms which might hinder operation. It is dangerous if the uniform is caught by brake lever or by the rotating part of drive chain.
- Do not wear slippers which might obstruct brake operation or transmission gear operation.
- Many automobile/motorcycle accidents happen because the automobile driver does not “see” the motorcyclist. Make yourself conspicuous to help avoid the accident that wasn't your fault :
 - Wear bright or reflective clothing.
 - Don't ride in another motorist's “blind spot”.

⚠ WARNING

- Not wearing a helmet increases the chance of serious injury or death in a crash.
- Be sure you and your passenger always wear a helmet, eye protection and other protective apparel when you ride.

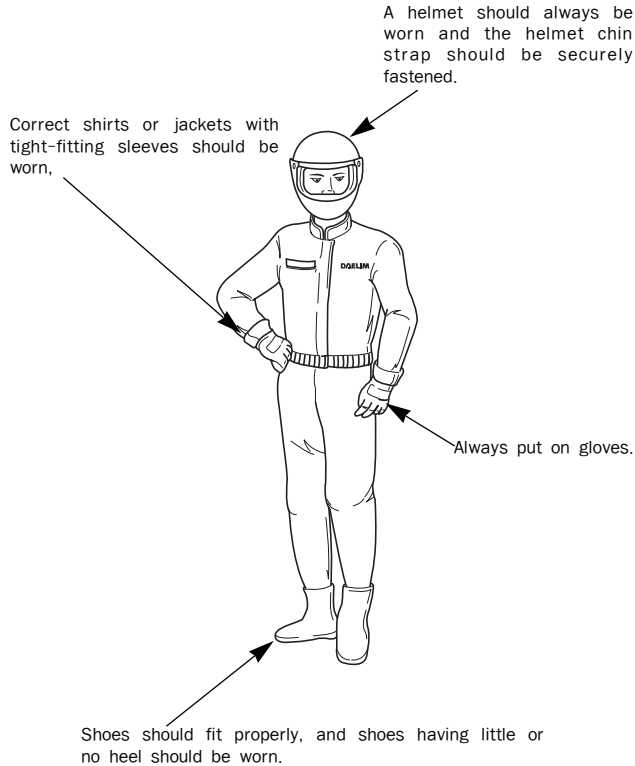

OPERATION

- Operators should naturally fix bodies to keep smooth driving.
- Please check whether or not you are unnaturally strained and strung up.
- Driving pose has a great influence on safe operation. Please always maintain the center of your body in the middle of seat. Especially do not sit at the rear seat because it may lessen the weight of front wheel and cause trembling steering wheel.
- A passenger should hold on to the vehicle or the operator with both hands and keep both feet on the pillion step bar.
- When wanting to turn, slightly lean to body toward the direction of the turn. It is unsafe if the body is not moved in union with the vehicle.
- Curvy roads and poor, unpaved roads constantly change in surface quality. Driving on these roads can be unsafe if certain safety precautions are not followed.
- In order to safely drive through these driving conditions, anticipate coming road conditions, slow down to at least half the normal speed, and relax your shoulders and wrists while securely holding the handles.
- Driving with one or both hands not holding the handles or the front wheel lifted can cause severe injury or death of the driver resulted from the turnover of the vehicle.

CARGO

- When carrying cargo, you must keep in mind that operating the motorcycle, especially when turning, will be different.
- Make sure not to overload the vehicle with goods as this can make the vehicle unstable during operation.

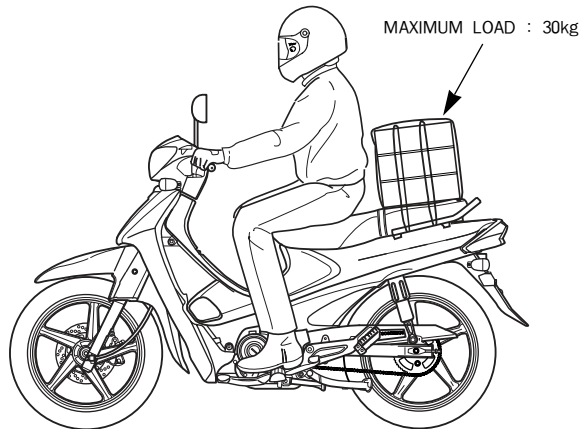

⚠ WARNING

- Overloading or improper loading can cause a crash and you can be seriously hurt or killed.
- Follow all load limits in this manual.

⚠ CAUTION

- Only load cargo in or on designated areas as placing or fastening cargo to other areas can cause damage to the vehicle.
- Do not place articles between the frame body cover and engine as this can burn the goods.
- Do not attach large or heavy items (such as a sleeping bag or tent) to the handle bars or fork. Unstable handling or slow steering response may result.

MODIFICATION

- Modification of vehicle structure or function deteriorates manipulability or causes exhaust noise to become louder shortening the vehicle life. These modifications are not only prohibited by law but also are the acts harmful to other people. Modifications are not covered by warranty.

ATTACHMENT

- Except designated attachment by DAELIM MOTOR CO., LTD., don't attach any extra lighting device, because it may cause an early discharging of battery.
- Carefully inspect the accessory to make sure it does not obscure any lights, reduce ground clearance and banking angle, or limit suspension travel, steering travel or control operation.
- Do not add electrical equipment that will exceed the motorcycle's electrical system capacity. A blown fuse could cause a dangerous loss of lights or engine power.
- This vehicle was not designed to pull a sidecar or trailer. Handling may be seriously impaired if so equipped.

MUFFLER

- Pay particular attention to fellow passenger so that he/she can prevent getting burnt by the hot muffler during travel.

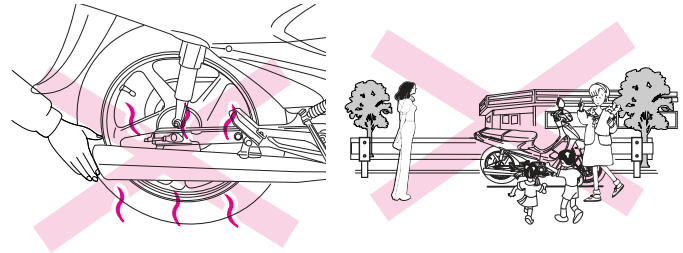

CAUTION

- Do not park in the place where many pedestrians are passing through. Pedestrians or children can be burned by contacting with the muffler.
- Fellow passenger care must pay enough attention not to be burn by contacting with the muffler.
- If haystack or vinyl is stuck to the muffler, fire can be occurred.

PARTS LOCATION

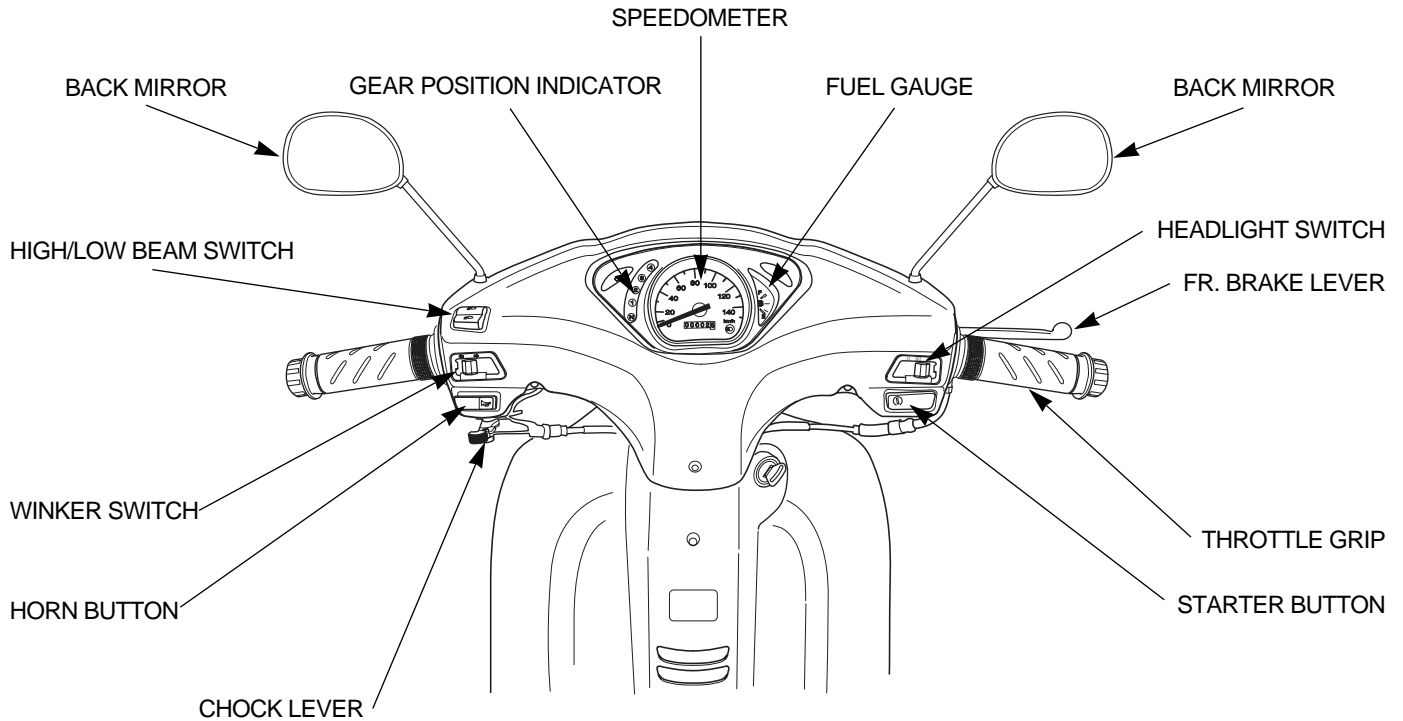

PARTS LOCATION

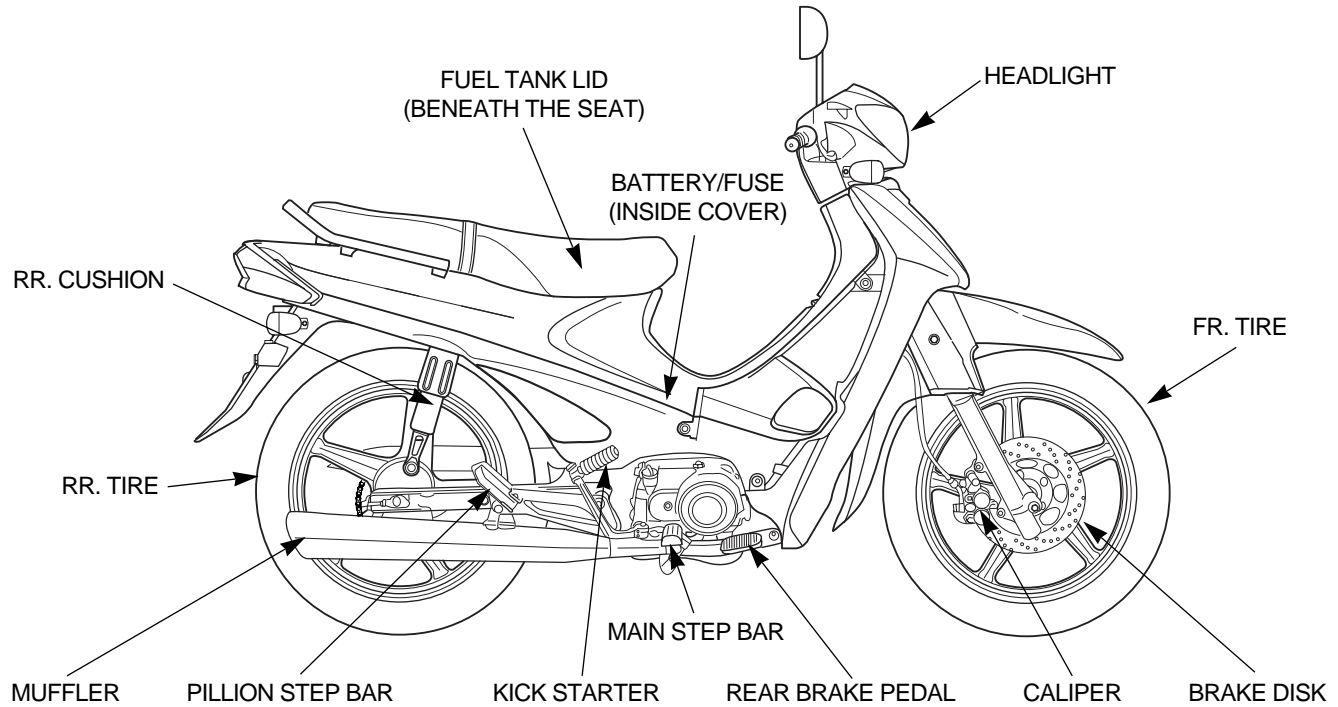

PARTS LOCATION

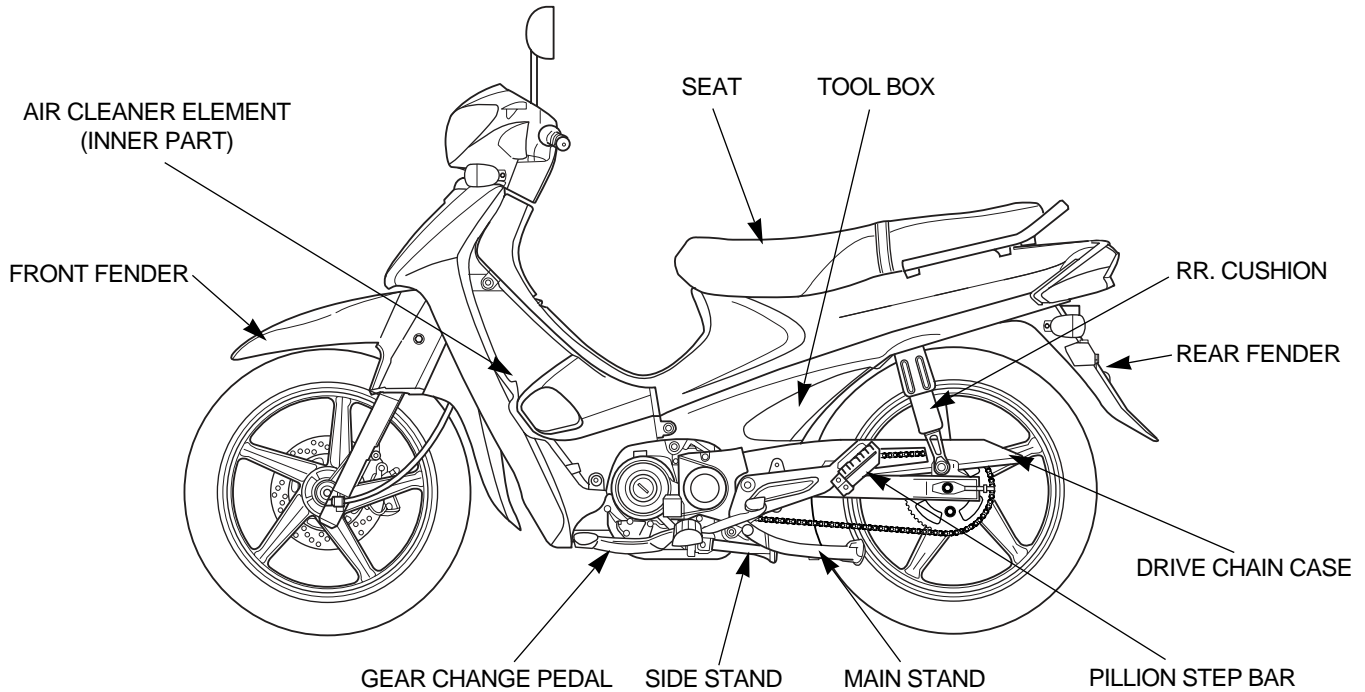

METER READING AND USAGE

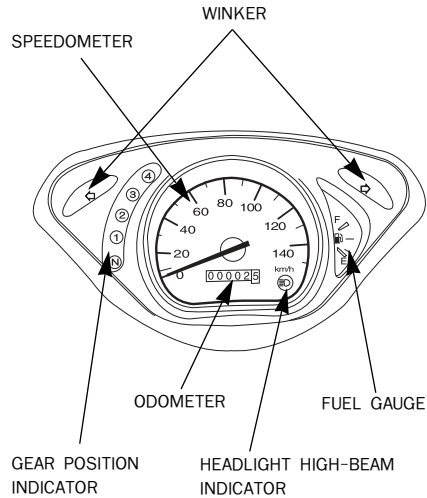

METER

<SPEEDOMETER>

Indicates speed in km/h during travel. Maintain legal speed limits to ensure safe operation.

<ODOMETER>

Indicates total operating distance in km.

FUEL GAUGE

Indicates amount of gasoline in fuel tank. (The fuel gauge needle always indicates gasoline level regardless of whether main switch is in "OFF" position or in "ON" position.) If needle is within E mark, immediately fill gasoline. Balance at this time is approximately 1.2 litres.

⚠ WARNING

- To avoid running out of fuel that may result in a sudden stop.

INDICATOR LAMPS

<HEADLIGHT HIGH-BEAM INDICATOR>

Turned on when the headlight is in high-beam position.

<WINKER INDICATOR>

If main switch is turned "ON" and winker is activated, the winker located in the direction of turning is turned ON.

<GEAR POSITION INDICATOR>

Displays the gear position when the main switch is set to "ON" and the gear is applied.

POSITION MARK	GEAR POSITION
N	NEUTRAL
1	1st
2	2nd
3	3rd
4	4th

The neutral gear indicator is turned "N" when the gear is in the neutral position.

The position mark is displayed according to corresponding the gear position.

SWITCH OPERATION

MAIN SWITCH

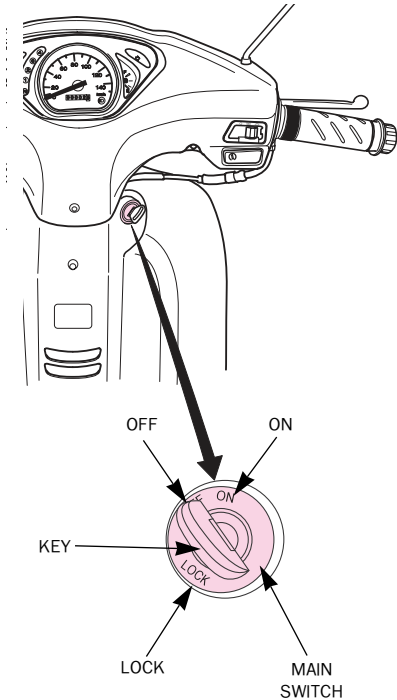

Main switch is used to turn on or turn off engine.

Key position	Function	Key
ON	Starts engine. Power is supplied to electrical circuits.	Key cannot be removed
OFF	Stops engine. Cuts off all electrical circuits.	Key can be removed
LOCK	Locks steering wheel. Cuts off all electrical circuits and steering wheel is locked.	Key can be removed

⚠ WARNING

- Do not manipulate main switch key during operation. If the main switch key is placed on "Off" or "Lock" position, all electrical system will not function. Never operate the main switch key during travel as it might cause unexpected accidents, If it is necessary to remove the main switch key, stop the vehicle first prior to removing.

⚠ CAUTION

- Prior to dismounting from the motorcycle, make sure to lock the steering wheel and remove key.
- If the key is left in "ON" position without starting engine, battery is discharged.
- Do not use a number of keys together with a metal key holder. The keys and the key holder may cause scratches or other damage to the cover while operating the motorcycle. (Recommend cloth or leather key holders)

STARTER BUTTON

If you press this button, starter motor runs and engine is started.

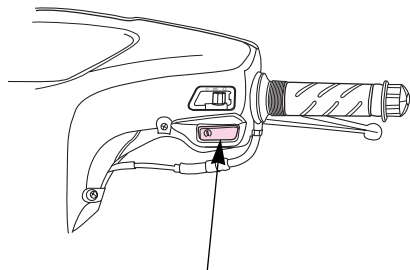

STARTER BUTTON

⚠ CAUTION



- Do not press starter button repeatedly because it consumes great amount of power causing battery to be exhausted sooner.

HEADLIGHT AND POSITION LAMP

<TURNING ON HEADLIGHT>

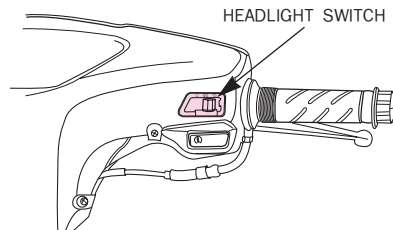
Put main switch key in "ON" position and manipulate headlight switch.



Switch position	Function
 (H)	Headlight, position lamp and taillight turned on
 (P)	Position lamp taillight turned on
○ (OFF)	Light turned off

⚠ CAUTION

- When you travel after sunset, put headlight in low-beam. This lets approaching vehicles know of your position and is helpful to safe driving.

<HEADLIGHT HIGH OR LOW BEAM OPERATION>

High beam or low beam can be operated by the use of high/low beam switch.

HEADLIGHT HIGH/LOW BEAM SWITCH

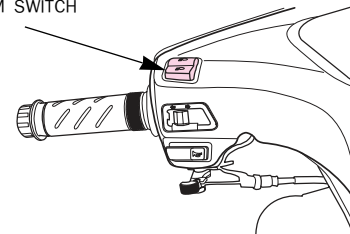

HIGH BEAM

≡D(HI) used when needing extra light.

LOW BEAM

≡D(LO) used when other vehicles are present, in the city, etc.

⚠ CAUTION

- Use the high beam only in the suburban road or when the usage of the high beam not hinder the safe driving of the car ahead.

WINKER SWITCH

Use winker switch when you change course of travel to left or right.

<HOW TO USE>

If this switch is turned on when the main switch is in "ON" status, winker is blinking. To release winker operation, return winker switch its original position.

⇒(R) ---- Used when making a right turn.

⇐(L) ---- Used when making a left turn.

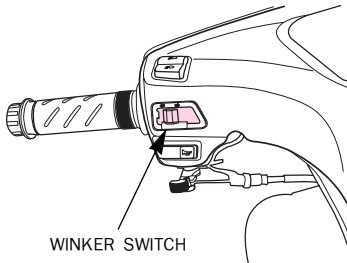

CAUTION

- The winker switch does not automatically turn back to its original position after completing the turn. Please set the switch back to its center position after turning.

HORN BUTTON

If horn button is pressed when main switch is in "ON" position, horn is sounded.

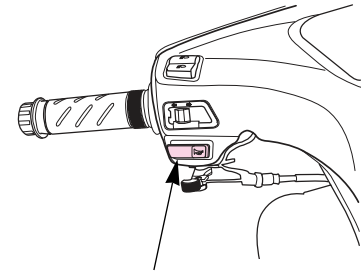

HORN BUTTON

EQUIPMENT USAGE

STEERING WHEEL LOCK

To prevent theft, lock steering wheel when parking the vehicle.

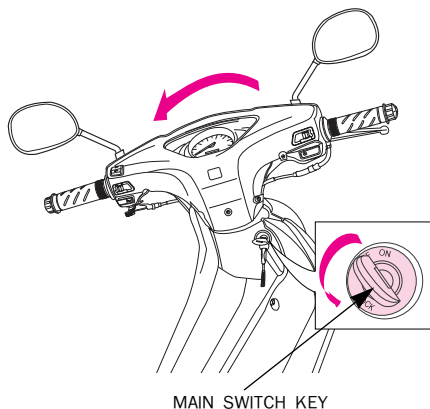

<HOW TO LOCK>

1. Turn the steering wheel to left completely.
2. Insert main switch key.
3. Press the key and turn steering wheel to "Lock" position.
4. Remove the key.

<HOW TO RELEASE>

Take steps in opposite order of locking.

⚠ WARNING

- Do not turn the key to LOCK while riding the vehicle; loss of vehicle control will result.

⚠ CAUTION

- To make sure steering wheel is locked properly, lightly turn steering wheel to left and right and verify lock.
- Park the vehicle in places free of traffic.
- Prior to operation, turn the steering wheel to left and right to verify if turning angles of left and right are equal.

REAR CUSHION ADJUSTMENT

Rear cushion can be adjusted using adjustment knob according to the loading weight.

<Operating Procedure >

- Park the vehicle by erecting the main stand.
- Rotate the adjustment knob of the rear cushion to the appropriate mode according to the loading weight. (The left and right cushion modes are identical.)

<Application Method >

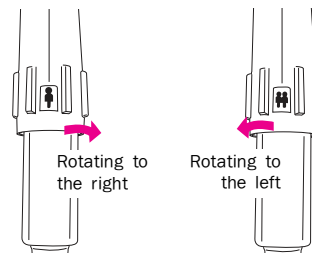

- Weak cushion effect
- Light cargo
- Single driving
- Strong cushion effect
- Heavy cargo
- Tandem driving

⚠ CAUTION

- Make sure the adjuster marks on left and right side are equal.

SELF INSPECTIONS BEFORE OPERATION

Self inspect the vehicle and have regular maintenance inspections for increased safety and the prevention of accidents. Self inspections before operation should be performed on a daily basis prior to operating the vehicle.

BRAKES

The front brake is the hydraulic disk type, and the rear brake is the drum brake type. As the brake pad wear, the brake fluid level drops.

There are no adjustments to perform, but fluid level and pad wear must be inspected periodically. The system must be inspected frequently to ensure there are no fluid leaks.

[FRONT BRAKE]

<BRAKE LEVER FREE PLAY>

Lightly squeeze the brake lever until tension is felt to check for an appropriate amount of free play. No free play in the brake lever or overly loose brake lever is indication of a problem in the brake system.

BRAKE LEVER FREE PLAY : 10~20mm

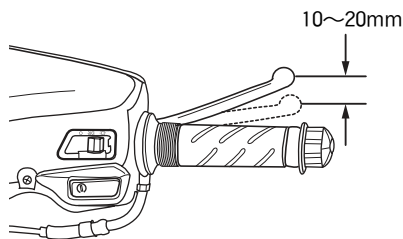

<BRAKE FLUID LEVEL>

⚠ WARNING

- Brake fluid may cause irritation. Avoid contact with skin or eyes. In case of contact, flush thoroughly with water and call a doctor if your eyes were exposed.
- KEEP OUT OF REACH OF CHILDREN

⚠ CAUTION

- When adding brake fluid, be very careful not to allow foreign materials to enter the reserve tank.
- Do not fill past upper level. This can cause brake fluid to leak out of the reserve tank.
- Do not let brake fluid contact vehicle parts as this damages painted areas. If oil contacts parts, quickly clean the fluid off using a dry cloth.
- Use recommended brake fluid as other types can undergo chemical changes.

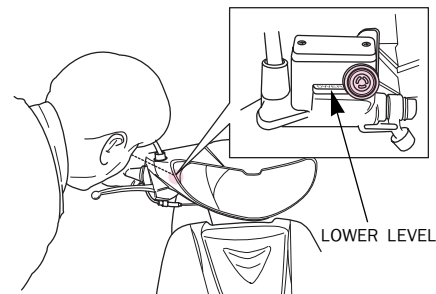

- Check that the fluid level is above the LOWER level mark with the vehicle in an upright position.
- Check through access cover which is observable through inspection groove located between the front handle cover and the right end section of headlight. (Use of a flash is recommended.)
- Brake fluid must be added to the reservoir whenever the fluid level begins to reach the LOWER level mark.

1. Remove the screws and take oil cup cap, diaphragm plate diaphragm off.
2. Replenish recommended brake fluid to the UPPER level inside reserve tank.

RECOMMENDED BRAKE FLUID is DOT3 or DOT4

3. Reinstall the diaphragm, diaphragm plate, oil cup cap.
4. Tighten the screws securely.

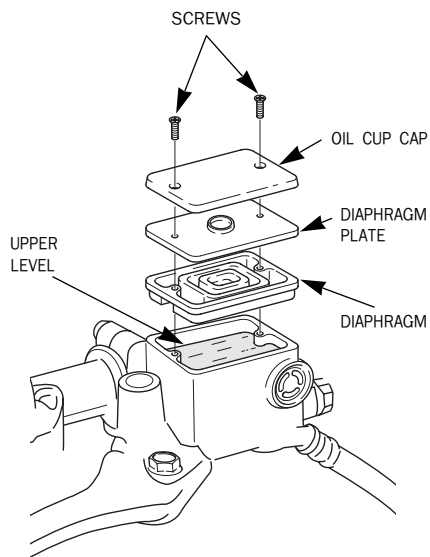

Other checks :

- Mark sure there are no fluid leaks.
- Check for deterioration or cracks in the hose and fitting.
- Check the brake pad for wear when refilling with brake fluid.

<BRAKE PAD INSPECTION>

Operate brake and, if the brake pad wear limit line reaches the brake disk side, it indicates the pad has reached wear limit.

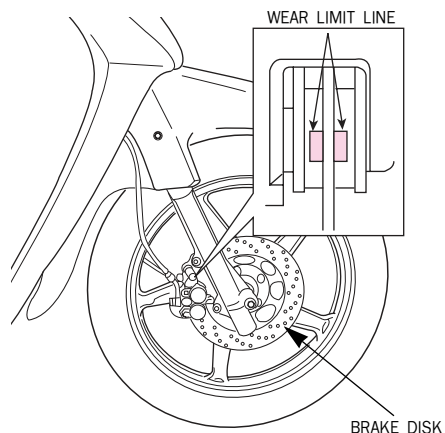

CAUTION

- The brake lever must be operated several times after replacement of the front brake pad.

[REAR BRAKE]

<BRAKE PEDAL FREE PLAY>

Push the brake pedal with hands for resistance and check if the pedal movement appropriate.

If brake pedal movements is inappropriate, adjust the pedal free play using the rear wheel brake adjuster nut.

- To adjust pedal free play, turn adjuster nut. After adjustment, push the brake pedal with hands until you feel resistance and verify the pedal free play is within prescribed level.

BRAKE PEDAL FREE PLAY : 20~30mm

▲ CAUTION

- After adjusting the brake, make sure that “□” part of the adjuster contacts the pin. Brake clearance can change when driving if this is not done.

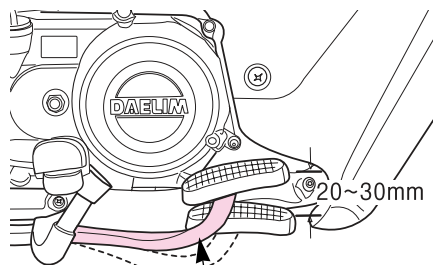

▲ BRAKE PEDAL

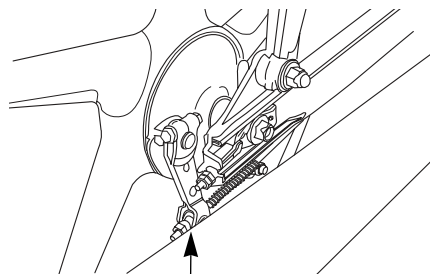

▲ ADJUSTER NUT

<REAR BRAKE SHOE INSPECTION>

After adjusting the brake, check the wear of the brake shoe. While tightly squeezing the rear brake pedal, if the “△” mark of the brake shoe is worn. Please take the motorcycle to a service center for repair.

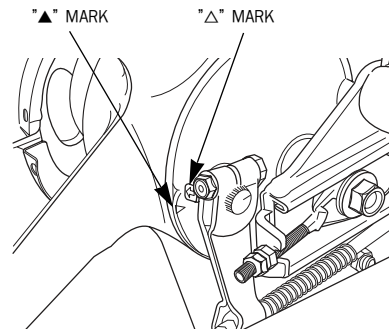

▲ CAUTION

- If the vehicle becomes worn-out, the replacement cycle of shoe may differ depending on the wear condition of the rim drum.

FUEL

<FUEL CHECK>

Check gasoline to see if there is a sufficient amount of gasoline to reach your destination.

- If the fuel gauge needle indicates E mark (red portion), fill fuel tank with gasoline as soon as possible.

Reserve fuel capacity :
Approximately 1.2 liter

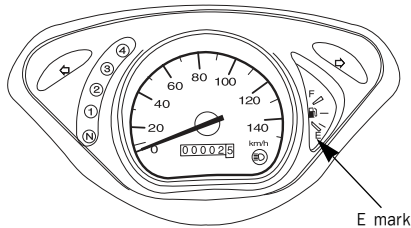

<REFUELING>

- Erect the seat.
- Fill the fuel after opening the fuel tank cap.
- Turn the fuel tank cap clockwise until the "△" mark on the fuel tank cap is aligned with the "△" mark located above the fuel tank.

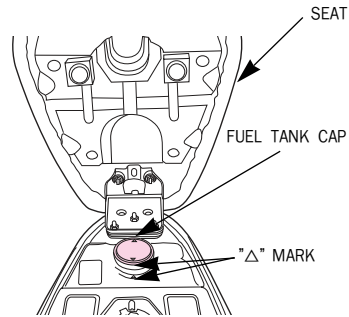

CAUTION

- Make sure to stop engine and stay away from fire when fueling.
- If gasoline is filled above the level plate bottom, gasoline may overflow.

<FUEL COCK>

The fuel cock lever arrow indicates operating position.

- ON --- Gasoline is supplied. Set fuel cock to this position when starting engine.
- OFF -- Fuel is not supplied. Set to this position except when the vehicle is operated.

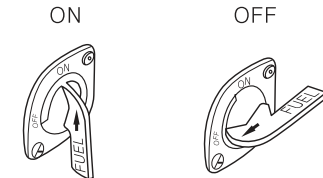

CAUTION

- After refueling, turn lever to "ON" position. If the lever is not turned to "ON" reserve fuel runs out during travel and vehicle cannot be operated.

TIRES

<TIRE PRESSURE CHECK>

Check for an appropriate level of air pressure by examining how the tire sits on the ground. If you notice any abnormalities in the shape of the tire with regard to the area contacting the ground, use a tire gauge to check tire pressure and adjust the tire pressure to the appropriate level.

<TIRE PRESSURE>

SIZE	FRONT	2.75-16-4PR	
	REAR	3.00-16-4PR	
TIRE PRESSURE (kgf/㎠ †)	1 PERSON RIDING	FRONT	1.75
		REAR	2.00
	2 PERSON RIDING	FRONT	1.75
		REAR	2.25

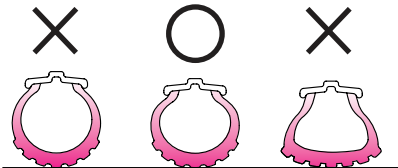

<CRACKS/DAMAGE>

Check tire tread and sides for cracks and damage.

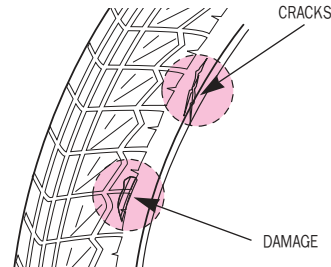

<ABNORMAL WEAR>

Check tire tread for signs of abnormal wear.

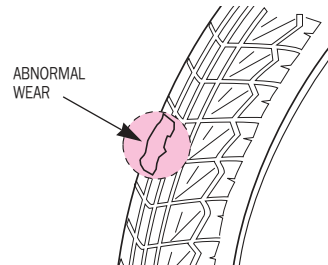

<FOREIGN MATERIALS>

Check tire tread and sides for nails, rocks, etc. That might have become wedged in the tire.

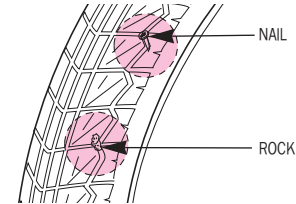

<TREAD DEPTH>

- Check the wear indicator (wear limit marking) to see if there is an insufficient amount of tread remaining.
- If the indicators are visible, replace tire with a new one.

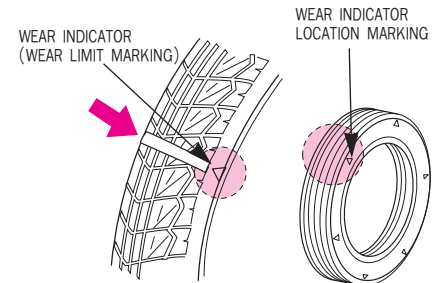

CAUTION

- If air pressure is inadequate or if there are cracks, damage or abnormal wear on tires, it may cause trembling steering wheel and flat tire.
- Insufficient air pressure may cause the heavy steering wheel making handling difficult, fuel over consumption and the excessive wear of tire outer area and excessive air pressure may cause easier wheel handling and lower fuel consumption. But it may also cause the excessive wear of tire center area.
- This motorcycle is equipped with tubeless tires. If you have flat tires, please contact authorised maintenance shops for inspection.

ENGINE OIL LEVEL CHECK

Put vehicle in upright position on flat ground and check engine oil level and degree of pollution.

- Run engine idle for approximately 2~3 minutes and stop engine.
Approximately 2~3 minutes thereafter, check engine oil and verify the oil level is between the upper and lower level of oil level gauge.
- Insert oil level gauge, without locking, and check oil level after removing oil gauge.
- If the oil level is near lower level, replenish oil to upper level.

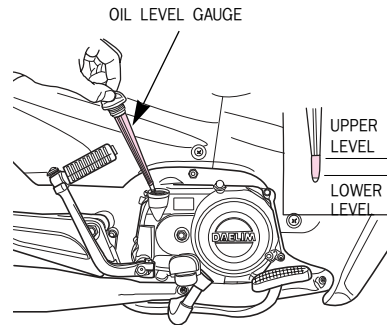

LIGHTS AND WINKER

<HEADLIGHT, TAILLIGHT>

Start the engine and make sure the lights turn on. Also check to see if the lights are damaged or if there is dirt on them.

<BRAKE LIGHT CHECK>

Turn the main switch to ON.

While separately operating the front and rear brakes, check to see if the brake light turns on. Also check to see if there is any damage to the lens or if there is dirt on the brake light.

<WINKER CHECK>

Turn the main switch to ON.

Check to see if all the winker in the front and rear of the vehicle (including left and right sides) are flashing properly. At the same time, check to make sure that the automatic sound signal of the winker is working. Check also to see if any of the lens are damaged or dirty.

OPERATION

BACK MIRROR

Sit squarely on the seat and check to see if you have a good view behind the vehicle by looking at the back mirrors. Also check for dirt and damage on the back mirrors.

LICENSE PLATE

Check to see if there is any dirt or damage to the license plate. Also check to see if the license plate is firmly secured to the vehicle.

PRE-RIDE INSPECTION

WARNING

- If the pre-ride inspection is not performed, severe personal injury or vehicle damage may result.

Inspect your vehicle every day before you ride it. The items listed here will only take a few minutes to inspect, and in the long run they can save time, expense, and possibly your life.

- Check for signs of abnormality which might have occurred on the previous day.
- Engine oil level - add engine oil if required (page 22). Check for leaks.
- Fuel level - fill fuel tank when necessary (page 20). Check for leaks.
- Front and rear brakes - check operation; make sure that is no brake fluid leakage (page 17~19).
- Tires - check condition and pressure (page 21~22).

- Drive chain - check condition and slack (page 37~38). Adjust and lubricate if necessary.
- Throttle - check for smooth opening and full closing in all steering positions.
- Lights and horn - check that headlight, tail/brake light, turn signals, indicators and horn function properly.
- Angle rear view mirror.

CAUTION

- Observe safety rules when conducting inspections.
- Conduct inspections on a flat, solid ground with the main stand erected.

If you are unable to correct trouble even after you make adjustment or correction, contact authorized maintenance shops, dealers or designated repair shops for necessary inspection and repairs.

STARTING THE ENGINE

Always follow the proper starting procedure described below.

- This vehicle is equipped with a side stand ignition cut-off system. The engine cannot be started if the side stand is down.

⚠ WARNING

- Never run the engine in an enclosed area. The exhaust contains poisonous carbon monoxide gas that can cause loss of consciousness and lead to death.

⚠ CAUTION

- Do not keep the starter button pressed for more than 5 seconds at a time. Release the starter button for approximately 10 seconds before pressing it again.

<PREPARATION>

Before starting, insert the key, turn the ignition switch ON and confirm the following:

- The transmission is in NEUTRAL (neutral indicator light ON)
- The fuel cock is ON.

<WHEN ENGINE IS COLD (WINTER)>

1. Open choke lever completely.

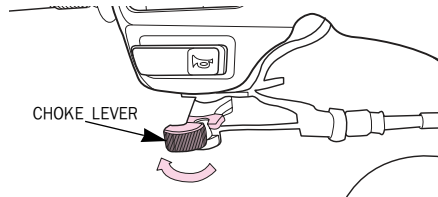

2. Close throttle grip, and press starter button.
3. Once engine is started, pull and release throttle grip repeatedly to run engine idle until engine is heated, and close choke lever completely. If engine warming up takes time, run engine idle with the choke lever slightly closed.

<WHEN ENGINE IS HOT (SUMMER)>

1. Close throttle grip and press starter button. (If engine is not started with 1-2 times trial, verify fuel cock lever is in "ON" position)
2. If engine is not started with throttle grip closed, open throttle grip approximately 1/8 to 1/4 and press starter button.

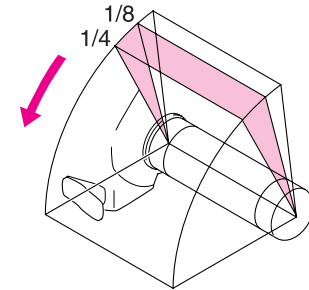

- It is possible that starting will be more difficult if the vehicle has not been used for a long period of time or if the fuel hole is plugged up (starting problems even when there is sufficient fuel in the fuel tank may be an indication of a plugged fuel hole).

When this happens, do not rotate the throttle grip and try the starter button a few times.

▲ NOTE

- Do not run engine idle unreasonably. This not only wastes fuel but also adversely affects engine.
- If starter button is pressed in gear position, vehicle may bring out to fall. Make sure gear is in neutral position prior to starting engine.

IF ENGINE CANNOT BE STARTED

If engine cannot be started or vehicle does not move, check the followings.

- Is there fuel in fuel tank?
- Are you operating in accordance with the instructions given in user's manual?
- Is fuse not cut?
- Is starter motor running?
- If starter motor is not running due to battery consumption, try starting motor by using kick start technique.

RUNNING-IN

During initial running-in newly machined surfaces will be in contact with each other and these surfaces will wear in quickly.

Running-in maintenance at 1,000km is designed to compensate for this initial minor wear.

Timely performance of the running-in maintenance will ensure optimum service life and performance from the engine.

The general rules as follows:

1. Never labour the engine with full throttle at low engine speeds. This rule is applicable not only during running-in but at all times.
2. Maximum continuous engine speed during the first 1,000km must not exceed 5,000 rpm.

▲ CAUTION

- Running the engine beyond recommended maximum engine speed can damage the engine.

RIDING

▲ NOTE

- Make sure you understand the function of the side stand mechanism. (see explanation for SIDE STAND on page 39)

1. After the engine has been warmed up, the vehicle is ready for riding.
2. While the engine is idling, depress the gearshift pedal to shift into 1st (low) gear.
3. Gradually increase engine speed by opening the throttle.
4. When the vehicle attains a mode-rate speed, close the throttle and shift to 2nd gear by depressing the gearshift pedal. This sequence is repeated to progressively shift to 3rd, 4th (top) gear.
5. Coordinate the throttle and brakes for smooth deceleration.
6. Both front and rear brakes should be used at the same time and should not be applied strongly enough to lock the wheel, or braking effectiveness will be reduced and control of the vehicle be difficult.

<GEAR SHIFTING>

Operating method of the gear is different between stopping and driving.

- Directly gear changing from top gear position to neutral is possible when stopping.
- When driving, gear changing is performed by 4th gear return type and gear changing from top gear position to neutral is impossible.
- When stopping gear changing from 4th gear position to neutral is possible.
- When changing gear during driving, change the gear after making the speed high enough to change the gear.

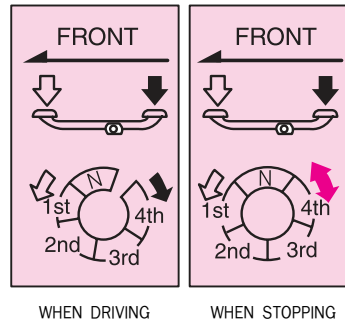

<GEAR DOWN OPERATION>

If you gear down when you need to drastically accelerate speed such as when you are passing another vehicle, speed can be accelerated. If you ride too fast, it adversely affects engine because engine revolution is excessive.

▲ NOTE

- Make sure side stand is in original position prior to starting vehicle. If side stand moves unsatisfactorily, check lubrication state on side stand joint.
- Shift gear adequately according to vehicle speed.
- To save fuel and maintain optimum vehicle life, do not accelerate or decelerate speed abruptly.
- Always start in the 1" gear, and start carefully as slow as possible.
- If you hear abnormal noise during travel, contact authorized maintenance shop immediately for inspection and necessary action.
- Maintain legal speed limits.

BRAKING

1. For normal braking, gradually apply both the front and rear brakes while down shifting to suit your road speed.
2. For maximum deceleration, close the throttle and apply the front and rear brakes firmly.

⚠ WARNING

- If you apply brakes only on front wheel or rear wheel, vehicle may slide off sideways and fall.
- If you apply brakes abruptly during travel in rain or on wet road, tires slide off and may cause accidents. Reduce speed and apply brake cautiously.
- Avoid repeated brake operation as it may cause brake temperature to rise, leading to braking effect deterioration.
- When possible, reduce speed or brake before entering a turn; closing the throttle or braking in mid-turn may cause wheel slip. Wheel slip will reduce control of the vehicle.

<ENGINE BRAKE>

If you turn throttle grip in reverse, engine brake functions and, if you need stronger braking, shift gear down from 4th to 3rd and so forth. When you travel on a long descent or on a sharp descent, use intermittent braking technique and engine brake simultaneously.

⚠ CAUTION

- Do not shift to lower gear while traveling at an excessive speed as it may suddenly increase the engine speed, adversely affect the engine and transmission, and cause the rear part of the vehicle to be shaken.

PARKING

1. After stopping the vehicle, shift the transmission into neutral, turn the fuel cock OFF, turn the ignition switch OFF and remove the key.
2. Put the vehicle on main stand and park on level ground in places free of traffic.
3. Use the side stand to support the vehicle while parked.
4. Turn the handlebar fully to the left and lock the steering to help prevent theft.

⚠ CAUTION

- Park the vehicle on firm, level ground to prevent it from falling over.
- Park in a safe area that will not block traffic. When you parked the vehicle after driving, make sure foot the vehicle beyond man's reach because engine and muffler are still hot.
- If you must park on a slight incline, aim the front of the vehicle uphill to reduce the possibility of rolling off the side stand or overturning.

MAINTENANCE

- The Required Maintenance Schedule specifies how often you should have your vehicle served, and what things need attention. It is essential that your vehicle be served as scheduled to retain its high level of safety, dependability, and emission control performance.
- These instructions are based on the assumption that the motorcycle will be used exclusively for its designed purpose. Sustained high speed operation, or operation in unusually wet or dusty conditions, will require more frequent service than specified in the MAINTENANCE SCHEDULE.
Consult your authorized Daelim dealer for recommendations applicable to your individual needs and use.

MAINTENANCE SCHEDULE

Perform the Self Inspections Before Operation at each scheduled maintenance period.

I: INSPECT AND, CLEAN, ADJUST, LUBRICATE OR REPLACE IF NECESSARY

R: REPLACE L: LUBRICATE C: CLEAN

ITEM		FREQUENCY	ODOMETER READING(NOTE1)					REMARK	
			× 1,000Km	1	4	8	12		16
			MONTH	1	6	12	18		24
★	FUEL LINE			I	I	I	I		
★	FUEL FILTER			R	R	R	R		
★	THROTTLE OPERATION		I	I	I	I	I		
★	CARBURETOR CHOKE		I	I	I	I	I		
	AIR CLEANER ELEMENT			C	C	C	C	NOTE(2)	
	SPARK PLUG			I	R	I	R		
★	VALVE CLEARANCE			I	I	I	I		
★	CARBURETOR IDLE		I	I	I	I	I		
★	ENGINE OIL		R	R	R	R	R		
★★	ENGINE OIL FILTER		R	R	R	R	R		
	DRIVE CHAIN		Every 1,000Km : I and L						

ITEM		FREQUENCY	ODOMETER READING(NOTE 1)					REMARK	
			× 1,000Km	1	4	8	12		16
			MONTH		6	12	18		24
★	BRAKE FLUID		I	I	I	I	R	NOTE(3)	
★	BRAKE SHOE / PAD WEAR		I	I	I	I	I		
	BRAKE SYSTEM		I	I	I	I	I		
★	BRAKE STOP SWITCH		I	I	I	I	I		
★	HEADLIGHT ADJUSTMENT		I	I	I	I	I		
★	SUSPENSION			I	I	I	I		
	CLUTCH		I	I	I	I	I		
	SIDE STAND			I	I	I	I		
★	BOLTS, NUTS, FASTENERS		I	I	I	I	I		
★★	WHEELS / TIRES		I	I	I	I	I		
★★	STEERING HANDLE BEARING		I	I	I	I	I		

- ★ If you do not have the appropriate tools or information to conduct maintenance, or if you feel you are not capable to perform maintenance on this vehicle, contact authorized dealers or repair shops for maintenance and repairs.
- ★★ To ensure safety, inspections and maintenance of these parts must be carried out by dealers, or repair centers.

NOTES : (1) At higher odometer readings, repeat at the frequency interval established here.

(2) Service more frequently when riding in unusually wet or dusty areas.

(3) Replace every 2 years, or at indicated odometer interval, whichever comes first. Replacement requires mechanical skill.

TOOL KIT

The tool kit is in the storage compartment inside the left sub side cover.

Some roadside repairs, minor adjustments and parts replacement can be performed with the tools contained in the kit.

- No.2 screwdriver
- Screwdriver grip
- 16mm Box wrench
- 10x12mm Spanner
- Tool bag

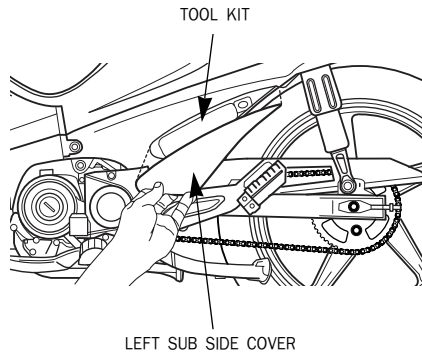

FRAME AND ENGINE NUMBERS

- The frame and engine numbers are needed when registering your vehicle.
- They may also be required by your dealer when ordering replacement parts.
- Record the numbers here for your reference.

FRAME NO. _____

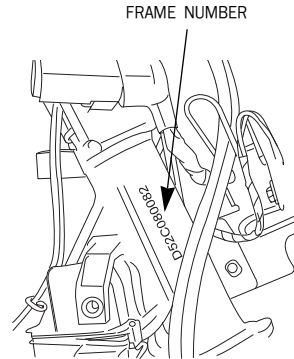

- The frame number is stamped on the right side of the steering head. (Remove the front top cover)
- The engine number is stamped on under of the left crankcase.

ENGINE NO. _____

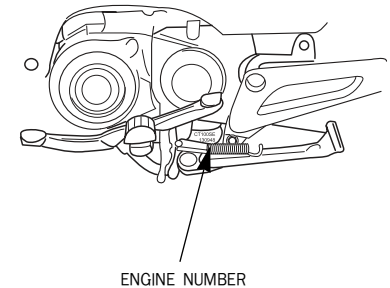

MAINTENANCE PRECAUTIONS

The following is an explanation of correct inspection methods, cleaning and parts replacing. Please always refer to this section when wanting to inspect or repair your vehicle.

▲ WARNING

- If your vehicle is overturned or involved in a collision, inspect control levers, cables, brake hoses, calipers, accessories, and other vital parts for damage. Do not ride the vehicle if damage impairs safe operation. Have your authorized Daelim dealer inspect the major components, including frame, suspension and steering parts, for misalignment and damage that you may not be able to detect.
- Use new, genuine Daelim parts or their equivalent for maintenance and repair. Parts which are not of equivalent quality may impair the safety of your motorcycle and the effective operation of the emission control systems.

▲ CAUTION

- Always observe safety rules when performing maintenance on the vehicle.
- Choose a flat surface and make sure the main stand is in a secure down position.
- Use correct tools.
- Conduct engine maintenance with the engine key out of the ignition.
- Be careful around the engine and muffler when performing maintenance as these areas can become extremely hot.
- After self maintenance, the waste material must be packed in the specified container and entrusted disposal to the authorized disposal company.
- Exhaust gas contains harmful substance such as carbon monoxide. Do not carry out inspections on vehicle in closed places, or in poorly ventilated places, with engine running.

THROTTLE GRIP

- Check for smooth rotation of the throttle grip from the fully open to the fully closed position at both full steering positions.
- Measure the throttle grip free play at the throttle grip flange. The standard free play should be approx : **2-6mm**
- To adjust the free play, turn the adjuster.

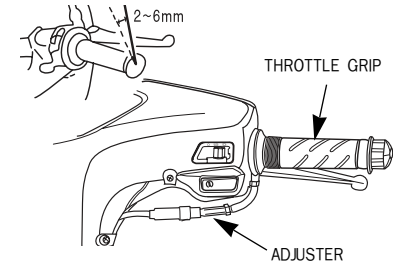

▲ WARNING

- Operating the vehicle with an inadequate throttle cable play can be hazardous. Inadequate throttle cable play can cause engine speed to rise suddenly when you turn the handlebars.

AIR CLEANER ELEMENT

If the air cleaner element is clogged with dust, there will be greater intake resistance, resulting in decreased power output and increased fuel consumption.

⚠ CAUTION

- Do not operate the engine without the air cleaner element in place or severe engine damage may result.
- If you usually ride in dusty areas or regularly operate in vehicle in wet, muddy conditions, you must inspect the air cleaner element more frequently than shown in the maintenance schedule.
- If, at any time, the air cleaner element is submerged in water, immediately clean the element and the inside of the air cleaner cover.

<REMOVING THE ELEMENT>

1. Remove the front top cover and the L,R front covers.
2. Loosen the 4 washer screws and remove the air cleaner cover.

3. Take off the air cleaner element.

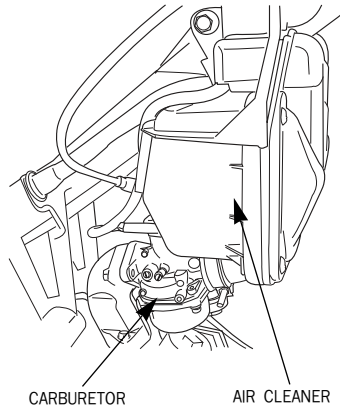

<WASHING THE ELEMENT>

1. Clean the air cleaner element in clean oil, squeeze excess oil, and then, wrapping it in a dry cloth, squeeze it again.



OIL : SAE 10W-30

2. Make sure all excess oil removed and reassemble the air cleaner element.

⚠ WARNING

- Be sure to keep cleaning solvent and oil away from children and pets. Dispose of used solvent and oil properly.

⚠ CAUTION

- If air cleaner element is inadequately assembled, dust and other waste materials are absorbed directly inducing cylinder wear and output deterioration, and adversely affecting engine durability. Assemble correctly.

CHANGING ENGINE OIL

If engine oil is polluted, it seriously affects the engine life span. Maintain appropriate level of oil, use correct type of oil and observe oil exchange period.

- Stand vehicle on the main stand on level ground and run engine idle (warm up) for approximately 2-3 minutes.
- Stop engine and place a container under the engine. Remove oil level gauge and drain plug bolt, and drain engine oil.
- Tighten the drain plug bolt.

DRAIN BOLT TORQUE: 2.0-3.0kgf · m

- Fill the crankcase with the recommended grade oil.

OIL CAPACITY : 0.75 ℓ

- Start the engine and keep it idle for a few minutes.
- Stop the engine and check the oil level. If the oil level is low, add the recommended engine oil.
- Check on oil leaks.

⚠ WARNING

- Be sure to keep oil away from children and pets. Dispose of used oil properly

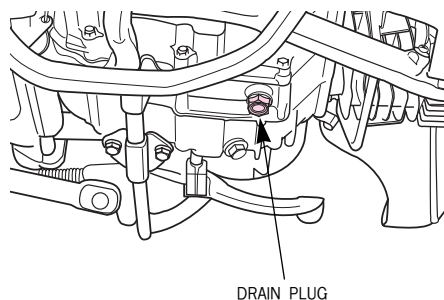
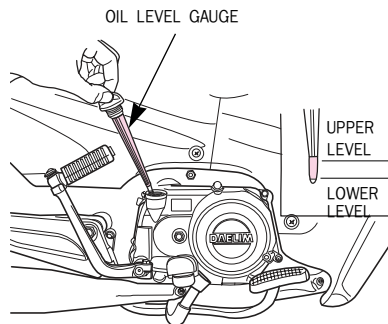

<RECOMMENDED OIL>

If oil sold on markets or privately-manufactured oil (low-grade) is used, engine life is adversely affected, and the privilege of warranty repairs cannot be guaranteed.

GRADE (SE, SF, SH)

⚠ CAUTION

- If you change engine oil immediately after engine is stopped, be careful of burns because the engine, muffler and engine oil are still hot.
- Exercise caution not to allow dust or other foreign matter to flow in when refilling engine oil.
- If oil level is lower or higher than prescribed level, engine is adversely affected.
- Do not mix oil with those of different manufacturers or grade, or do not use low-quality oil as it may cause deterioration of oil, leading to accidents.

SPARK PLUG

If electrode is stained or clearance is not right, satisfactory spark is not produced. Clean and make adjustment.

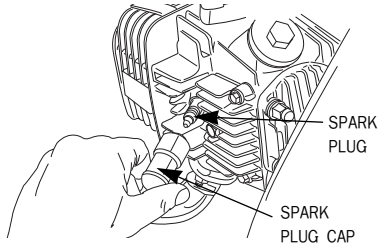

- Remove spark plug cap.
- Clean around the plug.
- Using a plug wrench, remove plug.
- Clean plug with plug cleaner.
- Check electrode for wear and corrosion. If the center of electrode became round, replace the electrode.
- Measure clearance using a feeler gauge.

PLUG GAP : 0.6-0.7mm

- Tighten with hands until the plug washer touches cylinder head.

STANDARD PLUG : C7HSA(NGK)

PLUG TORQUE: 14 kgf · m

- If new plug is installed, turn 1/2 and tighten using a plug wrench. If plug is reused, turn 1/3-1/4 and tighten.

CAUTION

- If plug of different maker or different heat value is used, it causes unsatisfactory engine starting, inadequate engine revolution and output deterioration.
- The spark plug must be securely tightened. An improperly tightened plug can become very hot and possibly damage the engine.
- To install a spark plug, turn it in as far as possible with your fingers, then tighten it with a wrench. Do not overtighten or cross thread the spark plug or the aluminum threads of the cylinder head will be damaged. Do not allow contaminants to enter the engine through the spark plug hole when the plug is removed.

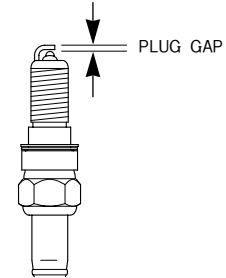

<DEALING WITH POOR STARTING>

When the starter doesn't work during driving in winter times or in a repeated short distance, use the suitable spark plug for this driving condition.

Poor starting may happen when nonstop driving in low speed, even though we produce standard plug.

In case starter isn't working well in driving repeatedly in a short distance or in an area with many traffic signals, use the C6HSA plug instead of standard plug C7HSA.

IDLE SPEED ADJUSTMENT

1. Put vehicle in upright position on a flat ground.
2. Start engine and let in run idle for a few minutes.
3. Using the throttle stop screw, adjust idling to prescribed level.

IDLE REVOLUTION: 1,600 ±100rpm

4. Tighten up pilot screw and loose backward 3/4.
5. Operate throttle lever lightly and verify there is no change in the number of idle running. If there is a change, repeat the process described in paragraph 3 and 4.

⚠ CAUTION

- Make sure that the engine is fully warmed up before adjusting the idle speed. Improper adjustment can result in increased engine wear.

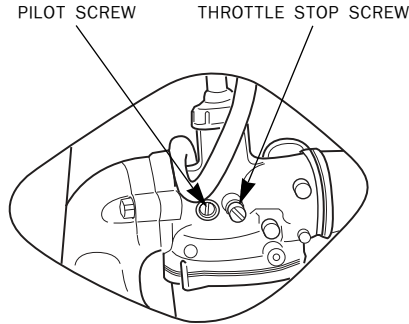

CLUTCH ADJUSTMENT

- Adjust the clutch only after turning off the engine.
- ① There are two types of clutch ; one-way clutch and clutch.
 - ② Adjust the clutch as follows ; Loosen the lock nut and turn the clutch adjuster clockwise until it stops and then counterclockwise. At this time, turn the adjuster 1/8~1/4 turn from where the screw get caught and tighten the lock nut completely.

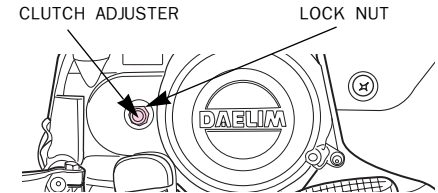

⚠ CAUTION

- When the adjustment is completed, the clutch must not slide when starting the engine and starting using the kick starter must be obtained easily. Check if the gear can be changed easily.

DRIVE CHAIN

- The service life of drive chain is dependent upon proper lubrication and adjustment. Poor maintenance can cause premature wear or damage to the drive chain and sprocket.
- The drive chain should be checked and lubricated as part of the Pre-ride Inspection.
- Under severe usage, or when the vehicle is ridden in unusually dusty or muddy areas, more frequent maintenance will be necessary.

⚠ WARNING

- For your safety, drive chain condition and adjustment should be checked prior to each use of the vehicle. Always follow the manufacturer's recommendations for proper lubrication and replacement of the chain.

<INSPECTION>

1. Turn the engine off, put vehicle in upright position on the main stand and shift the transmission into neutral.
2. Check slack in the lower drive chain run midway between the sprockets. Drive chain slack should be adjusted to allow the following vertical movement by hand: **20-30mm**
3. Roll the vehicle forward. Stop check drive chain slack. Repeat this procedure several times. Drive chain slack should remain constant. If the chain is slack only in certain sections, some links are kinked and binding, Binding and kinking can frequently be eliminated by lubrication.

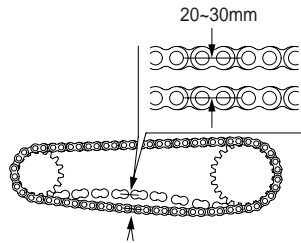

4. Rotate the rear wheel slowly and inspect the drive chain and sprockets for any of the following conditions:

■ DRIVE CHAIN

- ① Damaged rollers
- ② Loose Pins
- ③ Dry or Rusted Link
- ④ Kinked or Binding Link
- ⑤ Excessive Wear
- ⑥ Improper Adjustment
- ⑦ Missing O-ring

■ SPROCKETS

- ⑧ Excessively Worn Teeth
- ⑨ Broken or Damaged Teeth

- A drive chain with damaged rollers, loose pins or missing O-ring must be replaced.
- A chain which appears dry or shows signs of rust, requires supplementary lubrication.

<ADJUSTMENT>

- Drive chain slack should be checked and adjusted, if necessary, every 1,000km.
- When operated at sustained high speeds or under conditions of frequent rapid acceleration, the chain may require more frequent adjustment.

1. Place the vehicle on its main stand with the transmission in neutral and the ignition switch off.
2. Loose the axle nut.
3. Loose the lock nuts on both sides of the swingarm.
4. Turn both adjusting nuts an equal number of turns until the correct drive chain slack is obtained. Turn the adjusting nuts clockwise to tighten the chain or counterclockwise to provide more slack. Adjust the chain slack at a point midway between the drive sprocket and the rear wheel sprocket. Rotate the rear wheel and recheck slack at other section of the chain.

Chain slack should be : 20~30mm

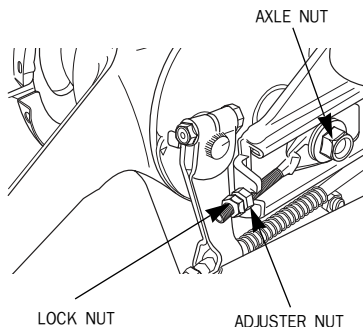

5. Tighten the axle nut to specified torque.

AXLE NUT TORQUE : 4.0~5.0kgf.m

6. Tighten the adjusting nuts lightly, then tighten the lock nuts by holding the adjusting nuts with a spanner.

▲ WARNING

- If a torque wrench is not used for this installation, see your authorized dealer as soon as possible to verify proper assembly.

▲ CAUTION

- Excessive chain slack could cause the chain to come off the sprockets, resulting in loss of control or serious engine damage.
- Make sure the right and left chain adjuster graduations are set in the same position.
- After adjusting chain, check the rear brake pedal free play.

WHEEL REMOVAL

[FRONT WHEEL REMOVAL]

1. Raise the front wheel off the ground by placing a support block under the engine.
2. Loosen the oval screw and remove the speedometer cable.

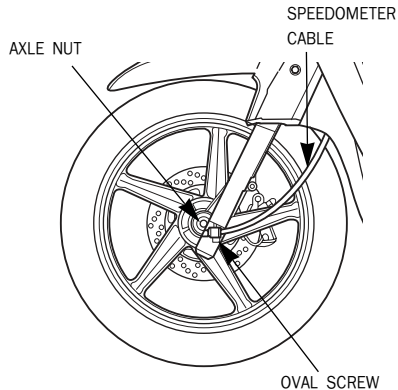

⚠ CAUTION

- Do not operate brake lever after the front wheel is removed. It will make wheel assembling difficult.

3. Remove the front caliper assembly from the fork by removing the fixing bolts.
4. Loosen the axle nut.
5. Withdraw the front wheel axle and remove the front wheel.

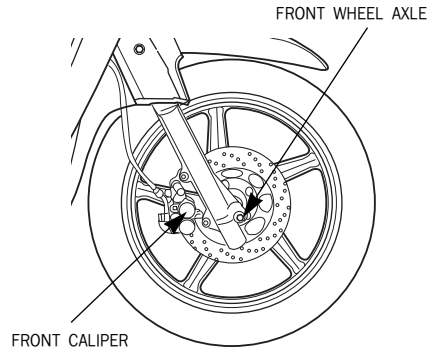

6. Install in the reverse order of removal.

⚠ CAUTION

- When installing the wheel, carefully fit the left brake disk between the brake pads to avoid damaging the pads.

- Prior to assembling, match the depressed part() of the speedometer gear box with the projected part of the left front fork.
- Fit the caliper over the disk, taking care not to damage the brake pads. Install the caliper fixing bolts, and tighten to a torque of : **2.7kgf.m**
- Tighten the front axle nut to the specified torque.

FRONT AXLE NUT TORQUE : 5.0~7.0kgf.m

- After assembling, operate brake for a number of times and see if wheel is turning smoothly without getting interruption.

⚠ WARNING

- If a torque wrench was not used for installation, see your authorized dealer as soon as possible to verify proper assembly. Improper assembly may lead to loss of braking capacity.

[REAR WHEEL REMOVAL]

1. Set vehicle on main stand in upright position on level ground.
2. Loosen the rear brake adjuster nut and remove the brake rod from the brake arm.
3. Loosen the drive chain adjusting lock nuts and adjusting nuts.

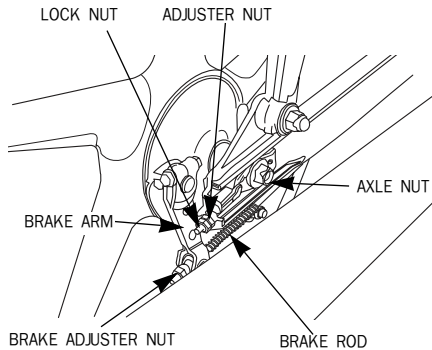

4. Loosen the rear brake stopper bolt securing the rear brake panel.
5. Loosen the rear wheel axle nut and remove the rear wheel axle and the rear wheel.

6. Install in the reverse order of removal.
- REAR AXLE NUT TORQUE : 4.0~5.0kgf.m**

- After installing the wheel, apply the brake several times and then check if the wheel rotates freely. Recheck the wheel if the brake drags or if the wheel does not rotate freely.

⚠ CAUTION

- After installing the wheel, adjust the rear brake and drive chain free play.

⚠ WARNING

- If torque wrench was not used for installation, see your authorized dealer as soon as possible to verify proper assembly. Improper assembly may lead to loss of braking capacity.

SIDE STAND

- Erect main stand and place vehicle in upright position on level ground.
- Check the spring for damage or loss of tension and the side stand assembly for freedom of movement.
- Check the side stand ignition cut-off system;
 - ① Put the side stand up.
 - ② Start the engine.
 - ③ Lower the side stand. The engine should stop as you put the side stand down.
- If the side stand system does not operate as described, inspect it in the closest authorized repair center.

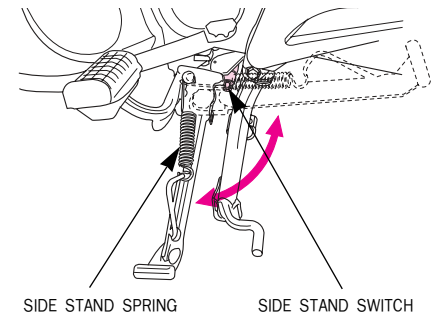

BATTERY

It is not necessary to check the battery electrolyte level or add distilled water as the battery is a maintenance-free (sealed) type. If your battery seems weak and/or is leaking electrolyte (causing hard starting or other electrical troubles), contact your authorized Daelim dealer.

⚠ CAUTION

- Removing the battery cap strip can damage the cap strip and result in leaks and eventual battery damage.
- When the vehicle is to be stored for an extended period of time, remove the battery from the vehicle and charge it fully. Then store it in a cool, dry place. If the battery is to be left in the vehicle, disconnect the negative cable from the battery terminal.

⚠ WARNING

- The battery gives off explosive gases; keep sparks, flames, and cigarettes away. Provide adequate ventilation when charging or using the battery in an enclosed space.

⚠ WARNING

- Battery acid is poisonous and corrosive. Avoid contact with eyes, skin, clothing, and painted surfaces. If battery acid comes in contact with any of these, flush immediately with large amounts of water. If acid contacts the eyes or skin, get medical attention.
- KEEP OUT OF REACH OF CHILDREN.
- Even though the battery is sealed, it still vents explosive gases. Do not allow open flames or sparks near the battery.

<BATTERY REMOVAL>

1. Turn the ignition switch OFF.
2. Loosen the 2 special screws and remove the right side cover.
3. Remove the battery holder by removing the mount bolt.
4. Disconnect the negative \ominus terminal lead from the battery first, then disconnect the positive \oplus terminal lead.
5. Pull out the battery from the battery box.

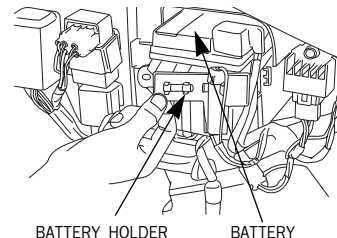

BATTERY HOLDER

BATTERY

⚠ CAUTION

- Make sure that terminals do not contact with other adjacent parts when handling \oplus/\ominus terminals.

<CLEANING BATTERY TERMINALS>

- If the battery terminal is polluted, or in rust, separate battery and clean it.
- Battery terminal in rust with white powder should be cleaned with warm water. In case of serious rust of battery terminal, disassemble the battery cord and grind it with wirebrush or sandpaper.



FUSE REPLACEMENT

Turn off the main switch to see if the fuse is severed. If the fuse is severed, exchange the fuse into 7A fuse.

- Fuse is installed inside fuse holder located near battery.
- To separate fuse, open fuse holder, hold both ends of fuse cord and pull up, and pull out the fuse connector crosswise.
- If the fuse immediately becomes severed after being changed with the new one, check another problem of the electric system.

⚠ WARNING

- Never use a fuse with a different rating from that specified. Serious damage to the electrical system or a fire may result, causing a dangerous loss of lights or engine power.

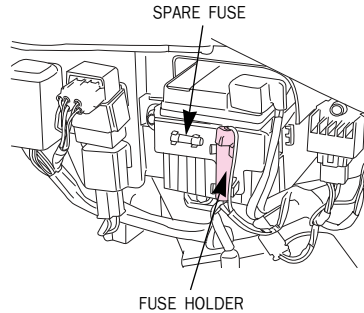

<DISASSEMBLY> <ASSEMBLY>

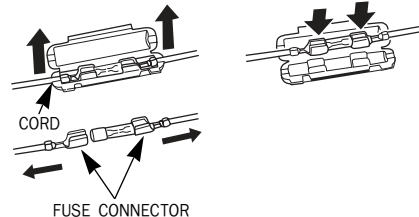

⚠ CAUTION

- Turn the ignition switch OFF before checking or replacing fuse to prevent accidental short-circuiting.
- When disassemble fuse, make sure that fuse holder isn't separated.
- After assembling fuse in the part of connector, check if fuse moves easily to a line. If fuse moves easily, it may cause an accident at heating.
- When replacing any of the electrical parts (lights and gauges), be sure to replace them with the recommended parts. Using different parts can lead to the fuses burning out or damage to the battery.
- When washing the vehicle take special card not to allow to be splashed in the area of the fuse.

BULB REPLACEMENT

- Be sure to turn the ignition switch OFF when replacing the bulb.
- Do not use bulbs other than that specified.
- After installing a new bulb, check that the light operates properly.

⚠ WARNING

- The light bulb becomes very hot while the light is ON, and remain hot for a while after it is turned OFF. Be sure to let it cool down before servicing.

⚠ CAUTION

- Do not put finger prints on the headlight bulb, as they may create hot spots on the bulb and cause it to break. Wear clean gloves while replacing the bulb. If you touch the bulb with your bare hands, clean it with a cloth moistened with alcohol to prevent its early failure.

[HEADLIGHT BULB]

- Before replacing the bulb, be sure to check the switches for loose connection of the connector.
1. Remove the back mirrors.
 2. Loosen the 4 screws and remove the front handle cover.
 3. Slightly press down on the bulb holder and turn it counterclockwise.
 4. Slightly press down on the socket and turn it counterclockwise.
 5. Install a new bulb in the reverse order of removal.

HEADLIGHT BULB : 12V 35/35W

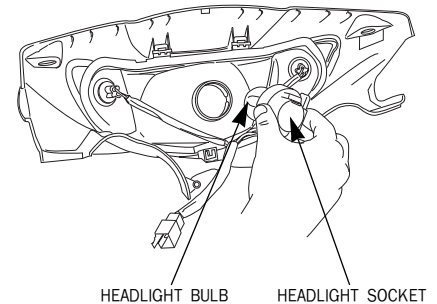
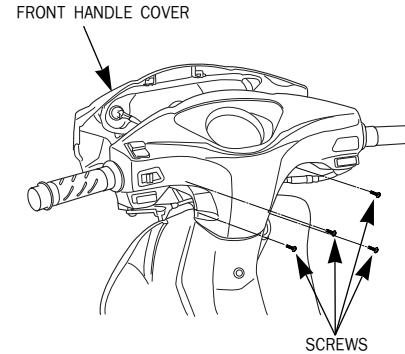

[TAIL/STOPLIGHT BULB]

1. Loosen the 2 screws and remove the taillight lens.
2. Slightly press down on the bulb and turn it counterclockwise.
3. Install a new bulb in the reverse order of removal.

TAIL/STOPLIGHT BULB : 21V 21/5W

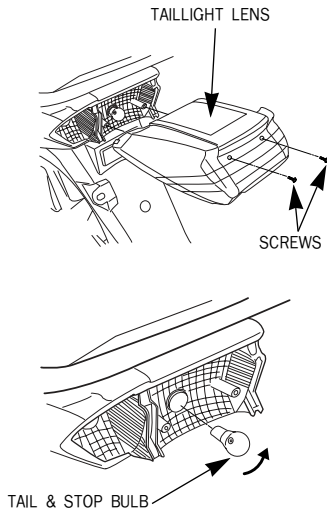

[WINKER BULB]

<Front winker bulb>

1. Press the winker lens groove and open the winker lens using plain screwdriver.
2. Slightly press down on the bulb and turn it counterclockwise.
3. Install a new bulb in the reverse order of removal.

FRONT WINKER BULB : 12V10Wx2

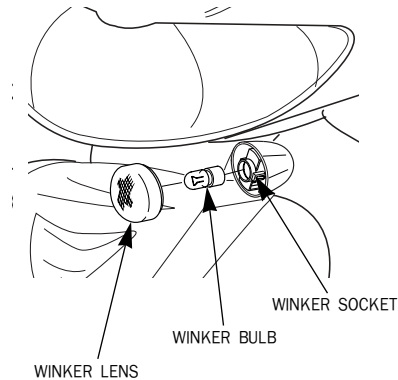

<Rear winker bulb>

1. Press the winker lens groove and open the winker lens using plain screwdriver.
2. Slightly press down on the bulb and turn it counterclockwise.
3. Install a new bulb in the reverse order of removal.

REAR WINKER BULB : 12V10Wx2

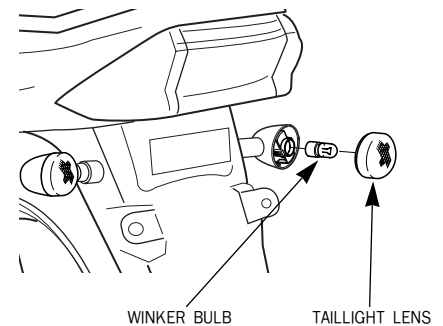

CABLE RUBBER PART

A rubber part is assembled on the cable to protect the inner cable.

Make sure that this part is placed firmly around the correct part of the cable. When washing the car, do not directly spray water on to the rubber part is dirty, use a dry cloth to clean this area.

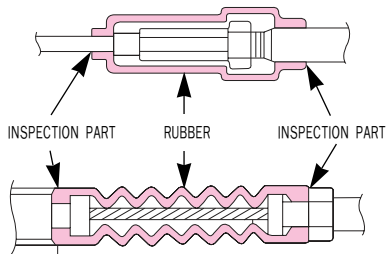

CAUTION

- Infiltration of the foreign materials or water caused by damage of lever (disengagement, tearing, etc.) may cause freezing in winter season resulting in faulty operation, sudden acceleration and braking force decrease. If any damage is found, replace with the new one immediately.

CLEANING

Clean your vehicle regularly to protect the surface finishes and inspect for damage, wear, and oil, coolant or brake fluid leakage.

CAUTION

- Make sure to stop the engine prior to car washing.
- High pressure water (or air) can damage certain parts of the vehicle.
- Be careful not to allow water to enter the muffler during the washing. Water inside the muffler may cause an improper engine starting or rust occurrence.
- Do not let water get inside the braking system during the washing, as water inside the brake system may weaken the braking power. Upon completion of washing, select a safe place where there is no traffic obstruction, and start the vehicle.

Lightly apply the brake while driving at a slow speed and check the braking power. If the braking power has been weakened, apply brake lightly while driving at a slow speed to dry up the brake system.

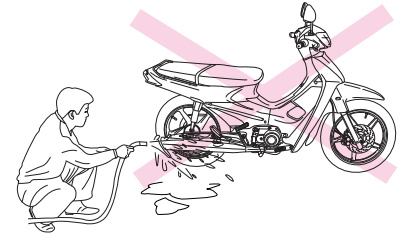

1. After cleaning, rinse the vehicle thoroughly with plenty of clean water. Strong detergent residue can corrode alloy parts.
2. Dry the vehicle, start the engine, and let it run for several minutes.
3. Test the brakes before riding the vehicle. Several applications may be necessary to restore normal braking performance.
4. Lubricate the drive chain immediately after washing and drying the vehicle.

WARNING

- Braking efficiency may be temporarily impaired immediately after washing the vehicle. Anticipate longer stopping distance to avoid a possible accident.

STORAGE GUIDE

Extended storage, such as for winter, requires that you take certain steps to reduce the effects of deterioration from non-use of the motorcycle.

In addition, necessary repairs should be made **BEFORE** storing the motorcycle; otherwise, these repairs may be forgotten by the time the vehicle is removed from storage.

<STORAGE>

- Change the engine oil and filter.
- Empty the fuel tank into an approved gasoline container using a commercially available hand siphon or an equivalent method.
- If storage will last more than one month, carburetor draining is very important, to assure proper performance after storage.

CAUTION

- Gasoline is extremely flammable and is explosive under certain conditions. Perform this operation in a well-ventilated area with the engine stopped. Do not smoke or allow flames or sparks in the area where gasoline is drained or stored and where the fuel tank is refueled.
- Remove the battery. Store in an area protected from freezing temperatures and direct sunlight. Slow charge the battery once a month.
- Wash and dry the vehicle. Wax all painted surfaces.
- Inflate the tires to their recommended pressures. Place the vehicle on blocks to raise both tires off the ground.
- Cover the vehicle (don't use plastic or other coated materials) and store in an unheated area, free of dampness with a minimum of daily temperature variation. Do not store the vehicle in direct sunlight.

<REMOVAL FROM STORAGE>

- Uncover and clean the vehicle.
- Change the engine oil if more than 4 months have passed since the start of storage.
- Charge the battery as required. Install the battery.
- Perform all Self Inspections Before Operation checks (page 17).
Test ride the motorcycle at low speeds in a safe riding area away from traffic.

SAFE DRIVING

PREPARATION BEFORE DRIVING

- Performing daily inspection
- Putting on the protective gears (Helmet, glove, goggles, etc.)
- Bringing the driver's licence
- Determinating the path to the desired destination

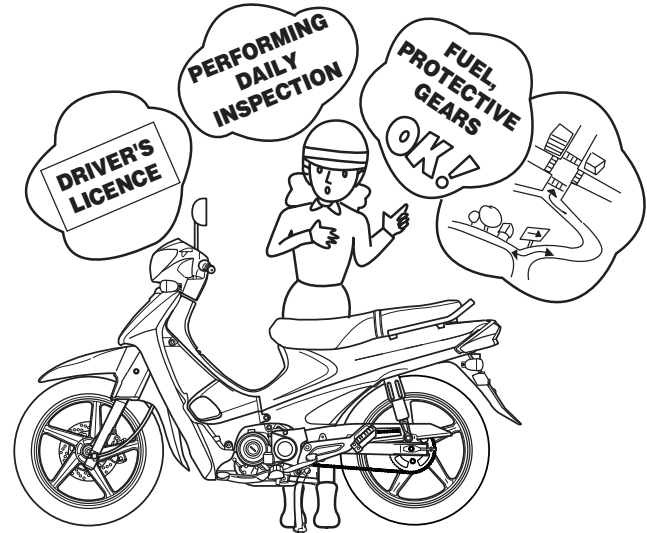

DRIVING METHOD

DRIVING POSITION

The appropriate driving position is most important thing to driving safely.

- ① Eyes : Look at the front direction widely.
- ② Shoulders : Relieve the tension.
- ③ Arms : Relieve the tension and bend arms to inside and let them act as the spring.
- ④ Hands : Grip the handle the position away from the inside end of the handle with distance of one finger to facilitate the operation of the switch and lever.
- ⑤ Wrist : Keep the state to act freely without applying excessive force to the shoulder and arms.
- ⑥ Knees : Press the fuel tank slightly.
- ⑦ Feet : Place the feet to face the front parallel and make the step bar be placed in the center of feet.

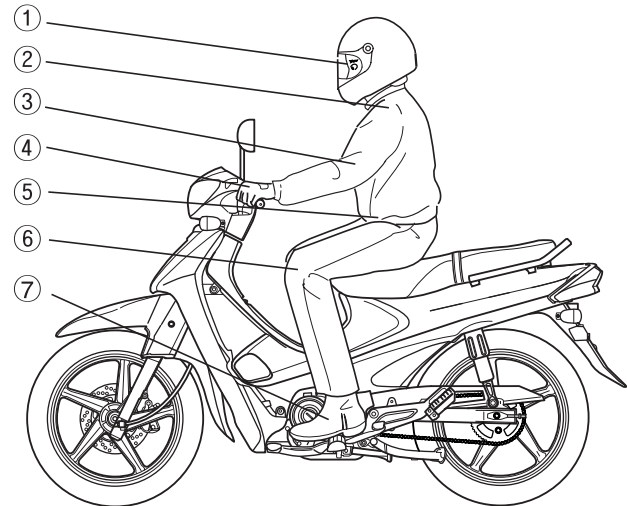

PRECAUTION WHEN DRIVING

- Secure the safe distance.
- Drive protectively.
- Do not obstruct the traffic.
- Do not drive on the pedestrian way or walkway.
- Drive on the left driveway when passing away.
- Make sure that you can apply the brake anytime.
- Always apply the brake when stopping temporarily.
- Do not drive excessively long distance and take enough break.
- If any abnormality is found, stop driving and contact service center to inspect the vehicle.
- Restart the vehicle after 2~3 min when it is turned over.
- Always turn on the headlight at night.

STARTING

Prior to starting always look around to avoid accident.

- ① Get on the vehicle after pulling back the stand.
- ② Start driving slowly after turning on the winker and releasing the brake while ensuring the safety around the vehicle.

CAUTION

- Return the side stand to its original position. Keep driving without doing this may cause turnover accident.
- Drive the vehicle only on the driveway. Driving on the walkway can cause accident. Also, if the wheel is transformed when advancing directly to the walkway, the vehicle can be overturned resulting in injury of the driver due to the driving instability.
- Overspeed driving on the unpaved road can cause the vehicle to be overturned resulting in injury of the driver due to the driving instability.
- Do not drive in the gravel road. If any gravel enters the wheel or engine case, the vehicle can be overturned resulting in injury of the driver.
- If possible, do not drive close to the sea or on the road where calcium chloride is treated. The muffler, external parts and welded parts can be corroded rapidly, and also in case of damage of the frame, the vehicle can be overturned resulting in injury of the driver.

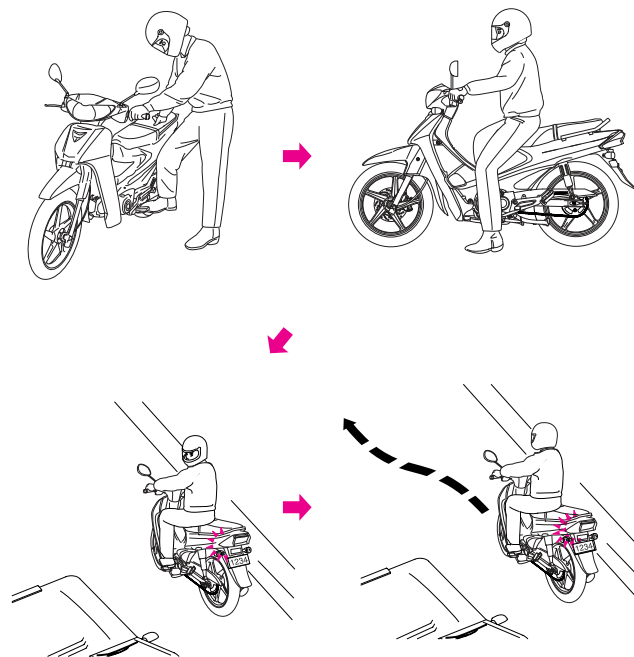

TURNING METHOD

PRINCIPLE OF TURN

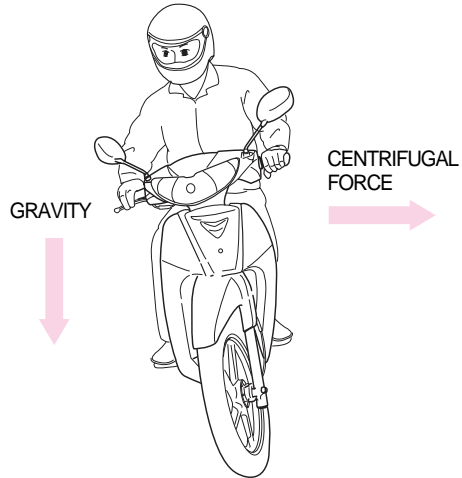

The basic principle of turn is balancing using the centrifugal force which makes motorcycle go outside and the gravity which makes vehicle fall inside.

EFFECT OF SPEED

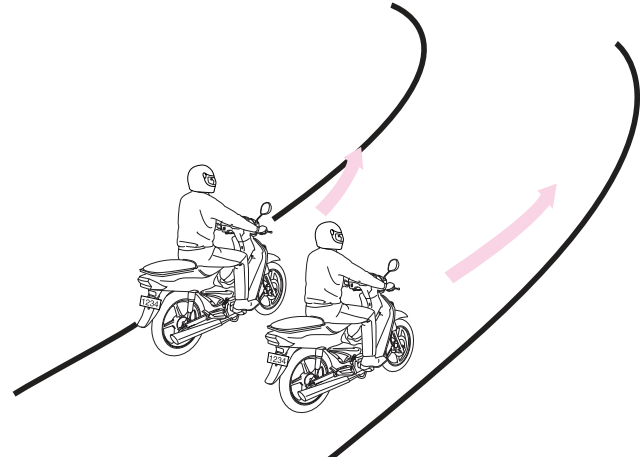

The centrifugal force increases in inverse portion to the radius of a curve and in portion to the square speed. Decelerate prior to entering the curved way to reduce the centrifugal force.

3 POSITIONS OF TURNING

The basic principle of turn is balancing using combined force of the centrifugal force and the gravity.

All 3 positions require straightening the head and keeping the eyes horizontally.

< LEAN-WITH >

This is a turning position with motorcycle and driver in a line.

This position is the most natural and exact, so driver must learn it thoroughly.

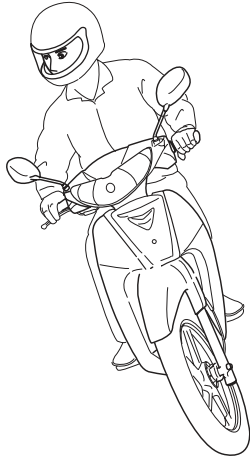

< LEAN-IN >

This is a turning position with driver leaned inside more than motorcycle. This position is adequate to drive on the rained or slippery road because it has best road holding.

However, special attention is required because front visual field is poor when driver leans inside more than motorcycle.

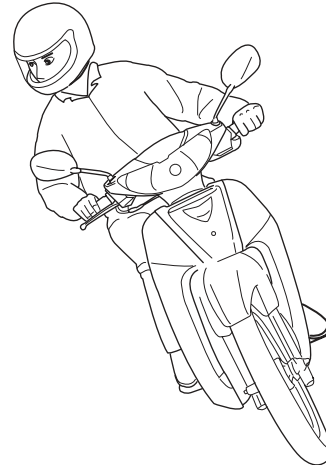

TURNING METHOD

< LEAN-OUT >

This is a turning position with motorcycle leaned inside more than driver, which is opposite to the lean-in position. With this position, quick turn is well performed and driver can obtain wide front visual field adequate to drive on the rained or slippery road because it has best road holding. However, special attention is required because there is danger of slipping on the bad holding road.

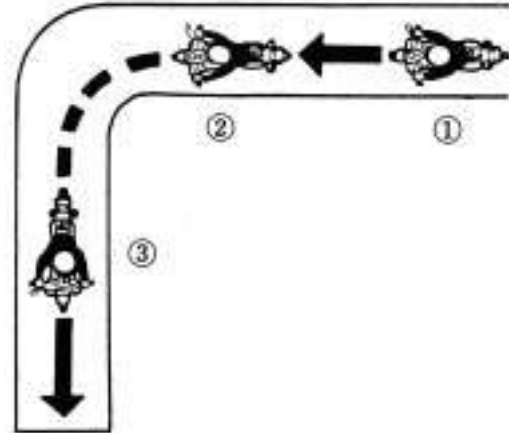
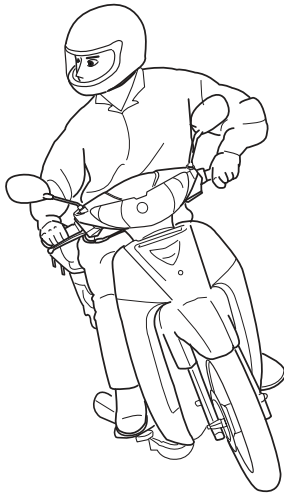

- ① Turn the throttle grip to its original position and decelerate using both front and rear brakes.
- ② Lean the vehicle toward inside of turn circle while driving slowly at constant speed.
- ③ Accelerate gradually.

PRECAUTION WHEN TURNING

Do not drive inside of large truck's turn circle.

< DEAD ANGLE ZONE >

Dead angle zone is the sight range which cannot be identified by driver and increases in proportion to the width of the vehicle.

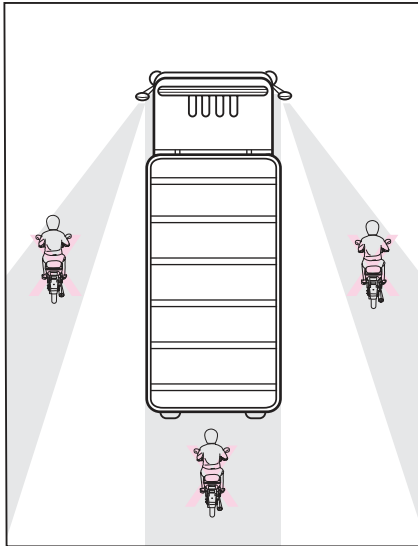

< DISTANCE BETWEEN THE FRONT AND REAR WHEEL TURN >

It is distance between path of the front and rear wheel and increases in proportion to the length of the vehicle.

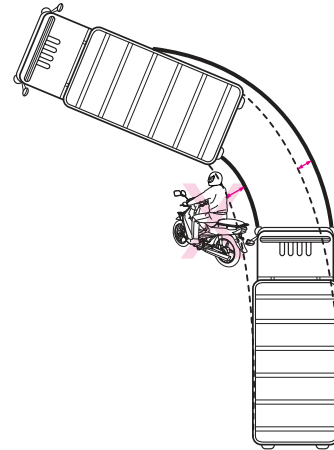

BRAKING METHOD

BASIC PRINCIPLE OF BRAKE (FRICTION FORCE)

- Vehicle is braked using friction between road surface and tires.
- Braking distance increases 1.5 times on wet road and 3 times on icy road because friction force of road surface is decreased.

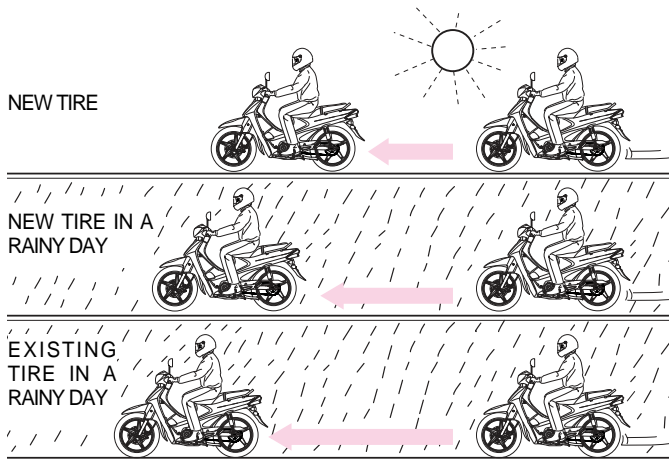

RESTRAINT OF BRAKE EFFECT (INERTIA)

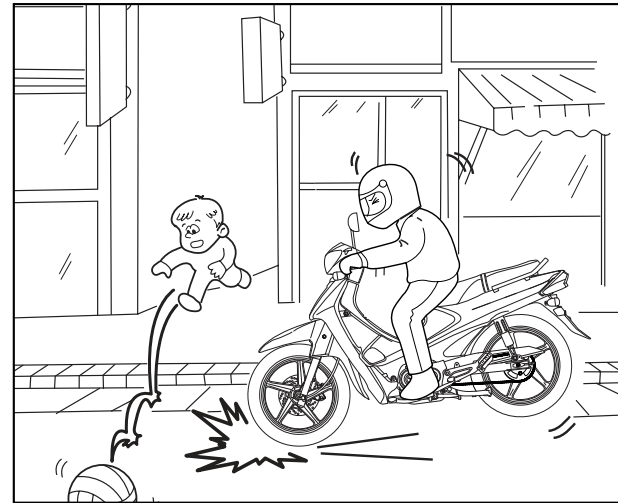

Due to the inertia, vehicle does not stop immediately after applying the brake.

BRAKING METHOD

- Turn the throttle grip to its original position and decelerate using the engine brake.
- Erect the vehicle straight.
- Brake using both front and rear brakes.

COMPARISON OF BRAKING DISTANCE

· Vehicle speed : 50 km/h

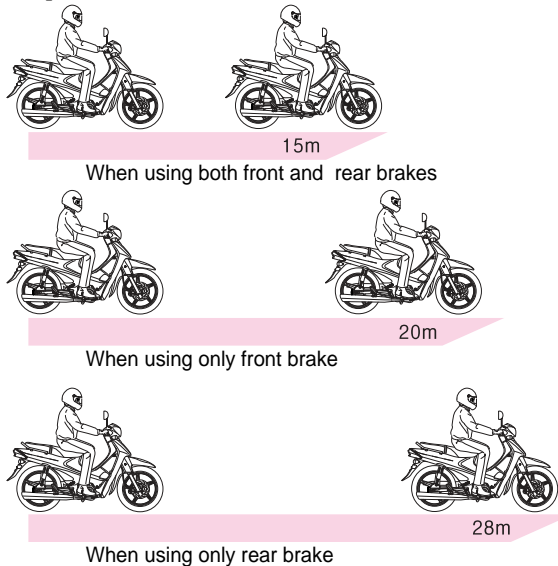

IMPACT WHEN COLLISION

Learn the proper braking method to prevent accident.

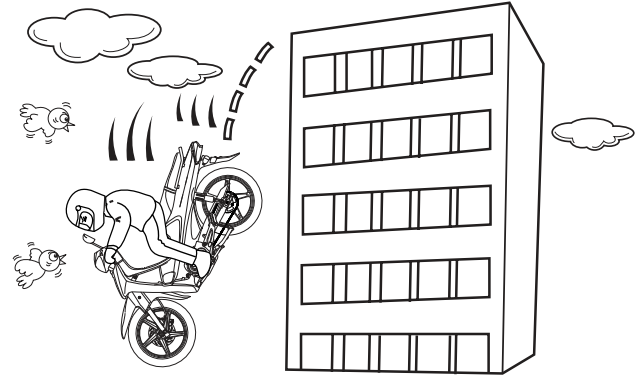

Impact increases in proportion to the speed and weight. The impact when collision to concrete wall at 50 km/h is same as one when falling from the height of 10m.

WIRING DIAGRAM

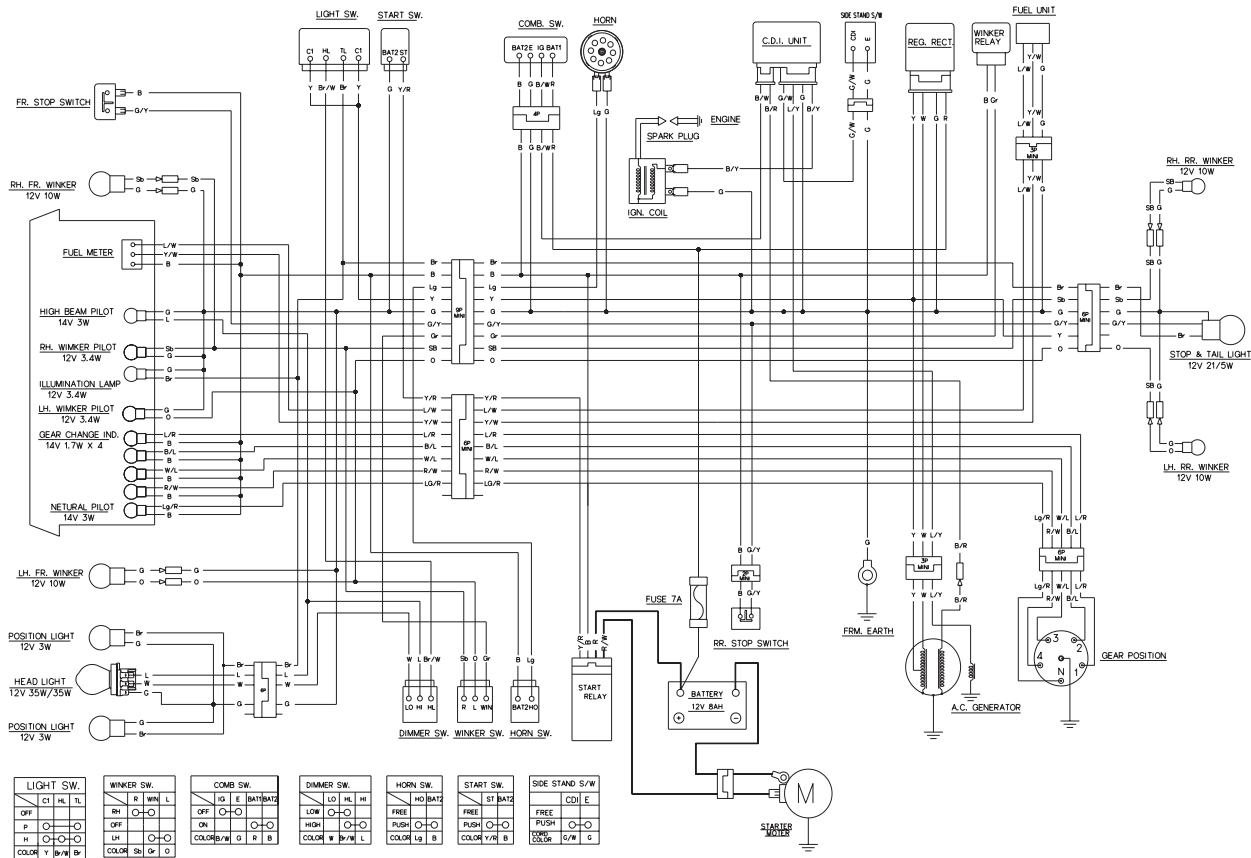

MEMO :

.....

.....

.....

.....

.....

.....

.....

.....

.....

.....

.....

.....

.....

.....

.....

.....

.....

 **Ace**¹¹⁰

OWNER'S MANUAL

03. 2003 PRINTED

03. 2003 PUBLICATION

NO COPY



DAELIM MOTOR CO.,LTD.



DAELIM MOTOR CO., LTD.
<http://www.daelimmotor.com>

■ HEAD OFFICE (FACTORY)

#58, SUNG SAN-DONG, CHANG WON, KYUNGNAM, KOREA

TEL : (82-55) 239-7000 / FAX : (82-2) 2269-7997