

This manual should be considered a permanent part of the scooter and should remain with the scooter when it is resold.

This Owner's Manual covers the CHF50 and CHF50S models. You may find descriptions of equipment and features that are not on your particular model. All illustrations are based on the CHF50 model, unless noted otherwise.

This publication includes the latest production information available before printing. Honda Motor Co., Ltd. reserves the right to make changes at any time without notice and without incurring any obligation.

No part of this publication may be reproduced without written permission.

The vehicle pictured on the front cover may not match your vehicle.

© 2008 Honda Motor Co., Ltd.

**2009
Honda CHF50/S
Metropolitan
OWNER'S MANUAL**

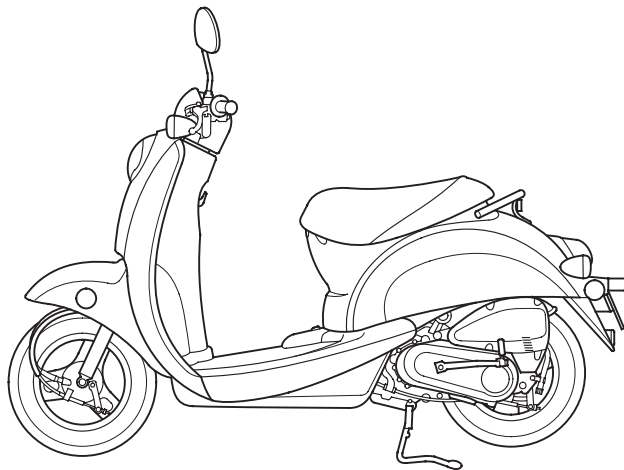

Introduction

Congratulations on choosing your Honda scooter.

When you own a Honda, you're part of a worldwide family of satisfied customers — people who appreciate Honda's reputation for building quality into every product.

Your Honda is designed for on road use by one rider only.

Before riding, take time to get acquainted with your scooter and how it works. To protect your investment, we urge you to take responsibility for keeping your scooter well maintained. Scheduled service is a must, of course. But it's just as important to observe the break-in guidelines, and perform all pre-ride and

other periodic checks detailed in this manual.

We also recommend that you read this owner's manual before you ride. It's full of facts, instructions, safety information, and helpful tips. To make it easy to use, the manual contains a detailed list of topics at the beginning of each section, and both an in-depth table of contents and an index at the back of the book.

As you read this manual, you will find information that is preceded by a **NOTICE** symbol. This information is intended to help you avoid damage to your Honda, other property, or the environment.

Introduction

Read the Warranties Booklet (page 191) thoroughly so you understand the coverages that protect your new Honda and are aware of your rights and responsibilities.

If you have any questions, or if you ever need special service or repairs, remember that your Honda dealer knows your scooter best and is dedicated to your complete satisfaction.

Please report any change of address or ownership to your Honda dealer so we will be able to contact you concerning important product information.

You may also want to visit our website at www.honda.com.

Happy riding!

California Proposition 65 Warning

WARNING: This product contains or emits chemicals known to the State of California to cause cancer and birth defects or other reproductive harm.

A Few Words About Safety

Your safety, and the safety of others, is very important. And operating this scooter safely is an important responsibility.

To help you make informed decisions about safety, we have provided operating procedures and other information on labels and in this manual. This information alerts you to potential hazards that could hurt you or others.

Of course, it is not practical or possible to warn you about all hazards associated with operating or maintaining a scooter. You must use your own good judgment.

You will find important safety information in a variety of forms, including:

- **Safety Labels** — on the scooter.
- **Safety Messages** — preceded by a safety alert symbol  and one of three signal words: **DANGER**, **WARNING**, or **CAUTION**.

These signal words mean:

Safety Messages

A Few Words About Safety

DANGER

You **WILL** be **KILLED** or **SERIOUSLY HURT** if you don't follow instructions.

WARNING

You **CAN** be **KILLED** or **SERIOUSLY HURT** if you don't follow instructions.

CAUTION

You **CAN** be **HURT** if you don't follow instructions.

- **Safety Headings** — such as Important Safety Reminders or Important Safety Precautions.
- **Safety Section** — such as Scooter Safety.
- **Instructions** — how to use this scooter correctly and safely.

This entire manual is filled with important safety information — please read it carefully.

Contents

These pages give an overview of the contents of your owner's manual. The first page of each section lists the topics covered in that section.

Scooter Safety 1

Important safety information you should know, plus a look at the safety-related labels on your scooter.

Instruments & Controls..... 13

The location and function of indicators and controls on your scooter and operating instructions for various controls and features.

Before Riding 29

The importance of wearing a helmet and other protective gear, how to make sure you and your scooter are ready to ride, and important information about loading.

Basic Operation & Riding 43

How to start and stop the engine, and use the brakes. Also, includes riding precautions and important information about riding with cargo.

Contents

Servicing Your Honda 65

Why your scooter needs regular maintenance, what you need to know before servicing your Honda, an owner maintenance schedule, and instructions for specific maintenance and adjustment items.

Tips 137

How to store and transport your scooter and how to be an environmentally responsible rider.

Taking Care of the Unexpected 145

What to do if you have a flat tire, your engine won't start, etc.

Technical Information 165

ID numbers, technical specifications, and other technical facts.

Consumer Information 187

Information on warranties, emission controls, how to get Honda service manuals, and...

“Reporting Safety Defects” 196

Table of Contents 198

Sequential listing of topics in this owner's manual.

Index 202

Quick Reference

Handy facts about fuel, engine oil, tire sizes, and air pressures.

This section presents some of the most important information and recommendations to help you ride your scooter safely. Please take a few moments to read these pages. This section also includes a special message for parents and information about the location of safety labels on your scooter.

Important Safety Information	2
Important Message to Parents	5
Accessories & Modifications	9
Safety Labels	11

Important Safety Information

Your scooter can provide many years of service and pleasure — if you take responsibility for your own safety and understand the challenges you can meet while riding.

There is much that you can do to protect yourself when you ride. You'll find many helpful recommendations throughout this manual. The following are a few that we consider to be most important.

Always Wear a Helmet

It's a proven fact: helmets significantly reduce the number and severity of head injuries. So always wear an approved motorcycle helmet. We also recommend that you wear eye protection, sturdy boots, gloves, and other protective gear (page 30).

Never Carry a Passenger

Your scooter is designed for one person only. There are no handholds, footrests, or seat for a second person — so never carry a passenger. A passenger could interfere with your ability to move around to maintain your balance and control of the scooter.

Important Safety Information

Take Time to Learn & Practice

Even if you have ridden other scooters, take time to become familiar with how this scooter works and handles. Practice in a safe area until you build your skills and get accustomed to the scooter's size and weight.

Because many accidents involve inexperienced or untrained riders, we urge all riders to take a certified course approved by the Motorcycle Safety Foundation (MSF). See page 32 .

Ride Defensively

The most frequent scooter collision happens when a car turns left in front of a scooter. Another common situation is a car moving suddenly into your lane.

Always pay attention to other vehicles around you, and do not assume that other drivers see you. Be prepared to stop quickly or make an evasive maneuver. For other riding tips, see the booklet, *You and Your Motorcycle Riding Tips*, which came with your new scooter (USA only).

Make Yourself Easy to See

Some drivers do not see scooters because they are not looking for them. To make yourself more visible, wear bright reflective clothing, position yourself so other drivers can see you, signal before turning or changing lanes, and use your horn when it will help others notice you.

Important Safety Information

Ride within Your Limits

Pushing limits is another major cause of scooter accidents. Never ride beyond your personal abilities or faster than conditions warrant. Remember that alcohol, drugs, fatigue, and inattention can significantly reduce your ability to make good judgments and ride safely.

Don't Drink and Ride

Alcohol and riding don't mix. Even one drink can reduce your ability to respond to changing conditions, and your reaction time gets worse with every additional drink. So don't drink and ride, and don't let your friends drink and ride either.

Keep Your Honda in Safe Condition

It's important to keep your scooter properly maintained and in safe riding condition. To help avoid problems, inspect your scooter before every ride and perform all recommended maintenance. Never exceed load limits (page 38), and do not modify your scooter (page 10) or install accessories that would make your scooter unsafe (page 9).

Important Message to Parents

In certain states, it may be legal for a young person to operate this scooter. If it is permissible in your area and you plan to allow a young person to operate this scooter, we urge you to read this message. Your child's safety is very important to Honda.

Riding a scooter can be fun. But, as with riding a bicycle, bad judgment can result in injury, and we don't want that to happen! As a parent, you can help prevent accidents by making good decisions about if, when, and how your youngster rides this scooter.

Riding Readiness

The first decision you'll need to make is whether your youngster is ready to ride. Riding readiness varies widely from one person to another, and age and size are not the only factors.

PHYSICAL ABILITY is an important consideration. For example, riders must be big enough to hold the scooter up, get on, and comfortably sit on the seat with both feet touching the ground. They should also be able to easily reach and work the brakes, throttle, and all other controls.

Important Message to Parents

ATHLETIC ABILITY is necessary for riding a scooter. Generally speaking, your youngster should be good at riding a bicycle before getting on a scooter. Can your youngster judge speeds and distances while riding a bicycle and react with proper hand and foot actions? Anyone who does not have good coordination, balance, and agility is not ready to ride this scooter.

MENTAL AND EMOTIONAL MATURITY are requirements for safe riding. Does your youngster think through problems and come to logical solutions? On a bicycle, does your youngster obey safe riding rules? Be honest! Young people who take unnecessary risks, make bad judgments, and don't obey rules are not ready to ride this scooter.

Instruction and Supervision

If you decide that your youngster is ready to safely operate this scooter, make sure both of you carefully read and understand the owner's manual before riding. Also be sure that your youngster has a helmet and other appropriate riding equipment and always wears it when operating the vehicle or sitting on it.

GOOD INSTRUCTION is an important part of hands-on training. The teacher can either be you or another responsible adult who has experience riding. (For help in finding a qualified instructor, talk with your Honda dealer.) Even if you're not the main teacher, it's up to you to ensure your youngster's safety. Remember, learning to ride a scooter is a gradual, step-by-step process. It takes time, patience, and practice — many hours over a period of weeks or months.

Important Message to Parents

SUPERVISION is another important obligation of parents. Even after youngsters have become skilled riders, they should always ride with adult supervision. It helps to regularly remind young riders of basic safety rules and precautions. And remember, it's your responsibility to see that the scooter is properly maintained and kept in safe operating condition.

SAFE AND RESPONSIBLE RIDING must be an on-going commitment — by you and your youngster. When you both put safety first, you can enjoy more peace of mind, and your youngster can enjoy more hours of safe riding.

Modifying your scooter or using non-Honda accessories can make your scooter unsafe. Before you consider making any modifications or adding an accessory, be sure to read the following information.

WARNING

Improper accessories or modifications can cause a crash in which you can be seriously hurt or killed.

Follow all instructions in this owner's manual regarding accessories and modifications.

Accessories

We strongly recommend that you use only Honda Genuine Accessories that have been specifically designed and tested for your scooter. Because Honda cannot test all other accessories, you must be personally responsible for proper selection, installation, and use of non-Honda accessories.

Check with your Honda dealer for assistance and always follow these guidelines:

- Make sure the accessory does not obscure any lights, reduce ground clearance and lean angle, limit suspension travel or steering travel, alter your riding position, or interfere with operating any controls. (cont'd)

Accessories & Modifications

- Do not add any electrical equipment that will exceed the scooter's electrical system capacity (page 172). A blown fuse can cause a loss of lights or engine power (page 158).
- Do not pull a trailer or sidecar with your scooter. This scooter was not designed for these attachments, and their use can seriously impair your scooter's handling.
- Do not install any fairing or windscreen unless it was designed and tested by Honda for your scooter. Some fairings or windscreens, even smaller ones, can cause unstable handling of your scooter. This is especially true if the fairing or windscreen is poorly designed or improperly mounted.

Modifications

We strongly advise you not to remove any original equipment or modify your scooter in any way that would change its design or operation. Such changes could seriously impair your scooter's handling, stability, and braking, making it unsafe to ride.

Removing or modifying your lights, exhaust system, emission control system, or other equipment can also make your scooter illegal.

Safety Labels

Safety labels on your scooter either warn you of potential hazards that could cause serious injury or they provide important safety information. Read these labels carefully and don't remove them.

If a label comes off or becomes hard to read, contact your Honda dealer for a replacement.

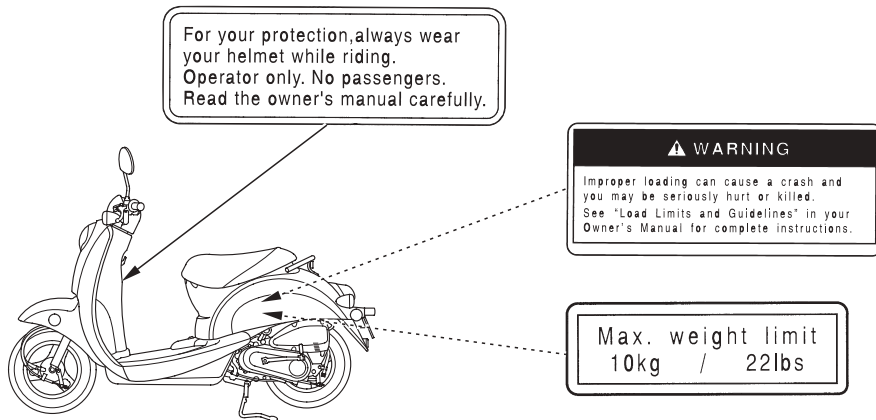

Safety Labels

TIRE INFORMATION		
Cold tire pressures :		
Front	125kPa	1.25kgf/cm ² 18psi
Rear	200kPa	2.00kgf/cm ² 29psi
Maximum weight capacity : 126kg (277lbs)		
Tire size : Front 90/90-10 50J		
Rear 90/90-10 50J		
Tire brand	Front	Rear
IRC	MB65	MB65
This scooter is equipped with tubeless tires.		
Maximum weight limit :		
Center compartment :		10kg (22lbs)
Front hook :		1.5kg (3lbs)
Read owner's manual.		

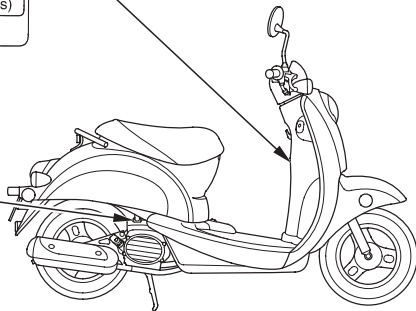

Instruments & Controls

This section shows the location of all gauges, indicators, and controls you would normally use before or while riding your scooter.

The items listed on this page are described in this section. Instructions for other components are presented in other sections of this manual where they will be most useful.

Operation Component Locations	14
Gauges & Indicators	17
Controls & Features.....	20
Ignition Switch	20
Start Button.....	22
Engine Stop Switch	22
Headlight Dimmer Switch	23
Turn Signal Switch.....	23
Horn Button	24
Rear Brake Lock.....	24
Seat Lock	26
Center Stand Lock.....	27

Operation Component Locations

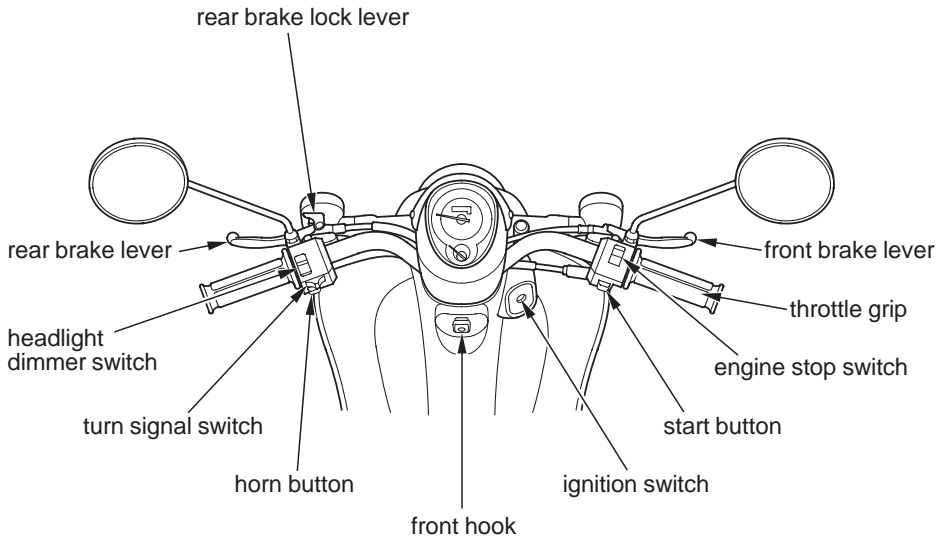

Operation Component Locations

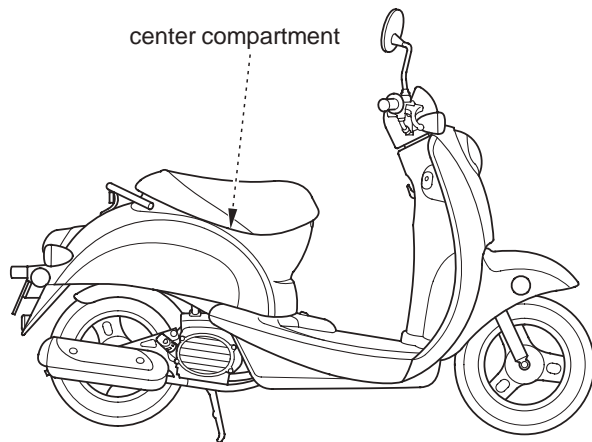

Operation Component Locations

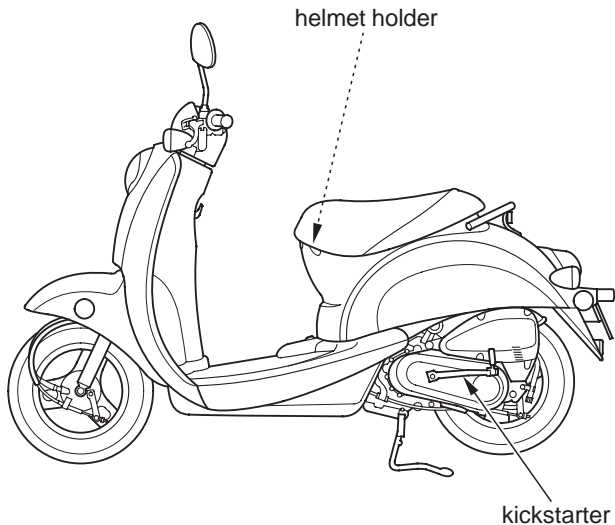

Gauges & Indicators

The gauges and indicators on your scooter keep you informed, alert you to possible problems, and make your riding safer and more enjoyable. Refer to the gauges and indicators frequently. Their functions are described on the following pages.

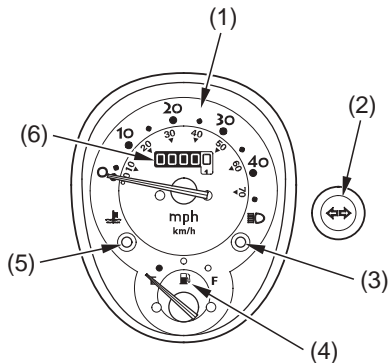

- (1) speedometer
- (2) turn signal indicator
- (3) high beam indicator
- (4) fuel gauge
- (5) high coolant temperature indicator
- (6) odometer

USA: Odometer reads in miles.

Canada: Odometer reads in kilometers.

Gauges & Indicators

Lamp Check

When applicable, the high beam indicator comes on when you turn the ignition switch ON and remains on until you select the low beam.

If this indicator does not come on when it should, have your Honda dealer check for a burned-out bulb or other problems.

Gauges & Indicators

1	speedometer	Shows riding speed in miles or kilometers per hour.
2	turn signal indicator (green)	Flashes when either turn signal operates.
3	high beam indicator (blue)	Lights when the headlight is on high beam.
4	fuel gauge	Shows the approximate fuel supply available. At F (Full), the fuel tank capacity including reserve is: 1.32 US gal (5.0 ℓ) When the gauge needle first points to the red dot, refill the tank as soon as possible. With the needle on the red dot there is: 0.32 US gal (1.2 ℓ)
5	high coolant temperature indicator (red)	Lights when the coolant is over the specified temperature. If the indicator comes on, pull safely to the side of the road. See pages 156 – 157 for instructions and cautions. When this indicator is lit, the vehicle speed will be automatically restricted.
6	odometer	Shows the total miles (USA) or kilometers (Canada) ridden.

Controls & Features

Ignition Switch

The ignition switch is used for starting and stopping the engine (page 45), opening the seat (page 26), and locking the steering to prevent theft (page 61). Insert the key and turn it to the right for the SEAT or ON position. Push down on the key and turn it to the left to the LOCK (steering lock) position.

To unlock the steering lock, insert and push down on the key and turn it to the right to the OFF position.

Key Position	Function
ON	Electrical circuits on.
SEAT	No electrical circuits function. Seat can be opened.
OFF	No electrical circuits function.
LOCK (steering lock)	No electrical circuits function. Allows the steering head to be locked.

Controls & Features

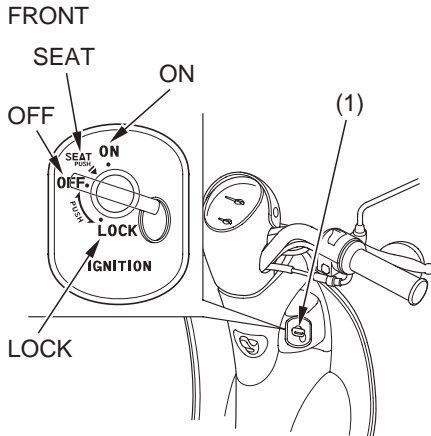

(1) ignition switch

Controls & Features

Start Button

The start button (1) is used for starting the engine. Pushing the button in starts the engine. See *Starting Procedure*, page 46.

The starter motor will not operate if the engine stop switch is in the OFF position when the start button is pushed.

The electric starter will only work when the brake lever is pulled in.

Engine Stop Switch



RIGHT HANDLEBAR (2)

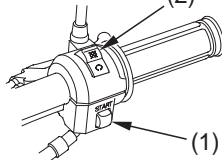

(1) start button

(2) engine stop switch

 OFF
 RUN

The engine stop switch (2) is used to stop the engine in an emergency. To operate, push the switch to the OFF position. The switch must be in the RUN position to start the engine, and it should normally remain in the RUN position even when the engine is OFF.

If your scooter is stopped with the ignition switch ON and the engine stop switch OFF, the taillight and license light will remain on, resulting in battery discharge.

Headlight Dimmer Switch



The headlight dimmer switch (1) is used to change between the high and low beams of the headlight. To operate, turn the switch to HI for high beam, LO for low beam.

Turn Signal Switch

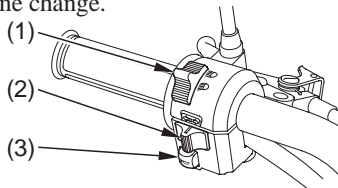

The turn signal switch (2) is used to signal a turn or a lane change. To operate, move the switch all the way in the proper direction and release it. The appropriate turn signal lights will start blinking. Remember to return the switch to the center (off) after completing your turn or lane change.



- (1) headlight dimmer switch  HI
(2) turn signal switch  LO
(3) horn button

Controls & Features

Horn Button



The horn is used to alert other motorists. To operate, push the horn button (3).

Rear Brake Lock

Be sure the rear brake is applied while starting and warming up the engine. The rear brake lock will not function if the rear brake is not adjusted properly (page 115).

To Apply the Brake Lock

Squeeze the rear brake lever (1) and set the brake lock lever (2).

The rear brake lock will not be applied if the rear brake is not adjusted properly (page 115).

LEFT HANDLEBAR

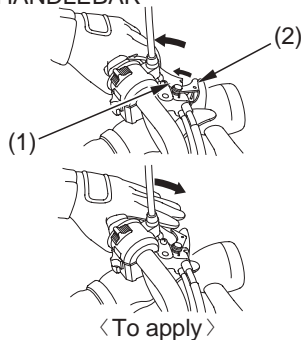

(1) rear brake lever (2) brake lock lever

To Release the Brake Lock

Squeeze the rear brake lever.

Before riding, make sure that the rear brake is fully released so there is no drag on the rear wheel.

LEFT HANDLEBAR

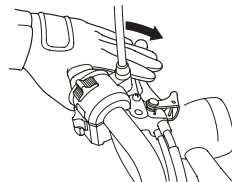
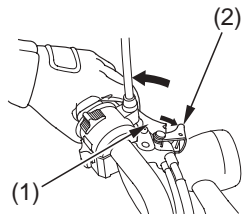

< To release >

- (1) rear brake lever
- (2) brake lock lever

Controls & Features

Seat Lock

The seat lock is in the ignition switch on the right side below the handlebar.

To open the seat, insert the ignition key (1) and push in the position of SEAT to unlock.

To lock the seat, lower and push down on it until it locks. Make sure the seat is securely closed before riding.

BELOW HANDLEBAR

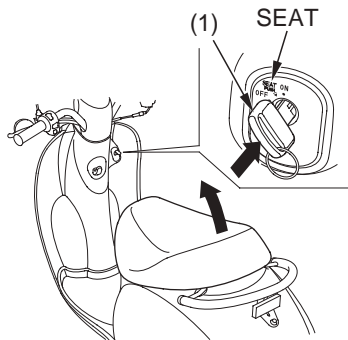

(1) ignition key

Center Stand Lock

Set the stand lock when the scooter is on its center stand.

To Lock the Center Stand

1. Place the scooter on its center stand and open the seat (page 26).
2. Turn the lock lever (1) to “LOCK.”
3. Lower and push down on the seat until it locks.

To Unlock the Center Stand

Turning the lock lever from “LOCK” to “UNLOCK” unlocks the center stand.

UNDER SEAT

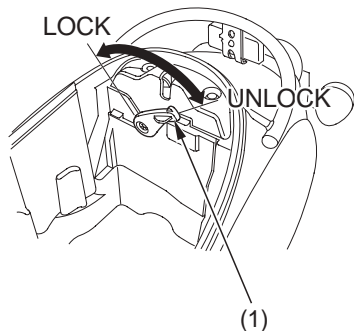

(1) lock lever

Before each ride, you need to make sure you and your Honda are both ready to ride. To help get you prepared, this section discusses how to evaluate your riding readiness, what items you should check on your scooter, and adjustments to make for your comfort, convenience, or safety. This section also includes important information about loading.

If you're a parent, be sure you also read the *Important Message to Parents* on page 5.

Are You Ready to Ride?	30
Protective Apparel.....	30
Rider Training	32
Is Your Scooter Ready to Ride?.....	34
Pre-ride Inspection	34
Load Limits & Guidelines.....	37
Loading.....	37
Load Limits	38
Loading Guidelines	39
Cargo Compartments.....	40
Center Compartment	40
Front Hook.....	41

Are You Ready to Ride?

Before you ride your scooter for the first time, we urge you to:

- Read this owner's manual.
- Make sure you understand all the safety messages.
- Know how to operate all the controls.

Before each ride, be sure:

- You feel well and are in good physical and mental condition.
- You are wearing an approved motorcycle helmet (with chin strap tightened securely), eye protection, and other protective clothing.
- You don't have any alcohol or drugs in your system.

Protective Apparel

For your safety, we strongly recommend that you always wear an approved motorcycle helmet, eye protection, boots, gloves, long pants, and a long-sleeved shirt or jacket whenever you ride.

Although complete protection is not possible, wearing proper gear can reduce the chance of injury when you ride.

Following are suggestions to help you choose the proper gear.

Are You Ready to Ride?

Helmets and Eye Protection

Your helmet is your most important piece of riding gear because it offers the best protection against head injuries. A helmet should fit your head comfortably and securely. A bright-colored helmet and reflective strips can make you more noticeable in traffic.

An open-face helmet offers some protection, but a full-face helmet offers more. Regardless of the style, look for a DOT (Department of Transportation) sticker on any helmet you buy (USA only). Always wear a face shield or goggles to protect your eyes and help your vision.

⚠ WARNING

Not wearing a helmet increases the chance of serious injury or death in a crash.

Be sure you always wear a helmet, eye protection, and other protective apparel when you ride.

Additional Riding Gear

In addition to a helmet and eye protection, we also recommend:

- Sturdy boots with non-slip soles to help protect your feet and ankles.
- Leather gloves to help protect your hands.

(cont'd)

Are You Ready to Ride?

- A motorcycle riding suit or jacket for comfort as well as protection. Bright-colored and reflective clothing can help make you more noticeable in traffic. Avoid loose clothes that could get caught on any part of your scooter.

Rider Training

Developing your riding skills is an on-going process. Even if you have ridden other scooters, take time to become familiar with how this scooter works and handles. Practice riding the scooter in a safe area to build your skills. Do not ride in traffic until you get accustomed to the scooter's controls, and feel comfortable with its size and weight.

We urge all riders to take a certified course approved by the Motorcycle Safety Foundation (MSF). New riders should start with the basic course, and even experienced riders will find the advanced course beneficial. For information about the MSF training course nearest you, call the national toll-free number: (800) 446-9227.

Other riding tips can be found in the *Riding Tips* booklet that came with your scooter (USA only).

Are You Ready to Ride?

ALWAYS wear a helmet.

You should also wear a face shield or goggles.

Clothes should be close-fitting.

Wear gloves.

Wear bright or reflective clothing.

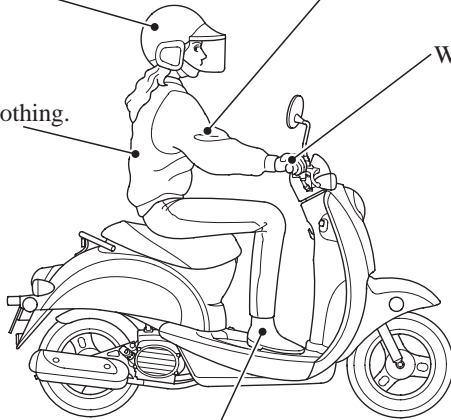

Boots should be close-fitting, have low heels and offer ankle protection.

Is Your Scooter Ready to Ride?

Before each ride, it's important to inspect your scooter and make sure any problem you find is corrected. A pre-ride inspection is a must, not only for safety, but because having a breakdown, or even a flat tire, can be a major inconvenience.

WARNING

Improperly maintaining this scooter or failing to correct a problem before riding can cause a crash in which you can be seriously hurt or killed.

Always perform a pre-ride inspection before every ride and correct any problems.

Pre-ride Inspection

Check the following items before you get on the scooter:

Tires & Wheels

Look at the tires. If a tire appears low, use an air pressure gauge to check its pressure. Also look for signs of excessive wear (page 120) or damage to the tires and wheels.

Is Your Scooter Ready to Ride?

*Leaks,
Loose
Parts*

Walk around your scooter and look for anything that appears unusual, such as a leak or loose cable.

Lights

Make sure the headlight, brakelight, taillight, and turn signals are working properly.

If you are carrying cargo, also check the following:

Load Limits Make sure you do not exceed the load limits (page 38).

Cargo Check that all cargo is secure.

Is Your Scooter Ready to Ride?

Check these items after you get on the scooter:

Throttle Rotate the throttle to check it moves smoothly without binding.

Brakes Pull the front and rear brake levers to check that they operate normally.

Indicators Turn the ignition on and check for normal operation of the gauges and indicators (page 17).

If you haven't ridden the scooter in over a week, you should also check other items, such as the oil level and other fluids. See *Periodic Maintenance* (page 72). Periodic maintenance should also be done at least once a month, no matter how often you ride.

Remember, be sure to take care of any problem you find, or have your Honda dealer correct it before you ride.

Load Limits & Guidelines

Your scooter has been designed to carry you and limited amount of cargo. When you add cargo, you may feel some difference during acceleration and braking. But so long as you keep your scooter well-maintained, with good tires and brakes, you can safely carry loads within the given limits and guidelines.

However, exceeding the weight limit or carrying an unbalanced load can seriously impair your scooter's handling, braking, and stability. Non-Honda accessories, improper modifications, and poor maintenance can also reduce your safety margin.

Loading

How much weight you put on your scooter, and how you load it, are important to your safety. Anytime you ride with cargo, you should be aware of the following information.

WARNING

Overloading or carrying a passenger can cause a crash and you can be seriously hurt or killed.

Follow all load limits and other loading guidelines in this manual.

Load Limits & Guidelines

Load Limits

Following are the load limits for your scooter:

maximum weight capacity:

277 lbs (126 kg)

includes the weight of the rider, all cargo, and all accessories.

maximum cargo weight:

25 lbs (11.5 kg)

includes following maximum compartment weights:

front hook: 3 lbs (1.5 kg)

center

compartment: 22 lbs (10 kg)

The weight of added accessories will reduce the maximum cargo weight you can carry.

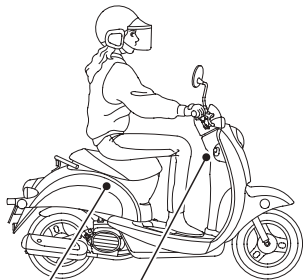

front hook;
weight limit — 3 lbs (1.5 kg)

center compartment;
weight limit — 22 lbs (10 kg)

Loading Guidelines

If you wish to carry more cargo, check with your Honda dealer for advice, and be sure to read the information regarding accessories on page 9.

Improperly loading your scooter can affect its stability and handling. Even if your scooter is properly loaded, you should ride at reduced speeds whenever carrying cargo.

Do not attach cargo to the rear grip.

Cargo Compartments

Center Compartment

The center compartment (1) is designed to carry up to 22 lbs (10 kg).

However, regardless of compartment capacity, be sure you do not exceed the maximum load and cargo weight limits.

To Open the Center Compartment

Place the scooter on its center stand and open the seat (page 26).

To Close the Center Compartment

Lower and push down on the seat until it locks.

Make sure the seat is securely closed before riding.

The center compartment may become heated by the engine. Do not store food and other articles which are flammable or susceptible to heat damage in this compartment.

Do not direct water under pressure against the center compartment as water will be forced into the compartment.

UNDER SEAT

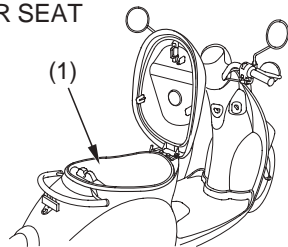

(1) center compartment

Front Hook

The front hook (1) may be used to hang a small shopping bag. Do not carry more than the maximum weight limit.

maximum weight limit: 3 lbs (1.5 kg)

Do not attach a large bag or other item that can interfere with the movement of your feet.

BELOW HANDLEBAR

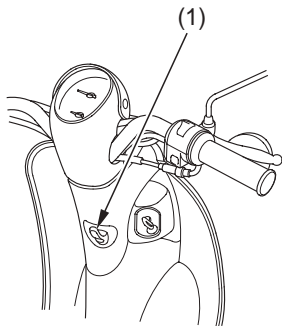

(1) front hook

Basic Operation & Riding

This section gives basic riding instructions, including how to start and stop your engine, and how to use the throttle and brakes. It also provides important information on riding with cargo.

To protect your new engine and enjoy optimum performance and service life, refer to Break-in Guidelines (page 175).

To protect the catalytic converter in your scooter's exhaust system, avoid extended idling and the use of leaded gasoline.

For information about carburetor adjustment for riding at high altitude, see page 176.

Safe Riding Precautions	44
Starting & Stopping the Engine	45
Preparation.....	45
Starting Procedure	46
How to Stop the Engine	50
Riding	51
Braking	58
Parking	60
Theft-prevention Tips	63
Riding with Cargo	64

Safe Riding Precautions

Before riding your scooter for the first time, please review the *Scooter Safety* section beginning on page 1, and the *Before Riding* section beginning on page 29.

Even if you have ridden other scooters, take time to become familiar with how this scooter works and handles. Practice in a safe area until you build your skills and get accustomed to the scooter's size and weight.

Make sure flammable materials such as dry grass or leaves do not come in contact with the exhaust system when riding, idling, or parking your scooter.

Starting & Stopping the Engine

Always follow the proper starting procedure described below.

For your safety, avoid starting or operating the engine in an enclosed area such as a garage. Your scooter's exhaust contains poisonous carbon monoxide gas which can collect rapidly in an enclosed area and cause illness or death.

This scooter has an automatic fuel valve and choke; there is no manual operation.

Do not use the electric starter for more than 5 seconds at a time. Release the start button for approximately 10 seconds before pressing it again.

Operate the kickstarter or start button for slightly longer than usual without opening the throttle if the scooter has been left standing for a long time or when the fuel tank has just been refilled.

Preparation

Before starting, turn the center stand lock lever from LOCK to UNLOCK (page 27), insert the key in the ignition switch, turn the ignition switch ON, and confirm the following:

- The engine stop switch is set to RUN.

Starting & Stopping the Engine

Starting Procedure

1. Place the scooter on its center stand.
2. Lock the rear wheel by squeezing the rear brake lever (1) and setting the brake lock lever (2).

⚠ CAUTION

Contact with the spinning rear wheel can cause you to be hurt.

Set the parking brake when the scooter is on its center stand.

The electric starter will only work when the brake lever is pulled in.

LEFT HANDLEBAR

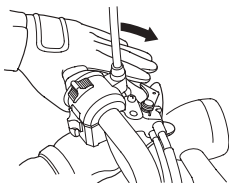
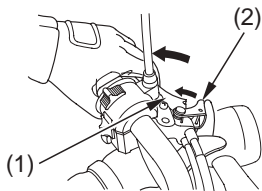

- (1) rear brake lever
(2) brake lock lever

Starting & Stopping the Engine

3. Make sure the engine stop switch is at RUN.
4. Turn the ignition switch (3) ON.

BELOW HANDLEBAR

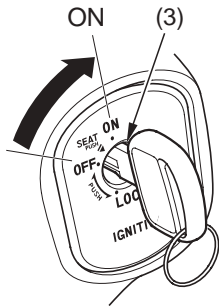

(3) ignition switch

5. With the throttle closed, push the start button (4). Release the start button as soon as the engine starts.

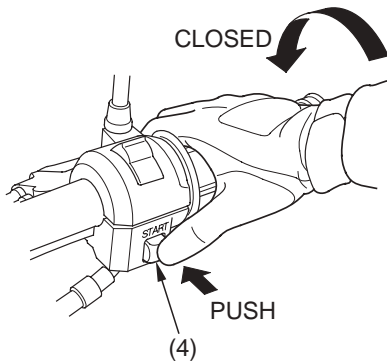

(4) start button

Starting & Stopping the Engine

6. Be sure to keep the throttle (5) closed and the rear brake locked while starting and warming up the engine.
7. Allow the engine to warm up before riding (see *Riding*, page 51).

Do not “blip” (rapidly open and close) the throttle. This action may cause the scooter to move forward suddenly.

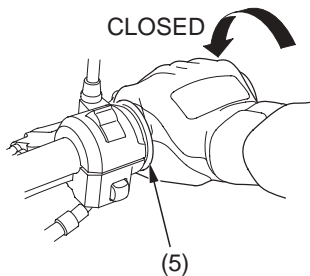

(5) throttle

To Start the Engine Without Electric Starter

1. Follow steps 1 – 4.
2. With the throttle closed, operate the kickstarter with a rapid, continuous motion.

Allowing the kickstarter to snap back freely against the pedal stop can damage the engine case.

Raise the kickstarter pedal after the kickstarter lever is returned to the stop.



Starting & Stopping the Engine

If You Cannot Restart a Warm Engine

1. Place the scooter on its center stand, squeeze the rear brake lever, and set the rear brake lock (page 24).
2. Open the throttle (1) $1/8$ – $1/4$ turn while starting the engine.

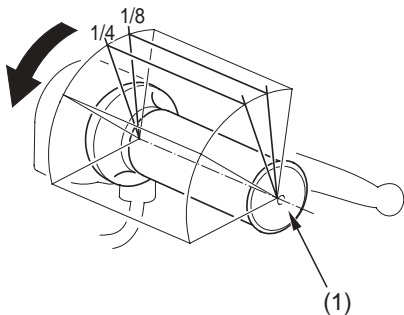

(1) throttle

Starting & Stopping the Engine

How to Stop the Engine

Normal Engine Stop

To stop the engine, turn the ignition switch OFF.

The engine stop switch should normally remain in the RUN position even when the engine is OFF.

If your scooter is stopped with the ignition switch ON and the engine stop switch OFF, the headlight, taillight and license light will remain on, resulting in battery discharge.

Emergency Engine Stop

To stop the engine in an emergency, use the engine stop switch. To operate, press the switch to the OFF position.

1. To prevent unexpected movement, make sure the throttle is closed and the rear brake is locked (page 24) before moving the scooter off its center stand.

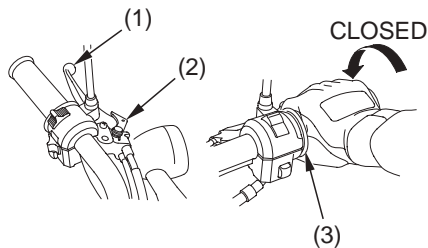

- (1) rear brake lever
- (2) brake lock lever
- (3) throttle

2. Stand on the left side of the scooter and push it forward and off the center stand.

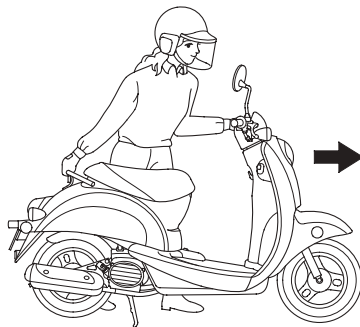

Riding

3. Mount the scooter from the left side, keeping at least one foot on the ground to steady the scooter.

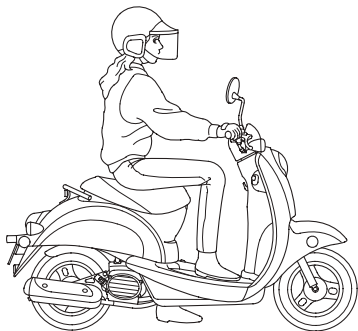

4. To unlock the rear wheel, squeeze the rear brake lever (1) until the brake lock lever (2) releases.

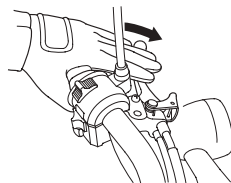
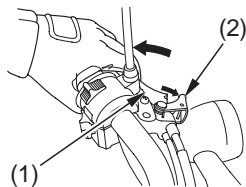

- (1) rear brake lever
(2) brake lock lever

5. Before starting off, indicate your direction with the turn signals, and check for safe traffic conditions. Grasp the handlebars firmly with both hands.

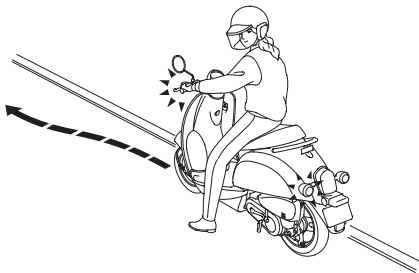

6. To accelerate, open the throttle (3) gradually. The scooter will move forward.

Do not blip (rapidly open and close) the throttle as the scooter will move forward suddenly.

7. To decelerate, close the throttle.

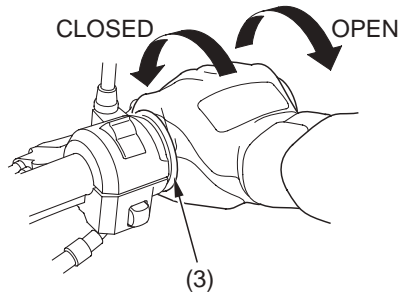

(3) throttle

Riding

8. To slow the scooter, reduce the throttle (3) and apply the front and rear brakes (4) together.

Using only one brake reduces stopping performance. Excessive brake application may cause either wheel to lock, reducing control of the scooter.

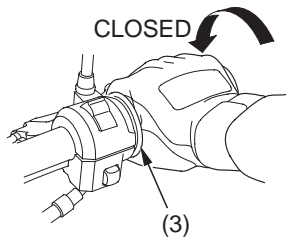

(3) throttle

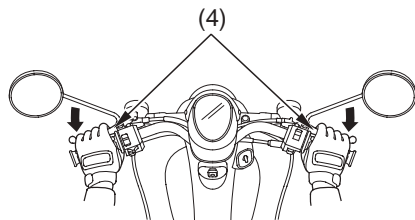

(4) front and rear brakes

9. When approaching a corner or turn, slow the scooter by closing the throttle (3) fully and applying both the front (5) and rear (6) brakes at the same time.

10. After completing a turn, open the throttle gradually to accelerate the scooter.

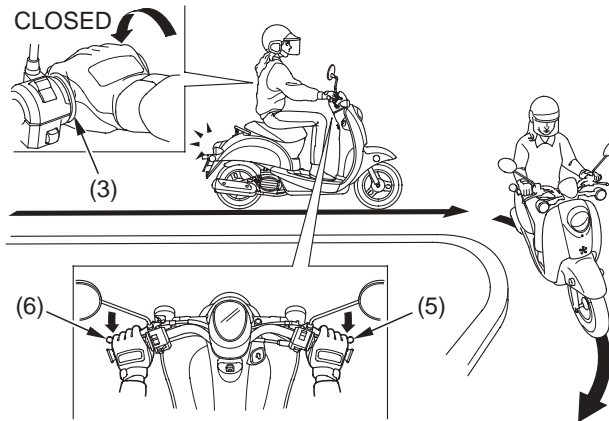

(3) throttle

(5) front brake

(6) rear brake

Riding

11. When descending a steep grade, close the throttle (3) fully and apply both the front (5) and rear (6) brakes to slow the scooter.

Avoid continued use of the brakes, which may cause the brakes to overheat and reduce braking efficiency.

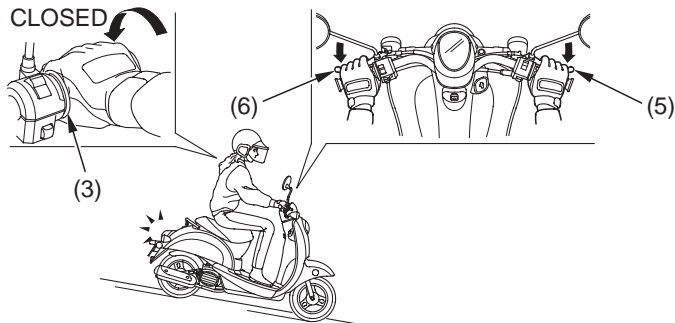

(3) throttle

(5) front brake

(6) rear brake

12. When riding in wet or rainy conditions or loose surfaces, the ability to maneuver and stop is reduced. For your safety:
- Exercise extreme caution when braking, accelerating, or turning.
 - Ride at slower speeds and allow for extra stopping distance.
 - Keep the scooter as upright as possible.
 - Use extreme caution when riding over slippery surface such as railroad tracks, iron plates, manhole covers, painted lines, etc.

Braking

Your scooter is equipped with a Linked Braking System. Operating the front brake lever applies the front brake. Operating the rear brake lever applies the rear brake and a portion of the front brake. For full braking effectiveness, use the front and rear brake levers simultaneously.

As with a conventional scooter braking system, excessively hard application of the brake controls may cause wheel lock, reducing control of the scooter.

As a general rule, the front braking system provides about 70 percent of total stopping power.

To slow or stop, apply the front and rear brake levers smoothly.

Gradually increase braking as you feel the brakes slowing your speed.

For support, before coming to a complete stop, put your left foot down first, then your right foot down.

Applying the brakes too hard may cause the wheels to lock and slide, reducing control of your scooter. If this happens, release the brake controls, steer straight ahead until you regain control, then reapply the brakes more gently.

When possible, reduce your speed or complete braking before entering a turn. Avoid braking or closing the throttle quickly while turning. Either action may cause one or both wheels to slip and reduce your control of your scooter.

Your ability to brake in a turn and to brake hard in an emergency situation are important riding skills. We suggest attending a Motorcycle Safety Foundation experienced rider training course (page 32) to retain these skills.

When riding in wet or rainy conditions, or on loose surfaces, the ability to maneuver and stop will be reduced. All of your actions should be smooth under these conditions. Rapid acceleration, braking or turning may cause loss of control.

For your safety, exercise extreme caution when braking, accelerating or turning.

When descending a long, steep grade, use both brakes intermittently. Continuous brake application can overheat the brakes and reduce their effectiveness.

Riding with your hand on either brake lever may actuate the brakelight, giving a false indication to other drivers. It may also overheat the brakes, reducing effectiveness.

Parking

1. Look for a level parking area. If you can't park on a paved surface, make sure the ground surface is firm, especially under the center stand. Make sure flammable materials such as dry grass or leaves do not come in contact with the exhaust system when parking your scooter. Refer to *Catalytic Converter*, page 183.

If you must park on a hill, position the rear tire against the curb at a 45 degree angle.

2. Use the center stand and center stand lock (page 27) to support the scooter while parked.
- To lower the center stand, stand on the left side of the scooter. Hold the left handle grip and rear grip. Press down on the tip of the stand with

your right foot and, simultaneously, pull up and back.

- If you have to park on a soft surface, insert something solid under the stand for support.

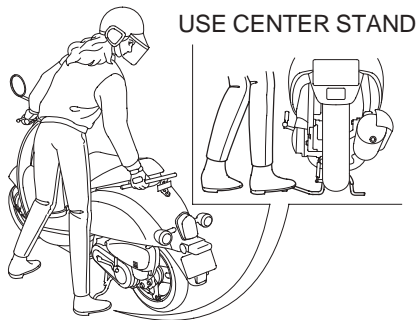

3. Use the steering lock, which locks the handlebar in place. Turn the handlebar all the way to the left. Push in on the ignition key (1) and turn it to LOCK. Remove the key.
(To unlock the steering lock, insert and push down on the key and turn it to the right to the OFF position.)

LOCK STEERING

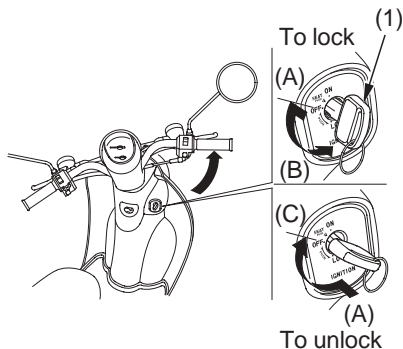

(1) ignition key

(A) push in

(B) turn to LOCK

(C) turn to UNLOCK

Parking

4. Use the helmet holder (2), located on the left side below the seat, to secure your helmet with your scooter:

- Open the seat (page 26).
- Hang your helmet on the holder.
- Lower the seat to lock.

To remove a helmet, open the seat (page 26). Remove the helmet from the helmet holder. Lower and push down on the seat until it locks. Make sure the seat is securely closed before riding.

UNDER SEAT

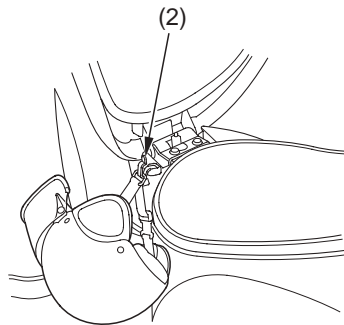

(2) helmet holder

Theft-prevention Tips

- Park your scooter in a locked garage whenever possible. If a garage isn't available, park in a concealed area or in a well-lit area with enough pedestrian traffic to discourage a thief.
 - Always take the ignition key with you.
 - Always use the steering lock (page 61), even if you're parking for just a minute or two. A thief can easily push an unlocked scooter to a waiting truck.
 - In addition to the steering lock, use a good quality anti-theft device made specifically to lock a scooter to a secure object.
- If you decide to use an anti-theft device, select one of good quality and be sure to follow the manufacturer's instructions.
 - Keep your owner's manual, current registration, and insurance information with your scooter. This will make it easier for the authorities to find you if your scooter is stolen and recovered.

Riding with Cargo

Your scooter is designed for use by one rider only. Whenever you add cargo, you must be careful not to exceed the total load limits for this vehicle (*Load Limits*, page 38). Make sure your cargo is properly secured (*Loading Guidelines*, page 39).

Be aware that carrying heavy cargo can affect acceleration, braking, and handling.

To help keep your scooter in good shape, this section includes a Maintenance Schedule for required service, a list of periodic checks you should perform at least once a month, and step-by-step instructions for specific maintenance tasks. You'll also find important safety precautions, information on fuels and oils, and tips for keeping your Honda looking great.

For information about the exhaust emission and noise emission requirements of the U.S. Environmental Protection Agency (EPA) and Environment Canada (EC), see page 177 .

For information about replacing fuses, see page 158 .

USA only

Maintenance, replacement or repair of the emission control devices and systems may be performed by any motorcycle repair establishment or individual using parts that are “certified” to EPA standards.

Before You Service Your Honda

The Importance of Maintenance.....	68
Maintenance Safety.....	69
Important Safety Precautions.....	70
Periodic Maintenance.....	72
Maintenance Schedule	74
Maintenance Record.....	79

(cont'd)

Servicing Your Honda

Service Preparations

Maintenance Component Locations	81
Owner's Manual Storage.....	84
Maintenance Lid Removal	85
Plug Maintenance Lid Removal	86

Service Procedures

Fluids & Filters

Fuel	87
Engine Oil & Strainer Screen.....	90
Coolant.....	100
Air Cleaner	104
Crankcase Breather	106

Engine

Throttle	107
Engine Idle Speed.....	109
Spark Plug	111

Chassis

Brakes	114
Tires	118

Electrical

Battery	125
Appearance Care	130

Servicing Your Honda

The following table summarizes the three types of inspections and servicing recommendations for your scooter. Both the pre-ride inspection and the scheduled maintenance at the recommended intervals are necessary to assure safe and dependable performance. The periodic checks provide additional confidence in your scooter's performance.

Type of Inspection/Service	Refer to page:	When Performed	Who Performs
Pre-ride Inspection	34	before every ride	you
Periodic Maintenance	72	monthly*	you
Maintenance Schedule	74	interval on schedule	your Honda dealer**

* more often if you ride frequently or long distances; or anytime you clean your scooter

** unless you have the proper tools and service data and are mechanically qualified

An optional tool kit may be available. Check with your Honda dealer's parts department.

The Importance of Maintenance

Keeping your scooter well-maintained is absolutely essential to your safety. It's also a good way to protect your investment, get maximum performance, avoid breakdowns, and have more fun. A properly maintained scooter will also help to reduce air pollution.

Remember, proper maintenance is the owner's responsibility. Be sure to inspect your scooter before each ride, perform the periodic checks, and follow the Maintenance Schedule in this section.

WARNING

Improperly maintaining this scooter or failing to correct a problem before you ride can cause a crash in which you can be seriously hurt or killed.

Always follow the inspection and maintenance recommendations and schedules in this owner's manual.

If your scooter overturns or is involved in a crash, be sure your Honda dealer inspects all major parts, even if you are able to make some repairs.

This section includes instructions on how to perform some important maintenance tasks. If you have basic mechanical skills, you can perform many of these tasks with the appropriate tools.

Other tasks that are more difficult and require special tools are best performed by professionals. Wheel removal should normally be handled only by a Honda technician or other qualified mechanic. Instructions are included in this manual only to assist in emergency service.

Some of the most important safety precautions follow. However, we cannot warn you of every conceivable hazard that can arise in performing maintenance. Only you can decide whether or not you should perform a given task.

WARNING

Failure to properly follow maintenance instructions and precautions can cause you to be seriously hurt or killed.

Always follow the procedures and precautions in this owner's manual.

Maintenance Safety

Important Safety Precautions

- Make sure the engine is off before you begin any maintenance or repairs. This will help eliminate several potential hazards:

Carbon monoxide poisoning from engine exhaust. Be sure there is adequate ventilation whenever you operate the engine.

Burns from hot scooter parts. Let the engine and exhaust system cool before touching.

Injury from moving parts. Do not run the engine unless instructed to do so.

- Read the instructions before you begin, and make sure you have the tools and skills required.
- To help prevent the scooter from falling over, park it on a firm, level surface, using the center stand to provide support.
- Be sure the rear brake lock is set before running the engine while the scooter is supported by the center stand. This will prevent the rear wheel from spinning and avoid the possibility of someone being injured from contacting the wheel.
- To reduce the possibility of a fire or explosion, be careful when working around gasoline. Use only non-flammable solvent, not gasoline, to clean parts. Keep cigarettes, sparks, and flames away from all fuel-related parts.

Remember that your Honda dealer knows your scooter best and is fully equipped to maintain and repair it. To ensure the best quality and reliability, use only new Honda Genuine Parts or their equivalents for repair and replacement. If you have the tools and skills required for additional maintenance jobs, you can purchase an official Honda Service Manual (page 188).

Periodic Maintenance

In addition to the regularly scheduled maintenance (page 74) and daily pre-ride inspection (page 34), consider performing the periodic checks on the following page at least once a month, even if you haven't ridden your scooter, or as often as once a week if you ride frequently or for long distances. It's a good idea to perform this maintenance any time you clean your scooter.

Check the odometer reading and perform any scheduled maintenance checks that are needed (page 74). Remember, more frequent checks may be needed for riding in severe conditions.

Periodic Maintenance

Tires & Wheels	<p>Check the air pressure with a gauge and add air if needed (page 118). Examine the tread for wear (page 120). Look closely for nails, embedded objects, cuts, and other types of damage (page 120). Roll your scooter so you can inspect the entire surface.</p> <p>Check the condition of the wheels.</p>
Fluids	<p>Check the levels of the engine oil (page 94) and coolant (page 101). Add the correct fluid as necessary, and investigate the cause of any low fluid level.</p>
Lights	<p>Make sure the headlight, brakelight, taillight, and turn signals are working properly.</p>
Freeplay	<p>Check the freeplay of the front and rear brake levers (page 114), and throttle grip.</p>
Fuses	<p>Make sure you have a full supply of spare fuses.</p>
Nuts & Bolts	<p>Check the major fasteners and tighten as needed.</p>

Maintenance Schedule

The required Maintenance Schedule that follows specifies how often you should have your scooter serviced, and what things need attention. It is essential to have your scooter serviced as scheduled to maintain safe, dependable performance and proper emission control.

The service intervals in this Maintenance Schedule are based on average riding conditions. Some items will need more frequent service if you ride in unusually wet or dusty areas or at full throttle. Consult your Honda dealer for recommendations applicable to your individual needs and use.

Some items in the Maintenance Schedule can be performed with basic mechanical skills and hand tools. Procedures for these items are provided in this manual. Other items involve more extensive procedures and may require special training, tools, and equipment. We recommend that you have your Honda dealer perform these tasks unless you have advanced mechanical skills and the required tools and equipment. Procedures for such items in this schedule are provided in an official Honda Service Manual available for purchase (page 188).

Maintenance Schedule

If you do not feel capable of performing a given task or need assistance, remember that your Honda dealer knows your scooter best and is fully equipped to maintain and repair it. If you decide to do your own maintenance, use only Honda Genuine Parts or their equivalents for repair or replacement to ensure the best quality and reliability.

Perform the pre-ride inspection (page 34) and owner maintenance (page 76) at each scheduled maintenance period.

Each item on the maintenance schedule requires some mechanical knowledge. Certain items (particularly those marked * and **) may require more technical information and tools. Consult your Honda dealer.

* Should be serviced by your Honda dealer, unless you have the proper tools and service data and are mechanically qualified. Refer to the official Honda Service Manual (page 188).

** In the interest of safety, we recommend these items be serviced only by your Honda dealer.

Maintenance Schedule

Summary of Maintenance Schedule Notes & Procedures:

NOTES:

1. At higher odometer readings, repeat at the frequency interval established here.
2. Service more frequently if the scooter is ridden in unusually wet or dusty areas.
3. Service more frequently if the scooter is ridden often at full throttle or in the rain.
4. Replace every 2 years.
Replacement requires mechanical skill.

Maintenance Procedures:

I: inspect and clean, adjust, lubricate,
or replace, if necessary

C: clean

A: adjust

L: lubricate

R: replace

Maintenance Schedule

ITEM			FREQUENCY	ODOMETER READING (Note 1)					Refer to page
				× 1,000 mi	0.6	2.5	5	7.5	
			NOTE	× 1,000 km	1.0	4	8	12	
EMISSIONS-RELATED ITEMS	*	FUEL LINE						I	—
	*	THROTTLE OPERATION				I	I	I	—
		AIR CLEANER	2					R	105
		CRANKCASE BREATHER	3			C	C	C	106
		SPARK PLUG					R		111
	*	VALVE CLEARANCE		EVERY 15,000 mi (24,000 km) I					—
		ENGINE OIL		INITIAL = 600mi (1,000km) or 1 month : R REGULAR = EVERY 2,500mi (4,000km) or 6 months : R					94
	*	ENGINE OIL STRAINER SCREEN						C	98
	*	ENGINE IDLE SPEED			I	I	I	I	109
		RADIATOR COOLANT	4						101
	*	COOLING SYSTEM						I	—
*	SECONDARY AIR SUPPLY SYSTEM						I	—	

* Should be serviced by your Honda dealer, unless you have the proper tools and service data and are mechanically qualified. Refer to the official Honda Service Manual (page 188).

Maintenance Schedule

ITEM		FREQUENCY	NOTE	ODOMETER READING (Note 1)					Refer to page
				× 1,000 mi	0.6	2.5	5	7.5	
NON-EMISSION-RELATED ITEMS		BRAKE SHOES WEAR		× 1,000 km	1.0	4	8	12	117
		BRAKE SYSTEM							114
	*	BRAKE LOCK OPERATION							24
	*	HEADLIGHT AIM							—
	**	CLUTCH SHOES WEAR							—
	*	SUSPENSION							—
	*	NUTS, BOLTS, FASTENERS							—
	**	WHEELS/TIRES							—
	**	STEERING HEAD BEARINGS							

- * Should be serviced by your Honda dealer, unless you have the proper tools and service data and are mechanically qualified. Refer to the official Honda Service Manual (page 188).
- ** In the interest of safety, we recommend these items be serviced only by your Honda dealer.

Maintenance Record

Keeping an accurate maintenance record will help ensure that your scooter is properly maintained. Retain detailed receipts to verify the maintenance was performed. If the scooter is sold, these receipts should be transferred with the scooter to the new owner. Make sure whoever performs the maintenance completes this record. All scheduled maintenance, including the 600 mile (1,000 km) initial maintenance, is considered a normal owner operating cost and will be charged for by your dealer. Use the space under Notes to record anything you want to remind yourself about or mention to your dealer.

Miles (km)	Odometer	Date	Performed By:	Notes
600 (1,000)				
2,500 (4,000)				
5,000 (8,000)				
7,500 (12,000)				
10,000 (16,000)				

Maintenance Record

Miles (km)	Odometer	Date	Performed By:	Notes
12,500 (20,000)				
15,000 (24,000)				
17,500 (28,000)				
20,000 (32,000)				
22,500 (36,000)				
25,000 (40,000)				
27,500 (44,000)				
30,000 (48,000)				

Maintenance Component Locations

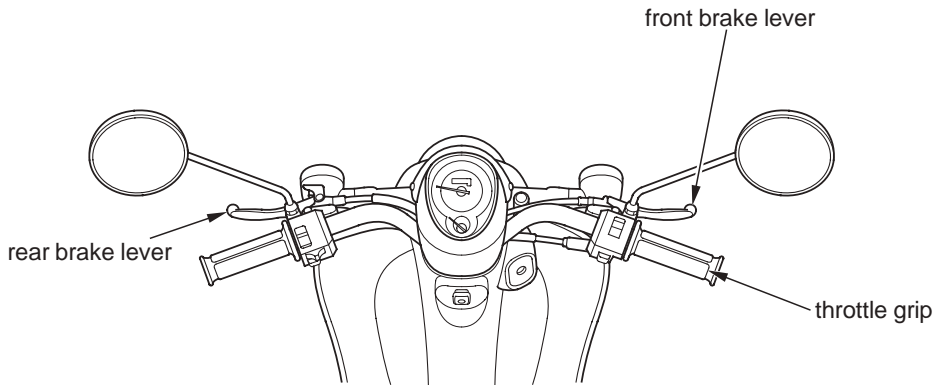

Maintenance Component Locations

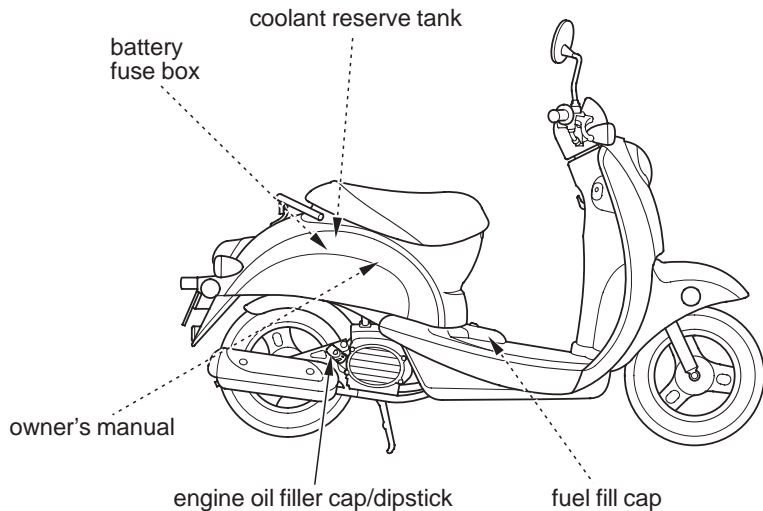

Maintenance Component Locations

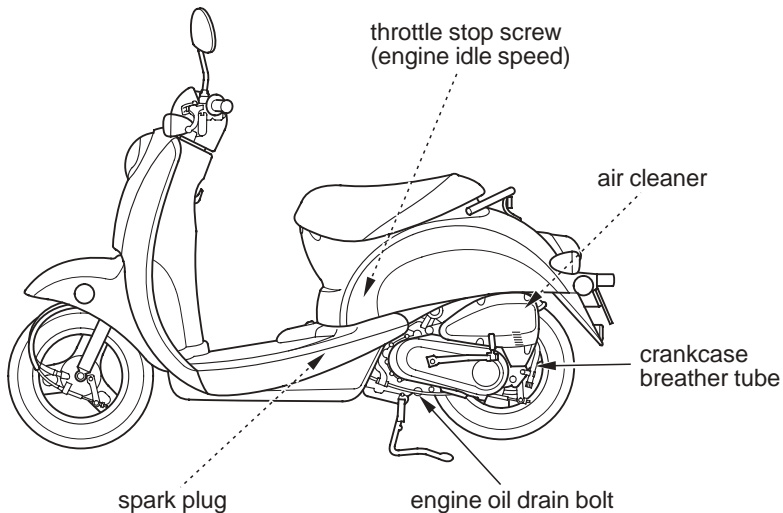

Owner's Manual Storage

Your scooter provides storage for the owner's manual so you'll have it with you for easy reference. Store your owner's manual (and other documents) in the plastic storage bag (1) in the center compartment under the seat.

Be careful not to flood this area when washing your scooter.

INSIDE CENTER COMPARTMENT

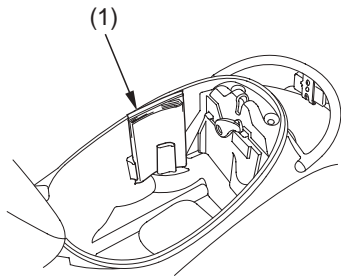

(1) storage bag

Maintenance Lid Removal

Refer to *Safety Precautions* on page 70 .

The maintenance lid must be removed to service the coolant, fuse and battery.

UNDER SEAT

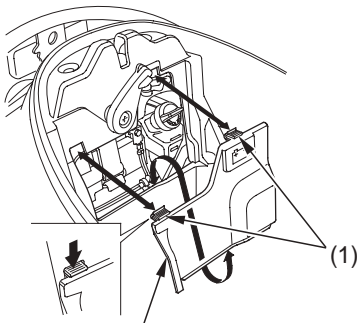

(1) tabs

(2)

(2) maintenance lid

Removal

1. Open the seat (page 26).
2. Release the tabs (1), then remove the maintenance lid (2).

Installation

- Installation can be done in the reverse order of removal.

Plug Maintenance Lid Removal

Refer to *Safety Precautions* on page 70 .

The plug maintenance lid must be removed to service the spark plug and engine idle speed.

STEPBOARD

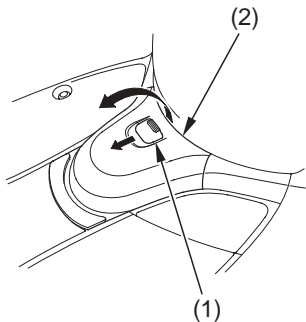

(1) tab

(2) fuel tank lid

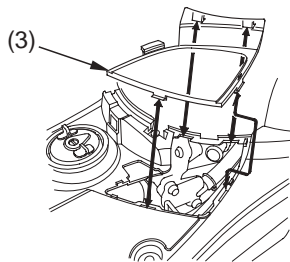

(3) plug maintenance lid

Removal

1. Pull the tab (1) and open the fuel tank lid (2).
2. Remove the plug maintenance lid (3).

Installation

- Installation can be done in the reverse order of removal.

Refer to *Safety Precautions* on page 70 .

Fuel Recommendation

type	unleaded
pump octane number	86 (or higher)

We recommend that you use unleaded fuel because it produces fewer engine deposits and extends the life of exhaust system components.

The use of leaded gas will damage the catalytic converter.

Your engine is designed to use any gasoline that has a pump octane number of 86 or higher. Gasoline pumps at service stations normally display the pump octane number. For information on the use of oxygenated fuels, see page 184.

Use of lower octane gasoline can cause persistent “pinging” or “spark knock” (a loud rapping noise) which, if severe, can lead to engine damage. Light pinging experienced while operating under a heavy load, such as climbing a hill, is no cause for concern.

If pinging or spark knock occurs at a steady engine speed under normal load, change brands of gasoline. If pinging or spark knock persists, consult your Honda dealer.

Fuel

Never use stale or contaminated gasoline or an oil/gasoline mixture. Avoid getting dirt, dust, or water in the fuel tank.

Fuel Capacity

Fuel tank capacity, including reserve:
1.32 US gal (5.0 ℓ)

Refueling Procedure

Refer to *Safety Precautions* on page 70 .

UNDER STEPBOARD

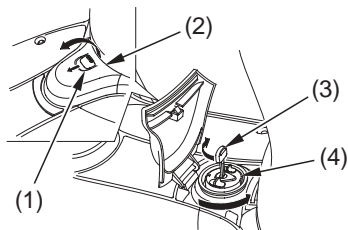

- | | |
|-------------------|-------------------|
| (1) tab | (3) ignition key |
| (2) fuel tank lid | (4) fuel fill cap |

1. Pull the tab (1) and open the fuel tank lid (2).
2. Insert the ignition key (3) in the fuel fill cap (4) and turn it clockwise.

3. Remove the fuel fill cap (4) by turning it counterclockwise.
4. Add fuel until the level reaches the bottom of the filler neck (5). Avoid overfilling the tank. There should be no fuel in the filler neck.

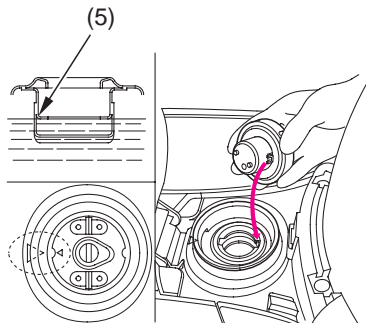

(5) filler neck

⚠ WARNING

Gasoline is highly flammable and explosive. You can be burned or seriously injured when handling fuel.

- Stop the engine and keep heat, sparks and flame away.
 - Handle fuel only outdoors.
 - Wipe up spills immediately.
5. After refueling, install the fuel fill cap by turning it clockwise.
 6. Turn the ignition key counterclockwise and remove it.
 7. Close the fuel tank lid.

Engine Oil & Strainer Screen

Engine oil quality is a major factor that affects both the performance and the service life of the engine.

Using the proper oil (page 91) and filter, and regularly checking, adding, and changing oil will help extend your engine's life. Even the best oil wears out. Changing oil helps get rid of dirt and deposits in the engine. Operating the engine with old or dirty oil can damage your engine. Running the engine with insufficient oil can cause serious damage to the engine and transmission.

Change the engine oil as specified in the maintenance schedule on page 77.

When running in very dusty conditions, oil changes should be performed more frequently than specified in the maintenance schedule.

Engine Oil & Strainer Screen

Oil Recommendation

API classification	SG or higher except oils labeled as energy conserving on the circular API service label
viscosity (weight)	SAE 10W-30
JASO T 903 standard	MA

suggested oil*

Pro Honda GN4 4-stroke oil (USA & Canada), or Honda 4-stroke oil (Canada only), or an equivalent motorcycle oil.

- * Suggested oils are equal in performance to SJ oils that are not labeled as energy conserving on the circular API service label.

Engine Oil & Strainer Screen

- Your scooter does not need oil additives. Use the recommended oil.
- Do not use API SH or higher oils displaying a circular API “energy conserving” service label on the container. They may affect lubrication.



NOT RECOMMENDED



OK

- Do not use non-detergent, vegetable, or castor based racing oils.

Other viscosities shown in the following chart may be used when the average temperature in your riding area is within the indicated range.

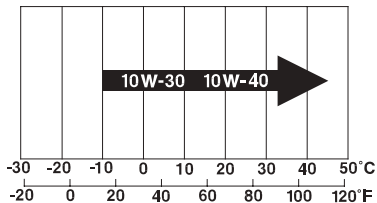

Engine Oil & Strainer Screen

JASO T 903 standard

The JASO T 903 standard is an index for engine oils for 4-stroke motorcycle engines.

There are two classes: MA and MB.

Oil conforming to the standard is labeled on the oil container. For example, the following label shows the MA classification.

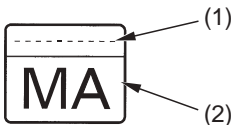

PRODUCT MEETING JASO T 903
COMPANY GUARANTEEING THIS MA PERFORMANCE:

- (1) code number of the sales company of the oil
- (2) oil classification

Engine Oil & Strainer Screen

Checking & Adding Oil

Refer to *Safety Precautions* on page 70 .

RIGHT SIDE

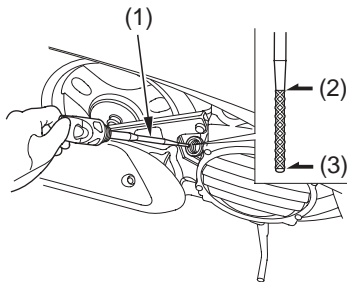

- (1) oil filler cap/dipstick
- (2) upper level mark
- (3) lower level mark

1. Park your scooter on its center stand on a firm, level surface.
2. Start the engine and let it idle for 3—5 minutes.
3. Stop the engine and wait 2—3 minutes.
4. Remove the oil filler cap/dipstick (1) and wipe it clean.
5. Insert the oil filler cap/dipstick until it seats, but don't screw it in.

Engine Oil & Strainer Screen

6. Remove the oil filler cap/dipstick and check the oil level.
 - If the oil is at or near the upper level mark (2) — you do not have to add oil.
 - If the oil is below or near the lower level mark (3) — add the recommended oil until it reaches the upper level mark. (Do not overfill.)
7. Reinstall the oil filler cap/dipstick.
8. Check for oil leaks.

Changing Engine Oil

Refer to *Safety Precautions* on page 70 .

This procedure requires mechanical skill and professional tools such as a torque wrench, as well as a means for disposing of the drained fluid (page 143). If you do not have the skills or the tools, see your Honda dealer.

Engine Oil & Strainer Screen

Drain the Engine Oil:

1. Park the scooter on its center stand on a firm, level surface.
2. If the engine is cold, start it and let it idle for 3–5 minutes. Turn the engine off. Wait 2–3 minutes for the oil to settle.
3. Place a drain pan under the engine oil drain bolt (1).
4. To drain the oil, remove the oil filler cap/dipstick (2), engine oil drain bolt, and sealing washer (3).

RIGHT SIDE

LEFT SIDE

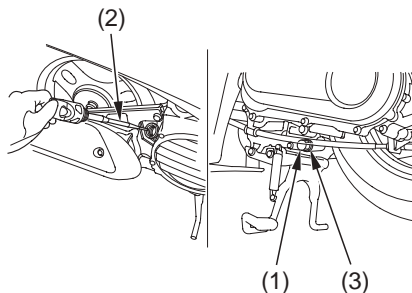

- (1) engine oil drain bolt
- (2) oil filler cap/dipstick
- (3) sealing washer

Engine Oil & Strainer Screen

5. Pour the drained oil into a suitable container and dispose of it in an approved manner (page 143).

NOTICE

Improper disposal of drained fluids is harmful to the environment.

6. Check the condition of the sealing washer on the engine oil drain bolt. Replace the washer every other time the oil is changed. Install the engine oil drain bolt and tighten it to the specified torque:
18 lbf·ft (24 N·m , 2.4 kgf·m)
7. Fill the crankcase with the recommended oil (page 91), approximately:
0.6 US qt (0.6 ℓ)

8. Install the oil filler cap/dipstick securely.
9. Lock the rear wheel (page 24).
10. Start the engine and let it idle for 3—5 minutes.
11. Stop the engine and wait 2—3 minutes.
12. Check that the oil level is at the upper level mark on the oil filler cap/dipstick (page 94).
13. Check that there are no oil leaks.

If a torque wrench is not used for installation, see your Honda dealer as soon as possible to verify proper assembly.

Engine Oil & Strainer Screen

Engine Oil Strainer Screen

Refer to *Safety Precautions* on page 70 .

1. Park the scooter on its center stand on a firm, level surface.
2. If the engine is cold, start it and let it idle for 3–5 minutes. Turn the engine off. Wait 2–3 minutes for the oil to settle.
3. Place a drain pan under the engine oil drain plug (1).
4. To drain the oil, remove the oil filler cap/dipstick (2), engine oil drain plug, spring (3) and oil strainer screen (4).

RIGHT SIDE

CRANKCASE

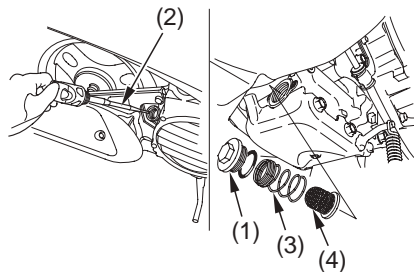

- (1) engine oil drain plug
- (2) oil filler cap/dipstick
- (3) spring
- (4) oil strainer screen

Engine Oil & Strainer Screen

5. Pour the drained oil into a suitable container and dispose of it in an approved manner (page 143).

NOTICE

Improper disposal of drained fluids is harmful to the environment.

6. Clean the oil strainer screen.
7. Check the oil strainer screen, sealing rubber, and oil plug O-ring are in good condition.
8. Install the oil strainer screen, spring, and engine oil drain plug. Tighten the engine oil drain plug to the specified torque:
14 lbf·ft (20 N·m , 2.0 kgf·m)

9. Fill the crankcase with the recommended oil (page 91), approximately:
0.7 US qt (0.7 ℓ)
10. Install the oil filler cap/dipstick securely.
11. Lock the rear wheel (page 24).
12. Start the engine and let it idle for 3–5 minutes.
13. Stop the engine and wait 2–3 minutes. Check that the oil level is at the upper level mark on the oil filler cap/dipstick (page 94).
14. Make sure there are no oil leaks.

If a torque wrench is not used for installation, see your Honda dealer as soon as possible to verify proper assembly.

Coolant

Your scooter's liquid cooling system dissipates engine heat through the coolant jacket that surrounds the cylinder and cylinder head.

Maintaining the coolant will allow the cooling system to work properly and prevent freezing, overheating, and corrosion.

Coolant Recommendation

Use Pro Honda HP coolant or an equivalent high quality ethylene glycol antifreeze containing corrosion protection inhibitors specifically recommended for use in aluminum engines. Check the antifreeze container label.

Use only distilled water as a part of the coolant solution. Water that is high in mineral content or salt may be harmful to the aluminum engine.

NOTICE

Using coolant with silicate inhibitors may cause premature wear of water pump seals or blockage of radiator passages. Using tap water may cause engine damage.

The factory provides a 50/50 solution of antifreeze and water in this scooter. This coolant solution is recommended for most operating temperatures and provides good corrosion protection.

Decreasing the concentration of antifreeze to less than 40% will not provide proper corrosion protection.

Increasing the concentration of antifreeze is not recommended because it decreases cooling system performance. Higher concentrations of antifreeze (up to 60%) should only be used to provide additional protection against freezing. Check the cooling system frequently during freezing weather.

Checking & Adding Coolant

Refer to *Safety Precautions* on page 70 .

UNDER SEAT

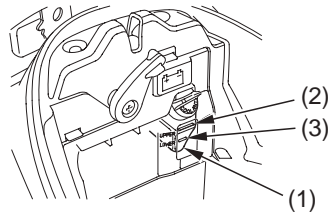

- (1) reserve tank
- (2) UPPER level mark
- (3) LOWER level mark

1. Park the scooter on its center stand on a firm, level surface.

(cont'd)

Coolant

2. Open the seat (page 26).
3. With the engine at normal operating temperature, check the coolant level in the reserve tank (1). It should be between the UPPER (2) and LOWER (3) level marks.

If the reserve tank is empty, or if coolant loss is excessive, check for leaks and see your Honda dealer for repair.

4. Remove the maintenance lid (page 85).
5. Remove the reserve tank cap (4).
Always add coolant to the reserve tank.
Do not attempt to add coolant by removing the radiator cap.

UNDER SEAT

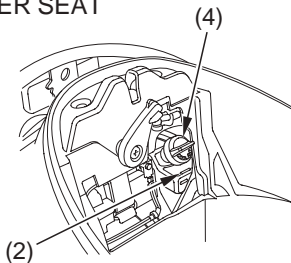

- (2) UPPER level mark
- (4) reserve tank cap

6. Add coolant to the reserve tank as required to bring the coolant level to the UPPER level mark.
7. Reinstall the reserve tank cap and maintenance lid.
8. Lower and push down on the seat until it locks.

Coolant Replacement

Refer to *Safety Precautions* on page 70 .

Coolant should be replaced by your Honda dealer, unless you have the proper tools and service data and are mechanically qualified. Refer to the official Honda Service Manual (page 188).

WARNING

Removing the radiator cap while the engine is hot can cause the coolant to spray out, seriously scalding you.

Always let the engine and radiator cool down before removing the radiator cap.

To properly dispose of drained coolant, refer to *You & the Environment*, page 143 .

NOTICE

Improper disposal of drained fluids is harmful to the environment.

Air Cleaner

Refer to *Safety Precautions* on page 70 .

Service the air cleaner more frequently if you ride in unusually wet or dusty areas. Your Honda dealer can help you determine the correct service interval for your riding conditions.

Your scooter's air cleaner has very specific performance requirements. Use a new Honda Genuine air cleaner specified for your model or an air cleaner of equivalent quality.

NOTICE

Using the wrong air cleaner may result in premature engine wear.

Proper air cleaner maintenance can prevent premature engine wear or damage, expensive repairs, low engine power, poor gas mileage, and spark plug fouling.

NOTICE

Improper or lack of proper air cleaner maintenance can cause poor performance and premature engine wear.

Replacement

1. Remove the tapping screws (1) and remove the air cleaner housing cover (2).

LEFT SIDE

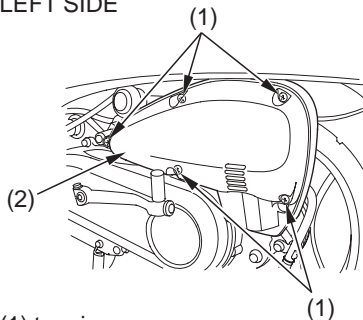

- (1) tapping screws
(2) air cleaner housing cover

LEFT SIDE

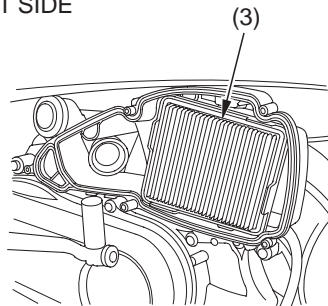

(3) air cleaner

2. Remove the air cleaner (3).
3. Discard the air cleaner.
4. Install a new air cleaner.
5. Install the removed parts in reverse order of removal.

Crankcase Breather

Refer to *Safety Precautions* on page 70 .

Service the crankcase breather more frequently if your scooter is ridden in the rain or often at full throttle. Service the breather if you can see deposits in the transparent section of the drain tube.

Draining

LEFT SIDE

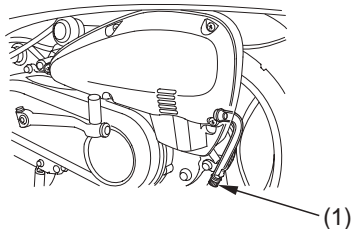

(1) crankcase breather tube plug

1. Place a drain pan under the crankcase breather tube plug (1).
2. Remove the plug to drain the deposits in the tube.
3. Reinstall the crankcase breather tube plug.

Throttle Freeplay

Refer to *Safety Precautions* on page 70 .

RIGHT HANDLEBAR

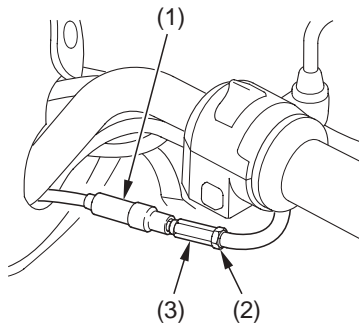

- (1) rubber dust cover (3) adjuster
(2) lock nut

Inspection

Check freeplay at the throttle grip flange.

Freeplay:

1/16 – 1/4 in (2 – 6 mm)

If necessary, adjust to the specified range.

Adjustment

1. Pull back the rubber dust cover (1).
2. Loosen the lock nut (2).
3. Turn the adjuster (3).
4. Tighten the lock nut. Return the dust cover to its normal position.
5. After adjustment, check for smooth rotation of the throttle grip from fully closed to fully open in all steering positions.

Throttle

Throttle Inspection

Refer to *Safety Precautions* on page 70 .

1. Check that the throttle assembly is positioned properly and the securing bolts are tight.
2. Check for smooth rotation of the throttle from fully open to fully closed in all steering positions. If there is a problem, see your Honda dealer.

Engine Idle Speed

The best way to assure proper carburetion is to see your Honda dealer for regularly scheduled servicing, including carburetor adjustment.

Remember, idle speed adjustment is not a “cure-all” for other problems in your engine’s fuel-delivery system. Adjusting the idle will not compensate for a fault elsewhere.

The engine must be at normal operating temperature for accurate idle speed adjustment.

For information about high altitude carburetor adjustment, see page 176 .

Idle Speed Adjustment

Refer to *Safety Precautions* on page 70 .

UNDER SEAT

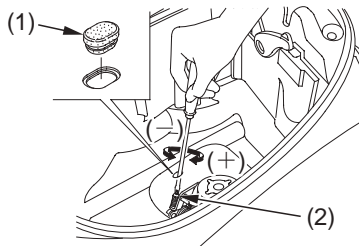

- (1) rubber plug (+) increase
(2) throttle stop screw (-) decrease

1. If the engine is cold, start it and warm it up with 10 minutes of stop-and-go riding. Stop the engine. (cont'd)

Engine Idle Speed

2. Place your scooter on its center stand on a firm, level surface.
3. Remove the plug maintenance lid (page 86).
4. Connect a tachometer to the engine.
5. Open the seat (page 26) and remove the rubber plug (1).
6. Lock the rear wheel by squeezing the rear brake lever and setting the lock lever (page 24).
Start the engine.
7. Adjust idle speed with the throttle stop screw (2).
Idle speed:
2,000 ± 100 rpm

Spark Plug Recommendation

standard spark plug	CR8EH-9 (NGK) or U24FER9 (DENSO)
for cold climate (below 5°C, 41°F)	CR7EH-9 (NGK) or U22FER9 (DENSO)
for extended high speed riding	CR9EH-9 (NGK) or U27FER9 (DENSO)

Use only the recommended type of spark plugs in the recommended heat range.

NOTICE

Using spark plugs with an improper heat range can cause engine damage.

Spark Plug Replacement

Refer to *Safety Precautions* on page 70.

1. Remove the plug maintenance lid (page 86).

UNDER STEPBOARD

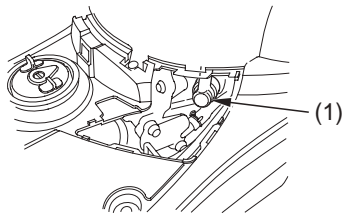

- (1) spark plug cap

(cont'd)

Spark Plug

2. Disconnect the spark plug cap (1).
Take care to avoid damaging the spark plug wire when disconnecting the cap.
3. Clean any dirt from around the spark plug base.
Using a spark plug wrench, remove the spark plug.
4. Discard the spark plug.
5. Check the spark plug gap (2), using a wire-type feeler gauge. If adjustment is necessary, bend the side electrode (3) carefully.
The gap should be:
0.031 – 0.035 in (0.80 – 0.90 mm)

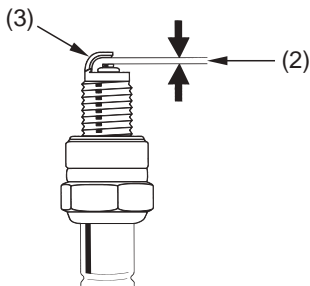

(2) spark plug gap (3) side electrode

6. With the plug washer attached, thread the spark plug in by hand to prevent cross-threading.

7. Tighten the spark plug:
- If the old plug is good:
1/8 turn after it seats.
 - If installing a new plug, tighten it twice to prevent loosening:
 - a) First, tighten the plug:
NGK: 1/2 turn after it seats.
DENSO: 1 turn after it seats.
 - b) Then loosen the plug.
 - c) Next, tighten the plug again:
1/8 turn after it seats.

NOTICE

An improperly tightened spark plug can damage the engine. If a plug is too loose, a piston may be damaged. If a plug is too tight, the threads may be damaged.

8. Reinstall the spark plug cap. Take care to avoid pinching any cables or wires.
9. Reinstall the plug maintenance lid.

Brakes

Mechanically activated drum braking systems on your scooter dissipate the heat generated by the friction of the brake shoes on the drum as the wheels are slowed.

Brake Lever Freeplay

Refer to *Safety Precautions* on page 70 .

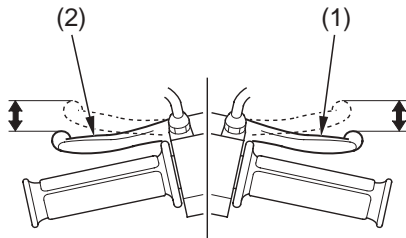

- (1) front brake lever
- (2) rear brake lever

Adjust the freeplay of the brake lever with the front wheel pointed straight ahead.

Inspection

1. Place your scooter on its center stand.
2. Check freeplay by pulling in slowly on the front brake lever (1) and rear brake lever (2) until each brake starts to engage.

Freeplay at the tip of the brake levers should be:

3/8 – 13/16 in (10 – 20mm)

If necessary, adjust to the specified range.

Adjustment

1. Adjust by turning the brake adjusting nut (3) a half-turn at a time. Make sure the cut-out on the adjusting nut is seated on the brake arm pin (4).

LEFT FRONT



LEFT REAR

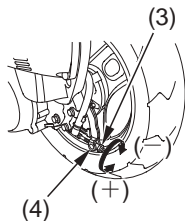

- (3) adjusting nut (+) increase freeplay
(4) brake arm pin (-) decrease freeplay

Brakes

2. Apply the brake, release it, and then spin the wheel and check that it rotates freely. Repeat this procedure several times.
3. Check the freeplay. If you can't adjust the freeplay properly, see your Honda dealer.

After adjustment, push the brake arm (5) to confirm that there is a gap between the rear brake adjusting nut (3) and the brake arm pin (4).

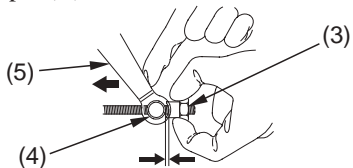

- (3) adjusting nut (5) brake arm
(4) brake arm pin

After adjustment, confirm the freeplay of the brake lever.

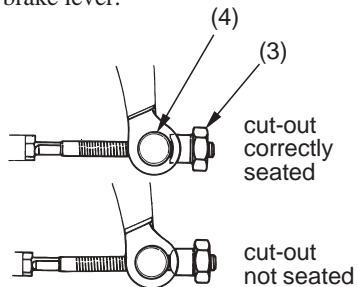

- (3) adjusting nut
(4) brake arm pin

Other Inspections

- Make sure the brake arm, spring, and fasteners are in good condition.

Brake Shoe Wear

Refer to *Safety Precautions* on page 70 .

The front and rear brakes are equipped with external brake wear indicators that let you check brake wear without disassembly. Application of the brake control causes the arrow on the brake arm to move toward a reference mark on the brake panel.

LEFT FRONT

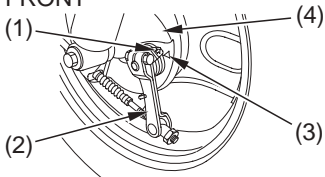

- (1) arrow (3) reference mark
(2) brake arm (4) brake panel

LEFT REAR

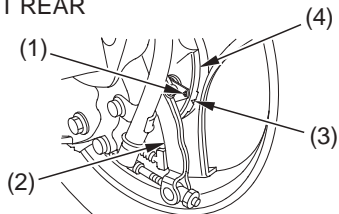

- (1) arrow (3) reference mark
(2) brake arm (4) brake panel

1. Place your scooter on its center stand.
2. Apply the brake and check the movement of the arrow (1) on the brake arm (2). Replace the brake shoes if the arrow aligns with the reference mark (3) on the brake panel (4) upon full application of the brake. If replacement is necessary, see your Honda dealer.

Tires

To safely operate your scooter, your tires must be the proper type and size, in good condition with adequate tread, and correctly inflated for the load you are carrying.

WARNING

Using tires that are excessively worn or improperly inflated can cause a crash in which you can be seriously hurt or killed.

Follow all instructions in this owner's manual regarding tire inflation and maintenance.

The following pages give detailed information on how and when to check

your air pressure, how to inspect your tires for wear and damage, and our recommendations for tire repair and replacement.

Air Pressure

Refer to *Safety Precautions* on page 70 .

Properly inflated tires provide the best combination of handling, tread life, and riding comfort. Generally, underinflated tires wear unevenly, adversely affect handling, and are more likely to fail from being overheated. Overinflated tires make your scooter ride harshly, are more prone to damage from road hazards, and wear unevenly.

We recommend that you visually check your tires before every ride and use an air pressure gauge to measure the air pressure at least once a month or any time you think the tires might be low. Even tires that are in good condition may lose one to two psi per month if not checked and adjusted regularly.

Tubeless tires have some degree of self-sealing ability if they are punctured. However, because leakage is often very slow, you should look closely for punctures whenever a tire is not fully inflated.

Always check air pressure when your tires are “cold” — after the scooter has been parked for at least three hours. If you check air pressure when your tires are

“warm” — even if your scooter has only been ridden for a few miles — the readings will be higher. If you let air out of warm tires to match the recommended cold pressures, the tires will be underinflated.

The recommended “cold” tire pressures are:

front	18 psi (125 kPa , 1.25 kgf/cm ²)
rear	29 psi (200 kPa , 2.00 kgf/cm ²)

Tires

Inspection

Refer to *Safety Precautions* on page 70 .

Whenever you check the tire pressures, you should also look for:

- Bumps or bulges in the side of the tire or the tread. Replace any tire that has a bump or bulge.
- Cuts, slits, or cracks in the tires. Replace the tire if you can see fabric or cord.
- Nails or other foreign objects embedded in the side of the tire or tread.
- Excessive tread wear.

Also, if you hit a pothole or hard object while riding, pull to the side of the road as soon as you safely can and carefully inspect the tires for damage.

Tread Wear

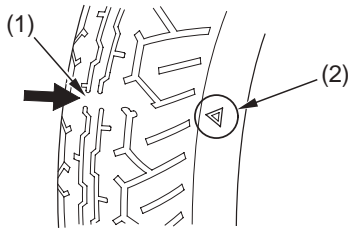

- (1) wear indicator
(2) wear indicator location mark

Inspect the wear indicator (1) to check for insufficient tread depth.

If the wear indicators are visible, replace the tire immediately as it is no longer safe.

Tire Repair

Refer to *Safety Precautions* on page 70 .

We strongly recommend that you replace, not repair, any tire that is punctured or damaged. As discussed below, a tire that is repaired, either temporarily or permanently, will have lower speed and performance limits than a new or undamaged tire.

A temporary repair can sometimes be made in an emergency situation.

However, since a temporary repair may not hold, you must ride very slowly, preferably without any cargo, and have the tire replaced or permanently repaired as soon as possible.

(For more information on temporary repairs, see *If You Have a Flat Tire*, page 152 .)

Tires

A permanent repair, such as an internal plug patch, can be made if a tire has only a small puncture in the tread area. With such a repair, you should not exceed 30 mph (50 km/h) for the first 24 hours. In addition, you may not be able to safely carry as much weight. If you choose to have a tire repaired, be sure the repair work is performed by a professional and that the wheel is balanced before you ride.

If you have a tire professionally repaired at a non-Honda facility, we recommend that you have the work checked by your Honda dealer.

Tire Replacement

Refer to *Safety Precautions* on page 70 .

The tires that came on your scooter were designed to match the performance capabilities of your scooter and provide the best combination of handling, braking, durability, and comfort.

When replacing, use the original equipment tires or equivalent tires of the same size, construction, speed rating, and load range as the originals.

WARNING

Installing improper tires on your scooter can affect handling and stability. This can cause a crash in which you can be seriously hurt or killed.

Always use the size and type of tires recommended in this owner's manual.

The recommended tires for your scooter are:

front	90/90-10 50J IRC MB65
rear	90/90-10 50J IRC MB65
type	bias-ply, tubeless

Tires

Whenever you replace a tire, remember:

- Have the wheel balanced after the tire is installed.
- Have the tire replaced by your Honda dealer if possible.

If you have a tire professionally replaced at a non-Honda facility, we recommend that you have the work checked by your Honda dealer.

Important Safety Reminders

- Do not install a tube inside a tubeless tire on this scooter. Excessive heat build-up can cause the tube to burst.
- Use only tubeless tires on this scooter. The rims are designed for tubeless tires, and during hard acceleration or braking, a tube-type tire could slip on the rim and cause the tire to rapidly deflate.

Your scooter has a maintenance-free type battery. You do not have to check the battery electrolyte level or add distilled water as you would with a conventional-type battery.

NOTICE

Your battery is a maintenance-free type and can be permanently damaged if the cap strip is removed.

Electrical accessories use current from the battery, even when the ignition is OFF. Limited operation also allows the battery to discharge. If you have electrical accessories on your scooter or do not ride frequently, we recommend that you charge the battery frequently (see *Battery Charging*, page 129).

If you do not expect to ride your scooter for at least two weeks, we recommend you remove the battery, or at least disconnect the battery cables (negative cable first).

If you plan to store your scooter, see *Battery Storage*, page 126 .

If your battery seems weak and/or is leaking electrolyte (causing slow starting or other electrical problems), see your Honda dealer.

WARNING: Battery posts, terminals and related accessories contain lead and lead compounds. **Wash your hands after handling.**

Battery

Battery Storage

Refer to *Safety Precautions* on page 70 .

If you plan to store your scooter, we recommend you remove the battery and store it where it can be charged at least every 30 days to maintain its service life.

If you do not remove the battery, we recommend disconnecting the battery cables (negative cable first).

You will get the best storage results from removing the battery and slow (trickle) charging it every 30 days (see *Battery Charging*, page 129).

Before you remove the battery, be sure to read all the information that follows, as well as the information on the battery label.

WARNING

The battery gives off explosive hydrogen gas during normal operation.

A spark or flame can cause the battery to explode with enough force to kill or seriously hurt you.

Wear protective clothing and a face shield, or have a skilled mechanic do the battery maintenance.

The battery is located in the battery box behind the maintenance lid.

UNDER SEAT

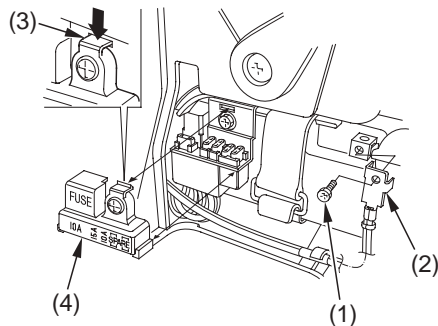

- (1) bolt
- (2) negative (-) terminal lead
- (3) tab
- (4) fuse box cover

Removal

1. Make sure the ignition switch is OFF.
2. Open the seat (page 26).
3. Remove the maintenance lid (page 85).
4. Remove the bolt (1) that secures the negative (-) terminal lead (2).
5. Release the tab (3), then remove the fuse box cover (4).
6. Remove the bolt (5) that secures the positive (+) terminal lead (6).
7. Release the rubber band (7) securing the battery (8).
8. Pull the battery out of the battery box.

(cont'd)

Battery

UNDER SEAT

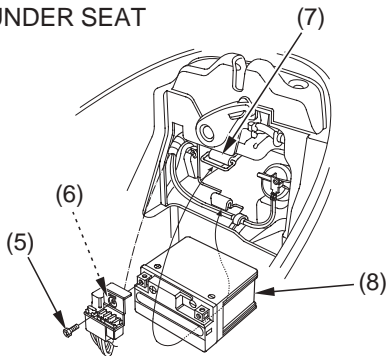

(5) bolt

(6) positive (+) terminal lead

(7) rubber band

(8) battery

9. Charge the battery (see following section), unless you have been riding regularly.

10. Store your battery in an easy-to-reach location off the floor, in an area protected from freezing temperatures and direct sunlight.
11. Clean the battery box after removing the battery for storage. Dry the battery box and, if paint is missing, re-paint the area.
12. Slow charge the battery (see following section) once every 30 days.

Installation

1. Reinstall in the reverse order of removal. Be sure to connect the positive (+) terminal first, then the negative (-) terminal.
2. Check all bolts and other fasteners are secure.

Battery Charging

Refer to *Safety Precautions* on page 70 .

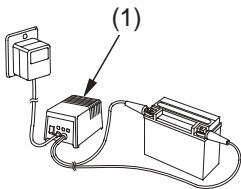

(1) “trickle” charger

Be sure to read the information that came with your battery charger and follow the instructions on the battery. Improper charging may damage the battery.

We recommend using a “trickle” charger (1) for home charging. These units can be left connected for long periods without risking damage to the battery. However, do not intentionally leave the charger connected longer than the time period recommended in the charger’s instructions.

Avoid using an automotive-type battery charger. An automotive charger can overheat a scooter battery and cause permanent damage.

Appearance Care

Frequent cleaning and polishing will keep your Honda looking newer longer. Frequent cleaning also identifies you as an owner who values your scooter. A clean scooter is also easier to inspect and service.

General Recommendations

Refer to *Safety Precautions* on page 70 .

- To clean your scooter, you may use:
 - water
 - a mild, neutral detergent and water
 - a mild spray and wipe cleaner/
polisher
 - a mild spray and rinse cleaner/
degreaser and water

- Avoid products that contain harsh detergents or chemical solvents that could damage the metal, paint, and plastic on your scooter.
- If your scooter is still warm from recent operation, give the engine and exhaust system time to cool off.
- Park in a shady area. Washing your scooter in bright sunlight may cause the finish to fade because water droplets intensify the sun's brightness. Spotting is also more likely because surface water can dry before you have time to wipe it off.
- Clean your scooter regularly to protect surface finishes.

- We recommend the use of a garden hose to wash your scooter. High pressure washers (like those at coin-operated car washes) can damage certain parts of your scooter.

NOTICE

High pressure water (or air) can damage certain parts of your scooter.

- After cleaning, inspect for damage, wear, and leaks (fuel, oil, and coolant).

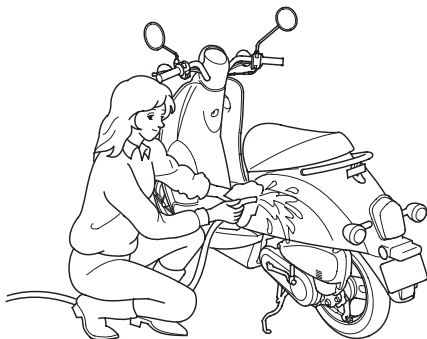

Appearance Care

Washing Your Scooter with a Mild Detergent

Refer to *Safety Precautions* on page 70 .

1. Rinse your scooter thoroughly with cool water to remove loose dirt.
2. Fill a bucket with cool water. Mix in a mild, neutral detergent, such as dish washing liquid or a product made especially for washing scooters or automobiles.
3. Wash your scooter with a sponge or a soft towel. As you wash, check for heavy grime. If necessary, use a mild cleaner/degreaser to remove the grime.
4. After washing, rinse your scooter thoroughly with plenty of clean water to remove any residue. Detergent residue can corrode alloy parts.
5. Dry your scooter with a chamois or a soft towel. Leaving water on the surface to air dry can cause dulling and water spots. As you dry, inspect for chips and scratches.
6. Start the engine and let it idle for several minutes. The engine heat will help dry moist areas.

7. As a precaution, ride your scooter at a slow speed and apply the brakes several times. This will help dry the brakes and restore normal braking performance.

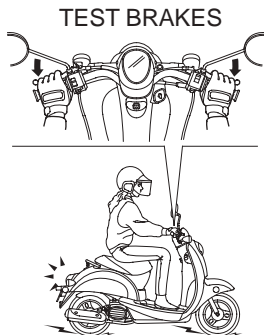

If the inside of the headlight lens appears clouded immediately after washing, it should clear after a few minutes of riding.

Spray Cleaning Your Scooter

Refer to *Safety Precautions* on page 70 .

Avoid using spray cleaner products on the tires or suspension components.

Suggestions for using spray cleaner(s) follow:

Appearance Care

Scooter Condition	Recommended Cleaning
Dust and fingerprint smudges.	Apply a spray cleaner/polish and wipe the paint, chrome, glass, and clear plastic.
Light road grime.	Spray any difficult-to-reach or very dirty areas with a spray cleaner/degreaser. Rinse and dry. Apply a spray cleaner/polish and wipe with a non-abrasive cloth.
Heavy grime. Oil leaks. Brake dust.	Use a spray cleaner/degreaser. If necessary, rub with a sponge. Rinse and dry. Apply a spray cleaner/polish and wipe with a non-abrasive cloth.
Dull, corroded chrome or aluminum.	Apply a high quality chrome/aluminum polish and wipe with a non-abrasive cloth.

Clean the Matte Painted Surface

Refer to *Safety Precautions* on page 70 .

Use a soft cloth or sponge, plenty of water, and a mild detergent to clean the matte paint. Dry with a soft, clean cloth.

Do not use polishing compounds or wax containing polishing compounds. These can damage or discolor the paint.

To keep your Honda looking new, clean and polish it frequently.

Appearance Care

Finishing Touches

Refer to *Safety Precautions* on page 70 .

After washing your scooter, consider using a commercially available spray cleaner/polish or quality liquid or paste wax to finish the job. Use only a non-abrasive polish or wax made specifically for scooters or automobiles. Apply the polish or wax according to the instructions on the container.

If a surface on your scooter is chipped or scratched, your Honda dealer has touch-up paint to match your scooter's color. Be sure to use your scooter's color code (page 168) when you buy touch-up paint.

If the frame has a chip that exposes the metal, first apply primer (to prevent corrosion) and then apply the touch-up paint. Several thin layers of touch-up paint are better than one thick coat.

Here's a few helpful tips on how to store and transport your Honda, and how to be an environmentally responsible scooter owner.

Storing Your Honda	138
Transporting Your Scooter.....	142
You & the Environment.....	143

Storing Your Honda

If you won't be riding for an extended period, such as during the winter, thoroughly inspect your scooter and correct any problem before storing it. That way, needed repairs won't be forgotten and it will be easier to get your scooter running again.

For more information about storage, refer to the *Honda Motorcycle Winter Storage Guide*, available from your Honda dealer (USA only).

We suggest you perform the following procedures to keep your scooter in top condition. These storage procedures will reduce the deterioration that can occur during storage.

Preparation for Storage

Refer to *Safety Precautions* on page 70 .

This procedure requires a means for draining and disposing of drained fuel (page 143).

1. Change the engine oil (page 95) and clean the oil strainer screen (page 98).
2. Make sure the cooling system is filled with a 50/50% antifreeze solution (page 100).
3. Fill the fuel tank. Make sure the fuel fill cap is properly installed.

Storing Your Honda

4. Drain the carburetor into an approved gasoline container and dispose of it in an approved manner (page 143). If storage will last longer than one month, carburetor draining is important, to assure proper performance after storage.

WARNING

Gasoline is highly flammable and explosive. You can be burned or seriously injured when handling fuel.

- Stop the engine and keep heat, sparks and flame away.
- Handle fuel only outdoors.
- Wipe up spills immediately.

5. To prevent rusting in the cylinder, perform the following:
- Remove the spark plug cap from the spark plug. Using tape or string, secure the cap to any convenient plastic body part so that it is positioned away from the spark plug.
 - Remove the spark plug from the engine and store it in a safe place. Do not connect the spark plug to the spark plug cap.
 - Pour a tablespoon (15 – 20 cc) of clean engine oil into the cylinder and cover the spark plug hole with a piece of cloth.

(cont'd)

Storing Your Honda

- With the engine stop switch in the RUN position, press the start button several times to crank the engine and distribute the oil.
 - Reinstall the spark plug and spark plug cap.
6. Remove the battery and charge it fully. Store it in an area protected from freezing temperatures and direct sunlight. Slow charge the battery (page 129) once a month.
 7. Wash and dry your scooter. Wax all painted surfaces. Apply rust-inhibiting oil to the chrome pieces.
 8. Inflate the tires to their recommended pressures (page 119).
 9. Store your scooter in an unheated area, free of dampness, away from sunlight, with a minimum of daily temperature variation.
 10. Place your scooter on blocks to lift both tires off the floor.
 11. Cover your scooter with a porous material. Avoid using plastic or similar non-breathing, coated materials that restrict air flow and allow heat and moisture to accumulate.

Removal from Storage

Refer to *Safety Precautions* on page 70 .

1. Uncover and clean your scooter.
2. If your scooter has been stored for more than four months — change the engine oil (page 95).
3. If your scooter has been stored for more than two months — ask your Honda dealer to drain and replace the fuel.
4. Charge the battery (page 129) as required. Install the battery.
5. Perform a pre-ride inspection (page 34), then test-ride your scooter at low speeds.

Transporting Your Scooter

If your scooter needs to be transported, it should be carried on a motorcycle trailer, or a truck or trailer with a flatbed area. Do not tow your scooter, as towing can seriously damage the transmission.

When contacting a towing or transporting service, be sure to ask if they have a flatbed area, a loading ramp or power ramp to safely lift the scooter, and motorcycle tie-down straps.

Owning and riding a scooter can be enjoyable, but you must do your part to protect nature.

Following are tips on how you can be an environmentally responsible scooter owner.

- **Choose Sensible Cleaners.** Use a biodegradable detergent when you wash your scooter. Avoid aerosol spray cleaners that contain chlorofluorocarbons (CFCs) which damage the atmosphere's protective ozone layer. Don't throw cleaning solvents away; see the following guidelines for proper disposal.

- **Recycle Wastes.** It's illegal and thoughtless to put used engine oil in the trash, down a drain, or on the ground. Used oil, gasoline, coolant, and cleaning solvents contain poisons that can hurt refuse workers and contaminate our drinking water, lakes, rivers, and oceans. Before changing your oil, make sure you have the proper containers. Put oil and other toxic wastes in separate sealed containers and take them to a recycling center. Call your local or state office of public works or environmental services to find a recycling center in your area, and to get instructions on how to dispose of non-recyclable wastes.

Taking Care of the Unexpected

This section discusses the more common problems that can occur with your scooter while you're riding. It tells you how to evaluate each problem and what actions you can take to try to resume riding. If the problem cannot be safely solved, this section also gives instructions on the proper way to have your scooter transported.

For information about transporting your scooter, see page 142 .

General Guidelines.....	146
If Your Engine Quits or Won't Start	147
If You Have a Flat Tire.....	152
If Your Engine Overheats.....	156
If a Fuse Blows.....	158
If You Crash.....	162
If You Lose Your Key	163
If Your Battery Is Low (or Dead).....	164

Taking Care of the Unexpected

General Guidelines

Keeping your scooter well-maintained is the best way to reduce the possibility of having a problem on the road.

Remember to take along your owner's manual, proper tools, and any other items (such as tire repair supplies and additional tools) that might help you solve a problem on your own.

Should you ever have a problem while riding, please follow these guidelines:

- Always put personal safety first.
- Take time to assess the situation and your options before deciding what to do.
- If the problem is relatively minor and you have the tools, supplies, and skills to make a temporary repair, be sure to have permanent repairs made as soon as possible.
- Do not continue riding if you are hurt or your scooter is not in safe riding condition.

Additional recommendations for specific problems follow.

If Your Engine Quits or Won't Start

Proper operation and maintenance can prevent starting and engine performance problems. In many cases, the cause of the problem may be a simple operational oversight.

If you have a problem starting the engine — or experience poor engine performance — the following information may help you. If you can't correct the problem, see your Honda dealer.

If your scooter won't start, listen as you press the start button. If you don't hear the starter motor turning, refer to the *Starter motor doesn't operate* symptom. If you can hear the starter motor working normally, refer to the *Starter motor works, but the engine won't start* symptom.

If Your Engine Quits or Won't Start

SYMPTOM: Starter motor doesn't operate.	
POSSIBLE CAUSE	WHAT TO DO
ignition switch OFF	Turn the ignition switch ON.
engine stop switch OFF	Turn the engine stop switch to RUN.
blown fuse	Replace with a new fuse of the same rating (page 158).
battery lead loose	Tighten the battery lead.
low (or dead) battery	Charge the battery (page 129). If charging doesn't help, see your Honda dealer.
faulty starter motor	If all possible causes are negative, the starter motor may be faulty. See your Honda dealer.

If Your Engine Quits or Won't Start

SYMPTOM: Starter motor works, but the engine won't start.	
POSSIBLE CAUSE	WHAT TO DO
out of fuel	Fill the fuel tank.
loose or unconnected spark plug cap	Install the spark plug cap securely. If the engine still won't start, see your Honda dealer.
loose battery cables	Tighten the battery terminal bolts.
weak battery	Charge the battery (page 129). If charging doesn't help, see your Honda dealer.

If Your Engine Quits or Won't Start

SYMPTOM: Engine starts, but runs poorly.	
POSSIBLE CAUSE	WHAT TO DO
idles roughly, too fast, stalls	Check engine idle adjustment (page 109). If the problem persists, see your Honda dealer.
overheating	Check the high coolant temperature indicator. Refer to <i>If Your Engine Overheats</i> , page 156 .
runs erratically, misfires	May damage catalytic converter. See your Honda dealer.
blubbers (rich fuel mixture)	See your Honda dealer.

If Your Engine Quits or Won't Start

SYMPTOM: Engine starts, but runs poorly (cont'd).	
POSSIBLE CAUSE	WHAT TO DO
sooty exhaust (rich fuel mixture)	See your Honda dealer.
detonates or pings under load	If applicable, switch to the recommended octane gasoline (page 87) or change your brand of gasoline. If the problem persists, see your Honda dealer.
afterfires (backfires)	May damage catalytic converter. See your Honda dealer.
pre-ignition (runs on after ignition switched OFF)	May damage catalytic converter. See your Honda dealer.

If You Have a Flat Tire

A flat tire is always unwelcome, especially if you are far from help. If you think you are losing air, or you hit a pothole or hard object, pull safely to the side of the road so you can inspect the tires and assess the situation. (Be sure to park on a firm, level surface and use the center stand for support.) You should examine the tire treads and sidewalls for foreign objects or damage. If you find a tire that has been punctured or damaged, you have two options.

Option 1:

Have Your Scooter Transported

If a tire has a major puncture or a cut in the tread or sidewall, or the bead has come loose from the rim, there is probably not much you can do except have your scooter transported to a Honda dealer or other

qualified service facility. Even with a simple puncture, this may be the safest and least troublesome solution. For transporting instructions, see page 142.

Option 2:

Make a Temporary Roadside Repair

If a tire has only a minor nail puncture and is not completely flat, you may be able to make an emergency repair that could allow you to continue riding to where you can get the tire replaced or permanently repaired.

If You Have a Flat Tire

WARNING

Riding your scooter with a temporary tire repair can be risky. If the temporary repair fails, you can crash and be seriously injured or killed.

If you must ride with a temporary tire repair, ride slowly and carefully and do not exceed 30 mph (50 km/h) until the tire is permanently repaired or replaced.

Due to the uncertainty of any temporary repair, you should ride slowly (not over 30 mph, 50 km/h) and carefully (preferably without cargo) until the tire is replaced or permanently repaired. Stop frequently and

check the air pressure. If the tire is losing pressure, it may be unsafe to continue riding. As the tire gets low, it will affect the handling of your scooter (especially with cargo) and it may overheat and blow out.

Types of Temporary Repairs

The following types of temporary repairs generally require a source of air to inflate the tire. Possible sources include CO₂ cartridges or cans of compressed air designed to inflate a tire.

If You Have a Flat Tire

- **Inflate the tire:** Tubeless tires have some self-sealing ability if they are punctured and the result is usually just a slow leak. If this is the case, you can try inflating the tire to see if it will hold air pressure. If you can see a nail or other object embedded in the tire tread, do not remove it at this time.
- **Plug the hole:** The idea here is to do something to temporarily stop the leak. If you have a tubeless tire repair kit, you can pull out the nail and try inserting an external plug in the puncture. Follow the instructions that came with the repair kit and be sure to inflate the tire to the correct pressure.

Should You Repair or Replace a Tire?

We strongly recommend that you replace, not permanently repair, any tire that is punctured or damaged, even if the tire has only a minor puncture. For a full discussion of repairs and replacement, see page 121 .

Emergency Wheel Removal/Installation

Refer to *Safety Precautions* on page 70 .

We recommend wheel removal be done only by your Honda dealer or another qualified mechanic. Do not attempt to remove the wheel on your own. Wheel removal requires mechanical skill and professional tools.

If Your Engine Overheats

Normally, the temperature of the coolant in the cooling system will rise to a level about midway between cold and boiling. Hot weather may cause the temperature to rise higher than normal. So will temporary stress such as climbing a hill. If you're stuck in stop-and-go traffic, the temperature may climb some, but the radiator fan is designed to prevent overheating. Be aware of these variations.

If the high coolant temperature indicator (page 17) comes on for no apparent reason, pull safely to the side of the road. If possible, park in a shady area.

As long as the high coolant temperature indicator is lit, the vehicle speed will be automatically restricted.

NOTICE

Continuing to ride with an overheated engine can cause serious engine damage.

- A steaming engine indicates a coolant leak. Shut the engine off and wait until the steaming stops. Look for a leak, but don't touch the engine or radiator system. Let everything cool off first.

If Your Engine Overheats

- Check the coolant level in the reserve tank, located behind the maintenance lid (page 101).

If the reserve tank is low or empty, don't ride without adding coolant (page 101).

After adding coolant, ride at moderate speeds (10 mph, 16 km/h). If the high coolant temperature indicator lights again, do not ride. The engine needs repair. Transport your scooter to a Honda dealer (page 142).

If the temperature drops to normal, check the coolant level. If it has gone down, add more coolant.

If you are able to resume riding, continue to monitor the high coolant temperature indicator frequently.

If there's a mild leak, you can ride for awhile, carefully watching the indicator. Be prepared to stop and add more coolant or water. If the leak is bad, transport your scooter to a Honda dealer (page 142).

If a Fuse Blows

All of the electrical circuits on your scooter have fuses to protect them from damage caused by excess current flow (short circuit or overload).

If something electrical on your scooter stops working, the first thing you should check for is a blown fuse.

Check all the fuses before looking elsewhere for another possible cause of the problem. Replace any blown fuses and check component operation.

- The main fuse and circuit fuse box (including spare fuses) are located near the battery.

Recommended Fuses

main fuse	15A
other fuses	10A

1. To prevent an accidental short circuit, turn the ignition switch OFF before checking or replacing the fuses.

If a Fuse Blows

- To access the main fuse and circuit fuses, open the seat (page 26) and remove the maintenance lid (page 85).

UNDER SEAT

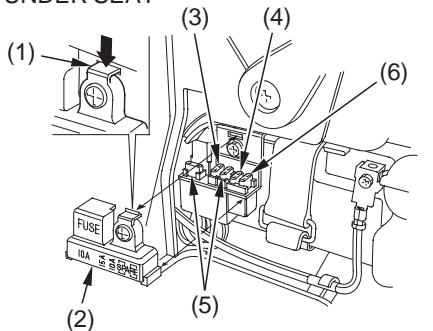

- | | |
|--------------------|---------------------|
| (1) tab | (4) spare main fuse |
| (2) fuse box cover | (5) circuit fuse |
| (3) main fuse | (6) spare fuse |

- Release the tab (1), then remove the fuse box cover (2).
- Pull the main fuse (3) out.
If it is blown (7), install the spare main fuse (4).
- To check or replace a circuit fuse (5), pull the old fuse out of its retaining clips. Look for a burned wire inside the fuse. If the fuse is blown (7), replace it with a spare fuse (6) of the same rating.

(cont'd)

If a Fuse Blows

If you do not have a replacement fuse with the proper rating for the circuit, install one with a lower rating.

NOTICE

Replacing a fuse with one that has a higher rating greatly increases the chance of damage to the electrical system.

MAIN FUSE & CIRCUIT FUSE

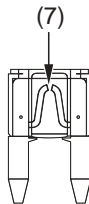

(7) blown fuse

6. Install the fuse box cover and maintenance lid.
7. Lower and push down on the seat until it locks.

If you replace a blown fuse with a spare fuse that has a lower rating, replace the fuse with the correct rating as soon as you can. Also remember to replace any spare fuses that were installed.

If the replacement fuse of the same rating burns out in a short time, there is probably a serious electrical problem on your scooter. Leave the blown fuse in that circuit and have your scooter checked by your Honda dealer.

If You Crash

Personal safety is your first priority after a crash. If you or anyone else has been injured, take time to assess the severity of the injuries and whether it is safe to continue riding. Call for emergency assistance if needed. Also follow applicable laws and regulations if another person or vehicle is involved in the crash.

If you decide that you are capable of riding safely, first evaluate the condition of your scooter. If the engine is still running, turn it off and look it over carefully; inspect it for fluid leaks, check the tightness of critical nuts and bolts, and secure such parts as the handlebar, control levers, brakes, and wheels.

If there is minor damage, or you are unsure about possible damage, ride slowly and cautiously. Sometimes, crash damage is hidden or not immediately apparent, so you should have your scooter thoroughly checked at a qualified service facility as soon as possible. Also, be sure to have your Honda dealer check the frame and suspension after any serious crash.

If your scooter cannot be ridden, see *Transporting Your Scooter*, page 142 .

If You Lose Your Key

Be sure to record your key number in the Quick Reference section at the rear of the manual. You'll need this number to have a duplicate key made.

A lost key won't be a problem if you take preventative action. Store one duplicate key in a safe place at home and carry a second duplicate in your wallet.

If you lose your key and aren't carrying a duplicate, either get your spare or have one made. If you don't know your key number, call the dealer where you purchased your Honda. They may have it listed in their records. If they don't, transport your scooter to them or the nearest Honda dealer. The dealer will probably have to remove the ignition switch assembly to find the key number so they can make a key for you.

If Your Battery Is Low (or Dead)

Jump starting is not recommended, especially if you use an automobile battery. The greater amperage of an automobile battery when the car engine is running can damage your scooter's electrical system.

Bump starting is also not recommended.

If you can't charge the battery or it appears unable to hold a charge, contact your Honda dealer.

Technical Information

This section contains dimensions, capacities, and other technical data, plus information on government requirements and how to break-in your scooter.

Vehicle Identification.....	166
Specifications	169
Break-in Guidelines	175
High Altitude Carburetor Adjustment	176
Emission Control Systems	177
Catalytic Converter	183
Oxygenated Fuels.....	184

Vehicle Identification

Serial Numbers

The VIN and engine serial number are required when you register your scooter. They may also be required when ordering replacement parts. You may record these numbers in the Quick Reference section at the rear of this manual.

The VIN (vehicle identification number) is stamped on the top of the framebody and also appears on the Safety Certification Label attached inside the leg shield.

INSIDE LEG SHIELD

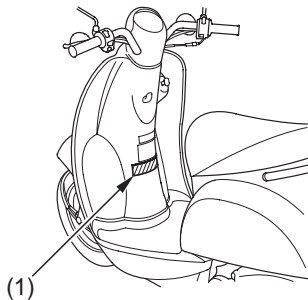

(1) VIN

Vehicle Identification

Remove the plug maintenance lid (page 86) to check the VIN (2).

UNDER STEPBOARD

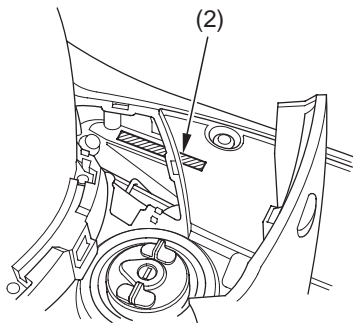

(2) VIN

The engine number (3) is stamped on the back of the crankcase near the rear wheel.

LEFT REAR

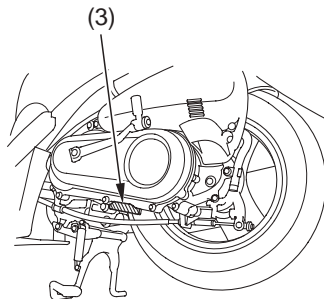

(3) engine number

Vehicle Identification

Color Label & Code

The color label is located in the center compartment. Open the seat (page 26) to check the label.

The color code is helpful when ordering replacement parts. You may record the color and code in the Quick Reference section at the rear of this manual.

INSIDE CENTER COMPARTMENT

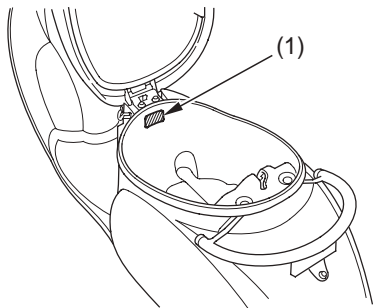

(1) color label

Specifications

Dimensions	
overall length	67.1 in (1,705 mm)
overall width	24.6 in (625 mm)
overall height	39.6 in (1,005 mm)
wheelbase	46.9 in (1,190 mm)
ground clearance	4.5 in (115 mm)

Specifications

Fuel & Lubricants	
fuel recommendation	unleaded gasoline, pump octane number of 86 or higher
fuel tank capacity	1.32 US gal (5.0 ℓ) including reserve
engine oil capacity	after disassembly: 0.7 US qt (0.7 ℓ) after draining: 0.6 US qt (0.6 ℓ)
engine oil recommendation	API Service Classification SG or higher except oils labeled as energy conserving on the circular API service label, SAE 10W-30, JASO T 903 standard MA, Pro Honda GN4 4-stroke oil (USA & Canada) or Honda 4-stroke oil (Canada only), or an equivalent motorcycle oil
cooling system, recommendation	Pro Honda HP Coolant or an equivalent high quality ethylene glycol antifreeze containing corrosion protection inhibitors specifically recommended for use in aluminum engines
cooling system, capacity	0.51 US qt (0.48 ℓ)

Specifications

Capacities	
passenger capacity	operator only. no passenger
maximum weight capacity	277 lbs (126 kg) rider, all cargo and accessories

Engine Specifications	
displacement	3.0 cu-in (49 cm ³)
bore & stroke	1.49 × 1.73 in (37.8 × 44.0 mm)
compression ratio	12 : 1
spark plug (standard)	CR8EH-9 (NGK) or U24FER9 (DENSO)
spark plug (cold climate)	CR7EH-9 (NGK) or U22FER9 (DENSO)
spark plug (high speed riding)	CR9EH-9 (NGK) or U27FER9 (DENSO)
spark plug gap	0.031 – 0.035 in (0.80 – 0.90 mm)
valve clearance (cold)	intake: 0.004 in (0.10 mm) exhaust: 0.007 in (0.19 mm)
idle speed	2,000 ± 100 rpm

Specifications

Power Transmission	
primary reduction	V-Belt
final reduction	12.115

Chassis & Suspension	
caster	26°30'
trail	2.8 in (72 mm)
tire size, front	90/90-10 50J IRC MB65
tire size, rear	90/90-10 50J IRC MB65
tire type	bias-ply, tubeless
tire pressure, front (cold)	18 psi (125 kPa , 1.25 kgf/cm ²)
tire pressure, rear (cold)	29 psi (200 kPa , 2.00 kgf/cm ²)

Electrical	
battery	12V-6 Ah
generator	0.19 kW/5,000 rpm

Specifications

Lights	
headlight	12V – 35/35W
brake/tail light	12V – 23/8W
turn signal lights	12V – 21W (front) 12V – 21W (rear)
instrument lights	12V – 1.7W (2 bulbs)
license light	12V – 5W
turn signal indicator	12V – 3.4W

Specifications

Fuses	
main	15A
other fuses	10A×2

Torque Specifications	
engine oil drain bolt	18 lbf·ft (24 N·m , 2.4 kgf·m)
engine oil drain plug	14 lbf·ft (20 N·m , 2.0 kgf·m)

Break-in Guidelines

Help assure your scooter's future reliability and performance by paying extra attention to how you ride during the first 60 miles (100 km).

During this period, avoid full-throttle starts and rapid acceleration.

High Altitude Carburetor Adjustment

Your engine's air-fuel mixture becomes overly rich when operated at high altitudes. Above 6,500 feet (2,000 m), a rich mixture can cause driveability problems, reduce engine performance, and increase fuel consumption. To compensate, you can have the carburetor adjusted for high altitude riding. See your Honda dealer.

However, the carburetor must be returned to standard factory specifications before riding again at lower altitudes (below 5,000 feet, 1,500 m). See your Honda dealer.

Sustained riding at lower altitudes with the lean high-altitude setting may cause rough idling, stalling, or engine damage from overheating.

Emission Control Systems

Exhaust Emission Requirements

The U.S. Environmental Protection Agency (EPA) and Environment Canada (EC) require that your scooter comply with applicable exhaust emissions standards during its useful life, when operated and maintained according to the instructions provided.

(For USA)

The Vehicle Emission Control Information label (1) is attached to the left side of the center compartment under the seat.

(For Canada)

The Vehicle Emission Control Information labels (2) are attached to the right and left sides of the center compartment under the seat.

LEFT SIDE

RIGHT SIDE

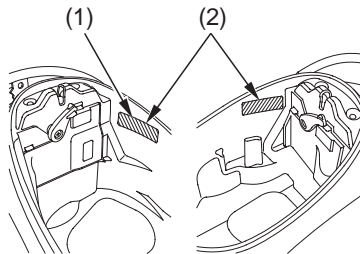

(1) vehicle emission control information label (For USA)

(2) vehicle emission control information label (For Canada)

Emission Control Systems

Noise Emission Requirements

The EPA also requires that scooters built after January 1, 1983 comply with applicable noise emission standards for one year or 3,730 miles (6,000 km) after the time of sale to the ultimate purchaser, when operated and maintained according to the instructions provided.

Warranty Compliance

Compliance with the terms of the Distributor's Warranties for Honda Scooter Emission Control Systems is necessary in order to keep the emissions system warranty in effect. (USA only)

Source of Exhaust Emissions

The combustion process produces carbon monoxide (CO), oxides of nitrogen (NO_x) and hydrocarbons (HC). Control of hydrocarbons and oxides of nitrogen is very important because, under certain conditions, they react to form photochemical smog when subjected to sunlight. Carbon monoxide does not react in the same way, but it is toxic.

Honda Motor Co., Ltd. utilizes various systems to reduce carbon monoxide, oxides of nitrogen and hydrocarbons.

Exhaust Emission Control System

The exhaust emission control system includes a secondary air supply system, and an oxidation catalytic converter.

No adjustment to these systems should be made although periodic inspection of the components is recommended.

Secondary Air Injection System

The secondary air injection system introduces filtered air into the exhaust gases in the exhaust port. The secondary air injection system helps improve emission control performance.

Oxidation Catalytic Converter

The oxidation catalytic converter is in the exhaust system. Through chemical reactions, they convert HC and CO in the engine's exhaust to carbon dioxide (CO₂) and water vapor.

Emission Control Systems

Crankcase Emission Control System

The engine is equipped with a closed crankcase system to prevent discharging crankcase emissions into the atmosphere. Blow-by gas is returned to the combustion chamber through the air cleaner and the carburetor.

Problems That May Affect Scooter Exhaust Emissions

If you are aware of any of the following symptoms, have the vehicle inspected and repaired by your authorized Honda scooter dealer.

Symptoms:

1. Hard starting or stalling after starting
2. Rough idle
3. Misfiring or backfiring during acceleration
4. After-burning (backfiring)
5. Poor performance (driveability) and poor fuel economy

Noise Emission Control System

TAMPERING WITH THE NOISE CONTROL SYSTEM IS PROHIBITED:

U. S. federal law prohibits, or Canadian provincial laws may prohibit the following acts or the causing thereof: (1) The removal or rendering inoperative by any person, other than for purposes of maintenance, repair or replacement, of any device or element of design incorporated into any new vehicle for the purpose of noise control prior to its sale or delivery to the ultimate purchaser or while it is in use; or (2) the use of the vehicle after such device or element of design has been removed or rendered inoperative by any person.

AMONG THOSE ACTS PRESUMED TO CONSTITUTE TAMPERING ARE THE FOLLOWING ACTS:

1. Removal of, or puncturing the muffler, baffles, header pipes or any other component which conducts exhaust gases.
2. Removal of, or puncturing of any part of the intake system.
3. Lack of proper maintenance.
4. Replacing any moving parts of the vehicle, or parts of the exhaust or intake system, with parts other than those specified by the manufacturer.

Emission Control Systems

Fuel Permeation Emission Control System

This vehicle complies with the Fuel Permeation Emission Control regulations of the U.S. Environmental Protection Agency (EPA) and Environment Canada (EC). The fuel tank, fuel hoses, and fuel vapor charge hoses used on this vehicle incorporate fuel permeation control technologies. Tampering with the fuel tank, fuel hoses, or fuel vapor charge hoses to reduce or defeat the effectiveness of the fuel permeation technologies is prohibited by federal regulations.

Catalytic Converter

This scooter is equipped with an oxidation catalytic converter.

The catalytic converter contains precious metals that serve as catalysts, promoting chemical reactions to convert the exhaust gasses without affecting the metals.

The catalytic converter acts on HC and CO. A replacement unit must be an original Honda part or its equivalent.

The catalytic converter must operate at a high temperature for the chemical reactions to take place. It can set fire to any combustible materials that come near it. Park your scooter away from high grasses, dry leaves, or other flammables.

A defective catalytic converter contributes to air pollution, and can impair your engine's performance. Follow these guidelines to protect your scooter's catalytic converter.

- Always use unleaded gasoline. Even a small amount of leaded gasoline can contaminate the catalyst metals, making the catalytic converter ineffective.
- Keep the engine in good running condition. A poorly running engine can cause the catalytic converter to overheat causing damage to the converter or the scooter.
- If your engine is misfiring, backfiring, stalling, or otherwise not running properly, stop riding and turn off the engine. Have your scooter serviced as soon as possible.

Oxygenated Fuels

Some conventional gasolines are being blended with alcohol or an ether compound. These gasolines are collectively referred to as oxygenated fuels. To meet clean air standards, some areas of the United States and Canada use oxygenated fuels to help reduce emissions. If you use an oxygenated fuel, be sure it is unleaded and meets the minimum octane rating requirement.

Before using an oxygenated fuel, try to confirm the fuel's contents. Some states/provinces require this information to be posted on the pump.

The following are the EPA-approved percentages of oxygenates:

ETHANOL (ethyl or grain alcohol) 10%
by Volume

You may use gasoline containing up to 10% ethanol by volume. Gasoline containing ethanol may be marketed under the name "Gasohol".

MTBE (Methyl Tertiary Butyl Ether) 15%
by Volume

You may use gasoline containing up to 15% MTBE by volume.

METHANOL (methyl or wood alcohol)
5% by Volume

You may use gasoline containing methanol containing up to 5% methanol by volume as long as it also contains cosolvents and corrosion inhibitors to protect the fuel system. Gasoline containing more than 5% methanol by volume may cause starting and/or performance problems. It may also damage metal, rubber, and plastic parts of your fuel system.

If you notice any undesirable operating symptoms, try another service station or switch to another brand of gasoline.

Fuel system damage or performance problems resulting from the use of an oxygenated fuel containing more than the percentages of oxygenates mentioned above are not covered under warranty.

Oxygenated fuels can damage paint and plastic. Be careful not to spill fuel when filling the fuel tank. Wipe up any spills immediately.

NOTICE

Oxygenated fuels can damage paint and plastic. Damage caused by spilled fuel is not covered by warranty.

Consumer Information

This section contains information on your warranty and how to get an official Honda Service Manual.

Authorized Manuals	188
Warranty Coverage	191
Warranty Service.....	192
Contacting Honda.....	193
Your Honda Dealer	194
The Honda Rider's Club (USA only)	195
Reporting Safety Defects (USA only)	196

Authorized Manuals

The Service Manual used by your authorized Honda dealer is available from Helm, Inc. (USA only.)

Also available but not necessary to service your model is the Honda Common Service Manual which explains theory of operation and basic service information for various systems common to all Honda motorcycles, motor scooters and ATVs.

These Honda manuals are written for the professional technician, but most mechanically-capable owners should find them easy to use if they have the proper tools and observe proper safety standards. Special Honda tools are necessary for some procedures.

Publication Item No.	Description	Price Each *
61GET07	2009 CHF50/S Service Manual	\$36.00
61CM002	Common Service Manual	\$48.00
31GGB600	2009 CHF50/S Owner's Manual	\$16.00
<i>* Prices are subject to change without notice and without incurring obligation.</i>		

Order On-Line: www.helminc.com

Order Toll Free: 1-888-CYCLE93 (1-888-292-5393)

(NOTE: For Credit Card Orders Only)

Monday — Friday 8:00 AM — 6:00 PM EST

OR

By completing this form you can order the materials desired. You can pay by check or money order, or charge to your credit card. Mail to Helm, Inc. at the address shown on the back of this order form (USA only).

Canada: See your Honda dealer to order authorized manuals.

Publication Item No.	Item Description	Qty.	Price Each*	Total Price
*Prices are subject to change without notice and without incurring obligation. Orders are mailed within 10 days. Please allow adequate time for delivery.	Sub Total			
	Purchaser's Sales Tax			
	Mich. add 6 %			
	Calif. add 7.25 %			
Handling Charge			\$3.75	
Grand Total				

**S
H
I
P
T
O**

NOTE: Dealers and Companies please provide dealer or company name, and also the name of the person to whose attention the shipment should be sent.

Customer Name _____ Attention _____

Street address/P. O. BOX _____ Apartment Number _____

City _____ State _____ Zip Code _____

Daytime Telephone Number () _____

**P
A
Y
M
E
N
T**

Check or money order enclosed payable to Helm Inc.
U.S. funds only. Do not send cash.

Check here if your billing address is different from the
shipping address shown above.

MasterCard

Account Number

Expiration: Mo. Yr.

VISA

Discover

Security Code

Customer Signature _____ Date _____

These Publications cannot be returned for credit without receiving advance authorization within 14 days of delivery. For returns, a restocking fee may be applied against the original order.

HELM P.O. BOX 07280, DETROIT, MICHIGAN 48207

Warranty Coverage

Your new Honda is covered by these warranties:

- Scooter Limited Warranty
- Emission Control System Warranty
- Noise Control Warranty

There are responsibilities, restrictions, and exclusions which apply to these warranties. Please read the Warranties Booklet given to you by your Honda dealer at the time of purchase. Be sure to keep your Honda owner's card with your Warranties Booklet (USA only).

It is important to realize that your warranty applies to defects in material or workmanship of your Honda. Your warranty coverage does not apply to normal wear or deterioration associated with using the scooter.

Your warranty coverage will not be voided if you choose to perform your own maintenance. However, you should have the proper tools and service information and be mechanically qualified. Failures that occur due directly to improper maintenance are not covered.

Almost all of your warranty coverage can be extended through the Honda Protection Plan (USA only). For more information, see your Honda dealer.

Warranty Service

Please remember that recommended maintenance interval servicing is not included in your warranty coverage. Additionally, your warranty does not apply to the normal wear of items (such as brakes, tires, etc.).

If you believe you have a problem with your scooter, call the service department of your Honda dealer. Make an appointment for an inspection and diagnosis. Remember, as the owner of the scooter, you will be asked to authorize that inspection. Your dealer will give you the results of the inspection. If the problem is covered under warranty, your dealer will perform the warranty repairs for you.

If you have questions about warranty coverage or the nature of the repair, it is best to talk to the Service Manager of your Honda dealer.

Sometimes, in spite of the best intentions of all concerned, a misunderstanding may occur. If you aren't satisfied with your dealer's handling of the situation, we suggest you discuss your problem with the appropriate member of the dealership's management team. If the problem has already been reviewed with the Service Manager, Parts Manager, Sales Manager, etc., contact the Owner of the dealership or their designated representative.

Contacting Honda

Your owner's manual was written to cover most of the questions you might ask about your Honda. Any questions not answered in the owner's manual can be answered by your Honda dealer. If your dealer doesn't have the answer right away, they will get it for you.

If you have a difference of opinion with your dealer, please remember that each dealership is independently owned and operated. That's why it's important to work to resolve any differences at the dealership level.

If you wish to comment on your experiences with your Honda or with your dealer, please send your comments to the following address (USA only):

Motorcycle Division, American Honda Motor Co., Inc., P.O. Box 2200, Torrance, CA 90509-2200, mailstop: 100-4C-7B, telephone: (866) 784-1870.

Canada: Refer to the Warranties Booklet that was supplied with your vehicle.

Please include the following information in your letter:

- name, address, and telephone number
- product model, year, and VIN
- date of purchase
- dealer name and address

We will likely ask your Honda dealer to respond, or possibly acknowledge your comments directly.

Your Honda Dealer

Once you purchase your new Honda, get familiar with the organization of your Honda dealer so you can utilize the full range of services available.

The service department is there to perform regular maintenance and unexpected repairs. It has the latest available service information from Honda. The service department will also handle warranty inspections and repairs.

The parts department offers Honda Genuine Parts, Pro Honda products, Honda Genuine Accessories (USA only), and Honda accessories and products (Canada only). The same quality that went into your Honda can be found in Honda Genuine replacement parts. You'll also find comparable quality in the accessories

and products available from the parts department.

The sales department offers the Honda Protection Plan to extend almost all of your warranty coverage (USA only). Your Honda dealer can inform you about competition and other riding events in your area. You'll also find that your dealer is a source of information about American Honda's Rider Education Centers and the Honda Rider's Club of America (USA only).

We're sure you'll be as pleased with the service your Honda dealer continues to provide after the sale as you are with the quality and dependability of your Honda.

The Honda Rider's Club (USA only)

You may be eligible for a Honda Rider's Club of America (HRCA) membership with the purchase of your new Honda. You can log on to the HRCA Clubhouse website for details at www.hrca.honda.com.

Reporting Safety Defects (USA only)

If you believe that your vehicle has a defect which could cause a crash or could cause injury or death, you should immediately inform the National Highway Traffic Safety Administration (NHTSA) in addition to notifying American Honda Motor Co., Inc.

If NHTSA receives similar complaints, it may open an investigation, and if it finds that a safety defect exists in a group of vehicles, it may order a recall and remedy campaign. However, NHTSA cannot become involved in individual problems between you, your dealer, or American Honda Motor Co., Inc.

To contact NHTSA, you may call the Vehicle Safety Hotline toll-free at 1-888-327-4236 (TTY: 1-800-424-9153); go to <http://www.safercar.gov>; or write to: Administrator, NHTSA, 1200 New Jersey Avenue, SE., Washington, DC 20590.

You can also obtain other information about motor vehicle safety from <http://www.safercar.gov>.

Table of Contents

The following presents the contents of each section of your owner's manual.

SCOOTER SAFETY	1
Important Safety Information	2
Important Message to Parents	5
Accessories & Modifications	9
Safety Labels	11
INSTRUMENTS & CONTROLS	13
Operation Component Locations	14
Gauges & Indicators	17
Controls & Features	20
Ignition Switch	20
Start Button	22
Engine Stop Switch	22
Headlight Dimmer Switch	23
Turn Signal Switch	23
Horn Button	24
Rear Brake Lock	24

Seat Lock	26
Center Stand Lock	27
BEFORE RIDING.....	29
Are You Ready to Ride?	30
Protective Apparel	30
Rider Training	32
Is Your Scooter Ready to Ride?.....	34
Pre-ride Inspection	34
Load Limits & Guidelines.....	37
Loading	37
Load Limits	38
Loading Guidelines	39
Cargo Compartments.....	40
Center Compartment	40
Front Hook.....	41

Table of Contents

BASIC OPERATION & RIDING.....	43
Safe Riding Precautions	44
Starting & Stopping the Engine	45
Preparation.....	45
Starting Procedure	46
How to Stop the Engine	50
Riding	51
Braking	58
Parking.....	60
Theft-prevention Tips	63
Riding with Cargo	64

SERVICING YOUR HONDA	65
<i>Before You Service Your Honda</i>	
The Importance of Maintenance.....	68
Maintenance Safety	69
Important Safety Precautions.....	70
Periodic Maintenance	72
Maintenance Schedule	74
Maintenance Record.....	79
 <i>Service Preparations</i>	
Maintenance Component Locations	81
Owner's Manual Storage.....	84
Maintenance Lid Removal	85
Plug Maintenance Lid Removal	86

(cont'd)

Table of Contents

SERVICING YOUR HONDA (cont'd)

Service Procedures

Fluids & Filters

Fuel	87
Engine Oil & Strainer Screen.....	90
Coolant.....	100
Air Cleaner	104
Crankcase Breather	106

Engine

Throttle	107
Engine Idle Speed.....	109
Spark Plug	111

Chassis

Brakes	114
Tires	118

Electrical

Battery	125
---------------	-----

Appearance Care	130
-----------------------	-----

TIPS

137	
Storing Your Honda	138
Transporting Your Scooter.....	142
You & the Environment.....	143

Table of Contents

TAKING CARE OF THE UNEXPECTED	145
General Guidelines	146
If Your Engine Quits or Won't Start ..	147
If You Have a Flat Tire	152
If Your Engine Overheats	156
If a Fuse Blows.....	158
If You Crash.....	162
If You Lose Your Key	163
If Your Battery Is Low (or Dead).....	164
TECHNICAL INFORMATION	165
Vehicle Identification.....	166
Specifications	169
Break-in Guidelines	175
High Altitude Carburetor Adjustment	176
Emission Control Systems	177
Catalytic Converter	183
Oxygenated Fuels.....	184

CONSUMER INFORMATION	187
Authorized Manuals	188
Warranty Coverage	191
Warranty Service.....	192
Contacting Honda.....	193
Your Honda Dealer	194
The Honda Rider's Club (USA only)	195
Reporting Safety Defects (USA only)	196
TABLE OF CONTENTS	198
INDEX	202
QUICK REFERENCE	

Index

A

accessories	9
air cleaner	104
air pressure, tires.....	118
altitude, high	176
American Honda, contacting.....	193
apparel, protective	30
appearance care	130

B

battery	125
brakes,	
freeplay	114
shoe wear	117
braking	58
break-in guidelines	175

C

capacity, fuel	88
carburetor, altitude adjustment.....	176
care, appearance	130
catalytic converter	183
center stand lock	27
cleaning, appearance care	130
color label	168
compartment,	
center.....	40
owner's manual	84
consumer information	187
controls & features	20
coolant.....	100
crankcase breather	106
customer service	193

D

defects, safety 196

E

emission control systems 177

engine,

idle speed 109

number 167

oil 90

overheats 156

pinging 87

starting 45

stop switch 22

stopping 50

won't start 147

environment 143

F

flat tire 152

fuel,

gauge 19

oxygenated 184

recommendation 87

tank capacity 88

fuses 158

Index

G

- gap, spark plug..... 112
- gasohol..... 184
- gasoline..... 87
- gauges & indicators..... 17

H

- headlight dimmer switch..... 23
- helmet holder..... 62
- high altitude carburetor adjustment 176
- high beam indicator..... 19
- high coolant temperature indicator..... 17, 19, 156
- Honda,
 - contacting..... 193
 - Rider's Club..... 195
 - dealer..... 194

- Honda service manual..... 188
- hook, front..... 41
- horn button..... 24

I

- identification, vehicle..... 166
- idle speed, engine..... 109
- ignition switch..... 20
- indicators..... 17
- inspection, pre-ride..... 34

K

- key, lost..... 163

L

- labels, safety..... 11
- lamp check..... 18

limit, weight.....	38
load limits	38
loading guidelines.....	39
lock,	
center stand	27
seat	26
steering.....	61

M

maintenance,	
component locations.....	81
importance	68
periodic	72
record	79
safety.....	69
schedule	74
manual, service	188
maximum weight limit	38
modifications	10

N

numbers, serial.....	166
----------------------	-----

O

odometer	19
oil, engine	90
operation component locations	14
overheat, engine.....	156
owner's manual storage.....	84
oxygenated fuels.....	184

Index

P

parking	60
pinging, engine	87
plug, spark.....	111
pre-ride inspection	34
problems, unexpected.....	145
protective apparel	30

R

rear brake lock lever	24
removal,	
maintenance lid.....	85
plug maintenance lid	86
reporting safety defects.....	196
rider training	3, 32
Rider's Club, Honda.....	195

riding,	
basic operation.....	43
clothing	30
precautions.....	44
safety.....	2
safety precautions.....	44
with cargo	64

S

safety,	
important precautions	70
labels	11
reporting defects.....	196
riding precautions	44
schedule, maintenance.....	74
seat lock	26
serial numbers.....	166
service,	
customer.....	193

manuals	188
warranty	192
spark knock.....	87
spark plug.....	111
specifications	169
speedometer	19
start button	22
starting,	
engine.....	45
troubleshooting	147
steering lock.....	61
stop switch, engine	22
stopping engine.....	50
storage,	
owner's manual	84
scooter.....	138
switch,	
engine stop.....	22
headlight dimmer.....	23
ignition.....	20

turn signal	23
-------------------	----

T

temperature indicator, coolant.....	19
theft-prevention tips	63
throttle.....	107
tires,	
air pressure.....	118
flat.....	152
replacing	122
training, rider	3, 32
transporting your scooter.....	142
trouble, unexpected	145
troubleshooting, starting.....	147
turn signal indicator.....	19

Index

V

vehicle identification no. (VIN)..... 166

W

warranty,
 coverage..... 191
 extended..... 191
 service 192
washing your scooter..... 130
weight limit..... 38

Quick Reference

The following is a brief, but important collection of information you need to know about your Honda. You'll also find space to record important notes.

How to Avoid Costly Repairs

The engine of your Honda can be the most expensive component to repair. Proper maintenance, especially the use of the recommended fluids and filters, prevents premature wear and damage.

Frequent causes of costly repairs are:

- Engine oil — insufficient quantity, improper oil.
- Air cleaner — dirty, leaking because of improper installation (poor seal).

Record important information on the following page:

Quick Reference

VIN	
Engine No.	
Ignition Key No.	
Color Label	
Owner's Name	
Address	
City/State	
Phone	
Dealer's Name	
Address	
City/State	
Phone	
Service Mgr.	

Quick Reference







Scheduled Maintenance	Initial: 600 miles (1,000 km) Regular: every 2,500 miles (4,000 km)
Pre-ride Inspection	Check the following items each time before you ride (page 34): tires, leaks, loose parts, brakes, indicators, lights.
Periodic Checks	Check the following items monthly (page 73): tires, fluids, lights, freeplay, fuses, nuts & bolts.
Fuel/Capacity	unleaded gasoline, pump octane number 86 or higher 1.32 US gal (5.0 l)
Engine Oil	API Service Classification SG or higher except oils labeled as energy conserving on the circular API service label, SAE 10W-30, JASO T 903 standard MA, Pro Honda GN4 4-stroke oil or equivalent
Maximum Weight Capacity	277 lbs (126 kg) rider, all cargo and accessories

Quick Reference

Tires	Front: 90/90-10 50J IRC MB65 Rear: 90/90-10 50J IRC MB65 Type: bias-ply, tubeless
Tire Pressure (cold)	Front: 18 psi (125 kPa , 1.25 kgf/cm ²) Rear: 29 psi (200 kPa , 2.00 kgf/cm ²)
Spark Plugs	standard: CR8EH-9 (NGK) or U24FER9 (DENSO) cold climate: CR7EH-9 (NGK) or U22FER9 (DENSO) high speed riding: CR9EH-9 (NGK) or U27FER9 (DENSO)
Coolant	ethylene glycol antifreeze (silicate-free) for aluminum engines in 50/50 solution with Pro Honda HP Coolant or an equivalent distilled water
Fuses	main: 15A other: 10A

Quick Reference

These symbols are used in Controls & Features section:

SYMBOL	COMPONENT	SEE PAGE
	RUN — engine stop switch	22
	OFF — engine stop switch	22
	HI — headlight dimmer switch	23
	LO — headlight dimmer switch	23
	turn signal switch	23
	horn button	24