

**Honda**  
**SH300/R**  
**SH300A/AR**

**OWNER'S MANUAL**

**MANUAL DEL PROPIETARIO**

**MANUAL DO PROPRIETÁRIO**



**Honda**  
**SH300/R**  
**SH300A/AR**

**OWNER'S MANUAL**



## **IMPORTANT INFORMATION**

- **OPERATOR AND PASSENGER**

This scooter is designed to carry the operator and one passenger. Never exceed the maximum weight capacity as shown on the accessories and loading label.

- **ON-ROAD USE**

This scooter is designed to be used only on the road.

- **READ THIS OWNER'S MANUAL CAREFULLY**

Pay special attention to the safety messages that appear throughout the manual. These messages are fully explained in the “A Few Words About Safety” section which appears before the Contents page.

This manual should be considered a permanent part of the scooter and should remain with the scooter when resold.

# Honda SH300/R - SH300A/AR OWNER'S MANUAL

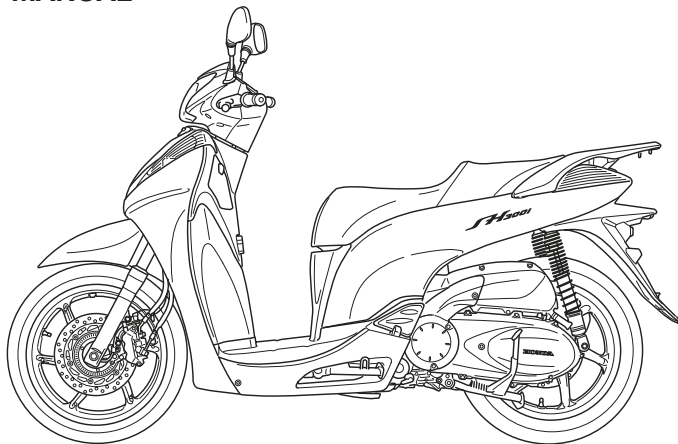

**All information in this publication is based on the latest production information available at the time of approval for printing. Honda Italia Industriale S.p.A. reserves the right to make changes at any time without notice and without incurring any obligation. No part of this publication may be reproduced without written permission.**

## WELCOME

The scooter presents you a challenge to master the machine, a challenge to adventure. You ride through the wind, linked to the road by a vehicle that responds to your commands as no other does. Unlike an automobile, there is no metal cage around you. Like an airplane, a pre-ride inspection and regular maintenance are essential to your safety. Your reward is freedom.

To meet the challenges safely, and to enjoy the adventure fully, you should become thoroughly familiar with this owner's manual BEFORE YOU RIDE THE SCOOTER.

As you read this manual, you will find information that is preceded by a **NOTICE** symbol. This information is intended to help you avoid damage to your scooter, other property, or the environment.

When servicing is required, remember that your Honda dealer knows your scooter best. If you have the required mechanical "know-how" and tools, your dealer can supply you with an Official Honda Service Manual to help you perform many maintenance and repair tasks.

Pleasant riding, and thank you for choosing a Honda!

- Following codes in this manual indicate each country.

	SH300/R - SH300A/AR
E	UK
F	France
ED	European direct sales
IIE	UK
IIF	France
IIIED	European direct sales

- The specifications may vary with each location.

## A FEW WORDS ABOUT SAFETY

Your safety, and the safety of others, is very important and operating this scooter safely is an important responsibility.

To help you make informed decisions about safety, we have provided operating procedures and other information on labels and in this manual. This information alerts you to potential hazards that could hurt you or others.

Of course, it is not practical or possible to warn you about all hazards associated with operating or maintaining a scooter. You must use your own good judgement.

You will find important safety information in a variety of forms, including:

- **Safety Labels** - on the scooter.
- **Safety Messages** - preceded by a safety alert symbol  and one of three signal words: **DANGER, WARNING, or CAUTION.**

These signal words mean:



**⚠ DANGER** You **WILL** be **KILLED** or **SERIOUSLY HURT** if you don't follow instructions.

**⚠ WARNING** You **CAN** be **KILLED** or **SERIOUSLY HURT** if you don't follow instructions.

**⚠ CAUTION** You **CAN** be **HURT** if you don't follow instructions.

- **Safety Headings** - such as Important Safety Reminders or Important Safety Precautions.
- **Safety Section** - such as Scooter Safety.
- **Instructions** - how to use this scooter correctly and safely.

This entire manual is filled with important safety information – please read it carefully.

# OPERATION

Page

1 **SCOOTER SAFETY**

- 1 Important safety information
- 2 Protective apparel
- 5 Load limits and guidelines

10 **PARTS LOCATION**

- 13 Instruments and indicators

26 **MAJOR COMPONENTS**

(Information you need to operate this scooter)

- 26 Suspension
- 27 Brakes
- 32 Coolant
- 35 Fuel
- 38 Engine oil
- 39 Tubeless tyres

45 **ESSENTIAL INDIVIDUAL COMPONENTS**

- 45 Ignition switch
- 46 Keys
- 48 Immobilizer system (HISS)
- 51 Right handlebar controls
- 52 Left handlebar controls

Page

53 **FEATURES**

(Not required for operation)

- 53 Steering lock
- 54 Seat lock
- 55 Helmet holder
- 56 Center compartment
- 57 Left compartment
- 58 Accessory socket
- 59 Document compartment
- 59 Shopping hook
- 60 Headlight aim vertical adjustment

61 **OPERATION**

- 61 Pre-ride inspection
- 63 Starting the engine
- 67 Running-in
- 68 Riding
- 75 Parking
- 76 Anti-theft tips

## **MAINTENANCE**

Page

77	<b>MAINTENANCE</b>
77	The importance of Maintenance
78	Maintenance safety
79	Safety precautions
80	Maintenance schedule
83	Tool kit
84	Serial numbers
85	Colour label
86	Air cleaner
88	Belt case air cleaner
90	Crankcase breather
91	Engine oil
94	Engine oil and Filter
97	Spark plug
100	Throttle operation
101	Coolant
102	Front and rear suspension inspection
103	Side stand
104	Brake pad wear
106	Battery
108	Fuse replacement
111	Bulb replacement

Page

119	<b>CLEANING</b>
123	<b>STORAGE GUIDE</b>
123	Storage
125	Removal from storage
126	<b>SPECIFICATIONS</b>
130	<b>CATALYTIC CONVERTER</b>



# SCOOTER SAFETY

## **IMPORTANT SAFETY INFORMATION**

Your scooter can provide many years of service and pleasure – if you take responsibility for your own safety and understand the challenges that you can meet on the road.

There is much that you can do to protect yourself when you ride. You'll find many helpful recommendations throughout this manual. The following are a few that we consider most important.

### **Always Wear a Helmet**

It's a proven fact: Helmets significantly reduce the number and severity of head injuries. So always wear an approved motorcycle helmet and make sure your passenger does the same.

We also recommend that you wear eye protection, sturdy boots, gloves and other protective gear (page 2).

### **Make Yourself Easy to See**

Some drivers do not see scooters because they are not looking for them. To make yourself more visible, wear bright reflective clothing, position yourself so other drivers can see you, signal before turning or changing lanes, and use your horn when it will help others notice you.

### **Ride Within Your Limits**

Pushing the limits is another major cause of scooter accidents. Never ride beyond your personal abilities or faster than conditions warrant. Remember that alcohol, drugs, fatigue and inattention can significantly reduce your ability to make good judgements and ride safely.

### **Don't Drink and Ride**

Alcohol and riding don't mix. Even one drink can reduce your ability to respond to changing conditions, and your reaction time gets worse with every additional drink. So don't drink and ride, and don't let your friends drink and ride either.

### **Keep Your Bike in Safe Conditions**

For safe riding, it's important to inspect your scooter before every ride and perform all recommended maintenance. Never exceed load limits and only use accessories that have been approved by Honda for this scooter.

See page 5 for more details.

### **PROTECTIVE APPAREL**

For your safety, we strongly recommend that you always wear an approved motorcycle helmet, eye protection, boots, gloves, long pants and a long-sleeved shirt or jacket whenever you ride. Although complete protection is not possible, wearing proper gear can reduce the chance of injury when you ride.

Following are suggestions to help you choose proper gear.

### **WARNING**

Not wearing a helmet increases the chance of serious injury or death in a crash.

Be sure you and your passenger always wear a helmet, eye protection and other protective apparel when you ride.

## **Helmets and Eye Protection**

Your helmet is your most important piece of riding gear because it offers the best protection against head injuries. A helmet should fit your head comfortably and securely. A bright-coloured helmet can make you more noticeable in traffic, as can reflective strips.

An open-face helmet offers some protection, but a full-face helmet offers more. Always wear a face shield or goggles to protect your eyes and help your vision.

## **Additional Riding Gear**

In addition to a helmet and eye protection, we also recommend:

- Sturdy boots with non-slip soles to help protect your feet and ankles.
- Leather gloves to keep your hands warm and help prevent blisters, cuts, burns and bruises.
- A motorcycle riding suit or jacket for comfort as well as protection. Bright-coloured and reflective clothing can help make you more noticeable in traffic. Be sure to avoid loose clothes that could get caught on any part of your scooter.

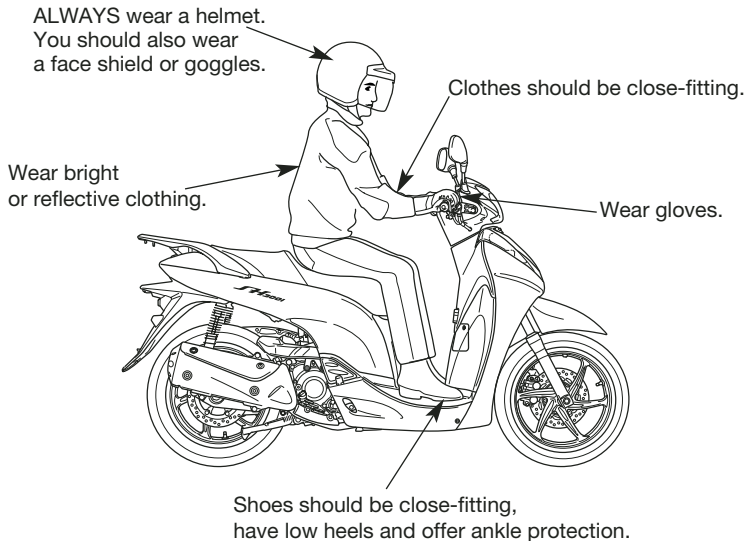



## LOAD LIMITS AND GUIDELINES

Your scooter has been designed to carry you, one passenger and a limited amount of cargo. When you add cargo or carry a passenger, you may feel some difference during acceleration and braking. But so long as you keep your scooter well-maintained, with good tyres and brakes, you can safely carry loads within the given limits and guidelines.

However, exceeding the weight limit or carrying an unbalanced load can seriously affect your scooter's handling, braking and stability. Non-Honda accessories, improper modifications, and poor maintenance can also reduce your safety margin.

The following pages give more specific information on loading, accessories and modifications.

## Loading

How much weight you put on your scooter and how you load it, are important to your safety. Anytime you ride with a passenger or cargo you should be aware of the following information.

### **WARNING**

Overloading or improper loading can cause a crash and you can be seriously hurt or killed.

Follow all load limits and other loading guidelines in this manual.

## Load limits

Following are the load limits for your scooter:

### Maximum weight capacity:

180 kg (397 lbs)

Includes the weight of the rider, passenger, all cargo and all accessories.

### Maximum cargo weight:

19 kg (42 lbs)

The weight of added accessories will reduce the maximum cargo weight you can carry.

Putting too much weight in individual storage compartments can also affect stability and handling. So be sure to stay within the limits given below:

### Maximum weight:

**in center compartment** 10 kg (22 lbs)

**in left compartment** 0.5 kg (1.0 lbs)

**shopping hook** 1.5 kg (3.0 lbs)

**rear carrier** 3.0 kg (6.6 lbs)

Rear carrier:  
weight limit:  
3.0 kg (6.6 lbs)

Center compartment:  
weight limit:  
10 kg (22 lbs)

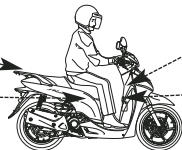

Left compartment:  
weight limit:  
0.5 kg (1.0 lbs)

Shopping hook:  
weight limit:  
1.5 kg (3.0 lbs)

## **Loading Guidelines**

Your scooter is primarily intended for transporting you and a passenger.

If you wish to carry more cargo, check with your Honda dealer for advice and be sure to read the information regarding accessories on page 8.

Improperly loading your scooter can affect its stability and handling. Even if your scooter is properly loaded, you should ride at reduced speeds whenever carrying cargo.

Follow these guidelines whenever you carry a passenger or cargo:

- Check that both tyres are properly inflated.
- If you change your normal load, you may need to adjust the rear suspension (see page 26).
- To prevent loose items from creating a hazard, make sure the left compartment and the center compartment are closed and that any other cargo is securely tied down before you ride away.
- Place cargo weight as close to the center of the scooter as possible.
- Balance cargo weight evenly on both sides.

## Accessories and modifications

Modifying your scooter or using non-Honda accessories can make your scooter unsafe. Before you consider making any modifications or adding an accessory, be sure to read the following information.

### **WARNING**

Improper accessories or modifications can cause a crash in which you can be seriously hurt or killed.

Follow all instructions in this owner's manual regarding accessories and modifications.

## Accessories

We strongly recommend that you use only genuine Honda accessories that have been specifically designed and tested for your scooter. Because Honda cannot test all other accessories, you must be personally responsible for proper selection, installation and use of non-Honda accessories. Check with your dealer for assistance and always follow these guidelines:

- Make sure the accessory does not obscure any lights, reduce ground clearance and banking angle, limit suspension travel or steering travel, alter your riding position or interfere with operating any controls.
- Be sure electrical equipment does not exceed the scooter's electrical system capacity (page 129). A blown fuse can cause a loss of lights or engine power.

- Do not pull a trailer or sidecar with your scooter. This scooter was not designed for these attachments, and their use can seriously impair your scooter's handling.

### **Modifications**

We strongly advise you not to remove any original equipment or modify your scooter in any way that would change its design or operation. Such changes could seriously impair your scooter's handling, stability and braking, making it unsafe to ride.

Removing or modifying your lights, mufflers, emission control system or other equipment can also make your scooter illegal.

## PARTS LOCATION

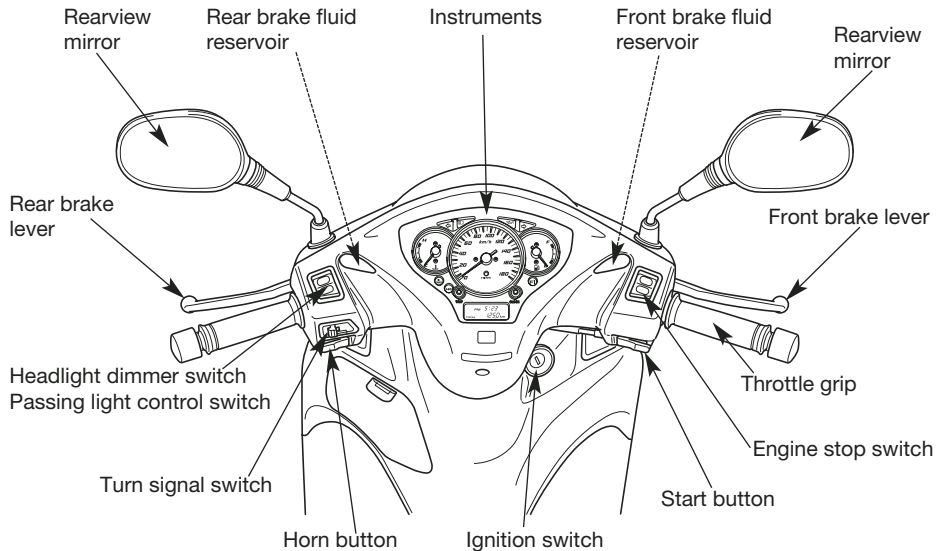

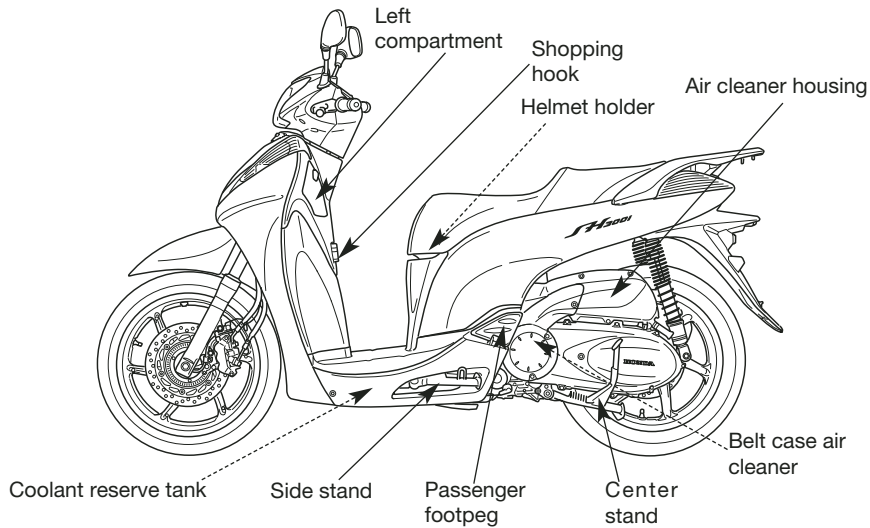

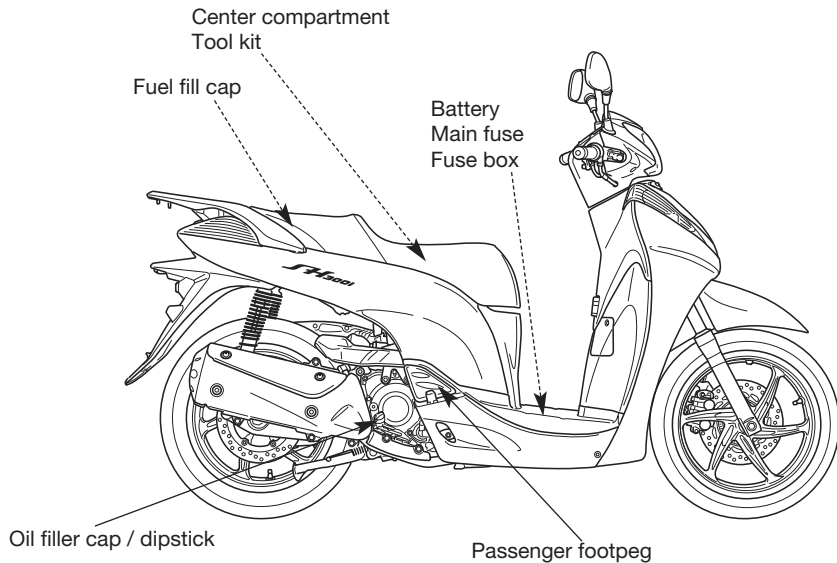





## INSTRUMENTS AND INDICATORS

The indicators are contained in the instrument panel. Their functions are described in the tables on the following pages.

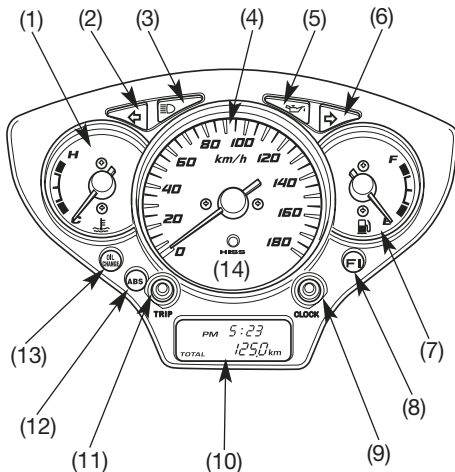
- (1) Coolant temperature gauge
- (2) Left turn signal indicator
- (3) High beam indicator
- (4) Speedometer
- (5) Low oil pressure indicator
- (6) Right turn signal indicator
- (7) Fuel gauge
- (8) PGM-FI malfunction indicator
- (9) Clock button
- (10) Multi-function display
- (11) Tripmeter reset button (TRIP)
- (12) Anti-lock brake system (ABS) indicator (SH300A/AR)
- (13) Oil change indicator
- (14) Immobilizer system (HISS) indicator



<b>(Ref. No.) Description</b>	<b>Function</b>
(1) Coolant temperature gauge	Shows coolant temperature (page 22). The coolant temperature gauge needle will swing to the maximum scale on the dial once when the ignition switch is turned ON.
(2) Left turn signal indicator (green)	Flashes when the left turn signal operates.
(3) High beam indicator (blue)	Lights when the headlight is on high beam.
(4) Speedometer	Shows riding speed. This shows your speed in kilometers per hour (km/h) and/or miles per hour (mph) depending on the type. The speedometer needle will swing to the maximum scale on the dial once when the ignition switch is turned ON.
(5) Low oil pressure indicator (red)	Lights when the engine oil pressure is below normal operating range. Should light when ignition switch is ON and engine is not running. Should go out when the engine starts, except for occasional flickering at or near idling speed when engine is warm.  <b>NOTICE</b> Running the engine with insufficient oil pressure may cause serious engine damage.

<b>(Ref. No.) Description</b>	<b>Function</b>
(6) Right turn signal indicator (green)	Flashes when the right turn signal operates.
(7) Fuel gauge	Shows approximate fuel supply available (page 23). The fuel gauge needle will swing to the maximum scale on the dial once when the ignition switch is turned ON.
(8) PGM-FI Malfunction Indicator Lamp (red)	Lights when there is any abnormality in the PGM-FI (Programmed Fuel Injection) system. It should also light for a few seconds and then go off when the ignition switch is turned ON and engine stop switch is at  (RUN). If it comes on at any other time, reduce speed and take the motorcycle to your Honda dealer as soon as possible.
(9) Clock button	This button is used to set the time (page 20); it also serves for the oil change indicator reset procedure (page 24).

<b>(Ref. No.) Description</b>	<b>Function</b>
(10) Multi-function display	The display includes the following functions; This display shows the initial display (page 18).
Odometer	Shows accumulated mileage (page 21)
Tripmeter A and B	Shows trip mileage (page 21)
Digital clock	Shows hours and minutes (page 20)
(11) Tripmeter reset button (TRIP)	The button is used to select the tripmeter A, the tripmeter B or the odometer (page 21). This button also serves for the oil change indicator reset procedure. (page 24).

<b>(Ref. No.) Description</b>	<b>Function</b>
(12) Anti-lock brake system (ABS) indicator (red) (SH300A/AR)	<p>This indicator light normally illuminates when the ignition switch is set to ON and is extinguished when the scooter is ridden at a speed of more than 10 km/h (6 mph).</p> <p>In the event of problems with the ABS system this indicator flashes and remains on (page 28-29).</p>
(13) Oil change indicator (yellow)	<p>Lights when specified maintenance interval for engine oil change is reached (page 24).</p>
(14) Immobilizer system (HISS) indicator (red)	<p>This indicator lights for a few seconds when the ignition switch is turned ON and the engine stop switch is at  (RUN). It will go off if the properly-coded key has been inserted. If an improperly-coded key has been inserted, the indicator will remain on and the engine will not start (page 48).</p> <p>When the blinking function of this indicator is valid and the ignition switch is off, it keeps blinking for 24 hours (page 49).</p>

## Initial Display

When the ignition switch is turned ON, the multi-function display (1) will temporarily show all the modes and digital segments so you can make sure the liquid crystal display is functioning properly.

The unit “mile” (2) will be displayed only for E type.

Digital clock (3) and tripmeter (4) will reset if the battery is disconnected.

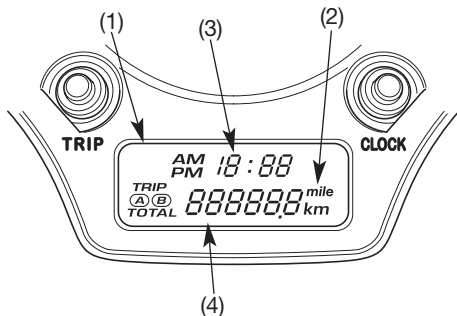

- (1) Multi-function display
- (2) Mile
- (3) Digital clock
- (4) Tripmeter

### Multi-function Display

Multi-function display (1) includes the following functions:

- Odometer/Tripmeter
- Digital clock

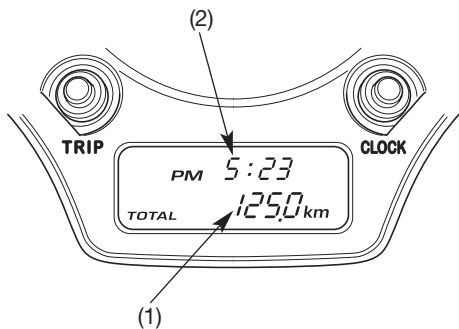

(1) Odometer/Tripmeter

(2) Digital clock

## Digital Clock

Shows hour and minute. To adjust the time, proceed as follows:

1. Turn the ignition switch ON.
2. Press and hold the CLOCK button (2) for more than 2 seconds. The clock will be set in the adjust mode with the display flashing.

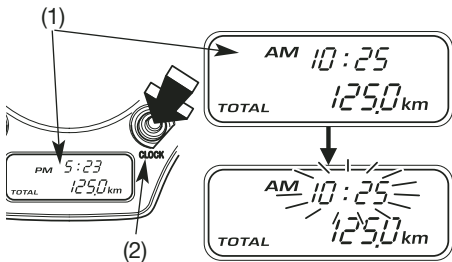

- (1) Digital clock  
(2) Clock button

3. To set the hour, press the CLOCK button until the desired time AM/PM displayed.
  - The time is advanced by one minute, each time the button is pushed.
  - The time is advanced by ten minutes, when the button is pushed and held.

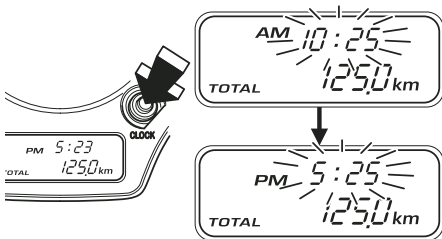

4. To end the adjustment, press the CLOCK button 5 seconds after the last adjustment, or turn the ignition switch OFF.



## Odometer/Tripmeter

The odometer (1) shows accumulated mileage.

### Shows mileage per trip.

There are two tripmeters, tripmeter A (2) and tripmeter B (3). Switch between the A and B displays by pressing the Tripmeter reset button (4) repeatedly.

### Resetting the tripmeter

To reset the tripmeter, push and hold the Tripmeter reset button (4) with the display in the tripmeter A or tripmeter B mode.

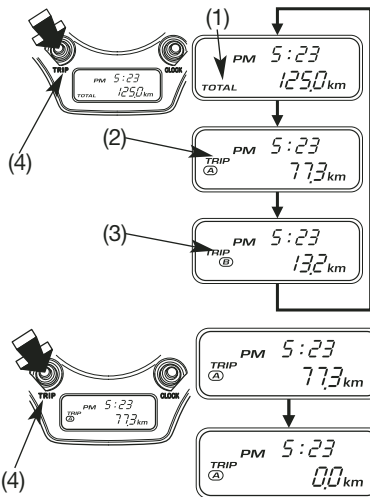

(1) Odometer  
(2) Tripmeter A

(3) Tripmeter B  
(4) Tripmeter reset  
button

## Coolant temperature gauge

The coolant temperature gauge (1) shows coolant temperature.

When the needle begins to move above the “C” (Cold) mark, the engine is warm enough for the scooter to be ridden. The normal operating temperature range is within the section between the “H” and “C” marks. If the needle reaches the red band (2), stop the engine and check the reserve tank coolant level.

Read pages 32-33 and do not ride the scooter until the problem has been solved.

### NOTICE

Exceeding maximum running temperature may cause serious engine damage.

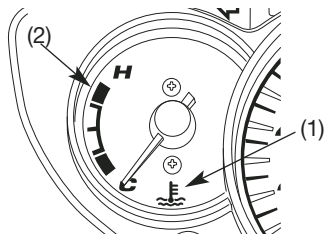

- (1) Coolant temperature needle
- (2) Red band

## Fuel gauge

The fuel gauge (1) shows the approximate fuel supply available in a graduated display. When the gauge needle enters the red band (2), fuel will be low and you should refill the tank as soon as possible. The amount of fuel left in the tank, with the vehicle set upright, when the needle enters the red band is approximately:

2.0 ℓ

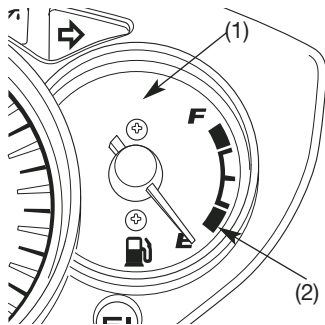

- (1) Fuel gauge needle
- (2) Red band

## Oil change indicator

The oil change indicator (1) illuminates when the distance covered by the scooter arrives at the oil change interval specified in the user and maintenance table program (page 81).

Reset the indicator after every oil change, as follows.

1. Visualise the total distance travelled on the display.
2. With the ignition key turned ON, press and hold the TRIP (2) and CLOCK (3) buttons for at least 2 seconds. The indicator will go out.

If the oil is changed before the oil change indicator illuminates, remember that the indicator must anyway be reset. In this case, follow the procedure described at points 1 and 2, but when you continue to hold down the reset button the oil change indicator will illuminate for 2 seconds and then switch off. This sequence of events means that the indicator has been reset.

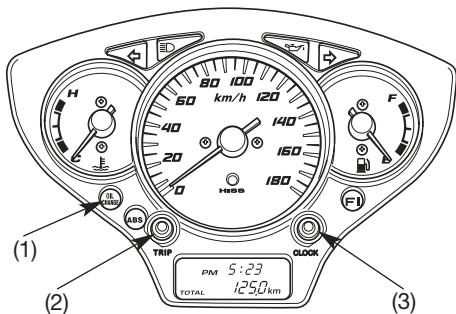

- (1) Oil change indicator
- (2) TRIP button
- (3) CLOCK button

**NOTE**

The first oil change is at 1000 km (600 miles), but in this case the indicator should not be reset. The indicator will appear after the scooter has covered approximately 6000 km (4000 miles for the type E). Therefore, after the second engine oil change as prescribed by the maintenance table (page 81) remember to reset the oil change indicator (page 24).

## MAJOR COMPONENTS

(Information you need to operate this scooter)

### SUSPENSION

The shock absorber (1) has 5 adjustment positions for different load or riding conditions.

Use a pin spanner (2) to adjust the rear shock.

Always adjust the shock absorber position in sequence (1-2-3-4-5 or 5-4-3-2-1).

Attempting to adjust directly from 1 to 5 or 5 to 1 may damage the shock absorber.

Position: 1 to 2 is for light loads and smooth road conditions. Positions 4 to 5 increase spring preload for a stiffer rear suspension, and can be used when the scooter is heavily loaded.

Be certain to adjust both shock absorbers to the same position.

Standard position: 3

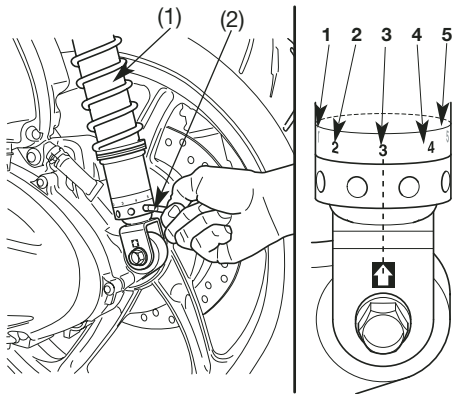

(1) Shock absorber

(2) Pin spanner

## **BRAKES**

### **Combined Brake System (CBS)**

This scooter is equipped with a Combined Brake System. Operating the rear brake lever applies the rear brake and a portion of the front brake. For full braking effectiveness, use both the front and rear brake lever simultaneously, as you would with a conventional scooter braking system.

As with a conventional scooter braking system, excessively hard application of the brake controls may cause wheel lock, reducing control of the scooter.

For normal braking, apply both the front and rear brake lever to match your road speed. For maximum braking, close the throttle and firmly apply the front and rear brake lever.

## **Anti-lock Brake System (ABS) (SH300A/AR)**

This model is also equipped with an Anti-lock Brake System (ABS) designed to help prevent wheel lock up during hard braking on uneven or other poor surfaces while running straight. Although the wheel may not lock up - if you are braking too hard in a turn the scooter can still lose traction, causing a loss of control.

In certain conditions, on uneven surfaces or loose terrain a scooter with ABS may have a longer stopping distance than a scooter without ABS.

The ABS system cannot compensate for road conditions, errors of judgement, or improper use of the brakes. It is always the responsibility of the rider to adopt a suitable road speed in relation to weather conditions, the road surface, and the traffic levels, while leaving an ample margin of safety.

The ABS system is self-regulating and always active.

- The ABS system may be engaged by sudden upward or downward level differences in the road surface.

Make sure you observe the prescriptions concerning tyres (page 39). The ABS computer acts on the basis of the comparative speeds of the front and rear wheel. The use of non-approved tyres can affect the speed of the wheels and supply confusing information to the ABS computer.

- The ABS system is not active at low speed (around 10 km/h (6 mph) or slower).
- The ABS system will not work if the battery is discharged.



## **ABS Indicator Light (SH300A/AR)**

This indicator normally illuminates when the ignition switch is set to ON and is extinguished when the scooter is ridden at a speed of more than 10 km/h (6 mph) .If there is a problem with the ABS system, this light flashes and remains on. When the indicator light is illuminated the ABS system is not operative.

If the ABS indicator illuminates while travelling, stop the scooter in a safe place and switch off the engine.

Return the ignition switch to ON. The indicator should illuminate and then switch off after the scooter has been ridden at a speed of more than 10 km/h (6 mph). If the indicator fails to switch off, this means the ABS system is not working, although the normal braking system will continue to work and supply the normal stopping power. In these conditions however the system should be checked over by an authorized

Honda dealer as soon as possible.

The ABS indicator may illuminate if the rear wheel is driven at high speed for more than 30 seconds when the scooter is upright on the stand. This reaction is perfectly normal. Set the ignition switch to OFF and then return it to ON. The indicator light should illuminate and then switch off after the scooter has been ridden at a speed of more than 30 km/h (19 mph).

## Inspection

Both the front and rear brakes are the hydraulic disc types.

As the brake pads wear, the brake fluid level drops.

There are no adjustments to perform, but fluid level and pad wear must be inspected periodically. The system must be inspected frequently to ensure there are no fluid leaks. If the control lever free travel becomes excessive, and the brake pads are not worn beyond the recommended limit (page 104-105), there is probably air in the brake system and it must be bled. See your Honda dealer for this service.

### Front Brake Fluid Level

With the scooter in an upright position, check the fluid level. It should be above the LOWER level mark (1). If the level is at or below the LOWER level mark (1), check the brake pads for wear (page 104-105).

Worn pads must be replaced.

If the pads are not worn, have your brake system inspected for leaks.

The recommended brake fluid is Honda DOT 4 brake fluid from a sealed container, or an equivalent.

### Front

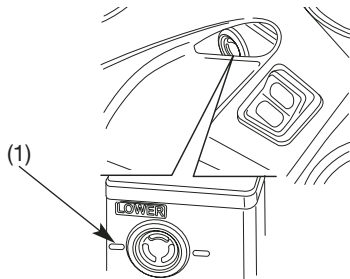

(1) LOWER level mark

### Rear Brake Fluid Level

With the scooter in an upright position, check the fluid level. It should be above the LOWER level mark (1). If the level is at or below the LOWER level mark (1), check the brake pads for wear (page 104-105).

Worn pads must be replaced.

If the pads are not worn, have your brake system inspected for leaks.

The recommended brake fluid is Honda DOT 4 brake fluid from a sealed container, or an equivalent.

### Other checks:

Make sure there are no fluid leaks. Check for deterioration or cracks in the hoses and fittings.

### **Rear**

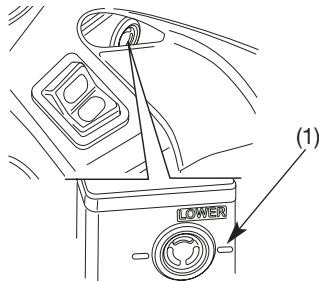

(1) LOWER level mark

## **COOLANT**

### **Coolant recommendation**

The owner must properly maintain the coolant to prevent freezing, overheating and corrosion. Use only high quality ethylene glycol antifreeze containing corrosion protection inhibitors specifically recommended for use in aluminum engines. (SEE ANTIFREEZE CONTAINER LABEL).

Use only low-mineral drinking water or distilled water as a part of the antifreeze solution. Water that is high in mineral content or salt may be harmful to the aluminum engine.

Using coolant with silicate inhibitors may cause premature wear of water pump seals or blockage of radiator passages.

Using tap water may cause engine damage.

The factory provides a 50/50 solution of antifreeze and distilled water in this scooter. This coolant solution is recommended for most operating temperatures and provides good corrosion protection. A higher concentration of antifreeze decreases the cooling system performance and is recommended only when additional protection against freezing is needed. A concentration of less than 40/60 (40% antifreeze) will not provide proper corrosion protection. During freezing temperatures, check the cooling system frequently and add higher concentrations of antifreeze (up to a maximum of 60% antifreeze) if required.

## Inspection

The reserve tank is located underneath, on the left hand side of the footrest.

Check the level of coolant in the reserve tank (1) when the engine is at normal operating temperature and the scooter is in a vertical position.

If the coolant level is under the Lower level mark (2) proceed as follows:

1. Remove the footrest cover (page 34)
2. Pull out the coolant tank compartment cover (page 34)
3. Remove the reserve tank cap (page 34) and add coolant mix until the "UPPER" level mark (3) is reached.

Always add coolant to the reserve tank. Do not attempt to add coolant by removing the radiator cap.

If the reserve tank is empty, or if coolant loss is excessive, check for leaks and see your Honda dealer for repair.

- Be sure to turn the ignition switch OFF before adding the coolant.

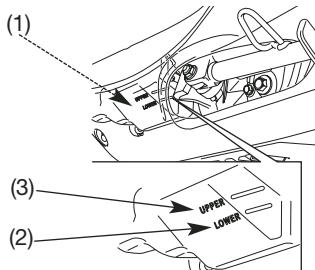

- (1) Reserve tank cap      (3) UPPER level mark  
(2) LOWER level mark

### Removing the footrest cover

1. Remove the two screws (1).
2. Remove the footrest cover with care (2).  
To replace it, perform the above operations in reverse order.

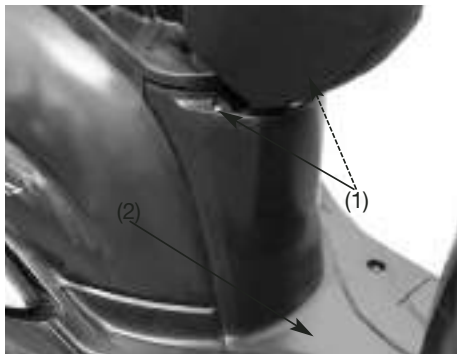

- (1) Screws
- (2) Footrest cover

**34**

### Removing the coolant tank compartment cover

1. Remove screw (1).
2. Lift up the coolant compartment cover (2) to uncover the reserve tank cap (3).  
To replace it, perform the above operations in reverse order.

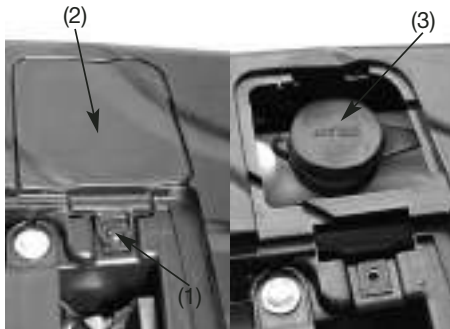

- (1) Screw
- (2) Coolant compartment cover
- (3) Tank cap

## FUEL

### Fuel tank

The fuel tank is located under the seat. Fuel tank capacity is: 9.10 ℓ.

To open the fuel fill cap (1) unlock and lift up the seat (page 54), then remove the fuel fill cap by turning it counterclockwise.

Do not overfill the tank.

There should be no fuel in the filler neck.

After refueling, be sure to tighten the fuel fill cap (1) firmly by turning it clockwise.

Make sure that the arrow marks (2) on the fuel fill cap and the fuel tank are aligned.

Use unleaded petrol with a research octane number of 91 or higher.

The use of leaded petrol will cause premature damage to the catalytic converter.

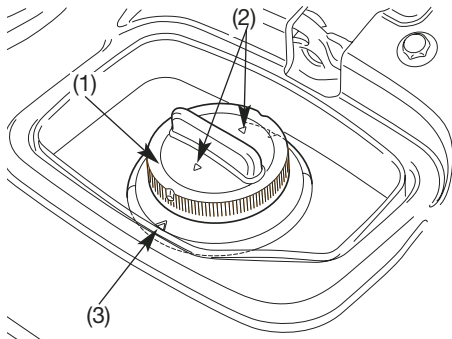

- (1) Fuel fill cap
- (2) Arrow marks
- (3) Marks

## **WARNING**

Petrol is highly flammable and explosive. You can be burned or seriously injured when handling fuel.

- Stop the engine and keep heat, sparks, and flame away.
- Refuel only outdoors.
- Wipe up spills immediately.

### NOTICE

If “spark knock” or “pinking” occurs at a steady engine speed under normal load, change brands of petrol. If spark knock or pinking persists, consult your Honda dealer. Failure to do so is considered misuse, and damage caused by misuse is not covered by Honda’s Limited Warranty.



### **Petrol containing alcohol**

If you decide to use a petrol containing alcohol (gasohol), be sure it's octane rating is at least as high as that recommended by Honda. There are two types of "gasohol": one containing ethanol, and the other containing methanol. Do not use petrol that contains more than 10% ethanol. Do not use petrol containing methanol (methyl or wood alcohol) that does not also contain cosolvents and corrosion inhibitors for methanol. Never use petrol containing more than 5% methanol, even if it has cosolvents and corrosion inhibitors.

Fuel system damage or engine performance problems resulting from the use of fuels that contain alcohol is not covered under the warranty. Honda cannot endorse the use of fuels containing methanol since evidence of their suitability is as yet incomplete.

Before buying fuel from an unfamiliar station, try to find out if the fuel contains alcohol. If it does, confirm the type and percentage of alcohol used. If you notice any undesirable operating symptoms while using a petrol that contains alcohol, or one that you think contains alcohol, switch to a petrol that you know does not contain alcohol.

## ENGINE OIL

### Engine oil level check

Check the engine oil level each day before riding the scooter.

The level must be maintained between the upper (1) and the lower (2) level marks on the oil filler cap/dipstick (3).

1. Start the engine and let it idle for 3-5 minutes. Make sure the red low oil pressure indicator goes off. If the light remains on, stop the engine immediately.
2. Stop the engine and put the scooter on its center stand on level ground.
3. After 2-3 minutes, remove the oil filler cap/dipstick (3), wipe it clean, and reinsert the oil filler cap/dipstick without screwing it in. Remove the oil filler cap/dipstick. The oil level should be between the upper (1) and lower (2) level marks on the oil filler cap/dipstick.
4. If required, add the specified oil (page 91) up to the upper level mark. Do not overfill.
5. Reinstall the oil filler cap/dipstick. Check for oil leaks.

### NOTICE

Running the engine with insufficient oil can cause serious engine damage.

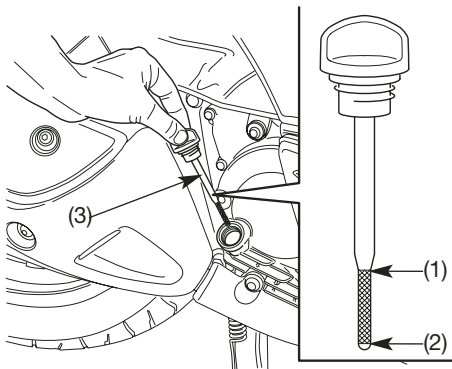

- (1) Upper level mark
- (2) Lower level mark
- (3) Oil filler cap/dipstick

## TUBELESS TYRES

To safely operate your scooter, your tyres must be the proper type and size, in good condition with adequate tread and correctly inflated for the load you are carrying. The following pages give more detailed information on how and when to check your air pressure, how to inspect your tyres for damage and what to do when your tyres need to be repaired or replaced.

### **WARNING**

Using tyres that are excessively worn or improperly inflated can cause a crash in which you can be seriously hurt or killed.

Follow all instructions in this owner's manual regarding tyre inflation and maintenance.

## Air pressure

Keeping your tyres properly inflated provides the best combination of handling, tread life and riding comfort. Generally, underinflated tyres wear unevenly, adversely affect handling and are more likely to fail from being overheated.

Overinflated tyres make your scooter ride more harshly, are more prone to damage from road hazards and wear unevenly.

We recommend that you visually check your tyres before every ride and use a gauge to measure air pressure at least once a month or any time you think the tyres might be low. Tubeless tyres have some self-sealing ability if they are punctured. However because leakage is often very slow, you should look closely for punctures whenever a tyre is not fully inflated.

Always check air pressure when your tyres are “cold” – when the scooter has been parked for at least three hours. If you check air pressure when your tyres are “warm” – when the scooter has been ridden for even a few miles – the readings will be higher than if the tyres were “cold”. This is normal, so do not let air out of the tyres to match the recommended cold air pressures given below. If you do, the tyres will be underinflated.

The recommended “cold” tyre pressures are:

kPa (kgf/cm <sup>2</sup> ,psi)		
Driver only	Front	200 (2.00, 29)
	Rear	225 (2.25, 33)
Driver and one passenger	Front	200 (2.00, 29)
	Rear	225 (2.25, 33)

## Inspection

Whenever you check the tyre pressures, you should also examine the tyre treads and sidewalls for wear, damage, and foreign objects:

Look for:

- Bumps or bulges in the side of the tyre or the tread. Replace the tyre if you find any bumps or bulges.
- Cuts, splits or cracks in the tyre. Replace the tyre if you can see fabric or cord.
- Excessive tread wear.

Also, if you hit a pothole or hard object, pull to the side of the road as soon as you safely can and carefully inspect the tyres for damage.

## Tread Wear

Replace tyres before tread depth at the centre of the tyre reaches the following limit:

Minimum tread depth	
Front:	1.5 mm (0.06 in)
Rear:	2.0 mm (0.08 in)

< For Germany >

German law prohibits use of tyres whose tread depth is less than 1.6 mm.

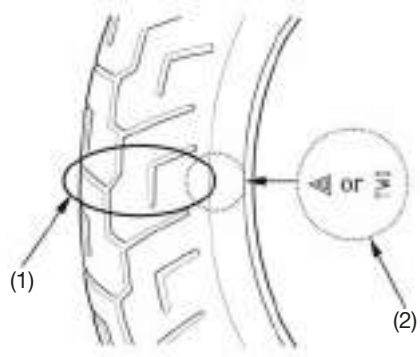

(1) Wear indicator

(2) Wear indicator location mark

## **Tyre repair**

If a tyre is punctured or damaged, you should replace it not repair it. As discussed below, a tyre that is repaired, either temporarily or permanently will have lower speed and performance limits than a new tyre.

A temporary repair, such as an external tubeless tyre plug may not be safe for normal speeds and riding conditions. If a temporary or emergency repair is made to a tyre, you should ride slowly and cautiously to a dealer and have the tyre replaced. If possible you should not carry a passenger or cargo until a new tyre is installed.

Even if a tyre is professionally repaired with a permanent internal patch plug, it will not be as good as a new tyre.

You should not exceed 80 km/h (50 mph) for the first 24 hours, or 130 km/h (80 mph) at any time thereafter. In addition you may not be able to safely carry as much weight as with a new tyre. Therefore, we strongly recommend that you replace a damaged tyre. If you choose to have the tyre repaired, be sure the wheel is balanced before you ride.

## Tyre replacement

The tyres that came on your scooter were designed to match the performance capabilities of your scooter and provide the best combination of handling, braking, durability and comfort.

### **WARNING**

Installing improper tyres on your scooter can affect handling and stability. This can cause a crash in which you can be seriously hurt or killed.

Always use the size and type of tyres recommended in this owner's manual.

The recommended tyres for your scooter are:

Front	110/70-16 M/C 52P BRIDGESTONE HOOP B03 G PIRELLI SPORT DEMON
Rear	130/70-16 M/C 61P BRIDGESTONE HOOP B02 G PIRELLI SPORT DEMON
Type	TUBELESS

Whenever you replace a tyre, use one that is equivalent to the original and be sure the wheel is balanced after the new tyre is installed.

### **Important safety reminders**

- Do not install a tube inside a tubeless tyre on this scooter. Excessive heat build-up can cause the tube to burst.
- Use only tubeless tyres on this scooter. The rims are designed for tubeless tyres and during hard acceleration or braking a tube-type tyre could slip on the rim and cause the tyre to rapidly deflate.



## ESSENTIAL INDIVIDUAL COMPONENTS

### IGNITION SWITCH

The ignition switch (1) is on the right side below the steering stem.

The headlight and taillights will come on whenever you turn the ignition switch ON. If your scooter is stopped with the ignition switch ON and the engine is not running, the headlight and taillights will still be on, resulting in battery discharge.

#### NOTICE

The original Honda rear top box is opened with the ignition key (only type IIE, IIF, IIIED).

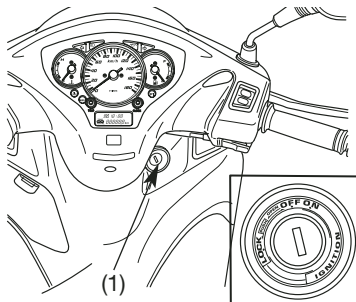

(1) Ignition switch

Key Position	Function	Key Removal
LOCK (steering lock)	Steering is locked. Engine and lights cannot be operated.	Key can be removed.
OFF	Engine and lights cannot be operated.	Key can be removed.
ON	Engine and lights can be operated.	Key cannot be removed.

## KEYS

This scooter has two keys and a key number plate.

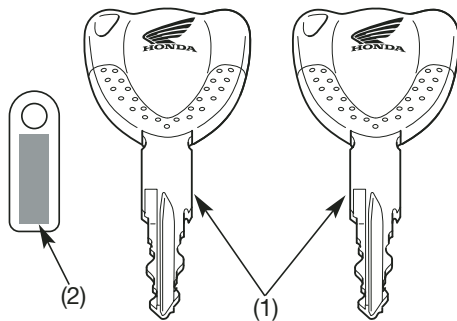

(1) Keys

(2) Key number plate

You will need the key number if you ever have to replace a key. Store the plate in a safe place.

To reproduce keys, bring all keys, key number plate and scooter to your Honda dealer.

Up to four keys can be registered with the immobilizer system (HISS), including the ones in hand.

If all keys are lost, the PGM-FI unit/ignition control module must be replaced. To avoid this possibility we recommend that if only one key is left, you immediately have it reproduced to ensure that a back up is available.

These keys contain electronic circuits that are activated by the immobilizer system (HISS).

They will not work to start the engine if the circuits are damaged.

- Do not drop the keys or set heavy objects on them.
- Do not grind, drill or in any way alter the original shape of the keys.
- Keep the keys away from magnetic objects.

## **IMMOBILIZER SYSTEM (HISS)**

HISS is the abbreviation of Honda Ignition Security System.

The immobilizer system (HISS) protects your scooter from theft. A properly-coded key must be used in the ignition switch for the engine to start. If an improperly-coded key (or other device) is used, the engine's starting circuit is disabled.

When the ignition switch is turned ON and the engine stop switch is at  (RUN), the immobilizer system (HISS) indicator lights for a few seconds, then goes off. If the indicator remains on, it means the system does not recognize the coding of the key. Turn the ignition switch to OFF, remove the key, reinsert and turn the switch ON again.

The immobilizer system (HISS) indicator (1) can continue to flash every 2 seconds during 24 hours when the ignition switch is OFF. Once the time has elapsed, the indicator lamp switches off automatically.

To activate flashing mode:

1. Set the ignition switch to ON.
2. Display the main odometer (TOTAL).
3. Press and hold the TRIP button (2) for more than two seconds.
4. The immobilizer system (HISS) indicator (1) will flash once, to indicate that the function has been enabled.
5. Turn the ignition switch to OFF. The indicator will start to flash.

The HISS is activated.

To disable flashing mode:

1. Carry out steps 1,2,3 above.
2. The immobilizer system (HISS) indicator (1) will flash once, to indicate that the function has been disabled.
3. Turn the ignition switch to OFF. The indicator will remain off.

The HISS is deactivated.

When the ignition switch is turned ON, the indicator light function is deactivated.

If you removed the battery, after you have refitted it, turn the ON/OFF switch to ON. The HISS mode is automatically reactivated and the indicator light flashes.

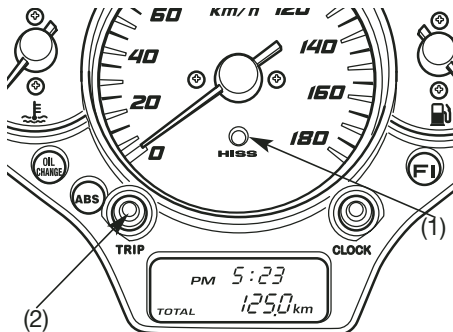

- (1) Immobilizer system (HISS) indicator  
(2) TRIP button

If the system repeatedly does not recognize the coding of your key, contact your Honda dealer.

- The system may not recognize the key's coding if any other immobilizer key is near the ignition switch. To make sure the system recognizes the key code, keep each immobilizer key on a separate ring.
- Do not attempt to alter the immobilizer system (HISS) or add other devices to it. Electrical problems could result, making it impossible to start your scooter.
- If all keys are lost, the PGM-FI unit/ignition control module must be replaced.

#### EC Directives



This immobilizer system complies with the R & TTE (Radio equipment and telecommunications terminal equipment and the mutual recognition of their conformity) Directive.



The declaration of conformity to R & TTE Directive is provided to the owner at the time of purchase. The declaration of conformity should be kept at a safe place. When the declaration of conformity is lost or is not provided, contact your Honda dealer.

## RIGHT HANDLEBAR CONTROLS

### Engine Stop Switch

The engine stop switch (1) is next to the throttle grip. When the switch is in the  (RUN) position, the engine will operate. When the switch is in the  (OFF) position, the engine will not operate. This switch is intended primarily as a safety or emergency switch and should normally remain in the  (RUN) position.

If your scooter is stopped with the ignition switch ON and the engine stop switch  (OFF), the headlight and taillights will still be on, resulting in battery discharge.

### Start Button

The start button (2) is below the engine stop switch (1).

When the starter button is pressed, the starter motor cranks the engine. If the engine stop switch is in the  (OFF) position, the starter motor will not operate.

See page 63 for the starting procedure.





(1) Engine stop switch

(2) Start button

## LEFT HANDLEBAR CONTROLS



### Headlight dimmer switch (1)

Push the dimmer switch to  (HI) to select high beam or to  (LO) to select low beam.

### Passing light control switch (2)

When this switch is pressed down, the headlight flashes on to signal approaching cars or when passing.

### Turn signal switch (3)

Move to  (L) to signal a left turn,  (R) to signal a right turn. Press to turn signal off.

### Horn button (4)

Press the button to sound the horn.

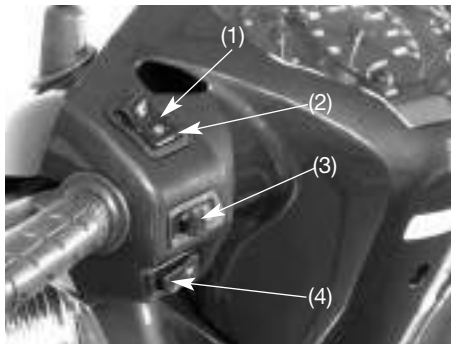

- (1) Headlight dimmer switch
- (2) Passing light control switch
- (3) Turn signal switch
- (4) Horn button



## FEATURES

(Not required for operation)

### STEERING LOCK

To lock the steering, turn the handlebars all the way to the left; turn the ignition key (1) to LOCK while pushing in.

Remove the ignition key.

To unlock the steering turn the ignition key to OFF.

Do not turn the ignition key to LOCK while riding the scooter; loss of vehicle control will result.

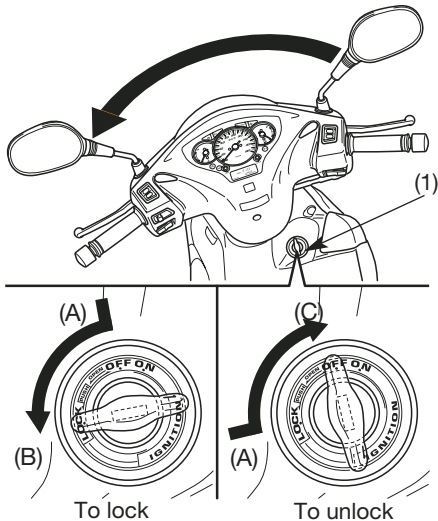

- (1) Ignition key
- (A) Push in
- (B) Turn to "LOCK"
- (C) Turn to "OFF"

## SEAT LOCK

The seat lock is on the ignition switch (1).

To open the seat, insert the ignition key (2), push in the key and turn to the OFF position, then turn it counterclockwise.

Lift the seat.

To lock the seat, lower and push down on the reverse side of the hook (3) of the seat until it locks. Ensure the seat is securely locked before riding the scooter.

Do not place luggage or clothing near the seat hook (3). It could make the seat difficult to open if it gets caught between the seat hook and catch while closing the seat.

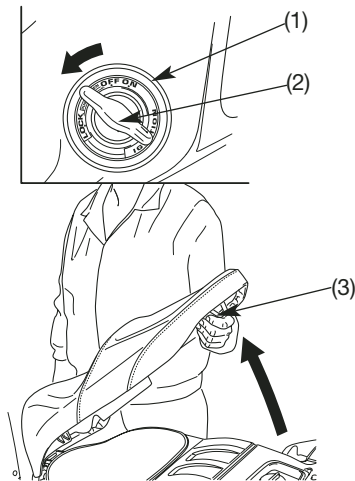

- (1) Ignition switch
- (2) Ignition key
- (3) Hook

## HELMET HOLDER

The helmet holder eliminates the need for carrying your helmet after parking your scooter. The helmet holder is located below the seat.

Open the seat (page 54).

Route either end of the helmet holder cable (1) through the helmet's D-ring (2).

Hook the loops of the wire onto the helmet holder (3) and lower the seat to lock.

The helmet holder wire is furnished in the tool kit. Remove the helmet wire and store it in the tool bag when it is not used.

### **⚠ WARNING**

Riding with a helmet attached to the holder can interfere with the rear wheel or the suspension and could cause a crash in which you can be seriously hurt or killed.

Use the helmet holder only while parked. Do not ride with a helmet secured by the holder.

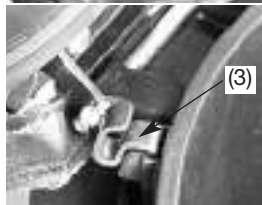

- (1) Helmet holder cable
- (2) D-ring
- (3) Helmet holder

## **CENTER COMPARTMENT**

The center compartment (1) is below the seat. Opening and closing: See “SEAT LOCK” (page 54).

### **MAXIMUM WEIGHT LIMIT:**

10 kg (22 lbs)

Never exceed the maximum weight limit; handling and stability may be severely affected.

The center compartment may become heated by the engine. Do not store food or other articles which are flammable or susceptible to heat damage in this compartment.

Do not direct water under pressure against the center compartment as water will be forced into the compartment.

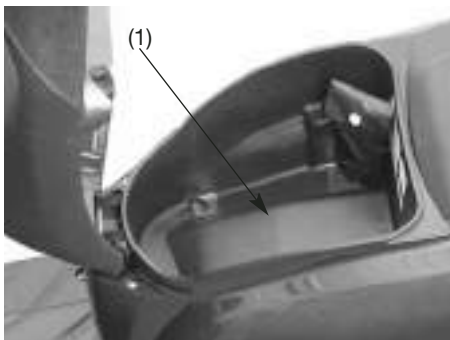

(1) Center compartment

## LEFT COMPARTMENT

There is left compartment (1) below the left side of the handlebar.

The maximum allowable load in the left compartment shall be no more than:

0.5 kg (1.0 lbs)

Do not open the left compartment while riding the scooter.

### To Open:

- Push and hold the knob (2), then open the left compartment (3).

### To Close:

1. Close the left compartment cover.

Make sure the left compartment cover is closed before riding.

When washing your scooter be careful not to flood this area with water.

Do not store valuables or fragile articles in the left compartment.

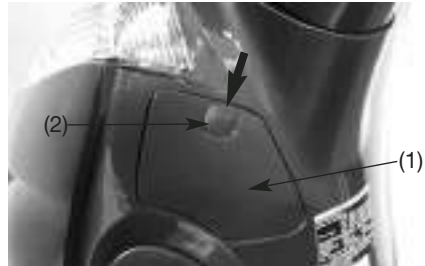

(1) Left compartment

(2) Knob

(3) Left compartment cover

## ACCESSORY SOCKET

The accessory socket (1) is in the left compartment.

Open the cover (2) to gain access to the accessory socket.

Rated capacity is:

12 watt (12 volt, 1amps).

To prevent battery run down or weak battery, keep the engine running while drawing current from the socket.

Set the headlight in the LO beam. Battery run down or damage to the accessory socket cause result.

To prevent entry foreign matter, be sure to close the cover when the accessory socket is not used.

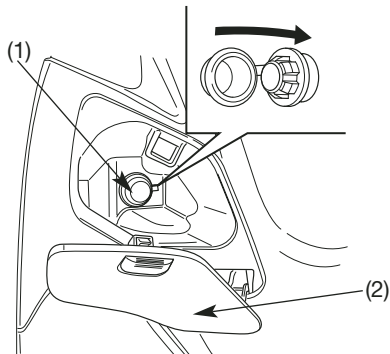

- (1) Accessory socket
- (2) Left compartment cover

## DOCUMENT COMPARTMENT

Document compartment (1) is located in the left compartment (page 57).



(1) Document compartment

## SHOPPING HOOK

The shopping hook (1) is provided below the handlebar.

### MAXIMUM WEIGHT LIMIT:

1.5 kg (3.0 lbs)

Do not attach large luggage to the hook that would hang out from the scooter and/or interfere with the movement of your feet.

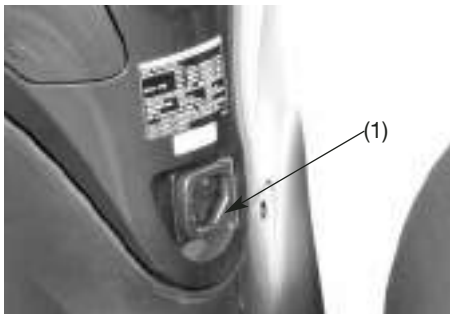

(1) Shopping hook

## HEADLIGHT AIM VERTICAL ADJUSTMENT

Vertical adjustment can be made by turning the screw (1) under front handle cover, in or out as necessary.

Obey local laws and regulations.

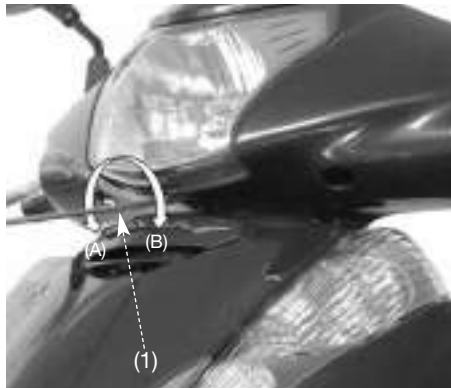

(1) Screw

(A) Up

(B) Down



## OPERATION

### PRE-RIDE INSPECTION

For your safety, it is very important to take a few moments before each ride to walk around your scooter and check its condition. If you detect any problem, be sure you take care of it or have it repaired by your Honda dealer.

#### **WARNING**

Improperly maintaining this scooter or failing to correct a problem before riding can cause a crash in which you can be seriously hurt or killed.

Always perform a pre-ride inspection before every ride and correct any problems.

1. Engine oil level - add engine oil if require (page 38). Check for leaks.
2. Fuel level - fill fuel tank when necessary (page 35). Check for leaks.
3. Coolant level - add coolant if required. Check for leaks (pages 32-33).
4. Front and rear brakes - check operation; make sure there is no brake fluid leakage (pages 27-31).
5. Tyres - check condition and pressure (pages 39-44).
6. Throttle - check for smooth opening and full closing in all steering positions.

7. Lights and horn - Check that the headlight, brake/tail light, turn signals, indicator lights and horn are all working properly.
8. Engine stop switch- check for proper function (page 51).
9. Side stand ignition cut-off system - check for proper function (page 103).

## **STARTING THE ENGINE**

Always follow the proper starting procedure described below.

This scooter has a fuel-injected engine with an automatic choke.

This scooter is equipped with a side stand ignition cut-off system. The engine cannot be started if the side stand is down.

A running engine will shut off if the side stand is lowered.

To protect the catalytic converter in your scooter's exhaust system, avoid extending idling and use of leaded petrol.

Your scooter's exhaust contains poisonous carbon monoxide gas. High levels of carbon monoxide can collect rapidly in enclosed areas such as a garage. Do not run the engine with the garage door closed. Even with the door open, run the engine only long enough to move your scooter out of the garage.

Do not use the electric starter for more than 5 seconds at a time. Release the starter button for approximately 10 seconds before pressing it again.

## Preparation

1. Place the scooter on its center stand.
2. Make sure that the engine stop switch is at  "RUN" (page 51).
3. Turn the ignition switch (1) to ON.

Confirm the following:

- The red low oil pressure indicator is ON.
- The Immobilizer system (HISS) indicator is OFF.
- The PGM-FI malfunction indicator lamp is OFF.
- The ABS indicator is ON (page 17) (SH300A/AR).

The low oil pressure indicator should go off a 2-3 seconds after the engine starts. If the light keeps flashing, stop the engine immediately and check the engine oil level.

## NOTICE

Operating the engine with insufficient oil pressure can cause serious engine damage.

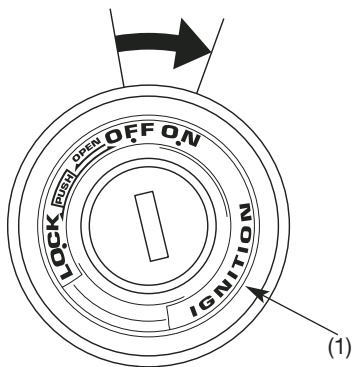

(1) Ignition switch

4. Squeeze the rear brake lever (2).  
The electrical starter will only work when the rear brake lever is squeezed and the side stand is up.

**⚠ CAUTION**

Contact with the spinning rear wheel can cause you to be hurt.



(2) Rear brake lever

5. With the throttle completely closed, push the start button (3). Release the starter button as soon as the engine starts.

The engine will not start if the throttle is fully open (because the electronic control module cuts off the fuel supply).



(3) Starter button

6. Be sure to keep the throttle closed locked while warming up the engine.
7. Allow the engine to warm up before riding (see “RIDING” page 68).

Do not “BLIP” the throttle (open and close rapidly) as the scooter will move forward suddenly.

Do not leave the scooter unattended while the engine is warming up.

Snapping the throttle or fast idling for more than about 5 minutes at normal air temperature may cause exhaust pipe discoloration.



**Ignition cut-off**

Your scooter is designed to automatically stop the engine and fuel pump if the scooter is over-turned (a banking sensor cuts off the ignition system). Before restarting the engine, you must turn the ignition switch to the OFF position and then back to ON.

**RUNNING-IN**

Help assure your scooter's future reliability and performance by paying extra attention to how you ride during the first 500 km (300 miles).

During this period avoid, full-throttle starts and rapid acceleration.

## RIDING

Review scooter safety (pages 1-9) before you ride.

Make sure flammable materials such as dry grass or leaves do not come in contact with the exhaust system when riding, idling or parking your scooter.

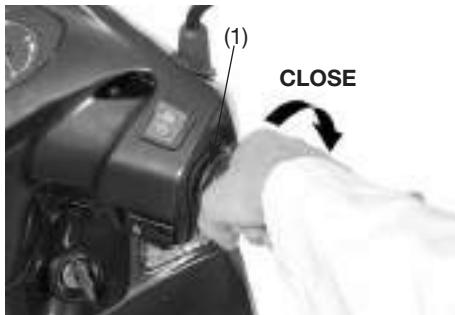

(1) Throttle

1. **Make sure the throttle (1) is closed** before moving the scooter off the center stand.
2. **Stand on the left side of the scooter** and push it forward off the center stand.

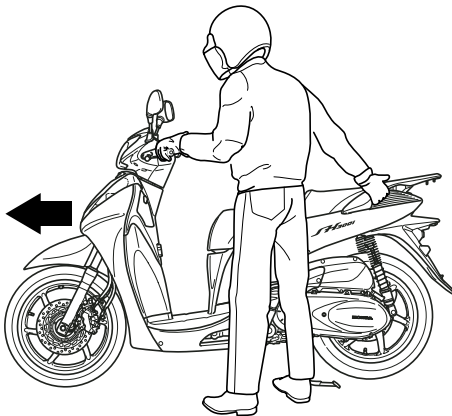



3. **Mount the scooter from the left side** keeping at least one foot on the ground to steady the scooter.

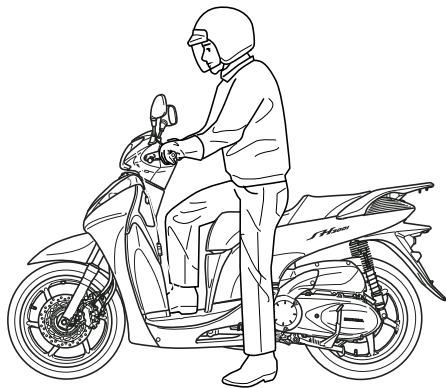

4. **Before starting off**, indicate your direction with the turn signals, and check for safe traffic conditions.  
Grasp the handlebars firmly with both hands.  
Never attempt one-handed operation: loss of vehicle control could result.

5. **To accelerate**, open the throttle (1) gradually; the scooter will move forward. Do not “BLIP” the throttle (open and close rapidly) as the scooter will move forward suddenly, causing possible loss of control.
6. **To decelerate**, close throttle.



(1) Throttle

7. **When slowing down the scooter,** coordination of the throttle (1) and front (2) and rear brakes (3), is most important.

Both front and rear brakes should be applied together. Independent use of only the front or rear brake reduces stopping performance.

Excessive brake application may cause either wheel to lock, reducing control of the scooter.



(1) Throttle



(2) Front brake

(3) Rear brake

8. **When approaching a corner or turn,** close the throttle (1) fully, and slow the scooter down by applying both front (2) and rear (3) brakes at the same time.



9. **After completing the turn,** open the throttle gradually to accelerate the scooter.

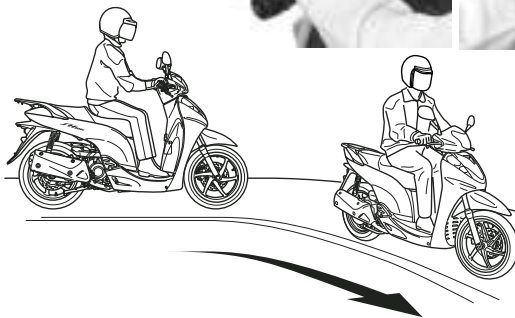

(1) Throttle

(2) Front brake

(3) Rear brake

10. **When descending a steep grade,** close the throttle (1) fully and apply both brakes (2), (3) to slow the scooter.

Avoid continuous use of the brakes, which may result in overheating and reduction of braking efficiency.

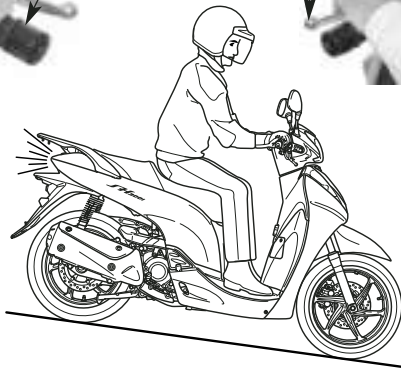
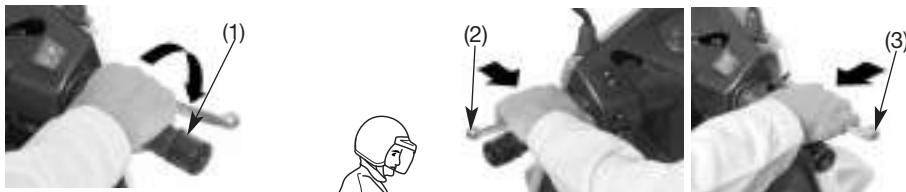

- (1) Throttle
- (2) Rear brake
- (3) Front brake

11. **When riding on wet or loose surfaces,**  
be especially cautious.

- When riding in wet or rainy conditions or on loose surfaces, the ability to maneuver and stop will be reduced.

For your safety:

- Exercise extreme caution when braking, accelerating or turning.
- Ride at slower speeds and allow for extra stopping distance.
- Keep the scooter as upright as possible.
- Use extreme caution when riding over slippery surfaces such as railroad tracks, iron plates, manhole covers, painted lines, etc.

## PARKING

1. After stopping the scooter turn the ignition switch to the OFF position and remove the key.
2. Use the center stand to support the scooter while parked.
3. Lock the steering to help prevent theft (page 53).

Park the scooter on firm, level ground to prevent it from falling over.

## HOW TO USE CENTER STAND

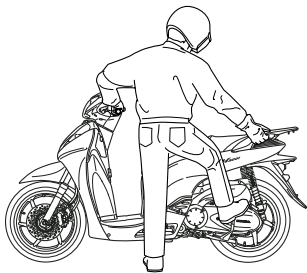

If you must park on a slight incline, aim the front of the scooter uphill to reduce the possibility of rolling off the center stand or overturning.

The exhaust pipe and muffler become very hot during operation and remain sufficiently hot to inflict burns if touched even after shutting off the engine.

Make sure flammable materials such as dry grass or leaves do not come in contact with the exhaust system when parking your scooter.

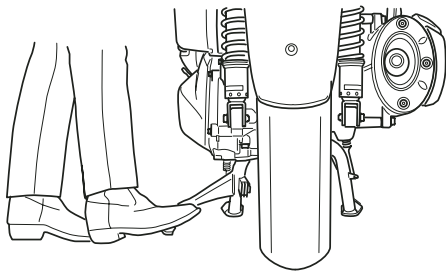

## ANTI-THEFT TIPS

1. Always lock the steering and never leave the key in the ignition switch. This sounds simple but people do forget (page 53).
2. Be sure the registration information for your scooter is accurate and current.
3. Park your scooter in a locked garage whenever possible.
4. Use an additional anti-theft device of good quality.

This scooter is equipped with pre-wiring for Honda anti-theft alarm.

Please contact your dealer to install a genuine Honda alarm accessory.

Only for E, F, ED, IIE, IIF, IIIED type models.

5. Put your name, address, and phone number in this owner's manual and keep it on your scooter at all times.

Many times stolen scooters are identified by information in the owner's manuals that are still with them.

NAME: \_\_\_\_\_

ADDRESS: \_\_\_\_\_

\_\_\_\_\_

\_\_\_\_\_

PHONE NO: \_\_\_\_\_

## LOCK STEERING

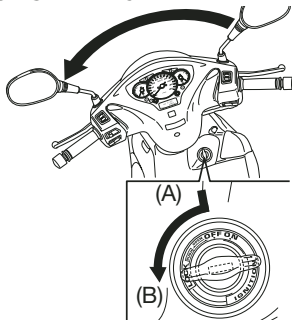

(A) Push in

(B) Turn to lock



## **MAINTENANCE**

### **THE IMPORTANCE OF MAINTENANCE**

A well maintained scooter is essential for safe, economical and trouble-free riding. It will also help reduce air pollution.

To help you properly care for your scooter, the following pages include a Maintenance Schedule and a Maintenance Record for regularly scheduled maintenance.

These instructions are based on the assumption that the scooter will be used exclusively for its designed purpose. Sustained high speed operation or operation in unusually wet or dusty conditions will require more frequent service than specified in the Maintenance Schedule. Consult your Honda Dealer for recommendations applicable to your individual needs and use.

If your scooter overturns or becomes involved in a crash, be sure your Honda dealer inspects all major parts, even if you are able to make some repairs.

### **WARNING**

Improperly maintaining this scooter or failing to correct a problem before you ride can cause a crash in which you can be seriously hurt or killed.

Always follow the inspection and maintenance recommendations and schedules in this owner's manual.

## **MAINTENANCE SAFETY**

This section includes instructions on some important maintenance tasks. You can perform some of these tasks with the tools provided – if you have basic mechanical skills.

Other tasks that are more difficult and require special tools are best performed by professionals. Wheel removal should normally be handled only by a Honda technician or other qualified mechanic; instructions are included in this manual only to assist in emergency service.

Some of the most important safety precautions follow. However, we cannot warn you of every conceivable hazard that can arise in performing maintenance. Only you can decide whether or not you should perform a given task.

## **WARNING**

Failure to properly follow maintenance instructions and precautions can cause you to be seriously hurt or killed.

Always follow the procedures and precautions in this owner's manual.

## SAFETY PRECAUTIONS

- Make sure the engine is off before you begin any maintenance or repairs. This will help eliminate several potential hazards;
  - **Carbon monoxide poisoning from engine exhaust.**  
Be sure there is adequate ventilation whenever you operate the engine.
  - **Burns from hot parts.**  
Let the engine and exhaust system cool before touching.
  - **Injury from moving parts.**  
Do not run the engine unless instructed to do so.
- Read the instructions before you begin and make sure you have the tools and skills required.
- To help prevent the scooter from falling over, park it on a firm, level surface, using the center stand to provide support.

- To reduce the possibility of a fire or explosion, be careful when working around petrol or batteries. Use only nonflammable solvent, not petrol, to clean parts. Keep cigarettes, sparks and flames away from the battery and all fuel-related parts.

Remember that your Honda dealer knows your scooter best and is fully equipped to maintain and repair it.

To ensure the best quality and reliability, use only new genuine Honda parts or their equivalents for repair and replacement.

## **MAINTENANCE SCHEDULE**

Perform the Pre-ride Inspection (page 61) at each scheduled maintenance period.

I: INSPECT AND CLEAN, ADJUST, LUBRICATE OR REPLACE IF NECESSARY

C: CLEAN R: REPLACE A: ADJUST L: LUBRICATE

The following Maintenance Schedule specifies all maintenance required to keep your scooter in peak operating condition. Maintenance work should be performed in accordance with standards and specifications of Honda by properly trained and equipped technicians. Your Honda dealer meets all of these requirements.

\* Should be serviced by your Honda dealer, unless the owner has the proper tools and service data and is mechanically qualified. Refer to the Official Honda Shop Manual.

\*\* In the interest of safety, we recommend these items be serviced only by your Honda dealer.

Honda recommends that your Honda dealer should road test your scooter after each periodic maintenance is carried out.

- NOTES:
- (1) At higher odometer readings, repeat at the frequency interval established here.
  - (2) Service more frequently if the scooter is ridden in unusually wet or dusty areas.
  - (3) Service more frequently when riding in rain or at full throttle.
  - (4) Replace every 2 years, or at the indicated odometer interval, whichever comes first.  
Replacement requires mechanical skill.
  - (5) Inspect every 12,000 km (8,000 mi) after replacement.
  - (6) Replace every 2 years. Replacement requires mechanical skill.

ITEM		FREQUENCY	COMES FIRST ↓	→	ODOMETER READING [NOTE (1)]									
					x 1000 km	1	6	12	18	24	30	36	REFER TO PAGE	
					x 1000 mi	0,6	4	8	12	16	20	24		
NOTE	MONTH		6	12	18	24	30	36						
*	FUEL LINE						I		I		I	-		
*	THROTTLE OPERATION						I		I		I	100		
	AIR CLEANER	NOTE (2)						R			R	86		
	CRANKCASE BREATHER	NOTE (3)				C	C	C	C	C	C	90		
	SPARK PLUG							R			R	97		
*	VALVE CLEARANCE								I			-		
	ENGINE OIL				R	R	R	R	R	R	R	91		
	ENGINE OIL FILTER				R		R		R		R	94		
	RADIATOR COOLANT	NOTE (4)					I		I		R	101		
*	COOLING SYSTEM						I		I		I	-		
*	SECONDARY AIR SUPPLY SYSTEM						I		I		I	-		

ITEM		FREQUENCY	COMES FIRST →	ODOMETER READING [NOTE (1)]								REFER TO PAGE
				x 1000 km	1	6	12	18	24	30	36	
		x 1000 mi	0,6	4	8	12	16	20	24			
		NOTE	MONTH		6	12	18	24	30	36		
*	DRIVE BELT		NOTE (5)				R			R	-	
	BELT CASE AIR CLEANER					C		C		C	88	
*	FINAL DRIVE OIL		NOTE (6)								-	
	BRAKE FLUID		NOTE (4)				R			R	30-31	
	BRAKE PADS WEAR										104-105	
	BRAKE SYSTEM										-	
*	HEADLIGHT AIM										-	
**	CLUTCH SHOES WEAR										-	
	SIDE STAND										103	
*	SUSPENSION										-	
*	NUTS,BOLTS,FASTNERS										-	
**	WHEELS/TIRES										-	
**	STEERING HEAD BEARINGS										-	

## TOOL KIT

The tool kit (1) is in the center compartment (page 56). Some roadside repairs, minor adjustments and parts replacement can be performed with the tools contained in the kit.

- Suspension adjusting pin spanner
- 8 x 10 mm open end wrench
- 12 x 14 mm open end wrench
- No. 1 Screw driver
- No. 3 Screw driver
- Screw driver handle
- 5 mm Hex wrench
- Spark plug wrench
- Helmet holder cable
- Tool bag

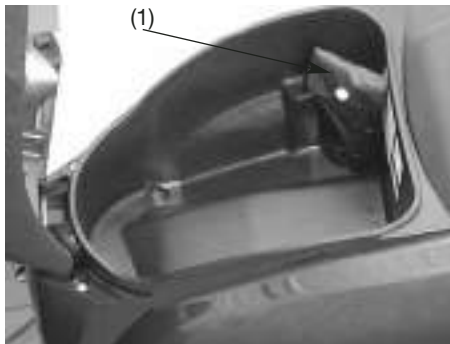

(1) Tool kit

## SERIAL NUMBERS

The frame and engine serial numbers are required when registering your scooter. They may also be required by your dealer when ordering replacement parts.

Record the numbers here for your reference.

FRAME No. \_\_\_\_\_

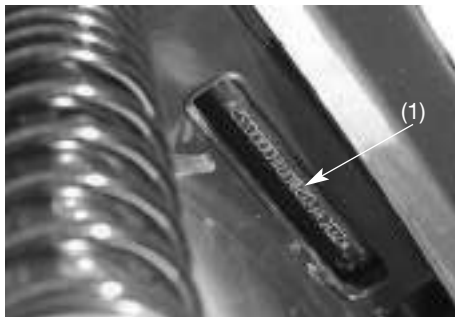

(1) Frame number

84

The frame number (1) is stamped on the right side of the frame body.

The engine serial number (2) is stamped on the lower left side of the crankcase near the rear wheel.

ENGINE No. \_\_\_\_\_

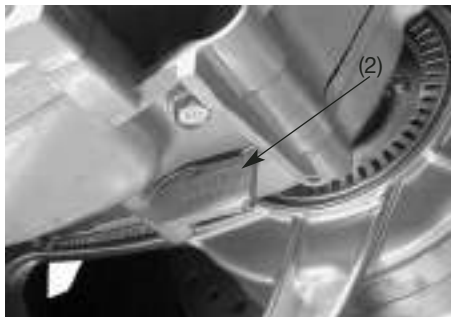

(2) Engine number



## COLOUR LABEL

The colour label (1) is attached to the center compartment (page 56).

It is helpful when ordering replacement parts. Record the colour and code here for your reference.

COLOUR \_\_\_\_\_

CODE \_\_\_\_\_

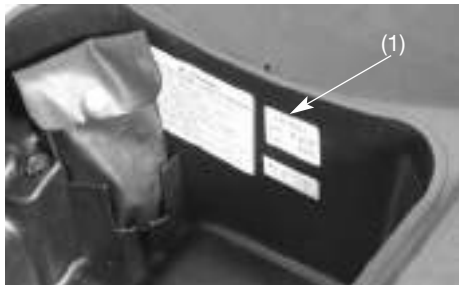

(1) Colour label

## AIR CLEANER

Refer to the Safety Precautions on page 79. The air cleaner should be serviced at regular intervals (page 86). Service more frequently when riding in unusually wet or dusty areas.

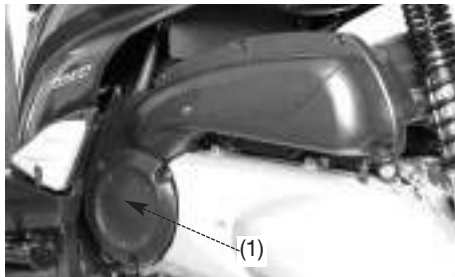

(1) Belt case air cleaner

1. First remove the air filter from the drive belt case (1) (page 88).
2. Remove the seven screws (2) from the air filter cover (3).  
Remove the cover itself.

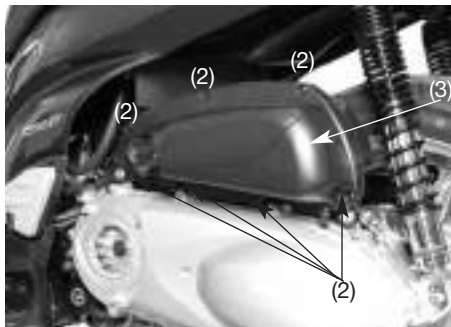

(2) Screws  
(3) Cover air filter

3. Remove the air filter (4), unfastening the three internal screws (5). Dispose of the filter, and fit a replacement.
4. Use genuine Honda air cleaners exclusively. The use of air cleaners other than those specified may cause rapid engine wear and reduce performance.
5. Reinstall the removed parts in the reverse order of removal.

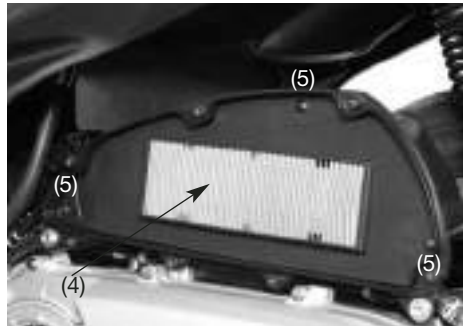

(4) Air filter  
(5) Internal screws

## BELT CASE AIR CLEANER

Refer to the Safety Precautions on page 79.

1. Place the scooter on its center stand.

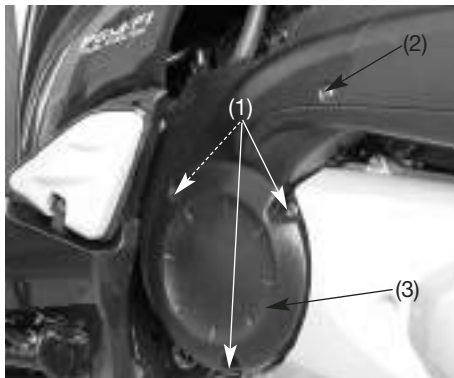

- (1) Bolts
- (2) Screw
- (3) Belt case cover

2. Remove the belt case cover three bolts (1) and screw (2). Remove the belt case cover (3) by releasing the three couplings (4).
3. Remove the air cleaner (5).

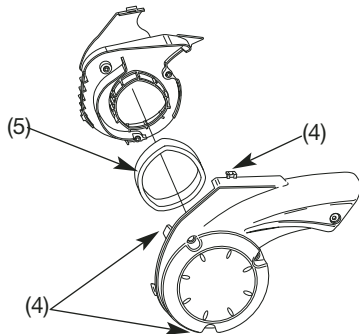

- (4) Couplings
- (5) Air cleaner

4. Wash the element in clean, nonflammable or high flash point solvent and let it dry thoroughly.

- Never use petrol or low flash point solvents for cleaning the air cleaner. A fire or explosion could result.
- Allow the element to dry thoroughly before installation.
- Do not apply oil to the element; damage to the drive belt will occur.

5. For installation, reverse the removal procedure.

## CRANKCASE BREATHER

Refer to the Safety Precautions on page 79.

1. Remove the drain tube (1) and drain deposits into a suitable container.
2. Reinstall the drain tube.

Service more frequently when riding in rain, at full throttle, or after the scooter is washed or overturned. Service if the deposit level can be seen in the transparent section of the drain tube.

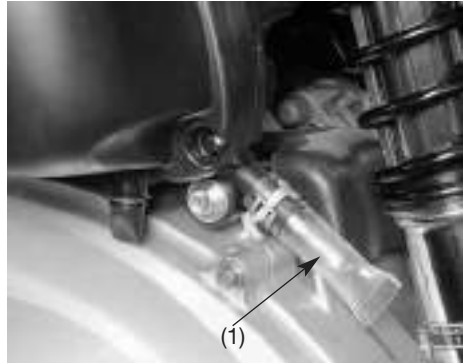

(1) Drain tube

## ENGINE OIL

Refer to the Safety Precautions on page 79.

### Oil Recommendation

API Classification	SG or higher except oils labeled as energy conserving on the circular API service label.
Viscosity	SAE 10W-30
JASO T 903 Standard	MB

Suggested Oil
Honda "4-STROKE MOTORCYCLE OIL" or equivalent.

Your scooter does not need oil additives. Use the recommended oil.

Do not use API SH or higher oils displaying a circular API "energy conserving" service label on the container. They may affect lubrication.



**NOT RECOMMENDED**



**OK**

Do not use non-detergent, vegetable or castor based racing oils.

**Viscosity:**

Viscosity grade of engine oil should be based on average atmospheric temperature in your riding area. The following provides a guide to the selection of the proper grade or viscosity of oil to be used at various atmospheric temperatures.

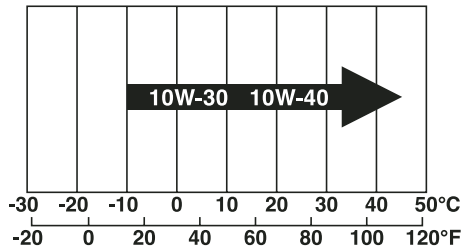



### JASO T 903 standard

The JASO T 903 standard is an index for choosing engine oils for 4-stroke motorcycle engines.

There are two classes: MA and MB.

Oil conforming to the standard is labeled on the oil container. For example, the following label shows the MA classification.

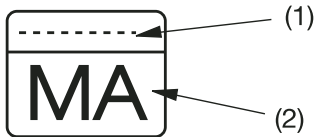

PRODUCT MEETING JASO T 903  
COMPANY GUARANTEEING THIS MA PERFORMANCE:

- (1) Code number of the sales company of the oil
- (2) Oil classification

## **Engine Oil and Filter**

Engine oil quality is the chief factor affecting engine service life. Change the engine oil as specified in the maintenance schedule (page 81).

When running in very dusty conditions, oil changes should be performed more frequently than specified in the maintenance schedule.

Please dispose of used engine oil in a manner that is compatible with the environment. We suggest you take it in a sealed container to your local recycling center or service station for reclamation. Do not throw in the trash or pour it on the ground or down a drain.

Used engine oil may cause skin cancer if repeatedly left in contact with the skin for prolonged periods. Although this is unlikely unless you handle used oil on a daily basis, it is still advisable to

thoroughly wash your hands with soap and water as soon as possible after handling used oil.

Changing the oil filter requires a special oil filter tool and a torque wrench. If you do not have these tools and the necessary skill, we recommend that you have your Honda dealer perform this service.

If a torque wrench is not used for this installation, see your Honda dealer as soon as possible to verify proper assembly.

Change the engine oil with the engine at normal operating temperature and the scooter on its side stand to assure complete and rapid draining.

1. Remove the oil filler cap/dipstick from the right crankcase cover (page 38).
2. Place an oil drain pan under the crankcase and remove the oil drain plug (1).



(1) Drain plug

3. Remove the oil filter (2) with a filter wrench and let the remaining oil drain out. Dispose of the used oil filter in a suitable container.

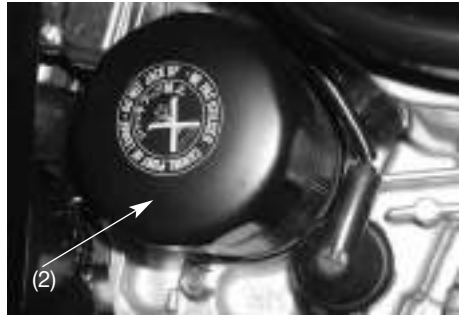

(2) Oil filter

4. Apply a thin coat of engine oil to the new oil filter rubber seal (3).
5. Using a special tool and a torque wrench, install the new oil filter and tighten to a torque of:  
Oil filter torque: 26 N•m (2.7 kgf•m)

Use only the Honda genuine oil filter or a filter of equivalent quality specified for your model. Using the wrong Honda filter or a non-Honda filter which is not of equivalent quality may cause engine damage.

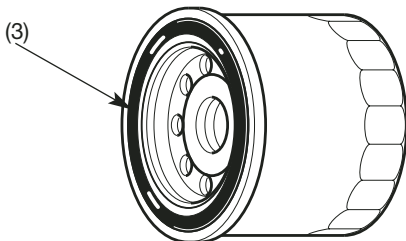

(3) Oil filter rubber seal

6. Install oil drain plug and tighten to a torque of:  
Oil drain plug torque: 25 N•m (2.5 kgf•m)
7. Refill with the recommended engine oil:  
1.4 ℓ.
8. Install the oil filler cap/dipstick.
9. Start the engine and let it idle for 3-5 minutes.
10. Stop the engine and after 2-3 minutes check that the oil level is at the upper level mark on the oil filler cap/dipstick with the scooter upright on firm, level ground.  
Make sure there are no oil leaks.

## SPARK PLUG

Refer to the Safety Precautions on page 79.

Recommended plug:

Standard:

LMAR8A-9 (NGK)

### NOTICE

Never use a spark plug with an improper heat range. Severe engine damage could result.

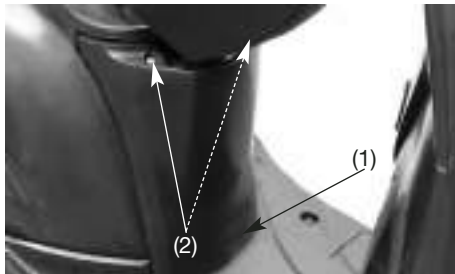

(1) Maintenance lid

(2) Screws

1. Remove the maintenance lid (1) by removing the two screws (2).
2. Disconnect the spark plug cap (3) from the spark plug.
3. Clean any dirt from around the spark plug base. Remove the spark plug using the plug wrench furnished in the tool kit.
4. Discard the spark plug.

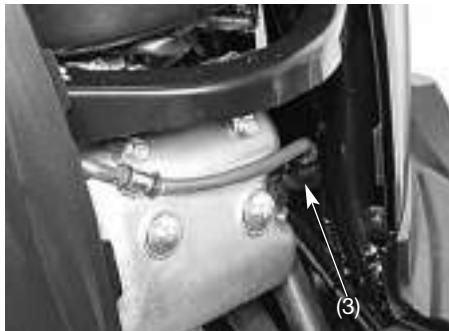

(3) Spark plug cap

5. Check the new spark plug gap (4) using a wire-type feeler gauge. If adjustment is necessary, bend the side electrode (5) carefully.

The gap should be:

0.80 - 0.90 mm (0.031 - 0.035 in)

Make sure the plug washer is in good condition.

6. With the plug washer attached, thread the spark plug in by hand to prevent cross-threading.

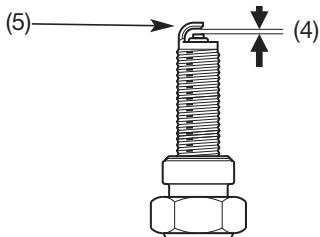

(4) Spark plug gap

(5) Side electrode

7. Tighten the spark plug:

- If the old plug is good:
  - 1/8 turn after it seats.
- If installing a new plug, tighten it twice to prevent loosening:
  - a) First, tighten the plug:
    - NGK: 1/2 turn after it seats.
  - b) Then loosen the plug.
  - c) Next, tighten the plug again:
    - 1/8 turn after it seats.

**NOTICE**

Improperly tightened spark plug can damage the engine. If a plug is too loose, a piston may be damaged. If a plug is too tight, the thread may be damaged.

8. Replace the cap properly on the spark plug, taking care to insert the protrusion (6) on the valve cover into the hole (7) on the spark plug cap rubber ring.
9. Install the remaining parts in the reverse order of removal.

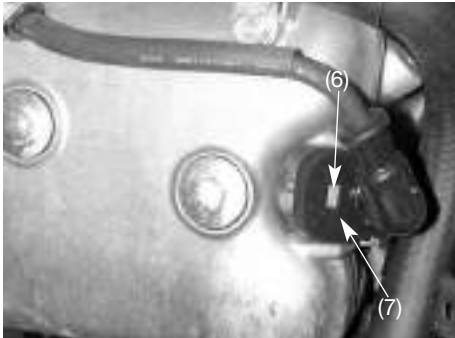

- (6) Valve cover protrusion  
(7) Spark plug cap rubber ring hole

## THROTTLE OPERATION

Refer to the Safety Precautions on page 79.

1. Check for smooth rotation of the throttle grip from the fully open to the fully closed position at both full steering positions.

2. Measure the throttle grip free play at the throttle grip flange.

The standard free play should be approximately:

2-6 mm (0.08 - 0.24 in)

To adjust the free play, slide the throttle cable boot (1), then loosen the lock nut (2) and turn the adjuster (3).

After adjustment, tighten the lock nut and return the throttle cable boot securely.

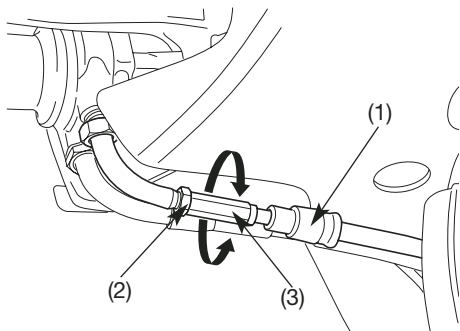

- (1) Throttle cable boot
- (2) Lock nut
- (3) Adjuster



## COOLANT

Refer to the Safety Precautions on page 79.

### Coolant replacement

Coolant should be replaced by a Honda dealer, unless the owner has proper tools and service data and is mechanically qualified. Refer to an official Honda Shop Manual.

Always add coolant to the reserve tank. Do not attempt to add coolant by removing the radiator cap.

## WARNING

Removing the radiator cap while the engine is hot can cause the coolant to spray out, seriously scalding you.

Always let the engine and radiator cool down before removing the radiator cap.

## **FRONT AND REAR SUSPENSION INSPECTION**

Refer to the Safety Precautions on page 79.

1. Check the fork assembly by locking the front brake and pumping the fork up and down vigorously. Suspension action should be smooth and there must be no oil leakage.
2. Swingarm bearings should be checked by pushing hard against the side of the rear wheel while the scooter is on the center stand. Freeplay indicates worn bearings.
3. Carefully inspect all front and rear suspension fasteners for tightness.

## SIDE STAND

Refer to the Safety Precautions on page 79.

Perform the following maintenance in accordance with the maintenance schedule.

### Functional Check:

- Check the side stand spring (1) for damage or loss of tension and the side stand assembly for freedom of movement.
- Check the side stand ignition cut-off system:
  1. Place the scooter on its center stand.
  2. Put the side stand up and start the engine.
  3. Lower the side stand. The engine should stop as you put the side stand down.

If the side stand system does not operate as described, see your Honda dealer for service.

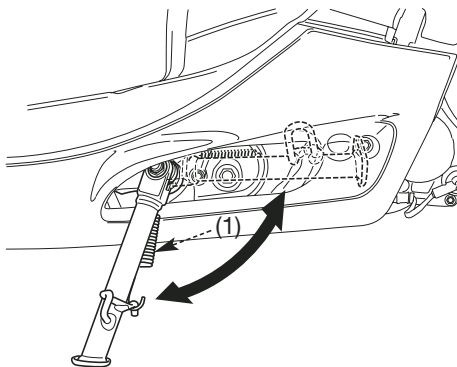

(1) Side stand spring

## **BRAKE PAD WEAR**

Refer to the Safety Precautions on page 79.

Brake pad wear depends upon the severity of usage, the type of riding, and road conditions. (Generally, the pads will wear faster on wet and dirty roads).

Inspect the pads at each regular maintenance interval (page 82).

### **Front brake**

Check the wear indicator mark (1) on each pad.

If either pad is worn to the wear indicator mark, replace both pads as a set. See your Honda dealer for this service.

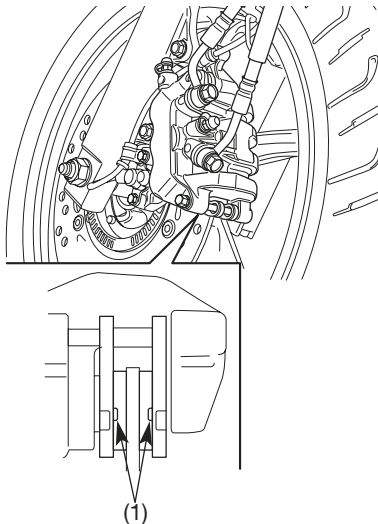

(1) Wear indicator mark

## Rear Brake

Check the cutouts (2) in each pad.

If either pad is worn to the cutouts, replace both pads as a set.

See your Honda dealer for this service.

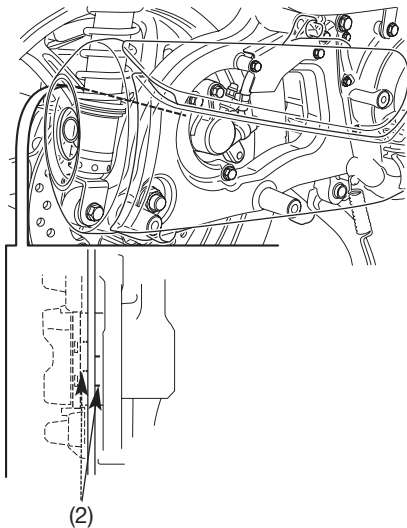

(2) Cutout

## BATTERY

Refer to the Safety Precautions on page 79.

It is not necessary to check the battery electrolyte level or add distilled water as the battery is a maintenance-free (sealed) type. If your battery seems weak and/or is leaking electrolyte (causing hard starting or other electrical troubles), contact your Honda dealer.

### NOTICE

Your battery is a maintenance-free type and can be permanently damaged if the cap is removed.

## WARNING

The battery gives off explosive hydrogen gas during normal operation.

A spark or flame can cause the battery to explode with enough force to kill or seriously hurt you.

Wear protective clothing and a face shield or have a skilled mechanic do the battery maintenance.

## Battery removal:

The battery is located in the battery compartment under the footrest cover.

1. Make sure that the ignition key is turned to OFF.
2. Remove the battery compartment cover (1) by removing the two screws (2).
3. Unfasten the two screws in the battery holder bracket (3) and remove the bracket itself.
4. First disconnect the negative terminal (-) (4) of the battery, and then the positive terminal (+) (5).
5. Remove the battery (6) from the compartment.

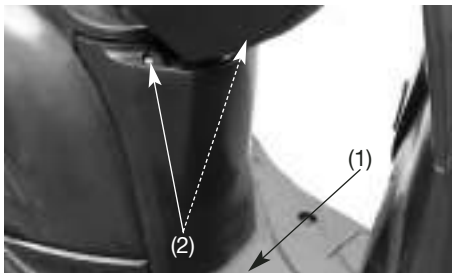

(1) Battery compartment cover (2) Screws

## Installation:

1. Reinstall in the reverse order of removal.  
Be sure to connect the positive (+) terminal first, then the negative (-) terminal.
2. Check all bolts and other fasteners are secure.

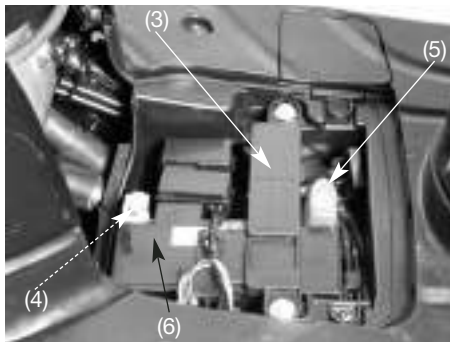

- (3) Bracket  
(4) Negative (-) terminal lead  
(5) Positive (+) terminal lead  
(6) Battery

## FUSE REPLACEMENT

Refer to the Safety Precautions on page 79.

When frequent fuse failure occurs, it usually indicates a short circuit or an overload in the electrical system. See your Honda dealer for repair.

### NOTICE

Turn the ignition switch OFF before checking or replacing fuses to prevent accidental short-circuiting.

Never use a fuse with a different rating from that specified. Serious damage to the electrical system or a fire may result, causing a dangerous loss of lights or engine power

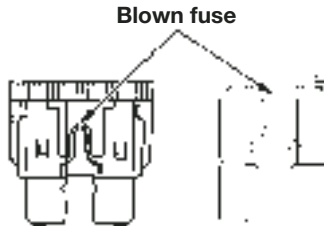



### Fuse boxes:

The fuse boxes are near the battery compartment under the footrest cover.

The specified fuses are:

10A, 15A SH300/R

10A, 15A, 30A SH300A/AR

Model SH300/R only has one fuse box.

Model SH300A/AR has two fuse boxes.

1. Remove the battery compartment cover (page 107).

2. Open the fuse box cover (1).

Remove the old fuse and install a new one. The spare fuses (2) are located in the fuse box.

3. Close the fuse box cover and refit the other parts as above in reverse order.

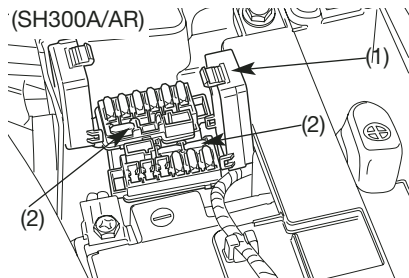
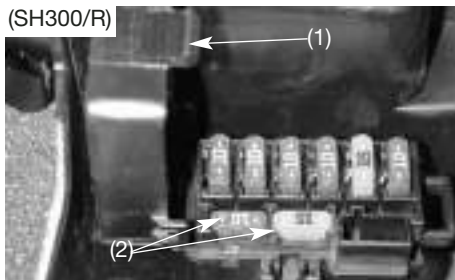

(1) Fuse box cover

(2) Spare fuses

### Main fuse:

The main fuse (1) is near the battery compartment under the footrest cover.

The specified fuse is:

30A

1. Lift the battery compartment cover (page 107).
2. Unfasten the two bolts on the battery holder bracket and remove it (page 107).
3. Disconnect the wire connector (2) of the starter magnetic switch.
4. Remove the old fuse and install a new one. The spare main fuse (3) is located alongside the magnetic starter switch housing.
5. Reconnect the connector, the battery holder bracket and install the battery compartment cover.  
Refit the other parts as above in reverse order.

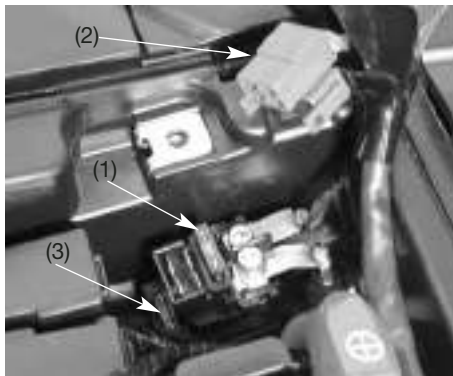

- (1) Main fuse  
(2) Wire connector  
(3) Spare fuse

## **BULB REPLACEMENT**

Refer to the Safety Precautions on page 79.

The light bulb becomes very hot while the light is ON, and remains hot for a while after it is turned OFF. Be sure to let it cool down before servicing.

Do not put finger prints on the headlight bulb, as they may create hot spots on the bulb and cause it to break.

Wear clean gloves while replacing the bulb. If you touch the bulb with your bare hands, clean it with a cloth moistened with alcohol to prevent its early failure.

- Be sure to turn the ignition switch OFF when replacing the bulb.
- Do not use bulbs other than those specified.
- After installing a new bulb, check that the light operates properly.

## Headlight bulb

1. Remove the right (1) and left (2) rearview mirror.
2. Remove the front screws (3) and the rear screws (4) of the front handle fairing.
3. Remove the headlight fairing (5) by disconnecting the four tabs. Be careful not to damage the tabs when you are removing it.

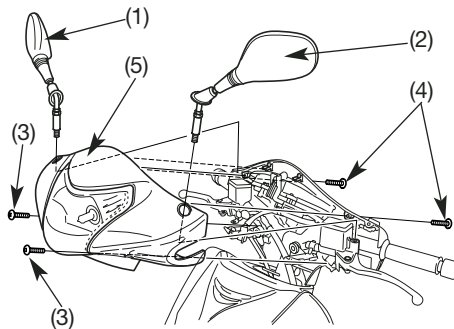

- (1) Right rearview mirror
- (2) Left rearview mirror
- (3) Front screws
- (4) Rear screws
- (5) Front handle fairing

4. Remove dust seal cover (6) and extract connector (7).
5. Turn bulb holder (8) counterclockwise and remove bulb (9).

To refit, perform the removal operations in reverse sequence ensuring you align the bulb locating tabs with the slots on the bulb socket.

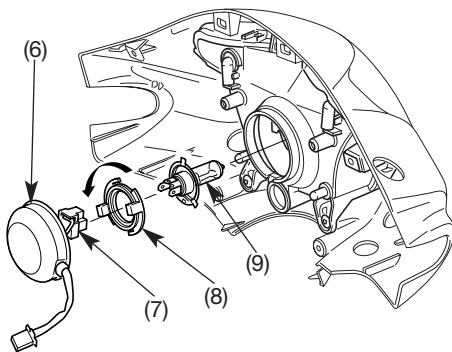

- (6) Dust seal cover
- (7) Connector
- (8) Bulb holder
- (9) Bulb

## Position Lights Bulb

### 1. Remove the front shield(1):

unfasten the top screws (2), disconnect the two expansions pins (3) and remove the shield by disconnecting the bottom tabs(4). Be careful not to damage the tabs (4) at the bottom of the shield when you are removing it.

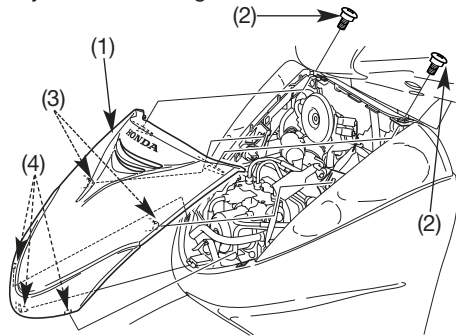

(1) Front shield

(2) Top screws

(3) Expansions pins

(4) Bottom tabs

**114**

### 2. Remove the bulb socket (5) from its seat.

### 3. Extract the bulb (6) without turning it.

### 4. To replace the bulb perform the removal operations in reverse sequence.

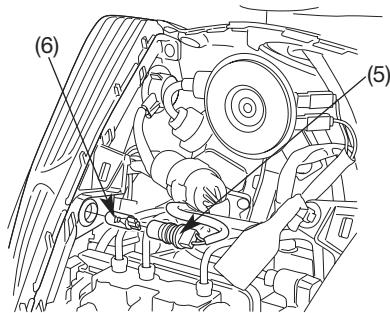

(5) Bulb socket

(6) Bulb

### Brake /Taillight bulb

1. Remove the taillight lens (1) by removing the two screws (2).
2. Remove the bulb (3) by pressing in and turning counterclockwise.
3. Install a new bulb in the reverse order of removal.

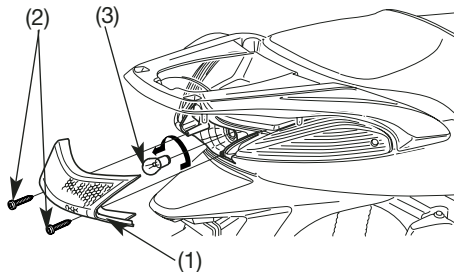

- (1) Taillight lens
- (2) Screws
- (3) Bulb

## Front Turn Signals Bulb

1. Remove the front shield (page 114).
2. Remove the bulb socket (1) from its seat by turning it counterclockwise.
3. Unscrew bulb (2) by turning it counterclockwise to remove it.
4. To replace the bulb perform the removal operations in reverse sequence.
  - Use only the amber bulb.

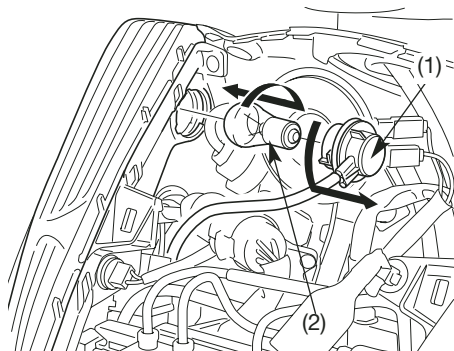

(1) Bulb socket

(2) Bulb



## Rear turn signal bulb

1. Remove the taillight lens (1) (page 115).
2. Remove the screw (2) from the turn signal bulb glass (3), and remove the glass.
3. Remove the bulb (4) from its seat by pressing in and turning counterclockwise.
4. Install a new bulb in the reverse order of removal.
  - Use only the amber bulb.

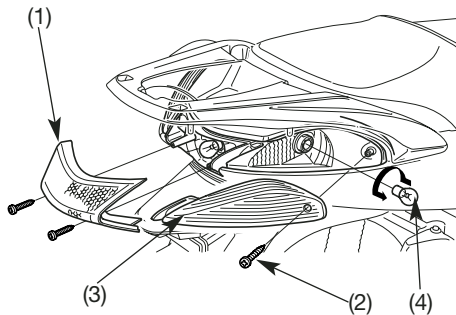

- (1) Taillight lens
- (2) Screw
- (3) Turn signal bulb glass
- (4) Bulb

## License Light Bulb

1. Remove the screw (1).
2. Remove the license light cover (2).
3. Pull out the connector (3).
4. Pull out the bulb (4) without turning.
5. Install a new bulb in the reverse order of removal.

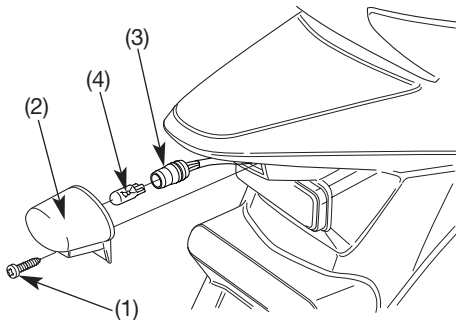

- (1) Screw
- (2) License light cover
- (3) Connector
- (4) Bulb

## CLEANING

Clean your scooter regularly to protect the surface finishes and inspect for damage, wear, and oil, coolant or brake fluid leakage.

Avoid cleaning products that are not specifically designed for scooter or automobile surfaces.

They may contain harsh detergents or chemical solvents that could damage the metal, paint, and plastic on your scooter.

If the scooter is still warm from recent operation give the engine and exhaust system time to cool off.

We recommend avoiding the use of high pressure water spray (typical in coin-operated car washes).

### NOTICE

High pressure water (or air) can damage certain parts of the scooter.

### Washing the scooter

1. Rinse the scooter thoroughly with cool water to remove loose dirt.
2. Clean the scooter with a sponge or soft cloth using cool water.

Avoid directing water to muffler outlets and electrical parts.

3. Clean the plastic parts using a cloth or sponge dampened with a solution of mild detergent and water. Rub the soiled area gently rinsing it frequently with fresh water. Take care to keep brake fluid or chemical solvents off the scooter.

They will damage the plastic and painted surfaces.

The inside of the headlight lens may be clouded immediately after washing the scooter. Moisture condensation inside the headlight lens will disappear gradually by lighting the headlight in high beam. Run the engine while keeping the headlight on.

4. After cleaning, rinse the scooter thoroughly with plenty of clean water. Strong detergent residue can corrode alloy parts.
5. Dry the scooter, start the engine and let it run for several minutes.
6. Test the brakes before riding the scooter. Several applications may be necessary to restore normal braking performance.

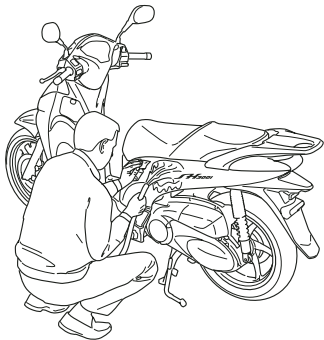

Braking efficiency may be temporarily impaired immediately after washing the scooter.

Anticipate longer stopping distance to avoid a possible accident.

#### TEST BRAKES

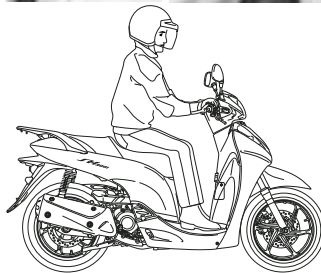

### **Finishing Touches**

After washing your scooter, consider using a commercially available spray cleaner/polish or quality liquid or paste wax to finish the job. Use only a non-abrasive polish or wax made specifically for motorcycles or automobiles. Apply the polish or wax according to the instructions on the container.

### **Removing Road Salt**

The salt contained in the road surface freezing prevention medicine which a road was sprayed with in winter, and the seawater becomes the cause which rust occurs in.

Wash your scooter by the following point after it runs through such a place.

1. Clean the scooter using cool water (page 119).

Do not use warm water.

This worsens the effect of the salt.

2. Dry the scooter and protect the surface of the metal with wax.

### **Painted Aluminum Wheel Maintenance**

Aluminum may corrode from contact with dirt, mud, or road salt. Clean the wheels after riding through any of these substances. Use a wet sponge and mild detergent. Avoid stiff brushes, steel wool, or cleaners containing abrasives or chemical compounds.

After washing, rinse with plenty of water and dry with a clean cloth.

### **Exhaust Pipe Maintenance**

The exhaust pipe is stainless steel but may become stained by oil or mud. If necessary, remove heat stains with a liquid abrasive.

### **Clean The Windshield (optional accessory)**

Using plenty of water, clean the windshield with a soft cloth or sponge, (avoid using detergents or any kind of chemical cleaner on the windshield). Dry with a soft, clean cloth.

To avoid possible scratching or other damage, use only water and a soft cloth or sponge to clean the windshield.

For a dirtier windshield, use a diluted neutral detergent with a sponge and plenty of water. Make sure to wash off all the detergent, (Detergent residue may cause windshield cracks).

Replace the windshield if scratches cannot be removed and they obstruct clear vision.

Do not let battery electrolyte, brake fluid or other acid chemicals get on the windshield and screen garnish.

They will damage the plastic.

## STORAGE GUIDE

Extended storage, such as for winter, requires that you take certain steps to reduce the effects of deterioration from non-use of the scooter. In addition, necessary repairs should be made BEFORE storing the scooter; otherwise these repairs may be forgotten by the time the scooter is removed from storage.

## STORAGE

1. Change the engine oil and filter.
2. Make sure the cooling system is filled with a 50/50% antifreeze solution.
3. Empty the fuel tank into an approved petrol container using a commercially available hand siphon or an equivalent method. Spray the inside of the tank with an aerosol rust-inhibiting oil.  
Reinstall the fuel fill cap on the tank.

## WARNING

Petrol is highly flammable and explosive. You can be burned or seriously injured when handling fuel.

- Stop the engine and keep heat, sparks and flame away.
- Refuel only outdoors.
- Wipe up spills immediately.

4. To prevent rusting in the cylinder, perform the following:
  - Remove the spark plug cap from the spark plug. Using tape or string, secure the cap to any convenient plastic body part so that they are positioned away from the spark plug.
  - Remove the spark plug from the engine and store it in a safe place. Do not connect the spark plug to the spark plug cap.
  - Pour a tablespoon (15-20 cm<sup>3</sup>) of clean engine oil into the cylinder and cover the spark plug hole with a piece of cloth.
  - Crank the engine several times to distribute the oil.
  - Reinstall correctly the spark plug and spark plug cap (page 99).
5. Remove the battery. Store it in an area protected from freezing temperatures and direct sunlight.  
Slow charge the battery once a month.
6. Wash and dry the scooter. Wax all painted surfaces. Coat chrome with rustinhibiting oil.
7. Inflate the tyres to the recommended pressures. Place the scooter on blocks to raise both tyres off the ground.
8. Cover the scooter (do not use plastic or other coated materials) and store in an unheated area, free of dampness with a minimum of daily temperature variation. Do not store the scooter in direct sunlight.



## **REMOVAL FROM STORAGE**

1. Uncover and clean the scooter.
2. Change the engine oil if more than 4 months have passed since the start of storage.
3. Charge the battery as required.  
Install the battery.
4. Drain any excess aerosol rust-inhibiting oil from the fuel tank. Fill the fuel tank with fresh petrol.
5. Perform all Pre-ride Inspection checks (page 61-62).  
Test ride the scooter at low speeds in a safe riding area away from traffic.

## SPECIFICATIONS

### DIMENSIONS

Overall length	2096 mm
Overall width	730 mm
Overall height	1187 mm
Wheelbase	1430 mm

### CAPACITIES

Engine oil	
(after draining)	1.2 ℓ
(after draining and oil filter change)	1.4 ℓ
(after disassembly)	1.7 ℓ
Transmission oil	
(after draining)	0.28 ℓ
(after disassembly)	0.30 ℓ
Fuel tank	9.10 ℓ
Cooling system capacity	1.10 ℓ
Passenger capacity	Operator and one passenger
Maximum weight capacity	180 kg

## **ENGINE**

Bore and stroke	72 x 68.5 mm
Compression ratio	10.5:1
Displacement	279 cm <sup>3</sup>
Spark plug Standard	LMAR8A-9 (NGK)
Spark plug gap	0.80 - 0.90 mm
Idle speed	1.500 ± 100 min <sup>-1</sup> (rpm)

## **CHASSIS AND SUSPENSION**

Caster	27° 30'
Trail	98 mm
Tyre size, front	110/70 - 16M/C 52P Tubeless
Tyre size, rear	130/70 - 16M/C 61P Tubeless

## **POWER TRANSMISSION**

Primary reduction	V-Belt
Final reduction	8.571

## **ELECTRICAL**

Battery

12V - 11(10)AH

Generator

0,368kW / 5.000 min<sup>-1</sup> (rpm)

## **LIGHTS**

Headlight

12V - 55/60W

Stop/Tail light

12V - 21/5W

Turn signal light

Front

12V - 21W x 2

Rear

12V - 21W x 2

Position light

12V - 5W x 2

Instrument light

LED x 5

Turn signal indicator

12V - 1.4W x 2

High beam indicator

12V - 1.4W

Low oil pressure indicator

12V - 1.4W

PGM FI indicator

LED

Oil change indicator

LED

HISS indicator

LED

ABS indicator

LED.....SH300A/AR

License light

12V - 5W

## **FUSE**

Main fuse

30A

Other fuse

10A, 15A.....SH300/R

10A, 15A, 30A.....SH300A/AR

## CATALYTIC CONVERTER

This scooter is equipped with a catalytic converter.

The catalytic converter contains precious metals that serve as catalysts, promoting chemical reactions to convert the exhaust gasses without affecting the metals.

The catalytic converter acts on HC, CO, and NOx. A replacement unit must be an original Honda part or its equivalent.

The catalytic converter must operate at a high temperature for the chemical reactions to take place. It can set on fire any combustible materials that come near it.

Park your scooter away from high grasses, dry leaves, or other flammables.

A defective catalytic converter contributes to air pollution, and can impair your engine's performance. Follow these guidelines to protect your scooter's catalytic converter.

- Always use unleaded petrol. Even a small amount of leaded petrol can contaminate the catalyst metals, making the catalytic converter ineffective.
- Keep the engine tuned-up.
- Have your scooter diagnosed and repaired if it is misfiring, backfiring, stalling or otherwise not running properly.