

JAMES

INSTRUCTION BOOK

FOR 1954

CAPTAIN

200 cc MODEL K7

COTSWOLD

200 cc MODEL K7C

COMMANDO

200 cc MODEL J9

MANUFACTURERS:

THE JAMES CYCLE CO., LTD.

GOUGH ROAD

BIRMINGHAM, 11 :: ENGLAND

PRICE 2/6

JAMES

INSTRUCTION BOOK

1954 200 cc MODELS

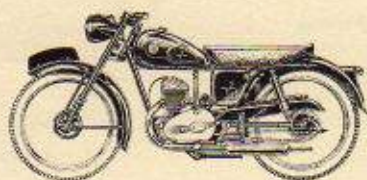

K7 CAPTAIN

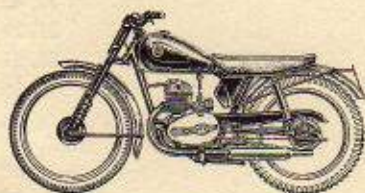

K7C COTSWOLD

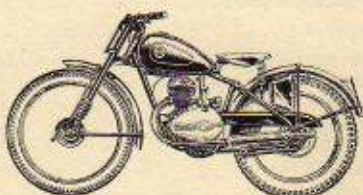

J9 COMMANDO

Manufacturers:

THE JAMES CYCLE COMPANY, LIMITED
GOUGH ROAD, BIRMINGHAM, 11, ENGLAND

Grams: "BICYCLES BIRMINGHAM"

Phone: VICtoria 2211 (5 lines)

Nearest Railway Station: Birmingham, Small Heath, B.R. Western Region

REF. 200/54 4M

PRICE: 2/6

<https://www.motomanuals.net/>

CONTENTS

Air cleaner	36							
Battery	32							
Brakes	56							
Bulbs	31, 33							
Carburetter	35, 36, 37							
Chains	40, 41							
Chromium plating	58							
Cleaning	58							
Clutch	24, 25, 26							
Condenser	28							
Contact breaker	28							
Controls	6, 7							
Decarbonising	22, 23							
Enamel	58							
Engine	20, 24, 25							
Engine number	4							
Faults in starting	8							
Foot gear change mechanism	44							
Forks	48, 49, 50, 51							
Frame number	4							
Free service scheme	4							
Fuel	8							
Gearbox	<table style="display: inline-table; vertical-align: middle;"> <tr> <td rowspan="2" style="font-size: 2em; vertical-align: middle;">{</td> <td>3 speed</td> <td style="text-align: right;">42, 43</td> </tr> <tr> <td>4 speed</td> <td style="text-align: right;">44, 45, 46, 47</td> </tr> </table>	{	3 speed	42, 43	4 speed	44, 45, 46, 47		
{	3 speed		42, 43					
	4 speed	44, 45, 46, 47						
Hubs	54, 55, 56							
Ignition	27, 28, 29							
Law	5, 6							
Lighting	30, 31, 32, 33, 34							
Lubrication — engine	21							
gearbox	44, 46							
Lubrication points	12, 40							
Magneto	27, 29							
Rear suspension	52, 53							
Recommended lubricants	12							
Rectifier	31							
Riding hints	8, 10							
Routine attention	11							
Running-in	9							
Saddle	57							
Service Department	13							
Silencer	34							
Spares and repairs	13							
Sparking plug	29, 30							
Speedometer	55							
Starting	8							
Stopping	9							
Symptoms of engine wear	22							
Technical data	<table style="display: inline-table; vertical-align: middle;"> <tr> <td rowspan="3" style="font-size: 2em; vertical-align: middle;">{</td> <td>K7</td> <td style="text-align: right;">14, 15</td> </tr> <tr> <td>K7C</td> <td style="text-align: right;">16, 17</td> </tr> <tr> <td>J9</td> <td style="text-align: right;">18, 19</td> </tr> </table>	{	K7	14, 15	K7C	16, 17	J9	18, 19
{	K7		14, 15					
	K7C		16, 17					
	J9	18, 19						
Timing ignition	29							
Tracing engine troubles	21, 38, 39							
Training	10							
Tools	34							
Twist grip	40							
Tyres	57							
Useful Information	50, 58							
Wiring diagrams	30, 33							
Wheels	54, 55, 56							

Introduction

It gives us great pleasure to deliver to you, together with this booklet, your new James lightweight motor cycle.

Your James has been designed and produced in the light of vast experience in the manufacture of lightweight motor cycles, and is built to give you many thousands of miles of reliable and economical personal transport. In operation, a James lightweight is as simple as it is possible for a high efficiency motor cycle to be and only the minimum of attention is necessary to keep it in first-class order.

This booklet was written for you and we strongly advise you to study it carefully in order to become thoroughly acquainted with your machine so that it may be a constant source of pleasure. It is hoped that the information given in the following pages will help both novice and experienced rider.

If you are an experienced motor cyclist you may think this handbook contains nothing you did not already know, but even the owner with many years of motor cycle riding behind him may commit serious errors in the care and maintenance of a new machine which may cause serious damage. It is the purpose of this booklet to rule out these possibilities, to acquaint you with important details concerning your motor cycle and to indicate those parts which require special care or regular lubrication.

It is in your interest to observe these instructions carefully. The service life, driving safety, and reliability of your James depend on the care you give it. Please consider this booklet as a guide destined to bring you quickly and safely to your destination.

A WORD ABOUT ROAD SENSE.

Skilled design and construction have made your James lightweight as safe as possible. It has first-class steering and brakes and is very easy to handle in traffic. The very manoeuvrability of your machine makes it necessary to exercise caution at all times. Take a pride in your riding technique : there are, unfortunately, a few motor cyclists whose reckless driving constitutes a menace, not only to themselves, but to other road users. Your example of courteous, careful and unobtrusive riding will materially contribute to road safety and to the reputation of a fine sport.

THE JAMES CYCLE CO. LTD.

December, 1953

Birmingham.

WHERE ARE THE FRAME AND ENGINE NUMBERS ?

Every James motor cycle is stamped with frame and engine numbers and it is in your interests to record these numbers in the spaces given below. These numbers enable identification of the machine and must be quoted when ordering spares and in any correspondence relating to your motor cycle.

FRAME NUMBER : This will be found stamped on the left-hand side of the steering head lug on both models K7 and K7C and the left-hand front engine lug on model J9. (Model numbers are used as prefixes).

ENGINE NUMBER : All models. This appears on the top of aluminium alloy crankcase front engine lug.

FRAME NUMBER
MODELS K7 and K7C

ENGINE NUMBER
ALL MODELS

FRAME NUMBER
MODEL J9

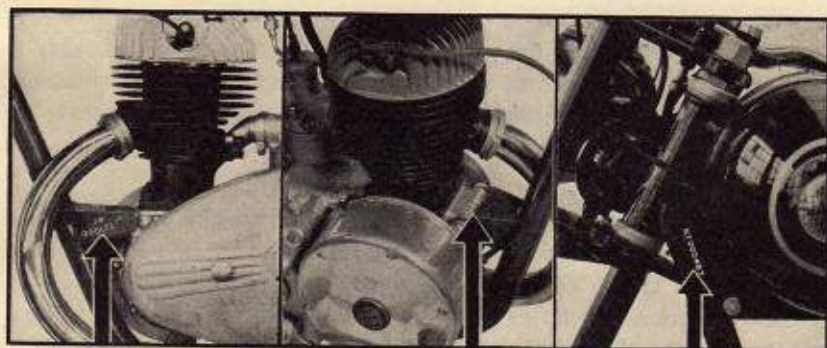

RECORD YOUR FRAME AND ENGINE NUMBER HERE FOR REFERENCE

FRAME	ENGINE

FREE SERVICE SCHEME.

All owners of **NEW MODELS** are entitled to one **FREE SERVICE AND INSPECTION** at 500 miles, or, at latest, three months after taking delivery.

This service is arranged by the supplying dealer to whom the **Free Service Voucher** must be handed. This voucher will be found in the tool box upon taking delivery of a new motor cycle.

The **INSPECTION AND SERVICE** consists of :

- (a) Check, and, if necessary, adjust :
 - (1) Contact breaker points.
 - (2) Sparking plug.
 - (3) Clutch.
 - (4) Chains.
 - (5) Brakes.
 - (6) Forks and steering head.
 - (7) Alignment of wheels.
 - (8) Tyre pressures.
- (b) Tighten all external nuts and bolts, including cylinder bolts.
- (c) Check all lighting equipment.
- (d) Clean out carburetter and adjust mixture.
- (e) Adjust and lubricate all cables.
- (f) Grease all nipples.
- (g) Check oil level in front chaincase.
- (h) Top-up gear box.
- (i) Test machine on the road.

NOTE.—Oils, greases and materials used are chargeable to the customer.

THE MACHINE AND THE LAW.

Every motor cycle used on the public roads of Great Britain must be registered and carry the registration numbers and licence disc allotted to it. The dealer, from whom the machine is bought, will, generally, attend to all matters legally essential before it is used on the public roads.

TO REGISTER A NEW MACHINE.

Send to the Local Registration Authority the following :

- (a) Form "RF1/2," duly completed.
- (b) The certificate of insurance.
- (c) The invoice you received from your dealer when you purchased the machine.
- (d) The appropriate registration fee.

In due course you will receive :

- (1) A Registration Book. (Commonly called the "log" book.)
- (2) A Licence Disc.
- (3) Your Insurance Certificate.
- (4) Your Invoice.

The Registration Book and the Licence Disc will bear the registration numbers that have been allotted to your machine and will also show the date the Road Licence expires. Your number plates must then be painted, in white upon a black background, with the registration numbers in characters of even thickness as follows :

The numbers on the front plate must be $1\frac{3}{4}$ " high, $1\frac{1}{4}$ " wide and $\frac{5}{16}$ " thick with spaces of $\frac{1}{2}$ " between each two characters.

The numbers on the rear plate must be $2\frac{1}{2}$ " high, $1\frac{3}{4}$ " wide and $\frac{3}{8}$ " thick with spaces $\frac{1}{2}$ " between each two characters.

The Licence Disc must be enclosed in a watertight container, having a transparent front, and this must be fixed to the machine in a conspicuous position, near the front and on the left-hand side.

Although it is not legally necessary to carry your Driving Licence, Insurance Certificate and Registration Book while driving your machine, it should be noted that Police Officers have authority to ask for the Driving Licence and Insurance Certificate at any time.

SPEEDOMETER.

A speedometer **MUST** be fitted to all motor cycles over 100 cc. It is supplied as standard equipment on the James Captain, Cotswold and Commando models.

LAMPS.

During the official "**LIGHTING UP**" hours the machine must exhibit a white light facing forwards and a red light facing rearwards. The rear number plate must be adequately illuminated by a white light.

Each electric light bulb **MUST** be marked with its "Wattage." (Beware of cheap, imported, bulbs that do not have this marking.)

All motor cycles made by us have electric equipment that complies with the law regarding position, size of bulbs, marking on bulbs and the correct illumination of the rear number plate.

THE DRIVER AND THE LAW.

The driver of a motor cycle **MUST** be **INSURED** against Third Party Claims and **MUST** be able to produce an **INSURANCE CERTIFICATE** showing that such an insurance is in force.

If your Insurance Certificate specifies you can only drive one particular machine you **MUST NOT DRIVE** any other machine unless its owner has a current Certificate covering "**ANY DRIVER**" and it is advisable to remember that, in the absence of such a provision the penalties for doing so are very heavy.

The driver of a motor cycle **MUST** hold a current **DRIVING LICENCE**. If you are a learner and hold a Provisional Driving Licence, your machine must show, front and back, the standard "L" plates in red and white and you must not take a **PILLION PASSENGER** unless that passenger is the holder of a current **UNRESTRICTED** driving licence.

As soon as you receive your driving licence, sign it in the appropriate place and do so each time it is renewed. It is an offence not to.

Make sure you are well acquainted with the recommendations set down in the "Highway Code," a copy of which can be obtained from any main Post Office.

CONTROLS LAYOUT

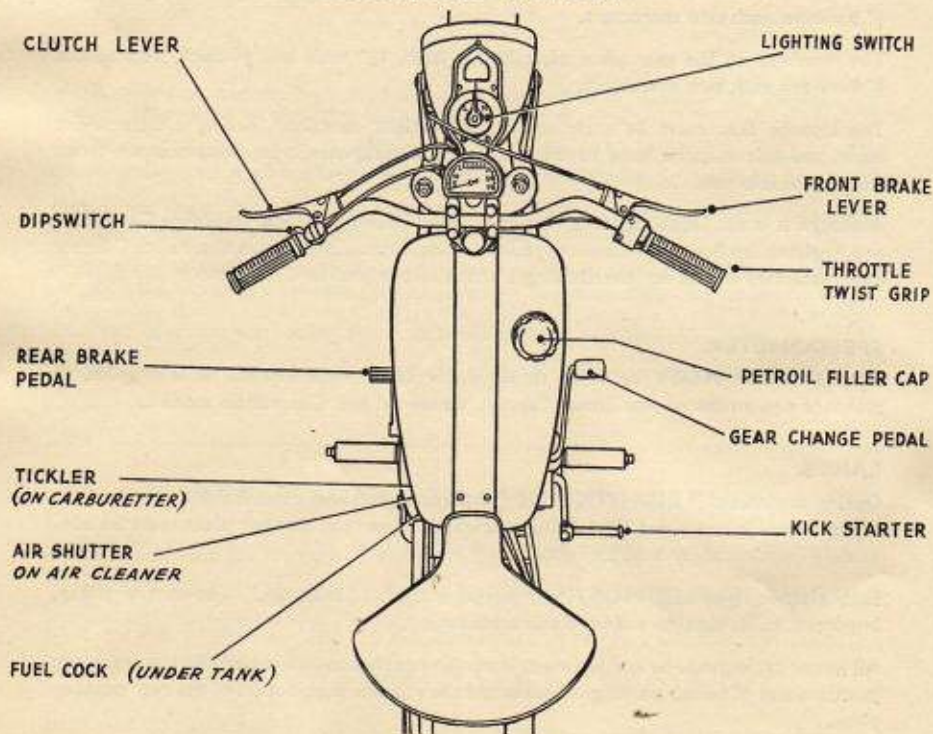

POSITION, FUNCTION AND OPERATION OF CONTROLS

THROTTLE TWIST GRIP. On right handlebar. Controls speed of engine. Twist towards rider to open. Away from rider to close.

CLUTCH LEVER. Large lever on left handlebar. Pull towards handlebar to release engine drive from rear wheel. Use when moving away from rest and also when changing gear. Always let the clutch in gently to prevent transmission snatch.

FRONT BRAKE LEVER. Large lever on right handlebar. Grip to operate front brake. Normally applied in conjunction with rear brake.

DECOMPRESSOR LEVER. On competition models K7C and J9 only. Small lever on right handlebar. Grip to operate cylinder head compression release valve. Used to start and as an additional engine control in trials.

REAR BRAKE PEDAL. To front of left-hand side footrest. Press down to operate rear brake.

GEAR CHANGE PEDAL. Horizontal lever in front of right-hand footrest. Move UP to select a lower gear. Move DOWN to select a higher gear. Neutral will be found between first (bottom) and second gear.

Position of gears from neutral (or free engine) :

First (or bottom gear)	UP.
Second gear	DOWN.
Third gear	DOWN AGAIN.
Four-speed gearboxes	DOWN YET AGAIN.

The pedal will always return to the same position and foot should be removed from lever between each gear change. Always grip the clutch lever when changing gears.

KICK STARTER. Vertical lever with folding crank on right of gearbox. Use to start engine.

LIGHTING SWITCH. (Direct lighting set — A.C. equipment.) In top of headlamp. Switch has three positions :

L	Pilot and rear lamps lit.
OFF	No lamps in use.
H	Head, rear and speedo lamps lit.

LIGHTING SWITCH. (Rectifier/Battery lighting set — A.C. — D.C. equipment.) In top of headlamp. Switch has four positions :

OFF	No lamps in use.
P	Parking lights in use — current supplied by battery.
H	Headlamp, tail light and speedo light in use, current supplied by battery.
DIRECT	Headlamp, tail light and speedo light in use — current supplied from flywheel generator with engine running.

AMMETER. Instrument in front of lighting switch. Indicates flow of current.

DIPSWITCH. On left handlebar. Deflects main headlamp beam downwards and to the left. Prevents dazzling oncoming drivers.

FILLER CAP. On top of fuel tank. Incorporates oil measure for refuelling. (Four measures to one gallon.) Screws on and off.

TICKLER. Small knob on carburettor body. Depress to provide rich mixture for starting.

AIR SHUTTER. Close to enrichen mixture for starting. Use in conjunction with tickler.

FUEL TAP. On left under tank. Pull knob to turn fuel ON. Push in to turn fuel OFF. Always push knob to Off position when stopping for any length of time.

PREPARING FOR THE ROAD.

FUEL.

PETROIL MIXTURE. When the machine first comes into the hands of the rider it will be ready, but for fuel, for the road. Fill the tank with a mixture of ONE part of oil to TWENTY parts of petrol, i.e., half a pint of oil to one gallon. For convenience a measure is attached to the filler cap (four measures to one gallon). Pour the petrol into the tank first, taking care to push the fuel cock OFF before putting in the oil. Now shake the machine from side to side once or twice to mix the contents of the tank. As the petrol supply is the sole means of lubricating the engine, never neglect to perform this trifling duty.

STARTING.

See that there is sufficient fuel in the tank.

Ensure gear lever is in NEUTRAL by rolling machine slightly forwards and backwards. (Neutral is between bottom and second gear.)

Pull fuel cock to ON position.

Close shutter on air cleaner and depress tickler until petrol appears.

Open twist grip about a quarter of its travel.

Standing over machine, depress kickstarter with a long steady swinging movement.

When engine starts do not forget to open the air shutter as fully as possible.

Re-starting when the engine is warm will require no flooding of the carburetter, neither will it be necessary to close the air shutter.

FAILURE TO START.

If repeated kicks fail to start after flooding (when cold) turn off fuel supply, open throttle wide and clear crankcase of excessive fuel by giving a number of rapid kicks to starter. Keep engine turning over quickly until it fires. Then do not close throttle but keep wide open until engine revolutions have built up and running is normal.

FAULTS IN STARTING.

Errors often made whilst starting motor cycles are as follows :

Opening throttle too wide : this destroys the advantage of a rich mixture.

Failure to lean the machine slightly to the left, so that pressing of the foot on the kick-starter causes rider and machine to overbalance.

Failure to appreciate that word "kickstarter" is a misnomer. What is really required is a steady swinging movement, the force on the crank being almost constant throughout its travel. A frantic jab does not produce the required spin of the engine.

Tickling the carburetter insufficiently. This operation must produce a head of fuel on the top of the carburetter body.

These faults are easily corrected with care and will result in greatly improved starting. It is **NOT** advisable to start the machine on the stand.

RIDING.

THE FIRST RUN. Novices are recommended to drive the machine slowly in bottom gear (for short distances only, of course) whilst making themselves familiar with the controls. This is best done by bringing the machine to rest and then restarting by a gradual engagement of the clutch several times. When this can be done without stopping or racing the engine, speed can be increased slightly and a change to the next gear made.

Raise the clutch lever and move the foot or hand control to the required position, after which the clutch lever must be gently released, while the throttle should be opened slightly to take the drive on the higher gear.

The change from a high gear to a lower gear is made in a similar manner. A little practice will probably be necessary in order to change gear with ease and certainty, with all movements correctly synchronised, but the gears are very easy to manipulate and will present little difficulty. The gear change mechanism on a new machine is generally a little stiff and will ease considerably when the machine has been run-in.

STOPPING.

Before slowing down glance to the rear to ascertain what vehicles are following and if necessary give the signal "I am going to slow down." (Full details of road signals will be found in The Highway Code available from H.M. Stationery Office).

To stop the machine, close the throttle, apply the brakes and when speed is down to a few miles per hour, raise the clutch. The engine thus assists the brakes in slowing down. Most slowing down, e.g., at traffic lights, can be done by allowing the engine to act as a brake and using the brakes themselves for the last few yards only. When the machine is to be left standing for any length of time, it is advisable to turn off the fuel supply, when approaching destination, allowing the engine to use up the supply of fuel in the carburettor while coming to rest.

This avoids the possibility of fuel draining into the engine with subsequent starting difficulties.

RIDING IN TRAFFIC.

In slow moving traffic engage lower gears. This permits the engine to run smoothly and enables overtaking to be accomplished in the minimum of time. The engine must never be allowed to labour, and the judicious selection of the right gear will prolong the life of the engine and the transmission system. Slipping the clutch should be avoided. Whenever in doubt about overtaking, always hang back.

RUNNING-IN.

The manner in which a new motor cycle is driven during the first 1,000 miles (1,600 kms.) can make or mar its eventual performance and useful life, and owners are therefore strongly advised to exercise great care during the vital "running-in" period. In a new machine, despite the most careful manufacture and assembly, each bearing surface has microscopic idiosyncrasies not entirely suited to the opposite surface and the initial period of "light duties" will give those working parts a mirror finish impossible to achieve by machinery.

Two-stroke engines are quickly run in, owing to the simple and efficient design. However, here, as in everything else, treatment must follow the dictates of common sense, and not too much should be attempted on the first ride. Do not exceed 40 m.p.h. in top gear for the first 100 miles or so and limit your throttle openings to two-thirds in any gear for the first 500 miles.

Sustained high speed should not be indulged in for at least 1,000 miles, when it will probably be time to adjust the contact-breaker point gap. How to do this is shown on page 28.

RIDING HINTS.

One of the most important rules to remember is : Before moving off, pulling out to overtake, turning right and turning left, glance over your shoulder to make sure it is safe to do so and if necessary give the correct signal.

If at first bottom gear will not engage whilst the machine is stationary, do not resort to force — simply raise the clutch and move the machine backwards and forwards for a second or two, then try again. In time this condition will disappear.

Take pride in making a smooth start : it is not clever or wise to race the engine and then let the clutch in suddenly to make a flying start. Make a smooth getaway after first glancing to the rear and signalling your intention.

Always drive on the engine and not on the brakes, thereby saving expense on brake liners. Remember that an engine in low gear is a safe and sure brake and that skidding is well-nigh impossible when using it so.

Change gear on hills **BEFORE** the engine has commenced to labour ; a good driver will learn to anticipate such a condition, and change down early.

When changing gear move the foot pedal to the full extent of its travel firmly and smoothly, at the same time as the clutch is disengaged.

Cornering. When approaching an uncertain bend at speed, change down if necessary and brake **BEFORE** entering the curve. On a left-hand bend, ease over near the crown of the road in order to sweep in close to the verge once round the corner. On a right-hand bend, always keep well in to the verge. Never accelerate into a bend.

When using the brakes, apply gentle pressure at first, increasing in strength as the road speed decreases.

Use your full headlight when riding at night unless in brightly lit streets.

Make full use of the dipswitch whilst riding at night ; this is a " courtesy control " and its use will be appreciated by oncoming drivers.

Always reduce speed when your visibility is lowered.

Many accidents are caused by rash over-taking. Be cautious, remembering that a small engine has not the acceleration of a larger machine. Every car driver has a blind spot in his mirror within which he cannot see you. Make sure that he knows you are there if you are overtaking. Similarly glance behind yourself before pulling out.

Remember that pedestrians, young or old, are the most likely to make unexpected changes in direction and speed, step off pavements, come from behind stationary vehicles or, in country districts, suddenly appear round the curve of a blind bend. Constant observation and anticipation is required to avoid them.

TRAINING FOR BEGINNERS.

Skill in motor cycling is not a gift. It has to be learnt and practised. Many clubs operate a scheme in co-operation with the R.A.C. and the A.C.U. for teaching young motor cyclists and beginners to become expert. For details apply to the Motor Cycle Department, Royal Automobile Club, 85 Pall Mall, London, S.W.1.

ROUTINE ATTENTION

Observing the servicing rules painstakingly means trouble-free running of your James machine and will preserve its value, while at the same time very little will be needed in the way of replacement parts.

Lubrication and adjustment of cycle and engine parts is of great importance and it is in your interest to carry out these simple jobs in accordance with the ROUTINE SERVICE PLAN given below. A list of recommended lubricants is given on page 12.

AFTER THE FIRST 200 MILES (320 kilometres).

Examine the contact breaker points (see page 28).

Check nuts and bolts for tightness.

Check adjustment of rear chain (see page 40).

Check steering head bearings (see page 48).

EVERY 500 MILES (800 kilometres).

Inspect oil level in gearbox and primary chaincase. If necessary top up with recommended oil. **FILL TO LEVEL PLUGS ONLY.**

Oil front fork sliders with oil gun.

WEEKLY.

Inspect tyres and check pressures (see page 57).

Clean sparking plug.

EVERY MONTH (every Fortnight in Summer).

Clean battery terminals and top-up with distilled water (Model K7). (See page 32.)

EVERY 1,000 MILES (1,600 kilometres).

Check, adjust and oil control cables, levers and twistgrip.

Check adjustment of rear chain. If rollers appear dry, oil with brush. In winter lubricate more frequently. If chain has collected much dirt remove and clean (see page 40).

Grease speedometer gearbox.

Check adjustment of head bearings.

Oil brake pedal pivots.

Clean and re-oil carburettor air filter.

Clean banjo filter gauze.

Check and adjust sparking plug gap.

Check contact breaker points gap.

EVERY 5,000 MILES (8,000 kilometres).

Drain and refill chaincase and gearbox, whilst engine is warm. **FILL TO LEVEL PLUGS ONLY**, over filling will lead to trouble.

Make thorough examination of lighting cables.

OCCASIONALLY.

Oil brake cam bearings to ensure smooth application. Oil too such parts as the rear brake lever, cable or rod pivots, and centre stand pivots. The saddle hinge pin should be oiled occasionally and checked to ensure that the saddle is free to pivot without being too tight.

Do **NOT** oil wheel hub bearings. (See page 54 "Hubs and Bearings.")

Decarbonise when the need is apparent (see pages 22 and 23).⁴⁴

LUBRICATION POINTS.

As far as normal lubrication points are concerned, the three models covered by this booklet are similar. Reference to the following diagram will therefore suffice for routine lubrication. Information relative to the correct lubrication of engine, chaincase, gearbox, telescopic forks, hub bearings, etc., will be found under the appropriate headings.

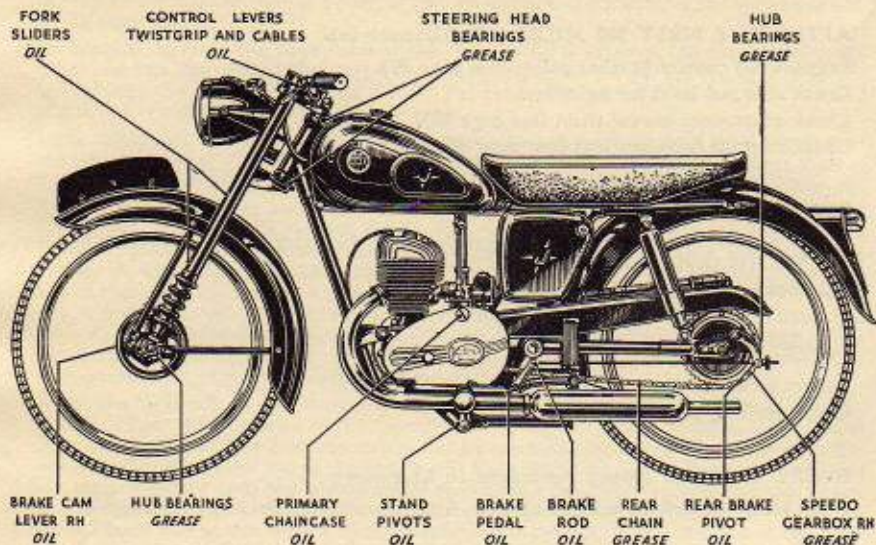

RECOMMENDED LUBRICANTS.

(U.K. and Overseas.)

	SHELL	WAKEFIELD	VACUUM	B.P.	ESSO
ENGINE ... (All Seasons)	Shell X-100 30	Castrol XL	Mobiloil A	Energol SAE 30	Essolube 30
GEARBOX	Shell Dentax 140	Castrol D	Mobilube C140	Energol SAE 140	Esso Gear Oil 140
CHAIN CASE	Shell Dentax 140	Castrol D	Mobilube C140	Energol SAE 140	Esso Gear Oil 140
EXPOSED CHAINS AND GREASE GUN	Shell Retinax A or CD	Castrol ease Graphited	Mobilgrease No. 2	Energrease C 3	Esso Grease Esso Chassis Grease
WHEEL HUBS	Shell Retinax A or RB	Castrol ease Heavy	Mobil Hub Grease	Energrease C 3	Esso Grease Esso Bearing Grease
FORKS and OIL CAN	Shell X-100 30	Castrol XL	Mobiloil A	Energol SAE 30	Essolube 30

For oil-damped telescopic forks and rear suspension units use any of the above brands in SAE 10 or SAE 20 (see appropriate instructions).

ALWAYS USE A BRANDED OIL OF GOOD REPUTE.

SPARES AND REPAIRS.

For the convenience of owners, James Spares Stockists are appointed for most districts, and customers are recommended to always apply to their nearest stockist. A list of stockists can be obtained on application (please enclose stamped and addressed envelope for reply).

When ordering spare parts, owners are advised to produce the original part as pattern, and to quote their full engine and frame numbers to enable identification.

Instructions regarding repairs should be clear and definite, otherwise the cost may be greater than expected. We shall be pleased to give estimates for repairs if parts are sent to us for that purpose. If the estimate is accepted, no charge will be made for the preliminary examination, but should the owner decide not to have the work carried out, a nominal charge may be made to cover the cost of whatever work may have been done to prepare the estimate. Parts sent to us as patterns or for repairs, should have attached to them a label with the sender's full name and address. Instructions regarding such parts should be sent separately.

Customers wishing to retain old parts which are replaced during overhaul or repair should state so before work commences, as normally such parts are scrapped upon removal.

If it is necessary to bring a machine, or parts, to the works for an urgent repair, it is essential that an appointment be made beforehand. This can be done by letter or telephone, and will avoid disappointment.

Orders should always be sent in list form and not as part of a letter.

For the benefit of owners visiting the Factory Service Department we give below a straightforward map indicating our exact position and Corporation 'bus services to and from City centre.

SPARES LIST.

A priced list of replacement parts covering K7, K7C and J9 models may be supplied at a cost of two shillings and sixpence, postage included.

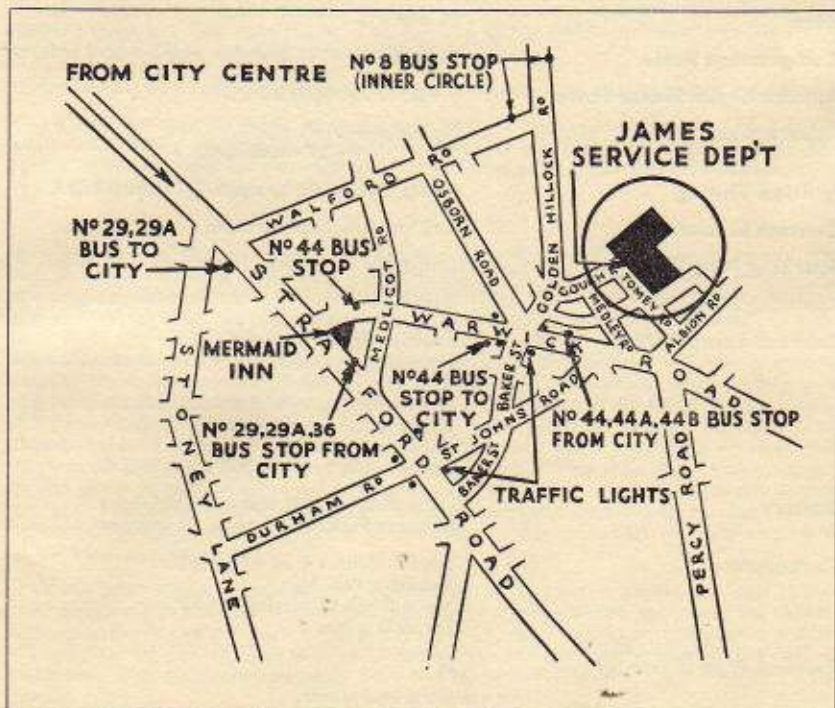

MODEL K7 197 cc. CAPTAIN

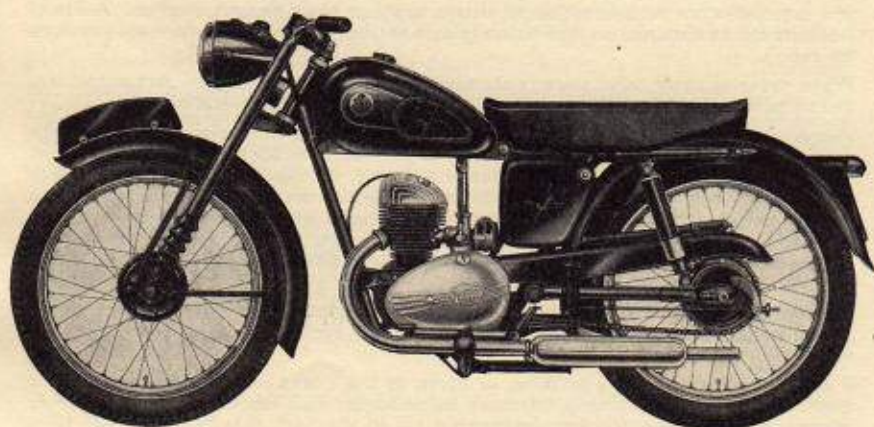

TECHNICAL DATA

Engine type	Villiers Mk. 8E two-stroke unit.
Cubic Capacity	197 cc (11.71 cu. ins.).
Stroke	72 mm.
Bore	59 mm.
Compression Ratio	7.25 : 1
Approx Brake Horse Power.	8.4 B.H.P. at 4000 R.P.M.
Rebore sizes (1)	Nominal $+0.015^{\circ}$.
(2)	$+0.030^{\circ}$ maximum.
Ignition Timing	Points commence to open $\frac{3}{32}^{\circ}$ before T.D.C.
Contact breaker gap	0.015° maximum separation.
Sparking Plug Type	Lodge HH14, 14 mm short reach.
Sparking Plug Gap	0.018° - 0.025° .
Correct Lamp Bulbs	Rectifier lighting set A.C./D.C. Head lamp : 6 volt. 24/24 watt double filament S.B.C. Pilot lamp : 6 volt. 3 watt M.B.C. Tail lamp : 6 volt. 3 watt M.B.C. *Tail stop-light : 6 volt. 3w/18w double filament. Speedo light : 6 volt. .17 amp. M.B.C.
Battery	Lucas PU7—E/9, 6 volt., 12 amp. hour. or Lucas PUZ7E-9, 6 volt., 12 amp. hour.
Carburetter	Type : Villiers S.24 single lever. Needle : No. 3 $\frac{1}{2}$. Normal needle setting : 1-95 $^{\circ}$. Throttle : No. 3.
Exhaust Pipe Diameter	1 $\frac{1}{2}^{\circ}$

* Not standard equipment.

Sprockets	Engine : 23 teeth.	Gearbox : 17 teeth.
	Clutch : 51 "	Rear : 44 "
Chains	Primary : $\frac{3}{8}$ " x $\frac{1}{2}$ " x .225 endless pre-stretched, 66 links. Renold No. 110038.	
	Rear : $\frac{1}{2}$ " x .335" x .205", 121 links. Renold No. 110044.	
Chain Adjustments	Primary : $\frac{1}{4}$ " whip.	
	Rear : $\frac{3}{8}$ " to $\frac{1}{2}$ " whip.	
Gearbox Ratios (close)	3 speed : 1 : 1 — 1.34 : 1 — 2.55 : 1.	
	4 speed : 1 : 1 — 1.35 : 1 — 1.8 : 1 — 2.9 : 1.	
Overall Gear Ratios	3 speed : Top 5.74 4 speed : Top 5.74	
	2nd 7.7	3rd 7.75
	1st 14.7	2nd 10.34
		1st 16.65
Engine Main Bearings	Ball : drive side (2) 20 x 47 x 14 mm. flywheel side (1) 20 x 52 x 15 mm.	
Big End Bearing	Roller : $\frac{1}{2}$ " x $\frac{1}{2}$ " (26 steel).	
Hub Bearings — Journal	15 x 35 x 11 mm front and rear.	
Steering Head Bearings	$\frac{1}{2}$ " balls (17 top, 17 bottom).	
Wheel Rim Sizes	Front WMI — 19.	
	Rear : WMI — 19.	
Tyre Sizes	Front : 3.00 x 19.	
	Rear : 3.00 x 19.	
Tyre Pressures (normal)	Front : 15 lbs. per sq. in.	
	Rear : 22 lbs. per sq. in.	
Brake Drum Diameter	5" front and rear.	
Brake Lining Width	$\frac{3}{4}$ ".	
Total Breaking Area	11 $\frac{1}{4}$ sq. ins. (76 cm ²).	
Spokes	Front L.H.	10 swg. x 8 $\frac{3}{4}$ " (18).
	Front R.H.	10 swg. x 7 $\frac{1}{2}$ " (18).
	Front nipples	10 swg. x .250" (36).
	Rear L.H.	10 swg. x 7 $\frac{3}{4}$ " (18).
	Rear R.H.	10 swg. x 8 $\frac{1}{2}$ " (18).
	Rear nipples	10 swg. x .250" (36).
Fuel Tank Capacity	2 $\frac{1}{4}$ Imperial gallons (10 litres).	
Fuel Mixture — Petroil	One part recommended oil to 20 parts petrol ($\frac{1}{2}$ pint oil to one gallon petrol or 4 filler cap measures to one gallon petrol).	
Gearbox Oil Capacity	Approx. $\frac{1}{2}$ pint. Fill to dipstick level mark.	
Chaincase Oil Capacity	Approx. $\frac{1}{2}$ pint. Fill to level plug.	
Rear Suspension Units	Oil	1 fluid ounce per unit (28.4 cc.)
Speedometer Head	Smiths 65 m.p.h. or 110 k.p.h. non-trip. " D " type.	
Speedo Cable Length	4' 4"	
Wheelbase (static)	50" (127 cm).	
Saddle Height	30" (76.2 cm).	
Ground Clearance	5 $\frac{1}{2}$ " (14 cm).	
Width Over Handlebars	25 $\frac{1}{2}$ " (65 cm).	
Overall Length	78" (198 cm).	
Approx. Weight	220 lbs. (100 kgms).	
Length of Dualseat	24".	

MODEL K7C 197 cc. COTSWOLD

"SCRAMBLES"

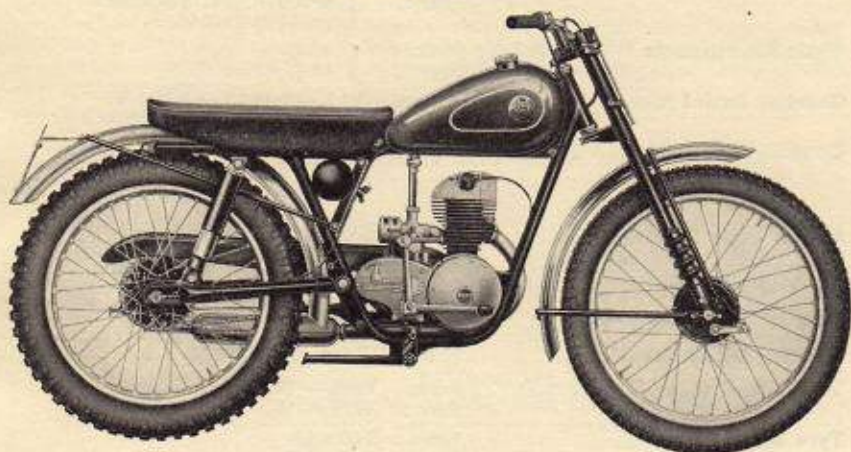

TECHNICAL DATA

Engine Type	Villiers Mk. 7E/4C two stroke unit.
Cubic Capacity	197 cc (11.71 cu. ins.).
Stroke	72 mm.
Bore	59 mm.
Compression Ratio	8.25 : 1.
Approx. Brake Horse Power	9.3 B.H.P. at 4300 R.P.M.
Rebore sizes (1)	Nominal +.015".
(2)	+.030" maximum.
Ignition Timing	Points commence to open $\frac{1}{8}$ " before T.D.C.
Contact Breaker Gap015" maximum separation.
Sparking Plug Type	Lodge HH14, 14 mm short reach.
Sparking Plug Gap018"-.025".
Correct Lamp Bulbs	Direct lighting set A.C. : Head lamp : 6 volt. 30/30 watt double filament S.B.C. Pilot lamp : 3.5 volt. .15 amp. M.E.S. Tail lamp : 6 volt. 3 watt M.B.C. Speedo light : 6 volt. .17 amp. M.B.C.
Carburetter	Type : Villiers S.24 single lever. Needle : No. 3 $\frac{1}{2}$. Normal needle setting : 1.95". Throttle : No. 3.
Exhaust Pipe Diameter	1 $\frac{1}{2}$ ".

Sprockets	Engine : 23 teeth. Clutch : 51 "	Gearbox : 17 teeth. Rear : 48 "
Chains	Primary : $\frac{3}{8}$ " x $\frac{1}{2}$ " x .225" endless pre-stretched 66 links. Renold No. 110038. Rear : $\frac{1}{2}$ " x .335" x .205". 121 links. Renold No. 110044.	
Chain Adjustments	Primary : $\frac{1}{2}$ " whip. Rear : $\frac{3}{8}$ " to $\frac{1}{2}$ " whip.	
Gearbox Ratios (Close)	4 speed : 1 : 1 — 1.35 : 1 — 1.8 : 1 — 2.9 : 1.	
Overall Gear Ratios	Top — 6.27 3rd — 8.48 2nd — 11.3 1st — 18.2	
Engine Main Bearings	Ball : drive side (2) 20 x 47 x 14 mm. flywheel side (1) 20 x 52 x 15 mm.	
Big End Bearing	Roller : $\frac{1}{2}$ " x $\frac{1}{2}$ " (26 steel).	
Hub Bearings — Journal	15 x 35 x 11 mm front and rear.	
Steering Head Bearings	$\frac{1}{2}$ " balls (17 top — 17 bottom).	
Wheel Rim Sizes	Front : WM1 — 21 Rear : WM2 — 19.	
Tyre Sizes	Front : 2.75 x 21. Rear : 3.50 x 19.	
Tyre Pressures (normal)	Front : 15 lbs. per sq. in. Rear : 25 lbs. per sq. in.	
Brake Drum Diameter	5" front and rear.	
Brake Lining Width	$\frac{3}{4}$ "	
Total Breaking Area	11 $\frac{1}{2}$ sq. ins. (76 cm ²).	
Spokes	Front L.H. 10 swg. x 9 $\frac{1}{8}$ " (18). Front R.H. 10 swg. x 8 $\frac{1}{2}$ " (18). Front nipples 10 swg. x .250" (36). Rear L.H. 10 swg. x 7 $\frac{1}{8}$ " (18). Rear R.H. 10 swg. x 8 $\frac{1}{16}$ " (18). Rear nipples 10 swg. x .250" (36).	
Fuel Tank Capacity	2 $\frac{1}{2}$ Imperial gallons (10 litres).	
Fuel Mixture — Petroil	One part recommended oil to 20 parts petrol ($\frac{1}{2}$ pint oil to one gallon petrol or 4 filler cap measures to one gallon petrol).	
Gearbox Oil Capacity	Approx. $\frac{1}{2}$ pint. Fill to oil level.	
Chaincase Oil Capacity	Approx. $\frac{1}{2}$ pint. Fill to level plug.	
Front Forks Oil Capacity	$\frac{1}{4}$ pint per fork leg (141 cc.)	
Rear Suspension Units Oil Capacity	1 fluid ounce per unit (28.4 cc.)	
Speedometer Head	Smiths 65 m.p.h. or 110 k.p.h. non trip.	
Speedo Cable Length	4' 4".	
Wheelbase (static)	50" (127 cm).	
Saddle Height	30" (76.2 cm).	
Ground Clearance	6 $\frac{1}{2}$ " (16 cm).	
Width Over Handlebars	27" (70 cm).	
Overall Length	76 $\frac{1}{2}$ " (194 cm).	
Approx. Weight	208 lbs. (95 kgms.).	

MODEL J9 197 cc. COMMANDO

"TRIALS"

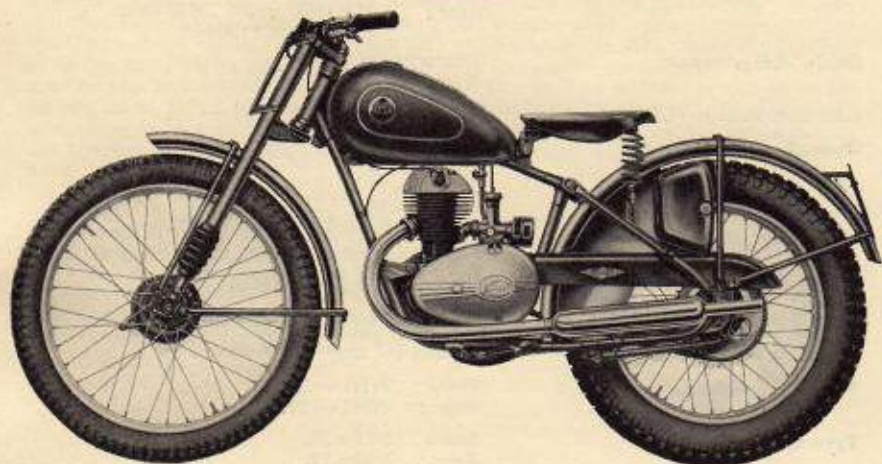

TECHNICAL DATA

Engine Type	Villiers Mk. 7E/4W two-stroke unit.
Cubic Capacity	197 cc (11.71 cu. ins.).
Stroke	72 mm.
Bore	59 mm.
Compression Ratio	8.25 : 1.
Approx. Brake Horse Power	9.3 B.H.P. at 4300 R.P.M.
Rebore sizes (1)	Nominal +.015".
(2)	+.030" maximum.
Ignition Timing	Points commence to open $\frac{11}{82}$ " before T.D.C.
Contact Breaker Gap	.015 maximum separation.
Sparking Plug Type	Lodge HH14, 14 mm short reach.
Sparking Plug Gap	.018"/.025".
Correct Lamp Bulbs	Direct Lighting set A.C. Head lamp : 6 volt. 30/30 watt double filament S.B.C. Pilot lamp : 3.5 volt. .15 amp. M.E.S. Tail lamp : 6 volt. 3 watt. M.B.C. Speedo light : 6 volt. .17 amp. M.B.C.
Carburettor	Type : Villiers 5.24 single lever. Needle : No. 3 $\frac{1}{2}$. Normal needle setting : 1.95". Throttle : No. 3.
Exhaust Pipe Diameter	1 $\frac{1}{4}$ ".

Sprockets	Engine : 23 teeth. Clutch : 51 "	Gearbox : 17 teeth. Rear : 50 "
Chains	Primary : $\frac{3}{8}$ " x $\frac{1}{4}$ " x $\cdot 225^\circ$ endless pre-stretched 66 links. Renold No. 110038. Rear : $\frac{1}{4}$ " x $\cdot 335^\circ$ x $\cdot 205^\circ$. 121 links. Renold No. 110044.	
Chain Adjustments	Primary : $\frac{1}{4}$ " whip. Rear : $\frac{3}{8}$ " to $\frac{1}{2}$ " whip.	
Gearbox Ratios (Wide)	4 speed : 1 : 1 — 1.35 : 1 — 2.3 : 1 — 3.47 : 1	
Overall Gear Ratios	Top — 6.54 3rd — 8.83 2nd — 15.0 1st — 22.6	
Engine Main Bearings	Ball : drive side (2) 20 x 47 x 14 mm. flywheel side (1) 20 x 52 x 15 mm.	
Big End Bearing	Roller : $\frac{1}{2}$ " x $\frac{1}{4}$ " (26 steel).	
Hub Bearings — Journal	15 x 35 x 11 mm front and rear.	
Steering Head Bearings	$\frac{1}{4}$ " balls (17 top — 17 bottom).	
Wheel Rim Sizes	Front : WM1 — 21. Rear : WM3 — 19.	
Tyre Sizes	Front : 2.75 x 21. Rear : 4.00 x 19.	
Tyre Pressures (normal)	Front : 15 lbs.	Rear : 27 lbs.
Brake Drum Diameter	5" front and rear.	
Brake Lining Width	$\frac{3}{4}$ ".	
Total Breaking Area	11 $\frac{3}{4}$ sq. ins. (76 cm ²).	
Spokes	Front L.H. 10 swg. x 9 $\frac{5}{8}$ " (18). Front R.H. 10 swg. x 8 $\frac{1}{4}$ " (18). Front nipples 10 swg. x $\cdot 250^\circ$ (36). Rear L.H. 10 swg. x 8 $\frac{9}{16}$ " (18). Rear R.H. 10 swg. x 7 $\frac{1}{2}$ " (18). Rear nipples 10 swg. x $\cdot 250^\circ$ (36).	
Fuel Tank Capacity	2 $\frac{1}{4}$ Imperial gallons (10 litres).	
Fuel Mixture — Petroil	One part recommended oil to 20 parts petrol ($\frac{1}{2}$ pint oil to one gallon petrol or 4 filler cap measures to one gallon petrol).	
Gearbox Oil Capacity	Approx. $\frac{1}{4}$ pint, fill to level plug.	
Chaincase Oil Capacity	Approx. $\frac{1}{4}$ pint, fill to level plug.	
Front Forks Oil Capacity	$\frac{1}{4}$ pint per fork leg (141 cc.)	
Speedometer Head	Smiths 65 m.p.h. or 110 k.p.h. non trip.	
Speedo Cable Length	4' 4".	
Wheelbase (static)	49" (124.5 cm).	
Saddle Height	31" (78.7 cm).	
Ground Clearance	8 $\frac{1}{2}$ " (21.6 cm).	
Width Over Handlebars	27" (70 cm).	
Overall Length	78" (198 cm).	
Approx. Weight	196 lbs. (89 kgms.).	

THE POWER UNIT.

Villiers 197 cc. Mark 8E and 7E Engines

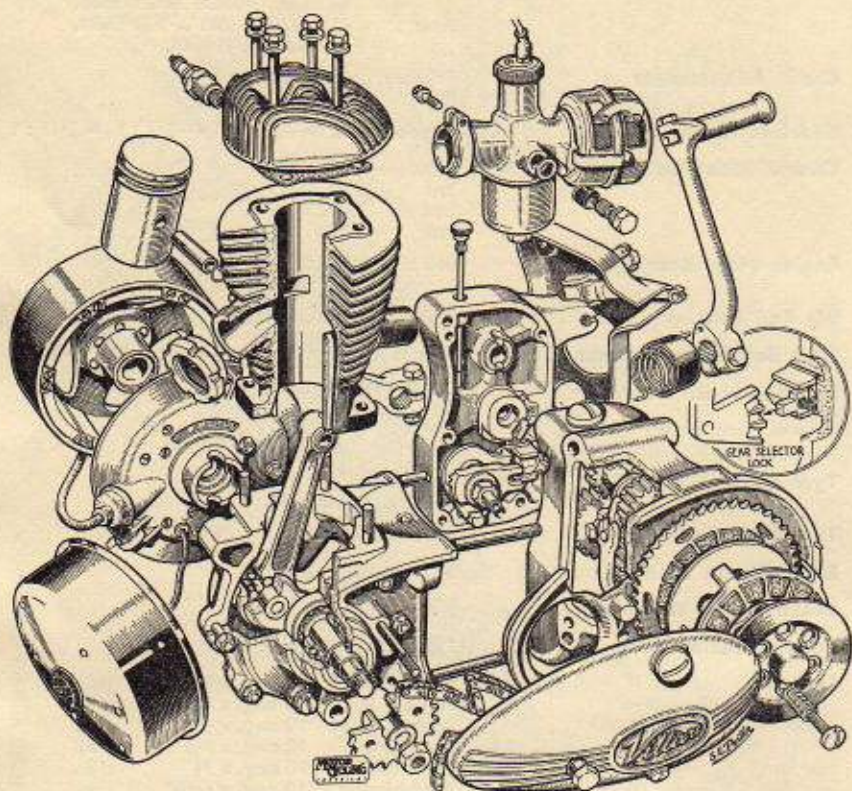

Drawing reproduced by kind permission of "Motor Cycling"

Noted for its almost unfailing reliability and its appetite for hard work, the Villiers 197 cc. two-stroke engine is a highly efficient power unit which, provided it is thoughtfully maintained and lubricated, will give years of service without requiring any major replacements. By virtue of its simplicity, it is cheap and easy to maintain and even owners with no previous motor cycling experience can confidently tackle normal adjustments, maintenance and minor repairs. In the case of major repairs, should they ever arise, we strongly advise the amateur mechanic to entrust the job to a qualified motor cycle repairer or ourselves. The above illustration shows the three-speed unit. The four-speed version is similar. Details of both gearboxes will be found in this booklet.

OPERATION OF TWO-STROKE ENGINE.

In the cylinder walls are arranged four holes or ports, viz. : one inlet port which permits the air fuel mixture to enter the crankcase, two transfer ports which, through passages in the sides of the cylinder, are in communication with the crankcase, and one exhaust port through which the burned charge is allowed to escape. Movement of the piston in a vertical direction is arranged to cover and uncover the ports at suitable times so that the mixture is first drawn from the carburettor through the inlet port into the crankcase. There it is compressed and then forced through the transfer passage into the cylinder above the piston, where it is further compressed. It is then ignited by a spark from the plug, and after expansion due to heat, escapes through the exhaust port into the exhaust pipe and silencer.

LUBRICATION OF ENGINE

In order to maintain the efficiency of the engine and to reduce wear to a minimum it is essential that all moving parts are adequately lubricated. The system adopted for Villiers two-stroke engines is the PETROIL system in which a given quantity of oil is mixed with the petrol. As the mixture first enters the crankcase and then into the cylinder, all working parts are adequately lubricated, and as the amount of fuel used will increase with the power output, it will be seen that a greater quantity of oil is supplied under arduous conditions.

The recommended petrol-oil ratio for James machines is twenty parts of petrol to one part of oil. This works out at 1 imp. gallon of petrol to $\frac{1}{2}$ pint of oil. For practical purposes, a $\frac{1}{2}$ pint oil measure is fitted to the fuel tank filler cap. Thus if one gallon of petrol is purchased, four measures ($\frac{1}{2}$ pint of oil) should be mixed with the petrol. Any fuel is suitable, grade A being preferred. Benzole mixtures can be used with complete safety.

Several countries have special petrol mixing pumps, and most garages are now equipped with petrol mixing cans for two-stroke motor cycles. Owners are strongly advised to ask for this service when purchasing petrol to ensure positive mixing before filling the tank.

If the filling station does not offer a petrol mixing service, it is best to fill the tank with petrol first and to pour the oil in afterwards. The machine should then be shaken from side to side to mix the contents of the tank.

Always remember to push the fuel cock to OFF before refuelling. It pays to buy oils of good repute and the following brands are recommended as providing first-class lubrication when mixed with petrol :

Shell X-100, Wakefield Castrol XL, Vacuum Mobiloil A, BP Energol SAE 30 and Essolube 30.

ENGINE MAINTENANCE.

Periodical decarbonising is the only maintenance job the average owner will want to tackle on the Villiers engine and full instructions are given on pages 22 and 23.

The exploded drawings herewith are self-explanatory, but despite the apparent simplicity of the engine we strongly advise the average owner not to attempt major repair jobs himself, but to entrust the work to a qualified mechanic or to our own Service Department. Splitting and re-assembling the crankcase halves, for instance, is a difficult matter demanding great care and skill, while considerable experience is needed to replace a big end assembly and true the shafts. The James Repairs Department is fully equipped and major repairs entrusted carry a full three months' guarantee. With these facilities at the disposal of James owners, we feel that it will repay our customers not to attempt too much, but to keep within the limits of this book.

TRACING TROUBLES

For the satisfactory running of any Villiers engine it is essential that three main conditions are fulfilled, and by making a systematic and intelligent investigation the faults can usually be located. If the engine stops, symptoms will generally give a clue to the cause, but where this is not the case, the trouble can be more easily traced by following a definite method of investigation. The three conditions mentioned above are as follows :

- (1) The required quantity of petrol-and-air mixture must enter the engine, which means that a proper supply of fuel has to be available from the carburetter, and that the throttle should open and close freely.
- (2) The sparking plug must give a good spark, at the right time in relation to the position of the piston on its upward stroke.
- (3) The engine must be in good mechanical condition, with no air leaks at the various joints.

There must also be efficient compression of the air in the cylinder and crankcase. This can be easily checked by putting the gearbox into the neutral position, and rotating the crankshaft by means of the kickstarter. On every revolution a definite resistance should be felt, caused by the air in the cylinder being compressed.

Making a Preliminary Check. When the cause of the trouble is not evident, carry out a preliminary check covering the following points ; if this fails to trace the cause reference should be made to the Fault Finding Chart (pages 38 and 39).

Having made sure that there is "petrol" in the tank, and that the tap is in the ON position, depress the tickler on the carburetter to ensure that there is no blockage in the fuel supply, either in the tap, fuel pipe, banjo union or fuel needle seating. If the fuel supply is clear, fuel will spurt from the vent hole in the side of the tickler cap.

Being satisfied that fuel is reaching the carburetter, next unscrew the sparking plug, and with the high tension lead still attached, lay the plug on the cylinder head. Turn the engine by means of the kickstarter, and if there is a good spark, it is possible that the ignition timing is incorrect.

Finally examine the carburetter controls to make certain that the throttle is actually opening when the twist grip lever is moved.

SYMPTOMS OF ENGINE WEAR.

BEARINGS.

After considerable service or as a result of inadequate lubrication or negligent driving, wear will occur in the mainshaft and connecting rod bearings.

In both cases the engine will become noticeably rough and probably produce rumbling noises in the case of worn main bearings and definite knocking sounds with a worn big end bearing. Small end wear alone is of little importance and is difficult to detect.

Main bearing wear can be checked by removing the flywheel magneto cover and feeling for up and down movement of the mainshaft by attempting to lift the flywheel.

To check big end wear, remove cylinder head, carburetter and cylinder. Hold the connecting rod firmly in the hand and feel for **up** and **down** movement at the bearing. Sideways movement can be ignored.

If either main bearing or big end bearings are worn, owners are advised to have a complete replacement crankshaft assembly fitted. Reconditioned exchange crankshaft units are available through our Service Dept.

CYLINDER.

Cylinder wear will normally occur only after a long period, but premature wear can be caused by careless running-in or insufficient or poor quality lubricant. The most obvious symptom will be a general drop in performance.

Lack of power can, of course, be due to reasons other than cylinder wear, but if after checking ignition and carburation, engine performance is still below normal, strip the engine and examine the piston rings, piston and cylinder walls for signs of wear in the form of burns, score marks, cracked rings and ovality of the cylinder bore. If the bore is clean, replacement piston rings will often improve engine performance. If a rebore is required, oversize pistons and rings are available (.015" O/S—030" O/S). Always fit a new cylinder base washer when re-assembling the engine. The cylinder head washer may not appear to be damaged but it is advisable to fit a new one each time the head is removed. A reconditioned cylinder exchange service is available. Prices on application to Service Dept.

DECARBONISING THE ENGINE.

We do not specify any particular mileage at which to carry out the task of decarbonisation as the rate at which carbon forms is largely dependant upon the way the rider treats his machine and also the type of riding it is used for. Carbon tends to form more quickly if a machine is used for short journeys than on long runs, when the engine becomes really warm and will blow out most of the carbon. Hence, while one machine may require attention at 2,000 miles another might have accumulated only a slight deposit at 5,000 miles. Irrespective of mileage, it will be time to decarbonise when excessive pinking is heard.

SEQUENCE OF OPERATIONS FOR DECARBONISING.

Remove H.T. lead from sparking plug, disconnect fuel pipe from tank, remove carburettor and exhaust pipe nut from cylinder.

Slacken cylinder head bolts, a quarter of a turn at a time, working diagonally, remove bolts and lift cylinder head.

If required, remove fuel tank, remembering that the top chromed strip should be taken off first.

Slacken and remove cylinder base nuts and spring washers, working diagonally as for head. Position piston at bottom of stroke.

Lift cylinder in one steady movement : do not twist or piston ring may be trapped in the ports.

Remove piston by extracting circlips with thin nosed pliers. Tap gudgeon pin out gently, holding piston so that no shock is transmitted to the connecting rod. It is not necessary to remove gudgeon pin completely.

Remove carbon deposit from cylinder head by careful and gentle scraping with a piece of copper strip or stick of solder sharpened to "screwdriver" shape. Avoid using a steel instrument as this is likely to score the alloy.

Carbon will form around the edges of the exhaust port and may, if neglected, constrict the orifice and hinder the passage of gases. Remove by chipping with aforementioned tool, taking care not to damage the bore.

The piston may be cleaned in the same way as the cylinder head and the top rubbed gently to remove all trace of carbon. The correct way to replace it is with the top piston ring peg to the front. The piston rings may be removed without risk of damage by introducing three pieces of thin metal strip spaced round the piston (see illustration) and then sliding off the ring. Do not scratch the piston.

The piston rings should be bright all round and for the whole width indicating that the whole of the piston ring area is in contact with the cylinder bore. If piston rings are cracked or show brown patches denoting gas leakage, replace with new rings.

Behind the lower ring will be found an expander ring. This is fitted to reduce "piston slap" when the engine is cold. It will be necessary to clean carbon from the expander ring and as it will probably lose its "temper" owing to the heat, it is advisable to renew the expander ring when decarbonising.

Before re-assembling the engine check the piston ring gap. This is done by placing the ring inside the cylinder bore and pushing it against the skirt of the piston to ensure that it is square to the bore. The gap should be checked with a feeler gauge.

Minimum gap $\cdot 012'' \pm \cdot 008''$; Maximum gap $\cdot 03''$.

If gap exceeds $\cdot 03''$, discard and replace.

When re-assembling, fit piston in same manner as it was removed. REFIT CIRCLIPS.

Make sure all faced joints are clean and free from grit when re-building. Always fit new jointing washers at cylinder head and base .

Smear cylinder wall with oil, slide cylinder over the rings with piston at bottom of stroke by pressing side of ring opposite peg into slot and canting cylinder over to retain ring. Press in ring on either side of peg and swivel cylinder gently to and fro gradually lowering over ring. Repeat for lower ring.

Tighten cylinder base nuts and cylinder head bolts in the same order as they were removed. Remember to fit spring washers under base nuts.

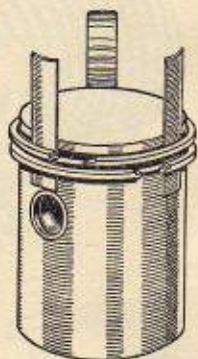

ENGINE AND CLUTCH.

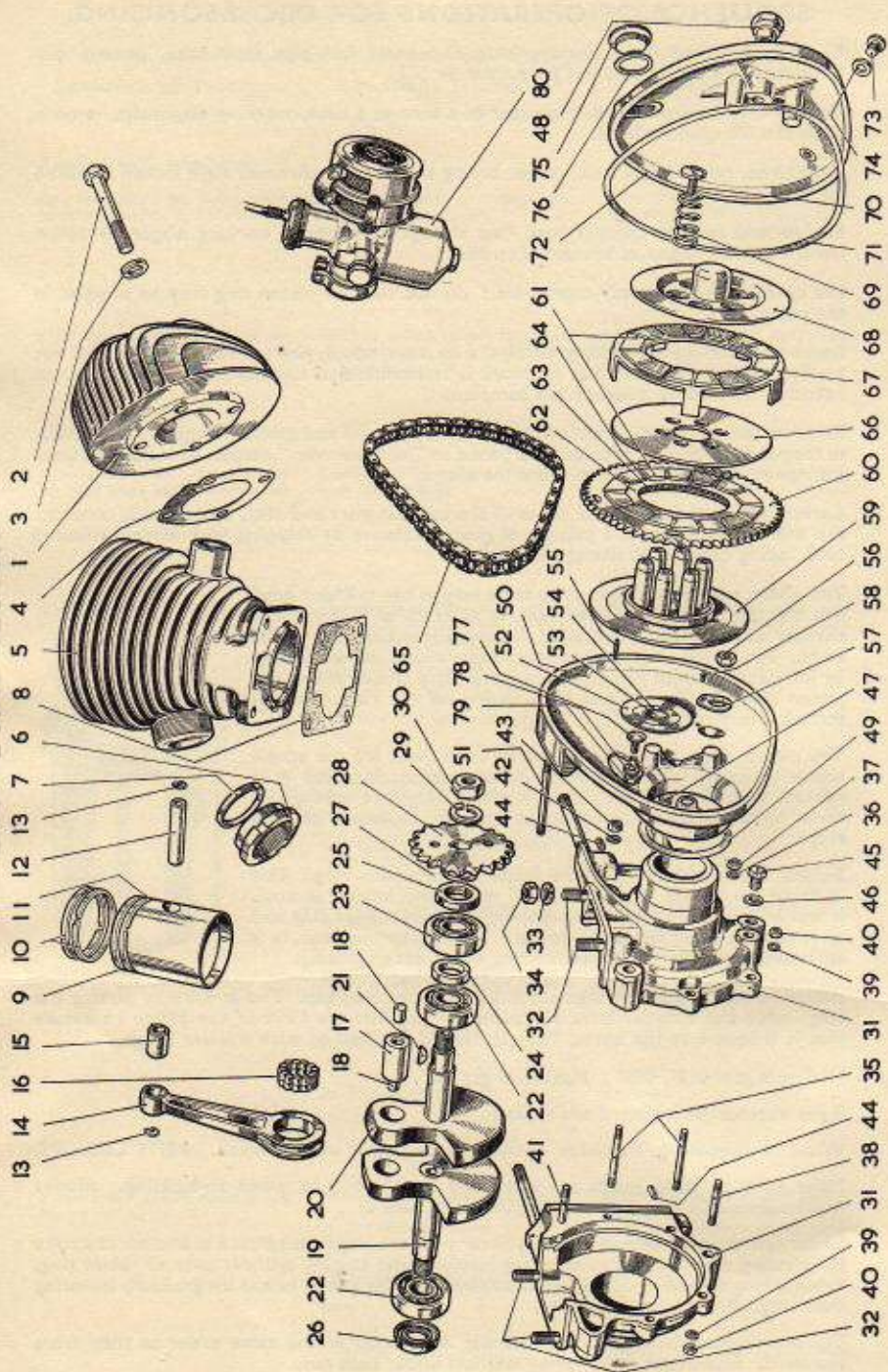

ENGINE AND CLUTCH.

- | | |
|--|---|
| 1 Cylinder head. | 42 Washer. |
| 2 " " bolt. | 43 Nut. |
| 3 Washer. | 44 Dowel in crankcase locating gearbox. |
| 4 Gasket for cylinder head. | 45 Crankcase drain plug. |
| 5 Cylinder. | 46 Washer. |
| 6 Nut for exhaust pipe. | 47 Stud for chaincase. |
| 7 Exhaust pipe washer. | 48 Nut. |
| 8 Gasket for cylinder base. | 49 Gasket. |
| 9 Piston. | 50 Chaincase, inner, with gland plate. |
| 10 " rings. | 51 Stud in chaincase or gearbox. |
| 11 Expander ring. | 52 Gland plate. |
| 12 Gudgeon pin. | 53 Felt washer. |
| 13 Circlip. | 54 Rivets for gland plate. |
| 14 Connecting rod. | 55 Dowel for outer chaincase. |
| 15 Small end bush. | 56 Cone nut for inner chaincase. |
| 16 Rollers for crankpin (26— $\frac{1}{8}$ " x $\frac{1}{4}$ ".) | 57 Lockwasher. |
| 17 Crankpin. | 58 Screw. |
| 18 " plug. | 59 Clutch centre assembly. |
| 19 Crankshaft, right-hand. | 60 Clutch sprocket assembly, comprising items |
| 20 " left-hand. | 61—65 inclusive. |
| 21 Key for engine sprocket. | 61 Cork for clutch sprocket and corked plate. |
| 22 Main bearing ball race. | 62 Ball retaining plate. |
| 23 " " " bearings. | 63 Ball bearings (50— $\frac{3}{16}$ ".) |
| 24 Distance piece for bearings. | 64 Rivet. |
| 25 Oil seal, crankshaft drive end. | 65 Primary chain. |
| 26 " " magneto end. | 66 Centre plate. |
| 27 Shim for engine sprocket. | 67 Corked plate. |
| 28 Engine sprocket. | 68 Front plate assembly. |
| 29 Spring washer. | 69 Spring. |
| 30 Nut. | 70 Screw. |
| 31 Crankcase, right- and left-hand halves. | 71 Gasket. |
| 32 Stud in crankcase for cylinder. | 72 Chaincase, outer. |
| 33 Spring washer. | 73 " " oil level screw. |
| 34 Nut. | 74 Washer. |
| 35 Stud (fitted) securing crankcase halves. | 75 Oil filler plug. |
| 36 Washer. | 76 Washer. |
| 37 Nut. | 77 Breather valve for chaincase. |
| 38 Stud (fitted) securing crankcase halves, short. | 78 Spring washer. |
| 39 Washer. | 79 Nut. |
| 40 Nut. | 80 Carburettor. |
| 41 Stud securing crankcase halves. | |

The clutch requires no attention beyond that of lubrication and correct adjustment of push rod to give the necessary clearance to prevent clutch slip. Whilst the clutch is engaged, i.e., driving, there must be a clearance between end of push rod and the clutch lever fitted to gearbox. A special adjuster having a knurled and slotted head is provided so that adjustment can be made without tools. There should be $\frac{1}{16}$ " total movement at end of gearbox clutch lever before commencing to depress the clutch springs.

DISMANTLING THE CLUTCH.

To strip the clutch and to gain access to the driving sprockets proceed as follows :

Remove primary chaincase cover retained by large domed nut, remembering to place a pan underneath to receive the oil.

Loosen engine sprocket (28) by placing "hammer tight" spanner over the locking nut (30) and giving the spanner a sharp blow with the hand gripped round the clutch springs. It will be found that this will loosen the nut sufficiently for it to be unscrewed by hand.

Unscrew the six clutch springs (69 and 70), withdraw metal plates and intermediate cork-insert plate to expose clutch sprocket (60).

Remove engine and clutch sprockets simultaneously with chain. The former is keyed on a parallel shaft. There are 50 $\frac{3}{16}$ " ball bearings in the clutch sprocket.

Unscrew hexagon nut holding clutch centre assembly (59) by inserting a strong screw-driver between shafts of assembly in such a manner as to prevent its rotation. The assembly is splined on the gearbox shaft and no key is therefore fitted.

Remove engine sprocket key, unscrew nut and washer at back of chaincase, over gearbox. Next, remove small screw and locking plate, below and to the left of the clutch shaft. The nut retained by these parts may now be taken away, when the rear half of the chaincase will be freed. Withdrawal of the case will expose the countershaft or final drive sprocket, held in place by a large thin nut and locking screw. (When re-assembling do not forget to replace the latter and also the engine sprocket-key and locking plate.)

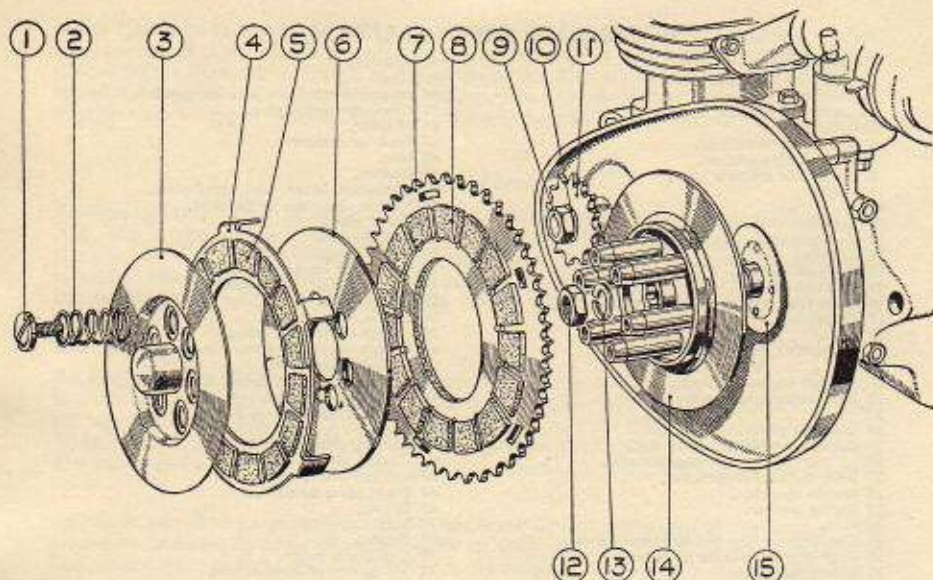

- 1 Clutch spring screw.
- 2 Clutch spring.
- 3 Chaincase gland plate.
- 4 Clutch plate — corked.
- 5 Cork insets.
- 6 Clutch centre plate.
- 7 Clutch sprocket assembly.
- 8 Cork insets.

- 9 Engine sprocket nut.
- 10 Engine sprocket shim.
- 11 Engine sprocket.
- 12 Mainshaft nut.
- 13 Mainshaft spring washer.
- 14 Clutch body.
- 15 Oil seal.

When removing the final drive sprocket do not take off the rear chain ; apply the rear brake so that the sprocket is tightly held by the chain. The same will apply when replacing the sprocket and tightening the nut.
Reverse order of removal when re-building.

PRIMARY CHAINCASE LUBRICATION.

Always specify one of the recommended makes and grades of oil. Do not overfill the chaincase ; excessive lubricant can cause nearly as much trouble as the lack of it. The level should be checked as often as possible. When refilling remove the level plug at the bottom of the case and fill through top filler hole until oil runs out of the plug-hole.

NOTE : The chaincase inner half and clutch centre assembly on 3 speed and 4 speed models are different and are not interchangeable. Owners should note this when purchasing spares. Other parts which differ are the clutch push rod, mainshaft nut and washer. A list of these components is given in the Spares List applicable to the three models covered by this booklet.

WHEN WRITING ON A TECHNICAL MATTER OR ORDERING REPLACEMENT PARTS, ALWAYS QUOTE THE FULL FRAME AND ENGINE NUMBERS — IF YOU ARE UNABLE TO QUOTE THE PART NUMBER SEND PART AS PATTERN.

MAGNETO.

The purpose of the high tension magneto is to produce a hot spark across the points of the sparking plug. The voltage required to produce this spark will vary according to the conditions. In a cold engine the voltage may have to be as high as 10,000 volts, but when the engine is warm, a voltage of between 4,000 and 6,000 will be sufficient to jump across the plug points. A magneto consists principally of permanent magnets, a high tension coil, a contact breaker and a condenser. In the Villiers magneto the magnets are secured to the rotating flywheel, and the high tension coils, contact breaker and condenser are stationary.

The Villiers flywheel magneto has six poles and provides current for both ignition and lighting. The same magneto is used for both DIRECT and RECTIFIER-BATTERY lighting sets although wiring connections differ and reference should be made to the wiring diagrams on pages 30 and 33.

If it is necessary to remove the flywheel magneto, a special "hammer tight" spanner should be used on the centre nut exposed on removal of the flywheel cover. The centre nut is imprisoned in the flywheel and acts as an extractor when turned anti-clockwise.

The armature plate which carries the ignition coil, lighting coils and contact breaker assembly is secured to the crankshaft by four screws. The high tension lead from ignition coil to sparking plug is detachable by unscrewing from armature plate, and when refitting it is important to make sure that the brass pad carried by the spring and secured to the terminal makes contact with the soldered disc on the outside of the ignition coil.

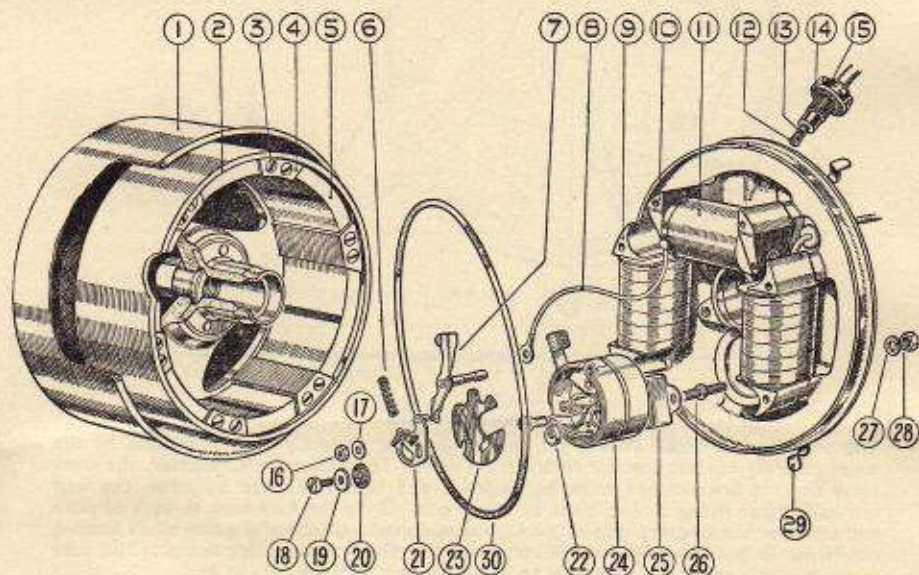

- | | | |
|--------------------------------|-------------------------------|--------------------------------|
| 1 Flywheel cover. | 10 H.T. coil end—right-hand. | 21 Point bracket. |
| 2 Flywheel assembly. | 11 H.T. coil. | 22 Point bracket adjuster cam. |
| 3 Screw, pole shoe. | 12 H.T. terminal pad. | 23 Insulating pad. |
| 4 Top plate, pole shoe, iron. | 13 H.T. terminal spring. | 24 Condenser box. |
| 4 Top plate, pole shoe, brass. | 14 H.T. terminal felt washer. | 25 Condenser. |
| 5 Magnet. | 15 H.T. terminal. | 26 Condenser box fixing stud. |
| 6 Rocker arm spring. | 16 Nut, L.T. lead. | 27 Washer for stud. |
| 7 Rocker arm. | 17 Brass washer. | 28 Nut for stud. |
| 8 Low tension lead | 18 Lockscrew, point bracket. | 29 Flywheel cover clip. |
| 9 Lighting coils with cheeks. | 19 Brass washer. | 30 Cover joint ring. |
| 10 H.T. coil end—left-hand. | 20 Insulating washer. | |

CONTACT BREAKER ASSEMBLY.

This is of the latest type requiring a screwdriver only to adjust the contact points.

To adjust the contact points proceed as follows :

Turn flywheel clockwise until rocker pad is on top of cam profile of flywheel boss. Release the screw "A" (see illustration below). Position bracket "B" by turning adjuster cam "C" until .015" feeler gauge can be inserted between the contact points. Tighten screw "A" and withdraw feeler gauge. It is not necessary to disturb nut "D" when adjusting point gap.

A felt pad is used to keep the cam in a slightly oily condition, and is impregnated when new with grease. This can if visibly dry, be oiled with a small amount of the heaviest oil available. It is better, however, to soak the pad in a molten high temperature grease if it is convenient to detach the box itself for this operation. If too much oil is put on the felt pad it may creep along the rocker arm, get on the contact points, and so cause ignition trouble.

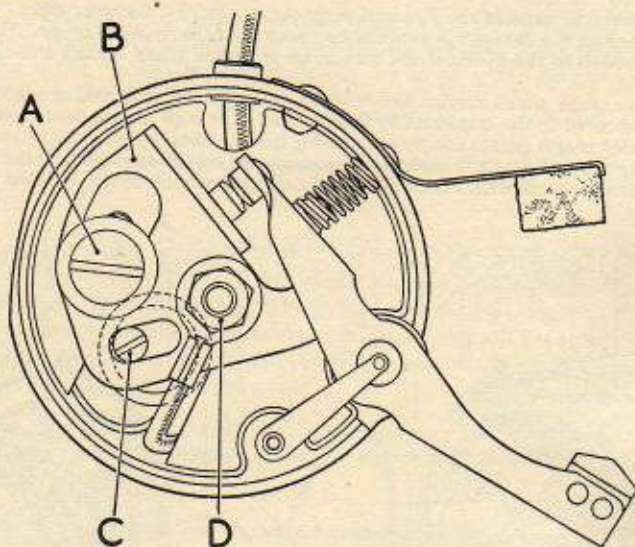

CONDENSER.

The condenser is fitted behind the contact breaker assembly and is retained by the studs securing contact breaker to armature plate. To replace the condenser, the complete contact breaker box must be removed and before this can be done, the four armature plate fixing screws must be taken out. Undo the two nuts at back of plate and unsolder the primary lead at the high tension coil. Unscrew the two studs holding condenser in position and remove screw holding the lead from condenser. This lead must be unsoldered to enable same to be withdrawn through hole in box.

A faulty condenser is usually indicated by continuous and excessive sparking at the contact points, but before fitting a new condenser, make sure the studs holding the condenser are really tight to ensure a good EARTH. Occasional sparking is normal and may be ignored.

IGNITION FAILURE.

The cause of ignition failure will generally be found to be due to the condition of the sparking plug or contact breaker points, or faulty insulation of plug wire or contact breaker connections. Serious trouble in the form of condenser or coil breakdown is very rare.

The first step in dealing with ignition trouble should be to remove plug from engine and examine the points to see whether they are oily and the gap correctly set between .018" and .025". If the insulator is fouled with oil and carbon, there may be sufficient leakage to prevent correct sparking and cleaning will be necessary. Fitting a new plug will readily show whether the failure is due to plug or not.

The plug lead should then be examined for cracks or other faults. The contact breaker can then be examined without removing the flywheel to see whether the points are opening correctly. When the points are fully open there should be a gap of .015". The surfaces must also be clean and free from oil and severe pitting. A piece of stiff paper will usually remove oil or grease. If the points are burned or pitted they should be cleaned with a fine carborundum stone if available, otherwise fine emery cloth can be used, wiping off any traces of metal or emery dust with petrol-soaked rag.

As a result of wear of the heel of the rocker arm bearing on the cam the point gap will be reduced. This wear should be negligible if the felt oiling pad is kept moist with suitable lubricant.

TIMING THE MAGNETO.

Timing marks are provided on the armature plate and flywheel rim. In the armature plate a slot is cut in line with the high tension terminal, and the mark stamped on flywheel rim coincides with the slot when the piston is at the TOP of stroke, the necessary amount of advance being allowed for. To check timing, fit flywheel loosely to shaft, and having set piston at $\frac{3}{8}$ " before top dead centre, rotate flywheel without turning crankshaft until contact breaker points commence to open. Tighten up flywheel centre nut sufficiently to turn crankshaft, rotate until piston is at top of stroke, when timing marks should be opposite each other. Finally, tighten up centre nut hard with "hammer tight" spanner and replace flywheel cover.

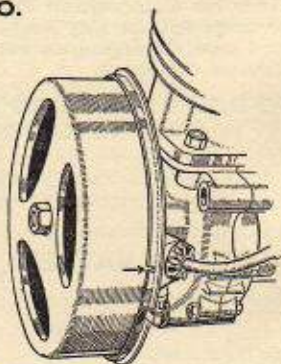

SPARKING PLUG.

A Lodge HH14 (14 mm. short reach) plug is fitted as original equipment. This plug will stand up to the maximum power output of the engine without pre-ignition and if the carburettor mixture is correct, little trouble should be experienced. The point gap should be checked every 2,000 miles and reset to .018"—.025" if necessary.

It is a good plan to carry a spare plug of the correct type so that when the plug in use requires cleaning, it can be removed and the clean spare inserted in its place. Keep the spare plug well wrapped up, to protect the all-important points.

CLEANING THE PLUG.

Grip body very gently in a vice and remove gland nut to free the insulator. Wash in petrol, scraping insulator with a knife or rubbing with fine emery to remove carbon, and wash again. The body can be cleaned internally by scraping and wiped with a petrol-soaked rag. The electrodes should be very carefully scraped. DO NOT rub a wire brush over the points—this will have a ruinous effect. When re-assembling tighten gland nut as much as possible.

Set point gaps to .018"—.025" by tapping OUTSIDE electrodes—NEVER tap the central electrode.

Do not overtighten the plug in the cylinder head; this may result in stripped threads and flattening of the copper washer. A whitish deposit on the insulator denotes a weak carburettor mixture.

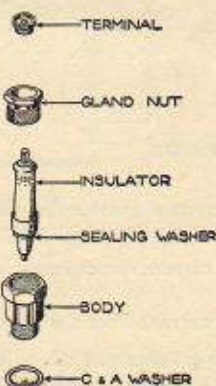

BRIDGING OF PLUG GAP.

This occurs in the form of a deposit between the central electrode and earth points, causing a short circuit and preventing a spark. It is sometimes mistaken for oiling-up but the cause is believed to be the addition of Ethyl Fluid in varying percentages to fuel, the basic quality of which varies considerably. The high working temperature of a two-stroke engine appears to be the reason for this bridging and it follows that a weak mixture, retarded ignition, a choked exhaust system or anything likely to increase the working temperature may result in bridging. Attention to the following will result in an increased mileage before it becomes necessary to clear the points.

- Ensure ignition timing is correct and contact breaker gap is between $.014''$ — $.016''$.
- The carburettor may be set to give a richer mixture.
- The normal spark plug gap should be increased as much as possible consistent with easy starting and good running.

Poor condition of the contact breaker points and connections may also lead to failure.

Note for Competition Models. For competitive use, we recommend Lodge R49 or Lodge R50 sparking plugs. These plugs have high heat values and should only be used once the engine has been "warmed" up with the Lodge HH14 plug fitted as standard equipment.

TO ENSURE BEST PERFORMANCE AND MINIMUM TROUBLE, ALWAYS FIT THE SPARKING PLUG RECOMMENDED BY THE MANUFACTURERS.

RECTIFIER BATTERY LIGHTING SET—MODEL K7 CAPTAIN

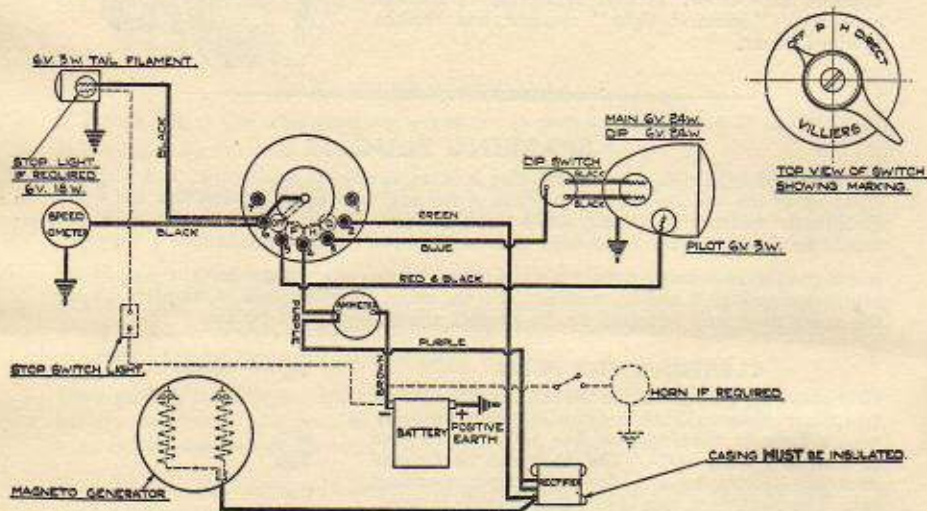

This system enables the rider to be completely independent of the state of charge of the battery for night riding, and the headlamp bulb may be illuminated either by—

A.C. current direct from the generator (switch position marked "Direct")

or

D.C. current from the battery (switch position marked "H").

Parking lights and all other accessories are always operated from current obtained from the battery (switch position marked "P").

When the switch is in the "Direct" position no light can be obtained at the main bulb when the engine is not running, because, in this position the headlamp bulb is not connected to the battery and no current is being produced by the generator. In all the other switch positions the lamps are independent of engine speed, as they are connected to the battery through the headlamp switch.

It is recommended that the "Direct" position should be used on every possible occasion, as this means no current is being taken from the battery by the headlamp. In addition to this, a small charge will also be given to the battery when the engine is running at moderate speeds.

There are two very important precautions which **MUST** be observed in the assembly of this type of lighting set.

- (1) **THE RECTIFIER CASING MUST BE COMPLETELY INSULATED FROM THE FRAME.** The essential is that there should be no direct metallic connection between the casing of the rectifier and any part of the motor cycle.

On the K7 Captain, the Selenium type rectifier is fitted to the back of the battery container and is thus sandwiched out of harm's way between toolbox and battery box. To gain access to the rectifier, it is advisable to remove the toolbox on right hand side of machine. The rectifier itself is secured to the battery container by 4 bolts and if the rectifier is removed it is most important that the insulating fibre distance pieces and washers should be undamaged and replaced in their correct position.

ALWAYS REFER TO THE APPROPRIATE WIRING DIAGRAM WHEN CHECKING CONNECTIONS OR REPLACING CABLES.

- (2) **THE POSITIVE TERMINAL OF THE BATTERY MUST BE CONNECTED TO EARTH.**

NOTE.—In some cases the lead shown on the diagram connecting the generator to the rectifier, may be replaced by a lead from the generator to the No. 2 terminal in the switch. This, of course, does not affect the operation in any way.

IMPORTANT.—When the rectifier lighting set is used, the rectifier and battery must be connected up before starting the engine. If the battery has been removed, the rectifier must be disconnected from the magneto. Failure to do so may result in a burnt out rectifier. It is also important that the lead from magneto to rectifier should not short to earth as this will partially demagnetise the magneto if battery is in circuit.

REPLACEMENT BULBS.

"RECTIFIER-BATTERY" LIGHTING SET.

Head lamp	6 volt, 24/24 watt, twin filament, pre-focus.
Pilot lamp	6 volt. 3 watt M.B.C.
Tail lamp	6 volt. 3 watt M.B.C.
Tail bulb — Stop-light	6 volt. 3/18 watt, twin filament.
Speedo light	6 volt. .17 amp. M.B.C.

BATTERY.

Early K7 Captain models are fitted with a Lucas type PU7-E/9, 6 volt, 12 amp hours battery but later models (February, 1954 onwards) will be supplied with "dry charged" batteries—Lucas type PUZ7E-9, capacity 6 volt, 12 amp hours. The PU7-E/9 is a normal lead/acid battery and requires no description beyond maintenance notes which are given further on. It should be noted that once charged, that is—when the battery is actually in service, the normal attention required for both batteries is identical.

Lucas "Dry charged" batteries are supplied without electrolyte, but with their plates in a charged condition. No initial charging is required and to bring the battery into service it is only necessary to fill the cells with electrolyte, prepared by mixing concentrated sulphuric acid and distilled water. The cell filler holes are sealed to exclude moisture and air before the battery is brought into service and the seals should be removed immediately before electrolyte is poured in.

Preparation of Electrolyte: In the U.K. and countries where temperatures are normally below 90°F. (32°C.) electrolyte of 1.270 S.G. is required, viz: 1 part acid (1.835 S.G.) to 2.8 parts distilled water. In tropical climates where temperatures frequently rise above 90°F., electrolyte of 1.210 S.G. is recommended, viz: 1 part acid (1.835 S.G.) to 4 parts distilled water.

Electrolyte should be mixed in a glass or earthenware vessel or lead lined tank. Temperature of filling room, battery and electrolyte should be maintained at between 60°F. and 100°F.

Batteries filled in this way are 90% charged. After filling, a dry charged battery needs only the attention normally given to lead-acid type batteries.

BATTERY MAINTENANCE.

It will be noted that directions are expressed in terms of TIME instead of MILEAGE as is usually the case with motor cycles.

This is because deterioration soon sets in if the battery is left standing without attention for any length of time. To keep the battery in good condition, maintenance must be carried out whether the machine is in use or not.

Every month (every fortnight in summer), remove battery from pressed steel container, clean terminals, and top-up the three cells to $\frac{1}{8}$ " above the level of the plates with distilled water — NOT tap water, as this contains impurities detrimental to the battery. Pour the distilled water through a glass funnel or syringe.

Many lighting troubles can be traced to unseen corrosion between the surfaces of the battery terminals; the positive is earthed to reduce this effect to a minimum, but keep the terminals clean. A little grease smeared on them will help prevent corrosion.

Do not keep distilled water in receptacles made of any kind of metal as this will quickly render it impure — make use of a clean glass bottle or jar. Rainwater collected in a jar makes a satisfactory substitute for distilled water.

NEVER bring a naked light near a battery with vent plugs removed or when the battery is being charged; the gas given off by the electrolite is dangerously explosive.

Battery acid is highly corrosive; therefore throw away any cleaning rags used to clean the battery lest their use on other parts of the machine causes rust.

NEVER let a battery completely run down; if this does occur, get it charged as soon as possible, or its length of life may be seriously shortened.

DIRECT LIGHTING SET—MODELS K7C and J9.

If required, a lighting set can be fitted to models K7C and J9. This is a Direct lighting system in which the alternating current is taken direct from the lighting coils in the flywheel generator to the lamps via the headlamp switch. There is no separate earthing cable, the lighting coil windings are earthed inside the magneto

A dry cell battery provides current for parking lights, and owners are advised to make maximum use of the Direct lighting and to use the dry battery for parking purposes only. The battery should be thrown away when exhausted, replacement being perfectly straightforward.

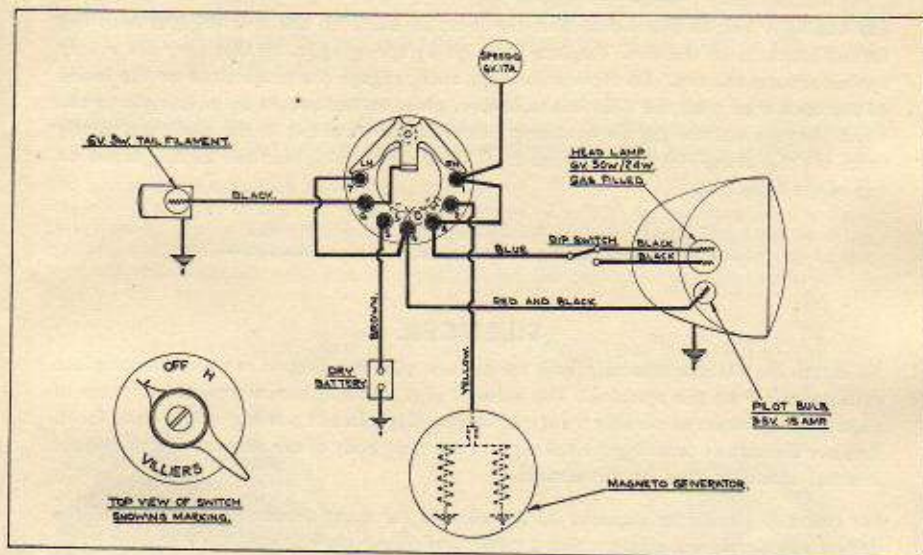

REPLACEMENT BULBS.

"DIRECT" LIGHTING SET.

Head lamp	6 volt. 30/30 watt, double filament S.B.C.
Pilot lamp	3.5 volt. .15 amp. M.E.S.
Tail lamp	6 volt. 3 watt M.B.C.
Speedo	6 volt. .17 amp. M.B.C.

HEADLAMP.

The switch panel is retained by four screws and supports the wiring harness. The main bulb has twin filaments, one filament providing the main driving beam and the other a dipped beam, brought into operation by the dipper switch on the left handlebar, when required. The pilot bulb is mounted behind the reflector and shines through a small window in the reflector under the main bulb.

The design of the lamp holder, lamp and reflector assembly is such that when the bulb is correctly positioned, no focussing is required.

The reflector and front glass are made up as one assembly and no attempt should be made to separate them. The components cannot be purchased separately.

REMOVING LIGHT UNIT AND HEADLAMP RIM.

Slacken the screw on top of the lamp body at the front, pull the rim outward from the top and, as the front comes away, lower slightly to disengage bottom tag from lamp shell. Twist the back shell in an anti-clockwise direction and pull it off. The main bulb can then be removed from its housing in the reflector assembly. The lamp rim is secured to the light unit by spring clips which can be removed by pressing with a screwdriver blade, at the same time working away from the edge.

REPLACING RIM AND LIGHT UNIT.

Lay the light unit in the rim so that the location block on the unit engages with the forked brackets on the rim. Replace the clips by springing in, so that they are evenly spaced around the rim. To replace the back shell, engage the projections on the inside of the back shell with the slots in the holder, press on and secure by twisting it to the right. Engage bottom tag on headlamp rim with the small slit in the shell, and gently force the top of the rim back into the shell, after which re-tighten the locking screw on top of the lamp body.

SILENCER.

To detach the silencer assembly from the exhaust pipe it is best to remove the complete exhaust unit from the machine. The exhaust pipe nut may be unscrewed by means of a special C-spanner, obtainable from our Service Department ; it has a right-hand form. Remove the screws securing the tail pipe to the main body of the silencer and the whole internal assembly may be withdrawn.

No attention should be required by the silencer for many thousands of miles, and the design is so simple and efficient that a method of cleaning will immediately suggest itself.

TOOLS.

The standard tool kit supplied with new machines consists of :

- | | |
|--|--|
| 1 Plug spanner. | 1 Open ended $\frac{3}{16}$ " x $\frac{1}{2}$ " spanner. |
| 1 Magneto spanner with .015" feeler gauge. | 1 " " $\frac{7}{16}$ " spanner. |
| 1 Screwdriver. | 2 Tyre levers. |
| 1 Exhaust pipe spanner. | 1 Hand pump. |
| 1 Open ended $\frac{5}{16}$ " x $\frac{3}{8}$ " spanner. | |

Special tools available.

Villiers hammer tight spanner.
Oil gun.

Grease gun.
Rivet extractor.

Optional Equipment.

Combined crashbar and legshields.
Pannier frames and bags.
Electric horn (K7C and J9).
Stop-light.

Windscreen.
Pillion footrests.
Rear carrier (K7 with saddle).
Direct lighting set (K7C and J9).

CARBURETTER.

The function of the carburetter is to supply a mixture of fuel and air in correct proportion under all conditions. In the Villiers carburetter the float chamber surrounds the centrepiece with jet, and inside the chamber the annular float rises as the fuel enters, until reaching the correct level. The fuel supply is then cut off by the conical ended needle operated by a forked lever resting on top of float. Fuel enters the jet body through a side hole and passes into the centrepiece through a small calibrated hole.

The throttle operated by the cable opens up the air supply to the inlet port and is fitted with a long taper needle which extends below the throttle and into the centre-piece. The combination of suitable jet size, degree of taper and position of taper needle gives a correct mixture strength at all throttle openings.

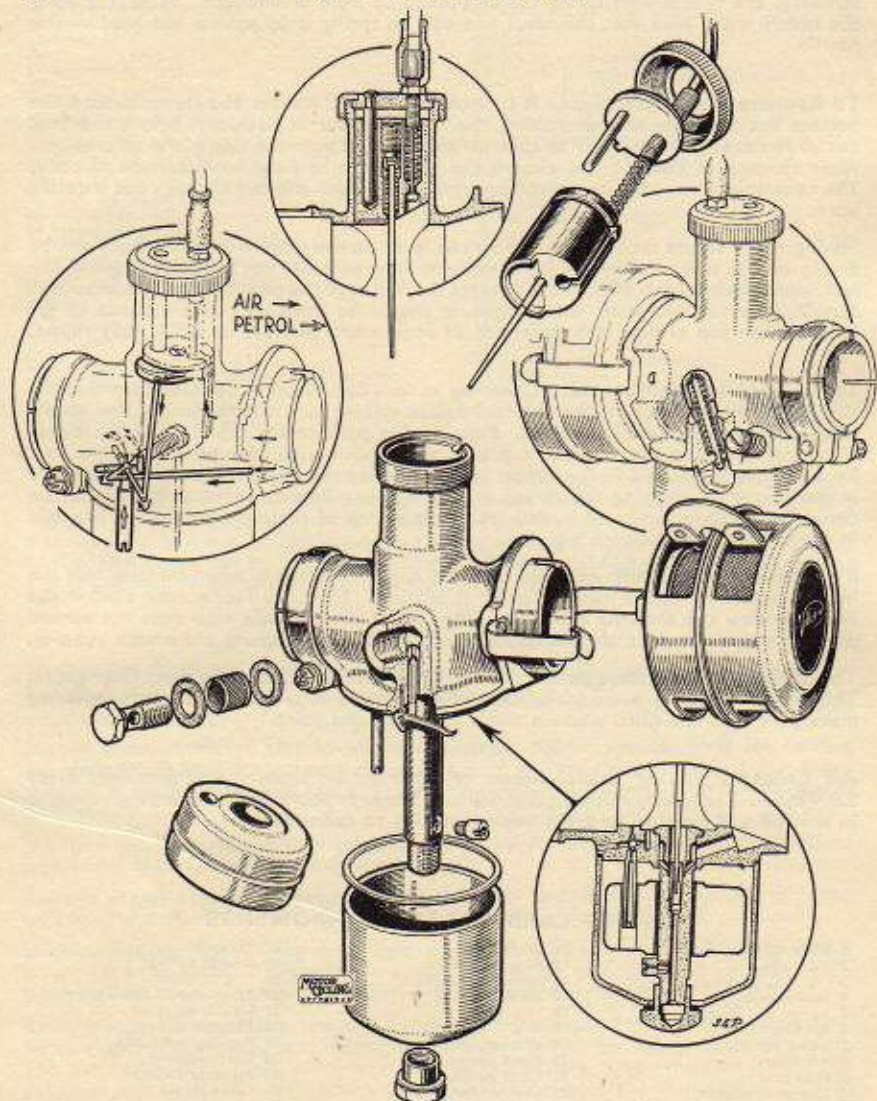

Exploded diagrams of Villiers Type S.24 Carburetter by courtesy of "Motor Cycling."

In the Type S.24 carburetter fitted to James Captain, Cotswold and Commando models, the position of taper needle in relation to the throttle is adjustable by means of the special screw situated in centre at top of throttle. This adjustment is provided to suit individual engines, and it should not be necessary to alter the maker's setting except after considerable mileage. The standard setting from throttle to end of taper needle is 1.95".

DISMANTLING.

To Change the Taper Needle. Remove throttle from body after unscrewing the top ring, and in the centre at top of throttle will be found a small slotted screw. This is the adjuster referred to in the previous paragraph, and when this is removed by unscrewing, the needle with spring can be pushed up from underneath. When replacing the needle make sure that the small end coil on spring is up against the head of the needle.

To Remove the Centrepiece. It is necessary first to remove the throttle, then the bottom nut and fibre washer holding the float chamber in position. Before the float can be removed it is necessary to unscrew the main jet from the side of the centrepiece. After removal of float do not disturb the pilot jet tube fixed to underside of body. The centrepiece can now be pushed up from underneath and out through the throttle bore.

Having removed the centrepiece, the forked lever on the underside of the body can be swung on one side to allow the fuel needle to drop out. Do not alter the shape of the fuel needle lever as this component governs the height of the petrol in the float chamber. Should, however, the lever be damaged, it should be reset to give a distance of $\frac{3}{16}$ " between the top of float and underside of body when the fuel needle is fully raised.

To Re-assemble Carburetter. Clean the various components and make sure that the tickler vent hole is clear. Insert the centrepiece making sure that the forked fuel needle lever and fuel needle are in position. Place float in position and replace main jet in side of centrepiece. Clean out the float cup and replace with large fibre joint washer at top. Replace bottom nut and fibre washer, but do not use too much force, otherwise there is the danger of stripping the thread of centrepiece. Replace throttle in body at the same time guiding the taper needle into hole in top of centrepiece. Locate top disc in top of body and screw on top ring.

If the carburetter has been removed from the engine, make sure when refitting that the body is pushed on to the manifold as far as possible. There are four narrow slots in the body to allow the securing clip to function, and if the manifold stub does not extend past the end of the slots, air will be sucked in causing hard starting and erratic running.

The carburetter has a banjo petrol pipe fitting inside of which is a fine mesh filter gauze. This filter should be periodically cleaned by dipping in petrol, and when replacing make sure that the fibre washers make a petrol-tight joint.

Air Cleaner. The air cleaner should be removed for cleaning approximately every 2,000 miles. Remove by releasing clip, dip the cleaner in petrol and, after drying, immerse in thin oil and hang up to drain before refitting to carburetter.

LIST OF CARBURETTER COMPONENTS

1 Body with fuel bush.	14 Bottom nut.	27 Throttle.
2 " clip.	15 Pilot jet needle.	28 Needle spring.
3 " " screw.	16 Spring for needle.	29 " collar.
4 Fuel needle.	17 Tickler spring.	30 Taper needle No. 3½.
5 " " lever.	18 " " split pin.	31 Needle adjuster.
6 Air filter clip.	19 " " split pin.	32 Throttle spring.
7 Screw for clip.	20 Washer, small hole.	33 Top disc with peg.
8 Air filter.	21 Banjo union.	34 Cable adjuster.
9 Pilot jet.	22 Filter gauze.	35 Adjuster locknut.
10 Cup joint washer.	23 Washer, large hole.	36 Cable nipple.
11 Float.	24 Banjo bolt.	37 " cover.
12 " cup.	25 Main jet, centrepiece.	38 Top ring.
13 Bottom nut washer.	26 Centrepiece.	39 Throttle cable complete.

TYPE S.24 CARBURETTER.

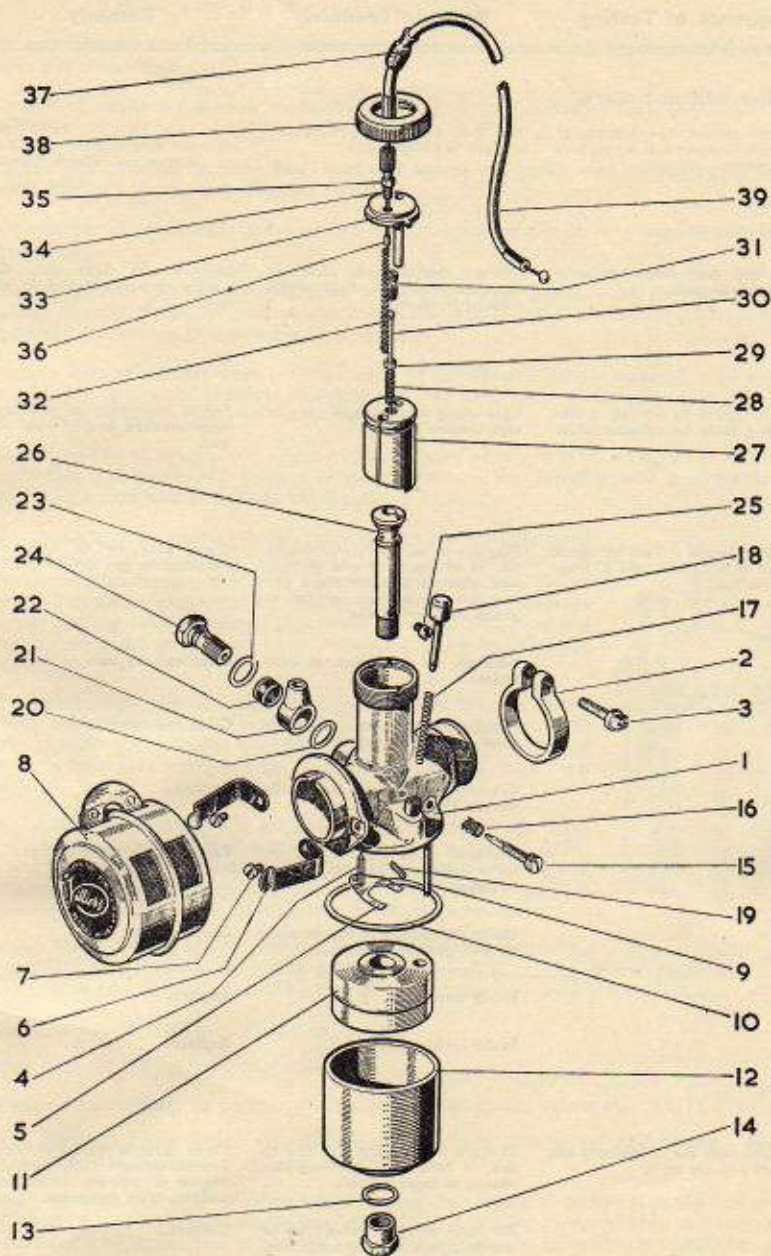

See key on opposite page.

ENGINE — FAULT FINDING CHART.

Sequence of Testing.	Possible Trouble.	Remedy.
Engine will not start.		
Depress tickler on carburetter to check whether fuel is reaching carburetter.	No fuel reaching carburetter, air lock in petrol pipe.	Turn tap to ON, refill tank, clear air vent in filler cap. Turn on reserve tap where fitted.
If no fuel, even when tap is on and fuel is in tank.	Choked petrol pipe, filter on tap, filter in banjo. Fuel needle sticking in seating.	Remove and clean out. Dismantle carburetter and fit new needle.
Test for spark by holding sparking plug body on cylinder head.	Leak along insulation of plug or high tension lead.	Try a new plug of the type recommended and/or new H.T. lead.
If still no spark : Test for spark at end of H.T. lead held $\frac{1}{4}$ " from cylinder fins.	Plug points may be oily or sooted up. If no spark at end of H.T. lead, contact breaker point gap may be too narrow, or points pitted or dirty or oily.	Clean plug or fit new one. Adjust point gap to .015". Clean.
	Moisture on insulation of condenser.	Clean and dry out.
	High tension terminal not making good contact on ignition coil.	Clean and correct.
	Cracked insulation of adjustable contact breaker point.	Replace.
	Damaged insulating sleeving on wires connecting contact breaker to coil or condenser.	Replace with new sleeving.
	Faulty connection to low tension wire of ignition coil.	Correct.
	Faulty condenser.	Replace.
	Faulty ignition coil.	Replace.
If above tests are satisfactory but engine will not start.	Mixture may be too rich due to use of strangler, or incorrect setting of taper needle.	Open throttle wide and depress kickstarter several times to clear engine of petrol, adjust taper needle, drain crankcase.
	Air leaks at carburetter stub or manifold joint causing weak mixture.	Correct.
	Incorrect ignition timing.	Check following instructions given.

FAULT FINDING CHART — (continued).

Sequence of Testing.	Possible Trouble.	Remedy.
Engine Four or Eight Strokes.		
Strangler may not be fully open or taper needle in a too high position. Air filter may need cleaning.	Mixture too rich.	Lower taper needle by moving to a WEAKER position. Lower needle by adjuster screw fitted in throttle.
Check by watching for excessive smoke from exhaust pipe or silencer.	Engine may four stroke for a little while after standing due to accumulation of oil in crankcase.	Usually ceases when engine has been running for a few minutes unless too much oil has been mixed with the petrol.
	Flooding of carburetter.	Persistent flooding is usually due to dirt under fuel needle seating, or sticking fuel needle, damaged seating or punctured float.
Engine Lacks Power.		
	Engine out of tune, bearings worn. Unsuitable sparking plug. Loss of compression.	Overhaul. Replace with recommended type. Tighten cylinder head bolts. Replace worn piston rings.
	Incorrect "petrol" mixture.	Correct mixture is 1 part oil, 20 parts petrol.
	Excessive carbon deposit on piston crown and cylinder head.	Decarbonise.
	Exhaust system choked with carbon.	Clean out silencer and exhaust pipes.
	Incorrect carburetter setting.	Check and adjust.
	Air cleaner choked.	Wash in petrol, drain and dip in thin oil.
	Obstruction in fuel supply.	Clean out tap, fuel pipe and filters.
	Incorrect ignition timing.	Check and adjust.
	Brakes binding.	Adjust.
	Driving chains too tight.	Adjust.
Engine will not run Slowly.		
	Weak mixture due to air leaks at carburetter stub or manifold joint, crankcase and cylinder base joints.	Tighten all joints.
	Crankcase drain screw loose or missing.	Tighten or replace.
	Worn crankshaft bearings or leaking seal.	Replace.
	Ignition timing too far advanced.	Correct.
Engine Suddenly Stops Firing.		
	Sparking plug lead detached.	Replace and tighten nut.
	Plug points bridged by oil, carbon, or deposit caused by use of leaded petrol.	Clean or replace.
	Short circuit of high tension current by water on H.T. lead.	Dry out.

LUBRICATION OF CONTROLS.

All controls should be adequately lubricated to ensure complete control of the machine at all times. These include levers, cables, brake connections. Small lengths of cable that are exposed should be smeared with grease.

Avoid excessive use of oil on the control levers, as the oil is likely to run along the lever and make them slippery and unpleasant to operate. Do not forget to oil the centre stand pivots.

TWIST GRIP ADJUSTMENT.

Adjustment of the spring tension on the twist grip sleeve is effected by means of a screw and locknut in the bottom half of the twist grip casting. To increase tension turn the screw clockwise and tighten locknut.

The twist grip should not be adjusted so that it is difficult to turn as this will probably result in an aching wrist. Adjustment should be such that the grip is easy to operate but remains in position when the hand is removed for signalling, etc.

CARBURETTER CABLE ADJUSTMENT.

A certain amount of slack may develop in the throttle cable after a time ; this can be taken up by means of the adjuster on top of the carburetter.

CHAINS.

A chain is an assembly of links with rollers connected together by outer link plates and held together by rivets. If it is kept clean, adequately lubricated and correctly adjusted, a chain will give little trouble and will wear out long before breaking point is reached.

The front chain is fully enclosed in an oil bath and consequently wear will be negligible over a long period. The rear chain, being exposed and more heavily loaded is more likely to give trouble through neglect and should be regularly checked for tension and frequently lubricated.

ADJUSTMENT OF REAR CHAIN.

The rear chain will probably require adjusting after completion of the first 200 miles (320 kms) owing to stretch which occurs with all new chains. To take up the play, loosen both rear spindle nuts. The adjusters must be rotated the same number of turns in the same direction to keep the wheel in alignment, until there is approximately $\frac{3}{8}$ " to $\frac{1}{2}$ " up and down movement in the bottom run of the chain. Check adjustment in various positions by rotating the wheel a little. This is necessary because there is always one spot tighter than the rest. After adjusting, do not forget to tighten the spindle nuts. Re-adjust knurled nut on the brake rod to obtain the correct tension.

Never drive with the chain too tight — this will ruin the gearbox main bearing very rapidly.

CLEANING AND LUBRICATING THE CHAIN.

A chain cannot be cleaned merely by drenching with oil while in position on the machine. The best way to do the job is as follows :

Remove spring clip and connecting link and take chain off the sprockets. Soak in a bath of paraffin using a stiff brush to remove all external dirt and allow paraffin to run through the joints of the chain. All grit and dirt between the joints must be removed. Swill in clean paraffin and hang over a pan to allow it to drain.

Immerse chain in a tin containing graphited grease that has been heated until fluid over a pan of boiling water. Move the chain about in the grease until grease has cooled off to normal semi-solid state. Remove chain from grease and wipe off surplus.

NOTE.—When replacing chain, see that the spring clip faces in direction of drive, i.e., closed end of link should face forwards on top run of chain.

ALTERATIONS TO LENGTH OF REAR CHAIN.

If chain has an even number of pitches, that is, a cranked link is not used in the chain, remove the rivets holding the second pair of outer link plates (see A) which will shorten the chain by four rollers and two pairs of outer link plates. Replace with a cranked double link and single connecting link (B).



If chain has an odd number of pitches, remove rivets holding the second pair of outer links (see A) (first pair will be cranked) and replace with single connecting link and inner link (B).

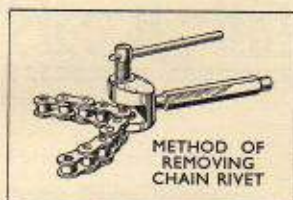
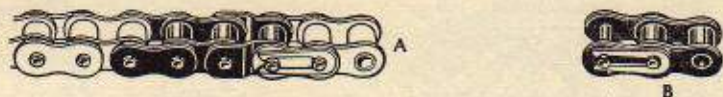

CHAIN COMPONENTS

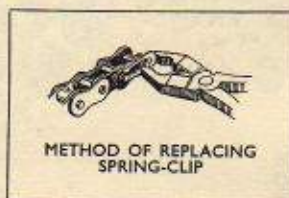

FITTING A NEW REAR CHAIN.

To simplify the task of fitting a new rear chain, disconnect the old chain at the rear wheel sprocket by removing the single connecting spring link. Connect old chain to new chain, when by pulling the bottom run of the old chain, the new one can easily be carried round the gearbox sprocket, whereupon the old chain is disconnected and the ends of the new one connected together. Care should be taken when fitting a new chain to keep it from contact with the floor or any place where it is likely to collect grit, etc.

REPLACEMENT CHAINS.

Model	K7 Captain	K7C Cotswold	J9 Commando
PRIMARY CHAIN			
Size	$\frac{3}{8}'' \times \frac{1}{4}'' \times .225''$	$\frac{3}{8}'' \times \frac{1}{4}'' \times .225''$	$\frac{3}{8}'' \times \frac{1}{4}'' \times .225''$
No. of links	66	66	66
Renolds No.	110038	110038	110038
REAR CHAIN			
Size	$\frac{1}{2}'' \times .335'' \times .205''$	$\frac{1}{2}'' \times .335'' \times .205''$	$\frac{1}{2}'' \times .335'' \times .205''$
No. of links	121	123	116
Renolds No.	110044	110044	110044

DISMANTLING 3-SPEED GEARBOX.

If it is necessary to gain access to the interior of the gearbox proceed as follows :

Drain oil through bottom plug (12).

Remove kick-starter lever (86) and foot gear control (49). Both are retained on their splined shafts by pinch bolts (51).

The gearbox dust cover (77) is held by three screws ; removal of this cover will give access to the bushed end plate (66). The clutch lever (83) will then come away, as it is held only by pressure of the clutch adjuster (82). Unscrew clutch cable adjuster at top left of end plate.

The end plate is retained in position by three screws and three hexagon nuts. Before removing them, however, loosen large dome nut (65) alongside the foot lever shaft, this houses the selector plunger assembly. When all nuts and screws are removed, the plate will be ready to slide off : remove, leaving kick-starter shaft (40) in position in low gear ratchet pinion. If need be, the kick-starter pawl (41) may be removed by pressing down spring and plunger and sliding the pawl along its seating.

The mainshaft cannot be removed unless the clutch unit has been dismantled as described on page 25. When this has been done, the mainshaft will come away, leaving final drive sprocket (5) and high gear sleeve pinion (26) in position. The layshaft (30) may be withdrawn most easily by taking out the selector quadrant (18) retained by a bearing pin at the side of the box.

To replace the layshaft, pinion assembly and sliding pinion operator (33), push the layshaft right into its bush, ensuring the operator is correctly fitted. Before fitting the end plate, remove the selector plunger (19) and spring, and place kick-starter shaft in the end plate bush, turning it to its stop pin (63). This will facilitate pushing the plate home.

The positive stop gear change mechanism at the back of the end plate should not be interfered with unless absolutely necessary, as it is very easy to re-assemble incorrectly. If, for any reason, dismantling is required, follow the order of assembly shown on the exploded drawing very closely.

The end plate and dust cover are thin aluminium alloy castings and when replacing fixing screws and nuts it is important that the respective washers should be in their recesses. The hexagon nut washers **MUST** be fitted, or a cracked dust cover may ensue.

Clean all faced joints with petrol when re-fitting, using a jointing compound such as gold size.

The mainshaft fixed pinion (29) engaging with the layshaft ratchet pinion is a press fit on the mainshaft and cannot be easily removed whilst in the gearbox. This also applies to the fixed pinion on the layshaft (31).

If all the parts are correctly fitted and positioned, the end plate will slide home without difficulty. If it will not do so, do not force it on, but find out the reason.

It is best to strip and re-assemble the gearbox with the gears in the NEUTRAL position ; you can then ensure that the knob on the selector quadrant assembly is properly placed in the fork of the operating lever (58).

ADJUSTMENT OF MAINSHAFT.

This is carried out by means of the barrel adjuster (82) in the dust cover end plate. Slacken slotted locknut (69) and turn barrel centre gently in a clockwise direction until only a trace of end play exists. Tighten collar securely. To avoid premature wear, leave a little end play (about .002").

After re-assembling gearbox, engage gears one by one to make sure everything is in working order.

FOOT CHANGE MECHANISM — 3-SPEED GEARBOX.

We do not recommend that the foot change mechanism should be removed, but if this is necessary for any replacement of the parts, proceed as follows :

Remove the circlip outside the cover on the end of the foot change spindle ; the shaft will then slide out complete with all the ratchet members. In order to strip down the shaft, turn down the locking plate tab (61) and hexagon nut (62). Note the position of all the parts before dismantling, as it is easy to re-assemble incorrectly, which will prevent the mechanism from working at all. Do not lose or damage the phosphor bronze shims (59) found under the washer with the "D" shaped hole. Before re-assembling make sure the face teeth on both ratchet members are not damaged. Do not attempt to remove the "D" shaped stop pin which is pressed into the gearbox cover.

GEARBOX LUBRICATION — 3-SPEED GEARBOX.

Remove the oil level dipstick, situated alongside the oil filler plug on the top of the gearbox, to check oil level. The "full" position is indicated by the groove about $\frac{3}{8}$ " from bottom of dipstick. If level is found to be below level of dipstick, remove filler plug and top-up with the oil recommended (SAE 140). Examine every 1,000 miles approximately, and drain every 5,000 miles by removing drain plug in bottom of box.

LIST OF 4-SPEED GEARBOX COMPONENTS

1	K.S. crank pedal.	40	Layshaft.
2	" " "	41	Layshaft low gear pinion, 16T.
3/4	" " pedal spring and ball.	42	" 2nd " " 21T.
5	" " bolt.	43	" 3rd " " 24T.
6	Operator shaft securing pin.	44	" high " " and K.S. pinion 27T.
7	Dished washer.	45	" bush pen steel washer.
8	Gear indicator.	46	K.S. pawl plunger.
9	Outer bush for operator.	47	" " " spring.
10	Stop plate and spring retainer.	48	" shaft.
11	Control ratchet, female.	48a	" " bush.
13	" " male.	49	" pawl.
14	Control plate.	51	" oil seal ring.
15	Bush for control plate pin.	52	Selector plunger spring.
—	Spring stop for control plate.	53	" " box washer and nut.
16	Operating pin for pawl plate.	54	Drain plug.
17	Pawl plate spring.	55	Ball race (small).
18	Adjuster plate.	56	Grease nipple.
19	Lever return spring.	57	K.S. return spring.
20	Operator shaft (complete with lever).	58	Short control lever.
21	Gear box inner cover.	59	Bearing cap.
22	K.S. stop plate.	60	Mainshaft nut, left-hand thread.
23	Inside operator.	61	Oil thrower.
24	" " anchor pins.	62	K.S. stop plate pin.
25	Mainshaft high gear pinion 15T.	63	Operator bush.
26	Dip stick.	64	Clutch lever.
27	Ball race (large).	65	Bearing cap pins, $1\frac{1}{2}$ " x $\frac{1}{2}$ " hex., $\frac{1}{2}$ " x $\frac{1}{2}$ " hex.
28	Oil seal retainer.	66	Clutch lever adjuster sleeve and ball.
29	Gear box oil seal.	67	" " pin.
30	Final drive sprocket, 17T.	68	Foot change rubber.
31	Sprocket gland nut.	69	" " lever.
31a	" " felt washer.	70	Gear box outer cover.
31b	" " locking screw.	71	K.S. crank pinch pin, nut.
32	Mainshaft low gear pinion 26T.	72	Cover pins, 3 " x $\frac{1}{2}$ " CH., $1\frac{1}{8}$ " x $\frac{1}{2}$ " CH., $\frac{1}{2}$ " x $\frac{1}{2}$ " CH.
33	" " sleeve.	73	Clip bolt for lever.
34	Layshaft bush (box).	74	Inspection cover.
35	Gear box case.	75	" " pin.
36	Selector plunger and selector plunger box assembled.	77	Nut for adjuster plate pin.
37	Mainshaft.	78	Adjuster plate pin.
38	" " sliding gear, 21T and 18T.	79	Bush for adjuster pin.
39	Operator fork.	80	Spring stop for adjuster plate.

VILLIERS 4 SPEED GEARBOX

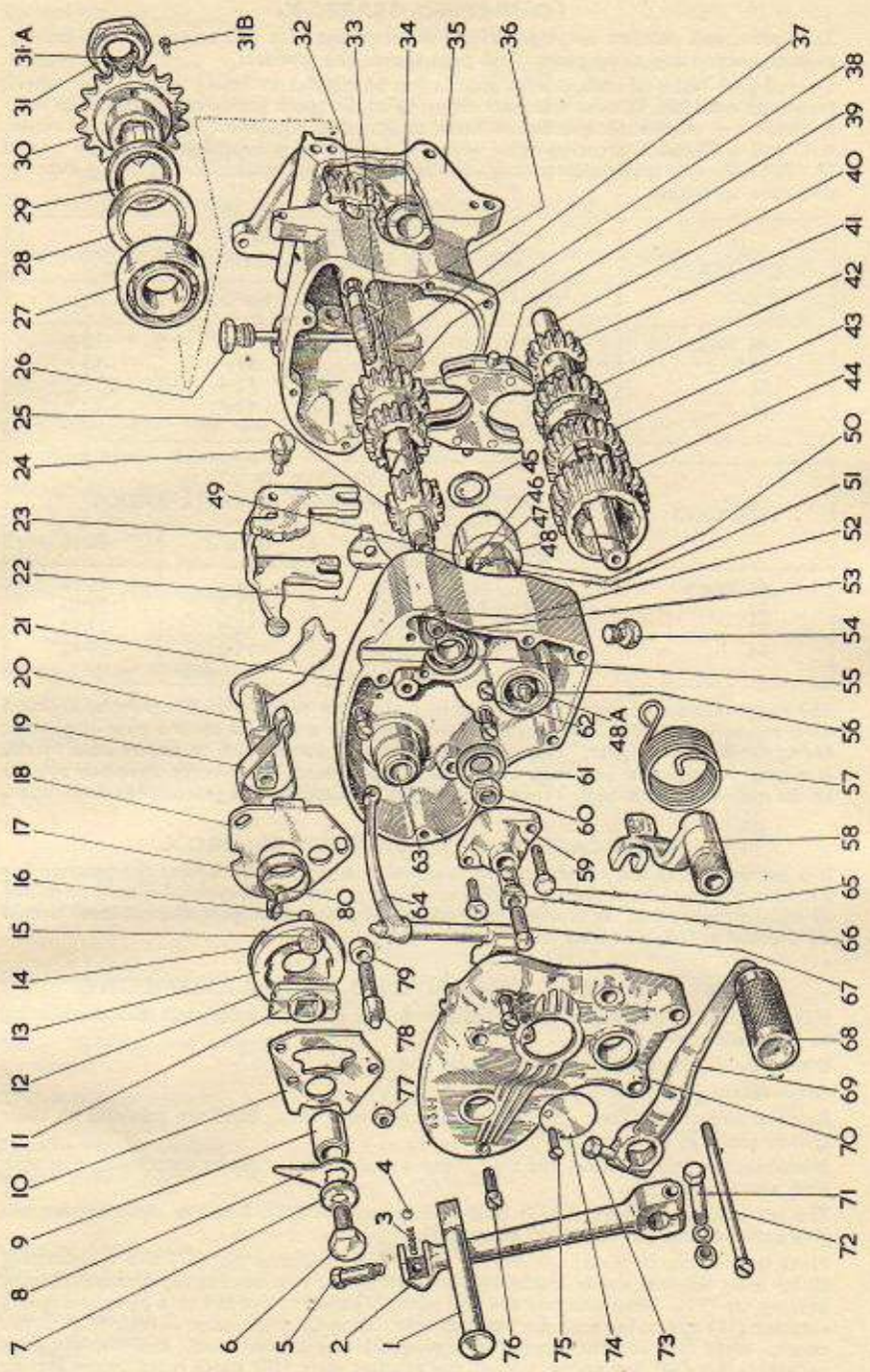

FOUR-SPEED GEARBOX.

The four-speed gearbox employs driving dogs on the first and top gears and driving pegs on second and third gears. The pegs are on the layshaft.

Overall gear ratios of competition models can be altered by fitting varying rear wheel sprockets available in even numbers from 48 to 54 teeth inclusive. A 48-tooth rear sprocket and close ratio gearbox is fitted as standard equipment on scrambles model K7C and a 50-tooth sprocket with wide ratio gearbox is supplied with trials model J9. The following tables indicate the variations which can be obtained by fitting alternative rear sprockets.

SPROCKET	MODEL K7C CLOSE RATIO GEARBOX (OVERALL RATIOS)			
	Top	Third	Second	First
48 Teeth	6.27	8.48	11.3	18.2
50 "	6.53	8.81	11.75	18.9
52 "	6.79	9.17	12.4	19.7
54 "	7.05	9.52	12.7	20.4

SPROCKET	MODEL J9 WIDE RATIO GEARBOX OVERALL RATIOS			
	Top	Third	Second	First
48 Teeth	6.27	8.48	14.41	21.78
50 "	6.53	8.81	15.0	22.62
52 "	6.79	9.17	15.6	23.58
54 "	7.05	9.52	16.2	24.42

The gearbox internal ratios can be altered from close to wide or inversely by fitting a different mainshaft slider and layshaft low gear, also a layshaft second gear slider and corresponding lower gear. Therefore, should a K7C owner wish to obtain wide ratios, it is only necessary to exchange these four components. The reverse obviously applies to the owner of a J9 model. When fitted to the K7 Captain, this gearbox has close ratios.

LUBRICATION OF FOUR-SPEED GEARBOX.

It is recommended that oil and grease are used in equal proportions as the gearbox has a tendency to leak if oil alone is employed. Light grease and engine oil should be mixed in equal proportions. A dipstick is provided with the filler plug and oil level should be checked at frequent intervals.

4-SPEED GEARBOX DISMANTLING AND RE-ASSEMBLING.

If it is desired to gain access to the interior of the gearbox proceed as follows, referring to illustrations of page 45.

Dismantle clutch as indicated on page 25.

Drain oil through bottom plug (34).

Remove kick-starter lever (2) and foot change lever (69). Both are retained on their splined shafts by pinch bolts (71 and 73).

Disconnect the clutch cable, and then remove gear indicator (8) by unscrewing operator shaft securing pin (6).

The gearbox outer cover (70) is held by nine screws (72). Removal of this cover will give access to the gearbox inner cover (21).

Next remove clutch lever, unscrewing clutch lever adjuster pin (67) and withdrawing clutch lever adjuster sleeve and ball (66). Unscrew the two bearing cap pins and remove bearing cap (59). Next unscrew the two nuts (77) and remove the stop plate and spring retainer (10) and outer bush for operator (9). Then the male control ratchet (13), the control plate (14) and the pawl plate spring (17) may be removed. Pull out the shaft control levers (58), but do not disturb the adjuster plate (18) which is set before leaving works and should not be altered in setting.

Unscrew the left-hand thread mainshaft nut (60) and pull off oil thrower (61), take out the cover bolts, unscrew the selector plunger box unit nut and washer (53) and remove the gearbox cover (21). The kick-starter mechanism is removed with the cover. Now the mainshaft (37) may be withdrawn followed by the layshaft (40), layshaft gears, and mainshaft sliding gears and selector fork in one block, tipping the inside operator (23) to disengage from the selector fork (39). Unscrew the final drive sprocket gland unit (31), after removing the locking screw (31B). Then remove the final drive sprocket (30) with a puller, exposing the oil seal (29), retainer (28) and ballrace (27). The mainshaft sleeve (33) and mainshaft low gear pinion may now be withdrawn. Both ballraces, large (27) and small (55) are of the interference fit type and the cases must be heated for removal. Fitting new ballraces is by the normal press-in operation.

Re-assembling. Press in ballrace (27), oil seal (29) and oil seal retainer (28) in the main bearing housing. Place the mainshaft sleeve pinion (32) on the sleeve (33). Put the screwed end of the sleeve through the ballrace and place the final drive sprocket (30) on the splines from the outside of the gearbox. Secure the locknut (31), felt washer (31A) and locking screw (31B).

Fit the inside operator (23) into the case with two anchor pins (24). Make sure that the operator is quite free and the vee-slots move central to the plunger box hole.

Assemble the layshaft and see that the mainshaft sliding gear (38) is free to slide on the sleeve, then fit the assembled layshaft with the operator fork (39) in position between the mainshaft sliding gear and the layshaft sliding gears (42 and 43). Locate the pegs of the selector fork in the slots of the inside operator and ease the assembly into the box. Now make sure that all these parts are operating easily with no undue friction. Fit the mainshaft high gear pinion (25) on the mainshaft and insert in the mainshaft sleeve, giving a liberal coating of oil, then fit the end cover carrying the small ballrace (55), the kick-starter shaft assembly and the operator shaft. Place the recessed oil return washer (61) (recess away from ballrace) on the end of the mainshaft and screw on the left-hand nut (60). Lightly tighten down the plunger box (36) first, with the plunger and spring in position; the plain portion above the thread serves as a locating dowel. Make sure that the plunger engages in the vee-slots on the inside operator and doesn't twist and ride over them. The ball end of the inside operator arm should be located in the spoon attached to the operating lever.

It should now be possible to revolve the shafts and gears in all gear positions and neutral.

The clutch can now be fitted after the push rod end piece has been inserted, also the push rod, bearing cap and clutch lever, followed by the kick-starter spring (57). The spring tension should be between quarter and half turn when the kick-starter crank (2) is up against the stop.

Re-assembly of Footchange. The adjuster plate (18) and lever return spring (19) should first be fitted if these have been removed, the spring being placed underneath the adjuster plate with the open end around the tang. Do not tighten the adjuster plate pins (78) which hold this plate in position. Next fit the control lever (58) over the kick-start shaft and engage the tang on the short arm in the spring. Fit the control plate with the male control ratchet assembled in position, followed by the female control ratchet which fits on the square operator shaft. Rotate the adjuster plate slightly until the teeth on the male ratchet engage the slots of both sides of the female ratchet when the short control lever is moved for changing up or down in second and third gear, then tighten up the adjuster plate pins (78). The stop plate and spring retainer (10) can now be placed on and fastened down with the two $\frac{1}{4}$ " nuts (77). It may be necessary to file the stop plate slightly if a new one is being fitted in order to correctly engage any gear before the control plate bush comes into contact with the stops. Care should be taken not to file away too much of the stops as this will allow the selectors to be taken past the correct gear.

If all has been made to satisfactorily operate up to this point, grease the foot change mechanism and fit the clutch lever and foot change cover. Before tightening the cheese-headed bolts, fit the out bush for operator shaft (9), gear indicator (8) recessed washer (7) and securing pin (6), then fit the kick-start crank and foot change lever to the desired positions. This completes assembly from the cover end and it remains only to fit the clutch.

TELESCOPIC FRONT FORKS — MODEL K7 CAPTAIN.

Regular lubrication of the sliders is the only attention necessary to keep the forks in first-class working order. Simply use the oil gun sparingly, every week. The action is by spring only and in the design of this fork wearing parts have been reduced to the bushes in the fork tube assembly and the sliders themselves. It will be seen, therefore, that need for replacement will only arise after a very lengthy mileage and then it is preferable that the forks themselves be returned to the works for the necessary repairs. The latter will be necessary as the bushes in the tube assembly are line reamed after being fitted and for this reason replacement bushes are only supplied to overseas customers.

There is a single tri-pressure coil spring in each leg, the bottom of which is anchored inside the slider and held in position by twisting the spring from one-and-a-half to two complete turns clockwise. The top of the spring is then held by another anchorage which in turn is attached to a cap telescoping in the fork tube assembly. This latter cap is bolted to the top of the tube. The three-rate loading of the spring takes care of all road surfaces.

To dismantle forks, first place machine on rear stand and arrange a box or similar object under the engine so that the front of the machine is well clear of the ground. Next take away the front wheel as described on page 54, and then remove front mudguard with stays and stand attached. With the handlebar centre clips removed, the bar itself can then be laid on the tank without interfering with the controls, giving immediate access to the head stem helmet nut. By unscrewing this with its right-hand thread it only remains to take away the two bolts holding the fork top plate to the tubes to enable the plate to be tapped off lightly. Remember to tap each side a little at a time to prevent distortion. The speedometer can now be uncoupled — flex and lighting. The head bearing is now in full view. By unscrewing the thin nut and removing the shims, the adjusting cone, which is a sliding fit on the stem can be lifted, leaving the balls — nineteen in each race — but at this stage some support should be given to the head stem to prevent it falling involuntarily. Make careful note of the number of shims fitted by selective assembly between the top cone and the locknut, and make sure that they are re-positioned in this order when re-assembling.

The stem can now be withdrawn from the head of the machine if so desired, but in that event the headlamp, of course, will need to be taken off and protected from external damage. At this stage it will be possible to deal with the fork as a sub-assembly and for this purpose the head stem can be held lightly in a vice. The plastic gaiters should be loosened and each slider telescoped to extend the spring at the top end with the anchorage attached. As mentioned previously, the spring should be unscrewed anti-clockwise from the slider and this will then enable the latter to be withdrawn from each tube without further hindrance.

When re-building, the plastic gaiters should be fitted 2" from the bottom fork ends, and the top should be just below the bottom bush grease nipple.

STEERING HEAD.

The head bearing is adjusted in the following manner: loosen head stem domed nut and carefully screw down the thin nut underneath the top plate until excessive play has been taken up. The adjusting cone is a sliding fit on the stem. Do not adjust head bearing too tightly, as this will make the steering heavy and may also ruin the bearings.

Need for adjustment is indicated by a slight "bump" when upward pressure is exerted on the handlebar ends. Test for slackness at the end of the first 200 miles (320 kms), and thereafter every 1,000 miles (1,600 kms).

TELESCOPIC FORKS

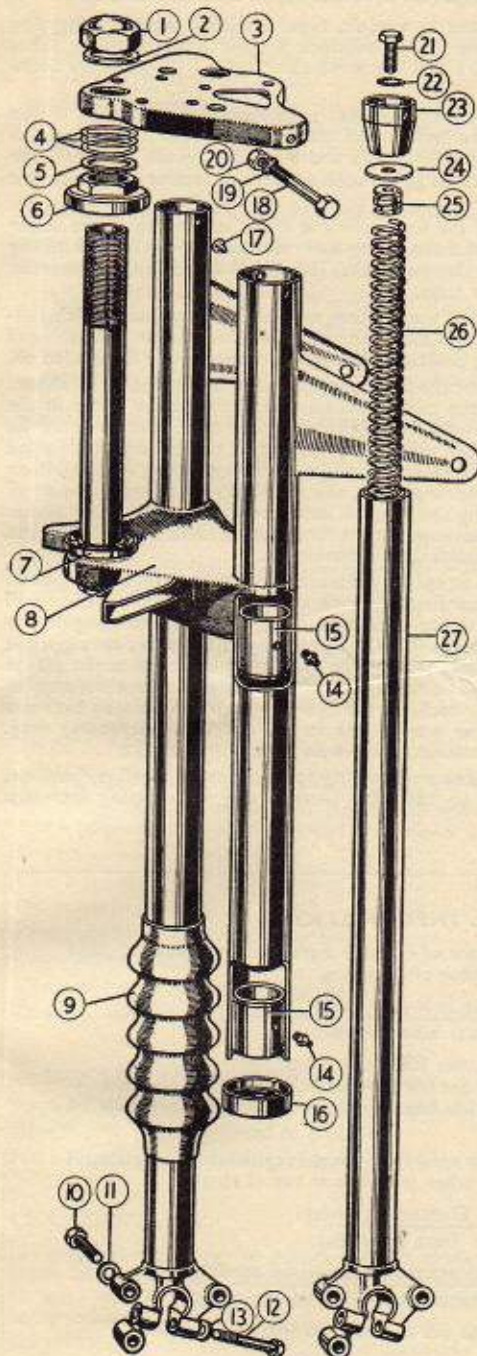

- 1 Domed nut — steering stem.
- 2 Plain washer 1" dia.
- 3 Top plate.
- 4 Shims .005" thick.
- 5 Plain washer 1" x 16 s.w.g.
- 6 Adjusting race.
- 7 Fork crown race.
- 8 Fork crown, steering stem and outer tubes assembly.
- 9 Plastic bellows.
- 10 Mudguard stay bolt.
- 11 Mudguard stay washer.
- 12 Fork end pinch bolt $\frac{1}{16}$ " BSF.
- 13 Fork end pinch washer $\frac{1}{16}$ " BSF.
- 14 Oil nipples.
- 15 Bearing bush — Tufnol.
- 16 Oil seal.
- 17 Rubber vent plug.
- 18 Top plate bolt $2 \frac{1}{2}$ " x $\frac{1}{4}$ " x 26.
- 19 Shakeproof washer.
- 20 Hexagon nut.
- 21 Top spring adaptor bolt $\frac{5}{16}$ " BSF.
- 22 Shakeproof washer.
- 23 Top spring support cup.
- 24 Plain washer.
- 25 Top spring adaptor.
- 26 Triple rate spring.
- 27 Inner slider and fork end.

FORK EXCHANGE SERVICE

As previously mentioned, the fork bearings are line reamed after fitting, and whilst this is a simple operation when the necessary equipment is available it should not be attempted by the amateur mechanic. When replacements are necessary owners resident in Britain may return the outer tube assembly to our Service Department and obtain an exchange unit with new bearings.

Prices available on application.

COMPETITION FORKS—OIL DAMPED MODELS K7C and J9

In the telescopic forks fitted to K7C and J9 models, tubular sliding members carrying the fork ends operate in widely spaced Tufnol bearings pressed into the outer tubes of the fork assembly. These bearings are line reamed after fitting. Oil seals are fitted to each bearing.

The damping mechanism comprises a small diameter tube fixed concentrically within the sliding tube and extending approximately half way up the slider. Apertures of varying size in the damper tube act as inflow port and metering holes. Screwed into the top of the damper tube is a damper rod guide bush which also retains the lower end of the main spring.

An adaptor carrying the upper end of the fork spring is fitted at the top of the outer tubes and this also retains the piston rod extending down the centre of the fork spring and through the bush at the top of the damper tube. The piston fitted at the lower end of the rod is a sliding fit in the damper tube.

Light lubricating oil ($\frac{1}{2}$ pint SAE 20) fills the bottom of each leg to a level which submerges the damper chamber. The oil will also filter into the chamber on both sides of the piston so that in the normal riding position, the system is completely filled with oil.

As the front wheel rises over a bump, or the head drops when braking, the inner sliders and damper tubes rise in relation to the outer fork tubes and the piston drops in the cylinder with little resistance from oil until a hole in the damper tube is covered by the piston. Further movement of the piston will tend to compress the oil which is forced out of the metering holes with ensuing retarding effect on fork stroke. As the piston moves further downwards closing remaining holes, the oil must pass through the small holes or past the piston, thus increasing the drag on fork movement. When the piston has closed all the holes, further fork movement must force the oil ONLY past the piston with consequent high pressure and resistance to movement.

When the fork returns to normal due to spring pressure, suction created by the piston in the damper tube causes a slight retarding effect on the return stroke. Suction will decrease as oil is sucked past the piston and enters metering holes. Continuing on the recoil stroke, oil on the top of the piston will be compressed and be forced through the top metering hole until the piston closes it. Oil can then only escape past the piston or rod bearing with consequent drag on fork recoil. Finally, when fork returns to normal level due to the weight of the machine, the cylinder above the piston becomes a semi-vacuum until oil returns by the way it was forced out with decreasing drag. When fork has regained its normal position there is no pressure at all.

Thus when riding on good road surfaces no damping takes place on small deflections, but as fork deflection increases due to bad road surface, the oil damping increases proportionately.

USEFUL INFORMATION

Cubic capacity (c.c.) = Square of cylinder bore in centimetres \times .7854 \times stroke in centimetres \times number of cylinders.

Engine R.P.M. = $\frac{166 \times \text{m.p.h.} \times \text{gear ratio}}{\text{radius of rear wheel in inches}}$

Horse Power — A.C.U. formula: 100 c.c. = 1 h.p.

R.A.C. formula: Square of cylinder bore in mm. \times number of cylinders — 1613. If the bore is given in inches instead of mm, the division becomes 2.5 instead of 1613.

Compression Ratio — Divide volume of space in cylinder when piston is at bottom of stroke by volume when piston is at top of stroke.

Speed in M.P.H. = $\frac{3600 \times \text{Distance (yards)}}{1760 \times \text{Time (seconds)}}$

Top Gear Ratio = $\frac{\text{Clutch sprocket} \times \text{Rear wheel sprocket}}{\text{Engine sprocket} \times \text{Gear box sprocket}}$

M.P.H. \times 88 = feet per minute (60 m.p.h. = 88 feet per second.)

OIL DAMPED TELESCOPIC FORKS. COMPETITION MODELS K7C AND J9.

Fork Maintenance.

Insert oil with oil gun every 200 miles through the four nipples provided.

Draining and Filling Damping Chamber.

To drain oil, remove plugs situated immediately above wheel nuts on outer sides of fork legs.

When refilling, ensure fibre washers are fitted behind draining plugs. Pour in oil through filler plugs at top of each fork leg. Capacity per fork leg is 100 cc. or $\frac{1}{2}$ pint. OVERFILLING WILL LEAD TO TROUBLE.

Recommended viscosity for normal use SAE 20. Thicker oils can be used to vary the degree of damping.

Removal of Spring and Damper Unit.

Place motor cycle on stand and insert a wad of rag between mudguard and fork crown to prevent damage to mudguard when spring units are withdrawn. Remove head locknut and washer and disconnect drive cable from speedometer. Remove fixing pins from top of fork legs and lift top plate giving access to spring units. Downward pressure on the forks will allow spring top adaptor to rise above the top of the outer strut, and removal of drain plug and pin on inner side of fork leg will allow the complete spring nut to be withdrawn from the inner strut. Inner struts may be removed by detaching plastic gaiters from outer struts and withdrawing downwards. It is advisable to take off the front wheel and mudguard if it is intended to remove the inner struts.

Dismantling Spring and Damper Unit.

Remove upper spring adaptor complete with cup, and unscrew spring from lower adaptor. Detach lower spring adaptor from damper tube by turning anti-clockwise. The piston and rod may now be withdrawn.

Re-assembling.

To re-assemble, reverse the above procedure making sure the springs are right home on the adaptors, and fork ends are in line. If fork ends require turning, release the nut holding the upper adaptor to the adaptor cup, and turn the complete inner strut and spring assembly until the fork end is in line, ensuring the spring has not moved on the adaptors. Re-tighten nut.

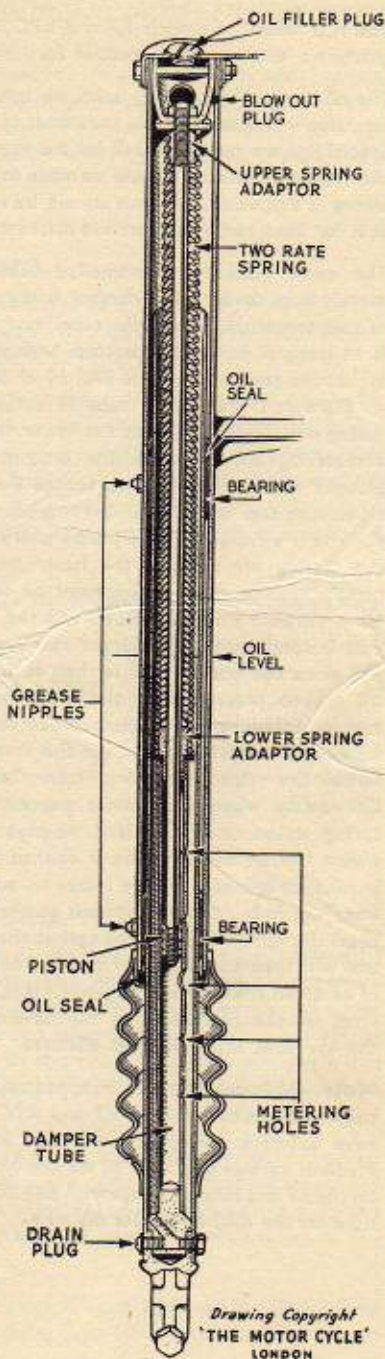

Drawing Copyright
'THE MOTOR CYCLE'
LONDON

REAR SUSPENSION — MODELS K7 AND K7C.

The rear wheel of models K7 and K7C is mounted in a fork pivoting just behind the gearbox ; this works on rubber torsion bushes which should never be lubricated.

The oil damped rear spring units are assembled with precision and will not call for any attention whatever for many thousands of miles, even the topping-up can be disregarded. Special jigs are required both for the assembling and dismantling of these units and for this reason no attempt should be made to dismantle them without these jigs. If anything wrong is suspected, the unit should be sent back to your dealer or to the works just as it has been removed from the machine.

The outer plated and enamelled tubes are merely dust covers. The damper unit consists of two concentric tubes, the outer one which is an integral part of the bottom anchorage is in fact the reservoir for the SAE 10 or SAE 20 oil (28.4 cc.) The inner tube is detachable, having a ball-seated valve at the lower end and a metering hole 1" from the bottom. The plunger rod is screwed and locked into the aluminium top anchorage. On the bottom of the rod is a cut-away brass piston which forms the seating for a valve, the latter having a certain amount of free movement on the rod for a purpose described later. As the spring unit is compressed the plunger rod descends, and since the bottom ball is then seated, the oil has to pass through the metering hole supplemented by the amount which can pass between the valve and seat (on the downward stroke the valve moves away from the seat). Conversely when the unit is depressed the spring action causes rebound, so that as the piston ascends the ball valve is opened to take in oil supplemented by the intake through the metering hole. On the upward stroke, however, the valve will be seated against the piston and will then not permit of such a free escape of oil as on the downward stroke. It is, therefore, on the rebound that the advantage of the hydraulic action is most effective.

Note—Although identical in appearance, rear suspension units fitted to K7 and K7C model have different springs internally as follows : Medium springs and SAE 10 oil are employed on the K7 and Heavy springs with SAE 20 oil are used for the K7C scrambles machine.

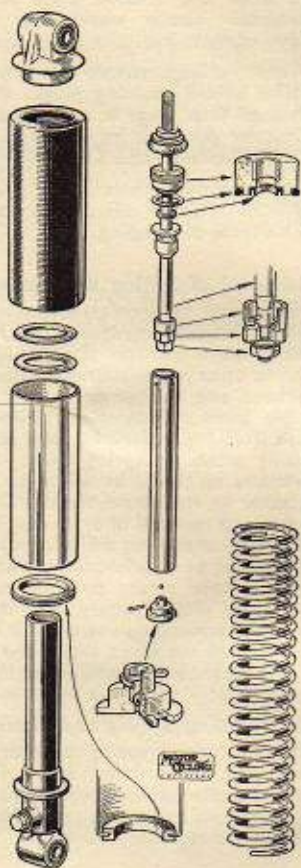

Drawing reproduced by courtesy of "Motor Cycling"

REAR SUSPENSION UNIT DIAGRAM

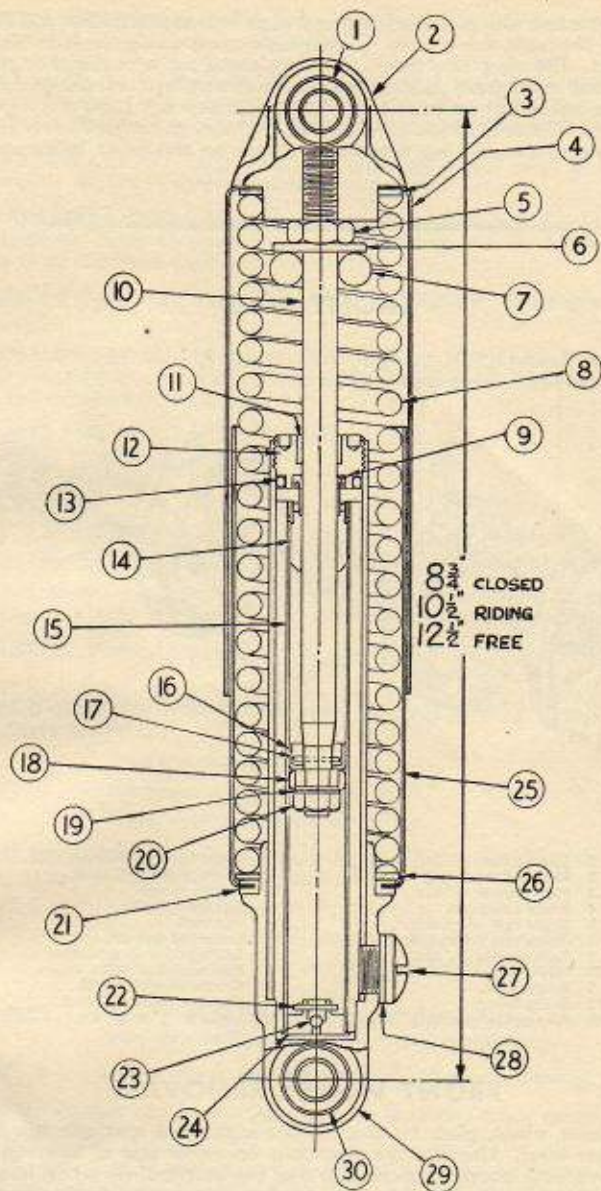

- 1 Top rubber bonded bush.
- 2 Top spring anchorage.
- 3 Washer for spring cover.
- 4 Outer cover.
- 5 Locknut.
- 6 Buffer washer.
- 7 Rubber buffer.
- 8 Coil spring.
- 9 Inner gland seal.
- 10 Damper rod.
- 11 Damper gland bush.

- 12 Damper gland.
- 13 Outer gland seal.
- 14 Damper rod guides.
- 15 Damper tube.
- 16 Damper valve.
- 17 Damper valve pin.
- 18 Damper valve seats.
- 19 Plain washer.
- 20 Hexagon nut.

- 21 Grummet for inner spring cover.
- 22 Split pin for valve body.
- 23 Non-return valve ball.
- 24 Non-return valve body.
- 25 Inner cover.
- 26 Washer for spring cover.
- 27 Filler and drain plug.
- 28 Plug washer.
- 29 Bottom spring anchorage.
- 30 Bottom rubber bonded bush.

HUBS AND BEARINGS.

Both hubs are packed with grease when new and no further lubrication will be required for five or ten thousand miles, when it is advisable to dismantle the hubs for attention to the bearings. The old grease should then be cleaned out with petrol or paraffin and the hubs packed with fresh lubricant when re-assembling. When dismantling and assembling the hubs refer to exploded drawings. If bearings show any sign of wear, fit replacements. The need to exclude dirt from the bearings cannot be over emphasised. Competition riders should keep a particular check on this point before entering an event.

FRONT HUB

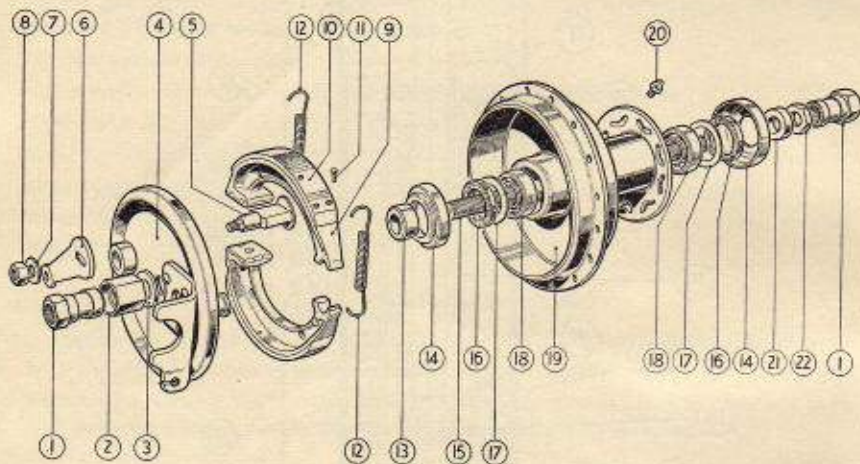

- | | |
|---|---|
| 1 Spindle nut. | 12 Return spring — brake shoe. |
| 2 Recessed locknut $\frac{11}{16}$ " x $\frac{1}{8}$ " dia. | 13 Distance piece $\frac{1}{4}$ " thick. |
| 3 Plain washer $\frac{11}{16}$ " dia. | 14 Enclosure cup. |
| 4 Brake backplate. | 15 Spindle $\frac{11}{16}$ " x 26. |
| 5 Brake cam and washer. | 16 Felt seal. |
| 6 Brake cam lever. | 17 Enclosure washer. |
| 7 Plain washer $\frac{11}{16}$ " dia. | 18 Bearing 15 x 35 x 11 mm. |
| 8 Hexagon nut $\frac{11}{16}$ " x 26. | 19 Hub shell and brake drum. |
| 9 Brake shoe. | 20 Grease nipple $\frac{1}{4}$ " x 26. |
| 10 Brake lining. | 21 Distance piece $\frac{1}{8}$ " thick. |
| 11 Rivets $\frac{11}{16}$ " dia. x $\frac{3}{16}$ " long. | 22 Locknut $\frac{11}{16}$ " x $\frac{11}{16}$ " dia. |

FRONT WHEEL REMOVAL.

To remove front wheel, place machine on the stand and uncouple the brake cable from handlebar lever. Unscrew the pinchbolts on either side of fork legs under the wheel axle, but leave loosely in position to take the weight of the wheel later on. Now remove the axle nut on the **left side** first and then the other on the **off side**, after which the wheel will come away on taking out the pinchbolts. When putting the wheel back in the machine, first tighten both wheel nuts, followed by locking the pinchbolt on the **right side** only. Next, put up the stand, and standing astride the machine, depress the forks vigorously a few times to enable the nearside leg to assume its own lateral position on the wheel nut, which is sleeved. It can then be kept in position by locking the pinchbolt on this side. The importance of following this sequence, particularly when re-assembling, must be emphasised as otherwise the fork action or alignment may be affected.

REAR HUB — MODELS K7 AND K7C.

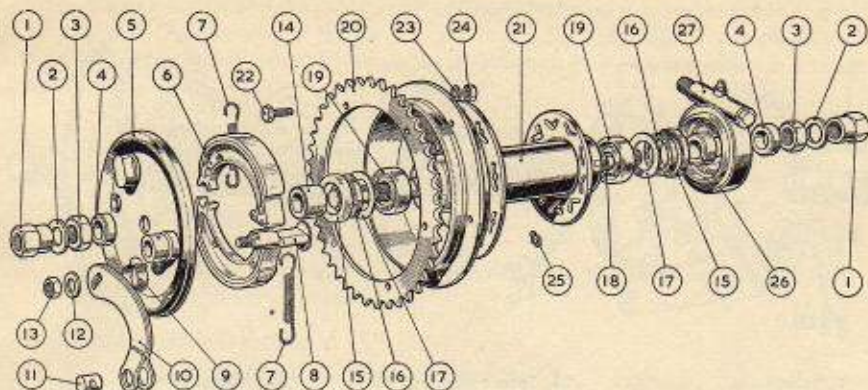

- 1 Spindle nut $\frac{5}{8}$ " x 26 t.p.i.
- 2 Plain washer $\frac{1}{8}$ " dia.
- 3 Locknut $\frac{1}{2}$ " x $\frac{1}{2}$ " thick x 26 t.p.i.
- 4 Distance piece $\frac{1}{8}$ " x $\frac{1}{2}$ " long.
- 5 Back plate.
- 6 Brake shoe with liner.
- 7 Brake shoe return spring.
- 8 Brake cam.
- 9 Oil seal spring clip.
- 10 Brake cam lever.
- 11 " " " roller.
- 12 Plain washer $\frac{1}{8}$ " dia.
- 13 Hex. nut $\frac{1}{2}$ " x 26 t.p.i.
- 14 Distance piece $\frac{1}{8}$ " x $\frac{3}{8}$ " long.

- 15 Dust seal cap.
- 16 Felt washer.
- 17 Dust seal washer.
- 18 Spindle.
- 19 Journal bearing 15 x 35 x 11 mm.
- 20 Rear sprocket ring 44T.
- " " " 48T (K7C).
- 21 Hub shell and brake drum.
- 22 Hex. bolt $\frac{1}{2}$ " x $\frac{3}{8}$ " x 26 t.p.i.
- 23 Shakeproof washer $\frac{1}{2}$ " dia.
- 24 Hex. nut $\frac{1}{2}$ " x 26 t.p.i.
- 25 Greaser $\frac{1}{2}$ " x 26 t.p.i.
- 26 Distance piece $\frac{1}{8}$ " x $\frac{1}{2}$ " long.
- 27 Speedo drive gearbox.

REAR WHEEL REMOVAL.

Place machine on stand, disconnect chain, taking care not to let it trail on the ground, unscrew brake rod adjuster and speedo drive gland nut. Slacken both spindle nuts. The wheel can then be readily eased out. When replacing, make sure that back plate locking boss is engaged in its groove in the fork end. Remember also that $\frac{1}{2}$ " whip should be allowed in the rear chain.

It is wise to always check wheel alignment after removal. The simplest way is to use a thin piece of string stretched taut across both wheels with the front wheel pointing straight ahead. The string should just touch each tyre at both sides of the wheel centre. An alternative method is to use a perfectly straight board placed alongside the wheels so that it touches each one. If necessary turn the handlebar so that the front wheel touches the board at two points. If both tyres do not make contact at two points, slacken the rear wheel spindle nuts and turn adjusters until wheel is correctly aligned.

SPEEDO DRIVE.

A nipple is provided on the speedometer gearbox and a little grease should be inserted by means of a pressure gun every 1,000 miles (1,600 kms). If the speedo drive has been removed for any reason, do not forget to replace the distance piece behind it. As bearings bed down, the clearance between the speedometer and hub shell will be reduced. Shims must be used to ensure this clearance is maintained when bearings are adjusted. If the engaging projections on the speedo drive are tight in the locations on the hub, the speedo drive will be damaged.

The speedometer head does not require any lubrication and should never be interfered with.

REAR HUB — MODEL J9.

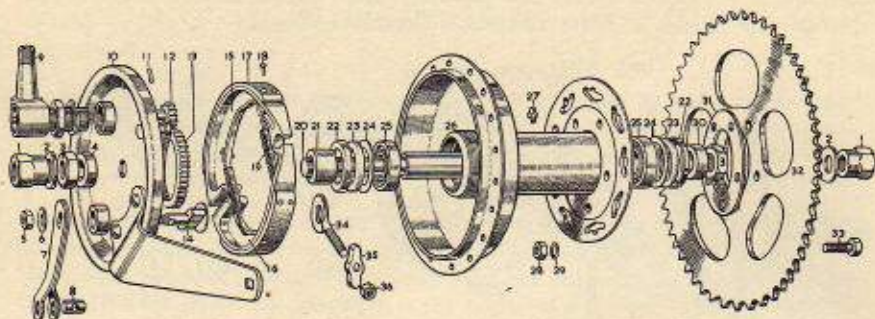

- | | | |
|-------------------------|---------------------------------|----------------------------------|
| 1 Spindle nut. | 13 Speedo gear ring 45T. | 25 Journal bearing. |
| 2 Plain washer. | 14 Brake cam. | 26 Hub shell and brake drum. |
| 3 Locknut. | 15 " shoe — upper. | 27 Grease nipple. |
| 4 Distance piece. | 16 " " — lower. | 28 Sprocket nut. |
| 5 Brake cam nut. | 17 " lining. | 29 " shakeproof washer. |
| 6 " " lever washer. | 18 " rivet. | 30 Distance piece. |
| 7 " " " roller. | 19 Return spring. | 31 " ring $\frac{1}{2}$ " thick. |
| 8 " " " roller. | 20 Spindle $\frac{1}{8}$ " dia. | 32 Rear sprocket 52T. |
| 9 Speedo drive gearbox. | 21 Distance piece. | 33 " bolt. |
| 10 Backplate. | 22 Dust cap. | 34 Chain adjuster. |
| 11 Speedo pinion rivet. | 23 Felt washer. | 35 " " cap. |
| 12 " " 14T. | 24 Enclosure washer. | 36 " " nut. |

BRAKES.

If the brakes are correctly adjusted and oil is never used to lubricate the bearings, the brakes will require no attention for many thousands of miles.

Never use petrol or paraffin to wash brake shoes. These liquids have an adverse affect on the liners, and much braking efficiency may be lost thereby.

Never rasp the surfaces of brake liners with a coarse file or stiff wire brush to provide increased friction — this treatment has exactly the opposite effect.

Brake cable or rod adjustment should be such that only a slight movement of the lever or pedal is sufficient to operate the brake, but at the same time, the wheels must spin freely when the brakes are off. To give the correct adjustment, screw up the adjuster until the liners are just fouling the drum, then slack off two complete turns.

After altering the tension of the rear chain, check the adjustment of the brake rod.

BRAKE LINING EXCHANGE SERVICE

RECONDITIONED BRAKE SHOES COMPLETE WITH NEW LININGS CAN BE SUPPLIED BY OUR SERVICE DEPARTMENT IN EXCHANGE FOR OLD UNITS. PRICES AVAILABLE ON APPLICATION.

TYRES.

To obtain the maximum mileage from the tyres, maintenance should be regular and painstaking. Once a week check the tyre pressures with a gauge and at the same time examine the outer covers to ensure no particles of gravel, etc., are wedged in the tread. The pressure required naturally varies according to the weight carried by the tyre and the total weight is unevenly distributed between the two tyres, so that if a passenger is carried the pressure should be increased by approximately 2 lbs.

RECOMMENDED TYRE PRESSURES — SOLO.

Model	K7 Captain	K7C Cotswold	J9 Commando
Front	15 lbs.	15 lbs.	15 lbs.
Rear	22 lbs.	25 lbs.	27 lbs.

The following hints will also assist in prolonging the life of the tyres :

Clean oil and grease from the tyres with petrol as soon as possible.

Ensure correct alignment of the wheels.

Cross tramlines at as near a right-angle as possible. They are dangerous, particularly in wet weather and may damage the tread.

Fierce braking and acceleration quickly wear away the tread. Apply brakes gently to avoid skidding, and when starting from rest, accelerate steadily on a small throttle opening.

TYRE REMOVAL.

Deflate tyre by removing cap and nut from valve stem, and unscrewing inner valve. A small key for this purpose is found on the top of the valve cover.

Push outer-cover right into wheel rim well opposite valve, and insert tyre lever under cover as near as the valve as possible. If the opposite side is properly in the well the edge of the cover should come over the rim without using force.

Work around cover until all of it is over the rim, then remove inner-tube by pushing valve up through hole and gently easing out. Remove opposite side of cover in the same way — pushing into well, inserting lever in other side and working off.

TYRE REPLACEMENT.

It is seldom necessary to remove the outer-cover completely with normal punctures, but if the tyre has been taken off proceed as follows : Work one side of tyre over rim, insert inner-tube and pump up sufficiently to remove any kinks ; place valve in hole and screw the securing nut about $\frac{1}{4}$ " up the shaft. The white spot on side of outer-cover should be positioned over valve.

Move free edge of cover over rim opposite valve and work round rim, equally on either side of valve until a few inches remain free. The valve should be in the centre of this free length and no difficulty should be experienced in getting it over the edge of rim providing the rest of the cover is right down in the well.

Once tyre is home, inflate to about half pressure and manipulate cover until tread runs evenly ; when rotation of the wheel has shown this to be so, inflate to correct pressure. Do not forget to replace the valve cap. This prevents the ingress of dirt.

When fitting new tyres it is a good plan to smear a little soft soap around the rim to ease the cover on.

SADDLE — MODEL J9.

Whilst adjustment of the saddle for height and tilt is self-explanatory, it should be noted that the right-hand side of the nose peak is threaded. This is to enable the hinge pin to act as a pivot for the saddle.

When adjusting, the hinge pin should be tightened slightly, then slacked back for one complete turn, and the nut screwed home. There will then be enough play for the saddle to pivot freely, making for comfortable riding. Oil the hinge pin from time to time.

CLEANING.

Make a practice of giving the machine a really good clean as often as possible, keeping a soft cloth specially for the purpose. By careful cleaning the original sheen of enamelled parts may be retained indefinitely.

Where mud is thickly caked on, do not attempt to brush it off; abrasive particles will rapidly damage the enamel. Water from a small hose or a wet sponge should be used, taking care not to let water into the carburetter, magneto and brake linings.

Never garage a dripping machine after a wet run. Remove moisture by dabbing gently with a soft cloth, i.e., butter muslin.

Salt laid down in city streets during snowy winter periods has a corrosive effect on enamel and chromium plating. A useful tip is to smear the wheel rims (particularly chromed rims) and other exposed parts of the machine with a film of oil or grease. This can easily be removed with a petrol-soaked rag when the weather improves.

Tins of quick-drying lacquer in the correct James maroon shade can be purchased through most James spares stockists and will be found useful for touching-up spots where the enamel has accidentally been removed.

CHROMIUM PLATING.

In damp weather, small spots of rust-like deposit may be observed on chromium plating. It is not rust but the action of certain salts used in the plating process. If attended to in good time such spots can easily be removed by rubbing with a good brand of chromium polish. NEVER USE HOUSEHOLD METAL POLISH ON CHROMIUM PLATING.

In summer, when wet conditions are less frequent, it is best to clean plating with a damp chamois leather cloth and soft rag.

ALUMINIUM ALLOY CASTINGS.

A certain amount of road dirt and oil will inevitably gather on the cast alloy surfaces of the engine crankcase, primary chaincase, gearbox and carburetter, and regular cleaning will not only improve the appearance of the machine but will avoid dirt stains on trouser legs and shoes. A clean engine unit is also easier and more pleasant to maintain.

Such parts can be cleaned with a stiff brush dipped in petrol or trichloro, alternately, we recommend a special detergent available from most motor cycle accessory retailers, i.e., GUNK. This product is simply brushed on to the alloy parts and hosed off with water. GUNK is sold in tins and full instructions are given by the makers.

If this method of cleaning is employed care should be taken to cover the carburetter to prevent the entry of water and consequent starting difficulties. Surplus water should always be wiped off with a clean rag.

USEFUL INFORMATION

Table of Gradients

Gradient	Per cent.	No. of feet rise or fall in one mile
1 in 5	20	1056
1 " 6	17	880
1 " 7	14	754
1 " 8	12½	635
1 " 9	11	587
1 " 10	10	528
1 " 11	9	480
1 " 12	8	440
1 " 13	7½	406
1 " 14	7	377
1 " 15	6½	352
1 " 16	6¼	330
1 " 17	6	310
1 " 18	5½	293
1 " 19	5	277
1 " 20	5	264

NOTES.

THE JAMES GUARANTEE AND CONDITIONS OF SALE.

We give the following guarantee with our motor cycles, motor cycle combinations, and sidecars, including all accessories and component parts other than tyres, saddles, chains, and lighting and electrical equipment, and other than accessories and component parts supplied to the order of the Purchaser and differing from those comprised in the standard specifications supplied with our motor cycles, motor cycle combinations and sidecars, but including accessories and parts supplied by way of exchange as hereinafter provided. This guarantee is given in place of any implied conditions or warranties or any liabilities whatsoever statutory or otherwise; no guarantee except that hereinafter contained and no conditions or warranty whatsoever statutory or otherwise is given or is to be implied, nor are we to be under any liability whatsoever except under the guarantee hereinafter contained. Any statement, description, condition, or representation contained in any catalogue advertisement, leaflet or other publication shall not be construed as enlarging, varying or overriding anything herein contained. In the case of machines (a) which have been used for "hiring out" purposes or (b) any motor cycle and/or sidecar used for any dirt track, cinder track or grass track racing or competitions (or any competition of any kind within an enclosure for which a charge is made for admission to take part in or view the competition) or (c) machines from which the trade mark, name or manufacturing number has been altered or removed or (d) any machines in which parts have been used not supplied by or approved by the motor cycle manufacturer, or (e) any machine from which the silencing system as fitted by the manufacturer has been partially or wholly removed or interfered with, no guarantee, condition or warranty of any kind statutory or otherwise is given or is to be implied nor are we to be under any liability whatsoever in respect of any such machine.

We guarantee, subject to the conditions mentioned below, that all precautions which are usual and reasonable have been taken by us to secure excellence of materials and workmanship, but this guarantee is to extend and be in force for six months only from date of purchase, or date of exchange in case of any accessory or part supplied by way of exchange as hereinafter provided, and damages for which we make ourselves responsible under this guarantee are limited to the free repair or supply of a new part or accessory in exchange for the part of the motor cycle, motor cycle combination or sidecar or accessory which may have proved defective. We undertake, subject to the conditions mentioned below, to make good in manner aforesaid any part or accessory covered by this guarantee which has proved defective within the said period of six months. We do not undertake to replace or refix, or bear the cost of replacing or refixing any such new part or accessory in the motor cycle, motor cycle combination or sidecar. As motor cycles, motor cycle combinations and sidecars are easily liable to derangement by neglect or misuse, this guarantee does not apply to defects caused by wear and tear, misuse or neglect.

The term "misuse" shall include, amongst others, the following acts:

1. The attaching of a sidecar to a motor cycle in such a manner as to cause damage or calculated to render the latter unsafe when ridden.
2. The use of a motor cycle or of a motor cycle and sidecar combined, when carrying more persons or a greater weight than that for which the machine was designed by the manufacturers.
3. The attaching of a sidecar to a motor cycle by any form of attachment not provided, supplied, or approved by the manufacturers, or to a motor cycle which is not designed for such use.

We do not guarantee tyres, saddles, chains or lighting and electrical equipment or any accessories or component parts supplied to the order of the Purchaser differing from those comprised in the standard specifications supplied with our motor cycles, motor cycle combinations or sidecars. As regards all such tyres, saddles, chains, lighting and electrical equipment, accessories and component parts, no guarantee condition or warranty of any kind statutory or otherwise is given or is to be implied, and we are to be under no liability whatsoever in respect thereof.

CONDITIONS OF GUARANTEE.

If a defective part or accessory should be found in our motor cycles, motor cycle combinations or sidecars, or in any part or accessory supplied by way of exchange as before provided, it must be sent to us CARRIAGE PAID, and accompanied by an intimation from the owner that he desires to have it repaired or exchanged free of charge under our guarantee and he must also furnish us at the same time with the number of the machine, the date of the purchase or the date when the alleged defective part or accessory was exchanged as the case may be.

Failing compliance with the above, such articles will lie here at THE RISK OF THE OWNER, and this guarantee and any implied guarantee, warranty or condition shall not be enforceable.

REPAIRS.

Any motor cycle, motor cycle combination or sidecar sent to us to be plated, enamelled or repaired will be repaired upon the following conditions, i.e., we guarantee that all precautions which are usual and reasonable have been taken by us to secure excellence of materials and workmanship, such guarantee to extend and be in force for three months only from time such work shall have been executed, and this guarantee is in lieu and in exclusion of all conditions and warranties statutory or otherwise and all liabilities whatsoever and the damages recoverable are limited to the cost of any further work which may be necessary to amend and make good the work found to be defective.

