

OPERATING AND MAINTENANCE INSTRUCTIONS

JAWA MOPED

CONGRATULATIONS...

You becoming the proud owner of a new MOPED and thank you for selecting a JAWA MOPED - Universally known for superb engineering, workmanship and reliability.

A few moments spent with the MOPED Owners Manual and the JAWA MAINTENANCE MANUAL will help you operate your new JAWA in its operating condition at minimum expense.

We wish you many happy and safe miles on your new JAWA MOPED.



MOTOR DRIVEN CYCLE 50 cc
MODEL M - 210
Manufacture: ZMV, š. p. Kolárovo
Czechoslovakia



ZMV KOLÁROVO

The moped is a single-track motor vehicle of simple design, easy to handle and control.

No special skill is required for its maintenance.

To get well acquainted with it, we recommended, that you read this Owner's Handbook prior to its use.

In this way you will avoid any inconvenience and trouble, and the moped will serve you to your full satisfaction.

We wish you many happy and carefree miles on your new moped

ZMV, š. p. Kolárovo
CSFR

The design of the moped, its specifications, description and illustrations contained herein are liable to changes resulting from further development and improvements.

CONTENTS	I. Technical data
	II. Controls
	III. Riding instructions
	IV. Maintenance and adjustments
	V. Rear telescopic suspension units
	VI. Toolkit
	VII. Troubleshooting
	VIII. Spare parts

Benefit yourself of the advantages offered to you by the automatic two-speed gearbox of your moped.

Description of the automatic function of the gearbox.

After the engine has started, the moped starts moving in response to the opening of the throttle (accelerating) without any use of the other control elements on the handlebars (single speed moped only). By further acceleration (increasing the speed of the moped), the second gear is engaged automatically and smoothly. When riding uphill, the change to 1st.-speed gear takes place automatically.

In addition to this control by road speed, the moped provides for a momentous control (depending on the turning of the twist grip).

Thus you can use the controls of your machine in the following ways:

1. Starting at full throttle - sports style riding. The change from 1st to 2nd gear takes place at a lower R.P.M. and at a higher road speed.
2. Starting with only partly opened throttle is more economical. The change from 1st to 2nd gear takes place at a lower engine speed and an increased road speed.
3. In city traffic, riding behind a slower vehicle in 2nd gear while decelerating by throttling down is more economical and less noisy as when changing down to 1st gear.
4. When riding in 2nd gear at a certain steady (free-running) speed, it is possible to change immediately to the 1st gear and to accelerate effectively by turning down the throttle.
5. Braking with the engine to a stop in the more economical and less noisy 2nd gear after the disengagement of the starting clutch will avoid engine stalling.

IDENTIFICATION NUMBER IS LOCATED	a. on steering head	b. on left-hand top side of engine
IGNITION TIMING	1 to 1.5 mm before piston T.D.C.	
FUEL MIXTURE	1:40 during first 400 km (200 miles)	1:50 after break in

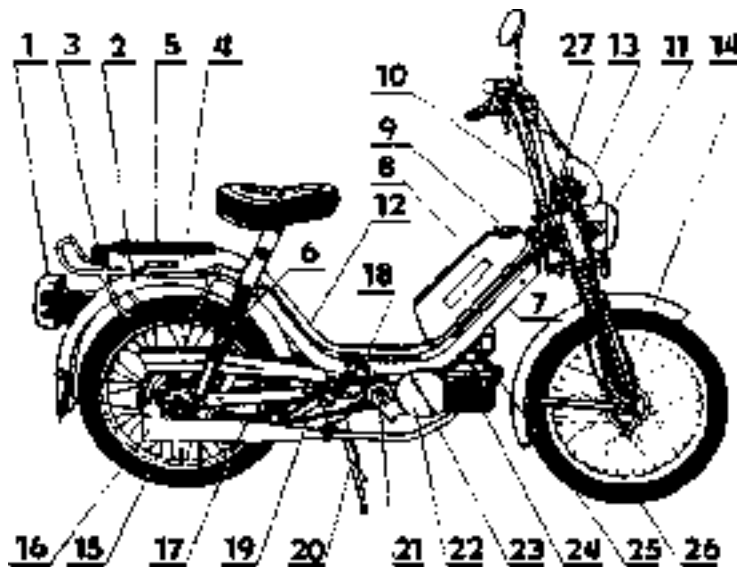

Fig. 1 Jawa Moped — Main Parts

1. Tail lamp, 2. Rear mudguard, 3. Tire pump, 4. Luggage carrier, 5. Tool kit, 6. Rear telescopic suspension unit, 7. Intake air cleaner, 8. Fuel tank, 9. Fuel tank filler cap, 10. Handlebars, 11. Headlamp, 12. Frame, 13. Front fork, 14. Front mudguard, 15. Rear wheel, 16. Exhaust silencer, 17. Pedal drive transmission chain, 18. Pedal cranks and pedals, 19. Engine drive transmission chain, 20. Stand, 21. Engine drive disengaging lug, 22. Alternator (under cover), 23. Exhaust pipe, 24. Engine, 25. Spark plug with cable shoe, 26. Front wheel, 27. Speedometer.

I. TECHNICAL DATA

Engine type	air-cooled single cylinder	
Engine capacity	49. c. s. (3 cu. in)	
Cylinder bore/piston stroke	39/41 (1.55/1.61")	
Engine output	1.75 kW at 5000 r.p.m. ±8%	
Clutches	automatic centrifugal for single speed / automatic two-speed unit	
Transmission of driving moment to rear wheel	in 1st. gear - overall ratio 1:24.4231 in 2nd gear-overall ratio 1:13.7305 1:14.875 single speed 20 MPH 1:12.750 single speed 30 MPH	
Primary transmission	indented belt	
Secondary transmission	stud link chain	
Pedal drive transmission ratio	1:0.692	
Pedal start	overall ratio 1:0.0504	
Front suspension	telescopic front fork without shock absorbers — 60 mm stroke	
Rear suspension	suspension units without shock absorbers — 60 mm stroke	
Brakes	internal-expanding shoe brakes controlled by levers on handlebars	
Brake dimensions	85x20 mm (3.55 x 0.79")	
Tires, front and rear	2 ¼" x 16"	
Tire inflation pressures	-front 2 atm (196 kPa) (28 Lbs/in ²)	-rear 2,5 atm. (245 kPa) (35 Lbs/in ²)
Moped weight	51 kg - 112 Lbs.	
Basic load	135 kg - 297 Lbs.	
Speed	40 km/h	
Fuel tank filling capacity	4.2 litres - 1 US Gal.	
Climb ability	25%	
Noise	70 decibels	
Ignition	6 V, non-contact, semiconductor system	
Spark plug	PAL N7, CHAMPION L-89CM, L-85, L-86, NGK B6HS, BOSH - W7AC	
Headlamp	6V/15W	
Tail lamp	6V/5 W, 6V/10W	
Speedometer light	6V/1.2W	
Alternator	6V/30W	

Note: Over loaded moped (max. 100 kg) decreases speed.

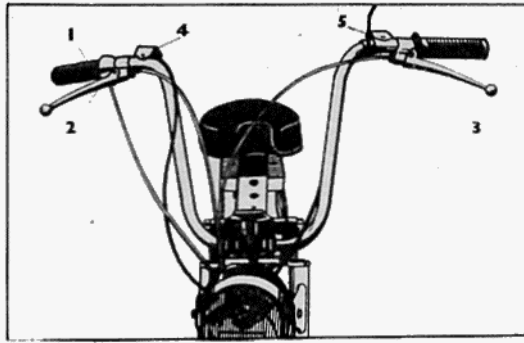

Fig. 2 – Controls

- 1. Twistgrip**
- 2. Front brake lever**
- 3. Rear brake lever**
- 4. Ignition switch OFF**
- 5. Buzzer**

II. CONTROLS

The following few controls of the moped are easy to operate:

- a) Throttle twist grip (1, Fig.2) by the rotation of which the clutch is engaged or disengaged automatically while the throttle is opened or closed and thus the vehicle accelerates or decelerates.
- b) Front brake lever (2, Fig.2) and rear brake lever (3, Fig.2), by the depressing of which the vehicle is braked and stopped.
- c) Light switch (Fig. 3)
- d) Buzzer push button (Fig.2)
- e) Fuel cock lever (Fig. 6,)
- f) Choke (Fig.7)
- g) Pedals (Fig. 8)
- h) Engine drive disengaging mechanism (Fig. 9)

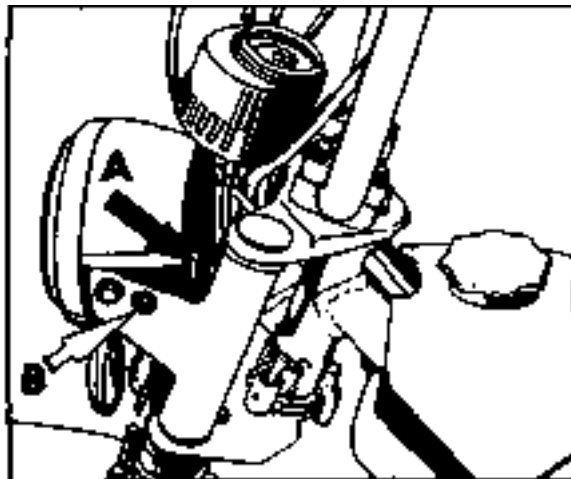

**Fig.3 – Headlamp and tail lamp switch
(in the bottom part of headlamp)**

III. RIDING INSTRUCTIONS

Before starting check:

- brakes
- tire pressures
- amount of fuel in the tank
- functioning light (while engine is running)
- correct tensioning of secondary chain.

Fuelling

The fuel used in the moped is gas mixed with oil in the recommended ratio. Use regular gas and observe the mixing ratio when filling the fuel tank using a funnel with a strainer when filling the tank.

Fuel mixing ratio - 1:40 during the break in period 1:50 after the break in period.

Starting a Moped

Open the fuel cock (Fig6) push in the choke pin (Fig.7) as far as it will go the pin returns immediately into its original position but the air intake remains throttled – the engine is supplied with a richer mixture.

Two methods can be used for starting the engine.

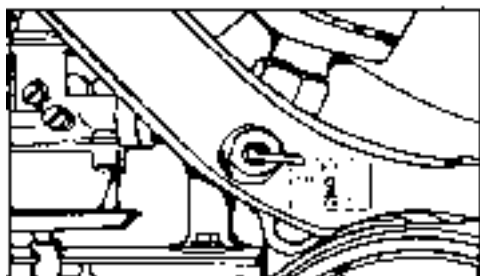

Fig. 6
Fuel cock

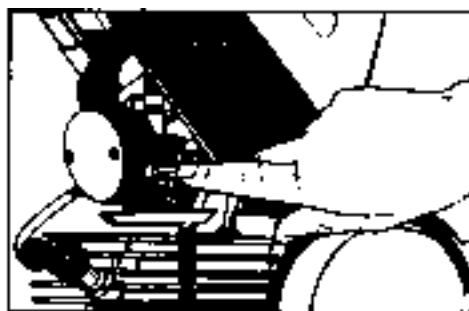
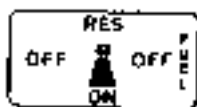

Fig. 7 - Air intake shut - choke pushed

To Start Cold Engine in Summer

a) Pull up the moped on its stand, push in the choke pin, rotate the twist grip through one-half of its rotation range, set the pedal forward at an angle of about 30 degrees from the vertical, depress the pedal energetically and engine should start. If the engine does not fire, repeat this procedure.

After the engine has started running let it warm up and then rotate the twist grip as far as it will go to open the choke. Then back off the twist grip so that the engine runs at idling speed and is ready to go. Jerk it from the stand on to the wheels and move off by accelerating (opening the throttle).

DO NOT SIT ON THE MACHINE DURING THIS STARTING PROCEDURE.

b) Starting by pedalling: With the vehicle standing on wheels push in the choke, and rotate the twist grip as described in paragraph a). Use the pedals to start the engine. As soon as the engine fires accelerate by opening the throttle.

Starting the Engine in the Cold Season

When the temperature drops below 0°C, it is necessary to modify the starting procedure as follows:-

Proceed with the actual starting as in point a) with the only difference that the twist grip must be turned three quarters of its total rotation range to prevent the opening of the air intake flap. Prolong the engine warm-up period in proportion to the falling temperature.

NOTE: For safety reasons, the starting method as per point b) is not recommended on ice and snow covered roads.

NOTE: IF NECESSARY, YOU CAN ASSIST THE ENGINE BY PEDALLING, ESPECIALLY WHEN CLIMBING A LONG OR STEEP GRADIENT.

Running in a new machine

The way a new moped is run affects its life, performance, and fuel consumption.

Therefore observe the following instructions during the break in period.

a) Mix the fuel — regular gas with two cycle oil in 40:1 ratio.
Note: Use two cycle oil only!

b) Use this fuel during the break-in period (for about 400 km-200 miles) and do not exceed the maximum speed over
(25 km/h for 30 km moped)
(35 km/h for 40 km moped)
(40 km/h for 50 km moped)

with the throttle opened no more than by 1/2 to 3/4 of the twist grip.

c) When riding down a long hill do not throttle down but decelerate by applying the brakes, and never exceed the speed.

d) Remember that the engine is cooled less efficiently when riding in the warm season with the wind in your back.

e) Do not let the engine idle too long and do not race it unnecessarily after stopping the moped.

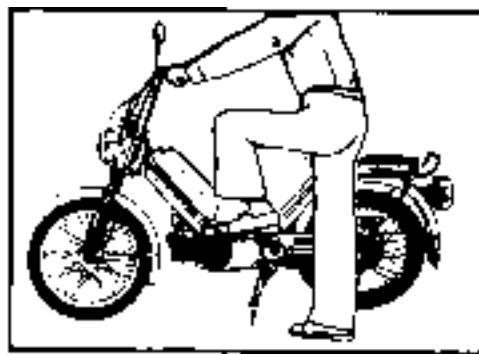

Fig.8 - Engine starting

Braking and stopping

If you have to slow down, release the twist grip and apply the brakes by pulling the brake levers (2.3 -Fig.2). Proceed in the same way to stop the moped. The reduction of engine speed results in the disengagement of the driving clutch, and the engine runs at idling speed. To continue the ride, just accelerate (turn the twist grip). The driving clutch engages and the moped starts moving. At the end of the trip stop the engine by depressing kill switch push button and shut off the fuel supply by turning the lever of the fuel cock (Fig. 6)

Disengagement of engine drive

To disengage the drive, the engine must be off and the moped at a standstill.

If you intend to use the moped as a bicycle, (after using up the fuel) pull the driving lug (in the direction away from the engine) and rotate it 90 degrees clockwise or counter clockwise, and then release it (Fig.9). The driving lug will remain engaged in this position and the drive is not transmitted from the engine to the rear wheel.

To re-engage the engine, pull the driving lug, rotate it 90 degrees, and release it. After moving the moped slightly on its wheels, or after turning the rear wheel, the driving lug retracts automatically in mesh with the engine.

NOTE: Do not disengage the engine drive when riding downhill. Use the engine disengaging device when pushing or handling the moped, when testing the engine with the moped stationary, and when pedalling to complete a trip with a defective engine or when out of fuel. When changing the disengaging mechanism, engine must be OFF.

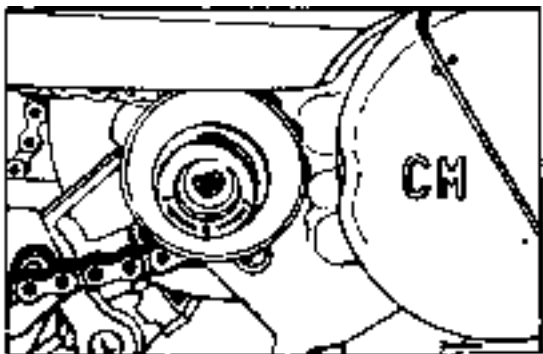

Fig. 9 - Engine drive disengaging mechanism

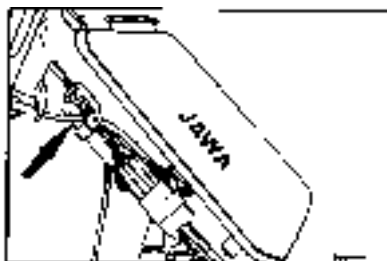

Fig. 10 Air cleaner

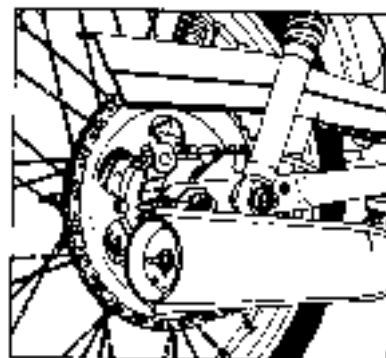

Fig.11 Exhaust silencer

IV. MAINTENANCE AND ADJUSTMENTS

Moped Maintenance

Use only water and detergents to clean the varnished and chrome plated parts of the machine. After washing, wipe these parts dry with chamois leather.

Clean plastic and rubber parts with water only. Never use gas, kerosene or other solvents for washing varnished, plastic and rubber parts as these solvents have detrimental effects on such parts. When hosing down the moped, avoid spraying water over the carburettor, the ignition system, and the filling screw of the gearbox with the venting hole.

As a safety precaution, take a short ride and apply the brakes several times to dry them after washing.

Wash the filter element of the air cleaner (Fig.10) occasionally with gas and blow it through with compressed air.

Remove carbon deposits from hole „A" of the silencer (Fig. 11) occasionally with a wooden stick. At a noticeable loss of engine power check whether the exhaust silencer is clogged with carbon deposits. The exhaust tail-end pipe can be removed after screwing off nut „B".

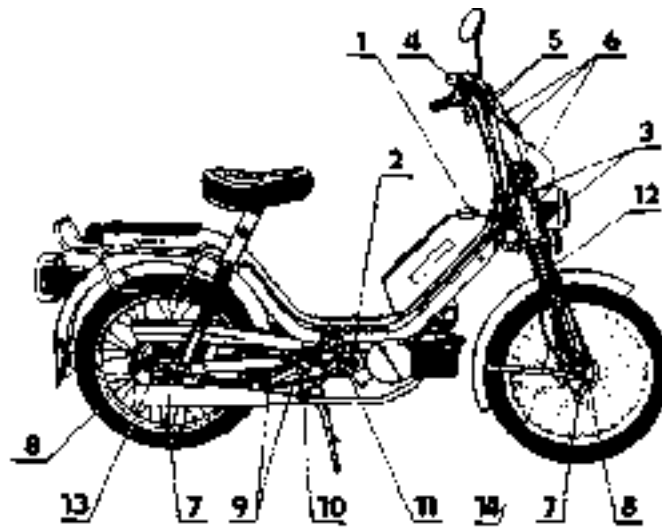

FIG. 12 — Lubrication chart

LUBRICATION

Lubrication Chart (Fig.12, 12a)

Pos. No.	Lubrication point	Lubricating	Notes
1	Engine	out board oil, two stroke oil	Permanent lubrication by mixing oil and gas in 1:50 ratio, or 1:40 ratio during break in period
2*	Gearbox	Dry — one speed engine oil brand SAE 30	Filling 60 c.c. (0.06 litres)
3*	Steering	bearing grease	Wash and lubricate on disassembly
4	Twistgrip	lubricating grease	Smear sliding parts with it after washing them
5	Brake levers	oil SAE 30	
6	Handle cables	thin oil (graphite)	Drop a few drops into bearing tubing
7	Wheel bearing	bearing grease	Top up grease in the bearing
8	Brake nipple pins, brake toggles, brake shoe pivots	lubricating grease	After cleaning, coat them sparingly with grease
9	Chain and sprocket on the shaft	graphite oil, or grease	Clean
10	Pedal shaft	oil SAE 30	
11	Pedal bearings	oil SAE 30	
12	Telescopic front fork legs	oil SAE 30	
13	Freewheel	oil SAE 30	Drop a few drops into the bearing tubing
14	Speedometer drive cable	thin graphite oil	

*1 To ensure a reliable function of the freewheel at extremely low temperatures, we recommend the use of thinner M 3A oil (or another oil with similar specifications).

The gearbox oil should be changed after riding while the engine and the oil are still warm. Remove the drain plug (Pos. 2. Fig. 13) on the bottom of the crankcase (engine). After draining the oil, it is recommended to flush the gearbox with flushing oil. The level of the filled-in fresh oil must reach to the control hole „3”. Check the oil level in the gearbox occasionally and refill it when necessary.

Single speed engine is without filler plug screw, control and drain plug screw.

(no it isn't, some do have them & the handbooks for the older single speeds tell you to put oil in the gearbox. - jkw)

MAINTENANCE SCHEDULE

After the first 800 km (500 miles)

- Change gearbox oil. (Two speed engine only)
- Clean and adjust the carburettor.
- Tighten cylinder head nuts.
- Check for loose bolts and screws.
- Adjust and lubricate the chains and sprocket.
- Adjust brakes.

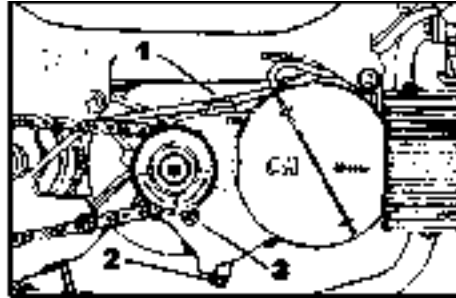

Fig. 13 — Oil filling and drain screw plugs

1. Filler plug, 2. Drain plug, 3. Oil level control

After the first 2,000 km (1,300 miles)

- Change gearbox oil. (Two speed engine only)
- Clean carburettor.
- Clean the filter element of intake silencer.
- Adjust and lubricate chains and sprocket.
- Adjust brakes.
- Check all bolts and screws.
- Check for loose wheel nuts and spoke nipples.
- Lubricate bowden cables.

After every 1,500 to 2,000 km (930 - 1,300 miles)

- Remove carbon deposits from the exhaust silencer and exhaust pipe (elbow).

After every 3,000 km (2,000 miles)

- Check oil level. (Two speed engine only)
- Inspect and clean filter element of intake silencer.

After every 6,000 km (4,000 miles)

- Inspect and clean the spark plug.
- Change the gearbox oil. (Two speed engine only)
- Clean the carburettor.
- Clean the filter element of intake silencer.
- Adjust and lubricate chains and sprocket.
- Adjust brakes.
- Check all bolts and screws.
- Check for loose wheel nuts and spoke nipples.
- Lubricate all lubricating points.
- Remove carbon deposits from exhaust silencer and exhaust pipe (elbow).

Lubricate the chains and the freewheel, and clean the brakes more frequently during rainy weather.

Saddle Height Adjusting (Fig.14)

The position of the saddle can be adjusted as required within the range of 25 mm after loosening the two screws.

Handlebar Mounting (Fig.15)

The handlebars are attached to the front fork with hexagonal screws. Check occasionally for loose screws. The position of the handlebars is not adjustable.

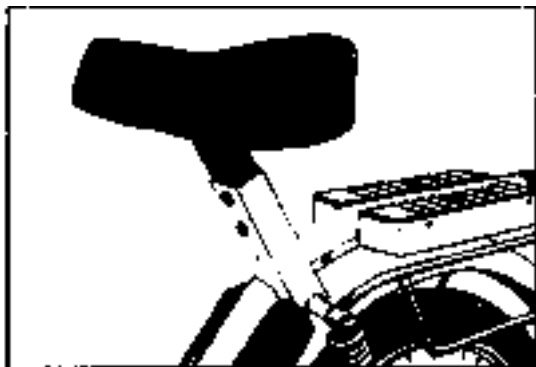

Fig. 14 - Saddle position adjusting

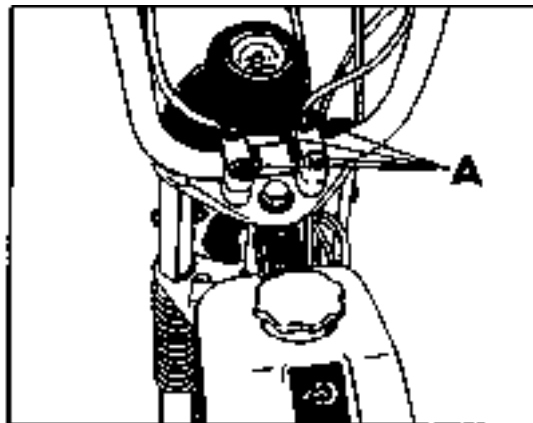

Fig. 15 - Handlebars mounting

Adjusting of Brakes

A screw is provided on the handlebars (Fig.16) for adjusting the front brake. First loosen the knurled nut (1) of the brake by loosening or tightening screw (2) so that when pressed (pulled) toward the grip there is a clearance of 20 to 30 mm between the lever and the grip. Then retighten nut (1). When the brake lever can no longer be adjusted by means of set screw (2) adjust the required clearance by means of the brake toggle (Fig.17).

For adjusting the rear brake use the adjusting nut (1), Fig. 18. If this is no longer adjustable by set screw on the handlebars re-set the brake toggle on the splined shaft. The rear brake can then again be adjusted by means of the adjusting nut (1) Fig.18. After adjusting the brakes check whether they are not too tight. With the moped resting on its stand, spin the wheels and check for free rotation.

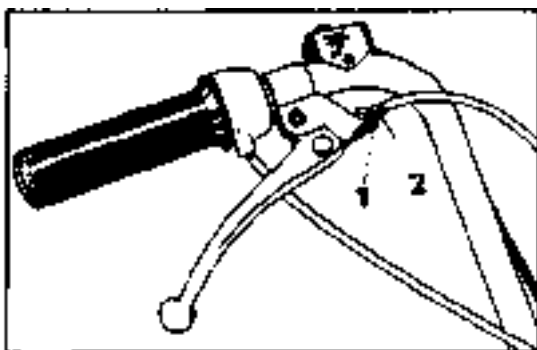

Fig.16 - Front brake adjustment

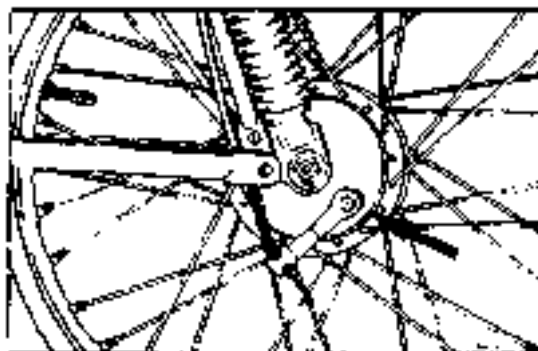

Fig. 17 - Front brake adjustment

Tensioning of Chains

To take up the tension of the chain from the engine, first loosen the nut of the rear wheel spindle (Pos. No. 3, Fig.18). Now adjust the chain by tightening the nuts (4) of the chain tensioner (2) on either side of the frame. The sag of the chain when compressed midway with the fingers must be about 15 mm. After tensioning, check the alignment of the track of both wheels with the aid of a perfectly straight lath, and then firmly retighten the spindle nut. The tension of the chain from the pedals can be adjusted by means of the tension pulley (a) on the left-hand side of the moped (Fig.19).

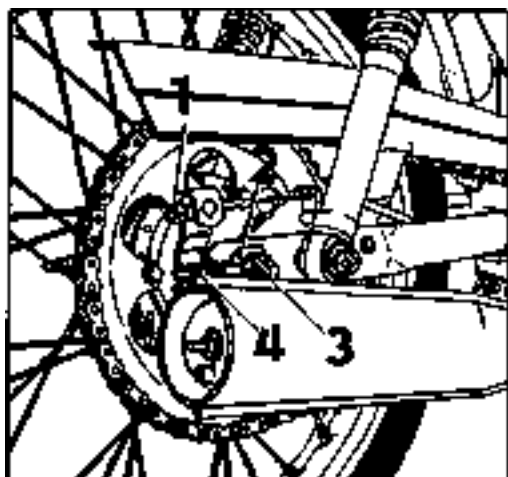

Fig.18 — Adjusting of rear brake and engine drive transmission chain

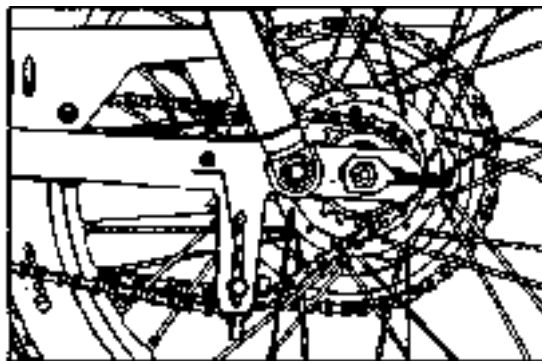

Fig.19 — Adjusting of pedal drive transmission chain

Carburettor (Fig.20)

In the case of a defective carburettor, we recommend that you bring the moped to an authorised service station or repair shop where skilled mechanics will correct the defect, and correctly clean and adjust the carburettor. When cleaning the jets, use only gas and compressed air.

The JIKOV 2912 DC carburettor has the following parts and adjustments:

- main jet 63
- idling jet 35
- throttle valve needle set in second notch from top
- idling mixture control screw backed off from the basic adjusting position by 1 - 1/2 turns

The stop screw of the throttle (sleeve) valve is used for adjusting the idling speed.

To increase the idling speed tighten the screw, and to decrease the idling speed, loosen the screw as necessary.

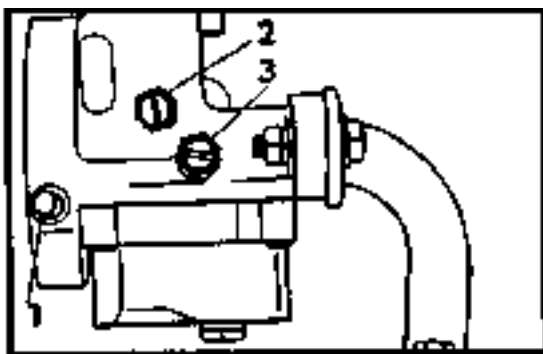

Fig.20 — Carburettor

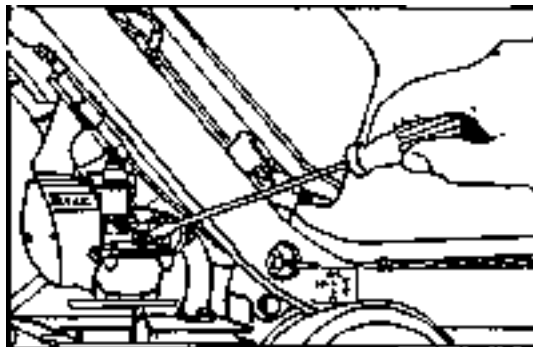

Fig.21 — Carburettor adjustment

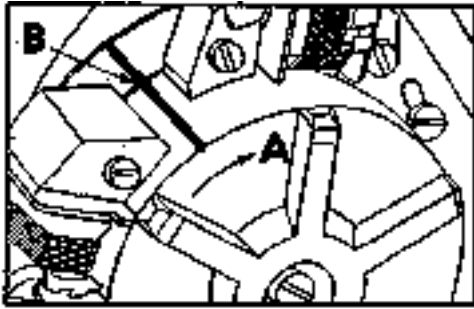

Fig. 22 - Ignition timing

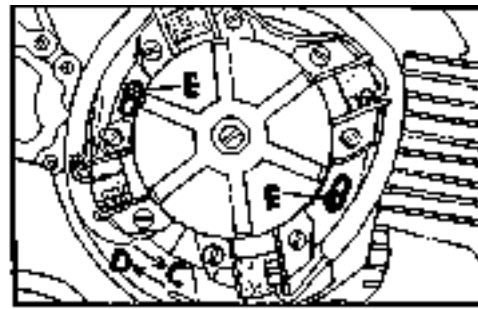

Fig. 23 - Ignition tuning

Ignition

The moped is equipped with a non-contact semiconductor ignition system, which does not require any maintenance except cleaning the spark plug. It is practically fail-proof and a defect can only be the result of unwarranted interference on the part of the owner. Ignition adjustment is unnecessary since no mechanical wear can take place. Ignition advance should be adjusted only if the stator screws have become loose or after the removal of the alternator. We recommend therefore not to interfere with the ignition adjustment. In the case of a failure go to a specialised workshop.

Timing instructions

Tools needed: dial indicator or timing pin (both available from JAWA) Procedure: Remove spark plug and insert dial indicator into hole. Find top dead centre by turning the rotor until the dial gauge reads as high as it can. Zero-out gauge and turn rotor backwards (counter-clockwise) one and one-half millimetres (1.5mm). Compare the mark on the rotor with the mark on the stator. If they are in the same position the timing is correct and does not need adjustment. If the marks do not match up, loosen the screws holding the stator (Fig.23, E) and rotate stator until the marks are in alignment and retighten screws.

V. REAR TELESCOPIC SUSPENSION UNITS

They are of simple design, without shock absorbers with a stroke of 60 mm that require no maintenance. Hydraulic shock absorbers are supplied on special order.

VI. TOOL KIT

Tool kit is placed in the tool box compartment.

1. universal spanner
2. screwdriver 3 mm size
3. box spanner 10 mm
4. rod 5 mm
5. box spanner 13/17 mm
6. spark plug box spanner, size 21
7. tire pump
8. steering lock

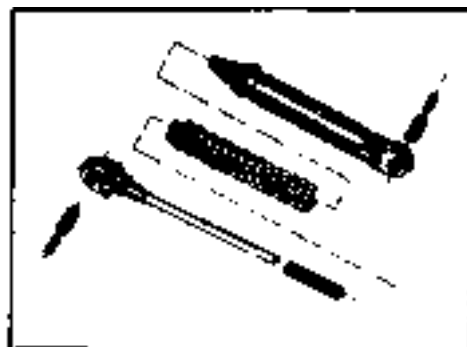

Fig. 24 - Rear telescopic suspension unit

Note: Insert the tire pump into the rear part of frame with the folding plate pointing upwards and handle pointing towards plastic cap.

VII. TROUBLE SHOOTING

If engine will not start, check the following

1. Closed fuel cock.
2. No fuel in the fuel tank.
3. Faulty fuel supply - clogged fuel line, clogged wire-gauze filter or carburettor jet, water in float chamber.
4. Faulty ignition system:
Excessive carbon on the spark plug, damaged (cracked) plug insulator, incorrect (excessive) gap between plug electrodes, faulty thyristor unit, faulty ignition coil or faulty stator frame.
5. Flooded engine
Correction: Shut the fuel cock OFF. Open the throttle fully and step on the pedals with the moped propped on its stand, or start moving by pedalling till the engine fires. Open ON the fuel cock only after the engine has started running. It may also be necessary to remove the spark plug and clean it. Then crank the engine several times to force excessive fuel out of the engine through the spark plug hole replace the plug and repeat the starting procedure.
6. Starting clutch slips or it is only.
The defect can be ascertained after removing the cover of the ignition system. In the case of a defective clutch, the crankshaft with the rotor does not rotate.

A. If engine starts but runs erratically

1. Overheated engine.
2. Faulty spark plug.
3. Partly obstructed fuel supply or main jet clogged with dirt.
4. Leaky crankcase.
5. Damaged cable shoe.
6. Faulty ignition.

B. The engine loses power

1. Clogged air cleaner.
2. Clogged exhaust silencer.
3. Damaged sealing rig of the crankcase.
4. Damaged piston, cylinder or piston rings.
5. Damaged cylinder head gasket.
6. Incorrect ignition timing.

C. The engine does not lose power but (he acceleration is poor or the moped cannot reach its maximum speed.

1. Brake shoes are fouling the brake drums.
2. Under inflated tires.
3. Slipping driving clutch or slipping 2nd-speed clutch. (Two speed moped only)

VIII. SPARE PARTS

The moped serial number and year of manufacture are stamped on the ID plate affixed on the front part of the frame. The engine number is embossed on the crankcase.

The moped serial number is intended for the registration of the machine. When ordering spare parts please indicate the serial number and year of manufacture of your moped.

PARTS & ACCESSORIES

Click on links below

[*Motorcycle Parts & Accessories*](#)

[*Dirt Bike Parts & Accessories*](#)

[*Cruiser Motorcycle Parts & Accessories*](#)

[*Japanese Motorcycle OEM Parts & Online Schematics*](#)

[*Save Up to 45% on Motorcycle Tires*](#)

[*Motorcycle Gear Buyer's Guide & Reviews*](#)

[*Motorcycle Gear Closeout Sale*](#)

[*Free Shipping On All Mini Bikes*](#)

[*Cycle Gear - Free Shipping*](#)

[*Mega Motor Madness*](#)



[*www.ClassicCycles.org*](http://www.ClassicCycles.org)