



KYMCO



PEOPLE'S 50 & 125 & 200

OWNER'S MANUAL

Do not remove this Owner's Manual from the vehicle. Read this manual carefully before operating the vehicle, as it contains important safety information.

Read this manual carefully.



This Owner's Manual contains important information on the safety, operation and maintenance of your KYMCO scooter.

Anyone who operates your scooter should carefully read and understand the contents of this manual before riding the scooter.

For your safety, understand and follow all of the warnings contained in this Owner's Manual and the labels applied to your scooter.

This Owner's Manual should be considered a permanent part of the vehicle. Keep it with your scooter at all times.

ON-ROAD USE ONLY This scooter has been designed to be used on the road.

Particularly important information is called out in this manual by the following icons and notations:



The SAFETY ALERT symbol with the exclamation point in the triangle means ATTENTION! BE ALERT! YOUR SAFETY CAN BE AFFECTED.



Failure to follow instructions associated with a WARNING symbol could result in severe injury or death to the rider, a passenger, a bystander, or a person inspecting or repairing the scooter.



A CAUTION symbol indicates that special precautions must be taken to avoid damaging the scooter.



The NOTE symbol indicates key information about a procedure or clarifies an operation.

California Proposition 65



This product contains or emits chemicals known to the State of California to cause cancer and birth defects or other reproductive harm.

TABLE OF CONTENTS



Manual Icon Legend	(inside of front-cover)	
CA Prop 65 Warning	(inside of front-cover)	
Table of Contents	1	
SECTION 1 - SAFETY	2 - 6	
Foreword	2	
Scooter Safety	3 - 4	
Load Limits & Guidelines	5	
Accessories & Modifications	6	
SECTION 2 - CONTROLS & FEATURES	7 - 15	
Locations of Parts & Controls	7 - 9	
Vehicle Identification Numbers	10	
Keys	11	
Ignition Switch & Steering Lock	11 - 12	
Right-hand Handlebar Switch	13	
Engine-stop Switch	13	
Electric Start Button	13	
Left-hand Handlebar Switch	13 - 14	
Headlight Dimmer Switch	13	
Turn Signal Switch	13	
Turn Signals	14	
Horn Button	14	
Under-seat Storage Compartment	14	
Helmet Hooks	15	
Power Socket	15	
Main Stand	16	
Front Luggage Box	16	
Instruments	17 - 18	
Clock & Trip-meter	18 - 19	
Rear Shock Absorbers	20	
Passenger Foot Rests	20	
SECTION 3 - OPERATION	21 - 41	
Break-in Recommendations	21	
Tire Break-in	22	
Pre-ride Inspection	23 - 33	
Engine Oil Inspection	24	
Tire Inspection	24 - 25	
Fuel Level / Filler Cap	26	
Brake Inspection	27 - 30	
Steering & Handlebar Inspection	30	
Instrument Inspection	31	
Horn & Lights Inspection	31 - 32	
Chassis Inspection	32 - 33	
Starting the Engine (electric start)	33 - 35	
Starting the Engine (kick start)	35	
Riding Your Scooter	36 - 40	
Parking Your Scooter	40 - 41	
SECTION 4 - MAINTENANCE	42 - 61	
Importance of Maintenance	42	
Maintenance Schedule	43 - 44	
Tires	45	
Tire Pressure	45	
Engine Oil	46	
Engine Oil Level Inspection & Change	46 - 47	
Transmission Fluid Change	48	
Air Filter Maintenance	49	
Spark Plug	50	
Fuel System	51	
Battery	51 - 52	
Fuses	53	
Brake Fluid Level Inspection	54 - 55	
Brake Lever & Shoe Adjustment	55	
Cleaning Your Scooter	56 - 57	
Storage	58 - 59	
Maintenance Record	60 - 61	
Specifications (People S 50)	62	
Specifications (People S 125)	63	
Specifications (People S 200)	64	
Emission - KYMCO Clean Air System	65	
Emission Information & EPA Warranty	66	
KYMCO Limited Scooter Warranty	67	
Index	68	
Identification Numbers Record	(inside of back-cover)	

SECTION 1 - FOREWORD & SAFETY INTRODUCTION



Thank you for purchasing this KYMCO People S scooter, and welcome to the KYMCO riding family.

Please read this Owner's Manual carefully before riding so that you will be thoroughly familiar with the proper operation of your scooter's controls, its features, its capabilities, and its limitations.

To ensure a long, trouble-free life for your scooter, be sure to provide it with proper care and maintenance as set forth in this manual.

For replacement parts and accessories, you should always use genuine KYMCO products, as they have been specially designed for your vehicle and manufactured to meet KYMCO's demanding standards.

Keep this Owner's Manual aboard your scooter at all times, so that you can refer to it whenever you need information. This manual should be considered a permanent part of the scooter, and should remain with the scooter when it is sold.

All information, illustrations, photographs and specifications contained in this manual are based on the latest product information available at the time of publication. Due to improvements or other changes, there may be information in this manual that differs slightly from your vehicle. KYMCO reserves the right to make product and publication changes at any time, without notice, and without incurring any liability.

IMPORTANT SAFETY INFORMATION

Your scooter can provide you with many years of service and pleasure if you take responsibility for your own safety and understand the challenges that you can meet on the road. There is much that you can do to protect yourself when you ride. You will find many helpful recommendations throughout this manual. Here are some very important safety tips:

Wear a helmet

Scooter safety equipment starts with a quality helmet. One of the most serious injuries you can suffer in a crash is a head injury. Always wear a properly approved helmet. You should also wear suitable eye protection.

Make yourself easy to see

To make yourself more visible, wear bright, reflective clothing; position yourself so other drivers can see you; signal before turning or changing lanes; and use your horn when it will help others notice you.

Know your limits

Ride within the boundaries of your own skill at all times. Knowing these limits and staying within them will help you avoid accidents.

Keep your scooter in safe condition

For safe riding, it is important to inspect your scooter before every ride and perform all recommended maintenance. Never exceed load limits, and only use accessories that have been approved by KYMCO for this scooter.

Inspect your scooter before riding

Do not forget to perform an entire safety inspection to ensure your, and your passenger's safety, before each ride.

Be extra safety conscious on bad weather days

Riding on bad weather days, especially wet ones, requires extra caution. Braking distance can double on a rainy day. Stay off of painted surfaces, manhole covers and greasy appearing areas on the pavement, as they can be especially slippery. Use extreme caution at railway crossings and on metal gratings and bridges. Whenever you are in doubt about the road conditions, slow down.

Modification

Modification of your scooter, or removal of original equipment may render the vehicle unsafe or illegal. Obey all applicable equipment regulations in your area.

PROTECTIVE APPAREL

For your safety, always wear an approved motorcycle or scooter helmet, eye protection, boots, gloves, long pants, and a long-sleeved shirt or jacket whenever you ride your scooter.

Helmets and protection

Your helmet is your most important piece of riding gear because it offers the best protection against head injuries. Your helmet should fit your head comfortably and securely. Always wear a face shield or goggles to protect your eyes and aid your vision.

Additional riding gear

In addition to a helmet and eye protection, you should also use:

- Sturdy boots with nonslip soles to help protect your feet and ankles
- Leather gloves to keep your hands warm and help prevent blisters, cuts, burns and bruises
- A motorcycle or scooter riding suit or jacket that has been designed for comfort, as well as protection. Bright colored and reflective clothing can help make you more noticeable in traffic. Be sure to avoid loose clothing that can get caught on any part of your scooter.

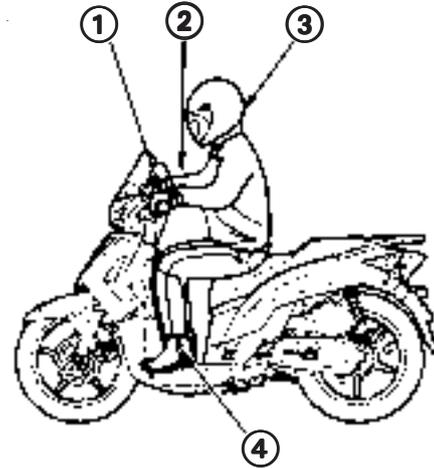

- ① Wear gloves and use both hands to grasp the handlebar when riding
- ② Wear bright or reflective clothing. Clothes should fit properly (not too tight or loose)
- ③ Always wear a helmet and eye protection
- ④ Footwear should be the proper size, have low heels, and offer ankle protection

WARNING

Not wearing a helmet increases your chance of serious injury or death in a crash.

WARNING

Be sure you and your passenger always wear an approved motorcycle helmet that fits properly. You should also wear eye protection and other protective apparel when you ride.

These general guidelines may help you decide how to add accessories to your scooter and how to load it properly.

Load limits

These specifications are the load limits for your People S scooter. Overloading the scooter will affect its stability and handling. Be sure to stay within the limits given below:

Maximum weight capacity (Includes the weight of the rider, passenger, cargo and accessories): 330 lb (150 kg)

Maximum cargo weight: 25.3 lb (11.5 kg)

Rear carrier (rack) ⑤ weight limit: 11 lbs (5 kg)

Under-seat compartment ⑥ weight limit: 11 lbs (5 kg)

Front luggage box ⑦ weight limit: 3.3 lbs (1.5 kg)

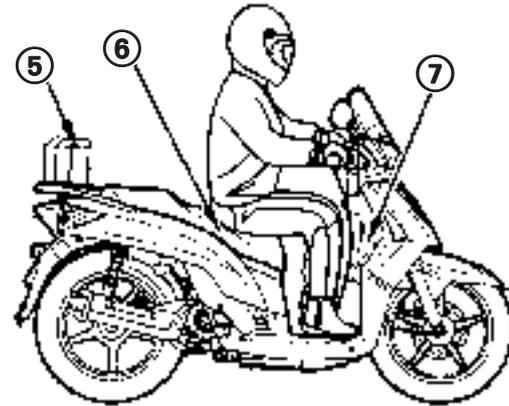

Loading guidelines

Improperly loading your scooter will affect its stability and handling. You should ride at reduced speeds when you are carrying a passenger or cargo. Follow these guidelines whenever you carry a passenger or cargo:

- Check that both tires are properly inflated
- To prevent loose items from creating a hazard, make sure all cargo is securely tied down before you ride
- Place cargo weight as close to the center of the scooter as possible
- Balance cargo weight evenly on both sides of the scooter

WARNING

Overloading or improper loading will affect vehicle handling, stability and braking, and can lead to an accident. Never exceed the stated load capacity of your scooter. Cargo should be properly distributed and securely attached. Reduce speed when carrying cargo. Allow greater distances for braking.

There is a large variety of accessories available to KYMCO scooter owners. KYMCO cannot control the quality or suitability of accessories you may wish to purchase. But the addition of unsuitable accessories to your scooter can lead to unsafe operating conditions. It is not possible for KYMCO to test each accessory on the market, or all of the combinations of the available accessories. Your KYMCO dealer will be happy to assist you in selecting quality accessories and see that they are installed correctly.

Use extreme caution when selecting and installing the accessories for your scooter.

No modifications

KYMCO strongly advises you against removing any original equipment or modifying your scooter in any way that would change its design or operation.

⚠ WARNING

Improper accessories or modifications can make your scooter unsafe and can lead to an accident.

Never modify your scooter through the improper installation or use of accessories. All parts and accessories added to this vehicle should be genuine KYMCO or equivalent components designed for use on this scooter.

All accessories should be installed and used according to the product's instructions. If you have any questions, consult an authorized KYMCO dealer.

SECTION 2 - CONTROLS & FEATURES

Location of parts & controls

- ① Battery & Fuse
- ② Helmet Holder
- ③ Ignition Switch
- ④ Speedometer
- ⑤ Engine Stop Switch & Starter Button
- ⑥ Exhaust Muffler
- ⑦ Main Stand
- ⑧ Front Luggage Box

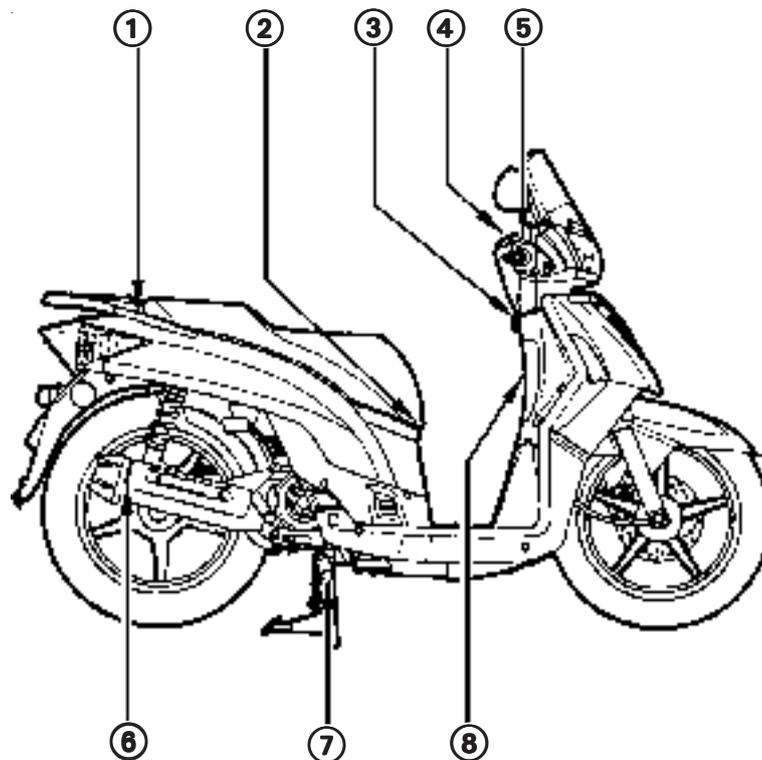

NOTE: Your scooter may differ slightly in appearance from the images in this manual.

Location of parts & controls

- ① Headlight HI/LO-beam Switch, Passing Light Button, Turn Signal Switch & Horn Button
- ② Helmet Holder
- ③ Under-seat Storage Compartment
- ④ Fuel Filler Cap
- ⑤ Seat Lock
- ⑥ Center Hook (for helmet or bag)
- ⑦ Side Stand
- ⑧ Kick Start Lever
- ⑨ Air Cleaner Assembly

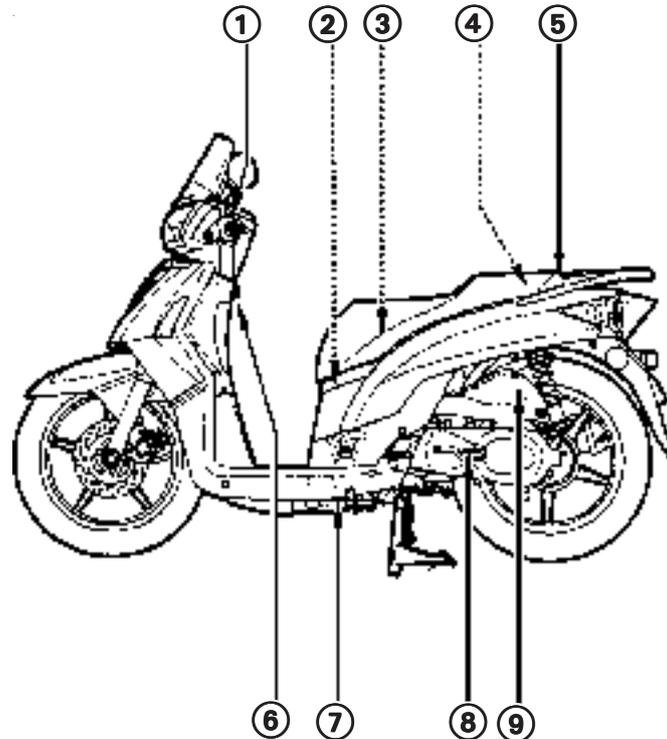

Location of parts & controls

- ① Right Front Fork
- ② Right Front Turn Signal
- ③ Front Brake Lever
- ④ Right Mirror
- ⑤ Headlight
- ⑥ Left Mirror
- ⑦ Rear Brake Lever
- ⑧ Left Front Turn Signal
- ⑨ Left Front Fork & Front Brake

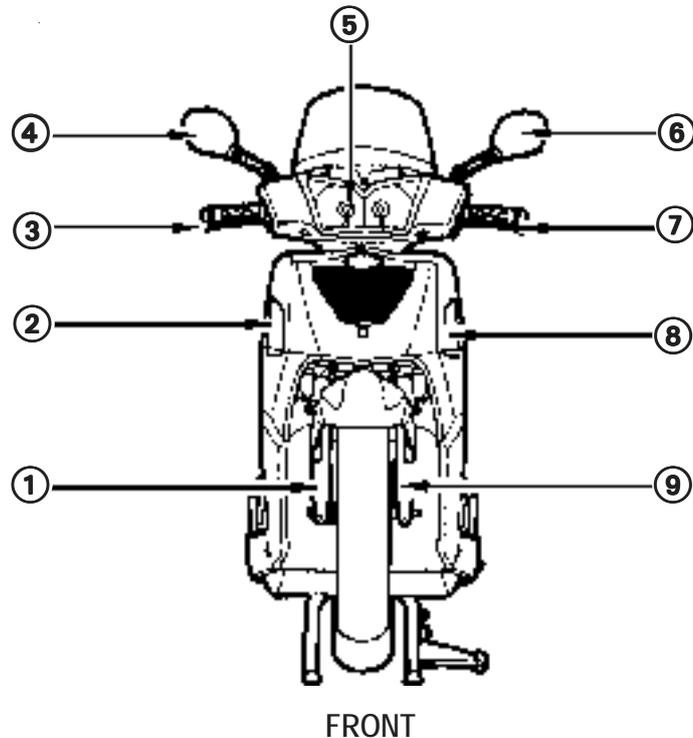

NOTE: Your scooter may differ slightly in appearance from the images in this manual.

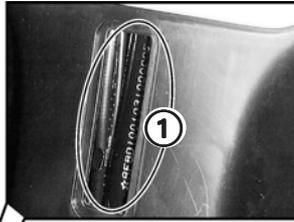

VEHICLE IDENTIFICATION NUMBERS

You scooter had identification numbers stamped into the frame and engine cases during manufacture.

VIN (Vehicle Identification Number) or Frame Number

To view the VIN ①, remove the cover on the frame cover by releasing its tab with a flat-head screw driver.

ESN (Engine Serial Number)

The ESN ②, is stamped on the left engine case.

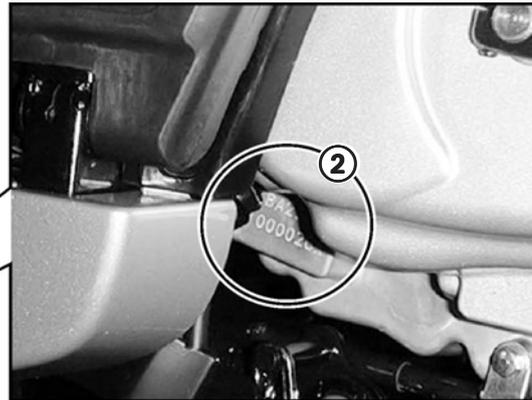
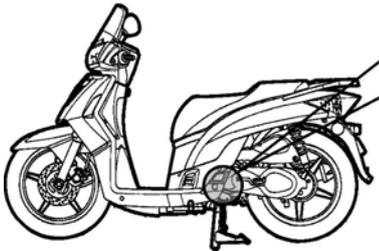
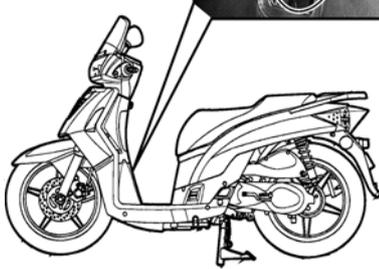

NOTE:

Write your scooter's VIN and ESN in the boxes provided in the inside, rear cover of this Owner's Manual.

Keys

Your People S scooter is supplied with two identical ignition switch keys. The ignition key operates the ignition switch, the steering lock, and is used to open the seat to gain access to the front luggage box and the under-seat storage compartment (and fuel filler cap).

Key code tab



The keys have a unique code which is stamped on the tab supplied with the keys. This code is not stamped on the scooter and is not recorded in the vehicle's basic documentation for security reasons. Since this code is required if you need replacement keys, record this important code in the box provided on the inside, rear cover of this Owner's Manual.

NOTE: Your scooter's keys may differ slightly in appearance from the images in this manual.

Ignition switch & Steering lock

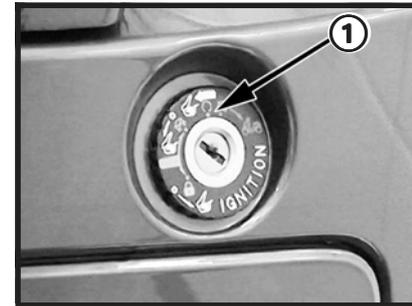

① ON  : In this position, electrical power is connected to start and operate the engine (the key cannot be removed).

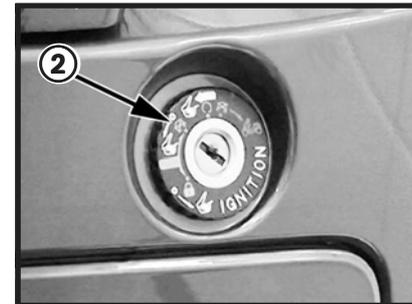

② OFF  : In this position, electrical power is disconnected and the engine cannot start or operate (the key can be removed).

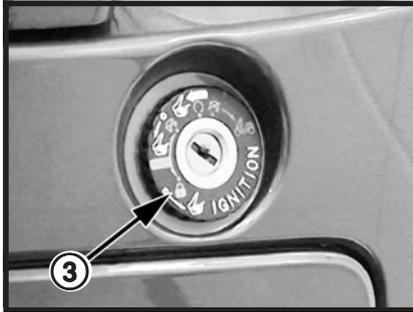

- ③ **LOCK**  : In this position, the steering is locked, electrical power is disconnected and the engine cannot start or operate (the key can be removed).

Locking the steering

Turn the handlebar fully to the left. Press in and rotate the ignition switch key counterclockwise to the “**LOCK** ” position. The steering will now be locked. Remove the ignition switch key.

CAUTION

After locking the ignition switch, turn the handlebar gently to confirm that the steering is locked. Do not park your scooter in a position that will interfere with vehicle or pedestrian traffic.

WARNING

Do not turn the ignition switch to the lock position when riding, as this could cause the steering to lock, and you could lose control of your scooter.

Unlocking the steering

Insert and rotate the ignition switch key clockwise from the “**LOCK** ” position to the “**OFF** ” or “**ON** ” position. The steering is now unlocked, and you may start and operate the scooter.

Right handlebar switch

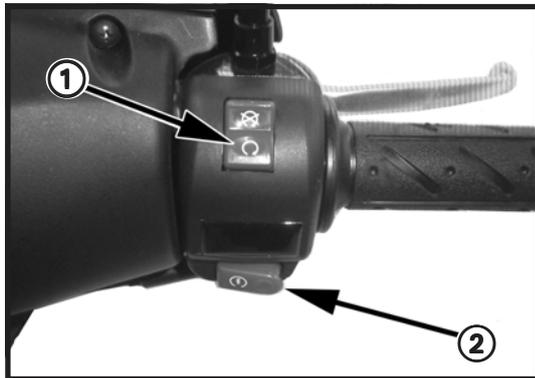

Engine stop switch ①:

The engine stop switch turns off the ignition, stopping the engine. The scooter's lights and horn still function.

Electric starter button ②:

Press the electric starter button to activate the starter motor.

NOTE: The starter motor will not engage unless a brake lever is squeezed at the same time the starter button is pressed.

⚠ CAUTION

To prevent damage to the starter motor, do not operate the starter motor for more than five seconds at a time. If the scooter fails to start immediately, check the fuel level and the battery condition, and allow the starter motor to cool before attempting to start the engine again.

Left handlebar switch

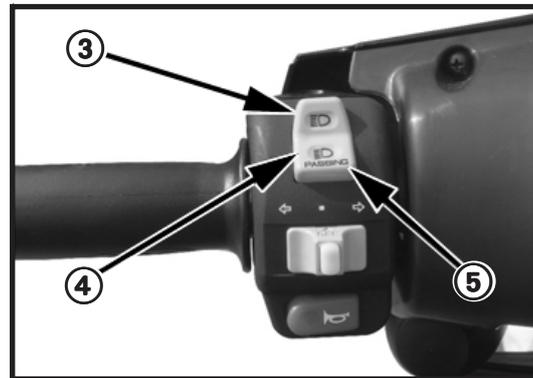

Headlamp switch -- UP ③:

The upper switch position turns the headlight high beam on. The high beam indicator light on the dash is activated as well.

Headlamp switch -- DOWN ④:

The lower switch position turns the headlight low beam on.

Passing light button - PRESS DOWN ⑤:

When downward pressure is applied to the headlight rocker switch, the high beam is activated. When pressure is released, the low beam setting is restored. This enables you to rapidly flick the headlight high beam on and off to signal other vehicles that you wish to pass.

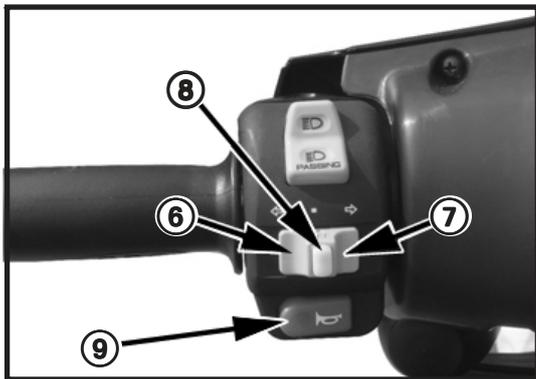

Turn signal switch:

Use the turn signal indicator to signal to other traffic that you intend to turn or change lanes. The turn signal light on the dash will flash to indicate that the switch is engaged.

- ⑥ Slide the turn switch to the left to activate the left turn signal.
 - ⑦ Slide the switch to the right to activate the right turn signal.
- To cancel the turn signal, press down on the signal switch ⑧.

Horn button ⑨:

Press the horn button to sound the horn.

NOTE: The horn will only sound when the ignition is "ON".

Under-seat storage compartment

Your scooter is equipped with an under-seat storage compartment that permits you to secure your helmet or other items.

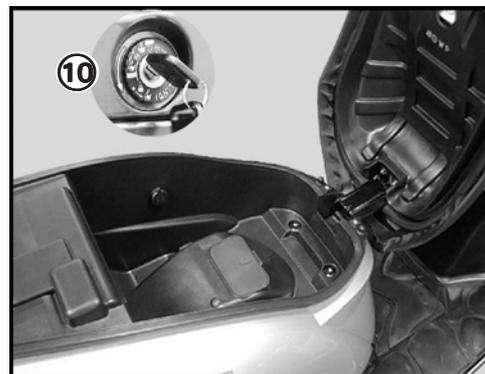

To open the seat, stop the engine and rotate the ignition switch key counterclockwise in the ignition switch ⑩ from the "OFF" position to the "ON" position. When the latch releases, lift up the seat.

Under-seat compartment weight limit: 11 lbs (5 kg)

To close the seat, lower the seat and press down until it is secured by the latch. Gently lift up on the seat to make sure it is locked before riding.

WARNING

Never exceed the maximum weight limit of the storage compartment, as vehicle handling and stability may be severely affected. Do not leave the ignition switch key under the seat.

Helmet hooks

Your scooter has two helmet hooks ⑪ so you can hang your helmet(s) outside of the under-seat storage compartment.

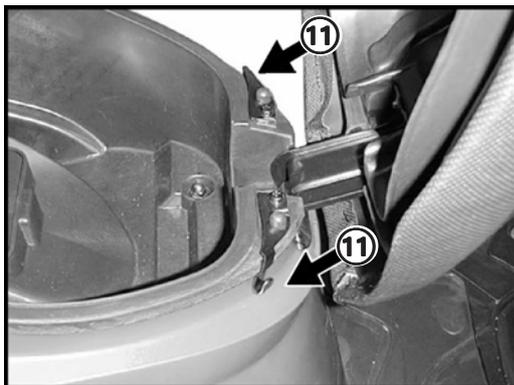

With the seat up, put the helmet's retaining ring onto the helmet hook. Lower and press down on the seat to lock it and secure the helmet in place. To remove the helmet, open the seat.

⚠ WARNING

Do not ride your scooter with a helmet hanging from a helmet hook, as this can interfere with your ability to control your scooter and may cause an accident.

The under-seat storage compartment may become warm from engine heat. Therefore, do not store any items in this compartment that are susceptible to heat damage, such as food or flammable materials.

Power socket

Your scooter is equipped with a SAE 12-VDC power socket ⑫ in the under-seat storage compartment.

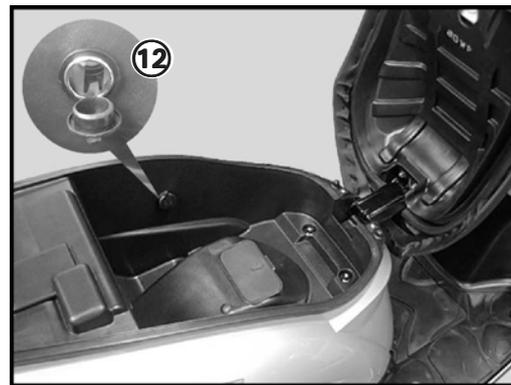

The power socket can be used to connect and power accessories such as a cell-phone charger.

⚠ CAUTION

Close the socket's protective cover when it is not in use. When connecting accessories and chargers to the power socket, read and follow the accessory's instructions to prevent damage to the device or your scooter.

Front luggage box

Your scooter is equipped with a front luggage box that permits you to secure your gloves or other items.

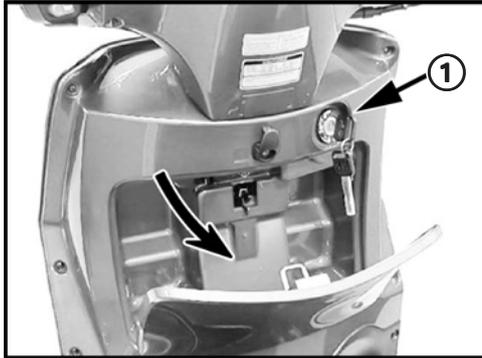

To open the luggage box, insert the ignition switch key into the ignition switch ① and turn it from the “ ” position to the “ ” position, and the cover will automatically open.

Front luggage box weight limit: 3.3 lbs (1.5 kg)

To close the luggage box cover, lift it up and press it in place until it is secured by the latch. Gently pull down on the cover to make sure it is locked before riding.

WARNING

Never exceed the maximum weight limit of the front luggage box. Do not leave the ignition switch key under the seat.

Main stand (center stand)

Your People S scooter is equipped with a main (center) stand.

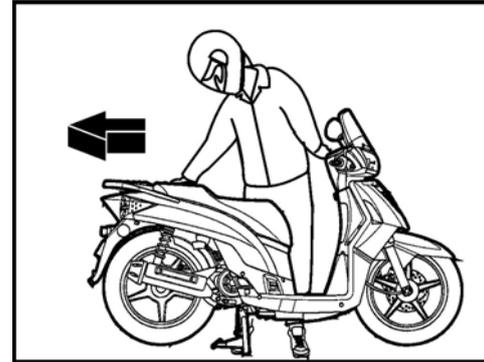

To park your scooter on the main stand, stand on the left side of the scooter and grasp the handlebar with your left hand, while grasping the side of the rear rack with your right hand. Step down on the foot pad of the main stand with your foot while pulling up and back on the rear rack. This lifting motion will allow the scooter to rock backwards and up onto the main stand.

CAUTION

Always park your the scooter on firm, level ground to help prevent it from falling over. If you must park on an incline, aim the front of your scooter uphill.

Instruments & Indicators

Your People S scooter is equipped with a multifunction meter and indicator set. This set includes an analog speedometer and fuel level display, and a digital clock and odometer. The set also includes indicator lamps to alert you to headlight and turn signal functions.

- ① **Mode & Adjustment Buttons:** Used to adjust the clock's time setting and to reset the trip odometer.
- ② **Clock:** Indicates the time (24-hour format).
- ③ **Odometer:** Indicates the total riding mileage of the scooter.
- ④ **Speedometer (outer dial):** Indicates the road speed in MPH (miles per our).
- ⑤ **Fuel Gauge:** Indicates the amount of gasoline in the fuel tank. Refill the tank with unleaded gasoline before the needle reaches the "E" (empty) mark. (Best practice is to maintain the fuel level no lower than the one-quarter mark above empty whenever possible).
- ⑥ **Speedometer (inner dial):** Indicates the road speed in K/PH (kilometers per hour).

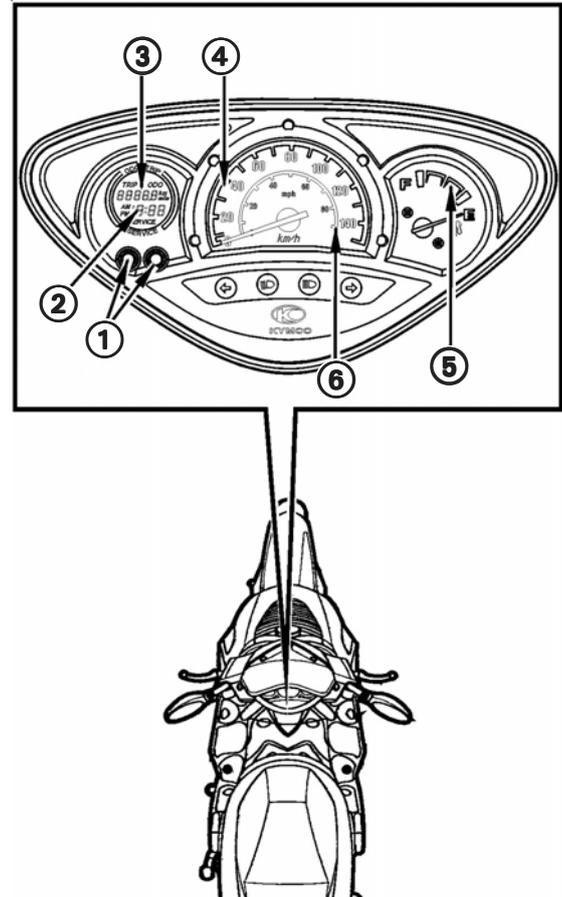

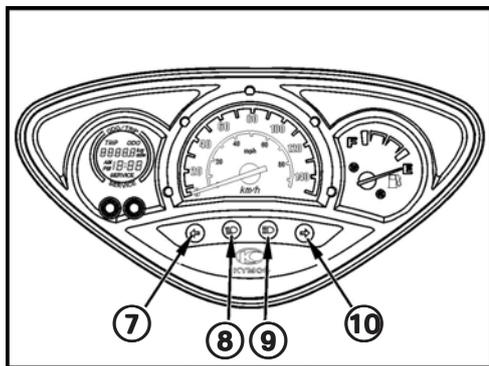

- ⑦ **Left Turn Signal Indicator Light:** Flashes when the left turn signals are being used.
- ⑧ **Low Beam Indicator Light:** This light is illuminated when the headlight low beam is on.
- ⑨ **High Beam Indicator Light:** This light is illuminated when the headlight high beam is on.
- ⑩ **Right Turn Signal Indicator Light:** Flashes when the right turn signals are being used.

Digital Clock & Trip-meter

Use the following instructions to set the digital clock and odometer display on your People S scooter. The odometer can be toggled between "miles" or "kilometers", has a resettable trip meter, and a mileage-based service reminder feature.

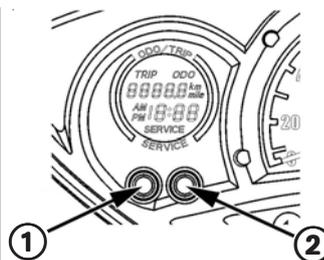

- ① **Mode Button**
- ② **Adjustment Button**

These buttons enable you to adjust and change the digital display's functions.

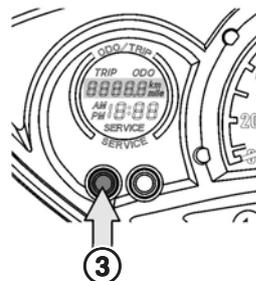

Changing the odometer/trip-meter from "Miles" to "Kilometers":

Press and hold the **Mode Button ③** for two seconds to switch between "miles" or "kilometers" display on the odometer/trip-meter.



Changing from odometer display to trip-meter display:
Press and hold the **Adjustment Button ④** for two seconds to switch between “odometer” and “trip-meter” display.

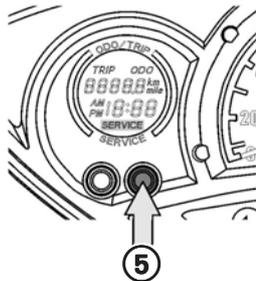

Resetting the Service Reminder:
[The Service Reminder will flash to remind you to change the engine oil - DO NOT reset until the oil change is complete]
Press and hold the **Adjustment Button ⑤** for five seconds to access the service reminder mode.



While in service reminder mode, press and hold the **Mode Button ⑥** and the **Adjustment Button ⑦** at the same time for two seconds to reset the reminder.
To return to the odometer display, press and hold the **Adjustment Button ⑦** for two seconds.

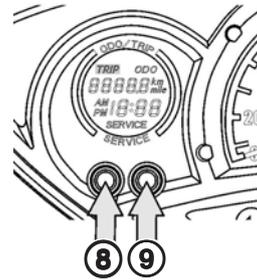

Trip-meter reset:
While in the trip meter display, press and hold the **Mode Button ⑧** and the **Adjustment Button ⑨** at the same time for two seconds to reset the trip-meter.

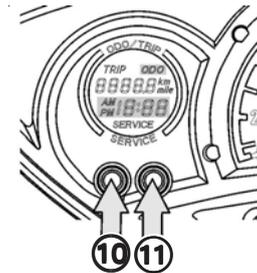

Adjusting the clock time:
While in the odometer mode, press and hold the **Mode Button ⑩** and the **Adjustment Button ⑪** at the same time for two seconds in the *Odometer Mode* until the clock's hour display begins to flash.
Then press the **Adjustment Button** to change the hour setting.
Press the **Mode Button** until the clock's minute display begins to flash and use the **Adjustment Button** to change the minute setting.
Press the **Mode Button** and the **Adjustment Button** again simultaneously to exit the clock adjustment mode.

Rear shock absorbers

You can adjust the spring preload of your scooter's shock absorbers to match the load it will be carrying.

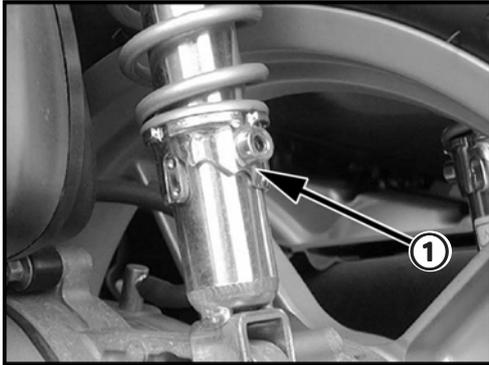

1. Insert the rod tool from the tool kit into the preload collar ① on each shock absorber and rotate the collar to increase or decrease the spring preload.
2. There are three steps on the spring preload collar. The center step "medium" is the standard setting. The longer step "hard", and the shorter step "soft", are optional settings based upon your load and riding preference.

⚠ CAUTION

When adjusting the spring preload, rotate each shock absorber's collar to the same setting.

Passenger foot rest

Your People S scooter is equipped with fold-down foot rests ② for use when you are carrying a passenger.

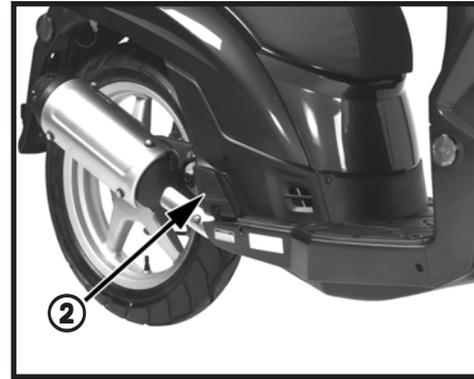

⚠ WARNING

Riding with a passenger will change the handling characteristics of your scooter. Allow for extra braking distance and use extra care when riding in traffic.

Be sure you and your passenger should always wear approved and properly fitting motorcycle helmets. You and your passenger should also wear eye protection and other protective apparel when you ride.

Break-in recommendations

The first 600 miles (1,000 km) of riding are the most important in the life of your scooter. Following proper break-in procedures during this time will help ensure maximum life and performance from your new scooter. Proper break-in operation allows the machined surfaces to polish each other and mate smoothly.

Your scooter's reliability and performance depend on your exercise of special care and restraint during the break-in period. It is especially important that you avoid operating the engine in a manner which could expose the engine parts to excessive heat.

The following guidelines should be followed during the break-in period:

Maximum throttle operation:

Initial 300 miles (600 km): Less than 1/2 throttle

Up to 600 miles (1,000 km): Less than 3/4 throttle

Vary the engine speed:

The engine speed should be varied and not held at a constant rate for long periods of time. This allows the parts to be "loaded" with pressure, and then unloaded, allowing the parts to cool. This aids in the mating process of the engine and transmission components. It is essential that some stress be placed

on these components during break-in to ensure that this mating process occurs. Do not, however, apply excessive load on the scooter's drive line.

Avoid constant low speed:

Operating the engine at constant low speed (light load) can cause parts to glaze and not seat in properly. Allow the engine to accelerate freely through the gears, without exceeding the recommended throttle openings.

Avoid using full throttle for the first 300 miles (600 km).

The initial service:

The 200 mile (300 km) initial service is the most important service your scooter will receive. **Take extra care to observe your scooter's initial service in a timely fashion.** During the break-in period, all of the engine components will have worn in, and all of the other parts will have seated in, so adjustments will be required. All fasteners will be tightened, and the contaminated engine oil will be replaced.

NOTE: Completion of the 200 mile (300 km) initial service will ensure optimum service life and performance from your scooter. Do not delay in having this service performed once your scooter reaches this mileage.

⚠ CAUTION

The 200 mile (300 km) service should be performed as outlined in the maintenance schedule section of this owner's manual. Pay particular attention to the cautions and warnings in the Maintenance Schedule section.

Unless you have formal training as a service technician and have access to KYMCO technical reference materials, it is strongly suggested that you have the initial service performed by a KYMCO dealer.

Breaking in the new tires

New tires need proper break-in to assure maximum performance, just as your scooter's engine does. Wear in the tread surface by gradually increasing your cornering lean angles over the first 100 miles (160 km) before attempting maximum lean angles. Avoid hard acceleration, hard cornering, and hard braking for the first 100 miles (160 km).

⚠ WARNING

Failure to break in your tires could cause the tires to slip and could result in your losing control of the scooter.

Use extra care when riding on new tires. Perform proper break-in of the tires as described in this Owner's Manual, and avoid hard acceleration, hard cornering, and hard braking for the first 100 miles (160 km).

Troubleshooting

It can be frustrating if your scooter fails to start, or stops running while you are riding. In the rare instance this occurs, take a few moments to check the following items. This checklist covers some of the most common, simple problems which may arise, and which can be quickly resolved.

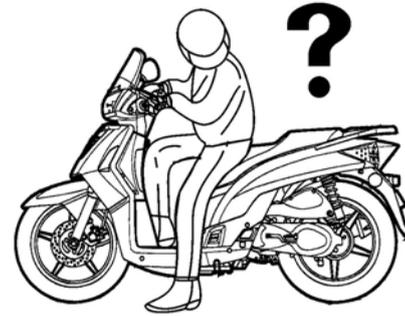

- ✓ Do you have enough gasoline in the fuel tank?
- ✓ Did you follow the correct procedure for starting the engine?
- ✓ Is the battery voltage low (you may need to kick start your scooter)?
- ✓ Is the main fuse in good condition?

NOTE: Use this Owner's Manual to check components and adjustments that are within your technical ability. If you cannot resolve the problem, do not hesitate to contact your KYMCO dealer for assistance.

Pre-ride inspection (PRI)

For your safety, it is very important to take a few moments before each ride to walk around your scooter and check its condition. If you detect any problem, be sure to address it immediately, or have it corrected by your KYMCO dealer.

WARNING

Improperly maintaining your scooter or failing to correct a problem before riding can cause a crash in which you can be seriously hurt or killed.

Always perform a pre-ride inspection before every ride and correct any problems.

1. Engine oil level: Add engine oil if required (page 24). Check for leaks.
2. Tires: Check condition and inflation pressure (pages 24 & 25).
3. Fuel level: Fill fuel tank when necessary (page 26). Check for leaks.
4. Front and rear brakes: Check operation, making sure there is proper free-play at the left lever, and that there is brake fluid in the front brake fluid reservoir (pages 27 through 30).

5. Steering: Check for smooth operation in all steering positions (page 30).
6. Instruments: Make sure the speedometer, fuel level gauge and indicator lights function (page 31).
7. Lights and horn: Check that headlight, tail/brake light, turn signals, indicators and horn function properly (pages 31 & 32).
8. Chassis: Check for overall proper function (pages 32 & 33).

CAUTION

Performing pre-ride inspections does not take the place of regular maintenance. Follow the maintenance schedule recommendations on pages 42 - 44 of this manual.

After one month of use or 200 miles (300 km) of riding, which ever occurs first, contact your KYMCO dealer to perform an initial service on your scooter.

This initial service is the most important service in the life of your scooter, and includes checks and adjustments that will help ensure that your scooter operates efficiently and safely.

PRI - Engine oil level inspection

NOTE: Park your scooter on the main stand, on level ground.

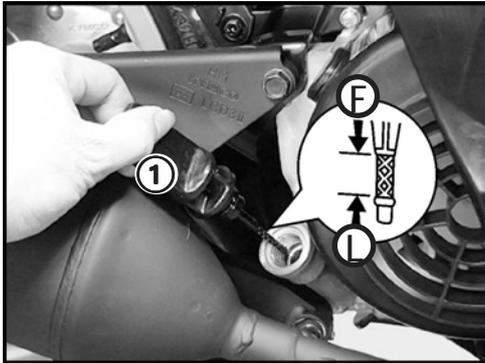

1. Unscrew the dip stick ①, remove it and wipe it with a clean cloth
2. Reinsert the dip stick until the threaded part of the dip stick touches the engine case. Do not thread the dipstick into the engine case.
3. Remove the dip stick again and inspect the oil level on the stick. The engine oil level should be above the "L" mark but not higher than the "F" mark. Add or remove oil as required.

CAUTION

Do not overfill the engine with oil. Overfilling the engine can cause oil leaks and/or oil contamination of the air filter element. Always make sure the oil level is above the "L" mark but not higher than the "F" mark.

WARNING

Use extreme caution when performing the oil level inspection or any other checks if the scooter's engine has been recently operated. The engine oil, engine case and muffler can become very hot creating a burn hazard.

PRI - Tire inspection

The condition of your scooter's tires is vital for operational efficiency and your safety. Check the tires' inflation pressure ②, the tread depth, and for damage before each ride.

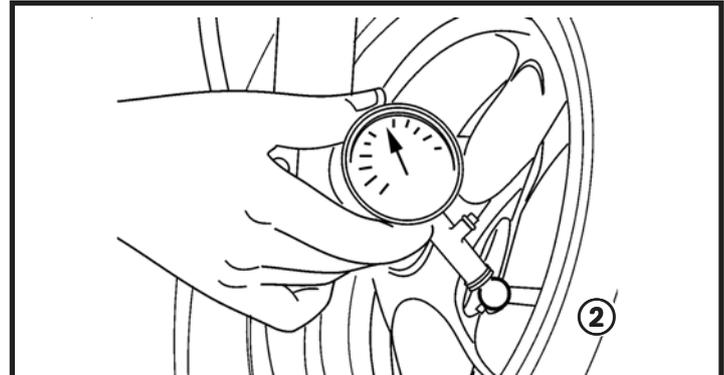

Front tire (rider only):	22.0 PSI (1.50kg/cm ²)
Rear tire (rider only):	29.0 PSI (2.0 kg/cm ²)
Front tire (rider & passenger):	25.0 PSI (1.75 kg/cm ²)
Rear tire (rider & passenger):	32.0 PSI (2.25 kg/cm ²)

1. Measure and adjust the tire pressure when the tires are touching the ground (while no one is seated on the scooter).

NOTE: Measure the pressure before riding, as the heat generated during operation may cause improper readings.

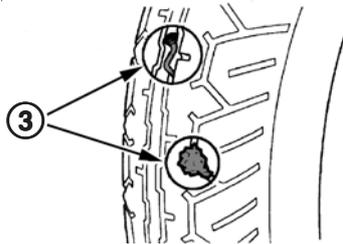

2. Inspect the tires for nails, screws and other objects (3) that may be imbedded into the rubber.

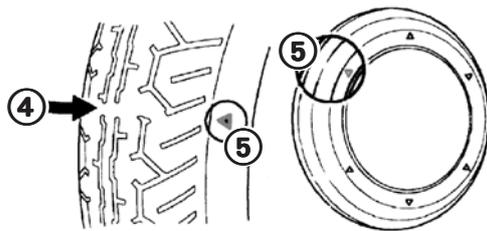

3. Check the tread depth (4) at the wear indicator points (5). If the tread is worn smooth at these points, the tire must be replaced.

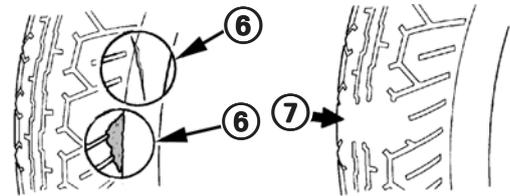

4. Check for damage (6) (blisters or cuts) in the side wall, or for significant flat spots (7) on the tires' tread. Replace the tire immediately if any damage of this type is present.

WARNING

The tires on your scooter must be replaced if they:

- Leak air (even at a slow rate)
- Have any damage on the tread or side wall areas
- Have been damaged by intrusion of objects, such as a nail
- Are worn as evidenced by the wear indicators

Failure to replace a tire in poor condition will cause an unsafe riding condition. Replace worn or damaged tires immediately for your, and your passenger's, safety.

Consult your KYMCO dealer for tire repair or replacement service.

PRI - Fuel level inspection / Refilling

When the fuel level gauge needle approaches "E" (indicating the tank is nearly empty), refill the tank with unleaded gasoline.

To open the fuel filler cap:

1. With the engine "OFF", place the scooter on its main stand and open the seat (see page 14 of this manual).

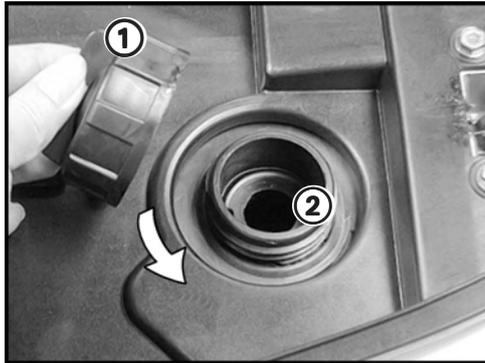

2. Rotate the cap ① counterclockwise to access the fuel filler ②.
3. Add fuel (per the recommendations listed here).

Fuel recommendation

Use unleaded gasoline with a research octane number of 91 or higher. Unleaded gasoline will extend spark plug life.

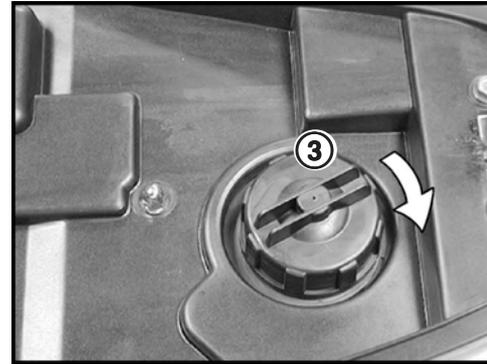

4. Replace the fuel filler cap ③ and secure it to the fuel filler by rotating clockwise. Close the seat.

⚠ CAUTION

Do not overfill the tank. There should be no fuel in the fuel filler neck. Excess fuel can contaminate the evaporative emission canister, resulting in poor drivability.

⚠ WARNING

Gasoline is highly flammable and explosive. You can be burned or seriously injured while handling fuel.

- * Stop the engine and keep heat, sparks, and flame away.
- * Refuel only outdoors.
- * Clean up fuel spills immediately.

PRI - Brake fluid inspection

The right brake lever on your People S scooter controls the front hydraulic brake.

NOTE:

On the People S scooter the left brake lever controls the rear mechanical drum brake.

Check the fluid level through the inspection window on the brake fluid master cylinder reservoir(s).

1. Verify that the fluid level is between the "L" mark ① and the "F" mark ② in the brake fluid reservoir window. See the MAINTENANCE section of this Owner's Manual for additional information about the front brake fluid.

WARNING

As the brake pads wear, the brake fluid level drops as the hydraulic system automatically compensates for the wear. There are no adjustments to perform, but fluid level and pad wear must be inspected periodically to make sure the brakes will function properly.

The system must also be inspected for fluid leaks. Leaks can cause the system to lose pressure and not function.

To prevent damage to the brake system, only use DOT 4 brake fluid from a sealed container. Never allow contaminants (dirt, water, etc.) to enter the brake fluid reservoir. See your KYMCO dealer for this service.

CAUTION

Brake fluid can damage paint and plastic, so handle the brake fluid with care. When adding brake fluid, be sure that the reservoir is horizontal before removing the cover so you will not spill fluid onto the scooter.

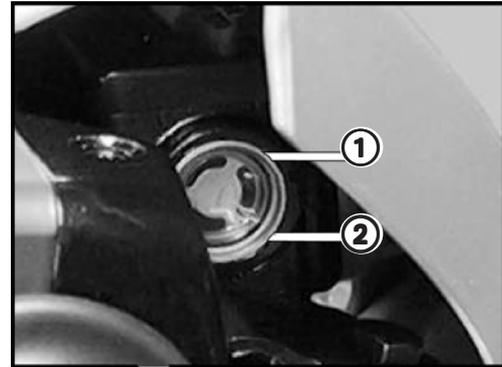

PRI - Front brake pad wear inspection

Visually inspect the front brake pads on your scooter for wear. The pads' surface has grooves that will indicate the amount of life left in each pad. If the grooves are visible, there is adequate brake pad material. If the grooves are no longer visible, or their depth is severely reduced, the pads require replacement.

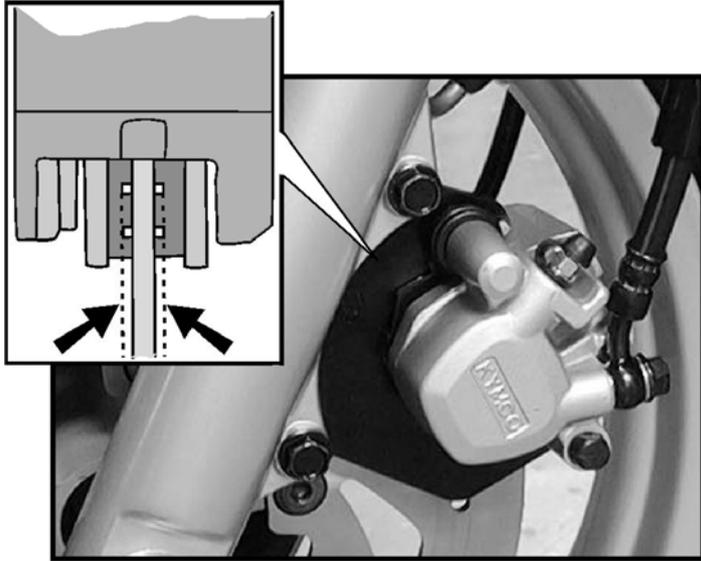

NOTE: Your scooter's brake system components may differ slightly in appearance from the images in this manual.

WARNING

As the brake pads wear, the brake fluid level drops as the hydraulic system automatically compensates for the wear. The brake fluid level must be inspected at the same time you inspect the brake pads for wear.

If the wear indicator grooves in the front brake pads are no longer visible, it is an indication that the brake pads are worn and require replacement. Consult your KYMCO dealer for any brake-related service.

WARNING

Prolonged and repetitive use of the vehicle's hydraulic brakes for high speed stops will cause overheating of the brake fluid and premature brake pad wear, which can cause unexpected loss of braking ability.

PRI - Rear brake inspection

The left brake lever on your People S scooter controls the rear mechanical, drum-style brake. Before riding, you should inspect the rear brake shoe wear and the brake lever play.

Brake shoe wear inspection:

1. The rear drum brake is equipped with a brake shoe wear indicator. When the brake is applied, an arrow on the brake arm  moves towards reference marks  on the brake hub.

NOTE: See illustration on next page:

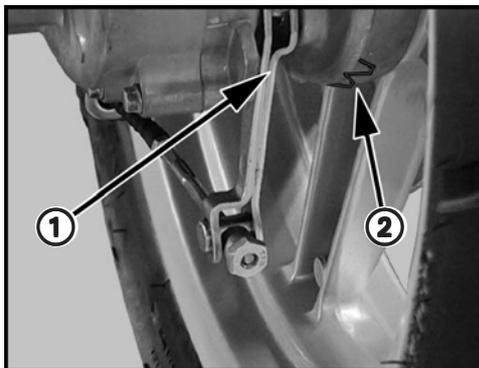

2. If the arrow points to the reference marks when the rear brake is fully applied, the shoes are worn and require replacement.

⚠ WARNING

If the brake arm pointer is outside of the adjustment range markings the brake shoes must be inspected and may require replacement. If your scooter requires brake shoe replacement, see your KYMCO dealer for this service.

Brake lever inspection & adjustment:

Your People S scooter requires the proper brake lever free-play so the brakes will be responsive and will not drag, causing premature wear to the brake pads. The free-play is the measured distance between the brake lever at rest and the point at which the brake first begins to engage.

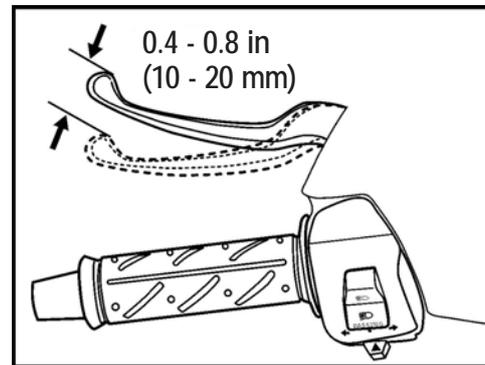

1. Measure the free-play at the left brake lever end: 0.4 - 0.8 in (10 - 20 mm).
2. Use the cable adjuster on left brake lever perch for minor free play adjustment.

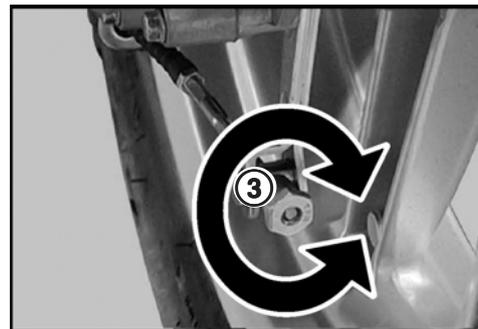

NOTE: See next page for the remainder of the rear brake lever inspection & adjustment process.

3. Park the scooter on the main stand and rotate the adjusting nut on the brake arm clockwise to decrease the lever free play. Rotate the adjusting nut counterclockwise to increase the lever free play.

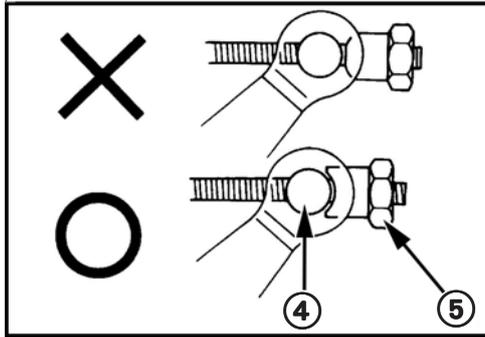

⚠ CAUTION

Make sure the cutout on the adjusting nut ⑤ is seated on the brake arm pin ④ after making adjustments.

⚠ WARNING

Make sure the rear wheel turns freely after free play adjustment, so the brake will function properly and not wear prematurely.

PRI - Steering & handlebar inspection
Before riding, inspect your scooter's handlebars for damage, and make sure the steering's side-to-side and up-and-down movement is smooth.

1. Apply the front brake (right lever) and press down and release pressure on the handlebar, listening for any abnormal noise.
2. As you press down and release, also feel for any looseness from the chassis transmitted to the handlebar.
3. Turn the handlebar from the center fully to the left and then fully to the right, feeling for any loose components and listening for any abnormal sounds.

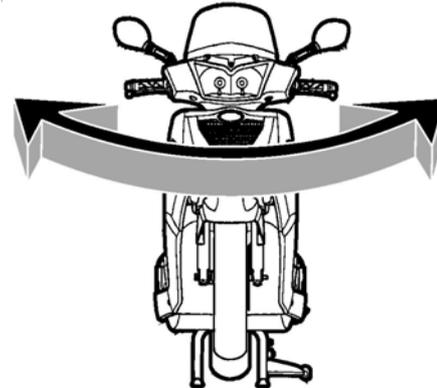

⚠ WARNING

If the steering does not move smoothly or feels obstructed, do not ride your scooter. See your KYMCO dealer immediately for repairs or adjustment.

PRI - Instrument inspection

Before you begin your ride, make sure the scooter's instruments are functioning.

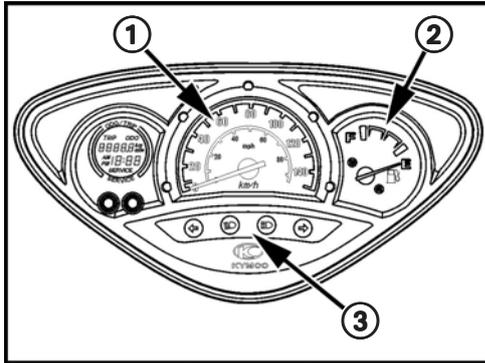

1. Does the speedometer ① needle move as the scooter moves?
2. Does the fuel level gauge needle ② indicate the fuel level?
3. Do the indicator lights ③ (turn signal and high-beam, for example) function?

NOTE: Contact your KYMCO dealer for repair of your scooter's instruments if they are not functioning properly.

PRI - Horn & lights inspection

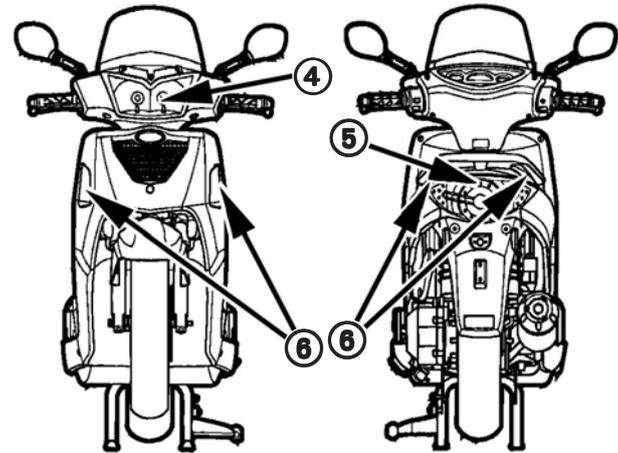

1. Turn on the ignition switch to see if the headlight ④ and the tail light ⑤ are illuminated. Check the lenses for dirt or damage.
2. Squeeze each brake lever to make sure the brake lamp in the tail light ⑤ illuminates.
3. Operate the turn signal switch to make sure the turn signals ⑥ flash. Make sure each of the four signals flash, and the lenses are free of dirt and are not broken.

4. Turn the ignition switch to "ON -  and press the horn button  to make sure the horn sounds.

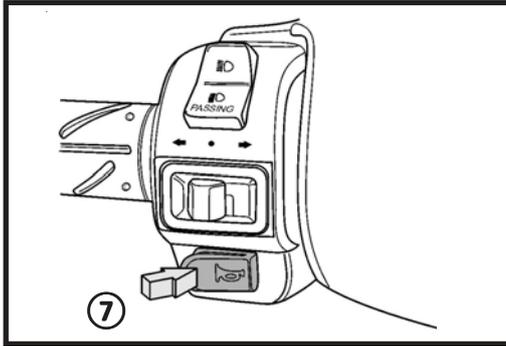

⚠ WARNING

The horn is an essential safety item, as it alerts other traffic to your presence.

The headlight must be in good working order to illuminate your riding path at night.

The tail/brake light is required so other traffic can see your scooter and be alerted to your intention to stop or slow down.

The turn signals indicate your turning intentions.

Because all of these systems are vital safety items, contact your KYMCO dealer for replacement bulbs or electrical system repair should there be any malfunctions.

PRI - Chassis inspection

Complete the pre-ride inspection of your scooter by checking items on its chassis.

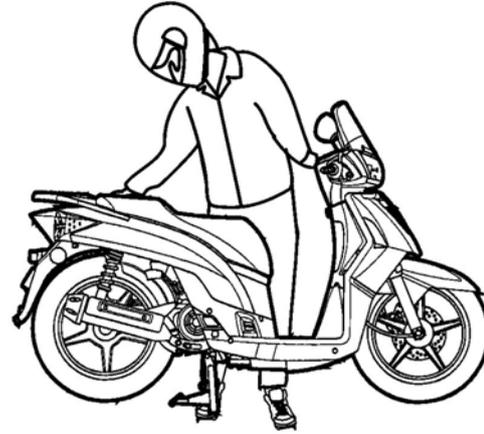

Front suspension & rear shock absorber: Check the operation of the suspension by pressing down on the handlebars and seat. Make sure the suspension returns in a smooth fashion.

Brake lever operation: Check that the rear brake (left lever) and the front brake (right lever) have pressure and lock the wheels when you squeeze them.

Mirrors: Adjust the mirrors while seated on the scooter **BEFORE** you begin riding.

License plate: Make sure your license plate is securely mounted and your registration is current.

Reflectors: Look to make sure all of the safety reflectors are still mounted to your scooter. Replace any missing or damaged reflectors.

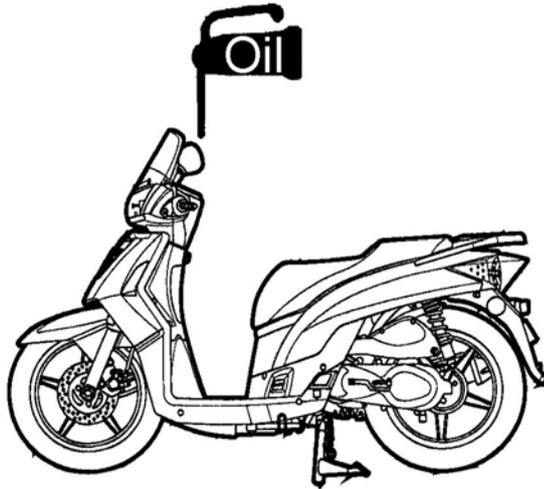

Lubrication points: Occasionally check and lubricate certain controls and points on the scooter as indicated in the periodic maintenance schedule (see pages 42 - 44).

Starting the engine (electric start)

To start your scooter using the electric starter motor, follow this procedure:

NOTE: Before starting, check the engine oil and fuel levels. Take the scooter off of the main or side stand.



1. Unlock the steering with the ignition switch key and turn the ignition switch to the "ON -  " position.

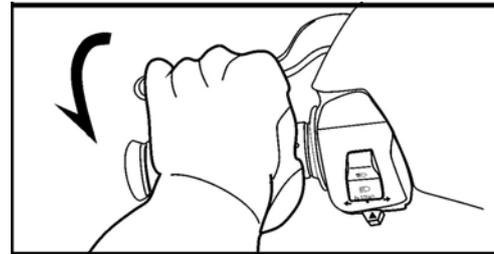

2. Apply the rear brake (left lever) .

⚠ WARNING

The brake must be adjusted and functioning properly to lock the rear wheel during starting, or the scooter could accelerate away when the engine starts.

NOTE: The rear brake must be held for the starter motor to engage the engine. It is normal for the stop light to be illuminated during starting.

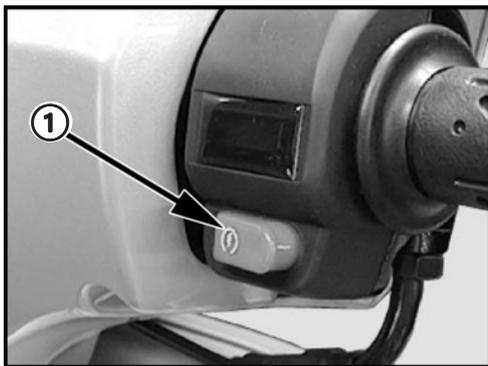

3. Press the starter button ① without rotating the throttle grip.

⚠ CAUTION

To prevent damage to the starter motor, do not operate the starter motor for more than five seconds at a time. If the scooter fails to start immediately, check the fuel level and the battery condition, and allow the starter motor to cool before attempting to start the engine again.

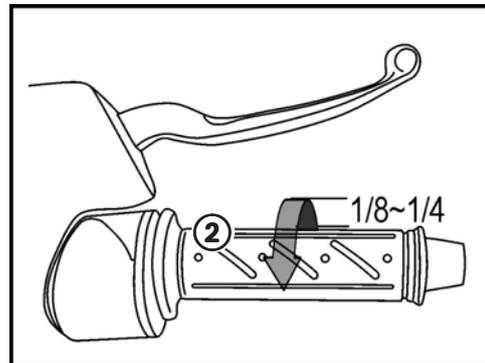

NOTE: If the scooter's engine is warm and does not start immediately, rotate the throttle grip ② to 1/8 to 1/4 open to help the engine start.

NOTE: If the scooter has not been ridden for a long period of time it may be hard to start. Add fresh fuel and press the starter button several times in succession to try to start the engine. If the scooter does not start, contact your KYMCO dealer, as your scooter may need to have its fuel system cleaned and adjusted.

⚠ WARNING

Once the scooter starts, the rear wheel may spin. To avoid injury, keep your body and clothing away from the rear wheel.

4. Allow a cold engine to warm up for 2 - 3 minutes before riding.

⚠ CAUTION

Do not press the starter button once the engine is running or the starter motor and engine may be damaged.

Starting the engine (kick start)

To start your scooter using the kick start lever ③, follow the electric starting procedure, but use the kick lever in place of the electric start button.



3. While squeezing the rear brake lever, kick down on the kick start lever without rotating the throttle grip.

NOTE: If the scooter's engine is warm and does not start immediately, rotate the throttle grip ④ to 1/8 to 1/4 open to help the engine start.

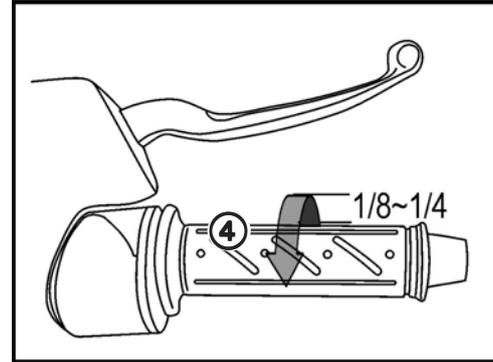
⚠ WARNING

Once the scooter is started, fold the kick start lever back to its original position.

⚠ WARNING

Your scooter's exhaust emits poisonous carbon monoxide gas. High levels of carbon monoxide can collect rapidly in enclosed areas such as a garage. Do not run the scooter's engine with the garage door closed. Even with the door open, run the engine only long enough to move your scooter out of the garage.

Riding your scooter

NOTE: After starting, allow the engine oil to circulate before riding your scooter. Allow sufficient idling time after warm or cold engine start-up before applying load or revving the engine. This allows time for the lubricating oil to reach all the critical engine components.

NOTE: Review the scooter safety recommendations on pages 2 through 6 before you ride.

⚠ WARNING

You and your passenger should always wear appropriate safety apparel such as a helmet, eye protection, gloves and other protective clothing each time you ride the scooter. Never wear any items that will adversely affect your safety.

⚠ CAUTION

Make sure flammable materials such as dry grass or leaves do not come into contact with the exhaust system when riding, idling, or parking your scooter.

⚠ CAUTION

Keep your finger away from the starter button ① while the engine is running. You can damage the engine or the starter mechanism if you engage the starter motor when the engine is running.

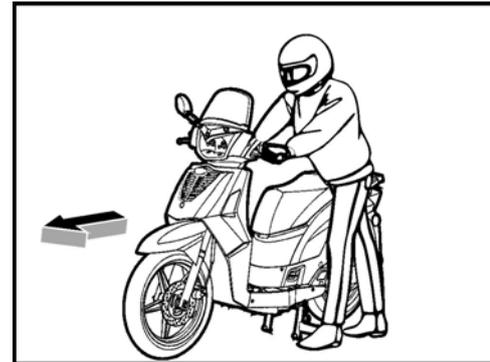

1. Make sure the throttle is closed and the rear brake is engaged before moving the scooter off the main stand.

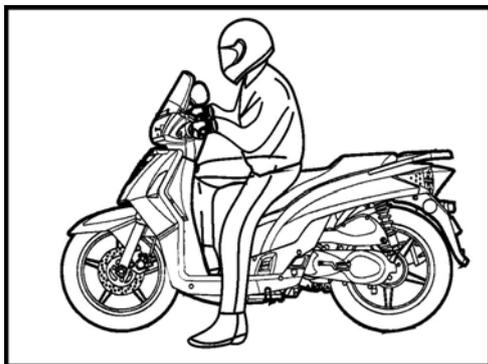

2. Mount the scooter from the left side and sit in an upright position on the seat. Place both hands on the handlebars and touch the ground with your left foot for stability.

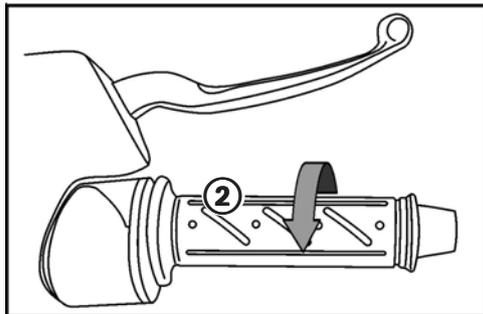

3. Release the rear brake and slowly rotate the throttle grip ② so that the engine power will be transmitted smoothly to the rear wheel.

⚠ CAUTION

In hot weather the engine could overheat if it idles for a long period of time. Very slow speed traffic could also cause the scooter to overheat. To promote engine longevity, permit the engine to cool in these situations. Avoid sudden acceleration and prolonged high speed use that can accelerate engine wear. Moderate use will prolong the engine life of the scooter.

4. You will control the scooter's speed with the throttle grip.

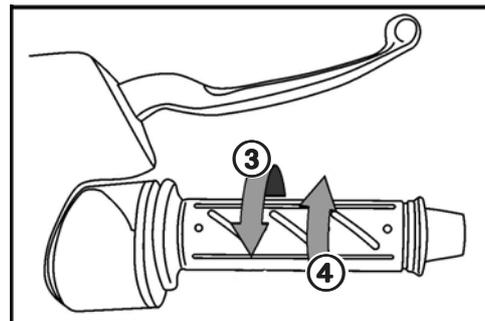

Rotating the grip towards you ③ will increase the scooter's speed.

Rotating the grip away from you ④ will decrease the scooter's speed.

5. Limit the maximum speed of your scooter during the first 600 miles (1,000 km) of operation. Keep the road speed below 25 MPH (40 KPH) during this break-in period.

⚠ WARNING

Use the scooter's turn signals to signal your intention to merge into traffic. Always scan around you and check the rear view mirrors so you are aware of other traffic. Use caution as you merge into traffic, keeping to the right until you match the pace of the traffic.



6. Use both brake levers when slowing and stopping the scooter. Release the throttle when braking.

⚠ WARNING

Avoid using just one brake to stop the scooter, as this will affect the tires' grip.

Avoid sudden braking, as this will also affect the tires' grip and can cause an accident.

NOTE: Decreasing the scooter's speed with a balanced application of both brake levers and a reduction of throttle will reduce the distance required to stop. Squeeze the levers lightly at first, and then increase the pressure when stopping.

⚠ WARNING

Prolonged and repetitive use of the vehicle's hydraulic brakes for high speed stops will cause overheating of the brake fluid and premature brake pad wear which can cause unexpected loss of braking ability.

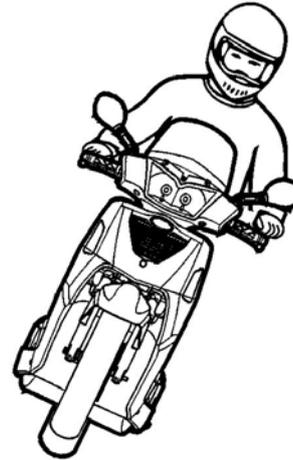

7. When riding and turning the scooter, use smooth movements.

NOTE: At certain speeds your scooter will turn more effectively by leaning your body, than by applying pressure on the handlebars. Practice steering in an open, traffic-free area until you are familiar with the handling characteristics of your scooter.

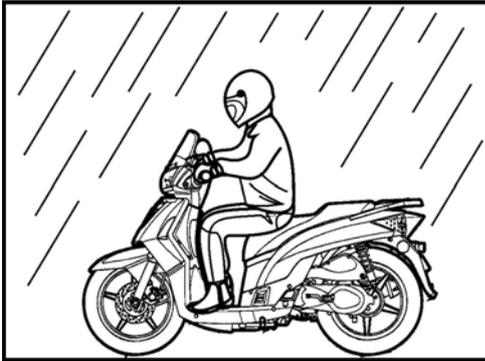

⚠ WARNING

Reduce your speed when riding your scooter in the rain. Wet road surfaces reduce tire grip and greatly increases the distance required for safe braking. A wet surface also reduces tires grip during cornering. Reduced tire grip will make it more difficult to control your scooter and may cause an accident.

⚠ WARNING

Reduce your speed when riding on uneven or loose road surfaces. When riding downhill, use less throttle and brake intermittently to control the vehicle's speed. These conditions reduce tire grip and can cause an accident.

8. As you approach a turn, or plan to stop, use the turn signals well in advance to alert other traffic of your intentions.

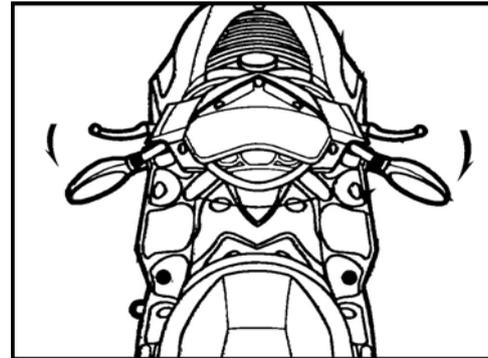

Scan for other vehicles around you, turn your head and use the scooter's mirrors. Slowly move to the right side of the road. Close the throttle, apply the brake smoothly, as the brake light will warn vehicles behind you that you are braking.

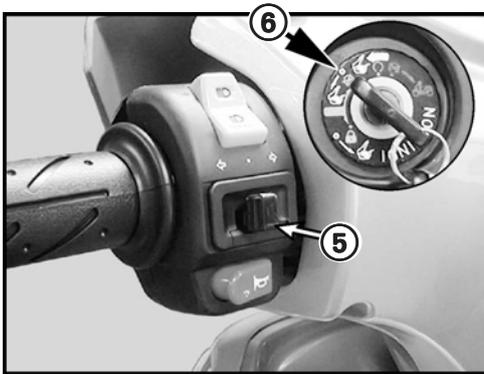

9. When you stop the scooter, press the center of the turn signal indicator switch ⑤ to cancel the signal flashing. Turn the ignition switch to the "OFF" position ⑥ to stop the engine and turn off the scooter's electrical system.

⚠ WARNING

Never operate the ignition switch while riding your scooter. If the ignition switch is turned during riding it could turn off the engine and lights, possibly causing you to lose control of the scooter.

With the lights off, your scooter may not be visible to other traffic, and this could cause a traffic accident.

Only operate the ignition switch when the scooter is not moving.

Parking your scooter

Use the following procedure and suggestions when parking your scooter.

1. Place the scooter on level ground.

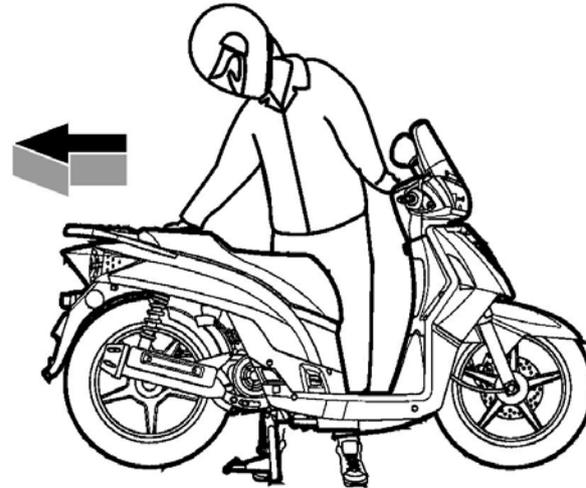

2. Stand on the left side of the scooter and grasp the handlebar with your left hand, while grasping the side of the rear rack with your right hand. Step down on the foot pad of the main stand with your foot, while pulling up and back on the rear rack. This lifting motion will allow the scooter to rock backwards and up onto the main stand.

⚠ CAUTION

The scooter may fall over if it is not parked on level ground.

Make sure flammable materials such as dry grass or leaves do not come into contact with the exhaust system when parking your scooter.

Lock the steering of your scooter (see pages 11 & 12) to reduce the risk of theft.

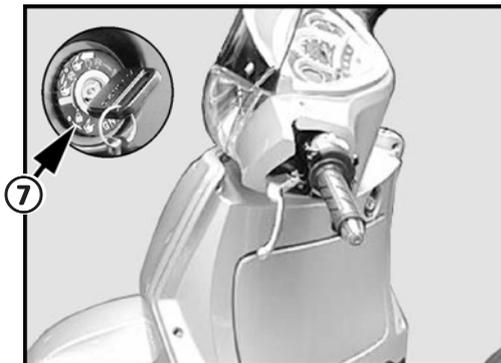

3. Stop the engine using the engine stop switch. Turn the handlebars to the left and rotate the ignition key in the ignition switch to the "🔒" position ⑦ to lock the steering.

⚠ WARNING

Do not park your scooter in a place that hinders traffic, or that is unsafe to you or to others.

The importance of maintenance

Maintaining your scooter properly is essential for safe, economical and trouble-free riding. It will also help reduce air pollution and maximize fuel economy.

To help you properly care for your scooter, the following pages in this Owner's Manual include a maintenance schedule to help you make sure your scooter is serviced at the appropriate intervals.

These instructions are based on the assumption that your scooter will be used exclusively for its designed purpose. Sustained, high-speed operation, or operation in unusually wet or dusty conditions, will require more frequent service than specified in the maintenance schedule. Consult your KYMCO dealer for recommendations applicable to your individual needs and use.

NOTE: Always follow the inspection and maintenance recommendations and schedules in this Owner's Manual.

WARNING

If your scooter tips over or becomes involved in a crash, be sure your KYMCO dealer inspects all major parts, even if you are able to make some repairs.

Improperly maintaining this scooter, or failing to correct a problem before you ride, could result in a crash in which you could be seriously hurt or killed.

WARNING

When performing maintenance on your scooter, you may need to start the engine. Running your scooter's engine indoors or in a garage can be hazardous. Exhaust gas contains carbon monoxide, a gas that is colorless and odorless, and can cause death or severe injury. Operate the engine only where there is adequate ventilation, preferably outdoors.

Maintenance Schedule

Perform the pre-ride inspection (see pages 23 - 33) at each scheduled maintenance period. This interval should be judged by odometer reading or months, whichever comes first.

Maintenance Schedule Legend (see page 44):

I: INSPECT AND CLEAN, ADJUST, LUBRICATE OR REPLACE IF NECESSARY

C: CLEAN **R:** REPLACE **A:** ADJUST **L:** LUBRICATE **T:** TIGHTEN

The maintenance schedule chart on page 44 specifies the maintenance required to keep your People S scooter in peak operating condition. Maintenance work should be performed in accordance with KYMCO standards and specifications by properly trained and equipped technicians. Your KYMCO dealer meets all of these requirements.

- * Should be serviced by your KYMCO dealer, unless you have the proper tools, service data and are technically qualified.
- ** In the interest of safety, we recommend these items be serviced only by your KYMCO dealer. KYMCO USA recommends that your KYMCO dealer road test your scooter after each periodic maintenance service is completed.
- # Does not apply to People S 50, 125 or 200 models

Maintenance Schedule Notes (see page 44):

1. At higher odometer readings, repeat at the frequency interval listed here.
2. Service more frequently if the scooter is ridden in unusually wet or dusty areas.
3. Service more frequently when riding in rain or at full throttle.
4. **"PRI"** indicates that the item should be checked as part of the Pre-Ride Inspection (see page 23 through 33)
5. **"See page"** indicates on which page of the Owner's Manual you will find information about the required maintenance.
6. **"Dealer"** indicates maintenance or service procedure that should be performed by your KYMCO dealer.

Maintenance Schedule - People S 50, 125 & 200

ITEM	MILEAGE							Pre-ride inspection	See page
	200 mi 300 km	600 mi 1000 km	1850 mi 3000 km	3100 mi 5000 km	4300 mi 7000 km	5500 mi 9000 km	7000 mi 11000 km		
Engine oil *	R	R	R	R	R	R	R	PRI	24, 46
Engine oil strainer *	C	-	C	-	C	-	C	-	47
Gear oil *	R	-	R	-	R	-	R	-	48
Coolant #	-	-	-	-	-	-	R	-	Dealer
Spark plug *	C	I	C	R	C	I	R	-	50
Valve clearance **	A	-	A	-	A	-	A	-	Dealer
Carburetor **	I	-	I	-	I	-	I	-	Dealer
Drive belt **	-	-	-	-	I	-	-	-	Dealer
Air cleaner *	C	I	R	I	R	I	R	-	49
Battery *	I	I	I	I	I	I	I	PRI	51, 52
Fuel filter **	-	-	-	-	R	-	-	-	Dealer
Brake system **	I	I	I	I	I	I	I	PRI	27, 54
Tires **	I	I	I	I	I	I	I	PRI	24, 45
Bolts & nuts *	T	I	I	T	I	I	T	PRI	33

I: INSPECT AND CLEAN, ADJUST, LUBRICATE OR REPLACE IF NECESSARY

C: CLEAN R: REPLACE A: ADJUST L: LUBRICATE T: TIGHTEN

Tires

WARNING

Failure to follow these warnings may result in an accident due to tire failure. The tires on your scooter are a crucial link between your scooter and the road. You and your passenger's personal safety are dependant upon the condition of your scooter's tires.

Follow these instructions:

- Check tire condition and pressure, and adjust the inflation pressure before each ride.
- Avoid overloading your scooter.
- Replace a tire when worn to the specified limit, or if you find any damage such as cuts or cracks.
- Always use the proper size and type of tires as specified in this Owner's Manual.
- Balance the wheel after tire installation.
- Read this section of Owner's Manual carefully.

Failure to perform a reasonable break-in of the tires could cause tire slippage and loss of control.

Use extra care when riding on new tires, as the grip will be limited. Perform proper break-in of the tires, as set forth in the break-in recommendation section of this manual. Avoid hard acceleration, hard cornering, and hard braking for the first 100 miles (160 km).

NOTE: Check the tire inflation pressure and tire tread condition at the periods listed in the Periodic Maintenance Schedule. For maximum safety and good tire life, the tire pressures should be inspected more often.

Tire pressure

Insufficient air pressure in the tires not only accelerates tire wear, but it also affects the stability of your scooter. Under-inflated tires make smooth cornering difficult, and overinflated tires decrease the amount of tire in contact with the ground, which can lead to skids and loss of control. Make sure that the tire pressures on your scooter are within the specified limits at all times.

NOTE: Tire pressure should only be adjusted when the tires are cold.

Front tire (rider only):	22.0 PSI (1.50kg/cm ²)
Rear tire (rider only):	29.0 PSI (2.0 kg/cm ²)
Front tire (rider & passenger):	25.0 PSI (1.75 kg/cm ²)
Rear tire (rider & passenger):	32.0 PSI (2.25 kg/cm ²)

Engine oil

Engine oil recommendation

Use a premium quality, 4-stroke engine oil to ensure longer service life of your scooter. Only use oils that have a SJ rating per the API service classification.

Engine oil capacity (50): 0.90 qt (0.85 L)

Engine oil capacity (125 & 200): 1.20 qt (1.10 L)

Engine oil viscosity: SAE 10W-40

If this viscosity is not available, select an alternative engine oil according to the chart shown below.

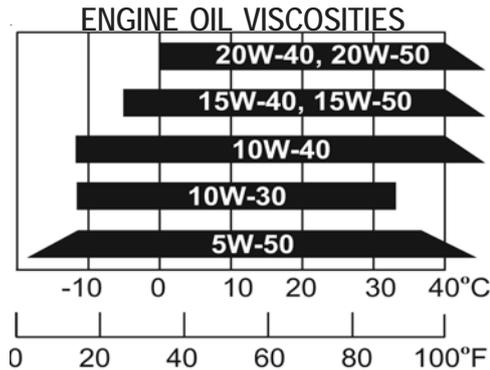

Engine oil level inspection

Check the engine oil level each day before riding your scooter (see page 24).

⚠ WARNING

The engine and related components can become very hot. Use care when inspecting or adjusting the oil level to avoid injury. If needed, let the engine and exhaust system cool before working in those areas.

Prolonged contact with used engine oil can cause skin cancer. Although rare, this possibility exists if you handle oil on a frequent basis. Thoroughly wash your hands with soap and water as soon as possible after handling used oil.

Engine oil replacement

Engine oil quality is the primary factor affecting engine longevity. Change your scooter's engine oil as specified in the maintenance schedule (see page 42 - 44).

NOTE: When riding your scooter in very dusty conditions, oil changes should be performed more frequently than specified in the maintenance schedule.

NOTE: Always dispose of used engine oil in an environmentally responsible manner. You should take the drained oil in a sealed container to your local recycling center or service station for reclamation. Do not throw the oil in the trash, pour it on the ground, or pour it down a drain.

NOTE: Change the engine oil with the engine at normal operating temperature and with the scooter positioned on its main stand, to assure complete and rapid draining.

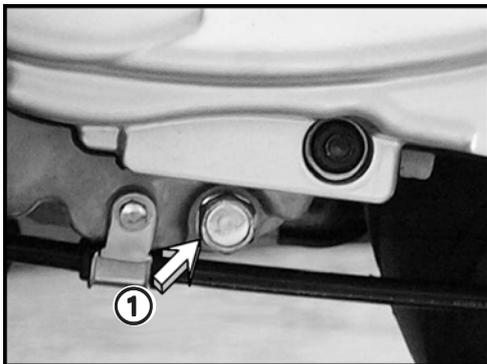

1. Place a suitable container (drain pan) under the left crankcase. Remove the drain bolt (1) to drain the oil.

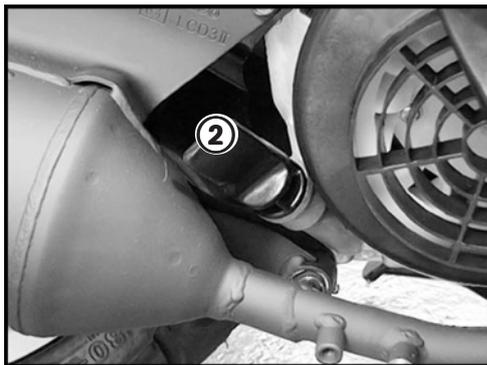

2. Remove the oil filler/dipstick (2) from the right crankcase cover.

3. Replace the drain bolt (1). Tighten it to the specified torque.

Oil drain plug torque: 18 lb-ft (25 N-m)

4. Add engine oil through the oil filler/dipstick hole.

Engine oil capacity (50): 0.90 qt (0.85 L)

Engine oil capacity (125 & 200): 1.20 qt (1.10 L)

Engine oil viscosity: SAE 10W-40

CAUTION

Do not overfill the engine with oil. Overfilling the engine can cause oil leaks and/or oil contamination of the air filter element. Always make sure the oil level is above the "L" mark but not higher than the "F" mark on the dipstick.

5. Refer to page 24: Wipe the dipstick off with a clean cloth and reinstall it in its hole, but do not thread it into the engine case. Push the dip stick in until it touches the case.
6. Remove the dip stick and visually inspect the oil level on the stick. The engine oil level should be above the "L" mark but not higher than the "F" mark. Add or remove oil as required.
7. Replace the oil filler/dipstick and tighten it securely.

Transmission fluid change

1. Place the scooter on its main stand.

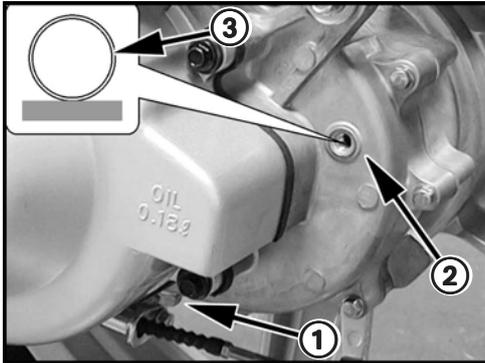

2. Place a suitable container (drain pan) under the transmission case on its left side. Remove the drain bolt (1) to drain the fluid.
3. After the fluid has drained out, reinstall the drain bolt with a new sealing washer and tighten it to the specified torque.

Transmission fluid drain bolt torque: 15 lb-ft (20 N-m)

4. Remove the transmission fluid filler bolt from the filler hole (2).
5. Add the exact specified fluid through the fluid filler hole. Only fill the transmission so the fluid level stays below the filler hole (3).

Transmission fluid type: SAE 90
 Transmission fluid capacity (50): 0.13 qt (0.12 L)

Transmission fluid capacity (125 & 200): 0.25 qt (0.21 L)

NOTE: The fill amount specified is the amount to use after completely draining the used transmission fluid.

⚠ CAUTION

Do not exceed the specified amount when adding transmission fluid. If too much fluid is added to the transmission case, it could be forced into the air cleaner assembly during operation, causing air filter contamination and poor engine performance.

⚠ CAUTION

Using the wrong transmission fluid type or viscosity may cause premature transmission component wear.

Air cleaner filter element

The air cleaner filter element should be serviced at regular intervals. Service the element more often when riding in unusually wet or dusty areas.

1. Remove the six air cleaner cover screws (1).

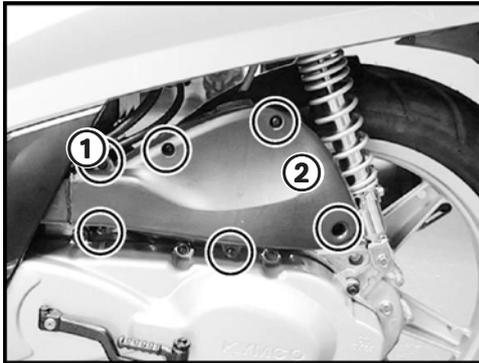

2. Remove the air cleaner case cover (2).

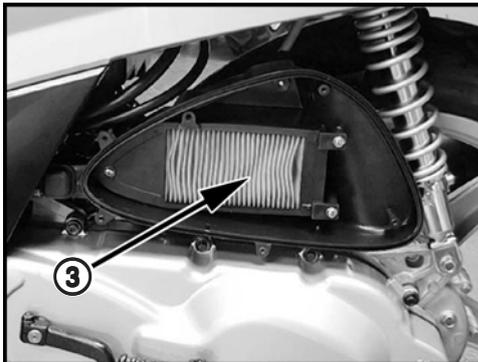

4. Remove the air cleaner element (air filter) (3).

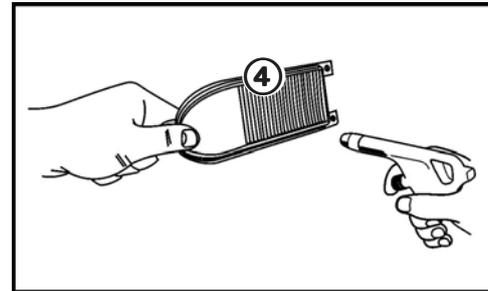

5. If lightly soiled, clean the filter (4) with compressed air. If very dirty (or if the filter is at the replacement interval per the maintenance schedule) discard the air cleaner element.
6. Install the cleaned or new air cleaner element. Use a KYMCO genuine air cleaner element or an equivalent air cleaner element specified for your scooter.
7. Complete the installation by reinstalling the air cleaner parts in the reverse order of removal.

CAUTION

Improper installation of the filter can cause water or dirt to enter the engine, causing premature wear.

Using the wrong air cleaner element or a non-KYMCO air cleaner element which is not of equivalent quality may cause premature engine wear or performance problems.

Spark plug

Remove the carbon deposits from the spark plug with a small wire brush, a pick ① or a spark plug cleaning machine. After cleaning (or when installing a new spark plug) readjust the spark plug gap ② to the specified limit by using a spark plug gap thickness gauge. The spark plug should also be replaced if the sealing washer ③ has been compressed flat from multiple installations. The spark plug should be replaced periodically. Under normal usage, a spark plug's porcelain tip ④ should appear light brown or tan in color. If the spark plug porcelain tip is very white or glazed appearing, then the spark plug has been operating too hot. In such a situation, you should replace the standard spark plug with a spark plug that has a colder heat range (usually a higher number; consult with your KYMCO dealer when selecting an alternate spark plug).

Recommended spark plug

Spark plug type: CR7HSA

Spark plug gap ②: 0.024 - 0.028 in
(0.6 - 0.7 mm)

⚠ CAUTION

An improper spark plug may have an incorrect fit or heat range for your engine. This may cause severe engine damage which will not be covered under warranty. Never use a spark plug with an improper heat range, as severe engine damage may result.

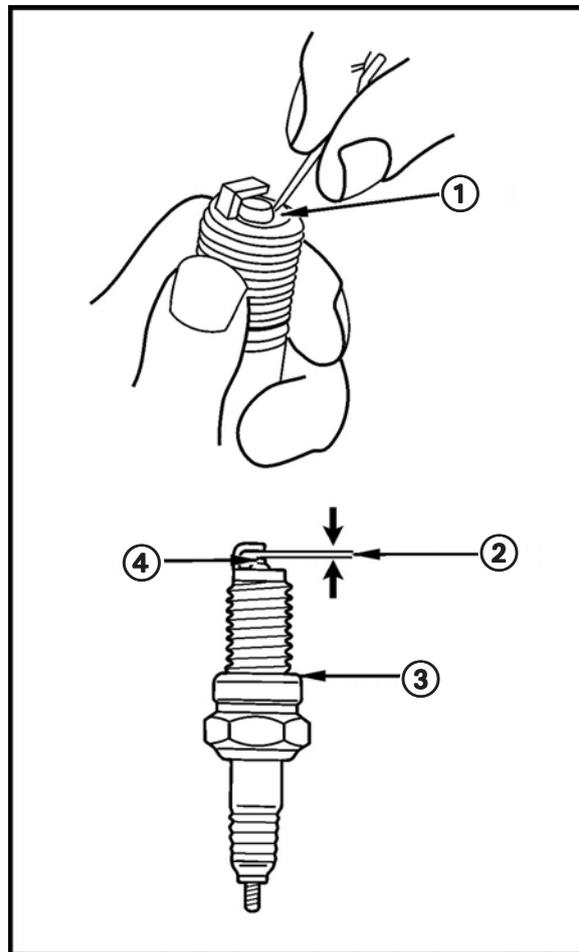

Fuel system & hoses

Check the fuel hoses and fittings for any signs of leakage.

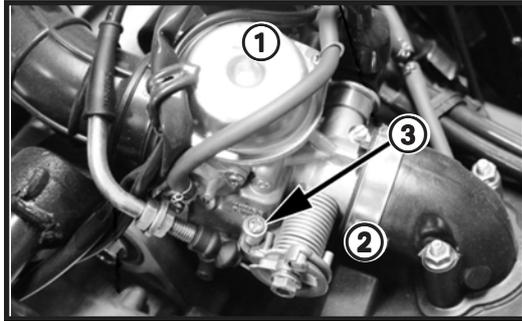

1. Check for leakage at the carburetor ①.
2. Check for leakage from the fuel hoses, clamps and joints ②.
3. Check for leakage at the fuel filter.
4. Check for leakage at the fuel tank.

Engine idle speed: 1700 RPM

1. Adjust the engine idle speed using the adjustment screw on the carburetor throttle cable linkage ③.

WARNING

Replace any fuel system components that are leaking fuel. Contact your KYMCO dealer for fuel system service, repairs or engine idle speed adjustment.

Battery

Your KYMCO scooter is equipped with a maintenance-free (sealed) battery. Therefore, it is not necessary to check the battery's electrolyte level or add distilled water.

NOTE: If your battery seems weak and/or is leaking electrolyte (causing hard starting or other electrical troubles), contact your KYMCO dealer immediately .

CAUTION

Your battery is a maintenance-free type and can be permanently damaged if the cap strip is removed.

Charge the battery with a charger specifically designed for use with a maintenance-free type battery. Using another type of charger can damage the battery.

WARNING

Your scooter's battery gives off explosive hydrogen gas during normal operation. A spark or flame can cause the battery to explode with enough force to kill or seriously injure you.

Wear protective clothing and a face shield, or have a qualified technician perform the battery maintenance.

Battery removal & installation

The battery is in a compartment below the scooter's floorboard mat. To remove the battery for service, follow this procedure:

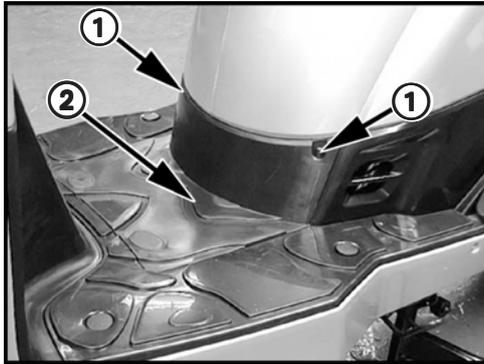

1. Make sure the ignition switch is "OFF - ". Remove the two cover screws 1 and remove the battery cover.

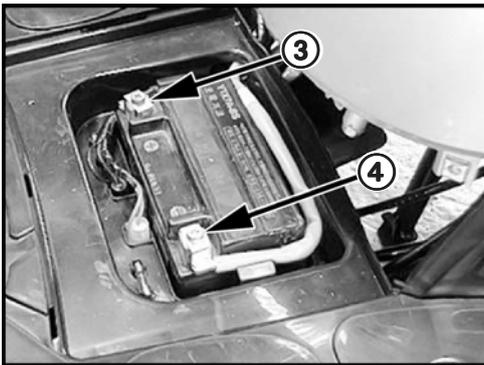

2. When removing the battery for charging or replacement, disconnect the negative (-) terminal lead ③ from the battery first, then disconnect the positive (+) terminal lead ④.
3. Remove the battery.

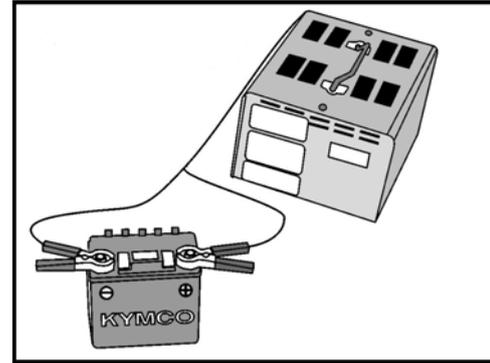

4. Use a charger specifically designed for a maintenance-free type battery. Using another type of battery charger may damage the battery and prevent it from becoming fully charged.
5. When installing the battery, connect the positive(+) terminal lead ④ first, then the negative (-) terminal lead ③.
6. Replace the battery cover ② and screws.

NOTE: Always keep the ignition switch OFF when servicing the battery. See your KYMCO dealer for electrical system diagnosis and repair.

Fuses

When frequent fuse failures occur, it usually indicates a short circuit or an overload in the electrical system.

Charging system fuse (50):	7A
Charging system fuse (125 & 200):	15A
Ignition system fuse (50):	7A
Ignition system fuse (125 & 200):	10A

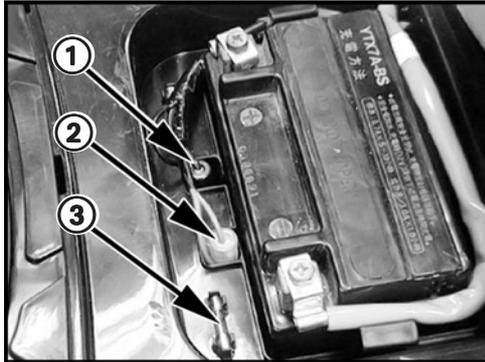

1. The charging system and ignition system fuses (and a spare fuse) are located in the battery compartment. Remove the battery compartment cover - see page 52.
2. The charge fuse ①, the ignition fuse ②, and the spare fuse ③ are adjacent to the battery.
3. To replace a fuse, pull the fuse holder out of the battery compartment.

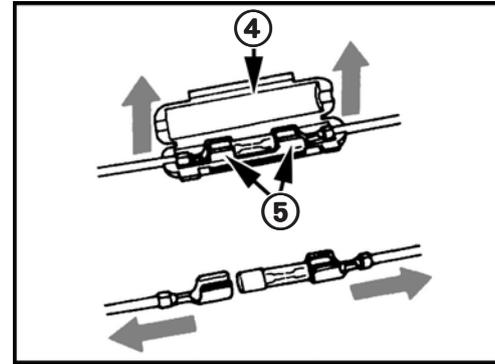

4. Slide the fuse ④ out of the holder clips ⑤.
5. Install a new fuse of the proper specification into the holder clips.
6. Press the fuse and the holder clips back into the holder.
7. Close the fuse holder and set it back in place.

WARNING

Never use a fuse with a different rating from that specified. Serious damage to the electrical system or a fire hazard may result, causing a dangerous loss of lights or engine power.

Wire & cable cover inspection

The control cables and connection points of the scooter's wire harness have rubber covers that protect them from dirt and moisture.

1. The covers ① should be checked periodically to make sure they are in good condition .
2. The covers should also be pulled back ② to make sure the electrical terminals, are not contaminated by moisture, dirt or corrosion that could affect their electrical integrity.
3. When the cover is pulled back, make sure the connectors tabs ③ are secured so the connectors will not separate during operation.

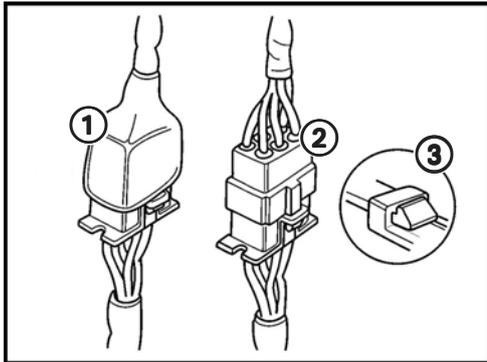

⚠ CAUTION

Use a moist rag to clean debris off of the covers.

⚠ WARNING

Corrosion on electrical connectors can alter or disrupt the electrical function of your scooter. Use a quality, dielectric grease to lubricate and protect electrical connectors.

Always keep ignition switch OFF when servicing the electrical connectors. See your KYMCO dealer for any electrical system diagnosis and repair.

Brake fluid (front brake)

Your scooter is equipped with a hydraulic front brake. Check the brake fluid level window on the master cylinder reservoir on the handlebars per the maintenance schedule.



Adding brake fluid:

1. Remove the two Phillips screws retaining the master cylinder cap. Remove the cap.
2. Add the specified type of brake fluid to bring the level above the "MIN" level in the window ④ (see image on prior page).
3. Wipe the master cylinder cap and gasket with a clean cloth and reinstall the cap, tightening the screws securely.

Brake fluid type: DOT 4

WARNING

Do not mix brake fluid types. Doing so may cause brake failure and could result in an accident.

Do not allow brake fluid to touch the scooter's body work, as it will damage the painted surface.

Brake lever & shoe adjustment (rear brake)

Your scooter requires the proper lever free-play and brake shoe adjustment so the rear brake will be responsive and will not drag, causing premature wear to the brake shoes.

Note: The free-play is the measured distance between the brake lever at rest and the point at which the brake first begins to engage (see page 29).

1. Measure the free-play at the left brake lever end ⑤:
0.4 - 0.6 in (10 - 20 mm).

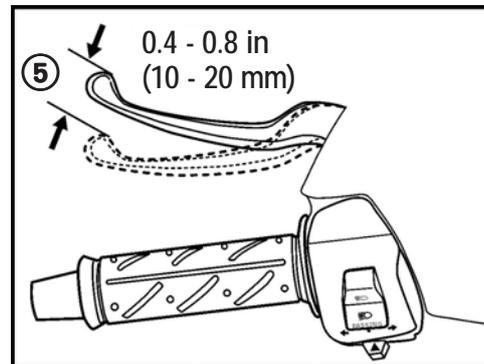

2. Adjust the rear brake free-play so the pointer on the brake arm is within the adjustment range markings on the transmission case (see page 29 & 30).
4. Use the cable end adjuster to set the free-play (see page 30).

WARNING

Make sure the rear wheel turns freely after free-play adjustment so the brake will function properly and not wear prematurely.

If the brake arm pointer is outside of the adjustment range markings, the brake shoes must be inspected and may need to be replaced. If your scooter requires brake shoe replacement, see your KYMCO dealer for this service.

Cleaning

Clean your scooter regularly to protect the surface finishes and inspect for damage, wear, and oil, coolant or brake fluid leakage.

Avoid cleaning products that are not specifically designed for scooter, motorcycle, or automobile surfaces. Nonspecific cleaners may contain harsh detergents or chemical solvents that could damage the metal, paint, and plastic on your scooter.

NOTE: If your scooter is still warm from recent operation, give the engine and exhaust system time to cool off before washing. Avoid the use of high pressure water spray (typical in coin-operated car washes), as this powerful spray can damage components on your scooter.



Washing your scooter

1. Rinse the scooter thoroughly with cool water to remove any loose dirt.
2. Clean the scooter with a sponge or soft cloth using cool water. Avoid directing water at muffler outlets and electrical parts.
3. Clean the plastic parts using a cloth or sponge dampened with a solution of mild detergent and water. Rub the soiled area gently, rinsing it frequently with fresh water. Take care to keep brake fluid or other chemical solvents away from the scooter, as they will damage the plastic and painted surfaces.

4. After cleaning, rinse the scooter thoroughly with plenty of clean water. This rinsing is required to remove detergent residue which can corrode alloy parts.
5. Dry the scooter and then start the engine, allowing it to run for several minutes.

NOTE: The inside of the headlight lens may become clouded immediately after washing the scooter. Moisture condensation inside the headlight lens will disappear gradually as it is heated by the headlight. After washing, run the engine while keeping the headlight on to dissipate any condensation.

6. Test the brakes before riding the scooter. Several applications of the brakes may be necessary to restore normal braking performance.

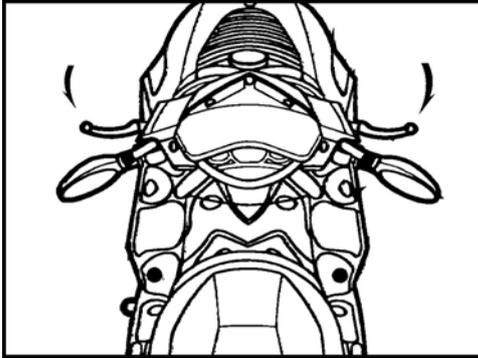

NOTE: Due to water on the brake components, braking efficiency may be temporarily impaired immediately after washing the scooter. Anticipate longer stopping distances to avoid a possible accident.

Finishing touches:

After washing your scooter, consider using a commercially-available spray cleaner/polish or a quality liquid or paste wax to enhance and protect the paint's finish. Use only a nonabrasive polish or wax made specifically for scooters, motorcycles, or automobiles. Apply the polish or wax according to the instructions on the container.

Removing road salt

The salt used in some communities to prevent road icing can become very corrosive to your scooter. Wash your scooter as soon as possible if it comes in contact with road salt (or sea water).

1. Clean the scooter using cool water (see page 56). Do not use warm water; as this will increase the corrosive effect of the salt.
2. Dry the scooter and protect painted and metal surfaces with wax or polish.

Painted aluminum wheel maintenance

Even if protected by paint, aluminum may corrode from contact with dirt, mud, or road salt. Clean the scooter's wheels with a wet sponge and mild detergent. Avoid stiff brushes, steel wool, or cleaners containing abrasives or chemical compounds.

After washing, rinse with plenty of water and dry with a clean cloth. Apply touch-up paint to the wheels where damage has occurred.

Exhaust pipe maintenance

The exhaust system is stainless steel, but it can become stained by oil or mud. If necessary, remove heat stains with a liquid kitchen-counter abrasive.

STORAGE GUIDE

Extended storage, such as for the winter months, requires that you take certain steps to reduce the effects of deterioration from the non-use of your scooter. Whenever possible, perform any necessary periodic maintenance or repairs before storage so the scooter will be in good condition for riding when it is removed from storage.

Storage

1. Change the engine oil and filter.
2. Drain the carburetor (if equipped) and empty the fuel tank into an approved gasoline container using a commercially available hand siphon or an equivalent method. Spray the inside of the tank with an aerosol rust-inhibiting oil. Close the fuel filler cap on the fuel tank

WARNING

Gasoline is highly flammable and explosive. You can be burned or seriously injured when handling fuel. Stop the engine and keep heat, sparks, and flame away. Refuel the scooter outdoors and wipe up any spills immediately.

3. To prevent rusting in the cylinder, perform the following:
 - Remove the spark plug cap from the spark plug, and use tape or string to secure the cap to any convenient plastic body part so that it is positioned away from the spark plugs.*
 - Remove the spark plug from the engine and store it in a safe, dry place. Do not connect the spark plug to the spark plug cap.*
 - Pour a tablespoon (15 - 20 cc) of clean engine oil into the cylinder and cover the spark plug hole with a piece of cloth.*
 - Crank the engine several times to distribute the oil.*
 - Reinstall the spark plug and spark plug cap.*
4. Remove the battery. Store it in an area protected from freezing temperatures and direct sunlight. Slow charge the battery once a month (use a quality charger designed for use on a maintenance-free type battery).
5. Wash and dry the scooter. Wax all painted surfaces. Coat the chrome or bare aluminum parts with rust inhibiting oil.
6. Inflate the tires to their recommended pressures. Place the scooter on blocks to raise both tires off the ground.
7. Cover the scooter (do not use plastic or other coated materials) and store in an unheated area, free of excessive moisture, with a minimum of daily temperature variation. Do not store the scooter in direct sunlight, as the sun's UV rays can damage the body work and other components.

Removal from storage

1. Uncover and clean the scooter.
2. Change the engine oil if more than 1 month has passed since the start of storage.
3. Charge the battery as required (use a quality charger designed for use on a maintenance-free type battery). Install the battery.
4. Drain any excess aerosol rust-inhibiting oil from the fuel tank. Fill the fuel tank with fresh gasoline.
5. Perform all the pre-ride inspection checks (see pages 23 - 33). Test ride the scooter at low speeds in a safe riding area, away from traffic.

Dimensions

Overall length	79.1 in (2010 mm)
Overall width	28.3 in (720 mm)
Overall height	51.2 in (1300 mm)
Wheel base	53.5 in (1360mm)
Seat height	31.5 in (800 mm)
Dry weight	240.3lbs (109 kg)

Capacities

Engine oil	0.9 US qt. (0.85L)
Transmission oil	0.13 qt (0.12 L)
Fuel tank	1.8 US gal (6.8 L)
Maximum weight capacity	330 lb (150 kg)

Engine

Type	Four-stroke, air-cooled SOHC
Displacement	49.5 cm ³ (3.0 cu. in)
Bore and stroke	1.53in X 1.61 in (39 X 41.4 mm)
Compression ratio	11:1
Spark plug	CR7HSA
Idle speed	1700 RPM
Cooling system	Forced Air (fan)
Starting system...	Electric starter motor (kick-start back-up)
Transmission	Automatic CVT

Chassis

Tire size, front	100/80 - 16
Tire size, rear	110/70 - 16
Chassis material	Steel
Front suspension	Telescopic forks
Rear suspension	Twin shock absorber
Brake (front)	Disc type
Brake (rear)	Drum/shoe type

Electrical

Ignition type	DC-CDI
Battery	12v-6Ah
Headlight	12v 35/35W
Tail/brake light	12v 5/21W
Turn signal light	12v 10W X 4
Position light	12v5W (front & rear)
Main Fuse	7A

Dimensions

Overall length	80.7 in (2050 mm)
Overall width	28.3 in (720 mm)
Overall height	51.2 in (1300 mm)
Wheel base	53.2in (1350mm)
Seat height	31.5 in (800 mm)
Dry weight	255.7 lbs (116 kg)

Capacities

Engine oil	1.2 US qt. (1.1 L)
Transmission oil.....	0.25 qt (0.21 L)
Fuel tank	1.8 US gal (6.8 L)
Maximum weight capacity	330 lb (150 kg)

Engine

Type	Four-stroke, air-cooled SOHC
Displacement	1.25 cm ³ (7.6 cu. in)
Bore and stroke	2.06in X 2.27 in (52.4 X 57.8 mm)
Compression ratio	9.3:1
Spark plug	CR7HSA
Idle speed	1700 RPM
Cooling system	Forced Air (fan)
Starting system...	Electric starter motor (kick-start back-up)
Transmission	Automatic CVT

Chassis

Tire size, front	100/80 - 16
Tire size, rear	120/80 - 16
Chassis material	Steel
Front suspension	Telescopic forks
Rear suspension	Twin shock absorber
Brake (front)	Disc type
Brake (rear)	Drum/shoe type

Electrical

Ignition type	DC-CDI
Battery	12v-6Ah
Headlight	12v 35/35W
Tail/brake light	12v 5/21W
Turn signal light	12v 10W X 4
Position light	12v5W (front & rear)
Fuses	10A / 15A

Dimensions

Overall length 80.7 in (2050 mm)
 Overall width 28.3 in (720 mm)
 Overall height 51.2 in (1300 mm)
 Wheel base 53.2in (1350mm)
 Seat height 31.5 in (800 mm)
 Dry weight 326.9 lbs (122 kg)

Capacities

Engine oil 1.2 US qt. (1.1 L)
 Transmission oil 0.25 qt (0.21 L)
 Fuel tank 1.8 US gal (6.8 L)
 Maximum weight capacity 330 lb (150 kg)

Engine

Type Four-stroke, air-cooled SOHC
 Displacement 1.63 cm³ (9.94 cu. in)
 Bore and stroke 2.36in X 2.27 in (60 X 57.8 mm)
 Compression ratio 9.5:1
 Spark plug CR7HSA
 Idle speed 1700 RPM
 Cooling system Forced Air (fan)
 Starting system... Electric starter motor (kick-start back-up)
 Transmission Automatic CVT

Chassis

Tire size, front 100/80 - 16
 Tire size, rear 120/80 - 16
 Chassis material Steel
 Front suspension Telescopic forks
 Rear suspension Twin shock absorber
 Brake (front) Disc type
 Brake (rear) Drum/shoe type

Electrical

Ignition type DC-CDI
 Battery 12v-6Ah
 Headlight 12v 35/35W
 Tail/brake light 12v 5/21W
 Turn signal light 12v 10W X 4
 Position light 12v5W (front & rear)
 Fuses 10A / 15A

KYMCO Clean-Air System

The KYMCO Clean-Air System is a secondary air suction system that helps the exhaust gases to burn more completely. When the engine's exhaust is sent into the exhaust system, it contains some unused fuel. This exhaust is still hot enough to burn the unused fuel. The Clean-Air system introduces more air so the oxygen will then permit the unused fuel to burn in the exhaust system. This continued burning action uses up a great deal of the normally unused fuel and other gases, as well as changing a significant portion of the poisonous carbon monoxide into harmless carbon dioxide. The Clean-Air system does not use any energy from the engine and does not affect the scooter's performance.

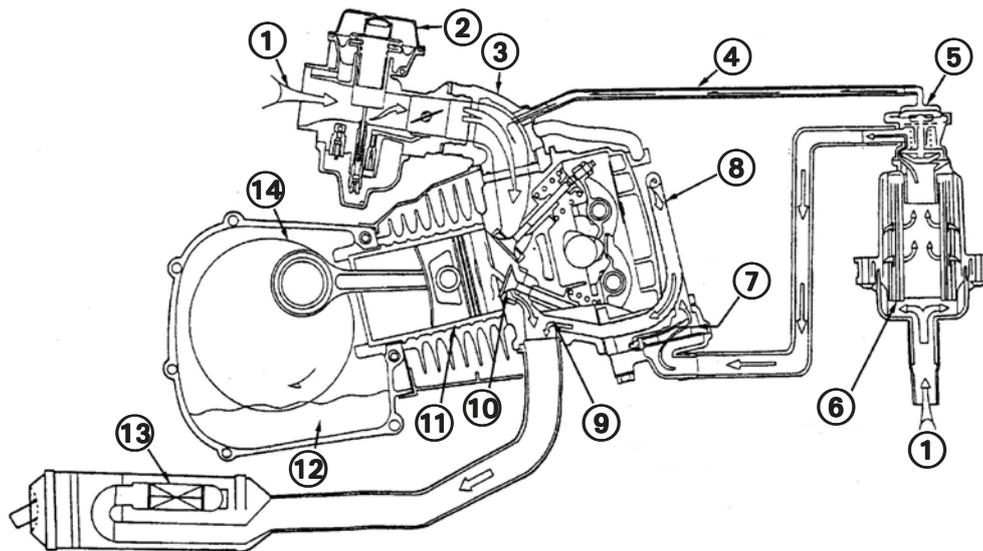

- ① Fresh Air
- ② Carburetor
- ③ Intake manifold
- ④ Vacuum hose
- ⑤ Air injection control valve
- ⑥ Air injection air cleaner
- ⑦ Reed valve
- ⑧ Air pipe
- ⑨ Fresh air
- ⑩ Exhaust valve
- ⑪ Piston & cylinder
- ⑫ Engine oil
- ⑬ Catalytic converter
- ⑭ Crankshaft

Crankcase Emission Control System

Your People S scooter's engine is equipped with a closed crankcase system. Blow-by gases are routed back into the combustion chamber via the intake system. This system does not allow the blow-by gases to enter the atmosphere.

Exhaust Emission Control System

The exhaust emissions from your scooter are controlled by engine design, factory-set fuel delivery, ignition settings, and exhaust system design. This system also includes a catalyzer in the exhaust system.

Noise Exhaust Emission Control System

The engine, intake and exhaust systems of your scooter were designed to comply with federal, state and local noise level requirements. Do not modify the engine, intake or exhaust components, as doing so will affect compliance with these noise level requirements.

Please do not modify or change any KYMCO-designed components that may alter the sound or emission level from your People S scooter.

KYMCO LIMITED WARRANTY

NOISE EMISSIONS

KYMCO USA Inc, 5 Stan Perkins Road, Spartanburg, SC 29307, USA warrants that this vehicle was designed, manufactured and equipped so that when new, it would conform with the applicable Motorcycle Noise Regulations of the U.S. EPA Environmental Protection Agency.

This warranty is not limited to any particular part, component or system of the vehicle. Defects in design, assembly, or in any part, component or system of the vehicle which, at the time of sale to the first purchaser, caused noise emission levels to exceed applicable Federal standards in effect at the time of manufacture, are covered by this warranty.



KYMCO MOTORCYCLE AND SCOOTER LIMITED WARRANTY

KYMCO USA Inc, 5 Stan Perkins Road, Spartanburg, SC 29307, USA warrants for a period of twenty four- (24) months from the date of initial retail purchase from an authorized KYMCO dealer that each new KYMCO motorcycle or scooter shall be free, under normal use and maintenance, from any defect in material and workmanship subject to the following conditions, exclusions, obligations and limitations.

1. **EXCLUSIONS.** The following are specifically excluded from the terms and provisions of this warranty:
 - a. Any KYMCO motorcycle or scooter engaged in competitive racing or related use.
 - b. Any KYMCO motorcycle or scooter utilized for rental purposes.
2. **COVERAGE.** Any material or workmanship found to be defective by KYMCO within the warranty period and limitations shall be repaired without charge for parts or labor at any authorized KYMCO dealer located within the United States of America.
3. **WARRANTY PERIOD.** The warranty is effective from the date of purchase by the original owner with the following limitations:
 - SECTION 1 – All parts and repair labor are covered for the first 365 days.
 - SECTION 2 – Engine and electrical parts and repair labor are covered for the first 540 days.
 - SECTION 3 – Engine parts and repair labor are covered for 730 days.
4. **OWNER'S OBLIGATIONS.** The following obligations must be fulfilled by vehicle's owner to maintain KYMCO warranty coverage:
 - a. Owner must deliver the motorcycle or scooter to an authorized KYMCO dealer or equally qualified service facility for inspection, maintenance, services and adjustments according to the Periodic Maintenance chart contained in the owner's manual.
 - b. All inspection, maintenance services and adjustments are to be performed at the owner's expense.
5. **LIMITATIONS.** This warranty shall not apply to or include any of the following:
 - a. The normal expense of routine maintenance services and adjustments. This also includes parts that require replacement due to normal wear, such as spark plugs, drive chains, belt drives, air cleaner elements, brake shoes, cables, fuses, oils, coolants and tires.
 - b. Damage from the lack of periodic maintenance, or damage resulting from repairs, adjustments, maintenance operations, or the use of non-genuine parts or accessories, fuel or fluids that do not follow KYMCO service recommendations.
 - c. Damage caused by collision, improper operation, or caused by loading beyond the vehicle's rated load capacity.
 - d. Damage caused by modifications made to the vehicle to increase performance.
 - e. Damage caused by improper storage or transport, or towing or transportation expenses to move the vehicle to a KYMCO dealer for service or repair.
 - f. Damage caused by natural disasters such as fires, floods, collision or theft, or any damage caused by the passage of time such as fading, peeling or other deterioration caused by outside elements.
 - g. Repair or replacement of worn items caused by the use of the motorcycle or scooter, and normal operational characteristics such as engine sounds, vibration, seepage (and other situations not considered defects by KYMCO).
6. **LIMITED LIABILITY.**
 - a. The liability of KYMCO under the twenty four- (24) month warranty is limited solely to the remedying of defects materials or workmanship by an authorized KYMCO dealer at its place of business during customary business hours. This warranty does not cover inconvenience or loss of use of the motorcycle or scooter, or transportation of the motorcycle or scooter to or from a KYMCO dealer.
 KYMCO SHALL NOT BE LIABLE FOR ANY OTHER EXPENSE, LOSS OR DAMAGE, WHETHER DIRECT, INCIDENTAL, CONSEQUENTIAL OR EXEMPLARY ARISING IN CONNECTION WITH THE SALE OR USE OF, OR INABILITY TO USE, THE KYMCO MOTORCYCLE OR SCOOTER FOR ANY PURPOSE. SOME STATES DO NOT ALLOW THE EXCLUSION OR LIMITATION OF ANY INCIDENTAL OR CONSEQUENTIAL DAMAGES, SO THE ABOVE LIMITATION OR EXCLUSION MAY NOT APPLY TO YOU.
 - a. NO EXPRESS WARRANTY IS GIVEN BY KYMCO WITH RESPECT TO THE KYMCO MOTORCYCLE OR SCOOTER EXCEPT AS SPECIFICALLY SET FORTH HEREIN. ANY WARRANTY IMPLIED BY LAW, INCLUDING ANY WARRANTY OF MERCHANTABILITY OR FITNESS FOR A PARTICULAR PURPOSE, IS EXPRESSLY LIMITED TO THE TWENTY FOUR- (24) MONTH WARRANTY TERM SET FORTH HEREIN. THE FOREGOING STATEMENTS OF WARRANTY ARE EXCLUSIVE AND IN LIEU OF ALL OTHER REMEDIES. SOME STATES DO NOT ALLOW LIMITATIONS ON HOW LONG AN IMPLIED WARRANTY LASTS, SO THE ABOVE LIMITATIONS MAY NOT APPLY TO YOU.
 - b. No dealer is authorized to modify this KYMCO Limited motorcycle or scooter Warranty.
7. **LEGAL RIGHTS.** THIS WARRANTY GIVES YOU SPECIFIC LEGAL RIGHTS, AND YOU MAY ALSO HAVE OTHER RIGHTS WHICH VARY FROM STATE TO STATE.

Issue Number: xxxxxxxxxxxxxxxxx
 Revised: June 5, 2008

Accessories & Modifications	6	Helmet Hooks	15	Right-hand Handlebar Switch	13
Air Filter Maintenance	49	Horn & Lights Inspection	31 - 32	Scooter Safety	3 - 4
Battery	51 - 52	Horn Button	14	SECTION 1 - SAFETY	2 - 6
Brake Fluid Level Inspection	54 - 55	Identification Numbers Record (inside of back-cover)		SECTION 2 - CONTROLS & FEATURES	7 - 15
Brake Inspection	27 - 30	Ignition Switch & Steering Lock	11 - 12	SECTION 3 - OPERATION	21 - 41
Brake Lever & Shoe Adjustment	55	Importance of Maintenance	42	SECTION 4 - MAINTENANCE	42 - 61
Break-in Recommendations	21	Index	68	Spark Plug	50
CA Prop 65 Warning	(inside of front-cover)	Instrument Inspection	31	Specifications (People S 125)	63
Chassis Inspection	32 - 33	Instruments	17 - 18	Specifications (People S 200)	64
Cleaning Your Scooter	56 - 57	Keys	11	Specifications (People S 50)	62
Clock & Trip-meter	18 - 19	KYMCO Limited Scooter Warranty	67	Starting the Engine (electric start)	33 - 35
Electric Start Button	13	Left-hand Handlebar Switch	13 - 14	Starting the Engine (kick start)	35
Emission - KYMCO Clean Air System	65	Load Limits & Guidelines	5	Steering & Handlebar Inspection	30
Emission Information & EPA Warranty	66	Locations of Parts & Controls	7 - 9	Storage	58 - 59
Engine Oil Inspection	24	Main Stand	16	Table of Contents	1
Engine Oil Level Inspection & Change	46 - 47	Maintenance Record	60 - 61	Tire Break-in	22
Engine Oil	46	Maintenance Schedule	43 - 44	Tire Inspection	24 - 25
Engine-stop Switch	13	Manual Icon Legend	(inside of front-cover)	Tire Pressure	45
Foreword	2	Parking Your Scooter	40 - 41	Tires	45
Front Luggage Box	16	Passenger Foot Rests	20	Transmission Fluid Change	48
Fuel Level / Filler Cap	26	Power Socket	15	Turn Signal Switch	13
Fuel System	51	Pre-ride Inspection	23 - 33	Turn Signals	14
Fuses	53	Rear Shock Absorbers	20	Under-seat Storage Compartment	14
Headlight Dimmer Switch	13	Riding Your Scooter	36 - 40	Vehicle Identification Numbers	10

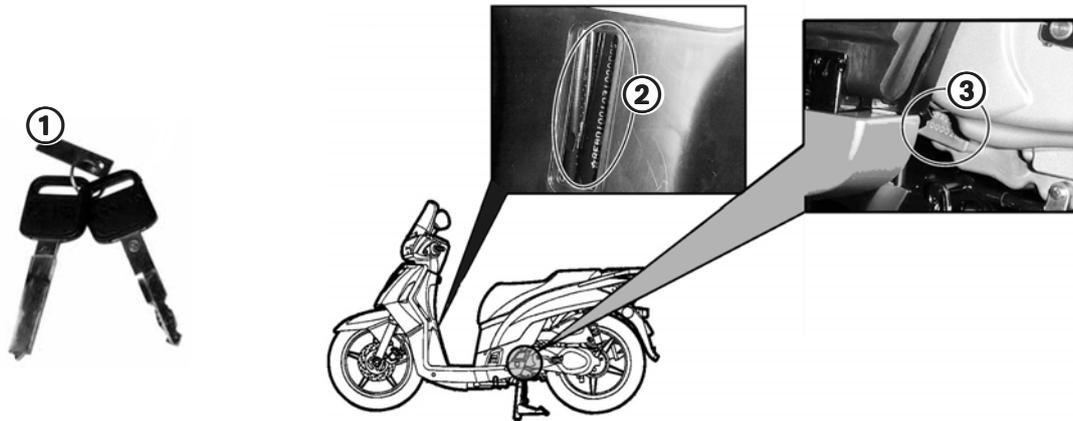

1. IGNITION SWITCH KEY IDENTIFICATION NUMBER

The ignition switch key identification code is stamped on tab ① supplied with the key. If you require a replacement key, you will need this code to obtain a new key from your authorized KYMCO dealer. Record the key number in the box above.

2. VEHICLE IDENTIFICATION NUMBER (VIN)

3. ENGINE SERIAL NUMBER (ESN)

Record the Vehicle Identification Number ② and Engine Serial Number ③ in the boxes above for future reference (to assist you in ordering parts from your authorized KYMCO dealer or for reference in case the vehicle is stolen).

NOTE: *Your scooter's keys may differ in appearance from those shown in this manual.*



**5 Stan Perkins Road
Spartanburg, SC 29307
Telephone: (888) 235-3417
FAX: (864) 327-4745**

**Prepared: March 2009
T300-BA40BB-US-A5**