



Super 8 50

Super 8 150

OWNER'S MANUAL

Do not remove this Owner's Manual from the vehicle. Read this manual carefully before operating the vehicle as it contains important safety information.

Read this manual carefully.



This Owner's Manual contains important information on safety, operation and maintenance of your KYMCO Super 8 scooter. Any one who operates your scooter should carefully read and understand the contents of this manual before riding the scooter. For your safety, understand and follow all of the warnings contained in this Owner's Manual and the labels applied to your scooter. This Owner's Manual should be considered a permanent part of the vehicle, keep it with your scooter at all times.

ON-ROAD USE ONLY This scooter has been designed to be used on the road.

Particularly important information is called out in this manual by the following icons and notations:



The SAFETY ALERT symbol with the exclamation point in the triangle means ATTENTION! BE ALERT! YOUR SAFETY CAN BE AFFECTED.

 **WARNING**

Failure to follow instructions associated with a WARNING symbol could result in severe injury or death to the rider, a passenger, a bystander, or a person inspecting or repairing the scooter.

 **CAUTION**

A CAUTION symbol indicates that special precautions must be taken to avoid damaging the scooter.

 **NOTE**

The NOTE symbol indicates key information about a procedure or to clarify an operation.

California Proposition 65

 **WARNING**

This product contains or emits chemicals known to the State of California to cause cancer and birth defects or other reproductive harm.

TABLE OF CONTENTS



Manual Icon Legend	(inside of front-cover)	
CA Prop 65 Warning	(inside of front-cover)	
Table of Contents	1	
SECTION 1 - SAFETY	2 - 6	
Foreword	2	
Scooter Safety	3 - 4	
Load Limits & Guidelines	5	
Accessories & Modifications	6	
SECTION 2 - CONTROLS & FEATURES	7 - 13	
Locations of Parts & Controls	7	
Keys	8	
Ignition Switch	8	
Right-hand Handlebar Switch	9	
Engine-stop Switch	9	
Electric Start Button	9	
Left-hand Handlebar Switch	10	
Headlight Dimmer Switch	10	
Turn Signal Switch	10	
Under-seat Storage Compartment	11	
Helmet Posts	11	
Main Stand	12	
Instruments	12 - 13	
Passenger Pegs	13	
SECTION 3 - OPERATION	14 - 30	
Break-in Recommendations	14	
Tire Break-in	15	
Troubleshooting	15	
Pre-ride Inspection	16 - 23	
Engine Oil Inspection	17	
Brake Lever Free-play Inspection	17	
Tire Inspection	18 - 19	
Fuel Level / Filler Cap	19	
Fuel Recommendation	19	
Steering & Handlebar Inspection	20	
Instrument Inspection	20	
Brake Adjustment & Pad Inspection	21	
Horn & Lights Inspection	22	
Chassis Inspection	23	
Starting the Engine (electric start)	24 - 25	
Starting the Engine (kick start)	25	
Riding Your Scooter	26 - 29	
Parking Your Scooter	30	
SECTION 4 - MAINTENANCE	31 - 48	
Importance of Maintenance	31	
Maintenance Schedule	32 - 33	
Tires	34	
Tire Pressure	34	
Air Filter Maintenance	35	
Fuel Hoses	36	
Battery	36 - 37	
Fuses	37	
Engine Oil	38	
Engine Oil Level Inspection & Change	38 - 39	
Transmission Fluid Inspection & Change	40	
Spark Plug	41	
Brake Fluid Level Inspection	41	
Cleaning Your Scooter	42 - 43	
Storage	44	
Maintenance Record	45	
Specifications (50 model)	46	
Specifications (150 model)	47	
Exhaust Emission Control System	48 - 49	
Emission Information & EPA Warranty	50	
KYMCO Limited Scooter Warranty	51	
Index	52	
Identification Numbers Record	(inside of back-cover)	

SECTION 1 - FOREWORD & SAFETY INTRODUCTION



Thank you for purchasing this KYMCO Super 8 scooter, and welcome to the KYMCO riding family. Please read this owner's manual carefully before riding so that you will be thoroughly familiar with the proper operation of your scooter's controls, its features, its capabilities, and its limitations.

To ensure a long, trouble-free life for your scooter, provide it with the proper care and maintenance as described in this manual.

For replacement parts and accessories, you should always use genuine KYMCO products, as they have been specially designed for your vehicle and manufactured to meet KYMCO's demanding standards.

Keep this owner's manual aboard your scooter at all times, so that you can refer to it whenever you need information. This manual should be considered a permanent part of the scooter and should remain with the scooter when it is sold.

All information, illustrations, photographs and specifications contained in this manual are based on the latest product information available at the time of publication. Due to improvements or other changes, there may be information in this manual that differs slightly from your vehicle. KYMCO reserves the right to make product and publication changes at any time, without notice, and without incurring any obligation.

IMPORTANT SAFETY INFORMATION

Your scooter can provide you many years of service and pleasure if you take responsibility for your own safety and understand the challenges that you can meet on the road. There is much that you can do to protect yourself when you ride. You will find many helpful recommendations throughout this manual. Here are some very important safety tips:

Wear a helmet

Scooter safety equipment starts with a quality helmet. One of the most serious injuries you can suffer in a crash is a head injury. Always wear a properly approved helmet. You should also wear suitable eye protection.

Make yourself easy to see

To make yourself more visible, wear bright reflective clothing, position yourself so other drivers can see you, signal before turning or changing lanes, and use your horn when it will help others notice you.

Know your limits

Ride within the boundaries of your own skill at all times. Knowing these limits and staying within them will help you to avoid accidents. Always ride with both hands on the handlebars.

Keep your scooter in safe condition

For safe riding, it is important to inspect your scooter before every ride and perform all recommended maintenance. Never exceed load limits, and only use accessories that have been approved by KYMCO for this scooter.

Inspect your scooter before riding

Remember to perform an entire safety inspection to ensure you, and your passenger's safety, before each ride.

Be extra cautious on bad weather days

Riding on bad weather days, especially wet ones, requires extra caution. Braking distances can double on a rainy day. Stay off of the painted surfaces, manhole covers and greasy appearing areas on the pavement, as they can be especially slippery. Use extreme caution at railway crossings and on metal gratings and bridges. Whenever you are in doubt about the road conditions, slow down.

Modification

Modification of your scooter, or removal of original equipment may render the vehicle unsafe or illegal. Obey all applicable equipment regulations in your area.

PROTECTIVE APPAREL

For your safety, always wear an approved motorcycle or scooter helmet, eye protection, boots, gloves, long pants, and a long-sleeved shirt or jacket whenever you ride your scooter.

Helmets and protection

Your helmet is your most important piece of riding gear because it offers the best protection against head injuries. Your helmet should fit your head comfortably and securely. Always wear a face shield or goggles to protect your eyes and to aid your vision.

Additional riding gear

In addition to a helmet and eye protection, you should also use:

- Sturdy boots with nonslip soles to help protect your feet and ankles
- Leather gloves to keep your hands warm and help prevent blisters, cuts, burns and bruises
- A motorcycle or scooter riding suit or jacket that has been designed for comfort as well as protection. Bright colored and reflective clothing can help make you more noticeable in traffic. Be sure to avoid loose clothing that can get caught on any part of your scooter.



- ① Wear gloves
- ② Wear bright or reflective clothing. Clothes should fit properly (not too tight or loose)
- ③ Always wear a helmet. You should also wear eye protection
- ④ Footwear should be the proper size, have low heels, and offer ankle protection

WARNING

Not wearing a helmet increases your chance of serious injury or death in a crash.

WARNING

Be sure you and your passenger always wear an approved motorcycle helmet that fits properly. You should also wear eye protection and other protective apparel when you ride.

These general guidelines may help you decide how to add accessories to your scooter and how to load it properly.

Load limits

These specifications are the load limits for your Super 8 scooter. Overloading the scooter will affect its stability and handling, be sure to stay within the limits listed below:

Maximum weight capacity

(includes the weight of the rider, passenger, cargo and accessories): 330 lbs (150 kg)

Maximum cargo weight: 33 lb (15 kg)

Rear carrier (rack) ⑤ weight limit: 22 lbs (10 kg)

Under-seat compartment ⑥ weight limit: 11 lbs (5 kg)



Loading guidelines

Improperly loading your scooter will affect its stability and handling. You should ride at reduced speeds when you are carrying a passenger or cargo. Follow these guidelines whenever you carry a passenger or cargo:

- Check that both tires are properly inflated
- To prevent loose items from creating a hazard, make sure all cargo is securely tied down before you ride
- Place cargo weight as close to the center of the scooter as possible
- Balance cargo weight evenly on both sides of the scooter

WARNING

Overloading or improper loading will affect vehicle handling, stability and braking, and can lead to an accident. Never exceed the stated load capacity of your scooter. Cargo should be properly distributed and securely attached. Reduce speed when carrying cargo and allow for more room for braking.

There is a large variety of accessories available to KYMCO scooter owners. KYMCO cannot have direct control over the quality or suitability of any accessories you may wish to purchase. The addition of unsuitable accessories to your scooter can lead to unsafe operating conditions. It is not possible for KYMCO to test each available accessory on the market or combinations of all such available accessories; however, your KYMCO dealer can assist you in the selection and installation of quality accessories.

Use extreme caution when selecting and installing the accessories for your scooter.

No modifications

KYMCO strongly advises you against removing any original equipment from, or modifying your scooter in any way that would change its design or operation.

⚠ WARNING

Improper accessories or modifications can make your scooter unsafe and can lead to an accident.

Never modify your scooter through the improper installation or use of accessories. All parts and accessories added to this vehicle should be genuine KYMCO or equivalent components designed for use on this scooter and should be installed and used according to the accessory manufacturer's instructions. If you have any questions, consult an authorized KYMCO dealer.

SECTION 2 - CONTROLS & FEATURES



Location of parts & controls

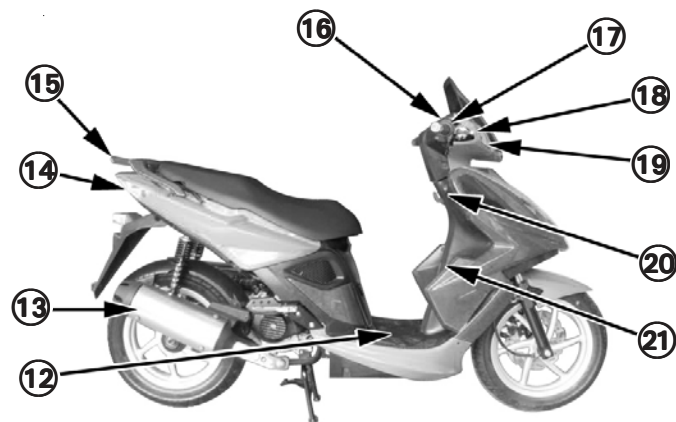
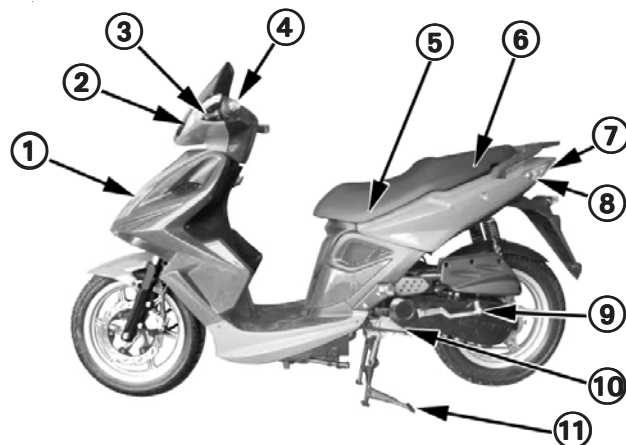

- ① Headlights
- ② Front Turn Signal
- ③ Rear Brake Lever
- ④ Turn Signal Switch, Headlight dimmer switch, Horn Button
- ⑤ Under-seat Storage
- ⑥ Fuel Filler (gas cap)
- ⑦ Tail/Brake Light

- ⑧ Rear Turn Signal
- ⑨ Kick Start Lever
- ⑩ ESN (Engine Serial Number)
- ⑪ Main Stand
- ⑫ Battery
- ⑬ Muffler
- ⑭ Rear Turn Signal

- ⑮ Rear Carrier (rack)
- ⑯ Instruments
- ⑰ Throttle, Engine Stop Switch & Starter Button
- ⑱ Front Brake Lever
- ⑲ Front Turn Signal
- ⑳ Ignition Switch
- ㉑ VIN (Vehicle Identification Number)

NOTE: Write your scooter's VIN and ESN in the boxes provided on the inside, rear cover of this Owner's Manual.

NOTE: Your scooter may differ slightly in appearance from the images in this manual.

Keys

Your Super 8 scooter is supplied with two identical ignition switch keys ①. The ignition key operates the ignition switch, and the steering lock, and is used to open the seat to gain access to the under-seat storage compartment.

NOTE: The keys have a unique code stamped on the tab supplied with the keys. This code is not stamped on the scooter or recorded in the vehicle's basic documentation (for security reasons). Since this code is required to obtain replacement keys, record this important code in the box provided on the inside, rear cover of this Owner's Manual.



Ignition switch & Steering lock

Use the ignition key to operate the ignition switch and the steering lock:

OFF Position: All electrical circuits are off. The engine will not start or run. The key can be removed from the ignition switch.



ON Position: The ignition circuit is "ON" and engine can now be started. The key cannot be removed from the ignition switch in this position.



LOCK Position: To lock the steering, turn the handlebar all the way to the left, push in and turn the key to the "LOCK" position and remove the key. All electrical circuits are off and the key can be removed.



⚠ CAUTION

After locking the ignition switch, turn the handlebar gently to confirm that the steering is locked.

⚠ WARNING

Do not turn the ignition switch to the lock position when riding, as this could cause the steering to lock and result in you losing control of your scooter. Do not park your scooter in a position that will interfere with vehicle or pedestrian traffic.

Right handlebar switch

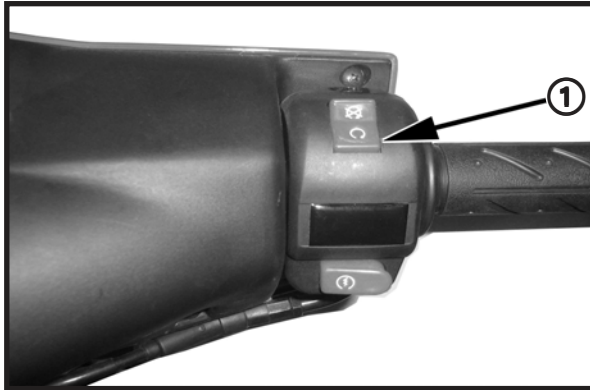

Engine stop switch ① "⊗" & "⊕":

The engine stop switch turns off the ignition, stopping the engine. The scooter's lights and horn will still function.

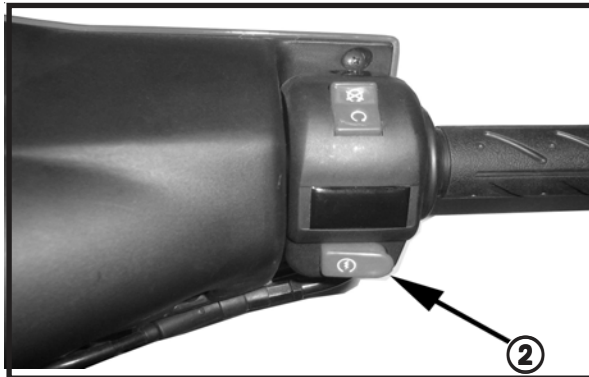

Electric starter button ② "⊕":

Press the electric starter button to activate the starter motor.

NOTE: The starter motor will not engage unless the ignition switch is "ON" and one of the brake levers are squeezed at the same time the starter button is pressed.

⚠ CAUTION

To prevent damage to the starter motor, do not operate the starter motor for more than five seconds at a time. If the scooter fails to start immediately, check the fuel level and the battery condition, and allow the starter motor to cool before attempting to start the engine again.

Left handlebar switch

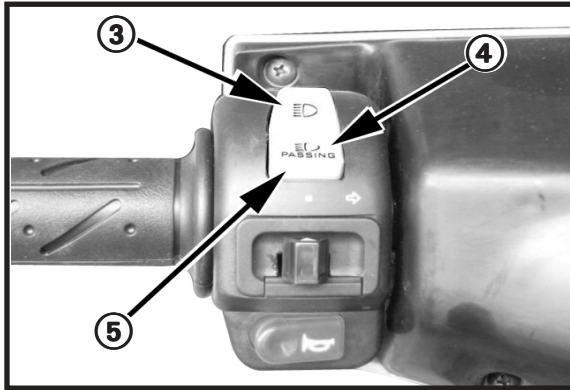

Dimmer switch -UP ③:

"" switch position turns the headlight high beam on and the high beam indicator light on the dash is activated as well.

Dimmer switch -DOWN ④:

"" switch position turns the headlight low beam on.

Passing light button - PRESS DOWN ⑤:

Press down on the rocker switch to rapidly flick the headlight high beam on and off to signal other vehicles that you wish to pass.

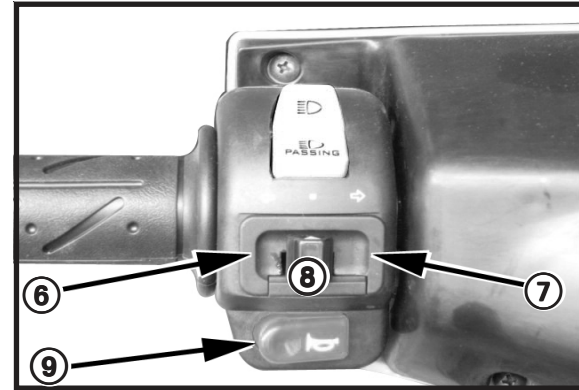

Turn signal switch:

Use the turn signal indicator to signal to other traffic your intention to turn or change lanes. The turn signal light on the dash will flash to alert the rider that the switch is engaged.

⑥ "" for turning to the "left".

⑦ "" for turning to the "right".

To cancel the turn signal, press in on the signal switch ⑧.

Horn button ⑨ "":

Press the horn button to sound the horn.

NOTE: The horn will only sound when the ignition is "ON".

Under-seat storage compartment

Your Super 8 scooter is equipped with an under-seat storage compartment that permits you to secure your helmet or other items.

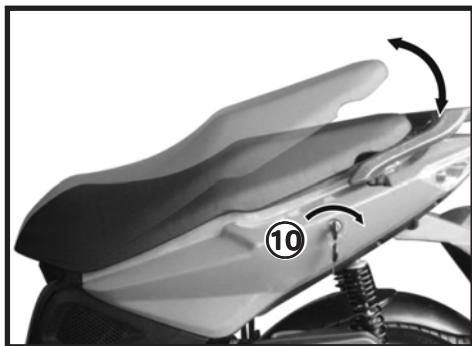

To open the seat, insert the ignition switch key into the seat lock (10) and turn it clockwise. When the latch releases, lift up the seat.

Under-seat compartment weight limit: 11 lbs (5 kg)

To close the seat, lower the seat and press down until it is secured by the latch. Gently lift up on the seat to make sure it is locked before riding.

WARNING

Never exceed the maximum weight limit of the storage compartment, as vehicle handling and stability may be severely affected. Do not leave the ignition switch key under the seat.

Helmet posts

Your Super 8 scooter has two helmet posts (11) so you can secure your helmet(s) outside of the under-seat storage compartment.

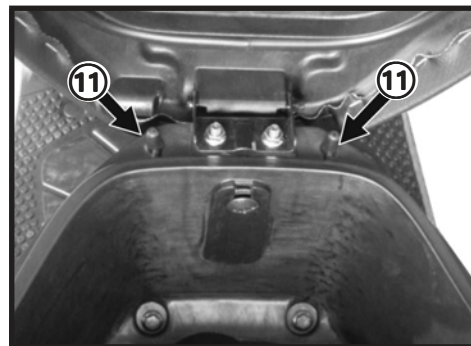

With the seat up, put the helmet's retaining ring onto the helmet post. Lower and press down on the seat to lock it and secure the helmet in place. To remove the helmet, open the seat.

WARNING

Do not ride your scooter with a helmet hanging from a helmet post. The helmet can interfere with your ability to control your scooter, causing an accident.

The under-seat storage compartment may become warm from engine heat. Do not store food, or flammable materials, which are susceptible to heat damage in this compartment.

Main stand (center stand)

Your Super 8 scooter is equipped with a main (center) stand.



To park your scooter on the main stand, stand on the left side of the scooter and grasp the handlebar with your left hand while grasping the side of the rear rack with your right hand. Step down on the foot pad of the main stand with your foot while pulling up and back on the rear rack. This lifting motion will allow the scooter to rock backwards and up onto the main stand.

⚠ CAUTION

Always park your the scooter on firm, level ground to help prevent it from falling over. If you must park on an incline, aim the front of your scooter uphill.

Instruments

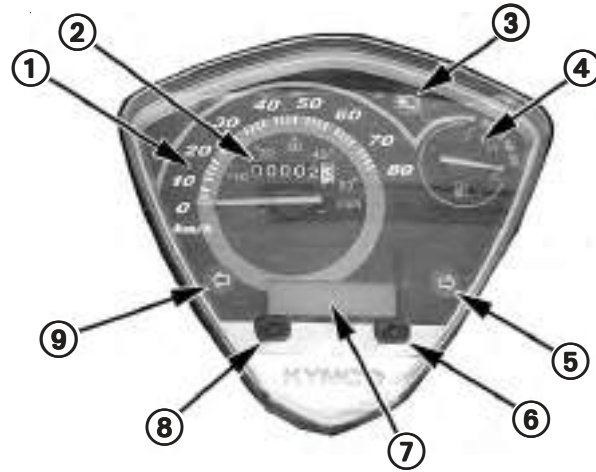

- ① **Speedometer:** Indicates the road speed in MPH (miles per hour) and K/PH (kilometers per hour).
- ② **Odometer:** Indicates the total riding mileage of the scooter.
- ③ **High Beam Indicator Light:** This light is illuminated when the headlight high beam is on.
- ④ **Fuel Gauge:** This gauge indicates the amount of gasoline in the fuel tank. As the needle approaches "E" that indicates the tank is near empty and should be refilled with unleaded gasoline.

- ⑤ **Right Turn Signal Indicator Light:** Flashes when the right turn signal is being used.
- ⑥ **Clock Adjust Button:** Pressing this button will advance the clock for adjusting the time display.
- ⑦ **Clock:** Digital clock display.
- ⑧ **Clock Setting Button:** Pressing this button will activate the “adjust mode” of the clock. Press the adjust button ⑥ to change the display. Press the setting button again after adjusting the time to “lock” the clock display.
- ⑨ **Left Turn Signal Indicator Light:** Flashes when the left turn signal is being used.

1. To move the passenger pegs ⑩ out from the scooter’s body, press the release button ⑪.
2. When you are not carrying a passenger, press the pegs back into place.

WARNING

Riding with a passenger will change the handling characteristics of your scooter. Allow for extra braking distance and use extra care when riding in traffic.

Be sure you and your passenger always wear an approved motorcycle helmet that fits properly. You should also wear eye protection and other protective apparel when you ride.

Passenger foot pegs

Your Super 8 scooter is equipped with additional pegs for use when you are carrying a passenger.

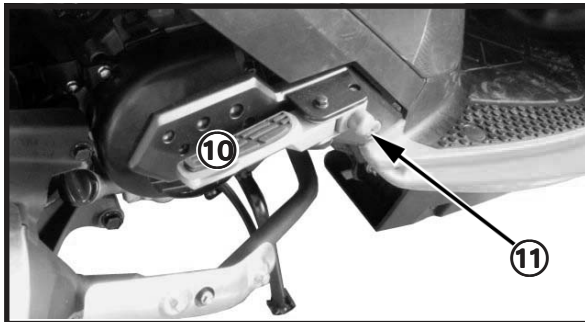

Break-in recommendations

The first 600 miles (1,000 km) of riding are the most important in the life of your scooter. Proper break-in operation during this time will help ensure maximum life and performance from your new scooter. Proper break-in operation allows the machined surfaces to polish each other and mate smoothly.

Your scooter's reliability and performance depend on special care and restraint exercised during the break-in period. It is especially important that you avoid operating the engine in a manner which could expose the engine parts to excessive heat.

The following guidelines should be followed during the break-in period:

Maximum throttle operation:

Initial 300 miles (600 km): Less than 1/2 throttle

Up to 600 miles (1,000 km): Less than 3/4 throttle

Vary the engine speed:

The engine speed should be varied and not held at a constant rate for long periods of time. This allows the parts to be "loaded" with pressure, and then unloaded, allowing the parts to cool. This aids in the mating process of the engine and transmission components. It is essential that some stress be placed

on these components during break-in to ensure this mating process. Do not, however, apply excessive load on the scooter's drive line.

Avoid constant low speed:

Operating the engine at constant low speed (light load) can cause parts to glaze and not seat in properly. Allow the engine to accelerate freely through the gears, without exceeding the recommended throttle openings.

Avoid using full throttle for the first 300 miles (500 km).

The initial service:

Observe your first and most critical service. The 200 mile (300 km) initial service is the most important service your scooter will receive. During the break-in period all of the engine components will have worn in and all of the other parts will have seated in, so adjustments will be required. All fasteners will be tightened, and the contaminated engine oil will be replaced.

NOTE: Completion of the 200 mile (300 km) initial service will ensure optimum service life and performance from your scooter. Do not delay in having this service performed once your scooter reaches this mileage.

⚠ CAUTION

The 200 mile (300 km) service should be performed as outlined in the maintenance schedule section of this owner's manual. Pay particular attention to the cautions and warnings in the maintenance schedule section.

Unless you have formal training as a service technician and have access to KYMCO technical reference materials, it is strongly suggested that you have the initial service performed by a KYMCO dealer.

Breaking in the new tires

New tires need proper break-in to assure maximum performance, just as your scooter's engine does. Wear in the tread surface by gradually increasing your cornering lean angles over the first 100 miles (160 km) before attempting maximum lean angles. Avoid hard acceleration, hard cornering, and hard braking for the first 100 miles (160 km).

⚠ WARNING

Failure to break in your tires could cause the tires to slip and could result in you losing control of the scooter.

Use extra care when riding on new tires. Perform proper break-in of the tires as described in this Owner's Manual and avoid hard acceleration, hard cornering, and hard braking for the first 100 miles (160 km).

Troubleshooting

It can be frustrating if your scooter fails to start or stops running while you are riding. In the rare instance this happens, take a few moments to check some items and you may be back to riding your scooter soon.



- ✓ Do you have enough gasoline in the fuel tank?
- ✓ Did you follow the correct procedure for starting the engine?
- ✓ Is the battery voltage low (you may need to kick start your scooter)?
- ✓ Is the main fuse in good condition?

NOTE: Use this Owner's Manual to check components and adjustments that are within your technical ability. If you cannot resolve the problem, do not hesitate to contact your KYMCO dealer for assistance.

Pre-ride inspection (PRI)

For your safety, it is very important to take a few moments before each ride to walk around your scooter and check its condition. If you detect any problem, be sure to address it immediately, or have it corrected by your KYMCO dealer.

WARNING

Improperly maintaining your scooter or failing to correct a problem before riding can cause a crash in which you can be seriously hurt or killed.

Always perform a pre-ride inspection before every ride and correct any problems.

1. Engine oil level: Add engine oil if required (page 17). Check for leaks.
2. Front and rear brakes: Check operation, make sure there is proper free-play at the levers (page 17). Inspect the brake pads and shoes for wear (page 21)
3. Tires: Check condition and inflation (pages 18 & 19).
4. Fuel level: Fill fuel tank when necessary (page 19). Check for leaks.
6. Steering: Check for smooth operation in all steering positions (page 20).

7. Lights and horn: Check that headlight, tail/brake light, turn signals, indicators and horn function properly (page 22).
8. Chassis: Check for overall proper function (page 23).

CAUTION

Performing pre-ride inspections does not take the place of regular maintenance. Follow the maintenance schedule recommendations on pages 31 - 48 of this manual.

After one month of use or 200 miles (300 km) of riding, which ever occurs first, contact your KYMCO dealer to have an initial service of your scooter performed.

This initial service is the most important service in the life of your scooter, and includes checks and adjustments that will help ensure that your scooter operates efficiently and safely.

PRI - Engine oil level inspection

NOTE: Park your scooter on the main stand, on level ground.

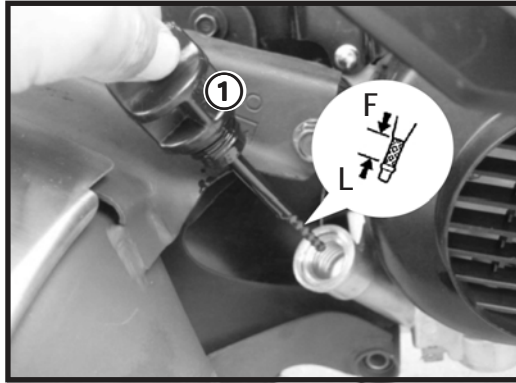

1. Unscrew the dip stick ①, remove it and wipe it with a clean cloth
2. Re-insert the dip stick, slide it down until the threaded part touches the engine case, but do not thread it into the case.
3. Remove the dip stick and visually note the oil level on the stick. The engine oil level should be above the "L" mark but not higher than the "F" mark. Add or remove oil as required.

CAUTION

Do not overfill the engine with oil. Overfilling the engine can cause oil leaks and/or oil contamination of the air filter element. Always make sure the oil level is above the "L" mark but not higher than the "F" mark.

WARNING

Use extreme caution when performing the oil level inspection or any other checks if the scooter's engine has been recently run. The engine oil, engine case and muffler can become very hot creating a burn hazard.

PRI - Brake inspection

Your scooter requires the proper brake lever free-play so the brakes will be responsive and will not drag, causing premature wear to the brake pads.

The free-play is the measured distance between the brake lever at rest and a fully applied brake.

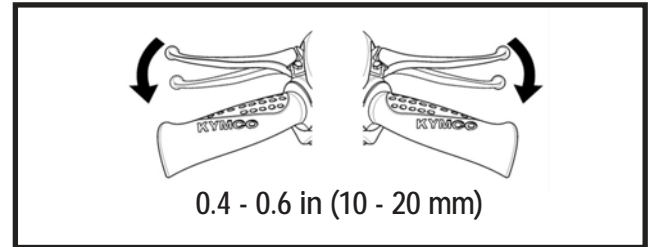

1. Measure the free-play and the brake lever end (0.4 - 0.6 in (10 - 20 mm)).
2. Use the cable adjuster on each brake lever perch for minor free play adjustment. For major adjustment, see the maintenance section of this Owner's Manual.

PRI - Tire inspection

The condition of your scooter's tires is vital for operational efficiency and your safety. Check the tires' inflation pressure, the tread depth, and look for damage before each ride.

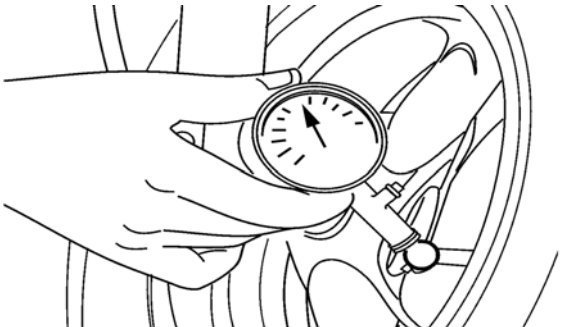

Front tire (rider only):	25.0 PSI (1.75 kg/cm ²)
Rear tire (rider only):	29.0 PSI (2.0 kg/cm ²)
Front tire (rider & passenger):	25.0 PSI (1.75 kg/cm ²)
Rear tire (rider & passenger):	32.0 PSI (2.25 kg/cm ²)

1. Measure and adjust the tire pressure when the tires are touching the ground (with no one seated on the scooter).

NOTE: Measure the pressure before riding, as the heat generated during operation may cause improper readings. Do not inflate the tires beyond 35.0 PSI (2.5 kg/cm²).

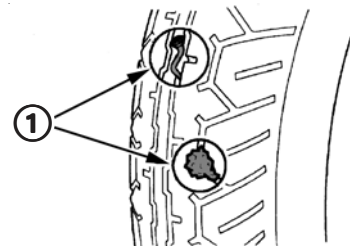

2. Inspect the tires for nails, screws and other objects (1) that may be imbedded into the rubber.

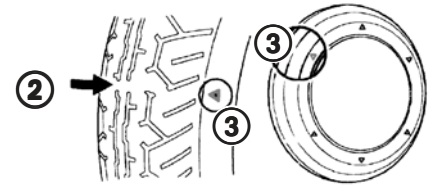

3. Check the tread depth (2) at the wear indicator points (3). If the tread is worn smooth at these points, the tire must be replaced.

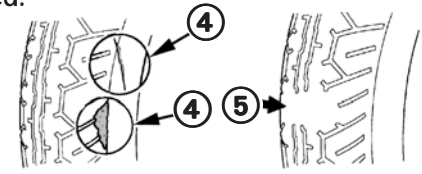

4. Check for damage (4) (blisters or cuts) in the side wall, or for significant flat spots (5) on the tires' tread. Replace the tire immediately if any damage of this type is present.

⚠ WARNING

The tires on your scooter must be replaced if they:

- Leak air (even at a slow rate)
- Have any damage on the tread or side wall areas
- Have been damaged by intrusion of objects, such as a nail
- Are worn as evidenced by the wear indicators

Failure to replace a tire in poor condition will cause an unsafe riding condition on your scooter. Replace worn or damaged tires immediately for your and your passenger's, safety.

Consult your KYMCO dealer for replacement tire service.

PRI - Fuel level inspection / Refilling
When the fuel level gauge needle approaches "E" (indicating the tank is nearly empty) refill the tank with unleaded gasoline.

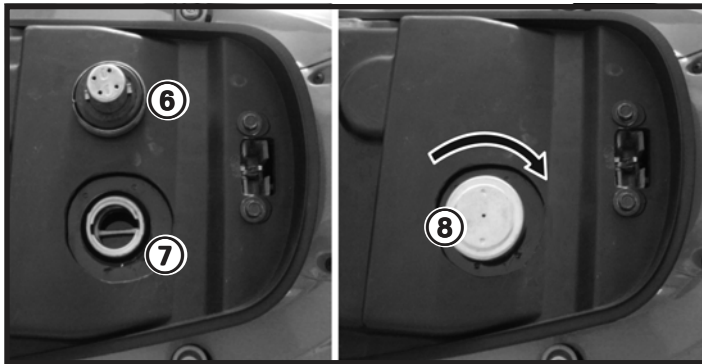

1. Stop the engine and turn the ignition switch to "OFF".
2. Unlock and raise the seat (see page 11).
3. Turn the fuel cap (6) counterclockwise to access the fuel tank filler.
4. Add fuel through the filler opening (7).
5. After filling, replace the cap (8) and turn it clockwise to secure it to the tank.

Fuel recommendation

Use unleaded gasoline with a research octane number of 91 or higher. Unleaded gasoline will extend spark plug life.

⚠ CAUTION

Do not overfill the tank. There should be no fuel in the filler neck (7). Excess fuel can contaminate the evaporative emission canister, resulting in poor driveability.

⚠ WARNING

Gasoline is highly flammable and explosive. You can be burned or seriously injured while handling fuel.

- * Stop the engine and keep heat, sparks, and flame away.
- * Refuel only out doors.
- * Clean up fuel spills immediately.

PRI - Steering & handlebar inspection

Before riding, inspect your scooter's handlebars for damage and to make sure the steering's side-to-side and up-and-down movement is smooth.

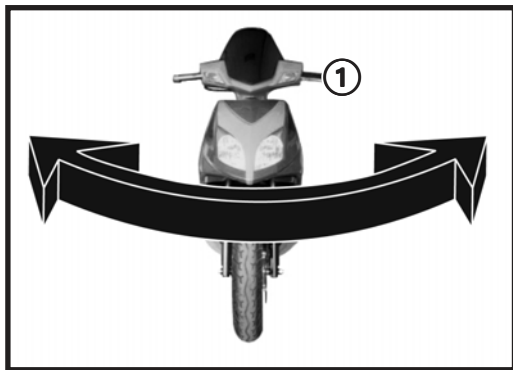

1. Visually inspect the handlebars ① for any damage.
2. Apply the front brake (right lever) and press down and release pressure on the handlebar and listen for any abnormal noise.
3. As you press down and release, feel for any looseness from the chassis transmitted to the handlebar.
4. Turn the handlebar from the center fully to the left and then fully to the right, feeling for any loose components and listen for any abnormal sounds.

WARNING

If you detect any looseness or abnormal sounds during your steering inspection, do not ride your scooter. Consult your KYMCO dealer for chassis service.

PRI - Instrument inspection

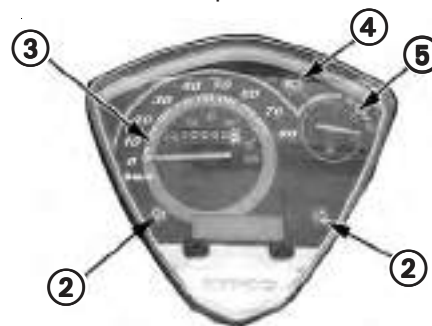

Before your ride, and as you begin your ride, make sure the instruments are functioning.

1. Is the fuel level gauge needle ⑤ indicating the fuel level?
2. Do the indicator lights (turn signal ② and high beam ④) function?
3. Does the speedometer needle ③ move as the scooter moves?

NOTE: Contact your KYMCO dealer for repair of your scooter's instruments if they are not functioning properly.

PRI - Brake lever free play inspection & adjustment

Before riding, inspect the rear brake lever free play and adjust it to the specified amount.

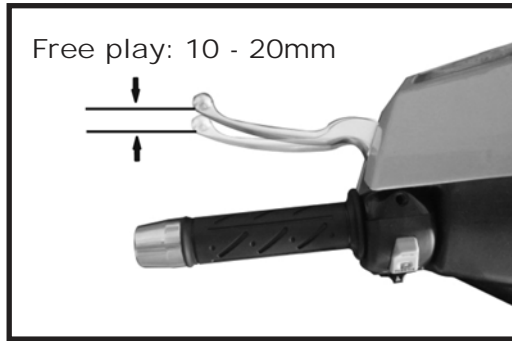

NOTE: Before adjusting the free play with the brake arm adjuster nut ⑥, turn the adjuster on the left brake lever perch as far as it will turn in a clockwise direction.

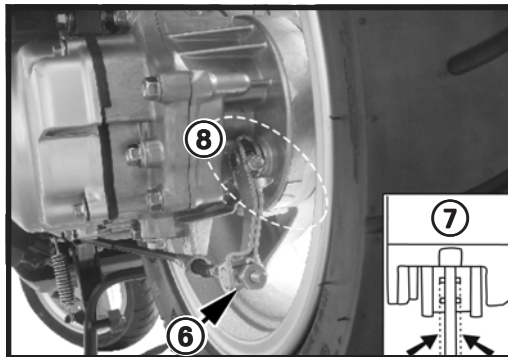

1. To perform free play adjustment outside of the range of the adjuster on the brake lever perch, use the adjuster nut ⑥ at the end of the brake cable where it connects to the brake arm.
2. Rotating the adjuster nut ⑥ clockwise reduces the brake lever free play. Rotating the adjuster nut counterclockwise increases the brake lever play.

WARNING

For appropriate brake action, make sure the groove of the adjusting nut is aligned with the pin in the brake arm.

PRI - Brake pad inspection

Inspect the brake pad and shoe thickness to verify there is enough material for the brakes to function properly.

1. If the wear indicator grooves in the front brake pads are no longer visible ⑦, it is an indication that the brake pads are worn and require replacement.
2. If the "△" mark on the rear brake indicator ⑧ aligns with the "△" mark on the brake hub it is an indication that the brake shoes are worn and require replacement.

WARNING

The brakes will wear quickly if the lever is continually applied during riding (dragging the brake). Consult your KYMCO dealer for braking system service.

PRI - Horn & lights inspection

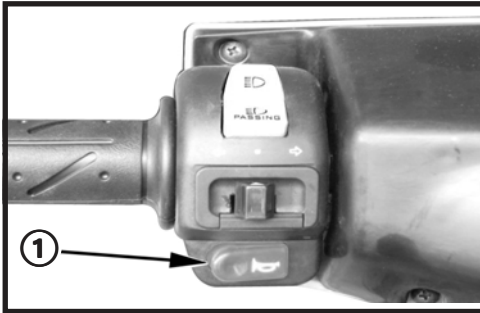

1. Turn the ignition switch to "ⓐ" and press the horn button ① to check if it sounds.

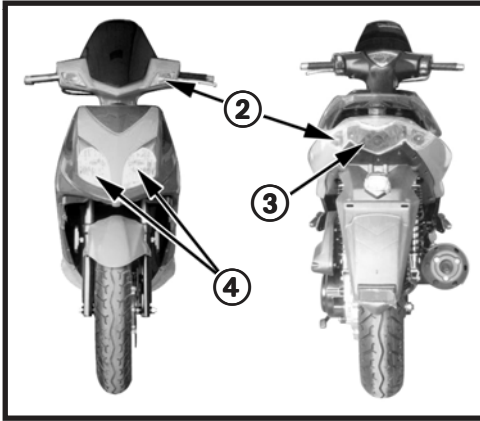

2. Turn on the headlight switch to see if the headlight ④ and the tail light ③ are illuminated. Check the lenses for dirt or damage.
3. Squeeze each brake lever to make sure the brake lamp in the tail light ③ illuminates.
4. Operate the turn signal switch to make sure the turn signals ② flash. Make sure each of the four signals flash and the lenses are free of dirt and are not broken.

 **WARNING**

The horn is an essential safety item as it will alert other traffic to your presence.

The headlight must be in good working order to illuminate your riding path at night.

The tail/brake light is required so others in traffic can see your scooter and be alerted to your intention to stop or slow down.

The turn signals indicate your turning intentions.

Because all of these systems are vital safety items, contact your KYMCO dealer for replacement bulbs or electrical system service or repair should there be any malfunctions.

PRI - Chassis inspection

Complete the pre-ride inspection of your scooter by checking items on its chassis.



Front suspension & rear shock absorber: Check the operation of the suspension by pressing down on the handlebars and seat. Make sure the suspension returns in a smooth fashion.

Brake lever operation: Check that the rear brake (left lever) and the front brake (right lever) have pressure and lock the wheels when you squeeze the levers.

Mirrors: Adjust the mirrors' aim while seated on the scooter BEFORE you begin riding.

License plate: Make sure your license plate is securely mounted and your registration is up to date.

Reflectors: Look to make sure all of the safety reflectors are still mounted to your scooter. Replace any missing or damaged reflectors.

Lubrication points: Occasionally check and lubricate certain controls and points on the scooter as called for in the periodic maintenance schedule (see pages 32 and 33).

Starting the engine (electric start)

To start your scooter using the electric starting motor, follow this procedure:

NOTE: Before starting, check the engine oil and fuel levels. Take the scooter off of the main stand.

1. Unlock the steering with the ignition switch key ①
2. Turn the ignition switch to "ON".

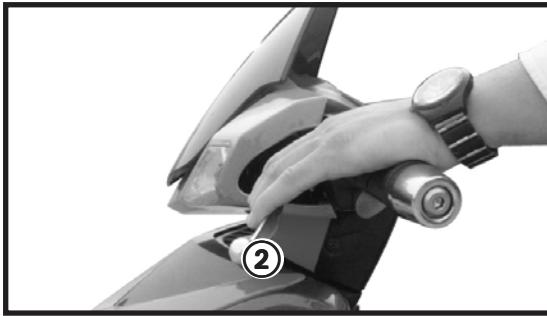

3. Apply the rear brake ② (left lever) .

⚠ WARNING

The brake must be adjusted and functioning properly to lock the rear wheel during starting or the scooter could accelerate away when the engine starts.

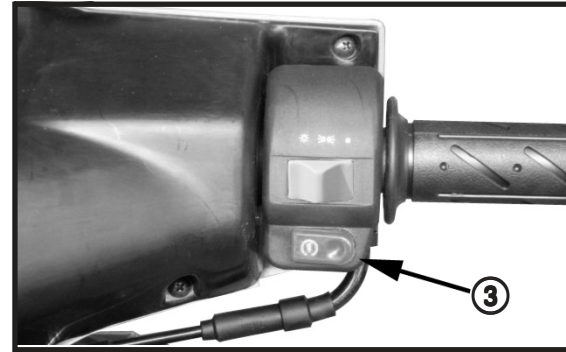

4. Press the starter button ③ without rotating the throttle grip.

NOTE: The rear brake must be held for the starter motor to engage the engine. It is normal for the stop light to be illuminated during starting.

NOTE: If the scooter's engine is warm and does not start immediately, rotate the throttle grip 1/8 to 1/4 open to help the engine start.

⚠ CAUTION

To prevent damage to the starter motor, do not operate the starter motor for more than five seconds at a time. If the scooter fails to start immediately, check the fuel level and the battery condition, and allow the starter motor to cool before attempting to start the engine again.

5. Allow a cold engine to warm 2 - 3 minutes before riding.

⚠ WARNING

Once the scooter starts, the rear wheel may spin. To avoid injury, keep your body and clothing away from the rear wheel.

⚠ CAUTION

Do not press the starter button once the engine is running or the starter motor and engine can be damaged.

NOTE: If the scooter has not been ridden for a long period of time it may be hard to start. Add fresh fuel, press down on the choke knob, and press the starter button several times in succession to try to start the engine. If the scooter does not start, contact your KYMCO dealer, as your scooter may need to have its fuel system cleaned and adjusted.

⚠ WARNING

Your scooter's exhaust emits poisonous carbon monoxide gas. High levels of carbon monoxide can collect rapidly in enclosed areas such as a garage. Do not run the scooter's engine with the garage door closed. Even with the door open, run the engine only long enough to move your scooter out of the garage.

Starting the engine (kick start)

To start your scooter using the kick start lever, follow the electric starting procedure but use the kick lever in place of the electric start button.

- While squeezing the rear brake lever, kick down on the kick start lever ④ without rotating the throttle grip.

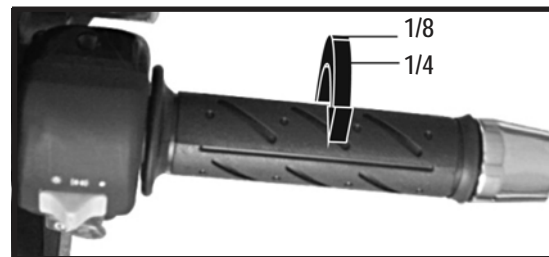

NOTE: If the scooter's engine is warm and does not start immediately, rotate the throttle grip 1/8 to 1/4 open to help the engine start.

⚠ WARNING

Once the scooter is started, fold the kick start lever back to its original position.

Riding your scooter

NOTE: After starting, allow the engine oil to circulate before riding your scooter. Allow sufficient idling time after warm or cold engine start-up before applying load or revving the engine. This allows time for the lubricating oil to reach all the critical engine components.

NOTE: Review the scooter safety recommendations on pages 3 and 4 before you ride.

CAUTION

Make sure flammable materials such as dry grass or leaves do not come in contact with the exhaust system when riding, idling, or parking your scooter.



2. Mount the scooter from the left side and sit on the seat upright. Place both hands on the handlebars and touch the ground with your left foot for stability.



1. Make sure the throttle is closed and the rear brake is engaged before moving the scooter off the main stand.

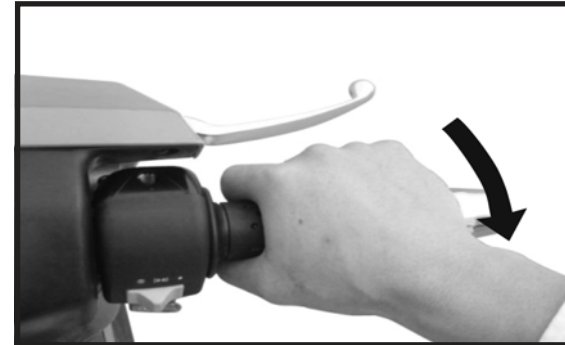

3. Release the rear brake and slowly rotate the throttle grip so the engine power will be transmitted to the rear wheel smoothly.

WARNING

Use the scooter's turn signals to signal your intention to merge into traffic. Always scan around you and in the rear view mirrors so you are aware of other traffic. Use caution as you merge into traffic, keeping to the right until you match the pace of the traffic.

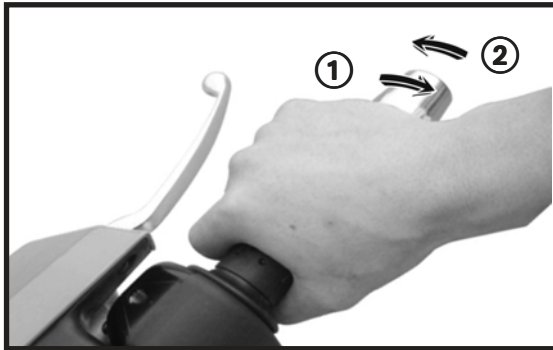

4. Control the scooter's speed with the throttle grip.

Rotating the grip towards you ① will increase the scooter's speed.

Rotating the grip away from you ② will decrease the scooter's speed.

NOTE: Decreasing the scooter's speed with a balanced application of both brake levers and a reduction of throttle will reduce the distance required to stop.

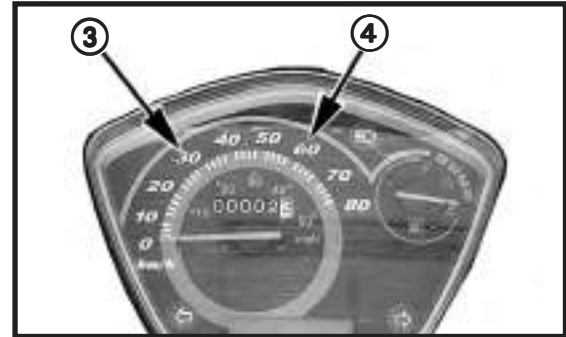

5. Limit the maximum speed of your scooter during the first 600 miles (1,000 km) of operation.

Super 8 - 50: Keep the road speed below 20 MPH (30 KPH) ③ during this break-in period.

Super 8 - 150: Keep the road speed below 40 MPH (60 KPH) ④ during this break-in period.

CAUTION

In hot weather, the engine can overheat if it idles for a long period of time. Very slow speed traffic may also cause the scooter to overheat. To promote engine longevity, permit the engine to cool in these situations.

Avoid sudden acceleration and prolonged high speed use that can accelerate engine wear.

Moderate use will prolong the engine life of the scooter.



6. Use both brake levers when slowing and stopping the scooter. Release the throttle when braking.

NOTE: Decreasing the scooter's speed with a balanced application of both brake levers and a reduction of throttle will reduce the distance required to stop. Squeeze the levers lightly at first and then increase the pressure when stopping.

⚠ WARNING

Avoid using just one brake to stop the scooter, as this will affect the tire's grip.

Avoid sudden braking, as this will also affect the tire's grip and can cause an accident.

7. When riding and turning the scooter, use smooth movements.

NOTE: At certain speeds your scooter will turn more effectively by leaning your body, rather than by applying pressure on the handlebars. Practice steering in an open area free of traffic until you are familiar with the handling characteristics of your scooter.



⚠ WARNING

Reduce your speed when riding on uneven or loose road surfaces. When riding downhill, decrease the throttle opening and use intermittent braking to control the vehicle's speed. Failure to take appropriate precautions may result in an accident.



⚠ WARNING

Reduce your speed when riding your scooter in the rain. Wet road surfaces reduce tire grip and greatly increases the distance required for safe braking. Wet surfaces also reduces tire grip during cornering. Reduced tire grip will make it more difficult to control your scooter and may result in an accident.

8. As you approach a turn, or plan to stop, use the turn signals well in advance to alert other traffic of your intentions. Scan for other vehicles around you and slowly move to the right side of the road. Close the throttle and apply the brakes smoothly, as the scooter's brake light will alert vehicles behind you that you are braking.

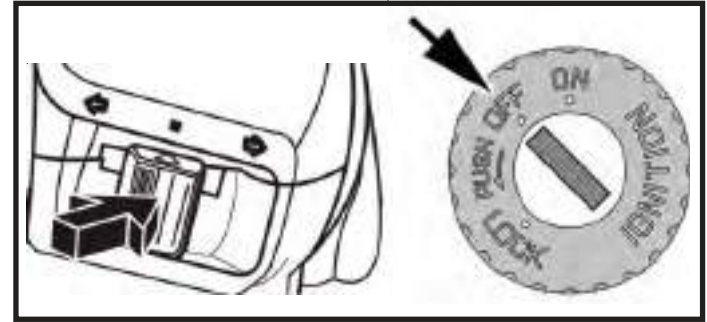

9. When you stop the scooter, press the center of the turn signal indicator switch to cancel the signal flashing. Turn the ignition switch to the "OFF" position to stop the engine and turn off the scooter's electrical system.

⚠ WARNING

Never operate the ignition switch while riding your scooter.

If the ignition switch is turned during riding it could turn off the engine and lights, possibly causing you to lose control of the scooter.

With the lights off, your scooter may not be visible to other traffic, and this could cause a traffic accident.

Only operate the ignition switch when the scooter is not moving.

Parking your scooter

Use the following procedure and suggestions when parking your scooter.



1. Place the scooter on level ground.
2. Stand on the left side of the scooter and grasp the handlebar with your left hand while grasping the side of the rear rack with your right hand. Step down on the foot pad of the main stand with your foot while pulling up and back on the rear rack. This lifting motion will allow the scooter to rock backwards and up onto the main stand.

⚠ CAUTION

The scooter may fall over if it is not parked on level ground.

Make sure flammable materials such as dry grass or leaves do not come in contact with the exhaust system when parking your scooter.

Lock the handlebars of your scooter (see page 8) to reduce the risk of theft.



⚠ WARNING

Do not park your scooter in a place that hinders traffic, or that is unsafe to you or others.

SECTION 4 - MAINTENANCE



The importance of maintenance

Maintaining your scooter properly is essential for safe, economical and trouble-free riding. It will also help reduce air pollution and maximize fuel economy.

To help you properly care for your scooter, the following pages in this Owner's Manual include a maintenance schedule to help you make sure your scooter is serviced at the appropriate intervals.

These instructions are based on the assumption that your scooter will be used exclusively for its designed purpose. Sustained high speed operation, or operation in unusually wet or dusty conditions, will require more frequent service than specified in the maintenance schedule. Consult your KYMCO dealer for recommendations applicable to your individual needs and use.

NOTE: Always follow the inspection and maintenance recommendations and schedules in this Owner's Manual.

WARNING

If your scooter tips over or becomes involved in a crash, be sure your KYMCO dealer inspects all major parts, even if you are able to make some repairs.

Improperly maintaining this scooter or failing to correct a problem before you ride could result in a crash in which you could be seriously hurt or killed.

WARNING

When performing maintenance on your scooter, you may need to start the engine. Running your scooter's engine indoors or in a garage can be hazardous. Exhaust gas contains carbon monoxide, a colorless and odorless gas that can cause death or severe injury. Operate the engine only where there is adequate ventilation, preferably outdoors.

Maintenance schedule

Perform the pre-ride inspection (see pages 16 - 23) at each scheduled maintenance period. This interval should be judged by odometer reading or months, whichever comes first.

Maintenance schedule legend (see page 33):

I: INSPECT AND CLEAN, ADJUST, LUBRICATE OR REPLACE IF NECESSARY

C: CLEAN R: REPLACE A: ADJUST L: LUBRICATE T: TIGHTEN

The maintenance schedule on page 35 specifies the maintenance required to keep your Sento 50 scooter in peak operating condition. Maintenance work should be performed in accordance with KYMCO standards and specifications by properly trained and equipped technicians. Your KYMCO dealer meets all of these requirements.

* Should be serviced by your KYMCO dealer, unless you have the proper tools, service data and are technically qualified.

** In the interest of safety, we recommend these items be serviced only by your KYMCO dealer. KYMCO USA recommends that your KYMCO dealer road test your scooter after each periodic maintenance service is completed.

Maintenance schedule notes (see page 33):

1. At higher odometer readings, repeat at the frequency interval listed here.
2. Service more frequently if the scooter is ridden in unusually wet or dusty areas.
3. Service more frequently when riding in rain or at full throttle.
4. "PRI" indicates that the item should be checked as part of the Pre-ride Inspection (see page 16 through 23)
5. "See page" indicates on which page of the Owner's Manual you will find information about the required maintenance.
6. "Dealer" indicates maintenance or service procedure that should be performed by your KYMCO dealer.

Maintenance schedule - Super 8 (50 & 150 models)

ITEM	MILEAGE							Pre-ride inspection	See page
	200 mi 300 km	600 mi 1000 km	1850 mi 3000 km	3100 mi 5000 km	4300 mi 7000 km	5500 mi 9000 km	7000 mi 11000 km		
Engine oil *	R	R	R	R	R	R	R	PRI	17, 38
Engine oil strainer *	C	-	C	-	C	-	C	-	38, 39
Gear oil *	R	-	R	-	R	-	R	-	40
Spark plug *	C	I	C	R	C	I	R	-	41
Valve clearance **	A	-	A	-	A	-	A	-	Dealer
Carburetor **	I	-	I	-	I	-	I	-	Dealer
Drive belt **	-	-	-	-	I	-	-	-	Dealer
Air cleaner *	C	I	R	I	R	I	R	-	35
Battery *	I	I	I	I	I	I	I	PRI	36, 37
Fuel filter **	-	-	-	-	R	-	-	-	Dealer
Brake system **	I	I	I	I	I	I	I	PRI	17, 21, 41
Tires **	I	I	I	I	I	I	I	PRI	18, 34
Bolts & nuts *	T	I	I	T	I	I	T	PRI	23

I: INSPECT AND CLEAN, ADJUST, LUBRICATE OR REPLACE IF NECESSARY

C: CLEAN R: REPLACE A: ADJUST L: LUBRICATE T: TIGHTEN

Tires

⚠ WARNING

Failure to follow these warnings may result in an accident due to tire failure. The tires on your scooter are a crucial link between your scooter and the road. You and your passenger's personal safety are dependant upon the condition of your scooter's tires.

Follow these instructions:

- Check tire condition and pressure, and adjust the inflation pressure before each ride.
- Avoid overloading your scooter.
- Replace a tire when worn to the specified limit, or if you find any damage such as cuts or cracks.
- Always use the proper size and type of tires as specified in this Owner's Manual.
- Balance the wheel after tire installation.
- Read this section of the Owner's Manual carefully.

Failure to perform a reasonable break-in of the tires could cause the tires to slip and lose control.

Use extra care when riding on new tires, as the grip will be limited. Perform proper break-in of the tires, as stated in the break-in recommendation section of this manual. Avoid hard acceleration, hard cornering, and hard braking for the first 100 miles (160 km).

NOTE: Check the tire inflation pressure and tire tread condition at the periods listed in the periodic maintenance schedule. For maximum safety and good tire life, the tire pressures should be inspected more often.

Tire pressure

Insufficient air pressure in the tires not only accelerates tire wear, but it also affects the stability of your scooter. Under-inflated tires make smooth cornering difficult, and overinflated tires decrease the amount of tire in contact with the ground, which can lead to skids and loss of control. Make sure that the tire pressures on your scooter are within the specified limits at all times.

NOTE: Tire pressure should only be adjusted when the tires are cold.

Front tire (rider only):	25.0 PSI (1.75 kg/cm ²)
Rear tire (rider only):	29.0 PSI (2.0 kg/cm ²)

Front tire (rider & passenger):	25.0 PSI (1.75 kg/cm ²)
Rear tire (rider & passenger):	32.0 PSI (2.25 kg/cm ²)

Air cleaner filter element

The air cleaner filter element should be serviced at regular intervals. Service the element more often when riding in unusually wet or dusty areas.

1. Open seat (see page 11).

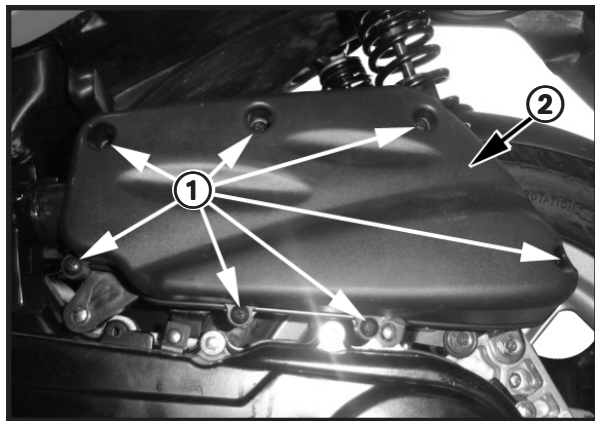

2. Remove air cleaner cover screws ①.
3. Remove the air cleaner case cover ② and remove the air cleaner element ③.
4. If lightly soiled, clean the filter ③ with compressed air. If very dirty (or if the filter is at the replacement interval per the maintenance schedule) discard the air cleaner element.

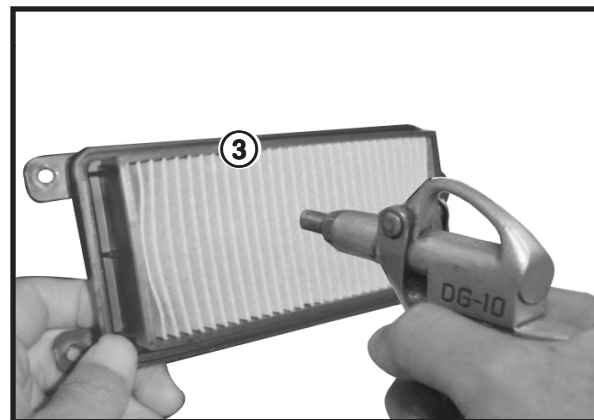

6. Install the cleaned or new air cleaner element. Use the KYMCO genuine air cleaner element or an equivalent air cleaner element specified for your scooter.
7. Complete the installation by reinstalling the air cleaner parts in the reverse order of removal.

CAUTION

Improper installation for the filter can cause water or dirt to enter the engine causing premature wear. Using the wrong KYMCO air cleaner element or a non-KYMCO air cleaner element which is not of equivalent quality may cause premature engine wear or performance problems.

Fuel hoses

Check the fuel hoses and fitting for any signs of leakage.

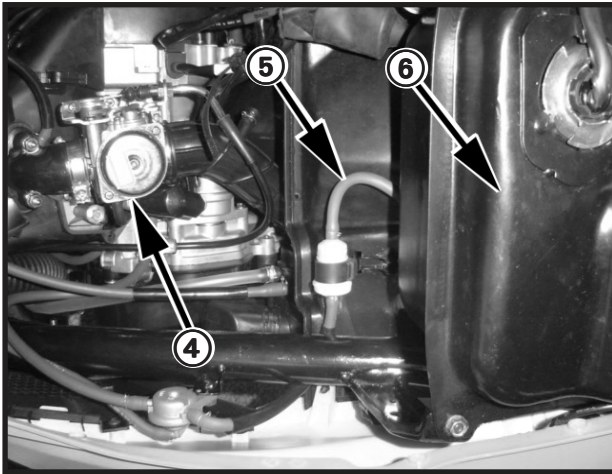

1. Check for leakage at the carburetor (4).
2. Check for leakage from the fuel hoses, clamps and joints (5).
3. Check for leakage at the fuel tank (6).

⚠ WARNING

Replace any fuel system components that are leaking fuel. Contact your KYMCO dealer for fuel system service and repairs.

Battery

Your KYMCO scooter is equipped with a maintenance-free (sealed) battery, so it is not necessary to check the battery's electrolyte level or add distilled water.

NOTE: If your battery seems weak and/or is leaking electrolyte (causing hard starting or other electrical troubles), contact your KYMCO dealer immediately .

⚠ CAUTION

Your battery is a maintenance-free type and can be permanently damaged if the cap strip is removed.

Charge the battery with a charger specifically designed for use with a maintenance-free type battery. Using another type of charger can damage the battery.

⚠ WARNING

Your scooter's battery gives off explosive hydrogen gas during normal operation. A spark or flame can cause the battery to explode with enough force to kill or seriously injure you. Wear protective clothing and a face shield, or have a qualified technician perform the battery maintenance.

Battery removal & installation

The battery ① is in the battery box under the floor board mat ②.

NOTE: Always keep ignition switch OFF when servicing the battery.

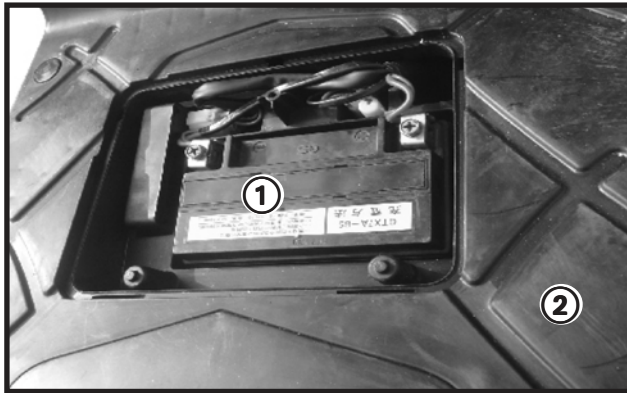

1. When removing the battery for charging or replacement, disconnect the negative (-) terminal lead from the battery first, then disconnect the positive (+) terminal lead.
2. When installing the battery, connect the positive terminal lead (+) first, then the negative terminal lead (-).

Fuses

When frequent fuse failures occur, it usually indicates a short circuit or an overload in the electrical system.

NOTE: See your KYMCO dealer for electrical system diagnosis and repair.

Fuse replacement

FUSE SIZES: 7A, 10A, 10A

1. Open the fuse holder ③. Pull the fuse holder clips ④ out of the holder.
2. Slide the fuse ⑤ out of the holder clips.
3. Install a new fuse ⑥ of the proper specification into the holder clips.
4. Press the fuse and the holder clips ④ back into the holder.
5. Close the fuse holder ③ and set it back in place.

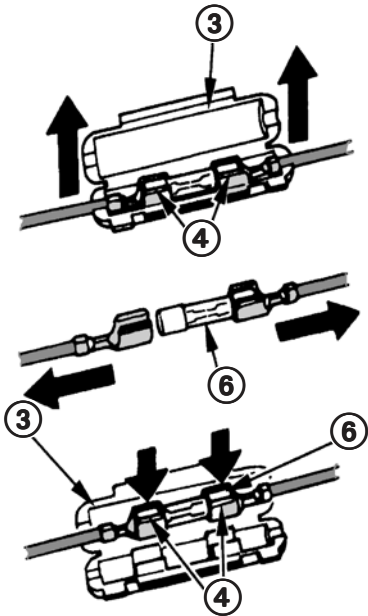

WARNING

Never use a fuse with a different rating from that specified. Serious damage to the electrical system or a fire hazard may result, causing a dangerous loss of lights or engine power.

Engine oil

Engine oil recommendation

Use a premium quality 4-stroke engine oil to ensure longer service life of your scooter. Only use oils that have a SG rating per the API service classification.

Engine oil capacity - Super 8-50: 0.85 qt (0.8 L)

Engine oil capacity - Super 8-150: 0.95 qt (0.9 L)

Engine oil viscosity: SAE 15W-40

If this viscosity is not available, select an alternative engine oil according to the chart shown below.

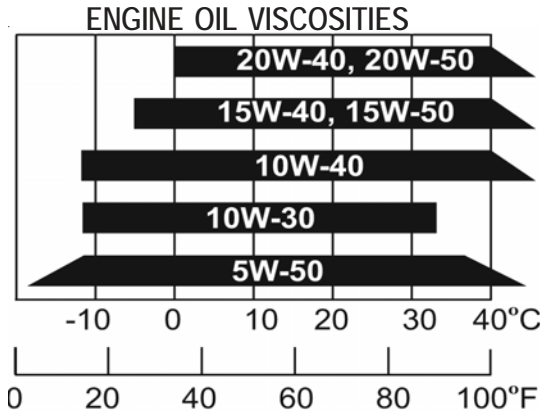

Engine oil level inspection

Check the engine oil level each day before riding your scooter (see page 17).

⚠ WARNING

The engine and related components can become very hot. Use care when inspecting or adjusting the oil level to avoid injury. If needed, let the engine and exhaust system cool before working in those areas.

Prolonged contact with used engine oil can cause skin cancer. Although rare, this possibly exists if you handle oil on a frequent basis. Thoroughly wash your hands with soap and water as soon as possible after handling used oil.

Engine oil replacement

Engine oil quality is the primary factor affecting engine longevity. Change your scooter's engine oil as specified in the maintenance schedule (see page 32).

NOTE: When riding your scooter in very dusty conditions, oil changes should be performed more frequently than specified in the maintenance schedule.

NOTE: Always dispose of used engine oil in an environmentally responsible manner. You should take the drained oil in a sealed container to your local recycling center or service station for reclamation. Do not throw the oil in the trash, pour it on the ground, or pour it down a drain.

NOTE: Change the engine oil with the engine at normal operating temperature with the scooter positioned on its main stand to assure complete and rapid draining.

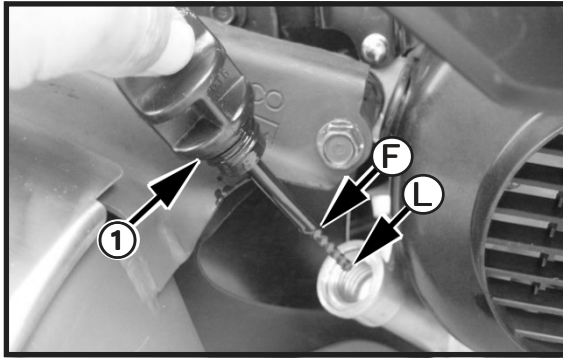

1. Remove the oil filler/dipstick ① from the right crankcase cover.

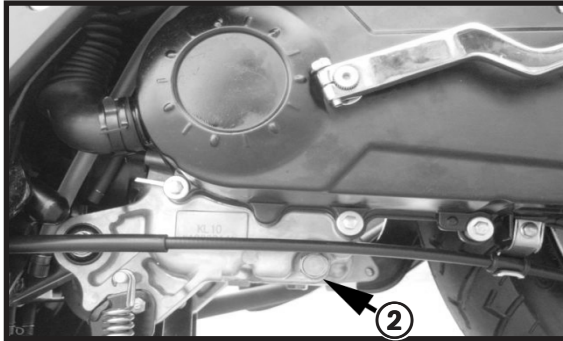

2. Place a suitable container (drain pan) under the left crankcase. Remove the drain bolt ② to drain the oil.

NOTE: When draining the engine oil, remove the oil strainer from the bottom of the crankcase and clean the screen.

3. Replace the drain bolt ②. Tighten it to the specified torque.
Oil drain plug torque: 18 lb-ft (25 N-m)
4. Add engine oil through the oil filler/dipstick hole.
Engine oil capacity - Super 8-50: 0.85 qt (0.8 L)
Engine oil capacity - Super 8-150: 0.95 qt (0.9 L)
Engine oil viscosity: SAE 15W-40

CAUTION

Do not overfill the engine with oil. Overfilling the engine can cause oil leaks and/or oil contamination of the air filter element. Always make sure the oil level is above the "L" mark but not higher than the "F" mark on the dipstick.

5. Wipe the dipstick ① off with a clean cloth and reinstall it in its hole, but do not thread it into the engine case. Push the dip stick to the engine case until it touches the case.
6. Remove the dip stick and visually inspect the oil level on the stick. The engine oil level should be above the "L" mark but not higher than the "F" mark. Add or remove oil as required.
7. Replace the oil filler/dipstick and tighten it securely.

Transmission fluid change

1. Place the scooter on its main stand.

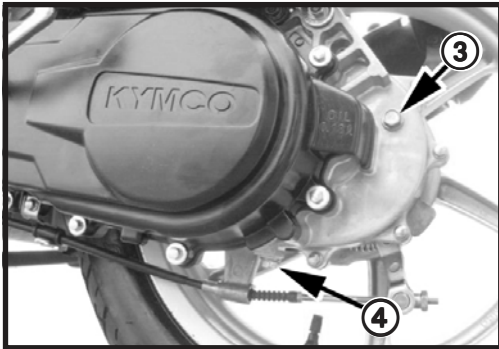

2. Place a suitable container (drain pan) under the transmission case on its left side. Remove the drain bolt (4) to drain the fluid.
3. After the fluid has drained out, reinstall the drain bolt with a new sealing washer and tighten it to the specified torque.

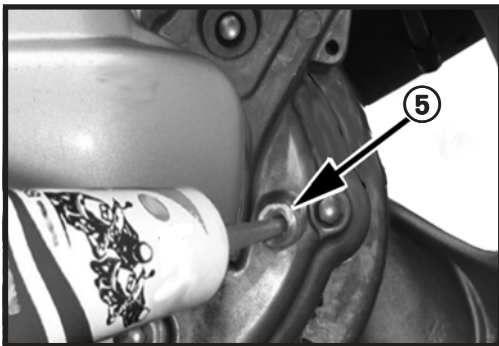

Transmission fluid drain bolt torque: 15 lb-ft (20 N-m)

4. Remove the transmission fluid filler bolt (3).
5. Add the exact amount of the specified fluid through the fluid filler hole (5).

Transmission fluid type: SAE 90

Transmission fluid capacity: 0.19 qt (0.18 L)

NOTE: The fill amount specified is the amount to use after completely draining the used transmission fluid.

⚠ CAUTION

Do not exceed the specified amount when adding transmission fluid. If too much fluid is added to the transmission case it could be forced into the air cleaner assembly during operation, causing air filter contamination and poor engine performance.

6. Install the transmission fluid filler bolt with a new sealing washer and tighten it to the specified torque.

Transmission fluid filler bolt torque: 15 lb-ft (20 N-m)

⚠ CAUTION

Using the wrong transmission fluid type or viscosity may cause premature transmission component wear.

Spark plug

Remove the carbon deposits from the spark plug with a small wire brush or a spark plug cleaning machine. After cleaning (or when installing a new spark plug) readjust the spark plug gap to specified limit by using a spark plug gap thickness gauge. The spark plug should be replaced periodically. Under normal usage, a spark plug's porcelain tip should appear light brown or tan in color. If the spark plug porcelain tip is very white or glazed appearing, then the spark plug has been operating too hot. In such a situation, you should replace the standard spark plug with a spark plug that has a colder heat range (usually a higher number; consult with your KYMCO dealer when selecting an alternate spark plug).

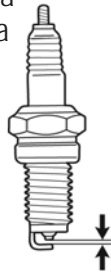
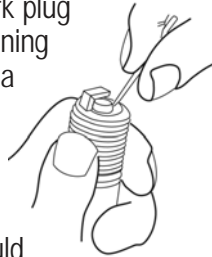

Recommended spark plug

Spark plug type: CR7HSA

Spark plug gap: 0.024 - 0.028 in
(0.6 - 0.7 mm)

CAUTION

An improper spark plug may have an incorrect fit or heat range for your engine. This may cause severe engine damage which will not be covered under warranty. Never use a spark plug with an improper heat range, as severe engine damage may result.

Brake fluid

Your scooter is equipped with a hydraulic front brake. Check the brake fluid level window ① on the master cylinder reservoir on the handlebars per the maintenance schedule.

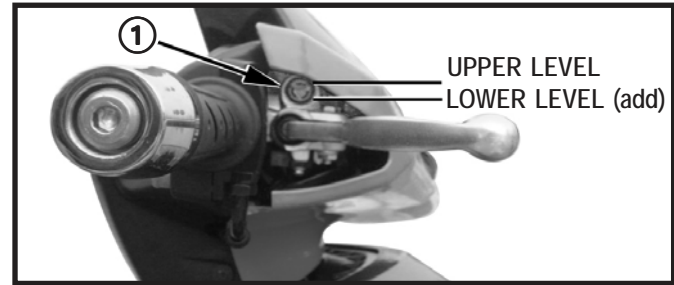

Adding brake fluid:

1. Remove the handlebar cowl and the two Phillips screws retaining the master cylinder cap. Remove the cap.
2. Add the specified type of brake fluid to bring the level up to the "UPPER" level in the window.
3. Wipe the master cylinder cap and gasket with a clean cloth and reinstall the cap, tightening the screws securely.

Brake fluid type: DOT 4

WARNING

Do not mix brake fluid types, as it may cause brake failure and could result in an accident. Do not allow brake fluid to touch the body work, as it will damage its surface.

Cleaning

Clean your scooter regularly to protect the surface finishes and inspect for damage, wear, and oil, coolant or brake fluid leakage.

Avoid cleaning products that are not specifically designed for scooter, motorcycle, or automobile surfaces. Nonspecific cleaners may contain harsh detergents or chemical solvents that could damage the metal, paint, and plastic on your scooter.

NOTE: If your scooter is still warm from recent operation, give the engine and exhaust system time to cool off before washing. Avoid the use of high pressure water spray (typical in coin-operated car washes), as the powerful spray can damage components on your scooter.

Washing your scooter

1. Rinse the scooter thoroughly with cool water to remove any loose dirt.
2. Clean the scooter with a sponge or soft cloth using cool water. Avoid directing water at muffler outlets and electrical parts.
3. Clean the plastic parts using a cloth or sponge dampened with a solution of mild detergent and water. Rub the soiled area gently, rinsing it frequently with fresh water. Take care to keep brake fluid or other chemical solvents away from the scooter, as they will damage the plastic and painted surfaces.

4. After cleaning, rinse the scooter thoroughly with plenty of clean water. This rinsing is required to remove detergent residue which can corrode alloy parts.
5. Dry the scooter and then start the engine, allowing it to run for several minutes.



NOTE: The inside of the headlight lens may become clouded immediately after washing the scooter. Moisture condensation inside the headlight lens will disappear gradually as it is heated by the headlight. After washing, run the engine while keeping the headlight on to dissipate any condensation.

6. Test the brakes before riding the scooter. Several applications of the brakes may be necessary to restore normal braking performance.

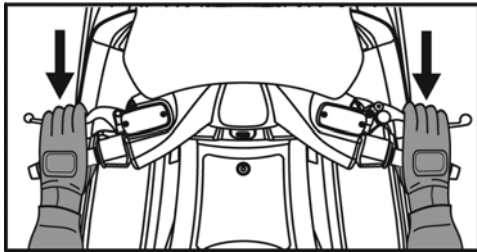

NOTE: Due to water on the brake components, braking efficiency may be temporarily impaired immediately after washing the scooter. Anticipate longer stopping distances to avoid a possible accident.

Finishing touches:

After washing your scooter, consider using a commercially-available spray cleaner/polish or a quality liquid or paste wax to enhance and protect the paint's finish. Use only a nonabrasive polish or wax made specifically for scooters, motorcycles, or automobiles. Apply the polish or wax according to the instructions on the container.

Removing road salt

The salt used in some communities to prevent road icing can become very corrosive to your scooter. Wash your scooter as soon as possible if it comes in contact with road salt (or sea water).

1. Clean the scooter using cool water (see page 42). Do not use warm water, as this will increase the corrosive effect of the salt.
2. Dry the scooter and protect painted and metal surfaces with wax or polish.

Painted aluminum wheel maintenance

Even if protected by paint, aluminum may corrode from contact with dirt, mud, or road salt. Clean the scooter's wheels with a wet sponge and mild detergent. Avoid stiff brushes, steel wool, or cleaners containing abrasives or chemical compounds.

After washing, rinse with plenty of water and dry with a clean cloth. Apply touch-up paint to the wheels where damage has occurred.

Exhaust pipe maintenance

The exhaust system is stainless steel, but it can become stained by oil or mud. If necessary, remove heat stains with a liquid kitchen-counter abrasive.

STORAGE GUIDE

Extended storage, such as for the winter months, requires that you take certain steps to reduce the effects of deterioration from the non-use of your scooter. Whenever possible, perform any necessary periodic maintenance or repairs before storage so the scooter will be in good condition for riding when it is removed from storage.

Storage

1. Change the engine oil and filter.
2. Drain the carburetor (if equipped) and empty the fuel tank into an approved gasoline container using a commercially available hand siphon or an equivalent method. Spray the inside of the tank with an aerosol rust-inhibiting oil. Close the fuel filler cap on the fuel tank

WARNING

Gasoline is highly flammable and explosive. You can be burned or seriously injured when handling fuel. Stop the engine and keep heat, sparks, and flame away. Refuel the scooter outdoors and wipe up any spills immediately.

3. To prevent rusting in the cylinder, perform the following:
 - Remove the spark plug cap from the spark plug, and use tape or string to secure the cap to any convenient plastic body part so that it is positioned away from the spark plugs.*
 - Remove the spark plug from the engine and store it in a safe, dry place. Do not connect the spark plug to the spark plug cap.*
 - Pour a tablespoon (15 - 20 cc) of clean engine oil into the cylinder and cover the spark plug hole with a piece of cloth.*

Crank the engine several times to distribute the oil.

Reinstall the spark plug and spark plug cap.

5. Remove the battery. Store it in an area protected from freezing temperatures and direct sunlight. Slow charge the battery once a month (use a quality charger designed for use on a maintenance-free type battery).
6. Wash and dry the scooter. Wax all painted surfaces. Coat the chrome or bare aluminum parts with rust inhibiting oil.
7. Inflate the tires to their recommended pressures. Place the scooter on blocks to raise both tires off the ground.
8. Cover the scooter (don't use plastic or other coated materials) and store in an unheated area, free of excessive moisture, with a minimum of daily temperature variation. Do not store the scooter in direct sunlight, as the sun's UV rays can damage the body work and other components.

Removal from storage

1. Uncover and clean the scooter.
2. Change the engine oil if more than 1 month has passed since the start of storage.
3. Charge the battery as required (use a quality charger designed for use on a maintenance-free type battery). Install the battery.
4. Drain any excess aerosol rust-inhibiting oil from the fuel tank. Fill the fuel tank with fresh gasoline.
5. Perform all the pre-ride inspection checks (see pages 16 - 23). Test ride the scooter at low speeds in a safe riding area, away from traffic.

DATE	MILEAGE	SERVICE PERFORMED & NOTES

Dimensions

Overall length	76.3 in (1940 mm)
Overall width	29.3 in (745 mm)
Overall height	48 in (1365 mm)
Wheel base	53.7 in (1365 mm)
Seat height	31 in (787 mm)
Dry weight	233.5 lbs (118 kg)

Capacities

Engine oil	0.85 qt (0.8 L)
Transmission oil	0.19 qt (0.18 L)
Fuel tank	1.5 US gal (6.0 L)
Maximum weight capacity	330 lbs (150 kg)

Engine

Type	Four-stroke, air-cooled SOHC
Displacement	49 cc (3.0 cu. in)
Bore and stroke	1.53in X 1.61 in (39 X 41.4 mm)
Compression ratio	11:1
Carburetor	Keihin 16.5 mm
Spark plug	CR7HSA
Idle speed	1900 RPM
Cooling system	Forced Air (fan)
Starting system...	Electric starter motor (kick-start back-up)
Transmission	Automatic CVT

Chassis

Tire size, front	100/80 - 14
Tire size, rear	120/80 - 14
Chassis material	Steel
Front suspension	Telescopic forks
Rear suspension	Dual shock absorbers
Brake (front)	Disc type
Brake (rear)	Drum/shoe type

Electrical

Ignition type	DC-CDI
Battery	12v-7Ah
Headlight	12v 60/55W x 2
Tail/brake light	12v0.47W LED & (12v4.4W LED)
Turn signal light	12v 10W X 4
Position light	12v5W (front) & 12v0.47W LED (rear)
Fuse sizes	7A, 10A

Dimensions

Overall length	76.3 in (1940 mm)
Overall width	29.3 in (745 mm)
Overall height	48 in (1365 mm)
Wheel base	53.7 in (1365 mm)
Seat height	31 in (787 mm)
Dry weight	258 lbs (118 kg)

Capacities

Engine oil	0.95 qt (0.9 L)
Transmission oil	0.19 qt (0.18 L)
Fuel tank	1.5 US gal (6.0 L)
Maximum weight capacity	330 lbs (150 kg)

Engine

Type	Four-stroke, air-cooled SOHC
Displacement	149.4 cc (9.1 cu. in)
Bore and stroke	2.26 x 2.27 in (57.4 X 57.8 mm)
Compression ratio	10.7:1
Carburetor	Keihin 22.1 mm
Spark plug	CR7HSA
Idle speed	1700 RPM
Cooling system	Forced Air (fan)
Starting system...	Electric starter motor (kick-start back-up)
Transmission	Automatic CVT

Chassis

Tire size, front	100/80 - 14
Tire size, rear	120/80 - 14
Chassis material	Steel
Front suspension	Telescopic forks
Rear suspension	Dual shock absorbers
Brake (front)	Disc type
Brake (rear)	Drum/shoe type

Electrical

Ignition type	DC-CDI
Battery	12v-7Ah
Headlight	12v 60/55W x 2
Tail/brake light	12v0.47W LED & (12v4.4W LED)
Turn signal light	12v 10W X 4
Position light	12v5W (front) & 12v0.47W LED (rear)
Fuse sizes	7A, 10A

Exhaust emission control (for EURO3 and other markets)

Super 8 scooters for certain markets are equipped with an emission control system which draws fresh air into the exhaust system to complete combustion of hydrocarbons that were not burned in the engine's combustion chamber process. This system also includes a catalytic converter in the muffler, and does not use any engine power, and does not affect the driveability of the scooter. It does reduce the scooter's exhaust emissions levels so they meet Euro 3-required specifications.

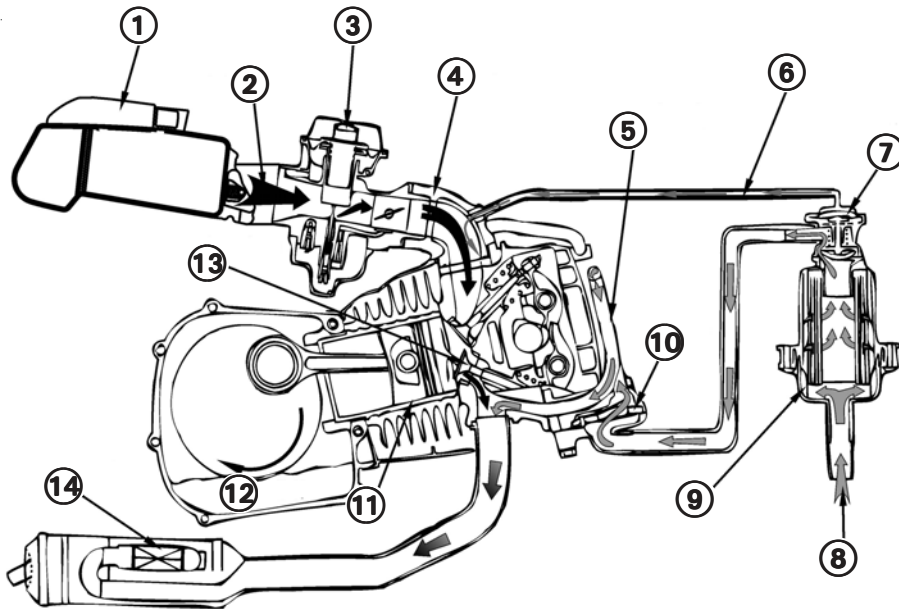

Exhaust emission control components

- ① Air Cleaner
- ② Fresh Air
- ③ Carburetor
- ④ Intake pipe (manifold)
- ⑤ Secondary Air Pipe
- ⑥ Vacuum Hose
- ⑦ Air Suction Valve
- ⑧ Fresh Air
- ⑨ Secondary Air Cleaner
- ⑩ Reed Valve
- ⑪ Cylinder & Piston
- ⑫ Engine Oil
- ⑬ Exhaust Valve
- ⑭ Catalytic Converter

Exhaust emission control system maintenance

The exhaust emission control system does not require extraordinary care to ensure its proper function. Adhere to the following procedures to make sure the system functions properly so your scooter will not excessively pollute the environment.

1. Make sure the air cleaner filter element is kept in good condition. See page 42 for cleaning procedures.
2. The engine oil should be changed regularly to promote proper engine efficiency and reduce pollutants that accumulate in used engine oil. Change the engine oil as specified in the maintenance schedule on pages 32 and 33 of this manual.
3. Use the proper type of gasoline. Your scooter's engine has been developed to use unleaded gasoline (see page 19 for the fuel recommendations). Using the improper type of fuel, such as a leaded fuel or fuel with performance-enhancing additives will increase exhaust pollutants and will reduce the efficiency of your scooter's engine.

WARNING

Immediately repair or replace any fuel or emission system component that will affect the efficiency and emission of your scooter.

Never modify your scooter as improper modifications will affect the safety, the performance and emission output of your scooter.

Be aware that only a authorized KYMCO dealer has the tools, the expertise and the technical resources to properly diagnose and repair the emission system components on your Super 8 scooter. Do not attempt to effect repairs of this type yourself and you will endanger the environment and your safety.

Crankcase Emission Control System

Your Super 8 scooter's engine is equipped with a closed crankcase system. Blow-by gases are routed back in to the combustion chamber via the intake system. This system does not allow the blow-by gases to enter the atmosphere.

Exhaust Emission Control System

The exhaust emissions from your Super 8 scooter are controlled by engine design, factory-set fuel delivery, ignition settings, and exhaust system design. This system also includes a catalyzer in the exhaust system (see page 48).

Noise Exhaust Emission Control System

The engine, intake and exhaust systems of your Super 8 scooter were designed to comply with federal, state and local noise level requirements. Do not modify the engine ,intake or exhaust components, as doing so will affect compliance these noise level requirements.

Please do not modify or change any KYMCO-designed components that may alter the sound or emission level from your Super 8 scooter.

KYMCO LIMITED WARRANTY NOISE EMISSIONS

KYMCO USA Inc, 5 Stan Perkins Road, Spartanburg, SC 29307, USA warrants that this vehicle was designed, manufactured and equipped so that when new, it would conform with the applicable Motorcycle Noise Regulations of the U.S. EPA Environmental Protection Agency.

This warranty is not limited to any particular part, component or system of the vehicle. Defects in design, assembly, or in any part, component or system of the vehicle which, at the time of sale to the first purchaser, caused noise emission levels to exceed applicable Federal standards in effect at the time of manufacture, are covered by this warranty.



KYMCO MOTORCYCLE AND SCOOTER LIMITED WARRANTY

KYMCO USA, Inc. 5 Stan Perkins Road, Spartanburg, SC 29307 USA warrants for a period of twenty four- (24) months from the date of initial retail purchase from an authorized KYMCO dealer that each new KYMCO motorcycle or scooter shall be free, under normal use and maintenance, from any defect in material and workmanship subject to the following conditions, exclusions, obligations and limitations:

1. **EXCLUSIONS.** The following are specifically excluded from the terms and provisions of this warranty:
 - a. Any KYMCO motorcycle or scooter engaged in competitive racing or related use.
 - b. Any KYMCO motorcycle or scooter utilized for rental purposes.
2. **COVERAGE.** Any material or workmanship found to be defective by KYMCO within the warranty period and limitations shall be repaired without charge for parts or labor at any authorized KYMCO dealer located within the United States of America.
3. **WARRANTY PERIOD.** The warranty is effective from the date of purchase by the original owner with the following limitations:
 - SECTION 1 – All parts and repair labor are covered for the first 365 days.
 - SECTION 2 – Engine and electrical parts and repair labor are covered for the first 540 days.
 - SECTION 3 – Engine parts and repair labor are covered for 730 days.

4. **OWNERS OBLIGATIONS.** The following obligations must be fulfilled by vehicle's owner to maintain KYMCO warranty coverage:

- a. Owner must deliver the motorcycle or scooter to an authorized KYMCO dealer or equally qualified service facility for inspection, maintenance, services and adjustments according to the Periodic Maintenance chart contained in the owner's manual.
- b. All inspection, maintenance services and adjustments are to be performed at the owner's expense.

5. **LIMITATIONS.** This warranty shall not apply to or include any of the following:
 - a. The normal expense of routine maintenance services and adjustments. This also includes parts that require replacement due to normal wear, such as spark plugs, drive chains, belt drives, air cleaner elements, brake shoes, cables, fuses, oils, coolants and tires.
 - b. Damage from the lack of periodic maintenance, or damage resulting from repairs, adjustments, maintenance operations, or the use of non-genuine parts or accessories, fuel or fluids that do not follow KYMCO service recommendations.
 - c. Damage caused by collision, improper operation, or caused by loading beyond the vehicle's rated load capacity.
 - d. Damage caused by modifications made to the vehicle to increase performance.
 - e. Damage caused by improper storage or transport, or towing or transportation expenses to move the vehicle to a KYMCO dealer for service or repair.
 - f. Damage caused by natural disasters such as fires, floods, collision or theft, or any damage caused by the passage of time such as fading, peeling or other deterioration caused by outside elements.
 - g. Repair or replacement of worn items caused by the use of the motorcycle or scooter and normal operational characteristics such as engine sounds, vibration, seepages (and other situations not considered defects by KYMCO).

6. LIMITED LIABILITY.

- a. The liability of KYMCO under the twenty four- (24) month warranty is limited solely to the remedying of defects materials or workmanship by an authorized KYMCO dealer at its place of business during customary business hours. This warranty does not cover inconvenience or loss of use of the motorcycle or scooter, or transportation of the motorcycle or scooter to or from a KYMCO dealer.

KYMCO SHALL NOT BE LIABLE FOR ANY OTHER EXPENSE, LOSS OR DAMAGE, WHETHER DIRECT, INCIDENTAL, CONSEQUENTIAL OR EXEMPLARY ARISING IN CONNECTION WITH THE SALE OR USE OF, OR INABILITY TO USE, THE KYMCO MOTORCYCLE OR SCOOTER FOR ANY PURPOSE. SOME STATES DO NOT ALLOW THE EXCLUSION OR LIMITATION OF ANY INCIDENTAL OR CONSEQUENTIAL DAMAGES, SO THE ABOVE LIMITATION OR EXCLUSION MAY NOT APPLY TO YOU.

- a. NO EXPRESS WARRANTY IS GIVEN BY KYMCO WITH RESPECT TO THE KYMCO MOTORCYCLE OR SCOOTER EXCEPT AS SPECIFICALLY SET FORTH HEREIN. ANY WARRANTY IMPLIED BY LAW, INCLUDING ANY WARRANTY OF MERCHANTABILITY OR FITNESS FOR A PARTICULAR PURPOSE, IS EXPRESSLY LIMITED TO THE TWENTY FOUR- (24) MONTH WARRANTY TERM SET FORTH HEREIN. THE FOREGOING STATEMENTS OF WARRANTY ARE EXCLUSIVE AND IN LIEU OF ALL OTHER REMEDIES. SOME STATES DO NOT ALLOW LIMITATIONS ON HOW LONG AN IMPLIED WARRANTY LASTS, SO THE ABOVE LIMITATIONS MAY NOT APPLY TO YOU.
 - b. No dealer is authorized to modify this KYMCO Limited motorcycle or scooter Warranty.
7. **LEGAL RIGHTS.** THIS WARRANTY GIVES YOU SPECIFIC LEGAL RIGHTS, AND YOU MAY ALSO HAVE OTHER RIGHTS WHICH VARY FROM STATE TO STATE.

Accessories & Modifications	6	Headlight Dimmer Switch	10	Right-hand Handlebar Switch	9
Air Filter Maintenance	35	Helmet Posts	11	Scooter Safety	3 - 4
Battery	36 - 37	Horn & Lights Inspection	22	SECTION 1 - SAFETY	2 - 6
Brake Adjustment & Pad Inspection	21	Identification Numbers Record (inside of back-cover)		SECTION 2 - CONTROLS & FEATURES	7 - 13
Brake Fluid Level Inspection	41	Ignition Switch	8	SECTION 3 - OPERATION	14 - 30
Brake Lever Free-play Inspection	17	Importance of Maintenance	31	SECTION 4 - MAINTENANCE	31 - 48
Break-in Recommendations	14	Index	52	Spark Plug	41
CA Prop 65 Warning	(inside of front-cover)	Instrument Inspection	20	Specifications (150 model)	47
Chassis Inspection	23	Instruments	12 - 13	Specifications (50 model)	46
Cleaning Your Scooter	42 - 43	Keys	8	Starting the Engine (electric start)	24 - 25
Electric Start Button	9	KYMCO Limited Scooter Warranty	51	Starting the Engine (kick start)	25
Emission Information & EPA Warranty	50	Left-hand Handlebar Switch	10	Steering & Handlebar Inspection	20
Engine Oil Inspection	17	Load Limits & Guidelines	5	Storage	44
Engine Oil Level Inspection & Change	38 - 39	Locations of Parts & Controls	7	Table of Contents	1
Engine Oil	38	Main Stand	12	Tire Break-in	15
Engine-stop Switch	9	Maintenance Record	45	Tire Inspection	18 - 19
Exhaust Emission Control System	48 - 49	Maintenance Schedule	32 - 33	Tire Pressure	34
Foreword	2	Manual Icon Legend	(inside of front-cover)	Tires	34
Fuel Hoses	36	Parking Your Scooter	30	Transmission Fluid Inspection & Change	40
Fuel Level / Filler Cap	19	Passenger Pegs	13	Troubleshooting	15
Fuel Recommendation	19	Pre-ride Inspection	16 - 23	Turn Signal Switch	10
Fuses	37	Riding Your Scooter	26 - 29	Under-seat Storage Compartment	11



1. IGNITION SWITCH KEY IDENTIFICATION NUMBER

The ignition switch key identification code is stamped on tab ① supplied with the key. If you require a replacement key, you will need this code to obtain a new key from your authorized KYMCO dealer. Record the key number in the box above.

2. VEHICLE IDENTIFICATION NUMBER (VIN)

3. ENGINE SERIAL NUMBER (ESN)

Record the Vehicle Identification Number ② and Engine Serial Number ③ in the boxes above for future reference (to assist you in ordering parts from your authorized KYMCO dealer or for reference in case the vehicle is stolen).

NOTE: *Your scooter and its keys may differ in appearance from those shown in this manual.*



**5 Stan Perkins Road
Spartanburg, SC 29307
Telephone: (888) 235-3417
FAX: (864) 327-4745**

**Prepared: July 2008
T300-KL10SA30SB-US-A5**