



OWNER'S MANUAL

**⚠ Read this manual carefully before operating this vehicle.**

# MT-10

MOTORCYCLE

---

*MTN1000 (MT-10)*

B5Y-28199-E0

Safety information	1
Description	2
Special features	3
Instrument and control functions	4
For your safety – pre-operation checks	5
Operation and important riding points	6
Periodic maintenance and adjustment	7
Motorcycle care and storage	8
Specifications	9
Consumer information	10
Index	11

 **Read this manual carefully before operating this vehicle. This manual should stay with this vehicle if it is sold.**

Declaration of Conformity:

Hereby, YAMAHA MOTOR ELECTRONICS Co., Ltd declares that the radio equipment type, IMMOBILIZER, B5Y-00 is in compliance with Directive 2014/53/EU.

The full text of the EU declaration of conformity is available at the following internet address:

[https://global.yamaha-motor.com/eu\\_doc/](https://global.yamaha-motor.com/eu_doc/)

Frequency band: 134.2 kHz

The maximum radio frequency power: 49.0 [dB $\mu$ V/m]

Manufacturer:

YAMAHA MOTOR ELECTRONICS Co., Ltd

1450-6 Mori, Mori-machi, Shuchi-Gun, Shizuoka, 437-0292 Japan

Importer:

YAMAHA MOTOR EUROPE N.V.

Koolhovenlaan 101, 1119 NC Schiphol-Rijk, 1117 ZN, Schiphol, the Netherlands

**For UK**



Declaration of Conformity:

Hereby, YAMAHA MOTOR ELECTRONICS Co., Ltd declares that the radio equipment type, IMMOBILIZER, B5Y-00 is in compliance with the Radio Equipment Regulations 2017.

The full text of the declaration of conformity is available at the following internet address:

[https://global.yamaha-motor.com/eu\\_doc/](https://global.yamaha-motor.com/eu_doc/)

Frequency band: 134.2 kHz

The maximum radio frequency power: 49.0 [dB $\mu$ V/m]

Manufacturer:

YAMAHA MOTOR ELECTRONICS Co., Ltd

1450-6 Mori, Mori-machi, Shuchi-Gun, Shizuoka, 437-0292 Japan

Importer:

YAMAHA MOTOR EUROPE N.V., BRANCH UK

Units A2-A3, Kingsley Business Park, Forsyth Road, Woking, Surrey. GU21 5SA. United Kingdom.

# Introduction

---

EAU10103

Welcome to the Yamaha world of motorcycling!

As the owner of the MTN1000, you are benefiting from Yamaha's vast experience and newest technology regarding the design and manufacture of high-quality products, which have earned Yamaha a reputation for dependability.

Please take the time to read this manual thoroughly, so as to enjoy all advantages of your MTN1000. The Owner's Manual does not only instruct you in how to operate, inspect and maintain your motorcycle, but also in how to safeguard yourself and others from trouble and injury.

In addition, the many tips given in this manual will help keep your motorcycle in the best possible condition. If you have any further questions, do not hesitate to contact your Yamaha dealer.

The Yamaha team wishes you many safe and pleasant rides. So, remember to put safety first!

Yamaha continually seeks advancements in product design and quality. Therefore, while this manual contains the most current product information available at the time of printing, there may be minor discrepancies between your motorcycle and this manual. If there is any question concerning this manual, please consult a Yamaha dealer.

EWA10032



---



**Please read this manual carefully and completely before operating this motorcycle.**

---

# Important manual information

EAU10134

Particularly important information is distinguished in this manual by the following notations:

	<b>This is the safety alert symbol. It is used to alert you to potential personal injury hazards. Obey all safety messages that follow this symbol to avoid possible injury or death.</b>
	<b>A WARNING indicates a hazardous situation which, if not avoided, could result in death or serious injury.</b>
	<b>A NOTICE indicates special precautions that must be taken to avoid damage to the vehicle or other property.</b>
<b>TIP</b>	<b>A TIP provides key information to make procedures easier or clearer.</b>

\*Product and specifications are subject to change without notice.

# **Important manual information**

---

---

EAU10202

**MTN1000  
OWNER'S MANUAL  
©2022 by Yamaha Motor Co., Ltd.  
1st edition, October 2021  
All rights reserved.  
Any reprinting or unauthorized use  
without the written permission of  
Yamaha Motor Co., Ltd.  
is expressly prohibited.  
Printed in Japan.**

# Table of contents

<b>Safety information</b> .....	1-1	Catalytic converter .....	4-33	Checking the spark plugs .....	7-9
<b>Description</b> .....	2-1	Seat.....	4-33	Canister .....	7-10
Left view .....	2-1	Adjusting the front fork .....	4-34	Engine oil.....	7-10
Right view .....	2-2	Adjusting the shock absorber assembly .....	4-36	Why Yamalube .....	7-11
Controls and instruments .....	2-3	Luggage strap holders .....	4-39	Coolant .....	7-12
<b>Special features</b> .....	3-1	EXUP system.....	4-39	Air filter element.....	7-14
YRC (Yamaha Ride Control) .....	3-1	Auxiliary DC jack.....	4-40	Checking the engine idling speed .....	7-14
Glossary .....	3-4	Sidestand .....	4-40	Valve clearance .....	7-15
YRC functions visual guide .....	3-5	Ignition circuit cut-off system.....	4-41	Tires.....	7-15
Cruise control system.....	3-6	<b>For your safety – pre-operation checks</b> .....	5-1	Cast wheels .....	7-18
Yamaha variable speed limiter (YVSL) .....	3-8	<b>Operation and important riding points</b> .....	6-1	Adjusting the clutch lever free play.....	7-18
<b>Instrument and control functions</b> ...	4-1	Engine break-in.....	6-1	Checking the brake lever free play.....	7-19
Immobilizer system.....	4-1	Starting the engine.....	6-2	Brake light switches.....	7-20
Main switch/steering lock.....	4-2	Shifting .....	6-3	Checking the front and rear brake pads .....	7-20
Handlebar switches .....	4-3	Tips for reducing fuel consumption .....	6-4	Checking the brake fluid level.....	7-21
Indicator lights and warning lights.....	4-5	Parking.....	6-5	Changing the brake fluid.....	7-22
Display.....	4-9	<b>Periodic maintenance and adjustment</b> .....	7-1	Drive chain slack .....	7-22
MENU screen .....	4-18	Tool kits.....	7-2	Cleaning and lubricating the drive chain.....	7-23
Clutch lever .....	4-27	Periodic maintenance charts.....	7-3	Checking and lubricating the cables.....	7-24
Shift pedal .....	4-27	Periodic maintenance chart for the emission control system .....	7-3	Checking and lubricating the throttle grip .....	7-24
Brake lever .....	4-28	General maintenance and lubrication chart .....	7-5	Checking and lubricating the brake and shift pedals .....	7-25
Brake pedal .....	4-28			Checking and lubricating the brake and clutch levers .....	7-25
Brake control system (BC).....	4-29				
Fuel tank cap .....	4-30				
Fuel .....	4-31				
Fuel tank overflow hose .....	4-32				

# Table of contents

---

Checking and lubricating the sidestand.....	7-26
Lubricating the swingarm pivots ...	7-26
Checking the front fork .....	7-27
Checking the steering.....	7-27
Checking the wheel bearings .....	7-28
Battery .....	7-28
Replacing the fuses .....	7-29
Vehicle lights .....	7-31
Supporting the motorcycle.....	7-32
Troubleshooting.....	7-32
Troubleshooting chart.....	7-33
<b>Motorcycle care and storage .....</b>	<b>8-1</b>
Matte color caution .....	8-1
Care.....	8-1
Storage .....	8-4
<b>Specifications.....</b>	<b>9-1</b>
<b>Consumer information .....</b>	<b>10-1</b>
Identification numbers .....	10-1
Diagnostic connector .....	10-2
Vehicle data recording.....	10-2
<b>Index.....</b>	<b>11-1</b>



EAU1028C

## Be a Responsible Owner

As the vehicle's owner, you are responsible for the safe and proper operation of your motorcycle.

Motorcycles are single-track vehicles. Their safe use and operation are dependent upon the use of proper riding techniques as well as the expertise of the operator. Every operator should know the following requirements before riding this motorcycle.

He or she should:

- Obtain thorough instructions from a competent source on all aspects of motorcycle operation.
- Observe the warnings and maintenance requirements in this Owner's Manual.
- Obtain qualified training in safe and proper riding techniques.
- Obtain professional technical service as indicated in this Owner's Manual and/or when made necessary by mechanical conditions.
- Never operate a motorcycle without proper training or instruction.

Take a training course. Beginners should receive training from a certified instructor. Contact an authorized motorcycle dealer to find out about the training courses nearest you.

## Safe Riding

Perform the pre-operation checks each time you use the vehicle to make sure it is in safe operating condition. Failure to inspect or maintain the vehicle properly increases the possibility of an accident or equipment damage. See page 5-1 for a list of pre-operation checks.

- This motorcycle is designed to carry the operator and a passenger.
- The failure of motorists to detect and recognize motorcycles in traffic is the predominating cause of automobile/motorcycle accidents. Many accidents have been caused by an automobile driver who did not see the motorcycle. Making yourself conspicuous appears to be very effective in reducing the chance of this type of accident.

### Therefore:

- Wear a brightly colored jacket.

- Use extra caution when you are approaching and passing through intersections, since intersections are the most likely places for motorcycle accidents to occur.
- Ride where other motorists can see you. Avoid riding in another motorist's blind spot.
- Never maintain a motorcycle without proper knowledge. Contact an authorized motorcycle dealer to inform you on basic motorcycle maintenance. Certain maintenance can only be carried out by certified staff.
- Many accidents involve inexperienced operators. In fact, many operators who have been involved in accidents do not even have a current motorcycle license.
- Make sure that you are qualified and that you only lend your motorcycle to other qualified operators.
- Know your skills and limits. Staying within your limits may help you to avoid an accident.
- We recommend that you prac-

# Safety information

---

1

tice riding your motorcycle where there is no traffic until you have become thoroughly familiar with the motorcycle and all of its controls.

- Many accidents have been caused by error of the motorcycle operator. A typical error made by the operator is veering wide on a turn due to excessive speed or undercornering (insufficient lean angle for the speed).
- Always obey the speed limit and never travel faster than warranted by road and traffic conditions.
- Always signal before turning or changing lanes. Make sure that other motorists can see you.
- The posture of the operator and passenger is important for proper control.
- The operator should keep both hands on the handlebar and both feet on the operator footrests during operation to maintain control of the motorcycle.
- The passenger should always hold onto the operator, the seat strap or grab bar, if equipped,

with both hands and keep both feet on the passenger footrests. Never carry a passenger unless he or she can firmly place both feet on the passenger footrests.

- Never ride under the influence of alcohol or other drugs.
- This motorcycle is designed for on-road use only. It is not suitable for off-road use.

## **Protective Apparel**

The majority of fatalities from motorcycle accidents are the result of head injuries. The use of a safety helmet is the single most critical factor in the prevention or reduction of head injuries.

- Always wear an approved helmet.
- Wear a face shield or goggles. Wind in your unprotected eyes could contribute to an impairment of vision that could delay seeing a hazard.
- The use of a jacket, heavy boots, trousers, gloves, etc., is effective in preventing or reducing abrasions or lacerations.
- Never wear loose-fitting clothes, otherwise they could catch on the

control levers, footrests, or wheels and cause injury or an accident.

- Always wear protective clothing that covers your legs, ankles, and feet. The engine or exhaust system become very hot during or after operation and can cause burns.
- A passenger should also observe the above precautions.

## **Avoid Carbon Monoxide Poisoning**

All engine exhaust contains carbon monoxide, a deadly gas. Breathing carbon monoxide can cause headaches, dizziness, drowsiness, nausea, confusion, and eventually death.

Carbon Monoxide is a colorless, odorless, tasteless gas which may be present even if you do not see or smell any engine exhaust. Deadly levels of carbon monoxide can collect rapidly and you can quickly be overcome and unable to save yourself. Also, deadly levels of carbon monoxide can linger for hours or days in enclosed or poorly ventilated areas. If you experience any symptoms of carbon monoxide poisoning, leave the area immediately, get fresh air, and **SEEK MEDICAL TREAT-**

**MENT.**

- Do not run engine indoors. Even if you try to ventilate engine exhaust with fans or open windows and doors, carbon monoxide can rapidly reach dangerous levels.
- Do not run engine in poorly ventilated or partially enclosed areas such as barns, garages, or carports.
- Do not run engine outdoors where engine exhaust can be drawn into a building through openings such as windows and doors.

**Loading**

Adding accessories or cargo to your motorcycle can adversely affect stability and handling if the weight distribution of the motorcycle is changed. To avoid the possibility of an accident, use extreme caution when adding cargo or accessories to your motorcycle. Use extra care when riding a motorcycle that has added cargo or accessories. Here, along with the information about accessories below, are some general guidelines to follow if loading cargo to your motorcycle:

The total weight of the operator, passenger, accessories and cargo must not exceed the maximum load limit.

**Operation of an overloaded vehicle could cause an accident.**

<b>Maximum load:</b> 173 kg (381 lb)
---

When loading within this weight limit, keep the following in mind:

- Cargo and accessory weight should be kept as low and close to the motorcycle as possible. Securely pack your heaviest items as close to the center of the vehicle as possible and make sure to distribute the weight as evenly as possible on both sides of the motorcycle to minimize imbalance or instability.
- Shifting weights can create a sudden imbalance. Make sure that accessories and cargo are securely attached to the motorcycle before riding. Check accessory mounts and cargo restraints frequently.
- Properly adjust the suspension for your load (suspension-ad-

justable models only), and check the condition and pressure of your tires.

- Never attach any large or heavy items to the handlebar, front fork, or front fender. These items, including such cargo as sleeping bags, duffel bags, or tents, can create unstable handling or a slow steering response.
- **This vehicle is not designed to pull a trailer or to be attached to a sidecar.**

**Genuine Yamaha Accessories**

Choosing accessories for your vehicle is an important decision. Genuine Yamaha accessories, which are available only from a Yamaha dealer, have been designed, tested, and approved by Yamaha for use on your vehicle.

Many companies with no connection to Yamaha manufacture parts and accessories or offer other modifications for Yamaha vehicles. Yamaha is not in a position to test the products that these aftermarket companies produce. Therefore, Yamaha can neither en-

# Safety information

---

1

dorse nor recommend the use of accessories not sold by Yamaha or modifications not specifically recommended by Yamaha, even if sold and installed by a Yamaha dealer.

## **Aftermarket Parts, Accessories, and Modifications**

While you may find aftermarket products similar in design and quality to genuine Yamaha accessories, recognize that some aftermarket accessories or modifications are not suitable because of potential safety hazards to you or others. Installing aftermarket products or having other modifications performed to your vehicle that change any of the vehicle's design or operation characteristics can put you and others at greater risk of serious injury or death. You are responsible for injuries related to changes in the vehicle.

Keep the following guidelines in mind, as well as those provided under "Loading" when mounting accessories.

- Never install accessories or carry cargo that would impair the performance of your motorcycle. Carefully inspect the accessory before

using it to make sure that it does not in any way reduce ground clearance or cornering clearance, limit suspension travel, steering travel or control operation, or obscure lights or reflectors.

- Accessories fitted to the handlebar or the front fork area can create instability due to improper weight distribution or aerodynamic changes. If accessories are added to the handlebar or front fork area, they must be as lightweight as possible and should be kept to a minimum.
- Bulky or large accessories may seriously affect the stability of the motorcycle due to aerodynamic effects. Wind may attempt to lift the motorcycle, or the motorcycle may become unstable in cross winds. These accessories may also cause instability when passing or being passed by large vehicles.
- Certain accessories can displace the operator from his or her normal riding position. This improper position limits the free-

dom of movement of the operator and may limit control ability, therefore, such accessories are not recommended.

- Use caution when adding electrical accessories. If electrical accessories exceed the capacity of the motorcycle's electrical system, an electric failure could result, which could cause a dangerous loss of lights or engine power.

## **Aftermarket Tires and Rims**

The tires and rims that came with your motorcycle were designed to match the performance capabilities and to provide the best combination of handling, braking, and comfort. Other tires, rims, sizes, and combinations may not be appropriate. See page 7-15 for tire specifications and for information on servicing and replacing your tires.

## **Transporting the Motorcycle**

Be sure to observe following instructions before transporting the motorcycle in another vehicle.

- Remove all loose items from the motorcycle.

- Check that the fuel cock (if equipped) is in the off position and that there are no fuel leaks.
- Shift the transmission into gear (for models with a manual transmission).
- Secure the motorcycle with tie-downs or suitable straps that are attached to solid parts of the motorcycle, such as the frame or upper front fork triple clamp (and not, for example, to rubber-mounted handlebars or turn signals, or parts that could break). Choose the location for the straps carefully so the straps will not rub against painted surfaces during transport.
- The suspension should be compressed somewhat by the tie-downs, if possible, so that the motorcycle will not bounce excessively during transport.

## Left view

2

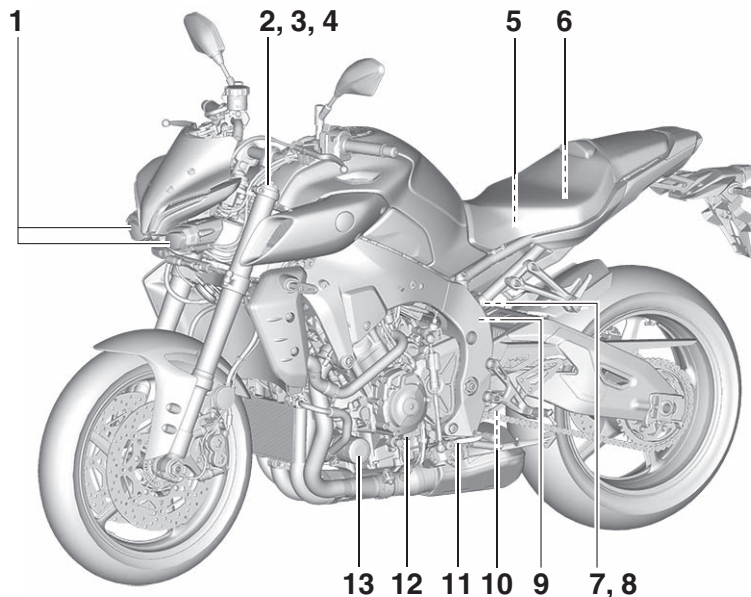

- |  |   |
|--|---|
| 1. Headlight (page 7-31)                               | 9. Spring preload adjuster (page 4-36)        |
| 2. Spring preload adjuster (page 4-34)                 | 10.Rebound damping force adjuster (page 4-36) |
| 3. Rebound damping force adjuster (page 4-34)          | 11.Shift pedal (page 4-27)                    |
| 4. Compression damping force adjuster (page 4-34)      | 12.Engine oil level check window (page 7-10)  |
| 5. Battery (page 7-28)                                 | 13.Engine oil filter cartridge (page 7-10)    |
| 6. Fuses (page 7-29)                                   |   |
| 7. Fast compression damping force adjuster (page 4-36) |   |
| 8. Slow compression damping force adjuster (page 4-36) |   |

## Right view

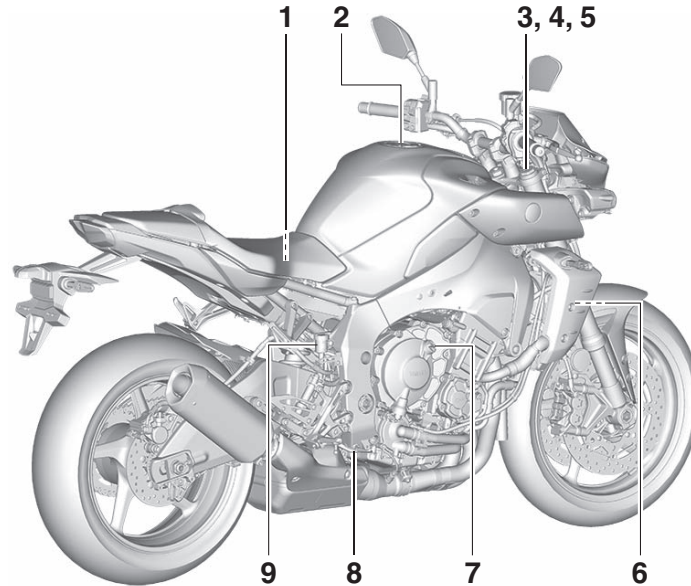

1. Tool kit (page 7-2)
2. Fuel tank cap (page 4-30)
3. Spring preload adjuster (page 4-34)
4. Rebound damping force adjuster (page 4-34)
5. Compression damping force adjuster (page 4-34)
6. Coolant reservoir (page 7-12)
7. Engine oil filler cap (page 7-10)
8. Brake pedal (page 4-28)

9. Rear brake fluid reservoir (page 7-21)

## Controls and instruments

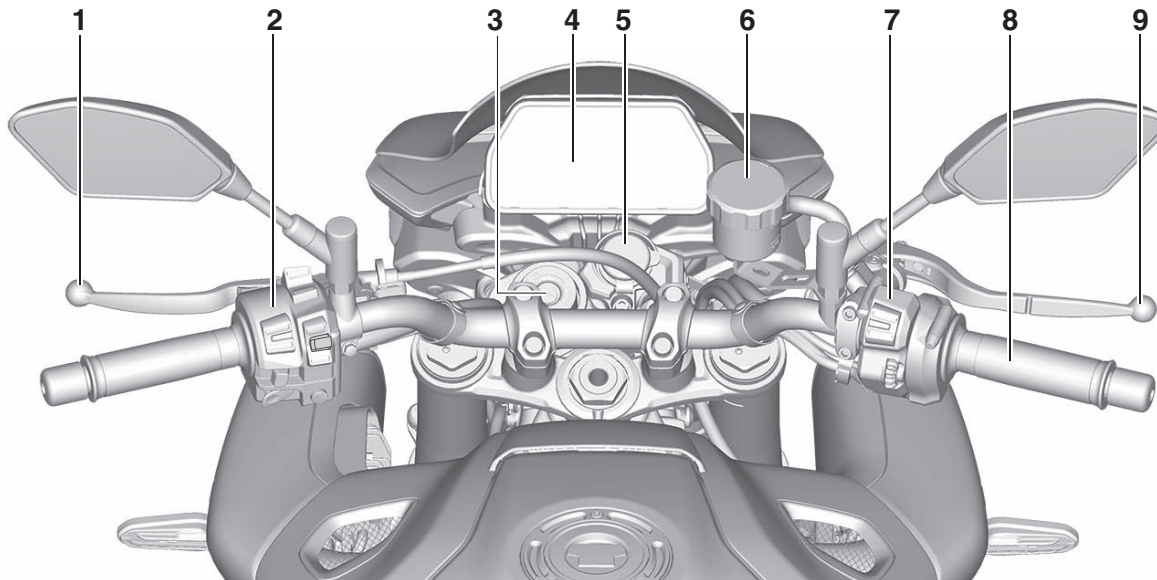

1. Clutch lever (page 4-27)
2. Left handlebar switches (page 4-3)
3. Main switch/steering lock (page 4-2)
4. Instrument panel (page 4-5, 4-9)
5. Auxiliary DC jack (page 4-40)
6. Front brake fluid reservoir (page 7-21)
7. Right handlebar switches (page 4-3)
8. Throttle grip

9. Brake lever (page 4-28)



EAU93683

## YRC (Yamaha Ride Control)

Yamaha Ride Control is a system that incorporates numerous sensors and controls to support an improved riding experience. The vehicle senses and can react to forces along the longitudinal (front-to-back), lateral (left-to-right), and vertical (up-and-down) axes. Lean angle and G-force accelerations are also detected. This information is processed multiple times a second and the related physical systems are automatically adjusted as necessary. The following functions represent individual YRC items which can be turned on/off or adjusted to suit various riders and riding conditions. For setting details, see pages 4-16 and 4-18.

EWA18221

### WARNING

**The Yamaha Ride Control (YRC) system is not a substitute for the use of proper riding techniques or the expertise of the operator. This system cannot prevent loss of control caused by rider errors such as traveling faster than warranted by road and traffic conditions, including loss**

**of traction due to excessive speed when entering turns, when accelerating hard at a sharp lean angle, or while braking, and it cannot prevent front wheel slip or front wheel lift. As with any motorcycle, always ride within in your limits, be aware of surrounding conditions, and ride appropriately for those conditions. Become thoroughly familiar with the way the motorcycle handles with various YRC settings before attempting more advanced maneuvers.**

## PWR

The power delivery mode system consists of four different control maps which regulate throttle valve opening in relation to the degree of throttle grip operation, thus providing you with a selection of modes to fit your preferences and the riding environment.

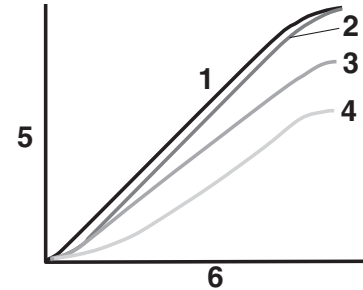

1. PWR 1
2. PWR 2
3. PWR 3
4. PWR 4
5. Throttle valve opening
6. Throttle grip operation

## Traction control system

The traction control system helps maintain traction when accelerating. If sensors detect that the rear wheel is starting to slip (uncontrolled spinning), the traction control system assists by regulating engine power as needed until traction is restored. The traction control system indicator/warning light flashes to let the rider know that traction control has engaged.

This traction control system automati-

# Special features

3 cally adjusts according to the vehicle's lean angle. To maximize acceleration, when the vehicle is upright a less amount of traction control is applied. When cornering, a greater amount of traction control is applied.



Traction control system

## TIP

- The traction control system may engage when the vehicle travels over a bump.
- You may notice slight changes in engine and exhaust sounds when the traction control or other YRC systems engage.
- When the traction control system is turned off the SCS and LIF are also turned off automatically.

EWA15433

## WARNING

**The traction control system is not a substitute for riding appropriately for the conditions. Traction control cannot prevent loss of traction due to excessive speed when entering turns, when accelerating hard at a sharp lean angle, or while braking, and cannot prevent front wheel slipping. As with any vehicle, approach surfaces that may be slippery with caution and avoid especially slippery surfaces.**

When the key is turned to "ON", the traction control system automatically turns on. The traction control system can be turned on or off manually only when the key is in the "ON" position and the motorcycle is stopped.

## TIP

Turn the traction control system off to help free the rear wheel if the motorcycle gets stuck in mud, sand, or other soft surfaces.

ECA16801

## NOTICE

**Use only the specified tires. (See page 7-15.) Using different sized tires will prevent the traction control system from controlling tire rotation accurately.**

## SCS

The slide control system regulates engine power output when a sideward slide is detected in the rear wheel. It adjusts power output based on data from the IMU. This system supports the traction control system to contribute to a smoother ride.

## EBM

The engine brake management system reduces engine torque when decelerating. The fuel injection, ignition timing, and electronic throttle valve are electronically adjusted by the ECU. There are 2 settings to suit the track, riding conditions, or your personal preference.

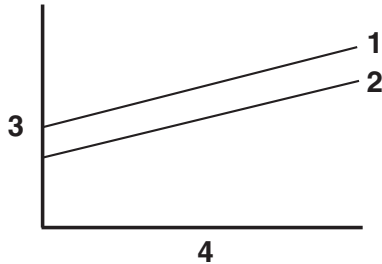

1. EBM1
2. EBM2
3. Engine brake force
4. Engine r/min

EWA20880

## **WARNING**

**Make sure the engine has sufficiently slowed before shifting to a lower gear. Engaging a lower gear when the engine speed is too high could make the rear wheel lose traction. This could cause loss of control, an accident and injury. It could also cause engine or drivetrain damage.**

### Quick shifter

The quick shifter allows for clutch lever-less, electronically-assisted shift-

ing. When the sensor on the shift rod detects the appropriate motion in the shift pedal, engine power output is momentarily adjusted to allow for the gear change to occur.

The quick shifter does not operate when the clutch lever is pulled, therefore normal shifting can be done even when the quick shifter is set to on. Check the quick shifter indicator for current status and usability information.

Quick shifter usability	Indicator
Upshifting OK	
Downshifting OK	
Upshifting and downshifting OK	
Quick shifter cannot be used	
Quick shifter turned off	

### Upshifting conditions

- Vehicle speed of at least 20 km/h (12 mi/h)
- Engine speed of at least 2100 r/min

### Downshifting conditions

- Vehicle speed of at least 20 km/h (12 mi/h)
- Engine speed of at least 2000 r/min

- Engine speed sufficiently away from red zone

### TIP

- QS ▲ and QS ▼ can be individually set.
- Shifting into or out of neutral must be done using the clutch lever.

### LIF

The lift control system reduces the rate at which the front wheel will continue to rise during extreme acceleration, such as during starts or out-of-corner exits. When front-wheel lift is detected, engine power is regulated to slow front-wheel lift while still providing good acceleration.

### BC

The brake control system regulates hydraulic brake pressure for the front and rear wheels when the brakes are applied and wheel lock is detected. This system has two settings.

BC1 is standard ABS, which adjusts brake pressure based on vehicle speed and wheel speed data. BC1 is designed to engage and maximize brak-

# Special features

ing when the vehicle is upright.  
BC2 uses additional data from the IMU to regulate applied brake power when cornering to suppress lateral wheel slip.

EAU93670

3

BC1/BC2

BC2

BC2



ABS

## Glossary

ABS - Anti-lock Brake System

ABS ECU - Anti-lock Brake System

Electronic Control Unit

BC - Brake Control

EBM - Engine Brake Management

ECU - Engine Control Unit

IMU - Inertial Measurement Unit

LIF - Lift Control System

PWR - Power delivery mode

SC - Stability Control

SCS - Slide Control System

YRC - Yamaha Ride Control

EWA20891

## WARNING

The brake control system is not a substitute for the use of proper riding and braking techniques. The brake control system cannot prevent all loss of traction due to over-braking from excessive speed, or lateral wheel slip when braking on slippery surfaces.

## YRC functions visual guide

3

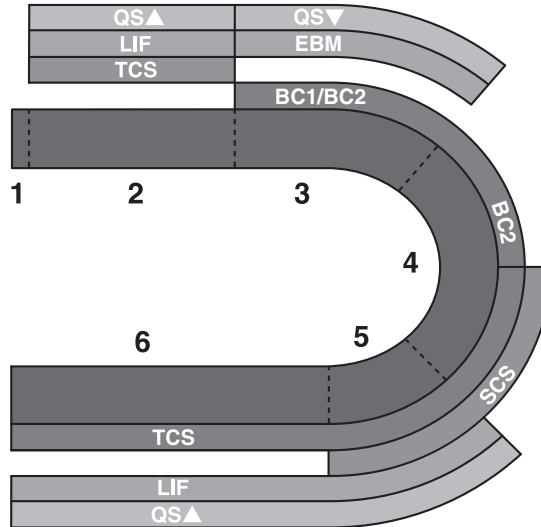

1. Start
2. Acceleration
3. Braking
4. Apex
5. Exit

6. Straightaway

# Special features

EAU94382

## Cruise control system

This model is equipped with a cruise control system designed to maintain a set cruising speed without the need to hold open the throttle by hand.

The cruise control system operates only when riding in 4th, 5th or 6th gear at speeds between approximately 50 km/h (31 mi/h) and 192 km/h (119 mi/h).



EWA21240

### ⚠ WARNING

- **Improper use of the cruise control system may result in loss of control, which could lead to an accident. Do not activate the cruise control system in heavy traffic, poor weather conditions, or among winding, slippery, hilly, rough or gravel roads.**
- **When traveling uphill or downhill, the cruise control system may not be able to maintain the set cruising speed.**
- **To prevent accidentally activating the cruise control system, turn it off when not in use. Make sure that the cruise control sys-**

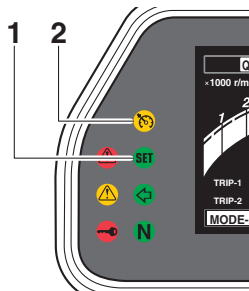
tem indicator light “” is off.



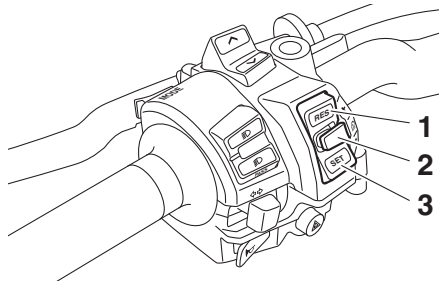

1. Cruise control setting indicator light “”
2. Cruise control system indicator light “”



1. Cruise control/YVSL setting switch “RES+”
2. Cruise control/YVSL power switch “”
3. Cruise control/YVSL setting switch “SET-”

## Activating and setting the cruise control system

1. Push the cruise control/YVSL power switch “” located on the left handlebar. The cruise control system indicator light “” will come on.
2. Push the “SET-” side of the cruise control/YVSL setting switch to activate the cruise control system. Your current traveling speed will become the set cruising speed. The cruise control setting indicator light “” will come on.

## Adjusting the set cruising speed

While the cruise control system is operating, push the “RES+” side of the cruise control/YVSL setting switch to increase the set cruising speed or the “SET-” side to decrease the set speed.

### TIP

Pushing the setting switch once will change the set speed in increments of approximately 1.0 km/h (1.0 mi/h). Holding the setting switch will change the set speed in increments of 10 km/h (10 mi/h).

You can also manually increase your traveling speed using the throttle. After you have accelerated, you can set a new cruising speed by pushing the “SET-” side of the setting switch. If you do not set a new cruising speed, when you decrease the throttle, the vehicle will decelerate to the previously set cruising speed.

## TIP

The current cruise control speed setting can be viewed on the vehicle information displays. (See page 4-12.)

## Deactivating the cruise control system

Perform one of the following operations to cancel the set cruising speed. The “SET” indicator light will go off.

- Turn the throttle grip past the closed position in the deceleration direction.

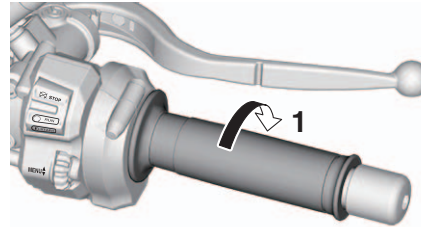

1. Deceleration direction

- Apply the front or rear brake.
- Disengage the clutch.
- Shift gears

Push the cruise control/YVSL power switch “MODE” to turn off the cruise control system. The “RES+” indicator light and the “SET” indicator light will go off.

## TIP

Traveling speed decreases as soon as the cruise control system is deactivated; unless the throttle grip is turned.

## Using the resume function

Push the “RES+” side of the cruise control/YVSL setting switch to reactivate the cruise control system. The traveling

speed will return to the previously set cruising speed. The “SET” indicator light will come on.

EWA16351

## WARNING

It is dangerous to use the resume function when the previously set cruising speed is too high for current conditions.

## TIP

Pushing the cruise control/YVSL power switch “MODE” while the system is operating will turn the system off completely and erase the previously set cruising speed. You will not be able to use the resume function until a new cruising speed has been set.

## Automatic deactivation of the cruise control system

The cruise control system for this model is electronically controlled and is linked with the other control systems. The cruise control system will automatically deactivate under the following conditions:



- The cruise control system is not



# Special features

3

able to maintain the set cruising speed.

- Wheel slip or wheel spin is detected. (If the traction control system has not been turned off, the traction control system will operate normally while the cruise control system is active)
- The start/engine stop switch is set to the “” position.
- The engine stalls.
- The sidestand is lowered.

When traveling with a set cruising speed, if the cruise control system is deactivated under the above conditions, the “” indicator light will go off and the “” indicator light will flash for 4 seconds, and then go off.

When not traveling with a set cruising speed, if the start/engine stop switch is set to the “” position, the engine stalls, or the sidestand is lowered, then the “” indicator light will go off (the “” indicator light will not flash).

If the cruise control system is automatically deactivated, please stop and confirm that your vehicle is in good operating condition.

Before using the cruise control system

again, activate it using the cruise control/YVSL power switch “”.

## TIP

In some cases, the cruise control system may not be able to maintain the set cruising speed when the vehicle is traveling uphill or downhill.

- When the vehicle is traveling uphill, the actual traveling speed may become lower than the set cruising speed. If this occurs, accelerate to the desired traveling speed using the throttle.
- When the vehicle is traveling downhill, the actual traveling speed may become higher than the set cruising speed. If this occurs, the cruise control/YVSL setting switch cannot be used to adjust the set cruising speed. To reduce the traveling speed, apply the brakes. When the brakes are applied, the cruise control system will deactivate.

EAU93493

## Yamaha variable speed limiter (YVSL)

This model is equipped with the Yamaha variable speed limiter (YVSL) which limits the vehicle to a maximum speed set by the rider.

The YVSL can be set to any speed limit between 50 km/h (31 mi/h) and 192 km/h (119 mi/h). When the set speed limit is reached, the engine output is restricted to keep the vehicle from exceeding set speed limit without throttle control.

EWA21200

## WARNING

- **Improper use of the YVSL system may result in loss of control, which could lead to an accident. Do not activate the YVSL system in heavy traffic, poor weather conditions, or among winding, slippery, hilly, rough or gravel roads.**
- **The YVSL system may not be able to maintain the set speed limit when traveling uphill, downhill, or under sudden acceleration.**



- To prevent accidentally activating the YVSL system, turn it off when not in use. Make sure that the YVSL display is off.

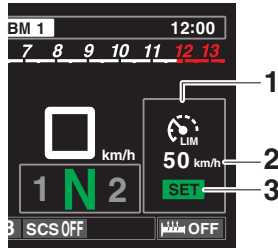

1. YVSL display
2. Speed setting indicator
3. YVSL “SET” indicator icon

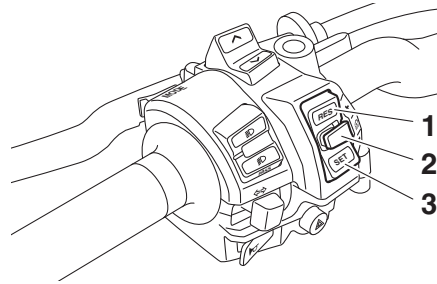

1. Cruise control/YVSL setting switch “RES+”
2. Cruise control/YVSL power switch “MODE”
3. Cruise control/YVSL setting switch “SET-”

## TIP

In some cases, the YVSL system may not be able to maintain the set speed limit when the vehicle is traveling downhill, under sudden acceleration, or immediately following a gear shift.

- If the vehicle exceeds the set speed limit by 5 km/h (3 mi/h) or more for more than 3 seconds, the YVSL “SET” indicator icon will flash until the vehicle speed decreases to within the limit.
- If the vehicle traveling speed becomes higher than the set speed

limit, apply the brakes. When the YVSL disengages, engine output is gradually derestricted to ensure a smooth transition to full rider control of the throttle.

## Activating and setting the YVSL

1. Push the cruise control/YVSL power switch “MODE” located on the left handlebar. The cruise control system indicator light “” will come on.
2. Push the cruise control/YVSL power switch “MODE” a second time to switch to the YVSL standby mode. The fuel meter (gear indicator in track mode) will be replaced by the YVSL “SET” indicator icon and a speed setting indicator.
3. Push the “SET-” side of the cruise control/YVSL setting switch to activate the YVSL. The YVSL “SET” indicator icon will come on and the speed limit will be set to your current traveling speed which will be shown on the YVSL speed setting indicator.

# Special features

3

## TIP

- Pushing the cruise control/YVSL power switch “MODE” while the cruise control system is active and the cruise control setting indicator light “SET” is on will also switch to the YVSL standby mode.
- The cruise control system and the YVSL control system cannot both be active at the same time.
- If the color of the speed setting indicator icon has changed and flashes, have a Yamaha dealer check the vehicle.

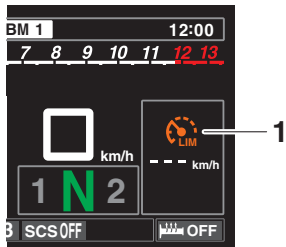

1. Speed setting indicator icon

## Adjusting the speed limit

While the YVSL is activated, push the

“RES+” side of the cruise control/YVSL setting switch to increase the set speed limit or the “SET-” side to decrease the set speed limit.

## TIP

Pushing the setting switch once will change the set speed in increments of approximately 1.0 km/h (1.0 mi/h). Holding the setting switch will change the set speed in increments of 10 km/h (10 mi/h).

## Deactivating the YVSL

When the YVSL is disengaged, engine output is gradually derestricted to ensure a smooth transition to full rider control of the throttle.

Perform one of the following operations to deactivate the YVSL:

- Turn the throttle grip past the closed position in the deceleration direction. The YVSL “SET” indicator icon will go off and the system will return to standby mode.

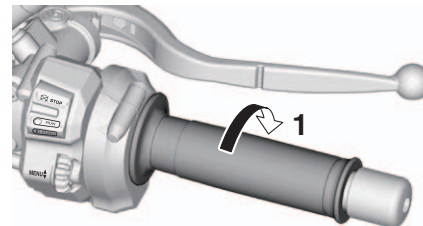

1. Deceleration direction

- Push the cruise control/YVSL power switch “MODE” located on the left handlebar. The YVSL display will go off and return to the fuel meter (gear display in track mode).

## Using the resume function

Push the “RES+” side of the cruise control/YVSL setting switch to reactivate the YVSL when in standby mode. The speed limit will return to the previously set speed limit. The YVSL “SET” indicator icon will come on.

EWA21210



**WARNING**

It is dangerous to use the resume function when the previously set

**speed limit is too low for current conditions.**

---

### **TIP**

---

Pushing the cruise control/YVSL power switch  while the YVSL system is operating will turn the system off completely and erase the previously set speed limit. You will not be able to use the resume function until a new speed limit has been set.

---

# Instrument and control functions

## Immobilizer system

EAU1097B

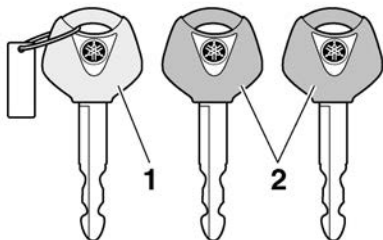

1. Code re-registering key (red bow)
2. Standard keys (black bow)

This vehicle is equipped with an immobilizer system to help prevent theft by re-registering codes in the standard keys. This system consists of the following:

- a code re-registering key
- two standard keys
- a transponder (in each key)
- an immobilizer unit (on the vehicle)
- an ECU (on the vehicle)
- a system indicator light (page 4-7)

### About the keys

The code re-registering key is used to register codes in each standard key.

Store the code re-registering key in a safe place. Use a standard key for daily operation.

When key replacement or re-registering is necessary, bring the vehicle and the code re-registering key along with any remaining standard keys to a Yamaha dealer to have them re-registered.

### TIP

- Keep the standard keys as well as keys of other immobilizer systems away from the code re-registering key.
- Keep other immobilizer system keys away from the main switch as they may cause signal interference.

ECA11823

### NOTICE

**DO NOT LOSE THE CODE RE-REGISTERING KEY! CONTACT YOUR DEALER IMMEDIATELY IF IT IS LOST! If the code re-registering key is lost, the existing standard keys can still be used to start the vehicle. However, registering a new standard key is impossible. If all keys**

**have been lost or damaged, the entire immobilizer system must be replaced. Therefore, handle the keys carefully.**

- **Do not submerge in water.**
- **Do not expose to high temperatures.**
- **Do not place near magnets.**
- **Do not place near items that transmit electrical signals.**
- **Do not handle roughly.**
- **Do not grind or alter.**
- **Do not disassemble.**
- **Do not put two keys of any immobilizer system on the same key ring.**

## Main switch/steering lock

EAU10474

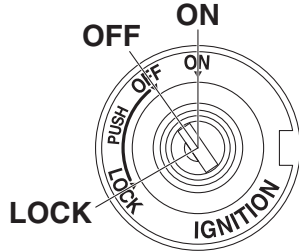

The main switch/steering lock controls the ignition and lighting systems, and is used to lock the steering. The various positions are described below.

### TIP

Be sure to use the standard key (black bow) for regular use of the vehicle. To minimize the risk of losing the code re-registering key (red bow), keep it in a safe place and only use it for code re-registering.

EAU84035

### ON

All electrical circuits are supplied with power and the vehicle lights are turned

on. The engine can be started. The key cannot be removed.

### TIP

- The headlight(s) will turn on when the engine is started.
- To prevent battery drain, do not leave the key in the "ON" position without the engine running.

EAU10664

### OFF

All electrical systems are off. The key can be removed.

EWA10062

### WARNING

**Never turn the key to "OFF" or "LOCK" while the vehicle is moving. Otherwise the electrical systems will be switched off, which may result in loss of control or an accident.**

EAU73803

### LOCK

The steering is locked and all electrical systems are off. The key can be removed.

### To lock the steering

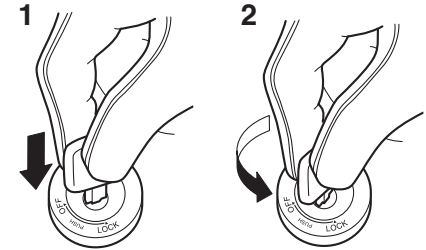

1. Push.
2. Turn.

1. Turn the handlebars all the way to the left.
2. With the key in the "OFF" position, push the key in and turn it to "LOCK".
3. Remove the key.

### TIP

If the steering will not lock, try turning the handlebars back to the right slightly.

# Instrument and control functions

## To unlock the steering

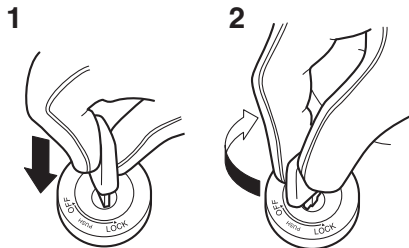

1. Push.
2. Turn.

Push the key in and turn it to “OFF”.

## Handlebar switches

EAU66055

### Left

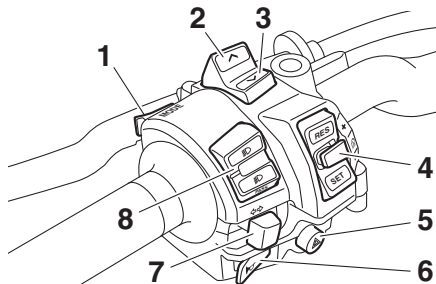

1. “MODE” switch
2. MODE up “^” switch
3. MODE down “v” switch
4. Cruise control/YVSL switches
5. Hazard switch “Δ”
6. Horn switch “b”
7. Turn signal switch “←/→”
8. Dimmer/Pass switch “≡/≡/PASS”

### Right

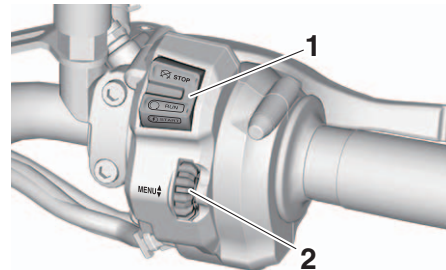

1. Stop/Run/Start switch “⊗/⊙/⊚”
2. Wheel switch “MENU↕”

EAU91630

### Dimmer/Pass switch “≡/≡/PASS”

Set this switch to “≡” for the high beam and to “≡” for the low beam. While the headlight is set on low beam, push the switch down towards “PASS” to flash the high beam and to mark the start of each lap when using the lap timer.

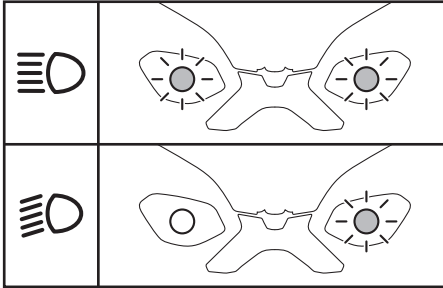

EAU66040

## Turn signal switch “↔/↔”

To signal a right-hand turn, push this switch to “↔”. To signal a left-hand turn, push this switch to “↔”. When released, the switch returns to the center position. To cancel the turn signal lights, push the switch in after it has returned to the center position.

EAU66030

## Horn switch “📢”

Press this switch to sound the horn.

EAU94790

## Stop/Run/Start switch “🔌/🔌/🔌”

To crank the engine with the starter, set this switch to “🔌”, and then push the switch down towards “🔌”. See page

6-2 for starting instructions prior to starting the engine.

Set this switch to “🔌” to stop the engine in case of an emergency, such as when the vehicle overturns.

EAU91670

## Hazard switch “⚠️”

Use this switch to turn on the hazard lights (simultaneous flashing of all turn signal lights). The hazard lights are used in case of an emergency or to warn other drivers when your vehicle is stopped where it might be a traffic hazard.

The hazard lights can be turned on or off only when the key is in the “ON” position. You can turn the main switch to the “OFF” or “LOCK” position, and the hazard lights will continue to flash. To turn off the hazard lights, turn the main switch to the “ON” position and operate the hazard switch again.

ECA10062

## NOTICE

**Do not use the hazard lights for an extended length of time with the engine not running, otherwise the battery may discharge.**

EAU94151

## Cruise control/YVSL switches

See page 3-6 for an explanation of the cruise control system.

See page 3-8 for an explanation of the YVSL.

EAU93623

## “MODE” and select switches

Use the “MODE” switch, the MODE up “^” switch and the MODE down “v” switch to change YRC modes or edit the PWR, TCS, and SCS settings from the main screen.

**MODE up “^”** - push this switch to change the selected YRC setting upward.

**“MODE”** - push this switch to scroll left to right among the MODE, PWR, TCS, and SCS.

**MODE down “v”** - push this switch to change the selected YRC setting downward.

## TIP

- The traction control system can only be turned off from the main screen. Select TCS with the “MODE” switch, then push and hold the MODE up “^” switch un-

# Instrument and control functions

til TCS OFF is displayed. To turn the traction control system back on, use the MODE down “∨” switch.

- When the traction control system has been turned off, the SCS and LIF systems are also turned off for all YRC modes.
- See “YRC Setting” on page 4-18 for more information on how to customize YRC modes and adjust YRC item setting levels.

EAU66100

## Wheel switch “MENU”

When the main screen is set to STREET MODE, use the wheel switch to scroll and reset the information display items.

When the main screen is set to TRACK MODE, use the wheel switch to scroll and reset the information display items and to activate the lap timer.

When the display has been changed to the MENU screen, use the wheel switch to navigate the setting modules and make setting changes.

Operate the wheel switch as follows.

**Rotate up** - rotate the wheel upward to

scroll up/left or increase a setting value.

**Rotate down** - rotate the wheel downward to scroll down/right or decrease a setting value.

**Short push** - briefly press the switch inward to make and confirm selections.

**Long push** - press the switch inward for one second to reset an information display item or to access and exit the MENU screen.









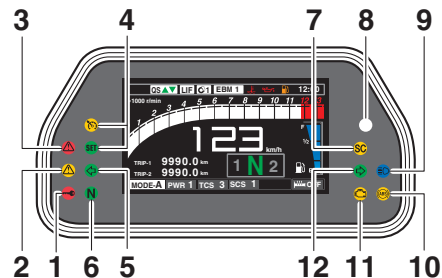



## TIP

- See page 4-9 for more information on the main screen and its functions.
- See page 4-18 for more information on the MENU screen and how to make setting changes.

EAU4939R

## Indicator lights and warning lights



1. Immobilizer system indicator light “”
2. Auxiliary system warning light “”
3. Oil pressure and Coolant temperature warning light “”
4. Cruise control indicator lights “” / “”
5. Left turn signal indicator light “”
6. Neutral indicator light “”
7. Stability control indicator light “”
8. Shift indicator light “”
9. High beam indicator light “”
10. ABS warning light “”
11. Malfunction indicator light “”
12. Right turn signal indicator light “”



EAU88280

## Turn signal indicator lights “” and “”

Each indicator light will flash when its corresponding turn signal lights are flashing.

EAU88300

## Neutral indicator light “”

This indicator light comes on when the transmission is in the neutral position.

EAU88310

## High beam indicator light “”

This indicator light comes on when the high beam of the headlight is switched on.

EAU91650

## Cruise control indicator lights “”/ “”

These indicator lights come on when the cruise control system is activated. (See page 3-6.)

### TIP

When the vehicle is turned on, these lights should come on for a few seconds and then go off. Otherwise, have a Yamaha dealer check the vehicle.

EAU88331

## Malfunction indicator light (MIL) “”

This light comes on or flashes if a problem is detected in the engine or other vehicle control system. If this occurs, have a Yamaha dealer check the on-board diagnostic system. The electrical circuit of the warning light can be checked by turning the vehicle power on. The light should come on for a few seconds, and then go off. If the light does not come on initially when the vehicle power is turned on, or if the light remains on, have a Yamaha dealer check the vehicle.

ECA26820

### NOTICE

**If the MIL starts flashing, reduce engine speed to prevent exhaust system damage.**

### TIP

The engine is sensitively monitored by the on-board diagnostic system to detect deterioration or malfunction of the emission control system. Therefore the MIL may come on or flash due to vehicle modifications, lack of maintenance,

or excessive/improper use of the motorcycle. To prevent this, observe these precautions.

- Do not attempt to modify the software of the engine control unit.
- Do not add any electrical accessories that interfere with engine control.
- Do not use aftermarket accessories or parts such as suspension, spark plugs, injectors, exhaust system, etc.
- Do not change the drivetrain specifications (chain, sprockets, wheels, tires, etc.).
- Do not remove or alter the O2 sensor, air induction system, or exhaust parts (catalysts or EXUP, etc.).
- Maintain the drive chain properly.
- Maintain correct tire pressure.
- Maintain proper brake pedal height to prevent rear brake from dragging.
- Do not operate the vehicle in an extreme manner. For example, repeated or excessive opening and closing of the throttle, racing, burn-outs, wheelies, extended

# Instrument and control functions

half-clutch use, etc.

## ABS warning light “”

EAU91500

In normal operation, the ABS warning light comes on when the vehicle is turned on, and goes off after traveling at a speed of 5 km/h (3 mi/h) or higher.

### TIP

If the warning light does not work as described above, or if the warning light comes on while riding, the ABS may not work correctly. Have a Yamaha dealer check the vehicle as soon as possible.

EWA21120

## WARNING

If the ABS warning light does not turn off after reaching 5 km/h (3 mi/h), or if the warning light comes on while riding:

- Use extra caution to avoid possible wheel lock during emergency braking.
- Have a Yamaha dealer check the vehicle as soon as possible.

## Shift indicator light “”

EAU67434

This indicator light comes on when it is time to shift to the next higher gear. The engine speeds at which it comes on or goes off can be adjusted. (See page 4-23.)

### TIP

When the vehicle is turned on, this light should come on for a few seconds and then go off. If the light does not come on, or if the light remains on, have a Yamaha dealer check the vehicle.

EAU88350

## Immobilizer system indicator light

“”

When the main switch is turned off and 30 seconds have passed, the indicator light will flash steadily to indicate the immobilizer system is enabled. After 24 hours have passed, the indicator light will stop flashing, however the immobilizer system is still enabled.

### TIP

When the vehicle is turned on, this light should come on for a few seconds and then go off. If the light does not come

on, or if the light remains on, have a Yamaha dealer check the vehicle.

## Transponder interference

If the immobilizer system indicator light flashes in the pattern, slowly 5 times then quickly 2 times, this could be caused by transponder interference. If this occurs, try the following.

1. Make sure there are no other immobilizer keys close to the main switch.
2. Use the code re-registering key to start the engine.
3. If the engine starts, turn it off, and try starting the engine with the standard keys.
4. If one or both of the standard keys do not start the engine, take the vehicle and all 3 keys to a Yamaha dealer to have the standard keys re-registered.

EAU88391

## Stability control indicator light “”

This indicator light comes on when the traction control system, SCS, or LIF systems have engaged. It will also come on if the traction control system is

set to “OFF” or if the traction control system becomes disabled while riding.

## TIP

When the vehicle is turned on, this light should come on for a few seconds and then go off. If the light does not come on, or if the light remains on, have a Yamaha dealer check the vehicle.

EAU88362

## Oil pressure and Coolant temperature warning light “”

This warning light comes on if the engine oil pressure is low or if the coolant temperature is high. If this occurs, stop the engine immediately.

## TIP

- When the vehicle is first turned on, this light should come on until the engine is started.
- If a malfunction is detected, this light will come on and the oil pressure icon will flash.

ECA22441

## NOTICE

**If the oil pressure and coolant warning light does not go off after start-**

**ing the engine or if it comes on while the engine is running, stop the vehicle and engine immediately.**

- **If the engine is overheating, the coolant temperature warning icon will come on. Let the engine cool. Check the coolant level (see page 7-34).**
- **If the engine oil pressure is low, the oil pressure warning icon will come on. Check the oil level (see page 7-10).**
- **If the warning light remains on after letting the engine cool and confirming the proper oil level, have a Yamaha dealer check the vehicle. Do not continue to operate the vehicle!**

EAU88370

## Auxiliary system warning light “”

This warning light comes on if a problem is detected in a non-engine-related system.

## TIP

When the vehicle is turned on, this light should come on for a few seconds and then go off. Otherwise, have a Yamaha

dealer check the vehicle.

# Instrument and control functions

EAU93636

## Display

The display has two different main screen display modes, STREET MODE and TRACK MODE. Most of the functions are viewable in either mode, but the layout differs slightly. The following items can be found on the display.

### STREET MODE

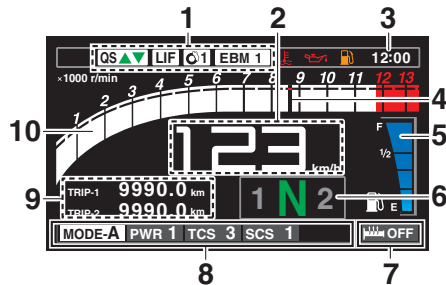

1. YRC items QS/LIF/BC/EBM
2. Speedometer
3. Clock
4. Revolution peak hold indicator
5. Fuel meter
6. Transmission gear display
7. Grip warmer indicator (if equipped)
8. YRC items MODE/PWR/TCS/SCS
9. Information display
10. Tachometer

### TRACK MODE

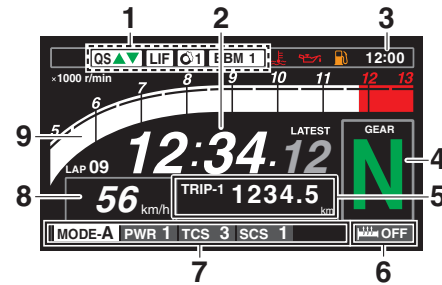

1. YRC items QS/LIF/BC/EBM
2. Lap timer
3. Clock
4. Transmission gear display
5. Information display
6. Grip warmer indicator (if equipped)
7. YRC items MODE/PWR/TCS/SCS
8. Speedometer
9. Tachometer

EWA18210

## **WARNING**

**Stop the vehicle before making any setting changes. Changing settings while riding can distract the operator and increase the risk of an accident.**

# Instrument and control functions

## TIP

- This model uses a thin-film-transistor liquid-crystal display (TFT LCD) for good contrast and readability in various lighting conditions. However, due to the nature of this technology, it is normal for a small number of pixels to be inactive.
- The display units can be switched between kilometers/miles and Celsius/Fahrenheit. (See page 4-22.)

## Speedometer

The speedometer shows the vehicle's traveling speed.

## Tachometer

The tachometer shows the engine speed, as measured by the rotational velocity of the crankshaft, in revolutions per minute (r/min).

## TIP

- In TRACK MODE, the tachometer starts at 5000 r/min.
- In STREET MODE, the tachometer can be color-adjusted and has

a revolution peak hold indicator which can be turned on or off.

ECA10032

## NOTICE

**Do not operate the engine in the tachometer red zone.**

**Red zone: 11800 r/min and above**

## Fuel meter

The fuel meter indicates the amount of fuel in the fuel tank. The display segments of the fuel meter disappear from "F" (full) towards "E" (empty) as the fuel level decreases.

When the last segment starts flashing, or the fuel level warning icon comes on, refuel as soon as possible.

## TIP

- If all the fuel meter display segments flash repeatedly, have a Yamaha dealer check the related circuits.
- When the Yamaha variable speed limiter (YVSL) system is operating in STREET MODE, the fuel meter is replaced by the YVSL display. (See page 3-8.)

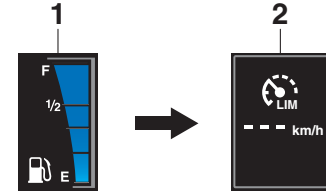

1. Fuel meter
2. YVSL display

## Clock

The clock uses a 12-hour time system.

## Transmission gear display

This shows which gear the transmission is in. This model has 6 gears and a neutral position. The neutral position is indicated by the neutral indicator light "N" and by the transmission gear display "N".

## TIP

When the Yamaha variable speed limiter (YVSL) system is operating in TRACK MODE, the transmission gear display is replaced by the YVSL display.

# Instrument and control functions

play. (See page 3-8.)







1. Transmission gear display
2. YVSL display

## Revolution peak hold indicator

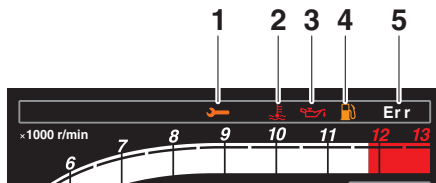
This small bar momentarily appears within the tachometer to mark the most recent peak engine speed.

## Warning icons



1. Auxiliary system warning “”
2. Coolant temperature warning “”
3. Oil pressure warning “”
4. Fuel level warning “”
5. Error mode warning “Err”

When an error is detected, the following error-related warning icons will then be viewable.

## Auxiliary system warning “”

This icon appears if a problem is detected in a non-engine-related system.

## Coolant temperature warning “”

This icon appears when the coolant temperature is high. Stop the vehicle and turn off the engine. Allow the en-

gine to cool.

ECA10022

## NOTICE

**Do not continue to operate the engine if it is overheating.**

## Oil pressure warning “”

This icon appears when the engine oil pressure is low. When the vehicle is first turned on, engine oil pressure has yet to build, so this icon will come on and stay on until the engine has been started.

## TIP

If a malfunction is detected, the oil pressure warning icon will flash repeatedly.

ECA26410

## NOTICE

**Do not continue to operate the engine if the oil pressure is low.**

## Fuel level warning “”

This icon comes on when approximately 4.0 L (1.06 US gal, 0.88 Imp.gal) of fuel remains in the tank.

# Instrument and control functions

## Error mode warning “Err”

When an internal error occurs (e.g., communication with a system controller has been cut off), the error mode warning will appear as follows.

“Err” and “” indicates an ECU error.

“Err” only indicates an ABS ECU error.

## TIP

Depending on the nature of the error, the display may not function properly and YRC settings may be impossible to change. Additionally, ABS may not function properly. Use extra care when braking and have a Yamaha dealer check the vehicle immediately.

## Information display

The information display items are:

A.TEMP: air temperature

C.TEMP: coolant temperature

TRIP-1: tripmeter 1

TRIP-2: tripmeter 2

F-TRIP: fuel reserve tripmeter

ODO: odometer

“”: cruise control speed setting

FUEL AVG: average fuel consumption

CRNT FUEL: current fuel consumption

FUEL CON: the amount of fuel con-

sumed

## TIP

TRIP-1, TRIP-2, F-TRIP, FUEL CON, and FUEL AVG items can be individually reset.

The display items are grouped into 4 customizable pairs (DISPLAY 1-4). In TRACK MODE only a single item can be displayed at a time. See “Display Setting” on page 4-25

Rotating the wheel switch above cycles the DISPLAY groups in order:

STREET MODE: → DISPLAY-1 → DISPLAY-2 → DISPLAY-3 → DISPLAY-4 → Grip warmer function →

TRACK MODE: → FASTEST → AVERAGE → Grip warmer function → DISPLAY-1 → DISPLAY-2 → DISPLAY-3 → DISPLAY-4 →

## TIP

The grip warmer function will only be displayed if equipped on the vehicle. See “Grip warmer” on page 4-15

Air temperature:

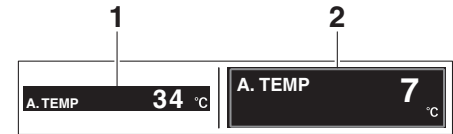

1. Display in STREET MODE
2. Display in TRACK MODE

The air temperature is displayed from  $-9^{\circ}\text{C}$  ( $16^{\circ}\text{F}$ ) to  $50^{\circ}\text{C}$  ( $122^{\circ}\text{F}$ ) in  $1^{\circ}\text{C}$  ( $1^{\circ}\text{F}$ ) increments. The temperature displayed may vary from the actual ambient temperature.

## TIP

- “--” will be displayed if the detected temperature is lower.
- “--” will be displayed if the detected temperature is higher.

# Instrument and control functions

## Coolant temperature:

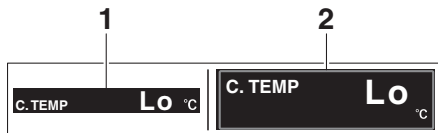

1. Display in STREET MODE
2. Display in TRACK MODE

The coolant temperature is displayed from 41 °C (106 °F) to 124 °C (255 °F) in 1 °C (1 °F) increments.

### TIP

- If the vehicle coolant temperature is below 41 °C (106 °F) the coolant temperature display will read “Lo”
- If the vehicle coolant temperature is above 124 °C (255 °F) the coolant temperature display will read “Hi”

## Tripmeters:

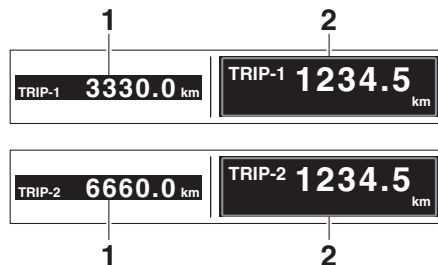

1. Display in STREET MODE
2. Display in TRACK MODE

TRIP1 and TRIP2 show the distance traveled since they were last set to zero.

### TIP

TRIP-1 and TRIP-2 will reset to 0 and begin counting again after 9999.9 has been reached.

## Fuel reserve tripmeter:

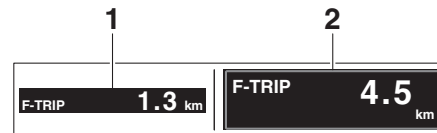

1. Display in STREET MODE
2. Display in TRACK MODE

When the fuel tank reserve level has been reached, F-TRIP appears automatically and begins recording distance traveled from that point. After refueling and traveling some distance, F-TRIP will automatically disappear.

### TIP

The MENU cannot be accessed while F-TRIP is displayed. To access the MENU while F-TRIP is active, first switch the information display to another item using the wheel switch.



# Instrument and control functions

## Odometer:

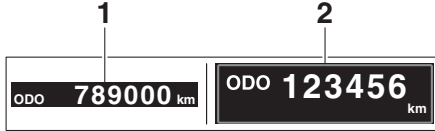

1. Display in STREET MODE
2. Display in TRACK MODE

The odometer shows the total distance traveled by the vehicle.

**TIP** \_\_\_\_\_  
ODO will lock at 999999 and cannot be reset.

## Cruise control speed setting:

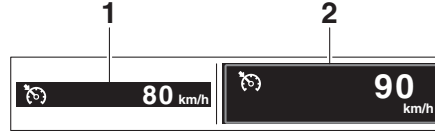

1. Display in STREET MODE
2. Display in TRACK MODE

Displays the selected speed setting for the cruise control system. To adjust this speed setting, see page 3-6 for an explanation of the cruise control system.

## Average fuel consumption:

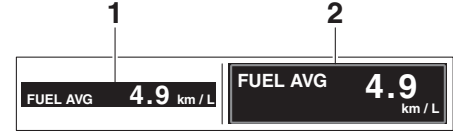

1. Display in STREET MODE
2. Display in TRACK MODE

The average fuel consumption display can be set to “km/L” or “L/100km”. See page 4-22.

**TIP** \_\_\_\_\_  
After resetting the average fuel consumption display, “--.-” will be shown until the vehicle has traveled 1 km.

# Instrument and control functions

## Current fuel consumption:

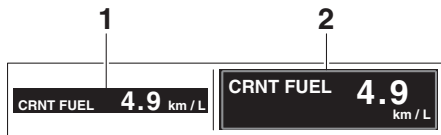

1. Display in STREET MODE
2. Display in TRACK MODE

The current fuel consumption display can be set to “km/L” or “L/100km”. See page 4-22.

### **TIP**

If traveling at speeds under 10 km/h, “--.-” will be displayed.

## Fuel consumption trip meter:

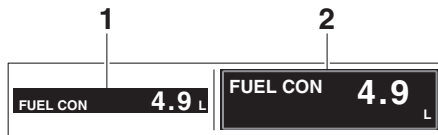

1. Display in STREET MODE
2. Display in TRACK MODE

Displays how much fuel has been consumed since the trip meter was last reset.

### **TIP**

The current fuel consumption function should be used for general reference only. Do not use this figure to estimate the distance that can be traveled on the current tank of fuel.

## To reset information display items

1. Use the wheel switch to scroll through the display items until the item you want to reset appears.

2. STREET MODE: Short push the wheel switch and the item group will flash for 5 seconds. If both items in the group are resettable, the top item will flash first. Scroll down to select the bottom item. TRACK MODE: Short push the wheel switch and the information display will flash for 5 seconds.
3. While the item is flashing, long push the wheel switch and the item will reset.

## **Grip warmer indicator (if equipped)**

The grip warmers can be used when the engine is running. There are 3 customizable temperature presets that can be customized between 10 different temperature levels (See “Grip Warmer Setting”4-27).

The indicator displays the current temperature setting as “OFF” or segments (LO/MIDDLE/HIGH).

## To activate the grip warmer

1. Use the wheel switch to highlight the grip warmer display with the cursor.
2. Short push the wheel switch and

# Instrument and control functions

- the indicator will start flashing.
3. Rotate the wheel switch to select the temperature preset.
  4. Short push the wheel switch to confirm the selection and the grip warmer indicator will stop flashing.

ECA17932

## NOTICE

- **Be sure to wear gloves when using the grip warmers.**
- **Do not use the grip warmers in warm weather.**
- **If the handlebar grip or throttle grip becomes worn or damaged, stop using the grip warmers and replace the grips.**

## YRC icons

The current YRC MODE preset and its related settings are shown on various icons at the top and bottom of the main screen.

Settings for YRC items PWR, TCS, SCS, QS “▲”, QS “▼”, LIF, EBM, and BC “⊙” are organized into presets (MODE-A, MODE-B, MODE-C, and MODE-D). The settings for each MODE preset can be customized via

the YRC setting menu. (See page 4-18.)

## TIP

- YRC settings shown on the bottom of the main screen (PWR, TCS, and SCS) can be adjusted independently from the main screen.
- YRC settings shown on the top of the main screen (QS “▲”, QS “▼”, LIF, BC “⊙” and EBM) cannot be adjusted independently from the main screen. To change these values, use the YRC Setting MENU. (See page 4-18.)
- The LIF icon only show as active/inactive but have different setting levels that can be adjusted in the YRC Setting MENU. (See page 4-18.)
- The BC “⊙” and EBM icons show both active/inactive as well as the current setting level.

The YRC modes come preset from the factory for different riding conditions. When using the factory presets, the suggested YRC modes are as follows.  
MODE-A: suitable for track riding  
MODE-B: softer track-riding setting  
MODE-C: suitable for road use

MODE-D: street use or rainy weather

## To change YRC modes or make setting changes

1. Use the “MODE” switch to scroll left to right and highlight the item you want to adjust.
2. Use the MODE up “^” or MODE down “v” switches to change the selected item value

## TIP

- When the malfunction indicator light “

4

# Instrument and control functions

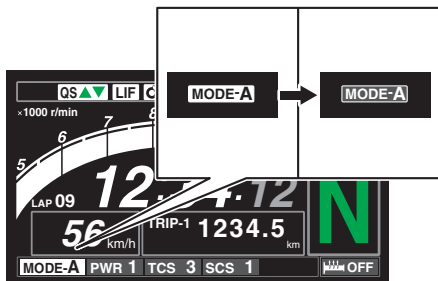

## Turning off the traction control system

To turn off the traction control system, select TCS with the “MODE” switch, then press and hold the MODE up “^” switch until TCS OFF is displayed.

To turn the traction control system back on, select TCS OFF and then press the MODE down “v” switch (the traction control system will return to its previous setting).

### TIP

Turning off the traction control system will turn off the SCS and LIF systems for all YRC mode presets.

## Lap timer

This stopwatch function measures and

records up to forty laps. On the main screen, the lap timer shows the current lap time and lap number (indicated by the LAP mark). Use the Dimmer/Pass switch “≡/≡/PASS” to mark lap times. When a lap is completed, the lap timer will show the latest lap time (marked by the LATEST indicator) for five seconds.

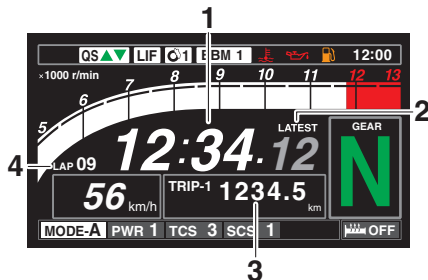

1. Lap time
2. Latest lap time indicator “LATEST”
3. Information display item
4. Lap number

## To use the lap timer

1. While in TRACK MODE, short push the wheel switch. The information display will flash for five seconds.

2. While the information display item is flashing, rotate the wheel switch upward. The lap timer will flash for five seconds.
3. While the lap timer is flashing, long push the wheel switch to activate the lap timer or stop the lap timer.
4. When the lap timer has been activated and the headlight is set on low beam, push the switch down towards “PASS” to flash the high beam and start the timer.

### TIP

- The engine must be running to use the lap timer.
- Set the information display to FASTEST or AVERAGE for additional lap time information.
- Accessing the MENU screen will automatically stop the lap timer.
- Whenever the lap timer is stopped, the current lap will not be recorded.
- The lap time record can be viewed and reset from the MENU screen.

## MENU screen

EAU93645

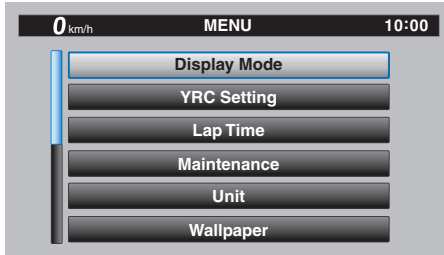

The MENU main screen contains the following setting modules.

Module	Description
Display Mode	Switch the display between STREET MODE and TRACK MODE
YRC Setting	Adjust YRC settings
Lap Time	View and reset lap times
Maintenance	View and reset maintenance interval tripmeters
Unit	Set fuel consumption and distance units
Wallpaper	Set display background colors
Shift Indicator	Turn the shift indicator on/off and adjust tachometer settings
Display Setting	Select the information display groupings

Brightness	Adjust screen brightness
Grip Warmer Setting	Adjust grip warmer presets (if equipped)
Clock	Adjust the clock
All Reset	Return all settings to factory defaults

### MENU access and operation

Access the MENU by pressing and holding the wheel switch (long push) while the vehicle is not in motion.

Rotate the wheel switch up or down to highlight modules/items or increase/decrease values.

Briefly press the wheel switch inward (short push) to select menu items and confirm setting values.

Press and hold the wheel switch (long push) until the screen returns to the main display to exit the MENU at any time.

### TIP

- Certain menu screens have an upward pointing triangle mark item. Select the triangle mark to save settings changes and exit the current screen.
- Should vehicle motion be detected, the screen will automatically

exit the MENU and return to the main display.

- To ensure that the desired settings changes are saved, be sure to exit each menu via the triangle mark (if displayed). Exiting the settings menu by pressing and holding (long push) the wheel switch may not save settings changes.

### “Display Mode”

There are two main screen display modes, STREET MODE and TRACK MODE.

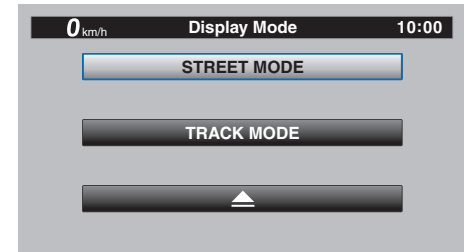

### “YRC Setting”

This module allows you to customize the four YRC mode presets (MODE-A, MODE-B, MODE-C, and MODE-D) by

# Instrument and control functions

adjusting the setting levels (or on/off status as applicable) of YRC items PWR, TCS, SCS, QS “▲”, QS “▼”, LIF, EBM, and BC.

## TIP

The traction control system has 5 setting levels.

4

## PWR

Select PWR-1 for the most aggressive throttle response, PWR-2 and PWR-3 for smoother throttle grip/engine response, and use PWR-4 for rainy days or whenever less engine power is desirable.

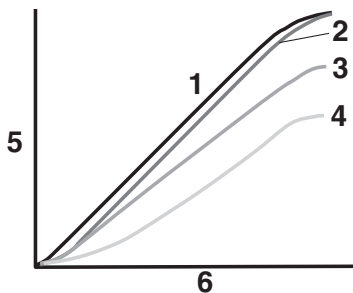

1. PWR 1
2. PWR 2
3. PWR 3
4. PWR 4
5. Throttle valve opening
6. Throttle grip operation

## Traction control system

This model uses a variable traction control system. For each setting level, the farther the vehicle is leaned over, the more traction control (system intervention) is applied. There are 5 setting levels available. Setting level 1 applies the least system intervention, while setting level 5 applies the most overall traction control.

## TIP

- The traction control system can only be turned off completely via the main screen using the “MODE” switch and MODE up “^” switch. See “Turning off the traction control system” on page 4-17.
- When the traction control system has been turned off; TCS, SCS and LIF will be set to OFF and cannot be adjusted. When the traction control system is turned on again, these related-traction control functions will return to their previous setting levels.

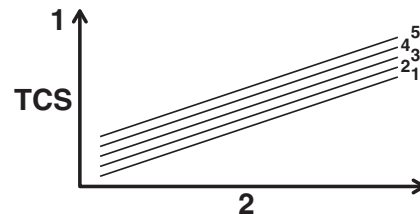

1. System intervention
2. Lean angle

# Instrument and control functions

## SCS

SCS can be set to OFF, 1, 2, and 3. OFF turns the slide control system off, setting level 1 provides the least system intervention, and setting level 3 provides the most system intervention.

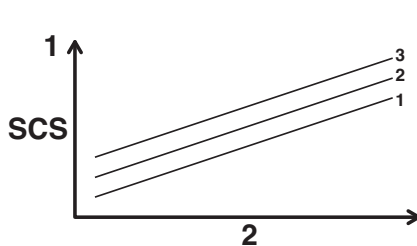

1. System intervention
2. Sideward slide

## Quick shifter

The quick shifter is divided into QS ▲ (upshift) and QS ▼ (downshift) sections. QS ▲ and QS ▼ are not linked and can be independently turned on or off.

OFF turns the respective upshift or downshift function off, and the clutch lever must then be used when shifting in that direction.

## LIF

LIF can be set to 1, 2, 3, or OFF. Setting level 3 most strongly reduces wheel lift, and setting level 1 provides the least system intervention. OFF turns LIF off.

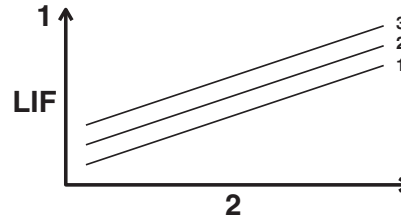

1. System intervention
2. Wheel lift

## EBM

This system has two settings. Level 1 provides the least system intervention, and therefore the strongest engine braking. Level 2 provides the most system intervention, and therefore the least engine braking.

## BC

Select BC1 when only standard ABS is desired. Select BC2 to have the brake

control system also regulate brake pressure while cornering to suppress lateral wheel slip.

## TIP

For skilled riders and when riding at the track, due to varying conditions, BC2 brake system engagement may come on sooner than expected relative to your desired cornering speed or intended cornering line.

## To customize a YRC mode or adjust a YRC item

1. While the “YRC Setting” screen is displayed, and the YRC mode box “YRC” is highlighted. Short push the wheel switch to enter the box and then select the YRC mode preset (A, B, C, or D) that you want to adjust.

# Instrument and control functions

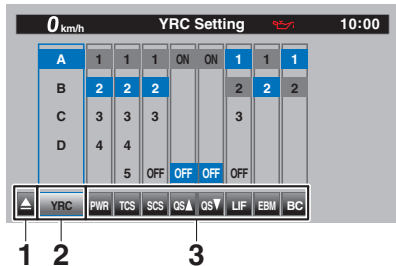

1. Triangle mark
  2. YRC mode box
  3. YRC item
2. Select the YRC item PWR, TCS, SCS, QS ▲, QS ▼, LIF, EBM, or BC that you want to adjust.

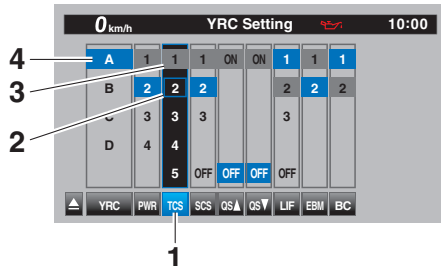

1. YRC item
2. Current level setting
3. Factory preset level
4. YRC mode

## TIP

- When a YRC item is selected, the current setting level is highlighted blue and the factory preset level is highlighted grey.
- Factory preset levels vary depending on the selected YRC mode preset.

3. When finished, select the triangle mark on the far left to return to the MENU screen.

## “Lap Time”

This module allows you to view and de-

lete the lap time record. The fastest lap and the average lap time stored in the lap time record are displayed at the top of the screen. Use the wheel switch to scroll and see all lap times. The top three fastest laps will be highlighted in silver. Up to 40 laps can be stored in memory. If more than 40 laps are recorded, the oldest laps (starting from lap 1) will be overwritten.

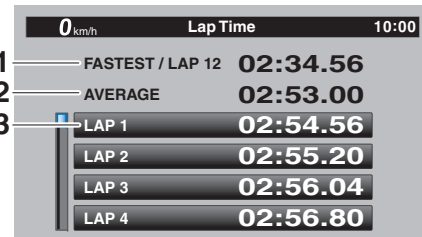

1. Fastest lap
2. Average lap time
3. Lap time record

This module has two options. “Display” allows you to view the lap time record. “Reset” allows you to delete the lap time record data.



# Instrument and control functions

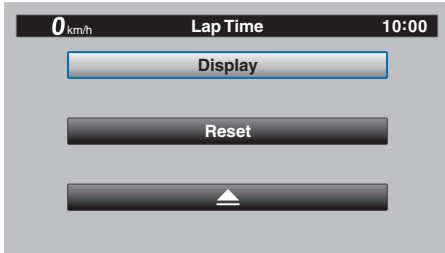

## “Maintenance”

This module allows you to record distance traveled between engine oil changes (use the OIL item), and for two other items of your choice (use INTERVAL 1 and INTERVAL 2).

### To reset a maintenance item

1. Select the item you want to reset.

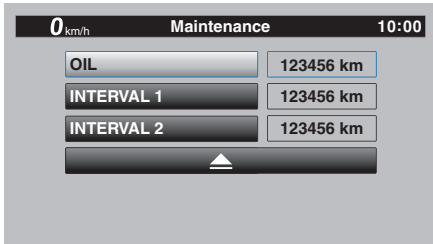

2. Long push the wheel switch to reset the item.

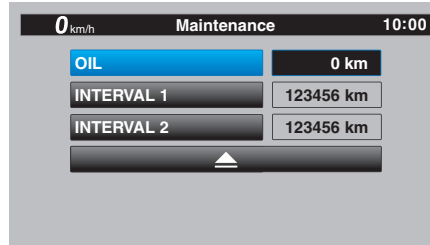

**TIP** \_\_\_\_\_  
Maintenance item names cannot be changed.  
\_\_\_\_\_

## “Unit”

This module allows you to switch the display between kilometers and miles. When using kilometers, the fuel consumption units can be changed between km/L or L/100km. When using miles, only MPG will be available.

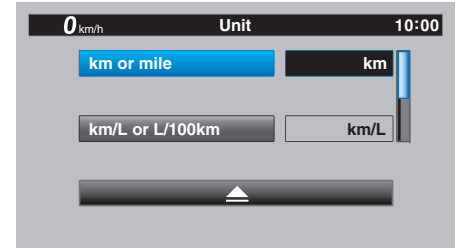

## “Wallpaper”

This module allows you to individually set the STREET MODE and TRACK MODE display background colors to black or white for both day and night settings. A photo sensor equipped in the instrument panel detects lighting conditions and will automatically change the display between its day and night settings. The photo sensor also controls a subtle automatic brightness adjustment function within both day and night modes to suit ambient light conditions.

# Instrument and control functions

4



1. Photo sensor

## “Shift indicator”

The shift indicator module contains the following sub-modules.

Module	Description
Shift IND Setting	Set the shift indicator pattern to “ON”, “Flash”, or “OFF” and adjust at what r/min the indicator will come on and go off.
Shift IND Brightness	Adjust the brightness of the shift indicator.
Tach IND Setting	Set the tachometer color display to “ON” or “OFF” and adjust at what r/min the tachometer will be green and orange.
Peak Rev IND Setting	Set the tachometer peak rev indicator to “ON” or “OFF”.

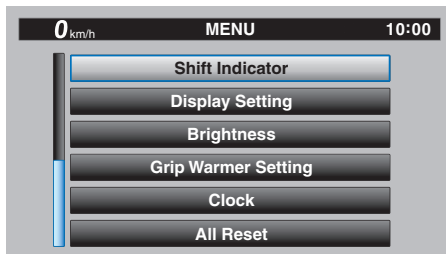

## To make setting changes

1. Select “Shift IND Setting”.

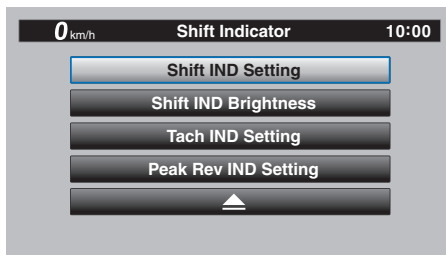

2. Select “IND Mode”.

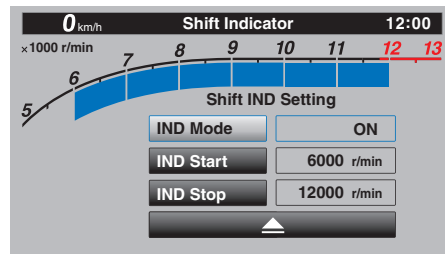

3. Select “ON” to have the indicator light steadily, “OFF” to turn the indicator off, or “Flash” to have the shift indicator flash when the indicator start threshold has been reached.

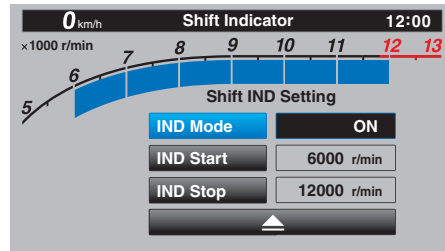

4. Select “IND Start”.

# Instrument and control functions

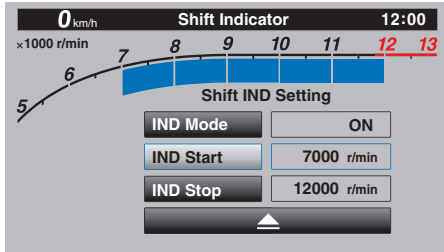

5. Rotate the wheel switch to adjust the r/min at which the shift timing indicator light will come on. “IND Start” operational range is 5000–12800 r/min.

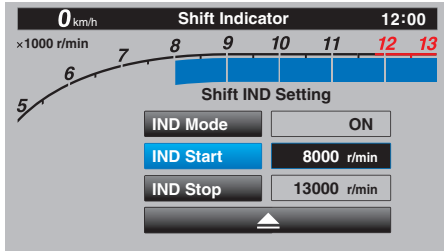

6. Select “IND Stop”, and then rotate the wheel switch to adjust the r/min at which the shift timing indicator will go off. “IND Stop” operational

range is 5500–13000 r/min.

## TIP

The blue area on the tachometer indicates the currently set operational range of the shift indicator light.

## “Shift IND Brightness”

The shift timing indicator light has six brightness levels. Short push the wheel switch to confirm the setting and exit.

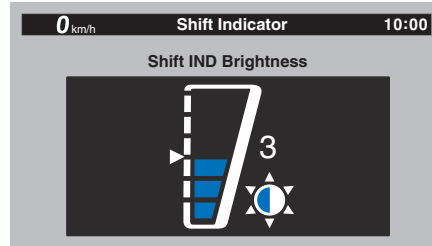

## “Tach IND Setting”

This module allows you to turn the tachometer color display on or off. When turned off, the tachometer will display all r/min levels below the red zone in black or white (depending on wallpaper settings). When turned on, the mid and

mid-to-high r/min zones can be set to come on in green and then orange colors.

1. Select “IND Mode”.

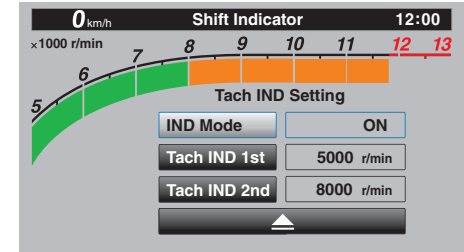

2. Select ON to turn the tachometer color display mode on (or select OFF to turn this function off).

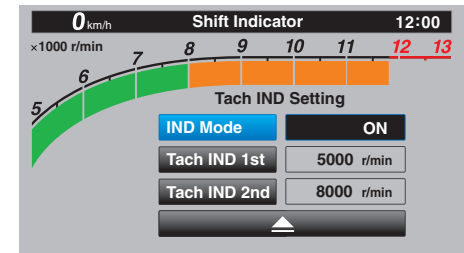

3. Select “Tach IND 1st” to set the green zone starting r/min.

# Instrument and control functions

4

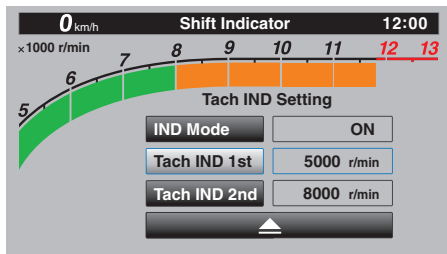

4. Set the starting r/min by rotating and then short pushing the wheel switch. All r/min above this value up to the “Tach IND 2nd” setting value (or the 11800 r/min red zone), will be displayed in green.

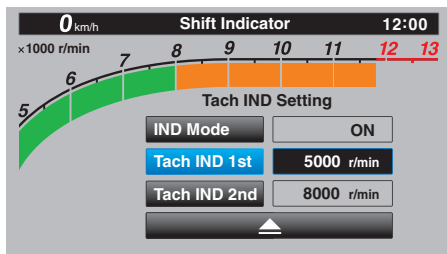

**TIP**  
Green bar start setting range: 5000–11800 r/min.

5. Select “Tach IND 2nd”.

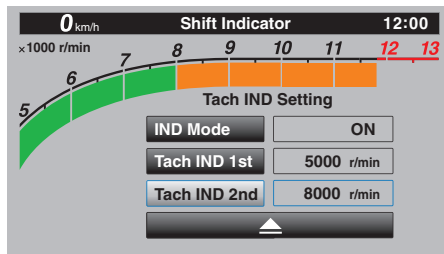

6. Set the orange color starting r/min by rotating and then short pushing the wheel switch. All r/min above this figure until the 11800 r/min red zone, will be displayed in orange.

**TIP**  
Orange bar start setting range: 5000–11800 r/min.

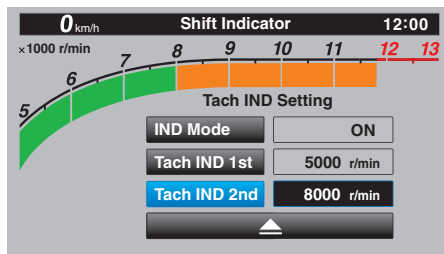

## “Peak Rev IND Setting”

This module allows you to turn the revolution peak hold indicator on or off.

## “Display Setting”

This module allows you to set how the information display items (like TRIP-1, ODO, C. TEMP, etc.) are grouped on the main screen. There are four display groups.

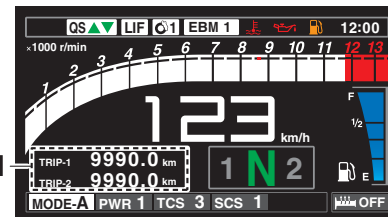

1. Information display item (STREET MODE)

# Instrument and control functions

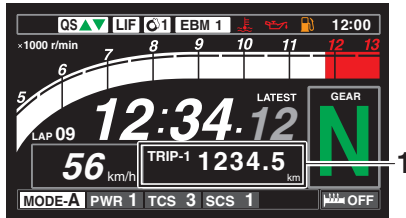

1. Information display item (TRACK MODE)

## To set the display groups

1. “DISPLAY-1”, “DISPLAY-2”, “DISPLAY-3” and “DISPLAY-4” are displayed.

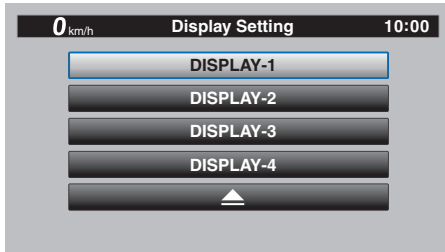

2. For example, let's select “DISPLAY-1”.
3. Select “STREET MODE 1-1”.

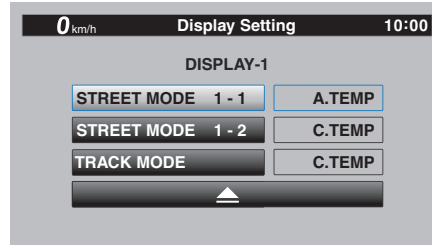

4. Select the desired information display item with the wheel switch.

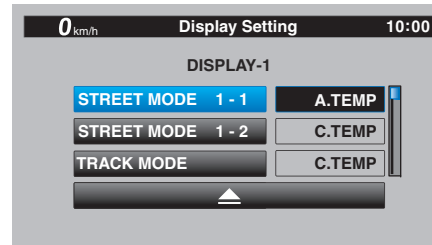

## TIP

The information display items which can be selected are:

- A.TEMP: air temperature
- C.TEMP: coolant temperature
- TRIP-1: tripmeter 1
- TRIP-2: tripmeter 2

ODO: odometer

SPEED: cruise control speed setting

FUEL AVG: average fuel consumption

CRNT FUEL: current fuel consumption

FUEL CON: the amount of fuel consumed

5. Select “STREET MODE 1-2” or “TRACK MODE” to set the remaining DISPLAY-1 group items.

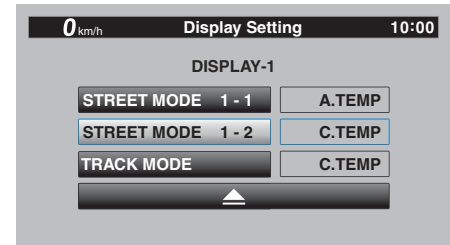

6. Select the triangle symbol to exit.  
To set the other display groups, repeat from step 3.

## “Brightness”

This module allows you to adjust the general brightness level of the display screen.

# Instrument and control functions

## “Grip Warmer Setting” (if equipped)

This module is for adjusting the temperature values for the grip warmer presets (LO/MIDDLE/HIGH). Each preset can be set from 1 (low heat) to 10 (high heat).

4

## “Clock”

This module allows you to set the clock.

## “All Reset”

This module resets everything, except the odometer and clock, to its factory preset or default setting.

Select YES to reset all items. After selecting YES, all items will be reset and the screen will automatically return to the MENU screen.

## Clutch lever

EAU12823

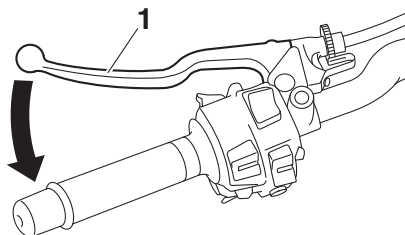

1. Clutch lever

To disengage the drivetrain from the engine, such as when shifting gears, pull the clutch lever toward to the handlebar. Release the lever to engage the clutch and transmit power to the rear wheel.

### **TIP**

The lever should be pulled rapidly and released slowly for smooth shifting. (See page 6-3.)

## Shift pedal

EAU83692

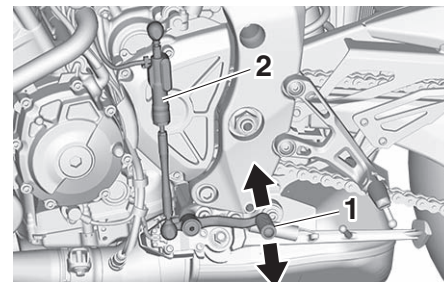

1. Shift pedal
2. Shift sensor

The shift pedal is located on the left side of the motorcycle. To shift the transmission to a higher gear, move the shift pedal up. To shift the transmission to a lower gear, move the shift pedal down. (See page 6-3.)

The shift rod is equipped with a shift sensor, which is part of the quick shifter. The shift sensor reads up and down movement, as well as the strength of the input force when the shift pedal is moved.

### **TIP**

To prevent unintended shifts, the quick

shifter is programmed to ignore unclear input signals. Therefore, be sure to shift using quick and sufficiently forceful inputs.

## Brake lever

EAU93080

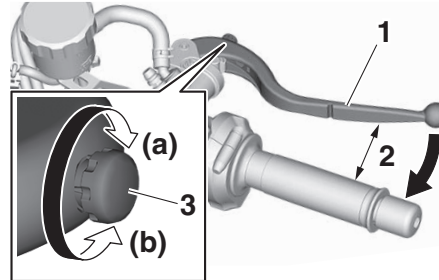

1. Brake lever
2. Distance
3. Brake lever position adjusting knob

The brake lever is located on the right side of the handlebar. To apply the front brake, pull the lever toward the throttle grip.

The brake lever is equipped with a brake lever position adjusting knob. To adjust the distance between the brake lever and the throttle grip, turn the adjusting knob while holding the lever pushed away from the throttle grip.

Turn the adjusting knob in direction (a) to increase the distance. Turn the adjusting knob in direction (b) to decrease the distance.

## Brake pedal

EAU12944

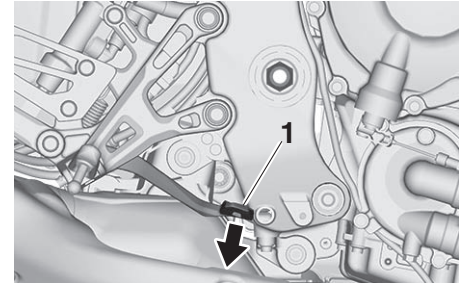

1. Brake pedal

The brake pedal is located on the right side of the motorcycle. To apply the rear brake, press down on the brake pedal.

# Instrument and control functions

EAU94200

## Brake control system (BC)

The brake control system regulates hydraulic brake pressure for the front and rear wheels independently when the brakes are applied and wheel lock is detected. This system has two settings which can be changed in the settings MENU. (See page 4-18.)

BC1 is standard ABS, which adjusts brake pressure based on vehicle speed and wheel speed data. BC1 is designed to engage and maximize braking when the vehicle is upright. BC2 uses additional data from the IMU to regulate applied brake power when cornering to suppress lateral wheel slip. Regarding ABS, operate the brakes as you would conventional brakes. When the brake control system engages, a pulsating sensation may be felt at the brake lever or brake pedal as the hydraulic unit rapidly applies and reduces brake pressure. In this situation, continue to apply the brake lever and brake pedal to allow the ABS to work—do not “pump the brakes” as this will reduce braking effectiveness.

EWA16051

### WARNING

**Always keep a sufficient distance from the vehicle ahead to match the riding speed even with ABS.**

- **The ABS performs best with long braking distances.**
- **On certain surfaces, such as rough or gravel roads, the braking distance may be longer with the ABS than without.**

The ABS hydraulic unit is monitored by the ABS ECU, which will revert the system to conventional braking if a malfunction occurs.

EWA20891

### WARNING

**The brake control system is not a substitute for the use of proper riding and braking techniques. The brake control system cannot prevent all loss of traction due to over-braking from excessive speed, or lateral wheel slip when braking on slippery surfaces.**

### TIP

The ABS performs a self-diagnostic

test when the vehicle is started and reaches a speed of 5 km/h (3 mi/h). During this test, a clicking noise may be audible from the hydraulic control unit, and a vibration may be felt at the brake lever or pedal, but this is normal.

ECA20100

### NOTICE

**Be careful not to damage the wheel sensor or wheel sensor rotor; otherwise, improper performance of the ABS will result.**

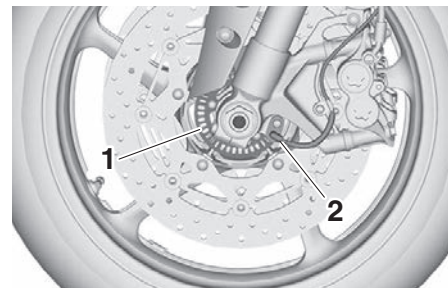

1. Front wheel sensor rotor
2. Front wheel sensor



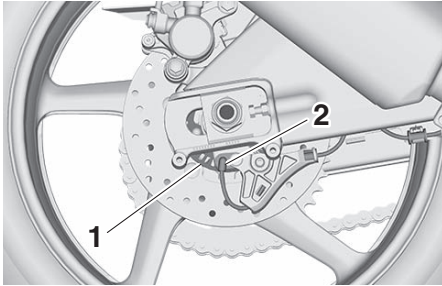

1. Rear wheel sensor rotor
2. Rear wheel sensor

## Fuel tank cap

EAU13077

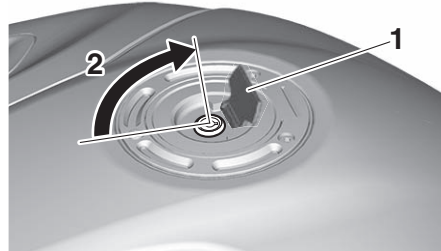

1. Fuel tank cap lock cover
2. Unlock.

### To open the fuel tank cap

Open the fuel tank cap lock cover, insert the key, and then turn it 1/4 turn clockwise. The lock will be released and the fuel tank cap can be opened.

### To close the fuel tank cap

With the key still inserted, push down the fuel tank cap. Turn the key 1/4 turn counterclockwise, remove it, and then close the lock cover.

### TIP

The fuel tank cap cannot be closed unless the key is in the lock. In addition,

the key cannot be removed if the cap is not properly closed and locked.

EWA11092

### WARNING

Make sure that the fuel tank cap is properly closed after filling fuel. Leaking fuel is a fire hazard.

# Instrument and control functions

## Fuel

Make sure there is sufficient gasoline in the tank.

EAU13222

EWA10882

### **WARNING**

Gasoline and gasoline vapors are extremely flammable. To avoid fires and explosions and to reduce the risk of injury when refueling, follow these instructions.

1. Before refueling, turn off the engine and be sure that no one is sitting on the vehicle. Never refuel while smoking, or while in the vicinity of sparks, open flames, or other sources of ignition such as the pilot lights of water heaters and clothes dryers.
2. Do not overfill the fuel tank. When refueling, be sure to insert the pump nozzle into the fuel tank filler tube. Stop filling when the fuel reaches the bottom of the filler tube. Because fuel expands when it heats up, heat from the engine or the sun can cause fuel to spill out of the fuel tank.

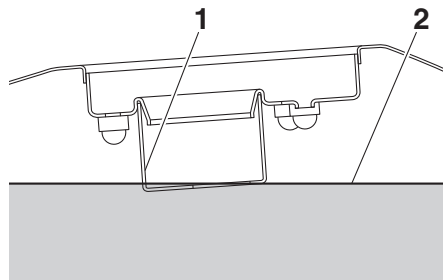

1. Fuel tank filler tube
2. Maximum fuel level
3. Wipe up any spilled fuel immediately. **NOTICE: Immediately wipe off spilled fuel with a clean, dry, soft cloth, since fuel may deteriorate painted surfaces or plastic parts.**<sup>[ECA10072]</sup>
4. Be sure to securely close the fuel tank cap.

EWA15152

### **WARNING**

Gasoline is poisonous and can cause injury or death. Handle gasoline with care. Never siphon gasoline by mouth. If you should swallow some gasoline or inhale a lot of gasoline vapor, or get some gasoline in

your eyes, see your doctor immediately. If gasoline spills on your skin, wash with soap and water. If gasoline spills on your clothing, change your clothes.

EAU86072

Your Yamaha engine was designed to use unleaded gasoline with a research octane number of 95 or higher. If engine knocking or pinging occurs, use a gasoline of a different brand or higher octane rating.

#### **Recommended fuel:**

Unleaded gasoline (E10 acceptable)

#### **Octane number (RON):**

95

#### **Fuel tank capacity:**

17 L (4.5 US gal, 3.7 Imp.gal)

#### **Fuel tank reserve:**

4.0 L (1.06 US gal, 0.88 Imp.gal)



or vehicle performance problems.

ECA11401

**NOTICE**

**Use only unleaded gasoline. The use of leaded gasoline will cause severe damage to internal engine parts, such as the valves and piston rings, as well as to the exhaust system.**

**TIP**

- This mark identifies the recommended fuel for this vehicle as specified by European regulation (EN228).
- Confirm the gasoline pump nozzle has the same fuel identification mark.

**Gasohol**

There are two types of gasohol: gasohol containing ethanol and that containing methanol. Gasohol containing ethanol can be used if the ethanol content does not exceed 10% (E10). Gasohol containing methanol is not recommended by Yamaha because it can cause damage to the fuel system

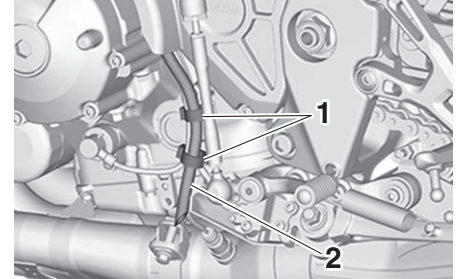
**Fuel tank overflow hose**

1. Clamp
2. Fuel tank overflow hose

The overflow hose drains excess gasoline and directs it safely away from the vehicle.

Before operating the vehicle:

- Check the fuel tank overflow hose connection.
- Check the fuel tank overflow hose for cracks or damage, and replace it if necessary.
- Make sure that the fuel tank overflow hose is not blocked, and clean it if necessary.
- Make sure that the fuel tank overflow hose is positioned as shown.

# Instrument and control functions

**TIP**  
See page 7-10 for canister information.

EAU13435

## Catalytic converter

The exhaust system contains catalytic converter(s) to reduce harmful exhaust emissions.

EWA10863

### **WARNING**

The exhaust system is hot after operation. To prevent a fire hazard or burns:

- Do not park the vehicle near possible fire hazards such as grass or other materials that easily burn.
- Park the vehicle in a place where pedestrians or children are not likely to touch the hot exhaust system.
- Make sure that the exhaust system has cooled down before doing any maintenance work.
- Do not allow the engine to idle more than a few minutes. Long idling can cause a build-up of heat.

EAU94110

## Seat

### To remove the seat

1. Open the seat lock cover, insert the key into the seat lock, and then turn the key counterclockwise.

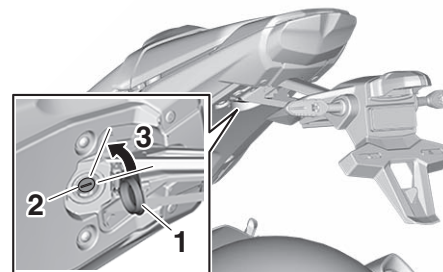

1. Seat lock cover
2. Seat lock
3. Unlock.

2. While holding the key in that position, slide the seat backward and then lift the rear of the seat up, and then pull the seat off.

### To install the seat

1. Insert the projections into the seat holders as shown.

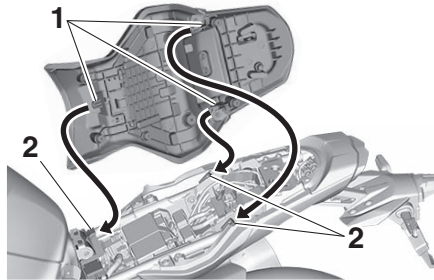

1. Projection
2. Seat holder

2. Push the rear of the seat down to lock it in place.
3. Remove the key.

## TIP

Make sure that the seat is properly secured before riding.

ECA27380

## NOTICE

The IMU is located under the seat. It is not user serviceable and very sensitive, so we advise against handling the IMU directly.

- Do not remove, modify, or place any foreign materials in or around the IMU.

- Do not subject the IMU to strong shocks.

## Adjusting the front fork

This model is equipped with adjustable suspension. The spring preload, rebound damping force, and compression damping force of each leg can be adjusted.

EWA10181

## ⚠ WARNING

Always adjust both fork legs equally, otherwise poor handling and loss of stability may result.

ECA22472

## NOTICE

- Use extra care to avoid scratching the anodized finish when making suspension adjustments.
- To avoid damaging the suspension's internal mechanisms, do not attempt to turn beyond the maximum or minimum settings.

## Spring preload

Turn the adjusting nut in direction (a) to increase the spring preload.

Turn the adjusting nut in direction (b) to decrease the spring preload.

# Instrument and control functions

To set the spring preload, turn the adjuster in direction (b) until it stops, and then count the turns in direction (a).

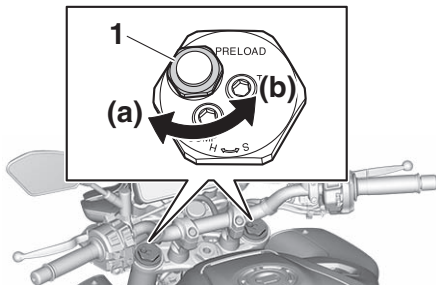

1. Spring preload adjusting nut

## Spring preload setting:

Minimum (soft):

0 turn(s) in direction (a)

Standard:

9 turn(s) in direction (a)

Maximum (hard):

15 turn(s) in direction (a)

## TIP

When turning the spring preload adjuster in direction (a), it may turn beyond the stated specifications, however such adjustments are ineffective and may damage the suspension.

## Rebound damping force

Turn the adjusting bolt in direction (a) to increase the rebound damping force.

Turn the adjusting bolt in direction (b) to decrease the rebound damping force.

To set the rebound damping force, turn the adjuster in direction (a) until it stops, and then count the clicks in direction (b).

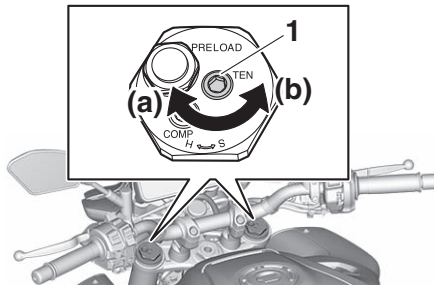

1. Rebound damping force adjusting bolt

## Rebound damping setting:

Minimum (soft):

14 click(s) in direction (b)

Standard:

6 click(s) in direction (b)

Maximum (hard):

1 click(s) in direction (b)

## TIP

- When turning the damping force adjuster in direction (a), the 0 click position and the 1 click position may be the same.
- When turning the damping force adjuster in direction (b), it may click beyond the stated specifications, however such adjustments are ineffective and may damage the suspension.

## Compression damping force

Turn the adjusting bolt in direction (a) to increase the compression damping force.

Turn the adjusting bolt in direction (b) to decrease the compression damping force.

To set the compression damping force, turn the adjuster in direction (a) until it stops, and then count the clicks in direction (b).

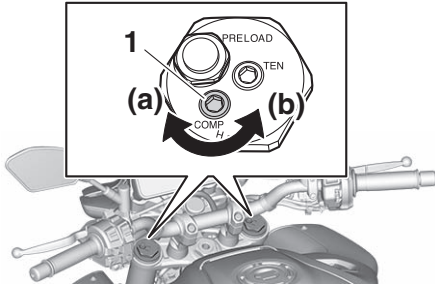

1. Compression damping force adjusting bolt

### Compression damping setting:

Minimum (soft):

23 click(s) in direction (b)

Standard:

17 click(s) in direction (b)

Maximum (hard):

1 click(s) in direction (b)

### TIP

- When turning the damping force adjuster in direction (a), the 0 click position and the 1 click position may be the same.
- When turning the damping force adjuster in direction (b), it may click beyond the stated specifications, however such adjustments are ineffective and may damage the

suspension.

## Adjusting the shock absorber assembly

This model is equipped with adjustable suspension. The spring preload, rebound damping force, fast compression damping force, and slow compression damping force can be adjusted.

ECA10102

### NOTICE

**To avoid damaging the mechanism, do not attempt to turn beyond the maximum or minimum settings.**

## Spring preload

1. Loosen the locknut.
2. Turn the adjusting ring in direction (a) to increase the spring preload. Turn the adjusting ring in direction (b) to decrease the spring preload. The spring preload setting is determined by measuring distance A. The longer distance A is, the higher the spring preload; the shorter distance A is, the lower the spring preload.
  - Use the special wrench includ-

# Instrument and control functions

ed in the tool kit to make the adjustment.

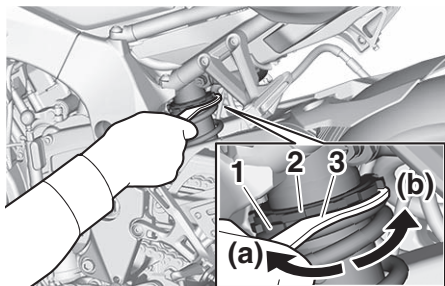

1. Spring preload adjusting ring
2. Locknut
3. Special wrench

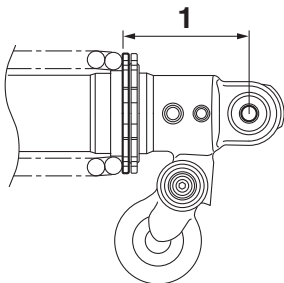

1. Distance A

## Spring preload:

Minimum (soft):

Distance A = 76.5 mm (3.01 in)

Standard:

Distance A = 80.5 mm (3.17 in)

Maximum (hard):

Distance A = 84.5 mm (3.33 in)

3. Tighten the locknut to the specified torque. **NOTICE: Always tighten the locknut against the adjusting ring, and then tighten the locknut to the specified torque.**<sup>[ECA22760]</sup>

## Tightening torque:

Locknut:

28 N·m (2.8 kgf·m, 21 lb·ft)

## Rebound damping force

Turn the adjusting screw in direction (a) to increase the rebound damping force. Turn the adjusting screw in direction (b) to decrease the rebound damping force.

To set the rebound damping force, turn the adjuster in direction (a) until it stops, and then count the clicks in direction (b).

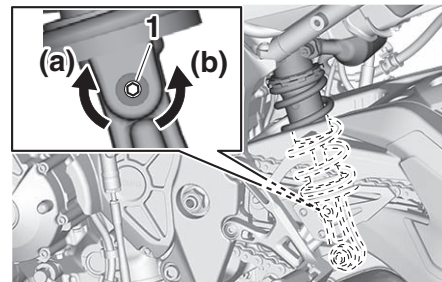

1. Rebound damping force adjusting screw

## Rebound damping setting:

Minimum (soft):

23 click(s) in direction (b)

Standard:

11 click(s) in direction (b)

Maximum (hard):

1 click(s) in direction (b)

## TIP

- When turning the damping force adjuster in direction (a), the 0 click position and the 1 click position may be the same.
- When turning the damping force adjuster in direction (b), it may click beyond the stated specifications, however such adjustments are ineffective and may damage the



suspension.

## Compression damping force

### Fast compression damping force

Turn the adjusting bolt in direction (a) to increase the compression damping force.

Turn the adjusting bolt in direction (b) to decrease the compression damping force.

To set the compression damping force, turn the adjuster in direction (a) until it stops, and then count the turns in direction (b).

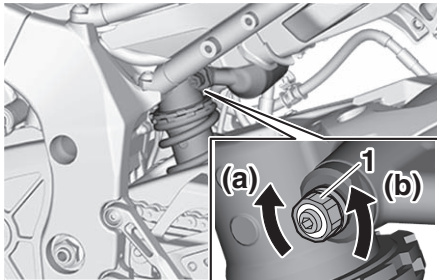

1. Fast compression damping force adjusting bolt

### **Fast compression damping setting**

Minimum (soft):  
5.5 turn(s) in direction (b)  
Standard:  
3 turn(s) in direction (b)  
Maximum (hard):  
0 turn(s) in direction (b)

### **TIP**

When turning the damping force adjuster in direction (b), it may turn beyond the stated specifications, however such adjustments are ineffective and may damage the suspension.

### Slow compression damping force

Turn the adjusting screw in direction (a) to increase the compression damping force.

Turn the adjusting screw in direction (b) to decrease the compression damping force.

To set the compression damping force, turn the adjuster in direction (a) until it stops, and then count the clicks in direction (b).

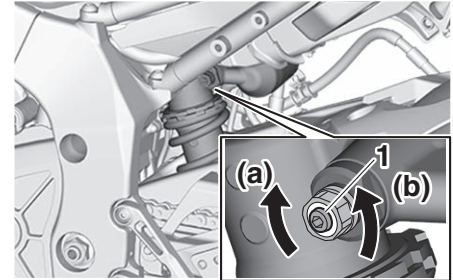

1. Slow compression damping force adjusting screw

### **Slow compression damping setting**

Minimum (soft):  
18 click(s) in direction (b)  
Standard:  
12 click(s) in direction (b)  
Maximum (hard):  
1 click(s) in direction (b)

### **TIP**

- When turning the damping force adjuster in direction (a), the 0 click position and the 1 click position may be the same.
- When turning the damping force adjuster in direction (b), it may click beyond the stated specifications, however such adjustments are in-

# Instrument and control functions

effective and may damage the suspension.

EWA10222

## **⚠ WARNING**

This shock absorber assembly contains highly pressurized nitrogen gas. Read and understand the following information before handling the shock absorber assembly.

- Do not tamper with or attempt to open the cylinder assembly.
- Do not subject the shock absorber assembly to an open flame or other high heat source. This may cause the unit to explode due to excessive gas pressure.
- Do not deform or damage the cylinder in any way. Cylinder damage will result in poor damping performance.
- Do not dispose of a damaged or worn-out shock absorber assembly yourself. Take the shock absorber assembly to a Yamaha dealer for any service.

## Luggage strap holders

EAU84680

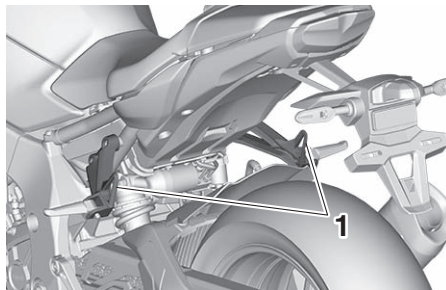

1. Luggage strap holder

Use the indicated strap points to secure luggage ties to the vehicle.

EAU67050

## EXUP system

This model is equipped with Yamaha's EXUP (EXhaust Ultimate Power valve) system. This system boosts engine power by means of a valve that controls exhaust flow within the exhaust chamber.

ECA15611

## **NOTICE**

The EXUP system has been set and extensively tested at the Yamaha factory. Changing these settings without sufficient technical knowledge may result in poor performance of or damage to the engine.

## Auxiliary DC jack

EAU49454

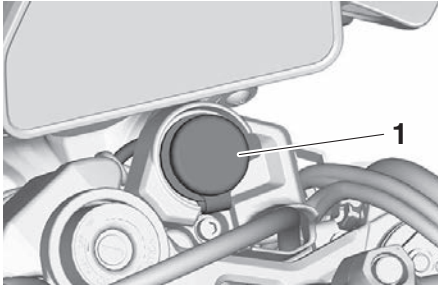

1. Auxiliary DC jack cap

A 12-V accessory connected to the auxiliary DC jack can be used when the main switch is on.

ECA15432

### NOTICE

The accessory connected to the auxiliary DC jack should not be used with the engine turned off, and the load must never exceed 12 W (1.0A), otherwise the fuse may blow or the battery may discharge.

### To use the auxiliary DC jack

1. Turn the main switch off.
2. Remove the auxiliary DC jack cap.

3. Turn the accessory off.
4. Insert the accessory plug into the auxiliary DC jack.

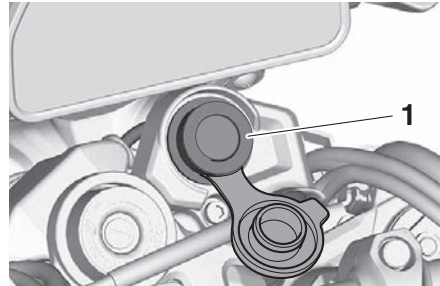

1. Auxiliary DC jack

5. Turn the main switch on, and start the engine. (See page 6-2.)
6. Turn the accessory on.

EWA14361

### ! WARNING

To prevent electrical shock or short-circuiting, make sure that the cap is installed when the auxiliary DC jack is not being used.

EAU15306

## Sidestand

The sidestand is located on the left side of the frame. Raise the sidestand or lower it with your foot while holding the vehicle upright.

### TIP

The built-in sidestand switch is part of the ignition circuit cut-off system, which cuts the ignition in certain situations. (See the following section for an explanation of the ignition circuit cut-off system.)

EWA10242

### ! WARNING

The vehicle must not be ridden with the sidestand down, or if the sidestand cannot be properly moved up (or does not stay up), otherwise the sidestand could contact the ground and distract the operator, resulting in a possible loss of control. Yamaha's ignition circuit cut-off system has been designed to assist the operator in fulfilling the responsibility of raising the sidestand before starting off. Therefore, check this system regularly and have a

# Instrument and control functions

---

Yamaha dealer repair it if it does not function properly.

---

EAU57952

## Ignition circuit cut-off system

This system prevents in-gear engine starts unless the clutch lever is pulled and the sidestand is up. Also, it will stop the running engine should the sidestand be lowered while the transmission is in gear.

Periodically check this system via the following procedure.

### TIP

---

- This check is most reliable if performed with a warmed-up engine.
  - See pages 4-2 and 4-3 for switch operation information.
-

# Instrument and control functions

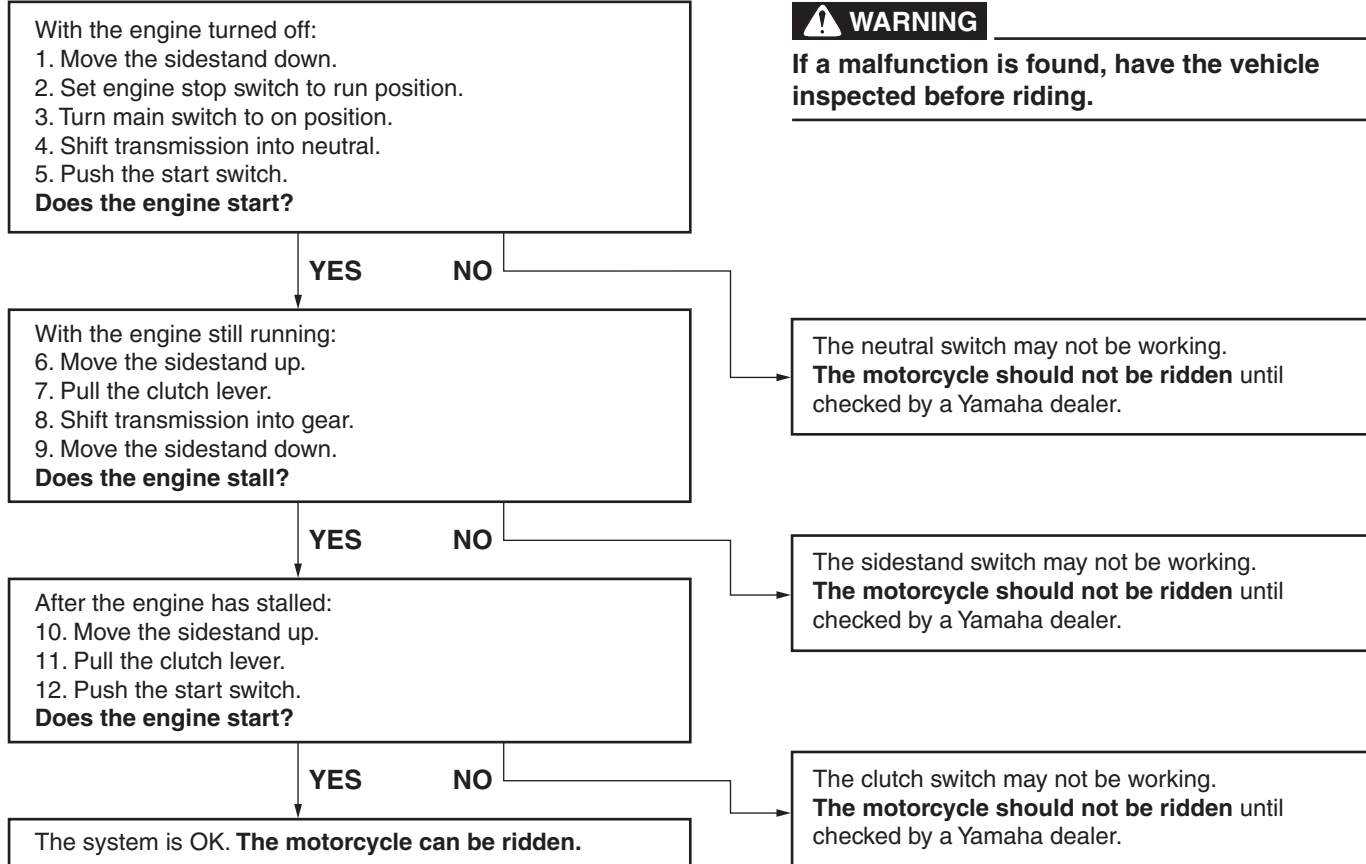

# For your safety – pre-operation checks

EAU1559B

Inspect your vehicle each time you use it to make sure the vehicle is in safe operating condition. Always follow the inspection and maintenance procedures and schedules described in the Owner's Manual.

EWA11152

## **WARNING**

**Failure to inspect or maintain the vehicle properly increases the possibility of an accident or equipment damage. Do not operate the vehicle if you find any problem. If a problem cannot be corrected by the procedures provided in this manual, have the vehicle inspected by a Yamaha dealer.**

5

Before using this vehicle, check the following points:

ITEM	CHECKS	PAGE
Fuel	<ul style="list-style-type: none"><li>• Check fuel level in fuel tank.</li><li>• Refuel if necessary.</li><li>• Check fuel line for leakage.</li><li>• Check fuel tank breather/overflow hose for obstructions, cracks or damage, and check hose connection.</li></ul>	4-31, 4-32
Engine oil	<ul style="list-style-type: none"><li>• Check oil level in engine.</li><li>• If necessary, add recommended oil to specified level.</li><li>• Check vehicle for oil leakage.</li></ul>	7-10
Coolant	<ul style="list-style-type: none"><li>• Check coolant level in reservoir.</li><li>• If necessary, add recommended coolant to specified level.</li><li>• Check cooling system for leakage.</li></ul>	7-12
Front brake	<ul style="list-style-type: none"><li>• Check operation.</li><li>• If soft or spongy, have Yamaha dealer bleed hydraulic system.</li><li>• Check brake pads for wear.</li><li>• Replace if necessary.</li><li>• Check fluid level in reservoir.</li><li>• If necessary, add specified brake fluid to specified level.</li><li>• Check hydraulic system for leakage.</li></ul>	7-20, 7-21

# For your safety – pre-operation checks

ITEM	CHECKS	PAGE
<b>Rear brake</b>	<ul style="list-style-type: none"> <li>• Check operation.</li> <li>• If soft or spongy, have Yamaha dealer bleed hydraulic system.</li> <li>• Check brake pads for wear.</li> <li>• Replace if necessary.</li> <li>• Check fluid level in reservoir.</li> <li>• If necessary, add specified brake fluid to specified level.</li> <li>• Check hydraulic system for leakage.</li> </ul>	7-20, 7-21
<b>Clutch</b>	<ul style="list-style-type: none"> <li>• Check operation.</li> <li>• Lubricate cable if necessary.</li> <li>• Check lever free play.</li> <li>• Adjust if necessary.</li> </ul>	7-18
<b>Throttle grip</b>	<ul style="list-style-type: none"> <li>• Check for smooth rotation and automatic return.</li> </ul>	7-24
<b>Control cables</b>	<ul style="list-style-type: none"> <li>• Make sure that operation is smooth.</li> <li>• Lubricate if necessary.</li> </ul>	7-24
<b>Drive chain</b>	<ul style="list-style-type: none"> <li>• Check chain slack.</li> <li>• Adjust if necessary.</li> <li>• Check chain condition.</li> <li>• Lubricate if necessary.</li> </ul>	7-22, 7-23
<b>Wheels and tires</b>	<ul style="list-style-type: none"> <li>• Check for damage.</li> <li>• Check tire condition and tread depth.</li> <li>• Check air pressure.</li> <li>• Correct if necessary.</li> </ul>	7-15, 7-18
<b>Brake and shift pedals</b>	<ul style="list-style-type: none"> <li>• Make sure that operation is smooth.</li> <li>• Lubricate pedal pivoting points if necessary.</li> </ul>	7-25
<b>Brake and clutch levers</b>	<ul style="list-style-type: none"> <li>• Make sure that operation is smooth.</li> <li>• Lubricate lever pivoting points if necessary.</li> </ul>	7-25
<b>Sidestand</b>	<ul style="list-style-type: none"> <li>• Make sure that operation is smooth.</li> <li>• Lubricate pivot if necessary.</li> </ul>	7-26
<b>Chassis fasteners</b>	<ul style="list-style-type: none"> <li>• Make sure that all nuts, bolts and screws are properly tightened.</li> <li>• Tighten if necessary.</li> </ul>	—
<b>Instruments, lights, signals and switches</b>	<ul style="list-style-type: none"> <li>• Check operation.</li> <li>• Correct if necessary.</li> </ul>	—
<b>Sidestand switch</b>	<ul style="list-style-type: none"> <li>• Check operation of ignition circuit cut-off system.</li> <li>• If system is not working correctly, have Yamaha dealer check vehicle.</li> </ul>	4-40

# Operation and important riding points

---

EAU15952

Read the Owner's Manual carefully to become familiar with all controls. If there is a control or function you do not understand, ask your Yamaha dealer.

EWA10272

## **WARNING**

**Failure to familiarize yourself with the controls can lead to loss of control, which could cause an accident or injury.**

---

6

## Engine break-in

There is never a more important period in the life of your engine than the period between 0 and 1600 km (1000 mi). For this reason, you should read the following material carefully.

Since the engine is brand new, do not put an excessive load on it for the first 1600 km (1000 mi). The various parts in the engine wear and polish themselves to the correct operating clearances. During this period, prolonged full-throttle operation or any condition that might result in engine overheating must be avoided.

EAU16842

r/min.

## 1600 km (1000 mi) and beyond

The vehicle can now be operated normally.

ECA10311

## **NOTICE**

- **Keep the engine speed out of the tachometer red zone.**
  - **If any engine trouble should occur during the engine break-in period, immediately have a Yamaha dealer check the vehicle.**
- 

## **TIP**

During and after the engine break-in period, the exhaust heat may cause discoloration of the exhaust pipe, but this is normal.

---

EAU17085

## 0–1000 km (0–600 mi)

Avoid prolonged operation above 5900 r/min. **NOTICE: After 1000 km (600 mi) of operation, the engine oil must be changed and the oil filter cartridge or element replaced.**<sub>[ECA10303]</sub>

## 1000–1600 km (600–1000 mi)

Avoid prolonged operation above 7100



EAU91411

ECA24110

## Starting the engine

The ignition circuit cut-off system will enable starting when:

- the transmission is in the neutral position or
- the transmission is in gear, the sidestand is up, and the clutch lever is pulled.

### To start the engine

1. Turn the main switch on and set the engine stop switch to the run position.
2. Confirm the indicator and warning light(s) come on for a few seconds, and then go off. (See page 4-5.)

### TIP

- Do not start the engine if the malfunction indicator light remains on.
- The oil pressure and coolant temperature warning light should come on and stay on until the engine is started.
- The ABS warning light should come on and stay on until the vehicle reaches a speed of 5 km/h (3 mi/h).

### **NOTICE**

**If a warning or indicator light does not work as described above, have a Yamaha dealer check the vehicle.**

3. Shift the transmission into the neutral position.
4. Start the engine by pushing the start switch.
5. Release the start switch when the engine starts, or after 5 seconds. Wait 10 seconds before pressing the switch again to allow battery voltage to restore.

### **TIP**

If the engine fails to start, try again with the throttle grip turned by a 1/4 turn (20 degrees) open.

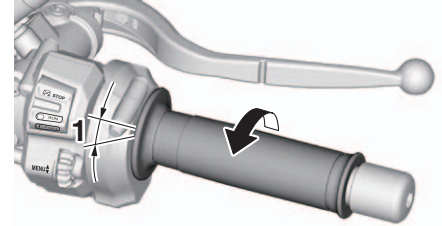

1. 1/4 turn (20 degrees)

ECA11043

### **NOTICE**

**For maximum engine life, never accelerate hard when the engine is cold!**

# Operation and important riding points

EAU68221

EAU67084

## TIP \_\_\_\_\_

This model is equipped with:

- an inertial measurement unit (IMU). This unit stops the engine in case of a turnover. Turn the main switch off and then on before attempting to restart the engine. Failing to do so will prevent the engine from starting even though the engine will crank when pushing the start switch.
- an engine auto-stop system. The engine stops automatically if left idling for 20 minutes. If the engine stops, simply push the start switch to restart the engine.

## Shifting

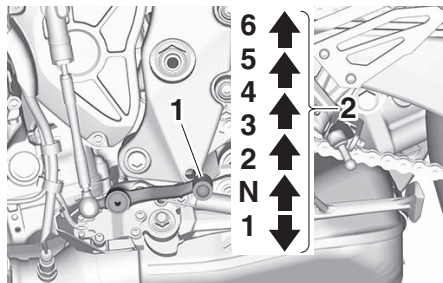

1. Shift pedal
2. Gear positions

Shifting gears lets you control the amount of engine power available for starting off, accelerating, climbing hills, etc.

This model is equipped with a quick shifter. See pages 3-3 and 4-20.

## TIP \_\_\_\_\_

To shift into neutral (**N**), gently depress the shift pedal from 2nd gear, or slightly raise it while in 1st gear.

ECA22523

## NOTICE \_\_\_\_\_

- **When shifting, press the shift**

pedal firmly until you feel the gear shift is complete.

- **Even with the transmission in the neutral position, do not coast for long periods of time with the engine off, nor tow the motorcycle for long distances. The transmission is properly lubricated only when the engine is running. Inadequate lubrication may damage the transmission.**
- **Except when using the quick shifter, always pull the clutch lever when changing gears to avoid damaging the engine, transmission, and drivetrain.**

EAU85370

## To start out and accelerate

1. Pull the clutch lever to disengage the clutch.
2. Shift the transmission into first gear. The neutral indicator light should go out.
3. Open the throttle gradually, and at the same time, release the clutch lever slowly.
4. After starting out, close the throttle, and at the same time, quickly pull

the clutch lever in.

5. Shift the transmission into second gear. (Make sure not to shift the transmission into the neutral position.)
6. Open the throttle part way and gradually release the clutch lever.
7. Follow the same procedure when shifting to the next higher gear.

EAU85380

## To decelerate

1. Release the throttle and apply both the front and the rear brakes smoothly to slow the motorcycle.
2. As the vehicle decelerates, shift to a lower gear.
3. When the engine is about to stall or runs roughly, pull the clutch lever in, use the brakes to slow the motorcycle, and continue to down-shift as necessary.
4. Once the motorcycle has stopped, the transmission can be shifted into the neutral position. The neutral indicator light should come on and then the clutch lever can be released.

EWA17380

## WARNING

- **Improper braking can cause loss of control or traction. Always use both brakes and apply them smoothly.**
- **Make sure that the motorcycle and the engine have sufficiently slowed before shifting to a lower gear. Engaging a lower gear when the vehicle or engine speed is too high could make the rear wheel lose traction or the engine to over-rev. This could cause loss of control, an accident and injury. It could also cause engine or drive train damage.**

EAU16811

## Tips for reducing fuel consumption

Fuel consumption depends largely on your riding style. Consider the following tips to reduce fuel consumption:

- Shift up swiftly, and avoid high engine speeds during acceleration.
- Do not rev the engine while shifting down, and avoid high engine speeds with no load on the engine.
- Turn the engine off instead of letting it idle for an extended length of time (e.g., in traffic jams, at traffic lights or at railroad crossings).

# Operation and important riding points

---

EAU17214

## Parking

When parking, stop the engine, and then remove the key from the main switch.

EWA10312

### **WARNING**

- Since the engine and exhaust system can become very hot, park in a place where pedestrians or children are not likely to touch them and be burned.
- Do not park on a slope or on soft ground, otherwise the vehicle may overturn, increasing the risk of a fuel leak and fire.
- Do not park near grass or other flammable materials which might catch fire.

EAU17246

EWA15123

EAU17303

Periodic inspection, adjustment, and lubrication will keep your vehicle in the safest and most efficient condition possible. Safety is an obligation of the vehicle owner/operator. The most important points of vehicle inspection, adjustment, and lubrication are explained on the following pages.

The intervals given in the periodic maintenance charts should be simply considered as a general guide under normal riding conditions. However, depending on the weather, terrain, geographical location, and individual use, the maintenance intervals may need to be shortened.

## **WARNING**

EWA10322

**Failure to properly maintain the vehicle or performing maintenance activities incorrectly may increase your risk of injury or death during service or while using the vehicle. If you are not familiar with vehicle service, have a Yamaha dealer perform service.**

## **WARNING**

**Turn off the engine when performing maintenance unless otherwise specified.**

- **A running engine has moving parts that can catch on body parts or clothing and electrical parts that can cause shocks or fires.**
- **Running the engine while servicing can lead to eye injury, burns, fire, or carbon monoxide poisoning – possibly leading to death. See page 1-2 for more information about carbon monoxide.**

EWA15461

## **WARNING**

**Brake discs, calipers, drums, and linings can become very hot during use. To avoid possible burns, let brake components cool before touching them.**

Emission controls not only function to ensure cleaner air, but are also vital to proper engine operation and maximum performance. In the following periodic maintenance charts, the services related to emissions control are grouped separately. These services require specialized data, knowledge, and equipment. Maintenance, replacement, or repair of the emission control devices and systems may be performed by any repair establishment or individual that is certified (if applicable). Yamaha dealers are trained and equipped to perform these particular services.

# Periodic maintenance and adjustment

---

EAU85240

your Yamaha dealer perform it for you.

## Tool kits

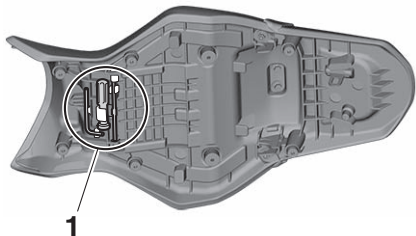

1. Tool kit

7

The on-board tool kit is in the location shown. Also, an additional tool kit was handed out separately at the time of vehicle purchase.

The information included in this manual and the tools provided in the tool kits are intended to assist you in the performance of preventive maintenance and minor repairs. However, a torque wrench and other tools are necessary to perform certain maintenance work correctly.

### **TIP**

If you do not have the tools or experience required for a particular job, have

# Periodic maintenance and adjustment

EAU71033

## Periodic maintenance charts

### TIP

- Items marked with an asterisk should be performed by your Yamaha dealer because these items require special tools, data, and technical skills.
- From 50000 km (30000 mi), repeat the maintenance intervals starting from 10000 km (6000 mi).
- **The annual checks must be performed every year, except if a distance-based maintenance is performed instead.**

EAU71051

## Periodic maintenance chart for the emission control system

NO.	ITEM	CHECK OR MAINTENANCE JOB	ODOMETER READING					ANNUAL CHECK
			1000 km (600 mi)	10000 km (6000 mi)	20000 km (12000 mi)	30000 km (18000 mi)	40000 km (24000 mi)	
1	* Fuel line	<ul style="list-style-type: none"> <li>• Check fuel hoses for cracks or damage.</li> <li>• Replace if necessary.</li> </ul>		√	√	√	√	√
2	* Spark plugs	<ul style="list-style-type: none"> <li>• Check condition.</li> <li>• Adjust gap and clean.</li> </ul>		√		√		
		<ul style="list-style-type: none"> <li>• Replace.</li> </ul>			√		√	
3	* Valve clearance	<ul style="list-style-type: none"> <li>• Check and adjust.</li> </ul>	Every 40000 km (24000 mi)					
4	* Fuel injection	<ul style="list-style-type: none"> <li>• Check engine idle speed.</li> </ul>	√	√	√	√	√	√
		<ul style="list-style-type: none"> <li>• Check and adjust synchronization.</li> </ul>		√	√	√	√	√
5	* Exhaust system	<ul style="list-style-type: none"> <li>• Check for leakage.</li> <li>• Tighten if necessary.</li> <li>• Replace gaskets if necessary.</li> </ul>	√	√	√	√	√	
6	* Evaporative emission control system	<ul style="list-style-type: none"> <li>• Check control system for damage.</li> <li>• Replace if necessary.</li> </ul>			√		√	

# Periodic maintenance and adjustment

NO.	ITEM	CHECK OR MAINTENANCE JOB	ODOMETER READING					ANNUAL CHECK
			1000 km (600 mi)	10000 km (6000 mi)	20000 km (12000 mi)	30000 km (18000 mi)	40000 km (24000 mi)	
7	* <b>Air induction system</b>	<ul style="list-style-type: none"> <li>• Check the air cut-off valve, reed valve, and hose for damage.</li> <li>• Replace any damaged parts if necessary.</li> </ul>		√	√	√	√	√



# Periodic maintenance and adjustment

EAU71353

## General maintenance and lubrication chart

NO.	ITEM	CHECK OR MAINTENANCE JOB	ODOMETER READING					ANNUAL CHECK
			1000 km (600 mi)	10000 km (6000 mi)	20000 km (12000 mi)	30000 km (18000 mi)	40000 km (24000 mi)	
1	* Diagnostic system check	<ul style="list-style-type: none"> <li>Perform dynamic inspection using Yamaha diagnostic tool.</li> <li>Check the error codes.</li> </ul>	√	√	√	√	√	√
2	* Air filter element	<ul style="list-style-type: none"> <li>Replace.</li> </ul>	Every 40000 km (24000 mi)					
3	Clutch	<ul style="list-style-type: none"> <li>Check operation.</li> <li>Adjust.</li> </ul>	√	√	√	√	√	
4	* Front brake	<ul style="list-style-type: none"> <li>Check operation, fluid level, and for fluid leakage.</li> <li>Adjust brake lever free play.</li> <li>Replace brake pads if necessary.</li> </ul>	√	√	√	√	√	√
5	* Rear brake	<ul style="list-style-type: none"> <li>Check operation, fluid level, and for fluid leakage.</li> <li>Replace brake pads if necessary.</li> </ul>	√	√	√	√	√	√
6	* Brake hoses	<ul style="list-style-type: none"> <li>Check for cracks or damage.</li> </ul>		√	√	√	√	√
		<ul style="list-style-type: none"> <li>Replace.</li> </ul>	Every 4 years					
7	* Brake fluid	<ul style="list-style-type: none"> <li>Change.</li> </ul>	Every 2 years					
8	* Wheels	<ul style="list-style-type: none"> <li>Check runout and for damage.</li> <li>Replace if necessary.</li> </ul>		√	√	√	√	
9	* Tires	<ul style="list-style-type: none"> <li>Check tread depth and for damage.</li> <li>Replace if necessary.</li> <li>Check air pressure.</li> <li>Correct if necessary.</li> </ul>		√	√	√	√	√
10	* Wheel bearings	<ul style="list-style-type: none"> <li>Check bearing for looseness or damage.</li> </ul>		√	√	√	√	
11	* Swingarm pivot bearings	<ul style="list-style-type: none"> <li>Check operation and for excessive play.</li> </ul>		√	√	√	√	
		<ul style="list-style-type: none"> <li>Lubricate with lithium-soap-based grease.</li> </ul>	Every 50000 km (30000 mi)					

7

# Periodic maintenance and adjustment

NO.	ITEM	CHECK OR MAINTENANCE JOB	ODOMETER READING					ANNUAL CHECK
			1000 km (600 mi)	10000 km (6000 mi)	20000 km (12000 mi)	30000 km (18000 mi)	40000 km (24000 mi)	
12	Drive chain	<ul style="list-style-type: none"> <li>• Check chain slack, alignment and condition.</li> <li>• Adjust and lubricate chain with a special O-ring chain lubricant thoroughly.</li> </ul>	Every 1000 km (600 mi) and after washing the motorcycle, riding in the rain or riding in wet areas					
13	* Steering bearings	<ul style="list-style-type: none"> <li>• Check bearing assemblies for looseness.</li> </ul>	√	√		√		
		<ul style="list-style-type: none"> <li>• Moderately repack with lithium-soap-based grease.</li> </ul>			√		√	
14	* Steering damper	<ul style="list-style-type: none"> <li>• Check operation and for oil leakage.</li> </ul>		√	√	√	√	
15	* Chassis fasteners	<ul style="list-style-type: none"> <li>• Make sure that all nuts, bolts and screws are properly tightened.</li> </ul>		√	√	√	√	√
16	* Brake lever pivot shaft	<ul style="list-style-type: none"> <li>• Lubricate with silicone grease.</li> </ul>		√	√	√	√	√
17	Brake pedal pivot shaft	<ul style="list-style-type: none"> <li>• Lubricate with lithium-soap-based grease.</li> </ul>		√	√	√	√	√
18	Clutch lever pivot shaft	<ul style="list-style-type: none"> <li>• Lubricate with lithium-soap-based grease.</li> </ul>		√	√	√	√	√
19	Shift pedal pivot shaft	<ul style="list-style-type: none"> <li>• Lubricate with molybdenum disulfide grease.</li> </ul>		√	√	√	√	√
20	Sidestand	<ul style="list-style-type: none"> <li>• Check operation.</li> <li>• Lubricate with lithium-soap-based grease.</li> </ul>		√	√	√	√	√
21	* Sidestand switch	<ul style="list-style-type: none"> <li>• Check operation and replace if necessary.</li> </ul>	√	√	√	√	√	√
22	* Front fork	<ul style="list-style-type: none"> <li>• Check operation and for oil leakage.</li> <li>• Replace if necessary.</li> </ul>		√	√	√	√	
23	* Shock absorber assembly	<ul style="list-style-type: none"> <li>• Check operation and for oil leakage.</li> <li>• Replace if necessary.</li> </ul>		√	√	√	√	

# Periodic maintenance and adjustment

NO.	ITEM	CHECK OR MAINTENANCE JOB	ODOMETER READING					ANNUAL CHECK
			1000 km (600 mi)	10000 km (6000 mi)	20000 km (12000 mi)	30000 km (18000 mi)	40000 km (24000 mi)	
24	* Rear suspension relay arm and connecting arm pivoting points	<ul style="list-style-type: none"> <li>• Check operation.</li> </ul>		√	√	√	√	
25	* Engine oil	<ul style="list-style-type: none"> <li>• Change (warm engine before draining).</li> <li>• Check oil level and vehicle for oil leakage.</li> </ul>	√	√	√	√	√	√
26	* Engine oil filter cartridge	<ul style="list-style-type: none"> <li>• Replace.</li> </ul>	√		√		√	
27	* Cooling system	<ul style="list-style-type: none"> <li>• Check coolant level and vehicle for coolant leakage.</li> </ul>		√	√	√	√	√
		<ul style="list-style-type: none"> <li>• Change.</li> </ul>	Every 3 years					
28	* EXUP system	<ul style="list-style-type: none"> <li>• Check operation, cable free play and pulley position.</li> </ul>	√		√		√	
29	* Front and rear brake switches	<ul style="list-style-type: none"> <li>• Check operation.</li> </ul>	√	√	√	√	√	√
30	* Moving parts and cables	<ul style="list-style-type: none"> <li>• Lubricate.</li> </ul>		√	√	√	√	√
31	* Throttle grip	<ul style="list-style-type: none"> <li>• Check operation.</li> <li>• Lubricate throttle grip housing tube guides.</li> </ul>		√	√	√	√	√
32	* Lights, signals and switches	<ul style="list-style-type: none"> <li>• Check operation.</li> <li>• Adjust headlight beam.</li> </ul>	√	√	√	√	√	√

# Periodic maintenance and adjustment

---

EAU72800

## TIP

---

- Air filter
    - This model's air filter is equipped with a disposable oil-coated paper element, which must not be cleaned with compressed air to avoid damaging it.
    - The air filter element needs to be replaced more frequently when riding in unusually wet or dusty areas.
  - Hydraulic brake service
    - Regularly check and, if necessary, correct the brake fluid level.
    - Every two years replace the internal components of the brake master cylinders and calipers, and change the brake fluid.
    - Replace the brake hoses every four years and if cracked or damaged.
-

EAU67110

## Checking the spark plugs

The spark plugs are important engine components, which should be checked periodically, preferably by a Yamaha dealer. Since heat and deposits will cause any spark plug to slowly erode, they should be removed and checked in accordance with the periodic maintenance and lubrication chart. In addition, the condition of the spark plugs can reveal the condition of the engine.

The porcelain insulator around the center electrode of each spark plug should be a medium-to-light tan (the ideal color when the vehicle is ridden normally), and all spark plugs installed in the engine should have the same color. If any spark plug shows a distinctly different color, the engine could be operating improperly. Do not attempt to diagnose such problems yourself. Instead, have a Yamaha dealer check the vehicle.

If a spark plug shows signs of electrode erosion and excessive carbon or other deposits, it should be replaced.

**Specified spark plug:**  
NGK/LMAR9E-J

Before installing a spark plug, the spark plug gap should be measured with a wire thickness gauge and, if necessary, adjusted to specification.

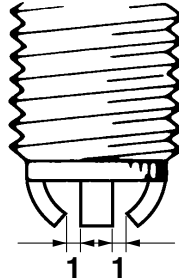

1. Spark plug gap

### Spark plug gap:

0.6–0.7 mm (0.024–0.028 in)

Clean the surface of the spark plug gasket and its mating surface, and then wipe off any grime from the spark plug threads.

### Tightening torque:

Spark plug (new):  
18 N·m (1.8 kgf·m, 13 lb·ft)

Spark plug (after checking):  
13 N·m (1.3 kgf·m, 9.6 lb·ft)

## NOTICE

Do not use any tools to remove or install the spark plug cap, otherwise the ignition coil coupler may get damaged. The spark plug cap may be difficult to remove because the rubber seal on the end of the cap fits tightly. To remove the spark plug cap, simply twist it back and forth while pulling it out; to install it, twist it back and forth while pushing it in.

ECA10841

# Periodic maintenance and adjustment

## Canister

EAU36113

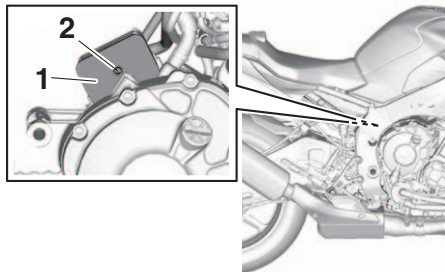

1. Canister
2. Canister breather

This model is equipped with a canister to prevent the discharging of fuel vapor into the atmosphere. Before operating this vehicle, make sure to check the following:

- Check each hose connection.
- Check each hose and canister for cracks or damage. Replace if damaged.
- Make sure that the canister breather is not blocked, and if necessary, clean it.

## Engine oil

EAU94850

The engine oil level should be checked before each ride. In addition, the engine oil must be changed and the oil filter cartridge replaced by your Yamaha dealer at the intervals specified in the periodic maintenance chart.

### Recommended engine oil:

Full synthetic  
10W-40, 15W-50

### Oil quantity:

Oil change:

3.90 L (4.12 US qt, 3.43 Imp.qt)

With oil filter removal:

4.10 L (4.33 US qt, 3.61 Imp.qt)

ECA11621

## NOTICE

- **In order to prevent clutch slippage (since the engine oil also lubricates the clutch), do not mix any chemical additives. Do not use oils with a diesel specification of “CD” or oils of a higher quality than specified. In addition, do not use oils labeled “ENERGY CONSERVING II” or higher.**

- **Make sure that no foreign material enters the crankcase.**

## To check the engine oil level

1. After warming up the engine, wait a few minutes for the oil level to settle for an accurate reading.
2. With the vehicle on a level surface, hold it upright for an accurate reading.
3. Check the oil level through the check window located at the bottom of the left-side of the crankcase.

## TIP

The engine oil should be between the minimum and maximum level marks.

# Periodic maintenance and adjustment

EAU85450

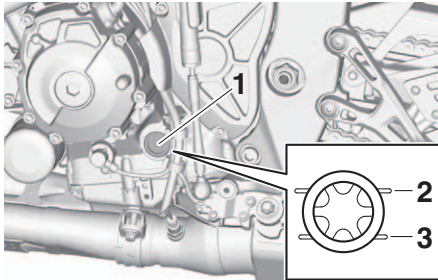

1. Engine oil level check window
  2. Maximum level mark
  3. Minimum level mark
4. If the engine oil is at or below the minimum level mark, remove the oil filler cap and add oil

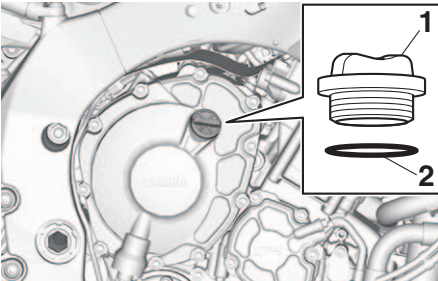

1. Engine oil filler cap
2. O-ring

5. Check the O-ring for damage, and replace if necessary.
6. Install the engine oil filler cap.

## Why Yamalube

YAMALUBE oil is a Genuine YAMAHA Part born of the engineers' passion and belief that engine oil is an important liquid engine component. We form teams of specialists in the fields of mechanical engineering, chemistry, electronics and track testing, and have them develop the engine together with the oil it will use. Yamalube oils take full advantage of the base oil's qualities and blend in the ideal balance of additives to make sure the final oil clears our performance standards. Thus, Yamalube mineral, semisynthetic and synthetic oils have their own distinct characters and value. Yamaha's experience gained over many years of research and development into oil since the 1960's helps make Yamalube the best choice for your Yamaha engine.

# YAMALUBE®

# Periodic maintenance and adjustment

## Coolant

The coolant level should be checked regularly. In addition, the coolant must be changed at the intervals specified in the periodic maintenance chart.

### Recommended coolant:

YAMALUBE coolant

### Coolant quantity:

Coolant reservoir (max level mark):

0.24 L (0.25 US qt, 0.21 Imp.qt)

Radiator (including all routes):

2.25 L (2.38 US qt, 1.98 Imp.qt)

7

## TIP

If genuine Yamaha coolant is not available, use an ethylene glycol antifreeze containing corrosion inhibitors for aluminum engines and mix with distilled water at a 1:1 ratio.

## To check the coolant level

Since the coolant level varies with engine temperature, check when the engine is cold.

1. Park the vehicle on a level surface.
2. With the vehicle in an upright position, look at the coolant level in the

EAUS1203

reservoir.

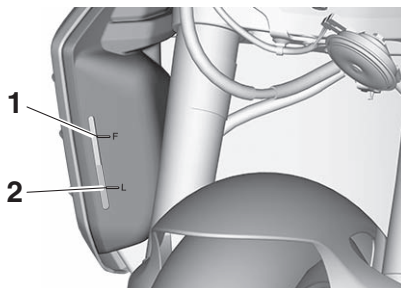

1. Maximum level mark
2. Minimum level mark

3. If the coolant is at or below the minimum level mark, remove the coolant reservoir cap by referring to the following procedure.
4. Remove the quick fastener.

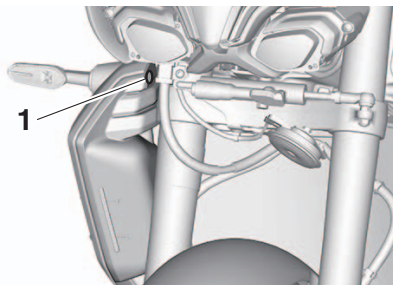

1. Quick fastener

## TIP

The quick fastener is removed by pushing in the center pin and then pulling the fastener out.

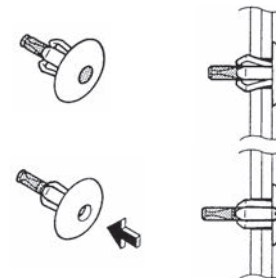

5. Pull the coolant reservoir cover A toward you as shown, and then remove it by sliding it downward. **NOTICE:** When removing the coolant reservoir cover A, remove it while making sure that it does not contact the radiator fin. [ECA27400]

EAU94092



# Periodic maintenance and adjustment

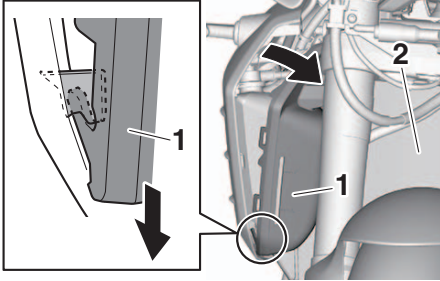

1. Coolant reservoir cover A
  2. Radiator fin
6. Remove the bolt, and then remove the coolant reservoir cover B.

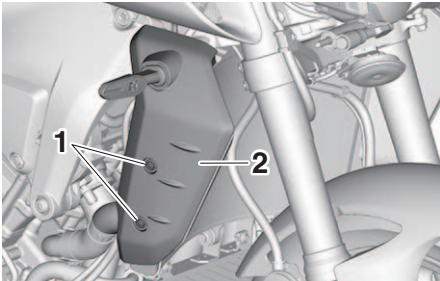

1. Bolt
  2. Coolant reservoir cover B
7. Remove the coolant reservoir cap.  
**WARNING! Remove only the**

coolant reservoir cap. Never attempt to remove the radiator cap when the engine is hot.<sup>[EWA15162]</sup>

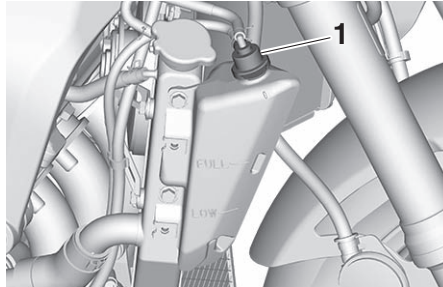

1. Coolant reservoir cap
8. Add coolant to the maximum level mark. **NOTICE: If coolant is not available, use distilled water or soft tap water instead. Do not use hard water or salt water since it is harmful to the engine. If water has been used instead of coolant, replace it with coolant as soon as possible, otherwise the cooling system will not be protected against frost and corrosion. If water has been added to the coolant, have a**

Yamaha dealer check the anti-freeze content of the coolant as soon as possible, otherwise the effectiveness of the coolant will be reduced.<sup>[ECA10473]</sup>

9. Install the coolant reservoir cap.
10. Place the coolant reservoir cover B in its original position, and then tighten the bolts to the specified torque.

## Tightening torque:

Coolant reservoir cover bolt:  
4.3 N·m (0.43 kgf·m, 3.2 lb·ft)

11. Place the coolant reservoir cover A in its original position, and then install the quick fastener.

## TIP

The quick fastener is installed by pushing out the center pin, inserting the fastener into the cover, and then by pushing the center pin flush with the fastener head.

# Periodic maintenance and adjustment

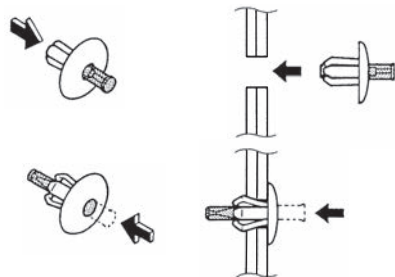

EAU36765

## Air filter element

The air filter element must be replaced at the intervals specified in the periodic maintenance and lubrication chart. Have a Yamaha dealer replace the air filter element.

EAU44735

## Checking the engine idling speed

Check the engine idling speed and, if necessary, have it corrected by a Yamaha dealer.

**Engine idling speed:**  
1200–1400 r/min

EAU33032

## Changing the coolant

The coolant must be changed at the intervals specified in the periodic maintenance and lubrication chart. Have a Yamaha dealer change the coolant.

**WARNING! Never attempt to remove the radiator cap when the engine is hot.**<sup>[EWA10382]</sup>

EAU21403

EAU94081

## Valve clearance

The valves are an important engine component, and since valve clearance changes with use, they must be checked and adjusted at the intervals specified in the periodic maintenance chart. Unadjusted valves can result in improper air-fuel mixture, engine noise, and eventually engine damage. To prevent this from occurring, have your Yamaha dealer check and adjust the valve clearance at regular intervals.

### TIP

This service must be performed when the engine is cold.

## Tires

Tires are the only contact between the vehicle and the road. Safety in all conditions of riding depends on a relatively small area of road contact. Therefore, it is essential to maintain the tires in good condition at all times and replace them at the appropriate time with the specified tires.

### Tire air pressure

The tire air pressure should be checked and, if necessary, adjusted before each ride.

EWA10504

### WARNING

Operation of this vehicle with improper tire pressure may cause severe injury or death from loss of control.

- The tire air pressure must be checked and adjusted on cold tires (i.e., when the temperature of the tires equals the ambient temperature).
- The tire air pressure must be adjusted in accordance with the riding speed and with the total

weight of rider, passenger, cargo, and accessories approved for this model.

### Cold tire air pressure:

#### 1 person:

Front:

250 kPa (2.50 kgf/cm<sup>2</sup>, 36 psi)

Rear:

290 kPa (2.90 kgf/cm<sup>2</sup>, 42 psi)

#### 2 persons:

Front:

250 kPa (2.50 kgf/cm<sup>2</sup>, 36 psi)

Rear:

290 kPa (2.90 kgf/cm<sup>2</sup>, 42 psi)

### Maximum load:

Vehicle:

173 kg (381 lb)

The vehicle's maximum load is the combined weight of the rider, passenger, cargo, and any accessories.

EWA10512

### WARNING

Never overload your vehicle. Operation of an overloaded vehicle could cause an accident.

# Periodic maintenance and adjustment

## Tire inspection

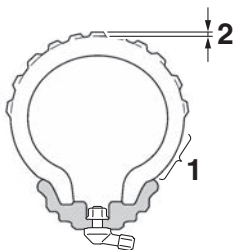

1. Tire sidewall
2. Tire tread depth

**7** The tires must be checked before each ride. If the center tread depth reaches the specified limit, if the tire has a nail or glass fragments in it, or if the sidewall is cracked, have a Yamaha dealer replace the tire immediately.

**Minimum tire tread depth (front and rear):**  
1.6 mm (0.06 in)

### TIP

The tire tread depth limits may differ from country to country. Always comply with the local regulations.

EWA10472

### WARNING

- Have a Yamaha dealer replace excessively worn tires. Besides being illegal, operating the vehicle with excessively worn tires decreases riding stability and can lead to loss of control.
- The replacement of all wheel and brake-related parts, including the tires, should be left to a Yamaha dealer, who has the necessary professional knowledge and experience to do so.
- Ride at moderate speeds after changing a tire since the tire surface must first be “broken in” for it to develop its optimal characteristics.

## Tire information

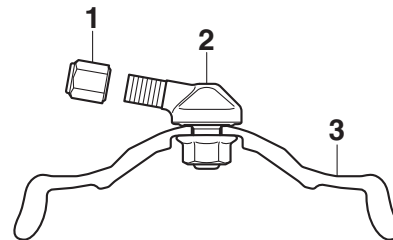

1. Tire air valve cap with seal
2. Clamp-in valve
3. Wheel rim

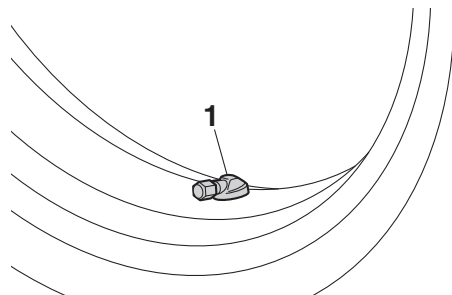

1. Tire air valve

This model is equipped with tubeless tires and tire air valves. Tires age, even if they have not been

# Periodic maintenance and adjustment

used or have only been used occasionally. Cracking of the tread and sidewall rubber, sometimes accompanied by carcass deformation, is an evidence of ageing. Old and aged tires shall be checked by tire specialists to ascertain their suitability for further use.

EWA21231

## WARNING

- The front and rear tires should be of the same make and design, otherwise the handling characteristics of the motorcycle may be different, which could lead to an accident.
- Always make sure that the valve caps are securely installed to prevent air pressure leakage.
- Use only the tire valves and valve cores listed below to avoid tire deflation during a ride.
- The tire air valve original position is with the valve cap pointing to the right side of the vehicle, perpendicular (90 degree right angle) to the axis of the wheel. If the tire air valve becomes misaligned, do not twist it back to its original position by

**yourself. Otherwise, leakage may occur. Have a Yamaha dealer inspect the valve.**

After extensive tests, only the tires listed below have been approved for this model by Yamaha.

### Front tire:

Size:

120/70ZR17M/C(58W)

Manufacturer/model:

BRIDGESTONE/BATTLAX HY-PERSPORT S22F

### Rear tire:

Size:

190/55ZR17M/C(75W)

Manufacturer/model:

BRIDGESTONE/BATTLAX HY-PERSPORT S22R

### FRONT and REAR:

Tire air valve:

PVR251

EWA10601

## WARNING

This motorcycle is fitted with super-high-speed tires. Note the following points in order to make the most efficient use of these tires.

- Use only the specified replacement tires. Other tires may run

the danger of bursting at super high speeds.

- Brand-new tires can have a relatively poor grip on certain road surfaces until they have been “broken in”. Therefore, it is advisable before doing any high-speed riding to ride conservatively for approximately 100 km (60 mi) after installing a new tire.
- The tires must be warmed up before a high-speed run.
- Always adjust the tire air pressure according to the operating conditions.

# Periodic maintenance and adjustment

EAU21963

## Cast wheels

To maximize the performance, durability, and safe operation of your vehicle, note the following points regarding the specified wheels.

- The wheel rims should be checked for cracks, bends, warpage or other damage before each ride. If any damage is found, have a Yamaha dealer replace the wheel. Do not attempt even the smallest repair to the wheel. A deformed or cracked wheel must be replaced.
- The wheel should be balanced whenever either the tire or wheel has been changed or replaced. An unbalanced wheel can result in poor performance, adverse handling characteristics, and a shortened tire life.

7

EAU94121

## Adjusting the clutch lever free play

Measure the clutch lever free play as shown.

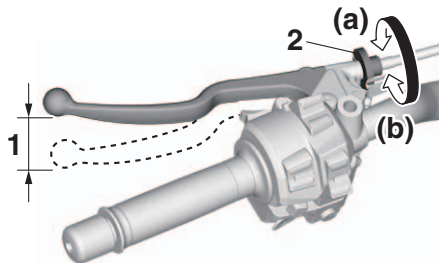

1. Clutch lever free play
2. Clutch lever free play adjusting bolt

**Clutch lever free play:**  
10.0–15.0 mm (0.39–0.59 in)

Periodically check the clutch lever free play and, if necessary, adjust it as follows.

To increase the clutch lever free play, turn the clutch lever free play adjusting bolt at the clutch lever in direction (a). To decrease the clutch lever free play, turn the adjusting bolt in direction (b).

## TIP

If the specified clutch lever free play cannot be obtained as described above, proceed as follows.

1. Fully turn the adjusting bolt at the clutch lever in direction (a) to loosen the clutch cable.
2. Loosen the locknut further down the clutch cable.
3. To increase the clutch lever free play, turn the clutch lever free play adjusting nut in direction (a). To decrease the clutch lever free play, turn the adjusting nut in direction (b).

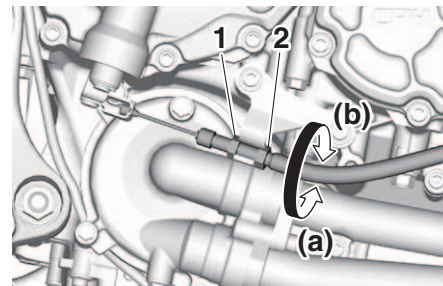

1. Locknut
2. Clutch lever free play adjusting nut

4. Tighten the locknut to the specified

# Periodic maintenance and adjustment

torque.

## Tightening torque:

Locknut:

7 N·m (0.7 kgf·m, 5.2 lb·ft)

## Checking the brake lever free play

EAU37914

sult in loss of control and an accident.

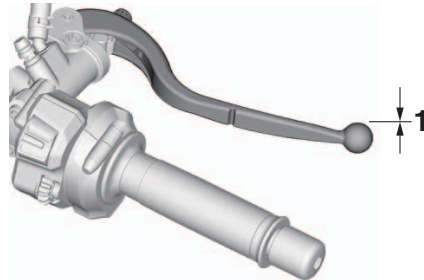

1. No brake lever free play

There should be no free play at the brake lever end. If there is free play, have a Yamaha dealer inspect the brake system.

EWA14212

## **WARNING**

A soft or spongy feeling in the brake lever can indicate the presence of air in the hydraulic system. If there is air in the hydraulic system, have a Yamaha dealer bleed the system before operating the vehicle. Air in the hydraulic system will diminish the braking performance, which may re-

# Periodic maintenance and adjustment

## Brake light switches

EAU36505

The brake light should come on just before braking takes effect. The brake light is activated by switches connected to the brake lever and brake pedal. Since the brake light switches are components of the anti-lock brake system, they should only be serviced by a Yamaha dealer.

## Checking the front and rear brake pads

EAU22393

The front and rear brake pads must be checked for wear at the intervals specified in the periodic maintenance and lubrication chart.

### Front brake pads

EAU36891

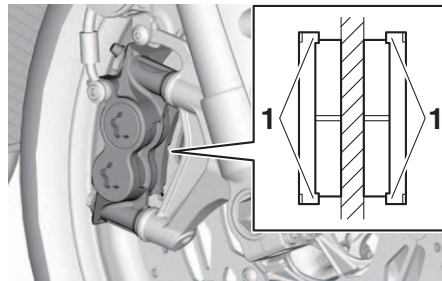

1. Brake pad wear indicator

Each front brake pad is provided with wear indicators, which allows you to check the brake pad wear without having to disassemble the brake. To check the brake pad wear, check the position of the wear indicators while applying the brake. If a brake pad has worn to the point that a wear indicator almost

touches the brake disc, have a Yamaha dealer replace the brake pads as a set.

### Rear brake pads

EAU46292

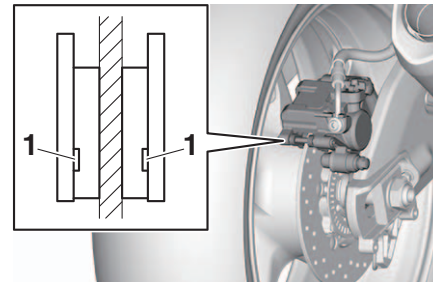

1. Brake pad wear indicator groove

Each rear brake pad is provided with wear indicator grooves, which allow you to check the brake pad wear without having to disassemble the brake. To check the brake pad wear, check the wear indicator grooves. If a brake pad has worn to the point that a wear indicator groove almost appears, have a Yamaha dealer replace the brake pads as a set.



# Periodic maintenance and adjustment

## Checking the brake fluid level

EAU22584

Before riding, check that the brake fluid is above the minimum level mark.

### TIP

Make sure the reservoir is parallel to the ground when checking.

**Specified brake fluid:**  
DOT 4

### NOTICE

ECA17641

**Brake fluid may damage painted surfaces or plastic parts. Always clean up spilled fluid immediately.**

## Front brake

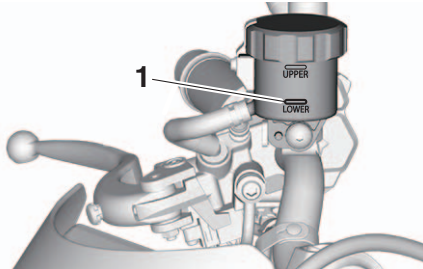

1. Minimum level mark

## Rear brake

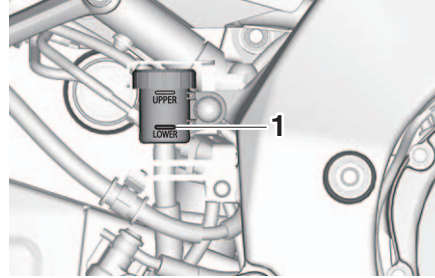

1. Minimum level mark

As the brake pads wear, it is normal for the brake fluid level to gradually go down.

- A low brake fluid level may indicate worn brake pads or brake system leakage; therefore, be sure to check the brake pads for wear and the brake system for leakage.
- If the brake fluid level goes down suddenly, have a Yamaha dealer check the cause before further riding.

EWA15991

### **⚠ WARNING**

**Improper maintenance can result in loss of braking ability. Observe these precautions:**

- Insufficient brake fluid may allow air to enter the brake system, reducing braking performance.
- Clean the filler cap before removing. Use only DOT 4 brake fluid from a sealed container.
- Use only the specified brake fluid; otherwise, the rubber seals may deteriorate, causing leakage.
- Refill with the same type of brake fluid. Adding a brake fluid other than DOT 4 may result in a harmful chemical reaction.
- Be careful that water does not enter the brake fluid reservoir when refilling. Water will significantly lower the boiling point of the fluid and may result in vapor lock.

# Periodic maintenance and adjustment

## Changing the brake fluid

EAU22734

Have a Yamaha dealer change the brake fluid every 2 years. In addition, have the seals of the master cylinders and brake calipers, as well as the brake hoses replaced at the intervals listed below or sooner if they are damaged or leaking.

- Brake seals: every 2 years
- Brake hoses: every 4 years

## Drive chain slack

EAU22762

The drive chain slack should be checked before each ride and adjusted if necessary.

### To check the drive chain slack

EAU74253

1. Place the motorcycle on the sides-stand.

### TIP

When checking and adjusting the drive chain slack, there should be no weight on the motorcycle.

2. Shift the transmission into the neutral position.
3. Measure the drive chain slack as shown.

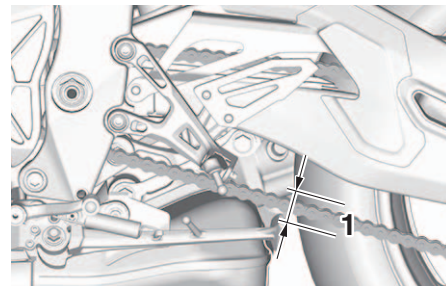

1. Drive chain slack

### Drive chain slack:

20.0–30.0 mm (0.79–1.18 in)

4. If the drive chain slack is incorrect, adjust it as follows. **NOTICE: Improper drive chain slack will overload the engine as well as other vital parts of the motorcycle and can lead to chain slippage or breakage. To prevent this from occurring, keep the drive chain slack within the specified limits.**<sup>[ECA10572]</sup>

EAU74260

### To adjust the drive chain slack

Consult a Yamaha dealer before adjusting the drive chain slack.

# Periodic maintenance and adjustment

EAU23027

1. Loosen the axle nut and the locknut on each side of the swingarm.
2. To tighten the drive chain, turn the drive chain slack adjusting bolt on each side of the swingarm in direction (a). To loosen the drive chain, turn the adjusting bolt on each side of the swingarm in direction (b), and then push the rear wheel forward.

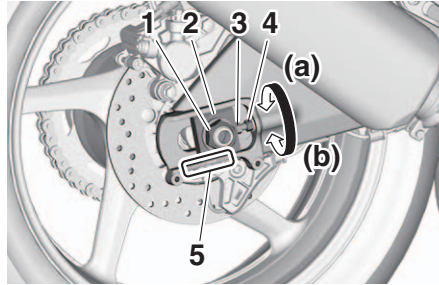

## TIP

Using the alignment marks on each side of the swingarm, make sure that both drive chain pullers are in the same position for proper wheel alignment.

1. Axle nut
2. Drive chain puller
3. Drive chain slack adjusting bolt
4. Locknut
5. Alignment marks

3. Tighten the axle nut, then the locknuts to their specified torques.

### Tightening torques:

Axle nut:

190 N·m (19 kgf·m, 140 lb·ft)

Locknut:

16 N·m (1.6 kgf·m, 12 lb·ft)

4. Make sure that the drive chain pullers are in the same position, the drive chain slack is correct, and the drive chain moves smoothly.

## Cleaning and lubricating the drive chain

The drive chain must be cleaned and lubricated at the intervals specified in the periodic maintenance and lubrication chart, otherwise it will quickly wear out, especially when riding in dusty or wet areas. Service the drive chain as follows.

ECA10584

### NOTICE

**The drive chain must be lubricated after washing the motorcycle, riding in the rain or riding in wet areas.**

1. Clean the drive chain with a drive chain cleaner and a small soft brush. **NOTICE: To prevent damaging the O-rings, do not clean the drive chain with steam cleaners, high-pressure washers or inappropriate solvents.**<sup>[ECA11122]</sup>
2. Wipe the drive chain dry.
3. Thoroughly lubricate the drive chain with a special O-ring chain lubricant. **NOTICE: Do not use engine oil or any other lubri-**

# Periodic maintenance and adjustment

---

cants for the drive chain, as they may contain substances that could damage the O-rings.<sup>[ECA11112]</sup>

EAU23098

## Checking and lubricating the cables

The operation of all control cables and the condition of the cables should be checked before each ride, and the cables and cable ends should be lubricated if necessary. If a cable is damaged or does not move smoothly, have a Yamaha dealer check or replace it.

**WARNING! Damage to the outer housing of cables may result in internal rusting and cause interference with cable movement. Replace damaged cables as soon as possible to prevent unsafe conditions.**<sup>[EWA10712]</sup>

### Recommended lubricant:

Yamaha cable lubricant or other suitable cable lubricant

EAU82490

## Checking and lubricating the throttle grip

The operation of the throttle grip should be checked before each ride. In addition, the throttle grip housing should be lubricated by a Yamaha dealer at the intervals specified in the periodic maintenance chart.

# Periodic maintenance and adjustment

EAU88560

## Checking and lubricating the brake and shift pedals

The operation of the brake and shift pedals should be checked before each ride, and the pedal pivots should be lubricated if necessary.

### Brake pedal

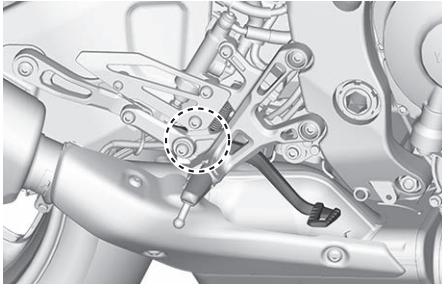

### Shift pedal

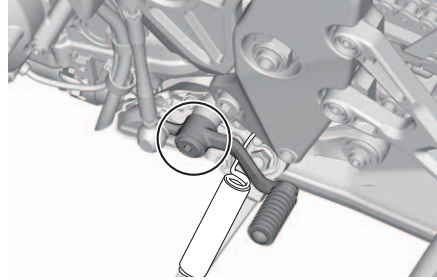

#### Recommended lubricants:

Brake pedal:  
Lithium-soap-based grease

Shift pedal:  
Molybdenum disulfide grease

EAU94800

## Checking and lubricating the brake and clutch levers

The operation of clutch lever should be checked before each ride, and the lever pivot should be lubricated if necessary. The brake lever pivot must be lubricated by a Yamaha dealer at the intervals specified in the periodic maintenance and lubrication chart.

### Clutch lever

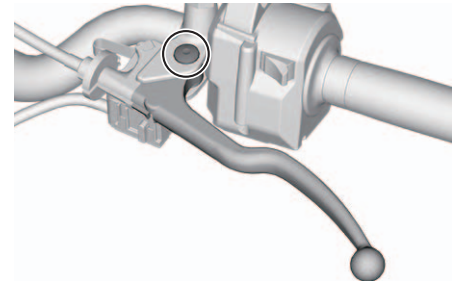

# Periodic maintenance and adjustment

## Brake lever

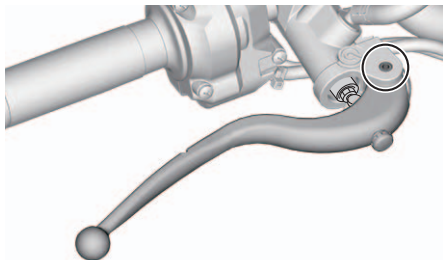

### Recommended lubricants:

- Clutch lever:  
Lithium-soap-based grease
- Brake lever:  
Silicone grease

EAU23203

## Checking and lubricating the sidestand

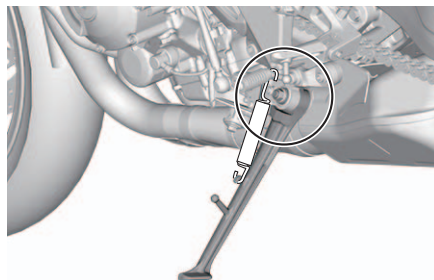

The operation of the sidestand should be checked before each ride, and the sidestand pivot and metal-to-metal contact surfaces should be lubricated if necessary.

EWA10732

### **WARNING**

**If the sidestand does not move up and down smoothly, have a Yamaha dealer check or repair it. Otherwise, the sidestand could contact the ground and distract the operator, resulting in a possible loss of control.**

**Recommended lubricant:**  
Lithium-soap-based grease

EAUM1653

## Lubricating the swingarm pivots

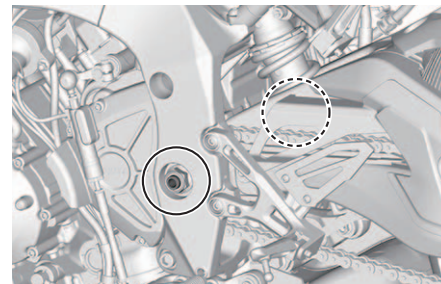

The swingarm pivots must be lubricated by a Yamaha dealer at the intervals specified in the periodic maintenance and lubrication chart.

**Recommended lubricant:**  
Lithium-soap-based grease

EAU23273

## Checking the front fork

The condition and operation of the front fork must be checked as follows at the intervals specified in the periodic maintenance and lubrication chart.

### To check the condition

Check the inner tubes for scratches, damage and excessive oil leakage.

### To check the operation

1. Place the vehicle on a level surface and hold it in an upright position. **WARNING! To avoid injury, securely support the vehicle so there is no danger of it falling over.**<sup>[EWA10752]</sup>
2. While applying the front brake, push down hard on the handlebars several times to check if the front fork compresses and rebounds smoothly.

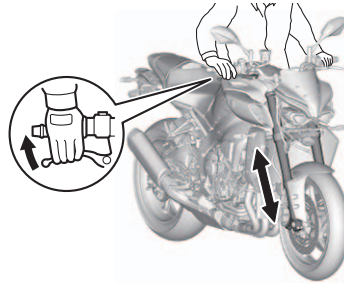

ECA10591

### NOTICE

**If any damage is found or the front fork does not operate smoothly, have a Yamaha dealer check or repair it.**

EAU23285

## Checking the steering

Worn or loose steering bearings may cause danger. Therefore, the operation of the steering must be checked as follows at the intervals specified in the periodic maintenance and lubrication chart.

1. Raise the front wheel off the ground. (See page 7-32.) **WARNING! To avoid injury, securely support the vehicle so there is no danger of it falling over.**<sup>[EWA10752]</sup>
2. Hold the lower ends of the front fork legs and try to move them forward and backward. If any free play can be felt, have a Yamaha dealer check or repair the steering.

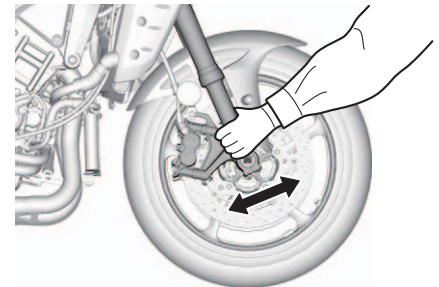



# Periodic maintenance and adjustment

EAU23292

## Checking the wheel bearings

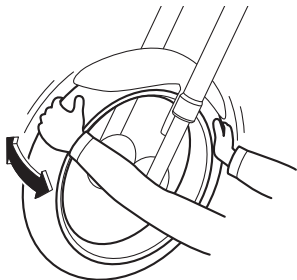

The front and rear wheel bearings must be checked at the intervals specified in the periodic maintenance and lubrication chart. If there is play in the wheel hub or if the wheel does not turn smoothly, have a Yamaha dealer check the wheel bearings.

7

EAU50292

## Battery

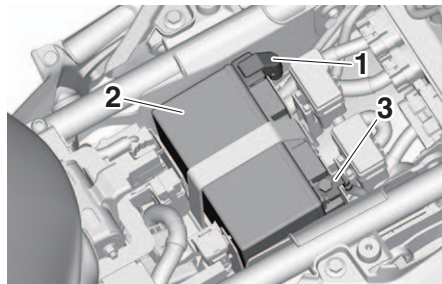

1. Positive battery lead (red)
2. Battery
3. Negative battery lead (black)

The battery is located under the seat. (See page 4-33.)

This model is equipped with a VRLA (Valve Regulated Lead Acid) battery. There is no need to check the electrolyte or to add distilled water. However, the battery lead connections need to be checked and, if necessary, tightened.

EWA10761

### **WARNING**

- **Electrolyte is poisonous and dangerous since it contains sulfuric acid, which causes severe burns. Avoid any contact with**

skin, eyes or clothing and always shield your eyes when working near batteries. In case of contact, administer the following **FIRST AID**.

- **EXTERNAL:** Flush with plenty of water.
- **INTERNAL:** Drink large quantities of water or milk and immediately call a physician.
- **EYES:** Flush with water for 15 minutes and seek prompt medical attention.
- **Batteries produce explosive hydrogen gas. Therefore, keep sparks, flames, cigarettes, etc., away from the battery and provide sufficient ventilation when charging it in an enclosed space.**
- **KEEP THIS AND ALL BATTERIES OUT OF THE REACH OF CHILDREN.**

### To charge the battery

Have a Yamaha dealer charge the battery as soon as possible if it seems to have discharged. Keep in mind that the



# Periodic maintenance and adjustment

battery tends to discharge more quickly if the vehicle is equipped with optional electrical accessories.

ECA16522

## NOTICE

**To charge a VRLA (Valve Regulated Lead Acid) battery, a special (constant-voltage) battery charger is required. Using a conventional battery charger will damage the battery.**

## To store the battery

1. If the vehicle will not be used for more than one month, remove the battery, fully charge it, and then place it in a cool, dry place.  
**NOTICE: When removing the battery, be sure to turn the main switch off, then disconnect the negative lead before disconnecting the positive lead.**<sup>[ECA16304]</sup>
2. If the battery will be stored for more than two months, check it at least once a month and fully charge it if necessary.
3. Fully charge the battery before installation. **NOTICE: When installing the battery, be sure to turn**

**the main switch off, then connect the positive lead before connecting the negative lead.**<sup>[ECA16842]</sup>

4. After installation, make sure that the battery leads are properly connected to the battery terminals.

ECA16531

## NOTICE

**Always keep the battery charged. Storing a discharged battery can cause permanent battery damage.**

## Replacing the fuses

EAU94161

The main fuse, ABS motor fuse, and fuse boxes containing individual circuit fuses are all located under the seat.

## TIP

Remove the starter relay cover by pulling it upward.

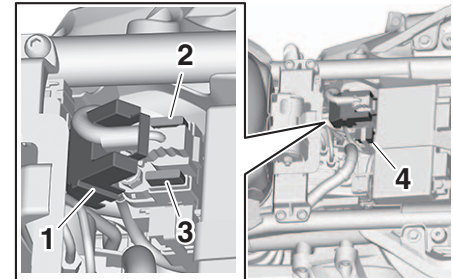

1. Starter relay cover
2. ABS motor spare fuse
3. ABS motor fuse
4. Main fuse

# Periodic maintenance and adjustment

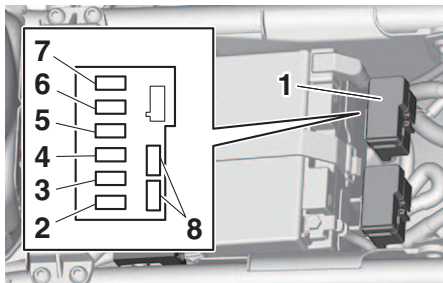

1. Fuse box 1
2. ABS solenoid fuse
3. Fuel injection system fuse
4. Electronic throttle valve fuse
5. Backup fuse
6. Sub radiator fan motor fuse
7. Radiator fan motor fuse
8. Spare fuse

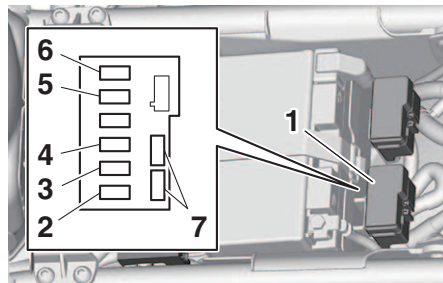

1. Fuse box 2
2. Ignition fuse
3. ABS ECU fuse
4. Signaling system fuse
5. Headlight fuse
6. Terminal fuse 1
7. Spare fuse

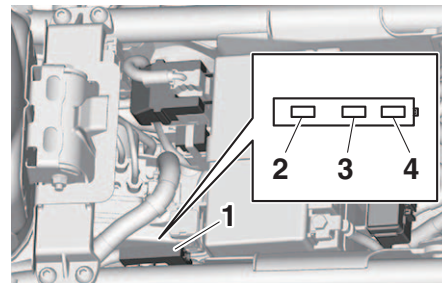

1. Fuse box 3
2. Brake light fuse
3. Cruise control fuse
4. Spare fuse

If a fuse is blown, replace it as follows.

1. Turn the key to "OFF" and turn off the electrical circuit in question.
2. Remove the blown fuse, and then install a new fuse of the specified amperage. **WARNING! Do not use a fuse of a higher amperage rating than recommended to avoid causing extensive damage to the electrical system and possibly a fire.** [EWA15132]

# Periodic maintenance and adjustment

EAU72980

## Specified fuses:

- Main fuse:  
50.0 A
- Terminal fuse 1:  
2.0 A
- Headlight fuse:  
10.0 A
- Signaling system fuse:  
7.5 A
- Ignition fuse:  
15.0 A
- Radiator fan motor fuse:  
15.0 A
- Sub radiator fan motor fuse:  
10.0 A
- ABS motor fuse:  
30.0 A
- ABS ECU fuse:  
7.5 A
- ABS solenoid fuse:  
15.0 A
- Fuel injection system fuse:  
15.0 A
- Backup fuse:  
10.0 A
- Electronic throttle valve fuse:  
7.5 A
- Brake light fuse:  
1.0 A
- Cruise control fuse:  
1.0 A

3. Turn the key to “ON” and turn on the electrical circuit in question to

- check if the device operates.
4. If the fuse immediately blows again, have a Yamaha dealer check the electrical system.

## Vehicle lights

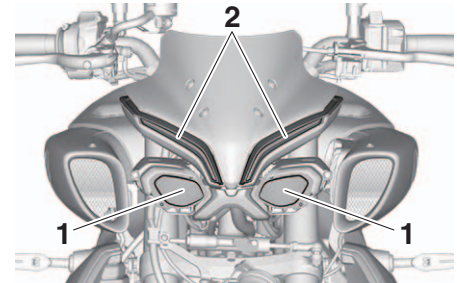

1. Headlight
2. Auxiliary light

This model is equipped with full-LED lighting. There are no user replaceable bulbs.

If a light does not come on, check the fuses and then have a Yamaha dealer check the vehicle.

ECA16581

### **NOTICE**

**Do not affix any type of tinted film or stickers to the headlight lens.**

# Periodic maintenance and adjustment

EAU67131

## Supporting the motorcycle

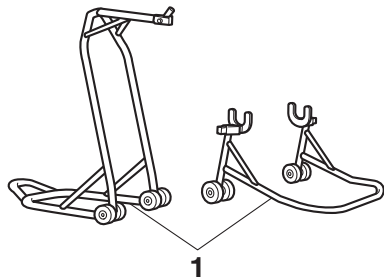

1. Maintenance stand (example)

7

Since this model is not equipped with a centerstand, use maintenance stands when removing the front or rear wheel or when performing other maintenance that requires the motorcycle to stand up right.

Check that the motorcycle is in a stable and level position before starting any maintenance.

EAU25872

## Troubleshooting

Although Yamaha motorcycles receive a thorough inspection before shipment from the factory, trouble may occur during operation. Any problem in the fuel, compression, or ignition systems, for example, can cause poor starting and loss of power.

The following troubleshooting charts represent quick and easy procedures for checking these vital systems yourself. However, should your motorcycle require any repair, take it to a Yamaha dealer, whose skilled technicians have the necessary tools, experience, and know-how to service the motorcycle properly.

Use only genuine Yamaha replacement parts. Imitation parts may look like Yamaha parts, but they are often inferior, have a shorter service life and can lead to expensive repair bills.

EWA15142

### **WARNING**

**When checking the fuel system, do not smoke, and make sure there are no open flames or sparks in the area, including pilot lights from water**

**heaters or furnaces. Gasoline or gasoline vapors can ignite or explode, causing severe injury or property damage.**

## Troubleshooting chart

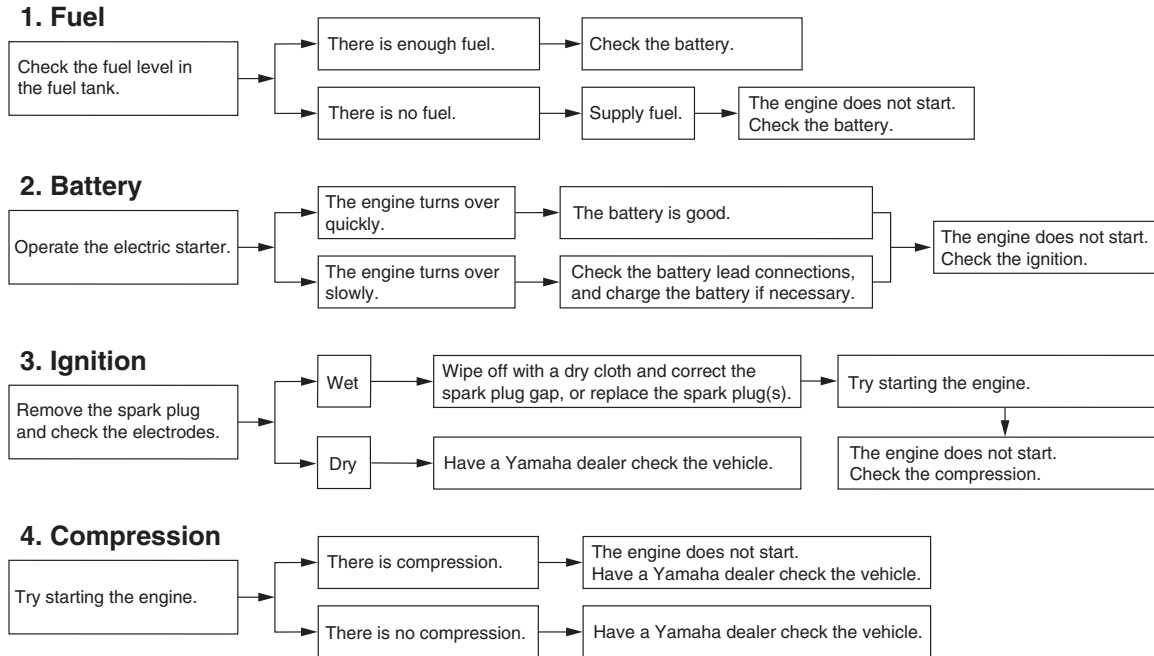

# Periodic maintenance and adjustment

EAU86420

## Engine overheating

EWAT1041

### **⚠ WARNING**

- Do not remove the radiator cap when the engine and radiator are hot. Scalding hot fluid and steam may be blown out under pressure, which could cause serious injury. Be sure to wait until the engine has cooled.
- Place a thick rag, like a towel, over the radiator cap, and then slowly rotate the cap counterclockwise to the detent to allow any residual pressure to escape. When the hissing sound has stopped, press down on the cap while turning it counterclockwise, and then remove the cap.

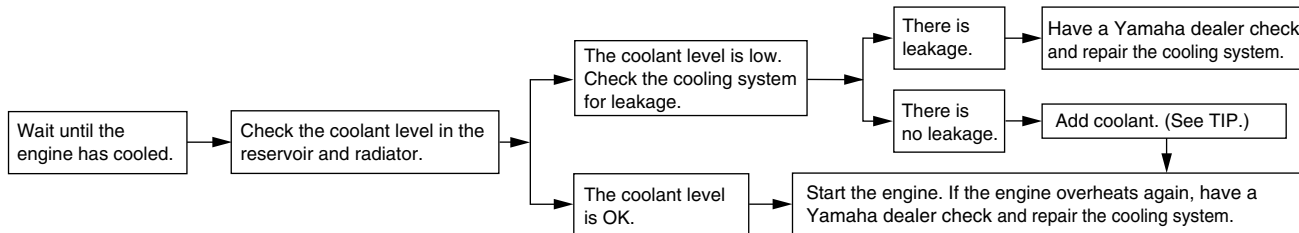

### TIP

If coolant is not available, tap water can be temporarily used instead, provided that it is changed to the recommended coolant as soon as possible.

EAU37834

EAU83443

ECA26280

## Matte color caution

### NOTICE

Some models are equipped with matte colored finished parts. Be sure to consult a Yamaha dealer for advice on what products to use before cleaning the vehicle. Using a brush, harsh chemical products or cleaning compounds when cleaning these parts will scratch or damage their surface. Wax also should not be applied to any matte colored finished parts.

ECA15193

## Care

Frequent, thorough cleaning of the vehicle will not only enhance its appearance but also will improve its general performance and extend the useful life of many components. Washing, cleaning, and polishing will also give you a chance to inspect the condition of the vehicle more frequently. Be sure to wash the vehicle after riding in the rain or near the sea, because salt is corrosive to metals.

### TIP

- The roads of heavy snowfall areas may be sprayed with salt as a de-icing method. This salt can stay on the roads well into spring, so be sure to wash the underside and chassis parts after riding in such areas.
- Genuine Yamaha care and maintenance products are sold under the YAMALUBE brand in many markets worldwide.
- See your Yamaha dealer for additional cleaning tips.

### NOTICE

Improper cleaning can cause cosmetic and mechanical damage. Do not use:

- high-pressure washers or steam-jet cleaners. Excessive water pressure may cause water seepage and deterioration of wheel bearings, brakes, transmission seals and electrical devices. Avoid high-pressure detergent applications such as those available in coin-operated car washers.
- harsh chemicals, including strong acidic wheel cleaners, especially on spoke or magnesium wheels.
- harsh chemicals, abrasive cleaning compounds, or wax on matte-finished parts. Brushes can scratch and damage the matte-finish, use soft sponge or towel only.
- towels, sponges, or brushes contaminated with abrasive cleaning products or strong chemicals such as, solvents,

# Motorcycle care and storage

---

**gasoline, rust removers, brake fluid, or antifreeze, etc.**

---

## Before washing

1. Park the vehicle out of direct sunlight and allow it to cool. This will help avoid water spots.
2. Make sure all caps, covers, electrical couplers and connectors are tightly installed.
3. Cover the muffler end with a plastic bag and a strong rubber band.
4. Pre-soak stubborn stains like insects or bird droppings with a wet towel for a few minutes.
5. Remove road grime and oil stains with a quality degreasing agent and a plastic-bristle brush or sponge. **NOTICE: Do not use degreasing agent on areas requiring lubrication such as seals, gaskets, and wheel axles. Follow product instructions.**<sup>[ECA26290]</sup>

## Washing

1. Rinse off any degreaser and spray down the vehicle with a garden hose. Use only enough pressure

to do the job. Avoid spraying water directly into the muffler, instrument panel, air inlet, or other inner areas such as underseat storage compartments.

2. Wash the vehicle with a quality automotive-type detergent mixed with cool water and a soft, clean towel or sponge. Use an old toothbrush or plastic-bristle brush for hard-to-reach places. **NOTICE: Use cold water if the vehicle has been exposed to salt. Warm water will increase salt's corrosive properties.**<sup>[ECA26301]</sup>
3. For windshield-equipped vehicles: Clean the windshield with a soft towel or sponge dampened with water and a pH neutral detergent. If necessary, use a high-quality windshield cleaner or polish for motorcycles. **NOTICE: Never use any strong chemicals to clean the windshield. Additionally, some cleaning compounds for plastic may scratch the windshield, so be sure to test all cleaning products before general application.**<sup>[ECA26310]</sup>

4. Rinse off thoroughly with clean water. Be sure to remove all detergent residues, as they can be harmful to plastic parts.

## After washing

1. Dry the vehicle with a chamois or absorbent towel, preferably micro-fiber terrycloth.
2. For drive chain-equipped models: Dry and then lubricate the drive chain to prevent rust.
3. Use a chrome polish to shine chrome, aluminum, and stainless steel parts. Often the thermally induced discoloring of stainless steel exhaust systems can be removed through polishing.
4. Apply a corrosion protection spray on all metal parts including chrome or nickel-plated surfaces. **WARNING! Do not apply silicone or oil spray to seats, hand grips, rubber foot pegs or tire treads. Otherwise these parts will become slippery, which could cause loss of control. Thoroughly clean the surfaces of these parts before**



## operating the vehicle.<sup>[EWA20650]</sup>

5. Treat rubber, vinyl, and unpainted plastic parts with a suitable care product.
6. Touch up minor paint damage caused by stones, etc.
7. Wax all painted surfaces using a non-abrasive wax or use a detail spray for motorcycles.
8. When finished cleaning, start the engine and let it idle for several minutes to help dry any remaining moisture.
9. If the headlight lens has fogged up, start the engine and turn on the headlight to help remove the moisture.
10. Let the vehicle dry completely before storing or covering it.

ECA26320

## NOTICE

- **Do not apply wax to rubber or unpainted plastic parts.**
- **Do not use abrasive polishing compounds as they will wear away the paint.**
- **Apply sprays and wax sparingly. Wipe off excess afterwards.**

EWA20660

## **WARNING**

**Contaminants left on the brakes or tires can cause loss of control.**

- **Make sure there is no lubricant or wax on the brakes or tires.**
- **If necessary, wash the tires with warm water and a mild detergent.**
- **If necessary, clean the brake discs and pads with brake cleaner or acetone.**
- **Before riding at higher speeds, test the vehicle's braking performance and cornering behavior.**

EAU83450

## **Cleaning the titanium muffler**

This model is equipped with a titanium muffler which requires special care. Use only a soft cloth or sponge and mild detergent with water to clean the muffler. This should remove fingerprints and other oil stains. If necessary, an alkaline pH cleaning product and soft brush may be used. However, do not use abrasive compounds or special treatments to clean the muffler, as these will wear away the protective fin-

ish.

## TIP

The thermally induced discoloring of the exhaust pipe leading into the titanium muffler is normal and cannot be removed.

# Motorcycle care and storage

---

EAU83472

## Storage

Always store the vehicle in a cool, dry place. If necessary, protect it against dust with a porous cover. Be sure the engine and the exhaust system are cool before covering the vehicle. If the vehicle often sits for weeks at a time between uses, the use of a quality fuel stabilizer is recommended after each fill-up.

ECA21170

### NOTICE

- **Storing the vehicle in a poorly ventilated room or covering it with a tarp, while it is still wet, will allow water and humidity to seep in and cause rust.**
- **To prevent corrosion, avoid damp cellars, stables (because of the presence of ammonia) and areas where strong chemicals are stored.**

## Long term storage

Before storing the vehicle long term (60 days or more):

1. Make all necessary repairs and

perform any outstanding maintenance.

2. Follow all instructions in the Care section of this chapter.
3. Fill up the fuel tank, adding fuel stabilizer according to product instructions. Run the engine for 5 minutes to distribute treated fuel through the fuel system.
4. For vehicles equipped with a fuel cock: Turn the fuel cock lever to the off position.
5. For vehicles with a carburetor: To prevent fuel deposits from building up, drain the fuel in the carburetor float chamber into a clean container. Retighten the drain bolt and pour the fuel back into the fuel tank.
6. Use a quality engine fogging oil according to product instructions to protect internal engine components from corrosion. If engine fogging oil is not available, perform the following steps for each cylinder:
  - a. Remove the spark plug cap and spark plug.
  - b. Pour a teaspoonful of engine oil

into the spark plug bore.

- c. Install the spark plug cap onto the spark plug, and then place the spark plug on the cylinder head so that the electrodes are grounded. (This will limit sparking during the next step.)
  - d. Turn the engine over several times with the starter. (This will coat the cylinder wall with oil.) **WARNING! To prevent damage or injury from sparking, make sure to ground the spark plug electrodes while turning the engine over.**<sup>[EWA10952]</sup>
  - e. Remove the spark plug cap from the spark plug, and then install the spark plug and the spark plug cap.
7. Lubricate all control cables, pivots, levers and pedals, as well as the sidestand and centerstand (if equipped).
  8. Check and correct the tire air pressure, and then lift the vehicle so that all wheels are off the ground. Otherwise, turn the wheels a little once a month in order to prevent

the tires from becoming degraded in one spot.

9. Cover the muffler outlet with a plastic bag to prevent moisture from entering it.
10. Remove the battery and fully charge it, or attach a maintenance charger to keep the battery optimally charged. **NOTICE: Confirm that the battery and its charger are compatible. Do not charge a VRLA battery with a conventional charger.**<sup>[ECA26330]</sup>

### TIP

---

- If the battery will be removed, charge it once a month and store it in a temperate location between 0-30 °C (32-90 °F).
  - See page 7-28 for more information on charging and storing the battery.
-

# Specifications

## Dimensions:

- Overall length:  
2100 mm (82.7 in)
  - Overall width:  
800 mm (31.5 in)
  - Overall height:  
1165 mm (45.9 in)
  - Seat height:  
835 mm (32.9 in)
  - Wheelbase:  
1405 mm (55.3 in)
  - Ground clearance:  
135 mm (5.31 in)
  - Minimum turning radius:  
3.4 m (11.16 ft)
- ## Weight:
- Curb weight:  
212 kg (467 lb)
- ## Engine:
- Combustion cycle:  
4-stroke
  - Cooling system:  
Liquid cooled
  - Valve train:  
DOHC
  - Cylinder arrangement:  
Inline
  - Number of cylinders:  
4-cylinder
  - Displacement:  
998 cm<sup>3</sup>
  - Bore × stroke:  
79.0 × 50.9 mm (3.11 × 2.00 in)

- Starting system:  
Electric starter

## Engine oil:

- Recommended brand:



- Type:  
Full synthetic
- SAE viscosity grades:  
10W-40, 15W-50
- Recommended engine oil grade:  
API service SG type or higher, JASO standard MA
- Engine oil quantity:  
Oil change:  
3.90 L (4.12 US qt, 3.43 Imp.qt)
- With oil filter removal:  
4.10 L (4.33 US qt, 3.61 Imp.qt)

## Coolant quantity:

- Coolant reservoir (up to the maximum level mark):  
0.24 L (0.25 US qt, 0.21 Imp.qt)
- Radiator (including all routes):  
2.25 L (2.38 US qt, 1.98 Imp.qt)

## Fuel:

- Recommended fuel:  
Unleaded gasoline (E10 acceptable)
- Octane number (RON):  
95
- Fuel tank capacity:  
17 L (4.5 US gal, 3.7 Imp.gal)

- Fuel reserve amount:  
4.0 L (1.06 US gal, 0.88 Imp.gal)

## Fuel injection:

- Throttle body:
- ID mark:  
B5Y1 00

## Drivetrain:

- Gear ratio:  
1st:  
2.600 (39/15)
- 2nd:  
2.176 (37/17)
- 3rd:  
1.842 (35/19)
- 4th:  
1.579 (30/19)
- 5th:  
1.381 (29/21)
- 6th:  
1.250 (30/24)

## Front tire:

- Type:  
Tubeless
- Size:  
120/70ZR17M/C(58W)
- Manufacturer/model:  
BRIDGESTONE/BATTLAX HYPERS-PORT S22F

## Rear tire:

- Type:  
Tubeless
- Size:  
190/55ZR17M/C(75W)

Manufacturer/model:  
BRIDGESTONE/BATTLAX HYPERS-  
PORT S22R

**Loading:**

Maximum load:  
173 kg (381 lb)

The vehicle's maximum load is the combined weight of the rider, passenger, cargo and any accessories.

**Front brake:**

Type:  
Hydraulic dual disc brake

**Rear brake:**

Type:  
Hydraulic single disc brake

**Front suspension:**

Type:  
Telescopic fork

**Rear suspension:**

Type:  
Swingarm (link suspension)

**Electrical system:**

System voltage:  
12 V

**Battery:**

Model:  
YTZ10S  
Voltage, capacity:  
12 V, 8.6 Ah (10 HR)

**Bulb wattage:**

Headlight:  
LED  
Brake/tail light:  
LED

Front turn signal light:  
LED

Rear turn signal light:  
LED

Auxiliary light:  
LED

License plate light:  
LED

# Consumer information

EAU53562

## Identification numbers

Record the vehicle identification number, engine serial number, and the model label information in the spaces provided below. These identification numbers are needed when registering the vehicle with the authorities in your area and when ordering spare parts from a Yamaha dealer.

VEHICLE IDENTIFICATION NUMBER:

ENGINE SERIAL NUMBER:

MODEL LABEL INFORMATION:

EAU26401

## Vehicle identification number

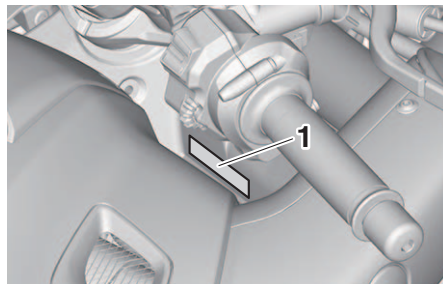

1. Vehicle identification number

The vehicle identification number is stamped into the steering head pipe. Record this number in the space provided.

### TIP \_\_\_\_\_

The vehicle identification number is used to identify your motorcycle and may be used to register your motorcycle with the licensing authority in your area.

---

EAU26442

## Engine serial number

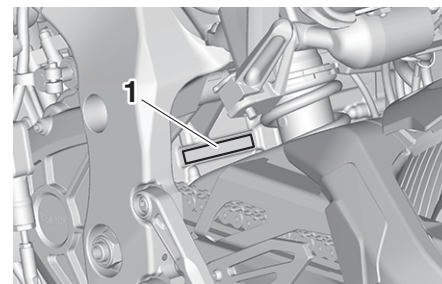

1. Engine serial number

The engine serial number is stamped into the crankcase.

EAU26481

## Model label

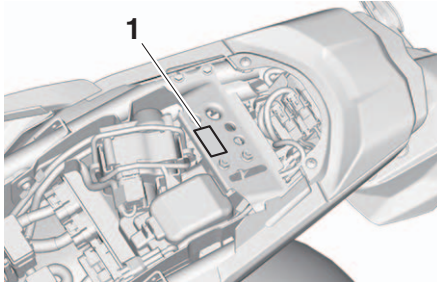

1. Model label

The model label is affixed to the frame under the seat. (See page 4-33.) Record the information on this label in the space provided. This information will be needed when ordering spare parts from a Yamaha dealer.

EAU69910

## Diagnostic connector

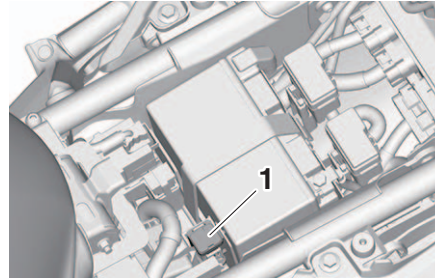

1. Diagnostic connector

The diagnostic connector is located as shown.

EAU85300

## Vehicle data recording

This model's ECU stores certain vehicle data to assist in the diagnosis of malfunctions and for research, statistical analysis and development purposes.

Although the sensors and recorded data will vary by model, the main data points are:

- Vehicle status and engine performance data
- Fuel-injection and emission-related data

This data will be uploaded only when a special Yamaha diagnostic tool is attached to the vehicle, such as when maintenance checks or service procedures are performed.

Vehicle data uploaded will be handled appropriately according to the following Privacy Policy.

## Privacy Policy

<https://www.yamaha-motor.eu/eu/en/privacy/privacy-policy/>

Yamaha will not disclose this data to a third party except in the following cas-

## Consumer information

---

es. In addition, Yamaha may provide vehicle data to a contractor in order to outsource services related to the handling of vehicle data. Even in this case, Yamaha will require the contractor to properly handle the vehicle data we provided and Yamaha will appropriately manage the data.

- With the consent of the vehicle owner
- Where obligated by law
- For use by Yamaha in litigation
- When the data is not related to an individual vehicle nor owner



- A**
- ABS warning light ..... 4-7
  - Air filter element..... 7-14
  - Auxiliary DC jack ..... 4-40
  - Auxiliary system warning light ..... 4-8
- B**
- Battery ..... 7-28
  - Brake and clutch levers, checking and lubricating..... 7-25
  - Brake and shift pedals, checking and lubricating..... 7-25
  - Brake control system (BC)..... 4-29
  - Brake fluid, changing ..... 7-22
  - Brake fluid level, checking ..... 7-21
  - Brake lever ..... 4-28
  - Brake lever free play, checking ..... 7-19
  - Brake light switches..... 7-20
  - Brake pedal ..... 4-28
- C**
- Cables, checking and lubricating ..... 7-24
  - Canister ..... 7-10
  - Care..... 8-1
  - Catalytic converter ..... 4-33
  - Clutch lever..... 4-27
  - Clutch lever free play, adjusting ..... 7-18
  - Coolant ..... 7-12
  - Cruise control indicator lights ..... 4-6
  - Cruise control system ..... 3-6
  - Cruise control/YVSL switches ..... 4-4
- D**
- Data recording, vehicle..... 10-2
  - Diagnostic connector ..... 10-2
  - Dimmer/Pass switch ..... 4-3
  - Display, main screen ..... 4-9
  - Display, menu screen.....4-18
  - Drive chain, cleaning and lubricating .....7-23
  - Drive chain slack .....7-22
- E**
- Engine break-in ..... 6-1
  - Engine idling speed, checking.....7-14
  - Engine oil ..... 7-10
  - Engine overheating ..... 7-34
  - Engine serial number ..... 10-1
  - EXUP system .....4-39
- F**
- Front and rear brake pads, checking .....7-20
  - Front fork, adjusting .....4-34
  - Front fork, checking.....7-27
  - Fuel .....4-31
  - Fuel consumption, tips for reducing .....6-4
  - Fuel tank cap.....4-30
  - Fuel tank overflow hose .....4-32
  - Fuses, replacing.....7-29
- G**
- Glossary .....3-4
- H**
- Handlebar switches ..... 4-3
  - Hazard switch.....4-4
  - High beam indicator light.....4-6
  - Horn switch ..... 4-4
- I**
- Identification numbers ..... 10-1
  - Ignition circuit cut-off system .....4-41
  - Immobilizer system .....4-1
  - Immobilizer system indicator light .....4-7
  - Indicator lights and warning lights .....4-5
- L**
- Luggage strap holders .....4-39
- M**
- Main switch/steering lock ..... 4-2
  - Maintenance and lubrication, periodic .... 7-5
  - Maintenance, emission control system... 7-3
  - Malfunction indicator light (MIL)..... 4-6
  - Matte color, caution ..... 8-1
  - Model label ..... 10-2
- N**
- Neutral indicator light ..... 4-6
- O**
- Oil pressure and Coolant temperature warning light ..... 4-8
- P**
- Parking..... 6-5
  - Part locations ..... 2-1
- S**
- Safety information ..... 1-1
  - Seat ..... 4-33
  - Shift indicator light ..... 4-7
  - Shifting ..... 6-3
  - Shift pedal.....4-27
  - Shock absorber assembly, adjusting .... 4-36
  - Sidestand..... 4-40
  - Sidestand, checking and lubricating .... 7-26
  - Spark plugs, checking..... 7-9
  - Special features ..... 3-1
  - Specifications..... 9-1
  - Stability control indicator light ..... 4-7
  - Starting the engine.....6-2
  - Steering, checking ..... 7-27
  - Stop/Run/Start switch ..... 4-4
  - Storage ..... 8-4
  - Supporting the motorcycle ..... 7-32
  - Swingarm pivots, lubricating ..... 7-26

# Index

---

---

## T

Throttle grip, checking and lubricating .....	7-24
Tires .....	7-15
Titanium muffler, cleaning .....	8-3
Tool kits .....	7-2
Troubleshooting .....	7-32
Troubleshooting chart .....	7-33
Turn signal indicator lights .....	4-6
Turn signal switch .....	4-4

## V

Valve clearance .....	7-15
Vehicle identification number .....	10-1
Vehicle lights .....	7-31

## W

Wheel bearings, checking .....	7-28
Wheels .....	7-18

## Y

Yamalube .....	7-11
YRC functions visual guide .....	3-5
YRC settings .....	4-18
YRC (Yamaha Ride Control) .....	3-1
YVSL .....	3-8



