





OWNER'S MANUAL

NMAX
NMAX 150
MOTORCYCLE

 **Read this manual carefully before operating this vehicle.**

GPD125-A
GPD150-A

BV3-F8199-E0

 **Read this manual carefully before operating this vehicle. This manual should stay with this vehicle if it is sold.**

Welcome to the Yamaha world of motorcycling!

As the owner of the GPD125-A/GPD150-A, you are benefiting from Yamaha's vast experience and newest technology regarding the design and manufacture of high-quality products, which have earned Yamaha a reputation for dependability. Please take the time to read this manual thoroughly, so as to enjoy all advantages of your GPD125-A/GPD150-A. The Owner's Manual does not only instruct you in how to operate, inspect and maintain your scooter, but also in how to safeguard yourself and others from trouble and injury.

In addition, the many tips given in this manual will help keep your scooter in the best possible condition. If you have any further questions, do not hesitate to contact your Yamaha dealer.

The Yamaha team wishes you many safe and pleasant rides. So, remember to put safety first!

Yamaha continually seeks advancements in product design and quality. Therefore, while this manual contains the most current product information available at the time of printing, there may be minor discrepancies between your scooter and this manual. If there is any question concerning this manual, please consult a Yamaha dealer.







Please read this manual carefully and completely before operating this scooter.

Important manual information

EAU63350

Particularly important information is distinguished in this manual by the following notations:

	This is the safety alert symbol. It is used to alert you to potential personal injury hazards. Obey all safety messages that follow this symbol to avoid possible injury or death.
	A WARNING indicates a hazardous situation which, if not avoided, could result in death or serious injury.
	A NOTICE indicates special precautions that must be taken to avoid damage to the vehicle or other property.
	A TIP provides key information to make procedures easier or clearer.

*Product and specifications are subject to change without notice.

EAUN0430

**GPD125-A/GPD150-A
OWNER'S MANUAL
©2016 PT Yamaha Indonesia Motor
Manufacturing
1st edition, December 2016
All rights reserved.
Any reprinting or unauthorized use
without the written permission of
PT Yamaha Indonesia Motor Manufac-
turing
is expressly prohibited.
Printed in Indonesia.**

Table of contents

Safety information	1-1	General maintenance and	
Further safe-riding points.....	1-5	lubrication chart.....	6-4
Description	2-1	Removing and installing panels	6-7
Left view	2-1	Checking the spark plug.....	6-9
Right view.....	2-2	Engine oil and oil strainer.....	6-10
Controls and instruments.....	2-3	Final transmission oil	6-12
Instrument and control functions	3-1	Coolant	6-13
Main switch/steering lock	3-1	Air filter and V-belt case air	
Keyhole shutter	3-2	filter elements	6-17
Indicator lights and warning		Checking the throttle grip	
lights	3-3	free play.....	6-19
Multi-function meter unit.....	3-4	Valve clearance.....	6-20
Handlebar switches.....	3-9	Tires	6-20
Front brake lever	3-10	Cast wheels	6-22
Rear brake lever.....	3-11	Checking the front and rear	
ABS	3-11	brake lever free play	6-23
Fuel tank cap.....	3-12	Checking the front and rear	
Fuel.....	3-13	brake pads.....	6-24
Fuel tank overflow hose	3-15	Checking the brake fluid level.....	6-25
Catalytic converter	3-15	Changing the brake fluid.....	6-26
Seat	3-16	Checking the V-belt	6-26
Storage compartments	3-16	Checking and lubricating the	
Sidestand	3-17	cables	6-27
Ignition circuit cut-off system.....	3-18	Checking and lubricating the	
For your safety – pre-operation		throttle grip and cable	6-27
checks	4-1	Lubricating the front and rear	
Operation and important riding		brake levers	6-28
points	5-1	Checking and lubricating the	
Starting the engine	5-1	centerstand and sidestand.....	6-28
Starting off.....	5-2	Checking the front fork	6-29
Acceleration and deceleration.....	5-3	Checking the steering	6-29
Braking	5-3	Checking the wheel bearings	6-30
Tips for reducing fuel		Battery	6-30
consumption	5-4	Replacing the fuses	6-32
Engine break-in	5-4	Headlight.....	6-33
Parking	5-5	Replacing an auxiliary light bulb ...	6-34
Periodic maintenance and		Brake light.....	6-35
adjustment	6-1	Replacing the taillight bulb	6-35
Owner's tool kit	6-2	Replacing a front turn signal	
Periodic maintenance chart for		light bulb.....	6-37
the emission control system.....	6-3	Replacing a rear turn signal	
		light bulb.....	6-38
		Troubleshooting	6-39
		Troubleshooting charts.....	6-40

Table of contents

Scooter care and storage	7-1
Matte color caution	7-1
Care	7-1
Storage	7-4
Specifications	8-1
Consumer information	9-1
Identification numbers	9-1
Diagnostic connector	9-2
Vehicle data recording	9-2
Index	10-1

EAU1026B

Be a Responsible Owner

As the vehicle's owner, you are responsible for the safe and proper operation of your scooter.

Scooters are single-track vehicles.

Their safe use and operation are dependent upon the use of proper riding techniques as well as the expertise of the operator. Every operator should know the following requirements before riding this scooter.

He or she should:

- Obtain thorough instructions from a competent source on all aspects of scooter operation.
- Observe the warnings and maintenance requirements in this Owner's Manual.
- Obtain qualified training in safe and proper riding techniques.
- Obtain professional technical service as indicated in this Owner's Manual and/or when made necessary by mechanical conditions.
- Never operate a scooter without proper training or instruction. Take a training course. Beginners should receive training from a certified instructor. Contact an authorized scooter dealer to find out about the training courses nearest you.

Safe Riding

Perform the pre-operation checks each time you use the vehicle to make sure it is in safe operating condition. Failure to inspect or maintain the vehicle properly increases the possibility of

an accident or equipment damage. See page 4-1 for a list of pre-operation checks.

- This scooter is designed to carry the operator and a passenger.
- The failure of motorists to detect and recognize scooters in traffic is the predominating cause of automobile/scooter accidents. Many accidents have been caused by an automobile driver who did not see the scooter. Making yourself conspicuous appears to be very effective in reducing the chance of this type of accident.

Therefore:

- Wear a brightly colored jacket.
- Use extra caution when you are approaching and passing through intersections, since intersections are the most likely places for scooter accidents to occur.
- Ride where other motorists can see you. Avoid riding in another motorist's blind spot.
- Never maintain a scooter without proper knowledge. Contact an authorized scooter dealer to inform you on basic scooter maintenance. Certain maintenance can only be carried out by certified staff.
- Many accidents involve inexperienced operators. In fact, many operators who have been involved in accidents do not even have a current driver's license.
- Make sure that you are qualified and that you only lend your scooter to other qualified operators.

Safety information

1

- Know your skills and limits. Staying within your limits may help you to avoid an accident.
- We recommend that you practice riding your scooter where there is no traffic until you have become thoroughly familiar with the scooter and all of its controls.
- Many accidents have been caused by error of the scooter operator. A typical error made by the operator is veering wide on a turn due to excessive speed or undercornering (insufficient lean angle for the speed).
 - Always obey the speed limit and never travel faster than warranted by road and traffic conditions.
 - Always signal before turning or changing lanes. Make sure that other motorists can see you.
- The posture of the operator and passenger is important for proper control.
 - The operator should keep both hands on the handlebar and both feet on the operator footrests during operation to maintain control of the scooter.
 - The passenger should always hold onto the operator, the seat strap or grab bar, if equipped, with both hands and keep both feet on the passenger footrests. Never carry a passenger unless he or she can firmly place both feet on the passenger footrests.
- Never ride under the influence of alcohol or other drugs.

- This scooter is designed for on-road use only. It is not suitable for off-road use.

Protective Apparel

The majority of fatalities from scooter accidents are the result of head injuries. The use of a safety helmet is the single most critical factor in the prevention or reduction of head injuries.

- Always wear an approved helmet.
- Wear a face shield or goggles. Wind in your unprotected eyes could contribute to an impairment of vision that could delay seeing a hazard.
- The use of a jacket, substantial shoes, trousers, gloves, etc., is effective in preventing or reducing abrasions or lacerations.
- Never wear loose-fitting clothes, otherwise they could catch on the control levers or wheels and cause injury or an accident.
- Always wear protective clothing that covers your legs, ankles, and feet. The engine or exhaust system become very hot during or after operation and can cause burns.
- A passenger should also observe the above precautions.

Avoid Carbon Monoxide Poisoning

All engine exhaust contains carbon monoxide, a deadly gas. Breathing carbon monoxide can cause headaches, dizziness, drowsiness, nausea, confusion, and eventually death.

Carbon Monoxide is a colorless, odorless, tasteless gas which may be present even if you do not see or smell

any engine exhaust. Deadly levels of carbon monoxide can collect rapidly and you can quickly be overcome and unable to save yourself. Also, deadly levels of carbon monoxide can linger for hours or days in enclosed or poorly ventilated areas. If you experience any symptoms of carbon monoxide poisoning, leave the area immediately, get fresh air, and **SEEK MEDICAL TREATMENT**.

- Do not run engine indoors. Even if you try to ventilate engine exhaust with fans or open windows and doors, carbon monoxide can rapidly reach dangerous levels.
- Do not run engine in poorly ventilated or partially enclosed areas such as barns, garages, or carports.
- Do not run engine outdoors where engine exhaust can be drawn into a building through openings such as windows and doors.

Loading

Adding accessories or cargo to your scooter can adversely affect stability and handling if the weight distribution of the scooter is changed. To avoid the possibility of an accident, use extreme caution when adding cargo or accessories to your scooter. Use extra care when riding a scooter that has added cargo or accessories. Here, along with the information about accessories below, are some general guidelines to follow if loading cargo to your scooter:

The total weight of the operator, passenger, accessories and cargo must not exceed the maximum load limit.

Operation of an overloaded vehicle could cause an accident.

<p>Maximum load: 168 kg (370 lb)</p>

When loading within this weight limit, keep the following in mind:

- Cargo and accessory weight should be kept as low and close to the scooter as possible. Securely pack your heaviest items as close to the center of the vehicle as possible and make sure to distribute the weight as evenly as possible on both sides of the scooter to minimize imbalance or instability.
- Shifting weights can create a sudden imbalance. Make sure that accessories and cargo are securely attached to the scooter before riding. Check accessory mounts and cargo restraints frequently.
- Properly adjust the suspension for your load (suspension-adjustable models only), and check the condition and pressure of your tires.
- Never attach any large or heavy items to the handlebar, front fork, or front fender. Such items can create unstable handling or a slow steering response.
- **This vehicle is not designed to pull a trailer or to be attached to a sidecar.**

Safety information

Genuine Yamaha Accessories

Choosing accessories for your vehicle is an important decision. Genuine Yamaha accessories, which are available only from a Yamaha dealer, have been designed, tested, and approved by Yamaha for use on your vehicle.

Many companies with no connection to Yamaha manufacture parts and accessories or offer other modifications for Yamaha vehicles. Yamaha is not in a position to test the products that these aftermarket companies produce. Therefore, Yamaha can neither endorse nor recommend the use of accessories not sold by Yamaha or modifications not specifically recommended by Yamaha, even if sold and installed by a Yamaha dealer.

Aftermarket Parts, Accessories, and Modifications

While you may find aftermarket products similar in design and quality to genuine Yamaha accessories, recognize that some aftermarket accessories or modifications are not suitable because of potential safety hazards to you or others. Installing aftermarket products or having other modifications performed to your vehicle that change any of the vehicle's design or operation characteristics can put you and others at greater risk of serious injury or death. You are responsible for injuries related to changes in the vehicle.

Keep the following guidelines in mind, as well as those provided under "Loading" when mounting accessories.

- Never install accessories or carry cargo that would impair the performance of your scooter. Careful-

ly inspect the accessory before using it to make sure that it does not in any way reduce ground clearance or cornering clearance, limit suspension travel, steering travel or control operation, or obscure lights or reflectors.

- Accessories fitted to the handlebar or the front fork area can create instability due to improper weight distribution or aerodynamic changes. If accessories are added to the handlebar or front fork area, they must be as lightweight as possible and should be kept to a minimum.
- Bulky or large accessories may seriously affect the stability of the scooter due to aerodynamic effects. Wind may attempt to lift the scooter, or the scooter may become unstable in cross winds. These accessories may also cause instability when passing or being passed by large vehicles.
- Certain accessories can displace the operator from his or her normal riding position. This improper position limits the freedom of movement of the operator and may limit control ability, therefore, such accessories are not recommended.
- Use caution when adding electrical accessories. If electrical accessories exceed the capacity of the scooter's electrical system, an electric failure could result, which could cause a dangerous loss of lights or engine power.

Aftermarket Tires and Rims

The tires and rims that came with your scooter were designed to match the performance capabilities and to provide the best combination of handling, braking, and comfort. Other tires, rims, sizes, and combinations may not be appropriate. Refer to page 6-20 for tire specifications and more information on replacing your tires.

Transporting the Scooter

Be sure to observe following instructions before transporting the scooter in another vehicle.

- Remove all loose items from the scooter.
- Point the front wheel straight ahead on the trailer or in the truck bed, and choke it in a rail to prevent movement.
- Secure the scooter with tie-downs or suitable straps that are attached to solid parts of the scooter, such as the frame or upper front fork triple clamp (and not, for example, to rubber-mounted handlebars or turn signals, or parts that could break). Choose the location for the straps carefully so the straps will not rub against painted surfaces during transport.
- The suspension should be compressed somewhat by the tie-downs, if possible, so that the scooter will not bounce excessively during transport.

Further safe-riding points

- Be sure to signal clearly when making turns.
- Braking can be extremely difficult on a wet road. Avoid hard braking, because the scooter could slide. Apply the brakes slowly when stopping on a wet surface.
- Slow down as you approach a corner or turn. Once you have completed a turn, accelerate slowly.
- Be careful when passing parked cars. A driver might not see you and open a door in your path.
- Railroad crossings, streetcar rails, iron plates on road construction sites, and manhole covers become extremely slippery when wet. Slow down and cross them with caution. Keep the scooter upright, otherwise it could slide out from under you.
- The brake pads or linings could get wet when you wash the scooter. After washing the scooter, check the brakes before riding.
- Always wear a helmet, gloves, trousers (tapered around the cuff and ankle so they do not flap), and a brightly colored jacket.
- Do not carry too much luggage on the scooter. An overloaded scooter is unstable. Use a strong cord to secure any luggage to the carrier (if equipped). A loose load will affect the stability of the scooter and could divert your attention from the road. (See page 1-3.)

Description

EAU63371

Left view

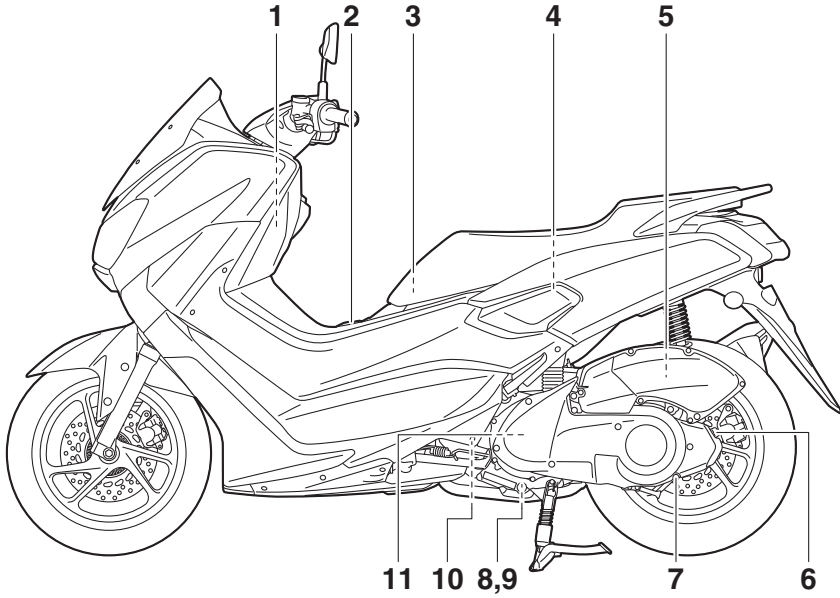

1. Front storage compartment (page 3-16)
2. Fuel tank cap (page 3-12)
3. Owner's tool kit (page 6-2)
4. Rear storage compartment (page 3-16)
5. Air filter element (page 6-17)
6. Final transmission oil filler cap (page 6-12)
7. Final transmission oil drain bolt (page 6-12)
8. Engine oil drain bolt A (page 6-10)
9. Engine oil drain bolt B (page 6-10)
10. Coolant drain bolt (page 6-14)
11. V-belt case air filter element (page 6-17)

Right view

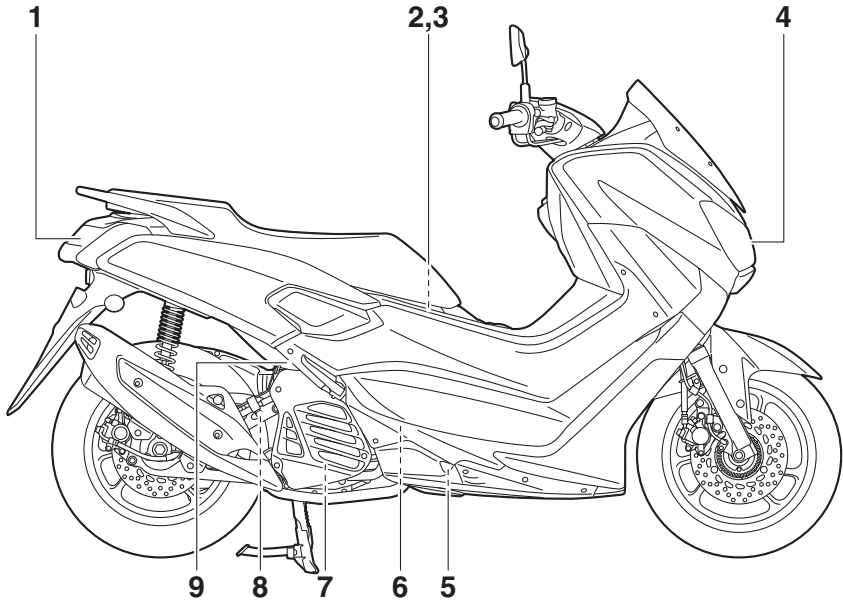

1. Tail/brake light (page 6-35)
2. Battery (page 6-30)
3. Fuse box (page 6-32)
4. Headlight (page 6-33)
5. Coolant reservoir (page 6-13)
6. Spark plug (page 6-9)
7. Coolant drain screw (page 6-14)
8. Engine oil filler cap (page 6-10)
9. Radiator cap (page 6-13)

Description

EAU63401

Controls and instruments

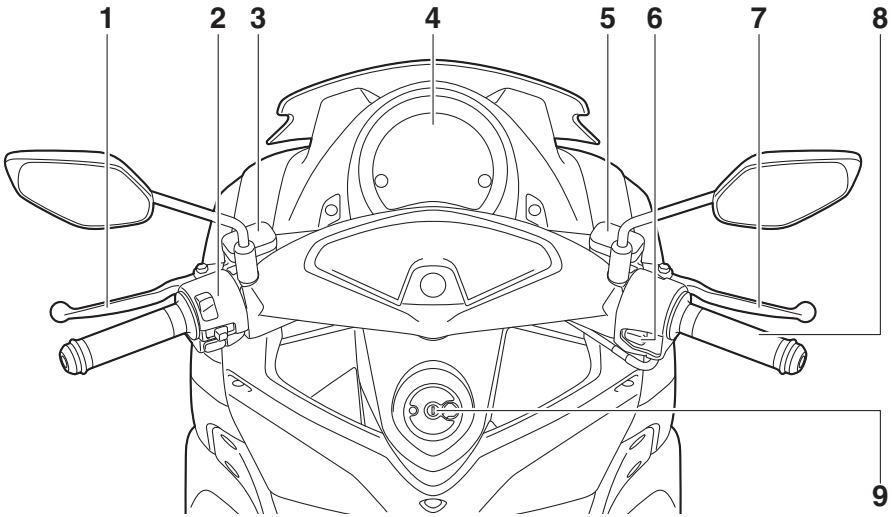

1. Rear brake lever (page 3-11)
2. Left handlebar switches (page 3-9)
3. Rear brake fluid reservoir (page 6-25)
4. Multi-function meter unit (page 3-4)
5. Front brake fluid reservoir (page 6-25)
6. Start switch (page 3-9)
7. Front brake lever (page 3-10)
8. Throttle grip (page 6-19)
9. Main switch/steering lock (page 3-1)

Instrument and control functions

Main switch/steering lock

EAU0264

EWA10062

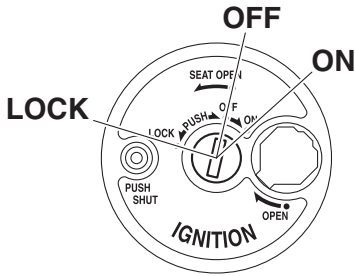

The main switch/steering lock controls the ignition and lighting systems, and is used to lock the steering. The various main switch positions are described below.

TIP

The main switch/steering lock is equipped with a keyhole shutter. (See page 3-2 for keyhole shutter opening and closing procedures.)

ON

EAU60600

All electrical circuits are supplied with power; the meter lighting, taillight and auxiliary lights come on, and the engine can be started. The key cannot be removed.

TIP

The headlight comes on automatically when the engine is started and stays on until the key is turned to "OFF", even if the engine stalls.

OFF

EAU10662

All electrical systems are off. The key can be removed.

WARNING

Never turn the key to "OFF" or "LOCK" while the vehicle is moving. Otherwise the electrical systems will be switched off, which may result in loss of control or an accident.

EAU1068B

LOCK

The steering is locked and all electrical systems are off. The key can be removed.

To lock the steering

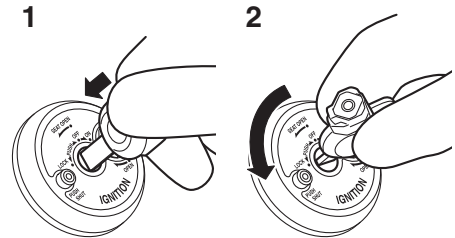

1. Push.
2. Turn.

1. Turn the handlebars all the way to the left.
2. With the key in the "OFF" position, push the key in and turn it to "LOCK".
3. Remove the key.

TIP

If the steering will not lock, try turning the handlebars back to the right slightly.

Instrument and control functions

EAUN0353

To unlock the steering

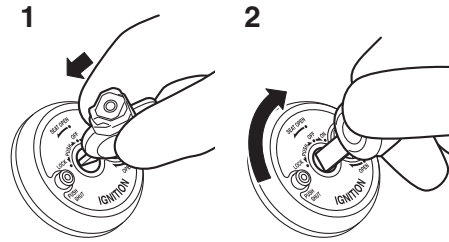

3

1. Push.
2. Turn.

From the “LOCK” position, push the key in and turn it to “OFF”.

Keyhole shutter

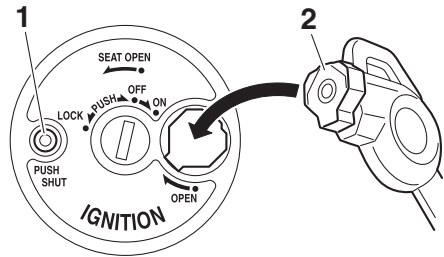

1. “PUSH SHUT” button
2. Key head

To open the keyhole shutter

Insert the key head into the keyhole shutter receptacle as shown, and then turn the key to the right to open the keyhole shutter.

To close the keyhole shutter

Press the “PUSH SHUT” button to close the keyhole shutter.

Instrument and control functions

Indicator lights and warning lights

EAU4939B

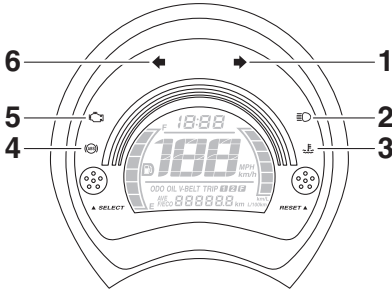

1. Right turn signal indicator light “↘”
2. High beam indicator light “≡○”
3. Coolant temperature warning light “⤴”
4. Anti-lock Brake System (ABS) warning light “(⊗)”
5. Engine trouble warning light “⚠”
6. Left turn signal indicator light “↙”

Turn signal indicator lights “↘” and “↙”

EAU11032

Each indicator light will flash when its corresponding turn signal lights are flashing.

High beam indicator light “≡○”

EAU11081

This indicator light comes on when the high beam of the headlight is switched on.

Coolant temperature warning light “⤴”

EAU67440

This warning light comes on if the engine overheats. If this occurs, stop the engine immediately and allow the engine to cool.

The electrical circuit of the warning light can be checked by turning the key to “ON”. The warning light should come on for a few seconds, and then go off.

If the warning light does not come on initially when the key is turned to “ON”, or if the warning light remains on, have a Yamaha dealer check the electrical circuit.

ECA10022

NOTICE

Do not continue to operate the engine if it is overheating.

TIP

If the engine overheats, see page 6-41 for further instructions.

Engine trouble warning light “⚠”

EAU73171

This warning light comes on if a problem is detected in the engine or other vehicle control system. If this occurs, have a Yamaha dealer check the on-board diagnostic system.

The electrical circuit of the warning light can be checked by turning the key to “ON”. The warning light should come on for a few seconds, and then go off.

If the warning light does not come on initially when the key is turned to “ON”, or if the warning light remains on, have a Yamaha dealer check the vehicle.

ABS warning light “(⊗)”

EAU1810

In normal operation, the ABS warning light comes on when the key is turned to “ON”, and goes off after traveling at a speed of 10 km/h (6 mi/h) or higher. If the ABS warning light:

Instrument and control functions

- does not come on when the key is turned to “ON”
- comes on or flashes while riding
- does not go off after traveling at a speed of 10 km/h (6 mi/h) or higher

The ABS may not work correctly. If any of the above occurs, have a Yamaha dealer check the system as soon as possible. (See page 3-11 for an explanation of the ABS.)

EWA16041

⚠ WARNING

If the ABS warning light does not go off after traveling at a speed of 10 km/h (6 mi/h) or higher, or if the warning light comes on or flashes while riding, the brake system reverts to conventional braking. If either of the above occurs, or if the warning light does not come on at all, use extra caution to avoid possible wheel lock during emergency braking. Have a Yamaha dealer check the brake system and electrical circuits as soon as possible.

TIP

The ABS warning light may come on while accelerating the engine with the vehicle on its centerstand, but this does not indicate a malfunction.

EAJN0983

Multi-function meter unit

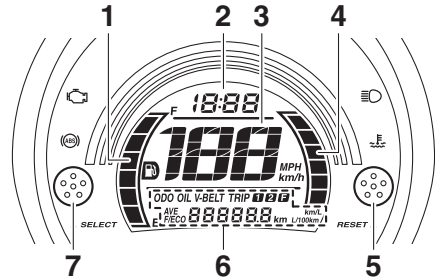

1. Fuel meter
2. Clock
3. Speedometer
4. Instantaneous fuel consumption meter
5. “RESET” button
6. Multi-function display
7. “SELECT” button

EWA12423

⚠ WARNING

Be sure to stop the vehicle before making any setting changes to the multi-function meter unit. Changing settings while riding can distract the operator and increase the risk of an accident.

The multi-function meter unit is equipped with the following:

- a speedometer
- a clock
- a fuel meter
- an instantaneous fuel consumption meter
- a multi-function display

TIP

- Be sure to turn the key to “ON” before using the “SELECT” and “RESET” buttons.
- For the UK: To switch the speedometer between km/h and MPH, press the “SELECT” button for

Instrument and control functions

one second when the multi-function meter is in odometer mode, tripmeter 1, or tripmeter 2 mode .

Speedometer

The speedometer shows the vehicle's traveling speed.

Clock

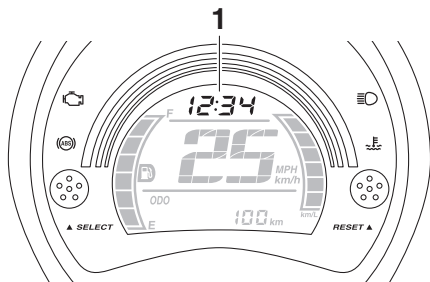

1. Clock

The clock uses a 12-hour time system.

To set the clock

1. Turn the key to "ON".
2. Push the "SELECT" button and "RESET" button together for at least two seconds.
3. When the hour digits start flashing, push the "RESET" button to set the hours.
4. Push the "SELECT" button, and the minute digits will start flashing.
5. Push the "RESET" button to set the minutes.
6. Push the "SELECT" button and then release it to start the clock.

Fuel meter

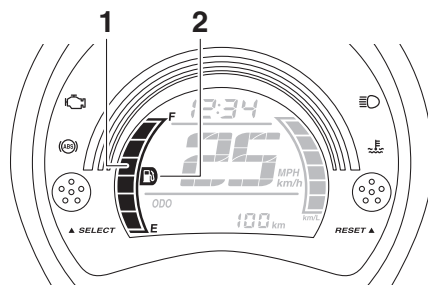

1. Fuel meter
2. Fuel level warning indicator "🛢"

The fuel meter indicates the amount of fuel in the fuel tank. The display segments of the fuel meter disappear towards "E" (Empty) as the fuel level decreases. When the last segment and fuel level warning indicator "🛢" start flashing, refuel as soon as possible.

TIP

If a problem is detected in the electrical circuit, the following cycle is repeated until the malfunction is corrected: fuel level segments and fuel level warning indicator "🛢" flash eight times, then go off for approximately 3 seconds. Have a Yamaha dealer check the electrical circuit.

Instrument and control functions

Instantaneous fuel consumption meter

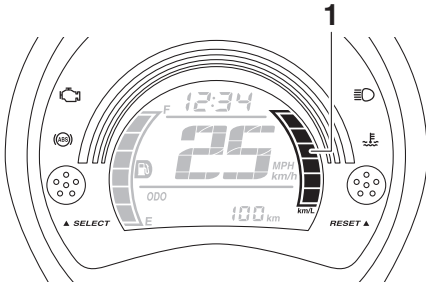

1. Instantaneous fuel consumption meter

This meter shows the instantaneous fuel consumption.

Depending on the display setting selected for the instantaneous fuel consumption mode “F/ECO”, the displayed segments increase or decrease.

- km/L and MPG (for the UK): The number of segments displayed increases the more efficiently the vehicle is being operated.
- L/100 km: The number of segments displayed decreases the more efficiently the vehicle is being operated.

Multi-function display

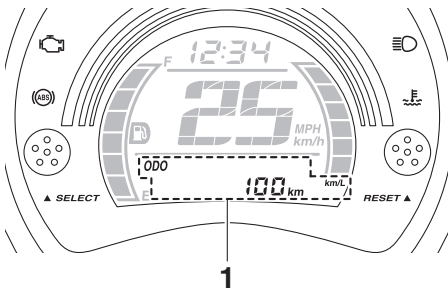

1. Multi-function display

The multi-function display is equipped with the following:

- an odometer
- two tripmeters (which show the distance traveled since they were last set to zero)
- a fuel reserve tripmeter (which shows the distance traveled since the last segment of the fuel meter started flashing)
- an instantaneous fuel consumption display
- an average fuel consumption display
- an oil change tripmeter
- a V-belt replacement tripmeter
- an oil change indicator
- a V-belt replacement indicator

Except for the UK:

Push the “SELECT” button to switch the display between the odometer mode “ODO”, tripmeter modes “TRIP 1” and “TRIP 2”, oil change tripmeter mode “OIL TRIP”, V-belt replacement tripmeter mode “V-BELT TRIP”, instantaneous fuel consumption mode “F/ECO” (km/L or L/100 km), and average fuel consumption mode “AVE F/ECO” (km/L or L/100 km) in the following order:

ODO → TRIP 1 → TRIP 2 → OIL TRIP → V-BELT TRIP → F/ECO → AVE F/ECO → ODO

For the UK:

Push the “SELECT” button to switch the display between the odometer mode “ODO”, tripmeter modes “TRIP 1” and “TRIP 2”, oil change tripmeter mode “OIL TRIP”, V-belt replacement tripmeter mode “V-BELT TRIP”, instantaneous fuel consumption mode

Instrument and control functions

“F/ECO” (MPG or L/100 km), and average fuel consumption mode “AVE F/ECO” (MPG or L/100 km) in the following order:

ODO → TRIP 1 → TRIP 2 → OIL TRIP
→ V-BELT TRIP → F/ECO → AVE
F/ECO → ODO

If the fuel level warning indicator “” and last segment of the fuel meter start flashing, the display automatically changes to the fuel reserve tripmeter mode “TRIP F” and starts counting the distance traveled from that point. In that case, push the “SELECT” button to switch the display between the various tripmeter, odometer, oil change tripmeter, V-belt replacement tripmeter, instantaneous fuel consumption and average fuel consumption modes in the following order:

TRIP F → TRIP 1 → TRIP 2 → OIL TRIP
→ V-BELT TRIP → F/ECO → AVE
F/ECO → ODO → TRIP F

To reset a tripmeter, select it by pushing the “SELECT” button, and then push the “RESET” button for at least one second.

TIP

- If you do not reset the fuel reserve tripmeter manually, it resets itself automatically and the display returns to the prior mode after refueling and traveling 5 km (3 mi).
- If you do not reset tripmeters 1 and 2, they will reset to 0 and continue counting after 9999.9 has been reached.

- The odometer will lock at 999999 and cannot be reset.

Instantaneous fuel consumption mode

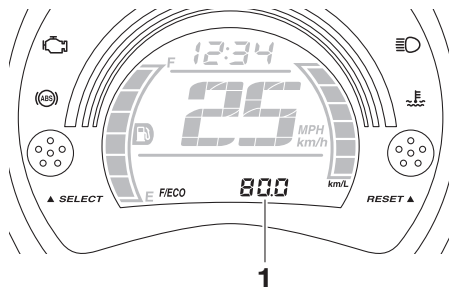

1. Instantaneous fuel consumption display

The instantaneous fuel consumption display can be set to either “km/L” or “L/100 km”, and either “MPG” or “L/100 km” (for the UK).

- “km/L”: The distance that can be traveled on 1.0 L of fuel under the current riding conditions is shown.
- “L/100 km”: The amount of fuel necessary to travel 100 km under the current riding conditions is shown.
- “MPG”: The distance that can be traveled on 1.0 Imp. gal of the fuel under the current riding conditions is shown.

To switch between the instantaneous fuel consumption display settings, push the “SELECT” button for one second.

TIP

- If traveling at speeds under 10 km/h (6 mi/h), “_ _ _” is displayed.
- When MPG is selected, no units indicator will be displayed.

Instrument and control functions

Average fuel consumption mode



1. Average fuel consumption display

This display shows the average fuel consumption since it was last reset. The average fuel consumption display can be set to either “km/L” or “L/100 km”, and either “MPG” or “L/100 km” (for the UK).

- “km/L”: The average distance that can be traveled on 1.0 L of fuel is shown.
- “L/100 km”: The average amount of fuel necessary to travel 100 km is shown.
- “MPG”: The average distance that can be traveled on 1.0 Imp. gal of fuel under the current riding conditions is shown.

To switch between the average fuel consumption display settings, push the “SELECT” button for one second. To reset the average fuel consumption, push the “RESET” button for at least one second.

TIP

- After resetting the average fuel consumption, “_ _.” will be shown until the vehicle has traveled 0.1 km (0.06 mi).
- When MPG is selected, no units indicator will be displayed.

Oil change tripmeter mode

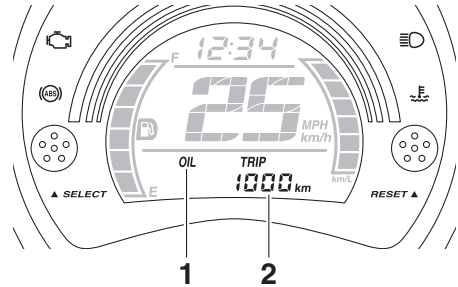

1. Oil change indicator “OIL”

2. Oil change tripmeter

The oil change tripmeter shows the distance traveled since it was last reset (i.e., since the last oil change).

The oil change indicator “OIL” will flash at the initial 1000 km (600 mi), and every 6000 km (3500 mi) thereafter to indicate that the engine oil should be changed.

After changing the engine oil, reset the oil change tripmeter and the oil change indicator. To reset them both, select the oil change tripmeter, and then push the “RESET” button for one second. Then, while “OIL” and the oil change tripmeter are flashing, push the “RESET” button for three seconds. The oil change indicator will be reset.

If the engine oil is changed before the oil change indicator comes on (i.e., before the periodic oil change interval has been reached), the oil change tripmeter must be reset for the next periodic oil change to be indicated at the correct time.

V-belt replacement tripmeter mode



1. V-belt replacement indicator “V-BELT”
2. V-belt replacement tripmeter

The V-belt replacement tripmeter shows the distance traveled since it was last reset (i.e., since the last V-belt replacement).

The V-belt replacement indicator “V-BELT” will flash at every 18000 km (10500 mi) thereafter to indicate that the V-belt should be replaced.

After replacing the V-belt, reset the V-belt replacement tripmeter and the V-belt replacement indicator. To reset them both, select the V-belt replacement tripmeter, and then push the “RESET” button for one second. Then, while “V-BELT” and the V-belt replacement tripmeter are flashing, push the “RESET” button for three seconds. The V-belt replacement indicator will be reset.

If the V-belt is replaced before the V-belt replacement indicator comes on (i.e., before the periodic V-belt replacement interval has been reached), the V-belt replacement tripmeter must be reset for the next periodic V-belt replacement to be indicated at the correct time.

Handlebar switches

Left

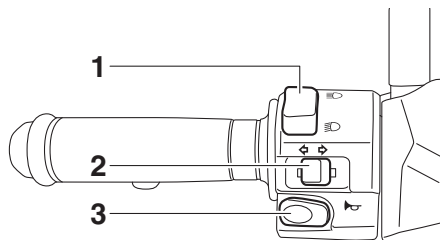

1. Dimmer switch “ \equiv / \equiv ”
2. Turn signal switch “ \leftarrow / \rightarrow ”
3. Horn switch “ 🔊 ”

Right

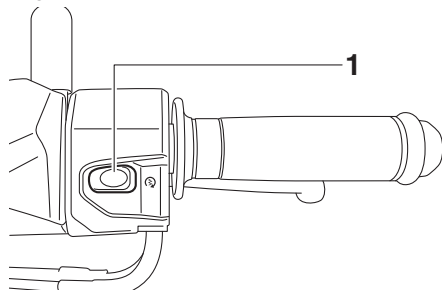

1. Start switch “ 🌀 ”

Dimmer switch “ \equiv / \equiv ”

EAU12401

Set this switch to “ \equiv ” for the high beam and to “ \equiv ” for the low beam.

Turn signal switch “ \leftarrow / \rightarrow ”

EAU12461

To signal a right-hand turn, push this switch to “ \rightarrow ”. To signal a left-hand turn, push this switch to “ \leftarrow ”. When released, the switch returns to the center position. To cancel the turn signal lights, push the switch in after it has returned to the center position.

Instrument and control functions

Horn switch “”

EAU12501

Press this switch to sound the horn.

Start switch “”

EAU12722

With the sidestand up, push this switch while applying the front or rear brake to crank the engine with the starter. See page 5-1 for starting instructions prior to starting the engine.

Front brake lever

EAU12902

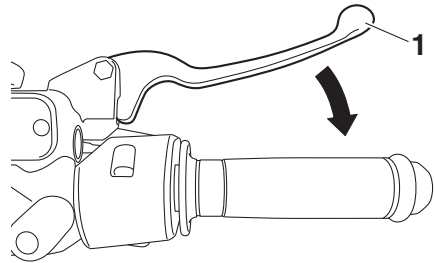

1. Front brake lever

The front brake lever is located on the right side of the handlebar. To apply the front brake, pull this lever toward the throttle grip.

Rear brake lever

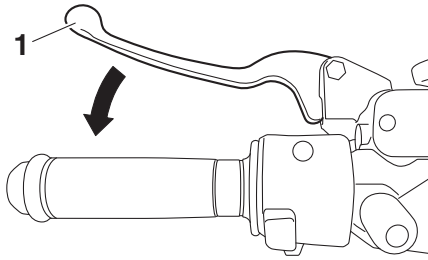

1. Rear brake lever

The rear brake lever is located on the left side of the handlebar. To apply the rear brake, pull this lever toward the handlebar grip.

ABS

The Yamaha ABS (Anti-lock Brake System) features a dual electronic control system, which acts on the front and rear brakes independently.

Operate the brakes with ABS as you would conventional brakes. If the ABS is activated, a pulsating sensation may be felt at the brake levers. In this situation, continue to apply the brakes and let the ABS work; do not “pump” the brakes as this will reduce braking effectiveness.

EWA16051

WARNING

Always keep a sufficient distance from the vehicle ahead to match the riding speed even with ABS.

- **The ABS performs best with long braking distances.**
- **On certain surfaces, such as rough or gravel roads, the braking distance may be longer with the ABS than without.**

The ABS is monitored by an ECU, which will revert the system to conventional braking if a malfunction occurs.

TIP

- The ABS performs a self-diagnosis test each time the vehicle first starts off after the key is turned to “ON” and the vehicle has traveled at a speed of 10 km/h (6 mi/h) or higher. During this test, a “clicking” noise can be heard from the front of the vehicle, and if either brake lever is even slightly applied, a vibration can be felt at the lever, but these do not indicate a malfunction.

Instrument and control functions

EAU66690

- This ABS has a test mode which allows the owner to experience the pulsation at the brake levers when the ABS is operating. However, special tools are required, so please consult your Yamaha dealer.

ECA20100

NOTICE

- 3** Be careful not to damage the wheel sensor or wheel sensor rotor; otherwise, improper performance of the ABS will result.

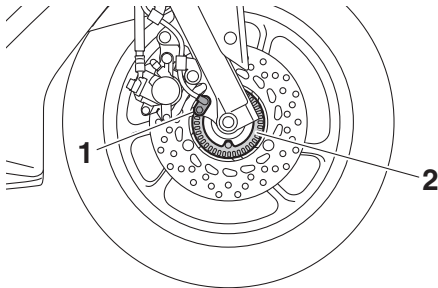

1. Front wheel sensor
2. Front wheel sensor rotor

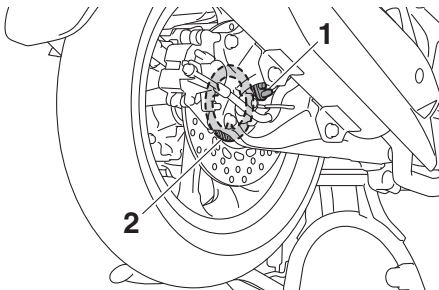

1. Rear wheel sensor
2. Rear wheel sensor rotor

Fuel tank cap

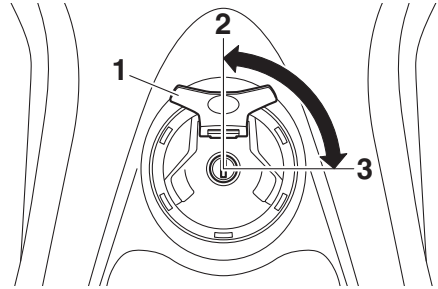

1. Fuel tank cap lock cover
2. Lock.
3. Unlock.

To remove the fuel tank cap

Open the fuel tank cap lock cover, insert the key into the lock, and then turn it 1/4 turn clockwise. The lock will be released and the fuel tank cap can be removed.

To install the fuel tank cap

1. Insert the fuel tank cap into the tank opening with the key inserted in the lock and with the “△” mark facing forward.

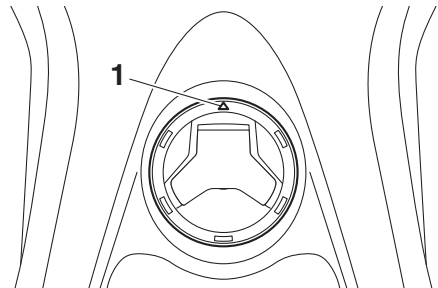

1. “△” mark
2. Turn the key counterclockwise to the original position, remove it, and then close the lock cover.

Instrument and control functions

EAU13213

TIP

The fuel tank cap cannot be installed unless the key is in the lock. In addition, the key cannot be removed if the cap is not properly installed and locked.

EWA10132

! WARNING

Make sure that the fuel tank cap is properly installed before riding. Leaking fuel is a fire hazard.

Fuel

Make sure there is sufficient gasoline in the tank.

EWA10882

! WARNING

Gasoline and gasoline vapors are extremely flammable. To avoid fires and explosions and to reduce the risk of injury when refueling, follow these instructions.

1. Before refueling, turn off the engine and be sure that no one is sitting on the vehicle. Never refuel while smoking, or while in the vicinity of sparks, open flames, or other sources of ignition such as the pilot lights of water heaters and clothes dryers.
2. Do not overfill the fuel tank. Stop filling when the fuel reaches the bottom of the filler tube. Because fuel expands when it heats up, heat from the engine or the sun can cause fuel to spill out of the fuel tank.

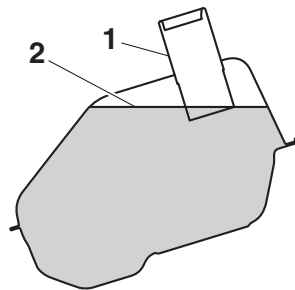

1. Fuel tank filler tube
2. Maximum fuel level

3. Wipe up any spilled fuel immediately. **NOTICE: Immediately wipe off spilled fuel with a clean,**

Instrument and control functions

dry, soft cloth, since fuel may deteriorate painted surfaces or plastic parts. ^[ECA10072]

4. Be sure to securely close the fuel tank cap.

EWA15152

WARNING

Gasoline is poisonous and can cause injury or death. Handle gasoline with care. Never siphon gasoline by mouth. If you should swallow some gasoline or inhale a lot of gasoline vapor, or get some gasoline in your eyes, see your doctor immediately. If gasoline spills on your skin, wash with soap and water. If gasoline spills on your clothing, change your clothes.

EAU76750

Recommended fuel:

Regular unleaded gasoline (Gasohol [E10] acceptable)

Fuel tank capacity:

6.6 L (1.7 US gal, 1.5 Imp.gal)

ECA11401

NOTICE

Use only unleaded gasoline. The use of leaded gasoline will cause severe damage to internal engine parts, such as the valves and piston rings, as well as to the exhaust system.



TIP

- This mark identifies the recommended fuel for this vehicle as specified by European regulation (EN228).
- Check that gasoline nozzle has the same identifier when fueling.

Your Yamaha engine has been designed to use regular unleaded gasoline with a research octane number of 95 or higher. If knocking (or pinging) occurs, use a gasoline of a different brand or premium unleaded fuel. Use of unleaded fuel will extend spark plug life and reduce maintenance costs.

Gasohol

There are two types of gasohol: gasohol containing ethanol and that containing methanol. Gasohol containing ethanol can be used if the ethanol content does not exceed 10% (E10). Gasohol containing methanol is not recommended by Yamaha because it can cause damage to the fuel system or vehicle performance problems.

Fuel tank overflow hose

EAU58301

EAU13434

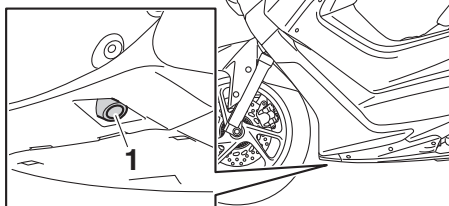

1. Fuel tank overflow hose

Before operating the vehicle:

- Check the fuel tank overflow hose connection and routing.
- Check the fuel tank overflow hose for cracks or damage, and replace it if necessary.
- Make sure that the fuel tank overflow hose is not blocked, and clean it if necessary.

Catalytic converter

This model is equipped with a catalytic converter in the exhaust system.

EWA10863

! WARNING

The exhaust system is hot after operation. To prevent a fire hazard or burns:

- Do not park the vehicle near possible fire hazards such as grass or other materials that easily burn.
- Park the vehicle in a place where pedestrians or children are not likely to touch the hot exhaust system.
- Make sure that the exhaust system has cooled down before doing any maintenance work.
- Do not allow the engine to idle more than a few minutes. Long idling can cause a build-up of heat.

ECA10702

NOTICE

Use only unleaded gasoline. The use of leaded gasoline will cause unreparable damage to the catalytic converter.

Instrument and control functions

EAU60621

EAU57081

Seat

To open the seat

1. Place the vehicle on the center-stand.
2. Insert the key into the main switch, and then turn it counterclockwise to “SEAT OPEN”.

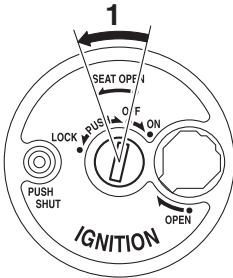

1. Open.

TIP

Do not push inward when turning the key.

3. Fold the seat up.

To close the seat

1. Fold the seat down, and then push it down to lock it in place.
2. Remove the key.

TIP

Make sure that the seat is properly secured before riding.

Storage compartments

Front storage compartment

The front storage compartment is located at the front of the vehicle. Use this compartment for small items.

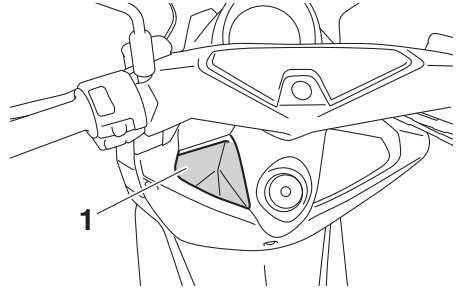

1. Front storage compartment

EWA17250

WARNING

- Do not exceed the load limit of 1.5 kg (3.3 lb) for the front storage compartment.
- Do not place anything in the front storage compartment that will interfere with your operating the vehicle.

Rear storage compartment

The rear storage compartment is located under the seat. Use this compartment for large items. (See page 3-16.)

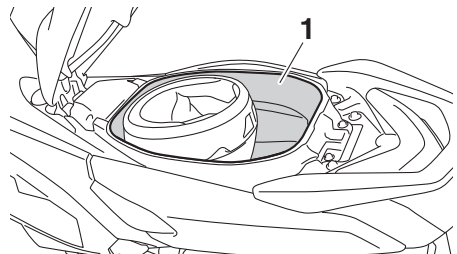

1. Rear storage compartment

! WARNING

- Do not exceed the load limit of 5 kg (11 lb) for the rear storage compartment.
- Do not exceed the maximum load of 168 kg (370 lb) for the vehicle.

ECA21150

NOTICE

Keep the following points in mind when using the storage compartment.

- Since the storage compartment accumulates heat when exposed to the sun and/or the engine heat, do not store anything susceptible to heat, consumables or flammable items inside it.
- To avoid humidity from spreading through the storage compartment, wrap wet articles in a plastic bag before storing them in the compartment.
- Since the storage compartment may get wet while the vehicle is being washed, wrap any articles stored in the compartment in a plastic bag.
- Do not keep anything valuable or breakable in the storage compartment.

TIP

Do not leave your vehicle unattended with the seat open.

Sidestand

The sidestand is located on the left side of the frame. Raise the sidestand or lower it with your foot while holding the vehicle upright.

TIP

The built-in sidestand switch is part of the ignition circuit cut-off system, which cuts the ignition in certain situations. (See the following section for an explanation of the ignition circuit cut-off system.)

EWA10242

! WARNING

The vehicle must not be ridden with the sidestand down, or if the sidestand cannot be properly moved up (or does not stay up), otherwise the sidestand could contact the ground and distract the operator, resulting in a possible loss of control. Yamaha's ignition circuit cut-off system has been designed to assist the operator in fulfilling the responsibility of raising the sidestand before starting off. Therefore, check this system regularly and have a Yamaha dealer repair it if it does not function properly.

Instrument and control functions

EAU66800

Ignition circuit cut-off system

Check the operation of the sidestand switch according to the following procedure.

Instrument and control functions

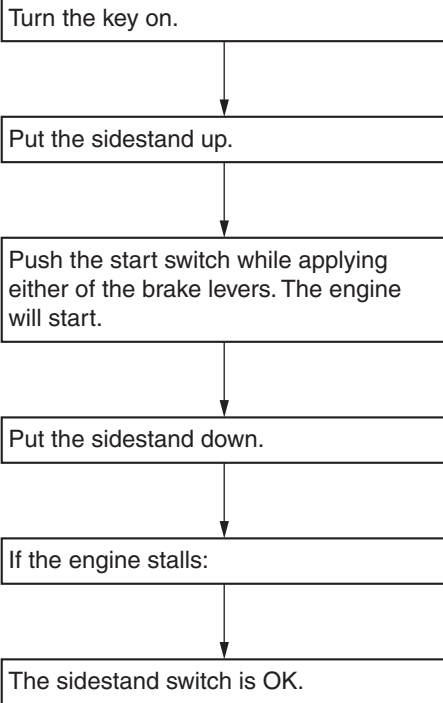

WARNING

- The vehicle must be placed on the centerstand during this inspection.
 - If a malfunction is noted, have a Yamaha dealer check the system before riding.
-

For your safety – pre-operation checks

EAU63440

Inspect your vehicle each time you use it to make sure the vehicle is in safe operating condition. Always follow the inspection and maintenance procedures and schedules described in the Owner's Manual.

EWA11152

WARNING

Failure to inspect or maintain the vehicle properly increases the possibility of an accident or equipment damage. Do not operate the vehicle if you find any problem. If a problem cannot be corrected by the procedures provided in this manual, have the vehicle inspected by a Yamaha dealer.

Before using this vehicle, check the following points:

ITEM	CHECKS	PAGE
Fuel	<ul style="list-style-type: none">• Check fuel level in fuel tank.• Refuel if necessary.• Check fuel line for leakage.• Check fuel tank overflow hose for obstructions, cracks or damage, and check hose connection.	3-13, 3-15
Engine oil	<ul style="list-style-type: none">• Check oil level in engine.• If necessary, add recommended oil to specified level.• Check vehicle for oil leakage.	6-10
Final transmission oil	<ul style="list-style-type: none">• Check vehicle for oil leakage.	6-12
Coolant	<ul style="list-style-type: none">• Check coolant level in reservoir.• If necessary, add recommended coolant to specified level.• Check cooling system for leakage.	6-13
Front brake	<ul style="list-style-type: none">• Check operation.• If soft or spongy, have Yamaha dealer bleed hydraulic system.• Check brake pads for wear.• Replace if necessary.• Check fluid level in reservoir.• If necessary, add specified brake fluid to specified level.• Check hydraulic system for leakage.	6-23, 6-24, 6-25
Rear brake	<ul style="list-style-type: none">• Check operation.• If soft or spongy, have Yamaha dealer bleed hydraulic system.• Check brake pads for wear.• Replace if necessary.• Check fluid level in reservoir.• If necessary, add specified brake fluid to specified level.• Check hydraulic system for leakage.	6-23, 6-24, 6-25
Throttle grip	<ul style="list-style-type: none">• Make sure that operation is smooth.• Check throttle grip free play.• If necessary, have Yamaha dealer adjust throttle grip free play and lubricate cable and grip housing.	6-19, 6-27

For your safety – pre-operation checks

ITEM	CHECKS	PAGE
Control cables	<ul style="list-style-type: none">• Make sure that operation is smooth.• Lubricate if necessary.	6-27
Wheels and tires	<ul style="list-style-type: none">• Check for damage.• Check tire condition and tread depth.• Check air pressure.• Correct if necessary.	6-20, 6-22
Brake levers	<ul style="list-style-type: none">• Make sure that operation is smooth.• Lubricate lever pivoting points if necessary.	6-28
Centerstand, side-stand	<ul style="list-style-type: none">• Make sure that operation is smooth.• Lubricate pivots if necessary.	6-28
Chassis fasteners	<ul style="list-style-type: none">• Make sure that all nuts, bolts and screws are properly tightened.• Tighten if necessary.	—
Instruments, lights, signals and switches	<ul style="list-style-type: none">• Check operation.• Correct if necessary.	—
Sidestand switch	<ul style="list-style-type: none">• Check operation of ignition circuit cut-off system.• If system is not working correctly, have Yamaha dealer check vehicle.	3-17

Operation and important riding points

EAU15952

Read the Owner's Manual carefully to become familiar with all controls. If there is a control or function you do not understand, ask your Yamaha dealer.

EWA10272

WARNING

Failure to familiarize yourself with the controls can lead to loss of control, which could cause an accident or injury.

EAU66721

Starting the engine

ECA10251

NOTICE

See page 5-4 for engine break-in instructions prior to operating the vehicle for the first time.

In order for the ignition circuit cut-off system to enable starting, the side-stand must be up.

See page 3-18 for more information.

1. Turn the main switch on.
 - The engine trouble warning light and the coolant temperature warning light should come on for a few seconds, then go off.
 - The ABS warning light should come on and stay on until the vehicle reaches a traveling speed of 10 km/h (6 mi/h).

ECA15486

NOTICE

If a warning light does not come on initially when the main switch is turned on, or if a warning light remains on, see page 3-3 for the corresponding warning light circuit check.

2. Close the throttle completely.
3. While applying the front or rear brake, push the start switch.

If the engine does not start, release the start switch, wait a few seconds, and then try again. Each starting attempt should be as short as possible to preserve the battery. Do not crank the engine more than 10 seconds on any one attempt.

Operation and important riding points

ECA11043

EAU45093

NOTICE

For maximum engine life, never accelerate hard when the engine is cold!

Starting off

1. While pulling the rear brake lever with your left hand and holding the grab bar with your right hand, push the scooter off the center-stand.

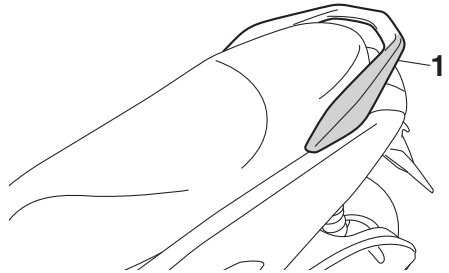

1. Grab bar

2. Sit astride the seat, and then adjust the rear view mirrors.
3. Switch the turn signals on.
4. Check for oncoming traffic, and then slowly turn the throttle grip (on the right) in order to take off.
5. Switch the turn signals off.

Operation and important riding points

Acceleration and deceleration

EAU16782

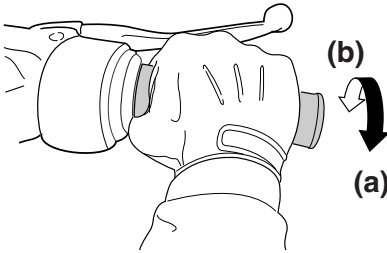

ZALUM0199

The speed can be adjusted by opening and closing the throttle. To increase the speed, turn the throttle grip in direction (a). To reduce the speed, turn the throttle grip in direction (b).

5

Braking

EAU16794

EWA10301

WARNING

- Avoid braking hard or suddenly (especially when leaning over to one side), otherwise the scooter may skid or overturn.
- Railroad crossings, streetcar rails, iron plates on road construction sites, and manhole covers become extremely slippery when wet. Therefore, slow down when approaching such areas and cross them with caution.
- Keep in mind that braking on a wet road is much more difficult.
- Ride slowly down a hill, as braking downhill can be very difficult.

1. Close the throttle completely.
2. Apply both front and rear brakes simultaneously while gradually increasing the pressure.

Tips for reducing fuel consumption

EAU16821

Fuel consumption depends largely on your riding style. Consider the following tips to reduce fuel consumption:

- Avoid high engine speeds during acceleration.
- Avoid high engine speeds with no load on the engine.
- Turn the engine off instead of letting it idle for an extended length of time (e.g., in traffic jams, at traffic lights or at railroad crossings).

Engine break-in

EAU16842

There is never a more important period in the life of your engine than the period between 0 and 1600 km (1000 mi). For this reason, you should read the following material carefully.

Since the engine is brand new, do not put an excessive load on it for the first 1600 km (1000 mi). The various parts in the engine wear and polish themselves to the correct operating clearances. During this period, prolonged full-throttle operation or any condition that might result in engine overheating must be avoided.

EAUM2012

0–1000 km (0–600 mi)

Avoid prolonged operation above 1/3 throttle. **NOTICE: After 1000 km (600 mi) of operation, be sure to replace the engine oil and final transmission oil.** [ECA11662]

1000–1600 km (600–1000 mi)

Avoid prolonged operation above 1/2 throttle.

1600 km (1000 mi) and beyond

The vehicle can now be operated normally.

ECA10271

NOTICE

If any engine trouble should occur during the engine break-in period, immediately have a Yamaha dealer check the vehicle.

Operation and important riding points

EAU17214

Parking

When parking, stop the engine, and then remove the key from the main switch.

EWA10312

WARNING

- Since the engine and exhaust system can become very hot, park in a place where pedestrians or children are not likely to touch them and be burned.
 - Do not park on a slope or on soft ground, otherwise the vehicle may overturn, increasing the risk of a fuel leak and fire.
 - Do not park near grass or other flammable materials which might catch fire.
-

Periodic maintenance and adjustment

EAU17246

Periodic inspection, adjustment, and lubrication will keep your vehicle in the safest and most efficient condition possible. Safety is an obligation of the vehicle owner/operator. The most important points of vehicle inspection, adjustment, and lubrication are explained on the following pages.

The intervals given in the periodic maintenance charts should be simply considered as a general guide under normal riding conditions. However, depending on the weather, terrain, geographical location, and individual use, the maintenance intervals may need to be shortened.

EWA10322

WARNING

Failure to properly maintain the vehicle or performing maintenance activities incorrectly may increase your risk of injury or death during service or while using the vehicle. If you are not familiar with vehicle service, have a Yamaha dealer perform service.

EWA15123

WARNING

Turn off the engine when performing maintenance unless otherwise specified.

- **A running engine has moving parts that can catch on body parts or clothing and electrical parts that can cause shocks or fires.**
- **Running the engine while servicing can lead to eye injury, burns, fire, or carbon monoxide poisoning – possibly leading to**

death. See page 1-2 for more information about carbon monoxide.

EWA15461

WARNING

Brake discs, calipers, drums, and linings can become very hot during use. To avoid possible burns, let brake components cool before touching them.

Periodic maintenance and adjustment

EAU39692

Owner's tool kit

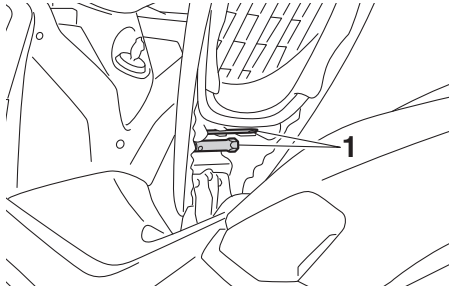

1. Owner's tool kit

The owner's tool kit is located on the bottom of the seat. (See page 3-16.)

The service information included in this manual and the tools provided in the owner's tool kit are intended to assist you in the performance of preventive maintenance and minor repairs. However, additional tools such as a torque wrench may be necessary to perform certain maintenance work correctly.

TIP

If you do not have the tools or experience required for a particular job, have a Yamaha dealer perform it for you.

Periodic maintenance and adjustment

EAU71020

TIP

- **The annual checks must be performed every year, except if a kilometer-based maintenance, or for the UK, a mileage-based maintenance, is performed instead.**
- From 30000 km (17500 mi), repeat the maintenance intervals starting from 6000 km (3500 mi).
- Items marked with an asterisk should be performed by a Yamaha dealer as they require special tools, data and technical skills.

EAU71060

Periodic maintenance chart for the emission control system

NO.	ITEM	CHECK OR MAINTENANCE JOB	ODOMETER READING					ANNUAL CHECK		
			X 1000 km							
			1	6	12	18	24			
X 1000 mi					0.6	3.5	7	10.5	14	
1	* Fuel line	<ul style="list-style-type: none"> • Check fuel hoses for cracks or damage. • Replace if necessary. 		√	√	√	√	√		
2	* Spark plug	<ul style="list-style-type: none"> • Check condition. • Adjust gap and clean. 		√		√				
		<ul style="list-style-type: none"> • Replace. 			√		√			
3	* Valve clearance	<ul style="list-style-type: none"> • Check and adjust. 		√	√	√	√			
4	* Fuel injection	<ul style="list-style-type: none"> • Check engine idle speed. 	√	√	√	√	√	√		
5	* Exhaust system	<ul style="list-style-type: none"> • Check for leakage. • Tighten if necessary. • Replace gasket if necessary. 	√	√	√	√	√			

Periodic maintenance and adjustment

EAU71361

General maintenance and lubrication chart

NO.	ITEM	CHECK OR MAINTENANCE JOB	ODOMETER READING					ANNUAL CHECK		
			X 1000 km							
			1	6	12	18	24			
X 1000 mi					0.6	3.5	7	10.5	14	
1	* Diagnostic system check	<ul style="list-style-type: none"> Perform dynamic inspection using Yamaha diagnostic tool. Check the error codes. 	√	√	√	√	√	√	√	√
2	* Air filter element	<ul style="list-style-type: none"> Replace. 	Every 18000 km (10500 mi)							
3	Air filter case check hose	<ul style="list-style-type: none"> Clean. 	√	√	√	√	√	√		
4	* V-belt case air filter element	<ul style="list-style-type: none"> Clean. Replace if necessary. 		√	√	√	√	√	√	√
5	* Front brake	<ul style="list-style-type: none"> Check operation, fluid level, and for fluid leakage. Replace brake pads if necessary. 	√	√	√	√	√	√	√	√
6	* Rear brake	<ul style="list-style-type: none"> Check operation, fluid level, and for fluid leakage. Replace brake pads if necessary. 	√	√	√	√	√	√	√	√
7	* Brake hoses	<ul style="list-style-type: none"> Check for cracks or damage. Replace. 		√	√	√	√	√	√	√
8	* Brake fluid	<ul style="list-style-type: none"> Change. 	Every 2 years							
9	* Wheels	<ul style="list-style-type: none"> Check runout and for damage. Replace if necessary. 		√	√	√	√			
10	* Tires	<ul style="list-style-type: none"> Check tread depth and for damage. Replace if necessary. Check air pressure. Correct if necessary. 		√	√	√	√	√	√	√
11	* Wheel bearings	<ul style="list-style-type: none"> Check bearing for looseness or damage. 		√	√	√	√	√		
12	* Steering bearings	<ul style="list-style-type: none"> Check bearing assemblies for looseness. 	√	√	√	√				
		<ul style="list-style-type: none"> Moderately repack with lithium-soap-based grease. 					√			
13	* Chassis fasteners	<ul style="list-style-type: none"> Make sure that all nuts, bolts and screws are properly tightened. 		√	√	√	√	√	√	√

Periodic maintenance and adjustment

NO.	ITEM	CHECK OR MAINTENANCE JOB	ODOMETER READING					ANNUAL CHECK		
			X 1000 km							
			1	6	12	18	24			
X 1000 mi					0.6	3.5	7	10.5	14	
14	Front and rear brake lever pivot shaft	<ul style="list-style-type: none"> Lubricate with silicone grease. 		√	√	√	√	√	√	√
15	Sidestand, center-stand	<ul style="list-style-type: none"> Check operation. Lubricate with lithium-soap-based grease. 		√	√	√	√	√	√	√
16	* Sidestand switch	<ul style="list-style-type: none"> Check operation and replace if necessary. 	√	√	√	√	√	√	√	√
17	* Front fork	<ul style="list-style-type: none"> Check operation and for oil leakage. Replace if necessary. 		√	√	√	√	√	√	
18	* Shock absorber assemblies	<ul style="list-style-type: none"> Check operation and for oil leakage. Replace if necessary. 		√	√	√	√	√	√	
19	Engine oil	<ul style="list-style-type: none"> Change (warm engine before draining). Check oil level and vehicle for oil leakage. 	At the initial interval and when the oil change indicator flashes or comes on [every 6000 km (3500 mi)].					√		
20	* Engine oil strainer	<ul style="list-style-type: none"> Clean. 	√							
21	* Final transmission oil	<ul style="list-style-type: none"> Check vehicle for oil leakage. 	√	√	√	√	√	√		
		<ul style="list-style-type: none"> Change. 	√		√		√			
22	* Cooling system	<ul style="list-style-type: none"> Check coolant level and vehicle for coolant leakage. 		√	√	√	√	√	√	√
		<ul style="list-style-type: none"> Change. 	Every 3 years							
23	* V-belt	<ul style="list-style-type: none"> Replace. 	When the V-belt replacement indicator flashes or comes on							
24	* Front and rear brake switches	<ul style="list-style-type: none"> Check operation. 	√	√	√	√	√	√	√	√
25	* Moving parts and cables	<ul style="list-style-type: none"> Lubricate. 		√	√	√	√	√	√	√
26	* Throttle grip housing and cable	<ul style="list-style-type: none"> Check operation and free play. Adjust the throttle cable free play if necessary. Lubricate the throttle grip housing and cable. 		√	√	√	√	√	√	√

Periodic maintenance and adjustment

NO.	ITEM	CHECK OR MAINTENANCE JOB	ODOMETER READING					ANNUAL CHECK	
			X 1000 km						
			1	6	12	18	24		
		X 1000 mi	0.6	3.5	7	10.5	14		
27	*	Lights, signals and switches	• Check operation. • Adjust headlight beam.	√	√	√	√	√	√

EAU72790

TIP

- Engine air filter and V-belt air filter
 - This model's engine air filter is equipped with a disposable oil-coated paper element, which must not be cleaned with compressed air to avoid damaging it.
 - The engine air filter element needs to be replaced and the V-belt air filter element needs to be serviced more frequently when riding in unusually wet or dusty areas.
- Hydraulic brake service
 - After disassembling the brake master cylinders and calipers, always change the fluid. Regularly check the brake fluid levels and fill the reservoirs as required.
 - Every two years replace the internal components of the brake master cylinders and calipers, and change the brake fluid.
 - Replace the brake hoses every four years and if cracked or damaged.

Periodic maintenance and adjustment

Removing and installing panels

EAU18773

The panels shown need to be removed to perform some of the maintenance jobs described in this chapter. Refer to this section each time a panel needs to be removed and installed.

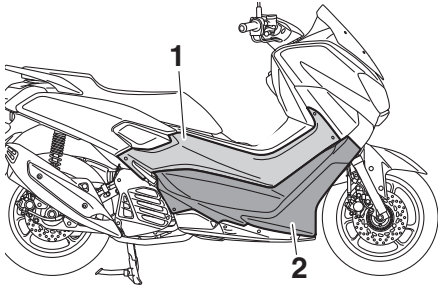

1. Panel A
2. Panel B

EAU67270

Panel A

To remove the panel

1. Remove the bolts.

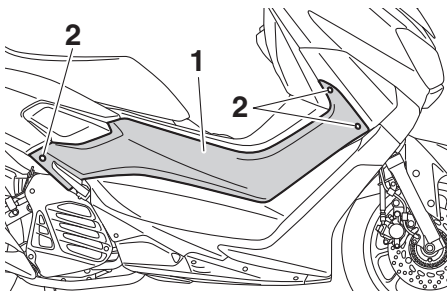

1. Panel A
2. Bolt

2. Extend the right passenger footrest, and then pull the panel outward.

To install the panel

1. Place the panel in the original position, and then install the bolts.

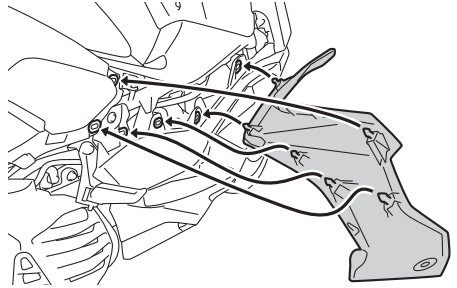

2. Retract the right passenger footrest to its original position.

Panel B

To remove the panel

1. Remove panel A.
2. Remove the quick fasteners and the bolt.

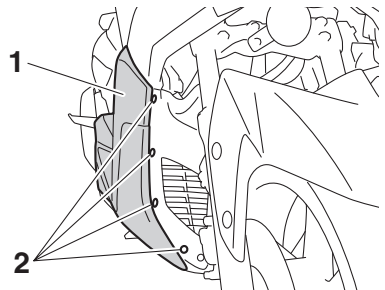

1. Panel B
2. Quick fastener

Periodic maintenance and adjustment

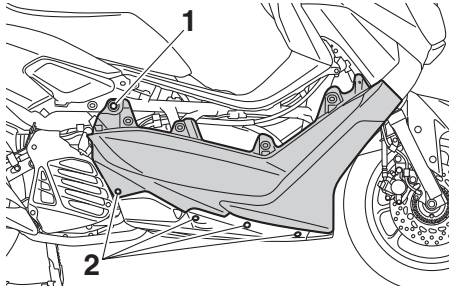

1. Bolt

2. Quick fastener

3. Remove the right floorboard mats by pulling them up.

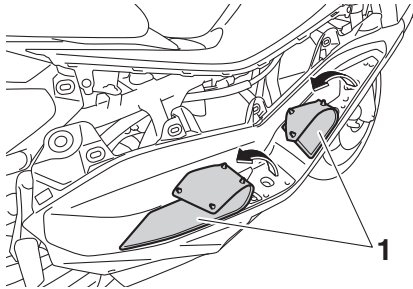

1. Floorboard mat

4. Remove the bolts, and then pull the panel outward.

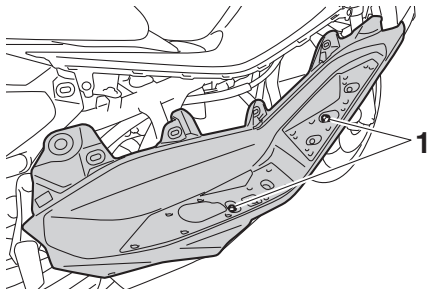

1. Bolt

2. Place the right floorboard mats in their original position and push them downward to secure them.
3. Install the bolt and the quick fasteners.
4. Install panel A.

To install the panel

1. Place the panel in the original position, and then install the bolts.

Periodic maintenance and adjustment

EAU67161

Checking the spark plug

The spark plug is an important engine component, which is easy to check. Since heat and deposits will cause any spark plug to slowly erode, the spark plug should be removed and checked in accordance with the periodic maintenance and lubrication chart. In addition, the condition of the spark plug can reveal the condition of the engine.

To remove the spark plug

1. Place the vehicle on the center-stand.
2. Remove panels A and B. (See page 6-7.)
3. Remove the spark plug cap.

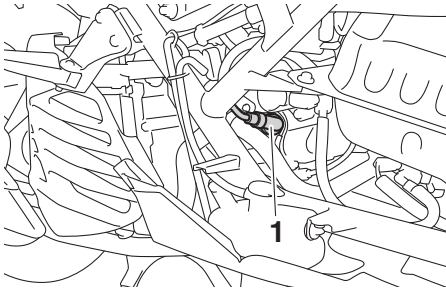

1. Spark plug cap

4. Remove the spark plug as shown, with the spark plug wrench included in the owner's tool kit.



1. Spark plug wrench

To check the spark plug

1. Check that the porcelain insulator around the center electrode of the spark plug is a medium-to-light tan (the ideal color when the vehicle is ridden normally).

TIP

If the spark plug shows a distinctly different color, the engine could be operating improperly. Do not attempt to diagnose such problems yourself. Instead, have a Yamaha dealer check the vehicle.

2. Check the spark plug for electrode erosion and excessive carbon or other deposits, and replace it if necessary.

Specified spark plug:
NGK/CPR8EA-9

3. Measure the spark plug gap with a wire thickness gauge and, if necessary, adjust the gap to specification.

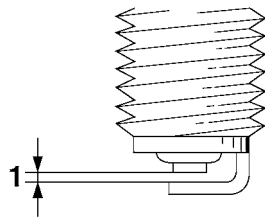

1. Spark plug gap

Spark plug gap:
0.8–0.9 mm (0.031–0.035 in)

Periodic maintenance and adjustment

EAU66991

To install the spark plug

1. Clean the surface of the spark plug gasket and its mating surface, and then wipe off any grime from the spark plug threads.
2. Install the spark plug with the spark plug wrench, and then tighten it to the specified torque.

Tightening torque:

Spark plug:
13 N·m (1.3 kgf·m, 9.4 lb·ft)

TIP

If a torque wrench is not available when installing a spark plug, a good estimate of the correct torque is 1/4–1/2 turn past finger tight. However, the spark plug should be tightened to the specified torque as soon as possible.

3. Install the spark plug cap.

TIP

Install the spark plug cap so that it is positioned as shown in the illustration and the spark plug lead does not contact any surrounding parts.

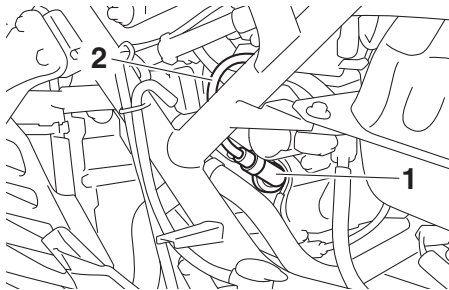

1. Spark plug cap
2. Spark plug lead

4. Install the panels.

Engine oil and oil strainer

The engine oil level should be checked before each ride. In addition, the oil must be changed and the oil strainer cleaned at the intervals specified in the periodic maintenance and lubrication chart.

To check the engine oil level

1. Place the vehicle on the center-stand. A slight tilt to the side can result in a false reading.
2. Start the engine, warm it up for several minutes, and then turn it off.
3. Wait a few minutes until the oil settles, remove the engine oil filler cap, wipe the engine oil dipstick clean, insert it back into the oil filler hole (without screwing it in), and then remove it again to check the oil level. **WARNING! The muffler and muffler protector become very hot during use. To avoid possible burns, let the muffler and protector cool before removing the oil filler cap.** [EWA17810]

TIP

The engine oil should be between the tip of the dipstick and the maximum level mark.

Periodic maintenance and adjustment

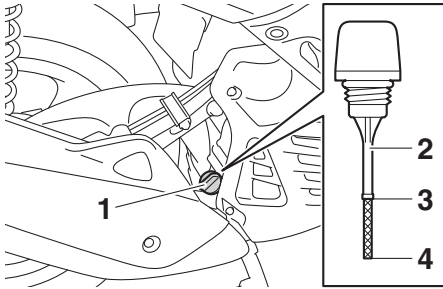

1. Engine oil filler cap
2. Engine oil dipstick
3. Maximum level mark
4. Tip of the engine oil dipstick

4. If the engine oil is not between the tip of the dipstick and the maximum level mark, add sufficient oil of the recommended type to raise it to the correct level.
5. Insert the dipstick into the oil filler hole, and then tighten the oil filler cap.

To change the engine oil and clean the oil strainer

1. Start the engine, warm it up for several minutes, and then turn it off.
2. Place an oil pan under the engine to collect the used oil.
3. Remove the engine oil filler cap and engine oil drain bolts A and B to drain the oil from the crankcase.
NOTICE: When removing the engine oil drain bolt B, the O-ring, compression spring, and oil strainer will fall out. Take care not to lose these parts.

[ECAT1022]

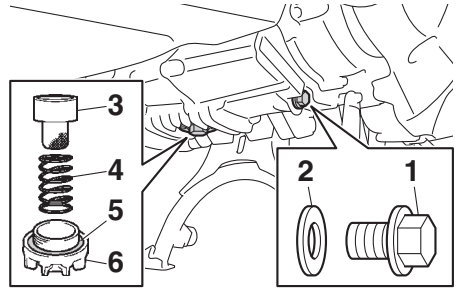

1. Engine oil drain bolt A
2. Gasket
3. Oil strainer
4. Compression spring
5. O-ring
6. Engine oil drain bolt B

4. Clean the engine oil strainer with solvent, and then check it for damage and replace it if necessary.
5. Install the engine oil strainer, compression spring, new O-ring and engine oil drain bolt B.

TIP

Make sure that the O-ring is properly seated.

6. Install engine oil drain bolt A and its new gasket, and then tighten both drain bolts to their specified torques.

Tightening torque:

- Engine oil drain bolt A:
20 N·m (2.0 kgf·m, 14 lb·ft)
Engine oil drain bolt B:
32 N·m (3.2 kgf·m, 23 lb·ft)

7. Refill with the specified amount of the recommended engine oil, and then install and tighten the oil filler cap.

Periodic maintenance and adjustment

EAU20067

Recommended engine oil:

See page 8-1.

Oil quantity:

0.90 L (0.95 US qt, 0.79 Imp.qt)

TIP

Be sure to wipe off spilled oil on any parts after the engine and exhaust system have cooled down.

ECA11621

NOTICE

- In order to prevent clutch slippage (since the engine oil also lubricates the clutch), do not mix any chemical additives. Do not use oils with a diesel specification of “CD” or oils of a higher quality than specified. In addition, do not use oils labeled “ENERGY CONSERVING II” or higher.
 - Make sure that no foreign material enters the crankcase.
8. Start the engine, and then let it idle for several minutes while checking it for oil leakage. If oil is leaking, immediately turn the engine off and check for the cause.
 9. Turn the engine off, and then check the oil level and correct it if necessary.
 10. Reset the oil change tripmeter and oil change indicator “OIL”. (See page 3-6 for reset procedures.)

Final transmission oil

The final transmission case must be checked for oil leakage before each ride. If any leakage is found, have a Yamaha dealer check and repair the scooter. In addition, the final transmission oil must be changed as follows at the intervals specified in the periodic maintenance and lubrication chart.

1. Start the engine, warm up the final transmission oil by riding the scooter for several minutes, and then stop the engine.
2. Place the scooter on the center-stand.
3. Place an oil pan under the final transmission case to collect the used oil.
4. Remove the final transmission oil filler cap and its O-ring from the final transmission case.

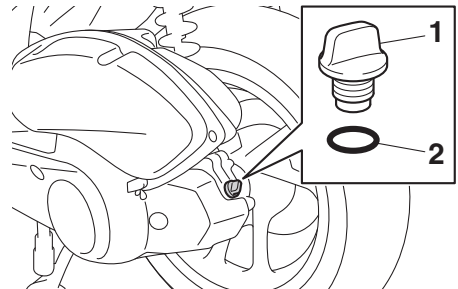

1. Final transmission oil filler cap
2. O-ring

5. Remove the final transmission oil drain bolt and its gasket to drain the oil from the final transmission case.

Periodic maintenance and adjustment

EAU20071

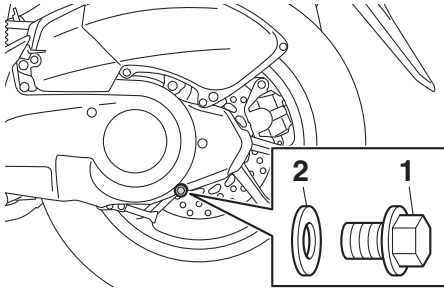

1. Final transmission oil drain bolt
2. Gasket

6. Install the final transmission oil drain bolt and its new gasket, and then tighten the bolt to the specified torque.

Tightening torque:

Final transmission oil drain bolt:
20 N·m (2.0 kgf·m, 14 lb·ft)

7. Refill with the specified amount of the recommended final transmission oil. **WARNING! Make sure that no foreign material enters the final transmission case. Make sure that no oil gets on the tire or wheel.** [EWA11312]

Recommended final transmission oil:

See page 8-1.

Oil quantity:

0.15 L (0.16 US qt, 0.13 Imp.qt)

8. Install the final transmission oil filler cap and its new O-ring, and then tighten the oil filler cap.
9. Check the final transmission case for oil leakage. If oil is leaking, check for the cause.

Coolant

The coolant level should be checked before each ride. In addition, the coolant must be changed at the intervals specified in the periodic maintenance and lubrication chart.

EAUN1090

To check the coolant level

1. Place the vehicle on the center-stand.

TIP

- The coolant level must be checked on a cold engine since the level varies with engine temperature.
- Make sure that the vehicle is positioned straight up when checking the coolant level. A slight tilt to the side can result in a false reading.

2. Check the coolant level through the check window.

TIP

The coolant should be between the minimum and maximum level marks.

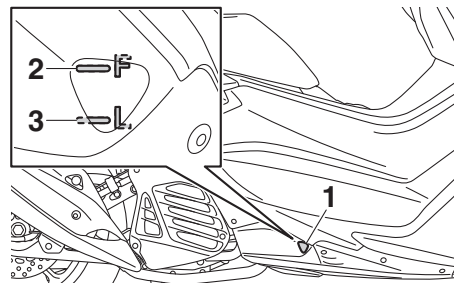

1. Coolant level check window
2. Maximum level mark
3. Minimum level mark

Periodic maintenance and adjustment

3. If the coolant is at or below the minimum level mark, remove the right floorboard mat by pulling it up.

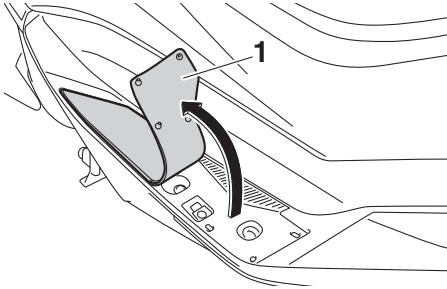

1. Floorboard mat

4. Remove the coolant reservoir cover.

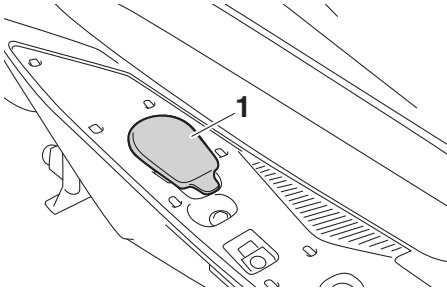

1. Coolant reservoir cover

5. Remove the coolant reservoir cap, add coolant to the maximum level mark, and then install the reservoir cap. **WARNING! Remove only the coolant reservoir cap. Never attempt to remove the radiator cap when the engine is hot.**

[EWA15162] **NOTICE:** If coolant is not available, use distilled water or soft tap water instead. Do not use hard water or salt water since it is harmful to the engine. If water has been used instead of coolant, replace it with coolant as soon as possible, other-

wise the cooling system will not be protected against frost and corrosion. If water has been added to the coolant, have a Yamaha dealer check the anti-freeze content of the coolant as soon as possible, otherwise the effectiveness of the coolant will be reduced. [ECA10473]

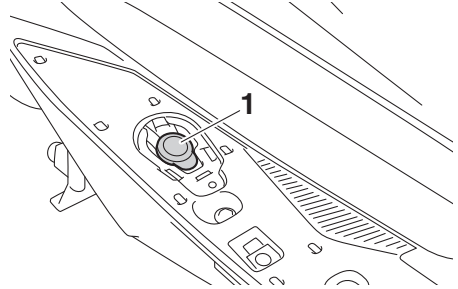

1. Coolant reservoir cap

Coolant reservoir capacity (up to the maximum level mark):

0.25 L (0.26 US qt, 0.22 Imp.qt)

6. Install the coolant reservoir cover.
7. Place the right floorboard mat in the original position and push it downward to secure it.

EAU67280

To change the coolant

1. Place the vehicle on a level surface and let the engine cool if necessary.
2. Remove panels A and B. (See page 6-7.)
3. Remove the radiator cover by removing the bolts.

Periodic maintenance and adjustment

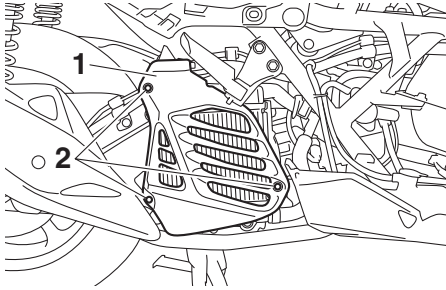

1. Radiator cover
2. Bolt

4. Place a container under the engine to collect the used coolant.
5. Remove the radiator cap.
WARNING! Never attempt to remove the radiator cap when the engine is hot. [EWA10382]

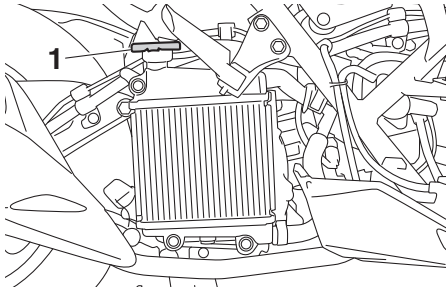

1. Radiator cap

6. Remove the coolant drain screw and its O-ring to drain the cooling system.

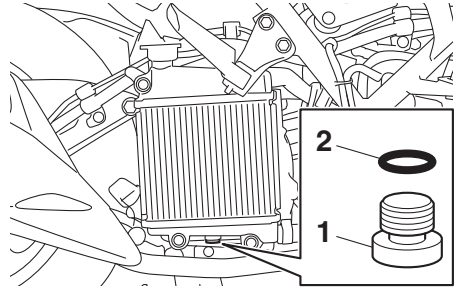

1. Coolant drain screw
2. O-ring

7. Remove the coolant drain bolt and its gasket to drain the cooling system.

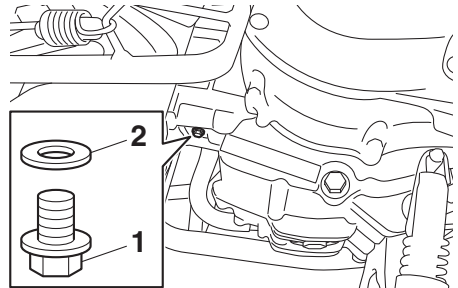

1. Coolant drain bolt
2. Gasket

8. Remove the coolant reservoir by removing the bolt.

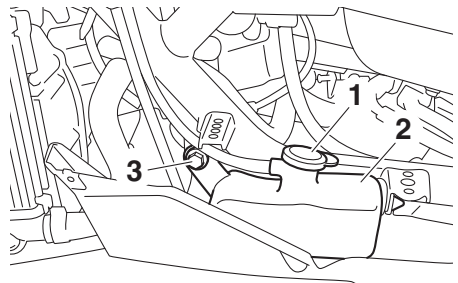

1. Coolant reservoir cap
2. Coolant reservoir
3. Bolt

Periodic maintenance and adjustment

9. Remove the coolant reservoir cap, and then turn the coolant reservoir upside down to empty it.
10. After the coolant is completely drained, thoroughly flush the cooling system with clean tap water.
11. Install the coolant reservoir by installing the bolt.
12. Install the coolant drain bolt and its new gasket, and then tighten the bolt to the specified torque.
13. Install the radiator cap, start the engine, let it idle for several minutes, and then turn it off.
14. Remove the radiator cap to check the coolant level in the radiator. If necessary, add sufficient coolant until it reaches the top of the radiator, and then install the radiator cap.
15. Start the engine, and then check the vehicle for coolant leakage. If coolant is leaking, have a Yamaha dealer check the cooling system.
16. Install the radiator cover by installing the bolts.
17. Install the panels.

Tightening torque:

Coolant drain bolt:
10 N·m (1.0 kgf·m, 7.2 lb·ft)

13. Install the coolant drain screw and its new O-ring.
14. Pour the recommended coolant into the reservoir to the maximum level mark, and then install the coolant reservoir cap.
15. Pour the recommended coolant into the radiator until it is full.

Antifreeze/water mixture ratio:

1:1

Recommended antifreeze:

High-quality ethylene glycol antifreeze containing corrosion inhibitors for aluminum engines

Coolant quantity:

Radiator (including all routes):
0.46 L (0.49 US qt, 0.40 Imp.qt)
Coolant reservoir (up to the maximum level mark):
0.25 L (0.26 US qt, 0.22 Imp.qt)

16. Install the radiator cap, start the engine, let it idle for several minutes, and then turn it off.
17. Remove the radiator cap to check the coolant level in the radiator. If necessary, add sufficient coolant

Periodic maintenance and adjustment

EAU67174

Air filter and V-belt case air filter elements

The air filter element should be replaced and the V-belt case air filter element should be cleaned at the intervals specified in the periodic maintenance and lubrication chart. Service the air filter elements more frequently if you are riding in unusually wet or dusty areas. The air filter check hose and V-belt case air filter check hose must be frequently checked and cleaned if necessary.

Cleaning the air filter check hose

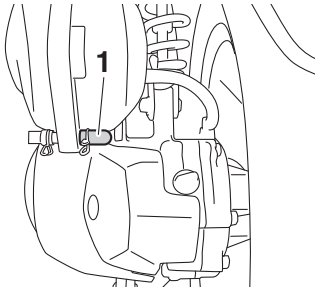

1. Air filter check hose

1. Check the hose on the rear side of the air filter case for accumulated dirt or water.
2. If dirt or water is visible, remove the hose from the clamp, clean it, and then install it.

TIP

If dirt or water was found in the check hose, be sure to check the air filter element for excessive dirt or damage and replace it if necessary.

Replacing the air filter element

1. Place the vehicle on the center-stand.

2. Remove the air filter case cover by removing the screws.

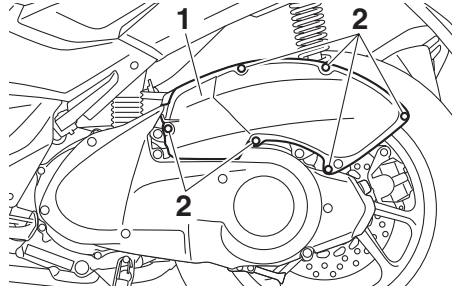

1. Air filter case cover
2. Screw

3. Pull the air filter element out.

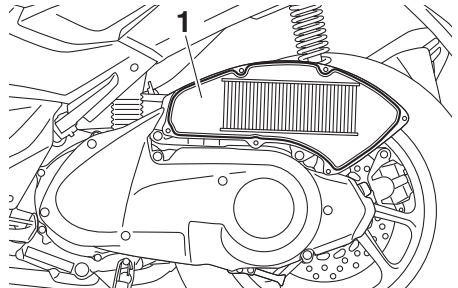

1. Air filter element

4. Insert a new air filter element into the air filter case. **NOTICE: Make sure that the air filter element is properly seated in the air filter case. The engine should never be operated without the air filter element installed, otherwise the piston(s) and/or cylinder(s) may become excessively worn.**

[ECA10482]

ECA21220

NOTICE

- The air filter element must be replaced at the intervals specified in the periodic maintenance and lubrication chart.

Periodic maintenance and adjustment

- The air filter element needs more frequent replacement if you are riding in unusually wet or dusty areas.
- Do not clean the air filter element by blowing it with compressed air.

5. Install the air filter case cover by installing the screws.

Cleaning the V-belt case check hose

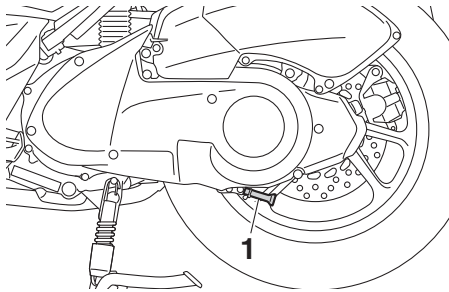

1. V-belt case check hose

1. Check the hose on the rear side of the V-belt case for accumulated dirt or water.
2. If dirt or water is visible, remove the hose from the clamp, clean it, and then install it.

TIP

If dirt or water was found in the check hose, be sure to check the V-belt case air filter element for excessive dirt or damage and clean or replace it if necessary.

Cleaning the V-belt case air filter element

1. Place the vehicle on the center-stand.

2. Remove the screws, and then pull the V-belt case air filter element cover outward and away from the V-belt case.

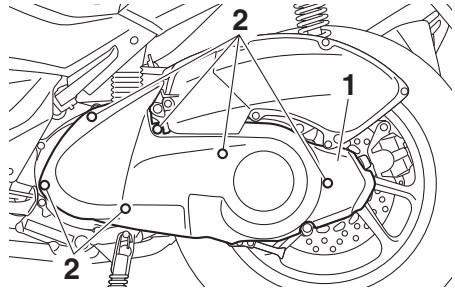

1. V-belt case air filter element cover
2. Screw

3. Pull the V-belt case air filter element out, and then clean it with solvent. After cleaning, remove the remaining solvent by squeezing the element. **WARNING! Use only a dedicated parts cleaning solvent. To avoid the risk of fire or explosion, do not use gasoline or solvents with a low flash point.** [EWA10432] **NOTICE: To avoid damaging the air filter element, handle it gently and carefully, and do not twist it.** [ECA10522]

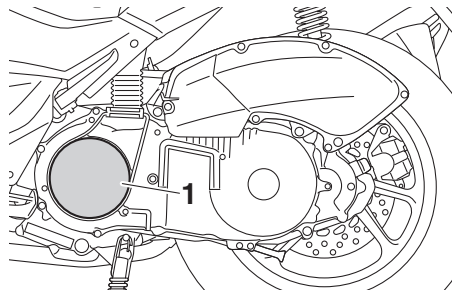

1. V-belt case air filter element

Periodic maintenance and adjustment

EAU21386

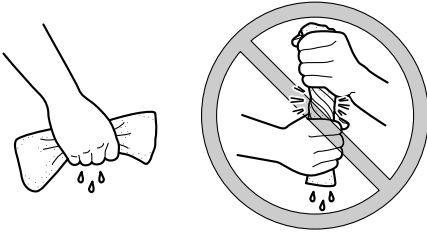

4. Apply oil of the recommended type to the entire surface of the sponge material, and then squeeze the excess oil out.

TIP

- The air filter element should be wet but not dripping.
- Check the air filter element for excessive dirt or damage and replace it if necessary.

Recommended oil:

Yamaha foam air filter oil or other quality foam air filter oil

5. Insert the element into the V-belt case.
6. Install the air filter element cover by installing the screws.

Checking the throttle grip free play

Measure the throttle grip free play as shown.

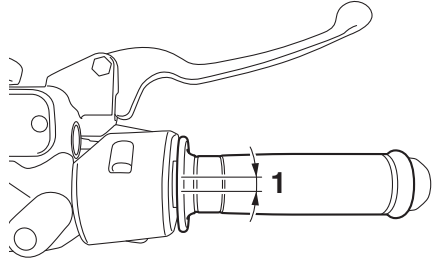

1. Throttle grip free play

Throttle grip free play:

3.0–5.0 mm (0.12–0.20 in)

Periodically check the throttle grip free play and, if necessary, have a Yamaha dealer adjust it.

Periodic maintenance and adjustment

EAU21402

EAU69760

Valve clearance

The valve clearance changes with use, resulting in improper air-fuel mixture and/or engine noise. To prevent this from occurring, the valve clearance must be adjusted by a Yamaha dealer at the intervals specified in the periodic maintenance and lubrication chart.

Tires

Tires are the only contact between the vehicle and the road. Safety in all conditions of riding depends on a relatively small area of road contact. Therefore, it is essential to maintain the tires in good condition at all times and replace them at the appropriate time with the specified tires.

Tire air pressure

The tire air pressure should be checked and, if necessary, adjusted before each ride.

EWA10504



Operation of this vehicle with improper tire pressure may cause severe injury or death from loss of control.

- **The tire air pressure must be checked and adjusted on cold tires (i.e., when the temperature of the tires equals the ambient temperature).**
 - **The tire air pressure must be adjusted in accordance with the riding speed and with the total weight of rider, passenger, cargo, and accessories approved for this model.**
-

Periodic maintenance and adjustment

Tire air pressure (measured on cold tires):

1 person:

Front:

150 kPa (1.50 kgf/cm², 22 psi)

Rear:

250 kPa (2.50 kgf/cm², 36 psi)

2 persons:

Front:

150 kPa (1.50 kgf/cm², 22 psi)

Rear:

250 kPa (2.50 kgf/cm², 36 psi)

Maximum load*:

168 kg (370 lb)

* Total weight of rider, passenger, cargo and accessories

Minimum tire tread depth (front and rear):

1.6 mm (0.06 in)

TIP

The tire tread depth limits may differ from country to country. Always comply with the local regulations.

EWA10472

WARNING

- Have a Yamaha dealer replace excessively worn tires. Besides being illegal, operating the vehicle with excessively worn tires decreases riding stability and can lead to loss of control.
- The replacement of all wheel and brake-related parts, including the tires, should be left to a Yamaha dealer, who has the necessary professional knowledge and experience to do so.
- Ride at moderate speeds after changing a tire since the tire surface must first be “broken in” for it to develop its optimal characteristics.

6

WARNING

Never overload your vehicle. Operation of an overloaded vehicle could cause an accident.

EWA10512

Tire inspection

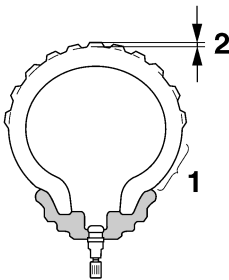

1. Tire sidewall
2. Tire tread depth

The tires must be checked before each ride. If the center tread depth reaches the specified limit, if the tire has a nail or glass fragments in it, or if the sidewall is cracked, have a Yamaha dealer replace the tire immediately.

Tire information

This model is equipped with tubeless tires and rubber tire air valves.

Tires age, even if they have not been used or have only been used occasionally. Cracking of the tread and sidewall rubber, sometimes accompanied by carcass deformation, is an evidence of ageing. Old and aged tires shall be checked by tire specialists to ascertain their suitability for further use.

Periodic maintenance and adjustment

EWA10462

EAU21963

WARNING

The front and rear tires should be of the same make and design, otherwise the handling characteristics of the vehicle may be different, which could lead to an accident.

After extensive tests, only the tires listed below have been approved for this model by Yamaha.

Front tire:

Size:

110/70-13M/C 48P

Manufacturer/model:

DUNLOP/SCOOTSMART

Rear tire:

Size:

130/70-13M/C 57P

Manufacturer/model:

DUNLOP/SCOOTSMART

Cast wheels

To maximize the performance, durability, and safe operation of your vehicle, note the following points regarding the specified wheels.

- The wheel rims should be checked for cracks, bends, warpage or other damage before each ride. If any damage is found, have a Yamaha dealer replace the wheel. Do not attempt even the smallest repair to the wheel. A deformed or cracked wheel must be replaced.
- The wheel should be balanced whenever either the tire or wheel has been changed or replaced. An unbalanced wheel can result in poor performance, adverse handling characteristics, and a shortened tire life.

Periodic maintenance and adjustment

Checking the front and rear brake lever free play

EAU50861

braking performance, which may result in loss of control and an accident.

Front

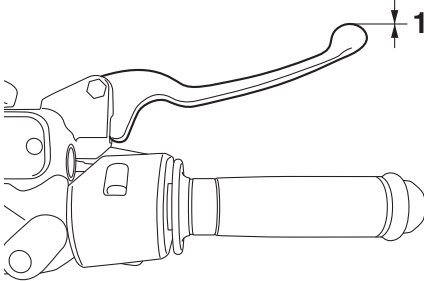

1. No brake lever free play

Rear

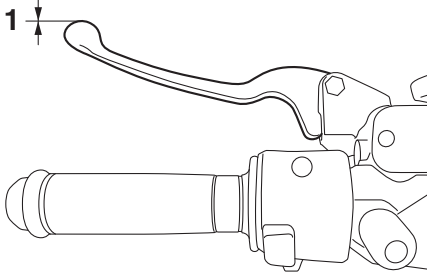

1. No brake lever free play

There should be no free play at the brake lever ends. If there is free play, have a Yamaha dealer inspect the brake system.

EWA14212

! WARNING

A soft or spongy feeling in the brake lever can indicate the presence of air in the hydraulic system. If there is air in the hydraulic system, have a Yamaha dealer bleed the system before operating the vehicle. Air in the hydraulic system will diminish the

Periodic maintenance and adjustment

Checking the front and rear brake pads

EAU22393

The front and rear brake pads must be checked for wear at the intervals specified in the periodic maintenance and lubrication chart.

Front brake pads

EAU22432

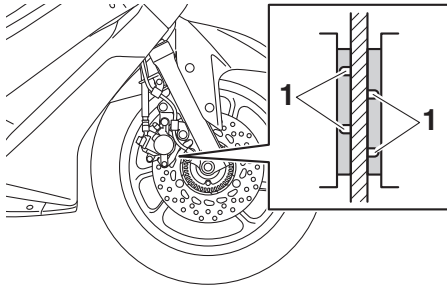

1. Brake pad wear indicator groove

Each front brake pad is provided with wear indicator grooves, which allow you to check the brake pad wear without having to disassemble the brake. To check the brake pad wear, check the wear indicator grooves. If a brake pad has worn to the point that the wear indicator grooves have almost disappeared, have a Yamaha dealer replace the brake pads as a set.

Rear brake pads

EAU22461

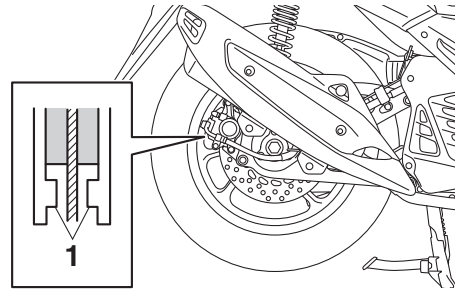

1. Brake pad wear indicator

Each rear brake pad is provided with a wear indicator, which allows you to check the brake pad wear without having to disassemble the brake. To check the brake pad wear, check the position of the wear indicator while applying the brake. If a brake pad has worn to the point that the wear indicator almost touches the brake disc, have a Yamaha dealer replace the brake pads as a set.

Periodic maintenance and adjustment

Checking the brake fluid level EAU40262

Before riding, check that the brake fluid is above the minimum level mark. Check the brake fluid level with the top of the reservoir level. Replenish the brake fluid if necessary.

Front brake

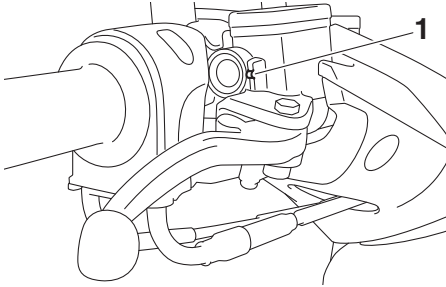

1. Minimum level mark

Rear brake

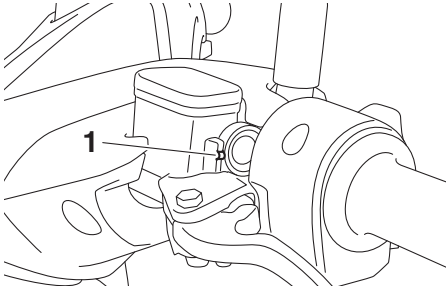

1. Minimum level mark

Specified brake fluid:
DOT 4

EWA16011

! WARNING

Improper maintenance can result in loss of braking ability. Observe these precautions:

- Insufficient brake fluid may allow air to enter the brake system, reducing braking performance.

- Clean the filler cap before removing. Use only DOT 4 brake fluid from a sealed container.
- Use only the specified brake fluid; otherwise, the rubber seals may deteriorate, causing leakage.
- Refill with the same type of brake fluid. Adding a brake fluid other than DOT 4 may result in a harmful chemical reaction.
- Be careful that water or dust does not enter the brake fluid reservoir when refilling. Water will significantly lower the boiling point of the fluid and may result in vapor lock, and dirt may clog the ABS hydraulic unit valves.

ECA17641

NOTICE

Brake fluid may damage painted surfaces or plastic parts. Always clean up spilled fluid immediately.

As the brake pads wear, it is normal for the brake fluid level to gradually go down. A low brake fluid level may indicate worn brake pads and/or brake system leakage; therefore, be sure to check the brake pads for wear and the brake system for leakage. If the brake fluid level goes down suddenly, have a Yamaha dealer check the cause before further riding.

Periodic maintenance and adjustment

EAU22733

Changing the brake fluid

Have a Yamaha dealer change the brake fluid at the intervals specified in the periodic maintenance and lubrication chart. In addition, have the oil seals of the master cylinders and calipers as well as the brake hoses replaced at the intervals listed below or whenever they are damaged or leaking.

- Oil seals: Replace every two years.
- Brake hoses: Replace every four years.

EAUJ0311

Checking the V-belt

The V-belt must be checked and replaced by a Yamaha dealer at the intervals specified in the periodic maintenance and lubrication chart.

Periodic maintenance and adjustment

EAU23098

Checking and lubricating the cables

The operation of all control cables and the condition of the cables should be checked before each ride, and the cables and cable ends should be lubricated if necessary. If a cable is damaged or does not move smoothly, have a Yamaha dealer check or replace it. **WARNING! Damage to the outer housing of cables may result in internal rusting and cause interference with cable movement. Replace damaged cables as soon as possible to prevent unsafe conditions.** [EWA10712]

Recommended lubricant:

Yamaha cable lubricant or other suitable cable lubricant

EAU49921

Checking and lubricating the throttle grip and cable

The operation of the throttle grip should be checked before each ride. In addition, the cable should be lubricated by a Yamaha dealer at the intervals specified in the periodic maintenance chart.

Periodic maintenance and adjustment

Lubricating the front and rear brake levers

EAU23173

Front brake lever

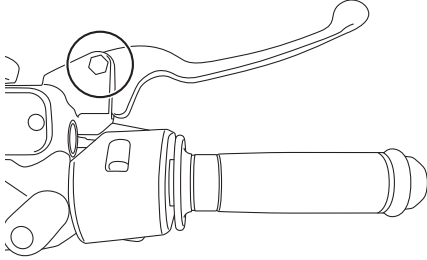

Rear brake lever

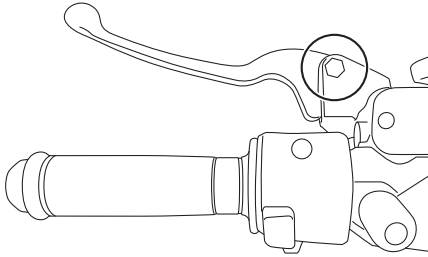

The pivoting points of the front and rear brake levers must be lubricated at the intervals specified in the periodic maintenance and lubrication chart.

Recommended lubricant:
Silicone grease

Checking and lubricating the centerstand and sidestand

EAU23215

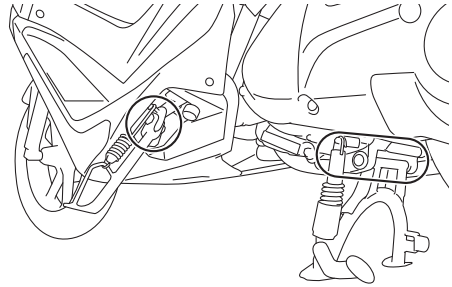

The operation of the centerstand and sidestand should be checked before each ride, and the pivots and metal-to-metal contact surfaces should be lubricated if necessary.

EWA10742

WARNING

If the centerstand or sidestand does not move up and down smoothly, have a Yamaha dealer check or repair it. Otherwise, the centerstand or sidestand could contact the ground and distract the operator, resulting in a possible loss of control.

Recommended lubricant:
Lithium-soap-based grease

Periodic maintenance and adjustment

EAU23273

EAU45512

Checking the front fork

The condition and operation of the front fork must be checked as follows at the intervals specified in the periodic maintenance and lubrication chart.

To check the condition

Check the inner tubes for scratches, damage and excessive oil leakage.

To check the operation

1. Place the vehicle on a level surface and hold it in an upright position. **WARNING! To avoid injury, securely support the vehicle so there is no danger of it falling over.** [EWA10752]
2. While applying the front brake, push down hard on the handlebars several times to check if the front fork compresses and rebounds smoothly.

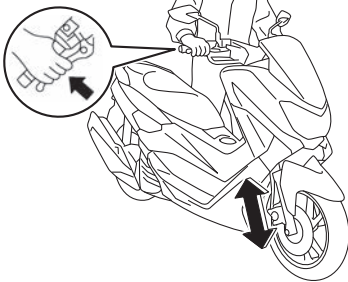

ECA10591

NOTICE

If any damage is found or the front fork does not operate smoothly, have a Yamaha dealer check or repair it.

Checking the steering

Worn or loose steering bearings may cause danger. Therefore, the operation of the steering must be checked as follows at the intervals specified in the periodic maintenance and lubrication chart.

1. Place the vehicle on the centerstand. **WARNING! To avoid injury, securely support the vehicle so there is no danger of it falling over.** [EWA10752]
2. Hold the lower ends of the front fork legs and try to move them forward and backward. If any free play can be felt, have a Yamaha dealer check or repair the steering.

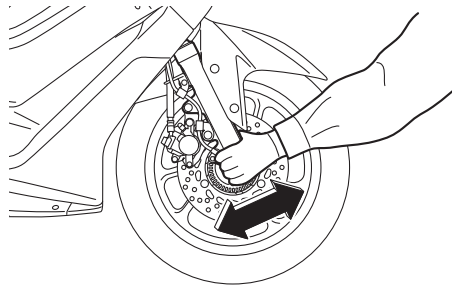

Periodic maintenance and adjustment

Checking the wheel bearings

EAU23292



The front and rear wheel bearings must be checked at the intervals specified in the periodic maintenance and lubrication chart. If there is play in the wheel hub or if the wheel does not turn smoothly, have a Yamaha dealer check the wheel bearings.

6

Battery

EAU50292

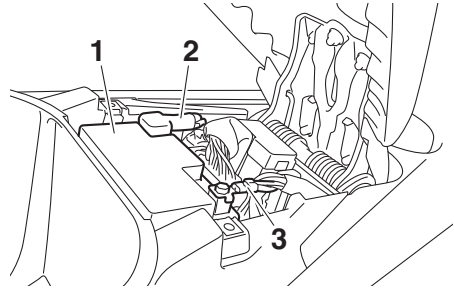

1. Battery
2. Positive battery lead (red)
3. Negative battery lead (black)

The battery is located under the seat. (See page 3-16.)

This model is equipped with a VRLA (Valve Regulated Lead Acid) battery. There is no need to check the electrolyte or to add distilled water. However, the battery lead connections need to be checked and, if necessary, tightened.

EWA10761

WARNING

- **Electrolyte is poisonous and dangerous since it contains sulfuric acid, which causes severe burns. Avoid any contact with skin, eyes or clothing and always shield your eyes when working near batteries. In case of contact, administer the following FIRST AID.**
 - **EXTERNAL:** Flush with plenty of water.
 - **INTERNAL:** Drink large quantities of water or milk and immediately call a physician.
 - **EYES:** Flush with water for 15 minutes and seek prompt medical attention.

Periodic maintenance and adjustment

- **Batteries produce explosive hydrogen gas. Therefore, keep sparks, flames, cigarettes, etc., away from the battery and provide sufficient ventilation when charging it in an enclosed space.**
 - **KEEP THIS AND ALL BATTERIES OUT OF THE REACH OF CHILDREN.**
-

To charge the battery

Have a Yamaha dealer charge the battery as soon as possible if it seems to have discharged. Keep in mind that the battery tends to discharge more quickly if the vehicle is equipped with optional electrical accessories.

ECA16522

NOTICE

To charge a VRLA (Valve Regulated Lead Acid) battery, a special (constant-voltage) battery charger is required. Using a conventional battery charger will damage the battery.

To store the battery

1. If the vehicle will not be used for more than one month, remove the battery, fully charge it, and then place it in a cool, dry place.
NOTICE: When removing the battery, be sure to turn the main switch off, then disconnect the negative lead before disconnecting the positive lead.^[ECA16304]
2. If the battery will be stored for more than two months, check it at least once a month and fully charge it if necessary.

3. Fully charge the battery before installation. **NOTICE: When installing the battery, be sure to turn the main switch off, then connect the positive lead before connecting the negative lead.**
^[ECA16842]
4. After installation, make sure that the battery leads are properly connected to the battery terminals.

ECA16531

NOTICE

Always keep the battery charged. Storing a discharged battery can cause permanent battery damage.

Periodic maintenance and adjustment

EAU66793

Replacing the fuses

The fuse boxes, which contain the fuses for the individual circuits, are located under the seat. (See page 3-16.)

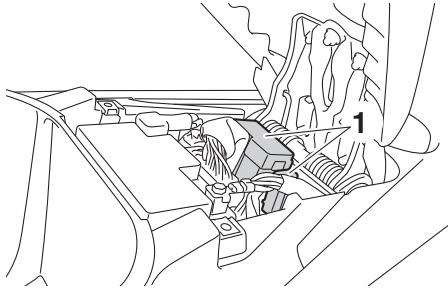

1. Fuse box

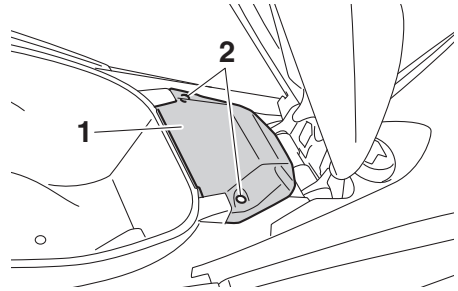

1. Battery cover

2. Screw

4. Remove the blown fuse, and then install a new fuse of the specified amperage. **WARNING! Do not use a fuse of a higher amperage rating than recommended to avoid causing extensive damage to the electrical system and possibly a fire.** [EWA15132]

6

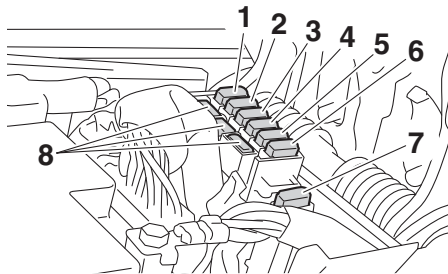

1. Main fuse 1
2. ABS solenoid fuse
3. Main fuse 2
4. Taillight fuse
5. Signaling system fuse
6. ABS control unit fuse
7. ABS motor fuse
8. Spare fuse

If a fuse is blown, replace it as follows.

1. Turn off the electrical circuit in question, and then turn off the main switch.
2. Open the seat. (See page 3-16.)
3. Remove the battery cover by removing the screws.

Specified fuses:

- Main fuse:
 - 15.0 A
- Main fuse 2:
 - 7.5 A
- Taillight fuse:
 - 7.5 A
- Signaling system fuse:
 - 7.5 A
- ABS motor fuse:
 - 30.0 A
- ABS solenoid fuse:
 - 15.0 A
- ABS control unit fuse:
 - 7.5 A

5. Turn the main switch on, and then turn on the electrical circuit in question to check if the device operates.

Periodic maintenance and adjustment

EAU62850

TIP _____

If the fuse immediately blows again, have a Yamaha dealer check the electrical system.

-
6. Install the battery cover by installing the screws.
 7. Close the seat.

Headlight

This model is equipped with an LED-type headlight.

If a headlight does not come on, have a Yamaha dealer check its electrical circuit.

ECA16581

NOTICE _____

Do not affix any type of tinted film or stickers to the headlight lens.

Periodic maintenance and adjustment

EAU67290

Replacing an auxiliary light bulb

This model is equipped with two auxiliary lights. If an auxiliary light bulb burns out, replace it as follows.

1. Remove the windshield by removing the screws.

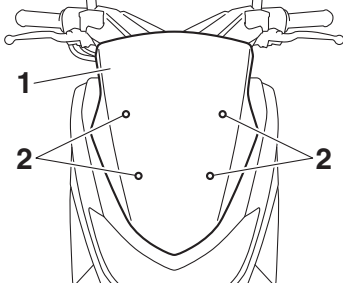

1. Windshield
2. Screw

2. Remove the headlight cover by removing the bolts.

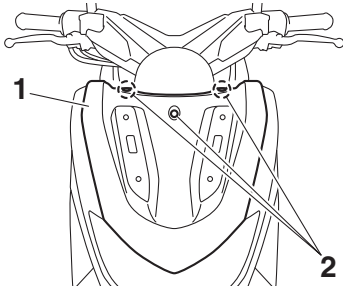

1. Headlight cover
2. Bolt

3. Remove the auxiliary light bulb socket (together with the bulb) by turning the socket counterclockwise.

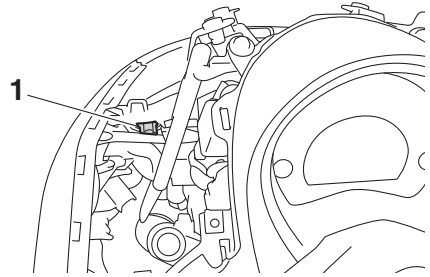

1. Auxiliary light bulb socket

4. Remove the burnt-out bulb by pulling it out.

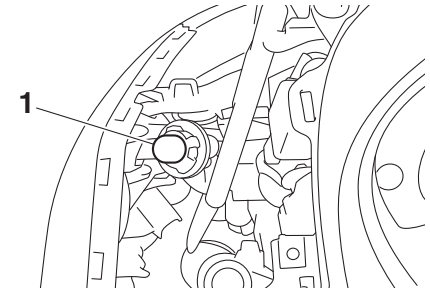

1. Auxiliary light bulb

5. Insert a new bulb into the socket.
6. Install the socket (together with the bulb) by turning it clockwise.
7. Install the headlight cover by installing the bolts.

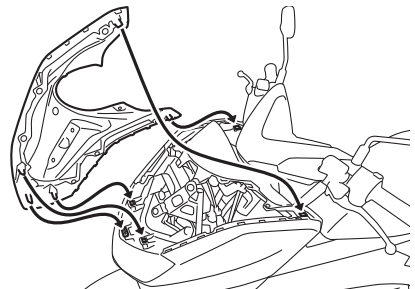

8. Install the windshield by installing the screws.

Periodic maintenance and adjustment

Brake light

EAU67300

This model is equipped with an LED-type brake light.

If the brake light does not come on, have a Yamaha dealer check it.

Replacing the taillight bulb

EAU67310

1. Open the seat. (See page 3-16.)
2. Remove the grab bar by removing the bolts.

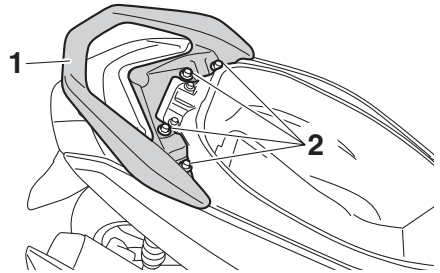

1. Grab bar
2. Bolt

3. Remove the taillight cover by removing the screws.

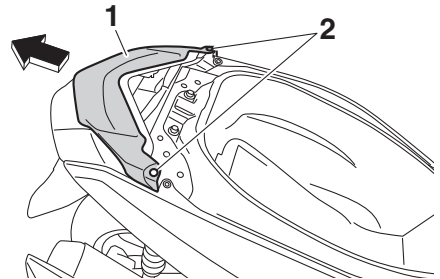

1. Taillight cover
2. Screw

4. Remove the quick fasteners and screws.

Periodic maintenance and adjustment

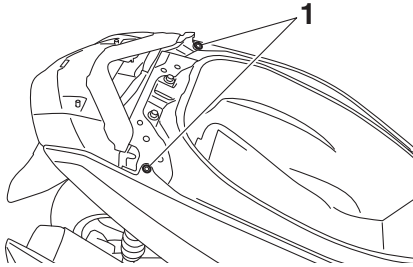

1. Quick fastener

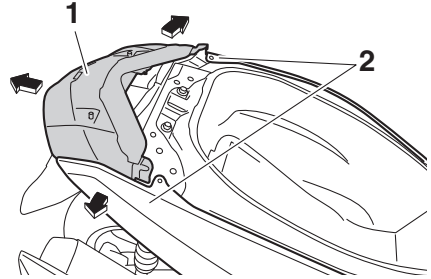

1. Taillight unit
2. Side cover

6. Remove the taillight bulb socket (together with the bulb) by turning it counterclockwise.

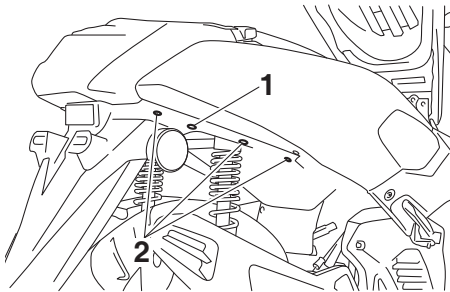

1. Screw
2. Quick fastener

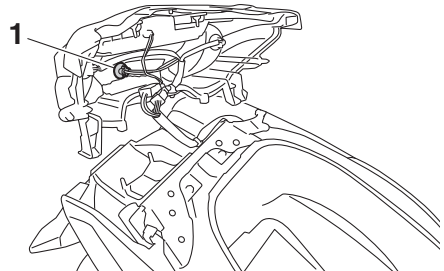

1. Taillight bulb socket

7. Remove the burnt-out bulb by pulling it out.

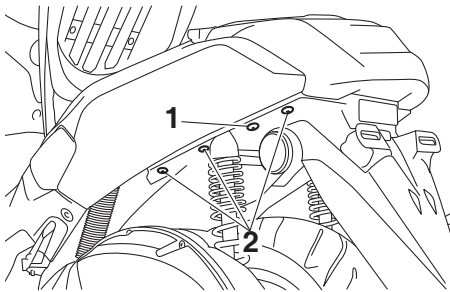

1. Screw
2. Quick fastener

5. Pull the left and right side covers slightly outward and pull the taillight unit rearward.

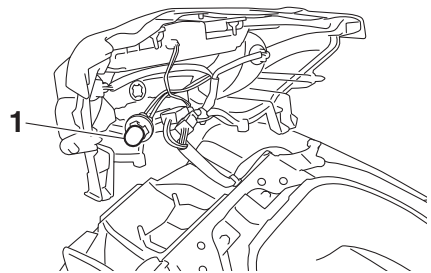

1. Taillight bulb

8. Insert a new bulb into the socket.
9. Install the socket (together with the bulb) by turning it clockwise.

Periodic maintenance and adjustment

EAU43054

10. Place the taillight unit in the original position, and then install the screws and quick fasteners.
11. Install the taillight cover by installing the screws.

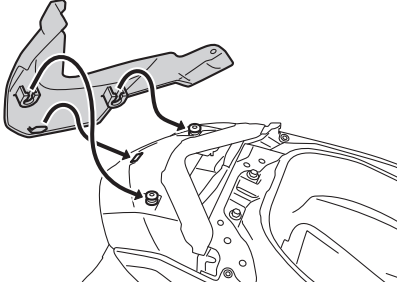

12. Install the grab bar by installing the bolts, and then tightening them to the specified torque.

Tightening torque:

Grab bar bolt:
17 N·m (1.7 kgf·m, 12 lb·ft)

13. Close the seat.

Replacing a front turn signal light bulb

1. Place the vehicle on the center-stand.
2. Remove the turn signal light bulb socket (together with the bulb) by turning it counterclockwise.

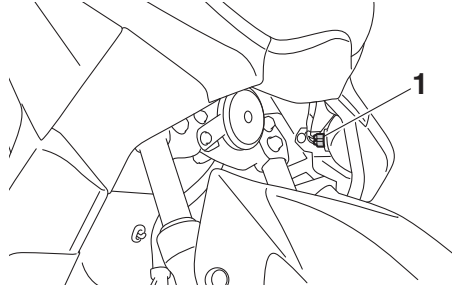

1. Turn signal light bulb socket

3. Remove the burnt-out bulb by pulling it out.

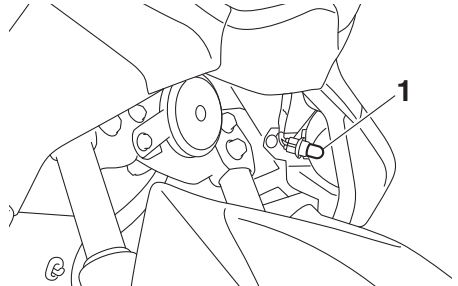

1. Turn signal light bulb

4. Insert a new bulb into the socket.
5. Install the socket (together with the bulb) by turning it clockwise.

Periodic maintenance and adjustment

EAU67320

Replacing a rear turn signal light bulb

1. Open the seat. (See page 3-16.)
2. Remove the grab bar by removing the bolts.

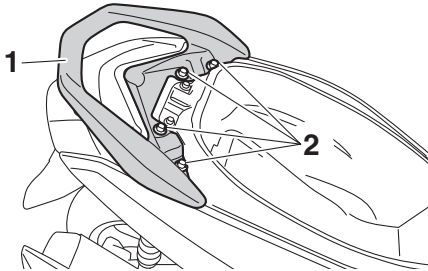

1. Grab bar
2. Bolt

3. Remove the taillight cover by removing the screws.

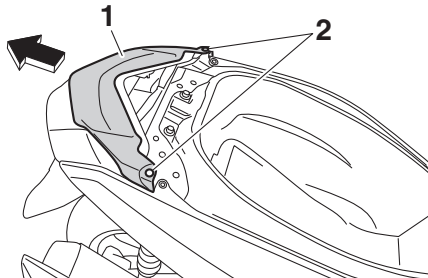

1. Taillight cover
2. Screw

4. Remove the turn signal light bulb socket (together with the bulb) by turning it counterclockwise.

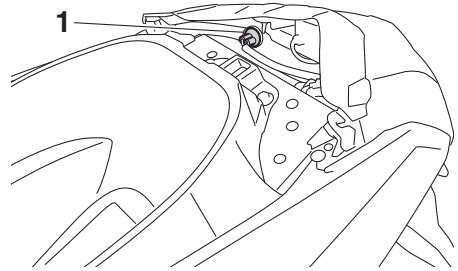

1. Turn signal light bulb socket

5. Remove the burnt-out bulb by pulling it out.

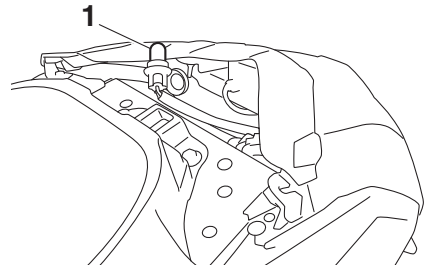

1. Turn signal light bulb

6. Insert a new bulb into the socket.
7. Install the socket (together with the bulb) by turning it clockwise.
8. Install the taillight cover by installing the screws.

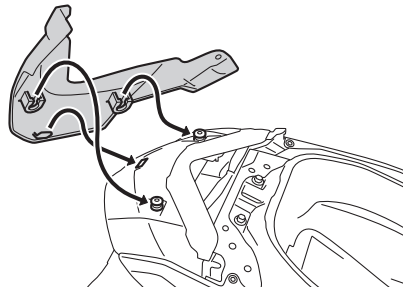

9. Install the grab bar by installing the bolts, and then tightening them to the specified torque.

Periodic maintenance and adjustment

EAU25883

Tightening torque:

Grab bar bolt:
17 N·m (1.7 kgf·m, 12 lb·ft)

10. Close the seat.

Troubleshooting

Although Yamaha scooters receive a thorough inspection before shipment from the factory, trouble may occur during operation. Any problem in the fuel, compression, or ignition systems, for example, can cause poor starting and loss of power.

The following troubleshooting charts represent quick and easy procedures for checking these vital systems yourself. However, should your scooter require any repair, take it to a Yamaha dealer, whose skilled technicians have the necessary tools, experience, and know-how to service the scooter properly.

Use only genuine Yamaha replacement parts. Imitation parts may look like Yamaha parts, but they are often inferior, have a shorter service life and can lead to expensive repair bills.

EWA15142

WARNING

When checking the fuel system, do not smoke, and make sure there are no open flames or sparks in the area, including pilot lights from water heaters or furnaces. Gasoline or gasoline vapors can ignite or explode, causing severe injury or property damage.

Periodic maintenance and adjustment

EAU68020

Troubleshooting charts

Starting problems or poor engine performance

1. Fuel

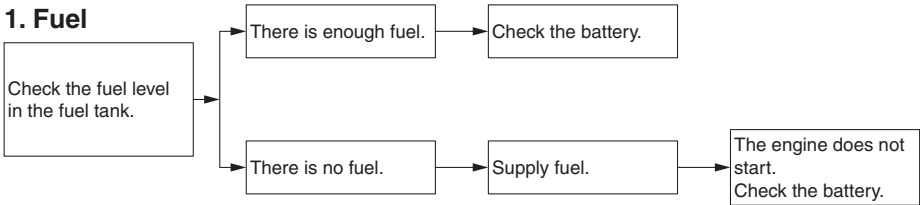

2. Battery

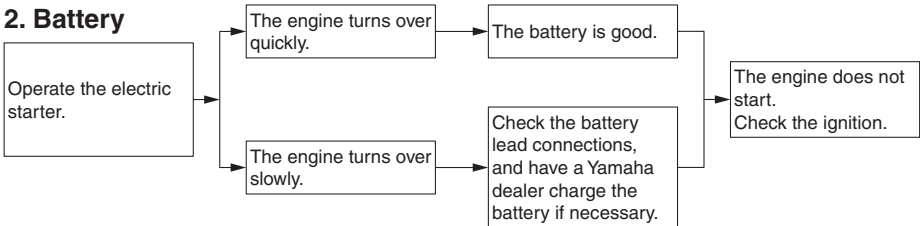

3. Ignition

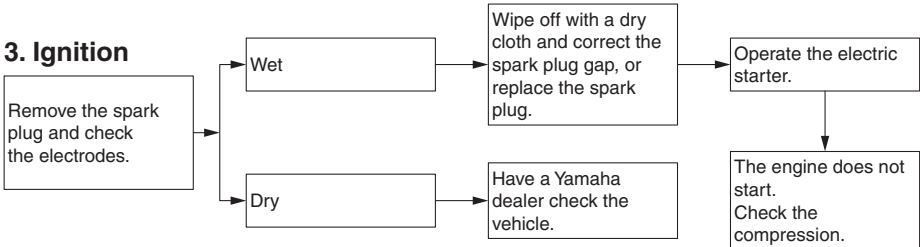

4. Compression

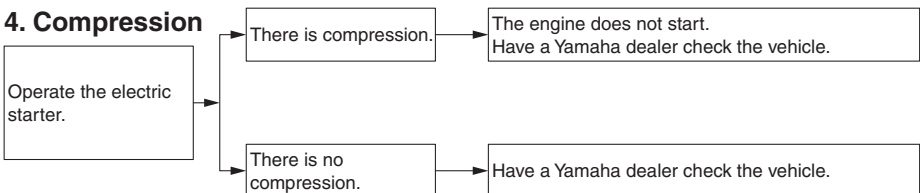

Periodic maintenance and adjustment

Engine overheating

EWAT1041

! WARNING

- Do not remove the radiator cap when the engine and radiator are hot. Scalding hot fluid and steam may be blown out under pressure, which could cause serious injury. Be sure to wait until the engine has cooled.
- Place a thick rag, like a towel, over the radiator cap, and then slowly rotate the cap counterclockwise to the detent to allow any residual pressure to escape. When the hissing sound has stopped, press down on the cap while turning it counterclockwise, and then remove the cap.

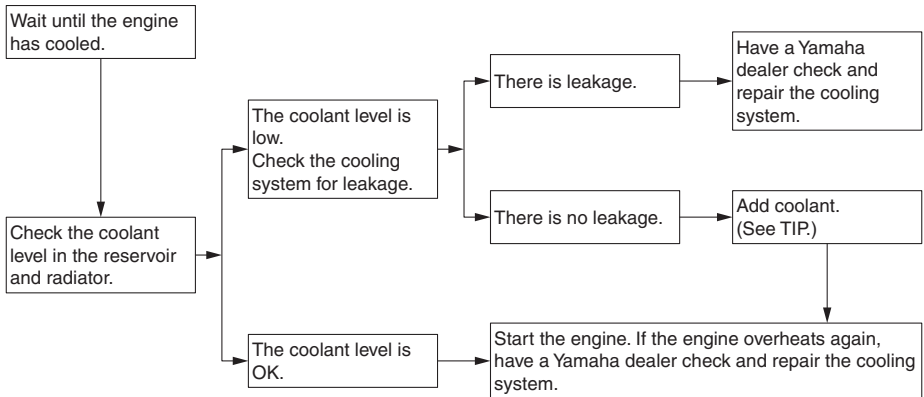

6

TIP

If coolant is not available, tap water can be temporarily used instead, provided that it is changed to the recommended coolant as soon as possible.

Scooter care and storage

Matte color caution

EAU37834

EAUN1000

NOTICE

ECA15193

Some models are equipped with matte colored finished parts. Be sure to consult a Yamaha dealer for advice on what products to use before cleaning the vehicle. Using a brush, harsh chemical products or cleaning compounds when cleaning these parts will scratch or damage their surface. Wax also should not be applied to any matte colored finished parts.

Care

While the open design of a scooter reveals the attractiveness of the technology, it also makes it more vulnerable. Rust and corrosion can develop even if high-quality components are used. A rusty exhaust pipe may go unnoticed on a car, however, it detracts from the overall appearance of a scooter. Frequent and proper care does not only comply with the terms of the warranty, but it will also keep your scooter looking good, extend its life and optimize its performance.

Before cleaning

1. Cover the muffler outlet with a plastic bag after the engine has cooled down.
2. Make sure that all caps and covers as well as all electrical couplers and connectors, including the spark plug cap, are tightly installed.
3. Remove extremely stubborn dirt, like oil burnt onto the crankcase, with a degreasing agent and a brush, but never apply such products onto seals, gaskets and wheel axles. Always rinse the dirt and degreaser off with water.

Cleaning

ECA10784

NOTICE

- **Avoid using strong acidic wheel cleaners, especially on spoked wheels. If such products are used on hard-to-remove dirt, do not leave the cleaner on the affected area any longer than in-**

Scooter care and storage

structed. Also, thoroughly rinse the area off with water, immediately dry it, and then apply a corrosion protection spray.

- Improper cleaning can damage plastic parts (such as cowlings, panels, windshields, headlight lenses, meter lenses, etc.) and the mufflers. Use only a soft, clean cloth or sponge with water to clean plastic. However, if the plastic parts cannot be thoroughly cleaned with water, diluted mild detergent with water may be used. Be sure to rinse off any detergent residue using plenty of water, as it is harmful to plastic parts.
- Do not use any harsh chemical products on plastic parts. Be sure to avoid using cloths or sponges which have been in contact with strong or abrasive cleaning products, solvent or thinner, fuel (gasoline), rust removers or inhibitors, brake fluid, antifreeze or electrolyte.
- Do not use high-pressure washers or steam-jet cleaners since they cause water seepage and deterioration in the following areas: seals (of wheel and swing-arm bearings, fork and brakes), electric components (couplers, connectors, instruments, switches and lights), breather hoses and vents.
- For scooters equipped with a windshield: Do not use strong cleaners or hard sponges as they will cause dulling or scratching. Some cleaning

compounds for plastic may leave scratches on the windshield. Test the product on a small hidden part of the windshield to make sure that it does not leave any marks. If the windshield is scratched, use a quality plastic polishing compound after washing.

After normal use

Remove dirt with warm water, a mild detergent, and a soft, clean sponge, and then rinse thoroughly with clean water. Use a toothbrush or bottlebrush for hard-to-reach areas. Stubborn dirt and insects will come off more easily if the area is covered with a wet cloth for a few minutes before cleaning.

After riding in the rain, near the sea, or on salt-sprayed roads

Since sea salt or salt sprayed on roads during winter are extremely corrosive in combination with water, carry out the following steps after each ride in the rain, near the sea, or on salt-sprayed roads.

TIP

Salt sprayed on roads in the winter may remain well into spring.

1. Clean the scooter with cold water and a mild detergent after the engine has cooled down. **NOTICE: Do not use warm water since it increases the corrosive action of the salt.** [ECA10792]
2. Apply a corrosion protection spray on all metal, including chrome- and nickel-plated, surfaces to prevent corrosion.

Scooter care and storage

Cleaning the windshield

Avoid using any alkaline or strong acid cleaner, gasoline, brake fluid, or any other solvent. Clean the windshield with a cloth or sponge dampened with a neutral detergent, and after cleaning, thoroughly wash it off with water. For additional cleaning, use Yamaha Windshield Cleaner or other quality cleaner. Some cleaning compounds for plastics may leave scratches on surfaces of the windshield. Before using them, make a test by polishing an area which does not affect your visibility.

After cleaning

1. Dry the scooter with a chamois or an absorbing cloth.
2. Use a chrome polish to shine chrome, aluminum and stainless-steel parts, including the exhaust system. (Even the thermally induced discoloring of stainless-steel exhaust systems can be removed through polishing.)
3. To prevent corrosion, it is recommended to apply a corrosion protection spray on all metal, including chrome- and nickel-plated, surfaces.
4. Use spray oil as a universal cleaner to remove any remaining dirt.
5. Touch up minor paint damage caused by stones, etc.
6. Wax all painted surfaces.
7. Let the scooter dry completely before storing or covering it.

EWA10943

WARNING

Contaminants on the brakes or tires can cause loss of control.

- **Make sure that there is no oil or wax on the brakes or tires. If necessary, clean the brake discs and brake linings with a regular brake disc cleaner or acetone, and wash the tires with warm water and a mild detergent.**
- **Before operating the scooter test its braking performance and cornering behavior.**

ECAU0022

NOTICE

- **Apply spray oil and wax sparingly and make sure to wipe off any excess.**
- **Never apply oil or wax to any rubber parts, plastic parts or headlight, taillight and meter lenses, but treat them with a suitable care product.**
- **Avoid using abrasive polishing compounds as they will wear away the paint.**

TIP

- Consult a Yamaha dealer for advice on what products to use.
- Washing, rainy weather or humid climates can cause the headlight lens to fog. Turning the headlight on for a short period of time will help remove the moisture from the lens.

Storage

Short-term

Always store your scooter in a cool, dry place and, if necessary, protect it against dust with a porous cover. Be sure the engine and the exhaust system are cool before covering the scooter.

ECA10821

NOTICE

- **Storing the scooter in a poorly ventilated room or covering it with a tarp, while it is still wet, will allow water and humidity to seep in and cause rust.**
- **To prevent corrosion, avoid damp cellars, stables (because of the presence of ammonia) and areas where strong chemicals are stored.**

Long-term

Before storing your scooter for several months:

1. Follow all the instructions in the “Care” section of this chapter.
2. Fill up the fuel tank and add fuel stabilizer (if available) to prevent the fuel tank from rusting and the fuel from deteriorating.
3. Perform the following steps to protect the cylinder, piston rings, etc. from corrosion.
 - a. Remove the spark plug cap and spark plug.
 - b. Pour a teaspoonful of engine oil into the spark plug bore.
 - c. Install the spark plug cap onto the spark plug, and then place the spark plug on the cylinder

head so that the electrodes are grounded. (This will limit sparking during the next step.)

- d. Turn the engine over several times with the starter. (This will coat the cylinder wall with oil.)
- e. Remove the spark plug cap from the spark plug, and then install the spark plug and the spark plug cap. **WARNING! To prevent damage or injury from sparking, make sure to ground the spark plug electrodes while turning the engine over.** [EWA10952]

4. Lubricate all control cables and the pivoting points of all levers and pedals as well as of the side-stand/centerstand.
5. Check and, if necessary, correct the tire air pressure, and then lift the scooter so that both of its wheels are off the ground. Alternatively, turn the wheels a little every month in order to prevent the tires from becoming degraded in one spot.
6. Cover the muffler outlet with a plastic bag to prevent moisture from entering it.
7. Remove the battery and fully charge it. Store it in a cool, dry place and charge it once a month. Do not store the battery in an excessively cold or warm place [less than 0 °C (30 °F) or more than 30 °C (90 °F)]. For more information on storing the battery, see page 6-30.

Scooter care and storage

TIP _____

Make any necessary repairs before storing the scooter.

Dimensions:

- Overall length:
1955 mm (77.0 in)
- Overall width:
740 mm (29.1 in)
- Overall height:
1115 mm (43.9 in)
- Seat height:
765 mm (30.1 in)
- Wheelbase:
1350 mm (53.1 in)
- Ground clearance:
135 mm (5.31 in)
- Minimum turning radius:
2.0 m (6.56 ft)

Weight:

- Curb weight:
127 kg (280 lb)

Engine:

- Combustion cycle:
4-stroke
- Cooling system:
Liquid cooled
- Valve train:
SOHC
- Number of cylinders:
Single cylinder
- Displacement:
125 cm³ (GPD125-A)
155 cm³ (GPD150-A)
- Bore × stroke:
52.0 × 58.7 mm (2.05 × 2.31 in) (GPD125-A)
58.0 × 58.7 mm (2.28 × 2.31 in) (GPD150-A)
- Compression ratio:
10.5 : 1 (GPD150-A)
11.2 : 1 (GPD125-A)
- Starting system:
Electric starter
- Lubrication system:
Wet sump

Engine oil:

- Recommended brand:
YAMALUBE
- SAE viscosity grades:
10W-40
- Recommended engine oil grade:
API service SG type or higher, JASO
standard MA or MB

- Engine oil quantity:
Oil change:
0.90 L (0.95 US qt, 0.79 Imp.qt)

Final transmission oil:

- Type:
Motor oil SAE 10W-30 type SE or higher or
Gear oil SAE 85W GL-3
- Quantity:
0.15 L (0.16 US qt, 0.13 Imp.qt)

Coolant quantity:

- Coolant reservoir (up to the maximum level
mark):
0.25 L (0.26 US qt, 0.22 Imp.qt)
- Radiator (including all routes):
0.46 L (0.49 US qt, 0.40 Imp.qt)

Air filter:

- Air filter element:
Oil-coated paper element

Fuel:

- Recommended fuel:
Regular unleaded gasoline (Gasohol [E10]
acceptable)
- Fuel tank capacity:
6.6 L (1.7 US gal, 1.5 Imp.gal)
- Fuel reserve amount:
1.4 L (0.37 US gal, 0.31 Imp.gal)

Fuel injection:

- Throttle body:
ID mark:
2DS1 00

Spark plug(s):

- Manufacturer/model:
NGK/CPR8EA-9
- Spark plug gap:
0.8–0.9 mm (0.031–0.035 in)

Clutch:

- Clutch type:
Dry, centrifugal, shoe

Drivetrain:

- Primary reduction ratio:
1.000
- Final drive:
Gear
- Secondary reduction ratio:
10.208 (56/16 × 35/12)
- Transmission type:
V-belt automatic

Chassis:

- Frame type:
Underbone

Specifications

Caster angle:

26.0 °

Trail:

92 mm (3.6 in)

Front tire:

Type:

Tubeless

Size:

110/70-13M/C 48P

Manufacturer/model:

DUNLOP/SCOOTSMART

Rear tire:

Type:

Tubeless

Size:

130/70-13M/C 57P

Manufacturer/model:

DUNLOP/SCOOTSMART

Loading:

Maximum load:

168 kg (370 lb)

(Total weight of rider, passenger, cargo and accessories)

Tire air pressure (measured on cold tires):

1 person:

Front:

150 kPa (1.50 kgf/cm², 22 psi)

Rear:

250 kPa (2.50 kgf/cm², 36 psi)

2 persons:

Front:

150 kPa (1.50 kgf/cm², 22 psi)

Rear:

250 kPa (2.50 kgf/cm², 36 psi)

Front wheel:

Wheel type:

Cast wheel

Rim size:

13M/C x MT3.00

Rear wheel:

Wheel type:

Cast wheel

Rim size:

13M/C x MT3.50

Front brake:

Type:

Hydraulic single disc brake

Specified brake fluid:

DOT 4

Rear brake:

Type:

Hydraulic single disc brake

Specified brake fluid:

DOT 4

Front suspension:

Type:

Telescopic fork

Spring:

Coil spring

Shock absorber:

Hydraulic damper

Wheel travel:

100 mm (3.9 in)

Rear suspension:

Type:

Unit swing

Spring:

Coil spring

Shock absorber:

Hydraulic damper

Wheel travel:

90 mm (3.5 in)

Electrical system:

System voltage:

12 V

Ignition system:

TCl

Charging system:

AC magneto

Battery:

Model:

YTZ7V

Voltage, capacity:

12 V, 6.0 Ah (10 HR)

Bulb wattage:

Headlight:

LED

Brake/tail light:

LED/10.0 W

Front turn signal light:

10.0 W

Rear turn signal light:

10.0 W

Auxiliary light:

5.0 W

Meter lighting:

LED

High beam indicator light:

LED

Turn signal indicator light:

LED

Coolant temperature warning light:

LED

Engine trouble warning light:

LED

ABS warning light:

LED

Fuse(s):

Main fuse:

15.0 A

Main fuse 2:

7.5 A

Taillight fuse:

7.5 A

Signaling system fuse:

7.5 A

ABS control unit fuse:

7.5 A

ABS motor fuse:

30.0 A

ABS solenoid fuse:

15.0 A

Consumer information

EAU53562

Identification numbers

Record the vehicle identification number, engine serial number, and the model label information in the spaces provided below. These identification numbers are needed when registering the vehicle with the authorities in your area and when ordering spare parts from a Yamaha dealer.

VEHICLE IDENTIFICATION NUMBER:

ENGINE SERIAL NUMBER:

MODEL LABEL INFORMATION:

<input type="radio"/>
<input type="radio"/>

9

Vehicle identification number

EAU26411

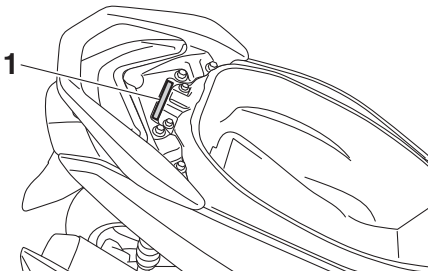

1. Vehicle identification number

The vehicle identification number is stamped into the frame.

TIP

The vehicle identification number is used to identify your vehicle and may be used to register it with the licensing authority in your area.

EAU26442

Engine serial number

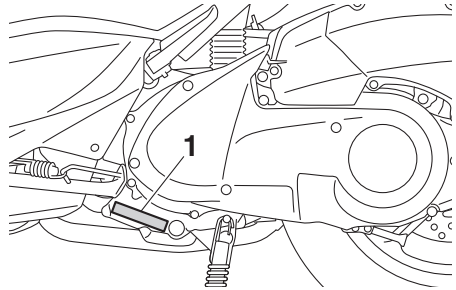

1. Engine serial number

The engine serial number is stamped into the crankcase.

EAU26501

Model label

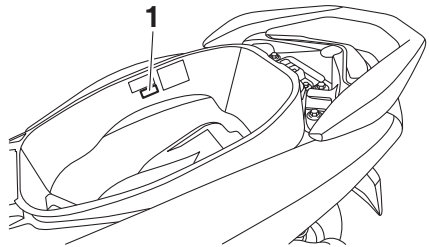

1. Model label

The model label is affixed to the inside of the rear storage compartment. (See page 3-16.) Record the information on this label in the space provided. This information will be needed when ordering spare parts from a Yamaha dealer.

Diagnostic connector

EAU69910

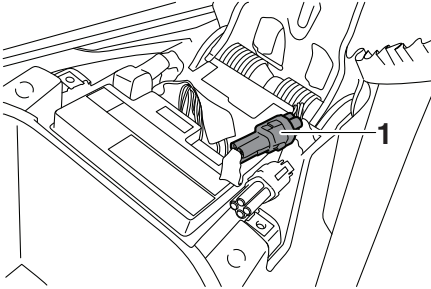

1. FI diagnostic connector

The diagnostic connector is located as shown.

Vehicle data recording

This model's ECU stores certain vehicle data to assist in the diagnosis of malfunctions and for research and development purposes. This data will be uploaded only when a special Yamaha diagnostic tool is attached to the vehicle, such as when maintenance checks or service procedures are performed.

Although the sensors and recorded data will vary by model, the main data points are:

- Vehicle status and engine performance data
- Fuel-injection and emission-related data

Yamaha will not disclose this data to a third party except:

- With the consent of the vehicle owner
- Where obligated by law
- For use by Yamaha in litigation
- For general Yamaha-conducted research purposes when the data is not related to an individual vehicle nor owner

Index

- A**
- ABS 3-11
 - ABS warning light 3-3
 - Acceleration and deceleration 5-3
 - Air filter and V-belt case air filter elements 6-17
 - Auxiliary light bulb, replacing 6-34
- B**
- Battery 6-30
 - Brake fluid, changing 6-26
 - Brake fluid level, checking 6-25
 - Brake lever, front 3-10
 - Brake lever, rear 3-11
 - Brake levers, lubricating 6-28
 - Brake light 6-35
 - Braking 5-3
- C**
- Cables, checking and lubricating 6-27
 - Care 7-1
 - Catalytic converter 3-15
 - Centerstand and sidestand, checking and lubricating 6-28
 - Coolant 6-13
 - Coolant temperature warning light 3-3
- D**
- Data recording, vehicle 9-2
 - Diagnostic connector 9-2
 - Dimmer switch 3-9
- E**
- Engine break-in 5-4
 - Engine oil and oil strainer 6-10
 - Engine serial number 9-1
 - Engine trouble warning light 3-3
- F**
- Final transmission oil 6-12
 - Front and rear brake lever free play, checking 6-23
 - Front and rear brake pads, checking 6-24
 - Front fork, checking 6-29
 - Fuel 3-13
 - Fuel consumption, tips for reducing 5-4
 - Fuel tank cap 3-12
 - Fuel tank overflow hose 3-15
 - Fuses, replacing 6-32
- H**
- Handlebar switches 3-9
 - Headlight 6-33
 - High beam indicator light 3-3
 - Horn switch 3-10
- I**
- Identification numbers 9-1
 - Ignition circuit cut-off system 3-18
 - Indicator lights and warning lights 3-3
- K**
- Keyhole shutter 3-2
- M**
- Main switch/steering lock 3-1
 - Maintenance and lubrication, periodic ... 6-4
 - Maintenance, emission control system 6-3
 - Matte color, caution 7-1
 - Model label 9-1
 - Multi-function meter unit 3-4
- P**
- Panels, removing and installing 6-7
 - Parking 5-5
 - Part locations 2-1
- S**
- Safe-riding points 1-5
 - Safety information 1-1
 - Seat 3-16
 - Sidestand 3-17
 - Spark plug, checking 6-9
 - Specifications 8-1
 - Starting off 5-2
 - Starting the engine 5-1
 - Start switch 3-10
 - Steering, checking 6-29
 - Storage 7-4
 - Storage compartments 3-16
- T**
- Taillight bulb, replacing 6-35
 - Throttle grip and cable, checking and lubricating 6-27
 - Throttle grip free play, checking 6-19
 - Tires 6-20
 - Tool kit 6-2
 - Troubleshooting 6-39
 - Troubleshooting charts 6-40
 - Turn signal indicator lights 3-3
 - Turn signal light bulb (front), replacing 6-37
 - Turn signal light bulb (rear), replacing 6-38
 - Turn signal switch 3-9
- V**
- Valve clearance 6-20
 - V-belt, checking 6-26
 - Vehicle identification number 9-1

W

Wheel bearings, checking	6-30
Wheels.....	6-22

