



Marathon 125 PRO

EURO 4



MANUEL DE PROPRIÉTAIRE
OWNER'S MANUAL
MANUAL DEL PROPIETARIO

Bienvenu! welcome! Bienvenido!



*GARANTIE CONSTRUCTEUR DE 2 ANS (PIÈCES ET MAIN D'OEUVRE). TWO YEARS OF WARRANTY (PARTS AND MANPOWER). DOS AÑOS DE GARANTÍA (M.O.Y PIEZAS).



RIEJU S.A. is grateful for the confidence you have put in their company and would like to congratulate you on your choice of motorbike.

The **Marathon 125c.c. PRO EURO 4** are the result of the long-term experience that **RIEJU** has had in competitions, which has led to the development of a high performance vehicle.

The objective of this owner's manual is to denote the use and maintenance of your vehicle, we ask you to read the instructions and information that follow carefully.

We wish to remind you that the life of the vehicle depends on how it is maintained. Maintaining the vehicle in perfect working condition reduces the cost of repair.

This manual has to be considered as an integrated component of the motorbike and must remain part of the basic equipment, and handed over in the event of a change of vehicle ownership.

In the event of any problems, please consult the RIEJU dealer who will assist you or check our web www.riejumoto.com.

Please remember that for your motorbike to perform correctly, you should always fit original spare parts.



CONTENTS

MOTORBIKE DESCRIPTION.....	6	ROUTINE TESTING.....	15
DELIVERY OF THE MOTORCYCLE.....	7	Front brake.....	15
IDENTIFICATION OF THE MOTORBIKE.....	9	Rear brake.....	16
ENGINE IDENTIFICATION NUMBER.....	9	Brake fluid level and brake pad wear.....	16
MAIN ELEMENTS OF THE MOTORBIKE.....	10	Throttle twist grip.....	17
KEYS.....	10	Lights, indicators and warning lamps.....	17
HANDLE BAR SWITCHES.....	10	Start switch.....	17
Indicator Switch.....	10	Tyres.....	18
Horn button.....	11	INSTRUMENT AND INDICATORS.....	19
Main and dip beam light switch.....	11	Speedometer (Kmh and Mph).....	19
Cold start (CHOKE).....	11	Out of gear (Neutral) indicator.....	19
CLUTCH LEVER.....	12	Temperature warning lamp.....	19
FRONT BRAKE LEVER.....	12	Headlight Main beam warning light.....	20
REAR BRAKE PEDAL.....	12	Direction indicator warning lamp.....	20
GEAR BOX PEDAL.....	13	Engine warning lamp.....	20
PETROL TANK.....	13	INSTRUMENT DESCRIPTION.....	21
PETROL TAP.....	14	ADJUST BUTTON FUNCTION INSTRUCTION.....	22



SELECTION MILES	22	GEAR BOX PEDAL.....	31
USE OF TRIP	22	CARBURETTOR	32
TOTAL HOUR	23	BATTERY (CHECKING THE BATTERY).....	32
HOUR METER	23	FRONT SUSPENSION.....	33
SELECT BUTTON FUNCTION INSTRUCTION.....	24	REAR SUSPENSION.....	33
12 / 24 HOURS MODE	24	COOLING SYSTEM.....	34
STOPWATCH	24	SPARK PLUG CHECK.....	35
SPEED RECORD	25	CHECKING & FILLING THE ENGINE OIL LEVEL.....	36
TO ENTER THE SETTING MODE.....	26	CHAIN ADJUSTMENT AND TENSION.....	37
CIRCUMFERENCE AND SENSOR POINT	26	AIR FILTER.....	38
WHEEL DIAMETER AND PULSES	27	CLEANING AND STORAGE	40
CLOCK SETTINGS	28	CLEANING.....	40
MOTORBIKE OPERATION.....	29	LONG-TIME STORAGE.....	41
STARTING AND RIDING	29	CHECKS BEFORE USING MOTORCYCLE	42
RUNNING IN.....	30	TECHNICAL SPECIFICATIONS & CHARACTERISTICS.....	43
ACCELERATION.....	30	MAINTENANCE.....	45
TO BRAKE (SLOWING DOWN).....	31		
STOPPING	31		



MOTORBIKE DESCRIPTION

This motorbike has a 124c.c. single cylinder; liquid cooled four stroke motor. With a piston diameter of 52 mm and it has a 58,6 mm bore.

The motor has an electronic Ignition system, CDI and a high-tension coil. The Generator provides 235 Watts and 12 volts via a regulator to supply power for the bike electrics.

Engine power is delivered to final drive chain via a Multiple metal clutch with constant pressure springs, submerged in an oil bath.

The engine is anchored to a highly resistant perimeter type chassis, with tapered steering bearings.

The front suspension in the Marathon 125 PRO consists of a hydraulic fork with bars, The rear suspension with variable transmission consists of a shock absorber anchored to a progressive articulated rod system (Progressive Racing System - PRS) which provides great operational smoothness with variable transmission also incorporate a gas shock absorber with spring preload adjustment.

The front and rear brakes use a disk made of stainless steel and radial calipers.



DELIVERY OF THE MOTORCYCLE (PRE DELIVERY INSPECTION & HANDOVER)

USER MANUAL – very important this explains in detail the essential functions of the motorcycle, safe use and important maintenance practices.

WARRANTY REGISTRATION – complete the necessary information, pass a copy to the owner, and return a copy immediately to your **RIEJU** distributor.

OPERATION - Explain the functions & correct handling of the motorcycle.

WARNINGS - Explain the importance of warning labels to ensure a long life of the motorcycle.

KEYS - Deliver the full set and recommend making a note of the key item reference.

FIRST SERVICE - Explain the importance of the service at 500 km and the ongoing service schedule.

PERIODIC MAINTENANCE - Explain the need of the periodic maintenance and indicates that don't do the correct maintenance and services indicates can be cause to loose the waraanty.



DELIVERY OF THE MOTORCYCLE (PRE DELIVERY INSPECTION & HANDOVER)

ADJUSTMENTS :

MIRRORS - Set to the correct position for the user.

CLUTCH LEVER - Adjust to suit.

REAR BRAKE LEVER ADJUSTMENT - Adjust to the correct height for the user.

GEAR LEVER ADJUSTMENT- Adjust to the correct height for the user.



WARNING: Changes on the bike don't authorized by RIEJU, or use of parts that don't are ORIGINAL SPARE PARTS from RIEJU on the warranty period. Release RIEJU from any responsibility on the damages produce on the bike and cancel the warranty.



IDENTIFICATION OF THE MOTORBIKE

On the chassis you will find your motorbike's identification number engraved

The number is stamped on the right hand side of the front frame (Steering head.) is unique to every machine. This number is required to register your vehicle, this chassis or VIN number should be quoted when requesting warranty assistance or genuine Rieju spare parts.



ENGINE IDENTIFICATION NUMBER

The engine serial number is located on the top, left side bottom of the left crankcase.

The engine number will serve as a reference when requesting spare parts from the dealership.

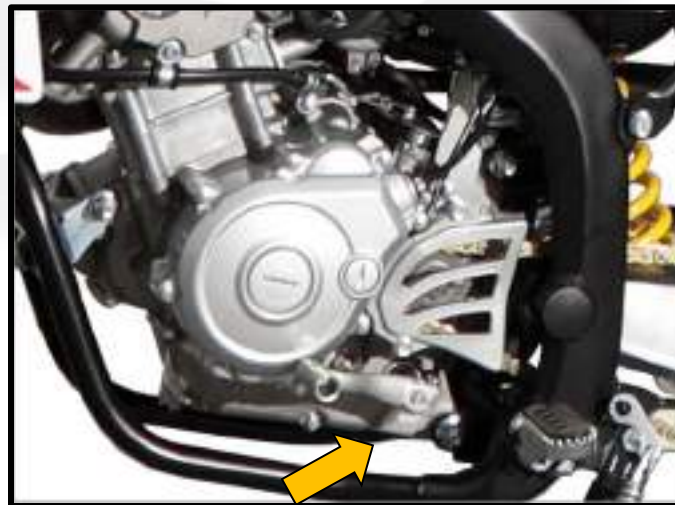



MAIN ELEMENTS OF THE MOTORBIKE

KEYS

With this model, you will be given a set of keys, which are used for the Ignition switch/Steering lock.

HANDLE BAR SWITCHES

1- Indicator Switch

This has 3 positions: in the centre position it is deactivated, to indicate right it must be moved to the right and to indicate left it must be moved to the left.



NOTE: Note that the button always returns to the central position, to switch off the direction indicators push button.

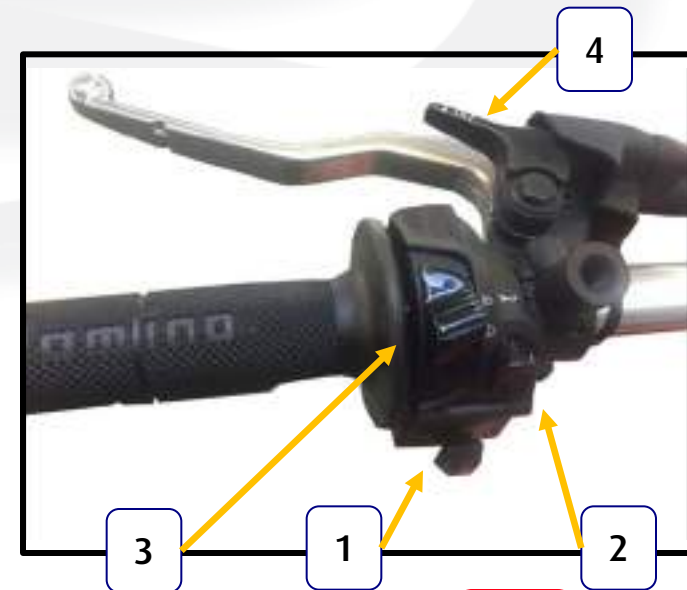



2-. Horn button

Press the button to activate the horn.

3-. Main and dip beam light switch

This switch has two positions: when it's down the dip beam is on and in the upper position the main beam is illuminated.

This model incorporates a bulb of 12V 35/35W H4 for light of main and dip beam and of 12V 5W for position light.



CAUTION: Use other type of bulb or change of power of it can cause damages on the optics of the vehicle. This type of fault is exempt from warranty.

4-. Cold start (CHOKE)

When the motor is cold, the choke lever should be placed in the On position.



WARNING: Once the motor has reached it's normal working temperature, return the choke lever go back to it's original position, otherwise it could cause the motor to misfire.



CLUTCH LEVER

The clutch lever is situated on the left-hand side of the handlebar. To activate it, pull the lever towards the grip or handlebar.



FRONT BRAKE LEVER

The front brake lever is situated on the right-hand side of the handlebar. To activate the front brake, pull the lever towards the handlebar.

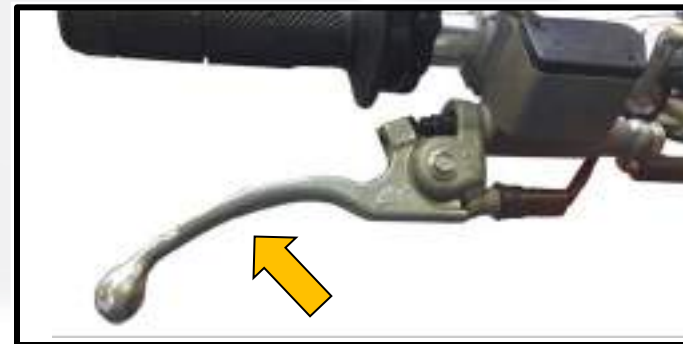

REAR BRAKE PEDAL

The rear brake pedal is on the right-hand side of the motorbike. To activate it, press downwards with the foot.

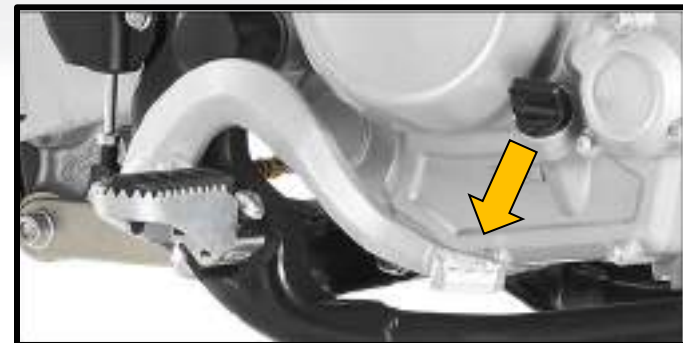



GEAR BOX PEDAL

This is situated underneath the left part of the motor, it is activated with the foot taking it all the way and then letting it go back to its' original position before changing gear again. To put the motorbike into first gear, the pedal has to be pressed downwards. To change the other gears, lift the lever upwards with the toe.

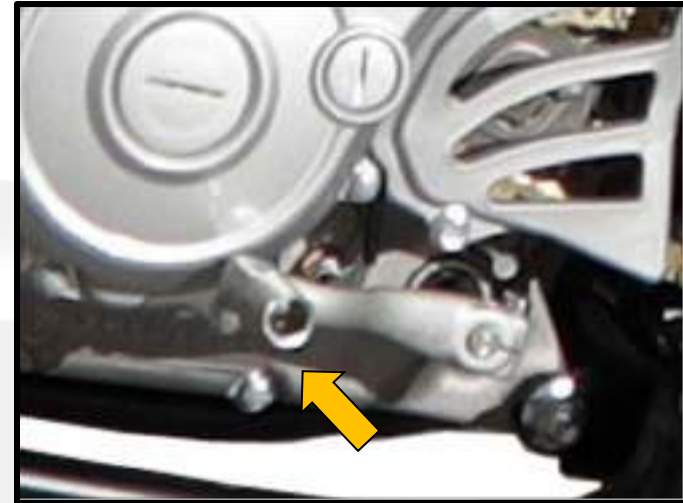

PETROL TANK

To get to the tank, open it using the stop- per of the tank, turning it anti-clockwise.

The capacity of the tank is 6 liters.



CAUTION: Use only Unleaded petrol E5, without oil, the use of another type of fuel can damage the engine and this damages will not be considered as warranty.





PETROL TAP

The petrol tap is situated on the left-hand side of the vehicle, under the fuel tank. It has three positions :

OFF: With the lever in this position, the fuel will not go through. Put the lever in this position when the motor is not running when parked and garaged.

ON: With the lever in this position, the fuel goes to the carburettor. Normal driving is done with the lever in this position.

RES: this position is RESERVE. If you run out of fuel while you are driving with the lever in the "ON" position, turn the lever to this position. Fill the tank as soon as possible, then it is important to remember to turn the lever back to "ON".



TIP: Do not drive normally in RESERVE position as you could run out of petrol.





ROUTINE TESTING

Front brake

Pulling in the front brake lever operates the front brake by pumping brake fluid from the master cylinder to the front brake calliper. The brake pads are pushed by the calliper pistons against the front disc. Slowing the bike down.

The braking surface of the disc should be free of oil and dirt to ensure maximum braking efficiency. If for any reason the master cylinder is empty of brake fluid after checking for pad wear it should be topped up as necessary. If there is air in the system the brakes will need to be bled.

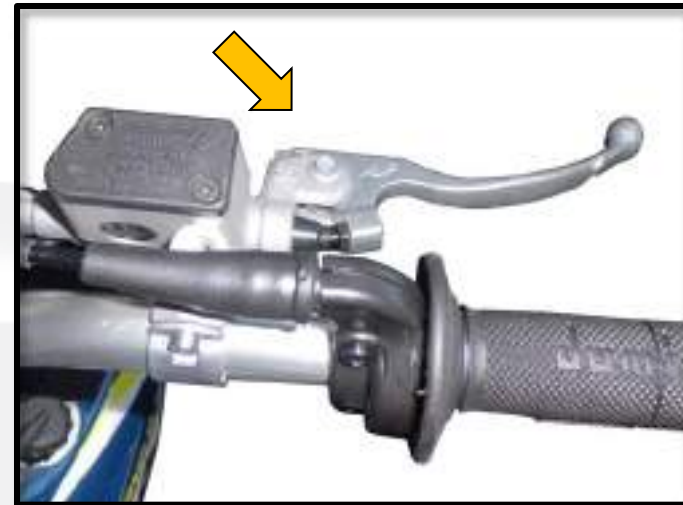

WARNING: Bled the baking system will do by one professional, Rieju recommend do this operation by your official RIEJU dealer.



Rear brake

Periodically check the brake fluid level in the reservoir situated on top of the rear brake master cylinder and under the rear right hand panel, to top up.



CAUTION: If the reservoir is empty please go to your official RIEJU dealer.

Brake fluid level and brake pad wear

Check that the level of brake fluid is correct, if not, Check for brake pad wear. If the pad material is less than 2mm thick, the pads should be replaced. If the pads are not worn out, top up the brake reservoir with brake fluid.



WARNING: Brake fluid is corrosive and will damage paintwork, if spilt wash off with water immediately.



TIP: Always remember that the above must be carried out by a RIEJU official service.





Throttle twist grip (1)

Ensure it works correctly, by turning the grip and verifying if the free play is correct. The grip should return to closed position when released.

Lights, indicators and warning lamps

Check operation of all lights, and direction indicators plus the oil warning lamp and petrol reserve panel lights. Replace bulbs as necessary.

Start switch (2)

This switch is used to start the engine, after verifying that the gear-change pedal is in the neutral position.

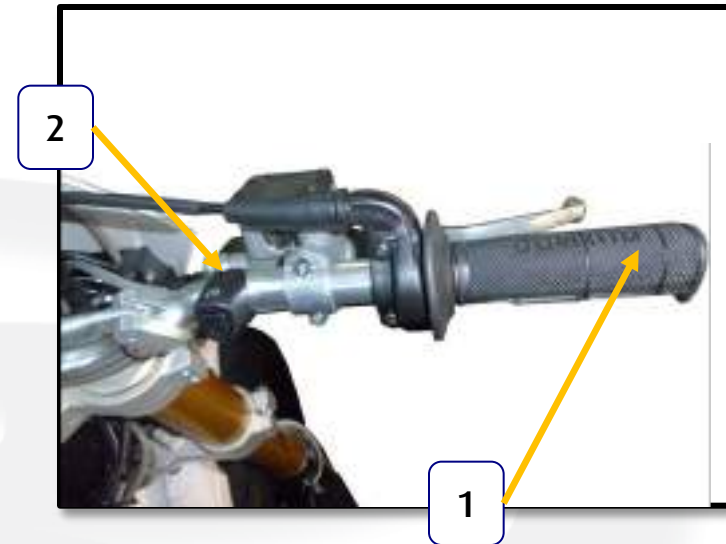



Tyres

The tyre pressure directly effect the road holding ride comfort and braking distance, the, therefore check the tyre pressures regularly for your own safety.



ADVICE: Make sure that the rim is central and not damaged, as well as the wear on the tyres. Do not overload the vehicle as this will effect stability, and increases tyre wear.



CAUTION: when the pressure is very high, the tyres can no longer absorb any shocks, transmitting any road sur- face defects directly to the chassis, handlebar and rider.

PRESSURES

TYRE	FRONT	REAR
Off-road	1,7 Kg/Cm ²	1,8 Kg/Cm ²
Super Motard	2,2 Kg/Cm ²	2,4 Kg/Cm ²



INSTRUMENT AND INDICATORS

1.- Speedometer (Kmh and Mph)

2.- Out of gear (Neutral) indicator (**N**)

This light comes on when the gear change lever is in the neutral (N) position, that is to say, out of gear.

3.- Temperature warning lamp ()

This light is very important as it can tell us if there is an excessive increase in engine running temperature due to an engine fault or a low level of cooling liquid in the radiator.



ATTENTION: Do not use the bike with this warning light on, as this may cause serious damage to the engine, consult your RIEJU dealer as soon as possible.

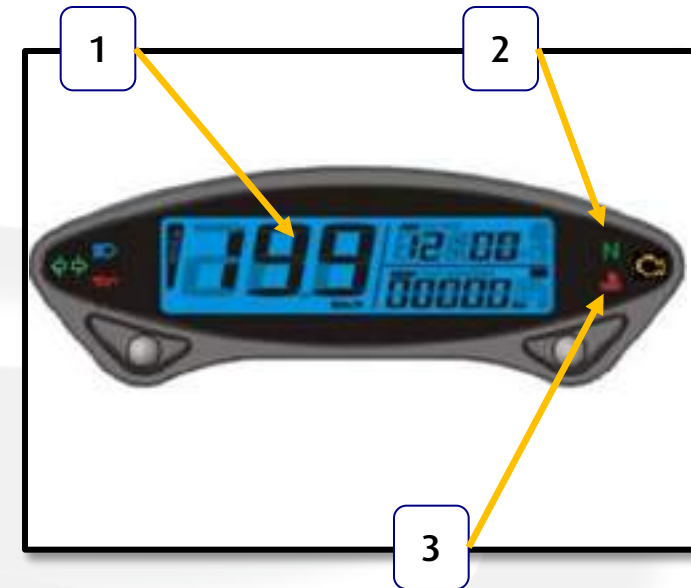



4.- Headlight Main beam warning light ()

This indicator comes on when the headlights are on main beam.

5.- Direction indicator warning lamp ()

This indicator comes on when we activate the direction indicators.

6.- Engine warning lamp ()

This indicator comes on when on fail is detected on the engine.





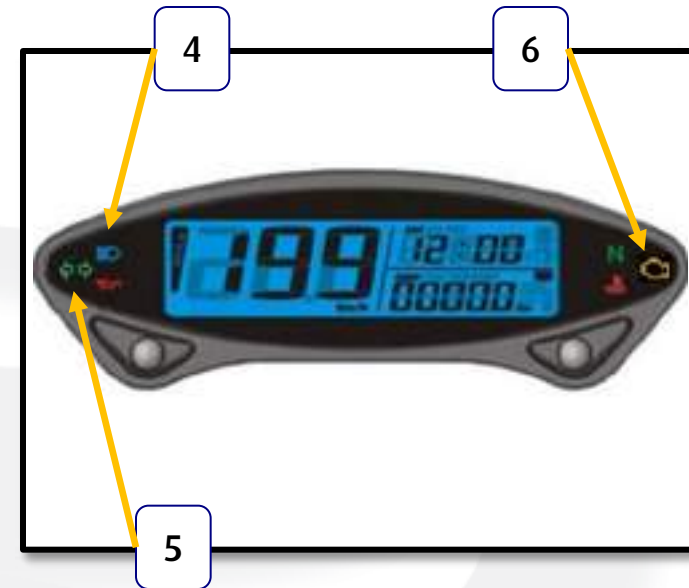

ATTENTION: Do not use the bike with this warning light on, as this may cause serious damage to the engine, consult your RIEJU dealer as soon as possible.





INSTRUMENT DESCRIPTION

Indicator lights

- High beam light ()
- Direction light ()
- Engine alarm ()
- Neutral light ()
- Temperature ()

Speedometer

- Display unit: Km/h or MPH.

- Clock: 12/24 MODE
- Stopwatch: According to setup distance to record the testing time.
- Speed Log: Average speed and max speed record



- Volt Meter: Display range 4 levels

Odo meter

- Display range 0-99999 Km (mile)
- Display unit: 1 Km (mile) Trip meter
- Display range 0-9999,9 Km (mile)
- Display Unit 0,1 Km (mile)

Select button

- Press the Select button in the main screen to switch between 12/24 hour mode, speedometer record, stopwatch, and MAX record.

Adjust Button

- Press the Adjust button in the main screen to switch between ODO, TripA/B, Total Hour meter, Hour meter A/B.
- Press and hold the Adjust button for 3 seconds in Trip A/B screen to reset.
- Press and hold the Adjust button for 3 seconds in Hour meter A/B screen to reset



ADJUST BUTTON FUNCTION INSTRUCTION

SELECTION MILES: In main screen (function "ODO" selected), you could hold pressing the Adjust button for 3 seconds to change the speed unit Km to miles.

USE OF TRIP: In main screen, press the **Adjust button** once to switch the function from odometer to trip.

Hold pressing the **Adjust button** for 3 seconds to reset the "TRIP A".

Press the **Adjust button** to switch from "TRIP A" to "TRIP B".

Hold pressing the **Adjust button** for 3 seconds to reset the "TRIP B".

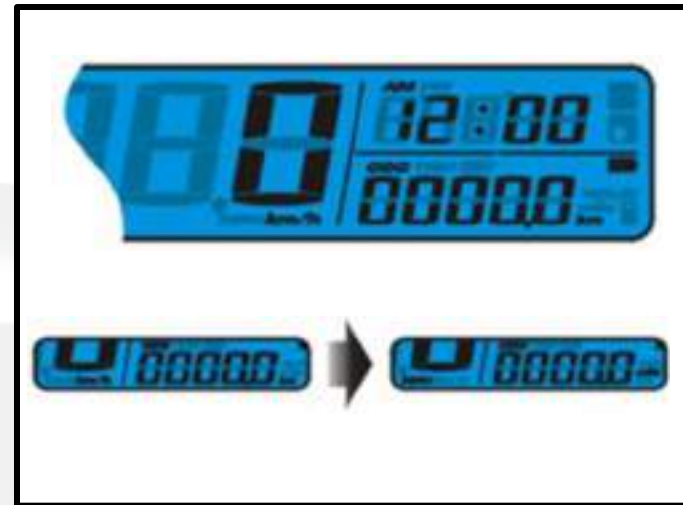



TOTAL HOUR: Press the **Adjust button** to switch from trip B to total hour meter.

HOUR METER: Press the **Adjust button** to switch from total hour meter to hour meter A.

Press and hold the **Adjust button** for 3 seconds to reset the hour meter A.

Press the **Adjust button** to switch from hour meter A to hour meter B.

Press and hold the **Adjust button** for 3 seconds to reset the hour meter A.

Press the **Adjust button** to switch from hour meter B to back to the main screen.





SELECT BUTTON FUNCTION INSTRUCTION

12 / 24 HOURS MODE: In main screen (function "ODO" selected), press and hold the **Select button** for 3 seconds to change between 12/24 hour mode. If 24 hour mode is chosen then the AM/PM symbol will not be displayed

STOPWATCH: Press the **Select button** during main screen to switch from Clock to Stopwatch.

Press and hold the **Select button** for 1 seconds to reset the Stopwatch

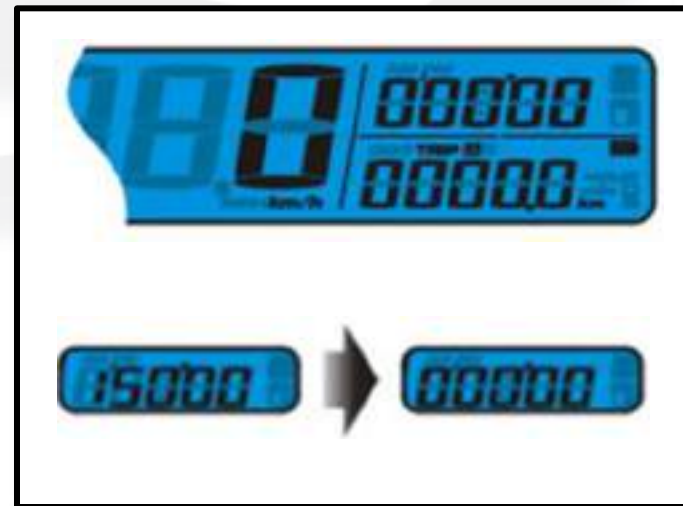
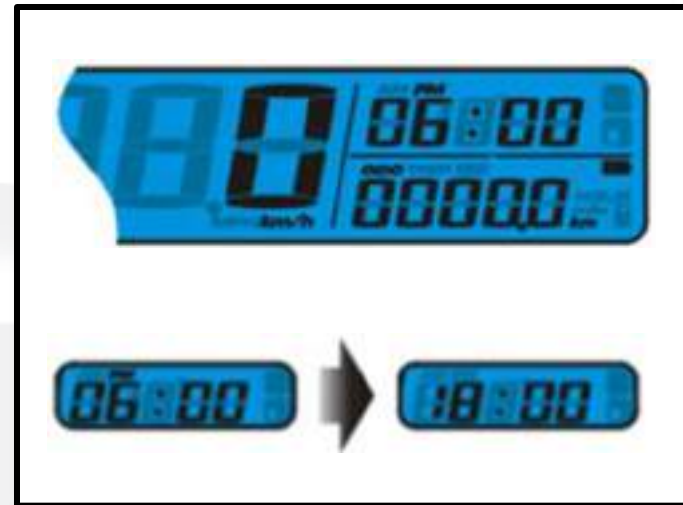



SPEED RECORD: Press the **Select button** to switch from Stopwatch to Speed Record.

Press and hold the **Select button** for 3 seconds to reset the Speed Record. Average speed and the Max speed display in the 3 seconds rotation.

Press the **Select button** to switch from Speed Record back to main screen.

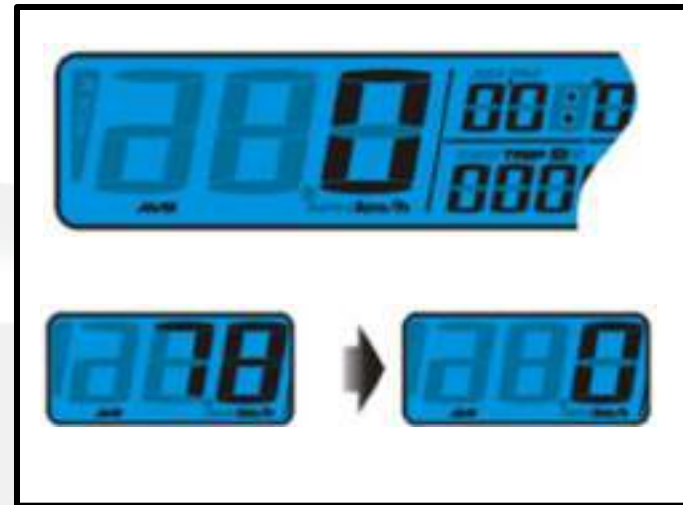



TO ENTER THE SETTING MODE

In main screen, press down the **Adjust and Select button** for 3 seconds to enter the tire circumference and sensing point setting (for changing different size tire.)

CIRCUMFERENCE AND SENSOR POINT SETTING : Press the **Adjust Button** to enter the circumference setting.

Press the **Select Button** to change the setting and press the **Adjust Button** for three times to enter the sensing point setting.

Press the **Select button** to move to the digit you want to set.

Press **Adjust button** to go back to tire circumferences value & sensing point setting screen.

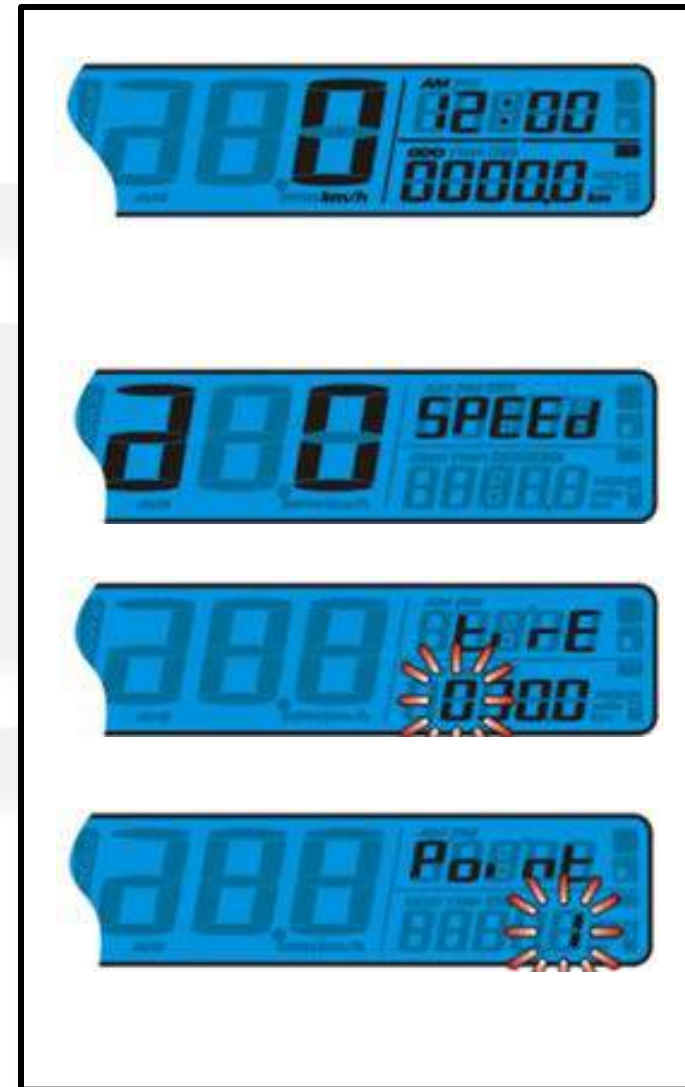



WHEEL DIAMETER AND NUMBER OF PULSES

The wheel diameter and the number of pulses will be the following:

TYRE	DIAMETER	PULSES
Off-road	2100	6
Super Motard	2030	6



ATTENTION: Put different values as indicated will produce that the speed shown by the dashboard will be incorrect, any consequences produced by this issue will not be a RIEJU responsibility.



CLOCK SETTINGS: To enter the clock (Hour) Setting press the **Adjust button** on the circumferences value & sensing point setting screen.

Press the **Select button** to enter the clock (Hour) setting.

Press the **Select button** to choose the hour/minute you want to set.

Press **Adjust button** to get back to Clock setting screen.

 **ATTENTION:** Other functions are the factory settings should not be changed.

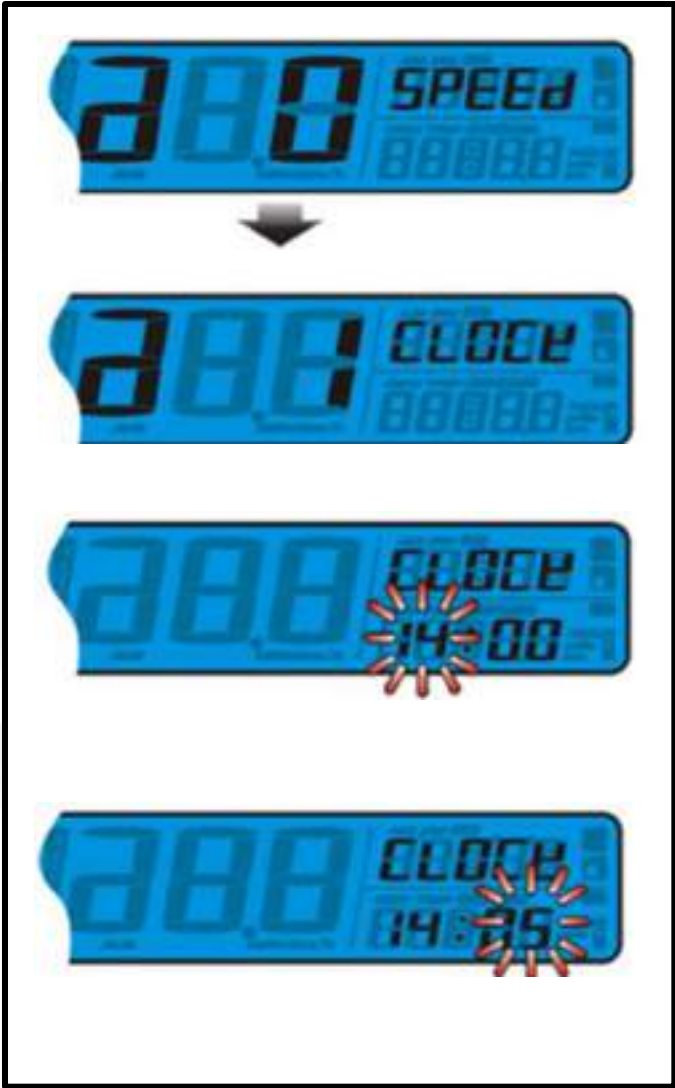



MOTORBIKE OPERATION

It is very important to know how to operate your vehicle correctly.



ATTENTION: Remember that you must not leave the motor running in an enclosed area, as the toxic gas from the exhaust could cause serious health problems.

STARTING AND RIDING

Open the petrol tap. If the motor is cold, fully open the choke lever. Turn the ignition key one position clockwise and check the engine is in neutral, with the throttle closed press the starting button to turn the engine over. Pull in the clutch lever and put the motorbike in first gear (Down one click), slowly release the clutch lever while at the same time accelerating slowly once moving allow the clutch lever to go its rest position (OUT) and ride away. Do not accelerate too much until the motor is warm enough



ATTENTION: Before riding the motor should be warm, never accelerate or ride hard when the motor is cold. This will prevent pre-mature damage to your engine.



RUNNING IN

The most important period of your motorbike's life is between 0 and 500 kilometers and because of this we ask you to read the following instructions carefully. In the first 500 kilometers, the motorbike must not be overworked as the motor is new and the different parts of the motor have to wear in, until it works perfectly. During this period, avoid prolonged use of the motorbike at high revolutions or in conditions that could cause overheating.



ATTENTION: As indicate on the Service Manual you must done the firts Service at 500 Km in your Official rieju Workshop. Is essential done the services indicates on the Service Manual and equire the signature and stamp of the Workshop at time to pick up the bike. Don't make the service as the Km indicates is reason for loss the vehicle warranty.

ACCELERATION

Riding speed and acceleration is controlled by opening or closing the throttle. Operating the twist grip toward you increases the speed and away from decreases the engine revolutions.



TO BRAKE (SLOWING DOWN)

Close the throttle; activate the front and rear brakes simultaneously, increasing the pressure progressively.



WARNING: Sudden braking can cause skidding.

STOPPING

Close the throttle and activate both brakes simultaneously and when the vehicle has reduced speed, Pull in the clutch lever all the way. To stop the motor, switch off the ignition and remove key. Once the motor has stopped always close the petrol tap.

GEAR BOX PEDAL

The Gear lever is located near the left hand engine case of the motor and is activated with the foot taking it all the way down or up, letting it come back to its' original position before changing gear again. To put the motorbike into first gear, the pedal has to be pushed downwards, to put in other gears lift the lever up as far as it will go with the toe. Gear changing should be done carefully to ensure the gear you want is selected before releasing the clutch.



CARBURETTOR

The carburettor provides the correct petrol air mixture to the engine. If the settings are tampered with poor performance and/or overheating may occur. If you have any problems please refer to your **RIEJU dealer**.

BATTERY (CHECKING THE BATTERY)

If you see rust on the terminals and the ends of the terminals, they should be cleaned with a wire brush.

If so, remove the cables and scrub the terminals. After cleaning, reconnect the terminals and apply grease on the ends of the wires and the terminals.



WARNING: Make sure the connections are correct, otherwise you will damage the battery and the harness. Remember that you should pay particular attention to the handling and treatment of the battery as it contains sulphuric acid and therefore run the risk of burning skin, eyes and clothing. Also, keep away from flames sparks. When changing the battery, change it with the same specification battery.



FRONT SUSPENSION

The front suspension consists of a hydraulic fork which has been crafted to the highest standards of technology and design.

- Upside down fork of Ø41 mm.
- Oil capacity : 400 c.c. per leg.
- Type oil recommended : LIQUI MOLY OIL FORK SAE 10W.



REAR SUSPENSION

The rear suspension consists of a gas-assisted hydraulic monoshock absorber with separate gas reservoir and spring preload adjustment via the nut located under the shock absorber spring by means of the PRS progressive articulated rod system.

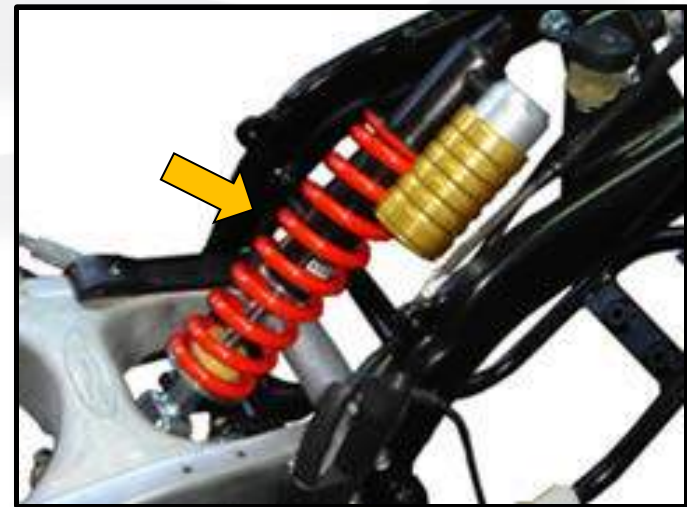



COOLING SYSTEM

The radiator is mounted on the front right-hand side of the motorbike behind a protective grill; The radiators propose is to maintain a constant engine temperature by cooling the hot water which is pumped around the engine.



ADVICE: To check the level of coolant, carefully undo the radiator cap off and top up if necessary.



CAUTION: never open the top of the radiator when the motor is hot, because the boiling liquid could escape under the pressure, which is dangerous.

Use only anti-freeze liquid. In this way we can avoid the water freezing causing damage to the water pump and water pipe ruptures. Do not top up with tap water as the calcium content could damage the radiator.





SPARK PLUG CHECK

The spark plug is an important part of the motor and it is easy to check. Take the spark plug out and check it periodically, the high combustion temperatures and carbon deposits may effect the efficiency of the engine. If the electrode is too eroded or carbon deposits are excessive, change the spark plug.

NGK CR8E

Before fitting a new spark plug, check the gap between electrodes. This gap must be between 0,6- 0,7 mm.



CAUTION: When installing the spark plug, always clean the area, around the plug hole to prevent any dirt etc. from entering the combustion chamber. Screw the spark plug in by hand, trying to make sure that it is not cross threaded finally tighten with the correct tool.

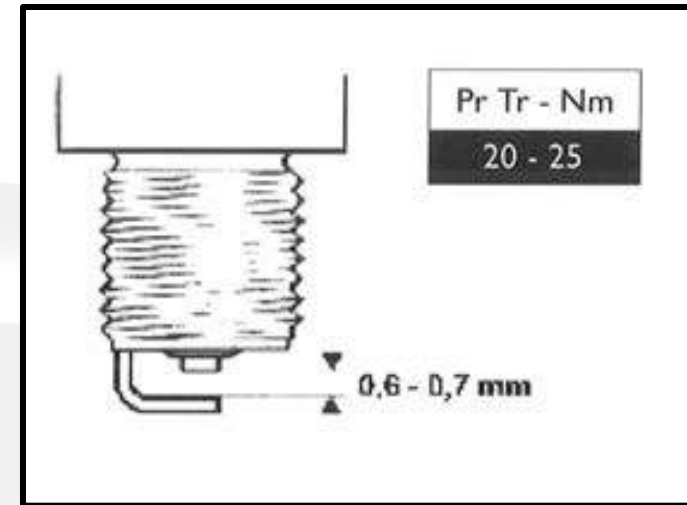



CHECKING AND FILLING THE ENGINE OIL LEVEL

To check the oil level the engine will cold and the bike placed in horizontal position.

The oil level is indicated by the dip stick (A) oil, placed on the bottom right of the engine.

 **ADVICE:** Check oil level regularly.

Checking and filling the oil: Unscrew the dipstick (A) wipe the dipstick with a cloth and place back into the guide. Then remove it again. Check the engine oil level:

The oil level should be between the two top lines (b) minimum (a). Oil below advised level, fill to the correct level.

 **ADVICE:** See technical specifications to check the oil recommend by RIEJU.

 **WARNING:** Drive with the bike at minimum level (a) can damage the engine. The damages produce by this cause it will not admit as warranty.

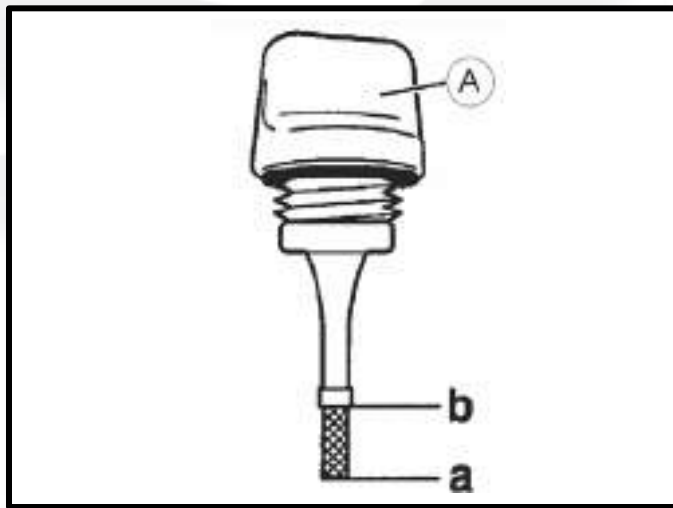
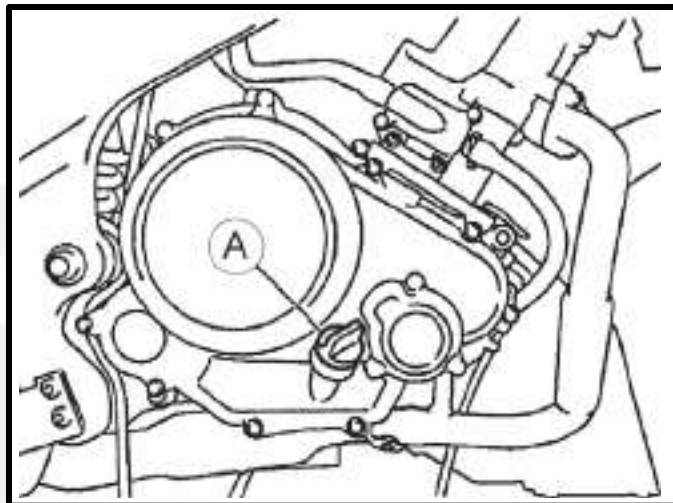



CHAIN ADJUSTMENT AND TENSION

The motorcycle must be positioned vertically with its wheels on the firmly on the ground.

The chain must be adjusted to have a tolerance of 30 to 40 mm. At the midpoint between the output gear and the rear sprocket (see picture).



ATTENTION: The chain should be kept in perfect cleanliness and be properly lubricated each week.

To adjust to the correct tension you must perform these steps on both sides of the wheel:

- 1 - Set the gearbox in neutral and loosen the nuts (A) and (B).
- 2 - Using the bolts (C) adjust the chain tension, ensuring it is always the same distance on both sides of the axle. To do so use the rule marks on of the swing arm.
- 5 - Set the position using the 2 nuts (B) and tighten the nut (A) that secures the rear wheel axle

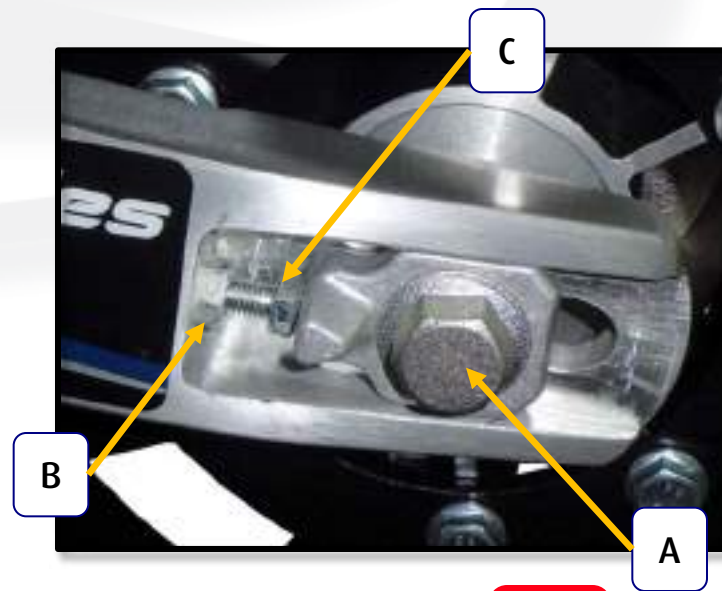



AIR FILTER

To ensure that the engine runs correctly, the air filter must be kept clean and oiled.

In order to access the air filter, disassemble the motorbike seat, allowing free access to the filter box. Remove the cover, which is attached to the box by a screw (A), and remove the filter housing.





After removal, check to see if the foam filter is blocked, in which case wash with specific product to clean foam filter, apply some air filter foam oil, Rieju suggest use LIQUI MOLY FOAM FILTER OIL, then squeeze the filter material between your hands to remove surplus oil. Do not wring out the filter element, as this will damage the foam. When refitting the air filter sure that the foam fits the box correctly so that no air can enter the engine without being filtered. It must be cleaned more frequently if the motorcycle is used in humid or dusty places.



ATTENTION: Don't do the periodic maintenance of this component and the correct cleaning can be the root cause of a bad carburetion of the bike and bad function of the engine and can damage it. Damages for this cause will exclude of the warranty.





CLEANING AND STORAGE

CLEANING

Frequent and thorough cleaning of your motorbike will not only improve its performance and lengthen the useful life of its components but also emphasize the appearance of the motorbike. Order of cleaning:

- 1- Cover the exhaust pipe outlet/inlet to prevent water entering the system.
- 2- Check that the spark plug and all caps are firmly in place.
- 3- If the engine is very dirty apply a degreaser.



ATTENTION: DO NOT apply degreaser to the wheel axle, chain or brake discs.

- 4- Remove the degreasing agent along with the dirt using a low pressure water source such as a hosepipe.



ATTENTION: Rieju accepts no responsibility for the use of degreasing agents which stain and/or cause deterioration to the motorbikes components. Rieju accepts no responsibility for any possible damage resulting from the use of pressurized water to clean the motorbike. The carburettor provides the correct petrol air mixture to the engine. If the settings are tampered with poor performance and/or overheating may occur. If you have any problems please refer to your RIEJU dealer.



5- After all dirt has been washed off; the surfaces should be washed with warm water and mild detergent soap.

6- Remove any soap and with cold water and dry all surfaces. Clean the seat with vinyl upholstery cleaner.

7- Once cleaned, start the engine and allow it to idle for a few minutes, this will completely dry all the components and at the same time leave all connections moisture free.

LONG-TIME STORAGE

For prolonged storage of the motorbike, it is advised that all cleaning procedures above are adhered to prevent any likelihood of deterioration. Once the motorbike has been thoroughly cleaned it can be readied for storage as follows:

1- Drain all fuel from the tank, pipes and the carburettor.

2- Lubricate all control cables.

3- Seal the exhaust pipe to prevent the entry of any moisture.

4- Remove the battery and charge at least once a month, be careful to ensure the battery is stored in the correct conditions.



CHECKS BEFORE USING MOTORCYCLE

Check the following points before using your motorcycle

ITEMS TO BE CHECKED	CHECK-UP	IF NECESSARY...
Accelerator grip	Movement	Adjustment
Tyres	Pressure and wear	Pump up or replace
Battery	Charge level	Charge
Steering	The softness of the steering, the flexibility of the movement, that does not present slacks	
Lights and indicators Instrument panel	Work correctly Work correctly	Replace
Clutch	Smooth operation	Adjustment
Front and rear brakes Disc brakes	Brake pads for wear and test brakes Damages or dusty	Replace
Petrol tank	Level	Refill
Transmission chain	Tension and condition of chain and sprocket	Lubricate



ATENCIÓN: Each time the vehicle is used, it should be checked as above. If during these checks any abnormality is established, it should be repaired before using the motorcycle.



TECHNICAL SPECIFICATIONS AND CHARACTERISTICS

COMPONENT	SPECIFICATIONS
ENGINE	
Type	4 stroke water cooled
Engine capacity	124 cm ³
Model cylinders	1 inclined forwards
Piston size	52,0x58,6mm (2,05x2,31")
Compression ratio	11,20:1
Starting system	Electrical
PETROL	
Type	Unleaded petrol E5 
OIL FILTER	
Type	Paper
OIL PUMP	
Type	Mechanic



COMPONENT	SPECIFICATIONS
ENGINE OIL	
Lubrication system	Autolube
Oil type	LIQUI MOLY MOTORCYCLE 4T SAE 10W30 / 20W50
Cantidad Aceite de Motor	1,15 l (1,22 US qt) (1,01 Imp. qt)
Sin sustitución del conjunto filtro aceite	0,95 l (1,00 US qt) (0,84 Imp. qt)
Con sustitución del filtro de aceite	1,00 l (1,06 US qt) (0,88 Imp. qt)
WATER PUMP	
Type	Mechanical
SPARK PLUG	
Type	NGK/CR8E
Electrode Clearance	0,6-0,7mm (0,028-0,031")

 **Advice:** Contact your authorized RIEJU workshop in case of any problem or breakdown of the vehicle.



MAINTENANCE

MAINTENANCE OPERATIONS	500 Km	3500 km	6500 Km	9500 Km	12500 Km
Brake system checks	C	C	C	C	C
Transmission oil level checks * * Oil filter it will changed too	R	R	R	R	R
Chain tension and wear checks	C & L	C & L	C & L	R	C & L
Suspension Checks	C	C	C	C	C
Check, adjust and lubricate controls and cables	C	C	C	C	C
Cleaning and greasing of air filter	CL & L	CL & L	CL & L	CL & L	R
Inspect and adjust carburettor	C	C	C	C	C
Inspect and adjust the sparkplug	C	R	R	R	R
Inspect all nuts and bolts for the chassis and plastics	C	C	C	C	C

C:CONTROL; R: REPLACEMENT; L:LUBRICATION; L=CLEANING



MAINTENANCE OPERATIONS	500 Km	3500 km	6500 Km	9500 Km	12500 Km
Check the electrical System	C	C	C	C	C
Valves adjustment	C	C	C	C	C
Inspect radiator liquid levels	C	C	C	C	C
Inspect exhaust system	C	C	C	C	C
Check terminals and battery condition	C	C	C	C	C
Check oil pump operation	C	C	C	C	C
Tyre	C	C	C	C	C

C:CONTROL; R: REPLACEMENT; L:LUBRICATION; L=CLEANING



CAUTION: Maintenance schedule can change on function of the bike use, conduction, environmental conditions, etc...



RIEJU®

...for everyday adventure