

SINNIS
MOTORCYCLES

USER'S MANUAL



AKUMA

INTRODUCTION

Congratulations on becoming the proud owner of a new Sinnis motorcycle.

At Sinnis we are committed to giving you the best possible experience throughout and having made your purchase, we are here to support you throughout your journey with us, providing you with dedicated aftersales care and advice on your new bike. Sinnis has your transport requirements at it's heart.

Your motorcycle is designed for road use only, in line with our UK transport laws and for operation as recommended by the manufacturer (stated within this User Manual). Please ensure you read this User Manual prior to operation and seek advice from Sinnis or your Sinnis Dealer Representative if you are unsure on any points relating to your motorcycle or its operation. The data, instructions and specifications in this User Manual are based upon the latest design features.

Sinnis and the manufacturer reserve the rights to make changes to the specifications of our vehicles without warning, as we are devoted to making continuous improvements to our products and services. We always therefore welcome suggestions and feedback from our customers, with a view to making such improvements. This User Manual is solely for your reference as our customer and hence any reproduction of this User Manual (by company or individual) is not permitted. All information contained in this manual is correct at the time of going to print and Sinnis Motorcycles accept no liability for out of date information.

For parts not listed herein, please contact Sinnis Motorcycles or your Sinnis Dealer Representative, or our Online Official Parts Catalogue, details on our website:
www.sinnismotorcycles.com



Join our EXCLUSIVE [Sinnis Owners Club](#) Facebook Page, where YOU as a Sinnis owner can share your riding stories, queries and photos.



Check out our [sinnis_motorcycles](#) Instagram page for the latest pictures of show events, lifestyle and new models.



Watch our Team's video diaries, reviews and maintenance tips on our [Sinnis Motorcycles YouTube Channel](#).

CONTENTS

Vehicle Identification Number (VIN) and Engine Number.....	3
Fuel system.....	3
Instrumentation panel.....	4
Left & right controllers.....	5
Operation controls.....	6
General inspection.....	7
Starting & warming up.....	8
Riding operation.....	9
Guide for safe riding.....	10
EFI system.....	11
Service & Maintenance Schedule, tyre pressures.....	12
Inspection & replacement of engine oil.....	13
Air filter cleaning & spark plugs.....	14
Brake inspection and maintenance, wheel adjustment.....	15
Chain cleaning and adjustment, throttle adjustment.....	16
Battery & fuse replacement.....	17
Cleaning and storage.....	18
Circuit diagram.....	19

VEHICLE IDENTIFICATION NUMBER (VIN) AND ENGINE NUMBER

1. The VIN is stamped on the standing pipe of the chassis.

2. Nameplate is riveted on the standing pipe of the chassis.

3. The engine number is stamped on the left side below the crankcase.



WARNING









1. Turn off the engine when refuelling, then turn the ignition switch to the OFF position and keep away from sources of ignition.
2. Refuel only until the fuel level reaches the bottom of the filler opening. Overfilling will cause fuel to leak from the cap, as fuel expands with heat.
3. Do not wash filler cap area with high pressure water, as water can potentially enter the tank.

FUEL SYSTEM

When refuelling, use Unleaded fuel with a minimum octane rating of 92 or above.











INSTRUMENTATION PANEL

NAME		SPECIFICATION
Ignition on		Turn the ignition key clockwise to provide power to the ignition
Ignition off		Turn the ignition key anti-clockwise to cut the power
Steering lock		With the handlebars at full lock to the left, turn the key anti-clockwise to engage the steering lock.
Gear indicator		Indicates the current gear selected. N or 0 means neutral
Speedometer		Indicates the running speed of your vehicle
Fuel guage		Indicates how much fuel is in the tank
Rev counter		Indicates the RPM (Revolutions Per Minute) of the engine.
Left turn indicator		Shows the rider is indicating to turn left
High beam		High beam is on
Right turn indicator		Shows the rider is indicating to turn right
Engine warning light		Illuminated at start, if constant, indicates engine fault
Engine temperature		Illuminates when engine temperature is exceeded

WARNING

1. Park the motorcycle in a safe place and use the steering lock when you are leaving the vehicle.
2. Run the motorcycle for a few moments prior to riding, to warm up the engine. Do not over rev a cold engine.
3. On long journeys, do not ride consistantly on the rev limiter as this can damage your engine.





LEFT AND RIGHT CONTROLLERS

NAME	SPECIFICATION
Passing-light switch 	When overtaking, press the button to flash others.
Hi Beam indicator 	Turn the switch to this position to use high beam
Low Beam indicator 	Turn the switch to this position to use low beam
Turning light switch 	Turn left/right turning light switch to this position, when changing riding direction
Horn button 	Press this button to use the form
Engine cut off switch 	Turn switch to shut off the engine completely, or to allow use
Sidelights on 	Sidelights are on upon startup automatically
Illuminating button 	This changes the colour of the dash illumination
Electric starter button 	Press this button for electric start. CAUTION: start bike with gear selection in neutral. Alternatively ensure the clutch lever is held in when starting.

CAUTION

When starting the motorcycle with the electric starter button, it should not take longer than 5 seconds to turn over. If the motorcycle does not start first time, allow a period of at least 10 seconds before attempting to start it again.

OPERATION CONTROLS

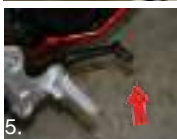
NAME	SPECIFICATION		
1. Throttle	Controls the fuel intake		
2. Gear selector	This bike has 5 gears (1 down, 4 up) Come off the throttle when changing gear		
3. Clutch lever	Disengages gears when changing		
4. Front brake lever	Controls the speed of the front wheel. Working stroke: 10mm-20mm		
5. Rear brake pedal	Controls the speed of the rear wheel. Working stroke: 20mm-30mm		

CAUTION

1. This bike has a manual clutch. When starting motorcycle, shift gear to neutral position or hold clutch lever in until ready to move.
2. If clutch slips or cannot fully disengage, we advise you take it to your dealer for professional adjustment.
3. It is essential to have your brakes checked regularly. We advise all maintenance and servicing is carried out at the recommended intervals by your Sinnis dealer, for both rider safety and the longevity of your vehicle.

WARNING

If in the event the front and rear brakes can't operate at the same time, ensure the vehicle is checked by your dealer to avoid the brakes locking up.

GENERAL INSPECTION

NO	ITEM	INSPECTION
1.	Fuel system	Check for any leaks and tank is not overfilled
2.	Oil	Check the level of the oil
3.	Electrical system	Check dashboard and electrical switches are functional
4.	Battery	Check battery visually for leaks and any furring
5.	Clutch/front brake lever	Check for any free movement/stability and travel within stated range
6.	Gearshift/rear brake	Check gearshift for free movement/stability and travel of brake pedal is within stated range
7.	Throttle	Check throttle for free movement/stability within stated range (2-6mm)
8.	Steering mechanism	Check steering for free movement/stability
9.	Chain	Check chain (15-25mm) for signs of abraision. Regularly lubricate
10.	Tire/wheel	Check tires for pressure, tread depth and abraision
11.	Illumination/signal indicator	Check headlight/sidelights and signal indicators are working correctly
12.	Brake	Check brake discs for any abraision and their performance
13.	Main/side stand	Check for any cracks or bend in the sidestand and the hinges/springs
14.	Tightening parts	Check for any parts which may appear to be loose

BREAK-IN PERIOD OF A BRAND NEW VEHICLE

After purchasing a new vehicle there is a break-in period for the engine. It is recommended that for the first 500 miles, do not over-rev the engine. Changing gear earlier than usual, can help to avoid over-revving. Also ensure there is oil at all times to avoid the engine siezing. For recommended servicing intervals, see page 12 or your Service Book which has the latest revisions.

Model	Engine Oil	engine oil	Fork Oil	Fork Oil	vale in (mm)	valve ex (mm)	Front Tyre PSI	Rear Tyre PSI
AKUMA	10w40 semi synthetic	1200ml	7.5w	176ml	0.04-0.06mm	0.05-0.08mm	32	34

STARTING AND WARMUP

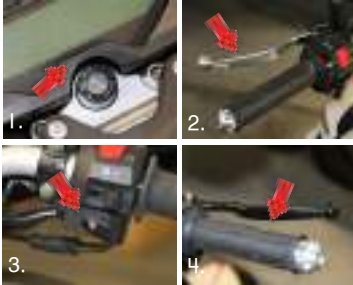

When starting the vehicle, each attempt should not exceed 5 seconds. Allowing at least 10 seconds before re-attempting. After three attempts, visually inspect motorcycle.

Once started, always allow the motorcycle to warm up for a few minutes before setting off. Carry out start and warmup as follows:

1. Turn key ignition to the 'on' position.
2. Either select 'N' for neutral on the gear selection, or hold the clutch lever in until ready to set off.
3. Press the engine start button.
4. Rotate the throttle towards you to rev (increase fuel intake) for a few seconds, then allow engine to idle 3-5 mins as it warms up.

CAUTION

1. This bike has a manual clutch. When starting motorcycle, shift gear to neutral position or hold clutch lever in until ready to move. If clutch slips or cannot fully disengage, we advise you take it to your Sinnis dealer for professional adjustment.
2. If engine can not be started successfully, wait for several minutes before the next attempt to protect the battery life.
3. To prolong the lifetime of your vehicle, run the motorcycle for 3-5 mins to pre-heat (as above) when cold starting. Do not over-rev the throttle when the vehicle is warming up.
4. The idle speed is regulated by the ECU and cannot be changed. If the idle speed seems too fast, or too slow, we advise you take it to your Sinnis dealer for professional adjustment.

RIDING OPERATION



1. To move off (with clutch held in) select 1st gear with the gear selector by your left foot.
2. Put your right foot on the rear brake.
3. Gently rotate throttle and slowly release the clutch and rear brake.

WARNING

1. Before riding, by UK laws you are obligated to wear a helmet. We recommend you also wear riding gloves, boots and protective clothing for your own personal safety.
2. If anything seems visually or functionally wrong about the vehicle, do not proceed to ride it. Take it to your nearest Sinnis authorised dealer.
3. Do not rotate the throttle or release the clutch suddenly when you want to increase the throttle. This could cause the motorcycle to become unstable when riding.

FIRST SERVICE

Recommendations provided are for the specified bike, this manual is written for. Your motorcycle must be inspected and serviced by an authorised Sinnis dealer, for full list of recommended service intervals, see page 12.

To locate your nearest Sinnis Dealer, please go the Find A Dealer page on our website:

<https://www.sinnismotorcycles.com/find-a-dealer/>

GUIDE FOR SAFE RIDING

1. ASCENDING AND DESCENDING SLOPES

When riding up and down steep slopes, select the appropriate gear:

For riding up steep slopes, use lower gears to increase the engine torque and avoid stalling the engine.

For riding down steep slopes, use higher gears to avoid over-revving the lower gears and maintain control over your descent.

2. RIDING IN WET WEATHER CONDITIONS

In wet or foggy weather, there will be low visibility and poor adhesion between the tires and the road.

Keep to a safe speed and do not accelerate or brake suddenly. Check tires for wear and check there is sufficient tread (legal limit of at least 3mm) for optimum grip.

As always when riding on slippery roads, keep to a safe speed and do not accelerate, brake or turn suddenly.

3. RIDING IN SNOW/ICY CONDITIONS

It is generally not recommended to ride in icy or snowy weather conditions. Should you be in a position where you have to ride in such weather, do not accelerate, brake or turn suddenly. Try to use the gears to slow down (engine braking) where possible, with no sudden braking. Steer slowly and plan ahead by slowing down in advance of approaching bends, junctions or hazards.

4. BRAKING DISTANCES

The faster the speed of travel, the longer the braking distance required, to stop the vehicle. This is doubled on wet roads. It is advisable to reduce your speed on wet roads or in poor visibility because of this. When braking use the rear brake followed by the front brake to control your speed.

5. EMISSIONS AND EXHAUST FUMES

Please note inhalation of exhaust fumes can be toxic. Do not run vehicle in an enclosed area.

EFI SYSTEM

ELECTRONIC FUEL INJECTION

The function of the EFI System is to regulate the mixture of air and fuel in the combustion chamber.

The EFI System is comprised of:

- ECU
- Injector
- Throttle parts
- Air intake and Pressure / Temperature sensor
- Ignition coil
- Crankshaft position sensor
- Fuel pump
- Oxygen sensor

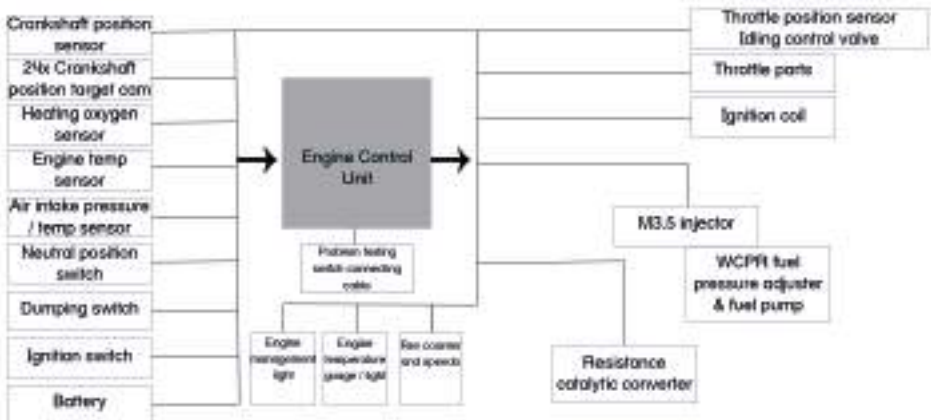

Service Interval Checks	4 stroke	1st	2nd	3rd	4th	5th	6th	7th	Every 2500 thereafter
		1000	2000	4000	6000	8000	10000	12000	
Service Item		!	!	!		!		!	
Engine Oil		Inspect	Replace	Replace	Replace	Replace	Replace	Replace	Replace
Oil Filter		Clean	Clean	Replace	Clean	Clean	Replace	Clean	Replace
Coolant Levels		Inspect		Inspect	Inspect	Inspect	Inspect	Replace	Inspect
Air Filter		Clean	Clean	Inspect	Clean	Clean	Replace	Clean	Clean
Petrol Filter		Check	Check	Replace	Check	Check	Replace	Check	Check/Replace
Gear Oil									
Valve Clearances		Inspect	Inspect	Inspect	Inspect	Inspect	Inspect	Inspect	Inspect
Throttle Cable Play		Adjust	Adjust	Adjust	Adjust	Adjust	Adjust	Adjust	Adjust
Carburetor		Inspect	Inspect			Inspect		Clean	Inspect/Clean
Spark Plug			Clean		Replace		Replace		Clean/Replace
Brake Pad Condition!			Check	Check	Check	Check	Check	Check	Check
Brake System!		Check	Check	Check	Check	Check	Check	Check	Check
Chains and Sprocket!			Check		Check	Check	Check	Check	Check
Belt Condition			Check		Check		Replace		Check
Suspension		Check		Check		Check		Check	Check
Headrace Bearings			Grease		Grease		Grease		Grease
Wheel Bearings!		Check	Check		Check		Check		Check
Tyre Condition and Pressures		Inspect	Inspect	Inspect	Inspect	Inspect	Inspect	Inspect	Check
Lights, Indicator, Horn, Brake Lights!		Inspect	Inspect	Inspect	Inspect	Inspect	Inspect	Inspect	Check
Side/Centrestand and Switches		Inspect	Inspect	Inspect	Inspect	Inspect	Inspect	Inspect	Inspect
Body panels and Fastenings		Inspect		Inspect		Inspect		Inspect	Inspect
Battery Condition/ Electrolyte Level		Check	Check	Check	Check	Check	Check	Check	Check

*Intervals are a guideline according to our research however in poor weather and winter riding intervals may need to be shorter with more frequent servicing. Servicing should be carried out within the Service Book times stated. Details correct at time of going to print.

*KM's to the nearest figure

Model	Engine Oil	engine oil	Fork Oil	Fork Oil	valve in (mm)	valve ex (mm)	Front Tyre PSI	Rear Tyre PSI
AKUMA	10w40 semi synthetic	1200ml	7.5w	176ml	0.04-0.06mm	0.05-0.08mm	32	34

INSPECTION AND REPLACEMENT OF ENGINE OIL

Replace engine oil periodically; replace oil after preheating several minutes.

1. Raise the bike upright to check the sightglass. Check if engine oil is blackened, if so it will need to be replaced (access cap, as pic 1.). Check if oil level is below the lower mark - it **MUST** be between the two marks, so top up if necessary.
2. When oil appears to be discoloured, remove drain bolt (place a container underneath) to drain engine oil fully, then replace with fresh oil as recommended by your Sinnis dealer.
3. When you think all the oil has been emptied, ensure bike is level to ensure all of the oil has been drained. Replace the drain bolt before refilling with the recommended grade of oil. We recommend semi-synthetic oil IOW40.



CAUTION

1. Support motorcycle with main stand to check the oil level, to ensure an accurate, balanced reading.
2. It is advisable to get the engine oil replaced by a professional at your local Sinnis dealer, where possible. If carrying out this procedure yourself, use the engine oil recommended by your Sinnis dealer. Should you use anything other than the recommended oil for your engine, your manufacturer's warranty may become void.
3. Do not add any chemical additive into the engine oil, as this can cause the clutch to slip.
4. After replacing the engine oil, check the levels once again.

Note: all details correct at time of going to print. Check your Service Book for any updates.

AIR FILTER CLEANING AND SPARK PLUGS

AIR FILTER

A dusty and blocked air filter will cause low power, high fuel consumption and rich concentration of mixed gas. It is recommended you inspect, clean and replace the air filter periodically.

1. Remove the air filter
2. Clear any dust or dirt with compressed air or change the filter. Clean the filter (with water only) and dry it. Alternatively replace the filter.
3. Ensure to re-install the filter in the correct position. If riding in dusty environments, inspect, clean and replace the air filter more regularly.
4. Do not use the following for air filter cleaning: fuel, flammable solvents or any substance with alkaline properties, else your manufacturer's warranty may become void.
5. Do not start the motorcycle until the filter is reinstalled correctly, else the piston, piston ring and cylinder block may become damaged and your manufacturer's warranty may become void. If uncertain, attend your local Sinnis dealer for advice or professional assistance.
6. As the above, ensure the filter is inspected regularly and changed when required. Regular maintenance and checks to your vehicle must be carried out, else your manufacturer's warranty may become void.

SPARK PLUGS

Spark plugs should be replaced every 2000km or 1250miles as per the Sinnis service schedule, located on page 12. Contact your local Sinnis dealer or further advice.

1. Remove any dirt from the cylinder head, to prevent dirt getting into the engine. Then the HT lead must be disconnected from the spark plug prior to its removal.
2. Only remove the spark plug once the engine has cooled to prevent damage to the cylinder head threads, using the correct-sized spark-plug socket.
3. Check the condition of the spark plug for deposits of oil, carbon, fuel or corrosion and clean if necessary. Ensure there is also a gap between the electrodes, else replace the spark plug.

BRAKE INSPECTION AND MAINTENANCE / WHEEL INSPECTION

HYDRAULIC BRAKE INSPECTION

Standard tolerance of front brake: 10mm-20mm

Standard tolerance of rear brake: 20mm-30mm

1. Pull the brake lever in and release, to feel for any extra play or resistance in the lever. Do the same with the rear brake pedal. If you can feel any abnormal function or the brake does not engage / release correctly, please visit your nearest Sinnis dealer for professional adjustment as your brake pads may also need to be replaced.
2. Check the front brake fluid level and fluid colour from the brake fluid reservoir. The front brake reservoir is located by the handlebars, the rear brake reservoir is located near the rear brake pedal. When either of these are lower than the marked lower limit, the brake fluid will need to be topped up. Recommended brake fluid is: DOT4
3. The brake disc thickness limit is 2mm. Check your brake discs for any unnatural wear, warping or damage. If there is any evident damage or the discs have become worn, ensure your brake discs are replaced by your nearest Sinnis dealer.

WHEEL INSPECTION

1. Should your tire pressures be too high, you may damage the tire or potentially risk a tire blow out. This will also affect your riding comfort. Similarly if your tire pressures are too low, you may damage the tire and risk a tire blow out. Under inflated tires will greatly impact and increase the vehicle's fuel consumption. Motorcycle tire pressure gauges are available from all good retailers. As a guide, tire pressures should be approx. 30psi of the front, 32psi rear.
2. If the inner tube valve of the tire is leaking, the tire will need to be replaced.
3. (For models with spoked wheels) check the spokes every service or 2000 miles, for any loose or damaged spokes. If identified, take the vehicle to your local Sinnis dealer for professional adjustment / replacement.

UK tire depth limits (correct at time of going to print)	Front wheel	2.0mm	Wheel warp limits	Axial	Spoked wheel 2.0mm	Aluminium wheel 0.8mm
	Rear wheel	3.0mm		Radial	Spoked wheel 2.0mm	Aluminium wheel 0.8mm

CHAIN CLEANING AND ADJUSTMENT / THROTTLE ADJUSTMENT

CHAIN MAINTENANCE

Clean any mud or dirt off the chain, then ensure chain is greased periodically at least every 2000 miles or sooner if required (due to poor weather conditions for example.) Inspect the chain visually on a regular basis. You may find it easier to use a paddock stand to allow the rear wheel to rotate freely while cleaning/greasing the chain. Also ensure the chain is not loose or sagging. If the chain appears to be too tight or too loose, attend your nearest Sinnis dealer for professional adjustment.

WARNING

Teeth can snap off if the chain is too loose, or if the links are too tight. This can cause the chain to snap – which could be very dangerous. It is important to examine your chain for wear on a regular basis.

The tolerance for the drive chain sag should be between 15-25mm.

SPROCKETS

Your chain and sprockets must be in exact alignment in order to prevent unnecessary wear and the possibility of a snapped chain. If the teeth of your sprockets are worn on one side but not the other, the chain is out of alignment. Special manufacturer marks on the swinging arm can be used to align the chain, but these are not considered precise enough. Seek professional assistance.

Sprocket teeth become worn through constant interaction with the chain. When the teeth have become sharp (or 'hooked') rather than blunt, it is time to replace the sprocket.

Generally you should change both your chain and your sprockets at the same time. New chains and sprockets are manufactured at exactly the same pitch, which means they wear out together at the same rate. A new chain on old sprockets could make for an incongruous match, reducing performance and accelerating the rate of wear.

THROTTLE CABLE

To adjust the throttle free-play, release the locknut and then the adjusting nut on the throttle valve cable, to loosen or tighten.

The tolerance of the throttle cable free-play, should be between 2-6mm.

BATTERY AND FUSE REPLACEMENT

BATTERY

A motorcycle battery can lose power and its charging capacity over time. Other factors may affect it also, such as:

Heat: High temperatures can reduce your battery's longevity and will increase the speed of discharge.

Vibration: Make sure your battery is secure and doesn't rattle around.

Sulfation: This can happen if the battery is constantly discharging or if electrolyte levels are too low.

Freezing: This shouldn't be an issue if your battery is fully charged. But if it isn't, the electrolyte could freeze and the casing could crack. Purchase a new battery if it freezes.

- Check your battery once a month
- Clean the battery terminals to prevent corrosion.
- Ensure terminal connectors are not loose. If they are, the bike may not start or it may only start intermittently.
- Check for leaks. Water in the casing could cause the connectors to rust.
- Keep your battery charged to prevent problems developing. The best way to do this is to ride your motorcycle regularly. If you are not going to ride for an extended period, remove battery and charge/keep the battery indoors. We recommend the use of a battery optimizer to ensure levels are never fully depleted, which will maintain the life of your battery.

FUSE REPLACEMENT

The fuses protect electrical overloading of the circuits and battery.

If a fuse burns out, seek assistance from your nearest Sinnis dealer or service station as there may be a wiring fault.

WARNING

The electrical load power can not exceed 20w. Any aftermarket electrical items fitted, such as GPS, anti-theft alarms or additional lighting may overload the vehicle's electrical capacity and potentially cause fire. It is recommended any additional electrical items you wish to have fitted to your motorcycle, are professionally fitted by your dealer, else you may damage the vehicle and void your Sinnis warranty.

CLEANING AND STORAGE

CLEANING YOUR MOTORCYCLE

It is important to clean your bike regularly, especially after riding in poor weather or where there is mud or debris which could cling to your bike and potentially cause rust. Salt on roads can also cause corrosion, so wash it off with cold water where possible. Hot water can react with salt to assist salt corrosion. Dry the bike off after washing to ensure nothing remains damp. There are various motorcycle cleaning cloths on the market which can be used for fine detail cleaning or to clean off dust and light soiling. Pressure washing is not advisable as this can damage seals and hoses. Ensure the chain is greased regularly as mentioned on page 16.

STORAGE

Motorcycles are best kept somewhere warm and dry out of the elements, such as a shed or a garage. However if you have to keep your vehicle outside at all times, there are a few things you can do to help protect it and ensure it remains functional through the winter.

1. Invest in a good-quality bike cover to keep your vehicle dry, if storing outside.
2. Start the bike regularly even if not riding it, to keep a little charge in the battery
3. Move the bike regularly to ensure the tires don't deform
4. If storing for the winter, disconnect and remove battery every few weeks and trickle charge indoors to maintain the life of the battery. We recommend the use of a battery optimizer.
5. Ask at your nearest Sinnis dealer for advice on fuel additives and tank draining, should your bike remain in long-term storage.
6. We recommend the use of a rust preventative anti-corrosion treatment such as ACF50 .
7. Ensure your vehicle is secure with a high-grade security chain/lock or anti-theft immobiliser.

WARNING

When using bike covers, ensure the exhaust has fully cooled before placing the cover on your bike or this can cause a potential fire hazard.

WIRING DIAGRAM

L.B	light blue
B	blue
W	white
R	red
P	purple
L.G	light green
G	green
Y	yellow
O	orange

letter/letter	means two color
letter A	means only the color as "letter" showing
letter B	means only the color as "letter" showing

