



Jiangsu Xinri E-vehicle Co., Ltd.

No.501 Xishan Road, Anzhen , Xishan District ,Wuxi, Jiangsu Province, P.R.China

www.sunraev.com

www.mikuev.com

Email: info@sunraev.com

Tel: +86-(0)510-8810 9820



MIKU MAX
Operator's Manual

CONTENTS

SECTION 01		Safety Guideline-definitions
SECTION 02		General Precautions
SECTION 03		The Manual Of Smart Chip Charger
SECTION 04		Performance
SECTION 05		Fast Assembly
SECTION 06		Pre-ride Checklist
SECTION 07		Power Pack & Charging
SECTION 08		Maintenance Tips
SECTION 09		Miku Key Case

01 / Safety Guideline-Definitions

This manual contains important information that you need to know and understand in order to protect YOUR SAFETY and to PREVENT EQUIPMENT PROBLEMS. The following symbols help you recognize this information. Please read the manual and pay attention to these sections.

WARNING!

Read and understand all safety precautions in this manual before operating. Failure to comply with instructions in this manual could result in personal injury, property damage, and/or voiding of your warranty.

**WARNING!**

It is your responsibility to know and obey all applicable local, state, and federal laws at all times while operating this electric scooter including but not limited to traffic safety, vehicle registration, emissions, and noise.



	DANGER: Damages indicate a certainty of strong possibility of personal injury or death if these cautions are not followed.
	WARNING: Warning indicates a strong possibility of equipment damage or possibility of personal injury if instructions are not followed.
	CAUTIONS: Cautions indicate a possibility of equipment damage if instructions are not followed.



WARNING! Improper operation or maintenance of this scooter could result in serious injury and property damage. Read and understand safety instructions, tips and operating instructions before using this scooter. Always obey all applicable local, state, and federal laws when operating this scooter.

**Save These Important Safety Instructions!**

Read and understand all of these safety instructions. Be sure to retain them for future use.

02/ General Precautions

- Read and follow all instructions in the manual of MIKU products, before attempting to operate this scooter. Don't disregard the Operator's Manual, or any other manual or documentation included with this scooter.
- Modifying the scooter and/or removing original equipment, and/or safety decals could make this scooter unsafe for operation.
- Replace any safety decals that become unreadable or detached from the scooter. Details provide critical warning about potential hazards or safety requirements.

Traffic safety

<p>Always follow the entire procedure checklist prior to starting or operating the scooter.</p>	<p>Your safety while riding this scooter decreases if you are unable to operate properly, alertness, or must be of sufficient age, understanding, mental capacity, and physical capability to safely operate this scooter.</p>
<p>Always obtain the appropriate, supervised instruction and sufficient practice in an unobstructed area before this scooter on any public thoroughfare.</p>	<p>Excessive vehicle speed is a leading cause of accidents, which can cause death or serious harm to you, other people, and/or property. Always obey all applicable traffic safety laws while operating this scooter. Be sure to account for current weather and traffic conditions and slow down if necessary.</p>

02

Traffic safety

<p>Use extreme caution when riding on wet, slippery, rough, or sloped terrain. There is an increased risk of loss of control which can result in injury, death, and/or property damage.</p>	<p>Use extreme caution when riding on wet, slippery, rough, or sloped terrain. There is an increased risk of loss of control which can result in injury, death, and/or property damage.</p>
<p>When the scooter and shut off the motor immediately if the scooter takes unusual noises or vibrations. Check the scooter for damage, excessive wear, or a fault on a path of loose or worn parts.</p>	<p>Never use this scooter to perform any type of racing, stunts, or jumps, spin-outs, donuts, or other maneuvers. You could injure yourself or others and/or cause property damage.</p>
<p>Never operate a scooter while under the influence of alcohol, drugs or medication of any kind. Such operation is dangerous to yourself and/or others and may be illegal in your location.</p>	<p>Check the pressure before operating the scooter using a properly calibrated air pressure gauge.</p>

03

03 / The manual of smart chip charger

Instruction

- 1 The charger should be matched with the alternating voltage of local power supply before connecting charger.
- 2 The charger is designed and tested for original battery from manufacturer. Do not use them for the other mismatching batteries.
- 3 The charger is tested and matched with its scooter. If the charger is used on other scooters, it might make different charging effect and/or cause battery damage.
- 4 Please connect charger and scooter before connect to local power supply, while you are going to charge the battery. Please disconnect the charger from local power supply while the battery's fully charged. Don't disconnect charger and scooter while the charger is connected with local power supply for safety reason.

- 5 Do not violently shake the charger. It might cause damage of the charger.
- 6 Keep the charger away from any water, dust or high temperature.
- 7 The charger creates the heat while working. It should be stored in well vented place and keep away from any inflammable things.
- 8 Keep away from children.
- 9 If any wire or shell was broken. Please send it to the professional repairing service. Don't open or repair it yourself. This act on will cause danger and lose warranty of the charger.
- 10 The charger is designed and made for electric scooter battery charging use. Don't make it for other use.
- 11 Any incorrect usage which does not follow this instruction will lose guarantee from seller.

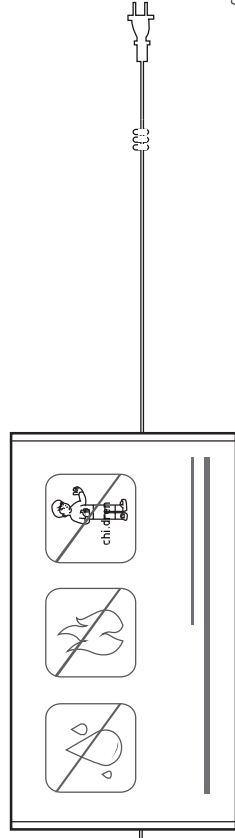

Using direction

- 1 While the charger is connected with battery, green light is turned on to indicate the testing status of charging.
- 2 While the charger is connected to 100V/220V 250V local AC power supply, the green light turns on red to indicate charging status.
- 3 After 4-6 hours charging, the red light turns to green to indicate the battery charging is finished.
- 4 While the charging is finished, the charger will cut off power from AC power supply automatically.

04 / performance

The performance of an electric scooter is different from gasoline engine driven or human powered vehicles. It's very important to understand how the MIKU electric scooter works before riding.

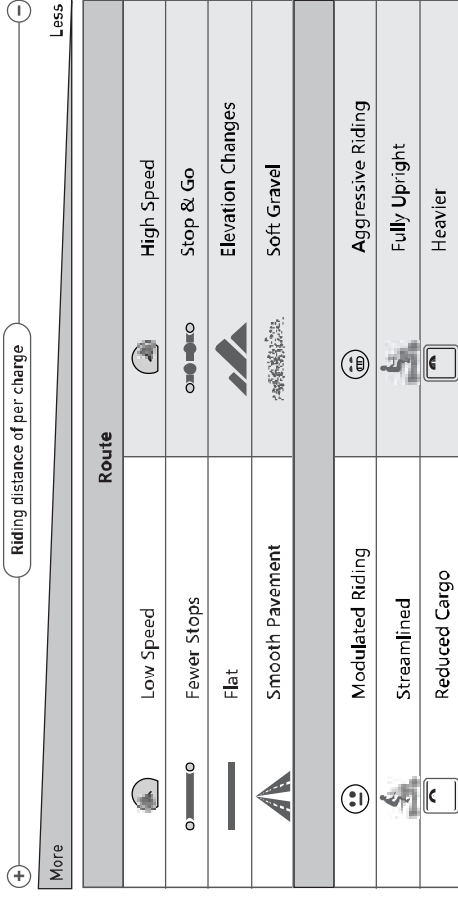



Weather	
Warm Weather	Cold Weather
No Wind	High Head Winds
Dry Roads	Slippery Roads
Scooter	
Inflated Tires	Underinflated Tires
Balanced Power Pack	Unbalanced Power Pack

Test condition: New vehicle with new battery, Temperature at 20°C, No wind, All lights (on the scooter) off, loading weight: a. 75kg, standard pressure.

- Riding habits, road conditions, environment and temperature might shorten the riding distance of per charge.
- Tire pressure and loading weight shorten driving distance of per charge.
- Riding distance of per charge might shorten in Winter because of battery's peculiarity.
- Riding distance of per charge will be shortened by battery life time loss.

05 / Fast Assembly

You can prepare for your first riding after simple 2-step assembly.

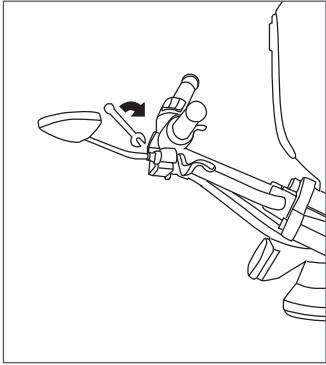

Step 1: Fasten mirrors on the fixing holes at steering bar and tighten with a wrench.

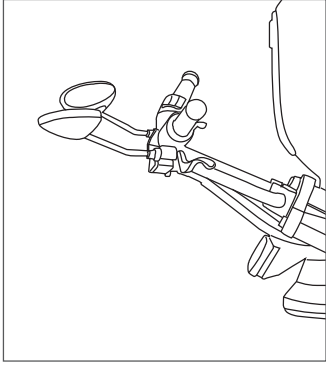

Step 2: Adjust mirrors to proper position.

06 / Pre-Ride Checklist



WARNING! Always perform the entire pre-ride checklist before using the scooter as this can help you spot problems that could interfere with safe scooter operation. Failure to follow the entire checklist before every ride can cause death, serious injury, and/or property damage to yourself and/or others.

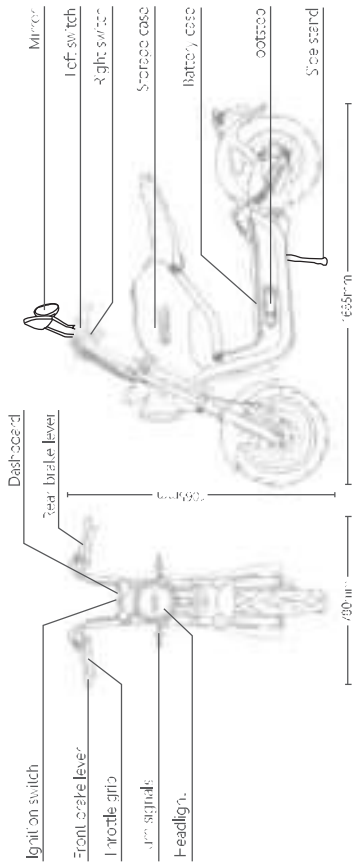

Ignition Switch

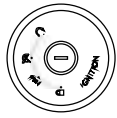

OFF Position

This position is used to turn the scooter OFF, disabling the electrical system.



ON Position

This position is used for operating the scooter. Install the key and turn clockwise. At this position the following occurrence occurs:

- Lights turn ON.
- Dashboard turns ON.



To Operate The Steering Lock:

- Turn the handlebar all the way to the left.
- With the key in the OFF position, push the key downward. Turn the key counter-clockwise.

To unlock the steering lock:

- Install the key, and turn clockwise.

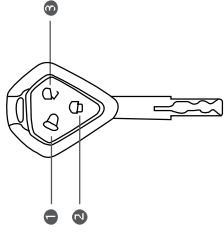

1 Alarm

Sound the alarm for tracking position of the scooter.

2 Lock

Turn on anti-theft system.

3 Unlock

Turn off anti-theft system.

Brake Levers & Throttle

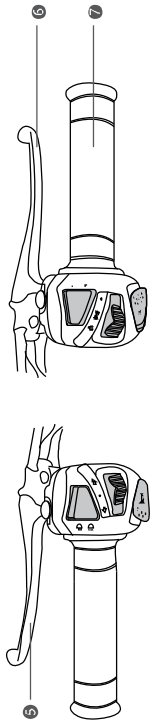

- **Rear brake lever (5)**: When stopping the scooter, squeeze the left brake lever smoothly and firmly to engage the rear brake. Always engage the rear brake first.
- **Front brake lever (6)**: Squeeze the right lever to engage the front brake. The right lever must be squeezed gently at first to avoid locking the front wheel.
- **Throttle grip (7)**: The rotary throttle grip is on the right handlebar. Accelerate by rotating the throttle towards you. Decelerate by rotating the throttle away from you. The throttle includes a safety spring that snaps the throttle back to and when released.



DANGER!
Use extreme caution when engaging the front brake to avoid locking the front wheel. Locking the front wheel can cause a serious accident.

Left&Right Switch

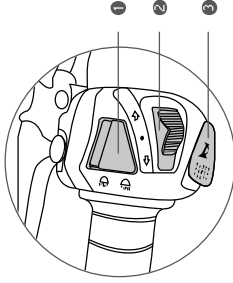

Left switch

- 1 High & low beam
- 2 Turn signal
- 3 Horn

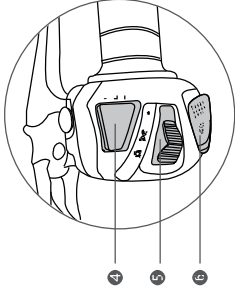

Right switch

- 4 3 speed control key: T:ECO, N:Normal, III:Sport
- 5 Headlight switch
- 6 Cruise control key:
The speed will be kept without throttle by press Cruise control key.
The cruise performance will be canceled by any braking operation.

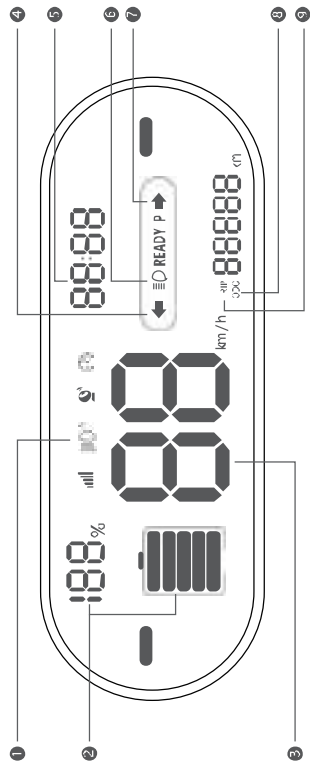
Dashboard

1 Daylight indicator

2 Energy level indicator

3 Speedometer

4 Left turn signal indicator

5 Riding time indicator

6 Total odometer

7 Right turn signal

8 Total odometer

9 Trip odometer

1 Daylight indicator

When the scooter is starting, the daylight indicator is turned on automatically.

2 Energy level indicator

This indicator and needle displays the amount of energy remaining in the power pack, similar to the fuel gauge on a gasoline-powered scooter.

3 Speedometer

The speedometer is a digital display in kilometers per hour (km/h).

4 Left turn signal indicator

Flashes green when a left turn is selected by the turn signal switch. This arrow remains flashing until the turn signal request has been canceled.

5 Riding time indicator

The clock displays riding time of single trip.

6 High beam indicator

When the headlight high beam is on, the indicator illuminates blue, and remains on until the high beam is turned off.

7 Right turn signal

Flashes green when a right turn is selected by the turn signal switch. This remains flashing until the turn signal request has been canceled.

8 Total odometer

The total odometer displays the total distance the scooter has been ridden in kilometers.

9 Trip odometer

The trip odometer displays the distance of single riding trip in kilometers.

Before Starting the Engine/Motor

- **Tires**
 - Ensure that both tires have at least 1/8 inch tread depth at center.
 - Both tires must be inflated to the pressure indicated on the tire sidewalls.
 - Replace the tires if tread height is less than 1/8 inch at the center of tires.
- **Throttle**
 - Check for smooth operation. Make sure throttle grip cable return to cut off power.
 - Check for frayed cable or damaged cable housing. Replace damaged cable to avoid electricity shock.
 - Check for mud, debris and ice in the throttle mechanism. Clean out any contamination.
- **Fasteners**
 - Check that all axles nuts and lug nuts are secure.
 - Check for missing fasteners. Replace as necessary.
 - Check that all other fasteners are secure. Tighten as necessary.
- **Steering**
 - Make sure steering turns freely.
 - Check for proper "toe-in" of wheels.
 - Lubricate/Adjust as necessary. See the Maintenance section.
- **Chassis frame** Check for bent/damaged components. Replace as necessary.
- **Battery** Check the overall level to ensure it is enough for riding.
- **Lights** Check for proper operation. Replace bulbs as necessary.

16

Shutting off the scooter

Always shut off the scooter by turning the ignition switch to OFF.



CAUTION: Squeeze brake lever will stop off the motor, however leaving the ignition switch at the ON position could drain the battery.

Stopping the scooter



DANGER! Wet, oily, or sandy roads reduce braking effectiveness. Harsh braking on these surfaces could lead to loss of control and a serious accident. Always reduce speed as gradually as possible.

When braking, always engage the rear brake first to retain maximum control of the scooter. Most of your stopping power comes from the front wheel.

Parking





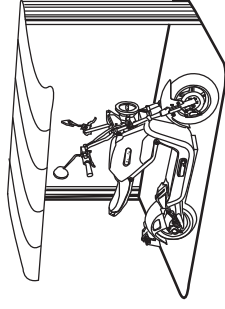

Always keep the key in the lock position when parking the scooter to prevent theft. Park on smooth and hard surface being sure to use the side stand whenever possible.

The side stand is combined with parking stop switch. The parking stop switch will cut off the power of the motor while the side stand is released.

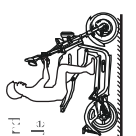



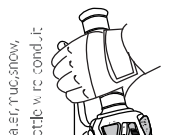

17





Motor safety

 <p>Keep the scooter free of dirt and debris, especially in the throttle linkage area.</p> 	 <p>Never tamper with, alter, or change the scooter motor settings. The motor governor is factory set and altering the motor from original charge rate speed is potentially dangerous to the operator, bystanders, and the motor itself.</p> 
 <p>Never start the engine or motor unless you are correctly seated with your hands fixed on the controls.</p> 	 <p>Operating the scooter in conditions where water, mud, snow, dirt, sand or other debris can get into the throttle wire conduit, and/or the throttle mechanism can cause the wire or throttle mechanism to bind which may lead to throttle sticking, loss of control, and possible crash injury and/or property damage.</p> 

Fasteners

 <p>Make sure that all screws, lock nuts, and bolts are properly tightened. Never over-tighten hardware that is designed to move, resulting moving parts can cause a loss of control and possible injury or death.</p> 	 <p>Always replace torque-wie locknuts with new locknuts of the same type after removing the old ones.</p> 
---	---

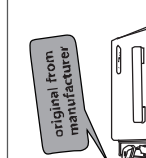
Battery charging

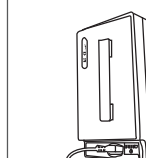
 <p>Check the local civil electricity power supply before battery charging. Make sure the battery charger is matched with the power supply.</p> 	 <p>Always use a Miku original battery charger from manufacturer. Improper charger might pose a fire or explosion risk.</p> 	 <p>The battery is fully charged while the status light on the charger turns green.</p> 
---	--	--

07 / Power Pack & Charging

Miku Max holds a portable power pack in the battery case at the bottom of the scooter. The power pack could be charged in the scooter or separately charged out of the scooter.

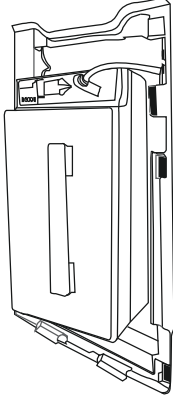
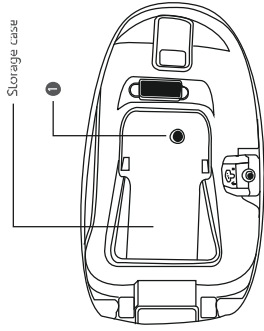
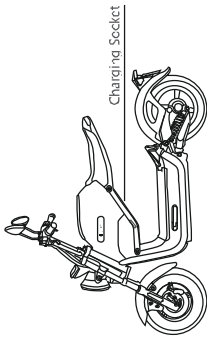
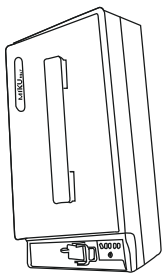

Charging on battery

- Take out the power pack from the battery case;
- Connect the charger plug to the charging socket on the power pack;
- The charging is in process if the charging indicators are on.

Charging on scooter

- Connect the charger plug to the charging socket on the scooter;
- The charging is in process if the red charging indicator on the charger are on.

Take the Power pack out

- Pull the button ① at the bottom of storage case to open the bottom case;
- Disconnect the wire and take the power pack out.

BATTERY POWER

INDICATOR INSTRUCTIONS



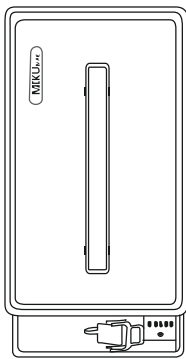



The battery is located within the power pack and requires no special break in period.

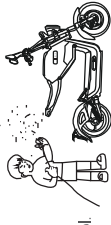

- The power indicators show 5 levels of battery power. Each indicator shows 20% of battery power.
- The power indicators are blinking while the battery is under charging.
- The power pack is fully charged while 5 power indicators are all staying on.

08/Maintenance Tips

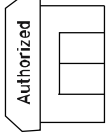
If you own a MIKU electric scooter you should know there are many things that can go wrong with you electric scooter to hinder its performance. That is why the way you care for your electric scooter is so important.

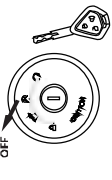
 <p>Don't modify the scooter from the manufacturer's original design and configuration.</p> 	 <p>Never wash or operate the scooter in freezing temperatures. Water can freeze in wire and the throttle mechanism, possibly resulting in throttle sticking, which can cause the throttle to continue to run and result in loss of control.</p> 
 <p>Assembly, maintenance and/or repair of this scooter should only be performed by designated dealers or authorized repair centers for scooter repairs to ensure quality work and safe scooter conditions.</p> 	 <p>While stopping always shut off the scooter to avoid unintended movement.</p> 

Item	Purpose	Rate
Brake	Check braking performance, prevent traffic accident due to braking malfunction	Daily
Tyre	Check tyre damage & air pressure, prevent flat tyre or power overconsumption during driving	Daily
Rim	Check rim strength & remove dirt in bearing, prevent rim breaking or jamming	Weekly
Shock absorber	Check front & rear shock absorbers, remove dirt & maintain lubrication, prevent shock absorber jamming	Weekly
Ignition & throttle	Check ignition & throttle, prevent jamming or occasional failure	Weekly
Wire	Check wire connector loose or damage, prevent wire malfunction	Weekly
Screw	Check wire connector loose or damage, prevent wire malfunction	Monthly
Battery	Check battery appearance & cell performance, prevent wire malfunction & lengthen lifespan	Monthly
Charger	Check whether charger wire damage, braking, off-line, input & output connector complete and reliable or not	Monthly
Lubrication	Check front wheel axle, brake need to add lubrication or not	Monthly
Cleaning	Surface cleaning	Monthly

09/Miku Key Case

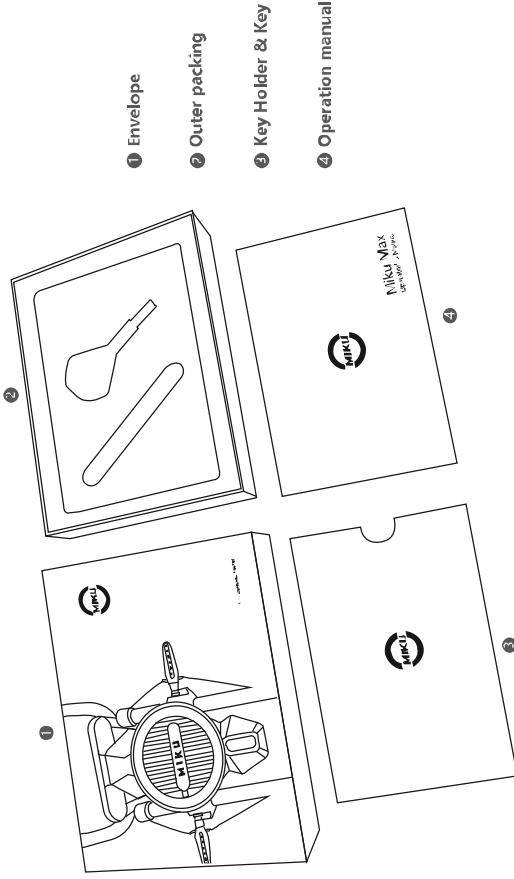

Serial No: _____

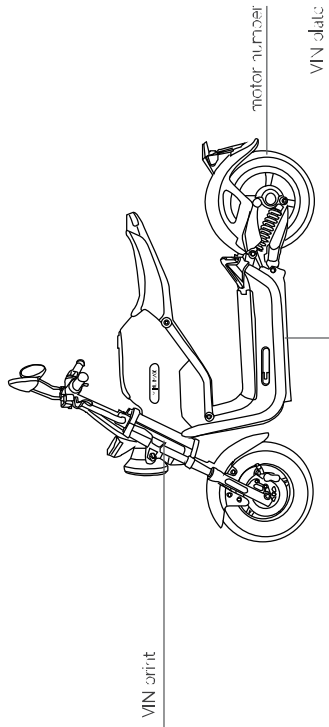

The vehicle identification number (VIN) is required for all warranty work, engine recovery, and consumer safety.
The complete VIN also appears on a plate at the bottom of class's frame.
The VIN print is located at a specific place of class's frame.

DESIGNED BY MIKU TEAM
2019.1V