

# USER INSTRUCTIONS

---

Welcome to the family of SOCCO owners! We will guide you to know every function for the right and safe use of TS smart electric bikes. To ensure your safety, please read this manual carefully before riding and make sure you are always following the requirements below:

- Fully understand the information in this manual, including but not limited to the relevant instructions, precautions and warnings.
- Fully understand the operation and contingency measures of TS smart electric bikes.
- Be fully aware of warning labels of TS smart electric bikes.
- SOCCO will take any responsibility resulting from the unauthorized modification, failure to use original spare parts, or installation of components that affect the performance and safety of the bike.

Please contact the SOCCO Customer Service Center if you have any questions about this bike. We are at our service at any time. Wish you safe and pleasant riding experience.

---

## Safety Instructions

To ensure the safety of you and others, please make sure to observe the following matters:

- Do not ride after you take medications which may affect your riding ability, drink alcohol, or when you are unwell.
- Observe traffic regulations and traffic signs and confirm the surrounding road conditions and bike conditions at any time, so as to actively avoid danger.
- Wear safety equipment, such as helmet, and appropriate protective clothing if necessary, such as gloves and boots.
- Perform a basic check each time before riding, so as to confirm the light, brake, tread and tire pressure and check other parts for looseness or abnormal noise, and regularly go to SOCCO Service Center for maintenance.
- In order to ensure the safety of you and others, please DO NOT use high beam in good lighting conditions. The continuous use of high beam will cause the visual disturbance to vehicles and pedestrians on the opposite side, thus affecting normal driving.
- Please do not make or answer any call during riding, which is likely to cause traffic accidents.

# DESCRIPTION OF COMPONENTS AND PARTS

## SCHEMATIC DIAGRAM OF COMPONENTS AND PARTS

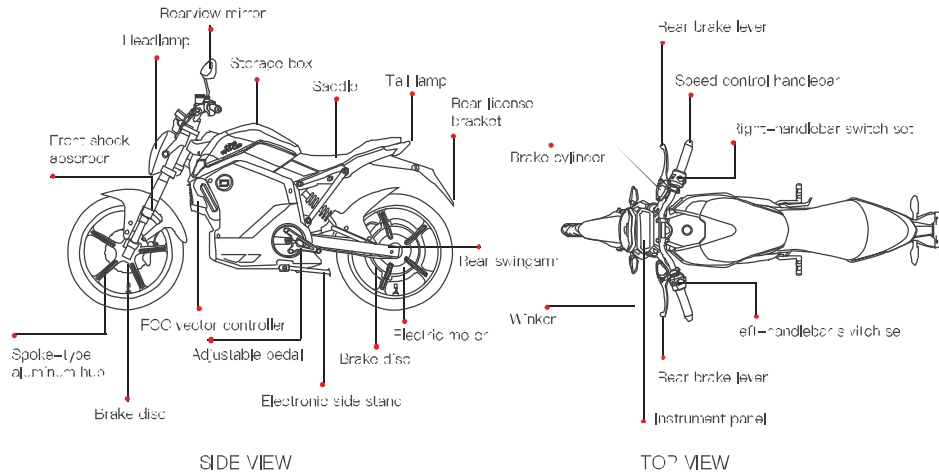

# DESCRIPTION OF COMPONENTS AND PARTS

## DIAGRAM OF INSTRUMENT PANEL

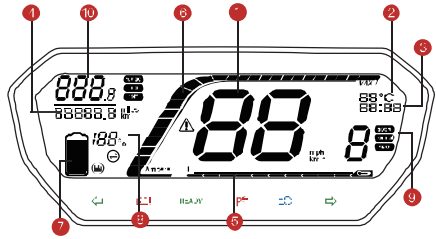

- ① Speed / fault code  
Display current speed. When fault indicator goes on, fault code will be displayed.
- ② Ambient temperature  
Display current ambient temperature.
- ③ Clock  
Display current time.
- ④ Total mileage  
Display the total mileage.
- ⑤ Controller temperature  
Display the temperature under current operating conditions.
- ⑥ Real-time current  
Display current, output current.
- ⑦ Power display bar  
Display current battery level.
- ⑧ Power display  
Display current battery level.
- ⑨ Gear display  
Display current gear.
- ⑩ Distance per charge/  
trip distance/  
rotating speed.

**RANGE** Remaining distance per charge. **RPM** Current rotating speed.

### TURN ON SWITCHING ADJUSTMENT MODE

1. Press the right beam switch for 3 times (i.e., the high beam indicator flashes for 3 times) in continuous time such as 4 seconds;
2. 4 seconds later, the current display mode (driving range / single mileage / revolving speed) is flashing, indicating that the motor has entered the adjustment mode.

### DISPLAY SWITCHING (DRIVING RANGE / SINGLE MILEAGE / REVOLVING SPEED)

Turn on switching adjustment mode, and turn on or off the high beam switch to toggle the display mode (driving range / single mileage / revolving speed) once. Cycle the switching in this way.

### SWITCH THE DISPLAY UNIT (KM AND MILE, KM/H AND MPH)

Retract the stick stand, and enable the switching adjustment mode. Toggle the "parking brake handle switch" from OFF (P gear indicator on) to ON (for 2 seconds), and then to OFF, thus switching the display units (km and mile, km/h and mph); toggle the "parking brake handle switch" from OFF to ON (for more than 2 seconds), and then to OFF, thus turning on the LCD backlight. (Remarks: now, the brightness is fixed at the brightest level).

- 1st Gear, corresponding to the number "1"
- 2nd Gear, corresponding to the number "2"
- 3rd Gear, corresponding to the number "3"

- Fault
- Charging
- Data connection
- High beam indicator, indicating high beam on.
- Parking indicator, indicating the parking state.
- Winker indicator, flashing in synchronization with the left and right winker.
- The charge indicator lamp lights up when less than ten electrically remains.



**READY** The start indicator lights up when the motor can be started.

# OPERATION GUIDE

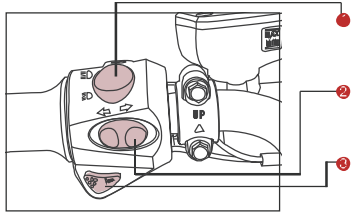
## START BUTTON



### 1 High/low beam switch button

-press  up to turn on the high beam.  
-press  down to turn on the low beam

### 2 Winker button

Dial to the left side to turn on the left winker.  
Dial to the right side to turn on the right winker.



### 3 Horn button

Press to make a sound and release to stop.

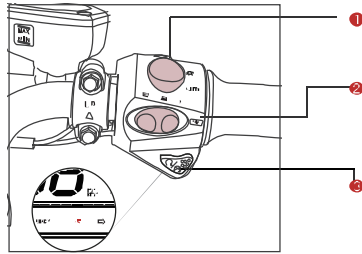
## SMART REMOTE CONTROLLER OPERATION



### 1 Headlamp button

Dial up to  to turn on the headlamp. Turn downward to AUTO to automatically turn on the headlights. The headlights turn on automatically according to the brightness of the environment.  
Dial down to  to turn off the headlamp.

### 2 Parking button

Parking button has two modes: press to park the bike and parking indicator P goes on; and press again to exit the parking status.

### 3 Gear shift button

The bike has three modes, i.e., 1 "eco", 2 "cruise", and 3 "spor.". Dial rightwards for "eco", middle for "normal" and left for "sport".

# OPERATION GUIDE

## HOW TO OPERATE THE PHYSICAL HANDLEBAR LOCK

After unlocking the bike with the Smart Remote Controller, press the start button, and the bike will be in the "Powered" state; press it again to turn off the bike.

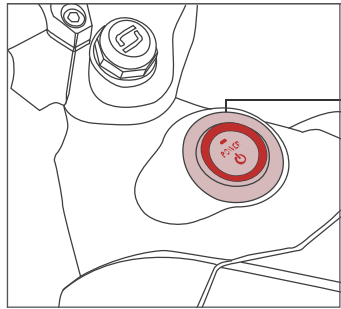

- 1. Outer ring light stays on; Power-on
- 2. Center Letter stays on; Standby
- 3. Center letter blinks; Protected

## OPEN THE STORAGE BOX AND SADDLE

With the advanced Smart Remote Controller, you can easily lock or unlock your TS smart electric bike by simply pressing the button within 50 meters.

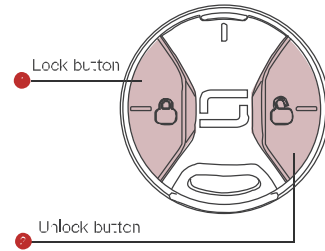

1. Lock button: When the bike is in the [Static State], press the lock button, and the start button flashes. The bike enters the [Locked State].
2. Unlock button: Press the unlock button, and the start button stays on. The bike enters into the [Unlocked State].

## OPERATION GUIDE

---

### OPEN THE STORAGE BOX AND SADDL

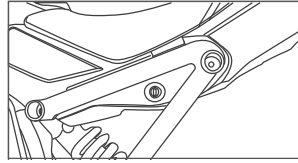
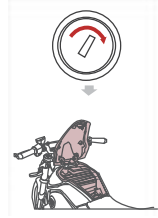
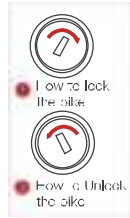
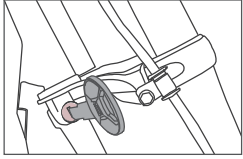

- 1 After the bike stops, turn the handlebar to the far left, insert the key into the physical handlebar lock, and rotate it rightwards to lock the bike.
- 2 Insert the key into the physical handlebar lock, and rotate it leftwards to unlock the bike.

- 1 Insert the key and rotate it rightwards, and the storage box will be opened when you hear a [Click] sound.



- 2 Insert the key and rotate it leftwards to open the saddle. Basic tools are provided inside saddle.

# OPERATION GUIDE

## OPERATION OF AIR SWITCH

As the protection switch for the main power of IS smart electric bike, the air switch will automatically disconnect to ensure safety when the bike circuit is abnormal or the current caused by short circuit exceeds the set safe value.

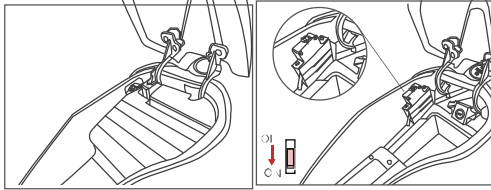

★ **TIPS:** In order to protect your safety, please turn off the air switch when cleaning, storing the bike for a long time, or re-moving the battery pack.

## OPERATION OF ADJUSTABLE PEDAL

The original adjustable pedal provides three riding modes, and can be adjusted for comfort.

1. Open the saddle and take out the included Allen wrench.
2. Unscrew the nut under the pedal.
3. Adjust the pedal to the appropriate position (three positions) and tighten the nut.

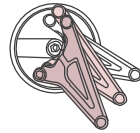
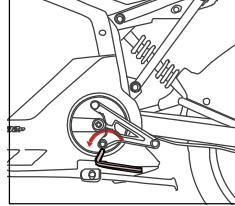

# RIDING GUIDE

---

## CHECKS BEFORE RIDING

Make sure to check the following items before riding a TS Smart Electric Bike, which will guarantee your safety on the road.

1. Whether the handlebar is stable and flexible when turning.

2. Whether the switches on the right and left handlebars can work normally.

3. Whether the speed control handle can work normally.

Make sure the tire pressure is normal. The suggested tire pressure is 20–25psi for front wheel and 26–32 psi for rear wheel.

4. Check tire surface for cracks, damage, wear, and foreign matter puncture or attachment.

5. Whether the tread depth is sufficient (>0.8 mm).

6. Whether any fault warning light on the instrument panel goes on after being powered.

7. Whether the battery is fully charged.

8. Whether the head and tail lights, brake lights and blinkers can work normally.

9. Whether the horn can work normally.

10. Whether the rear mirrors are clean. Adjust them to the appropriate angle.

11. Whether the brake oil is sufficient, and whether the handlebars and brake system can work normally.

12. If any abnormality or operational concern, please contact SOOO Customer Service Center.



# CHECKS BEFORE RIDING

---

## CHECKS BEFORE RIDING

1. Make sure to check the following items before riding the TS Smart Electric Bike, which will guarantee your safety on the road.

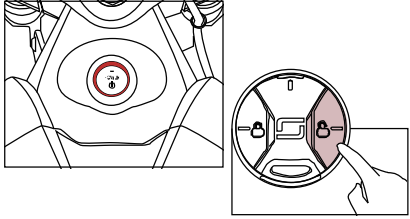

2. Put on the helmet, ride the TS, and retract the electronic side stand.

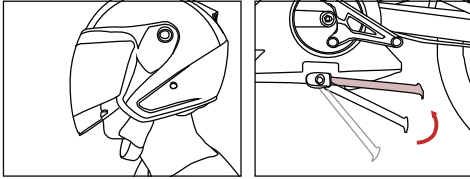

## CHECKS BEFORE RIDING

- 4 Press the "Star" button, and the bike enters the parking state, "Powered" state.

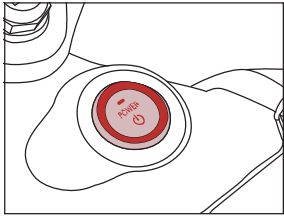

- 4 Press the "Parking" button to exit the parking state, and the parking indicator goes off.

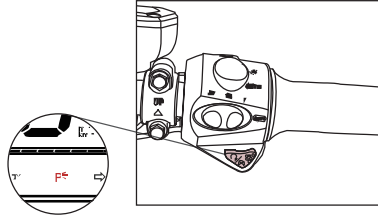

- 5 Gently turn the handlebar to side of the road.

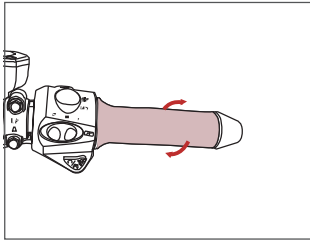

### ★ HES:

Before riding, make sure the electronic side stand is retracted and rotate the handlebar to ensure that the handlebar lock is closed.

If the parking button is pressed when riding, the bike will be dis-energized. So DO NOT press it when riding to avoid danger caused by the sudden loss of power.

If the electronic side stand is extended when riding, the bike will be dis-energized. So DO NOT extend the electronic side stand when riding to avoid danger caused by the sudden loss of power.

The bike must be fully stopped before starting. In case of abnormality during riding, please ride carefully or push it to a safe place. DO NOT try restarting the bike during riding or on the lane so as to avoid danger.

## BATTERY USE INSTRUCTIONS

### 01 How to charge the battery on the bike

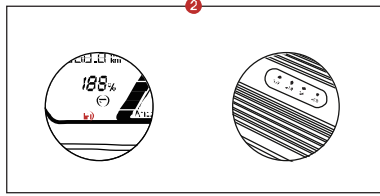
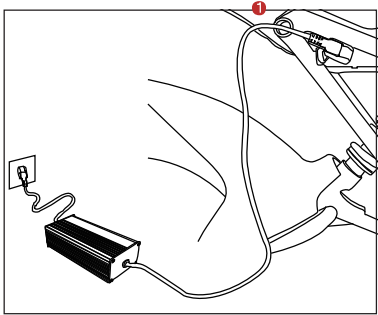

- 1 Insert the main charger plug into the charging port of the bike.
- 2 Insert the charger's AC power plug into the socket, and the battery starts charging when the charger indicator turns red.
- 3 The battery is fully charged if the charger indicator turns from red to green.

## BATTERY USE INSTRUCTIONS

### 02 How to charge the battery off the bike

1 Cover the storage case, close the air switch and take out the storage.

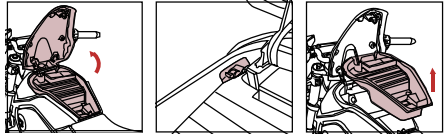

2 Disconnect the main battery plug.

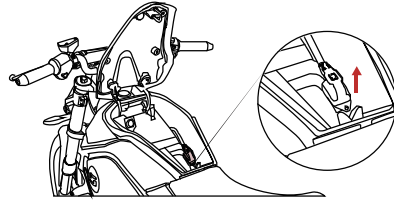

3 Insert the key into the anti-theft battery lock and rotate it rightwards to remove the battery from the bike.

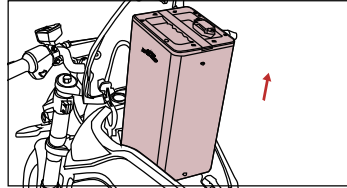
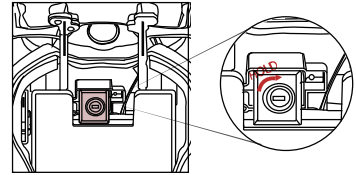

4 Insert the main plug of the charger into the battery charging port, and then insert the AC power plug of the charger into the socket. The green lights of the charger will flash in turn when charging normally.

# BATTERY USE INSTRUCTIONS

- 6 Cuando la batería es o completamente cargada, los indicadores de carga estarán en color verde.

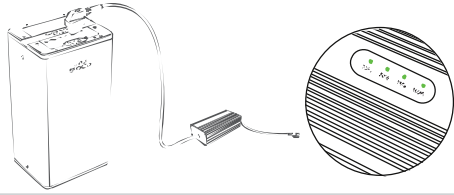

**TIPS:**  
Short circuit of the cables and the anode at the battery's input.

Keep it away from children, fire and heat source. It is strictly forbidden to throw it into the fire; violent movements, shock and extrusion are prohibited. Only the specified charger can be used, and other chargers are prohibited to charge the battery.

This product has been subject to strict inspection before leaving factory, and it is strictly prohibited to disassemble it. Please contact our company's after-sales department for any question.

**TIPS:**  
Do not expose the battery to water, and prevent it from being damped by water or rain.

Charge temperature: 0-45 °C; discharge temperature: -20-16 °C;  
Battery capacity will be reduced when placed in a low-temperature environment.

Charge the battery when you use it, but make sure to charge it before the capacity is lower than 20%. When it is not used for a long time, please remove it from the bike.

## STORAGE, MAINTENANCE AND TRANSPORTATION

Please charge the battery to full-charge state when storing or transporting it (after the battery is discharged, charge it for 3 hours). Place it in a dry and ventilated place.

Battery and charger should be kept in a clean, dry, and ventilated place. Keep them away from corrosive materials, power source and heat source.

Storage conditions: ambient temperature -20-43 °C, humidity < 65% RH;

When storing the charger, please disconnect it from the battery.

# MAINTENANCE

---

Regular maintenance can enhance the service life and driving safety of the TS smart electric bike. Please refer to the following suggestions and take care of your bike.

---

## ROUTINE CLEANING AND MAINTENANCE

**Cleaning:** Please use clean water and neutral detergent to clean it, and use soft cloths and sponges to clean the surface. It is prohibited to use metal brushes, sandpaper or the like to clean it, in order not to scratch the parts surface. After cleaning, dry it with soft cloths.

**TIPS:**  
Please disconnect the air switch before cleaning.  
Do not use strong water jet to directly wash it, so as to avoid the default of mechanical parts caused by water invasion.

**Storage:** try to park it in a dry and cool room to reduce the exposure to sun and rain and avoid the reduction of service life due to corrosion of parts.

When left unused for a long time, please turn off the air switch and disconnect the power supply circuit to prevent over discharging.

After long-term storage, please fully charge it before use.

---

## REGULAR INSPECTION AND MAINTENANCE

The new bike must be subject to the first inspection and maintenance in the SOCO Service Center when it reaches 1,000 km or two months (whichever comes first).

The bike is recommended to be subject to regular inspection and maintenance in the SOCO Service Center at every 3,000 km or six months (whichever comes first).

**TIPS:**  
Please disconnect the air switch before cleaning.  
Do not use strong water jet to directly wash it, so as to avoid the fault of mechanical parts caused by being damped.

## ROUTINE CLEANING AND MAINTENANCE

Regular maintenance can improve the service life and driving safety of the IS smart electric bikes. Please refer to the following suggestions and take care of your bike.

Failure	Causes	Solutions
The bike has no electricity, and the start button does not shine	Battery is poorly connected Air switch is not turned on	Connect the battery properly at its main plug Turn on the air switch
When turning the speed-regulating steering handlebar, the motor does not turn after being powered	Low battery Side stand is not retracted Parking key is not closed Brake handle does not return to the right position Steering handlebar failure The controller plug is loose Controller failure	Charge the battery Put away the side stand Close the parking key Close the brake handle at the right position Change handlebar Change controller Re-plug controller Change controller
Speed is slow or mileage is short	Low battery Under-inflated tire Heavily overloaded Brake pads interference Battery aging or normal usage	Charge the battery Inflate the tire, and check the tire pressure before riding Test on a good habit, and load the appropriate load Change the brake pads and check the brake system of the riding Change battery
Battery cannot be charged	Poor contact of the main plug of the charger Do not use the correct charger Battery aging or normal usage	Check whether the main plug is in a right place Use the special charger of the SOCC Charge battery

## ROUTINE CLEANING AND MAINTENANCE

Failure	Causes	Solutions
The instrument panel shows E9	Controller communication failure	Please contact after-sales service or dealer
The instrument panel shows E8	The controller is not working (possibly over current, blocking, under pressure, over temperature)	Please stop for a while and then start again
The instrument panel shows E7	Controller causes error or (possibly over current, blocking, under pressure, over temperature)	Please contact after-sales service or dealer
The instrument panel shows E6	Controller power line failure	Please contact after-sales service or dealer
The instrument panel shows E5	Controller hall sensor failure	Please check the hall sensor wire, or change it in the after-sales service
The instrument panel shows E4	Controller hall sensor failure	Please check whether the charging interface is in a right place or contact after-sales service or dealer
The instrument panel shows E3	Battery communication failure	Please stop charging, and check the charger
The instrument panel shows E2	Charging over voltage	Please stop charging, and check the charger
The instrument panel shows E1	Battery data: Temperature	Please stop charging and riding
The instrument panel shows E0	Battery data: High temperature	If the instrument shows showing E0, please stop riding
The instrument panel shows E9	Low temperature charge	Park the bike in cool or in a warm place, and wait for a moment
The instrument panel shows E8	Low temperature discharge	Park the bike in cool or in a warm place, and wait for a moment
The instrument panel shows E7	Abnormal network connection	Go to an open area or contact after-sales service or dealer