

tm
RACING

USES & RECOMMENDS



2-STROKE USE AND MAINTENANCE MANUAL

250-300 SMR - TSI / EN - TSI
250 - 300 MX - SMX

www.tmracing.it

<https://www.motomanuals.net/>



RECOGNIZING TM RACING MOTORCYCLE MODELS

EXAMPLE OF MOTORCYCLE MODEL

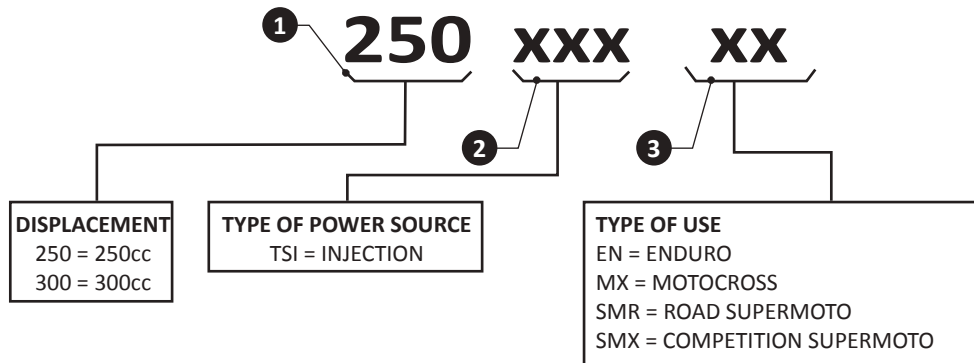

The displacement, type of power source and type of use define the model of motorcycle and engine of each TM Racing bike. The combination of codes 1 and 3 identifies the standard engine type. The combination of the three codes fully identifies the motorcycle model. In this Manual, all 3 codes are usually used to specify the motorcycle model to which certain information refers. If only codes 1 and 3 are indicated, followed by the word "ALL", it means that the information relates to all motorcycles with the standard engine, regardless of the type of use. Code 2 (Type of Use) used on its own means that the information refers to all motorcycles with that type of use, regardless of displacement and power source. All EN/SMR/SMM models are equipped as standard with electric start (E.S.) as well as kick start (K.S.). MX/SMX models have K.S. as standard and may be equipped with E.S. as an option.

Make a note of your motorcycle's serial numbers in the boxes below. If you contact TM for spare parts, updates or to report any issues, always quote the model, displacement, year of manufacture and, above all, the frame serial number and engine serial number.

FRAME SERIAL NUMBER

ENGINE SERIAL NUMBER

KEY SERIAL NUMBER

DEALER STAMP

TM reserves the right to make changes without prior notice. Specifications may vary from country to country. All indications are valid, subject to typos and printing errors.

GENERAL SAFETY REGULATIONS

Read this manual carefully before using your TM motorcycle.

Your safety and that of others depends not just on your riding abilities, but also on your knowledge of the vehicle and how to ride it safely. Do not use the vehicle on public roads or off-road without suitable preparation and apparel.

NOTE: The “Use and maintenance manual” is an integral part of the motorcycle and as such must remain with the vehicle even if it is sold on.

TM reserves the right to make any changes due to further development of its motorcycles. Illustrations are approximate and, in some cases, may not precisely match the part referred to. Reproduction of this publication, even partial, without written authorization is prohibited.

STRUCTURE OF THE MANUAL

The manual is divided into sections and sub-sections.

The following symbols may appear in the text:

DANGER

FAILURE TO COMPLY WITH THIS WARNING MAY LEAD TO SERIOUS INJURY OR DEATH.

DANGER

ALL MAINTENANCE WORK OR ADJUSTMENTS MARKED WITH THE ABOVE SYMBOL REQUIRE TECHNICAL KNOWLEDGE. THEREFORE, FOR YOUR SAFETY, HAVE SUCH OPERATIONS CARRIED OUT ONLY AT A SPECIALIZED TM WORKSHOP, SO THAT YOUR MOTORCYCLE IS SERVICED OPTIMALLY BY SPECIFICALLY TRAINED PERSONNEL.

WARNING

Failure to comply with that warning could result in damage to parts of the motorcycle or make it unsafe to use.

NOTE: Indicates operations or specific advice about the operation described.



INDICATES THAT THE OPERATION DESCRIBED MUST BE PERFORMED BY A SPECIALIZED TECHNICIAN OR BY A SPECIALIZED TM WORKSHOP.

CARBON MONOXIDE

If maintenance has to be carried out with the engine running, make sure that the work area is well ventilated. Never leave the engine running in enclosed spaces unless they have an extractor system for exhaust fumes.

DANGER

EXHAUST FUMES CONTAIN CARBON MONOXIDE, A POISONOUS GAS THAT CAN CAUSE LOSS OF CONSCIOUSNESS AND DEATH. CARBON MONOXIDE IS ODORLESS AND COLORLESS, MEANING THAT IT CANNOT BE DETECTED BY YOUR SENSE OF SMELL, VISION OR OTHER SENSES. DO NOT UNDER ANY CIRCUMSTANCES INHALE EXHAUST FUMES.

FUEL

Petrol is toxic. Keep petrol out of the reach of children. Do not use your mouth to siphon petrol. Avoid getting petrol on your skin. If you accidentally get petrol on you, change clothes immediately and use suitable detergents to thoroughly wash the area on which petrol was poured. If you accidentally swallow petrol, do not induce vomiting. Drink plenty of clean water or milk and seek medical advice immediately. If you accidentally get petrol in your eyes, rinse them with plenty of clean cool water and seek medical advice immediately.

Petrol containing alcohol

In case you decide to use petrol containing alcohol (petrol-alcohol mix), check that the number of octane is at least equal to the recommended value.

Two types of petrol-alcohol mix exist: one contains ethanol while the other methanol. Do not use petrol-alcohol mix containing more than 10% of ethanol. Do not use petrol-alcohol mix containing methanol (methyl alcohol or wood alcohol) unless they also contain co-solvents and corrosion inhibitors specific for methanol.

Never use petrol containing more than 5% of methanol, even if it contains co-solvents and corrosion inhibitors.

Possible problems to the engine performances caused by the use of fuels containing alcohol are not covered by warranty.

TM Racing cannot endorse the use of fuels containing methanol since the proofs of its adequacy are still insufficient.

Before purchasing petrol from a distributor you don't know, try to discover if its petrol contains alcohol.

If it does, determine the type and percentage of alcohol used. If, during operation, no negative effects are detected while using petrol containing alcohol or which you think may contain it, replace it with another you're certain it not contains alcohol.

 DANGER

THE FUEL USED IN AN INTERNAL COMBUSTION ENGINE IS HIGHLY FLAMMABLE AND MAY CAUSE EXPLOSIONS.

FILL UP WITH FUEL IN A WELL VENTILATED AREA, WITH THE ENGINE OFF.

SMOKING IS FORBIDDEN DURING REFUELING AND IN THE PRESENCE OF FUEL VAPORS.

AVOID CONTACT WITH NAKED FLAMES, SPARKS OR OTHER IGNITION SOURCES THAT COULD MAKE THE FUEL VAPORS CATCH FIRE OR EXPLODE.

PETROL IS A DANGEROUS SUBSTANCE AND MUST NOT BE DISPOSED OF IN THE ENVIRONMENT. ALWAYS USE APPROPRIATE DISPOSAL METHODS, DICTATED BY THE REGULATIONS IN FORCE IN THE COUNTRY WHERE THE PETROL IS USED.

DANGER OF BURNS** WARNING**

During use of the motorcycle, the engine, exhaust system components, cooling system components and braking system components get very hot and remain hot even after the engine has been turned off.

After riding the motorcycle, before touching any part of it, make sure that it has cooled enough to be handled.

COOLANT** DANGER**

FIRE RISK: IN SOME CONDITIONS, THE COOLANT IS FLAMMABLE. ITS FLAMES ARE INVISIBLE, BUT CAN CAUSE BURNS.

DO NOT POUR COOLANT ON EXHAUST SYSTEM COMPONENTS OR ON ENGINE COMPONENTS, AS THEY COULD BE HOT AND IGNITE THE COOLANT, WITH THE RISK OF BURNS. REMEMBER THAT THE FLAMES ARE INVISIBLE.

COOLANT MAY CAUSE SKIN IRRITATION AND IS TOXIC IF SWALLOWED.

KEEP COOLANT OUT OF THE REACH OF CHILDREN

COOLANT IS HIGHLY POLLUTING. THEREFORE, AFTER USE, IT MUST BE DISPOSED OF AT SPECIAL COLLECTION CENTERS IN COMPLIANCE WITH REGULATIONS IN FORCE IN THE COUNTRY IN WHICH THE MOTORCYCLE IS USED.

2-STROKE OIL AND GEARBOX OIL

⚠ DANGER

KEEP OUT OF THE REACH OF CHILDREN.

2-STROKE OIL AND GEARBOX OIL MAY SERIOUSLY DAMAGE SKIN IF REGULARLY HANDLED FOR LONG PERIODS AND REGULARLY. THOROUGHLY WASH YOUR HANDS AFTER HANDLING THE OIL.

WEAR LATEX OR EQUIVALENT GLOVES DURING MAINTENANCE WORK ON THE MOTORCYCLE.

GEARBOX OIL IS HIGHLY POLLUTING. THEREFORE, AFTER USE, IT MUST BE DISPOSED OF AT SPECIAL COLLECTION CENTERS IN COMPLIANCE WITH REGULATIONS IN FORCE IN THE COUNTRY IN WHICH THE MOTORCYCLE IS USED.

DO NOT POUR USED OIL INTO DRAINS OR RIVERS. DISPOSE OF FILTERS AT SPECIAL COLLECTION CENTERS IN COMPLIANCE WITH REGULATIONS IN FORCE IN THE COUNTRY IN WHICH THE MOTORCYCLE IS USED.

BRAKE AND CLUTCH FLUID

⚠ WARNING

Brake and clutch fluids are corrosive and can damage painted, plastic or rubber surfaces.

Protect components using a clean cloth when carrying out maintenance on the braking system and the clutch hydraulic system.

Use suitable personal protective equipment, such as gloves and goggles, for maintenance.

If you accidentally get the fluid in your eyes, immediately rinse them with plenty of fresh, clean water and seek medical advice immediately.

Keep out of the reach of children.

Brake and clutch fluids are highly polluting. Therefore, after use, they must be taken to special collection centers in compliance with regulations in force in the country in which the motorcycle is used.

LITHIUM IRON PHOSPHATE BATTERY

Motorcycles with electric start are fitted with a lithium iron phosphate (LIFEPO) battery

Lithium batteries are extremely high performance. Lithium iron phosphate cell technology is safe, but that does not prevent improper use of the battery, a short circuit between the poles, overheating, proximity to naked flames or sparks, charging with chargers other than the dedicated ones, from causing serious danger.

⚠ DANGER

- DO NOT EXPOSE THE BATTERY TO HEAT OR FIRE OR MICROWAVES; EXPLOSION HAZARD.
- DO NOT EXPOSE THE BATTERY TO TEMPERATURES HIGHER THAN 50°C; EXPLOSION HAZARD.
- DO NOT INSERT METAL OBJECTS IN THE BATTERY HOLDER COMPARTMENT.
- DO NOT PLACE OR CHARGE THE BATTERY AMONGST OTHER METAL OBJECTS (SUCH AS A TOOL BOX) OR WITH OTHER BATTERIES; DANGER OF GENERATING SHORT CIRCUITS.
- DO NOT IMMERSE THE BATTERY IN WATER OR OTHER LIQUIDS, DANGER OF SHORT CIRCUIT.
- AFTER REMOVING THE BATTERY FROM THE MOTORCYCLE, PLACE IT OUT OF THE REACH OF CHILDREN.

PROHIBITED OPERATIONS

- NEVER DISCHARGE THE BATTERY TO BELOW 8 V
- DO NOT USE INCOMPATIBLE CHARGERS TO CHARGE THE BATTERY.
- DO NOT USE EXTERNAL JUMPER LEADS - NEVER CHARGE A BATTERY THAT IS COMPLETELY DISCHARGED
- DO NOT PUSH START THE MOTORCYCLE IF THE BATTERY IS COMPLETELY DISCHARGED AND THE INSTRUMENT PANEL DOES NOT COME ON.
- DO NOT PIERCE THE BATTERY OR DAMAGE THE CASING.
- DO NOT CONNECT MORE THAN ONE BATTERY TO THE MOTORCYCLE ELECTRICAL SYSTEM.

RECOMMENDED OPERATIONS

- USE A COMPATIBLE BATTERY CHARGER OR A MAINTAINER.
- CONNECT THE MOTORCYCLE TO THE MAINTAINER IF YOU WILL NOT BE RIDING IT FOR LONGER THAN 7 DAYS. ALTERNATIVELY, DISCONNECT THE MOTORCYCLE BATTERY.
- CHECK THAT THE CHARGING SYSTEM ON THE MOTORCYCLE IS ALWAYS OPERATIONAL.
- CHECK THAT THE VOLTAGE SUPPLIED BY THE CHARGE CONTROLLER IS BETWEEN 13.8 V AND A MAXIMUM OF 14.6 V.

DISPOSAL

Used batteries must be taken to a collection center specializing in separate disposal, in compliance with regulations in force in the country in which the motorcycle is used.

Batteries must not be mixed with domestic or industrial waste.

TRANSPORTING THE MOTORCYCLE**⚠ WARNING**

- When transporting your TM motorcycle, make sure that it is secured in an upright position using straps or other mechanical fixing devices, to be fixed on sturdy parts of the motorcycle such as the handlebar, forks, large swing arm, etc.
- Do not secure the motorcycle by attaching straps or the like to the plastic panels.
- If the motorcycle falls, petrol could leak out, posing serious risks.

MIX

The motorcycle works by means of a mix of unleaded petrol (E5 - E10) and oil at 3%.

- If the automatic mixer is present, it is necessary to insert unleaded petrol (E5 - E10) in the fuel tank and to pour specific oil for mixers in the oil tank as described in the paragraph "Technical Data".
- If the mixer is not present, it is necessary to pour a previously created mix composed of unleaded petrol (E5 - E10) and 2-stroke oil at 3% in the fuel tank.

TYPE APPROVAL

All 250-300 versions are approved to be used by the rider only; transporting a passenger is forbidden.



IMPORTANT WARNINGS

TM sport motorcycles are designed and built to withstand stresses caused by normal road and competition use. Competition motorcycles comply with the rules of the respective categories currently in force at the leading international motorcycle associations.

Strict compliance with the checking, maintenance and calibration instructions for the engine and chassis indicated in this manual is essential for good operation and to prevent premature wear of motorcycle parts. Incorrect engine or chassis calibration may also compromise your safety and the safety of others.

Maintenance operations described in the "Maintenance schedule" must be carried out by a TM specialized workshop at the scheduled intervals, otherwise the warranty will be null and void.

If you contact TM for spare parts, updates or to report any issues, always quote the model, displacement, year of manufacture and, above all, the frame serial number and engine serial number.

Use the fuels and lubricants indicated in the use and maintenance manual as described in the maintenance schedule. Products of different brands may be used provided that they have equivalent specifications.

In the event of direct and consequential damage caused by tampering with or modification of the motorcycle, the warranty is null and void.

Using the motorcycle under extreme conditions, e.g.: on very muddy and wet terrain, may cause excessive wear on components such as transmission parts or brakes. Therefore, maintenance or replacement of some parts may be necessary sooner than the normal interval indicated in the maintenance schedule.

USE OF ALL MX / SMX MODELS IS NOT ALLOWED ON PUBLIC ROADS

If approved models are modified or tampered with in a way that changes their basic characteristics, their approval will no longer be valid.

All EN models are designed for use off-road (Enduro) and are not suitable for Motocross.





1. VEHICLE IDENTIFICATION.....	1•15		
Frame serial number.....	1•17		
Engine serial number.....	1•17		
2. CONTROL COMPONENTS.....	2•19		
Right-hand side main components topography.....	2•20		
Left-hand side main components topography.....	2•21		
Hydraulic clutch lever.....	2•22		
Nissin pump front brake lever (EN/MX).....	2•22		
Brembo pump front brake lever (OPTIONAL).....	2•22		
Brembo radial pump front brake lever (SMR).....	2•23		
Brembo 16x18 radial pump front brake lever (SMX).....	2•23		
Throttle.....	2•23		
Combination switch (EN).....	2•24		
Dimmer switch (SMR).....	2•24		
Double mapping switch (EN-MX).....	2•25		
Starter switch (SMR).....	2•25		
Start engine button (MX-SMX-EN).....	2•25		
Engine stop button (MX-SMX).....	2•26		
Key ignition / off switch (SMR).....	2•26		
Cold start device (TSI).....	2•26		
Cold start device (MX-SMX).....	2•27		
Digital electronic speedometer and indicators (EN / SMR).....	2•27		
Display.....	2•28		
Functions.....	2•29		
Gear shifting pedal.....	2•27		
Kick starter.....	2•36		
Rear brake pedal.....	2•36		
Steering lock (EN/SMR).....	2•36		
Fuel tank (TSI).....	2•37		
Fuel tank (MX-SMX).....	2•38		
Side stand.....	2•38		
Engine idle speed adjustment.....	2•39		
Fuel tap (MX-SMX).....	2•39		
3. INSTRUCTIONS FOR USE.....	3•41		
Indications for first use.....	3•43		
Safety regulations.....	3•43		
Running-in instructions.....	3•44		
Preliminary checks.....	3•44		
Electric start of the motorcycle.....	3•45		
Kick start of the motorcycle.....	3•46		
Cold start of the motorcycle.....	3•47		
Start with flooded engine.....	3•48		
Setting off.....	3•49		
Accelerating, shifting gears, slowing down.....	3•49		
Braking.....	3•49		
Stopping and parking.....	3•50		
Washing.....	3•51		
Precautions for winter use.....	3•51		
Storage.....	3•52		
Start-up after winter.....	3•53		
4. MAINTENANCE.....	4•53		
250-300 EN-SMR (TSI) maintenance table.....	4•54		
250-300 (MX/SMX) maintenance table.....	4•56		
Fork compression adjustment.....	4•57		
Fork rebound adjustment.....	4•60		
Varying pre-load and replacing fork springs.....	4•61		
Bleeding the telescopic fork.....	4•61		
Cleaning telescopic fork dust seal.....	4•62		
Shock absorber compression adjustment.....	4•62		
Standard adjustment.....	4•62		
Standard adjustment.....	4•63		
Shock absorber rebound adjustment.....	4•63		
Standard adjustment.....	4•63		
Varying pre-load and replacing shock absorber spring.....	4•64		
Basic suspension calibration depending on the weight of the rider.....	4•65		
Adapting fork basic calibration.....	4•65		
Adapting shock absorber basic calibration.....	4•65		
Checking shock absorber static sag.....	4•66		
Checking shock absorber rider sag.....	4•66		
Checking steering bearings and play adjustment.....	4•67		
Rear suspension linkage.....	4•68		
Checking chain tension.....	4•68		
Tensioning the chain (EN/MX/SMR/SMX).....	4•69		
Chain maintenance.....	4•70		
Chain wear.....	4•70		
Hydraulic clutch pump.....	4•71		
Checking and topping up the hydraulic fluid level.....	4•71		
Bleeding the hydraulic clutch.....	4•72		
Basic indications for TM disc brakes.....	4•72		
Nissin front brake pump (EN/MX).....	4•74		
Topping up brake fluid.....	4•74		
BREMBO front brake pump (Optional).....	4•75		
Topping up brake fluid.....	4•76		
BREMBO radial front brake pump (SMR).....	4•77		
BREMBO 16x18 radial front brake pump (SMX).....	4•78		
Changing basic position of rear brake pedal.....	4•79		
Checking rear brake fluid level.....	4•79		
Checking front brake pads.....	4•80		
Checking rear brake pads.....	4•81		
Replacing front brake pads.....	4•82		
Replacing rear brake pads.....	4•83		
Disassembling and assembling front wheel.....	4•84		
Disassembling and assembling rear wheel.....	4•85		
Checking spoke tension.....	4•86		
Tire pressure.....	4•87		
Checking speedometer magnetic sensor distance (EN/SMR).....	4•87		
Removing the seat.....	4•88		
Removing the tank.....	4•89		
Battery.....	4•91		
Charging the battery.....	4•92		
Electrical system components positioning.....	4•93		
Start control switch fuse.....	4•93		
Adjusting the height of the front headlamp.....	4•94		
Halogen headlight (EN).....	4•94		
Led headlight for models (EN/SMR) (Optional).....	4•95		
Replacing led front headlight (Optional).....	4•95		
Led taillight (EN/SMR).....	4•96		
Turn signal (EN/SMR).....	4•96		
Cooling.....	4•97		
Replacing exhaust silencer packing material.....	4•99		
Cleaning air filter.....	4•100		
Adjusting throttle control cables.....	4•102		
Adjusting idle speed.....	4•103		
Gearbox oil change.....	4•104		
Exhaust valve.....	5•105		
Resetting the exhaust valve.....	5•107		

5. DIAGNOSIS.....	5•111
Problem, cause, solution	5•112
Connecting Obd tool.....	5•116
6. TECHNICAL DATA	6•117
ENGINE TECHNICAL DATA 250 - 300 MX-SMX	6•119
ENGINE TECHNICAL DATA 250-300 EN/SMR	6•120
CARBURETTORS SETTING MX-SMX	6•121
ENGINE TIGHTENING TORQUES	6•121
LUBRICATION.....	6•121
CHASSIS TECHNICAL DATA.....	6•122
TIGHTENING TORQUES	6•122
7. WIRING DIAGRAMS.....	7•123
LIGHTS AND ACCESSORIES WIRING DIAGRAM EN-SMR	7•125
ENGINE WIRING DIAGRAM MX - SMX	7•126
ENGINE WIRING DIAGRAM SMR.....	7•127
ENGINE WIRING DIAGRAM EN.....	7•128
8. ALPHABETICAL INDEX.....	8•129

**1. VEHICLE
IDENTIFICATION**

**2. CONTROL
COMPONENTS**

**3. INSTRUCTIONS FOR
USE**

4. MAINTENANCE

5. DIAGNOSIS

6. TECHNICAL DATA

7. WIRING DIAGRAMS



1. VEHICLE IDENTIFICATION





FRAME SERIAL NUMBER

The frame serial number (1) is stamped on the right-hand side of the steering head.

Write this number in the space provided.

The serial number is also shown on a data plate (2) located on the left-hand side for EN / SMR models.

**ENGINE SERIAL NUMBER**

The engine serial number (1) is engraved on the back of the engine, near the shock absorber.

Write this number in the space provided at the start of the manual.

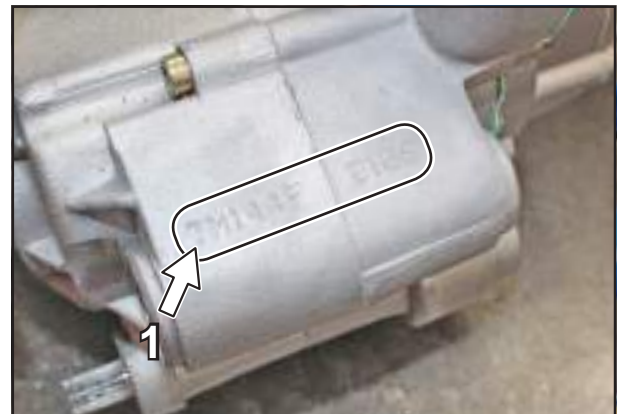



2. CONTROL COMPONENTS



RIGHT-HAND SIDE MAIN COMPONENTS TOPOGRAPHY

- 1 Throttle
- 2 Front light (EN - SMR)
- 3 Front indicator lights (EN - SMR)
- 4 Front wheel
- 5 Front suspensions
- 6 Exhaust manifold
- 7 Rear brake lever
- 8 Engine
- 9 Kick start lever
- 10 Pump with rear brake oil tank
- 11 Rear damper
- 12 Exhaust silencer
- 13 Rear wheel
- 14 Rear brake disc
- 15 Rear brake caliper
- 16 Right radiator
- 17 Radiator cap
- 18 Front brake lever
- 19 Mix oil tank cap (TSI)



19



LEFT-HAND SIDE MAIN COMPONENTS TOPOGRAPHY

- 1 Front brake disc
- 2 Front brake caliper
- 3 Left radiator
- 4 Voltage regulator
- 5 Fuel tank
- 6 Pump with front brake oil tank
- 7 Engine startup button
- 8 Double mapping switch (EN - MX)
- 9 Left switch (EN - SMR)
Engine switching off button (EN - MX - SMX)
- 10 Clutch lever with oil tank
- 11 Fuel tap (MX-SMX)
- 12 Carburettor (MX - SMX)
Throttle body (TSI)
- 13 Gearbox system lever
- 14 Kickstand
- 15 Secondary transmission chain
- 16 Crown
- 17 Rear indicator lights (EN - SMR)
- 18 Rear light/licence plate light (EN - SMR)
- 19 Seat
- 20 Battery
- 21 Air filter
- 22 Instrument
- 23 Key switch SMR

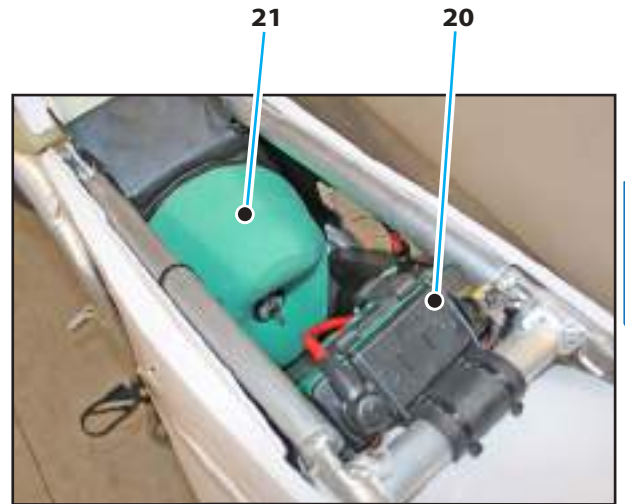

HYDRAULIC CLUTCH LEVER

The Brembo clutch pump (1) is located on the left-hand side of the handlebar.

The clutch lever (2) detaches the transmission from the engine.

To operate the clutch, pull the lever towards the grip as far as it will go.

The position of the lever relative to the grip can be altered to suit the rider.

See the "Maintenance" section.



NISSIN PUMP FRONT BRAKE LEVER (EN/MX)

The Nissin front brake pump (1) is located on the right-hand side of the handlebar.

The front brake lever (2) applies the front wheel brake.

The position of the front brake lever relative to the grip can be altered to suit the rider.

See the "Maintenance" section.



BREMBO PUMP FRONT BRAKE LEVER

The Brembo front brake pump (1) is located on the right-hand side of the handlebar.

The front brake lever (2) applies the front wheel brake.

The position of the front brake lever relative to the grip can be altered to suit the rider.

See the "Maintenance" section.

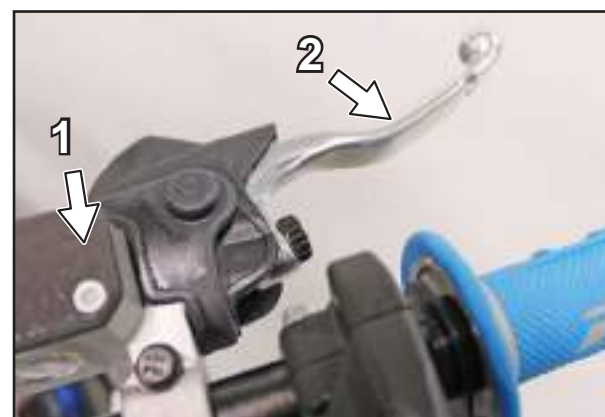

BREMBO RADIAL PUMP FRONT BRAKE LEVER (SMR)

The Brembo radial front brake pump (1) is located on the right-hand side of the handlebar.

The front brake lever (2) applies the front wheel brake.

The position of the front brake lever relative to the grip can be altered to suit the rider.

See the "Maintenance" section.



BREMBO 16X18 RADIAL PUMP FRONT BRAKE LEVER (SMX)

The Brembo radial front brake pump (1) is located on the right-hand side of the handlebar.

The front brake lever (2) applies the front wheel brake.

The position of the front brake lever relative to the grip can be altered to suit the rider.

See the "Maintenance" section.



THROTTLE

The throttle control (1) is located on the right-hand side of the handlebar.

To increase the power supplied by the engine (accelerate), turn the grip (2) towards you. To reduce power, turn the grip away from you.

Make sure that the grip always has 1-2 mm of play.

See the "Maintenance" section.



COMBINATION SWITCH (EN)

The combination switch (1) is located near the left-hand handlebar grip.

It is very intuitive to use.

When the motorcycle is started, the low beams come on. Rotate the ring (2) until the symbol (3) is at the symbol (4) to turn on the high beam.

Press button (5) to sound the horn.

Press the rocker switch (6) to the left to activate the LH turn signal, or to the right for the RH turn signal.

On 250 EN and 450 EN models, press button (7) to switch off the engine.



DIMMER SWITCH (SMR)

The dimmer switch (1) is located on the handlebar near the left-hand grip.

Its is traditional and simple to use.

Button (2) sounds the horn, whilst pressing button (3) to the left activates the LH turn signal, and to the right activates the RH turn signal.

Press the button to the center to switch off the turn signals.

The red button (4) selects low or high beam:

- pushed in: high beam;
- out: low beam.

Button (5) is for flashing the high beam.

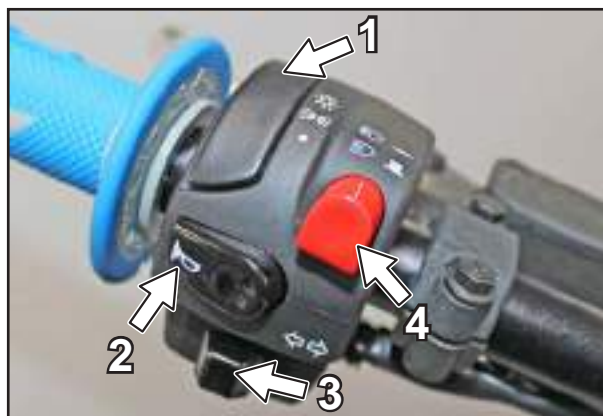

DOUBLE MAPPING SWITCH

These motorcycles versions are equipped with an engine mapping switch (1).

- If the switch is pressed in position (1a), it activates Map "1" for a "Full power" driving of the motorcycle.
- If the switch is pressed in position (1b), it activates Map "2" for a "Soft" driving of the motorcycle.
- It is possible to switch from a Full power driving to a Soft driving and vice versa while driving the motorcycle.

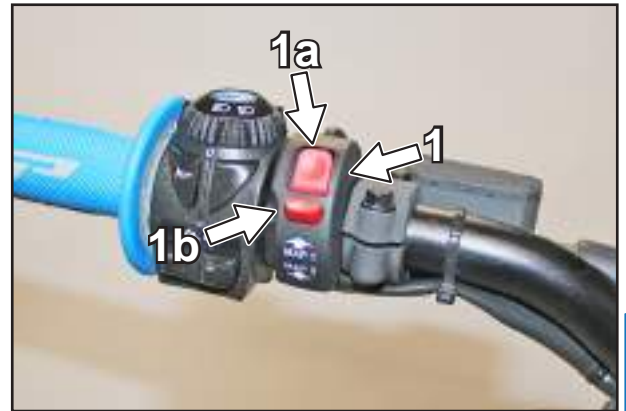

STARTER SWITCH (SMR)

Models equipped with a battery and electric start have a control with two buttons, one red (1) and one black (2), next to the throttle.

The red button (1) has two positions.

When pushed in, it prevents the engine from starting. The engine does not start even with the kick starter.



With the button pushed in, engine starting is disabled.

NOTE: If the button is pushed when the engine is running, the engine does not switch off.

We recommend leaving it this way until the next engine start, to avoid discharging the battery.



With the button in the "out" position, engine starting is enabled.

Therefore, never leave it in this position with the engine off, otherwise the ignition control unit, which draws current even when the engine is off, may discharge the battery.



- The black button (2) activates the starter motor.
- Set the gear control to "neutral", then press to start the engine and release as soon as the engine is running.
- Only use this control for a maximum of 5 seconds at a time, then wait another 5 seconds before trying again.
- After 3 or 4 attempts stop and look for possible problems.
- Never press this button while the engine is running.



START ENGINE BUTTON (MX E.S. / SMX E.S.)

The start engine button (1) is located near the right-hand handlebar grip.

- Set the gear control to "neutral", then press the button to start the engine and release it as soon as the engine is running.
- Only use this control for a maximum of 5 seconds at a time, then wait several seconds before trying again.
- After 3 or 4 attempts stop and look for possible problems.
- Never press this button while the engine is running.



ENGINE STOP BUTTON (MX / SMX)

The engine stop button (1) is located near the left-hand grip on the handlebar.

- Press this button to switch off the engine and release it as soon as the engine is off.

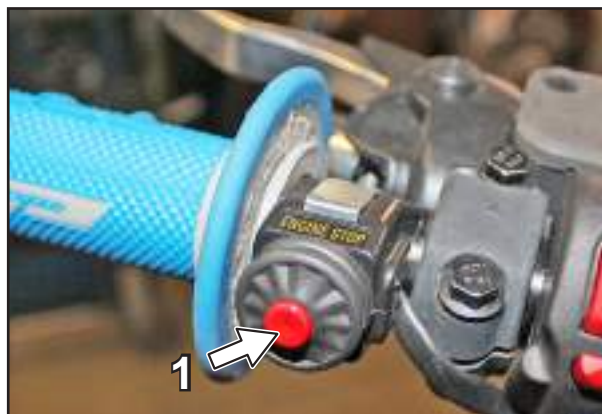

KEY IGNITION / OFF SWITCH (SMR)

SMR model have a cylinder (1) for the ignition key on the side of the dashboard.

- To enable engine starting, put the key in the cylinder (1) and turn it clockwise from the "⊗" symbol to the "⊙" symbol.
- To switch off the engine, turn the key anti-clockwise from the "⊙" symbol to the "⊗" symbol: the position in which the key can be removed.

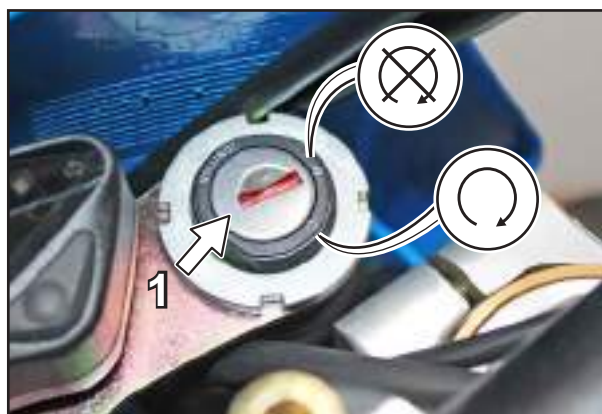

COLD START DEVICE (TSI)

This vehicle provides for a cold start device positioned on the throttle body.

- To activate the cold start device, pull the knob (1) externally, the knob remains in extracted position.
- After the vehicle start, wait a few seconds until the engine speed stabilizes (depending on ambient temperature), then disable the cold start device by moving the knob (1) to its initial position.

⚠ WARNING

ONLY activate the cold start device when the engine is switched off and cold.
NEVER activate it during motion.
Use the cold start device only if necessary.



COLD START DEVICE (MX - SMX)

This vehicle provides for a cold start device positioned on the on the carburettor.

- To activate the cold start device, raise the knob (1), the knob remains in raised position.
- After the vehicle start, wait a few seconds until the engine speed stabilizes (depending on ambient temperature), then disable the cold start device by moving the knob (1) to its initial position.

⚠ WARNING

ONLY activate the cold start device when the engine is switched off and cold. NEVER activate it during motion. Use the cold start device only if necessary.

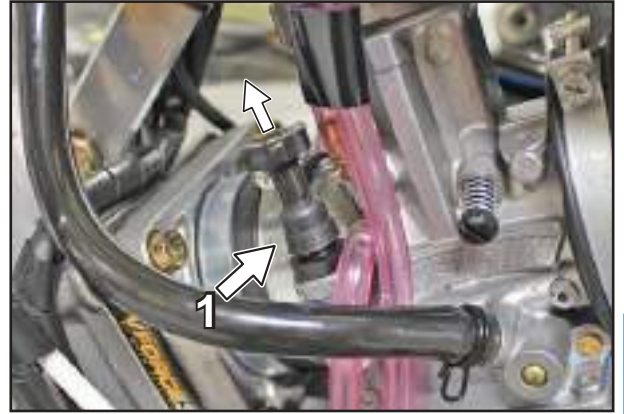

DIGITAL ELECTRONIC SPEEDOMETER AND INDICATORS (EN / SMR)

The digital speedometer consists of a large backlit display and a set of indicators.

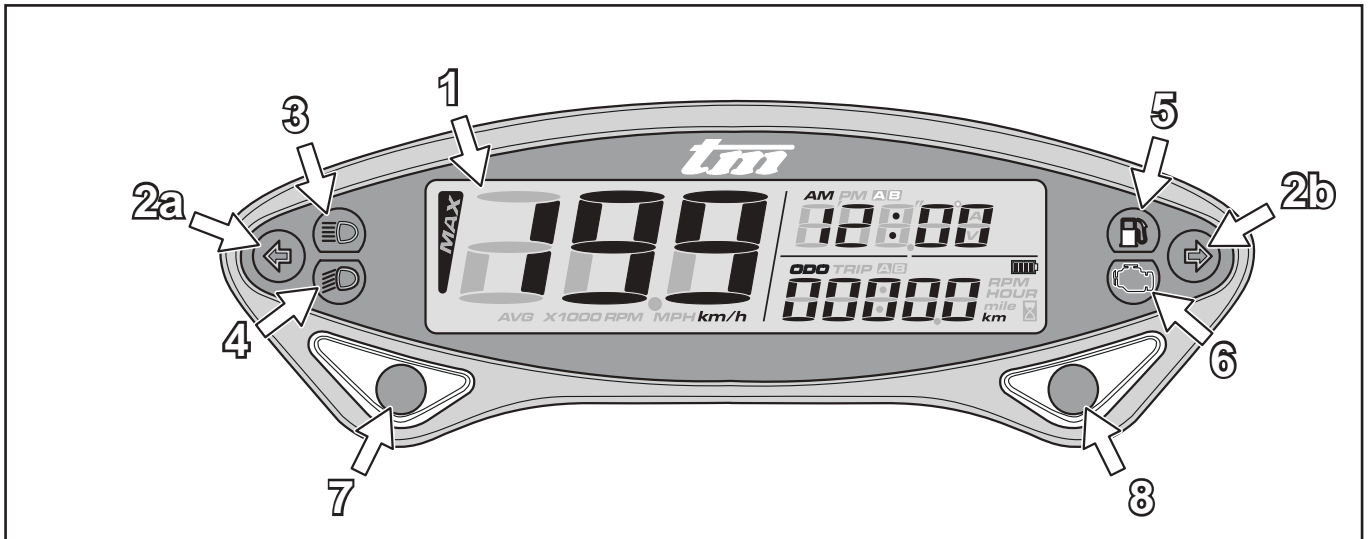

Legend of indicators and buttons:

- 1) **Backlit display.**
- 2a) **GREEN left turn signal indicator.**
- 2b) **GREEN right turn signal indicator.**
- 3) **BLUE high beam ON indicator.**
- 4) **GREEN low beam ON indicator.**
- 5) **AMBER fuel reserve indicator. (only for TSI)**
- 6) **ORANGE engine fault indicator.**
Contact a TM dealer as soon as possible if this indicator lights up while you are using the motorcycle.
- 7) **“Select” button.**
Press the button to select the following functions:
 - Show time in 12 or 24 hour format.
 - Show speed in km/h or mph.
 - Stopwatch.
 - Maximum speed record.
- 8) **“Adjust” button**
Press the button to view:
 - Odometer;
 - Trip “A” partial km/miles;
 - Trip “B” partial km/miles;
 - Total hours counter;
 - Partial hours counter “A”;
 - Partial hours counter “B”.

DISPLAY

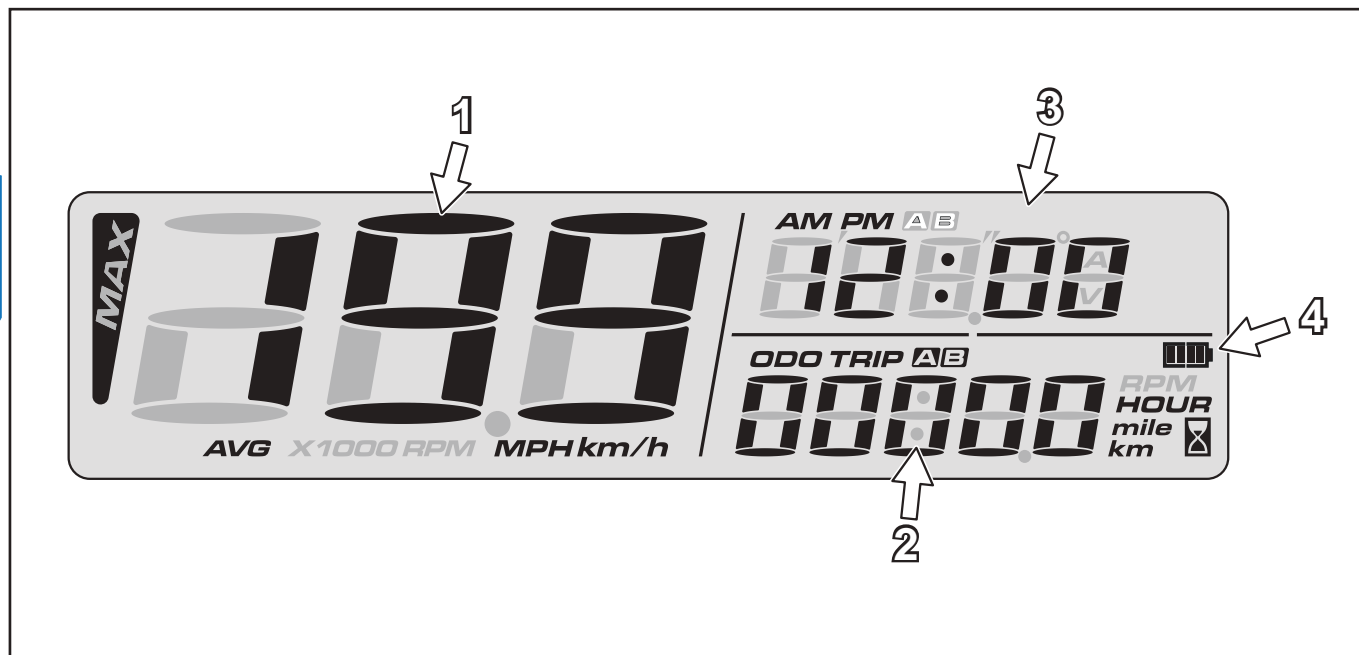

Display legend:

1) Speed indicator

Shows the vehicle speed. The top speed is 360 km/h - 225 mph.

Use the "Select" button to switch between speed in km/h or mph.

2) Odometer / "Trip" partial counters

This part of the display can be used to see the total km/miles travelled or partial km/miles travelled on the "Trip A" or "Trip B" counter. To show the various functions, use the "Adjust" button.

• Odometer

- Indicates total km/miles travelled.
- Maximum value is 99999 km/miles. When that maximum has been reached, the counter is reset and starts again from "0".
- Minimum record is 1 km/mile.

• "Trip" partial km/miles counters

Two partial counters, "Trip A" and "Trip B" can be set. Indicates the partial km/miles travelled. Maximum value is 9999.9 km/miles. When that maximum has been reached, the counter is reset and starts again from "0". Minimum record is 0.1 km/mile.

3) Clock / Stopwatch / Maximum speed

This area of the display can show the time, the stopwatch and the maximum speed reached. Use the "Select" button to access the various functions.

• Time

The time can be displayed in 12 or 24 hour format.

• Stopwatch

The stopwatch can be displayed, set to automatically start when the wheel begins turning and to stop when the wheel stops turning.

• Average speed / maximum speed

- The average speed can be displayed.
- The maximum speed reached can be displayed.
- The top speed is 360 km/h - 225 mph.

4) Battery status

The battery status is displayed;

= fully charged

= discharged, needs replacing.

FUNCTIONS

Partial km / miles selection

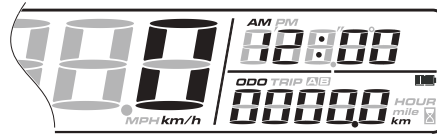

Starting on the home screen page, press the “Adjust” button once to switch from the odometer function (total km / miles travelled) to the “Trip A” partial km / miles travelled function.

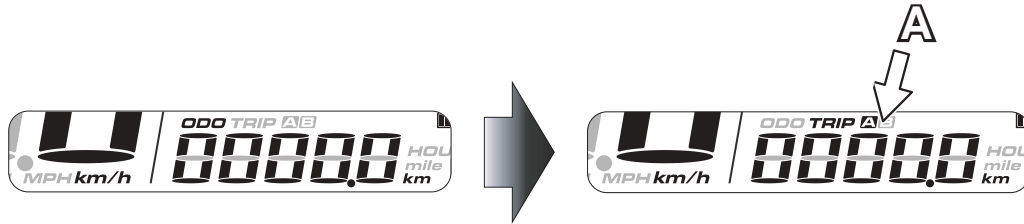

From “Trip A” press the “Adjust” button to go to the “Trip B” partial km/miles travelled function.

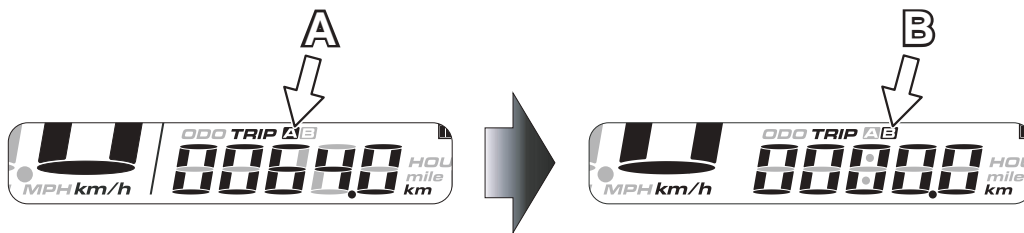

To reset the km/miles travelled both in “Trip A” and in “Trip B” with the function active press the “Adjust” button for three seconds

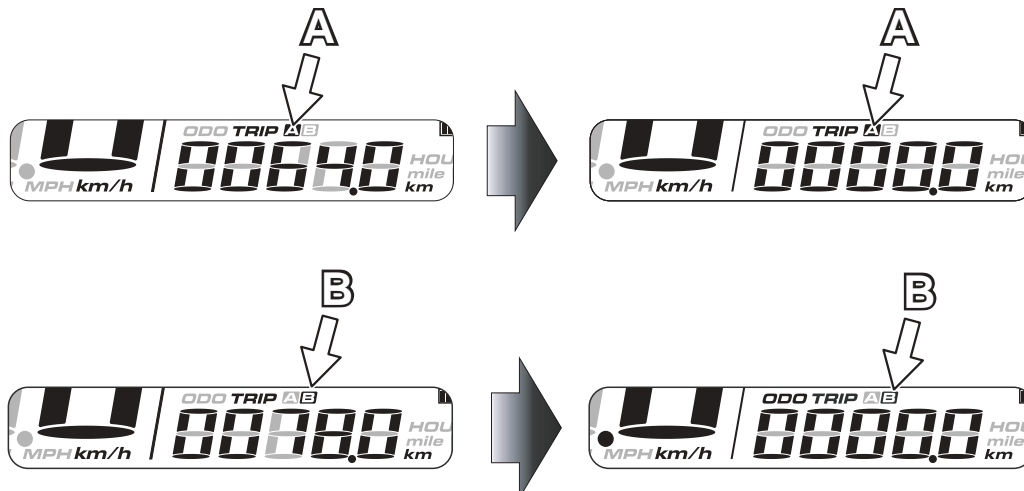

Km / Miles unit of measurement setting

Starting on the home screen page, with the ODO function set, press the “Adjust” button for three seconds to change the unit of measurement from km to miles, from km/h to mph and vice versa.

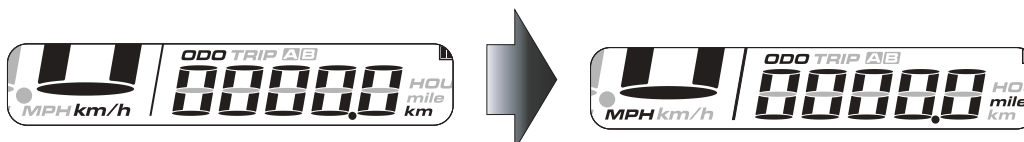

Hours counter selection

The instrument can count total hours of engine operation and partial hours of operation “A” and “B”.

- Display the “Trip B” section, then press the “Adjust” button once to display the total hours of engine operation (value cannot be reset).

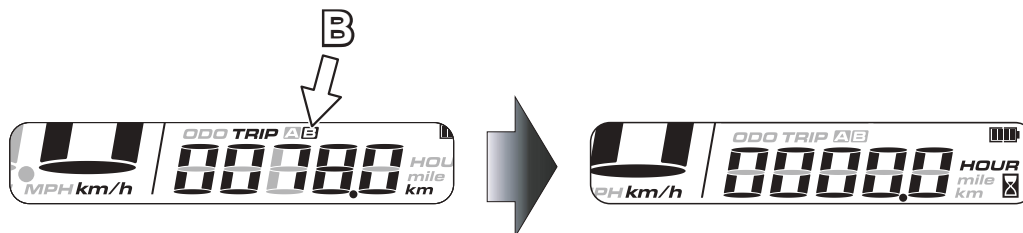

Press the “Adjust” button to switch from the total hours of engine operation to the partial hours of operation “A”.

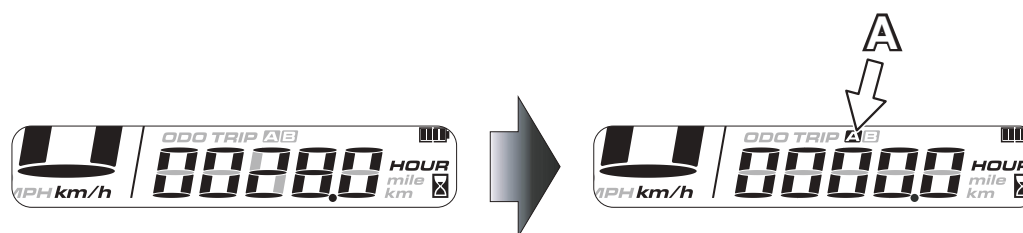

From “A” press the “Adjust” button to switch to the display of partial hours “B”.

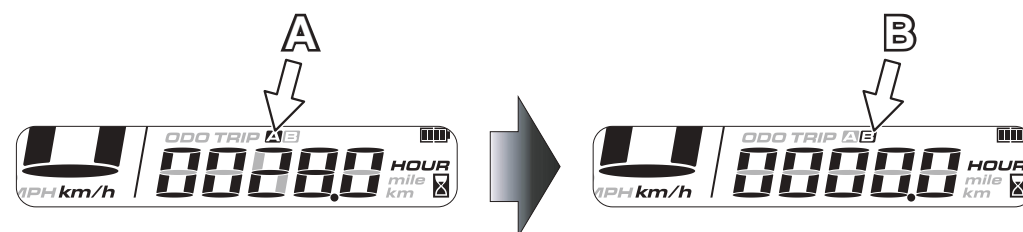

To reset the partial hours of operation both in “A” and in “B” with the function active press the “Adjust” button for three seconds.

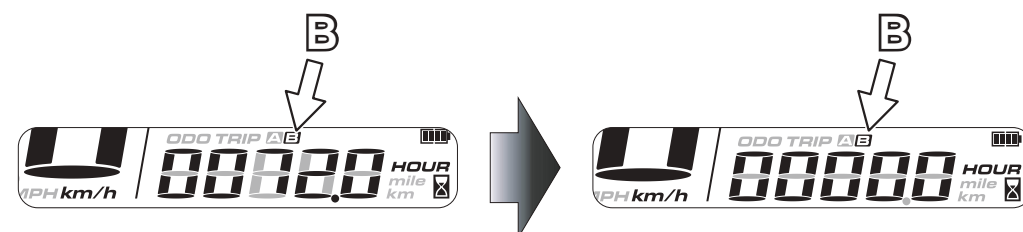
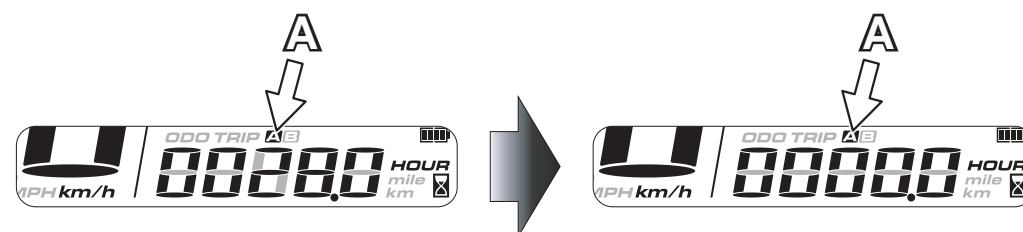

To return to the home screen page press the “Adjust” button.

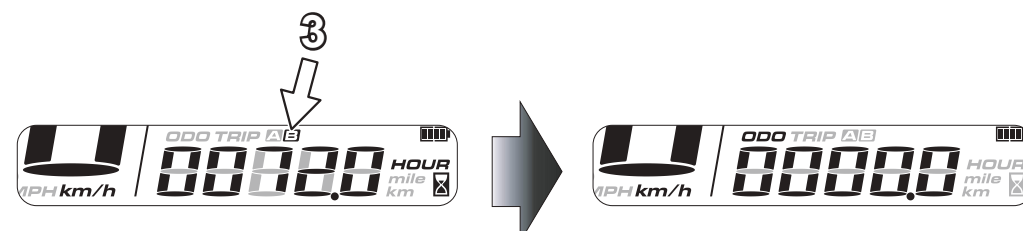

Setting the clock to 12 or 24 hour format

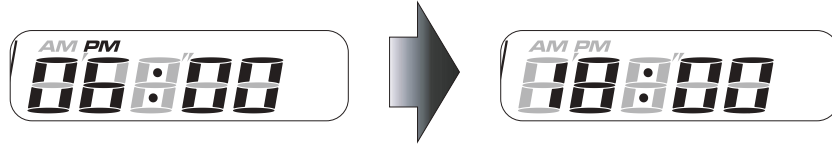

From the time home screen page, press the “Select” button from 3 seconds to change the clock display from 12 to 24 hour format or vice versa.

NOTE: When the clock is set to the 12 hour format, AM (morning) or PM (afternoon) will appear at the top.

Stopwatch



From the home screen page press the “Select” button to switch from the clock to the stopwatch.

NOTE: The stopwatch starts when the wheel begins turning and stops when the motorcycle comes to a stop; or you can press the “Select” button to start it.
To stop the stopwatch, press the “Select” button again.

To reset the stopwatch, press the “Select” button for 3 seconds.

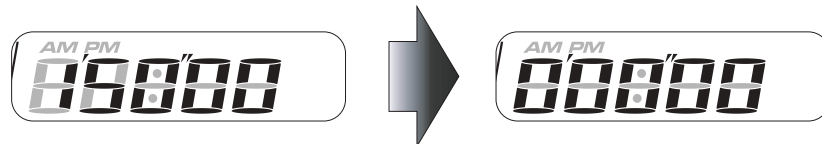

Display average speed / maximum speed

Set the stopwatch function, then press the “Select” button to display the maximum speed and the average speed. The display shows “AVG” and the top speed and average speed alternate onscreen every three seconds.



To reset the maximum speed and average speed, press the “Select” button for three seconds.

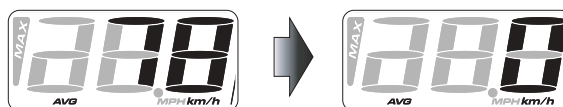

To return to the home screen page, press the “Select” button.

Setup

To open the “Setup” menu, simultaneously press the “Select” and “Adjust” buttons for several seconds.

You can use this menu to set the following functions:

- Wheel circumference and sensor setup



- Time



- Stopwatch start



- Odo



NOTE: To move from one setting to another, press the “Select” button.

- Setting the wheel circumference and sensor setup

Depending on the models, the following values must be set:

MODEL	CIRCUMFERENCE	SENSOR SETUP
EN	2100	04
SMR	1960	04

Set the wheel circumference and the sensor setup as follows:

From the home screen page simultaneously press the “Adjust” and “Select” buttons for three seconds to enter setup mode. The following screen page appears on the display:



Press the “Adjust” button and the following screen page appears on the display:

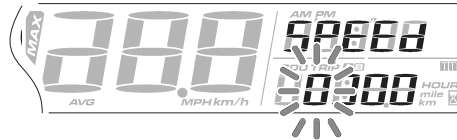

The editable value flashes;
for example, to set the circumference value “2130” and the sensor setup “04”, proceed as follows:

- press the “Setup” button twice to set the first number to “2”;
- press the “Adjust” button to move to the second editable number and press the “Setup” button once to set the number to “1”;
- press the “Adjust” button to move to the third editable number and press the “Setup” button three times to set the number to “3”;
- press the “Adjust” button to move to the fourth editable number. In this case, do not press the “Setup” button, as the number to be set is “0”;

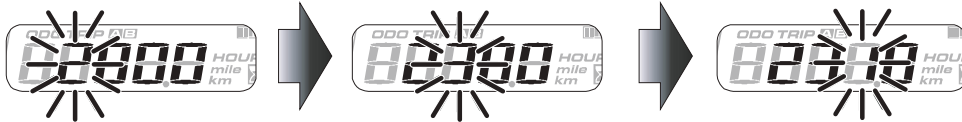

- press the “Adjust” button to set the sensor setup and the following screen page appears:



- in this case do not press the “Setup” button, as the number to be set is “0”;
- press the “Adjust” button to move to the second editable number and press the “Setup” button four times to set the number to “4”;

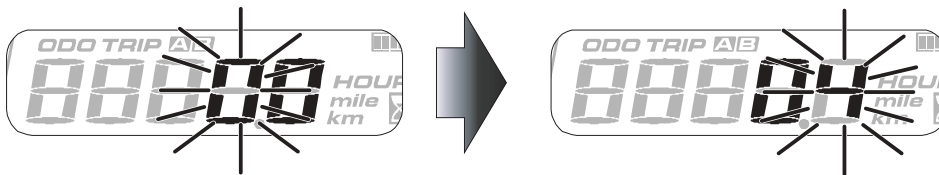

After several seconds of inactivity, the program automatically exits the setup mode and returns to the home screen page.

• Time setting

To set the time, proceed as follows:

Press the “Adjust” and “Select” buttons simultaneously for three seconds to enter setup mode. The following screen page appears on the display:



Press the “**Select**” button and the following screen page appears on the display:



Press the “**Adjust**” button and the following screen page appears on the display:

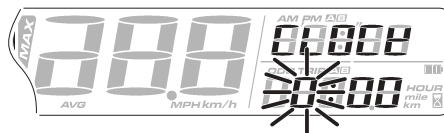

The hours value flashes. To set the hours, for example 14, press the “**Setup**” button as many times as needed to reach the desired hours number.

NOTE: Set the time according to the 12 or 24 hour format selected.

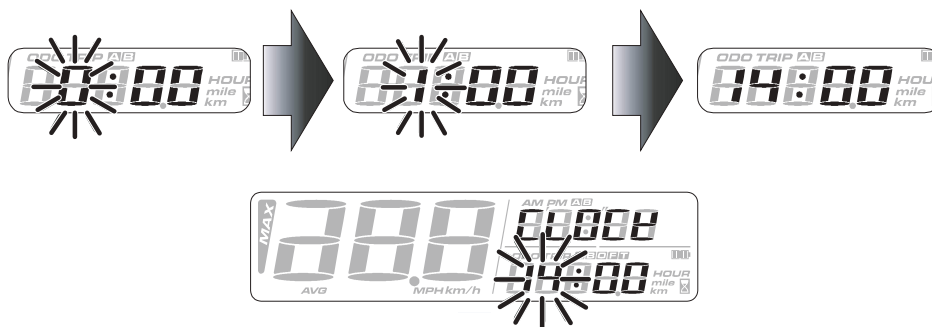

Press the “**Adjust**” button to move to the minutes setting. The following screen page is displayed:



The minutes value flashes. To set the minutes, for example 5, press the “**Setup**” button as many times as needed to reach the desired number of minutes.

NOTE: The minutes can be set from 0 to 59.

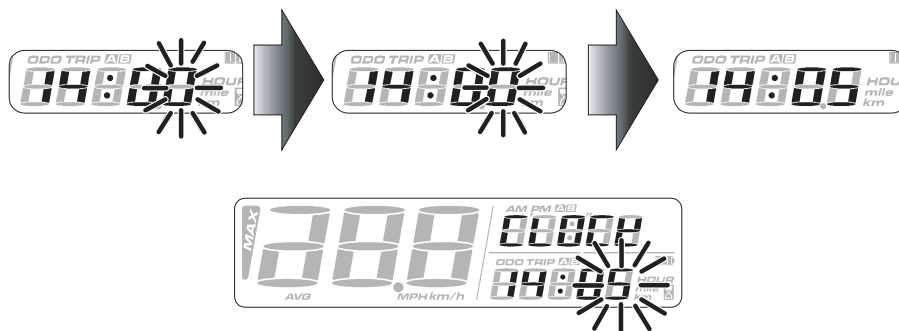

Press the “Adjust” button to return to the clock setting screen page:



Press the “Adjust” and “Select” buttons simultaneously for three seconds to exit the setup mode and return to the home screen page.



- **Stopwatch**

The stopwatch has been set to work automatically. It starts when the motorcycle begins moving and stops when the motorcycle comes to a stop.

NOTE: The default setting must not be changed. If necessary, go to the setup mode and check that its operation is set to “AUTO”.

- **Odo**

This function is not active.

NOTE: The default setting must not be changed. If necessary, go to the setup mode and check that operation is set to “OFF”.

GEAR SHIFTING PEDAL

The gear shifting pedal (1) is fitted on the left side of the engine.

The position of the gears is shown in the illustration.

Neutral is between first gear and second gear.

- To engage first gear, pull the clutch lever and press the gear shifting pedal downwards.
- To engage the other gears, pull the clutch lever and push the gear shifting pedal upwards.

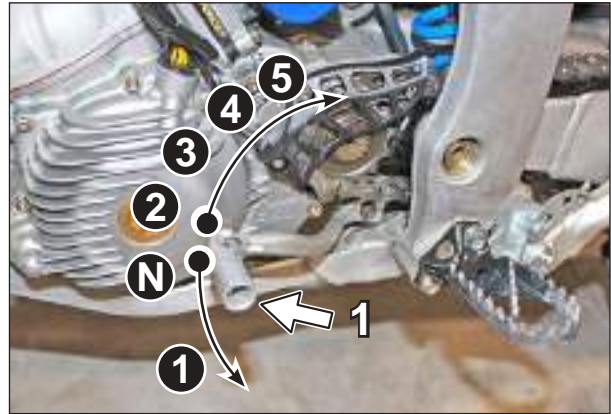

KICK STARTER

The kick starter (1) is on the right side of the engine.

Once in “neutral”, rotate the pedal outwards and use your foot to start the engine with it.

For SMR models, turn the key, as described in the relative paragraph, before starting the engine.

For all other models, simply use the pedal to start the engine.

Starting from the highest position, push the starter all the way down with fast, continuous movements.

Once the engine has started, fold the pedal in again.



REAR BRAKE PEDAL

The brake pedal (1) is located in front of the right-hand footrest.

The basic position can be adjusted to suit the rider.

See the “Maintenance” section.



STEERING LOCK (EN/SMR)

The steering lock (1) is on the left-hand side of the steering head.

This device allows you to prevent rotation of the handlebar, so that the motorcycle cannot be ridden.

- To lock the steering, turn the handlebar all the way to the right, move the protective tab (2), insert the key, turn it to the left and press it all the way down. Keeping it pressed down, turn it to the right and remove it.

⚠ WARNING

When you have unlocked the steering, do not leave the key in the lock. If you steer left, the key could bend or break.



FUEL TANK (TSI)

The fuel cap (1) is at the top of the fuel tank, in the front area of the motorcycle.

- To open it: unscrew the tank cap by turning it anti-clockwise.
- To close it: place the tank cap in the filler neck and turn it clockwise.

TM engines use super unleaded fuel (E5) - (E10).

E5 = Petrol containing up to 5% of ethanol in proportion to its volume.
E10 = Petrol containing up to 10% of ethanol in proportion to its volume.

Tank capacity:

MX / SMX ALL | 6.75 total
EN / SMR / SMM ALL | 6.75 total, of which 1 is reserve

⚠ WARNING

Fill the tank with unleaded petrol with a minimum octane number of 95. Never use petrol with octane lower than 95, as it could damage the engine. Fuel expands when heated. Therefore, in high temperatures, do not fill the tank to the top.
DO NOT pour petrol mixed with oil inside the tank as the motorcycle is equipped with an automatic mixer.

⚠ DANGER

PETROL IS HIGHLY FLAMMABLE AND TOXIC. HANDLE PETROL WITH EXTREME CARE. DO NOT FILL-UP WITH PETROL NEAR NAKED FLAME OR LIT CIGARETTES. ALWAYS TURN OFF THE ENGINE BEFORE FILLING UP WITH PETROL. TAKE CARE NOT TO GET PETROL ON THE ENGINE OR ON THE EXHAUST PIPE. IMMEDIATELY REMOVE ANY SPILT PETROL WITH A CLOTH. IF PETROL IS SWALLOWED OR GETS IN YOUR EYES, SEEK MEDICAL ADVICE IMMEDIATELY.

2 STROKE OIL TANK

The two stroke oil tank (2) is positioned inside the right hand area of the frame while the filler cap (3) is in its top area.

- Unscrew the cap (3) anticlockwise and pour a 2 stroke oil suitable for 2 stroke engines and for the automatic mixer inside the tank. (see paragraph "Technical Data").
- Screw the filler cap (3).

⚠ WARNING

The tank is equipped with a minimum level indicator (4). When oil level reaches half of the porthole, you have oil available only for one full tank of fuel and it is therefore necessary to restore its level.

Tank capacity: 800 gr of oil.

⚠ DANGER

KEEP 2 STROKE OIL AWAY FROM THE REACH OF CHILDREN. 2 STROKE OIL MAY CAUSE SERIOUS DAMAGES TO THE SKIN IF HANDLED FOR PROLONGED PERIODS OF TIME AND REGULARLY. WASH YOUR HANDS WITH EXTREME CARE AFTER HAVING HANDLED OIL. PAY ATTENTION NOT TO SPILL OIL ON THE EXTERNAL PARTS OF THE MOTORCYCLE, FRAME, ENGINE, RADIATOR. IF THAT HAPPENS, CLEAN USING WATER AND A CLOTH. DO NOT POUR OIL IN SEWERAGE OR IN RIVERS.

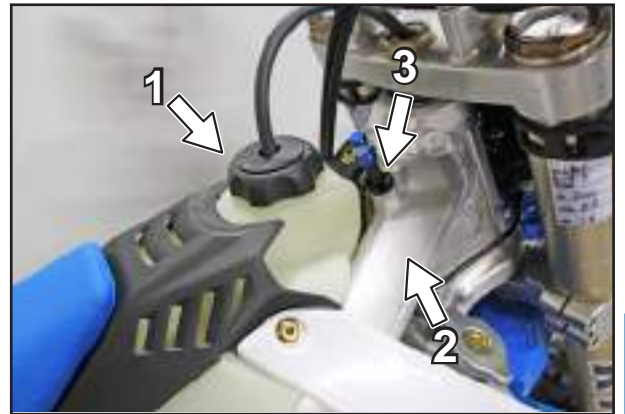

FUEL TANK (MX - SMX)

The fuel cap (1) is at the top of the fuel tank, in the front area of the motorcycle.

- To open it: unscrew the tank cap by turning it anti-clockwise.
- To close it: place the tank cap in the filler neck and turn it clockwise.

TM engines use a mix of super unleaded fuel (E5) - (E10) and 2 stroke oil at 3%.

E5 = Petrol containing up to 5% of ethanol in proportion to its volume.

E10 = Petrol containing up to 10% of ethanol in proportion to its volume.

Tank capacity:

Total of lt. 9,5, 1 of which is additional

⚠ WARNING

Fill the tank with a mix of unleaded petrol with a minimum octane number of 95 and oil at 3%.

Never use petrol with octane lower than 95, as it could damage the engine.

Only use 2 stroke oil suitable for 2 stroke engines, do not use engine oil. (see paragraph "Technical Data).

Fuel expands when heated. Therefore, in high temperatures, do not fill the tank to the top.

⚠ DANGER

PETROL IS HIGHLY FLAMMABLE AND TOXIC. HANDLE PETROL WITH EXTREME CARE. DO NOT FILL-UP WITH PETROL NEAR NAKED FLAME OR LIT CIGARETTES. ALWAYS TURN OFF THE ENGINE BEFORE FILLING UP WITH PETROL. TAKE CARE NOT TO GET PETROL ON THE ENGINE OR ON THE EXHAUST PIPE. IMMEDIATELY REMOVE ANY SPILT PETROL WITH A CLOTH. IF PETROL IS SWALLOWED OR GETS IN YOUR EYES, SEEK MEDICAL ADVICE IMMEDIATELY.

⚠ DANGER

KEEP 2 STROKE OIL AWAY FROM THE REACH OF CHILDREN.

2 STROKE OIL MAY CAUSE SERIOUS DAMAGES TO THE SKIN IF HANDLED FOR PROLONGED PERIODS OF TIME AND REGULARLY.

WASH YOUR HANDS WITH EXTREME CARE AFTER HAVING HANDLED OIL. PAY ATTENTION NOT TO SPILL OIL ON THE EXTERNAL PARTS OF THE MOTORCYCLE, FRAME, ENGINE, RADIATOR.

IF THAT HAPPENS, CLEAN USING WATER AND A CLOTH.

DO NOT POUR OIL IN SEWERAGE OR IN RIVERS.

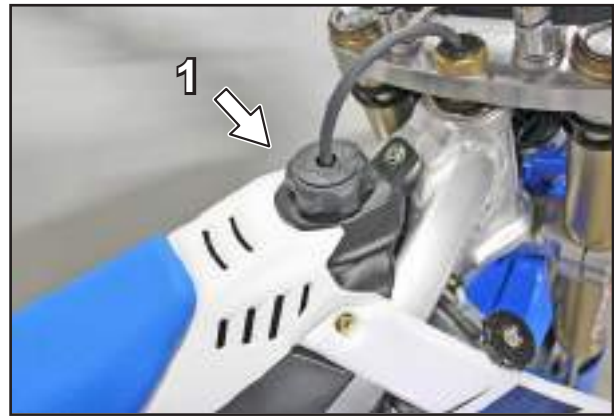

SIDE STAND

Use your foot to move the side stand (1) forward until it stops, then lean the motorcycle onto it.

Make sure that the ground is solid and the parking position is stable. For greater safety, engage 1st gear with the engine off.

When you lift the motorcycle, the side stand automatically lifts up.

⚠ WARNING

The side stand is only designed to support the weight of the motorcycle. Never sit on the motorcycle while it is resting on the side stand, as the side stand may be damaged and the motorcycle may fall over.



ENGINE IDLE SPEED ADJUSTMENT

The engine idle speed adjustment knob or the screw (1) is positioned on the left hand side of the motorcycle.

The engine speed is increased or decreased to the minimum by rotating the knob or the screw.

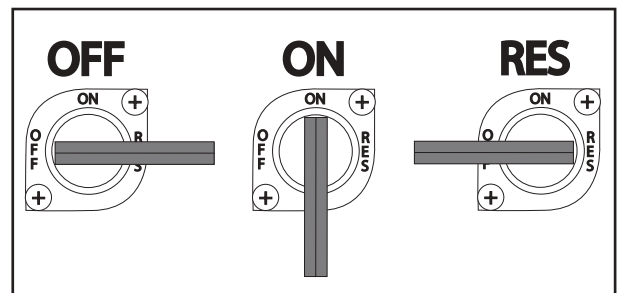
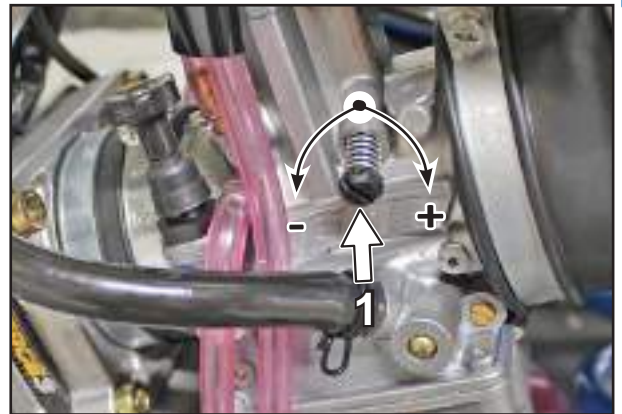
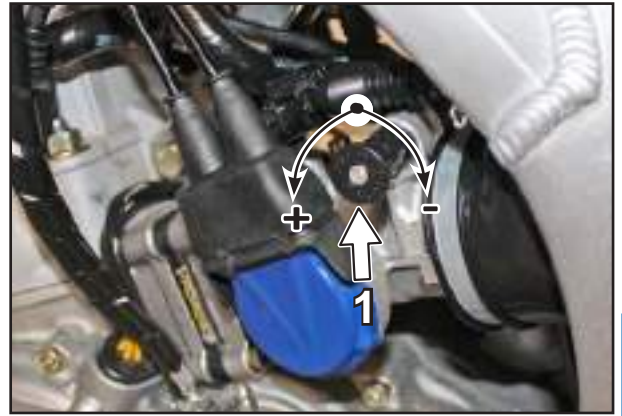

FUEL TAP (MX - SMX)

The fuel tap (1) is positioned under the tank on the left hand side of the motorcycle.

The tap has three positions:

- OFF = tap closed: there's no insertion of mix in the carburettor. It's a normal position when the motorcycle is stationary and switched off.
- ON = tap open: there's insertion of mix in the carburettor. It's a normal position while using the motorcycle.
- RES = reserve, indicates that the minimum level of mix inside the tank has been reached and that it is necessary to restore its level.

- Rotate the tap from "OFF" to "ON" in order to start the motorcycle.
- When, during the motorcycle use, the engine starts to switch off or works at intervals, rotate the tap (1) from position "ON" to "RES" (reserve) and restore the mix level inside the tank as soon as possible.





3. INSTRUCTIONS FOR USE





INDICATIONS FOR FIRST USE

- Make sure that the motorcycle's "PRE-DELIVERY OPERATIONS" have been completed by your TM dealer.
- Carefully read all of the instructions before using the motorcycle for the first time.
- Familiarize yourself with all of the controls.
- Adjust the clutch lever, the front brake lever and the brake pedal to the most comfortable position.
- Practice riding the motorcycle in an empty car park or on easy terrain before going for a long drive. Also try standing up while riding slowly, to get a feel for how the motorcycle handles.
- Do not choose routes that are too difficult for your skill level and experience.
- Hold the handlebar with both hands and keep your feet on the footrests.
- Make sure you do not press the brake pedal with your foot if you do not want to stop. If the brake pedal is not released, the brake pads rub continuously causing the brake to overheat.
- Do not make changes to the motorcycle and always use TM ORIGINAL SPARE PARTS. Spare parts from other manufacturers may affect the safety of the motorcycle.
- Motorcycles are sensitive to shifts in weight distribution. Luggage must be fastened near the center of the motorcycle and its weight must be evenly distributed between the front and rear wheels.
- Follow the running-in instructions.

⚠ WARNING

Although EN-SMR models have approval, they must be driven with care on roads. Above all, avoid long stretches with wide open throttle.

SAFETY REGULATIONS**⚠ DANGER**

- ALWAYS WEAR SUITABLE CLOTHES WHEN USING THE MOTORCYCLE. WISE BIKERS WHO RIDE A TM ALWAYS WEAR APPROVED HELMET, BOOTS, GLOVES AND JACKET, BOTH FOR LONG JOURNEYS AND SHORT DISTANCES. PROTECTIVE GEAR SHOULD BE HIGHLY VISIBLE TO ALLOW OTHER DRIVERS ON THE ROAD TO SEE THE BIKER IMMEDIATELY.
- DO NOT DRIVE AFTER CONSUMING ALCOHOL.
- ALWAYS USE TM ORIGINAL ACCESSORIES. FOR EXAMPLE, FRONT COVERINGS MAY AFFECT MOTORCYCLE PERFORMANCE AT HIGH SPEED. EVEN LUGGAGE, ADDITIONAL TANKS, ETC. MAY AFFECT MOTORCYCLE PERFORMANCE DUE TO THE DIFFERENT WEIGHT DISTRIBUTION.
- BOTH THE FRONT AND THE REAR WHEELS MUST BE FITTED WITH TIRES WITH THE SAME TYPE OF PROFILE.
- AFTER THE FIRST 30 MINUTES OF RIDING, YOU MUST CHECK THE TENSION OF THE SPOKES. SPOKE TENSION DECREASES RAPIDLY ON NEW WHEELS. IF YOU KEEP RIDING WITH LOOSE SPOKES, THEY MAY BREAK, CAUSING INSTABILITY (SEE CHECKING SPOKE TENSION).
- ALL EURO 4 MODELS ARE DESIGNED AND SET UP FOR ONLY 1 RIDER. CARRYING A PASSENGER IS PROHIBITED.
- COMPLY WITH TRAFFIC REGULATIONS AND DRIVE WITH CAUTION SO AS TO RECOGNIZE DANGER AS SOON AS POSSIBLE.
- ADJUST THE SPEED OF THE VEHICLE ACCORDING TO THE CONDITIONS OF THE ROAD AND YOUR DRIVING SKILLS.
- DRIVE WITH CAUTION ON UNKNOWN ROADS OR TERRAINS.
- WHEN GOING OFF ROAD, ALWAYS GO WITH A FRIEND WITH A SECOND MOTORCYCLE, SO YOU CAN HELP EACH OTHER IF NECESSARY.
- PROMPTLY REPLACE THE VISOR OR LENSES OF YOUR GLASSES. SCRATCHED VISORS OR GLASSES MAKE IT NEARLY IMPOSSIBLE TO SEE IN POOR LIGHT CONDITIONS.
- NEVER LEAVE THE MOTORCYCLE UNATTENDED WITH THE ENGINE RUNNING.

⚠ DANGER

- ONLY EN AND SMR MODELS HAVE APPROVAL FOR USE ON PUBLIC ROADS OR MOTORWAYS.
- WHEN RIDING YOUR MOTORCYCLE, ALWAYS BEAR IN MIND THAT LOUD NOISE MAY DISTURB OTHER PEOPLE.

RUNNING-IN INSTRUCTIONS

The component surfaces of a new motorcycle, despite precision machining, are not as smooth as the components of motorcycles that have been running for a long time. This is why running-in a new motorcycle is so important.

For optimal settling of moving parts, a new motorcycle must be brought to its maximum performance gradually.

The main rules to follow are:

1. After cold start, warm up the engine for about 1 minute before starting to use the motorcycle.
2. During the first 3 hours of use (1 hour for competitive use) the engine must be used only up to a maximum of 50% of its power. Plus, the number of revs must not exceed 9000 rpm for 250cc or 300cc engines and 6000 rpm for 450/530 cc engines.
3. During the subsequent 5 hours of use (1 hour for competitive use) the engine can be used up to a maximum of 75% of its power. Ride the motorcycle under a variety of conditions (road, easy off-road stretches). Do not go on long journeys without ever closing the throttle. Gradually increase and reduce throttle opening, alternating acceleration and deceleration with short periods at constant speed. Make sure that the coolant does not reach temperatures that are too high (indicated by fluid leaking from the bleeder hose).

By following these rules, you will obtain maximum performance and longer engine life.

It is essential that you carry out the operations described in the "Maintenance Schedule" during the running-in period.

Be particularly careful when replacing oil as metal particles that can detach from the surfaces of engine parts in contact during running-in circulate in the oil and are deposited in the cap with magnet. Therefore, replacing oil and cleaning the cap with magnet allows these particles to be definitively removed from the engine.

PRELIMINARY CHECKS

In order to drive safely, the motorcycle must be in good condition and well maintained. It is good practice to perform a general check on the motorcycle before every use.

It must include the following checks:

- 2 stroke oil and fuel level check (TSI)
- brake fluid level check;
- coolant level check;
- brakes correct operation check;
- brakes pipes and pads condition check;
- steering check, turning handlebar all the way in both directions;
- tires pressure and condition check;
- chain tension check;
- flexible cable controls check and adjustment if necessary;
- if carrying luggage, check that it is secured.

- Start the engine: check that the instrument display lights up and;
- turn on the high beam and check that the relative indicator comes on;
- activate the turn signals and check that the relative indicators come on;
- check that the rear brake light comes on;
- check that the horn works;
- check that after starting the "🔧" "Engine fault" indicator does not come on.

N.B.: For checks and any adjustments necessary, see the Maintenance section.

ELECTRIC START OF THE MOTORCYCLE

1. Raise the motorcycle, the kickstand (1) will raise automatically.
2. Get on the motorcycle from the left hand side.
3. Position the gearbox lever (2) in neutral.
4. For SMR models, rotate the key (3) of the start switch to "ON".
5. For MX-SMX models, rotate the fuel tap (4) to "ON".
6. Depending on the models, raise the knob (5) or pull the knob (6) and leave it in position.
7. Pull the clutch lever (7).
8. When the throttle is completely closed, press the start button (8) and release it as soon as the engine has started.

⚠ WARNING

After a few seconds from the engine start, move the knob (5) or (6) back to the initial position. If the engine has a low and irregular idle speed (9), adjust idle speed as described in the relative paragraph "Engine speed idle speed adjustment".

The engine idle speed will always have to be kept between 1700-1800 rpm. This value also eases the next starts.

⚠ DANGER

- DO NOT START THE ENGINE IN A CLOSED ROOM AND NEVER LEAVE IT ON IN SUCH ROOMS. EXHAUST GASSES ARE POISONOUS AND THE MAY CAUSE UNCONSCIOUSNESS AND DEATH. IN CASE OF ENGINE OPERATION, ALWAYS MAKE SURE SUFFICIENT VENTILATION IS PRESENT.
- ALWAYS CHECK THAT GEARBOX IS IN NEUTRAL BEFORE STARTING THE MOTORCYCLE. IF A GEAR IS ENGAGED WHEN STARTING THE MOTORCYCLE, THE LATTER WILL JUMP FORWARD AND MAY CAUSE DAMAGES TO YOURSELF AND TO THE MOTORCYCLE ITSELF.

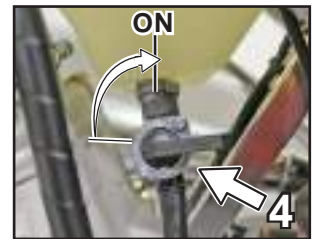
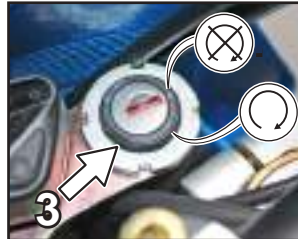
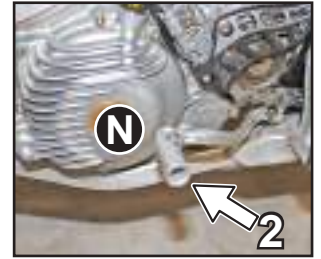

KICK START OF THE MOTORCYCLE

All the motorcycles are equipped with electric starting but, if it is necessary to start the motorcycle with the pedal (kick start), work as follows:

1. Raise the motorcycle, the kickstand (1) will raise automatically.
2. Get on the motorcycle from the left side.
3. Position the gearbox lever (2) in neutral.
4. For SMR models, rotate the key (3) of the start switch to "ON".
5. For MX-SMX models, rotate the fuel tap (4) to "ON".
6. Depending on the models, raise the knob (5) or pull the knob (6) and leave it in position.
7. Pull the clutch lever (7).
8. When your left foot is on the ground and the throttle is completely closed, activate the start pedal (8) using your right foot.

⚠ WARNING

Activate the start pedal 1-2 times using all the available stroke. Do not use the pedal repeatedly and/or for partial strokes; activating the pedal causes the engine to flood.

⚠ WARNING

After a few seconds from the start of the engine, move the knob (5) or (6) back to initial position. If the engine has a low and irregular idle speed (9), adjust idle speed as described in the relative paragraph "Engine idle speed adjustment".

The engine idle speed will always have to be kept between 1700-1800 rpm. This value also eases the next starts.

⚠ DANGER

- ALWAYS WEAR SOLID MOTORCYCLE BOOTS WHEN KICK STARTING THE ENGINE IN ORDER TO AVOID POSSIBLE INJURIES. YOU COULD SLIP FROM THE PEDAL OR THE ENGINE MAY CAUSE A KICKBACK AND CAUSE THE PEDAL TO HIT YOUR FOOT.
- ALWAYS PRESS THE START PEDAL STRONGLY UP TO THE END OF ITS STROKE WITHOUT ACCELERATING. A KICK START WITH A TOO LOW POWER OR WITH THE GAS KNOB OPEN INCREASES THE RISK OF A KICKBACK OF THE ENGINE.
- DO NOT START THE ENGINE IN A CLOSED ROOM AND NEVER LEAVE IT ON IN SUCH ROOMS. EXHAUST GASSES ARE POISONOUS AND THE MAY CAUSE UNCONSCIOUSNESS AND DEATH. IN CASE OF ENGINE OPERATION, ALWAYS MAKE SURE SUFFICIENT VENTILATION IS PRESENT.
- ALWAYS CHECK THAT GEARBOX IS IN NEUTRAL BEFORE STARTING THE MOTORCYCLE. IF A GEAR IS ENGAGED WHEN STARTING THE MOTORCYCLE, THE LATTER WILL JUMP FORWARD AND MAY CAUSE DAMAGES TO YOURSELF AND TO THE MOTORCYCLE ITSELF.

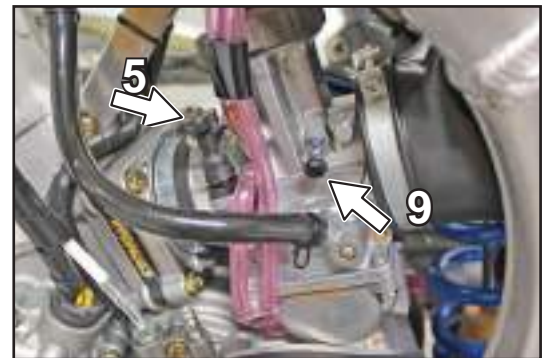
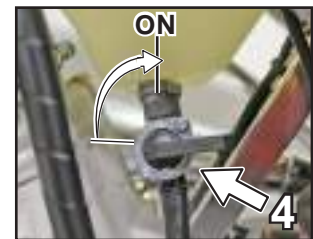

COLD START OF THE MOTORCYCLE

Cold start is intended when the coolant temperature is below 35°C.

- After having performed the preparations for start as described in the paragraphs "Electric start of the motorcycle" and "Kick start of the motorcycle", work as follows before starting the motorcycle:
- Depending on the models, raise the knob (1) or pull the knob (2) and leave it in position.
- Start the motorcycle as described in the relative paragraphs .
- Run the engine accelerating softly, after approx. 1 minute after the engine started, move the knob (1) or (2) back to initial position. If the engine has a low and irregular idle speed (3), , adjust idle speed as described in the relative paragraph "Engine idle speed adjustment".

The engine idle speed will always have to be kept between 1700-1800 rpm. This value also eases the next starts.

⚠ WARNING

Do not make the engine rpm increase too much while it's still cold. This may cause damages to the engine. Always let the engine warm up while stationary or while running at low rpm.

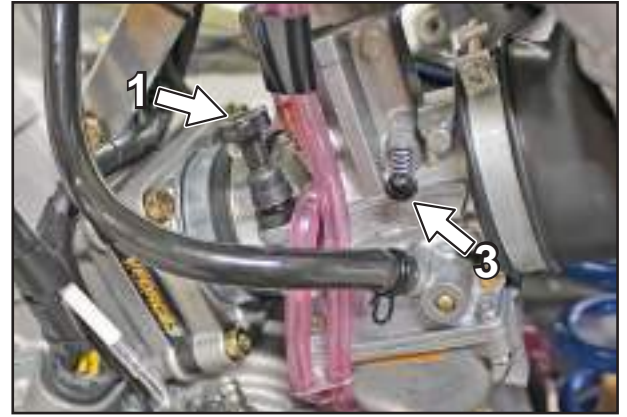

START WITH FLOODED ENGINE

In case of fall while using the motorcycle for sport or competitive reasons, an accidental shutting off of the engine occurs. In case you find difficulties restarting the motorcycle and you smell petrol, that indicates the engine has flooded.

To start the motorcycle, work as follows:

For motorcycle with throttle body (TSI)

1. Position the gearbox lever (1) in neutral.
2. For SMR models, check that the key (2) of the start switch is set to "ON".
3. When the throttle (3) is completely open:

SMR

Press the button (4)

EN

Press and keep pressed the button (4).

Activate the start pedal (5) approximately 5 times from top to bottom at normal speed.

4. When the throttle (3) is completely closed, for **SMR** models, check that the button (4) is in extracted position, then start the motorcycle as described in paragraph "Electric start of the motorcycle"

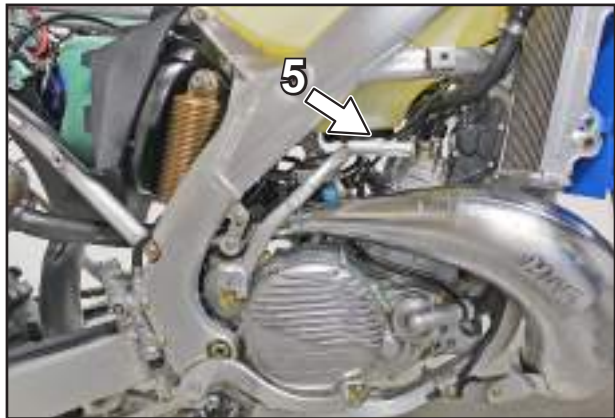
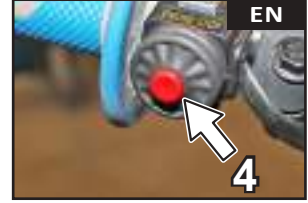
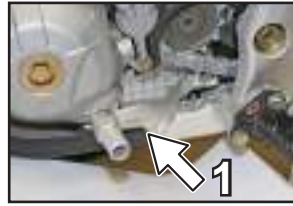

For motorcycle with carburettor (MX and SMX)

1. Position the gearbox lever (1) in neutral.
2. Close the fuel tap (2) in "OFF" position.
3. When the throttle (3) is completely closed, activate the start pedal (4) approximately 5 times from top to bottom at normal speed.
4. Open the fuel tap (2) in "ON" position.
5. When the throttle (3) is completely closed, start the motorcycle as described in paragraph "Electric start of the motorcycle".

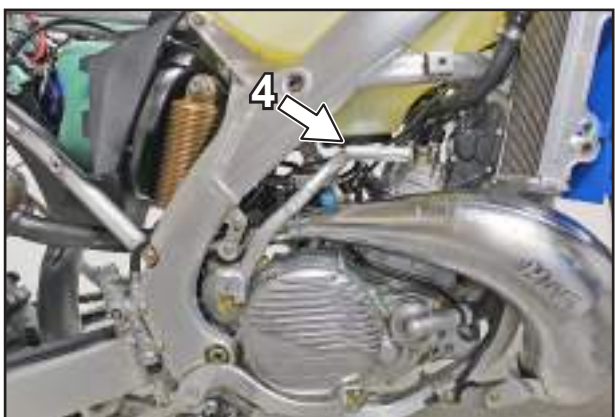
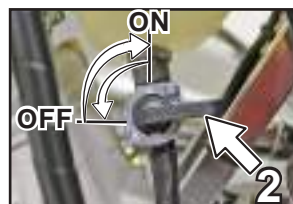

SETTING OFF

Put on a protective helmet and start the engine, then pull the clutch lever, engage 1st gear and slowly release the clutch lever while accelerating.

⚠ DANGER

NEVER RIDE THE MOTORCYCLE WITHOUT WEARING AN APPROVED PROTECTIVE HELMET AND/OR IF YOU ARE NOT IN GOOD PSYCHOLOGICAL AND PHYSICAL HEALTH.

BEFORE SETTING OFF, ALWAYS MAKE SURE THAT THE SIDE STAND IS FULLY RETRACTED. YOU CAN LOSE CONTROL OF THE MOTORCYCLE IF THE STAND DRAGS ON THE GROUND.

ACCELERATING, SHIFTING GEARS, SLOWING DOWN

1st gear, which you are using, is the gear used to set off and to go uphill. When circumstances permit (speed limit, traffic, incline), you can engage higher gears to increase speed. To do so, release the throttle while pulling the clutch lever, engage the next gear, release the clutch and accelerate up to a 1/2 turn of the throttle grip. Then engage the next gear and repeat until you reach the desired speed, always remaining within the limits in force.

Gradually opening the throttle promotes careful driving and limits consumption. Learn how far you need to turn the throttle grip based on the speed at which you want the motorcycle to move.

Release the throttle grip to reduce speed. If necessary, also brake and down shift, pulling the clutch lever and engaging a lower gear. Release the clutch slowly and accelerate or shift gears again. Always move up or down through the gears one at a time!

BRAKING

Release the throttle and, at the same time, gradually brake with the front and rear brakes.

Engage a lower gear if necessary. On dusty, wet or slippery surfaces, use the brakes and down shift as gently as possible without locking the wheels. Locking of the wheels leads to swerving and/or falling.

On long downhill roads, make use of engine braking.

To do so, engage 1st or 2nd gear without excessively increasing the revs. This way, you can brake much less and the brakes will not overheat.

⚠ DANGER

- IN RAIN, AFTER WASHING THE MOTORCYCLE, AFTER IMMERSION IN WATER, OR TRAVELLING OVER WET GROUND, BRAKING COULD BE DELAYED BECAUSE OF WET OR DIRTY BRAKE DISCS. THEREFORE, USE THE BRAKES REPEATEDLY AND CAUTIOUSLY, BEING SURE NOT TO OBSTRUCT TRAFFIC, UNTIL THE DISCS ARE DRY AND CLEAN.
- BRAKING CAN BE DELAYED EVEN WHEN TRAVELLING ON DIRTY ROADS OR ROADS COVERED WITH SALT. AGAIN, USE THE BRAKES REPEATEDLY AND CAUTIOUSLY, BEING SURE NOT TO OBSTRUCT TRAFFIC, UNTIL THE DISCS ARE CLEAN.
- DIRTY BRAKE DISCS CAUSE GREATER WEAR OF THE PADS AND DISCS.
- THE DISC, PADS, CALIPERS, AND BRAKE FLUID HEAT UP AFTER USING THE BRAKES. THE HOTTER THESE PARTS, THE LESS THE BRAKING EFFECT IS. IF OVERHEATING OCCURS, THE WHOLE BRAKING SYSTEM MAY FAIL.
- IF, WHILE BRAKING, THE FRONT BRAKE LEVER OR THE REAR BRAKE PEDAL STROKES ARE LONGER THAN USUAL, THERE IS A FAULT IN THE BRAKING SYSTEM. IN THIS CASE, HAVE AN AUTHORIZED TM WORKSHOP CHECK THE MOTORCYCLE.
- TM MODELS CAN BE RESTARTED ANY TIME WITH THE KICK STARTER OR ELECTRIC START. THEREFORE, TURN OFF THE ENGINE WHEN YOU INTEND TO KEEP THE MOTORCYCLE AT A STANDSTILL FOR MORE THAN 2 MINUTES.
- CHECK THE MOTORCYCLE AFTER EVERY FALL AS YOU DO BEFORE EVERY START-UP.
- A TWISTED HANDLEBAR MUST ALWAYS BE REPLACED. NEVER STRAIGHTEN THE HANDLEBAR, AS IT MAY LOSE ITS STRENGTH.

INFORMATION:

Standard TM motorcycles are not equipped with radiator cooling fans and the radiator dimensions are designed for optimum compactness and weight. The cooling system is sufficient for tourist or sport use. Consult a TM dealer if you want to use optional cooling fans.

⚠ WARNING

- Using the engine at high revs when it is still cold affects the length of engine life. Therefore, before running the engine at full speed, warm it up by driving a few kilometers at medium speed. The engine has reached its operating temperature as soon as the radiators become hot.
- Never down shift without having first slowed down. The engine revs would go too high and some of its components could be damaged. Also, the rear wheel could lock, causing you to lose control of the vehicle.
- If you feel abnormal vibrations while driving, make sure that the fixing screws on the motorcycle are fully tightened.
- If you hear strange noises while riding your motorcycle, stop immediately, turn off the engine and contact a TM dealer.

STOPPING AND PARKING

With the throttle fully released, brake the motorcycle until it stops while pulling the clutch lever. Shift into neutral and release the clutch. Keeping the engine at idle speed, press button (1) (EN), button (2) (MX / SMX) or turn the key (3) (SMR / SMM) to the "⊗" position to stop the engine.

We recommend leaving the red engine start prevention button (4) (EN) pressed in until the next engine start.

Park the motorcycle on solid ground and engage the steering lock, if present.

⚠ DANGER

DURING OPERATION, MOTORCYCLES PRODUCE A LOT OF HEAT. THE ENGINE, RADIATORS, EXHAUST SYSTEM, BRAKE DISCS, AS WELL AS SHOCK ABSORBERS, CAN ALL BECOME VERY HOT. NEVER TOUCH THESE PARTS WHEN DRIVING AND AFTER SWITCHING OFF THE ENGINE. PARK THE MOTORCYCLE IN SUCH A WAY AS TO PREVENT PEDESTRIANS FROM TOUCHING IT AND BURNING THEMSELVES.

⚠ WARNING

- Never park with the engine running or park where there is a risk of fire due to dry grass or other easily flammable material.

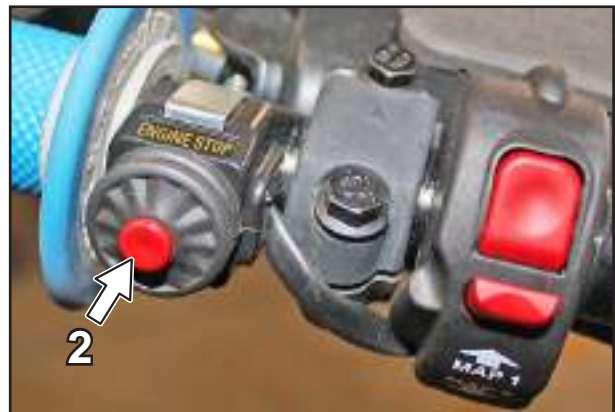

WASHING

- Regularly clean the motorcycle to keep the surface of plastic parts in good condition.
- Use hot water, a cleaning product available on the market and a sponge. Heavy dirt can be removed with a gentle jet of water.
- Plug the exhaust pipe before cleaning to prevent water from going in.
- Remove the air filter as described in the “Maintenance” section.

⚠ WARNING

Do not aim water jets directly at the filter case (1), or water may enter the engine zone.

- Use cleaning products available on the market to wash the engine. Use a suitable brush to clean particularly dirty parts.
- Once you have thoroughly rinsed the motorcycle with a gentle jet of water, dry with compressed air and a cloth. Immediately go for a short ride until the engine reaches the operating temperature and, at this point, also use the brakes. The water left in the areas that cannot be reached and on the brakes will evaporate thanks to the heat.
- Once the motorcycle has cooled down, oil or grease all sliding parts and bearings. Apply a specific spray to the chain.
- Apply a specific spray for contacts to all the electrical controls on the handlebar and electrical system connectors to prevent faults in the electrical system.

⚠ WARNING

Never clean the motorcycle with a high pressure cleaner or with a strong water jet! Otherwise, due to the high pressure, water could reach the electrical parts, connectors, flexible cable controls, bearings, etc. and cause faults or lead to early breakage of these parts.

PRECAUTIONS FOR WINTER USE

If the motorcycle is used in winter, you must consider the salt on the roads and take appropriate measures against the corrosive salt.

- Thoroughly wash the motorcycle after every use and let it dry.
- Apply an anti-corrosion product to the engine, exhaust system, frame, swing arm and all other shiny, galvanized or satin finished metal components (except brake discs).

⚠ DANGER

DO NOT ALLOW THE ANTI-CORROSION PRODUCT TO COME INTO CONTACT WITH THE BRAKE DISCS. THIS WOULD REDUCE THE BRAKING EFFECT CONSIDERABLY.

⚠ WARNING

After traveling on roads where salt has been spread, thoroughly wash the motorcycle with cold water and let it dry completely.

STORAGE

Take the following measures if the motorcycle is to be left unused for a long period:

- Thoroughly clean the motorcycle (see "WASHING").
- Change the gearbox oil. Old oil contains harmful impurities (see the "MAINTENANCE" section).
- Check the coolant level.
- Remove the spark plug and pour approx. 5 cc of engine oil into the cylinder through the spark plug hole. Activate the kick starter 10 times to allow the engine oil to be distributed on the cylinder wall. Then fit the spark plug again.
- Compress the piston to make the exhaust ports close.
- Empty the fuel tank and collect the fuel in a suitable container.
- Disconnect the cables and remove the battery. Plan a maintenance schedule if required.
- Adjust the tire pressure.
- Grease the bearings, control lever and footrest supports and the chain.
- The storage area should be dry and not subject to drastic temperature changes.
- Cover the motorcycle, preferably with a breathable sheet or cover. Do not use airtight materials, as moisture would be trapped and could cause corrosion.
- Place the motorcycle on a stand, so that its wheels are raised off the ground.

WARNING

Before storing the motorcycle for the winter, check the operation and wear of all components. If maintenance operations, repairs or modifications are required, it is a good idea to have them carried out during the winter (workshops are less busy). This means that you avoid long waits in the workshop at the start of the spring season.

WARNING

It is highly inadvisable to start the engine for brief periods of time when the motorcycle has been put into storage. The engine would not heat up sufficiently, and so the steam created during combustion would condense, oxidizing the valves and the exhaust system.

START-UP AFTER WINTER

- Fit the charged battery.
- Fill the tank with new fuel.
- Check the motorcycle as you do before any start-up. Go for a short test ride.

4. MAINTENANCE



250-300 EN-SMR (TSI) MAINTENANCE TABLE

A CLEAN MOTORCYCLE CAN BE INSPECTED FASTER AND AT A LOWER COST

	After 1 hour	Every 15 hours	Every 30 hours (after every ride)	Every 45 hours	Every 135 hours (75 hours of sports use)	Every year
Check steering bearings and play adjustment	•	•	•			
Clean and grease steering bearings and relative sealing elements						•
Bleed telescopic fork		•	•			
Clean dust seal			•			
Check seal and operation of fork and shock absorber			•			
Full fork maintenance				•	•	•
Full shock absorber maintenance				•	•	•
Check tightness of screws and linkage smooth running for rear suspension		•	•			
Check frame and swing arm		•	•			
Check swing arm bearings			•			
Lubricate movable parts (side stand, levers, etc.) and check their movement		•	•			
Check tightness of chassis screws (fork plates, fork feet, wheel pin nuts and screws, swing arm pin, shock absorber)	•	•	•			
Check wear on chain, junction mesh, pinion, sprocket and guides, chain tension		•	•			
Lubricate chain		•	•			
Check fluid level in hydraulic clutch control tank		•	•			
Change hydraulic clutch fluid						•
Check brake fluid level, pad thickness, front and rear brake discs		•	•			
Change front and rear brake fluid						•
Check condition and seal of brake pipes		•	•			
Check operation, adjustment, smoothness and play of front brake lever and rear brake pedal		•	•			
Check tightness of braking system screws		•	•			
Check wheel hubs, spoke tension and rim centering	•	•	•			
Check wheel bearing play		•	•			
Check tire condition and pressure	•	•	•			
Check battery and charge it if necessary		•	•			
Treat battery connections with grease for contacts		•	•			
Treat electrical contacts and switches with spray for contacts		•	•			
Check headlight orientation	•	•	•			
Check electrical system operation (low beam, high beam, stop light, turn signals, control indicators, horn, safety button/switch)		•	•			
Check cooling system seal and coolant level	•	•	•			
Check condition and arrangement of rubber pipes without bends	•	•	•			
Check condition and arrangement of bleeder hoses without bends	•	•	•			
Replace silencer soundproofing material			•			
Check exhaust system seal and fastening	•	•	•			
Clean air filter and filter housing		•	•			
Check condition and seal of throttle body coupler and filter housing		•	•			
Check fuel pressure		•	•			
Check throttle cable play and idle speed adjustment	•	•	•			
Check condition, smoothness and arrangement without bends, adjustment and lubrication of control cables		•	•			
Gearbox oil replacement	•	•	•			

250-300 EN-SMR (TSI) MAINTENANCE TABLE

A CLEAN MOTORCYCLE CAN BE INSPECTED FASTER AND AT A LOWER COST

	After 1 hour	Every 15 hours	Every 30 hours (after every ride)	Every 45 hours	Every 135 hours (75 hours of sports use)	Every year
Clean exhaust screw magnet		•	•			
Check tightness of engine fixing screws	•	•	•			
Replace spark plug and check cap					•	
Check exhaust valves					•	
Check cylinder and piston wear				•		
Fully change piston					•	
Check exhaust valve actuator play			•			
Exhaust valves replacement					•	
Fully change conrod					•	
Check clutch discs				•		
Check clutch springs				•		
Check transmission and gearbox					•	
Mixer oil pump replacement					•	
Fully change engine bearings					•	
Fully change engine oil seal					•	

⚠ WARNING

Change affected components if a defect is found or wear limits exceeded.
The above operations must be performed by an authorized TM workshop or by specialized personnel.
The hour meter is built into the dash.

250-300 (MX - SMX) MAINTENANCE TABLE

A CLEAN MOTORCYCLE CAN BE INSPECTED FASTER AND AT A LOWER COST

	After 1 hour	Every 10 hours (after every ride)	Every 20 hours	Every 30 hours	Every 40 hours	Every 50 hours	Every 75 hours	Every year
Check steering bearings and play adjustment	•	•	•	•	•			
Clean and grease steering bearings and relative sealing elements								•
Bleed telescopic fork		•	•	•	•			
Clean dust seal		•	•	•	•			
Check seal and operation of fork and shock absorber		•	•	•	•			
Full fork maintenance				•				
Full shock absorber maintenance				•				
Check tightness of screws and linkage smooth running for rear suspension		•		•				
Check frame and swing arm		•	•	•	•			
Check swing arm bearings			•		•			
Lubricate movable parts (side stand, levers, etc.) and check their movement		•	•	•	•			
Check tightness of chassis screws (fork plates, fork feet, wheel pin nuts and screws, swing arm pin, shock absorber)	•	•	•	•	•			
Check wear on chain, junction mesh, pinion, sprocket and guides, chain tension		•	•	•	•			
Lubricate chain		•		•				
Check fluid level in hydraulic clutch control tank		•	•	•	•			
Change hydraulic clutch fluid								•
Check brake fluid level, pad thickness, front and rear brake discs		•	•	•	•			
Change front and rear brake fluid								•
Check condition and seal of brake pipes		•	•	•	•			
Check operation, adjustment, smoothness and play of front brake lever and rear brake pedal		•	•	•	•			
Check tightness of braking system screws		•		•				
Check wheel hubs, spoke tension and rim centering	•	•	•	•	•			
Check wheel bearing play		•	•	•	•			
Check tire condition and pressure	•	•	•	•	•			
Check battery and charge it if necessary		•	•	•	•			
Treat battery connections with grease for contacts		•	•	•	•			
Treat electrical contacts and switches with spray for contacts		•	•	•	•			
Check cooling system seal and coolant level	•	•	•	•	•			
Check condition and arrangement of rubber pipes without bends	•	•	•	•	•			
Check condition and arrangement of bleeder hoses without bends	•	•		•				
Replace silencer soundproofing material		•	•	•	•			
Check exhaust system seal and fastening	•	•	•	•	•			
Clean air filter and filter housing		•	•	•	•			

250-300 (MX - SMX) MAINTENANCE TABLE
A CLEAN MOTORCYCLE CAN BE INSPECTED FASTER AND AT A LOWER COST

	After 1 hour	Every 10 hours (after every ride)	Every 20 hours	Every 30 hours	Every 40 hours	Every 50 hours	Every 75 hours	Every year
Check condition and seal of throttle body coupler and filter housing	•	•	•	•	•			
Check throttle cable play and idle speed adjustment	•	•	•	•	•			
Check condition, smoothness and arrangement without bends, adjustment and lubrication of control cables		•	•	•	•			
Gearbox oil replacement	•	•	•	•	•			
Clean exhaust screw magnet	•	•	•	•	•			
Check tightness of engine fixing screws	•	•	•	•	•			
Replace spark plug and check cap							•	
Check exhaust valves				•				
Check cylinder and piston wear				•				
Fully change piston						•		
Exhaust valves replacement							•	
Fully change conrod							•	
Check clutch discs			•		•			
Check clutch springs			•		•			
Check transmission and gearbox							•	
Check exhaust valve actuator play		•						
Fully change engine bearings							•	
Fully change engine oil seal							•	

⚠ WARNING

Change affected components if a defect is found or wear limits exceeded.

We recommend that you fit an hour meter.

The above operations must be performed by an authorized TM workshop or by specialized personnel.





THIS SYMBOL ALONGSIDE THE TITLE MEANS THAT THE OPERATION MUST BE PERFORMED AT AN AUTHORIZED TM WORKSHOP.

FORK COMPRESSION ADJUSTMENT

The compression hydraulic braking system determines the fork compression stroke. The degree of compression hydraulic braking can be adjusted to suit the rider and/or the installed spring rate.

KAYABA USD FORK

The adjusting screw (1) is in the upper part of the fork cap. Use a screwdriver. Turn it clockwise to increase braking, or anti-clockwise to reduce it. There are a total of 19 clicks available.

⚠ WARNING

Do not touch the bleeder screw (2).

⚠ WARNING

Before starting, tighten the adjuster from the standard position to “fully closed” while counting the clicks. Write down the number of clicks counted so that you can restore the standard adjustment if necessary. The clicks are normally indicated from the “fully closed” position. Both tubes must be adjusted in the same way.



STANDARD ADJUSTMENT

MX	12 clicks from fully closed
EN	14 clicks from fully closed
SMR	17 clicks from fully closed
SMX	12 clicks from fully closed

FORK REBOUND ADJUSTMENT

The rebound hydraulic braking system determines the fork rebound stroke. The degree of rebound hydraulic braking can be adjusted to suit the rider and/or the installed spring rate.

KAYABA USD FORK

The adjusting screw (1) is in the lower part of the fork foot. Use a screwdriver. Turn it clockwise to increase braking, or anti-clockwise to reduce it. There are a total of 21 clicks available.

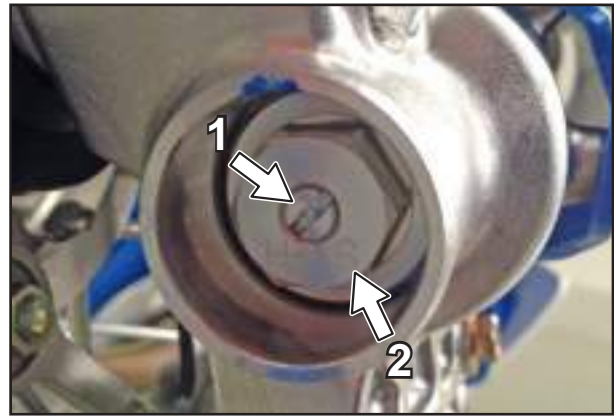

WARNING

Do not touch the hexagon nut (2) as it is not needed to alter rebound braking.

WARNING

Before starting, tighten the adjuster from the standard position to “fully closed” while counting the clicks. Write down the number of clicks counted so that you can restore the standard adjustment if necessary.

The clicks are normally indicated from the “fully closed” position.

Both tubes must be adjusted in the same way.

STANDARD ADJUSTMENT

MX	12 clicks from fully closed
EN	14 clicks from fully closed
SMR	15 clicks from fully closed
SMX	12 clicks from fully closed

VARYING PRE-LOAD AND REPLACING FORK SPRINGS

To vary the spring pre-load on these forks, you must partly disassemble them (see the specific manual of the fork fitted on the motorcycle).

You should absolutely not vary the spring pre-load on forks fitted by TM Racing.

If necessary, replace the springs with others that have a different rate.

⚠ WARNING

For further, more detailed information about the forks, see the instructions supplied by the fork manufacturer.

BLEEDING THE TELESCOPIC FORK

After every 5 hours of competition use, use the bleeder screws or valves to release any overpressure from inside the fork.

KAYABA USD FORK

The Kayaba fork has a screw (1).

- Before using the screw, lift the motorcycle onto a central stand so that the front wheel is not touching the ground.
- Unscrew the screw (1) completely without removing it and bleed the air.
- Tighten the screw (1) again.
- If the motorcycle is mainly used on the road, this operation only needs to be performed during regular maintenance.

⚠ WARNING

Excessive pressure inside the fork may cause oil to leak from the fork. If your fork leaks oil, try bleeding the air before replacing the sealing elements.



CLEANING TELESCOPIC FORK DUST SEAL

NOTE: You must contact a TM dealer to carry out this operation.

The dust seal (1) must prevent dust and dirt from entering the fork oil seal. However, dirt may get behind the dust seal over time. If the dirt is not removed, the oil seal ring, located behind it, may lose its seal.

Use a screwdriver to very carefully separate the dust seal (1) and the scrapper (2) from the outer tube (3) and push it down.

- Carefully clean the dust seal (1), the scrapper (2), the outer tube (3) and the inner tube (4) and liberally oil with silicone spray or with engine oil.
- Then re-fit the dust seal and the scrapper by manually pushing it into the seat in the outer tube.

WARNING

Perform this operation on both of the fork dust seals.

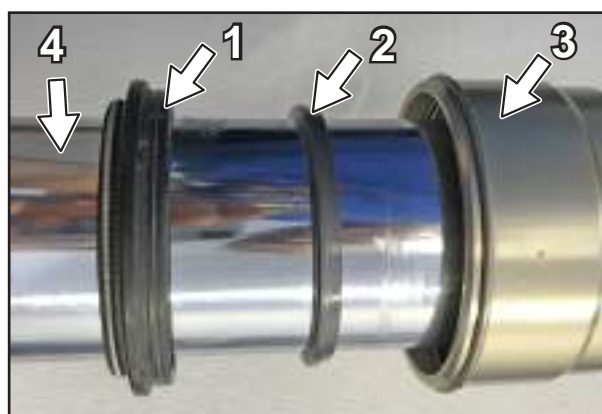

SHOCK ABSORBER COMPRESSION ADJUSTMENT

You can access the adjusting screw on the right-hand side of the motorcycle.

- **Low speeds** The adjusting screw (1) is on top of the shock absorber gas tank. Use a 5 mm Allen key. Turn it clockwise to increase braking, or anti-clockwise to reduce it. There are a total of 24 clicks available.

STANDARD ADJUSTMENT	
MX	16 clicks from fully closed
EN	15 clicks from fully closed
SMX	18 clicks from fully closed
SMR	18 clicks from fully closed

- **High speeds** The hexagon ring adjuster (2) is concentric to the low speed adjusting screw. Use a 14 mm hex wrench. Turn it clockwise to increase braking, or anti-clockwise to reduce it. There are a total of 20 clicks available.



STANDARD ADJUSTMENT

MX	12 clicks from fully closed
EN	12 clicks from fully closed
SMX	8 clicks from fully closed
SMR	16 clicks from fully closed

⚠ WARNING

Before starting, tighten the adjuster from the standard position to “fully closed” while counting the clicks. Write down the number of clicks counted so that you can restore the standard adjustment if necessary. The clicks are normally indicated from the “fully closed” position.

SHOCK ABSORBER REBOUND ADJUSTMENT
TM SHOCK ABSORBER

You can access the adjusting screw on the left-hand side of the motorcycle.

The adjusting screw (1) is on the fork coupling connecting the shock absorber to the linkage. Use a screwdriver. Turn it clockwise to increase braking, or anti-clockwise to reduce it. There are a total of 34 clicks available.

⚠ WARNING

Before starting, tighten the adjuster from the standard position to “fully closed” while counting the clicks. Write down the number of clicks counted so that you can restore the standard adjustment if necessary. The clicks are normally indicated from the “fully closed” position.

STANDARD ADJUSTMENT

MX	22 clicks from fully closed
EN	18 clicks from fully closed
SMX	15 clicks from fully closed
SMR	19 clicks from fully closed

VARYING PRE-LOAD AND REPLACING SHOCK ABSORBER SPRING

The spring pre-load can be varied by turning the adjusting ring. Each 1 turn of the adjusting ring varies the pre-load by 1.5 mm.

To make this operation easy, disassemble and carefully clean the shock absorber.

If pre-load variation is insufficient, you must replace the spring with one that has a different spring rate.

WARNING

Before starting, write down the basic adjustment. For example, how many turns of thread are visible above the adjusting ring.

- Loosen the locknut (1) and rotate the la nut (2).
- Rotate it anticlockwise (from above) to decrease pre-load, rotate it clockwise (from above) to increase pre-load.
- Tighten the locknut (1) after adjustment.

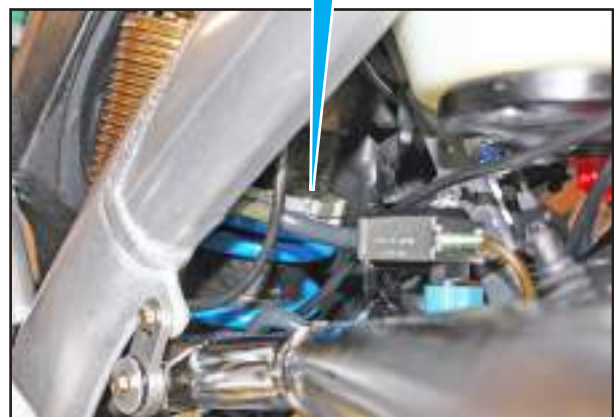
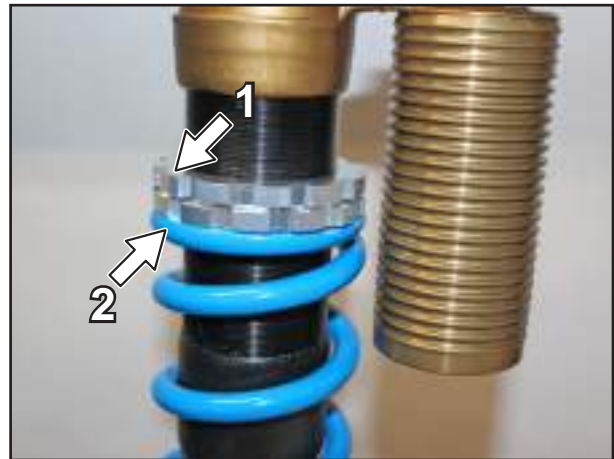

BASIC SUSPENSION CALIBRATION DEPENDING ON THE WEIGHT OF THE RIDER

For optimum motorcycle driving and to prevent the fork, shock absorber, swing arm and frame from being damaged, the basic calibration of the suspensions must be adjusted according to your weight.

The basic calibration of the suspensions (both the fork and shock absorber) involves mounting a certain type of spring and a set of adjustments of the compression and rebound braking.

TM motorcycles come calibrated for a rider weight (with full protective gear) of 70 - 80 kg. Adjust the calibration of the suspensions if your weight does not fall within this range.

The main element to check is the spring, both of the fork and the shock absorber. To check for correct spring rate, first measure the motorcycle rider sag.

Then adjust the compression and rebound braking.

For technical clarification regarding operation and calibration of TM motorcycle suspensions, contact your local TM dealer.

ADAPTING FORK BASIC CALIBRATION

Precise fork rider sag cannot be established for several reasons.

Minor variations in your body weight can be compensated for by adjusting the compression braking.

But if your fork is often bottoming or topping out, you must fit stiffer springs to avoid damaging the fork and frame.

Then re-adjust the compression and rebound braking.

ADAPTING SHOCK ABSORBER BASIC CALIBRATION

To establish whether or not the shock absorber spring is suitable for your weight, check rider sag.

But first the shock absorber static sag must be adjusted.

Both static sag and rider sag can be checked by taking a simple set of measurements on the motorcycle.

CHECKING SHOCK ABSORBER STATIC SAG

Correct shock absorber static sag corresponds to a static lowering of the motorcycle by 35 mm.

Variations exceeding 2 mm may affect motorcycle handling.

Procedure:

- Place the motorcycle on a stand, so that the rear wheel is not touching the ground.
- Measure the distance between the rear wheel pin and a fixed point (e.g.: a reference on a side) making sure that the straight line connecting the wheel pin to the fixed point is as perpendicular to the ground as possible and write down the value as measurement A.
- Place the motorcycle on the ground again.
- Ask someone to keep the motorcycle in an upright position.
- Measure the distance between the rear wheel pin and the fixed point again and write the value down as measurement B.
- The static sag is the difference between measurements A and B.

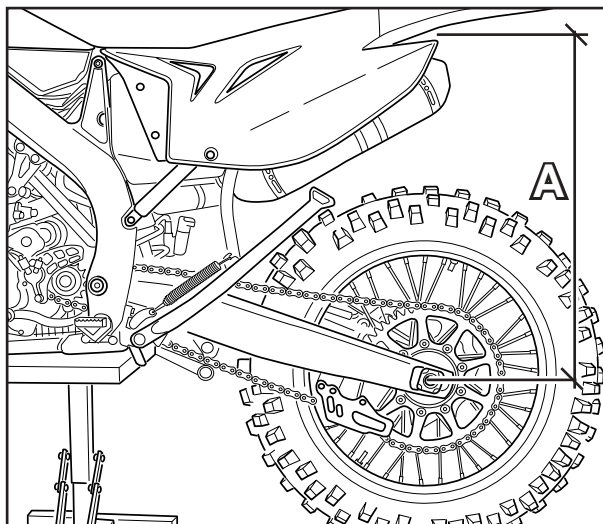

Example:

- Motorcycle on stand (measurement A): 600 mm
- Motorcycle on the ground with no load (measurement B): 565 mm
- Static sag: 35 mm

If the static sag is less than that, reduce the shock absorber spring pre-load.
If the static sag is greater than that, increase the spring pre-load.

See the “Varying pre-load and replacing shock absorber spring” section.

CHECKING SHOCK ABSORBER RIDER SAG

Correct shock absorber rider sag should correspond to a lowering of the motorcycle of 90÷105 mm.

Procedure:

- Ask someone to hold the motorcycle. Sit on the seat wearing full protective gear in the normal position (feet on the footrests) and bounce up and down a few times to allow the rear suspension set-up to settle.
- With the motorcycle loaded in this way, measure the distance between the same measuring points and write the value down as measurement C.
- The rider sag is the difference between measurements A and C.

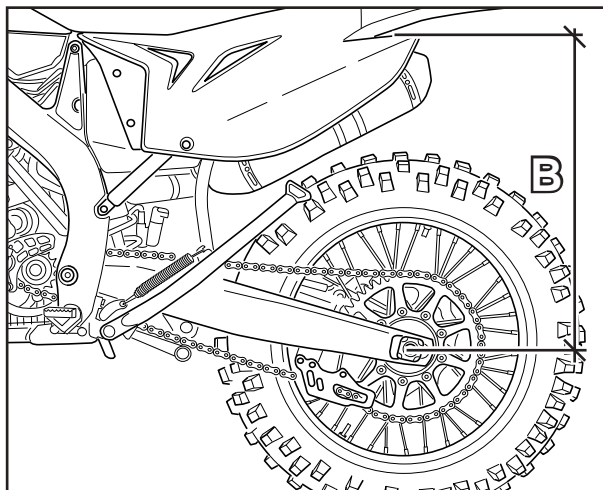

Example:

- Motorcycle on stand (measurement A) 600 mm
- Motorcycle on the ground with rider on it (measurement C) 510 mm
- Rider sag 90 mm

If rider sag is less than 90 mm, the spring is too “hard” (spring rate too high).
If the rider sag is greater than 105 mm, the spring is too “soft” (spring rate too low).

The spring rate is indicated on the spring wire. After fitting a different spring, set the static sag to 35 mm (± 2 mm) again.

In our experience, after replacing the spring with one that has a different spring rate, the degree of compression damping may remain unchanged. With a “softer” spring the degree of rebound damping can be reduced by several clicks, and with a “harder” spring it can be increased by several clicks.

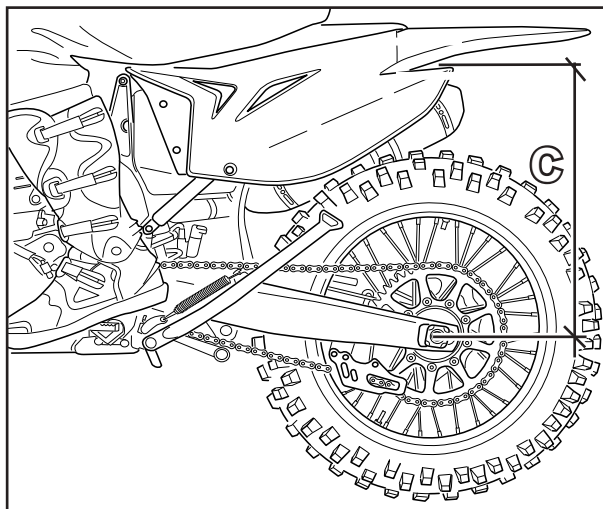

CHECKING STEERING BEARINGS AND PLAY ADJUSTMENT

- Regularly check steering bearing play.
- Position the motorcycle so that the front wheel is raised, turn the handlebar in both directions and move the fork back and forth. If the steering is hard to turn, the bearings are too tight and you need to loosen the ring nut (3). If the steering shakes, the bearings have play and ring-nut (3) must be tightened.
- To adjust, loosen the four M8 screws (1) and nut (2) of the fork head and tighten or loosen ring-nut (3) as necessary. Do not tighten ring nut (3) beyond the play elimination point to avoid damaging the bearings. Tighten the fork head nut and then the four M8 screws to 17 Nm.
- Make sure steering is smooth, without sticking or play.

⚠ DANGER

IF THE STEERING BEARINGS ARE TOO TIGHT OR HAVE PLAY, MOTORCYCLE HANDLING ON THE ROAD WILL BE IRREGULAR AND YOU COULD LOSE CONTROL OF THE MOTORCYCLE.

⚠ WARNING

Long journeys without the correct steering bearing adjustment could ruin the bearings and their seats in the frame. The steering bearings must be re-greased at least once a year.

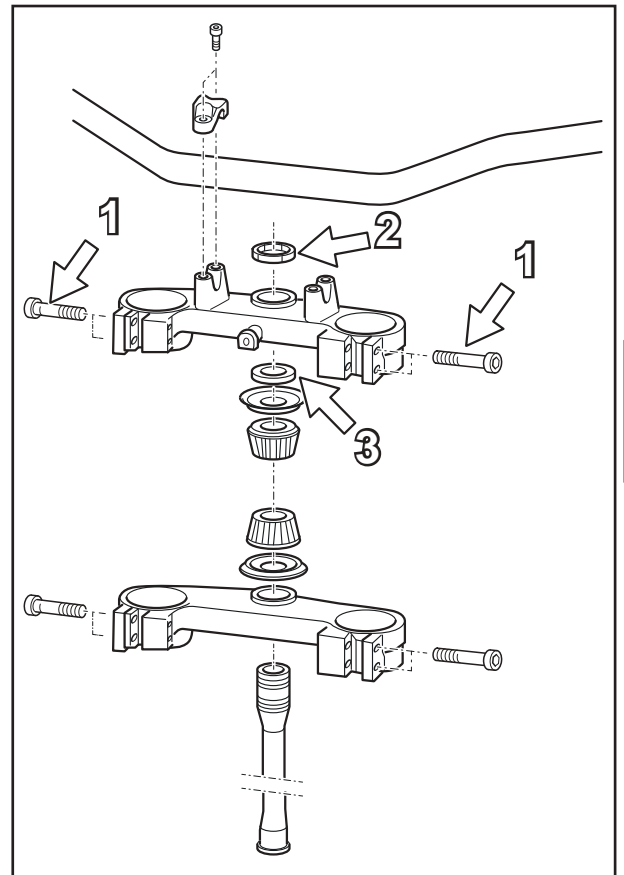
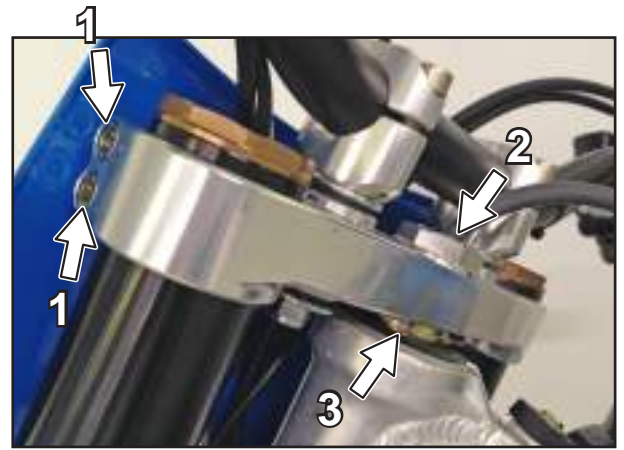



REAR SUSPENSION LINKAGE

The rear suspension of all TM motorcycles is equipped with a conrod and rocker mechanism that gradually modifies the leverage ratio between the wheel and shock absorber.

This mechanism works on the bearings, which must be cleaned and greased at the scheduled intervals to keep suspension operation efficient.

When washing the motorcycle with high pressure cleaners do not direct the jet at the suspension linkage.



CHECKING CHAIN TENSION

- To check chain tension, put the motorcycle up on the center stand.
- Push the chain upwards at the end of the chain guide.

The upper branch of the chain must be taut.

The distance between the swing arm and the lower branch of the chain (A) must be approx. 10 - 15 mm. Adjust the tension if necessary.

⚠ DANGER

- **IF THE CHAIN IS TOO TIGHT, THE FINAL TRANSMISSION COMPONENTS (CHAIN, PINION AND SPROCKET, GEARBOX AND REAR WHEEL BEARINGS) ARE SUBJECT TO MORE STRESS. IN ADDITION TO PREMATURE WEAR, IN EXTREME CASES, THE CHAIN OR THE GEARBOX SECONDARY SHAFT MAY BREAK.**
- **INSTEAD, IF THE CHAIN TENSION IS INSUFFICIENT IT CAN JUMP OFF THE PINION AND LOCK THE REAR WHEEL OR DAMAGE THE ENGINE.**
- **IN BOTH CASES YOU CAN EASILY LOSE CONTROL OF THE MOTORCYCLE.**

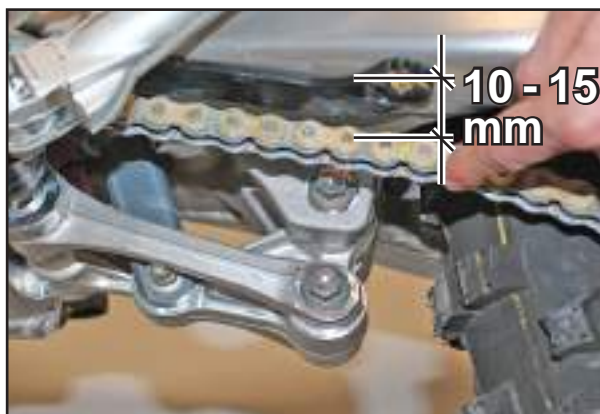

TENSIONING THE CHAIN

- Loosen the wheel pin nut (1), loosen the lock nuts (2) on both sides and turn the adjusting screws (3) on both sides, by the same extent.
- To increase chain tension, unscrew the adjusting screws.
- To reduce chain tension, tighten the adjusting screws. Do this until you achieve the correct chain tension.
- To align the rear wheel correctly, the marks (4) on the right and left chain tensioner must be in the same position relative to the reference marks (5).
- Tighten the lock nuts (2) of the adjusting screws (3).
- Before locking the wheel pin nut, ensure that the chain tensioners (6) are resting on the heads of the adjusting screws and that the rear wheel is aligned with the front wheel.
- Tighten the wheel pin nut (1) to 80 Nm.

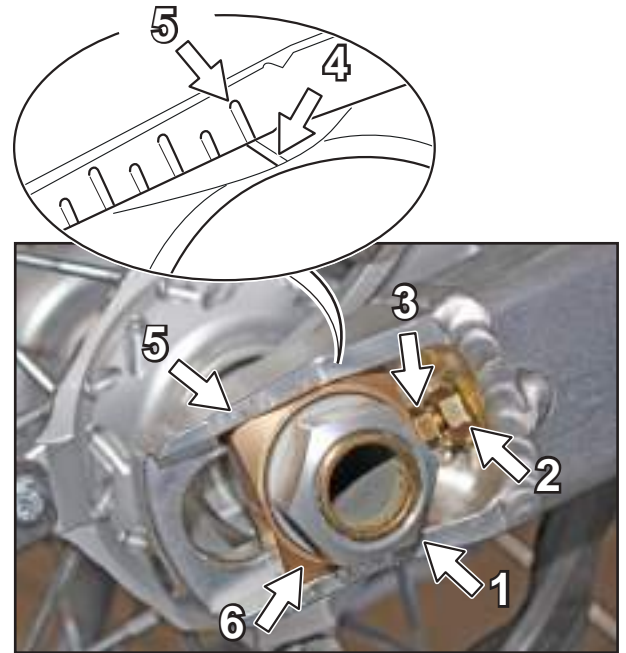

⚠ WARNING

If for assembly operations you do not have a torque wrench, get the tightening torque corrected as soon as possible at a specialized TM workshop. An incorrectly tightened wheel pin may make the motorcycle unstable.

CHAIN MAINTENANCE

The life span of the chain depends above all on maintenance.

Chains without an O-ring must be regularly cleaned in oil and then immersed in hot oil or treated with chain spray.

Maintenance of chains with O-ring is minimal.

The best way to clean it is with plenty of water.

Never use brushes or solvents to clean the chain.

When the chain is dry, use a specific spray for chains with O-rings.

DANGER

IT IS ESSENTIAL TO PREVENT THE LUBRICANT FROM REACHING THE REAR TIRE AND THE BRAKE DISC. OTHERWISE THE REAR WHEEL'S GRIP ON THE GROUND AND THE REAR BRAKE ACTION COULD BE SIGNIFICANTLY REDUCED AND YOU COULD EASILY LOSE CONTROL OF THE MOTORCYCLE.

WARNING

When assembling the chain joint (1), the closed part must always be in the direction of travel.

Always check for wear on the pinions, sprocket and guides. Replace these parts if necessary.

CHAIN WEAR

To check the level of wear on the chain, carefully follow these instructions:

- Shift into neutral, pull the upper branch of the chain upwards with a force of 10 - 15 kg.
- Now measure the distance of 18 links on the lower branch of the chain. If the distance is more than 272 mm, replace the chain.

Chains do not always wear evenly, therefore, you must repeat the measurement at various points of the chain.

When a new chain is fitted, also replace the pinion and sprocket. A new chain wears faster on old and worn pinions and sprocket.

WARNING

When replacing the chain, pinion and sprocket, we recommend fitting new self-locking nuts for the sprocket and using criss-cross tightening.

The nut tightening torque is 35 Nm.

HYDRAULIC CLUTCH PUMP

ADJUSTING THE LEVER POSITION

The position of the clutch lever (1) relative to the grip can be altered using the adjusting knob (2).

- Turn the knob (2) by clicks, clockwise to move the lever away or anti-clockwise to move the lever closer.

⚠ WARNING

When the operation is complete, check that there is some play in the clutch lever before the clutch is engaged.

The play must be around 3 mm.

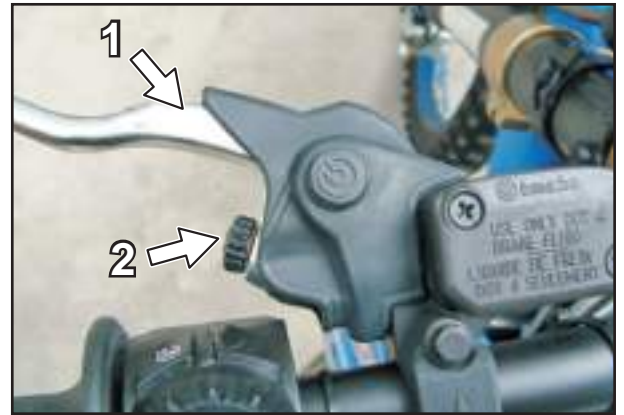

CHECKING AND TOPPING UP THE HYDRAULIC FLUID LEVEL

The fluid reservoir is part of the clutch pump located on the handlebar.

- Remove the screws (3), cover (4), and membrane (5).
- With the reservoir in a horizontal position the fluid level must be 5 mm below the edge.
- Top up if necessary. Use DOT4 brake hydraulic fluid.
- Re-fit the membrane, cover and screws and tighten them. Use water to wash away any hydraulic fluid that overflowed or was spilled.



⚠ DANGER

- **IF THE LEVEL OF THE HYDRAULIC FLUID DROPS BELOW THE PRESET LEVEL, THERE COULD BE LEAKS IN THE SYSTEM OR EARLY SIGNS OF A MECHANICAL PROBLEM.**
- **STORE HYDRAULIC FLUID OUT OF THE REACH OF CHILDREN.**
- **HYDRAULIC FLUID MAY IRRITATE SKIN. AVOID CONTACT WITH SKIN AND EYES. IF HYDRAULIC FLUID SPLASHES IN YOUR EYES, RINSE THOROUGHLY WITH WATER AND SEEK MEDICAL ADVICE.**

⚠ WARNING

- Only use DOT4 brake hydraulic fluid for the clutch hydraulic control. Never use DOT5 or other fluids.
- Prevent contact between brake hydraulic fluid and painted parts. Brake fluid corrodes paint.
- Only use clean brake fluid from a hermetically sealed container.



BLEEDING THE HYDRAULIC CLUTCH

- Remove the cover of the clutch pump on the handlebar to bleed the air.
- Connect the suction device to the bleeder screw (1) of the clutch cylinder on the engine and activate it while loosening bleeder screw (1). Continue until only fluid comes out of the bleeder screw (1).
- Tighten the bleeder screw (1).
- Disconnect the suction device.
During this operation make sure that the clutch pump reservoir level is always sufficient to prevent the pump from drawing air. Top up with DOT4 brake hydraulic fluid as required.



⚠ WARNING

- Use DOT4 brake hydraulic fluid for the clutch hydraulic control. Never use DOT5 or other fluids.
- Prevent contact between brake fluid and painted parts. Brake fluid corrodes paint.
- Only use clean brake fluid from a hermetically sealed container.



BASIC INDICATIONS FOR TM DISC BRAKES

CALIPERS

EN and MX models have floating front and rear calipers, i.e.: they are not joined to their support. Side compensation always allows the pads to rest on the discs in the optimum way.

In contrast, SMR/SMX models front calipers are fixed.

The brake caliper supporting screws must be secured with Loctite 243 and tightened to 25 Nm.

PADS

The minimum thickness of the friction material must never drop below 1 mm. In the event of replacement, we recommend that you always use the specific TM original spare part for your motorcycle.

BRAKE DISCS

- Wear reduces the thickness of the brake disc in the pad contact surface (1) zone.
- At their thinnest point (A), brake discs must have a thickness greater than the minimum thickness measurement "A" stamped on the disc.

⚠ DANGER

- BRAKE DISCS WHOSE THICKNESS IS LESS THAN THAT STAMPED ON THE DISC ARE A SAFETY RISK. WHEN THE WEAR LIMIT IS REACHED, REPLACE THE BRAKE DISCS IMMEDIATELY.
- HAVING THE BRAKING SYSTEM REPAIRED BY AN AUTHORIZED TM WORKSHOP IS MANDATORY.

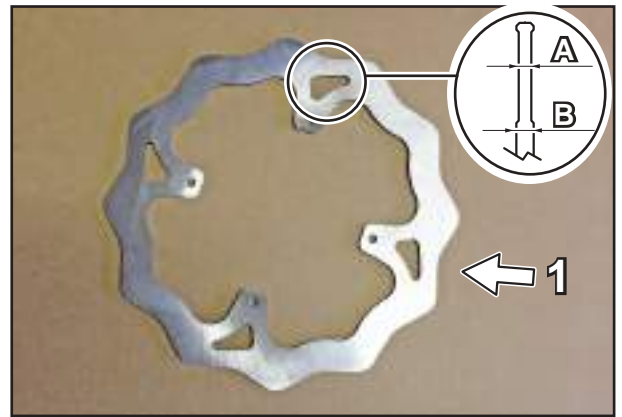

BRAKE FLUID RESERVOIRS

The brake fluid reservoirs for the front and rear brake are sized so that topping up is not necessary even if the brake pads are worn. In fact, as the pads wear, the fluid in the pipes takes up the space left by the pistons which have shifted to allow the pad to always rest on the disc. If the brake fluid level drops below the minimum value, this means that there is a leak in the braking system or that the brake pads are worn beyond the limits allowed.

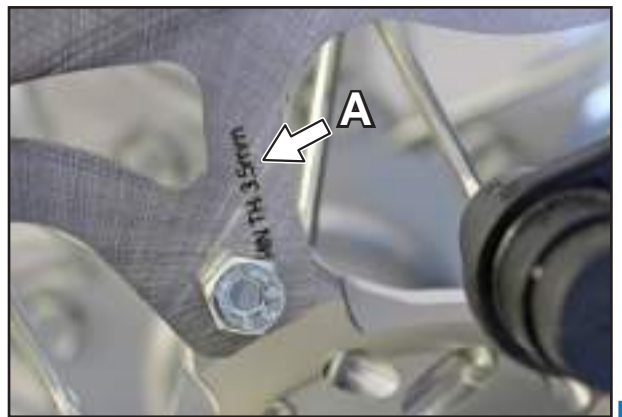

BRAKE FLUID

TM fills the braking systems with top quality DOT 4 brake fluid. We recommend topping up and full changes with the same type of fluid (DOT 4).

⚠ DANGER

CHANGE THE BRAKE FLUID AT LEAST ONCE A YEAR. CHANGE IT MORE OFTEN IF YOU FREQUENTLY WASH YOUR MOTORCYCLE. BRAKE FLUID ABSORBS MOISTURE. THEREFORE, STEAM BUBBLES CAN FORM IN "OLD" FLUID EVEN AT LOW TEMPERATURES AND THE BRAKING SYSTEM NO LONGER WORKS CORRECTLY.

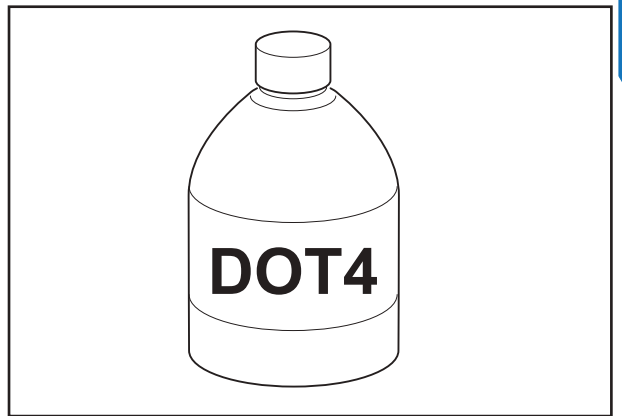

NISSIN FRONT BRAKE PUMP

ADJUSTING THE LEVER POSITION

The position of the front brake lever relative to the grip can be altered using the adjusting screw (1).

- Move the rubber protective cover (2).
- Loosen the lock nut (3) and turn the screw clockwise to move the lever away or anti-clockwise to move the lever closer.
- Tighten the lock nut (3) again.

⚠ WARNING

When the operation is complete, check that there is 3 mm of play in the front brake lever before the brake is engaged and that the front wheel can turn freely with the lever at rest. If this play is missing, pressure builds in the braking system and the front wheel brake may fail due to overheating or the wheel locking.



CHECKING BRAKE FLUID LEVEL

The fluid reservoir is part of the front brake pump located on the handlebar and is equipped with an inspection indicator (4). With the reservoir in the horizontal position, the fluid level must never drop below the indicator center line.

⚠ DANGER

IF THE BRAKE FLUID LEVEL DROPS BELOW THE MINIMUM VALUE, THIS MEANS THERE IS A LEAK IN THE BRAKING SYSTEM OR THAT THE BRAKE PADS ARE WORN BEYOND THE LIMITS ALLOWED.

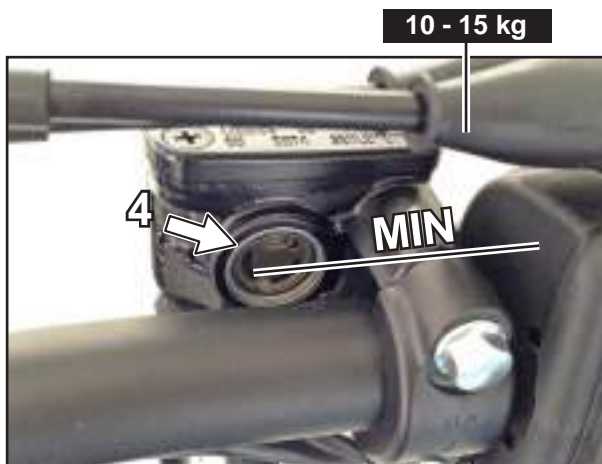

TOPPING UP BRAKE FLUID

- Remove the screws (5), cover (6), and membrane (7).
- Place the reservoir in a horizontal position and top up with DOT4 brake fluid, up to the top limit of the inspection indicator (3).
- Re-fit the membrane, cover and screws and tighten them. Use water to wash away any brake fluid that overflowed or was spilled.



⚠ DANGER

- STORE BRAKE FLUID OUT OF THE REACH OF CHILDREN.
- BRAKE FLUID MAY IRRITATE SKIN. AVOID CONTACT WITH SKIN AND EYES. IF BRAKE FLUID SPLASHES IN YOUR EYES, RINSE THOROUGHLY WITH WATER AND SEEK MEDICAL ADVICE.

⚠ WARNING

- Prevent contact between brake fluid and painted parts. Brake fluid corrodes paint.
- Only use clean brake fluid from a hermetically sealed container.

BREMBO FRONT BRAKE PUMP (OPTIONAL)**ADJUSTING THE LEVER POSITION**

The position of the front brake lever relative to the grip can be altered using the adjusting screw (1).

- Turn the knob (1) clockwise to move the lever away or anti-clockwise to move the lever closer.

⚠ WARNING

When the operation is complete, check that there is 3 mm of play in the front brake lever before the brake is engaged and that the front wheel can turn freely with the lever at rest. If this play is missing, pressure builds in the braking system and the front wheel brake may fail due to overheating or the wheel locking.

CHECKING BRAKE FLUID LEVEL

The fluid reservoir is part of the front brake pump located on the handlebar and is equipped with an inspection indicator (2). With the reservoir in the horizontal position, the fluid level must never drop below the indicator center line.

⚠ DANGER

IF THE BRAKE FLUID LEVEL DROPS BELOW THE MINIMUM VALUE, THIS MEANS THERE IS A LEAK IN THE BRAKING SYSTEM OR THAT THE BRAKE PADS ARE WORN BEYOND THE LIMITS ALLOWED.



TOPPING UP BRAKE FLUID

- Remove the screws (3), cover (4), and membrane (5).
- Place the reservoir in a horizontal position and top up with DOT4 brake fluid, up to the top limit of the inspection indicator (2).
- Re-fit the membrane, cover and screws and tighten them.
- Use water to wash away any brake fluid that overflowed or was spilled.

⚠ DANGER

- STORE BRAKE FLUID OUT OF THE REACH OF CHILDREN.
- BRAKE FLUID MAY IRRITATE SKIN. AVOID CONTACT WITH SKIN AND EYES. IF BRAKE FLUID SPLASHES IN YOUR EYES, RINSE THOROUGHLY WITH WATER AND SEEK MEDICAL ADVICE.

⚠ WARNING

- Prevent contact between brake fluid and painted parts. Brake fluid corrodes paint.
- Only use clean brake fluid from a hermetically sealed container.

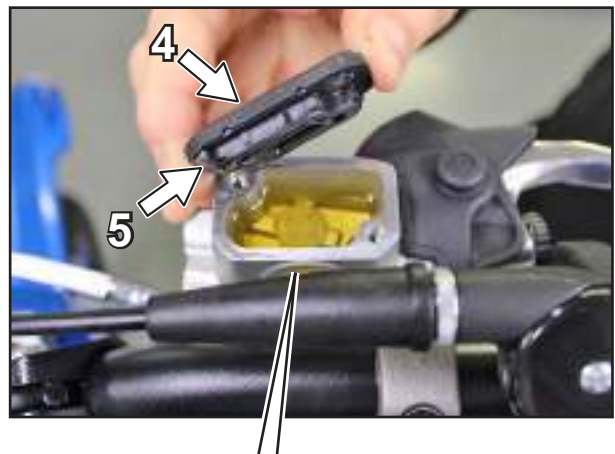
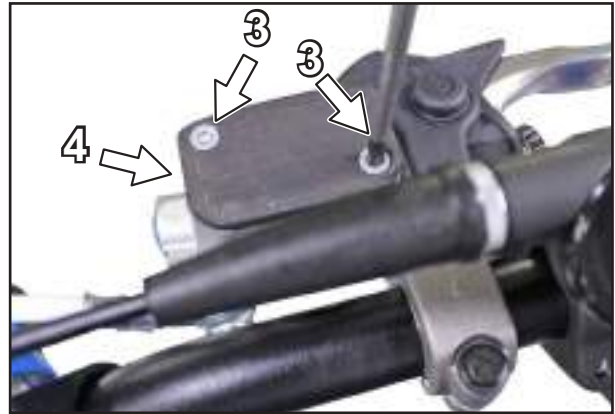

BREMBO RADIAL FRONT BRAKE PUMP (SMR)
ADJUSTING THE LEVER POSITION

The position of the front brake lever relative to the grip can be altered using the adjusting ring (1). Turn it clockwise to move the lever away, or anti-clockwise to move the lever closer.

⚠ WARNING

- When the operation is complete, check that there is at least 3 mm of play in the front brake lever before the brake is engaged and that the front wheel can turn freely with the lever at rest. If this play is missing, pressure builds in the braking system and the front wheel brake may fail due to overheating or the wheel locking.

CHECKING BRAKE FLUID LEVEL

The fluid reservoir (2) is transparent and allows fluid level inspection. With the reservoir in an upright position, the fluid level must always be between the MAX and MIN indications.

⚠ DANGER

- **IF THE BRAKE FLUID LEVEL DROPS BELOW THE MINIMUM VALUE, THIS MEANS THERE IS A LEAK IN THE BRAKING SYSTEM OR THAT THE BRAKE PADS ARE WORN BEYOND THE LIMITS ALLOWED.**

TOPPING UP BRAKE FLUID

Unscrew and remove the cover (3) and the membrane (4). Place the reservoir in a vertical position and top up with DOT4 brake fluid, up to the MAX limit on the reservoir. Refit the membrane and cover, then tighten them.

Use water to wash away any brake fluid that overflowed or was spilled.

⚠ DANGER

- **STORE BRAKE FLUID OUT OF THE REACH OF CHILDREN.**
- **BRAKE FLUID MAY IRRITATE SKIN. AVOID CONTACT WITH SKIN AND EYES. IF BRAKE FLUID SPLASHES IN YOUR EYES, RINSE THOROUGHLY WITH WATER AND SEEK MEDICAL ADVICE.**

⚠ WARNING

- Prevent contact between brake fluid and painted parts. Brake fluid corrodes paint.
- Only use clean brake fluid from a hermetically sealed container.



BREMBO 16X18 RADIAL FRONT BRAKE PUMP (SMX)

ADJUSTING THE LEVER POSITION

The position of the front brake lever relative to the grip can be altered using the adjusting wheel (1). Turn it clockwise to move the lever away, or anti-clockwise to move the lever closer.

⚠ WARNING

- When the operation is complete, check that there is 3 mm of play in the front brake lever before the brake is engaged and that the front wheel can turn freely with the lever at rest. If this play is missing, pressure builds in the braking system and the front wheel brake may fail due to overheating or the wheel locking.



CHECKING BRAKE FLUID LEVEL

The fluid reservoir (2) is transparent and allows fluid level inspection. With the reservoir in an upright position, the fluid level must always be between the MAX and MIN indications.

⚠ DANGER

- IF THE BRAKE FLUID LEVEL DROPS BELOW THE MINIMUM VALUE, THIS MEANS THERE IS A LEAK IN THE BRAKING SYSTEM OR THAT THE BRAKE PADS ARE WORN BEYOND THE LIMITS ALLOWED.



TOPPING UP BRAKE FLUID

Unscrew and remove the cover (3) and the membrane (4). Place the reservoir in a vertical position and top up with DOT4 brake fluid, up to the MAX limit on the reservoir. Refit the membrane and cover, then tighten them. Use water to wash away any brake fluid that overflowed or was spilled.

⚠ DANGER

- STORE BRAKE FLUID OUT OF THE REACH OF CHILDREN.
- BRAKE FLUID MAY IRRITATE SKIN. AVOID CONTACT WITH SKIN AND EYES. IF BRAKE FLUID SPLASHES IN YOUR EYES, RINSE THOROUGHLY WITH WATER AND SEEK MEDICAL ADVICE.

⚠ WARNING

- Prevent contact between brake fluid and painted parts. Brake fluid corrodes paint.
- Only use clean brake fluid from a hermetically sealed container.



CHANGING BASIC POSITION OF REAR BRAKE PEDAL

Loosen the lower lock nut M6 (1), turn the adjusting screw using the hexagonal head (2). Once you have found the ideal position, tighten the lock nut.

The pedal play is given by the pump piston stroke. Check that the pedal has approximately 1.5 cm of play before braking starts.

⚠ WARNING

- If this play is missing, pressure builds in the braking system and braking is applied on the rear wheel. The braking system overheats and, in extreme cases, it can fail completely.

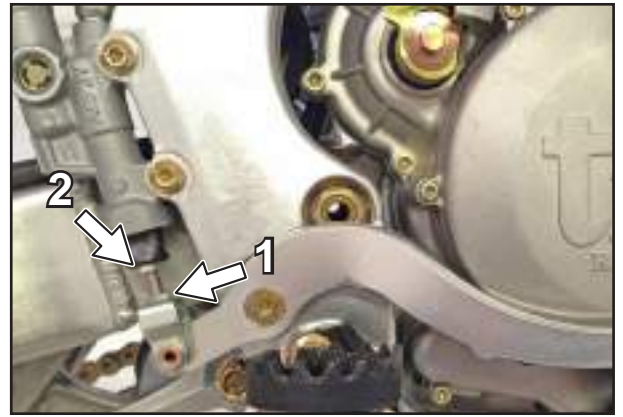

CHECKING REAR BRAKE FLUID LEVEL

The rear disc brake fluid reservoir is built into the rear brake pump. With the motorcycle upright, the level must always be over the center line of the indicator (1) on the pump body.

⚠ DANGER

- IF THE BRAKE FLUID LEVEL DROPS BELOW THE MINIMUM VALUE, THIS MEANS THERE IS A LEAK IN THE BRAKING SYSTEM OR THAT THE BRAKE PADS ARE COMPLETELY WORN AWAY.



TOPPING UP REAR BRAKE FLUID

Top-up as soon as the rear brake fluid level reaches the center line of the indicator on the pump body. To do so, unscrew the two screws (1) and remove the cover (2). Top up with DOT4 brake fluid, to the end of the indicator. Re-fit the cover and tighten the screws.

Use water to wash away any brake fluid that overflowed or was spilled.

⚠ DANGER

- STORE BRAKE FLUID OUT OF THE REACH OF CHILDREN.
- BRAKE FLUID MAY IRRITATE SKIN. AVOID CONTACT WITH SKIN AND EYES. IF BRAKE FLUID SPRAYS IN YOUR EYES, RINSE THOROUGHLY WITH WATER AND SEEK MEDICAL ADVICE.

⚠ WARNING

- Prevent contact between brake fluid and painted parts. Brake fluid corrodes paint !
- Only use clean brake fluid from a hermetically sealed container.



CHECKING FRONT BRAKE PADS

Check the brake pads from below. The thickness of the brake pad friction material must not be less than 1 mm. Replace the pads as soon as they reach this limit.

⚠ DANGER

- THE THICKNESS OF THE BRAKE PAD FRICTION MATERIAL MUST NOT BE LESS THAN 1 MM, OTHERWISE THE BRAKES MAY FAIL. REPLACE BRAKE PADS PROMPTLY TO ENSURE YOUR SAFETY.

⚠ WARNING

- If the brake pads are not replaced in time, they will be completely worn away and the steel parts of the pads will rub against the brake disc. This will significantly reduce the braking effect and deteriorate the disc.

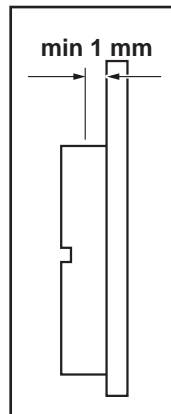

EN / MX FRONT

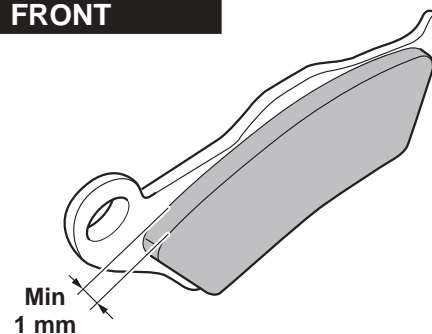

SMR / SMX FRONT

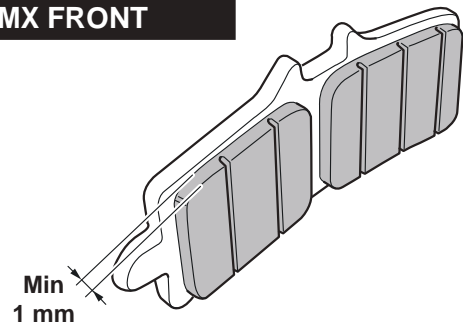

SMX FRONT 108 FUSA

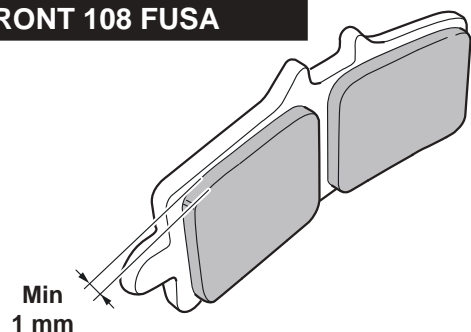

SMR FRONT 108 CNC

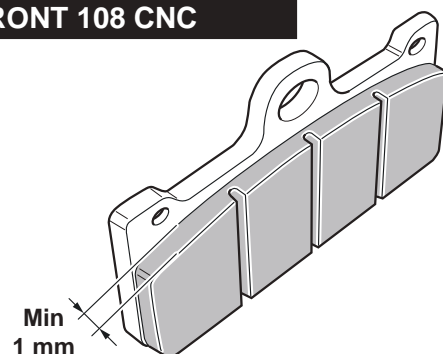

CHECKING REAR BRAKE PADS

Check the brake pads from the rear. The thickness of the brake pad friction material must not be less than 1 mm. Replace the pads as soon as they reach this limit.

⚠ DANGER

- **AT THE THINNEST POINT THE THICKNESS OF THE BRAKE PAD FRICTION MATERIAL MUST NOT BE LESS THAN 1 MM, OTHERWISE THE BRAKES MAY FAIL. REPLACE BRAKE PADS PROMPTLY TO ENSURE YOUR SAFETY.**

⚠ WARNING

- If the brake pads are not replaced in time, they will be completely worn away and the steel parts of the pads will rub against the brake disc. This will significantly reduce the braking effect and deteriorate the disc.

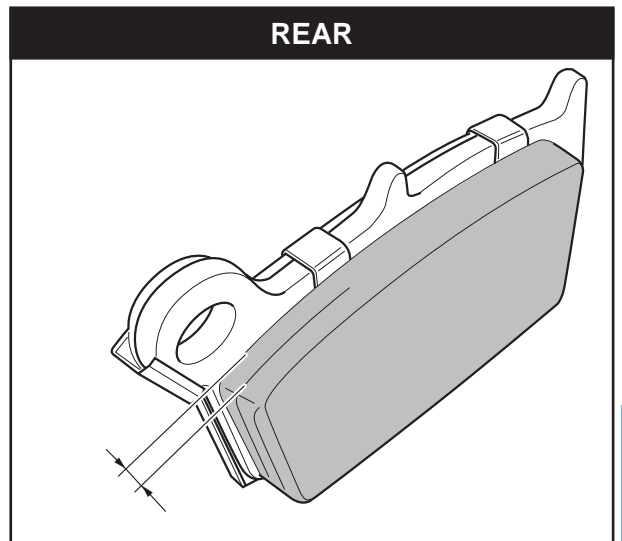
**REAR**

⚠ WARNING

- For all models: when the pistons are returned to their standard position to make way for the new pads, make sure that the fluid in the reservoir has room to expand. Do not carry out work without the cap fitted, otherwise as it expands the fluid could overflow, damaging parts of the motorcycle.



REPLACING FRONT BRAKE PADS

FOR MODELS WITH FLOATING CALIPER (EN/MX)

Take off the two clips (1), pull out pin (2) and remove the pads (3) from the caliper. Clean the brake caliper and the caliper support with compressed air. Also check that the linings of the guide pins are intact and run smoothly. Grease them if necessary.

Clean the pistons, open the pump reservoir, then push them towards the outside of the caliper to make room for the new pads.

Fit the right-hand brake pad and secure it with the pin. Fit the left-hand brake pad and insert the pin as far as the stop. Fit the clips. Make sure that while fitting the pads the sliding plate in the caliper support and the leaf spring are positioned correctly.

⚠ WARNING

- Do not operate the brake lever while removing the pads.
- Check that the pump reservoir oil level is correct. If necessary, top up as indicated in the relevant paragraph.

FOR MODELS WITH FUSA FIXED CALIPER (SMR/SMX)

Radial connection

- Unscrew the two M10 screws (1) and remove the caliper (2) from the foot. Take out the pads (3).
- Clean the pistons, then push them towards the outside of the caliper to make room for the new pads.

⚠ WARNING

- Do not operate the brake lever while removing the pads.
- Check that the pump reservoir oil level is correct. If necessary, top up as indicated in the relevant paragraph.
- Fit the pads correctly.
- Fit the caliper and tighten the M10 screws to 40Nm.

FOR MODELS WITH FIXED CALIPER MACHINED FROM SOLID METAL (OPT. SMX)

Radial connection

- Remove the clip (1) and extract the pin (2). Take out the worn pads.
- Clean the pistons, then push them towards the outside of the caliper to make room for the new pads.
- Insert the new pads.
- Fit the pin and the clip.

⚠ DANGER

- AFTER ASSEMBLY, CHECK THAT THE SAFETY DEVICES ARE CORRECTLY POSITIONED.
- AFTER ANY WORK ON THE BRAKING SYSTEM, OPERATE THE FRONT BRAKE LEVER TO MAKE THE PADS ADHERE TO THE DISC AND CHECK THE BRAKE FLUID LEVEL AND THE PLAY.
- ALWAYS KEEP THE BRAKE DISC COMPLETELY FREE OF OIL AND GREASE, OTHERWISE THE BRAKING EFFECT WOULD BE SIGNIFICANTLY REDUCED.

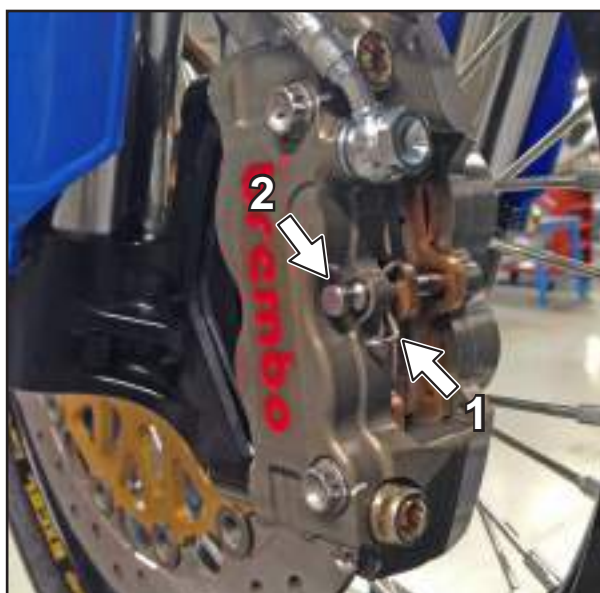
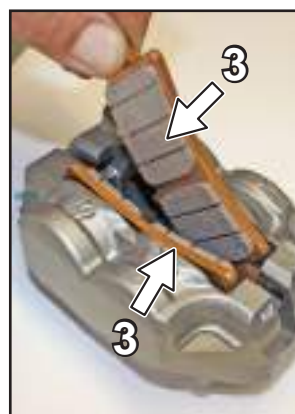
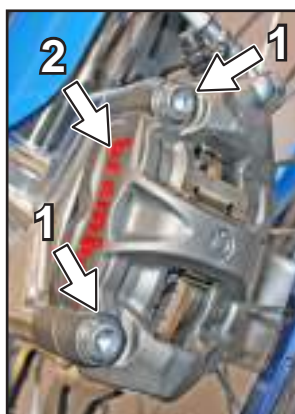



REPLACING REAR BRAKE PADS

FOR MODELS WITH FLOATING CALIPER (EN/MX/SMR/SMX)

- Open the brake pump reservoir by unscrewing the screws (1).
- Push the brake caliper (2) towards the disc, so that the piston returns to its standard position. Remove the cap (3) with a screwdriver and unscrew the pin (4) then remove the brake pads.
- Clean the pistons, then push them towards the outside of the caliper to make room for the new pads.
- Be careful of the fins (5) between the pads: they must be re-fitted with the greatest of care. Thoroughly clean the brake caliper with compressed air and check that the surface of the guide pins is intact.
- Fit the new pads, paying attention to the position of the fins. Insert the pin and tighten it. Re-fit the cap using a screwdriver. Tighten it securely.

⚠ WARNING

- Do not operate the brake pedal while removing the pads.
- Check that the pump reservoir oil level is correct. If necessary, top up as indicated in the relevant paragraph.

⚠ DANGER

- AFTER ASSEMBLY, CHECK THAT THE SAFETY DEVICES ARE CORRECTLY POSITIONED.
- AFTER ANY WORK ON THE BRAKING SYSTEM, OPERATE THE REAR BRAKE PEDAL TO MAKE THE PADS ADHERE TO THE DISC AND CHECK THE BRAKE FLUID LEVEL AND THE PLAY.
- ALWAYS KEEP THE BRAKE DISC COMPLETELY FREE OF OIL AND GREASE, OTHERWISE THE BRAKING EFFECT WOULD BE SIGNIFICANTLY REDUCED.

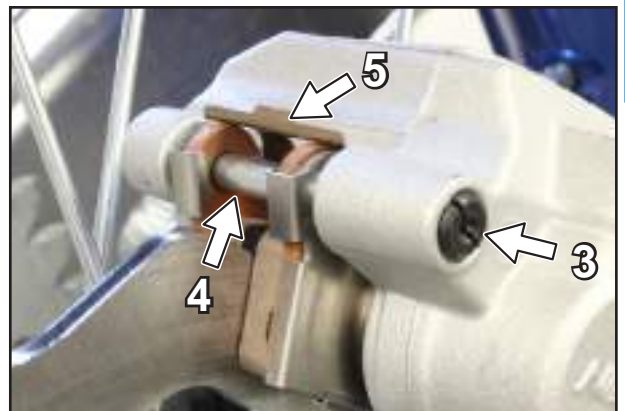

DISASSEMBLING AND ASSEMBLING FRONT WHEEL

- Position the motorcycle with the frame cradle on a stand to keep the front wheel off the ground.
- Loosen the aluminum flanged screw (1), loosen fixing screws (2) and (3) on the left and right fork feet and finish unscrewing the flanged screw (1).
- Hold the front wheel still and slide out the wheel pin (4).
If necessary, help the pin out by tapping the threaded end of the pin with a mallet (hammer with plastic head).
Alternatively, use a normal hammer, placing a pin punch in between.

⚠ WARNING

Never use the hammer directly on the pin. It could cause irreversible damage.

- Carefully remove the front wheel from the fork.

⚠ WARNING

- Never operate the brake lever when the front wheel has been removed.
- Always lay the wheel flat with the brake disc upwards to avoid damaging it.
- To re-fit the front wheel, carefully insert it in the fork, ensuring that you correctly insert the disc between the brake pads without damaging them. With the wheel correctly positioned, insert the wheel pin (4), positioning the spacer (5) on the left-hand part of the wheel.
- Screw in and temporarily tighten the flanged screw (1) until the wheel shim is locked. Tighten the locking screws (2) on the right-hand fork foot to prevent the wheel pin from turning and tighten the flanged screw to 40 Nm.
- Tighten the locking screws (3) on the left-hand fork foot to 12 Nm.
- Loosen the locking screws (2) on the right-hand foot again and remove the motorcycle from the stand. Operate the front brake and force the fork down several times to align its tubes.
- Definitely tighten the locking screws (2) on the right-hand fork foot to 12 Nm.

⚠ DANGER

- **IF FOR ASSEMBLY OPERATIONS YOU DO NOT HAVE A TORQUE WRENCH, GET THE TIGHTENING TORQUE CHECKED AS SOON AS POSSIBLE AT A SPECIALIZED TM WORKSHOP. AN INCORRECTLY TIGHTENED WHEEL PIN MAY MAKE THE MOTORCYCLE UNSTABLE.**
- **AFTER FITTING THE FRONT WHEEL, REPEATEDLY OPERATE THE BRAKE LEVER TO MAKE THE PADS ADHERE TO THE DISC AGAIN AND CHECK THE BRAKE FLUID LEVEL.**
- **ALWAYS KEEP THE BRAKE DISC FREE OF OIL AND GREASE. OTHERWISE THE BRAKING EFFECT WOULD BE SIGNIFICANTLY REDUCED.**

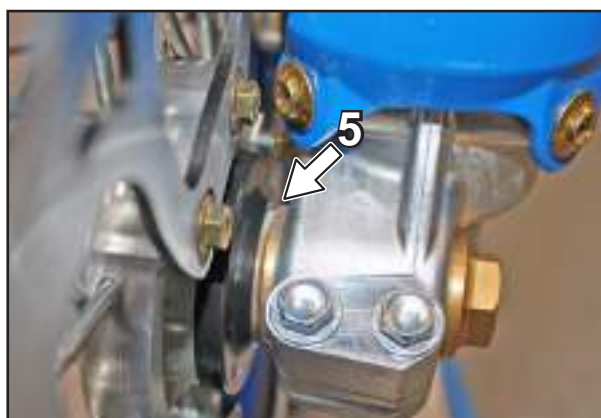
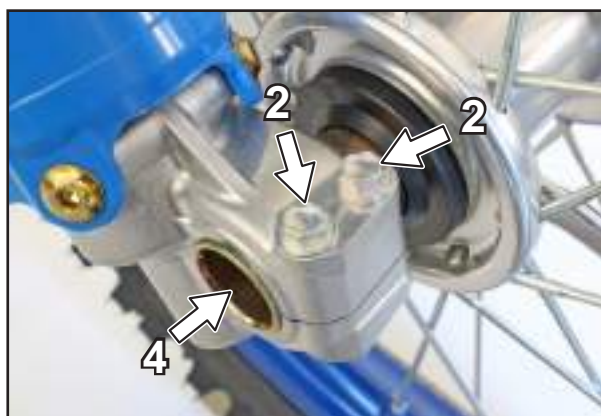
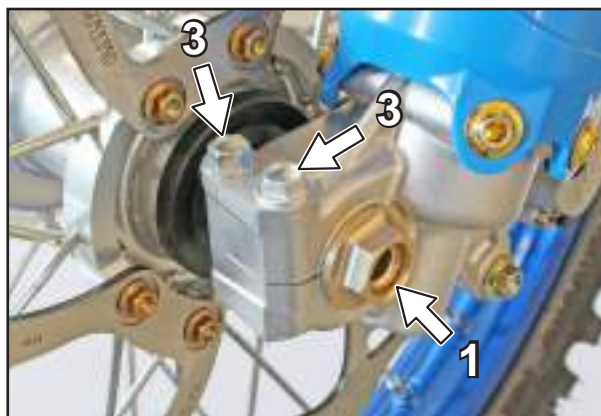

DISASSEMBLING AND ASSEMBLING REAR WHEEL

- Position the motorcycle with the frame cradle on a stand to keep the rear wheel off the ground. Unscrew the flanged nut (1) and, holding up the wheel, slide out the wheel pin (2), remove the chain tensioner slide (3) and the caliper (4) with its support, take the chain off the sprocket, and carefully remove the rear wheel from the swing arm. Pay attention to the wheel shims (5) on the sprocket side and the brake side.

⚠ WARNING

- Never operate the brake pedal when the rear wheel has been removed.
- Always lay the wheel flat with the brake disc upwards to avoid damaging it.
- When the wheel pin is removed, thoroughly clean the thread of both the wheel pin and the flanged nut, and re-grease them to prevent the thread from seizing.

⚠ WARNING

- Re-fit the spacers (5) as indicated in table "A".

Table - A		
	A	B
SMX	9 mm	8.5 mm
SMR	6 mm	8.5 mm
MX/EN	13.7 mm	13.7 mm

- To re-fit the rear wheel, insert the shim (sprocket side) in the hub, insert the wheel in the swing arm and, supporting the wheel, fit the chain on the sprocket and position the caliper (4) with its support. Insert the wheel pin (2) from the sprocket side halfway into the wheel to allow positioning of the shim (brake side).
- Push the pin in completely, insert the chain tensioner slide (3), screw on the nut (1) and tighten to 80 Nm.
- Before tightening the flanged nut, push the rear wheel forward to allow the chain tensioners to make contact with the heads of the adjusting screws.

⚠ DANGER

- IF FOR ASSEMBLY OPERATIONS YOU DO NOT HAVE A TORQUE WRENCH, GET THE TIGHTENING TORQUE CORRECTED AS SOON AS POSSIBLE AT A SPECIALIZED TM WORKSHOP. AN INCORRECTLY TIGHTENED WHEEL PIN MAY MAKE THE MOTORCYCLE UNSTABLE.
- AFTER FITTING THE REAR WHEEL, REPEATEDLY OPERATE THE BRAKE PEDAL TO MAKE THE PADS ADHERE TO THE DISC AGAIN AND CHECK THE BRAKE FLUID LEVEL AND THE PLAY.
- ALWAYS KEEP THE BRAKE DISC FREE OF OIL AND GREASE, OTHERWISE THE BRAKING EFFECT WOULD BE SIGNIFICANTLY REDUCED.

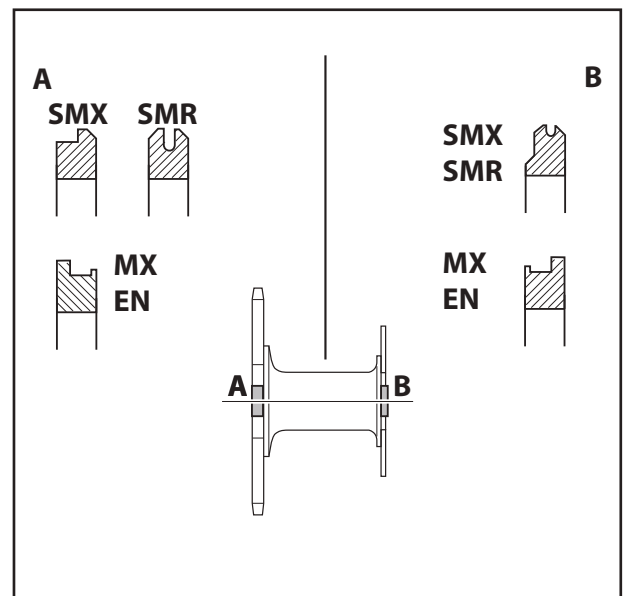
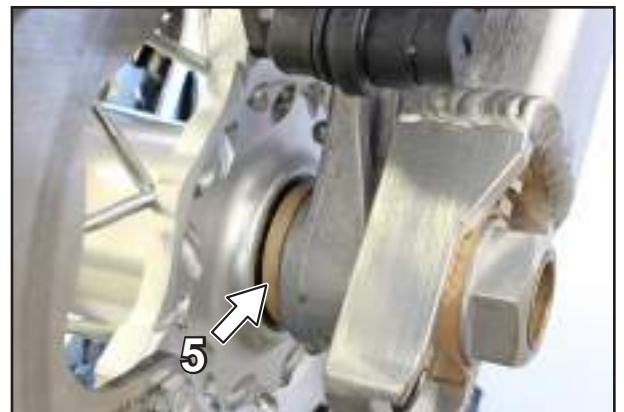
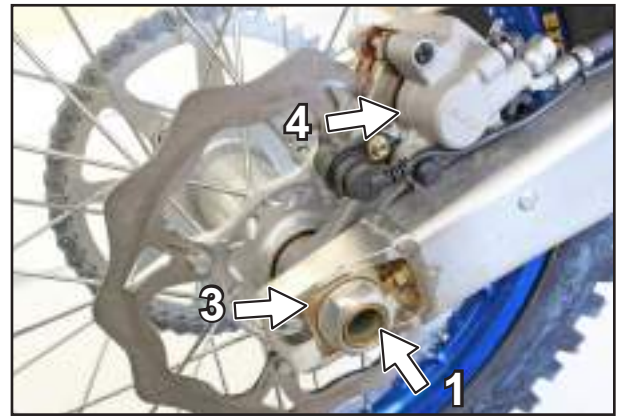

CHECKING SPOKE TENSION

Correct spoke tension is very important for the wheel stability and for safety on the road. An insufficiently taut spoke makes the wheel unstable and will quickly loosen other spokes. Check spoke tension regularly, especially on new motorcycles. To do this, strike each spoke with the end of a screwdriver (see photo): the spoke should produce a clear sound. Hollow sounds mean that the spokes are loose. In such a case, have the spokes adjusted and the wheel centered by a specialized workshop.

DANGER

- IF YOU CONTINUE TRAVELLING WITH INSUFFICIENTLY TAUT SPOKES THEY MAY BREAK, CAUSING INSTABILITY PROBLEMS.
- EXCESSIVELY TIGHT SPOKES MAY BREAK DUE TO LOCAL OVERLOADING.



TIRE PRESSURE

Tire type, condition and pressure affect motorcycle performance on the road and must therefore be checked before every ride.

- The size of the tires is indicated in the technical data and in the registration document.
- Check the condition of the tires before every ride. Ensure that the tires have no cuts, nails, or other sharp objects pushed into them. In terms of the minimum tread for road tires, comply with the regulations in force in your country. We recommend changing the tires not later than when the tread has reached a depth of 2 mm.
- Regularly check the pressure of "cold" tires. Correct pressure adjustment guarantees optimum comfort and maximum tire life.

⚠ DANGER

- **ONLY USE TIRES OF THE TYPE AND DIMENSIONS APPROVED FOR YOUR VEHICLE AND REQUIRED BY TM. DIFFERENT TIRES MAY NEGATIVELY AFFECT MOTORCYCLE PERFORMANCE ON THE ROAD AND BE THE CAUSE OF SANCTIONS UNDER THE REGULATIONS IN FORCE IN YOUR COUNTRY.**
- **TO GUARANTEE YOUR SAFETY AND THE SAFETY OF OTHERS, DAMAGED TIRES MUST BE REPLACED IMMEDIATELY.**
- **EXCESSIVELY WORN TIRES NEGATIVELY AFFECT MOTORCYCLE PERFORMANCE ON THE ROAD, ESPECIALLY ON WET SURFACES.**
- **INCORRECT PRESSURE LEADS TO ABNORMAL WEAR AND TIRE OVERHEATING.**

TIRE PRESSURE

	FRONT	REAR
MX/EN off road	1,0 bar	1,0 bar
EN on road	1,5 bar	1,5 bar
SMR/SMX	1,8 bar	1,8 bar



CHECKING SPEEDOMETER MAGNETIC SENSOR DISTANCE (EN/SMR)

The magnetic sensor is located on the rear wheel in all versions.

EN/SMR

The distance between the screw heads (2) and the sensor (1) must be 2 - 4 mm. Otherwise speedometer operation may be irregular. The bushing (3) adjusts the sensor distance. Do not remove it, otherwise the sensor (1) would touch the screws (2) and be damaged.

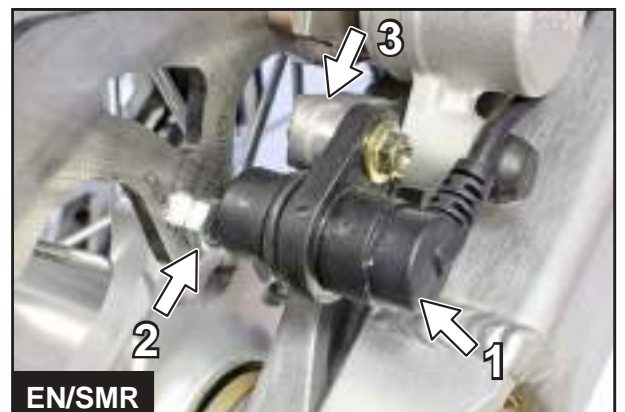

REMOVING THE SEAT

- Unscrew the screws (1) from both sides.

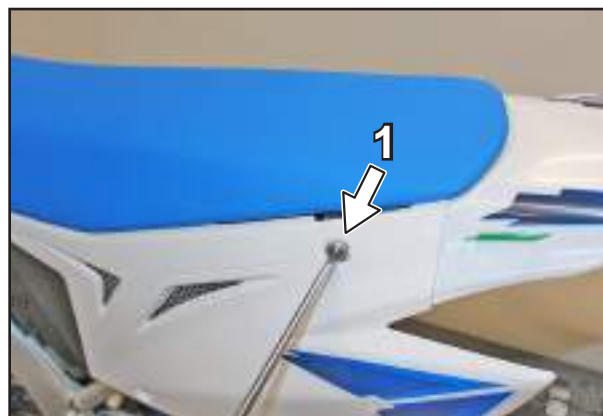

- Lift the rear part "A" of the seat (2).

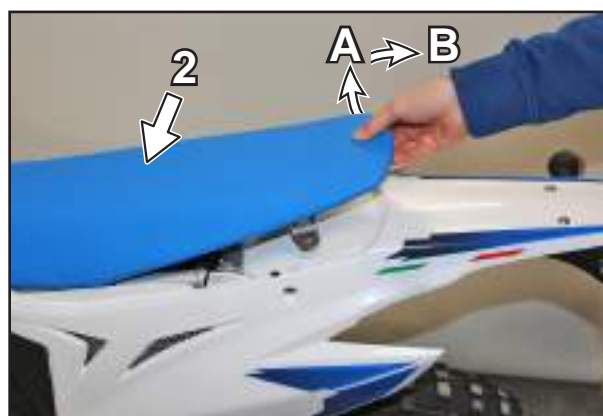

- Pull off the seat (2) towards the back of the motorcycle (B).

REMOVING THE TANK

Removing the tank of models (TSI)

- Remove the seat as described in the relative paragraph.
- Place a cloth under the quick coupling (1) to absorb possibly leaking petrol.
- Disconnect the quick coupling (1) of the hose (2) which connects the tank to the injectors by working on the tabs.
- Disconnect the electrical connections (3) of the petrol pump, level sensor, etc..
- Unscrew the conveyor (5) screws (4) on both sides.
- Unscrew the top screw (6).
- Remove the tank (7) from the frame by raising it complete of the conveyors (5).

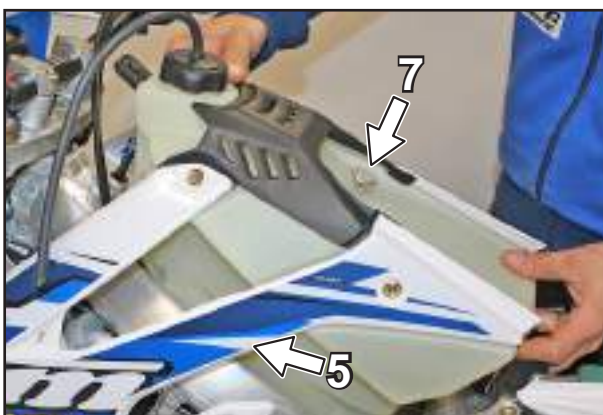
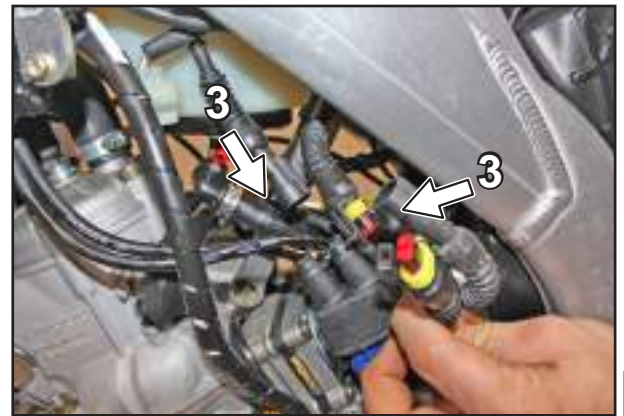
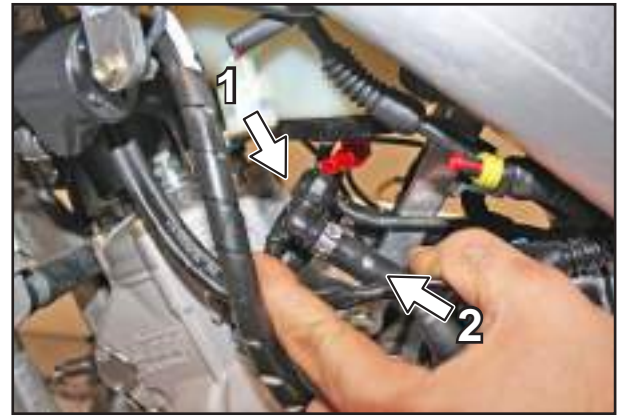

Removing the tank of models MX-SMX

- Remove the seat as described in the relative paragraph.
- Place a container to collect petrol possibly leaking from the hose.
- Close the fuel tap (1) "OFF"
- Open the clamp (2) and disconnect the hose (3) from the carburettor.
- Unscrew the conveyor (5) screws (4) on both sides.
- Unscrew the top screw (6).
- Remove the tank (7) from the frame by raising it complete of the conveyors (5).

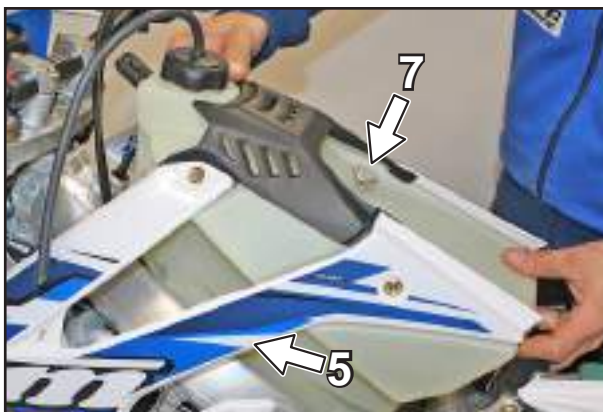
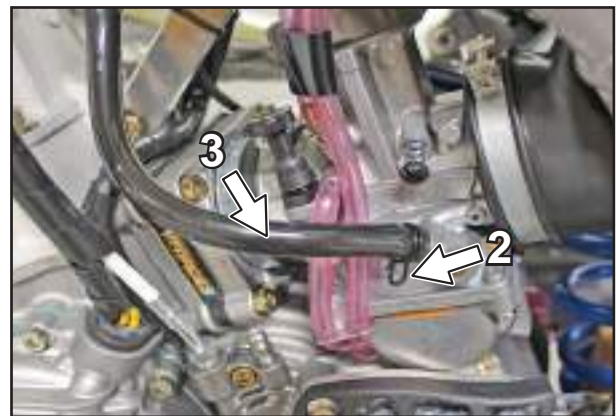
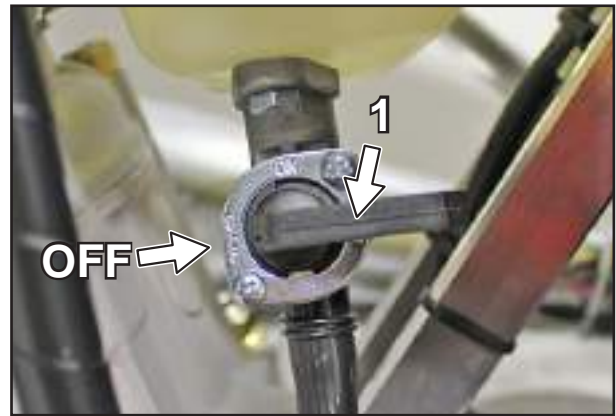

BATTERY

Remove the seat to access the battery.

The battery does not require maintenance.

It is not necessary to check the electrolyte level or top up with water. Simply keep the battery poles clean and, if necessary, lightly grease them with acid-free grease.

To remove the battery, first disconnect the cable from the negative pole (-) (1) then the cable from the positive pole (+) (2).

Disconnect the locking elastic band (3) and remove the battery.

To re-fit the battery, insert it with the terminals upwards and towards the rear of the motorcycle (see figure).

Connect first the cable for the positive pole (+) (2) and then the cable for the negative pole (-) (1).

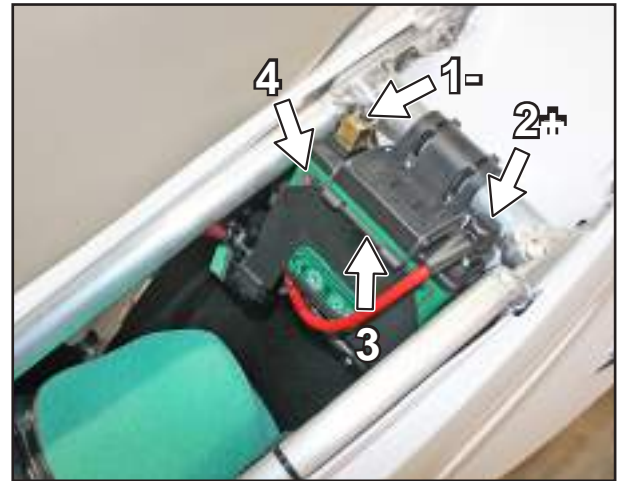

⚠ DANGER

- KEEP FAULTY BATTERIES OUT OF THE REACH OF CHILDREN AND DISPOSE OF THEM IN COMPLIANCE WITH THE REGULATIONS IN FORCE.
- AVOID ANY CONTACT BETWEEN THE POLES.

NOTE:

For more information about the battery, see the introductory part of this manual.

STORAGE

Do not store the battery in a room where temperature is higher than 50° or lower than -10°. If you intend not to use the motorcycle for a period longer than 15 days, it is advised to connect the battery to a charger or, alternatively, remember to recharge it every 15 days to protect it from possible damages. Always recharge the battery before it discharges completely in order to prolong its service life. Damage caused by a prolonged lack of recharge is irreversible and not covered by warranty.

Charge the battery ever three or four months.

In the event of prolonged storage (eight to ten months), charge to 100%, then test the battery with a Voltmeter. For longer battery life, regular battery maintenance must be carried out.

Make sure that batteries are kept out of the reach of children.

⚠ WARNING

- Do not use charge maintainers, battery tenders, fast chargers or other similar devices.
- Use of these devices may damage the battery, cause dangerous overheating, fires and explosions if they are not compatible.
- You must ALWAYS be present during battery charging.
- Do not charge the battery beyond the maximum voltage value indicated.

Check the external condition of the terminals and the plastic casing. Any signs of damage or unusual wear can be checked during the service. If you have any doubts about the condition of the battery, we recommend that you seek the opinion of a professional fitter.

⚠ DANGER

- DO NOT REMOVE THE BATTERY COVER, AND DO NOT PIERCE OR CUT THE OUTER PLASTIC CONTAINER: RISK OF SHORT CIRCUIT.

CHARGING THE BATTERY

⚠ DANGER

- WHEN CHARGING LIFEPO4 BATTERIES, ONLY USE LIFEPO4 BATTERY CHARGERS, SPECIFICALLY DESIGNED FOR LITHIUM ION BATTERIES.
- THE USE OF OTHER BATTERY CHARGERS COULD CAUSE DANGEROUS OVERHEATING AND EVEN BATTERY FIRES AND EXPLOSIONS.

If the battery noticeably heats up during charging, stop the charging. Allow the battery to cool before charging it. Do not under any circumstances short circuit the battery poles to check charging progress: the battery may explode.

Do not charge LIFEPO4 batteries using currents higher than those indicated and recommended: it could cause dangerous overheating. To avoid creating sparks, switch off the battery charger before disconnecting its terminals from the battery.

⚠ DANGER

- DO NOT CHARGE THE BATTERY BEYOND THE MAXIMUM VOLTAGE VALUE INDICATED.

NOTE: We recommend the following models for battery charging:

BRAND	SERIES	MODEL	VOLTAGE	CURRENT	X3 BATTERY CHARGER TIME
CTEK	XS	Lithium	12 V	3.60 A	3 h
TECMATE	Optimate	Lithium 0.8A	12 V	Auto 0.8 A	10 h

The use of other battery chargers may damage the battery.

Battery maintenance

- Do not store the battery in a room where temperature is higher than 50° or lower than -10°. If you intend not to use the motorcycle for a period longer than 15 days, it is advised to connect the battery to a charger or, alternatively, remember to recharge it every 15 days to protect it from possible damages.
- Always recharge the battery before it discharges completely in order to prolong its service life. Damage caused by a prolonged lack of recharge is irreversible and not covered by warranty.

ELECTRICAL SYSTEM COMPONENTS POSITIONING

- Remove the right and left panels in order to access the electrical system components.
- Remove the seat as described in the relative paragraph.
- Remove the side panels unscrewing the screws (1).
- On the left hand side of the motorcycle there are:
 - Indicator lights relay (2)
 - ECU control unit (3)
- On the right hand side of the motorcycle there are:
 - Ignition relay (4)
 - Start relay fuse (5) 30 A.
 - Start relay (6)
 - Spare fuse (7) 30A.
- The voltage regulator (8) is positioned under the left conveyor.

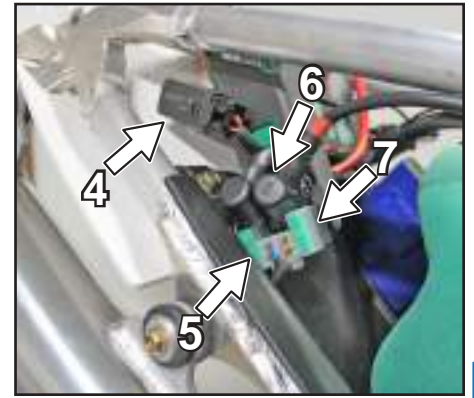
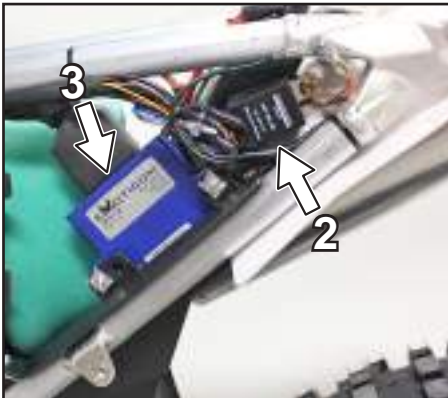

START CONTROL SWITCH FUSE

- Remove the spider as described in the relative paragraph.
- Remove the right side panel (1) unscrewing the screw (2).
- The fuse (3) is located in the relay (4) of the electric starter under the right side panel.
- The fuse rating is 30 Amperes.
- The recharge and ignition systems are protected by the fuse.
- Raise the start relay (4) by releasing it from its support.
- In the start relay (4) is also located a spare fuse (5) with a rating of 30 Ampere.

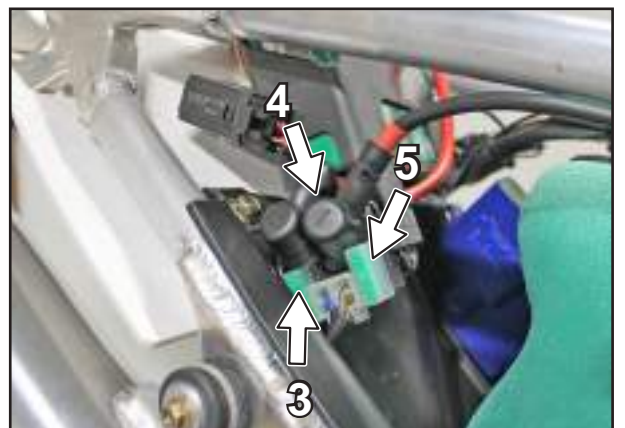
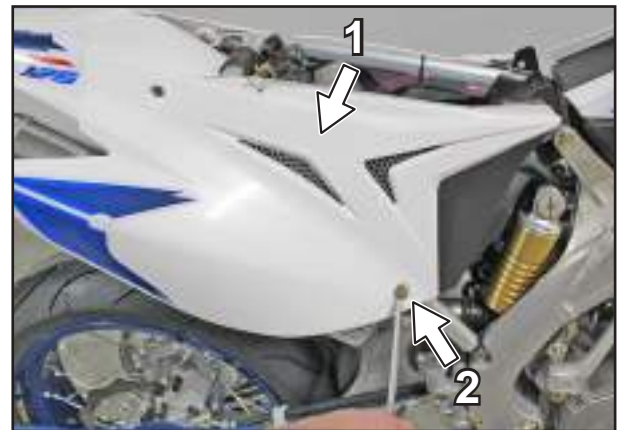

ADJUSTING THE HEIGHT OF THE FRONT HEADLAMP

To check if the headlamp angle is correct, with the tires inflated to the correct pressure and someone sitting on the seat, position the motorcycle correctly perpendicular to its longitudinal axis.

Place the bike facing a wall or screen, 10 m away from it. On the wall/screen mark a horizontal line corresponding to the height of the center of the lamp and a vertical line aligned with the longitudinal axis of the vehicle.

Carry out the check in twilight if possible.

When you switch on the high beam the upper cutoff point between the dark zone and the lit zone must be at a height not greater than 9/10ths of the height of the center of the bulb from the ground.

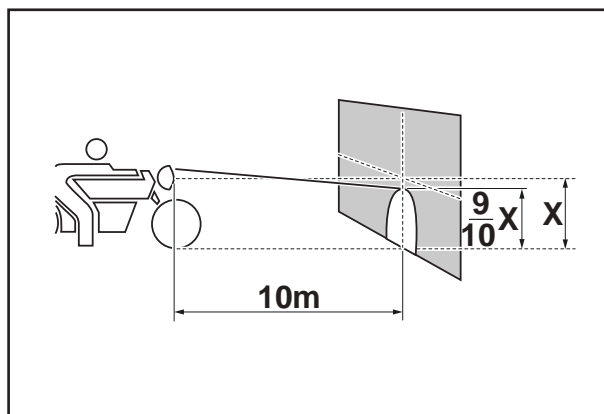

HALOGEN HEADLIGHT (EN)

ADJUSTING THE HEADLIGHT HEIGHT

The height of the front headlight is adjustable. Adjust the elastic straps fixing it to the forks so that the headlight is levelled frontally, then use the front screw (1) to adjust the height of the headlight. Turn clockwise to lift it, or anticlockwise to lower it.



REPLACING HEADLIGHT BULB

- Release both elastic straps (1), lift and move forward the headlight holder mask (2).
- Disconnect the central connector (3) and remove the rubber protection (4).
- Release the retainer (5) and carefully remove the halogen bulb (6).
- Fit the new bulb, the rubber protection (4) and the connector (3).
- Put the headlight holder mask (2) back on, securing it with the elastic straps (1).

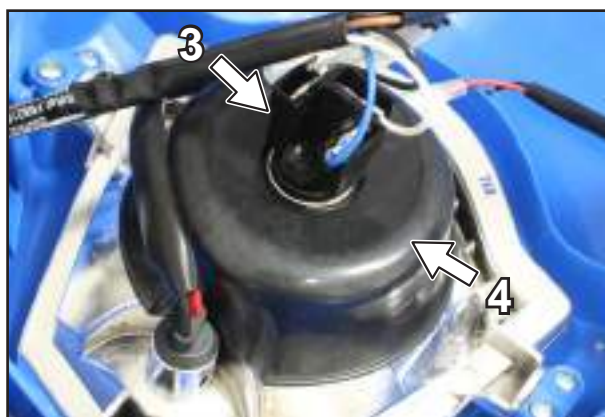
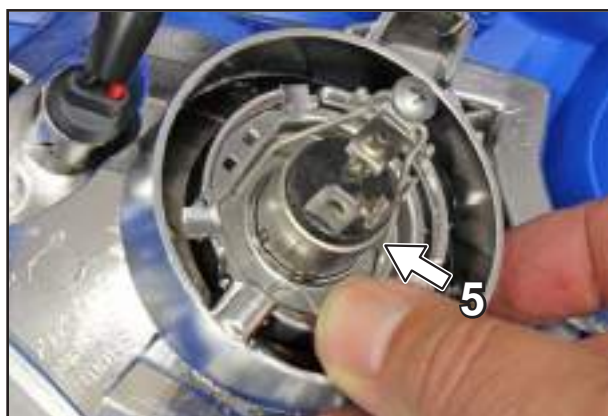
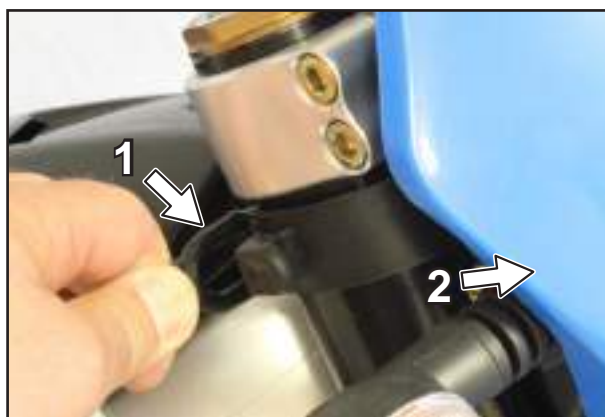

REPLACING POSITION LIGHT BULB

- Release both elastic straps, lift and move forward the headlight holder mask.
- Remove the bulb holder (1) from the reflector dish and replace the bulb (2). Re-fit the bulb holder (1).
- Put the headlight holder mask back on, securing it with the elastic straps.

⚠ WARNING

- Never touch the glass bulb with your fingers to avoid leaving traces of grease.
- To ensure that you fit the correct bulbs, refer to the “chassis technical data” table for your bike model.

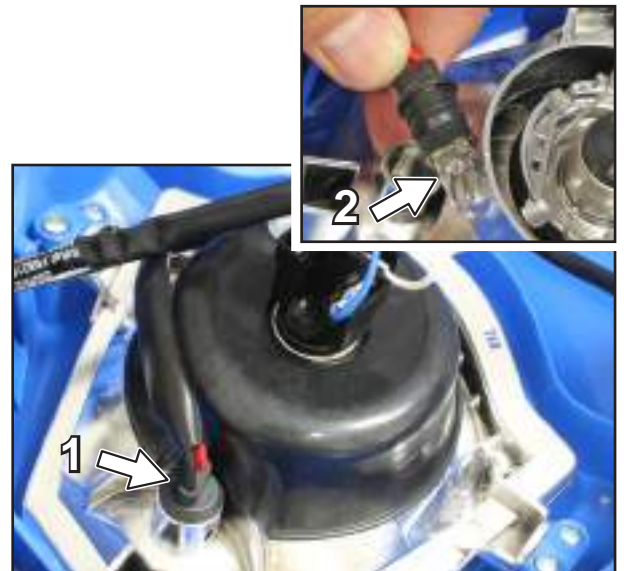

LED HEADLIGHT FOR MODELS (EN/SMR) (OPTIONAL)

ADJUSTING THE HEADLIGHT HEIGHT

The height of the front headlight is adjustable. Adjust the elastic straps fixing it to the forks so that the headlight is levelled frontally, then use the front screw (1) to adjust the height of the headlight. Turn clockwise to lift it, or anticlockwise to lower it.



REPLACING LED FRONT HEADLIGHT (OPTIONAL)

- Release both elastic straps, lift and move forward the headlight holder mask.
- Completely unscrew the headlight adjusting screw (1).
- Unscrew the screws (2) and disconnect the terminals from the bike lighting system. Then remove the front headlight (3). Since this is all one unit, the whole thing must be replaced. Ask a TM dealer for the original spare part.



LED TAILLIGHT (EN/SMR)

Unscrew the screws (1) and disconnect the terminals from the bike lighting system. Then remove the taillight unit. Since this is all one unit, the whole thing must be replaced. Ask a TM dealer for the original spare part.

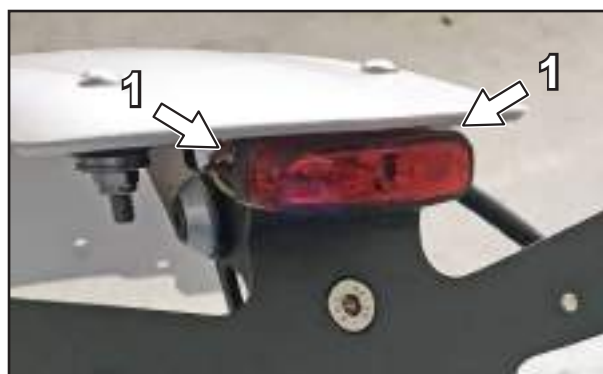

TURN SIGNAL (EN/SMR)

Replacing the bulb

Unscrew the screw (1) and remove the cover (2).

Replace the bulb with an equivalent one. Re-fit the cover (2) and tighten the screw (1).

⚠ WARNING

- Never touch the glass bulb with your fingers to avoid leaving traces of grease.
- To ensure that you fit the correct bulbs, refer to the "chassis technical data" table.

Led turn signals

The led turn signals (3) must be replaced after disconnecting the motorcycle light system terminals in case of malfunction.



COOLING

The water pump (1), housed in the engine forces coolant circulation. Both for motorcycles not equipped with thermostat and for those which are equipped with thermostat it is important, when the engine is cold, to moderate the engine rpm and speed. Proceed for at least 5 minutes at half throttle and at low speed to allow the engine to reach an adequate operating temperature. Cooling takes place thanks to the passage of air through the radiator fins. The lower the speed, the less the cooling effect. Dirty radiator fins also reduce the cooling effect.

A valve on the radiator cap (2) adjusts the pressure produced by high fluid temperature. Temperatures close to 120°C can be reached without problems. The coolant is a mixture of 40% antifreeze and 60% water. However, the antifreeze protection limit must be at least -25°C. This mixture protects against freezing and is good for preventing corrosion. Therefore, it must

⚠ WARNING

- Always use high quality products to prevent corrosion or the formation of foam.
- Overheating may occur in extreme weather or in stop-and-go traffic. To solve this problem, an electric fan kit is available as an optional accessory for models with electric start (ask your TM dealer for details).

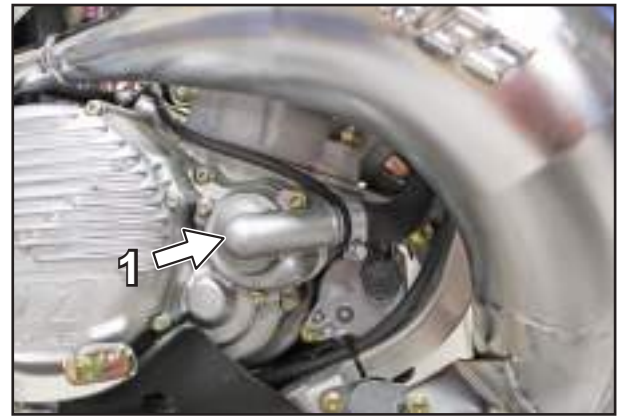

CHECKING COOLANT LEVEL

With the engine cold, open the radiator filler cap. The fluid must cover the channels by approximately 10 mm. The radiator channels. If the level is too low, top up immediately with more fluid mix and bleed the air. Use water only if strictly necessary and in small amounts, to avoid reducing the effective properties of the fluid.

⚠ DANGER

- IF POSSIBLE, CHECK THE COOLANT LEVEL WHILE THE ENGINE IS COLD. IF YOU NEED TO OPEN THE RADIATOR FILLER CAP WHILE IT IS HOT, FIRST COVER IT WITH A CLOTH AND THEN SLOWLY OPEN IT TO DISCHARGE THE OVERPRESSURE. CAUTION: DANGER OF BURNS!
- DO NOT DISCONNECT THE RADIATOR HOSES WHEN THE ENGINE IS HOT. LEAKING COOLANT AND HOT VAPORS CAN CAUSE SERIOUS BURNS.
- IN CASE OF BURNS, IMMEDIATELY PLACE BURNT AREAS UNDER COLD RUNNING WATER AND SEEK MEDICAL ADVICE.
- COOLANT IS TOXIC! KEEP IT OUT OF THE REACH OF CHILDREN.
- IF YOU SWALLOW COOLANT, SEEK MEDICAL ADVICE IMMEDIATELY.
- IF COOLANT GETS IN YOUR EYES, RINSE THEM IMMEDIATELY WITH COLD WATER AND SEEK MEDICAL ADVICE.

⚠ WARNING

- Always use high quality products to prevent corrosion or the formation of foam.

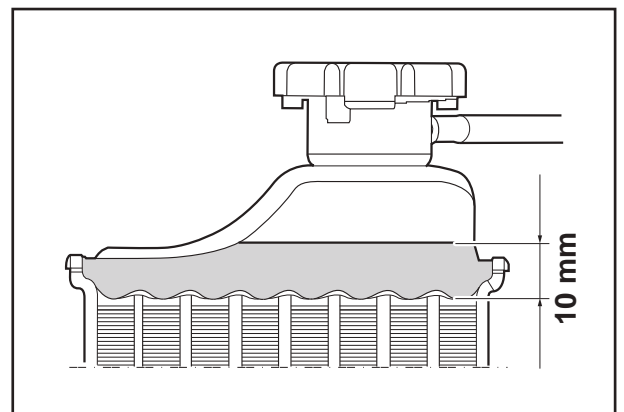



DRAINING, FILLING AND BLEEDING THE COOLING SYSTEM

Coolant can be drained by removing the screw (1) from the water pump cover on the right-hand side of the engine. Have a suitable basin ready to catch the draining fluid. The radiator cap must be open in order to drain the fluid. Once finished, screw in the drain screw and tighten to 12 Nm.

To fill the cooling system, pour the amount of coolant indicated in "Engine Technical Data" table in through the filler neck (2). Close the radiator cap and start the engine for a few seconds. Switch off the engine, open the cap again and check the level. Add more fluid if necessary.

Go for a short ride then check the coolant level again.

⚠ DANGER

- DRAIN THE COOLANT, IF POSSIBLE WITH THE ENGINE COLD. IF YOU NEED TO DRAIN THE COOLANT WHILE THE ENGINE IS HOT, FIRST COVER THE RADIATOR FILLER CAP WITH A CLOTH, THEN SLOWLY OPEN IT TO DISCHARGE THE OVERPRESSURE.

CAUTION: DANGER OF BURNS!

- IN CASE OF BURNS, IMMEDIATELY PLACE BURNT AREAS UNDER COLD RUNNING WATER AND SEEK MEDICAL ADVICE.
- COOLANT IS TOXIC! KEEP IT OUT OF THE REACH OF CHILDREN.
- IF YOU SWALLOW COOLANT, SEEK MEDICAL ADVICE IMMEDIATELY.
- IF COOLANT GETS IN YOUR EYES, RINSE THEM IMMEDIATELY WITH COLD WATER AND SEEK MEDICAL ADVICE.

⚠ WARNING

- After draining the coolant, when you fill up with coolant again you must bleed the cooling system.
- Always use high quality products to prevent corrosion or the formation of foam.

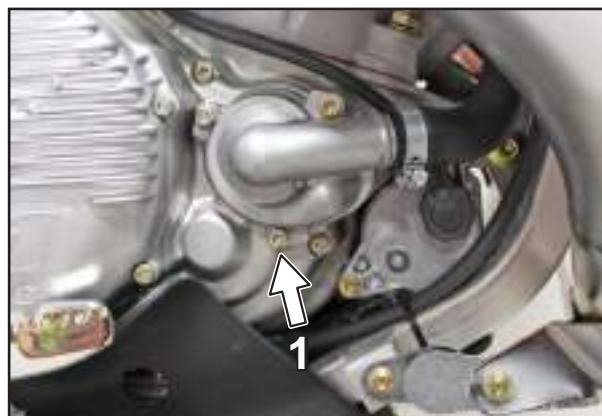



REPLACING EXHAUST SILENCER PACKING MATERIAL

The competition silencer is completely filled with sound absorbing material (fiberglass) to limit the motorcycle exhaust noise to within competition limits. Fiberglass tends to burn due to the high temperature reached by the exhaust fumes. This reduces both the noise absorption effect and the power. To replace the fiberglass, take the silencer off the motorcycle, removing the rivets (1) that secure the front cap (2) to the external pipe (3), remove the cap. Remove the sound absorbing material to be replaced. Insert TM's fiberglass cartridge (4) in the external hose. Re-fit the front cap (2) and secure it with the new rivets. Mount the silencer on the bike again. Grease the ends of the pipes to make fitting the silencer easier.

⚠ DANGER

- CAUTION: DANGER OF BURNS!
- THE EXHAUST SYSTEM GETS VERY HOT WITH THE MOTORCYCLE RUNNING. TO AVOID BURNS, ALLOW THE SYSTEM TO COOL BEFORE STARTING WORK ON IT.
- IN CASE OF BURNS, IMMEDIATELY PLACE BURNT AREAS UNDER COLD RUNNING WATER AND SEEK MEDICAL ADVICE.

⚠ WARNING

- Replace the fiberglass with new product purchased from TM dealers or, if that is not possible, with an equivalent product.
- Never use flammable material to pack the silencer.

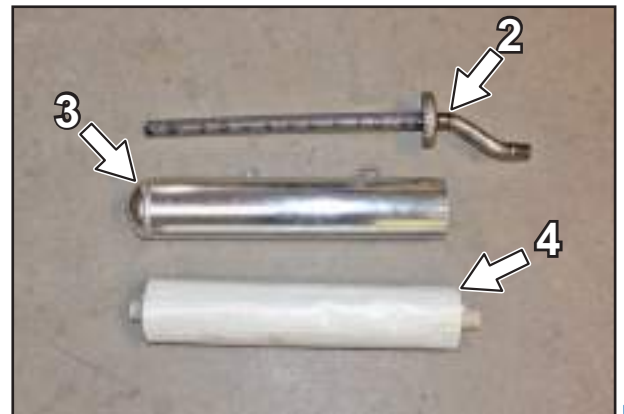
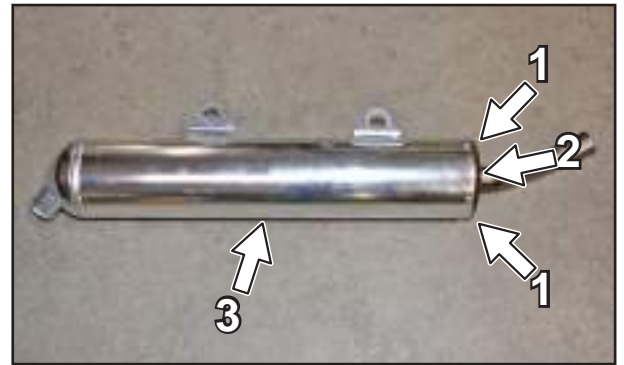

CLEANING AIR FILTER

Regularly clean and maintain the air filter.

A dirty air filter compromises air flow, reduces motorcycle power and increases fuel consumption. In some cases, dust may enter the engine and cause serious damage. Therefore, regular air filter maintenance is necessary.

- Remove the seat as described in the relevant paragraph.
- Unscrew the butterfly screw (1) and remove it.



- Carefully take the filter (2) out of the seat.



- Separate the sponge element (3) from the plastic cage (4). Carefully wash the sponge element with the special detergent and allow it to air dry completely. If necessary, gently squeeze the sponge but never wring it. Clean the plastic cage and the filter case and check that the sleeve connecting the carburettor/throttle body to the filter case is intact and positioned correctly.
- Oil the cage with filter oil, then put the sponge and cage back together. Re-fit the air filter, positioning it correctly on the supporting surface. Ensure that the edges of the sponge are not lifted or non-adhering to the supporting surface.
- Reinsert the filter (2) in its seat paying attention the filter drop part (5) is positioned pointing downwards.
- Re-screw the butterfly screw (1) again and tighten adequately.
- Re-fit the spider.

⚠ WARNING

- Do not clean the sponge element with petrol or oil, since they may corrode it. For correct maintenance, use the specific products available on the market for cleaning and lubrication.
- Never start the motorcycle without the air filter in place. Dust and dirt infiltration may cause damage and high levels of wear.
- Make sure that there is a perfect seal between the sleeve and the filter case. Also ensure that the sponge element is correctly fitted on the plastic cage. Any leaks may allow sand or dirt into the engine.

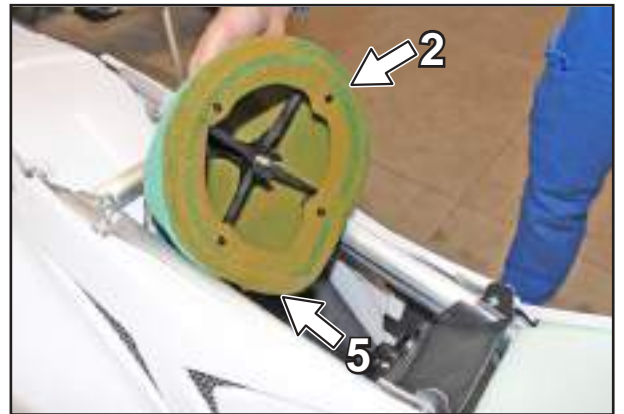
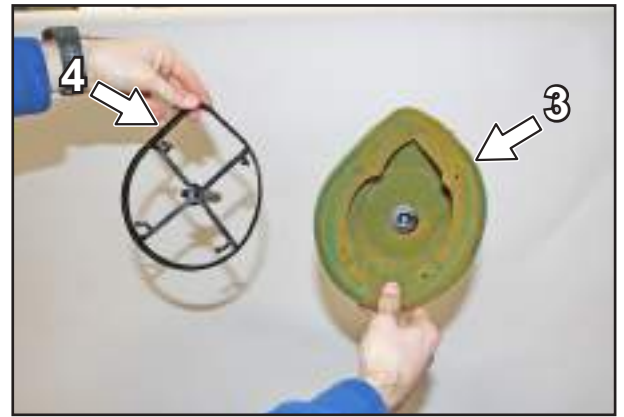

ADJUSTING THROTTLE CONTROL CABLES

Adjustment on models (TSI)

Adjustment on these models must be performed on the throttle body. The throttle grip must be adjusted to suit the rider, but must always have at least 1 - 2 mm of play.

- To adjust the play, move the protective cap (1).
- First adjust the (upper) opening cable, then the (lower) closing cable. Consult the information on the sheaths.

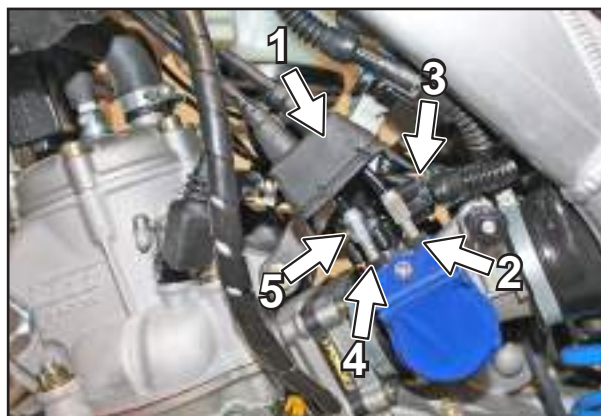

Opening cable

- Loosen the lock nut (2) and tighten or loosen the adjusting screw (3) to obtain the required play.
- Tightening the adjusting screw increases play.
- Loosening the adjusting screw reduces play.
- Tighten the lock nut and check that the grip rotates smoothly.

Closing cable

- Loosen the lock nut (4) and tighten or loosen the adjusting screw (5) to obtain the required play.
- Tightening the adjusting screw increases play.
- Loosening the adjusting screw reduces play.
- Tighten the lock nut and check that the grip rotates smoothly.
- Put the protective cap back in place at the end of adjustment.

⚠ WARNING

- With the engine running, ensure that the idle speed is correct and does not increase when you steer all the way right or left.

Adjustment on models (MX-SMX)

Adjustment on these models must be performed on the throttle. The throttle grip must be adjusted to suit the rider, but must always have at least 1 - 2 mm of play.

- To adjust the play, move the protective cap (1).
- Loosen the nut (2) and work on the registry (3).
- Tightening the registry increases play.
- Loosening the registry reduces play.
- Tighten the nut (2) and check that the grip rotates smoothly.
- Put the protective cap (1) back in place at the end of adjustment.



⚠ WARNING

- With the engine running, ensure that the idle speed is correct and does not increase when you steer all the way right or left.

ADJUSTING IDLE SPEED

Adjusting idle speed has a big impact on engine starting. That is to say, an engine with correct idle speed adjustment will be easier to start than an engine with incorrect idle speed.

Every TM Racing bike is delivered with an idle speed adjustment suitable for the type of motorcycle. This adjustment can be changed if necessary. With the engine running, warm enough and without touching the throttle grip, turn the knob (1) or the screw (2) located on the left-hand side of the bike.

Models (TSI)

Rotating the knob (1) clockwise decreases rpm while rotating it anticlockwise increases them.

Models (MX-MSX)

Rotating the screw (2) clockwise increases rpm while rotating it anticlockwise decreases them.

Do not set a too low idle speed.

If you have a rev counter available, never drop below 1700 ÷ 1800 rpm.

Instead of a rev counter, you can use the TM Racing diagnosis and programming "PDA".

⚠ WARNING

- Never adjust the idle speed with the engine off. You risk not being able to start the engine again.

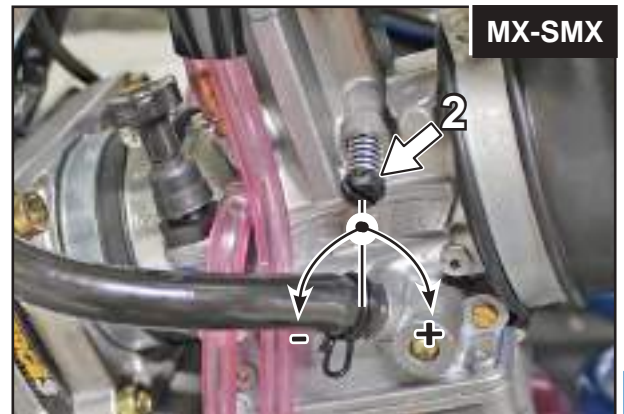
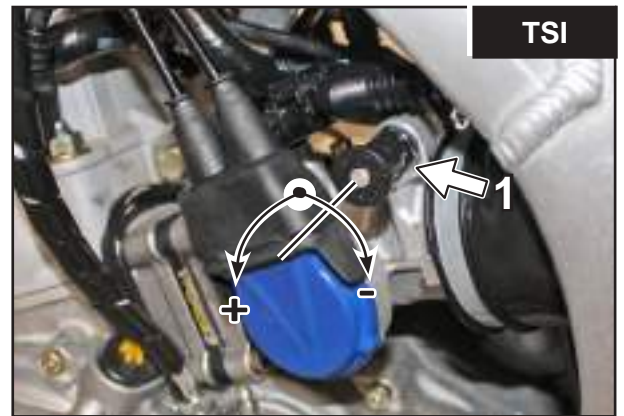

GEARBOX OIL CHANGE

Only use high quality oil of the type indicated in the chapter “Technical data”.

The oil must be changed with the engine off, but still warm enough to allow the used oil to drain more easily.

- Position the motorcycle on a flat surface and place a suitable basin under the engine. Unscrew the oil filler cap (1) on the right-hand side of the engine (clutch cover) and the drain cap (2) on the lower side of the engine, allowing the oil to drain into the basin.
- Wait until all of the oil has drained from the drainage holes. Then clean the seal surfaces, check the gaskets, clean any debris from the drainage cap magnets (3) and screw on the cap again, tightening them to 20 Nm.
- Prepare a measuring cup with the necessary amount of gearbox oil of the required type (see table) and pour approximately 650gr into the filler hole.
- Screw and tighten the cap to 20 Nm.
- Check the seal of the filler and drainage caps.

DANGER

- BEWARE OF HOT OIL AND ENGINE PARTS. RISK OF BURNS.

WARNING

- A level that is too low, poor quality oil or longer maintenance intervals than scheduled cause serious gearbox damage. Never pour too much oil into the gearbox.
If this happens, drain it.

ENGINE OIL QUANTITY TABLE

Oil change.....650 gr.

NOTE:

For the type of oil to be used, see the “Technical data” section.

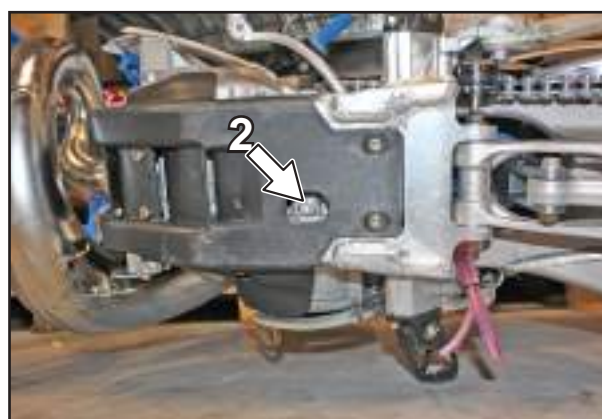

EXHAUST VALVE

Removing the exhaust valve

To remove the exhaust valve from the engine, work as follows:

- Disconnect the connector (1) from the valve.
- Remove the rubber cap (2).
- Unscrew the valve control screw (3).
- Unscrew the screws (4) that secure the valve to the engine.

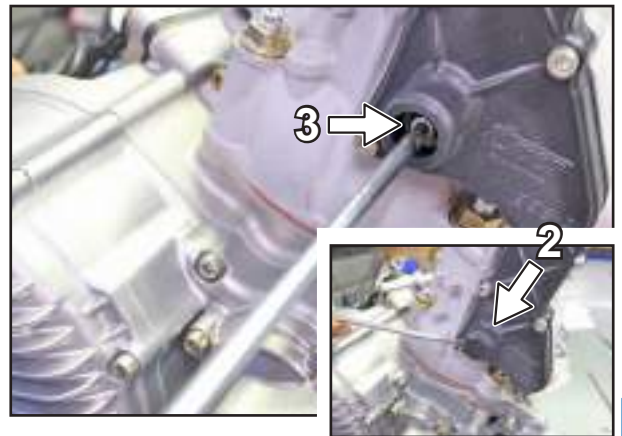
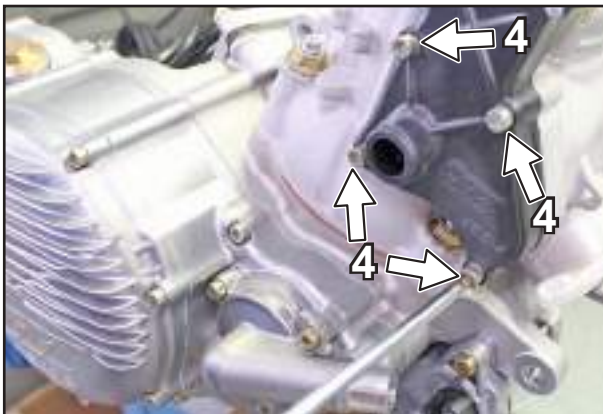
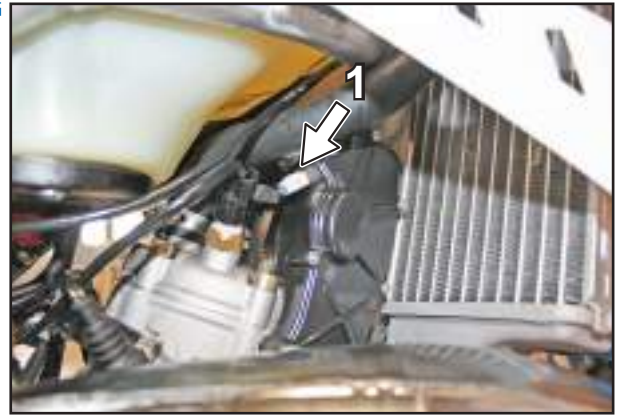

Disassembling the valve

- Unscrew the screws (5) and remove the cover (6).
- Unscrew the screw (7) which fixes the control rod (8) to the starter motor (9).

⚠ WARNING

Recover the O-ring (10).

- If the rod (8) must be replaced, adjust the distance of the new rod between the two heads and try it on the two measuring rods (11) positioned on the cover (6).
- Reassemble all the components working in reverse order paying attention to position the O-ring (10) correctly under the head.

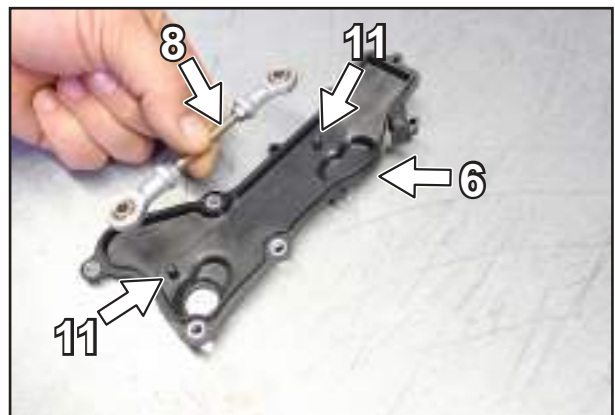
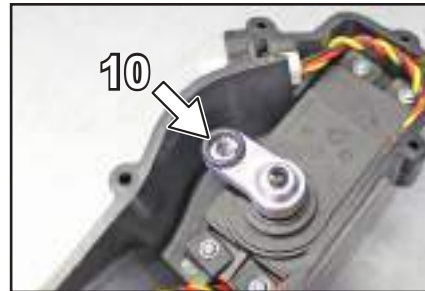
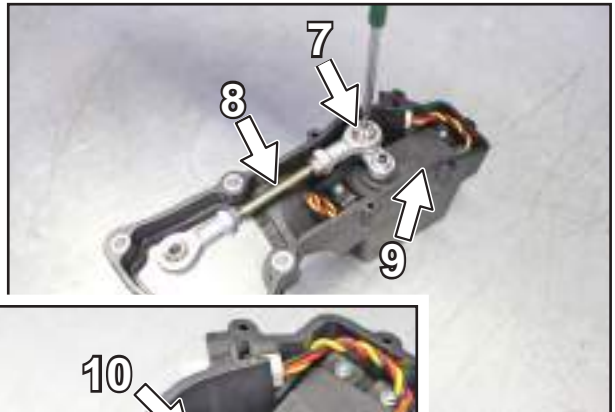
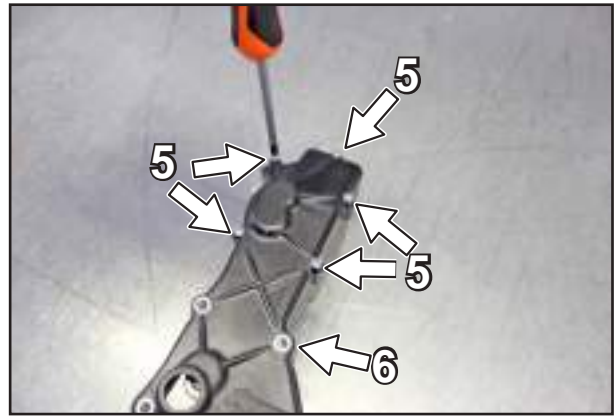

Reassembling the valve on the engine

Reassemble the valve working in reverse order to disassembly by tightening the screw (3) which secures the lower eye of the rod to the valve opening/closure lever.

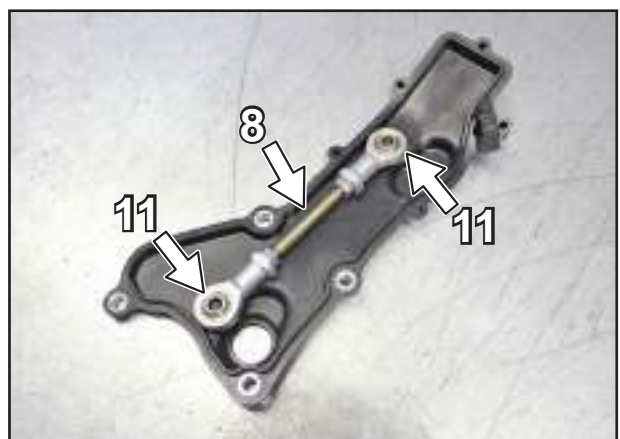
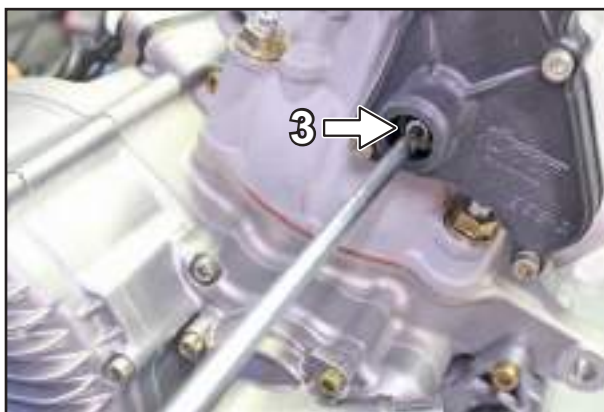

RESETTING THE EXHAUST VALVE

In case of malfunction or after replacing the valve it is necessary to carry out the RESET procedure.

Resetting the valve for models (TSI)

⚠ WARNING

Make sure the engine has switched off.

- Remove the seat as described in the relevant paragraph.
- Connect the cable (1) to the battery terminals.
- Press the mapping button (2) and select "MAP 1"
- Rotate the throttle grip (3) to the maximum opening and keep it in open position.
- Connect the connector (4) to the diagnostics socket (5).
- Within two seconds from the connector (4) connection, press the shutting off button (6) and keep it pressed for at least five seconds.
- Release the throttle grip (3).
- At this point, the actuator slowly searches for 0% and 100% points of opening by first moving to 100% and then to 0%.
- Once the two extremes have been memorized, the valve sets to 100% of opening.
- Disconnect the cable (1).
- Remove the cap (7).
- Reconnect the cable (1) as previously described.
- Work on the throttle grip (3) and check that, by means of the hole (8), the control rod moves.
- Once finished, re-fit the cap (7), disconnect the cable (1) and re-fit the seat.

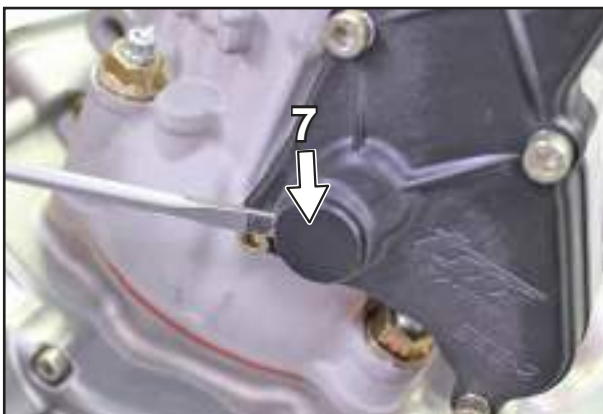
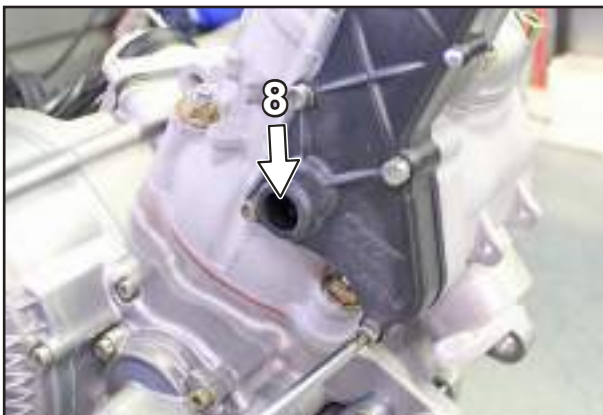
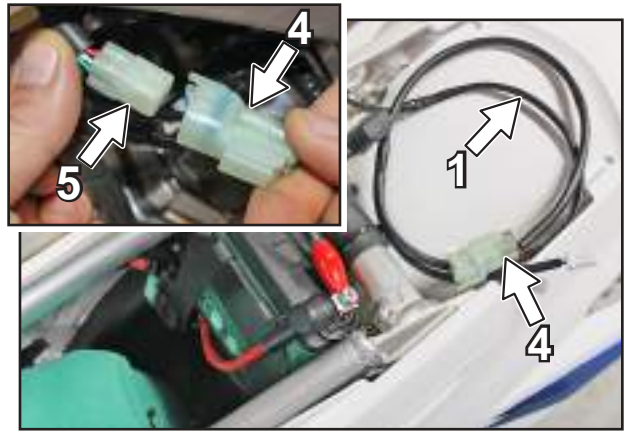

Resetting the valve for models (MX-SMX)

⚠ WARNING

Make sure the engine has switched off.

- Remove the seat as described in the relevant paragraph.
- Connect the cable (1) to the battery terminals.
- Press the mapping button (2) and select "MAP 1"
- Engage the 5[^] gear by means of the lever (3).
- Connect the connector (4) to the diagnostics socket (5).
- Within two seconds from the connector (4) connection, press the shutting off button (6) and keep it pressed for at least five seconds.
- At this point, the actuator slowly searches for 0% and 100% points of opening by first moving to 100% and then to 0%.
- Once the two extremes have been memorized, the valve sets to 100% of opening.
- Disconnect the cable (1) and move the gear back to neutral position "N".
- Remove the cap (7).
- Reconnect the cable (1) as previously described.
- Work on the gearbox (3) lever by engaging gears from 1[^] to 5[^] and check that, by means of the hole (8), the control rod positions in the following manner:

- 1[^] = 100%
- N = 0%
- 2[^] = 25%
- 3[^] = 50%
- 4[^] = 75%
- 5[^] = 100%

- Once finished, re-fit the cap (7), disconnect the cable (1) and re-fit the seat.

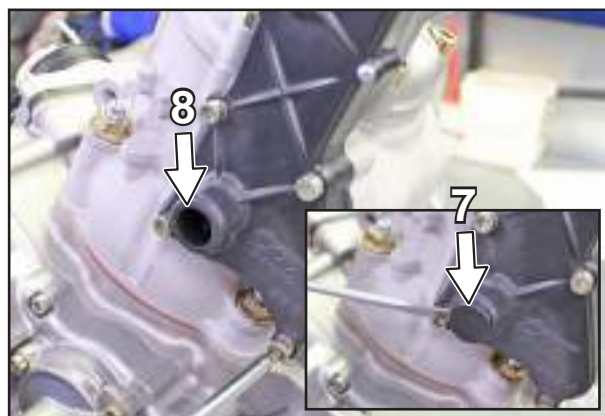
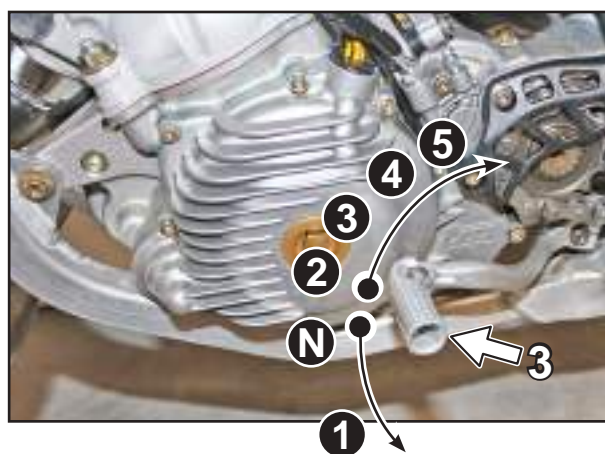
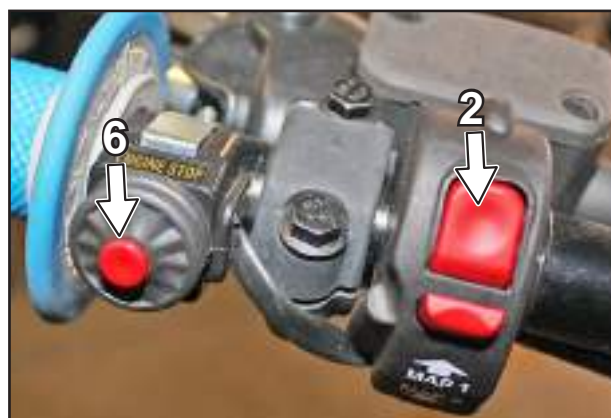
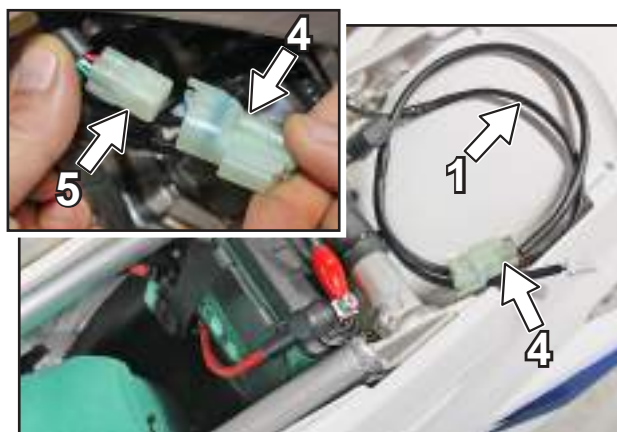

2 stroke oil circuit filling (ONLY TSI MODELS)

⚠ WARNING

Make sure the engine has switched off.

- Remove the seat as described in the relevant paragraph.
- Connect the cable (1) to the battery terminals.
- Press the mapping button (2) and select "MAP 2"
- Engage the 3rd gear by means of the lever (3).
- Press the shutting off button (4) and, while you keep it pressed, connect the connector (5) to the diagnostics socket (6).
- Keep the shutting off button pressed for more than 5 seconds, the mixer pump will start for a set cycle.
- In case you want to repeat the operation, press the shutting off button (4) for more than 5 seconds.
- Once filling has been completed, disconnect the cable (1) and re-fit the seat.

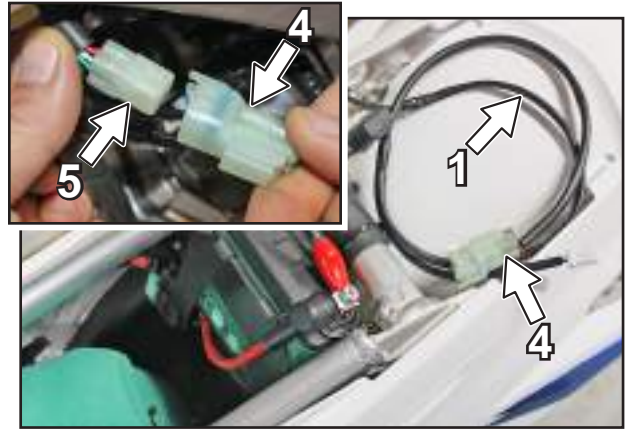





5. DIAGNOSIS









Performing the scheduled maintenance on your motorcycle will make encountering problems unlikely. However, should a problem occur, check the troubleshooting table and follow the instructions provided to solve the problem.



The table includes two columns indicating who should perform the work:

- the symbol  means that the work must be done by the user;
- the symbol  means that the work must be done by a technician or at an authorized TM workshop.

Therefore, for your safety, have such work done only at a specialized TM workshop, so that your motorcycle is serviced optimally by specifically trained personnel. Contact a TM dealer if you have any questions. For anything not covered here, consult the “PDA” section.

PROBLEM	CAUSE	SOLUTION		
ENGINE DOES NOT TURN OVER	Incorrect command	Correctly repeat the procedure to activate the starter motor according to the motorcycle model.	•	
	Ignition key not inserted or not turned (SMR).	Insert the ignition key and turn it clockwise.	•	
	Faulty start relay.	Check the start relay and replace it.		•
	Discharged battery.	Charge the battery and find the cause of discharging.		•
	Ambient temperature very low.	Start the engine using the kick starter vigorously.	•	
	Faulty starter motor.	Check the starter motor.		•
	Burnt out 30A fuse	Check the fuse and replace it if necessary	•	
				>>>

PROBLEM	CAUSE	SOLUTION		
ENGINE TURNS OVER BUT FAILS TO START	Incorrect command.	Correctly repeat the engine start procedure according to the motorcycle model.		
	No fuel supply to the engine.	Refuel.	•	
		Check the petrol pump connections and fuel pipe.	•	
		Check fuel pressure.		•
	Incorrect idle speed adjustment.	Correctly adjust the idle speed.	•	
	Flooded engine.	Perform start procedure with flooded engine.	•	
	Wet spark plug.	Clean and dry the spark plug or replace it if required.	•	
	Incorrect distance between electrodes.	Adjust the distance between electrodes to 0.8 mm.	•	
	Faulty ignition system EN-SMR.	Check the ignition system (Diagnostic Tool).		•
	Faulty injection system EN-SMR.	Check the injection system (Diagnostic Tool).		•
	Insufficient petrol circuit pressure	Replace the pump		•
	Damaged wiring.	Check the wiring, earth connections, connector integrity, cables and sheaths		•
	Damaged spark plug cap.	Check the spark plug cap and replace it if required.	•	
Faulty stop switch	Check the stop switch.		•	
Clogged air filter	Clean	•		
ENGINE DOES NOT KEEP RUNNING AT IDLE	Incorrect idle speed adjustment.	Correctly adjust the idle speed.	•	
	Damaged spark plug.	Replace the spark plug.	•	
	Faulty ignition system.	Check the ignition system (Diagnostic Tool).		•
ENGINE DOES NOT REACH FULL SPEED	Faulty ignition system.	Check the ignition system (PDA).		•
	Faulty injection system EN-SMR.	Check the injection system (PDA).		•
	Faulty ECU (engine control unit).	Replace the ECU.		•
	Exhaust valve actuator faulty or to be adjusted	Adjust the exhaust valve position		•
	Faulty valve control unit	Reset or replace the control unit		•
	Faulty spark plug	Replace the spark plug candela	•	

PROBLEM	CAUSE	SOLUTION		
INSUFFICIENT ENGINE POWER	Clogged air filter.	Clean or replace the air filter.	•	
	Faulty injection system EN-SMR.	Check the injection system (Diagnostic Tool).		•
	Exhaust system not sealed, deformed or silencer fiberglass needs replacing.	Check the faulty parts on the exhaust system, replace the fiberglass in the exhaust silencer.		•
	Exhaust valve not adjusted correctly	Check the valves wires Replace the control unit		•
	Faulty ignition system.	Check the ignition system (Diagnostic Tool).		•
	Faulty ECU (engine control unit).	Replace the ECU.		•
	Clogged fuel filter.	Replace the fuel filter.		•
ENGINE MISFIRES OR SWITCHES OFF WHILE RUNNING	No fuel supply to the engine.	Refuel. Check the petrol pump or carburettor connections and fuel pipe. Check fuel pressure (TSI)	•	•
	Damaged spark plug.	Replace the spark plug.	•	
	Faulty ignition system.	Check the ignition system (Diagnostic Tool).		•
	Faulty injection system.	Check the injection system (Diagnostic tool) (TSI).		•
	Exhaust valve not adjusted correctly	Check for the correct valve adjustment		•
	Faulty ECU (engine control unit).	Replace the ECU.		•
	Faulty battery	Replace	•	
ENGINE OVERHEATS EXCESSIVELY	Insufficient fluid in the cooling system.	Check and top-up the coolant level. Check the seal of the cooling system.	• •	
	Insufficient ventilation.	Ride for a while on a flat road at moderate speed without stressing the engine (you can fit an optional electric fan).	•	
	Air in cooling circuit.	Bleed the cooling system.	•	
	The radiator fins are very dirty.	Clean the radiator fins with water (not under pressure).	•	
	Formation of foam in the cooling system.	Replace the coolant using a good brand of anti-freeze.	•	
LIGHTS, SPEEDOMETER, HORN AND TURN SIGNALS DO NOT WORK	Burnt out fuse.	Check the fuse and replace it.	•	
	Connections	Check wiring		•
BATTERY IS DISCHARGED EVEN IF THE MOTORCYCLE HAS BEEN USED RECENTLY	The battery is not charged by the generator.	Check the generator and voltage regulator.		•
	The battery is damaged.	Replace the battery.		•
	External temperature too low	Check the battery	•	

CONNECTING OBD TOOL

- The socket for connecting this tool is on the left side of the motorcycle, under the tank.
- Take out the socket (1), remove the protective cap (2) and connect the tool.

⚠ WARNING

After making the required adjustments, put the protective cap (2) back on the socket (1).

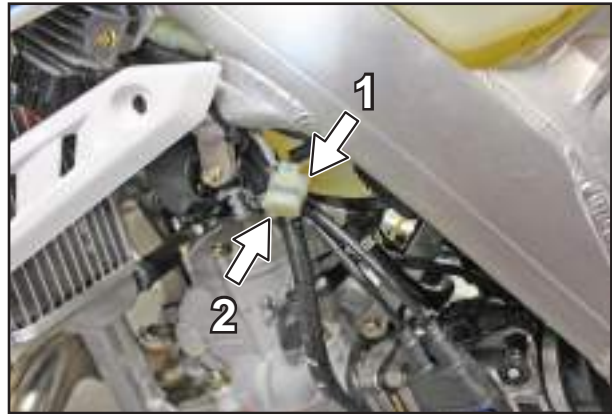

6. TECHNICAL DATA





ENGINE TECHNICAL DATA 250-300 MX SMX		
ENGINE	250	300
Type	Single cylinder 2-stroke, liquid-cooled	
Displacement	249,3 cm ³	293,1 cm ³
Bore/stroke	66.4x72	72x72
Compression	14.5:1	11.5:1
Fuel	(E5) / (E10) super unleaded fuel mixed with oil at 3%	
Squish height	1.5/1.6 mm	1.6/1.7 mm
Piston height from the cylinder surface to the PMS	- 0.50 mm	- 0.55/0.60 mm
Piston cylinder tolerance	0,06 / 0,07	
Engine shaft supports	2 roller bearings	
Small-end bearing	silvery needle roller cage	
Big-end bearing	needle roller cage	
Piston	forged in light alloy	
Segments	2 segments (GAP 0,60 / 0,65)	
Gearbox oil quantity	700 cc	
Primary transmission	straight-toothed gears 19/57	
Clutch	multiple disc oil bath	
Gearbox (with front couplings)	5 gears	
Gear ratios	1 ^a 15:27	
	2 ^a 17:25	
	3 ^a 19:23	
	4 ^a 21:21	
	5 ^a 23:20	
Ignition	CDI EMOTICOM	
Generator	12V 180W	
Regulator	KOKUSAN	
Spark plug	NGK BKR 8EIX	
Electrodes distance	0,7-0,75 mm	
Cooling	fluid, 40% antifreeze, 60% water (up to -25°C), circulation forced with pump	
Fluid amount	1 liter (see page 4-97)	

ENGINE TECHNICAL DATA 250-300 EN-SMR

ENGINE	250 EN	250 SMR	300 EN	300 SMR
Type	Single cylinder 2-stroke, liquid-cooled			
Displacement	249,3 cm ³		293,1 cm ³	
Bore/stroke	66.4x72 mm		72x72 mm	
Compression	12.5:1		11.5:1	
Fuel	(E5) / (E10) super unleaded fuel			
Engine lubrication	separated with Mikuni pump driven by engine ECU			
Squish height	1.6 mm		1.7 mm	
Piston height from the cylinder surface to the PMS	- 0.50 mm		- 0.55/0.60 mm	
Piston cylinder tolerance	0,08 / 0,09			
Engine shaft supports	2 roller bearings			
Small-end bearing	silvery needle roller cage			
Big-end bearing	needle roller cage			
Piston	forged in light alloy, graphitised shell			
Segments	2 segments (GAP 0,60 / 0,65)			
Gearbox oil quantity	700 cc			
Primary transmission	straight-toothed gears 19/57			
Clutch	multiple disc oil bath			
Gearbox (with front couplings)	5 gears			
Gear ratios	1 ^a 14:28			
	2 ^a 17:25			
	3 ^a 19:23			
	4 ^a 21:21			
	5 ^a 24:19			
Ignition	CDI EMOTICOM			
Generator	12V 180W			
Regulator	KOKUSAN			
Spark plug	NGK BKR 8EIX			
Electrodes distance	0,7-0,75 mm			
Cooling	fluid, 40% antifreeze, 60% water (up to -25°C), circulation forced with pump			
Fluid amount	1 liter (see page 4-97)			

CARBURETTORS SETTING MX-SMX

KEIHIN	250 MX	300 MX	300 SMX	300 MX BRASILE
Type	PWK 38	PWK 38	PWK 38	PWK 38
Needle	N0ZE	N1EH	NIEG	NOZG
Needle position	4 ^a mark	3 ^a mark	3 ^a mark	4 ^a mark
Guillotine	6,5	6,5	6,5	6,5
Maximum jet	180	180	180	190
Idle jet	45	45	45	50
Air screw turns	1.5 turns	1,5	1,5	1,5
Float position	16 mm standard	16 mm standard	20 mm modified	16 mm standard

ENGINE TIGHTENING TORQUES

Carter Allen screw, transmission torque, clutch torque, ignition torque	M 6	12 Nm
Oil drain screw cap	M14x1.5	20 Nm
Oil load screw cap	M14x1.5	20 Nm
Valve adjustment grub screws	M 5	8 Nm
Valve adjustment locknuts	M 5	8 Nm
Laminated body Allen screw	M6	12 Nm
Cylinder-head tightening flange screw	M 8	27 Nm
Base-cylinder tightening flange nuts	M 10	35 Nm
Water pump cover Allen screw	M 6	12 Nm
Water pump rotor	M 6	Loctite 243 + 15 Nm
Clutch hub nut	M18x1.5	Loctite 243 + 80 Nm
Clutch springs Allen screw	M 6	10 Nm
Ignition stator Allen screw	M 6	Loctite 243 + 10 Nm
Limit switch plate fixing countersunk screw	M 6	10 Nm
Allen screw for gear blocker	M 6	Loctite 243 + 10 Nm
Ignition pedal screw	M 6	Loctite 243 + 25 Nm
Gearbox lever Allen screw	M 6	Loctite 243 + 10 Nm
Generic screws/nuts	M 5	8 Nm
Generic screws/nuts	M 6	10 Nm
Generic screws/nuts	M 8	25 Nm

LUBRICATION

Gearbox Oil	BARDAHL GEAR BOX - SAE 10-40
Automatic Mixer Oil	BARDAHL KTS COMPETITION or oil for automatic mixer
Oil for mix	BARDAHL KXT Synthetic SAE 50
Clutch Oil	DOT 4
Brakes Oil	DOT 4
Radiator liquid	BARDAHL PERMANENT SPECIAL FLUID

CHASSIS TECHNICAL DATA			
	250-300 MX-SMX	250-300 EN	250-300 SMR
Frame	High resistance aluminum alloy perimeter		
Front suspension	KAYABA USD fork		
Front/rear suspension stroke	300/315 mm		
Rear suspension	Progressive linkage, TM Shock absorber		
Front disc brake	Ø 270 mm floating caliper		Ø 320 mm 4-piston caliper
Rear disc brake	Ø 245 mm floating caliper		Ø 270 mm SMR
Front/rear brake disc wear limit	mm. 0,4 below original thickness		
Front tire	80/100-21"	90/90-21"	120/70-17" opp. 110/70-17"
Air pressure "solo"	1,1 bar		
Rear tire	110/90-19"	140/80-18"	150/60-17"
Air pressure "solo"	1,1 bar		
Tank capacity	10 liters (1 of which is reserve)		
Final drive	13/49	13/51	13/40
Chain	5/8 x 1/4"		
Optional sprockets	48,49,50,51,52		38,39,40,41,42,43,44,45,46
Bulbs (EN/SMR only)	Headlight bulb (EN/SMR) HS1 12V 35/35W Front position light bulb (EN/SMR) 12V 5W W5W Rear/stop/licence plate position light (EN) Led 12V 0.9W / 0.006W (SMR) P21/5W 12V 21/5W BAY15d Indicator bulb R10W 12V 10W BA15S		

TIGHTENING TORQUES	250/300 MX/EN/SMX	250/300 SMR	
Front wheel pin flange nut	M20x1,5	M20x1,5	40 Nm
Front brake caliper fixing screw	M8	M10	30 Nm/40 Nm
Front brake disc fixing screw	M6 cl. 10,9	M6 cl. 10,9	15 Nm
Rear brake disc fixing screw	M6 cl. 10,9	M6 cl. 10,9	15 Nm
Top fork head tightening screw	M8	M8	20 Nm
Bottom fork head tightening screw	M8	M8	20 Nm
Marzocchi fork shoe tightening screw	M6	M6	12 Nm
Rear wheel pin flange nut	M22x1,5	M22x1,5	80 Nm
Swingarm pin flange nut	M16x1,5	M16x1,5	80 Nm
Handlebar tightening covers screws	M8	M8	20 Nm
Nut for elastic support to the handlebar	M10	M10	35 Nm
Top shock absorber nut	M10x1,25	M10x1,25	40 Nm
Bottom shock absorber screw	M10x1,25	M10x1,25	35 Nm
Crown gear nuts	M8	M8	35 Nm
Rear brake pedal registry nut	M6	M6	15 Nm
Engine fixing screw	M10	M10	45 Nm
Generic chassis screws	M6	M6	10 Nm
Generic chassis nuts	M8	M8	25 Nm
	M10	M10	45 Nm
	M6	M6	15 Nm
	M8	M8	30 Nm
	M10	M10	50 Nm

7. WIRING DIAGRAMS



LIGHTS AND ACCESSORIES WIRING DIAGRAM EN-SMR

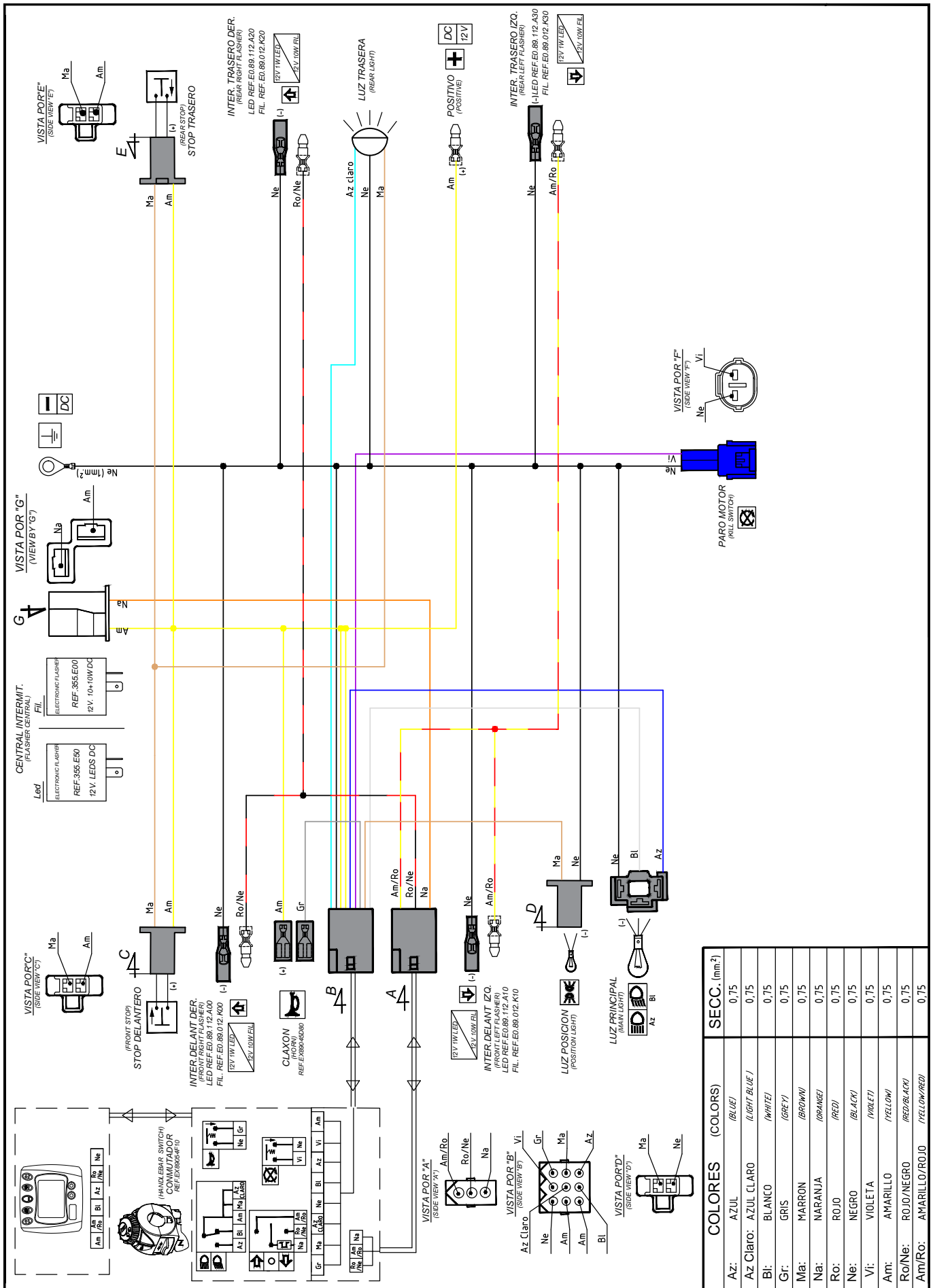

ENGINE WIRING DIAGRAM MX - SMX

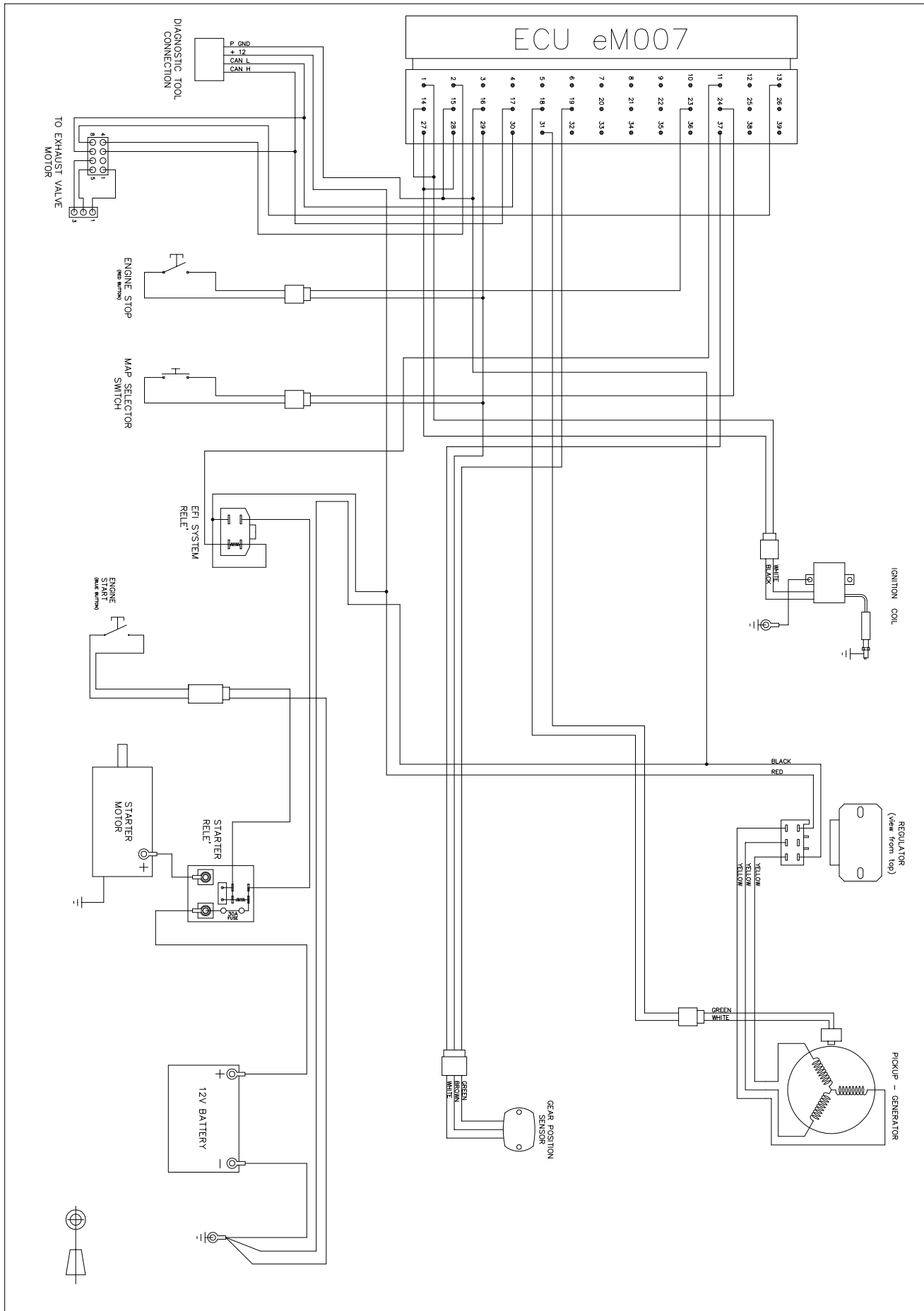

ENGINE WIRING DIAGRAM SMR

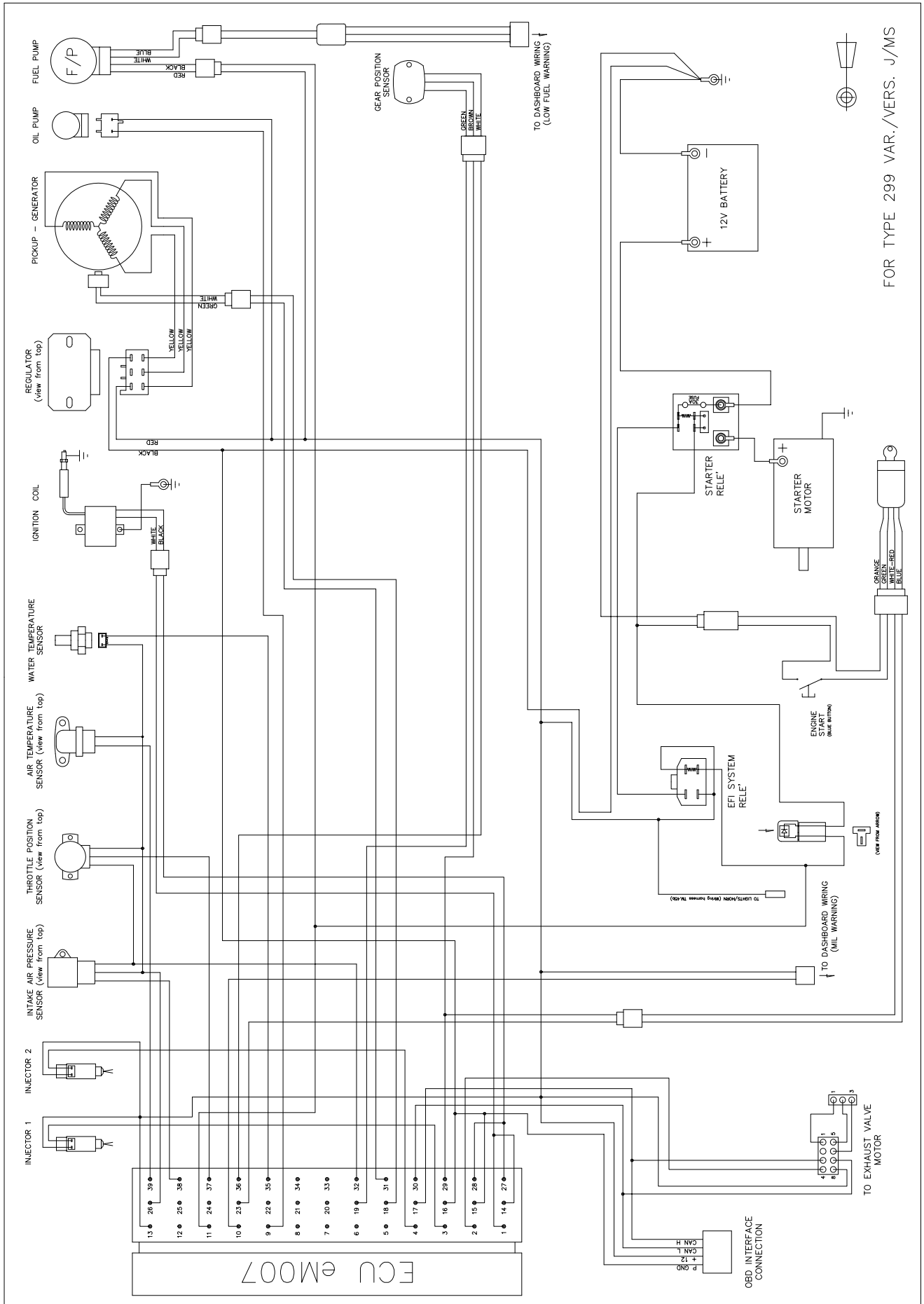

FOR TYPE 299 VAR./VERS. J/MS

ENGINE WIRING DIAGRAM EN

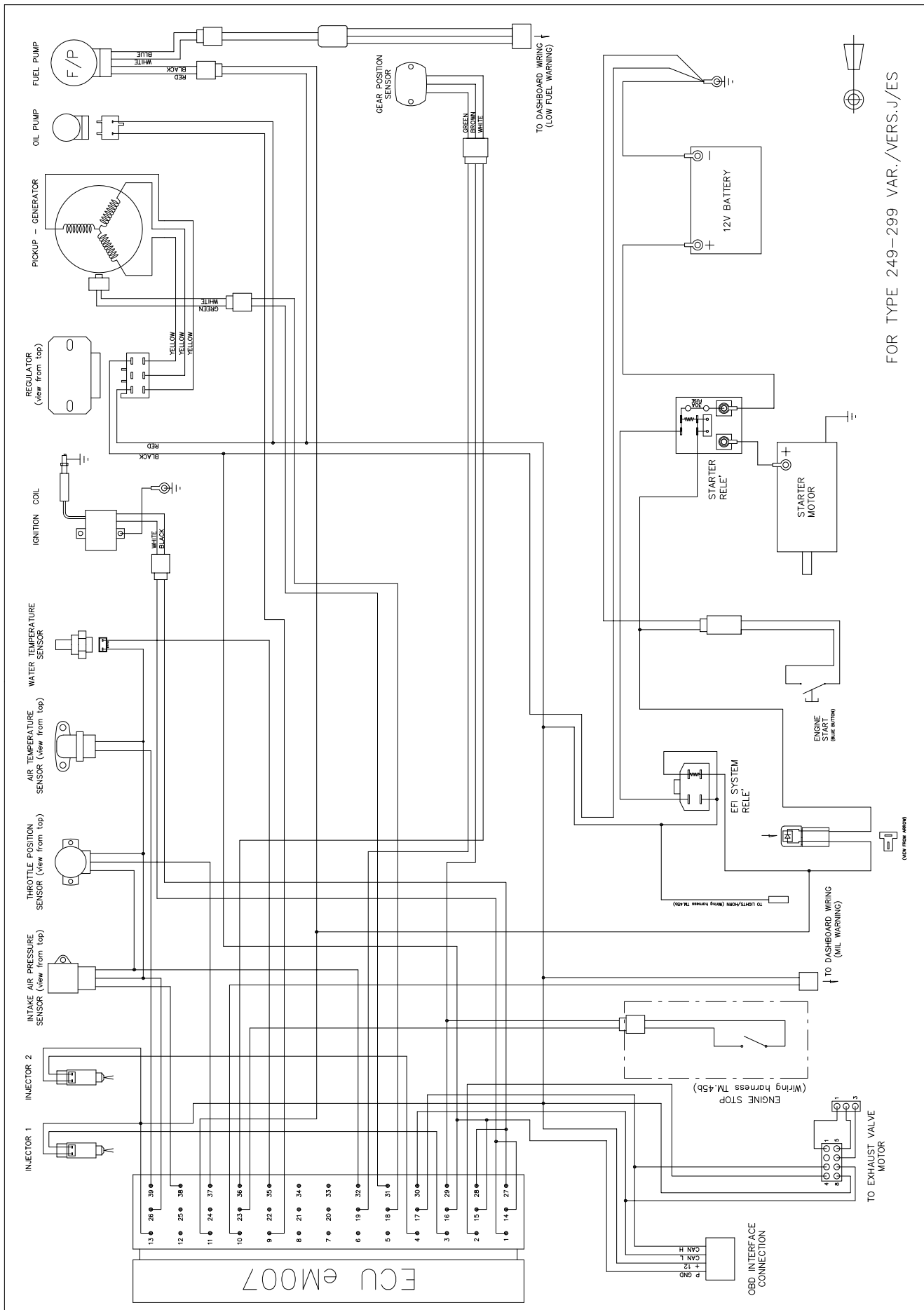

FOR TYPE 249-299 VAR./VERS./ES

ALPHABETICAL INDEX

2 stroke oil tank	2•37
2 stroke oil circuit filling (ONLY TSI MODELS)	4•109
250-300 en-smr (tsi) MAINTENANCE TABLE	4•54
250-300 (MX - SMX) MAINTENANCE TABLE	4•56

A

ACCELERATING, Shifting gears, slowing down	3•49
ADAPTING fork basic calibration	4•65
ADAPTING shock absorber basic calibration	4•65
Adjusting idle speed	4•103
ADJUSTING THE HEIGHT OF THE FRONT HEADLAMP	4•94
Adjusting THROTTLE control CABLES	4•102
Adjustment on models (MX-SMX)	4•102

B

Basic indications for TM disc brakes	4•72
Basic SUSPENSION calibration DEPENDING ON THE WEIGHT OF THE rider	4•65
Battery	4•91
Battery maintenance	4•92
Bleeding the hydraulic clutch	4•72
Bleeding the telescopic fork	4•61
Braking	3•49
BREMBO 16x18 RADIAL PUMP front brake lever (SMX)	2•23
BREMBO 16x18 RADIAL front brake PUMP (SMX)	4•78
BREMBO front brake PUMP (Optional)	4•75
BREMBO PUMP front brake lever	2•22
BREMBO RADIAL front brake PUMP (SMR)	4•77
BREMBO RADIAL PUMP front brake lever (SMR)	2•23

C

CARBURETTORS SETTING mx-smx	6•121
Chain maintenance	4•70
Chain wear	4•70
Changing basic position of rear brake pedal	4•79
Charging THE battery	4•92
CHASSIS TECHNICAL DATA	6•122
Checking AND TOPPING UP the HYDRAULIC fluid level	4•71
Checking chain tension	4•68
Checking front brake pads	4•80
Checking Rear brake fluid level	4•79
Checking rear brake pads	4•81
CHECKING shock absorber rider SAG	4•66
CHECKING SHOCK ABSORBER static SAG	4•66
Checking SPEEDOMETER magnetic sensor distance (EN/SMR)	4•87
Checking spoke tension	4•86
Checking steering bearings and play adjustment	4•67
Cleaning air filter	4•100
Cleaning Telescopic fork dust seal	4•62
COLD START DEVICE (MX - SMX)	2•27
COLD START DEVICE (TSI)	2•26
Cold start OF THE MOTORCYCLE	3•47
COMBINATION SWITCH (EN)	2•24
CONNECTING OBD TOOL	4•116
CONTROL COMPONENTS	2•19
Cooling	4•97

D

DIAGNOSIS	5•111
DIGITAL ELECTRONIC SPEEDOMETER AND INDICATORS (EN / SMR)	2•27
DIMMER SWITCH (SMR)	2•24
Disassembling and assembling front wheel	4•84
Disassembling and assembling rear wheel	4•85
Disassembling the valve	4•106
DISPLAY	2•28
DOUBLE MAPPING SWITCH	2•25

E

ELECTRIC START OF THE MOTORCYCLE	3•45
ELECTRICAL SYSTEM COMPONENTS POSITIONING	4•93
ENGINE IDLE SPEED ADJUSTMENT	2•39
Engine SERIAL number	1•17
Engine STOP button (MX / SMX)	2•26
ENGINE TECHNICAL DATA 250-300 mx smx	6•119
ENGINE TECHNICAL DATA 250-300 en-smr	6•120
ENGINE TIGHTENING TORQUES	6•121
ENGINE WIRING DIAGRAM EN	7•128
ENGINE WIRING DIAGRAM MX - SMX	7•126
ENGINE WIRING DIAGRAM SMR	7•127
EXHAUST VALVE	4•105

F

For motorcycle with carburettor (MX and SMX)	3•48
For motorcycle with throttle body (TSI)	3•48
Fork compression adjustment	4•59
Fork rebound adjustment	4•60
Frame SERIAL number	1•17
FUEL TANK (mx - smx)	2•38
FUEL TANK (TSI)	2•37
FUEL TAP (MX - SMX)	2•39
FUNCTIONS	2•29

G

Gear shifting PEDAL	2•36
GEARBOX OIL CHANGE	4•104

H

HALOGEN HEADLIGHT (EN)	4•94
HYDRAULIC CLUTCH lever	2•22
HYDRAULIC CLUTCH PUMP	4•71

I

Indications for first use	3•43
INSTRUCTIONS FOR USE	3•41

K

KEY ignition / OFF SWITCH (SMR)	2•26
Kick starter	2•36
KICK START OF THE MOTORCYCLE	3•46

L

LED HEADLIGHT FOR MODELS (EN/SMR) (OPTIONAL)	4•95
LED taillight (EN/SMR)	4•96
LEFT-HAND SIDE MAIN COMPONENTS TOPOGRAPHY	2•21
LIGHTS AND ACCESSORIES WIRING DIAGRAM EN-SMR	7•125
LUBRICATION	6•121

M

MAINTENANCE	4•53
Models (MX-MSX)	4•103
Models (TSI)	4•103

N

NISSIN front brake PUMP	4•74
NISSIN PUMP front brake lever (EN/MX)	2•22

O**P**

PRECAUTIONS FOR WINTER USE	3•51
PRELIMINARY CHECKS	3•44
PROBLEM, CAUSE, SOLUTION	5•112

R

REAR brake pedal	2•36
Rear suspension linkage	4•68
Reassembling the valve on the engine	4•106
Removing the exhaust valve	4•105
REMOVING THE SEAT	4•88
REMOVING THE TANK	4•89
Removing the tank of models MX-SMX	4•90
Removing the tank of models (TSI)	4•89
Replacing exhaust silencer packing material	4•99
Replacing front brake pads	4•82
REPLACING LED FRONT HEADLIGHT (OPTIONAL)	4•95
Replacing rear brake pads	4•83
RESETTING THE EXHAUST VALVE	4•107
Resetting the valve for models (MX-SMX)	4•108
Resetting the valve for models (TSI)	4•107
RIGHT-HAND SIDE MAIN COMPONENTS TOPOGRAPHY	2•20
Running-in instructions	3•44

S

SAFETY REGULATIONS	3•43
Setting off	3•49
SHOCK ABSORBER COMPRESSION ADJUSTMENT	4•62
SHOCK ABSORBER REBOUND ADJUSTMENT	4•63
SIDE STAND	2•38
Standard adjustment	4•59
Standard adjustment	4•60
Standard adjustment	4•62
Standard adjustment	4•63
Standard adjustment	4•63
START CONTROL SWITCH FUSE	4•93
Start engine button (MX E.S. / SMX E.S.)	2•25
Starter switch (SMR)	2•25
START-UP AFTER WINTER	3•52
START WITH FLOODED ENGINE	3•48
Steering lock (en/smr)	2•36
STOPPING AND PARKING	3•50
STORAGE	3•52

T

TECHNICAL DATA	6•117
TENSIONING the chain	4•69
THROTTLE	2•23
TIGHTENING TORQUES	6•122
Tire pressure	4•87
Topping up brake fluid	4•74
Topping up brake fluid	4•76

V

Varying pre-load AND REPLACING fork SPRINGS	4•61
VARYING PRE-LOAD AND REPLACING	
SHOCK ABSORBER SPRING	4•64
VEHICLE IDENTIFICATION	1•15

W

WASHING	3•51
WIRING DIAGRAMS	7•123



© TM RACING S.p.A.

Via Fano, 6 - 61122 Pesaro - Italy
Tel. +39 0721 25113 - Fax +39 0721 401808