

PREFACE

This Service Manual describes the technical features and servicing procedures for the KYMCO *AGILITY CITY 50 2T*.

Section 1 contains the precautions for all operations stated in this manual. Read them carefully before starting any operation.

Section 2 is the removal/installation procedures for the frame covers which are subject to higher removal/installation frequency during maintenance and servicing operations.

Section 3 describes the inspection/adjustment procedures, safety rules and service information for each part, starting from periodic maintenance.

Sections 6 through 17 give instructions for disassembly, assembly and inspection of engine, chassis frame and electrical equipment.

Most sections start with an assembly or system illustration and troubleshooting for the section. The subsequent pages give detailed procedures for the section.

Our company reserves the right to make any alteration in the design. The information and contents included in this manual may be different from the motorcycle in case specifications are changed.

TABLE OF CONTENTS

ENGINE	GENERAL INFORMATION	1
	FRAME COVERS/EXHAUST MUFFLER	2
	INSPECTION/ADJUSTMENT	3
	LUBRICATION SYSTEM	4
	ENGINE REMOVAL/INSTALLATION	5
	CYLINDER HEAD/ PISTON	6
	A.C. GENERATOR	7
	KICK STARTER/DRIVE PULLEY/ CLUTCH/DRIVEN PULLEY	8
	FINAL REDUCTION	9
	CRANKCASE/CRANKSHAFT	10
	CARBURETOR	11
CHASSIS	FRONT WHEEL/FRONT BRAKE/ FRONT SUSPENSION	12
	REAR WHEEL /REAR BRAKE /REAR SUSPENSION	13
ELECTRICAL EQUIPMENT	ELECTRICAL EQUIPMENT	14
	INSTRUMENT/SWITCHES/LIGHTS	15
	EXHAUST EMISSION CONTROL SYSTEM	16

1. GENERAL INFORMATION

1

ENGINE SERIAL NUMBER	1- 1	LUBRICATION POINTS	1-13
SPECIFICATIONS	1- 2	CABLE & HARNESS ROUTING	1-15
SERVICE PRECAUTIONS	1- 3	WIRING DIAGRAM.....	1-20
TORQUE VALUES	1-11	TROUBLESHOOTUNG	1-21
SPECIAL TOOLS	1-12		

ENGINE SERIAL NUMBER



1. GENERAL INFORMATION

SPECIFICATIONS

Motorcycle Name & Type		AGILITY CITY 50 2T		
Name & Model No.		LKD1		
Overall length (mm)		2050		
Overall width (mm)		735		
Overall height (mm)		1330		
Wheel base (mm)		1335		
Engine type		Air cooled 2-stroke		
Displacement		49.5cc		
Fuel Used		92# nonleaded gasoline		
Net weight (kg)	Front wheel	44		
	Rear wheel	56		
	Total	110		
Gross weight(kg)	Front wheel	45		
	Rear wheel	67		
	Total	144		
Tires	Front wheel	100/80 -16 56J		
	Rear wheel	120/80 -16 56J		
Ground clearance (mm)		112		
Performance	Braking distance (m)	7 (Initial speed 30km/h)		
	Min. turning radius (m)	1.99		
Engine	Starting system		Starting motor & kick starter	
	Type		Gasoline, 2-stroke	
	Cylinder arrangement		Single cylinder	
	Combustion chamber type		Semi-sphere	
	Valve arrangement		Reed valve & piston	
	Bore x stroke (mm)		39 x 41.4	
	Compression ratio		7.2:1 ±0.2	
	Compression pressure (kg/cm ² -rpm)		11.8kg/cm ² ±2	
	Max. output		4.0/6500	
	Max. torque		0.42/6000 kg m/rpm	
	Port timing	Intake	Open	Automatic controlled
			Close	Automatic controlled
		Exhaust	Open	—
			Close	—
	Valve clearance (cold) (mm)	Intake	—	
		Exhaust	—	
	Idle speed (rpm)		2000±100rpm	
	Lubrication System	Lubrication type		Separate type
		Oil pump type		Plunger type
		Oil filter type		Full-flow filtration
Lubrication oil capacity (liter)		1.1 liter		
Cooling Type		Forced air cooling		

Fuel System	Air cleaner type & No		Paper element, wet	
	Fuel capacity		6.0 liter	
	Carburetor	Type	Plunger type	
Piston dia. (mm)		—		
Venturi dia.(mm)		16		
Electrical Equipment	Ignition System	Type	CDI	
		Ignition timing	13.5°±1°BTDC/2000	
		Contact breaker	Non-contact point type	
		Spark plug	NGK BR8HSA	
	Spark plug gap	0.6~0.7mm		
Battery	Capacity		12V6AH	
Power Drive System	Clutch	Type	Dry multi-disc clutch	
		Transmission Gear	Type	Non-stage transmission
	Operation		Automatic centrifugal type	
	Reduction Gear		Type	Two-stage reduction
		Reduction ratio	1st	1.0-2.8
2nd	46/16*46/15			
Moving Device	Front Axle	Caster angle		27°
		Trail length		—
	Tire pressure (kg/cm ²)	Front	1.75	
		Rear	2.25	
	Turning angle	Left	45°	
Right		45°		
Brake system type		Front	DISK (180mm) brake	
		Rear	Drum (110mm) brake/ DISK (180mm) brake	
Damping Device	Suspension type		Front	TELESCOPE
			Rear	Unit Swing
	Shock absorber distance	Front	80	
Rear		82		
Frame type			Under Bone	

1. GENERAL INFORMATION

SERVICE PRECAUTIONS

- Make sure to install new gaskets, O-rings, circlips, cotter pins, etc. when reassembling.

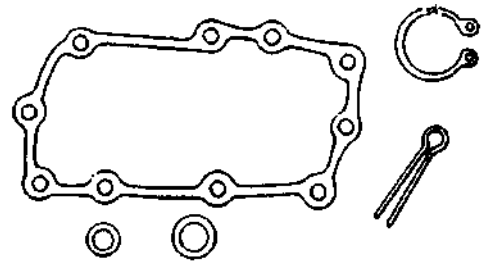

- When tightening bolts or nuts, begin with larger-diameter to smaller ones at several times, and tighten to the specified torque diagonally.

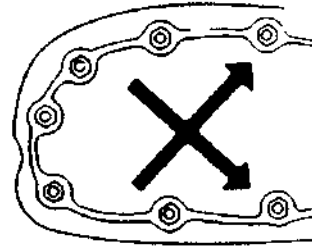

- Use genuine parts and lubricants

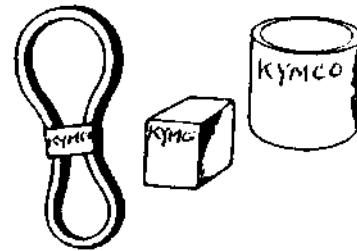

- When servicing the motorcycle, be sure to use special tools for removal and installation.

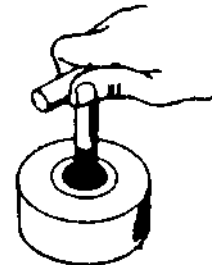

- After disassembly, clean removed parts. Lubricate sliding surfaces with engine oil before reassembly.

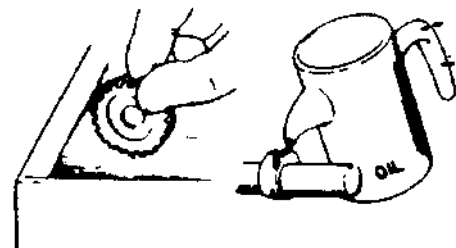

1. GENERAL INFORMATION

- Apply or add designated greases and lubricants to the specified lubrication points.

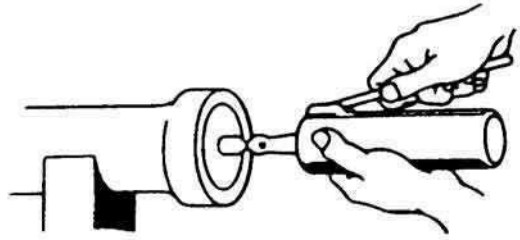

- After reassembly, check all parts for proper tightening and operation.

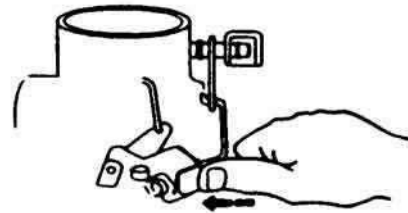

- When two persons work together, pay attention to the mutual working safety.



- Disconnect the battery negative (-) terminal before operation.
- When using a spanner or other tools, make sure not to damage the motorcycle surface.

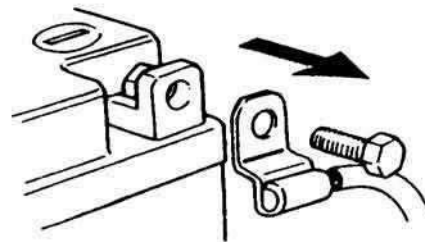

- After operation, check all connecting points, fasteners, and lines for proper connection and installation.
- When connecting the battery, the positive (+) terminal must be connected first.
- After connection, apply grease to the battery terminals.
- Terminal caps shall be installed securely.

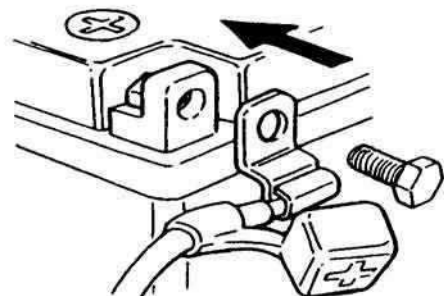

1. GENERAL INFORMATION

- If the fuse is burned out, find the cause and repair it. Replace it with a new one according to the specified capacity.

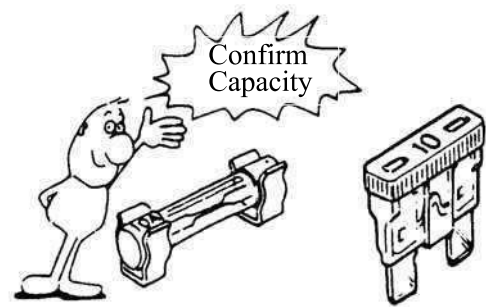

- After operation, terminal caps shall be installed securely.

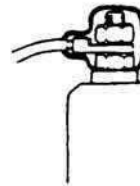

- When taking out the connector, the lock on the connector shall be released before operation.

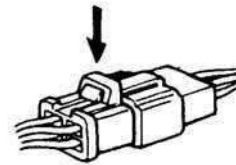

- Hold the connector body when connecting or disconnecting it.
- Do not pull the connector wire.



- Check if any connector terminal is bending, protruding or loose.

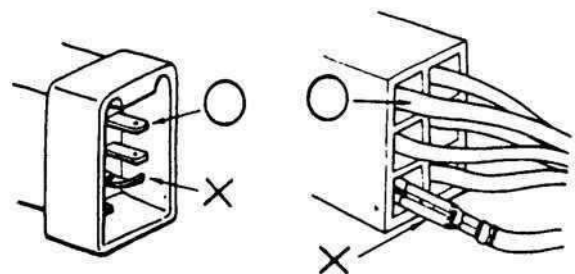

1. GENERAL INFORMATION

- The connector shall be inserted completely.
- If the double connector has a lock, lock it at the correct position.
- Check if there is any loose wire.

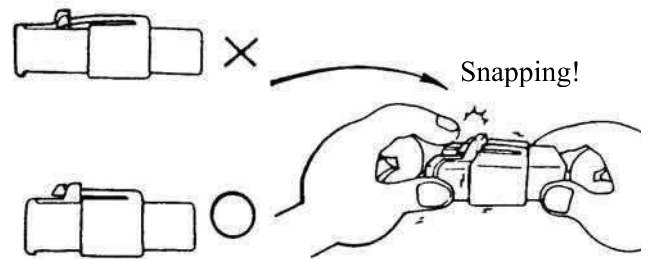

- Before connecting a terminal, check for damaged terminal cover or loose negative terminal.

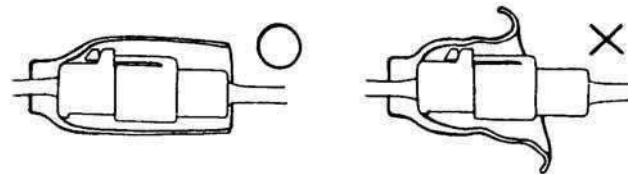

- Check the double connector cover for proper coverage and installation.

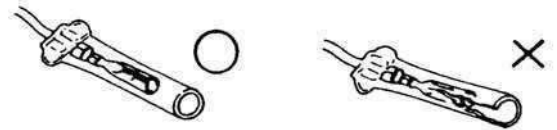

- Insert the terminal completely.
- Check the terminal cover for proper coverage.
- Do not make the terminal cover opening face up.

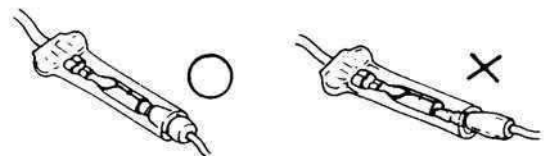

- Secure wire harnesses to the frame with their respective wire bands at the designated locations. Tighten the bands so that only the insulated surfaces contact the wire harnesses.

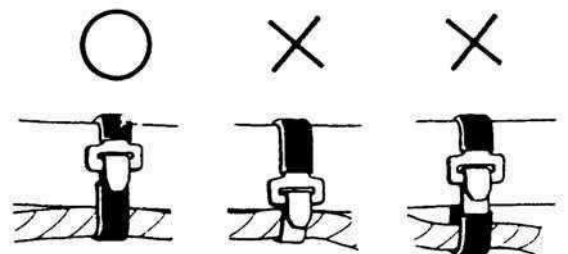

1. GENERAL INFORMATION

- After clamping, check each wire to make sure it is secure.

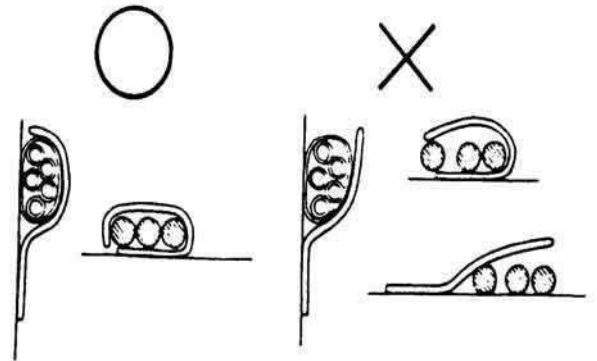

- Do not squeeze wires against the weld or its clamp



- After clamping, check each harness to make sure that it is not interfering with any moving or sliding parts.

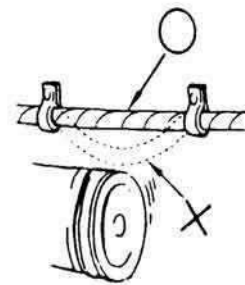

- When fixing the wire harnesses, do not make it contact the parts which will generate high heat.

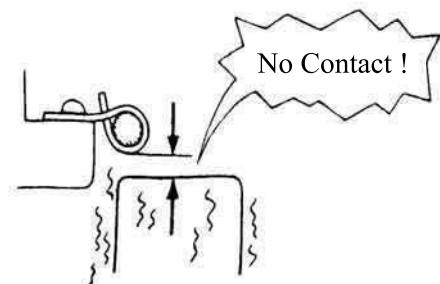

- Route wire harnesses to avoid sharp edges or corners. Avoid the projected ends of bolts and screws.
- Route wire harnesses passing through the side of bolts and screws. Avoid the projected ends of bolts and screws.

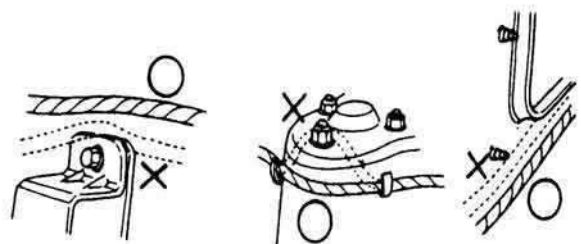

1. GENERAL INFORMATION

- Route harnesses so they are neither pulled tight nor have excessive slack.

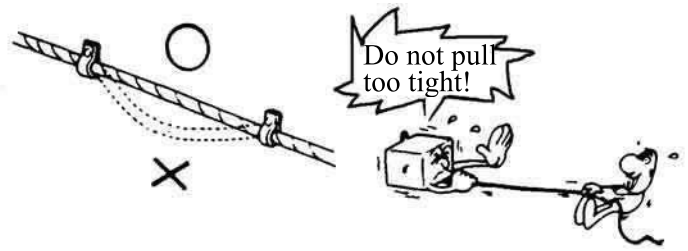

- Protect wires and harnesses with electrical tape or tube if they contact a sharp edge or corner

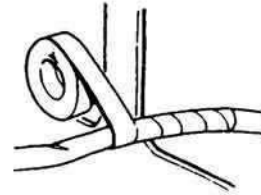

- When rubber protecting cover is used to protect the wire harnesses, it shall be installed securely.

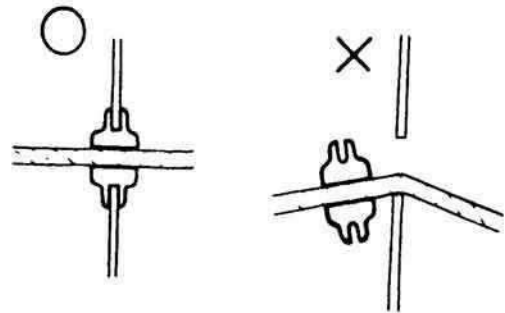

- Do not break the sheath of wire.
- If a wire or harness is with a broken sheath, repair by wrapping it with protective tape or replace it.

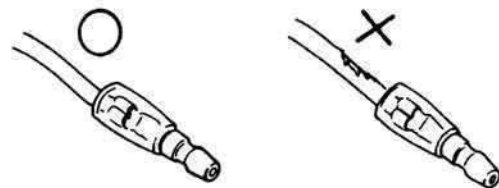

- When installing other parts, do not press or squeeze the wires.



1. GENERAL INFORMATION

- After routing, check that the wire harnesses are not twisted or kinked.

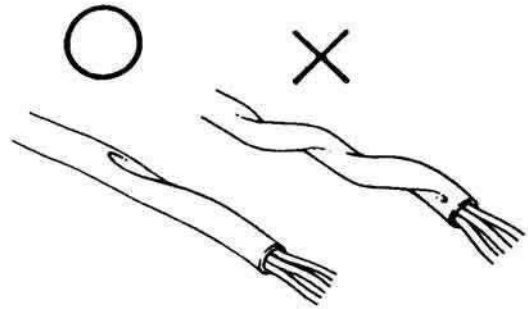

- Wire harnesses routed along with handlebar should not be pulled tight, have excessive slack or interfere with adjacent or surrounding parts in all steering positions.



- When a testing device is used, make sure to understand the operating methods thoroughly and operate according to the operating instructions.

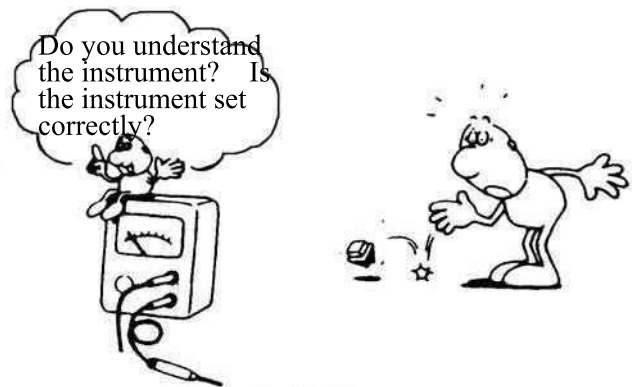

- Be careful not to drop any parts.

- When rust is found on a terminal, remove the rust with sand paper or equivalent before connecting.



- Do not bend or twist control cables. Damaged control cables will not operate smoothly and may stick or bind.

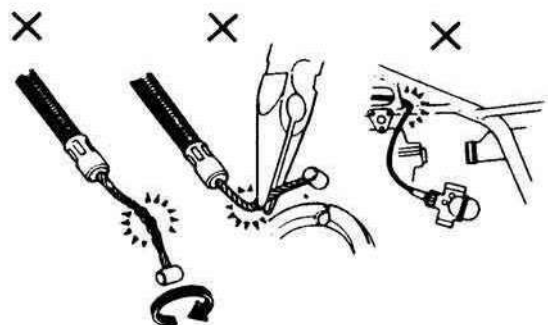

1. GENERAL INFORMATION

■ Symbols:

The following symbols represent the servicing methods and cautions included in this service manual.



Engine Oil

: Apply engine oil to the specified points. (Use designated engine oil for lubrication.)



Grease

: Apply grease for lubrication.



Gear Oil

: Transmission Gear Oil (90#)



: Use special tool.

: Caution



: Warning

(⇒12-3) : Refer to page 12-3.

1. GENERAL INFORMATION

TORQUE VALUES

STANDARD TORQUE VALUES

Item	Torque (kg-m)	Item	Torque (kg-m)
5mm bolt, nut	0.45-0.6	5mm screw	0.35-0.5
6mm bolt, nut	0.6-1.2	6mm screw, SH bolt	0.7-1.1
8mm bolt, nut	1.8-2.5	6mm flange bolt, nut	1.0-1.4
10mm bolt, nut	3.0-4.0	8mm flange bolt, nut	2.4-3.0
12mm bolt, nut	5.0-6.0	10mm flange bolt, nut	3.5-4.5

Torque specifications listed below are for important fasteners.

ENGINE

Item	Q'ty	Thread dia.(mm)	Torque (kg-m)	Remarks
Cylinder head bolt A	2	6	0.7-1.1	Double end bolt
Cylinder head bolt B	4	6	0.7-1.1	
Oil filter screen cap	1	30	1.0-2.0	Double end bolt Apply oil to threads
Exhaust muffler lock bolt	2	6	0.7-1.1	
Cylinder head flange nut	4	7	1.2-1.6	
Valve adjusting lock nut	2	3	0.07-0.09	
Cam chain tensioner slipper bolt	1	8	0.4-0.7	
Oil bolt	1	8	1.1-1.5	
Clutch outer nut	1	10	3.5-4.5	
Clutch drive plate nut	1	28	5.0-6.0	
Starter motor mounting bolt	2	6	0.8-1.2	
Oil pump bolt	3	4	0.1-0.3	
Drive face nut	1	10	5.5-6.5	
Spark plug	1	10	1.0-1.4	
A.C. generator stator bolt	2	6	0.8-1.2	
Cam chain tensioner bolt	1	6	0.8-1.2	

FRAME

Item	Q'ty	Thread dia.(mm)	Torque (kg-m)	Remarks
Steering stem lock nut	1	25.4	8.0-12.0	U-nut
Front axle nut	1	10	5.0-7.0	U-nut
Rear axle nut	1	14	11.0-13.0	U-nut
Rear shock absorber upper bolt	1	10	4.0-5.0	Apply locking agent
Rear shock absorber lower bolt	1	8	2.0-3.0	
Speedometer cable set screw	1	5	0.45-0.6	
Rear shock absorber lock nut	1	8	3.0-3.6	

1. GENERAL INFORMATION

AGILITY CITY 50 2T

SPECIAL TOOLS

Tool Name	Tool No.	Remarks	Ref. Page
Bearing puller 10.12.15.18 mm	E037	10.12.15.18mm bearing	10-3 10-4 12-6
Bushing remover L	E032	11102 bush engine hanger rubber	
Bushing remover S	EO19	11203 bush rear cushion under rubber	
Crankshaft bearing puller	E030	91005 radial bearing	
Crankshaft protector	E029	13000 crankshaft comp 12mm.14mm	
Clutch spring compressor	E027	2301a driven pully assy	9-9 9-12
Cushion assemble & disassemble tool	F004	52400 cushion assy	13-4
Flywheel holder	E017	31110 flywheel comp.2310a pully assy driven	9-5 9-9 9-13 14-7 14-9
Flywheel puller	E002	Left hand thread 27mm	14-7
Long socket wrench 32mm 8angle	F002	50306 steering stem	12-21 12-22
Oil seal & bearing installer	E014	Oil seal & bearing install	
Tool boox	E033	Special tools storage	
Tappet adjuster	E036	90012 screw tappet	3-5
Valve spring compressor	E038	Valve spring	7-7 7-8

1. GENERAL INFORMATION

LUBRICATION POINTS

ENGINE

Lubrication Points	Lubricant
Valve guide/valve stem movable part Cam lobes Valve rocker arm friction surface Cam chain Cylinder lock bolt and nut Piston surroundings and piston ring grooves Piston pin surroundings Cylinder inside wall Connecting rod/piston pin hole Connecting rod big end Crankshaft R/L side oil seal Starter reduction gear engaging part Countershaft gear engaging part Final gear engaging part Bearing movable part O-ring face Oil seal lip	<ul style="list-style-type: none"> •Genuine KYMCO Engine Oil (SAE15W-40) •API-SG Engine Oil
Starter idle gear Friction spring movable part/shaft movable part Shaft movable grooved part Kick starter spindle movable part	High-temperature resistant grease
A.C. generator connector Transmission case breather tube	Adhesive

1. GENERAL INFORMATION

FRAME

The following is the lubrication points for the frame.

Use general purpose grease for parts not listed.

Apply clean engine oil or grease to cables and movable parts not specified.

This will avoid abnormal noise and rise the durability of the motorcycle.

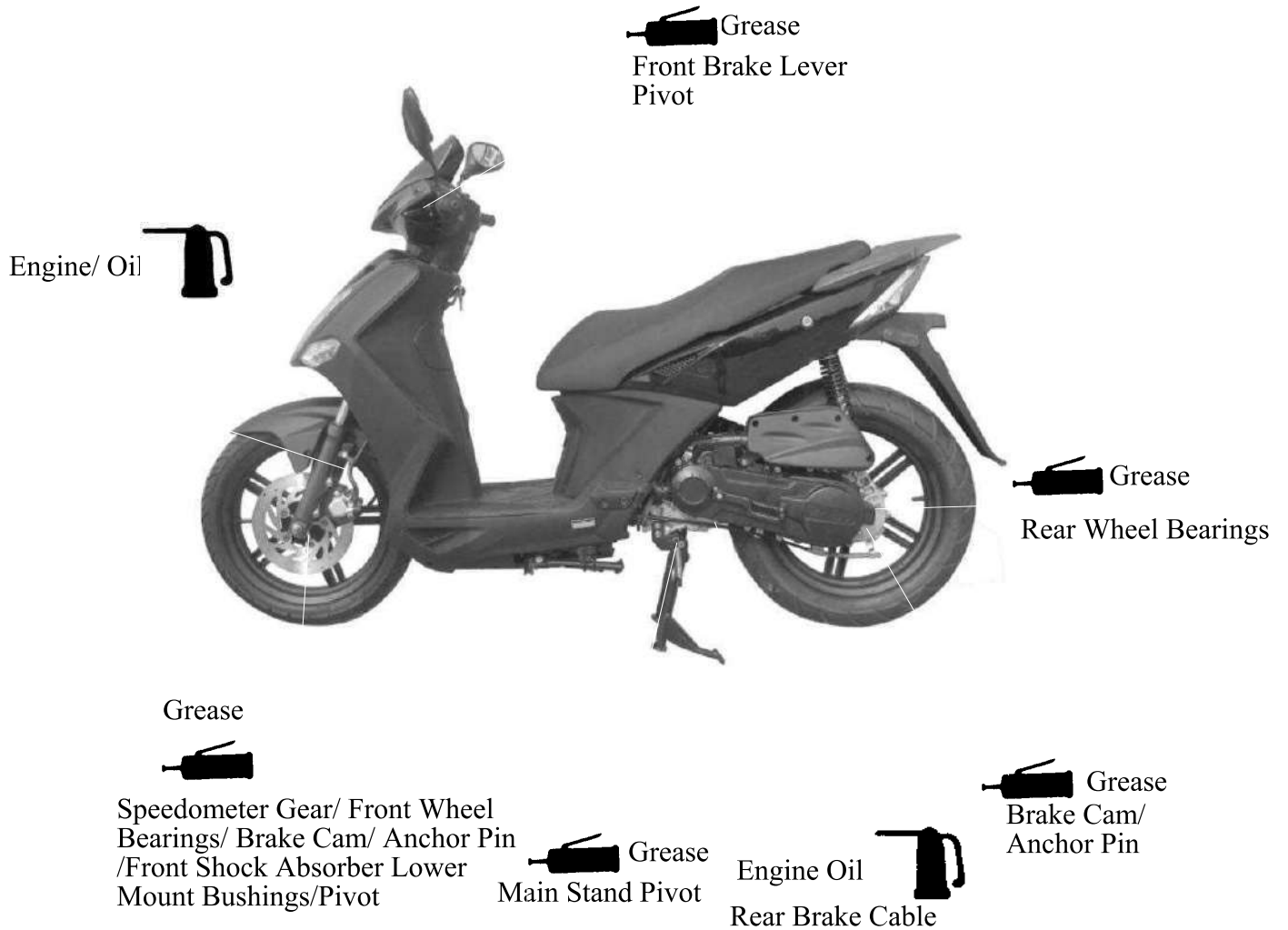

1. GENERAL INFORMATION

CABLE & HARNESS ROUTING

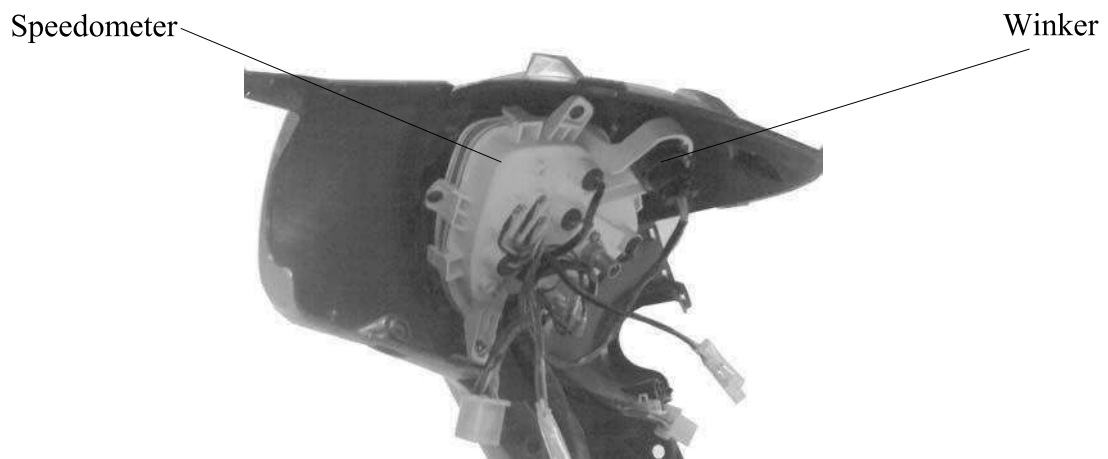
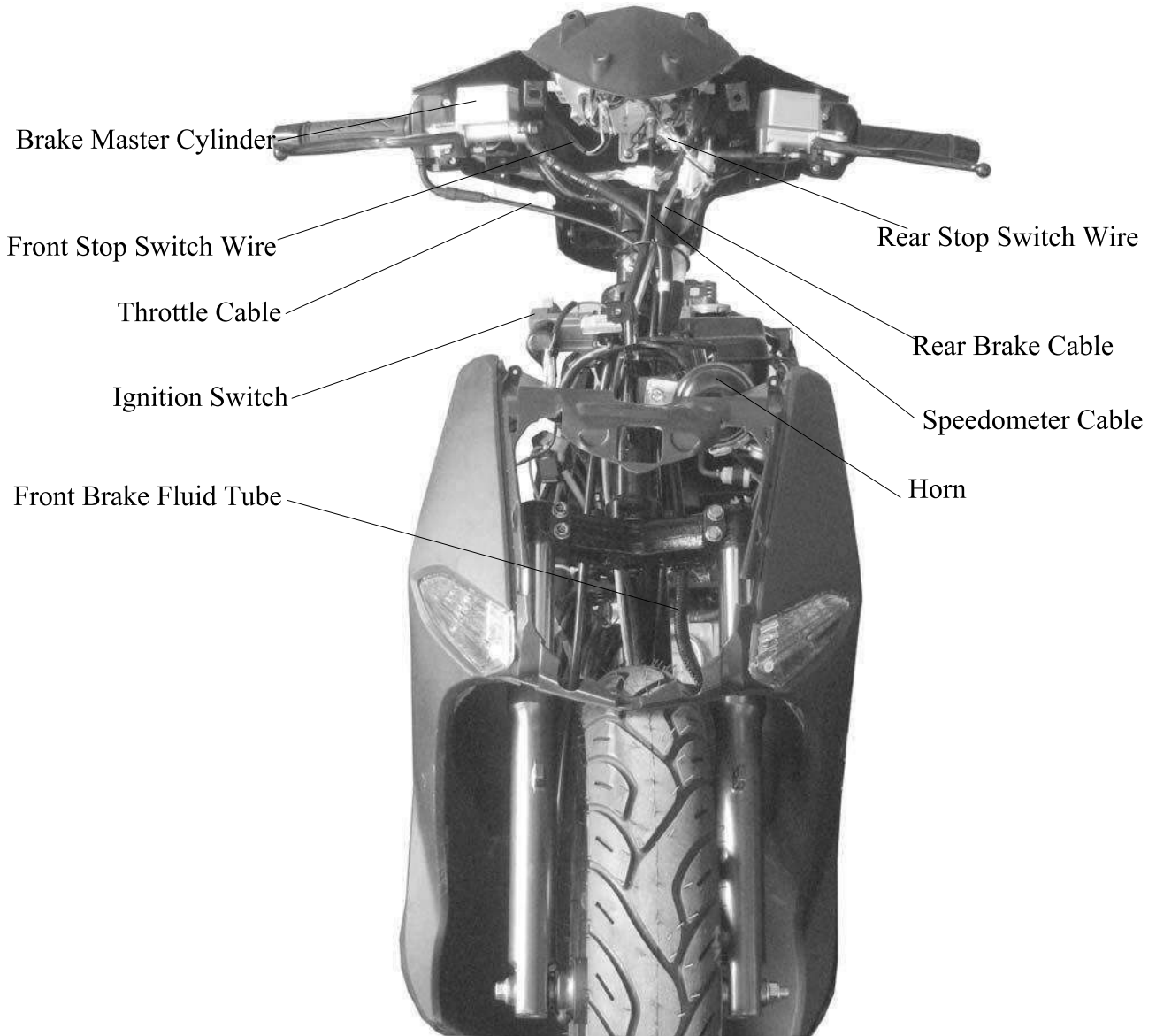

1. GENERAL INFORMATION

AGILITY CITY 50 2T

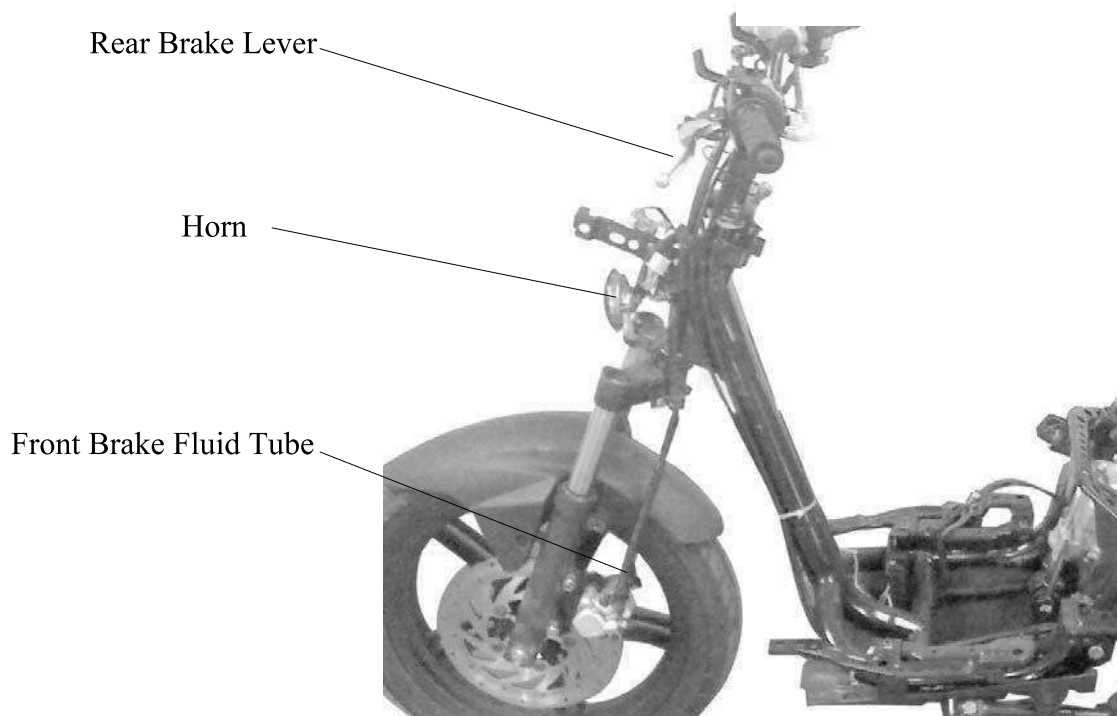
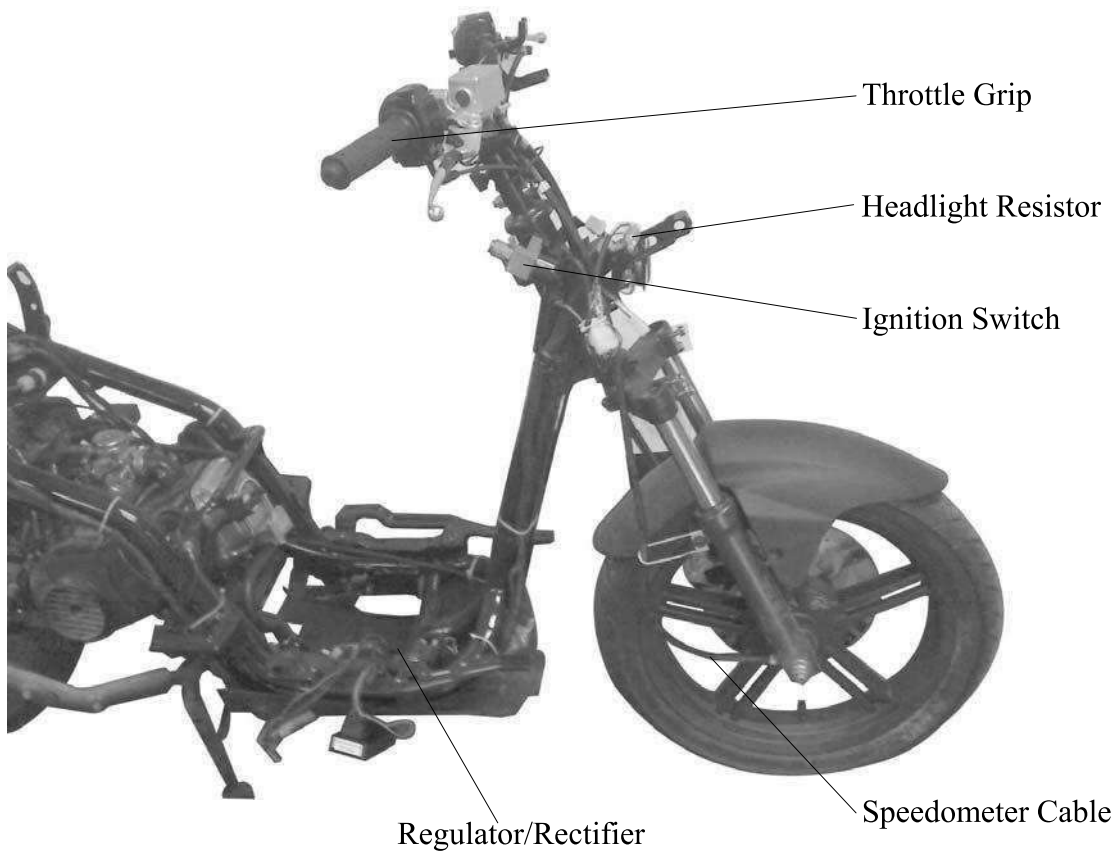

1. GENERAL INFORMATION

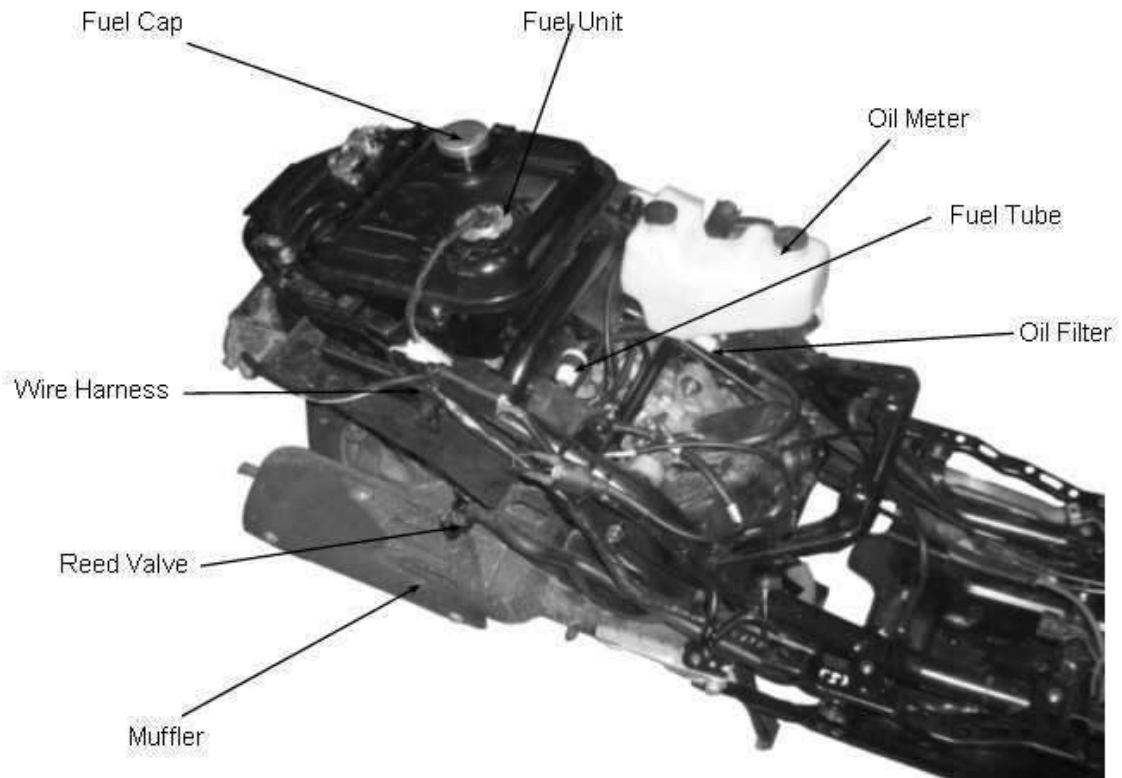
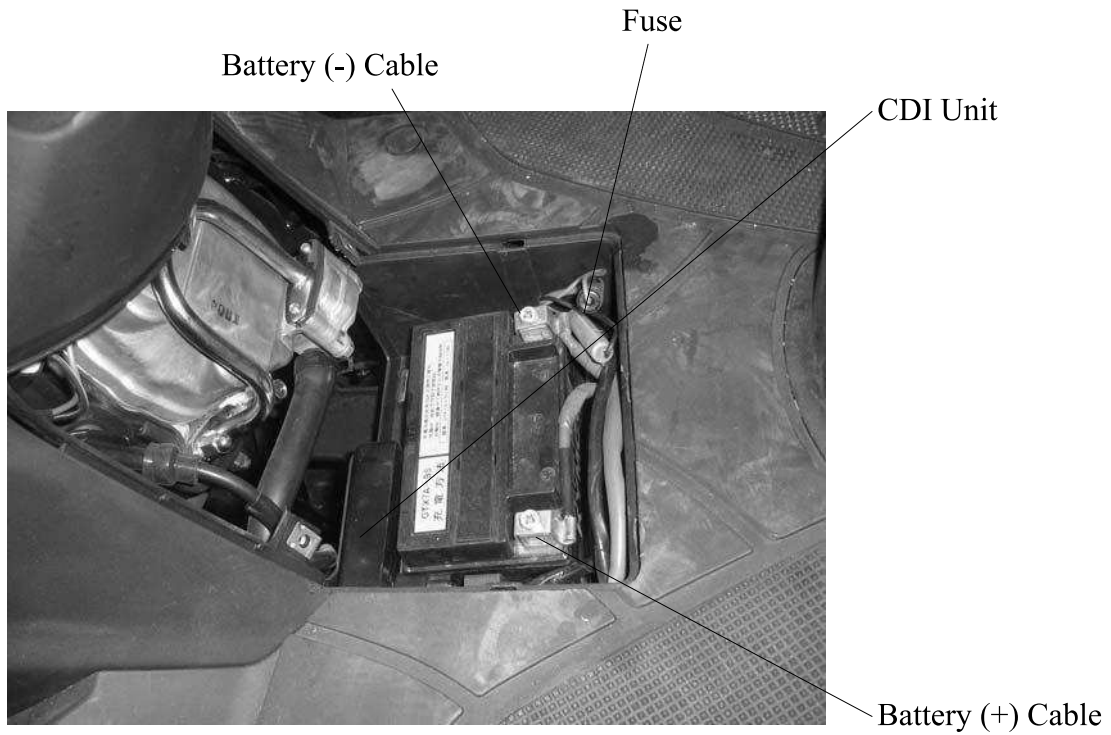

1. GENERAL INFORMATION

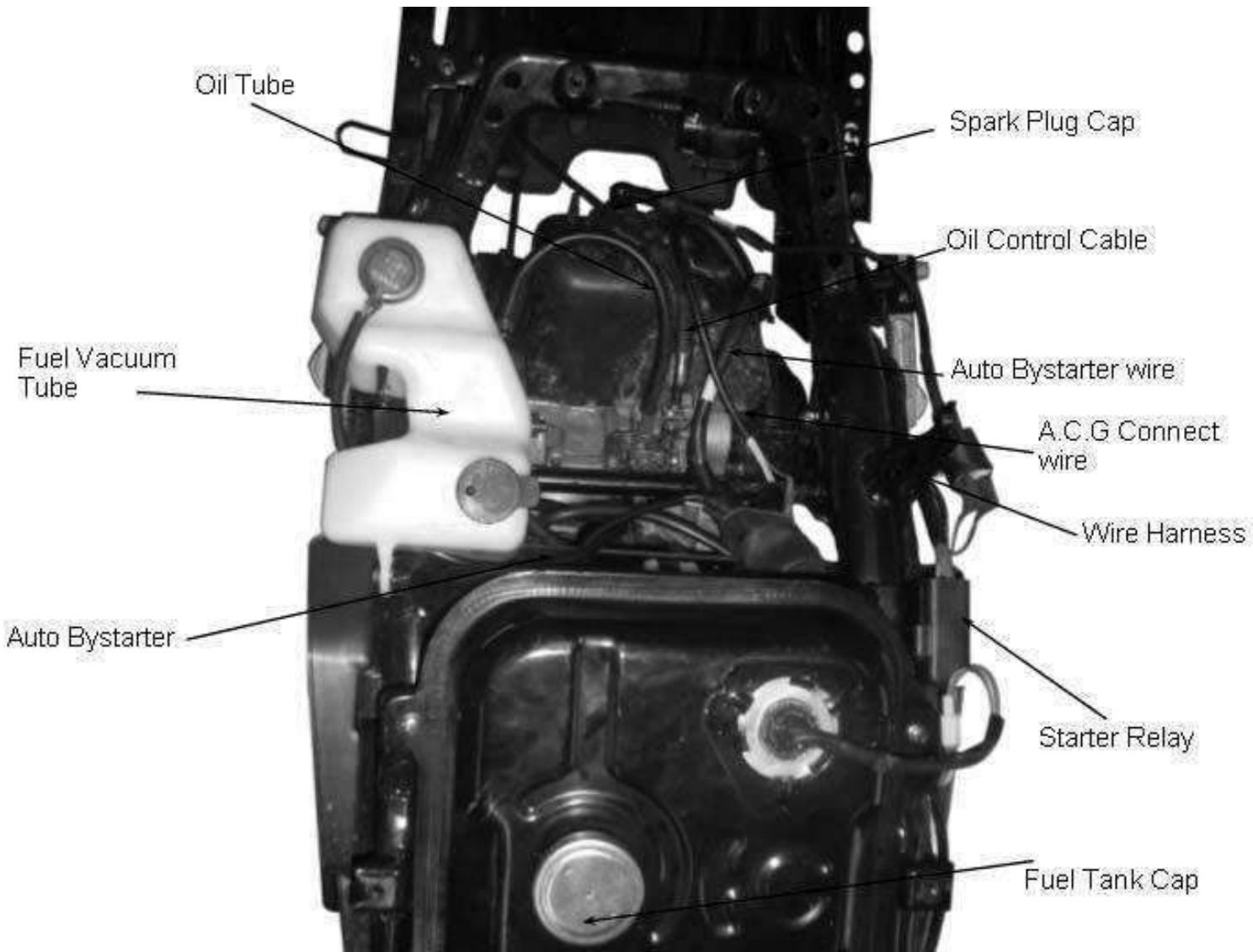

1. GENERAL INFORMATION

AGILITY CITY 50 2T

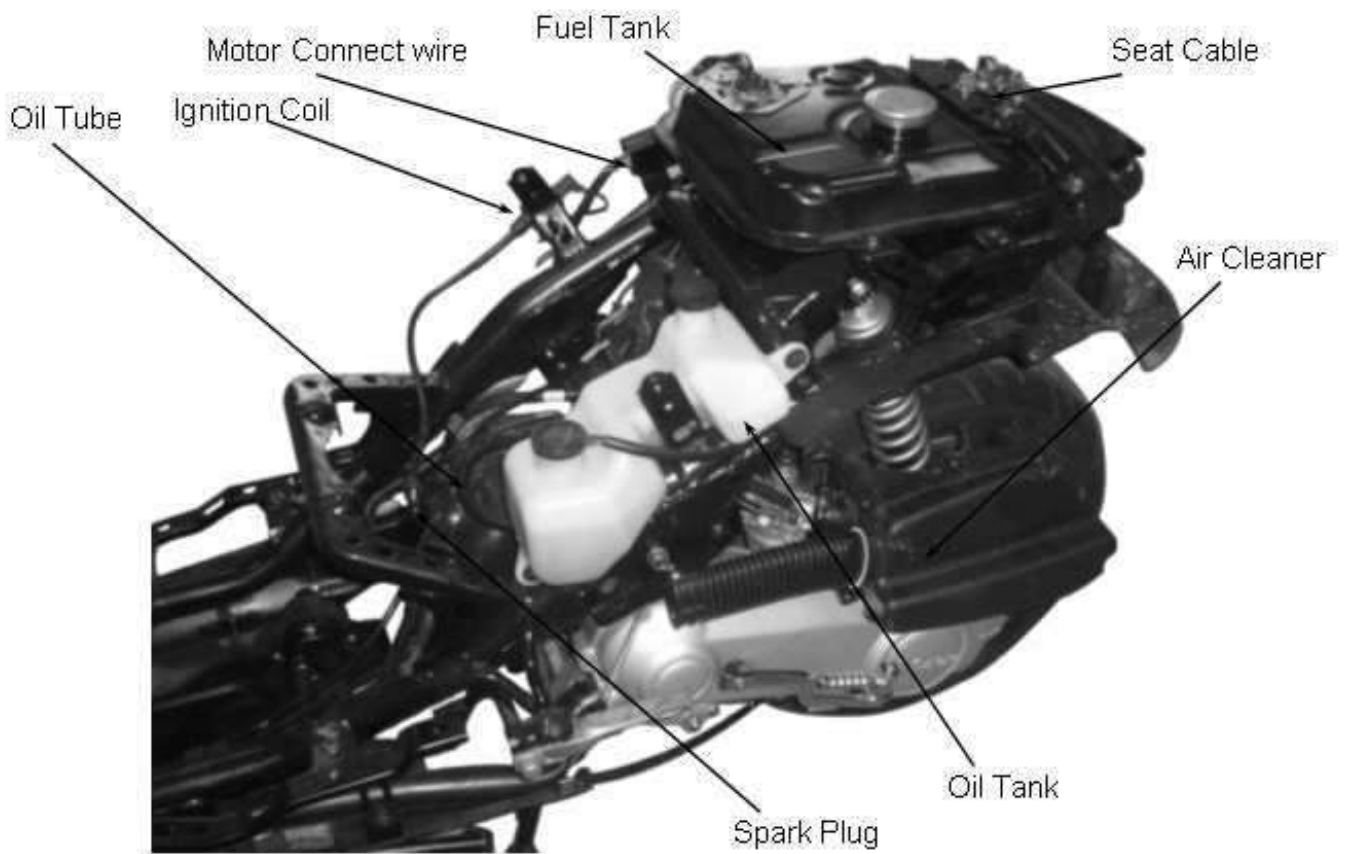

1. GENERAL INFORMATION

AGILITY CITY 50 2T

WIRING DIAGRAM

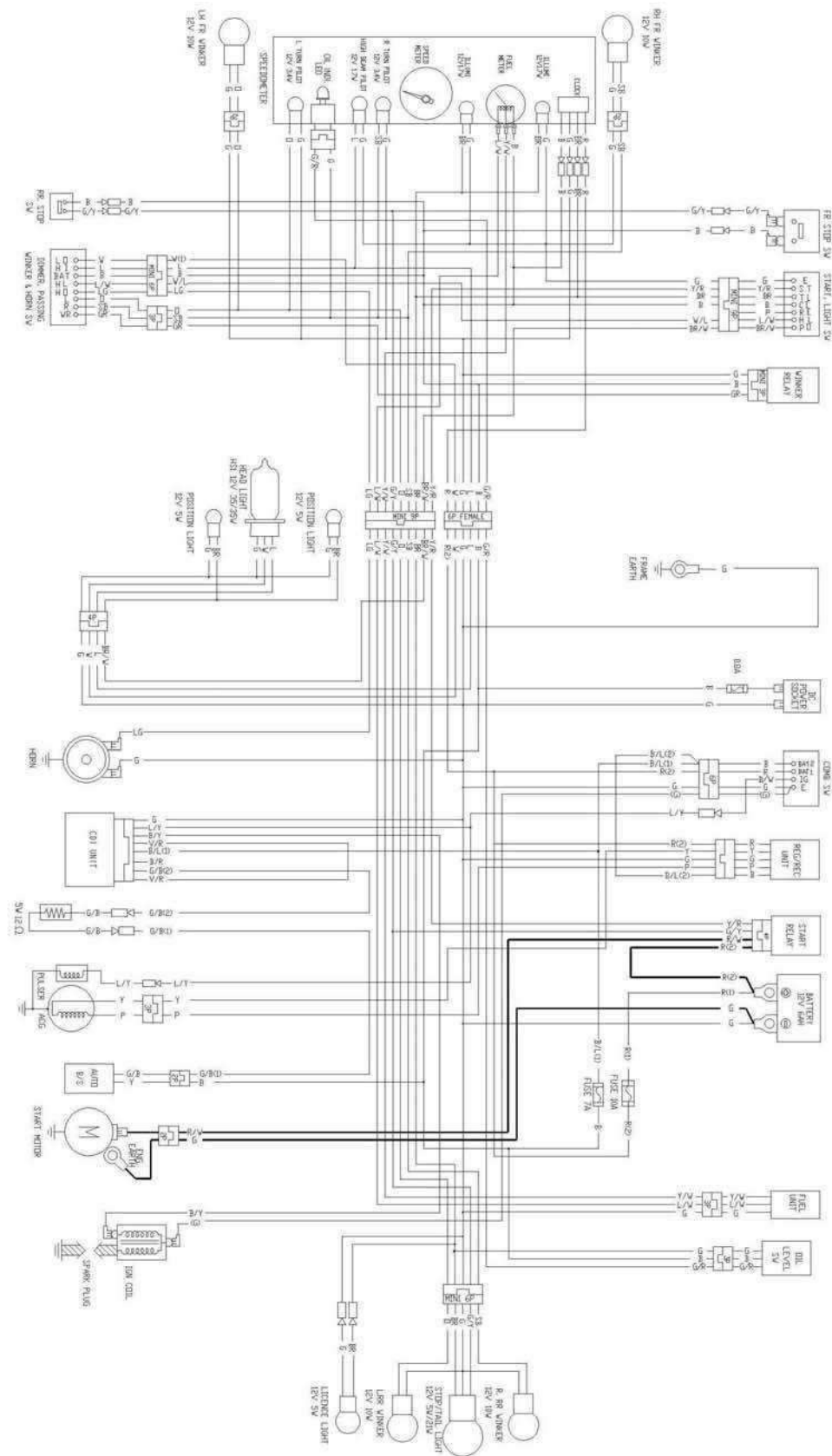

1. GENERAL INFORMATION

TROUBLESHOOTING

ENGINE WILL NOT START OR IS HARD TO START

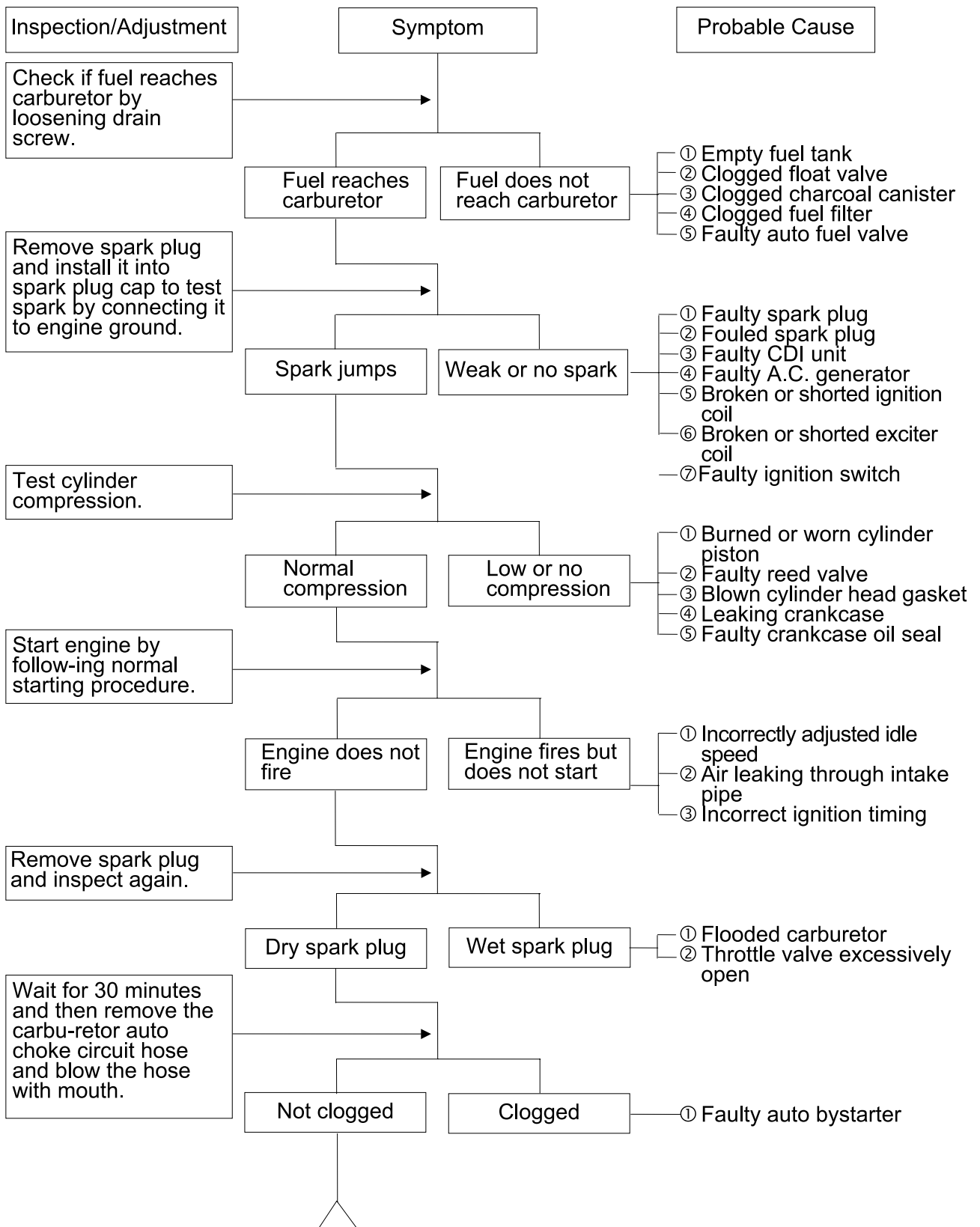

1. GENERAL INFORMATION

AGILITY CITY 50 2T

ENGINE STOPS IMMEDIATELY AFTER IT STARTS

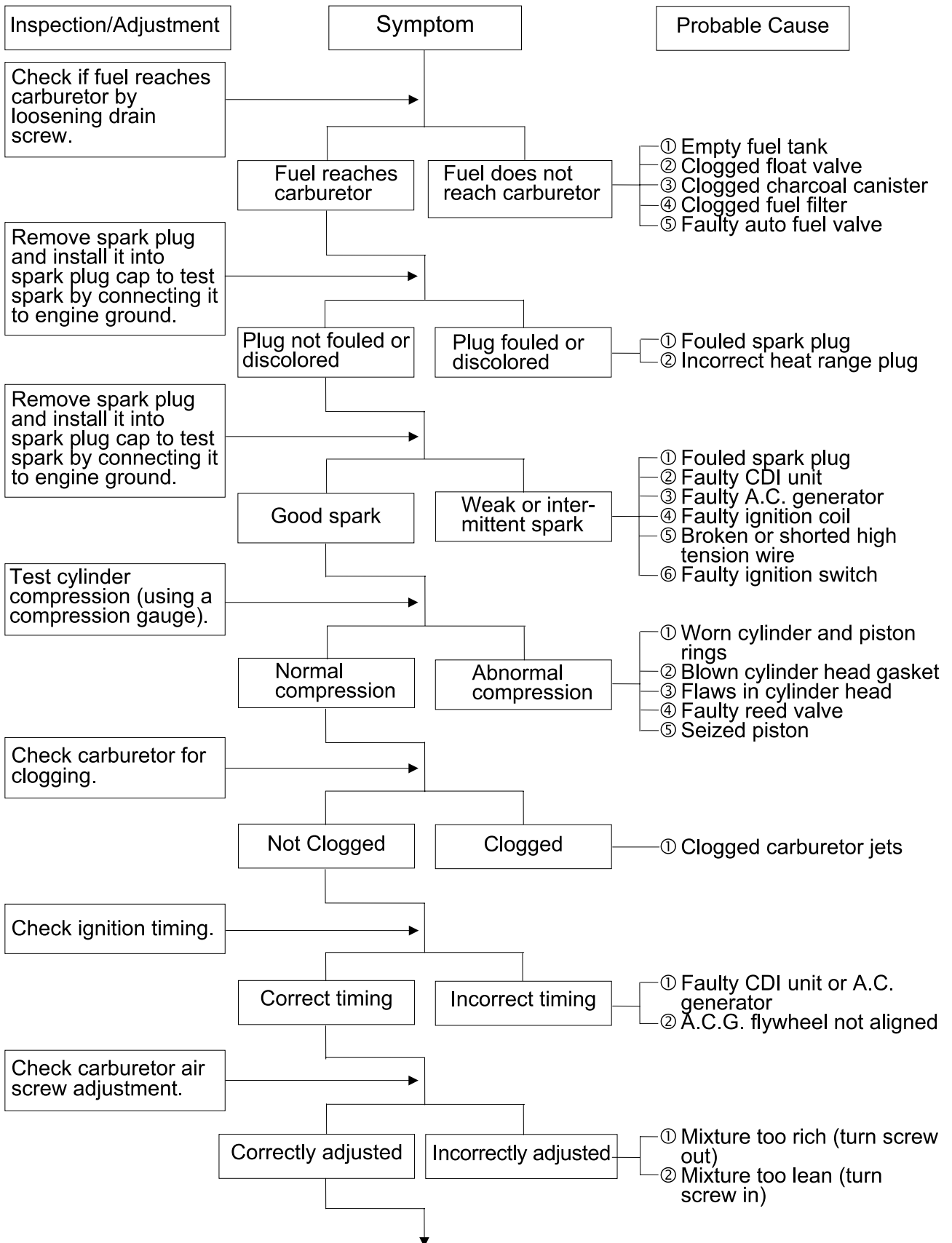

1. GENERAL INFORMATION

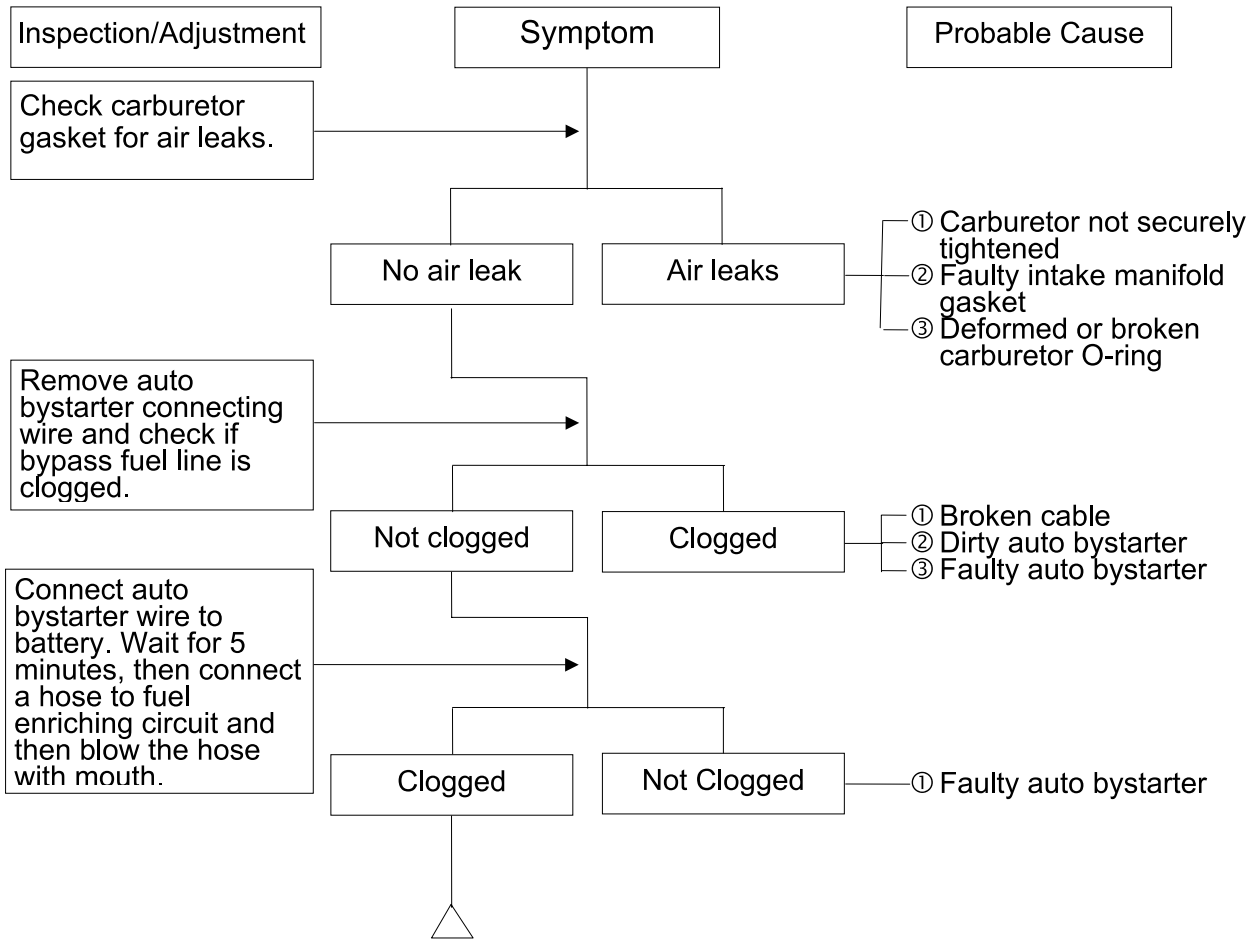

1. GENERAL INFORMATION

AGILITY CITY 50 2T

ENGINE LACKS POWER

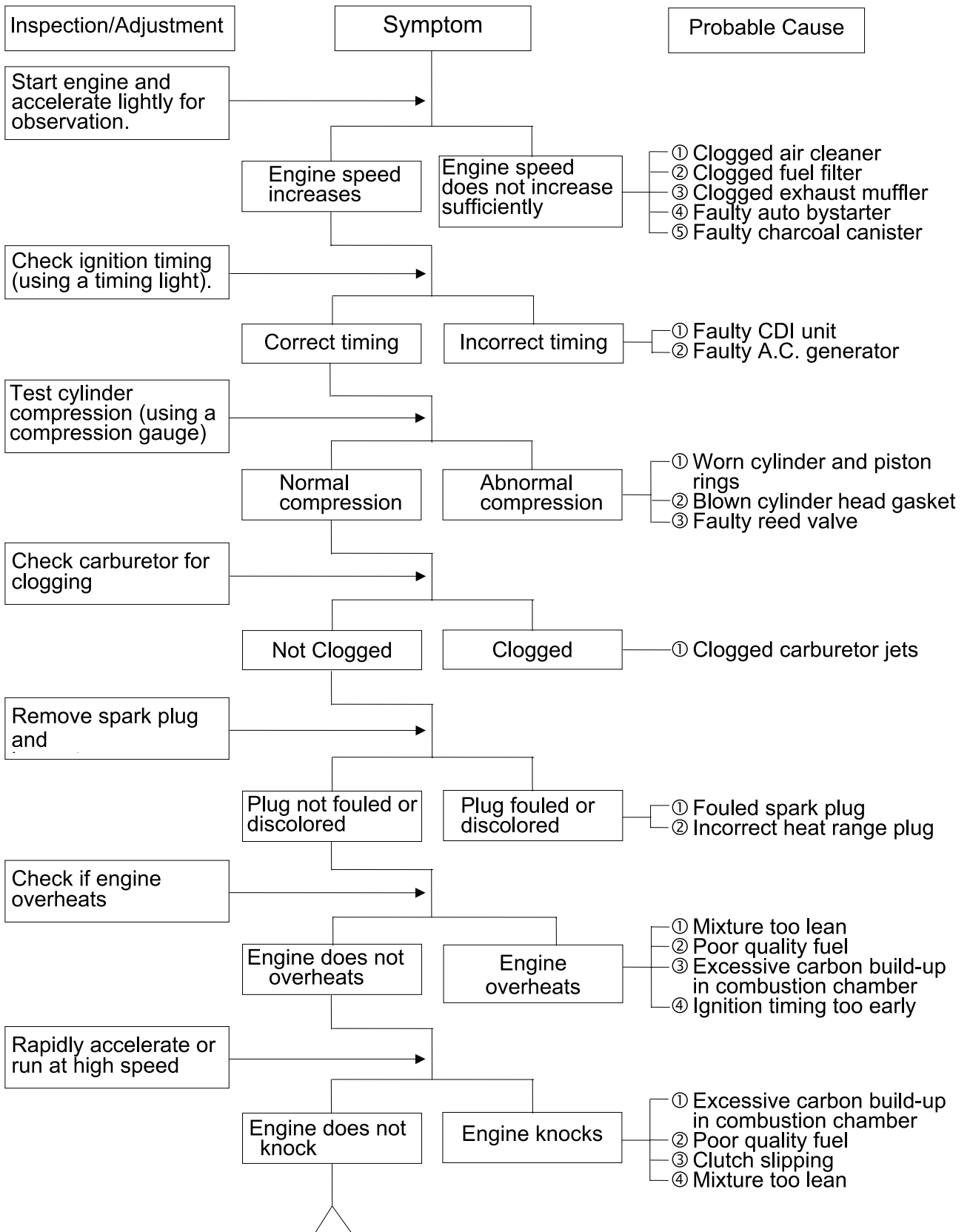

1. GENERAL INFORMATION

AGILITY CITY 50 2T

POOR PERFORMANCE (ESPECIALLY AT IDLE AND LOW SPEEDS)

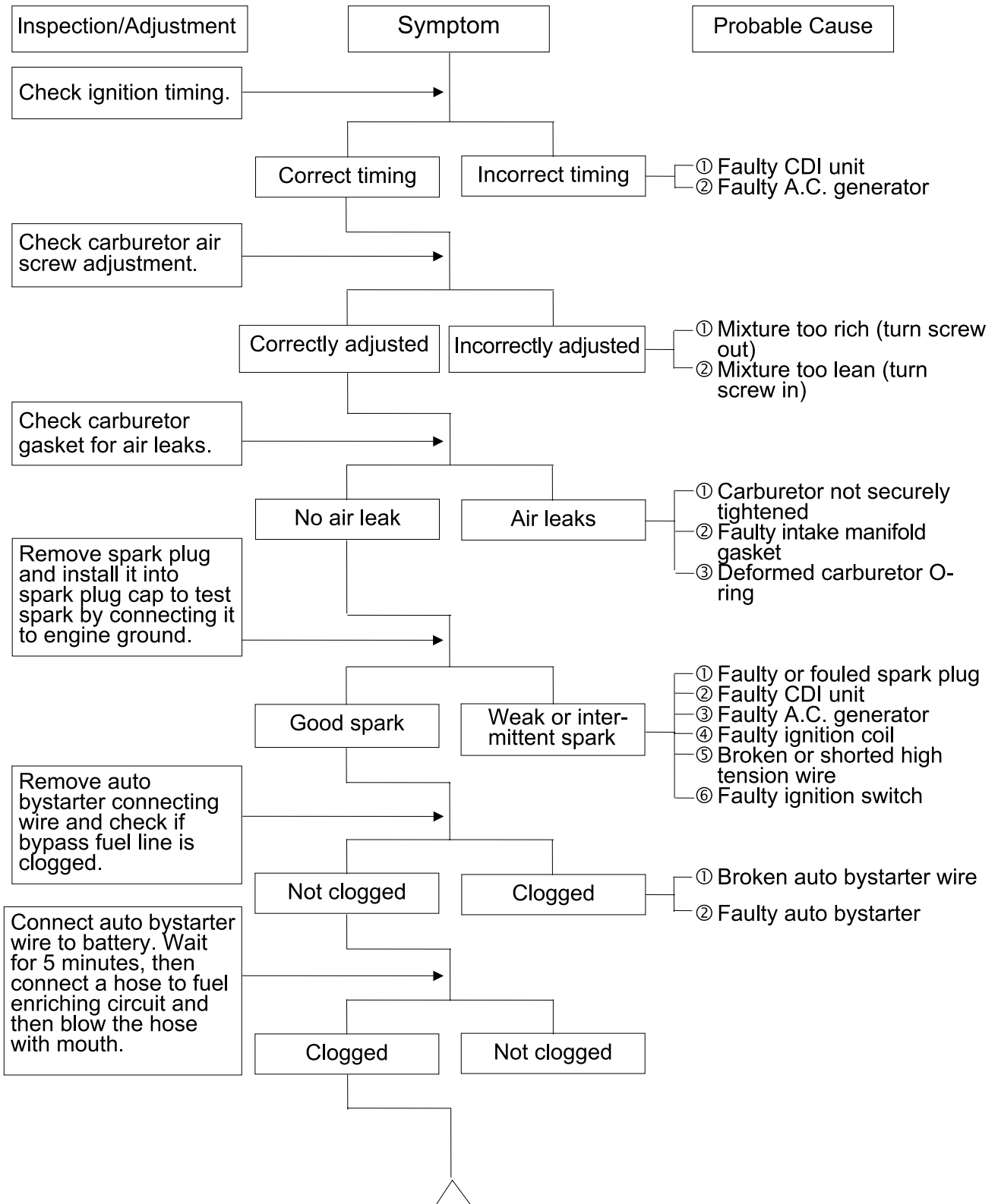

1. GENERAL INFORMATION

POOR PERFORMANCE (AT HIGH SPEED)

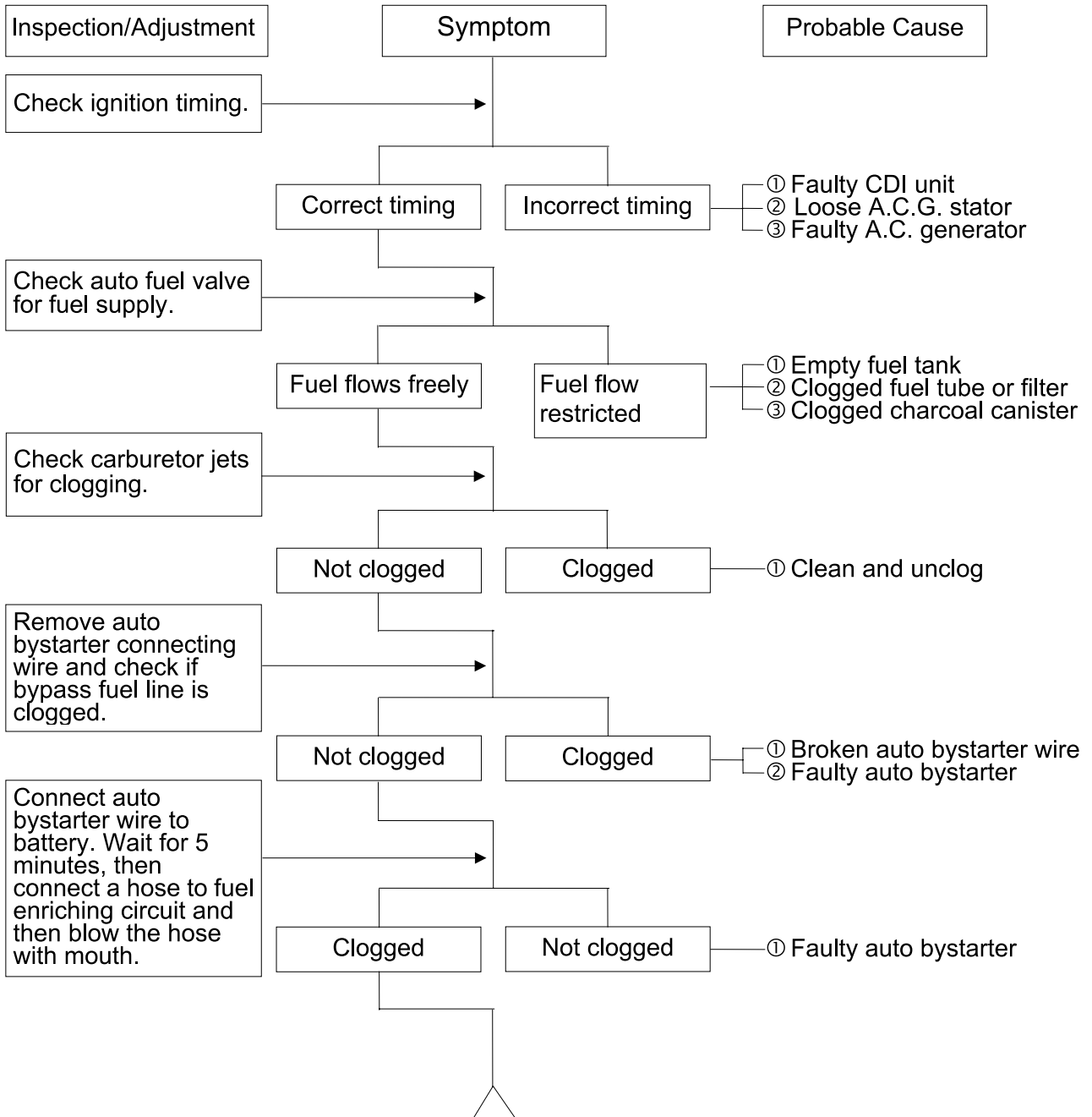

CLUTCH, DRIVE AND DRIVEN PULLEYS

Symptom	Probable Cause
Engine starts but motor-cycle does not move	<ul style="list-style-type: none"> ① Worn or slipping drive belt ② Broken ramp plate ③ Broken driven face spring ④ Separated clutch lining ⑤ Damaged driven pulley shaft splines ⑥ Damaged final gear ⑦ Seized final gear
Motorcycle creeps or engine starts but soon stops or seems to rush out (Rear wheel rotates when engine idles)	<ul style="list-style-type: none"> ① Broken shoe spring ② Clutch outer and clutch weight stuck ③ Seized pivot
Engine lacks power at start of a grade (poor slope performance)	<ul style="list-style-type: none"> ① Worn or slipping drive belt ② Worn weight rollers ③ Seized drive pulley bearings ④ Weak driven face spring ⑤ Worn or seized driven pulley bearings
Engine lacks power at high speed	<ul style="list-style-type: none"> ① Worn or slipping drive belt ② Worn weight rollers ③ Worn or seized driven pulley bearings
There is abnormal noise or smell while running	<ul style="list-style-type: none"> ① Oil or grease fouled drive belt ② Worn drive belt ③ Weak driven face spring ④ Worn or seized driven pulley bearings

STEERING HANDLEBAR DOES NOT TRACK STRAIGHT

Symptom	Probable Cause
	(Front and rear tire pressures are normal)
Steering is heavy	<ul style="list-style-type: none"> ① Steering stem nut too tight ② Broken steering steel balls
Front or rear wheel is wobbling	<ul style="list-style-type: none"> ① Excessive wheel bearing play ② Bent rim ③ Loose axle nut
Steering handlebar pulls to one side	<ul style="list-style-type: none"> ① Misaligned front and rear wheels ② Bent front fork

POOR SUSPENSION PERFORMANCE

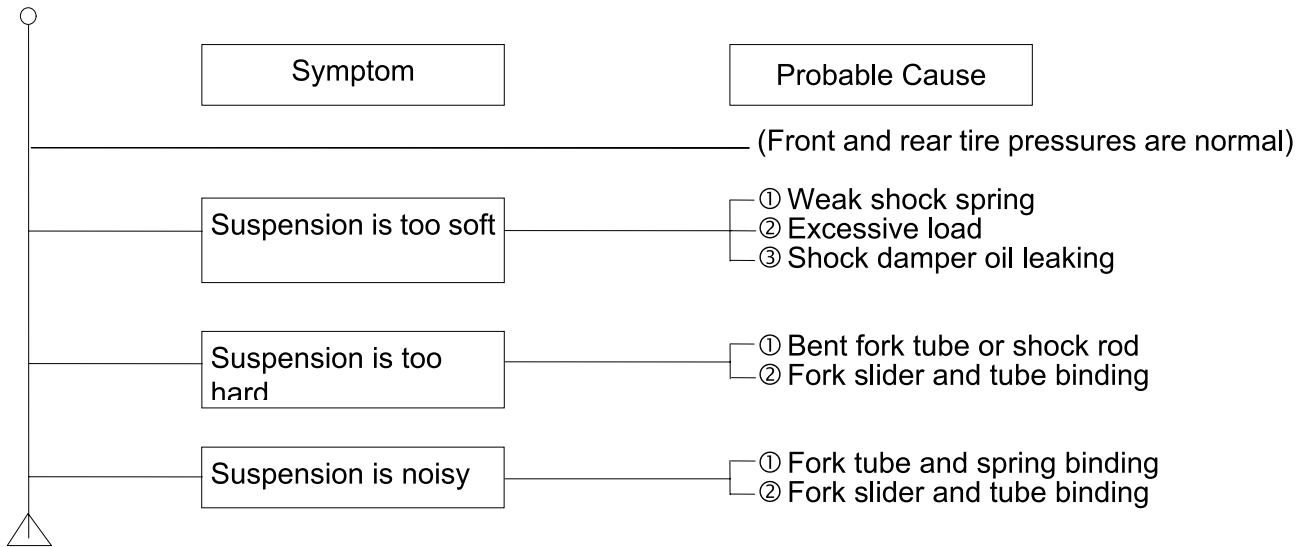

POOR BRAKE PERFORMANCE

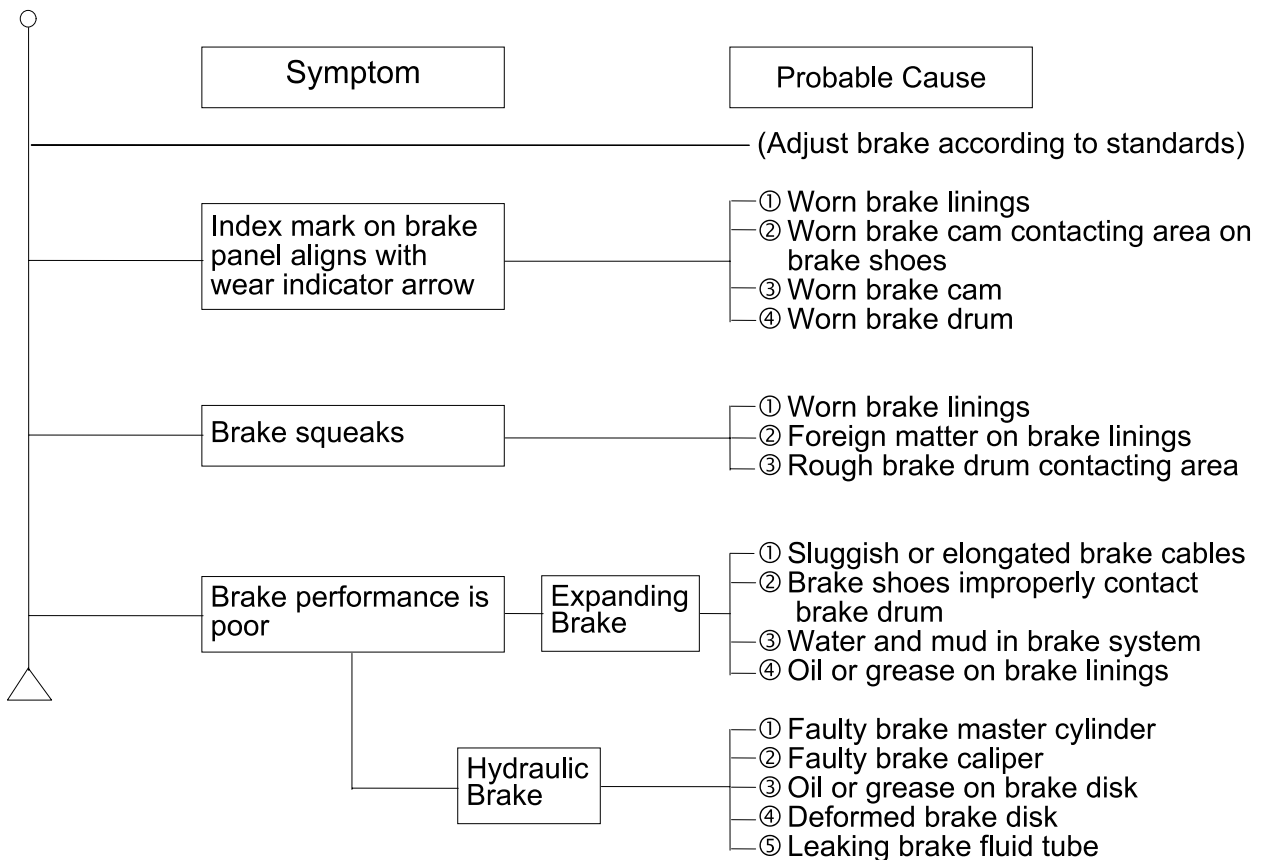

1. GENERAL INFORMATION

AGILITY CITY 50 2T

OIL METER

1. Motor oil indicator light does not come on when there is no motor oil (Ignition switch ON)

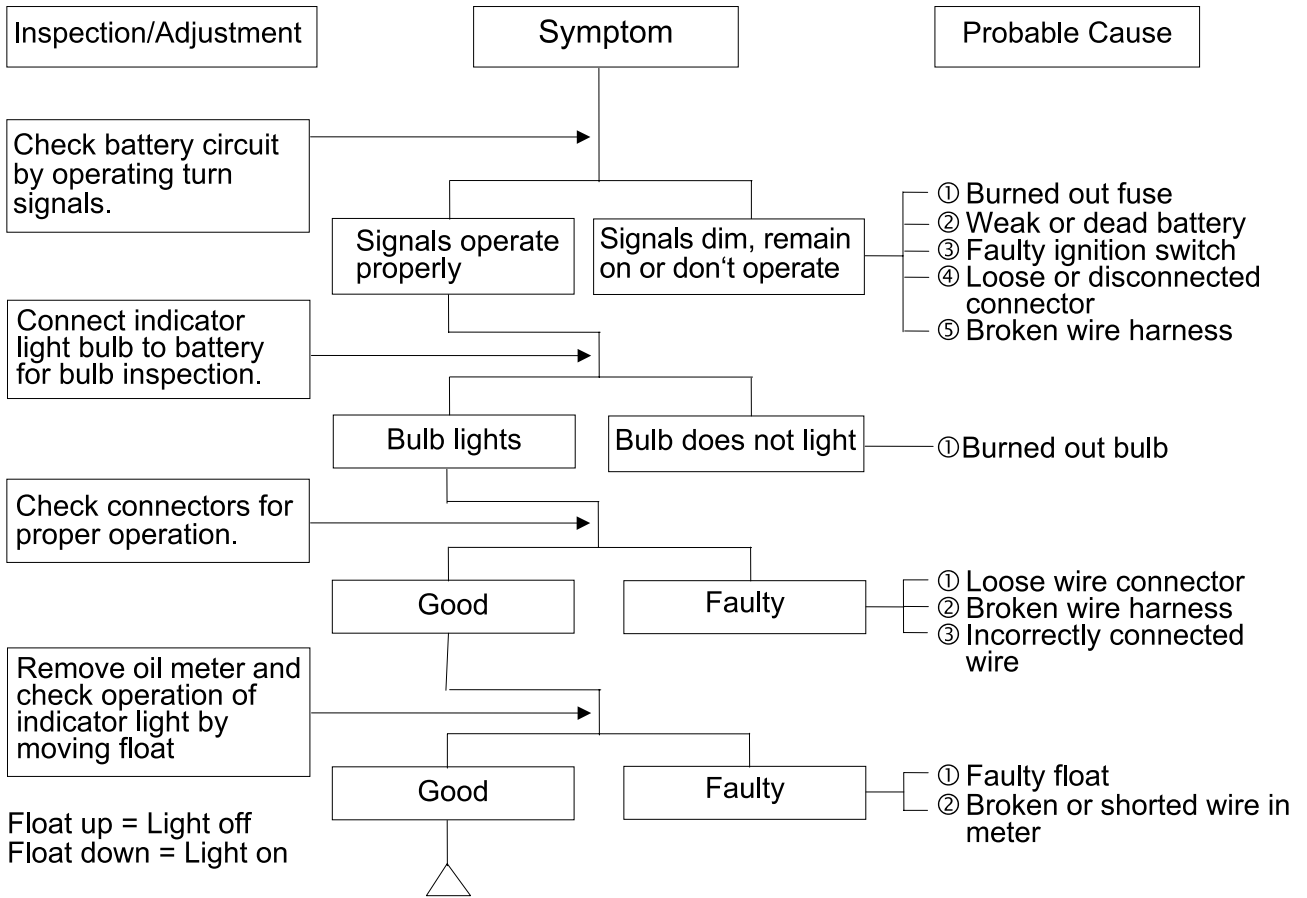

2. Motor oil is sufficient but the indicator light remains on (Ignition switch ON)

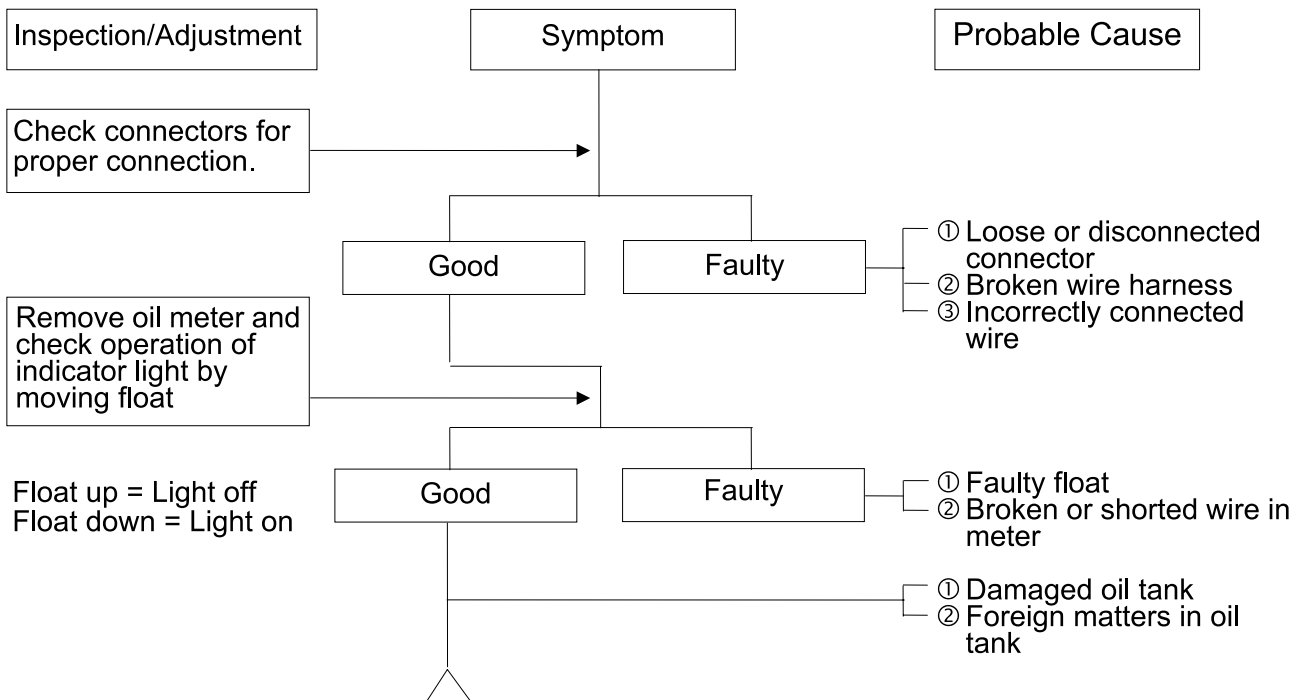

1. GENERAL INFORMATION

AGILITY CITY 50 2T

FUEL GAUGE

1. Pointer does not register correctly (Ignition switch ON)

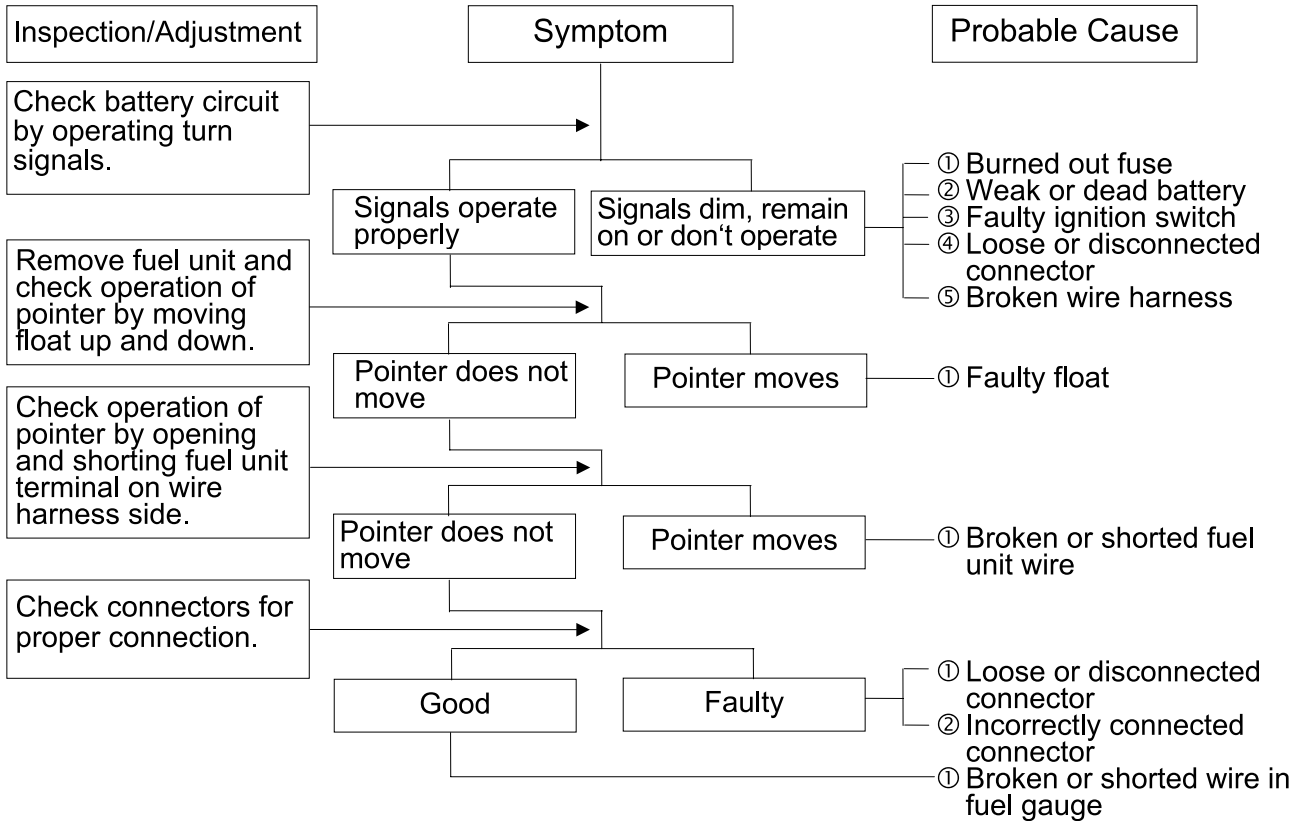

2. Pointer fluctuates or swings (Ignition switch ON)

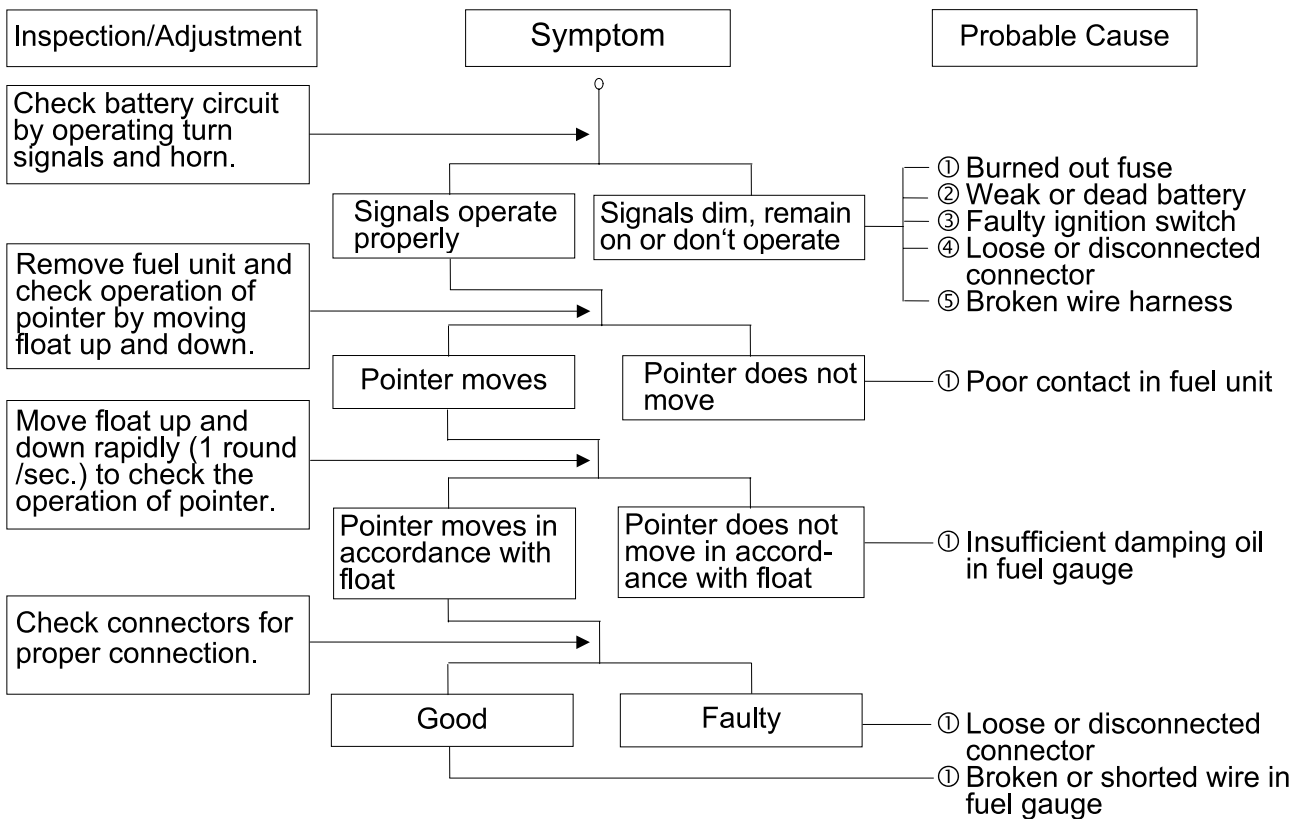

1. GENERAL INFORMATION

AGILITY CITY 50 2T

STARTER MOTOR

1. Starter motor won't turn

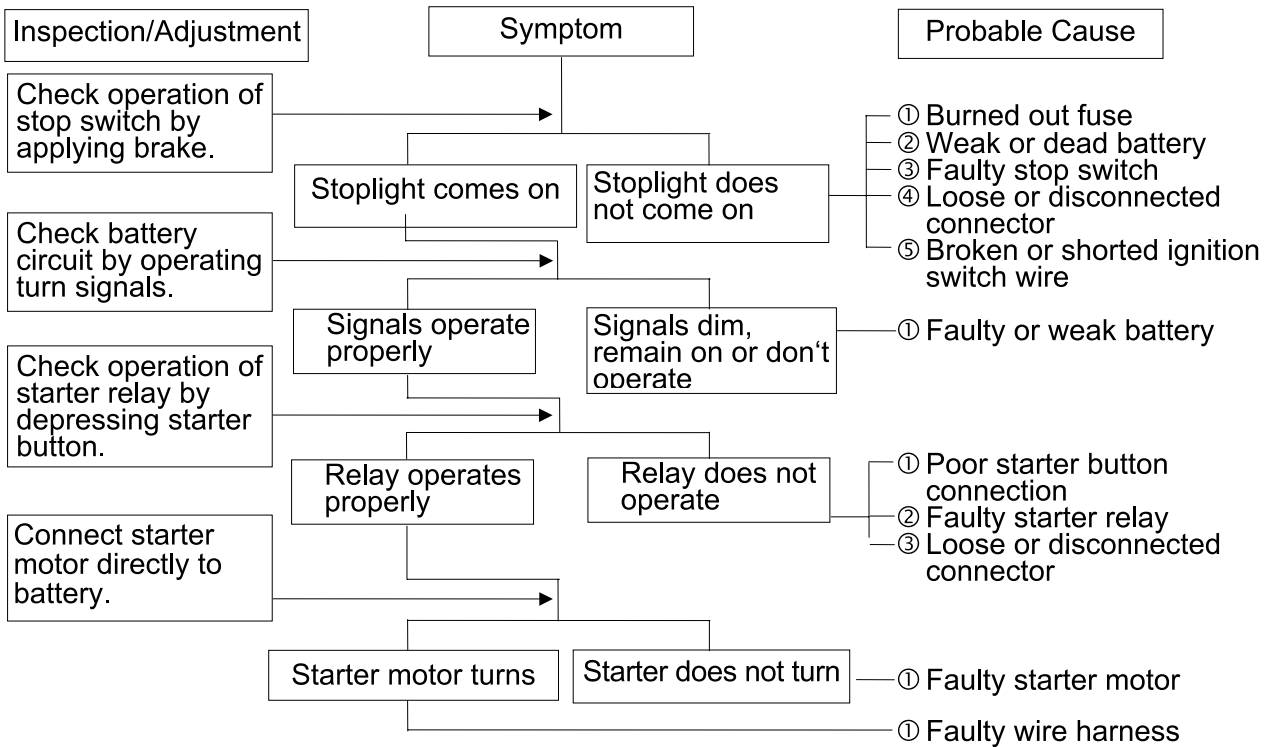

2. Starter motor turns slowly or idles

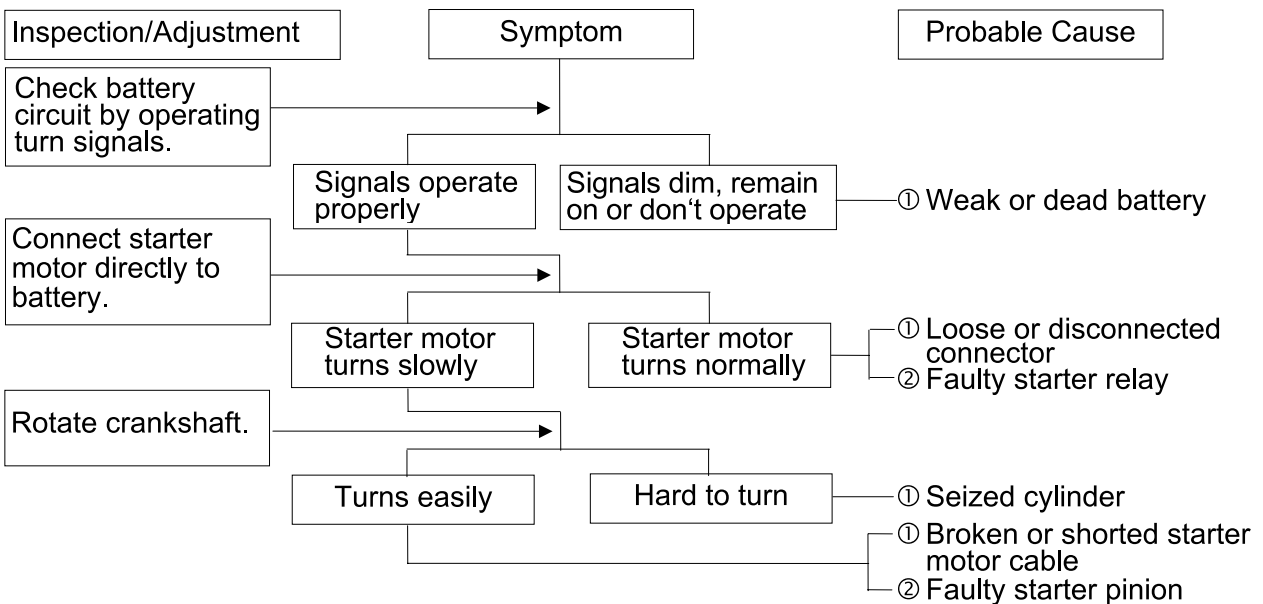

3. Starter motor does not stop turning

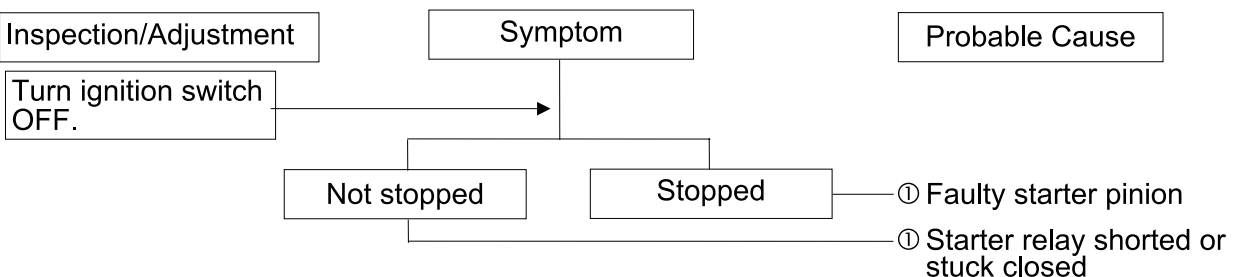

2. FRAME COVERS/EXHAUST MUFFLER

SERVICE INFORMATION	2-1	EXHAUST MUFFLER REMOVAL	2-5
FRAME COVERS	2-2		

SERVICE INFORMATION

GENERAL INSTRUCTIONS

- When removing frame covers, use special care not to pull them by force because the cover joint claws may be damaged.

Items Related for Removal

- Handlebar front cover ——— Handlebar rear cover
Headlight wire connector
- Handlebar rear cover ——— Speedometer cable and instrument light
wire connectors, etc.
- Frame body cover ——— Met-in box, rear grip, rear turn signal
lights, floor board
- Floor board ——— Frame body cover
Battery and wire connectors
- Leg Shield ——— Front cover, floor board

TORQUE VALUES

Exhaust muffler joint lock nut	1.0~1.4kgf-m
Exhaust muffler lock bolt	3.0~3.6kgf-m

2. FRAME COVERS/EXHAUST MUFFLER

FRAME COVERS

FRONT COVER REMOVAL

Remove the screw on the front cover and remove the front cover..

Remove the screws on the back of the mole assy front.

Remove the front brake fluid tube and speedometer cable

Remove the four bolt attaching the R/L front fork and remove the front fork.

Remove the mole assy

The installation sequence is the reverse of removal.

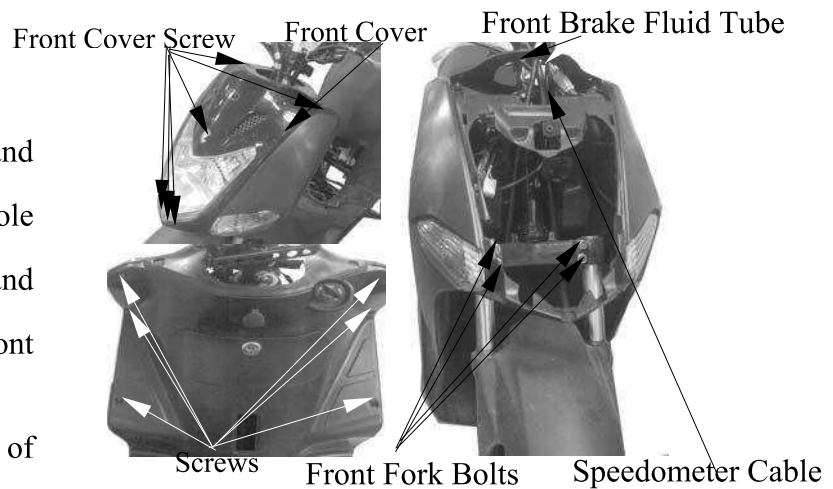

HANDLEBAR REAR COVER REMOVAL

Remove the handlebar rear cover screw.

Remove the clip mudguard attaching the sponge risor and sponge risor.

Disconnect the speedometer cable, right and left handlebar switch couplers, and the stop switch wire connectors.

Remove four screws inside the handlebar rear cover and remove the handlebar rear cover.

The installation sequence is the reverse of removal.

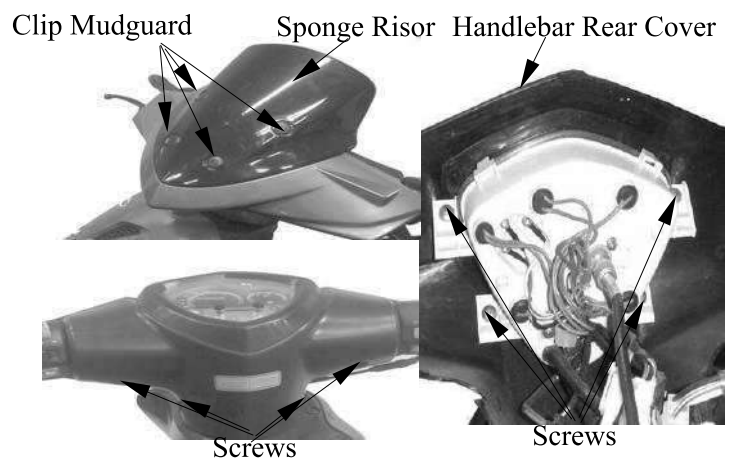

HANDLEBAR FRONT COVER REMOVAL

Remove the bolt attaching the handlebar front cover.

Remove the handlebar front cover.

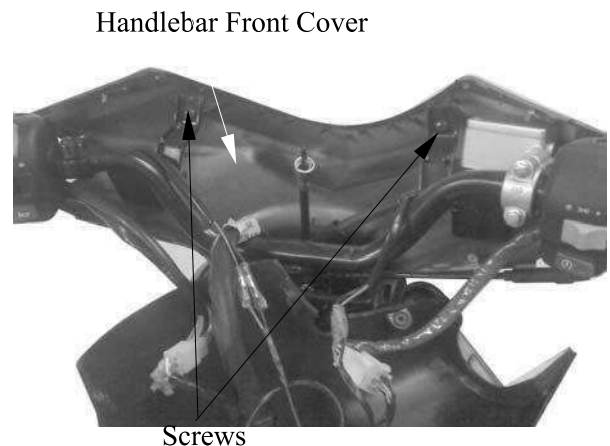

MET-IN BOX REMOVAL

Open the seat and remove the six bolt and two screws attaching the met-in box.

Remove the met-in box

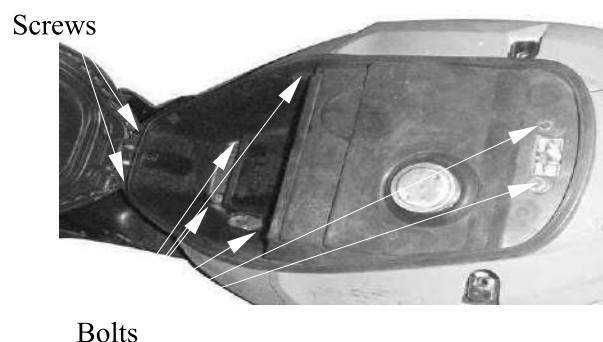

2. FRAME COVERS/EXHAUST MUFFLER

FRAME BODY COVER REMOVAL

Remove the two screws on the battery cover.
 Remove the battery cover
 Remove the six screws on the center cover
 Remove the center cover

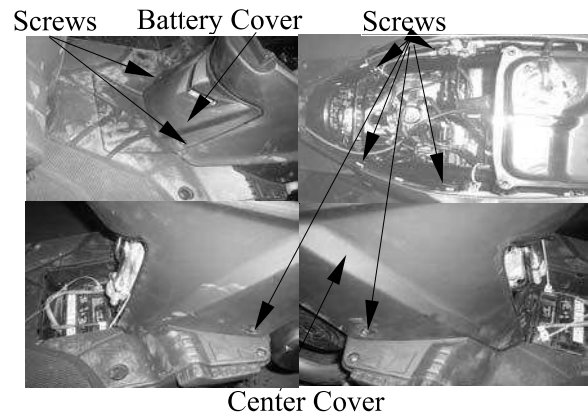

Center Cover

Remove the three bolts attaching the rear carrier.
 Remove the rear carrier.

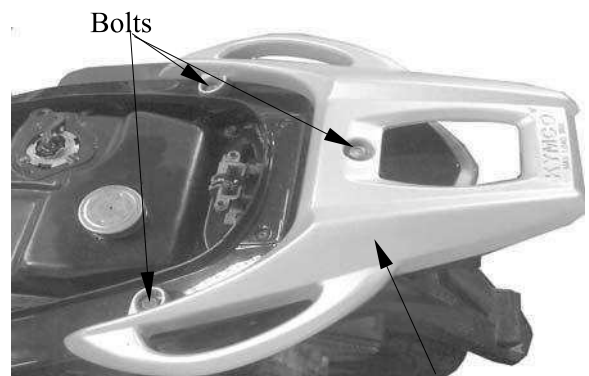

Rear Carrier

Remove the two bolts attaching the left and right rear step.
 Remove the rear step

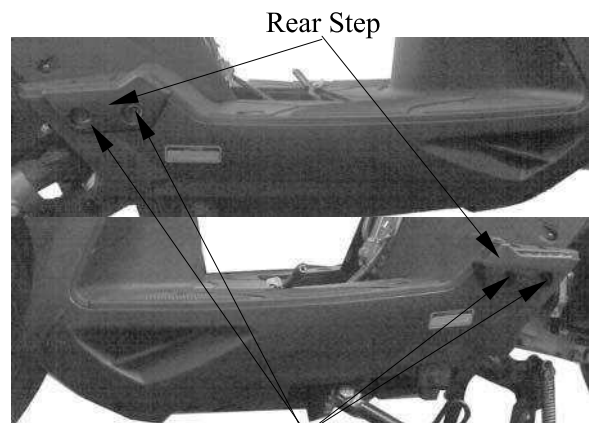

Rear Step

Remove the six screws attaching the left side and right side skirt.
 Remove the left side and right side skirt

* During removal, do not pull the joint claws forcibly to avoid damage.
 When installing, be sure to connect the seat lock wire.

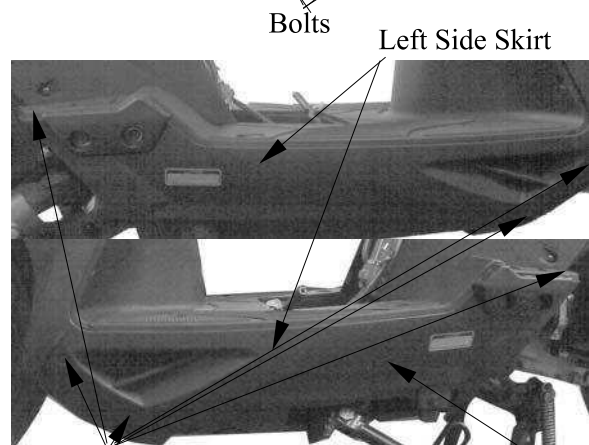

Bolts Left Side Skirt

Screws

Right Side Skirt

2. FRAME COVERS/EXHAUST MUFFLER

Remove the two screws on the center rear cover.
Remove the center rear cover.

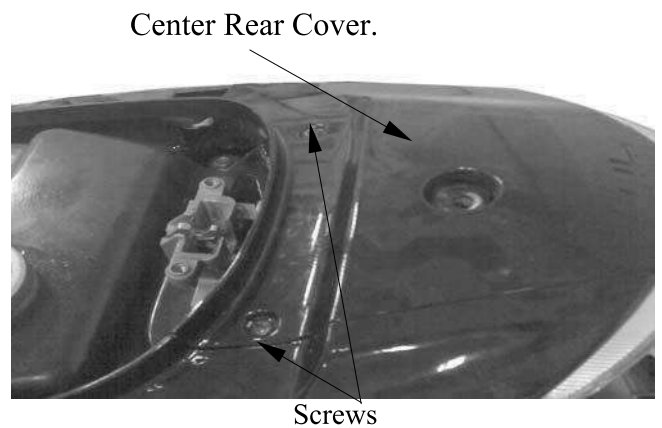

Remove the two bolts attaching the frame body cover.
Remove the three screws attaching the frame body cover.

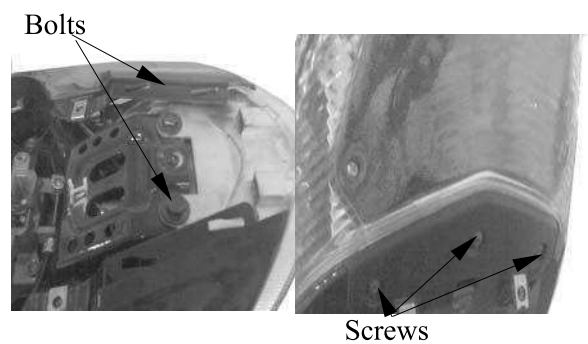

Remove the six screws attaching the frame body cover.

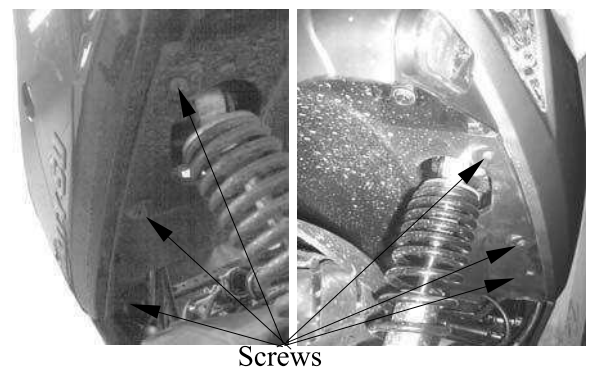

Remove the two bolts attaching the rear fender.
Disconnect the taillight wire connector.
Remove the rear fender.

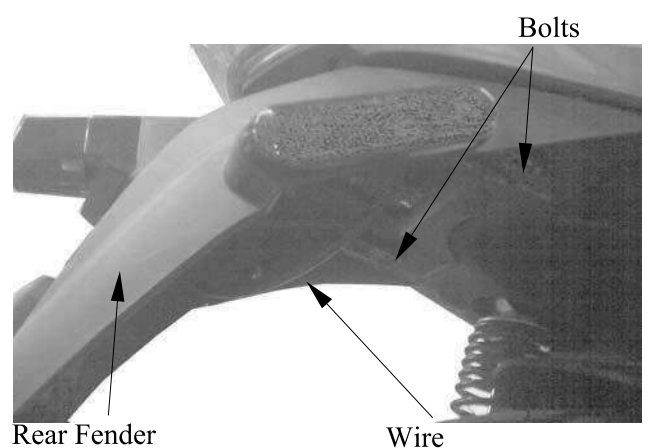

2. FRAME COVERS/EXHAUST MUFFLER

Disconnect the seat lock wire.

Disconnect the rear light wire connectors
Remove the left / right body cover and rear light.

The installation sequence is the reverse of remove.

* During removal, do not pull the joint claws forcibly to avoid damage.
When installing, be sure to connect the seat lock wire.

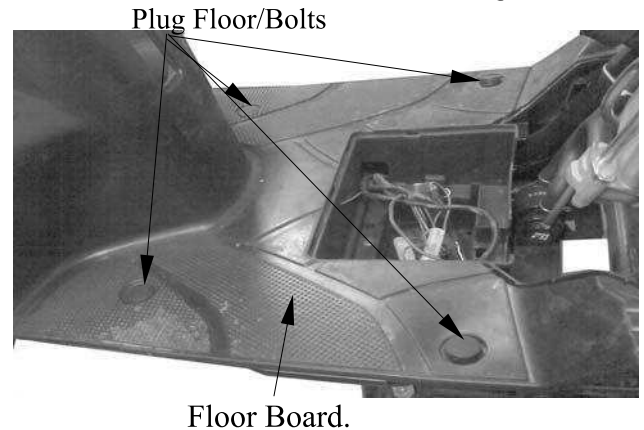
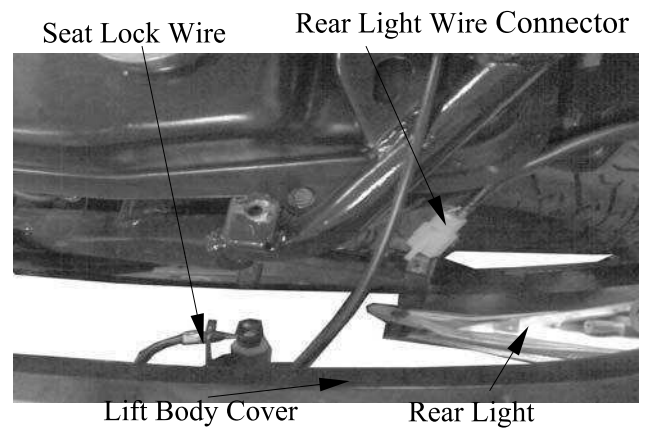

FLOOR BOARD REMOVAL

Remove the rear carrier. (⇒2-3)
Remove the met-in box. (⇒2-3)
Remove the frame body cover. (⇒2-4)
Remove the four bolts attaching the floor board.
Remove the floor board.

FRONT FENDER REMOVAL

Remove the L/R side bolts attaching the front fender and front fender.

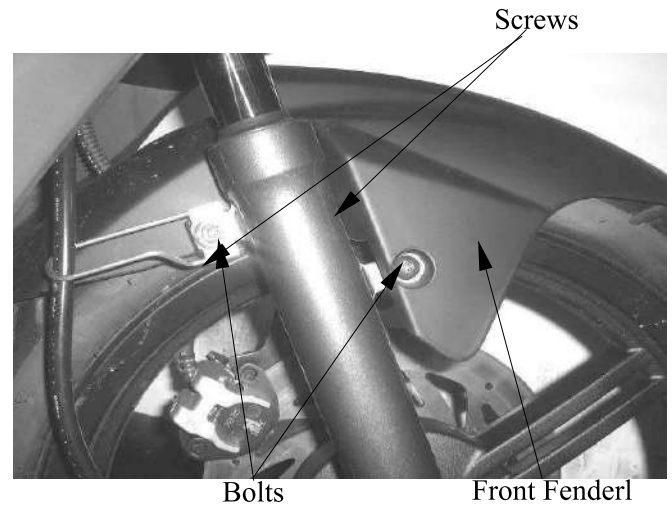

LEG SHIELD REMOVAL

Remove the two clip body on the lid leg shield
Remove the lid leg shield.
The installation sequence is the reverse of remove

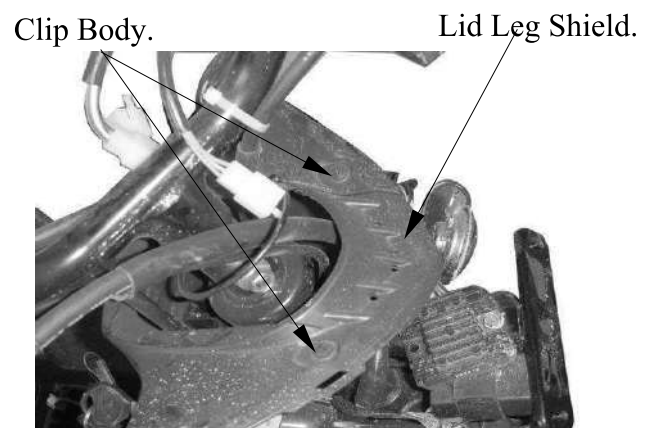

2. FRAME COVERS/EXHAUST MUFFLER

Remove the decorative ring.
 Remove the leg shield.
 Remove the bolt attaching the hook luggage.
 Remove the hook luggage.
 Remove the leg shield.
 The installation sequence is the reverse of remove

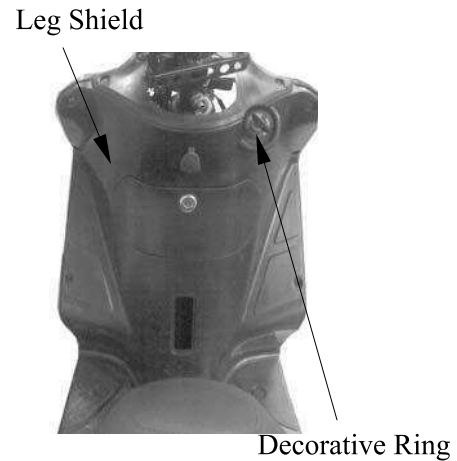

EXHAUST MUFFLER REMOVAL

Remove the two exhaust muffler joint lock nuts.
 Remove the three exhaust muffler lock bolts.
 Remove the exhaust muffler.
 Remove the exhaust muffler joint packing collar.

When installing, first install the exhaust muffler packing collar and then install the exhaust muffler.

First install and tighten the exhaust muffler joint lock nuts. Then, install and tighten the exhaust muffler lock bolts.

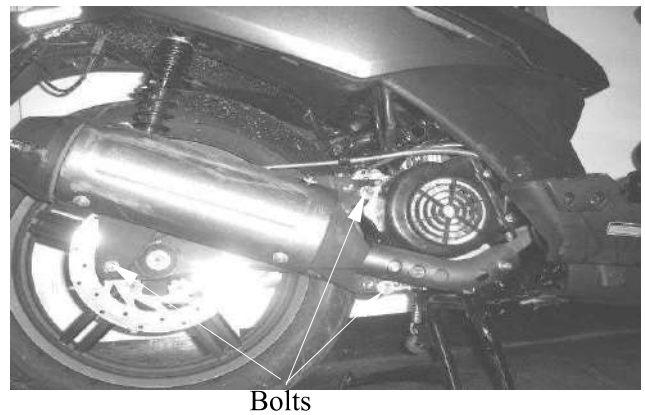

Torques:

Exhaust muffler lock bolt: 3.0~3.6kgf-m

Exhaust muffler joint lock nut: 1.0~1.4kgf-m

* Be sure to install a new exhaust muffler packing collar.

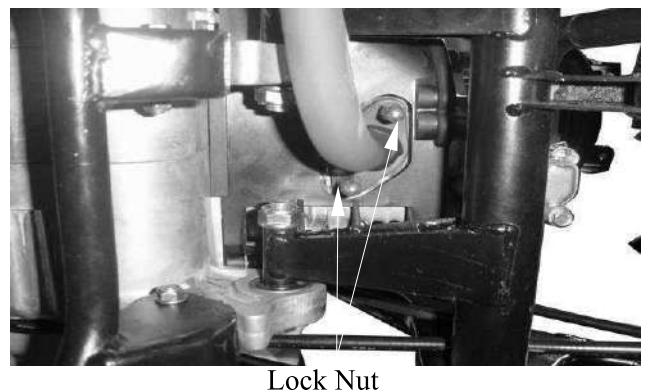

3. INSPECTION/ADJUSTMENT

SERVICE INFORMATION.....3-0	FINAL REDUCTION GEAR OIL.....3- 7
MAINTENANCE SCHEDULE.....3-2	DRIVE BELT.....3- 7
FUEL FILTER.....3-3	BRAKE SHOE3- 8
THROTTLE OPERATION.....3-3	BRAKE ADJUSTING NUT.....3- 8
AIR CLEANER3-4	HEADLIGHT AIM3- 9
SPARK PLUG3-4	CLUTCH SHOE WEAR.....3- 9
	SUSPENSION.....3- 9
CARBURETOR IDLE SPEED3-5	NUTS/BOLTS/FASTENERS.....3-10
IGNITION TIMING3-6	WHEELS/TIRES.....3-10
CYLINDER COMPRESSION3-6	STEERING HANDLEBAR3-11

SERVICE INFORMATION

GENERAL

 **WARNING**

- Before running the engine, make sure that the working area is well-ventilated. Never run the engine in a closed area. The exhaust contains poisonous carbon monoxide gas which may cause death to people.
- Gasoline is extremely flammable and is explosive under some conditions. The working area must be well-ventilated and do not smoke or allow flames or sparks near the working area or fuel storage area.

SPECIFICATIONS

ENGINE

- Throttle grip free play : 2~6mm
- Spark plug gap : 0.6~0.7mm
- Spark plug : NGK BR8HSA
-
- Valve clearance : IN: 0.12mm
: EX: 0.12mm
- Idle speed : 2000 ±100rpm
- Engine oil capacity:
- At disassembly : 0.9 liter
 - At change : 0.8 liter
- Gear oil capacity :
- At disassembly : 0.2 liter
 - At change : 0.18 liter

3. INSPECTION/ADJUSTMENT

Cylinder compression : 16 kg/cm²
Ignition timing: BTDC 28°/4000rpm

CHASSIS

Front brake free play: 10~20mm

Rear brake free play : 10~20mm

TIRE PRESSURE

	1 Rider	2 Riders
Front	1.5kg/cm ²	1.75kg/cm ²
Rear	2.0kg/cm ²	2.25kg/cm ²

TIRE SIZE:

Front : 100/80-14

Rear : 120/80-14

TORQUE VALUES

Front axle nut 5.0~7.0kgf-m

Rear axle nut 11~13kgf-m

3. INSPECTION/ADJUSTMENT

MAINTENANCE SCHEDULE

Perform the periodic maintenance at each scheduled maintenance period.

I: Inspect, and Clean, Adjust, Lubricate or Replace if necessary.

A: Adjust C: Clean R: Replace T: Tighten

Item	Frequency	Whichever comes first ⇒ ↓	Regular Service Mileage (km)											
			1000	2000	3000	4000	5000	6000	7000	8000	9000	10000	11000	12000
Engine oil			R New Motorcycle 300km	R		R		R		R		R		R
Engine oil filter screen						C				C				
Fuel filter screen												R		
Gear oil	Note 3		R New motorcycle 300km				R					R		
Valve clearance				A		A				A				A
Carburetor						I				I				C
Air Cleaner	Note 2,3		Replace at every 2000km											
Spark plug			Clean at every 3000km and replace if necessary											
Brake system			I	I	I	I	I	I	I	I	I	I	I	I
Drive belt										I				
Suspension						I				I				I
Nut, bolt, fastener										I				
Tire						I				I				I
Steering head bearing			I					I						I

- In the interest of safety, we recommend these items should be serviced only by an authorized KYMCO motorcycle dealer.

Note: 1. For higher odometer readings, repeat at the frequency interval established here.

2. Service more frequently when riding in dusty or rainy areas.

3. Service more frequently when riding in rain or at full throttle.

3. INSPECTION/ADJUSTMENT

FUEL FILTER

Remove the met-in box.
Check the fuel lines and replace any parts which show signs of deterioration, damage or leakage.

* Do not smoke or allow flames or sparks in your working area.



Fuel Line

THROTTLE OPERATION

Check the throttle grip for smooth movement.
Measure the throttle grip free play.

Free Play: 2~6mm

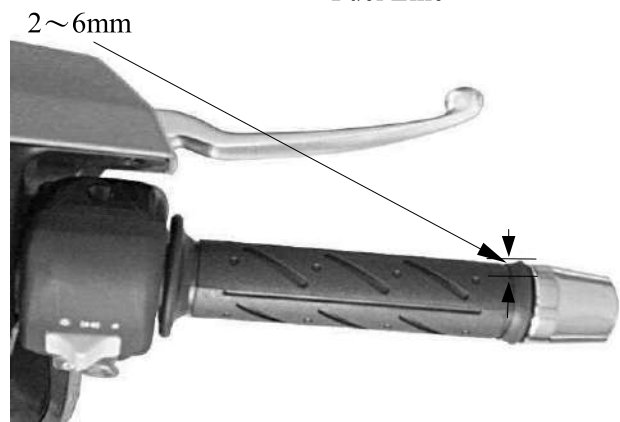

Major adjustment of the throttle grip free play is made at the carburetor side.
Adjust by loosening the lock nut and turning the adjusting nut.



Lock Nut

Adjusting Nut

Minor adjustment is made with the adjusting nut at the throttle grip side.
Slide the rubber cover out and adjust by loosening the lock nut and turning the adjusting nut.

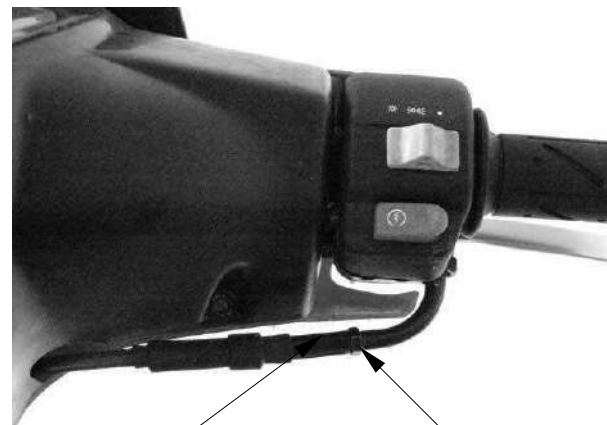

Adjusting Nut

Lock Nut

3. INSPECTION/ADJUSTMENT

AIR CLEANER

AIR CLEANER REPLACEMENT

Remove the air cleaner case cover screws and the cover by removing the six screws.

Remove the air cleaner element by removing the four screws.

Check the element and replace it if it is excessively dirty or damaged.

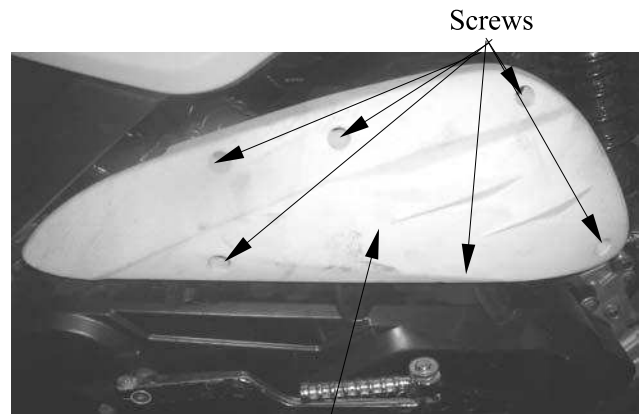

Air Cleaner Case Cover

Air Cleaner Element

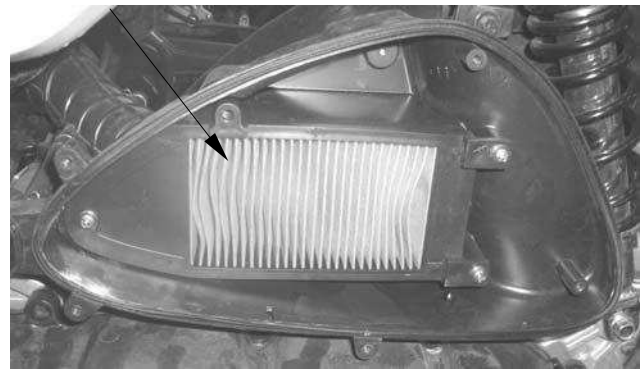

CHANGE INTERVAL

More frequent replacement is required when riding in unusually dusty or rainy areas.

- * The air cleaner element has a viscous type paper element. Do not clean it with any fluid.
- Be sure to install the air cleaner element and cover securely.

SPARK PLUG

Remove the spark plug.
Check the spark plug for wear and fouling deposits.

Clean any fouling deposits with a spark plug cleaner or a wire brush.

Specified Spark Plug:

NGK BR8HSA

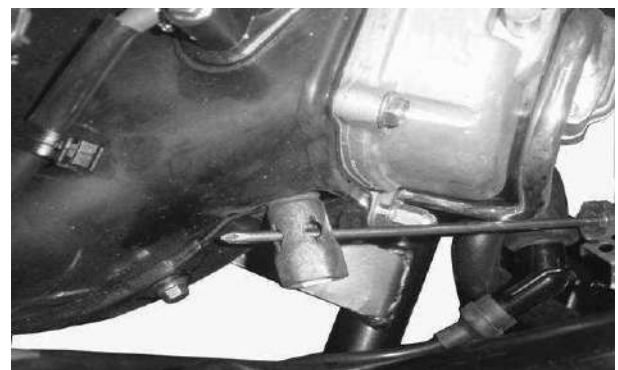

Measure the spark plug gap.

Spark Plug Gap: 0.6~0.7mm

- * When installing, first screw in the spark plug by hand and then tighten it with a spark plug wrench.

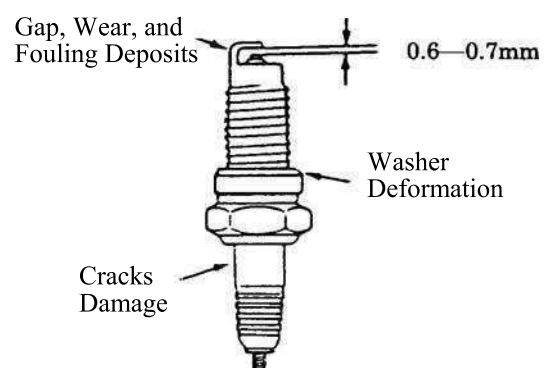

3. INSPECTION/ADJUSTMENT

CARBURETOR IDLE SPEED

- * • The engine must be warm for accurate idle speed inspection and adjustment.

Remove the inspection cover.
Warm up the engine before this operation.
Start the engine and connect a tachometer.
Turn the throttle stop screw to obtain the specified idle speed.

Idle Speed: 1900±100rpm

When the engine misses or run erratic, adjust the pilot screw.



Throttle Stop Screw

3. INSPECTION/ADJUSTMENT

IGNITION TIMING

* The CDI unit is not adjustable. If the ignition timing is incorrect, check the ignition system.

Remove the right of the fan cover.

Timing Hole Cap

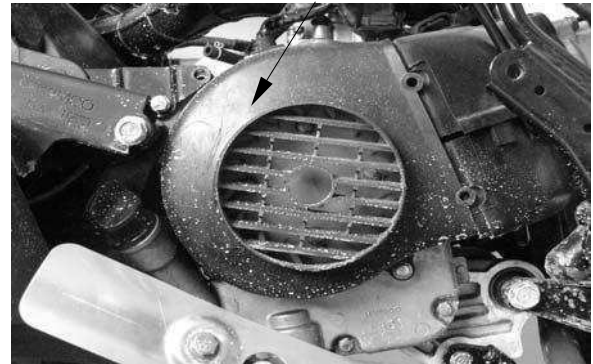

Check the ignition timing with a timing light. When the engine is running at idle speed, the ignition timing is correct if the "F" mark on the flywheel aligns with the index mark on the crankcase.

Timing Light

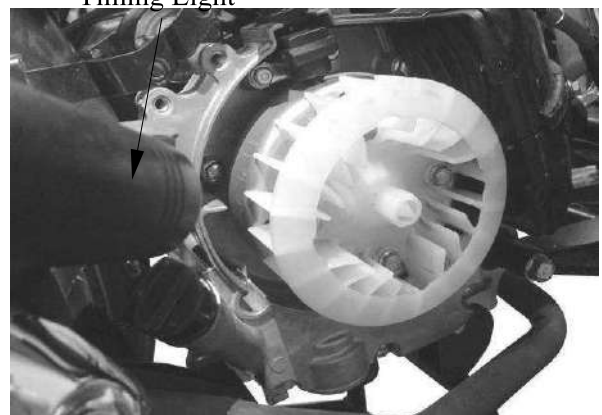

Also use a timing light to check the advance. Raise the engine speed to 4,000rpm and the index mark on the crankcase cover should be aligned with the advance mark on the flywheel.

CYLINDER COMPRESSION

Warm up the engine before compression test. Remove the met-in box and center cover. Remove the spark plug. Insert a compression gauge. Open the throttle valve fully and push the starter button to test the compression.

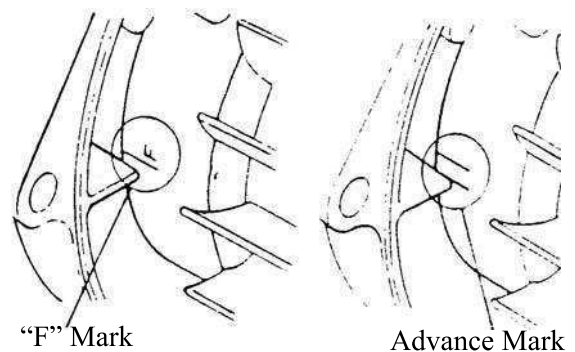

"F" Mark

Advance Mark

Compression: 16kg/cm²rpm

If the compression is low, check for the following:

- Leaky valves
- Valve clearance too small
- Leaking cylinder head gasket
- Worn piston rings
- Worn piston/cylinder

If the compression is high, it indicates that carbon deposits have accumulated on the combustion chamber and the piston head.

Compression Gauge



3. INSPECTION/ADJUSTMENT

FINAL REDUCTION GEAR OIL OIL LEVEL CHECK

- * Place the motorcycle on its main stand on level ground for oil level check.

Stop the engine and remove the oil check bolt. The oil level shall be at the oil check bolt hole.

If the oil level is low, add the recommended oil to the proper level.

Recommended Oil: SAE90#

Install the oil check bolt.

- * Make sure that the sealing washer is in good condition.

OIL CHANGE

Remove the oil check bolt.

Remove the oil drain bolt and drain the oil thoroughly.

Install the oil drain bolt.

Torque: 0.8~1.2kgf-m

- * Make sure that the sealing washer is in good condition.

Fill with the recommended oil.

Oil Capacity: At disassembly : 0.20 liter
At change : 0.18 liter

Reinstall the oil check bolt and check for oil leaks.

Torque: 0.8~1.2kgf-m

DRIVE BELT

Remove the left crankcase cover.

Inspect the drive belt for cracks or excessive wear.

Replace the drive belt with a new one if necessary and in accordance with the Maintenance Schedule.

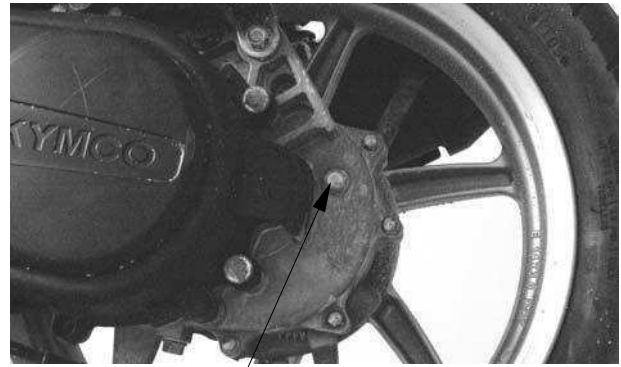

Oil Check Bolt/Sealing Washer

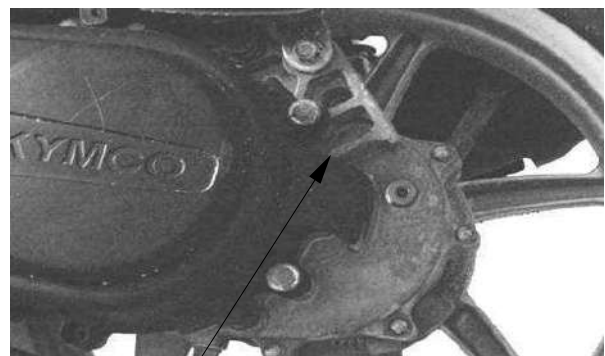

Oil Check Bolt Hole



Oil Drain Bolt/ Sealing Washer

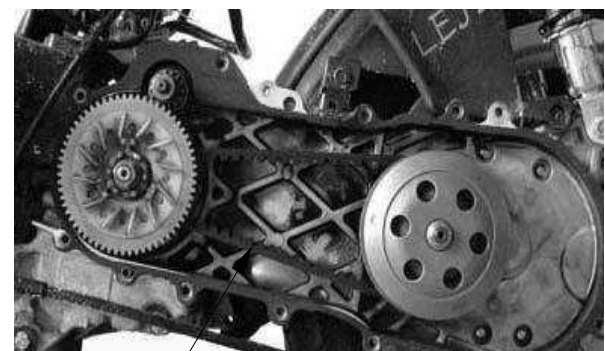

Drive Belt

3. INSPECTION/ADJUSTMENT

BRAKE SHOE

Replace the brake shoes if the arrow on the wear indicator plate aligns with the punch mark on the brake panel when the brake is fully applied.

Refer to page 12-7 and 13-3 for brake shoe replacement.

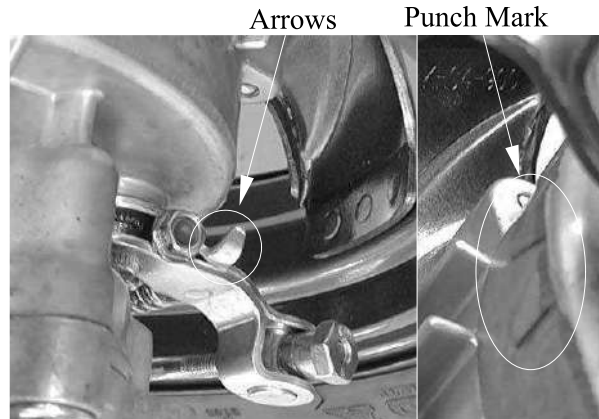

REAR BRAKE

Measure the rear brake lever free play.

Free Play: 10~20mm



BRAKE ADJUSTING NUT

If the free play do not fall within the limit, adjust by turning the adjusting nut.

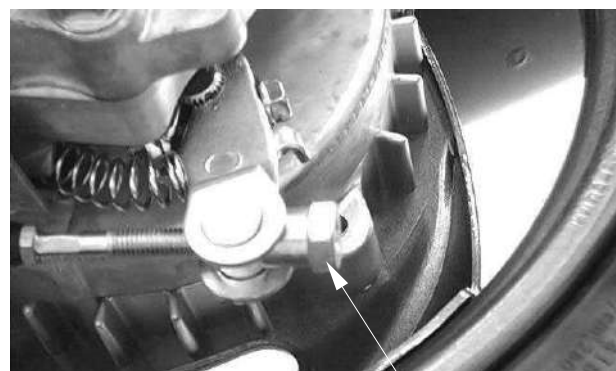

Adjusting Nut

FRONT/REAR BRAKE FLUID

Turn the steering handlebar upright and check if the rear brake fluid level should be between the upper and lower level lines.

Specified Brake Fluid: DOT-4 ◦

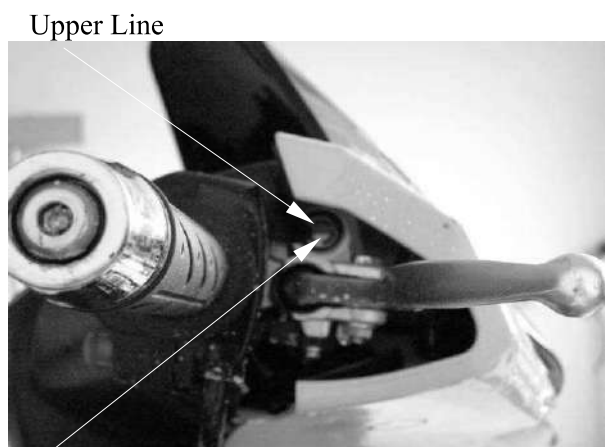

Lower Line

3. INSPECTION/ADJUSTMENT

If the free play do not fall within the limit, adjust by turning the adjusting nut.



Adjusting Nut

HEADLIGHT AIM

Turn the ignition switch ON and start the engine.

Turn on the headlight switch.

Adjust the headlight aim by turning the headlight aim adjusting screw.

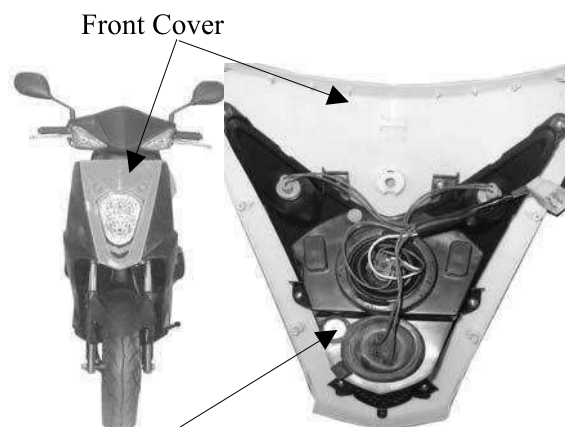

Front Cover

Adjusting Screw

CLUTCH SHOE WEAR

Start the engine and check the clutch operation by increasing the engine speed gradually.

If the motorcycle tends to creep, or the engine stalls, check the clutch shoes for wear and replace if necessary. (⇒9-11)

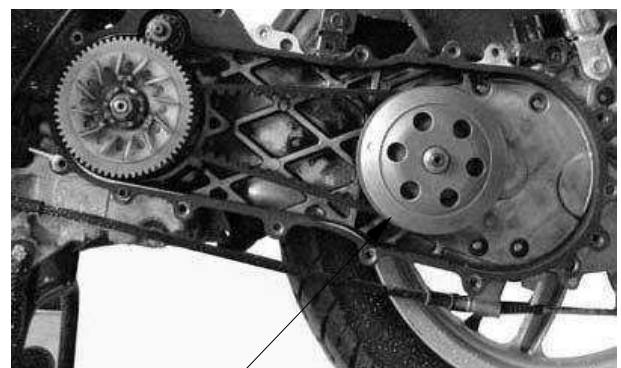

clutch

SUSPENSION

FRONT

Fully apply the front brake lever and check the action of the front shock absorbers by compressing them several times.

Check the entire shock absorber assembly for oil leaks, looseness or damage.



3. INSPECTION/ADJUSTMENT

REAR

Check the action of the rear shock absorber by compressing it several times.
 Check the entire shock absorber assembly for oil leaks, looseness or damage.
 Jack the rear wheel off the ground and move the rear wheel sideways with force to see if the engine hanger bushings are worn.



NUTS/BOLTS/FASTENERS

Check all important chassis nuts and bolts for looseness.
 Tighten them to their specified torque values if any looseness is found. (⇒1-11)

WHEELS/TIRES

Check the tires for cuts, imbedded nails or other damages.

Check the tire pressure.

* Tire pressure should be checked when tires are cold.



TIRE PRESSURE

	1 Rider	2 Riders
Front	1.5kg/cm ²	1.75kg/cm ²
Rear	2.00kg/cm ²	2.25kg/cm ²

TIRE SIZE

Front : 120/70-12

Rear : 130/70-12

Check the front axle nut for looseness.
 Check the rear axle nut for looseness.
 If the axle nuts are loose, tighten them to the specified torques.

Torques: Front : 5.0~7.0kgf-m

Rear : 11~13kgf-m



Front Axle Nut

3. INSPECTION/ADJUSTMENT

STEERING HANDLEBAR

Check that the control cables do not interfere with handlebar rotation.

Raise the front wheel off the ground and check that the steering handlebar rotates freely.

If the handlebar moves unevenly, binds, or has vertical movement, adjust the steering head bearing.

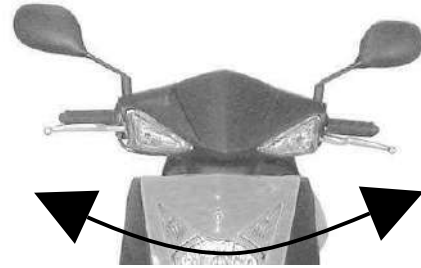

LUBRICATION SYSTEM

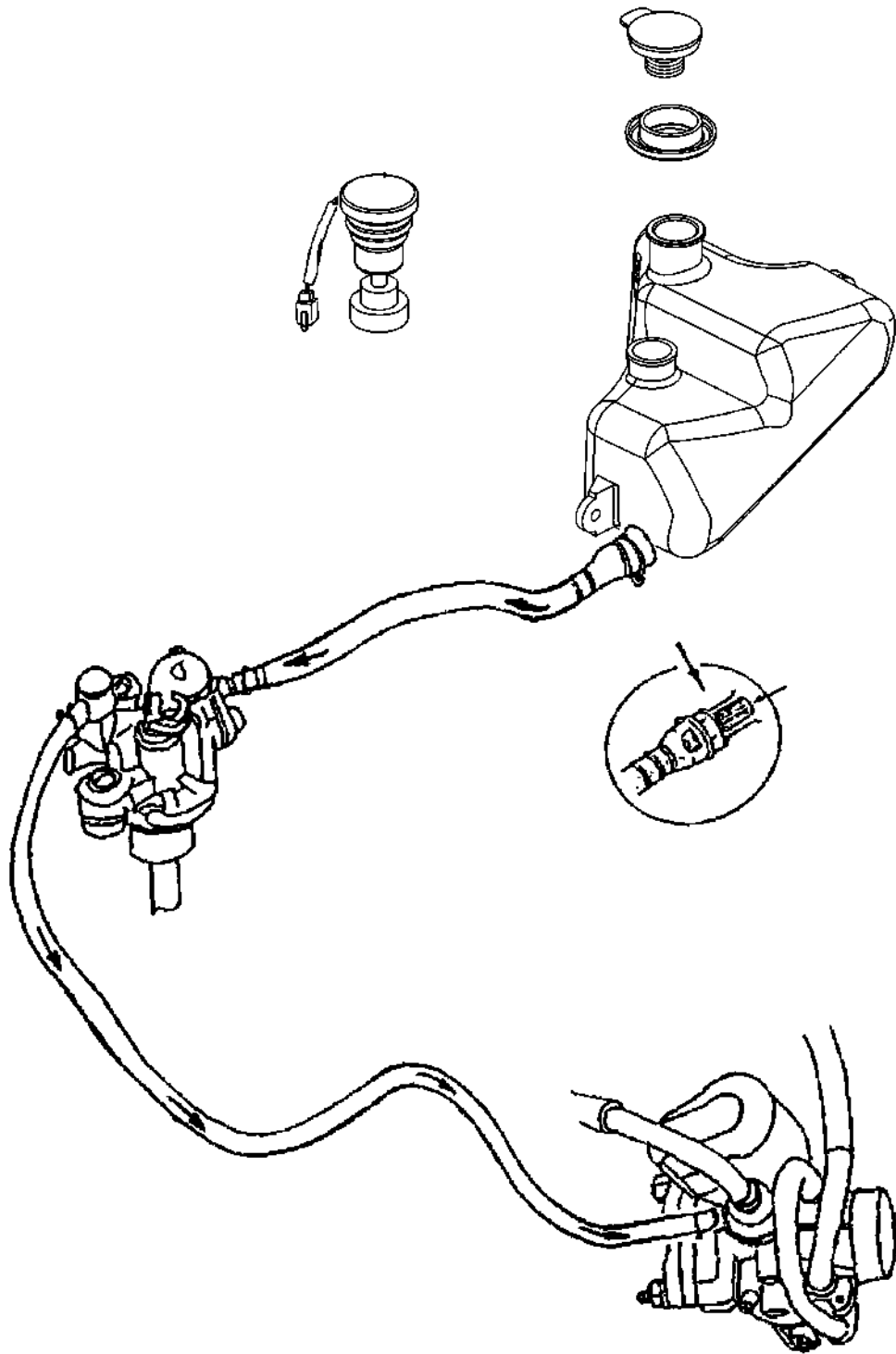

SERVICE INFORMATION

GENERAL INSTRUCTIONS

- Use care when removing and installing the oil pump not to allow dust and dirt to enter the engine and oil line.
- Do not attempt to disassemble the oil pump.
- Bleed air from the oil pump if there is air between the oil pump and oil line.
- If the oil is disconnected, refill the oil line with motor oil before connecting it.

SPECIFICATIONS

- Recommended Motor Oil: 2-stroke Motor Oil
- Oil Capacity : 1.1 liter
Light comes on : 0.5 liter

TROUBLESHOOTING

Excessive white smoke or carbon deposits on spark plug

- Oil pump not properly synchronized (excessive oil)
- Poor quality oil

Engine overheating

- Oil pump not properly adjusted (insufficient oiling)
- Poor quality oil

Seized piston

- No oil in tank or clogged oil line
- Oil pump not properly adjusted (insufficient oiling)
- Air in oil line
- Faulty oil pump

Oil not flowing out of tank to engine

- Clogged oil tank cap breather hole
- Clogged oil filter

OIL PUMP REMOVAL

* Do not allow foreign matters to enter the crankcase. Before removing the oil pump, clean the oil pump and crankcase surfaces.

Remove the met-in box. (⇒12-4)

Disconnect the oil pump control cable from the pump body.
 Disconnect the oil inlet line from the oil pump.
 Then, disconnect the oil outlet line.

* Before disconnecting the oil line, clip the oil line to avoid oil flowing out and then plug the oil line after it is disconnected.

Remove the oil pump control cable plate bolt.
 Remove the oil pump from the crankcase.

OIL PUMP INSPECTION

Remove the oil pump and inspect the following items:

- Weakened O-ring
- Damage to crankcase mating surface
- Damage to pump body
- Control lever operation
- Oil leaks through oil seals
- Worn or damaged pump pinion

* Do not disassemble the oil pump which cannot be used after disassembly.

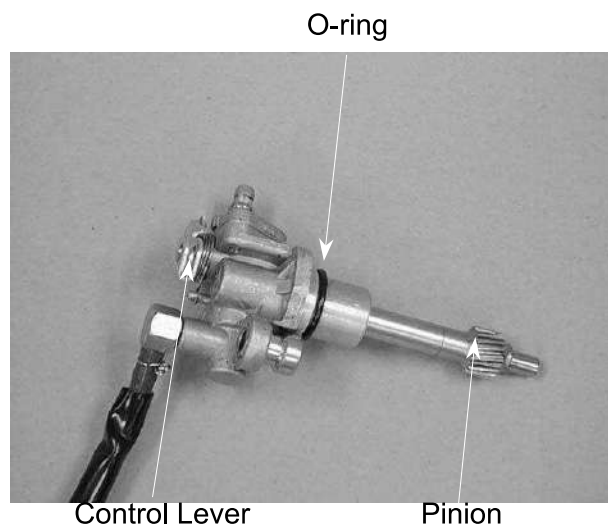
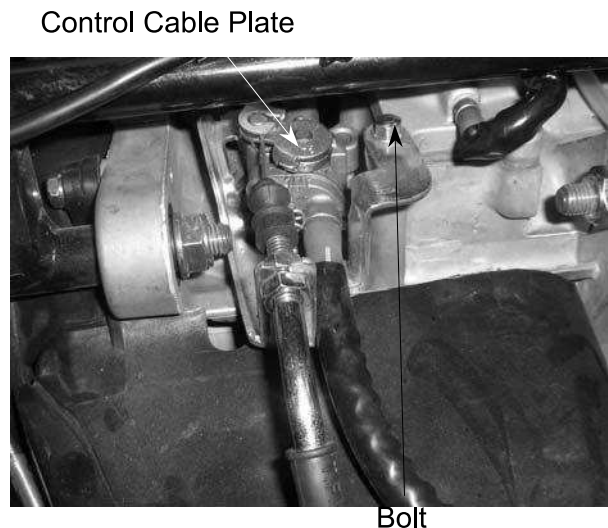
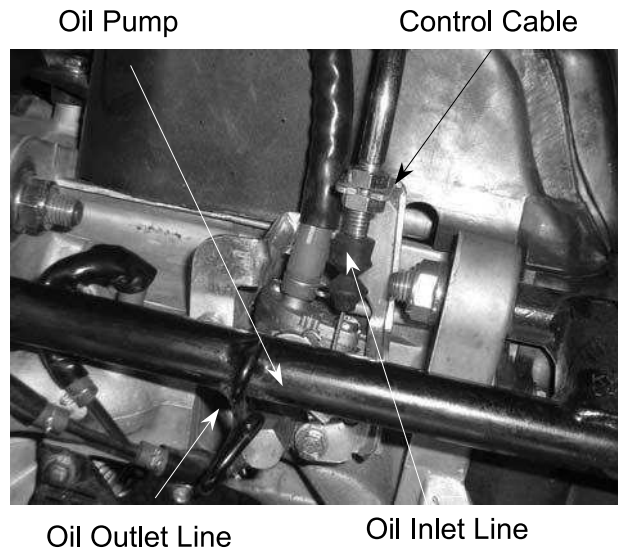

OIL PUMP INSTALLATION

*

- Lubricate the O-ring with grease or engine oil before installation.
- Make sure that the oil pump is inserted into the crankcase.
- Apply molybdenum disulfide or grease to the pump pinion.

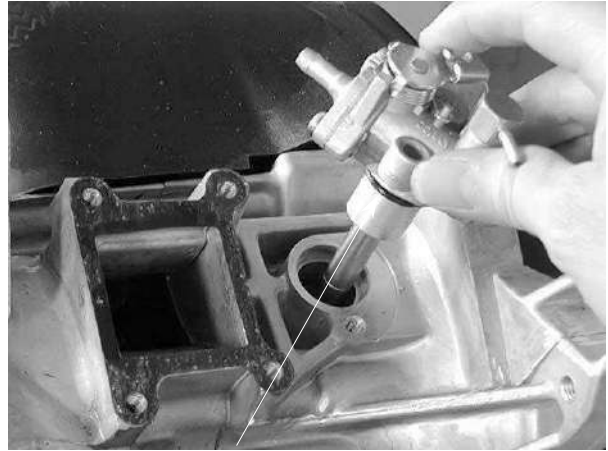

Grease or Engine Oil

Install the oil pump onto the crankcase.

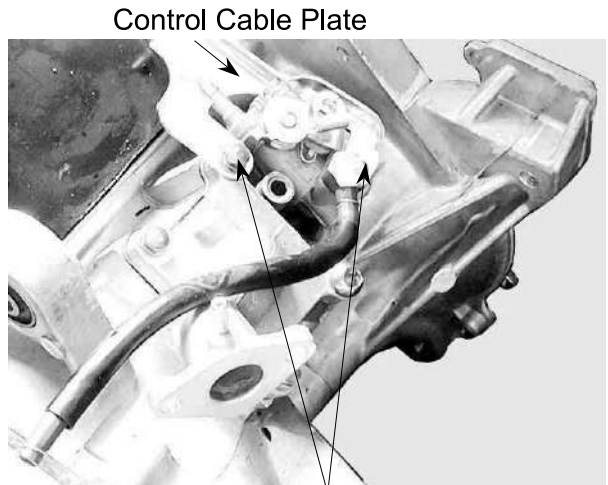

Control Cable Plate

Bolts

Install the oil pump control cable plate.
Connect the oil inlet line and oil outlet line properly.
Connect the oil pump control cable.
Bleed air from the oil pump.



Control Cable

Oil Inlet Line

OIL PUMP BLEEDING

*

- Air in the oil lines will block oil flow and result in severe engine damage.
- Bleed air from the oil lines and oil pump whenever the oil lines or pump have been removed or there is air in the oil lines.



OIL INLET LINE/OIL PUMP BLEEDING

Fill the oil tank with recommended oil.
Place a shop towel around the oil pump.
Disconnect the oil inlet line from the oil pump and clip it.
Fill the oil pump with oil by squirting clean oil through the joint. (About 3cc)
Fill the oil line with oil and connect it to the oil pump.

*

Bleed air from the oil inlet line first, then bleed air from the oil outlet line.

OIL OUTLET LINE BLEEDING

1. Disconnect the oil outlet line and bend it into U shape. Force air out of the tube by filling it with oil.
2. Start the engine and allow it to idle with the oil control lever in the fully open position. Visually check the oil flow.
3. If there is no oil flowing out within 1 minute, bleed air from the oil inlet line and oil pump.

*

- Never run the engine in a closed area.
- Do not increase the engine speed at will.

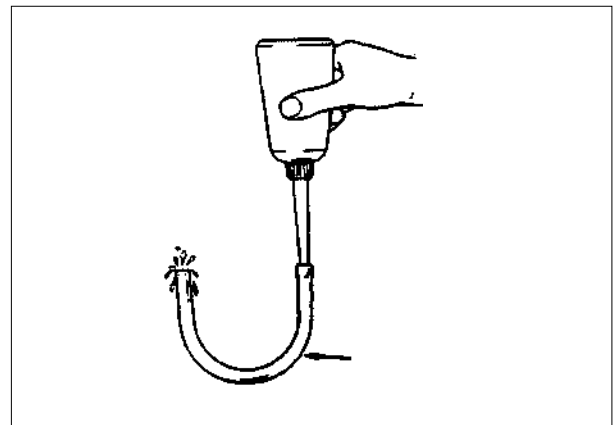

OIL TANK

OIL TANK REMOVAL

Remove the met-in box. (⇒12-5)
Remove the frame body cover. (⇒12-5)
Remove the rear carrier. (⇒12-5)
Remove the oil meter connector.
Remove the two bolts attaching the oil tank.
Disconnect the oil inlet line.
Drain the oil inside the oil tank into a clean container.
Remove the oil tank.
The installation sequence is the reverse of removal.

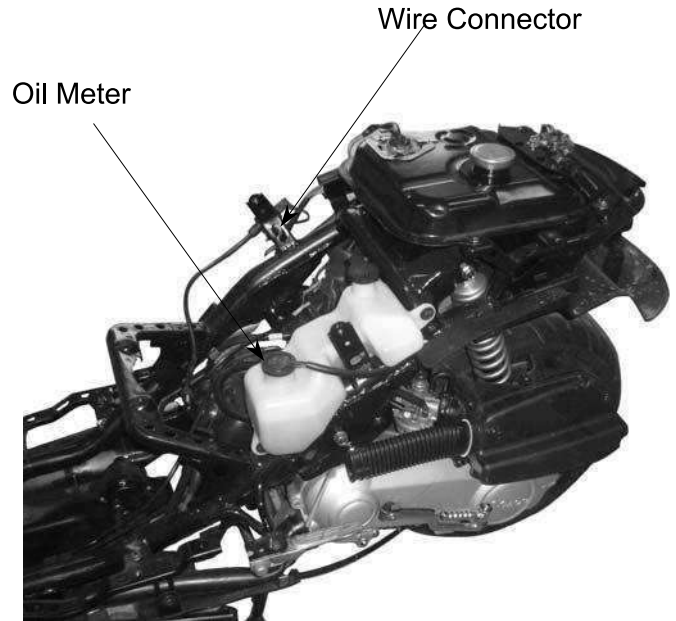

*

- Connect the oil line properly.
- Bleed air from the oil pump after installation.
- The oil tube clip (at the oil tank side) must be locked from inside of the oil tube joint.

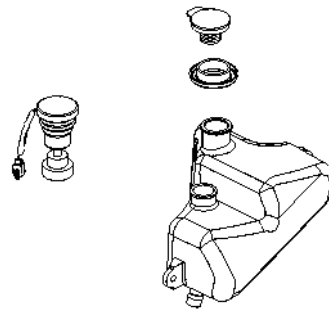

ENGINE REMOVAL/INSTALLATION

SERVICE INFORMATION 5-1
ENGINE REMOVAL..... 5-2
ENGINE INSTALLATION..... 5-4

SERVICE INFORMATION

GENERAL INSTRUCTIONS

- A floor jack or other adjustable support is required to support and maneuver the engine. Be careful not to damage the motorcycle body, cables and wires during engine removal.
- Use shop towels to protect the motorcycle body during engine removal.
- Parts requiring engine removal for servicing:
 - Crankcase
 - Crankshaft

TORQUE VALUES

Engine mounting bolt	4.5~5.5kg-m
Rear shock absorber lower mount bolt	2.4~3.0kg-m
Engine hanger bracket bolt	3.5~4.5kg-m

ENGINE REMOVAL

Remove the frame body cover.
Remove the two bolts attaching the air cleaner case.
Loosen the band between the air cleaner and carburetor to remove the air cleaner case.
Remove the carburetor cap.

Carburetor Cap Air Cleaner Case

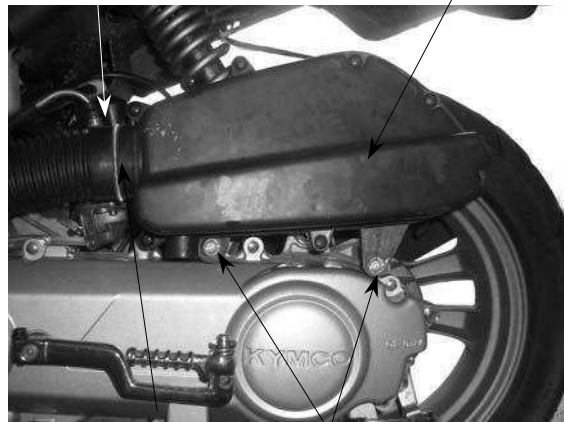

Band Bolt
AC Generator Wire Connector

Disconnect the auto bystarter, A.C. generator and starter motor wire connectors.

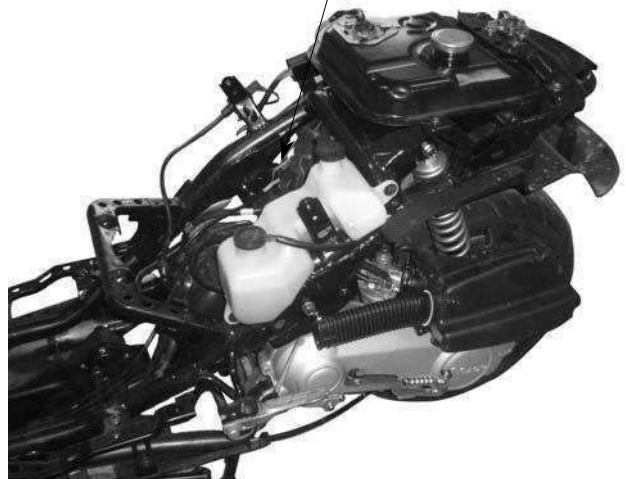

Disconnect the oil pump control cable from the pump body.
Disconnect the oil inlet line from the oil pump.
Remove the spark plug cap.

Oil Inlet Line



Oil Pump Control Cable Spark Plug Cap

* After the oil inlet line is disconnected, plug the oil line opening to prevent oil from flowing out.

Remove the rear brake adjusting nut and disconnect the brake cable from the crankcase.
Remove the rear brake cable clamp and rear brake cable.
Remove the rear shock absorber lower mount bolt.

Rear Shock Absorber Lower Mount Bolt



Rear Brake Cable

Remove the right and left engine mounting nuts.
Take out the right and left engine mounting bolts.
Lift the frame upward to separate it from the engine and be careful not to damage the rear fender.

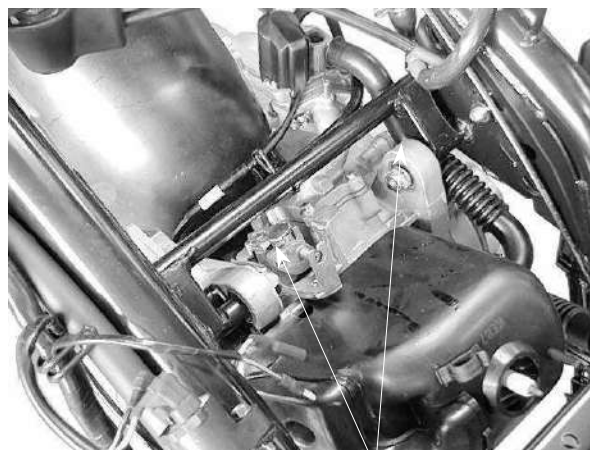

Engine Mounting Nuts

Engine Hanger

ENGINE HANGER BRACKET REMOVAL

Remove the engine hanger bracket bolt and engine hanger bracket.
The installation sequence is the reverse of removal.

Torque: 3.5~4.5kg-m



Engine Hanger Bracket Bolt

ENGINE HANGER BRACKET INSPECTION

Inspect the stopper rubbers and bushings for damage and replace with new ones if necessary.

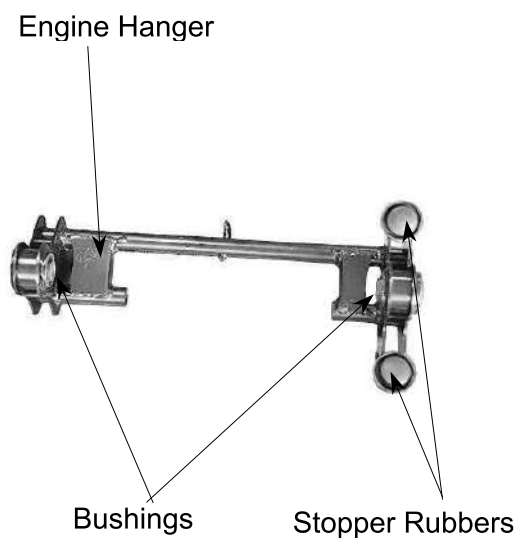

ENGINE INSTALLATION

Install the engine in the reverse order of removal.

* Cables and wires should be routed properly.

Torque Values:

- Engine mounting bolt : 4.5~5.5kg-m
- Rear shock absorber lower mount bolt:
: 2.4~3.0kg-m



Perform the following inspections and adjustments after installation.

- Throttle cable
- Oil pump control cable
- Rear brake cable
- Oil pump bleeding



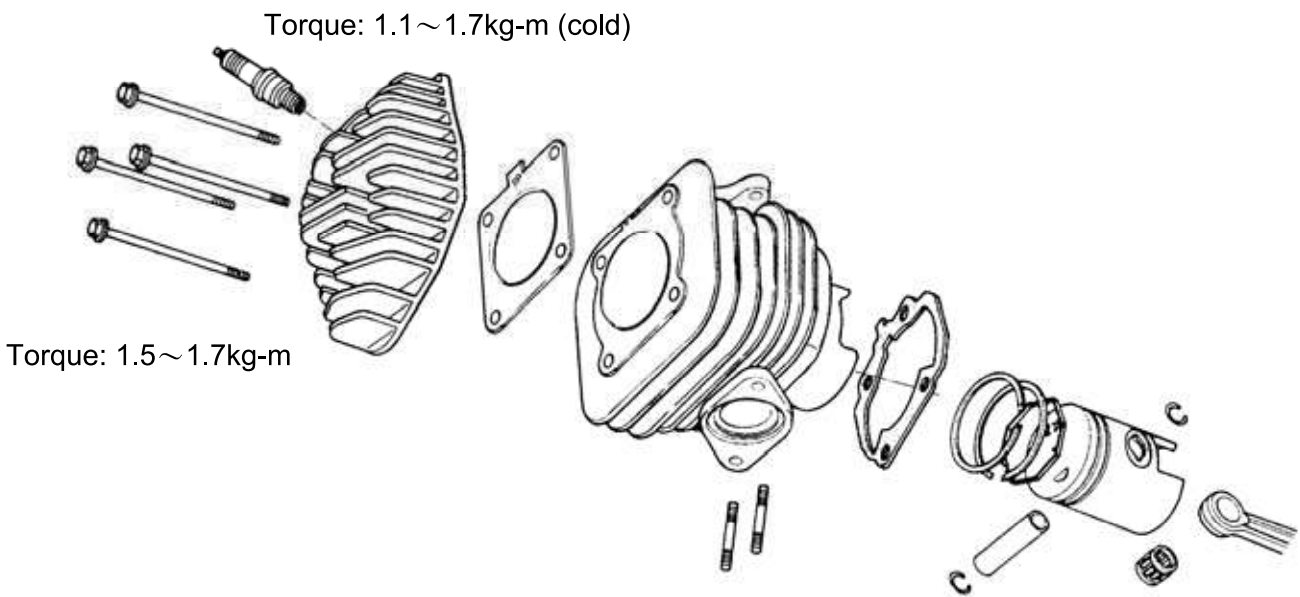

SERVICE INFORMATION

GENERAL INSTRUCTIONS

- The cylinder head, cylinder and piston can be serviced with the engine installed in the frame.
- Before disassembly, clean the engine to prevent dust from entering the engine.
- Remove all gasket material from the mating surfaces.
- Do not use a driver to pry between the cylinder and cylinder head, cylinder and crankcase.
- Do not damage the cylinder inside and the piston surface.
- After disassembly, clean the removed parts before inspection. When assembling, apply the specified engine oil to movable parts.

SPECIFICATIONS

Item	Standard (mm)	Service Limit (mm)
	AGILITY CITY 50 2T	AGILITY CITY 50 2T
Cylinder head warpage	—	0.10
Piston O.D.(5mm from bottom of piston skirt)	38.970~38.955	38.90
Cylinder-to- piston clearance		0.10
Piston pin hole I.D.	12.002~12.008	12.03
Piston pin O.D.	11.994~12.0	11.98
Piston-to-piston pin clearance	←	←
Piston ring end gap (top/second)	0.10~0.25	0.40
Connecting rod small end I.D.	17.005~17.017	17.03
Cylinder bore	39.0~39.025	39.05

TORQUE VALUES

Cylinder head bolt	1.5~1.7kg-m
Exhaust muffler joint lock nut	1.8~2.2kg-m
Exhaust muffler lock bolt	3.0~3.6kg-m
Spark plug	1.1~1.7kg-m

●TROUBLESHOOTING

Compression too low, hard starting or poor performance at low speed

- Leaking cylinder head gasket
- Loose spark plug
- Worn, stuck or broken piston and piston rings
- Worn or damaged cylinder and piston

Compression too high, overheating or knocking

- Excessive carbon build-up in cylinder head or on piston head

Abnormal noisy piston

- Worn cylinder and piston
- Worn piston pin or piston pin hole
- Worn connecting rod small end bearing

Abnormal noisy piston rings

- Worn, stuck or broken piston rings
- Worn or damaged cylinder

CYLINDER HEAD

REMOVAL

Remove the rear carrier.
Remove the frame body cover. (⇒12-5)
Remove the spark plug cap.

Spark Plug Cap

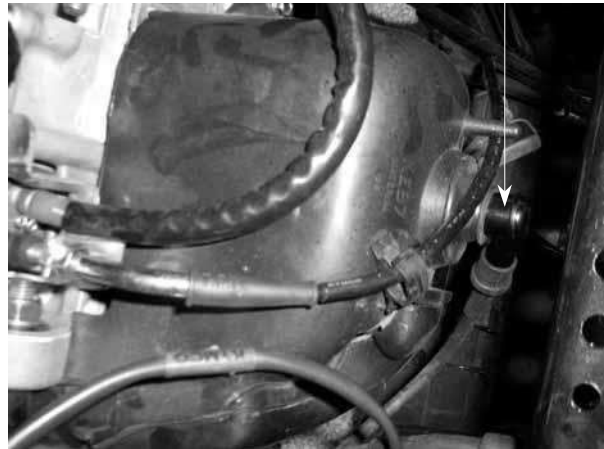

Remove the three bolts attaching the fan cover to remove the fan cover.
Remove the two joint lock nuts on the front of the exhaust muffler and then remove the two exhaust muffler lock bolts.
Remove the bolt attaching the engine hood to remove the engine hood.
The installation sequence is the reverse of removal.

Fan Cover/Engine Hood

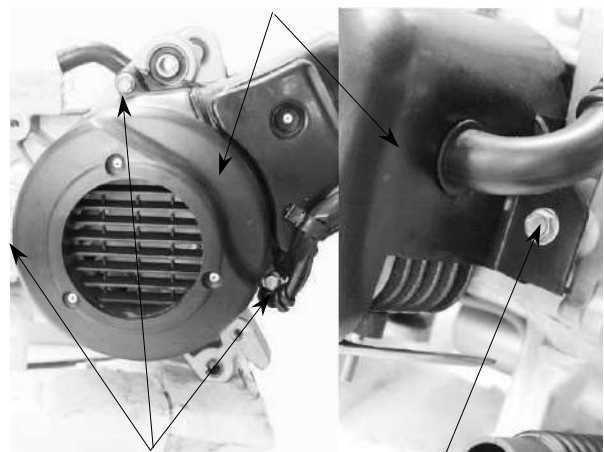

Bolts

Bolt

* When installing the exhaust muffler, first tighten the two nuts on the front and then tighten the two bolts.

Remove the spark plug.
Remove the cylinder head bolts and the cylinder head.

* Loosen the bolts diagonally in 2 or 3 times.

Cylinder head Bolts

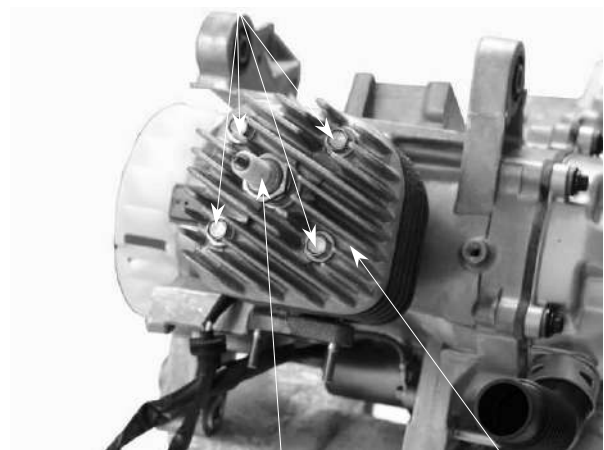

Spark Plug

Cylinder Head

COMBUSTION CHAMBER DECARBONIZING

Remove the carbon deposits from the combustion chamber

- * Avoid damaging the combustion chamber wall and cylinder mating surface.

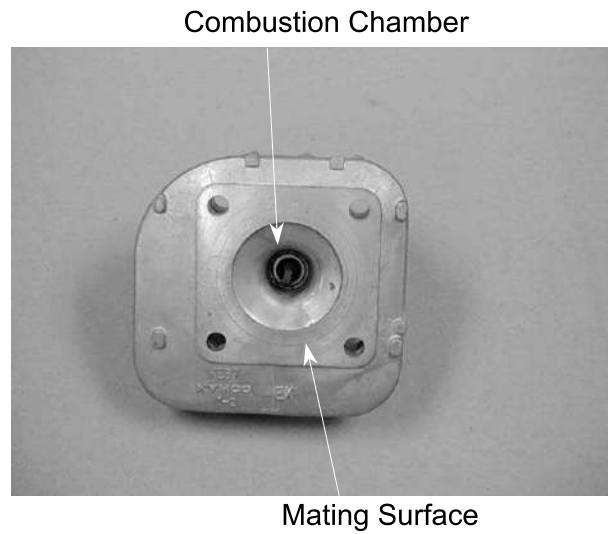

CYLINDER HEAD INSPECTION

Check the cylinder head for warpage with a straight edge and feeler gauge.

Service Limit:

0.10mm replace if over

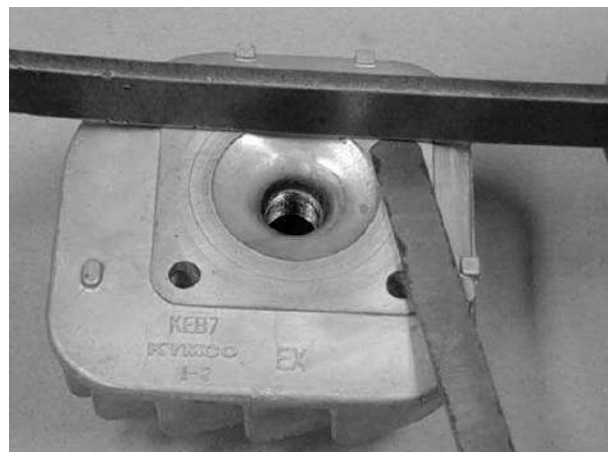

CYLINDER HEAD INSTALLATION

Install the cylinder head on the cylinder properly.

- * Be careful not to damage the mating surfaces.

Install a new cylinder head gasket onto the cylinder.

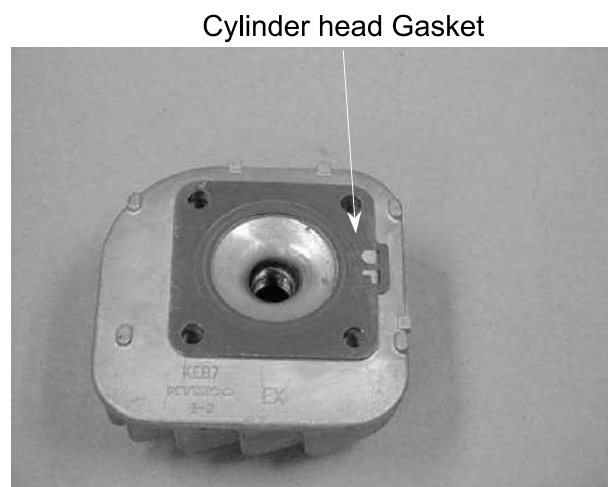

Cylinder Head Bolts Installation

Install and tighten the cylinder head bolts diagonally in 2 or 3 times.

Torque: 1.5~1.7kg-m

Install the spark plug.

Torque: 1.1~1.7kg-m

Cylinder head Bolts

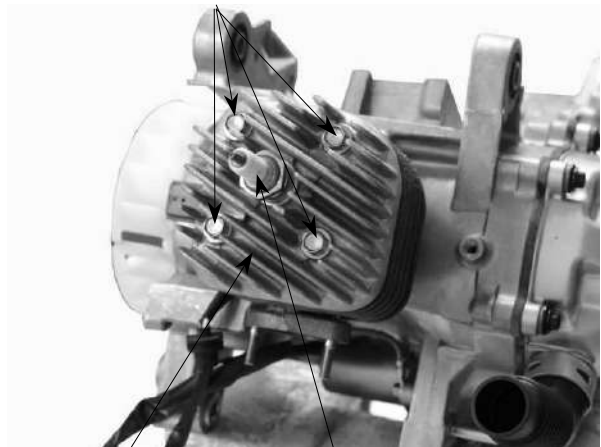

Cylinder Head

Spark Plug

Engine Hood Installation

Install the engine hood. (⇒6-3)

Install the spark plug cap. (⇒6-3)

Engine Hood

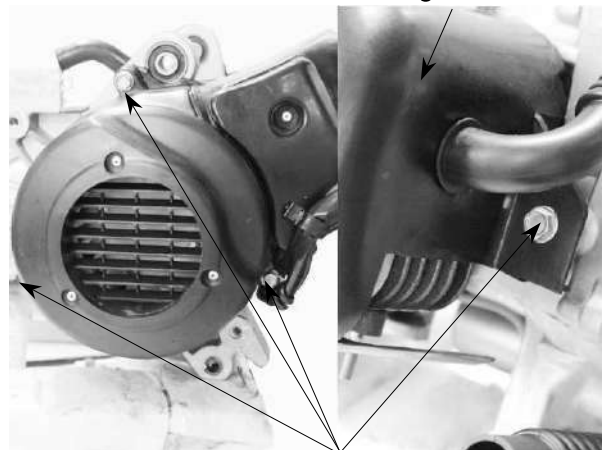

Bolts

Perform the following inspections after installation:

- Compression test
- Abnormal engine noise
- Cylinder air leaks



CYLINDER/PISTON

CYLINDER REMOVAL

- Remove the met-in box and seat.
- Remove the frame body cover.
- Remove the cylinder head.
- Remove the two exhaust muffler joint lock nuts and two exhaust muffler lock bolts.
- Remove the exhaust muffler.
- Remove the cylinder.
- Remove the cylinder gasket.

*

Do not pry between the cylinder and crankcase or strike the fins.

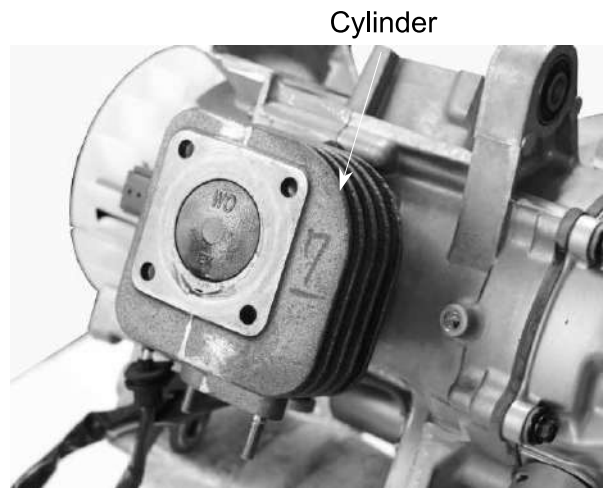

PISTON REMOVAL

- Remove the piston pin clip to remove the piston pin and piston.

*

- Do not damage or scratch the piston.
- Do not apply side force to the connecting rod when removing the piston pin.
- Place clean shop towels in the crankcase to keep the piston pin clip from falling into the crankcase.

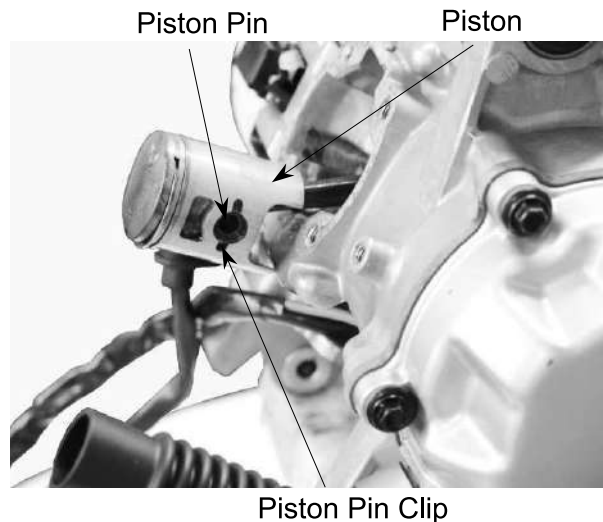

- Spread each piston ring and remove by lifting it up at a point just opposite the gap.
- Remove the expander.



CYLINDER/PISTON INSPECTION

Check the cylinder and piston for wear or damage.
Clean carbon deposits from the exhaust port area.

* Be careful not to damage the cylinder inside wall.



Measure the cylinder bore at three levels of A, B and C in both X and Y directions. Avoid the port area. Take the maximum figure measured to determine the cylinder bore.

Service Limit:

39.05mm replace if over

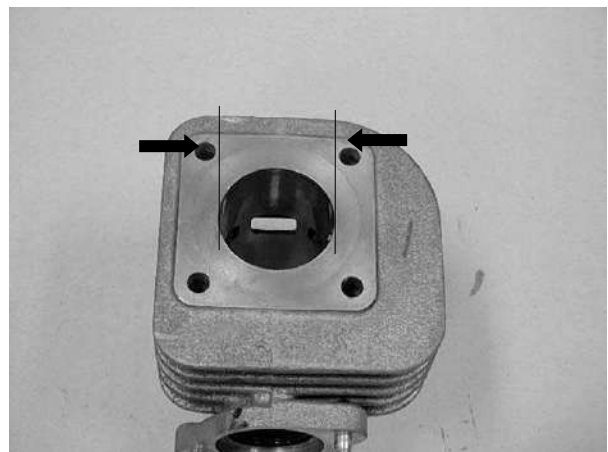

Inspect the top of the cylinder for warp.

Service Limit:

0.10mm replace if over

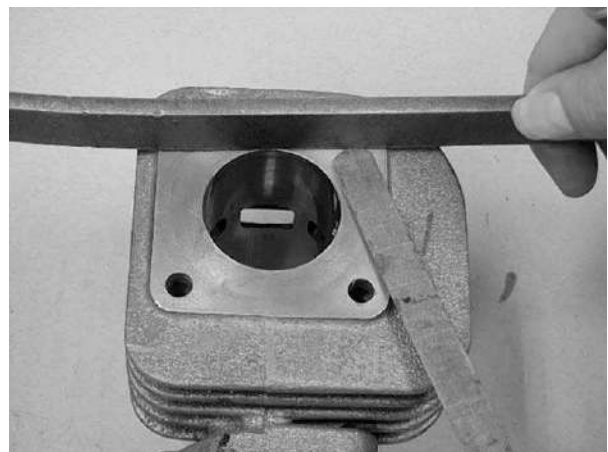

* The cylinder has an 'A' mark or no mark on it. When replacing the cylinder with a new one, use a cylinder having the same mark as the old one.



Measure the piston O.D. at a point 5mm from the bottom of the piston skirt.

Service Limit:
38.90mm replace if below

Measure the piston-to-cylinder clearance.

Service Limit:
0.10mm replace if over

Measure the piston pin hole I.D.

Service Limit:
12.03mm replace if over

Measure the piston pin O.D.

Service Limit:
11.98mm replace if below

Measure the piston-to-piston pin clearance.

Service Limit:
0.03mm replace if over

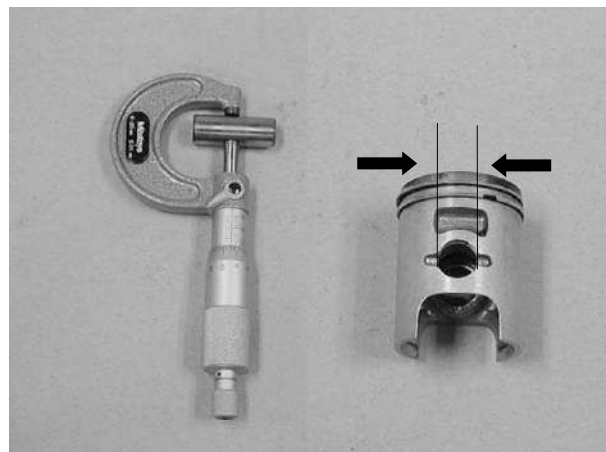
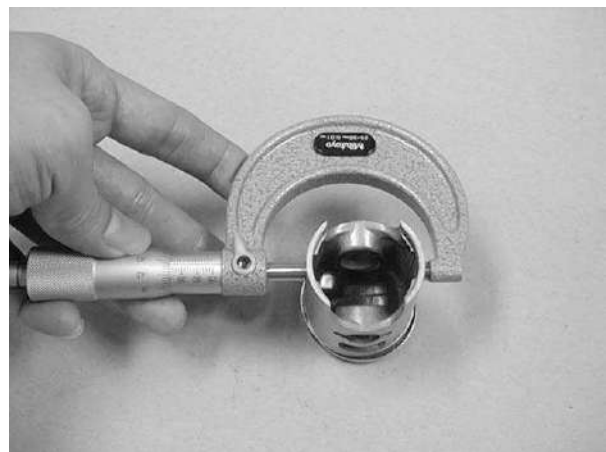

PISTON RING INSPECTION

Measure each piston ring end gap.

Service Limits: Top/Second
0.40mm replace if over

* Set each piston ring squarely into the cylinder using the piston and measure the end gap.

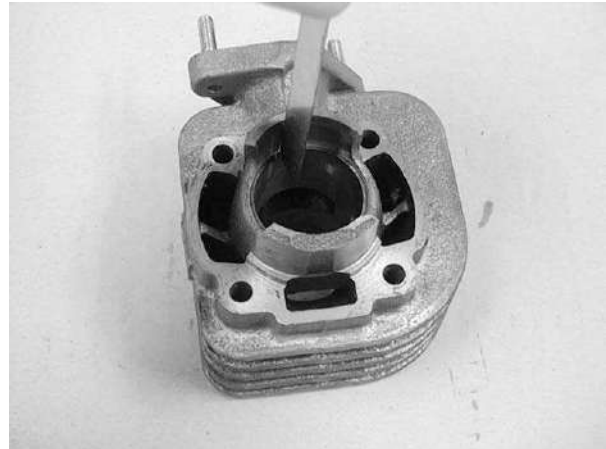

CONNECTING ROD SMALL END INSPECTION

Install the piston pin and bearing in the connecting rod small end and check for excessive play.

Measure the connecting rod small end I.D.

Service Limit:
17.03mm replace if over

<Small End I.D. Measurement>



PISTON/CYLINDER INSTALLATION

First install the expander in the second ring groove.

Then install the top and second rings in their respective ring grooves.

The piston rings should be pressed into the grooves with even force.

After installation, check and make sure that each ring is flush with the piston at several points around the ring.

A ring that will not compress means that the ring groove has carbon deposits in it and should be cleaned.

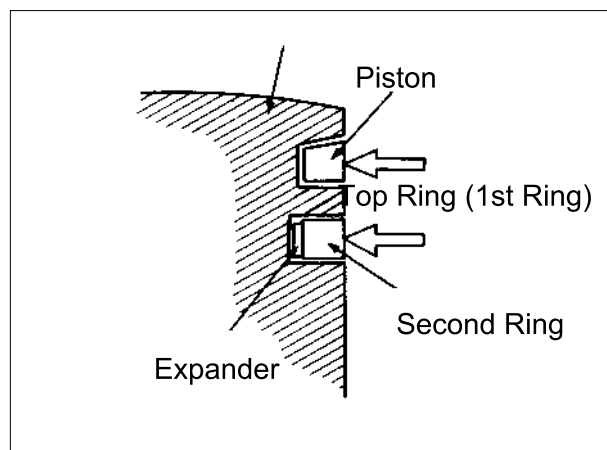

Install a new cylinder gasket on the mating surface between the cylinder and crankcase.



Make sure that the ring end gaps are aligned with the piston ring pins in the ring grooves.

Lubricate the cylinder inside and piston rings with engine oil and install the piston into the cylinder while compressing the piston rings.

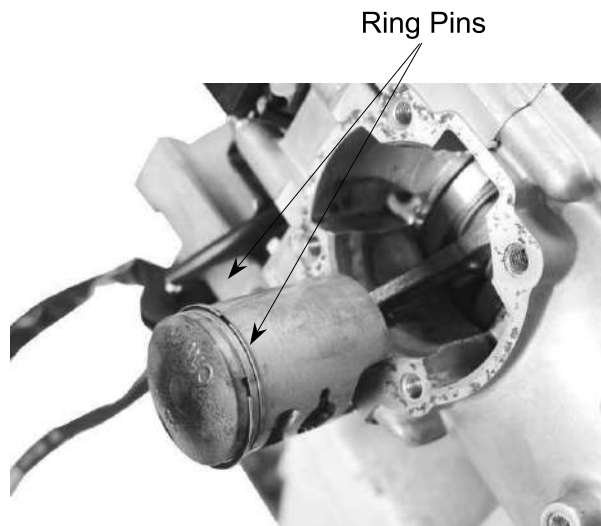

*

Be careful not to damage the piston.

Install the cylinder head.

Torque: 1.5~1.7kg-m

Install the exhaust muffler and tighten the exhaust muffler joint lock nuts.

Torque: 1.8~2.2kg-m

Tighten the exhaust muffler lock bolts.

Torque: 3.0~3.6kg-m

Install the frame covers.

Install the met-in box.

The installation sequence is the reverse of removal.

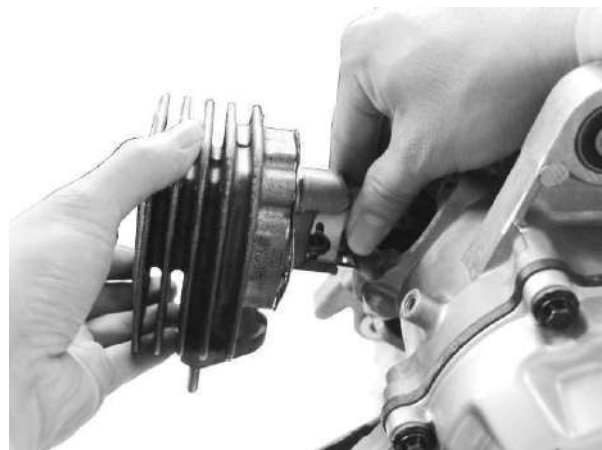

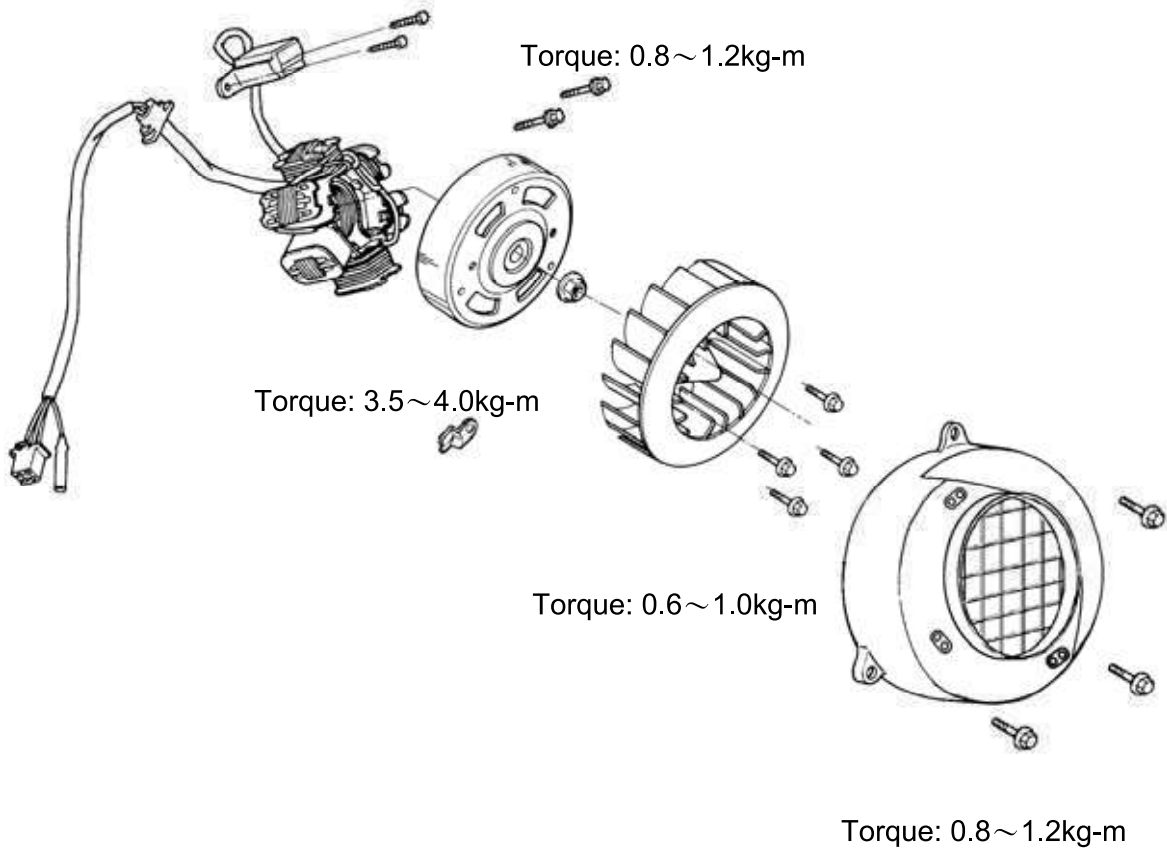

SERVICE INFORMATION

GENERAL INSTRUCTIONS

- All A.C. generator maintenance and inspection can be made with the engine installed.
- Refer to Section 15 for A.C. generator inspection.

TORQUE VALUE

Flywheel nut : 3.5~4.0kg-m

SPECIAL TOOLS

Flywheel puller
Universal holder

A.C. GENERATOR REMOVAL

Remove the three bolts attaching the fan cover to remove the fan cover.

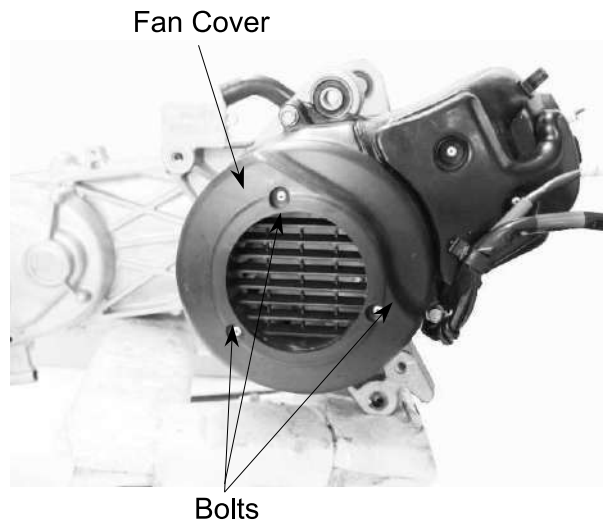

Remove the cooling fan by removing the four bolts.

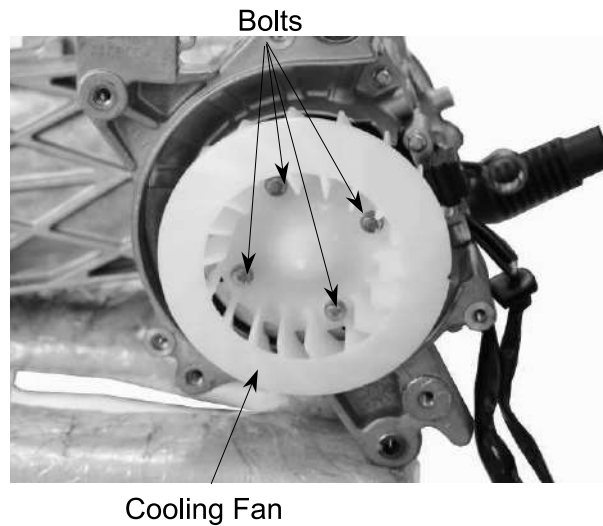

Hold the flywheel with an universal holder and then remove the 10mm flywheel nut.

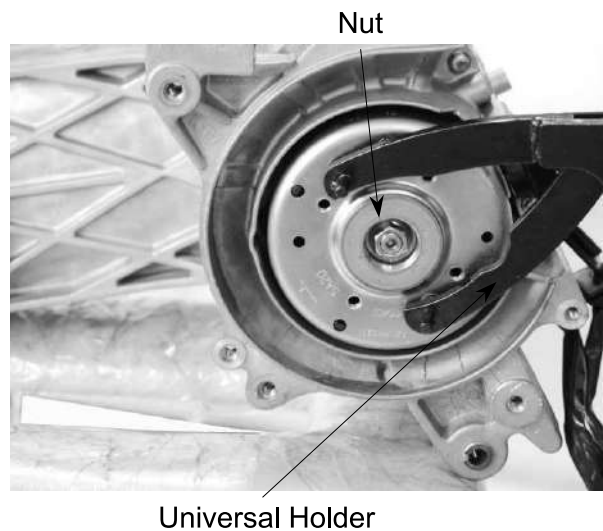

Remove the A.C. generator flywheel using the flywheel puller.

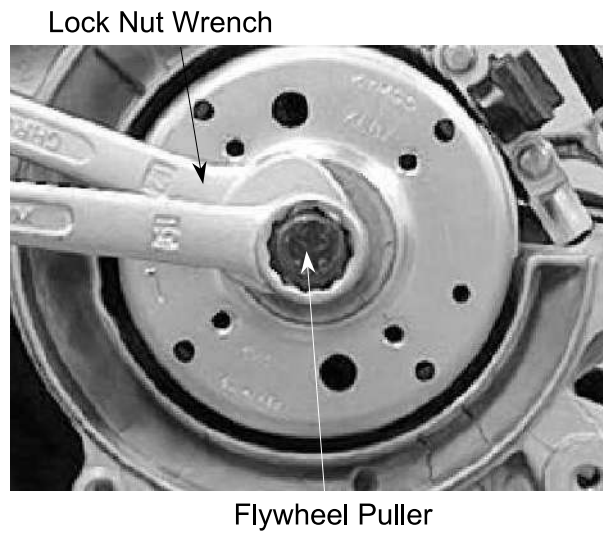

Remove the A.C. generator wire connector.

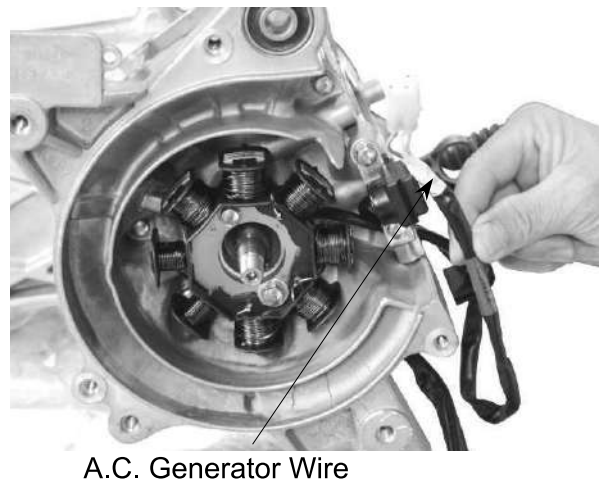

Remove the two pulser coil bolts and pulser coil from the right crankcase.
Remove the pulser coil wire clamp from the right crankcase.
Remove the two bolts attaching the A.C. generator stator.

* Be careful not to damage the disconnected wire.

A.C. GENERATOR INSTALLATION

Install the A.C. generator stator and pulser coil wire clamp onto the right crankcase, and then install the pulser coil.

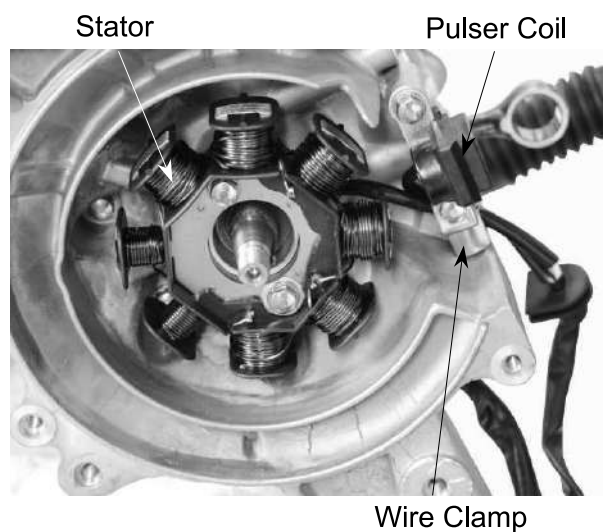

Install the A.C. generator and pulser coil bolts.
Connect the A.C. generator wire connector.

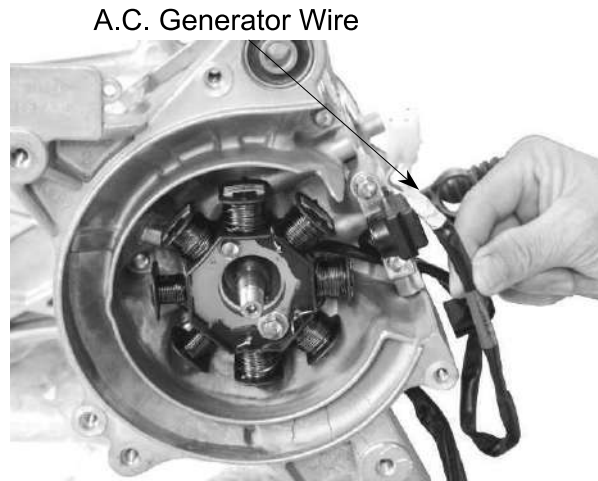

Clean the taper hole in the flywheel off any burrs and dirt.
Install the woodruff key in the crankshaft keyway.

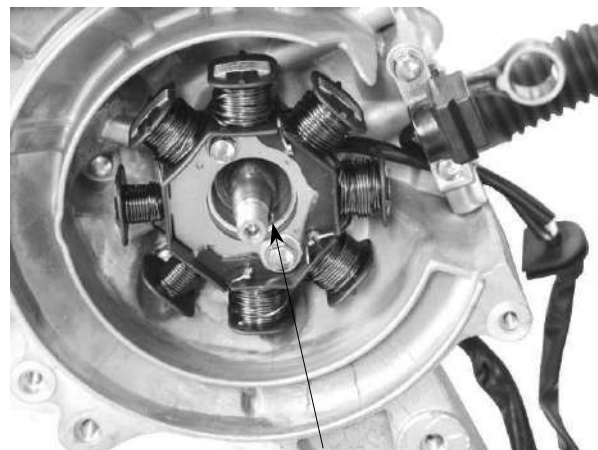

Woodruff Key

Install the flywheel onto the crankshaft with the flywheel groove aligned with the crankshaft woodruff key.
Hold the flywheel with the universal holder and install the 10mm flywheel flange nut.

Torque: 3.5~4.0kg-m

Start the engine and check the ignition timing.

Install other removed parts in the reserve order of removal.



Universal Holder

8. KICK STARTER/DRIVE PULLEY/ CLUTCH/DRIVEN PULLEY

AGILITY CITY 50 2T

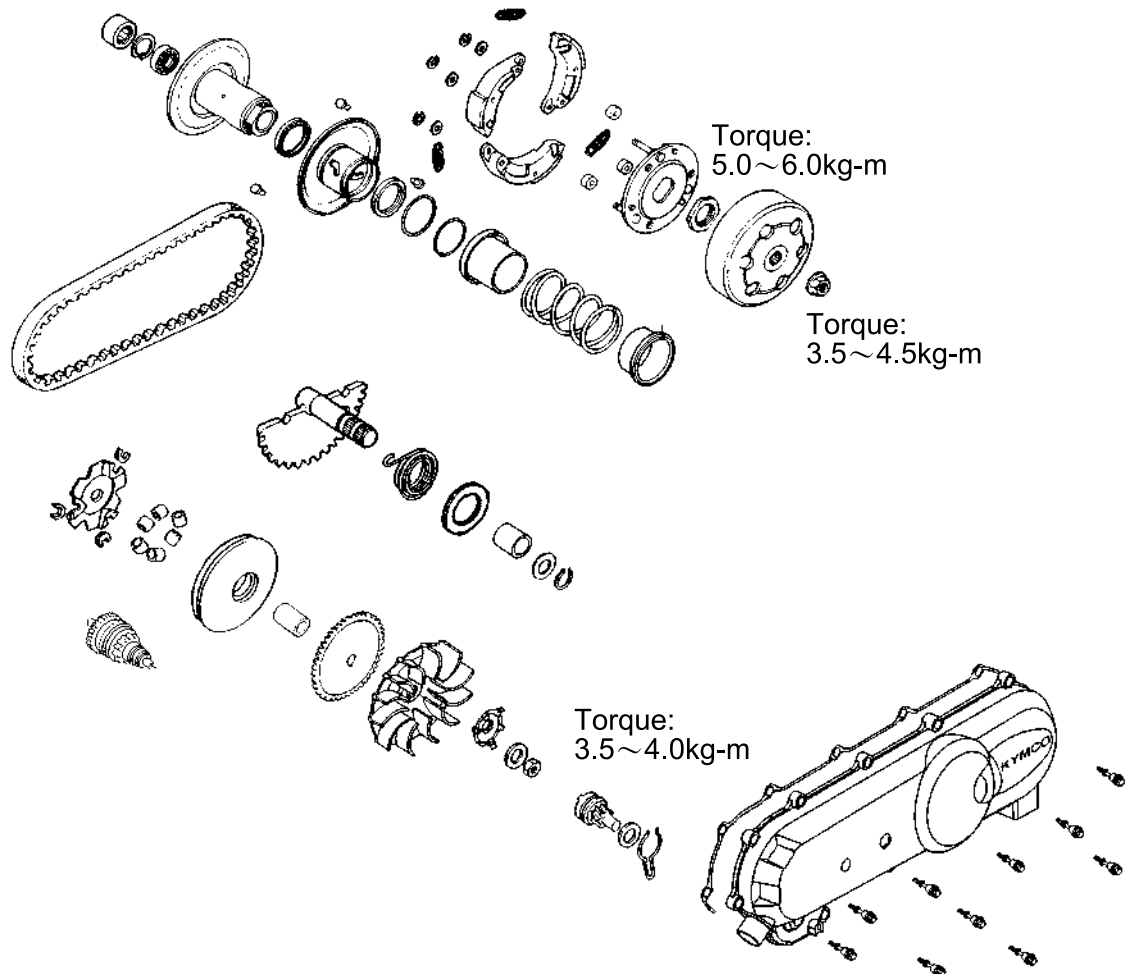

8. KICK STARTER/DRIVE PULLEY/ CLUTCH/DRIVEN PULLEY

AGILITY CITY 50 2T

SERVICE INFORMATION

GENERAL INSTRUCTIONS

- Avoid getting grease and oil on the drive belt and pulley faces.

SPECIFICATIONS	AGILITY CITY 50 2T	
	Standard (mm)	Service Limit (mm)
Drive pulley collar O.D.	20.01~20.025	24.24
Movable drive face I.D.	20.035~20.085	19.97
Weight roller O.D.	13.0	12.4
Clutch outer I.D.	107~107.2	107.5
Driven face spring free length	87.9	82.6
Driven face O.D.	33.965~33.985	33.94
Movable driven face I.D.	34.0~34.25	34.06
Drive belt width	18	17

TORQUE VALUES

Drive face nut	3.5~4.0kg-m
Clutch outer nut	3.5~4.5kg-m
Clutch drive plate nut	5.0~6.0kg-m

SPECIAL TOOLS

Lock nut wrench, 39mm	Universal holder
Clutch spring compressor	Lock nut socket wrench, 32mm
Bearing outer driver 37x40mm	Bearing driver pilot, 17mm
One-way clutch puller	Outer driver, 24x26mm

TROUBLESHOOTING

Engine starts but motorcycle won't move

- Worn drive belt
- Broken ramp plate
- Worn or damaged clutch lining

Engine stalls or motorcycle creeps

- Broken clutch weight spring

Poor performance at high speed or lack of power

- Worn drive belt
- Weak driven face spring
- Worn weight roller
- Faulty driven face

8. KICK STARTER/DRIVE PULLEY/ CLUTCH/DRIVEN PULLEY

AGILITY CITY 50 2T

KICK STARTER

LEFT CRANKCASE COVER REMOVAL

Remove the nine left crankcase cover bolts, left crankcase cover and dowel pins. Inspect the left crankcase cover seal rubber for damage or deterioration.

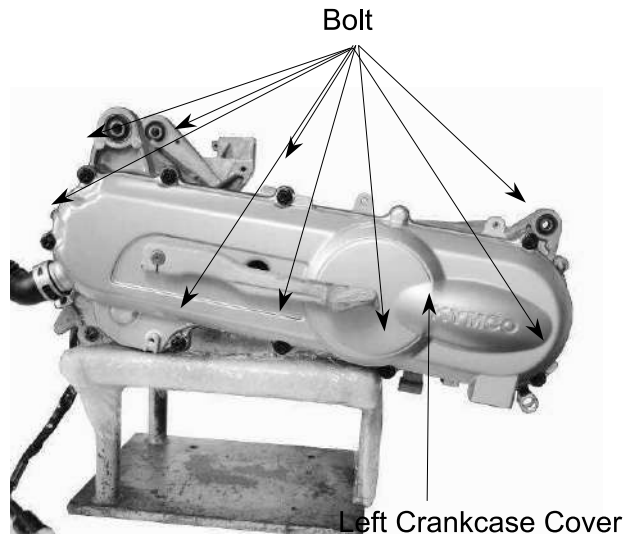

KICK STARTER SPINDLE REMOVAL

Remove the kick lever from the kick starter spindle. Remove the circlip and washer from the kick starter spindle.

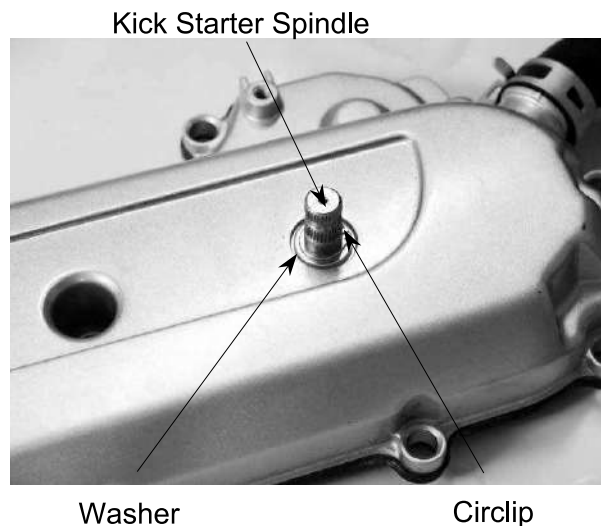

Slightly rotate the kick starter spindle to remove the kick starter driven gear together with the friction spring.

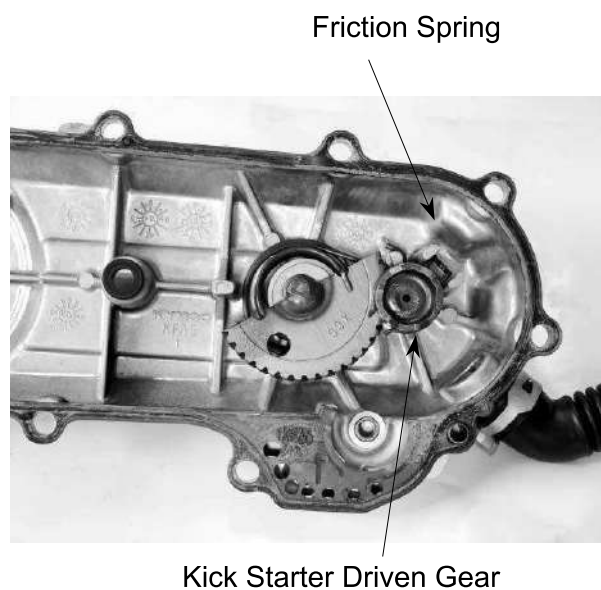

8. KICK STARTER/DRIVE PULLEY/ CLUTCH/DRIVEN PULLEY

AGILITY CITY 50 2T

Remove the kick starter spindle and return spring from the left crankcase cover.
Remove the kick starter spindle bushing.

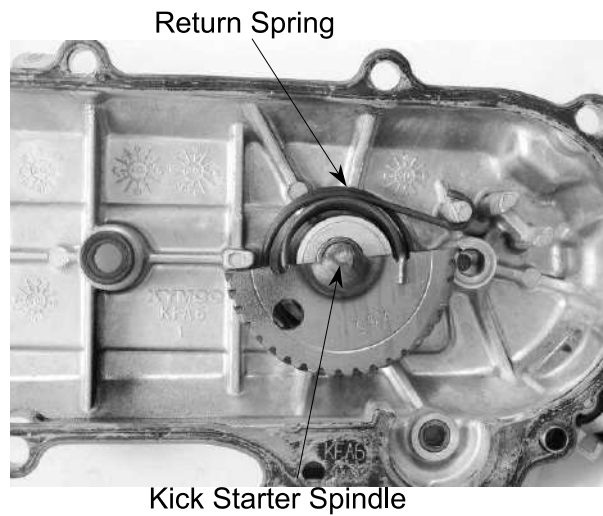

KICK STARTER SPINDLE INSPECTION

Inspect the kick starter spindle and gear for wear or damage.
Inspect the return spring for weakness or damage.
Inspect the kick starter spindle bushing for wear or damage.

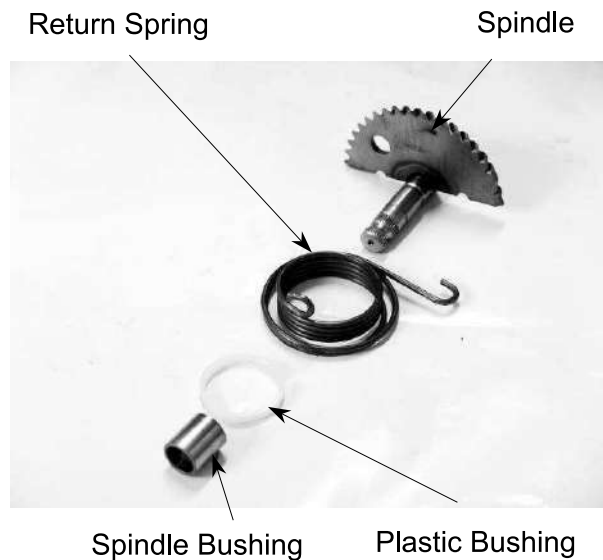

Check the kick starter driven gear for wear or damage.
Check the friction spring for wear or damage.

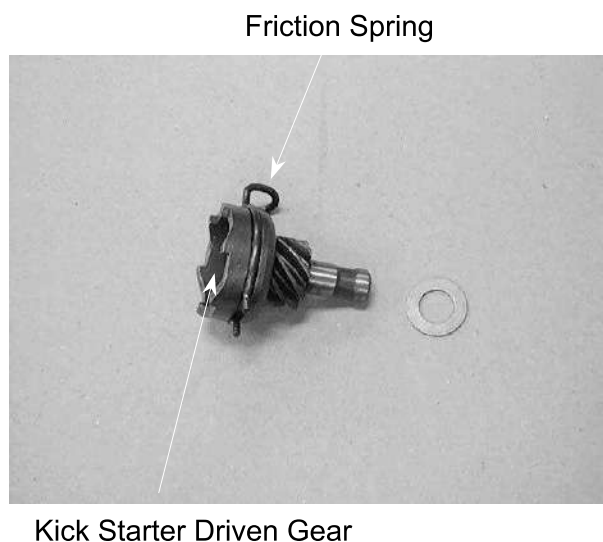

8. KICK STARTER/DRIVE PULLEY/ CLUTCH/DRIVEN PULLEY

AGILITY CITY 50 2T

Inspect the kick starter spindle and driven gear forcing parts for wear or damage.

Kick Starter Spindle Forcing Part

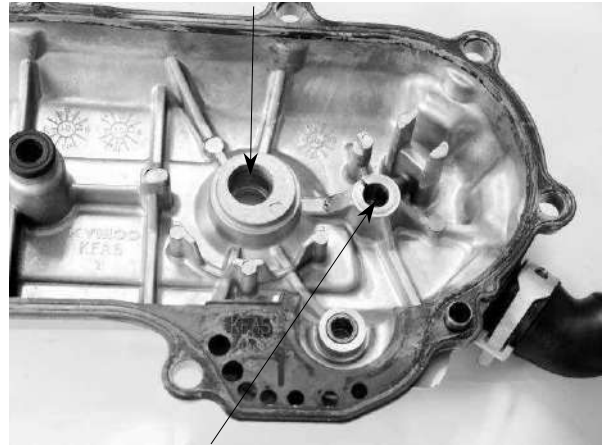

Kick Starter Driven Gear Forcing Part

KICK STARTER INSTALLATION

Install the kick starter spindle bushing and return spring onto the left crankcase cover.

* If the hooks of the return spring can not be installed properly, use a screw driver to press them into their locations respectively.

Friction Spring

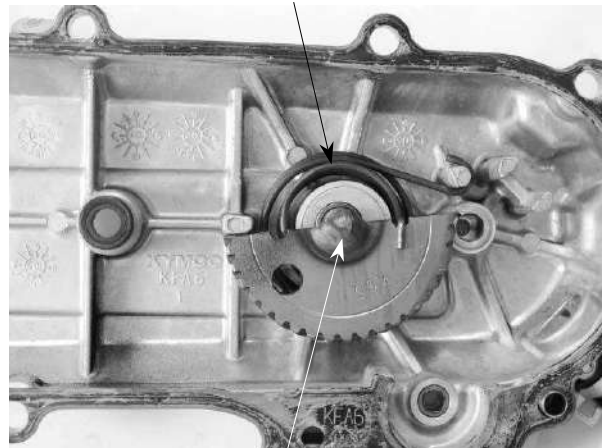

Kick Starter Spindle

Properly install the kick starter driven gear and friction spring as the figure shown.

Friction Spring

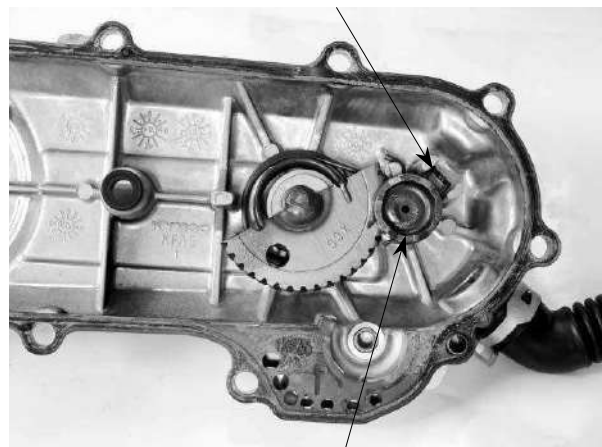

Kick Starter Driven Gear

8. KICK STARTER/DRIVE PULLEY/ CLUTCH/DRIVEN PULLEY

AGILITY CITY 50 2T

First install the washer and then the circlip onto the kick starter spindle.
Install the kick lever.

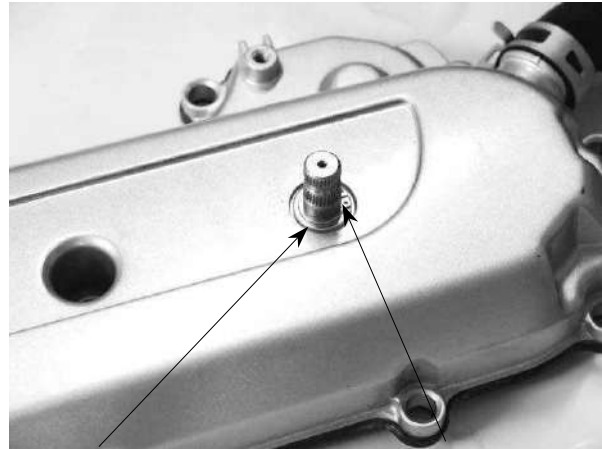

Washer

Circlip

LEFT CRANKCASE COVER INSTALLATION

First install the dowel pins and then the seal rubber.

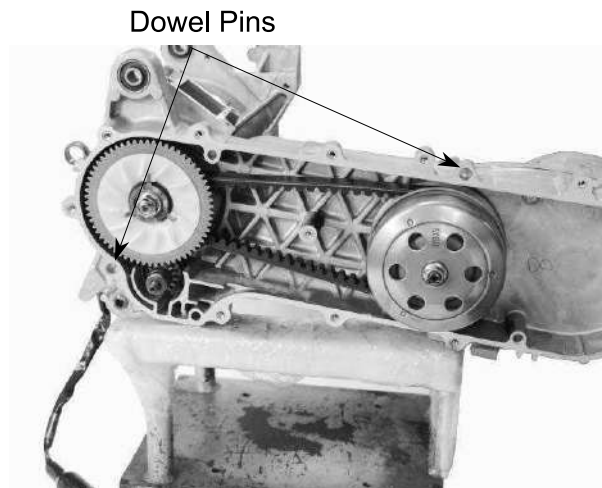

Dowel Pins

Install the left crankcase cover and tighten the ten bolts diagonally.
Connect the drive belt cooling air tube and install the circlip.

* For drum brake, note the location of the brake cable clamp and install the rear brake cable in place with the clamp.

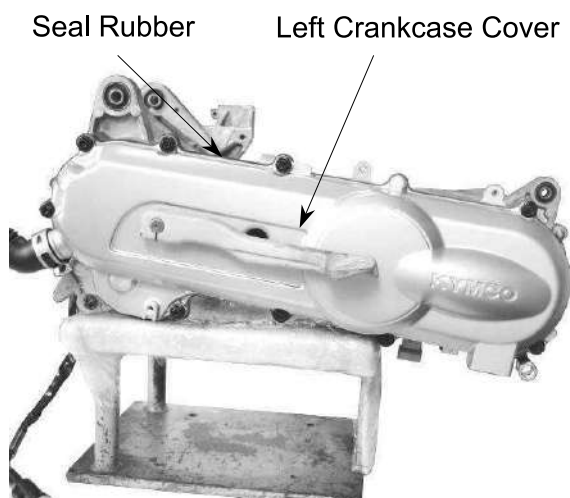

Seal Rubber

Left Crankcase Cover

8. KICK STARTER/DRIVE PULLEY/ CLUTCH/DRIVEN PULLEY

AGILITY CITY 50 2T

*
replacement.

r

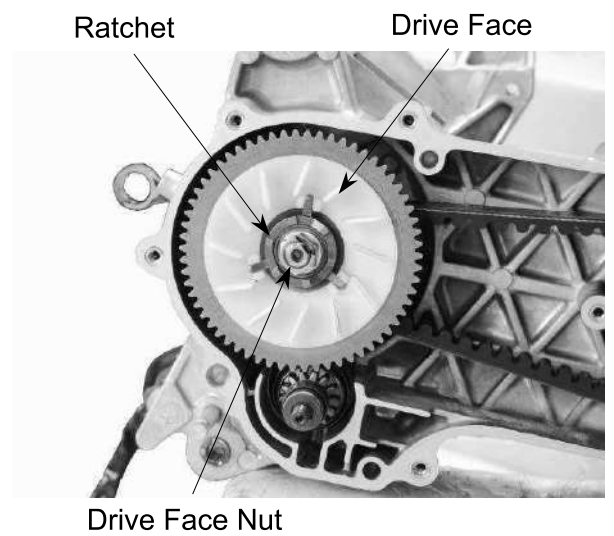
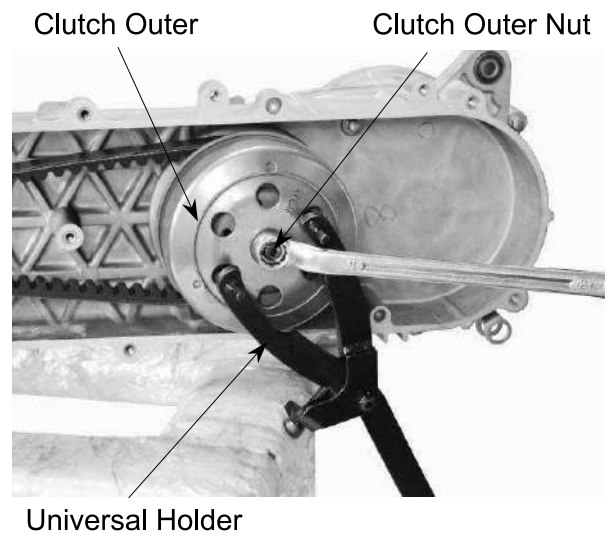
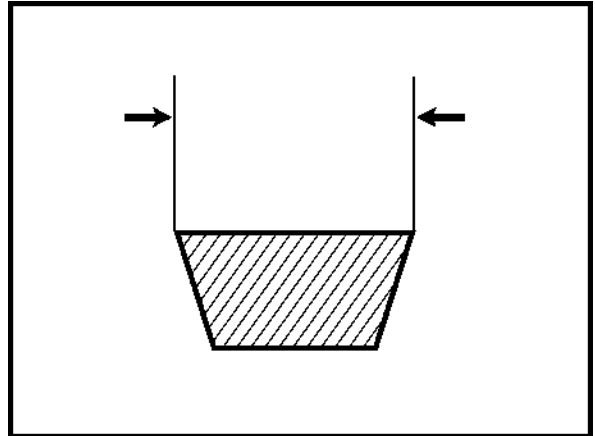

8. KICK STARTER/DRIVE PULLEY/ CLUTCH/DRIVEN PULLEY

AGILITY CITY 50 2T

Remove the drive belt from the clutch/
driven pulley.

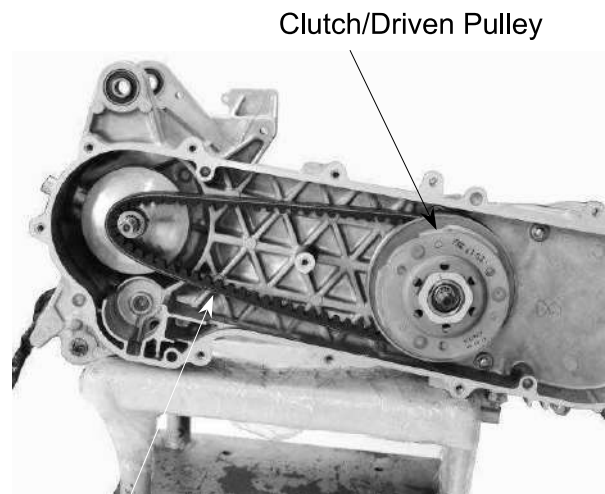

Drive Belt

DRIVE BELT INSTALLATION

Turn the driven pulley clockwise and lift it
up to expand the drive belt groove and then
install a new drive belt.

Drive Belt

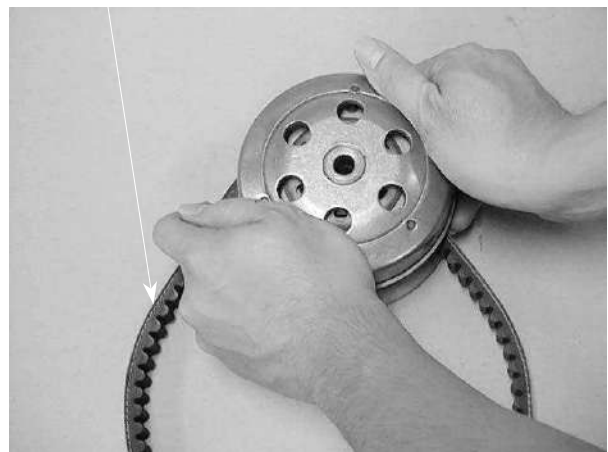

Set the drive belt on the drive pulley.
Install the drive pulley face, starting ratchet
and 12mm washer, then tighten the drive
face nut.

Torque: 3.5~4.0kg-m

* When installing the drive face nut, make
sure that the tooth spaces of the drive
pulley face and starting ratchet align
with the teeth of the crankshaft.

Drive Face Nut Drive Pulley Face Drive Belt

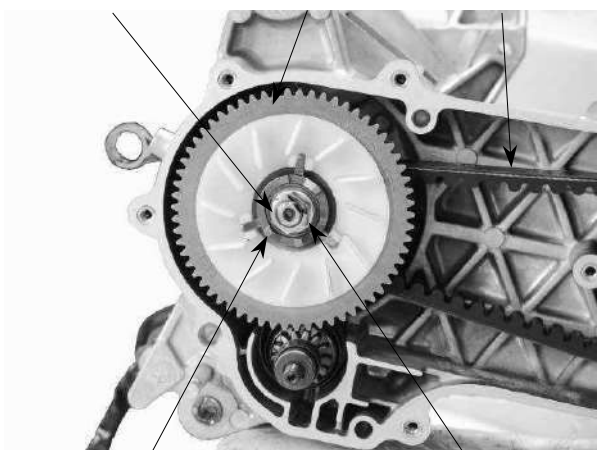

Starting Ratchet

12mm Washer

8. KICK STARTER/DRIVE PULLEY/ CLUTCH/DRIVEN PULLEY

AGILITY CITY 50 2T

DRIVE PULLEY

REMOVAL

Hold the drive pulley with the holder and remove the 12mm drive face nut. Remove the starting ratchet, 12mm washer and drive pulley face.

Drive Pulley Face

Starting Ratchet

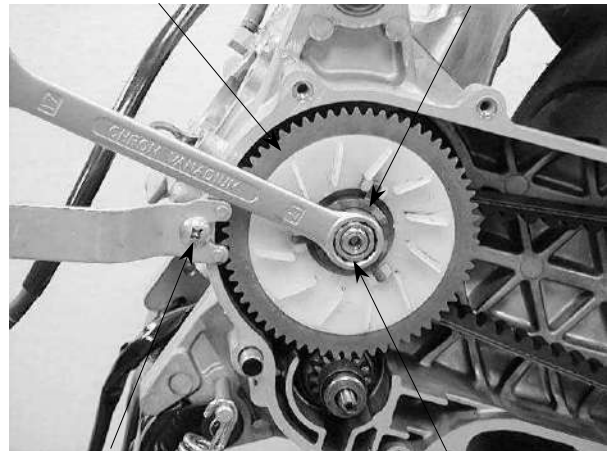

Face Holder

12mm Drive Face Nut

MOVABLE DRIVE FACE DISASSEMBLY

Remove the movable drive face and drive pulley collar from the crankshaft.

Drive Pulley Collar

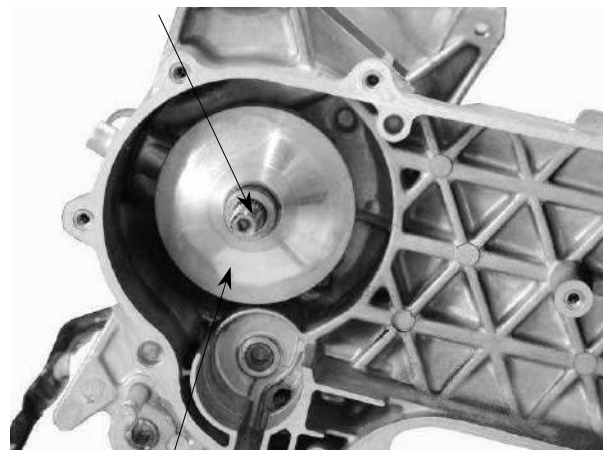

Movable Drive Face

Remove the ramp plate.

Ramp Plate



8. KICK STARTER/DRIVE PULLEY/ CLUTCH/DRIVEN PULLEY

AGILITY CITY 50 2T

MOVABLE DRIVE FACE INSPECTION

Remove the weight rollers.

Check each weight roller for wear or damage.

Measure each roller O.D.

Service Limit:

12.4mm replace if below

Weight Roller

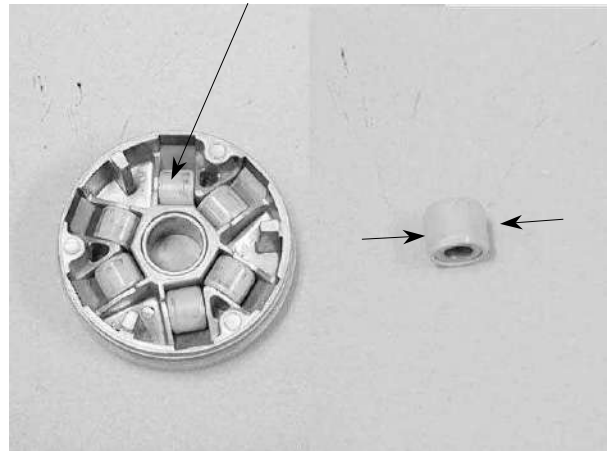

Measure the movable drive face bushing assembly I.D.

Service Limit:

20.3mm replace if over

Check the drive pulley collar for wear or damage.

Measure the O.D. of the drive pulley collar sliding surface.

Service Limit:

19.9mm replace if below

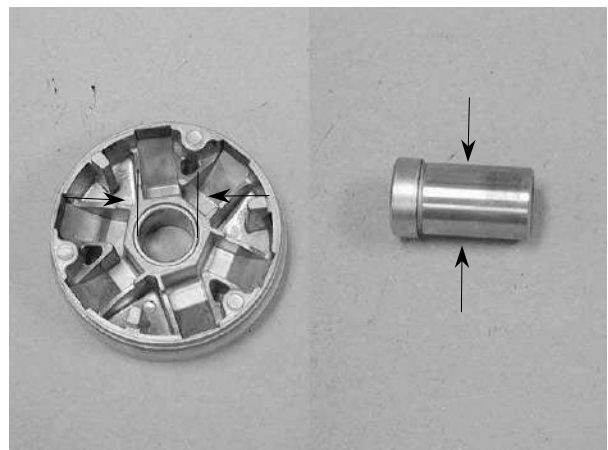

DRIVE PULLEY INSTALLATION

Install the drive pulley collar and movable drive face onto the crankshaft.

Movable Drive Face

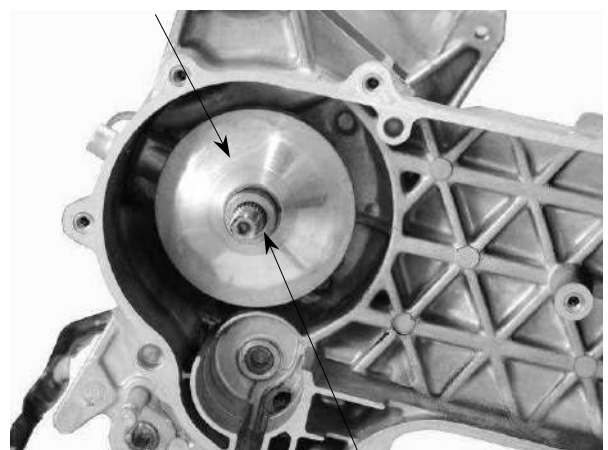

Drive Pulley Collar

8. KICK STARTER/DRIVE PULLEY/ CLUTCH/DRIVEN PULLEY

AGILITY CITY 50 2T

Install the drive belt on the crankshaft.
Install the drive face, starting ratchet and
washer, then tighten the 12mm drive face
nut.

Torque: 3.5~4.0kg-m

*
Keep grease or oil off the drive belt and
drive pulley faces.

Drive Pulley Face

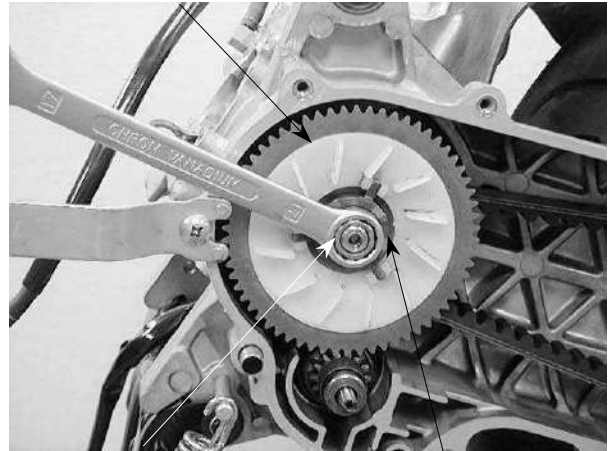

Drive Face Nut

Starting Ratchet

STARTER PINION REMOVAL

Remove the left crankcase cover. (⇒8-4)

Remove the drive pulley. (⇒8-8)

Remove the starter pinion.



Starter Pinion

INSPECTION

Inspect the starter pinion seat for wear.

Inspect the starter pinion for smooth
operation.

Inspect the starter pinion shaft forcing parts
for wear and damage.

INSTALLATION

Apply a small amount of grease to the
starter pinion teeth.

Install the starter pinion in the reverse order
of removal.

Shaft Forcing Parts



Starter Pinion

8. KICK STARTER/DRIVE PULLEY/ CLUTCH/DRIVEN PULLEY

AGILITY CITY 50 2T

CLUTCH/DRIVEN PULLEY

CLUTCH/DRIVEN PULLEY REMOVAL

Remove the drive pulley. (⇒8-8)
Hold the clutch outer with the universal holder and remove the 10mm clutch outer nut.
Remove the clutch outer.

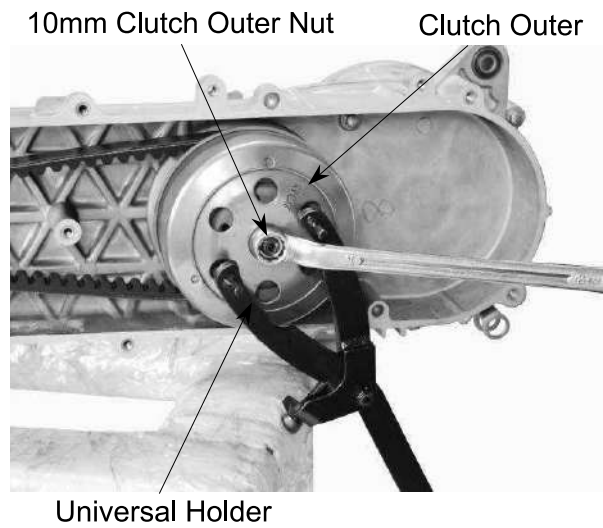

Remove the clutch/driven pulley.
Remove the drive belt from the clutch/driven pulley.

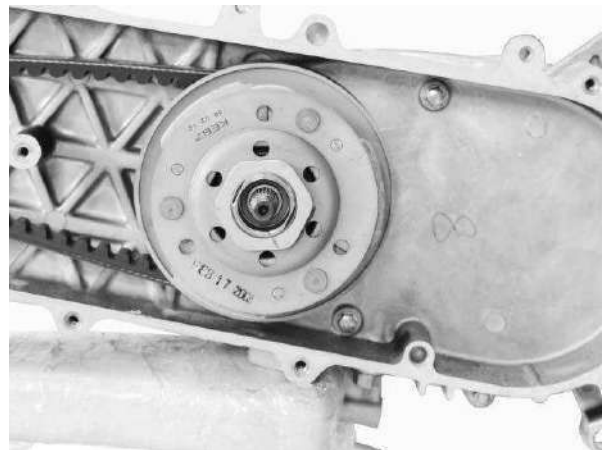

CLUTCH/DRIVEN PULLEY DIS-ASSEMBLY

Compress the clutch/driven pulley spring with the clutch spring compressor and remove the 28mm drive plate nut.
Remove the driven face spring.

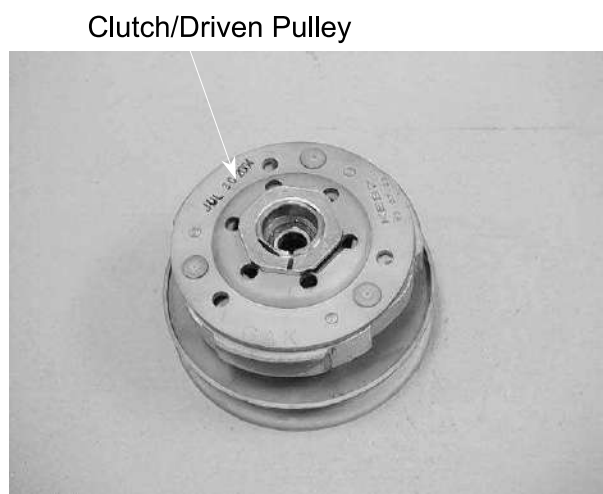

8. KICK STARTER/DRIVE PULLEY/ CLUTCH/DRIVEN PULLEY

AGILITY CITY 50 2T

Remove the seal collar.

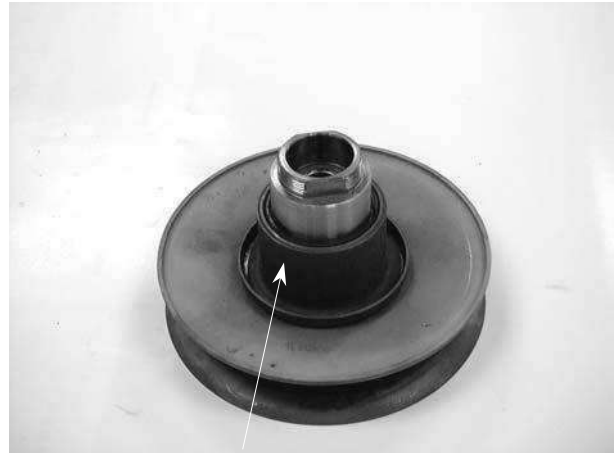

Seal Collar

Pull out the guide roller pins from the driven pulley and then remove the O-rings and oil seal from the driven pulley.

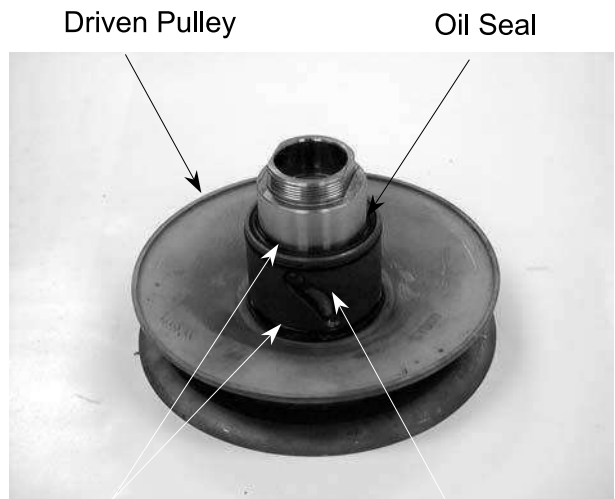

O-rings

Guide Roller Pin

CLUTCH/DRIVEN PULLEY INSPECTION

Inspect the clutch outer for wear or damage.

Measure the clutch outer I.D.

Service Limit:

107.5mm replace if below

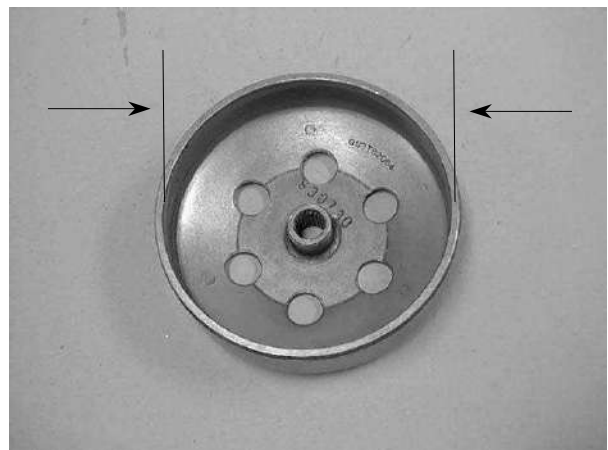

8. KICK STARTER/DRIVE PULLEY/ CLUTCH/DRIVEN PULLEY

AGILITY CITY 50 2T

Check the clutch shoes for wear or damage.

Measure the clutch lining thickness.

Service Limit: 2.0mm replace if below



Measure the driven face spring free length.

Service Limit:

82.6mm replace if below

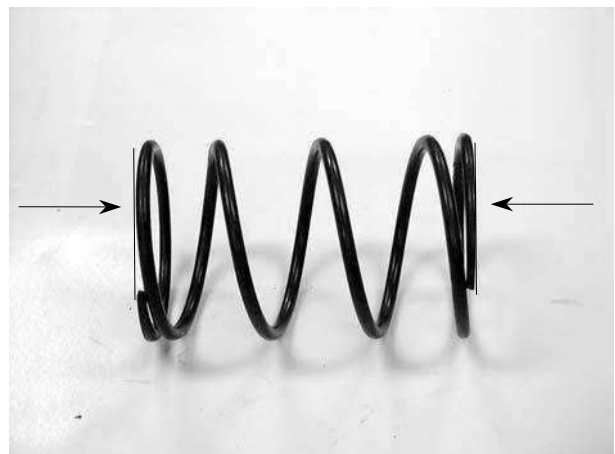

Check the driven face assembly for wear or damage.

Measure the driven face O.D.

Service Limit: 33.94mm replace if below

Check the movable driven face for wear or damage.

Measure the movable driven face I.D.

Service Limit: 34.06mm replace if below

Check the guide roller pins for stepped wear.



8. KICK STARTER/DRIVE PULLEY/ CLUTCH/DRIVEN PULLEY

AGILITY CITY 50 2T

DRIVEN PULLEY FACE BEARING REPLACEMENT

Check the needle bearings in the driven face and replace them if they have excessive play, damage or abnormal noise. Drive the inner bearing out of the driven pulley face.

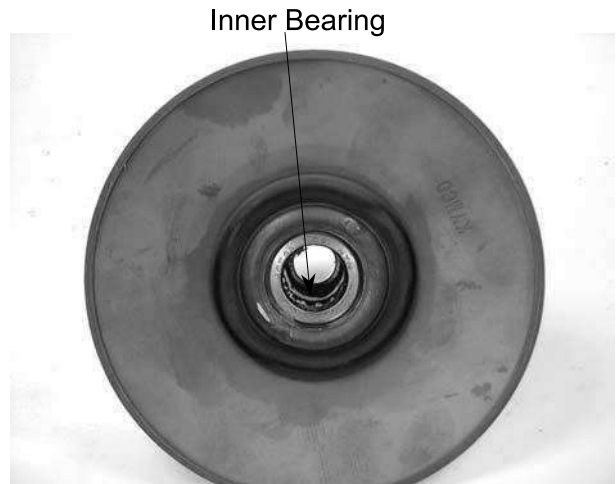

Remove the snap ring and drive the outer bearing out of the driven face.

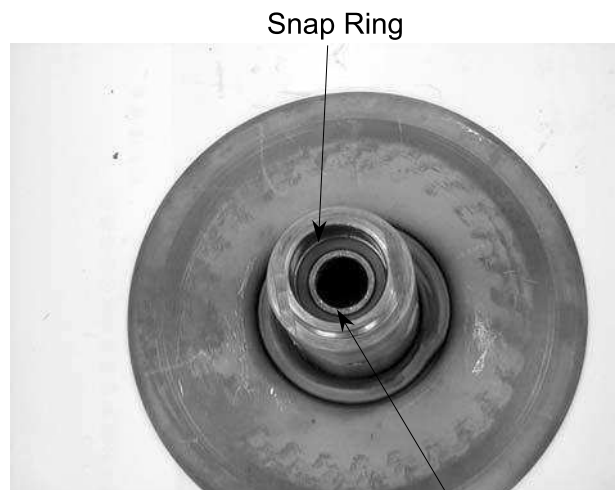

Outer Bearing

Drive a new outer bearing into the driven face with the sealed end facing up. Seat the snap ring in its groove.

* Pack all bearing cavities with 5.0~5.6g grease.
Specified grease: 230°C Heat-resistant grease

Bearing Outer Driver, 37x40mm



8. KICK STARTER/DRIVE PULLEY/ CLUTCH/DRIVEN PULLEY

AGILITY CITY 50 2T

Drive in a new needle bearing into the driven face with the mark facing up.

Bearing Driver Pilot



Outer Driver, 24x26mm

CLUTCH/DRIVEN PULLEY ASSEMBLY

First install the movable driven face onto the driven face. Then, install the guide roller pins, O-rings and a new oil seal.

Driven Pulley

Oil Seal

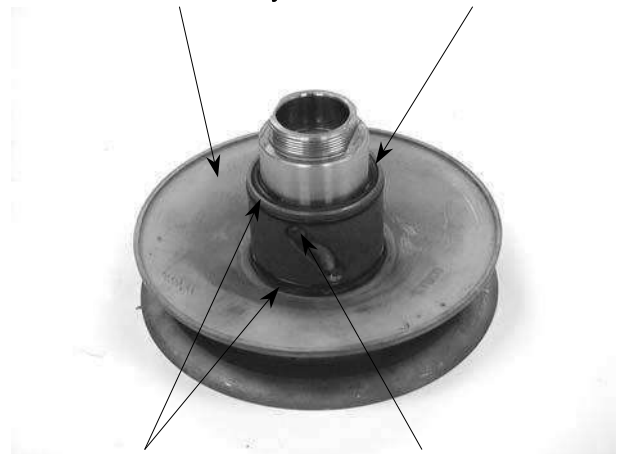

O-rings

Guide Roller Pin

Install the seal collar.



Seal Collar

8. KICK STARTER/DRIVE PULLEY/ CLUTCH/DRIVEN PULLEY

AGILITY CITY 50 2T

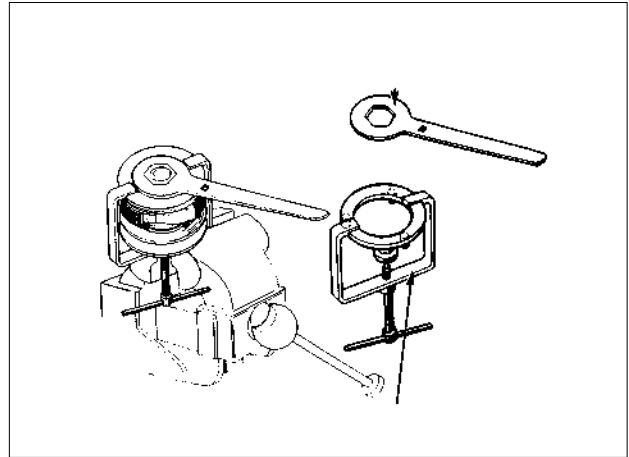

Clutch/Driven Pulley

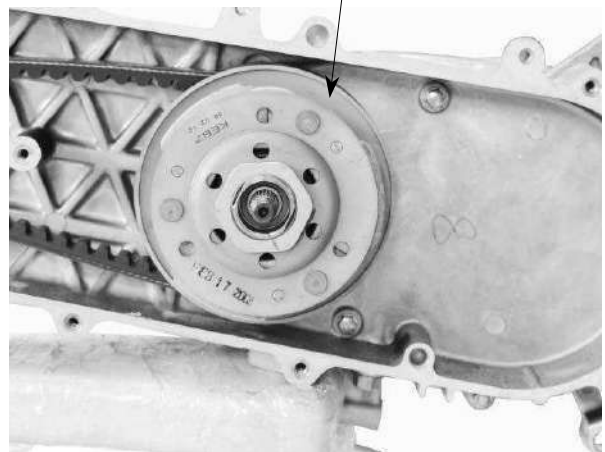

r

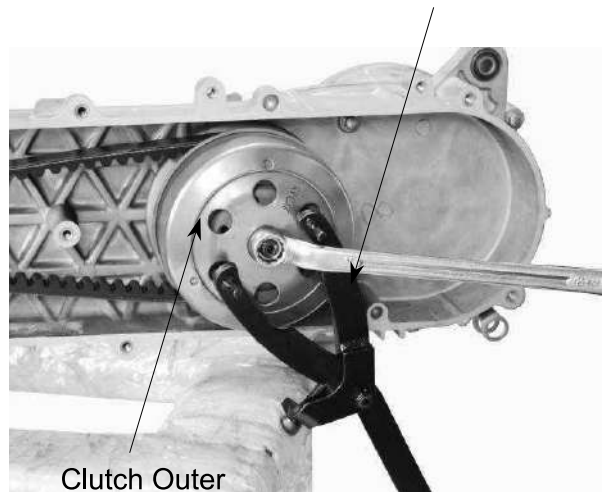

Clutch Outer

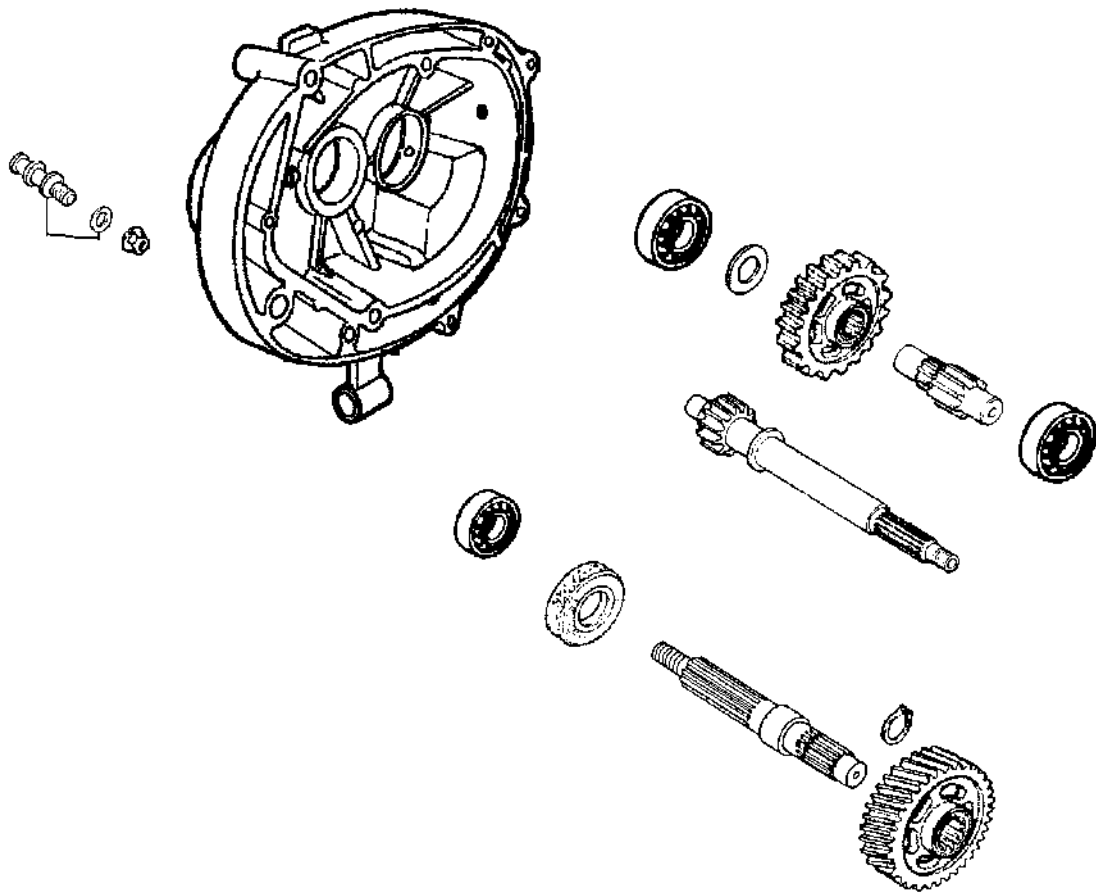

SERVICE INFORMATION

Specified Oil: SAE90#

At disassembly: 0.12 liter

At change: 0.10 liter

SPECIAL TOOLS

Bearing remover set, 12mm

Bearing remover set, 15mm

Crankcase assembly collar

Crankcase assembly shaft

Bearing outer driver, 37x40mm

Bearing outer driver, 32x35mm

Bearing driver pilot, 17mm

Bearing driver pilot, 15mm

Bearing driver pilot, 12mm

Bearing outer driver handle A

TROUBLESHOOTING

Engine starts but motorcycle won't move

- Damaged transmission
- Seized or burnt transmission

Abnormal noise

- Worn, seized or chipped gears
- Worn bearing

Oil leaks

- Oil level too high
- Worn or damaged oil seal

FINAL REDUCTION DISASSEMBLY

- Remove the rear wheel. (⇒14-3)
- Remove the left crankcase cover. (⇒8-4)
- Remove the clutch/driven pulley. (⇒8-15)
- Drain the transmission gear oil into a clean container.
- Remove the transmission case cover attaching bolts.
- Remove the transmission case cover.
- Remove the gasket and dowel pins.

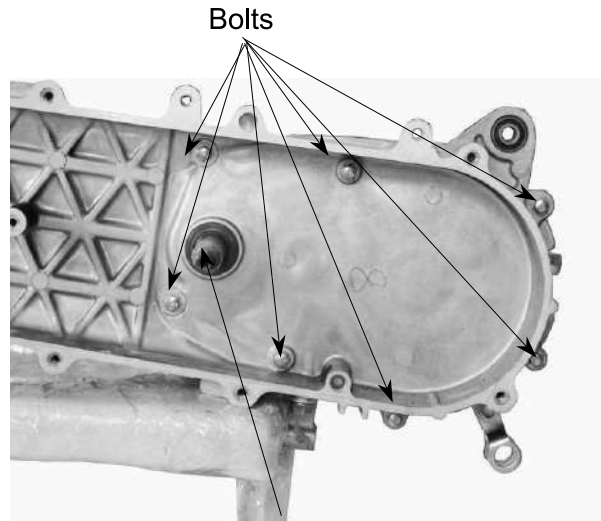

Driver shift

Remove the final gear and countershaft.

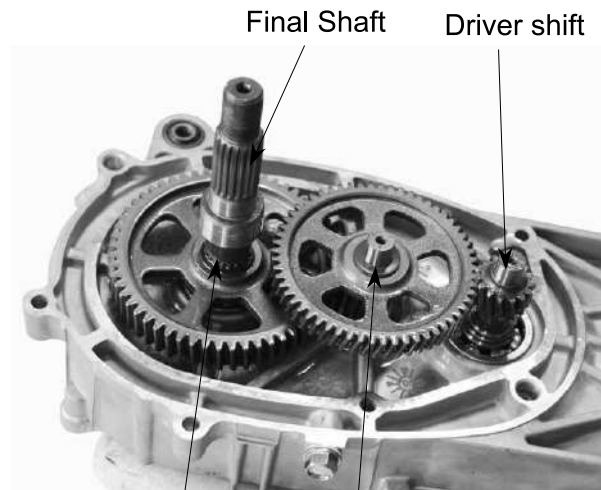

Final Gear Countershaft

FINAL REDUCTION INSPECTION

Inspect the countershaft and gear for wear or damage.

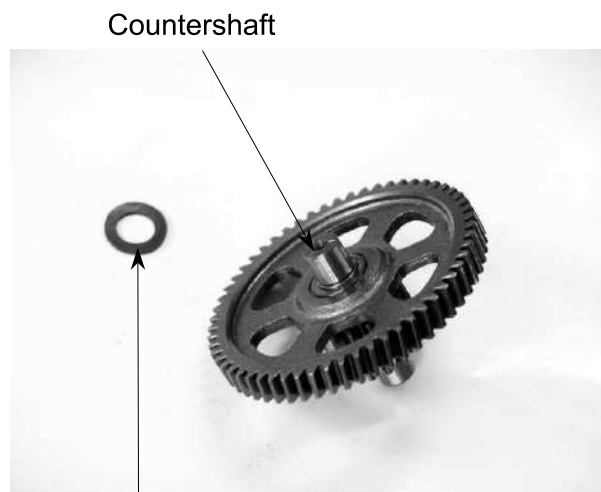

Resin Washer

9. FINAL REDUCTION

Inspect the final gear and final shaft for wear, damage or seizure.



Check the left crankcase bearings for excessive play and inspect the oil seal for wear or damage.

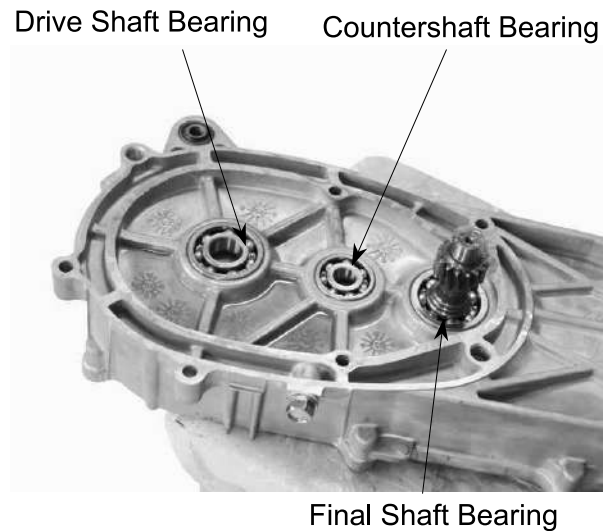

Inspect the drive shaft and gear for wear or damage.
Check the transmission case cover bearings for excessive play and inspect the final shaft bearing oil seal for wear or damage.

* Do not remove the transmission case cover except for necessary part replacement. When replacing the drive shaft, also replace the bearing and oil seal.



Drive Shaft Bearing Oil Seal

BEARING REPLACEMENT (Transmission Case Cover)

Remove the transmission case cover bearings using the bearing remover.
Remove the final shaft oil seal.

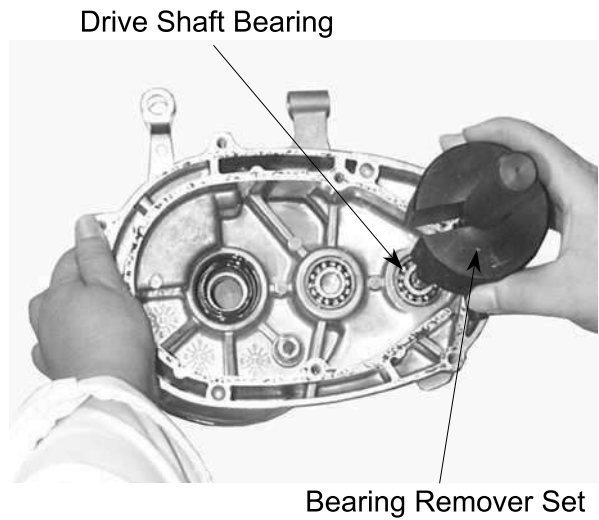

Drive new bearings into the transmission case cover.



BEARING REPLACEMENT (Left Crankcase Cover)

Remove the drive shaft.
Remove the drive shaft oil seal.
Remove the left crankcase bearings using the bearing remover.



Drive new bearings into the left crankcase.
Install a new drive shaft oil seal.

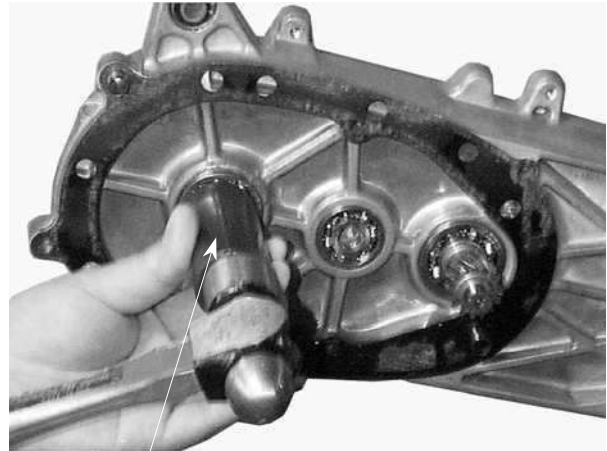

Bearing Outer Driver

FINAL REDUCTION ASSEMBLY

Install the drive shaft into the left crankcase.



Drive Shaft

Install the final gear and final shaft into the left crankcase.



Final Shaft

9. FINAL REDUCTION

AGILITY CITY 50 2T

Install the countershaft and gear into the left crankcase.
Install the resin washer onto the countershaft.
Install the dowel pins and a new gasket.

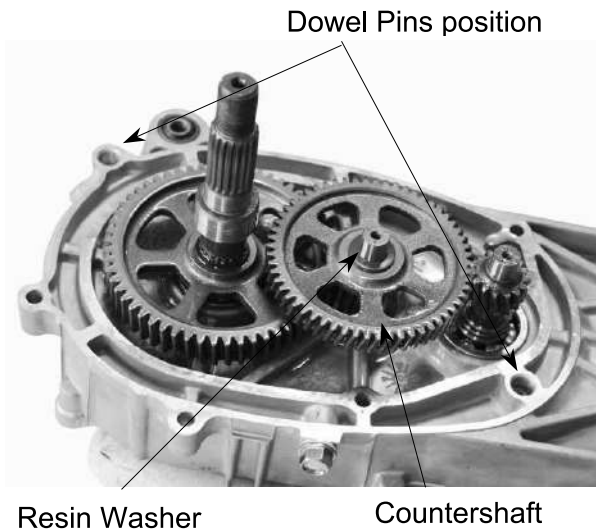

Install the transmission case cover.



Install and tighten the transmission case cover bolts.
Install the clutch/driven pulley. (⇒8-20)
Install other removed parts in the reverse order of removal.

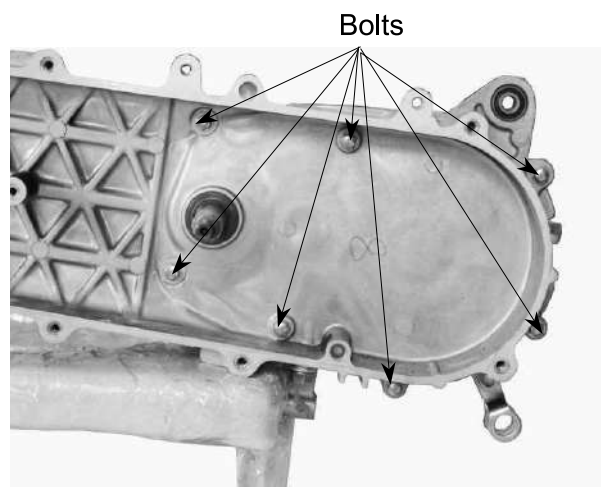

9. FINAL REDUCTION

After installation, fill the transmission case with the specified oil.

*

- Place the motorcycle on its main stand on level ground.
- Check the sealing washer for wear or damage.

Specified Gear Oil: SAE90#

Oil Capacity: at disassembly: 0.12 liter
at change: 0.09 liter

Install and tighten the oil check bolt.

Torque: 1.0~1.5kg-m

Start the engine and check for oil leaks.
Check the oil level from the oil check bolt hole and add the specified oil to the proper level if the oil level is low.

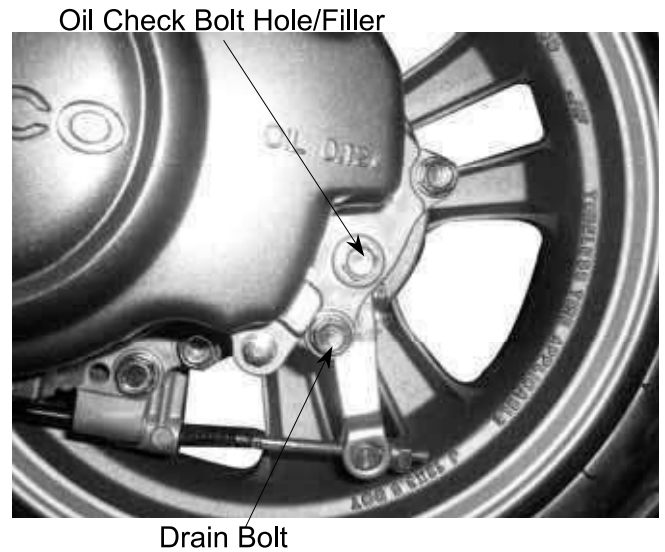

Torque: 0.8~1.2kg-m

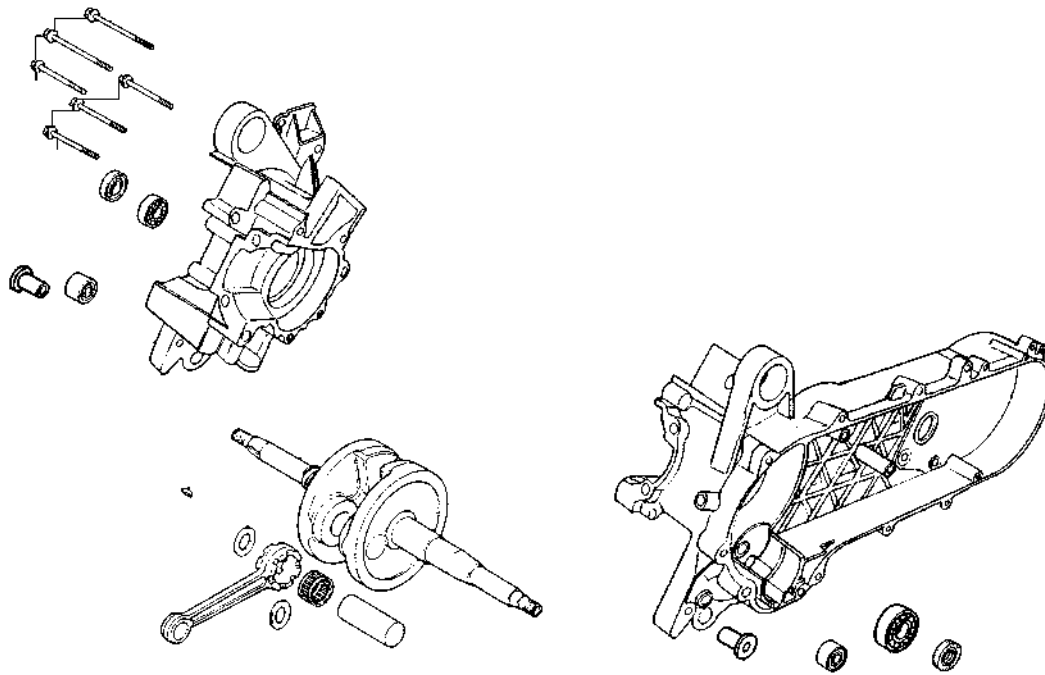

SERVICE INFORMATION

GENERAL INSTRUCTIONS

- This section covers crankcase separation to service the crankshaft.
- The following parts must be removed before separating the crankcase.

Engine (⇒Section 5)	Driven pulley (⇒Section 9)
Carburetor (⇒Section 11)	A.C. generator (⇒Section 7)
Oil pump (⇒Section 4)	Cylinder head/cylinder (⇒Section 6)
Reed valve (⇒Section 11)	
- When the left crankcase must be replaced, remove the following part in addition to the above.
 - Final reduction removal
- Special tools must be used for crankshaft and crankcase assembly. When separating the crankcase, the bearing will remain in the crankcase and it should be removed. When, assembling, drive a new bearing into the crankcase and install a new oil seal.

SPECIFICATIONS

Item	AGILITY CITY 50 2T	
	Standard (mm)	Service Limit (mm)
Connecting rod big end side clearance	—	0.60
Connecting rod big end radial clearance	—	0.04
Crankshaft runout A/B	—	0.15/0.10

SPECIAL TOOLS

Crankcase puller	Bearing outer driver handle A
Universal bearing puller	Bearing outer driver, 42x47mm
Crankcase assembly collar	Bearing driver pilot, 20mm
Crankcase assembly tool	Bearing outer driver, 37x40mm
	Bearing driver pilot, 17mm

TROUBLESHOOTING

Abnormal engine noise

- Excessive crank journal bearing play
- Excessive crankpin bearing play
- Excessive transmission bearing play

CRANKCASE SEPARATION

Remove the crankcase attaching bolts.

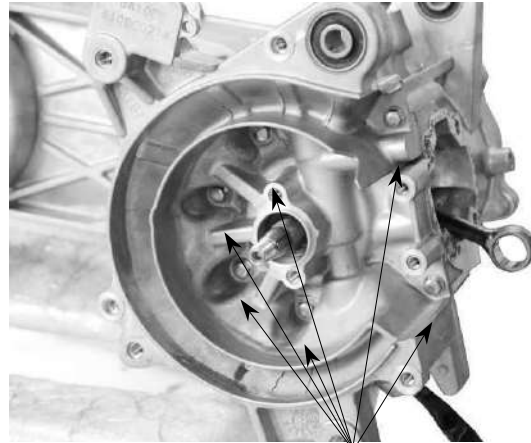

Bolts

Attach the crankcase puller on the right crankcase and remove the right crankcase from the left crankcase.

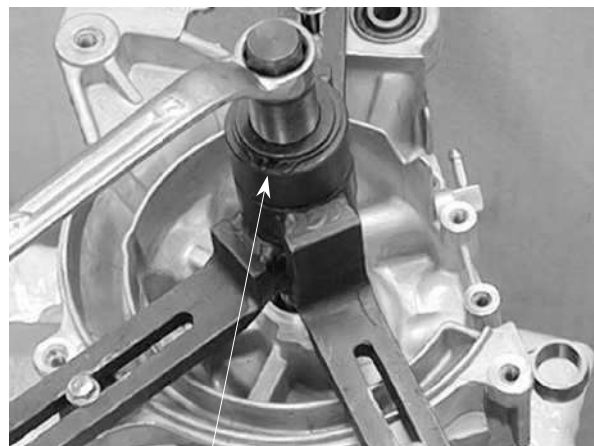

Crankcase Puller

CRANKSHAFT REMOVAL

Attach the crankcase puller on the left crankcase and remove the crankshaft from the left crankcase.

* When removing the crankshaft, do it slowly and gently.

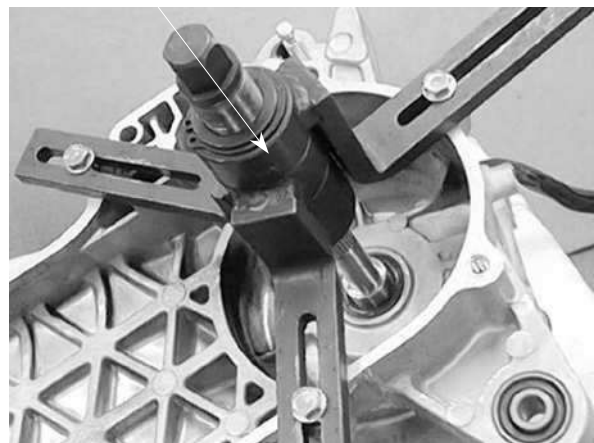

Crankcase Puller

10. CRANKCASE/CRANKSHAFT

AGILITY CITY50 2T

Remove the remaining bearing on the crankshaft side using the universal bearing puller.

* When separating the crankcase, the oil seals must be removed. Replace the oil seals with new ones.

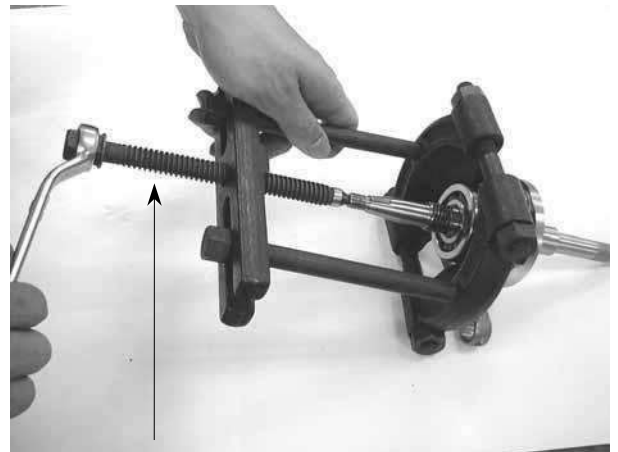

Universal Bearing Puller

CRANKSHAFT INSPECTION

Measure the connecting rod big end side clearance.

Service Limit: 0.6mm replace if over

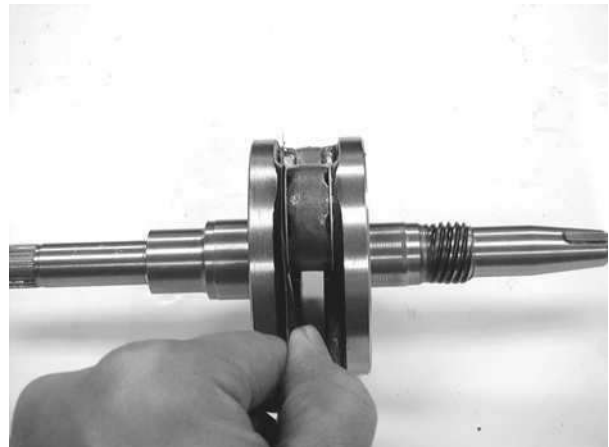

Measure the connecting rod big end radial clearance at two points in the X and Y directions.

Service Limit: 0.04mm replace if over

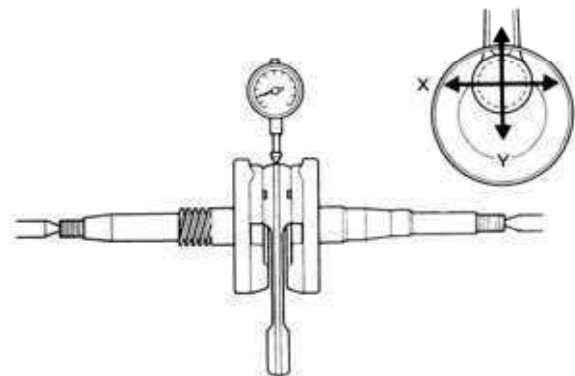

Measure the crankshaft runout.

Service Limit	
A	B
0.150mm replace if over	0.100mm replace if over

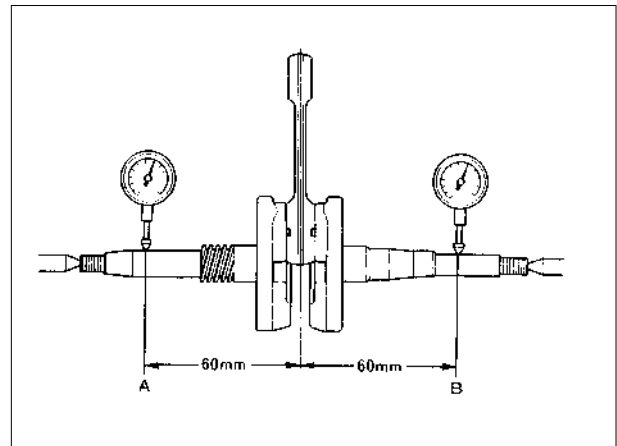

Check the crankshaft bearings for excessive play. The bearings must be replaced if they are noisy or have excessive play.

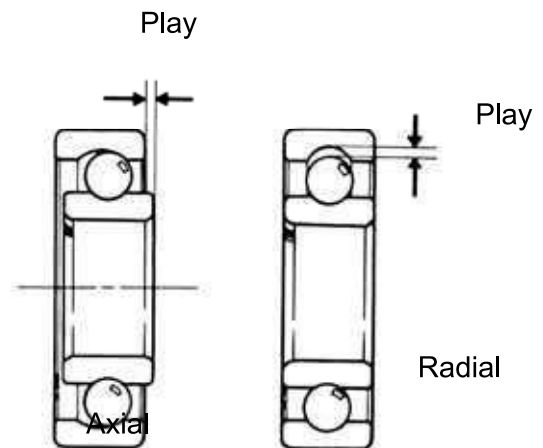

CRANKSHAFT INSTALLATION

Wash the crankshaft in cleaning solvent and then check for cracks or other faults.

*

- After check, apply clean engine oil to all moving and sliding parts.
- Remove all gasket material from the crankcase mating surfaces. Dress any roughness or irregularities with an oil stone.

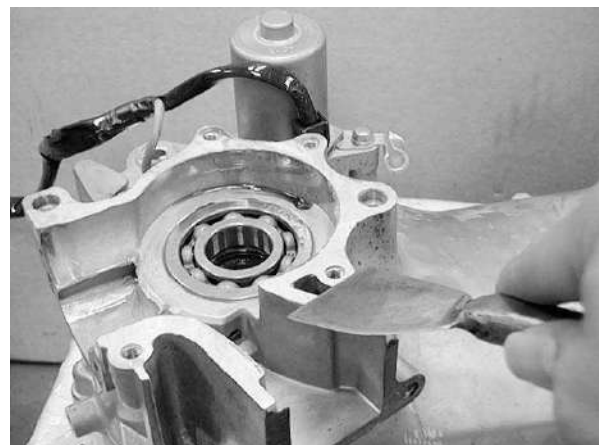

Drive a new crankshaft bearing into the right crankcase.

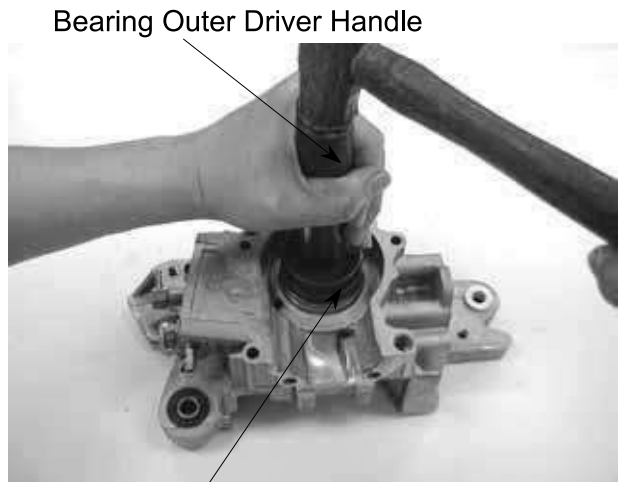

Bearing Outer Driver, 37x40mm
Bearing Driver Pilot, 17mm

Drive a new crankshaft bearing into the left crankcase.



Bearing Outer Driver, 42x47mm
Pilot, 20mm

Install the crankshaft into the left crankcase.

*

- Apply KYMCO ULTRA motor oil or molybdenum disulfide to the crankshaft bearings and connecting rod big end.
- Apply grease to the lip of the oil seal and then install it.

Crankcase Assembly Tool

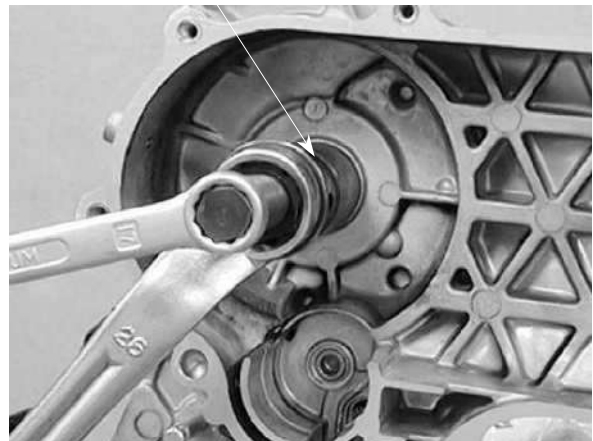

CRANKCASE ASSEMBLY

Install the dowel pins and a new gasket to the crankcase mating surface.

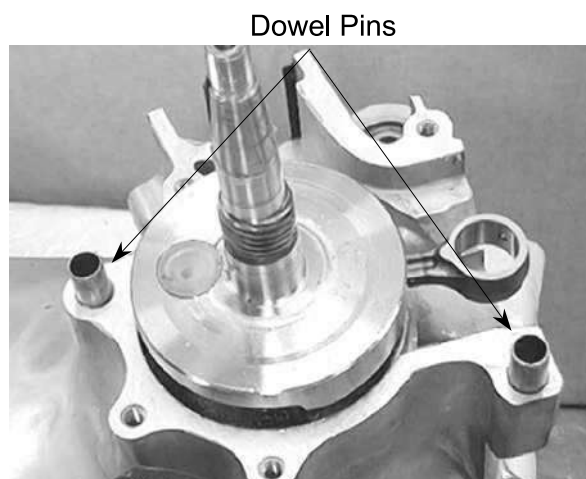

Assemble the crankcase halves.

Crankcase Assembly Tool

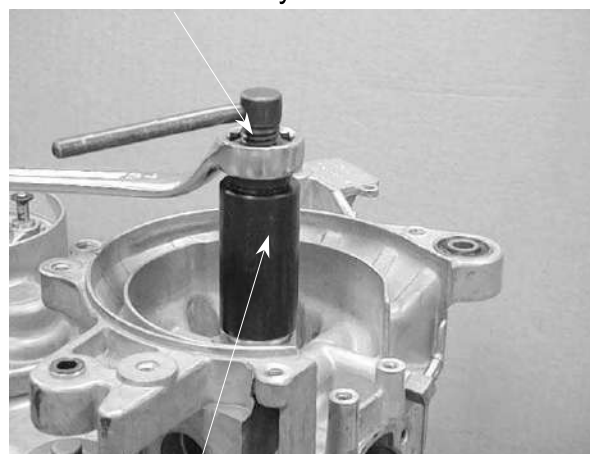

Crankcase Assembly Collar

The distance between the right crankcase oil seal and crankcase surface is about 12.5 ± 0.5 mm.

* When installing the oil seal, be careful to press it with even force.

Oil Seal



The distance between the left crankcase oil seal and crankcase surface is about 1.0mm.

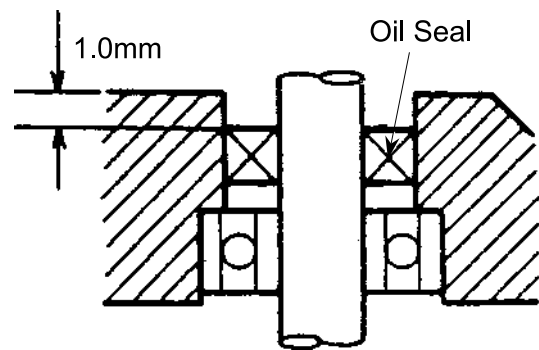

Install and tighten the crankcase attaching bolts.

*

smooth operation.

r



SERVICE INFORMATION

GENERAL INSTRUCTIONS

- When working with gasoline, keep away from sparks and flames..
- Note the locations of O-rings when disassembling and replace them with new ones during assembly.
- All cables, fuel lines and wires must be routed and secured at correct locations.
- Bleed air from the oil lines whenever they are disconnected.

SPECIFICATIONS

	AGILITY CITY 50 2T
Venturi dia.	16mm
Identification number	PB
Float level	8.6mm
Main jet	#72
Slow jet	#35
Air screw opening	$1\frac{1}{4} \pm \frac{1}{2}$
Idle speed	1850±100rpm
Throttle grip free play	2~6mm

SPECIAL TOOL

Float level gauge

TROUBLESHOOTING

Engine does not start

- No fuel in tank
- Too much fuel getting to cylinder
- Clogged fuel filter
- Clogged air cleaner

Lean mixture

- Clogged fuel jets
- Clogged fuel cap vent
- Clogged fuel filter
- Bent, kinked or restricted fuel line

- Faulty float valve
- Float level too low
- Clogged air cleaner

Engine idles roughly, stalls or runs poorly

- Incorrect idle speed
- Ignition malfunction
- Compression too low
- Incorrectly adjusted air screw
- Incorrect float level
- Clogged air cleaner
- Intake air leaks
- Fuel contaminated
- Faulty reed valve
- Clogged fuel jets

Rich mixture

- Faulty float valve
- Float level too high
- Clogged air jets

THROTTLE VALVE DIS-ASSEMBLY

Remove the rear carrier. (⇒12-5)
Remove the met-in box. (⇒12-4)
Remove the rubber cover.
Loosen carburetor cap and the throttle valve.



Rubber Cover

Disconnect the throttle cable from the throttle valve.



Throttle Valve

Remove the throttle valve spring, carburetor cap and rubber seal.

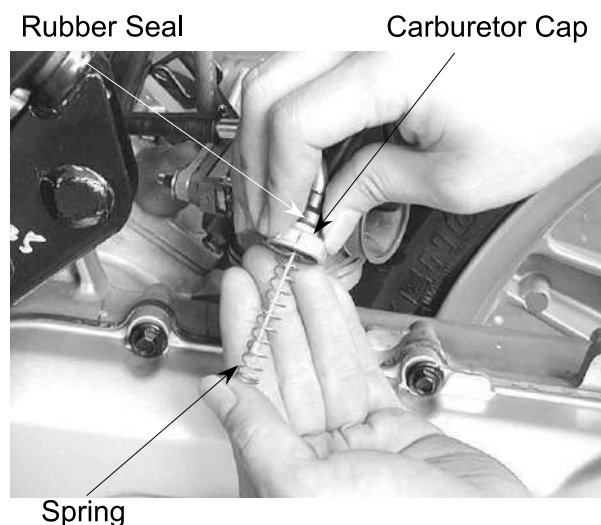

Rubber Seal

Carburetor Cap

Spring

Remove the jet needle by removing the needle clip.
Check the jet needle and throttle valve for wear or damage.



THROTTLE VALVE INSTALLATION

Install the jet needle on the throttle valve and secure with the needle clip.

Install the rubber seal on the throttle cable and then install the carburetor cap and throttle valve spring.



Connect the throttle cable to the throttle valve.



Install the throttle valve by aligning the groove in the throttle valve with the throttle stop screw.

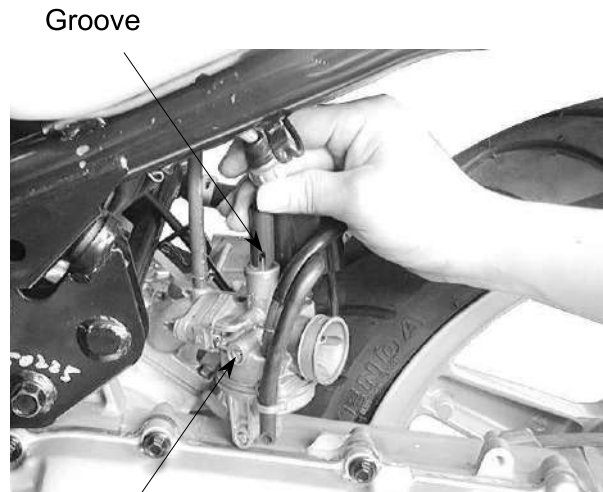

Throttle Stop Screw

Tighten the carburetor cap.
After installation, perform the following adjustments and inspections.

- Throttle cable free play (⇒3-12)
- Idle speed adjustment (⇒3-11)

Install the met-in box.

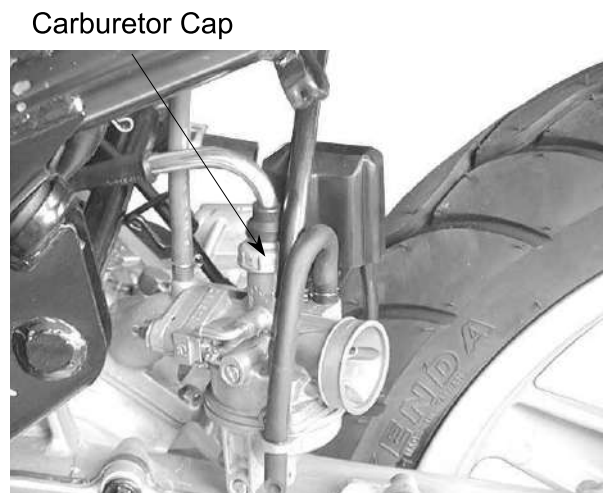

CARBURETOR REMOVAL

Remove the met-in box. (⇒12-4)
Remove the air cleaner by removing the air cleaner band screw and attaching bolts.
Disconnect the fuel tube.
Loosen the drain bolt to drain fuel from the carburetor.
Disconnect the auto bystarter wire connector.
Remove the two carburetor lock nuts.

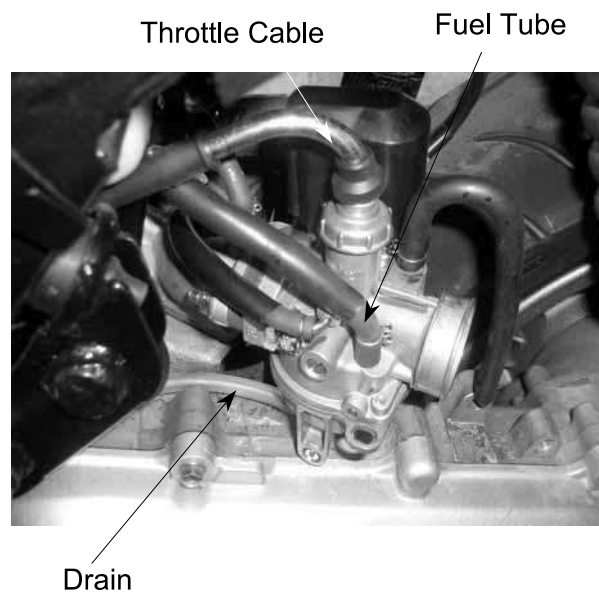

Remove the carburetor.

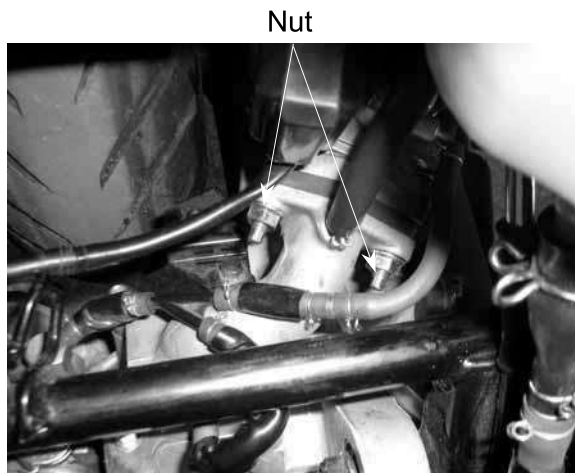

AUTO BYSTARTER

AUTO BYSTARTER INSPECTION

Measure the resistance between the auto bystarter wire terminals.

Resistance: 5Ω (10 minutes minimum after stopping the engine)

If the resistance exceeds 5Ω , replace the auto bystarter with a new one.



After the engine stops for 30 minutes, connect a hose to the fuel enriching circuit and blow the hose with mouth.

If air cannot be blown into the hose (clogged), the auto bystarter is faulty. Replace it with a new one.

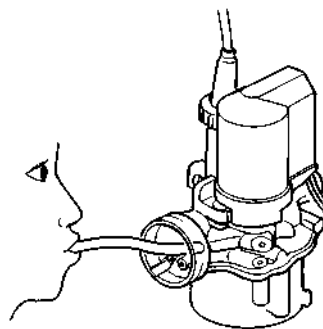

Connect the auto bystarter yellow wire to the battery positive (+) terminal and green/black wire to the battery negative (-) terminal and wait 5 minutes.

Connect a hose to the fuel enriching circuit and blow the hose with mouth.

If air can be blown into the hose, the auto bystarter is faulty and replace it with a new one.

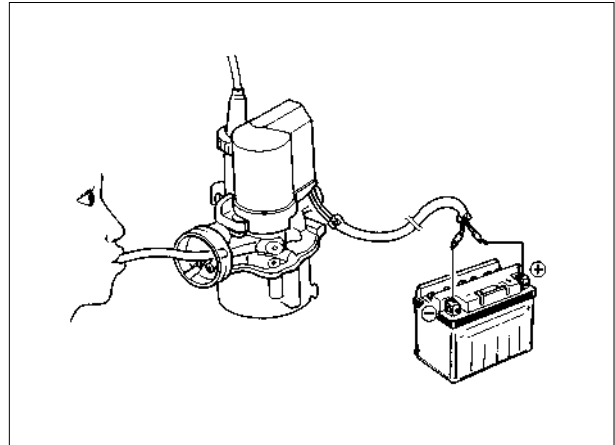

AUTO BYSTARTER REMOVAL

Remove the auto bystarter cover.
Remove the two auto bystarter set plate screws to remove the auto bystarter.

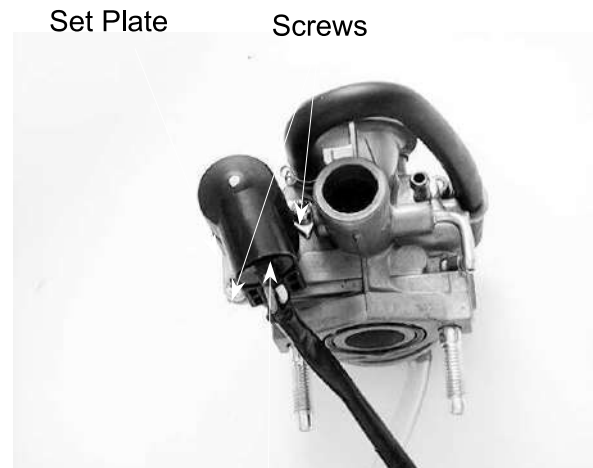

Auto Bystarter

Check the auto bystarter valve and needle for wear or damage.

Check the O-ring for wear or damage.



Bystarter Needle

Bystarter Valve

11. CARBURETOR

AGILITY CITY 50 2T

AUTO BYSTARTER INSTALLATION

Install the auto bystarter into the carburetor body until it bottoms..
Install the set plate and then tighten the two screws.

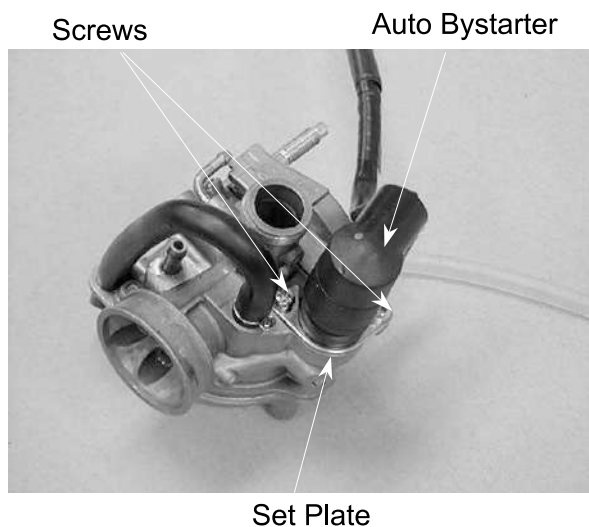

FLOAT CHAMBER

Remove the two float chamber screws and the float chamber.

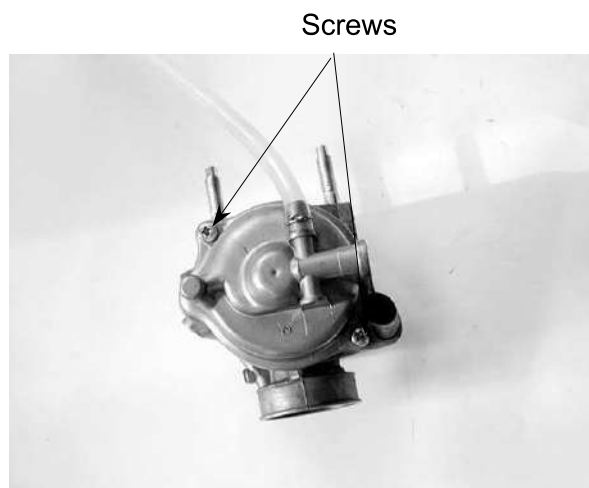

Remove the screw and O-ring.
Remove the float pin, float and float valve.

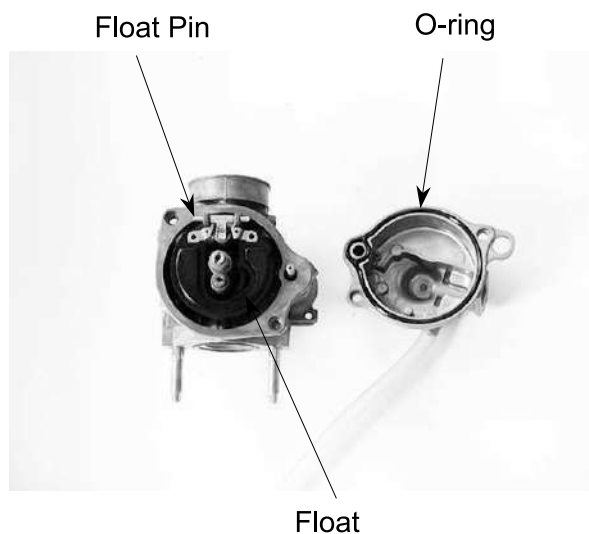

FLOAT/FLOAT VALVE INSPECTION

Inspect the float for damage or fuel inside the float.

Check the float valve seat for wear or damage.

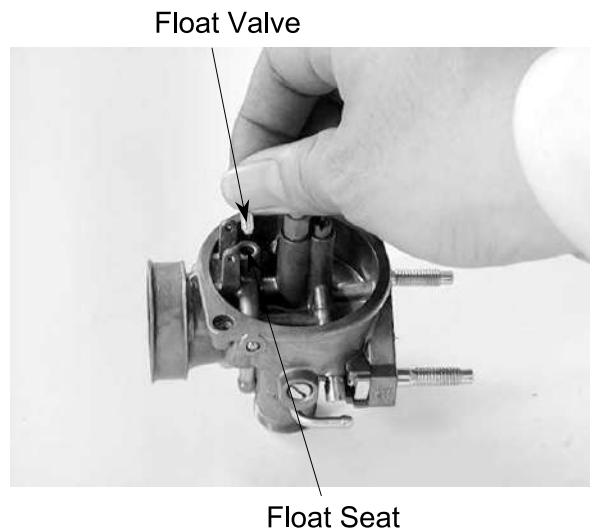

JETS/SCREWS REMOVAL

Before removing the throttle stop screw or air screw, record the number of rotations until it seats lightly. Then, remove them.

* Do not force the air screw against its seat to prevent damage.

Remove the main jet and needle jet holder.

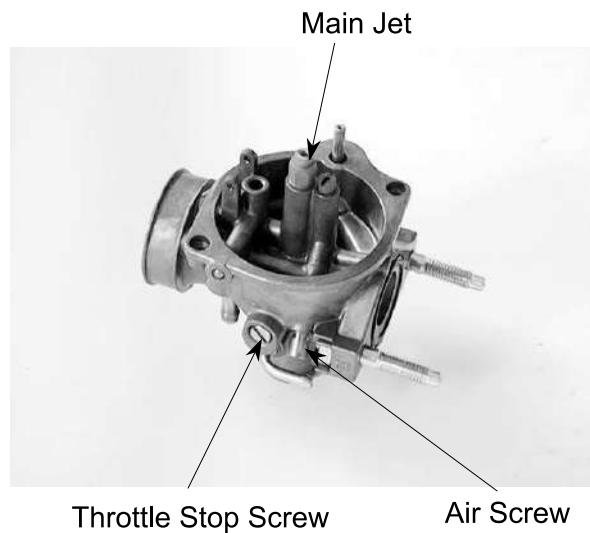

CARBURETOR PASSAGES CLEANING

Blow compressed air through all passages of the carburetor body with an air gun.

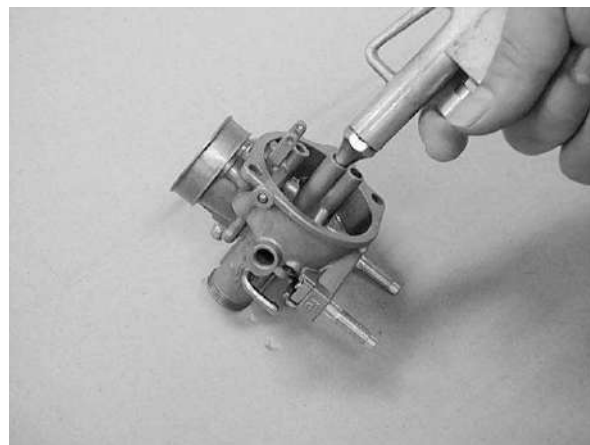

FLOAT CHAMBER ASSEMBLY

Install the main jet and needle jet holder.
Install the air screw and throttle stop screw according to the rotations recorded.

* If the air screw must be replaced, be sure to perform the air screw adjustment again.

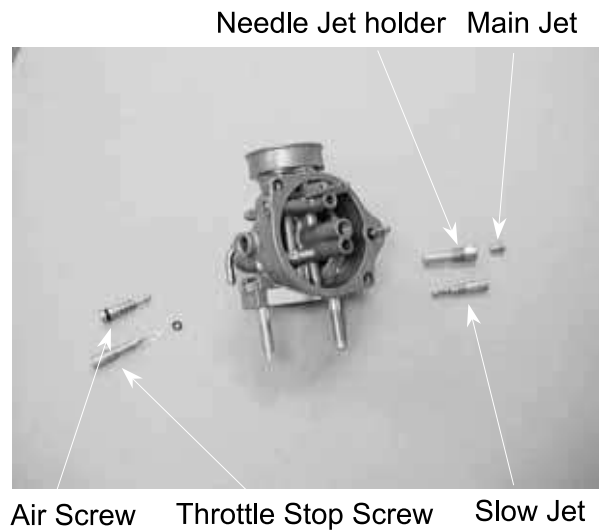

Install the float valve, float and float pin.
Tighten the float screw securely.

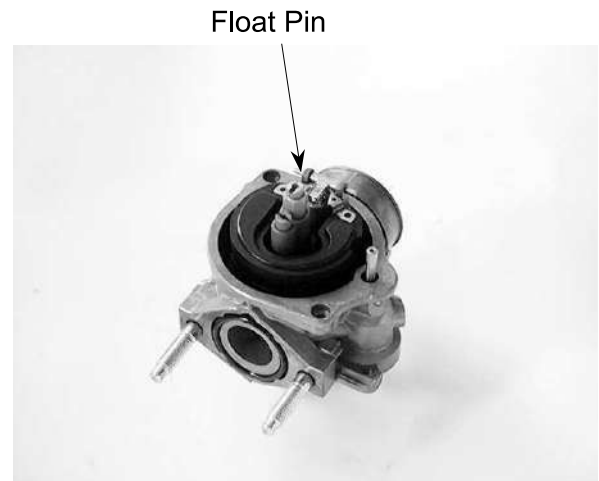

FLOAT LEVEL INSPECTION

Slightly tilt the carburetor and measure the float level with the float valve just connecting the float arm.

Float Level: 8.6mm

Replace the float if the level is out of the specified level range.

Install the O-ring.

Check the operation of the float and install the float chamber.

Tighten the screws.

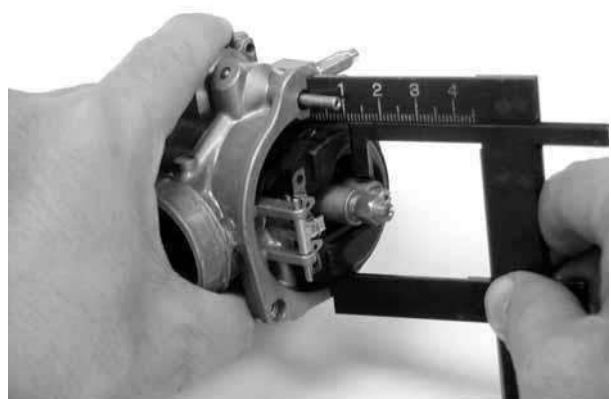

CARBURETOR INSTALLATION

- * When installation, do not allow foreign particles to enter the carburetor.

Check the carburetor insulator and O-ring for wear or damage.

Install the carburetor and insulator onto the intake manifold and tighten the two lock nuts.

Connect the fuel tube and auto bystarter wire connector.

- * Route the auto bystarter wire correctly and properly.

Install the carburetor cap. (⇒11-4)

Install the air cleaner onto the carburetor and tighten the band screw.

Install the met-in box. (⇒12-4)

AIR SCREW ADJUSTMENT

Remove the met-in box. (⇒12-4)

- * Warm up the engine before air screw adjustment.

Turn the air screw clockwise until it seats lightly and back it to the specification given.

Air Screw Opening:

: $1\frac{1}{4} \pm \frac{1}{2}$ turns

Start the engine and turn the air screw in or out slowly to obtain the highest engine speed.

- * Do not force the air screw against its seat to prevent damage.

Turn the throttle stop screw to obtain the specified idle speed.

Idle Speed:

: 2000 ± 100 rpm

Slightly increase the engine speed and make sure that the engine does not miss or run erratic.

If the adjustment of the air screw within the range of $\pm\frac{1}{2}$ turn makes no difference to the engine performance, check other related items.

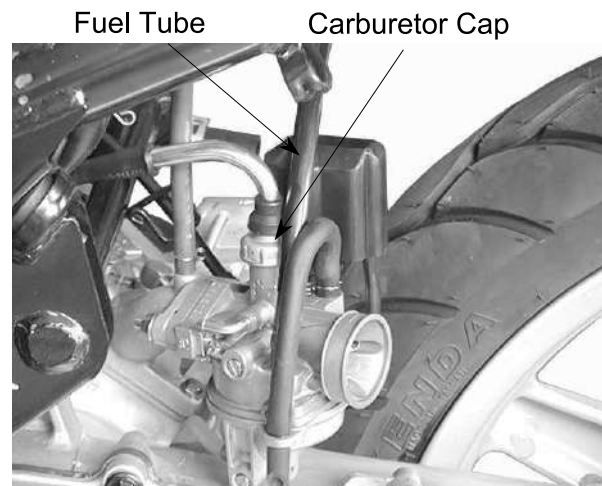
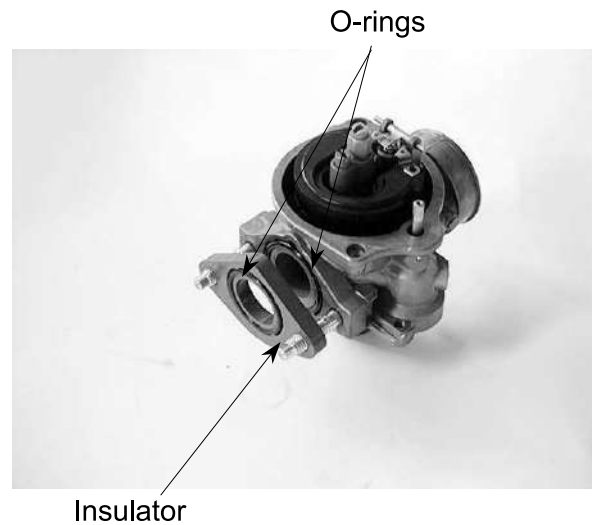

REED VALVE

REMOVAL

Remove the rear carrier.
Remove the frame body cover.
Remove the four intake manifold bolts and gasket.
Remove the reed valve and gasket.

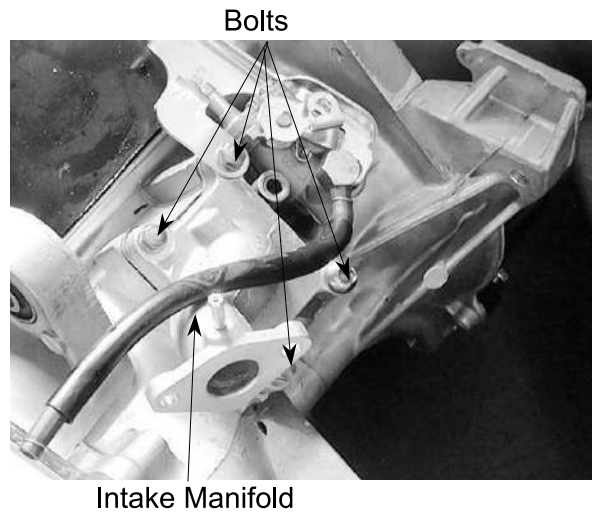

INSPECTION

Check the reed valve for damaged or weak reeds.
Check the reed valve seat for cracks, damage or clearance between the seat and reed.
Replace the valve if necessary.

* Do not disassemble or bend the reed stopper. To do so can cause loss of engine power and engine damage. If any of the stopper, reed or valve seat is faulty, replace them as a unit.

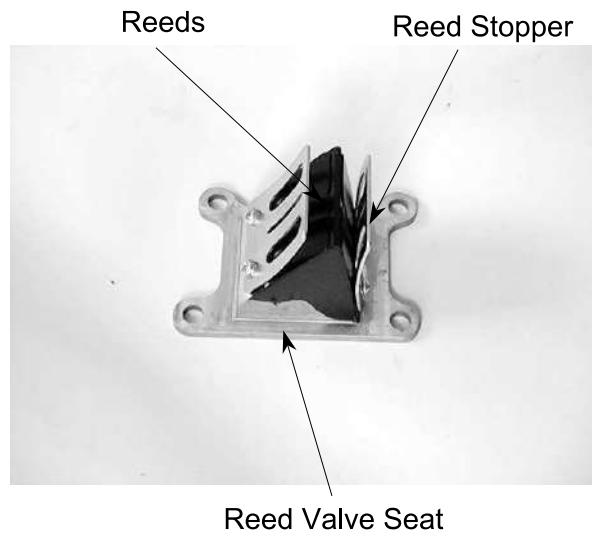

INSTALLATION

Install the reed valve in the reverse order of removal.

*

- Install a new gasket with the gasket indentation aligned with the reed valve.
- After installation, check for intake air leaks.

FUEL TANK

REMOVAL

- Remove the met-in box. (⇒12-4)
- Remove the frame body cover. (⇒12-5)
- Remove the rear carrier. (⇒12-5)
- Disconnect the fuel tube and vacuum tube at the auto fuel tank.
- Disconnect the fuel unit wire connector.
- Remove the fuel tank holder mounting bolts and fuel tank.
- Inspect the fuel unit. (⇒16-2)
- Replace the fuel unit if necessary.

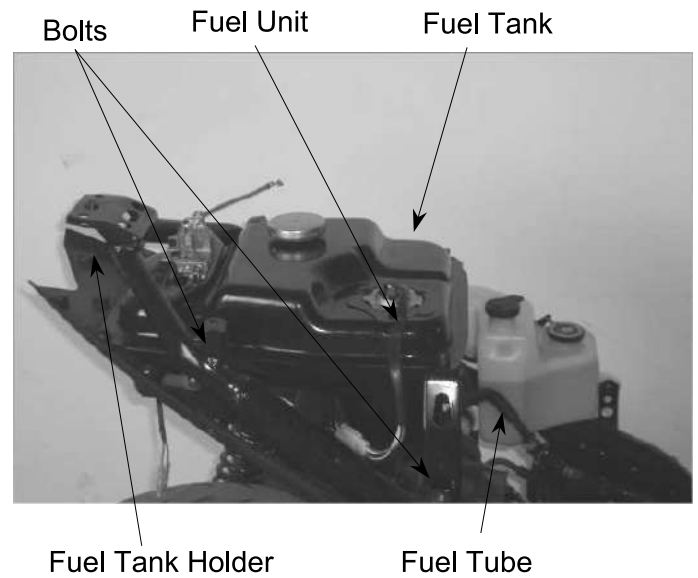

ASSEMBLY

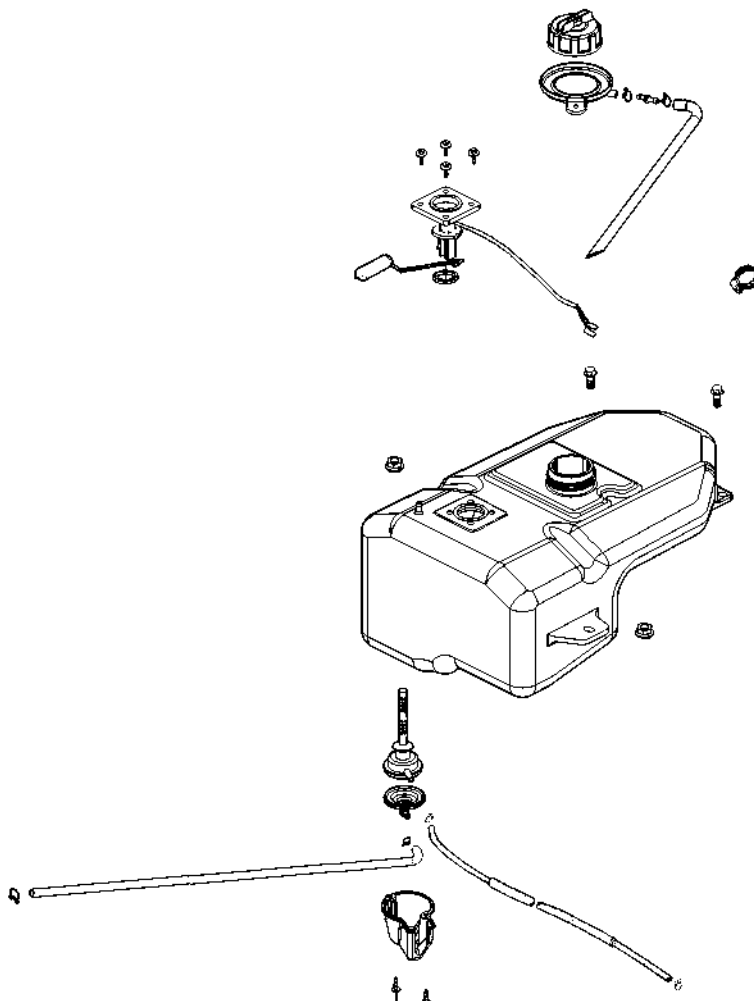

12. FRONT WHEEL/FRONT BRAKE/ FRONT SUSPENSION



AGILITY CITY 50 2T

SERVICE INFORMATION	12-1	FRONT SHOCK ABSORBER.....	12-18
TROUBLESHOOTING	12-2	FRONT FORK.....	12-21
STEERING HANDLEBAR.....	12-3		
FRONT WHEEL.....	12-4		

SERVICE INFORMATION

GENERAL INSTRUCTIONS

- Remove the motorcycle frame covers before removing the front wheel. Jack the motorcycle front wheel off the ground and be careful to prevent the motorcycle from falling down.
- During servicing, keep oil or grease off the brake drum and brake linings.

SPECIFICATIONS

Item		Standard (mm)	Service Limit (mm)
Axle shaft runout		—	0.2
Front wheel rim runout	Radial	—	2.0
	Axial	—	2.0
Front shock absorber spring free length		230	226.5

TORQUE VALUES

Handlebar bolt	4.5~5.5kgf-m
Steering stem lock nut	6.0~8.0kgf-m
Steering top cone race	0.5~1.3kgf-m
Front shock absorber bolt	3.0kgf-m
Front axle nut	5.0~7.0kgf-m
Brake arm bolt	0.8~1.2kgf-m

SPECIAL TOOLS

Long socket wrench,32mm 8angle

TROUBLESHOOTING

Hard steering (heavy)

- Excessively tightened steering stem top cone race
- Broken steering balls
- Insufficient tire pressure

Steers to one side or does not track straight

- Uneven front shock absorbers
- Bent front fork
- Bent front axle or uneven tire

Front wheel wobbling

- Bent rim
- Excessive wheel bearing play
- Bent spoke plate
- Faulty tire
- Improperly tightened axle nut

Soft front shock absorber

- Weak shock springs
- Insufficient damper oil

Front shock absorber noise

- Slider bending
- Loose fork fasteners
- Lack of lubrication

12. FRONT WHEEL/FRONT BRAKE/ FRONT SUSPENSION

STEERING HANDLEBAR

REMOVAL

Remove the handlebar front and rear covers.
(⇒2-2)
Remove the two bolts attaching each of the
front and rear brake levers.
Remove the front and rear brake levers.

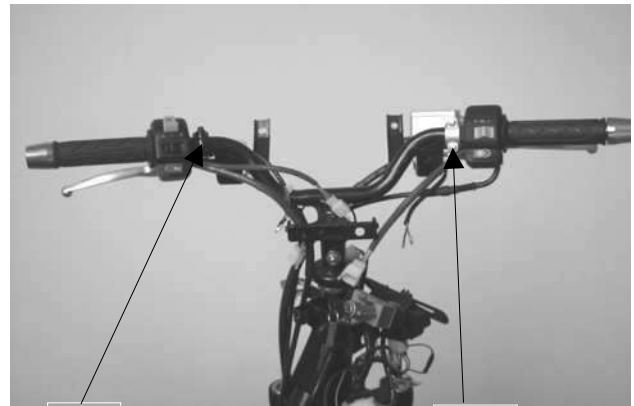

Bolts

Bolts

Screws

Throttle Pipe

Remove the two throttle holder screws and
throttle holder.
Disconnect the throttle cable from the throttle
pipe and then remove the throttle pipe from
the handlebar.

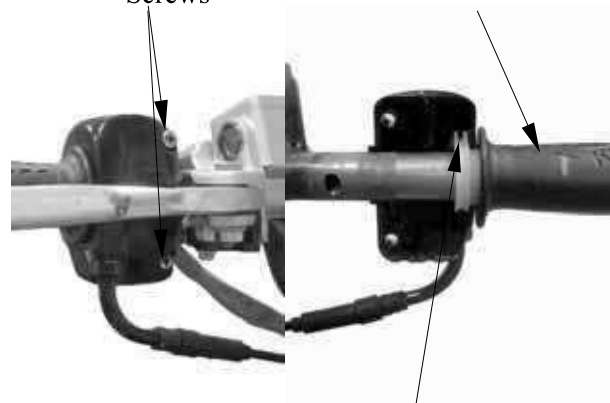

Throttle Cable

Remove the handlebar lock nut and bolt to
remove the handlebar.

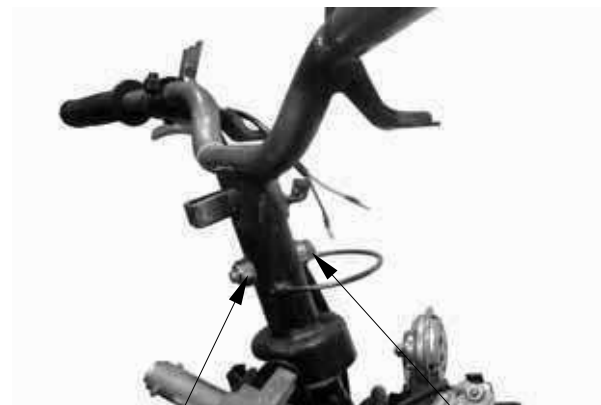

Nut

Bolt

Bolt Orifice

INSTALLATION

Install the handlebar onto the steering stem
by aligning the tab on the handlebar with the
bolt orifice on the steering stem.
Install and tighten the handlebar bolt and lock
nut.

Torque: 4.5~5.5kgf-m



12. FRONT WHEEL/FRONT BRAKE/ FRONT SUSPENSION

Apply grease to the tip of the throttle pipe.
Install the throttle pipe and connect the
throttle cable.

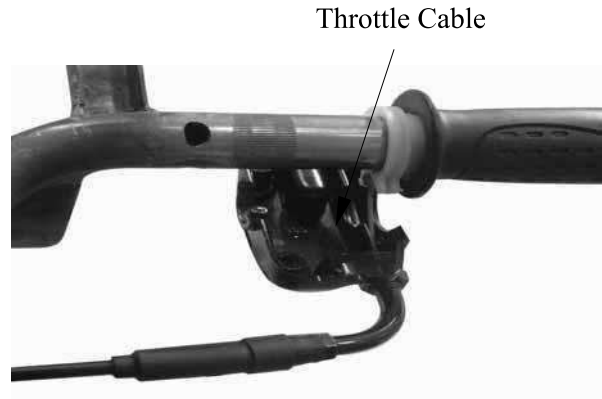

Install the front and rear brake levers in the
reverse order of removal.

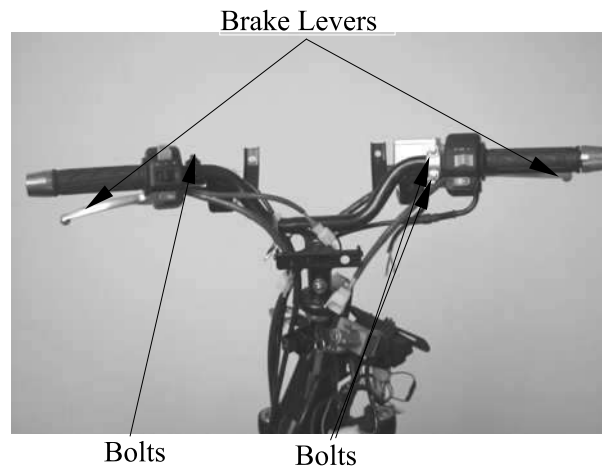

FRONT WHEEL

REMOVAL

Jack the motorcycle front wheel off the
ground.
Remove the speedometer cable set screw and
disconnect the speedometer cable.
Remove the front axle nut and pull out the
axle.
Remove the front wheel.
Remove the and speedometer gear box and
side collar.

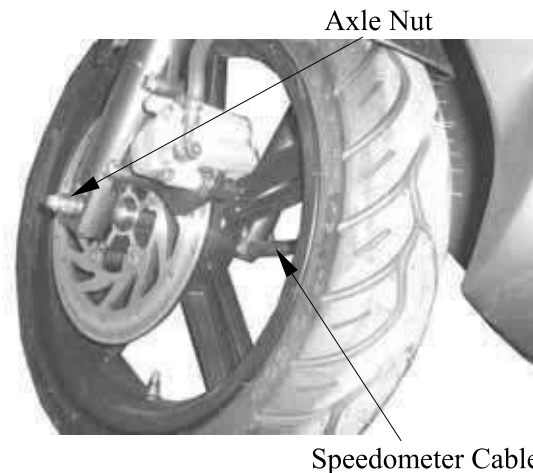

INSPECTION

AXLE RUNOUT

Set the axle in V blocks and measure the
runout using a dial gauge.
The actual runout is $\frac{1}{2}$ of the total indicator
reading.

Service Limit: 0.2mm replace if over

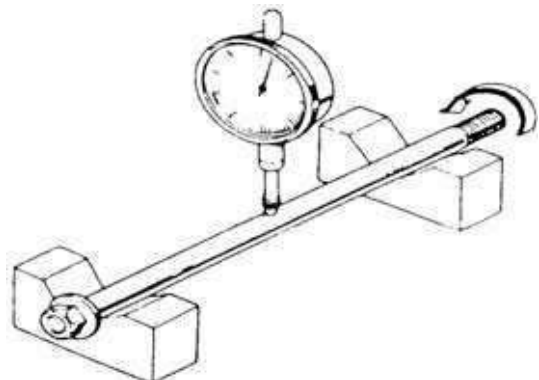

12. FRONT WHEEL/FRONT BRAKE/ FRONT SUSPENSION

WHEEL RIM

Check the wheel rim runout.

Service Limits:

Radial: 2.0mm replace if over

Axial: 2.0mm replace if over

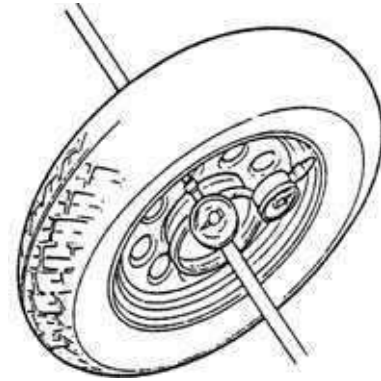

Turn the wheel bearings and replace the bearings if they are noisy or have excessive play.

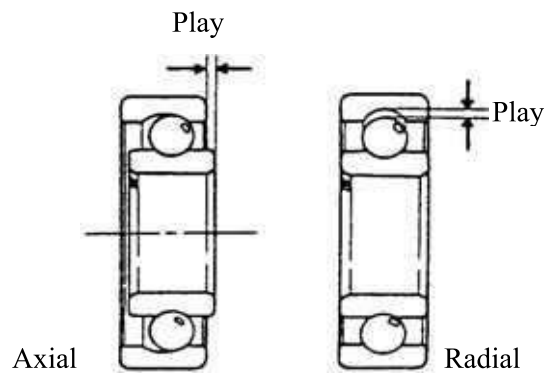

DISASSEMBLY

Remove the dust seal.



12. FRONT WHEEL/FRONT BRAKE/ FRONT SUSPENSION

Remove the front wheel bearings and distance collar.

Special

Bearing Puller



ASSEMBLY

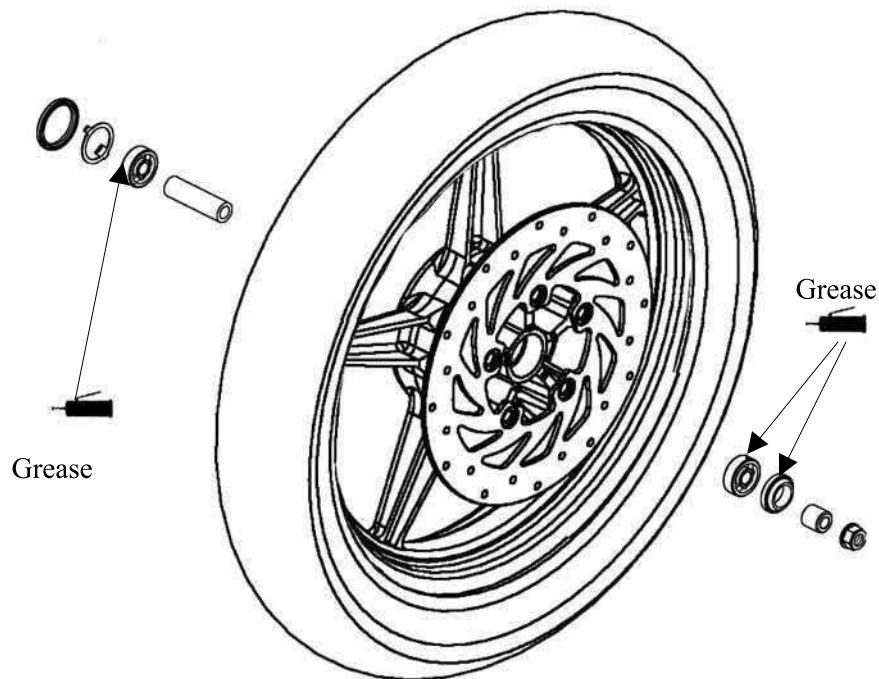

Pack all bearing cavities with grease.
Drive in the left bearing.
Install the distance collar.
Drive in the right bearing.

Drive in the bearing squarely with the sealed end facing out.



Outer Driver Pilot

12. FRONT WHEEL/FRONT BRAKE/ FRONT SUSPENSION

Apply grease to a new dust seal lip and install the dust seal.
Install the side collar.

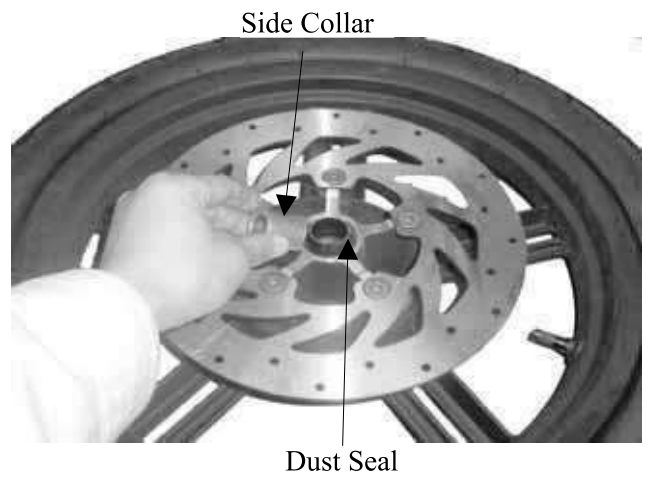

12. FRONT WHEEL/FRONT BRAKE/ FRONT SUSPENSION

HYDRAULIC BRAKE (FRONT BRAKE)

Brake Fluid Replacement/Air Bleeding

Check the brake fluid level on level ground.

- When operating the brake lever, the brake reservoir cap must be tightened securely to avoid spill of brake fluid.
- When servicing the brake system, use shop towels to cover plastic parts and coated surfaces to avoid damage caused by spill of brake fluid.

Upper Limit



Lower Limit

Brake Fluid Bleeding

In order to avoid spill of brake fluid, connect a transparent hose to the bleed valve.

Warning

Brake fluid spilled on brake pads or brake disk will reduce the braking effect. Clean the brake pads and brake disk with a high quality brake degreaser.

Fully apply the brake lever and then loosen the brake caliper bleed valve to drain the brake fluid until there is no air bubbles in the brake fluid. Then, tighten the bleed valve. Repeat these steps until the brake system is free of air.

Bleed Valve

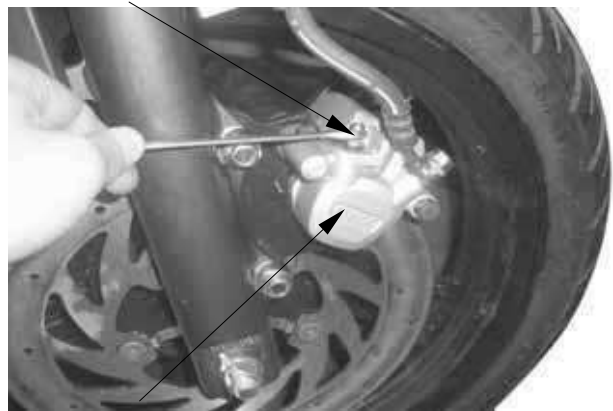

Front Brake Caliper

Brake Fluid Refilling

Add DOT-4 brake fluid to the brake reservoir.

- When bleeding, be careful not to allow air in the brake reservoir flowing into the brake system.
- When using a brake bleeder, follow the manufacturer's instructions.
- Never use dirty or unspecified brake fluid or mix different brake fluids because it will damage the brake system.

Make sure to bleed air from the brake system.

12. FRONT WHEEL/FRONT BRAKE/ FRONT SUSPENSION

Brake Pad/Disk Replacement

The brake pads must be replaced as a set to ensure the balance of the brake disk.

Remove the two bolts attaching the brake caliper.
Remove the brake caliper.
Downpress reed and remove the brake pads.
Install the brake pads in the reverse order of removal.

- Keep grease or oil off the brake pads to avoid brake failure.

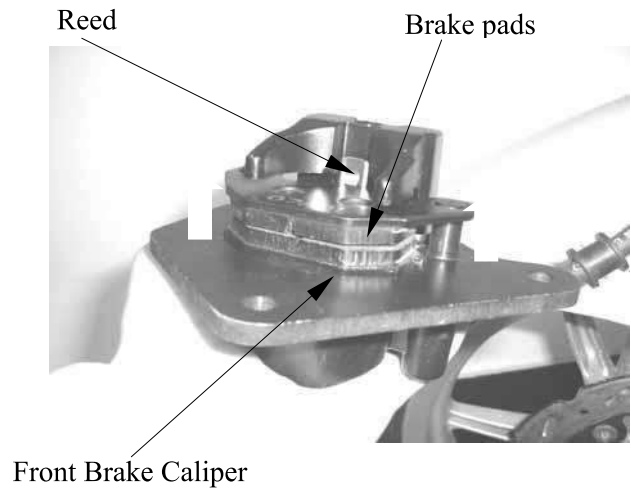

Brake Disk

Measure the brake disk thickness.

Service Limit: 3.0mm

Measure the brake disk runout.

Service Limit: 0.3mm



12. FRONT WHEEL/FRONT BRAKE/ FRONT SUSPENSION

BRAKE MASTER CYLINDER

Removal

First drain the brake fluid from the hydraulic brake system.

- When servicing the brake system, use shop towels to cover rubber and plastic parts and coated surfaces to avoid being contaminated by brake fluid.
- When removing the brake fluid pipe bolt, be sure to plug the pipe to avoid

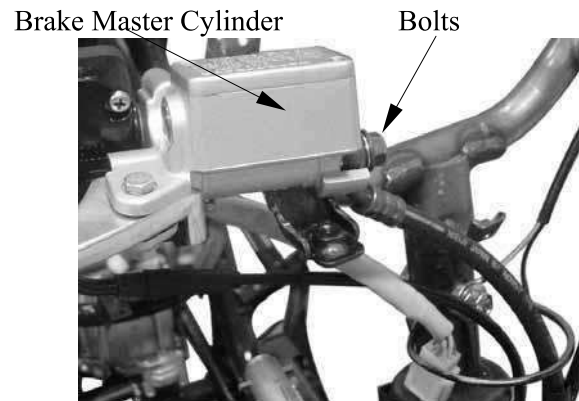

Disassembly

Remove the piston rubber cover and snap ring from the brake master cylinder.

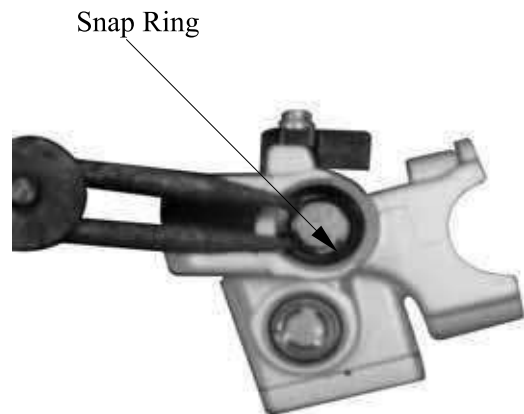

Remove the washer, main piston and spring from the brake master cylinder. Clean the inside of the master cylinder and brake reservoir with brake fluid.

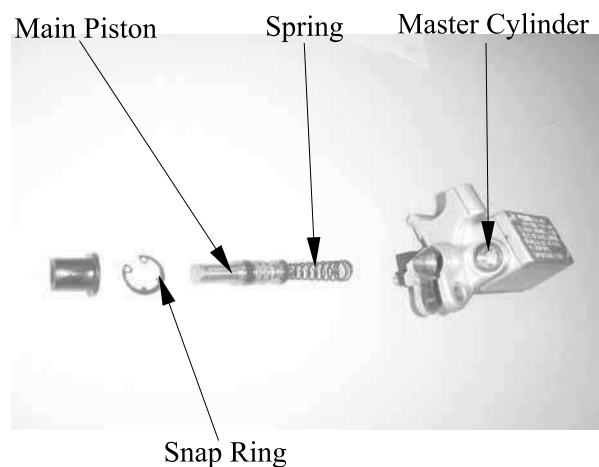

12. FRONT WHEEL/FRONT BRAKE/ FRONT SUSPENSION

Inspection

Measure the brake master cylinder I.D.

Service Limit: 12.75mm

Inspect the master cylinder for scratch or crack.

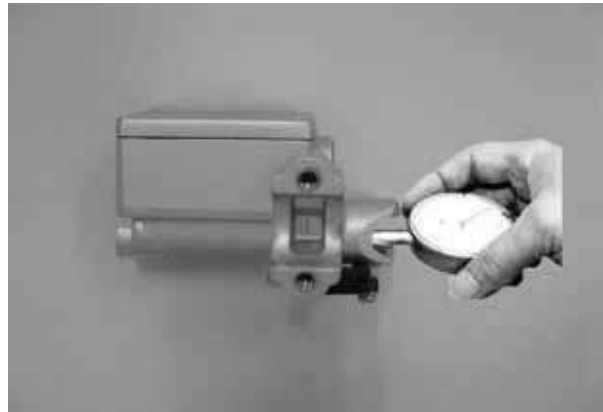

Measure the brake master cylinder piston O.D.

Service Limit: 12.6mm

Before assembly, inspect the 1st and 2nd rubber cups for wear.



Assembly

Before assembly, apply brake fluid to all removed parts.

Install the spring together with the 1st rubber cup.

- During assembly, the main piston and spring must be installed as a unit without exchange.
- When assembling the piston, soak the cups in brake fluid for a while.
- Install the cups with the cup lips facing the correct direction.



Install the main piston, spring and snap ring.

Install the rubber cover.

Install the brake lever.

12. FRONT WHEEL/FRONT BRAKE/ FRONT SUSPENSION

Disassembly

Remove the brake caliper seat from the brake caliper.

Brake Caliper Seat

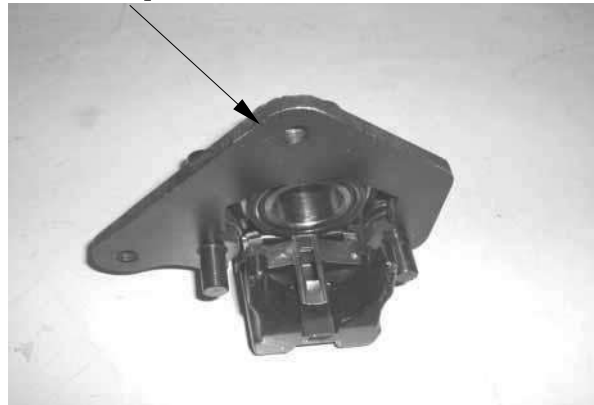

Remove the piston from the brake caliper.
If necessary, use compressed air to squeeze out the piston through the brake fluid inlet opening and place a shop towel under the caliper to avoid contamination caused by the removed piston.
Check the piston cylinder for scratch or wear and replace if necessary.

Compressed Air



Push the piston oil seal outward to remove it.
Clean the oil seal groove with brake fluid.

Be careful not to damage the piston surface.

Piston Oil Seal



12. FRONT WHEEL/FRONT BRAKE/ FRONT SUSPENSION

Place the brake master cylinder on the handlebar and install the holder with “up” mark facing up. Be sure to align the punch mark with the holder joint. First tighten the upper bolt and then tighten the lower bolt.

Torque: 3.0~4.0kgf-m

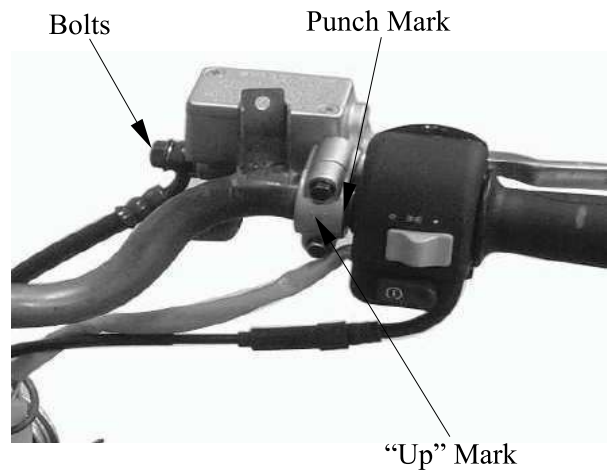

Install the brake fluid pipe with the attaching bolt and two sealing washers.

Install the handlebar covers. (⇒12-3)
Fill the brake reservoir with recommended brake fluid to the upper limit and bleed air according to the method stated in 12-10.

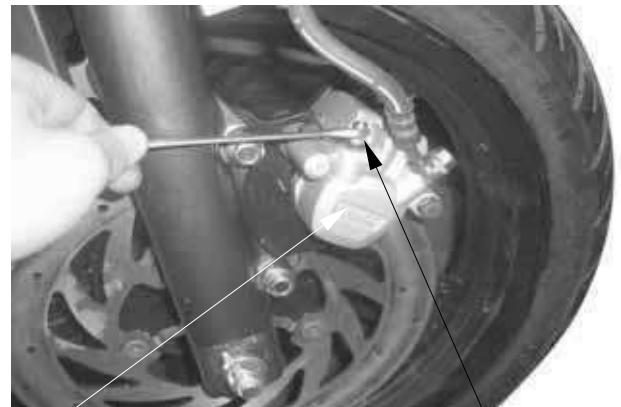

BRAKE CALIPER (FRONT)

Removal

Remove the brake caliper.
Place a clean container under the brake caliper and disconnect the brake fluid pipe from the caliper.

Do not spill brake fluid on any coated surfaces.

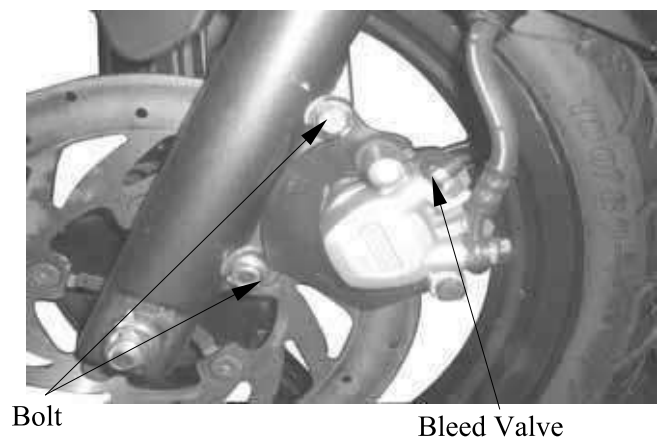

12. FRONT WHEEL/FRONT BRAKE/ FRONT SUSPENSION

Check the piston for scratch or wear.
Measure the piston O.D. with a micrometer.
Service Limit: 34mm



Check the caliper cylinder for scratch or wear
and measure the cylinder bore.
Service Limit: 34.5mm



Assembly

Clean all removed parts.
Apply silicon grease to the piston and oil seal.
Lubricate the brake caliper cylinder inside
wall with brake fluid.
Install the brake caliper piston with grooved
side facing out.

Install the piston with its outer end 3~
5mm protruding beyond the brake
caliper.



Wipe off excessive brake fluid with a clean
shop towel. Apply silicon grease to the
brake caliper seat pin and caliper inside.
Install the brake caliper seat.

12. FRONT WHEEL/FRONT BRAKE/ FRONT SUSPENSION

Installation

Install the brake caliper and tighten the two bolts.

Torque: 2.9~3.5kg-m

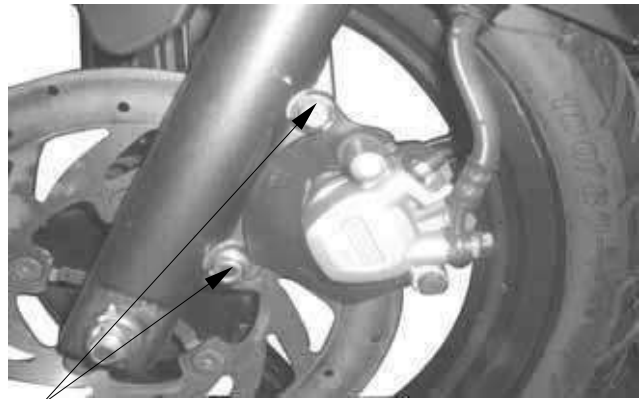

Bolts

Connect the brake fluid pipe to the brake caliper and tighten the fluid pipe bolt.

Torque: 2.5~3.5kg-m

Fill the brake reservoir with recommended brake fluid and bleed air from the brake system. (⇒12-10)



Bolt

12. FRONT WHEEL/FRONT BRAKE/ FRONT SUSPENSION

FRONT SHOCK ABSORBER

REMOVAL

Remove the front wheel. (⇒12-4)
Remove the front lower cover. (⇒2-2)
Remove the front inner fender.
Remove the front shock absorber upper mount bolts.
Loosen the lower mount bolts to remove the front shock absorbers.



Shock Absorber

Lower Mount Bolts

DISASSEMBLY

Remove the dust boot.
Remove the circlip.

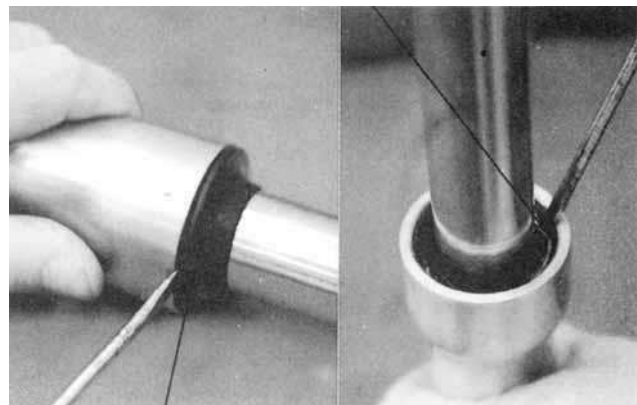

Dust Boot

Set the front shock absorber in a vise.
Remove the damper rod, hex bolt and copper washer.
Pull out the front shock absorber tube.

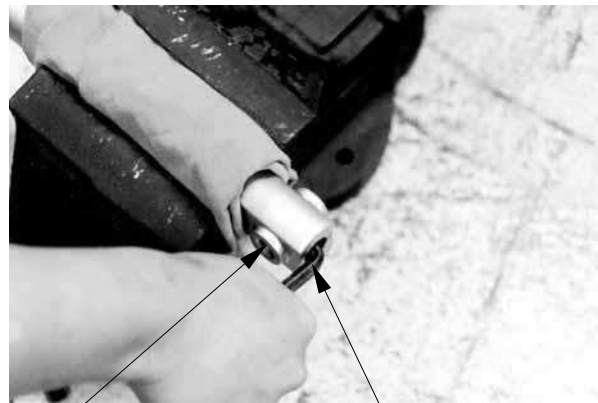

Washer/Bolt

Front Shock Absorber

Set the front shock absorber tube in a vise.
Remove the top nut, shock spring, damper, and damper spring from the front shock absorber tube.

- When holding the shock absorber tube, place a shop towel to protect it and do not apply too much force.

Shock Absorber Tube



12. FRONT WHEEL/FRONT BRAKE/ FRONT SUSPENSION



AGILITY CITY 50 2T

Measure the front shock absorber spring free length.

Service Limits: Right : 226.5mm
Left : 226.5mm

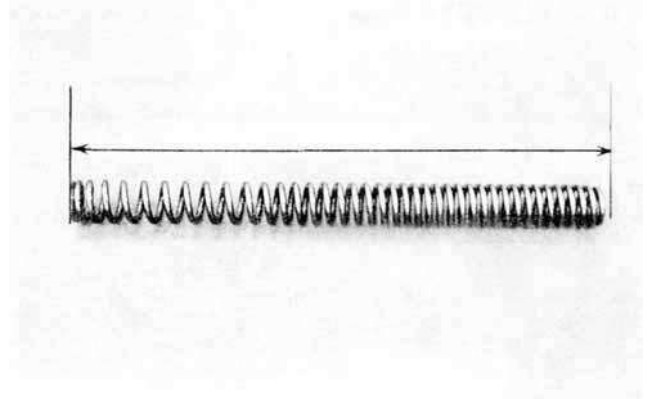

ASSEMBLY

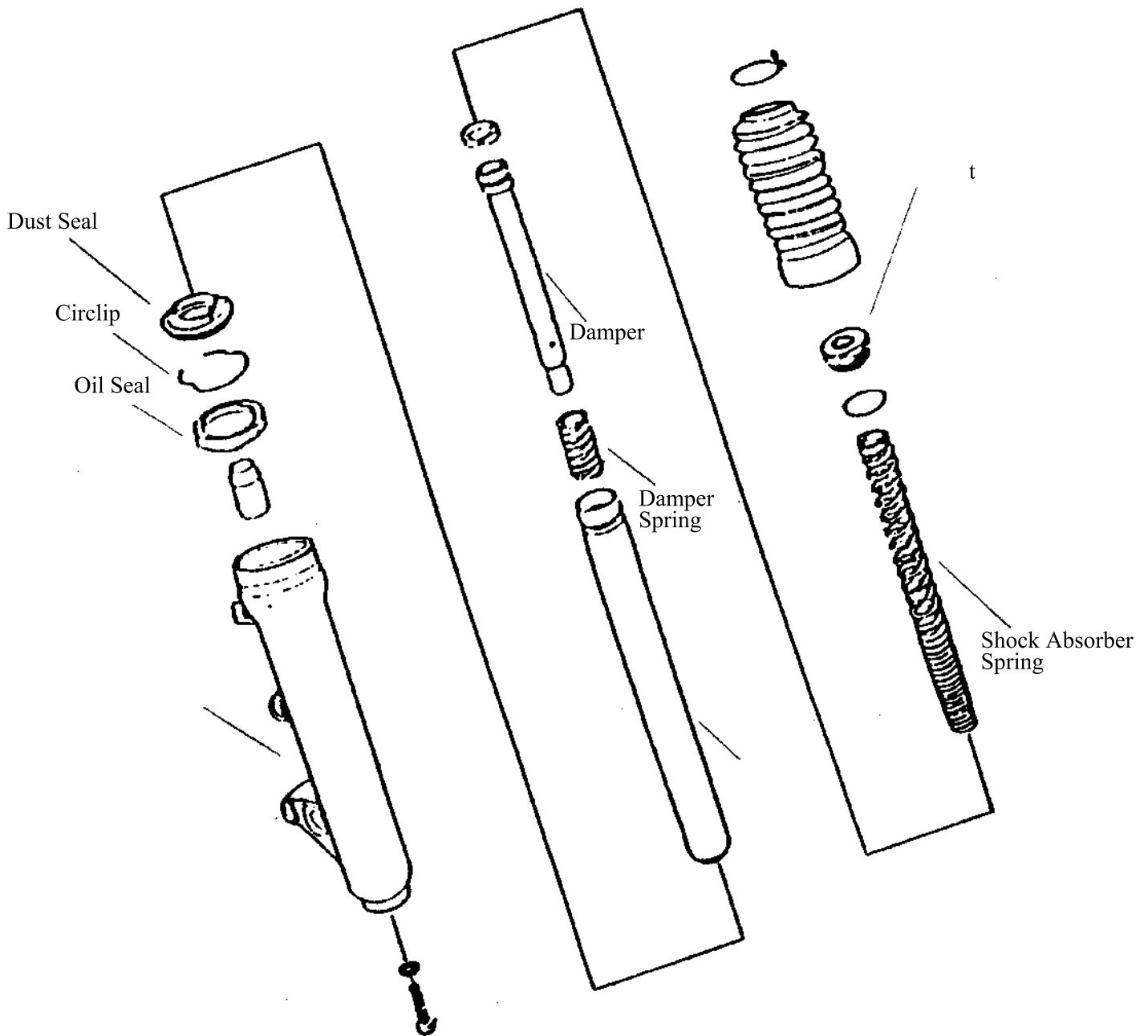

12. FRONT WHEEL/FRONT BRAKE/ FRONT SUSPENSION

Install the damper spring onto the damper rod and then install them into the front shock absorber tube.

Install the shock absorber spring onto the front shock absorber tube and tighten the top nut.

Install the front shock absorber spring with the closely wound coils facing down.



Shock Absorber Tube
Circlip

Set the front shock absorber in a vise. Insert the shock absorber tube into the shock absorber and tighten the hex bolt.

(Apply locking agent to the washer and install it together with the hex bolt.)

Torque: 3.0kgf-m

Add engine oil into the front shock absorber.

Specified Oil: SS#8

Oil Capacity: 97±1cc

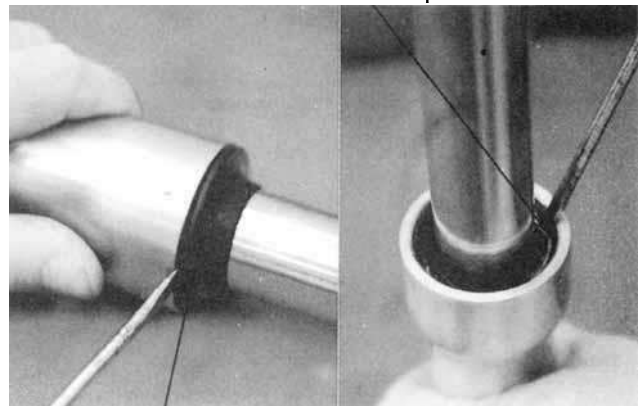

Dust Boot

Install the circlip.
Install the dust boot.

Upper Mount Bolts



Front Shock Absorber

Lower Mount Bolts

INSTALLATION

Install the front shock absorbers onto the steering stem.

Install and tighten the front shock absorber upper mount bolts.

Tighten the lower mount bolts.

Align the upper mount bolt hole with the groove on the front fork.

Install the front wheel. (⇒12-7)

12. FRONT WHEEL/FRONT BRAKE/ FRONT SUSPENSION



AGILITY CITY 50 2T

FRONT FORK

REMOVAL

Remove the steering handlebar. (⇒12-3)
Remove the front wheel. (⇒12-4)
Disconnect the speedometer cable.
Remove the steering stem lock nut using long socket wrench.

Special

Long Socket Wrench, 32mm 8Angle

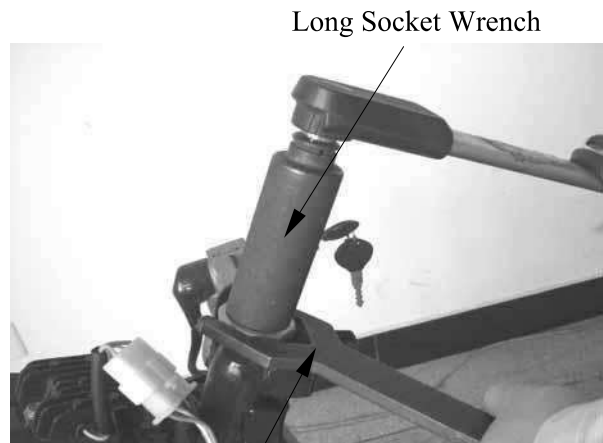

Lock Nut Wrench

Remove the top cone race and remove the steering stem.

- Be careful not to lose the steel balls (26 on top race and 29 on bottom race).

Inspect the ball races and cone races for wear or damage and replace if necessary.

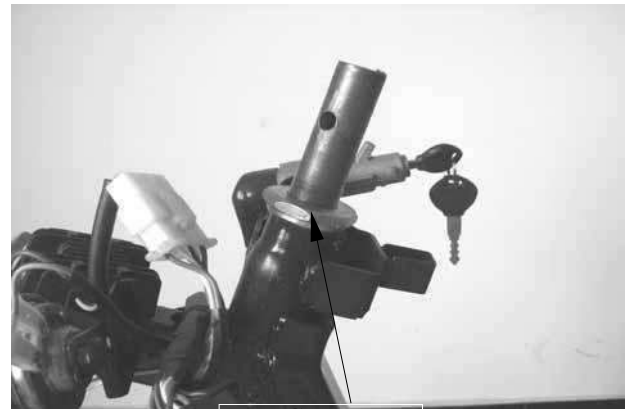

Top Cone Race

BOTTOM CONE RACE REPLACEMENT

Remove the bottom cone race using a chisel.

- Be careful not to damage the steering stem and front fork.

Drive a new bottom cone race into place with a proper driver.



Bottom Cone Race

BALL RACE REPLACEMENT

Drive out the top and bottom ball races.



Ball Race Remover

12. FRONT WHEEL/FRONT BRAKE/ FRONT SUSPENSION

Drive new top and bottom ball races into the steering head using the outer driver.

Be sure to completely drive in the ball races.

Driver Handle A



Outer Driver, 37x40mm

INSTALLATION

Apply grease to the top and bottom ball races and install 26 steel balls on the top ball race and 29 steel balls on the bottom ball race.

Apply grease to the ball races and install the front fork.



Steel Balls

Apply grease to the top cone race and install it.

Tighten the top cone race and then turn the steering stem right and left several times to make steel balls contact each other closely.

Check that the steering stem rotates freely without vertical play.

Top Cone Race

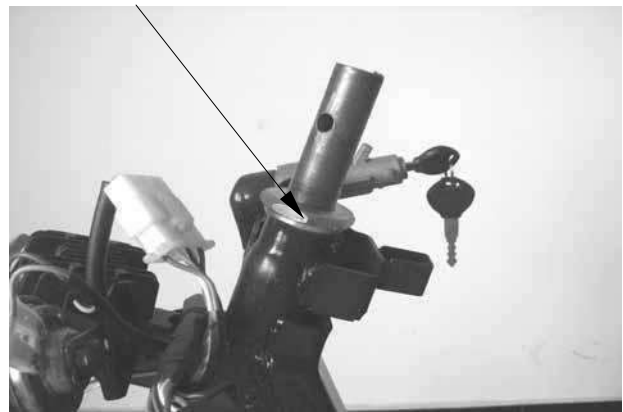

Install the steering stem lock nut and tighten it while holding the top cone race.

Torque: 6.0~8.0kgf-m

Install the front wheel. (⇒12-7)

Install the steering handlebar. (⇒12-3)

Install the speedometer cable. (⇒12-7)

Special

Long Socket Wrench, 32mm×8Angle

Long Socket Wrench

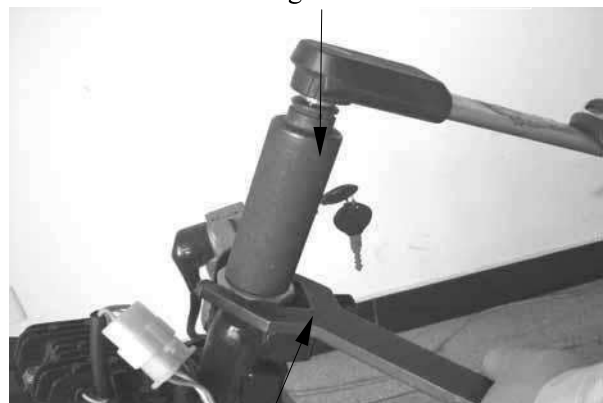

Lock Nut Wrench

13. REAR WHEEL/REAR BRAKE/ REAR SUSPENSION



AGILITY CITY 50 2T

SERVICE INFORMATION	13-1	REAR BRAKE.....	13-3
TROUBLESHOOTING.....	13-1	REAR SHOCK ABSORBER.....	13-4
REAR WHEEL	13-2		

SERVICE INFORMATION

GENERAL INSTRUCTIONS

- During servicing, keep oil or grease off the brake drum and brake linings.

SPECIFICATIONS

Item		Standard (mm)	Service Limit (mm)
Rear wheel	Rim runout	Radial	—
		Axial	—
	Rear brake drum I.D		131
Rear brake lining thickness		4.0	2.0
Rear shock absorber spring free length		225	210

TORQUE VALUES

Rear axle nut	11~13kgf-m
Rear shock absorber upper mount bolt	3.5~4.5kgf-m
Rear shock absorber lower mount bolt	2.4~3.0kgf-m
Exhaust muffler joint lock nut	1.0~1.4kgf-m
Exhaust muffler lock bolt	3.0~3.6kgf-m

Special Tool

Cushion Assemble & Disassemble Tool

TROUBLESHOOTING

Rear wheel wobbling

- Bent rim
- Faulty tire
- Axle not tightened properly

Soft rear shock absorber

- Weak shock absorber spring
- Faulty damper

Poor brake performance

- Brake not adjusted properly
- Worn brake linings
- Worn brake shoes at cam contacting area
- Worn brake cam
- Worn brake drum

13. REAR WHEEL/REAR BRAKE/ REAR SUSPENSION

REAR WHEEL

REMOVAL

- Remove the exhaust muffler. (⇒2-5)
- Remove the rear axle nut and rear shock absorber bolt.
- Remove the rear axle side collar and rear fork.
- Remove the rear wheel.

Rear Shock Absorber Bolt



Rear Axle Nut

Rear Fork

INSPECTION

Measure the rear wheel rim runout.

Service Limits:

Radial: 2.0mm replace if over

Axial: 2.0mm replace if over

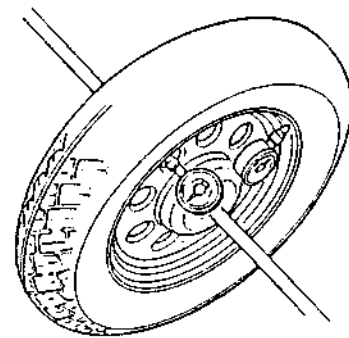

- Inspect the rear brake drum.
- Measure the rear brake drum I.D.
- Service Limits:** 130mm replace if over



INSTALLATION

- Install the rear wheel in the reverse order of removal.
- Tighten the rear axle nut.
- Torque:** 11.0-13.0kg-m
- Install the exhaust muffler.
- Torque:**
 - Exhaust muffler joint lock nut: 1.0~1.4kgf-m
 - Exhaust muffler lock bolt: 3.0~3.6kgf-m

First install and tighten the exhaust muffler joint lock nuts and then the exhaust muffler lock bolts.

Lock Bolts

Joint Lock Nuts

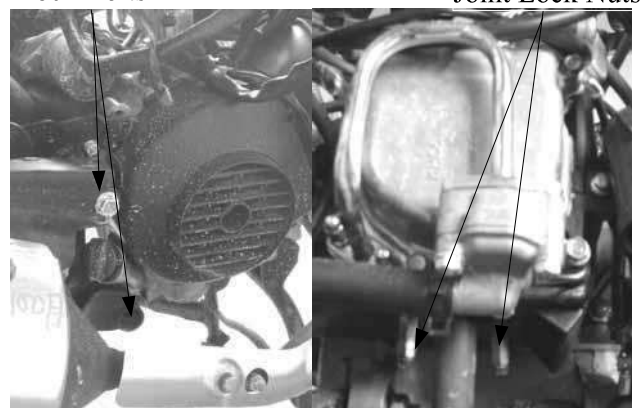

13. REAR WHEEL/REAR BRAKE/ REAR SUSPENSION

REAR BRAKE

BRAKE LINING INSPECTION

Measure the brake lining thickness.
Service Limit: 2.0mm replace if below

Keep oil or grease off the brake linings.

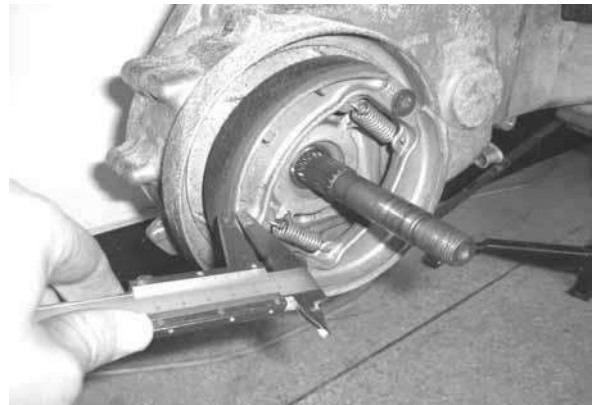

REAR BRAKE DISASSEMBLY

Remove the rear brake adjusting nut and disconnect the rear brake cable.
Remove the rear brake shoes.

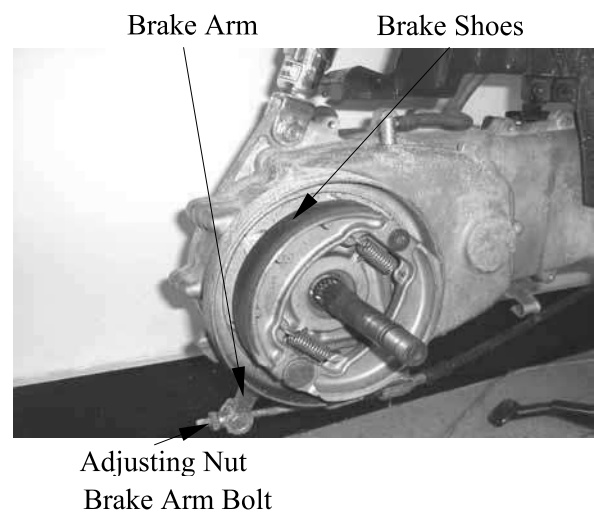

Remove the brake arm bolt to remove the brake arm.
Remove the brake cam.

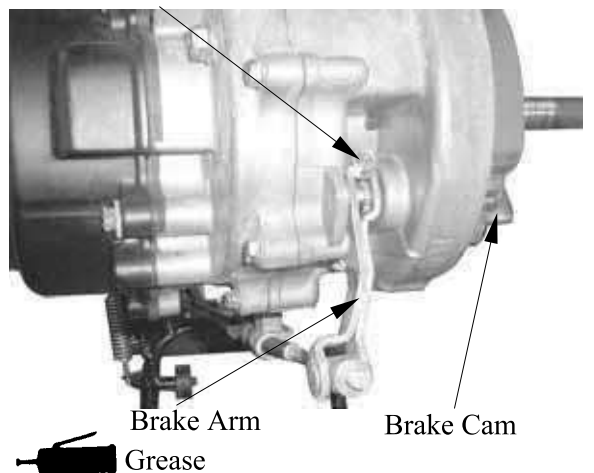

REAR BRAKE ASSEMBLY

Apply grease to the anchor pin.
Apply grease to the brake cam and install it.
Install the brake shoes.

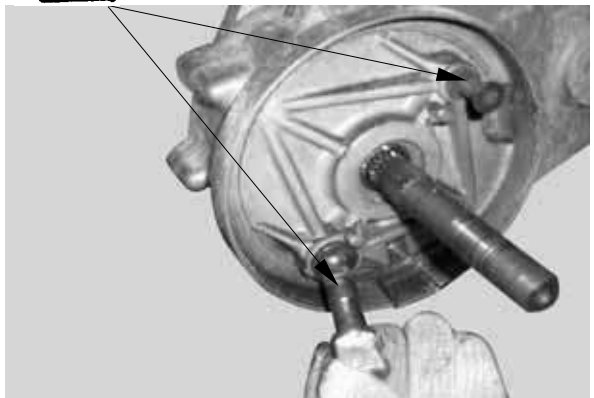

13. REAR WHEEL/REAR BRAKE/ REAR SUSPENSION

Apply a small amount of engine oil to the felt seal and install it to the brake cam.
Install the brake arm.

Align the wide groove on the wear indicator plate with the wide tooth of the brake cam.

Install and tighten the brake arm bolt.

Align the scribed line on the brake arm with the punch mark on the brake cam.

Install the brake arm return spring.
Install the brake arm pin.
Connect the brake cable and install the adjusting nut.
Install the rear wheel. (⇒13-2)
Adjust the rear brake lever free play. (⇒3-8)

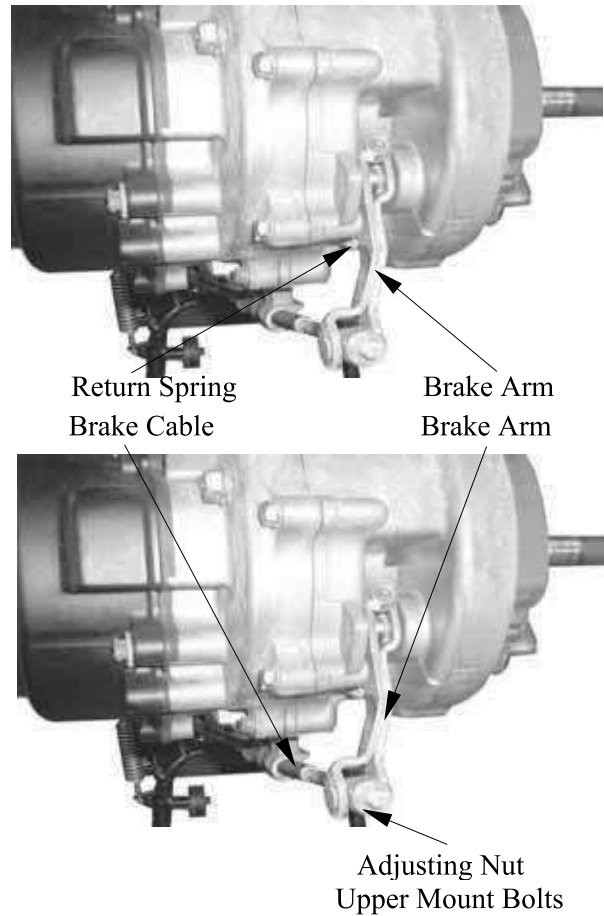

LEFT REAR SHOCK ABSORBER REMOVAL

Remove the frame body cover. (⇒2-3)
Remove the air cleaner case. (⇒5-19)

Remove the rear shock absorber upper and lower mount bolts.
Remove the rear shock absorber.

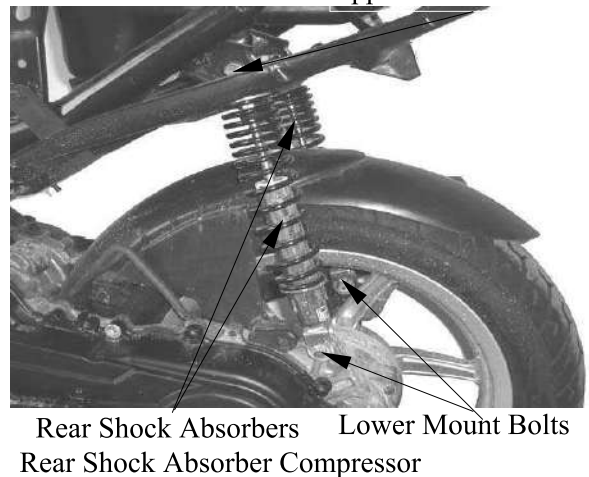

DISASSEMBLY

Install the rear shock absorber compressor as the figure shown.

Install the rear shock absorber lower joint into the rear shock absorber compressor.

Compress the rear shock absorber spring.

Special

Cushion Assemble & Disassemble Tool

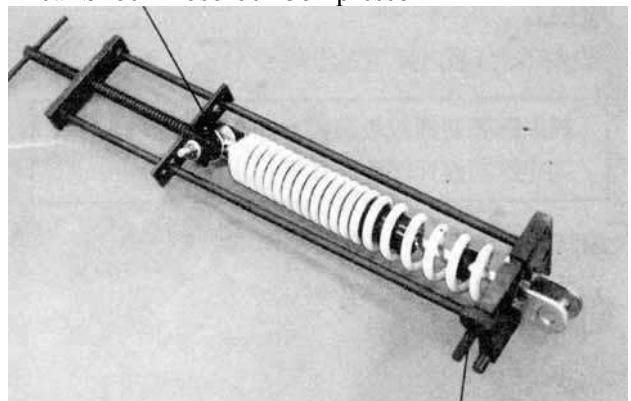

Cushion Assemble & Disassemble Tool

13. REAR WHEEL/REAR BRAKE/ REAR SUSPENSION



AGILITY CITY 50 2T

INSPECTION

Inspect the damper rod for bending or damage.
Inspect the damper for oil leaks.
Inspect the damper rubber for deterioration or damage.

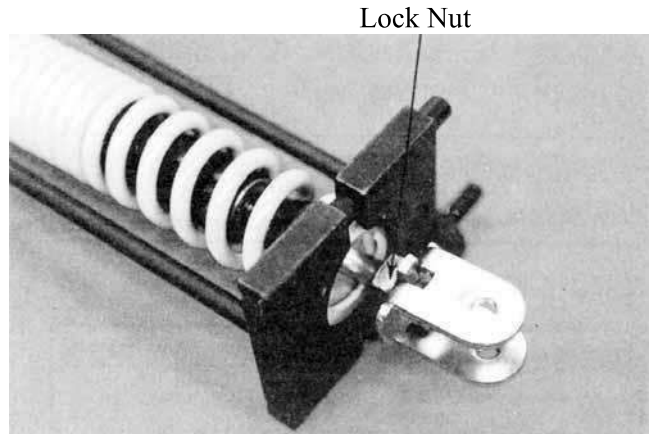

Measure the rear shock absorber spring free length.

Service Limit: 210mm replace if over

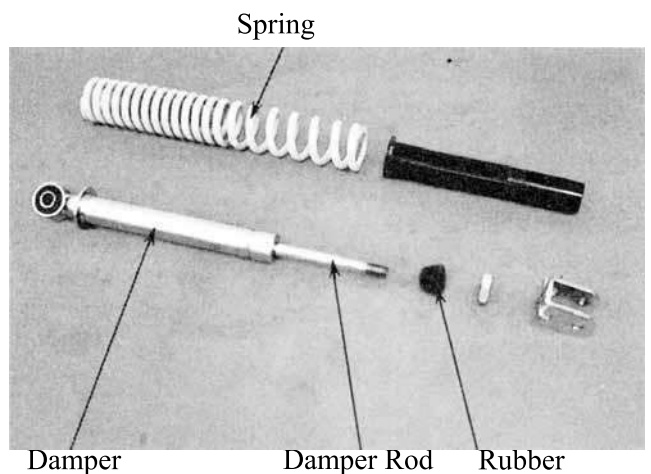

ASSEMBLY

Assemble the rear shock absorbers in the reverse order of disassembly.

- Install the shock absorber spring with loosely wound coils facing down.
- Apply locking agent to the lock nut threads and tighten the lock nut.

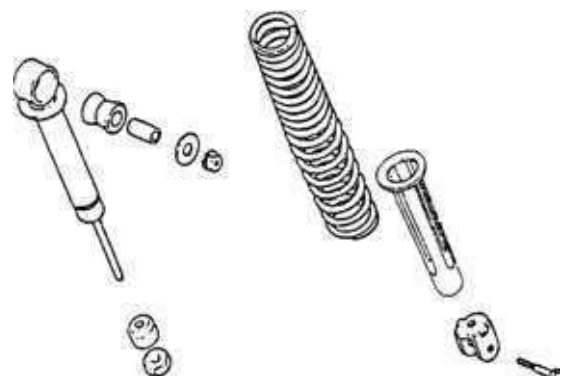
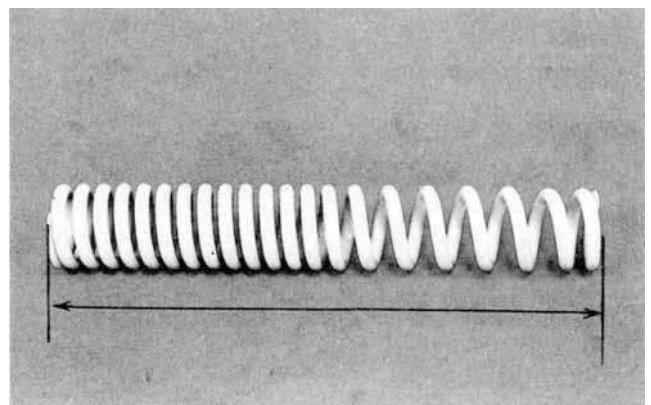

13. REAR WHEEL/REAR BRAKE/ REAR SUSPENSION

INSTALLATION

Install the rear shock absorber.
Install the rear shock absorber upper mount bolt and then the lower mount bolt.
Tighten the bolts.

Torque:

Upper Mount Bolt: 3.5~4.5kgf-m

Lower Mount Bolt: 2.4~3.0kgf-m

Install the air cleaner case. (⇒5-15)

Install the frame body cover. (⇒2-3)

Upper Mount Bolt

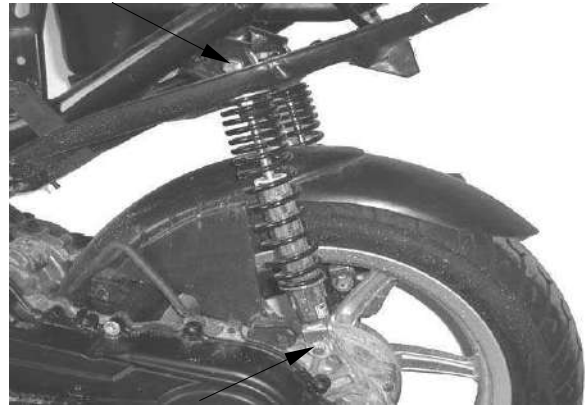

Lower Mount Bolt

SERVICE INFORMATION

GENERAL INSTRUCTIONS

- It is not necessary to check the battery electrolyte or fill with distilled water.
- Remove the battery from the motorcycle for charging. Do not remove the electrolyte cap..
- Do not quick charge the battery. Quick charging should only be done in an emergency..
- Charge the battery according to the charging current and time specified on the battery.
- When charging, check the voltage (open voltage) with an electric tester.
- When replacing the battery, do not use a traditional battery.

SPECIFICATIONS

SPECIFICATIONS		AGILITY CITY 50 2T	
Battery	Capacity	12V7AH	
	Voltage	13.0~13.2V	
	Charging current	Standard	0.4A/5H
		Quick	4A/0.5H
Spark plug	(NGK)	BR8HSA	
Spark plug gap		0.6~0.7mm	
Ignition coil resistance	Primary coil	0.2~0.3Ω	
	Secondary coil (with plug cap)	7.0~8.4KΩ	
	Secondary coil (without plug cap)	2.5~3.2KΩ	
Pulser coil resistance (20°C)		80~160Ω	
Ignition timing		13.5°±1°BTDC/2000rpm	

TROUBLESHOOTING

CHARGING SYSTEM

No power

- Dead battery
- Disconnected battery cable
- Fuse burned out
- Faulty ignition switch

Low power

- Weak battery
- Loose battery connection
- Charging system failure
- Faulty regulator/rectifier

Intermittent power

- Loose battery cable connection
- Loose charging system connection
- Loose connection or short circuit in ignition system
- Loose connection or short circuit in lighting system

Charging system failure

- Loose, broken or shorted wire or connector
- Faulty regulator/rectifier
- Faulty A.C. generator

IGNITION SYSTEM

No spark at plug

- Faulty spark plug
- Poorly connected, broken or shorted wire
 - Between A.C. generator and CDI unit
 - Between CDI unit and ignition coil
 - Between CDI unit and ignition switch
 - Between ignition coil and spark plug
- Faulty ignition switch
- Faulty ignition coil
- Faulty CDI unit
- Faulty A.C. generator

Engine starts but turns poorly

- Ignition primary circuit
 - Faulty ignition coil
 - Poorly connected wire or connector
- Ignition secondary circuit
 - Faulty ignition coil
 - Faulty spark plug
 - Poorly insulated plug cap
- Improper ignition timing
 - Battery voltage too low (6V max.)
 - Faulty CDI unit

STARTING SYSTEM

Starter motor won't turn

- Fuse burned out
- Weak battery
- Faulty ignition switch
- Faulty starter switch
- Faulty front or rear stop switch
- Faulty starter relay
- Poorly connected, broken or shorted wire
- Faulty starter motor

Lack of power

- Weak battery
- Loose wire or connection
- Foreign matter stuck in starter motor or pinion

Starter motor rotates but engine does not start

- Faulty starter pinion
- Starter motor rotates reversely
- Faulty starter clutch
- Weak battery

CHARGING SYSTEM

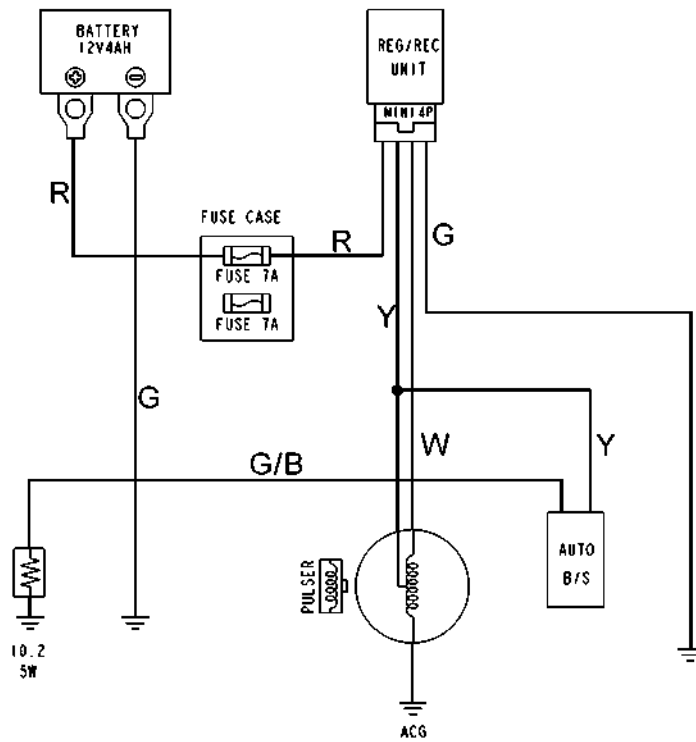
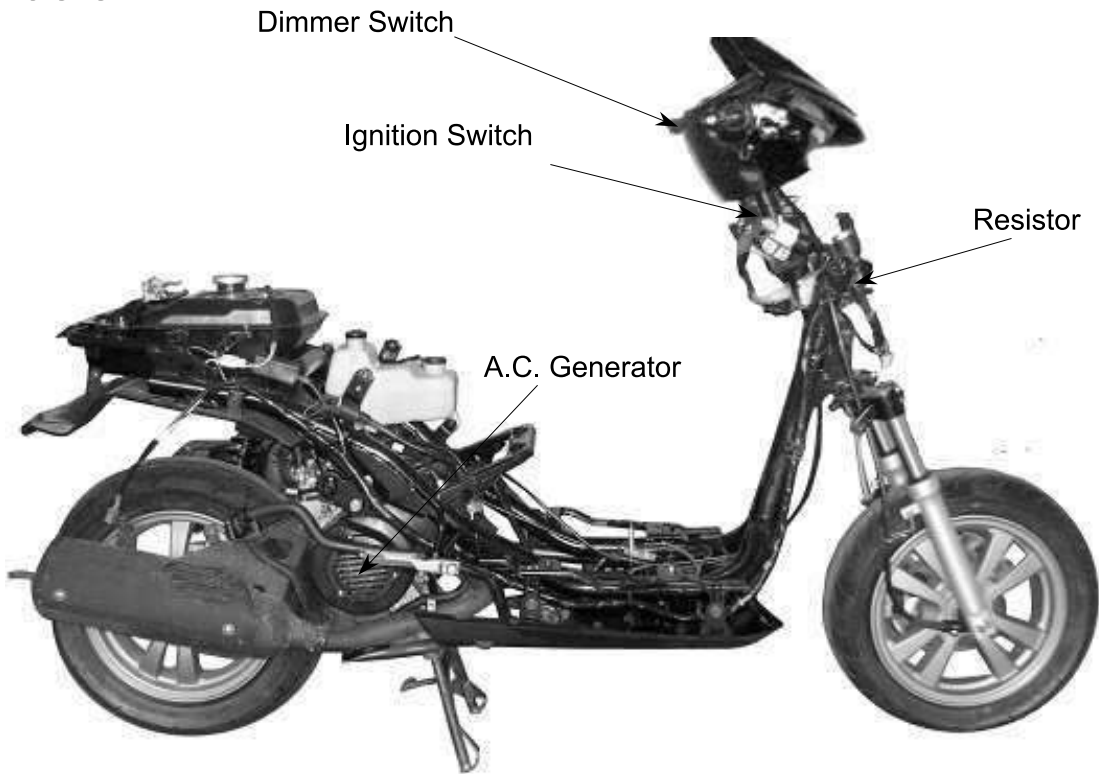

BATTERY REMOVAL

Remove the battery cover.
Disconnect the battery cables .

- *

First disconnect the battery negative (-) cable and then the positive (+) cable.

Remove the battery.
The installation sequence is the reverse of removal.

BATTERY CHARGING (OPEN CIRCUIT VOLTAGE) INSPECTION

Remove the battery cover and disconnect the battery cables.

Measure the voltage between the battery terminals.

Fully charged : 13.0V~13.2V

Undercharged : 12.3V max.

- *

Battery charging inspection must be performed with an electric tester.

CHARGING METHOD

Connect the charger positive (+) cable to the battery positive (+) cable.

Connect the charger negative (-) cable to the battery negative (-) cable.

- *

- Keep flames and sparks away from a charging battery.
 - Turn power ON/OFF at the charger, not at the battery terminals to prevent sparks near the battery.
 - Charge the battery according to the current specified on the battery surface.

Charging current:Standard: 0.4A

Quick : 4A

Charging time : Standard: 5 hours

Quick : 0.5 HOUR

After charging: Open circuit voltage: 12.8V min.

- *

- Quick charging should only be done in an emergency.
 - During quick charging, the battery temperature should not exceed 45°C .
 - Measure the voltage 30 minutes after the battery is charged.



Battery Cover

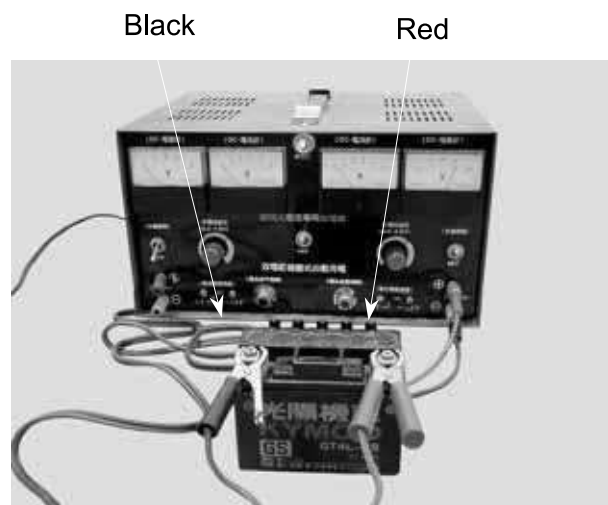

PERFORMANCE TEST

Warm up the engine.
Remove the floor mat and front tool box cover.

* Use a fully charged battery to check the charging system output.

Stop the engine and open the fuse box.
Disconnect the wire lead from the fuse terminal. Connect an ammeter between the wire lead and fuse terminal as shown.
Connect the battery positive (+) terminal to the voltmeter positive (+) probe and battery negative (-) terminal to the voltmeter negative (-) probe.
Start the engine, gradually increase engine speed to test the output:

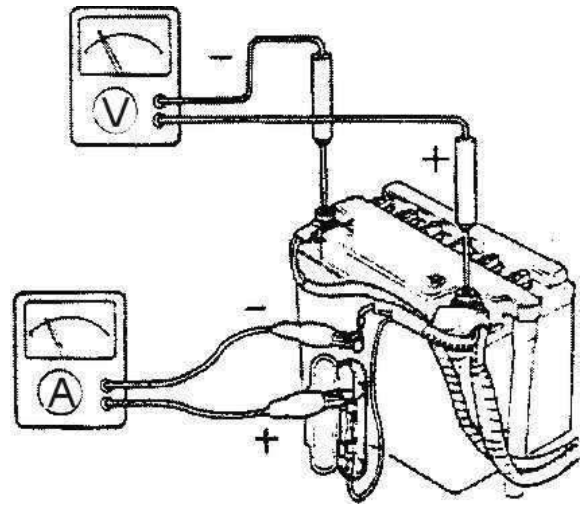

Position \ RPM	Day	Night
2500	1.3A min.	1.0A min.
6000	2.0A min.	2.0A min.

Charging Limit Voltage: $14.5 \pm 0.5V/8000rpm$
If the limit voltage is not within the specified range, check the regulator/ rectifier.



A.C. Generator Connector

A.C. GENERATOR (CHARGING COIL) INSPECTION

* Inspect with the engine installed.

Remove the met-in box. (\Rightarrow 12)
Disconnect the A.C. generator connector.
Measure the resistances between the charging coil terminals (white-green) and lighting coil terminals (yellow-green).

Resistances:

Charging coil	white-green	0.4 ~ 2Ω
Lighting coil	yellow-green	0.3 ~ 2Ω

Refer to 7-3 for A.C. generator removal.



RESISTOR INSPECTION

Remove the frame front cover. (⇒12)
 Measure the resistance between the resistor with ground.

Resistances:
 Resistor: 4.5~5.5Ω

* Faulty resistor is the cause of faulty operation of the auto bystarter.

Resister



REGULATOR/RECTIFIER INSPECTION

Remove the front cover. (⇒12)
 Disconnect the regulator/rectifier wire coupler and remove the bolt to remove the regulator/rectifier.

Measure the resistances between the terminals.
 Replace the regulator/rectifier if the readings are not within the specifications in the table below.

*

- Due to the semiconductor in circuit, it is necessary to use a specified tester for accurate testing. Use of an improper tester in an improper range may give false readings.
- Use a Sanwa Electric Tester (07208-0020000) or Kowa Electric Tester (TH-5H). The proper range for testing is listed below.

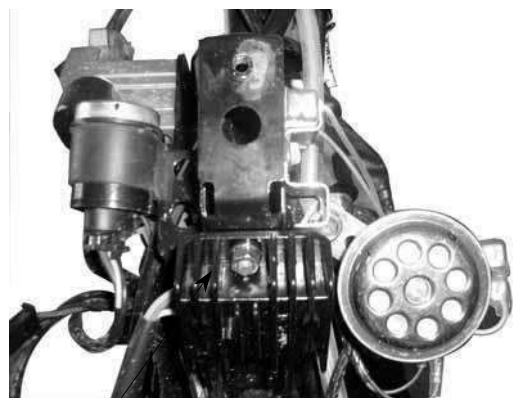

Regulator/Rectifier

Model	Brand	Range
SP-10D	Sanwa	KΩ
TH-5H	Kowa	100Ω

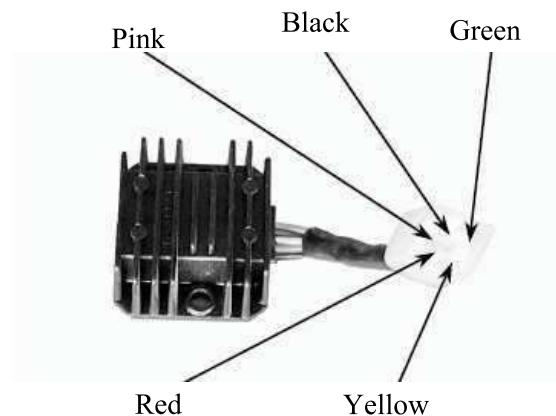

(+)Probe (-)Probe	Peach	Yellow	Red	Green	Black
Peach		∞	4-7K	∞	∞
Yellow	∞		4-7K	∞	∞
Red	∞	∞		∞	∞
Green	4-6K	4-6K	13-17K		1-2K
Black	4-7K	4-7K	13-17K	1-2K	

IGNITION SYSTEM

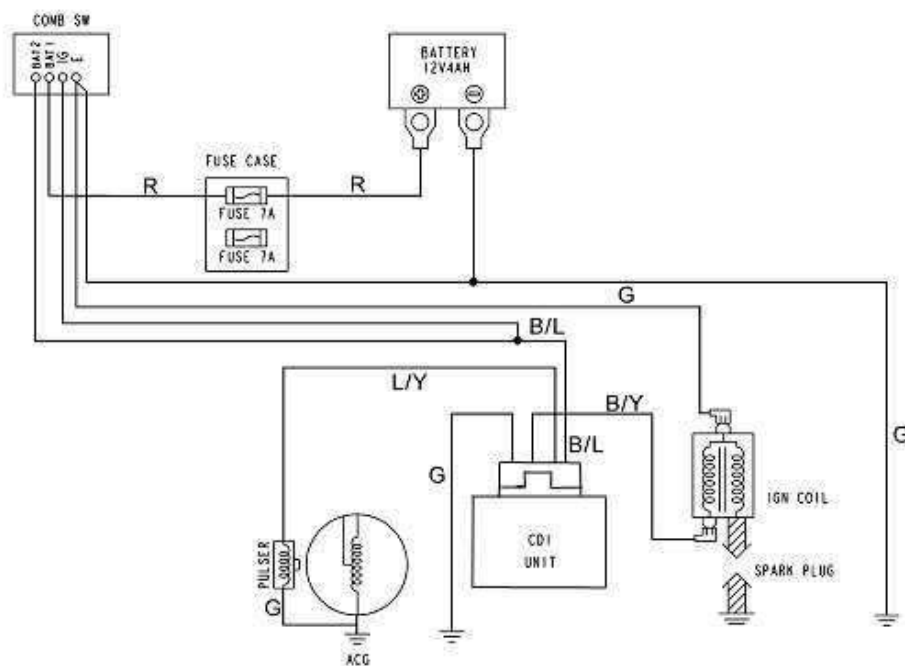
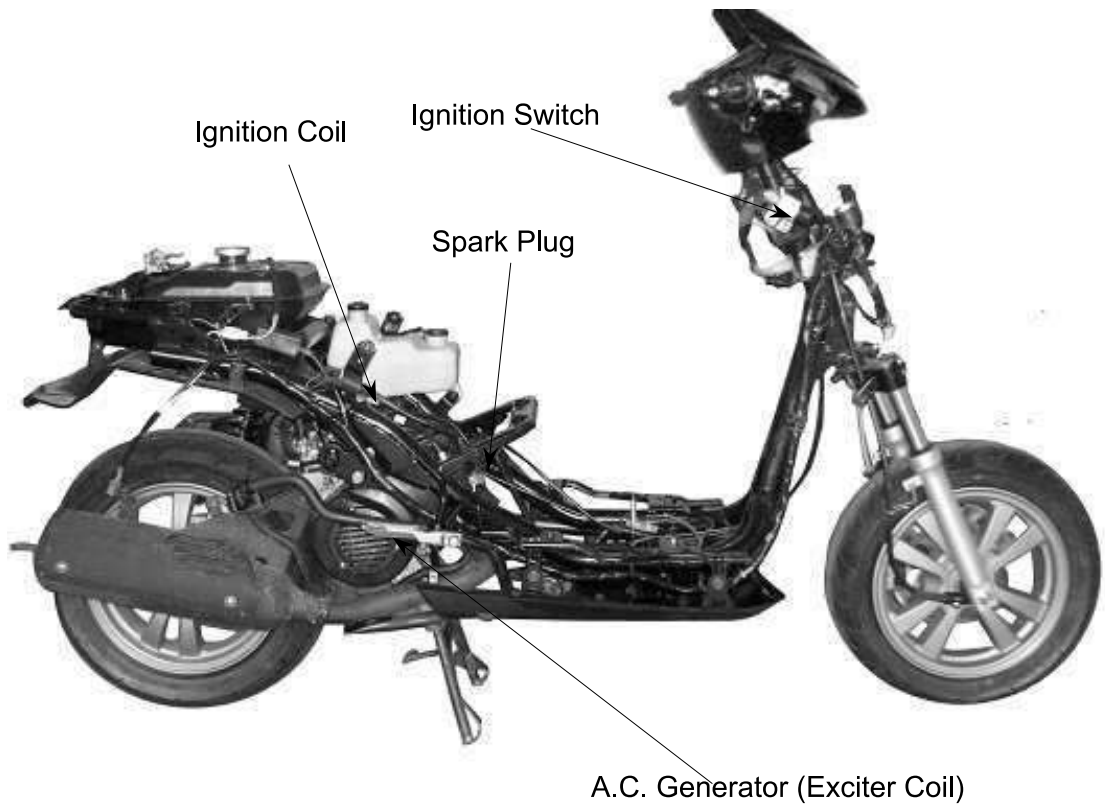

*

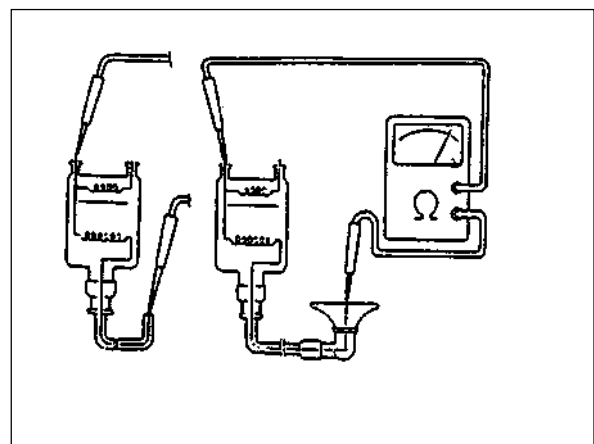
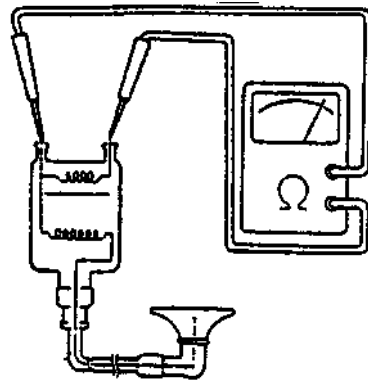

Figure B

Figure A



Ignition Coil

Performance Test

Remove the ignition coil.



Ignition Coil

Inspect the ignition coil with an ignition coil tester.

* Follow the ignition coil tester manufacturer's instructions.

1. Turn the changeover switch to 12V and connect the ignition coil to the tester.
2. Turn the power switch ON and check the spark from the watch window.
 - Good : Normal and continuous spark
 - Faulty: Weak or intermittent spark

* The test is performed at both conditions that the ignition coil is cold and hot.

A.C. GENERATOR

Exciter Coil/Pulser Coil Inspection

* This test is performed with the stator installed in the engine.

Remove the met-in box. (⇒12)
Disconnect the A.C. generator wire connector.
Measure the pulser coil resistance between the blue/yellow wire and ground.

Resistance (20°C): 100~150Ω



CDI UNIT INSPECTION

Remove the front cover.
 Disconnect the CDI coupler and remove the CDI unit.



CDI Unit

CDI CIRCUIT INSPECTION

Measure the resistance between the terminals.
 Replace the CDI unit if the readings are not within the specifications in the table below.

- *
- Due to the semiconductor in circuit, it is necessary to use a specified tester for accurate testing. Use of an improper tester in an improper range may give false readings.
 - Use a Sanwa Electric Tester or Kowa Electric Tester (TH-5H).
 - In this table, "Needle swings then returns" indicates that there is a charging current applied to a condenser. The needle will then remain at "∞" unless the condenser is discharged.

Blue/ Yellow

Black/Blue

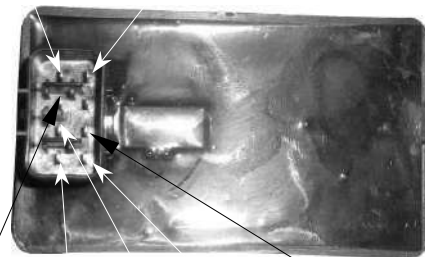

Violet/ Black
 Green

Black / Blue

Violet/Red

Green/ Black

Use the x KΩ range for the Sanwa Tester.
 Use the x 100Ω range for the Kowa Tester.

Unit: Ω

Probe⊕ (-)Probe	Black	Blue/ Yellow	Green	Black/ Yellow
Black		4~7MΩ	4~7MΩ	2~3MΩ
Blue/ Yellow	15~20KΩ		600~900Ω	1000~1500KΩ
Green	15~20MΩ	600~900Ω		4~7MΩ
Black/ Yellow	∞	∞	∞	

STARTING SYSTEM

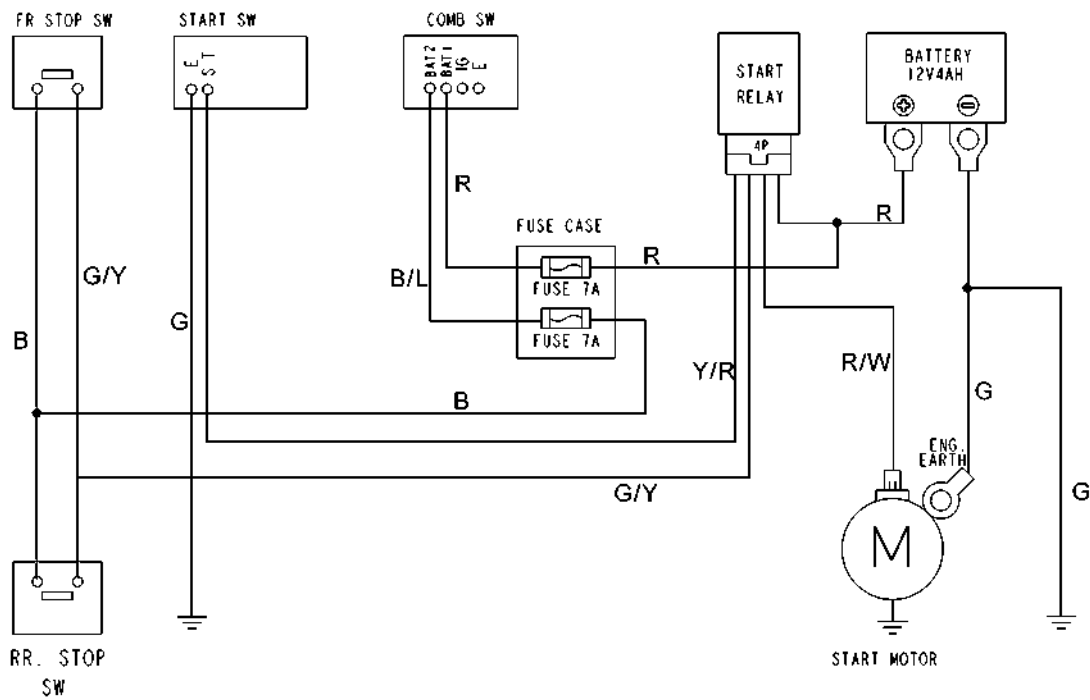
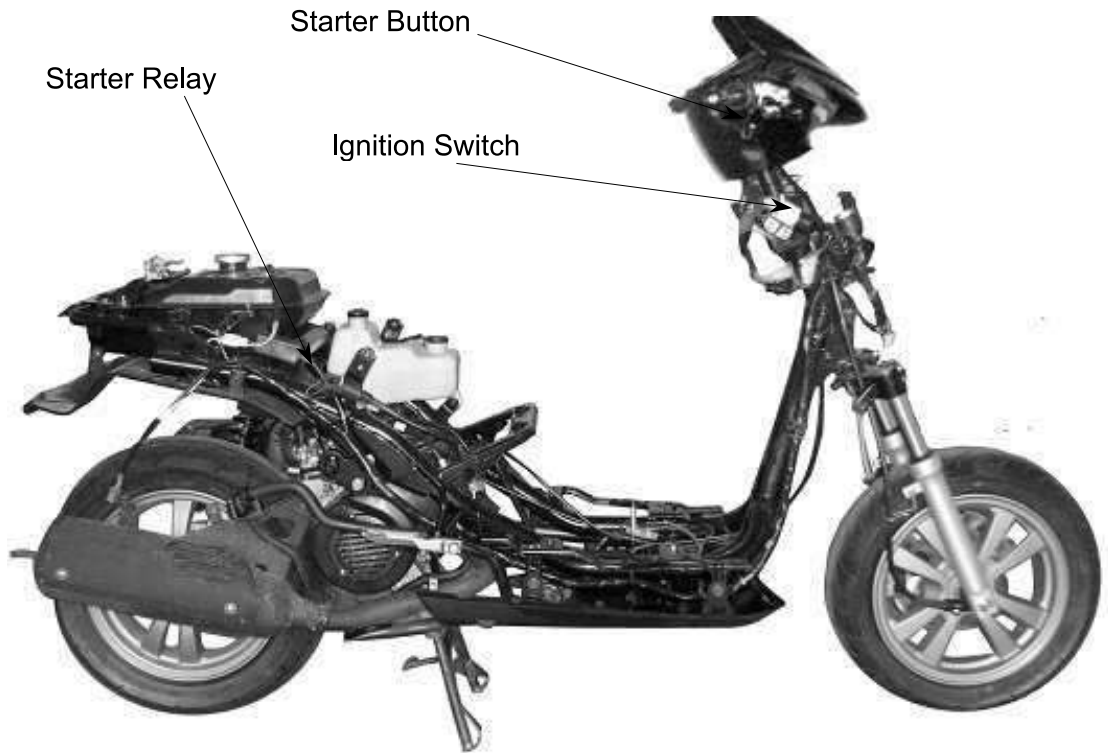

SERVICE INFORMATION

GENERAL INSTRUCTIONS

- Wires should be connected to other wires of the same color. Couplers must be connected to other couplers of the same color.
- All plastic plugs have locking tabs that must be released before disconnecting, and must be aligned when reconnecting.
- After installation of each switch, a continuity check must be performed.

TROUBLESHOOTING

Lights do not come on when ignition switch is "ON"

- Burned bulb
- Faulty switch
- Broken or shorted wire
- Fuse burned out
- Weak battery
- Poorly connected wire
- Faulty winker

Light dims

- Faulty ignition coil
- Wire or switch resistance too high
- Faulty regulator/rectifier

Headlight does not change when dimmer switch is turn to Hi or Lo

- Faulty or burned bulb
- Faulty dimmer switch

Motor oil indicator light does not come on (when motor oil is insufficient)

- Fuse burned out
- Dead battery
- Faulty ignition switch
- Faulty instrument
- Faulty oil meter

Motor oil indicator light winks

- Loose wire connection
- Broken wire
- Faulty oil meter

Fuel gauge pointer does not register correctly

- Disconnected wire or connector
- Broken wire
- Faulty float
- Faulty fuel unit
- Faulty instrument

Fuel gauge pointer fluctuates or swings

- Loose wire connection
- Faulty fuel unit
- Faulty instrument

FUEL UNIT

* No Smoking!

REMOVAL

Remove the seat.
Remove the body cover.
Disconnect the fuel unit wire connectors.

* Do not damage the fuel unit wire.

Remove the fuel unit.

* Be careful not to bend or damage the fuel unit float arm.

Fuel Unit

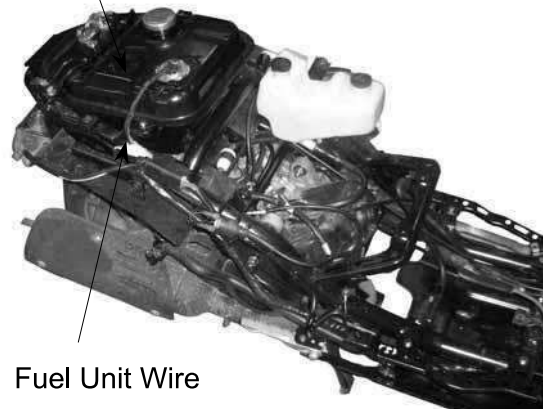

Fuel Unit Wire

INSPECTION

Remove the fuel unit.
Measure the resistance between the fuel unit wire terminals with the float at upper and lower positions.

RESISTANCES Unit: Ω

Wire Terminals	Upper	Lower
G~Y/W	20~40	560~580



FUEL GAUGE INSPECTION

Connect the fuel unit wire connectors and turn the ignition switch "ON".

* Before performing the following test, operate the turn signals to determine that the battery circuit is normal.

Check the fuel gauge needle for correct indication by moving the fuel unit float up and down.

Float Position	Needle Position
Upper	"F" (Full)
Lower	"E" (Empty)

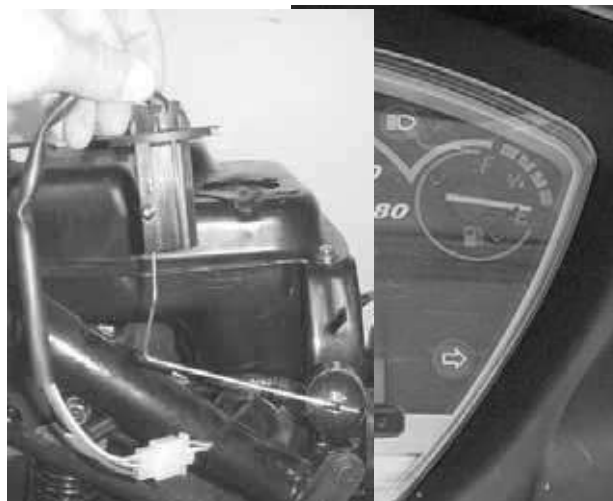

INSTALLATION

The installation sequence is the reverse of removal.

- * • Install the fuel unit at the connect position.

OIL METER

INSPECTION

Remove the met-in box. (⇒12-4)
 Remove the frame body cover. (⇒12-4)
 Disconnect the oil meter wire connectors and remove the oil meter. Keep the oil meter float at the lower position.
 Measure the resistances between the wire terminals as ① and ② shown in the left figure.

Wire Terminals	Resistance
Green/Red(+)-Black(-)	46Ω
Green(-)-Black(+)	∞

- * Before removing the oil meter, be sure to drain the motor oil and do not allow sparks or flames near the working area.

Oil Meter Operation Inspection

Connect the oil meter wire connectors and turn the ignition switch ON.
 Measure the resistance between the wire terminals with the float at upper position.

Green/Red(+)-Black(-)	About 300Ω
-----------------------	------------

- * Before performing the following test, operate the turn signals to determine that the battery circuit is normal.

Move the oil meter float up and down to see if the oil indicator light will go out and come on.

- * If the oil indicator light does not light, check for burned bulb, loose wire or connector. After correction, check again according to the method mentioned above.

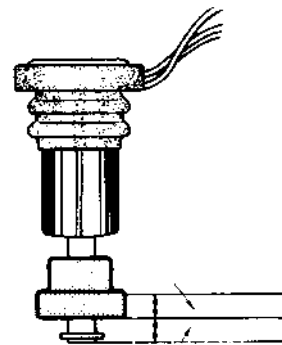
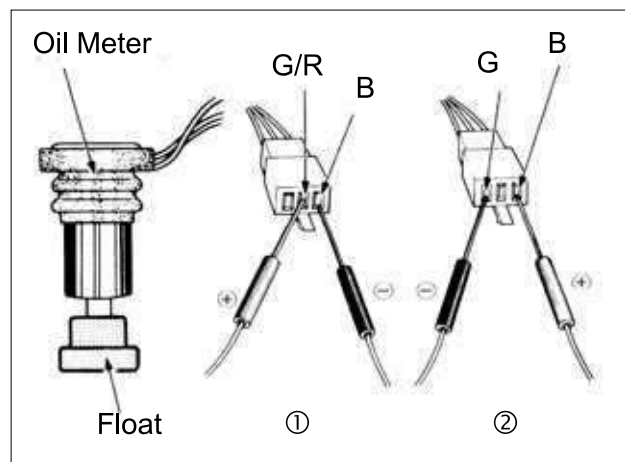
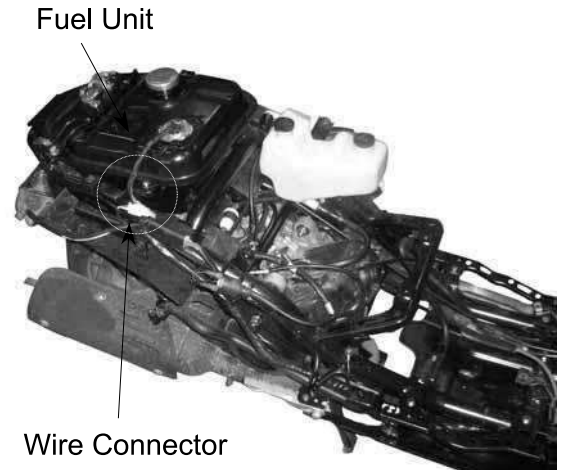

SWITCHES

IGNITION SWITCH INSPECTION

Remove the front cover. (⇒12)
 Disconnect the ignition switch wire couplers and check for continuity between the wire terminals.

Color	Red	Black/White	Green	Black
Symbol	BAT1	IG	E	BAT2
LOCK		○	○	
OFF		○	○	
ON	○			○



IGNITION SWITCH REPLACEMENT

Remove the front cover. (⇒12)
 Disconnect the ignition switch wire couplers.
 Remove the two mounting bolts and remove the ignition switch.
 The installation sequence is the reverse of removal.

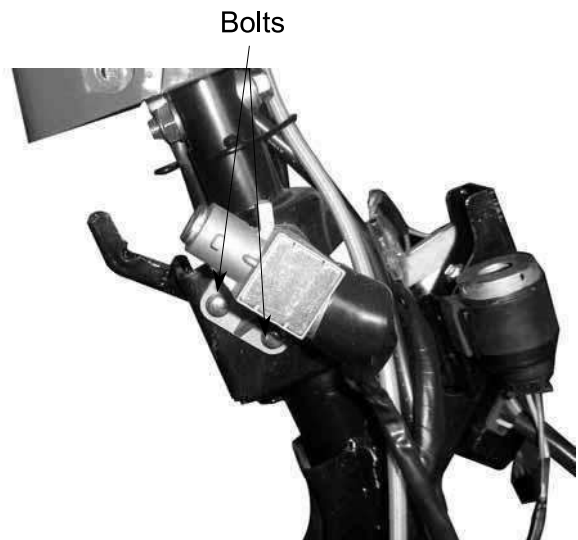

DIMMER SWITCH INSPECTION

Check for continuity between wire terminals.

Color	W/L	L	We	Y
Symbol	HL	HI	LO	BAT
HI	○ — ○	○		
LO	○		○	
PASSING		○	○	○

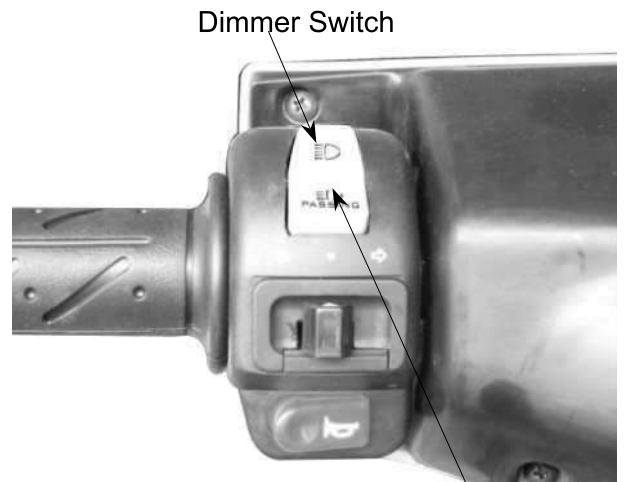

Passing Switch

TURN SIGNAL SWITCH INSPECTION

Check for continuity between the wire terminals.

Color	SB	O	GR
Symbol	R	L	WR
R	○ — ○		○
L		○ — ○	○



Turn Signal Switch

STARTER SWITCH INSPECTION

Check for continuity between wire terminals.
Push the starter button when measuring.

Color	Y/R	G
Symbol	ST	E
FREE		
PUSH	⊖	○

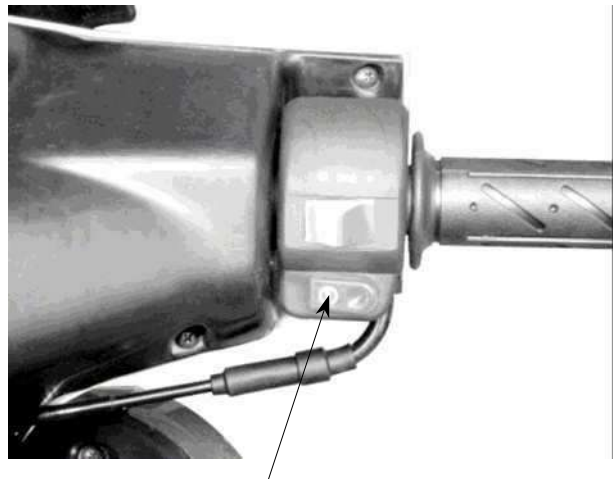

Starter Switch

HORN SWITCH INSPECTION

Check for continuity between wire terminals.
Push the horn button when measuring.

Color	Light Green	Brown / Blue
Symbol	HO	BAT
FREE		
PUSH	○	○



Horn Switch

Stop Switch Wire

STOP SWITCH INSPECTION

Remove the handlebar front cover. (⇒12)
Disconnect the front and rear stop switch wire couplers.
Check for continuity between the wire terminals when the front/rear brake lever is applied.



HORN INSPECTION

Remove the frame front cover.
 Disconnect the horn wire couplers. The horn is normal if it sounds when a 12V battery is connected across the horn wire terminals.



INSTRUMENTS

Remove the handlebar front cover.
 Remove the handlebar rear cover.
 Disconnect the handlebar switch couplers.
 Remove the three screws to remove the instruments.
 Install a new horn in the reverse order of removal.

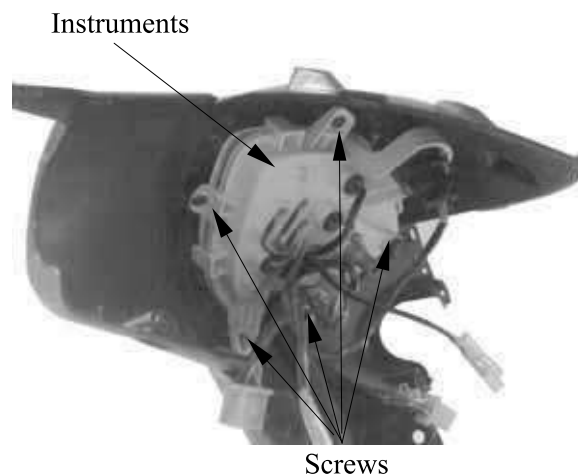

HEADLIGHT REMOVAL

Remove the screw on the front cover.
 Remove the two screws on the back of the front cover.
 Remove the front cover.



The installation sequence is the reverse of removal.

- Align the tab on the headlight with the groove on the handlebar cover.
- After installation, adjust the headlight beam.

BULB REPLACEMENT

Remove the headlight bulb Coupler.
Remove the headlight replace with new bulbs.
The installation sequence is the reverse of removal.



Headlight Bulb Coupler

TAILLIGHT/STOPLIGHT/REAR TURN SIGNAL LIGHT/LICENSE LIGHT

Remove the two screws attaching the rear protector molding.
Remove the rear protector molding and remove the two nuts attaching the rear light shell.
Remove the rear turn signal light bulb and replace with a new one.
The installation sequence is the reverse of removal.

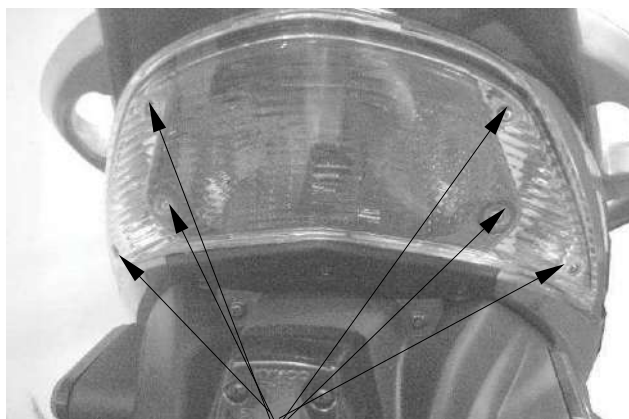

Nuts

17. EXHAUST EMISSION CONTROL SYSTEM

AGILITY CITY 50 2T

SCHEMATIC DRAWING

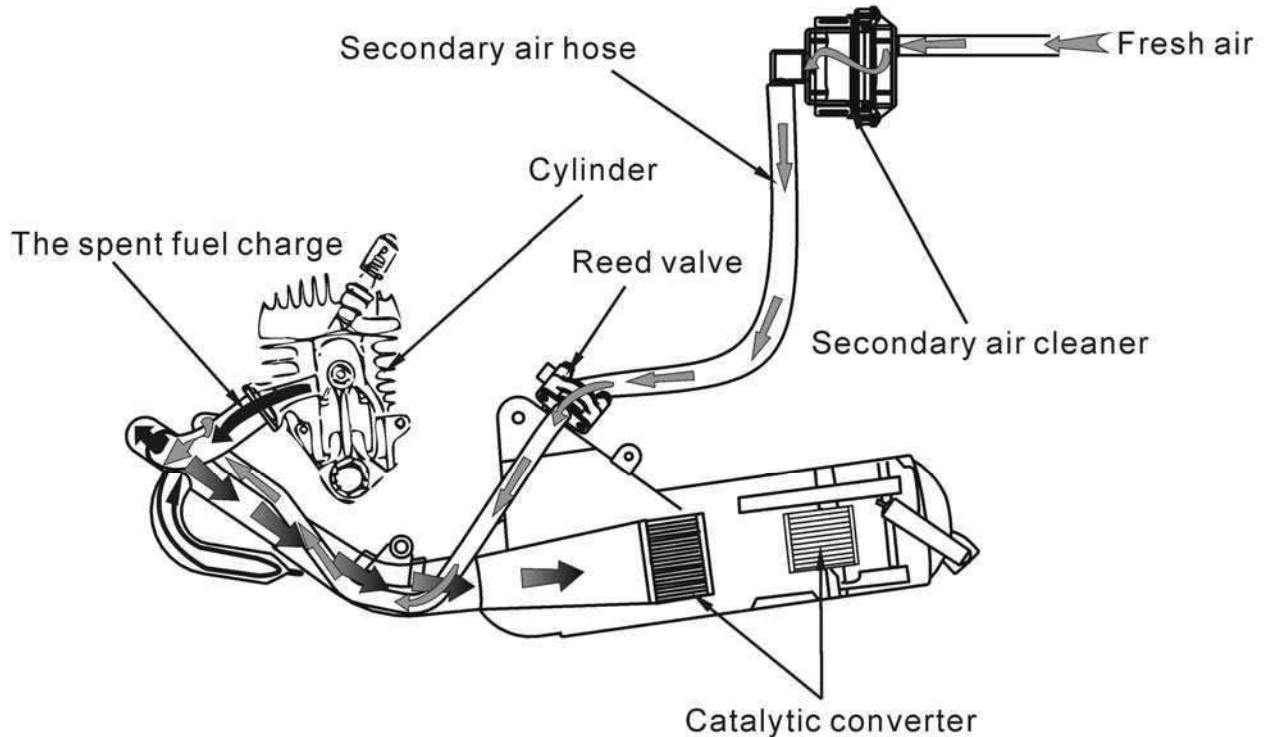

EXHAUST EMISSION CONTROL SYSTEM

The exhaust emission control system adopted in this model utilizes the reed valve to draw secondary air into the exhaust system for re-combustion by means of exhaust pulsation so as to minimize the exhaust emission.

FUNCTION

Item	Purpose	Function
Secondary Air Cleaner	Filter secondary air.	It filters the fresh air drawn for re-burning to prevent dirt or dust from affecting the operation of the air injection cut-off valve.
Air Injection Cut-off Valve	Prevent exhaust muffler noise and backfiring at sudden deceleration.	The air injection cut-off valve usually opens to lead air into the exhaust muffler in which air is re-burned to reduce CO. When the throttle valve closes suddenly, the air injection cut-off valve is actuated by vacuum to close and cut off secondary air in order to prevent exhaust muffler backfiring due to air in the exhaust system.
Reed Valve	Control the secondary air inlet to reduce CO.	When the motorcycle speed is less than 50km per hour, the reed valve operates to draw secondary air into the exhaust system for re-combustion.

17. EXHAUST EMISSION CONTROL SYSTEM

AGILITY CITY 50 2T

TROUBLESHOOTING

High CO at idle speed

1. Damaged or clogged reed valve
2. Damaged or clogged air injection cut-off valve
3. Clogged air cleaner

Backfiring at sudden deceleration

1. Damaged reed valve (malfunction)
2. Faulty air injection cut-off valve (unable to close)
3. Carburetor incorrectly adjusted
4. Faulty air cut-off valve
5. Leaking vacuum tube

Exhaust muffler noise

1. Faulty air injection cut-off valve
2. Broken vacuum tube
3. Faulty reed valve

SERVICE INFORMATION

GENERAL INSTRUCTIONS

- During operation, be careful to avoid scalding caused by the exhaust muffler.
- Note the locations of tubes for proper installation.
- Replace any damaged tube with a new one.
- Make sure to tighten the connector of each tube securely

TOOLS

- Vacuum pump

SPECIFICATIONS

Air injection cut-off valve actuating pressure

250mm/Hg 30 liter/min.

Reed valve stopper clearance 4.6mm

17. EXHAUST EMISSION CONTROL SYSTEM

AGILITY CITY 50 2T

SECONDARY AIR CLEANER / AIR INJECTION CONTROL VALVE (A.I.C.V.)

REMOVAL

Remove the seat. (⇒2-4)
Remove the body cover.
Disconnect the secondary air cleaner / (A.I.C.V) connecting tube.

INSPECTION

Remove two screws on the air cleaner/air injection control valve.
Replace new one when the filter elements obstruct considerable dirt.

INSTALLATION

The installation sequence is the reverse of removal.

- The secondary air cleaner must be assembled and installed properly to avoid dust entering the air cleaner.
- When installing, be careful not to bend or twist the tubes and check for proper installation.
- The tube length is very important to its performance, use the tube of same specification for replacement.

Secondary Air Cleaner / A.I.C.V.



Air Inlet Tube Bolt

Air Outlet Tube



Air Inlet Tube



17. EXHAUST EMISSION CONTROL SYSTEM

AGILITY CITY 50 2T

REED VALVE

REMOVAL

Disconnect the secondary air inlet tube connector.
Remove the reed valve cover three bolts.



Secondary Air Inlet Tube Clip

Remove the three bolts attaching the reed valve cover and the reed valve.



Reed Valve

INSPECTION

Check the reed valve for cracks, damage, big clearance or weak reeds. Replace if necessary.

Check the gasket and O-ring for damage or deterioration and replace if necessary.

Reed valve stopper clearance: 4.6mm

INSTALLATION

Install the reed valve in the reverse order of removal.

- When installing, be careful not to bend or twist the tubes and check for proper installation.



Reed Stopper