

# PREFACE

This Service Manual describes the technical features and servicing procedures for the KYMCO *AGILITY 50*

Section 1 contains the precautions for all operations stated in this manual. Read them carefully before starting any operation.

Section 2 is the removal/installation procedures for the frame covers which are subject to higher removal/installation frequency during maintenance and servicing operations.

Section 3 describes the inspection/adjustment procedures, safety rules and service information for each part, starting from periodic maintenance.

Sections 6 through 17 give instructions for disassembly, assembly and inspection of engine, chassis frame and electrical equipment.

Most sections start with an assembly or system illustration and troubleshooting for the section. The subsequent pages give detailed procedures for the section.

Our company reserves the right to make any alteration in the design. The information and contents included in this manual may be different from the motorcycle in case specifications are changed.

**KWANG YANG MOTOR CO., LTD.**  
**OVERSEAS SALES DEPARTMENT**  
**OVERSEAS SERVICE SECTION**

## TABLE OF CONTENTS

ENGINE	GENERAL INFORMATION	1
	FRAME COVERS/EXHAUST MUFFLER	2
	INSPECTION/ADJUSTMENT	3
	LUBRICATION SYSTEM	4
	FUEL SYSTEM	5
	ENGINE REMOVAL/INSTALLATION	6
	CYLINDER HEAD/VALVES	7
	CYLINDER/PISTON	8
	DRIVE AND DRIVEN PULLEYS/KICK STARTER	9
	FINAL REDUCTION	10
	CRANKCASE/CRANKSHAFT	11
CHASSIS	FRONT WHEEL/FRONT BRAKE/FRONT SUSPENSION	12
	REAR WHEEL /REAR BRAKE /REAR SUSPENSION	13
ELECTRICAL EQUIPMENT	BATTERY/CHARGING SYSTEM/A.C. GENERATOR	14
	IGNITION SYSTEM	15
	STARTING SYSTEM	16
	LIGHTS/INSTRUMENTS/SWITCHES	17

# 8. CYLINDER/PISTON

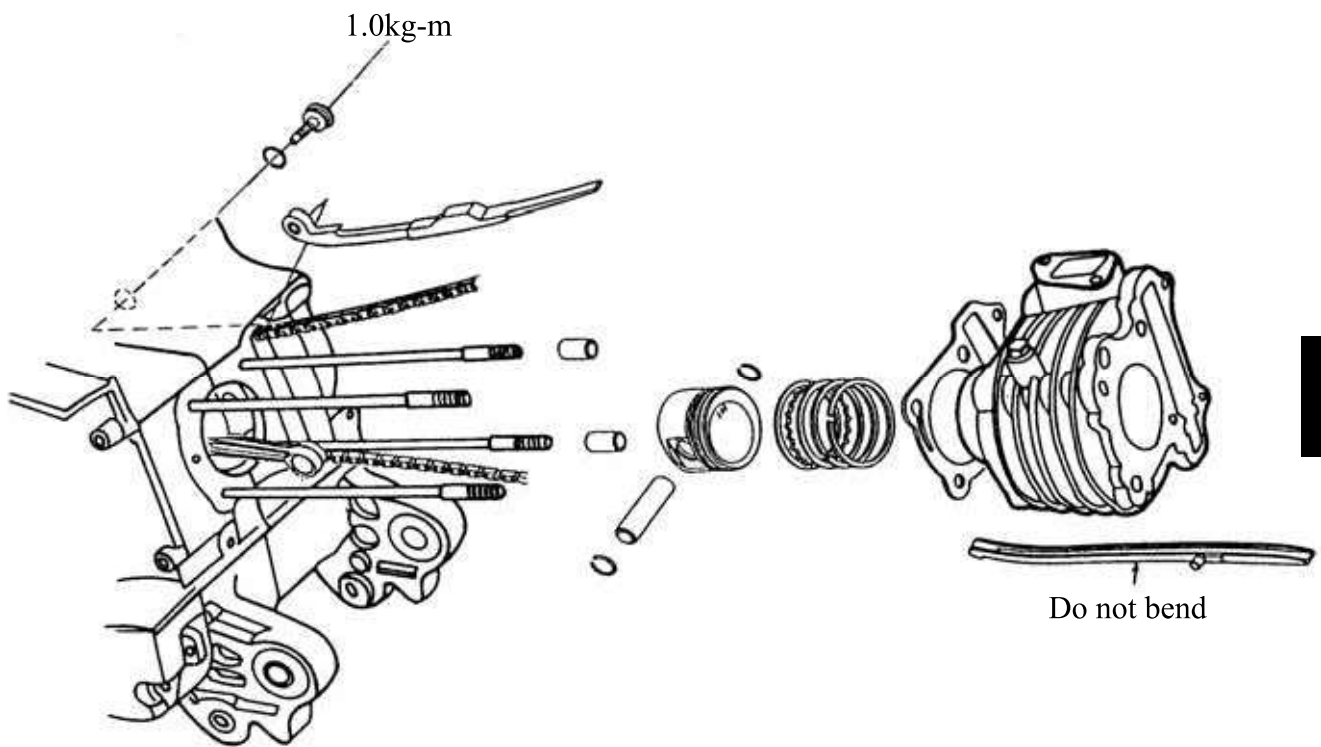

# 8. CYLINDER/PISTON

SERVICE INFORMATION.....8-1	PISTON REMOVAL..... 8-2
TROUBLESHOOTING.....8-1	PISTON INSTALLATION..... 8-6
CYLINDER REMOVAL .....8-2	CYLINDER INSTALLATION ..... 8-6

### SERVICE INFORMATION

#### GENERAL INSTRUCTIONS

- The cylinder and piston can be serviced with the engine installed in the frame.
- After disassembly, clean the removed parts and dry them with compressed air before inspection.

#### SPECIFICATIONS

Item		Standard (mm)	Service Limit (mm)	
Cylinder	I.D.	50.00-50.01		
	Warpage	—	0.05	
	Cylindricity	—	0.05	
	True roundness	—	0.05	
Piston, piston ring	Ring-to-clearance	Top	0.015-0.050	0.09
		Second	0.015-0.050	0.09
	Ring end gap	Top	0.08-0.20	0.45
		Second	0.05-0.20	0.45
		Oil side rail	0.20-0.70	—
	Piston O.D.		49.97-49.990	49.9
	Piston O.D. measuring		9mm from bottom of skirt	—
	Piston-to-cylinder clearance		0.010-0.040	0.1
Piston pin hole I.D.		13.002-13.008	13.04	
Piston pin O.D		12.994-13.000	12.96	
Piston-to-piston pin clearance		0.002-0.014	—	
Connecting rod small end I.D. bore		13.016-13.034	13.06	

### TROUBLESHOOTING

- When hard starting or poor performance at low speed occurs, check the crankcase breather for white smoke. If white smoke is found, it means that the piston rings are worn, stuck or broken.

#### Compression too low or uneven compression

- Worn, stuck or broken piston rings
- Worn or damaged cylinder and piston

#### Excessive smoke from exhaust muffler

- Worn or damaged piston rings
- Worn or damaged cylinder and piston

#### Compression too high

- Excessive carbon build-up in combustion chamber or on piston head

#### Abnormal noisy piston

- Worn cylinder, piston and piston rings
- Worn piston pin hole and piston pin

## 8. CYLINDER/PISTON

### CYLINDER REMOVAL

Remove the cylinder head. (⇒7-6)  
Remove the cam chain guide.  
Remove the cylinder.

Cylinder



Remove the cylinder gasket and dowel pins.  
Clean any gasket material from the cylinder surface.

Dowel Pins



Gasket

Piston Pin

### PISTON REMOVAL

Remove the piston pin clip.

Place a clean shop towel in the crankcase to keep the piston pin clip from falling into the crankcase.

Press the piston pin out of the piston and remove the piston.



Piston Rings

Piston

## 8. CYLINDER/PISTON

Inspect the piston, piston pin and piston rings.  
Remove the piston rings.

Take care not to damage or break the piston rings during removal.

Clean carbon deposits from the piston ring grooves.



Install the piston rings onto the piston and measure the piston ring-to-groove clearance.

**Service Limits:** **Top:** 0.09mm replace if over  
**2nd:** 0.09mm replace if over

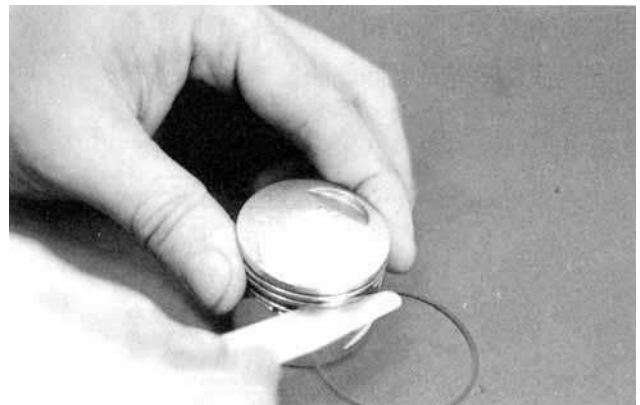

Remove the piston rings and insert each piston ring into the cylinder bottom.

Use the piston head to push each piston ring into the cylinder.

Measure the piston ring end gap.

**Service Limit:** 0.45mm replace if over



Measure the piston pin hole I.D.

**Service Limit:** 13.04mm replace if below



## 8. CYLINDER/PISTON

Measure the piston pin O.D.

**Service Limit:** 12.96mm replace if below

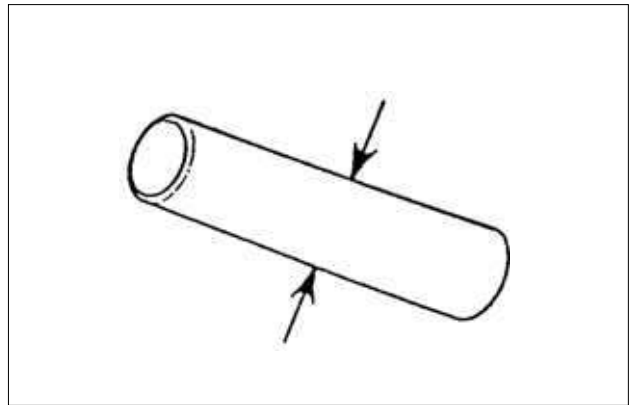

Measure the piston O.D.

Take measurement at 9mm from the bottom and 90° to the piston pin hole.

**Service Limit:** 38.9mm replace if below  
Measure the piston-to-piston pin clearance.

**Service Limit:** 0.02mm replace if over

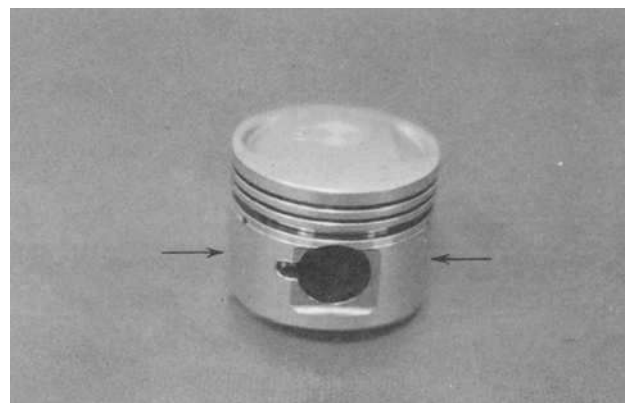

### CYLINDER INSPECTION

Inspect the cylinder bore for wear or damage. Measure the cylinder I.D. at three levels of top, middle and bottom at 90° to the piston pin (in both X and Y directions).

**Service Limit:** 39.10mm repair or replace if over

Measure the cylinder-to-piston clearance.

**Service Limit:** 0.1mm repair or replace if over

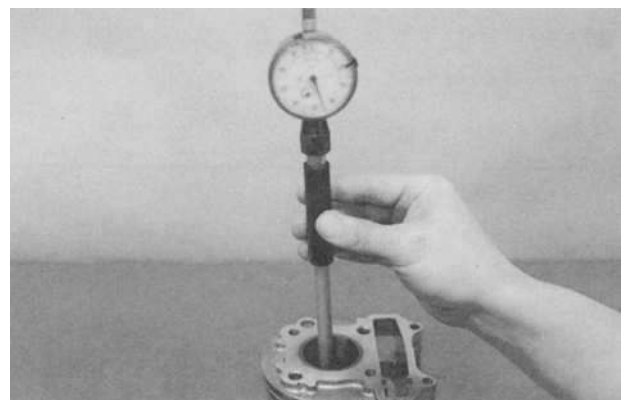

The true roundness is the difference between the values measured in X and Y directions. The cylindricity (difference between the values measured at the three levels) is subject to the maximum value calculated.

**Service Limits:**

**True Roundness:** 0.05mm repair or replace if over

**Cylindricity:** 0.05mm repair or replace if over

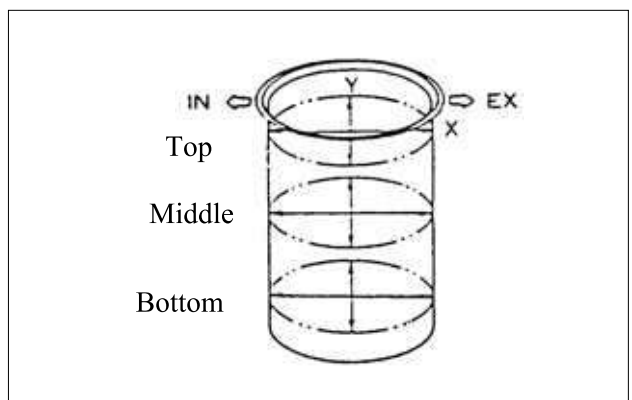

## 8. CYLINDER/PISTON

Inspect the top of the cylinder for warpage.  
**Service Limit:** 0.05mm repair or replace if over

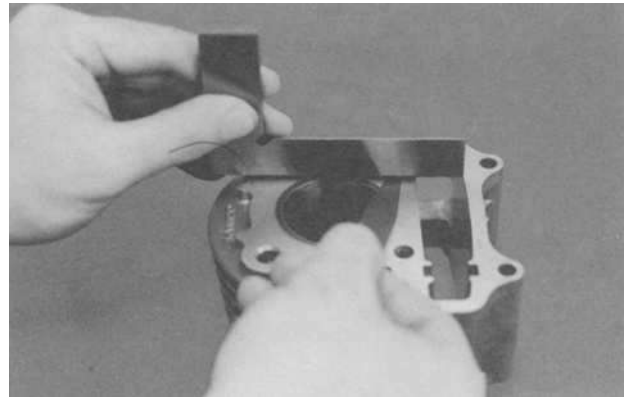

Measure the connecting rod small end I.D.  
**Service Limit:** 13.06mm replace if over



### PISTON RING INSTALLATION

Install the piston rings onto the piston.  
 Apply engine oil to each piston ring.

- Be careful not to damage or break the piston and piston rings.
- All rings should be installed with the markings facing up.
- After installing the rings, they should rotate freely without sticking.

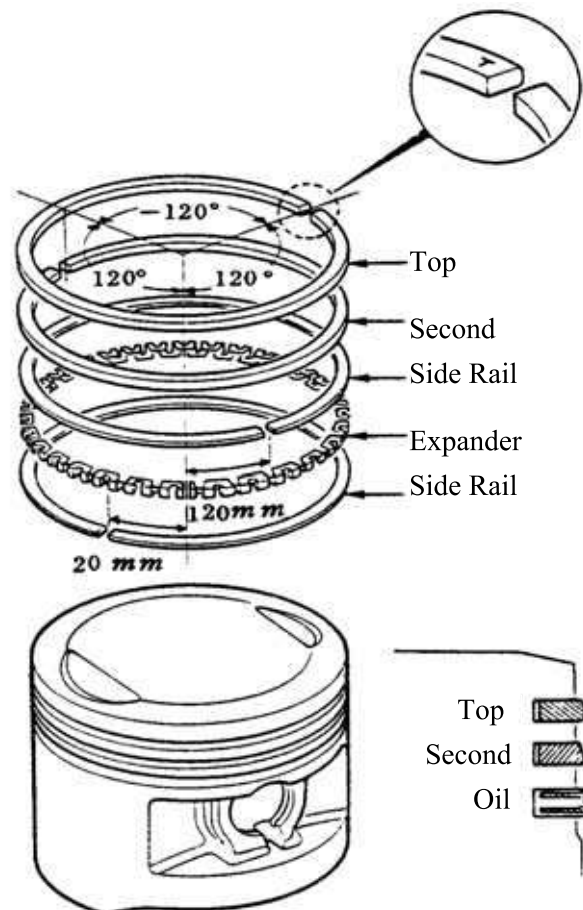





## 8. CYLINDER/PISTON

Install the cam chain guide.

Insert the tab on the cam chain guide into the cylinder groove.

Install the cylinder head. (⇒7-8)  
Loosely install the cylinder base bolts.

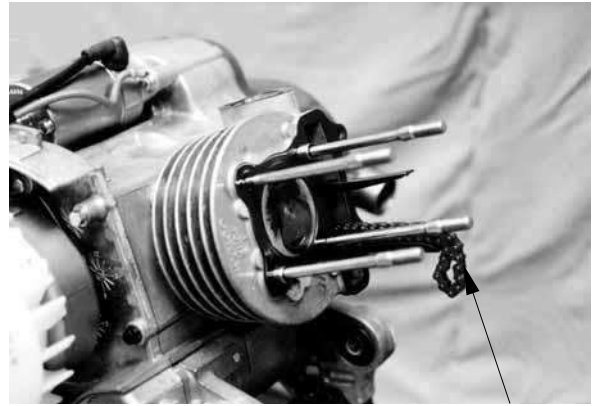

Cam Chain Guide

Tighten the cylinder base bolts.

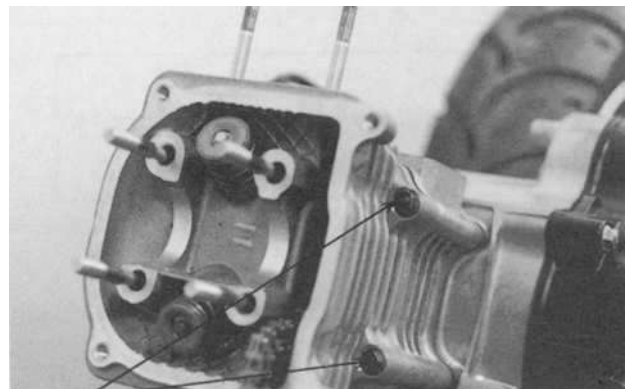

Cylinder Base Bolts



## 2. FRAME COVERS/EXHAUST MUFFLER

SERVICE INFORMATION .....	2-1	EXHAUST MUFFLER REMOVAL .....	2-5
FRAME COVERS .....	2-2		

### SERVICE INFORMATION

#### GENERAL INSTRUCTIONS

- When removing frame covers, use special care not to pull them by force because the cover joint claws may be damaged.

#### Items Related for Removal

- Handlebar front cover ——— Handlebar rear cover  
Headlight wire connector
- Handlebar rear cover ——— Speedometer cable and instrument light  
wire connectors, etc.
- Frame body cover ——— Met-in box, rear grip, rear turn signal  
lights, floor board
- Floor board ——— Frame body cover  
Battery and wire connectors
- Front tool box ——— Front cover, floor board

#### TORQUE VALUES

- |                                |              |
|--------------------------------|--------------|
| Exhaust muffler joint lock nut | 1.0~1.4kgf-m |
| Exhaust muffler lock bolt      | 3.0~3.6kgf-m |

## 2. FRAME COVERS/EXHAUST MUFFLER

AGILITY 50

### FRAME COVERS

#### FRONT COVER REMOVAL

Remove the screw on the front of the front cover.

Remove the six screws on the back of the front cover.

Remove the front cover.

The installation sequence is the reverse of removal.

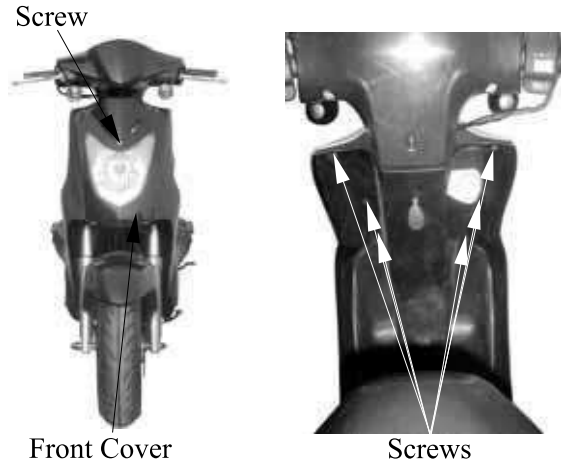

#### HANDLEBAR FRONT/REAR COVER REMOVAL

##### HANDLEBAR FRONT COVER REMOVAL

Remove the handlebar front cover screw.

Remove the two screws attaching the handlebar front cover.

Disconnect the headlight wire connector and remove the handlebar front cover.

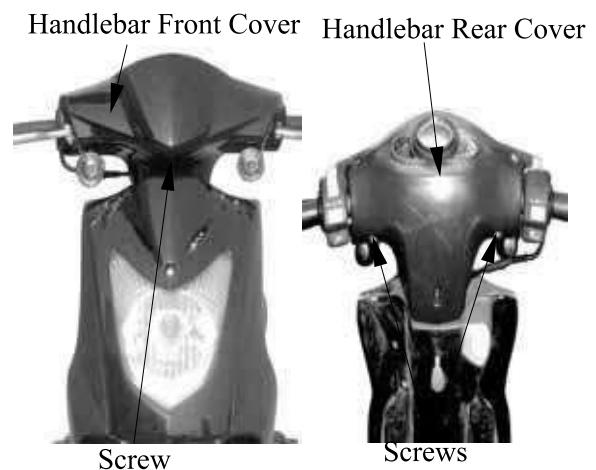

##### HANDLEBAR REAR COVER REMOVAL

Disconnect the speedometer cable, right and left handlebar switch couplers, and the stop switch wire connectors.

Remove the bolt attaching the handlebar rear cover.

Remove two screws inside the handlebar rear cover and remove the handlebar rear cover.

The installation sequence is the reverse of removal.

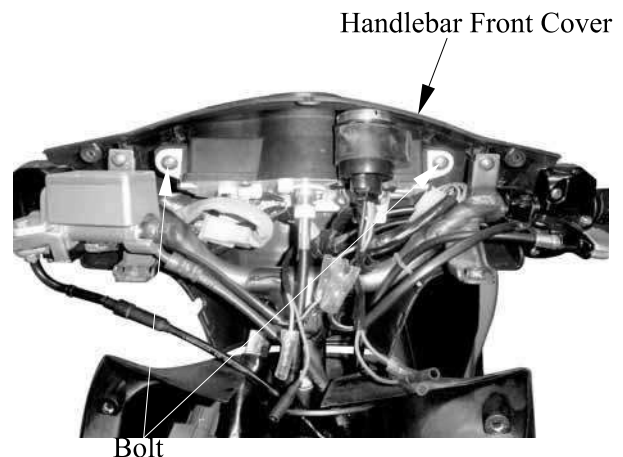

## 2. FRAME COVERS/EXHAUST MUFFLER

AGILITY 50

### MET-IN BOX REMOVAL

Open the seat and remove the two nuts and three bolt attaching the met-in box.  
Remove the met-in box .

Bolt



Bolts

### FRAME BODY COVER REMOVAL

Remove the center cover.

Center Cover



Remove the three bolts attaching the rear carrier.  
Remove the rear carrier.  
Remove the four bolts on the rear seat.  
Remove the rear seat

Rear Carrier

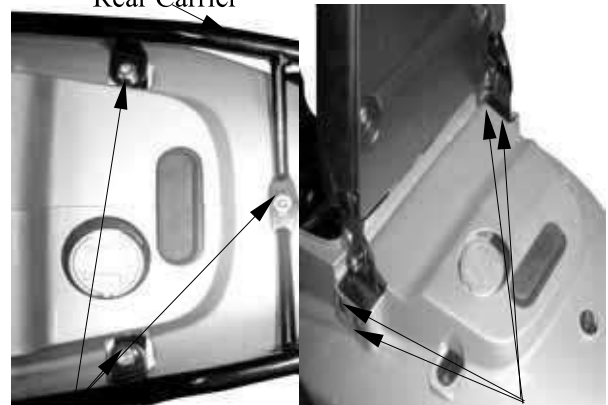

Bolts

Bolts

Remove the six screws on the rear part of the frame body cover.  
Remove the two screws on the front of the frame body cover.

Screws

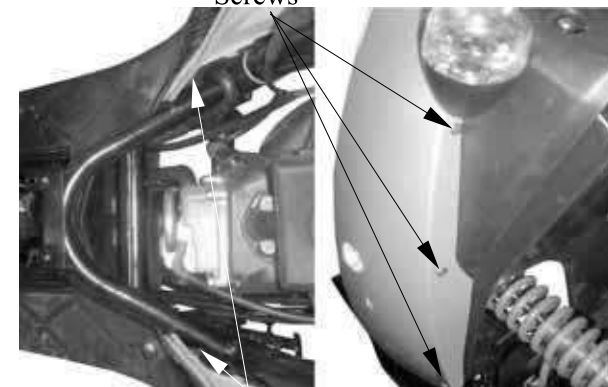

Screws

## 2. FRAME COVERS/EXHAUST MUFFLER

AGILITY 50

Disconnect the seat lock wire.  
Remove the frame body cover.

The installation sequence is the reverse of remove

Remove the three bolts attaching each of the right and left side covers.  
Remove the right and left side covers.

During removal, do not pull the joint claws forcedly to avoid damage.  
When installing, be sure to connect the seat lock wire.

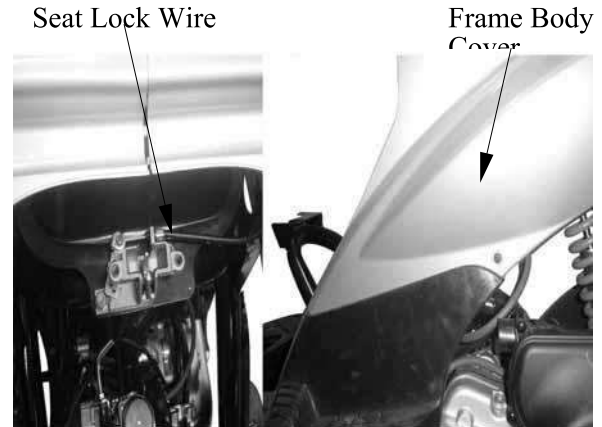

### FLOOR BOARD REMOVAL

Remove the rear carrier and rear seat. (⇒2-3)  
Remove the met-in box. (⇒2-3)  
Remove the frame body cover. (⇒2-4)  
Remove the eight bolts attaching the floor board.  
Remove the floor board.

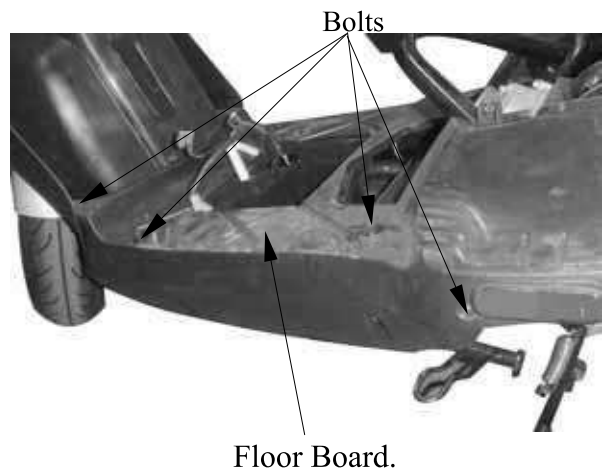

### BOTTOM PROTECTOR COVER REMOVAL

Remove the sixbolts on the bottom protector cover.  
Remove the bottom protector cover.

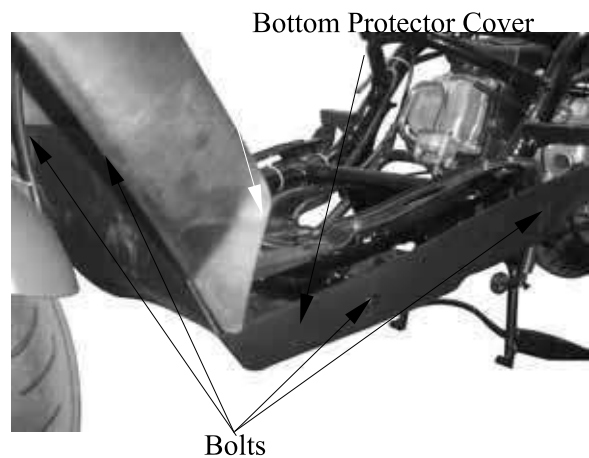

## 2. FRAME COVERS/EXHAUST MUFFLER

AGILITY 50

### LEG SHIELD REMOVAL

Remove the bolt leg shield.  
Remove the ignition switch decorative ring.  
Remove the leg shield.

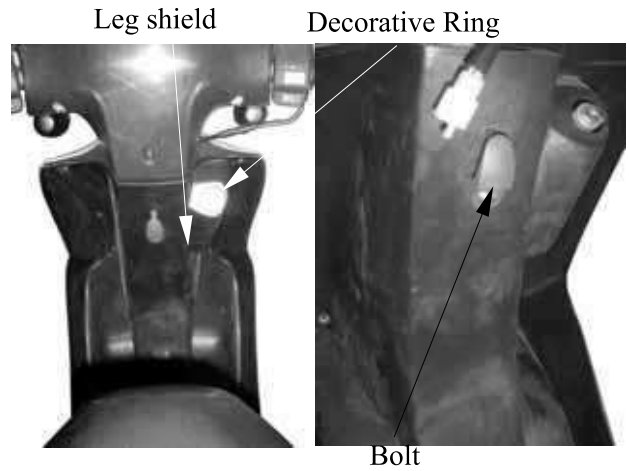

Leg shield

Decorative Ring

Bolt

### FRONT FENDER REMOVAL

Remove the two bolts attaching the front fender bracket.  
Remove the front fender.

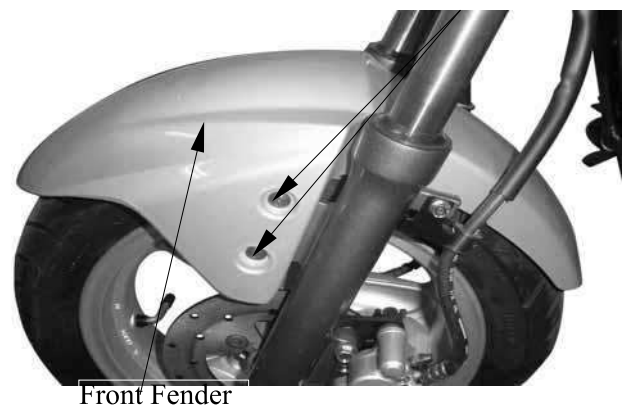

Bolts

Front Fender

### EXHAUST MUFFLER REMOVAL

Remove the two exhaust muffler joint lock nuts.  
Remove the two exhaust muffler lock bolts.  
Remove the exhaust muffler.  
Remove the exhaust muffler joint packing collar.

When installing, first install the exhaust muffler packing collar and then install the exhaust muffler.  
First install and tighten the exhaust muffler joint lock nuts. Then, install and tighten the exhaust muffler lock bolts.

#### Torques:

Exhaust muffler lock bolt: 3.0~3.6kgf-m  
Exhaust muffler joint lock nut: 1.0~1.4kgf-m

Be sure to install a new exhaust muffler packing collar.

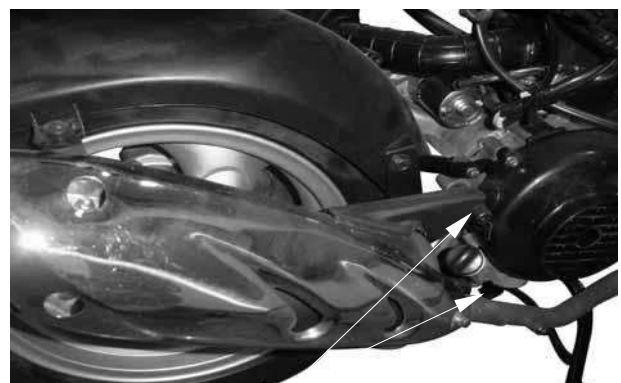

Bolts

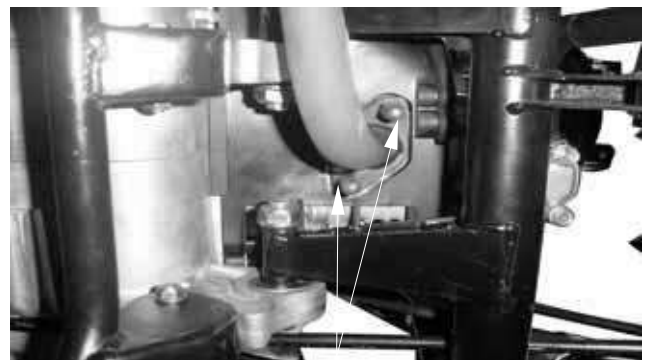

Lock Nut

<b>SERVICE INFORMATION.....3-0</b>	<b>FINAL REDUCTION GEAR OIL.....3- 7</b>
<b>MAINTENANCE SCHEDULE.....3-2</b>	<b>DRIVE BELT.....3- 7</b>
<b>FUEL FILTER.....3-3</b>	<b>BRAKE SHOE .....3- 8</b>
<b>THROTTLE OPERATION.....3-3</b>	<b>BRAKE ADJUSTING NUT.....3- 8</b>
<b>AIR CLEANER .....3-4</b>	<b>HEADLIGHT AIM .....3- 9</b>
<b>SPARK PLUG .....3-4</b>	<b>CLUTCH SHOE WEAR.....3- 9</b>
<b>VALVE CLEARANCE .....3-5</b>	<b>SUSPENSION .....3- 9</b>
<b>CARBURETOR IDLE SPEED .....3-5</b>	<b>NUTS/BOLTS/FASTENERS.....3-10</b>
<b>IGNITION TIMING .....3-6</b>	<b>WHEELS/TIRES.....3-10</b>
<b>CYLINDER COMPRESSION .....3-6</b>	<b>STEERING HANDLEBAR .....3-11</b>

### SERVICE INFORMATION

#### GENERAL

 **WARNING**

- Before running the engine, make sure that the working area is well-ventilated. Never run the engine in a closed area. The exhaust contains poisonous carbon monoxide gas which may cause death to people.
- Gasoline is extremely flammable and is explosive under some conditions. The working area must be well-ventilated and do not smoke or allow flames or sparks near the working area or fuel storage area.

#### SPECIFICATIONS

##### ENGINE

- Throttle grip free play : 2~6mm
- Spark plug gap : 0.6~0.7mm
- Spark plug : NGK C7HSA
  
- Valve clearance : IN: 0.04mm  
: EX: 0.04mm
- Idle speed : 1900 ±100rpm
- Engine oil capacity:
  - At disassembly : 0.85 liter
  - At change : 0.7 liter
- Gear oil capacity :
  - At disassembly : 0.11 liter
  - At change : 0.10 liter



### 3. INSPECTION/ADJUSTMENT

---

Cylinder compression : 16 kg/cm<sup>2</sup>  
Ignition timing: BTDC 28°/4000rpm

#### CHASSIS

Front brake free play: 10~20mm

Rear brake free play : 10~20mm

#### TIRE PRESSURE

	1 Rider	2 Riders
Front	1.5kg/cm <sup>2</sup>	1.75kg/cm <sup>2</sup>
Rear	2.0kg/cm <sup>2</sup>	2.25kg/cm <sup>2</sup>

#### TIRE SIZE:

Front : 120/70-12

Rear : 130/70-12

#### TORQUE VALUES

Front axle nut 5.0~7.0kgf-m

Rear axle nut 11~13kgf-m

### 3. INSPECTION/ADJUSTMENT

#### MAINTENANCE SCHEDULE

Perform the periodic maintenance at each scheduled maintenance period.

I: Inspect, and Clean, Adjust, Lubricate or Replace if necessary.

A: Adjust C: Clean R: Replace T: Tighten

Item	Frequency	Whichever comes first ⇄ ↓	Regular Service Mileage (km)											
			1000	2000	3000	4000	5000	6000	7000	8000	9000	10000	11000	12000
Engine oil			R New Motorcycle 300km	R		R		R		R		R		R
Engine oil filter screen						C				C				
Fuel filter screen												R		
Gear oil	Note 3		R New motorcycle 300km					R					R	
Valve clearance				A		A				A				A
Carburetor						I				I				C
Air Cleaner	Note 2,3		Replace at every 2000km											
Spark plug			Clean at every 3000km and replace if necessary											
Brake system			I	I	I	I	I	I	I	I	I	I	I	I
Drive belt										I				
Suspension						I				I				I
Nut, bolt, fastener										I				
Tire						I				I				I
Steering head bearing			I							I				I

- In the interest of safety, we recommend these items should be serviced only by an authorized KYMCO motorcycle dealer.

Note: 1. For higher odometer readings, repeat at the frequency interval established here.

2. Service more frequently when riding in dusty or rainy areas.

3. Service more frequently when riding in rain or at full throttle.

### 3. INSPECTION/ADJUSTMENT

#### FUEL FILTER

Remove the met-in box. (⇒2-3)  
 Check the fuel lines and replace any parts which show signs of deterioration, damage or leakage.

Do not smoke or allow flames or sparks in your working area.

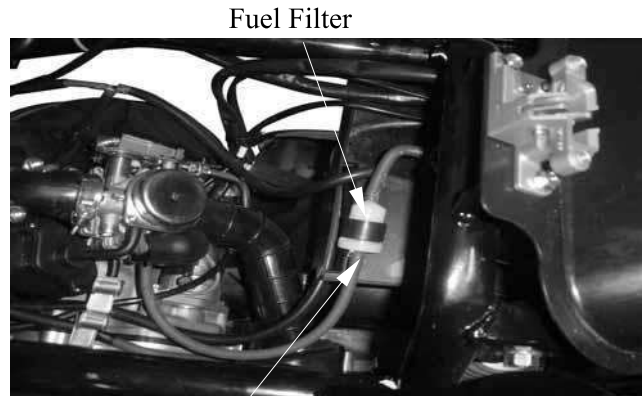

Fuel Filter

Fuel Line

#### THROTTLE OPERATION

Check the throttle grip for smooth movement.  
 Measure the throttle grip free play.

**Free Play:** 2~6mm

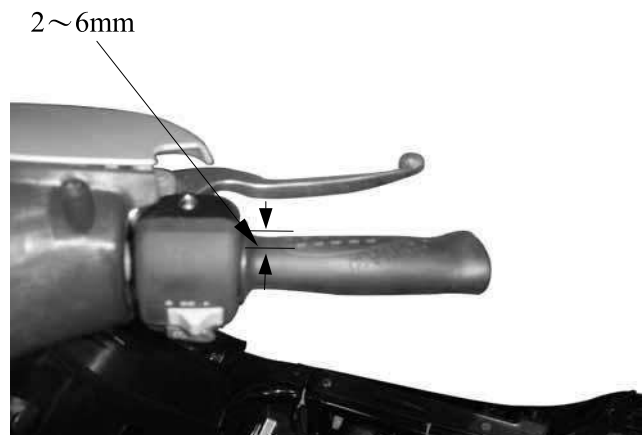

2~6mm

Major adjustment of the throttle grip free play is made at the carburetor side.  
 Adjust by loosening the lock nut and turning the adjusting nut.



Lock Nut

Adjusting Nut

Minor adjustment is made with the adjusting nut at the throttle grip side.  
 Slide the rubber cover out and adjust by loosening the lock nut and turning the adjusting nut.

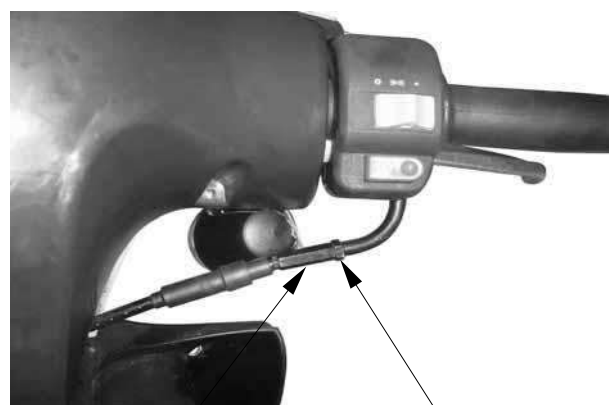

Adjusting Nut

Lock Nut

### 3. INSPECTION/ADJUSTMENT

#### AIR CLEANER

##### AIR CLEANER REPLACEMENT

Remove the air cleaner case cover screws and the cover by removing the seven screws.

Remove the air cleaner element by removing the four screws.

Check the element and replace it if it is excessively dirty or damaged.

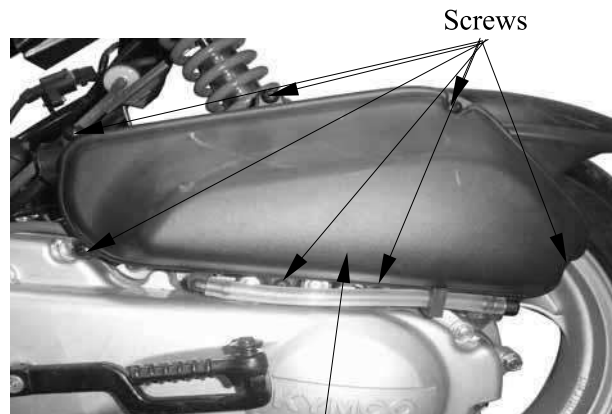

Air Cleaner Case Cover

##### CHANGE INTERVAL

More frequent replacement is required when riding in unusually dusty or rainy areas.

- The air cleaner element has a viscous type paper element. Do not clean it with any fluid.
- Be sure to install the air cleaner element and cover securely.

Air Cleaner Element



#### SPARK PLUG

Remove the spark plug.

Check the spark plug for wear and fouling deposits.

Clean any fouling deposits with a spark plug cleaner or a wire brush.

##### Specified Spark Plug:

CHAMPION-P-RZ9HC



Measure the spark plug gap.

**Spark Plug Gap:** 0.6~0.7mm

When installing, first screw in the spark plug by hand and then tighten it with a spark plug wrench.

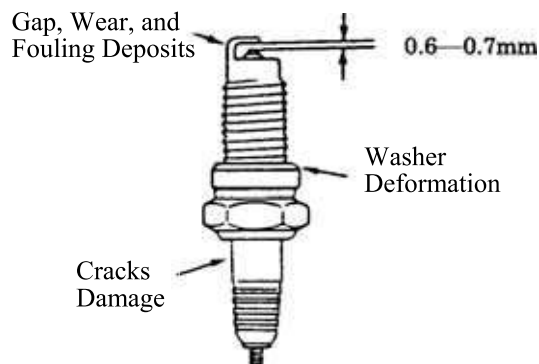

### 3. INSPECTION/ADJUSTMENT

#### VALVE CLEARANCE

Inspect and adjust valve clearance while the engine is cold (below 35°C).

- Remove the frame cover. (⇒2-3)
- Remove the six bolts on the cylinder head cover.
- Remove the cylinder head cover. (⇒7-3)
- Remove the cylinder head cover..

Cylinder Head Cover

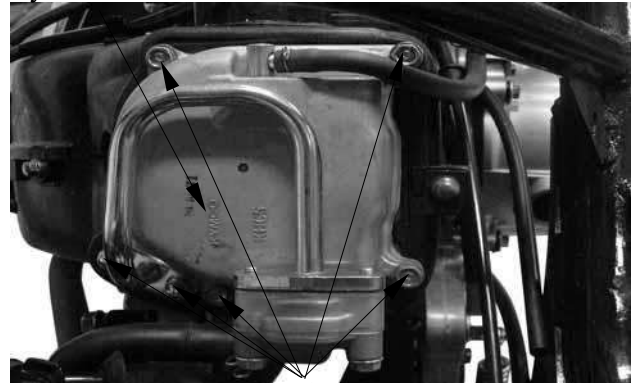

Bolts

Turn the flywheel counterclockwise so that the “T” mark on the flywheel aligns with the index mark on the crankcase to bring the round hole on the camshaft gear facing up to the top dead center on the compression stroke.

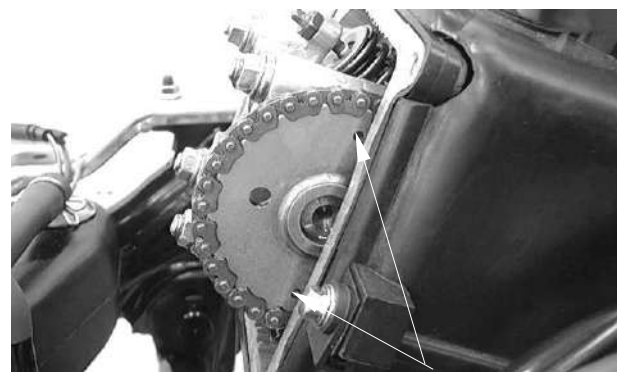

Round Hole

Inspect and adjust the valve clearance.

**Valve Clearance:** IN : 0.04mm  
EX: 0.04mm

Loosen the lock nut and adjust by turning the adjusting nut

Special

Tappet Adjuster

- Check the valve clearance again after the lock nut is tightened.

Tappet Adjuster



Feeler Gauge

#### CARBURETOR IDLE SPEED

- The engine must be warm for accurate idle speed inspection and adjustment.

Remove the inspection cover.  
Warm up the engine before this operation.  
Start the engine and connect a tachometer.  
Turn the throttle stop screw to obtain the specified idle speed.

**Idle Speed:** 1900±100rpm

When the engine misses or run erratic, adjust the pilot screw.



Throttle Stop Screw

### 3. INSPECTION/ADJUSTMENT

FILLY LX 50

#### IGNITION TIMING

The CDI unit is not adjustable. If the ignition timing is incorrect, check the ignition system. (⇒15-5)

Remove the right of the fan cover.



Check the ignition timing with a timing light. When the engine is running at idle speed, the ignition timing is correct if the “F” mark on the flywheel aligns with the index mark on the crankcase.



Also use a timing light to check the advance. Raise the engine speed to 4,000rpm and the index mark on the crankcase cover should be aligned with the advance mark on the flywheel.

#### CYLINDER COMPRESSION

Warm up the engine before compression test. Remove the met-in box and center cover. (⇒2-3)

Remove the spark plug.

Insert a compression gauge.

Open the throttle valve fully and push the starter button to test the compression.

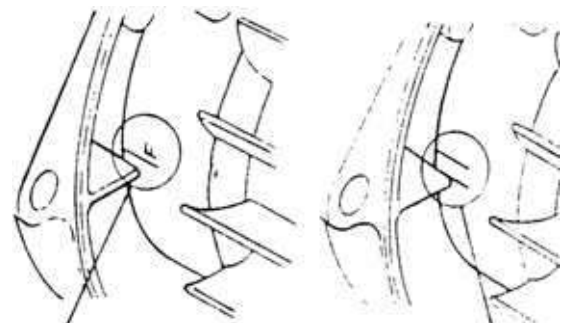

“F” Mark

Advance Mark

**Compression:** 16kg/cm<sup>2</sup>rpm

If the compression is low, check for the following:

- Leaky valves
- Valve clearance too small
- Leaking cylinder head gasket
- Worn piston rings
- Worn piston/cylinder

If the compression is high, it indicates that carbon deposits have accumulated on the combustion chamber and the piston head.

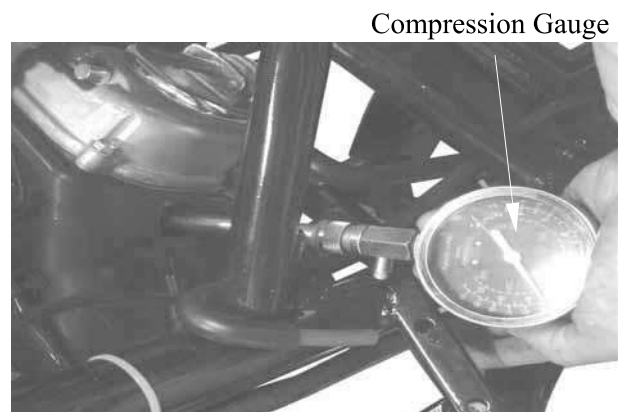

### 3. INSPECTION/ADJUSTMENT

#### FINAL REDUCTION GEAR OIL OIL LEVEL CHECK

Place the motorcycle on its main stand on level ground for oil level check.

Stop the engine and remove the oil check bolt. The oil level shall be at the oil check bolt hole.

If the oil level is low, add the recommended oil to the proper level.

**Recommended Oil: SAE90#**

Install the oil check bolt.

Make sure that the sealing washer is in good condition.



Oil Check Bolt/Sealing Washer



Oil Check Bolt Hole

#### OIL CHANGE

Remove the oil check bolt.

Remove the oil drain bolt and drain the oil thoroughly.

Install the oil drain bolt.

**Torque: 0.8~1.2kgf-m**

Make sure that the sealing washer is in good condition.

Fill with the recommended oil.

**Oil Capacity:** At disassembly : 0.11 liter  
At change : 0.10 liter

Reinstall the oil check bolt and check for oil leaks.

**Torque:0.8~1.2kgf-m**



Oil Drain Bolt/ Sealing Washer

#### DRIVE BELT

Remove the left crankcase cover. (⇒9-2)

Inspect the drive belt for cracks or excessive wear.

Replace the drive belt with a new one if necessary and in accordance with the Maintenance Schedule.

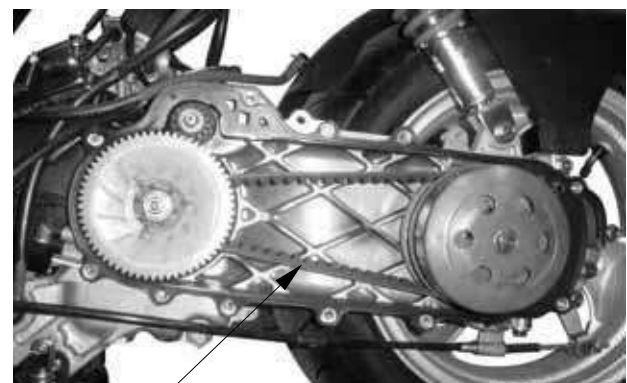

Drive Belt

### 3. INSPECTION/ADJUSTMENT

#### BRAKE SHOE

Replace the brake shoes if the arrow on the wear indicator plate aligns with the punch mark on the brake panel when the brake is fully applied.

Refer to page 12-7 and 13-3 for brake shoe replacement.

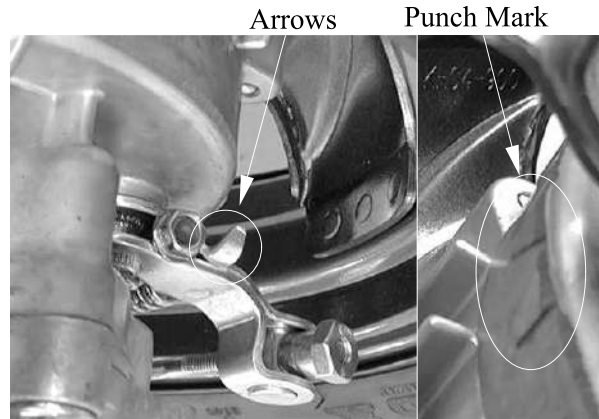

#### REAR BRAKE

Measure the rear brake lever free play.

**Free Play:** 10~20mm



#### BRAKE ADJUSTING NUT

If the free play do not fall within the limit, adjust by turning the adjusting nut.

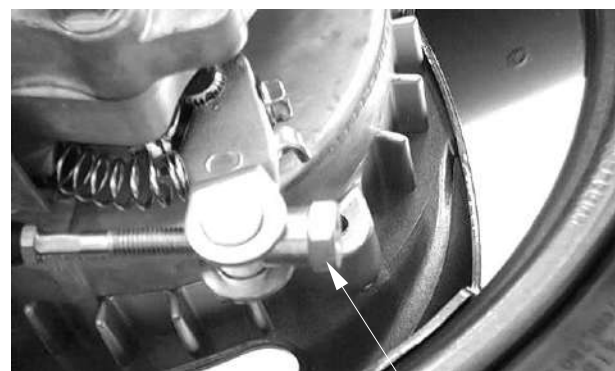

Adjusting Nut

#### BRAKE FLUID

Turn the steering handlebar upright and check if the rear brake fluid level should be between the upper and lower level lines.

**Specified Brake Fluid:** DOT-4 ◦

Upper Line



Lower Line



### 3. INSPECTION/ADJUSTMENT

If the free play do not fall within the limit, adjust by turning the adjusting nut.



Adjusting Nut

#### HEADLIGHT AIM

Turn the ignition switch ON and start the engine.  
Turn on the headlight switch.  
Adjust the headlight aim by turning the headlight aim adjusting screw.

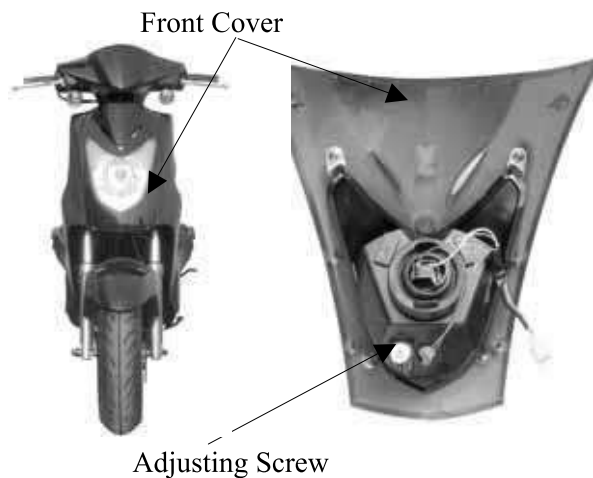

#### CLUTCH SHOE WEAR

Start the engine and check the clutch operation by increasing the engine speed gradually.  
If the motorcycle tends to creep, or the engine stalls, check the clutch shoes for wear and replace if necessary. (⇒9-11)

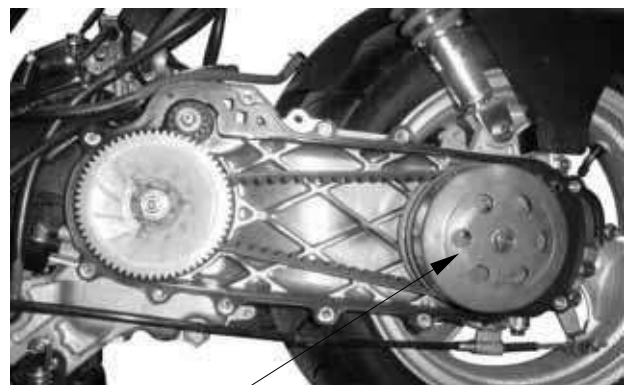

clutch

#### SUSPENSION

##### FRONT

Fully apply the front brake lever and check the action of the front shock absorbers by compressing them several times.  
Check the entire shock absorber assembly for oil leaks, looseness or damage.



### 3. INSPECTION/ADJUSTMENT

#### REAR

Check the action of the rear shock absorber by compressing it several times.  
 Check the entire shock absorber assembly for oil leaks, looseness or damage.  
 Jack the rear wheel off the ground and move the rear wheel sideways with force to see if the engine hanger bushings are worn.



#### NUTS/BOLTS/FASTENERS

Check all important chassis nuts and bolts for looseness.  
 Tighten them to their specified torque values if any looseness is found. (⇒1-11)

#### WHEELS/TIRES

Check the tires for cuts, imbedded nails or other damages.

Check the tire pressure.

Tire pressure should be checked when tires are cold.



#### TIRE PRESSURE

	1 Rider	2 Riders
Front	1.5kg/cm <sup>2</sup>	1.75kg/cm <sup>2</sup>
Rear	2.00kg/cm <sup>2</sup>	2.25kg/cm <sup>2</sup>

#### TIRE SIZE

**Front** : 120/70-12

**Rear** : 130/70-12

Check the front axle nut for looseness.  
 Check the rear axle nut for looseness.  
 If the axle nuts are loose, tighten them to the specified torques.

**Torques: Front** : 5.0~7.0kgf-m

**Rear** : 11~13kgf-m



Front Axle Nut

### **3. INSPECTION/ADJUSTMENT**

#### **STEERING HANDLEBAR**

Check that the control cables do not interfere with handlebar rotation.

Raise the front wheel off the ground and check that the steering handlebar rotates freely.

If the handlebar moves unevenly, binds, or has vertical movement, adjust the steering head bearing.



# 4. LUBRICATION SYSTEM

## LUBRICATION SYSTEM

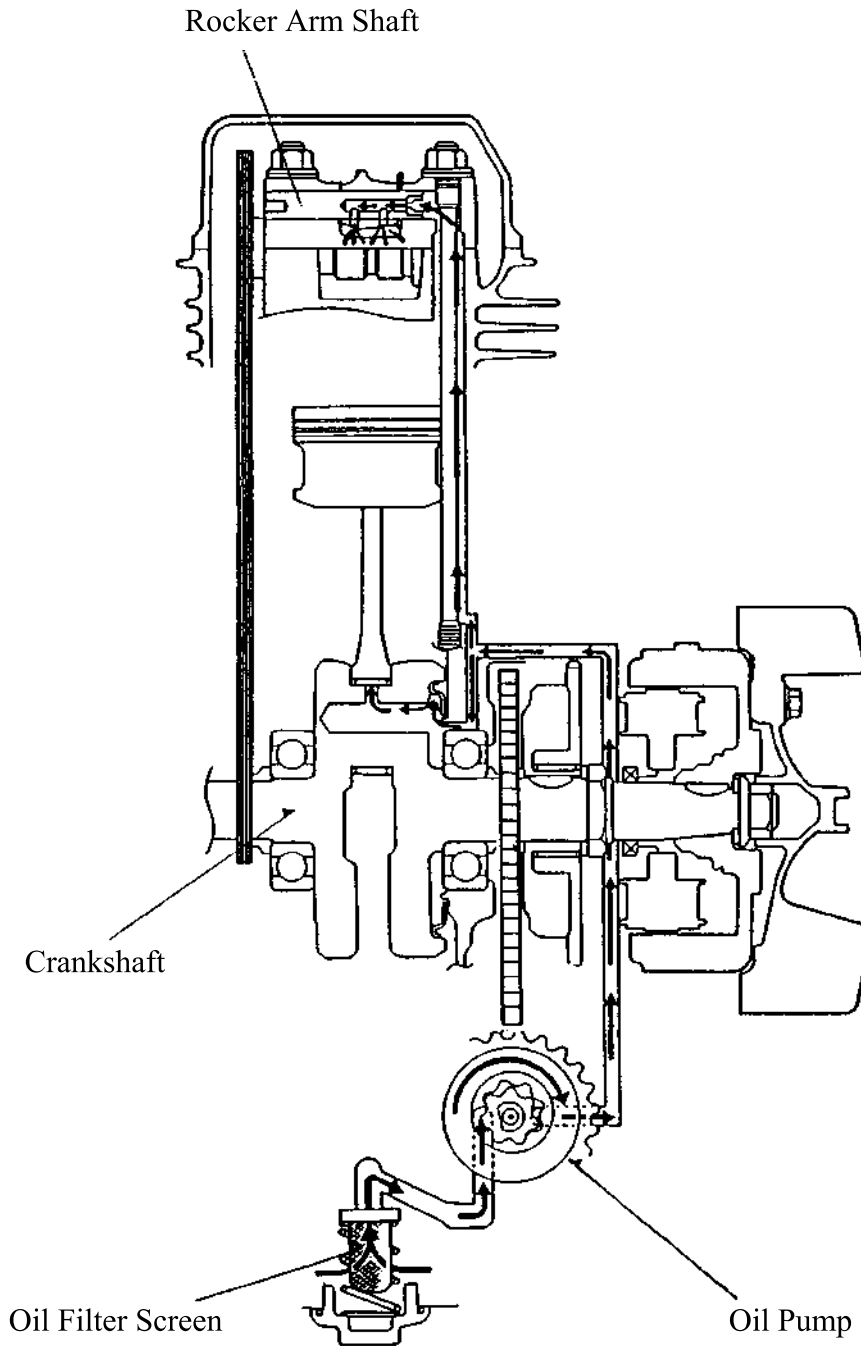

**4**

# 4. LUBRICATION SYSTEM

SERVICE INFORMATION.....	4-1	ENGINE OIL/OIL FILTER .....	4-2
TROUBLESHOOTING .....	4-1	OIL PUMP.....	4-3

## SERVICE INFORMATION

### GENERAL INSTRUCTIONS

- The maintenance of lubrication system can be performed with the engine installed in the frame.
- Use care when removing and installing the oil pump not to allow dust and foreign matters to enter the engine and oil line.
- Do not attempt to disassemble the oil pump. The oil pump must be replaced as a set when it reaches its service limit.
- After the oil pump is installed, check each part for oil leaks.

### SPECIFICATIONS

Item		Standard (mm)	Service Limit (mm)
Oil pump	Inner rotor-to-outer rotor clearance	—	0.12
	Outer rotor-to-pump body clearance	—	0.12
	Rotor end-to-pump body clearance	0.05~0.10	0.2

## TROUBLESHOOTING

### Oil level too low

- Natural oil consumption
- Oil leaks
- Worn or poorly installed piston rings
- Worn valve guide or seal

### Poor lubrication pressure

- Oil level too low
- Clogged oil filter or oil passages
- Not use the specified oil

## 4. LUBRICATION SYSTEM

### ENGINE OIL/OIL FILTER

#### OIL LEVEL

- Place the motorcycle upright on level ground for engine oil level check.
- Run the engine for 2~3 minutes and check the oil level after the engine is stopped for 2~3 minutes.

Remove the oil dipstick and check the oil level with the oil dipstick.  
If the level is near the lower level, fill to the upper level with the specified engine oil.

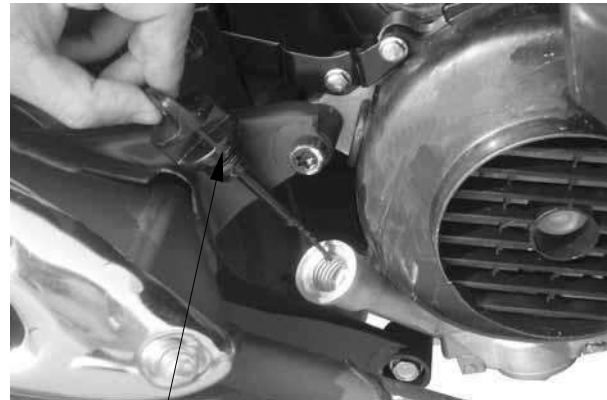

Oil Dipstick

#### OIL CHANGE

The engine oil will drain more easily while the engine is warm.

Remove the drain bolt to drain the engine oil thoroughly.  
Remove the oil filter screen cap and clean the oil filter screen with compressed air.



Oil Filter Screen Cap

Check the filter screen O-ring for damage and replace if necessary.  
Install the oil filter screen, spring and filter screen cap.

**Torque:** 1.0~2.0kgf-m

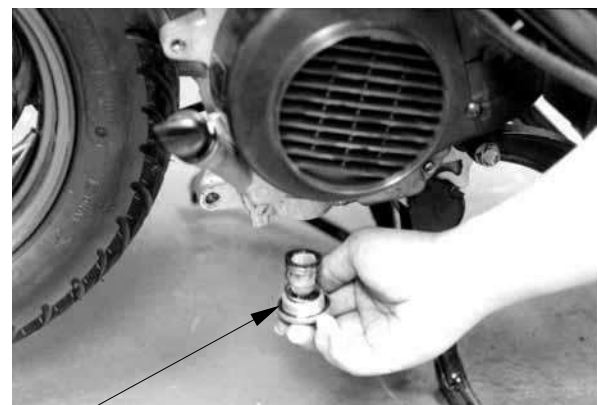

O-ring

Fill the crankcase with the specified engine oil to the proper level.

Oil Capacity: At disassembly : 0.85 liter

At change : 0.70 liter

Check for oil leaks and then start the engine and let it idle for few minutes.  
Recheck the oil level.

## 4. LUBRICATION SYSTEM

### OIL PUMP

#### REMOVAL

Remove the A.C. generator flywheel. (⇒14-7)

Remove the A.C. generator stator and pulsar coil. (⇒14-6)

Remove the eight right crankcase cover bolts and the right crankcase cover.

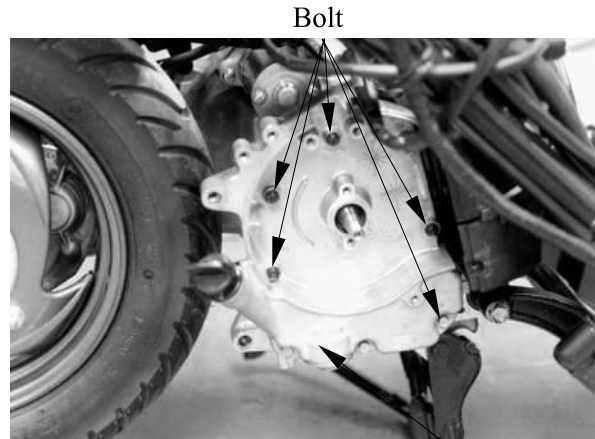

Right Crankcase Cover

Remove the gasket and dowel pins.

Remove the oil pump drive gear circlip.

Remove the oil pump gear.

Oil Pump Drive Gear

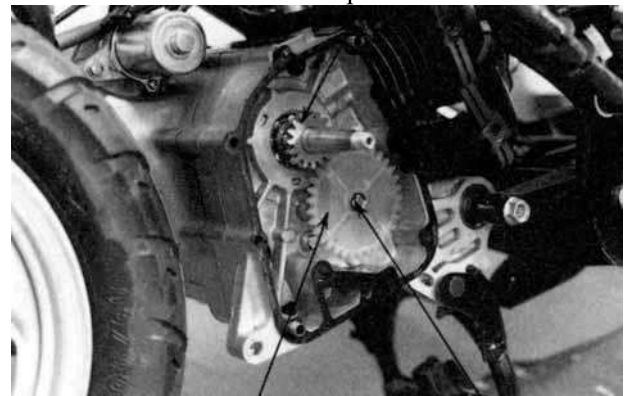

Oil Pump Gear

Circlip

Remove the oil pump mounting bolts.

Remove the oil pump.

Oil Pump

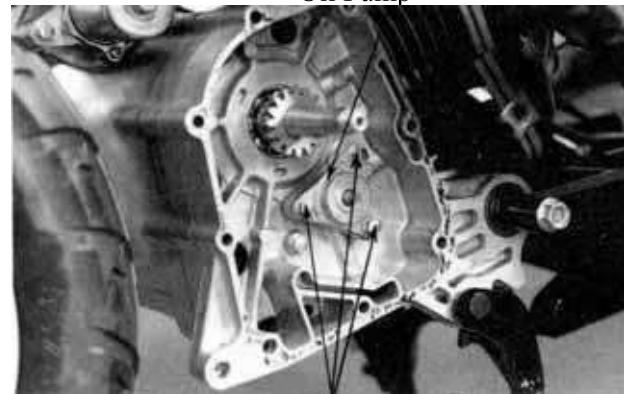

Bolts

Remove the two O-rings.

Inspect the two O-rings for damage or deterioration.

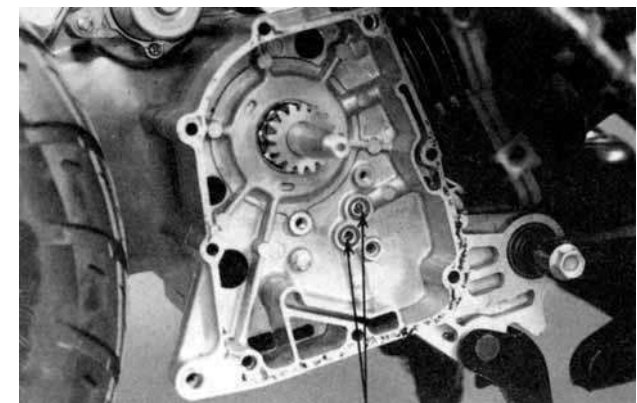

O-rings

## 4. LUBRICATION SYSTEM

### DISASSEMBLY

Remove the three oil pump boby screws.  
Disassembly the oil pump.

Oil Pump Boby

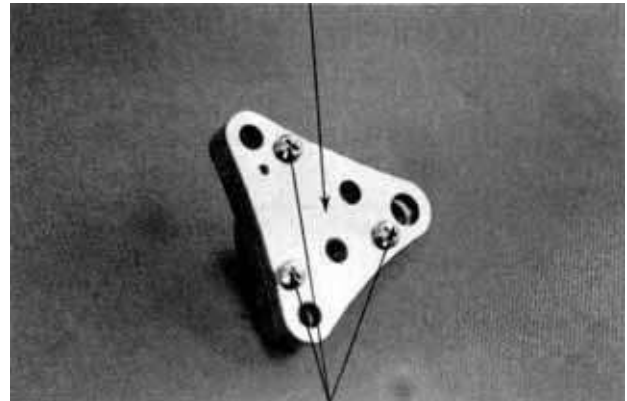

Screws

### INSPECTION

Measure the pump boby-to-outer rotor clearance.

**Service Limit:** 0.12mm

Outer Rotor



Oil Pump Boby

Measure the inner rotor-to-outer rotor clearance.

**Service Limit:** 0.12mm

Outer Rotor

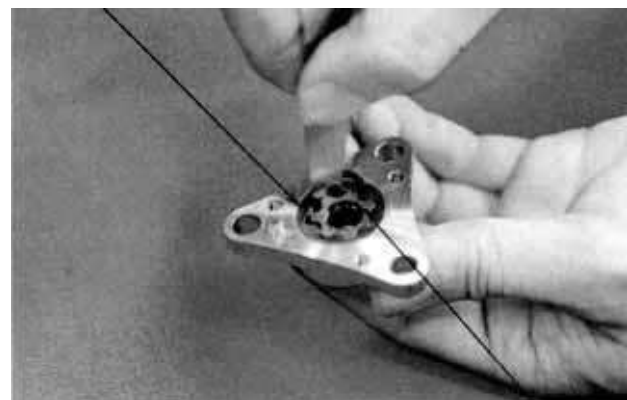

Inner Rotor

Measure the rotor end-to- pump boby clearance.

**Service Limit:** 0.2mm

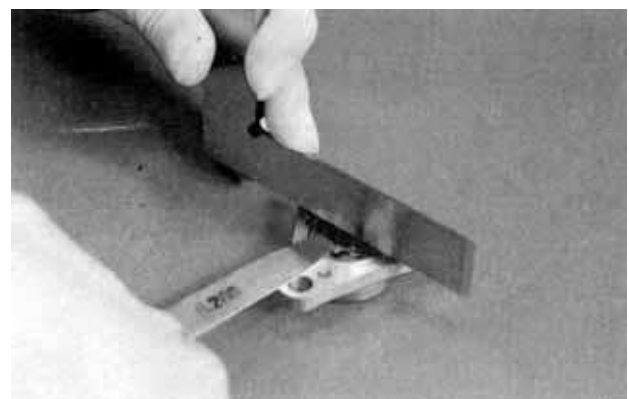



## 4. LUBRICATION SYSTEM

### ASSEMBLY

Install the outer rotor, inner rotor and pump shaft into the pump body.

Install the pump shaft by aligning the flat on the shaft with the flat in the inner rotor.

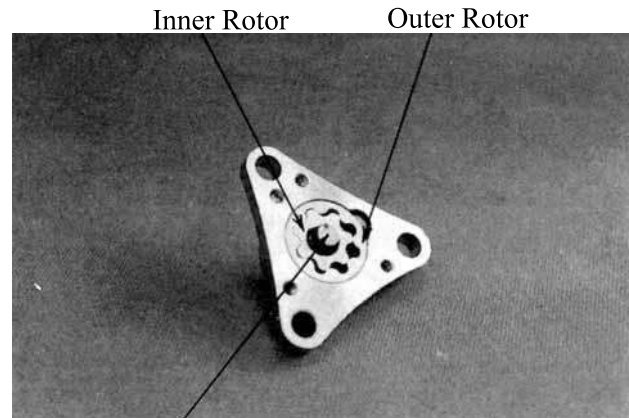

Pump Shaft

Install the pump cover and tighten the screws to secure the pump cover.

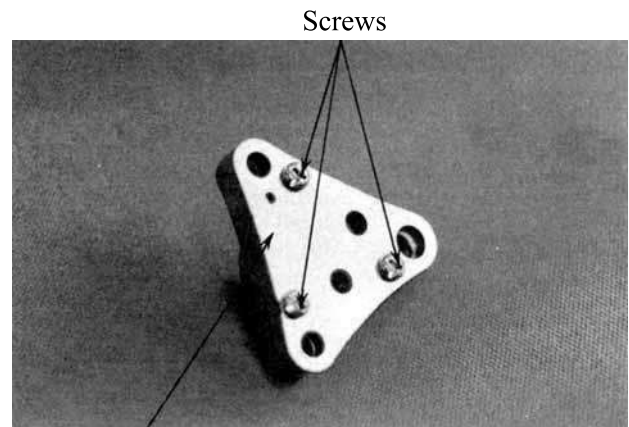

Pump Cover

### INSTALLATION

First install the two O-rings onto the oil pump base.

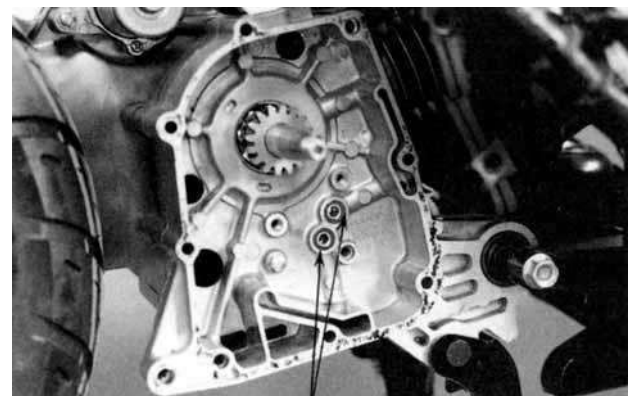

O-rings

Install the oil pump into the crankcase.

Fill the oil pump with engine oil before installation.

After the oil pump is installed, tighten the three mounting bolts.

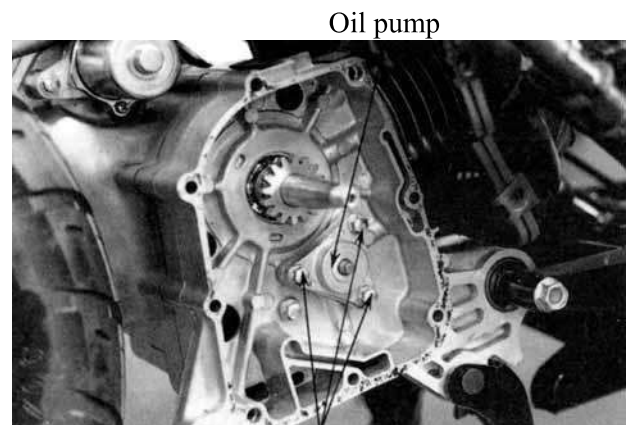

Bolts

## 4. LUBRICATION SYSTEM

Install the pump driven gear and secure it with the circlip.

**Torque:** 0.8~1.2kg-m

Pump Driven Gear



Circlip

Install the right crankcase cover and tighten the eight bolts.

**Torque:** 0.8~1.2kgf-m

Diagonally tighten the bolts in 2~3 times.

Right Crankcase Cover

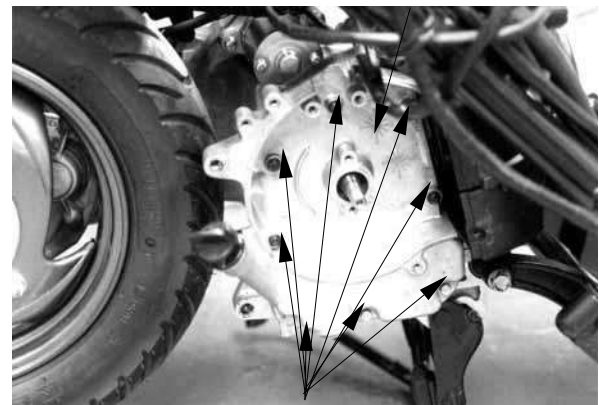

Bolts

**5. FUEL SYSTEM**

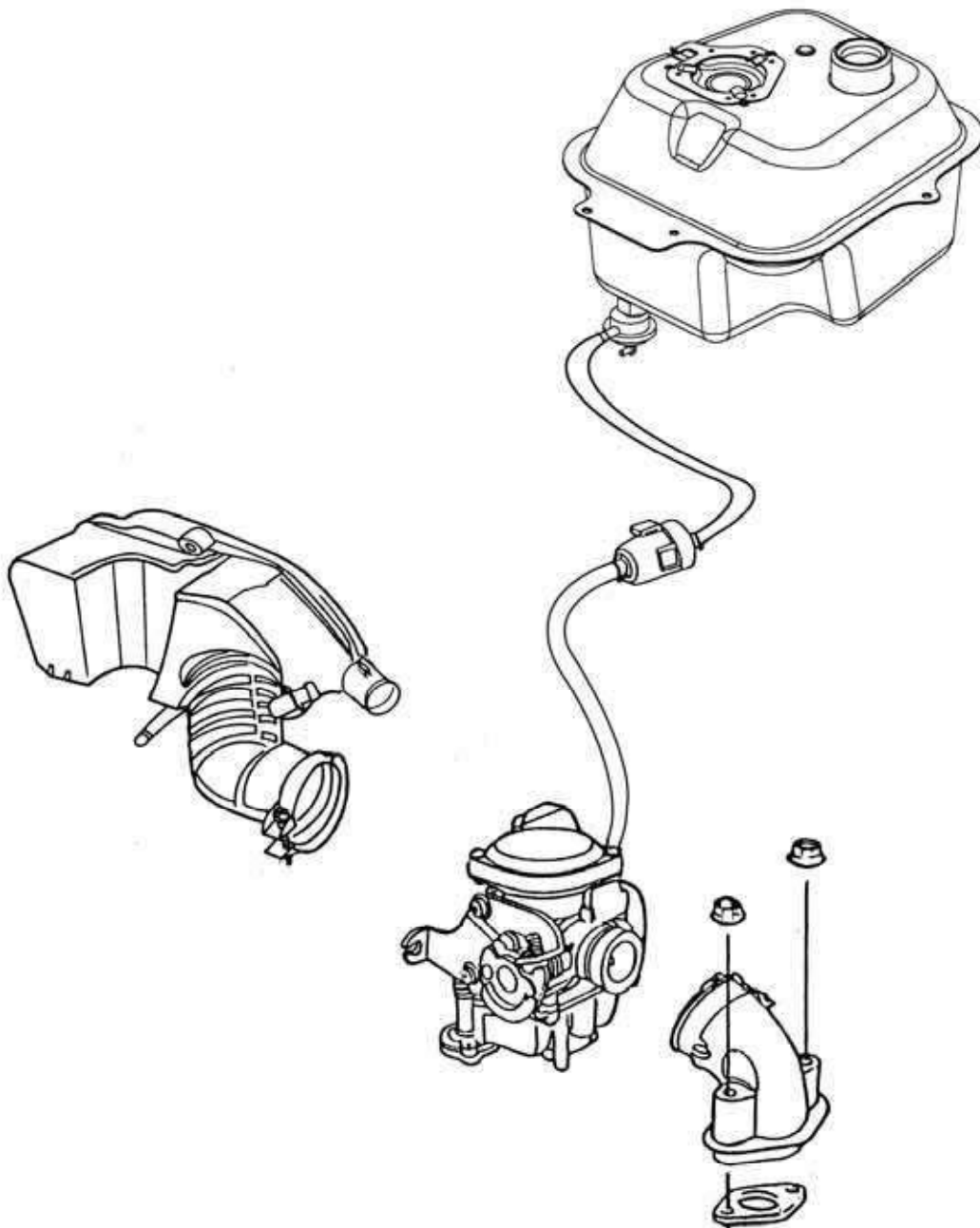

**5**

# 5. FUEL SYSTEM

AGILITY 50

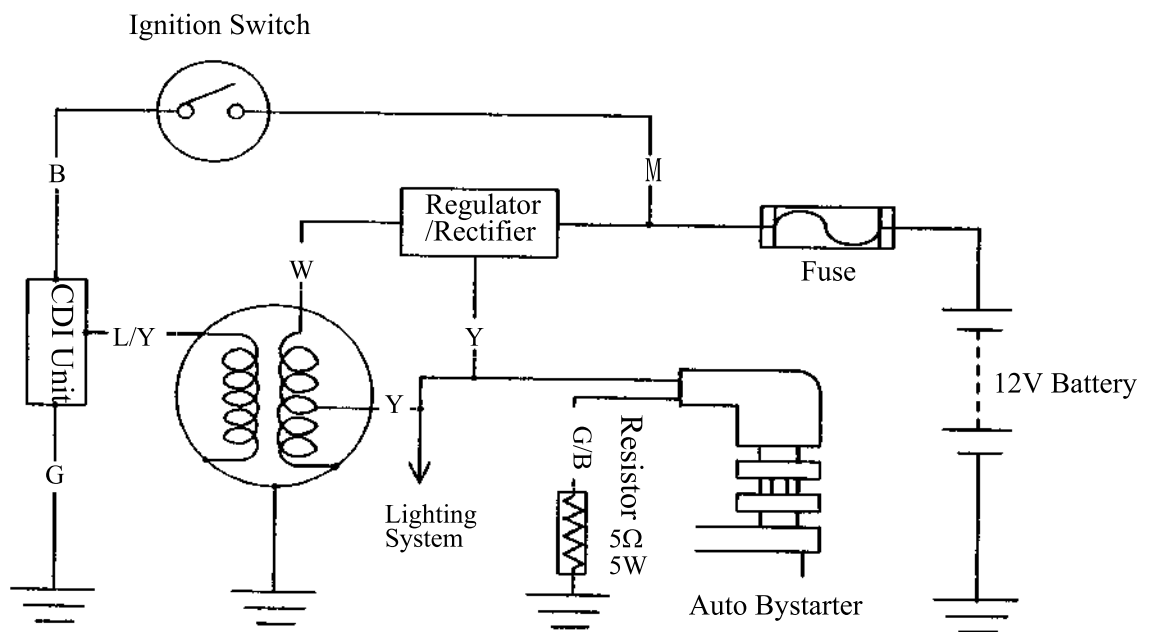
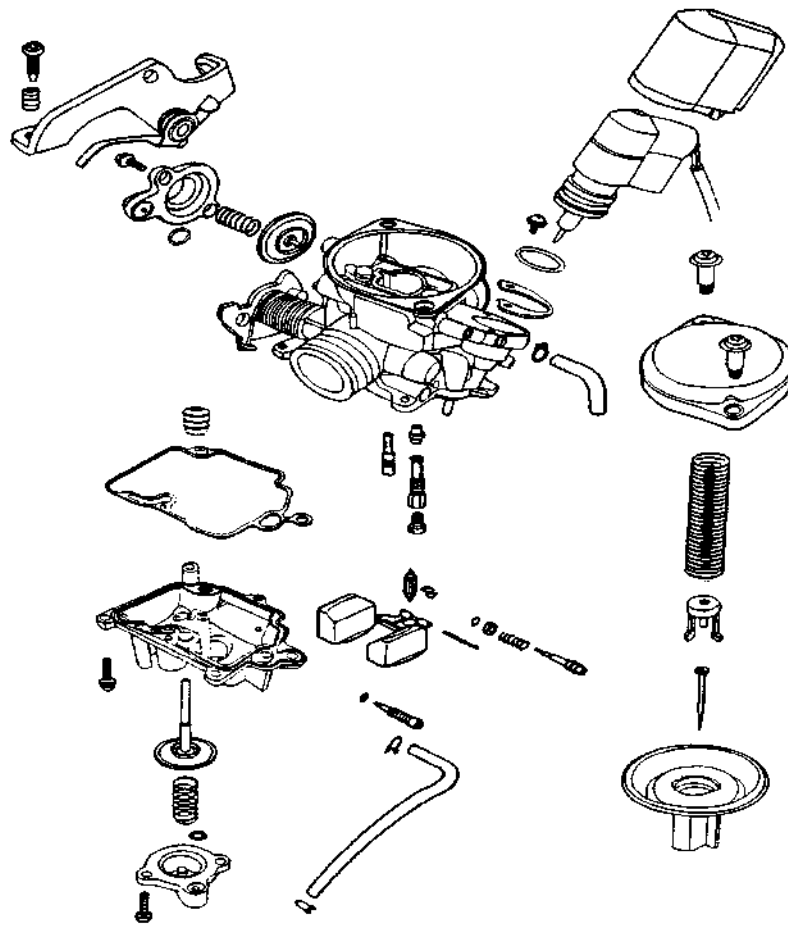

SERVICE INFORMATION.....5-2	ACCELERATING PUMP.....5-10
TROUBLESHOOTING.....5-3	CARBURETOR INSTALLATION.....5-11
CARBURETOR REMOVAL.....5-4	PILOT SCREW ADJUSTMENT.....5-12
AUTO BYSTARTER.....5-4	FUEL TANK.....5-13
AIR CUT-OFF VALVE.....5-6	FUEL UNIT.....5-14
VACUUM CHAMBER.....5-6	AIR CLEANER.....5-14
FLOAT CHAMBER.....5-8	

### SERVICE INFORMATION

#### GENERAL INSTRUCTIONS



Gasoline is very dangerous. When working with gasoline, keep sparks and flames away from the working area.  
Gasoline is extremely flammable and is explosive under certain conditions. Be sure to work in a well-ventilated area.

- When disassembling the carburetor, be sure to service the vacuum piston and float chamber.
- Do not bend or twist control cables. Damaged control cables will not operate smoothly.
- When disassembling fuel system parts, note the locations of O-rings. Replace them with new ones during assembly.
- Before float chamber disassembly, loosen the drain screw to drain the residual gasoline into a clean container.
- After the carburetor is removed, plug the intake manifold side with a clean shop towel to prevent foreign matters from entering.
- Remove the vacuum diaphragm before cleaning the carburetor air and fuel passages with compressed air to avoid damaging the vacuum diaphragm.
- When the motorcycle is not used for over one month, drain the residual gasoline from the float chamber to avoid erratic idling and clogged slow jet due to deteriorated fuel.

#### SPECIFICATIONS

Item	Standard	
Venturi dia. (mm)	20	
Type	CVK	
Float level (mm)	17	
Main jet	Commonly: #82	Speed limits vehicle: #80
Slow jet	#35	
Idle speed	2000rpm±100	
Throttle grip free play	2~6mm	
Pilot screw opening	2±1/2	

## **5. FUEL SYSTEM**

### **TROUBLESHOOTING**

#### **Engine is hard to start**

- No spark at plug (⇒Section 15)
- Compression too low
- No fuel to carburetor
  - Clogged fuel filter
  - Restricted fuel line
  - Faulty float valve
  - Incorrectly adjusted float level
- Engine flooded with fuel
  - Clogged air cleaner
  - Fuel overflowing
- Intake air leak
- Contaminated fuel
- Faulty auto bystarter
- Clogged idle system or auto bystarter passages

#### **Rich mixture**

- Faulty auto bystarter
- Faulty float valve
- Float level too high
- Clogged air jets
- Dirty air cleaner
- Flooded carburetor

#### **Backfiring at deceleration**

- Lean mixture in idle system
- Improper air cut-off valve operation

#### **Misfiring during acceleration**

- Faulty ignition system
- Lean mixture
- Faulty accelerating pump

#### **Engine idles roughly, stalls or runs poorly**

- Clogged fuel system
- Ignition malfunction
- Rich or lean mixture
- Contaminated fuel
- Intake air leak
- Incorrect idle speed
- Incorrectly adjusted pilot screw
- Clogged idle system or auto bystarter passages
- Incorrectly adjusted float level

#### **Lean mixture**

- Clogged fuel jets
- Faulty float valve
- Float level too low
- Clogged fuel system
- Intake air leak
- Improper vacuum piston operation
- Improper throttle operation

## 5. FUEL SYSTEM

### CARBURETOR REMOVAL

Remove the frame right side cover. (⇒2-4)  
 Disconnect the auto bystarter wire connector.  
 Remove the met-in box. (⇒2-3)

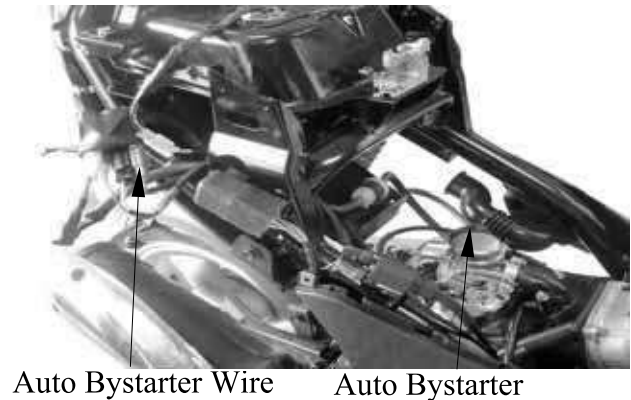

Auto Bystarter Wire      Auto Bystarter

Loosen the drain screw and drain the fuel from the float chamber.  
 Disconnect the fuel tube and vacuum tube at the carburetor.

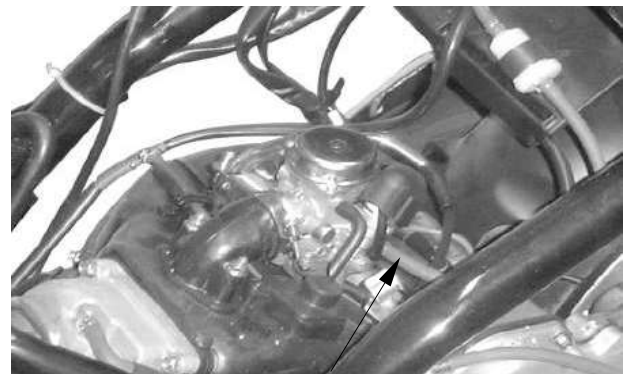

Fuel Tube

Loosen the throttle cable adjusting nut and lock nut, and disconnect the throttle cable from the carburetor.  
 Loosen the carburetor intake manifold band and air cleaner connecting tube band screws and then remove the carburetor.

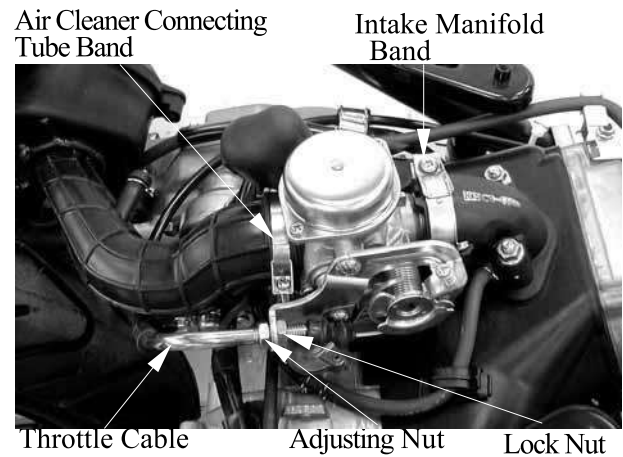

Throttle Cable      Adjusting Nut      Lock Nut

### AUTO BYSTARTER

#### OPERATION INSPECTION

Measure the resistance between the auto bystarter wire terminals.

**Resistance:** 10Ω max. (10 minutes minimum after stopping the engine)

If the reading is not within the limit, replace the auto bystarter with a new one.



# 5. FUEL SYSTEM

Vacuum Pump

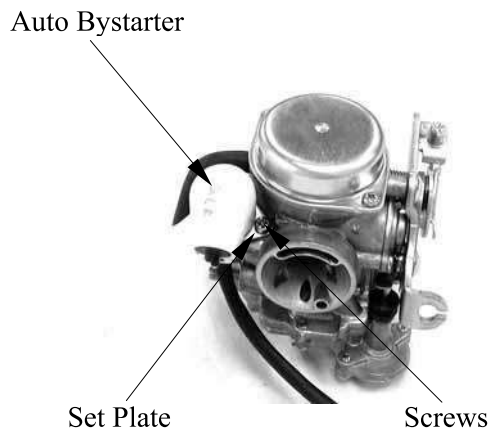
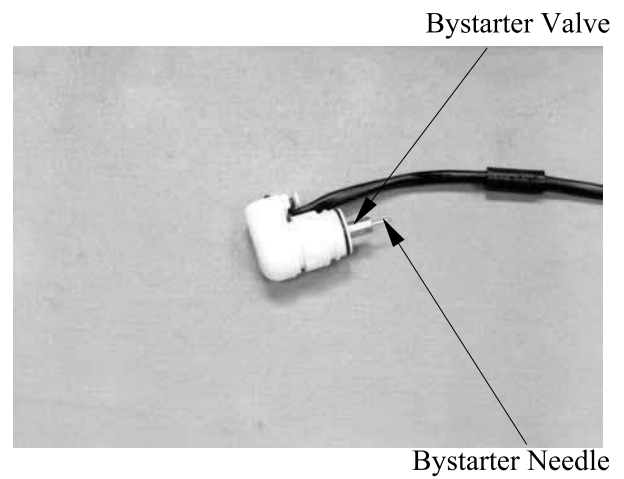
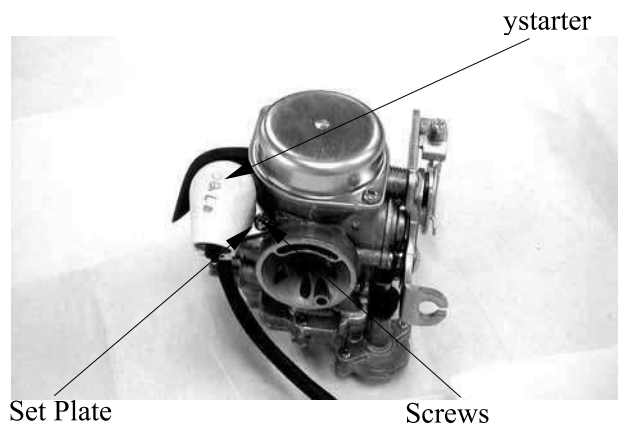
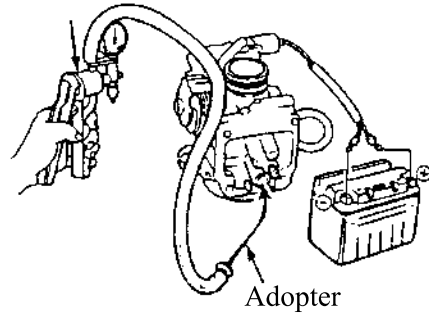

- Be sure to install the auto bystarter and set plate properly.
- Install the set plate with its bottom face facing down.



## 5. FUEL SYSTEM

AGILITY 50

### AIR CUT-OFF VALVE

#### DISASSEMBLY

Remove the two screws attaching the throttle cable set plate and the set plate.  
 Remove the two screws attaching the air cut-off valve.  
 Remove the spring and vacuum diaphragm.  
 Check the vacuum diaphragm for cracks or damage and check each passage for clogging.

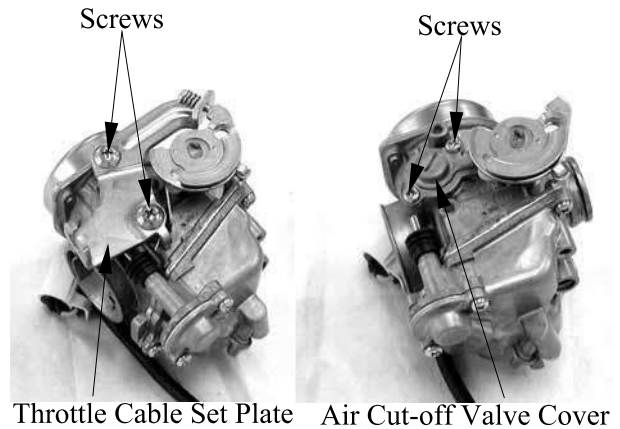

Throttle Cable Set Plate    Air Cut-off Valve Cover

#### ASSEMBLY

Install the vacuum diaphragm onto the carburetor.  
 Install the spring and air cut-off valve cover.  
 Install the throttle cable set plate and tighten the two screws.

- Be sure to set the vacuum diaphragm lip into the groove on the carburetor.
- When installing the air cut-off valve cover, make sure that the vacuum diaphragm is properly installed.

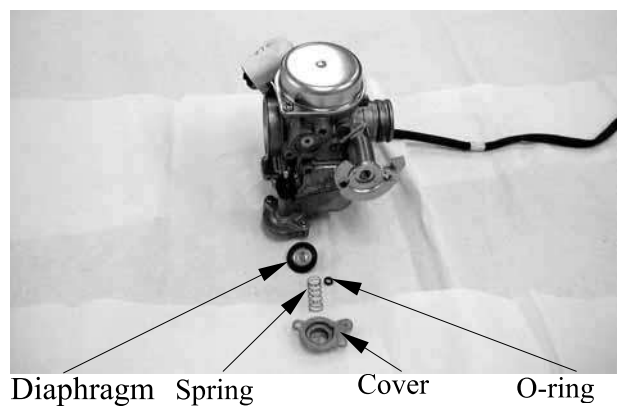

Diaphragm    Spring    Cover    O-ring

### VACUUM CHAMBER

#### DISASSEMBLY

Remove the two vacuum chamber cover screws and the cover.

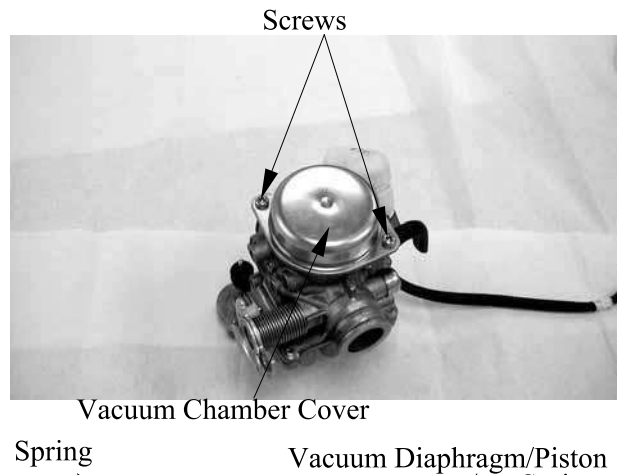

Vacuum Chamber Cover

Spring    Vacuum Diaphragm/Piston

Remove the spring and vacuum diaphragm/piston.

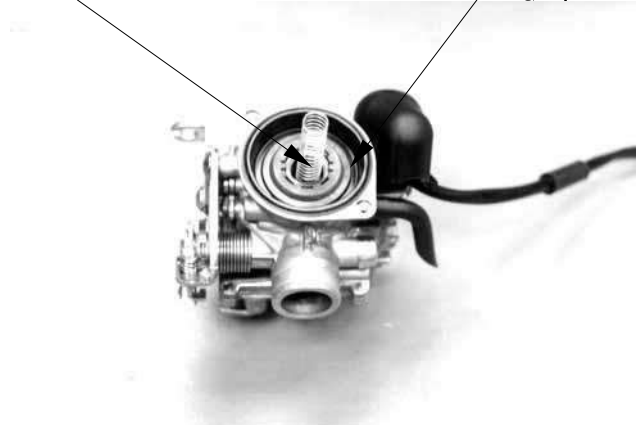

## 5. FUEL SYSTEM

Remove the needle holder and jet needle.

Be careful not to damage the vacuum diaphragm.

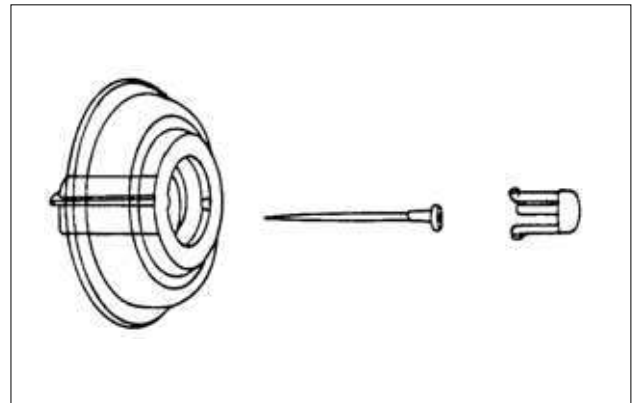

### INSPECTION

Inspect the needle for stepped wear.  
 Inspect the vacuum piston for wear or damage.  
 Inspect the diaphragm for deterioration and tears.

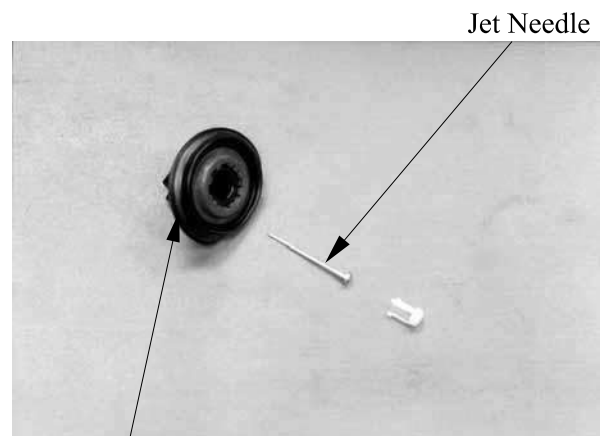

Vacuum Diaphragm

### ASSEMBLY

Install the vacuum piston/diaphragm in the carburetor body.  
 Install the spring and then install the vacuum chamber cover.  
 Tighten the two screws.

- Be careful not to damage the diaphragm.
- Hold the vacuum piston while tightening the vacuum chamber cover.

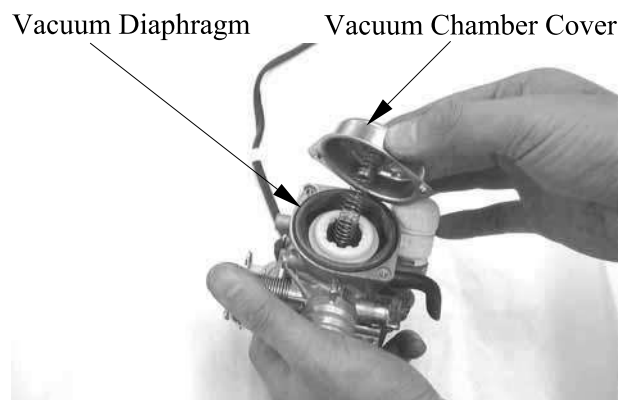

## 5. FUEL SYSTEM

### FLOAT CHAMBER DISASSEMBLY

Remove the three float chamber screws and the float chamber.

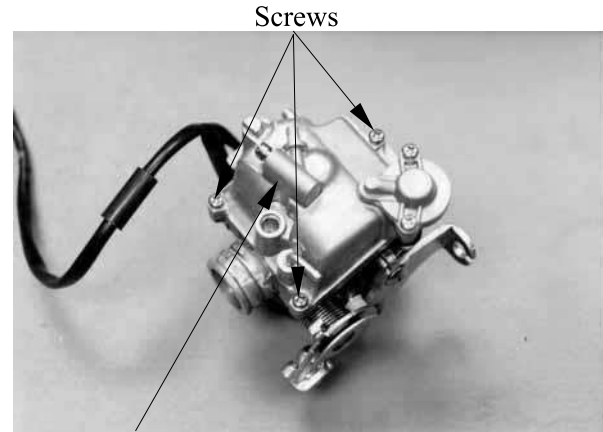

Float Chamber

Loosen the float pin screw.  
Remove the float pin, float and float valve.

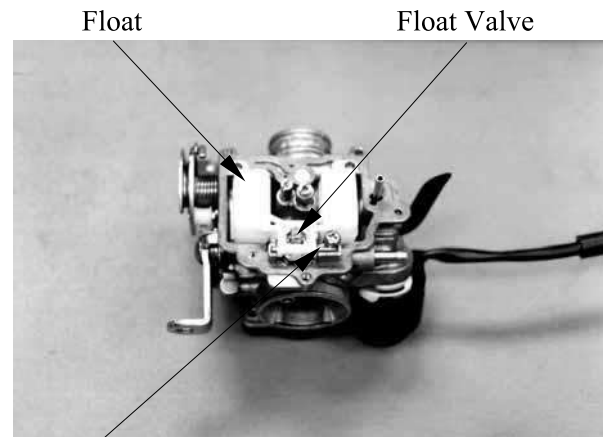

Float Pin

Remove the main jet, needle jet holder, needle jet, slow jet and pilot screw.

- Be careful not to damage the fuel jets and pilot screw.
- Before removing, turn the pilot screw in and carefully count the number of turns until it seats lightly and then make a note of this.
- Do not force the pilot screw against its seat to avoid seat damage.

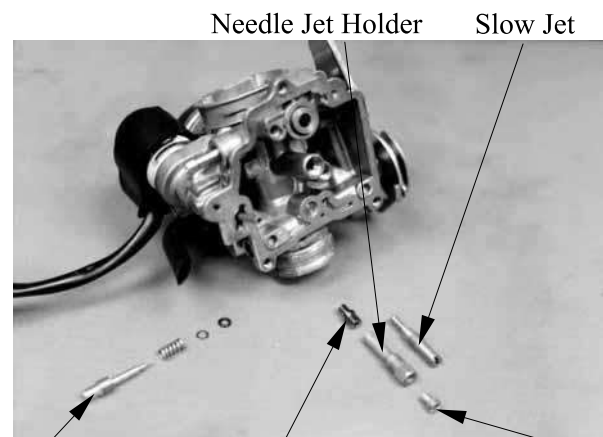

Pilot Screw

Needle Jet

Main Jet

Clean the removed fuel jets with detergent oil and blow them open with compressed air.  
Blow compressed air through all passages of the carburetor body.



## 5. FUEL SYSTEM

### INSPECTION

Inspect the float valve and valve seat for damage or clogging.

Inspect the float valve and valve seat contact area for stepped wear or contamination.

Worn or contaminated float valve and valve seat must be replaced because it will result in float level too high due to incomplete airtightness.

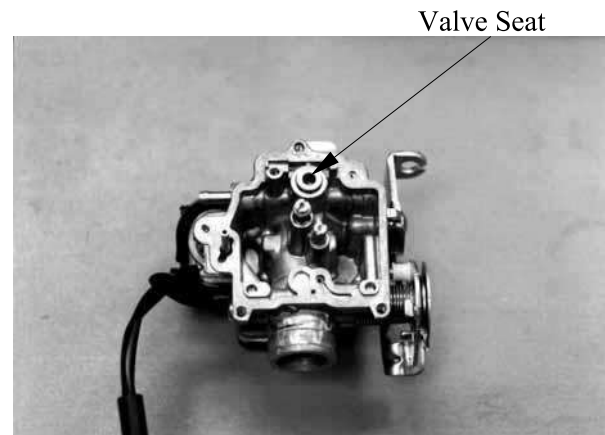

### ASSEMBLY

Install the slow jet, needle jet, needle jet holder, main jet and pilot screw.

Return the pilot screw to the original position as noted during removal.

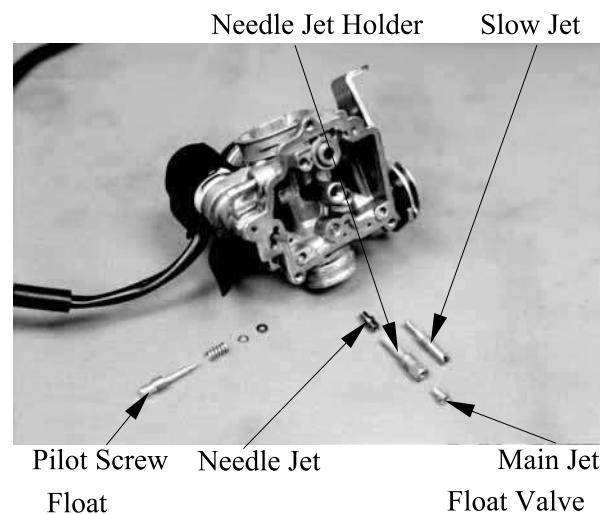

**Standard Opening:**  $2\pm\frac{1}{2}$  turns

Install the float valve, float and float pin. Secure the float pin with the screw.

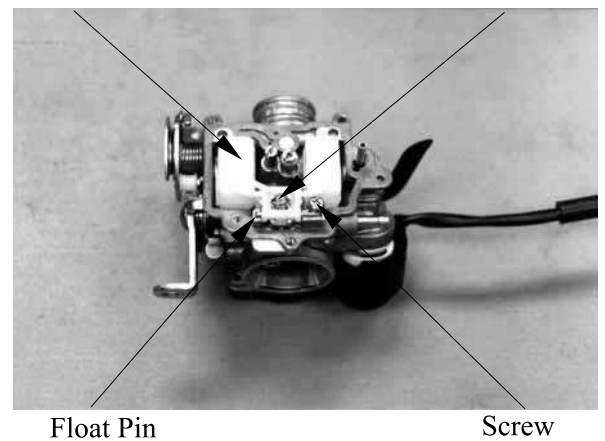

### FLOAT LEVEL INSPECTION

- Check the operation of the float valve and float before this inspection.
- Measure the float level by placing the float level gauge on the float chamber face parallel with the main jet.

Measure the float level.

**Float Level:** 17.0mm

This installation sequence is the reverse of removal.

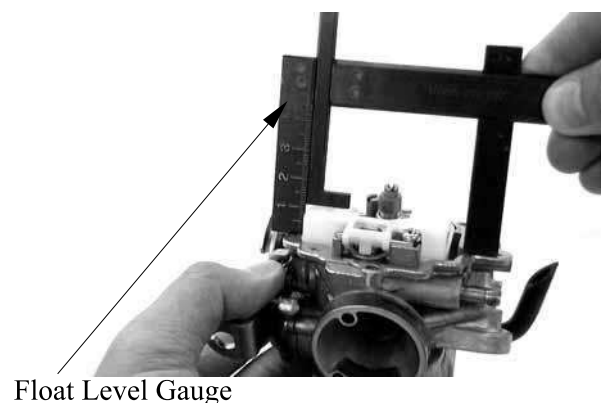

# 5. FUEL SYSTEM

## ACCELERATING PUMP

### DISASSEMBLY

Remove the two accelerating pump cover screws and accelerating pump cover. Remove the spring and accelerating pump diaphragm.

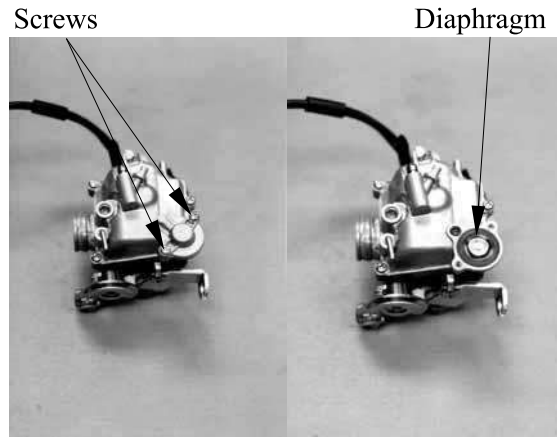

### INSPECTION

Inspect the accelerating pump diaphragm for cracks, damage or deterioration. Replace if necessary.

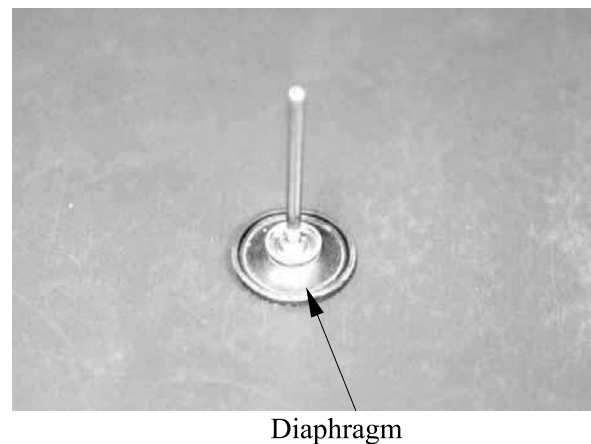

Check each accelerating pump fuel passage for clogging. Clean and blow them open with compressed air.

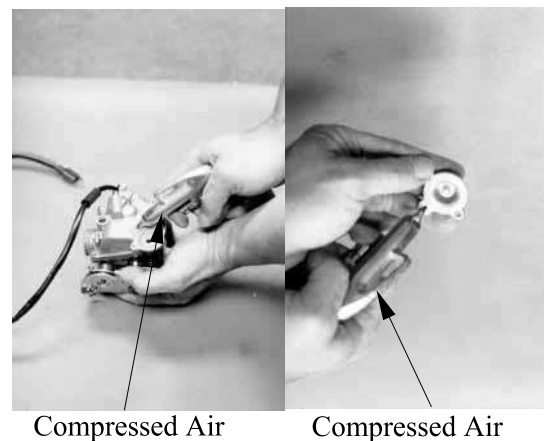

Install the accelerating pump in the reverse order of removal.

Be careful not to damage the diaphragm during installation.

## 5. FUEL SYSTEM

### CARBURETOR INSTALLATION

Tighten the drain screw.  
 Install the carburetor onto the intake manifold, aligning the tab on the carburetor with the cutout in the intake manifold.  
 Tighten the intake manifold band screw.  
 Install the air cleaner connecting tube and tighten the band screw.  
 Connect the throttle cable to the throttle wheel on the carburetor.  
 Tighten the lock nut.

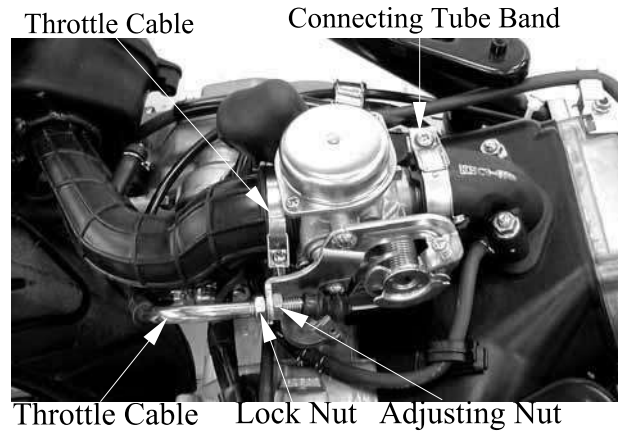

Connect the fuel tube and vacuum tube to the carburetor.



Fuel Tube

Connect the auto bystarter wire connector.  
 Perform the following inspections and adjustments:

- Throttle grip free play (⇒3-3)
- Carburetor idle speed (⇒3-5)



Auto Bystarter Wire Connector

## 5. FUEL SYSTEM

### PILOT SCREW ADJUSTMENT

#### \* ADJUSTMENT

- The pilot screw is factory pre-set and no adjustment is necessary. During carburetor disassembly, note the number of turns of the pilot screw and use as a reference when reinstalling it.
- Place the motorcycle on its main stand on level ground for this operation.



Pilot Screw

A tachometer must be used when adjusting the engine speed.  
Turn the pilot screw clockwise until it seats lightly and back it out to the specification given.

**Standard Opening:**  $2 \pm 1/2$  turns

- The carburetor must be adjusted when the engine is warm and the auto bystarter is closed.
- Do not force the pilot screw against its seat to prevent damage.

Warm up the engine and adjust the throttle stop screw to obtain the specified idle speed.

**Idle Speed:**  $1900 \pm 100$ rpm

Turn the pilot screw in or out slowly to obtain the highest engine speed. Slightly accelerate several times to make sure that the idle speed is within the specified range.  
If the engine misses or runs erratic, repeat the above steps.

Throttle Stop Screw



## 5. FUEL SYSTEM

### FUEL TANK REMOVE

Remove the net-in box. (⇒2-3)  
 Remove the frame center cover.  
 Remove the frame body cover. (⇒2-3)  
 Remove the four bolts on the fuel tank, take the upper seat lock off.  
 Disconnect the fuel unit wire connector.  
 Remove the fuel tank.  
 The installation sequence is the reverse of removal.

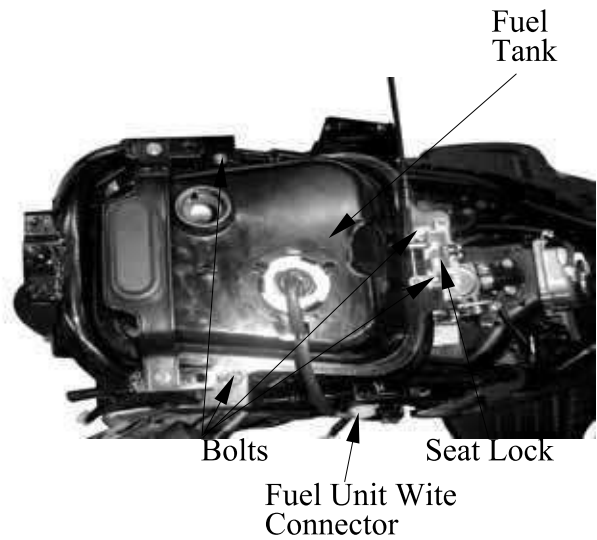

### FUEL STRAINER REMOVAL

Remove the fuel strainer from the fuel tank.

#### INSPECTION

Inspect if the fuel strainer is clogged and clean it with compressed air.

- When removing the fuel strainer, do not allow flames or sparks near the working area and drain the residual gasoline into a container.

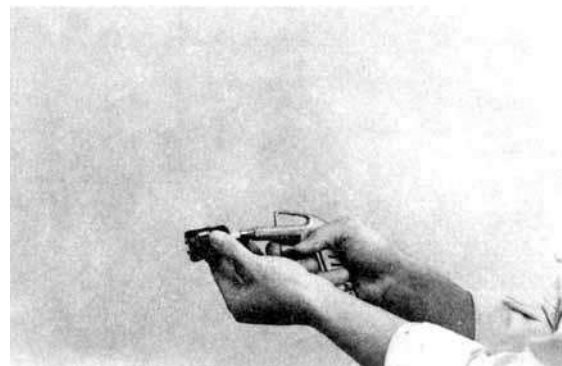

#### INSTALLATION

Install the fuel strainer with its arrow mark toward the fuel pump.

Fuel Strainer



Arrow Mark



## 5. FUEL SYSTEM

### FUEL UNIT

#### REMOVAL

Remove the related parts.  
 Disconnect the fuel unit wire connector.  
 Turn the fixed plate on the fuel unit, take the fuel unit off.

Do not bend the float arm on the fuel unit, otherwise the figure on the fuel meter will not correct.



#### INSTALLATION

Inspect if the fuel unit is damaged, or hardened.  
 Assemble the fuel unit in the reverse order of disassembly.

- Align the groove on the fuel unit with the angle on the fuel tank.
- Inspect if the fuel tank leaked after installing and filling the gasoling.

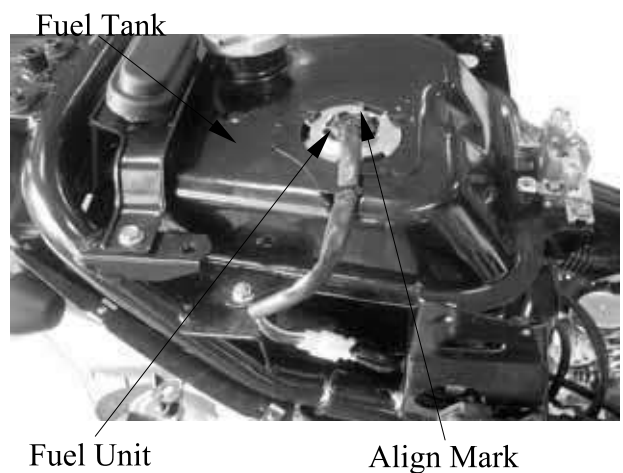

### AIR CLEANER

Loosen the air cleaner connecting tube band screw.  
 Disconnect the clinhead cover breather tube from the air cleaner.  
 Remove the two bolts and air cleaner case.

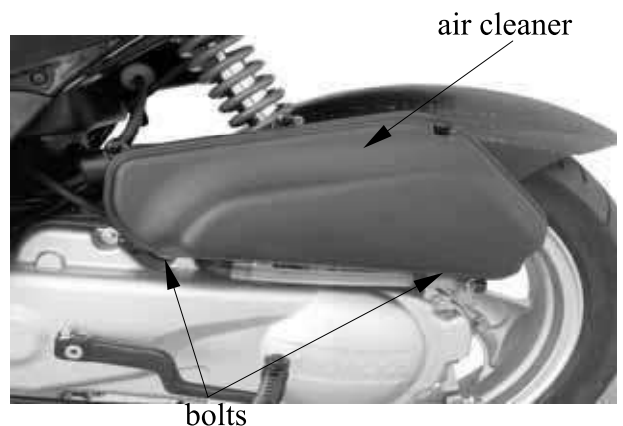

## 5. FUEL SYSTEM

The installation sequence is the reverse of removal.

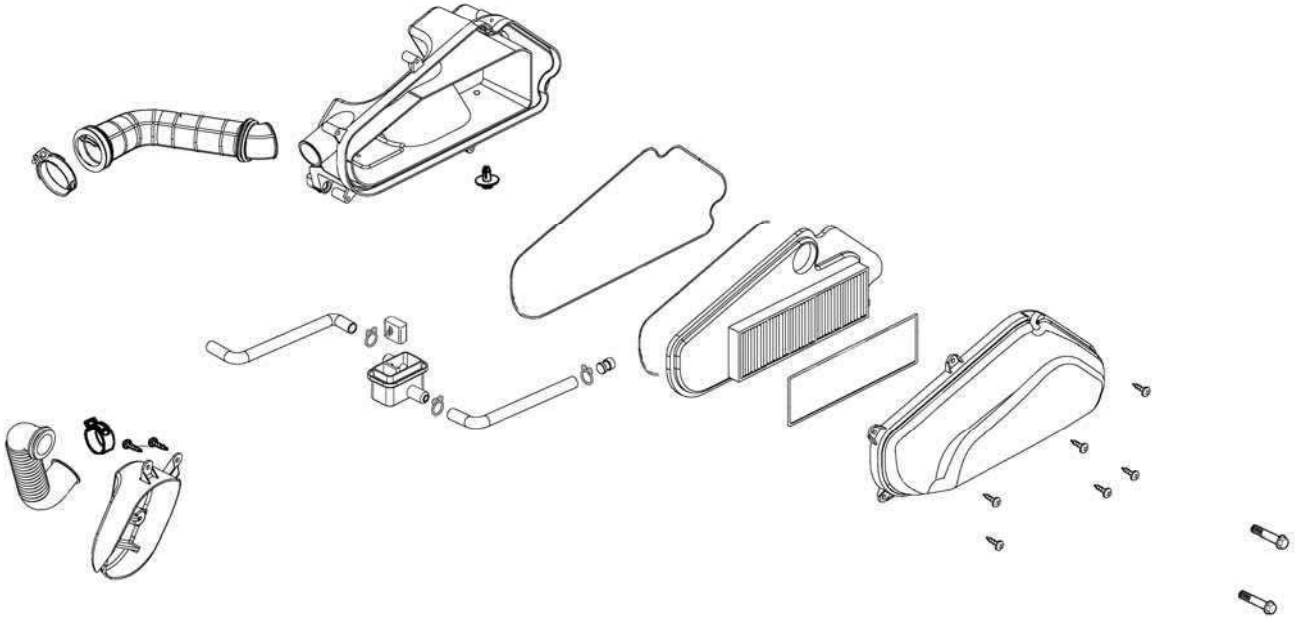

# 6. ENGINE REMOVAL/INSTALLATION

FILLY LX 50

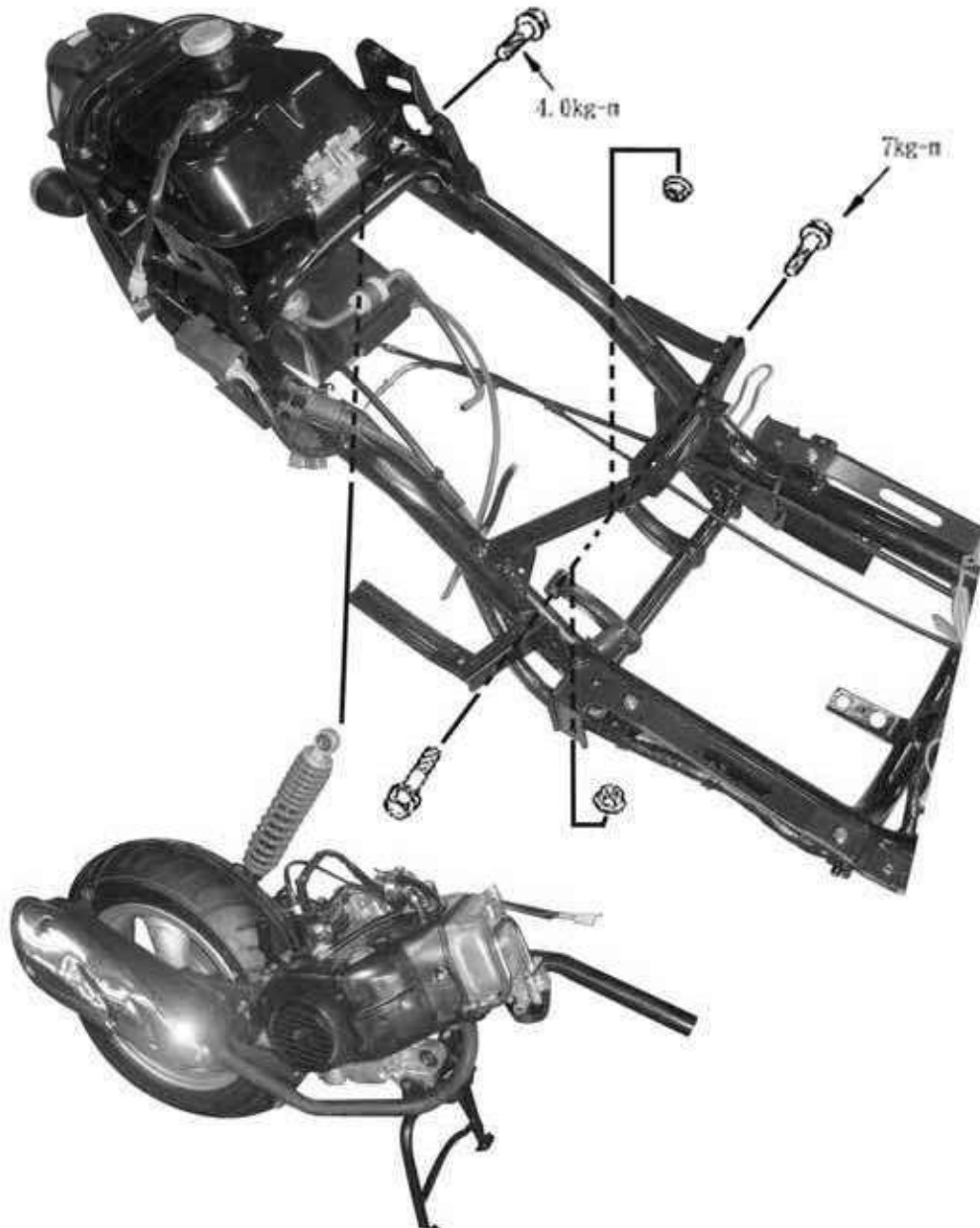

**6**

SERVICE INFORMATION .....	6-1	ENGINE INSTALLATION .....	6-4
ENGINE REMOVAL .....	6-2		

**SERVICE INFORMATION****GENERAL INSTRUCTIONS**

- A floor jack or other adjustable support is required to support and maneuver the engine. Be careful not to damage the motorcycle body, cables and wires during engine removal.
- Use shop towels to protect the motorcycle body during engine removal.
- Parts requiring engine removal for servicing:
  - Crankcase
  - Crankshaft

## 6. ENGINE REMOVAL/INSTALLATION

FILLY LX 50

### ENGINE REMOVAL

Disconnect the battery negative cable.  
 Remove the frame body cover. (⇒2-3)  
 Disconnect the spark plug high tension wire.  
 Disconnect the auto bystarter wire connector.  
 Disconnect the A.C. generator wire connector.



Negative Cable    Auto Bystarter Wire Connector

Disconnect the starter motor cable and earth cable from the starter motor.  
 Remove the fuel tube.

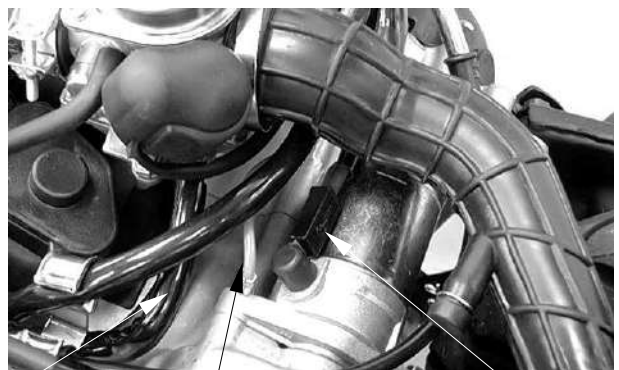

fuel tube    Earthr Cable    Starter Motor Cable

Remove the spark plug cap.



Spark Plug High Tension Wire

Disconnect the vacuum tube.  
 Loosen the throttle cable adjusting nut and lock nut, and disconnect the throttle cable from the carburetor.

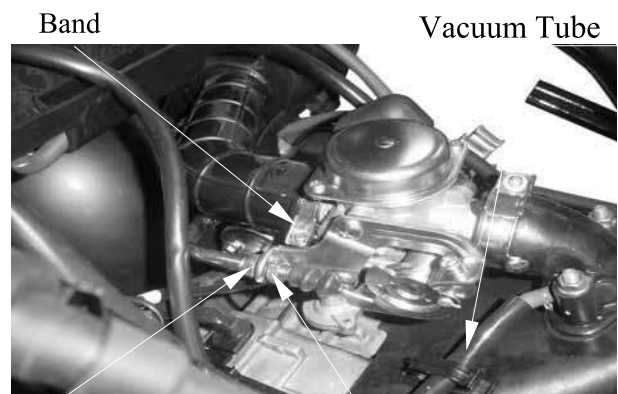

Band    Vacuum Tube  
 Lock Nut    Adjusting Nut

## 6. ENGINE REMOVAL/INSTALLATION

Loosen the drive belt air cleaner connecting tube band screw and remove the connecting tube.

Air Tube Band

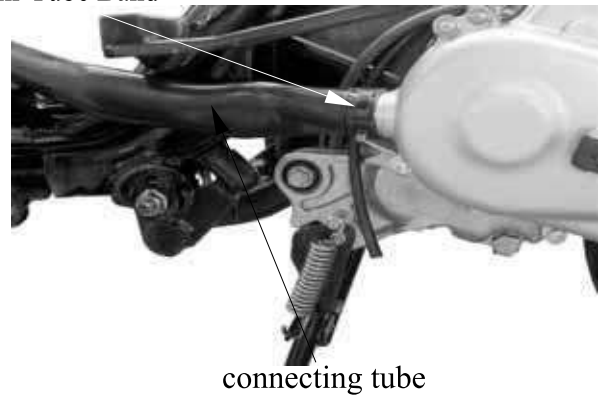

Remove the rear brake adjusting nut, connector pin rear brake cable.



Remove the rear shock absorber upper mount bolt.

Rear Shock Absorber Upper Mount Bolt



Remove the engine mounting bolt and move the motorcycle forward to separate it from the engine.  
Support the motorcycle with a floor jack.



Engine Hanger Bracket Bolt

Engine Mounting Bolt

## 6. ENGINE REMOVAL/INSTALLATION

FILLY LX 50

### ENGINE HANGER BRACKET REMOVAL

Remove the return spring from the main stand.  
Remove the main stand.

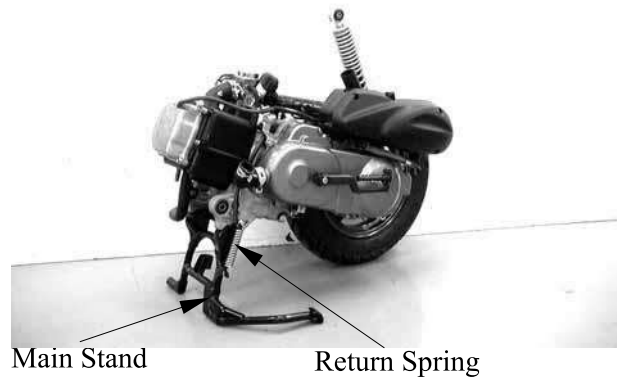

Remove the engine hanger bracket bolts and engine hanger bracket.  
Inspect the engine hanger bushings and stopper spring for wear or damage.

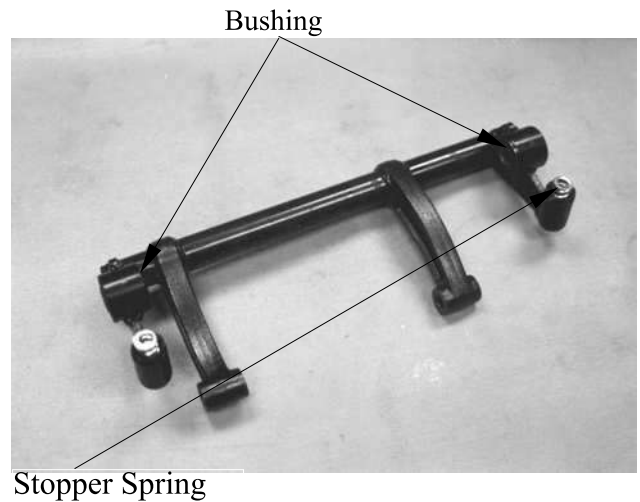

### ENGINE HANGER BRACKET INSTALLATION

Install the engine hanger bracket to the chassis and tighten the bolt.  
Install the main stand onto the engine and install the return spring.

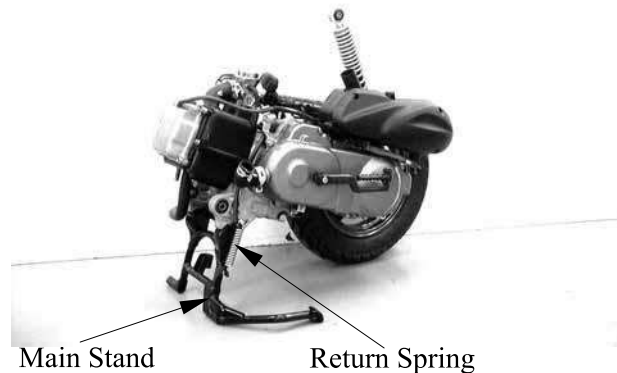

### ENGINE INSTALLATION

Install the engine and tighten the engine mounting bolt.

**Torque:** 4.5~5.5kgf-m

Tighten the rear shock absorber upper mount bolt.

**Torque:** 4.5~5.5kgf-m

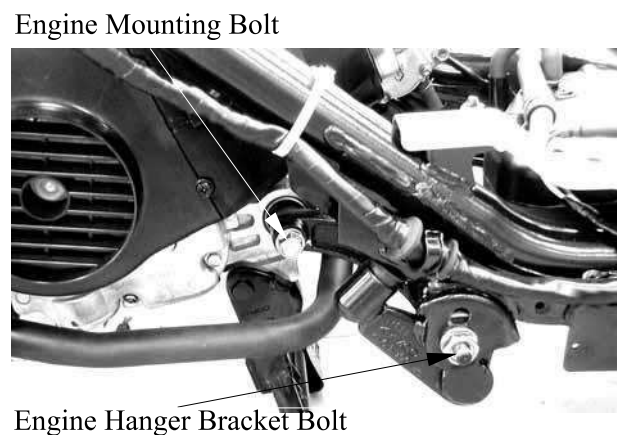

## 6. ENGINE REMOVAL/INSTALLATION

FILLY LX 50

Install the removed parts in the reverse order of removal.

Route the wires and cables properly.

After installation, inspect and adjust the following:

- Throttle grip free play (⇒3-3)
- Rear brake adjustment (⇒3-8)

Rear Shock Absorber Upper Mount Bolt





# 7. CYLINDER HEAD/VALVES

# 7

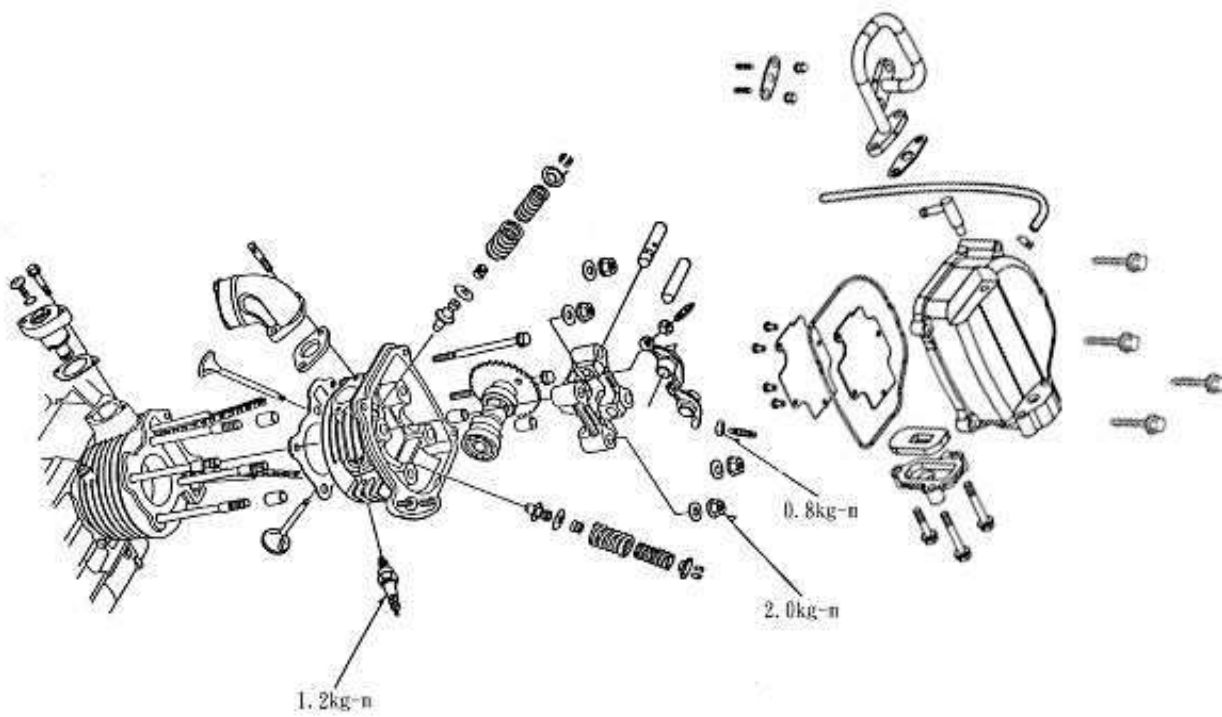

## 7. CYLINDER HEAD/VALVES

FILLY LX 50

SERVICE INFORMATION.....	7-1	CYLINDER HEAD DISASSEMBLY .....	7-7
TROUBLESHOOTING .....	7-2	CYLINDER HEAD ASSEMBLY .....	7-8
CAMSHAFT REMOVAL.....	7-3	CYLINDER HEAD INSTALLATION .....	7-8
CYLINDER HEAD REMOVAL .....	7-5	CAMSHAFT INSTALLATION.....	7-9

### SERVICE INFORMATION

#### GENERAL INSTRUCTIONS

- The cylinder head can be serviced with the engine installed in the frame.
- When assembling, apply molybdenum disulfide grease or engine oil to the valve guide movable parts, valve arm and camshaft sliding surfaces for initial lubrication.
- The camshaft is lubricated by engine oil through the cylinder head engine oil passages. Clean and unclog the oil passages before assembling the cylinder head.
- After disassembly, clean the removed parts and dry them with compressed air before inspection.
- After removal, mark and arrange the removed parts in order. When assembling, install them in the reverse order of removal.

#### SPECIFICATIONS

Item		Standard (mm)	Service Limit (mm)
Valve clearance (cold)	IN	0.04	—
	EX	0.04	—
Cylinder head compression		14kg/cm <sup>2</sup>	—
Cylinder head warpage		—	0.05
Camshaft cam height	IN	26.438	26.038
	EX	25.807	25.407
Valve rocker arm I.D.	IN	10.000-10.015	10.10
	EX	10.000-10.015	10.10
Valve rocker arm shaft O.D.	IN	9.972-9.987	9.91
	EX	9.972-9.987	9.91
Valve seat width	IN	1.0	1.8
	EX	1.0	1.8
Valve stem O.D.	IN	4.975-4.990	4.9
	EX	4.955-4.970	4.9
Valve guide I.D.	IN	5.000-5.012	5.03
	EX	5.000-5.012	5.03
Valve stem-to-guide clearance	IN	0.010-0.037	0.08
	EX	0.030-0.057	0.1
Valve spring free	Inner	31.1	30.1
	Outer	34.35	33.3

## 7. CYLINDER HEAD/VALVES

### TORQUE VALUES

Cylinder head nut	1.8~2.2kgf-m	Apply engine oil to threads
Valve clearance adjusting nut	0.7~1.1kgf-m	Apply engine oil to threads

### SPECIAL TOOLS

Valve spring compressor

### TROUBLESHOOTING

- The poor cylinder head operation can be diagnosed by a compression test or by tracing engine top-end noises.

#### Poor performance at idle speed

- Compression too low

#### Compression too low

- Incorrect valve clearance adjustment
- Burned or bent valves
- Incorrect valve timing
- Broken valve spring
- Poor valve and seat contact
- Leaking cylinder head gasket
- Warped or cracked cylinder head
- Poorly installed spark plug

#### Compression too high

- Excessive carbon build-up in combustion chamber

#### White smoke from exhaust muffler

- Worn valve stem or valve guide
- Damaged valve stem seal

#### Abnormal noise

- Incorrect valve clearance adjustment
- Sticking valve or broken valve spring
- Damaged or worn camshaft
- Worn cam chain guide
- Worn camshaft and rocker arm

## 7. CYLINDER HEAD/VALVES

### CAMSHAFT REMOVAL

Remove the center cover. (⇒2-3)  
 Remove the frame center.  
 Remove the four cylinder head cover bolts to remove the cylinder head cover.

Cylinder Head Cover

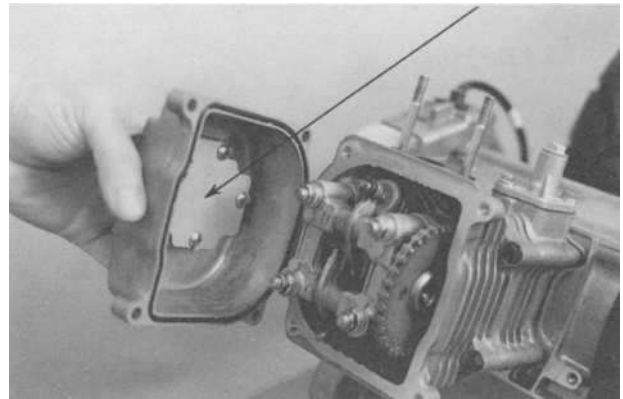

Remove the cam chain tensioner sealing bolt and spring.  
 Remove the two bolts attaching the cam chain tensioner and the tensioner.

Sealing Bolt

Bolts

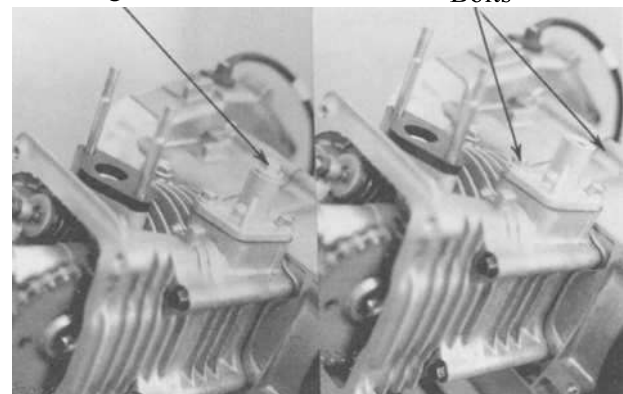

Turn the flywheel counterclockwise so that the "T" mark on the flywheel aligns with the index mark on the crankcase to bring the round hole on the camshaft gear facing up to the top dead center on the compression stroke.

Camshaft Gear

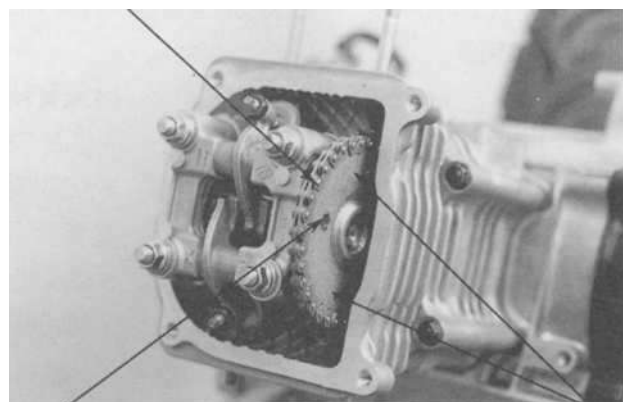

Round Hole

Punch Marks

Remove the two cylinder head bolts.  
 Remove the four cylinder head nuts and washers.  
 Remove the camshaft holder.

Diagonally loosen the cylinder head nuts in 2 or 3 times.

Washer Nut

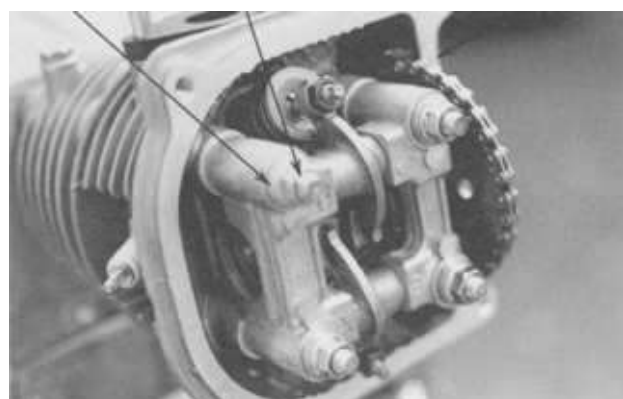

## 7. CYLINDER HEAD/VALVES

Remove the camshaft holder and dowel pins.

Camshaft Holder



Remove the camshaft gear from the cam chain and remove the camshaft.

Camshaft

Dowel Pins

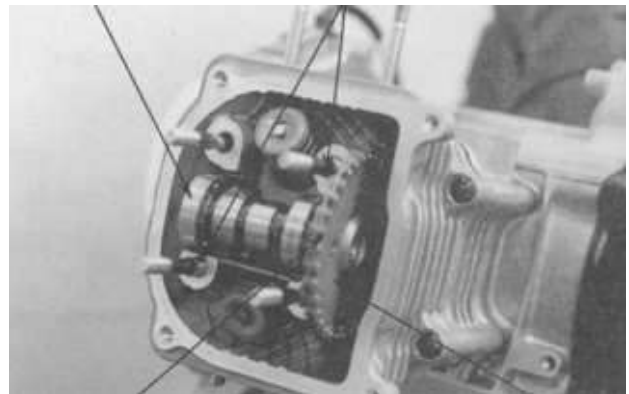

Cam Chain

Camshaft Gear

### CAMSHAFT INSPECTION

Check each cam lobe for wear or damage.  
Measure the cam lobe height.

#### Service Limits:

IN : 26.038mm replace if below

EX: 25.407mm replace if below

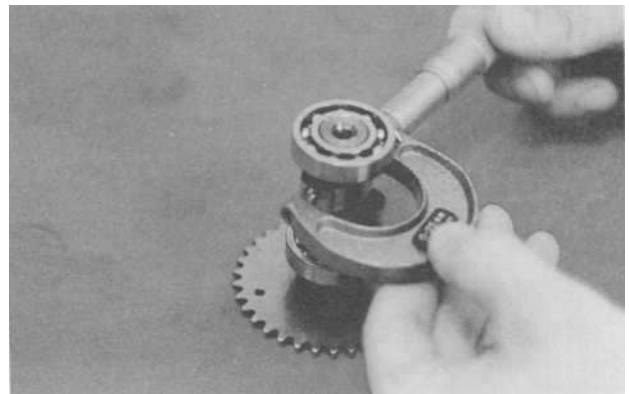

Check each camshaft bearing for play or damage. Replace the camshaft assembly with a new one if the bearings are noisy or have excessive play.

Camshaft Bearings

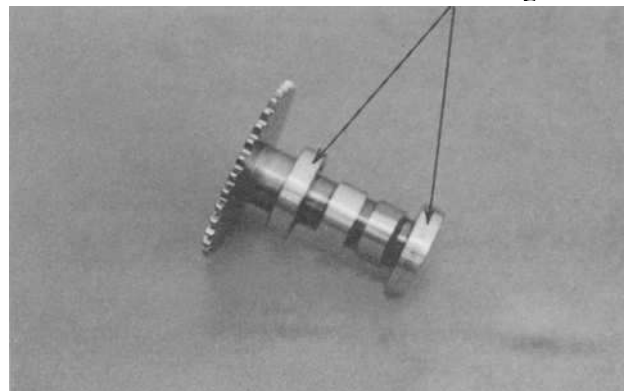

## 7. CYLINDER HEAD/VALVES

### CAMSHAFT HOLDER DISASSEMBLY

Take out the valve rocker arm shafts using a 5mm bolt.  
Remove the valve rocker arms.

Rocker Arm Shaft

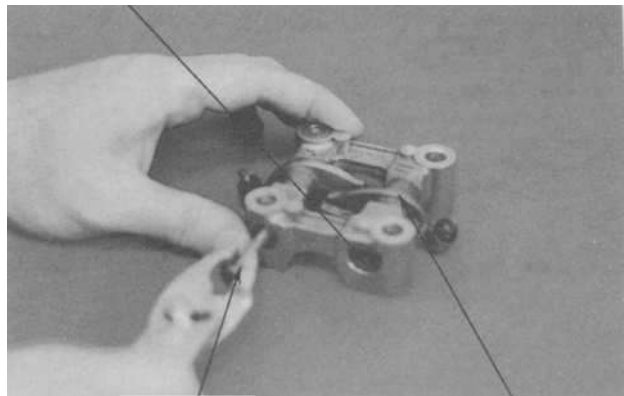

5mm Bolt

Rocker Arm

### CAMSHAFT HOLDER INSPECTION

Inspect the camshaft holder, valve rocker arms and rocker arm shafts for wear or damage.

\* If the valve rocker arm contact surface is worn, check each cam lobe for wear or damage.

Camshaft Holder

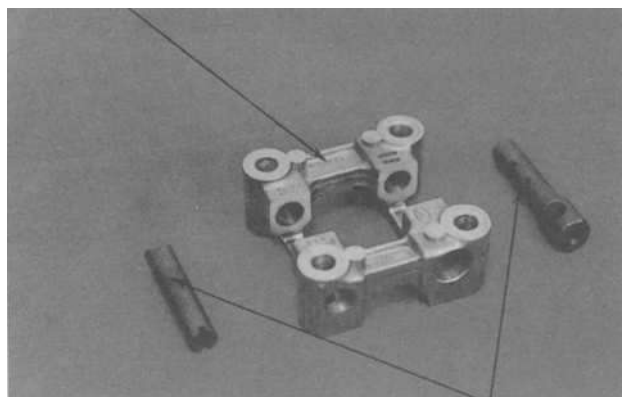

Rocker Arm Shafts

Measure the I.D. of each valve rocker arm.

**Service Limits:** IN:10.10mm replace if over  
EX:10.10mm replace if over

Measure each rocker arm shaft O.D.

**Service Limits:** IN: 9.91mm replace if over  
EX: 9.91mm replace if over

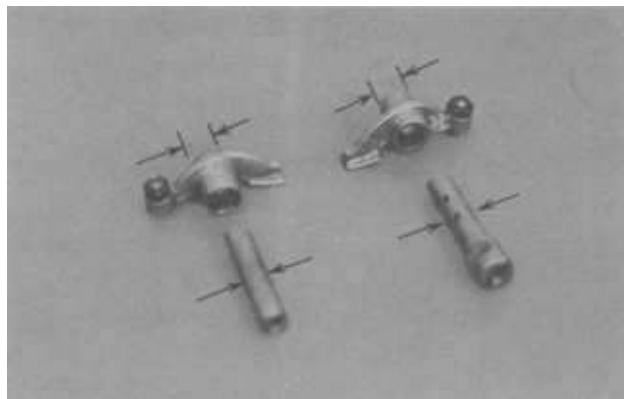

### CYLINDER HEAD REMOVAL

Remove the camshaft. (⇒7-3)  
Remove the carburetor. (⇒5-5)  
Remove the exhaust muffler. (⇒2-5)  
Remove the carburetor intake manifold.

Intake Manifold



## 7. CYLINDER HEAD/VALVES

Remove the cooling fan cover. (⇒14-6)  
 Remove the engine cover bolts and screws.  
 Separate the engine cover joint claws.

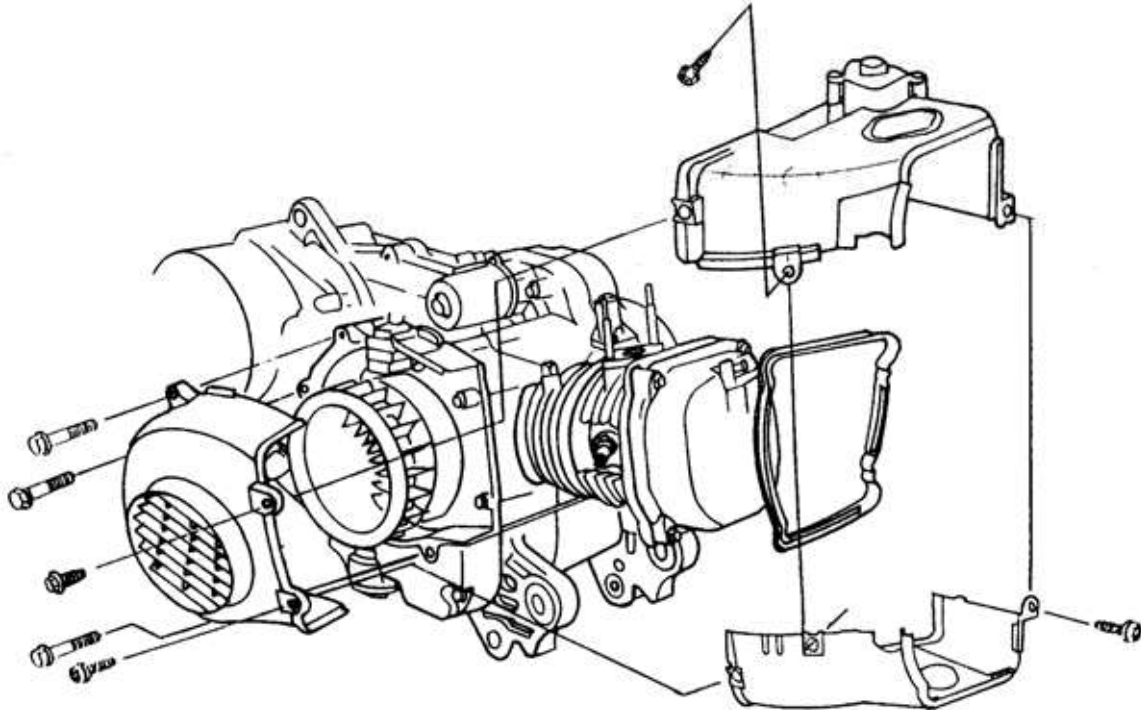

Remove the cylinder head.

Cylinder Head

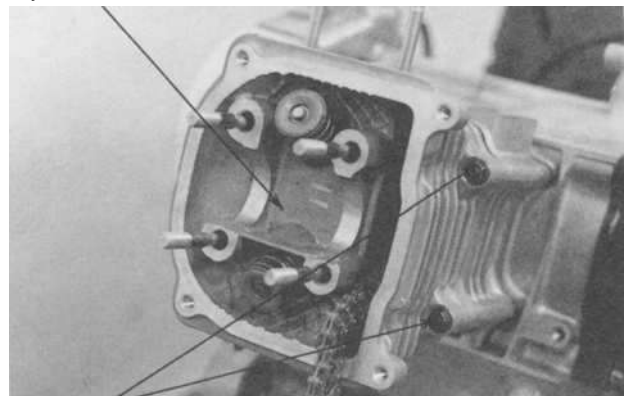

Bolts

Remove the dowel pins and cylinder head gasket.  
 Remove the cam chain guide.

Dowel Pins

Cylinder Head Gasket



Cam Chain Guide

## 7. CYLINDER HEAD/VALVES

### CYLINDER HEAD DISASSEMBLY

Remove the valve spring cotters, retainers, springs, spring seats and valve stem seals using a valve spring compressor.

- Be sure to compress the valve springs with a valve spring compressor.
- Mark all disassembled parts to ensure correct reassembly.

**Special**

Valve Spring Compressor

Valve Spring Compressor Attachment

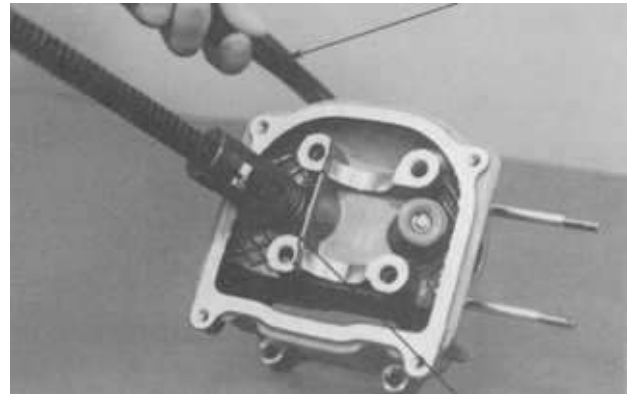

Valve Spring Compressor

Valve Spring Compressor Attachment

Remove carbon deposits from the combustion chamber.

Clean off any gasket material from the cylinder head mating surface.

Be careful not to damage the cylinder head mating surface.

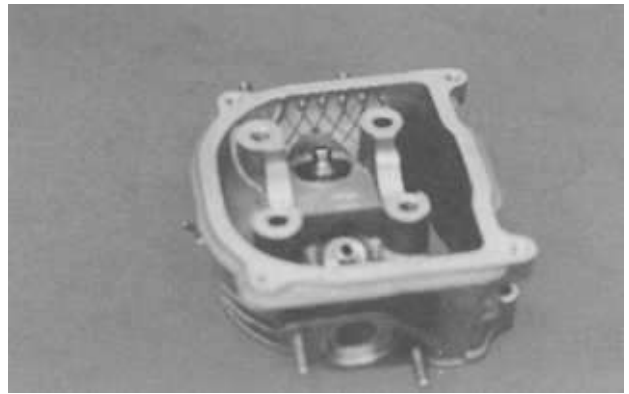

### INSPECTION

#### CYLINDER HEAD

Check the spark plug hole and valve areas for cracks.

Check the cylinder head for warpage with a straight edge and feeler gauge.

**Service Limit:** 0.05mm repair or replace if over

#### VALVE SPRING FREE LENGTH

Measure the free length of the inner and outer valve springs.

**Service Limits:**

Inner : 30.1mm replace if below

Outer : 33.3mm replace if below

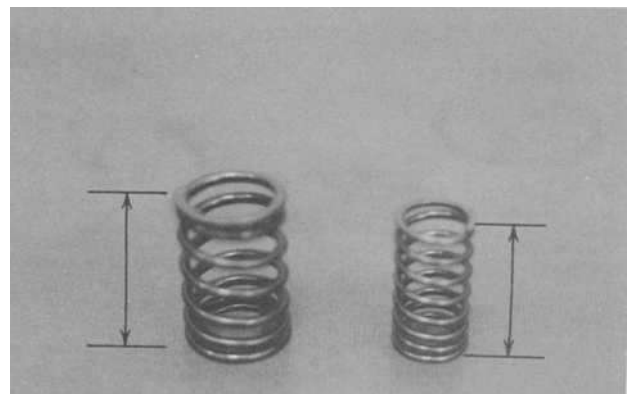



## 7. CYLINDER HEAD/VALVES

### VALVE/ VALVE GUIDE

Inspect each valve for bending, burning, scratches or abnormal stem wear.

Check valve movement in the guide.

Measure each valve stem O.D.

**Service Limits:** IN : 4.9mm replace if below

EX: 4.9mm replace if below

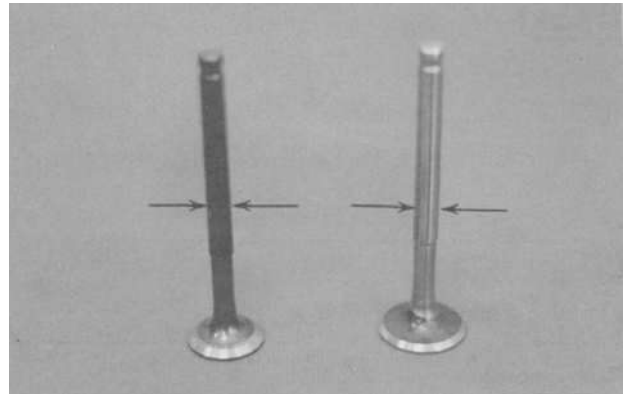

### CYLINDER HEAD ASSEMBLY

- When assembling, a valve spring compressor must be used.
- Install the cotters with the pointed ends facing down from the upper side of the cylinder head.

**Special**

Valve Spring Compressor

Valve Spring Compressor Attachment

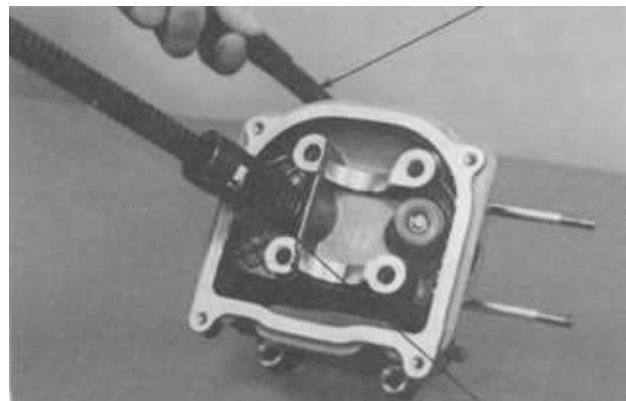

Valve Spring Compressor

Valve Spring Compressor Attachment

Tap the valve stems gently with a plastic hammer for 2~3 times to firmly seat the cotters.

Be careful not to damage the valves.

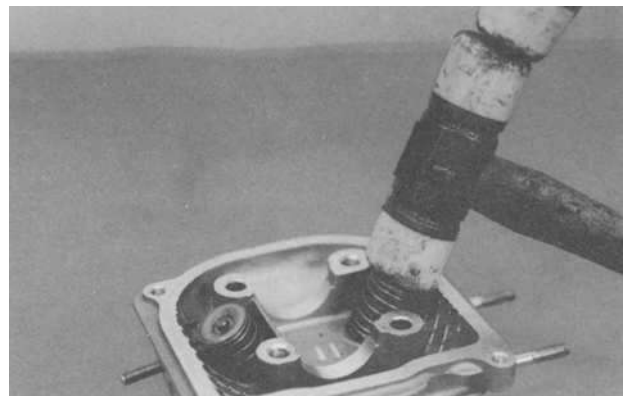

### CYLINDER HEAD INSTALLATION

Install the dowel pins and a new cylinder head gasket.

Install the cam chain guide.

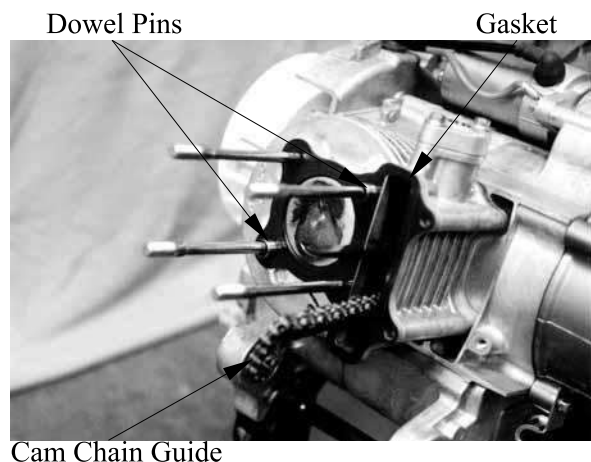

Cam Chain Guide

## 7. CYLINDER HEAD/VALVES

Install the cylinder head.

Cylinder Head

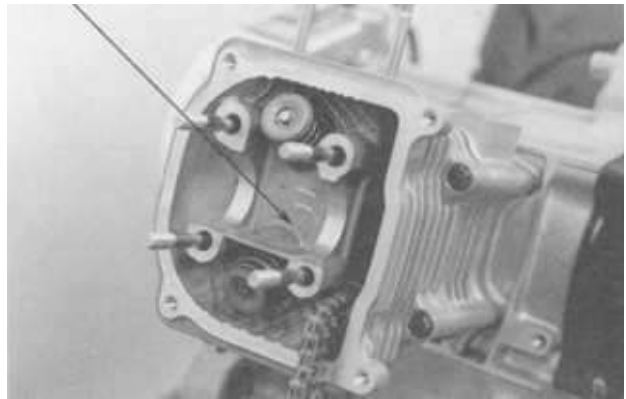

### CAMSHAFT HOLDER ASSEMBLY

First assemble the camshaft holder.  
Install the intake and exhaust valve rocker arms and rocker arm shafts.

- When installing the rocker arm shaft, align the shaft front end with the bolt hole of the camshaft holder.

Camshaft Holder

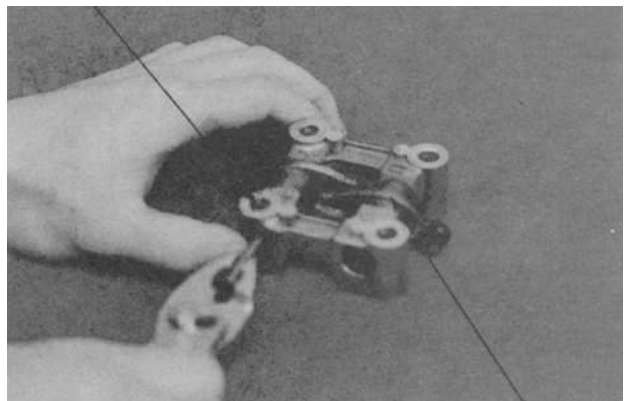

Valve Rocker Arm  
Camshaft Gear

### CAMSHAFT INSTALLATION

Turn the flywheel so that the “T” mark on the flywheel aligns with the index mark on the crankcase.

Keep the round hole on the camshaft gear facing up and align the punch marks on the camshaft gear with the cylinder head surface (Position the intake and exhaust cam lobes down.) and install the camshaft onto the cylinder head.

Install the cam chain over the camshaft gear.

Cam Chain

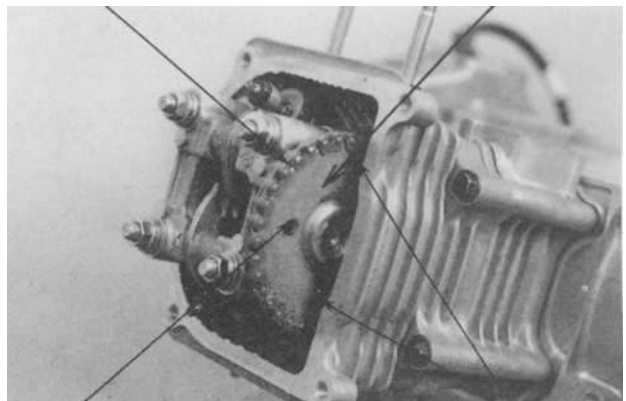

Round Hole

Punch Marks

Dowel Pins

Install the dowel pins.

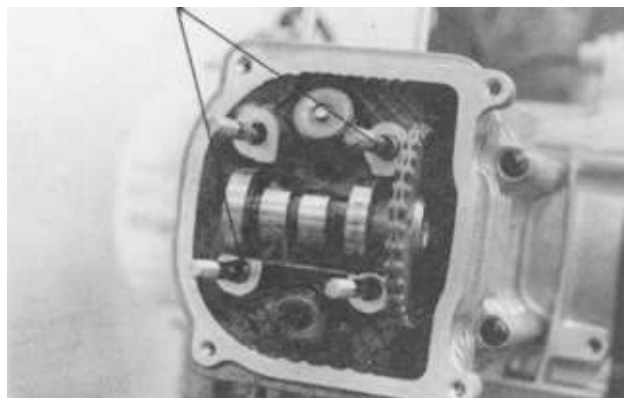

## 7. CYLINDER HEAD/VALVES

Install the camshaft holder, washers and nuts on the cylinder head.

Tighten the four cylinder head nuts and two bolts.

**Torque:** Cylinder head nut: 1.8~2.2kgf-m

- Apply engine oil to the threads of the cylinder head nuts.
- Diagonally tighten the cylinder head nuts in 2~3 times.

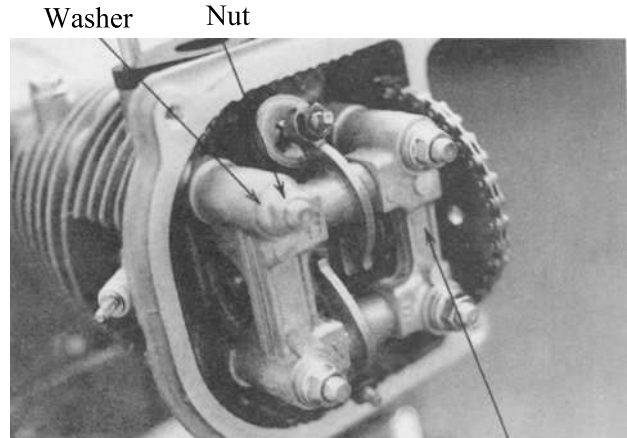

Washer Nut

Camshaft Holder

### CAM CHAIN TENSIONER INSTALLATION

First install a new cam chain tensioner gasket.

Install the tensioner using the two bolts.

Install the tensioner spring.

Install the O-ring and sealing bolt.

When installing the tensioner, release the lock pawl and push the push rod all the way in.

**Torque:** 0.45~0.6kgf-m

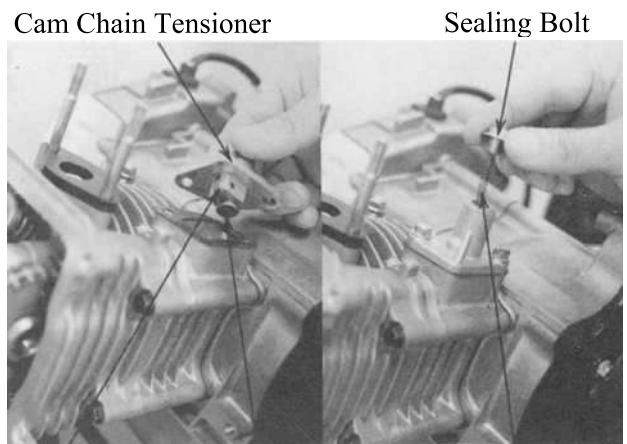

Cam Chain Tensioner

Sealing Bolt

Lock Pawl

Push Rod

Spring

Adjust the valve clearance. (⇒3-5)

Install a new cylinder head cover O-ring and install the cylinder head cover.

Be sure to install the O-ring into the groove properly.

Install and tighten the cylinder head cover bolts.

**Torque:** 0.8~1.2kgf-m

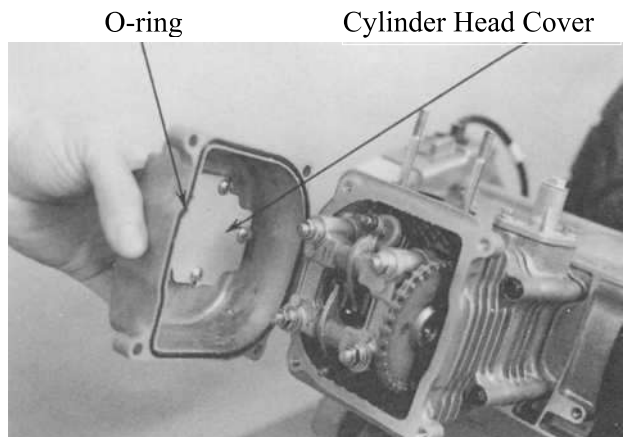

O-ring

Cylinder Head Cover

# 1. GENERAL INFORMATION

# 1

ENGINE SERIAL NUMBER .....	1- 1	LUBRICATION POINTS .....	1-13
SPECIFICATIONS .....	1- 2	CABLE & HARNESS ROUTING .....	1-15
SERVICE PRECAUTIONS .....	1- 3	WIRING DIAGRAM.....	1-20
TORQUE VALUES .....	1-11	TROUBLESHOOTUNG .....	1-21
SPECIAL TOOLS .....	1-12		

## ENGINE SERIAL NUMBER

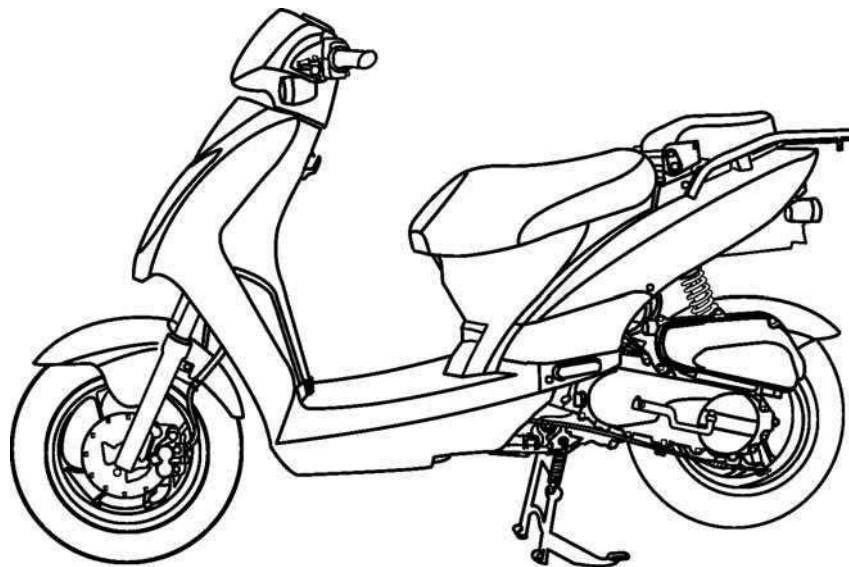

AGILITY 50



Location of Engine Serial Number

# 1. GENERAL INFORMATION

AGILITY 50

## SPECIFICATIONS

Motorcycle Name & Type		AGILITY 50		
Name & Model No.		KG10SA		
Overall length (mm)		1830		
Overall width (mm)		690		
Overall height (mm)		1130		
Wheel base (mm)		1325		
Engine type		O.H.C.		
Displacement		49.5cc		
Fuel Used		92# nonleaded gasoline		
Net weight (kg)	Front wheel	37.5		
	Rear wheel	55		
	Total	92.5		
Gross weight(kg)	Front wheel	38		
	Rear wheel	59		
	Total	97		
Tires	Front wheel	120/70 -12 56J		
	Rear wheel	130/70 -12 56J		
Ground clearance (mm)		112		
Perform- ance	Braking distance (m)	4 (Initial speed 20km/h)		
	Min. turning radius (m)	1.99		
Engine	Starting system		Starting motor & kick starter	
	Type		Gasoline, 4-stroke	
	Cylinder arrangement		Single cylinder	
	Combustion chamber type		Semi-sphere	
	Valve arrangement		O.H.C.	
	Bore x stroke (mm)		φ39.0 x 41.4	
	Compression ratio		11	
	Compression pressure (kg/cm <sup>2</sup> -rpm)		18	
	Max. output		3.5/7500kw/(r/min)	
	Max. torque		0.35/7000kg m/rpm	
	Port timing	Intake	Open	3°
			Close	7°
		Exhaust	Open	9°
			Close	1°
	Valve clearance (cold) (mm)	Intake	0.04	
		Exhaust	0.04	
	Idle speed (rpm)		1700±100rpm	
	Lubrication System	Lubrication type		Forced pressure & wet sump
		Oil pump type		Inner/outer rotor type
		Oil filter type		Full-flow filtration
Oil capacity		0.8 liter		
Cooling Type		Forced air cooling		
Fuel System	Air cleaner type & No		Paper element, wet	
	Fuel capacity		5.0 liter	
	Carburetor	Type	CVK	
		Piston dia. (mm)		
Venturi dia.(mm)		φ17equivalent		
Throttle type		Butterfly type		
Electrical Equipment	Ignition System	Type	CDI	
		Ignition timing	BTDC28°/4000rpm	
		Contact breaker	Non-contact point type	
		Spark plug	NGK C7HSA	
	Spark plug gap	0.6~0.7mm		
Battery	Capacity	12V4AH		
Power Drive System	Clutch	Type	Dry multi-disc clutch	
		Transmission Gear	Type	Non-stage transmission
	Reduction Gear	Operation	Automatic centrifugal type	
		Type	Two-stage reduction	
Reduction ratio	1st	0.8-3.1		
	2nd	11.05		
Moving Device	Front Axle	Caster angle	27°	
		Trail length	—	
	Tire pressure (kg/cm <sup>2</sup> )	Front	1.75	
		Rear	2.25	
Turning angle	Left	45°		
	Right	45°		
Brake system type		Front	DISK (180mm) brake	
		Rear	Drum (110mm) brake	
Damping Device	Suspension type	Front	TELESCOPE	
		Rear	Unit Swing	
	Shock absorber distance	Front	80	
		Rear	82	
Frame type		Under Bone		

# 1. GENERAL INFORMATION

## SERVICE PRECAUTIONS

- Make sure to install new gaskets, O-rings, circlips, cotter pins, etc. when reassembling.

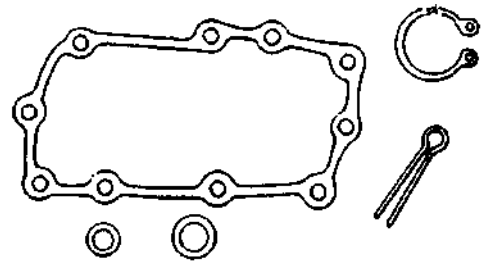

- When tightening bolts or nuts, begin with larger-diameter to smaller ones at several times, and tighten to the specified torque diagonally.

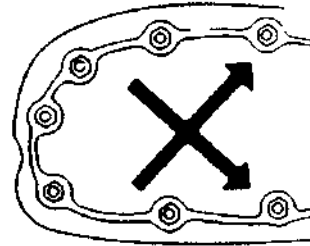

- Use genuine parts and lubricants

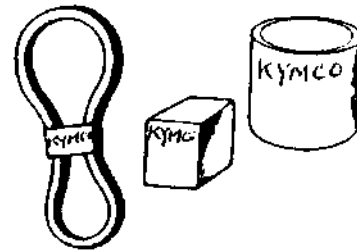

- When servicing the motorcycle, be sure to use special tools for removal and installation.



- After disassembly, clean removed parts. Lubricate sliding surfaces with engine oil before reassembly.

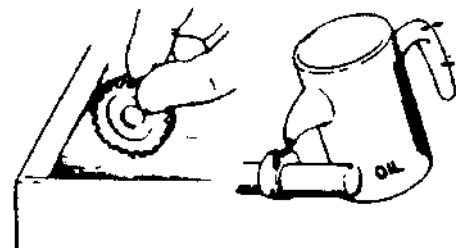

# 1. GENERAL INFORMATION

- Apply or add designated greases and lubricants to the specified lubrication points.

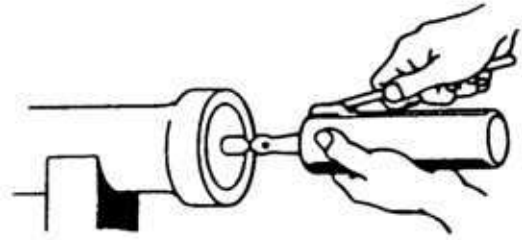

- After reassembly, check all parts for proper tightening and operation.

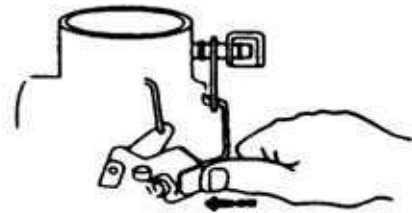

- When two persons work together, pay attention to the mutual working safety.



- Disconnect the battery negative (-) terminal before operation.
- When using a spanner or other tools, make sure not to damage the motorcycle surface.

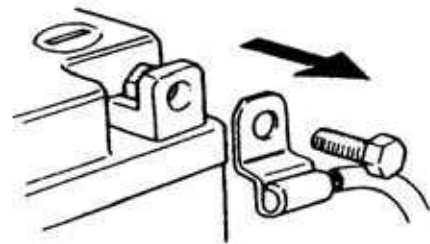

- After operation, check all connecting points, fasteners, and lines for proper connection and installation.
- When connecting the battery, the positive (+) terminal must be connected first.
- After connection, apply grease to the battery terminals.
- Terminal caps shall be installed securely.

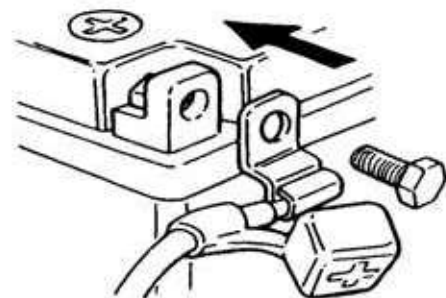

# 1. GENERAL INFORMATION

- If the fuse is burned out, find the cause and repair it. Replace it with a new one according to the specified capacity.

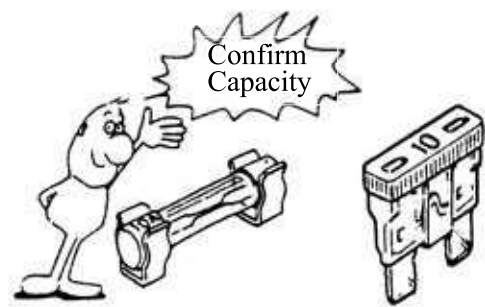

- After operation, terminal caps shall be installed securely.



- When taking out the connector, the lock on the connector shall be released before operation.

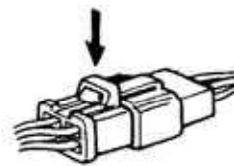

- Hold the connector body when connecting or disconnecting it.
- Do not pull the connector wire.



- Check if any connector terminal is bending, protruding or loose.

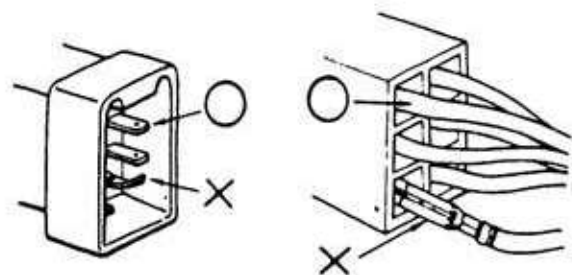



# 1. GENERAL INFORMATION

- The connector shall be inserted completely.
- If the double connector has a lock, lock it at the correct position.
- Check if there is any loose wire.

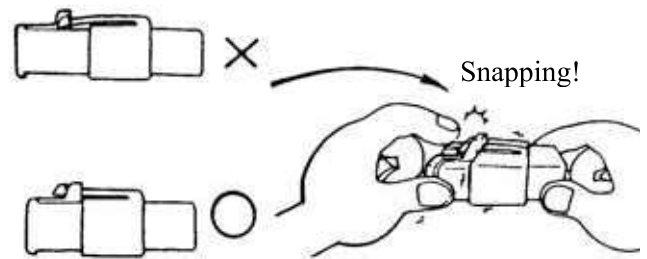

- Before connecting a terminal, check for damaged terminal cover or loose negative terminal.

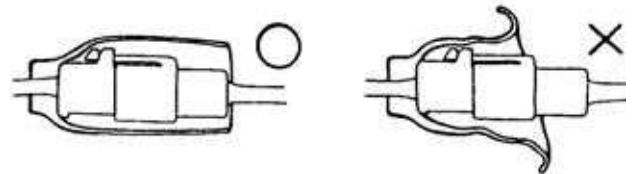

- Check the double connector cover for proper coverage and installation.



- Insert the terminal completely.
- Check the terminal cover for proper coverage.
- Do not make the terminal cover opening face up.



- Secure wire harnesses to the frame with their respective wire bands at the designated locations. Tighten the bands so that only the insulated surfaces contact the wire harnesses.

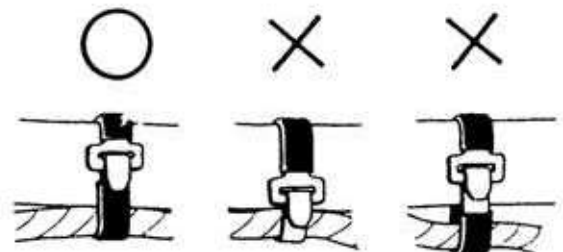

# 1. GENERAL INFORMATION

- After clamping, check each wire to make sure it is secure.

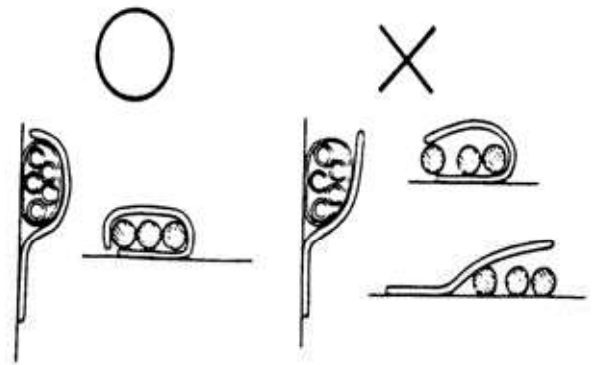

- Do not squeeze wires against the weld or its clamp



- After clamping, check each harness to make sure that it is not interfering with any moving or sliding parts.

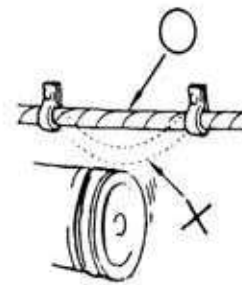

- When fixing the wire harnesses, do not make it contact the parts which will generate high heat.

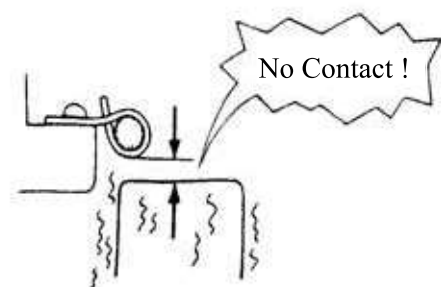

- Route wire harnesses to avoid sharp edges or corners. Avoid the projected ends of bolts and screws.
- Route wire harnesses passing through the side of bolts and screws. Avoid the projected ends of bolts and screws.

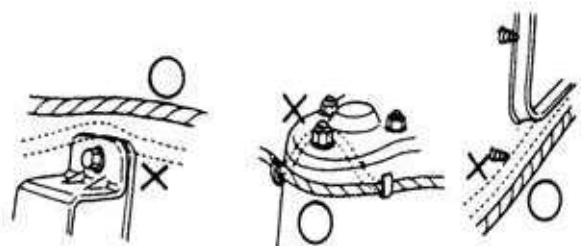

# 1. GENERAL INFORMATION

- Route harnesses so they are neither pulled tight nor have excessive slack.

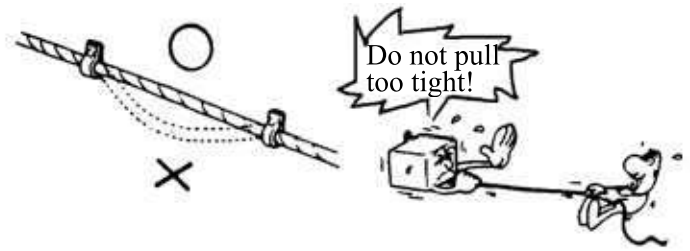

- Protect wires and harnesses with electrical tape or tube if they contact a sharp edge or corner

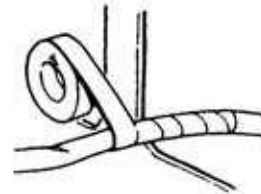

- When rubber protecting cover is used to protect the wire harnesses, it shall be installed securely.

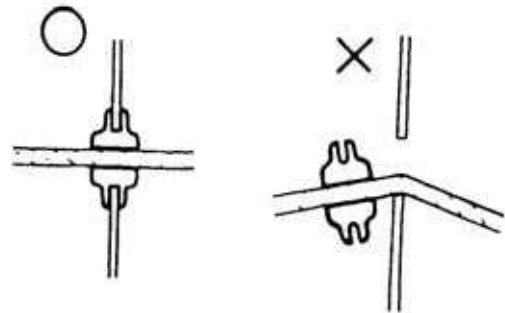

- Do not break the sheath of wire.
- If a wire or harness is with a broken sheath, repair by wrapping it with protective tape or replace it.

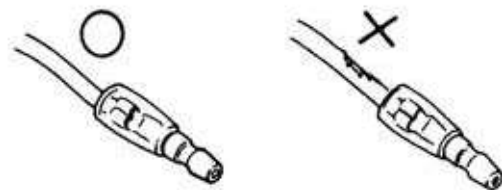

- When installing other parts, do not press or squeeze the wires.



# 1. GENERAL INFORMATION

- After routing, check that the wire harnesses are not twisted or kinked.

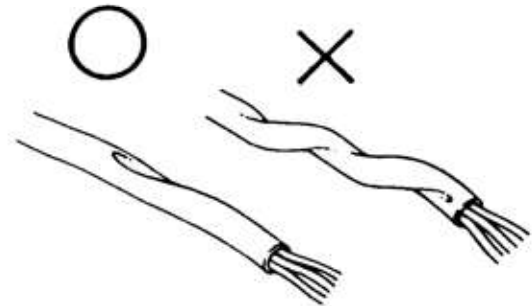

- Wire harnesses routed along with handlebar should not be pulled tight, have excessive slack or interfere with adjacent or surrounding parts in all steering positions.



- When a testing device is used, make sure to understand the operating methods thoroughly and operate according to the operating instructions.

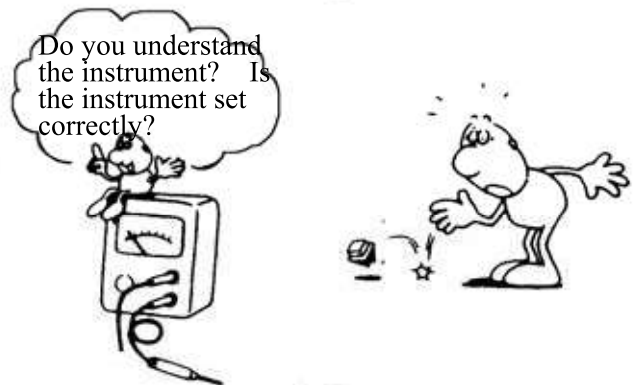

- Be careful not to drop any parts.

- When rust is found on a terminal, remove the rust with sand paper or equivalent before connecting.



- Do not bend or twist control cables. Damaged control cables will not operate smoothly and may stick or bind.

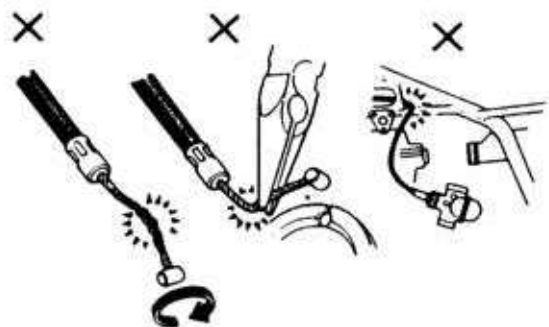

# 1. GENERAL INFORMATION

## ■ Symbols:

The following symbols represent the servicing methods and cautions included in this service manual.



Engine Oil

: Apply engine oil to the specified points. (Use designated engine oil for lubrication.)



Grease

: Apply grease for lubrication.



Gear Oil

: Transmission Gear Oil (90#)



: Use special tool.

: Caution



: Warning

(⇒12-3) : Refer to page 12-3.

# 1. GENERAL INFORMATION

## TORQUE VALUES

### STANDARD TORQUE VALUES

Item	Torque (kg-m)	Item	Torque (kg-m)
5mm bolt, nut	0.45-0.6	5mm screw	0.35-0.5
6mm bolt, nut	0.6-1.2	6mm screw, SH bolt	0.7-1.1
8mm bolt, nut	1.8-2.5	6mm flange bolt, nut	1.0-1.4
10mm bolt, nut	3.0-4.0	8mm flange bolt, nut	2.4-3.0
12mm bolt, nut	5.0-6.0	10mm flange bolt, nut	3.5-4.5

Torque specifications listed below are for important fasteners.

### ENGINE

Item	Q'ty	Thread dia.(mm)	Torque (kg-m)	Remarks
Cylinder head bolt A	2	6	0.7-1.1	Double end bolt
Cylinder head bolt B	4	6	0.7-1.1	
Oil filter screen cap	1	30	1.0-2.0	Double end bolt Apply oil to threads
Exhaust muffler lock bolt	2	6	0.7-1.1	
Cylinder head flange nut	4	7	1.2-1.6	
Valve adjusting lock nut	2	3	0.07-0.09	
Cam chain tensioner slipper bolt	1	8	0.4-0.7	
Oil bolt	1	8	1.1-1.5	
Clutch outer nut	1	10	3.5-4.5	
Clutch drive plate nut	1	28	5.0-6.0	
Starter motor mounting bolt	2	6	0.8-1.2	
Oil pump bolt	3	4	0.1-0.3	
Drive face nut	1	10	5.5-6.5	
Spark plug	1	10	1.0-1.4	
A.C. generator stator bolt	2	6	0.8-1.2	
Cam chain tensioner bolt	1	6	0.8-1.2	

### FRAME

Item	Q'ty	Thread dia.(mm)	Torque (kg-m)	Remarks
Steering stem lock nut	1	25.4	8.0-12.0	U-nut
Front axle nut	1	10	5.0-7.0	U-nut
Rear axle nut	1	14	11.0-13.0	U-nut
Rear shock absorber upper bolt	1	10	4.0-5.0	Apply locking agent
Rear shock absorber lower bolt	1	8	2.0-3.0	
Speedometer cable set screw	1	5	0.45-0.6	
Rear shock absorber lock nut	1	8	3.0-3.6	

## SPECIAL TOOLS

Tool Name	Tool No.	Remarks	Ref. Page
Bearing puller 10.12.15.18 mm	E037	10.12.15.18mm bearing	10-3 10-4 12-6
Bushing remover L	E032	11102 bush engine hanger rubber	
Bushing remover S	EO19	11203 bush rear cushion under rubber	
Crankshaft bearing puller	E030	91005 radial bearing	
Crankshaft protector	E029	13000 crankshaft comp 12mm.14mm	
Clutch spring compressor	E027	2301a driven pully assy	9-9 9-12
Cushion assemble & disassemble tool	F004	52400 cushion assy	13-4
Flywheel holder	E017	31110 flywheel comp.2310a pully assy driven	9-5 9-9 9-13 14-7 14-9
Flywheel puller	E002	Left hand thread 27mm	14-7
Long socket wrench 32mm 8angle	F002	50306 steering stem	12-21 12-22
Oil seal & bearing installer	E014	Oil seal & bearing install	
Tool boox	E033	Special tools storage	
Tappet adjuster	E036	90012 screw tappet	3-5
Valve spring compressor	E038	Valve spring	7-7 7-8

# 1. GENERAL INFORMATION

## LUBRICATION POINTS

### ENGINE

Lubrication Points	Lubricant
Valve guide/valve stem movable part Cam lobes Valve rocker arm friction surface Cam chain Cylinder lock bolt and nut Piston surroundings and piston ring grooves Piston pin surroundings Cylinder inside wall Connecting rod/piston pin hole Connecting rod big end Crankshaft R/L side oil seal Starter reduction gear engaging part Countershaft gear engaging part Final gear engaging part Bearing movable part O-ring face Oil seal lip	<ul style="list-style-type: none"> <li>•Genuine KYMCO Engine Oil (SAE15W-40)</li> <li>•API-SG Engine Oil</li> </ul>
Starter idle gear Friction spring movable part/shaft movable part Shaft movable grooved part Kick starter spindle movable part	High-temperature resistant grease
A.C. generator connector Transmission case breather tube	Adhesive



# 1. GENERAL INFORMATION

### FRAME

The following is the lubrication points for the frame.

Use general purpose grease for parts not listed.

Apply clean engine oil or grease to cables and movable parts not specified.

This will avoid abnormal noise and rise the durability of the motorcycle.

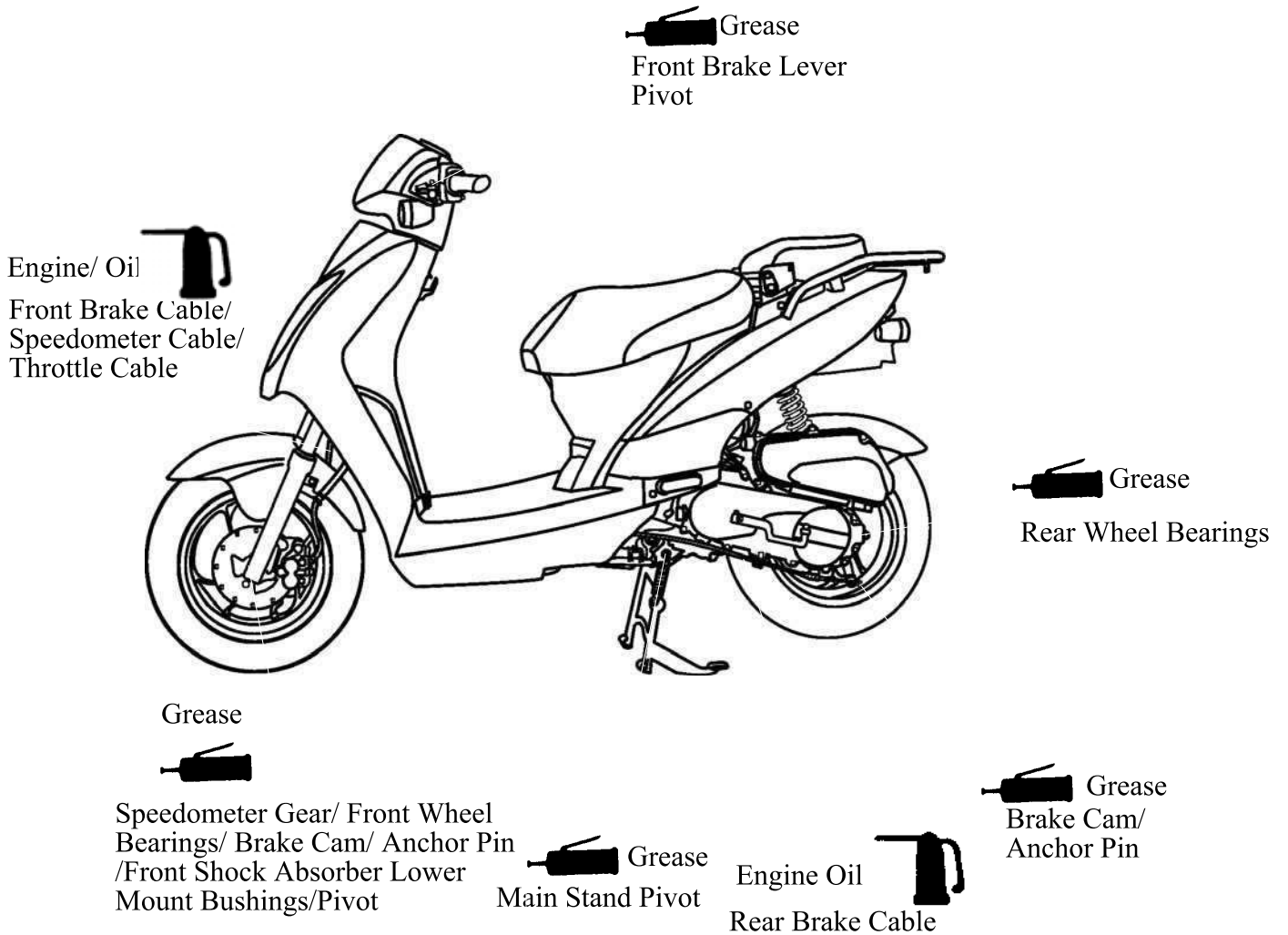

# 1. GENERAL INFORMATION

## CABLE & HARNESS ROUTING

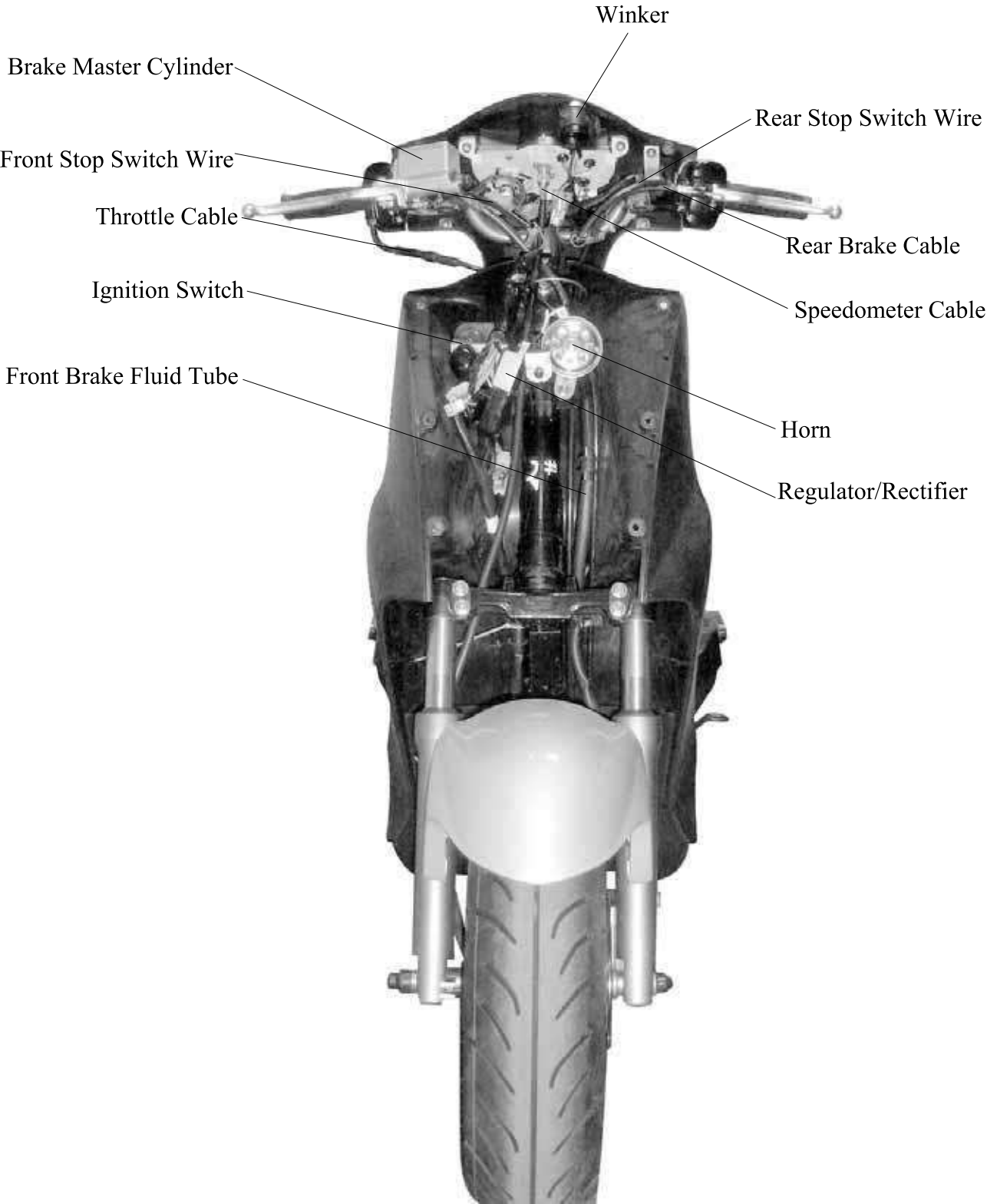

# 1. GENERAL INFORMATION

## AGILITY 50

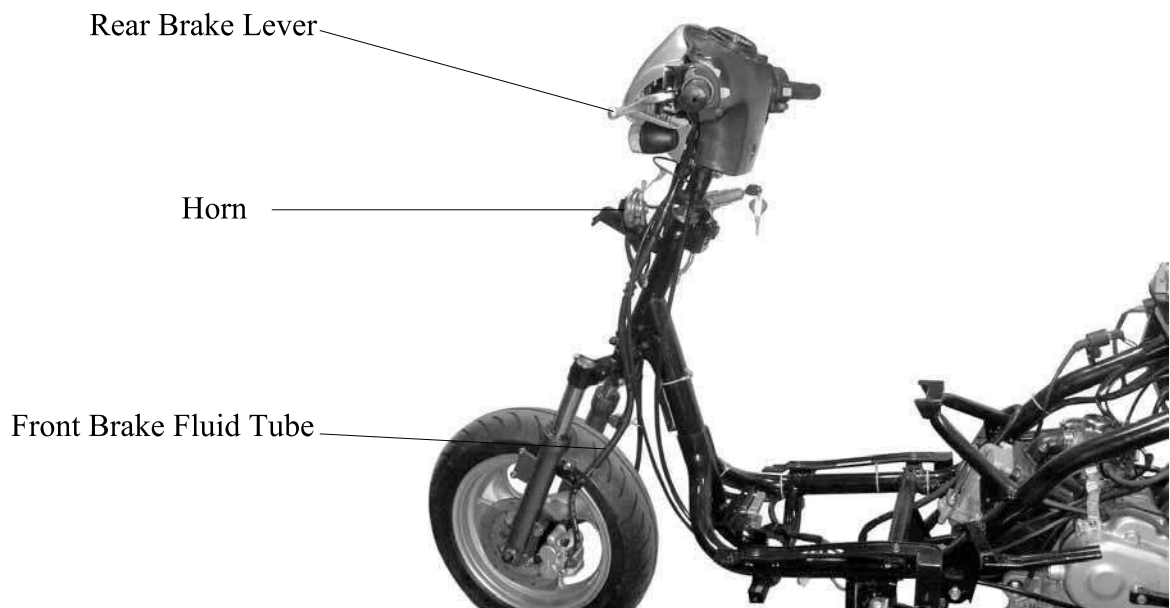
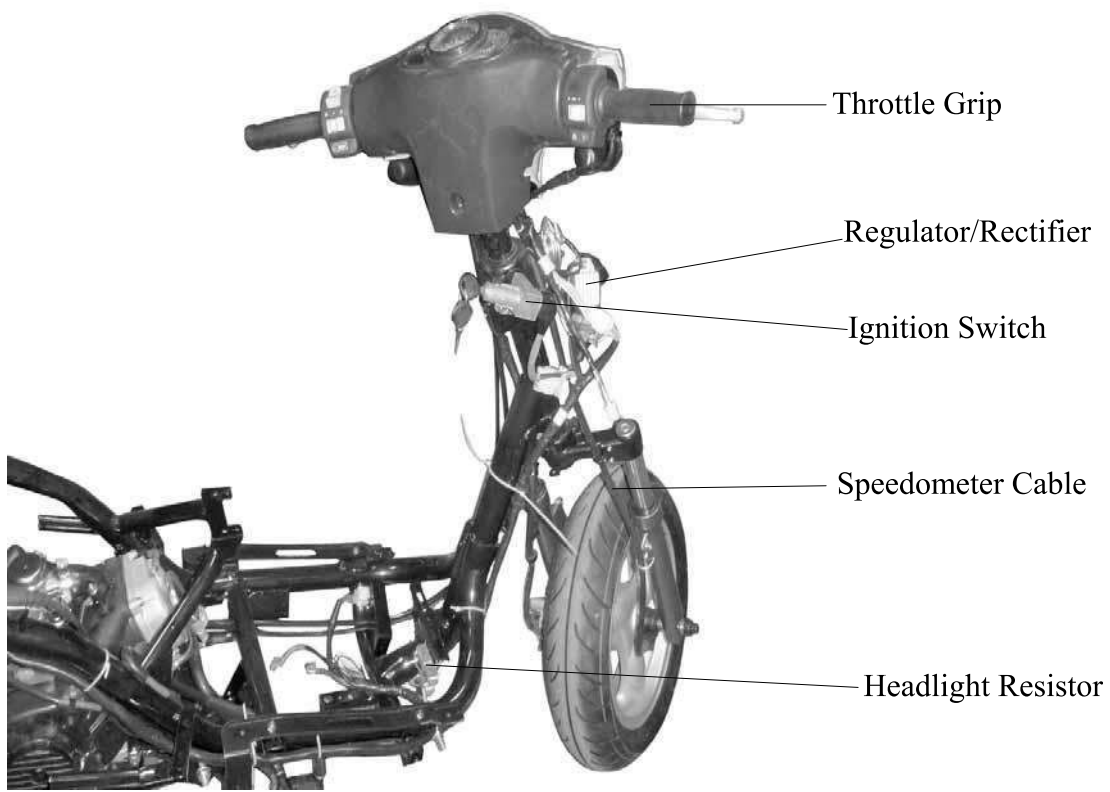

# 1. GENERAL INFORMATION

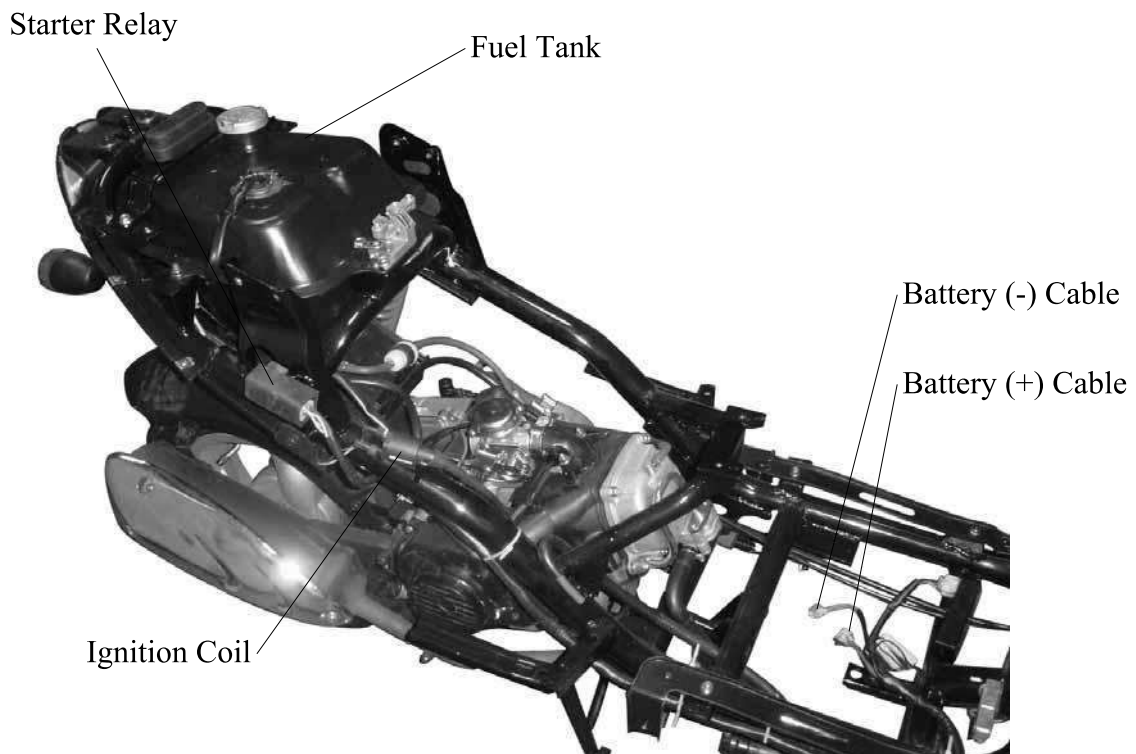
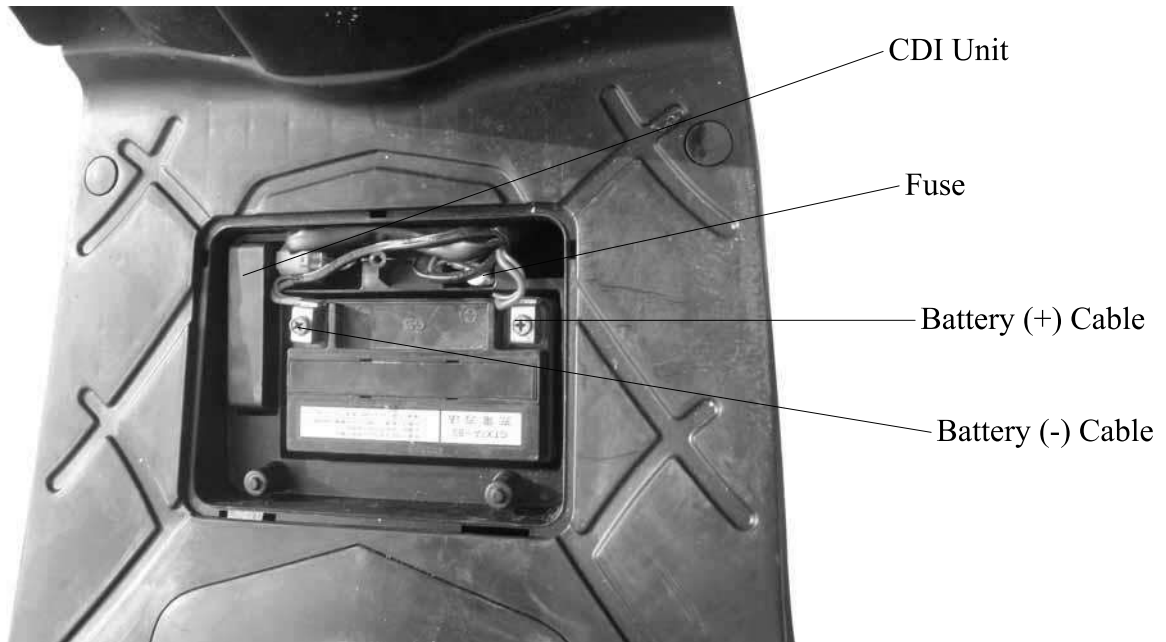

# 1. GENERAL INFORMATION

---

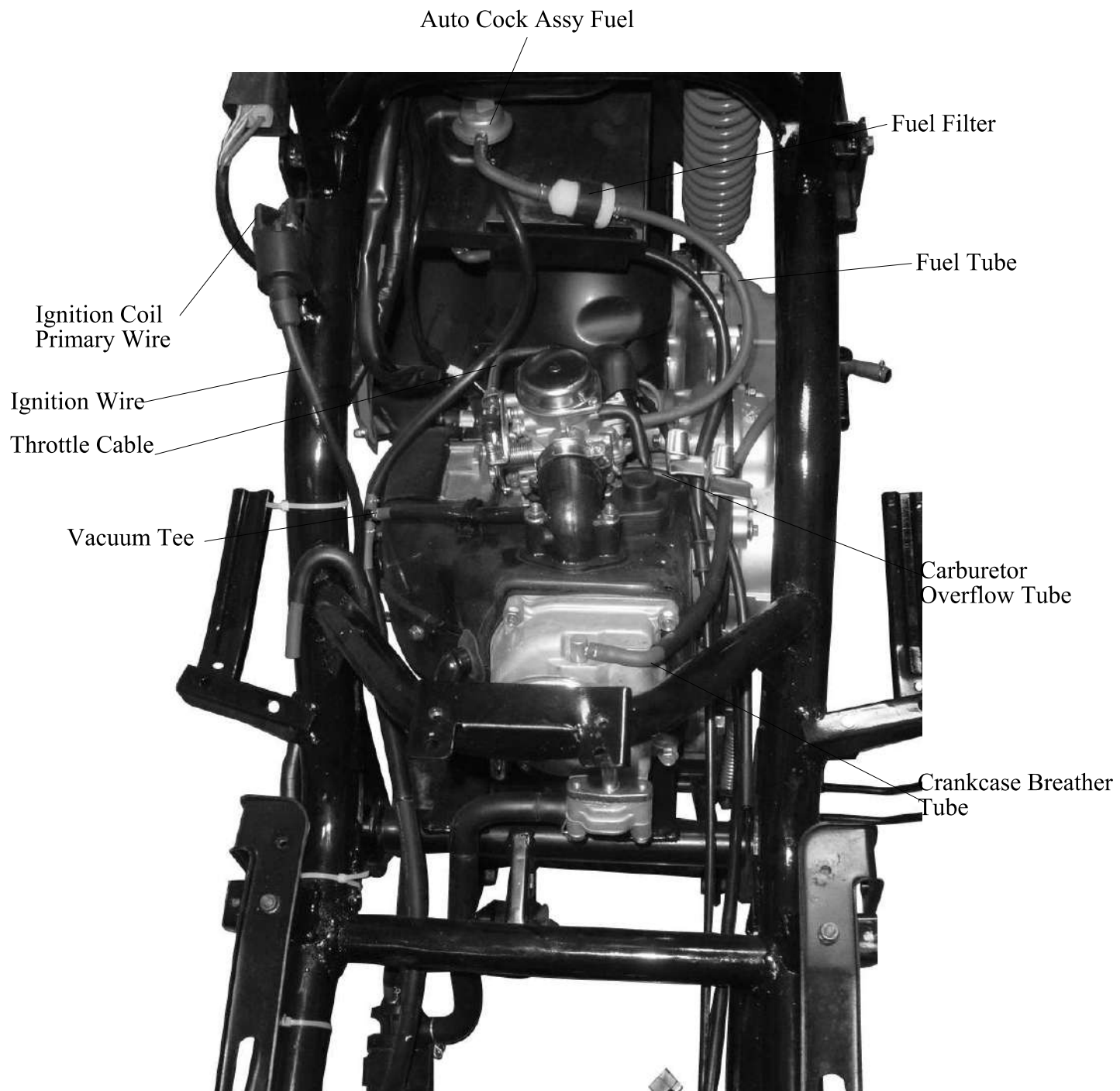

# 1. GENERAL INFORMATION

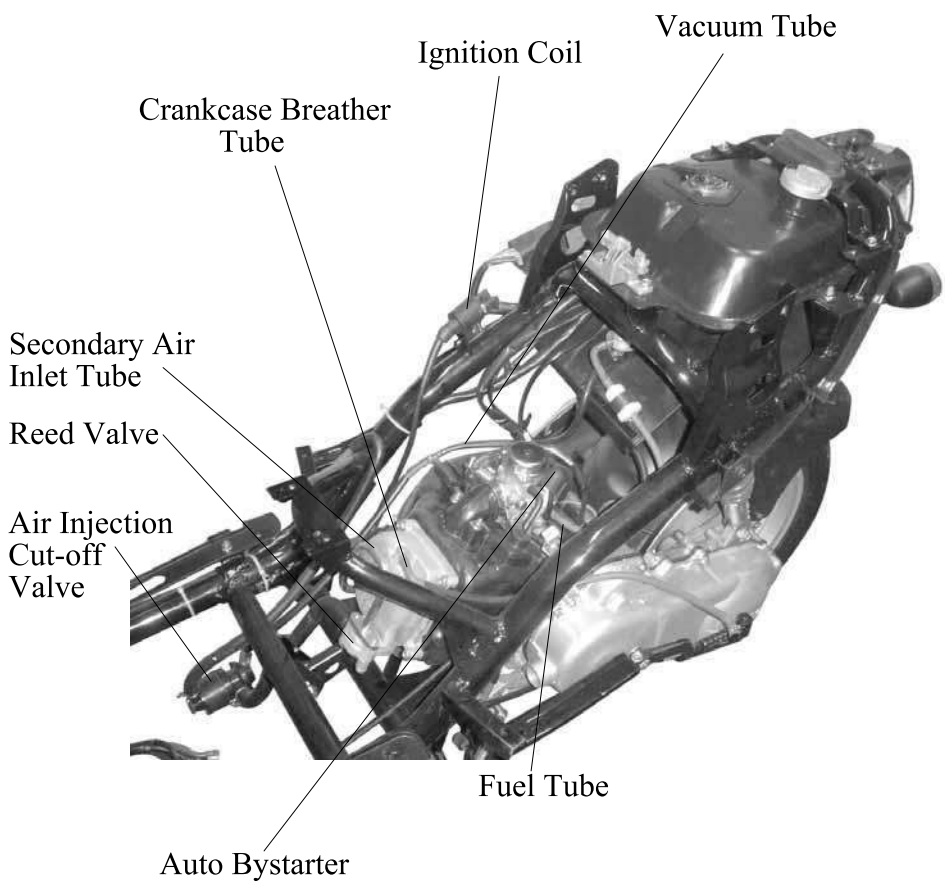
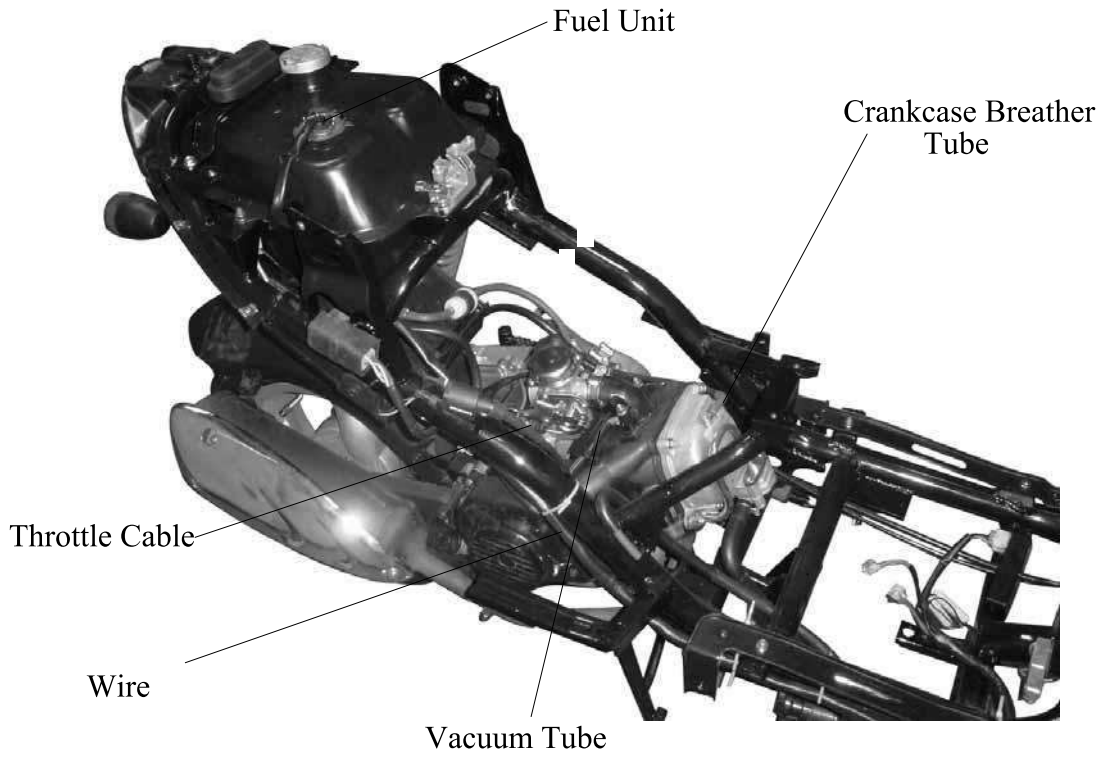

# 1. GENERAL INFORMATION

## WIRING DIAGRAM

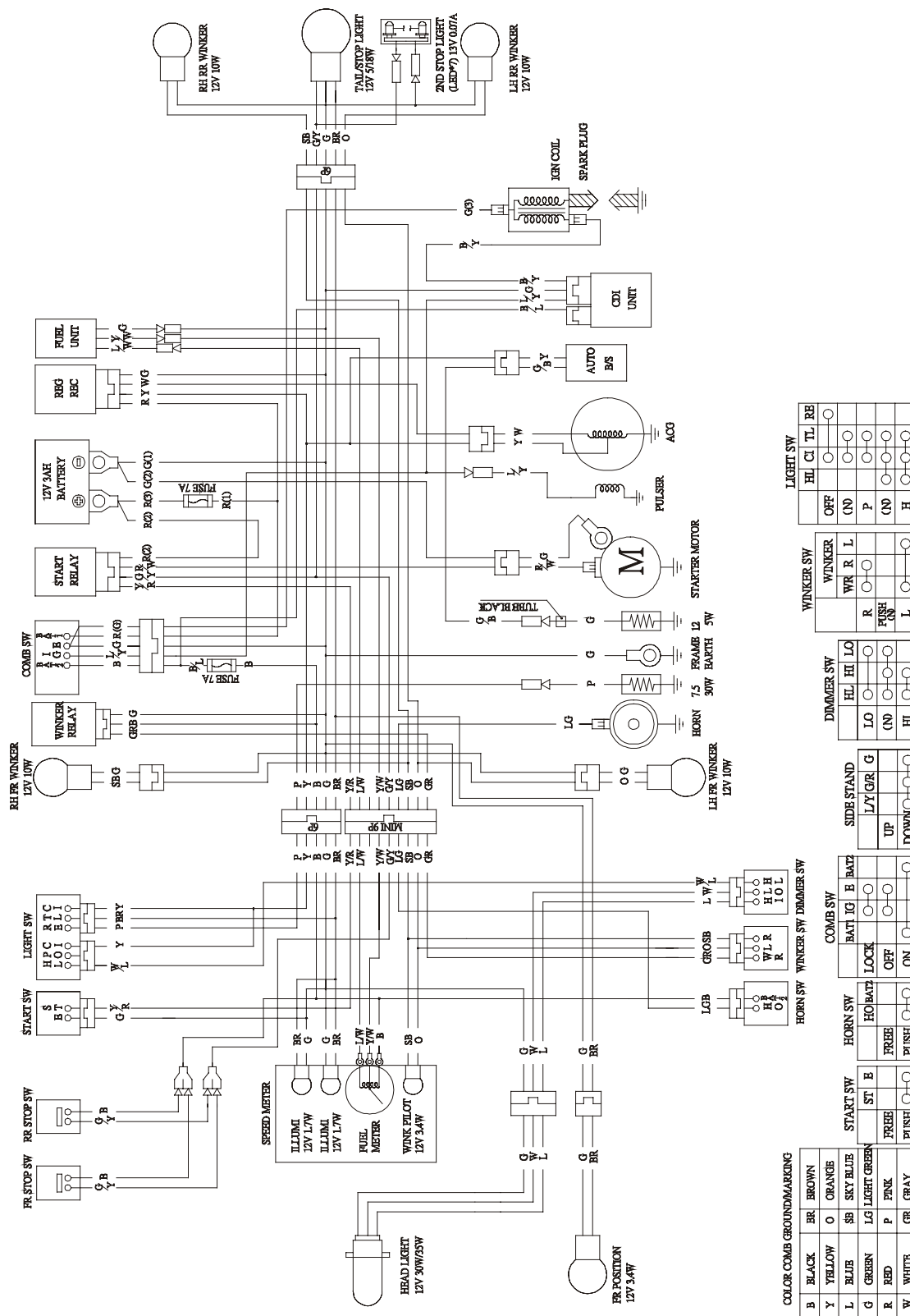

**COLOR COMB GROUND MARKING**

B	BLACK	BR	BROWN
Y	YELLOW	O	ORANGE
L	BLUE	SB	SKY BLUE
G	GREEN	LG	LIGHT GREEN
R	RED	P	PINK
W	WHITE	GR	GRAY

LIGHT SW		HL	CI	TL	RE
OFF		○	○	○	○
WINKER SW		WR	R	L	
		○	○	○	
DIMMER SW		HL	HI	LO	
		○	○	○	
SIDE STAND SW		UP	DOWN		
		○	○		
HORN SW		HO	BATZ		
		○	○		
START SW		ST	B		
		○	○		
COMBI SW		BAT	IG	B	BATZ
		○	○	○	○
WINKER SW DIMMER SW		LOCK	OFF	ON	
		○	○	○	

# 1. GENERAL INFORMATION

AGILITY 50

## TROUBLESHOOTING

### ENGINE WILL NOT START OR IS HARD TO START

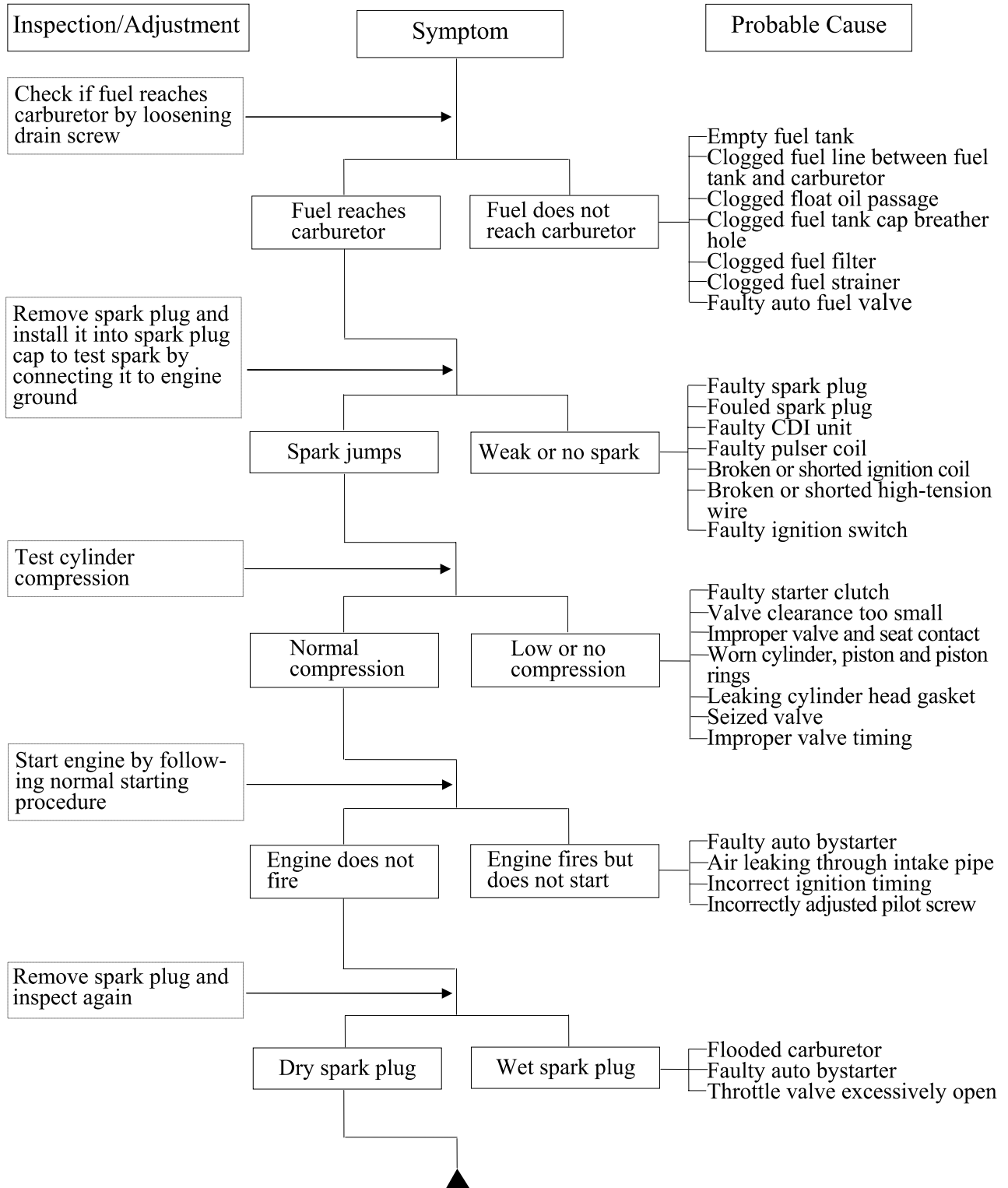



# 1. GENERAL INFORMATION

## AGILITY 50

### ENGINE LACKS POWER

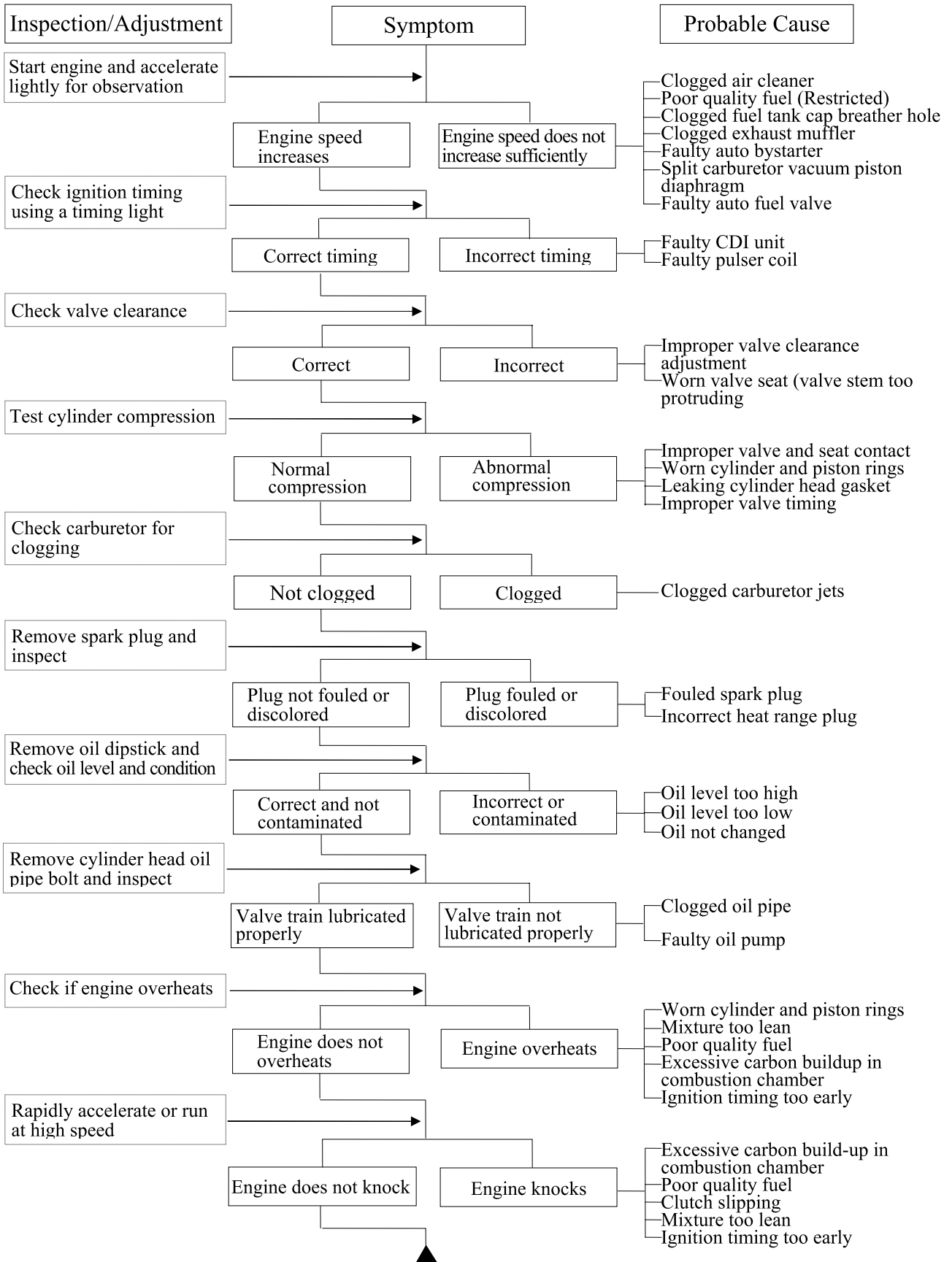

# 1. GENERAL INFORMATION

## AGILITY 50

### POOR PERFORMANCE (ESPECIALLY AT IDLE AND LOW SPEEDS)

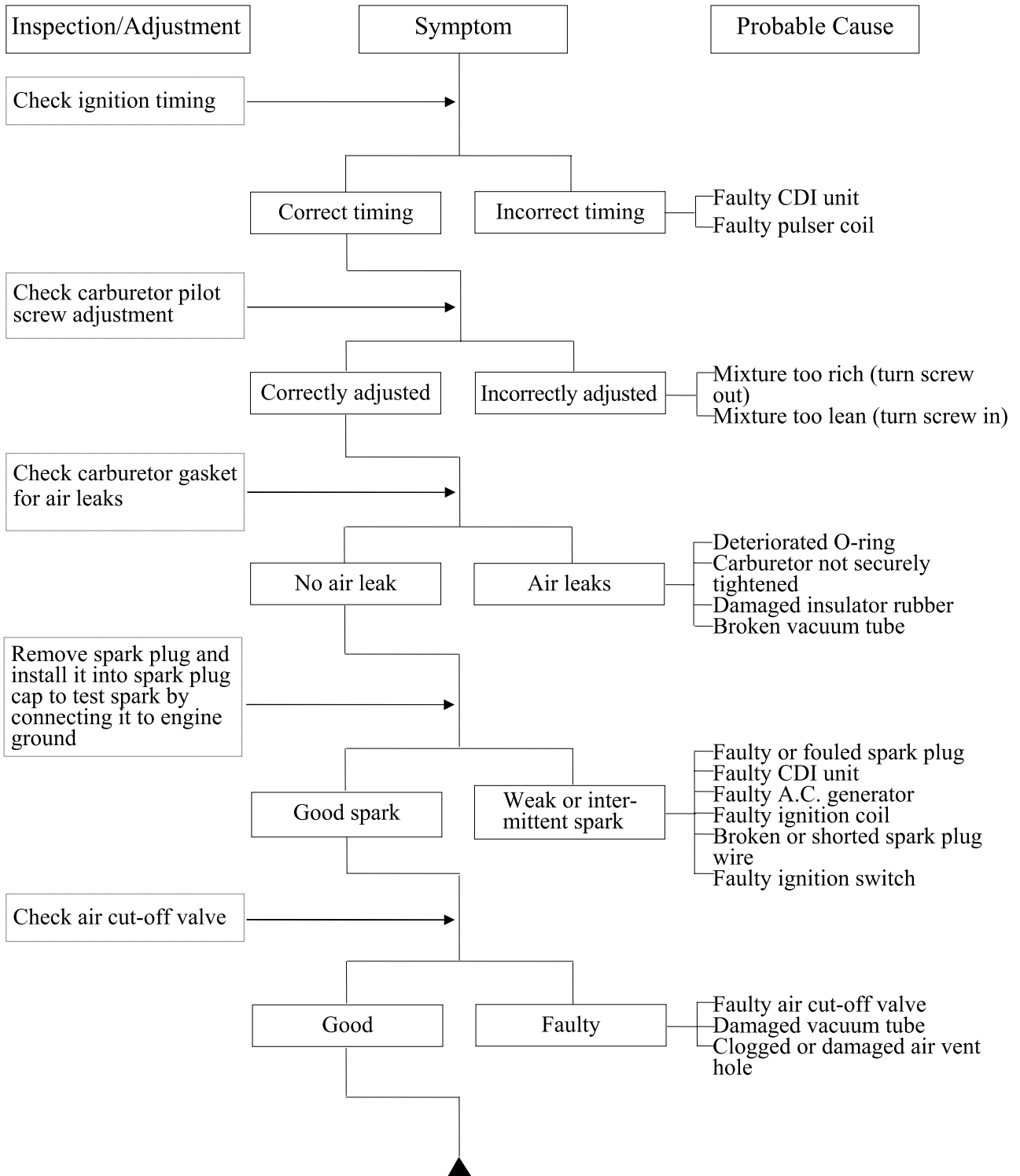

# 1. GENERAL INFORMATION

## POOR PERFORMANCE (AT HIGH SPEED)

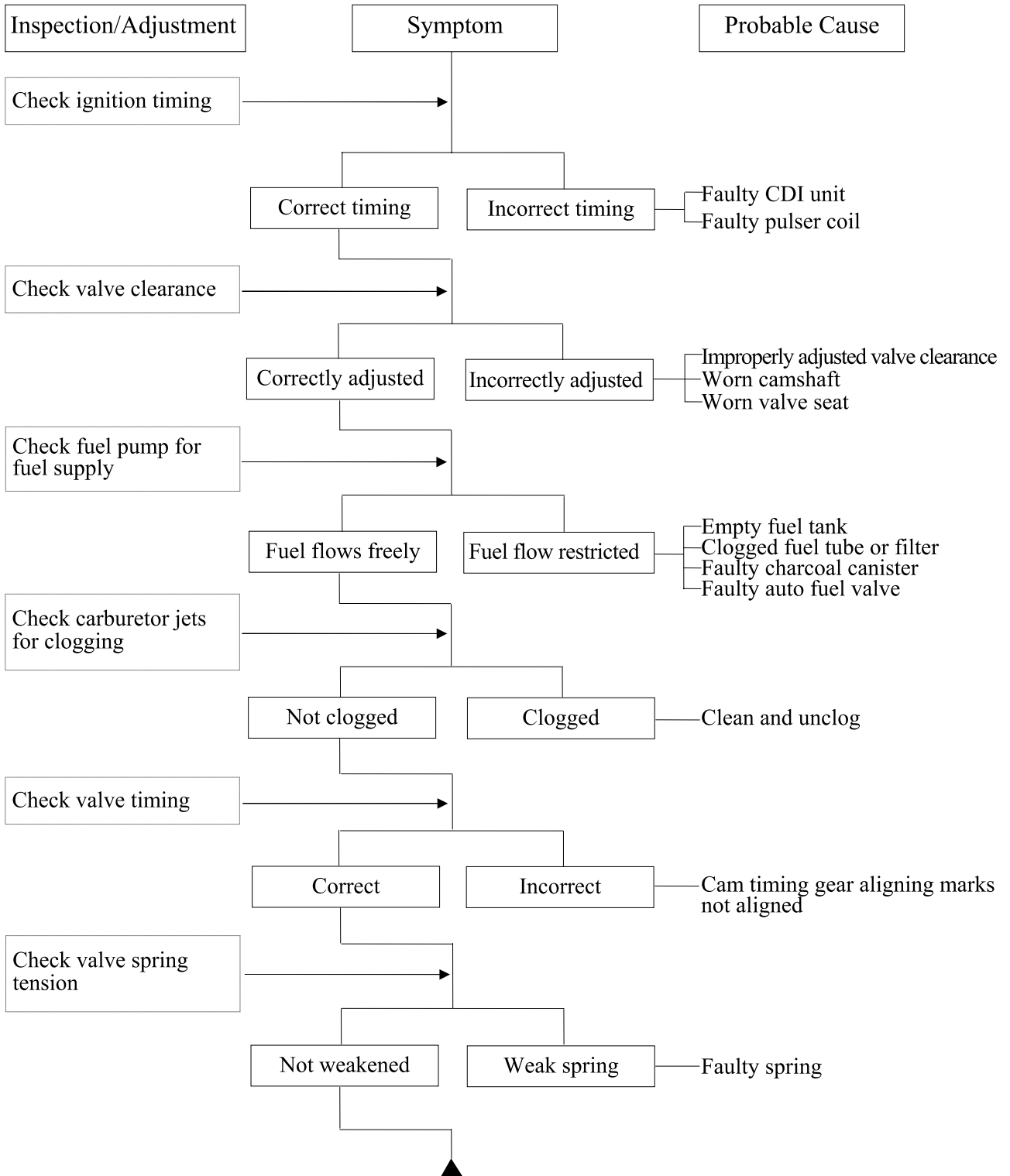

### POOR CHARGING (BATTERY OVER DISCHARGING OR OVERCHARGING)

#### Undercharging

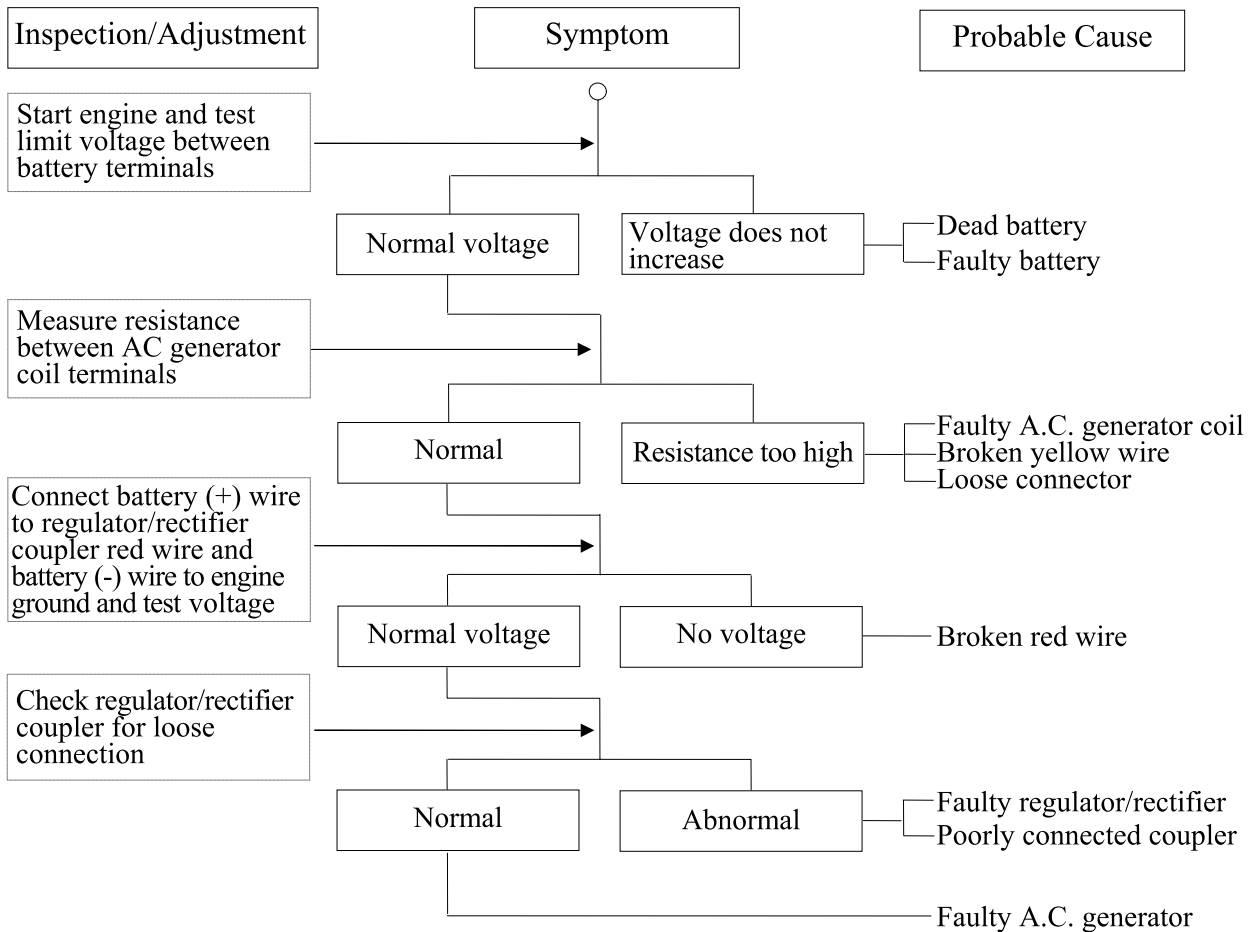

#### Overcharging

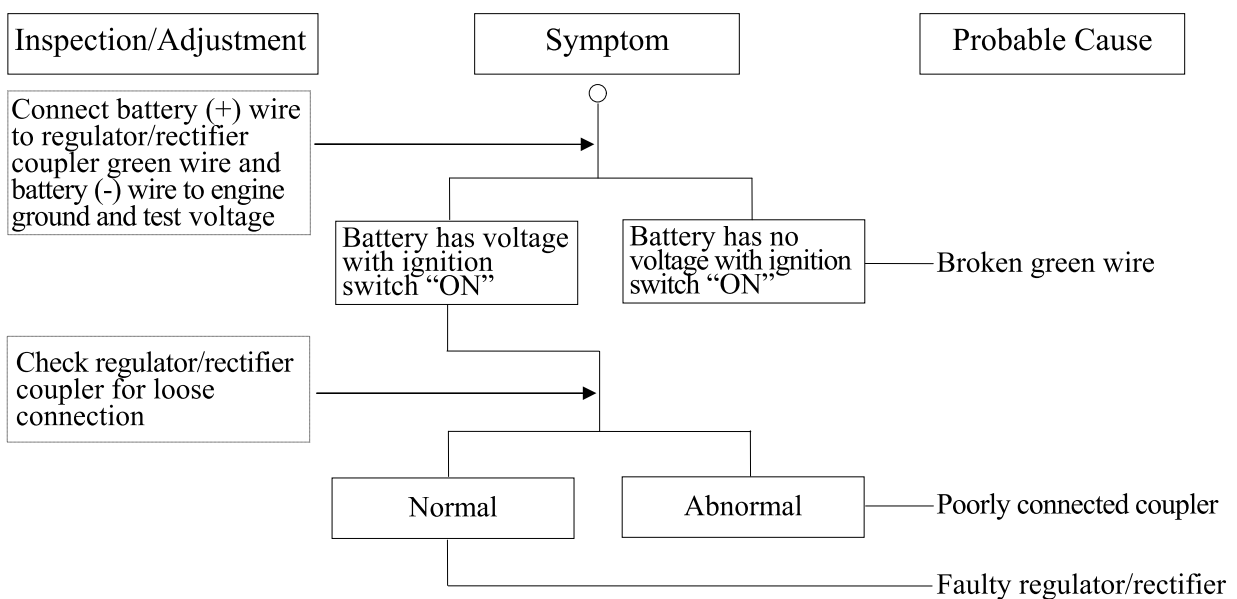

### NO SPARK AT SPARK PLUG

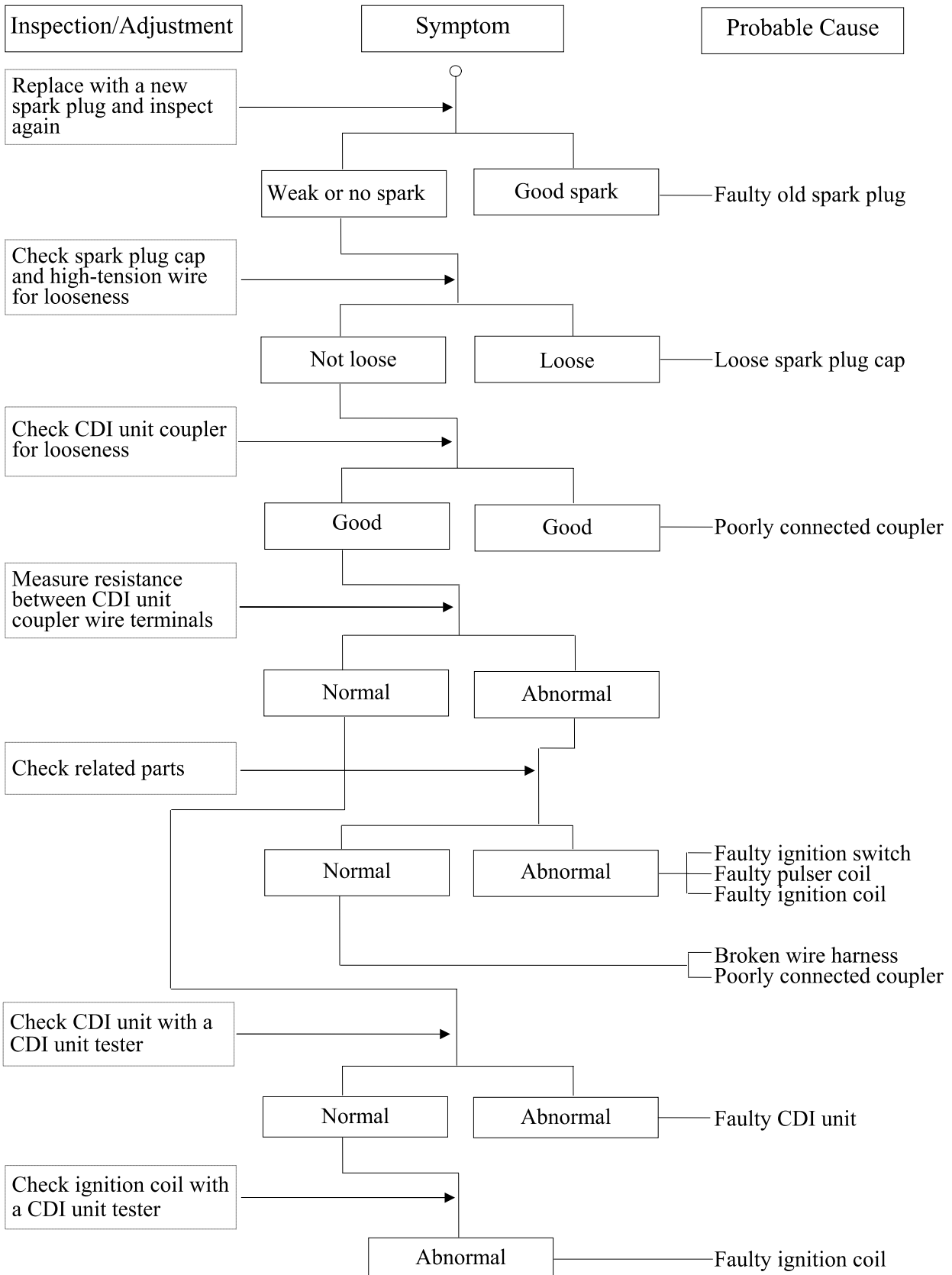

# 9. DRIVE AND DRIVEN PULLEYS/ KICK STARTER

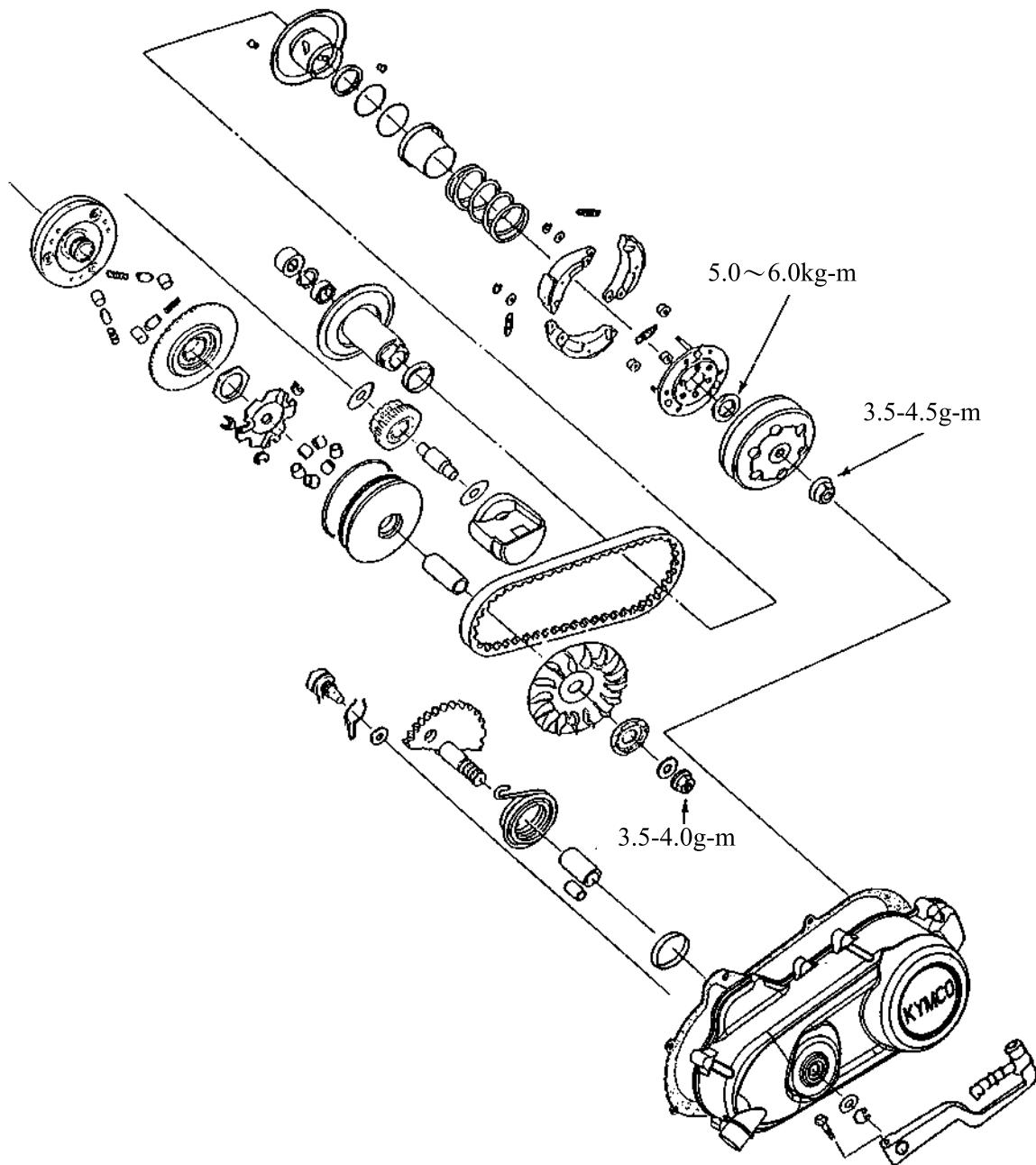

9



## 9. DRIVE AND DRIVEN PULLEYS/ KICK STARTER

### LEFT CRANKCASE COVER

#### REMOVAL

Loosen the drive belt air tube band screw.  
Remove the eight left crankcase cover bolts and left crankcase cover.  
Remove the seal rubber and dowel pins.  
Inspect the seal rubber for damage or deterioration.

Use specified genuine parts for replacement.

Left Crankcase Cover

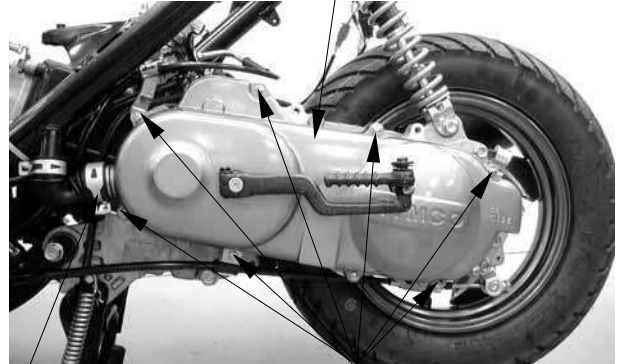

Air Tube Band

Bolts

### KICK STARTER

#### REMOVAL

Remove the kick lever from the kick starter spindle.  
Remove the circlip and washer from the kick starter spindle.

Kick Starter Spindle

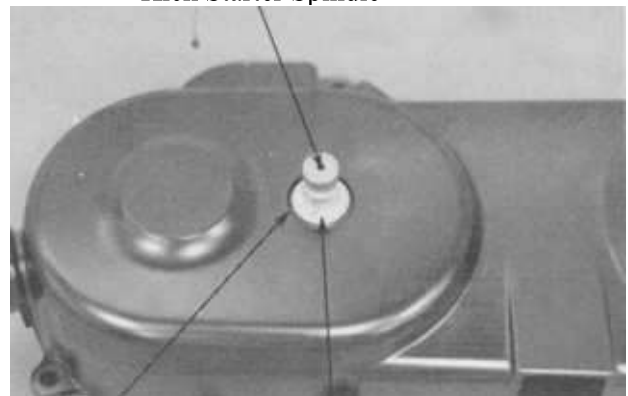

Washer

Circlip

Gently turn the kick starter spindle to remove the starter driven gear together with the friction spring.

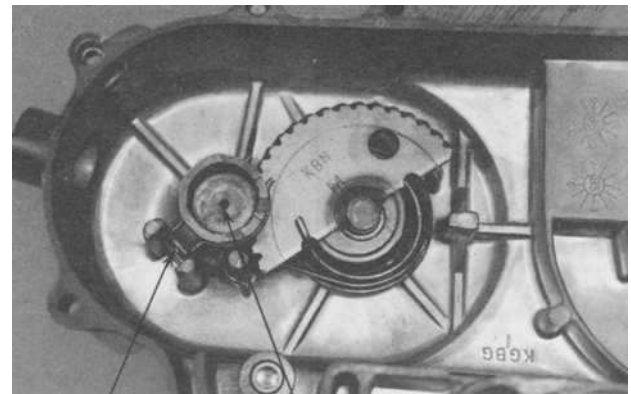

Friction Spring

Starter Driven Gear

Kick Starter Spindle

Remove the kick starter spindle and return spring from the left crankcase cover.  
Remove the kick starter spindle bushings.

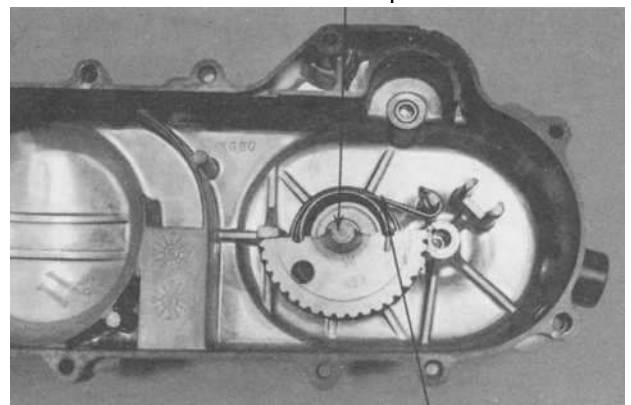

Return Spring



## 9. DRIVE AND DRIVEN PULLEYS/ KICK STARTER

#### INSPECTION

Inspect the kick starter spindle and gear for wear or damage.  
Inspect the return spring for weakness or damage.  
Inspect the kick starter spindle bushings for wear or damage.

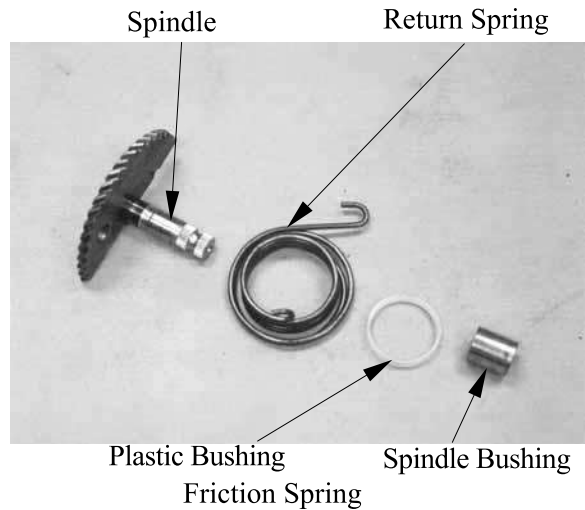

Inspect the starter driven gear for wear or damage.  
Inspect the friction spring for wear or damage.

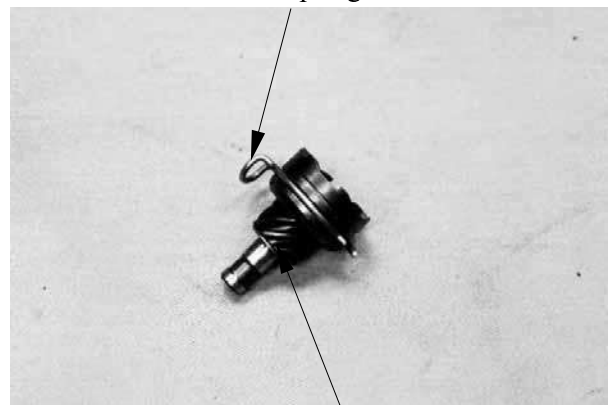

Inspect the kick starter spindle and starter driven gear forcing parts for wear or damage.

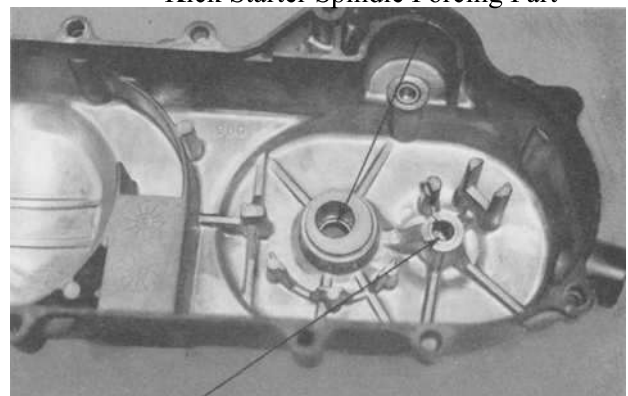

#### INSTALLATION

Install the kick starter spindle bushings and return spring onto the left crankcase cover.

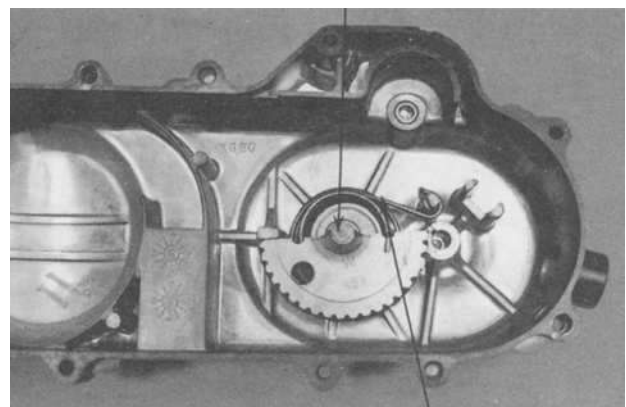

## 9. DRIVE AND DRIVEN PULLEYS/ KICK STARTER

Install the starter driven gear and friction spring onto the left crankcase cover as the figure shown.

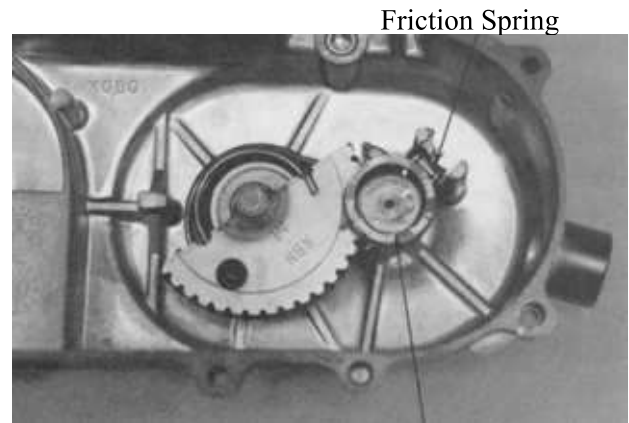

Starter Driven Gear

First install the washer and then install the circlip.  
Install the kick lever.

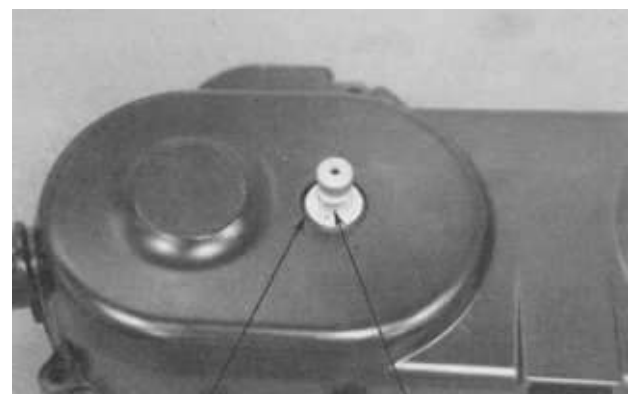

Washer

Circlip

### LEFT CRANKCASE COVER INSTALLATION

First install the dowel pins.  
Install the seal rubber.

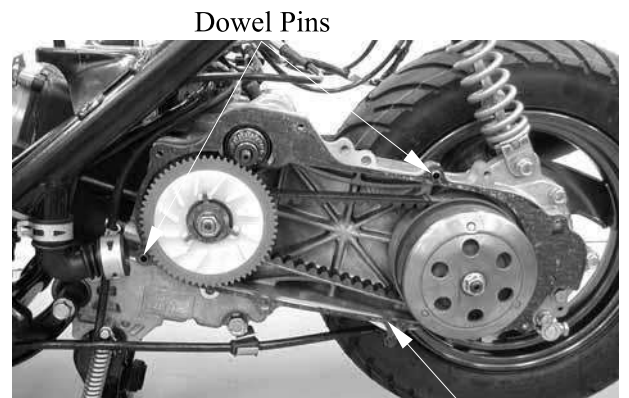

Dowel Pins

Seal Rubber

Install the left crankcase cover and tighten the eight left crankcase cover bolts diagonally.  
Connect the drive belt air tube and tighten the tube band screw.  
Install the rear brake cable clamp.



Left Crankcase Cover

Rear Brake Cable Clamp

## 9. DRIVE AND DRIVEN PULLEYS/ KICK STARTER

### DRIVE BELT

#### REMOVAL

Remove the left crankcase cover.

#### INSPECTION

Check the drive belt for cracks, separation or abnormal or excessive wear.  
Measure the drive belt width.

**Service Limit:** 16.5mm

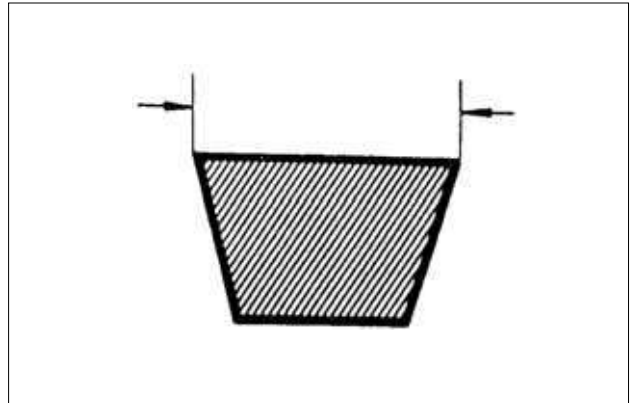

#### REPLACEMENT

Remove the eight left crankcase cover bolts and left crankcase cover. (⇒9-2)  
Hold the clutch outer with an universal holder and remove the clutch outer nut.

**Special**

Universal Holder

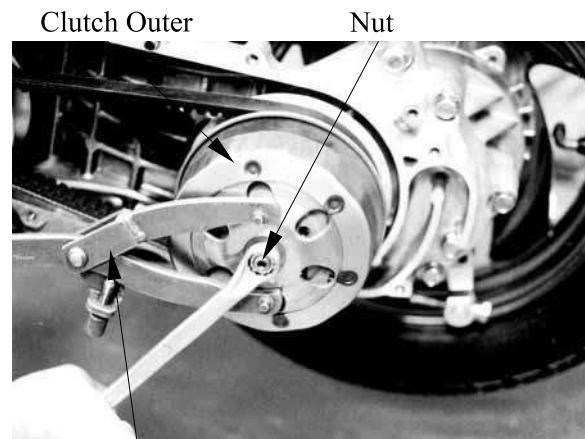

Universal Holder

Hold the drive pulley using a holder and remove the drive face nut, starting ratchet and washer.  
Remove the drive pulley face.

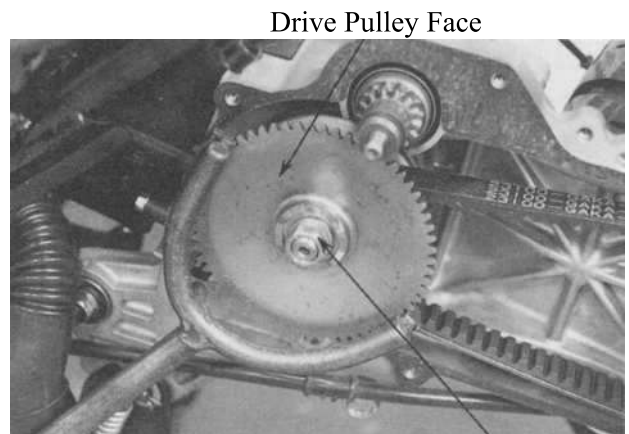

Drive Face Nut

Remove the drive belt from the clutch/driven pulley.

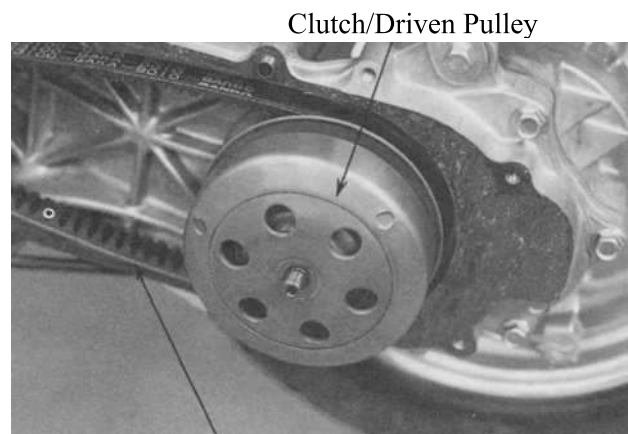

Clutch/Driven Pulley

## 9. DRIVE AND DRIVEN PULLEYS/ KICK STARTER

### INSTALLATION

Turn the driven pulley clockwise to widen the drive belt groove and lay a new drive belt on the driven pulley.

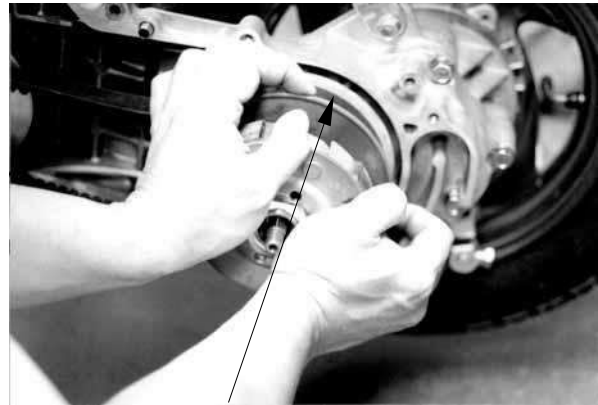

Drive Belt

Set the drive belt on the drive pulley face collar.  
Install the drive pulley face, starting ratchet washer. Install and tighten the drive face nut.

When installing, align the tooth space of the drive pulley face and starting ratchet with the crankshaft tooth and then tighten the nut.

Drive Face Nut Drive Pulley Face Drive Belt

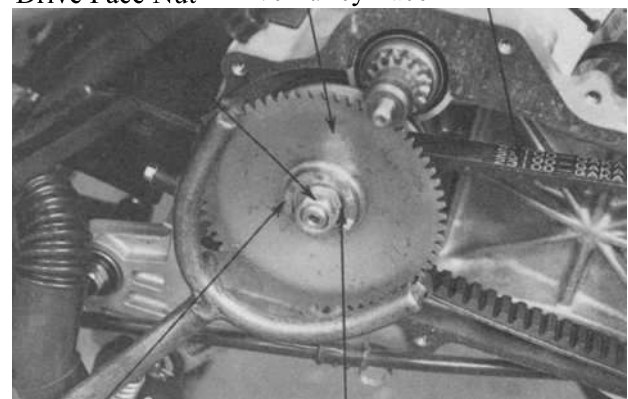

Starting Ratchet 10mmWasher

Drive Pulley Face Starting Ratchet

### DRIVE PULLEY

#### REMOVAL

Hold the drive pulley using a holder and remove the drive face nut, starting ratchet and washer.  
Remove the drive pulley face.



Drive Face Nut (10mm)

Movable Drive Face Assembly

#### DISASSEMBLY

Remove the movable drive face assembly and drive pulley collar from the crankshaft.

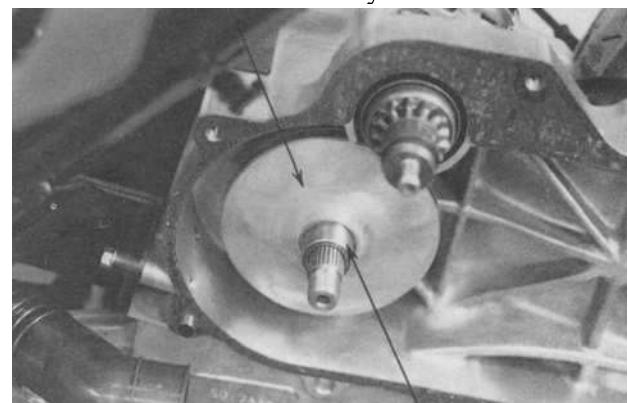

Drive Pulley Collar

## 9. DRIVE AND DRIVEN PULLEYS/ KICK STARTER

Remove the ramp plate.

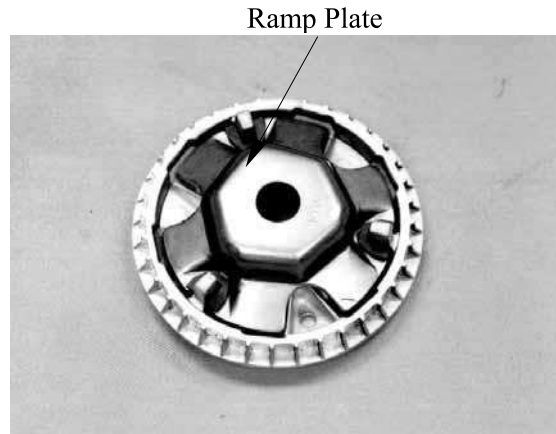

Remove the weight rollers.



### INSPECTION

Check each weight roller for wear or damage.  
Measure each weight roller O.D.

**Service Limit:** 12.4mm replace if below

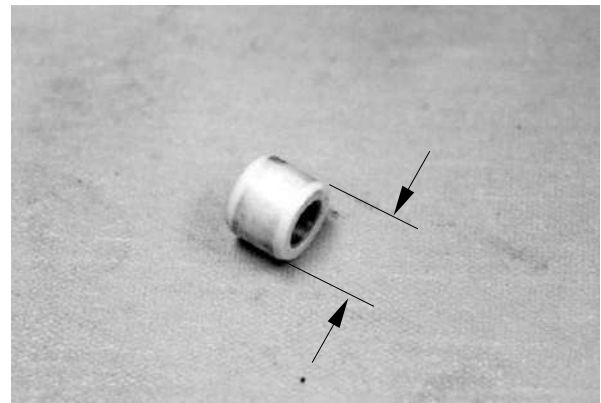

Check the drive pulley collar for wear or damage.  
Measure the O.D. of the drive pulley collar sliding surface.

**Service Limit:** 19.97mm replace if below

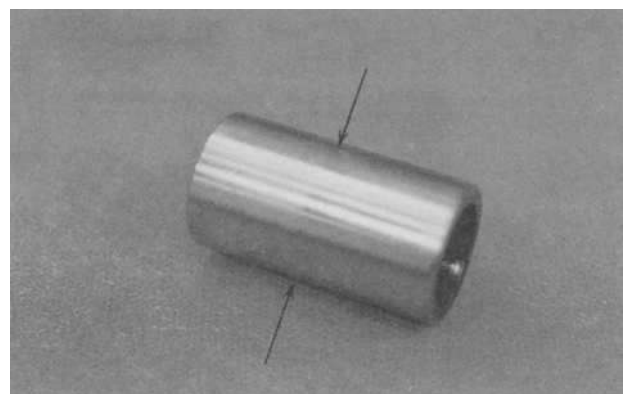

## 9. DRIVE AND DRIVEN PULLEYS/ KICK STARTER

### INSTALLATION

Install the drive pulley collar and movable drive face onto the crankshaft.

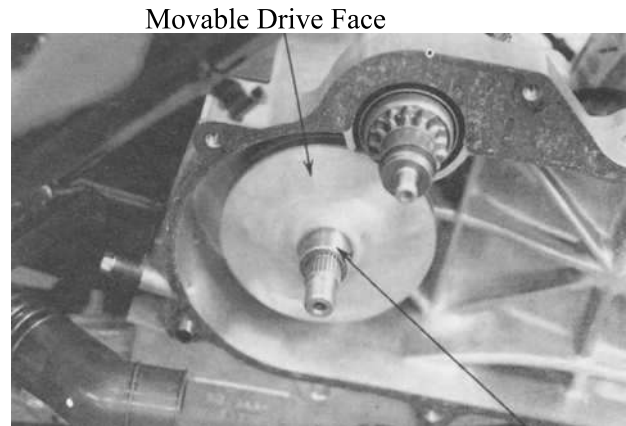

Movable Drive Face

Drive Pulley Collar

Set the drive belt on the drive pulley collar. Install the drive pulley face and tighten the drive face nut. (⇒9-6)

**Torque:** 5.5~6.5kgf-m

Do not get oil or grease on the drive belt or pulley faces.

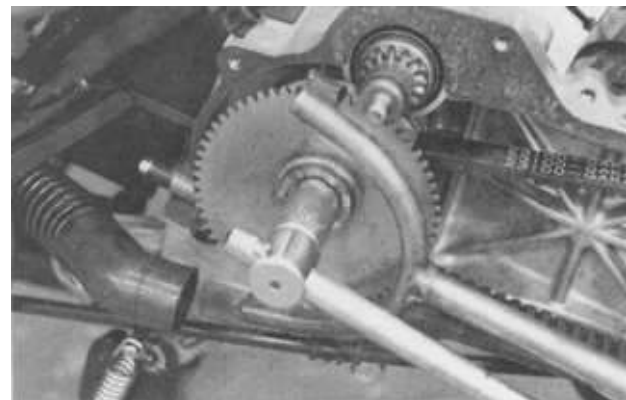

### STARTER PINION

#### REMOVAL

Remove the left crankcase cover.  
Remove the drive pulley.  
Remove the starter pinion holder.  
Remove the starter pinion.

#### INSPECTION

Inspect the starter pinion shaft forcing part for wear or damage.  
Inspect the starter pinion for smooth operation.  
Inspect the starter pinion and shaft for wear or damage.

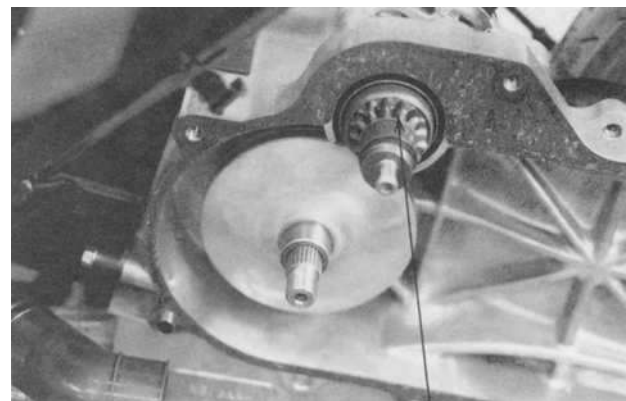

Starter Pinion

Starter Pinion Shaft

#### INSTALLATION

Apply a small amount of grease to the starter pinion shaft and install it in the reverse order of removal.



# 9. DRIVE AND DRIVEN PULLEYS/ KICK STARTER

### CLUTCH/DRIVEN PULLEY

#### REMOVAL

Remove the drive pulley. (⇒9-6)  
Hold the clutch outer with the universal holder and remove the clutch outer nut.  
Remove the clutch outer.

**Special**

Universal Holder

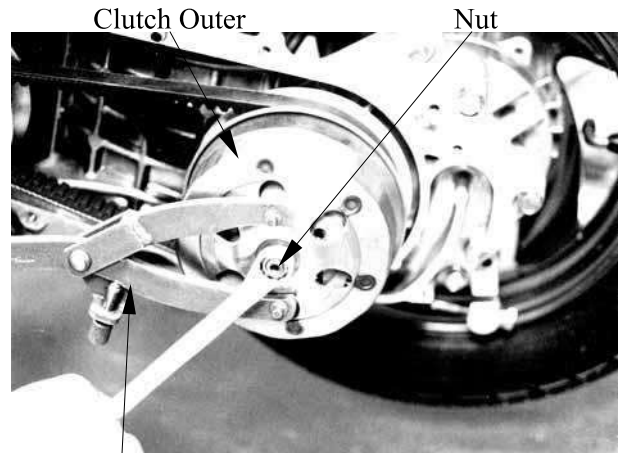

Universal Holder

Remove the clutch/driven pulley assembly  
Remove the drive belt from the clutch/driven pulley assembly.

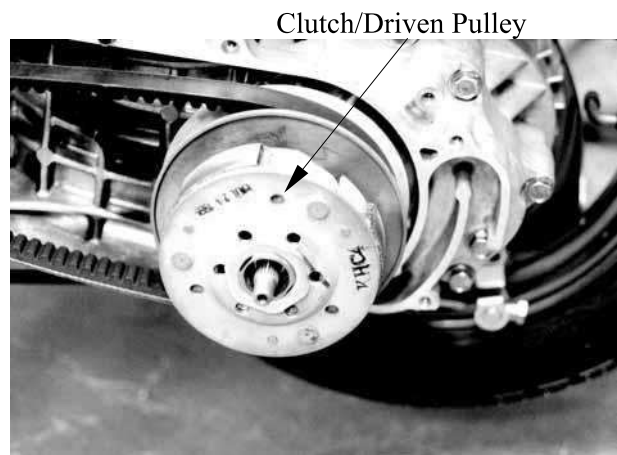

#### DISASSEMBLY

Hold the clutch/driven pulley assembly with the clutch spring compressor.  
Set the clutch spring compressor in a vise and remove the 39mm clutch drive plate nut.  
Loosen the clutch spring compressor and disassemble the driven pulley assembly.

**Special**

Clutch Spring Compressor

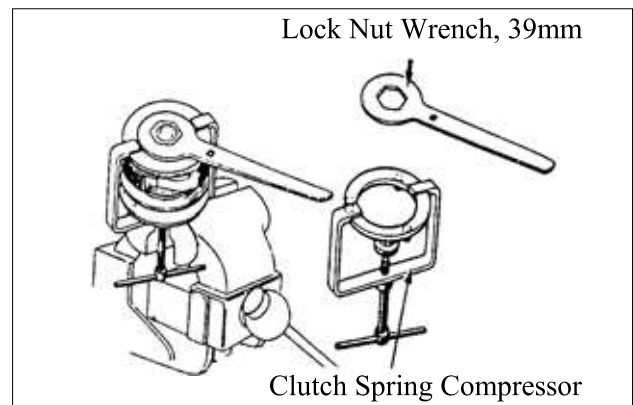

Remove the seal collar.

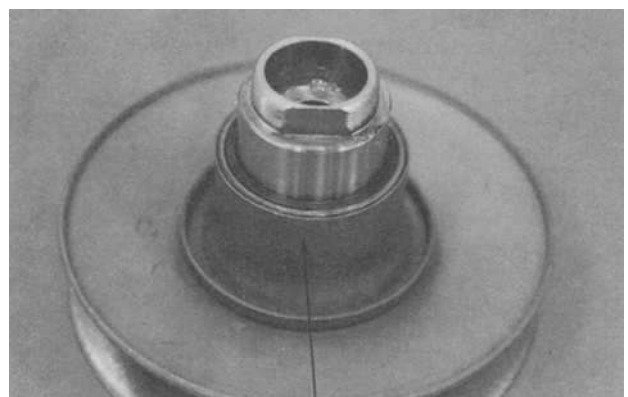

Seal Collar

## 9. DRIVE AND DRIVEN PULLEYS/ KICK STARTER

Pull out the guide roller pins and guide rollers.  
Remove the movable driven face from the driven face.  
Remove the O-rings and oil seal from the movable driven face.

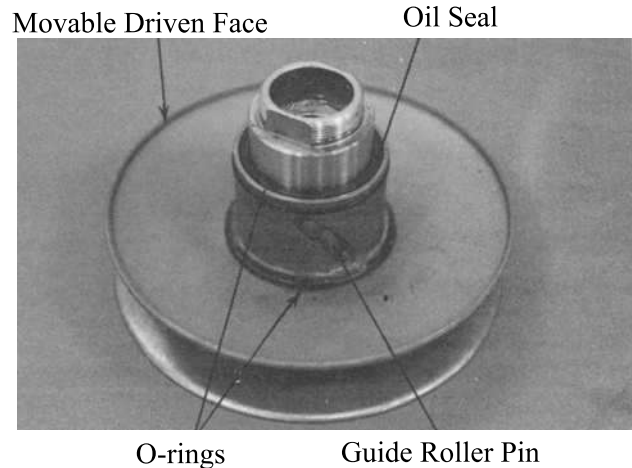

### INSPECTION

Inspect the clutch outer for wear or damage.  
Measure the clutch outer I.D.

**Service Limit:** 107.5mm replace if over

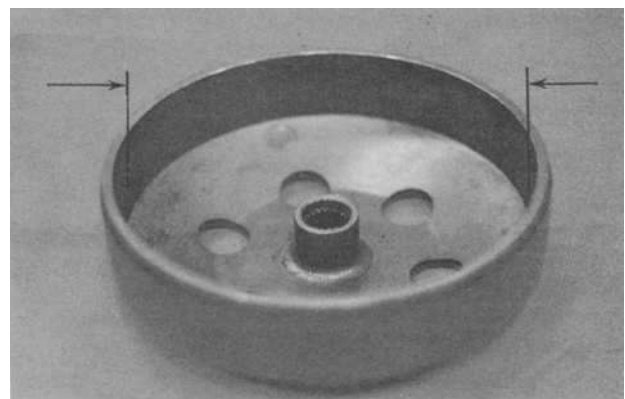

Check the clutch shoes for wear or damage.  
Measure the clutch lining thickness.

**Service Limit:** 2.0mm replace if below

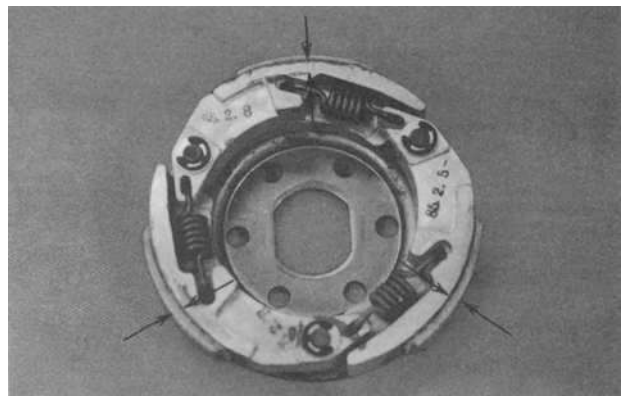

Measure the driven face spring free length.

**Service Limit:** 92.8mm replace if below

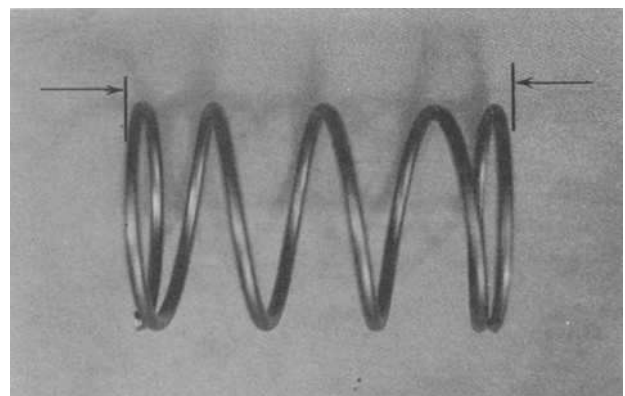



## 9. DRIVE AND DRIVEN PULLEYS/ KICK STARTER

Check the driven face for wear or damage.  
Measure the driven face O.D.

**Service Limit:** 33.94mm replace if below

Check the movable driven face for wear or damage.

Measure the movable driven face I.D.

**Service Limit:** 34.06mm replace if over

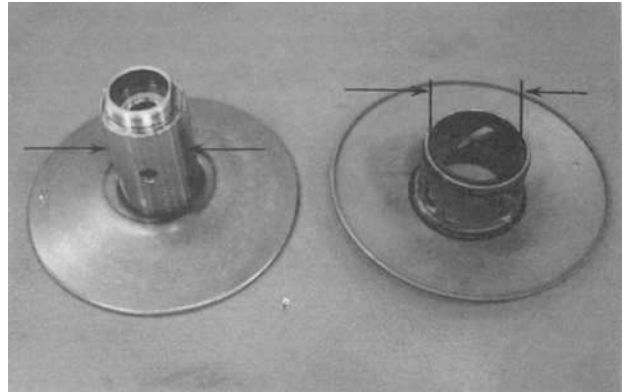

### DRIVEN PULLEY FACE BEARING REPLACEMENT

Drive the inner needle bearing out of the  
driven pulley face.

Discard the removed bearing and replace with  
a new one.

Inner Bearing

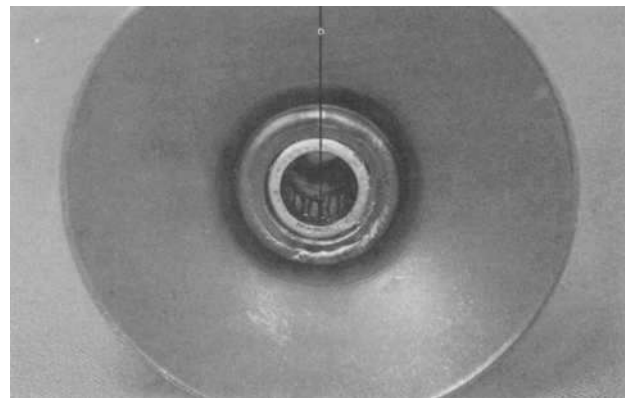

Remove the snap ring and drive the outer  
bearing out of the driven face.

Snap Ring

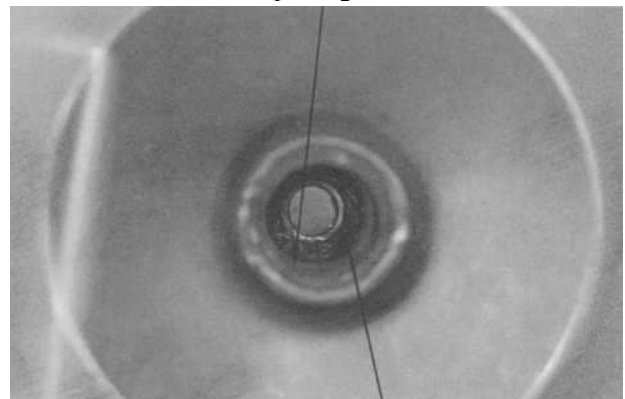

Outer Bearing  
Bearing Remover

Apply grease to the outer bearing.  
Drive a new outer bearing into the driven face  
with the sealed end facing up.  
Seat the snap ring in its groove.

Pack all bearing cavities with 5.0~5.6g  
grease.  
Specified grease: Heat resistance 230°C

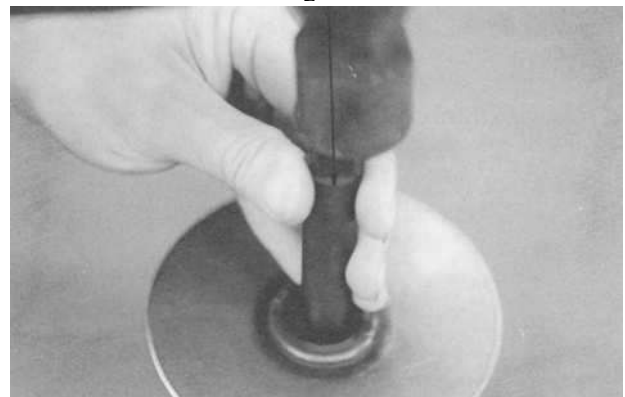

## 9. DRIVE AND DRIVEN PULLEYS/ KICK STARTER

Press a new needle bearing into the driven face.

Driver Handle

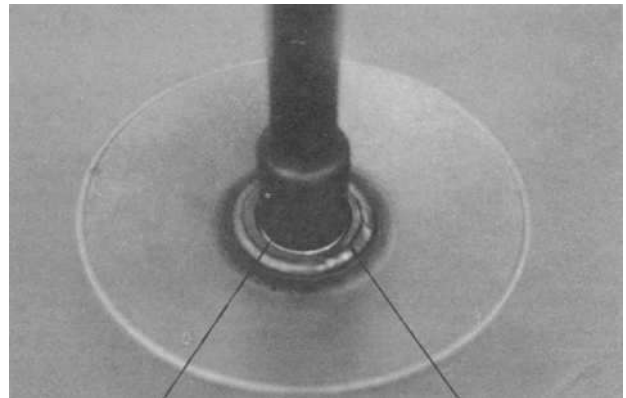

Outer Driver, 24x26mm  
Movable Driven Face

Pilot, 17mm  
Oil Seal

### ASSEMBLY

Install the movable driven face onto the driven face.  
Install the O-rings, guide rollers and guide roller pins.  
Install the a new oil seal.

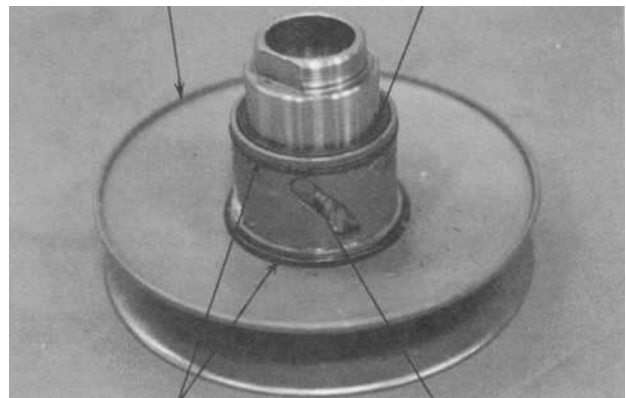

O-rings

Guide Roller Pin

Install the seal collar.

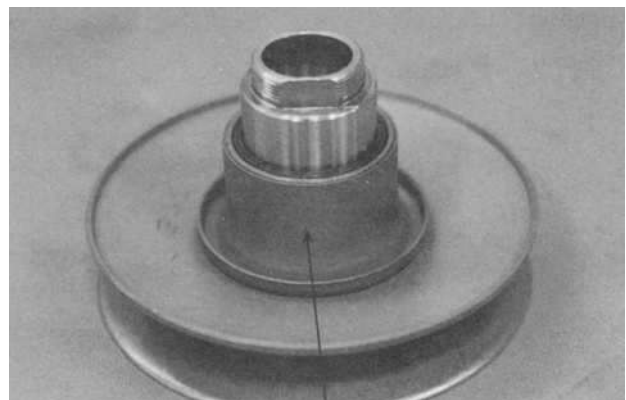

Seal Collar

Lock Nut Wrench, 39mm

Set the driven pulley assembly, driven face spring and clutch assembly onto the clutch spring compressor.  
Compress the clutch spring compressor and install the 39mm drive plate nut.  
Set the clutch spring compressor in a vise and tighten the drive plate nut to the specified torque.

**Torque:** 5.0~6.0kgf-m



Clutch Spring Compressor

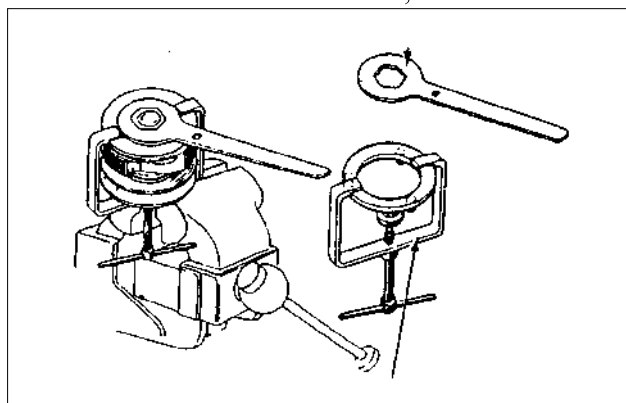

Clutch Spring Compressor

## 9. DRIVE AND DRIVEN PULLEYS/ KICK STARTER

### INSTALLATION

Lay the drive belt on the driven pulley and install the clutch/driven pulley onto the drive shaft.

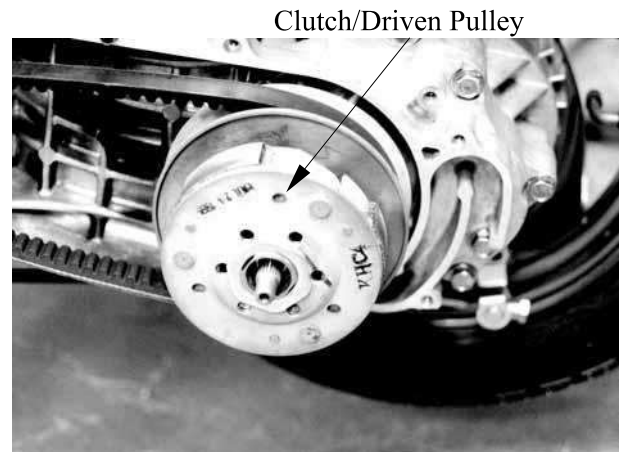

Install the clutch outer.  
Hold the clutch outer with the universal holder.  
Install and tighten the 10mm clutch outer nut.  
**Torque:** 3.5~4.5kgf-m  
Install the left crankcase cover. (⇒9-4)

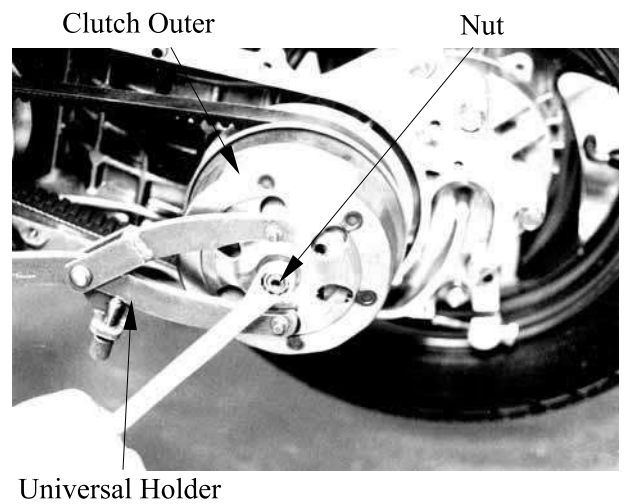

# 10. FINAL REDUCTION

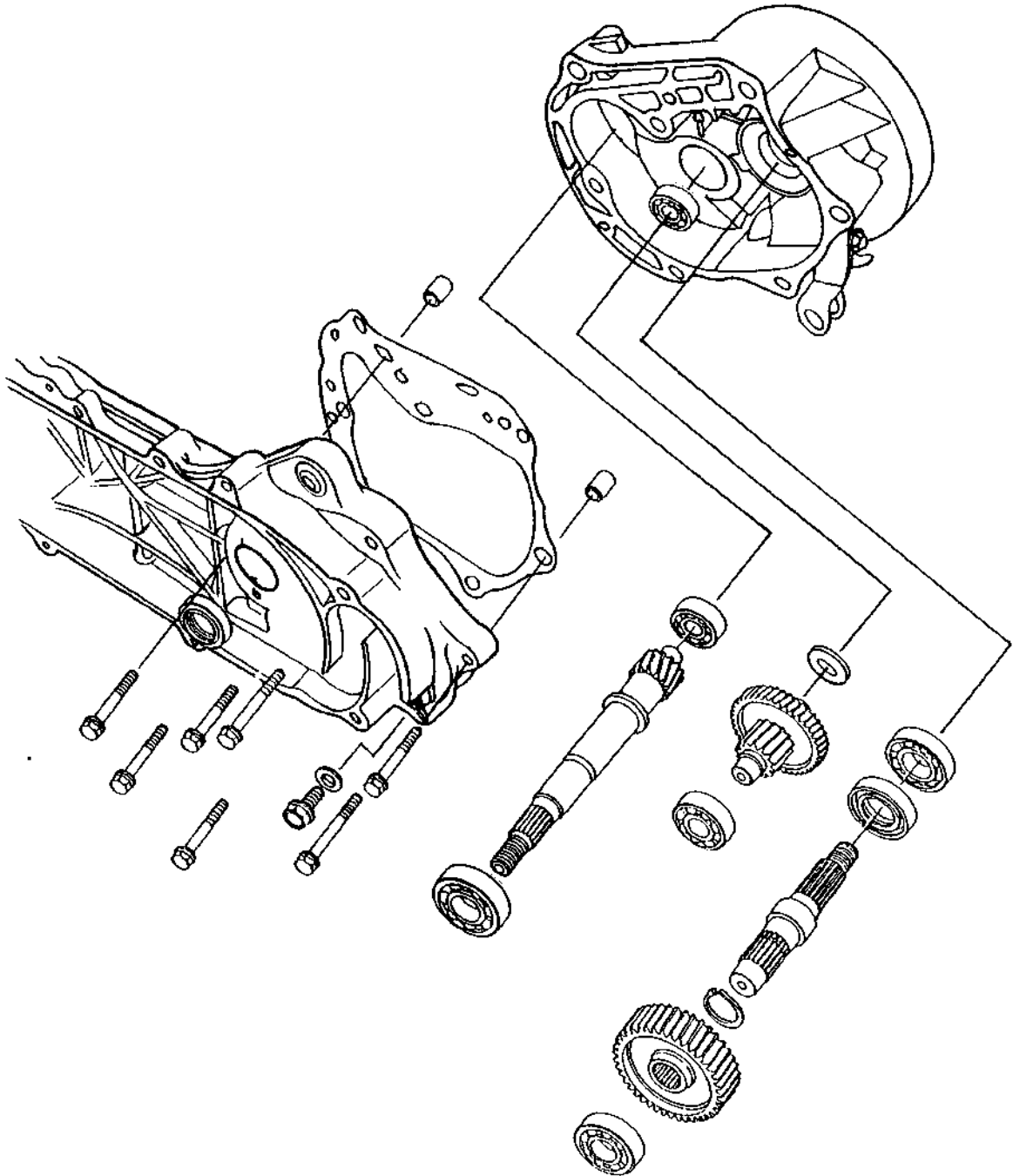

# 10. FINAL REDUCTION

SERVICE INFORMATION.....10-1	FINAL REDUCTION INSPECTION..... 10-2
TROUBLESHOOTING.....10-1	BEARING REPLACEMENT ..... 10-3
FINAL REDUCTION DISASSEMBLY ....10-2	FINAL REDUCTION ASSEMBLY..... 10-4

## SERVICE INFORMATION

### SPECIFICATIONS

Specified Oil: GEAR OIL SAE 90#

Oil Capacity:           At disassembly : 0.11 liter  
                                  At change           : 0.10 liter

### SPECIAL TOOLS

Bearing puller, 10,12,15,18mm

## TROUBLESHOOTING

### Engine starts but motorcycle won't move

- Damaged transmission
- Seized or burnt transmission
- Faulty drive belt
- Faulty clutch

### Abnormal noise

- Worn, seized or chipped gears
- Worn bearing

### Oil leaks

- Oil level too high
- Worn or damaged oil seal

# 10. FINAL REDUCTION

## FINAL REDUCTION DISASSEMBLY

- Remove the rear brake cable. (⇒13-3)
- Remove the rear wheel. (⇒13-2)
- Remove the left crankcase cover. (⇒9-2)
- Remove the clutch/driven pulley. (⇒9-10)
- Drain the transmission gear oil into a clean container.
- Remove the transmission case cover attaching bolts.
- Remove the transmission case cover.
- Remove the gasket and dowel pins.

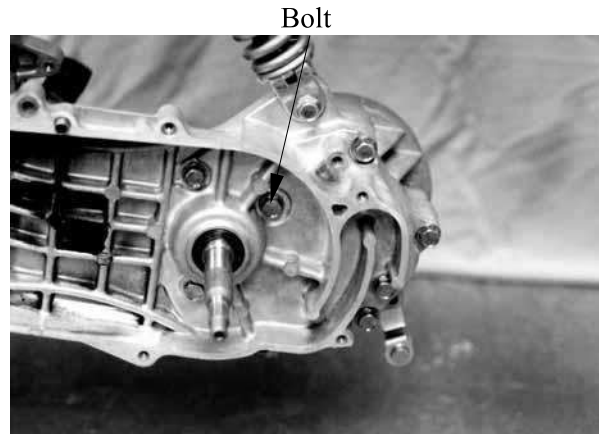

Remove the final gear and countershaft.

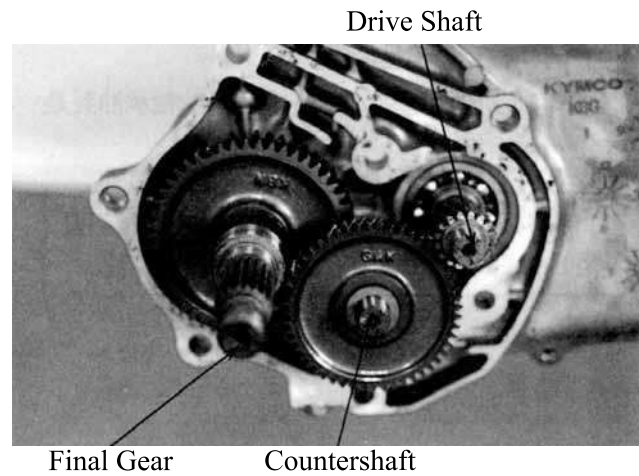

## FINAL REDUCTION INSPECTION

Inspect the countershaft and gear for wear or damage.

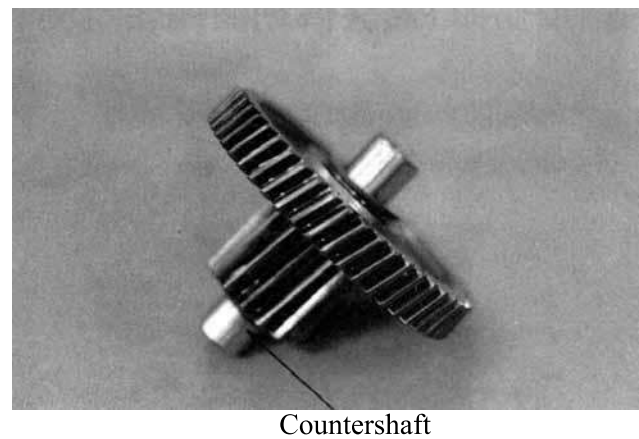

Inspect the final gear and final shaft for wear, damage or seizure.

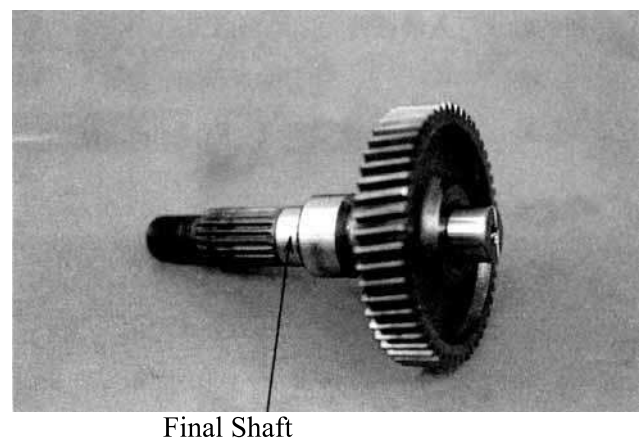

# 10. FINAL REDUCTION

Check the left crankcase bearings for excessive play and inspect the oil seal for wear or damage.

Drive Shaft Bearing

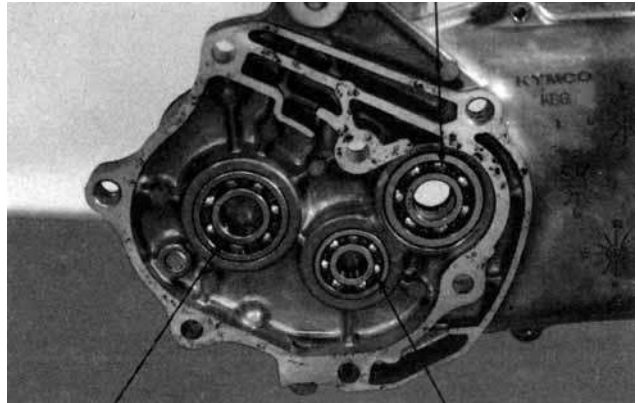

Final Shaft Bearing

Countershaft Bearing

Inspect the drive shaft and gear for wear or damage.  
Check the transmission case cover bearings for excessive play and inspect the final shaft bearing oil seal for wear or damage.

Do not remove the transmission case cover except for necessary part replacement. When replacing the drive shaft, also replace the bearing and oil seal.

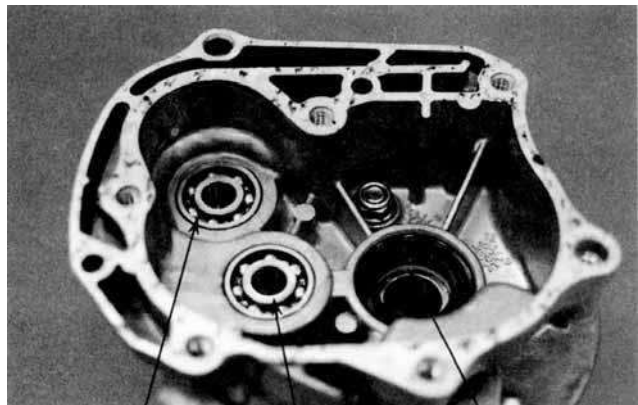

Countershaft Bearing Drive Shaft Bearing Oil Seal

Final Shaft Bearing

## BEARING REPLACEMENT (TRANSMISSION CASE COVER)

Remove the transmission case cover bearings using a bearing puller.  
Remove the final shaft oil seal.

**Special**

Bearing Puller

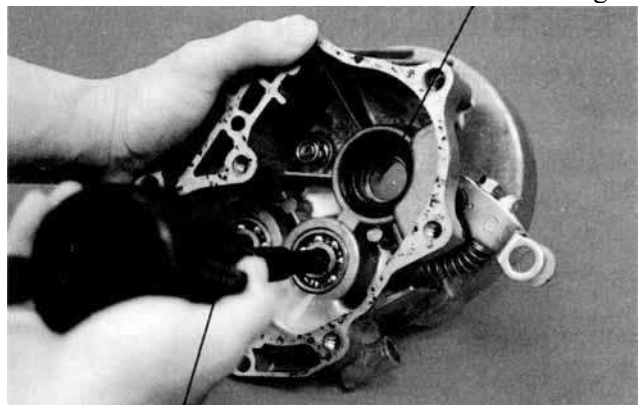

Bearing Puller

Drive new bearings into the transmission case cover.



Outer Driver, 32x35mm

## 10. FINAL REDUCTION

### BEARING REPLACEMENT (LEFT CRANKCASE)

Remove the drive shaft.  
Remove the drive shaft oil seal.  
Remove the left crankcase bearings using a bearing puller.

**Special**

Bearing Puller

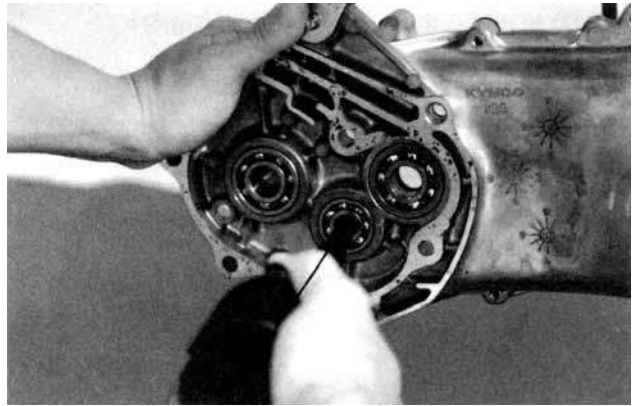

Bearing Puller, 12mm

Drive new bearings into the left crankcase.  
Install a new drive shaft oil seal.

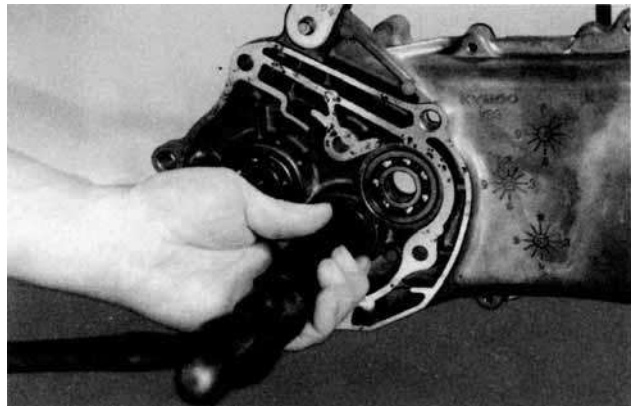

Pilot

### FINAL REDUCTION ASSEMBLY

Install the drive shaft into the left crankcase.

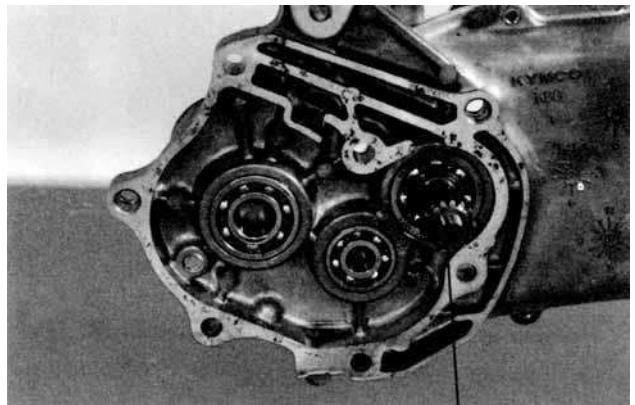

Drive Shaft

Install the final gear and final shaft into the left crankcase.

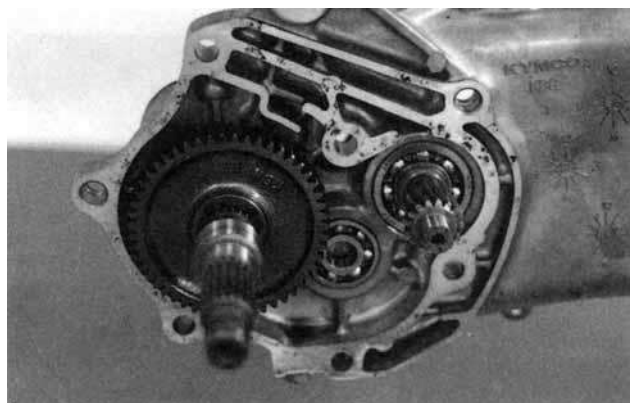



# 10. FINAL REDUCTION

Install the countershaft and gear into the left crankcase.  
 Install the resin washer onto the countershaft.  
 Install the dowel pins and a new gasket.

Resin Washer

Countershaft

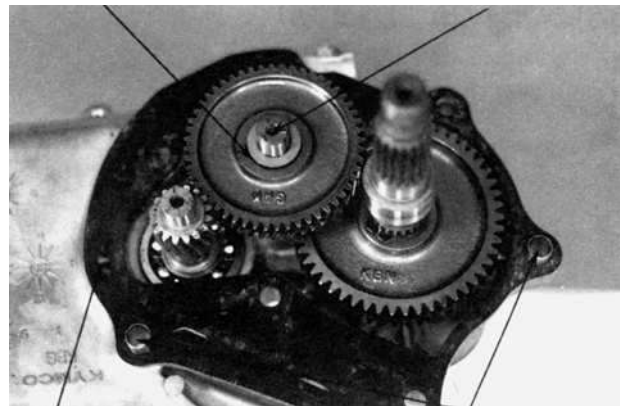

Gasket

Dowel Pins

Install the transmission case cover.



Transmission Case Cover

Install and tighten the transmission case cover bolts.

Install the clutch/driven pulley. (⇒9-13)

After installation, fill the transmission case with the specified oil. (⇒3-7)

- Place the motorcycle on its main stand on level ground.
- Check the oil sealing washer for wear or damage.

**Specified Gear Oil:** SAE90#

**Oil Capacity:**

At disassembly : 0.11 liter

At change : 0.10 liter

Install and tighten the oil check bolt.

**Torque:** 0.8~1.2kgf-m

Start the engine and check for oil leaks.  
 Check the oil level from the oil check bolt hole and add the specified oil to the proper level if the oil level is low.

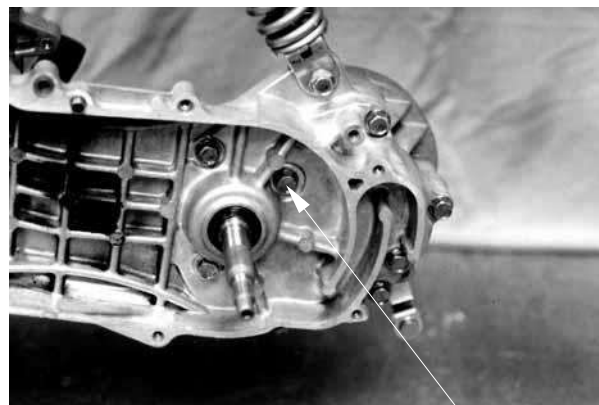

Bolt

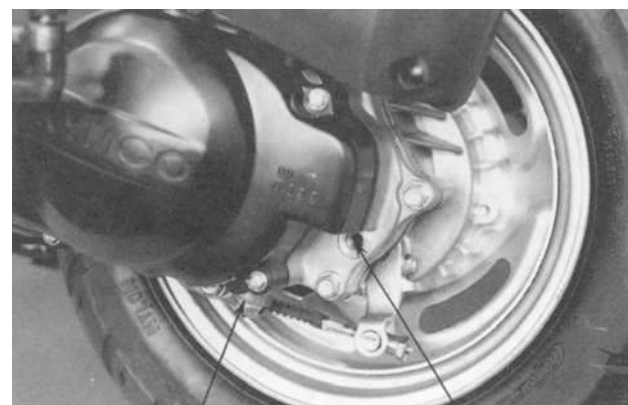

Drain Bolt

Oil Check Bolt Hole/Oil Filler

# 11. CRANKCASE/CRANKSHAFT

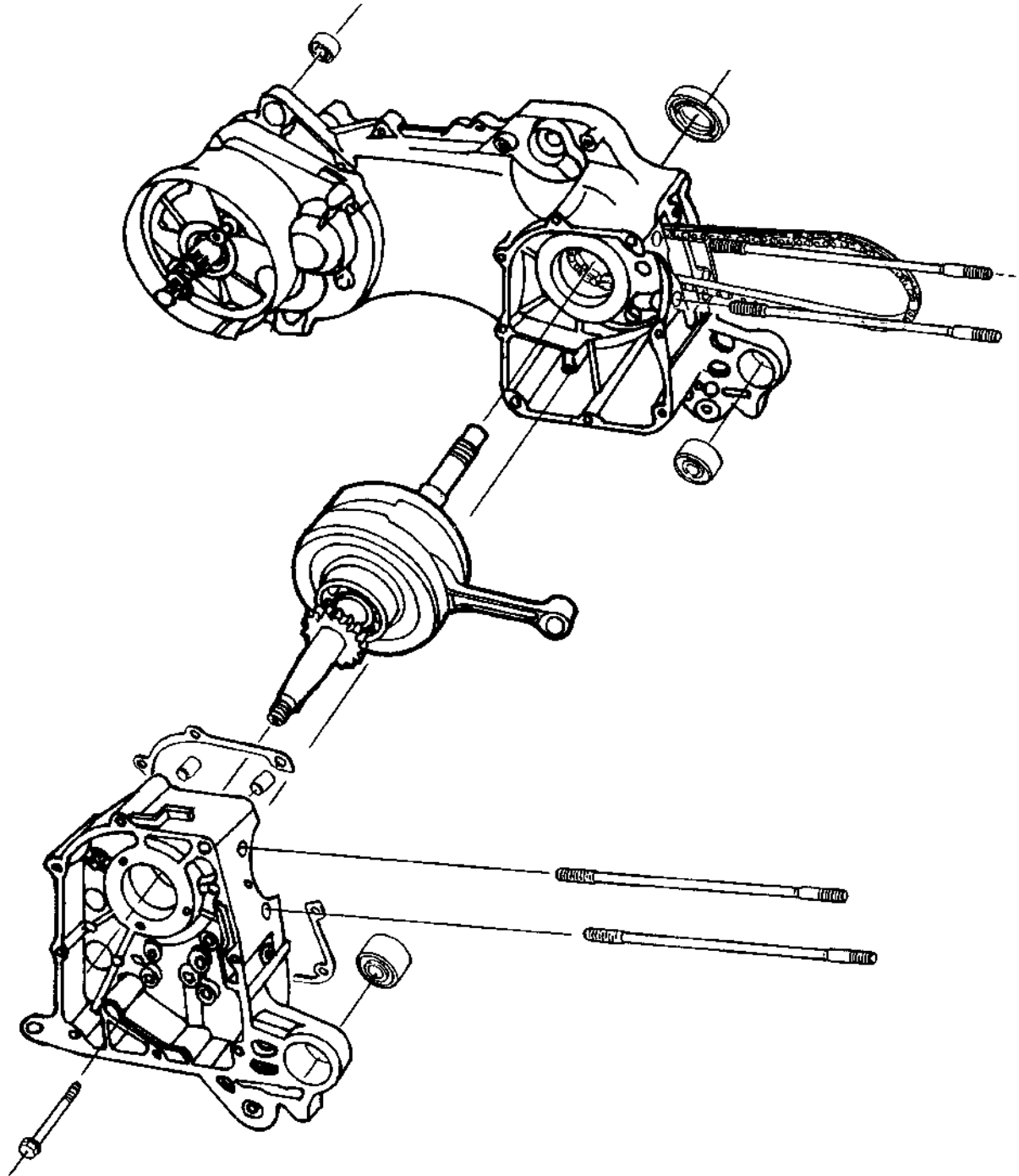

**11**

SERVICE INFORMATION.....	11-1	CRANKSHAFT.....	11-3
TROUBLESHOOTING .....	11-1	CRANKCASE ASSEMBLY.....	11-4
CRANKCASE SEPARATION .....	11-2		

## SERVICE INFORMATION

### GENERAL INSTRUCTIONS

- This section covers crankcase separation to service the crankshaft. The engine must be removed for this operation.
- The following parts must be removed before separating the crankcase.
  - Cylinder head (⇒Section 7)
  - Cylinder/piston (⇒Section 8)
  - Drive and driven pulleys (⇒Section 9)
  - A.C. generator (⇒Section 14)
  - Carburetor/air cleaner (⇒Section 5)
  - Rear wheel/rear shock absorber (⇒Section 13)
  - Starter motor (⇒Section 16)
  - Oil pump (⇒Section 4)

### SPECIFICATIONS

	Item	Standard (mm)	Service Limit (mm)
Crankshaft	Connecting rod big end side clearance	0.10~0.35	0.55
	Connecting rod big end radial clearance	0-0.008	0.05
	Runout	—	0.10

### TORQUE VALUES

Crankcase bolt	0.8~1.2kgf-m
Cam chain tensioner slipper bolt	0.8~1.2kgf-m

## TROUBLESHOOTING

### Excessive engine noise

- Excessive bearing play
- Excessive crankpin bearing play

# 11. CRANKCASE/CRANKSHAFT

## CRANKCASE SEPARATION

Remove the cam chain tensioner slipper bolt and cam chain tensioner slipper.

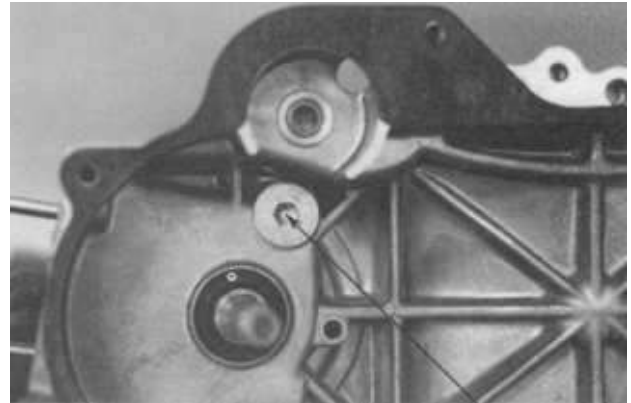

Cam Chain Tensioner Slipper Bolt

Remove the crankcase attaching bolt. Separate the left and right crankcase halves.

- Do not damage the crankcase gasket surface.
- Never use a driver to pry the crankcase mating surfaces apart.

Crankcase Bolt

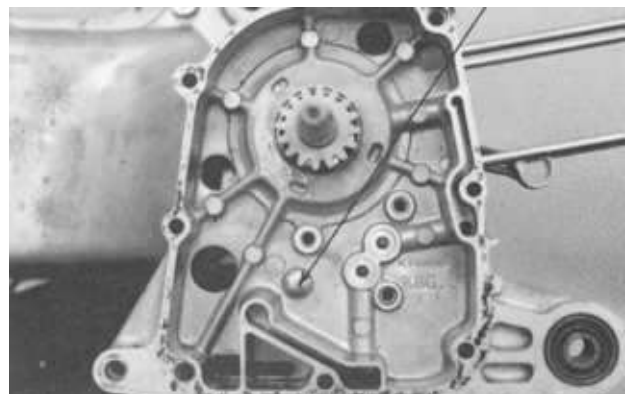

Remove the gasket and dowel pins.

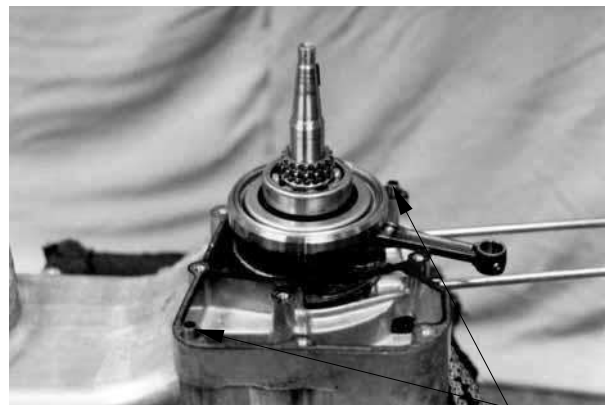

Dowel Pins

Remove the crankshaft from the left crankcase.  
Remove the cam chain.

Cam Chain

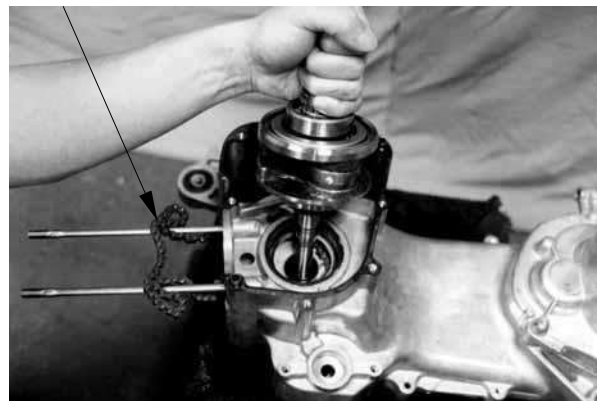

# 11. CRANKCASE/CRANKSHAFT

AGILITY 50

Clean off all gasket material from the crankcase mating surfaces.

Avoid damaging the crankcase mating surfaces.

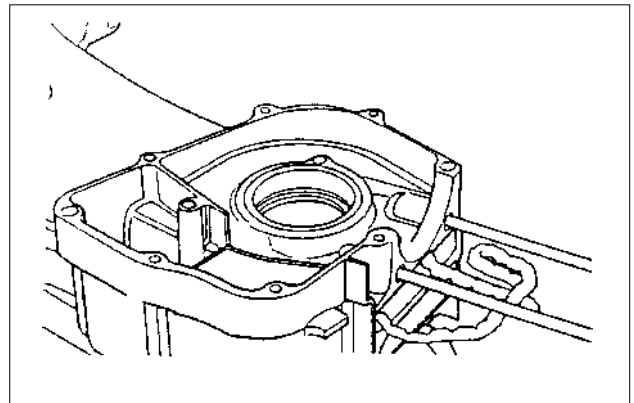

Remove the oil seal from the left crankcase.

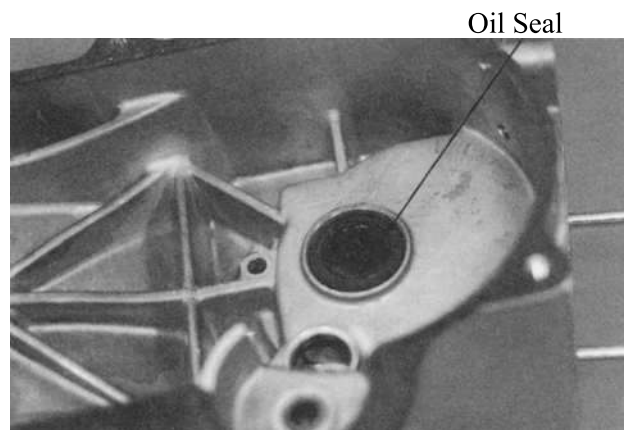

Remove the oil seal from the right crankcase.



## CRANKSHAFT

Measure the connecting rod big end side clearance.

**Service Limit:** 0.55mm replace if over



Connecting Rod Big End

# 11. CRANKCASE/CRANKSHAFT

AGILITY 50

Measure the connecting rod big end radial clearance at two points at right angles to the shaft.

**Service Limit:** 0.05mm replace if over

Measuring Location

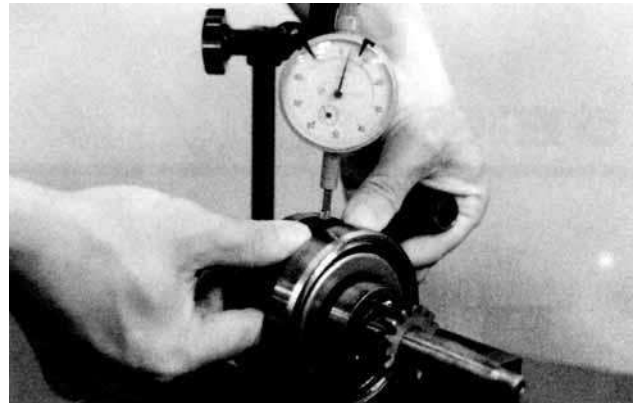

Measure the crankshaft runout.

**Service Limit:** 0.10mm replace if over

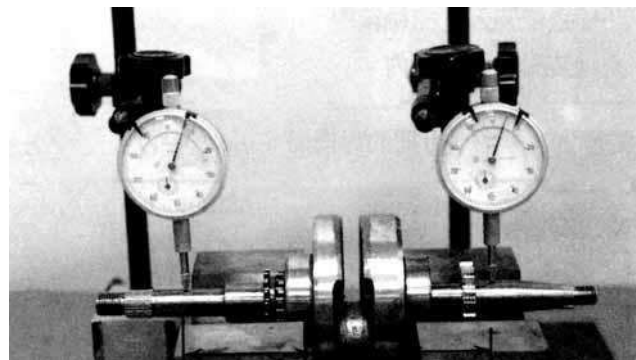

Turn the crankshaft bearings and check for excessive play.  
If they do not turn smoothly, quietly or if they fit loosely in the crankshaft, replace the crankshaft as a set.

Crankshaft Bearings

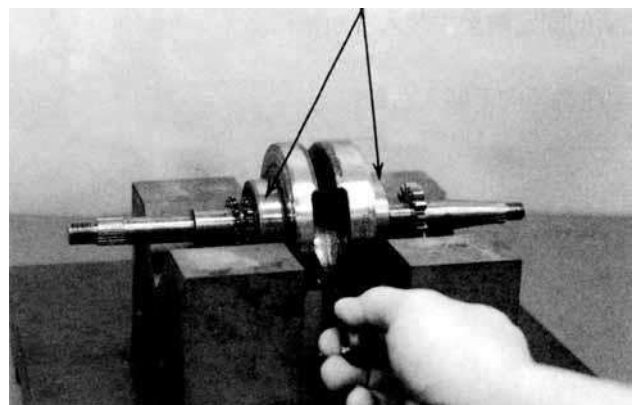

## CRANKCASE ASSEMBLY

Install new oil seals into the right and left crankcase .

Driver Handle A

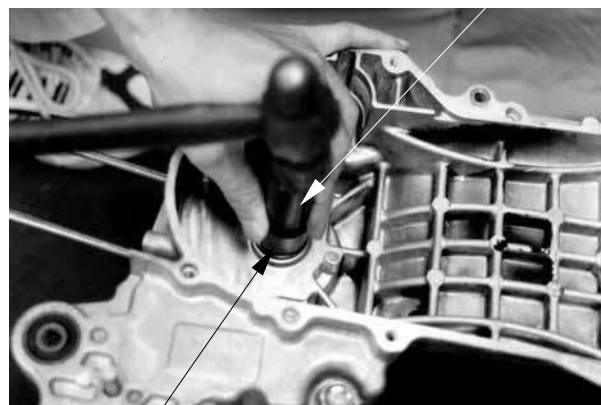

Outer Driver

# 11. CRANKCASE/CRANKSHAFT

AGILITY 50

Install the cam chain into the left crankcase.  
Install the crankshaft into the left crankcase.

When installing the cam chain, be careful not to damage the oil seal.

Install the dowel pins and a new gasket onto the left crankcase.

Place the right crankcase over the crankshaft and onto the left crankcase.

Tighten the crankcase attaching bolt.  
**Torque:** 0.8~1.2kgf-m

Driver Handle A

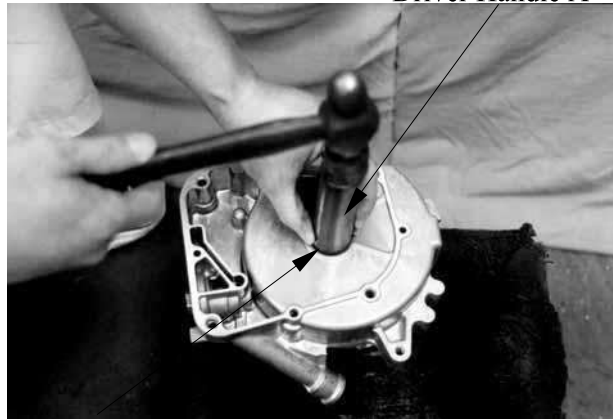

Outer Driver  
Cam Chain

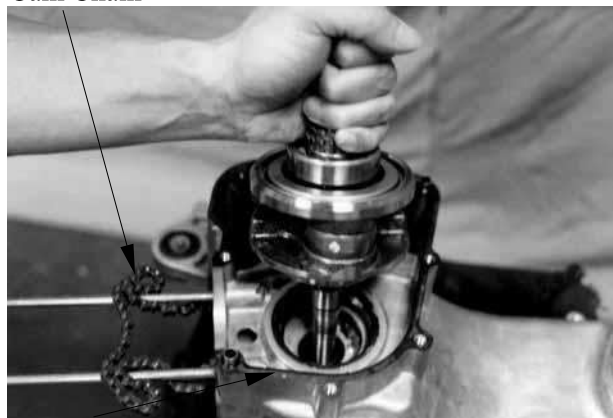

Gasket



Dowel Pins  
Crankcase Bolt

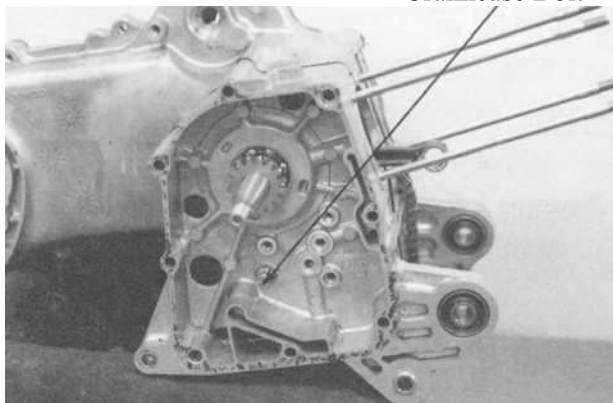

# 11. CRANKCASE/CRANKSHAFT

Install the cam chain tensioner slipper.  
Install a new O-ring onto the cam chain tensioner slipper bolt.  
Apply engine oil to the O-ring and tighten the bolt.

**Torque:** 0.8~1.2kgf-m

Be sure to install the O-ring into the groove.

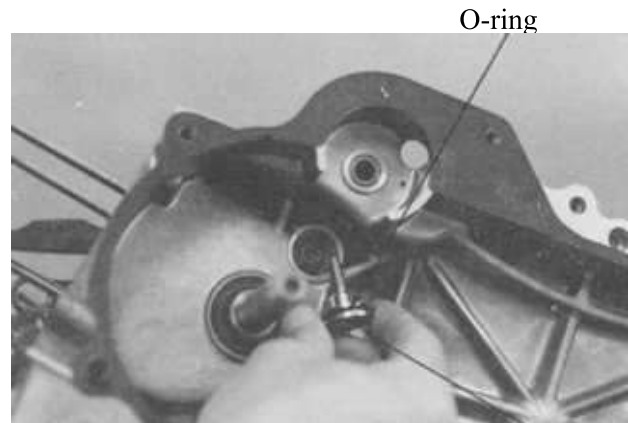

Cam Chain Tensioner Slipper Bolt





# 12. FRONT WHEEL/FRONT BRAKE/ FRONT SUSPENSION



AGILITY 50

SERVICE INFORMATION .....	12-1	FRONT BRAKE.....	12- 7
TROUBLESHOOTING .....	12-2	FRONT SHOCK ABSORBER.....	12-18
STEERING HANDLEBAR.....	12-3	FRONT FORK.....	12-21
FRONT WHEEL.....	12-4		

## SERVICE INFORMATION

### GENERAL INSTRUCTIONS

- Remove the motorcycle frame covers before removing the front wheel. Jack the motorcycle front wheel off the ground and be careful to prevent the motorcycle from falling down.
- During servicing, keep oil or grease off the brake drum and brake linings.

### SPECIFICATIONS

Item	Standard (mm)	Service Limit (mm)
Axle shaft runout	—	0.2
Front wheel rim runout	Radial	2.0
	Axial	2.0
Front brake drum I.D	110(SG20AB)	111(SG20AB)
Front brake lining thickness	4.0(SG20AB)	2.0(SG20AB)
Front shock absorber spring free length	210.9	206.4

### TORQUE VALUES

Handlebar bolt	4.5~5.5kgf-m
Steering stem lock nut	6.0~8.0kgf-m
Steering top cone race	0.5~1.3kgf-m
Front shock absorber bolt	3.0kgf-m
Front axle nut	5.0~7.0kgf-m
Brake arm bolt	0.8~1.2kgf-m

### SPECIAL TOOLS

Long socket wrench,32mm 8angle

## TROUBLESHOOTING

### Hard steering (heavy)

- Excessively tightened steering stem top cone race
- Broken steering balls
- Insufficient tire pressure

### Steers to one side or does not track straight

- Uneven front shock absorbers
- Bent front fork
- Bent front axle or uneven tire

### Poor brake performance

- Incorrectly adjusted brake
- Worn brake linings
- Contaminated brake lining surface
- Worn brake shoes at cam contacting area
- Worn brake drum
- Poorly connected brake arm

### Front wheel wobbling

- Bent rim
- Excessive wheel bearing play
- Bent spoke plate
- Faulty tire
- Improperly tightened axle nut

### Soft front shock absorber

- Weak shock springs
- Insufficient damper oil

### Front shock absorber noise

- Slider bending
- Loose fork fasteners
- Lack of lubrication

## 12. FRONT WHEEL/FRONT BRAKE/ FRONT SUSPENSION



AGILITY 50

### STEERING HANDLEBAR

#### REMOVAL

Remove the handlebar front and rear covers.  
(⇒2-2)

Remove the two bolts attaching each of the  
front and rear brake levers.

Remove the front and rear brake levers.



Bolts

Bolts

Screws

Throttle Pipe

Remove the two throttle holder screws and  
throttle holder.

Disconnect the throttle cable from the throttle  
pipe and then remove the throttle pipe from  
the handlebar.

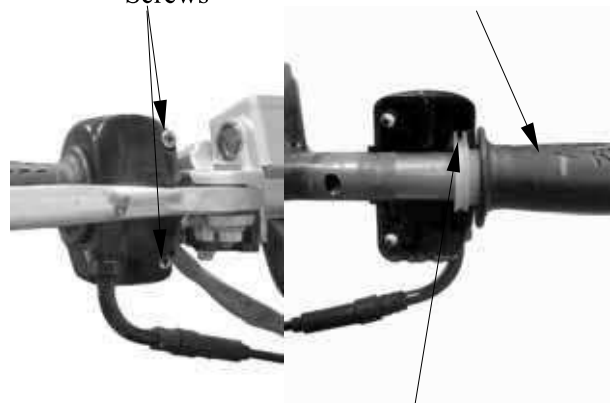

Throttle Cable

Remove the handlebar lock nut and bolt to  
remove the handlebar.

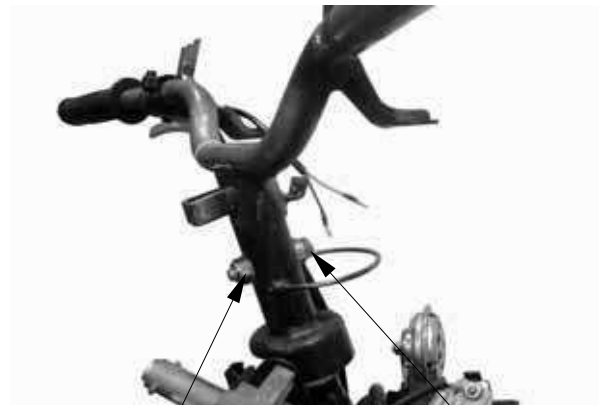

Nut

Bolt

Bolt Orifice

#### INSTALLATION

Install the handlebar onto the steering stem  
by aligning the tab on the handlebar with the  
bolt orifice on the steering stem.

Install and tighten the handlebar bolt and lock  
nut.

**Torque:** 4.5~5.5kgf-m



## 12. FRONT WHEEL/FRONT BRAKE/ FRONT SUSPENSION



AGILITY 50

Apply grease to the tip of the throttle pipe.  
Install the throttle pipe and connect the  
throttle cable.

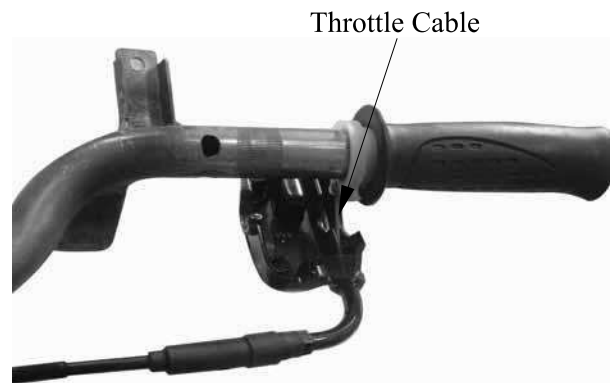

Install the front and rear brake levers in the  
reverse order of removal.

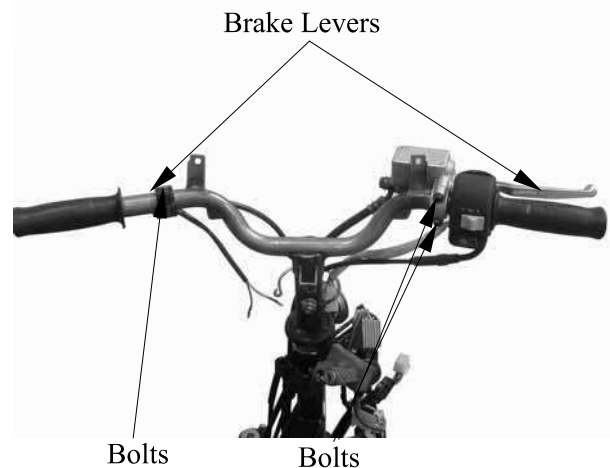

### FRONT WHEEL

#### REMOVAL

Jack the motorcycle front wheel off the  
ground.  
Remove the speedometer cable set screw and  
disconnect the speedometer cable.  
Remove the front brake cable.  
Remove the front axle nut and pull out the  
axle.  
Remove the front wheel.  
Remove the front brake panel and side collar.

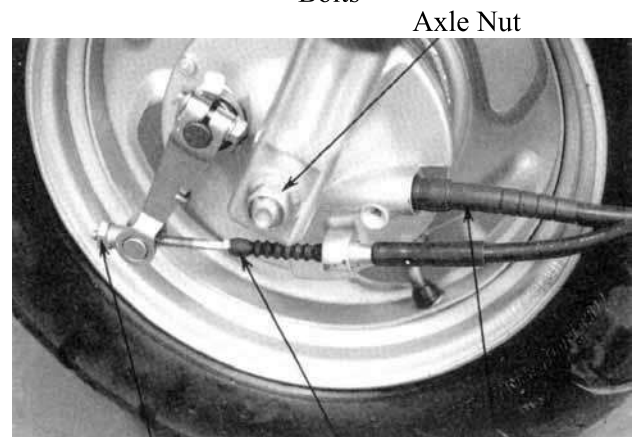

Adjusting Nut Brake Cable Speedometer Cable

#### INSPECTION

##### AXLE RUNOUT

Set the axle in V blocks and measure the  
runout using a dial gauge.  
The actual runout is  $\frac{1}{2}$  of the total indicator  
reading.

**Service Limit:** 0.2mm replace if over

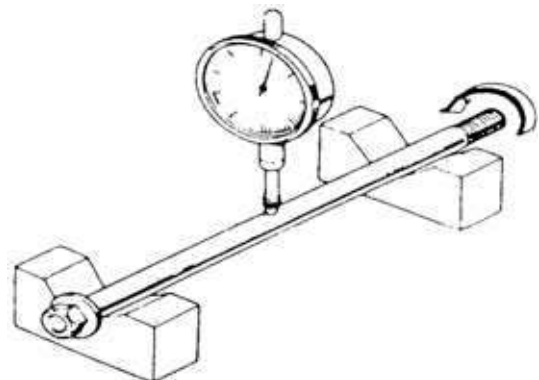

# 12. FRONT WHEEL/FRONT BRAKE/ FRONT SUSPENSION

### WHEEL RIM

Check the wheel rim runout.

#### Service Limits:

**Radial:** 2.0mm replace if over

**Axial:** 2.0mm replace if over

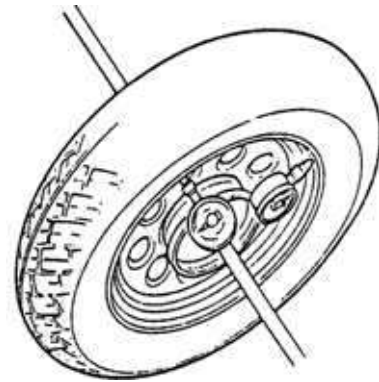

Turn the wheel bearings and replace the bearings if they are noisy or have excessive play.

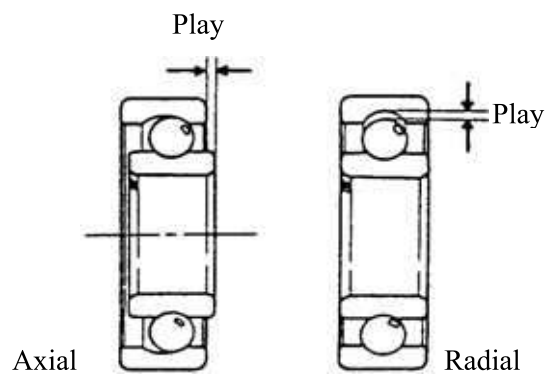

### DISASSEMBLY

Remove the dust seal.

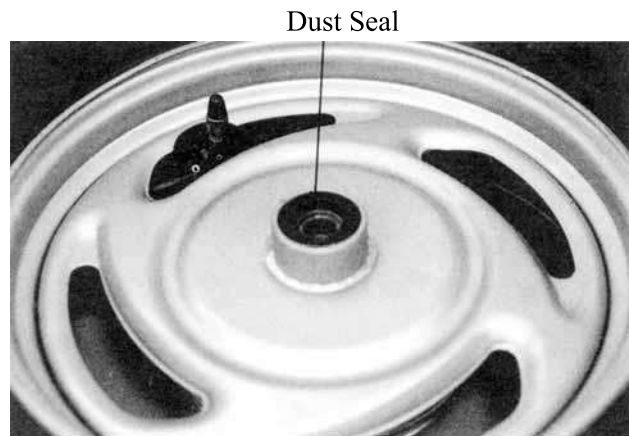

# 12. FRONT WHEEL/FRONT BRAKE/ FRONT SUSPENSION

Special

Bearing Puller



Pilot

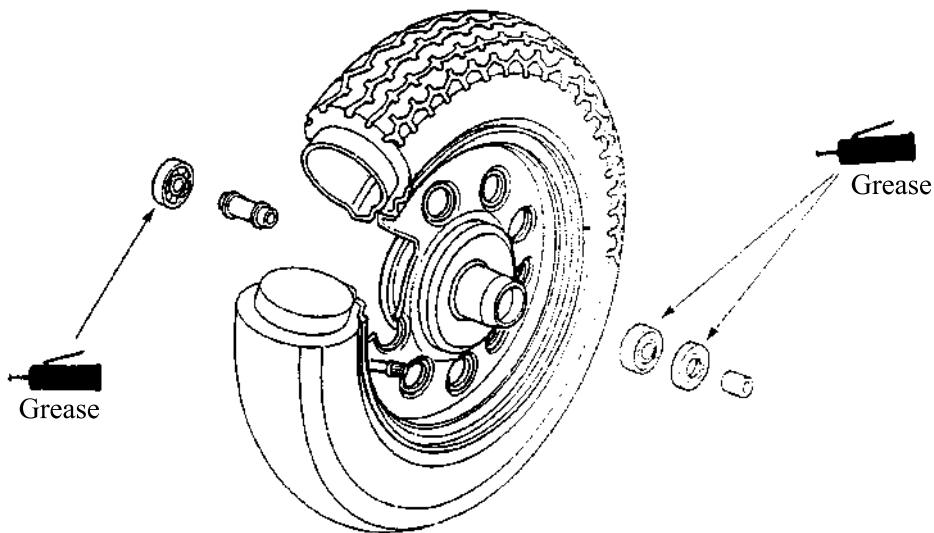

Drive in the bearing squarely with the sealed end facing out.



Outer Driver  
Pilot

## 12. FRONT WHEEL/FRONT BRAKE/ FRONT SUSPENSION

Apply grease to a new dust seal lip and install the dust seal.  
Install the side collar.

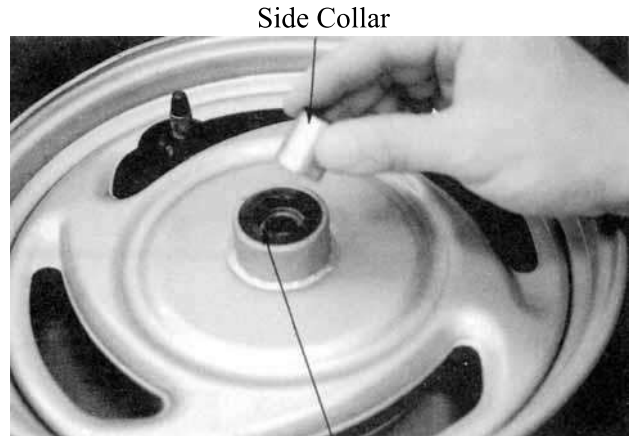

Dust Seal

### INSTALLATION

Install the front wheel by aligning the brake panel groove with the front fork tab.  
Insert the axle shaft and tighten the axle nut.

**Torque:** 4.5kg-m

Connect the speedometer cable and secure it with the screw.

Install the front brake cable and adjust the front brake lever free play.



Tab

### FRONT BRAKE

Remove the front wheel. (⇒12-4)  
Remove the front brake panel.

### INSPECTION

Measure the brake drum I.D.

**Service Limit:** 111mm replace if over



Measure each brake lining thickness.

**Service Limit:** 2.00mmmm replace if below

Keep oil or grease off the brake linings.

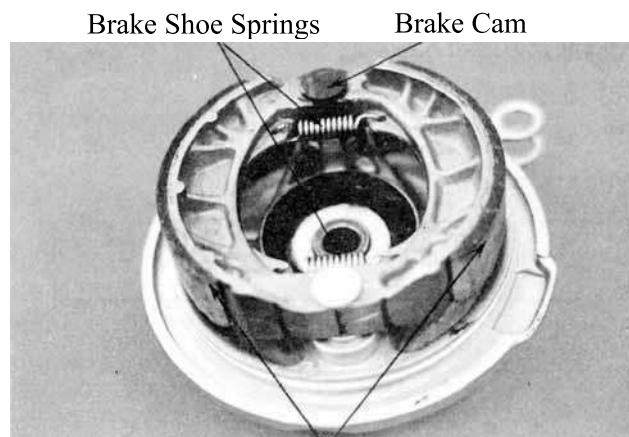

Brake Linings



# 12. FRONT WHEEL/FRONT BRAKE/ FRONT SUSPENSION

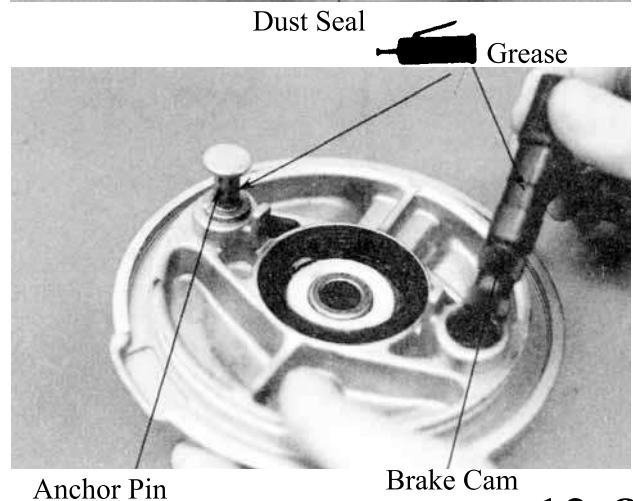
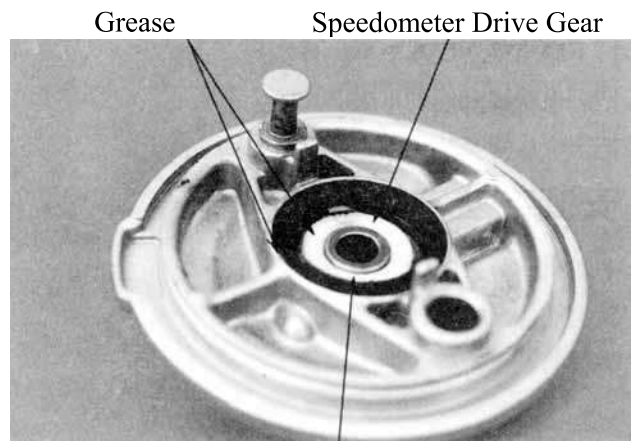
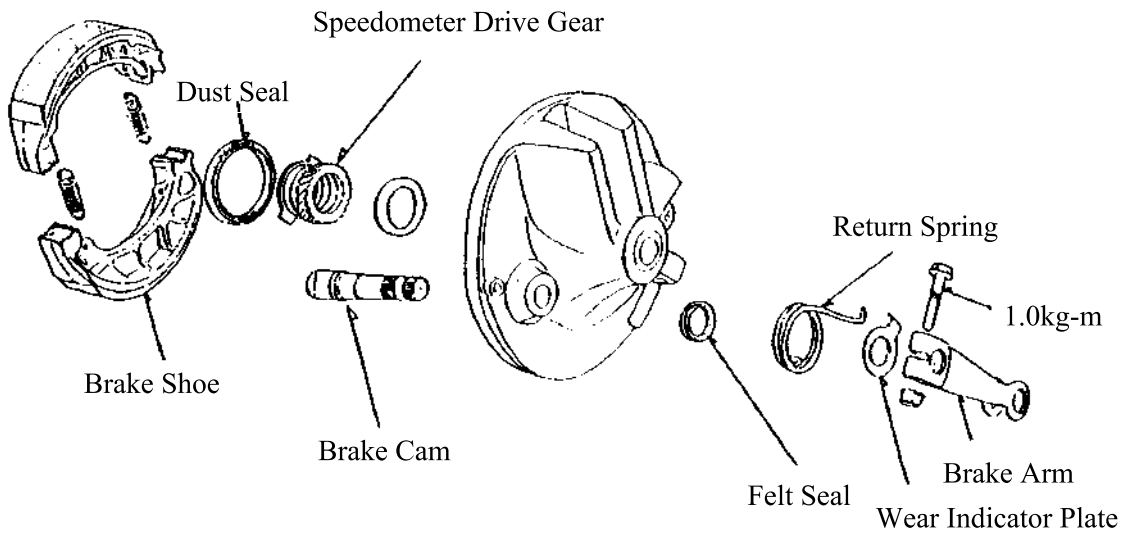

## 12. FRONT WHEEL/FRONT BRAKE/ FRONT SUSPENSION

Install the return spring by aligning the spring hook end with the hole in the brake panel.  
Apply a small amount of engine oil to the felt seal and install it to the brake panel.  
Install the wear indicator plate on the brake cam by aligning the tooth on the plate with the groove on the brake cam.

Wear Indicator Plate

Brake Cam

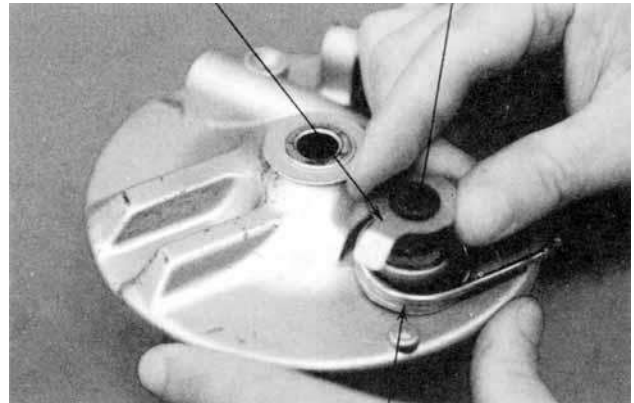

Return Spring

Install the brake arm on the brake cam by aligning the punch mark on the brake arm and the scribed line on the brake cam.  
Install and tighten the brake arm bolt.

**Torque:**0.8~1.2kgf-m

Bolt

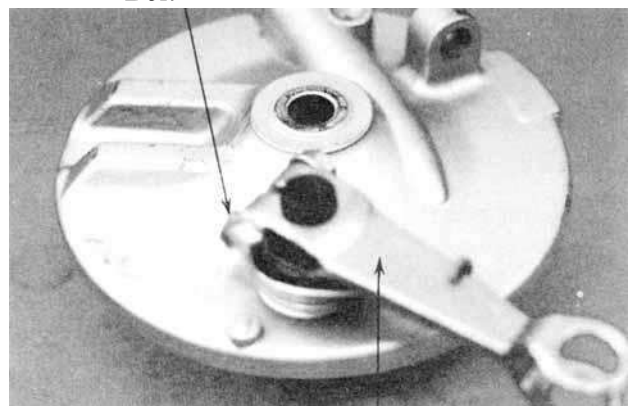

Brake Arm

Install the brake shoe springs to the brake shoes and then install the brake shoes into the brake panel.

### INSTALLATION

Install the brake panel onto the front wheel.  
Install the front wheel. (⇒12-7)  
Adjust the front brake lever free play.

Brake Shoe Springs

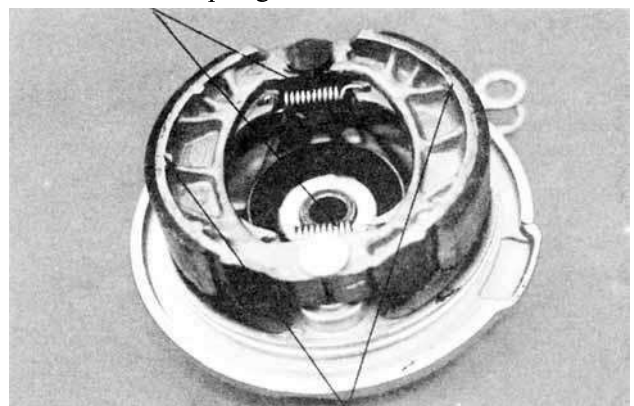

Brake Shoes

## 12. FRONT WHEEL/FRONT BRAKE/ FRONT SUSPENSION

### HYDRAULIC BRAKE (FRONT BRAKE)

#### Brake Fluid Replacement/Air Bleeding

Check the brake fluid level on level ground.

- When operating the brake lever, the brake reservoir cap must be tightened securely to avoid spill of brake fluid.
- When servicing the brake system, use shop towels to cover plastic parts and coated surfaces to avoid damage caused by spill of brake fluid.

Upper Limit

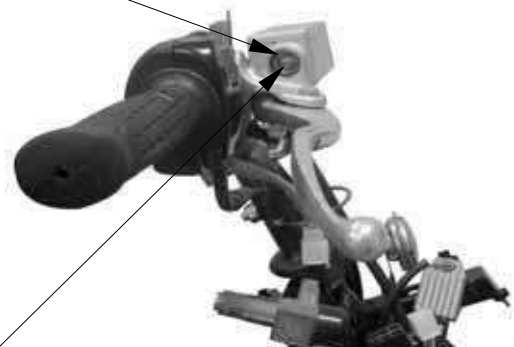

Lower Limit

### Brake Fluid Bleeding

In order to avoid spill of brake fluid, connect a transparent hose to the bleed valve.

#### Warning

Brake fluid spilled on brake pads or brake disk will reduce the braking effect. Clean the brake pads and brake disk with a high quality brake degreaser.

Fully apply the brake lever and then loosen the brake caliper bleed valve to drain the brake fluid until there is no air bubbles in the brake fluid. Then, tighten the bleed valve. Repeat these steps until the brake system is free of air.

Bleed Valve

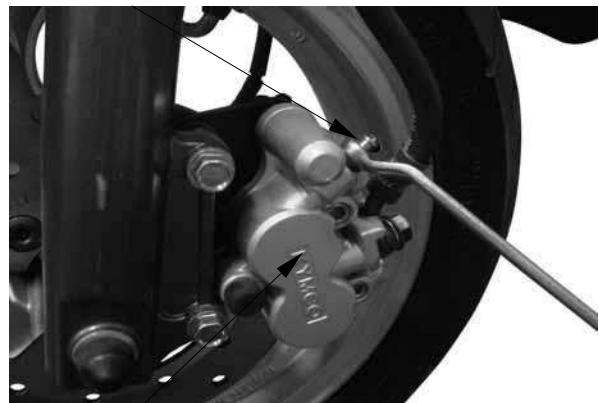

Front Brake Caliper

### Brake Fluid Refilling

Add DOT-4 brake fluid to the brake reservoir.

- When bleeding, be careful not to allow air in the brake reservoir flowing into the brake system.
- When using a brake bleeder, follow the manufacturer's instructions.
- Never use dirty or unspecified brake fluid or mix different brake fluids because it will damage the brake system.

Make sure to bleed air from the brake system.

## 12. FRONT WHEEL/FRONT BRAKE/ FRONT SUSPENSION

### Brake Pad/Disk Replacement

The brake pads must be replaced as a set to ensure the balance of the brake disk.

Remove the two bolts attaching the brake caliper.  
Remove the brake caliper.

Remove the brake pad pins to remove the brake pads.

Pad Pin



Front Brake Caliper

Install the brake pads in the reverse order of removal.

Tighten the brake pad pin bolts.

**Torque:** 1.5~2.0kgf-m

- Keep grease or oil off the brake pads to avoid brake failure.
- Do not reuse the brake pad pin bolts that have been removed.

Brake Pads



Front Brake Caliper

### Brake Disk

Measure the brake disk thickness.

**Service Limit:** 3.0mm

Measure the brake disk runout.

**Service Limit:** 0.3mm



## 12. FRONT WHEEL/FRONT BRAKE/ FRONT SUSPENSION

### BRAKE MASTER CYLINDER

#### Removal

First drain the brake fluid from the hydraulic brake system.

- When servicing the brake system, use shop towels to cover rubber and plastic parts and coated surfaces to avoid being contaminated by brake fluid.
- When removing the brake fluid pipe bolt, be sure to plug the pipe to avoid

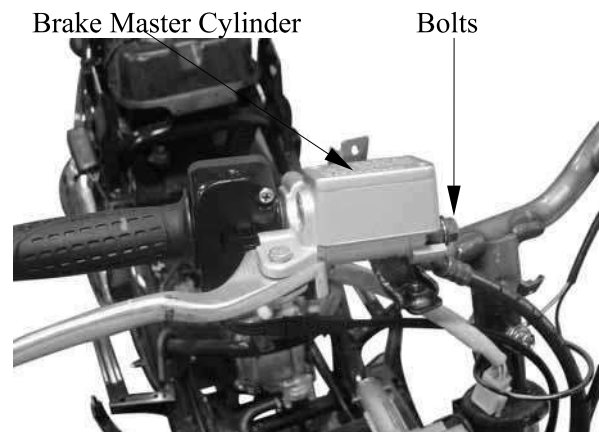

#### Disassembly

Remove the piston rubber cover and snap ring from the brake master cylinder.

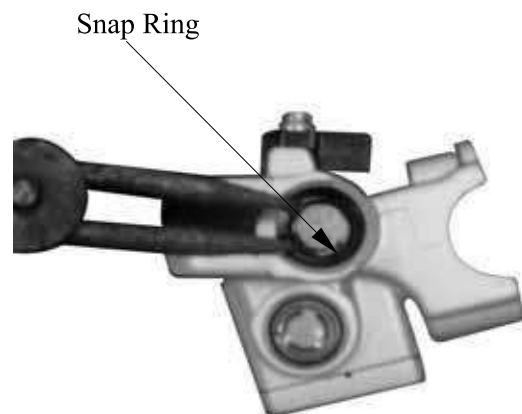

Remove the washer, main piston and spring from the brake master cylinder. Clean the inside of the master cylinder and brake reservoir with brake fluid.

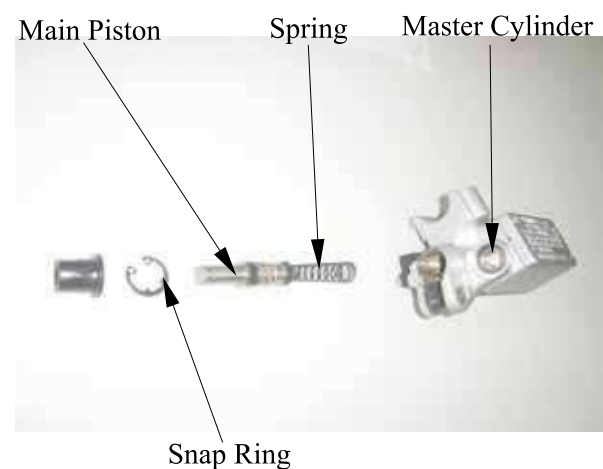

## 12. FRONT WHEEL/FRONT BRAKE/ FRONT SUSPENSION

### Inspection

Measure the brake master cylinder I.D.

**Service Limit:** 12.75mm

Inspect the master cylinder for scratch or crack.

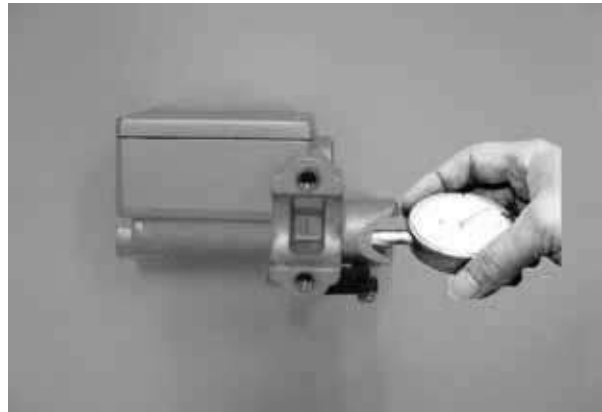

Measure the brake master cylinder piston O.D.

**Service Limit:** 12.6mm

Before assembly, inspect the 1st and 2nd rubber cups for wear.



### Assembly

Before assembly, apply brake fluid to all removed parts.

Install the spring together with the 1st rubber cup.

- During assembly, the main piston and spring must be installed as a unit without exchange.
- When assembling the piston, soak the cups in brake fluid for a while.
- Install the cups with the cup lips facing the correct direction.



Install the main piston, spring and snap ring.

Install the rubber cover.

Install the brake lever.

## 12. FRONT WHEEL/FRONT BRAKE/ FRONT SUSPENSION

### Disassembly

Remove the brake caliper seat from the brake caliper.

Brake Caliper Seat

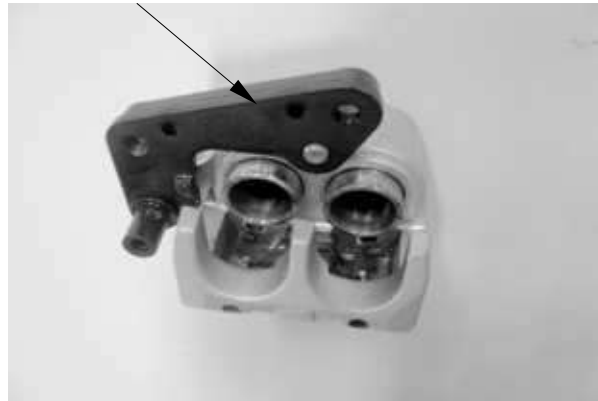

Remove the piston from the brake caliper. If necessary, use compressed air to squeeze out the piston through the brake fluid inlet opening and place a shop towel under the caliper to avoid contamination caused by the removed piston. Check the piston cylinder for scratch or wear and replace if necessary.

Compressed Air



Push the piston oil seal outward to remove it. Clean the oil seal groove with brake fluid.

Piston Oil Seal



Be careful not to damage the piston surface.

## 12. FRONT WHEEL/FRONT BRAKE/ FRONT SUSPENSION

Place the brake master cylinder on the handlebar and install the holder with “up” mark facing up. Be sure to align the punch mark with the holder joint. First tighten the upper bolt and then tighten the lower bolt.

**Torque:** 3.0~4.0kgf-m

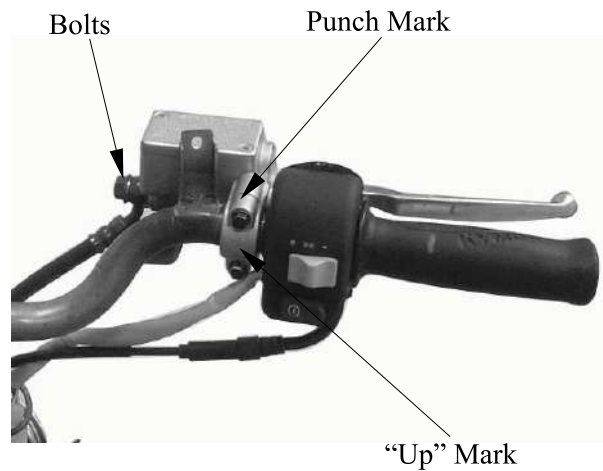

Install the brake fluid pipe with the attaching bolt and two sealing washers.

Install the handlebar covers. (⇒12-3)  
Fill the brake reservoir with recommended brake fluid to the upper limit and bleed air according to the method stated in 12-10.

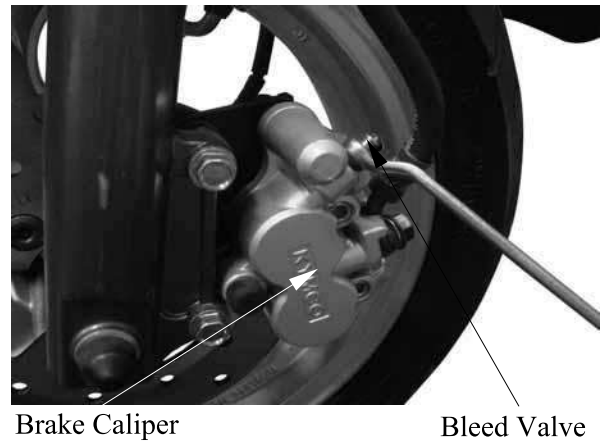

### BRAKE CALIPER (FRONT)

#### Removal

Remove the brake caliper.  
Place a clean container under the brake caliper and disconnect the brake fluid pipe from the caliper.

Do not spill brake fluid on any coated surfaces.

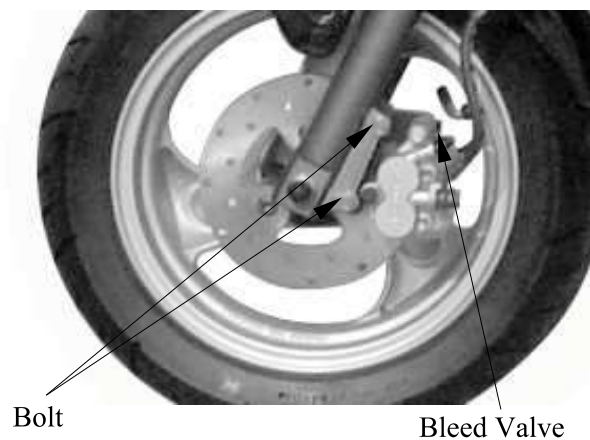



## 12. FRONT WHEEL/FRONT BRAKE/ FRONT SUSPENSION

Check the piston for scratch or wear.  
Measure the piston O.D. with a micrometer.  
**Service Limit:** 26.3mm



Check the caliper cylinder for scratch or wear  
and measure the cylinder bore.  
**Service Limit:** 26.45mm



### Assembly

Clean all removed parts.  
Apply silicon grease to the piston and oil seal.  
Lubricate the brake caliper cylinder inside  
wall with brake fluid.  
Install the brake caliper piston with grooved  
side facing out.

Install the piston with its outer end 3~  
5mm protruding beyond the brake  
caliper.

Wipe off excessive brake fluid with a clean  
shop towel. Apply silicon grease to the  
brake caliper seat pin and caliper inside.  
Install the brake caliper seat.



## 12. FRONT WHEEL/FRONT BRAKE/ FRONT SUSPENSION

### Installation

Install the brake caliper and tighten the two bolts.

**Torque:** 2.9~3.5kg-m



Bolts

Connect the brake fluid pipe to the brake caliper and tighten the fluid pipe bolt.

**Torque:** 2.5~3.5kg-m

Fill the brake reservoir with recommended brake fluid and bleed air from the brake system. (⇒12-10)



Bolt

## 12. FRONT WHEEL/FRONT BRAKE/ FRONT SUSPENSION

### FRONT SHOCK ABSORBER

#### REMOVAL

Remove the front wheel. (⇒12-4)  
Remove the front lower cover. (⇒2-2)  
Remove the front inner fender.  
Remove the front shock absorber upper mount bolts.  
Loosen the lower mount bolts to remove the front shock absorbers.

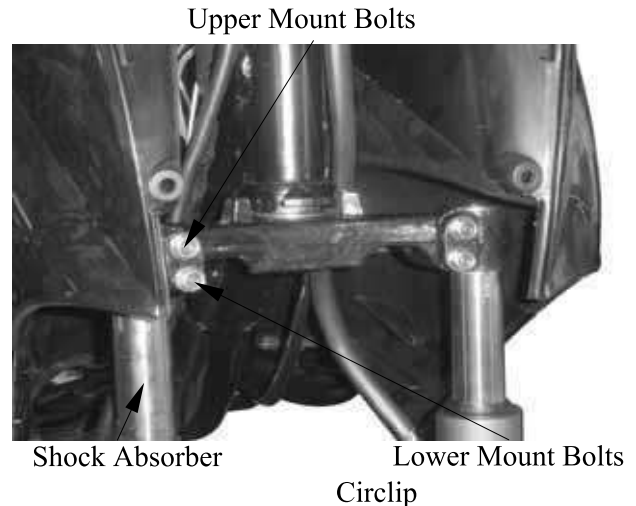

#### DISASSEMBLY

Remove the dust boot.  
Remove the circlip.

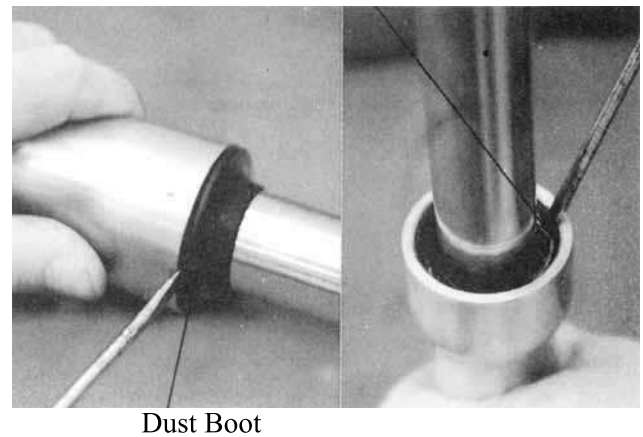

Set the front shock absorber in a vise.  
Remove the damper rod, hex bolt and copper washer.  
Pull out the front shock absorber tube.

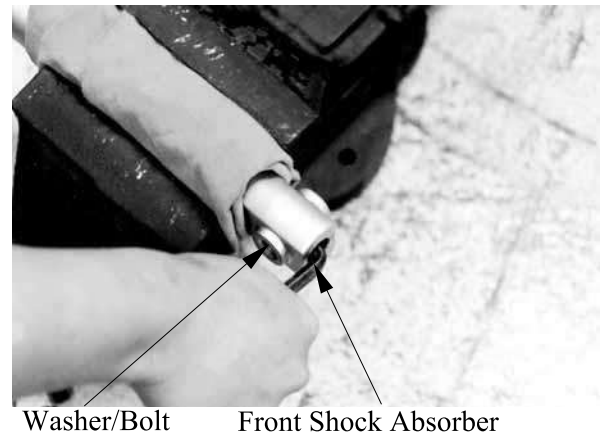

Set the front shock absorber tube in a vise.  
Remove the top nut, shock spring, damper, and damper spring from the front shock absorber tube.

- When holding the shock absorber tube, place a shop towel to protect it and do not apply too much force.

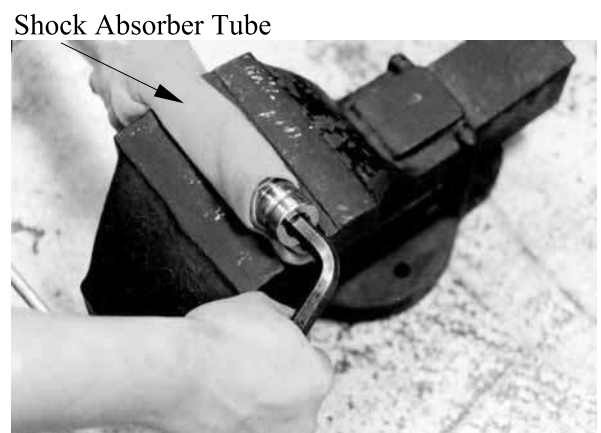

# 12. FRONT WHEEL/FRONT BRAKE/ FRONT SUSPENSION

Measure the front shock absorber spring free length.

**Service Limits:** Right : 206.4mm  
Left : 206.4mm

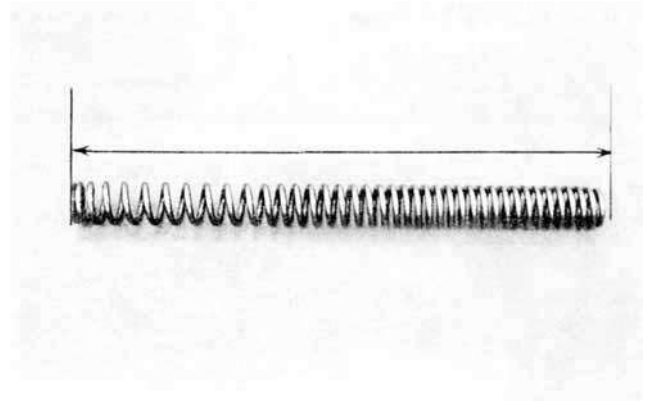

## ASSEMBLY

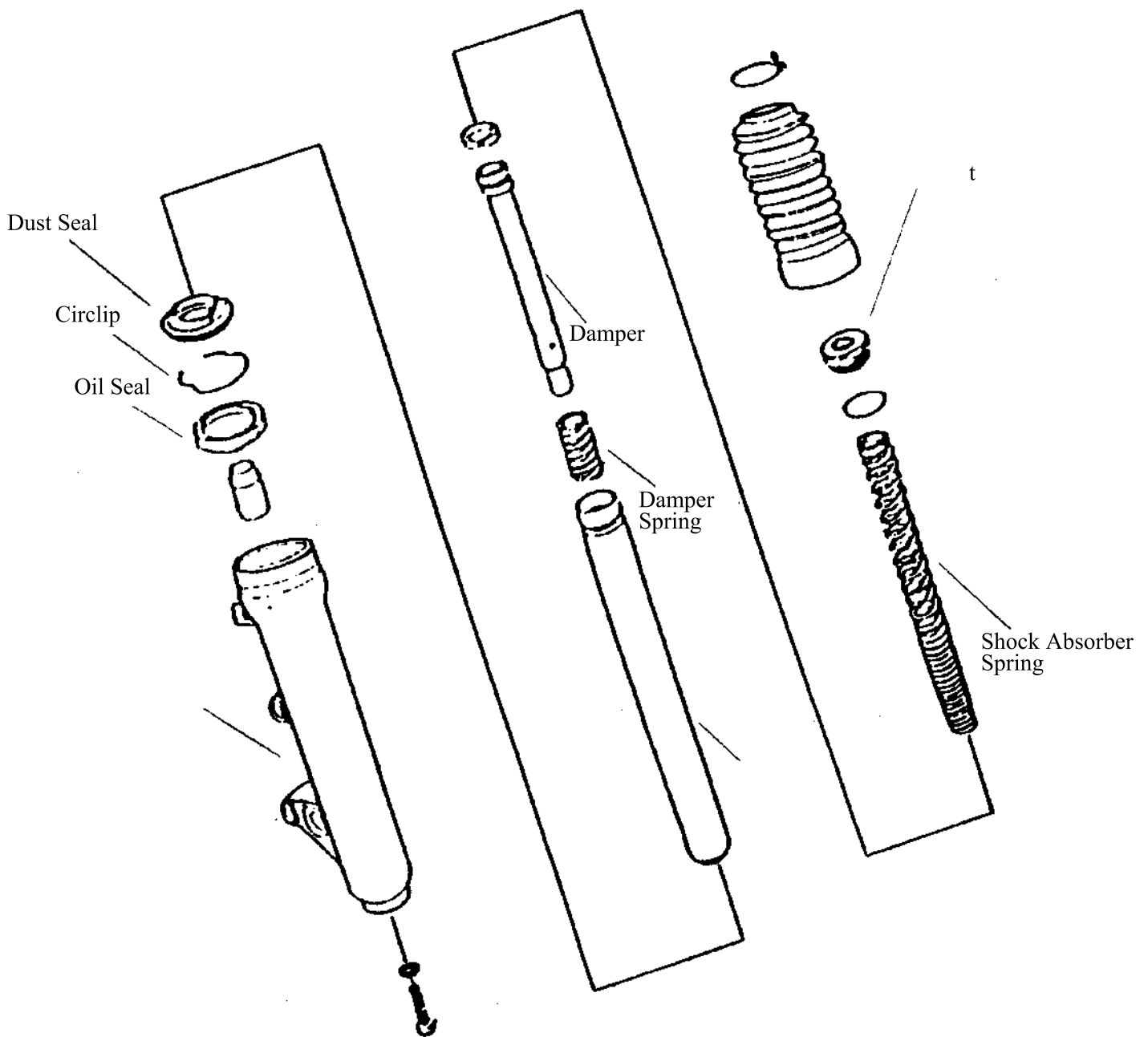

## 12. FRONT WHEEL/FRONT BRAKE/ FRONT SUSPENSION

Install the damper spring onto the damper rod and then install them into the front shock absorber tube.

Install the shock absorber spring onto the front shock absorber tube and tighten the top nut.

Install the front shock absorber spring with the closely wound coils facing down.



Shock Absorber Tube  
Circlip

Set the front shock absorber in a vise. Insert the shock absorber tube into the shock absorber and tighten the hex bolt. (Apply locking agent to the washer and install it together with the hex bolt.)

**Torque:** 3.0kgf-m

Add engine oil into the front shock absorber.

**Specified Oil:** SS#8

**Oil Capacity:** 38±1cc

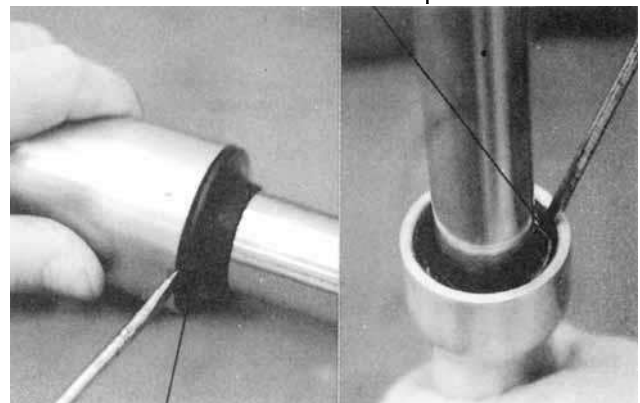

Dust Boot

Install the circlip.  
Install the dust boot.

Upper Mount Bolts



Front Shock Absorber

Lower Mount Bolts

### INSTALLATION

Install the front shock absorbers onto the steering stem.

Install and tighten the front shock absorber upper mount bolts.

Tighten the lower mount bolts.

Align the upper mount bolt hole with the groove on the front fork.

Install the front wheel. (⇒12-7)

# 12. FRONT WHEEL/FRONT BRAKE/ FRONT SUSPENSION

### FRONT FORK

#### REMOVAL

Remove the steering handlebar. (⇒12-3)  
Remove the front wheel. (⇒12-4)  
Disconnect the speedometer cable.  
Remove the steering stem lock nut using long socket wrench.

**Special**

Long Socket Wrench, 32mm 8Angle

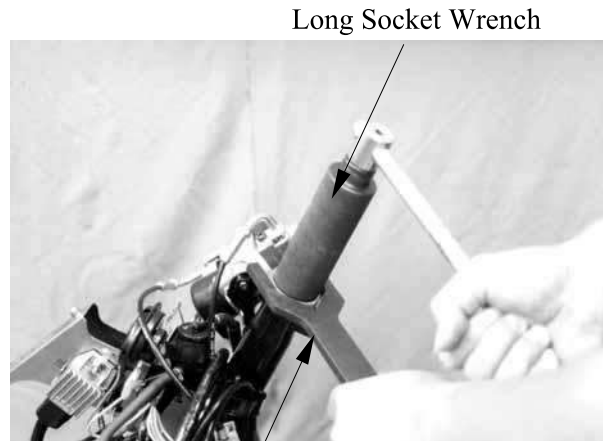

Long Socket Wrench

Lock Nut Wrench

Remove the top cone race and remove the steering stem.

- Be careful not to lose the steel balls (26 on top race and 29 on bottom race).

Inspect the ball races and cone races for wear or damage and replace if necessary.



Top Cone Race

#### BOTTOM CONE RACE REPLACEMENT

Remove the bottom cone race using a chisel.

- Be careful not to damage the steering stem and front fork.

Drive a new bottom cone race into place with a proper driver.

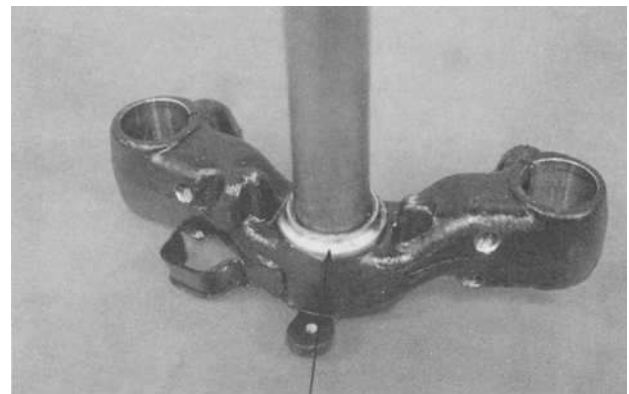

Bottom Cone Race

#### BALL RACE REPLACEMENT

Drive out the top and bottom ball races.

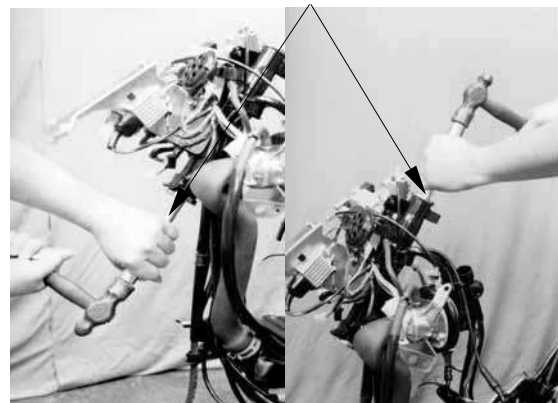

Ball Race Remover

## 12. FRONT WHEEL/FRONT BRAKE/ FRONT SUSPENSION

Drive new top and bottom ball races into the steering head using the outer driver.

Be sure to completely drive in the ball races.

Driver Handle A

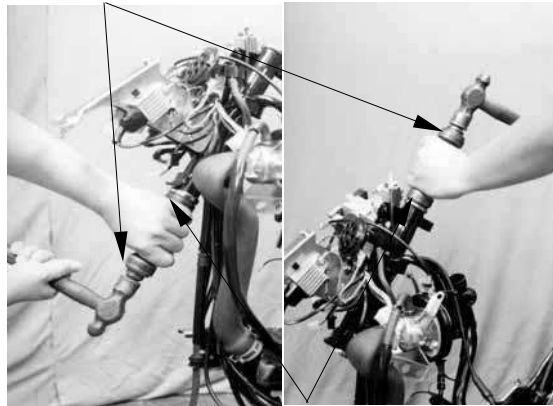

Outer Driver, 37x40mm

### INSTALLATION

Apply grease to the top and bottom ball races and install 26 steel balls on the top ball race and 29 steel balls on the bottom ball race. Apply grease to the ball races and install the front fork.



Steel Balls

Apply grease to the top cone race and install it.

Tighten the top cone race and then turn the steering stem right and left several times to make steel balls contact each other closely.

Check that the steering stem rotates freely without vertical play.

Top Cone Race



Long Socket Wrench



Lock Nut Wrench

Install the steering stem lock nut and tighten it while holding the top cone race.

**Torque:** 6.0~8.0kgf-m

Install the front wheel. (⇒12-7)

Install the steering handlebar. (⇒12-3)

Install the speedometer cable. (⇒12-7)

Special

Long Socket Wrench, 32mm 8Angle

# 13. REAR WHEEL/REAR BRAKE/ REAR SUSPENSION

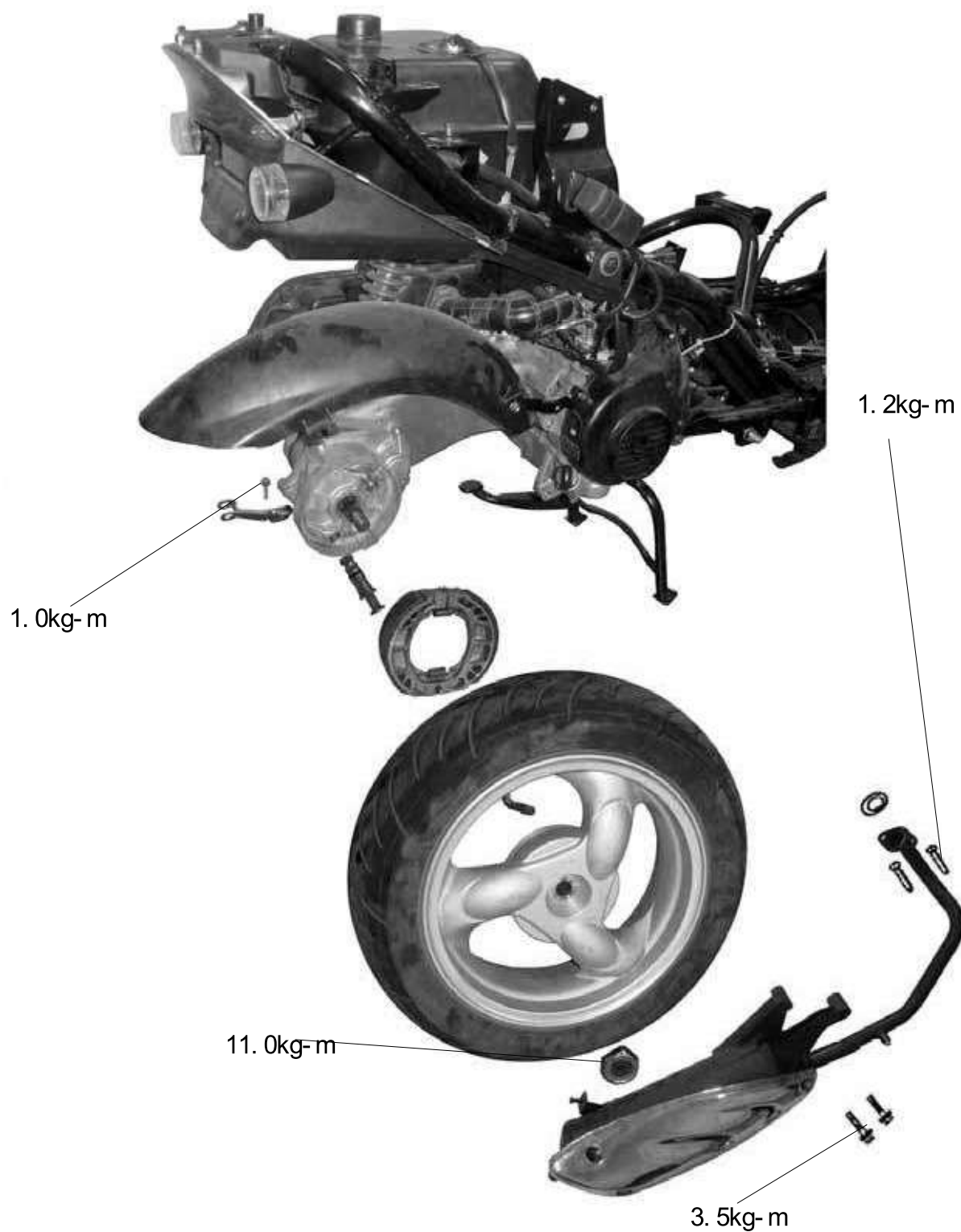



# 13. REAR WHEEL/REAR BRAKE/ REAR SUSPENSION

SERVICE INFORMATION .....	13-1	REAR BRAKE.....	13-3
TROUBLESHOOTING .....	13-1	REAR SHOCK ABSORBER.....	13-4
REAR WHEEL .....	13-2		

## SERVICE INFORMATION

### GENERAL INSTRUCTIONS

- During servicing, keep oil or grease off the brake drum and brake linings.

### SPECIFICATIONS

Item		Standard (mm)	Service Limit (mm)
Rear wheel	Rim runout	Radial	—
		Axial	—
	Rear brake drum I.D		110
Rear brake lining thickness		4.0	2.0
Rear shock absorber spring free length		202.5	198

### TORQUE VALUES

Rear axle nut	11~13kgf-m
Rear shock absorber upper mount bolt	3.5~4.5kgf-m
Rear shock absorber lower mount bolt	2.4~3.0kgf-m
Exhaust muffler joint lock nut	1.0~1.4kgf-m
Exhaust muffler lock bolt	3.0~3.6kgf-m

### Special Tool

Cushion Assemble & Disassemble Tool

## TROUBLESHOOTING

### Rear wheel wobbling

- Bent rim
- Faulty tire
- Axle not tightened properly

### Soft rear shock absorber

- Weak shock absorber spring
- Faulty damper

### Poor brake performance

- Brake not adjusted properly
- Worn brake linings
- Worn brake shoes at cam contacting area
- Worn brake cam
- Worn brake drum

# 13. REAR WHEEL/REAR BRAKE/ REAR SUSPENSION

## REAR WHEEL

### REMOVAL

Remove the exhaust muffler. (⇒2-5)  
Remove the rear axle nut to remove the rear wheel.

Rear Axle Nut

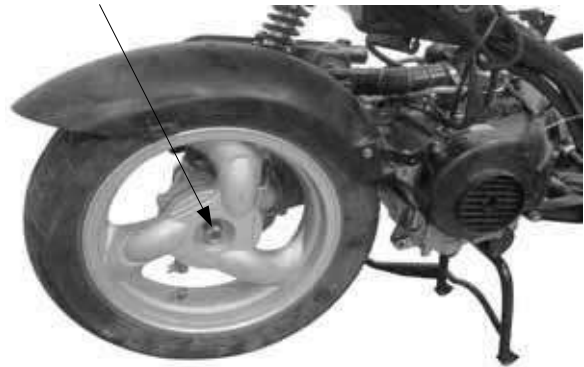

### INSPECTION

Measure the rear wheel rim runout.

#### Service Limits:

**Radial:** 2.0mm replace if over

**Axial:** 2.0mm replace if over

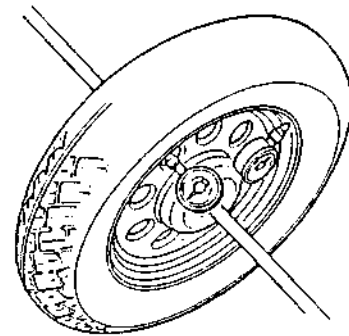

Inspect the rear brake drum.  
Measure the rear brake drum I.D.

**Service Limits:** 111mm replace if over

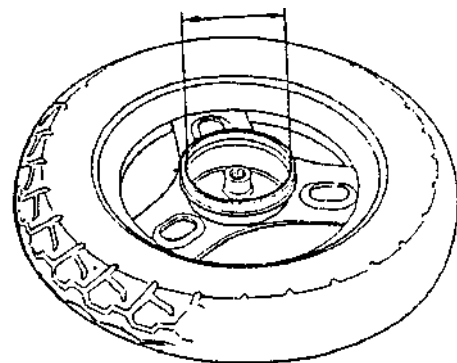

### INSTALLATION

Install the rear wheel in the reverse order of removal.

Tighten the rear axle nut.

**Torque:** 11.0-13.0kg-m

Install the exhaust muffler.

#### Torque:

Exhaust muffler joint lock nut: 1.0~1.4kgf-m

Exhaust muffler lock bolt: 3.0~3.6kgf-m

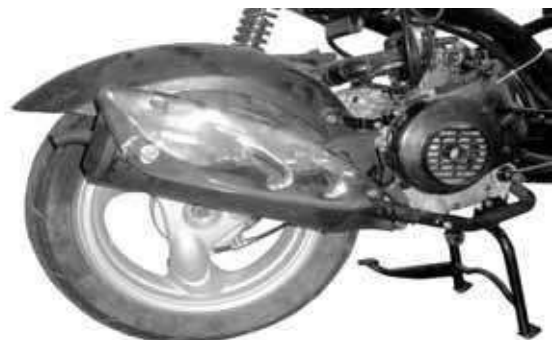

First install and tighten the exhaust muffler joint lock nuts and then the exhaust muffler lock bolts.

# 13. REAR WHEEL/REAR BRAKE/ REAR SUSPENSION



AGILITY 50

## REAR BRAKE

### BRAKE LINING INSPECTION

Measure the brake lining thickness.

**Service Limit:** 2.0mm replace if below

Keep oil or grease off the brake linings.

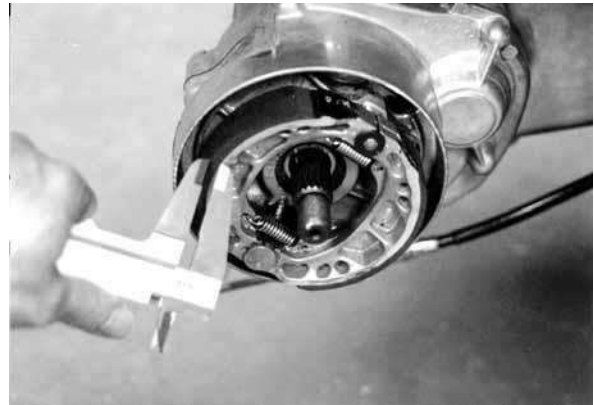

### REAR BRAKE DISASSEMBLY

Remove the rear brake adjusting nut and disconnect the rear brake cable.

Remove the rear brake shoes.

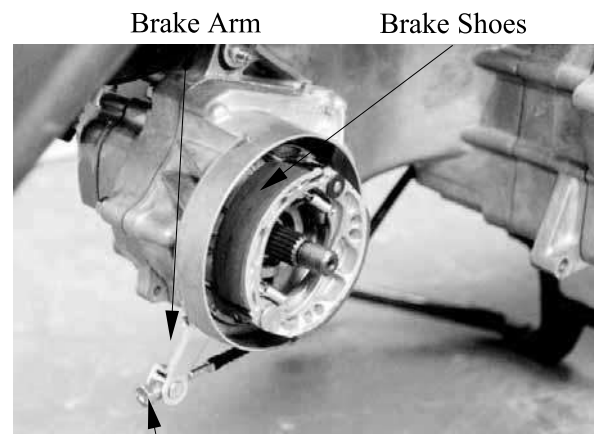

Remove the brake arm bolt to remove the brake arm, wear indicator plate and felt seal.  
Remove the brake cam.

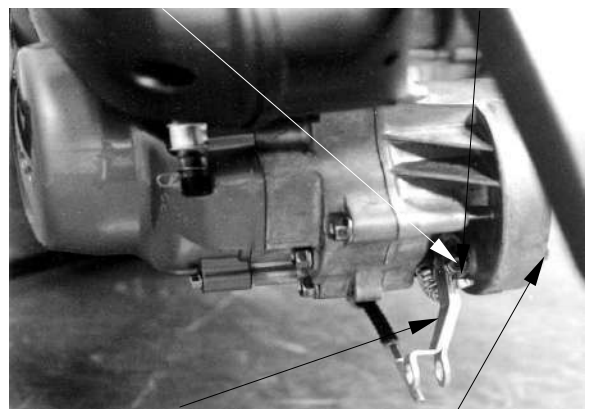

### REAR BRAKE ASSEMBLY

Apply grease to the anchor pin.

Apply grease to the brake cam and install it.

Install the brake shoes.

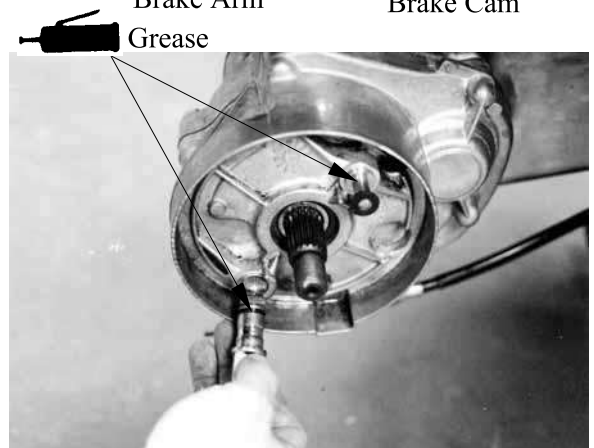

# 13. REAR WHEEL/REAR BRAKE/ REAR SUSPENSION

Apply a small amount of engine oil to the felt seal and install it to the brake cam.  
Install the wear indicator plate and brake arm.

Align the wide groove on the wear indicator plate with the wide tooth of the brake cam.

Install and tighten the brake arm bolt.

Align the scribed line on the brake arm with the punch mark on the brake cam.

Install the brake arm return spring.  
Install the brake arm pin.  
Connect the brake cable and install the adjusting nut.  
Install the rear wheel. (⇒13-2)  
Adjust the rear brake lever free play. (⇒3-8)

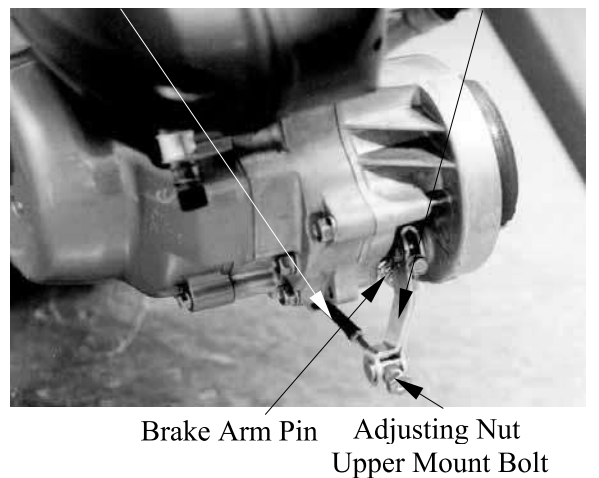
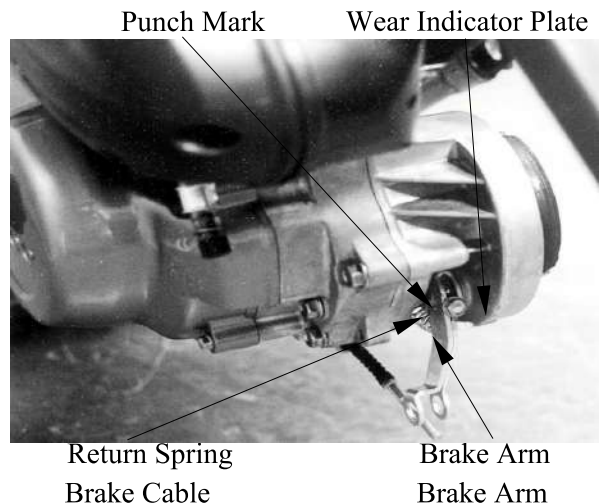

### REAR SHOCK ABSORBER

#### REMOVAL

Remove the frame body cover. (⇒2-3)  
Remove the air cleaner case. (⇒5-19)

Remove the rear shock absorber upper and lower mount bolts.  
Remove the rear shock absorber.



#### DISASSEMBLY

Install the rear shock absorber compressor as the figure shown.

Install the rear shock absorber lower joint into the rear shock absorber compressor.

Compress the rear shock absorber spring.

**Special**

Cushion Assemble & Disassemble Tool

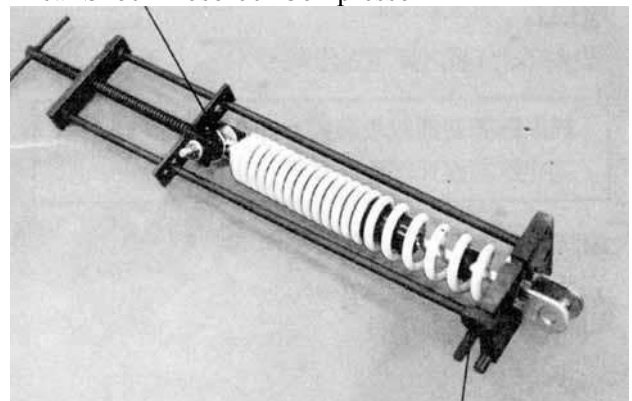

Cushion Assemble & Disassemble Tool

# 13. REAR WHEEL/REAR BRAKE/ REAR SUSPENSION

Loosen the lower joint lock nut.  
Remove the lower joint.  
Remove the lock nut, rubber and damper.

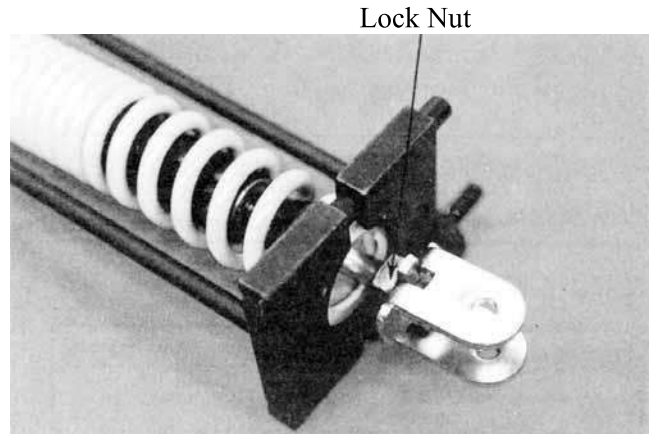

### INSPECTION

Inspect the damper rod for bending or damage.  
Inspect the damper for oil leaks.  
Inspect the damper rubber for deterioration or damage.

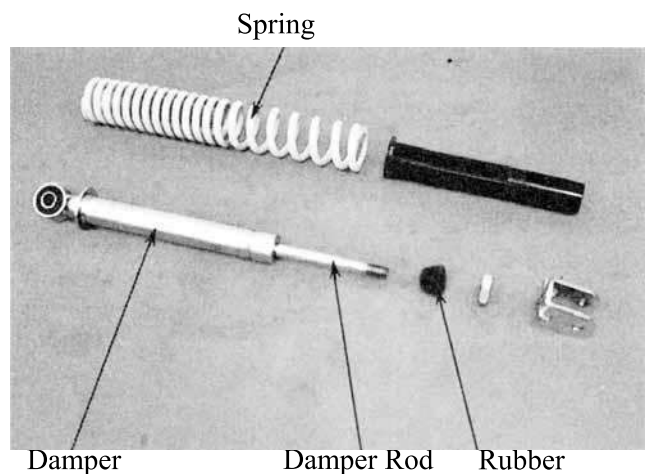

Measure the rear shock absorber spring free length.

**Service Limit:** 198mm replace if over

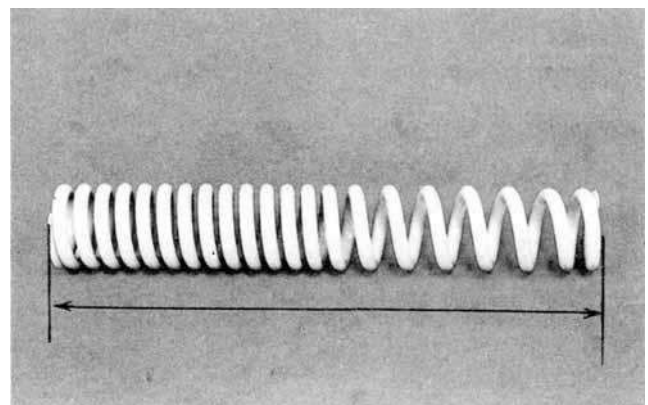

### ASSEMBLY

Assemble the rear shock absorbers in the reverse order of disassembly.

- Install the shock absorber spring with loosely wound coils facing down.
- Apply locking agent to the lock nut threads and tighten the lock nut.

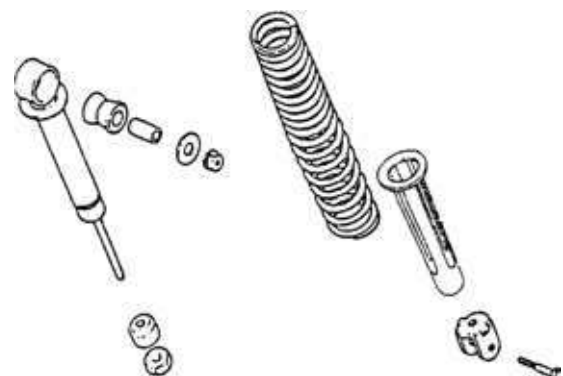

# 13. REAR WHEEL/REAR BRAKE/ REAR SUSPENSION

## INSTALLATION

Install the rear shock absorber.  
Install the rear shock absorber upper mount bolt and then the lower mount bolt.  
Tighten the bolts.

### Torque:

Upper Mount Bolt: 3.5~4.5kgf-m

Lower Mount Bolt: 2.4~3.0kgf-m

Install the air cleaner case. (⇒5-15)

Install the frame body cover. (⇒2-3)

Upper Mount Bolt



Lower Mount Bolt

# 14. BATTERY/CHARGING SYSTEM/ A.C. GENERATOR

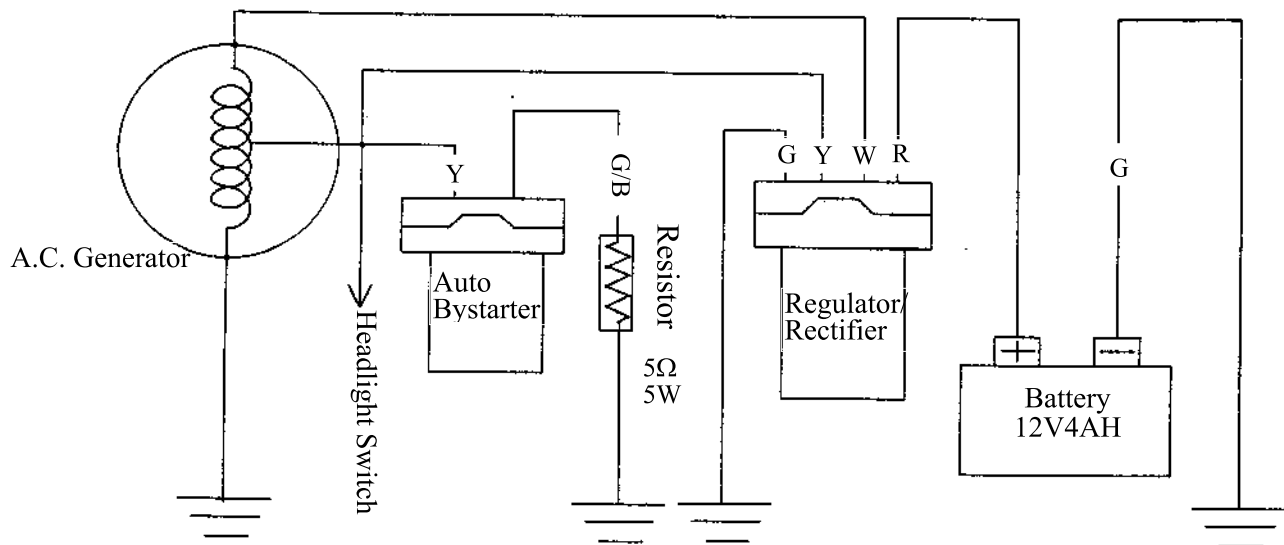
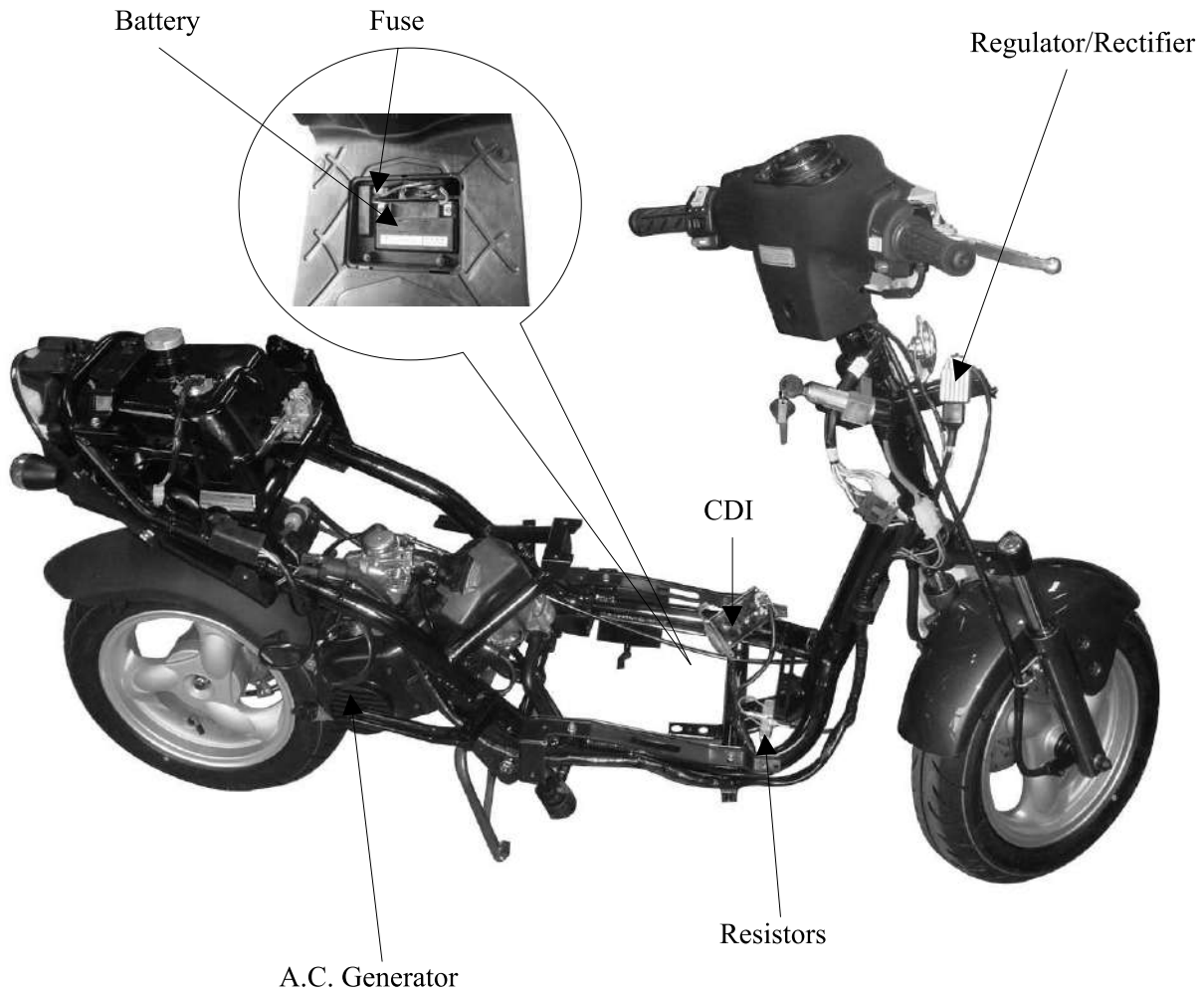

SERVICE INFORMATION.....	14-1	A.C. GENERATOR CHARGING COIL ...	14-6
TROUBLESHOOTING .....	14-2	RESISTOR INSPECTION.....	14-6
BATTERY.....	14-3	A.C. GENERATOR REMOVAL .....	14-6
CHARGING SYSTEM .....	14-4	A.C. GENERATOR INATALLATION ...	14-8
REGULATOR/RECTIFIER.....	14-5		

### SERVICE INFORMATION

#### GENERAL INSTRUCTIONS



The battery electrolyte (sulfuric acid) is poisonous and may seriously damage the skin and eyes. Avoid contact with skin, eyes, or clothing. In case of contact, flush with water and get prompt medical attention

- The battery can be charged and discharged repeatedly. If a discharged battery is not used for a long time, its service life will be shortened. Generally, the capacity of a battery will decrease after it is used for 2~3 years. A capacity-decreased battery will resume its voltage after it is recharged but its voltage decreases suddenly and then increases when a load is added.
- When a battery is overcharged, some symptoms can be found. If there is a short circuit inside the battery, no voltage is produced on the battery terminals. If the rectifier won't operate, the voltage will become too high and shorten the battery service life.
- If a battery is not used for a long time, it will discharge by itself and should be recharged every 3 months.
- A new battery filled with electrolyte will generate voltage within a certain time and it should be recharged when the capacity is insufficient. Recharging a new battery will prolong its service life.
- Inspect the charging system according to the sequence specified in the Troubleshooting.
- Do not disconnect and soon reconnect the power of any electrical equipment because the electronic parts in the regulator/rectifier will be damaged. Turn off the ignition switch before operation.
- It is not necessary to check the MF battery electrolyte or fill with distilled water.
- Check the load of the whole charging system.
- Do not quick charge the battery. Quick charging should only be done in an emergency.
- Remove the battery from the motorcycle for charging.
- When replacing the battery, do not use a traditional battery.
- When charging, check the voltage with a voltmeter.



# 14. BATTERY/CHARGING SYSTEM/ A.C. GENERATOR



AGILITY 50

## SPECIFICATIONS

Item		Standard	
Battery	Capacity/Model		12V-4AH
	Voltage (20°C)	Fully charged	13.1V
		Undercharged	12.3V
	Charging current		STD: 0.4A Quick: 4.0A
	Charging time		STD: 5~10hr Quick: 30min
A.C. Generator	Capacity		0.144KW/5000rpm
	Lighting coil resistance (20°C)		Yellow~Green 0.1~1.0Ω
	Charging coil resistance (20°C)		White~Green 0.2~1.2Ω
Regulator/Rectifier	Type		Single-phase half-wave SCR
	Limit voltage	Lighting	13.1~13.9V/5000rpm (Electric tester, tachometer)
		Charging	13.1±0.5V
Resistor	Resistance (20°C)		5W12Ω
	Resistance (20°C)		30W7.5Ω

## TORQUE VALUES

Pulser coil bolt	0.45~0.6kgf-m
Stator bolt	0.8~1.2kgf-m
Flywheel nut	3.5~4.5kgf-m
Cooling fan bolt	0.8~1.2kgf-m

## SPECIAL TOOLS

Universal holder  
Flywheel puller

## TESTING INSTRUMENTS

Kowa electric tester  
Sanwa electric tester

## TROUBLESHOOTING

### No power

- Dead battery
- Disconnected battery cable
- Fuse burned out
- Faulty ignition switch

### Low power

- Weak battery
- Loose battery connection
- Charging system failure
- Faulty regulator/rectifier

### Intermittent power

- Loose battery cable connection
- Loose charging system connection
- Loose connection or short circuit in lighting system

### Charging system failure

- Loose, broken or shorted wire or connector
- Faulty regulator/rectifier
- Faulty A.C. generator

# 14. BATTERY/CHARGING SYSTEM/ A.C. GENERATOR

## BATTERY

### REMOVAL

Remove the battery cover screws on the floor board.

Open the battery cover and remove the battery by removing the bolt and band.

First disconnect the battery negative (-) cable and then the positive (+) cable.

When disconnecting the battery positive (+) cable, do not touch the frame with tool; otherwise it will cause short circuit and sparks to fire the fuel.

The installation sequence is the reverse of removal.

First connect the positive (+) cable and the negative (-) cable to avoid short circuit.

### BATTERY VOLTAGE (OPEN CIRCUIT VOLTAGE) INSPECTION

Remove the floor board.

Open the battery cover and disconnect the battery cables.

Measure the voltage between the battery terminals.

Fully charged : 13.1V

Undercharged : 12.3V max.

Battery charging inspection must be performed with a voltmeter.

### CHARGING

Connect the charger positive (+) cable to the battery positive (+) terminal.

Connect the charger negative (-) cable to the battery negative (-) terminal.

- Keep flames and sparks away from a charging battery.
- Turn power ON/OFF at the charger, not at the battery terminals to prevent sparks near the battery to avoid explosion.
- Charge the battery according to the

- Quick charging should only be done in an emergency.
- Measure the voltage 30 minutes after the battery is charged.

Charging current: Standard : 0.4A

Quick : 4A

Charging time : Standard : 5~10 hours

Quick : 30 minutes

After charging: Open circuit voltage: 12.8V min.

Note: The battery temperature should not exceed 45°C during charging.

Battery Cover

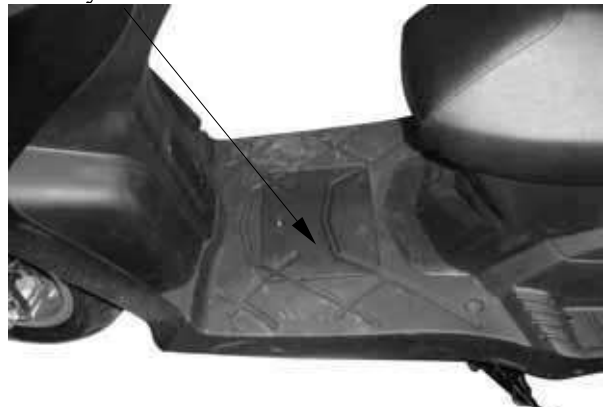

battery



negative (-) cable

positive (+) cable

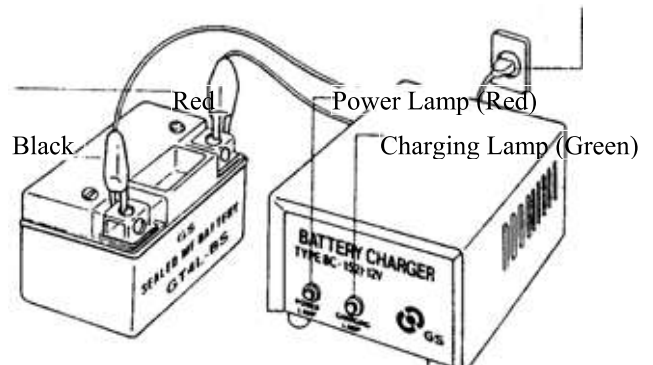
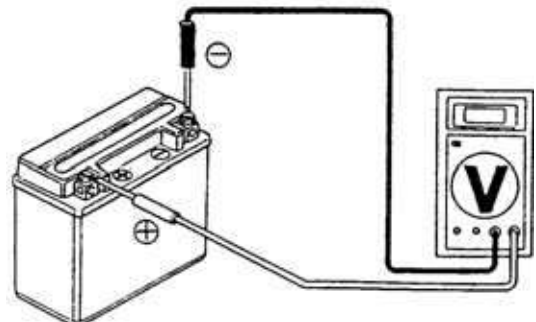

### CHARGING SYSTEM

#### SHORT CIRCUIT TEST

Disconnect the ground wire from the battery and connect an ammeter across the battery negative (-) terminal and the ground wire. Turn the ignition switch OFF and check for short circuit.

Connect the electric tester positive (+) terminal to ground wire and the tester negative (-) terminal to the battery negative (-) terminal.

If any abnormality is found, check the ignition switch and wire harness for short circuit .

#### CURRENT TEST

This inspection must be performed with an electric tester when the battery is fully charged.

Warm up the engine for inspection.

Connect the electric tester across the battery terminals. Disconnect the fuse and connect an ammeter between the fuse terminals.

Attach a tachometer to the engine.

Start the engine and gradually increase the engine speed to measure the limit voltage and current.

**Limit Voltage/Current:** 14~15V/0.5A max.  
(5000rpm max.)

If the limit voltage is not within the specified range, check the regulator/rectifier. (⇒14-5)

#### LIGHTING SYSTEM LIMIT VOLTAGE INSPECTION

Remove the handlebar front cover. (⇒2-2)

Measure the voltage with the electric tester in the AC range.

**Limit Voltage:** 12~14V/ (5000rpm max.)

If the limit voltage is not within the specified range, check the regulator/rectifier. (⇒14-5)

Perform this test with a fully charged battery.

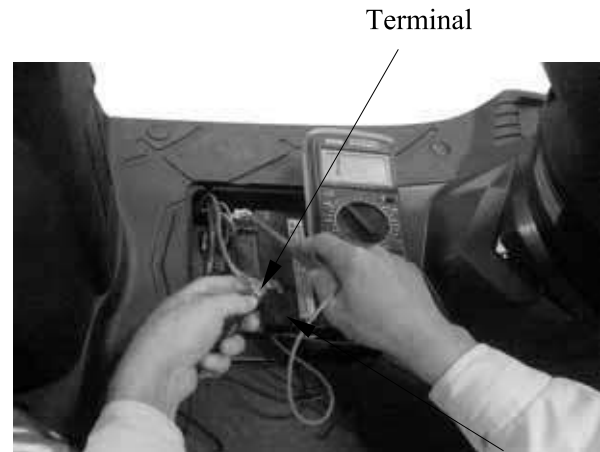

Battery

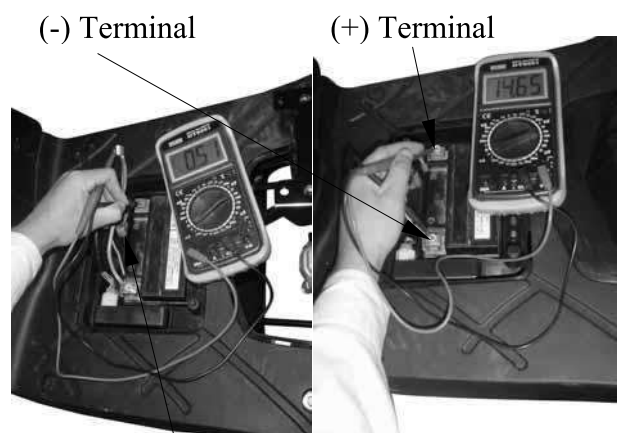

fuse  
Headlight Wire Coupler



# 14. BATTERY/CHARGING SYSTEM/ A.C. GENERATOR



AGIKITY 50

## REGULATOR/RECTIFIER

### MAIN HARNESS CIRCUIT INSPECTION

Remove the front covers. (⇒2-2)  
Remove the regulator/rectifier 4P coupler and check for continuity between the wire harness terminals according to the following :

Item (Wire Color)	Judgment
Between battery (red) and engine ground	Battery has voltage
Between ground (green) and engine ground	Continuity exists
Between lighting wire (yellow) and engine ground (Remove the resistor coupler and auto bystarter coupler and turn the lighting switch OFF for inspection)	A.C. generator stator has resistance
Between charging coil (white) and engine ground	A.C. generator stator has resistance

Regulator/Rectifier



### REGULATOR/RECTIFIER INSPECTION

If the main harness terminals are normal, check the regulator/rectifier coupler for loose connection and measure the resistances between the regulator/rectifier terminals.

- Do not touch the tester probes with your finger because human body has resistance.
- Use the following specified testers for accurate testing. Use of an improper tester in an improper range may give false readings.
  - Kowa Electric Tester
  - Sanwa Electric Tester
  - Kowa Electric Tester TH-5H
- Proper range for testing:
  - Use XKΩ range for Sanwa Tester
  - Use X100Ω range for Kowa Tester
- If the dry battery in the tester is weak, the readings will be incorrect. In this case, check the dry battery.
- The Kowa tester readings are 100 times the actual values. Be careful during testing.

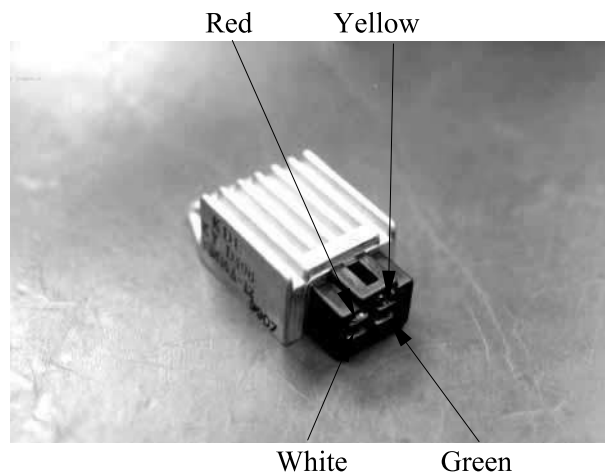

ProbeⓈ Probe(-)	White	Yellow	Red	Green
White		∞	3K-50K	∞
Yellow	∞		∞	5K-100K
Red	∞	∞		∞
Green	∞	5K-50K	∞	

Replace the regulator/rectifier if the readings are not within the specifications in the table.

### A.C. GENERATOR CHARGING COIL

The inspection of A.C. generator charging coil can be made with the engine installed.

#### INSPECTION

Disconnect the A.C. generator 2P connector. Measure the resistance between the A.C. generator white wire and engine ground with an electric tester.

**Standard:** 0.2~1.2Ω(at 20°C)

Replace the A.C. generator charging coil if the reading is not within the specifications.

Charging Coil Wire



### A.C. GENERATOR LIGHTING COIL

The inspection of A.C. generator lighting coil can be made with the engine installed.

#### INSPECTION

Disconnect the A.C. generator 2P connector. Measure the resistance between the A.C. generator yellow wire and engine ground with an electric tester.

**Standard:** 0.1~1.0Ω (20°C)

Replace the A.C. generator lighting coil if the reading is not within the specifications.



Lighting Coil Wire

### RESISTOR INSPECTION

Remove the front covers. (⇒2-2)  
Measure the resistance between the resistor lead and engine ground.

**Resistances:** 5W12Ω: 11~13Ω  
30W7.5Ω: 6~8Ω



Resistor

### A.C. GENERATOR

#### REMOVAL

Remove the right side cover. (⇒2-4)  
Remove the four bolts attaching the cooling fan cover to remove the fan cover.



Fan Cover

# 14. BATTERY/CHARGING SYSTEM/ A.C. GENERATOR

Remove the cooling fan by removing the four cooling fan attaching bolts.

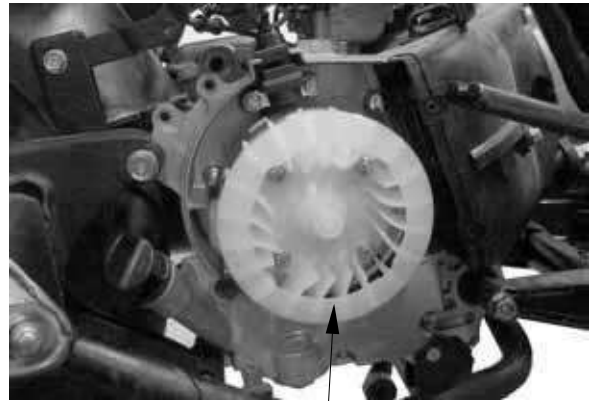

Cooling Fan

Hold the flywheel with an universal holder.  
Remove the flywheel nut.

**Special**

Universal Holder

Universal Holder



Remove the A.C. generator flywheel using the flywheel puller.  
Remove the woodruff key.

**Special**

Flywheel Puller



Flywheel Puller

Remove the A.C. generator wire connector.

A.C. Generator Wire Connector



# 14. BATTERY/CHARGING SYSTEM/ A.C. GENERATOR

Remove the A.C. generator wire set plate.  
Remove the pulser coil bolts.  
Remove the A.C. generator wire rubber sleeve and pulser coil from the right crankcase.  
Remove the two bolts and A.C. generator stator.

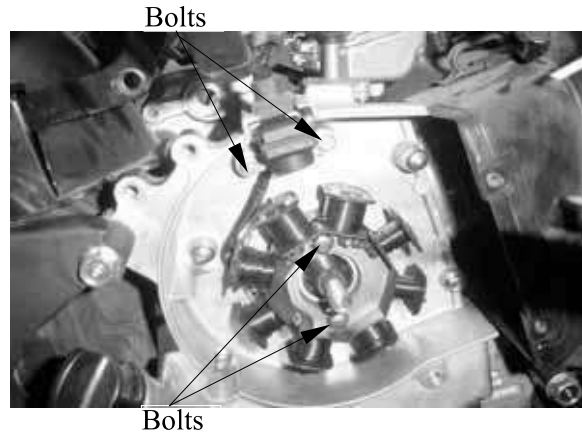

## A.C. GENERATOR INSTALLATION

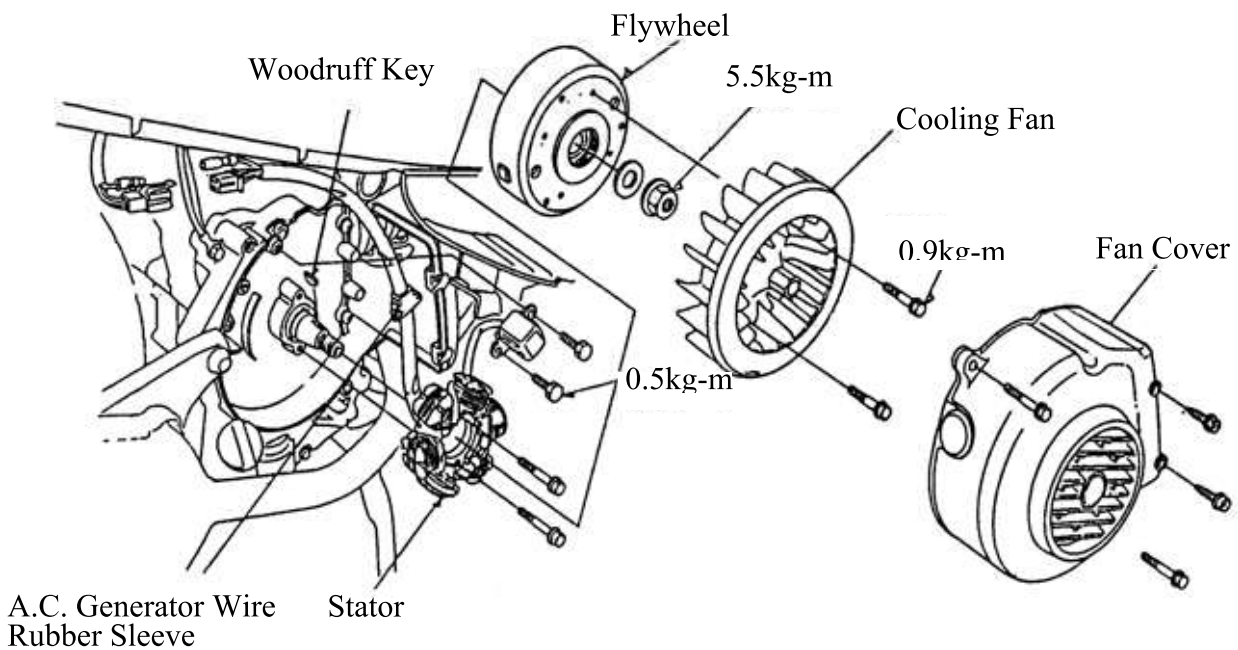

Install the A.C. generator stator and pulser coil onto the right crankcase.  
Tighten the stator and pulser coil bolts.  
**Torques: Pulser Coil** : 0.45~0.6kgf-m  
**Stator** : 0.8~1.2kgf-m

Install the A.C. generator wire rubber sleeve and A.C. generator wire set plate.

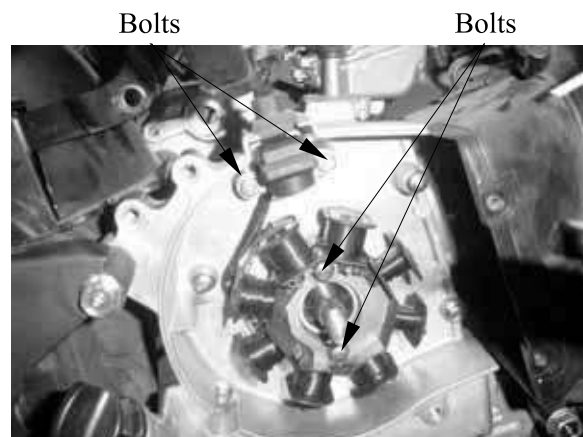

# 14. BATTERY/CHARGING SYSTEM/ A.C. GENERATOR

Connect the A.C. generator wire connector.

A.C. Generator Wire Connector



Clean the taper hole in the flywheel off any burrs and dirt.  
Install the woodruff key in the crankshaft keyway.

Woodruff Key



Install the flywheel onto the crankshaft with the flywheel hole aligned with the crankshaft woodruff key.

The inside of the flywheel is magnetic.  
Make sure that there is no bolt or nut before installation.

Universal Holder



Hold the flywheel with the universal holder and tighten the flywheel nut.

**Torque:** 3.5~4.5kgf-m

**Special**

Universal Holder

Install the cooling fan.

**Torque:** 0.8~1.2kgf-m

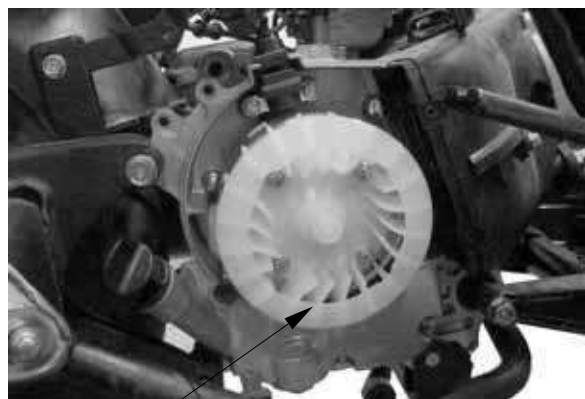

Cooling Fan



# 14. BATTERY/CHARGING SYSTEM/ A.C. GENERATOR

Install the fan cover.  
Install the right side cover. (⇒2-4)



Fan Cover

# 15. IGNITION SYSTEM

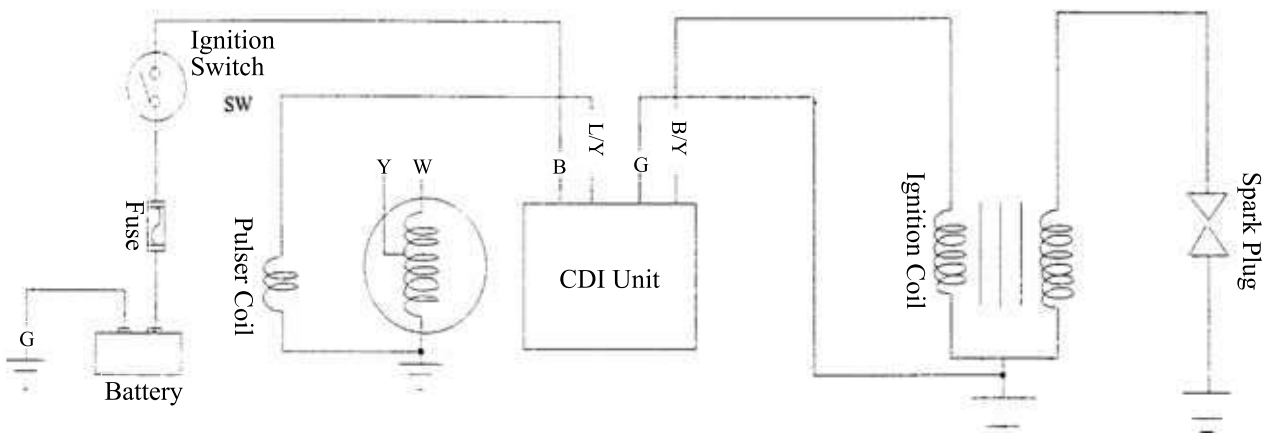
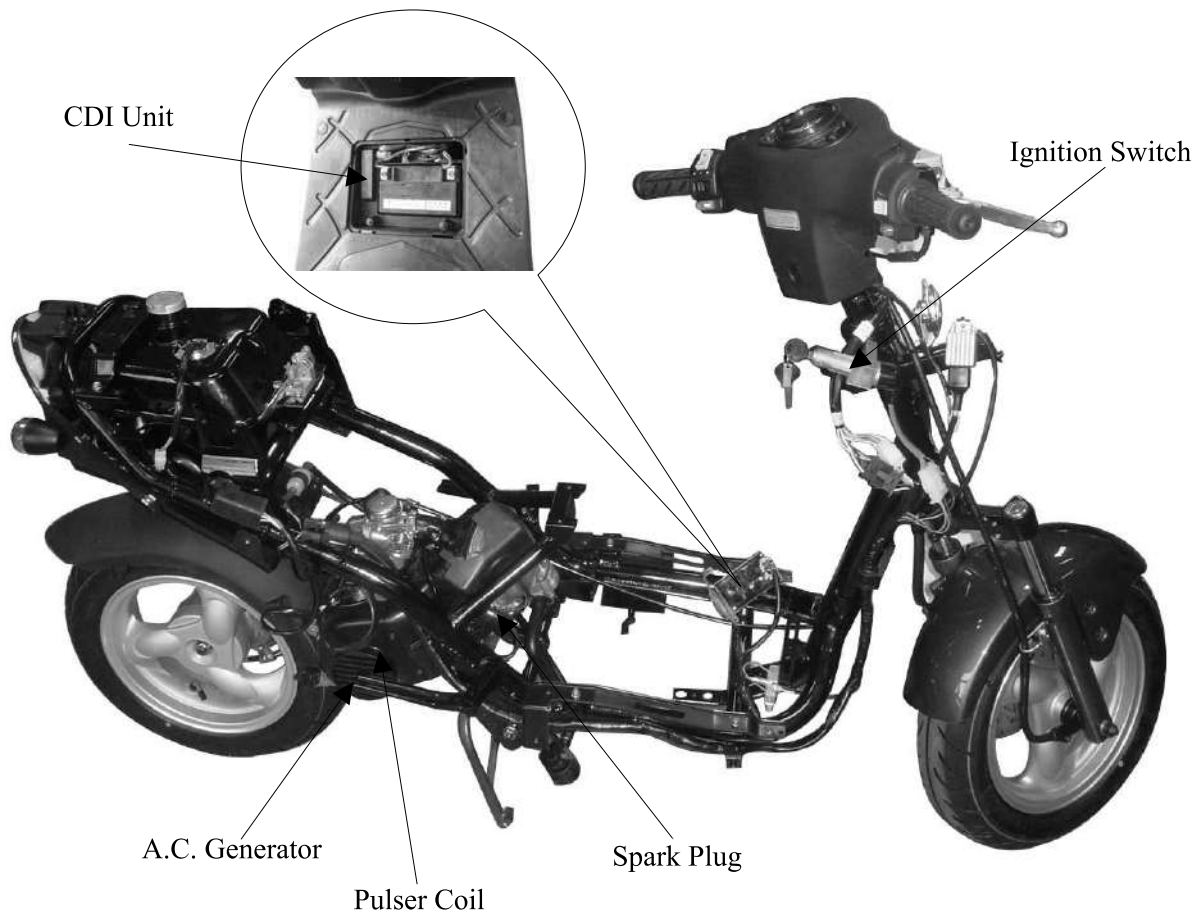

15

SERVICE INFORMATION .....	15-1	IGNITION COIL .....	15-4
TROUBLESHOOTING .....	15-2	PULSER COIL .....	15-5
CDI UNIT INSPECTION .....	15-3		

### SERVICE INFORMATION

#### GENERAL INSTRUCTIONS

- Check the ignition system according to the sequence specified in the Troubleshooting. (⇒15-2)
- The ignition system adopts CDI unit and the ignition timing cannot be adjusted.
- If the timing is incorrect, inspect the CDI unit and A.C. generator and replace any faulty parts.  
Inspect the CDI unit with a CDI tester
- Loose connector and poor wire connection are the main causes of faulty ignition system. Check each connector before operation.
- Use of spark plug with improper heat range is the main cause of poor engine performance.
- The inspections in this section are focused on maximum voltage. The inspection of ignition coil resistance is also described in this section.
- Inspect the ignition switch according to the continuity table specified in page 17-3.
- Inspect the spark plug referring to Section 3.
- Remove the A.C. generator and pulser coil referring to Section 14.

#### SPECIFICATIONS

Item		Standard	
Spark plug	Standard type	(NGK) C7HSA	
	Hot type	(NGK) C6HSA	
	Cold type	(NGK) C8HSA	
Spark plug gap		0.6~0.7mm	
Ignition timing	“F” mark	13° BTDC /1,700rpm±100RPM	
	Full advance	28° BTDC /4,000rpm±100RPM	
Ignition coil resistance (20°C)	Primary coil		0.1~1.0Ω
	Secondary coil	with plug cap	7~12KΩ
		without plug cap	3~5KΩ
Pulser coil resistance (20°C)		40~300Ω	
Ignition coil primary side max. voltage		12V min.	
Pulser coil max. voltage		2.1V min.	

#### TESTING INSTRUMENT

Kowa Electric Tester

or commercially available electric tester with resistance over 10MΩ/CDV

# 15. IGNITION SYSTEM

## TROUBLESHOOTING

### High voltage too low

- Weak battery or low engine speed
- Loose ignition system connection
- Faulty ignition coil
- Faulty CDI unit
- Faulty pulser coil

### Intermittent high voltage

- Faulty ignition switch
- Poorly connected CDI unit coupler
- Poorly connected or broken CDI ground wire
- Faulty pulser coil
- Loose high tension wire connection
- Faulty CDI unit

### Normal high voltage but no spark at plug

- Faulty spark plug
- Faulty spark plug cap

### No high voltage

- Faulty ignition switch
- Dead battery or faulty regulator/rectifier
- Faulty charging circuit
- Faulty ignition coil
- Faulty CDI unit

### No or intermittent high voltage

- Faulty ignition coil
- Weak battery
- Faulty charging system

# 15. IGNITION SYSTEM

## CDI UNIT INSPECTION

Remove the three battery cover screws.  
 Disconnect the CDI coupler and remove the CDI unit.  
 Measure the resistance between the terminals using the electric tester.

- Due to the semiconductor in circuit, it is necessary to use a specified tester for accurate testing. Use of an improper tester in an improper range may give false readings.
- Use a Sanwa Electric Tester or Kowa Electric Tester.
- In this table, “Needle swings then returns” indicates that there is a charging current applied to a condenser. The needle will then remain at “∞” unless the condenser is discharged.

Unit: KΩ

Probe⊕ (-)Probe	Black	Black/ Yellow	Blue/ Yellow	Green
Black		∞	1K~∞	10~60
Black/ Yellow	30~80		150~400	5~15
Blue/ Yellow	100~250	∞		40~90
Green	10~30	∞	60~200	



CDI Unit  
 Black

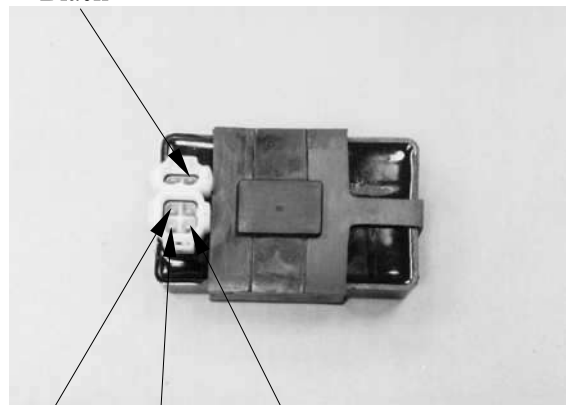

Black/  
 Yellow    Blue/  
 Yellow    Green

# 15. IGNITION SYSTEM

### IGNITION COIL REMOVAL

Remove the met-in box. (⇒2-3)  
 Remove the spark plug cap.  
 Disconnect the ignition coil wires and remove the ignition coil bolt and ignition coil.



Ignition Coil

### INSPECTION

#### CONTINUITY TEST

The CDI unit is not adjustable. If the timing is incorrect, inspect the CDI unit, pulser coil and A.C. generator and replace any faulty parts.

Measure the resistance between the ignition coil primary coil terminals.

**Resistance:** 0.1 ~ 1.0Ω

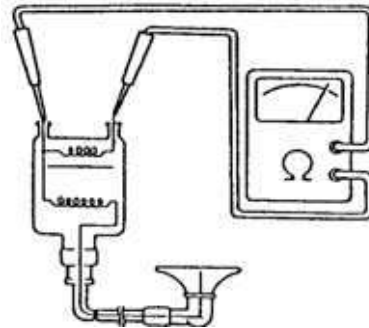

Measure the secondary coil resistances with and without the spark plug cap.

#### **Resistances:**

(with plug cap) : 7 ~ 12KΩ

(without plug cap) : 3 ~ 5KΩ

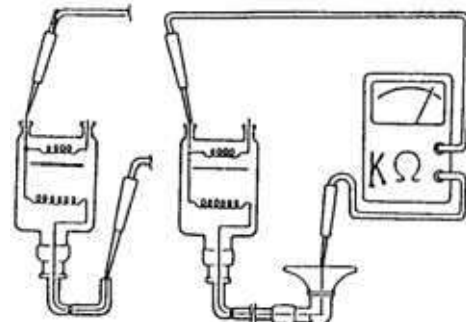

Correctly operate the tester following the manufacturer's instructions.

# 15. IGNITION SYSTEM

## PULSER COIL INSPECTION

This test is performed with the stator installed in the engine.

Remove the frame body cover. (⇒2-3)  
 Disconnect the A.C. generator connector.



Pulser Coil Coupler

Measure the pulser coil resistance between the blue/yellow and green wire terminals.

**Resistance:** 80~160Ω

Refer to page 14-6 for the A.C. generator removal.

## IGNITION TIMING INSPECTION

The CDI unit is not adjustable. If the ignition timing is incorrect, inspect the CDI unit, pulser coil and A.C. generator and replace any faulty parts.

Remove the timing hole cap.

Timing Hole Cap



Warm up the engine and check the ignition timing with a timing light.  
 When the engine is running at the ignition timing is correct if the “F” mark aligns with the index mark within  $\pm 2^\circ$ .

**Ignition Timing:** BTDC $28^\circ$ /4000rpm



“F” Mark

# 16. STARTING SYSTEM

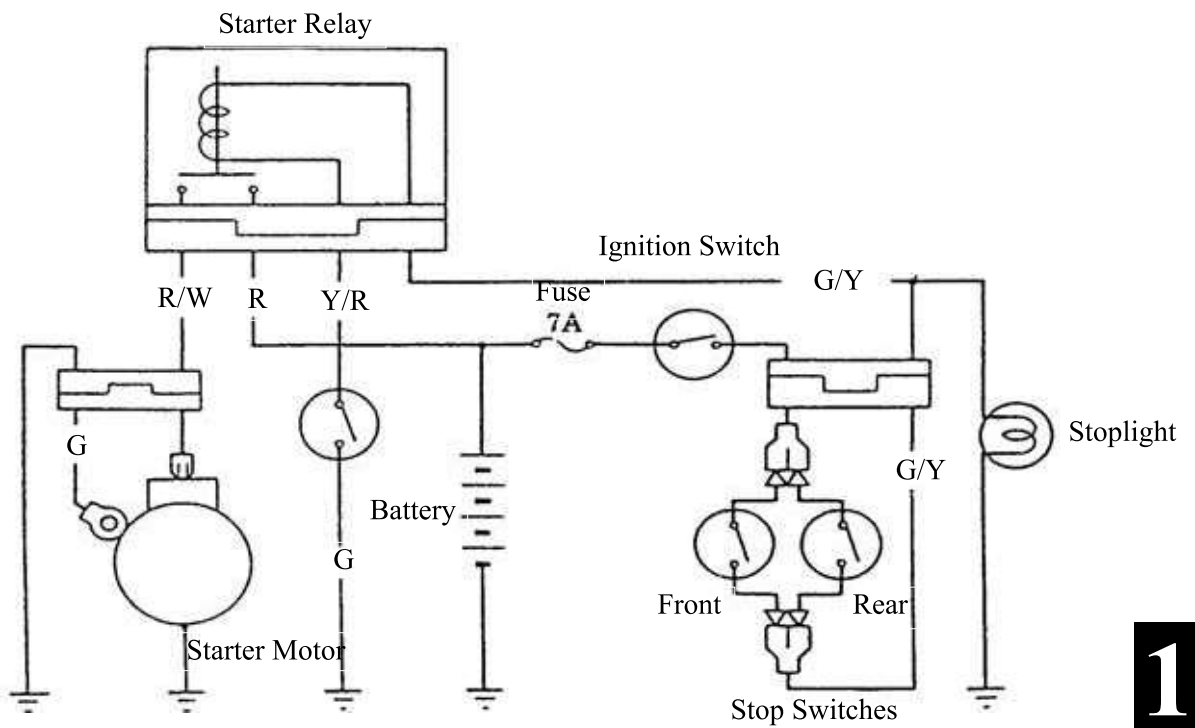
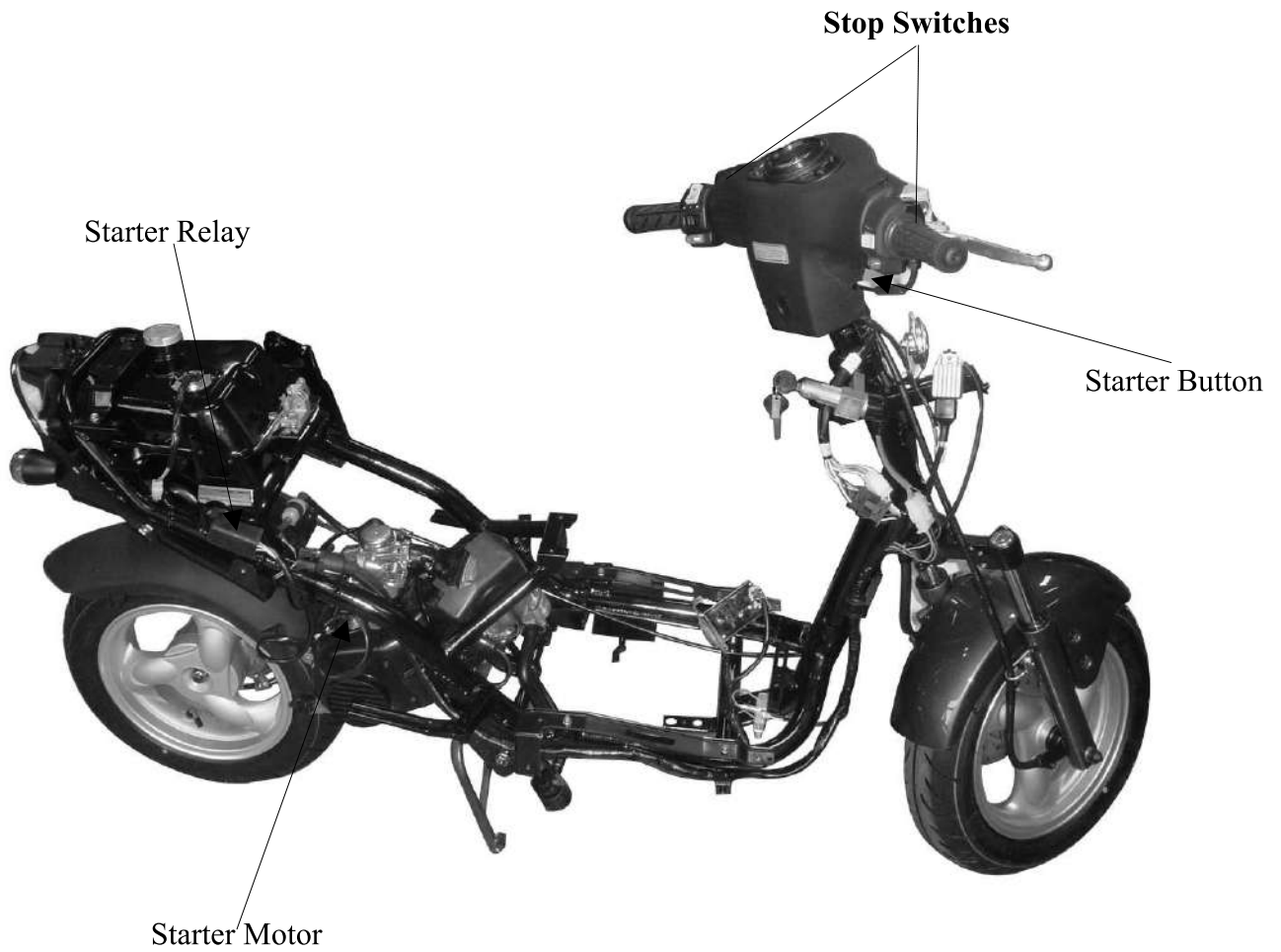



SERVICE INFORMATION.....	16-1	STARTER MOTOR .....	16-2
TROUBLESHOOTING.....	16-1	STARTER RELAY.....	16-4

## SERVICE INFORMATION

### GENERAL INSTRUCTIONS

- The removal of starter motor can be accomplished with the engine installed.

### SPECIFICATIONS

Item	Standard (mm)	Service Limit (mm)
Starter motor brush length	12.5	8.5

## TROUBLESHOOTING

### Starter motor won't turn

- Fuse burned out
- Weak battery
- Faulty ignition switch
- Faulty starter clutch
- Faulty front or rear stop switch
- Faulty starter relay
- Poorly connected, broken or shorted wire
- Faulty starter motor

### Lack of power

- Weak battery
- Loose wire or connection
- Foreign matter stuck in starter motor or gear

### Starter motor rotates but engine does not start

- Faulty starter clutch
- Starter motor rotates reversely
- Weak battery

# 16. STARTING SYSTEM

## STARTER MOTOR

### REMOVAL

Before removing the starter motor, turn the ignition switch OFF and remove the battery ground. Then, turn on the ignition switch and push the starter button to see if the starter motor operates properly.

Remove the front cover.

Remove the starter motor cable.

Remove the two starter motor mounting bolts and the motor.

Remove the waterproof rubber jacket and disconnect the starter motor cable connector.

### DISASSEMBLY

Remove the two starter motor case screws, front cover, motor case and other parts.

### INSPECTION

Inspect the removed parts for wear, damage or discoloration and replace if necessary. Clean the commutator if there is metal powder between the segments.

Check for continuity between pairs of the commutator segments and there should be continuity.

Also, make a continuity check between individual commutator segments and the armature shaft. There should be no continuity.



Starter Motor Cable  
Front Cover

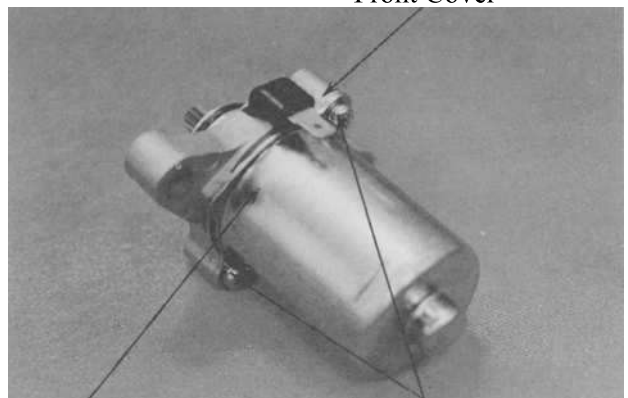

Motor Case      Case Screws

Commutator

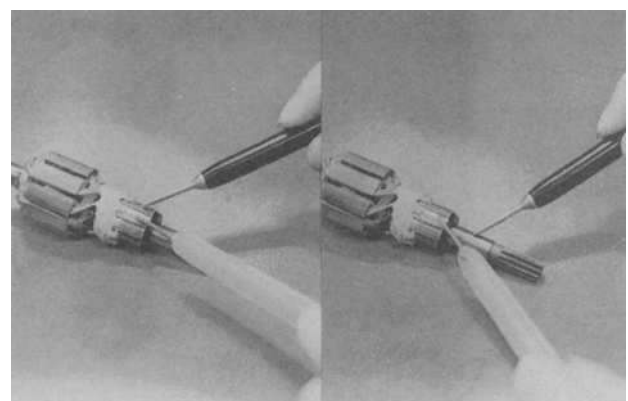
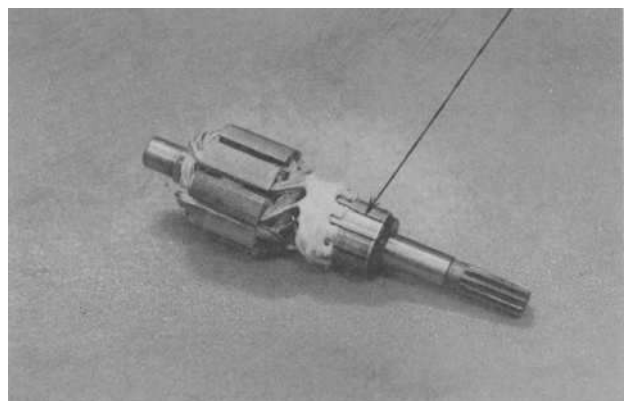

## 16. STARTING SYSTEM

### STARTER MOTOR CASE CONTINUITY CHECK

Check to confirm that there is no continuity between the starter motor wire terminal and the motor front cover.

Also check for the continuity between the wire terminal and each brush and there should be continuity.

Replace if necessary.

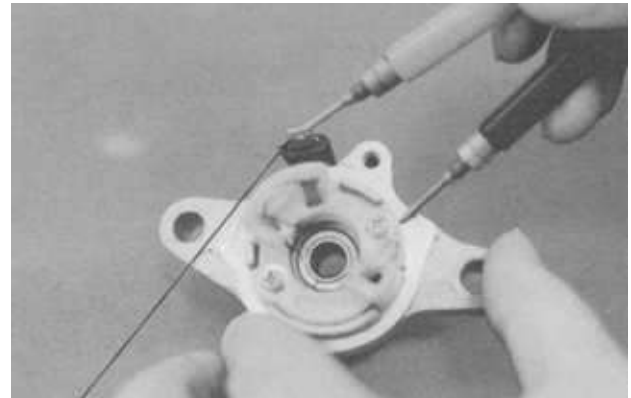

Wire Terminal

Measure the length of the brushes.

**Service Limit:** 8.5mm replace if below

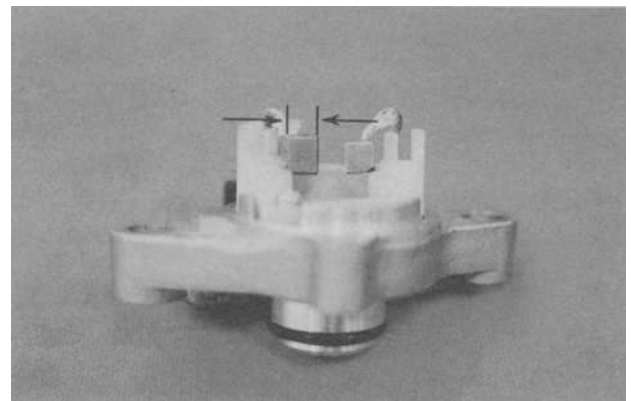

Check for continuity between the brushes. If there is continuity, replace with new ones.

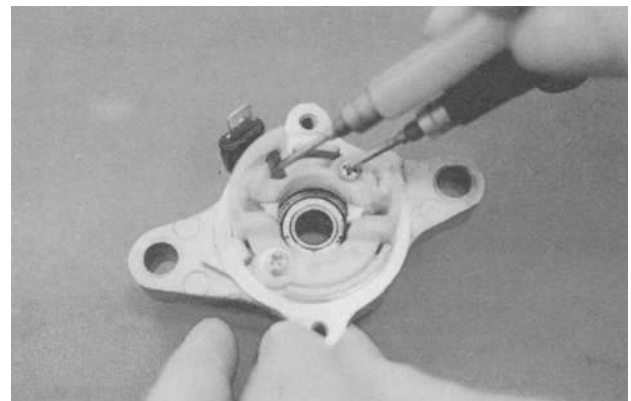

Check if the needle bearing in the front cover turns freely and has no excessive play.

Replace if necessary.

Check the dust seal for wear or damage.

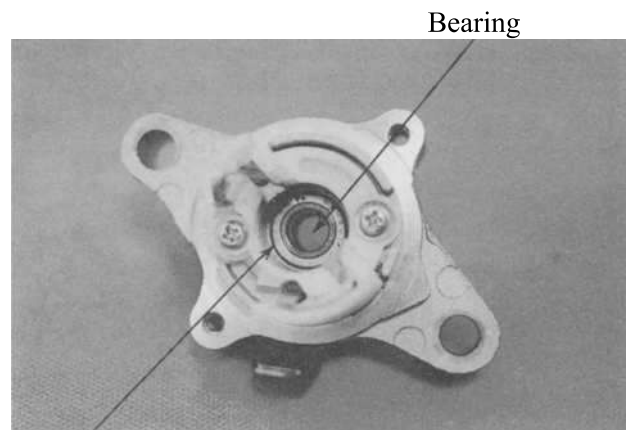

Dust Seal

# 16. STARTING SYSTEM

## ASSEMBLY

Apply grease to the dust seal in the front cover.  
 Install the brushes onto the brush holders.  
 Apply a thin coat of grease to the two ends of the armature shaft.  
 Insert the commutator into the front cover.

- Be careful not to damage the brush and armature shaft mating surfaces.
- When installing the commutator, the armature shaft should not damage the dust seal lip.

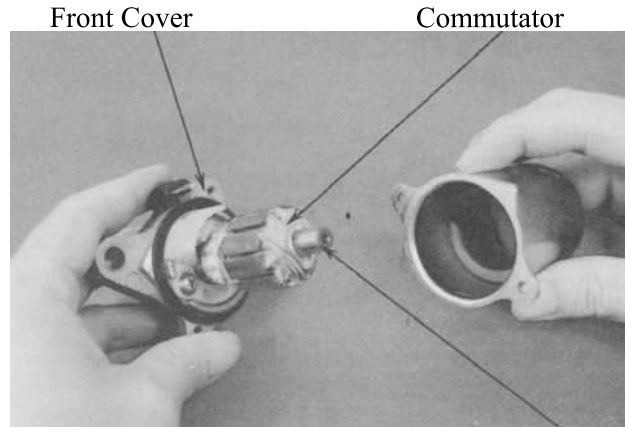

Install a new O-ring to the front cover.  
 Install the starter motor case, aligning the tab on the motor case with the tab on the front cover.  
 Tighten the starter motor case screws.

When assembling the front cover and motor case, slightly press down the armature shaft to assemble them.

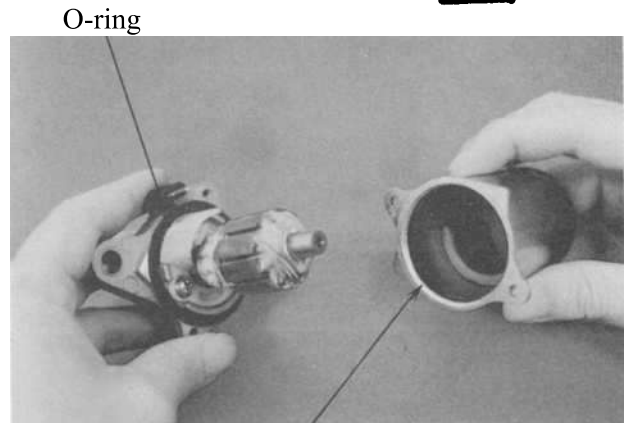

## STARTER RELAY

### INSPECTION

Remove the met-in box.  
 Remove the battery cover.  
 Remove the frame body cover. (⇒2-2)  
 Turn the ignition switch ON and the starter relay is normal if you hear a click when the starter button is depressed.  
 If there is no click sound:

- Inspect the starter relay voltage
- Inspect the starter relay ground circuit
- Inspect the starter relay operation



### STARTER RELAY VOLTAGE INSPECTION

Place the motorcycle on its main stand.  
 Measure the voltage between the starter relay connector green/yellow wire (-) and engine ground.  
 Turn the ignition switch ON and the battery voltage should be normal when the brake lever is fully applied.  
 If the battery has no voltage, inspect the stop switch continuity and cable.

Turn to the DCV position for the voltage meter, then inspect the starter relay.



Green/Yellow Wire

# 16. STARTING SYSTEM

## STARTER RELAY TEST

Remove the battery cover.  
 Disconnect the 4P connector from the starter relay and remove the starter relay.



Connect the starter relay (D) terminal to the 12V battery positive (+) terminal and the relay (C) terminal to the battery negative (-) terminal. Check for continuity between the starter relay (A) and (B) terminals. The relay is normal if there is continuity.

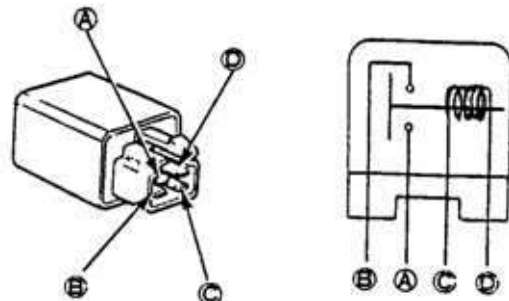

## STARTER MOTOR INSTALLATION

Apply engine oil to the starter motor O-ring and install the starter motor.  
 Tighten the two mounting bolts.  
 Connect the starter motor cable connector.

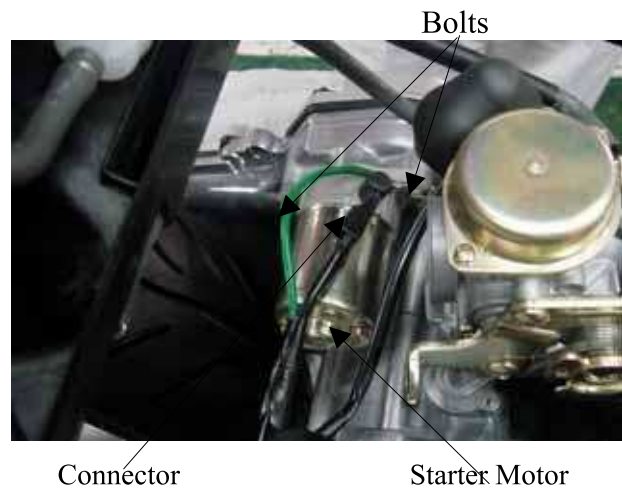

SERVICE INFORMATION .....	17-0	IGNITION SWITCH.....	17-3
TROUBLESHOOTING .....	17-0	STOP SWITCHES/HORN .....	17-4
FUEL UNIT .....	17-1	INSTRUMENTS.....	17-4
HANDLEBAR SWITCHES.....	17-2	HEADLIGHT/LIGHTS.....	17-5

## SERVICE INFORMATION

### GENERAL INSTRUCTIONS

- An electric tester is needed to measure or test the electric equipment.
- Be sure to use fuses and bulbs of the same specifications to avoid damage of electrical equipment.
- After installation of each switch, a continuity check must be performed. A continuity check can usually be made without removing the part from the motorcycle.

## TROUBLESHOOTING

### Lights do not come on when ignition switch is “ON”

- Burned bulb
- Faulty switch
- Broken wire
- Fuse burned out
- Weak battery
- Poorly connected or shorted wire
- Faulty winker

### Light dims

- Faulty ignition coil
- Wire or switch resistance too high
- Faulty regulator/rectifier

### Headlight does not change when dimmer switch is turn to Hi or Lo

- Faulty or burned bulb
- Faulty dimmer switch

### Fuel gauge pointer does not register correctly

- Disconnected wire or connector
- Broken wire
- Faulty float
- Faulty fuel unit
- Faulty instrument

### Fuel gauge pointer fluctuates or swings

- Loose wire connection
- Faulty fuel unit
- Faulty instrument

### FUEL UNIT

**No Smoking!**

#### REMOVAL

Remove the met-in box. (⇒2-3)  
 Remove the frame right side cover. (⇒2-4)  
 Disconnect the fuel unit wire connector.  
 Turn the fuel unit retainer counterclockwise to remove it.

Do not damage the fuel unit wire.

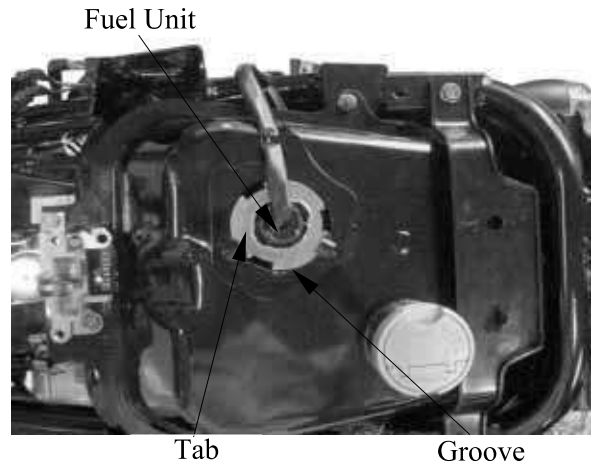

Remove the fuel unit.

Be careful not to bend or damage the fuel unit float arm.

#### INSTALLATION

The installation sequence is the reverse of removal.

- Align the groove on the fuel unit with the tab on the fuel tank.
- Align the arrow on the retainer with the arrow on the fuel tank.
- Turn the retainer clockwise to secure it.

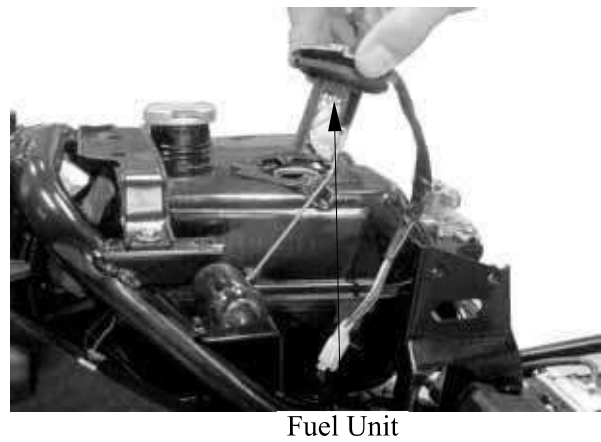

#### INSPECTION

Remove the fuel unit.  
 Measure the resistance between the fuel unit wire terminals with the float at upper and lower positions.

Wire Terminals	Upper	Lower
G~Y/W	30Ω	686Ω
G~L/W	566Ω	153Ω
Y/W~L/W	599Ω	599Ω

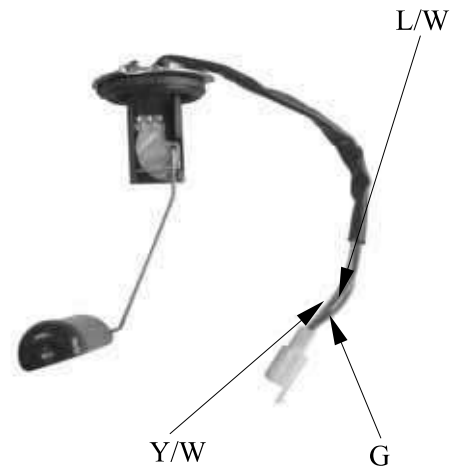

#### FUEL GAUGE INSPECTION

Connect the fuel unit wire connector and turn the ignition switch "ON".

Before performing the following test, operate the turn signals to determine that the battery circuit is normal.

Check the fuel gauge needle for correct indication by moving the fuel unit float up and down.

Float Position	Needle Position
Upper	"F" (Full)
Lower	"E" (Empty)

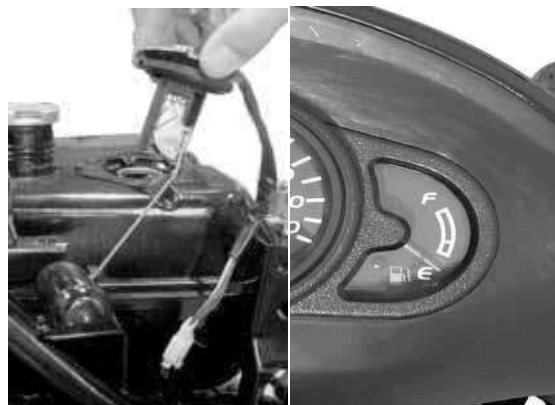

### HANDLEBAR SWITCHES

#### INSPECTION

Remove the handlebar front cover. (⇒2-2)  
 Disconnect the handlebar switch couplers and check for continuity between wire terminals. If there is any abnormality found, check each switch.

#### HEADLIGHT SWITCH

Color	Yellow	Brown	Pink	Yellow	Blue/White
•	○	—	○	○	
≡	○	○			
☼	○	○		○	○

Use the X1Ω range for test when using an electric tester.

#### STARTER SWITCH

Color	Yellow/Red	Green
FREE		
PUSH	○	○

#### DIMMER SWITCH

Color	White	Blue/White	Blue
≡	○	○	
≡		○	○

#### TURN SIGNAL SWITCH

Color	Gray	Light Blue	Orange
R	○	○	
N			
L	○		○

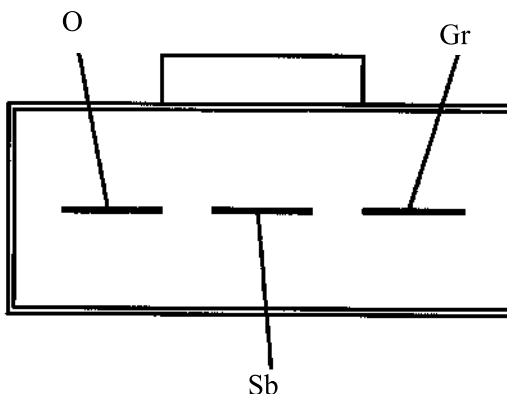
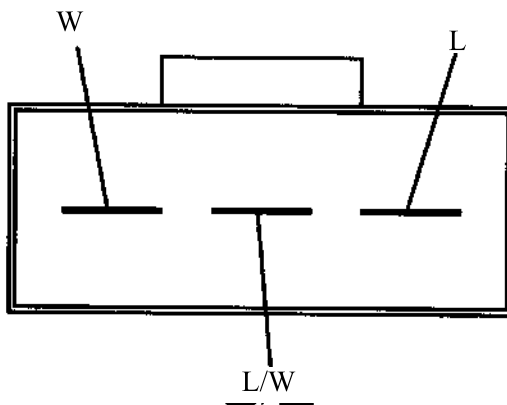
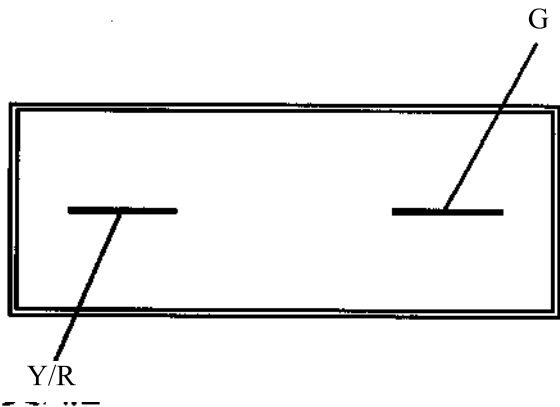
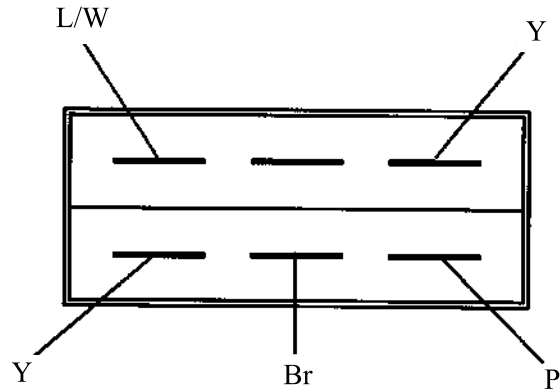



### HORN SWITCH

Color	Light Green	Black
FREE		
PUSH		

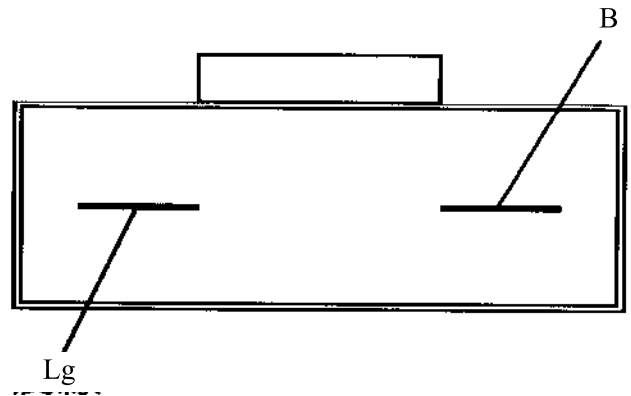

### SWITCH REPLACEMENT

Remove the front covers. (⇒2-2)  
 Remove the handlebar front cover. (⇒2-2)  
 The installation sequence is the reverse of removal.

### IGNITION SWITCH

#### INSPECTION

Remove the front covers. (⇒2-2)  
 Disconnect the ignition switch wire coupler.  
 Check for continuity between the wire terminals.

Color	Black	Red	Blue/ Yellow	Green
OFF				
ON				
LOCK				

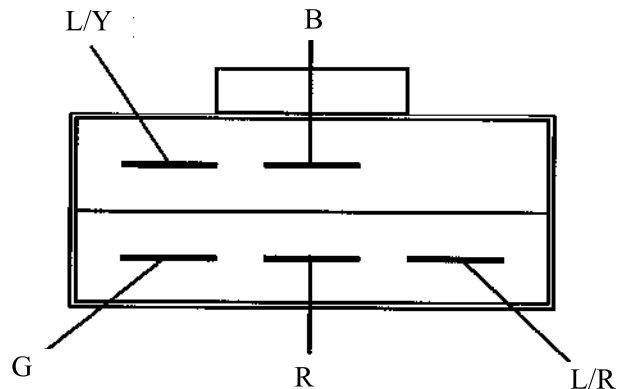

### IGNITION SWITCH REPLACEMENT

Remove the front covers. (⇒2-2)  
 Disconnect the ignition switch wire coupler.  
 Remove the two mounting bolts to remove the ignition switch decorative ring and holder.  
 Remove the two screws to remove the ignition switch from the ignition switch holder for replacement.  
 The installation sequence is the reverse of removal.

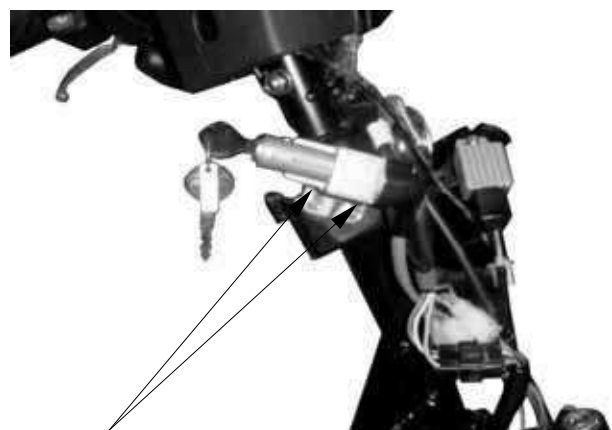

### STOP SWITCH

#### INSPECTION

Remove the handlebar front cover. (⇒2-2)  
 Disconnect the front stop switch wire coupler.  
 Check for continuity between the wire terminals when the front brake lever is applied. The switch is normal if there is continuity.  
 Disconnect the rear stop switch wire coupler.  
 Check for continuity between the wire terminals when the rear brake lever is applied. The switch is normal if there is continuity.



Coupler

### HORN

#### INSPECTION

Remove the front covers. (⇒2-2)  
 Disconnect the horn wire coupler.  
 The horn is normal if it sounds when a 12V battery is connected across the horn wire terminals.

#### REPLACEMENT

Disconnect the horn wire coupler.  
 Remove the two bolts attaching the horn.  
 Remove the horn.  
 The installation sequence is the reverse of removal.



### INSTRUMENTS

Remove the handlebar front cover. (⇒2-2)  
 Remove the handlebar rear cover. (⇒2-2)  
 Disconnect the handlebar switch couplers.  
 Remove the three screws to remove the instruments.  
 Install a new horn in the reverse order of removal.

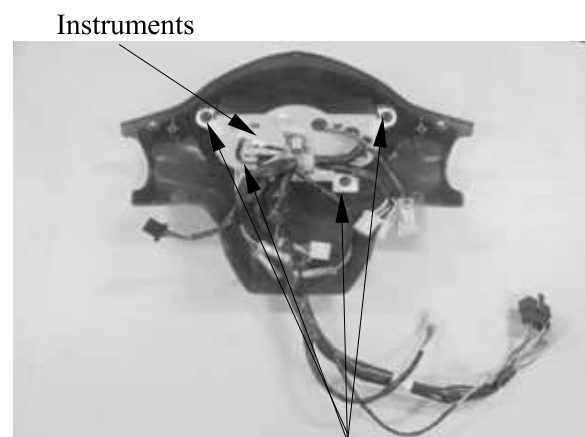

Instruments

Screws

### HEADLIGHT

#### REMOVAL

Remove the screw on the front of the front cover.

Remove the six screws on the back of the front cover.

Remove the front cover.

The installation sequence is the reverse of removal.

- Align the tab on the headlight with the groove on the handlebar cover.
- After installation, adjust the headlight beam. (⇒3-9)

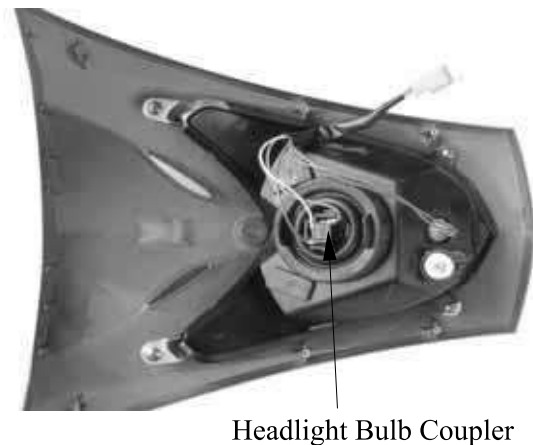
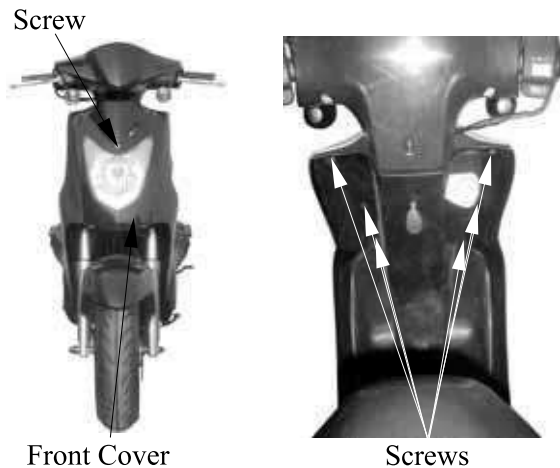

#### BULB REPLACEMENT

Remove the headlight bulb Coupler. (⇒2-2)

Remove the headlight replace with new bulbs.

The installation sequence is the reverse of removal.

#### TAILLIGHT/STOPLIGHT/REAR TURN SIGNAL LIGHT/LICENSE LIGHT

Remove the two screws attaching the rear protector molding.

Remove the rear protector molding and remove the two nuts attaching the rear light shell.

Remove the rear turn signal light bulb and replace with a new one.

The installation sequence is the reverse of removal.

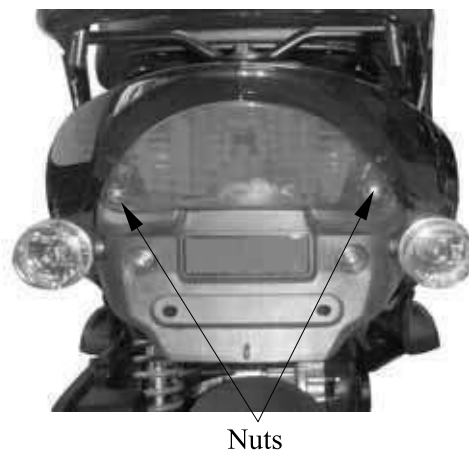

# 18. EVAPORATIVE/EXHAUST EMISSION CONTROL SYSTEM

EXHAUST EMISSION CONTROL SYSTEM DIAGRAM .....	18-0
EXHAUST EMISSION CONTROL SYSTEM .....	18-1
SERVICE INFORMATION .....	18-1
TROUBLESHOOTING .....	18-1
MAINTENANCE SCHEDULE .....	18-2
SECONDARY AIR CLEANER.....	18-3
AIR INJECTION CUT-OFF VALVE (A.I.C.V.) .....	18-4
REED VALVE .....	18-5
EXHAUST MUFFLER .....	18-6
EXHAUST EMISSION RELATED SYSTEM INSPECTION.....	18-7

## EXHAUST EMISSION CONTROL SYSTEM DIAGRAM

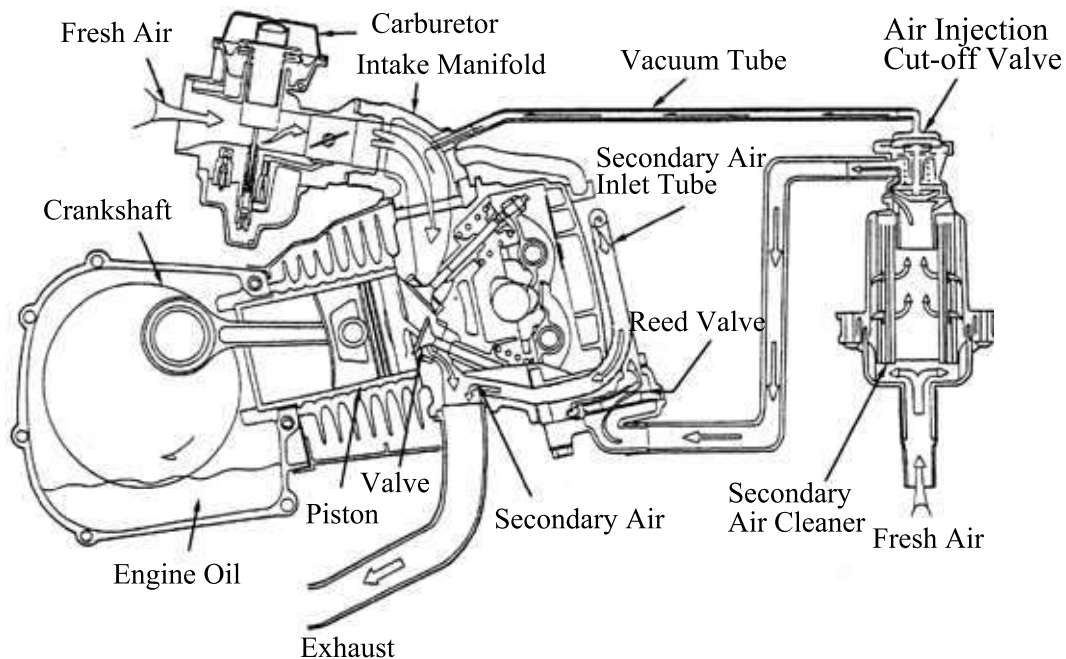

# 18. EVAPORATIVE/EXHAUST EMISSION CONTROL SYSTEM

---

## EXHAUST EMISSION CONTROL SYSTEM

The exhaust emission control system adopted in this model utilizes the reed valve to draw secondary air into the exhaust system for re-combustion by means of exhaust pulsation so as to minimize the exhaust emission.

### FUNCTION

Item	Purpose	Function
Secondary Air Cleaner	Filter secondary air.	It filters the fresh air drawn for re-burning to prevent dirt or dust from affecting the operation of the air injection cut-off valve.
Air Injection Cut-off Valve	Prevent exhaust muffler noise and backfiring at sudden deceleration.	The air injection cut-off valve usually opens to lead air into the exhaust muffler in which air is re-burned to reduce CO. When the throttle valve closes suddenly, the air injection cut-off valve is actuated by vacuum to close and cut off secondary air in order to prevent exhaust muffler backfiring due to air in the exhaust system.
Reed Valve	Control the secondary air inlet to reduce CO.	When the motorcycle speed is less than 50km per hour, the reed valve operates to draw secondary air into the exhaust system for re-combustion.

## SERVICE INFORMATION

### GENERAL INSTRUCTIONS

- During operation, be careful to avoid scalding caused by the exhaust muffler.
- Note the locations of tubes for proper installation.
- Replace any damaged tube with a new one.
- Make sure to tighten the connector of each tube securely

### TOOLS

- Vacuum pump —

### SPECIFICATIONS

- Air injection cut-off valve actuating pressure — 250mm/Hg — 30 liter/min.
- Reed valve stopper clearance — 6.6mm

## TROUBLESHOOTING

### High CO at idle speed

- Damaged or clogged reed valve
- Damaged or clogged air injection cut-off valve
- Clogged air cleaner

### Exhaust muffler noise

- Faulty air injection cut-off valve
- Broken vacuum tube
- Faulty reed valve

### Backfiring at sudden deceleration

- Damaged reed valve (malfunction)
- Faulty air injection cut-off valve (unable to close)
- Carburetor incorrectly adjusted
- Faulty air cut-off valve
- Leaking vacuum tube

# 18. EVAPORATIVE/EXHAUST EMISSION CONTROL SYSTEM

## MAINTENANCE SCHEDULE:

### (1) PERIODIC MAINTENANCE

Item	Service Mileage															
	300	1000	2000	3000	4000	5000	6000	7000	8000	9000	10000	11000	12000	13000	14000	15000
Lubrication System	Engine oil	R		R	R	R	R	R	R	R	R	R	R	R	R	R
	Oil filter screen	C		C			C				C					C
	Gear oil	R					R				R					R
	Motor oil filter						I				I					I
Fuel System	Fuel filter			I			I				I					I
	Fuel filter screen	C					C				C					C
	Carburetor			A			A				A					A
	Fuel line						I				I					I
Air Supply System	Air cleaner			R		R		R		R		R		R		R
	Charcoal canister			I			I				I					I
	Secondary air cleaner			I			R				R					R
	Secondary air inlet line										I					
	Intake manifold screw										I					
	Purge control valve			I			I				I					I
	Air lines						I				I					I
	Catalytic converter			I			I				I					I
Drive System	Cam chain			I			I				I					I
	Drive chain			I			I				I					I
	Drive belt			I			I				I					I
	Valve clearance			I			I				I					I
Ignition System	Spark Plug			I							R					
				I			R				R					R
	C.D.I.						I				I					I
	Ignition system wires						I				I					I
Others	Bolts and nuts		T	T	T	T	T	T	T	T	T	T	T	T	T	T
	Brake system		A	A	A	A	A	A	A	A	A	A	A	A	A	A
Remarks	I: Inspect, A: Adjust, C: Clean, R: Replace, T: Tighten •During riding or inspection, if any part is found to be cleaned, adjusted or replaced, do it directly and take a record if the exhaust emission control system is not seriously affected. It must be reported and approved if the exhaust emission control system is seriously affected.															

### (2) IRREGULAR MAINTENANCE:

Item	Contents
Ignition system	Inspect and repair when obvious symptoms of ignition failure, engine overheating and stalling are found frequently.
Carbon deposit removal	Remove carbon deposits from the exhaust system, cylinder head and piston head when the engine horsepower decreases greatly during the service mileage of 10000~15000 km.
Transmission system	Perform CVT system maintenance and inspection when the engine performance decreases obviously.
Piston	Severe use in the first 1000 km may cause worn or seized cylinder, piston and piston rings. Clean or replace with new ones if necessary.

# 18. EVAPORATIVE/EXHAUST EMISSION CONTROL SYSTEM

## SECONDARY AIR CLEANER

### REMOVAL

- Remove the met-in box. (⇒2-3)
- Remove the center cover. (⇒2-3)
- Remove the rear seat and rear carrier. (⇒2-3)
- Remove the frame body covers. (⇒2-4)
- Remove the floor board. (⇒2-4)

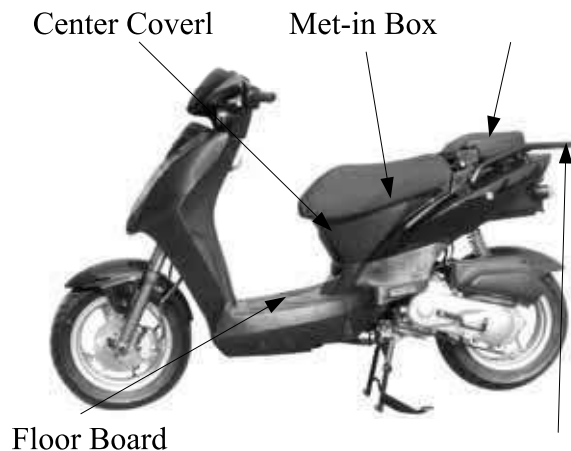

- Disconnect the secondary air cleaner connecting tube.
- Remove the air cleaner attaching the air cleaner.

### INSTALLATION

The installation sequence is the reverse of removal.

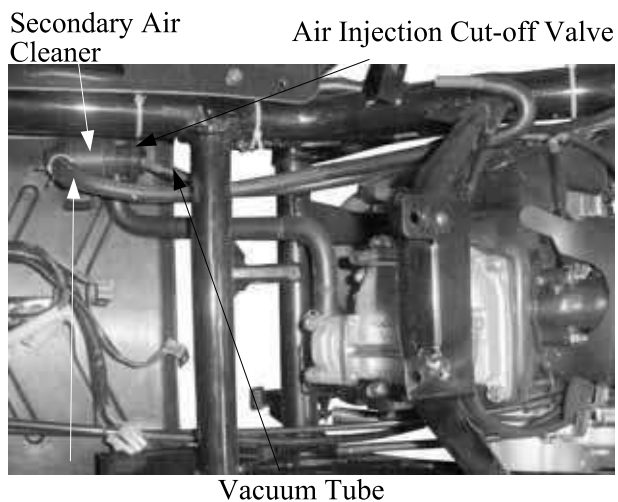

Tube to Reed Valve

### DISASSEMBLY

- Remove the two secondary air cleaner replace with new secondary air cleaner.

\*

- The secondary air cleaner must be assembled and installed properly to avoid dust entering the air cleaner.

