

TEXT

A.C. GENERATOR INSTALLATION	9 - 4	EXHAUST MUFFLER REMOVAL	2 - 6
A.C. GENERATOR REMOVAL	9 - 2	EXHAUST MUFFLER	17 - 2
AIR CLEANER	3 - 6	FINAL REDUCTION ASSEMBLY	8 - 5
AIR SCREW ADJUSTMENT	12 -10	FINAL REDUCTION DISASSEMBLY	8 - 2
AUTO BYSTARTER	12 - 5	FINAL REDUCTION GEAR OIL	3 - 9
BATTERY	15 - 4	FINAL REDUCTION INSPECTION	8 - 2
BRAKE CALIPER	13 -11	FLOAT CHAMBER	12 - 7
BRAKE SYSTEM	3 -11	FLOAT LEVEL INSPECTION	12 - 9
BULB REPLACEMENT	16 - 7	FRAME COVERS REMOVAL	2 - 2
CARBURETOR INSTALLATION	12 -10	FRONT BRAKE	13 - 8
CARBURETOR REMOVAL	12 - 4	FRONT FORK	13 -18
CHARGING SYSTEM	15 - 3	FRONT SHOCK ABSORBER	13 -14
CLUTCH/DRIVEN PULLEY	7 -11	FRONT WHEEL	13 - 5
COOLING SYSTEM	3 -10	FUEL LINE/FUEL FILTER	3 - 5
CRANKCASE ASSEMBLY	10 - 6	FUEL UNIT	16 - 2
CRANKCASE SEPARATION	10 - 2	HEADLIGHT AIM	3 -10
CRANKSHAFT INSPECTION	10 - 3	IGNITION SYSTEM	15 - 7
CRANKSHAFT INSTALLATION	10 - 4	IGNITION TIMING	3 - 7
CRANKSHAFT REMOVAL	10 - 2	INSPECTION AND MAINTENANCE	
CYLINDER COMPRESSION	3 - 8	SCHEDULE	3 - 2
CYLINDER HEAD	6 - 2	INSTRUMENT/HEADLIGHT	16 - 8
CYLINDER/PISTON	6 - 4	KICK STARTER	7 - 2
DRIVE BELT	7 - 6	LUBRICATION POINTS	1 -15
DRIVE BELT	3 - 9	LUBRICATION SYSTEM	3 -14
DRIVE PULLEY	7 - 8	NUTS/BOLTS/FASTENERS	3 -13
ENGINE INSTALLATION	5 - 4	OIL METER	16 - 3
ENGINE REMOVAL	5 - 2	OIL PUMP BLEEDING	4 - 4
ENGINE SERIAL NUMBER	1 - 1	OIL PUMP INSPECTION	4 - 2
EXHAUST EMISSION CONTROL SYSTEM	17- 1	OIL PUMP INSTALLATION	4 - 3
EXHAUST EMISSION RELATED SYSTEM		OIL PUMP REMOVAL	4 - 2
INSPECTION	17 - 3	OIL TANK	4 - 5

TEXT

RADIATOR	11 - 3	THERMOSENSOR	11 -11
REAR BRAKE DRUM	14 - 3	THERMOSTAT	11 -12
REAR SHOCK ABSORBER	14 - 5	THROTTLE OPERATION	3 - 5
REAR WHEEL	14 - 3	THROTTLE VALVE DISASSEMBLY	12 - 2
REED VALVE	12 -11	THROTTLE VALVE INSTALLATION	12 - 3
SERVICE INFORMATION	11 - 1	TORQUE VALUES	1 -13
SERVICE INFORMATION	14 - 1	TROUBLESHOOTING	11 - 1
SERVICE INFORMATION	10 - 1	TROUBLESHOOTING	14 - 1
SERVICE INFORMATION	12 - 1	TROUBLESHOOTING	10 - 1
SERVICE INFORMATION	13 - 1	TROUBLESHOOTING	12 - 1
SERVICE INFORMATION	15 - 1	TROUBLESHOOTING	13 - 2
SERVICE INFORMATION	16 - 1	TROUBLESHOOTING	15 - 1
SERVICE INFORMATION	6 - 1	TROUBLESHOOTING	16 - 1
SERVICE INFORMATION	7 - 1	TROUBLESHOOTING	6 - 1
SERVICE INFORMATION	8 - 1	TROUBLESHOOTING	7 - 1
SERVICE INFORMATION	9 - 1	TROUBLESHOOTING	8 - 1
SERVICE INFORMATION	2 - 1	TROUBLESHOOTING	1 -22
SERVICE INFORMATION	3 - 1	TROUBLESHOOTING	2 - 1
SERVICE INFORMATION	4 - 1	TROUBLESHOOTING	4 - 1
SERVICE INFORMATION	5 - 1	WATER PUMP	11 - 5
SERVICE PRECAUTIONS	1 - 3	WHEELS/TIRES	3 -13
SPARK PLUG	3 - 7	WIRING DIAGRAM	1 -21
SPECIAL TOOLS	1 -14		
SPECIFICATIONS	1 - 2		
STARTER PINION	7 -10		
STARTING SYSTEM	15 -11		
STEERING HANDLEBAR	13 - 3		
STEERING HANDLEBAR	3 -13		
STOP SWITCH INSPECTION	16 - 6		
SUSPENSION	3 -13		
SWITCHES	16 - 4		

PREFACE

This Service Manual describes the technical features and servicing procedures for the KYMCO B&W 50.

Section 1 contains the precautions for all operations stated in this manual. Read them carefully before any operation is started.

Section 2 is the removal/installation procedures for the frame covers which are subject to higher removal/installation frequency during maintenance and servicing operations.

Section 3 describes the inspection/adjustment procedures, safety rules and service information for each part, starting from periodic maintenance.

Sections 5 through 12 give instructions for disassembly, assembly and adjustment of engine parts. Section 13 is the removal/installation of chassis. Section 15 states the testing and measuring methods of electrical equipment.

Most sections start with an assembly or system illustration and troubleshooting for the section. The subsequent pages give detailed procedures for the section.

The information and contents included in this manual may be different from the motorcycle in case specifications are changed.

TABLE OF CONTENTS

ENGINE	GENERAL INFORMATION	1
	EXHAUST MUFFLER/FRAME COVERS	2
	INSPECTION/ADJUSTMENT	3
	LUBRICATION SYSTEM	4
	ENGINE REMOVAL/INSTALLATION	5
	CYLINDER HEAD/CYLINDER/PISTON	6
	KICK STARTER/DRIVE PULLEY/ CLUTCH/DRIVEN PULLEY	7
	FINAL REDUCTION	8
	A.C. GENERATOR	9
	CRANKCASE/CRANKSHAFT	10
	COOLING SYSTEM	11
	CARBURETOR	12
CHASSIS	STEERING HANDLEBAR/FRONT WHEEL/FRONT BRAKE/FRONT SHOCK ABSORBER/FRONT FORK	13
	REAR BRAKE/REAR BRAKE DRUM/REAR SHOCK ABSORBER	14
ELECTRICAL EQUIPMENT	ELECTRICAL EQUIPMENT	15
	INSTRUMENT/SWITCHES/LIGHTS	16
E/M	EVAPORATIVE/EXHAUST EMISSION CONTROL SYSTEM	17

KWANG YANG MOTOR CO., LTD.
OVERSEAS SALES DEPARTMENT
OVERSEAS SERVICE SECTION

1. GENERAL INFORMATION

GENERAL INFORMATION

ENGINE SERIAL NUMBER	1- 1
SPECIFICATIONS	1- 2
SERVICE PRECAUTIONS	1- 3
TORQUE VALUES	1-13
SPECIAL TOOLS	1-14
LUBRICATION POINTS	1-15
WIRING DIAGRAM.....	1-21
TROUBLESHOOTING.....	1-22

1. GENERAL INFORMATION

ENGINE SERIAL NUMBER

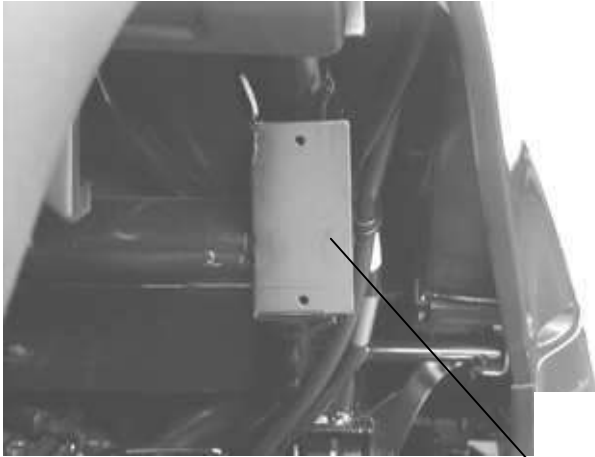

Vehicle Identification Serial Number

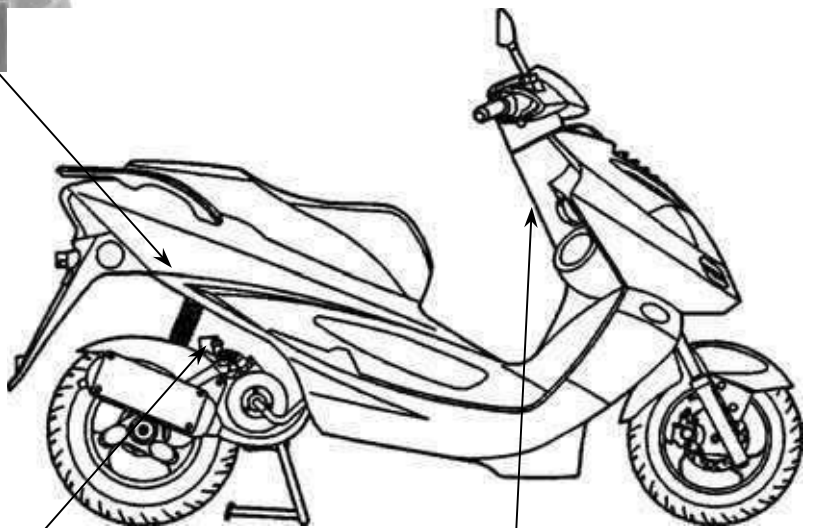

Location of Engine Serial Number



Location of Frame Serial Number

1. GENERAL INFORMATION

SPECIFICATIONS

Name & Model No.		B&W50		
Overall length		1940mm		
Overall width		740mm		
Overall height		1173mm		
Wheel base		1352mm		
Engine type		Water cooled 2-stroke		
Displacement		49.4cc		
Fuel Used		nonleaded gasoline		
Net weight (kg)	Front wheel	52.5		
	Rear wheel	67.5		
	Total	120		
Gross weight(kg)	Front wheel	79		
	Rear wheel	114		
	Total	193		
Tires	Front wheel	120/70-12 56J		
	Rear wheel	130/70-12 59J		
Ground clearance		155mm		
Performance	Braking distance (m)	4.4m /30km/H		
	Min. turning radius	2300mm		
Engine	Starting system		Starting motor & Kick starter	
	Type		Gasoline,2-stroke	
	Cylinder arrangement		Single cylinder	
	Combustion chamber type		Semi-sphere	
	Bore x stroke (mm)		39.0 x 41.4	
	Compression ratio		7.2:1	
	Compression pressure (kg/cm ² -rpm)		11.8	
	Max. output (kw/rpm)		3.09/6500	
	Max. torque (kg-m/rpm)		0.5/6000	
	Port timing	Intake (1mm)	Open	
			Close	
	Exhaust (1mm)	Open		
		Close		
	Valve clearance (cold)	Intake		
		Exhaust		
	Idle speed (rpm)		2000±100rpm	
	Lubrication System	Lubrication type		Separate type
		Oil pump type		Plunger type
		Oil filter type		Full-flow filtration
		Oil capacity		1.1 liters
		Exchanging capacity		0.9 liters
	Cooling Type		Water cooling	
	Fuel System	Air cleaner type & No		Sponge wet
Gear oil capacity		0.12 liters		
Fuel capacity		10 liters		
Carburetor		Type	P B	
	Piston dia.	13		
	Venturi dia.	14 equivalent		
Electrical Equipment	Ignition System	Type	CDI	
		Ignition timing	13.5°±2°/2000rpm	
	Spark plug	NGK BR8HSA		
		Spark plug gap	0.6~0.7mm	
	Battery	Capacity	12V4AH	
Power Drive System	Transmis- Clutch	Type	Dry multi-disc clutch	
		Type	Non-stage transmission	
		Operation	Automatic centrifugal type	
	Gear Reduction	Type	Two-stage reduction	
Reduction ratio		1st		
Moving Device	Front Axle	Caster angle		
		Connecting rod		
	Tire pressure (kg/cm ²)	Front	1.75	
		Rear	2.25	
	Turning angle	Left	42.5°	
		Right	42.5°	
Brake system type	Front	Disk brake		
	Rear	Drum brake		
Damping Device	Suspension type	Front	Telescope	
		Rear	Unit	
Frame type		Under pipe		

1. GENERAL INFORMATION

SERVICE PRECAUTIONS

- Make sure to install new gaskets, O-rings, circlips, cotter pins, etc. when reassembling.

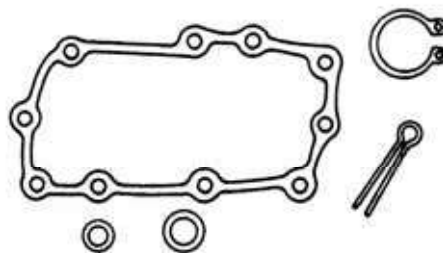

- When tightening bolts or nuts, begin with larger-diameter to smaller ones at several times, and tighten to the specified torque diagonally.

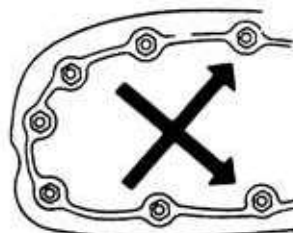

- Use genuine parts and lubricants.

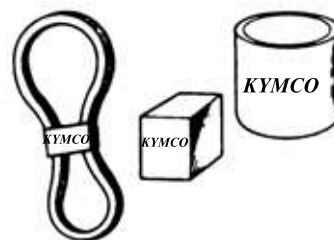

- When servicing the motorcycle, be sure to use special tools for removal and installation.



- After disassembly, clean removed parts. Lubricate sliding surfaces with engine oil before reassembly.



1. GENERAL INFORMATION

- Apply or add designated greases and lubricants to the specified lubrication points.

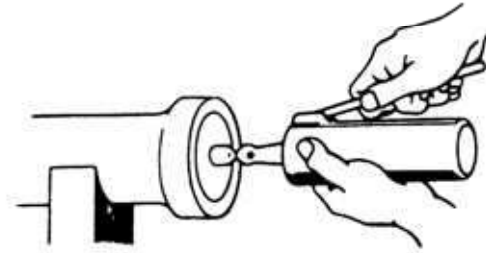

- After reassembly, check all parts for proper tightening and operation.

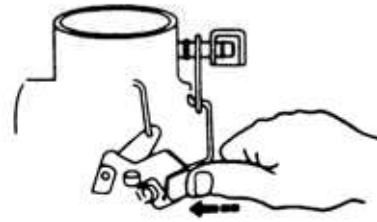

- When two persons work together, pay attention to the mutual working safety.

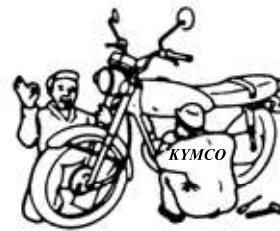

- Disconnect the battery negative (-) terminal before operation.
- When using a spanner or other tools, make sure not to damage the motorcycle surface.

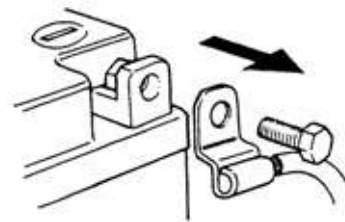

- After operation, check all connecting points, fasteners, and lines for proper connection and installation.
- When connecting the battery, the positive (+) terminal must be connected first.
- After connection, apply grease to the battery terminals.
- Terminal caps shall be installed securely.

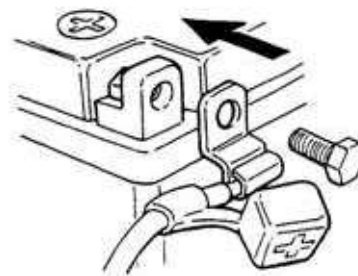

1. GENERAL INFORMATION

- If the fuse is burned out, find the cause and repair it. Replace it with a new one according to the specified capacity.

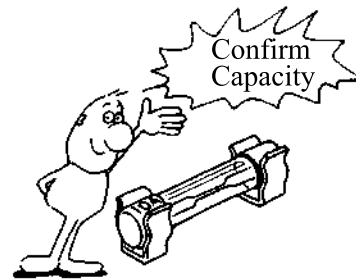

- After operation, terminal caps shall be installed securely.



- When taking out the connector, the lock on the connector shall be released before operation.

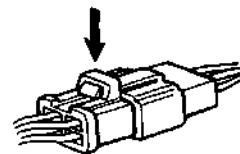

- Hold the connector body when connecting or disconnecting it.
- Do not pull the connector wire.



- Check if any connector terminal is bending, protruding or loose.

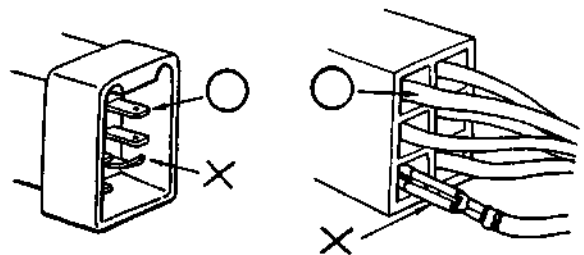

1. GENERAL INFORMATION

- The connector shall be inserted completely.
- If the double connector has a lock, lock it at the correct position.
- Check if there is any loose wire.

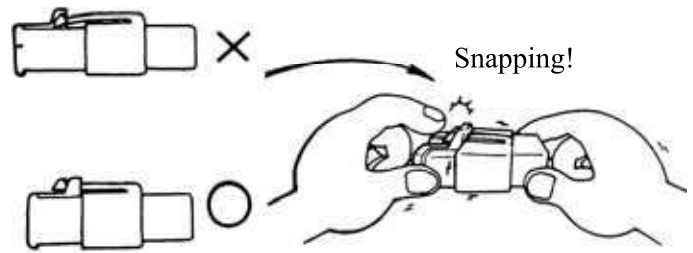

- Before connecting a terminal, check for damaged terminal cover or loose negative terminal.

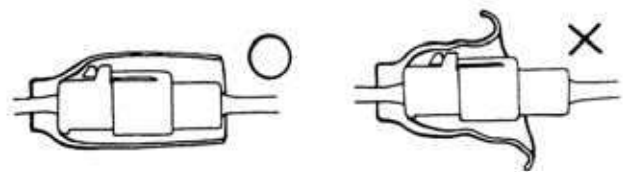

- Check the double connector cover for proper coverage and installation.



- Insert the terminal completely.
- Check the terminal cover for proper coverage.
- Do not make the terminal cover opening face up.



- Secure wire harnesses to the frame with their respective wire bands at the designated locations. Tighten the bands so that only the insulated surfaces contact the wire harnesses.

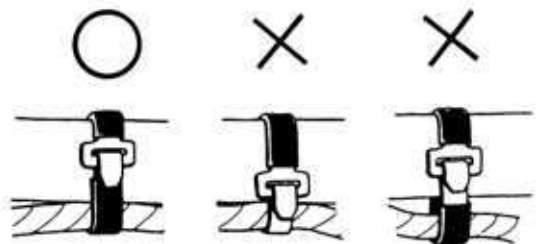

1. GENERAL INFORMATION

- After clamping, check each wire to make sure it is secure.

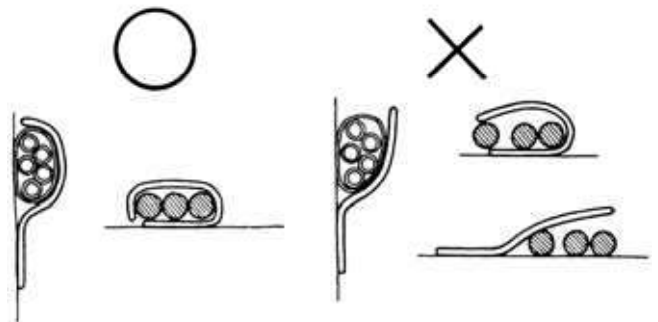

- Do not squeeze wires against the weld or its clamp.

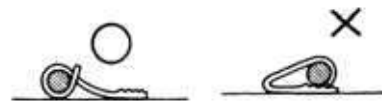

- After clamping, check each harness to make sure that it is not interfering with any moving or sliding parts.

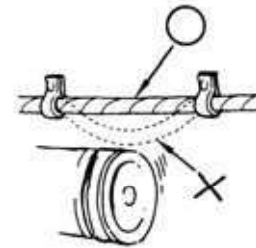

- When fixing the wire harnesses, do not make it contact the parts which will generate high heat.

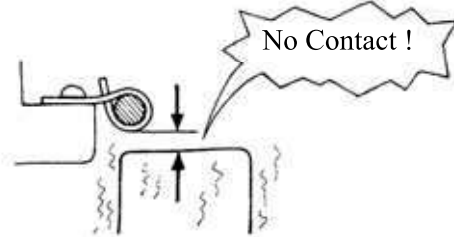

- Route wire harnesses to avoid sharp edges or corners. Avoid the projected ends of bolts and screws.
- Route wire harnesses passing through the side of bolts and screws. Avoid the projected ends of bolts and screws.

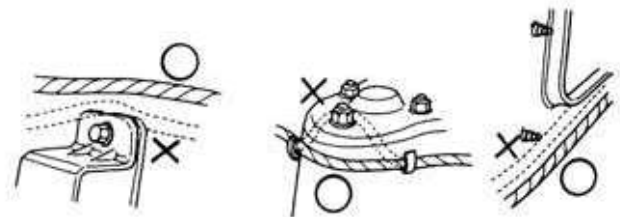

1. GENERAL INFORMATION

- Route harnesses so they are neither pulled tight nor have excessive slack.

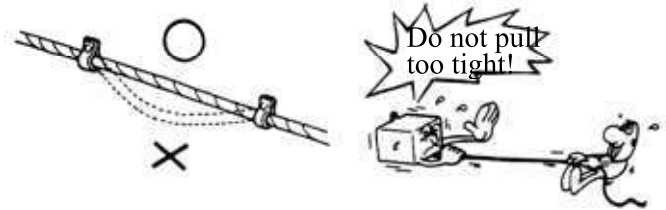

- Protect wires and harnesses with electrical tape or tube if they contact a sharp edge or corner.

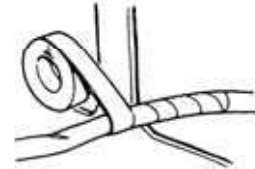

- When rubber protecting cover is used to protect the wire harnesses, it shall be installed securely.

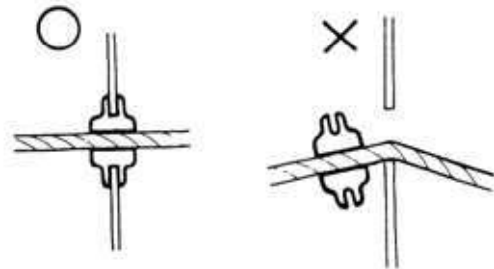

- Do not break the sheath of wire.
- If a wire or harness is with a broken sheath, repair by wrapping it with protective tape or replace it.

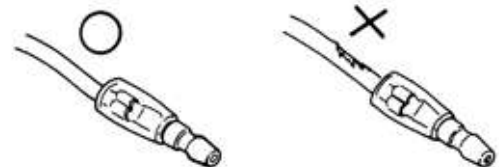

- When installing other parts, do not press or squeeze the wires.



1. GENERAL INFORMATION

- After routing, check that the wire harnesses are not twisted or kinked.

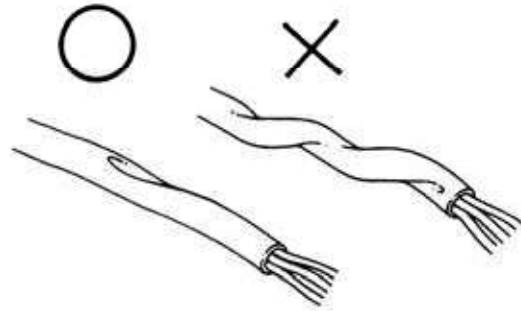

- Wire harnesses routed along with handlebar should not be pulled tight, have excessive slack or interfere with adjacent or surrounding parts in all steering positions.



- When a testing device is used, make sure to understand the operating methods thoroughly and operate according to the operating instructions.

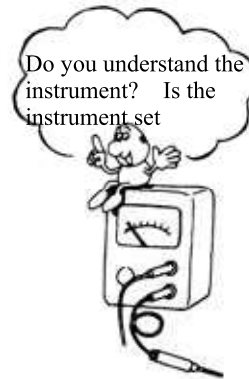

- Be careful not to drop any parts.



- When rust is found on a terminal, remove the rust with sand paper or equivalent before connecting.



1. GENERAL INFORMATION

■ Symbols:

The following symbols represent the servicing methods and cautions included in this service manual.



Engine Oil

: Apply engine oil to the specified points. (Use designated engine oil for lubrication.)



Grease

: Apply grease for lubrication.



Gear Oil

: Transmission Gear Oil (90#)



Special

: Use special tool.



: Caution



: Warning

1. GENERAL INFORMATION

SERVICE INFORMATION

ENGINE Item	Standard (mm)	Service Limit (mm)
	B&W50	B&W50
Cylinder head warpage	—	0.10
Piston O.D.(5mm from bottom of piston skirt)	38.955~38.970	38.90
Cylinder-to- piston clearance		0.10
Piston pin hole I.D.	12.002~12.008	12.03
Piston pin O.D.	11.994~12.0	11.98
Piston-to-piston pin clearance	0.002~0.014	0.03
Piston ring end gap (top/second)	0.10~0.25	0.40
Connecting rod small end I.D.	17.005~17.017	17.03
Cylinder bore	39.0~39.025	39.05
Drive belt width	18	17
Drive pulley collar O.D.	20.01~20.025	19.97
Movable drive face ID.	20.035~20.085	20.21
Weight roller O.D.	13.0	12.4
Clutch outer I.D.	107~107.2	107.5
Driven face spring free length	87.9	82.6
Driven face O.D.	33.965~33.985	33.94
Movable driven face I.D.	34.0~34.025	34.06
Connecting rod big end side clearance	—	0.60
Connecting rod big end radial clearance	—	0.04
Crankshaft runout A/B	—	L:0.15 R:0.10

CARBURETOR

	SH10CA(SP)	SH10CA(IT)	SH10CA(GR)
Venturi dia.	14mm		
Identification number	PB109• •	PB103• •	PB118• •
Float level	8.6mm		
Main jet(Unlimited/limited speed)	#75	#75	#88
Slow jet	#35		
Air screw opening	1¼±½		
Idle speed	2000±100rpm		
Throttle grip free play	2~6mm		
Jet needle clip notch	1 st notch		

1. GENERAL INFORMATION

FRAME

Item		Standard (mm)		Service Limit (mm)	
		B&W50		B&W50	
Axle shaft runout		—		0.2	
Front wheel rim runout	Radial				
	Axial				
Front shock absorber spring free length		221.5		204.3	
Rear wheel rim runout				2.0	
Brake drum I.D.	Front/rear	110		111	
Brake lining thickness	Front/rear	4.0/4.0		2.0/2.0	
Brake disk runout	Front/rear	—		0.30	
Rear shock absorber spring free length		214.7		197.7	

ELECTRICAL EQUIPMENT

			B&W50
Battery	Capacity		12V4AH
	Voltage		13.0~13.2V
	Charging current	Standard	0.4A/5H
		Quick	4A/0.5H
Spark plug	(NGK)		BR8HSA
Spark plug gap			0.6~0.7mm
Ignition coil resistance	Primary coil		0.153~0.187Ω
	Secondary coil (with plug cap)		6.99~10.21KΩ
	Secondary coil (without plug cap)		3.24~3.96KΩ
Pulser coil resistance (20°C)			80~160Ω
Ignition timing			13.5°±2°BTDC/2000rpm

1. GENERAL INFORMATION

TORQUE VALUES

ENGINE

Item	Thread dia. (mm)	Torque (N-m)	Remarks
Cylinder head bolt	BF7x115	14.7~16.7	(cold)
Clutch drive plate nut	10	34.3~39.2	
Clutch outer nut	NH10	34.3~44.1	
Drive face nut	NH12	49.0~58.8	
Oil check bolt	10	9.8~14.7	
Engine mounting bolt	BF10x95	44.1~53.9	
Engine hanger bracket bolt	BF10x50	34.3~44.1	
Exhaust muffler joint lock nut	NC6mm	9.8~13.7	
Exhaust muffler lock bolt	BF8x35	29.4~35.3	
Spark plug		10.8~16.7	(cold)

FRAME

Item	Thread dia. (mm)	Torque (N-m)	Remarks
Handlebar lock nut	10	44.1~49.0	Flange bolt/U-nut
Steering stem lock nut	25.4	78.4~117.6	
Steering top cone race	25.4	4.9~12.7	
Front axle nut	12	49.0~68.6	Flange U-nut
Rear axle nut	16	107.8~127.4	Flange U-nut
Front shock absorber:			
upper mount bolt	8	32.3	Flange bolt/U-nut
lower mount bolt		32.3	Cross head
hex bolt		14.7~29.4	Apply locking agent
Front damper nut	8	14.7~29.4	
Front pivot arm bolt			Flange screw/U-nut
Rear shock absorber:			
upper mount bolt	10	34.3~44.1	Flange nut
lower mount bolt	8	23.5~29.4	
lower joint nut	8	14.7~24.5	

Torque specifications listed above are for important fasteners. Others should be tightened to standard torque values below.

STANDARD TORQUE VALUES

SH bolt: 8mm

Flange 6mm bolt

Item	Torque (N-m)	Item	Torque (N-m)
5mm bolt, nut	4.4~5.9	5mm screw	3.43~4.9
6mm bolt, nut	7.8~11.8	6mm screw, SH bolt	6.86~10.8
8mm bolt, nut	17.6~24.5	6mm flange bolt, nut	9.8~13.7
10mm bolt, nut	29.4~39.2	8mm flange bolt, nut	23.5~29.4
12mm bolt, nut	49.0~58.8	10mm flange bolt, nut	14.7~44.1

1. GENERAL INFORMATION

SPECIAL TOOLS

Tool Name	Tool No.	Remarks
Universal bearing puller	E030	Crankshaft bearing removal
Lock nut socket wrench	F001	Top cone race holding
Lock nut wrench,	F001	Stem lock nut tightening
Crankcase puller	E026	Crankcase disassembly
Bearing remover set, 12mm (Spindle assy, 15mm) (Remover weight)	E020	Drive shaft bearing removal/installation
Bearing remover set, 15mm (Spindle assy, 15mm) (Remover head, 15mm) (Remover shaft, 15mm)	E018	Drive shaft bearing removal/installation
Bearing outer driver, 28x30mm	E014	Bearing installation
Clutch spring compressor	E027	Driven pulley disassembly/assembly
Crankcase assembly collar	E023	Driven shaft, crankshaft & crankcase assembly
Crankcase assembly tool	E024	Crankshaft & crankcase assembly
Ball race remover	F005	Steering stem bearing races
Rear shock absorber compressor	F004	Rear shock absorber disassembly/assembly
Universal holder	E017	Flywheel holding
Flywheel puller	E001	Flywheel removal
Pilot, 12mm	E020	Drive shaft bearing installation
Bearing outer driver, 32x35mm	E014	Drive shaft bearing installation Final shaft bearing installation
Bearing outer driver, 37x40mm	E014	Drive shaft bearing installation Final shaft bearing installation Crankshaft bearing installation
Outer driver, 24x26mm	E014	Driven pulley bearing installation

1. GENERAL INFORMATION

LUBRICATION POINTS

ENGINE

NO.	Lubrication Points	Lubricant	Remarks
1	Crankcase sliding & movable	JASO-FC or API-TC	
2	Cylinder movable parts		
3	Transmission gear (final gear)	SAE-90#	
4	Kick starter spindle bushing	Grease	
5	Drive pulley movable parts	Grease	
6	Starter pinion movable parts	Grease	

FRAME

Apply clean engine oil or grease to cables and movable parts not specified. This will avoid abnormal noise and rise the durability of the motorcycle.

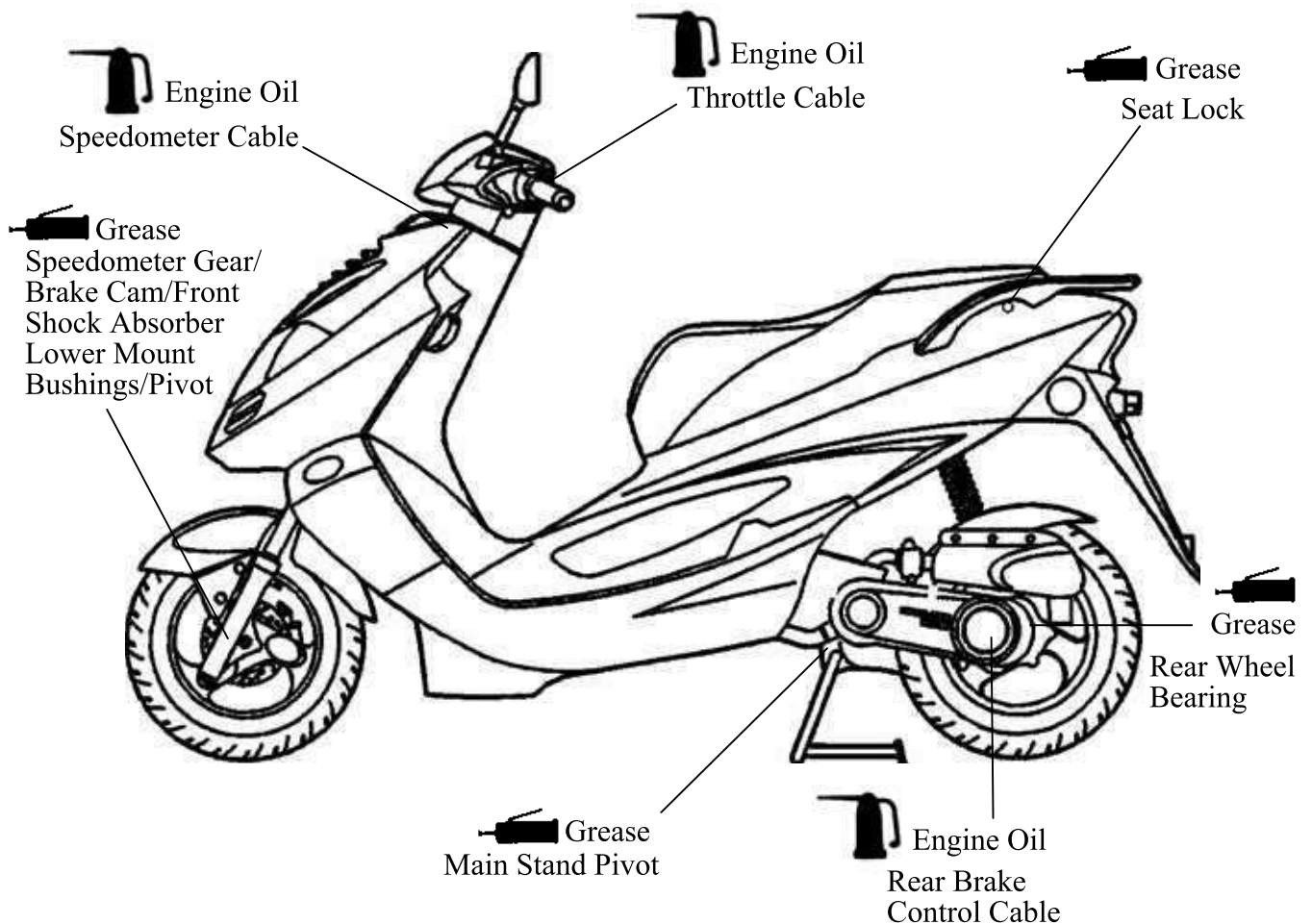

1. GENERAL INFORMATION

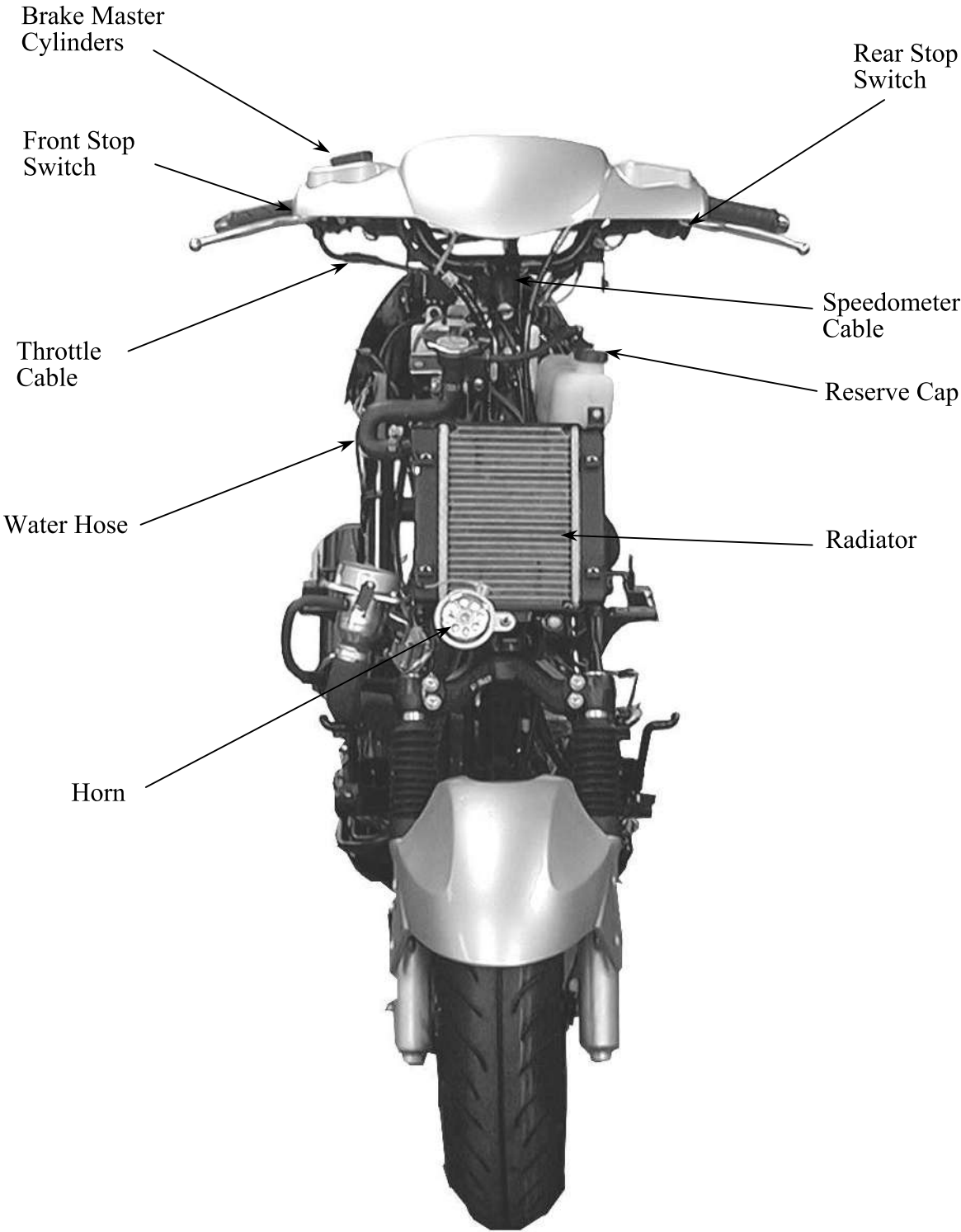

1. GENERAL INFORMATION

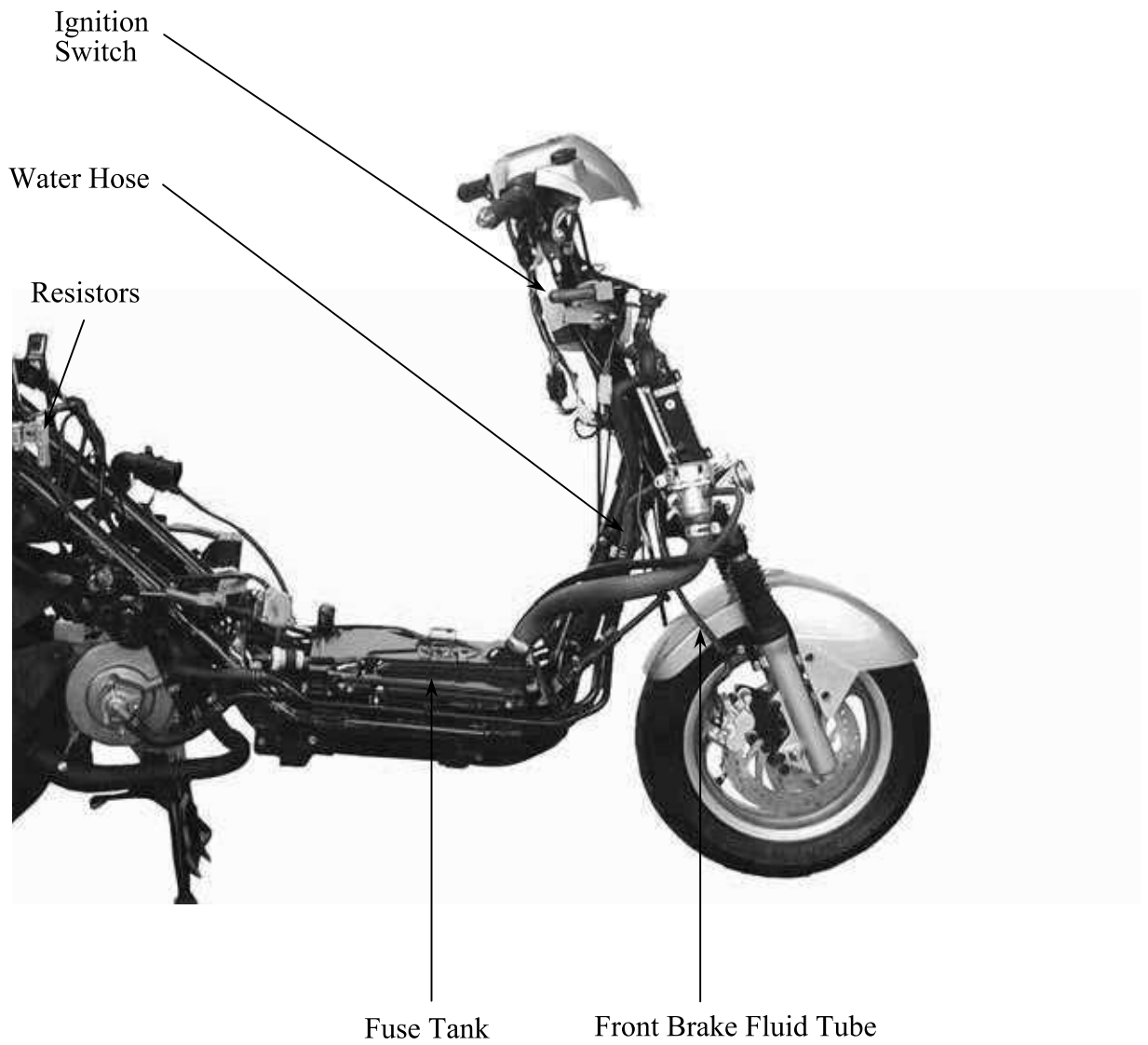

1. GENERAL INFORMATION

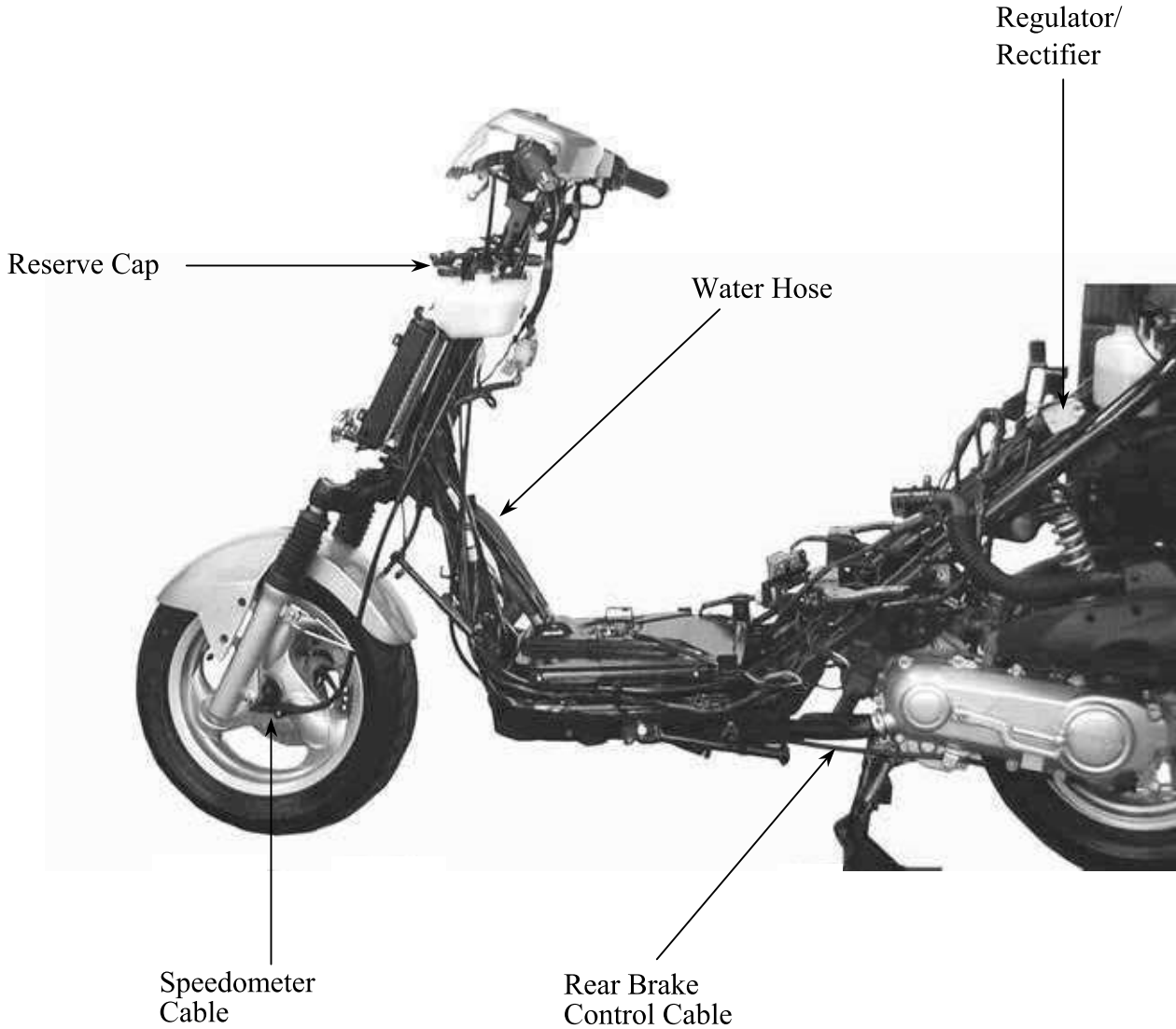

1. GENERAL INFORMATION

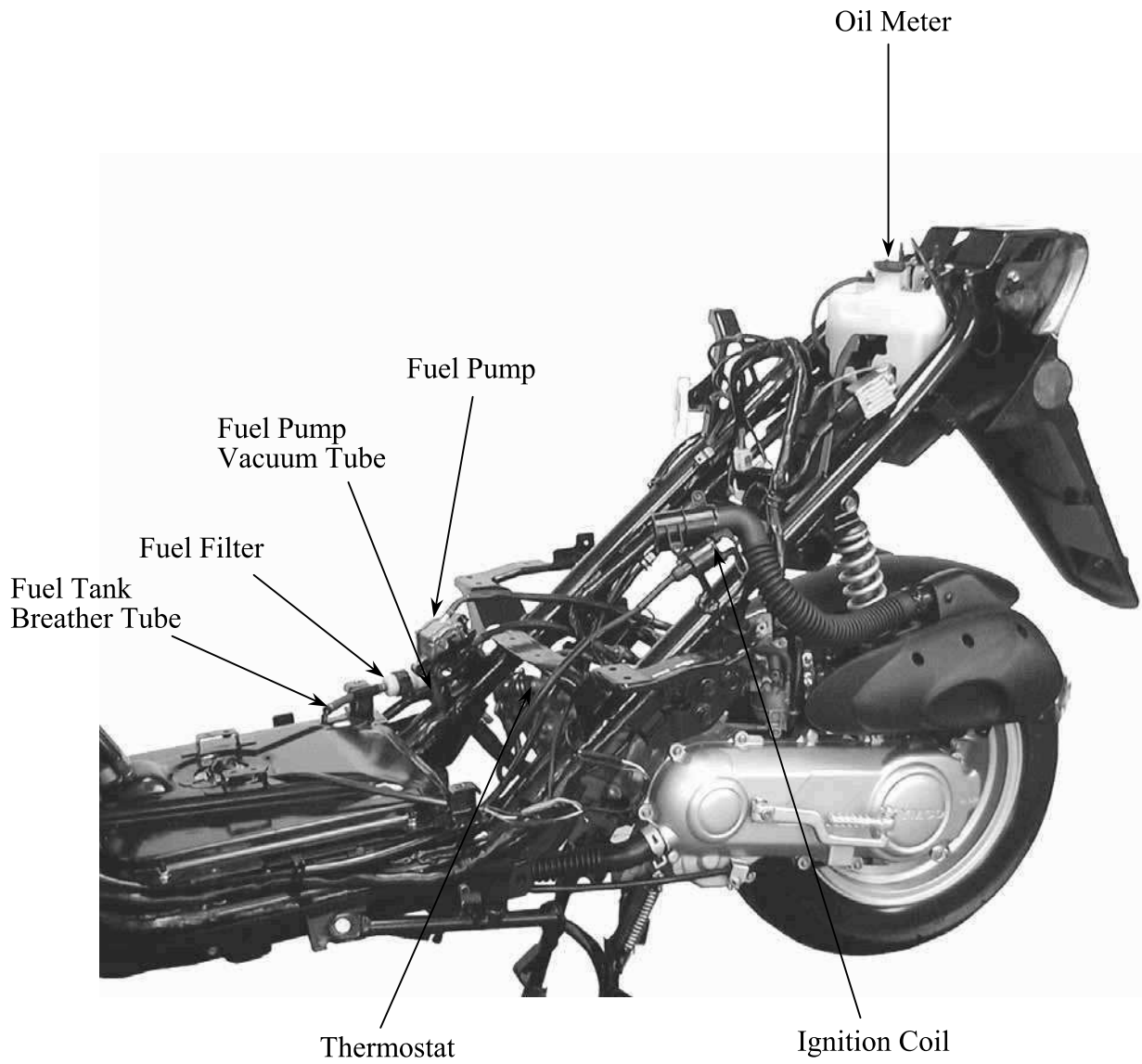

1. GENERAL INFORMATION

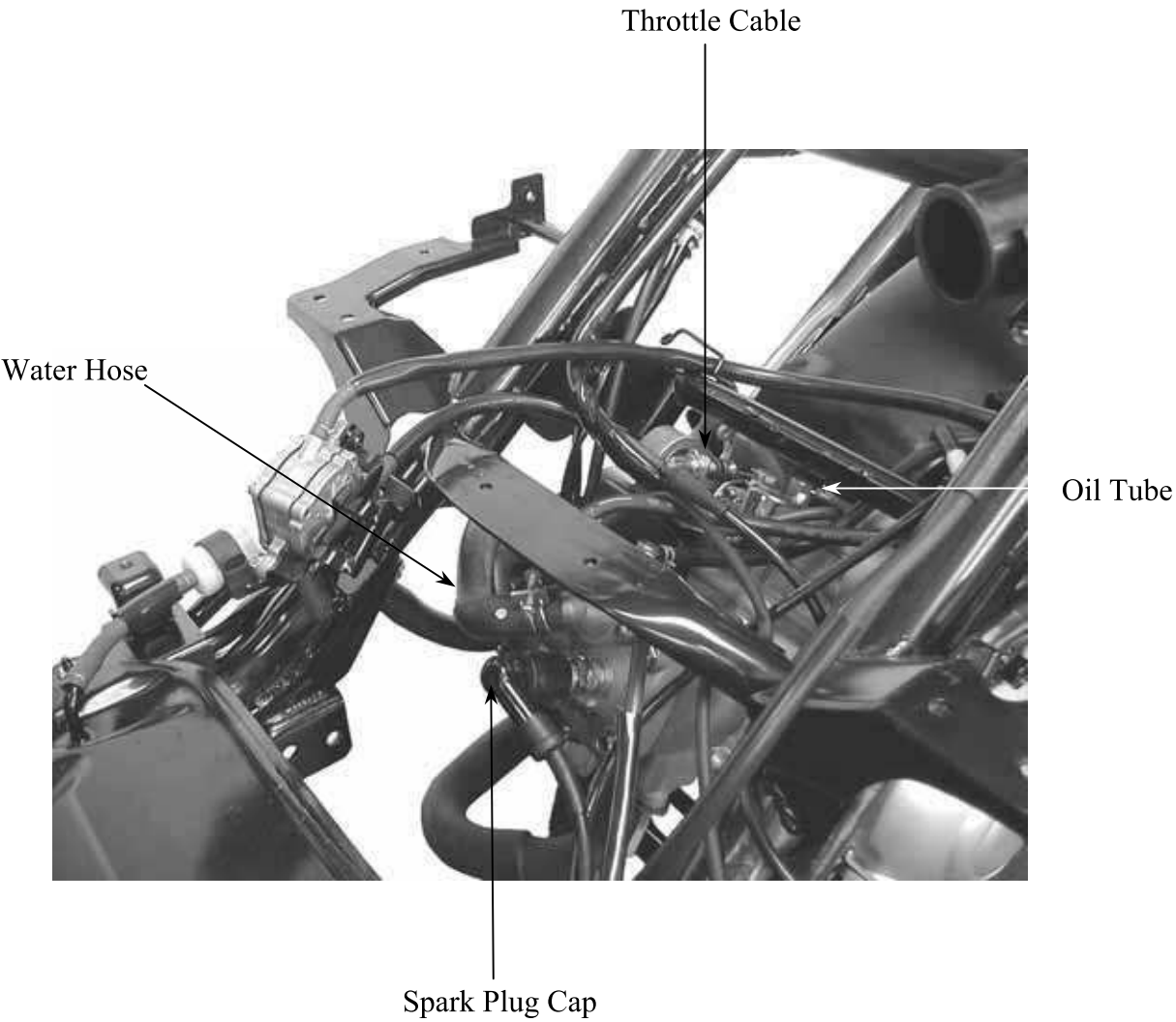

1. GENERAL INFORMATION

WIRING DIAGRAM

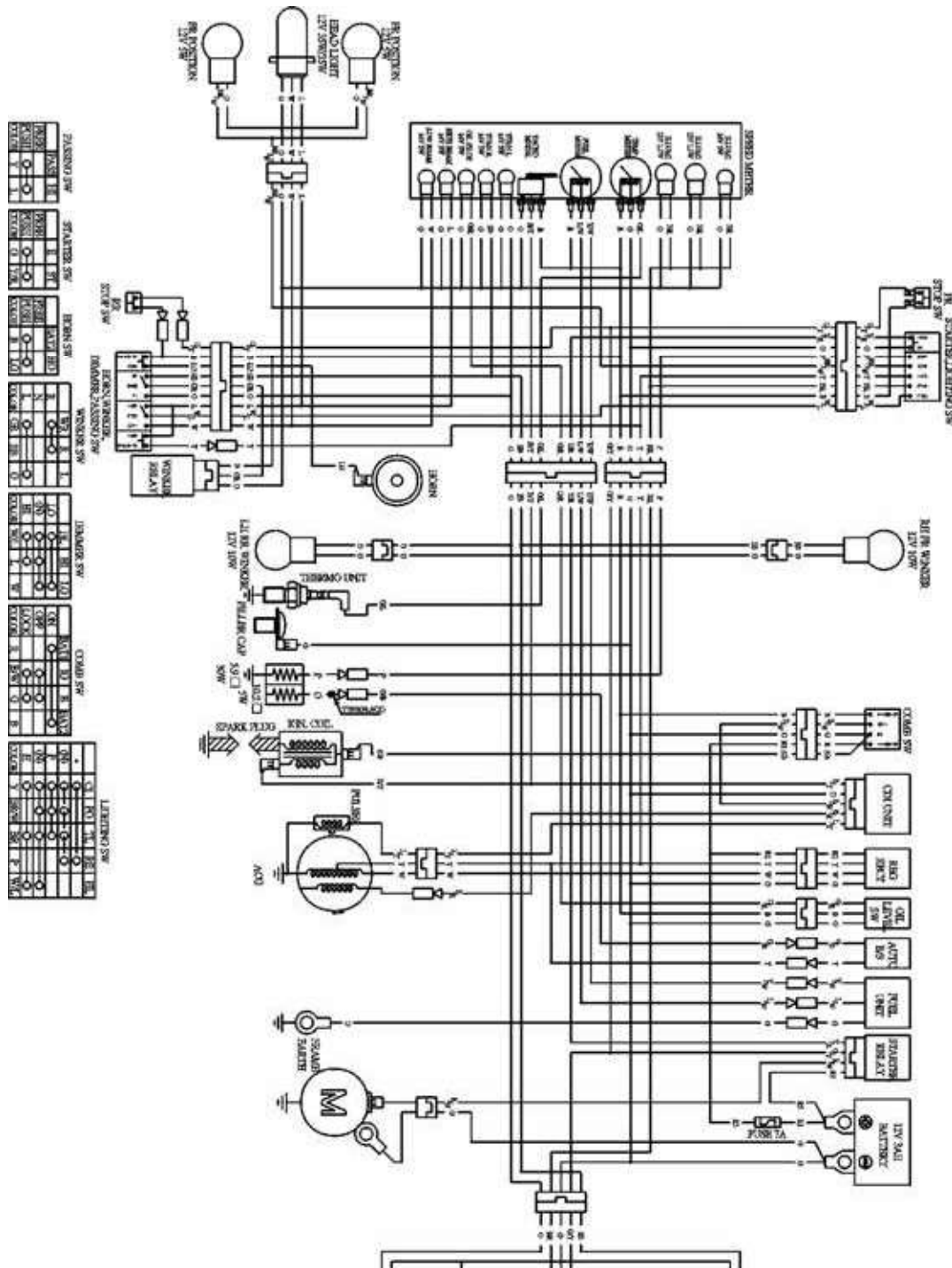

1. GENERAL INFORMATION

TROUBLESHOOTING

ENGINE WILL NOT START OR IS HARD TO START

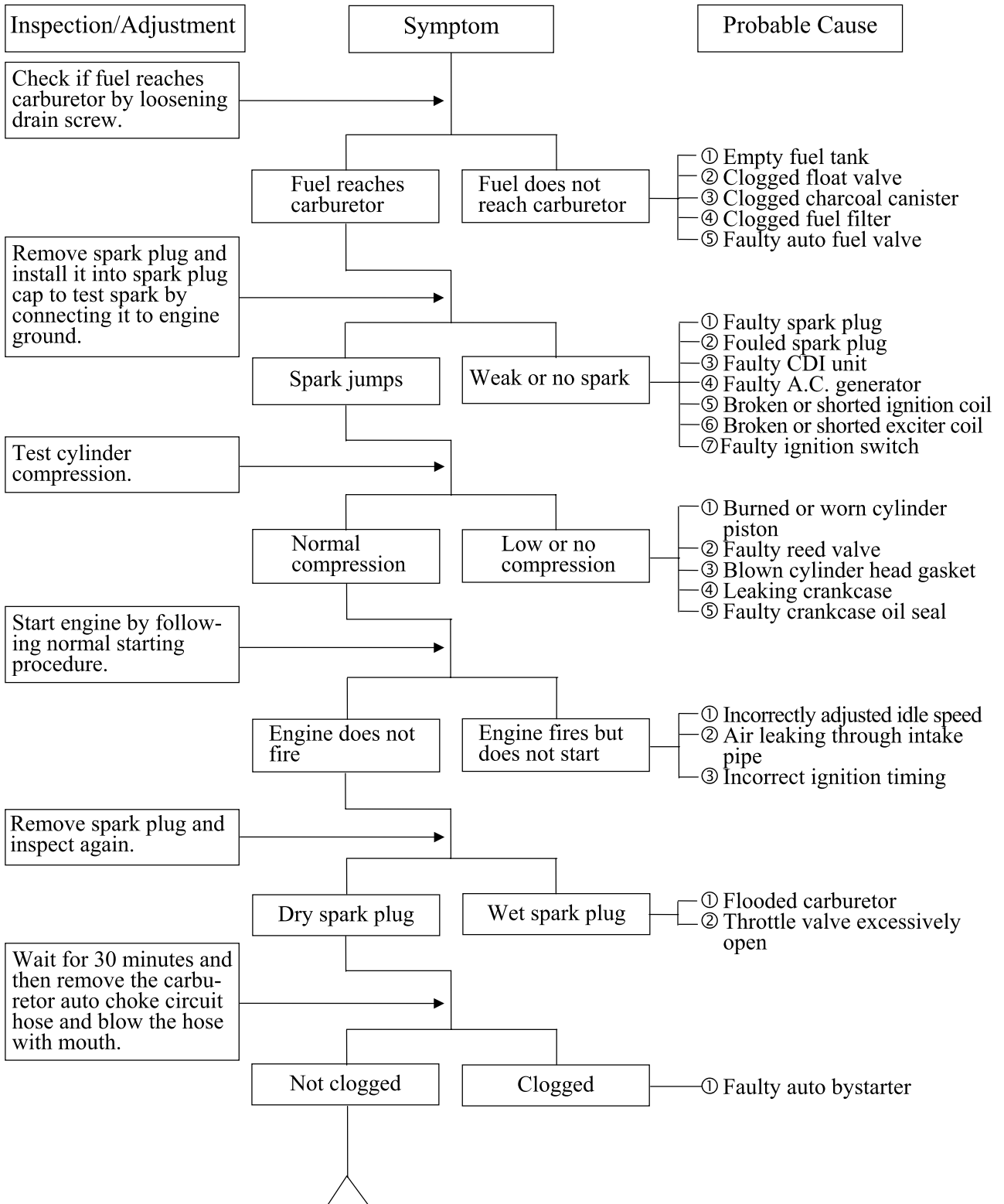

1. GENERAL INFORMATION

ENGINE STOPS IMMEDIATELY AFTER IT STARTS

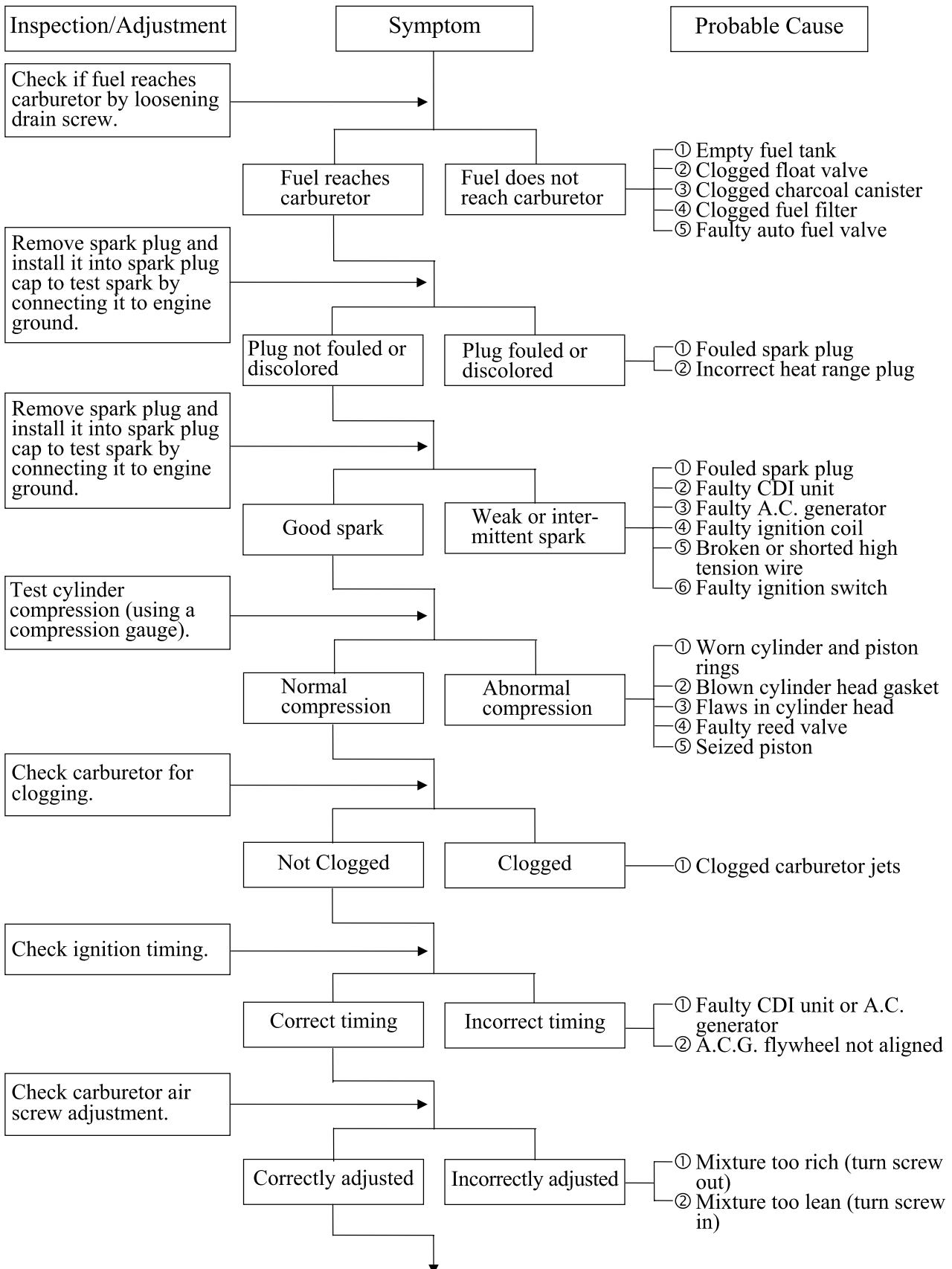

1. GENERAL INFORMATION

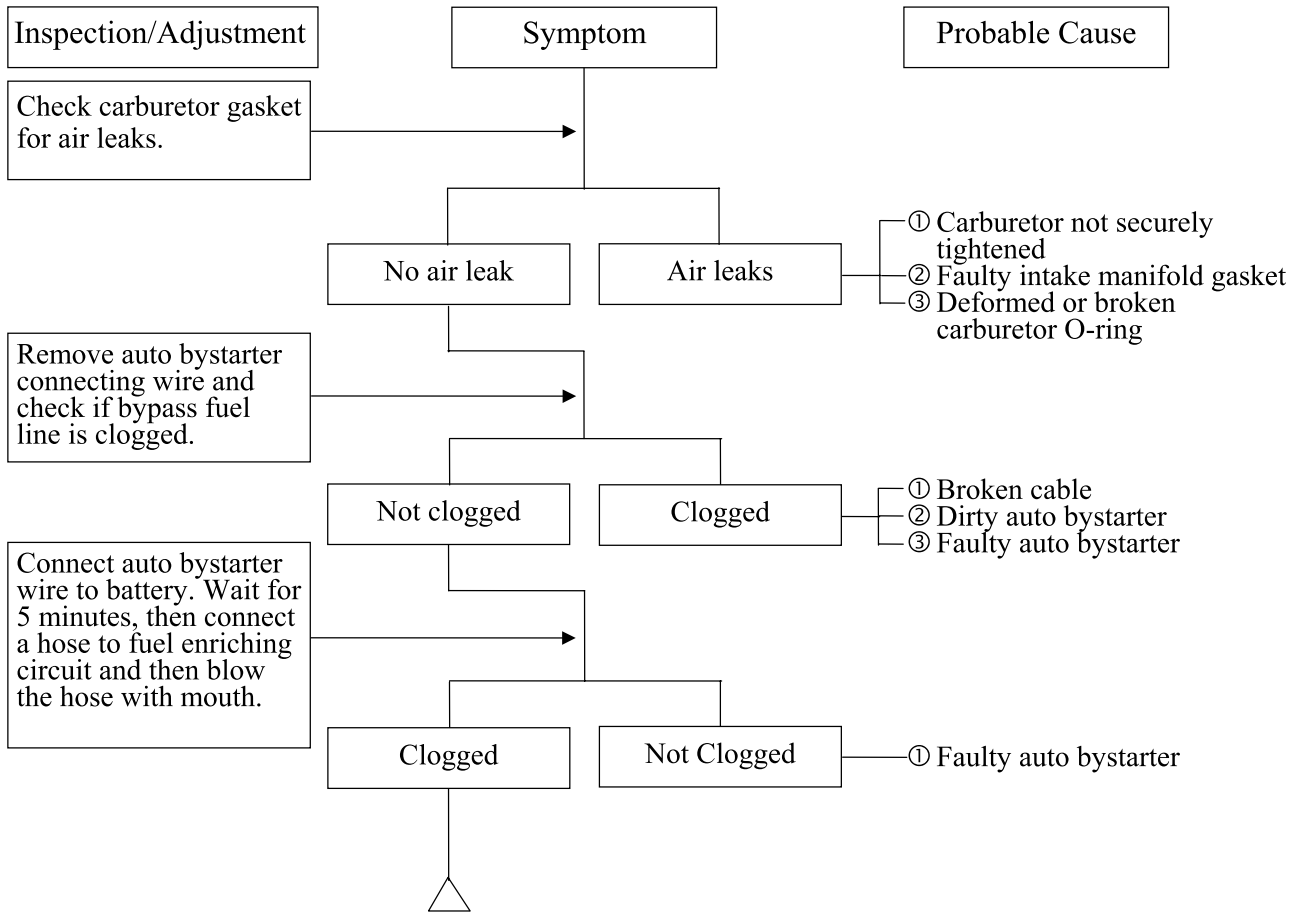

1. GENERAL INFORMATION

ENGINE LACKS POWER

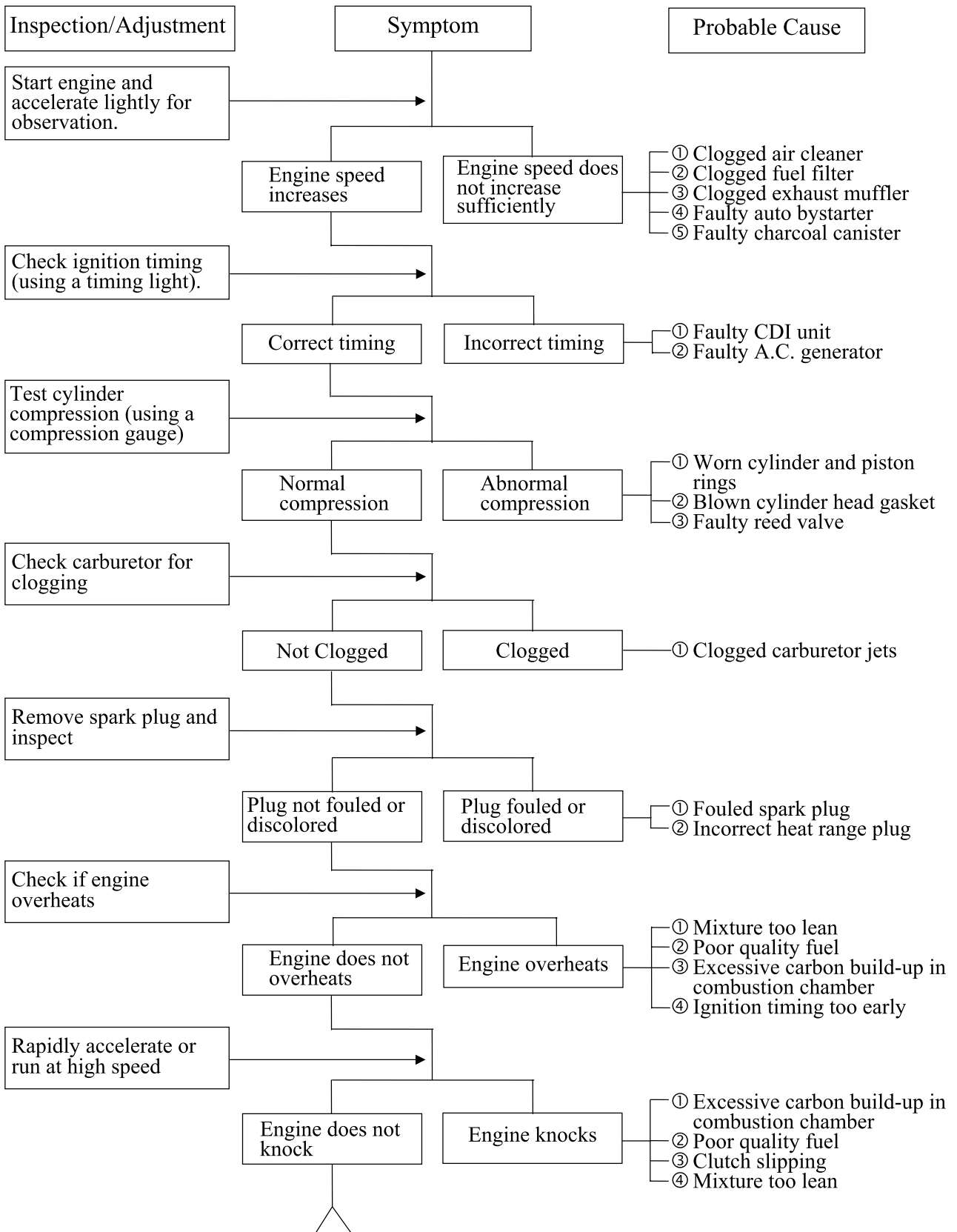

1. GENERAL INFORMATION

POOR PERFORMANCE (ESPECIALLY AT IDLE AND LOW SPEEDS)

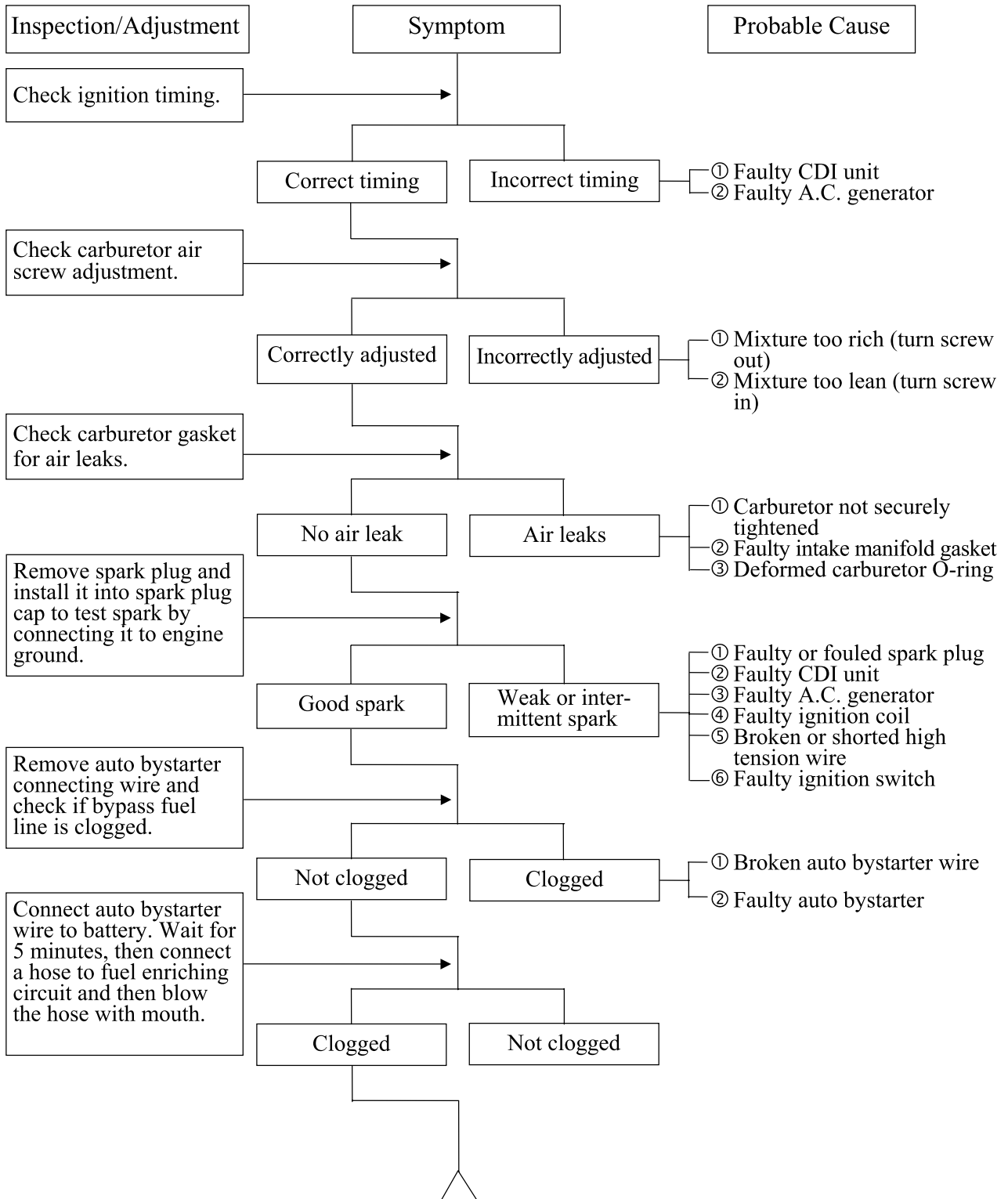

1. GENERAL INFORMATION

POOR PERFORMANCE (AT HIGH SPEED)

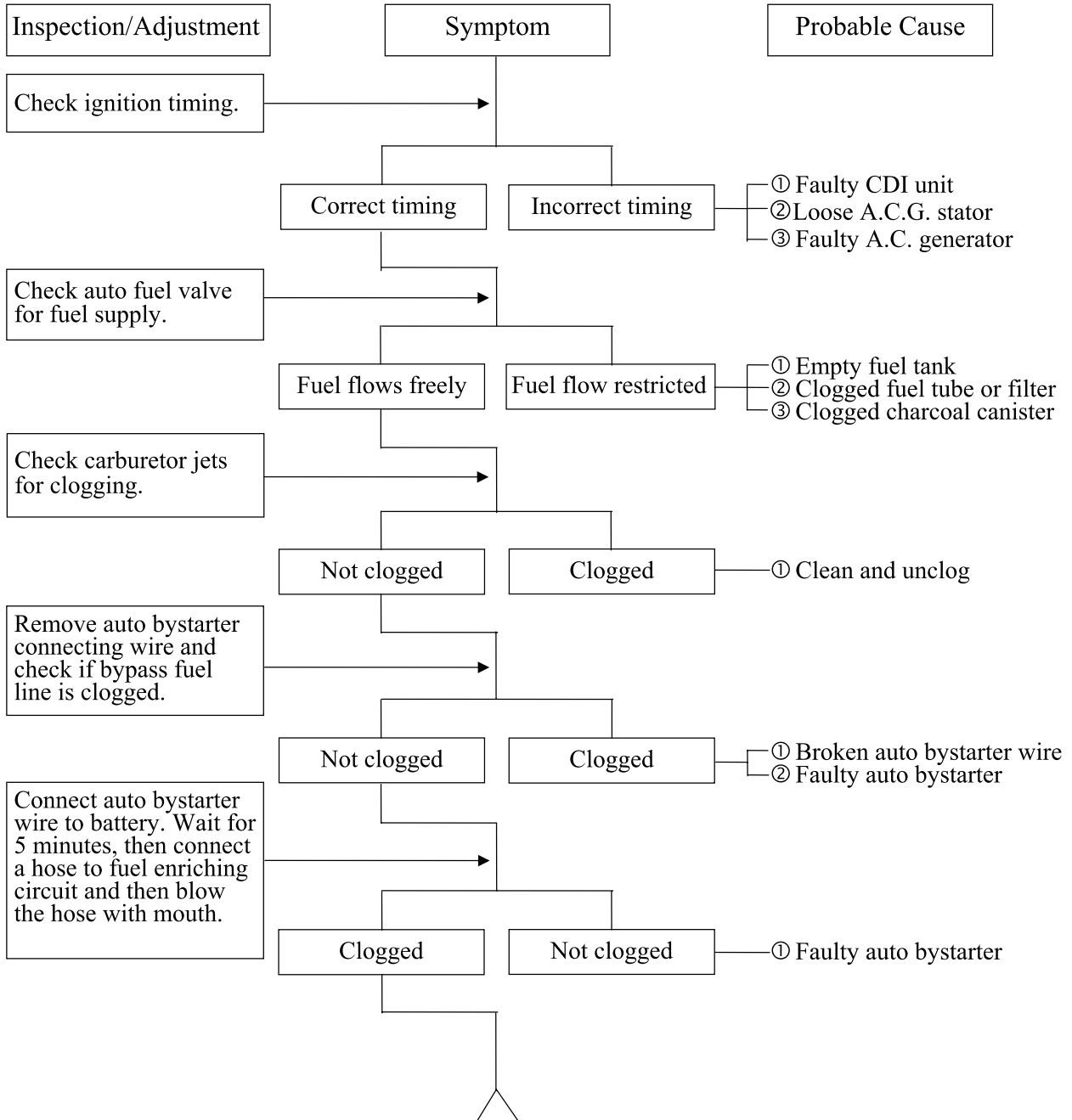

1. GENERAL INFORMATION

CLUTCH, DRIVE AND DRIVEN PULLEYS

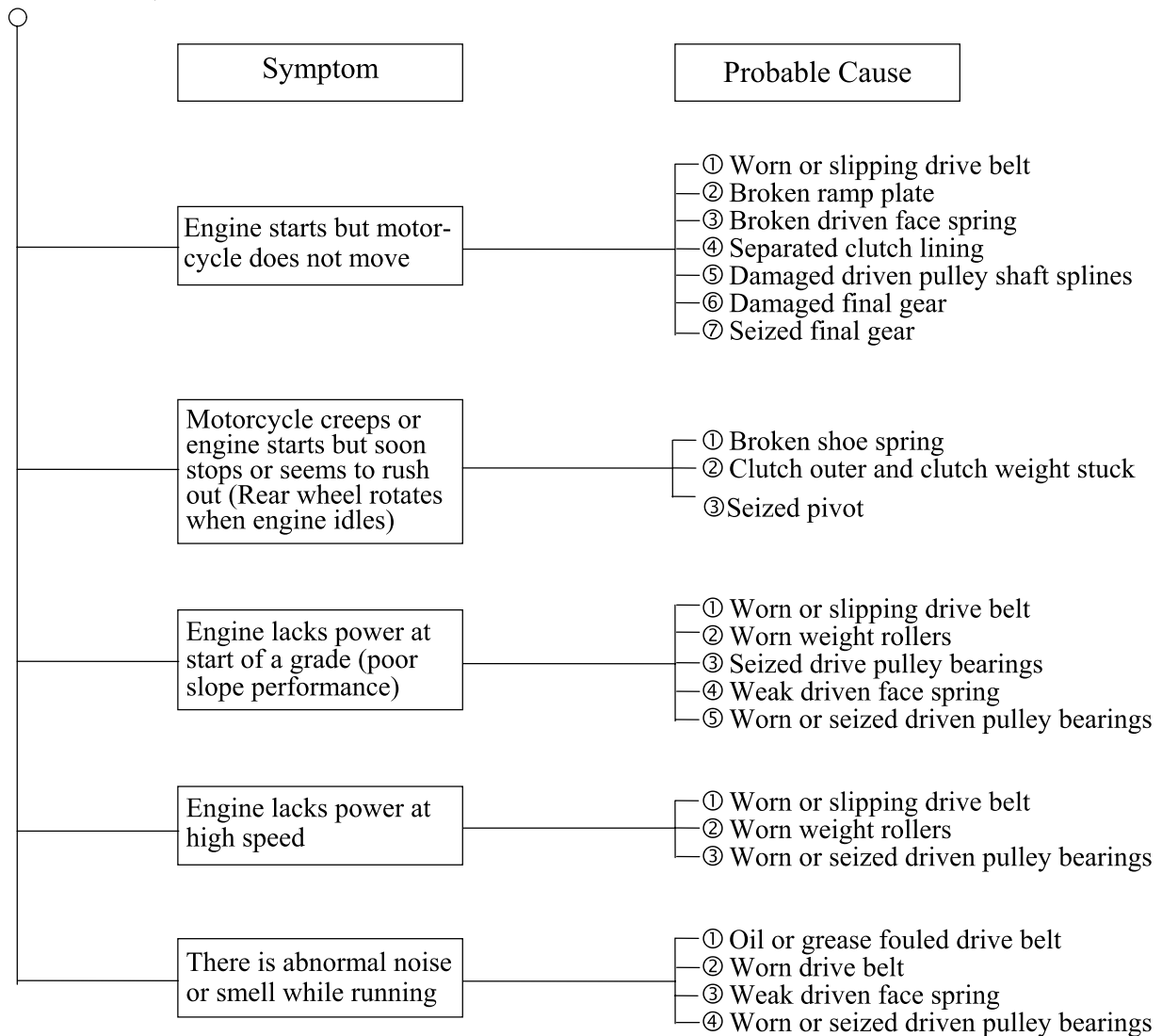

STEERING HANDLEBAR DOES NOT TRACK STRAIGHT

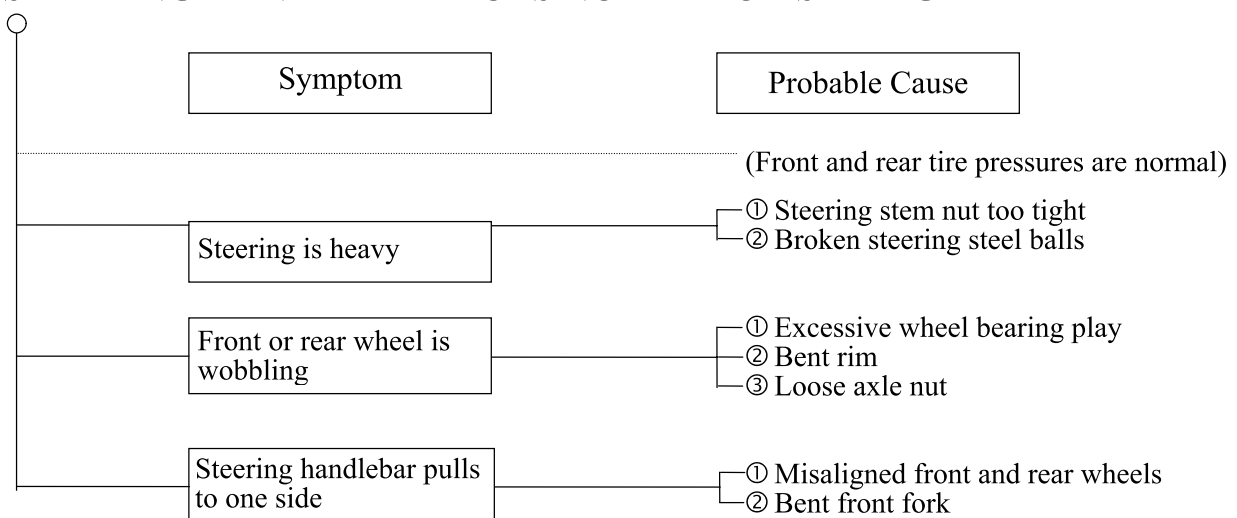

1. GENERAL INFORMATION

POOR SUSPENSION PERFORMANCE

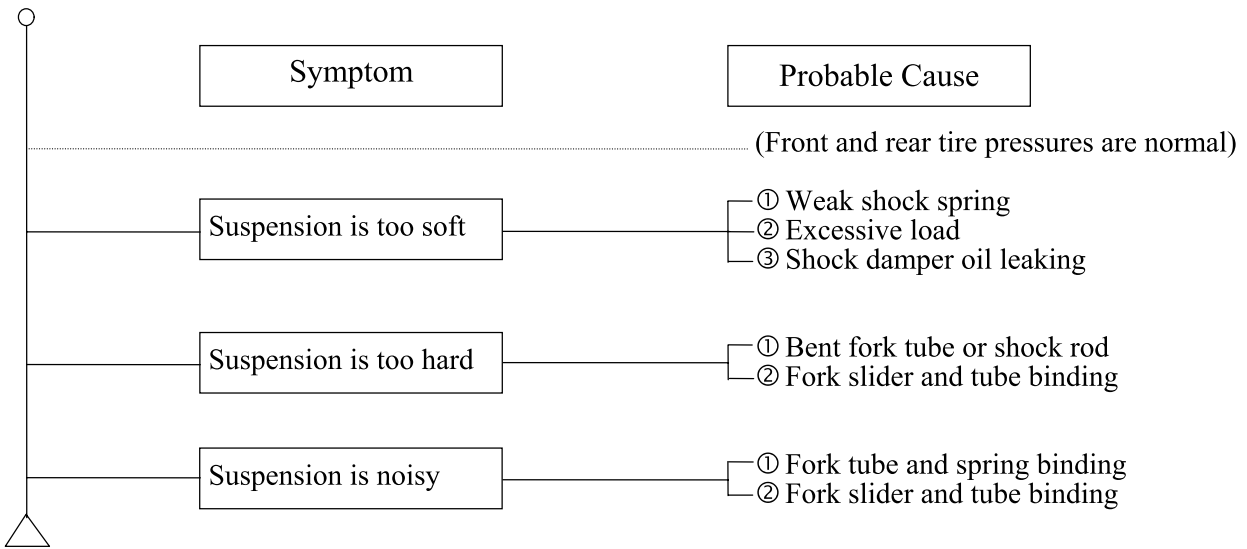

POOR BRAKE PERFORMANCE

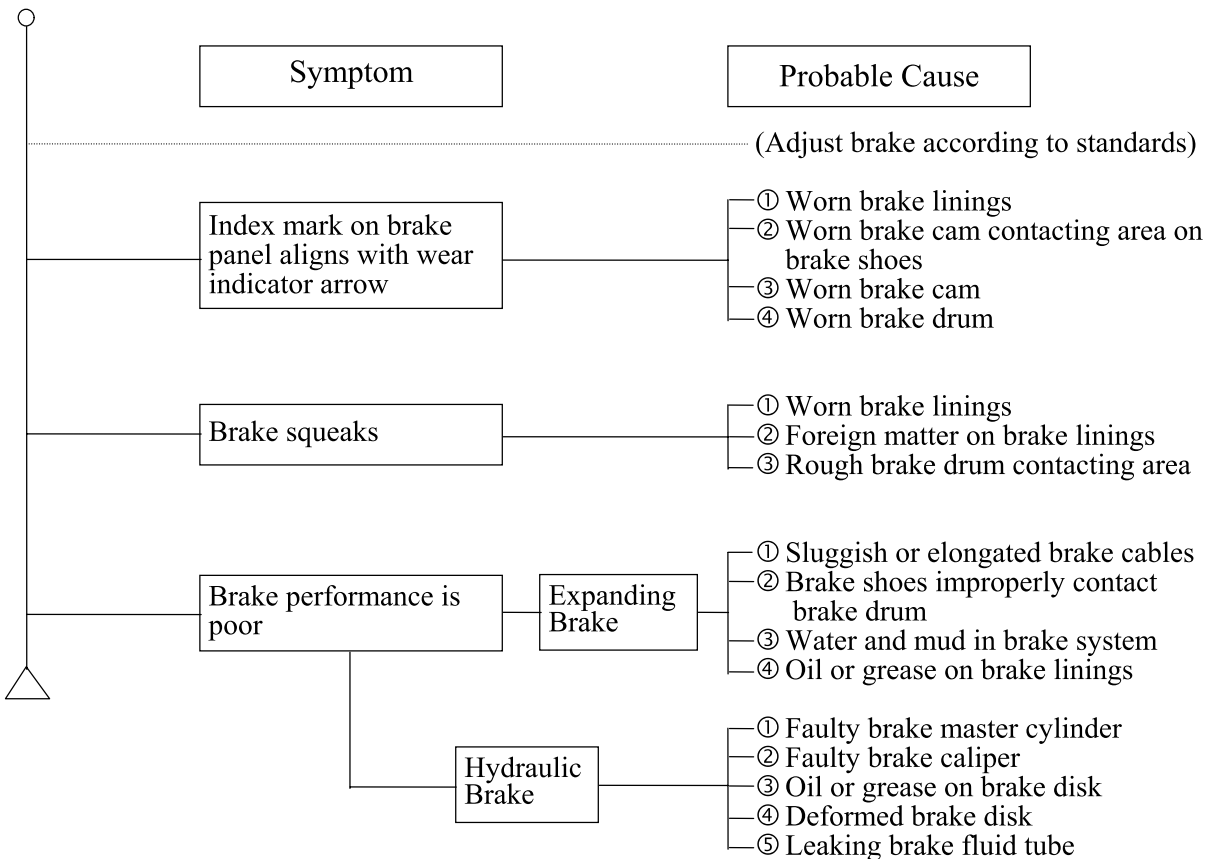

1. GENERAL INFORMATION

OIL METER

1. Motor oil indicator light does not come on when there is no motor oil (Ignition switch ON)

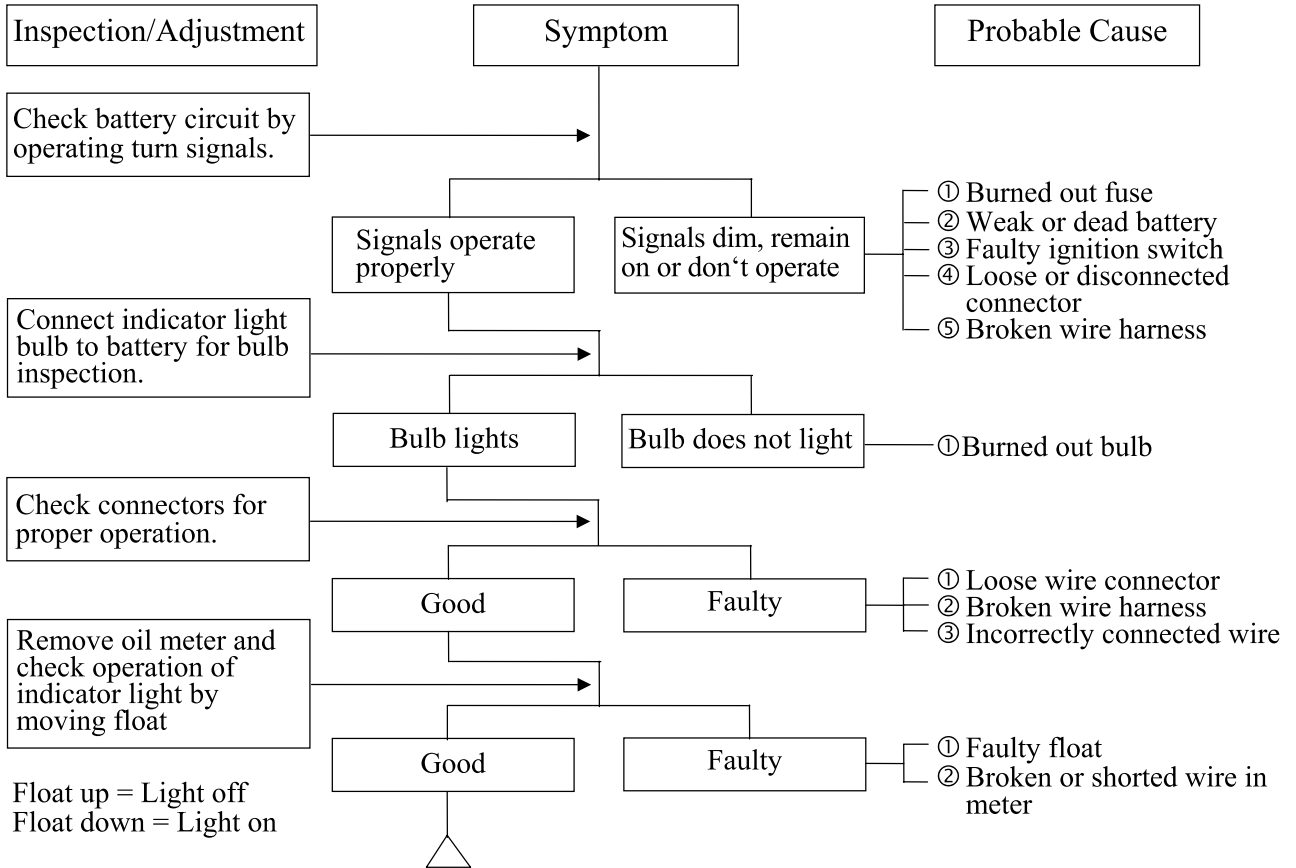

2. Motor oil is sufficient but the indicator light remains on (Ignition switch ON)

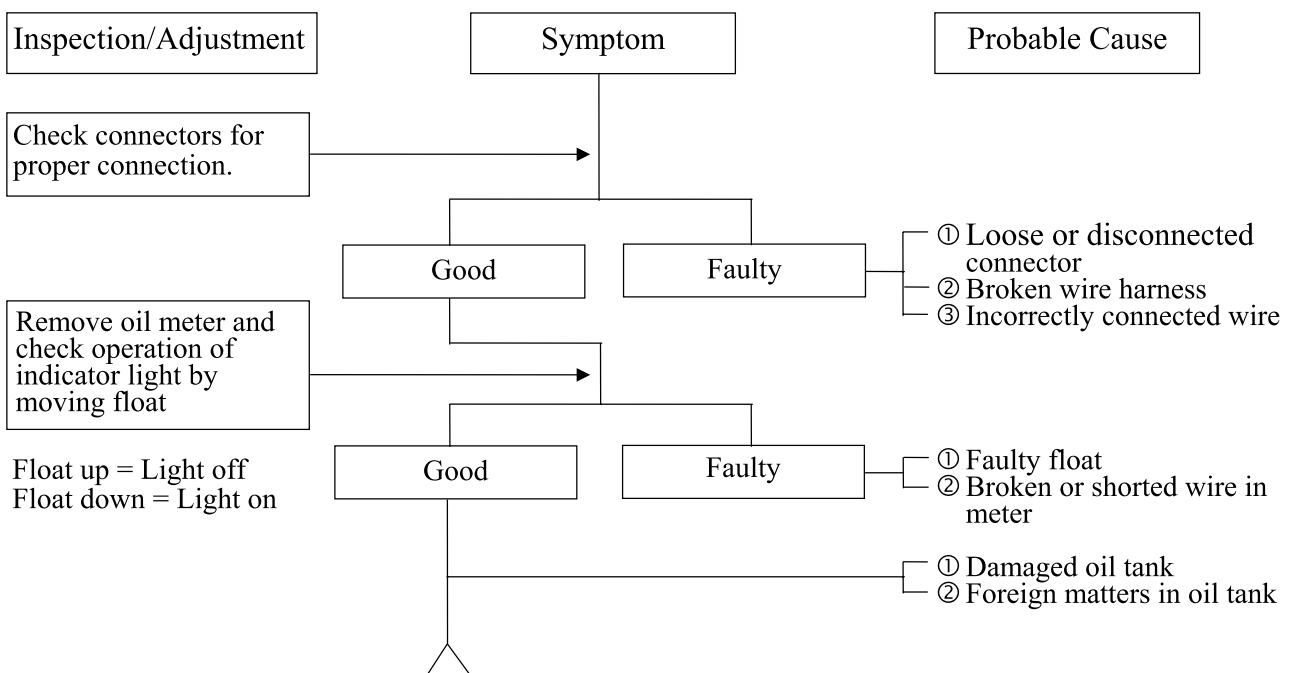

1. GENERAL INFORMATION

FUEL GAUGE

1. Pointer does not register correctly (Ignition switch ON)

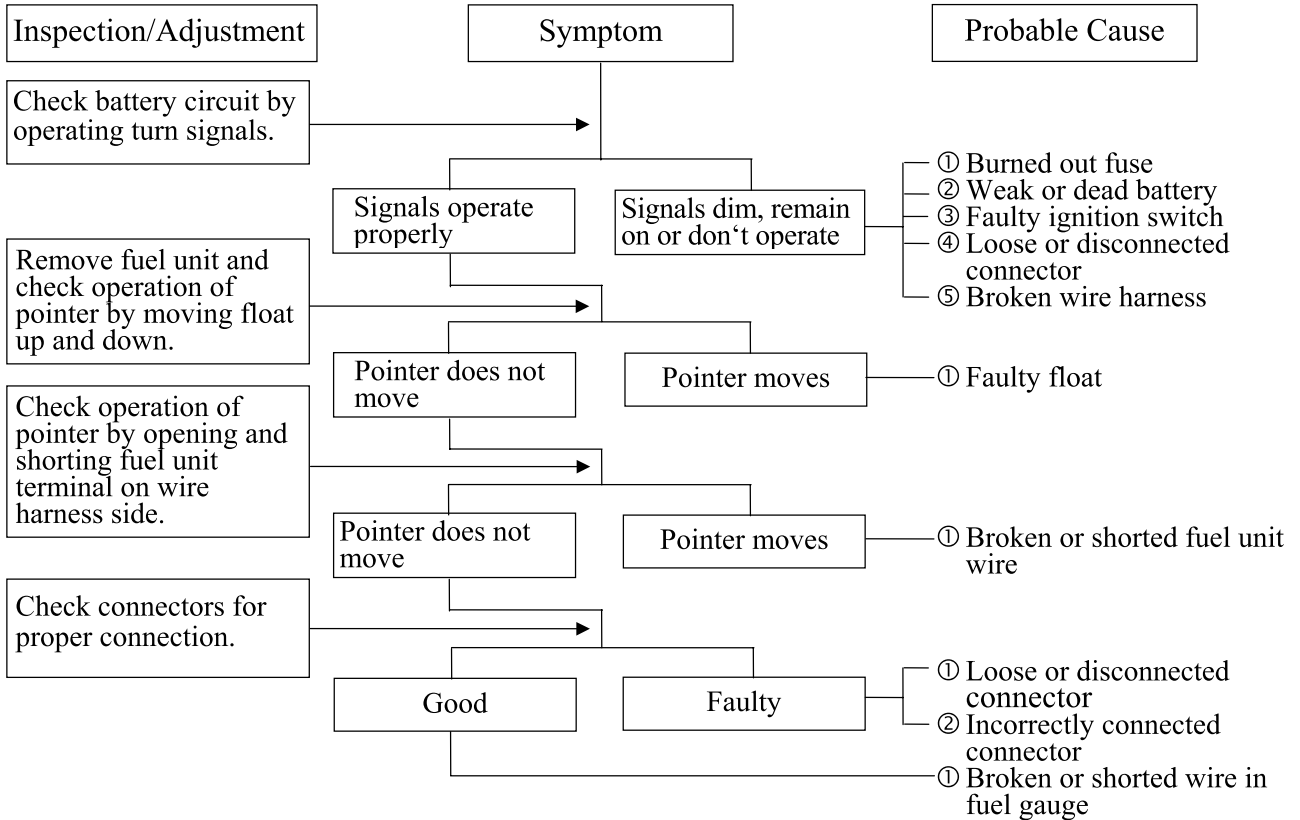

2. Pointer fluctuates or swings (Ignition switch ON)

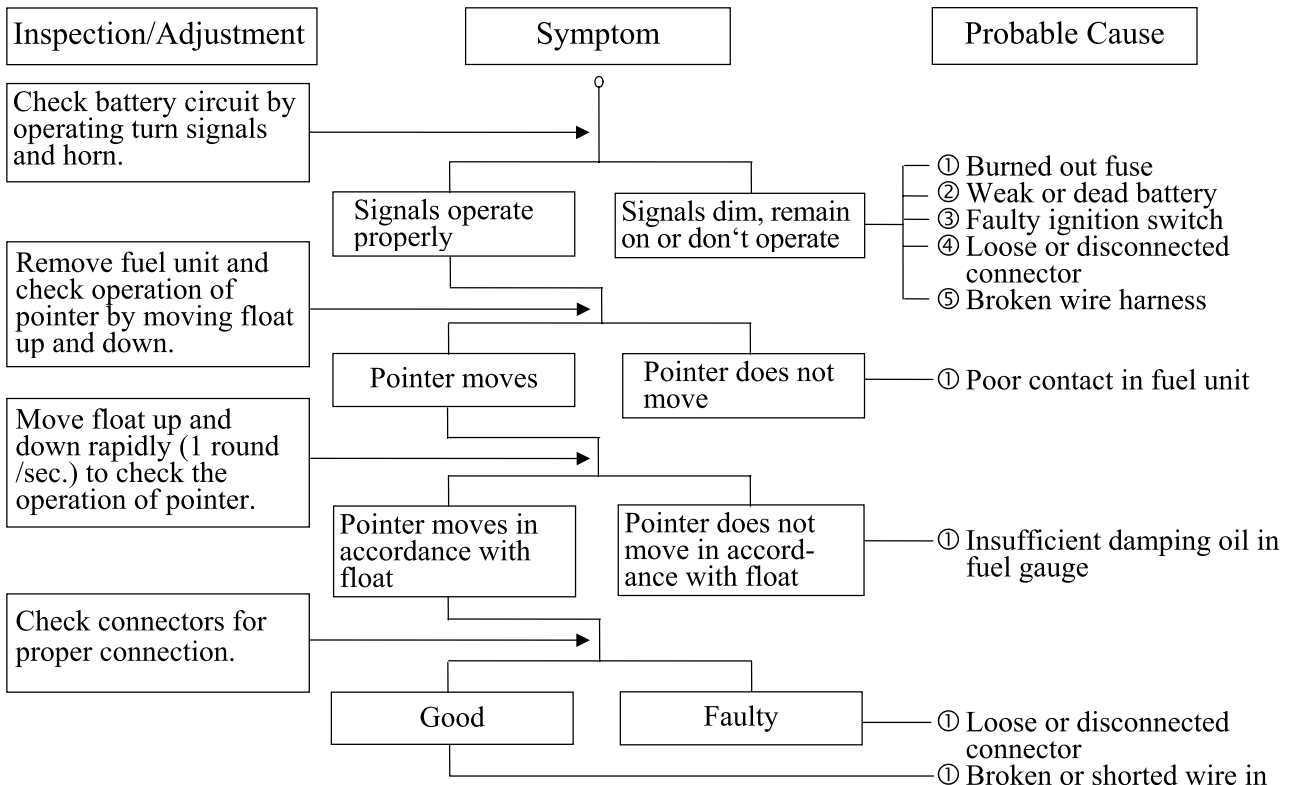

1. GENERAL INFORMATION

STARTER MOTOR

1. Starter motor won't turn

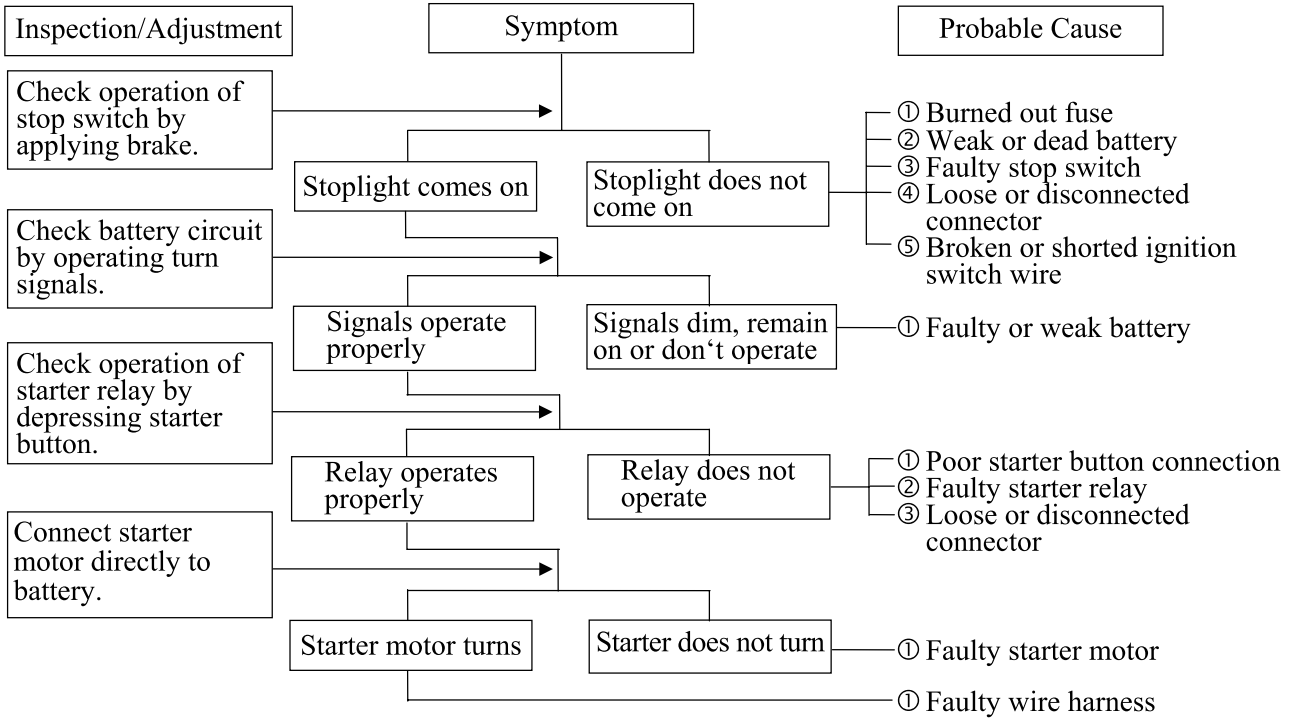

2. Starter motor turns slowly or idles

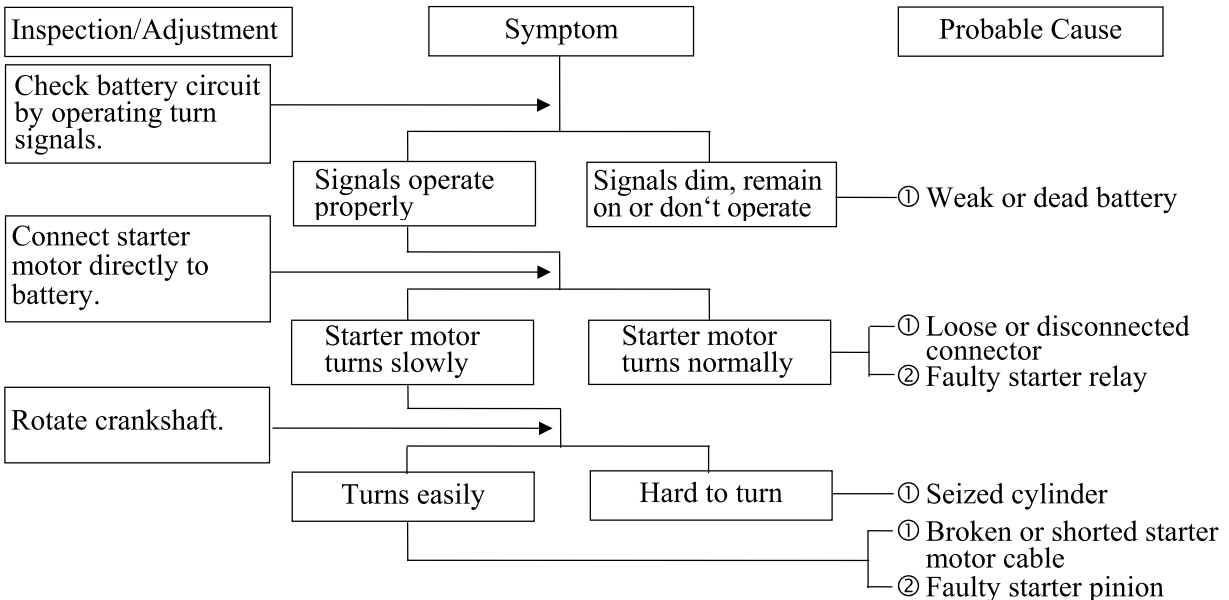

3. Starter motor does not stop turning

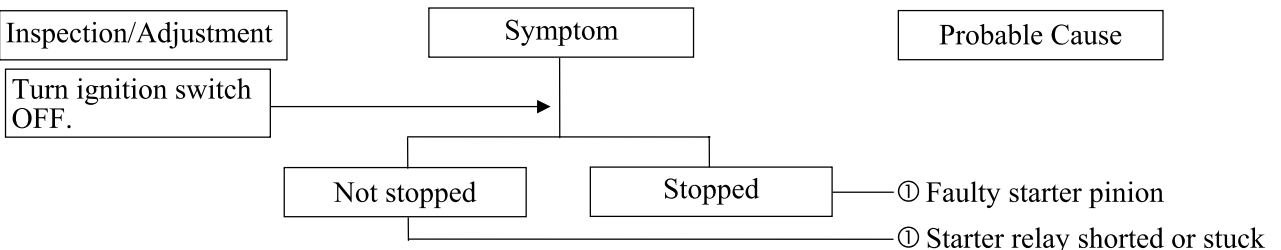

1. GENERAL INFORMATION

closed

2. EXHAUST MUFFLER/FRAME COVERS

EXHAUST MUFFLER/FRAME COVERS

SERVICE INFORMATION----- 2- 1
TROUBLESHOOTING----- 2- 1
FRAME COVERS REMOVAL ----- 2- 2
EXHAUST MUFFLER REMOVAL ----- 2- 6

2. EXHAUST MUFFLER/FRAME COVERS

SERVICE INFORMATION

GENERAL INSTRUCTIONS

- When removing frame covers, don't pull them by force because the cover joint claws may be damaged.
- Make sure to route cables and harnesses according to the Cable & Harness Routing.

TORQUE VALUES

Exhaust muffler lock bolt	34.3N-m
Exhaust muffler joint lock nut	11.8N-m

TROUBLESHOOTING

Noisy exhaust muffler

- Damaged exhaust muffler
- Exhaust muffler joint air leaks

Lack of power

- Caved exhaust muffler
- Clogged exhaust muffler
- Exhaust muffler air leaks

2. EXHAUST MUFFLER/FRAME COVERS

FRAME COVERS REMOVAL

REAR CARRIER & HAND RAIL REMOVAL

Remove the met-in box:
First remove the two bolts and two nuts attaching the met-in box.
Remove the battery, CDI and fuse.
Remove the met-in box.

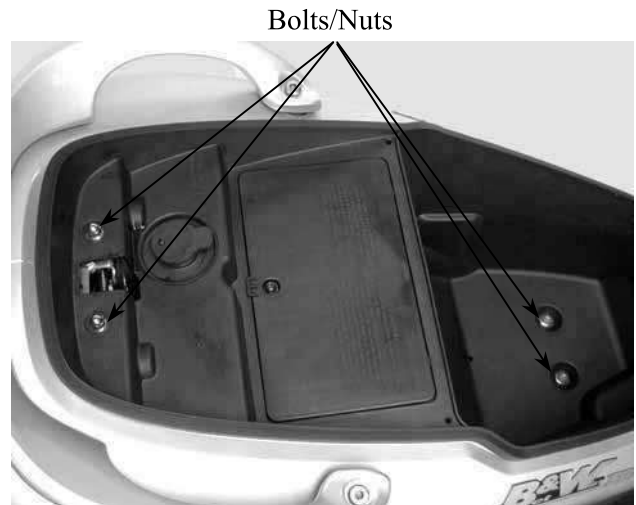

Remove the hand rail right and left lock hex bolts.
Remove the four hex bolts
Remove the rear carrier and hand rail.

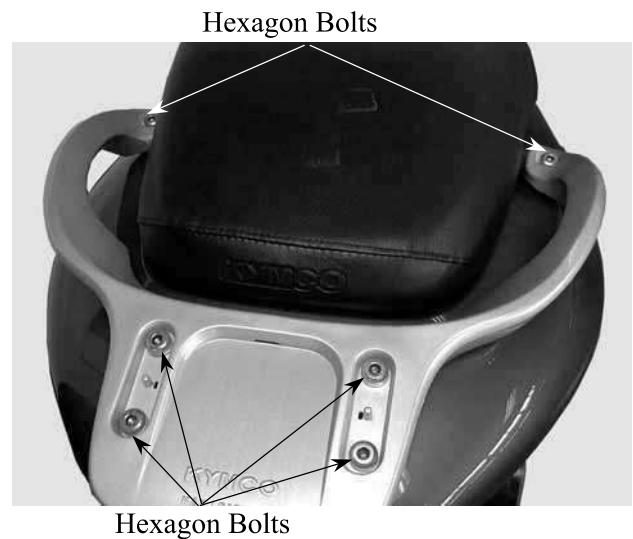

FRAME BODY COVER REMOVAL

Remove the one screws on the bottom of the center cover.
Remove the center cover.
Remove the two screws attaching the front part of the frame body cover.

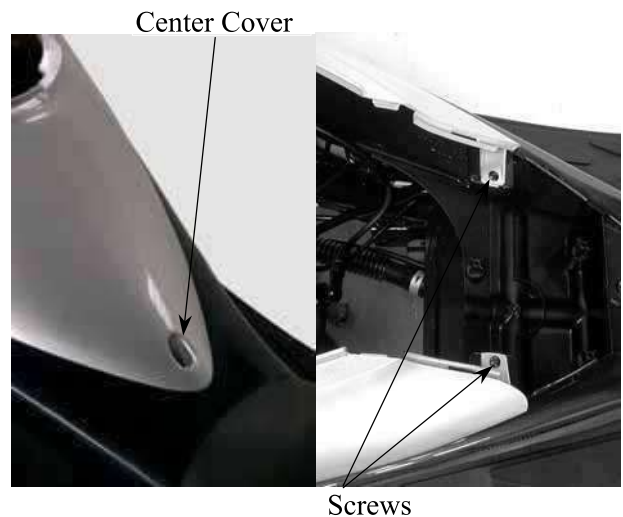

2. EXHAUST MUFFLER/FRAME COVERS

Remove the right and left screws on the rear part of the frame body cover.
Disconnect the seat lock wire.
Remove the frame body cover.



Screw

Remove the midst screw attaching the right and left side covers.

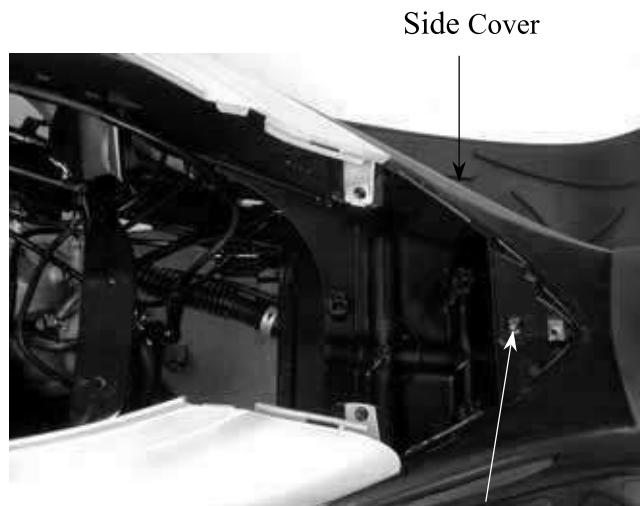

Side Cover

Screws

Remove the screws attaching the right and left side covers.



Screws

2. EXHAUST MUFFLER/FRAME COVERS

FLOOR BOARD REMOVAL

Remove the floor mat.
 Remove the center cover. (⇒2-3)
 Remove the ten screws and four screws attaching the front right and left side covers.
 Remove the two bottom cover adjusting screws.
 Remove the front right and left side covers.
 Remove the prop two bolts.
 Remove the two nuts
 Remove the six bolts attaching the floor board.
 Remove the floor board.
 The installation sequence is the reverse of removal.

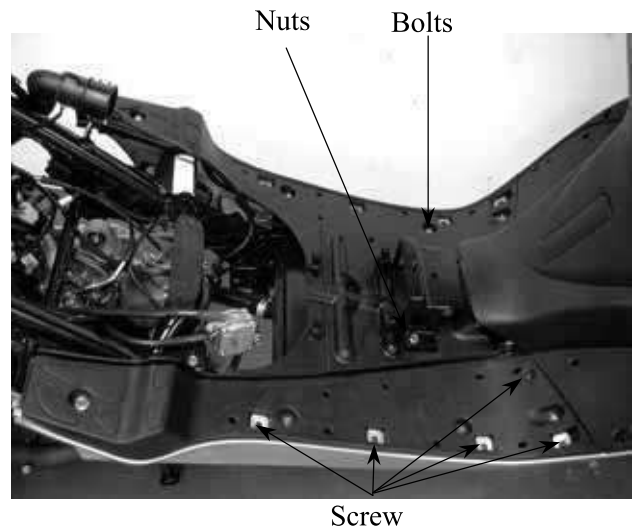

FRONT UPPER COVER REMOVAL

Remove the four screws on the back of the front upper cover.
 Remove the front upper cover.
 The installation sequence is the reverse of removal.

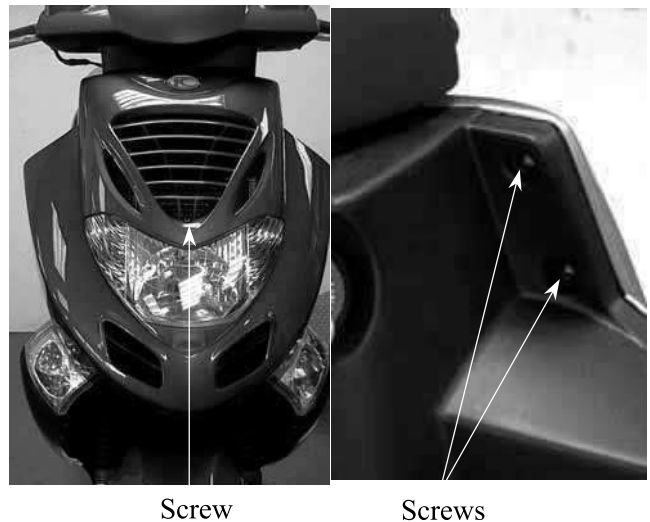

FRONT LOWER COVER REMOVAL

First remove the front upper cover.
 Remove the two screws attaching the front lower cover.
 Remove the four screws on the back of the front lower cover.
 Disconnect the right/left turn signal light wire connectors.
 Remove the front lower cover
 The installation sequence is the reverse of removal.

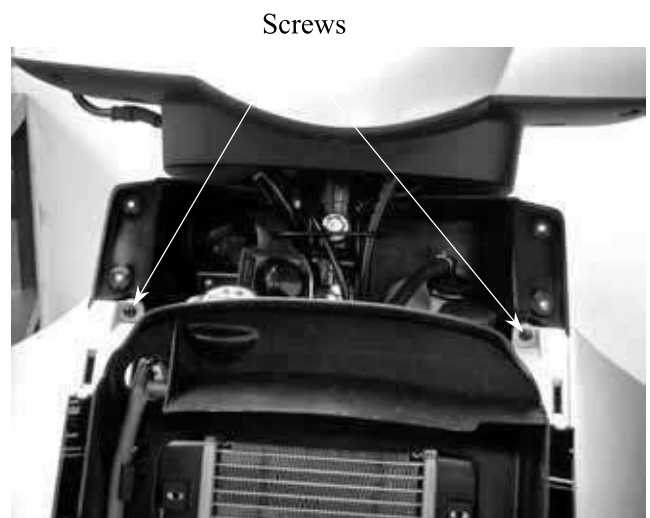

2. EXHAUST MUFFLER/FRAME COVERS

BACK COVER REMOVAL

Remove the front cover.
Remove the key moldings.
Remove the fuel cap moldings.
Remove the back cover bolt.

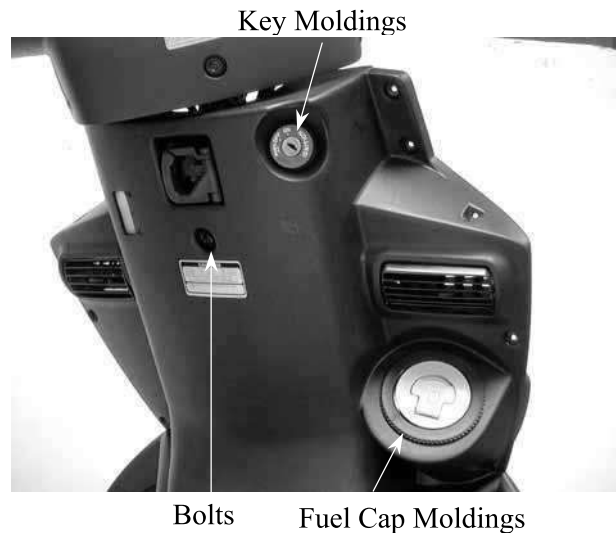

Remove the screws attaching fuel tank inlet tube joint.
Remove the back cover.

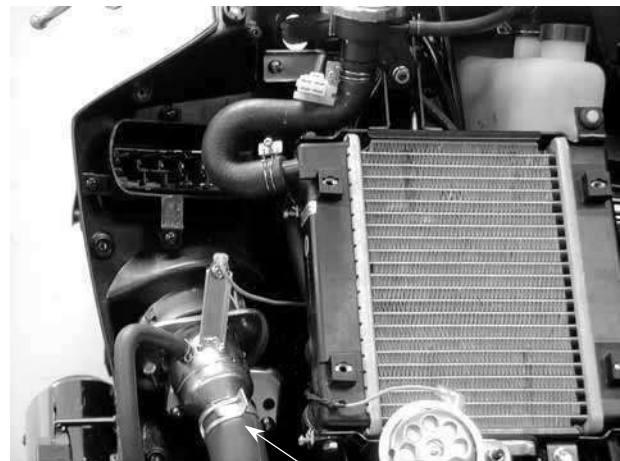

HANDLEBAR COVER REMOVAL

First remove the seven screws attaching the handlebar back cover.
Remove the handlebar back cover.

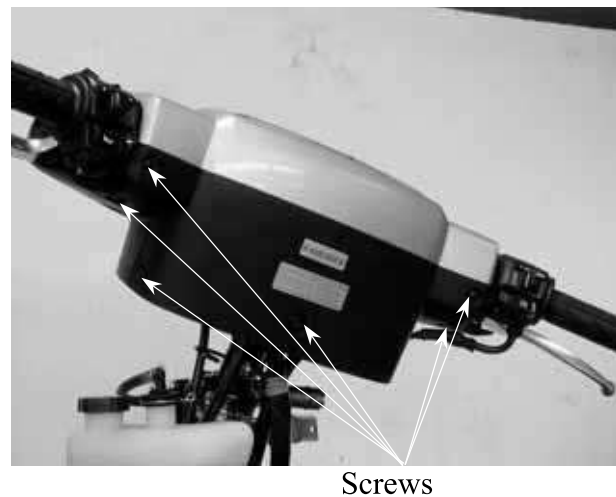

2. EXHAUST MUFFLER/FRAME COVERS

BOTTOM COVER REMOVAL

Remove the side stand.
 Remove the four bolts attaching the bottom cover.
 Remove the bottom cover.

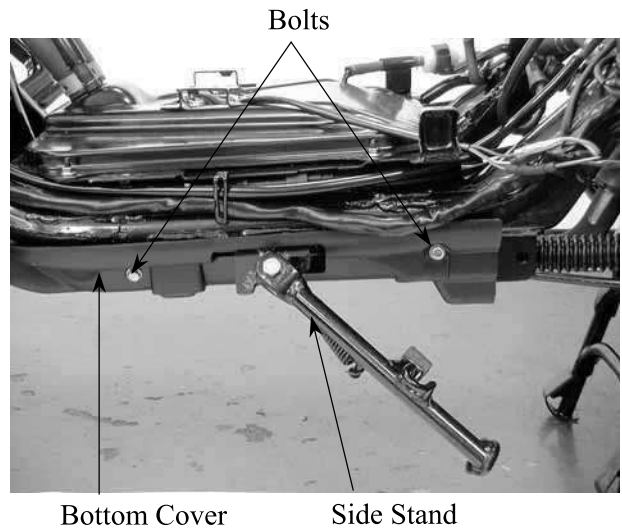

FRONT FENDER REMOVAL

Remove the two bolts attaching the fender.
 Remove the front fender cover.
 The installation sequence is the reverse of removal.

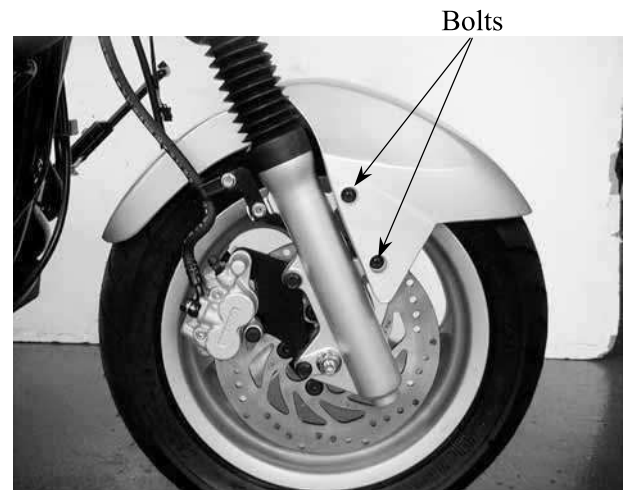

EXHAUST MUFFLER REMOVAL

Remove the two exhaust muffler joint lock nuts.
 Remove the two exhaust muffler lock bolts to remove the exhaust muffler.
 Remove the exhaust muffler joint packing collar.
 The installation sequence is the reverse of removal.

Torque:

Exhaust muffler joint lock nut: 11.8N-m
 Exhaust muffler lock bolt: 34.3N-m

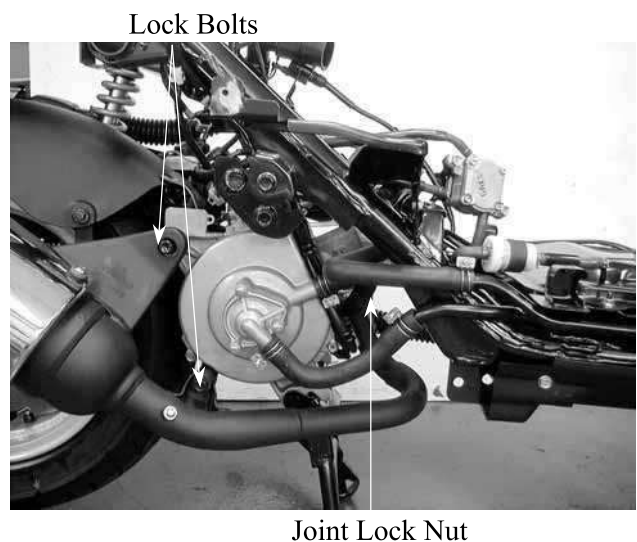

3. INSPECTION/ADJUSTMENT

INSPECTION/ADJUSTMENT

SERVICE INFORMATION-----	3- 1
INSPECTION AND MAINTENANCE SCHEDULE -----	3- 2
FUEL LINE/FUEL FILTER-----	3- 5
THROTTLE OPERATION-----	3- 5
AIR CLEANER -----	3- 6
SPARK PLUG-----	3- 7
IGNITION TIMING-----	3- 7
CYLINDER COMPRESSION -----	3- 8
FINAL REDUCTION GEAR OIL -----	3- 9
DRIVE BELT -----	3- 9
HEADLIGHT AIM -----	3-10
COOLING SYSTEM-----	3-10
BRAKE SYSTEM -----	3-11
NUTS/BOLTS/FASTENERS -----	3-13
WHEELS/TIRES -----	3-13
STEERING HANDLEBAR -----	3-13
SUSPENSION-----	3-13
LUBRICATION SYSTEM-----	3-14

3. INSPECTION/ADJUSTMENT

SERVICE INFORMATION

GENERAL

 WARNING
--

- Before running the engine, make sure that the working area is well-ventilated. Never run the engine in a closed area. The exhaust contains poisonous carbon monoxide gas which may cause death to people.
- Gasoline is extremely flammable and is explosive under some conditions. The working area must be well-ventilated and do not smoke or allow flames or sparks near the working area or fuel storage area.

SPECIFICATIONS

ENGINE

Throttle grip free play : 2~6mm
 Spark plug : NGK: BR8HSA
 Spark plug gap : 0.6~0.7mm
 Idle speed : 2000±100rpm

Lubrication oil capacity:	Cylinder compression : 11.8±2kg/cm ²
At disassembly : 1.1 liter	Ignition timing : BTDC 13.5°±2°/2000rpm
At change : 0.9 liter	Coolant capacity : 1165CC
Gear oil capacity :	Radiator capacity : 825CC
At disassembly : 0.12 liter	Reserve tank capacity : 340CC
At change : 0.09 liter	

CHASSIS

Rear brake free play: 10~20mm

TIRE

	1 Rider	2 Riders
Front	1.75kg/cm ²	2.00kg/cm ²
Rear	2.25kg/cm ²	2.25kg/cm ²

TIRE SPECIFICATION:

Front : 120/70-12 56J
 Rear : 130/70-12 59J

TORQUE VALUES

Front axle nut : 49.0~68.6N-m
 Rear axle nut : 107.8~127.4N-m

3. INSPECTION/ADJUSTMENT

INSPECTION AND MAINTENANCE SCHEDULE

(Note) 1. ○ means time for inspection.

2. ☆ means regular replacement for the specified parts.

This inspection and maintenance schedule is based upon average riding conditions.

Machines subjected to serve use, or ridden in unusually dusty areas, require more frequent servicing.

Inspection & Maintenance Item			Frequency				Judgment Standards	Remarks								
			Preride	1st month	Every 6 months	Every 12 months										
Suspension	Steering handlebar	Check for looseness and vertical play				○										
		Operating performance	○			○										
		Right/left turning angle				○										
	Front Fork	Damage			○	○										
		Check for front fork pivot installation			○	○		Check steering stem								
		Check front fork pivot for looseness and abnormal noise				○		Check steering stem								
Brake System	Brake Lever	Rear brake lever free play			○	○	Free play: 10~20mm									
		Brake lever operation	○													
		Brake performance		○	○	○										
	Lever/Cable	Looseness, abnormal noise and damage		○		○										
	Brake disk/lining(Brake drum/shoe)	Disk-to-lining clearance			○	○										
		Brake disk(shoe) and lining wear				☆										
		Brake drum wear and damage				○	Standard: Rear : 110 mm Service Limits: Rear : 111 mm									
Moving Device	Tire	Tire pressure	○		○	○	<table border="1"> <tr> <td></td> <td>Front</td> <td>Rear</td> </tr> <tr> <td>1 rider</td> <td>1.75 kg/cm²</td> <td>2.25 kg/cm²</td> </tr> <tr> <td>Tire Size</td> <td>120/70-12 56J</td> <td>130/70-12 59J</td> </tr> </table>		Front	Rear	1 rider	1.75 kg/cm ²	2.25 kg/cm ²	Tire Size	120/70-12 56J	130/70-12 59J
	Front	Rear														
1 rider	1.75 kg/cm ²	2.25 kg/cm ²														
Tire Size	120/70-12 56J	130/70-12 59J														

3. INSPECTION/ADJUSTMENT

Inspection & Maintenance Item			Frequency				Judgment Standards	Remarks
			Preride	1st month	Every 6 months	Every 12 months		
Moving Device	Motor-cycle	Tire crack and damage	<input type="radio"/>		<input type="radio"/>	<input type="radio"/>		
		Tire groove and abnormal wear	<input type="radio"/>		<input type="radio"/>	<input type="radio"/>	Groove Depth: Front: 0.8mm Rear : 0.8mm	
		Imbedded objects, gravel, etc.	<input type="radio"/>		<input type="radio"/>	<input type="radio"/>		
		Axle nut looseness			<input type="radio"/>	<input type="radio"/>	Torque Values: Front axle nut 49.0~68.6N-m Rear axle nut 107.8~127.4N-m	Axle nut torque
		Check wheel rim, rim edge and spoke plate for damage		<input type="radio"/>		<input type="radio"/>	Rim runout at rim end: Front: Axial 2.0mm Radial 2.0mm Rear: Axial 2.0mm Radial 2.0mm	
		Check front wheel bearing for excessive play and abnormal noise				<input type="radio"/>		
		Check front wheel bearing for excessive play and abnormal noise				<input type="radio"/>		
Damping Device	Frame Spring	Damage					Shock spring free length	
	Suspension arm	Connecting parts looseness and arm damage				<input type="radio"/>		
	Shock absorber	Oil leakage and damage				<input type="radio"/>		
		Assembly parts looseness abnormal noise				<input type="radio"/>		
Power Drive System	Clutch	Operation		<input type="radio"/>	<input type="radio"/>	<input type="radio"/>		
	Transmission case	Oil leakage and oil level			<input type="radio"/>	<input type="radio"/>	Oil level: Oil check bolt hole at lower hole edge	Rear wheel transmission case
Electrical Equipment	Ignition device	Spark plug condition			<input type="radio"/>	<input type="radio"/>	Plug gap: 0.6~0.7mm	
	Battery	Terminal connection				<input type="radio"/>		
	Wires	Loose connection and damage				<input type="radio"/>		

3. INSPECTION/ADJUSTMENT

Inspection & Maintenance Item			Frequency				Judgment Standards	Remarks
			Preride	1st month	Every 6 months	Every 12 months		
Engine	Body	Performance and abnormal noise			○	○		
		Conditions at low and high speeds		○	○	○		
		Exhaust smoke			○	○		
		Air cleaner			○	○		
	Lubrication system	Oil quality and quantity			○	○	<input type="checkbox"/> Oil level indicator Indicator light comes on when oil is insufficient	
		Oil leakage			○	○		
		Oil level	○					
		Check oil filter for clogging				○		
	Fuel System	Fuel leakage						
		Carburetor, throttle valve and auto bystarter				○		
		Check fuel filter for clogging				○		
		Fuel level	○					
		Fuel tube replacement					☆Every 4 years	
	Lights & Winker	Operation						
Winking action, dirt and damage		○						
Buzzer & Steering Lock	Operation				○			
Rearview Mirror & Reflector	Rearview mirror position	○					Rearview Mirror	
Reflector & License Plate	Dirt and damage	○						
Counter	Operation				○			
Exhaust Muffler	Joint looseness and damage				○			
	Exhaust muffler performance				○			
Body & Frame	Looseness and damage				○			
Abnormal Conditions Happened Last Time	Check if the abnormal conditions occur again	○						
Others	Lubrication points			○	○			
	Remove carbon deposits on combustion chamber, breather hole and exhaust muffler				○			

3. INSPECTION/ADJUSTMENT

FUEL LINE/FUEL FILTER

Remove the center cover.

Check the fuel lines and replace any parts which show signs of deterioration, damage or leakage.

Check for dirty or clogged fuel filter and replace with a new one if it is clogged.

- * Do not smoke or allow flames or sparks in your working area.

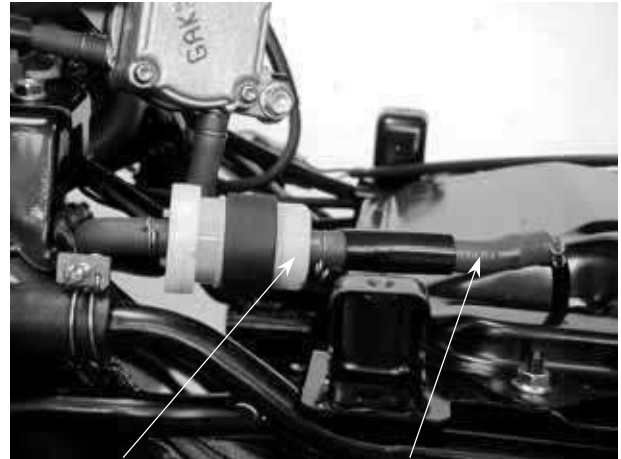

Fuel Filter

Fuel Line

THROTTLE OPERATION

Check the throttle grip for smooth movement.
Measure the throttle grip free play.

Free Play: 2~6mm



Major adjustment of the throttle grip free play is made with the adjusting nut at the carburetor side. Adjust by loosening the lock nut and turning the adjusting nut.

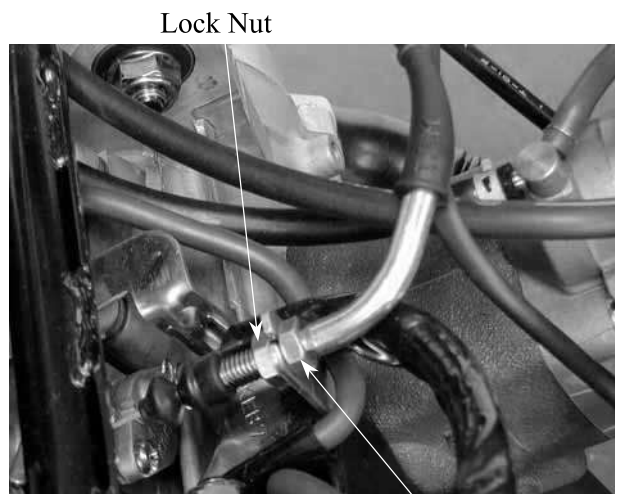

Lock Nut

Adjusting Nut

3. INSPECTION/ADJUSTMENT

Minor adjustment is made with the adjusting nut at the throttle grip side. Slide the rubber cover out and adjust by loosening the lock nut and turning the adjusting nut.

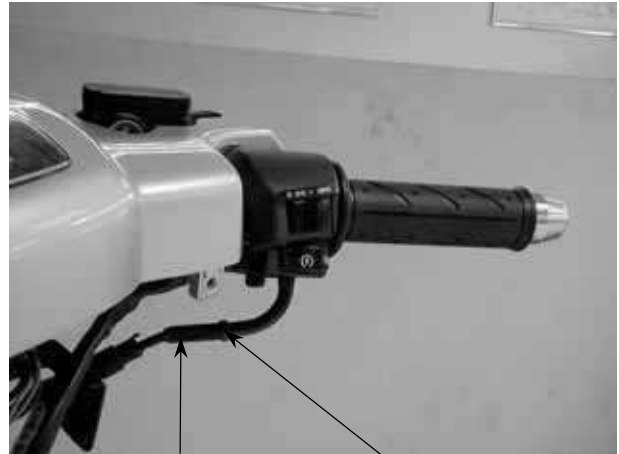

Adjusting Nut

Lock Nut

AIR CLEANER

Remove the seven air cleaner case cover screws and the cover.

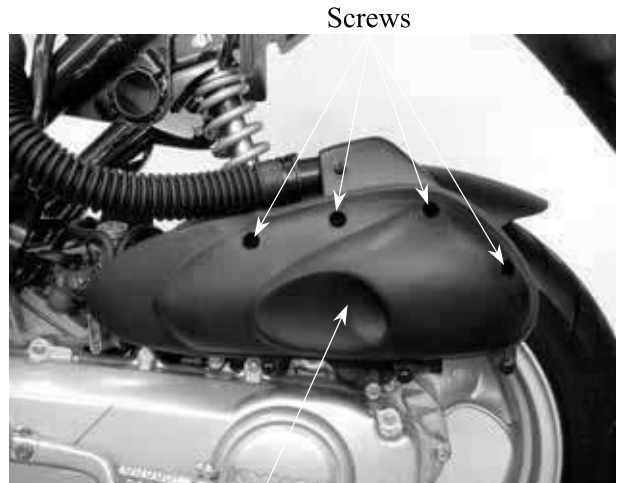

Screws

Air Cleaner Case Cover

Remove the air cleaner element. Check the element and replace it if it is excessively dirty or damaged.

CHANGE INTERVAL

More frequent replacement is required when riding in unusually dusty or rainy areas.

- * • The air cleaner element has a viscous type paper element. Do not clean it with compressed air.
- Be sure to install the air cleaner element and cover securely.



Air Cleaner Element

3. INSPECTION/ADJUSTMENT

SPARK PLUG

Remove the frame center cover.
Remove the spark plug cap and spark plug.
Check the spark plug for wear and fouling deposits.
Clean any fouling deposits with a spark plug cleaner or a wire brush.

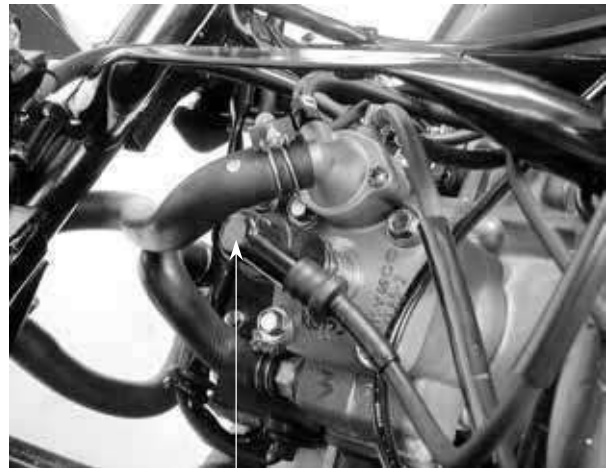

Spark Plug

Specified Spark Plug: NGK: BR8HSA

Measure the spark plug gap.

Spark Plug Gap: 0.6~0.7mm

- * • When installing, first screw in the spark plug by hand and then tighten it with a spark plug wrench.

Torque: 7.8~9.8N-m

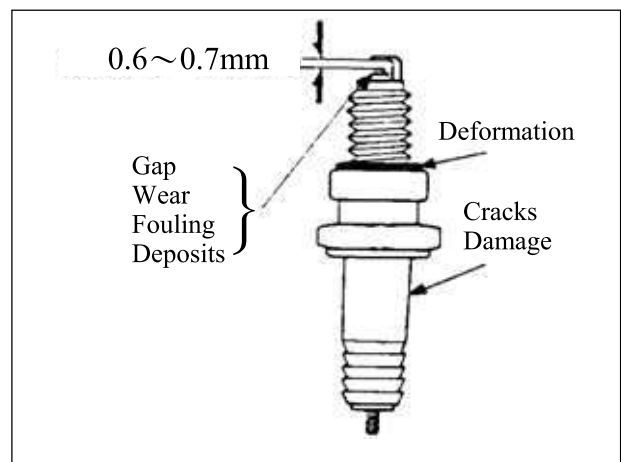

IGNITION TIMING

- * • The CDI unit is not adjustable.
• If the ignition timing is incorrect, check the ignition system,

Remove the two timing cap bolts and the timing cap.



3. INSPECTION/ADJUSTMENT

Check the ignition timing with a timing light. When the engine is running at the specified idle speed, the ignition timing is correct if the "F" mark on the flywheel aligns with the index mark on the crankcase cover. Also use a timing light to check the advance. Raise the engine speed to 4,000rpm. The index mark should be between the advance marks.



Timing Light

CYLINDER COMPRESSION

Warm up the engine before compression test. Remove the center cover and spark plug cap. Remove the spark plug . Insert a compression gauge. Open the throttle valve fully and push the starter button to test the compression.

Compression: $11.8 \pm 2 \text{kg/cm}^2$

If the compression is low, check for the following:

- Leaky valves
- Valve clearance too small
- Leaking cylinder head gasket
- Worn pistons
- Worn piston/cylinder

If the compression is high, it indicates that carbon deposits have accumulated on the combustion chamber and the piston head.



Compression Gauge

3. INSPECTION/ADJUSTMENT

FINAL REDUCTION GEAR OIL

- * Place the motorcycle on its main stand on level ground.

Stop the engine and remove the oil check bolt.
 The oil level shall be at the oil check bolt hole.
 If the oil level is low, add the recommended oil SAE90# to the proper level.

Install the oil check bolt.

- * Make sure that the sealing washer is in good condition.

Oil Check Bolt Hole/Oil Filler



OIL CHANGE

Remove the oil check bolt.
 Remove the oil drain bolt and drain the oil thoroughly.
 Install the oil drain bolt.
Torque: 9.8N-m

- * Make sure that the sealing washer is in good condition.

Fill the final reduction with the recommended oil SAE90#.

Gear Oil Capacity:

- At disassembly : 120 cc
- At change : 90 cc

Reinstall the oil check bolt and check for oil leaks.



Oil Drain Bolt/Sealing Washer

DRIVE BELT

Remove the left crankcase cover.
 Inspect the drive belt for cracks or excessive wear.
 Replace the drive belt with a new one if necessary and in accordance with the Maintenance Schedule.

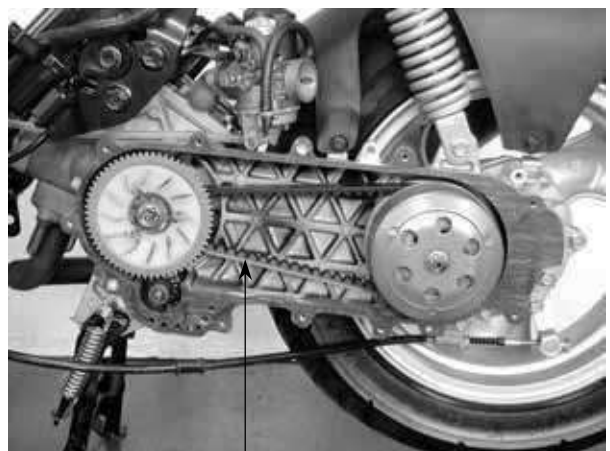

Drive Belt

3. INSPECTION/ADJUSTMENT

HEADLIGHT AIM

Turn the ignition switch ON.
Turn on the headlight switch.
Adjust the headlight aim by turning the headlight aim adjusting bolt.



Headlight Aim Adjusting Bolt

COOLING SYSTEM

COOLANT LEVEL INSPECTION

Place the motorcycle on its main stand on level ground.

Check the coolant level of the reserve tank and the level should be between the upper and lower level lines.

If necessary, fill the reserve tank with recommended coolant to the "F" level line.

Recommended Coolant: SIGMA Coolant
(Standard Concentration 30%)

- * • The coolant level does not change no matter the engine is warm or cold. Fill to the "F" (upper) line.

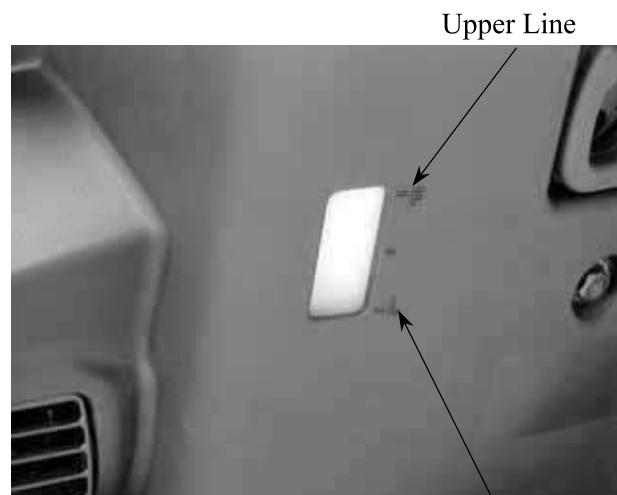

Lower Line

COOLANT REPLACEMENT

- * • Perform this operation when the engine is cold.

Remove the front cover.

Remove the radiator cap.

Remove the drain hoses to drain the coolant and tilt the motorcycle to the right and the coolant will drain more easily.

Drain the coolant in the reserve tank.

Reinstall the drain hoses.

Fill the radiator with the specified coolant.

- * • The coolant freezing point should be 5 °C lower than the temperature of the riding area.



Radiator Tank

3. INSPECTION/ADJUSTMENT

Start the engine and check if there is no bubbles in the coolant and the coolant level is stable. Reinstall the radiator cap.
 If there are bubbles in the coolant, bleed air from the system.
 Fill the reserve tank with the recommended coolant up to the upper line.



BRAKE SYSTEM

BRAKE LEVER

Measure the rear brake lever free plays.

Free Play: 10~20mm



If the free plays do not fall within the limits, turn the right and left adjusting nuts for adjustment.



“△” Marks <Rear>

Adjusting Nuts

3. INSPECTION/ADJUSTMENT

BRAKE FLUID

Turn the steering handlebar upright and check if the front/rear brake fluid level is at the upper limit. If the brake fluid is insufficient, fill to the upper limit.

Specified Brake Fluid: DOT-4

- * • The brake fluid level will decrease if the brake pads are worn.

Front Brake Reservoir



BRAKE DISK/BRAKE PAD

Check the brake disk surface for scratches, unevenness or abnormal wear. Check if the brake disk runout is within the specified service limit. Check if the brake pad wear exceeds the wear indicator line.

- * • Keep grease or oil off the brake disk to avoid brake failure.

Wear Indicator Line



Brake Disk

BRAKE DRUM/SHOE

《 Brake Shoe Wear 》

Replace the brake shoes if the arrow on the brake arm aligns with reference mark“△” on the brake panel when the brake is fully applied.

《 Brake Drum Wear/Damage 》

Check the brake drum appearance for damage. Check if the brake lining wear is within the specified service limit.

Check the brake operation for abnormal noise and brake drum inside for wear or damage.

“△” Marks <Rear>



Adjusting Nuts

3. INSPECTION/ADJUSTMENT

NUTS/BOLTS/FASTENERS

Check all important chassis nuts and bolts for looseness.
Tighten them to their specified torque values if any looseness is found.

WHEELS/TIRES

Check the tires for cuts, imbedded nails or other damages.
Check the tire pressure.

- * • Tire pressure should be checked when tires are cold.

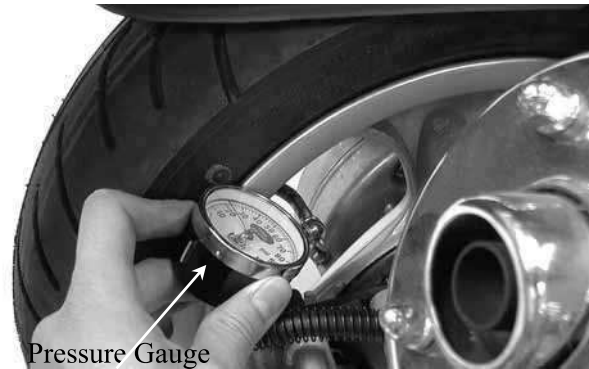

Tire Pressure

	1 Rider	2 Riders
Front	1.75kg/cm ²	2.00kg/cm ²
Rear	2.25kg/cm ²	2.25kg/cm ²

STEERING HANDLEBAR

Raise the front wheel off the ground and check that the steering handlebar rotates freely.
If the handlebar moves unevenly, binds, or has vertical movement, adjust the steering head bearing.



SUSPENSION

Check the action of the front/rear shock absorbers by compressing them several times. Check the entire shock absorber assembly for oil leaks, looseness or damage.
Jack the rear wheel off the ground and move the rear wheel sideways with force to see if the engine hanger bushings are worn.
Replace the engine hanger bushings if there is any looseness.



3. INSPECTION/ADJUSTMENT

LUBRICATION SYSTEM

《Oil Filter Cleaning》

Disconnect the oil tube at the oil pump side and allow oil to drain into a clean container. Remove the tube clip at the oil tank side and disconnect the oil tube. Remove the oil filter.

Clean the oil filter screen with compressed air. Install the oil filter in the reverse order of removal and fill the oil tank with specified oil up to the proper level. Bleed air from the oil pump and oil lines.

- *
- Connect the oil tubes securely.
 - Install the tube clip at the oil tank side and also install the clip to the lower oil tube that goes to the oil pump.
 - Check for oil leaks.

《Oil Pump Condition》

- * Adjust oil pump control cable after the throttle grip free play is adjusted.

Open the throttle valve fully and check that the index mark on the pump body aligns with the aligning mark on the oil pump control lever.

Reference tip alignment within 1mm of index mark on open side is acceptable.

Start and idle the engine, then slowly open the throttle to increase engine rpm and check the operation of the oil pump control lever.

If adjustment is necessary, adjust the oil pump control cable by loosening the control cable lock nut and turning the adjusting nut. After adjustment, tighten the lock nut.

- * Reference tip alignment within 1mm of index mark on open side is acceptable. However, the aligning mark on the control lever must never be on the closed side of the index mark, otherwise engine damage will occur because of insufficient lubrication.

If the oil pump is not synchronized properly, the following will occur:

- Excessive white smoke or hard starting due to pump control lever excessively open
- Seized piston due to pump control lever insufficiently open

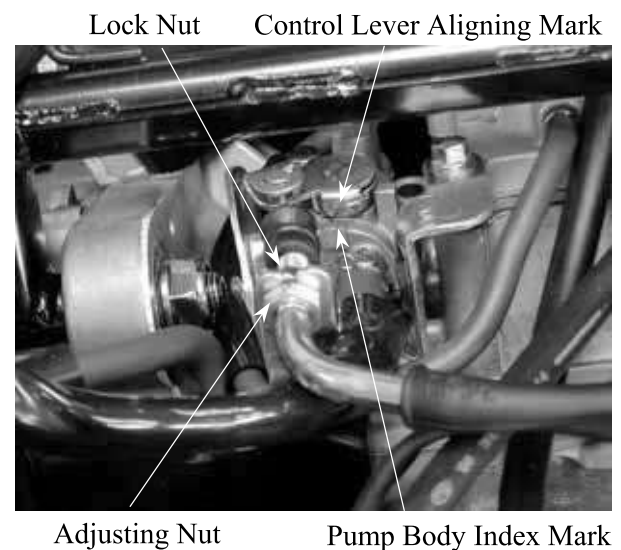
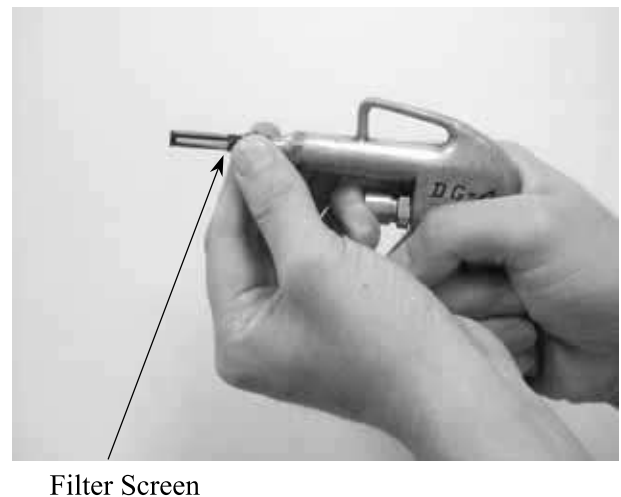
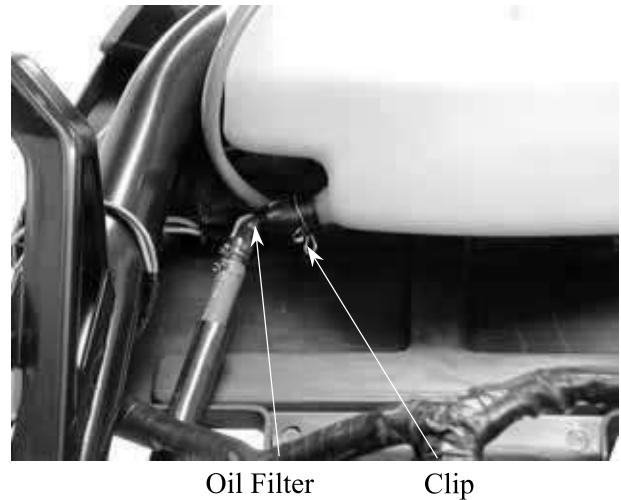

4. LUBRICATION SYSTEM

LUBRICATION SYSTEM

SERVICE INFORMATION	4-1
TROUBLESHOOTING	4-1
OIL PUMP REMOVAL.....	4-2
OIL PUMP INSPECTION	4-2
OIL PUMP INSTALLATION	4-3
OIL PUMP BLEEDING.....	4-4
OIL TANK	4-5

4. LUBRICATION SYSTEM

SERVICE INFORMATION

GENERAL INSTRUCTIONS

- Use care when removing and installing the oil pump not to allow dust and dirt to enter the engine and oil line.
- Do not attempt to disassemble the oil pump.
- Bleed air from the oil pump if there is air between the oil pump and oil line.
- If the oil is disconnected, refill the oil line with motor oil before connecting it.

SPECIFICATIONS

- Recommended Motor Oil: JASO-2TFC 2-stroke Motor Oil
- Oil Capacity : 1.1 liter
Light comes on : 0.3 liter

TROUBLESHOOTING

Excessive white smoke or carbon deposits on spark plug

- Oil pump not properly synchronized (excessive oil)
- Poor quality oil

Engine overheating

- Oil pump not properly adjusted (insufficient oiling)
- Poor quality oil

Seized piston

- No oil in tank or clogged oil line
- Oil pump not properly adjusted (insufficient oiling)
- Air in oil line
- Faulty oil pump

Oil not flowing out of tank to engine

- Clogged oil tank cap breather hole
- Clogged oil filter

4. LUBRICATION SYSTEM

OIL PUMP REMOVAL

Do not allow foreign matters to enter the crankcase. Before removing the oil pump, clean the oil pump and crankcase surfaces.

Remove the met-in box. (⇒2-2)

Disconnect the oil pump control cable from the pump body.
Disconnect the oil inlet line from the oil pump.
Then, disconnect the oil outlet line.

Before disconnecting the oil line, clip the oil line to avoid oil flowing out and then plug the oil line after it is disconnected.

Remove the oil pump control cable plate bolt and copper washer.
Remove the oil pump from the crankcase.

OIL PUMP INSPECTION

Remove the oil pump and inspect the following items:

- Weakened O-ring
- Damage to crankcase mating surface
- Damage to pump body
- Control lever operation
- Oil leaks through oil seals
- Worn or damaged pump pinion

Do not disassemble the oil pump which cannot be used after disassembly.

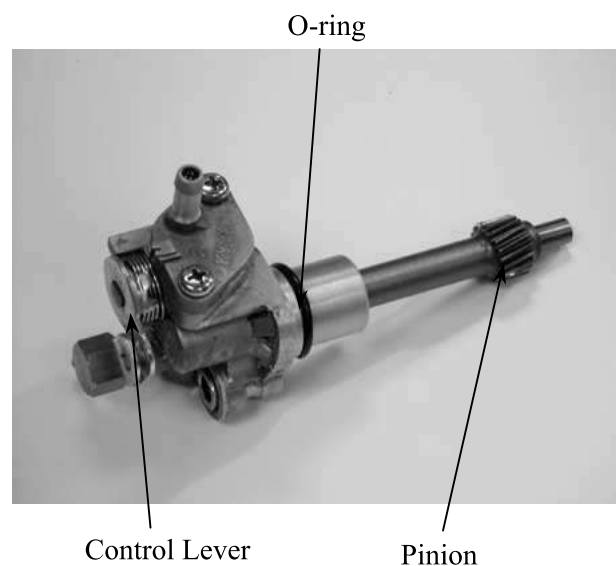
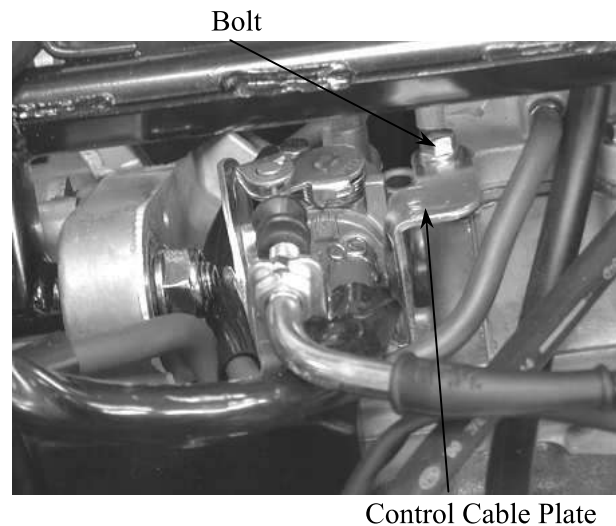
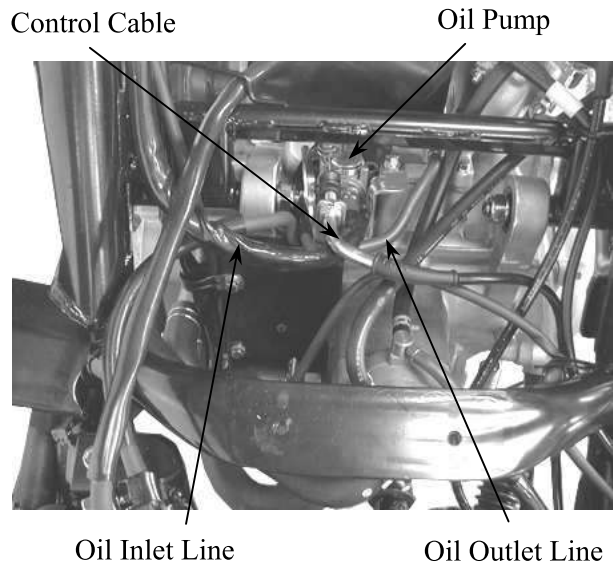

4. LUBRICATION SYSTEM

OIL PUMP INSTALLATION

- Lubricate the O-ring with grease or engine oil before installation.
- Make sure that the oil pump is inserted into the crankcase.
- Apply molybdenum disulfide or grease to the pump pinion.



Grease or Engine Oil

Install the oil pump onto the crankcase.

Control Cable Plate

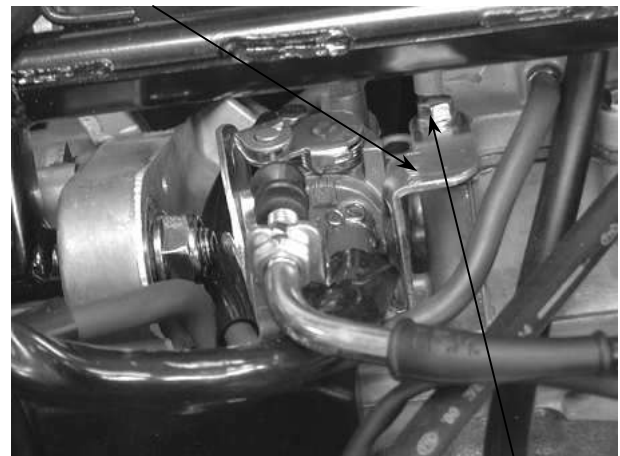

Bolt

Install the oil pump control cable plate.
Connect the oil inlet line and oil outlet line properly.
Connect the oil pump control cable.
Bleed air from the oil pump.

Control Cable

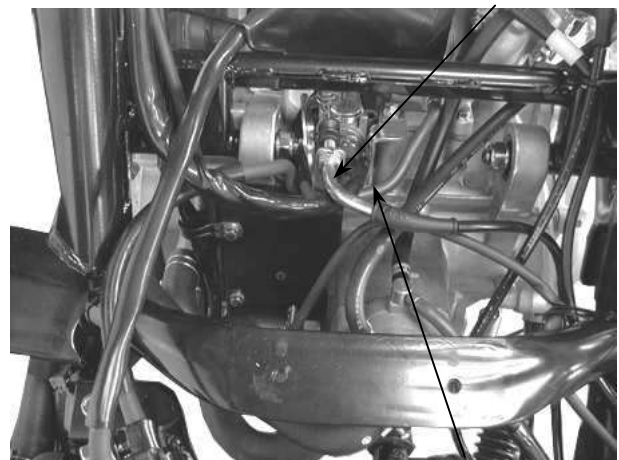

Oil Outlet Line

4. LUBRICATION SYSTEM

OIL PUMP BLEEDING

- Air in the oil lines will block oil flow and result in severe engine damage.
- Bleed air from the oil lines and oil pump whenever the oil lines or pump have been removed or there is air in the oil lines.

Oil Pump Oil Outlet Line



Intake Manifold

OIL INLET LINE/OIL PUMP BLEEDING

Fill the oil tank with recommended oil.
 Place a shop towel around the oil pump.
 Disconnect the oil inlet line from the oil pump and clip it.
 Fill the oil pump with oil by squirting clean oil through the joint. (About 3cc)
 Fill the oil line with oil and connect it to the oil pump.

- Bleed air from the oil inlet line first, then bleed air from the oil outlet line.

OIL OUTLET LINE BLEEDING

1. Disconnect the oil outlet line and bend it into U shape. Force air out of the tube by filling it with oil.
2. Start the engine and allow it to idle with the oil control lever in the fully open position. Visually check the oil flow.
3. If there is no oil flowing out within 1 minute, bleed air from the oil inlet line and oil pump.

- Never run the engine in a closed area.
- Do not increase the engine speed at will.

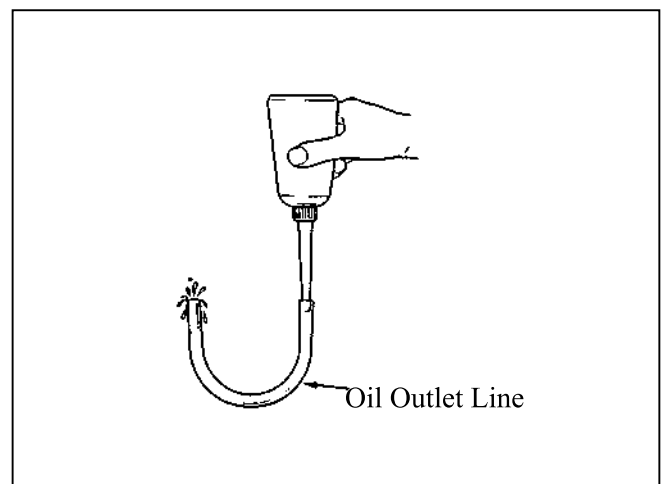

Oil Tube

4. LUBRICATION SYSTEM

OIL TANK

OIL TANK REMOVAL

Remove the seat and met-in box. (⇒2-2)
 Remove the battery.
 Remove the battery cover screw and the battery cover.
 Remove the oil meter connector.
 Remove the two bolts attaching the oil tank.
 Disconnect the oil inlet line.
 Drain the oil inside the oil tank into a clean container.
 Remove the oil tank.
 The installation sequence is the reverse of removal.

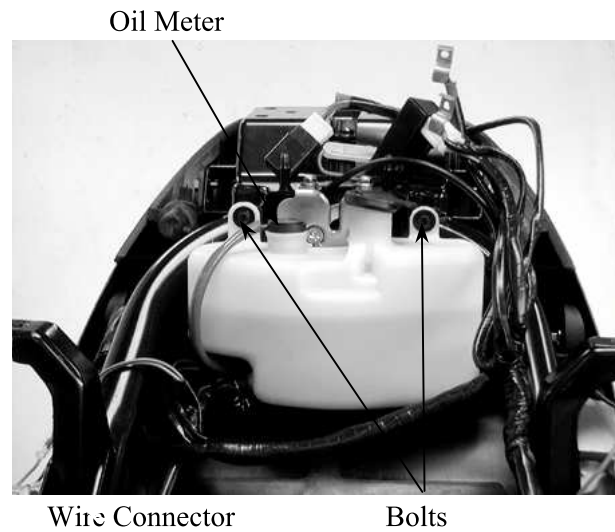

- •
- Connect the oil line properly.
 - Bleed air from the oil pump after installation.
 - The oil tube clip (at the oil tank side) must be locked from inside of the oil tube joint.

5. ENGINE REMOVAL/INSTALLATION

5

ENGINE REMOVAL/INSTALLATION

SERVICE INFORMATION	5-1
ENGINE REMOVAL	5-2
ENGINE INSTALLATION	5-4

5. ENGINE REMOVAL/INSTALLATION

SERVICE INFORMATION

GENERAL INSTRUCTIONS

- Parts requiring engine removal for servicing:
 - Crankcase
 - Crankshaft

TORQUE VALUES

Engine mounting bolt	44.1 ~ 53.9N-m
Engine hanger bracket bolt	44.1 ~ 53.9N-m
Rear shock absorber lower mount bolt	23.5 ~ 29.4N-m
Rear shock absorber upper mount bolt	34.3 ~ 44.1N-m

5. ENGINE REMOVAL/INSTALLATION

ENGINE REMOVAL

Remove the frame body cover. (⇒2-2)
 Remove the two bolts attaching the air cleaner case.
 Loosen the band between the air cleaner and carburetor to remove the air cleaner case.
 Remove the carburetor cap.

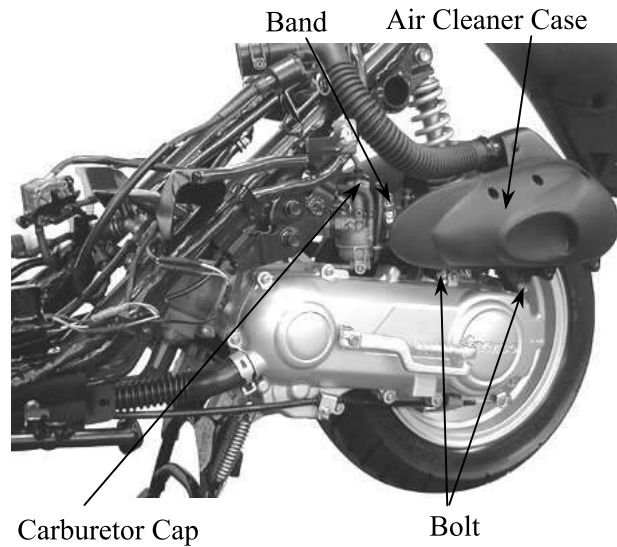

Disconnect the oil pump control cable from the pump body.
 Disconnect the oil inlet line from the oil pump.

* After the oil inlet line is disconnected, plug the oil line opening to prevent oil from flowing out.

Disconnect the auto bystarter, A.C. generator, thermosensor wire couplers and starter motor wire connectors.
 Disconnect the fuel tube and vacuum tube that go to the carburetor from the fuel strainer.

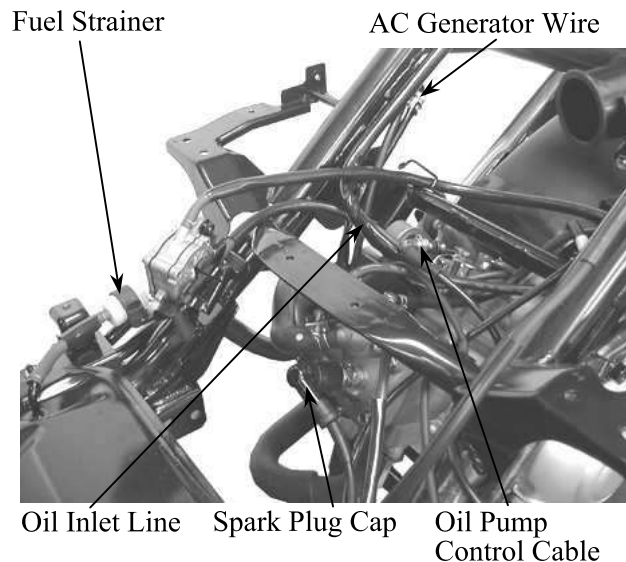

Remove the spark plug cap.
 Drain the coolant. (⇒3-10)
 Disconnect the water hose.

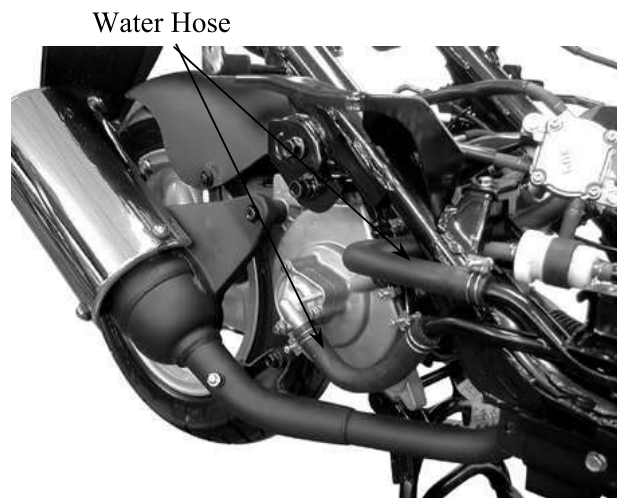

5. ENGINE REMOVAL/INSTALLATION

Remove the rear brake adjusting nut and disconnect the brake cable from the crankcase.
 Remove the rear brake cable clamp and rear brake cable.
 Remove the cooling tube band on the left crankcase cover and disconnect the cooling tube.
 Remove the rear shock absorber lower mount bolt.

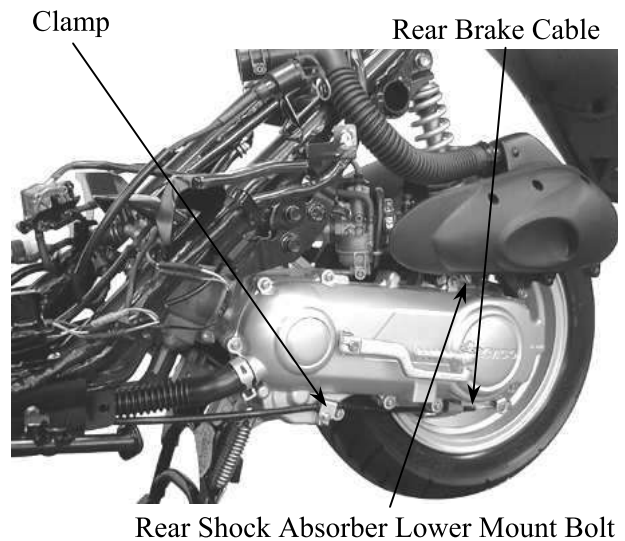

Remove the right and left engine mounting nuts.
 Take out the right and left engine mounting bolts.
 Lift the frame upward to separate it from the engine and be careful not to damage.

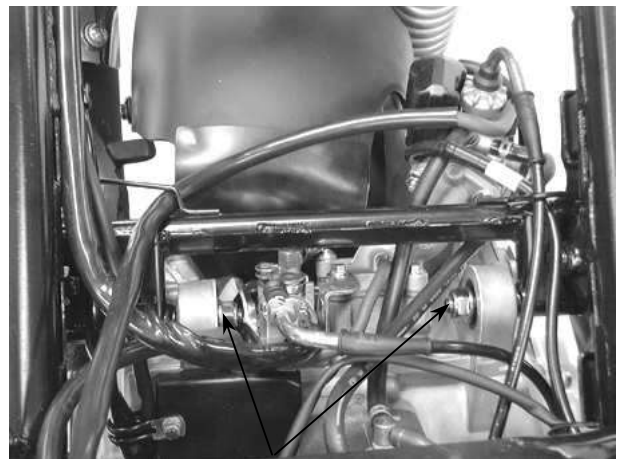

ENGINE HANGER BRACKET REMOVAL

Remove the engine hanger bracket bolt and engine hanger bracket.
 The installation sequence is the reverse of removal.

Torque:44.1 ~ 53.9N·m

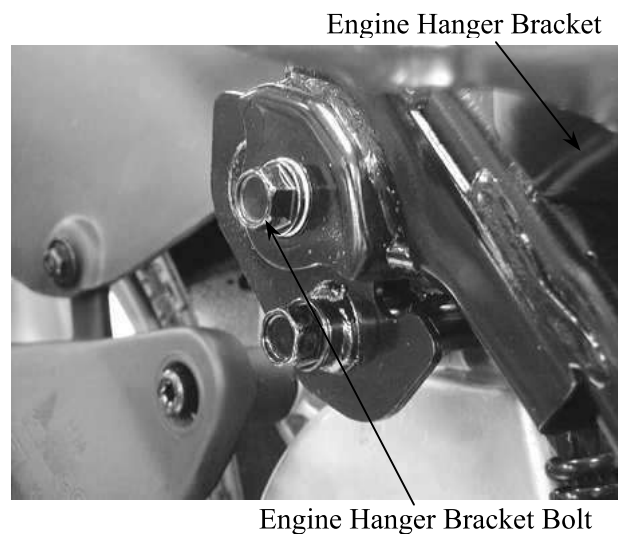

5. ENGINE REMOVAL/INSTALLATION

ENGINE HANGER BRACKET INSPECTION

Inspect the stopper rubbers and bushings for damage and replace with new ones if necessary.

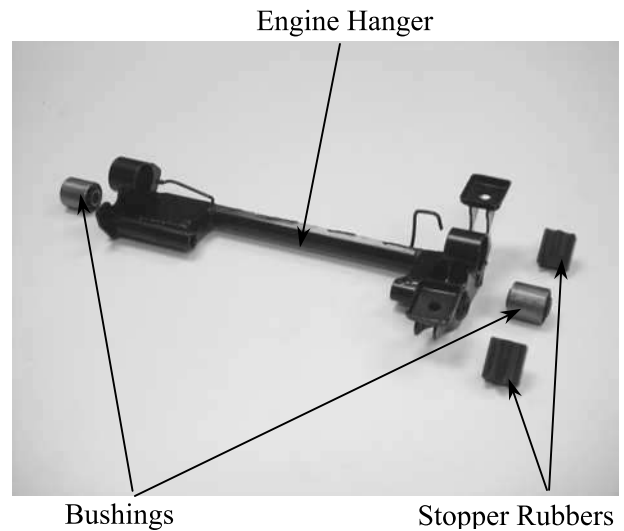

ENGINE INSTALLATION

Install the engine in the reverse order of removal.

Cables and wires should be routed properly.

Torque Values:

Engine mounting bolt : 44.1 ~ 53.9N-m

Rear shock absorber lower mount bolt:
23.5 ~ 29.4N-m



Perform the following inspections and adjustments after installation.

- Throttle cable
- Oil pump control cable (⇒4-2)
- Rear brake system (⇒3-11)
- Oil pump bleeding (⇒4-4)



6. CYLINDER HEAD/CYLINDER/PISTON



CYLINDER HEAD/CYLINDER/PISTON



SERVICE INFORMATION 6-1
TROUBLESHOOTING 6-1
CYLINDER HEAD 6-2
CYLINDER/PISTON 6-4

6. CYLINDER HEAD/CYLINDER/PISTON

SERVICE INFORMATION

GENERAL INSTRUCTIONS

- The cylinder head, cylinder and piston can be serviced with the engine installed in the frame.
- Before disassembly, clean the engine to prevent dust from entering the engine.
- Remove all gasket material from the mating surfaces.
- Do not use a driver to pry between the cylinder and cylinder head, cylinder and crankcase.
- Do not damage the cylinder inside and the piston surface.
- After disassembly, clean the removed parts before inspection. When assembling, apply the specified engine oil to movable parts.

SPECIFICATIONS

Item	Standard (mm)	Service Limit (mm)
	B&W50	B&W50
Cylinder head warpage	—	0.10
Piston O.D.(5mm from bottom of piston)	38.970~38.955	38.90
Cylinder-to- piston clearance	0.03~0.07	0.10
Piston pin hole I.D.	12.002~12.008	12.03
Piston pin O.D.	11.994~12.0	11.98
Piston-to-piston pin clearance	0.002~0.014	0.03
Piston ring end gap (top/second)	0.10~0.25	0.40
Connecting rod small end I.D.	17.005~17.017	17.03
Cylinder bore	39.0~39.025	39.05

TORQUE VALUES

Cylinder head bolt	14.7~16.66N-m
Exhaust muffler joint lock nut	9.8~13.72N-m
Exhaust muffler lock bolt	29.4~35.28N-m
Spark plug	10.78~16.66N-m

TROUBLESHOOTING

Compression too low, hard starting or poor performance at low speed

- Leaking cylinder head gasket
- Loose spark plug
- Worn, stuck or broken piston and piston rings
- Worn or damaged cylinder and piston

Compression too high, overheating or knocking

- Excessive carbon build-up in cylinder head or on piston head

Abnormal noisy piston

- Worn cylinder and piston
- Worn piston pin or piston pin hole
- Worn connecting rod small end bearing

Abnormal noisy piston rings

- Worn, stuck or broken piston rings
- Worn or damaged cylinder

6. CYLINDER HEAD/CYLINDER/PISTON

CYLINDER HEAD

REMOVAL

Remove the rear carrier.
 Remove the frame body cover. (⇒2-2)
 Drain the coolant.
 Disconnect the thermosensor wire from the thermosensor.
 Disconnect the water hose from the thermostat housing.

Spark Plug Cap

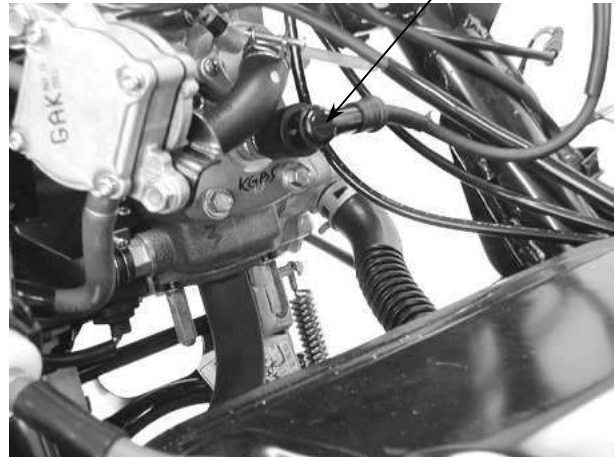

Remove the spark plug cap.
 Remove the two joint lock nuts on the front of the exhaust muffler and then remove the two exhaust muffler lock bolts.
 The installation sequence is the reverse of removal.

* When installing the exhaust muffler, first tighten the two nuts on the front and then tighten the two bolts.

Exhaust muffler joint lock nut

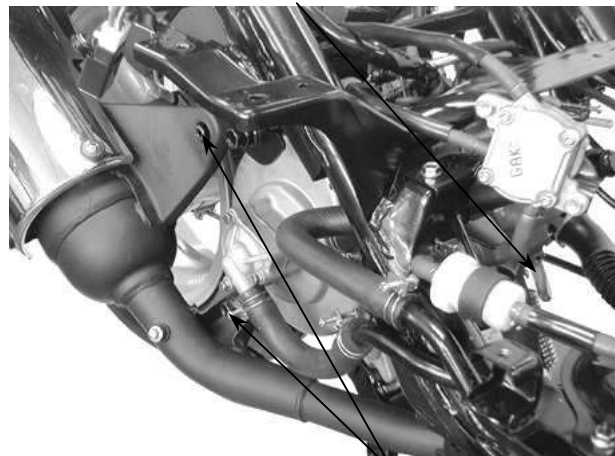

Bolts

Remove the spark plug.
 Remove the cylinder head bolts and the cylinder head.

* Loosen the bolts diagonally in 2 or 3 times.

Cylinder head Bolts

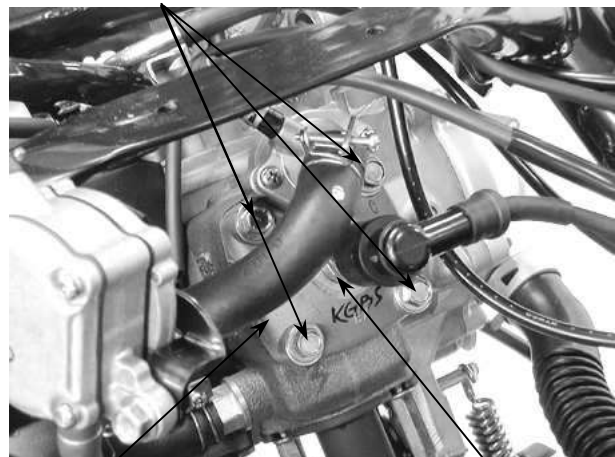

Cylinder Head

Spark Plug

Remove the cylinder head gasket.

6. CYLINDER HEAD/CYLINDER/PISTON

COMBUSTION CHAMBER DECARBONIZING

Remove the carbon deposits from the combustion chamber

- * Avoid damaging the combustion chamber wall and cylinder mating surface.

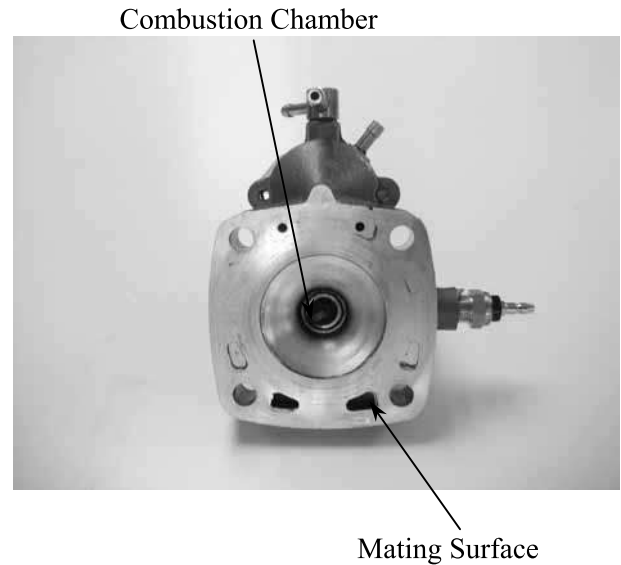

CYLINDER HEAD INSPECTION

Check the cylinder head for warpage with a straight edge and feeler gauge.

Service Limit: 0.10mm replace if over

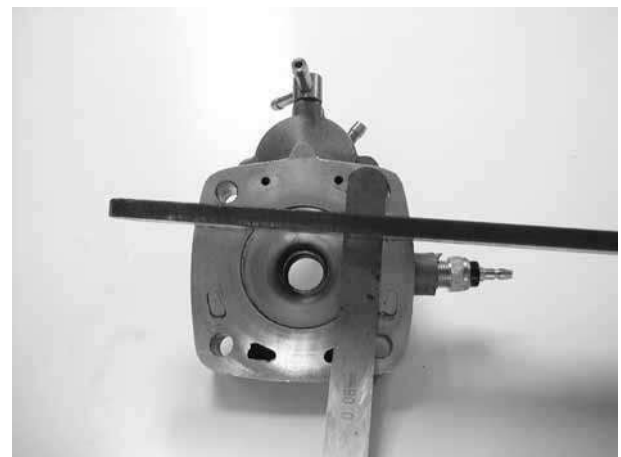

CYLINDER HEAD INSTALLATION

Install the cylinder head on the cylinder properly.

- * Be careful not to damage the mating surfaces.

Install a new cylinder head gasket onto the cylinder.



6. CYLINDER HEAD/CYLINDER/PISTON

Cylinder Head Bolts Installation

Install and tighten the cylinder head bolts diagonally in 2 or 3 times.

Torque: 14.7~16.66N-m

Install the spark plug.

Torque: 10.78~16.66N-m

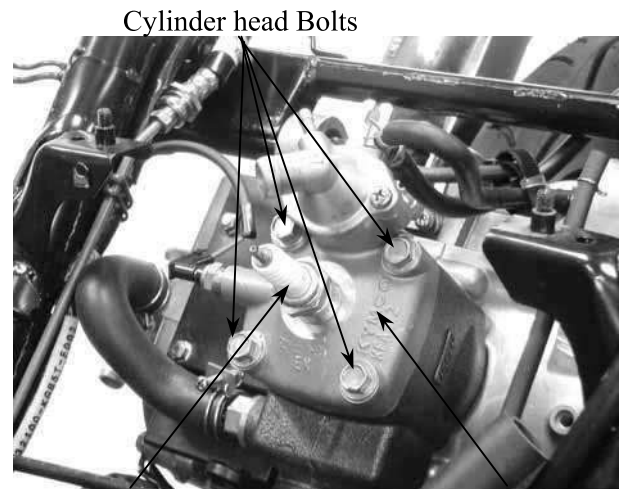

Spark Plug

Cylinder Head

CYLINDER/PISTON

CYLINDER REMOVAL

Remove the met-in box and seat.
 Remove the frame body cover.
 Remove the cylinder head. (6-3)
 Remove the two exhaust muffler joint lock nuts and two exhaust muffler lock bolts.
 Remove the exhaust muffler.
 Remove the cylinder.
 Remove the cylinder gasket.

* Do not pry between the cylinder and crankcase or strike the fins.

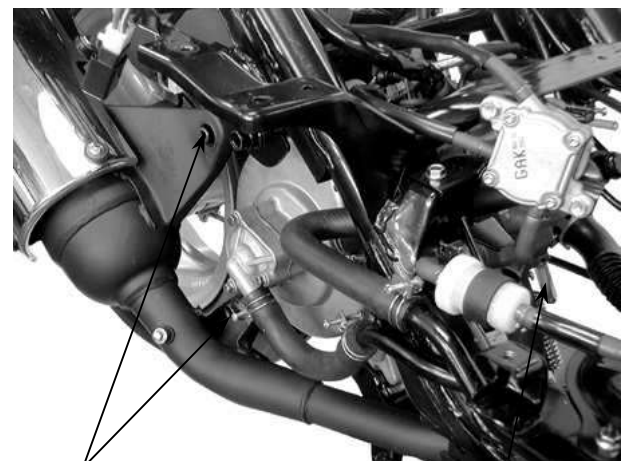

Exhaust Muffler Lock Bolts

Joint Lock Nuts

PISTON REMOVAL

Remove the piston pin clip to remove the piston pin and piston.

*

- Do not damage or scratch the piston.
- Do not apply side force to the connecting rod when removing the piston pin.
- Place clean shop towels in the crankcase to keep the piston pin clip from falling into the crankcase.

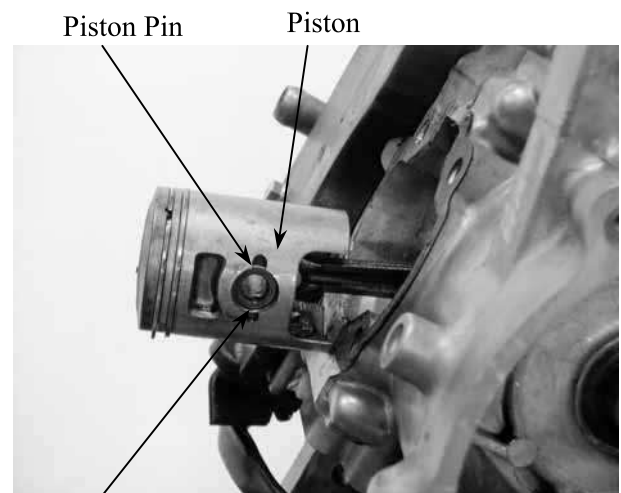

Piston Pin Clip

6. CYLINDER HEAD/CYLINDER/PISTON

Spread each piston ring and remove by lifting it up at a point just opposite the gap. Remove the expander.



CYLINDER/PISTON INSPECTION

Check the cylinder and piston for wear or damage.
Clean carbon deposits from the exhaust port area.

* Be careful not to damage the cylinder inside wall.



Measure the cylinder bore at three levels of A, B and C in both X and Y directions. Avoid the port area. Take the maximum figure measured to determine the cylinder bore.

Service Limit: 39.05mm replace if over

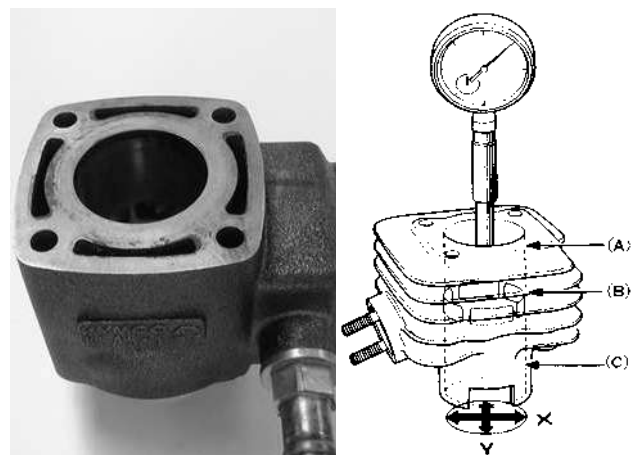

6. CYLINDER HEAD/CYLINDER/PISTON

Inspect the top of the cylinder for warpage.

Service Limit: 0.10mm replace if over



*

The cylinder has an A mark or no mark on it. When replacing the cylinder with a new one, use a cylinder having the same mark as the old one.



A Mark

Measure the piston O.D. at a point 5mm from the bottom of the piston skirt.

Service Limit: 38.90mm replace if below

Measure the piston-to-cylinder clearance.

Service Limit: 0.10mm replace if over



6. CYLINDER HEAD/CYLINDER/PISTON

Measure the piston pin hole I.D.

Service Limit: 12.03mm replace if over

Measure the piston pin O.D.

Service Limit: 11.98mm replace if below

Measure the piston-to-piston pin clearance.

Service Limit: 0.03mm replace if over

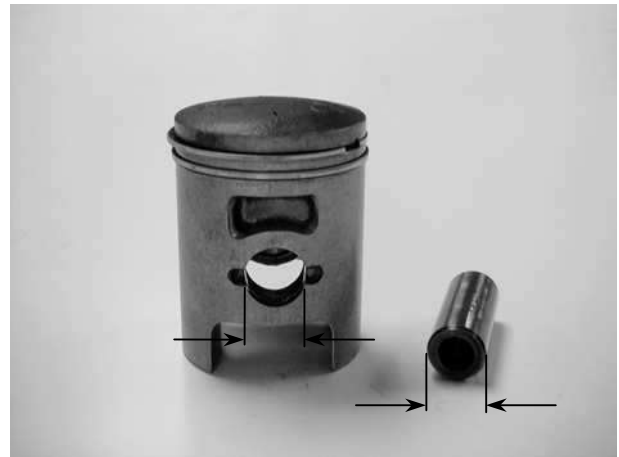

PISTON RING INSPECTION

Measure each piston ring end gap.

Service Limits: Top/Second
0.40mm replace if over

* Set each piston ring squarely into the cylinder using the piston and measure the end gap.

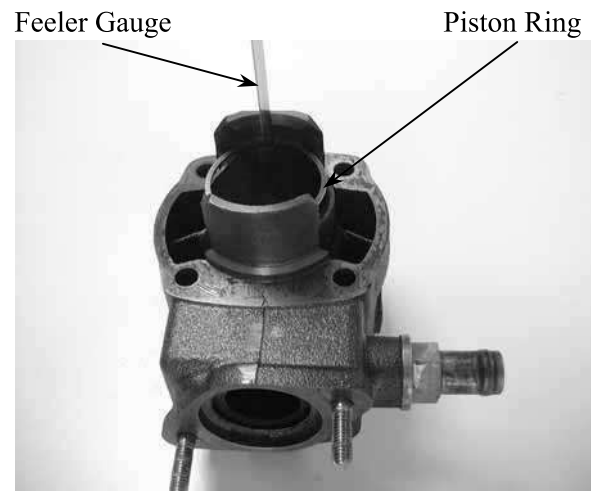

CONNECTING ROD SMALL END INSPECTION

Install the piston pin and bearing in the connecting rod small end and check for excessive play.

Measure the connecting rod small end I.D.

Service Limit: 17.03mm replace if over



6. CYLINDER HEAD/CYLINDER/PISTON

PISTON/CYLINDER INSTALLATION

First install the expander in the second ring groove.

Then install the top and second rings in their respective ring grooves.

The piston rings should be pressed into the grooves with even force.

After installation, check and make sure that each ring is flush with the piston at several points around the ring.

A ring that will not compress means that the ring groove has carbon deposits in it and should be cleaned.

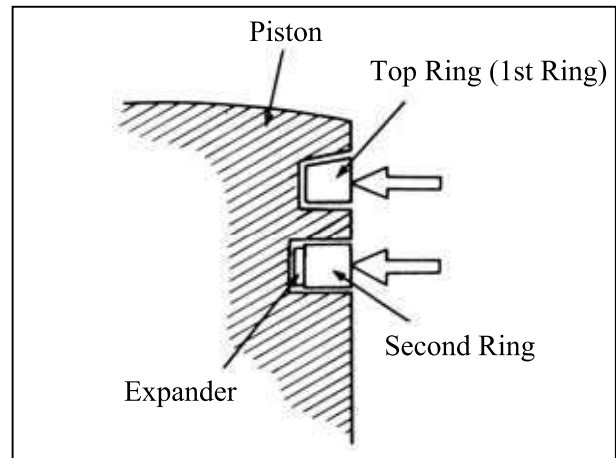

Install a new cylinder gasket on the mating surface between the cylinder and crankcase.



Make sure that the ring end gaps are aligned with the piston ring pins in the ring grooves.

Lubricate the cylinder inside and piston rings with engine oil and install the piston into the cylinder while compressing the piston rings.

* Be careful not to damage the piston.

Install the cylinder head.

Torque: 14.7~16.66N-m

Install the exhaust muffler and tighten the exhaust muffler joint lock nuts.

Torque: 9.8~13.72N-m

Tighten the exhaust muffler lock bolts.

Torque: 29.4~35.28N-m

Install the frame covers.



**KICK STARTER/DRIVE PULLEY/
CLUTCH/DRIVEN PULLEY**



SERVICE INFORMATION 7- 1
TROUBLESHOOTING 7- 1
KICK STARTER..... 7- 2
DRIVE BELT 7- 6
DRIVE PULLEY 7- 8
STARTER PINION 7-10
CLUTCH/DRIVEN PULLEY..... 7-11

7. KICK STARTER/DRIVE PULLEY/ CLUTCH/DRIVEN PULLEY



Bet & Win 50

SERVICE INFORMATION

GENERAL INSTRUCTIONS

- Avoid getting grease and oil on the drive belt and pulley faces.

SPECIFICATIONS	Standard (mm)		Service Limit (mm)	
	Item	B&W50	B&W50	
Drive pulley collar O.D.	20.01~20.025	19.97		
Movable drive face I.D.	20.035~20.085	20.21		
Weight roller O.D.	13.0	12.4		
Clutch outer I.D.	107~107.2	107.5		
Driven face spring free length	87.9	82.6		
Driven face O.D.	33.965~33.985	33.94		
Movable driven face I.D.	34.0~34.025	34.06		
Drive belt width	18	17		

TORQUE VALUES

Drive face nut	34.3~39.2N-m
Clutch outer nut	34.3~44.1N-m
Clutch drive plate nut	49.0~58.8N-m

SPECIAL TOOLS

Lock nut wrench, 28mm	Universal holder
Clutch spring compressor	Lock nut socket wrench, 32mm
Bearing outer driver 37x40mm	Bearing driver pilot, 17mm
One-way clutch puller	Outer driver, 24x26mm

TROUBLESHOOTING

Engine starts but motorcycle won't move

- Worn drive belt
- Broken ramp plate
- Worn or damaged clutch lining

Poor performance at high speed or lack of power

- Worn drive belt
- Weak driven face spring
- Worn weight roller
- Faulty driven face

Engine stalls or motorcycle creeps

- Broken clutch weight spring

7. KICK STARTER/DRIVE PULLEY/ CLUTCH/DRIVEN PULLEY

KICK STARTER

LEFT CRANKCASE COVER REMOVAL

Remove the drive belt cooling air tube connector circlip.
Remove the nine left crankcase cover bolts, left crankcase cover and dowel pins.
Inspect the left crankcase cover seal rubber for damage or deterioration.

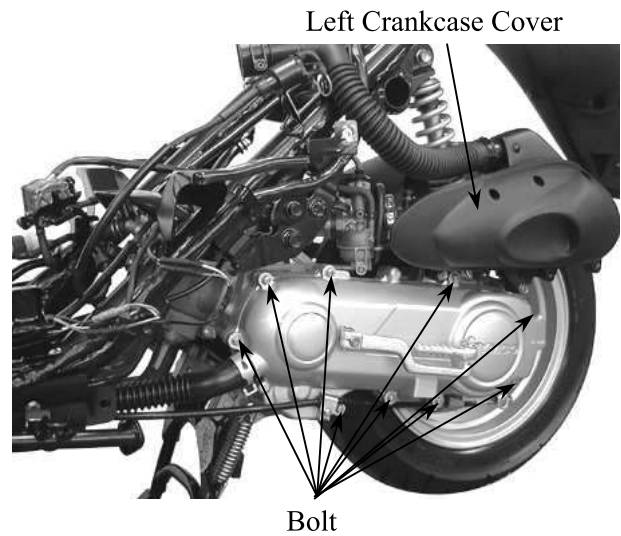

KICK STARTER SPINDLE REMOVAL

Remove the kick lever from the kick starter spindle.
Remove the circlip and washer from the kick starter spindle.

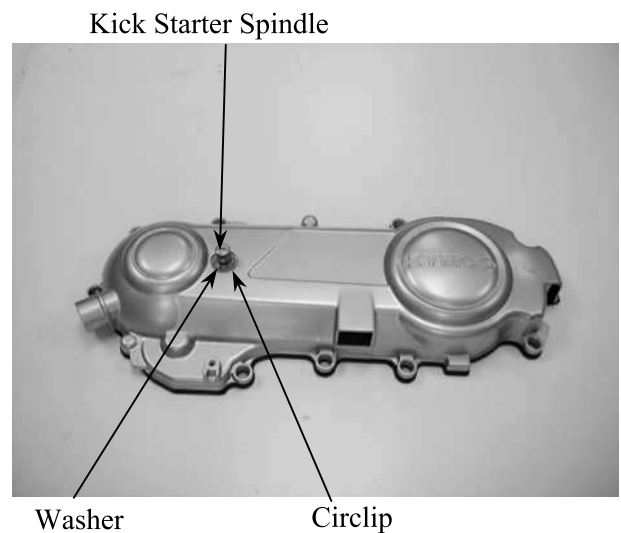

Slightly rotate the kick starter spindle to remove the kick starter driven gear together with the friction spring.

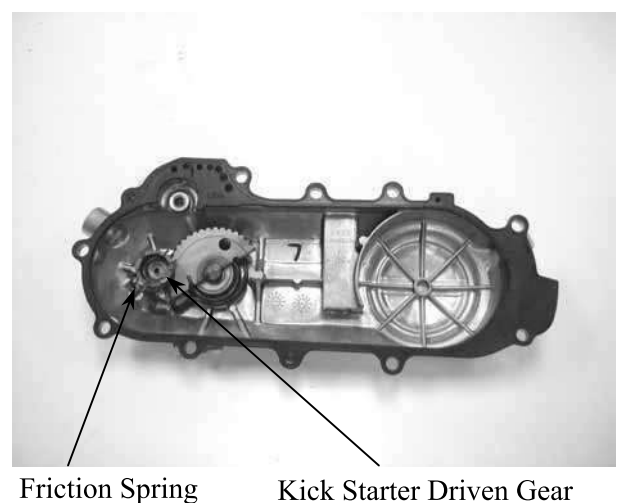

7. KICK STARTER/DRIVE PULLEY/ CLUTCH/DRIVEN PULLEY

Remove the kick starter spindle and return spring from the left crankcase cover.
Remove the kick starter spindle bushing.

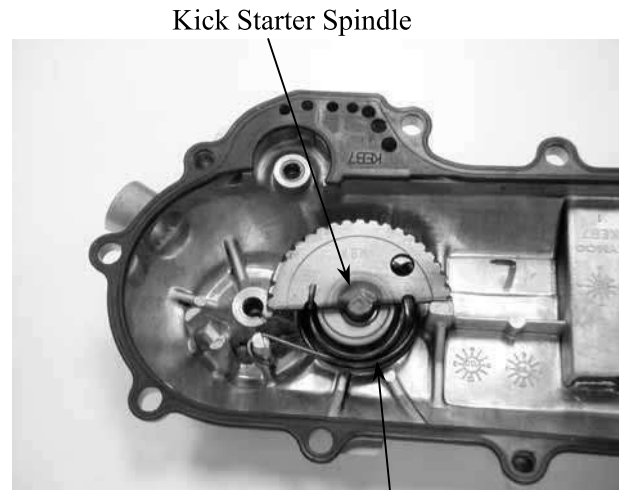

Return Spring

KICK STARTER SPINDLE INSPECTION

Inspect the kick starter spindle and gear for wear or damage.
Inspect the return spring for weakness or damage.
Inspect the kick starter spindle bushing for wear or damage.

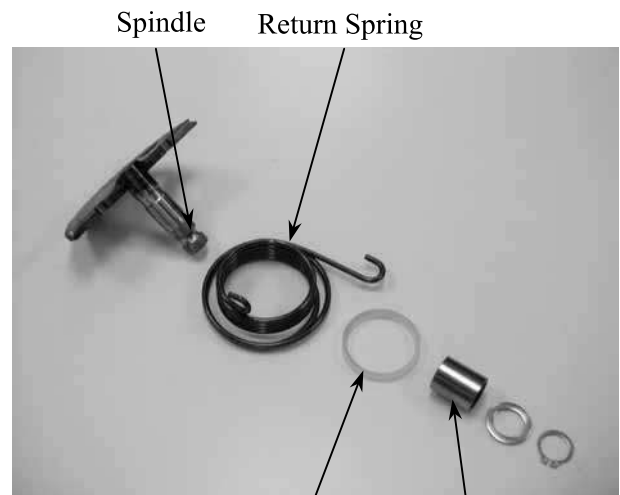

Plastic Bushing Spindle Bushing

Check the kick starter driven gear for wear or damage.
Check the friction spring for wear or damage.



Kick Starter Driven Gear

7. KICK STARTER/DRIVE PULLEY/ CLUTCH/DRIVEN PULLEY

Inspect the kick starter spindle and driven gear forcing parts for wear or damage.

Kick Starter Spindle Forcing Part

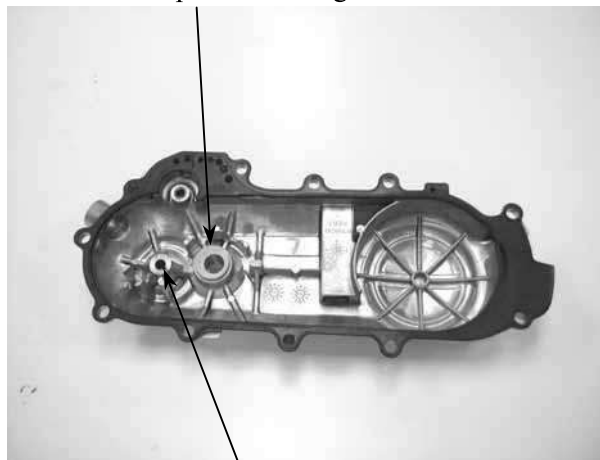

Kick Starter Driven Gear Forcing Part

KICK STARTER INSTALLATION

Install the kick starter spindle bushing and return spring onto the left crankcase cover.

* If the hooks of the return spring can not be installed properly, use a screw driver to press them into their locations respectively.



Kick Starter Spindle

Friction Spring

Properly install the kick starter driven gear and friction spring as the figure shown.

Friction Spring

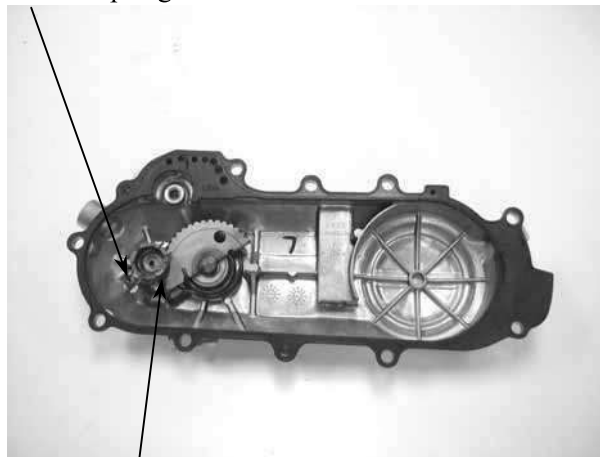

Kick Starter Driven Gear

7. KICK STARTER/DRIVE PULLEY/ CLUTCH/DRIVEN PULLEY

First install the washer and then the circlip onto the kick starter spindle.
Install the kick lever.



Washer

Circlip

LEFT CRANKCASE COVER INSTALLATION

First install the dowel pins and then the seal rubber.

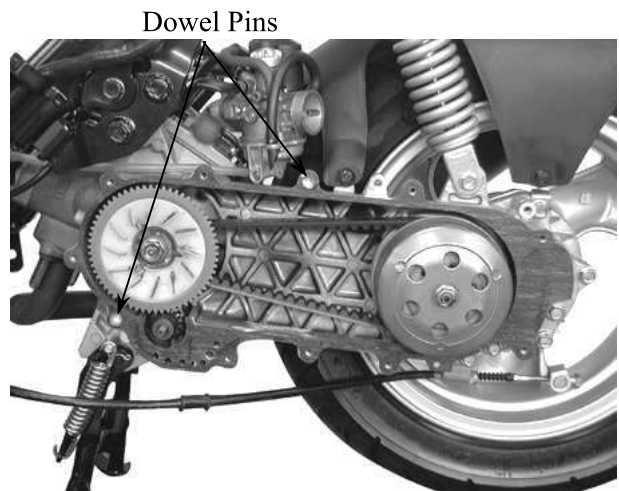

Dowel Pins

Install the left crankcase cover and tighten the nine bolts diagonally.
Connect the drive belt cooling air tube and install the circlip.



Left Crankcase Cover

7. KICK STARTER/DRIVE PULLEY/ CLUTCH/DRIVEN PULLEY

DRIVE BELT

Remove the left crankcase cover.

INSPECTION

Check the drive belt for cracks, separation or abnormal or excessive wear.
Measure the drive belt width.

Service Limit:

SH10CA: 17mm replace if below

* Use specified genuine parts for replacement.

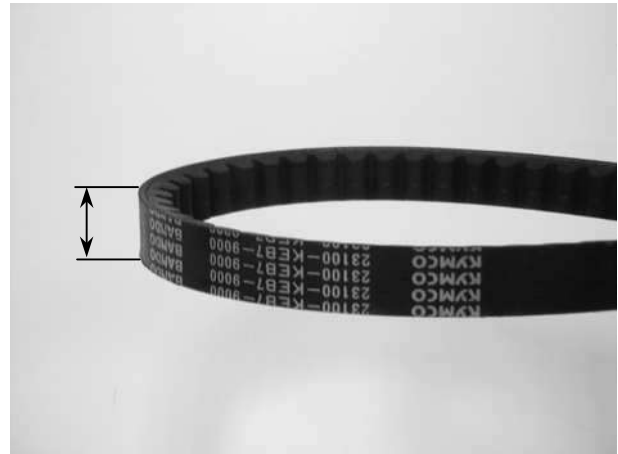

REPLACEMENT

Remove the nine left crankcase cover bolts and left crankcase cover. (⇒7-2)
Hold the clutch outer with the universal holder and remove the 14mm clutch outer nut and clutch outer.

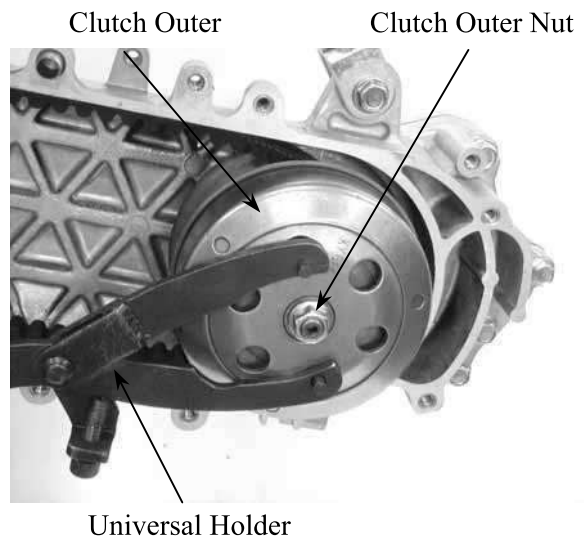

Hold the drive pulley with the holder and remove the 17mm drive face nut.
Remove the starting ratchet.
Remove the drive pulley face.

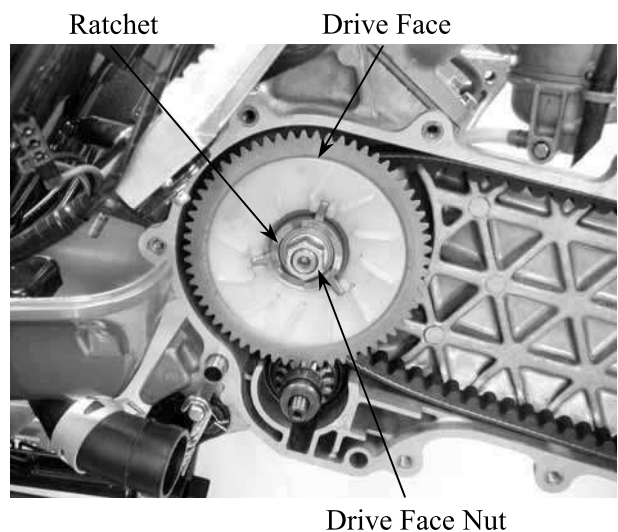

7. KICK STARTER/DRIVE PULLEY/ CLUTCH/DRIVEN PULLEY

Remove the drive belt from the clutch/
driven pulley.

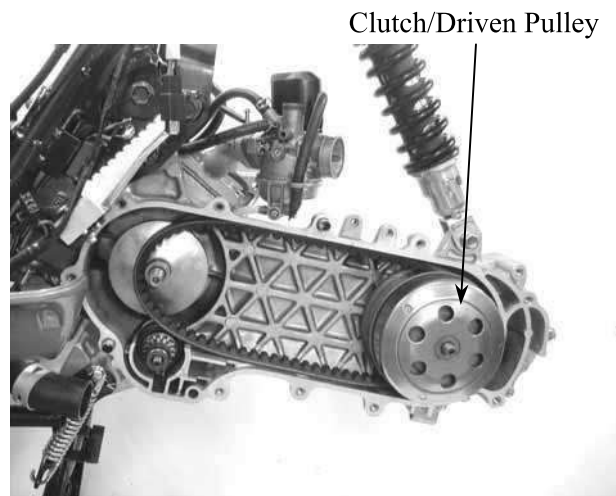

DRIVE BELT INSTALLATION

Turn the driven pulley clockwise and lift it
up to expand the drive belt groove and then
install a new drive belt.

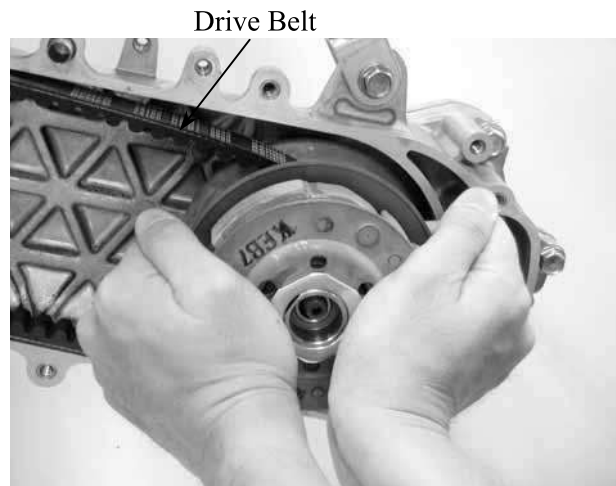

Set the drive belt on the drive pulley.
Install the drive pulley face, starting ratchet
and 17mm washer, then tighten the drive
face nut.

Torque: 34.3~39.2N-m

* When installing the drive face nut, make
sure that the tooth spaces of the drive
pulley face and starting ratchet align
with the teeth of the crankshaft.

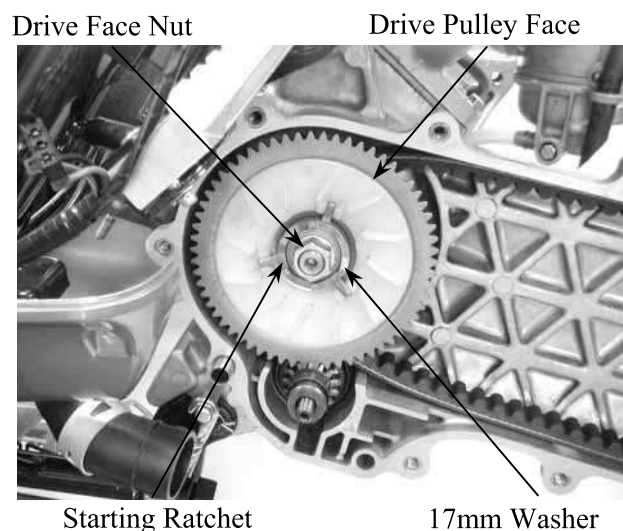

7. KICK STARTER/DRIVE PULLEY/ CLUTCH/DRIVEN PULLEY

DRIVE PULLEY

REMOVAL

Hold the drive pulley with the holder and remove the 17mm drive face nut. Remove the starting ratchet, 17mm washer and drive pulley face.

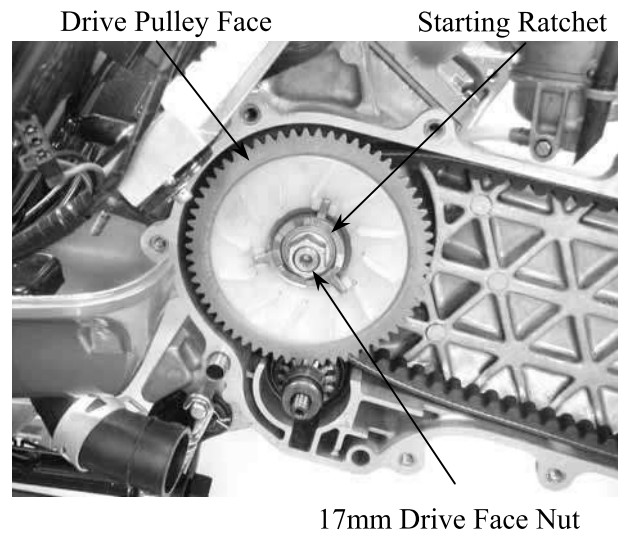

MOVABLE DRIVE FACE DISASSEMBLY

Remove the movable drive face and drive pulley collar from the crankshaft.

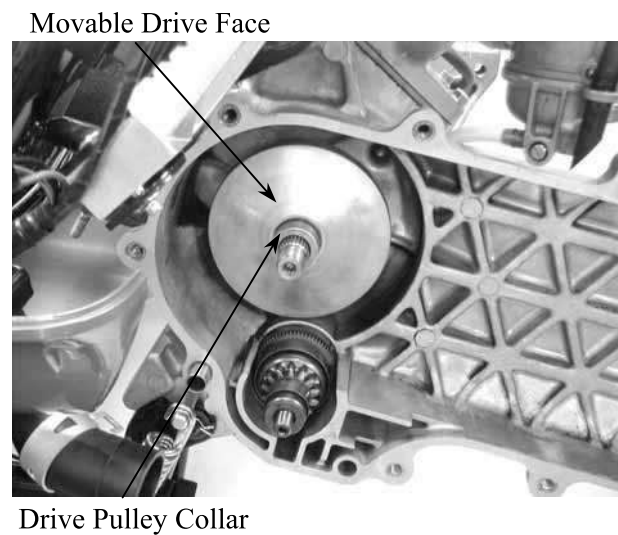

Remove the ramp plate.



7. KICK STARTER/DRIVE PULLEY/ CLUTCH/DRIVEN PULLEY

Remove the weight rollers.

Weight Roller



MOVABLE DRIVE FACE INSPECTION

Check each weight roller for wear or damage.

Measure each roller O.D.

Service Limit: 12.4mm replace if below

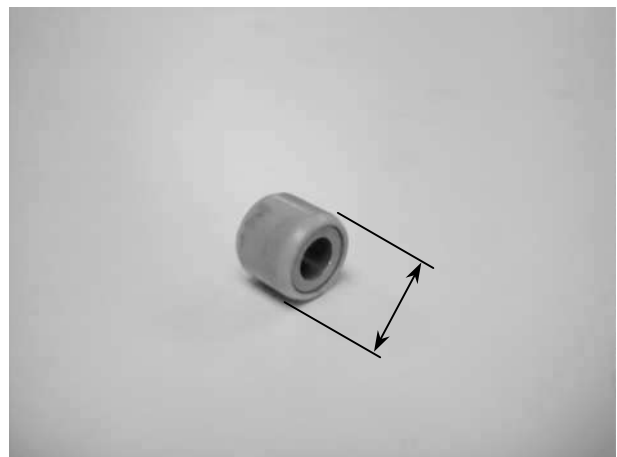

DRIVE PULLEY INSTALLATION

Install the drive pulley collar and movable drive face onto the crankshaft.

Movable Drive Face

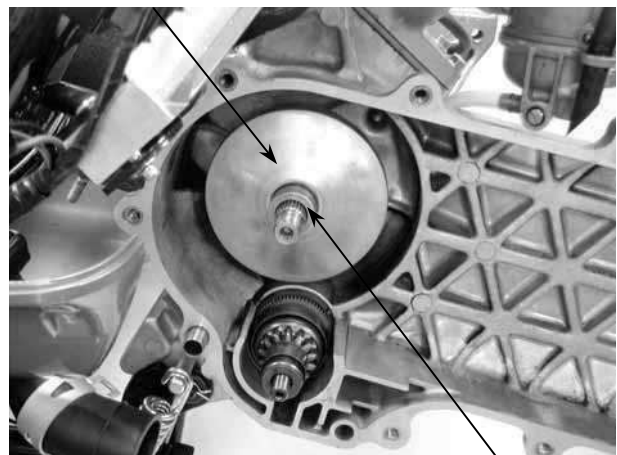

Drive Pulley Collar

7. KICK STARTER/DRIVE PULLEY/ CLUTCH/DRIVEN PULLEY

Install the drive belt on the crankshaft.
Install the drive face, starting ratchet and
washer, then tighten the 17mm drive face
nut.

Torque: 34.3~39.2N-m

Keep grease or oil off the drive belt and
drive pulley faces.

Drive Pulley Face

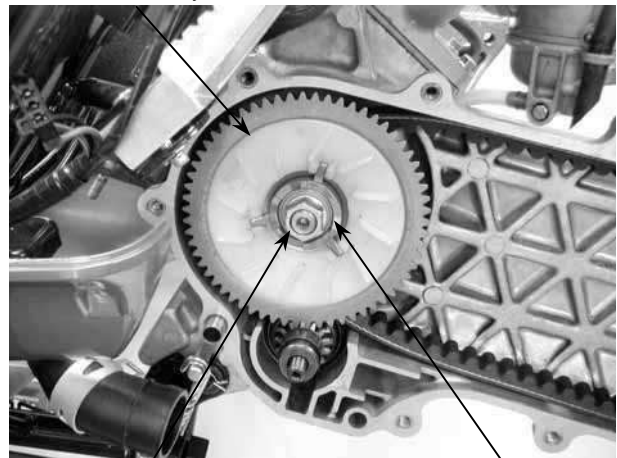

Drive Face Nut

Starting Ratchet

STARTER PINION

REMOVAL

Remove the left crankcase cover. (⇒7-2)
Remove the drive pulley. (⇒7-6)
Remove the starter pinion.



Starter Pinion

INSPECTION

Inspect the starter pinion seat for wear.
Inspect the starter pinion for smooth
operation.
Inspect the starter pinion shaft forcing parts
for wear and damage.

INSTALLATION

Apply a small amount of grease to the
starter pinion teeth.
Install the starter pinion in the reverse order
of removal.

Shaft Forcing Parts



Starter Pinion

7. KICK STARTER/DRIVE PULLEY/ CLUTCH/DRIVEN PULLEY

CLUTCH/DRIVEN PULLEY

CLUTCH/DRIVEN PULLEY REMOVAL

Remove the drive pulley. (⇒7-6)
Hold the clutch outer with the universal holder and remove the 14mm clutch outer nut.
Remove the clutch outer.

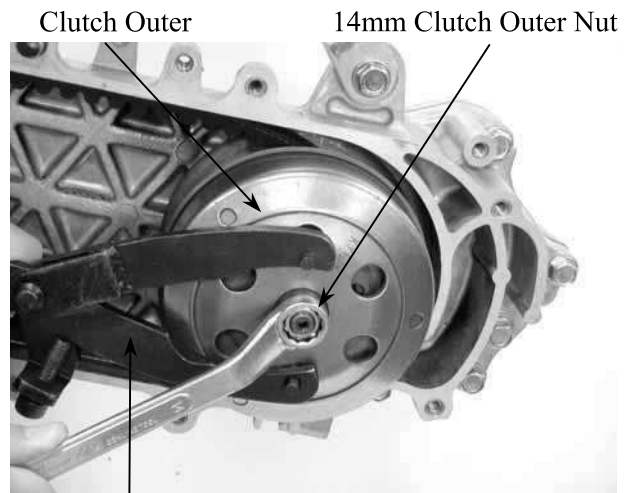

Universal Holder

Remove the clutch/driven pulley.
Remove the drive belt from the clutch/driven pulley.

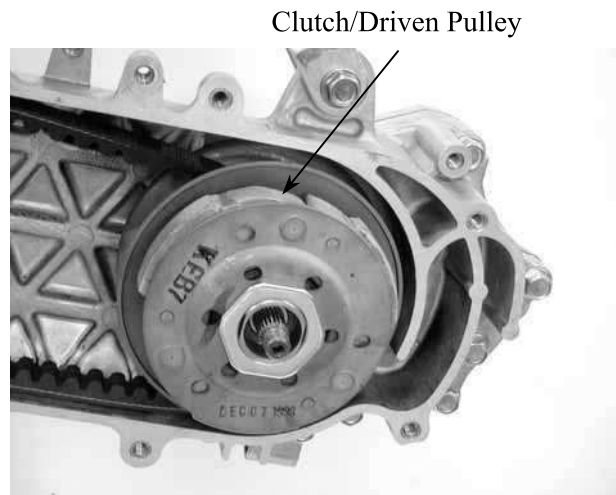

Clutch/Driven Pulley

CLUTCH/DRIVEN PULLEY DISASSEMBLY

Compress the clutch/driven pulley spring with the clutch spring compressor and remove the 28mm drive plate nut.
Remove the driven face spring.

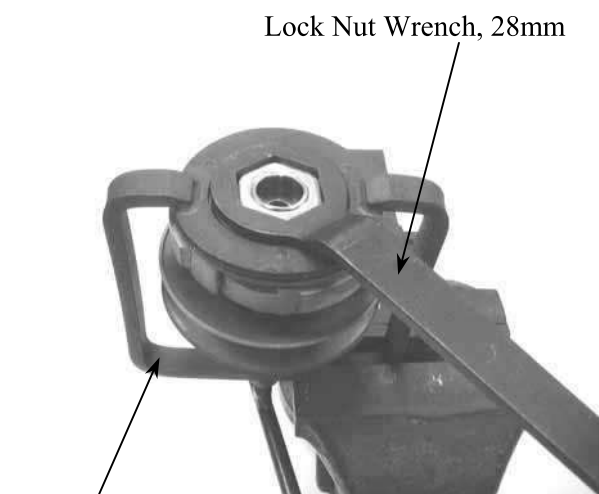

Clutch Spring Compressor

7. KICK STARTER/DRIVE PULLEY/ CLUTCH/DRIVEN PULLEY

Remove the seal collar.



Seal Collar

Pull out the guide roller pins from the driven pulley and then remove the O-rings and oil seal from the driven pulley.

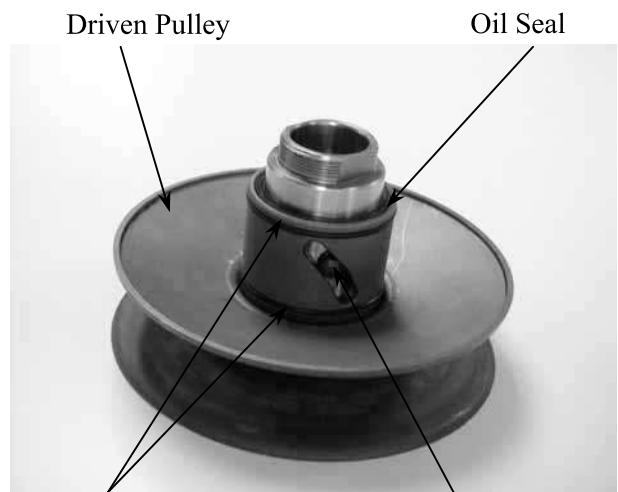

O-rings

Guide Roller Pin

CLUTCH/DRIVEN PULLEY INSPECTION

Inspect the clutch outer for wear or damage.
Measure the clutch outer I.D.

Service Limit:

SH10CA: 107.5mm replace if over

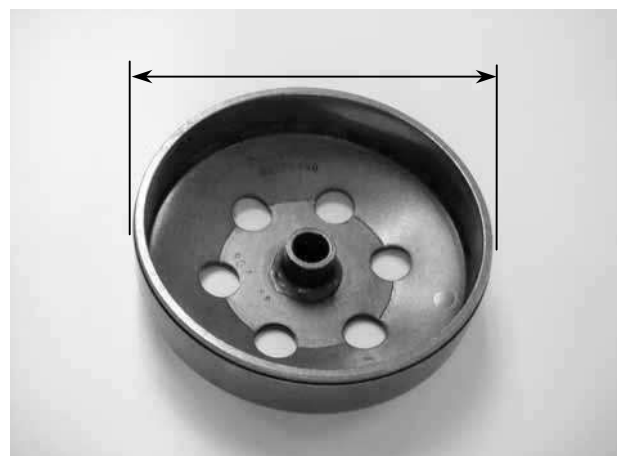

7. KICK STARTER/DRIVE PULLEY/ CLUTCH/DRIVEN PULLEY

Check the clutch shoes for wear or damage.
Measure the clutch lining thickness.

Service Limit: 2.0mm replace if below



Measure the driven face spring free length.

Service Limit: 82.6mm replace if below

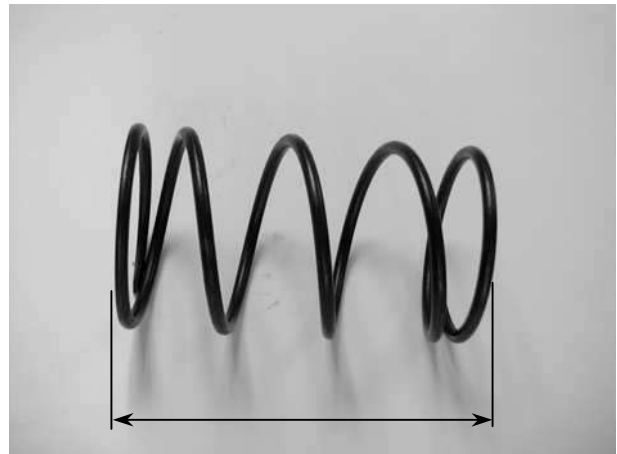

Check the driven face assembly for wear or damage.

Measure the driven face O.D.

Service Limit: 33.94mm replace if below

Check the movable driven face for wear or damage.

Measure the movable driven face I.D.

Service Limit: 34.06mm replace if over

Check the guide roller pins for stepped wear.

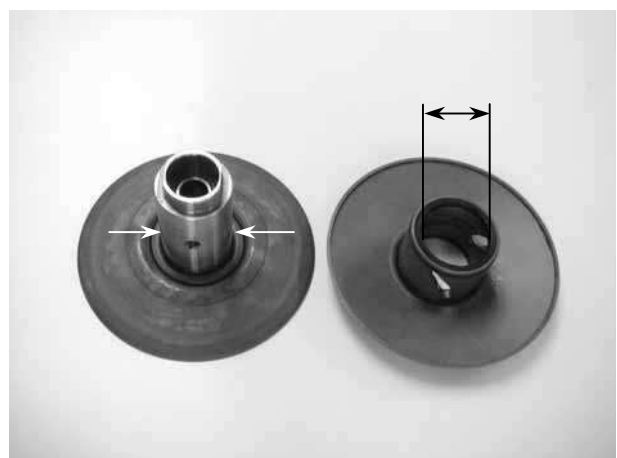

7. KICK STARTER/DRIVE PULLEY/ CLUTCH/DRIVEN PULLEY

DRIVEN PULLEY FACE BEARING REPLACEMENT

Check the needle bearings in the driven face and replace them if they have excessive play, damage or abnormal noise. Drive the inner bearing out of the driven pulley face.

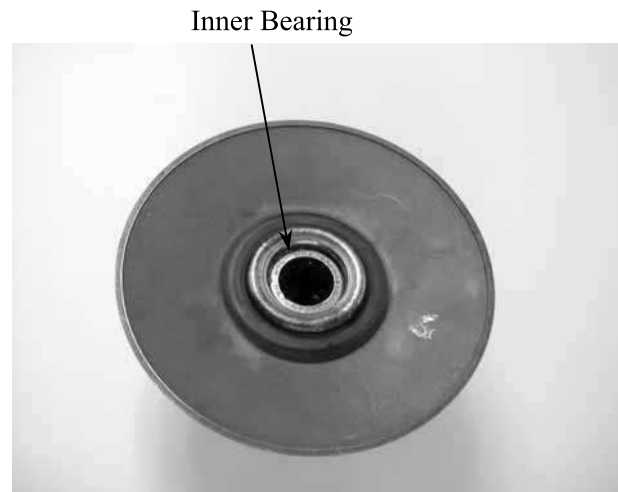

Remove the drive outer bearing out of the driven face.



Drive a new outer bearing into the driven face with the sealed end facing up. Seat the snap ring in its groove.

- * Pack all bearing cavities with 5.0~5.6g grease.
Specified grease: 230°C Heat-resistant grease



7. KICK STARTER/DRIVE PULLEY/ CLUTCH/DRIVEN PULLEY

Drive in a new needle bearing into the driven face with the mark facing up.

Bearing Driver Pilot

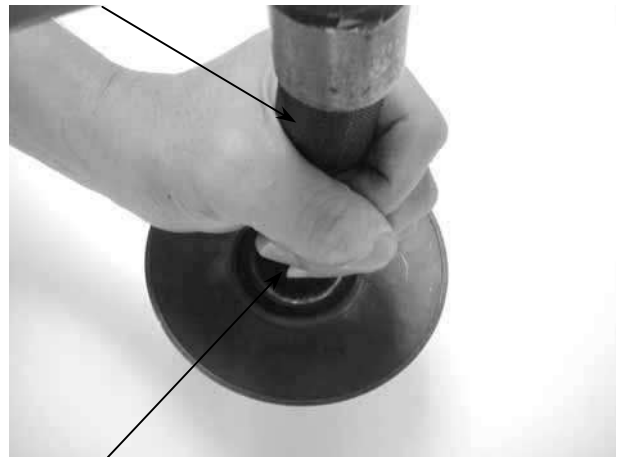

Outer Driver

CLUTCH/DRIVEN PULLEY ASSEMBLY

First install the movable driven face onto the driven face. Then, install the guide roller pins, O-rings and a new oil seal.

Driven Pulley

Oil Seal

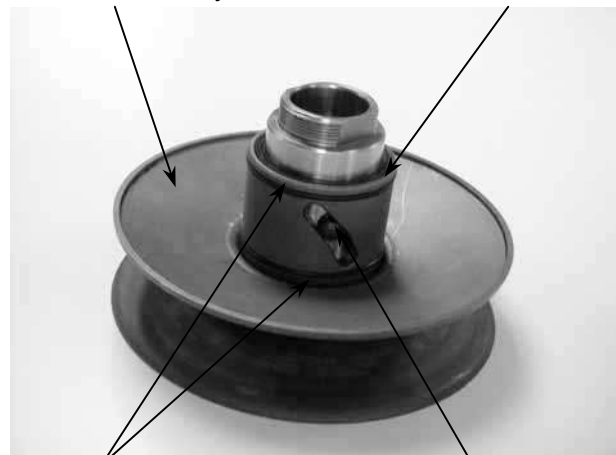

O-rings

Guide Roller Pin

Install the seal collar.



Seal Collar

7. KICK STARTER/DRIVE PULLEY/ CLUTCH/DRIVEN PULLEY

Set the driven pulley, driven face spring and clutch assembly onto the clutch spring compressor. Compress the tool and install the 28mm drive plate nut. Tighten the 28mm nut to the specified torque.

Torque: 49.0~58.8N-m



CLUTCH/DRIVEN PULLEY INSTALLATION

Install the drive belt on the clutch/driven pulley and then install the clutch/driven pulley onto the drive shaft.

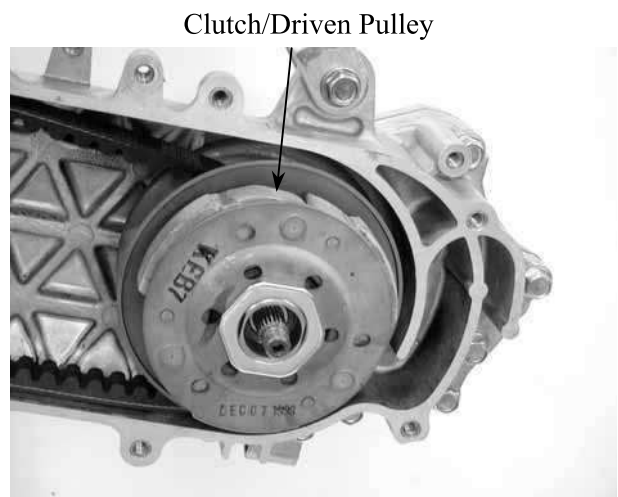

Install the clutch outer.
Hold the clutch outer with the universal holder.
Install and tighten the 14mm clutch outer nut.

Torque: 34.3~44.1N-m

Install the left crankcase cover. (⇒7-5)

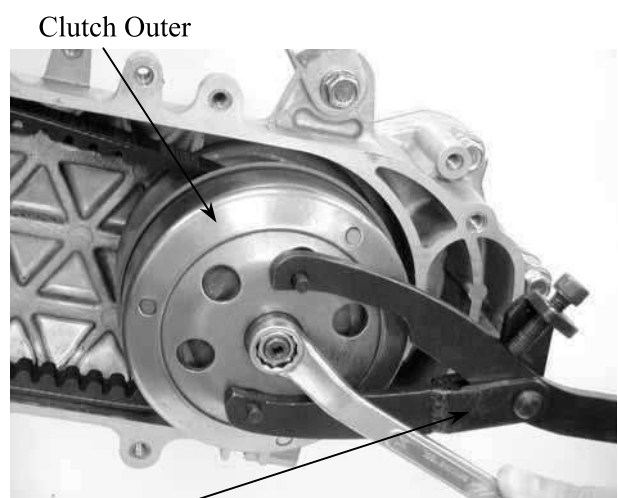

Universal Holder

8. FINAL REDUCTION

FINAL REDUCTION

SERVICE INFORMATION 8-1

TROUBLESHOOTING 8-1

FINAL REDUCTION DISASSEMBLY 8-2

FINAL REDUCTION INSPECTION..... 8-2

FINAL REDUCTION ASSEMBLY 8-5



8. FINAL REDUCTION

SERVICE INFORMATION

Specified Oil: SAE90#
At disassembly: 0.12 liter
At change: 0.09 liter

SPECIAL TOOLS

Bearing remover set, 12mm
Bearing remover set, 15mm
Crankcase assembly collar
Crankcase assembly shaft
Bearing outer driver, 37x40mm
Bearing outer driver, 32x35mm
Bearing driver pilot, 17mm
Bearing driver pilot, 15mm
Bearing driver pilot, 12mm
Bearing outer driver handle A

TROUBLESHOOTING

Engine starts but motorcycle won't move

- Damaged transmission
- Seized or burnt transmission

Abnormal noise

- Worn, seized or chipped gears
- Worn bearing

Oil leaks

- Oil level too high
- Worn or damaged oil seal

8. FINAL REDUCTION

FINAL REDUCTION DISASSEMBLY

Remove the rear wheel. (⇒14-2)
Remove the left crankcase cover. (⇒7-2)
Remove the clutch/driven pulley. (⇒7-11)
Drain the transmission gear oil into a clean container.
Remove the transmission case cover attaching bolts.
Remove the transmission case cover.
Remove the gasket and dowel pins.

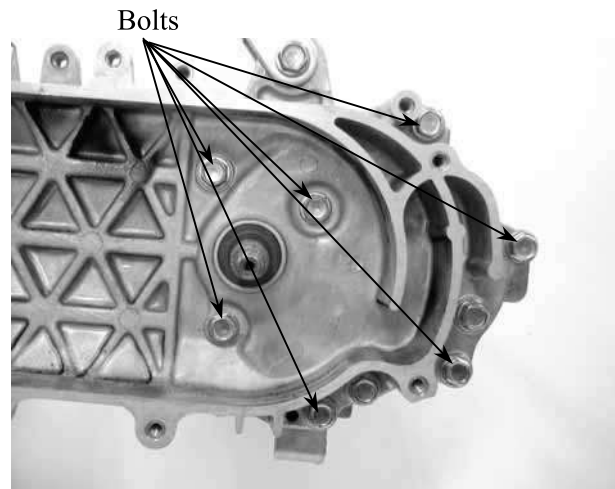

Remove the final gear and countershaft.

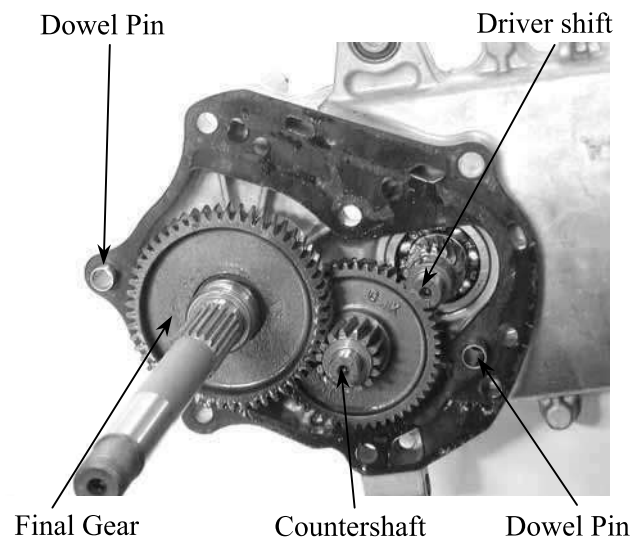

FINAL REDUCTION INSPECTION

Inspect the countershaft and gear for wear or damage.



Countershaft

8. FINAL REDUCTION

Inspect the final gear and final shaft for wear, damage or seizure.



Check the left crankcase bearings for excessive play and inspect the oil seal for wear or damage.

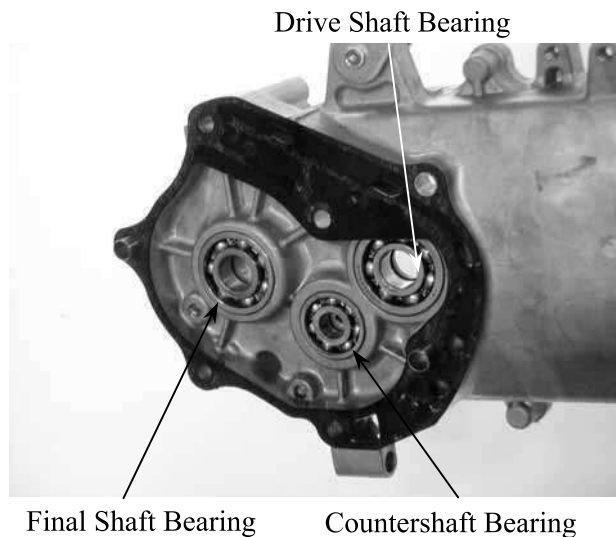

Inspect the drive shaft and gear for wear or damage.
Check the transmission case cover bearings for excessive play and inspect the final shaft bearing oil seal for wear or damage.

* Do not remove the transmission case cover except for necessary part replacement. When replacing the drive shaft, also replace the bearing and oil seal.

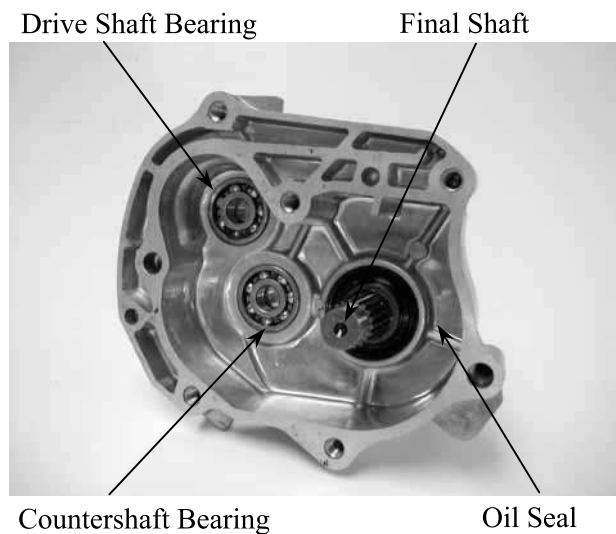

8. FINAL REDUCTION

BEARING REPLACEMENT (Transmission Case Cover)

Remove the transmission case cover bearings using the bearing remover.
Remove the final shaft oil seal.

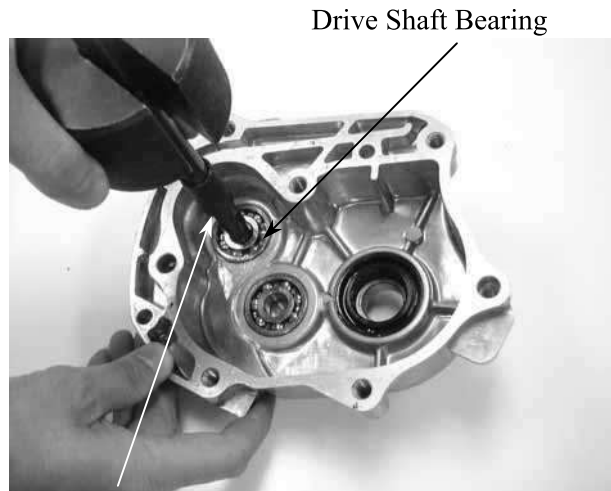

Bearing Remover Set

Drive new bearings into the transmission case cover.



Bearing Outer Driver

BEARING REPLACEMENT (Left Crankcase Cover)

Remove the drive shaft.
Remove the drive shaft oil seal.
Remove the left crankcase bearings using the bearing remover.

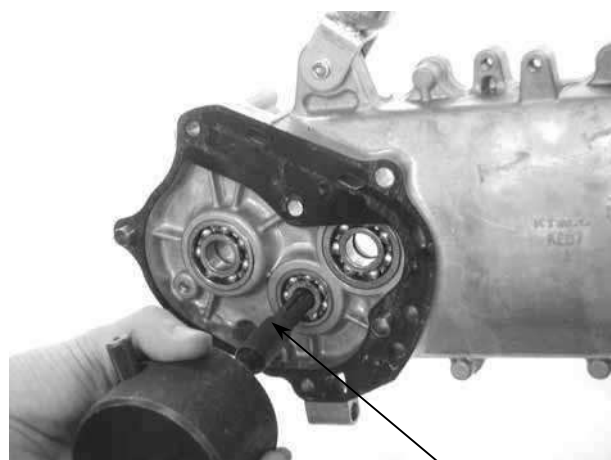

Bearing Remover Set

8. FINAL REDUCTION

Drive new bearings into the left crankcase.
Install a new drive shaft oil seal.

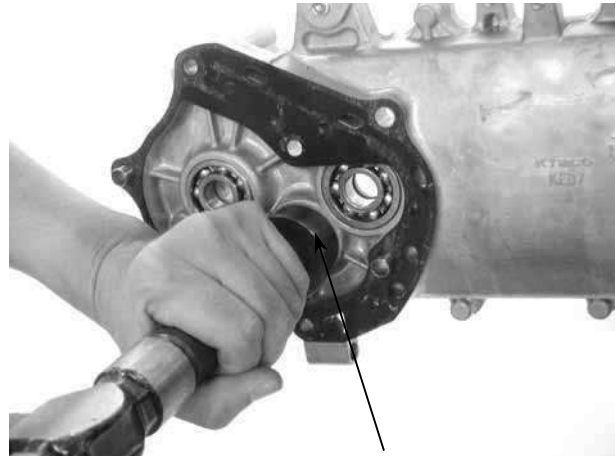

Bearing Outer Driver

FINAL REDUCTION ASSEMBLY

Install the drive shaft into the left crankcase.



Drive Shaft

Install the countershaft gear into the left crankcase.

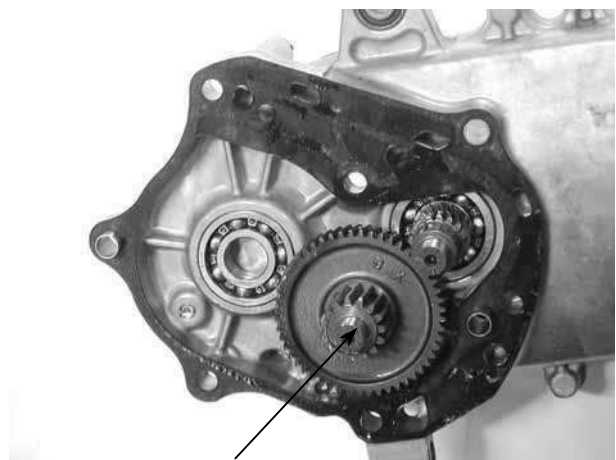

Countershaft Gear

8. FINAL REDUCTION

Install the final gear and final shaft into the left crankcase.
Install the dowel pins and a new gasket.

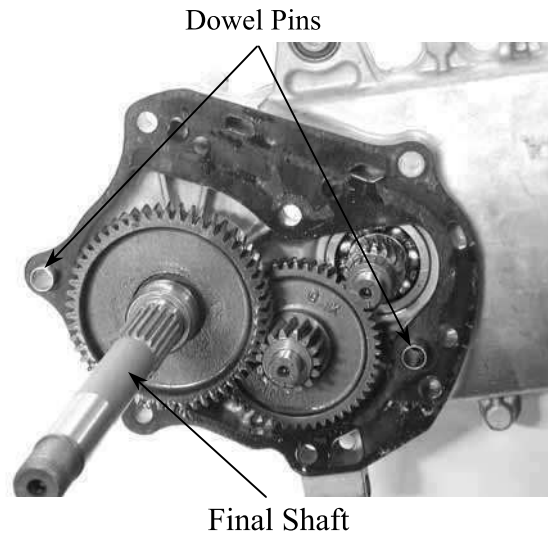

Install the transmission case cover.

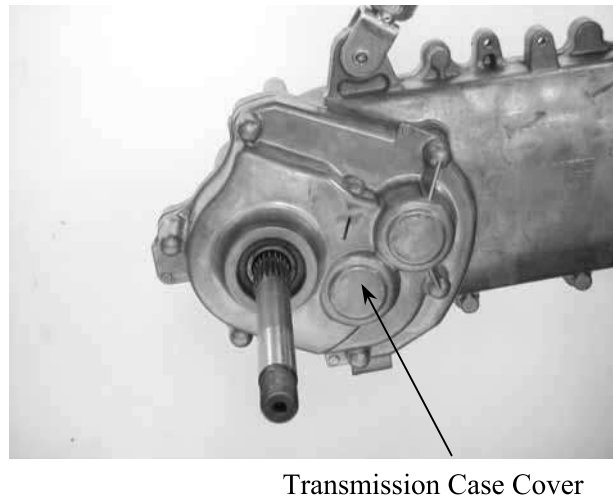

Install and tighten the transmission case cover bolts.
Install the clutch/driven pulley. (⇒7-15)
Install other removed parts in the reverse order of removal.

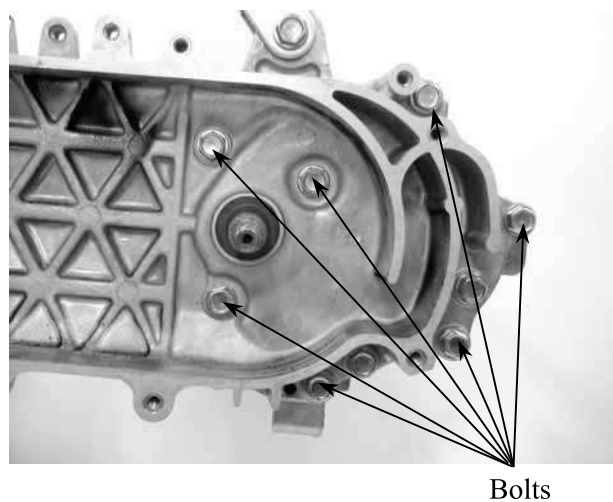

8. FINAL REDUCTION

After installation, fill the transmission case with the specified oil.

*

- Place the motorcycle on its main stand on level ground.
- Check the sealing washer for wear or damage.

Specified Gear Oil: SAE90#

Oil Capacity: at disassembly: 0.12 liter

at change: 0.09 liter

Install and tighten the oil check bolt.

Torque: 9.8~14.7N-m

Start the engine and check for oil leaks.

Check the oil level from the oil check bolt hole and add the specified oil to the proper level if the oil level is low.

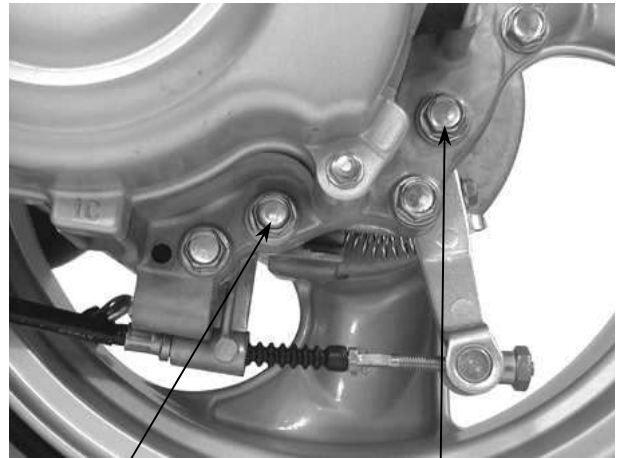

Drain Bolt

Oil Check Bolt Hole/Filler

9. A.C. GENERATOR



A.C. GENERATOR

SERVICE INFORMATION 9-1
A.C. GENERATOR REMOVAL..... 9-2
A.C. GENERATOR INSTALLATION 9-4



9. A.C. GENERATOR

SERVICE INFORMATION

GENERAL INSTRUCTIONS

- All A.C. generator maintenance and inspection can be made with the engine installed.
- Refer to Section 15 for A.C. generator inspection.

TORQUE VALUE

Flywheel nut : 34.3 ~ 39.2N-m

SPECIAL TOOLS

Flywheel puller
Universal holder

9. A.C. GENERATOR

A.C. GENERATOR REMOVAL

Disconnect the water hoses from the right crankcase cover.

Remove the three bolts attaching the right crankcase cover and the cover.

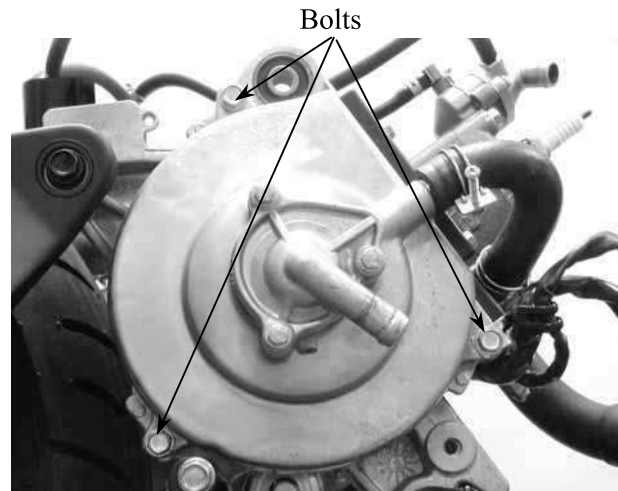

Hold the flywheel with an universal holder and then remove the flywheel nut.

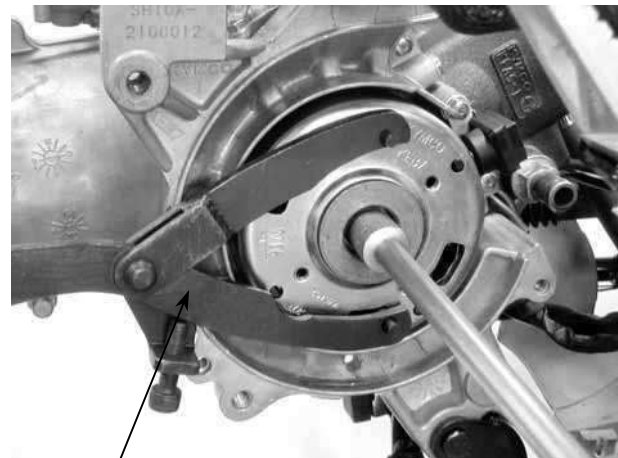

Universal Holder

9. A.C. GENERATOR

Remove the A.C. generator flywheel using the flywheel puller.

Lock Nut Wrench

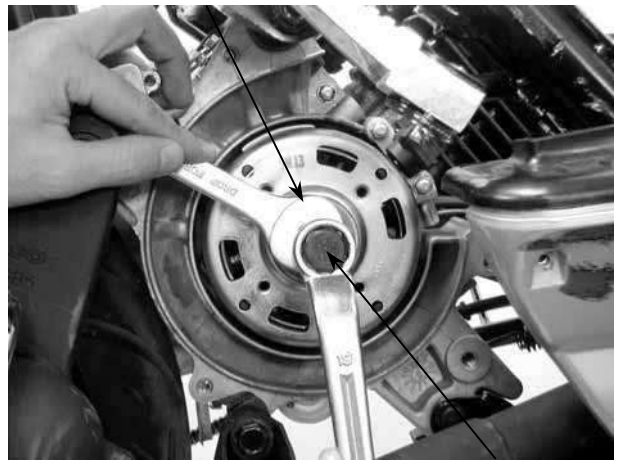

Flywheel Puller

Remove the A.C. generator wire connector.

A.C. Generator Wire Connector



Remove the two pulser coil bolts and pulser coil from the right crankcase.
 Remove the pulser coil wire clamp from the right crankcase.
 Remove the two bolts attaching the A.C. generator stator.

*

Be careful not to damage the disconnected wire.

Stator

Wire Clamp



Pulser Coil

9. A.C. GENERATOR

A.C. GENERATOR INSTALLATION

Install the A.C. generator stator and pulser coil wire clamp onto the right crankcase, and then install the pulser coil.

Connect the A.C. generator wire connector.

A.C. Generator Wire Connector



Clean the taper hole in the flywheel off any burrs and dirt.
Install the woodruff key in the crankshaft keyway.

Woodruff Key



Install the flywheel onto the crankshaft with the flywheel groove aligned with the crankshaft woodruff key.
Hold the flywheel with the universal holder and install the flywheel flange nut.

Torque: 34.3~39.2N-m

Start the engine and check the ignition timing. (⇒3-7)

Install other removed parts in the reserve order of removal.

Universal Holder



10. CRANKCASE/CRANKSHAFT

CRANKCASE/CRANKSHAFT

SERVICE INFORMATION 10-1
TROUBLESHOOTING 10-1
CRANKCASE SEPARATION 10-2
CRANKSHAFT REMOVAL..... 10-2
CRANKSHAFT INSPECTION 10-3
CRANKSHAFT INSTALLATION 10-4
CRANKCASE ASSEMBLY..... 10-6

10. CRANKCASE/CRANKSHAFT

SERVICE INFORMATION

GENERAL INSTRUCTIONS

- This section covers crankcase separation to service the crankshaft.
- The following parts must be removed before separating the crankcase.

Engine (⇒Section 5)	Driven pulley (⇒Section 7)
Carburetor (⇒Section 12)	A.C. generator (⇒Section9)
Oil pump (⇒Section 4)	Cylinder head/cylinder (⇒Section 6)
Reed valve (⇒Section 12)	
- When the left crankcase must be replaced, remove the following part in addition to the above.
Final reduction removal
- Special tools must be used for crankshaft and crankcase assembly. When separating the crankcase, the bearing will remain in the crankcase and it should be removed. When assembling, drive a new bearing into the crankcase and install a new oil seal.

SPECIFICATIONS

Item	Standard (mm)	Service Limit (mm)
	B&W50	B&W50
Connecting rod big end side clearance	—	0.60
Connecting rod big end radial clearance	—	0.04
Crankshaft runout A/B	—	0.15/0.10

SPECIAL TOOLS

Crankcase puller	Bearing outer driver handle A
Universal bearing puller	Bearing outer driver, 42x47mm
Crankcase assembly collar	Bearing driver pilot, 20mm
Crankcase assembly tool	Bearing outer driver, 37x40mm
	Bearing driver pilot, 17mm

TROUBLESHOOTING

Abnormal engine noise

- Excessive crank journal bearing play
- Excessive crankpin bearing play
- Excessive transmission bearing play

10. CRANKCASE/CRANKSHAFT

CRANKCASE SEPARATION

Remove the crankcase attaching bolts.

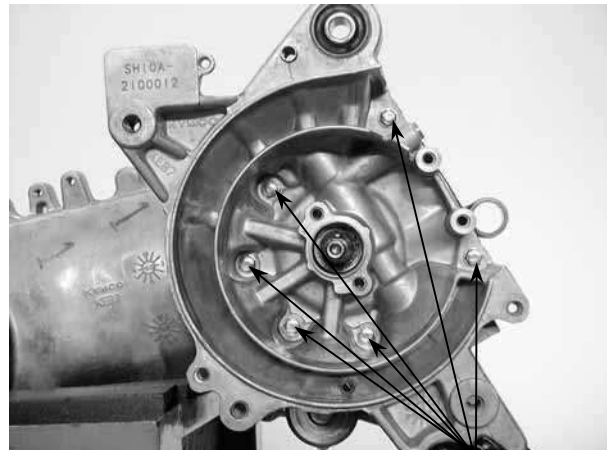

Bolts

Attach the crankcase puller on the right crankcase and remove the right crankcase from the left crankcase.

Crankcase Puller



CRANKSHAFT REMOVAL

Attach the crankcase puller on the left crankcase and remove the crankshaft from the left crankcase.

When removing the crankshaft, do it slowly and gently.

Crankcase Puller



10. CRANKCASE/CRANKSHAFT

Remove the remaining bearing on the crankshaft side using the universal bearing puller.

- When separating the crankcase, the oil seals must be removed. Replace the oil seals with new ones.

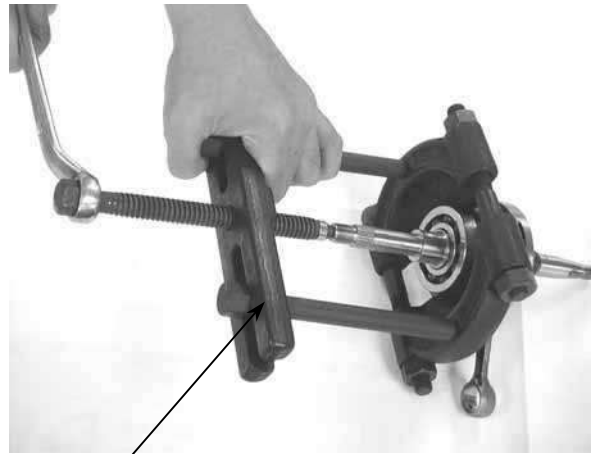

Universal Bearing Puller

CRANKSHAFT INSPECTION

Measure the connecting rod big end side clearance.

Service Limit: 0.6mm replace if over

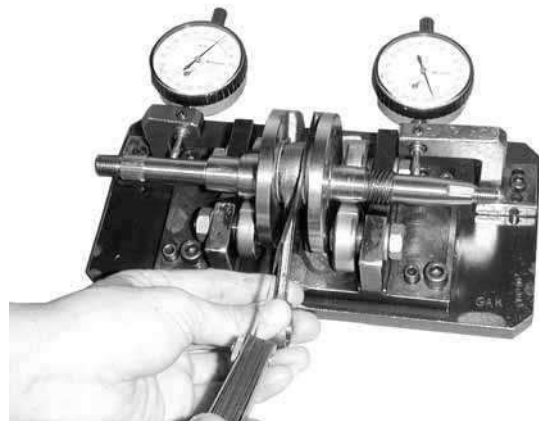

Measure the connecting rod big end radial clearance at two points in the X and Y directions.

Service Limit: 0.04mm replace if over

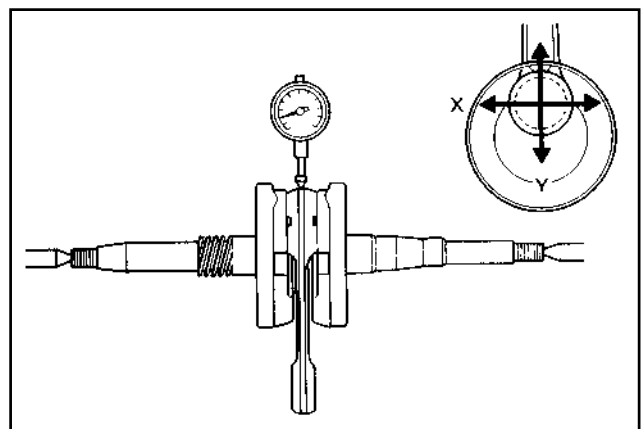

10. CRANKCASE/CRANKSHAFT

Measure the crankshaft runout.

Service Limit	
A	B
0.150mm replace if over	0.100mm replace if over

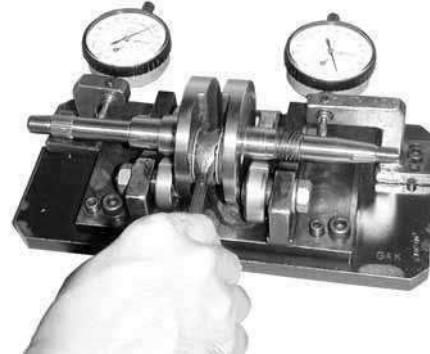

Check the crankshaft bearings for excessive play.
The bearings must be replaced if they are noisy or have excessive play.

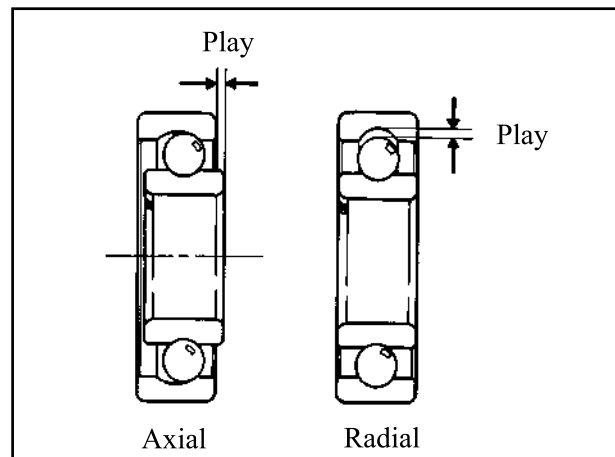

CRANKSHAFT INSTALLATION

Wash the crankshaft in cleaning solvent and then check for cracks or other faults.

- After check, apply clean engine oil to all moving and sliding parts.
- Remove all gasket material from the crankcase mating surfaces. Dress any roughness or irregularities with an oil stone.

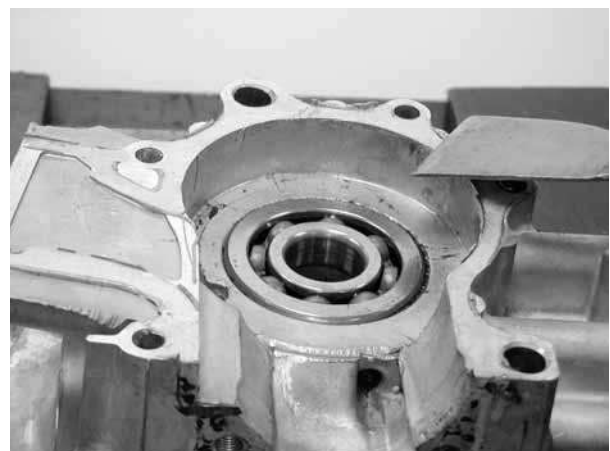

10. CRANKCASE/CRANKSHAFT

Drive a new crankshaft bearing into the right crankcase.

Bearing Outer Driver Handle A

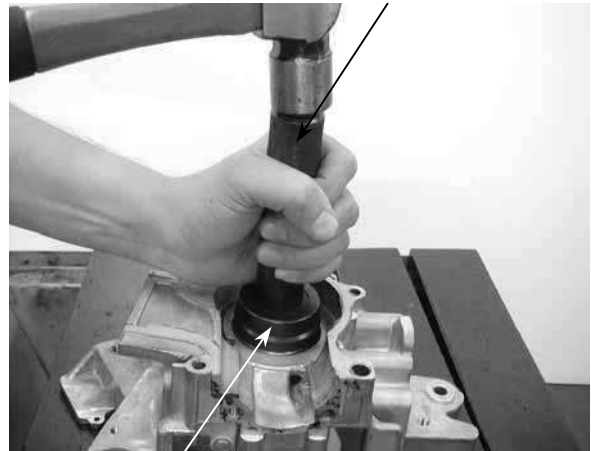

Bearing Outer Driver, 37x40mm
Bearing Driver Pilot, 17mm

Drive a new crankshaft bearing into the left crankcase.

Bearing Outer Driver Handle A



Bearing Outer Driver, 42x47mm
Pilot, 20mm

Install the crankshaft into the left crankcase.

Crankcase Assembly Tool

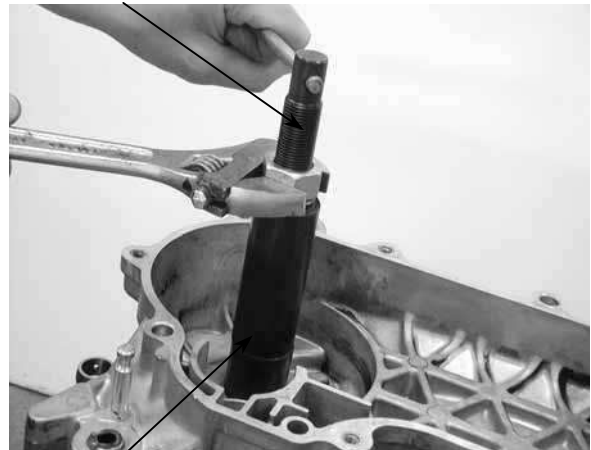

Crankcase Assembly Collar

- Apply KYMCO ULTRA motor oil or molybdenum disulfide to the crankshaft bearings and connecting rod big end.
- Apply grease to the lip of the oil seal and then install it.

10. CRANKCASE/CRANKSHAFT

CRANKCASE ASSEMBLY

Install the dowel pins and a new gasket to the crankcase mating surface.

Dowel Pins



Assemble the crankcase halves.



Crankcase Assembly Tool

The distance between the right crankcase oil seal and crankcase surface is about 12.5 ± 0.5 mm.

When installing the oil seal, be careful to press it with even force.



Crankcase Oil Seal

10. CRANKCASE/CRANKSHAFT

The distance between the left crankcase oil seal and crankcase surface is about 1.0mm.

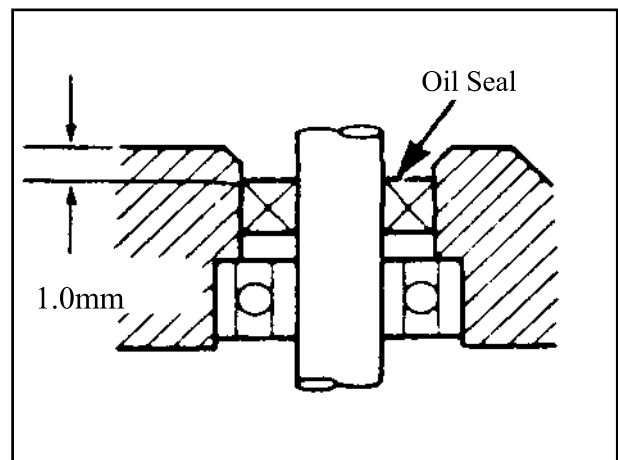

Install and tighten the crankcase attaching bolts.

- After assembly, check the crankshaft for smooth operation.

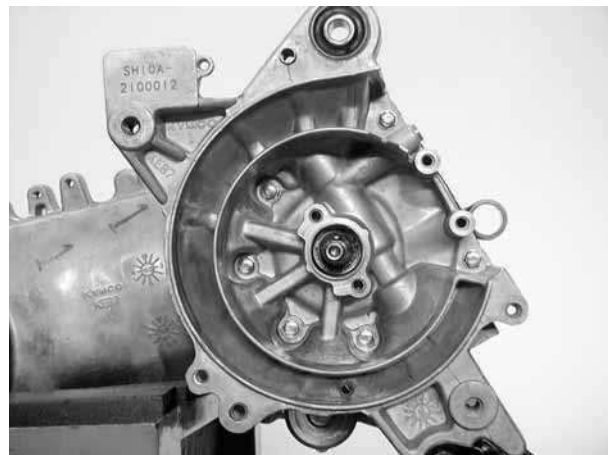

11. COOLING SYSTEM

COOLING SYSTEM

SERVICE INFORMATION-----	11- 1
TROUBLESHOOTING-----	11- 1
RADIATOR -----	11- 3
WATER PUMP -----	11- 5
THERMOSENSOR-----	11-11
THERMOSTAT-----	11-12

11. COOLING SYSTEM

SERVICE INFORMATION

GENERAL INSTRUCTIONS

- The water pump must be serviced after removing the engine. Other cooling system service can be done with the engine installed in the frame.
- The engine must be cool before servicing the cooling system.
When the coolant temperature is over 100°C, never remove the radiator cap to release the pressure because the boiling coolant may cause danger.
- Avoid spilling coolant on painted surfaces because the coolant will corrode the painted surfaces. Wash off any spilled coolant with fresh water as soon as possible.
- After servicing the system, check for leaks with a cooling system tester.

SPECIAL TOOL

Mechanical seal driver

TORQUE VALUES

Water pump impeller	9.8~13.72N-m
Water pump cover bolt	7.84~11.76N-m

TROUBLESHOOTING

Engine temperature too high

- Faulty temperature gauge or thermosensor
- Faulty radiator cap
- Faulty thermostat
- Insufficient coolant
- Passages blocked in hoses or water jacket
- Clogged radiator fins
- Passages blocked in radiator
- Faulty water pump

Temperature gauge pointer does not register the correct coolant temperature

- Faulty temperature gauge or thermosensor
- Faulty thermostat

Coolant leaks

- Faulty pump mechanical (water) seal
- Deteriorated O-rings
- Damaged or deteriorated water hoses

11. COOLING SYSTEM

SPECIFICATIONS

Thermostat temperature	Begins to open	80±2°C	
	Full-open	90°C	
	Valve lift	3.5~4.5mm	
Coolant capacity		Total system 1165cc	Radiator: 825cc Reserve tank: 340cc

COOLANT GRAVITY

Temp. °C Coolant concentration	0	5	10	15	20	25	30	35	40	45	50
5%	1.009	1.009	1.008	1.008	1.007	1.006	1.005	1.003	1.001	0.009	0.997
10%	1.018	1.107	1.017	1.016	1.015	1.014	0.013	1.011	1.009	1.007	1.005
15%	1.028	1.027	1.026	1.025	1.024	1.022	1.020	1.018	1.016	1.014	1.012
20%	1.036	1.035	1.034	1.033	1.031	1.029	1.027	1.025	1.023	1.021	1.019
25%	1.045	1.044	1.043	1.042	1.040	1.038	1.036	1.034	1.031	1.028	1.025
30%	1.053	1.051	1.051	1.049	1.047	1.045	1.043	1.041	1.038	1.035	1.032
35%	1.063	1.062	1.060	1.058	1.056	1.054	1.052	1.049	1.046	1.043	1.040
40%	1.072	1.070	1.068	1.066	1.064	1.062	1.059	1.056	1.053	1.050	1.047
45%	1.080	1.078	1.076	1.074	1.072	1.069	1.056	1.063	1.062	1.057	1.054
50%	1.086	1.084	1.082	1.080	1.077	1.074	1.071	1.068	1.065	1.062	1.059
55%	1.095	1.093	1.091	1.088	1.085	1.082	1.079	1.076	1.073	1.070	1.067
60%	1.100	1.098	1.095	1.092	1.089	1.086	1.083	1.080	1.077	1.074	1.071

COOLANT MIXTURE (WITH ANTI-RUST AND ANTI-FREEZING EFFECTS)

Freezing Point	Mixing Rate	KYMCO SIGMA Coolant Concentrate	Distilled Water
-9°C	20%		
-15°C	30%	360cc	825cc
-25°C	40%		
-37°C	50%		
-44.5°C	55%		

Cautions for Using Coolant:

- Use coolant of specified mixing rate. (The mixing rate of 360cc KYMCO SIGMA coolant concentrate + 825cc distilled water is 30%.)
- Do not mix coolant concentrate of different brands.
- Do not drink the coolant which is poisonous.
- The freezing point of coolant mixture shall be 5°C lower than the freezing point of the riding area.

11. COOLING SYSTEM

RADIATOR

RADIATOR INSPECTION

Remove the front upper cover. (⇒2-3)

Remove the front lower cover. (⇒2-3)

Front Upper Cover



Front Lower Cover

Inspect the radiator soldered joints and seams for leaks.

Blow dirt out from between core fins with compressed air. If insects, etc., are clogging the radiator, wash them off. Carefully straighten any bent fins.

Radiator



RADIATOR REMOVAL

Drain the coolant. (⇒3-10)

Disconnect the air vent tube from the radiator filler.

Remove the overflow tube clamp and disconnect the overflow tube.

Overflow Tube



Air Vent Tube

11. COOLING SYSTEM

Loosen the hose band and disconnect the upper and lower hose from the radiator.

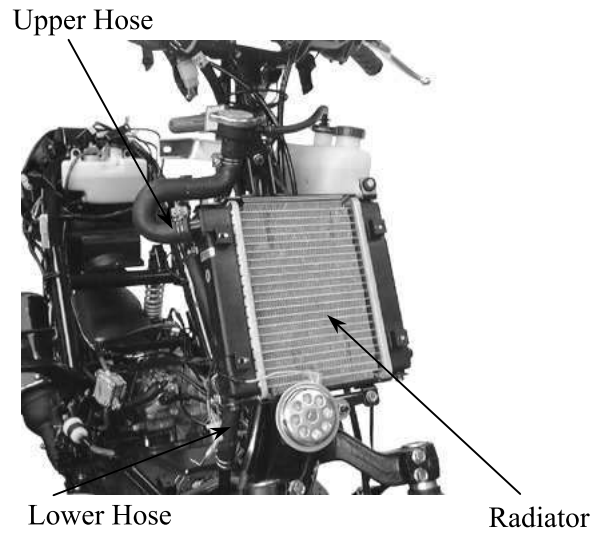

Remove the two bolts and two nuts on the radiator.

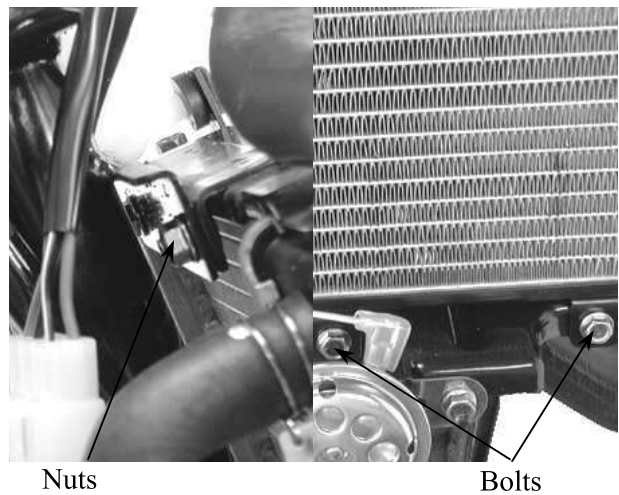

RADIATOR INSTALLATION

Install the radiator on the radiator bracket with the two bolts and two nuts.

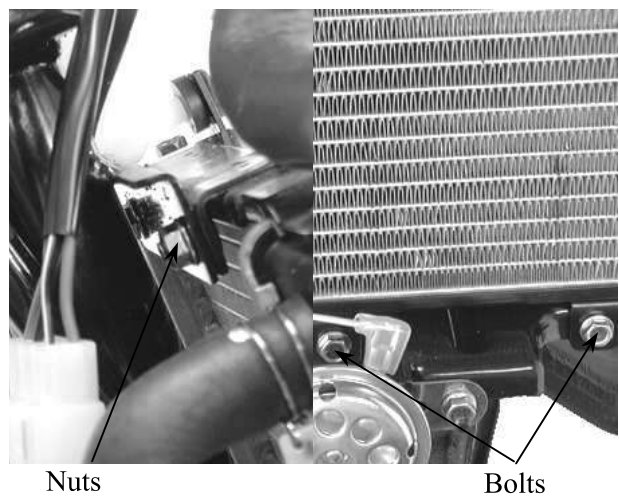

11. COOLING SYSTEM

Connect the upper and lower hoses and secure them with hose bands.

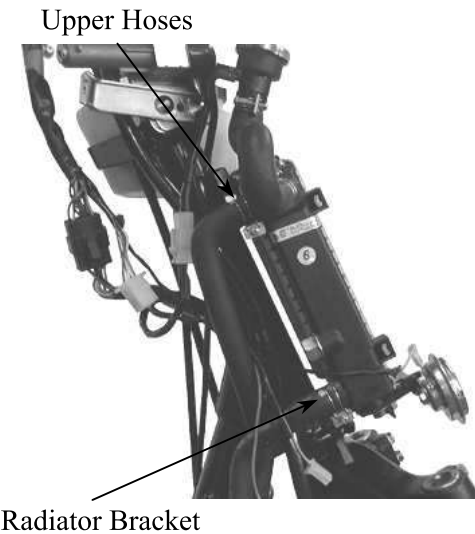

Connect the overflow tube and secure with the tube clamp.
Connect the air vent tube to the radiator filler.
Fill the radiator with coolant.
After install, check for coolant leaks.

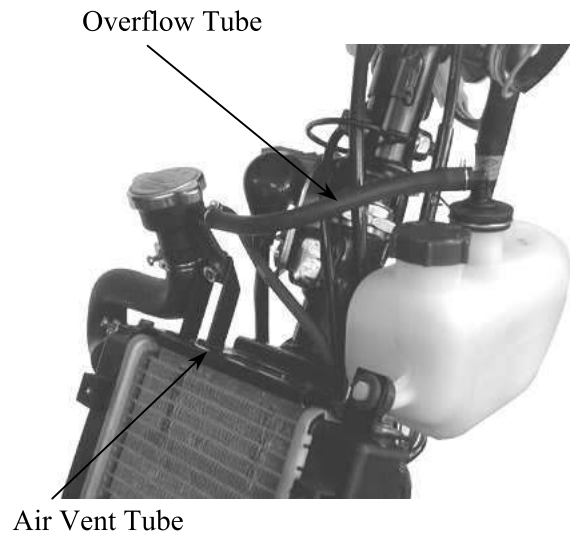

WATER PUMP

MECHANICAL SEAL (WATER SEAL) INSPECTION

Inspect the telltale hole for signs of mechanical seal coolant leakage.
If the mechanical seal is leaking, remove the right crankcase cover and replace the mechanical seal.

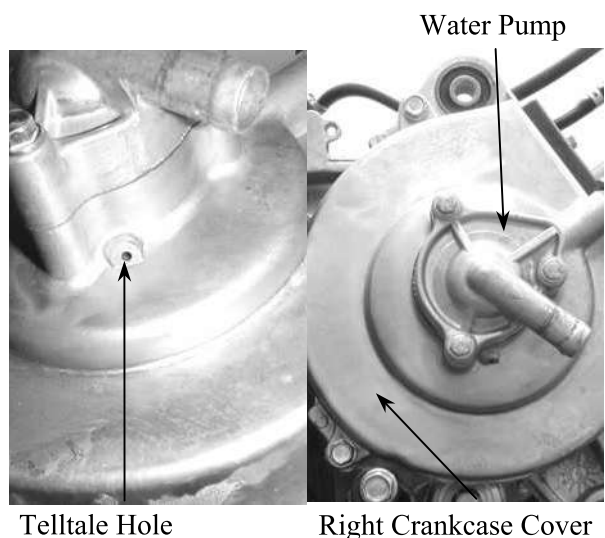

11. COOLING SYSTEM

WATER PUMP/IMPELLER REMOVAL

Remove the engine from the frame. (⇒5-2)



Remove the three bolts and the water pump cover, gasket and two dowel pins.

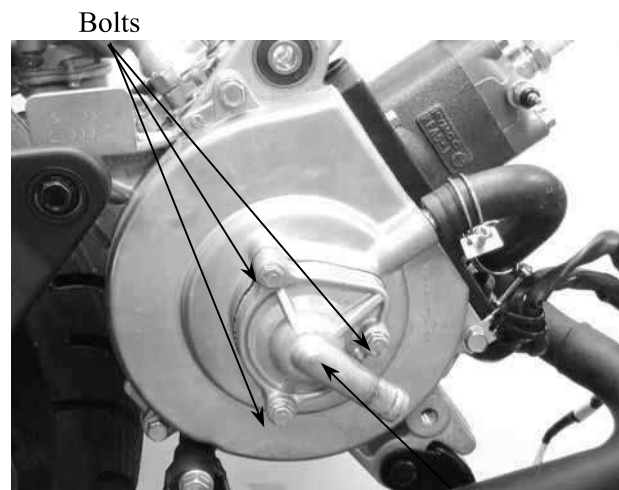

Bolts

Water Pump Cover

Remove the water pump impeller.

* The impeller has left hand threads.

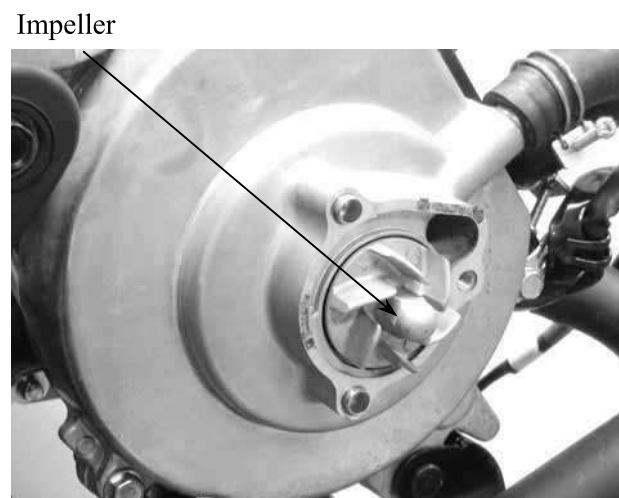

Impeller

11. COOLING SYSTEM

Inspect the mechanical (water) seal and seal washer for wear or damage.

* The mechanical seal and seal washer must be replaced as a set.

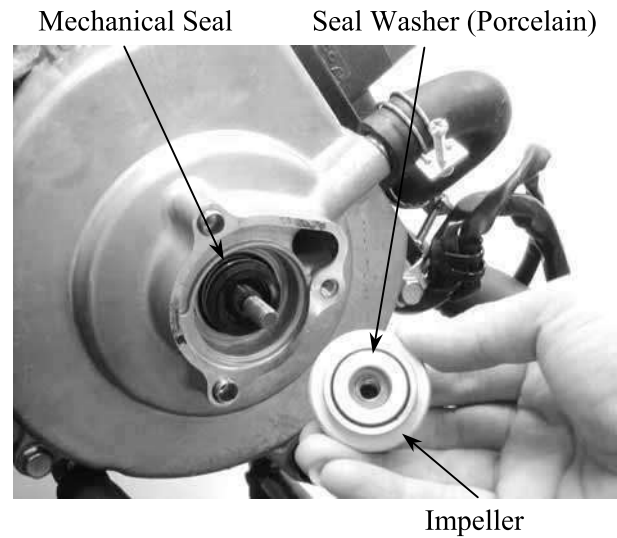

WATER PUMP SHAFT REMOVAL

Disconnect the water hose from the right crankcase cover.
 Remove the two timing cap bolts and the timing cap.
 Remove the three bolts attaching the water pump assembly.
 Remove the water pump assembly and dowel pins.

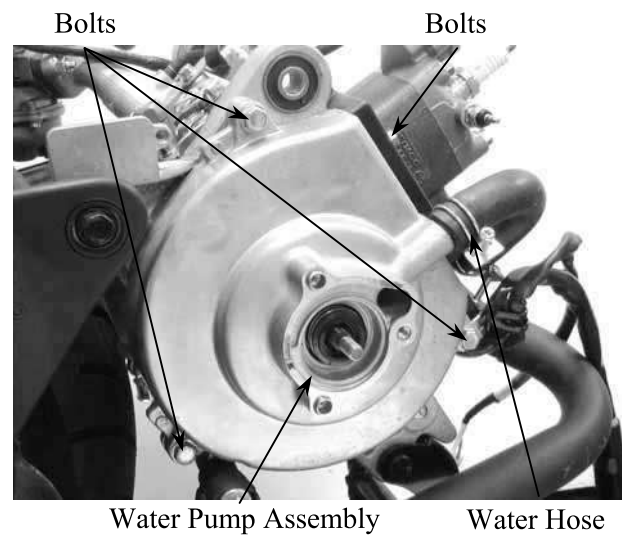

Remove the water pump shaft from the water pump assembly.

Water Pump Assembly

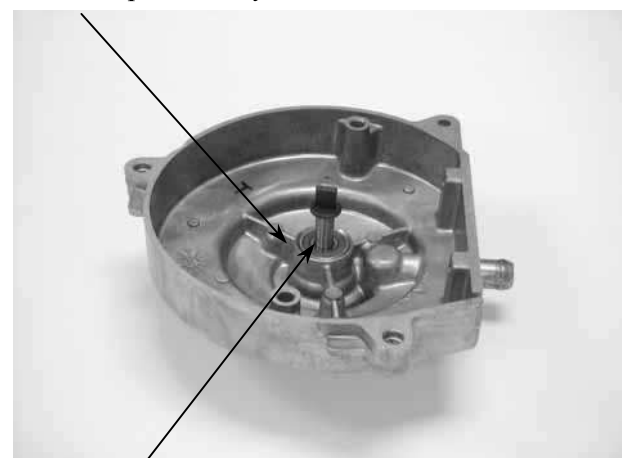

Water Pump Shaft

11. COOLING SYSTEM

**WATER PUMP BEARING/
MECHANICAL SEAL REMOVAL**
Remove the water pump shaft inside bearing.

Water Pump Assembly

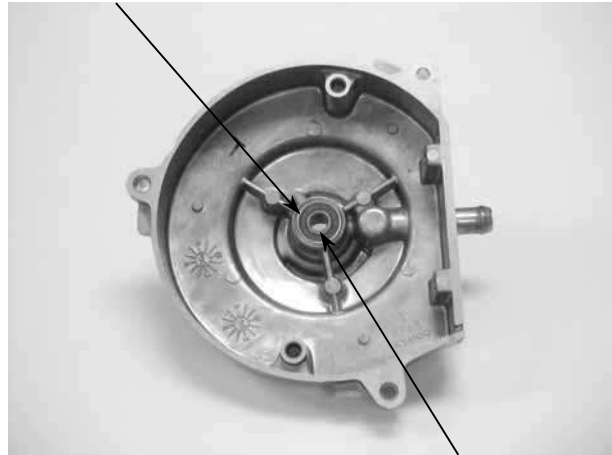

Inside Bearing

Drive the mechanical seal out of the water pump assembly from the outer.

Water Pump Assembly

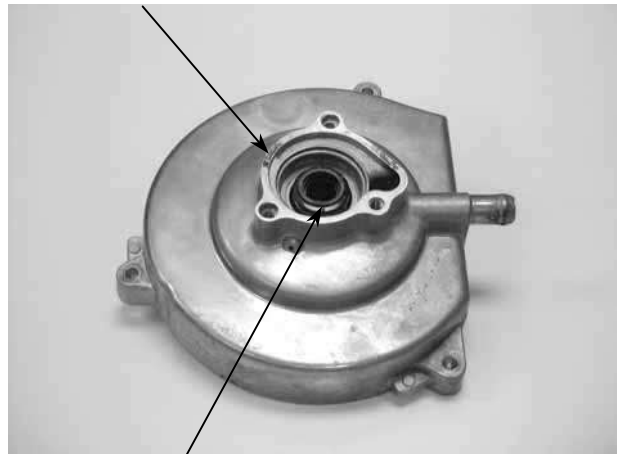

Mechanical Seal (Water Seal)

Remove the water pump shaft outer bearing.

Outer Bearing

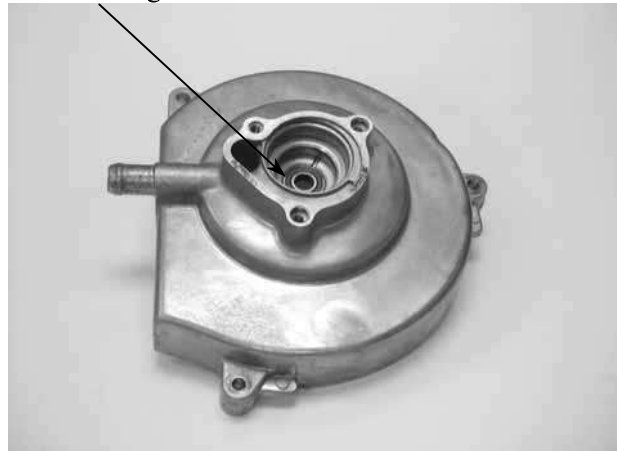

11. COOLING SYSTEM

WATER PUMP BEARING/ MECHANICAL SEAL INSTALLATION

Drive a new water pump shaft outer bearing into the water pump assembly from the inside.

Drive a new water pump shaft inside bearing into the water pump assembly from the inside.

Water Pump Assembly

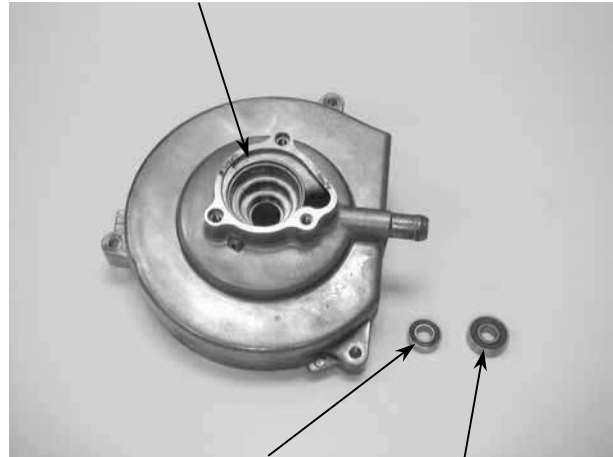

Outer Bearing

Inside Bearing

Drive in a new mechanical seal using a mechanical seal driver.

* Apply sealant to the right crankcase cover fitting surface of a new mechanical seal and then drive in the mechanical seal.

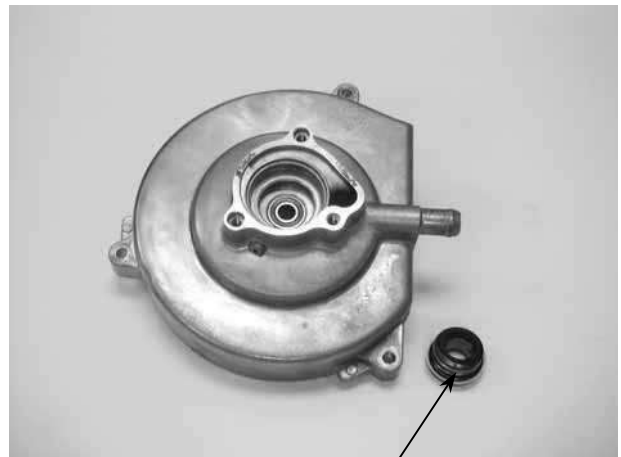

Mechanical Seal

Install the water pump shaft into the water pump assembly.

Water Pump Shaft

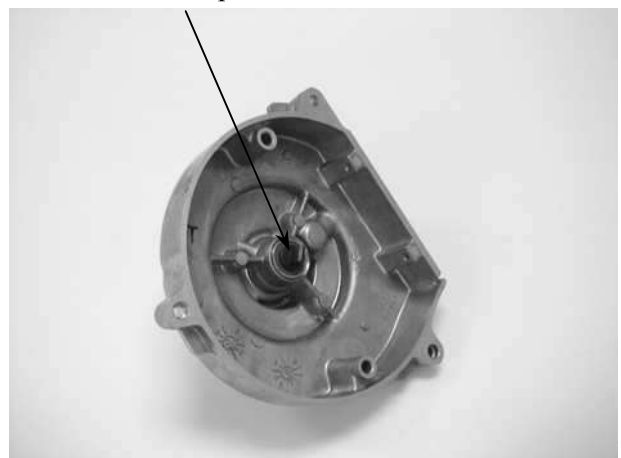

11. COOLING SYSTEM

Install the dowel pins and then install the water pump assembly to the right crankcase.

Tighten the three bolts to secure the water pump assembly.

Install the two timing cap bolts and the timing cap.

* When installing the water pump assembly, aligning the tab on the water pump shaft with the groove on the A.C. generator nut.

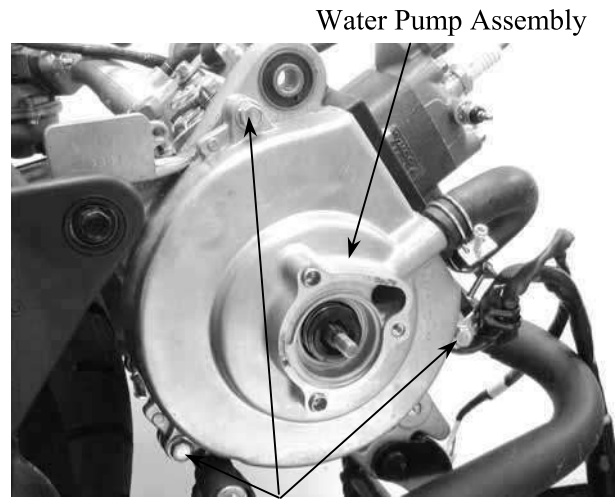

Bolts

WATER PUMP/IMPELLER INSTALLATION

When the mechanical seal is replaced, a new seal washer must be installed to the impeller.

Install the impeller onto the water pump shaft.

Torque: 9.8 ~ 13.72N-m

* The impeller has left hand threads.

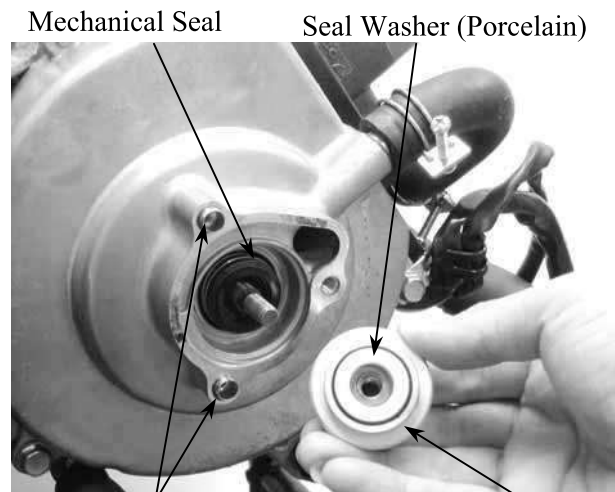

Dowel Pins

Impeller

Install the two dowel pins and a new gasket. Install the water pump cover and tighten the three bolts.

Torque: 7.84 ~ 11.76N-m

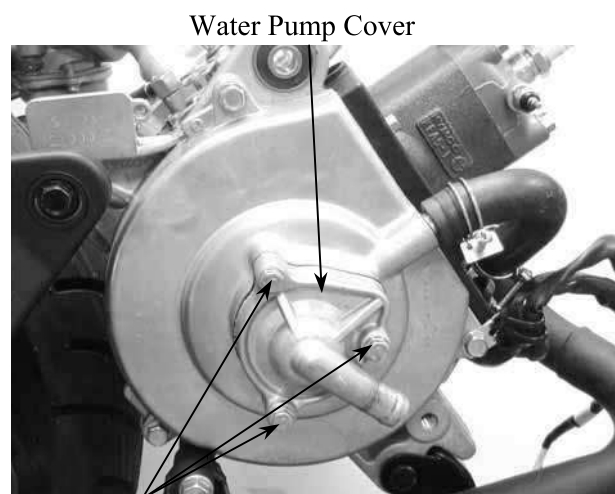

Bolts

11. COOLING SYSTEM

THERMOSENSOR

THERMOSENSOR REMOVAL

Remove the seat, met-in box and frame body cover.
 Drain the coolant.
 Disconnect the thermosensor wire.
 Remove the thermosensor.

Thermosensor



Thermosensor Wire

THERMOSENSOR INSPECTION

Suspend the thermosensor in a pan of water over a burner and measure the resistance through the sensor as the water heats up.

Temperature(°C)	50	80	100	120
Resistance(Ω)	154	52	27	16

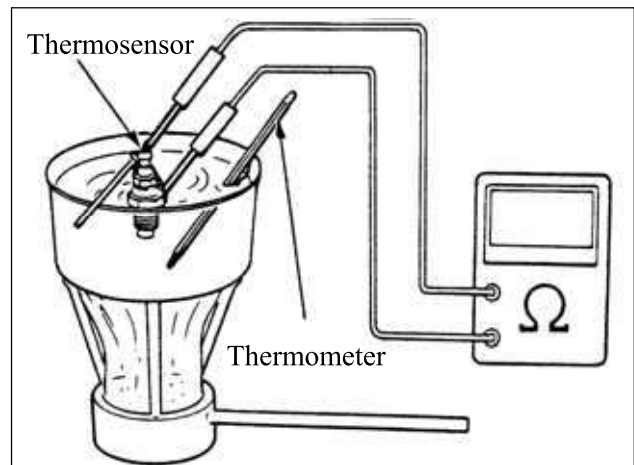

THERMOSENSOR INSTALLATION

Apply 3-BOND No. 1212 sealant or equivalent to the cylinder head threads and install it into the thermostat housing.
 Connect the thermosensor wire.
 Fill the reserve tank with coolant. (⇒3-10)
 Install the frame body cover, met-in box and seat. (⇒2-3)

* Be sure to bleed air from the cooling system.

Thermosensor



11. COOLING SYSTEM

THERMOSTAT

THERMOSTAT REMOVAL

Remove the seat, met-in box and frame body cover.
 Drain the coolant.
 Disconnect the water hose from the thermostat housing.

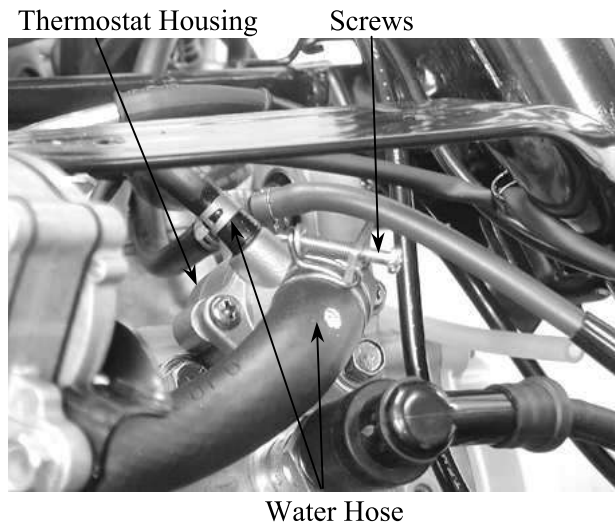

Remove the two screws and separate the thermostat housing cover .
 Remove the thermostat from the thermostat housing.



THERMOSTAT INSPECTION

Suspend the thermostat in a pan of water over a burner and gradually raise the water temperature to check its operation.

Technical Data

Begins to open	80±2°C
Full-open	90°C
Valve lift	3.5~4.5mm

- * Do not let the thermostat touch the pan as it will give a false reading.
 • Replace the thermostat if the valve stays open at room temperature.
 • Test the thermostat after it is opened for about 5 minutes and holds the temperature at 70°C.

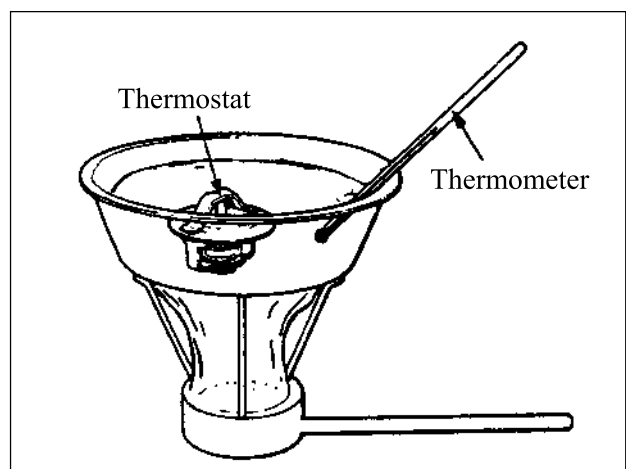

11. COOLING SYSTEM

THERMOSTAT INSTALLATION

The installation sequence is the reverse of removal.

Fill the cooling system with the specified coolant. (⇒3-10)

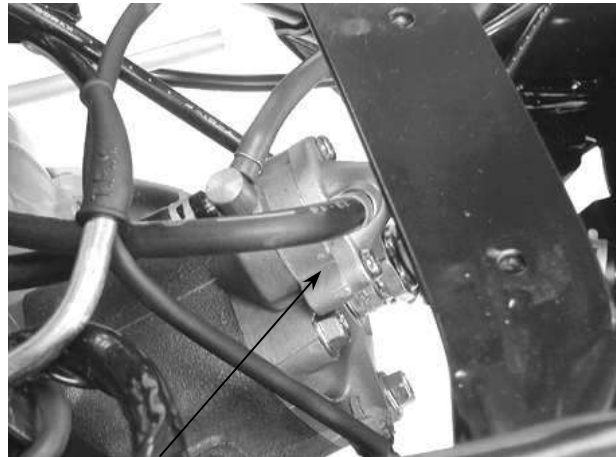

Thermostat Housing

**CARBURETOR/FUEL PUMP/
FUEL TANK**

SERVICE INFORMATION	12- 1
TROUBLESHOOTING	12- 1
THROTTLE VALVE DISASSEMBLY	12- 2
THROTTLE VALVE INSTALLATION.....	12- 3
CARBURETOR REMOVAL	12- 4
AUTO BYSTARTER.....	12- 5
FLOAT CHAMBER	12- 7
FLOAT LEVEL INSPECTION	12- 9
CARBURETOR INSTALLATION	12-10
AIR SCREW ADJUSTMENT	12-10
REED VALVE	12-11

12. CARBURETOR/FUEL PUMP/ FUEL TANK

SERVICE INFORMATION

GENERAL INSTRUCTIONS

- When working with gasoline, keep away from sparks and flames..
- Note the locations of O-rings when disassembling and replace them with new ones during assembly.
- All cables, fuel lines and wires must be routed and secured at correct locations.
- Bleed air from the oil lines whenever they are disconnected.

SPECIFICATIONS	SH10CA(SP)	SH10CA(IT)	SH10CA(GR)
Venturi dia.	14mm		
Identification number	PB109• •	PB103• •	PB118• •
Float level	8.6mm		
Main jet(Unlimited/limited speed)	#75	#75	#88
Slow jet	#35		
Air screw opening	1¼± ½		
Idle speed	2000±100rpm		
Throttle grip free play	2~6mm		

SPECIAL TOOL

Float level gauge

TROUBLESHOOTING

Engine does not start

- No fuel in tank
- Too much fuel getting to cylinder
- Clogged fuel filter
- Clogged air cleaner

Lean mixture

- Clogged fuel jets
- Clogged fuel cap vent
- Clogged fuel filter
- Bent, kinked or restricted fuel line

- Faulty float valve
- Float level too low
- Clogged air cleaner

Engine idles roughly, stalls or runs poorly

- Incorrect idle speed
- Ignition malfunction
- Compression too low
- Incorrectly adjusted air screw
- Incorrect float level
- Clogged air cleaner
- Intake air leaks
- Fuel contaminated
- Faulty reed valve
- Clogged fuel jets

Rich mixture

- Faulty float valve
- Float level too high
- Clogged air jets

12. CARBURETOR/FUEL PUMP/ FUEL TANK

THROTTLE VALVE DISASSEMBLY

Remove the rear carrier. (⇒2-3)
Remove the met-in box. (⇒2-4)
Loosen the carburetor cap and remove the throttle valve.

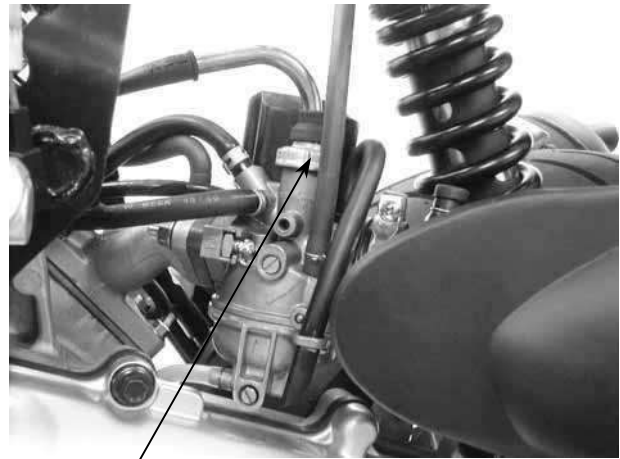

Carburetor Cap

Disconnect the throttle cable from the throttle valve.

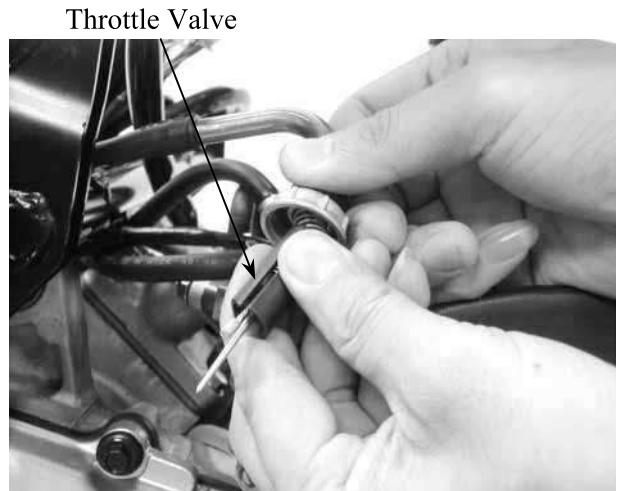

Throttle Valve

Remove the throttle valve spring, carburetor cap and rubber seal.

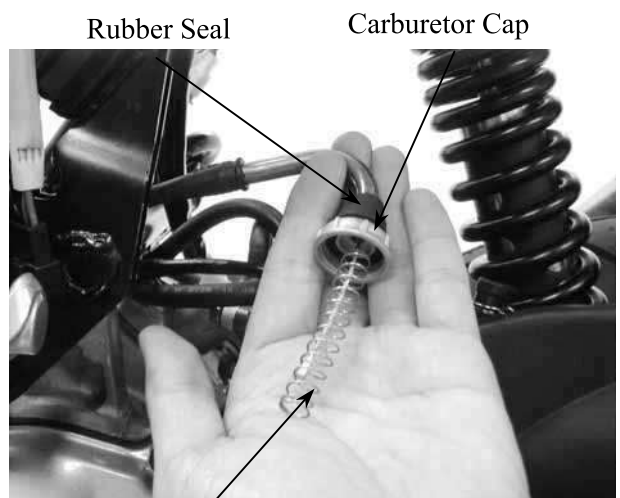

Rubber Seal

Carburetor Cap

Spring

12. CARBURETOR/FUEL PUMP/ FUEL TANK

Remove the jet needle by removing the needle clip.
Check the jet needle and throttle valve for wear or damage.

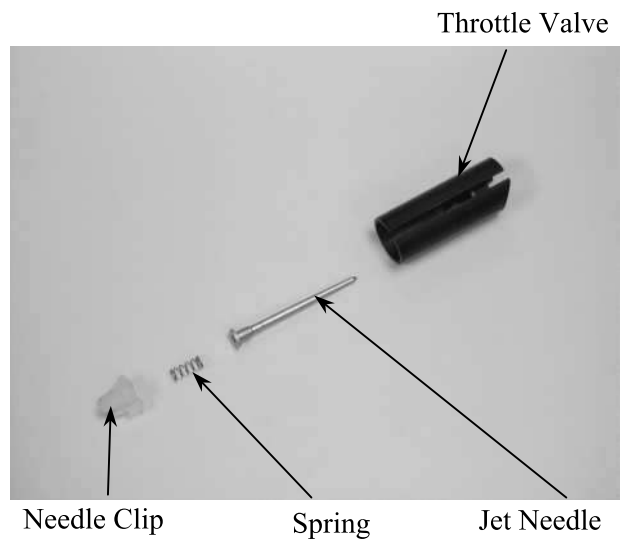

THROTTLE VALVE INSTALLATION

Install the jet needle on the throttle valve and secure with the needle clip.

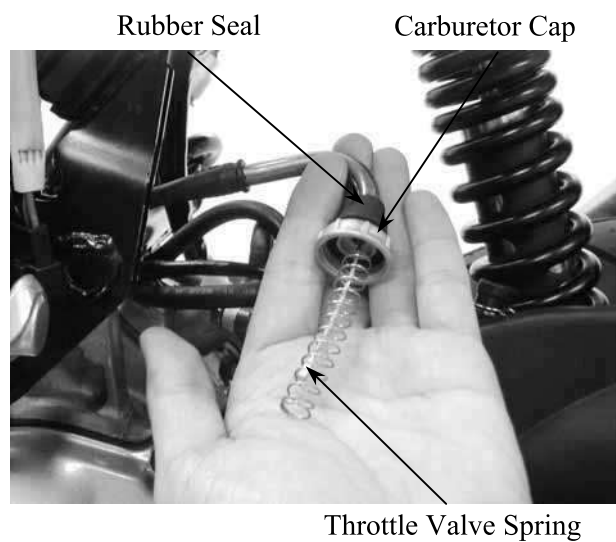

Install the rubber seal on the throttle cable and then install the carburetor cap and throttle valve spring.
Connect the throttle cable to the throttle valve.

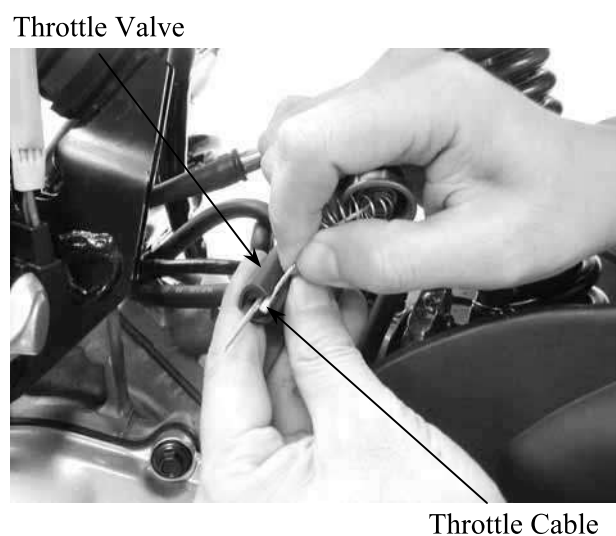

12. CARBURETOR/FUEL PUMP/ FUEL TANK

Install the throttle valve by aligning the groove in the throttle valve with the throttle stop screw.

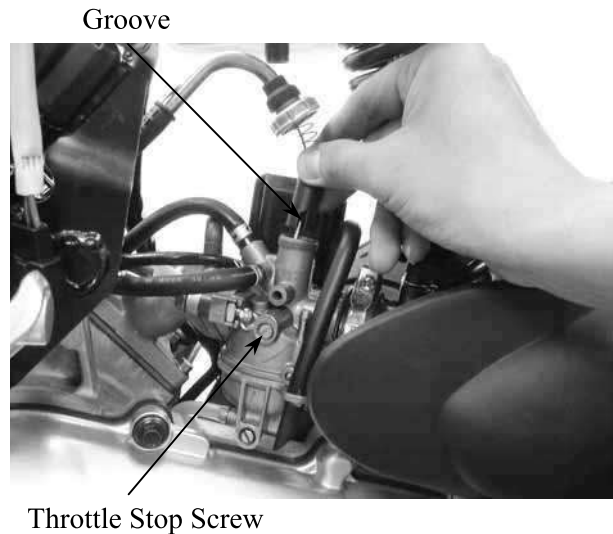

Tighten the carburetor cap.
After installation, perform the following adjustments and inspections.

- Throttle cable free play (⇒3-12)
- Idle speed adjustment (⇒3-11)

Install the met-in box.



CARBURETOR REMOVAL

Remove the met-in box. (⇒2-3)
Remove the air cleaner by removing the air cleaner band screw and attaching bolts.
Disconnect the fuel tube.
Loosen the drain bolt to drain fuel from the carburetor.
Disconnect the auto bystarter wire connector.

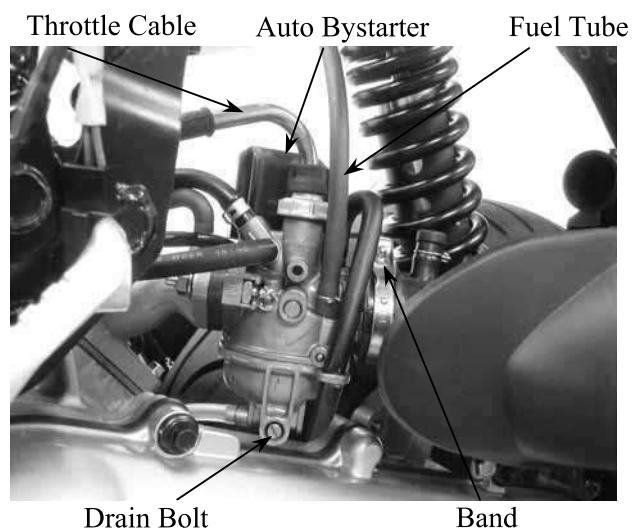

12. CARBURETOR/FUEL PUMP/ FUEL TANK

Remove the two carburetor lock nuts.
Remove the carburetor and water hose.

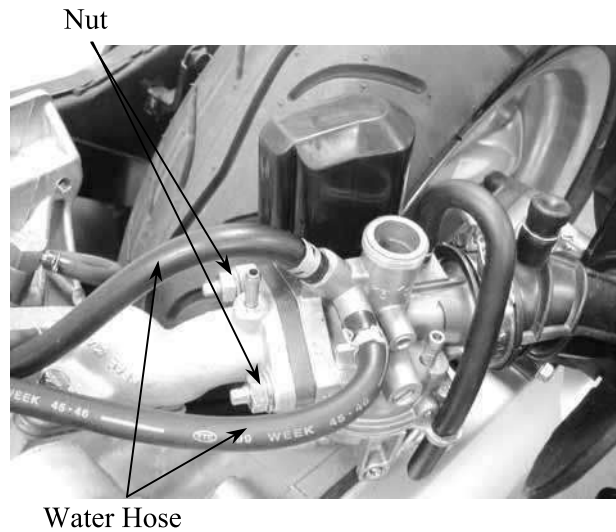

AUTO BYSTARTER

AUTO BYSTARTER INSPECTION

Measure the resistance between the auto bystarter wire terminals.

Resistance: 5Ω (10 minutes minimum after stopping the engine)

If the resistance exceeds 5Ω , replace the auto bystarter with a new one.



After the engine stops for 30 minutes, connect a hose to the fuel enriching circuit and blow the hose with mouth.
If air cannot be blown into the hose (clogged), the auto bystarter is faulty.
Replace it with a new one.

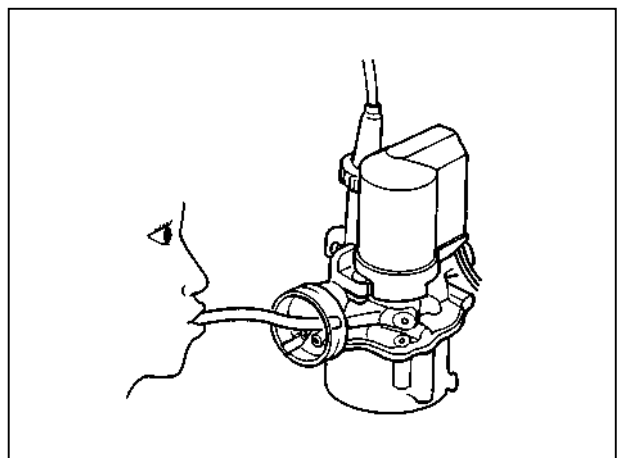

12. CARBURETOR/FUEL PUMP/ FUEL TANK

Connect the auto bystarter yellow wire to the battery positive (+) terminal and green/black wire to the battery negative (-) terminal and wait 5 minutes.

Connect a hose to the fuel enriching circuit and blow the hose with mouth.

If air can be blown into the hose, the auto bystarter is faulty and replace it with a new one.

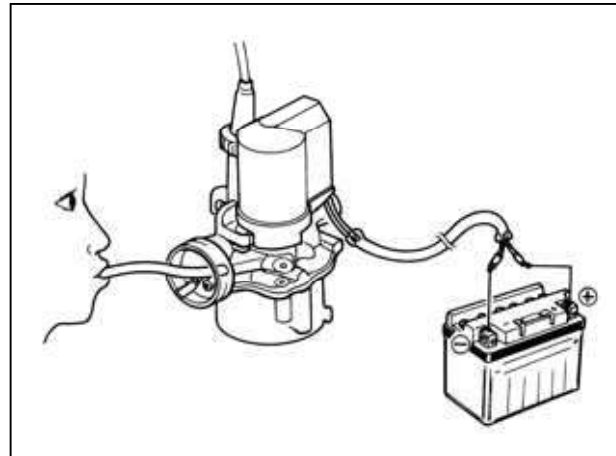

AUTO BYSTARTER REMOVAL

Remove the auto bystarter cover.

Remove the two auto bystarter set plate screws to remove the auto bystarter.

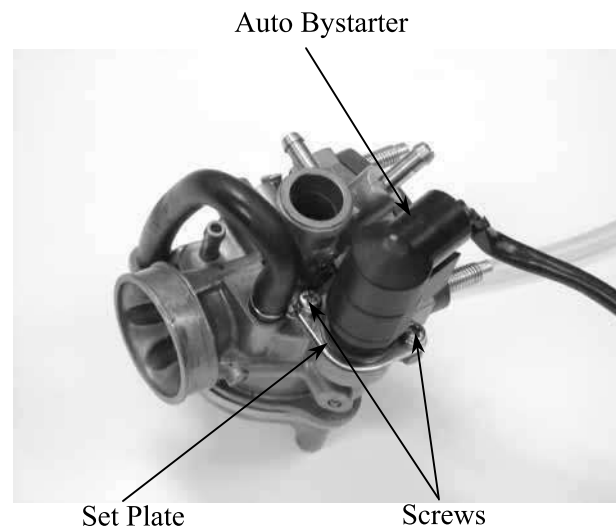

Check the auto bystarter valve and needle for wear or damage.

Check the O-ring for wear or damage.

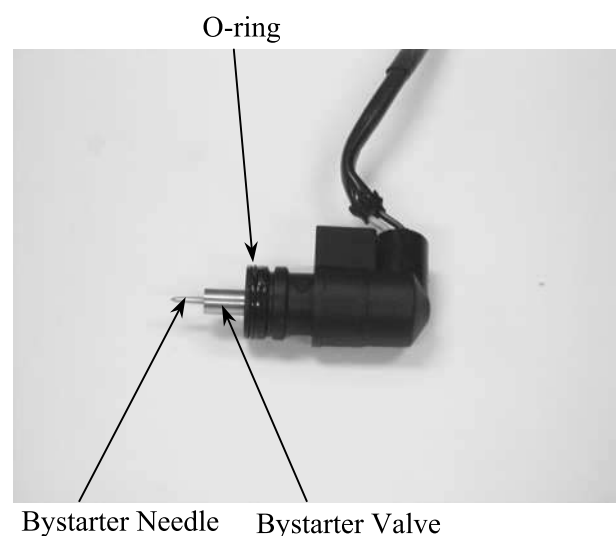

12. CARBURETOR/FUEL PUMP/ FUEL TANK

AUTO BYSTARTER INSTALLATION

Install the auto bystarter into the carburetor body until it bottoms..
Install the set plate and then tighten the two screws.

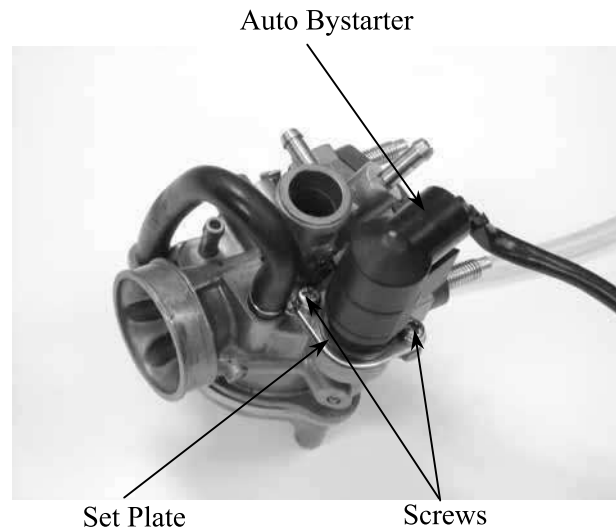

FLOAT CHAMBER

Remove the two float chamber screws and the float chamber.

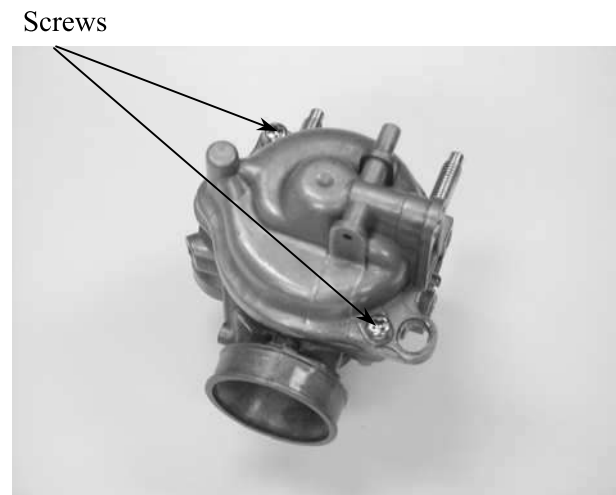

Remove the screw and O-ring.
Remove the float pin, float and float valve.

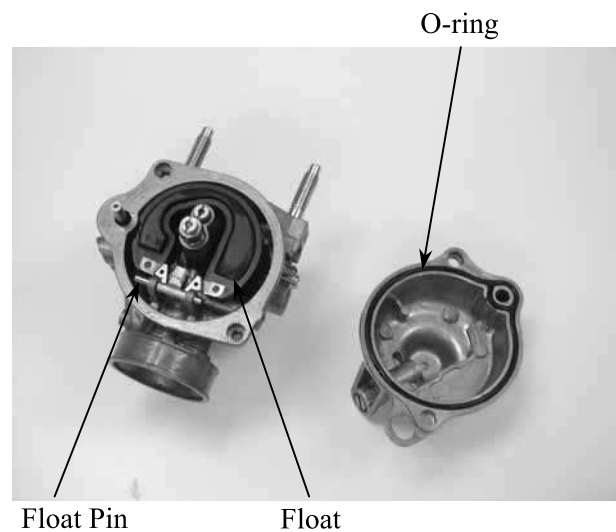

12. CARBURETOR/FUEL PUMP/ FUEL TANK

FLOAT/FLOAT VALVE INSPECTION

Inspect the float for damage or fuel inside the float.
Check the float valve seat for wear or damage.

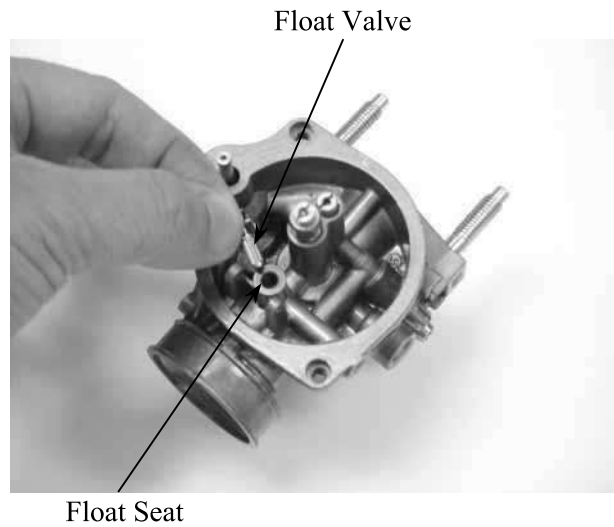

JETS/SCREWS REMOVAL

Before removing the throttle stop screw or air screw, record the number of rotations until it seats lightly. Then, remove them.

* Do not force the air screw against its seat to prevent damage.

Remove the main jet and needle jet holder.

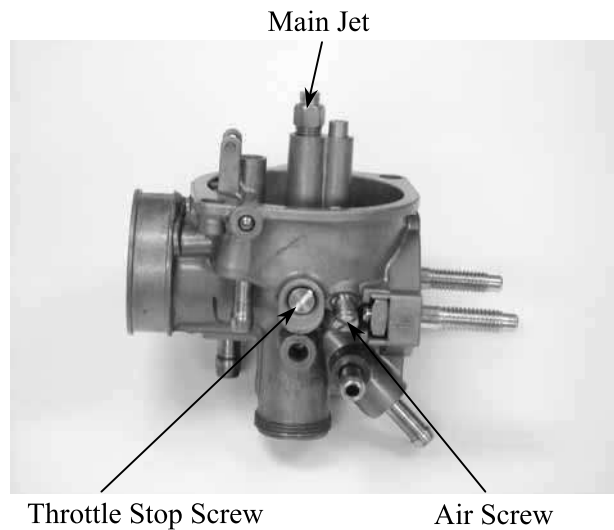

CARBURETOR PASSAGES CLEANING

Blow compressed air through all passages of the carburetor body with an air gun.

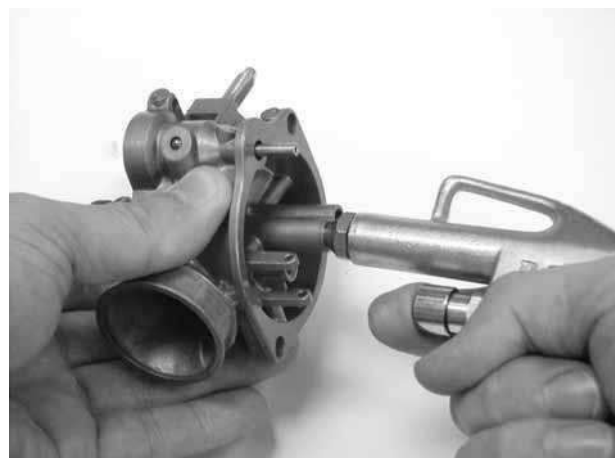

12. CARBURETOR/FUEL PUMP/ FUEL TANK

FLOAT CHAMBER ASSEMBLY

Install the main jet and needle jet holder.
Install the air screw and throttle stop screw
according to the rotations recorded.

*

If the air screw must be replaced, be
sure to perform the air screw adjustment
again.

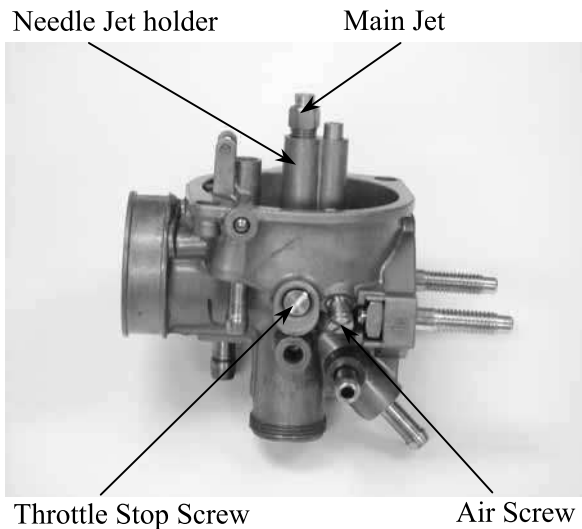

Install the float valve, float and float pin.
Tighten the float screw securely.

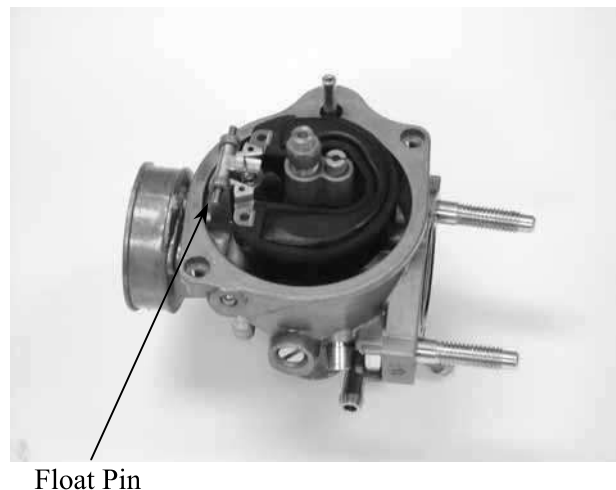

FLOAT LEVEL INSPECTION

Slightly tilt the carburetor and measure the
float level with the float valve just
connecting the float arm.

Float Level: 8.6 mm

Replace the float if the level is out of the
specified level range.

Install the O-ring.

Check the operation of the float and install
the float chamber.

Tighten the screws.



12. CARBURETOR/FUEL PUMP/ FUEL TANK

CARBURETOR INSTALLATION

- * When installation, do not allow foreign particles to enter the carburetor.

Check the carburetor insulator and O-ring for wear or damage.
Install the carburetor and insulator onto the intake manifold and tighten the two lock nuts.
Connect the fuel tube and auto bystarter wire connector.

- * Route the auto bystarter wire correctly and properly.

Install the carburetor cap. (⇒12-4)
Install the air cleaner onto the carburetor and tighten the band screw.
Install the met-in box. (⇒2-3)

AIR SCREW ADJUSTMENT

Remove the met-in box. (⇒2-3)

- * Warm up the engine before air screw adjustment.

Turn the air screw clockwise until it seats lightly and back it to the specification given.

Air Screw Opening:

SH10CA: $1\frac{1}{4} \pm \frac{1}{2}$ turns

Start the engine and turn the air screw in or out slowly to obtain the highest engine speed.

- * Do not force the air screw against its seat to prevent damage.

Turn the throttle stop screw to obtain the specified idle speed.

Idle Speed:

SH10CA: 2000 ± 100 rpm

Slightly increase the engine speed and make sure that the engine does not miss or run erratic.
If the adjustment of the air screw within the range of $\pm\frac{1}{2}$ turn makes no difference to the engine performance, check other related items.

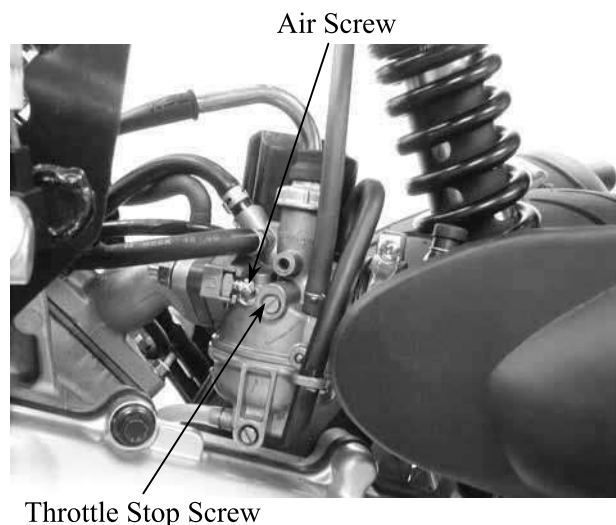
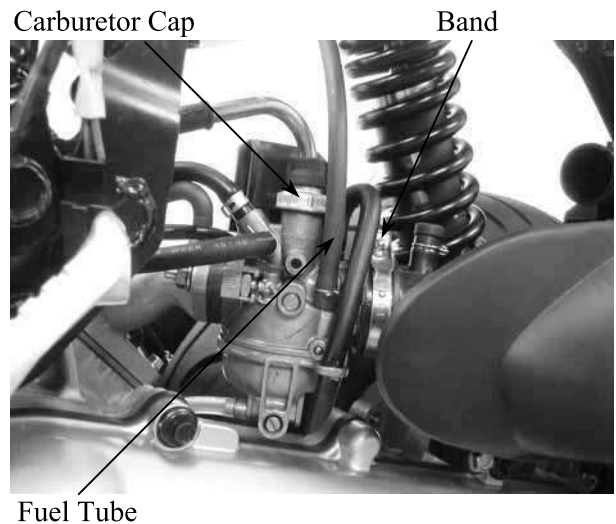
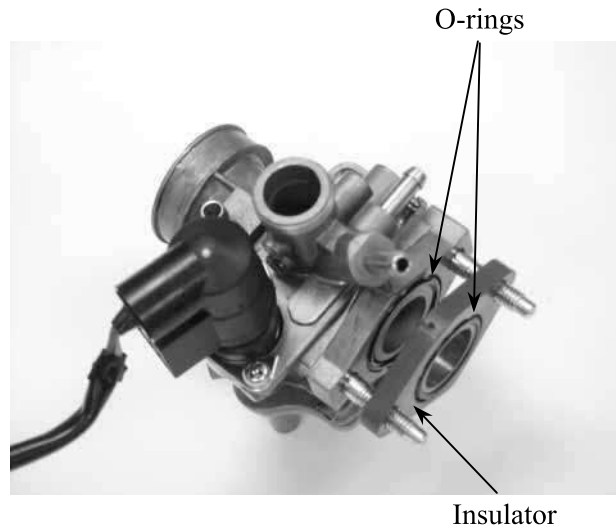

12. CARBURETOR/FUEL PUMP/ FUEL TANK

REED VALVE

REMOVAL

Remove the rear carrier.
Remove the frame body cover.
Remove the four intake manifold bolts and gasket.
Remove the reed valve and gasket.

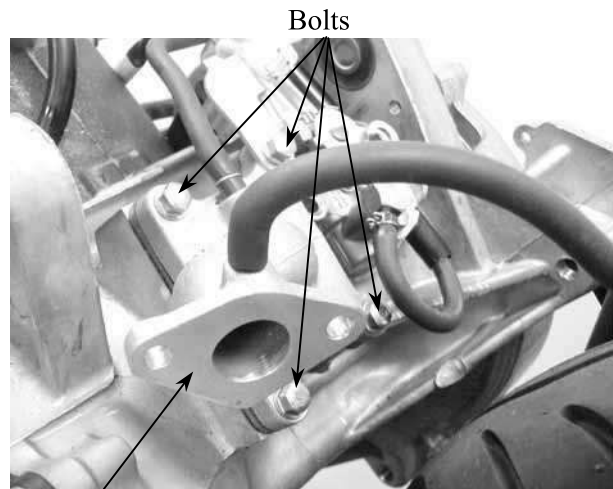

Intake Manifold

INSPECTION

Check the reed valve for damaged or weak reeds.
Check the reed valve seat for cracks, damage or clearance between the seat and reed.
Replace the valve if necessary.

* Do not disassemble or bend the reed stopper. To do so can cause loss of engine power and engine damage. If any of the stopper, reed or valve seat is faulty, replace them as a unit.

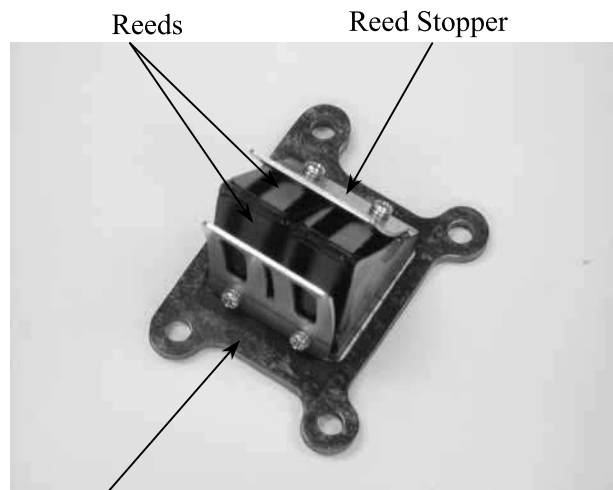

Reed Valve Seat

INSTALLATION

Install the reed valve in the reverse order of removal.

*

- Install a new gasket with the gasket indentation aligned with the reed valve.
- After installation, check for intake air leaks.

12. CARBURETOR/FUEL PUMP/ FUEL TANK

FUEL PUMP REMOVAL

Remove the frame center cover.
Disconnect the fuel pump inlet, outlet and vacuum tubes.
Remove the two fuel pump attaching bolts and the fuel pump.

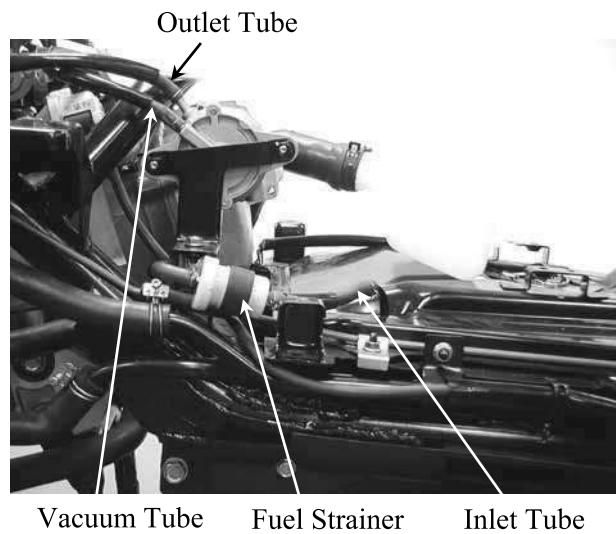

FUEL PUMP DISASSEMBLY

Remove the four fuel pump body screws.

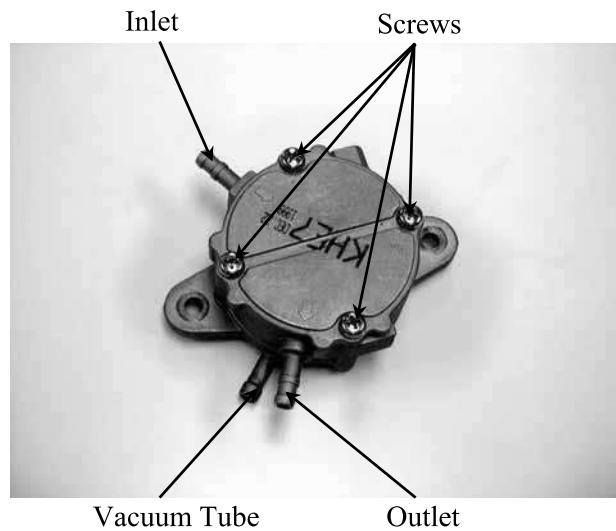

Disassemble the fuel pump.

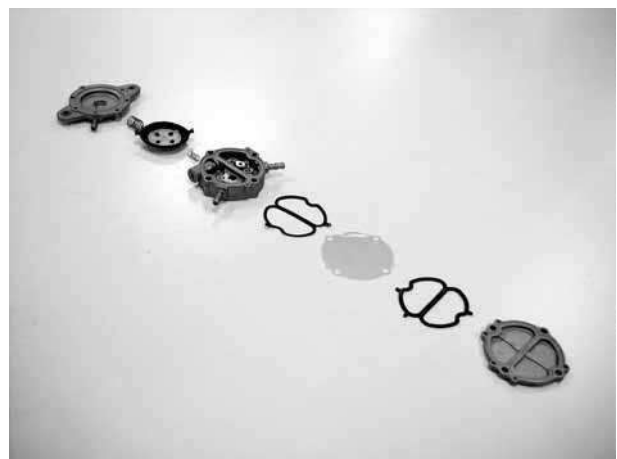

12. CARBURETOR/FUEL PUMP/ FUEL TANK

FUEL PUMP INSPECTION

Inspect the fuel pump diaphragms A and B for damage.
Inspect each gasket for damage.

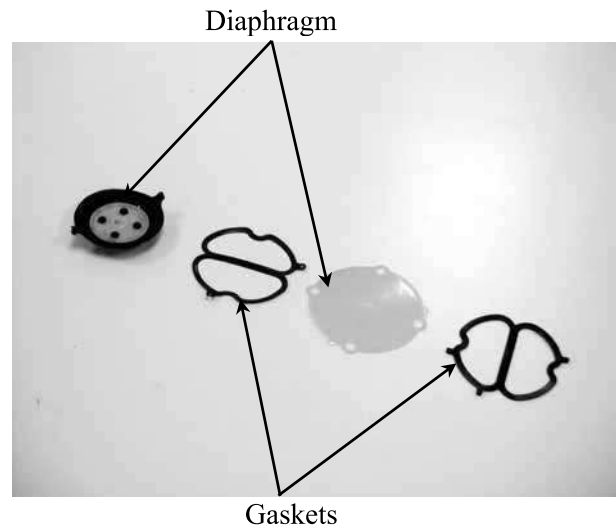

Inspect the suction valve, outlet valve and relief valve in the fuel pump body for damage, cracks or foreign matters.

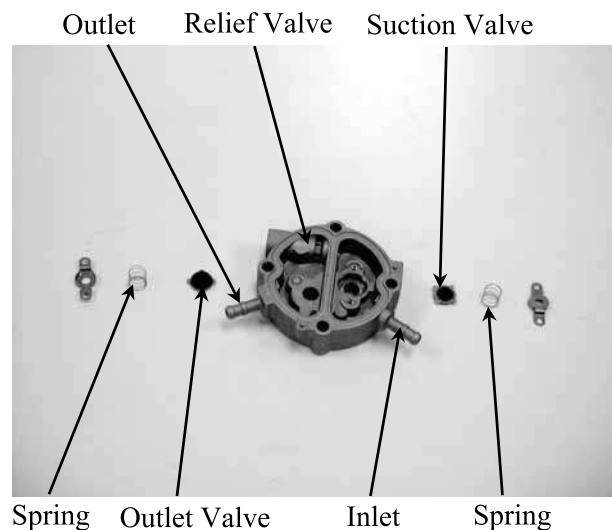

FUEL PUMP ASSEMBLY

Assemble the fuel pump in the reverse order of disassembly.

- * During assembly, be sure to install the gaskets and diaphragms properly to avoid damage.
- * Do not allow any foreign matter to enter the fuel pump during assembly.

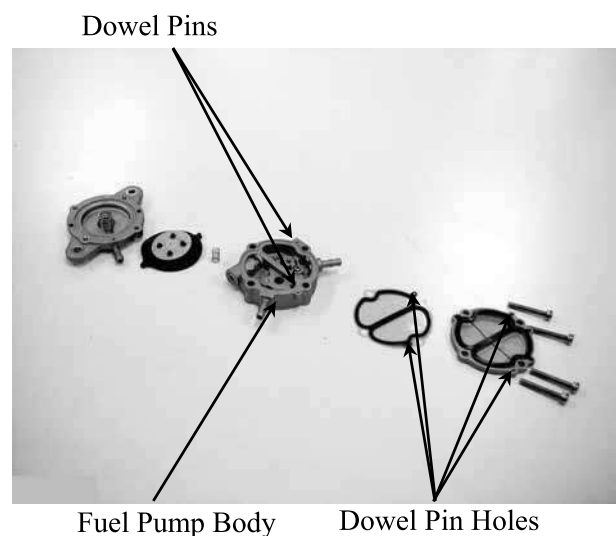

12. CARBURETOR/FUEL PUMP/ FUEL TANK

FUEL PUMP INSTALLATION

Install the fuel pump and secure it with the two bolts.
Connect the fuel pump inlet, outlet and vacuum tubes.
Install the seat, met-in box and frame center cover.

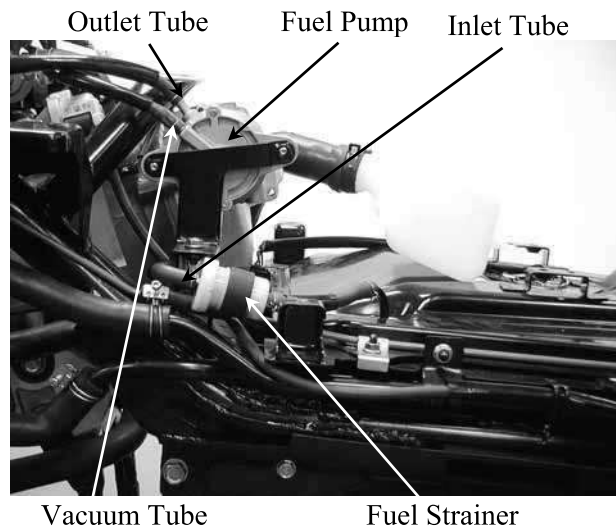

Measure the fuel pump output.
Start the engine and disconnect the fuel outlet tube and place a clean container under the tube to check the fuel output.
Output: 40cc/1500rpm/10 seconds .

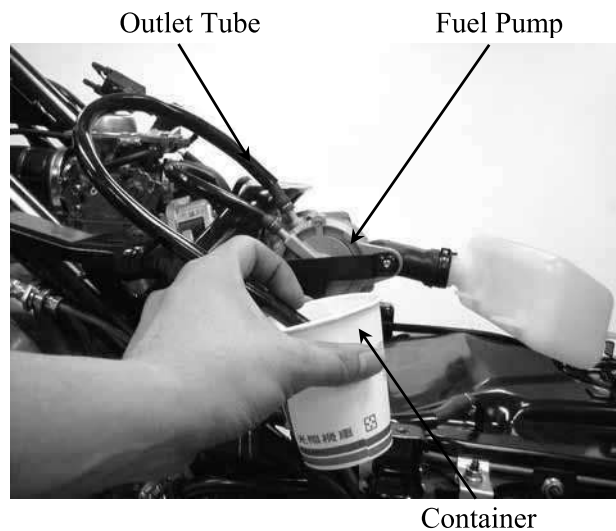

FUEL TANK REMOVAL

Remove the floor board. (⇒2-4)
Remove the leg shield . (⇒2-5)
Disconnect the fuel unit wire connector.
Remove the fuel tube between the fuel tank and the fuel filler.
Disconnect the fuel vapor tube.
Remove the fuel tank.
The installation sequence is the reverse of removal.

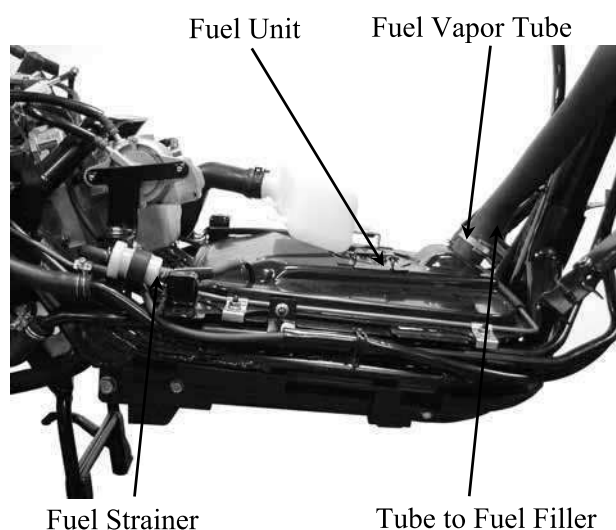

12. CARBURETOR/FUEL PUMP/ FUEL TANK

FUEL STRAINER REMOVAL

Remove the fuel strainer from the fuel tank.

INSPECTION

Inspect if the fuel strainer is clogged and clean it with compressed air.

- * When removing the fuel strainer, do not allow flames or sparks near the working area and drain the residual gasoline into a container.



INSTALLATION

Install the fuel strainer with its arrow mark toward the fuel pump.

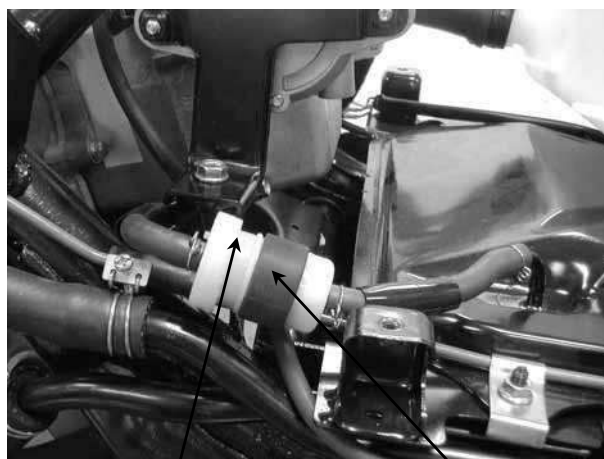

Arrow Mark

Fuel Strainer

STEERING HANDLEBAR/FRONT WHEEL/FRONT BRAKE/FRONT SHOCK ABSORBER/FRONT FORK

SERVICE INFORMATION-----	13- 1
TROUBLESHOOTING-----	13- 2
STEERING HANDLEBAR -----	13- 3
FRONT WHEEL -----	13- 5
FRONT BRAKE -----	13- 8
BRAKE CALIPER -----	13-11
FRONT SHOCK ABSORBER-----	13-14
FRONT FORK -----	13-18

13. STEERING HANDLEBAR/FRONT WHEEL/FRONT BRAKE/FRONT SHOCK ABSORBER/FRONT FORK



BET & WIN 50

SERVICE INFORMATION

GENERAL INSTRUCTIONS

- Remove the motorcycle frame covers before removing the front wheel, steering handlebar, front shock absorber and front fork. Jack the motorcycle front wheel off the ground and be careful to prevent the motorcycle from falling down.
- During servicing, keep oil or grease off the brake pads and brake disk.

SPECIFICATIONS

Item	Standard (mm)	Service Limit (mm)
Axle shaft runout	—	0.2
Front wheel rim runout	Radial	2.0
	Axial	2.0
Front brake pad thickness	4.0	2.0
Front shock absorber spring free length	221.5	204.3
Brake disk thickness	3.8~4.2	3.0
Brake disk runout	—	0.30
Brake master cylinder I.D.	11.0~11.043	11.055
Brake master cylinder piston O.D.	10.957~10.970	10.945
Brake caliper piston O.D.	25.335~25.368	25.30
Brake caliper cylinder I.D.	25.400~25.45	25.485

TORQUE VALUES

Steering stem lock nut	78.4~117.6N-m
Steering top cone race	4.9~12.74N-m
Front shock absorber bolt	19.6~24.5N-m
Front axle nut	44.1~49.0N-m
Brake caliper bolt	24.5~34.3N-m

SPECIAL TOOLS

Lock nut wrench
Front shock absorber compressor
Ball race remover
Driver handle
Outer driver
Bearing remover
Bearing remover head, 12mm

TROUBLESHOOTING

Hard steering (heavy)

- Excessively tightened steering stem top cone race
- Broken steering balls
- Insufficient tire pressure

Steers to one side or does not track straight

- Uneven front shock absorbers
- Bent front fork
- Bent front axle or uneven tire

Poor brake performance

- Worn brake pads
- Contaminated brake pad surface
- Deformed brake disk
- Air in brake system
- Deteriorated brake fluid
- Worn brake master cylinder piston oil seal
- Clogged brake fluid line
- Unevenly worn brake caliper

Front wheel wobbling

- Bent rim
- Loose front axle
- Bent spoke plate
- Faulty tire
- Improperly tightened axle nut

Soft front shock absorber

- Weak shock springs
- Insufficient damper oil

Front shock absorber noise

- Slider bending
- Loose fork fasteners
- Lack of lubrication

13. STEERING HANDLEBAR/FRONT WHEEL/FRONT BRAKE/FRONT SHOCK ABSORBER/FRONT FORK



BET & WIN 50

STEERING HANDLEBAR

REMOVAL

Remove the handlebar front and rear covers.

(⇒2-7)

Remove the front brake master cylinder attaching bolts.

Remove the front upper cover. (⇒2-3)

Remove the front lower cover. (⇒2-3)

Remove the leg shield. (⇒2-4)

Remove the floor board. (⇒2-5)

Brake Master Cylinders

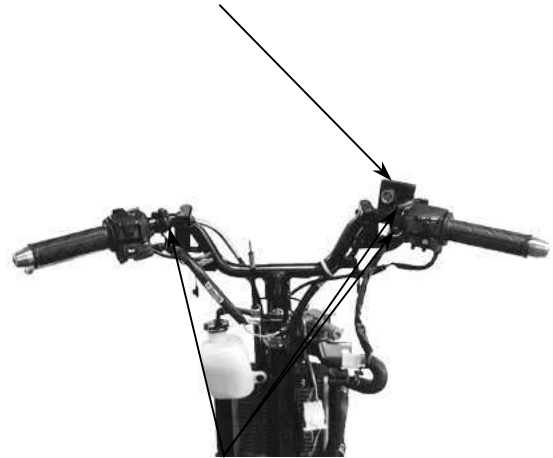

Bolts

Remove the four screws attaching the right and left handlebar switches.

Disconnect the throttle cable from the throttle grip and remove the throttle grip from the handlebar.

Throttle Grip

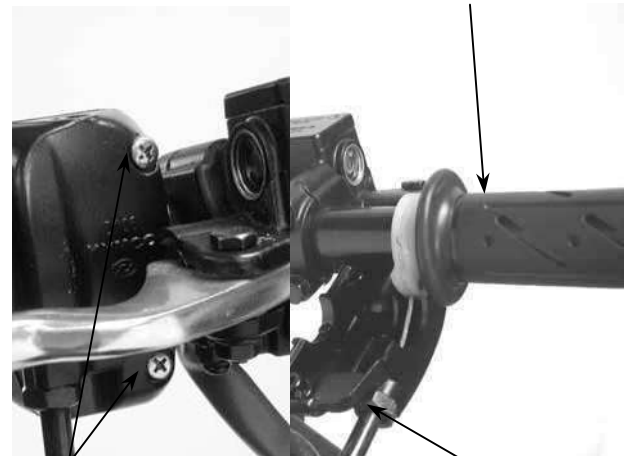

Screws

Throttle Cable

Remove the handlebar lock nut and take out the bolt.

Remove the handlebar.



Lock Nut

Bolt

13. STEERING HANDLEBAR/FRONT WHEEL/FRONT BRAKE/FRONT SHOCK ABSORBER/FRONT FORK



BET & WIN 50

INSTALLATION

Install the handlebar onto the steering stem and install the handlebar lock nut and bolt. Tighten the bolt to the specified torque.

Torque: 39.2~49.0N-m

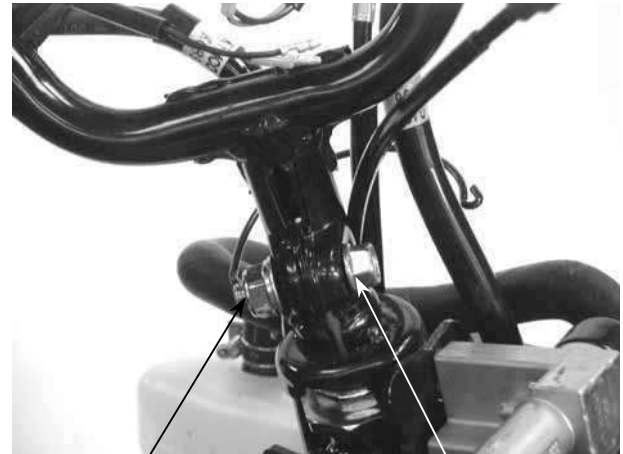

Lock Nut

Bolt

Lubricate the throttle grip front end with grease and then install the throttle grip. Connect the throttle cable to the throttle grip. Install the right and left handlebar switches and tighten the screws.

- * Adjust the throttle grip free play to the specified range of 2~6mm.

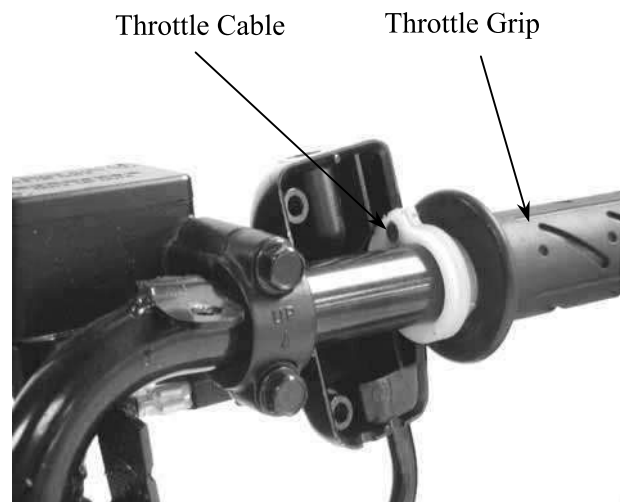

Throttle Cable

Throttle Grip

Install the front and rear brake master cylinders.

- * Install the brake master cylinders by aligning the index marks.

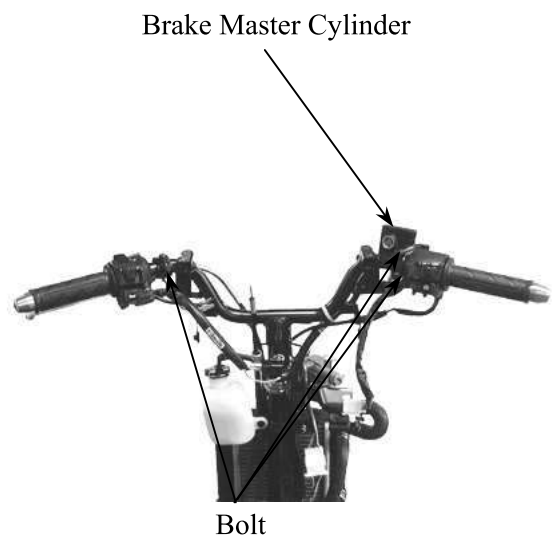

Brake Master Cylinder

Bolt

13. STEERING HANDLEBAR/FRONT WHEEL/FRONT BRAKE/FRONT SHOCK ABSORBER/FRONT FORK



BET & WIN 50

FRONT WHEEL

REMOVAL

Jack the motorcycle front wheel off the ground.
Remove the front axle nut to pull out the axle.
Remove the front wheel and the speedometer gear unit.



Axle Nut

Speedometer Gear Unit

INSPECTION

AXLE RUNOUT

Set the axle in V blocks and measure the runout using a dial gauge.
The actual runout is $\frac{1}{2}$ of the total indicator reading.

Service Limit: 0.2mm replace if over

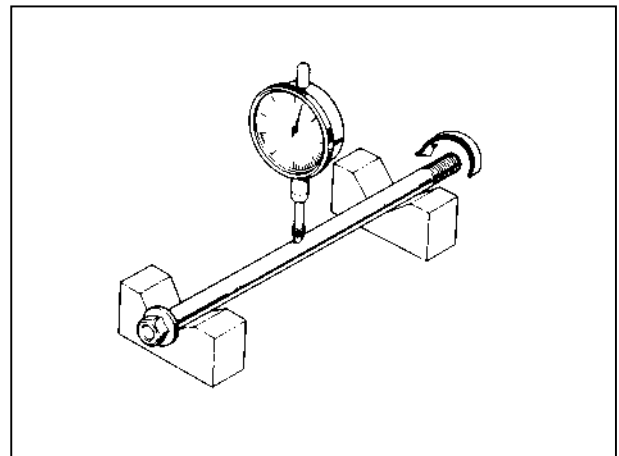

WHEEL RIM

Check the wheel rim runout.

Service Limits:

Radial: 2.0mm replace if over

Axial: 2.0mm replace if over

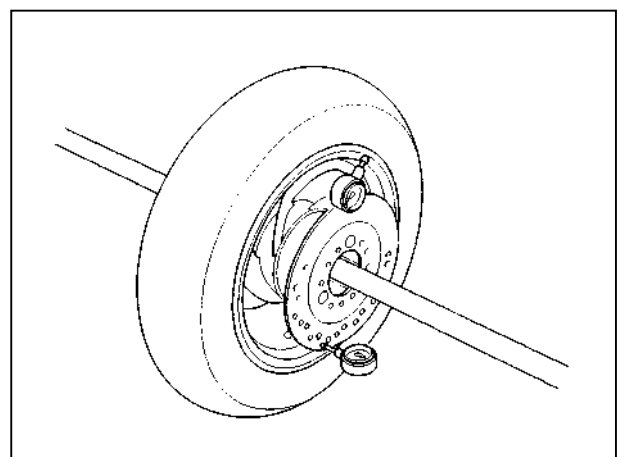

FRONT WHEEL BEARING

Remove the side collar and dust seal.



Turn the inner race of each bearing with your finger to see if they turn smoothly and quietly. Also check if the outer race fits tightly in the hub. Replace the bearings if the races do not turn smoothly, quietly, or if they fit loosely in the hub.

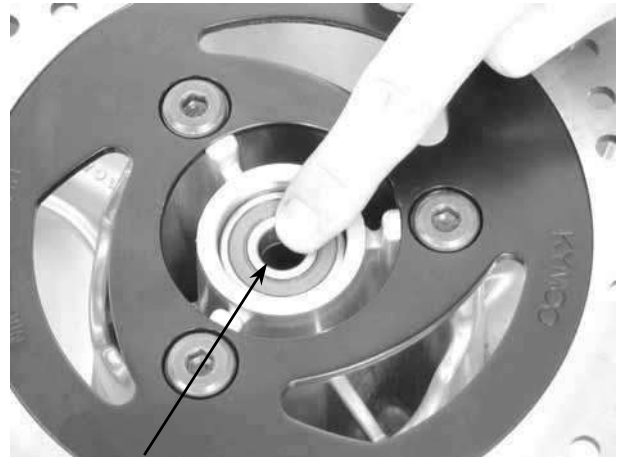

Wheel Bearing

BEARING REPLACEMENT

Remove the front wheel bearings and distance collar.

Special Tools

Bearing Remover

Bearing Remover Head, 12mm



13. STEERING HANDLEBAR/FRONT WHEEL/FRONT BRAKE/FRONT SHOCK ABSORBER/FRONT FORK



BET & WIN 50

Pack all bearing cavities with grease.
Drive in the left bearing.
Install the distance collar.
Drive in the right bearing.

- * Do not allow the bearings to tilt while driving them in.
- * Drive in the bearing squarely with the sealed end facing out.

Special Tools

Outer driver
Driver handle



Outer Driver

INSTALLATION

Apply grease to the speedometer gear unit.
Install the speedometer gear unit by aligning its retaining pawl with the hub cutout.

- * If not aligned, the retaining pawl will be deformed when the axle nut is tightened.
- * After installing the axle, turn the wheel to make sure that the speedometer drive shaft rotates freely.



Hub Cutout

Pawl

Install the front wheel by aligning the speedometer gear unit groove with the front shock absorber tab.
Insert the axle and tighten the axle nut.

- * When installing the front wheel, position the brake disk between the two brake pads.

Torque: 44.1 ~ 49.0N-m

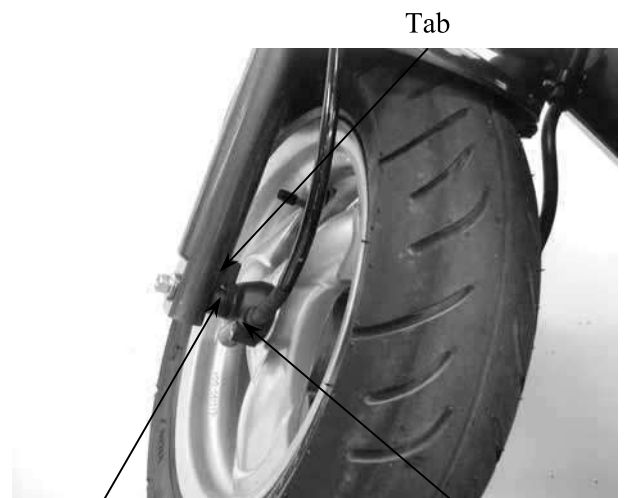

Groove

Speedometer Gear Unit

FRONT BRAKE

BRAKE MASTER CYLINDER

REMOVAL

- Remove the handlebar covers. (⇒2-7)
- First drain the brake fluid from the hydraulic brake system.
- Disconnect the front stop switch wire connector.
- Remove the brake fluid tube bolt.
- Remove the two bolts attaching the brake master cylinder
- Remove the brake master cylinder.

- * • When servicing the brake system, use shop towels to cover rubber and plastic parts and coated surfaces to avoid being contaminated by brake fluid.
- When removing the brake fluid tube bolt, be sure to plug the tube end to avoid brake fluid leakage.

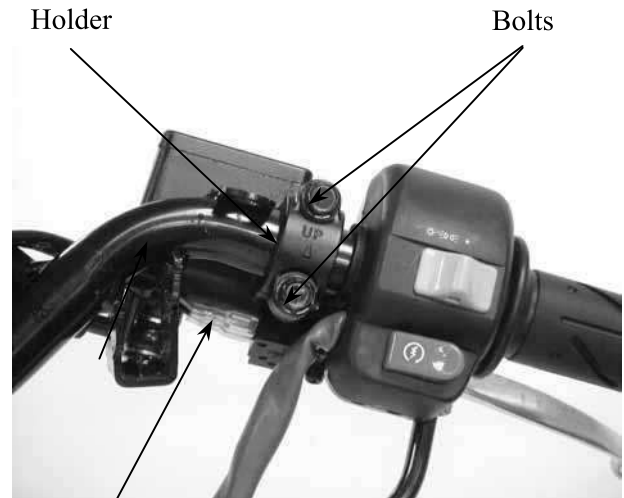

Stop Switch Wire Connector

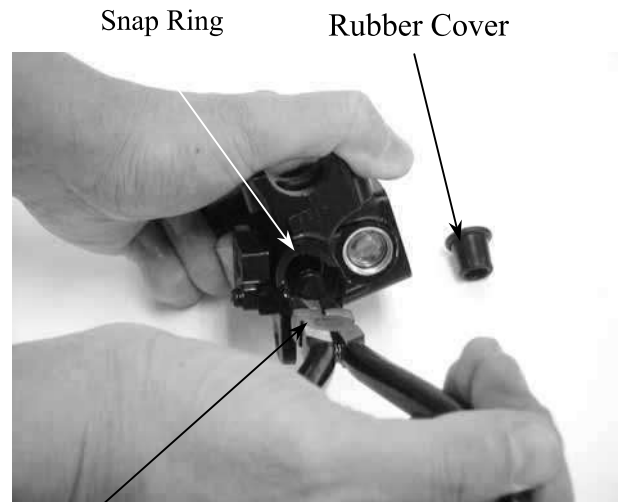

Snap Ring Pliers (Close)

DISASSEMBLY

- Remove the brake lever bolt and the brake lever.
- Remove the piston rubber cover and snap ring from the brake master cylinder.

- Remove the washer, main piston and spring from the brake master cylinder.
- Clean the inside of the master cylinder and brake reservoir with brake fluid.

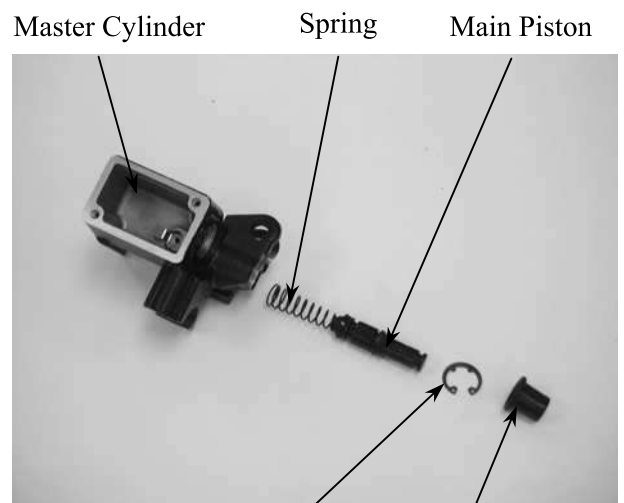

Snap Ring Rubber Cover

13. STEERING HANDLEBAR/FRONT WHEEL/FRONT BRAKE/FRONT SHOCK ABSORBER/FRONT FORK

INSPECTION

Measure the brake master cylinder I.D.
Inspect the master cylinder for scratches or cracks.

Service Limit: 12.75mm

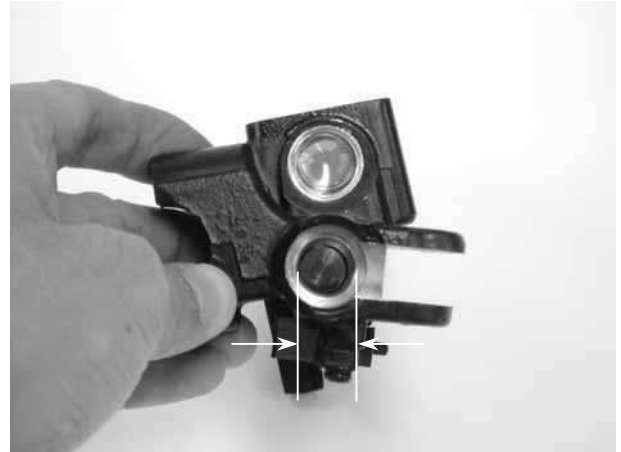

Measure the brake master cylinder piston O.D.

Service Limit: 12.645mm

Before assembly, inspect the 1st and 2nd rubber cups for wear.



ASSEMBLY

Before assembly, apply brake fluid to all removed parts.

Install the spring together with the 1st rubber cup.

*

- During assembly, the main piston and spring must be installed as a unit without exchange.
- When assembling the piston, soak the cups in brake fluid for a while.
- Install the cups with the cup lips facing the correct direction.

Install the main piston, spring and snap ring.
Install the rubber cover.
Install the brake lever.

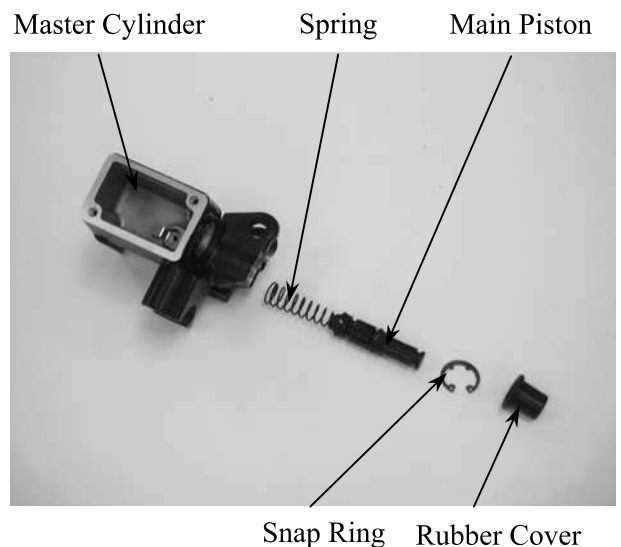

13. STEERING HANDLEBAR/FRONT WHEEL/FRONT BRAKE/FRONT SHOCK ABSORBER/FRONT FORK



BET & WIN 50

Place the brake master cylinder on the handlebar and install the holder with the “up” mark facing up. Also align the punch mark with the holder joint seam.

First tighten the upper bolt and then tighten the lower bolt.

Torque: 9.8~13.72N-m



Fluid Tube Bolt

“Up” Mark

Install the brake fluid tube with the attaching bolt and two sealing washers. Connect the front stop switch wire connector. Install the handlebar covers. (⇒2-7)



Stop Switch Wire Connector

BRAKE FLUID REFILLING

Keep the handlebar upright and remove the brake reservoir cover and diaphragm. Add DOT-4 brake fluid to the brake reservoir.

- * When bleeding, be careful not to allow air in the brake reservoir flowing into the brake system.
- * When using a brake bleeder, follow the manufacturer's instructions.
- * Never use dirty or unspecified brake fluid or mix different brake fluids because it will damage the brake system.



BRAKE FLUID BLEEDING

Keep the handlebar upright and remove the brake reservoir cover and diaphragm. Add the specified brake fluid to the upper limit.

- * Do not allow dust or water to enter the brake system during refilling.
- * When servicing the brake system, use shop towels to cover plastic parts and coated surfaces to avoid damage caused by splash of brake fluid.

In order to avoid spilling brake fluid, connect a transparent hose to the bleed valve.

Warning

Brake fluid spilled on brake pads or brake disk will reduce the braking effect. Clean the brake pads and brake disk with a high quality brake degreaser.

Fully apply the brake lever and then loosen the brake caliper bleed valve to drain the brake fluid until there is no air bubbles in the brake fluid. Then, tighten the bleed valve. Repeat these steps until the brake system is free of air.

BRAKE CALIPER

REMOVAL

First drain the brake fluid from the hydraulic brake system.

Remove the brake fluid tube bolt.

Remove the two bolts attaching the brake caliper.

Remove the brake caliper.

DISASSEMBLY

Remove the two brake pads dowel pins from the brake caliper.

Remove the brake pads.



Bleed Valve

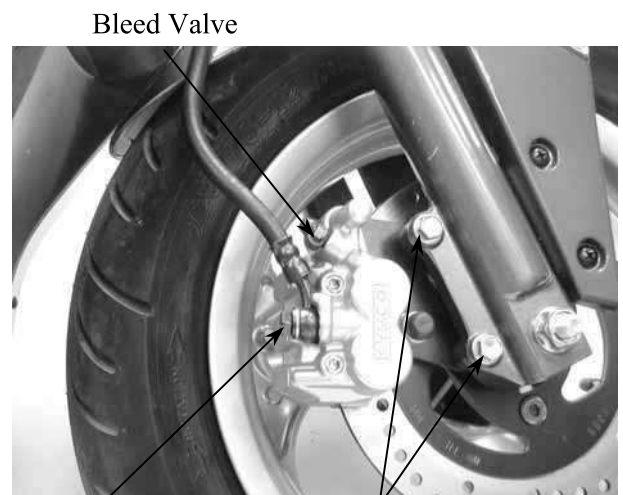

Bleed Valve

Fluid Tube Bolt

Bolts

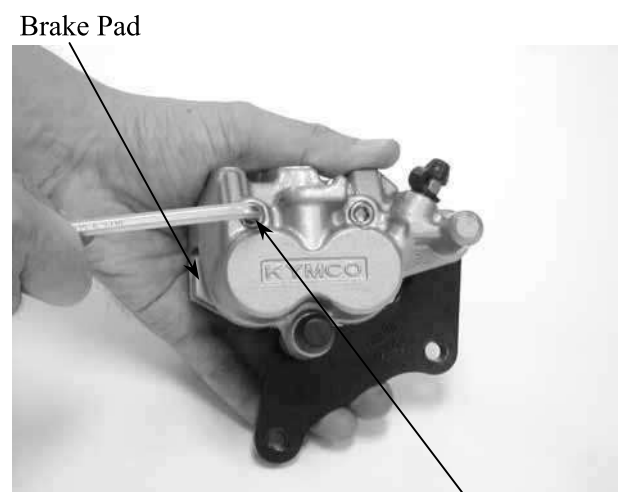

Brake Pad

Dowel Pin

13. STEERING HANDLEBAR/FRONT WHEEL/FRONT BRAKE/FRONT SHOCK ABSORBER/FRONT FORK



BET & WIN 50

Remove the piston from the brake caliper. If necessary, use compressed air to squeeze out the piston through the brake fluid inlet opening and place a shop towel under the caliper to avoid contamination caused by the removed piston. Check the piston cylinder for scratches or wear and replace if necessary.

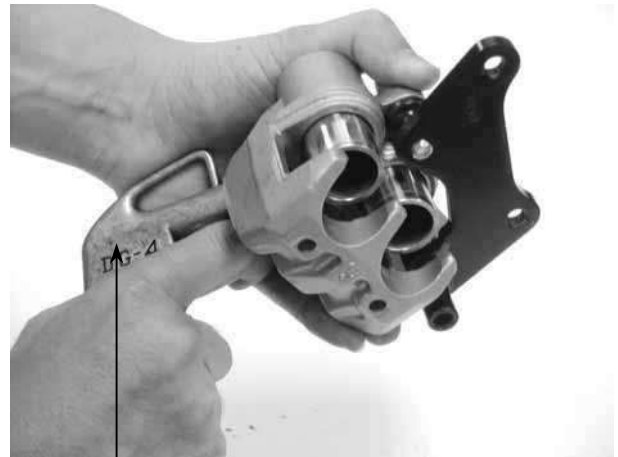

Compressed Air

Push the piston oil seal outward to remove it. Clean the oil seal groove with brake fluid.

* Be careful not to damage the piston surface.



Piston Oil Seal

Check the piston for scratches or wear. Measure the piston O.D. with a micrometer gauge.

Service Limit: 25.30mm

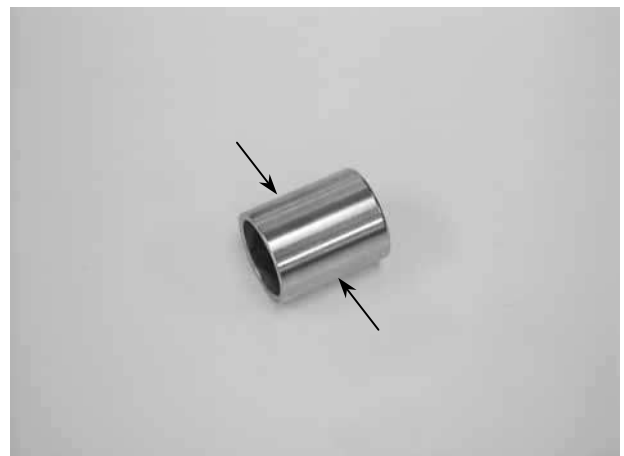

13. STEERING HANDLEBAR/FRONT WHEEL/FRONT BRAKE/FRONT SHOCK ABSORBER/FRONT FORK



BET & WIN 50

Check the caliper cylinder for scratches or wear and measure the cylinder bore.

Service Limit: 25.45mm



ASSEMBLY

Clean all removed parts.

Apply silicon grease to the piston and oil seal.

Lubricate the brake caliper cylinder inside wall with brake fluid.

Install the brake caliper piston with grooved side facing out.

* Install the piston with its outer end protruding 3~5mm beyond the brake caliper.

Wipe off excessive brake fluid with a clean shop towel. Apply silicon grease to the brake caliper seat pin and caliper inside. Install the brake caliper seat.



INSTALLATION

Install the brake caliper to the shock absorber and tighten the two bolts.

Torque: 24.5~34.3N-m

* When installing the brake caliper, be sure to position the brake disk between the two brake pads.



Fluid Tube Bolt

Brake Caliper

13. STEERING HANDLEBAR/FRONT WHEEL/FRONT BRAKE/FRONT SHOCK ABSORBER/FRONT FORK



BET & WIN 50

Connect the brake fluid tube to the brake caliper and tighten the fluid tube bolt.

Torque: 24.5~34.3N-m

Fill the brake reservoir with the specified brake fluid and bleed air from the brake system. (⇒13-11)

* When installing the brake fluid tube, be sure to install the two sealing washers.

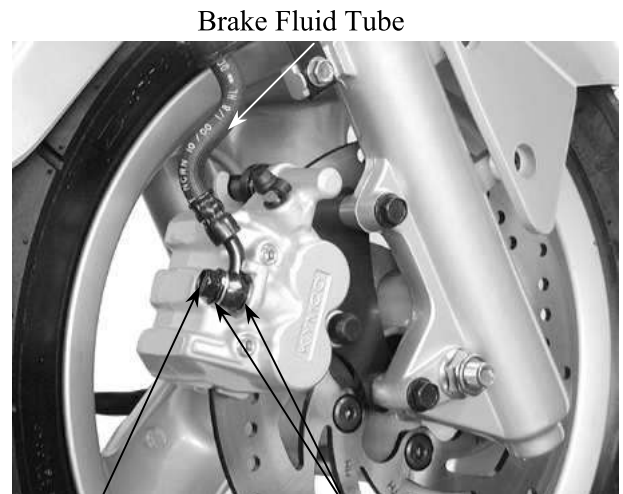

Fluid Tube Bolt Washers

FRONT SHOCK ABSORBER

REMOVAL

Remove the front upper cover. (⇒2-3)

Remove the front lower cover. (⇒2-3)

Remove the front wheel. (⇒13-5)

Remove the front brake caliper. (⇒13-11)

Remove the front shock absorber upper mount bolts.

Loosen the lower mount bolts to remove the front shock absorbers.

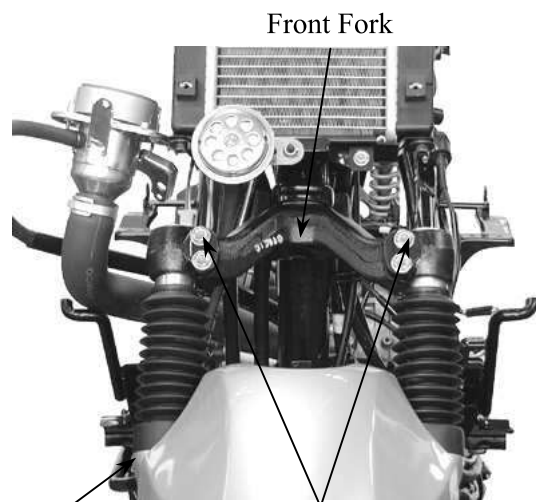

Shock Absorber Mount Bolts

DISASSEMBLY

Remove the dust boot.

Remove the dust seal.

Remove the circlip.

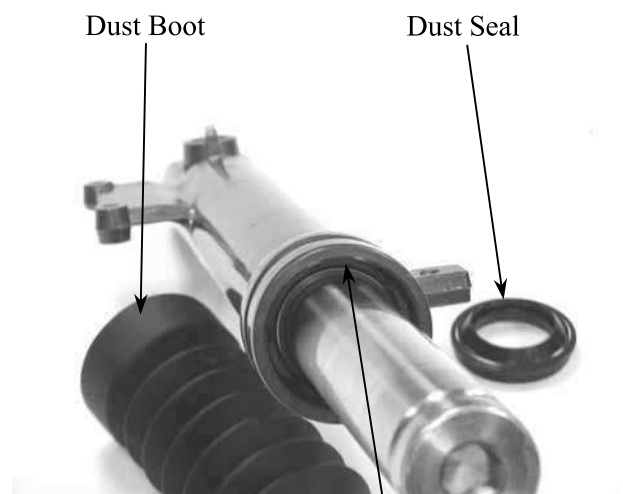

Circlip

13. STEERING HANDLEBAR/FRONT WHEEL/FRONT BRAKE/FRONT SHOCK ABSORBER/FRONT FORK

Set the front shock absorber in a vise.
Remove the damper rod hex bolt and copper washer.
Pull out the front shock absorber tube.

* After the hex bolt is removed, place a container under the front shock absorber to drain the engine oil from it.

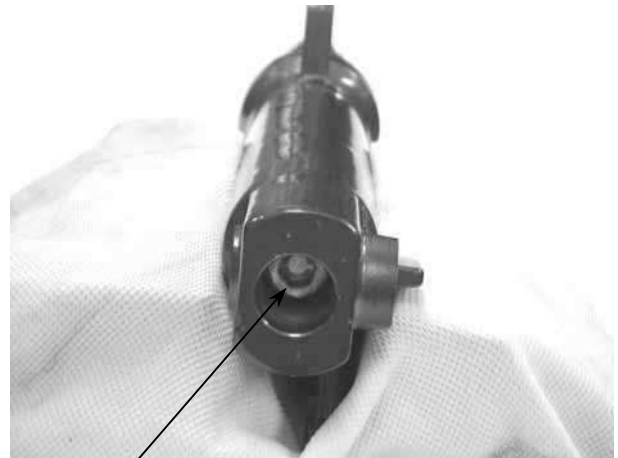

Hex Bolt

Set the front shock absorber tube in a vise.
Remove the lock nut on the front shock absorber tube.
Take out the shock absorber spring and damper rod.

* When holding the shock absorber tube, place a shop towel to protect it and do not apply too much force.



Lock Nut

Shock Absorber Tube

INSPECTION

Inspect the following items and replace if necessary.

- Front shock absorber tube bending, damage or wear
- Weak front shock absorber spring
- Damper and damper rod bending
- Oil seal damage or wear

Shock Absorber Tube



13. STEERING HANDLEBAR/FRONT WHEEL/FRONT BRAKE/FRONT SHOCK ABSORBER/FRONT FORK



BET & WIN 50

Measure the front shock absorber spring free length.

Service Limit: 233mm replace if below



ASSEMBLY

Install the damper spring onto the damper rod and then install them into the front shock absorber tube.

Install the shock absorber spring onto the front shock absorber tube.

Set the front shock absorber tube in a vise and then tighten the lock nut.

* When holding the shock absorber tube, place a shop towel to protect it and do not apply too much force.



Set the front shock absorber in a vise. Insert the shock absorber tube into the shock absorber and then install the copper washer and tighten the damper rod hex bolt.

* Apply locking agent to the washer and hex bolt and install them together.

Add engine oil into the front shock absorber.

Torque: 14.7~29.4N-m

Specified Oil: SS#8

Oil Capacity: 52cc

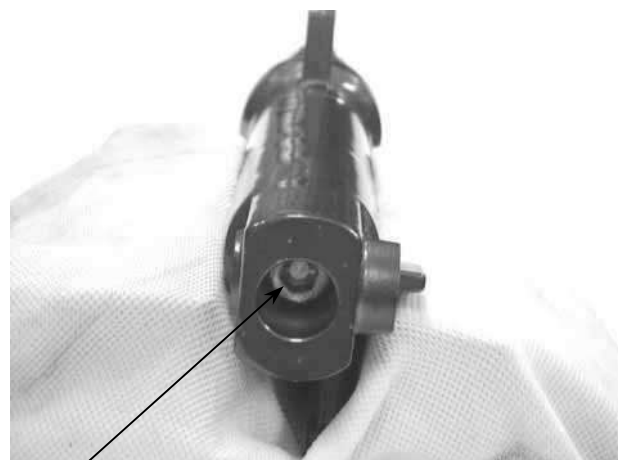

Hex Bolt

13. STEERING HANDLEBAR/FRONT WHEEL/FRONT BRAKE/FRONT SHOCK ABSORBER/FRONT FORK



BET & WIN 50

Install the oil seal
Install the circlip.
Install the dusts seal and dust boot.

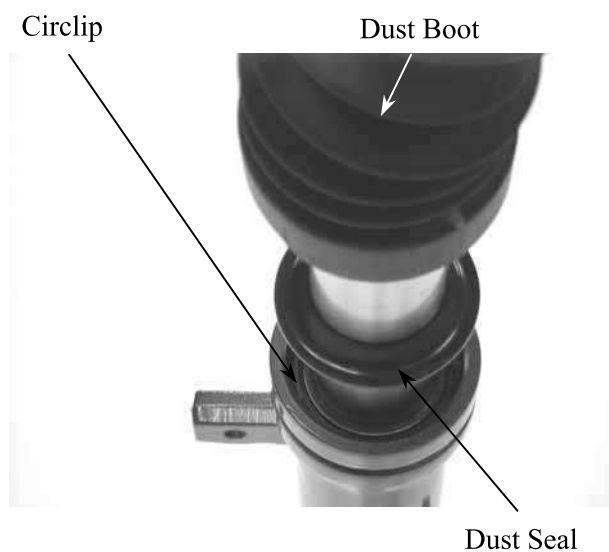

INSTALLATION

Install the front shock absorbers onto the front fork.
Install and tighten the front shock absorber upper mount bolts.
Tighten the lower mount bolts.

* Align the upper mount bolt hole with the groove on the front fork.

Install the front wheel. (⇒13-7)



FRONT FORK

REMOVAL

- Remove the handlebar covers. (⇒2-6)
- Remove the steering handlebar. (⇒13-4)
- Remove the front upper cover. (⇒2-5)
- Remove the front lower cover. (⇒2-5)
- Remove the front inner fender. (⇒2-6)
- Remove the front wheel. (⇒13-5)
- Remove the front brake caliper. (⇒13-11)
- Hold the steering stem top cone race and remove the steering stem lock nut.

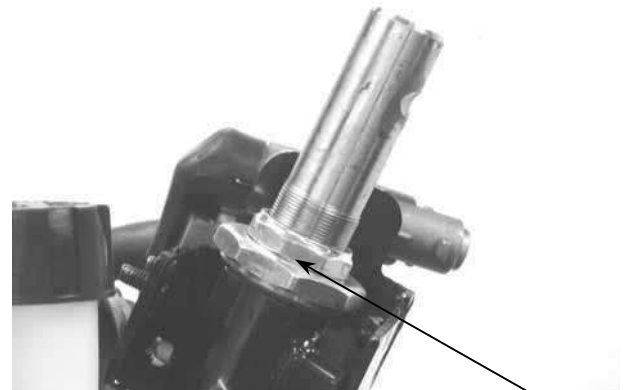

Lock Nut

Remove the top cone race and remove the front fork.

* Be careful not to lose the steel balls (26 on top race and 29 on bottom race).

Inspect the ball races, cone races and steel balls for wear or damage. Replace if necessary.

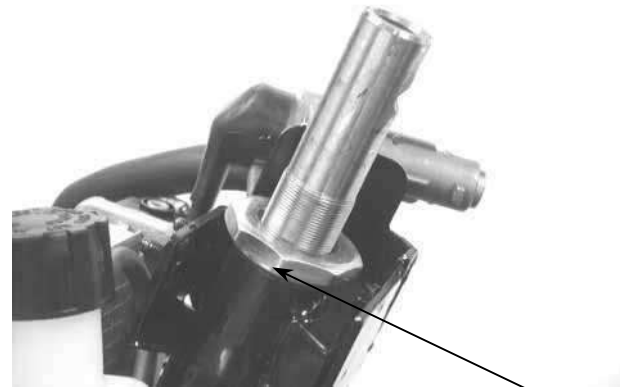

Top Cone Race

BOTTOM CONE RACE REPLACEMENT

Remove the bottom cone race using a chisel. Drive a new bottom cone race into place with a proper driver.

* Be careful not to damage the steering stem and front fork.

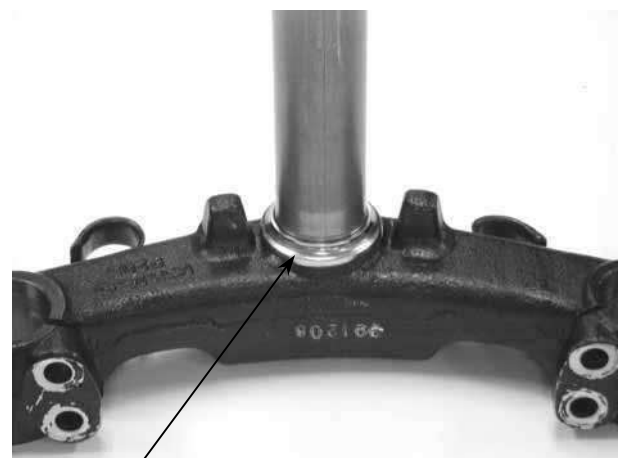

Bottom Cone Race

13. STEERING HANDLEBAR/FRONT WHEEL/FRONT BRAKE/FRONT SHOCK ABSORBER/FRONT FORK



BET & WIN 50

BALL RACE REPLACEMENT

Drive out the ball races.

Ball Race Remover

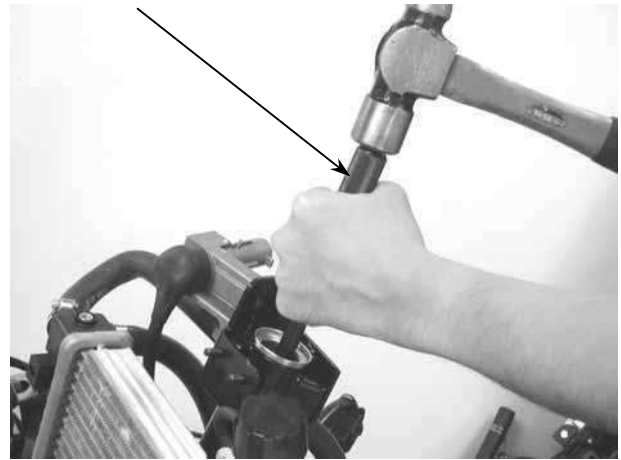

Drive in new ball races.

*

Be sure to drive the ball races into place completely.

Outer Driver

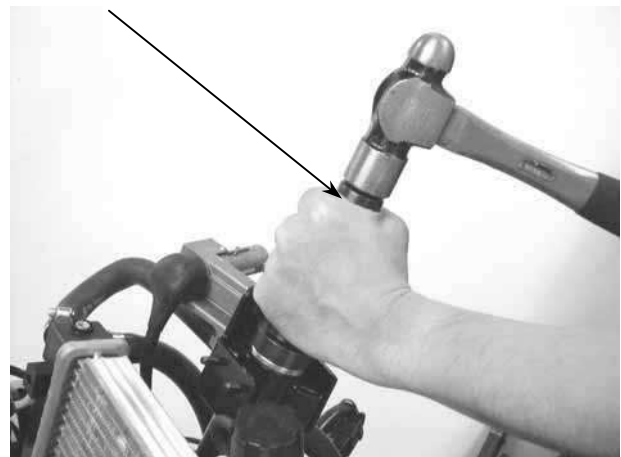

INSTALLATION

Apply grease to the top and bottom ball races and install 26 steel balls on the top ball race and 29 steel balls on the bottom ball race. Then, install the front fork.

Top Cone Race

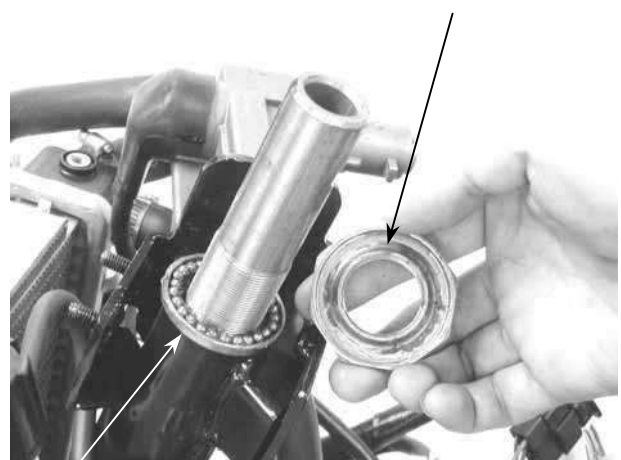

Ball Race

13. STEERING HANDLEBAR/FRONT WHEEL/FRONT BRAKE/FRONT SHOCK ABSORBER/FRONT FORK



BET & WIN 50

Apply grease to the top cone race and install it.

Tighten the top cone race and then turn the steering stem right and left several times to make steel balls contact each other closely.

*

Check that the steering stem rotates freely without vertical play.

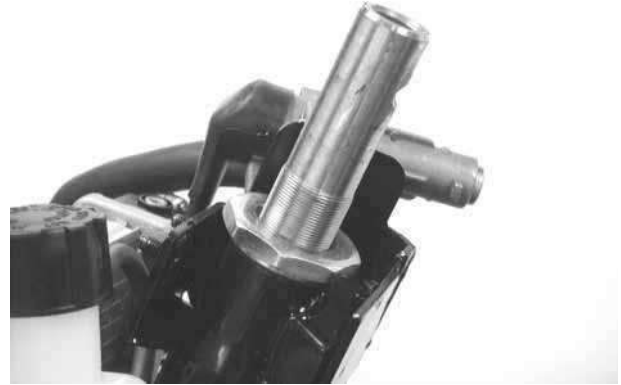

Install the steering stem lock nut and tighten it while holding the top cone race.

Torque: 78.4~117.6N-m

Install the front wheel. (⇒13-7)

Install the front brake caliper. (⇒13-12)

Install the front inner fender. (⇒2-6)

Install the throttle grip and the right and left handlebar switches. (⇒13-5)

Install the right and left brake master cylinders. (⇒13-5)

Lock Nut Wrench

Lock Nut Socket

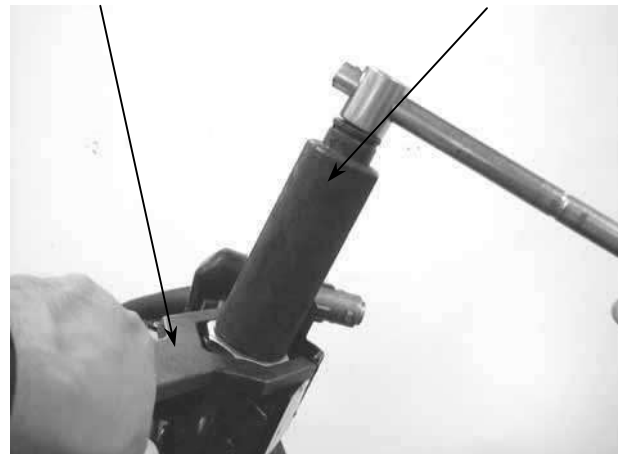

14. REAR BRAKE/REAR FORK/REAR WHEEL/REAR SHOCK ABSORBER

REAR BRAKE/REAR BRAKE DRUM/ REAR SHOCK ABSORBER

SERVICE INFORMATION-----	14-1
TROUBLESHOOTING-----	14-1
REAR WHEEL-----	14-2
REAR BRAKE DRUM -----	14-3
REAR SHOCK ABSORBER -----	14-5

14. REAR BRAKE/REAR FORK/REAR WHEEL/REAR SHOCK ABSORBER

SERVICE INFORMATION

GENERAL INSTRUCTIONS

- When performing the services stated in this section, the engine and exhaust muffler must be cold to avoid scalding.
- During servicing, keep oil or grease off the brake pads and brake disk.

SPECIFICATIONS

Item	Standard (mm)	Service Limit (mm)
Rear wheel rim runout	—	2.0
Rear shock absorber spring free length	214.7	197.7
Rear brake drum I.D.	110	111
Rear brake disk/ lining thickness	3.5~3.8/4.0	3.0/2.0
Rear brake disk runout	—	0.30
Rear brake master cylinder I.D.	12.700~12.743	12.755
Rear brake master cylinder piston O.D.	12.657~12.684	12.645
Rear brake caliper cylinder I.D.	33.895~33.928	33.860
Rear brake caliper piston O.D.	33.960~34.010	34.045

TORQUE VALUES

Exhaust muffler lock bolt	29.4~39.2N-m
Rear axle nut	78.4~98.0N-m
Rear shock absorber lower mount bolt	19.6~29.4N-m
Rear shock absorber upper mount bolt	39.2N-m
Rear damper lock nut	14.7~24.5N-m (apply locking agent)
Rear brake caliper bolt	19.6~29.4N-m

SPECIAL TOOLS

Rear shock absorber remover
Shock absorber spring compressor

TROUBLESHOOTING

Rear wheel wobbling

- Bent rim
- Faulty tire
- Axle not tightened properly

Soft rear shock absorber

- Weak shock absorber spring
- Damper oil leaks

Rear wheel noise

- Worn rear wheel axle bearings
- Worn rear fork bearings
- Deformed rear fork

Poor brake performance

- Air in brake system
- Deteriorated brake fluid
- Contaminated brake pad surface
- Worn brake pads
- Clogged brake fluid line
- Deformed brake disk
- Unevenly worn brake caliper

14. REAR BRAKE/REAR FORK/REAR WHEEL/REAR SHOCK ABSORBER

REAR WHEEL

REMOVAL

Remove the exhaust muffler. (⇒2-6)

Remove the rear axle nut to remove the rear wheel.



Rear Axle Nut

INSPECTION

Measure the rear wheel rim runout.

Service Limits:

Radial: 2.0mm replace if over

Axial: 2.0mm replace if over

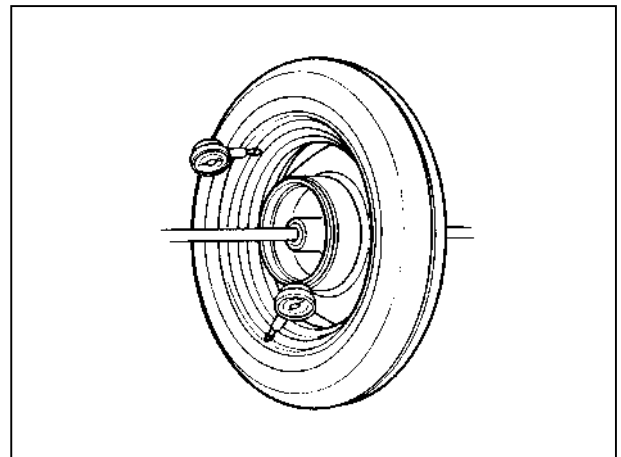

INSTALLATION

Install the rear wheel and apply SAE30# engine oil to the axle threads. Then, tighten the rear axle nut.

Torque values:

Rear axle nut: 107.8~127.4N-m



Rear Axle Nut

14. REAR BRAKE/REAR FORK/REAR WHEEL/REAR SHOCK ABSORBER

REAR BRAKE DRUM

Remove the rear wheel. (⇒14-3)
Inspect the rear brake drum.
Measure the rear brake drum I.D.
Service Limit: 95.5mm replace if over

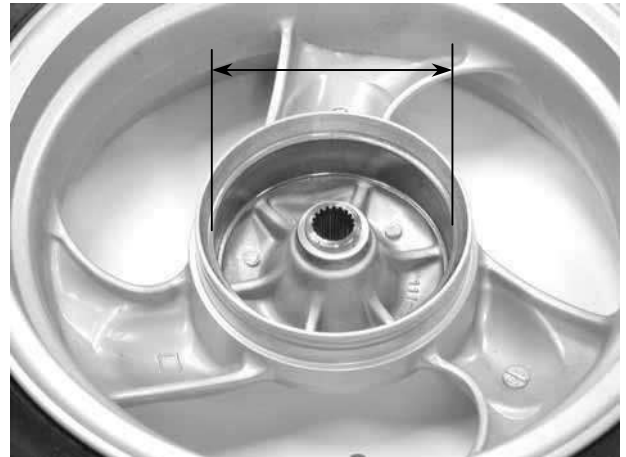

BRAKE LINING INSPECTION

Measure the brake lining thickness.
Service Limit: 2.0mm replace if below

* Keep oil or grease off the brake linings.



REAR BRAKE DISASSEMBLY

Remove the rear brake adjusting nut and disconnect the rear brake cable.
Remove the rear brake shoes.

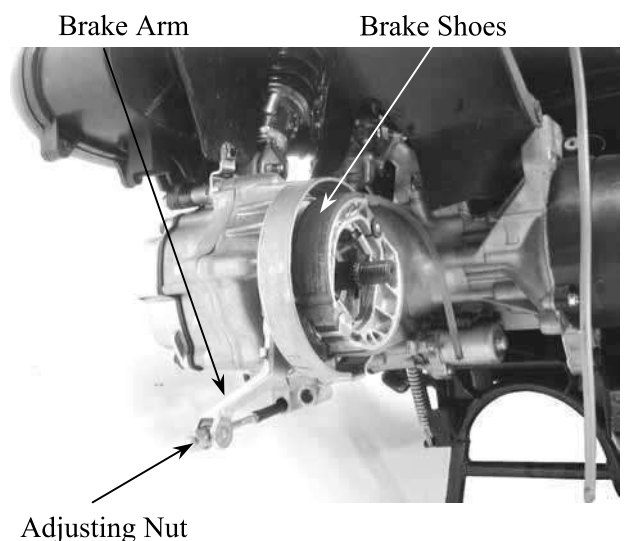

14. REAR BRAKE/REAR FORK/REAR WHEEL/REAR SHOCK ABSORBER

Remove the brake arm bolt to remove the brake arm, wear indicator plate and felt seal. Remove the brake cam.

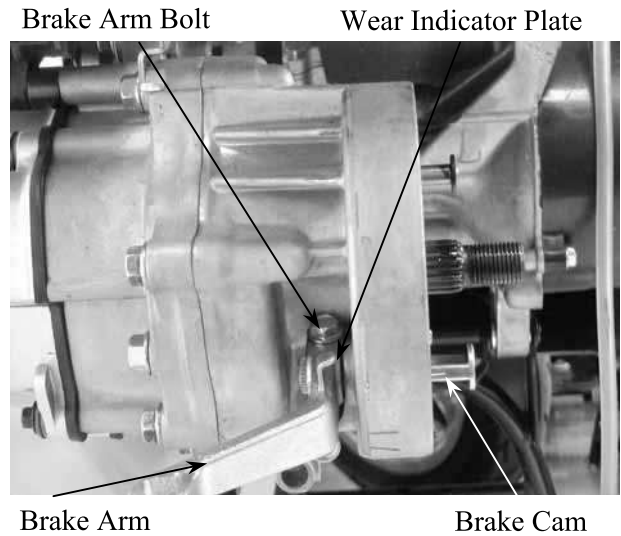

REAR BRAKE ASSEMBLY

Apply grease to the anchor pin and brake shoe moving parts.
Apply grease to the brake cam and install it.



Apply engine oil to the felt seal and install it to the brake cam.
Install the wear indicator plate.

* Align the wide tooth of the wear indicator plate with the wide groove on the brake cam.

Install the brake arm onto the brake cam.

* Align the punch mark on the brake arm with the scribed line on the brake cam.

Install and tighten the brake arm bolt.
Install the brake arm return spring.
Install the brake shoes.

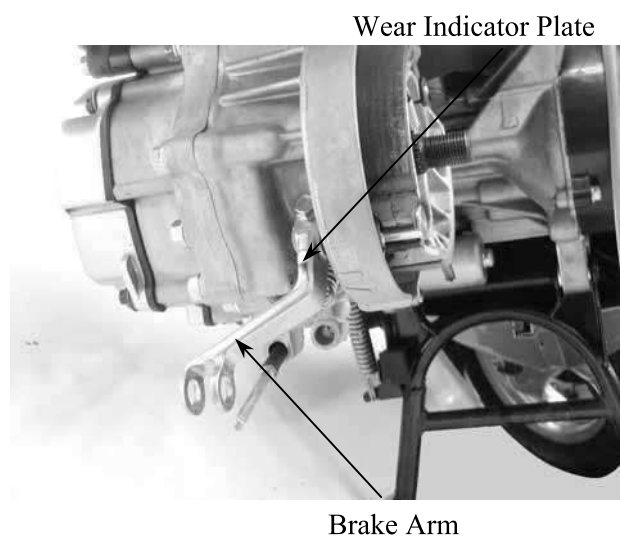

14. REAR BRAKE/REAR FORK/REAR WHEEL/REAR SHOCK ABSORBER

Install the brake arm pin.
Connect the brake cable and install the adjusting nut.
Install the rear wheel.
Adjust the rear brake lever free play. (⇒3-12)

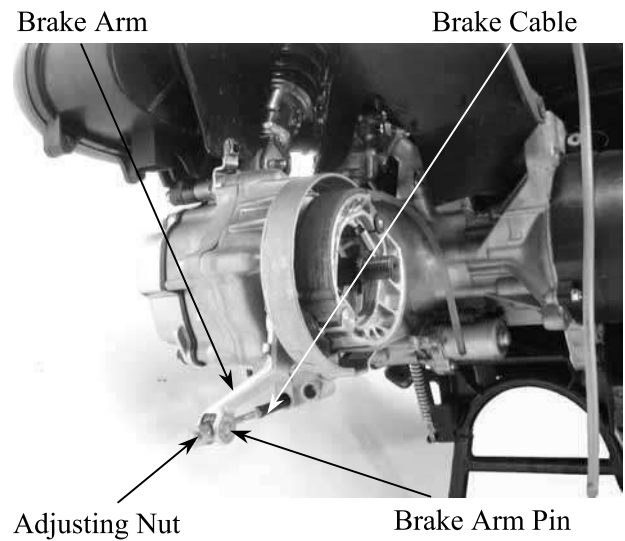

REAR SHOCK ABSORBER

REMOVAL

Remove the rear carrier and frame body cover. (⇒2-2)
Remove the met-in box. (⇒2-2)
Remove the two air cleaner bolts.

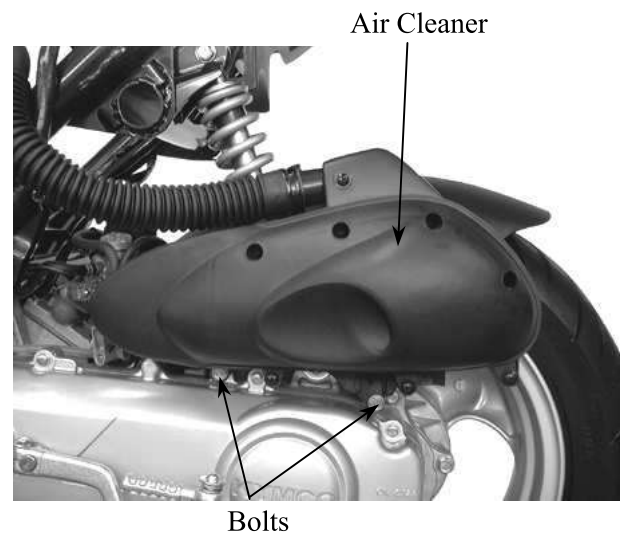

Remove the rear shock absorber upper mount bolt.
Remove the left rear shock absorber upper and lower mount bolts.
Remove the left rear shock absorbers.

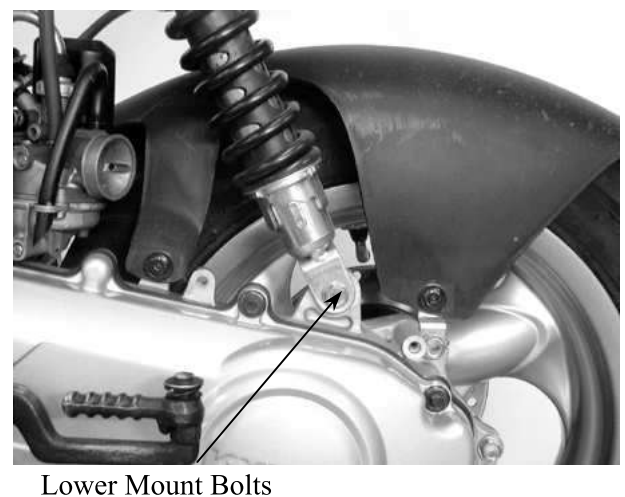

14. REAR BRAKE/REAR FORK/REAR WHEEL/REAR SHOCK ABSORBER

DISASSEMBLY

Disassemble the left rear shock absorbers using the rear shock absorber remover.

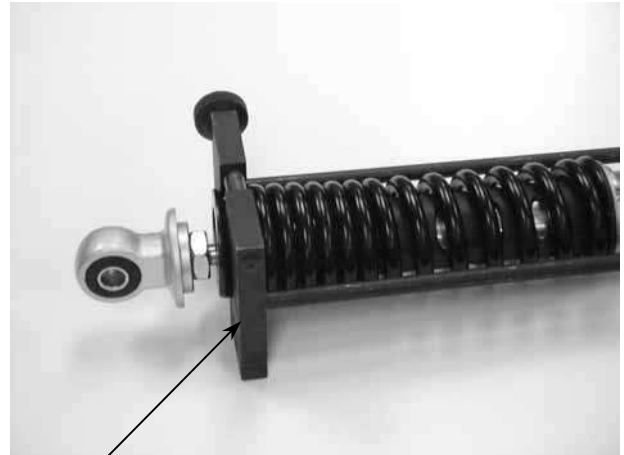

Rear Shock Absorber Remover

INSPECTION

Inspect the damper rod for bending or damage.
Inspect the damper for oil leaks.
Inspect the damper rubber for deterioration or damage.

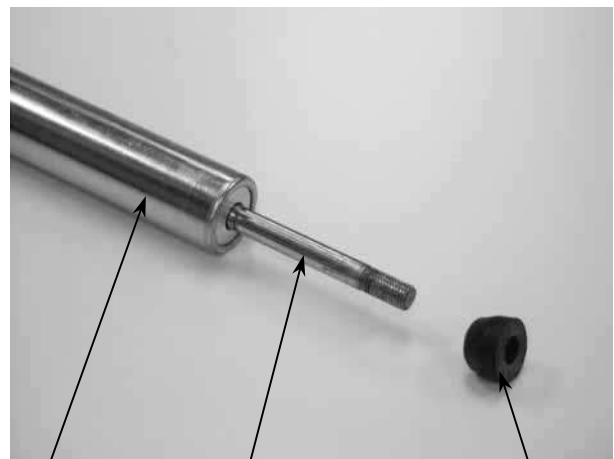

Damper

Damper Rod

Rubber

Measure the front shock absorber spring free length.

Service Limit: 226mm

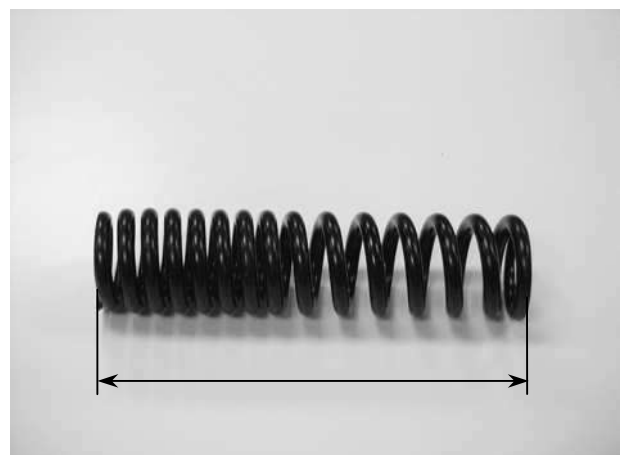

14. REAR BRAKE/REAR FORK/REAR WHEEL/REAR SHOCK ABSORBER

ASSEMBLY

Assemble the rear shock absorbers in the reverse order of disassembly.



INSTALLATION

Install the rear shock absorbers in the reverse order of removal.

Torque:

Upper Mount Bolt: 39.2N-m

Lower Mount Bolt: 19.6~29.4N-m



Lower Mount Bolts

15. ELECTRICAL EQUIPMENT

15

ELECTRICAL EQUIPMENT

SERVICE INFORMATION	15- 1
TROUBLESHOOTING	15- 1
CHARGING SYSTEM	15- 3
BATTERY	15- 4
IGNITION SYSTEM	15- 7
STARTING SYSTEM.....	15-11

15. ELECTRICAL EQUIPMENT

SERVICE INFORMATION

GENERAL INSTRUCTIONS

- It is not necessary to check the battery electrolyte or fill with distilled water.
- Remove the battery from the motorcycle for charging. Do not remove the electrolyte cap..
- Do not quick charge the battery. Quick charging should only be done in an emergency..
- Charge the battery according to the charging current and time specified on the battery.
- When charging, check the voltage (open voltage) with an electric tester.
- When replacing the battery, do not use a traditional battery.

SPECIFICATIONS

		B&W50
Battery	Capacity	12V4AH
	Voltage	13.0~13.2V
	Charging current	Standard Quick
Spark plug	(NGK)	BR8HSA
Spark plug gap		0.6~0.7mm
Ignition coil resistance	Primary coil	0.153~0.187Ω
	Secondary coil (with plug cap)	6.99~10.21KΩ
	Secondary coil (without plug cap)	3.24~3.96KΩ
Pulser coil resistance (20°C)		80~160Ω
Ignition timing		13.5°±2°BTDC/2000rpm

TROUBLESHOOTING

CHARGING SYSTEM

No power

- Dead battery
- Disconnected battery cable
- Fuse burned out
- Faulty ignition switch

Low power

- Weak battery
- Loose battery connection
- Charging system failure
- Faulty regulator/rectifier

Intermittent power

- Loose battery cable connection
- Loose charging system connection
- Loose connection or short circuit in ignition system
- Loose connection or short circuit in lighting system

Charging system failure

- Loose, broken or shorted wire or connector
- Faulty regulator/rectifier
- Faulty A.C. generator

15. ELECTRICAL EQUIPMENT

IGNITION SYSTEM

No spark at plug

- Faulty spark plug
- Poorly connected, broken or shorted wire
 - Between A.C. generator and CDI unit
 - Between CDI unit and ignition coil
 - Between CDI unit and ignition switch
 - Between ignition coil and spark plug
- Faulty ignition switch
- Faulty ignition coil
- Faulty CDI unit
- Faulty A.C. generator

Engine starts but turns poorly

- Ignition primary circuit
 - Faulty ignition coil
 - Poorly connected wire or connector
- Ignition secondary circuit
 - Faulty ignition coil
 - Faulty spark plug
 - Poorly insulated plug cap
- Improper ignition timing
 - Battery voltage too low (6V max.)
 - Faulty CDI unit

STARTING SYSTEM

Starter motor won't turn

- Fuse burned out
- Weak battery
- Faulty ignition switch
- Faulty starter switch
- Faulty front or rear stop switch
- Faulty starter relay
- Poorly connected, broken or shorted wire
- Faulty starter motor

Lack of power

- Weak battery
- Loose wire or connection
- Foreign matter stuck in starter motor or pinion

Starter motor rotates but engine does not start

- Faulty starter pinion
- Starter motor rotates reversely
- Faulty starter clutch
- Weak battery

15. ELECTRICAL EQUIPMENT

CHARGING SYSTEM

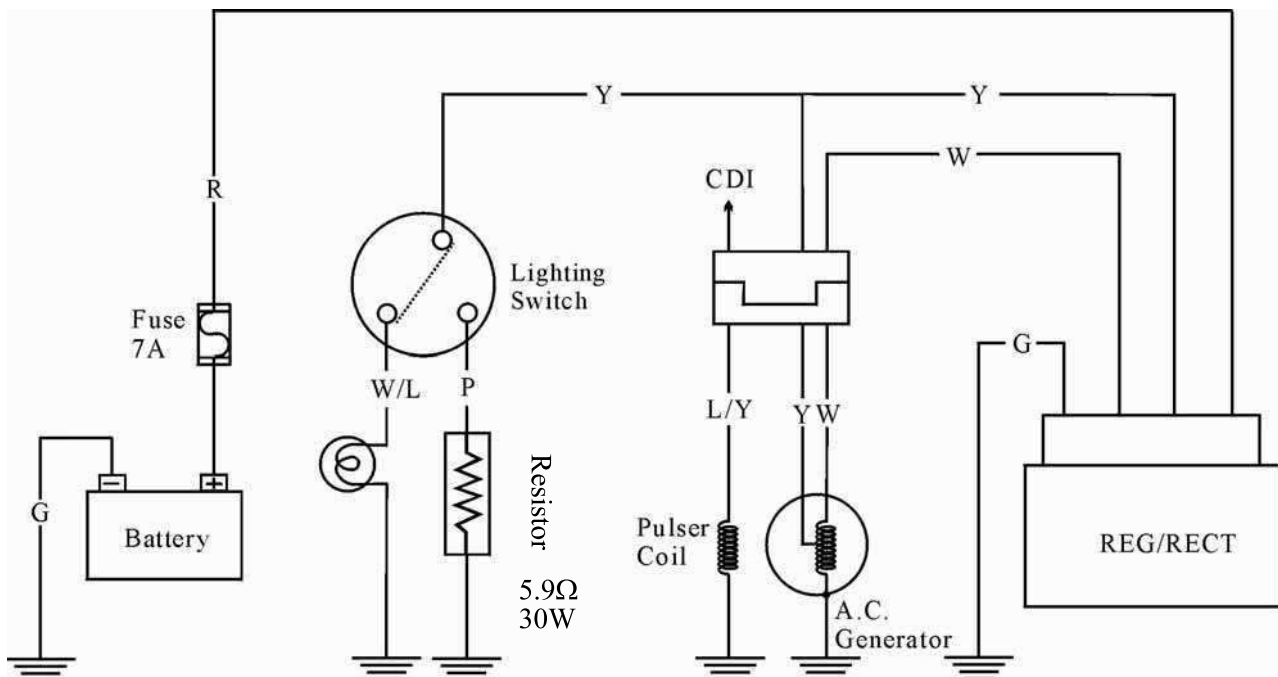

15. ELECTRICAL EQUIPMENT

BATTERY

Remove the seat and met-in box. (⇒2-3)
Remove the battery cover screw and the battery cover.
Remove the battery.
First disconnect the battery negative (-) cable and then the positive (+) cable.

* When disconnecting the battery positive (+) cable, do not touch the frame with tool; otherwise it will cause short circuit and sparks to fire the fuel.

The installation sequence is the reverse of removal.

BATTERY VOLTAGE INSPECTION (OPEN CIRCUIT VOLTAGE)

Disconnect the battery cables.
Measure the voltage between the battery terminals.
Fully charged : 13.0V ~ 13.2V
Undercharged : 12.3V max.

* Battery charging inspection must be performed with an electric tester.

CHARGING

Connect the charger positive (+) cable to the battery positive (+) cable.
Connect the charger negative (-) cable to the battery negative (-) cable.

*

- Keep flames and sparks away from a charging battery.
- Turn power ON/OFF at the charger, not at the battery terminals to prevent sparks near the battery.
- Charge the battery according to the current specified on the battery surface.

Charging current: Standard : 0.4A
Quick : 4A
Charging time : Standard : 5 hours
Quick : 0.5 hours
After charging: Open circuit voltage: 12.8V min.

*

- Quick charging should only be done in an emergency.
- During quick charging, the battery temperature should not exceed 45°C.
- Measure the voltage 30 minutes after the battery is charged.

Battery Cover Screw

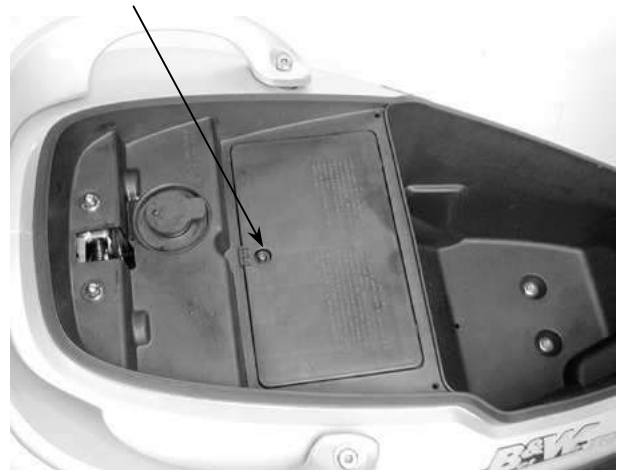

Battery

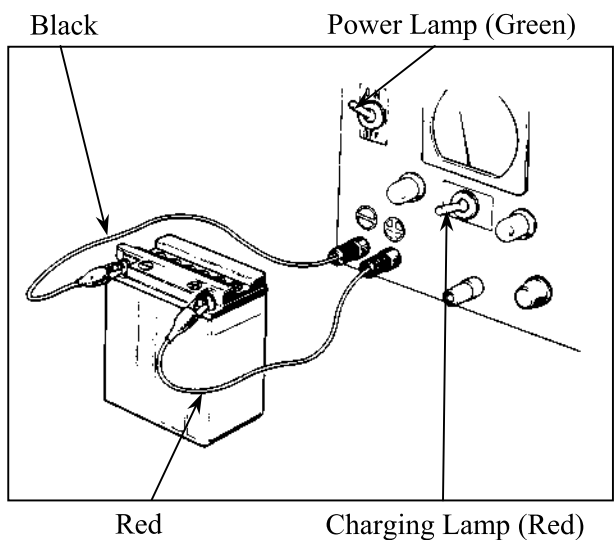

15. ELECTRICAL EQUIPMENT

PERFORMANCE TEST

Warm up the engine.
Remove the floor mat and battery cover.

* Use a fully charged battery to check the charging system output.

Stop the engine and open the fuse box. Disconnect the wire lead from the fuse terminal. Connect an ammeter between the wire lead and fuse terminal as shown. Connect the battery positive (+) terminal to the voltmeter positive (+) probe and battery negative (-) terminal to the voltmeter negative (-) probe. Start the engine, gradually increase engine speed to test the output:

Position \ RPM	Day	Night
2500	1.3A min.	1.0A min.
6000	2.0A min.	2.0A min.

Charging Limit Voltage: $14.5 \pm 0.5V/8000rpm$
If the limit voltage is not within the specified range, check the regulator/ rectifier.

A.C. GENERATOR (CHARGING COIL) INSPECTION

* Inspect with the engine installed.

Remove the met-in box, rear carrier and frame body cover. (⇒2-2)
Disconnect the A.C. generator connector.
Measure the resistances between the charging coil terminals (white-green) and lighting coil terminals (yellow-green).

Resistances:

Charging coil	white-green	0.2 ~ 1.2Ω
Lighting coil	yellow-green	0.3 ~ 1.0Ω

Refer to 8-3 for A.C. generator removal.

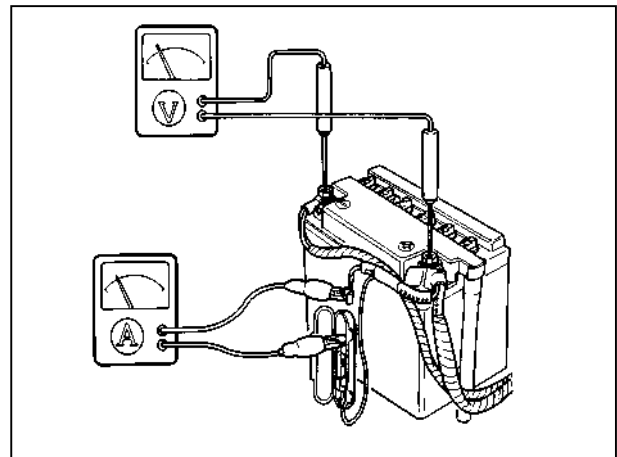

A.C. Generator Connector



15. ELECTRICAL EQUIPMENT

RESISTOR INSPECTION

Remove the front upper/lower cover. (⇒2-3)
 Measure the resistance between the resistor B pink wire and ground.
 Measure the resistance between the resistor A green/black wire and ground.

Resistances:

- Resistor A: 9.9 ~ 10.5Ω
- Resistor B: 5.6 ~ 6.2Ω

* Faulty resistor is the cause of faulty operation of the auto bystarter.



Resistor A Resistor B

REGULATOR/RECTIFIER INSPECTION

Remove the front upper/lower cover. (⇒2-3)
 Disconnect the regulator/rectifier wire coupler and remove the bolt to remove the regulator/rectifier.

Measure the resistances between the terminals.
 Replace the regulator/rectifier if the readings are not within the specifications in the table below.

*

- Due to the semiconductor in circuit, it is necessary to use a specified tester for accurate testing. Use of an improper tester in an improper range may give false readings.
- Use a Sanwa Electric Tester (07208-0020000) or Kowa Electric Tester (TH-5H). The proper range for testing is listed below.

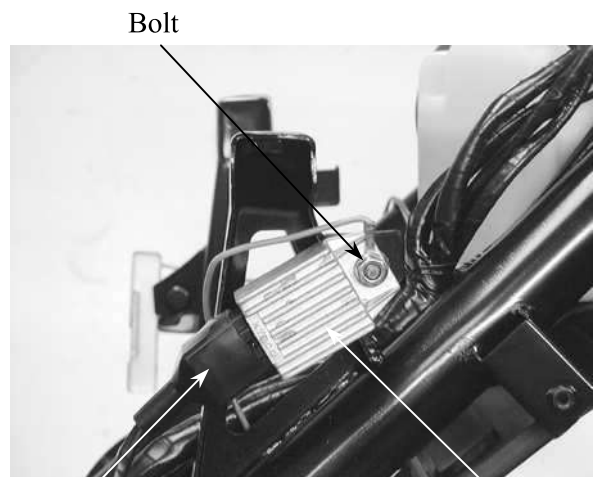

Coupler Regulator/Rectifier

Model	Brand	Range
SP-10D	Sanwa	KΩ
TH-5H	Kowa	100Ω

Probe⊕ Probe(-)	A (R)	B (W)	C (Y)	D (G)
A (R)		∞	∞	∞
B (W)	3-10KΩ		∞	∞
C (Y)	∞	∞		33-35KΩ
D (G)	∞	∞	33-35KΩ	

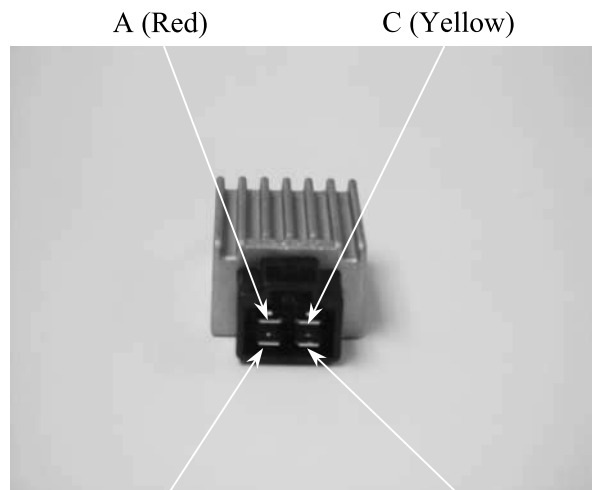

B (White) D (Green)

15. ELECTRICAL EQUIPMENT

IGNITION SYSTEM

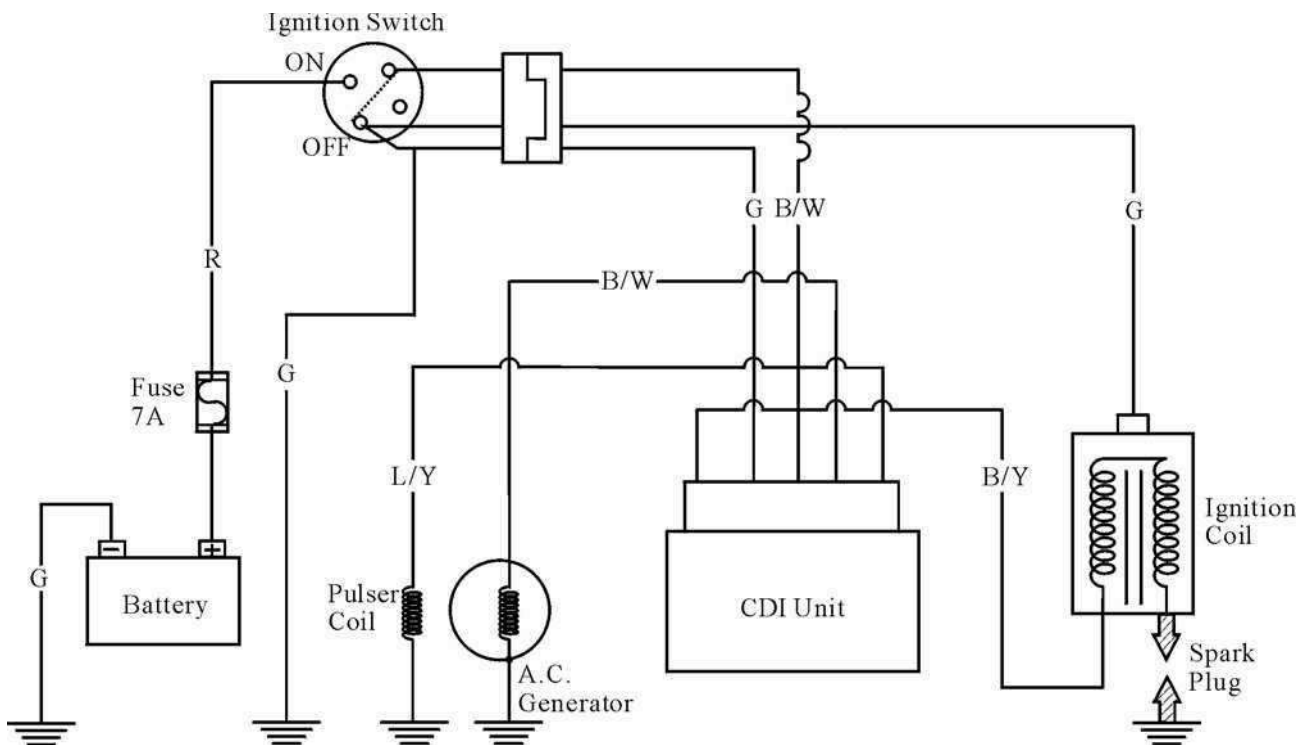

15. ELECTRICAL EQUIPMENT

IGNITION COIL INSPECTION

Continuity Test

* This test is to inspect the continuity of ignition coil.

Remove the met-in box. (⇒ 12-4)
 Measure the resistance between the ignition coil primary coil terminals.

Resistance (20°C): 0.153 ~ 0.187Ω

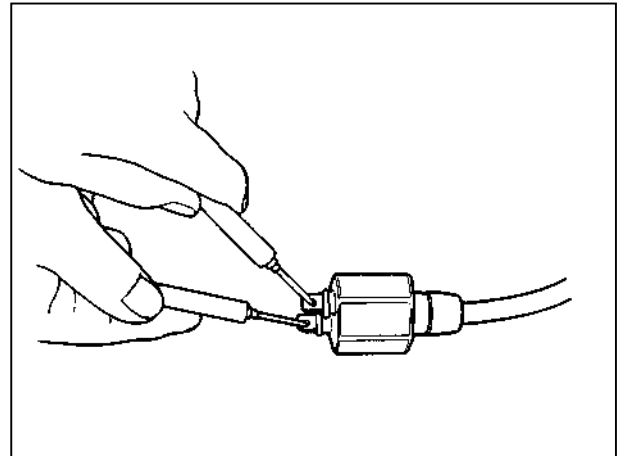

Measure the secondary coil resistance between the spark plug cap and the primary coil terminal as Figure A shown.

Resistance (20°C) (with plug cap): 6.99 ~ 10.21KΩ

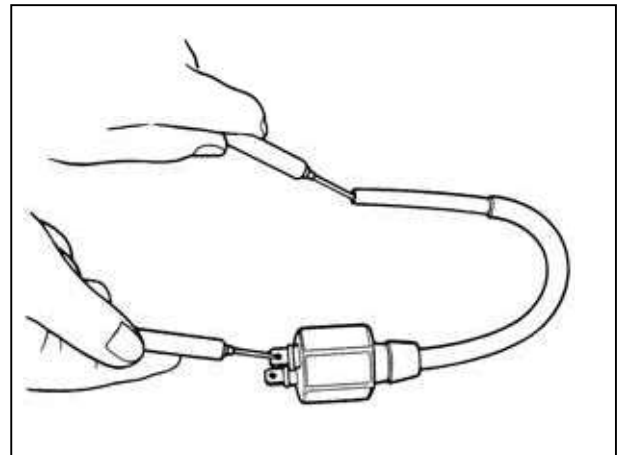

Measure the secondary coil resistance between the ignition coil terminal and the primary coil terminal as Figure B shown.

Resistance (20°C) (without plug cap): 3.24 ~ 3.96KΩ

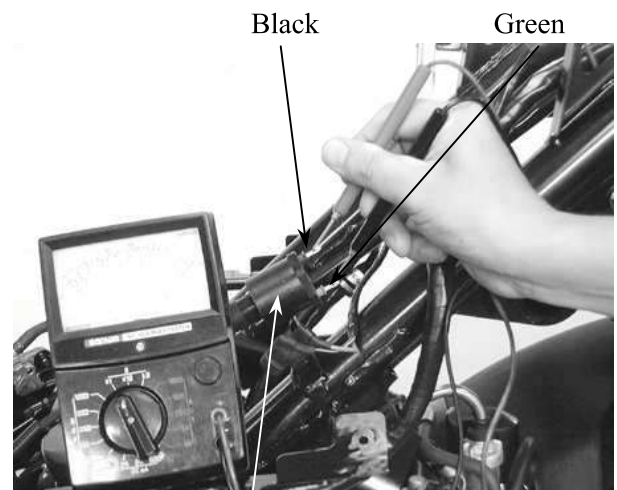

15. ELECTRICAL EQUIPMENT

Ignition Coil

Performance Test

Remove the ignition coil.



Ignition Coil

Inspect the ignition coil with an ignition coil tester.

* Follow the ignition coil tester manufacturer's instructions.

1. Turn the changeover switch to 12V and connect the ignition coil to the tester.
2. Turn the power switch ON and check the spark from the watch window.
 - Good : Normal and continuous spark
 - Faulty : Weak or intermittent spark

* The test is performed at both conditions that the ignition coil is cold and hot.

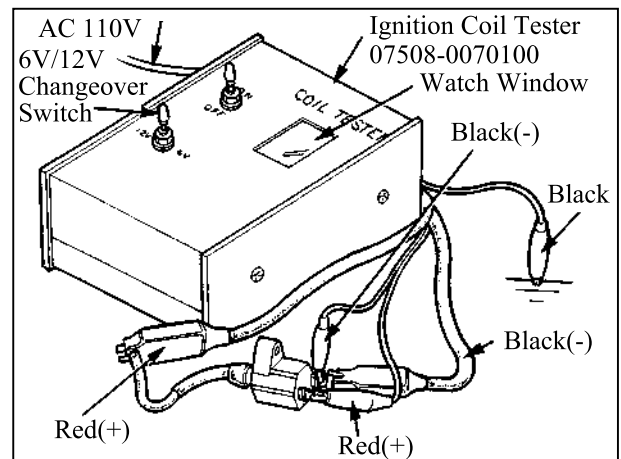

A.C. GENERATOR

Exciter Coil/Pulser Coil Inspection

* This test is performed with the stator installed in the engine.

Remove the met-in box. (⇒ 12-4)

Disconnect the A.C. generator wire connector.

Measure the pulser coil resistance between the blue/yellow wire and ground.

Resistance (20°C): 80~160Ω



Blue/Yellow

15. ELECTRICAL EQUIPMENT

CDI UNIT INSPECTION

Open the front tool box and remove the bolt.
 Remove the front tool box. (⇒2-4)
 Disconnect the CDI coupler and remove the CDI unit.

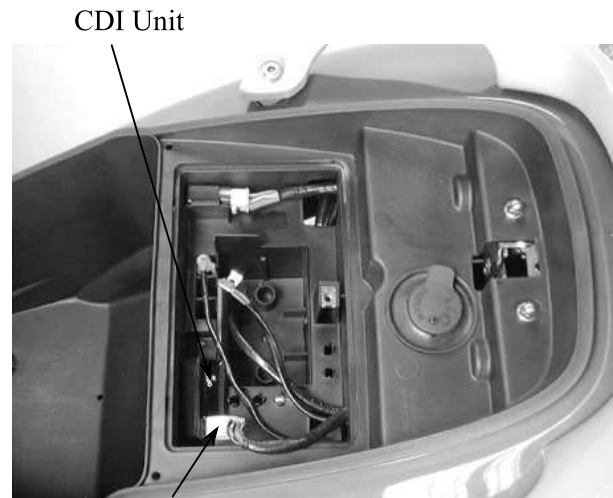

CDI CIRCUIT INSPECTION

Measure the resistance between the terminals.
 Replace the CDI unit if the readings are not within the specifications in the table below.

- Due to the semiconductor in circuit, it is necessary to use a specified tester for accurate testing. Use of an improper tester in an improper range may give false readings.
- Use a Sanwa Electric Tester or Kowa Electric Tester (TH-5H).
- In this table, “Needle swings then returns” indicates that there is a charging current applied to a condenser. The needle will then remain at “∞” unless the condenser is discharged.

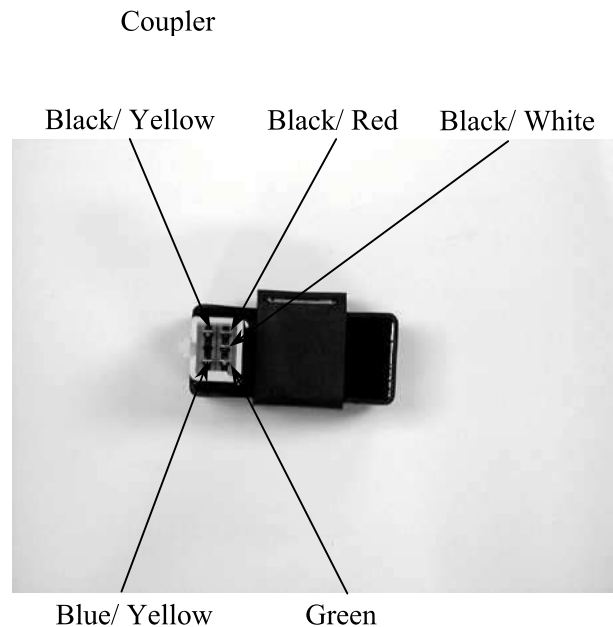

Use the x KΩ range for the Sanwa Tester.
 Use the x 100Ω range for the Kowa Tester.
 Unit: KΩ

Probe⊕ (-)Probe	Black/ Yellow	Blue/ Yellow	Black/ Red	Black/ White	Green
Black/ Yellow		∞	∞	∞	∞
Blue/ Yellow	∞		45	110	24
Black/ Red	∞	∞		5.3	∞
Black/ White	∞	∞	∞		
Green	∞	∞	18	60	

15. ELECTRICAL EQUIPMENT

STARTER RELAY INSPECTION

Open the front tool box and remove the bolt.
Remove the front tool box. (⇒2-4)
Disconnect the starter relay coupler and then
remove the starter relay.

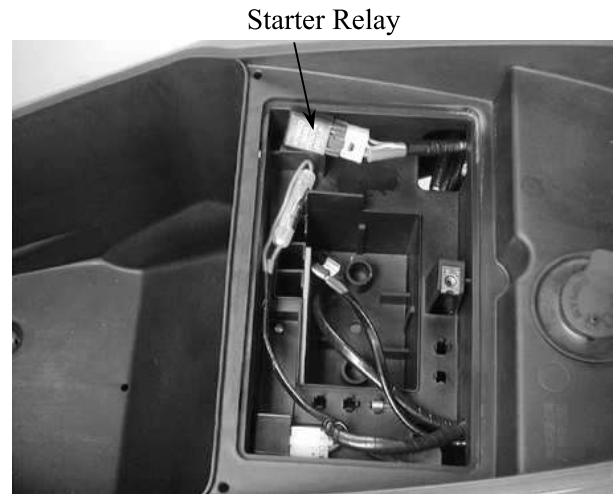

Connect the starter relay green/yellow terminal to the 12V battery positive (+) terminal and the relay yellow/red terminal to the battery negative (-) terminal. Check for continuity between the starter relay red and red/white terminals. The relay is normal if there is continuity.

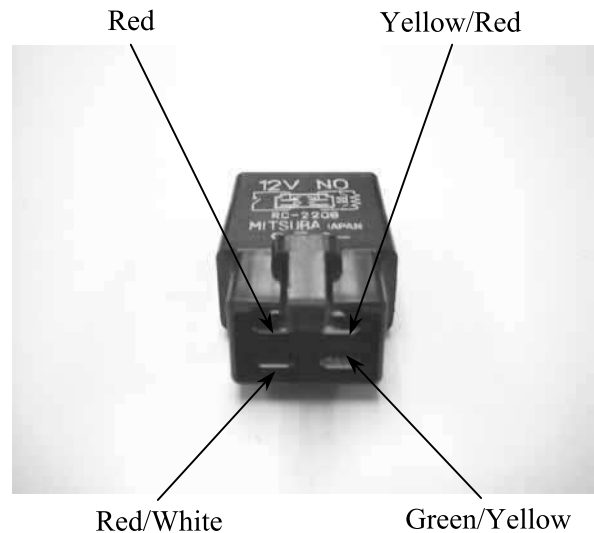

STARTER MOTOR REMOVAL

Disconnect the starter motor cable.
Remove the two bolts attaching the starter motor and remove the starter motor.
The installation sequence is the reverse of removal.

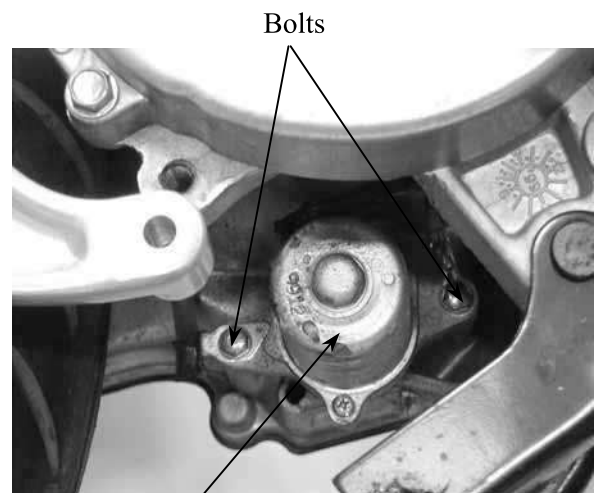

15. ELECTRICAL EQUIPMENT

STARTER MOTOR INSPECTION

Connect a battery across the starter motor and check for its operation.

*

1. Do not turn the starter motor for a long time.
2. This inspection should be done with a fully charged battery.

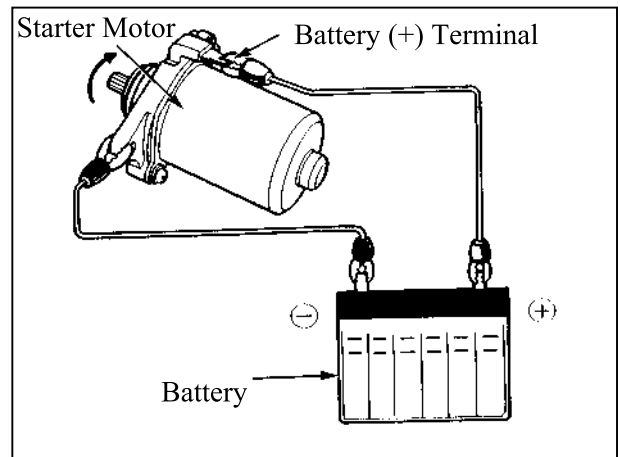

16. INSTRUMENT/SWITCHES/LIGHTS

INSTRUMENT/SWITCHES/LIGHTS

SERVICE INFORMATION	16-1
TROUBLESHOOTING	16-1
FUEL UNIT.....	16-2
OIL METER.....	16-3
SWITCHES	16-4
STOP SWITCH INSPECTION.....	16-6
BULB REPLACEMENT	16-7
INSTRUMENT/HEADLIGHT	16-8

16. INSTRUMENT/SWITCHES/LIGHTS

SERVICE INFORMATION

GENERAL INSTRUCTIONS

- Wires should be connected to other wires of the same color. Couplers must be connected to other couplers of the same color.
- All plastic plugs have locking tabs that must be released before disconnecting, and must be aligned when reconnecting.
- After installation of each switch, a continuity check must be performed.

TROUBLESHOOTING

Lights do not come on when ignition switch is "ON"

- Burned bulb
- Faulty switch
- Broken or shorted wire
- Fuse burned out
- Weak battery
- Poorly connected wire
- Faulty winker

Light dims

- Faulty ignition coil
- Wire or switch resistance too high
- Faulty regulator/rectifier

Headlight does not change when dimmer switch is turn to Hi or Lo

- Faulty or burned bulb
- Faulty dimmer switch

Motor oil indicator light does not come on (when motor oil is insufficient)

- Fuse burned out
- Dead battery
- Faulty ignition switch
- Faulty instrument
- Faulty oil meter

Motor oil indicator light winks

- Loose wire connection
- Broken wire
- Faulty oil meter

Fuel gauge pointer does not register correctly

- Disconnected wire or connector
- Broken wire
- Faulty float
- Faulty fuel unit
- Faulty instrument

Fuel gauge pointer fluctuates or swings

- Loose wire connection
- Faulty fuel unit
- Faulty instrument

16. INSTRUMENT/SWITCHES/LIGHTS

FUEL UNIT

* No Smoking!

REMOVAL

Remove the frame body cover. (⇒2-3)
 Disconnect the fuel unit wire connectors.
 Turn the fuel unit retainer counterclockwise to remove it.

* Do not damage the fuel unit wire.

Remove the fuel unit.

* Be careful not to bend or damage the fuel unit float arm.

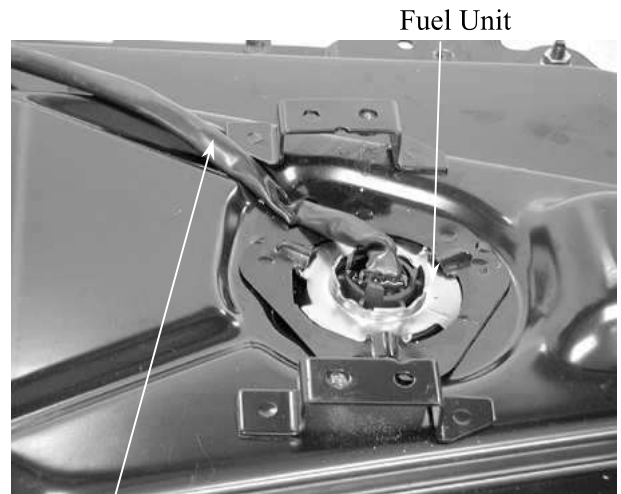

Fuel Unit Wire

INSPECTION

Remove the fuel unit.
 Measure the resistance between the fuel unit wire terminals with the float at upper and lower positions.

Wire Terminals	Upper	Lower
G~Y/W	33Ω	686Ω
G~L/W	566Ω	53Ω
Y/W~L/W	600Ω	600Ω

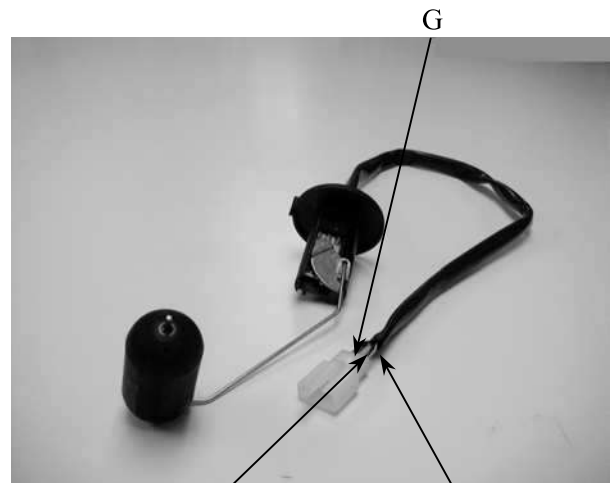

Y/W

L/W

FUEL GAUGE INSPECTION

Connect the fuel unit wire connectors and turn the ignition switch "ON".

* Before performing the following test, operate the turn signals to determine that the battery circuit is normal.

Check the fuel gauge needle for correct indication by moving the fuel unit float up and down.

Float Position	Needle Position
Upper	"F" (Full)
Lower	"E" (Empty)

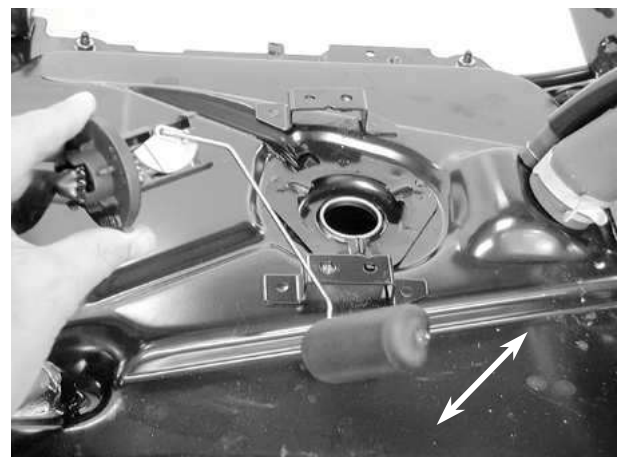

16. INSTRUMENT/SWITCHES/LIGHTS

INSTALLATION

The installation sequence is the reverse of removal.

- *
 - Align the tab on the fuel unit with the groove on the fuel tank.
 - Turn the retainer clockwise to secure it.

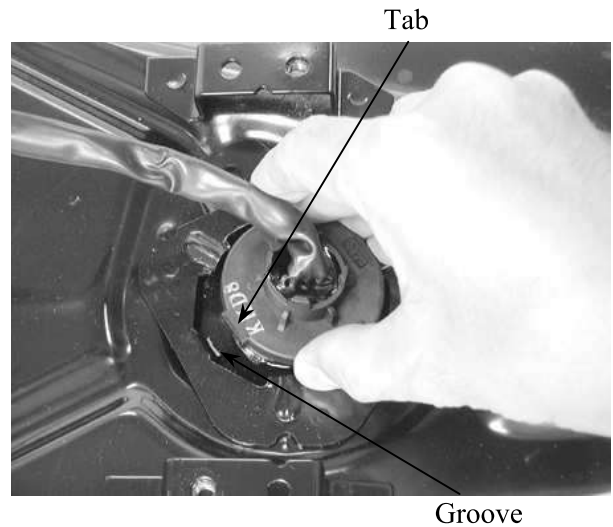

OIL METER

INSPECTION

Remove the met-in box. (⇒2-2)
 Remove the frame body cover. (⇒2-2)
 Disconnect the oil meter wire connectors and remove the oil meter. Keep the oil meter float at the lower position.
 Measure the resistances between the wire terminals as ① and ② shown in the left figure.

Wire Terminals	Resistance
Green/Red(+) ~ Black(-)	5 ~ 16Ω
Green(-) ~ Black(+)	∞

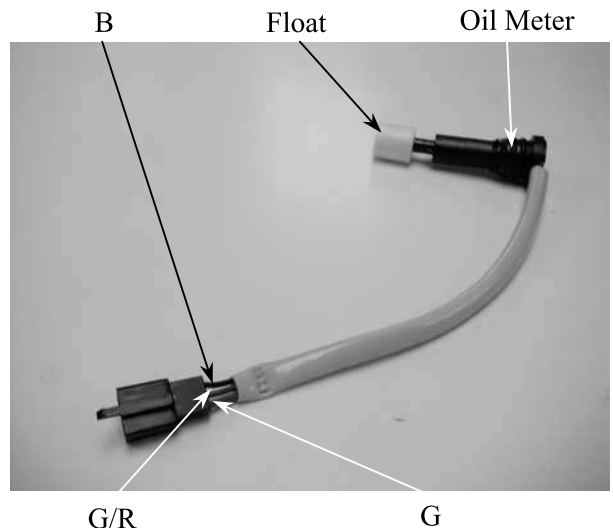

- *
 Before removing the oil meter, be sure to drain the motor oil and do not allow sparks or flames near the working area.

Oil Meter Operation Inspection

Connect the oil meter wire connectors and turn the ignition switch ON.
 Measure the resistance between the wire terminals with the float at upper position.

Green/Red(+) ~ Black(-)	About 340Ω
-------------------------	------------

- *
 Before performing the following test, operate the turn signals to determine that the battery circuit is normal.



16. INSTRUMENT/SWITCHES/LIGHTS

Move the oil meter float up and down to see if the oil indicator light will go out and come on.

* If the oil indicator light does not light, check for burned bulb, loose wire or connector. After correction, check again according to the method mentioned above.

Oil Indicator Light



SWITCHES

IGNITION SWITCH INSPECTION

Remove the front upper/lower cover. (⇒2-3)
Disconnect the ignition switch wire couplers and check for continuity between the wire terminals.

Color	Red	Black/White	Green	Black
Symbol	BAT ₁	IG	E	BAT ₂
LOCK		○—○	○	
OFF		○—○	○	
ON	○			○

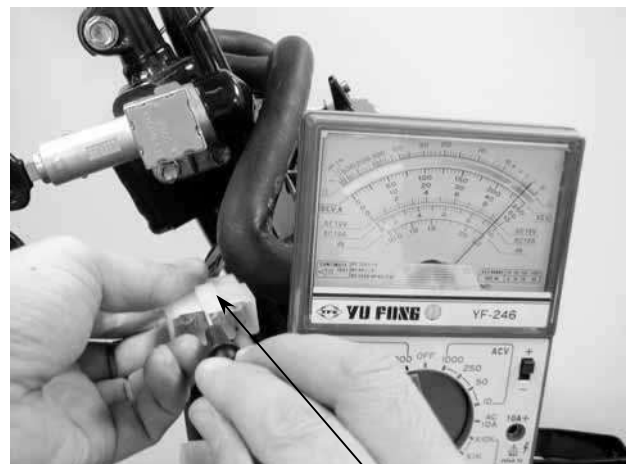

Ignition Switch Coupler

IGNITION SWITCH REPLACEMENT

Remove the front upper/lower cover. (⇒2-3)
Disconnect the ignition switch wire couplers.
Remove the two mounting bolts and remove the ignition switch.
The installation sequence is the reverse of removal.

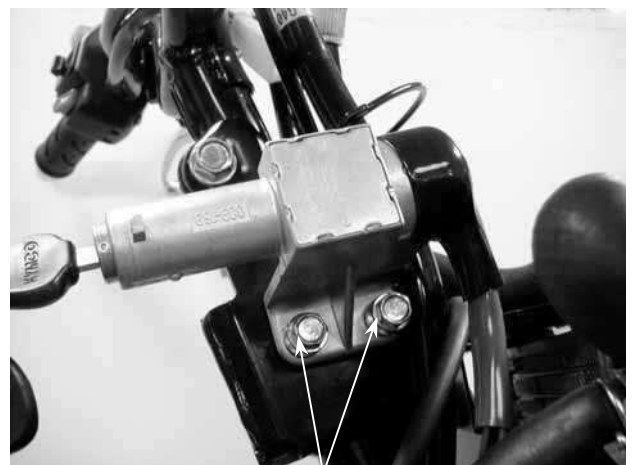

Bolts

16. INSTRUMENT/SWITCHES/LIGHTS

HEADLIGHT SWITCH INSPECTION

Remove the handlebar lower cover. (⇒2-7)
 Disconnect the headlight switch wire coupler and check for continuity between wire terminals.

Color	Blue/White	Yellow	Brown	Pink
Symbol	HL	CI	TL	RE
OFF		○		○
P		○	○	
H	○	○	○	

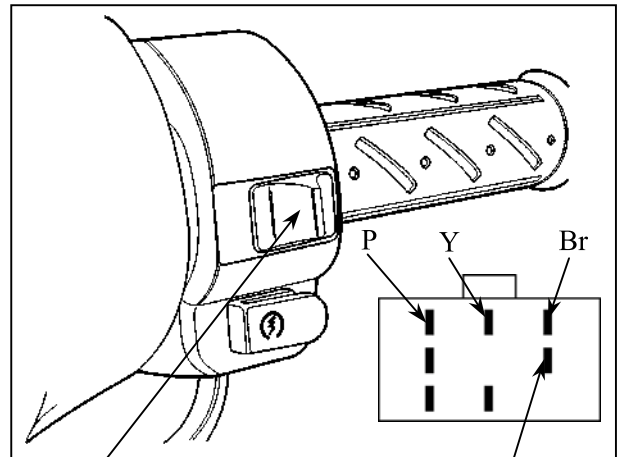

Headlight Switch

L/W

DIMMER SWITCH INSPECTION

Check for continuity between wire terminals.

Color	White/Blue	Blue	White	Black
Symbol	HL	HI	LO	BAT ₂
HI	○	○		
LO	○		○	
PASSING		○	○	○

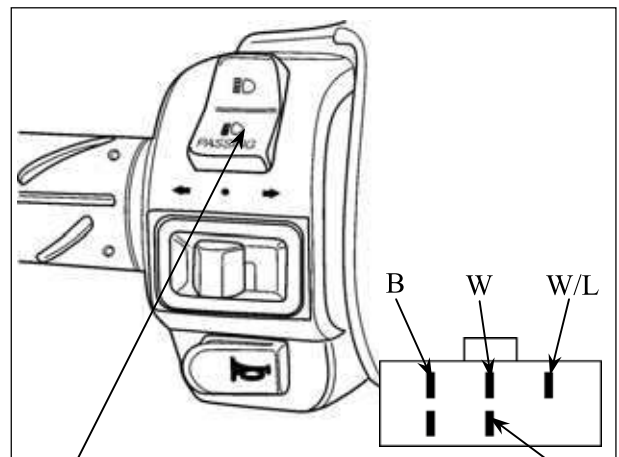

Dimmer Switch

L

TURN SIGNAL SWITCH INSPECTION

Check for continuity between the wire terminals.

Color	Light Blue	Orange	Gray
Symbol	R	L	WR
R	○		○
L		○	○

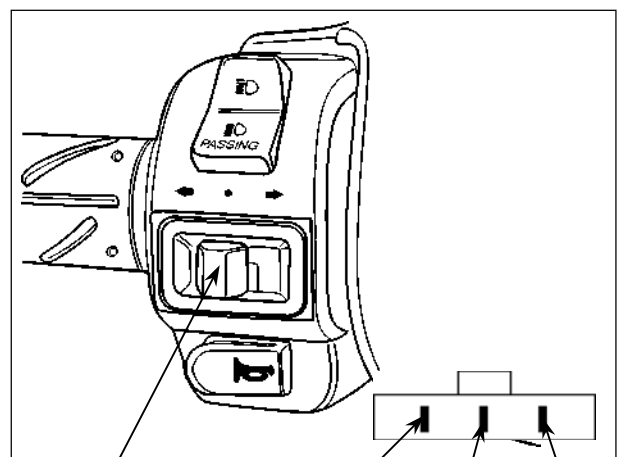

Turn Signal Switch

SB

O

Gr

16. INSTRUMENT/SWITCHES/LIGHTS

STARTER SWITCH INSPECTION

Check for continuity between wire terminals.
Push the starter button when measuring.

Color	Yellow/Red	Green
Symbol	ST	E
FREE		
PUSH	○ — ○	○ — ○

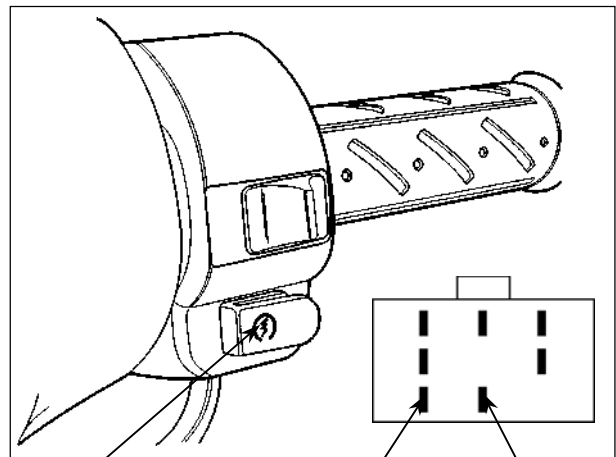

Starter Switch

G

Y/R

HORN SWITCH INSPECTION

Check for continuity between wire terminals.
Push the horn button when measuring.

Color	Light Green	Black
Symbol	HO	BAT ₂
FREE		
PUSH	○ — ○	○ — ○

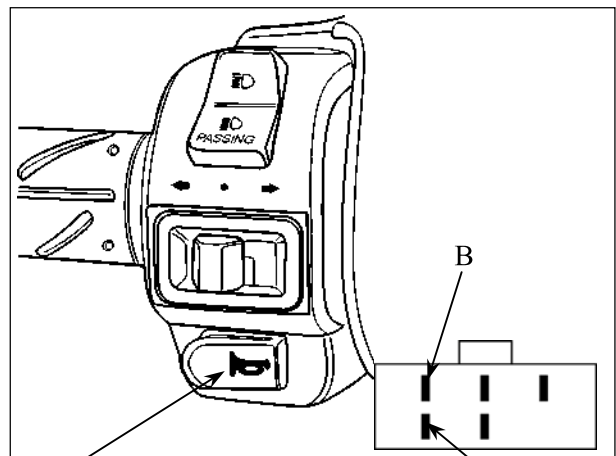

Horn Switch

B

Lg

STOP SWITCH INSPECTION

Remove the handlebar lower cover. (⇒2-7)
Disconnect the front stop switch wire couplers.
Check for continuity between the wire terminals when the front/rear brake lever is applied.



16. INSTRUMENT/SWITCHES/LIGHTS

HORN INSPECTION

Remove the front upper/lower cover. (⇒2-3)
 Disconnect the horn wire couplers. The horn is normal if it sounds when a 12V battery is connected across the horn wire terminals.



FRONT TURN SIGNAL LIGHT REPLACEMENT

Remove the turn signal light shell and the bulb.
 Replace with new ones.

* Replace with new bulbs of the same specifications.



TAILLIGHT/STOPLIGHT/REAR TURN SIGNAL LIGHT BULB REPLACEMENT

Taillight Shell Removal:
 Remove two screws attaching the taillight shell.
 Remove the taillight shell and stop light bulb.
 Remove the rear turn signal light bulbs.
 The installation sequence is the reverse of removal.

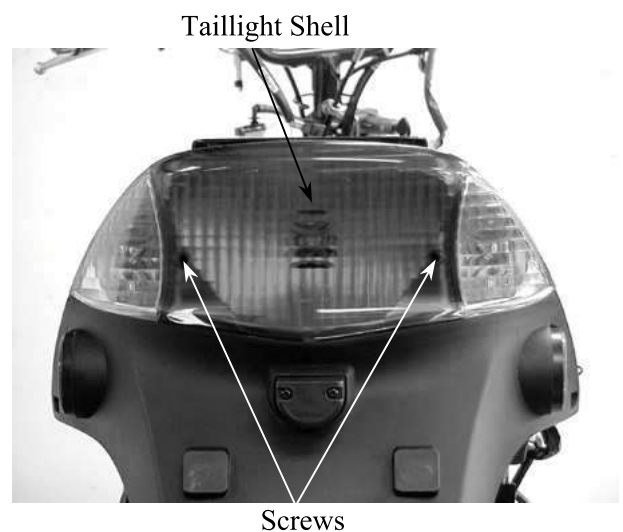

16. INSTRUMENT/SWITCHES/LIGHTS

INSTRUMENT

REMOVAL

Remove the front upper cover. (⇒2-5)
 Disconnect the instrument wire couplers and connectors.
 Disconnect the speedometer cable.
 Remove the four screws attaching instrument cover and leg shield.
 Remove the instruments.

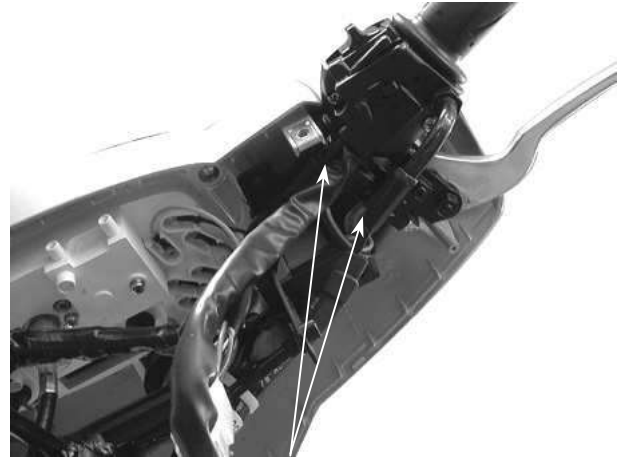

Screws

SPEEDOMETER REMOVAL

Disconnect the speedometer cable.
 Disconnect the speedometer wire connector.
 Remove the three screws attaching the speedometer.
 Remove the speedometer.
 The installation sequence is the reverse of removal.

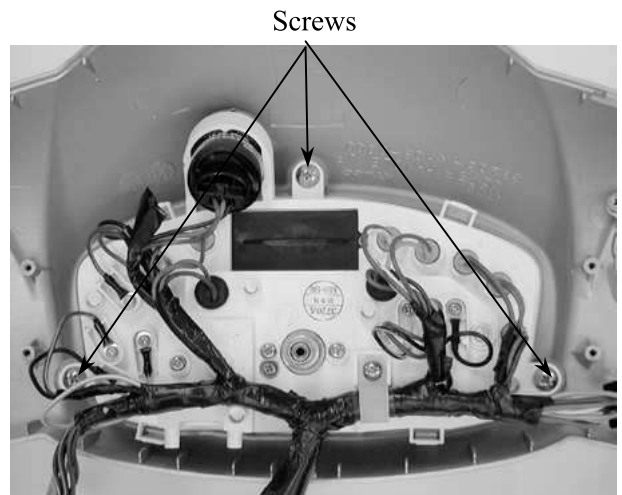

Screws

HEADLIGHT

REMOVAL/BULB REPLACEMENT

Remove the front upper/lower cover. (⇒2-3)
 Remove the bulb sockets and bulbs.

*

- The model adopts krypton gas bulb. When installing, do not directly touch the bulb glass with fingers.
- Use bulbs of the same specifications for replacement.

The installation sequence is the reverse of removal.

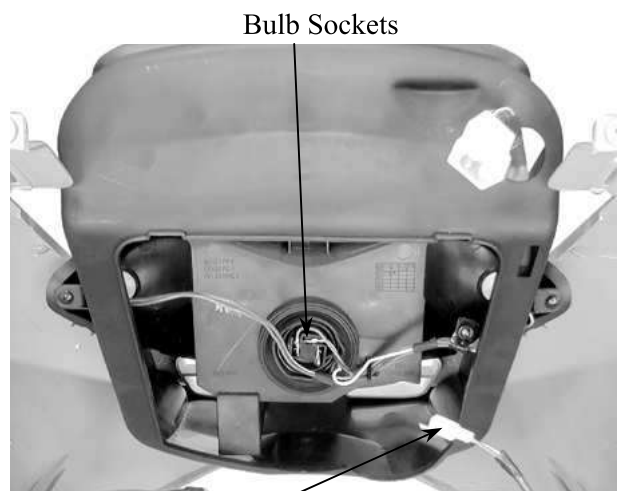

Bulb Sockets

Coupler

**EVAPORATIVE/EXHAUST EMISSION
CONTROL SYSTEM**

EXHAUST EMISSION CONTROL SYSTEM..... 17-1
EXHAUST MUFFLER..... 17-2
EXHAUST EMISSION RELATED SYSTEM INSPECTION 17-3

EXHAUST EMISSION CONTROL SYSTEM

The exhaust emission control system adopted by this model is an oxidizing catalytic converter which is located in the middle of the exhaust muffler to reduce pollutants in the exhaust emission.

Exhaust Muffler Diagram

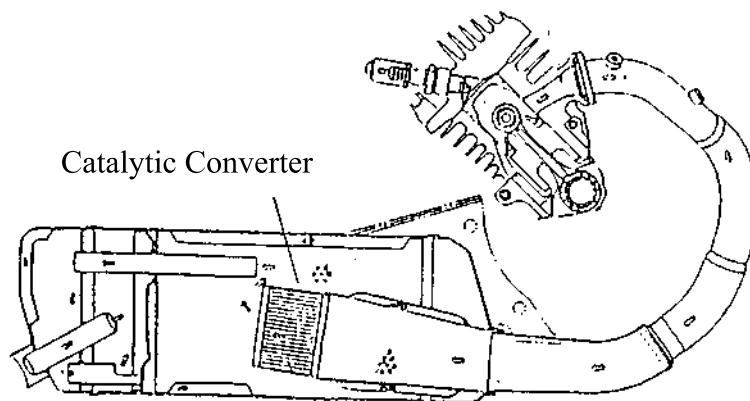

FUNCTION

Item	Purpose	Function
Oxidizing Catalytic Converter	Reduce the concentration of HC and CO in the exhaust emission.	The precious metal in the oxidizing catalytic converter is used to oxidize HC and CO in the exhaust emission into CO ₂ and H ₂ O to avoid air pollution.

TROUBLESHOOTING

Lack of power and high CO & HO

1. Clogged exhaust muffler
2. Faulty oxidizing catalytic converter
3. Carburetor adjusted improperly
4. Clogged air cleaner
5. Faulty spark plug
6. Incorrect ignition timing

Engine runs erratic at idle speed and high fuel consumption

1. Clogged exhaust muffler
2. Clogged carburetor
3. Clogged air cleaner
4. Faulty spark plug
5. Incorrect ignition timing

EXHAUST MUFFLER

REMOVAL

Remove the two exhaust muffler joint lock nuts and two exhaust muffler lock bolts.
Remove the exhaust muffler.

- * • The temperature of exhaust muffler is very high. Be careful to avoid burns during working.

Exhaust Muffler Joint Lock Nut

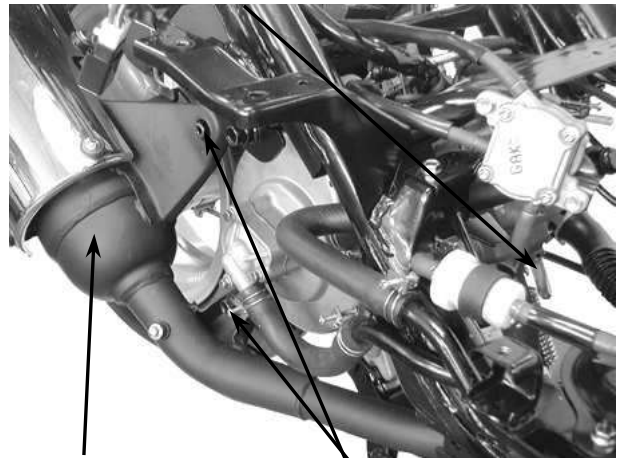

Exhaust Muffler

Lock Bolts

INSPECTION

1. Inspect the exhaust muffler and joint for damage or crack. Replace if necessary.
2. Inspect the exhaust muffler joint packing collar for deformation or damage. Replace if necessary.

INSTALLATION

1. Install the exhaust muffler in the reverse order of removal.

- *
 - A large amount of unburned mixture flowing into the high-heat catalytic converter will burn again and cause damage to the converter due to overheat. Pay attention to the following.
 - Use unleaded gasoline only. (Leaded gasoline will cause catalytic converter failure.)
 - During riding, do not turn the ignition switch OFF to avoid a large amount of unburned mixture flowing into the exhaust muffler.
 - Faulty ignition system or fuel system will cause overheat and damage to the catalytic converter.

EXHAUST EMISSION RELATED SYSTEM INSPECTION

- Clean or replace the air cleaner.
- Clean and adjust the carburetor.
- Inspect the auto bystarter system.
- Clean and inspect the spark plug.
- Inspect the ignition system.

EXHAUST EMISSION TEST AND ADJUSTMENT

1. Start the engine and warm up for several minutes. (Engine surface temperature 50°C ~ 60°C)
2. Adjust the idle speed to:: SH10CA:2000±100rpm
3. Connect the emission tester sampling pipe to the exhaust muffler.
Standard:
CO: 3±0.5%
HC: 7000PPM max.
4. If CO or HC exceeds the specified values, adjust the carburetor air screw (A.S.) until CO and HC are within the specified standard values.
A.S. Opening: SH10CA: 1¼± ½ turns
5. If the adjustment of carburetor makes no difference, inspect exhaust emission related system.