

**By KWANG YANG Motor Co., Ltd.  
1st Edition, Jan 2010  
All rights reserved. Any reproduction or  
unauthorized use without the written  
permission of KWANG YANG Motor Co., Ltd.  
is expressly prohibited.  
T300-SK60AB-A2**

---

## PREFACE

This Service Manual describes the technical features and servicing procedures for the KYMCO **Downtown 300i ABS**

Section 1 contains the precautions for all operations stated in this manual. Read them carefully before any operation is started.

Section 2 is the removal/installation procedures for the frame covers which are subject to removal/installation frequency during maintenance and servicing operations.

Section 3 describes the inspection/adjustment procedures, safety rules and service information for each part, starting from periodic maintenance.

Sections 5 to 12 give instructions for disassembly, assembly and adjustment of engine parts. Section 13 is the AFI system. Section 14 to 15 is the removal/ installation of chassis. Section 16 to 19 states the testing and measuring methods of electrical equipment.

Most sections start with an assembly or system illustration and troubleshooting for the section. The subsequent pages give detailed procedures for the section.

The information and contents included in this manual may be different from the motorcycle in case specifications are changed.

**KWANG YANG MOTOR CO., LTD.**  
**QUALITY TECHNOLOGY DEPT.**  
**EDUCATION SECTION**

## TABLE OF CONTENTS

ENGINE	GENERAL INFORMATION	1
	EXHAUST MUFFLER/FRAME COVERS	2
	INSPECTION/ADJUSTMENT	3
	LUBRICATION SYSTEM	4
	ENGINE REMOVAL/INSTALLATION	5
	CYLINDER HEAD/VALVES	6
	CYLINDER/PISTON	7
	DRIVE AND DRIVEN PULLEYS/V-BELT	8
	FINAL REDUCTION	9
	A.C. GENERATOR/STARTER CLUTCH	10
	CRANKCASE/CRANKSHAFT	11
	COOLING SYSTEM	12
	FUEL INJECTION SYSTEM	13
CHASSIS	STEERING HANDLEBAR/FRONT WHEEL/FRONT BRAKE/FRONT SHOCK ABSORBER/FRONT FORK	14
	REAR BRAKE/REAR FORK/REAR WHEEL/REAR SHOCK ABSORBER	15
ELECTRICAL EQUIPMENT	BATTERY/CHARGING SYSTEM	16
	IGNITION SYSTEM	17
	STARTING SYSTEM	18
	LIGHTS SWITCHES / FUEL PUMP	19
	EVAPORATIVE EMISSION CONTROL SYSTEM	20
ABS	ANTI-LOCK BRAKE SYSTEM	21

# 1. GENERAL INFORMATION

---



---

## GENERAL INFORMATION

---

SERIAL NUMBER .....	1-1
SPECIFICATION .....	1-2
SERVICE PRECAUTIONS .....	1-5
TORQUE VALUES .....	1-9
SPECIAL TOOLS .....	1-10
LUBRICATION POINTS .....	1-11
CABLE & HARNESS ROUTING .....	1-13
TROUBLESHOOTING .....	1-14

# 1. GENERAL INFORMATION

## SERIAL NUMBER

Location of Frame Serial Number  
(inside luggage box)

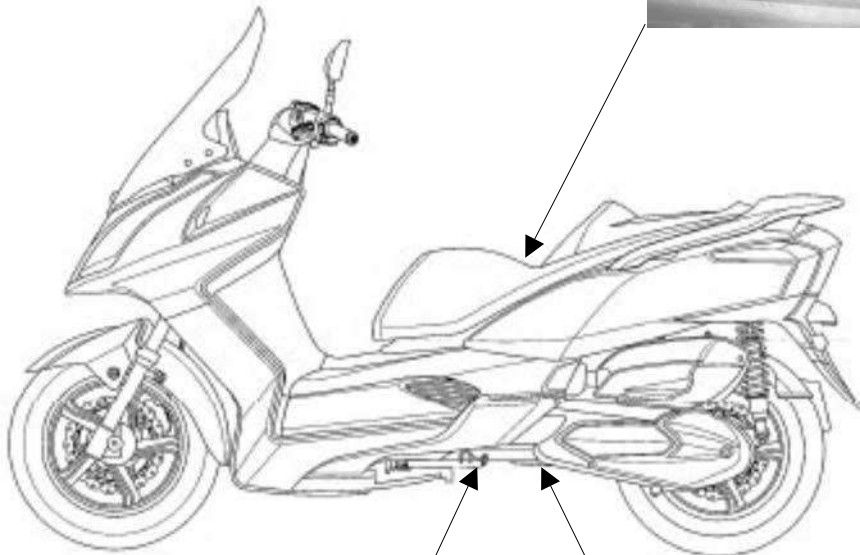

Location of Vehicle Identification  
Number (VIN)



Location of Engine Serial Number



# 1. GENERAL INFORMATION

## SPECIFICATIONS

Name		Downtown 300i
Model No.		SK60AB
Overall length		2200 mm
Overall width		800 mm
Overall height		1410 mm
Wheel base		1545 mm
Engine type		4 stroke O.H.C.
Displacement		298.9 cc
Fuel Used		92# nonleaded gasoline
Curb weight (kg)	Front wheel	79
	Rear wheel	110
	Total	189
Max. weight (kg)	Front wheel	149
	Rear wheel	205
	Total	354
Ground clearance (mm)		140
Braking distance (m)		7.9m / 40 km/hr
Min. turning radius (m)		2.6
<b>Engine part</b>		
Starting system		Starting motor
Type		Gasoline 4-cycle
Cylinder arrangement		Single cylinder
Combustion chamber type		Semi-sphere
Valve arrangement		O.H.C.-4V
Bore x stroke (mm)		$\phi 72.7 * 72$
Compression ratio		10.8:1
Compression pressure (kg/cm <sup>2</sup> -rpm)		16-570 rpm
Max. output (ps/rpm)		29 / 7750
Max. torque (kg-m/rpm)		2.7 / 6500
Intake Timing	Open	-9.5° BTDC
	Close	37.5° BTDC
Exhaust Timing	Open	40° BTDC
	Close	10° BTDC
Valve clearance	Intake	0.10
	Exhaust	0.10
Idle speed (rpm)		1600±100 rpm
Cooling Type		Liquid cooling
Lubrication type		Forced pressure & wet sump
Oil pump type		Inner/outer rotor

Oil filter type		Full-flow filtration
Oil capacity		1.5 liter
Exchanging capacity		1.3 liter
<b>Fi injection system</b>		
Air cleaner type & No		Paper element, wet
Fuel capacity		12.5 liters
Brand		Keihin
Throttle Body		Butterfly type
Venturi diameter (mm)		34
Fuel pump pressure		2.5 bar
<b>Electrical system</b>		
Ignition type		ECU
Ignition timing		10° BTDC / idle 33° / 6500min
Spark plug		CR7E (NGK)
Spark plug gap		0.6~0.7mm
Battery Capacity		12V10AH
<b>Transmission system</b>		
Clutch type		Dry multi-disc
Transmission type		CVT
Operation type		Auto centrifugal
Reduction gear type		Two-stage reduction
Reduction ratio	1 <sup>st</sup>	0.72 ~ 2.24
	2nd	7.222
<b>Moving device</b>		
Tire type		Tubeless
Tire spec.	Front wheel	120/80-14 58S
	Rear wheel	150/70-13 64S
Tire pressure (kg/cm <sup>2</sup> )	Front wheel	2.0
	Rear wheel	2.25
Wheel material		Aluminium
Turning angle	Left	40°
	Right	40°
Brake type	Front	ABS
	Rear	ABS
<b>Damping Device</b>		
Suspension type	Front	Telescope
	Rear	Swing arm
Shock absorber stroke	Front	110 mm
	Rear	100 mm

# 1. GENERAL INFORMATION

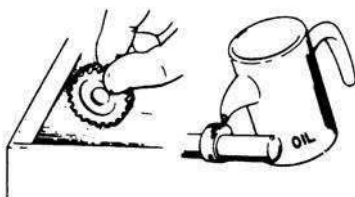
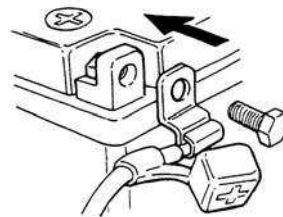
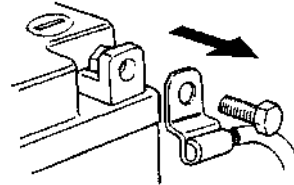
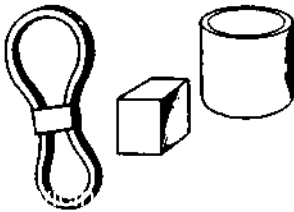
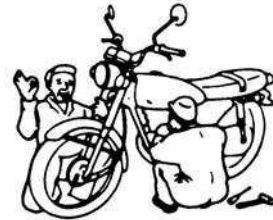
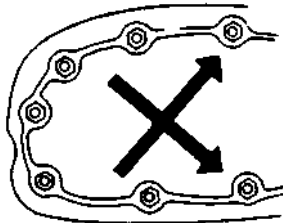
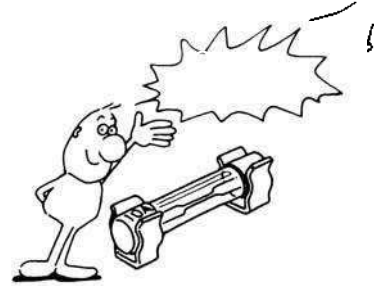
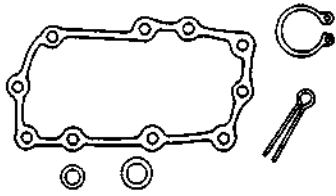

# 1. GENERAL INFORMATION

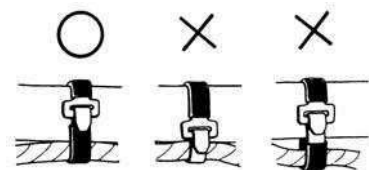
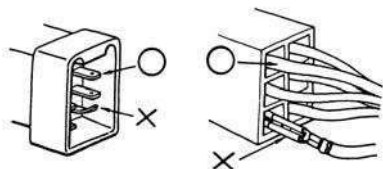
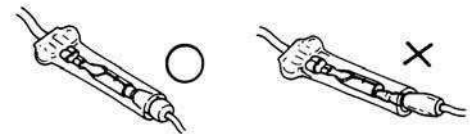
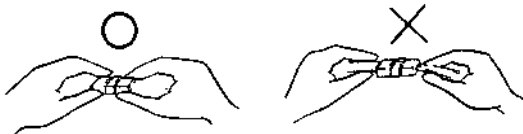
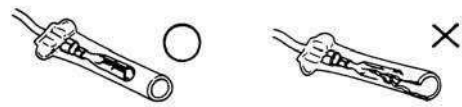
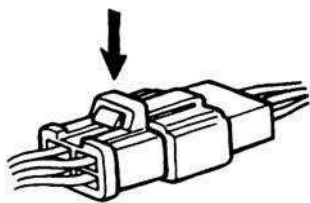
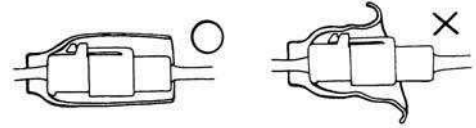
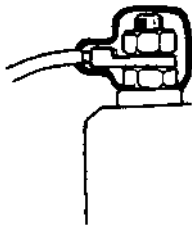
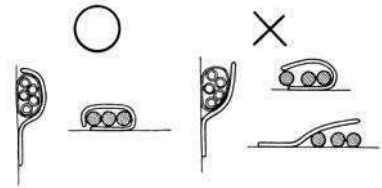
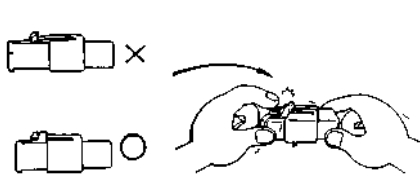

# 1. GENERAL INFORMATION

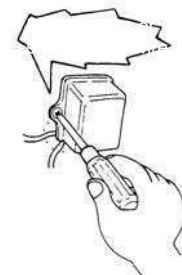
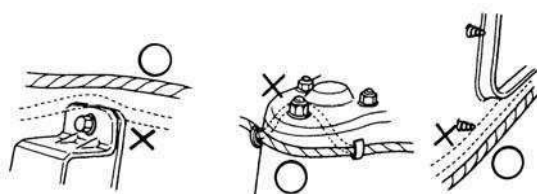
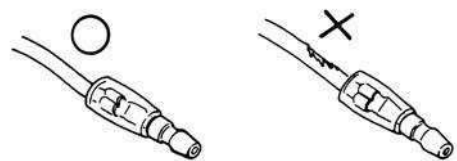
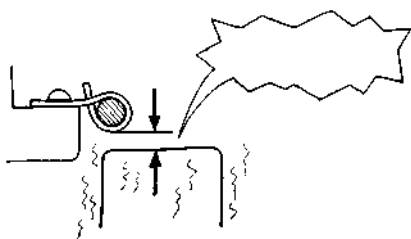
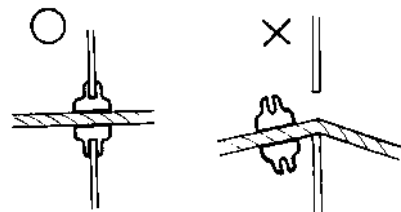
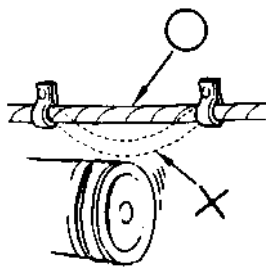
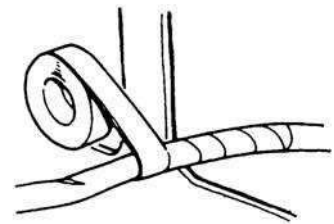
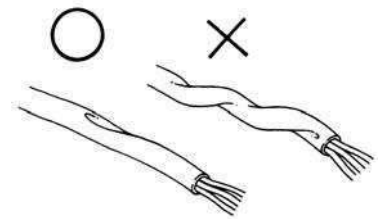
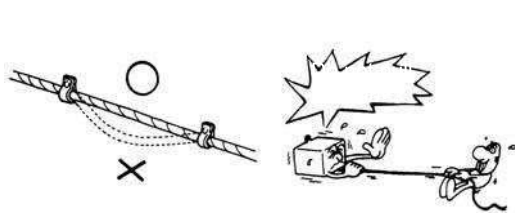

# 1. GENERAL INFORMATION

---

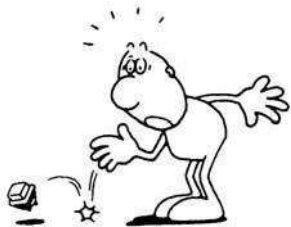
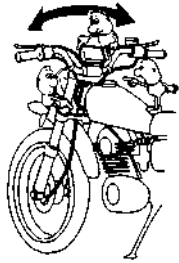

# 1. GENERAL INFORMATION

---



# 1. GENERAL INFORMATION

## TORQUE VALUES

### STANDARD TORQUE VALUES

Item	Torque (kgf-m)	Item	Torque (kgf-m)
5mm bolt, nut	0.45~0.6	5mm screw	0.45~0.6
6mm bolt, nut	0.8~1.2	6mm screw, SH bolt	0.7~1.1
8mm bolt, nut	1.8~2.5	6mm flange bolt, nut	1.0~1.4
10mm bolt, nut	3.0~4.0	8mm flange bolt, nut	2.4~3.0
12mm bolt, nut	5.0~6.0	10mm flange bolt, nut	3.0~4.5

### ENGINE

Item	Qty	Thread size (mm)	Torque (kgf-m)	Remarks
Cylinder head stud bolt:				
1.Stud bolt (Inlet pipe side)	2	6	0.7~1.1	Double end bolt
2.Stud bolt (EX pipe side)	2	8	0.7~1.1	Double end bolt
Cylinder head stud nut	4	10	3.4~3.8	
Right crankcase cover bolt	15	6	1.0~1.4	
Left crankcase cover bolt	15	6	1.0~1.4	
Bolt B stud 10*180	4	10	1.0~1.4	Apply oil to thread
Valve adjusting lock nut	4	5	0.7~1.1	Apply oil to thread
Cam sprocket bolt	2	6	1.0~1.4	
Transmission oil check\drain bolt	2	8	0.8~1.2	
Engine oil drain bolt	1	12	2.0~3.0	
Clutch outer nut	1	12	5.0~6.0	
Starter motor mounting bolt	2	6	1.0~1.4	
Mission case bolt	6	8	1.8~2.2	
Drive face nut	1	14	9.0~10.0	Apply oil to thread
Drive plate comp	1	28	5.0~6.0	
Cam chain tensioner bolt	2	6	1.0~1.4	
Cam chain tensioner pivot	1	8	0.8~1.2	
Oneway clutch bolt	3	8	1.8~2.2	Apply thread lock
ACG flywheel nut	1	14	5.5~6.5	
Spark plug	1	12	1.5~2.0	
Water pump impeller	1	7	1.0~1.4	Left thread

# 1. GENERAL INFORMATION

## TORQUE VALUES FRAME

Item	Qty	Thread size (mm)	Torque (kgf-m)	Remarks
Steering:				
1.Stem lock nut	1	BC1	6.0~8.0	
2.Handle post bolt	1	10	4.0~5.0	U - nut
3.Bridge bolt	1	8	2.4~3.0	
4.Race nut (head)	1	BC1	1.8~2.2	
Brake:				
1.Front/Rear caliper bolt	1	10	3.0~4.0	
2.Brake hose bolt	1	10	3.0~4.0	
3.Disk bolt	5	8	3.2~3.8	
Engine hanger:				
1.Fram side	2	14	6.0~7.0	U - nut
2.Engine side	1	10	4.5~5.5	U - nut
Rear fork bolt	2	10	3.0~4.0	
Speed sensor cable	1	6	1.0~1.4	
O2 sensor	1	12	2.0~3.0	
Rear carrier	4	8	2.0~2.8	
Front axle nut	1	14	1.5~2.5	
Rear axle nut	1	16	11~13	U - nut
Rear cushion upper/lower bolt	1	10	3.5~4.5	



# 1. GENERAL INFORMATION

---

## SPECIAL TOOLS

Tool Name	Tool No.	Remarks	Ref. Page
Flywheel puller	E003	A.C. generator flywheel removal	4.10
Tappet adjuster	E012	Tapper adjustment	3.7
Oil seal & bearing installer	E014	Oil seal & bearing install	9.10.11
Flywheel holder	E021	A.C. generator flywheel holding	4.10
Clutch spring compressor	E053	Clutch disassembly	9
#41 Nut & Fitting	E028	Clutch disassembly	9
Thread protector	E029	Protect the crankshaft's thread	10
Bearing puller 10,12,15,18mm	E037	Bearing removal	10
Valve cotter installer	E051	Valve cotter installation	7
Lock nut socket wrench	F002	Steering stem removal or install	12

# 1. GENERAL INFORMATION

---

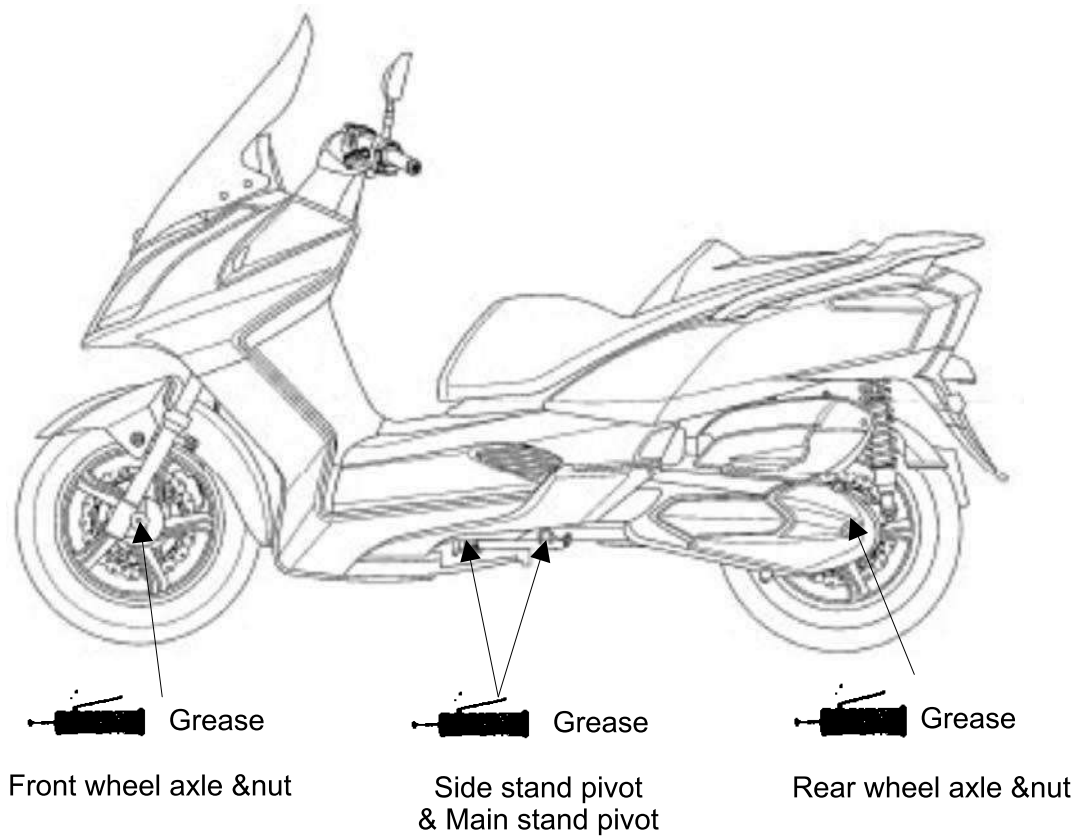

# 1. GENERAL INFORMATION

## CABLE & HARNESS ROUTING

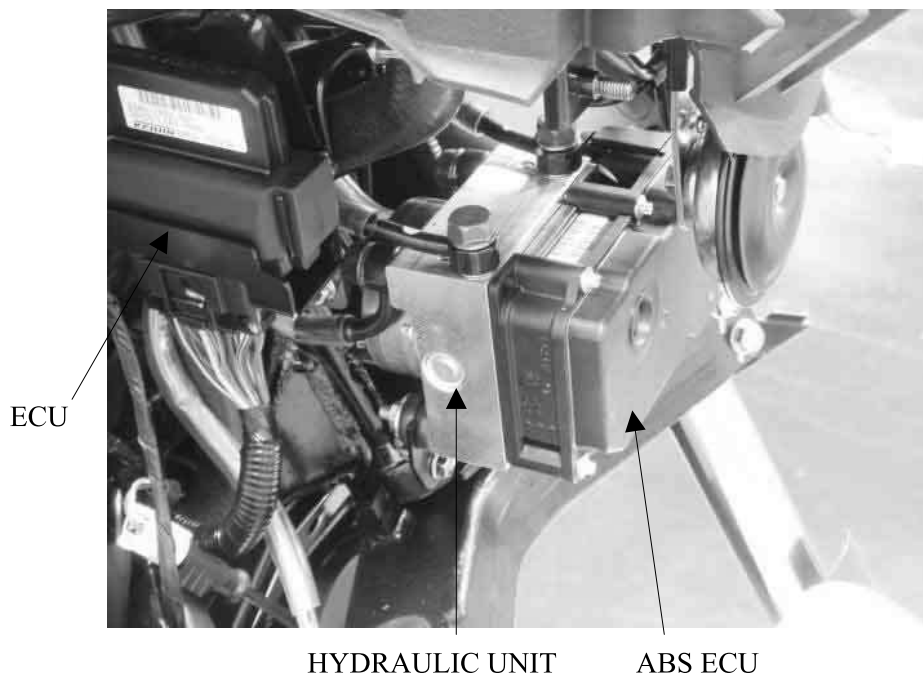
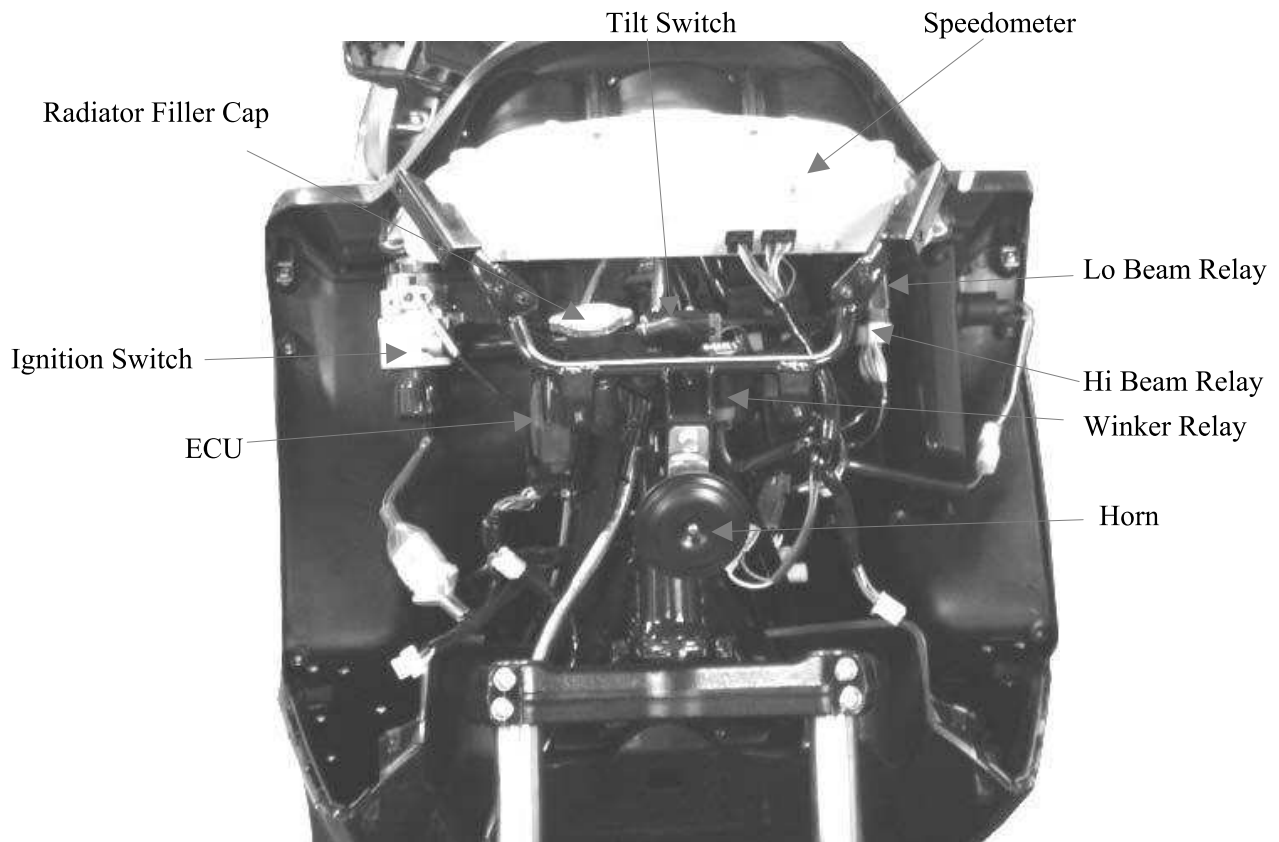

# 1. GENERAL INFORMATION

---

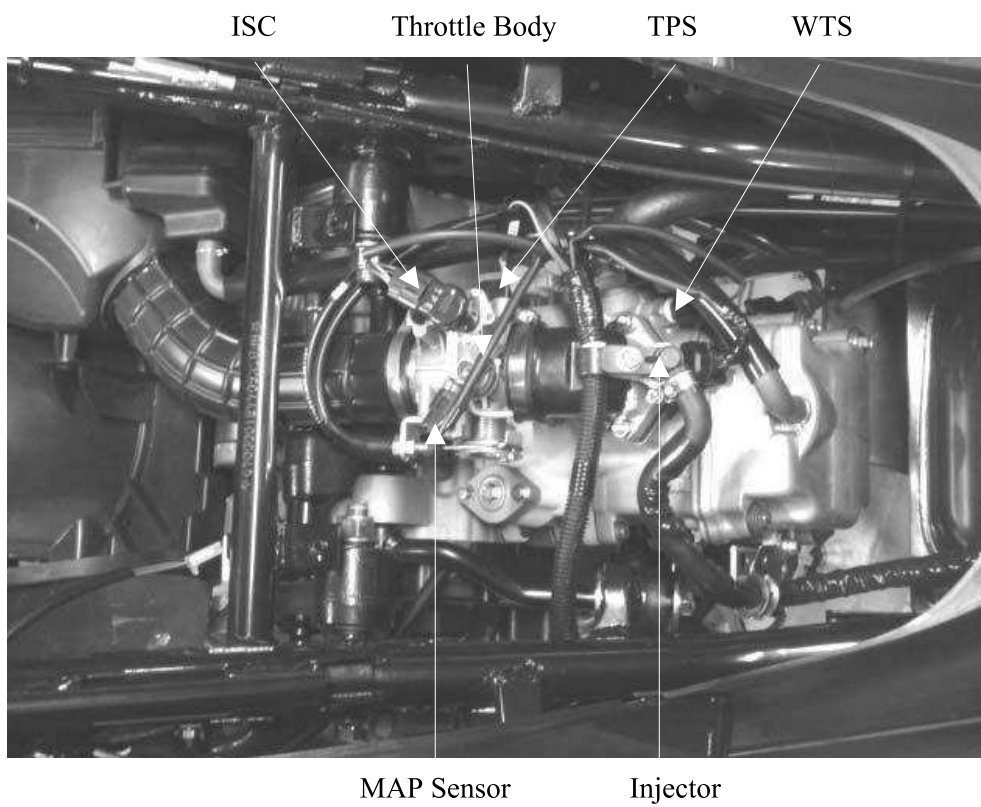

# 1. GENERAL INFORMATION

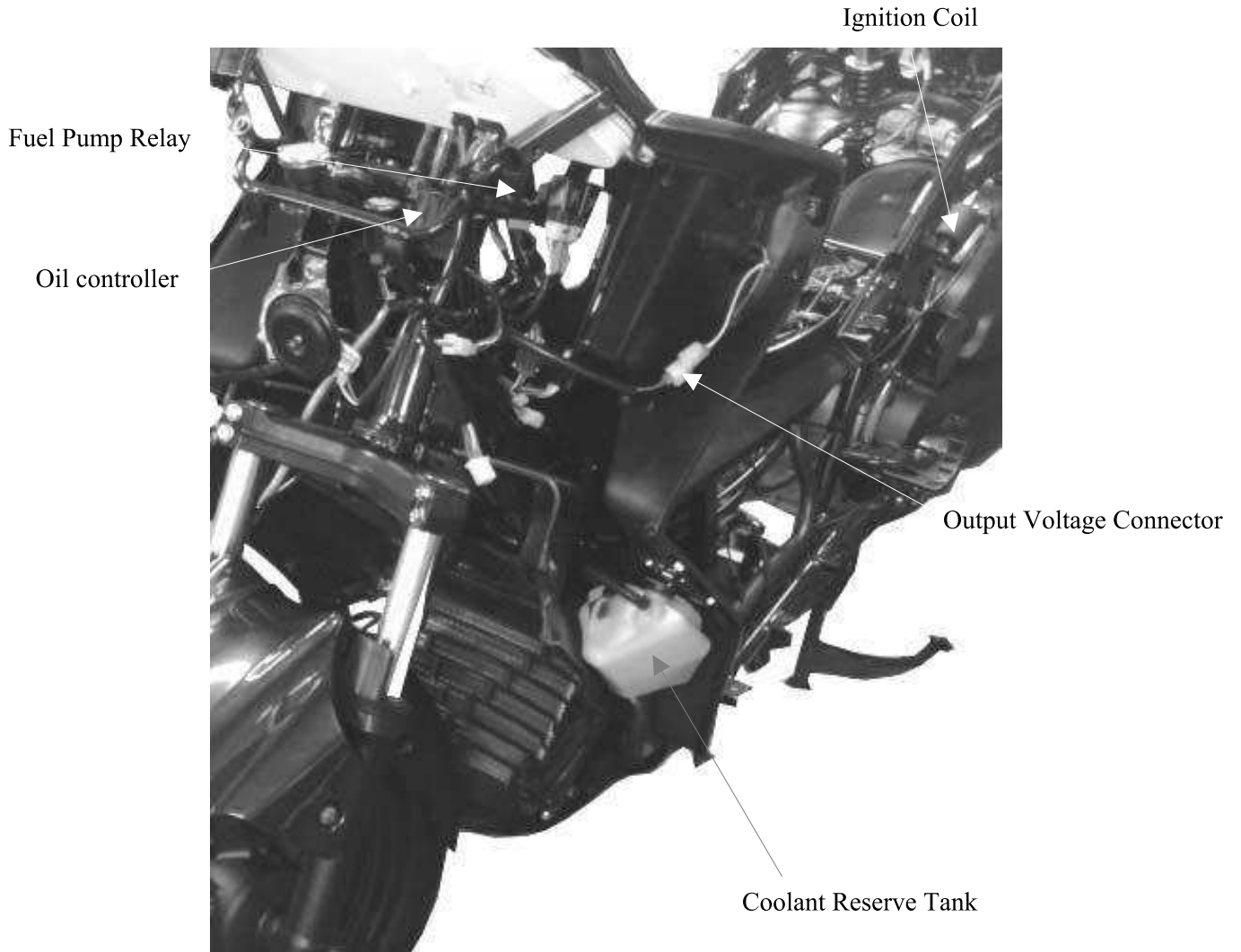

# 1. GENERAL INFORMATION

---

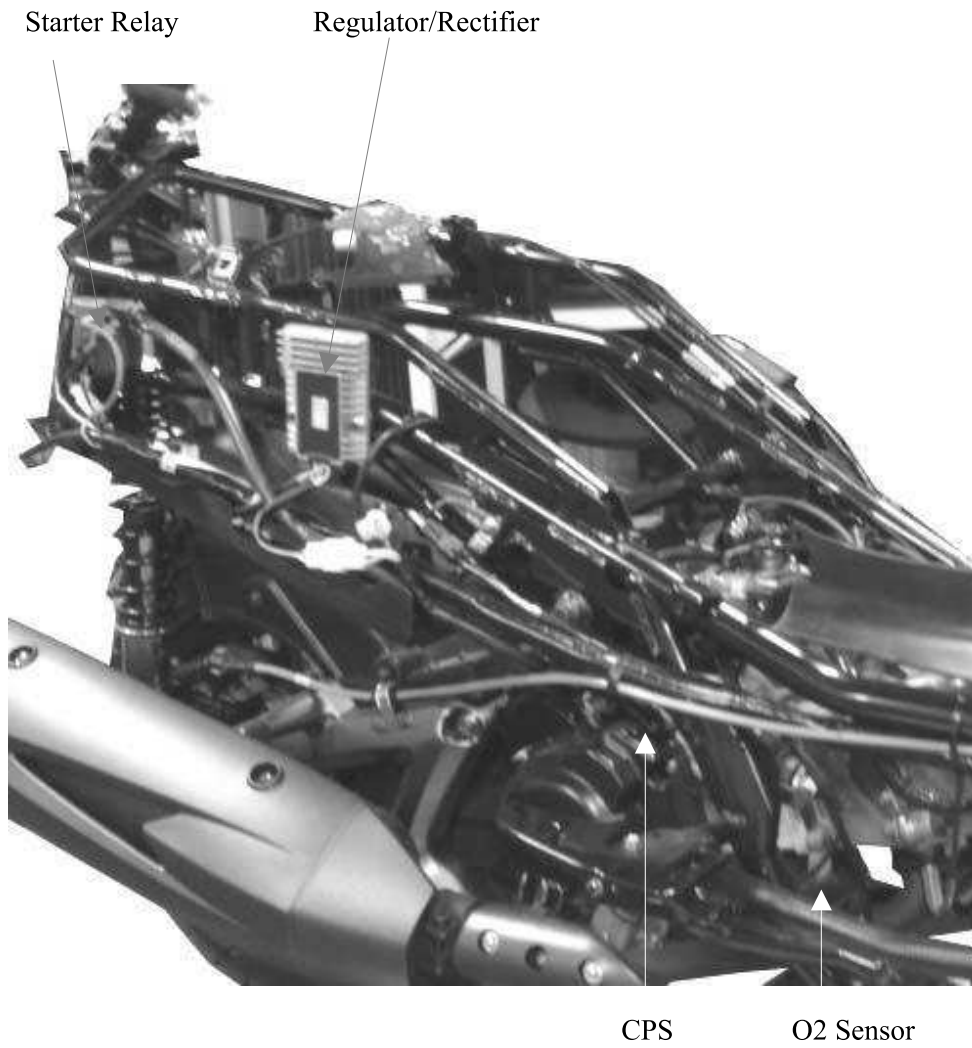

# 1. GENERAL INFORMATION

## TROUBLESHOOTING

### ENGINE WILL NOT START OR IS HARD TO START

<b>Possible cause</b>
-----------------------

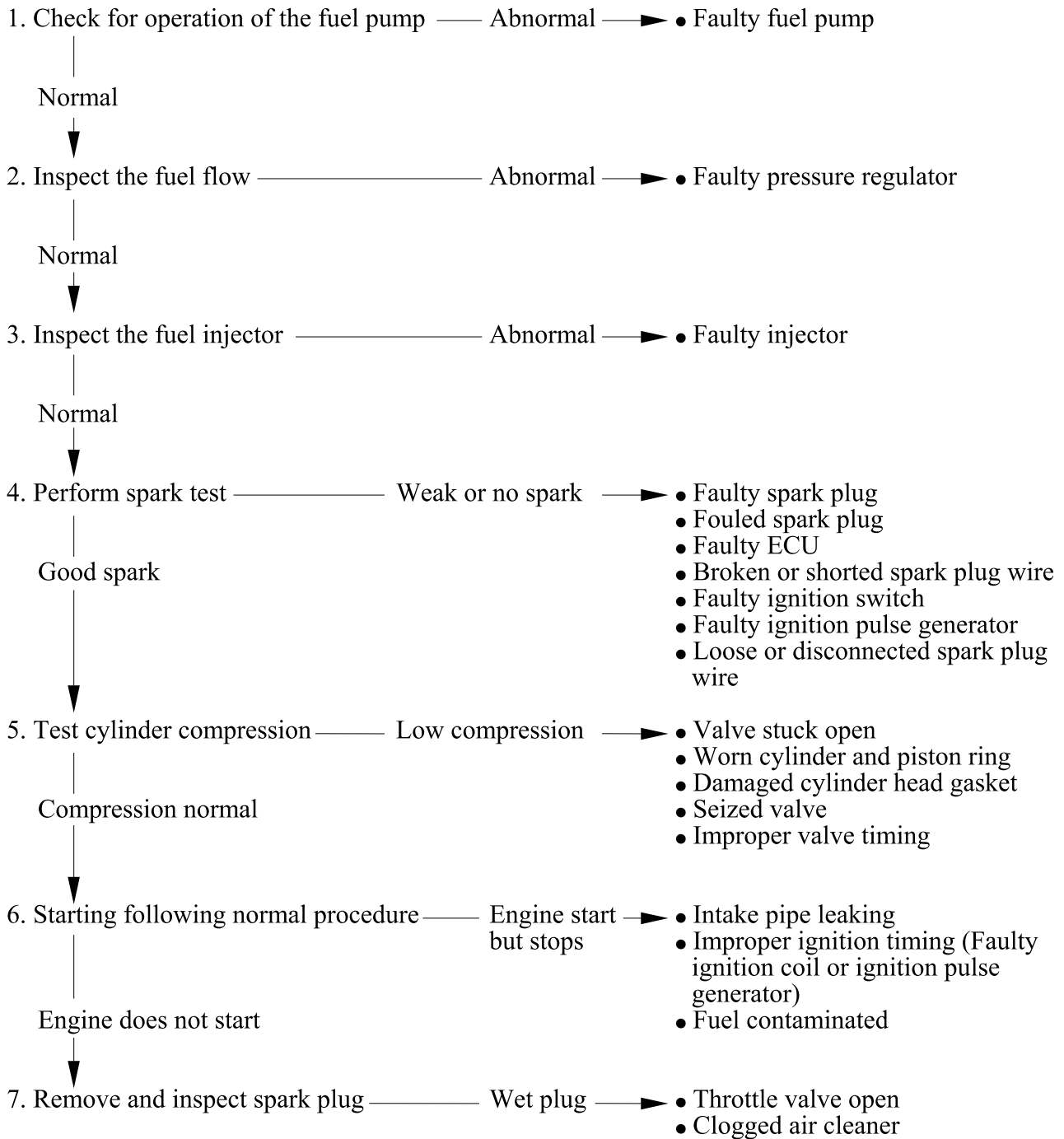

# 1. GENERAL INFORMATION

## ENGINE LACKS POWER

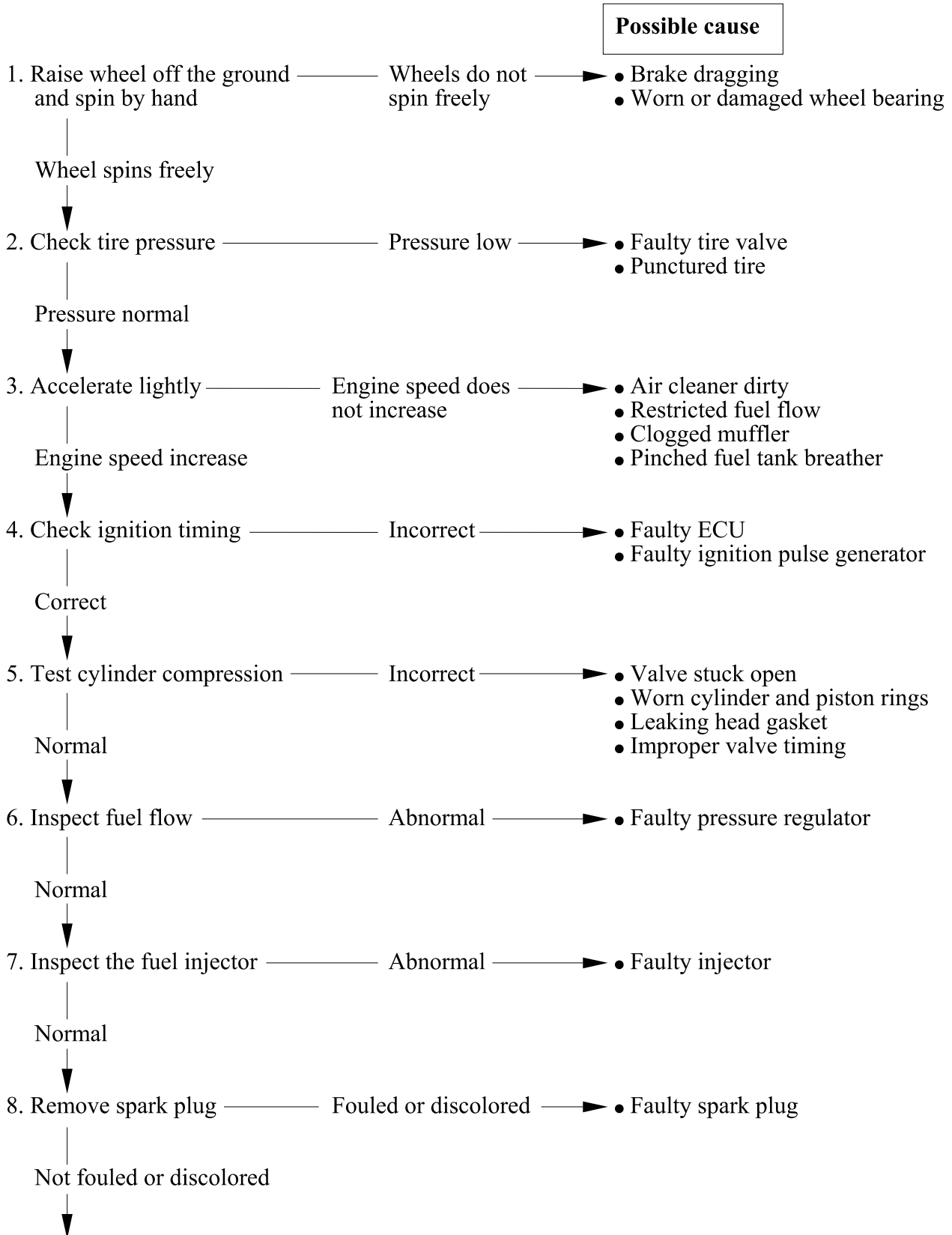



# 1. GENERAL INFORMATION

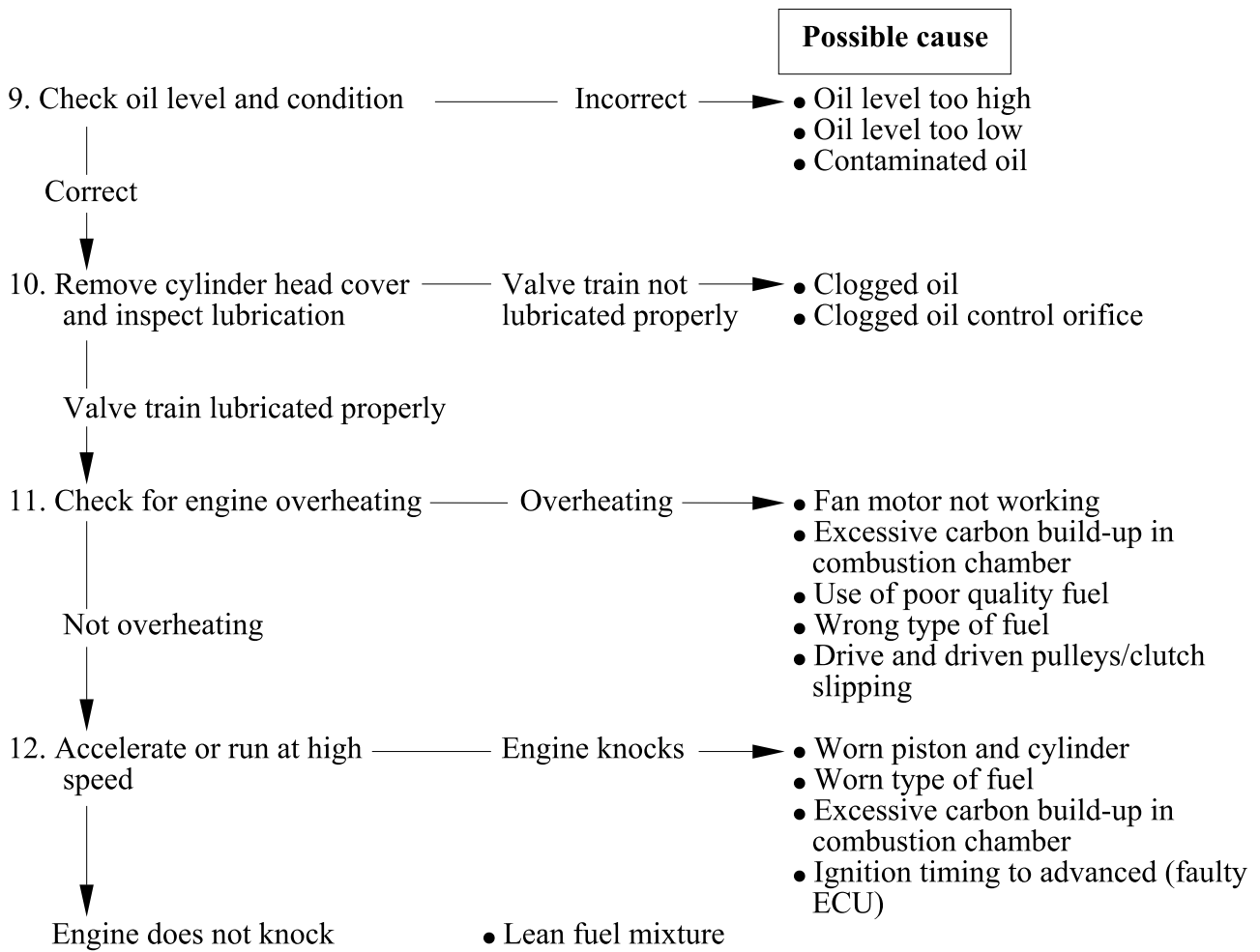

# 1. GENERAL INFORMATION

## POOR PERFORMANCE AT LOW AND IDLE SPEED

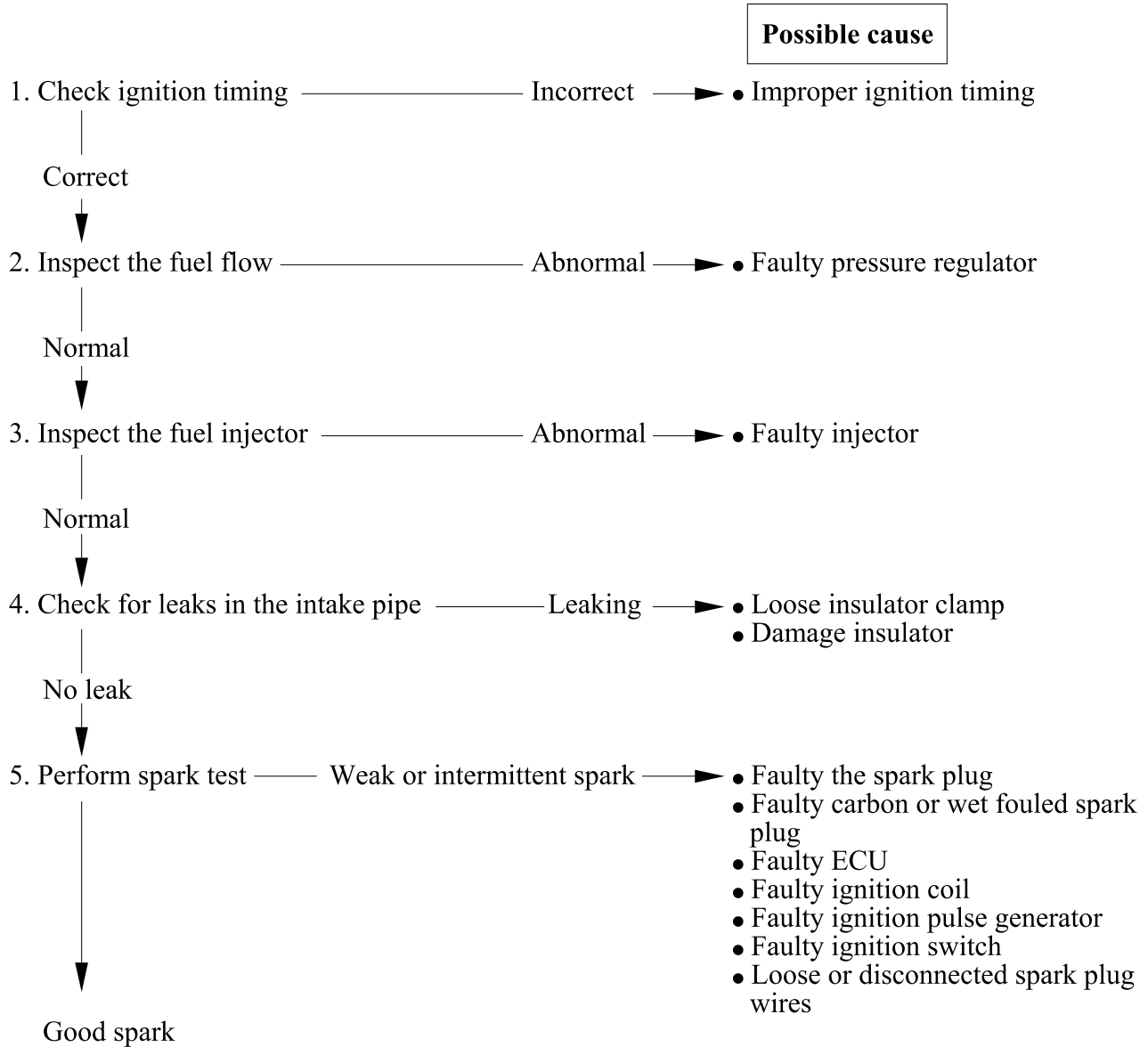

# 1. GENERAL INFORMATION

## POOR PERFORMANCE AT HIGH SPEED

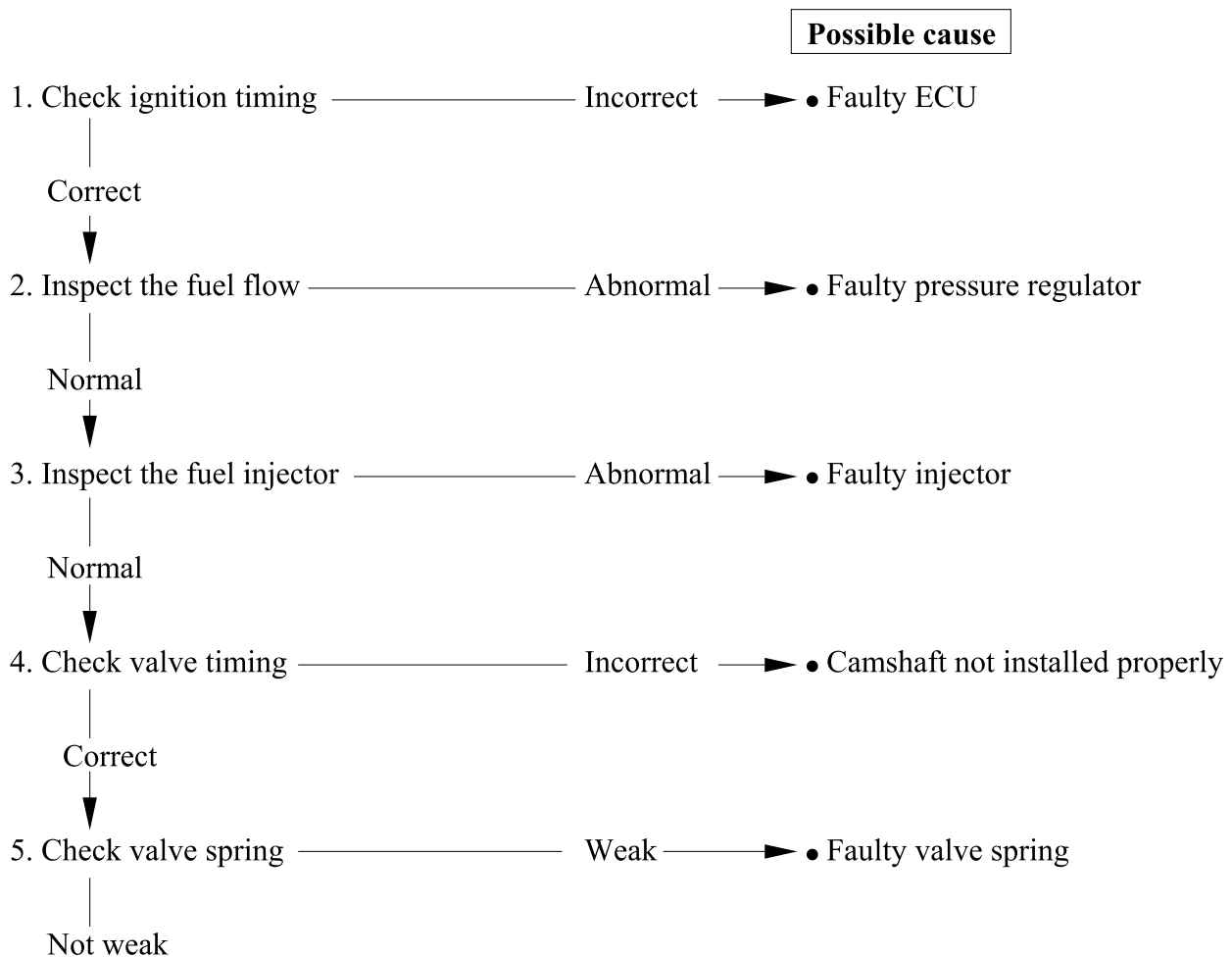

## POOR HANDLING

		Possible cause
1. If steering is heavy		▶ • Steering stem adjusting nut too tight ▶ • Damaged steering head bearings
2. If either wheel is wobbling		▶ • Excessive wheel bearing play ▶ • Bent rim ▶ • Improper installed wheel hub ▶ • Swing arm pivot bearing excessively worn ▶ • Bent frame
3. If the motorcycle pulled to one side		▶ • Faulty the shock absorber ▶ • Front and rear wheel not aligned ▶ • Bent fork ▶ • Bent swing arm ▶ • Bent axle

## 2. EXHAUST MUFFLER/FRAME COVERS

---

---

---

---

---

---

---

---

**2**

---

### EXHAUST MUFFLER/FRAME COVERS

---

SERVICE INFORMATION-----	2- 1
TROUBLESHOOTING-----	2- 1
FASTENER REMOVAL AND REINSTALLATION-----	2- 2
FRAME COVERS REMOVAL/INSTALLATION-----	2- 3
EXHAUST MUFFLER -----	2-14

## 2. EXHAUST MUFFLER/FRAME COVERS

---

### SERVICE INFORMATION

#### GENERAL INSTRUCTIONS

- When removing frame covers, use care not to pull them by force because the cover joint claws may be damaged.
- Make sure to route cables and harnesses according to the Cable & Harness Routing.

#### TORQUE VALUES

Exhaust muffler pipe nuts	1.8~2.2 kgf-m
Exhaust muffler brake /RR Fork	3.2~3.8 kgf-m
RR fork/Engine case	3.0~4.0 kgf-m

### TROUBLESHOOTING

#### Noisy exhaust muffler

- Damaged exhaust muffler
- Exhaust muffler joint air leaks

#### Lack of power

- Caved exhaust muffler
- Clogged exhaust muffler
- Exhaust muffler air leaks

## 2. EXHAUST MUFFLER/FRAME COVERS

### FASTENER REMOVAL AND REINSTALLATION

#### REMOVAL

Depress the head of fastener center piece ①.  
Pull out the fastener.

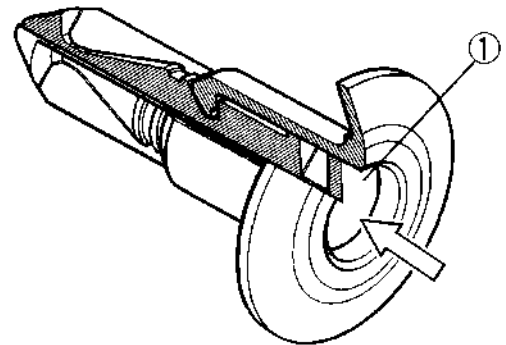

#### INSTALLATION

Let the center piece stick out toward the head so that the pawls ② close.  
Insert the fastener into the installation hole.

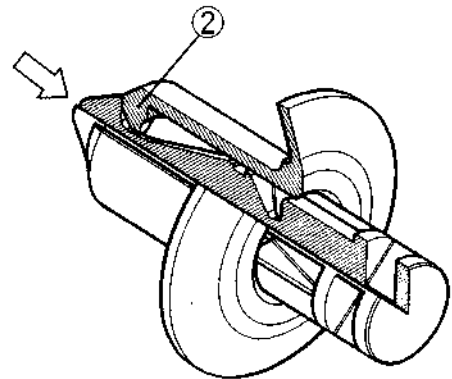

\* To prevent the pawl ② from damage, insert the fastener all the way into the installation hole

Push in the head of center piece until it becomes flush with the fastener outside face.

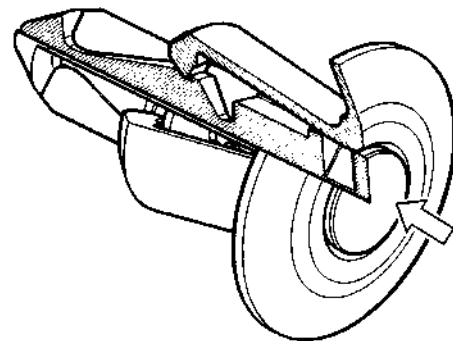

## 2. EXHAUST MUFFLER/FRAME COVERS

### FRAME COVERS REMOVAL/ INSTALLATION

#### SEAT

Unlock the seat with the ignition key.  
Open the seat.

Remove the two nuts and the seat.

Installation is in the reverse order of removal.



#### LUGGAGE BOX

Unlock the seat with the ignition key.  
Open the seat.

Remove four bolts, and the fastener on the right side of luggage box, then lift luggage box.



Luggage Box Light Connector

Disconnect the luggage box light connector,  
then remove the luggage box.

Installation is in the reverse order of removal.



## 2. EXHAUST MUFFLER/FRAME COVERS

### CENTER COVER

Remove the luggage box.

Remove the center cover.

\* During removal, do not pull the joint claws forcedly to avoid damage.

Installation is in the reverse order of removal.



Remove four bolts and then remove the rear carrier.





## 2. EXHAUST MUFFLER/FRAME COVERS

Installation is in the reverse order of removal.



### UPPER/LOWER HANDLEBAR COVER

Remove the four screws and then remove upper handlebar cover.

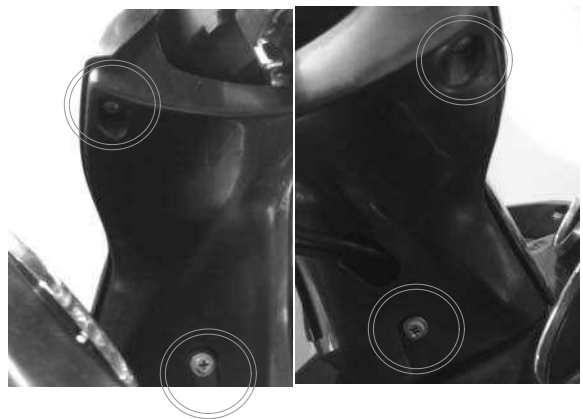

Remove the four screws, then remove the bottom handlebar cover.

Disconnect the throttle cable refer to the “**THROTTLE BODY /TPS**” section, then pull the throttle cable out from the lower cover. Remove the lower cover.



Installation is in the reverse order of removal.

## 2. EXHAUST MUFFLER/FRAME COVERS

---

### WINDSHIELD/WINDSHIELD GARNISH

Remove five bolts and windshield garnish.



## 2. EXHAUST MUFFLER/FRAME COVERS

### FRONT CENTER COVER

Remove the windshield  
Remove four screws, then remove the front center cover.  
Remove the front cover.  
Installation is in the reverse order of removal.



### FRONT COVER

Remove the small front cover(black) screw  
Remove the small front cover(black)  
Remove two nuts.

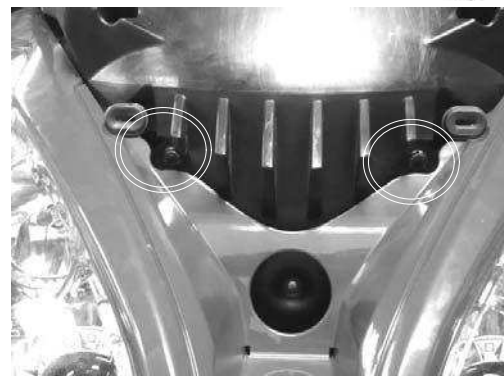

Remove eight screws from the inner cover.  
Remove the front cover



## 2. EXHAUST MUFFLER/FRAME COVERS

Disconnect the headlight/position light connector and right/left turn signal light connectors.

Installation is in the reverse order of removal.



### FRONT FENDER

Remove four screws attaching to the front fender.

Installation is in the reverse order of removal.



### RIGHT/LEFT FOOT SKIRT

Remove the six screws attaching to the right or left skirt.

\* During removal, do not pull the joint claws forcedly to avoid damage.

Installation is in the reverse order of removal.

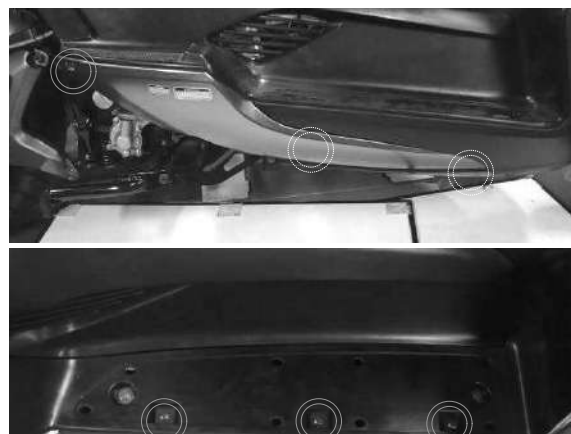

## 2. EXHAUST MUFFLER/FRAME COVERS

### FRONT LOWER COVER

Remove the front cover  
Remove the foot skirt

Remove seven screws and front lower cover.

Installation is in the reverse order of removal.



### REAR FENDER

Remove the body cover and then the rear fender.

Installation is in the reverse order of removal.



### BODY COVER

Remove the rear center cover.  
Remove the right and left foot skirts

Remove the rear carrier.

Remove six screws and two nuts, then  
remove the body cover.



## 2. EXHAUST MUFFLER/FRAME COVERS

### TIRE FENDER

Remove the body cover.

Remove four bolts attaching to the tire fender

Installation is in the reverse order of removal.

Taillight Connector

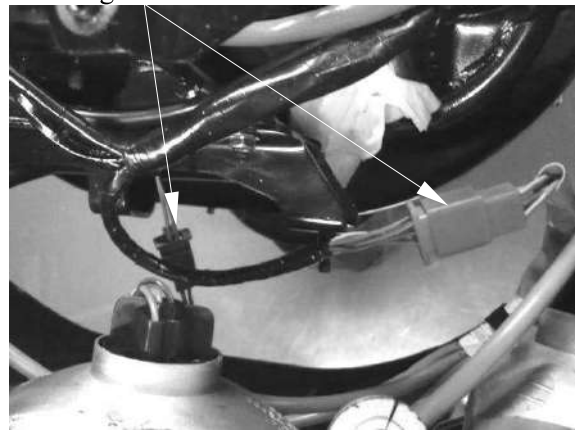

### FLOORBOARD

Remove the body cover

Remove the right /left skirt

Remove two screws.



## 2. EXHAUST MUFFLER/FRAME COVERS

Remove eight bolts, then remove the floorboard.

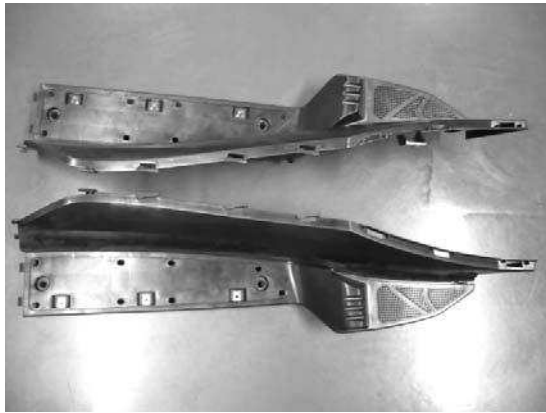

### UNDER COVER

Remove four bolts  
Remove the under cover.

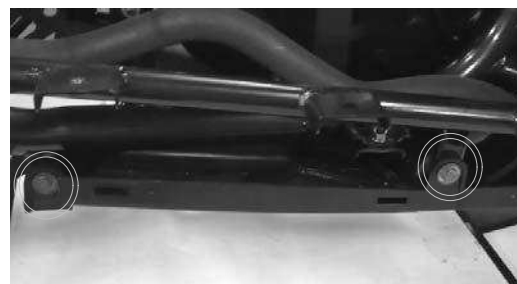

## 2. EXHAUST MUFFLER/FRAME COVERS

Remove the fuel tank cap cover.

Installation is in the reverse order of removal.

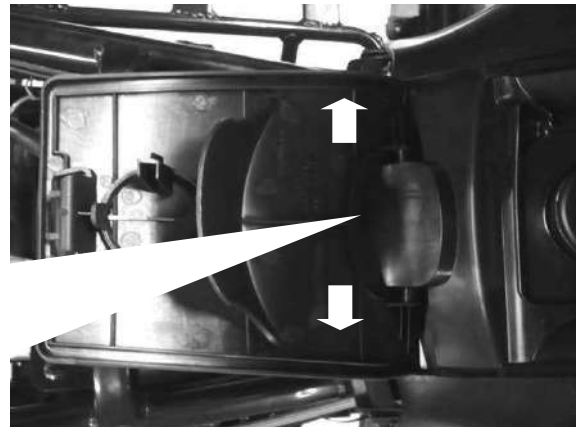

### METER PANEL

Disconnect the speedometer wires.  
Disconnect the DC power connectors.

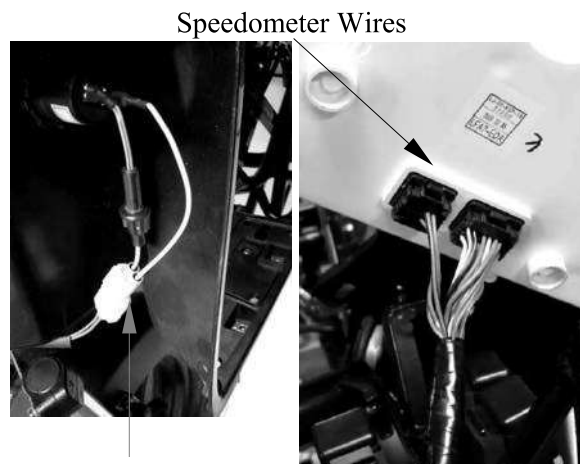

DC power Connectors

Remove one screws  
Remove the ignition key garnish  
Remove three screws from the inner cover,  
then remove the handler panel.

Installation is in the reverse order of removal.





## 2. EXHAUST MUFFLER/FRAME COVERS

### INNER COVER

Remove the front cover.  
Remove the front lower cover.  
Remove the floorboard

Remove four bolts and front glove box one screw.

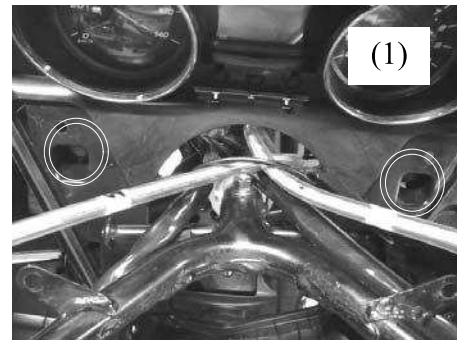

Remove two fastener bolts, then remove the fuel tank fill cap.  
Remove the inner cover

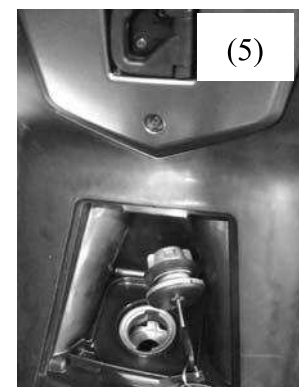
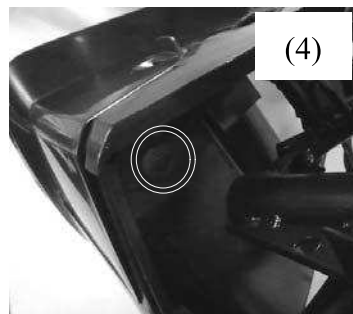
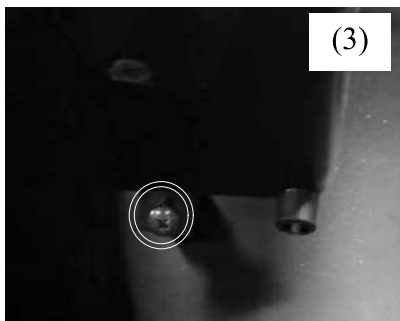
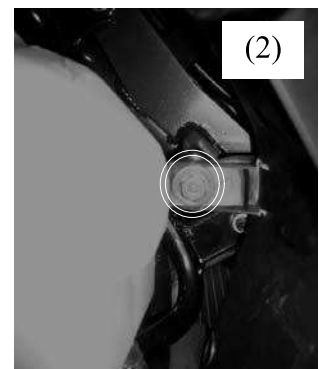

## 2. EXHAUST MUFFLER/FRAME COVERS

### EXHAUST MUFFLER

#### REMOVAL

Disconnect the connector with O2 heater/O2 sensor.



Remove the two exhaust pipe joint nuts

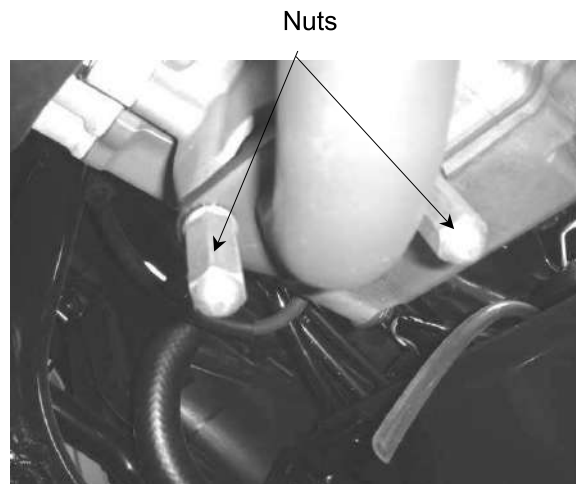

Remove three muffler mount bolts and muffler and gasket.



## 2. EXHAUST MUFFLER/FRAME COVERS

### INSTALLATION

Replace the gasket with a new one.  
Install the exhaust muffler and three mounting bolt.

Install and tighten the two exhaust pipe joint nuts to the specified torque

**Torque:** 20 N•m (2 kgf•m,)

Tighten the three mounting bolts

**Torque:** 35 N•m (3.5 kgf•m,)

Remove the coolant tank cover.



Gasket

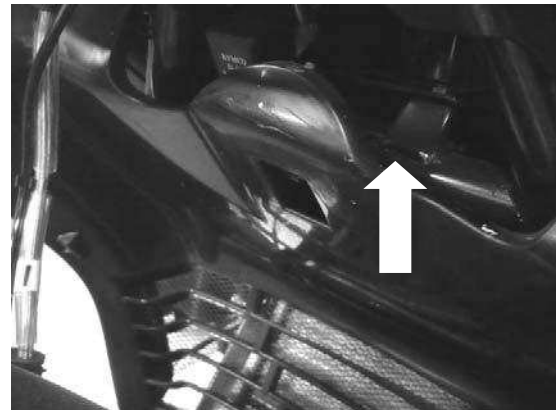

### 3. INSPECTION/ADJUSTMENT

---

---

---

---

---

---

---

---

**3**

#### INSPECTION / ADJUSTMENT

---

SERVICE INFORMATION-----	3- 1
MAINTENANCE SCHEDULE-----	3- 2
THROTTLE OPERATION -----	3- 3
ENGINE OIL -----	3- 4
RESERVE TANK -----	3- 5
AIR CLEANER -----	3- 6
SPARK PLUG -----	3- 6
VALVE CLEARANCE-----	3- 7
CYLINDER COMPRESSION -----	3- 7
FINAL REDUCTION GEAR OIL -----	3- 8
DRIVE BELT -----	3- 8
BRAKE SYSTEM -----	3- 9
CLUTCH SHOE WEAR -----	3- 10
SUSPENSION-----	3- 10
NUTS/BOLTS/FASTENERS-----	3- 11
WHEELS/TIRES -----	3- 11
STEERING HANDLEBAR -----	3- 11
SIDE STAND -----	3- 12

### 3. INSPECTION/ADJUSTMENT

#### SERVICE INFORMATION

##### GENERAL

 <b>WARNING</b>
--

- Before running the engine, make sure that the working area is well ventilated. Never run the engine in a closed area. The exhaust contains poisonous carbon monoxide gas, which may cause death to people.
- Gasoline is extremely flammable and is explosive under some conditions. The working area must be well ventilated and do not smoke or allow flames or sparks near the working area or fuel storage area.

##### SPECIFICATIONS

###### ENGINE

Throttle grip free play : 2~6 mm  
 Spark plug : NGK: CR7E  
 Spark plug gap : 0.6 mm ~ 0.7 mm  
 Valve clearance : IN: 0.10 mm EX: 0.10 mm  
 Idle speed : 1600±100 rpm

###### Engine oil capacity:

Cylinder compression: 16±2 kg/cm<sup>2</sup>  
 At disassembly : 1.5 Liter                      Ignition timing : ECU  
 At change : 1.3 Liter                              Coolant type : Water Cooling

###### Gear oil capacity :

At disassembly : 0.23 Liter  
 At change : 0.21 Liter

##### TIRE

	1 Rider	2 Riders
Front	2.00 kg/cm <sup>2</sup>	2.00 kg/cm <sup>2</sup>
Rear	2.25 kg/cm <sup>2</sup>	2.25 kg/cm <sup>2</sup>

##### TIRE SPECIFICATION

Front : 120/80-14 58S  
 Rear : 150/70-13 64S

##### TORQUE VALUES

Front axle nut : 2 kg-m  
 Rear axle nut : 12 kg-m

##### SPECIAL TOOL

Tappet Adjuster E012

### 3. INSPECTION/ADJUSTMENT

#### Maintenance schedule

Perform the pre-ride inspection (see page 21) at each scheduled maintenance period. This interval should be judged by odometer reading or months, whichever comes first.

#### Maintenance schedule legend

I: INSPECT AND CLEAN, ADJUST, LUBRICATE OR REPLACE IF NECESSARY

C: CLEAN      R: REPLACE      A: ADJUST      L: LUBRICATE

The maintenance schedule on the following two pages specifies the maintenance required to keep your **DOWNTOWN 300i** scooter in peak operating condition. Maintenance work should be performed in accordance with KYMCO standards and specifications by properly trained and equipped technicians. Your KYMCO dealer meets all of these requirements.

- \* Should be serviced by your KYMCO dealer, unless you have the proper tools, service data and are technically qualified.
- \*\* In the interest of safety, we recommend these items be serviced only by your KYMCO dealer. KYMCO recommends that your KYMCO dealer road test your scooter after each periodic maintenance service is completed.

ITEM		FREQUENCY	WHICHEVER COMES FIRST	ODOMETER READING									
				X 1000 km	1	5	10	15	20	25	30		
				X 1000 mi	0.6	3	6	9	12	15	18		
				MONTH	1	6	12	18	24	30	36		
*	AIR CLEANER					R	R	R	R	R	R	R	R
	SPARK PLUGS					I	R	I	R	I	R		
*	THROTTLE OPERATION					I	I	I	I	I	I	I	I
*	VALVE CLEARANCE					I	A	I	A	I	A		
*	FUEL LINE						I		I		I		
	CRANKCASE BREATHER				C	C	C	C	C	C	C	C	C
*	ENGINE OIL				R	R	R	R	R	R	R	R	R
*	ENGINE OIL SCREEN					C	R	C	R	C	R		
*	ENGINE OIL FILTER				R	R	R	R	R	R	R	R	R
*	ENGINE IDLE SPEED						I		I		I		
*	TRANSMISSION OIL				R	R	R	R	R	R	R	R	R
*	DRIVE BELT					I	I	I	I	I	I	I	I
**	CLUTCH SHOE WEAR						I		I		I		
	BRAKE FLUID					I	R	I	R	I	R		
	BRAKE PAD WEAR					I	I	I	I	I	I	I	I
	BRAKE SYSTEM					I	I	I	I	I	I	I	I
*	BRAKE LIGHT SWITCH					I	I	I	I	I	I	I	I
**	STEERING BEARINGS					I	I	I	I	I	I	I	I
*	HEADLIGHT AIM					I	I	I	I	I	I	I	I
*	NUTS, BOLTS, FASTENERS					I	I	I	I	I	I	I	I
**	WHEELS/TIRES					I	I	I	I	I	I	I	I
**	COOLANT					I	R	I	R	I	R		

### 3. INSPECTION/ADJUSTMENT

#### THROTTLE OPERATION

Check the throttle grip for smooth movement.  
Measure the throttle grip free play.

**Free Play:** 2~6 mm

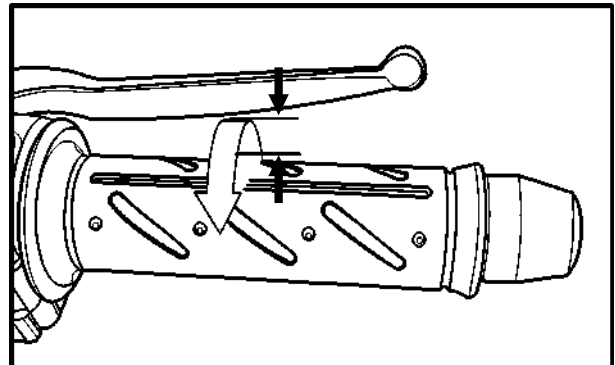

Major adjustment of the throttle grip free play is made with the adjusting nut at the throttle body side. Adjust by loosening the lock nut and turning the adjusting nut.

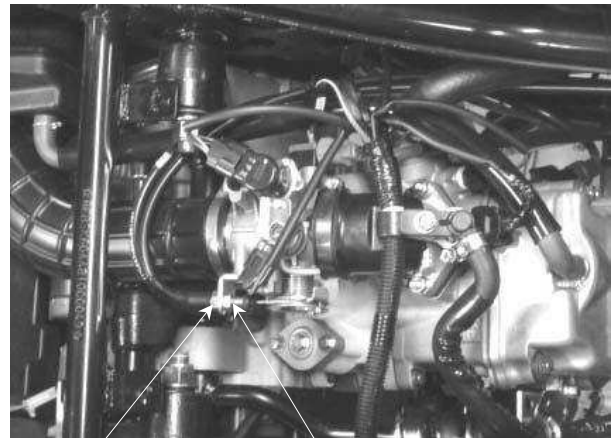

Minor adjustment is made with the adjusting nut at the throttle grip side.

Slide the rubber cover(1) out and adjust by loosening the lock nut(3) and turning the adjusting nut(2).

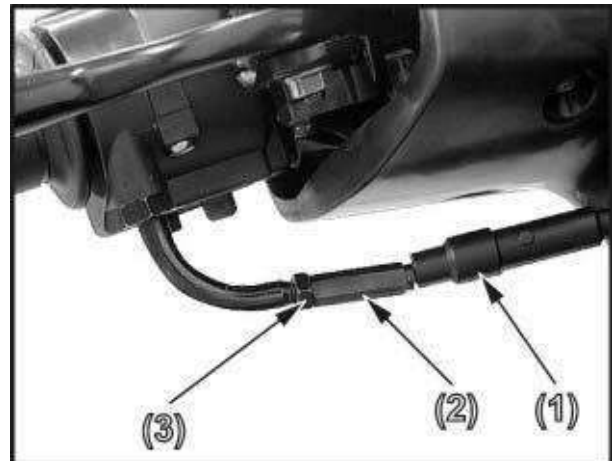

### 3. INSPECTION/ADJUSTMENT

#### ENGINE OIL

##### OIL LEVEL INSPECTION

Stop the engine and support the scooter upright on the level ground.  
 Wait for 2~3 minutes and check the oil level with the dipstick. Do not screw in the dipstick when checking the oil level.

##### OIL CHANGE

Remove the oil drain bolt to drain the engine oil.  
 Install the aluminum washer and tighten the oil drain bolt.

**Torque:** 2.5 kg-m

- \* • Replace the aluminum washer with a new one if it is deformed or damaged.

Pour the recommended oil through the oil filler hole.

##### OIL CAPACITY

Engine oil capacity: 1.5 L  
 Engine oil exchanging capacity: 1.3 L  
 Engine Oil Viscosity : SAE 5W50

##### OIL FILTER SCREEN INSPECTION

Drain the engine oil.  
 Remove the oil filter screen attaching the left-under crankcase.  
 Clean the oil filter screen.  
 Install the oil filter screen and filter screen cap.

Fill the engine with recommended engine oil.

##### OIL FILTER REPLACEMENT

Remove the oil filler cap attaching the right-under crankcase cover.



Oil Drain Bolt



Oil Filter Screen

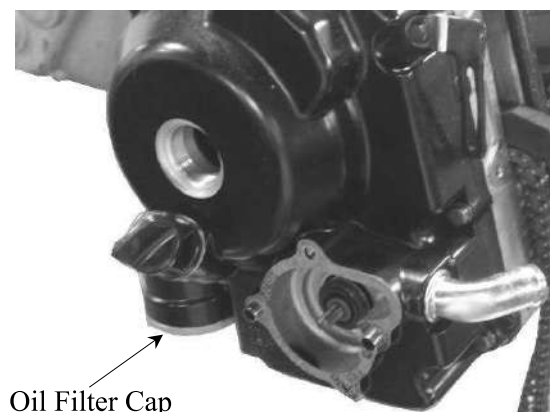

Oil Filter Cap



### 3. INSPECTION/ADJUSTMENT

The spring will come out when the filter cap is removed.

Let the engine oil drain out.

Check that the O-ring is in good condition.



Spring

Install a new oil filter.

\* Make sure the rubber seal on the oil filter facing the left crankcase.



### RESERVE TANK COOLANT LEVEL INSPECTION

The reserve tank is under left floorboard .Check the coolant level through the inspection window(1) at the left side skirt while the engine is at the normal operating temperature , with the scooter In an upright position.

If the coolant level is below the LOWER level mark(3), remove the left floor mat ,remove the lid screw(4), the reserve tank lid(5), and then the reserve tank cap(6) to add coolant mixture until it reaches the upper level mark .

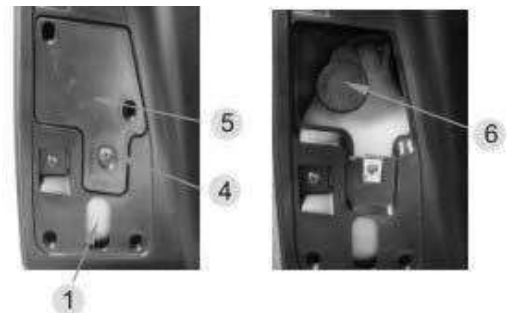

\* Add coolant to the reserve tank only. Do not attempt to add coolant by removing the radiator cap. Coolant in the radiator is under pressure and is very hot and can cause serious burns.



### 3. INSPECTION/ADJUSTMENT

#### AIR CLEANER

##### AIR FILTER REPLACEMENT

Remove the body cover.  
 Remove seven screws attaching to the air cleaner cover.  
 Remove six screws attaching to the filter.  
 Check the filter and replace it if it is excessively dirty or damaged.



Air Cleaner Cover

##### CHANGE INTERVAL

More frequent replacement is required when riding in unusually dusty or rainy areas.

- \* • The air cleaner element has a viscous type paper element. Do not clean it with compressed air.
- Be sure to install the air cleaner element and cover securely.

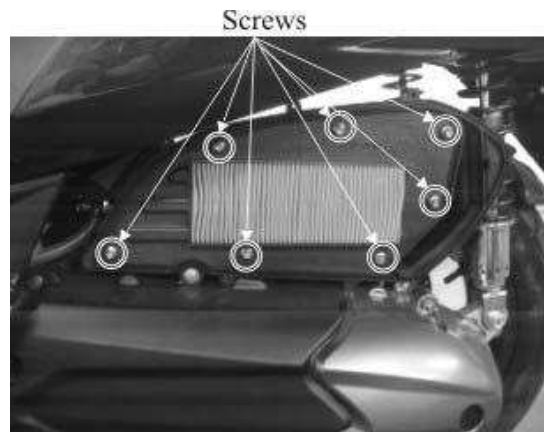

Screws

#### SPARK PLUG

Remove the spark plug cap and spark plug.  
 Check the spark plug for wear and fouling deposits.  
 Clean any fouling deposits with a spark plug cleaner or a wire brush.

**Specified Spark Plug:** NGK-CR7E

Measure the spark plug gap.

**Spark Plug Gap:** 0.6 – 0.7 mm



Spark Plug

- \* • When installing, first screw in the spark plug by hand and then tighten it with a spark plug wrench.

**Torque:** 17.2 N-m

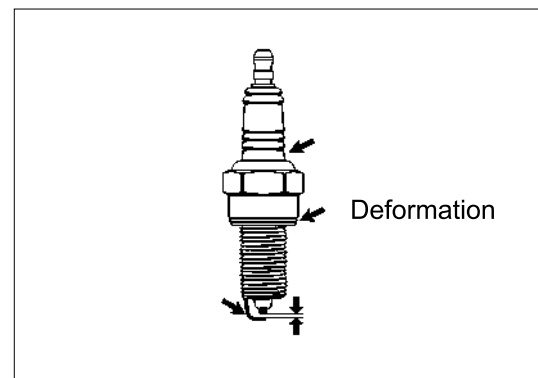

### 3. INSPECTION/ADJUSTMENT

#### VALVE CLEARANCE

- \* • Inspect and adjust valve clearance while the engine is cold (below 35°C).

Remove the seat assy and luggage box.  
Remove the four bolts and then cylinder head cover.

Turn the A.C. generator flywheel to the top dead center (TDC) on the compression stroke so that the "T" mark on the flywheel aligns with the index mark on the left crankcase cover.

Inspect and adjust valve clearance.

**Valve Clearance:** IN: 0.10 mm  
EX: 0.10 mm

Loosen the lock nut and adjust by turning the adjusting nut



Valve Adjuster E012  
Feeler Gauge

- \* • Check the valve clearance again after the lock nut is tightened.

Cylinder Head Cover

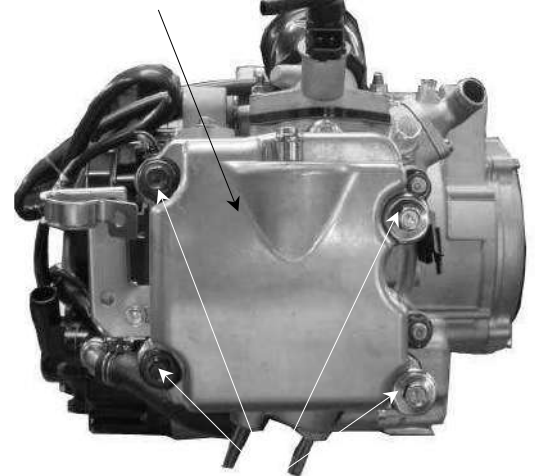

Bolts

Top Dead Center Mark



#### CYLINDER COMPRESSION

Warm up the engine before compression test.

Remove the center cover and luggage box.  
Remove the spark plug.  
Insert a compression gauge.  
Open the throttle fully and push the starter button to test the compression.

**Max. Compression: 16±2 kg/cm<sup>2</sup> - 570 rpm**

If the compression is low, check for the following:

- Leaky valves
- Valve clearance too small
- Leaking cylinder head gasket
- Worn piston rings
- Worn piston/cylinder

If the compression is high, it indicates that carbon deposits have accumulated on the combustion chamber and the piston head.

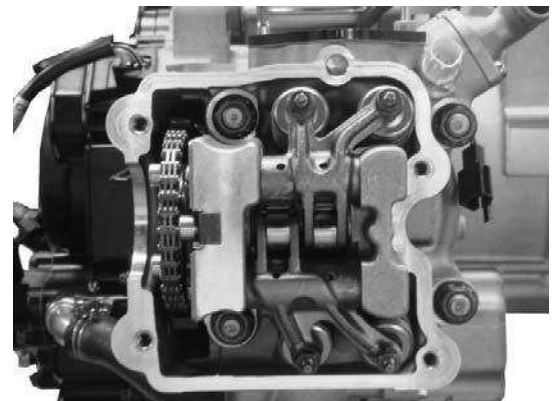

## 3. INSPECTION/ADJUSTMENT

### FINAL REDUCTION GEAR OIL

- \* • Place the scooter on its main stand on level ground.

Remove the transmission fluid drain bolt.  
Remove the transmission fluid filler bolt, then slowly rotate the rear wheel to drain the fluid.  
Fill the transmission with the recommend fluid to the capacity listed below.

**Transmission fluid type: SAE 90**

**Transmission fluid capacity: 0.23 L**

**Transmission fluid exchanging capacity: 0.21 L**

Install the transmission filler bolt and tighten it to the specified torque.



Oil Drain Bolt



Oil Filler Bolt

### DRIVE BELT

Remove the left crankcase cover.  
Inspect the drive belt for cracks or excessive wear.  
Replace the drive belt with a new one if necessary and in accordance with the Maintenance Schedule.

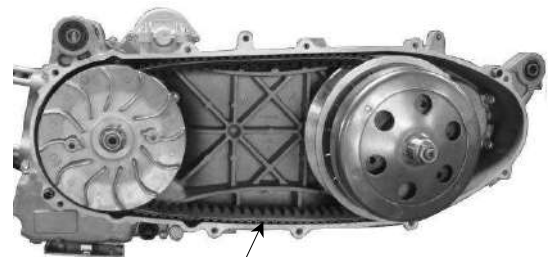

Drive Belt

### 3. INSPECTION/ADJUSTMENT

#### BRAKE SYSTEM

There is adjuster on each brake lever. Each adjuster has four positions so that the released lever position can be adjusted to suit the rider's hands.

To adjust the distance of the lever from the handlebar grip, push the lever (1) forward and turn the adjuster knob (2) to align the number with the arrow mark (3) on the lever holder.



#### BRAKE DISK/BRAKE PAD

Check the brake disk surface for scratches, unevenness or abnormal wear.

Check if the brake disk runout is within the specified service limit.

Check if the brake pad wear exceeds the wear indicator line.

\* Keep grease or oil off the brake disk to avoid brake failure.

Front Brake disk

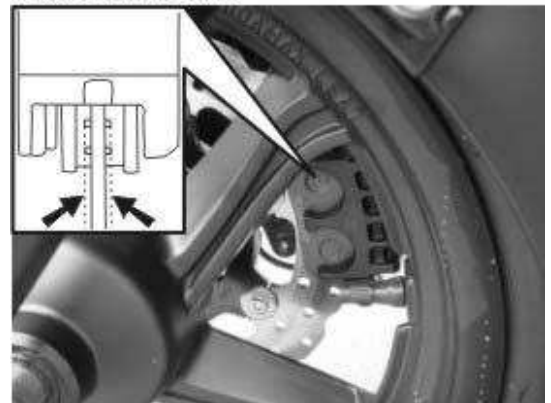

Rear Brake disk

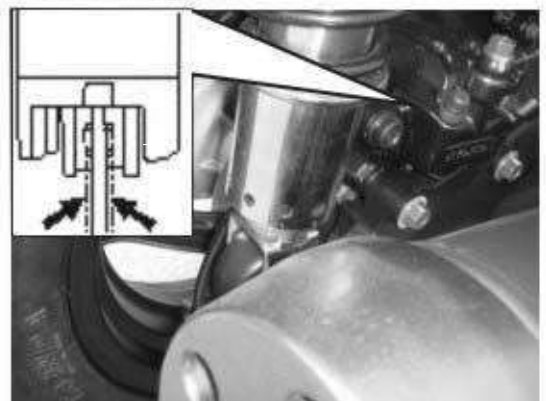

#### BRAKE FLUID

Turn the steering handlebar upright and check if both brake fluid levels is at the upper limit. If the brake fluid is insufficient, fill to the upper limit.

**Specified Brake Fluid: DOT-4**

\* The brake fluid level will decrease if the brake pads are worn.

Brake fluid reservoir



### 3. INSPECTION/ADJUSTMENT

#### CLUTCH SHOE WEAR

Start engine and check the clutch operation by increasing the engine speed gradually. If the motorcycle tends to creep or the engine stop, check the clutch shoes for wear and replace if necessary.



#### SUSPENSION

##### FRONT

Check the action of the front shock absorbers by compressing them several times.

Check the entire shock absorber assembly for oil leaks, looseness or damage.



##### REAR

Each shock absorber(4) on your scooter has 5 spring preload adjustment positions for different load or riding conditions.

Use a pin spanner(5) to adjust the rear shock spring preload. Position 1 is for light loads and smooth road conditions. Position 3 to 5 increase spring preload for a stiffer rear suspension and can be used when the scooter is heavily loaded.

Be certain to adjust both shock absorbers to the same spring preload positions.

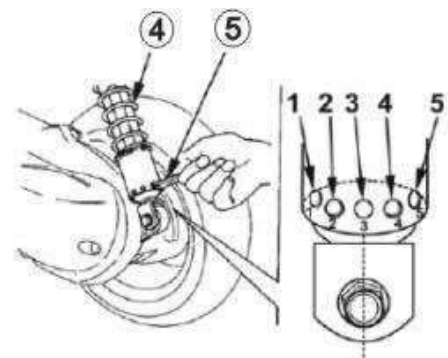

### 3. INSPECTION/ADJUSTMENT

#### NUTS/BOLTS/FASTENERS

Check all important chassis nuts and bolts for looseness.

Tighten them to their specified torque values if any looseness is found.

#### WHEELS/TIRES

Check the tires for cuts, imbedded nails or other damages.

Check the tire pressure.

- \* • Tire pressure should be checked when tires are cold.

#### Tire Pressure

	1 Rider	1 Rider (with passenger)
Front	2.00 kg/cm <sup>2</sup>	2.00 kg/cm <sup>2</sup>
Rear	2.25 kg/cm <sup>2</sup>	2.25 kg/cm <sup>2</sup>

#### Tire Size:

Front 120/80-14 58S  
Rear 150/70-13 64S

Check the front axle nut for looseness.

Check the rear axle nut for looseness.

If the axle nuts are loose, tighten them to the specified torques.

#### Torque:

Front axle nut 2 kg-m  
Rear axle nut 12 kg-m

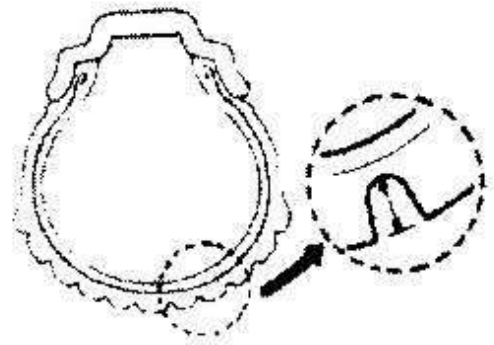

Front Axle Nut



Rear Axle Nut

#### STEERING HANDLEBAR

Raise the front wheel off the ground and check that the steering handlebar rotates freely.

If the handlebar moves unevenly, binds, or has vertical movement, adjust the steering head bearing.



## 3. INSPECTION/ADJUSTMENT

### SIDE STAND

Your scooter's side stand is not only necessary when you park, but it contains an important safety feature. This feature cuts-off the ignition if you try to ride the scooter when the side stand is down. Perform the following side stand inspection.



### INTERLOCK FUNCTION CHECK

Check the side stand ignition cut-off system,

1. Place the scooter on its center stand.
2. Put the side stand up and start the engine.
3. Lower the side stand. The engine should stop as you put the side stand down.



\* If the side stand system does not operate as described, see your KYMCO dealer for service.



## 4. LUBRICATION SYSTEM

---

---

---

---

---

---

---

---



### LUBRICATION SYSTEM

---

LUBRICATION SYSTEM .....	4-1
SERVICE INFORMATION.....	4-2
TROUBLESHOOTING .....	4-2
ENGINE OIL/OIL FILTER .....	4-3
OIL PUMP .....	4-5

# 4. LUBRICATION SYSTEM

## LUBRICATION PART

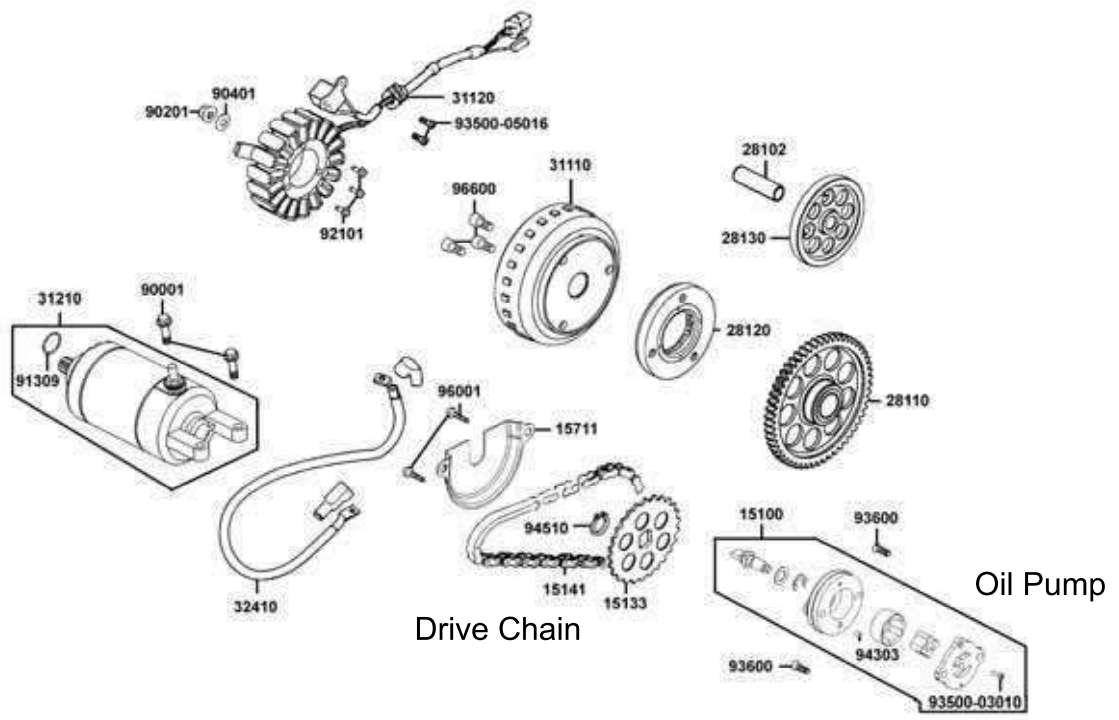
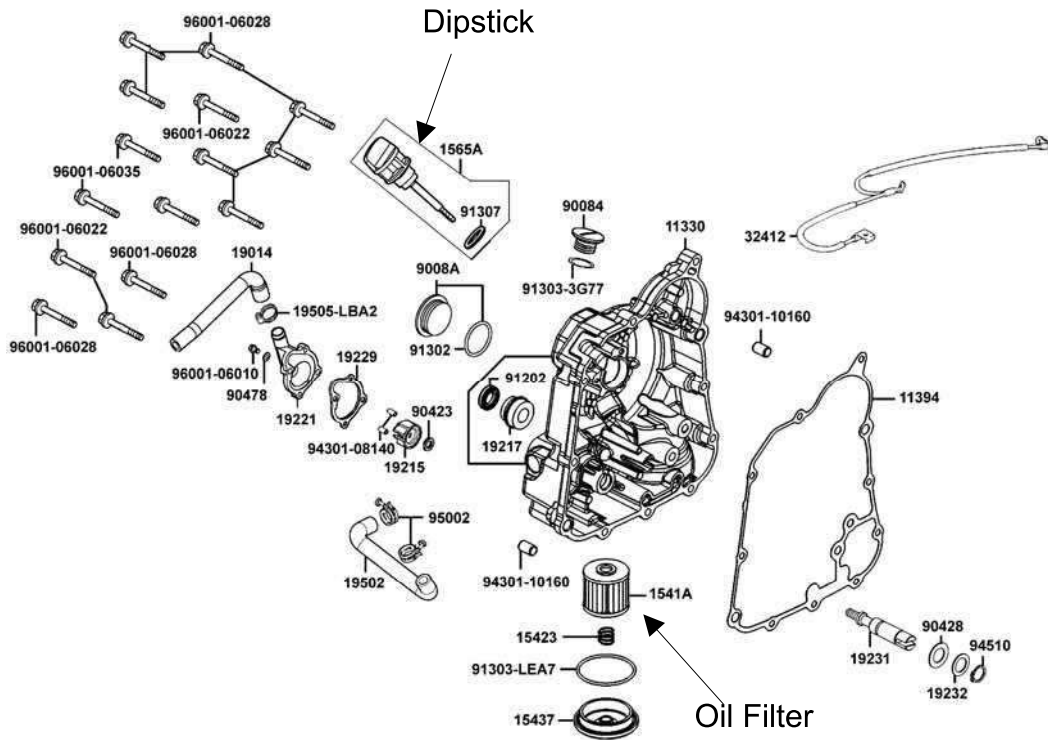

## 4. LUBRICATION SYSTEM

---

### SERVICE INFORMATION

#### GENERAL INSTRUCTIONS

- The maintenance of lubrication system can be performed with the engine installed on the frame.
- Drain the coolant before starting any operations.
- Carefully when removing and installing the oil pump not to allow dust and foreign matters to enter the engine and oil line.
- Do not attempt to disassemble the oil pump. The oil pump must be replaced as a set when it reaches its service limit.
- After the oil pump is installed, check each part for oil leaks.

#### SPECIFICATIONS

##### ENGINE OIL

Engine Oil Capacity	At disassembly: 1.5 liter    At change: 1.3 liter
Recommended Oil	SAE5W50#    API: SJ

#### TROUBLESHOOTING

##### Oil level too low

- Natural oil consumption
- Oil leaks
- Worn piston rings
- Worn valve guide
- Worn valve guide seal

##### Poor lubrication pressure

- Oil level too low
- Clogged oil filter or oil passage
- Faulty oil pump

##### Oil contamination

- Oil not changed often enough
- Faulty cylinder head gasket
- Loose cylinder head bolts

## 4. LUBRICATION SYSTEM

### ENGINE OIL/OIL FILTER

- \* • Place the scooter upright on level ground for engine oil level check.
- Run the engine for 2~3 minutes and check the oil level after the engine is stopped for 2~3 minutes.

Remove the oil dipstick and check the oil level with the oil dipstick.

If the level is near the lower level, fill to the upper level with the recommended engine oil.

Oil Dipstick



### OIL CHANGE

- \* • The engine oil will drain more easily while the engine is warm.

Remove the oil drain bolt located at the left side of the engine to drain the engine oil. After the oil has been completely drained, install the aluminum washer and tighten the oil drain bolt.

**Torque:** 24.5 N-m

Pour the recommended oil through the oil filler hole.



Oil Filter Screen

### OIL FILTER SCREEN

Drain the engine oil.

Remove the oil filter screen cap.

Remove the oil filter screen and spring.

Check the oil filter screen for clogging or damage and replace if necessary. Check the filter screen O-ring for damage and replace if necessary.

Install the oil filter screen, spring, O-ring and filter screen cap.

**Torque:** 10.0 N-m (7.2 lb-ft)

**Recommended Oil:** SAE5W50# API: SJ

#### Oil Capacity:

At disassembly: 1.5 liter

At change: 1.3 liter

Start the engine and check for oil leaks. Start the engine and let it idle for few minutes, then recheck the oil level.

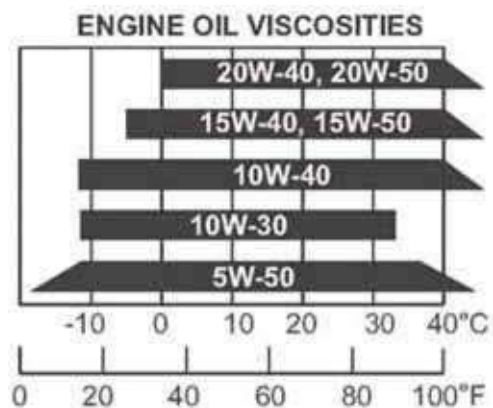

## 4. LUBRICATION SYSTEM

### OIL FILTER REPLACEMENT

Remove the oil filler cap attaching the right-under crankcase cover.



Oil Filter Cap

The spring will come out when the filter cap is removed.

Let the engine oil drain out.

Check that the O-ring is in good condition.



Spring

Install a new oil filter.

\* Make sure the rubber seal on the oil filter facing the left crankcase



## 4. LUBRICATION SYSTEM

### OIL PUMP REMOVAL

Remove twelve bolts attaching the right crankcase cover.  
Remove the A.C. generator flywheel with special tool.

#### Special tool:

Flywheel Puller	E003
Universal Holder	E021



Remove the gasket and dowel pins.  
Remove the starter idle gear and starter clutch.

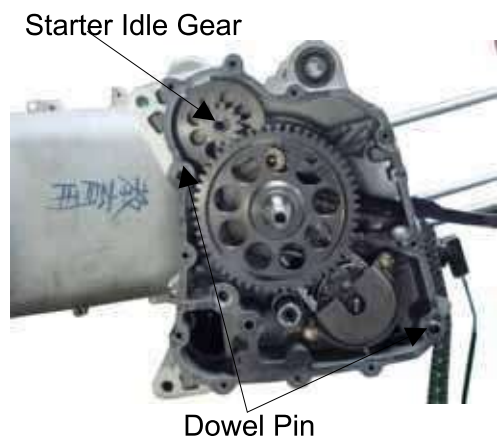

Remove the two bolts and oil separator cover.



Remove the oil pump driven gear clip to remove the oil pump driven gear and drive chain.



## 4. LUBRICATION SYSTEM

Remove two oil pump mounting bolts and the oil pump.

### OIL PUMP INSTALLATION

Install the oil pump into the crankcase.

- \* Install the oil pump with the arrow on the pump body facing up and fill the oil pump with engine oil before installation.



Arrow Mark

Pump Shaft

After the oil pump is installed, tighten the two mounting bolts.  
Install the pump driven gear and drive chain by aligning the pump driven gear with the cutout in the pump shaft.  
Install and tighten the pump driven gear bolts.  
Install the oil separator cover and tighten the bolts.



Oil Separator Cover

Install the starter idle gear and starter clutch.  
Install the gasket and dowel pins.

Install the right crankcase cover and tighten the twelve bolts.

**Torque: 1.2 kg-m**

- \* Diagonally tighten the bolts in 2 ~ 3 times.

Starter Idle Gear



Dowel Pin

---

# 5. ENGINE REMOVAL/INSTALLATION

---

---

---

---

---

---

---



---

## ENGINE REMOVAL/INSTALLATION

---

SERVICE INFORMATION-----	5-1
ENGINE REMOVAL/INSTALLATION-----	5-2
ENGINE HANGER -----	5-6



## 5. ENGINE REMOVAL/INSTALLATION

---

### SERVICE INFORMATION

#### GENERAL INSTRUCTIONS

- A floor jack or other adjustable support is required to support and maneuver the engine. Be careful not to damage the scooter body, cables and wires during engine removal.
- Use shop towels to protect the scooter body during engine removal.
- Drain the coolant before removing the engine.
- After the engine is installed, fill the cooling system with coolant and be sure to bleed air from the water jacket. Start the engine to check for coolant leaks.
- Before removing the engine, the rear brake caliper must be removed first. Be careful not to bend or twist the brake fluid tube.

#### SPECIFICATIONS

##### Engine oil capacity:

At disassembly: 1.5 L

At change: 1.3 L

##### Coolant capacity:

Radiator:	766 cc
Hose with cool coolant:	169 cc
Hose with hot coolant:	194 cc
Reserve tank:	590 cc
Total capacity:	1719 cc

#### TORQUE VALUES

90304-GHE8-0040	Engine hanger (Engine side)	5.0 kgf-m (50 N-m)
90305-LBD4-9000	Engine hanger (Frame side)	6.5 kgf-m (65 N-m)
95801-10060	Rear fork mount bolts	3.5 kgf-m (35 N-m)
90305-KFW6-9120-M1	Rear axle nut	12.0 kgf-m (120 N-m)
95801-10035-00	Rear cushion lower/upper mount bolts	4.0 kgf-m (40 N-m)

# 5. ENGINE REMOVAL/INSTALLATION

## ENGINE REMOVAL/INSTALLATION

### REMOVAL

- Remove the air cleaner
- Disconnect the connector including of ISC, Throttle body, TPS, WTS, MAP sensor and injector.
- Disconnect the O2 sensor connector.
- Disconnect the throttle cables.
- Disconnect the Regulator/Rectifier connector.
- Disconnect the starter relay wire from starter motor.
- Remove a bolt from fuel hose guide.
- Disconnect the fuel hose from fuel injector.

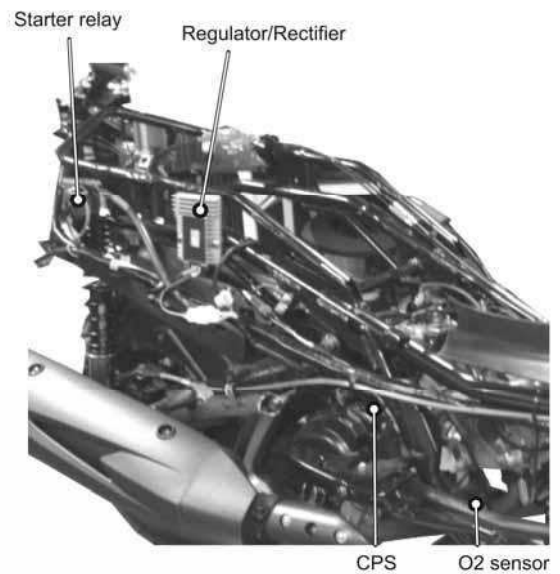
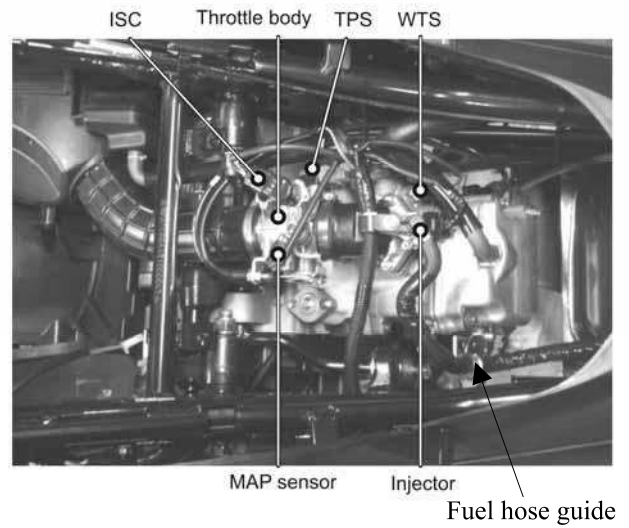

- Disconnect the input water hose.
- Disconnect the air bleed hose.

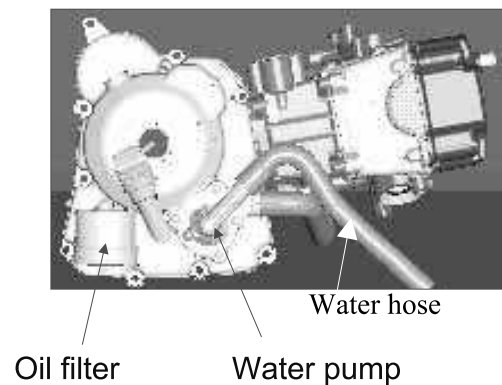

## 5. ENGINE REMOVAL/INSTALLATION

Remove the muffler.

Remove the rear fork mounting bolts (1) attaching to the crankcase.

**Torque:** 3.5 kgf-m (35 N-m)

Remove the rear axle nut (2).

**Torque:** 12.0 kgf-m (120 N-m)

Remove two bolts (3) attaching to rear brake hose clamps.

Remove two bolts (4) attaching to the rear brake caliper.

**Torque:** 3.2 kgf-m (32 N-m)

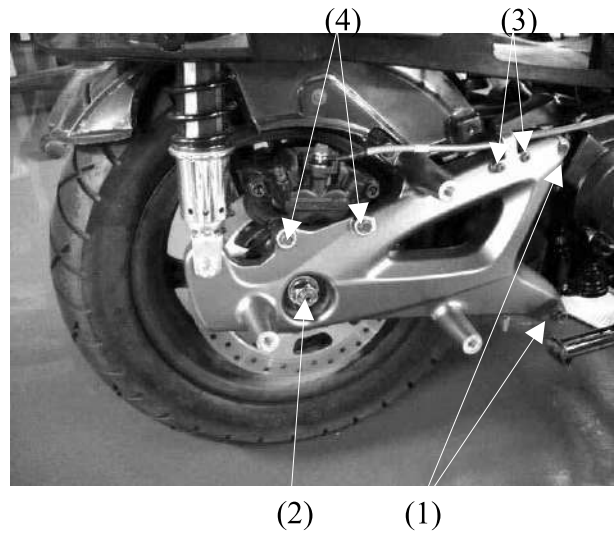

Disconnect the alternator connector (5).

Disconnect the ignition pulse generator connector (6).

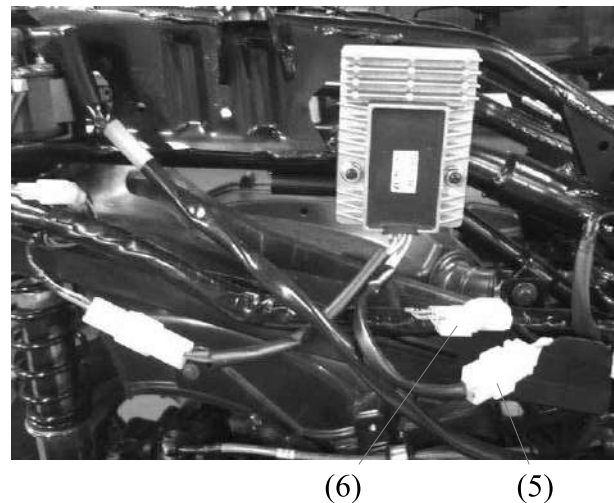

Release the rubber cap and remove the terminal screw (7) to disconnect the start motor cable from the start motor.

Remove the bolt and engine ground cable.

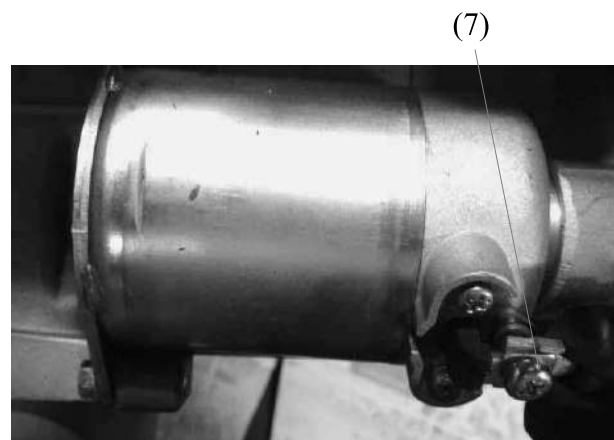

## 5. ENGINE REMOVAL/INSTALLATION

Remove the spark plug cap.

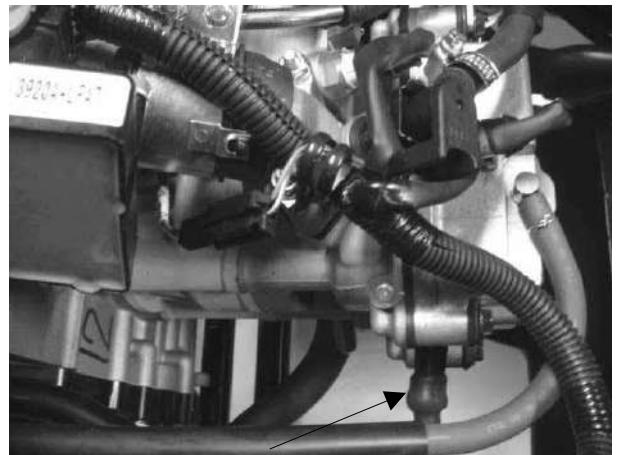

Spark Plug Cap

Disconnect the lower radiator hose from lower radiator pipe.

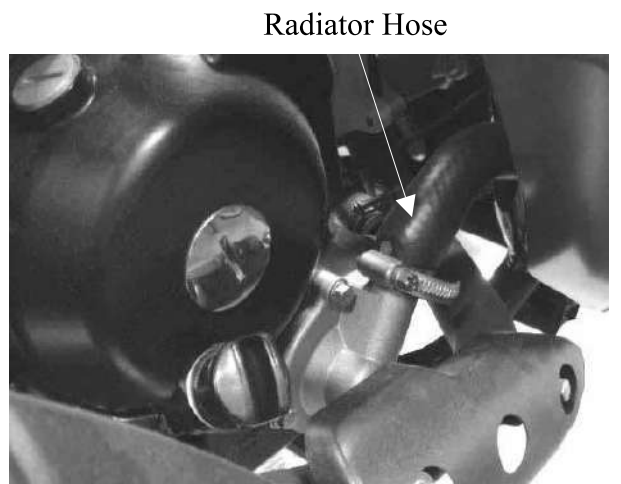

Radiator Hose

Remove the right and left rear cushion lower mount bolts.

**Torque:** 4.0 kgf-m (40N-m)



Mount Bolt

## 5. ENGINE REMOVAL/INSTALLATION

Remove the engine mount nut and pull it out.  
Remove the engine from the frame.

At removing the engine, be careful not to catch your hand or finger between the engine hanger and crankcase.

**Torque:** 6.5 kgf-m (65 N-m)

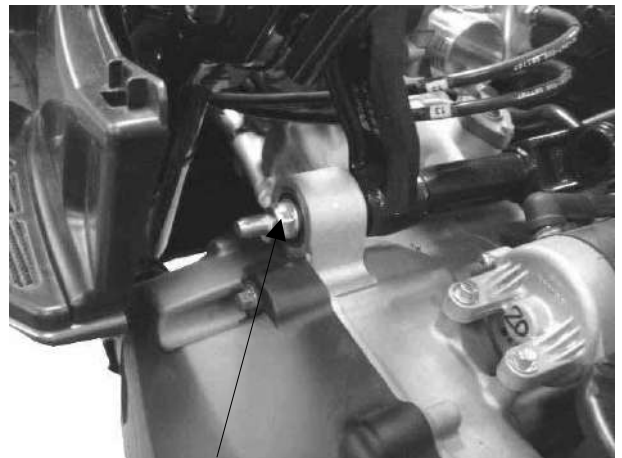

Mount Nut

### INSTALLATION

Installation is in the reverse order of removal.

After installation, inspect and adjust the following:

- Throttle grip free play
  - Fill the cooling system with coolant and start the engine to bleed air from the system.
- API/ABV Reset (Refer to chapter14, page 17)

## 5. ENGINE REMOVAL/INSTALLATION

---

### ENGINE HANGER

#### REMOVAL

Remove the engine mount nut and pull it out.

Be careful to put the engine down.

Remove the left/right engine hanger mount bolt.

Remove the engine from frame.

#### INSTALLATION

Installation is in the reverse order of removal.

Tighten the engine hanger mount bolts to the specified torque.

**Torque:** 6.5 kgf-m (65 N-m)

Mount Nut

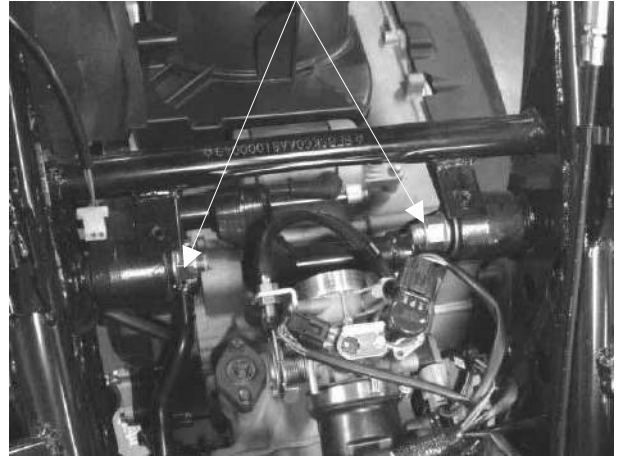

## 6. CYLINDER HEAD/VALVES

---

---

---

---

---

---

---

---

**6**

### CYLINDER HEAD/VALVES

---

SCHEMATIC DRAWING-----	6-1
SERVICE INFORMATION-----	6-2
TROUBLESHOOTING -----	6-3
CYLINDER HEAD COVER REMOVAL -----	6-4
CAMSHAFT REMOVAL-----	6-4
CYLINDER HEAD REMOVAL-----	6-6
CYLINDER HEAD DISASSEMBLY -----	6-7
CYLINDER HEAD ASSEMBLY -----	6-8
CYLINDER HEAD INSTALLATION -----	6-9
CAMSHAFT INSTALLATION-----	6-9
CYLINDER HEAD COVER INSTALLATION -----	6-11

# 6. CYLINDER HEAD/VALVES

Downtown 300i ABS

## SCHEMATIC DRAWING

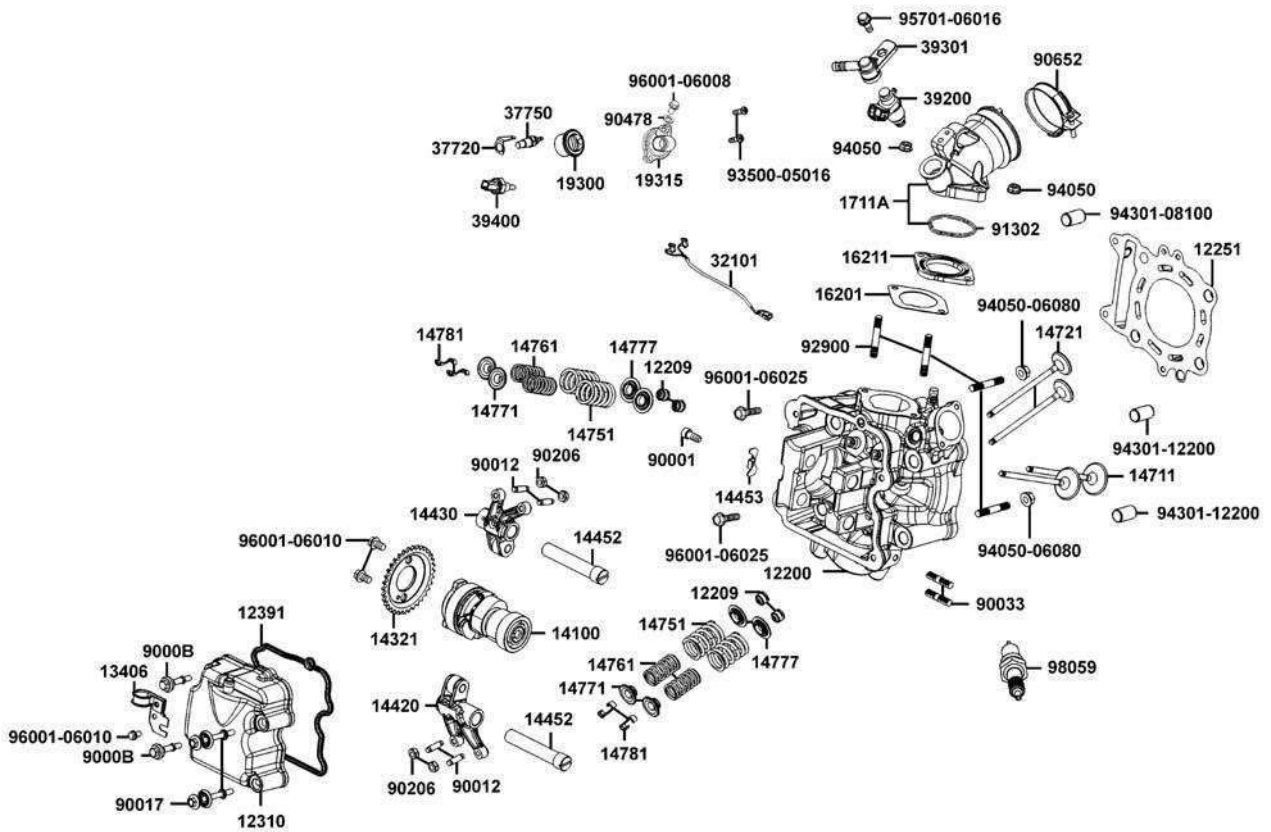



## 6. CYLINDER HEAD/VALVES

### SERVICE INFORMATION

#### GENERAL INSTRUCTIONS

- The cylinder head can be serviced with the engine installed in the frame. Coolant in the radiator and water hoses must be drained.
- When assembling, apply molybdenum disulfide grease or engine oil to the valve guide movable parts and valve arm sliding surfaces for initial lubrication.
- The valve rocker arms are lubricated by engine oil through the engine oil passages. Clean and unclog the oil passages before assembling the cylinder head.
- After disassembly, clean the removed parts and dry them with compressed air before inspection.
- After removal, mark and arrange the removed parts in order. When assembling, install them in the reverse order of removal.

SPECIFICATIONS		Standard (mm)
Item		
Valve clearance (cold)	IN	0.10
	EX	0.10
Cylinder head compression pressure		16 kg/cm <sup>2</sup>
Camshaft cam height	IN	34.2987
	EX	34.1721
Valve rocker arm I.D.	IN	10.00 ~ 10.015
	EX	10.00 ~ 10.015
Valve rocker arm shaft O.D.	IN	9.972 ~ 9.987
	EX	9.972 ~ 9.987
Valve seat width	IN	1.2
	EX	1.2
Valve stem O.D.	IN	4.990 ~ 4.975
	EX	4.970 ~ 4.955
Valve guide I.D.	IN	5.00 ~ 5.012
	EX	5.00 ~ 5.012
Valve stem-to-guide clearance	IN	0.010 ~ 0.037
	EX	0.030 ~ 0.057

#### TORQUE VALUES

Item	Qty	Thread size (mm)	Torque (kgf-m)	Remarks
Cylinder head stud bolt:				
1.Stud bolt (Inlet pipe side)	2	6	0.7~1.1	Double end bolt
2.Stud bolt (EX pipe side)	2	8	0.7~1.1	Double end bolt
Bolt B stud 10*180	4	10	1.0~1.4	Apply oil to thread
Valve adjusting lock nut	4	5	0.7~1.1	Apply oil to thread
Cam sprocket bolt	2	6	1.0~1.4	

#### SPECIAL TOOL

Valve spring compressor

E063

## 6. CYLINDER HEAD/VALVES

### TROUBLESHOOTING

- The poor cylinder head operation can be diagnosed by a compression test or by tracing engine top-end noises.

#### **Poor performance at idle speed**

- Compression too low

#### **Compression too low**

- Incorrect valve clearance adjustment
- Burned or bent valves
- Incorrect valve timing
- Broken valve spring
- Poor valve and seat contact
- Leaking cylinder head gasket
- Warped or cracked cylinder head
- Poorly installed spark plug

#### **Compression too high**

- Excessive carbon build-up in combustion chamber

#### **White smoke from exhaust muffler**

- Worn valve stem or valve guide
- Damaged valve stem oil seal

#### **Abnormal noise**

- Incorrect valve clearance adjustment
- Sticking valve or broken valve spring
- Damaged or worn camshaft
- Worn cam chain tensioner
- Worn camshaft and rocker arm

## 6. CYLINDER HEAD/VALVES

### CYLINDER HEAD COVER REMOVAL

Remove the met-in box.  
Remove the body cover and center cover.  
Disconnect the breather hose to air cleaner.  
Remove the cylinder head cover four bolts.  
Remove the cylinder head cover.

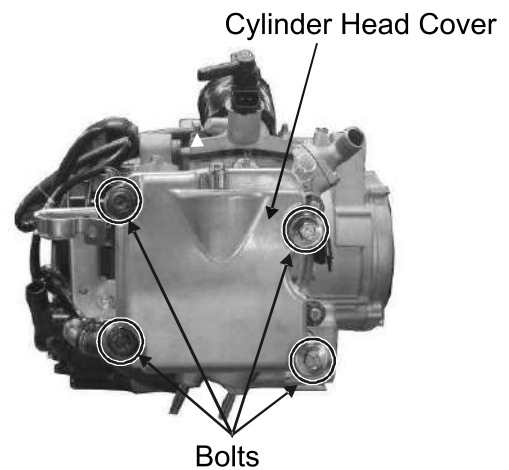

### CAMSHAFT REMOVAL

Remove the injector and inlet pipe.  
Remove two screws attaching the thermostat.

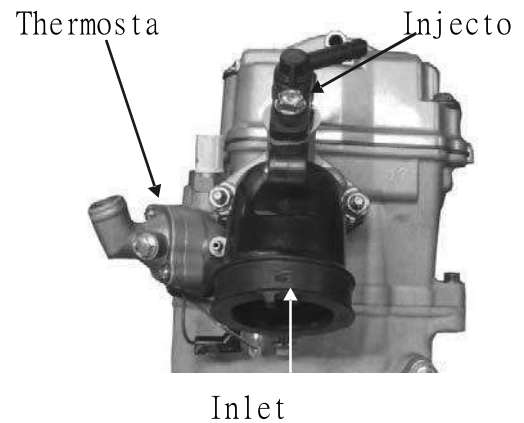

Turn the cam chain tensioner screw clockwise to tighten it.

**Torque:** 1.0 kgf-m (9.8 N-m)

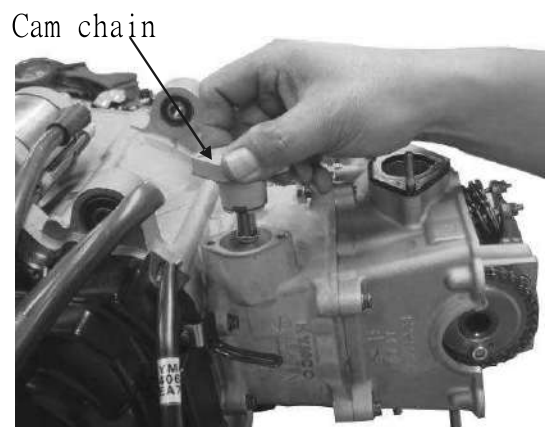

## 6. CYLINDER HEAD/VALVES

Remove four nuts attaching to the cylinder head.

Remove two bolts attaching to the camshaft gear.

Remove the camshaft gear from the cam chain.

- \*
  - Diagonally loosen the cylinder head cap nuts in 2 or 3 times.

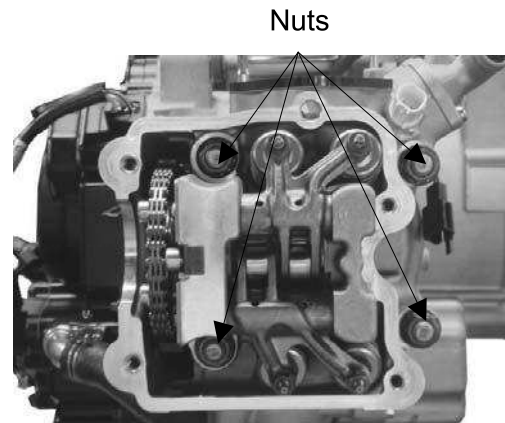

Remove the set plate located beside the rocker arm shaft.

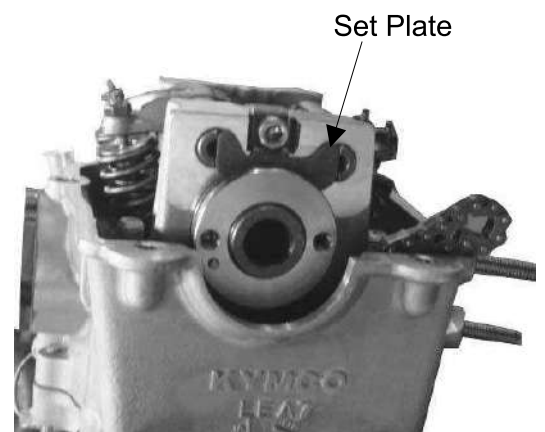
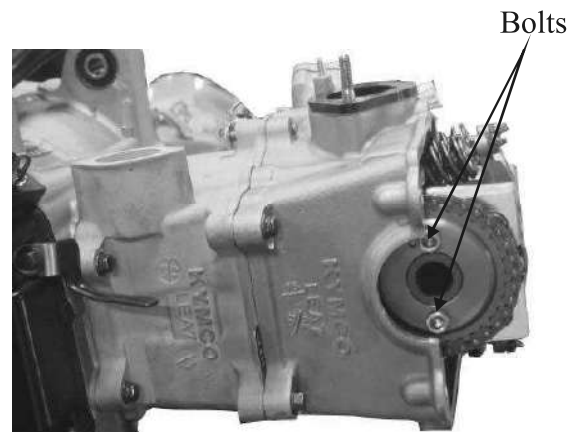

## 6. CYLINDER HEAD/VALVES

Remove the rocker arm with bolt as shown.

Rocker Arm

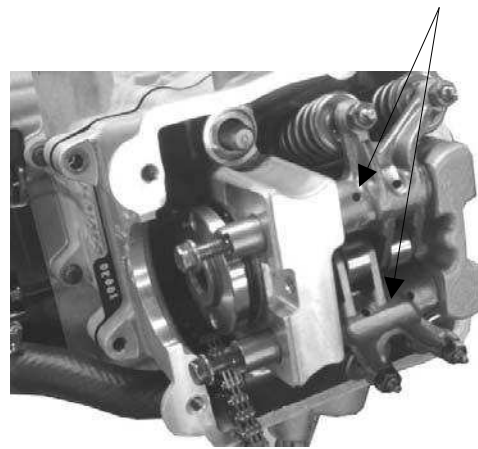

### CAMSHAFT INSPECTION

Check each cam lobe for wear or damage. Check each camshaft bearing for play or damage. Replace the camshaft assembly with a new one if the bearings are noisy or have excessive play.

\* If the surface of rocker arm is worn, check each cam lobe for wear or damage.

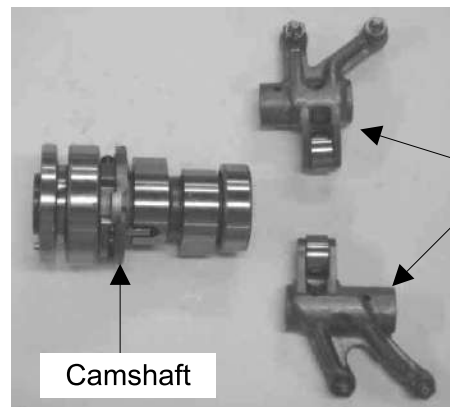

### CYLINDER HEAD REMOVAL

Remove the muffler.  
 Remove the throttle body.  
 Drain the coolant from the radiator and water hose, then remove the thermostat water hose.  
 Remove the camshaft.  
 Remove the Temp/Map Sensor and intake manifold.  
 Remove the bolt attaching the thermostat housing and the thermostat housing.  
 Remove the cylinder head.

Bolt

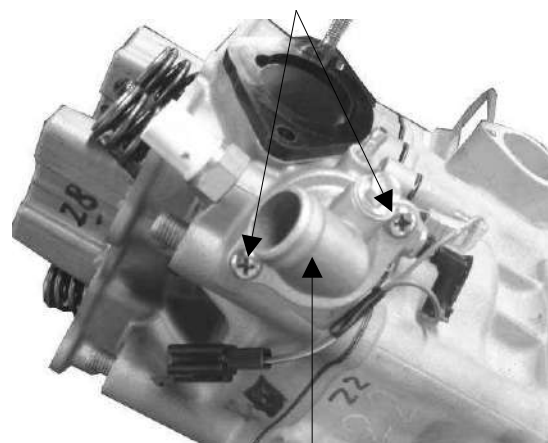

Thermostat

## 6. CYLINDER HEAD/VALVES

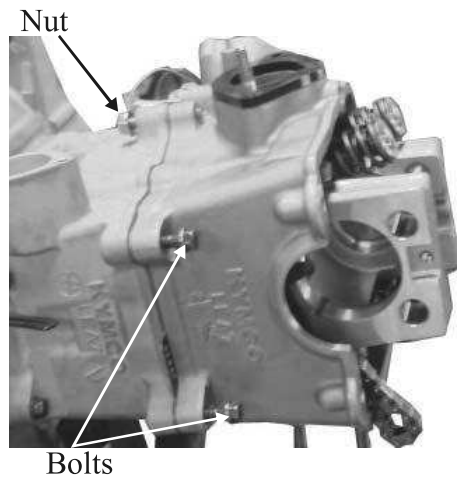

\* Be careful not to drop any gasket material into the engine.

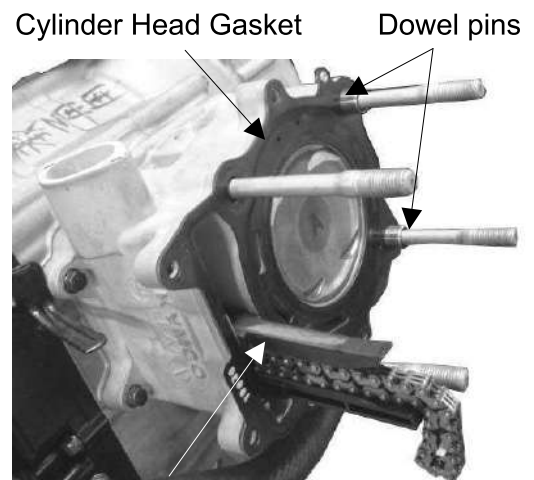

\*

**Special**

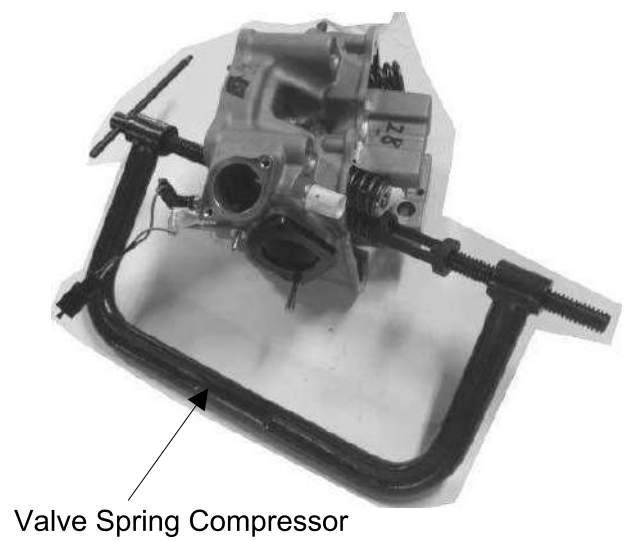

## 6. CYLINDER HEAD/VALVES

### VALVE STEM INSPECTION

Inspect each valve for bending, burning, or abnormal stem wear.

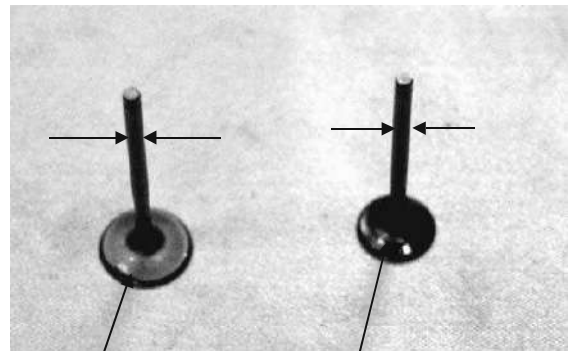

Intake valve

Exhaust valve

Remove carbon deposits from the combustion chamber.

Clean off any gasket remnants from the cylinder head contact surface.

\* Be careful not to damage the cylinder head mating surface.

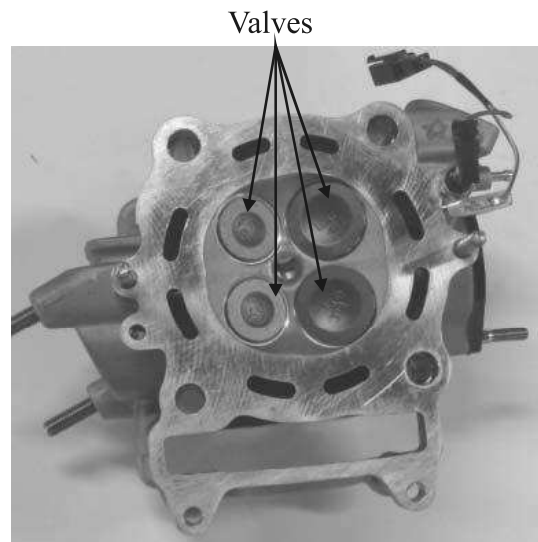

### CYLINDER HEAD ASSEMBLY

Install the valve spring seats and stem seals.

Lubricate each valve stem with engine oil and insert the valves into the valve guides.

Be sure to install new valve stem seals.

Install the valve spring.



Valve spring compressor E040

\*

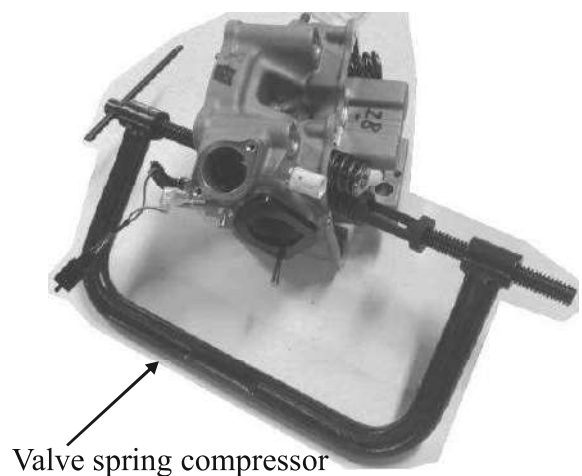

## 6. CYLINDER HEAD/VALVES

### CYLINDER HEAD INSTALLATION

Install the dowel pins and a new cylinder head gasket.

Install the cam chain guide.

- \*
- Clean the intake valve rocker arm shaft off any grease before installation.

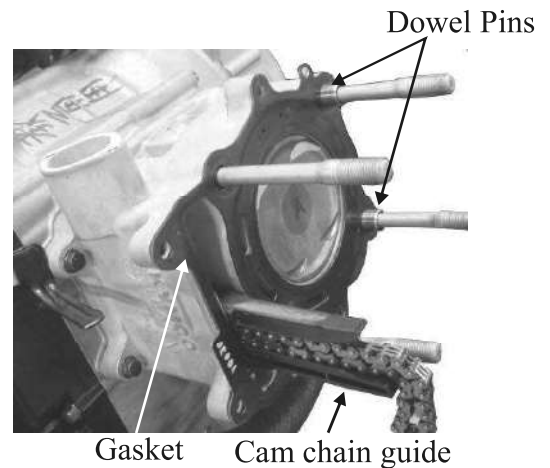

Install the cylinder head.  
Install the camshaft.

Install the intake valve rocker arm and the rocker arm shafts.

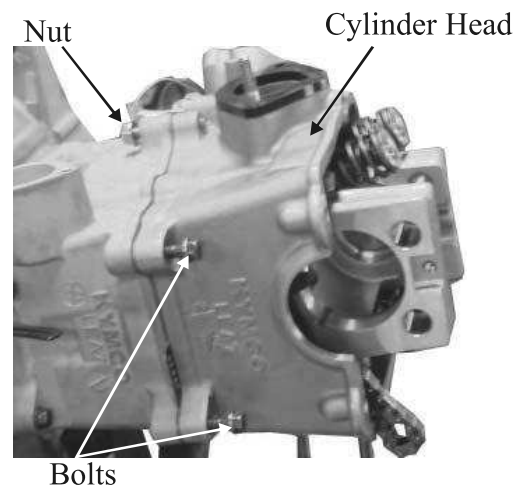

### CAMSHAFT INSTALLATION

Install the set plate to prevent the rocker arm shaft from pull out.

**Torque:** 1.2 kgf-m (8.9 N-m)

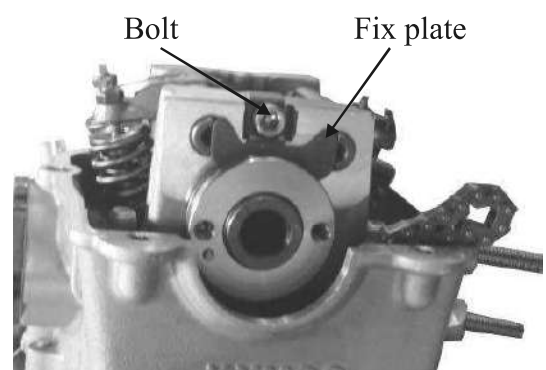



## 6. CYLINDER HEAD/VALVES

Tighten the four cylinder head nuts and the four bolts between the cylinder head and cylinder.

### Torque:

Cylinder head nuts: 3.6 kgf-m (35.3 N-m)

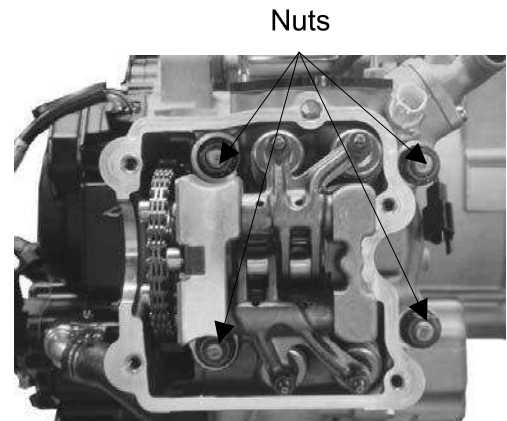

Turn the A.C. generator flywheel so that the "T" mark on the flywheel aligns with the index mark on the right crankcase cover. Keep the round hole on the camshaft gear facing up and align two bolts on the camshaft gear with the cylinder head surface (Position the intake and exhaust cam lobes down.) and install the cam chain over the camshaft gear.

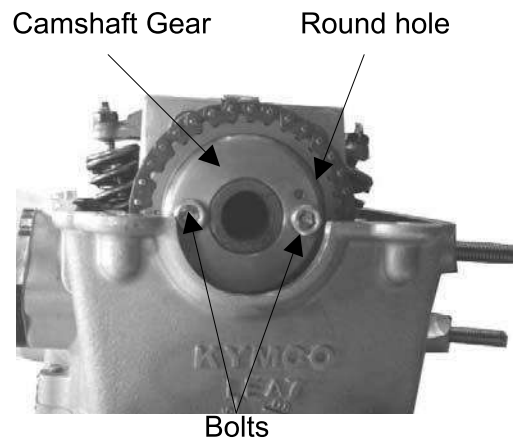

- \*
- Apply engine oil to the threads of the cylinder head cap nuts.
  - Diagonally tighten the cylinder head cap nuts in 2~3 times.
  - First tighten the cylinder head cap nuts and then tighten the bolts between the cylinder and cylinder head to avoid cracks.

Install the thermostat bolt.

**Torque:** 1.2 kgf-m (11.8 N-m)

Turn the cam chain tension screw counter-clockwise to release it.

## 6. CYLINDER HEAD/VALVES

### CYLINDER HEAD COVER INSTALLATION

Adjust the valve clearance.  
Install a new cylinder head cover O-ring and install the cylinder head cover.

\* Be sure to install the O-ring into the groove properly.

Install the inlet pipe.  
Install the injector.  
Install and tighten the cylinder head cover bolts.

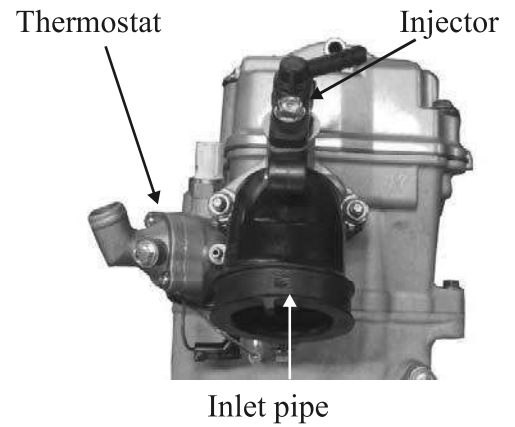

## 7. CYLINDER/PISTON

---

---

---

---

---

---

---

---

---

### CYLINDER/PISTON

**7**

SCHEMATIC DRAWING-----	7-1
SERVICE INFORMATION-----	7-2
TROUBLESHOOTING -----	7-2
CYLINDER REMOVAL -----	7-3
PISTON REMOVAL -----	7-3
PISTON INSTALLATION -----	7-7
CYLINDER INSTALLATION -----	7-7

# 7. CYLINDER/PISTON

## SCHEMATIC DRAWING

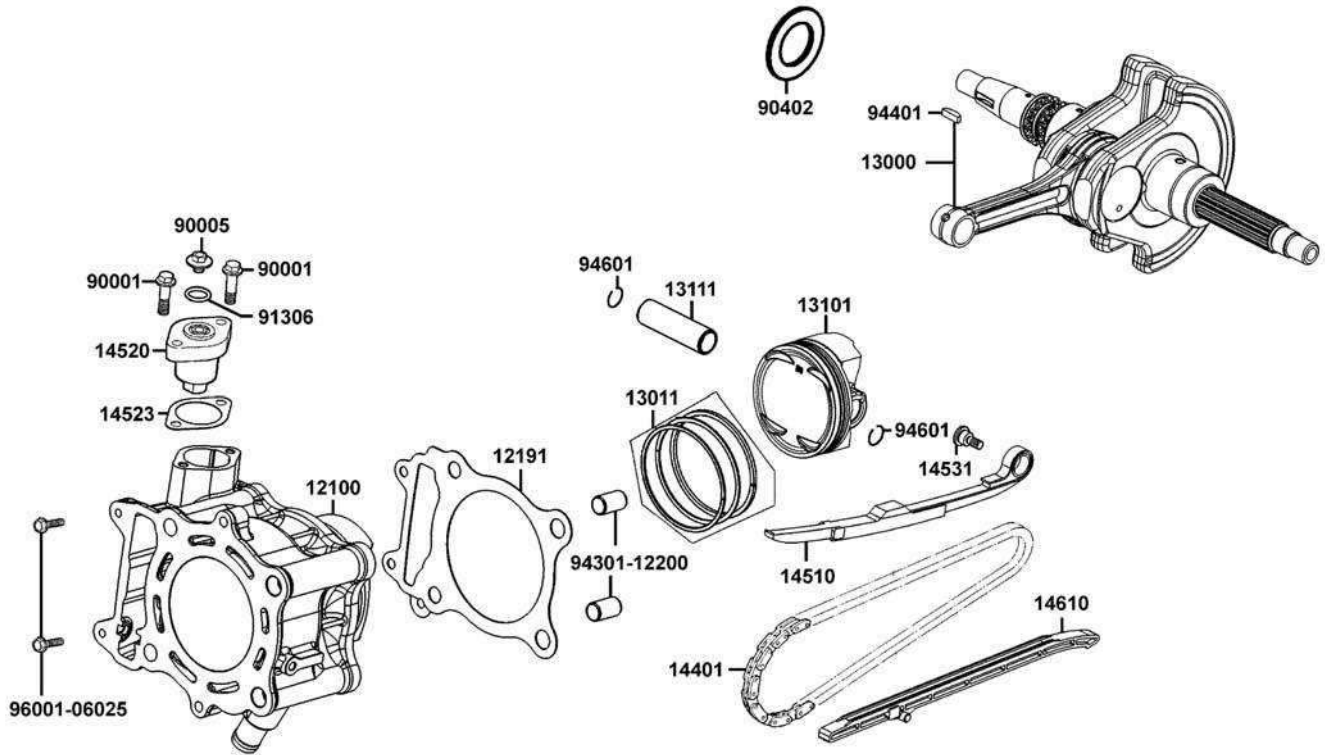

## 7. CYLINDER/PISTON

### SERVICE INFORMATION

#### GENERAL INSTRUCTIONS

- The cylinder and piston can be serviced with the engine installed in the frame.
- When installing the cylinder, use a new cylinder gasket and make sure that the dowel pins are correctly installed.
- After disassembly, clean the removed parts and dry them with compressed air before inspection.

#### SPECIFICATIONS

Item		Standard (mm)	Service Limit (mm)	
Cylinder	I.D.	72.705~72.715	72.80	
Piston, piston ring	Ring-to-groove clearance	top	0.015~0.055	
		Second	0.015~0.055	
	Ring end gap	top	0.10~0.25	
		Second	0.10~0.25	
		Oil side rail	0.2~0.7	
	Piston O.D.		72.67~72.69	72.6
	Piston O.D. measuring position		9mm from bottom of skirt	
	Piston-to-cylinder clearance		0.010~0.040	0.1
Piston pin hole I.D.		15.002~15.008	15.04	
Piston pin O.D		14.994~15.000	16.96	
Piston-to-piston pin clearance		0.002~0.014	0.02	
Connecting rod small end I.D. bore		15.016~15.034	15.06	

#### TROUBLESHOOTING

- When hard starting or poor performance at low speed occurs, check the crankcase breather for white smoke. If white smoke is found, it means that the piston rings are worn, stuck or broken.

##### Compression too low or uneven compression

- Worn or damaged cylinder and piston rings
- Worn, stuck or broken piston rings

##### Excessive smoke from exhaust muffler

- Worn or damaged piston rings
- Worn or damaged cylinder and piston

##### Compression too high

- Excessive carbon build-up in combustion chamber or on piston head

##### Abnormal noisy piston

- Worn cylinder, piston and piston rings
- Worn piston pin hole and piston pin
- Incorrectly installed piston

## 7. CYLINDER/PISTON

### CYLINDER REMOVAL

Remove the cylinder head.  
Remove the cam chain guide.  
Remove the cylinder.

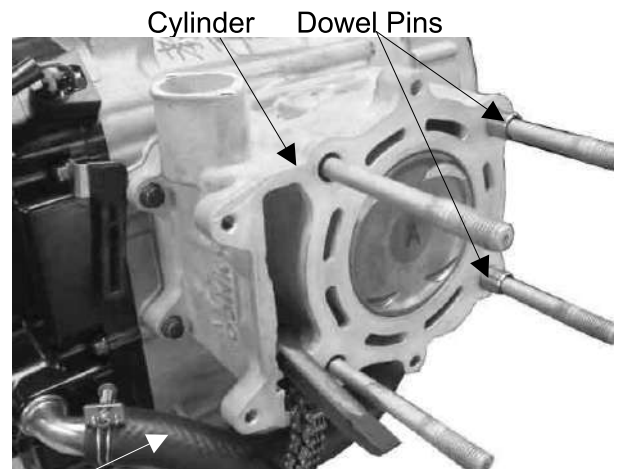

Water Hose

Remove the cylinder gasket and dowel pins.  
Clean any gasket material from the cylinder surface.

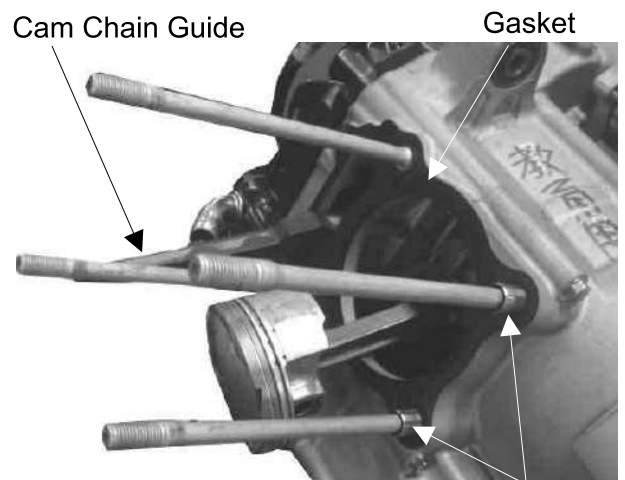

Cam Chain Guide

Gasket

Dowel Pins

### PISTON REMOVAL

Remove the piston pin clip.  
Press the piston pin out of the piston.

\* Place a clean towel in the crankcase to keep the piston pin clip from falling into the crankcase.

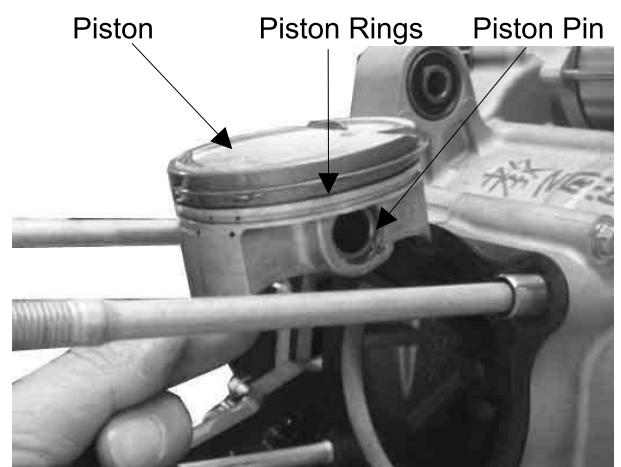

Piston

Piston Rings

Piston Pin

## 7. CYLINDER/PISTON

Inspect the piston, piston pin and piston rings.  
Remove the piston rings.

\* Take care not to damage or break the piston rings during removal.

Clean carbon deposits from the piston ring grooves.

Install the piston rings onto the piston and measure the piston ring-to-groove clearance.

**Service Limits:**

**Top:** 0.09 mm replace if over  
**2nd:** 0.09 mm replace if over

Remove the piston rings and insert each piston ring into the cylinder bottom.

\* Use the piston head to push each piston ring into the cylinder.

Measure the piston ring end gap.

**Service Limit:** 0.5mm replace if over

Measure the hole I.D. of piston pin

**Service Limit:** 15.04 mm replace if over

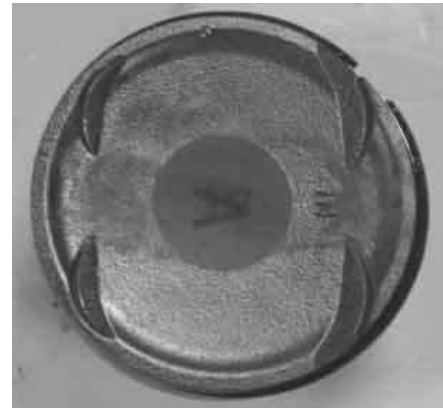

# 7. CYLINDER/PISTON



\*

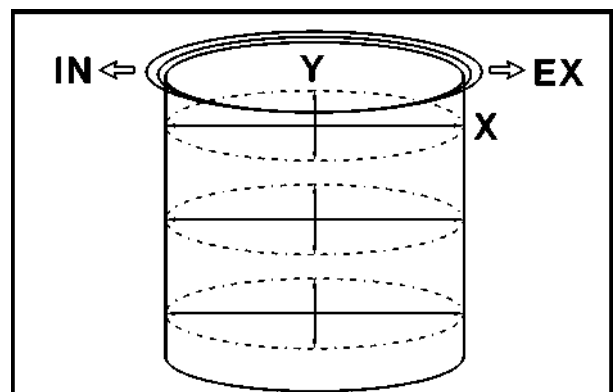



## 7. CYLINDER/PISTON

Measure the connecting rod small end I.D.

**Service Limit:** 15.06 mm replace if over

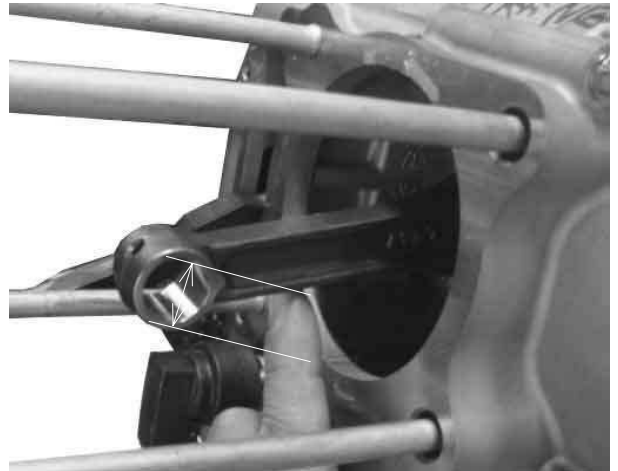

### PISTON RING INSTALLATION

Install the piston rings onto the piston.  
Apply engine oil to each piston ring.

- \*
- Be careful not to damage the piston and piston rings during assembly.
  - All rings should be installed with the markings facing up.
  - After installing the rings, they should rotate freely without sticking.
  - Stagger the ring end gaps as the figure shown.

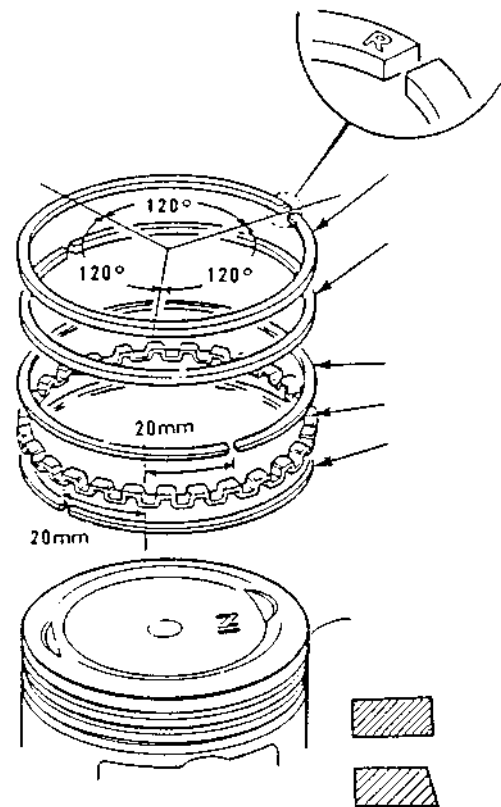

## 7. CYLINDER/PISTON

### PISTON INSTALLATION

Remove any gasket material from the crankcase surface.

- \* 
 • Be careful not to drop foreign matters into the crankcase.

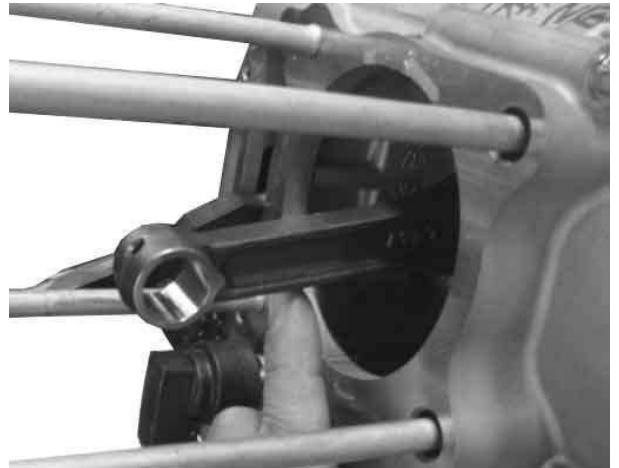

Install the piston, piston pin and a new piston pin clip.

- \* 
 • Position the piston "IN" mark on the intake valve side.  
 • Place a clean towel in the crankcase to keep the piston pin clip from falling into the crankcase.

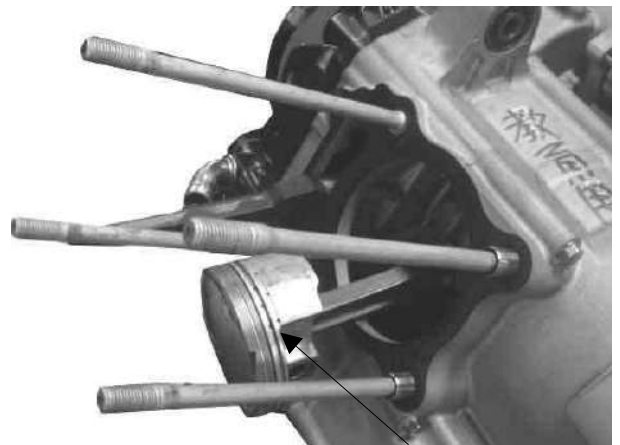

Piston

### CYLINDER INSTALLATION

Install the dowel pins and a new cylinder gasket on the crankcase.

- \* 
 The piston must be changed in pair with cylinder.

2	B	$\phi 72.7 \begin{matrix} 0 \\ -0.010 \end{matrix}$	$\phi 72.7 \begin{matrix} +0.020 \\ +0.010 \end{matrix}$	0.010~0.030
1	A	$\phi 72.7 \begin{matrix} -0.010 \\ -0.020 \end{matrix}$	$\phi 72.7 \begin{matrix} +0.010 \\ 0 \end{matrix}$	0.010~0.030
NO	MARK	PISTON O.D.	CYLINDER BORE	CLEARANCE

## 7. CYLINDER/PISTON

Install the cam chain guide.

- \* • Insert the tab on the cam chain guide into the cylinder groove.

Install the cylinder head gasket and dowel pins.

Connect the water hose to the cylinder.

Install the cylinder head.

Tighten the cylinder base bolt.

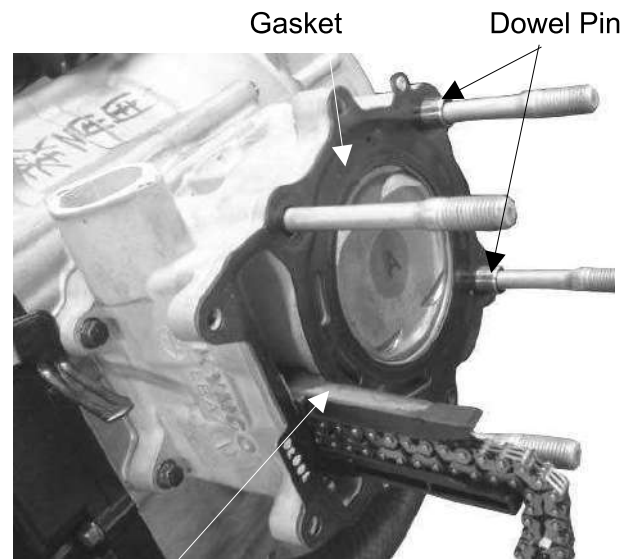

Cam Chain Guide



# 8. DRIVE AND DRIVEN PULLEYS/ V-BELT



Downtown 300i ABS

## SCHEMATIC DRAWING

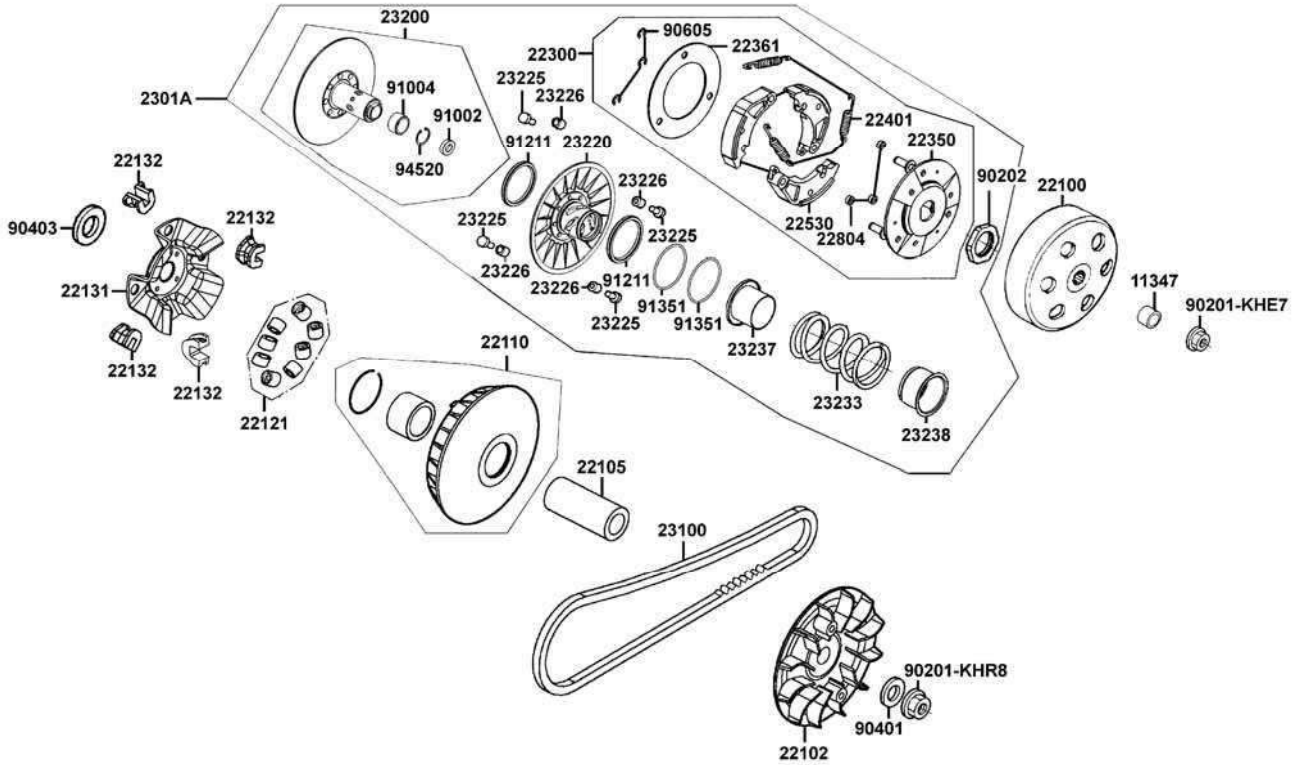

## 8. DRIVE AND DRIVEN PULLEYS/ V-BELT

### SERVICE INFORMATION

#### GENERAL INSTRUCTIONS

- The drive pulley, clutch and driven pulley can be serviced with the engine installed.
- Avoid getting grease and oil on the drive belt and pulley faces. Remove any oil or grease from them to minimize the slipping of drive belt and drive pulley.

#### SPECIFICATIONS

Item	Standard (mm)	Service Limit (mm)
Clutch lining thickness	4.0	2.0
Clutch outer I.D.	152.1~152.2	152.2
Weight roller O.D	19.92~20.08	20

#### TORQUE VALUES

Drive face nut	9.5 kgf-m (93.1 N-m)	Apply oil
Clutch outer nut	5.5 kgf-m (54 N-m)	
Clutch drive plate nut	5.5 kgf-m (54 N-m)	

#### SPECIAL TOOLS

Universal holder	E017
Clutch spring compressor/#41 Nut & Fitting	E053 & E028

#### TROUBLESHOOTING

##### Engine starts but motorcycle won't move

- Worn drive belt
- Broken ramp plate
- Worn or damaged clutch lining
- Broken driven face spring

##### Lack of power

- Worn drive belt
- Weak driven face spring
- Worn weight roller
- Faulty driven face

##### Engine stalls or motorcycle creeps

- Broken clutch weight spring

## 8. DRIVE AND DRIVEN PULLEYS/ V-BELT

### LEFT CRANKCASE COVER

#### REMOVAL

Remove the met-in box and carrier.  
Remove the body cover, center cover and rear fender A together.  
Remove the protector cover of left crankcase cover.  
Remove the bolts attaching to the left crankcase cover.  
Remove the gasket and dowel pins.



#### INSPECTION

Check the bearing for wear or damage.  
Replace the bearing with a new one if the bearing is noisy or have excessive play.



Bearing

### DRIVE PULLEY

#### DRIVE PULLEY FACE REMOVAL

Remove the left crankcase cover.  
Hold the drive pulley using a universal holder and remove the drive face nut and washer.  
Remove the drive pulley face.



Universal HolderE017

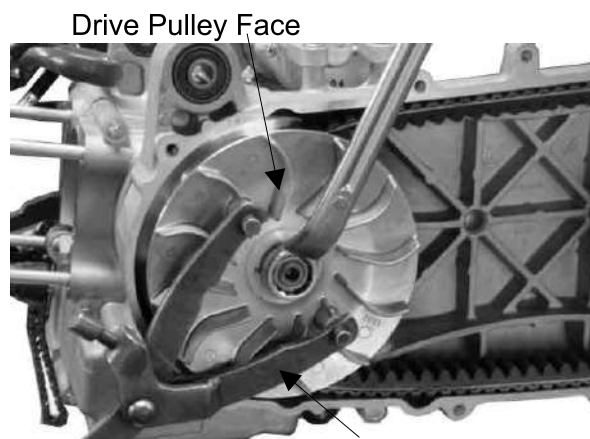

Drive Pulley Face

### CLUTCH OUTER/DRIVEN PULLEY/V-BELT

#### REMOVAL

Remove the drive pulley face.  
Hold the clutch outer with the universal holder and remove the clutch outer nut, bushing and washer.



Universal HolderE017

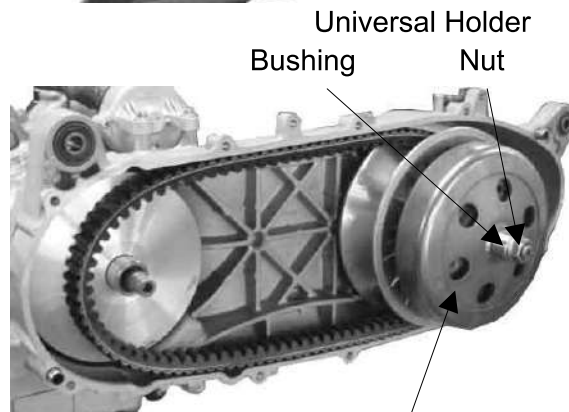

Universal Holder  
Bushing Nut

Movable Drive Face

## 8. DRIVE AND DRIVEN PULLEYS/ V-BELT

### INSPECTION

Check the drive belt for cracks, separation or abnormal or excessive wear.

Replace a new belt at every 20,000km.

- \* 

• Use specified genuine parts for replacement.
--

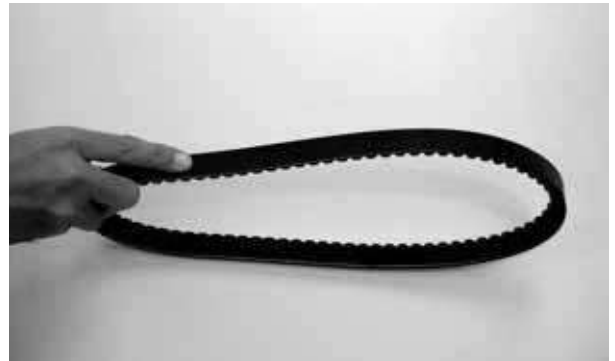

### MOVABLE DRIVE FACE ASSEMBLY

Remove the pulley face, clutch outer, driven pulley and belt.

Remove the movable drive face assembly.

Remove the drive pulley collar.

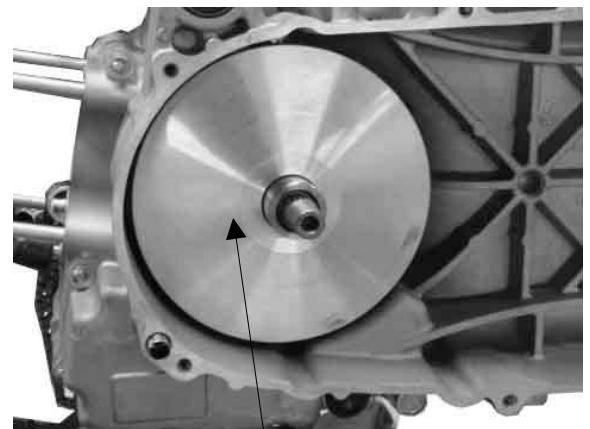

Movable Drive Face Assembly

### DISASSEMBLY

Remove the ramp plate.

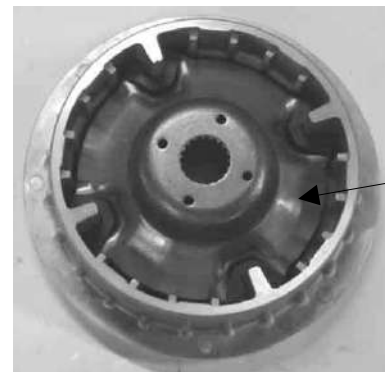

Ramp Plate

Remove the weight rollers.

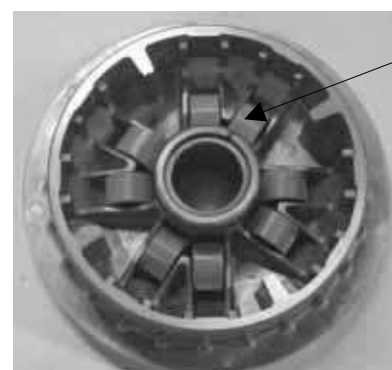

Weight Roller

# 8. DRIVE AND DRIVEN PULLEYS/ V-BELT

### INSPECTION

Check each weight roller for wear or damage.



Check the movable drive face bushing for wear or damage.



### ASSEMBLY

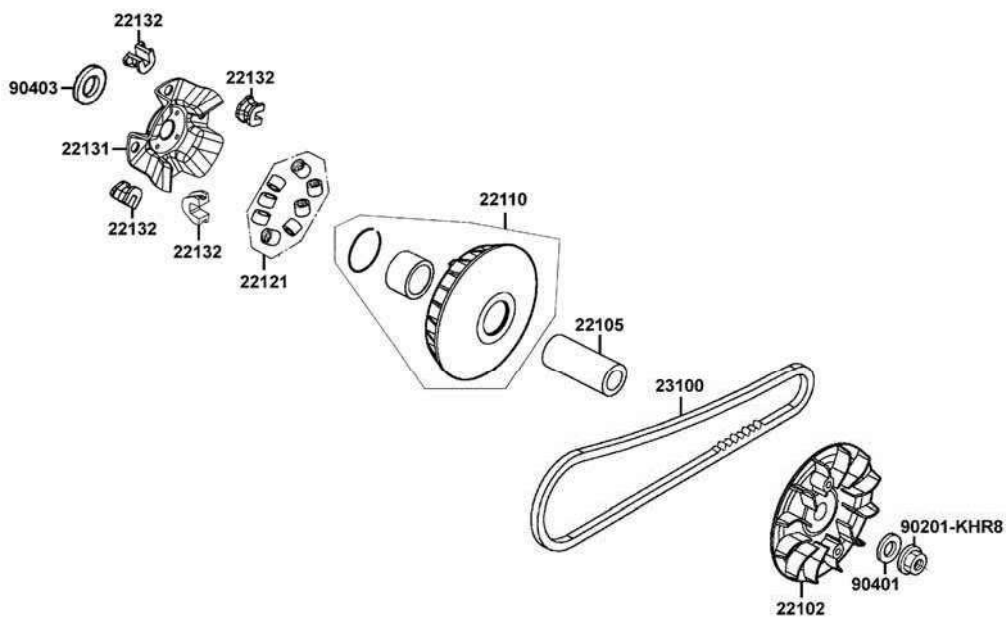



## 8. DRIVE AND DRIVEN PULLEYS/ V-BELT

Install the weight rollers into the movable drive face.

- \* The direction of all weight rolls is same. The color side is towards to clockwise.

Install the ramp plate.

Insert the drive pulley collar into the movable drive face.

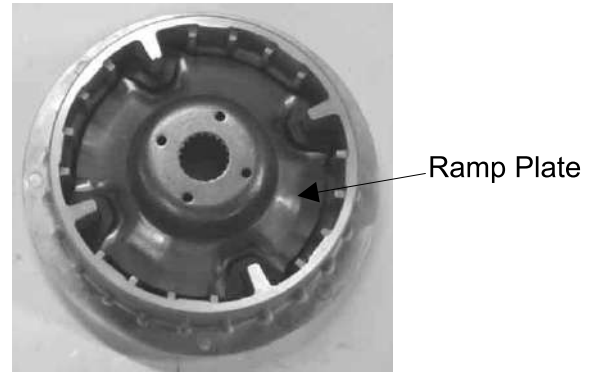

### INSPECTION

Inspect the clutch outer for wear or damage. Measure the clutch outer I.D.

**Service Limit:** 153.5 mm replace if over

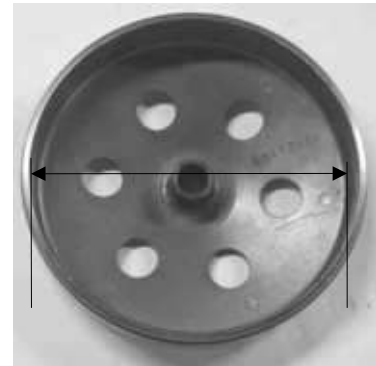

Check the clutch shoes for wear or damage. Measure the clutch lining thickness.

**Service Limit:** 2.0 mm replace if below

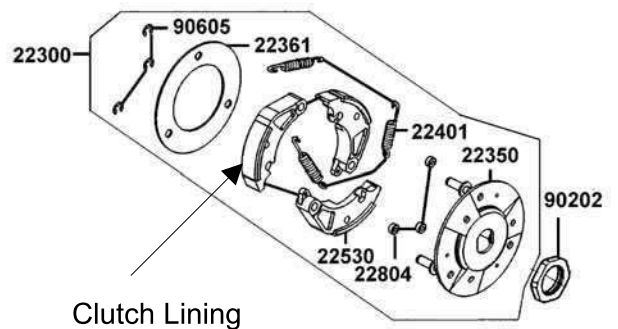

# 8. DRIVE AND DRIVEN PULLEYS/ V-BELT

## CLUTCH/DRIVEN PULLEY DISASSEMBLY

Hold the clutch/driven pulley assembly with the clutch spring compressor.

Set the tool in a vise and remove the clutch drive plate nut.

- \* Be sure to use a clutch spring compressor to avoid spring damage.



Clutch Spring Compressor            E053  
Fittings & Nut Wrench, 41mm        E033

Loosen the clutch spring compressor and disassemble the clutch/driven pulley assembly.  
Remove the seal collar.

Pull out the guide roller pins and guide rollers.  
Remove the movable driven face from the driven face.

Remove the oil seal from the movable driven face.

Clutch Spring Compressor

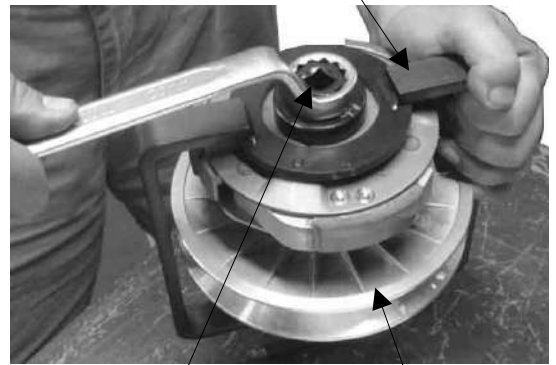

Lock Nut Wrench

y



## ASSEMBLY

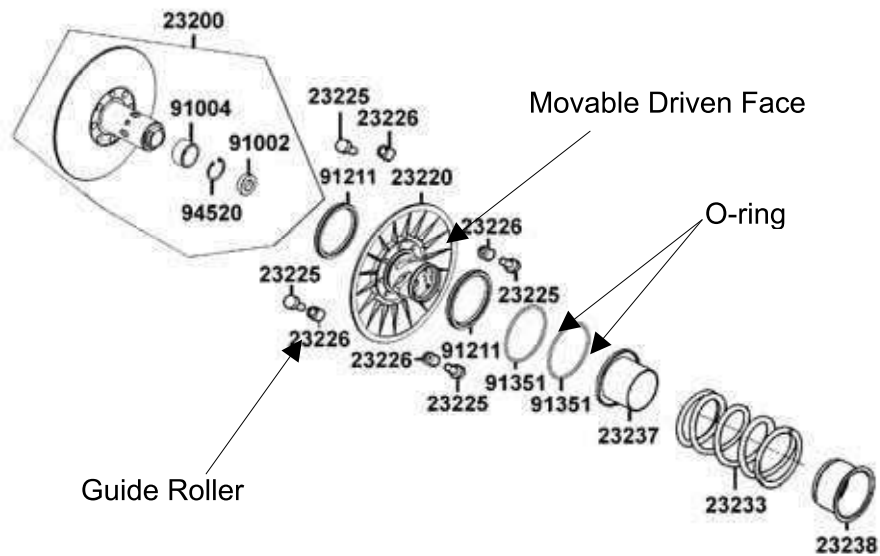

## 8. DRIVE AND DRIVEN PULLEYS/ V-BELT

### INSPECTION

Measure the driven face spring free length.

**Service Limit:** 136 mm replace if below

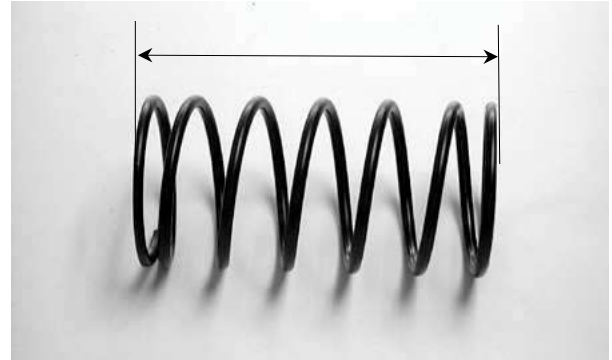

### DRIVEN PULLEY FACE BEARING REPLACEMENT

Check the bearings for play and replace them if they have excessive play.

Drive the inner needle bearing out of the driven pulley face.

- \* Discard the removed bearing and replace with a new one.

Remove the snap ring and drive the outer bearing out of the driven face.

- \* Discard the removed bearing and replace with a new one.

Apply grease to the outer bearing.  
Drive a new outer bearing into the driven face with the sealed end facing up.

Seat the snap ring in its groove.  
Apply grease to the driven face bore areas.

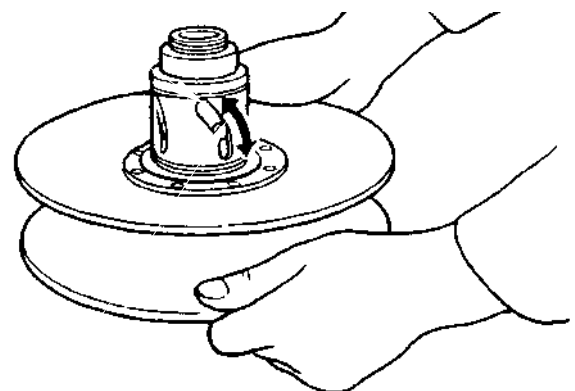

## 8. DRIVE AND DRIVEN PULLEYS/ V-BELT

Press a new needle bearing into the driven face.

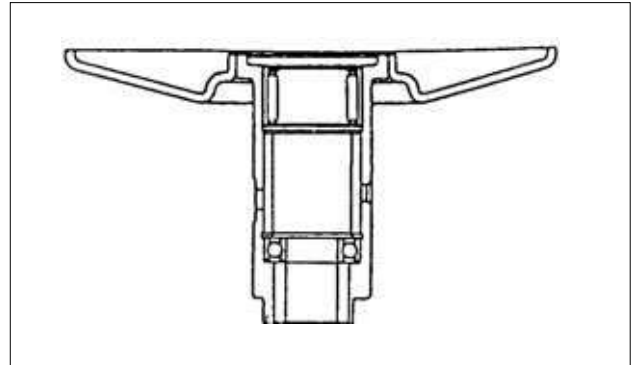

### **CLUTCH DISASSEMBLY**

Remove the clips and retainer plate to disassemble the clutch.

- \* • Keep grease off the clutch linings.

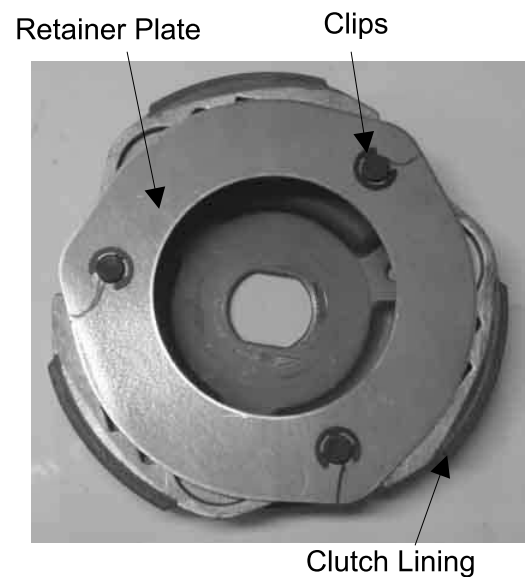

# 8. DRIVE AND DRIVEN PULLEYS/ V-BELT

## CLUTCH ASSEMBLY

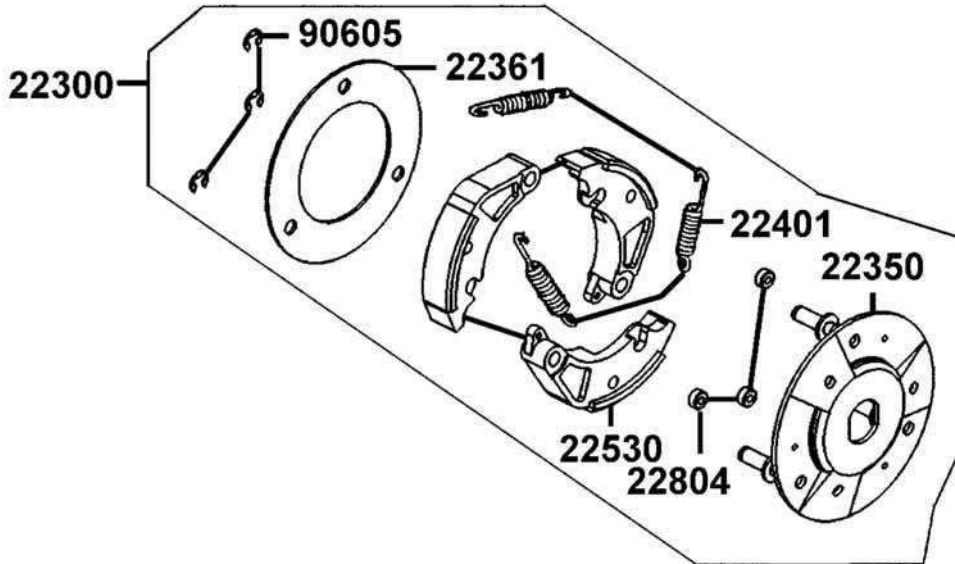

Install the damper rubbers on the drive plate pins.  
Install the clutch weights/shoes and clutch springs onto the drive plate.  
Install the retainer plate and secure with the clips.

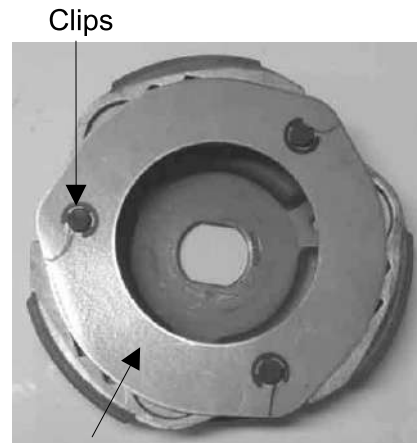

Drive Plate

### CLUTCH / DRIVEN PULLEY ASSEMBLY

Clean the pulley faces and remove any grease from them.  
Apply grease to the O-rings and install them onto the moveable driven face.

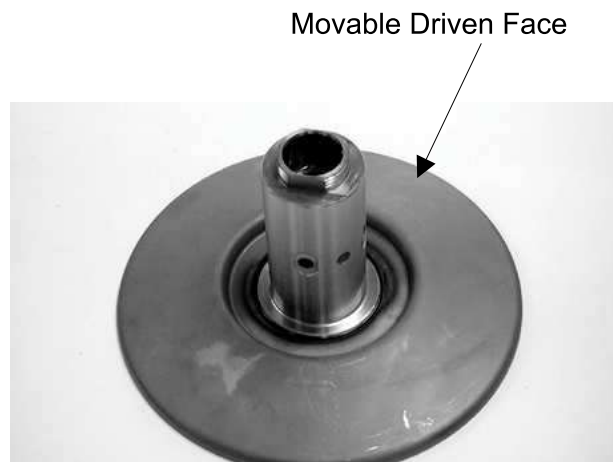

## 8. DRIVE AND DRIVEN PULLEYS/ V-BELT

Install the movable driven face onto the driven face.

Apply grease to the guide rollers and guide roller pins and then install them into the holes of the driven face.

Install the seal collar.

Remove any excessive grease.

- \* Be sure to clean the driven face off any grease.

Set the driven pulley assembly, driven face spring and clutch assembly onto the clutch spring compressor.

- \* Align the flat surface of the driven face with the flat on the clutch drive plate.

Compress the tool and install the drive plate nut.

Set the tool in a vise and tighten the drive plate nut to the specified torque.

**Torque:** 75 N-m

- \* Be sure to use a clutch spring compressor to avoid spring damage.

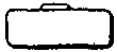

Clutch Spring Compressor            E053  
Fittings & Nut Wrench, 41mm        E033

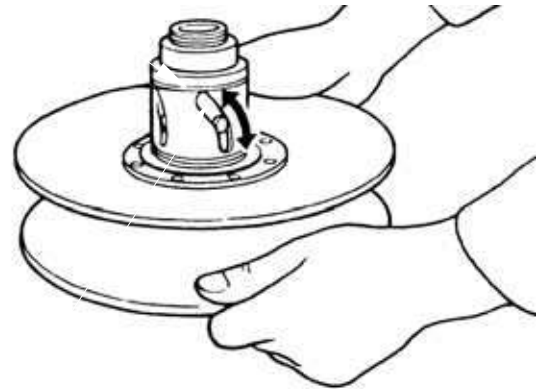

Clutch Spring Compressor

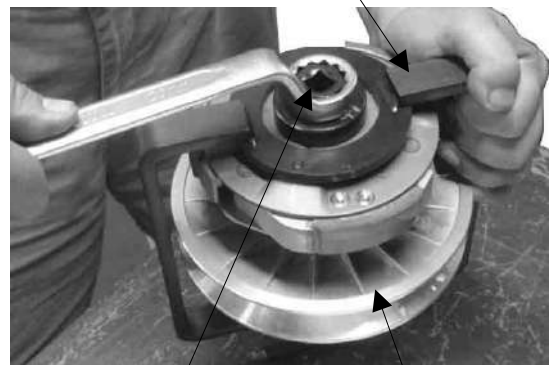

Lock Nut Wrench

y

## 8. DRIVE AND DRIVEN PULLEYS/ V-BELT

### INSTALLATION

Install the movable drive face assembly and drive pulley collar onto the crankshaft.

Drive Pulley Collar

Movable Drive Face Assembly

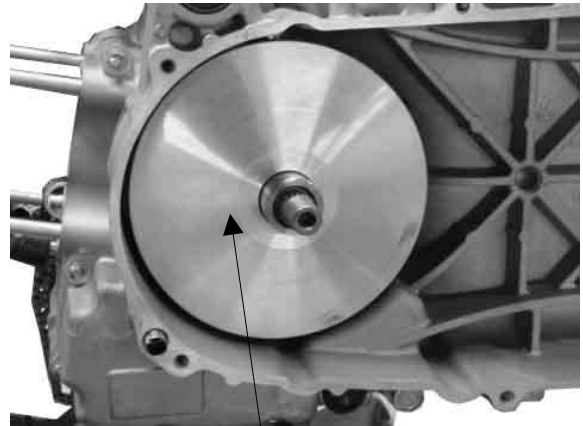

Movable Drive Face Assembly

Put the drive belt on the driven pulley.  
Put the drive belt on the drive pulley collar.  
Install the clutch/driven pulley and clutch outer onto the drive shaft.

\* • Keep grease off the drive shaft.

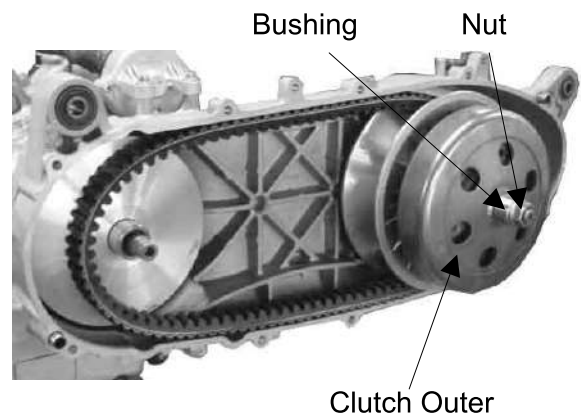

Install washer and the clutch outer nut.  
Hold the clutch outer with the universal holder to tighten clutch outer nut.

**Torque:** 54 N-m

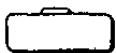

Universal Holder      E017

Install the drive pulley face, washer and drive face nut.  
Hold the drive pulley with the universal holder and tighten the drive face nut.

**Torque:** 93.1 N-m

\*

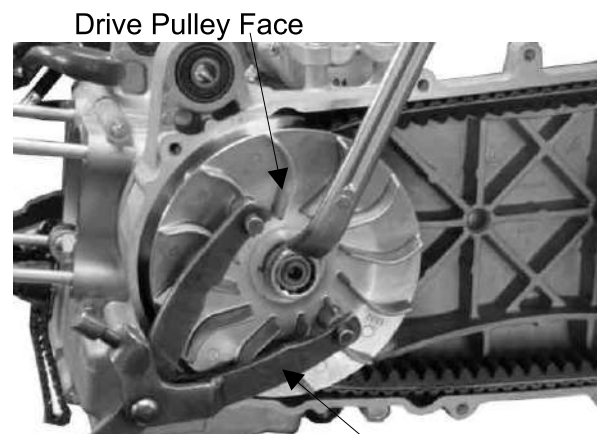

Universal Holder

## 8. DRIVE AND DRIVEN PULLEYS/ V-BELT

---

Install the left crankcase cover.



Left Crankcase Cover



# 9. FINAL REDUCTION

---

---

---

---

---

---

---

---

## FINAL REDUCTION

---

SCHEMATIC DRAWING-----	9-1
SERVICE INFORMATION-----	9-2
TROUBLESHOOTING -----	9-2
FINAL REDUCTION DISASSEMBLY -----	9-3
FINAL REDUCTION INSPECTION -----	9-3
FINAL REDUCTION ASSEMBLY -----	9-5



# 9. FINAL REDUCTION

## SCHEMATIC DRAWING

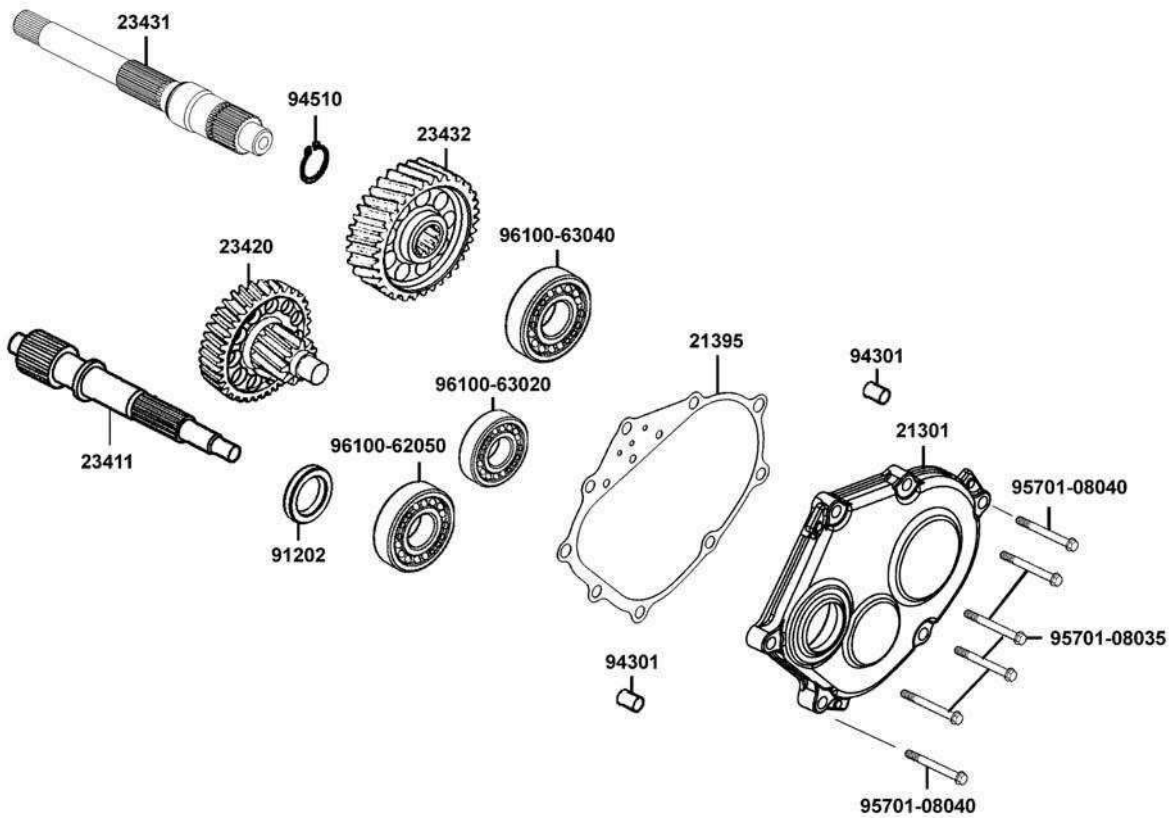

## 9. FINAL REDUCTION

---

### SERVICE INFORMATION

#### GENERAL INSTRUCTIONS

- The servicing operations of this section can be made with the engine installed.
- When replacing the drive shaft, use a special tool to hold the bearing inner race for this operation.

#### SPECIFICATIONS

Specified Oil: SAE 90#

Oil Capacity:

At disassembly : 0.23 liter

At change : 0.21 liter

#### TORQUE VALUES

Transmission case bolt

0.8-1.2 kgf-m (9.8 N-m)

Oil check/drain bolt

1.8-2.2 kgf-m (19.7 N-m)

#### SPECIAL TOOLS

Bearing puller

E037

#### TROUBLESHOOTING

##### Engine starts but motorcycle won't move

- Damaged transmission
- Seized or burnt transmission

##### Abnormal noise

- Worn, seized or chipped gears
- Worn bearing

##### Oil leaks

- Oil level too high
- Worn or damaged oil seal

## 9. FINAL REDUCTION

### FINAL REDUCTION DISASSEMBLY

Remove the exhaust muffler.  
Remove the rear brake caliper.  
Remove the right rear shock absorber.  
Remove the rear fork.  
Remove the rear wheel.  
Remove the left crankcase cover.  
Remove the clutch outer/driven pulleys.  
Drain the transmission gear oil into a clean container.  
Remove the transmission case cover attaching bolts.  
Remove the transmission case cover.

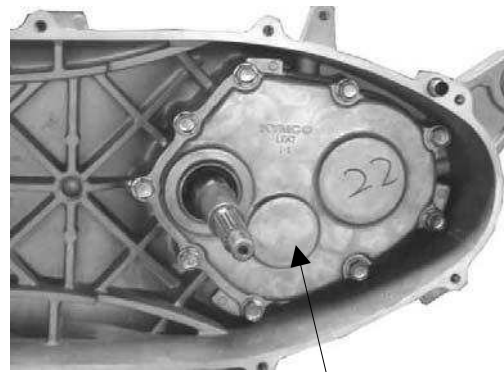

Transmission Case Cover

Remove the gasket and dowel pins.

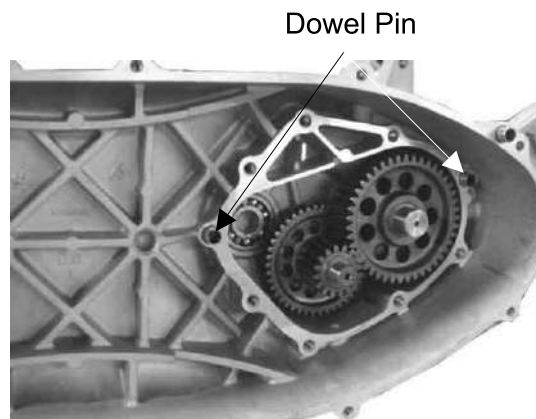

Dowel Pin

Remove the final shaft.  
Remove the final gear and countershaft.



Final Shaft

Final Gear

### FINAL REDUCTION INSPECTION

Inspect the countershaft and gear for wear or damage.



Countershaft

## 9. FINAL REDUCTION

Inspect the final gear and final shaft for wear, damage or seizure.

Drive Shaft Bearing

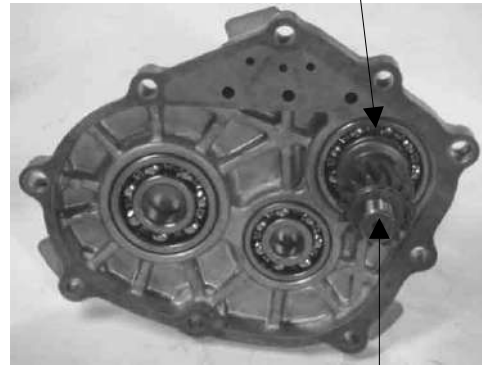

Drive Shaft

Check the left crankcase bearings for excessive play and inspect the oil seal for wear or damage.

Inspect the drive shaft and gear for wear or damage.

Drive Shaft Bearing

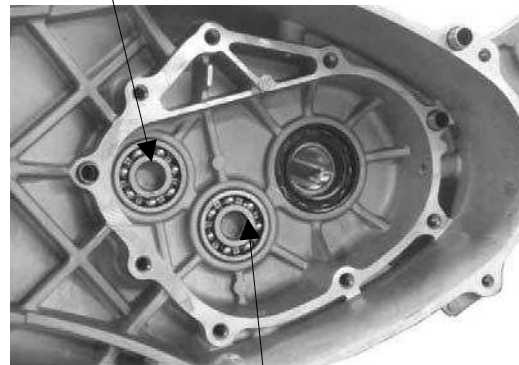

Countershaft Bearing

Check the transmission case covers bearings for excessive play and inspect the final shaft bearing oil seal for wear or damage.

\*

Do not remove the transmission case cover except for necessary part replacement. When replacing the drive shaft, also replace the bearing and oil seal.

Drive Shaft Bearing



Drive Shaft

## 9. FINAL REDUCTION

### FINAL REDUCTION ASSEMBLY

Install the drive shaft into the left crankcase.  
Put the final gear on the left crankcase.

Install the countershaft and gear into the left crankcase.

Install the final shaft into the final gear and transmission case.

Install the dowel pins and a new gasket.

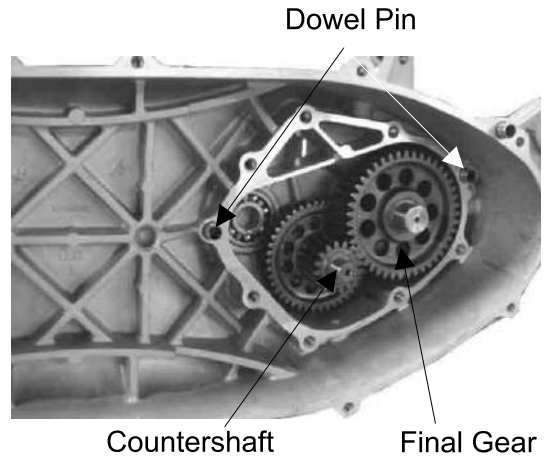

Install the transmission case cover.  
Install and tighten the transmission case cover bolts.  
Install the clutch outer/driven pulley.  
Install other removed parts in the reverse order of removal.

#### Torque:

Transmission case bolt 0.8-1.2 kgf-m  
(9.8 N-m)

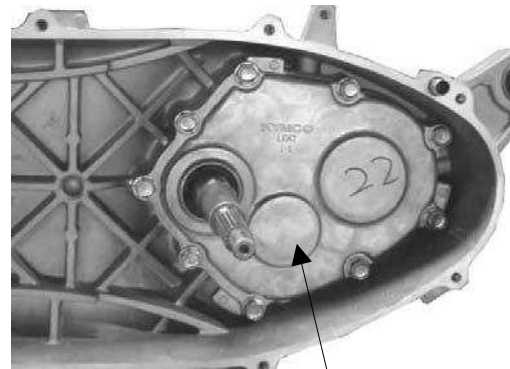

After installation, fill the transmission case with the specified oil.

\*

- Place the scooter on its main stand on level ground.
- Check the oil-sealing washer for wear or damage.

**Specified Gear Oil:** SAE90#

#### Oil Capacity:

At disassembly : 0.23 liter  
At change : 0.21 liter

Install and tighten the oil check bolt.

#### Torque:

Oil filler/drain bolt 1.8-2.2 kgf-m (19.7 N-m)

Start the engine and check for oil leaks.  
Check the oil level from the oil check bolt hole and add the specified oil to the proper level if the oil level is low.

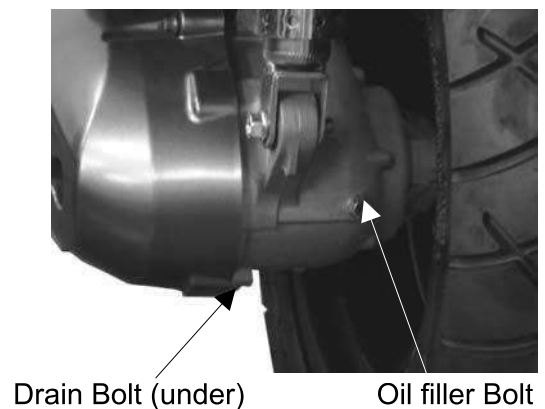

---

# 10. A.C. GENERATOR/STARTER CLUTCH

---

---

## A.C. GENERATOR/STARTER CLUTCH

---

SCHEMATIC DRAWING-----	10-1
SERVICE INFORMATION-----	10-2
TROUBLESHOOTING -----	10-2
RIGHT CRANKCASE COVER REMOVAL-----	10-3
STATOR REMOVAL-----	10-3
FLYWHEEL REMOVAL-----	10-4
STARTER CLUTCH -----	10-4
FLYWHEEL INSTALLATION -----	10-8
STATOR INSTALLATION -----	10-9
RIGHT CRANKCASE COVER INSTALLATION -----	10-9

**10**

# 10. A.C. GENERATOR/STARTER CLUTCH

Downtown 300i ABS

## SCHEMATIC DRAWING

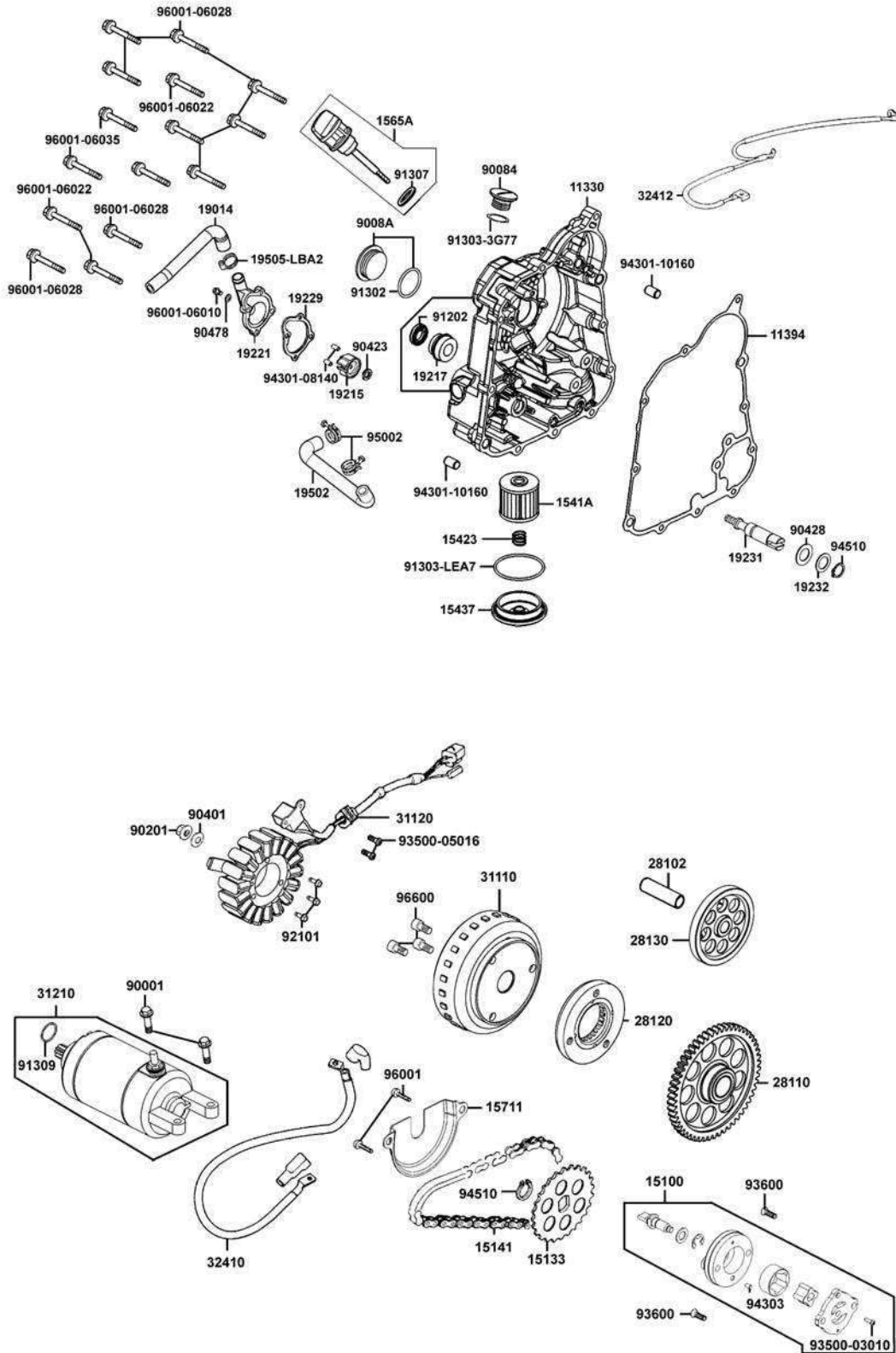



# 10. A.C. GENERATOR/STARTER CLUTCH

## SERVICE INFORMATION

### GENERAL INSTRUCTIONS

- All operations and inspections in this section can be made with the engine installed.
- Should drain the coolant before removing the right crankcase cover.
- Be careful not to drain the coolant when the engine temperature is high. (Perform this operation when the engine is cold.)
- Drain the coolant into a clean container.
- Drain the engine oil into a clean container before removing the right crankcase cover.
- When the right crankcase cover is installed, fill with the recommended engine oil and coolant. Remember to bleed air from the water hose.

### SPECIFICATIONS

Engine oil: SAE 5W/50#  
API-SJ above

Engine quality: Synthetic

Oil capacity at change: 1.5 Liter

Coolant capacity:

Radiator capacity:	0.766 liter
Hose with cool coolant:	0.169 liter
Hose with hot coolant:	0.194 liter
Upper limit for reserve tank capacity:	0.590 liter
Lower limit for reserve tank capacity:	0.370 liter

### SPECIAL TOOLS

Flywheel puller	E003
Flywheel holder	E021

### SPECIFICATIONS

Item	Standard (mm)	Service Limit (mm)
Starter driven gear I.D.	22.026~22.045	22.15mm
Starter driven gear O.D.	42.195~42.208	41.5mm

### TORQUE VALUES

Flywheel nut : 5.5~6.5 kgf-m (58.8 N-m)

### TROUBLESHOOTING

Refer to chapter 1 for A.C. generator troubleshooting.

#### **Starter motor rotates but engine does not start**

- Faulty starter clutch
- Starter motor rotates reversely
- Weak battery

## 10. A.C. GENERATOR/STARTER CLUTCH

### RIGHT CRANKCASE COVER REMOVAL

Disconnect the water hoses from the water pump cover.

Disconnect the water hoses from the right crankcase cover.

Remove 12 bolts attaching the right crankcase cover and the cover.



Water Hose

Remove the bolt between water pump cover and oil filter.

Remove right crankcase cover.

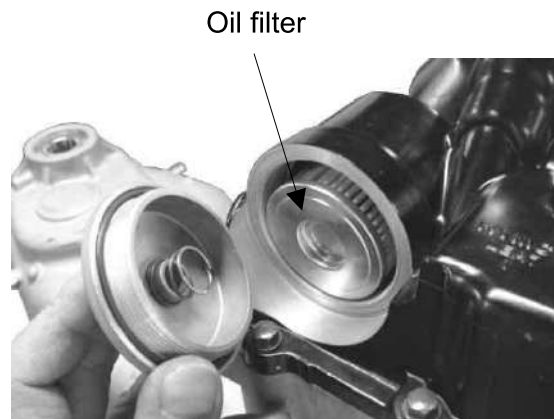

Oil filter

### STATOR REMOVAL

Remove two screws attaching the pulsar coil.

Remove three A.C. generator stator bolts and the stator.

\* When removing the pulsar coil and stator, be careful not to damage them to avoid short-circuit or broken wire.

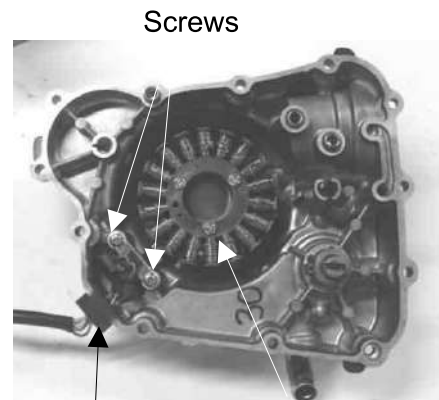

Screws

Pulsar Coil

A.C. Generator Stator

## 10. A.C. GENERATOR/STARTER CLUTCH

### FLYWHEEL REMOVAL

Hold the flywheel with a flywheel holder and remove the flywheel nut and washer.

Special

Flywheel holder E021

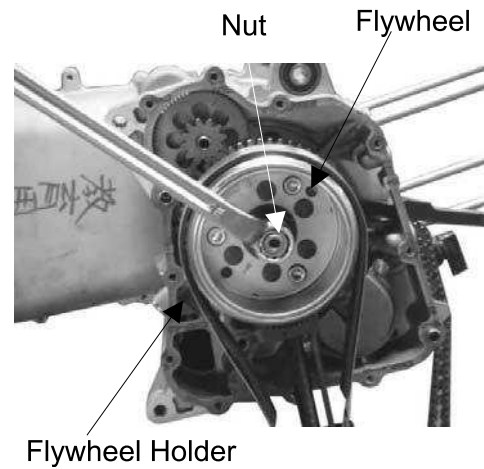

Remove the flywheel with a flywheel puller.

Special

Flywheel puller E003

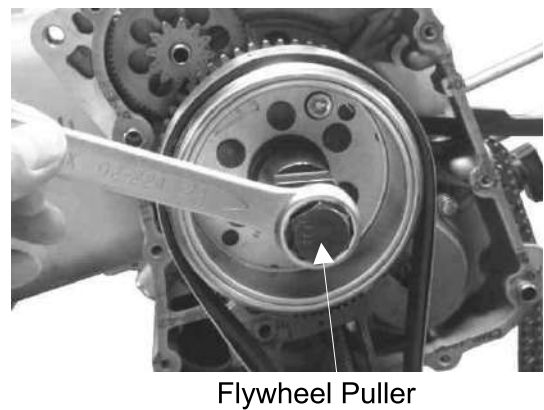

### STARTER CLUTCH REMOVAL

Remove the starter driven gear.  
Remove the starter idle gear and shaft.

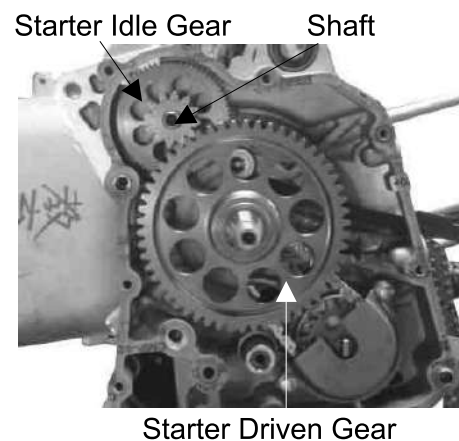

## 10. A.C. GENERATOR/STARTER CLUTCH

### OIL PUMP REMOVAL

Remove the attaching bolts and oil separator cover.

Oil Separator Cover

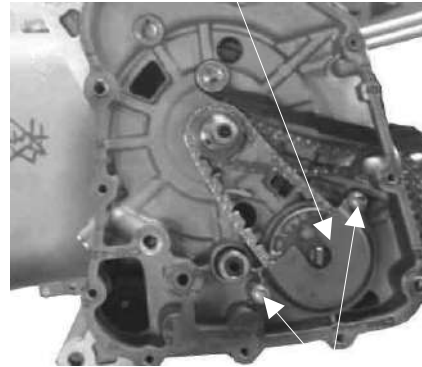

Bolts

Spread the clip off and remove the oil pump driven gear, then remove the oil pump drive chain.

Remove the cam chain.

Oil Pump Drive chain

Cam Chain

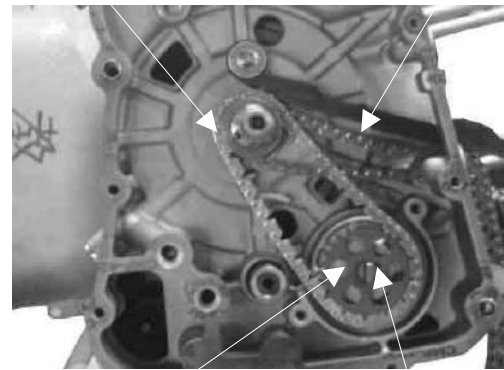

Oil Pump Driven Gear

Clip

Remove the two oil pump bolts to remove the oil pump.

Bolts



Oil pump

## 10. A.C. GENERATOR/STARTER CLUTCH

### INSPECTION

Inspect the starter driven gear for wear or damage.

Measure the starter driven gear I.D. and O.D.

#### Service Limits:

**I.D.:** 22.15mm replace if over

**O.D.:** 41.50mm replace if below

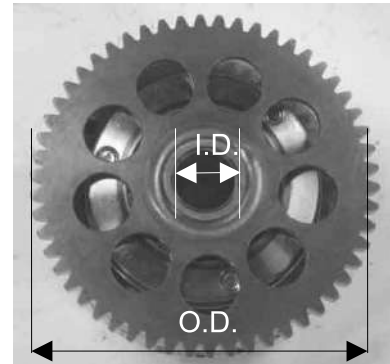

Inspect the starter idle gear and shaft for wear or damage.

Starter Idle Gear

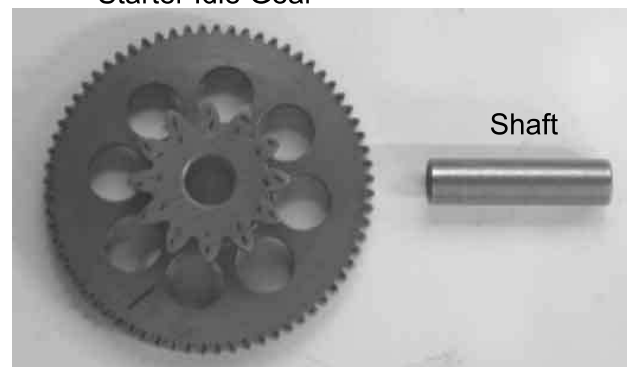

Inspect the starter one-way clutch for wear or damage.

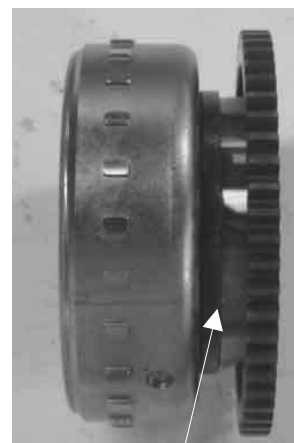

Starter One-way Clutch

# 10. A.C. GENERATOR/STARTER CLUTCH

## INSTALLATION

Install oil pump and tighten two bolts.  
 Make sure that the pump shaft rotates freely.  
 The arrow of oil pump is upside.  
 Install cam chain.

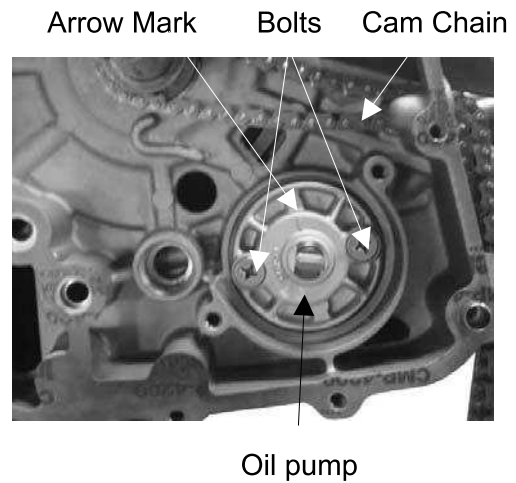

Install the pump drive chain and driven gear, then set the clip securely on the pump shaft.

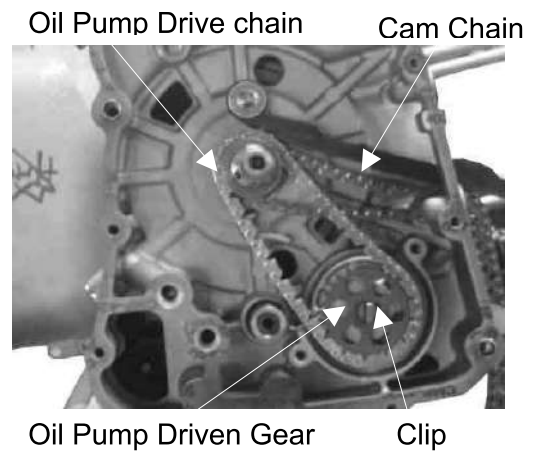

Install the oil separator cover properly.

\* Fit the tab of the separator cover into the slit in the separator.



# 10. A.C. GENERATOR/STARTER CLUTCH

Install the starter idle gear and shaft.  
Install the starter driven gear onto the crankshaft.

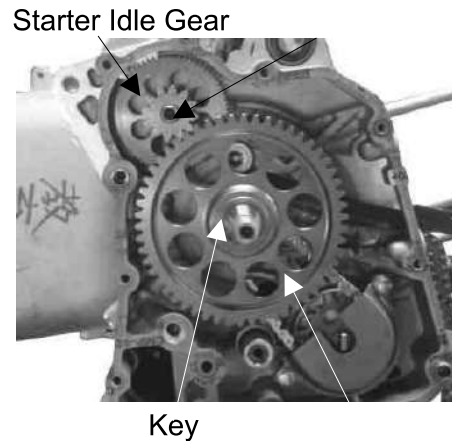

## FLYWHEEL INSTALLATION

Install the flywheel onto the crankshaft by aligning the key on the crankshaft with the groove in the flywheel.

- \* 
 • Before installation, check and make sure that the inside of the flywheel is not contaminated.

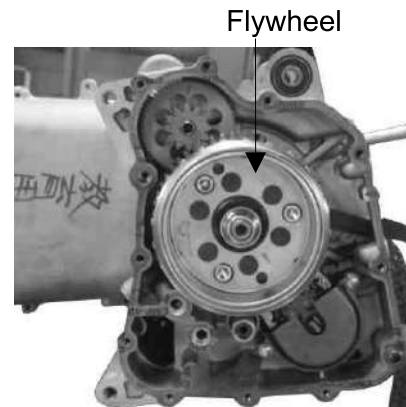

Install washer and nut.  
Hold the flywheel with the flywheel holder and tighten the flywheel nut.

**Torque:** 5.5~6.5 kgf-m (58.8 N-m)  
Remove the flywheel nut and washer.



Flywheel holder E021

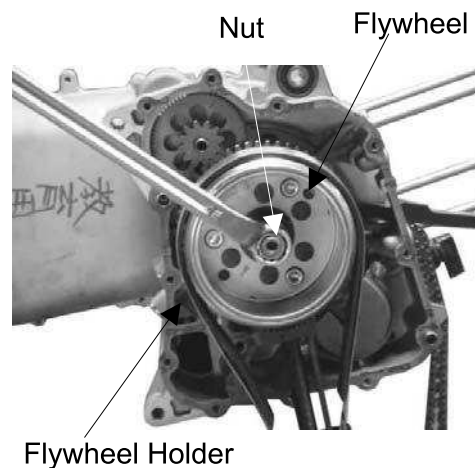

## 10. A.C. GENERATOR/STARTER CLUTCH

### STATOR INSTALLATION

Install the A.C. generator stator on the right crankcase cover and secure it with the three bolts.

Install the pulsar coil on the right crankcase cover and secure it with the two screws.

Install the wire grommet in the groove in the right crankcase cover securely.

\* Be sure to route the stator wire under the pulsar coil.

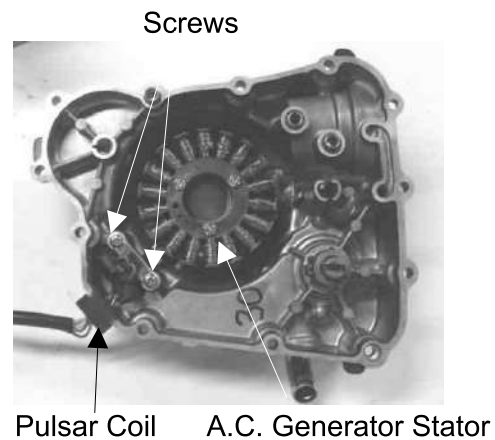

### RIGHT CRANKCASE COVER INSTALLATION

Install the two dowel pins and a new gasket.

Install the right crankcase cover over the crankcase, aligning the water pump shaft groove with the oil pump shaft.



Tighten 12 bolts attaching to right crankcase cover.

Connect the water hoses to the right crankcase cover and water pump cover.

Add the recommended engine oil.

Fill the cooling system with the specified coolant.

\* Be sure to bleed air from the water hose after filling the coolant.

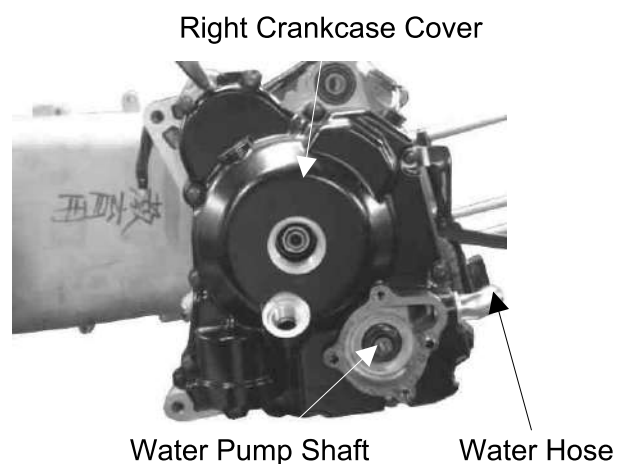



# 11. CRANKCASE/CRANKSHAFT

---

---

---

---

---

---

---

---

---

## CRANKCASE/CRANKSHAFT

---

SCHEMATIC DRAWING-----	11-1
SERVICE INFORMATION-----	11-2
TROUBLESHOOTING -----	11-2
CRANKCASE SEPARATION-----	11-3
CRANKSHAFT INSPECTION -----	11-4
CRANKCASE ASSEMBLY-----	11-5

# 11. CRANKCASE/CRANKSHAFT

## SCHEMATIC DRAWING

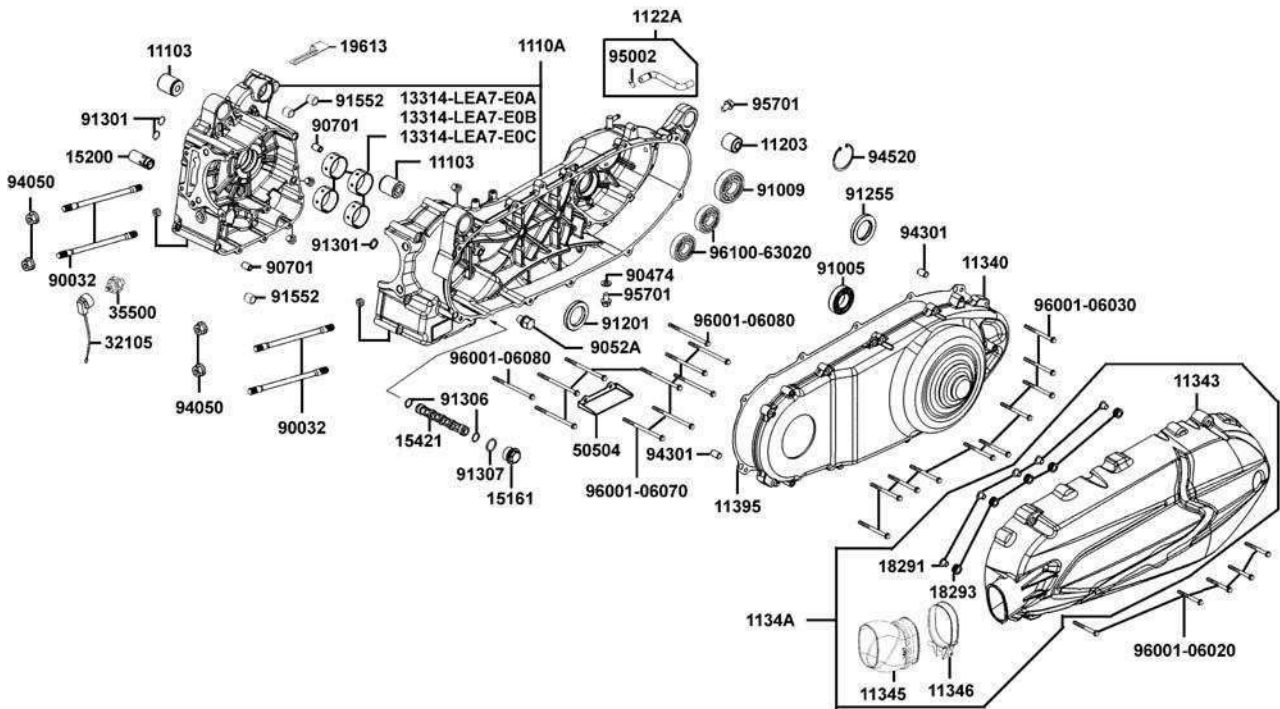

# 11. CRANKCASE/CRANKSHAFT

## SERVICE INFORMATION

### GENERAL INSTRUCTIONS

- This section covers crankcase separation to service the crankshaft. The engine must be removed for this operation.
- When separating the crankcase, never use a driver to knock the crankcase forcedly to prevent damaging the mating surfaces.
- When installing the crankcase, do not use an iron hammer to tap it.
- When installing the crankcase or crankshaft, must be replaced in pair.
- The following parts must be removed before separating the crankcase.

Cylinder head

Cylinder/piston

Right crankcase cover/drive and driven pulley

A.C. generator/starter clutch

Rear wheel/rear shock absorber

Starter motor

Oil pump

### SPECIFICATIONS

	Item	Standard (mm)	Service Limit (mm)
Crankshaft	Connecting rod big end side clearance	0.15~0.35	0.6
	Connecting rod big end radial clearance	0~0.008	0.05

### TORQUE VALUES

Crankcase cover bolt	1.0~1.4 kgf-m (11.8 N-m)
Cam chain tensioner pivot	0.8~1.2 kgf-m (9.8 N-m)

### TROUBLESHOOTING

#### Excessive engine noise

- Excessive bearing play
- Excessive crankpin bearing play
- Worn piston pin and piston pin hole

## 11. CRANKCASE/CRANKSHAFT

### CRANKCASE SEPARATION

Remove bolts attaching left crankcase.  
Place the crankcase with the left crankcase  
down and remove the right crankcase from  
the left crankcase.

- \* • Never use a driver to knock the  
crankcase mating surfaces apart.



Remove the engine oil screen.

Engine oil screen



Remove the crankshaft from the left  
crankcase.

Left Crankcase

Crankshaft

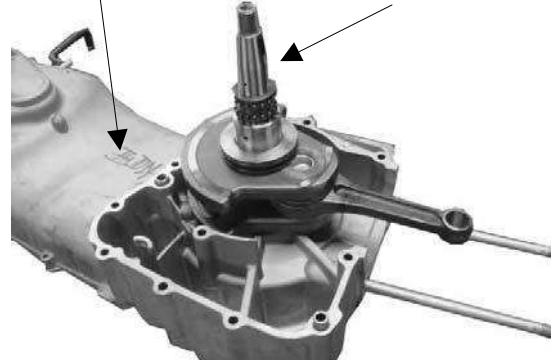

## 11. CRANKCASE/CRANKSHAFT

Remove the oil seal from the left crankcase.



### CRANKSHAFT INSPECTION

Measure the connecting rod big end side clearance.

**Service Limit:** 0.6 mm replace if over

Measure the connecting rod small end I.D.

**Service Limit:** 17.06 mm replace if over

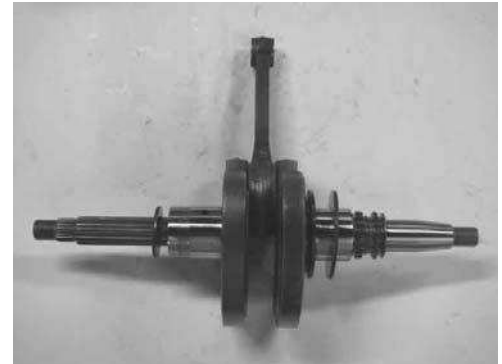

Measure the crankshaft bearing play.

**Service Limits:**

Axial : 0.20 mm replace if over

Radial: 0.05 mm replace if over

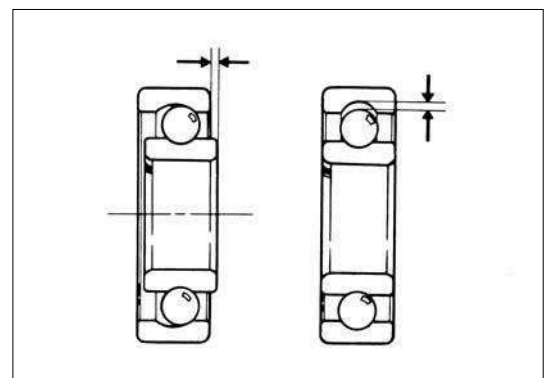

# 11. CRANKCASE/CRANKSHAFT

## CRANKCASE ASSEMBLY

Install a new oil seal onto the left crankcase.  
Place the left crankcase down and install the crankshaft into the left crankcase.

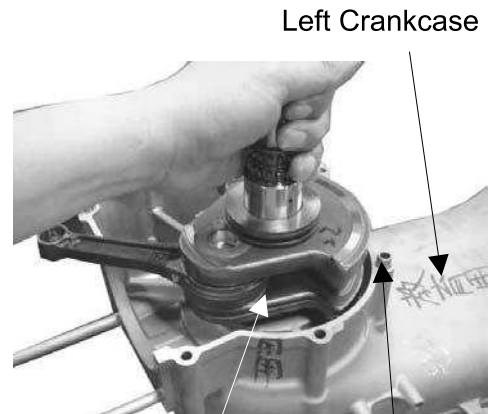

- \*
  - Avoid damaging the oil seal.
  - Apply grease to the lip of the oil seal.

- \*
  - Avoid damaging the crankcase mating surfaces.

Install the two dowel pins.

Place the right crankcase over the crankshaft and onto the left crankcase.

- \*
  - Install the right crankcase squarely and do not tap it with an iron or plastic hammer.

Install and tighten the right and left crankcase attaching bolts.

Install the engine oil screen.

- \*
  - To install the crankshaft or crankcase, must be replaced in pair.

Crankcase Bearing	Crankcase mark			
Crankshaft	A	B	C	D
Crankshaft mark	A	B	C	D
A	black	green	green	Red
B	green	green	Red	

# 12. COOLING SYSTEM

---

---

---

---

---

---

---

---

---

---

## COOLING SYSTEM

---

SCHEMATIC DRAWING-----	12-	1
SERVICE INFORMATION-----	12-	2
TROUBLESHOOTING -----	12-	2
COOLING SYSTEM TESTING-----	12-	4
RADIATOR -----	12-	4
WATER PUMP -----	12-	8
THERMOSENSOR-----	12-	11
THERMOSTAT-----	12-	12

# 12. COOLING SYSTEM

## SCHEMATIC DRAWING

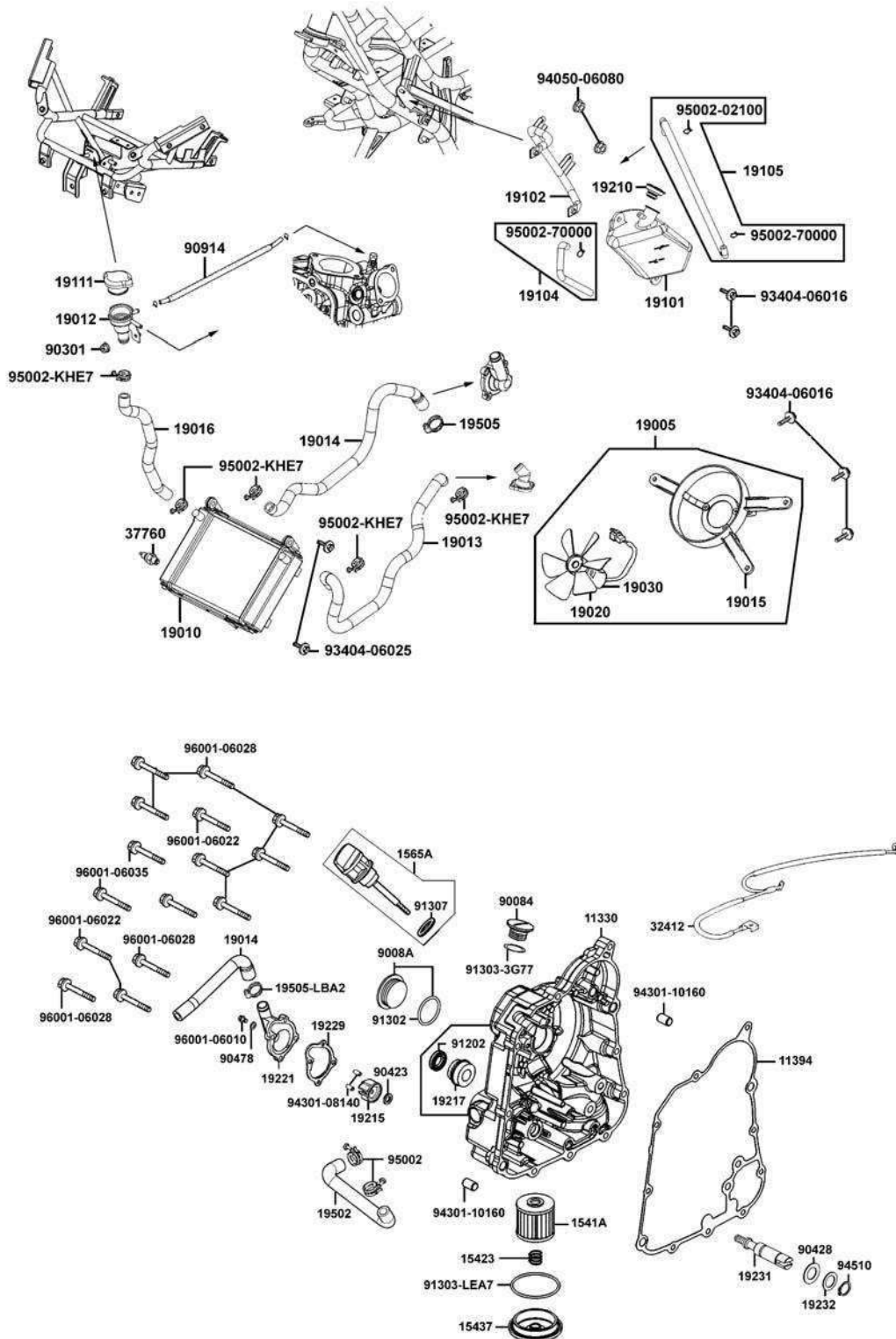



## 12. COOLING SYSTEM

### SERVICE INFORMATION

#### GENERAL INSTRUCTIONS

- The water pump must be serviced after removing the engine. Other cooling system service can be done with the engine installed in the frame.
- The engine must be cool before servicing the cooling system.  
When the coolant temperature is over 100°C, never remove the radiator cap to release the pressure because the boiling coolant may cause danger.
- Avoid spilling coolant on painted surfaces because the coolant will corrode the painted surfaces. Wash off any spilled coolant with fresh water as soon as possible.
- After servicing the system, check for leaks with a cooling system tester.

#### TORQUE VALUES

Water pump impeller	1.0~1.4 kgf-m (11.8 N-m)
Water pump cover bolt	1.0~1.4 kgf-m (11.8 N-m)

#### TROUBLESHOOTING

##### Engine temperature too high

- Faulty temperature gauge or thermosensor
- Faulty radiator cap
- Faulty thermostat
- Insufficient coolant
- Passages blocked in hoses or water jacket
- Clogged radiator fins
- Passages blocked in radiator
- Faulty water pump

##### Coolant leaks

- Faulty pump mechanical (water) seal
- Deteriorated O-rings
- Damaged or deteriorated water hoses

##### Temperature gauge shows the wrong temperature

- Faulty temperature gauge or thermosensor
- Faulty thermostat

#### SPECIFICATIONS

Radiator cap relief pressure		0.9±0.15 kg/cm <sup>2</sup>	
Thermostat temperature	Begins to open	71 °C	
	Full-open	80 °C	
	Valve lift	3.5~4.5 mm	
Coolant capacity		Total 1719 cc	Radiator: 766 cc Reserve tank: 590 cc Hose: 363 cc

## 12. COOLING SYSTEM

### COOLANT GRAVITY CHART

Temp. °C Coolant concentration	0	5	10	15	20	25	30	35	40	45	50
5%	1.009	1.009	1.008	1.008	1.007	1.006	1.005	1.003	1.001	0.999	0.997
10%	1.018	1.107	1.017	1.016	1.015	1.014	0.013	1.011	1.009	1.007	1.005
15%	1.028	1.027	1.026	1.025	1.024	1.022	1.020	1.018	1.016	1.014	1.012
20%	1.036	1.035	1.034	1.033	1.031	1.029	1.027	1.025	1.023	1.021	1.019
25%	1.045	1.044	1.043	1.042	1.040	1.038	1.036	1.034	1.031	1.028	1.025
30%	1.053	1.051	1.051	1.049	1.047	1.045	1.043	1.041	1.038	1.035	1.032
35%	1.063	1.062	1.060	1.058	1.056	1.054	1.052	1.049	1.046	1.043	1.040
40%	1.072	1.070	1.068	1.066	1.064	1.062	1.059	1.056	1.053	1.050	1.047
45%	1.080	1.078	1.076	1.074	1.072	1.069	1.056	1.063	1.062	1.057	1.054
50%	1.086	1.084	1.082	1.080	1.077	1.074	1.071	1.068	1.065	1.062	1.059
55%	1.095	1.093	1.091	1.088	1.085	1.082	1.079	1.076	1.073	1.070	1.067
60%	1.100	1.098	1.095	1.092	1.089	1.086	1.083	1.080	1.077	1.074	1.071

### COOLANT MIXTURE (WITH ANTI-RUST AND ANTI-FREEZING EFFECTS)

Freezing Point	Mixing Rate	KYMCO SIGMA Coolant Concentrate	Distilled Water
-9°C	20 %	344cc	1375cc
-15°C	30 %	516cc	1203cc
-25°C	40 %	688cc	1031cc
-37°C	50 %	860cc	859cc
-44.5°C	55 %	945cc	774cc

\*

- Use coolant of specified mixing rate. (The mixing rate of 860cc KYMCO SIGMA coolant concentrate + 859cc distilled water is 50%.)
- Do not mix coolant concentrate of different brands.
- Do not drink the coolant, which is poisonous.
- The freezing point of coolant mixture shall be 5°C lower than the freezing point of the riding area.

## 12. COOLING SYSTEM

### COOLING SYSTEM TESTING RADIATOR CAP INSPECTION

Install the radiator cap onto the radiator tester and apply specified pressure to it. It must hold specified pressure for at least six seconds.

- \* Apply water to the sealing cap surface before testing.

#### Radiator Cap Relief Pressure:

$0.9 \pm 0.15 \text{ kg/cm}^2$

Install the radiator tester onto the radiator and apply specified pressure to it. It must hold specified pressure for at least six seconds.

Check the water hoses and connectors for leaks.

- \* The test pressure should not exceed  $1.05 \text{ kg/cm}^2$ . Excessive pressure can damage the radiator and its hose connectors.

### RADIATOR

#### RADIATOR INSPECTION

Remove the front cover.

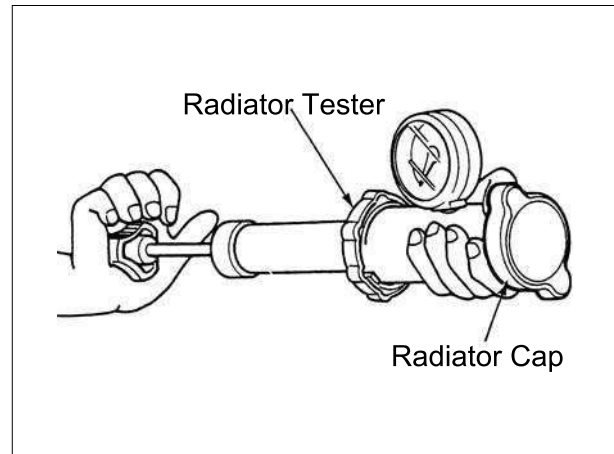

## 12. COOLING SYSTEM

Inspect the radiator soldered joints and seams for leaks.

Blow dirt out from between core fins with compressed air. If insects are clogging the radiator, wash them off. Carefully straighten any bent fins.

Outlet Tube of Reserve Tank

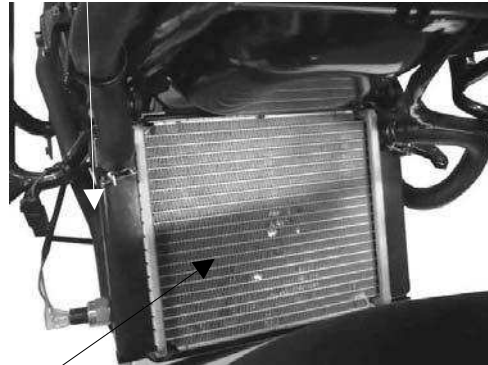

Radiator

### RADIATOR REMOVAL

Drain the coolant.

Disconnect the outlet tube of the reserve tank.

Remove the overflow tube clamp and disconnect the overflow tube.

Disconnect the air vent tube from the radiator filler.

Disconnect the fan motor wire coupler.

Air Vent Tube



Overflow Tube

Loosen the hose band and disconnect the upper hose and lower hose from the radiator.

Disconnect the thermostatic switch wire coupler.

Outlet Tube of Reserve Tank

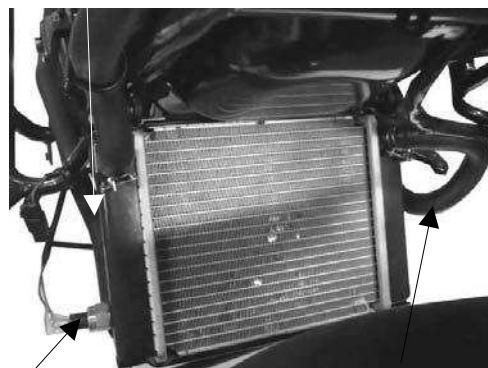

Thermostatic Switch

Outlet Tube of Reserve Tank

## 12. COOLING SYSTEM

Remove three bolts/nuts on the radiator.  
Remove the radiator.

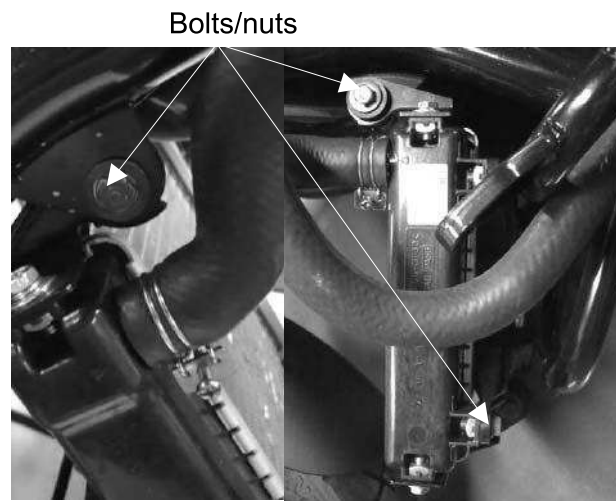

### **RADIATOR DISASSEMBLY**

Remove three bolts and then remove the fan rubber from the radiator.

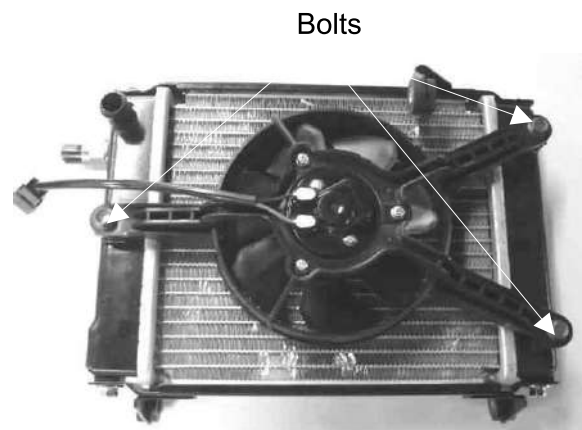

Check fan motor by battery.



## 12. COOLING SYSTEM

### THERMOSTATIC SWITCH

When the coolant temperature is lower than 85 °C, the thermostatic switch OFF.

When coolant temperature is over 90 °C, the thermostatic switch ON.

Thermostatic Switch

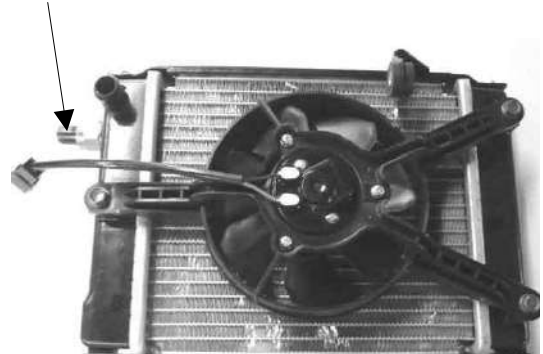

### RADIATOR INSTALLATION

Install the fan rubber on the radiator with three bolts.

Install the radiator on the radiator bracket with three bolts/nuts.

Connect the upper and lower hoses and secure them with hose bands.

Connect the thermostatic switch wire.

Connect the fan motor wire couplers.

Connect the overflow tube and secure with the tube clamp.

Fill the radiator with coolant.

Connect the vent tube to the radiator filler.

After installation, check for coolant leaks.

Connect the outlet tube of the reservoir and secure with the tube clamp.

Air Vent Tube

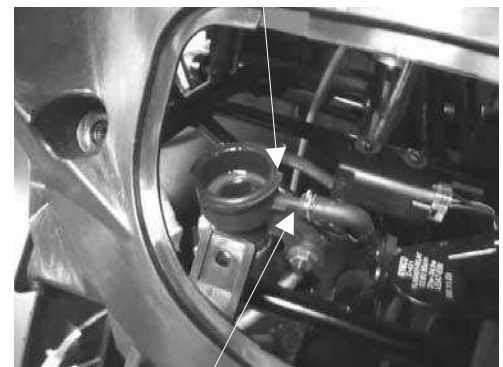

Overflow Tube

\* If you want to refill the coolant, the following procedure must be checked.

1. Please make the radiator filler and the air vent tube to be separated.
2. Start the engine, filled in the coolant till the coolant flowed out from the air vent tube.

## 12. COOLING SYSTEM

### WATER PUMP

#### MECHANICAL SEAL (WATER SEAL) INSPECTION

Inspect the telltale hole for signs of mechanical seal coolant leakage.

If the mechanical seal is leaking, remove the right crankcase cover and replace the mechanical seal.

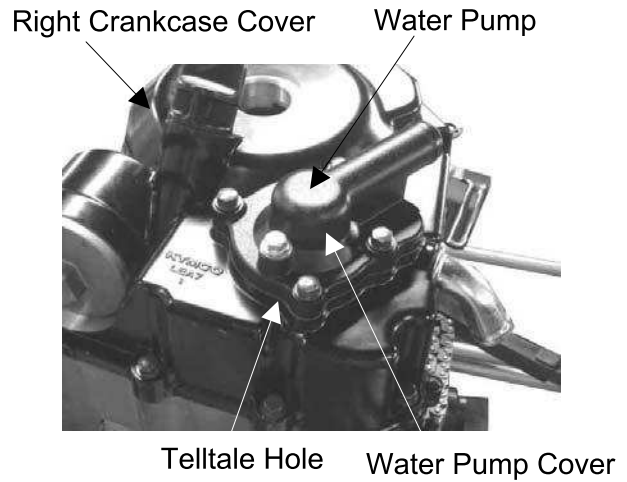

#### WATER PUMP/IMPELLER REMOVAL

Remove the coolant inlet hose and outlet hose.

Remove four bolts and the water pump cover, gasket and 2 dowel pins.

Remove the water pump impeller.

\* The impeller has left hand threads.

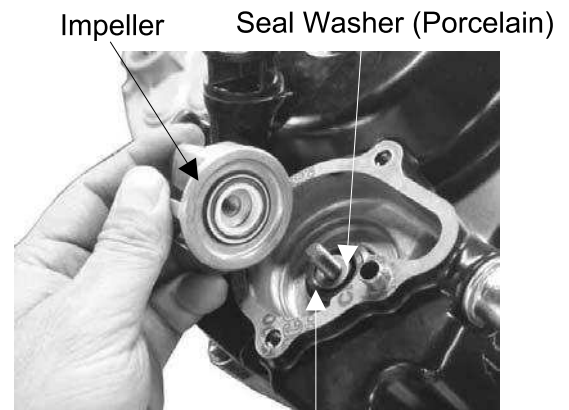

Mechanical (Water) Seal

Inspect the mechanical (water) seal and seal washer if wear or damage.

\* The mechanical seal and seal washer must be replaced as a set.



Water pump shaft

## 12. COOLING SYSTEM

### WATER PUMP SHAFT REMOVAL

Disconnect the water hose from the right crankcase cover.

Remove bolts attaching the right crankcase cover.

Remove the water pump bearing snap ring from the water pump assembly.

Remove the water pump shaft and inner bearing.

Remove the water pump shaft outer bearing.

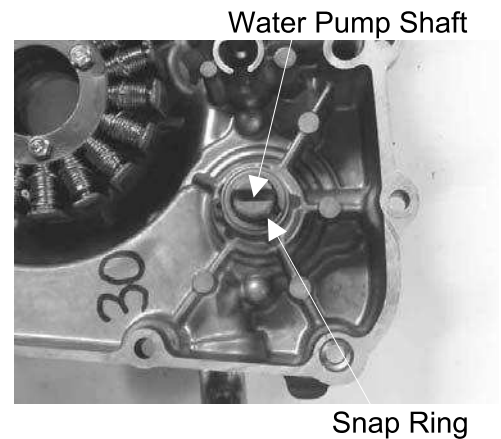

### MECHANICAL SEAL REPLACEMENT

Drive the mechanical seal out of the water pump assembly from the inside.

\* Apply sealant to the right crankcase cover of a new mechanical seal and then drive in the mechanical seal.

### WATER PUMP SHAFT INSTALLATION

Drive a new water pump shaft outer bearing into the water pump assembly from the inside.

Install the water pump shaft and shaft inner bearing into the water pump assembly.

Install the snap ring to secure the inner bearing properly.

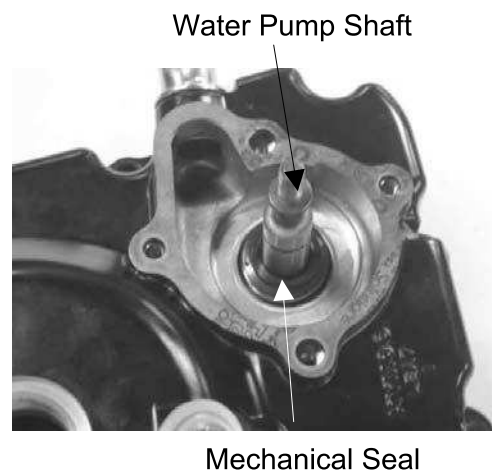



## 12. COOLING SYSTEM

Install the dowel pins and a new gasket and then install the water pump assembly to the right crankcase cover.

Tighten 12 bolts to secure the right crankcase cover.

\* When installing the water pump assembly, aligning the groove on the water pump shaft with the tab on the oil pump shaft.

### WATER PUMP/IMPELLER INSTALLATION

When the mechanical seal is replaced, a new seal washer must be installed to the impeller.

Install the impeller onto the water pump shaft.

**Torque:** 1.0~1.4 kgf-m (11.8 N-m)

\* The impeller has left hand threads.

Install two dowel pins and a new gasket.

Install the water pump cover and tighten the 4 bolts.

**Torque:** 1.0~1.4 kgf-m (11.8 N-m)

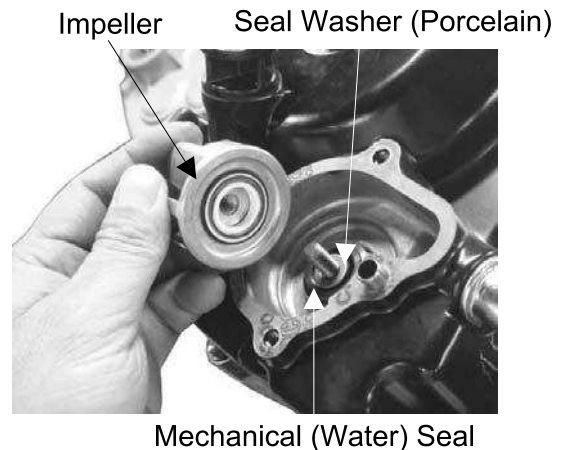

## 12. COOLING SYSTEM

### THERMOSENSOR

#### THERMOSENSOR REMOVAL

Remove the met-in box and carrier.  
 Remove the body cover, center cover and rear fender cover A.

Drain the coolant.

Disconnect the thermosensor wire.

Remove the thermosensor.

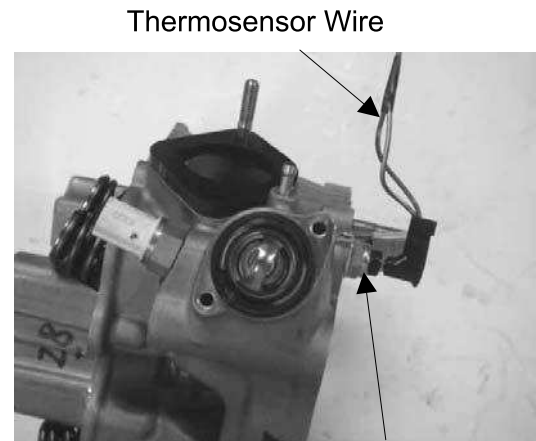

Thermosensor

#### THERMOSENSOR INSPECTION

Suspend the thermosensor in a pan of water over a burner and measure the resistance through the sensor as the water heats up.

Temperature(°C)	50	80	100	120
Resistance(Ω)	154	52	27	16

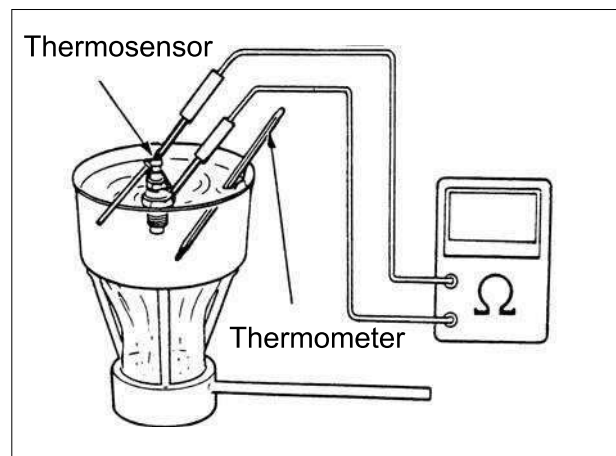

# 12. COOLING SYSTEM

## THERMOSTAT

### THERMOSTAT REMOVAL

Remove the met-in box and carrier.  
 Remove the body cover, center cover and rear fender cover A.

Drain the coolant.  
 Disconnect the thermosensor wire from the thermosensor.  
 Disconnect the water hose from the thermostat housing.  
 Disconnect the air vent tube from the thermostat housing.  
 Remove the mounting bolt and the thermostat housing from the cylinder head.

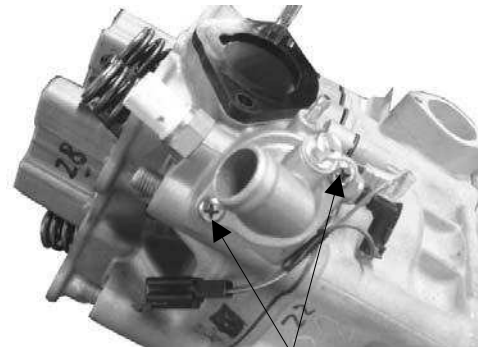

Bolts

Remove two bolts and separate the thermostat housing halves.  
 Remove the thermostat from the thermostat housing.

### THERMOSTAT INSPECTION

Suspend the thermostat in a pan of water over a burner and gradually raise the water temperature to check its operation.

#### Technical Data

Begins to open	71 °C
Full-open	80 °C
Valve lift	3.5~4.5mm



Thermosensor Wire

Thermostat

- \* Do not make the thermostat touch the pan as it will give a false reading.
- \* Replace the thermostat if the valve stays open at room temperature.
- \* Test the thermostat after it is opened for about 5 minutes and holds the temperature at 70°C.

### THERMOSTAT INSTALLATION

- \* Replace the O-ring with a new one and apply grease to it.

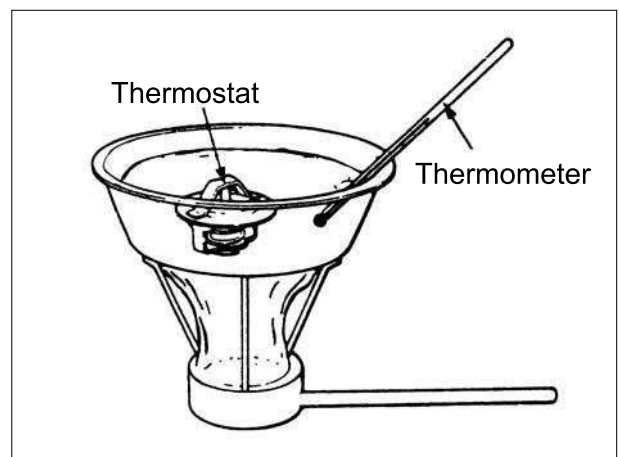

Fill the cooling system with the specified coolant.

---

## FUEL INJECTION SYSTEM

---

SERVICE INFORMATION-----	13- 1
SPECIFICATIONS -----	13- 2
INJECTION SYSTEM DIAGRAM -----	13- 3
PARTS LOCATION -----	13- 4
TROUBLESHOOTING-----	13- 6
SELF-DIAGNOSTIC PROCEDURES WITHOUT DIAGNOSTIC TOOL-----	13- 7
EFI SELF-DIAGNOSIS CHECK ENGINE LAMP (CELP) FAILURE CODES-----	13- 8
SELF-DIAGNOSIS RESET PROCEDURE -----	13- 9
CELP FAILURE CODES LIST-----	13-10
TPS/ISC RESET -----	13-13
FUEL PUMP -----	13-14
FUEL CUT-OFF RELAY -----	13-16
TILT SWITCH-----	13-17
ELECTRONIC CONTROL UNIT (ECU)-----	13-18
FUEL INJECTOR -----	13-20
WTS SENSOR -----	13-22
O <sup>2</sup> SENSOR -----	13-23
THROTTLE BODY/MAP/ISC/TPS -----	13-24
DIAGNOSTIC TOOL CONNECTOR-----	13-27
DIAGNOSTIC TOOL OPERATION INSTRUCTIONS-----	13-28
VEHICLE CAN NOT BE STARTED -----	13-40
MANUAL TROUBLE SHOOTING PROCEDURE-----	13-41

## SERVICE INFORMATION

### GENERAL INSTRUCTIONS

- Scooter services can be done with the engine installed in the frame.
- Be sure to relieve the fuel pressure before fuel pump or fuel hose removal.
- Bending or twisting the control cables will affect operation and could cause the cables to stick or bind, resulting in loss of vehicle control.
- Work in a fully ventilated area. Smoking or allowing flames or sparks in the work area or where gasoline is stored can cause a fire or explosion.
- Do not apply the Carburetor Cleaners to the inside of the throttle body, which is coated with molybdenum.
- Do not snap the throttle valve from fully open to fully close after the throttle cable has been removed; it may cause incorrect idle speed.
- Do not loosen or tighten the painted bolts and screws of the throttle body. Loosening or tightening them can cause throttle and idle valve synchronization failure.
- Seal the cylinder head intake ports with tape or a clean towel to prevent dirt and debris from entering the intake ports after the throttle body has been removed.
- Do not damage the throttle body. It may cause incorrect throttle and idle valve synchronization.
- Do not take the fuel pump on the ground downward.
- Always replace the packing when the fuel pump is removed.
- The electronic fuel injection system is equipped with the self-diagnostic system. If the Check Engine Lamp “CELP” illuminate while riding, follow the self-diagnostic procedures to solve the problem.
- A faulty AFI problem is often related to poorly connected or corroded connectors. Check those connections before proceeding.
- When disassembling the fuel injection parts, note the location of the O-rings. Replace them with new ones upon reassembly.
- Do not disconnect the battery negative (-) or positive (+) cable while engine is running, it may cause ECU damage.
- **Do not disconnect or connect the ECU connector during the ignition switch “ON”; it may cause the ECU damage.**

# 13. FUEL INJECTION SYSTEM



Downtown 300i ABS

## SPECIFICATIONS

ITEM		SPECIFICATIONS
Throttle body identification number		LEA7
Idle speed		1600±100 rpm
Throttle grip free play		2~6 mm (1/16~1/4 in)
Fuel injector resistance (at 20°C/68°F)		11.7±0.6 Ω
Fuel pump resistance (at 20°C/68°F)	Float at full position	1100±33 Ω
	Float at empty position	100±3 Ω
Fuel pump standard pressure (at 40 L/Hr)		294±6 kPa (3 Bar)
Water temperature sensor resistance	At -20°C/-4°F	18.8 KΩ
	At 40°C/104°F	1.136 KΩ
	At 100°C/212°F	0.1553 KΩ
Intake pressure sensor (MAP) pressure (at 1~4.2 V)		13.332 kPa (0.13332 kgf/cm <sup>2</sup> , 1.89 psi)~ 119.99 kPa (1.1999 kgf/cm <sup>2</sup> , 17.04 psi)
Inductive ignition coil		Primary: 3.57~4.83 Ω Secondary: 10.42~14.49K Ω
Throttle position sensor (TPS) resistance (at 20°C/68°F)		3500~6500 Ω
Crank position sensor voltage (at 200 rpm)		100~130 Ω
O <sup>2</sup> heater sensor resistance (at 20°C/68°F)		6.7~9.5 Ω (engine warming condition)
Tilt switch voltage	Standard	0.4~1.4 V
	Over 65° (fall down)	3.7~4.4 V

## INJECTION SYSTEM DIAGRAM

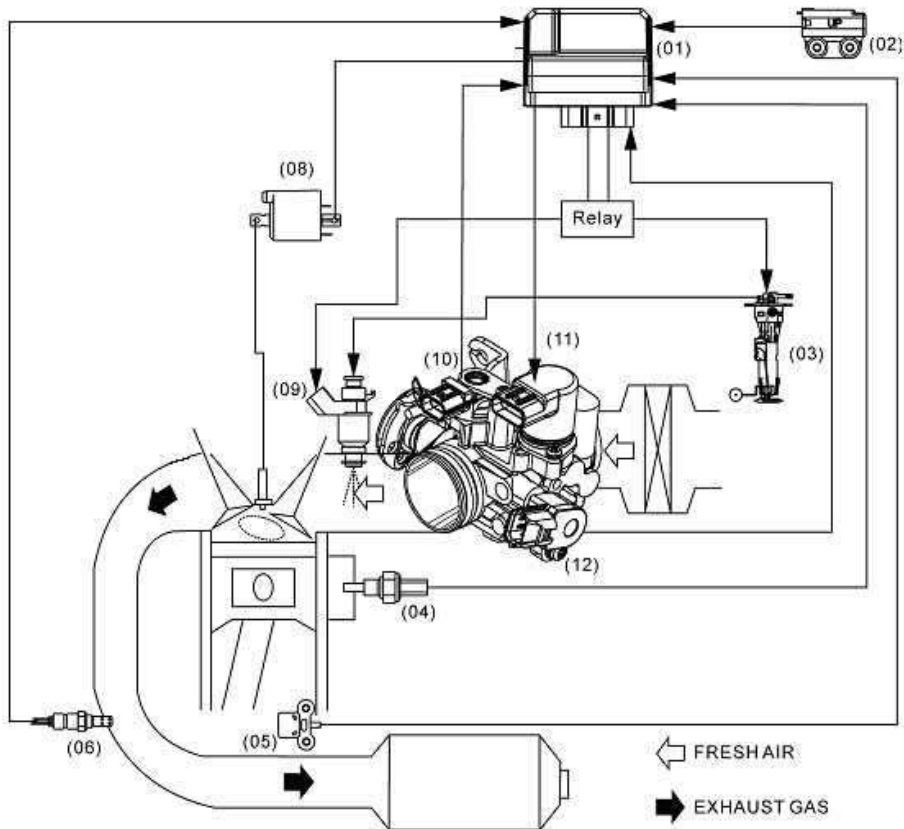

No.	FULL NAME	ABBREVIATIONS
(01)	Electronic control unit	ECU
(02)	Tilt switch (Angle detect sensor)	ROLL
(03)	Fuel pump/Fuel level unit	FP
(04)	Water temperature sensor	WTS sensor
(05)	Crank position sensor (Pulser)	CPS
(06)	Oxygen/Oxygen heater sensor	O <sup>2</sup> /O <sup>2</sup> Heat sensor
(08)	Inductive ignition coil	IG
(09)	Fuel injector (Nozzle)	INJ
(10)	Intake pressure sensor	MAP sensor
(11)	Idle air bypass valve	ISC
(12)	Throttle position sensor	TPS

## PARTS LOCATION

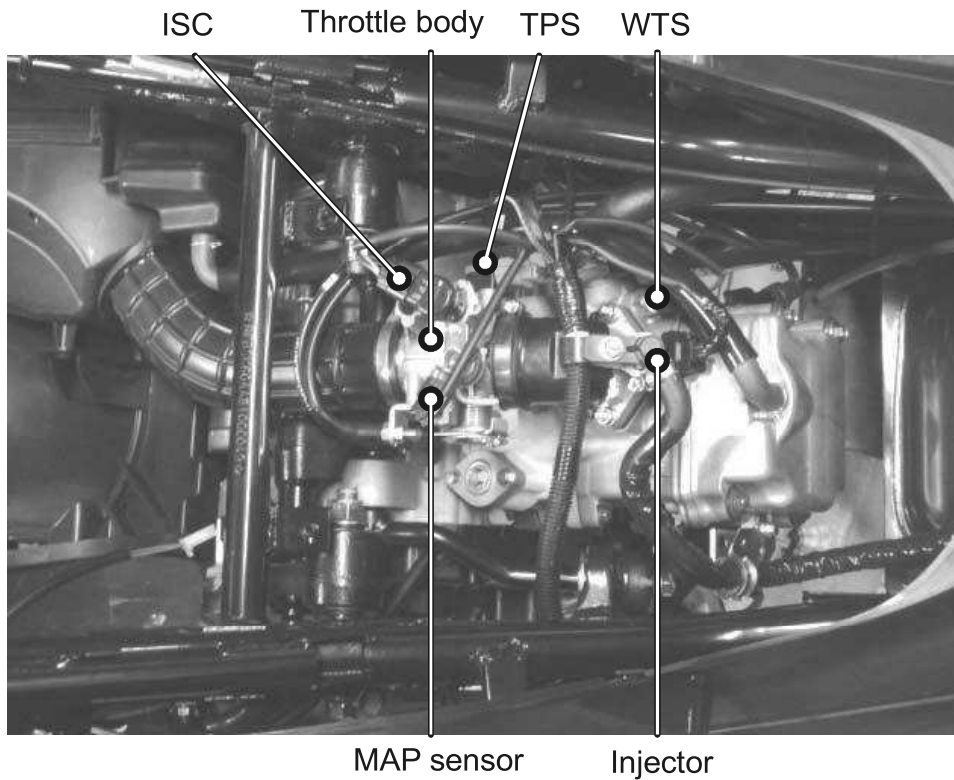
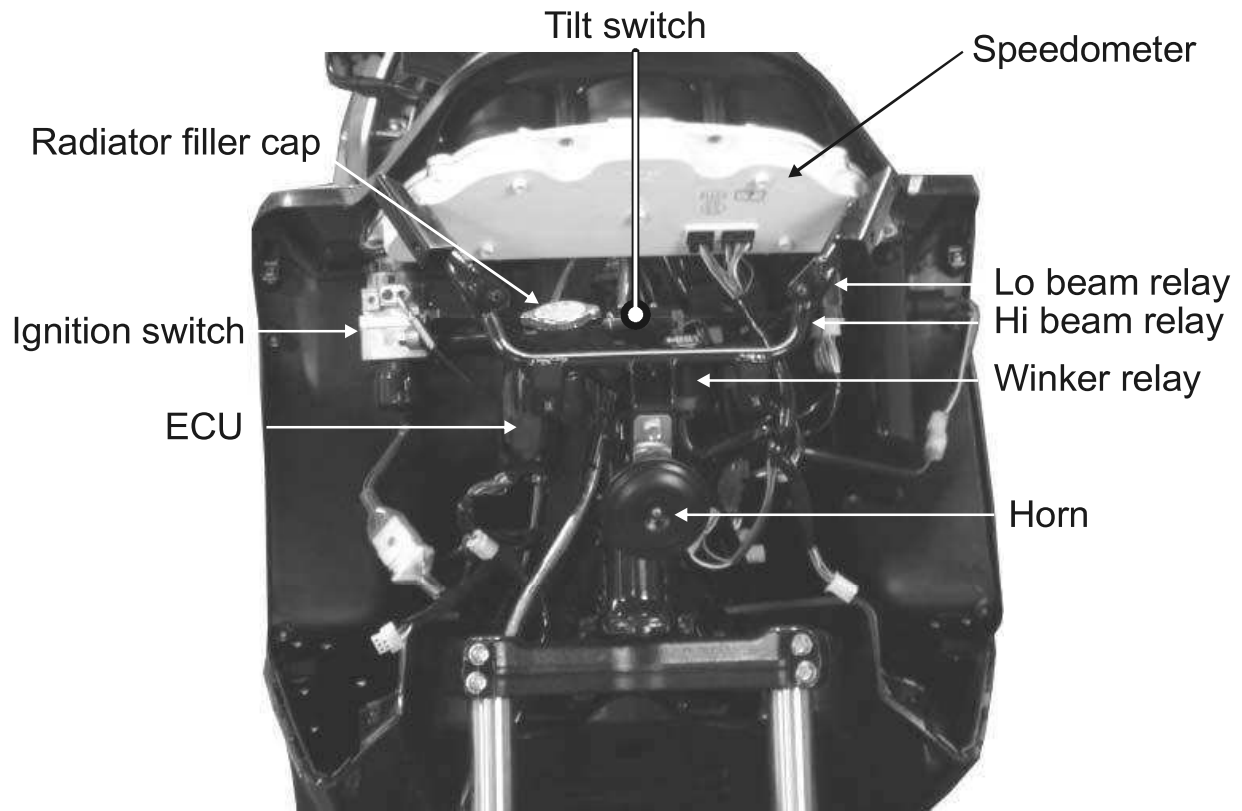



# 13. FUEL INJECTION SYSTEM

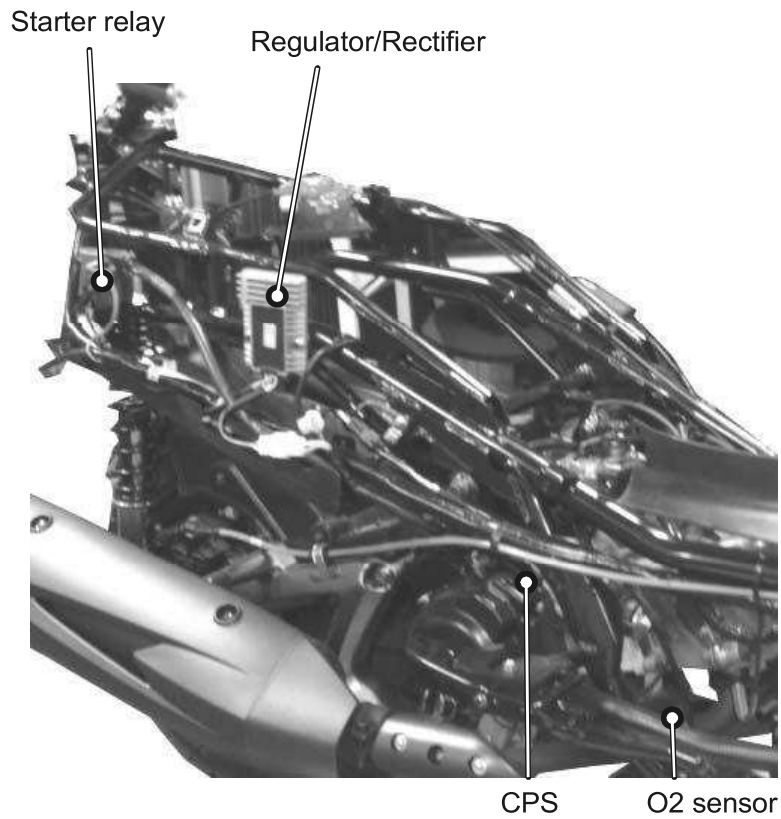
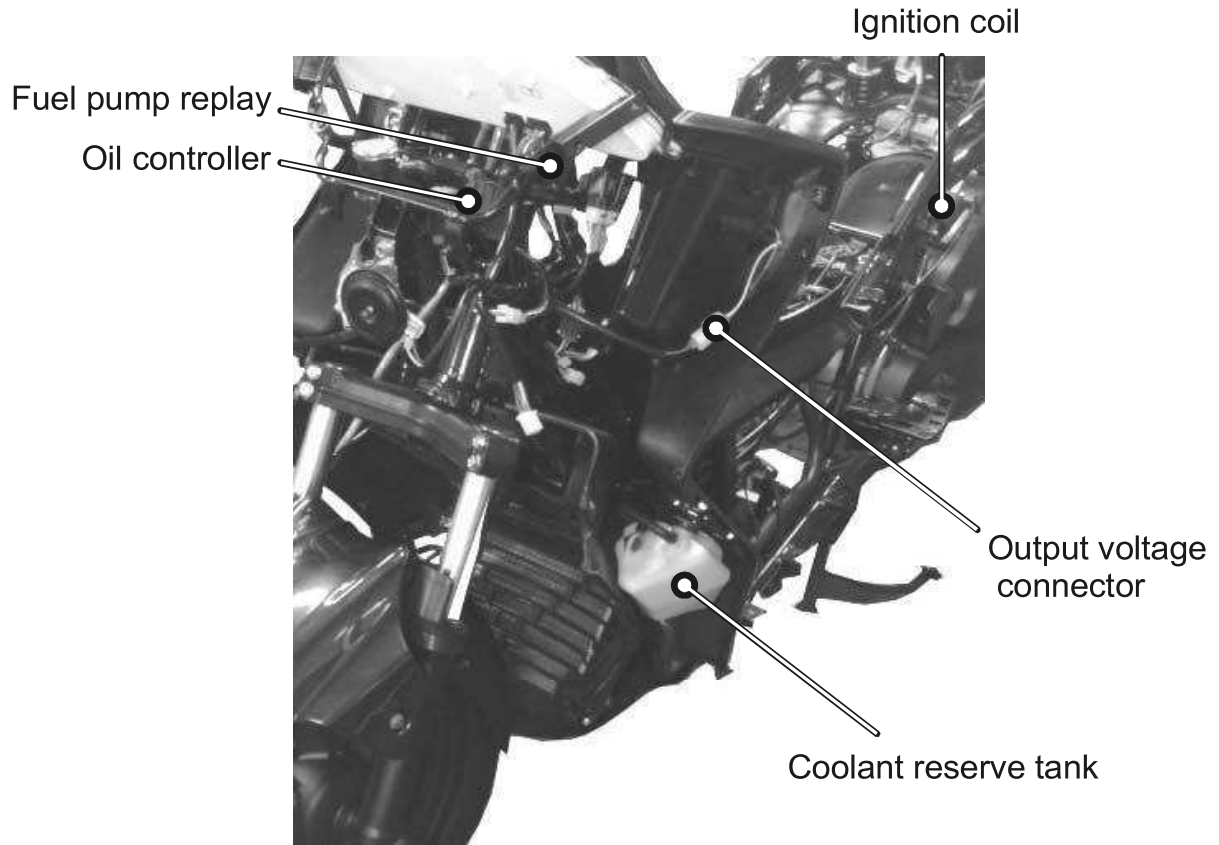

## TROUBLESHOOTING

### Engine fail to start

- Intake manifold air leak
- Fuel contaminated/deteriorated
- Pinched or clogged fuel hose
- Faulty fuel pump
- Clogged fuel filter, throttle body
- Sticking fuel injector needle
- Faulty fuel pump operating system
- Carbon deposit stayed on the fuel injector
- Spark plug dirty
- Fuel pressure incorrect

### Engine stall, hard to start, rough idling

- Intake air leak
- Fuel contaminated/deteriorated
- Pinched or clogged fuel hose
- Idle speed fail to adjust
- Fail to perform PTS/ISC reset

### Backfiring or misfiring during acceleration

- Ignition system malfunction

### Poor performance (drive ability) and poor fuel economy

- Pinched or clogged fuel hose
- Faulty injector

## SELF-DIAGNOSTIC PROCEDURES WITHOUT DIAGNOSTIC TOOL

### SELF-DIAGNOSTIC PROCEDURES

\* It can be performed without diagnostics program.

Place the scooter on its main stand.  
Put the side stand up and the engine stop switch is at "RUN".

- Turn key to On position.
- The CELP will be lighting for two seconds and then off.
- If the engine has problem, the CELP will blink to show the failure codes.
- There're 11 failure codes for the KEHIN system.

If the vehicle gets more failure codes, the CELP will be blinking from a lower number, then show the higher number after three seconds. All failure codes would be appeared repeatedly.

\* No matter when the "CELP" illuminated while riding condition, should find out the cause of the problem as soon as

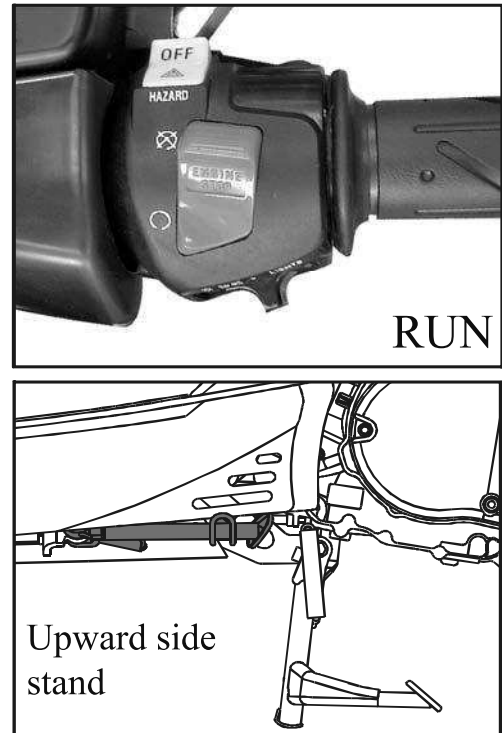

Battery warning indicator

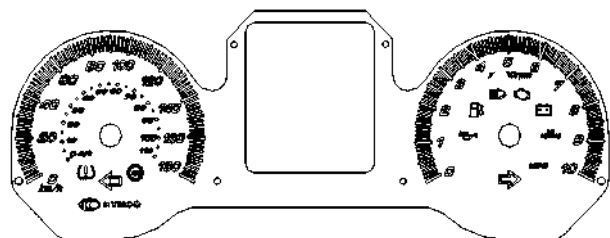
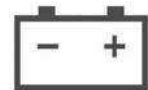
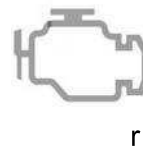

## EFI SELF-DIAGNOSIS CHECK ENGINE LAMP (CELP) FAILURE CODES

The “CELP” denotes the failure codes. When the indicator lights for one second that is equal to ten.

For example: one longer blink illumination and two shorter blinks (0.5 second x 2) of the indicator is equal to 12 blinks. Follow code 12.

If more than a damaged part has occurred, the “CELP” begins blinking in order.

For example: If the indicator blinks six times, then shows one second illumination and two blinks, so there are two failures have occurred. Follow code 6 and 12.

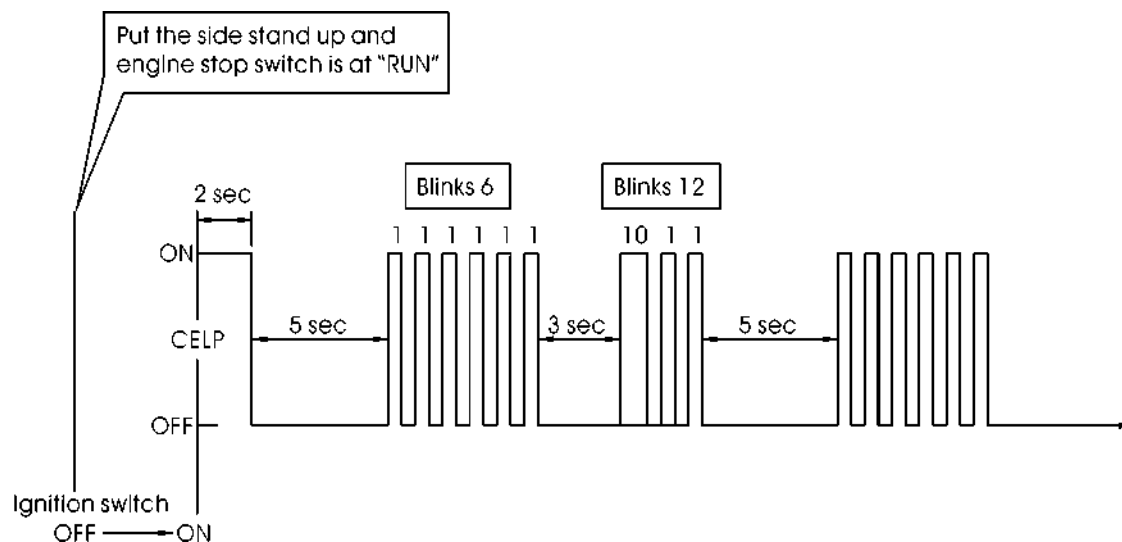

## SELF-DIAGNOSIS RESET PROCEDURE

1. Put the side stand up and engine stop switch is at "RUN".
2. Turn the key to the ON position and wait for ten seconds.
3. Fully open the throttle and wait for ten seconds.
4. Release the throttle.
5. The indicator will blink twice (0.5 second) after five seconds quickly.
6. Self-diagnosis memory data is disappeared after the CELP lamp is off.

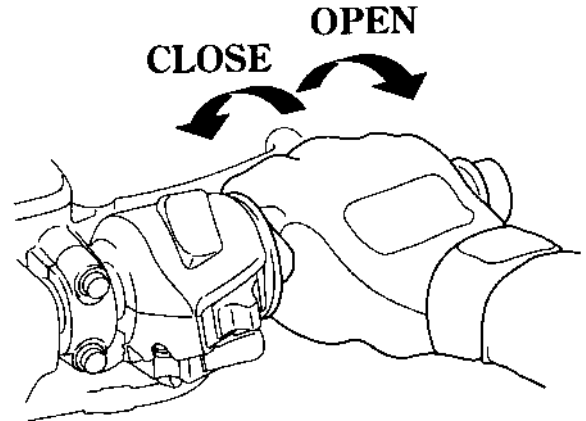

\* The self-diagnosis can not be reset when has still problem inside the system.

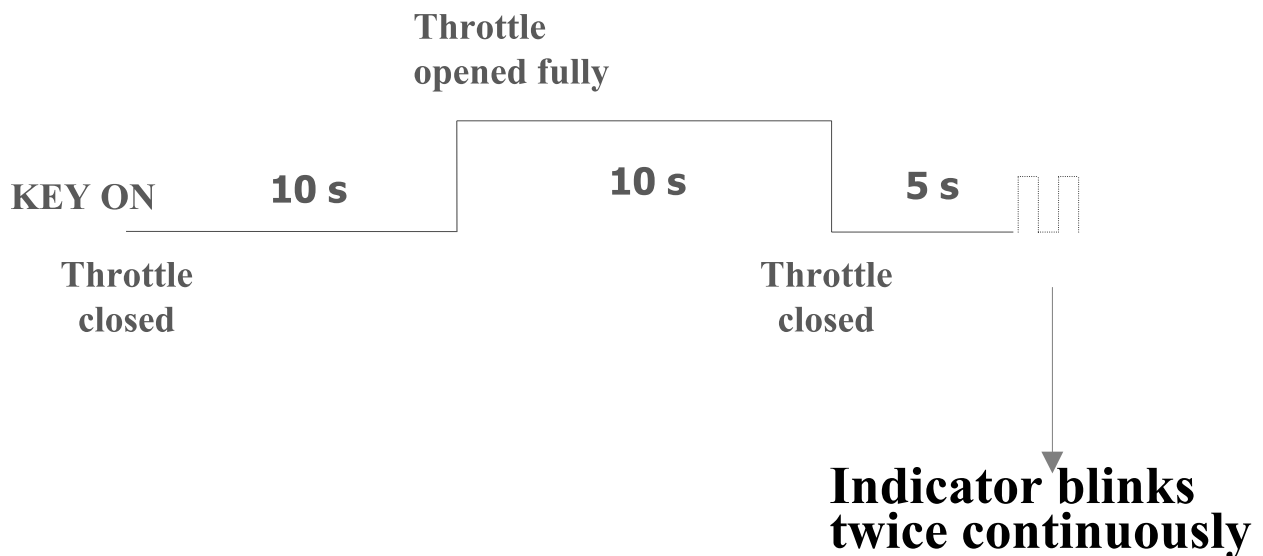

## CELP FAILURE CODES LIST

Blinks	Failure Codes (diagnostic tool)	Contents	Causes	Symptoms
06	P0120	Faulty TPS	<ul style="list-style-type: none"> <li>● Faulty TPS voltage range (0.3~4.5 V)</li> <li>● Loose or poor connection on TPS Sensor</li> <li>● Open or short circuit on the TPS wire</li> <li>● Faulty TPS itself.</li> </ul>	Engine operates normally
09	P0105	Faulty MAP	<ul style="list-style-type: none"> <li>● Faulty MAP voltage range (1~4.2 V)</li> <li>● Loose or poor connection on MAP Sensor</li> <li>● Open or short circuit on MAP wire</li> <li>● Faulty MAP itself</li> </ul>	Engine operates normally
12	P0115	Faulty WTS (water temperature)	<ul style="list-style-type: none"> <li>● Faulty ECT <math>\Omega</math> range (-20°C: 18.8 <math>\Omega</math>/40°C: 1.136 <math>\Omega</math>/100°C: 0.1553 <math>\Omega</math>)</li> <li>● Loose or poor connection on ECT</li> <li>● Open or short circuit on ECT wire</li> <li>● Faulty ECT</li> </ul>	Engine operates normally
15	P1630	Faulty Tilt switch (Roll)	<ul style="list-style-type: none"> <li>● Faulty Tilt switch voltage range (inclined angle &lt;65°: 0.4~1.4 V/ Inclined angle &gt;65°: 3.7~4.4 V)</li> <li>● Loose or poor connection on Tilt switch</li> <li>● Open or short circuit in Tilt switch wire</li> <li>● Faulty tilt switch</li> </ul>	Engine operates normally
17	P0130	Faulty O <sup>2</sup> sensor	<ul style="list-style-type: none"> <li>● Faulty O<sup>2</sup> sensor voltage range (A/F below 14.7: &gt; 0.7V/ A/F over 14.7: &lt; 0.18 V)</li> <li>● Loose or poor connection on O<sup>2</sup> sensor</li> <li>● Open or short circuit on O<sup>2</sup> sensor wire</li> <li>● Faulty O<sup>2</sup> sensor</li> </ul>	Engine operates normally
33	P0201	Faulty injector (Nozzle)	<ul style="list-style-type: none"> <li>● Faulty Fuel injector <math>\Omega</math> range (9.945~13.5 <math>\Omega</math>)</li> <li>● Loose or poor connection on injector</li> <li>● Open or short circuit on injector wire</li> <li>● Faulty fuel injector</li> </ul>	Engine fail to be operated

Blinks	Failure Codes (diagnostic tool)	Contents	Causes	Symptoms
37	P0351	Faulty inductive ignition coil	<ul style="list-style-type: none"> <li>● Faulty Inductive ignition coil <math>\Omega</math> range (<math>4.2 \Omega \pm 15\%</math>)</li> <li>● Loose or poor connection on inductive ignition coil</li> <li>● Open or short circuit on inductive ignition coil wire</li> <li>● Faulty inductive ignition coil</li> </ul>	Engine fail to be operated
41	P0230	Faulty fuel pump	<ul style="list-style-type: none"> <li>● Faulty Fuel pump <math>\Omega</math> range (F: <math>1100 \pm 33 \Omega</math> E: <math>100 \pm 3 \Omega</math>)</li> <li>● Loose or poor connection on fuel pump</li> <li>● Open or short circuit on fuel pump wire</li> <li>● Faulty fuel pump</li> </ul>	Engine fail to be operated
45	P0135	Faulty O <sup>2</sup> sensor heater	<ul style="list-style-type: none"> <li>● Faulty O<sup>2</sup> sensor heater <math>\Omega</math> range (<math>6.7 \Omega \sim 9.5 \Omega</math>)</li> <li>● Loose or poor connection on O<sup>2</sup> sensor heater</li> <li>● Open or short circuit on O<sup>2</sup> sensor heater wire</li> <li>● Faulty O<sup>2</sup> sensor heater</li> </ul>	Engine starts normally but not smooth
49	P1505	Faulty ISC	<ul style="list-style-type: none"> <li>● Loose or poor contacts on ISC</li> <li>● Open or short circuit in ISC wire</li> <li>● Faulty ISC</li> </ul>	Engine operates normally
66	P0335	Faulty CPS	<ul style="list-style-type: none"> <li>● Loose or poor connection on CPS sensor</li> <li>● Open or short circuit on CPS wire</li> <li>● Faulty CPS sensor</li> </ul>	Engine starts normally but not smooth

## SPARK PLUG ANTI-FLOOD

When have not failure code occurs and pressing starter switch repeatedly, can still not start the engine, maybe the spark plug is wet by fuel, perform the spark plug anti-flood to purge the fuel in the engine.

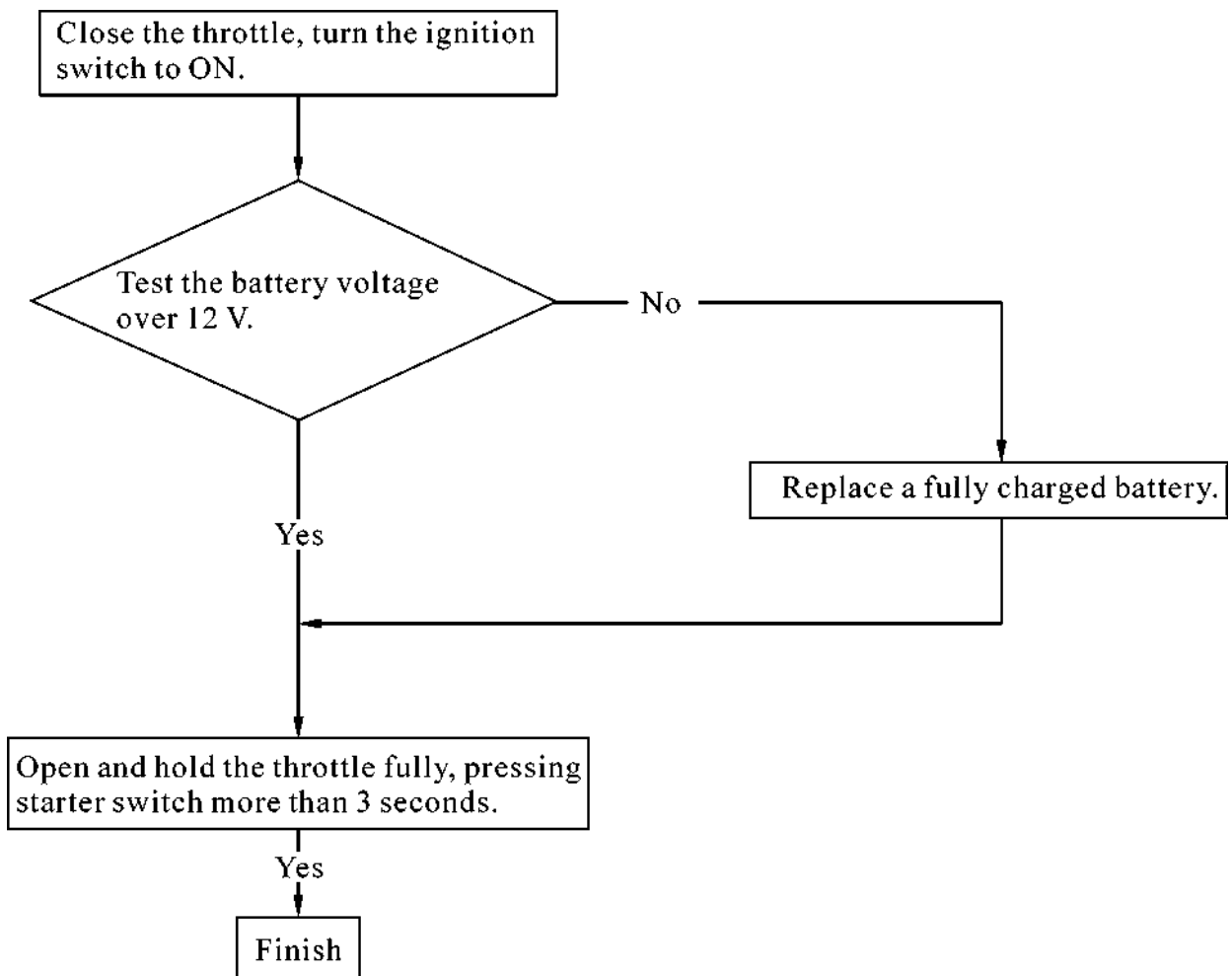



### TPS/ISC RESET

- If close or open the throttle grip randomly, the ECU may record the incorrect TPS when the ECU or the throttle body has been reinstalled. It can cause hard to start engine or idling speed is not smooth when engine installation.
- ISC has a motor inside, which controls ISC valve to obtain smooth idling speed. The ECU may record the incorrect ISC position during the engine speed isn't working when the ECU or the throttle body has been reinstalled. It can cause engine stop, hard to start engine or rough idling speed.

The throttle position sensor (TPS) and idle air bypass valve (ISC) have to be reset when throttle body, MAP, TPS, ISC or ECU has been reinstalled.

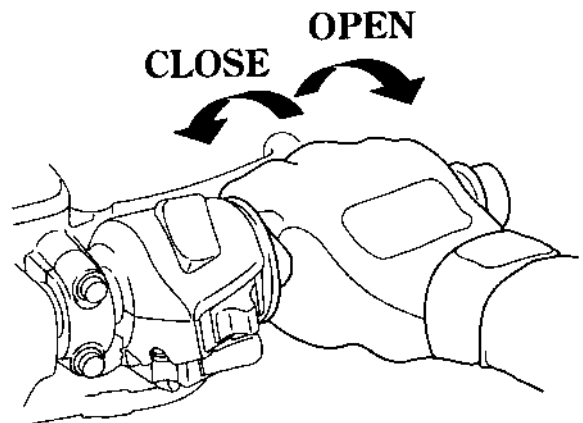

### TPS/ISC RESET PROCEDURE

1. Put the side stand up and engine stop switch is at "RUN".
2. Turn the key to the OFF position.
3. Fully open the throttle.
4. Turn the key to the ON position.
5. Release the throttle after waiting for eight seconds.
6. Turn the key to the OFF position.
7. Turn the key to the ON position.
8. TPS and ISC have been reset successfully.

If fail to reset, repeat the steps from 1 to 8.

## FUEL PUMP

### INSPECTION

Put the side stand up and the engine stop switch is at “RUN”

Disconnect the fuel pump/fuel unit connector.

Connect the multimeter (+) probe to the Red/Black terminal and the multi-meter (-) probe to the Green terminal.

Turn the ignition switch to “ON” and measure the voltage between the terminals.

It should be shown the current battery voltage for a few seconds.

If there is still battery voltage, replace the fuel pump.

If there is not any battery voltage, inspect the following:

- Fuse B (10 A)
- Fuel cut-off relay
- ECU

Measure the resistance between the Red/Black and Green terminals of the fuel pump side connector.

**Standard** (at 20°C/68°F): 1.9±0.3 Ω

### Fuel level sensor inspection

Measure the resistance between the Yellow/White and Green terminals of the fuel pump side connector.

**Standard** (at 20°C/68°F):

Float at full position	1100±33 Ω
Float at empty position	100±3 Ω

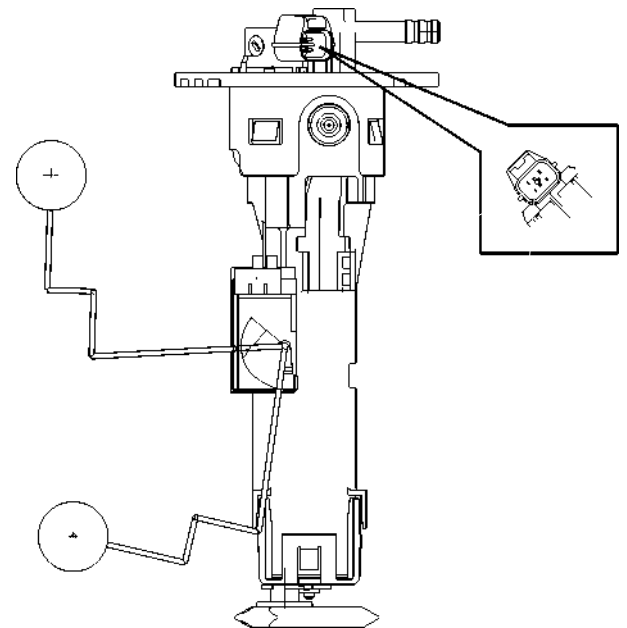

## REMOVAL

Disconnect the connector and fuel band from the fuel pump.  
Remove the six screws onto the fuel pump.  
Remove the fuel pump and O-ring.

Fuel Pump Connector      Hose band

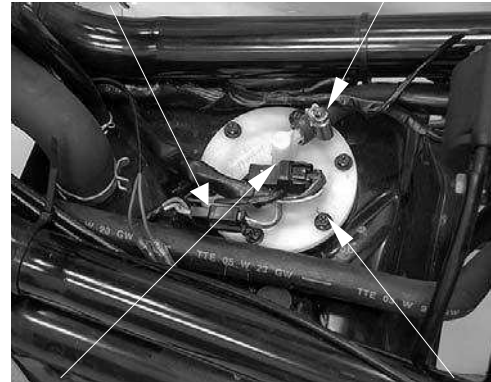

Connector      Screw

## INSTALLATION

Replace a new O-ring on the fuel tank.  
Don't damage the fuel pump wire and ensure the connector rearward carefully.

**Torque:** 0.35 kgf-m (3.5 N-m, 2.5 lbf-ft)



O-ring

## FUEL OUTPUT PRESSURE INSPECTION

Turn the key to the OFF position.  
Use the fuel hose clamp.  
Disconnect the fuel hose from the fuel injector.  
Connect the fuel pressure gauge.  
Turn the key to the ON position.  
Check the fuel pressure.

**Standard:3.0 Bar**

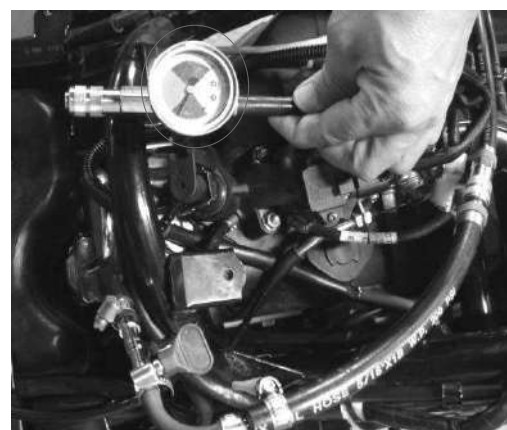

\* **If the fuel output pressure is less than 3.0 bar, may fail to start the engine or in trouble in case of riding.**

## FUEL CUT-OFF RELAY

### INSPECTION

Remove the fuel cut-off relay.  
Connect the ohmmeter to the fuel cut-off relay connector terminals.

#### Connection: Black – Red/Black

Connect 12 V battery with the fuel cut-off relay connector.

#### Connection: Blue/Black – Black

There should be continuity only when 12 V battery connected.

If there is not continuity when the 12 V battery is connected, replace a fuel cut-off relay.

### REMOVAL

Disconnect the fuel cut-off relay connector and remove it from frame.

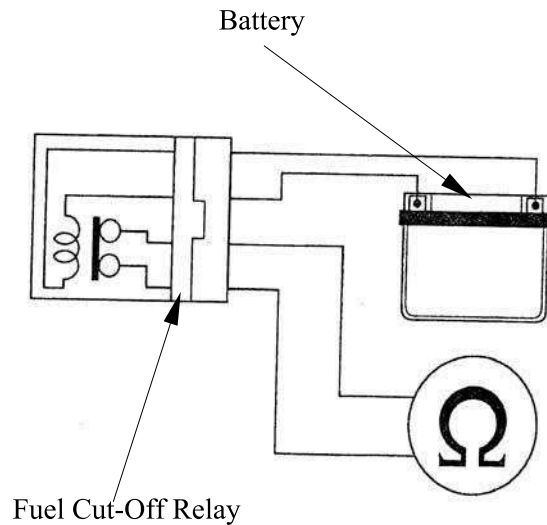

Fuel pump relay

Oil controller

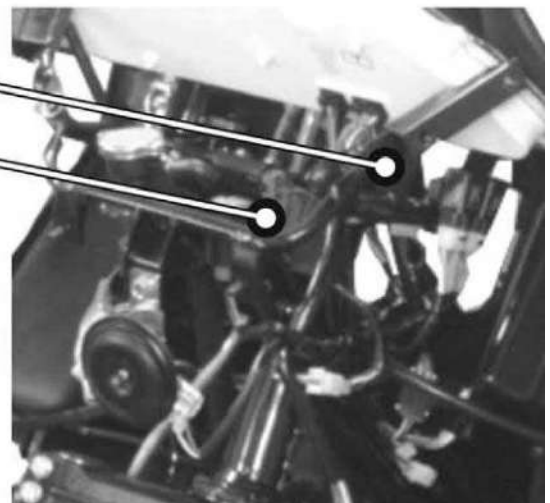

## TILT SWITCH

### INSPECTION

Support the scooter level surface.  
Put the side stand up and engine stop switch is at “RUN”.

Turn the ignition switch to “OFF”  
Remove the screws, washers and tilt switch.

\* Do not disconnect the tilt switch connector during inspection.

Place the tilt switch vertical as shown, and turn the ignition switch to “ON”.

Measure the voltage between the following terminals of the tilt switch connector with the connector connected.

Terminal	Normal
Violet/Red (+) – Green/Pink (-)	5 V (ECU voltage)
Black/Blue (+) – Green/Pink (-)	0.4 ~ 1.4 V

Incline the tilt switch  $65 \pm 10$  degrees to the left or right with the ignition switch turned to “ON”.

Measure the voltage between the following terminals of the tilt switch connector with the connector connected.

Terminal	Normal
Violet/Red (+) – Green/Pink (-)	5 V (ECU voltage)
Black/Blue (+) – Green/Pink (-)	3.7 ~ 4.4 V

If repeat this test, first turn the ignition switch to “OFF”, then turn the ignition switch to “ON”.

### REMOVAL/INSTALLATION

Disconnect the connector and remove two screws.

Remove the Tilt switch.

Installation is in the reverse order of removal.

\* Install the tilt switch with its “UP” mark facing up.

Tighten the mounting screws securely.

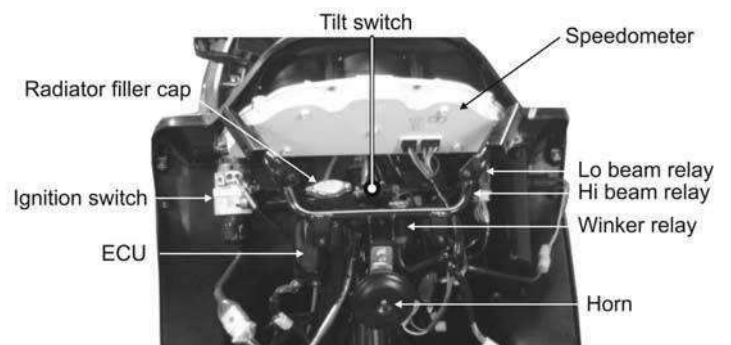
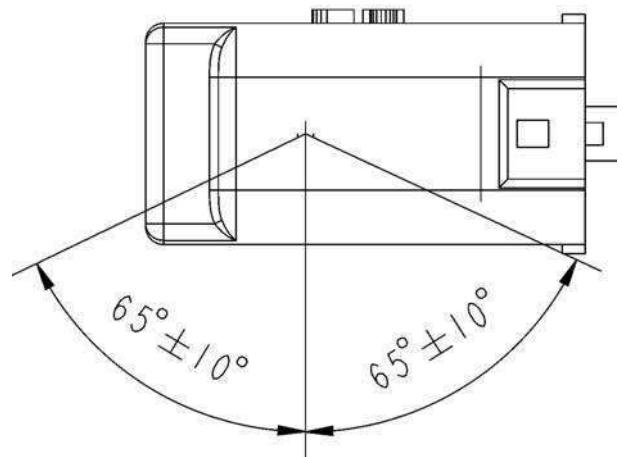
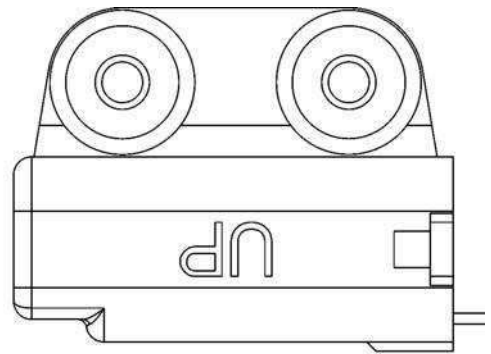

## ELECTRIC CONTROL UNIT (ECU)

### REMOVAL/INSTALLATION

- \* Do not disconnect or connect the ECU connector during the ignition switch "ON"; it may cause the ECU damaged.
- The throttle position sensor (TPS) and idle air bypass valve (ISC) have to be reset when throttle body, MAP, TPS, ISC or ECU has been reinstalled.

Disconnect the ECU connector and remove the ECU from the frame.

Installation is in the reverse order of the removal.

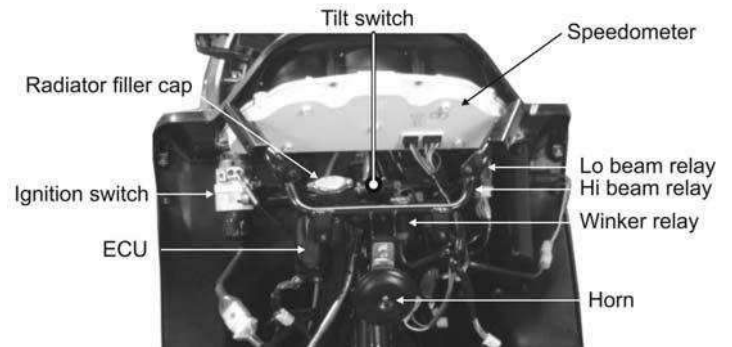

## INSPECTION

Disconnect and remove the ECU from the frame.

Check for continuity between pin 35 and 36 of the ECU side connector.

There should be continuity at all times.

Check for continuity between each pins 8, 9 and 24 of the ECU side connector.

There should be continuity at all times.

Check for continuity between pin 24 and 36 of the ECU side connector.

There should be no continuity at all times.

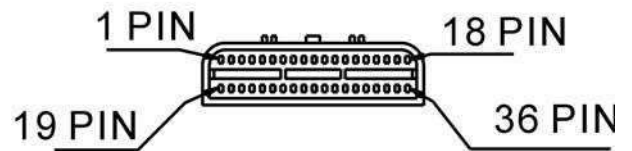
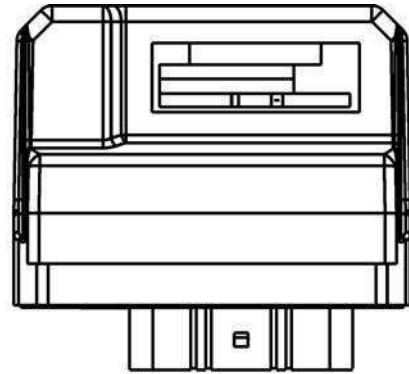

## ECU PIN FUNCTION

PIN NO.	NAME	FUNCTION	PIN NO.	NAME	FUNCTION
1	IGP	Ignition power	19	BATT	Battery
2	ROLL	Roll sensor (Tilt switch)	20	—	—
3	CRK-P	Crank pulse sensor	21	MIL	Multi indicator lamp (ECLP)
4	—	—	22	TW	Water temperature sensor (ECT)
5	TH	Throttle position sensor	23	—	—
6	PM	Manifold pressure sensor (Intake pressure sensor)	24	SG	Sensor ground
7	HEGO	HEGO sensor (O <sub>2</sub> sensor)	25	—	—
8	LG	Logic ground	26	—	—
9	CRK-M	Crank pulse sensor ground	27	—	—
10	K-LINE	Diagnostic tool	28	—	—
11	FLPR	Fuel pump relay	29	—	—
13	VCC	Sensor power output (+5V)	31	ISCAN	Idle speed control (ISC) / A (-)
14	ISCBP	Idle speed control (ISC) B (+)	32	ISCBN	Idle speed control (ISC) / B (-)
15	ISCAP	Idle speed control (ISC) A (+)	33	NE	Meter
16	INJ	Injection	34	—	—
17	HEGO HT	HEGO HT sensor (O <sub>2</sub> HT sensor)	35	PG1	Power ground
18	IG	Ignition coil	36	PG2	Power ground

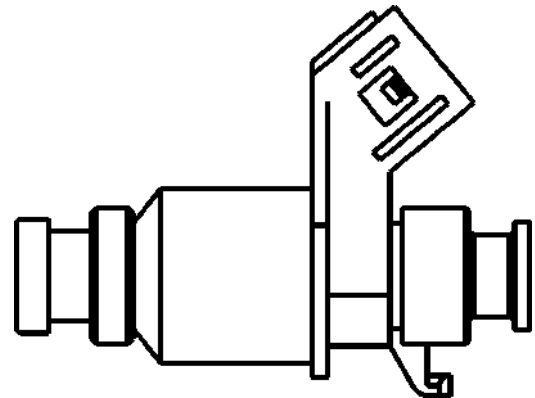

r

Bolt

\*  
Ensure the fuel pipe without any pressure, then remove the fuel injector.  
**STEP 1: Disconnect the fuel pump relay or fuel pump connector.**  
**STEP 2: Turn the key to the ON position. Starting the engine till the engine stop working.**



O-ring

Fuel Injector



## INSTALLATION

Apply the engine oil to a new O-ring.  
Install the fuel injector into the fuel pipe.  
Ensure the tab of the fuel injector inserted into the groove of the fuel pipe.

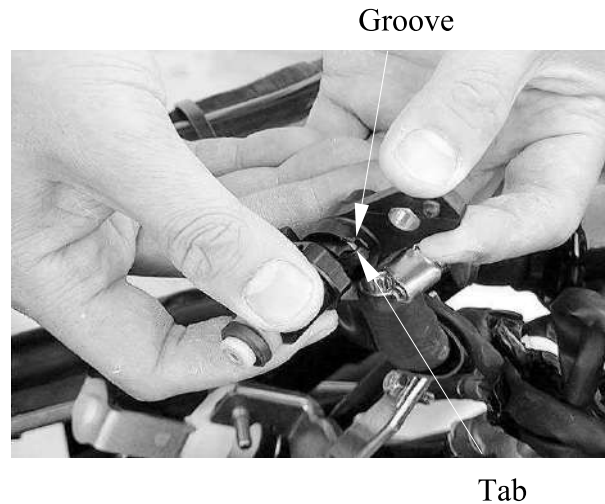

Install the fuel pipe into the intake manifold by aligning the dowel pin.  
Be careful not to damage the O-ring.  
Tighten the fuel pipe mounting bolt.

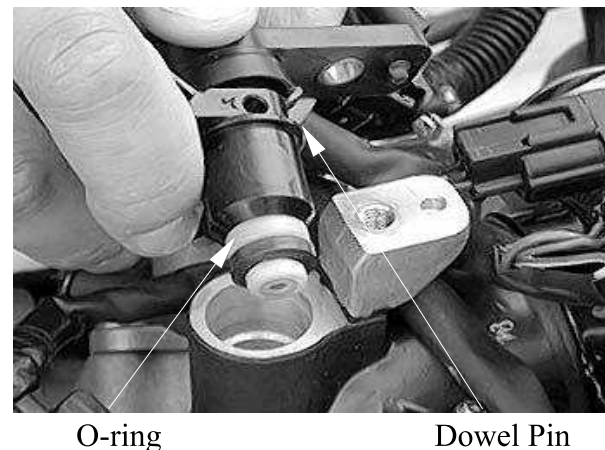

## FUEL INJECTOR CLEANING

### PROBLEM

1. Fuel Injector cannot output the fuel.
2. The Injector injection time (ms) is shorter or longer.

**Standard:** < 1.6ms

### ANALYSIS

Injector block (With some carbons).

### TROUBLESHOOTING

1. Use the specified injector cleaner.
2. Pouring the liquid of carburetor cleaner until half container.
3. Connect the battery as picture.
4. The injector cleaner with the flash relay.
5. Keeping the fuel Injector operation.
6. Waiting for 20~30 minutes.
7. Cleaning the carbons completely.

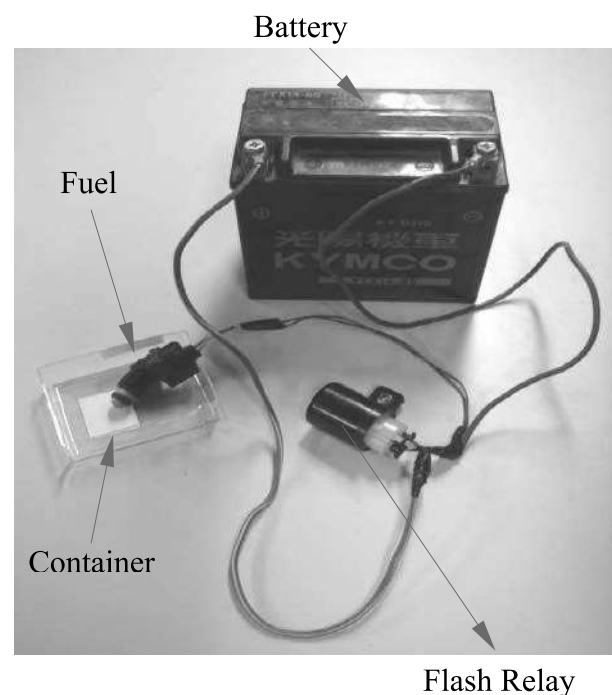

## WTS SENSOR (Water Temperature Sensor)

### REMOVAL / INSTALLATION

Drain the coolant from the cooling system.  
 Disconnect the WTS sensor connector from the sensor.  
 Remove the WTS sensor and O-ring.

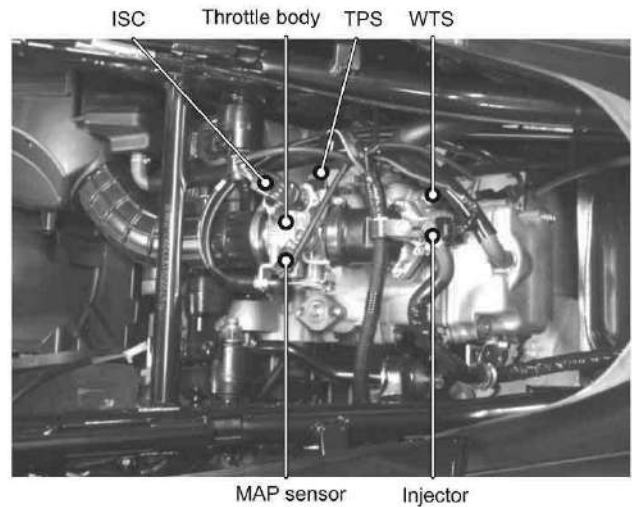

Install a new O-ring and WTS sensor.

\* Always replace an O-ring with a new one.

Tighten the WTS sensor to the specified torque.

**Torque:** 1.2 kgf-m (12 N-m, 8.6 lbf-ft)

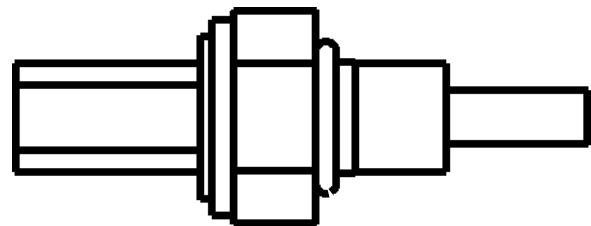

Connect the WTS sensor connector.

Fill the cooling system with the recommended coolant.

### INSPECTION

Measure the resistance at the WTS sensor terminals.

### STANDARD

°C	-20	40	100
KΩ	18.8	1.136	0.1553

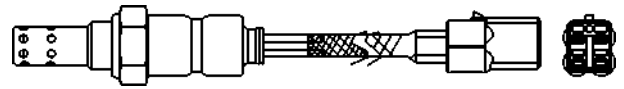

\*

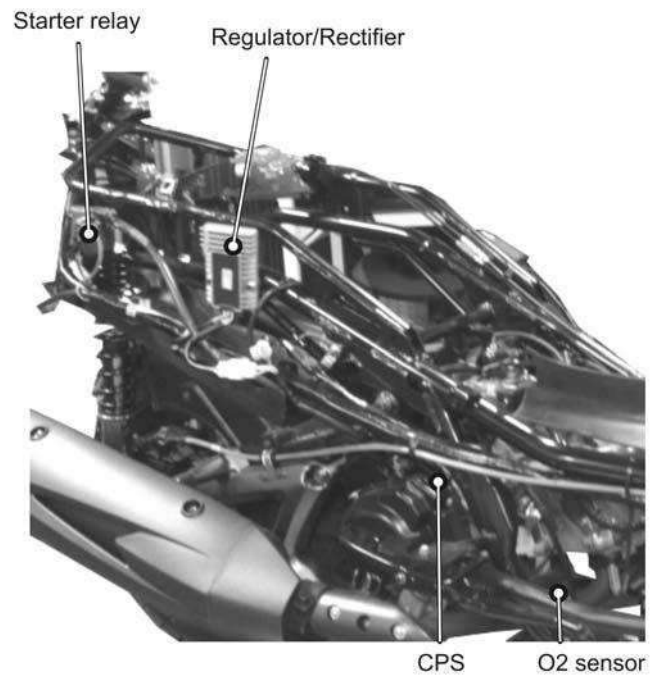

## THROTTLE BODY/MAP/ISC/TPS

- Turn off the ignition switch while replacement.
- Check and confirm if the voltage is over 12V by a voltmeter after replacement.
- Check and confirm if the other connectors are installed correctly after replacement.
- Do not damage the throttle body, it may cause the throttle and idle valve isn't synchronization.
- The throttle body is preset in KYMCO factory, do not disassemble it by a wrong way.
- Do not loosen or tighten the painted bolts and screws for the throttle body. Loosen or tighten them can cause the throttle and idle valve to synchronization failure.
- **TPS and ISC have to be reset after the throttle body MAP, TPS, ISC or ECU has been reinstalled.**

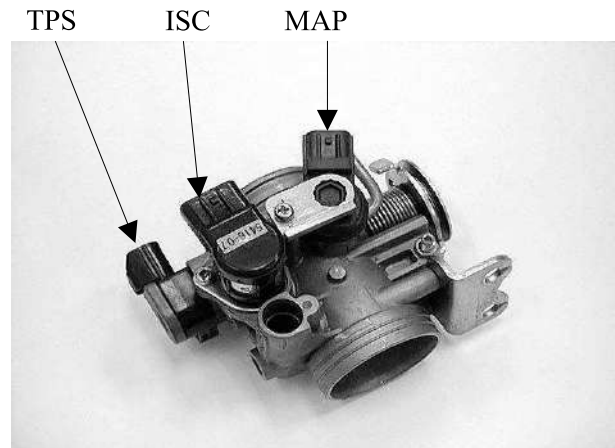

## MAP INSPECTION

Support the scooter on a level surface.

Put the side stand up and engine stop switch is at "RUN".

Turn the ignition switch to "ON" position.

Measure if the ECU voltage outputs to the MAP between the following terminals of the MAP connector.

Terminal	Normal
Violet/Red (+) – Green/Pink (-)	5 V

### TPS INSPECTION

Support the scooter on a level surface.  
 Put the side stand up and engine stop switch is at "RUN".  
 Turn the ignition switch to "ON".  
 Measure if the ECU voltage outputs to TPS between the following terminals of the TPS connector.

Terminal	Normal
Violet/Red (+) – Green/Pink (-)	5 V

**Throttle position sensor (TPS) resistance (at 20°C/68°F) 3500~6500 Ω**

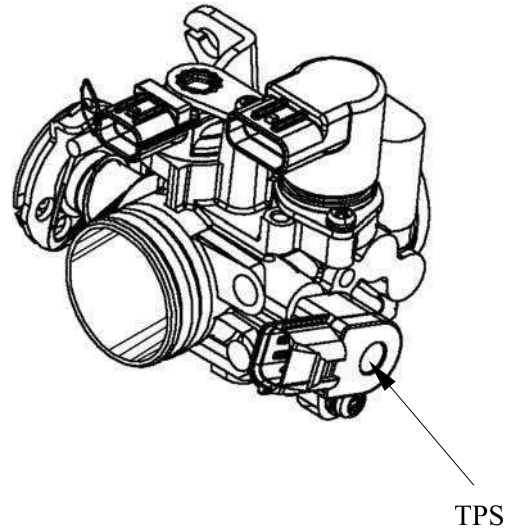

### REMOVAL

Loosen the throttle cables with the adjusting nuts.  
 Disconnect the throttle cable ends from throttle seat.

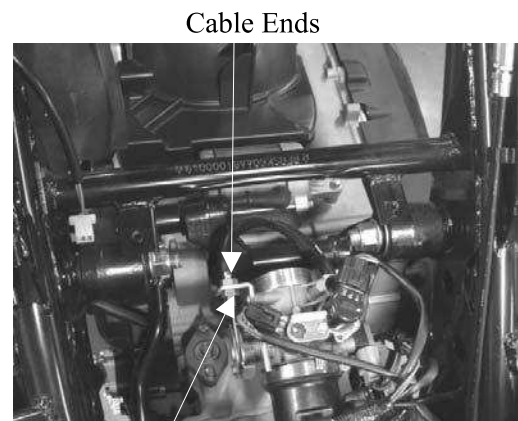

Adjusting Nuts

Disconnect the TPS, ISC and MAP sensor connectors.  
 Loosen the air cleaner connecting hose band screw.  
 Loosen the intake manifold band screw.  
 Remove the throttle body, MAP sensor, TPS sensor and ISC sensor as a set.

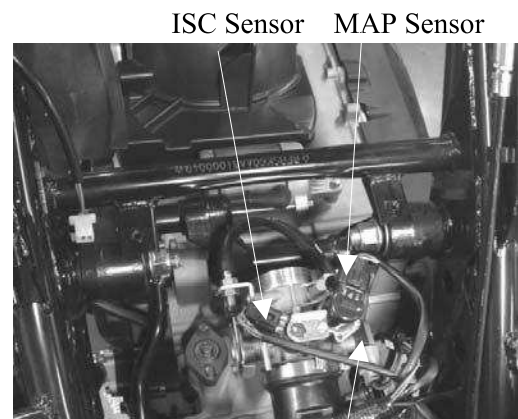

TPS Sensor

## DISASSEMBLY

\*

The throttle position sensor (TPS) and idle air bypass valve (ISC) have to be reset when the throttle body MAP, TPS, ISC or ECU has been reinstalled.

Remove the screw and then remove the ISC and set plate.

Remove the screw and set plate.

Remove the MAP

Remove the screw AND then remove the TPS.

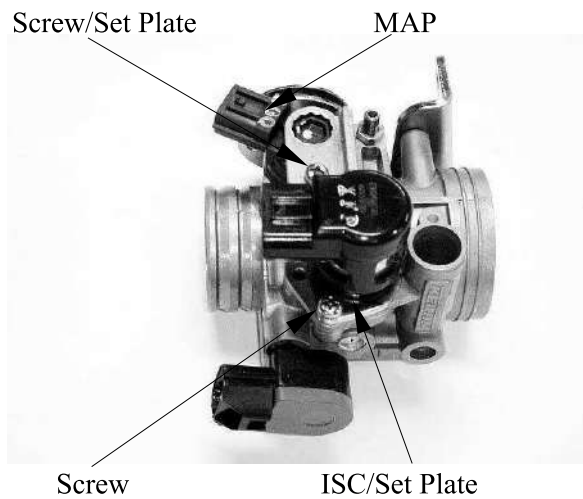

## ASSEMBLY

\*

The throttle position sensor (TPS) and idle air bypass valve (ISC) have to reset when the throttle body MAP, TPS, ISC or ECU has been reinstalled.

Apply oil onto a new O-ring.

When install the TPS onto the throttle body, being careful not to damage the O-ring.

Install and tighten the screw securely.

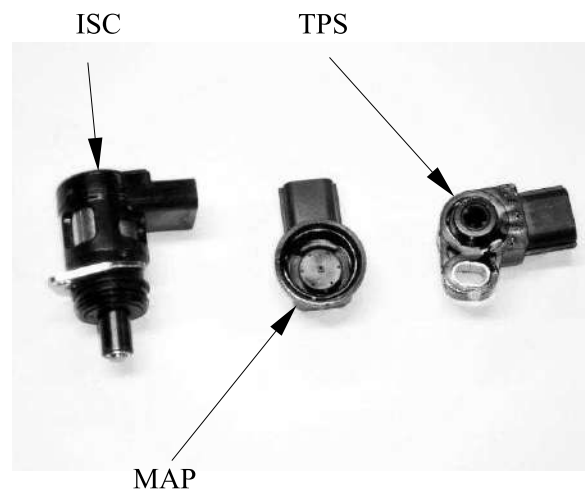
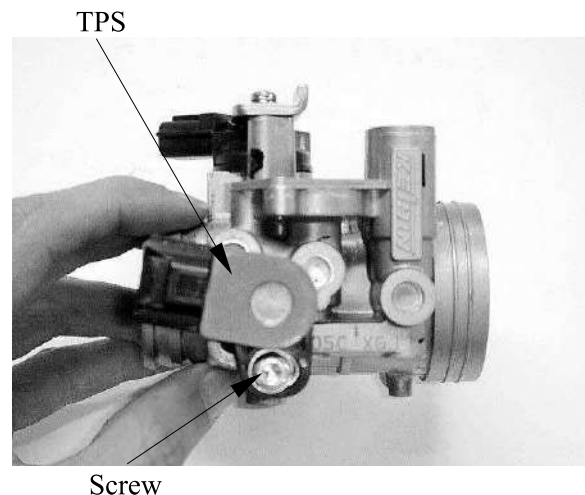

Apply oil onto a new O-ring.

When install the MAP onto the throttle body, being careful not to damage the O-ring.

\* Always replace an O-ring with a new one.

Install the set plate and tighten the screw securely.

Apply oil onto a new O-ring.

When install the ISC and set plate onto the throttle body, being careful not to damage the O-ring.

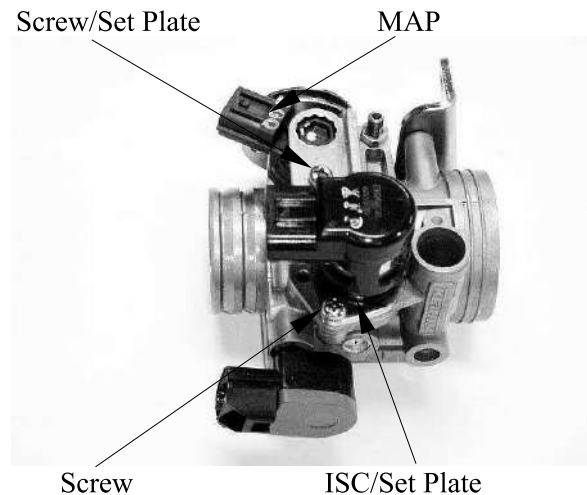
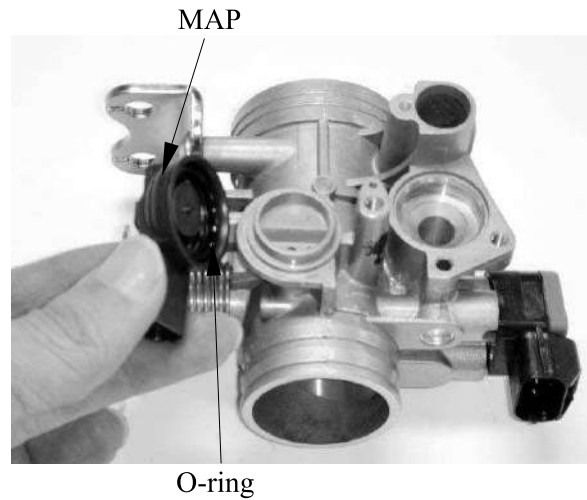

## DIAGNOSTIC TOOL CONNECTOR

### INSPECTION

Put the side stand up and engine stop switch is at "RUN".

Turn the ignition switch to "ON"

Measure the voltage between the following terminals of the diagnostic tool connector with PDA tester.

Terminal	Normal
Black (+) – Green (-)	Battery voltage
White/Yellow (+) – Green (-)	Battery voltage – 1 V



Diagnostic Connector



**FI DIAGNOSTIC TOOL  
OPERATION INSTRUCTIONS  
3620A-LEB2-E00**



## . FI DIAGNOSTIC TOOL

- This tool is developed by KYMCO and for KYMCO vehicle only.
- Please refer to the specification when serving this vehicle.
- This tool is without battery inside. The power is provided from vehicle.
- This software can be updated with computer for new model through the USB cable. The power required of tool is connected with 12V battery.
  
- For connection, please connect this tool with the connector of ECU. It's available when turning on the ignition switch.
- The side stand must be upward when serving the diagnostic procedure.
- The function includes ECU version, model name, data analysis and reset.
  - ECU version: includes model name, ECU number, identifications number and software version.
  - Failure codes: DTC reading, DTC clearing and troubleshooting.
  - Data analysis: For ECU's software inspection.
  - Reset: For the setting function adjustment.

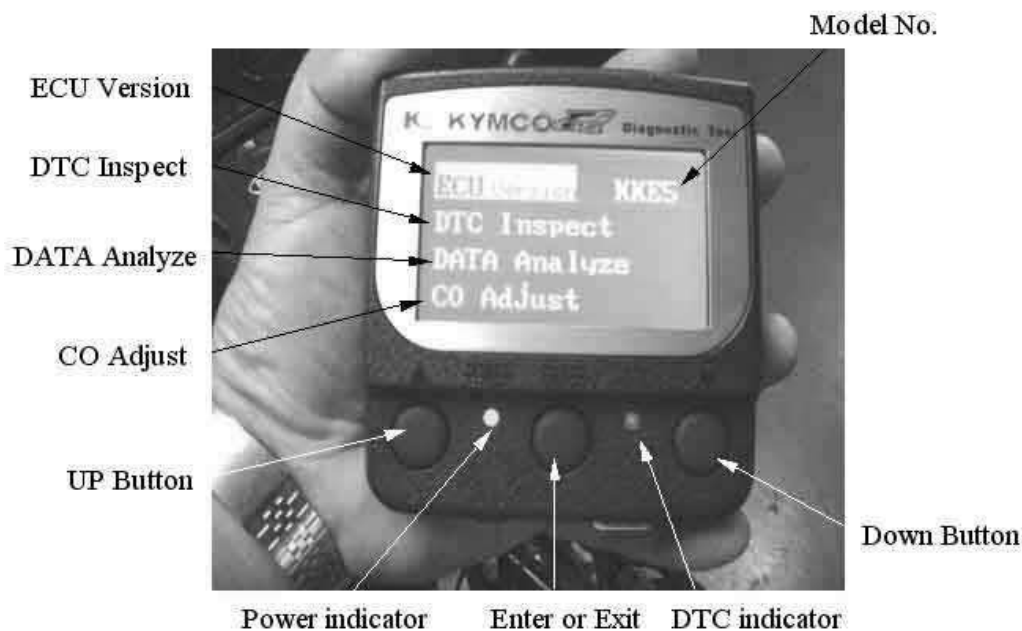

### . DTC INSPECTION PROCEDURE

Showing four functions on the screen when switching on power.



LEA7 is for  
Downtown 300i

A). ECU version: Including of model name, ECU number, identifications number and software version.

Press the " Enter " button

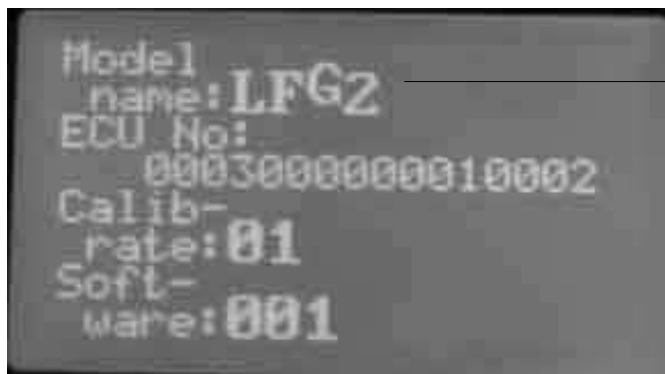

LEA7 is for  
Downtown 300i

B). Press the " Down " button and then turn to the first page.



LEA7 is for  
Downtown 300i

C). Press the " Enter " button to check the DTC failure code



LEA7 is for  
Downtown 300i

D). Press the " Enter " button

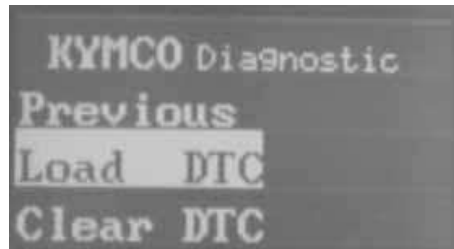

E). Press the " Enter " button

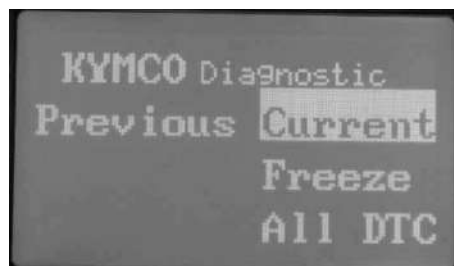

F). Display what's DTC number on this DTC-List.

Press the " Enter " button and then turn to the previous page

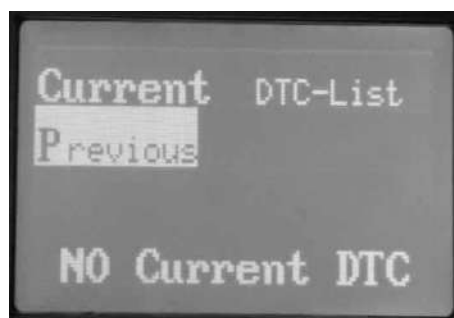

G). Press the " UP " button

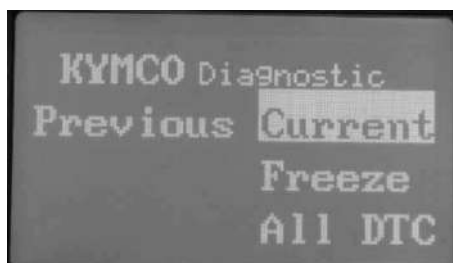

H). Press the " Enter " button and then turn to the previous page with red color.

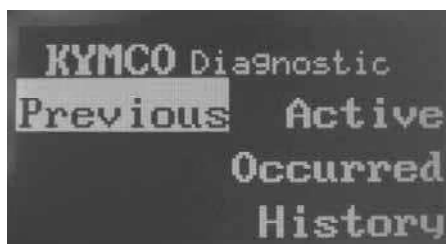

I). Press the " UP " button

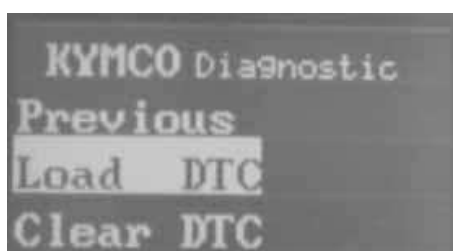

## 5. FUEL INJECTION SYSTEM

J). Press the " Enter " button and then turn to the first page.

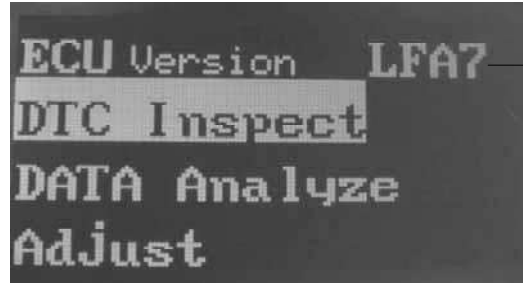

LEA7 is for  
Downtown 300i



LEA7 is for  
Downtown 300i

### . DTC CLEAR PROCEDURE

A). Check the DTC



LEA7 is for  
Downtown 300i

B). Press the " Enter " button



LEA7 is for  
Downtown 300i

C). Choose " Load DTC "  
Press the " Down " button

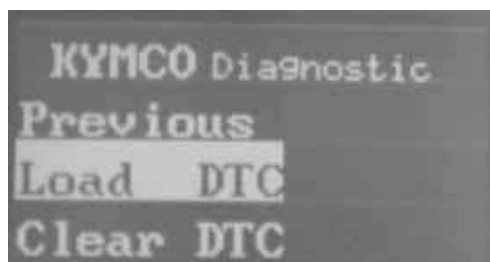

D). Press the " Enter " button and the indicator is lighting.

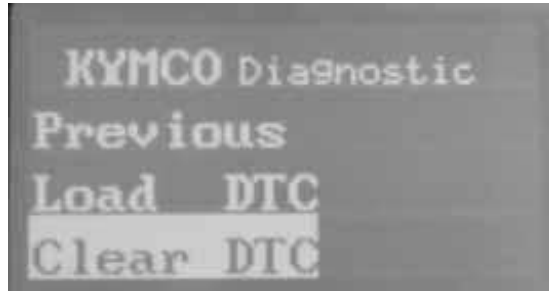

E). Clearing DTC completed if the indicator is off.

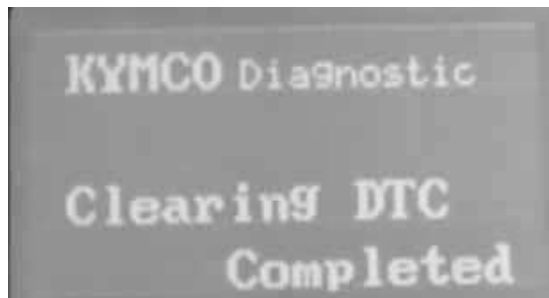



### . DATA ANALYSIS PROCEDURE

A). Press the " Down " twice



LEA7 is for  
Downtown 300i

B). Choose " Data Analyze"

Press the " Enter " button to enter page 01

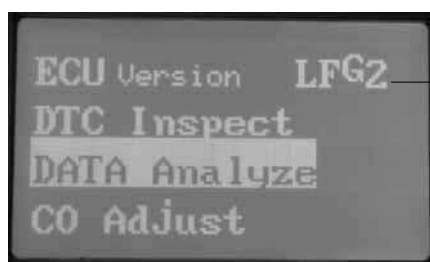

LEA7 is for  
Downtown 300i

C). Down-page 01

The measure figures including of Engine speed, Battery voltage and DTC number.

Press the " Down " button to enter page 02.

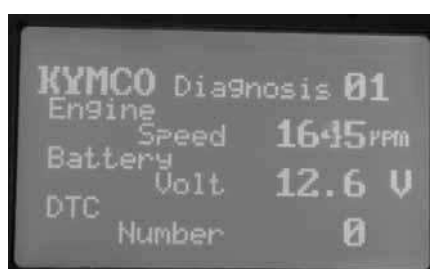

## 5. FUEL INJECTION SYSTEM

### D). Down-page 02

The measure figures including of TPS position, Intake pressure and Intake air temperature.

Press the “ Down” button to enter page 03.

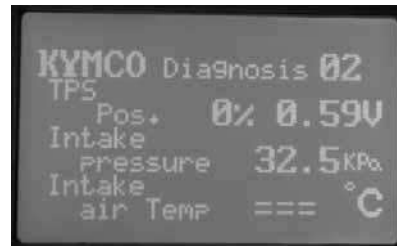

### E). Down-page 03

The measure figures including of Atmosphere pressure, Fuel Injector interval and Ignition advance timing.

Press the “ Down” button to enter page 04.

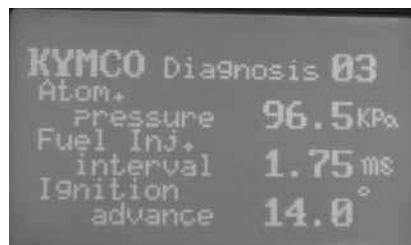

### F). Down-page 04

The measure figures including of Engine temperature, O2 sensor voltage and O2 heater activation.

Press the “ Down” button to enter page 05.



## 5. FUEL INJECTION SYSTEM

---

### G). Down-page 05

The measure figures including of ISC target, ISC step and ISC learn step.

Press the “ Down ” button to enter page 06.



### H). Down-page 06

The measure figures including of ISC motor state.

Press the “ Down ” button to enter page 07.

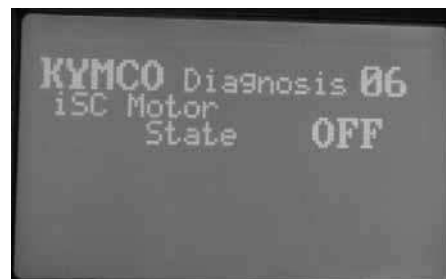

### I). Down-page 07

The measure figures including of Cut Out voltage.

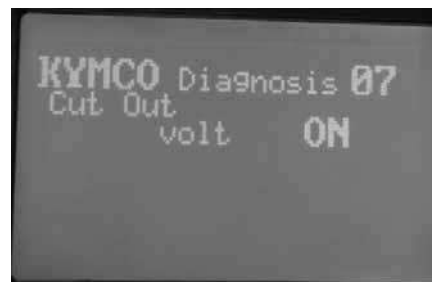

J). Press the " UP " to the previous page.

## 5. FUEL INJECTION SYSTEM

---

### 五. Vehicle can not be started – Handling method (Steps)

#### **Preliminary Checking: 6 basic inspection**

1. Is the battery with voltage (12 V or higher)
2. Key-On and listen for any action with Fuel Pump / Fuel Pump Relay (It will turn off automatically in 5-10 seconds)
3. Key-On to check for any failure lamp light up on dashboard.
4. Is the Idle screw of Throttle Valve being changed or loose?
5. Has the vehicle under regular service? Is the gas station a good one?
  
6. Is the spark plug the correct model of specified by the vehicle builder?

#### **Vehicle can not be started?**

Check for any Failure code. (Failure Lamp on / How to tell the Failure code?)

Turn on power to see if the engine inspection / failure lamp off?

If it flashes continuously or light up for long time, the vehicle is at failure -→ read the Failure Code?

#### **Methods:**

1. Reading DTC from speedometer, if PDA or diagnosis tool is not available.
2. Reading DTC from Diagnosis tool, if it is available.

## 5. FUEL INJECTION SYSTEM

### 六. Manual Trouble Shooting Procedure

#### How to read DTC from speedometer?

New Phase 5 Fuel Injection Engine Vehicle DTC Reading:

Automatic indication – ECU upgrade version (with Oxygen sensor):

Reading DTC from speedometer directly.

Key On → light off in 2 seconds. When the engine inspection lamp is light up again, it starts to deliver failure code. If no show, there is without any failure.

Note:

1. The “CELP” denotes the failure codes. When the indicator lights for 1 second it is equivalent 10 blinks. For example, a 1 second illumination and two blinks (0.5 second x 2) of the indicator equals 12 blinks. Refer to DTC 12.
2. If more than one failure occurs, the “CELP” shows the blinks in the occurred order. For example, if the indicator blinks 6 times, then shows one second illumination and two blinks, two failures have occurred. Refer to DTC 6 and DTC 12.

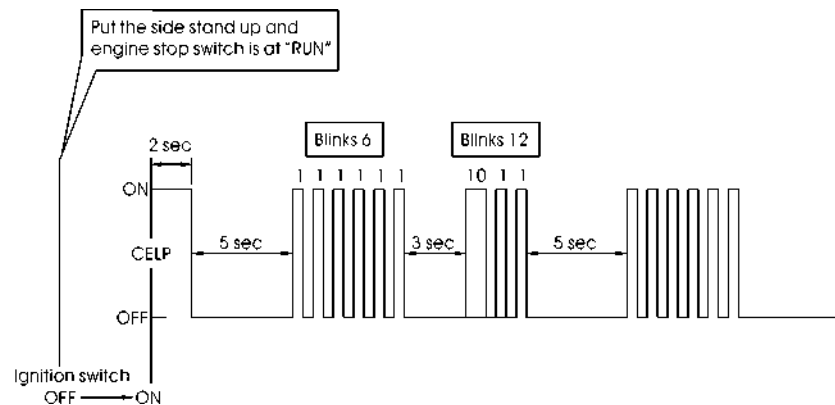

**After excluding trouble, how the DTC can be cleared? Confirm the failure is excluded.**

- Turn on power but maintain not started and keep the engine inspection lamp light up for 4 cycles. If it is off automatically, it means the historical DTC is cleared automatically.
- Use PDA or diagnosis tool: clear Historical Failure code
- Check again to confirm DTC is excluded.

Turn on power again. When there is no residual historical failure cod. Start the engine and if no failure lamp is on or flashing, it is Okay.

---

**HANDLEBAR/FRONT WHEEL/FRONT BRAKE/  
FRONT SHOCK ABSORBER/STEERING STEM**

---

SERVICE INFORMATION-----	14- 1
TROUBLESHOOTING-----	14- 2
HANDLEBAR -----	14- 3
FRONT WHEEL-----	14- 6
FRONT BRAKE FLUID-----	14- 9
FRONT BRAKE PAD -----	14-12
BRAKE DISC INSPECTION -----	14-13
FRONT SHOCK ABSORBER-----	14-14
STEERING STEM-----	14-15

**SERVICE INFORMATION**

**GENERAL INSTRUCTIONS**

- Remove the motorcycle frame covers before removing the front wheel, steering handlebar, front shock absorber and front fork. Jack the motorcycle front wheel off the ground and be careful to prevent the motorcycle from falling down.
- During servicing, keep oil or grease off the brake pads and brake disk.

**SPECIFICATIONS**

**Unit: mm (in)**

Item	Standard	Service Limit
Axle shaft runout	—	0.2 mm (0.008 in)
Brake disk thickness	3.8 ~ 4.2 (0.15 ~ 0.165)	0.3 mm (0.012 in)
Brake disk runout	—	—
Brake master cylinder I.D.	12.7 ~ 12.74 (0.508 ~ 0.5096)	—
Brake master cylinder piston O.D.	12.65 ~ 12.68 (0.506 ~ 0.5072)	—
Brake caliper piston O.D.	26.93 ~ 26.96 (1.0602 ~ 1.0614)	—
Brake caliper cylinder I.D.	27 ~ 27.05 (1.063 ~ 1.065)	—

**TORQUE VALUES**

Handlebar lock nut	45 N-m (4.5 kgf-m)
Steering stem lock nut	70 N-m (7.0kgf-m)
Steering stem pinch bolt	27 N-m (2.7 kgf-m)
Front axle	20 N-m (2.0 kgf-m,)
Master cylinder reservoir cover screw	1.6N-m (0.16 kgf-m)
Master cylinder holder bolt	12 N-m (1.2 kgf-m)
Brake lever pivot bolt	2.0 N-m (0.2 kgf-m)
Brake lever pivot nut	10.0 N-m (1.0 kgf-m)
Brake light switch screw	1.0 N-m (0.1 kgf-m)
Brake caliper mounting bolt	35 N-m (3.5 kgf-m)
	ALOC bolt: replace with a new one.
Brake caliper bleed screw	5.5N-m (0.55 kgf-m)
Brake hose oil bolt	35 N-m (3.5 kgf-m)

**SPECIAL TOOLS**

Lock nut wrench	F00002
Oil seal and bearing installer	E00014
Bearing puller	E00037
Lock nut wrench	F00023
Ball cone remover	F00009
Ball cone installer	F00019

## **TROUBLESHOOTING**

### **Hard steering (heavy)**

- Excessively tightened steering stem top cone race
- Broken steering balls
- Insufficient tire pressure

### **Steers to one side or does not track straight**

- Uneven front shock absorbers
- Bent front fork
- Bent front axle or uneven tire

### **Poor brake performance**

- Worn brake pads
- Contaminated brake pad surface
- Deformed brake disk
- Air in brake system
- Deteriorated brake fluid
- Worn brake master cylinder piston oil seal
- Clogged brake fluid line
- Unevenly worn brake caliper

### **Front wheel wobbling**

- Bent rim
- Loose front axle
- Bent spoke plate
- Faulty tire
- Improperly tightened axle nut

### **Soft front shock absorber**

- Weak shock springs
- Insufficient damper oil

### **Front shock absorber noise**

- Slider bending
- Loose fork fasteners
- Lack of lubrication



## HANDLEBAR

### REMOVAL

Remove the lower handlebar cover and front cover.

Remove two bolts and disconnect the brake light switch wire, then remove the rear brake master cylinder.

Remove the two bolts and disconnect the brake light switch wire, then remove the front brake master cylinder.

Remove the inner cover.



Brake Light  
Switch Wire

Front Light  
Switch Wire

Remove the handlebar lock nut and take out the bolt.

Remove the handlebar and collar.

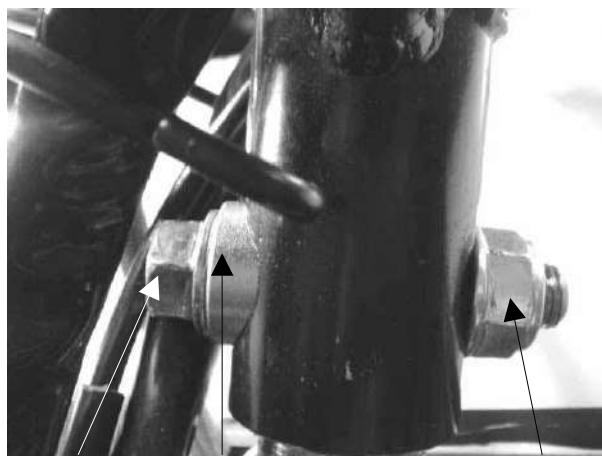

Bolt

Collar

Lock nut

### INSTALLATION

Install the handlebar onto the steering stem and install the handlebar collar, lock nut and bolt.

Tighten the bolt to the specified torque.

**Torque:** 4.5 kgf-m (45 N-m, 32 lbf-ft)



## 14. HANDLEBAR/FRONT WHEEL/FRONT BRAKE/ FRONT SHOCK ABSORBER/STEERING STEM

Install the front and rear master cylinders and connect the brake light switch wires.



### DISASSEMBLY

Remove two screws attaching to the right handlebar switch.



Screws

Disconnect the throttle cable from the throttle grip.  
Remove the right handlebar switch.

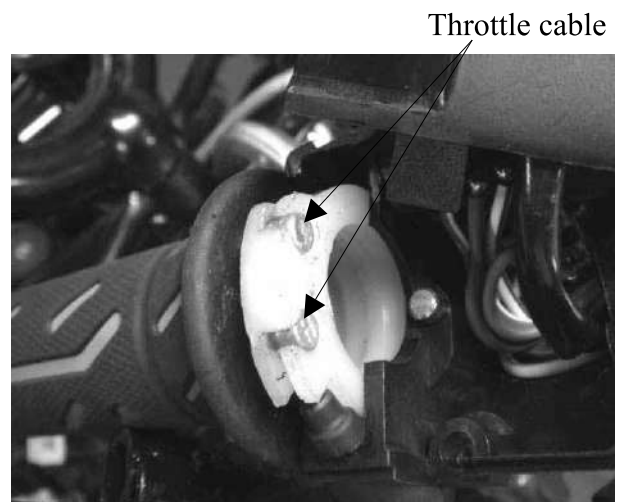

Throttle cable

Remove two screws and then remove the left handlebar switch.



Screws

**ASSEMBLY**

Install the left handlebar switch.

- \* Align the pin on the left handlebar switch with the hole on the handlebar.

Install and tighten the two screws securely.

Install the right handlebar switch.

- \* Align the pin on the right handlebar switch with the hole on the handlebar.

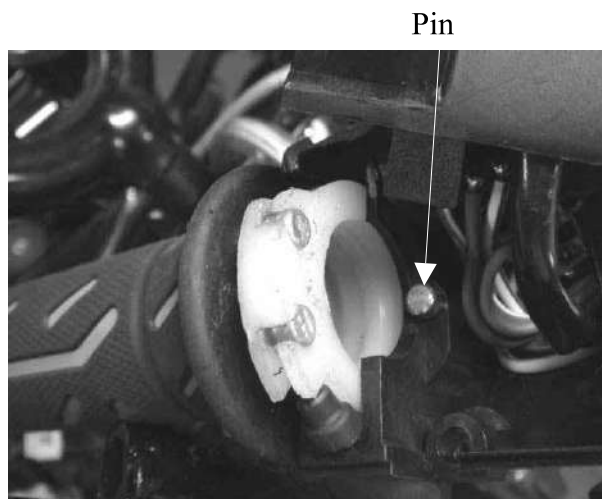

Pin

Lubricate the throttle grip front end with grease and then connect the throttle cable to the throttle grip.

Install and tighten the two screws.

## FRONT WHEEL

### REMOVAL

Jack the scooter front wheel off the ground.  
Remove the bolt and then pull out the axle.  
Remove the front wheel and collar.

Bolt



### AXLE RUNOUT INSPECTION

Set the axle in V blocks and measure the runout using a dial gauge.

The actual runout is 1/2 of the total indicator reading.

**Service Limit:** 0.2 mm (0.008 in)

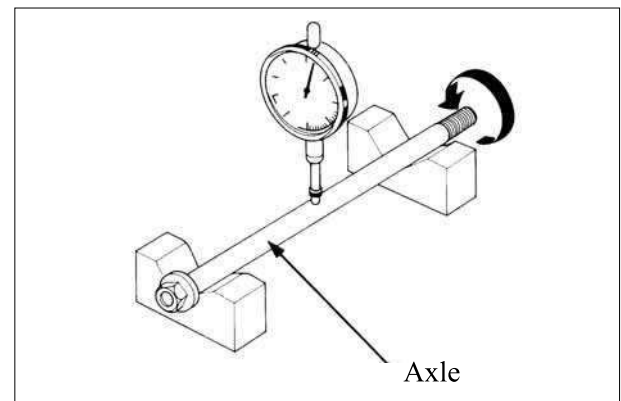

### WHEEL RIM INSPECTION

Check the wheel rim runout.

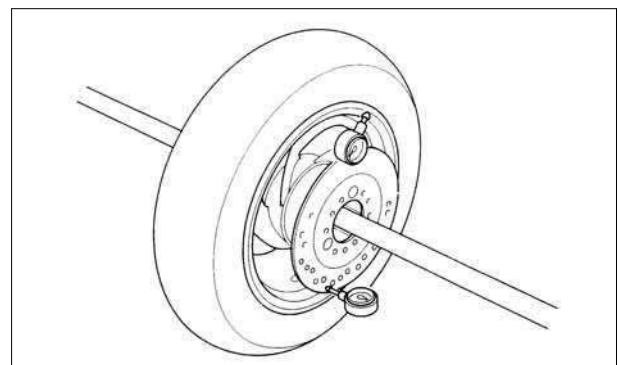

**INSTALLATION**

Apply grease to the collar, then install the collar onto the wheel.

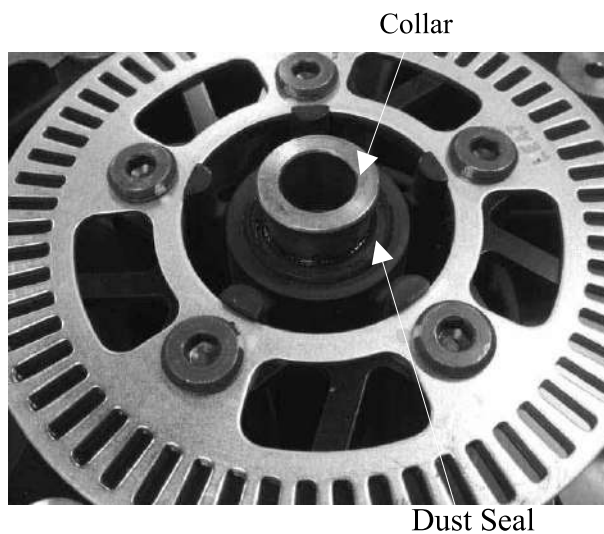

Install the speedometer speed wheel sensor.

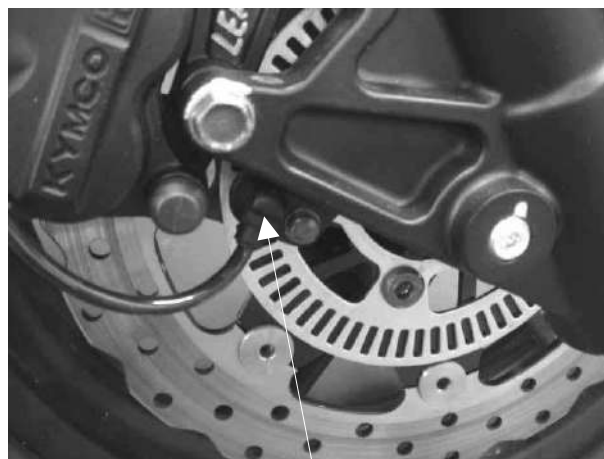

**DISASSEMBLY**

Remove the side collar and dust seal.

Turn the inner race of each bearing with your finger to see if they turn smoothly and quietly. Also check if the outer race fits tightly in the hub.

Replace the bearings if the races do not turn smoothly, quietly, or if they fit loosely in the hub.

Remove the front wheel bearing by using the special tool.

**Special tool:**

Bearing puller                      E00037

Remove the distance collar from wheel.

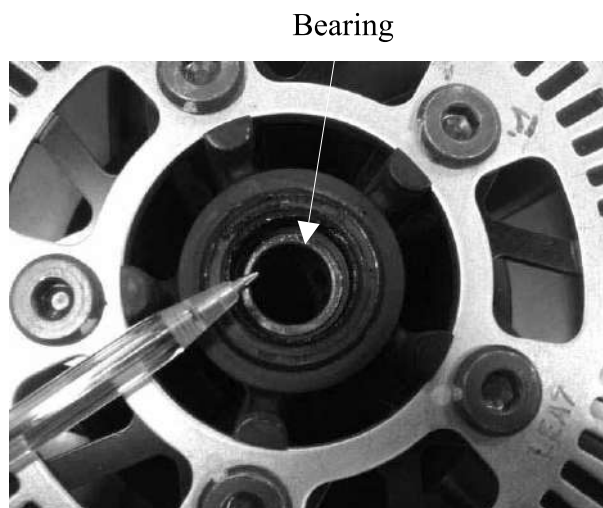

Remove the front wheel bearing by using the special tool.

**Special tool:**

Bearing puller E00037

**ASSEMBLY**

Install the front wheel bearing by using the special tool.

**Special tool:**

Bearing installer E00014

Install the distance collar.

Install the front wheel bearing by using the special tool.

Apply grease to the collar, then install the collar onto the wheel.

Bearing

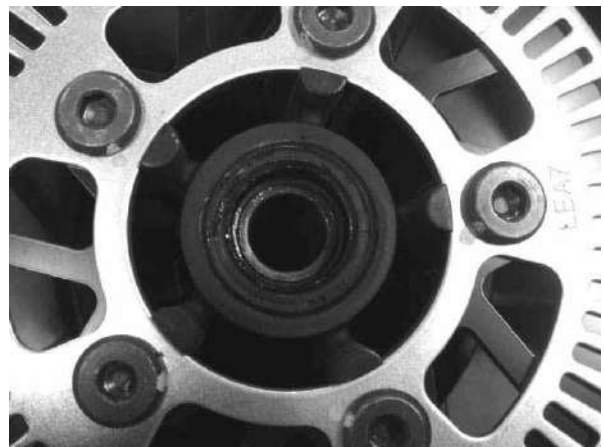
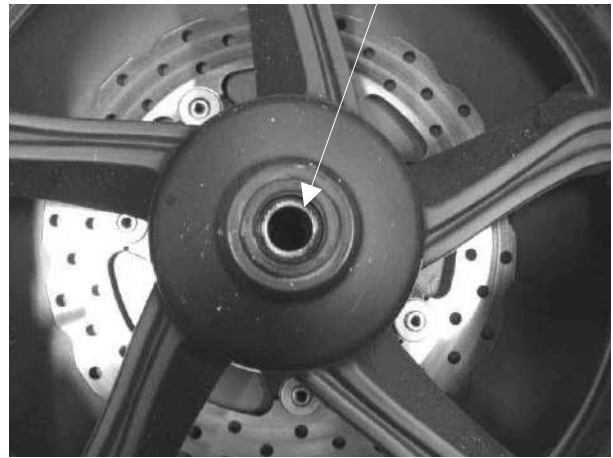

## **FRONT BRAKE FLUID**

### **FLUID REPLACEMENT/AIR BLEEDING**

\*

- A contaminated brake disc or pad reduces stopping power. Discard contaminated pads and clean a contaminated disc with a high quality brake degreasing agent.
- Do not allow foreign material to enter the system when filling the reservoir.
- Avoid spilling brake fluid on painted, plastic or rubber parts. Place a rag over these parts whenever the system is serviced.



### **BRAKE FLUID DRAINING**

Make sure that the master cylinder parallel to the ground before removing the reservoir cover.

Remove two screws.

Remove the reservoir cover, diaphragm plate and diaphragm.

Connect a bleed hose to the bleed valve.



Loosen the bleed valve and apply the brake lever.

Stop operating the brake when no more fluid flows out of the bleed valve.

**BRAKE FLUID FILLING/AIR  
BLEEDING**

\* Do not mix different types of fluid since they are not compatible.

Fill the master cylinder with DOT 4 to the upper level.

Connect a commercially available brake bleeder to the front caliper bleed valve.

Check the fluid level often while bleeding the brake to prevent air from being pumped into the system.

Pump the brake bleeder and loosen the front caliper bleed valve. Add fluid when the fluid level in the master cylinder is low to prevent drawing air into the system.

Repeat the above procedures until no air bubbles appear in the plastic hose.

Close the front caliper bleeding valve and operate the front brake lever.

If it's still spongy, bleeding the system again.

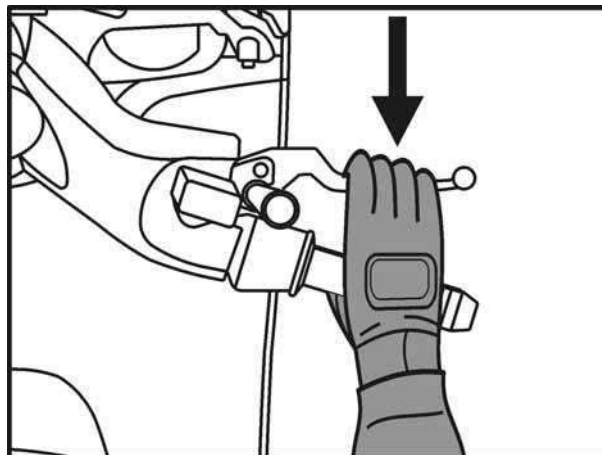



If the brake bleeder is not available, perform the following procedure.

Pump up the system pressure with the brake lever until there are no air bubbles in the fluid flowing out of the reservoir small hole and lever resistance is felt.

1. Pump the brake lever several times, then squeeze the brake lever all the way and loosen the bleed valve 1/4 turn. Wait several seconds and close the bleed valve.

\* Do not release the brake lever until the bleed valve has been closed.

2. Release the brake lever slowly until the bleed valve has been closed. Add fluid when the fluid level in the master cylinder is low to prevent drawing air into the system.
3. Repeat the steps 1 - 2 until there are no air bubbles in the bleed hose.

After bleeding air completely, tighten the bleed valve to the specified torque.

**Torque:** 6 N-m (0.6 kgf-m, 4.3 lbf-ft)

Fill the reservoir to the casting ledge with DOT 4 to the upper level.

Install the diaphragm, set plate and reservoir cover and tighten the screws to the specified torque.

**Torque:** 2 N-m (0.2 kgf-m, 1.1 lbf-ft)

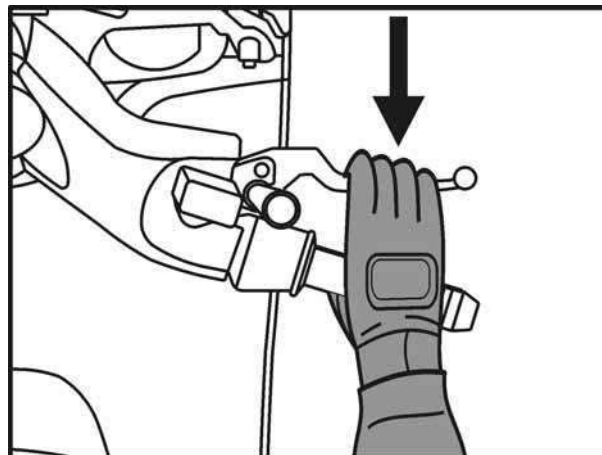

## FRONT BRAKE PAD

### BRAKE PAD REPLACEMENT

Remove the pad pins.

Remove the two caliper mounting bolts, then remove the caliper.

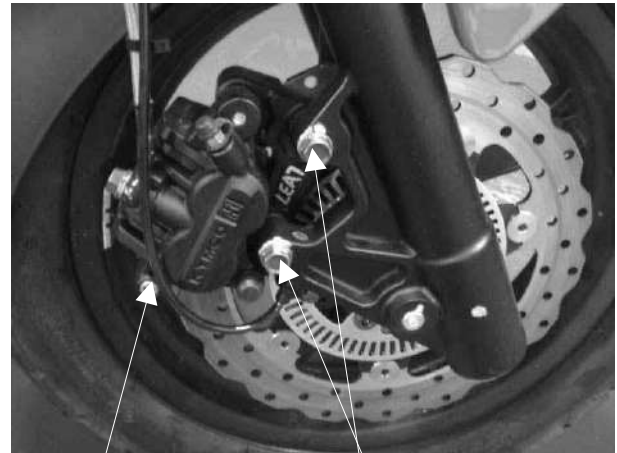

Pad Pins

Bolts

Brake Pads

Remove the brake pads.



\* Always replace the brake pads in pairs to ensure even disc pressure.



Install new pads so that their ends rest on the pad retainer on the brake properly.

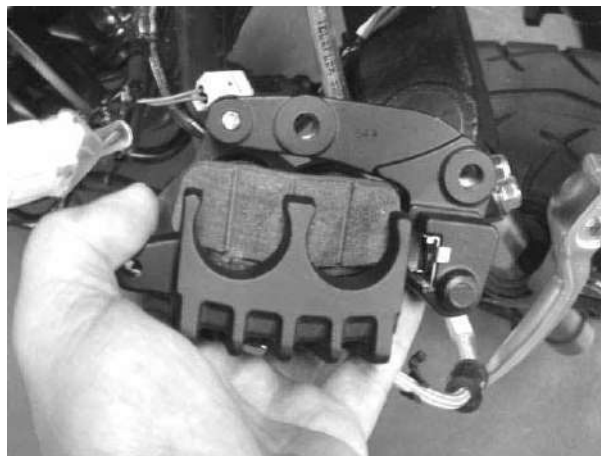

Install the pad pin by pushing the pads against the pad spring to align the pad pin holes in the pads and caliper.

Install the front caliper onto the fork leg and then install and tighten the new two caliper mounting bolts to the specified torque.

**Torque:** 35 N-m (3.5 kgf-m)

Tighten the pad pins to the specified torque.

**Torque:** 18 N-m (1.8 kgf-m, 13 lbf-ft)



## **BRAKE DISC INSPECTION**

Visually inspect the brake disc for damage or cracks.

Measure the brake disc thickness.

**Service limits:** 3 mm (0.12 in)

Replace the brake disc if the smallest measurement is less than the service limit.

Measure the brake disc warpage.

**Service limits:** 0.3 mm (0.012 in)



## FRONT SHOCK ABSORBER

### REMOVAL

Remove the front cover and front fender.  
Remove the front brake caliper  
Remove the front wheel  
Remove the speed wheel sensor bolt and then remove the brake hose guide from right front shock absorber.  
Remove the speedometer cable guide from left front shock absorber.  
Remove two mounting bolts and then remove the right/left front shock absorber.



Speed Wheel Sensor

### INSTALLATION

Installation is in the reverse order of removal.

\* Tighten the shock absorber mounting bolt to the specified torque.

**Torque: 2.7 kgf-m (27 N-m, 19.5 lbf-ft)**

**Specified Oil: SS#8**  
**Oil Capacity: 185 cc**

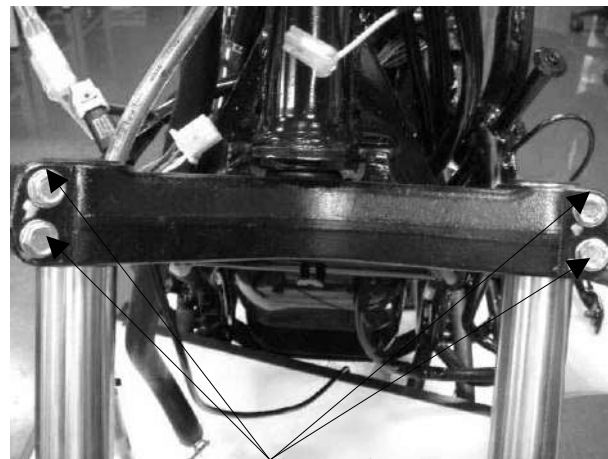

Mounting Bolts

### INSPECTION

Inspect the following items and replace if necessary.

- Front shock absorber tube bending, damage or wear
- Weak front shock absorber spring
- Damper and damper rod bending
- Oil seal damage or wear

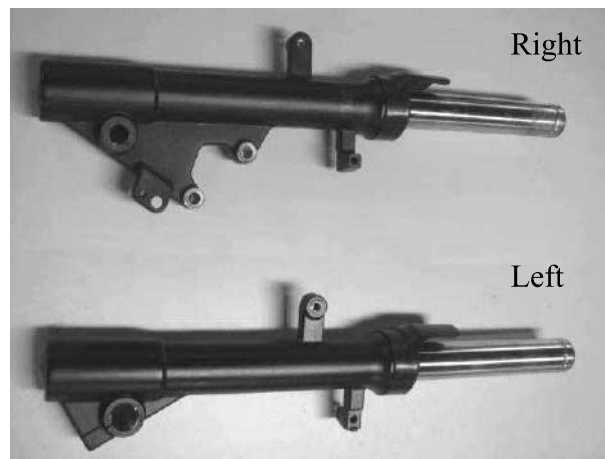

## STEERING STEM

### REMOVAL

Remove the steering handlebar.  
Remove the front brake hose and speed wheel sensor connector from the guide.



Hold the steering stem top cone race and remove the steering stem lock nut by using the special tool.

### Special tool:

Lock nut wrench            F00002



Lock Nut Wrench

### Top Cone Race



Remove the top cone race and washer.  
Remove the steering stem.

\* Be careful not to lose the steel balls (26 on top race and 19 on bottom race).



### Special tool:

Lock nut wrench            F00023

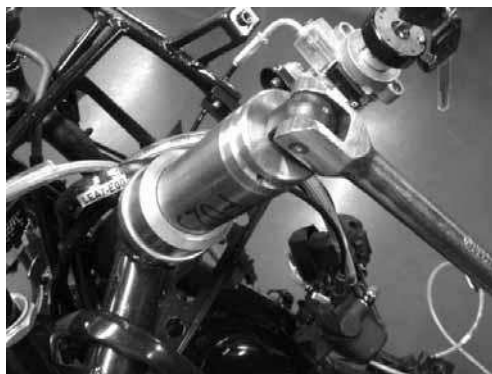

## 14. HANDLEBAR/FRONT WHEEL/FRONT BRAKE/ FRONT SHOCK ABSORBER/STEERING STEM

Inspect the ball races, cone races and steel balls for wear or damage. Replace if necessary.

Remove the top balls.

Remove the upper ball race by using a chisel if necessary.

Ball



Top Ball Cone Race

Remove the bottom balls.

Remove the bottom ball race by using a pipe if necessary.

Bottom Ball Race

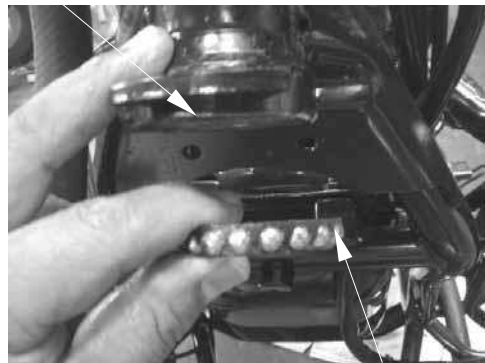

Bottom Balls

Remove the bottom cone race by using a chisel if necessary.

\* Be careful not to damage the steering stem.

Bottom Cone Race

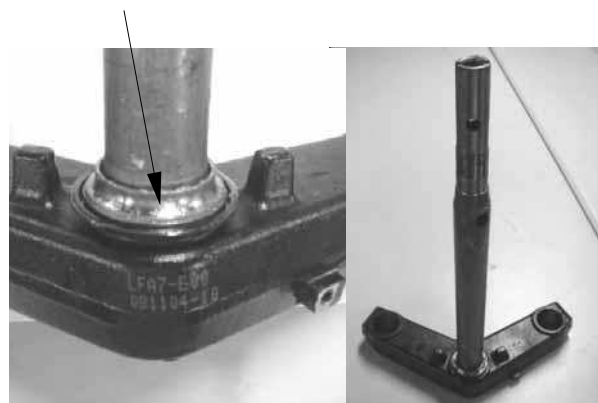

### INSTALLATION

Install the new bottom cone race onto the steering stem.

Install the new upper and bottom ball races into the frame.

Apply grease to the top and bottom ball races and install new steel balls on the top ball race and new steel balls on the bottom ball race.

Install the steering stem.



Apply grease to the top cone race and install it.

Tighten the top cone race and then turn the steering stem right and left several times to make steel balls contact each other closely.

\*  
Check the steering stem rotates freely without vertical play.

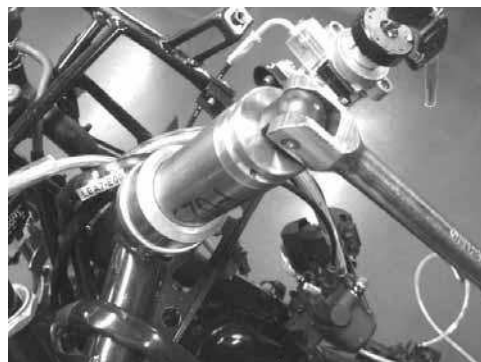

#### Special tool:

Lock nut wrench                      F00023

Install the steering stem lock nut and tighten it to the specified torque by using the special tool while holding the top cone race.

**Torque:** 7 kgf-m (70 N-m)

#### Special tool:

Lock nut wrench                      F00002



# 15. REAR BRAKE/REAR FORK/REAR WHEEL/REAR SHOCK ABSORBER



Downtown 300i ABS

---

---

---

---

---

---

---

## REAR BRAKE/REAR FORK/REAR WHEEL/ REAR SHOCK ABSORBER

---

SCHEMATIC DRAWING-----	15-1
SERVICE INFORMATION-----	15-2
TROUBLESHOOTING-----	15-2
REAR BRAKE-----	15-3
REAR FORK-----	15-6
REAR WHEEL-----	15-7
REAR SHOCK ABSORBER-----	15-7



# 15. REAR BRAKE/REAR FORK/REAR WHEEL/REAR SHOCK ABSORBER



Downtown 300i ABS

## SCHEMATIC DRAWING

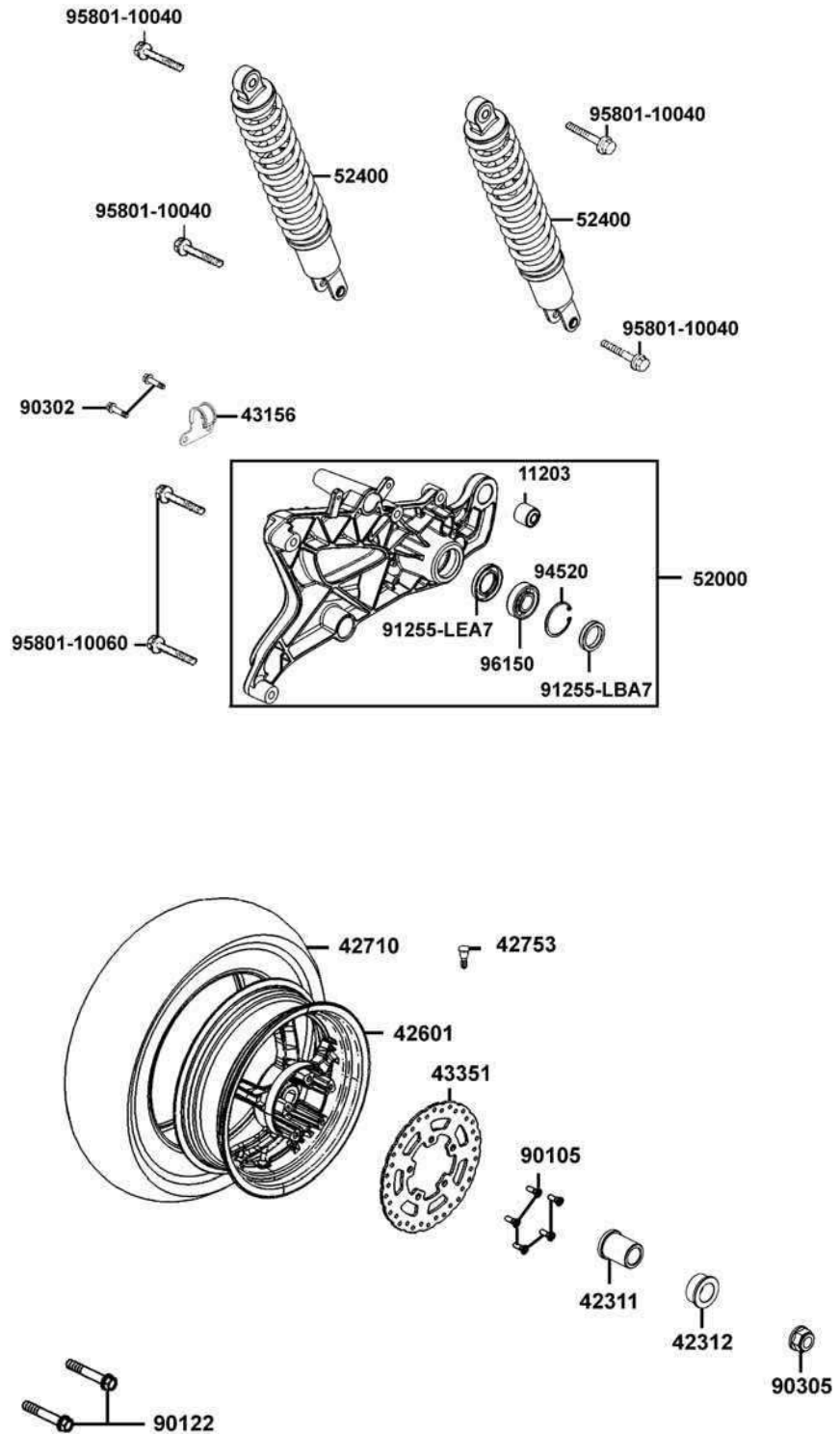

# 15. REAR BRAKE/REAR FORK/REAR WHEEL/REAR SHOCK ABSORBER



Downtown 300i ABS

## SERVICE INFORMATION

### GENERAL INSTRUCTIONS

- When performing the services stated in this section, the engine and exhaust muffler must be cold to avoid scalding.
- During servicing, keep oil or grease off the brake pads and brake disk.

### SPECIFICATIONS

Item	Standard (mm)
Rear wheel rim runout	—
Rear brake disk thickness	5.0
Rear brake disk runout	—
Rear brake master cylinder I.D.	25.33 ~ 25.36
Rear brake master cylinder piston O.D.	25.40 ~ 25.45

### TORQUE VALUES

Exhaust muffler lock bolt	35 N-m (4 kgf-m)
Exhaust muffler pipe nut	20 N-m (2 kgf-m)
Rear axle nut	120 N-m (12 kgf-m)
Rear shock absorber lower mount bolt	40 N-m (4 kgf-m)
Rear shock absorber upper mount bolt	40 N-m (4 kgf-m)
<b>Rear brake caliper holder bolt</b>	<b>35 N-m (3.5 kgf-m)</b>

### TROUBLESHOOTING

#### Rear wheel wobbling

- Bent rim
- Faulty tire
- Axle not tightened properly

#### Soft rear shock absorber

- Weak shock absorber spring
- Damper oil leaks

#### Rear wheel noise

- Worn rear wheel axle bearings
- Worn rear fork bearings
- Deformed rear fork

#### Poor brake performance

- Air in brake system
- Deteriorated brake fluid
- Contaminated brake pad surface
- Worn brake pads
- Clogged brake fluid line
- Deformed brake disk
- Unequal worn brake caliper

# 15. REAR BRAKE/REAR FORK/REAR WHEEL/REAR SHOCK ABSORBER

## REAR BRAKE

### REAR BRAKE CALIPER REMOVAL

First remove the exhaust muffler.  
Remove the rear brake fluid tube bolt and disconnect the brake fluid tube.  
Remove two bolts attaching the rear brake caliper.  
Remove the rear brake caliper.

When removing the brake fluid tube, use shop towels to cover plastic parts and coated surfaces to avoid damage.

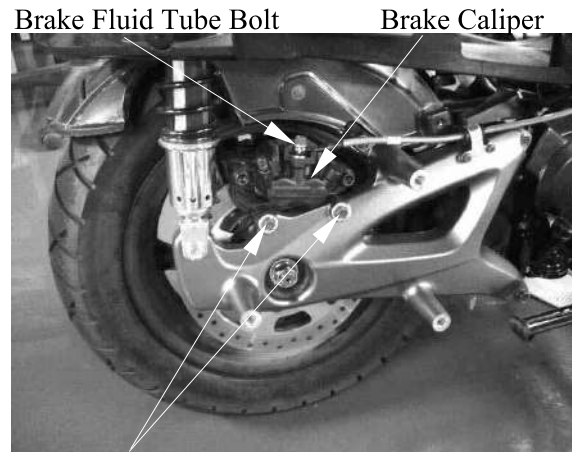

Bolts

### INSPECTION

Inspect the brake pads and brake disk.  
Measure the brake disk thickness.  
Visually check the brake pad thickness .



Brake Disk

### DISASSEMBLY

Remove two brake pads dowel pins and three bolts from the brake caliper.  
Remove the brake pads.

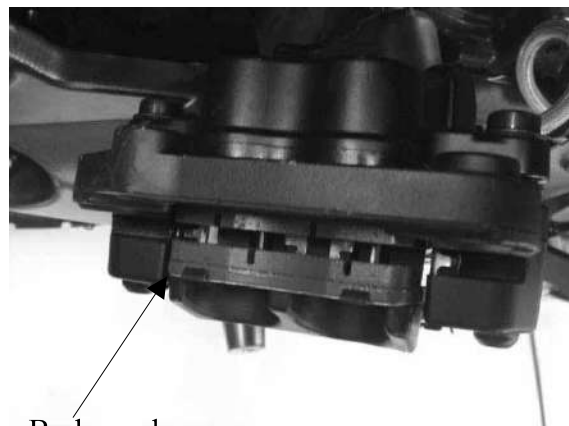

## 15. REAR WHEEL/REAR BRAKE/ REAR SUSPENSION

Remove the piston from the brake caliper.  
If necessary, use compressed air to squeeze out the piston through the brake fluid inlet opening and place a towel under the caliper to avoid contamination caused by the removed piston.  
Check the piston cylinder for scratches or wear and replace if necessary.

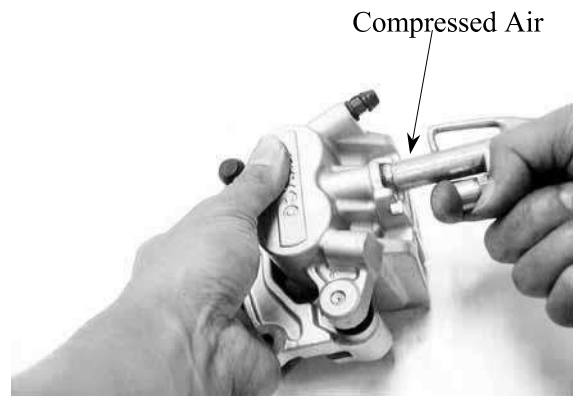

Check the caliper cylinder for scratches or wear and measure the cylinder bore.



### ASSEMBLY

Install the two spring plates onto the groove of the caliper.



# 15. REAR WHEEL/REAR BRAKE/ REAR SUSPENSION

Make sure the spring plate next to the brake pad dowel pin orientation.

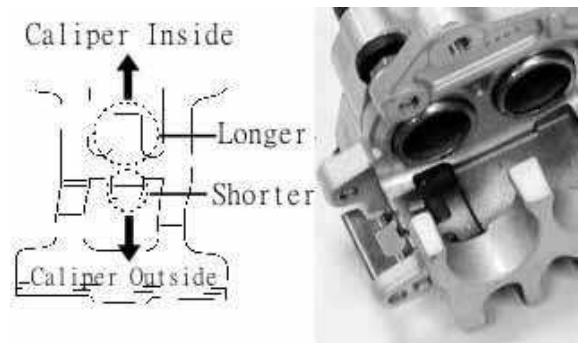

Install two brake pads.

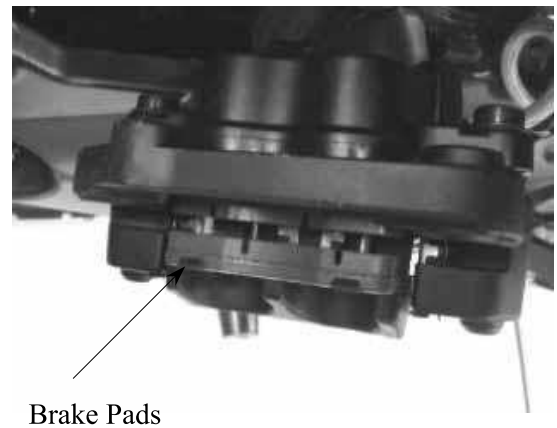

## INSTALLATION

Install the brake caliper to the rear fork and tighten the two bolts.

**Torque: 35 N-m (3.5 kgf-m)**

Connect the brake fluid tube to the brake caliper and install fluid tube bolt, copper washers and tighten the fluid tube bolt.

Fill the brake reservoir with the specified brake fluid and bleed air from the brake system.

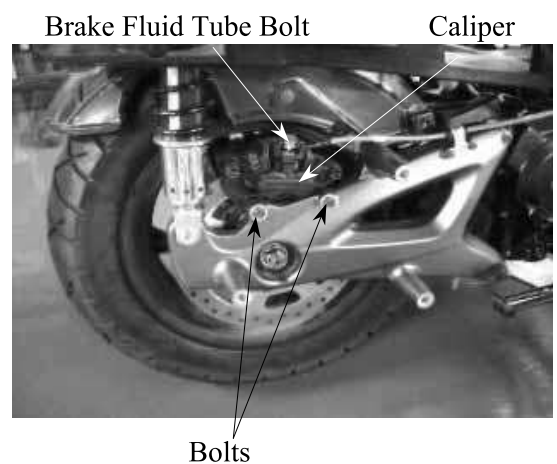

When installing the brake fluid tube, be sure to install the two copper sealing washers.

# 15. REAR WHEEL/REAR BRAKE/ REAR SUSPENSION

## REAR FORK

### REMOVAL

Remove the exhaust muffler.

Remove the rear brake caliper.



Bear Axle Nut

Remove the right rear shock absorber lower mount bolt.

Remove the rear axle nut and remove the collar.

Remove the rear fork.

The installation sequence is the reverse of removal.

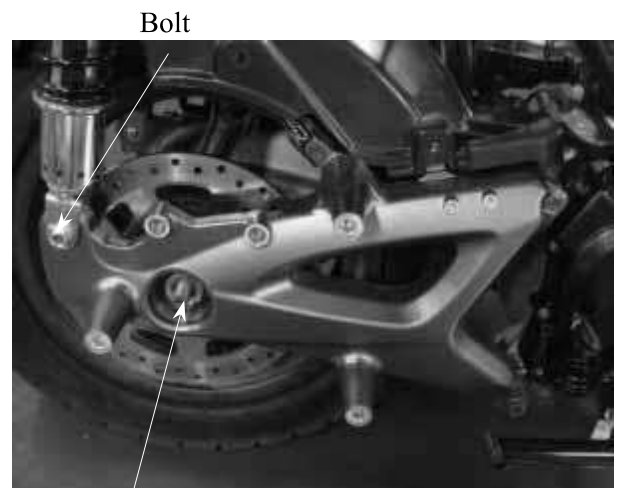

Bolt

Bear Axle Collar

# 15. REAR WHEEL/REAR BRAKE/ REAR SUSPENSION

## REAR WHEEL REMOVAL

- Remove the exhaust muffler.
- Remove the rear brake caliper.
- Remove the rear fork.
- Remove the rear axle collar.
- Remove the rear wheel.



Bear Axle Collar

## INSTALLATION

The installation sequence is the reverse of removal.

### Torque:

- Rear shock absorber lower mount bolt: 40 N-m (4 kgf-m)
- Rear axle nut 120 N-m (12 kgf-m)

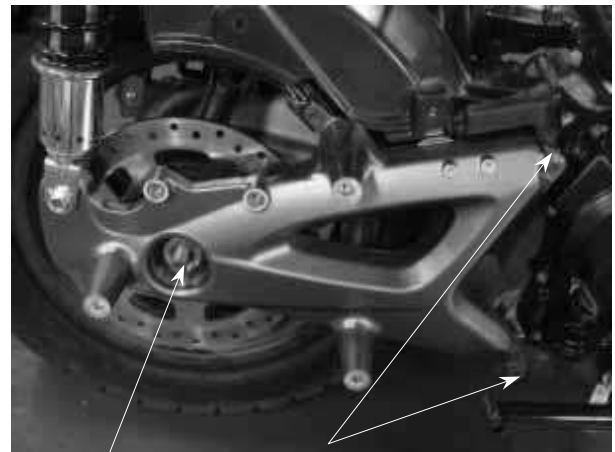

Bear Axle Collar Bolts

## REAR SHOCK ABSORBER REMOVAL

- Remove the met-in box and carrier.
- Remove the body cover, center cover and rear fender A together.
- Remove the right/left rear shock absorber upper and lower mount bolts.
- Remove the right and left rear shock absorbers.

## INSTALLATION

Install the rear suspension in the reverse order of removal.

### Torque:

- Upper Mount Bolt: 40 N-m (4 kgf-m)
- Lower Mount Bolt: 40 N-m (4 kgf-m)



Bolts

# 15. REAR WHEEL/REAR BRAKE/ REAR SUSPENSION

## Suspension

Each shock absorber ⑨ on your scooter has 5 spring preload adjustment positions for different load or riding conditions.

Use a pin spanner ⑩ to adjust the rear shock spring preload. Position 1 is for light loads and smooth road conditions. Position 3 to 5 increase spring preload for a stiffer rear suspension and can be used when the scooter is heavily loaded. Be certain to adjust both shock absorbers to the same spring preload positions.

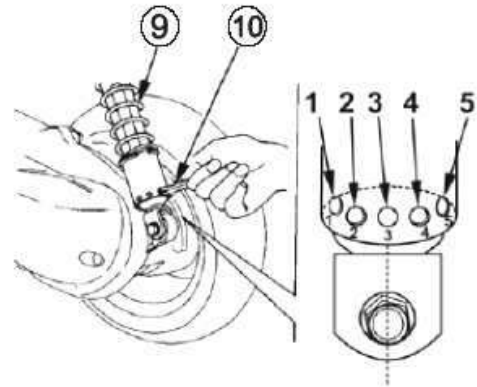

## Standard spring preload position: 3

### **CAUTION**

Always adjust the shock absorber pre-load position in sequence (1-2-3-4-5 or 5-4-3-2-1). Attempting to adjust directly from 1 to 5 or 5 to 1 may damage the shock absorber.



---

# 16. BATTERY/CHARGING SYSTEM

---

---

---

---

---

**16**

---

---

## BATTERY/CHARGING SYSTEM

---

CHARGING SYSTEM LAYOUT .....	16-1
CHARGING CIRCUIT .....	16-1
SERVICE INFORMATION.....	16-2
TROUBLESHOOTING.....	16-3
BATTERY CHARGING .....	16-4
CHARGING SYSTEM .....	16-6
REGULATOR/RECTIFIER .....	16-6

# 16. BATTERY/CHARGING SYSTEM

## CHARGING SYSTEM LAYOUT

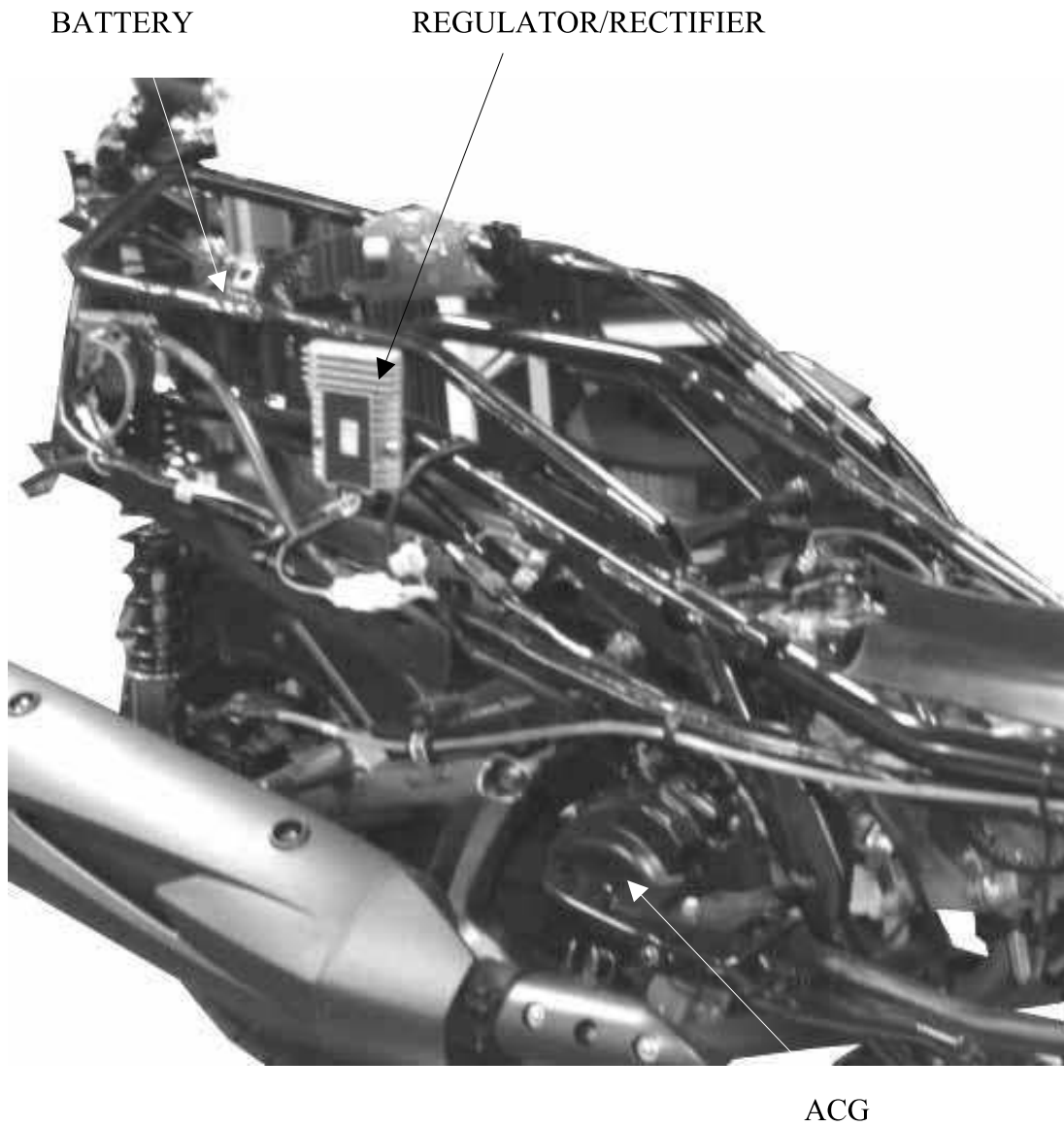

# 16. BATTERY/CHARGING SYSTEM

## SERVICE INFORMATION

### GENERAL INSTRUCTIONS

\* The battery electrolyte (sulfuric acid) is poisonous and may seriously damage the skin and eyes. Avoid contact with skin, eyes, or clothing. In case of contact, flush with water and get prompt medical attention

- The battery can be charged and discharged repeatedly. If a discharged battery is not used for a long time, its service life will be shortened. Generally, the capacity of a battery will decrease after it is used for 2~3 years. A capacity-decreased battery will resume its voltage after it is recharged but its voltage decreases suddenly and then increases when a load is added.
- When a battery is overcharged, some symptoms can be found. If there is a short circuit inside the battery, no voltage is produced on the battery terminals. If the rectifier won't operate, the voltage will become too high and shorten the battery service life.
- If a battery is not used for a long time, it will discharge by itself and should be recharged every 3 months.
- A new battery filled with electrolyte will generate voltage within a certain time and it should be recharged when the capacity is insufficient. Recharging a new battery will prolong its service life.
- Inspect the charging system according to the sequence specified in the Troubleshooting.
- Do not disconnect and soon reconnect the power of any electrical equipment because the electronic parts in the regulator/rectifier will be damaged. Turn off the ignition switch before operation.
- It is not necessary to check the MF battery electrolyte or fill with distilled water.
- Check the load of the whole charging system.
- Do not quick charge the battery. Quick charging should only be done in an emergency.
- Remove the battery from the motorcycle for charging.
- When replacing the battery, do not use a traditional battery.
- When charging, check the voltage with an electric tester.

### SPECIFICATIONS

		Item	Standard
Battery	Capacity		12V10AH
	Voltage (20°C)	Fully charged	13.2V
		Insufficient charged	< 12.3V
	Charging current		1.2A* 5~10H

# 16. BATTERY/CHARGING SYSTEM

---

## TROUBLESHOOTING

### No power

- Dead battery
- Disconnected battery cable
- Fuse burned out
- Faulty ignition switch

### Low power

- Weak battery
- Loose battery connection
- Charging system failure
- Faulty regulator/rectifier

### Intermittent power

- Loose battery cable connection
- Loose charging system connection
- Loose connection or short circuit in ignition system

### Charging system failure

- Loose, broken or shorted wire or connector
- Faulty regulator/rectifier
- Faulty A.C. generator

# 16. BATTERY/CHARGING SYSTEM

## BATTERY

### REMOVAL

The battery is in the battery box below seat.

1. Remove the seat.
2. Remove the met-in box
3. Remove four screws and then the battery retainer.

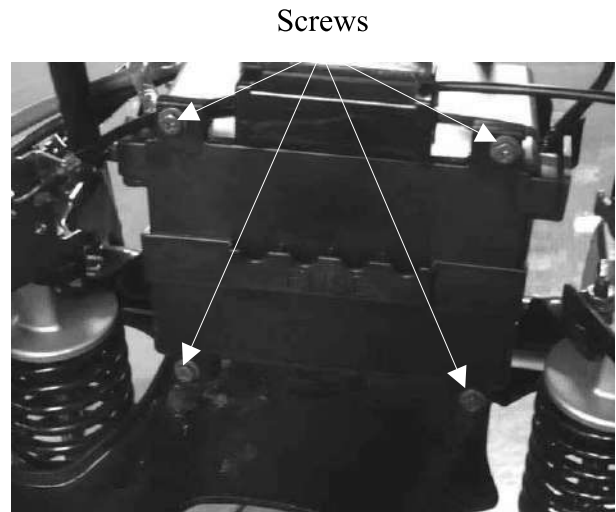

4. Pull battery out to expose the terminal leads
5. Disconnect the negative (-) terminal lead from the battery first, then disconnect the positive (+) terminal lead.
6. Remove the battery from the battery box.

(+) Terminal

(-) Terminal



### BATTERY INSTALLATION

Install in the reverse order of the removal.

\* When install the battery, first connect the positive (+) cable and then negative (-) cable to avoid short circuit.

### VOLTAGE INSPECTION

Remove the battery cover.

Measure the battery voltage by using a commercially available digital multimeter.

**Voltage (20°C/68°F):**

**Fully charged: 13.0 ~ 13.2 V**

**Insufficient charged: < 12.3 V**

## 16. BATTERY/CHARGING SYSTEM

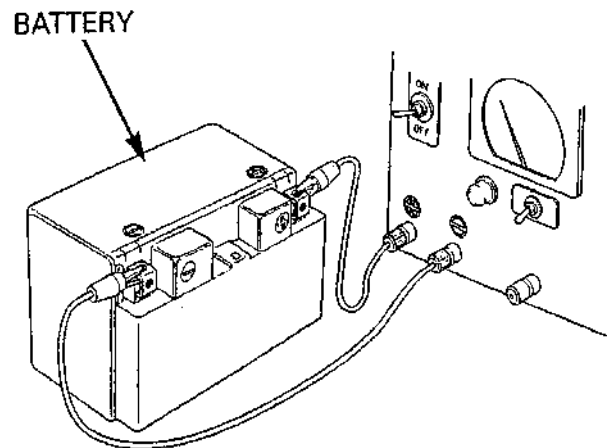

\*



\* Do not disconnect the battery or any cable in the charging system without first switching off the ignition switch. Failure to follow this precaution can damage the tester or electrical

# 16. BATTERY/CHARGING SYSTEM

## REGULATOR/RECTIFIER

### WIRE HARNESS INSPECTION

Remove the luggage box  
Disconnect the regulator/rectifier connectors.  
Check the connectors for loose contacts of corroded terminals.

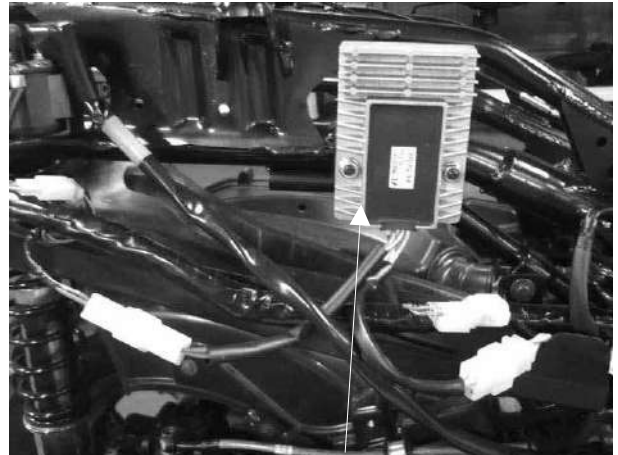

Regulator/Rectifier

### BATTERY WIRE

Measure the voltage between the Red/White wire terminal and ground.  
There should be battery voltage at all times.

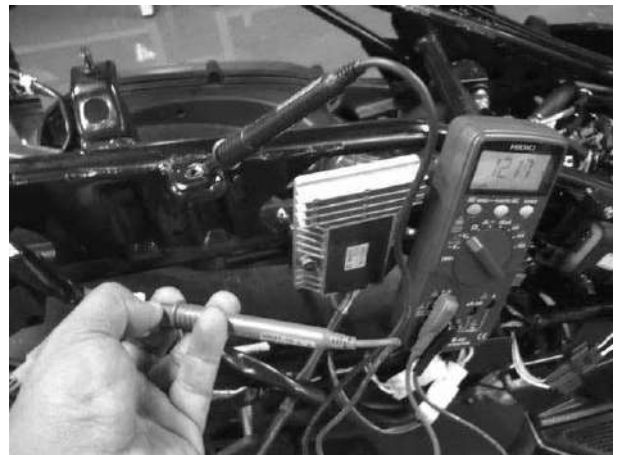

### GROUND WIRE

Check the continuity between the Green wire terminal and ground.  
There should be continuity at all times.



## 16. BATTERY/CHARGING SYSTEM

### CHARGING COIL WIRE

Measure the resistance between each Yellow wire terminals.

**Standard:** 0.4 ~ 0.6  $\Omega$  (20°C/68°F)

Disconnect the regulator/rectifier connector.  
Check for continuity between each Yellow wire terminal regulator/rectifier side and ground.

There should be no continuity.



### REMOVAL/INSTALLATION

Remove the side body cover.

Disconnect the regulator/rectifier connectors.

Remove the two bolts, regulator/rectifier.

Installation is in the reverse order of removal.

Regulator/Rectifier

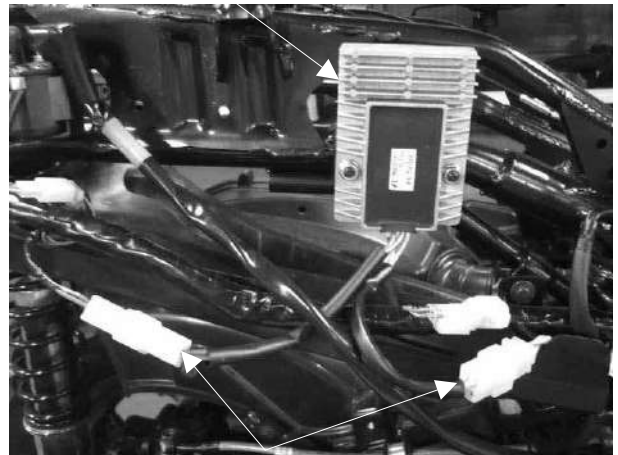

Connectors



# 17. IGNITION SYSTEM

---

---

---

**17**

---

---

## IGNITION SYSTEM

---

IGNITION SYSTEM LAYOUT .....	17-1
SERVICE INFORMATION.....	17-2
TROUBLESHOOTING .....	17-2
SPARK PLUG .....	17-3
IGNITION COIL INSPECTION .....	17-3
A.C. GENERATOR INSPECTION.....	17-4
TILT SWITCH INSPECTION .....	17-4

# 17. IGNITION SYSTEM

## IGNITION SYSTEM LAYOUT

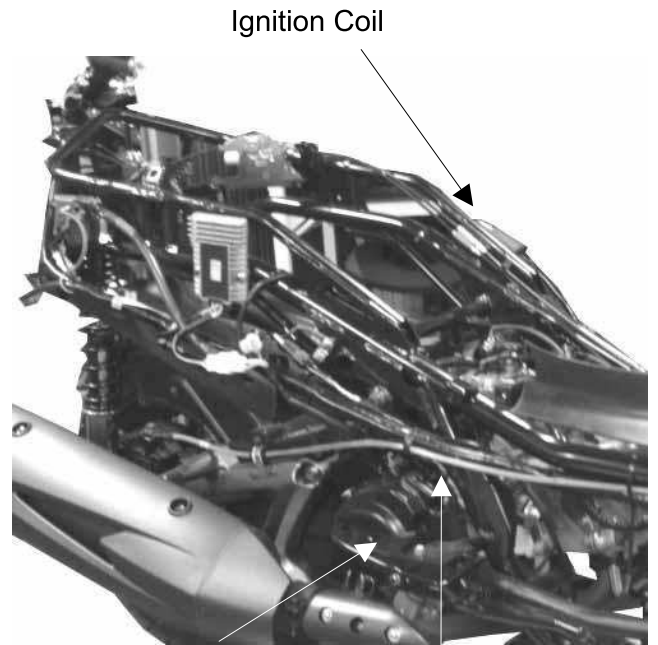
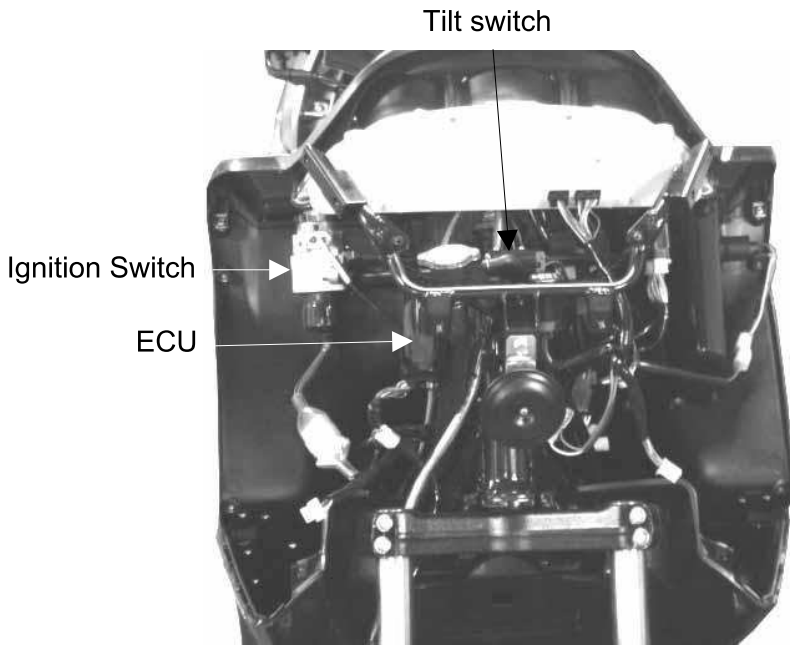

A.C. Generator Crank Position Sensor

## IGNITION CIRCUIT

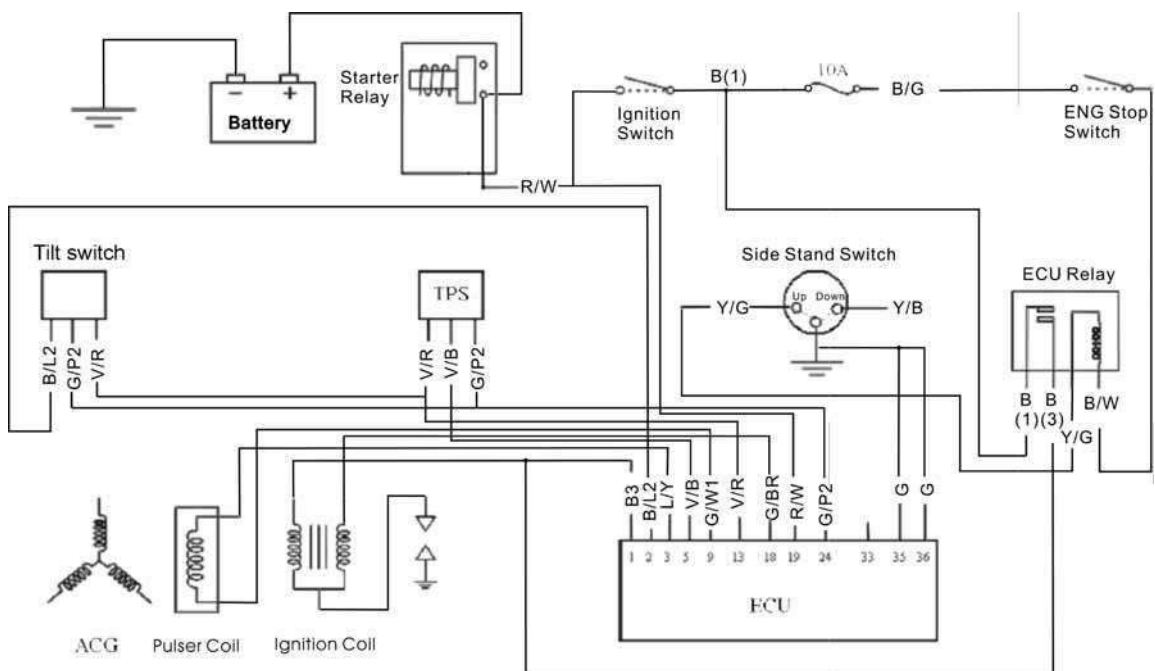

# 17. IGNITION SYSTEM

## SERVICE INFORMATION

### GENERAL INSTRUCTIONS

- Some electrical components may be damaged if terminals or connectors are connected or disconnected while the ignition switch is "ON" and current is present.
- When servicing the ignition system, always follow the steps in the troubleshooting on page 17-2.
- The ignition timing cannot be adjusted since the ignition control module is already adjusted in factory.
- The ignition control module or ECU maybe damaged if dropped or the connector is disconnected when the key is " ON " , the excessive voltage may damage the ignition control module or ECU. Always turn off the ignition switch before servicing.
- A faulty ignition system is often related to poor connections. Check those connections before proceeding.
- Make sure the battery is adequately charged. Using the starter motor with weak battery results in a slower engine cranking speed as well as no spark at the spark plug.
- Use a spark plug of the correct heat range. Using spark plug with an incorrect heat range can damage the engine.

### SPECIFICATIONS

Item		Standard
Spark plug	Standard type	NGK CR7E
Spark plug gap		0.6 ~ 0.7 mm
Inductive Ignition Coil	Primary coil	3.57~4.83 Ω
	Secondary coil without plug cap	10.42~14.49 KΩ
Throttle Position Sensor		3500~6500 Ω
Fuel Pump		1.9 Ω about
Fuel Injector		11.7±0.6 Ω
Water Temperature Sensor		2.076KΩ±10% (25°C)
Oxygen Sensor ( engine warming condition )		6.7 Ω~9.5 Ω
Crank Position Sensor		115Ω±15Ω
Tilt Switch		0.4V~1.4V(normal) 3.7V~4.4V (fall down)

### TROUBLESHOOTING

#### No peak voltage

- Short circuit in engine stop switch or ignition switch wire.
- Faulty engine stop switch or ignition switch.
- Loose or poorly connected ignition control module connectors.
- Open circuit or poor connection in ground wire of the ignition control module.
- Faulty crank position sensor.
- Faulty ignition control module.

#### Peak voltage is normal, but no spark jumps at the plug

- Faulty spark plug or leaking ignition coil secondary current.
- Faulty ignition coil.

# 17. IGNITION SYSTEM

## SPARK PLUG

For spark plug inspection and adjustment, refer to page 3-5.

## IGNITION COIL INSPECTION

Remove the seat and met-in box. (⇒2-6)  
Remove the ignition coil.

Ignition Coil

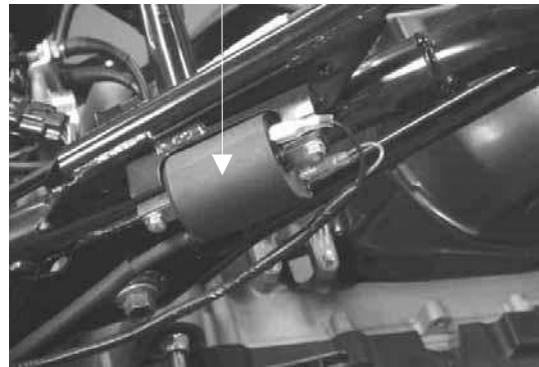

## IGNITION COIL CONTINUITY TEST

Inspect the continuity of the ignition coil, primary coil and secondary coil.

\* This is a general test. Accurate ignition coil test must be performed with an ignition unit tester.

Primary Coil

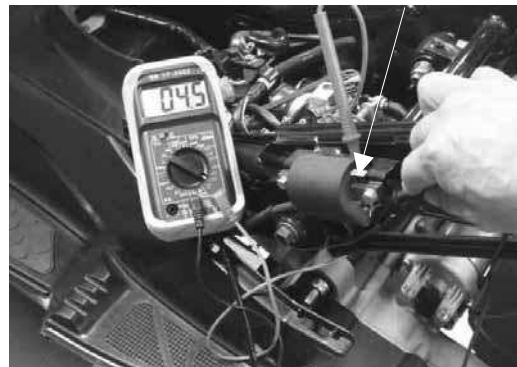

Secondary Coil with plug cap



Measure the ignition coil resistances at 20°C.

Primary coil	3.57~4.83 Ω
Secondary coil with plug cap	15 ~ 19 KΩ
Secondary coil without plug cap	10 ~14 KΩ

Secondary Coil without plug cap



# 17. IGNITION SYSTEM

## A .C. GENERATOR INSPECTION

### CRANK POSITION SENSOR INSPECTION

\* This test is performed with the stator installed in the engine.

Remove the seat and met-in box.  
 Disconnect the Crank Position Sensor Wire Coupler.  
 Measure the resistance between the blue/yellow and green/white wire terminals.

Blue/Yellow ~ Green/White	115Ω±15Ω
---------------------------	----------

## TILT SWITCH INSPECTION

Support the scooter level surface.  
 Put the side stand up and engine stop switch is at "RUN".  
 Turn the ignition switch to "OFF".  
 Remove the screws, washers and tilt switch.

\* Do not disconnect the tilt switch connector during inspection.  
 The capacity of battery must be fully charged.

Place the tilt switch vertical as shown at the ignition switch "ON". Measure the voltage as below.

Terminal	Standard
Violet/Red (+) – Green/Pink (-)	5 V (ECU voltage)
Black/Blue (+) – Green/Pink (-)	0.4 ~ 1.4 V less

Incline the tilt switch 65±10 degrees to the left or right at the ignition switch "ON". Measure the voltage as below.

Terminal	Standard
Violet/Red (+) – Green/Pink (-)	5 V (ECU voltage)
Black/Blue (+) – Green/Pink (-)	3.7 ~ 4.4 V

If repeat this test, first turn the ignition switch to "OFF", then turn the ignition switch to "ON".



Crank Position Sensor Wire Coupler

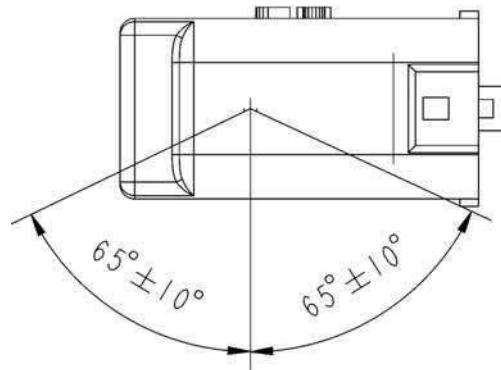
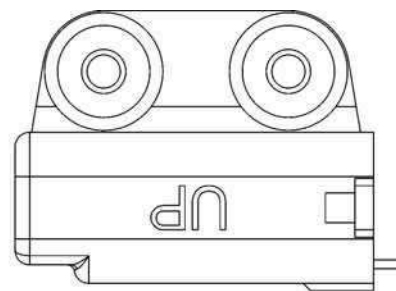

Tilt Switch "UP" Mark Screws

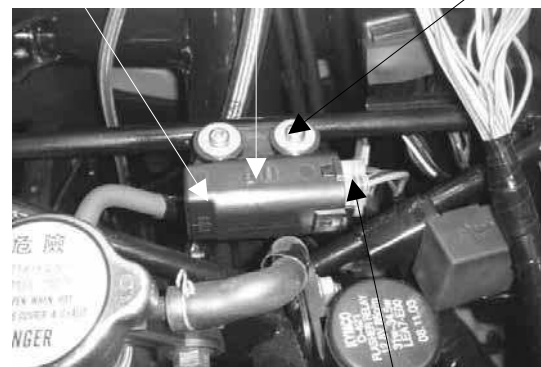

Connector

## 17. IGNITION SYSTEM

### REMOVAL/INSTALLATION

Disconnect the connector and remove two screws, then remove tilt switch.

Installation is in the reverse order of removal.

- \* Install the tilt switch with its “up” mark facing up.

Tighten the mounting screws securely.

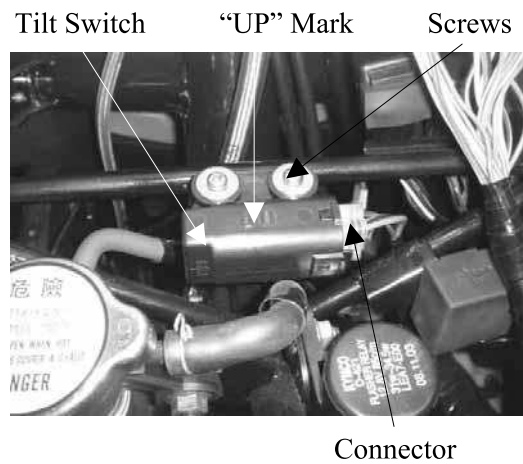

## 18. STARTING SYSTEM

---

---

---

---

---

---

---

---

---

---

**18**

### STARTING SYSTEM

---

STARTING SYSTEM LAYOUT .....	18-1
SERVICE INFORMATION.....	18-2
TROUBLESHOOTING .....	18-2
STARTER MOTOR.....	18-3
STARTER RELAY INSPECTION.....	18-4

# 18. STARTING SYSTEM

## STARTING SYSTEM LAYOUT

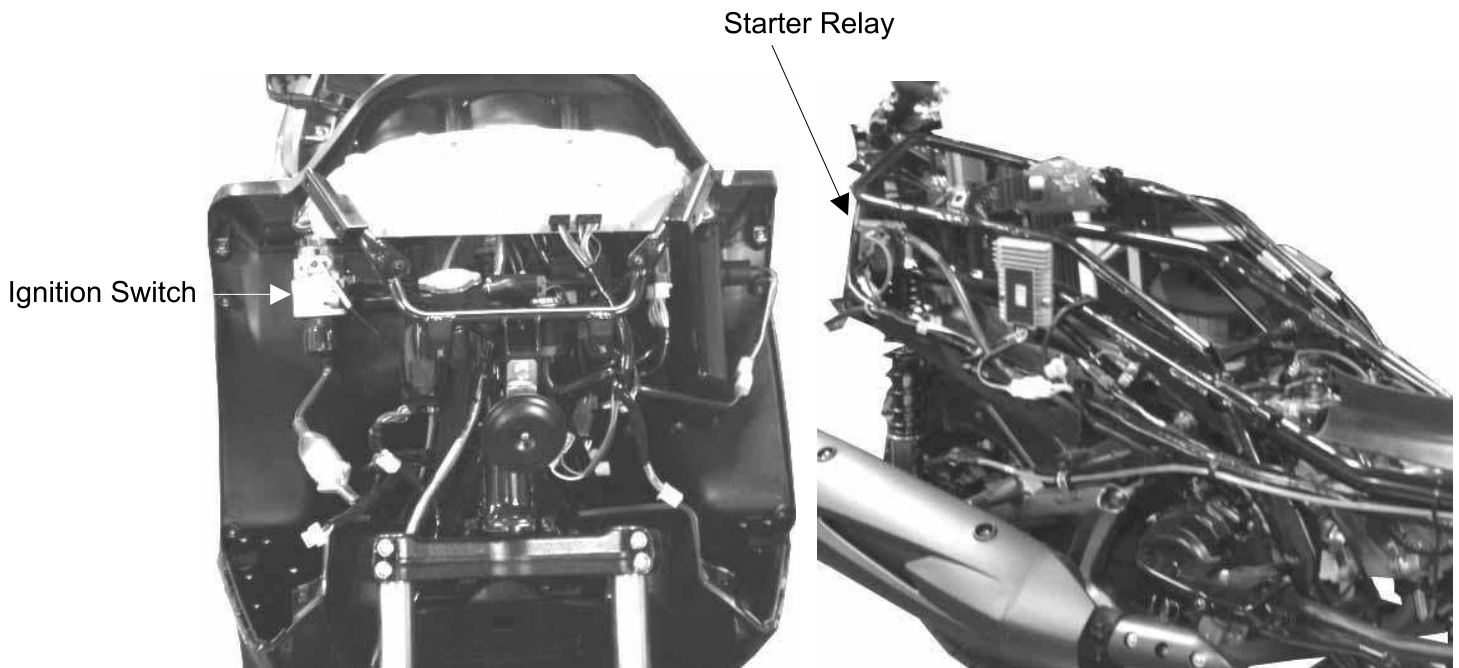

## STARTING CIRCUIT

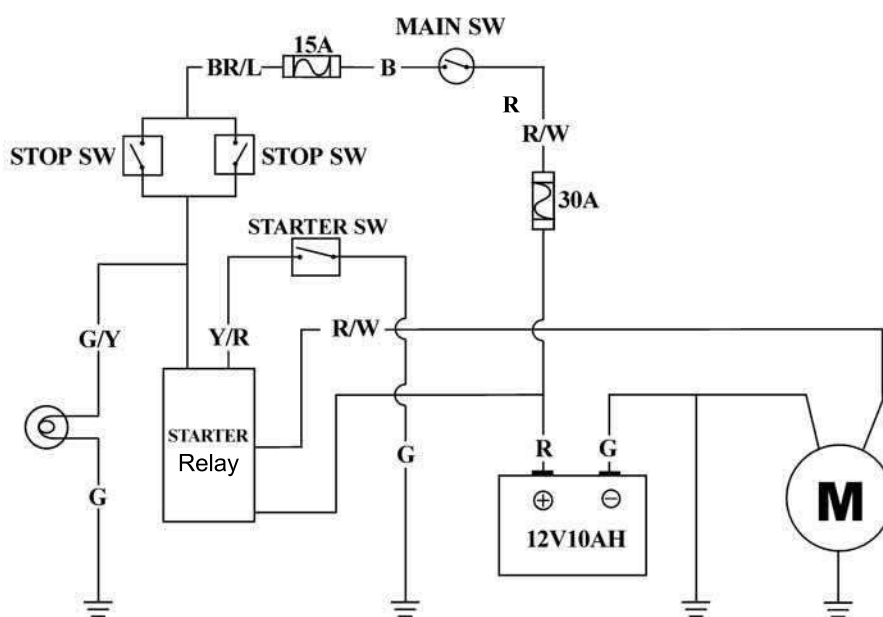



# 18. STARTING SYSTEM

## SERVICE INFORMATION

### GENERAL INSTRUCTIONS

- The removal of starter motor can be accomplished with the engine installed.
- After the starter clutch is installed, be sure to add the engine oil and coolant and then bleed air from the cooling system.

### SPECIFICATIONS

Item	Standard (mm)	Service Limit (mm)
Starter motor brush length	12.5mm	8.5mm

### TORQUE VALUES

Starter motor mounting bolt	6.7~10.8 N-m
Starter motor case screw	2.9~4.9 N-m
Starter clutch bolt	9.8~13.7 N-m

### SPECIAL TOOLS

Flywheel holder	E021
Flywheel puller	E003

### TROUBLESHOOTING

#### Starter motor won't turn

- Fuse burned out
- Weak battery
- Faulty ignition switch
- Faulty starter clutch
- Faulty front or rear stop switch
- Faulty starter relay
- Poorly connected, broken or shorted wire
- Faulty starter motor

#### Lack of power

- Weak battery
- Loosed wire or connection
- Foreign matter stuck in starter motor or gear

#### Starter motor rotates but engine does not start

- Faulty starter pinion
- Starter motor rotates reversely
- Weak battery

## 18. STARTING SYSTEM

### STARTER MOTOR

#### REMOVAL

\* Before removing the starter motor, turn the ignition switch OFF and remove the battery ground. Then, turn on the ignition switch and push the starter button to make sure the starter motor can't operate securely.

Remove the seat, met-in box and carrier.  
Remove the body cover, center cover and rear fender A together.  
Remove the nut goes to the starter relay and relax cable band to disconnect the starter motor cable.

Remove two start motor mounting bolts and the motor.

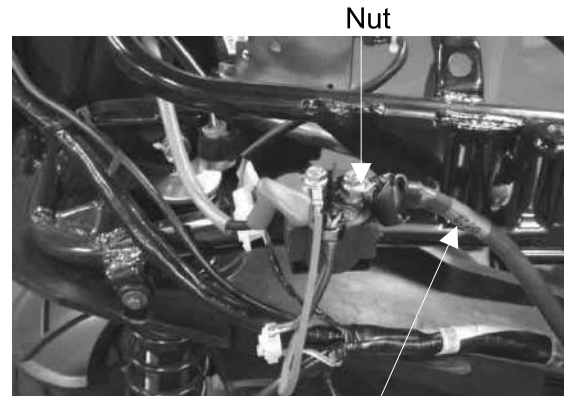

Nut  
Starter Motor Cable

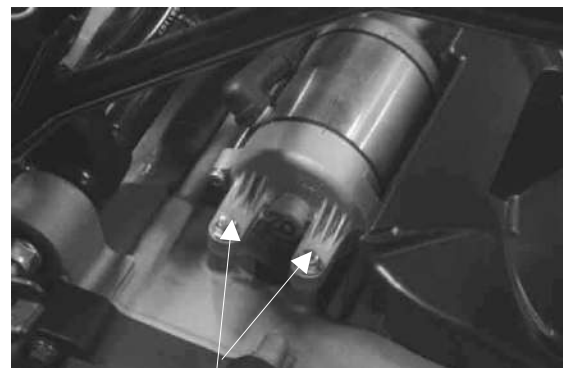

Bolts

# 18. STARTING SYSTEM

## INSTALLATION

Connect the starter motor cable.  
 Check the O-ring for wear or damage and replace if necessary.  
 Apply grease to the O-ring and install it to the starter motor.  
 Tighten the two mounting bolts.

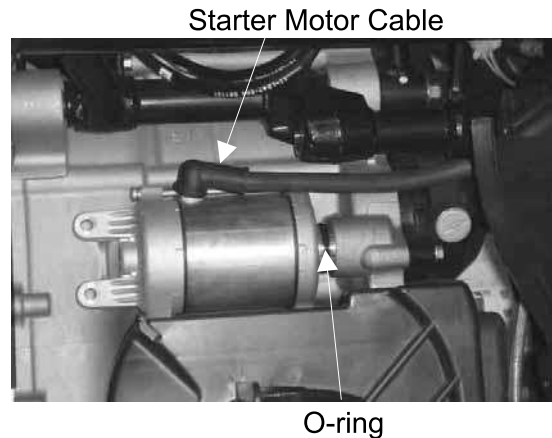

## STARTER RELAY INSPECTION

Disconnect the starter relay wire connector.  
 Check for continuity between the yellow/red wire and green/yellow wire.  
 There should be continuity when the starter button is depressed.  
 If there is no continuity, check the starter button for continuity and inspect the wire.



Yellow/Red Wire

## OPERATION TEST

Connect the electric meter to the starter relay terminals that connect to the battery positive cable and the starter motor cable.  
 Connect a fully charged battery across the starter relay yellow/red and green/yellow wire terminals.  
 Check for continuity between the starter relay large terminals. The relay is normal if there is continuity and hear sounds.

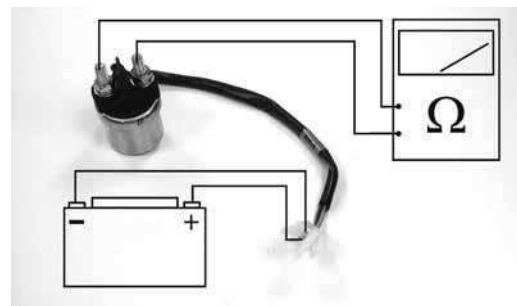

Starter Relay test chart

---

**19. LIGHTS SWITCHES/ FUEL PUMP**

---

---

**LIGHTS/METERS/SWITCHES**

---

SERVICE INFORMATION-----	19- 1
BULB REPLACEMENT -----	19- 2
BRAKE LIGHT SWITCH-----	19- 6
IGNITION SWITCH -----	19- 6
HANDLEBAR SWITCH -----	19- 7
LUGGAGE BOX LIGHT SWITCH -----	19- 9
FUEL PUMP -----	19-10
SIDE STAND SWITCH -----	19-13
HORN -----	19-14

# 19. LIGHTS SWITCHES/ FUEL PUMP

Downtown 300i ABS

## ELECTRICAL EQUIPMENT LAYOUT

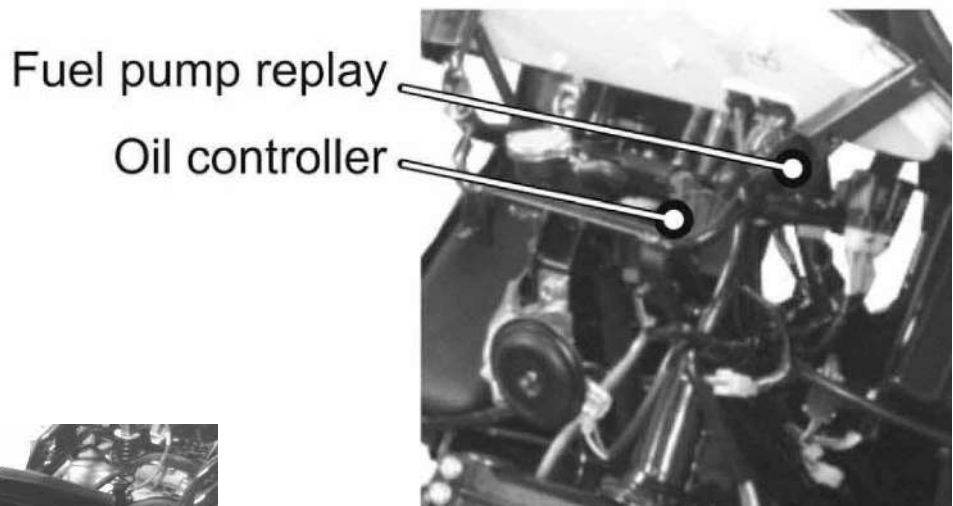
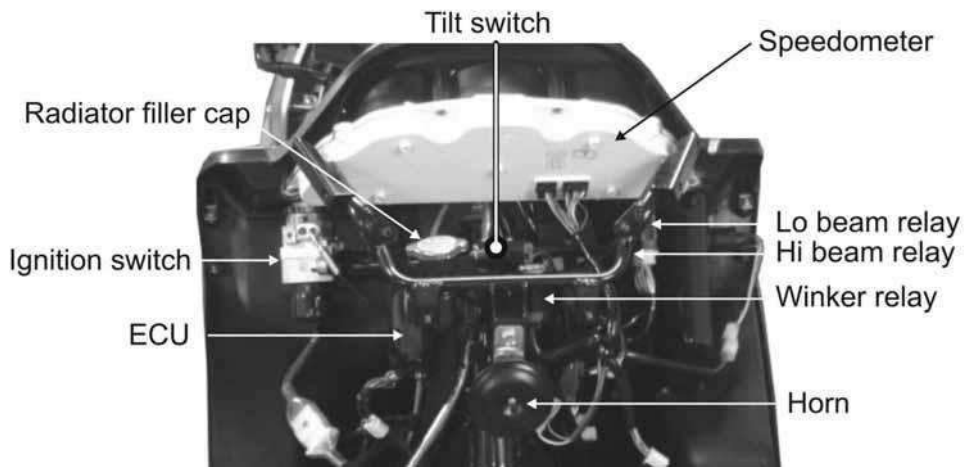

# 19. LIGHTS SWITCHES/ FUEL PUMP

## SERVICE INFORMATION

### GENERAL

A halogen head light bulb becomes very hot while the head light is on, and remains for a while after it is turned off. Be sure to let it cool down before servicing.

- Note the following when replacing the halogen headlight bulb
  - Wear clean gloves while replacing the bulb. Do not put finger prints on the headlight bulb, as they may create hot spots on the bulb and cause it to fail.
  - If you touch the bulb with your bare hands, clean it with a cloth moistened with alcohol to prevent its early failure.
  - Be sure to install the dust cover after replacing the bulb.
- Check the battery condition before performing any inspection that requires proper battery voltage.
- A continuity test can be made with the switches installed on the scooter.
- Route the wires and cables properly after servicing each component.

### TROUBLESHOOTING

#### Lights do not come on when ignition switch is "ON"

- Burned bulb
- Faulty switch
- Poorly connected, broken or shorted wire

#### Temperature gauge does not register correctly

- Faulty temperature gauge
- Faulty thermosensor
- Broken or shorted wire between the temperature gauge and thermosensor

#### Fuel gauge does not work or wrong show figures

- Faulty fuel gauge
- Faulty fuel unit
- Poorly connected wire between fuel gauge and fuel unit
- Fuse burned out

### SPECIFICATIONS

Fuse	10A,15A,30A
Headlight bulb	12V 35W/35W *2
Turn signal light bulb	12V 21W(Front) / 10W(Rear)
Stoplight/taillight	12V 21/5W

**BULB REPLACEMENT****LICENSE LIGHT**

Remove the seat assembly and luggage box.  
Remove the body covers.  
Disconnect the license bulb socket.  
Remove the bulb and replace with a new one.

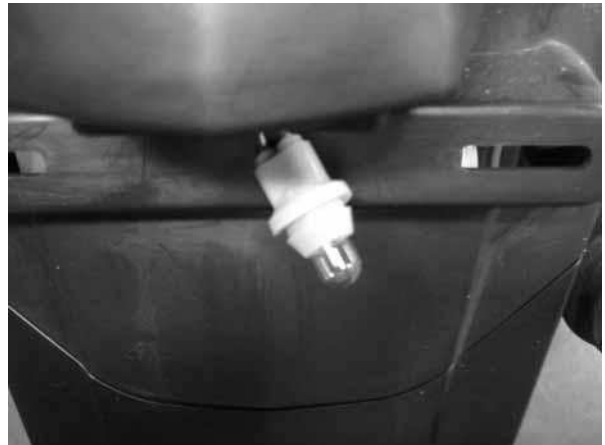

## 19. LIGHTS/METERS/SWITCHES

### HEADLIGHT

A halogen headlight bulb becomes hot while the headlight is ON and remains for a while after it is turned OFF. Be sure to let it cool down before servicing.

### REMOVAL

Remove the front cover  
Disconnect the headlight cover  
Disconnect the headlight connector from the headlight bulb.

Connector

Headlight Bulb

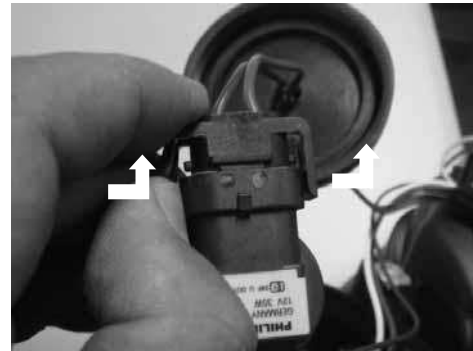
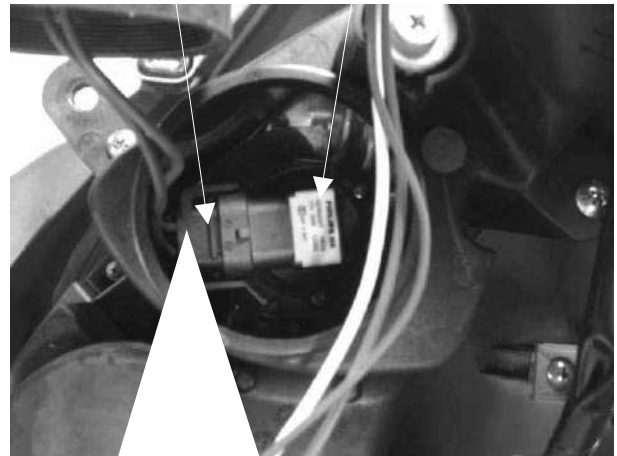

### INSTALLATION

Install a new bulb into the headlight case.  
Install the headlight and connect the headlight connector





## 19. LIGHTS/METERS/SWITCHES

---

Put the headlight wires into the headlight unit and then cover the waterproof rubber.



Press the waterproof rubber around with hand until its seat.

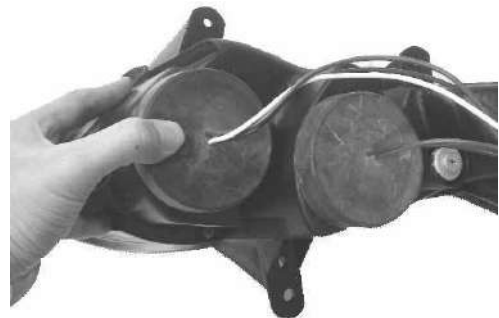

### INSPECTION

Confirm if the waterproof rubber is covered firmly.



## 19. LIGHTS/METERS/SWITCHES

### FRONT TURN SIGNAL LIGHT

Remove the front cover.  
Turn the bulb socket, then remove the front turn signal light.



Push and turn the bulb counterclockwise to remove it, then replace with a new one.

Installation is in the reverse order of removal.



### TAILLIGHT/BRAKE LIGHT/REAR TURN SIGNAL LIGHT

Remove the seat and met-in, then remove the taillight bulb socket.



## 19. LIGHTS/METERS/SWITCHES

---

### REAR TURN SIGNAL LIGHT

Push and turn the bulb counterclockwise to remove it, then replace with a new one.

Installation is in the reverse order of removal.



Rear Turn Signal Light



Taillight/Brake Light

# 19. LIGHTS/METERS/SWITCHES

## BRAKE LIGHT SWITCH

Remove the upper handlebar cover.  
 Disconnect front or rear brake light switch connectors and check for continuity between the switch terminals.  
 There should be continuity with the front or rear brake lever squeezed, and there should be no continuity with the front or rear brake lever is released.



Front Brake Light Switch

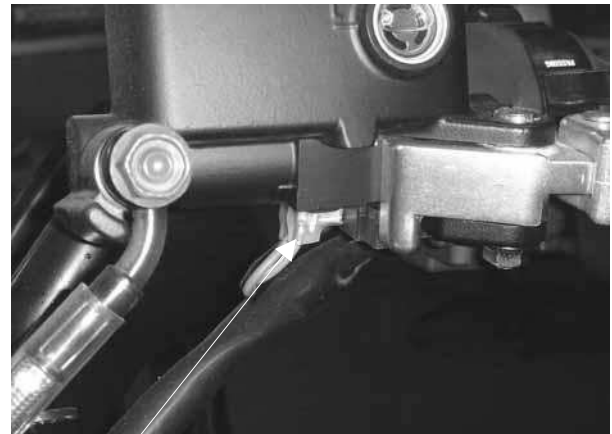

Rear Brake Light Switch

## IGNITION SWITCH

### INSPECTION

Remove the front cover.  
 Disconnect the ignition switch connector and check the ignition switch for continuity at the switch side connector terminals.  
 Continuity should exist between the color code wires as follows:

COMB SW

	BAT2	IG	E	BAT1	HA
LOCK		○—○			
OFF		○—○		○—○	
ON	○—			○—○	
COLOR	B	B/W	G	R	B/L



# 19. LIGHTS/METERS/SWITCHES

## RIGHT HANDLEBAR SWITCH

### INSPECTION

Remove the front cover

Disconnect the right handlebar switch connector and check for continuity at switch side connector terminals.

Continuity should exist between the color code wires as follows:

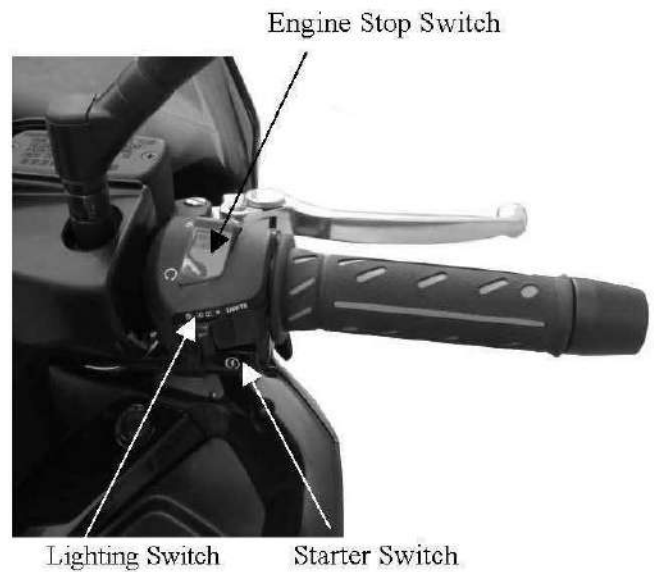

LIGHTING SW

	BAT3	PO	TL	HL
•				
(N)				
P	○	○	○	
(N)	○	○	○	○
H	○	—	○	○
COLOR	BR/L	BR/W	BR	W/L

STARTER SW

	E	ST
FREE		
PUSH	○	○
COLOR	G	Y/R

ENGINE STOP SW

	IG	BAT3
OFF		
RUN	○	○
COLOR	B/W	B/G

# 19. LIGHTS/METERS/SWITCHES

## LEFT HANDLEBAR SWITCH

### INSPECTION

Disconnect the left handlebar switch connector and check for continuity at switch side connector terminals.

Continuity should exist between the color code wires as follows:

WINKER SW

	WR	R	L
R	○	○	
N			
L	○		○
COLOR	GR	SB	O

HORN SW

	BAT4	HO
FREE		
PUSH	○	○
COLOR	BR/L	LG

DIMMER SW

	HL	HI	LO
LO	○		○
(N)	○	○	○
HI	○	○	
COLOR	W/L	L	W

PASSING SW

	BAT4	HI
FREE		
PUSH	○	○
COLOR	BR/L	L

Dimmer Switch

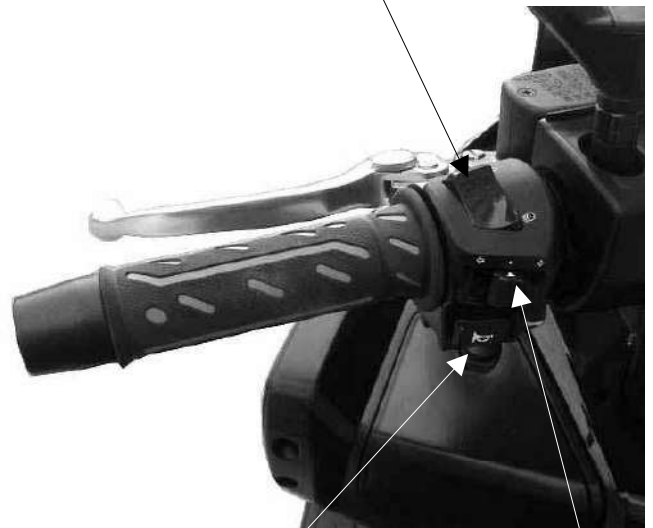

Horn Switch      Turn Signal light Switch

Passing Switch



## LUGGAGE BOX LIGHT SWITCH

### INSPECTION

Remove the luggage box

Disconnect the luggage box light switch connector and check the luggage box light switch for continuity between the switch terminals.

There should be no continuity with the luggage box light switch pushed, and there should be continuity with the luggage box light switch is released.

Luggage box light switch

Connector



## 19. LIGHTS/METERS/SWITCHES

### FUEL PUMP

#### REMOVAL

Remove the seat and met-in  
Remove the center cover  
Remove the fuel pump connector  
Be sure to relieve the fuel pressure before removing fuel pump or fuel hose.  
Remove the six nuts and fuel unit connectors then remove the fuel hose.

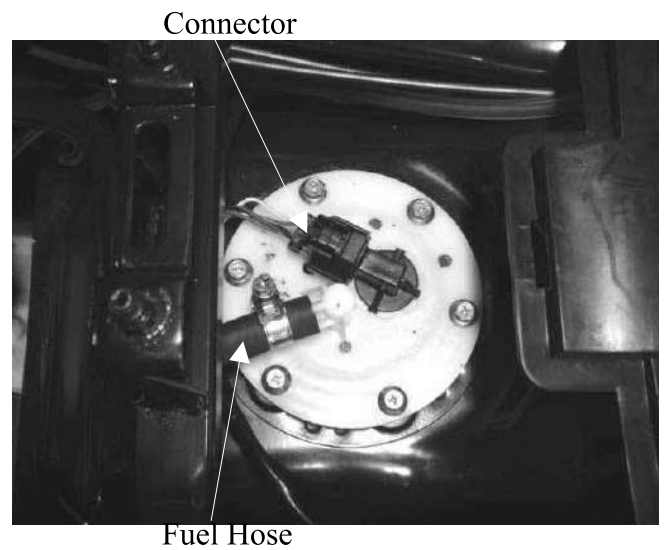

Remove the fuel pump



Check the fuel pump O-ring.  
If was damage, replace a new one.

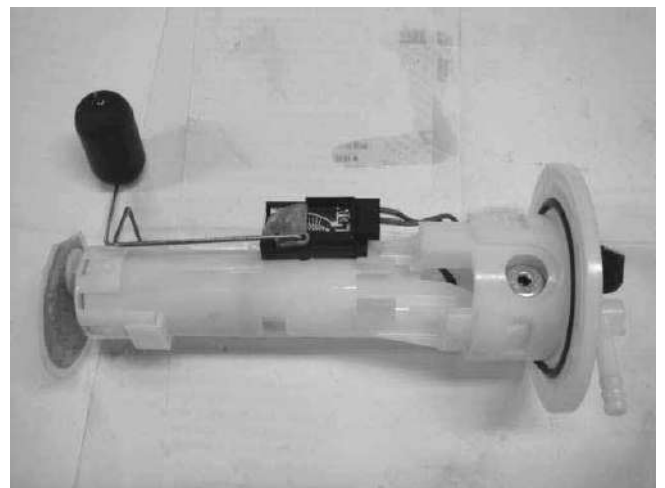

# 19. LIGHTS/METERS/SWITCHES

## INSPECTION

Connect the fuel unit wire connectors and turn the ignition switch “ON”.

Before performing the following test, operate the turn signals to determine that the battery circuit is normal.

Measure the resistance between the Red/Black and Green wire of the fuel unit connector.

**Standard** (at 20°C/68°F):

Float at full position	About 1100 Ω
Float at empty position	About 100 Ω

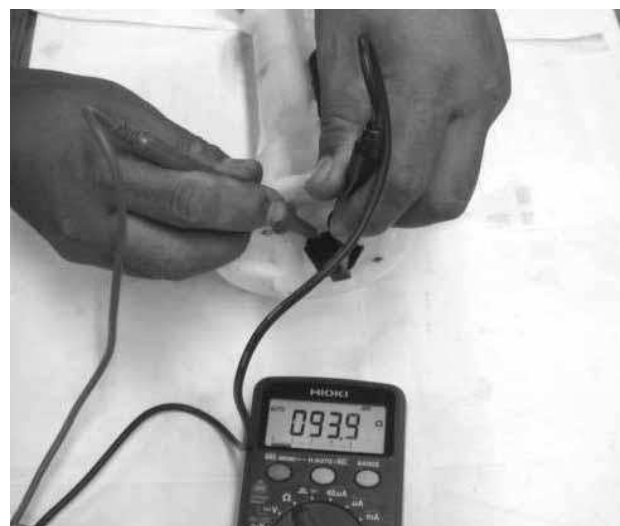
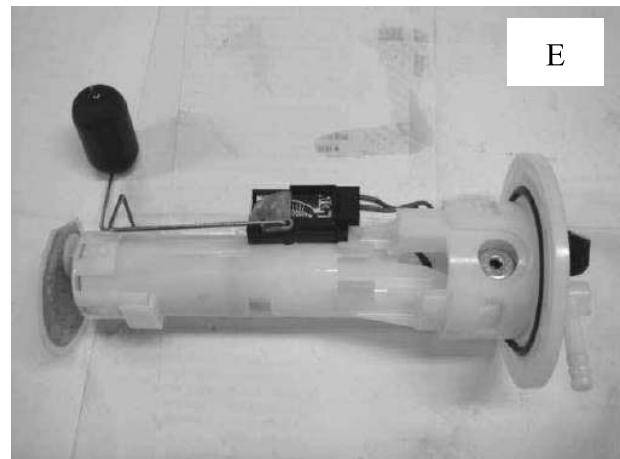
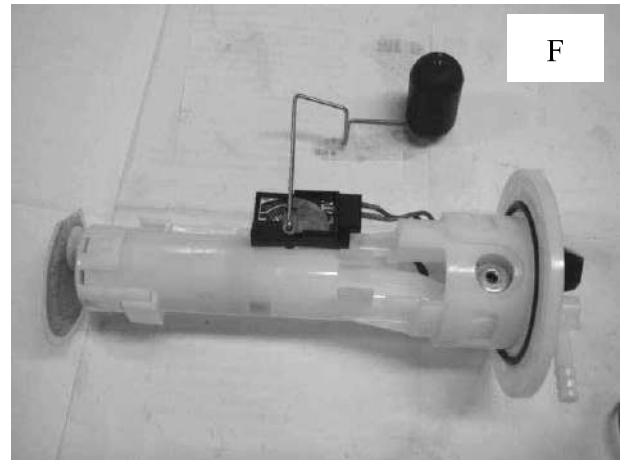



## 19. LIGHTS/METERS/SWITCHES

### SIDE STAND SWITCH

#### INSPECTION

Remove the luggage box.

Side stand switch is located on side stand.

Disconnect the side stand switch connector.

There should be continuity between the Yellow/Green and Green with the side stand is up.

There should be continuity between the Yellow/Black and Green with the side stand is down.

Connector



UP



DOWN

## 19. LIGHTS/METERS/SWITCHES

---

### HORN

#### INSPECTION

Remove the front cover.

Disconnect the horn connectors from the horn.

Connect a 12 V battery to the horn terminals.

The horn is normal if it sounds when the 12 V battery is connected across the horn terminals.



---

**EVAPORATIVE EMISSION CONTROL SYSTEM**

---

SCHEMATIC DRAWING .....	20-1
EVAPORATIVE EMISSION CONTROL SYSTEM FUNCTION.....	20-2
TROUBLESHOOTING.....	20-2
SERVICE INFORMATION .....	20-3
PERGE CONTROL VALVE .....	20-4
CHARCOAL CANISTER.....	20-6

**SCHEMATIC DRAWING**



**Charcoal Canister/ Purge Control Valve**



**Air Cleaner**

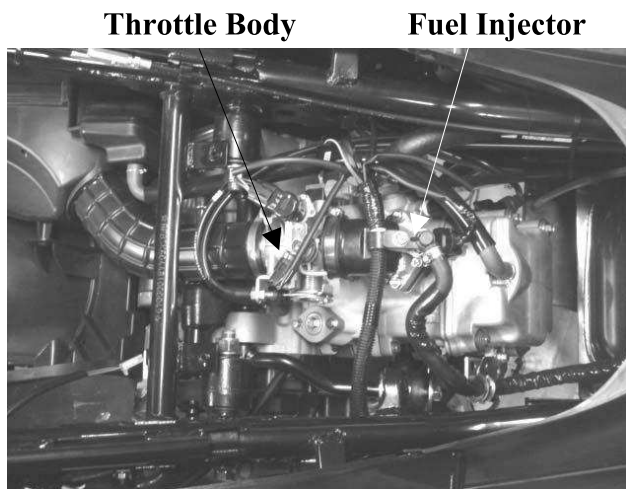

**Throttle Body**

**Fuel Injector**

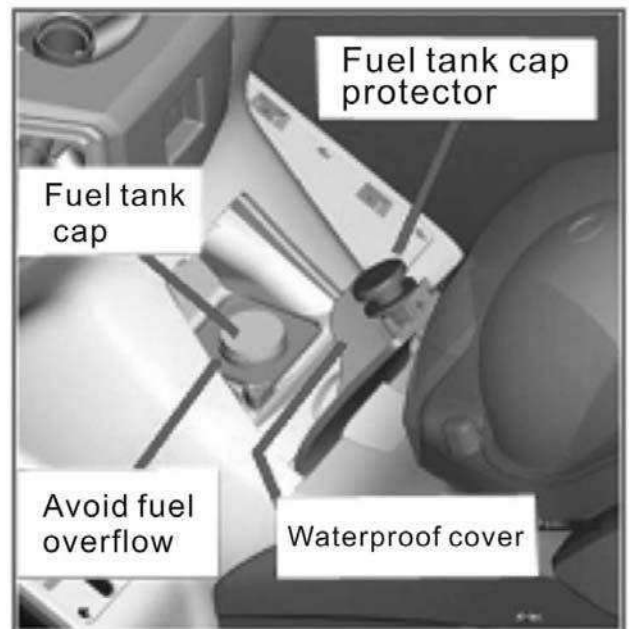

**Fuel tank cap protector**

**Fuel tank cap**

**Avoid fuel overflow**

**Waterproof cover**

## EVAPORATIVE EMISSION CONTROL SYSTEM FUNCTION

### FOREWORD:

The Evaporative Emission Control System is abbreviated to E.E.C. System. This device collects the fuel vapor from the fuel tank and then the fuel vapor is drawn into the engine for re-burning to avoid air pollution caused by the fuel vapor diffused into the air.

### FUNCTION

Item	Purpose	Function
Purge Control Valve	Control vaporized HC from fuel tank not to diffuse into the air.	The charcoal canister absorbs vaporized HC from the fuel tank. When the engine is running and the purge control valve is open, the fuel vapor in the charcoal canister is drawn into the engine for re-burning.
Charcoal Canister	Absorb and store the vaporized HC from the fuel tank and carburetor.	The vaporized HC is absorbed in the charcoal canister and the specified volume of HC in the emission should not exceed 2g.
P.C.V. System	Completely recover the HC from blow-by gas in the crankcase for re-burning.	Through the P.C.V. system, the blow-by gas from the crankcase is separated into fuel vapor and fuel and then drawn into the cylinder for re-burning.

## TROUBLESHOOTING

### Engine loses power or runs erratic at idle speed

1. Clogged P.C.V. system
2. Clogged air cleaner
3. Faulty purge control valve
4. Loose or broken E.E.C. system tubes

### Engine idles or accelerates roughly

1. Faulty fuel cut-off valve
2. Faulty purge control valve
3. Clogged or faulty charcoal canister

### SERVICE INFORMATION

#### GENERAL INSTRUCTIONS

- Do not smoke or allow flames or sparks near the working area.
- Note the locations of tubes for proper installation.
- Replace any damaged tube with a new one.
- Make sure to tighten the connector of each tube securely.

#### TOOLS

- Vacuum pump – A937X – 014 – XXXX
- Pressure pump –

#### SPECIFICATIONS

Purge control valve vacuum pressure	45mm/Hg
Charcoal canister capacity	90cc

#### A. LEAKAGE TEST PIPING DIAGRAM

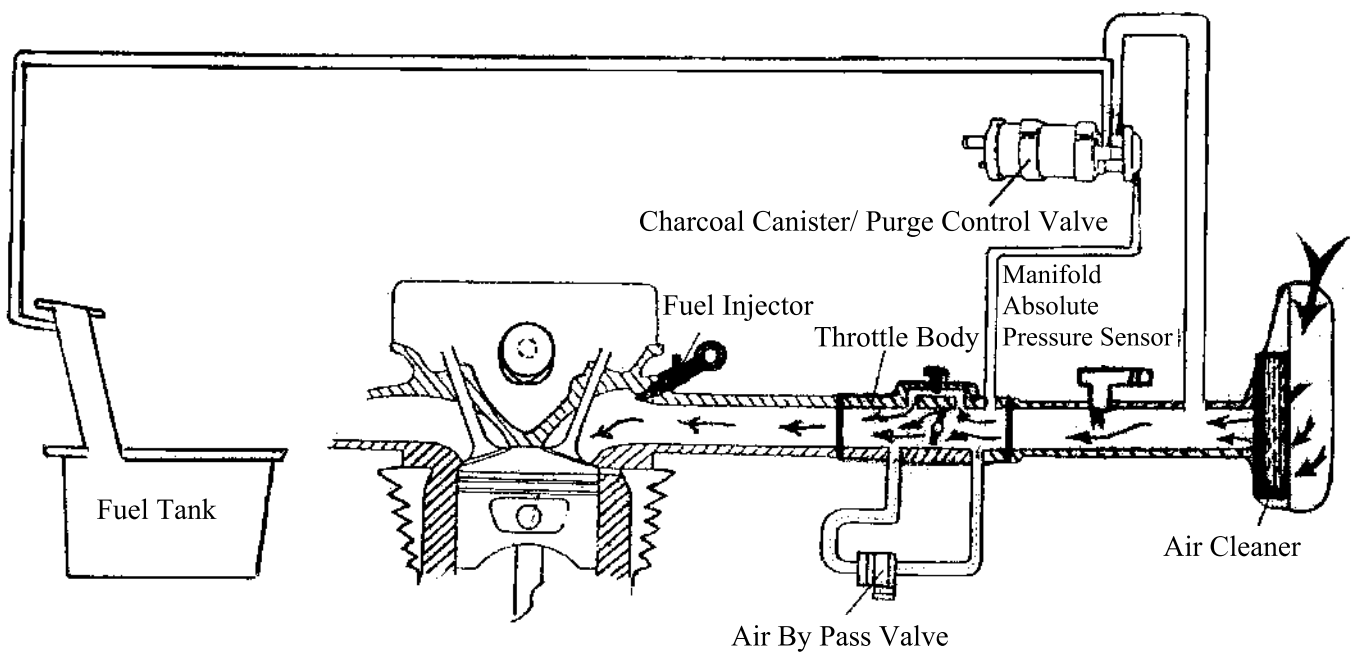

### PURGE CONTROL VALVE REMOVAL

1. Remove the front cover.
2. Disconnect the purge control valve vacuum tube that goes to the throttle body and the tubes that go to the air cleaner and charcoal canister. Remove the charcoal canister/purge control valve.

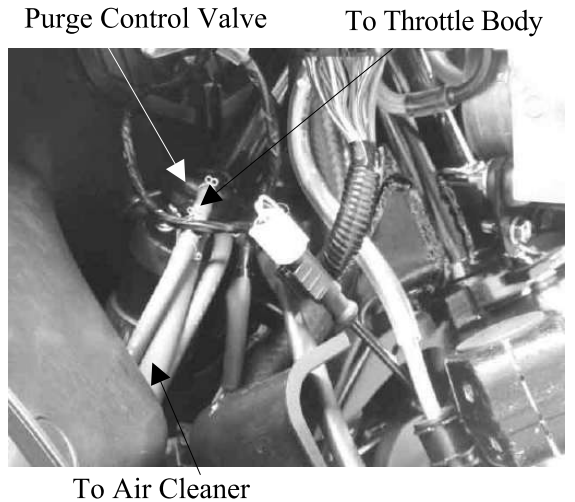

### INSPECTION

Connect a vacuum pump to the purge control valve tube that goes to the air cleaner and apply vacuum pressure of 250mm/Hg. The specified vacuum must be maintained for one minute. Replace the purge control valve with a new one if vacuum is not maintained.

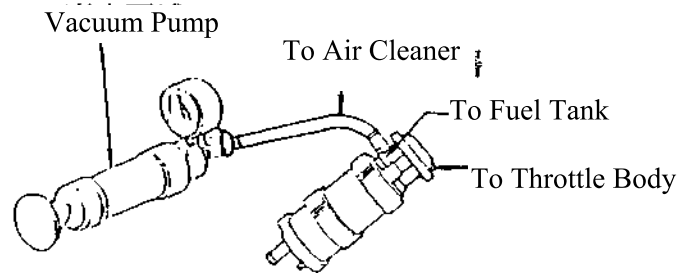

Connect a vacuum pump to the purge control valve tube that goes to the carburetor vacuum tube and apply vacuum pressure of 45mm/Hg. The specified vacuum must be maintained for one minute. Replace the purge control valve with a new one if vacuum is not maintained.

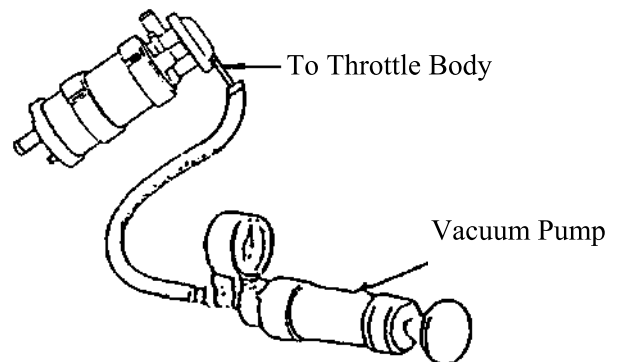

### PURGE CONTROL VALVE FLOW INSPECTION

1. Connect a vacuum pump to the purge control valve vacuum tube and apply vacuum pressure of 45mm/Hg.
2. Connect a pressure pump to the tube that goes to the charcoal canister and apply pressure. The flow must be over 9.4 liters per minute and replace the purge control valve with a new one if the specified flow is not reached.

\* To prevent damage to the purge control valve, do not use high air pressure sources. Use a hand operated pressure pump only.

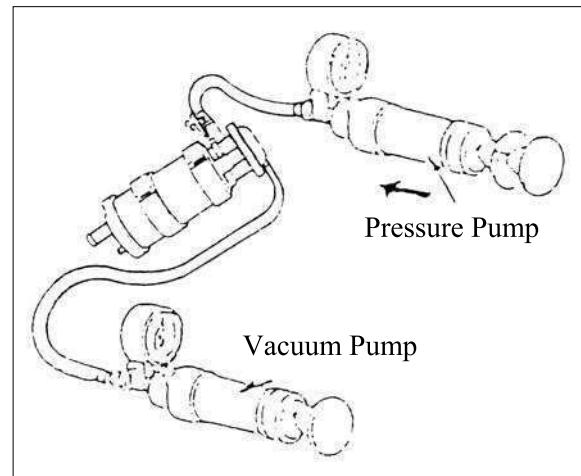

### INSTALLATION

1. Install the purge control valve in the reverse order of removal.
2. Route and reconnect the purge control valve tubes properly and securely.

\* Be careful not to bend, twist or kink the tubes during installation.



### CHARCOAL CANISTER

#### REMOVAL

1. Remove the front cover.
2. Disconnect the charcoal canister tubes that go to the fuel tank and purge control valve.
3. Remove the charcoal canister.

Charcoal Canister      To Throttle Body

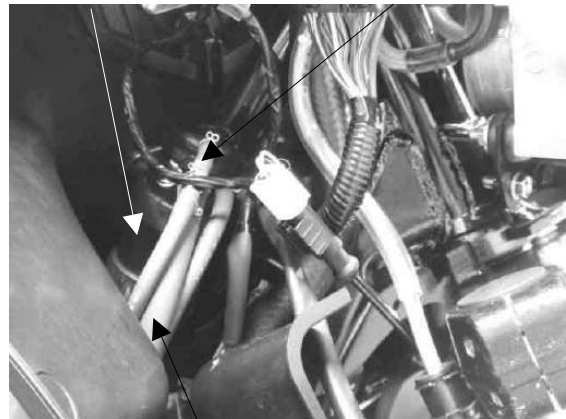

To Air Cleaner

#### INSPECTION

1. Plug the tube that goes to the fuel tank and plug the blow-by tube. Then connect a hose to the canister. Blow the hose with mouth. The charcoal canister is normal if air can be blown into it. If clogged, replace it with a new one.
2. Check the charcoal for cracks and replace if necessary.

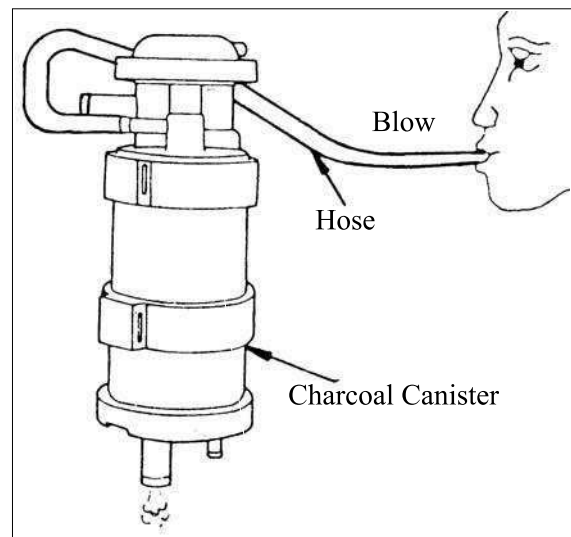

#### INSTALLATION

Install the charcoal canister in the reverse order of removal.

\*

- The charcoal canister must be installed to its original position to avoid affecting its performance.
- Do not bend, twist or kink the tubes during installation.

**ANTI-LOCK BRAKE SYSTEM (ABS)****21**

## 21 . ANTI-LOCK BRAKE SYSTEM (ABS)

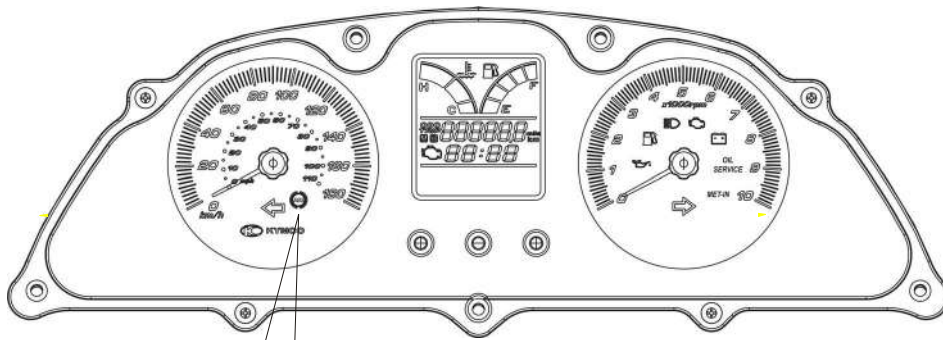

**ABS**

**ABS indicator location**



## 21 . ANTI-LOCK BRAKE SYSTEM (ABS)

---

\*

## 21 . ANTI-LOCK BRAKE SYSTEM (ABS)

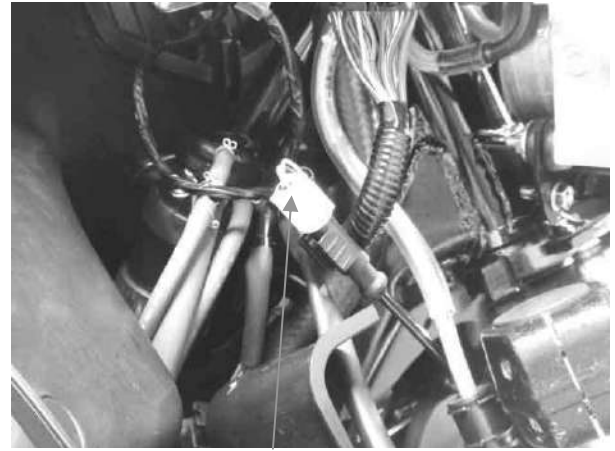

Front Wheel speed Sensor's connector

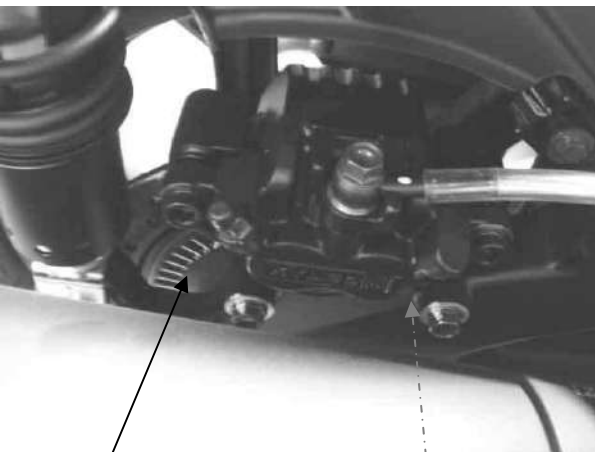

Front Wheel speed Sensor Rotor    Rear Wheel speed Sensor



Rear Wheel speed Sensor's connector

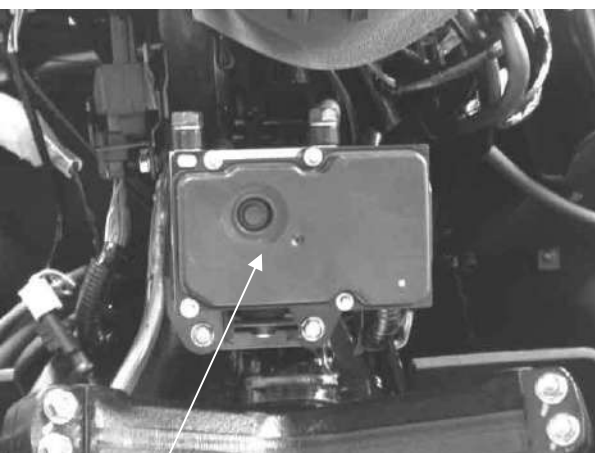

ABS ECU & ABS Hydraulic Unit

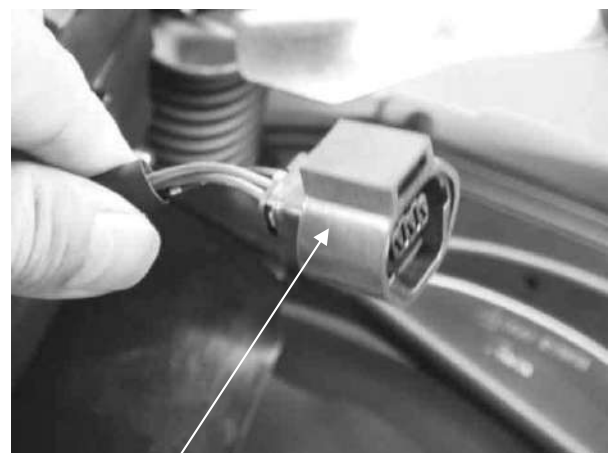

ABS diagnosis tool Connector (Near battery position)

## 21 . ANTI-LOCK BRAKE SYSTEM (ABS)

Front Wheel Speed



Front Wheel Speed Sensor Rotor



Front Wheel speed Sensor's connector



<Front Wheel Speed Sensor>

※ **Standard clearance:** Less than 0.8mm between the Front wheel speed sensor and Front Wheel Speed Sensor Rotor

## 21 . ANTI-LOCK BRAKE SYSTEM (ABS)

---

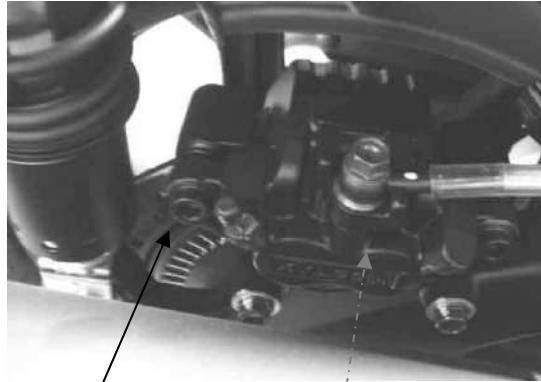

Front Wheel Speed Sensor Rotor    Rear Wheel Speed Sensor



<Rear Wheel Speed Sensor>



Rear Wheel speed Sensor's connector

**Front wheel speed sensor and  
Front Wheel Speed Sensor Rotor**

## 21 . ANTI-LOCK BRAKE SYSTEM (ABS)

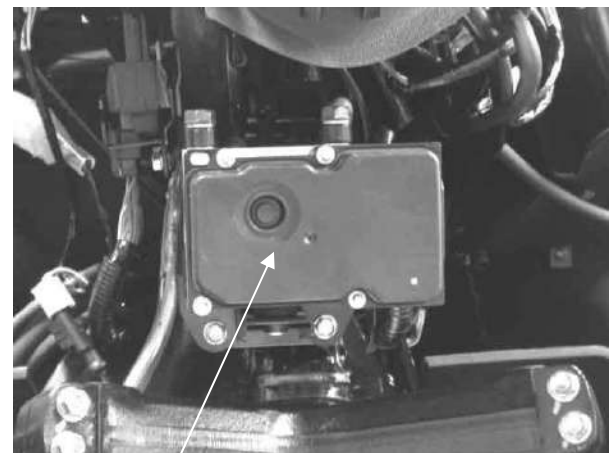
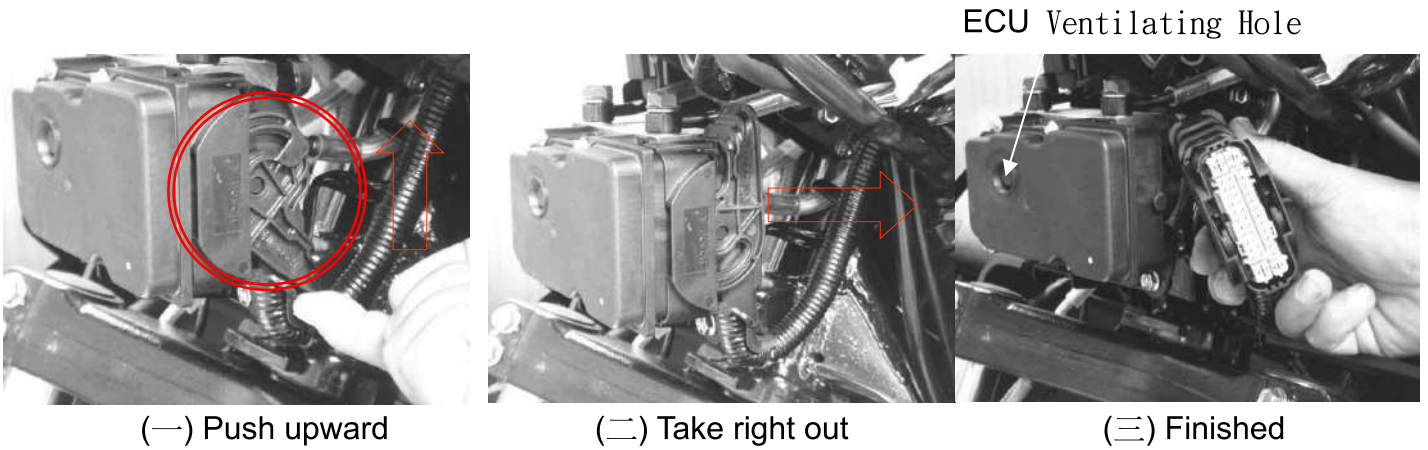

ABS ECU & ABS Hydraulic unit

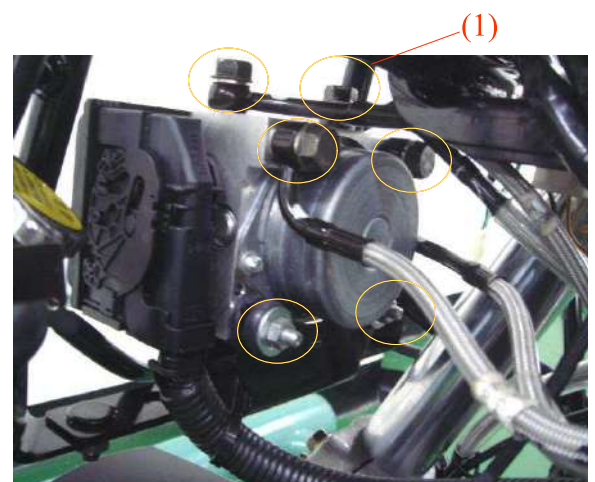

\* When replacing a new Hydraulic Unit, don't need to drain the brake fluid.



## 21 . ANTI-LOCK BRAKE SYSTEM (ABS)

---

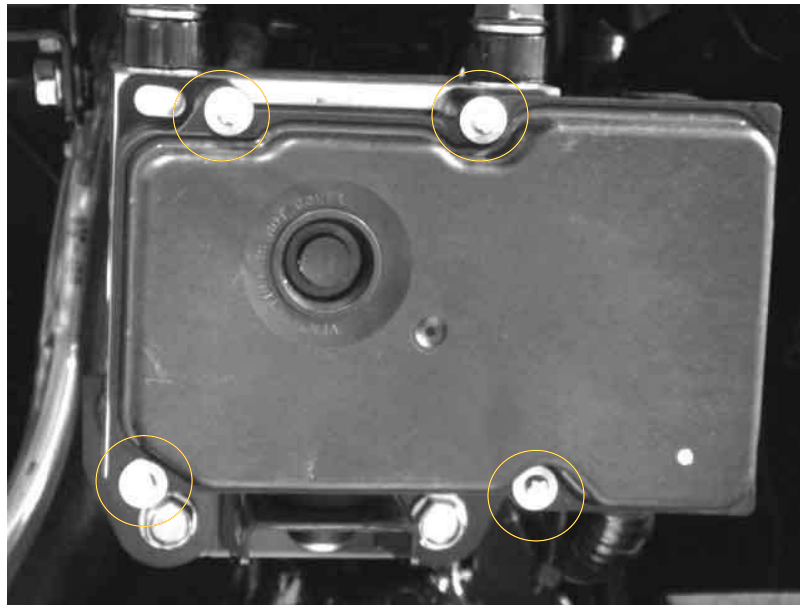

\* ***Don't remove four special bolts to take out the ABS ECU. If remove it during the guarantee period. KYMCO can not take a responsibility for it.***

Oil tube bolt 4 \* 3.5 kgf-m



# 21 . ANTI-LOCK BRAKE SYSTEM (ABS)



**Self-Diagnostic Tool Connector**

## 21 . ANTI-LOCK BRAKE SYSTEM (ABS)

---

```
Model  
name: LEA7  
ECU  
No: 0825294848  
Calib-  
rate: 6J600000  
Soft-  
ware: K6I 186J6000
```

```
SetFirst Diagnose  
Previous  
1. JetEngineECU  
2. ABS SYS ECU *
```

```
ECU Version ABS8M  
DTC Inspect  
DATA Analyze  
Adjust
```

```
Model  
name: ABS8M  
ECU  
No: LFH1-E00  
Calib-  
rate:  
Soft-  
ware:
```

## 21 . ANTI-LOCK BRAKE SYSTEM (ABS)

---

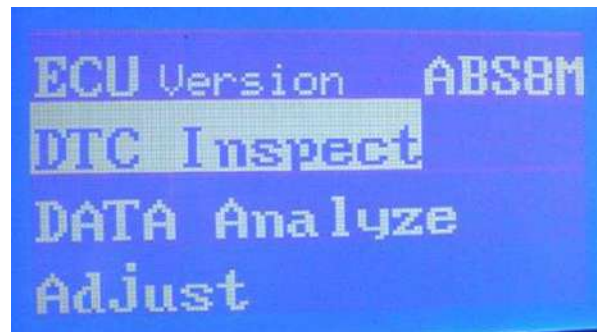

ECU Version ABS8M  
DTC Inspect  
DATA Analyze  
Adjust

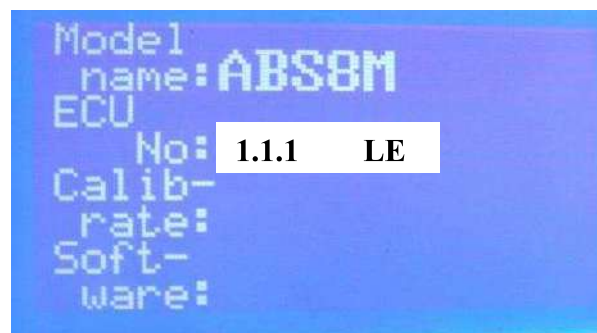

Model  
name: ABS8M  
ECU  
No: 1.1.1 LE  
Calib-  
rate:  
Soft-  
ware:

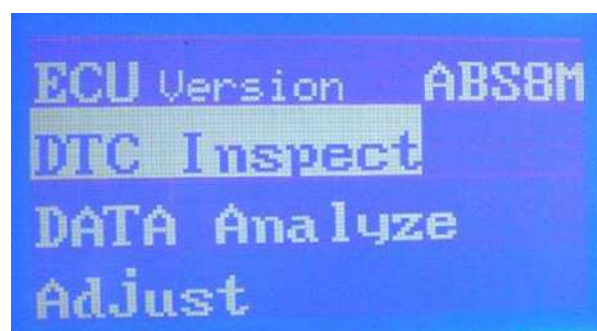

ECU Version ABS8M  
DTC Inspect  
DATA Analyze  
Adjust

## 21 . ANTI-LOCK BRAKE SYSTEM (ABS)

---

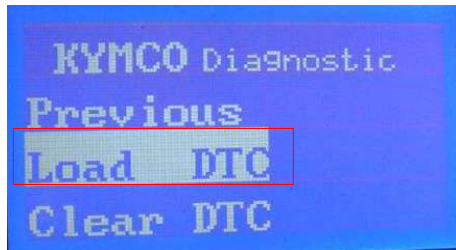

KYMCO Diagnostic  
Previous  
Load DTC  
Clear DTC

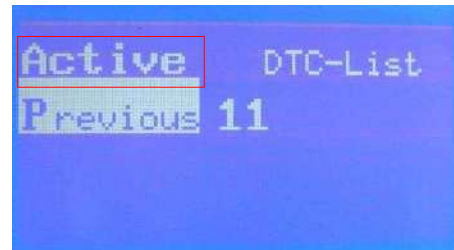

Active DTC-List  
Previous 11

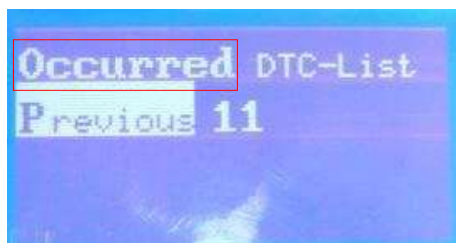

Occurred DTC-List  
Previous 11

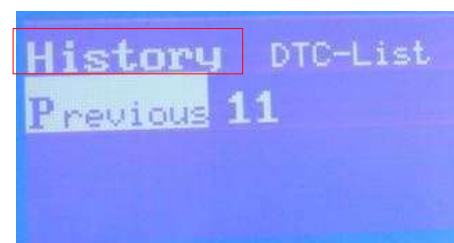

History DTC-List  
Previous 11

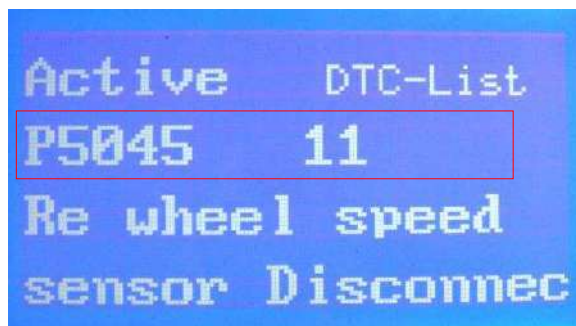

Active DTC-List  
P5045 11  
Rr wheel speed  
sensor Disconnec



Active DTC-List  
P5043 09  
Fr wheel speed  
sensor Disconnec



## 21 . ANTI-LOCK BRAKE SYSTEM (ABS)

---

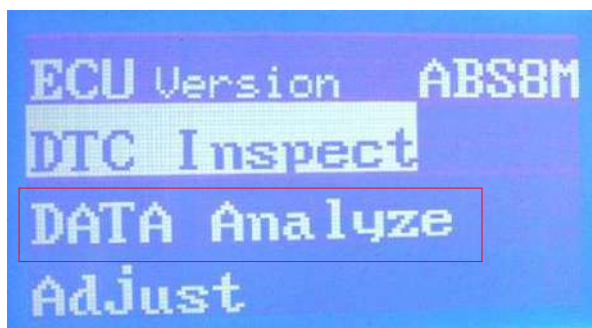
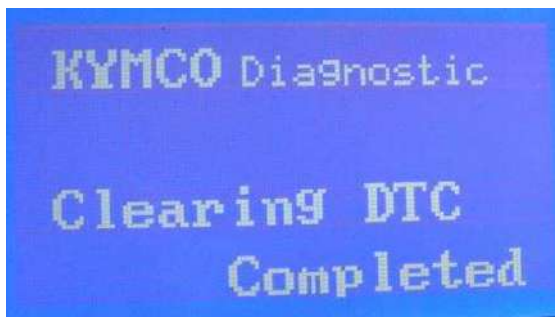
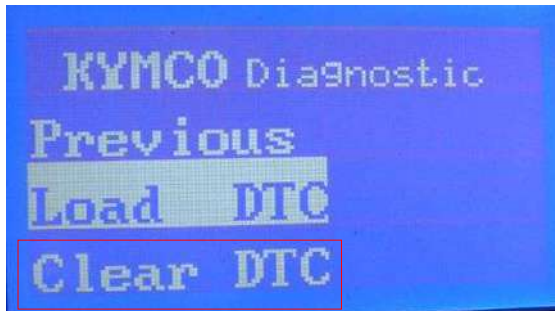

## 21 . ANTI-LOCK BRAKE SYSTEM (ABS)

---

### **KYMCO Diagnosis 01**

**Fr Speed            5 km/hr**

**Re Speed            5 km/hr**

**Battery Volt        12.6V**

\* You can turn the front or rear wheel to check if the wheel speed is figured.

## 21 . ANTI-LOCK BRAKE SYSTEM (ABS)

<b>Bosch ABS8m DTC LIST</b>		
<b>Code NO (Diagnostic Tool ) 3620A-LEB2- E00</b>	<b>DTC (PDA)</b>	<b>description</b>
01	5013	Rear Inlet Valve malfunction(EV)
02	5014	Rear Outlet Valve malfunction (AV)
03	5017	Front Inlet Valve malfunction (EV)
04	5018	Front Outlet Valve malfunction (AV)
05	5019	Valve Relay malfunction (Failsafe relay)
06	5025	Deviation between Wheel speeds (WSS_GENERIC)
07	5035	Pump Motor Malfunction
08	5042	Front wheel speed sensor malfunction-Plausibility
09	5043	Front wheel speed sensor Disconnection/gnd Short/Uz Short
10	5044	Rear wheel speed sensor malfunction - Plausibility
11	5045	Rear wheel speed sensor Disconnection/gnd Short/Uz Short
12	5052	Power Supply Malfunction (Under Voltage)
13	5053	Power Supply Malfunction (Over Voltage)
14	5055	ECU malfunction