

---

**By KWANG YANG Motor Co., Ltd.  
First Edition, Sep 2003  
All rights reserved. Any reproduction or  
unauthorized use without the written permission of  
KWANG YANG Motor Co., Ltd.  
is expressly prohibited.  
4121-LBA7-S00**

---

---

# PREFACE

This Service Manual describes the technical features and servicing procedures for the KYMCO *Mongoose/KXR 250*.

Section 1 contains the precautions for all operations stated in this manual. Read them carefully before starting any operation.

Section 2 is the removal/installation procedures for the frame covers which are subject to higher removal/installation frequency during maintenance and servicing operations.

Section 3 describes the inspection/adjustment procedures, safety rules and service information for each part, starting from periodic maintenance.

Sections 4 through 19 give instructions for disassembly, assembly and inspection of engine, chassis frame and electrical equipment.

Most sections start with an assembly or system illustration and troubleshooting for the section. The subsequent pages give detailed procedures for the section.

The information and contents included in this manual may be different from the motorcycle in case specifications are changed.
---

## TABLE OF CONTENTS

GENERAL INFORMATION		1
FRAME COVERS/EXHAUST MUFFLER		2
INSPECTION/ADJUSTMENT		3
LUBRICATION SYSTEM		4
FUEL SYSTEM		5
ENGINE	ENGINE REMOVAL	6
	CYLINDER HEAD/VALVES	7
	CYLINDER/PISTON	8
	DRIVE AND DRIVEN PULLEYS	9
	FINAL REDUCTION/TRANSMISSION SYSTEM	10
	CRANKCASE/CRANKSHAFT/BALANCE SHAFT	11
COOLING SYSTEM		12
BRAKE SYSTEM		13
CHASSIS	FRONT WHEEL/FRONT SUSPENSION/STEERING SYSTEM	14
	REAR WHEEL/AXLE/SUSPENSION	15
ELECTRICAL EQUIPMENT	BATTERY/CHARGING SYSTEM/A.C. GENERATOR	16
	IGNITION SYSTEM	17
	STARTING SYSTEM	18
	BULBSREMOVAL/INSTRUMENT/HORN	19

**KWANG YANG MOTOR CO., LTD.**  
**OVERSEAS SALES DEPARTMENT**  
**OVERSEAS SERVICE SECTION**

---

---

## GENERAL INFORMATION

---

SERIAL NUMBER-----	1- 1
SPECIFICATIONS-----	1- 2
SERVICE PRECAUTIONS-----	1- 3
TORQUE VALUES-----	1-11
SPECIAL TOOLS-----	1-12
LUBRICATION POINTS-----	1-13
CABLE & HARNESS ROUTING-----	1-16
WIRING DIAGRAM-----	1-19
TROUBLESHOOTING-----	1-21

# 1. GENERAL INFORMATION

## SERIAL NUMBER

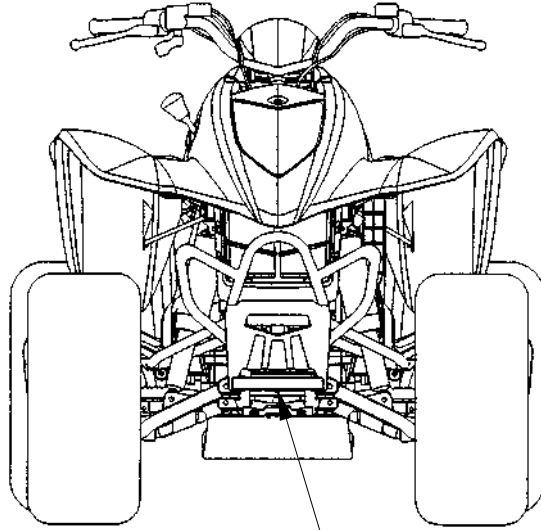

Location of Frame Serial Number

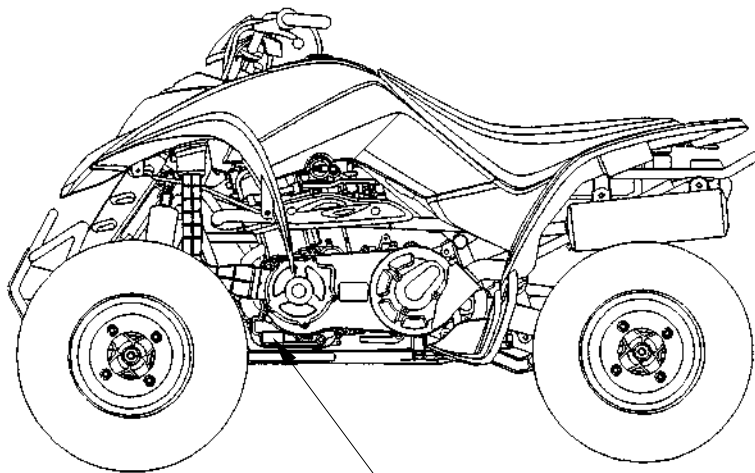

Location of Engine Serial Number



# 1. GENERAL INFORMATION

## SPECIFICATIONS

Name & Model No.		LA50AA/AB		
Motorcycle Name & Type		Mongoose/KXR		
Overall length (mm)		1700		
Overall width (mm)		1070		
Overall height (mm)		1080		
Wheel base (mm)		1180		
Engine type		O.H.C.		
Displacement (cc)		249		
Fuel Used		92# nonleaded gasoline		
Net weight (kg)	Front wheel	93.1		
	Rear wheel	84.9		
	Total	178		
Gross weight(kg)	Front wheel	100		
	Rear wheel	91		
	Total	191		
Tires	Front wheel	21*7-10		
	Rear wheel	20*11-9		
Ground clearance (mm)		130		
Performance	Breaking distance (m)(30KPH)	29.27 below		
	Min. turning radius (m)	2.865		
Engine	Starting system		Starting motor	
	Type		Gasoline, 4-stroke	
	Cylinder arrangement		Single cylinder	
	Combustion chamber type		Semi-sphere	
	Valve arrangement		O.H.C., chain drive	
	Bore x stroke (mm)		72.7 x 60	
	Compression ratio		10.3:1	
	Compression pressure (kg/cm <sup>2</sup> )		15.0	
	Max. output (ps/rpm)		17/7000	
	Max. torque (kg m/rpm)		2.0/5500	
	Port timing	Intake (1mm)	Open	8.1° BTDC
			Close	41° ABDC
		Exhaust (1mm)	Open	37° BBDC
			Close	7.9° ATDC
	Valve clearance (cold) (mm)	Intake	0.1	
		Exhaust	0.1	
	Idle speed (rpm)		1500rpm	
	Lubrication System	Lubrication type		Forced pressure & Wet sump
		Oil pump type		Inner/outer rotor type
		Oil filter type		Full-flow filtration
		Oil capacity		1.6 liter
		Oil exchanging capacity		1.4 liter
	Cooling Type		Water cooling	

Fuel System	Air cleaner type & No		Sponge		
	Fuel capacity		13 liters		
	Carburetor	Type	PD		
		Float lever	14.8mm		
		Venturi dia.(mm)	φ22		
Throttle type		PISTON			
Electrical Equipment System	Ignition System	Type	CDI		
		Ignition timing	5°BTDC/2000rpm		
		Contact breaker	Non-contact point type		
		Spark plug	DPR7EA-9		
	Spark plug gap	0.6~0.7mm			
Battery	Capacity	12V12AH			
Power Drive System	Clutch	Type	CVT		
		Type	Helical gear/spur gear		
	Transmission Gear	Operation	Automatic centrifugal Type		
		Type	Chain drive		
	Reduction Gear	Reduction ratio	1st	24.7	
			2nd	9.33	
	Reverse ratio		47.4		
Moving Device	FR/RR tire rolling circumference(mm)		1675/1596		
	Tire pressure (kg/cm <sup>2</sup> )	Front	0.28		
		Rear	0.28		
	Turning angle	Left	40°		
Right		40°			
Brake system type	Rear	Disk brake			
	Front	Disk brake			
Damping Device	Suspension type	Front	Double wishbone		
		Rear	Link suspension		
Frame type		Steel tube frame			

## SERVICE PRECAUTIONS

- Make sure to install new gaskets, O-rings, circlips, cotter pins, etc. when reassembling.

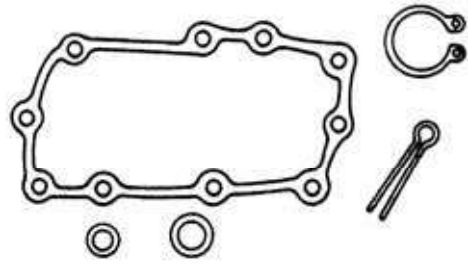

- When tightening bolts or nuts, begin with larger-diameter to smaller ones at several times, and tighten to the specified torque diagonally.

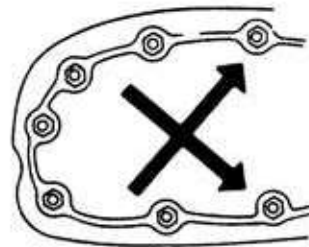

- Use genuine parts and lubricants.

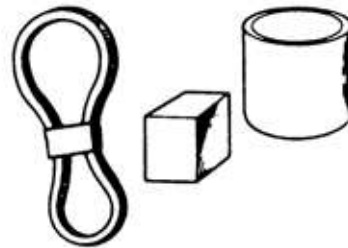

- When servicing the motorcycle, be sure to use special tools for removal and installation.



- After disassembly, clean removed parts. Lubricate sliding surfaces with engine oil before reassembly.

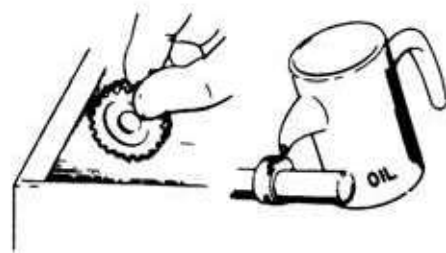

# 1. GENERAL INFORMATION

- Apply or add designated greases and lubricants to the specified lubrication points.

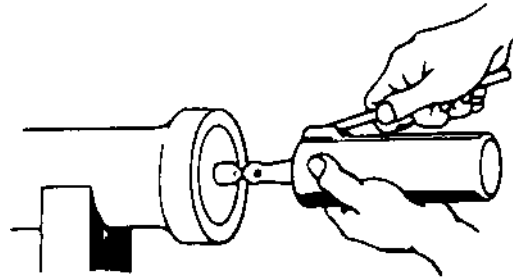

- After reassembly, check all parts for proper tightening and operation.

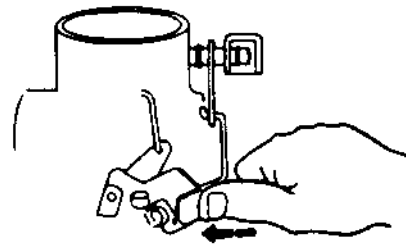

- When two persons work together, pay attention to the mutual working safety.

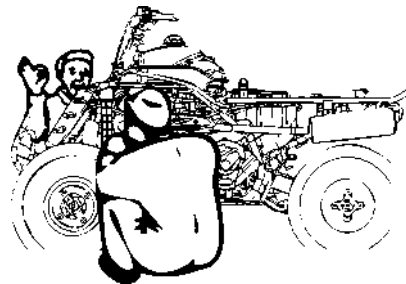

- Disconnect the battery negative (-) terminal before operation.
- When using a spanner or other tools, make sure not to damage the motorcycle surface.

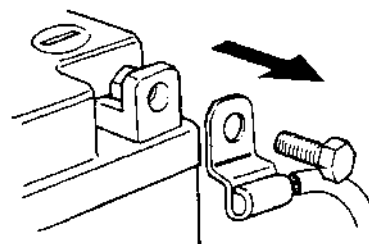

- After operation, check all connecting points, fasteners, and lines for proper connection and installation.
- When connecting the battery, the positive (+) terminal must be connected first.
- After connection, apply grease to the battery terminals.
- Terminal caps shall be installed securely.

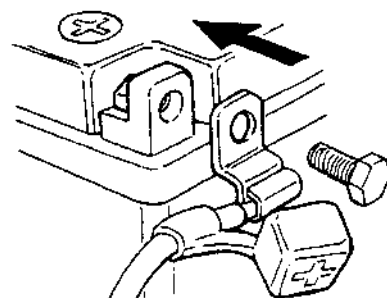

# 1. GENERAL INFORMATION

- If the fuse is burned out, find the cause and repair it. Replace it with a new one according to the specified capacity.



- After operation, terminal caps shall be installed securely.



- When taking out the connector, the lock on the connector shall be released before operation.

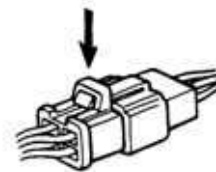

- Hold the connector body when connecting or disconnecting it.
- Do not pull the connector wire.

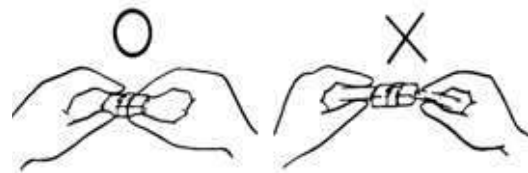

- Check if any connector terminal is bending, protruding or loose.

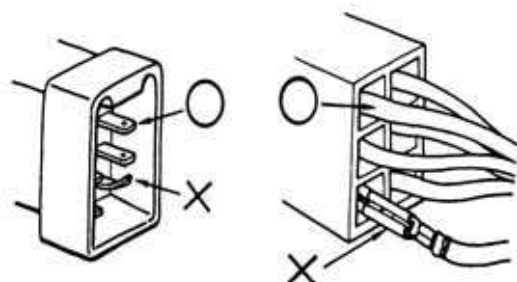



# 1. GENERAL INFORMATION

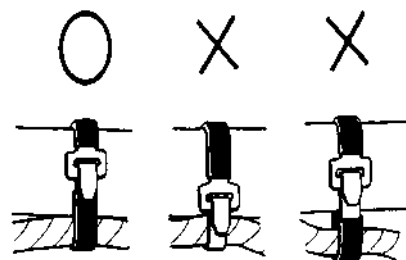
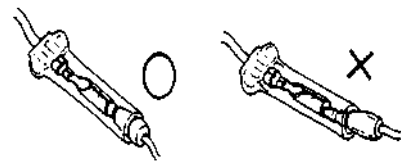
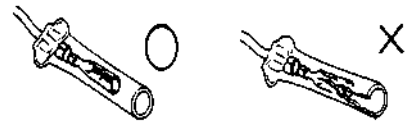
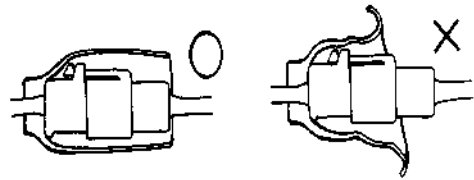
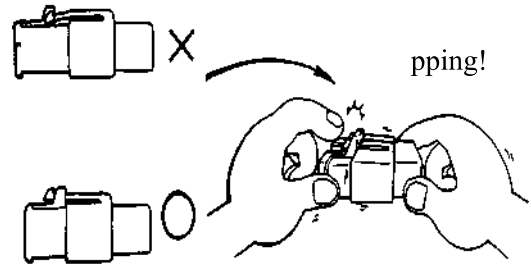

# 1. GENERAL INFORMATION

- After clamping, check each wire to make sure it is secure.

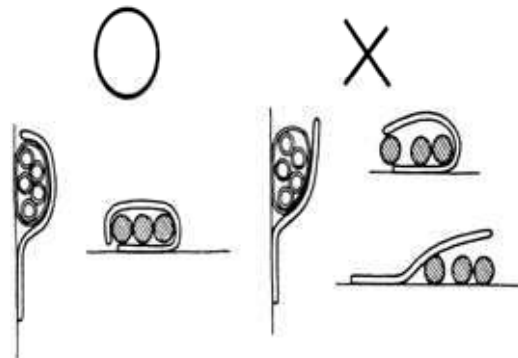

- Do not squeeze wires against the weld or its clamp.



- After clamping, check each harness to make sure that it is not interfering with any moving or sliding parts.

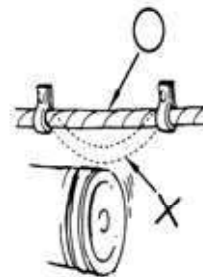

- When fixing the wire harnesses, do not make it contact the parts which will generate high heat.

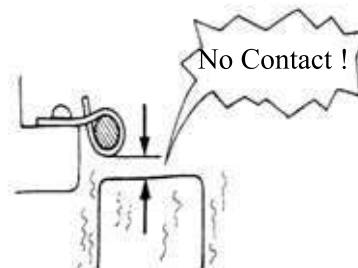

- Route wire harnesses to avoid sharp edges or corners. Avoid the projected ends of bolts and screws.
- Route wire harnesses passing through the side of bolts and screws. Avoid the projected ends of bolts and screws.

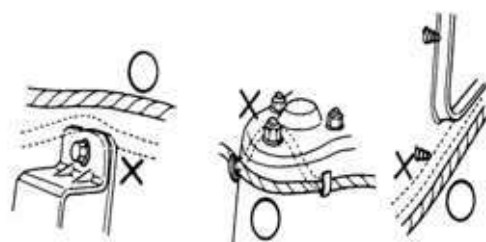

# 1. GENERAL INFORMATION

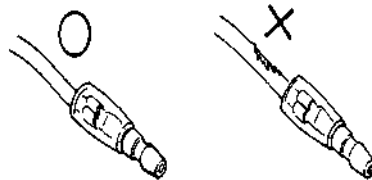
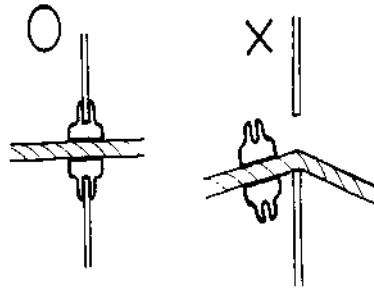
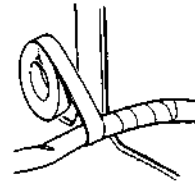
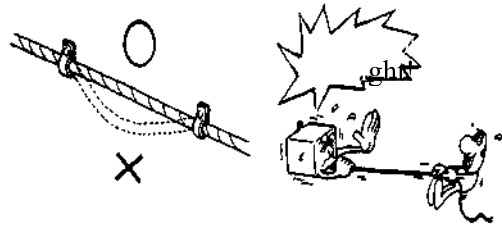

Do not press  
or squeeze  
the wire.

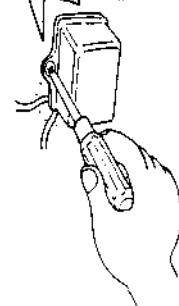

# 1. GENERAL INFORMATION

- After routing, check that the wire harnesses are not twisted or kinked.

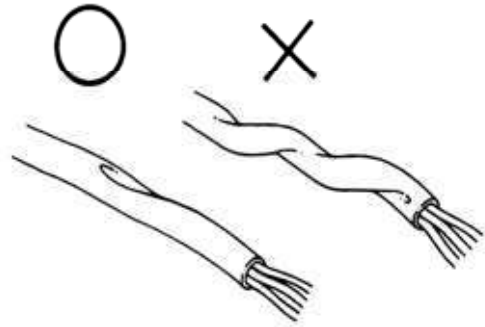

- Wire harnesses routed along with handlebar should not be pulled tight, have excessive slack or interfere with adjacent or surrounding parts in all steering positions.

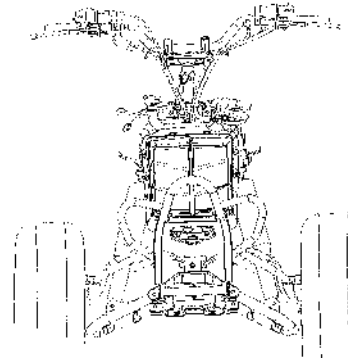

- When a testing device is used, make sure to understand the operating methods thoroughly and operate according to the operating instructions.

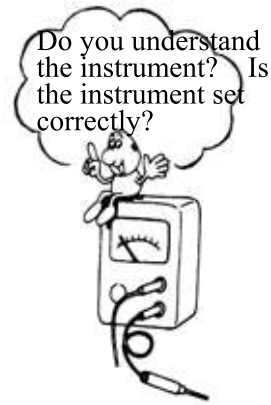

- Be careful not to drop any parts.



- When rust is found on a terminal, remove the rust with sand paper or equivalent before connecting.



# 1. GENERAL INFORMATION

---

■ Symbols:

The following symbols represent the servicing methods and cautions included in this service manual.



: Apply engine oil to the specified points. (Use designated engine oil for lubrication.)



: Apply grease for lubrication.



: Transmission Gear Oil (90#)



: Use special tool.



: Caution



: Warning

# 1. GENERAL INFORMATION

## TORQUE VALUES

### STANDARD TORQUE VALUES

Item	Torque (kgf-m)	Item	Torque (kgf-m)
5mm bolt and nut	0.45~0.6	4mm screw	0.2~0.4
6mm bolt and nut	0.8~1.2	5mm screw	0.35~0.5
8mm bolt and nut	1.8~2.5	6mm screw, SH bolt	0.7~1.1
10mm bolt and nut	3.0~4.0	6mm flange bolt and nut	1.0~1.4
12mm bolt and nut	5.0~6.0	8mm flange bolt and nut	2.4~3.0
14mm bolt and nut	6.0~8.0	10mm flange bolt and nut	3.5~4.5

Torque specifications listed below are for important fasteners.

### ENGINE

Item	Q'ty	Thread dia.(mm)	Torque (kgf-m)	Remarks
Stud bolt	4	8	0.7~1.1	
Oil filter screen cap	1	30	1.0~2.0	
Seat ball stopper bolt	1	14	4.5~5.0	
L cover	10	6	1.0~1.4	
Cam shaft holder	4	8	2.3~2.7	Apply oil
Tappet ADJ nut	2	5	0.7~1.1	Apply oil
Pivot tensioner bolt	1	8	0.8~1.2	
Lifter tensioner bolt	2	6	1.0~1.4	
Lifter tensioner cap	1	6	0.35~0.5	
Mission case bolt	9	8	2.4~3.0	
Mission fill bolt	1	12	2.0~3.0	
Driver face nut	1	14	9.0~10.0	Apply oil
Clutch outer nut	1	12	5.0~6.0	
Drive plate nut	1	28	5.0~6.0	
Oneway clutch bolt	3	8	1.8~2.2	Apply thread lock
ACG flywheel nut	1	14	5.5~6.5	
Spark plug	1	12	1.5~2.0	
Water pump impeller	1	7	1.0~1.4	
Drain plug	1	12	2.0~3.0	
Oil pump screw	1	3	0.1~0.3	
Head CYL stud bolt (IN pipe)	2	6	0.7~1.1	
Head CYL stud bolt (EX pipe)	2	8	0.7~1.1	
A.C.G Startor	3	5	0.8~1.0	

# 1. GENERAL INFORMATION

## FRAME

Item	Q'ty	Thread dia.(mm)	Torque (kgf-m)	Remarks
Steering stem nut	1	14	6.0~8.0	
Front swing arm nut	8	10	4.0~5.0	
Front wheel nut	8	12	4.0~5.0	
Rear wheel nut	8	12	4.0~5.0	
Front wheel hub nut	2	14	6.0~8.0	
Rear wheel hub nut	2	16	9.0~11.0	
Front shock absorber upper mount bolt	2	10	3.5~4.5	
Front shock absorber lower mount bolt	2	10	3.5~4.5	
Rear shock absorber upper mount bolt	1	10	3.5~4.5	
Rear shock absorber lower mount bolt	1	10	3.5~4.5	
Rear swing arm axle	1	14	6.0~8.0	
Rear hub nut	2	10	3.5~4.5	
Rear wheel shaft nut	2	40	11.0~13.0	
Rear engine bracket upper bolt	1	10	3.5~4.5	
Rear engine bracket lower bolt	1	10	3.5~4.5	
Engine hanger bracket bolt	1	10	3.5~4.5	
Exhaust muffler lock bolt (frame)	2	8	3.2~3.8	
Exhaust muffler lock nut (engine)	2	8	1.8~2.2	
Rod-end nut	4	8	2.5~3.5	

## SPECIAL TOOLS

Tool Name	Tool No.	Remarks Ref. Page
Flywheel puller	E003	
Valve adjuster	E012	
Valve spring compressor	E040	
Oil seal and bearing install	E014	
Universal holder	E017	
Flywheel holder	E021	
Clutch spring compressor	E034	
Bearing puller	E037	
Nut wrench	F010	

## LUBRICATION POINTS

### ENGINE

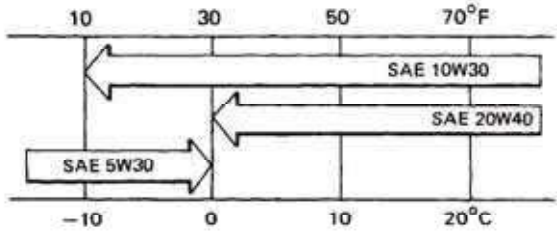
Lubrication Points	Lubricant
Valve guide/valve stem movable part Cam lobes Valve rocker arm friction surface Cam chain Cylinder lock bolt and nut Piston surroundings and piston ring grooves Piston pin surroundings Cylinder inside wall Connecting rod/piston pin hole Connecting rod big end Crankshaft right side oil seal Crankshaft one-way clutch movable part Oil pump drive chain Balance gear A.C. generator Starter one-way clutch Bearing movable part O-ring face Oil seal lip	<ul style="list-style-type: none"> <li>•Genuine KYMCO Engine Oil (SAE15W-40)</li> <li>•API SG Engine Oil</li> </ul> 
Transmission gear and movable parts	Gear oil: SAE90#



# 1. GENERAL INFORMATION

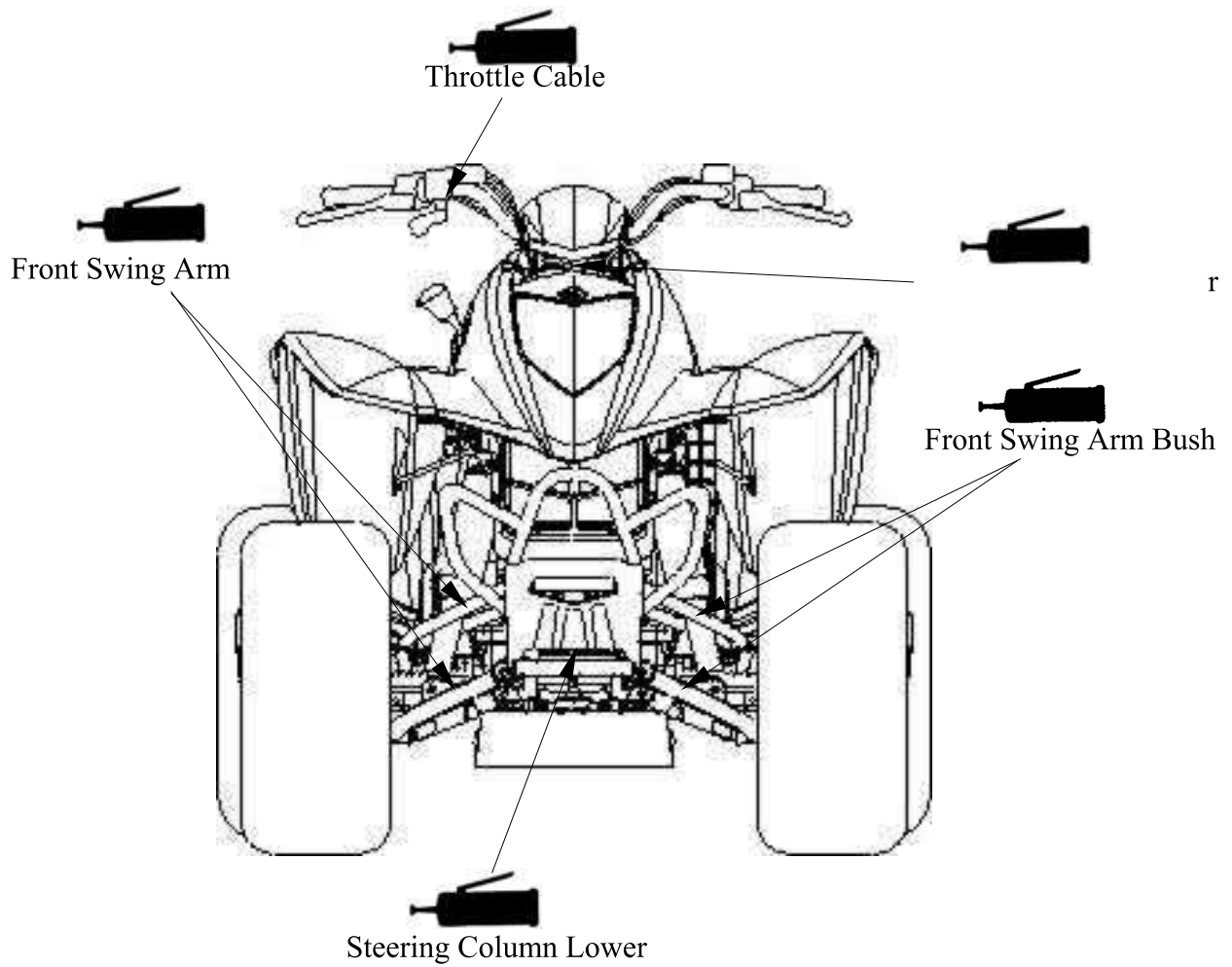

# 1. GENERAL INFORMATION

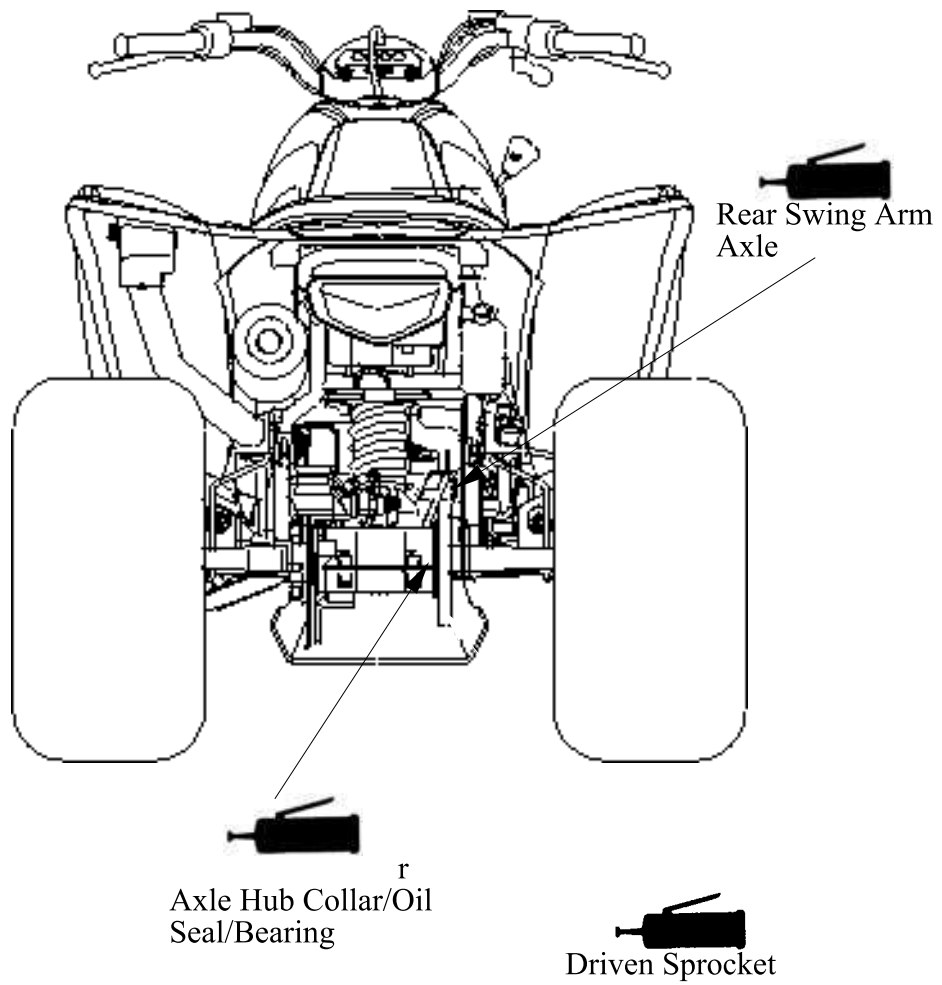

# 1. GENERAL INFORMATION

## CABLE & HARNESS ROUTING

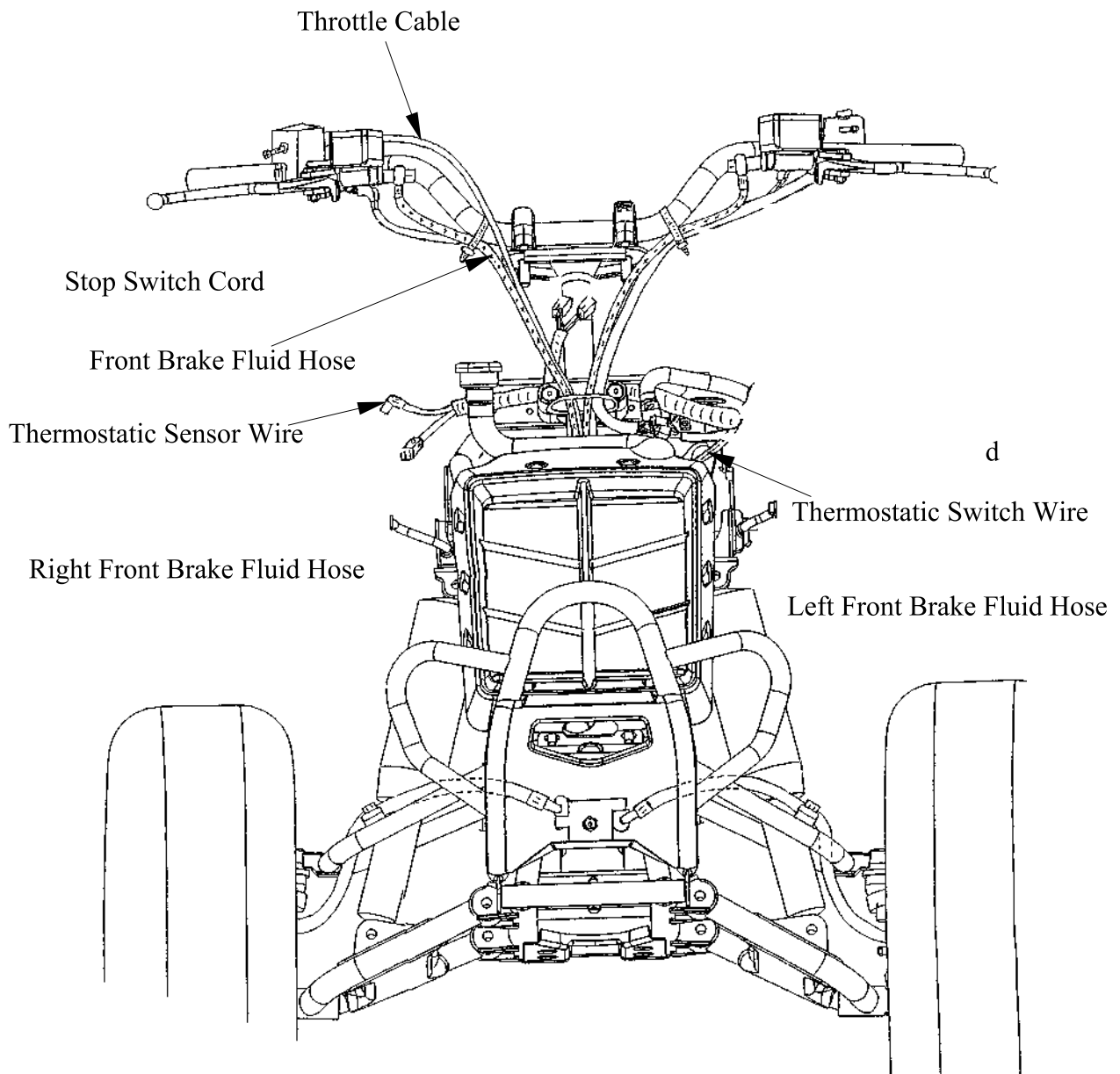

# 1. GENERAL INFORMATION

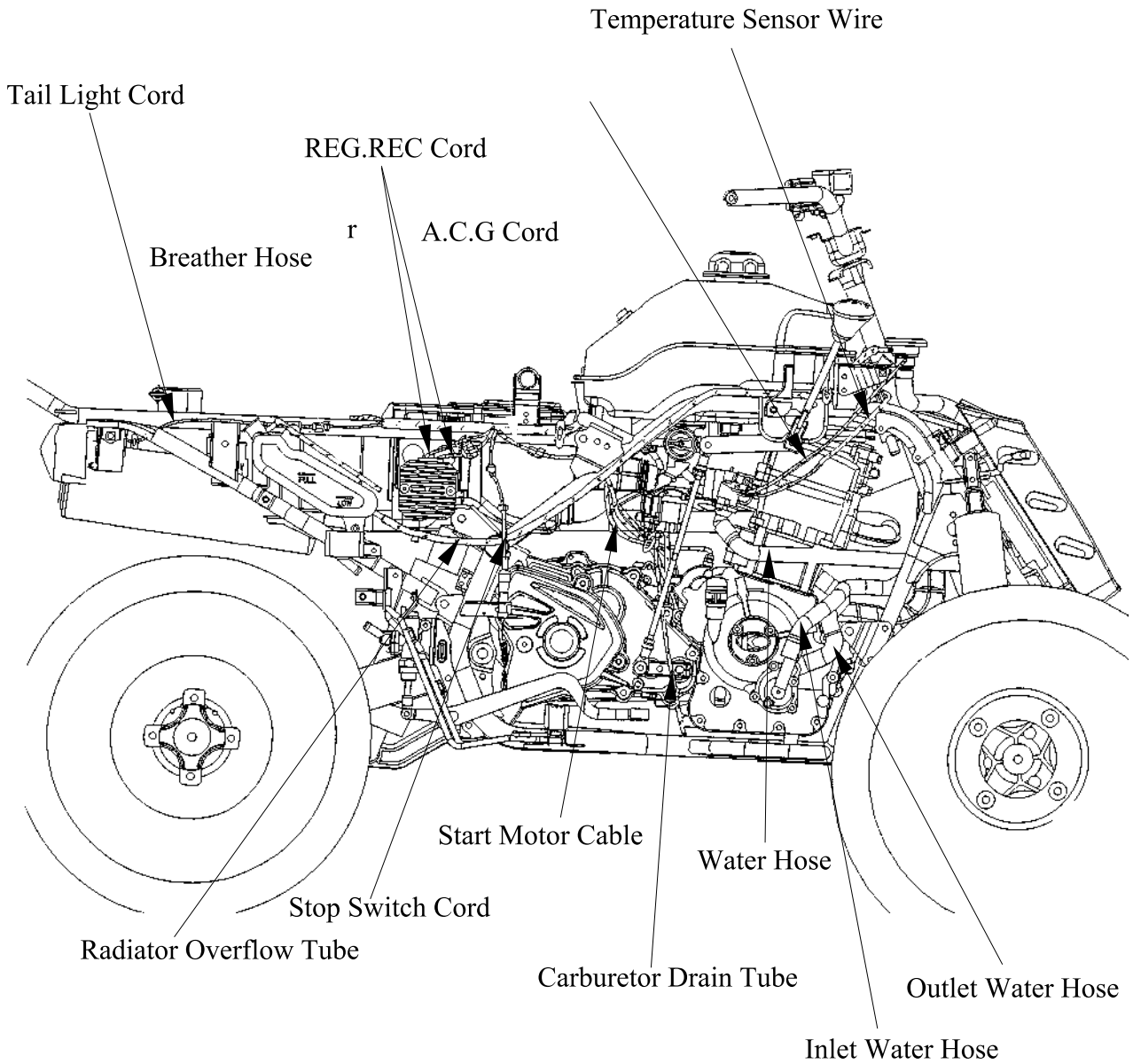

# 1. GENERAL INFORMATION

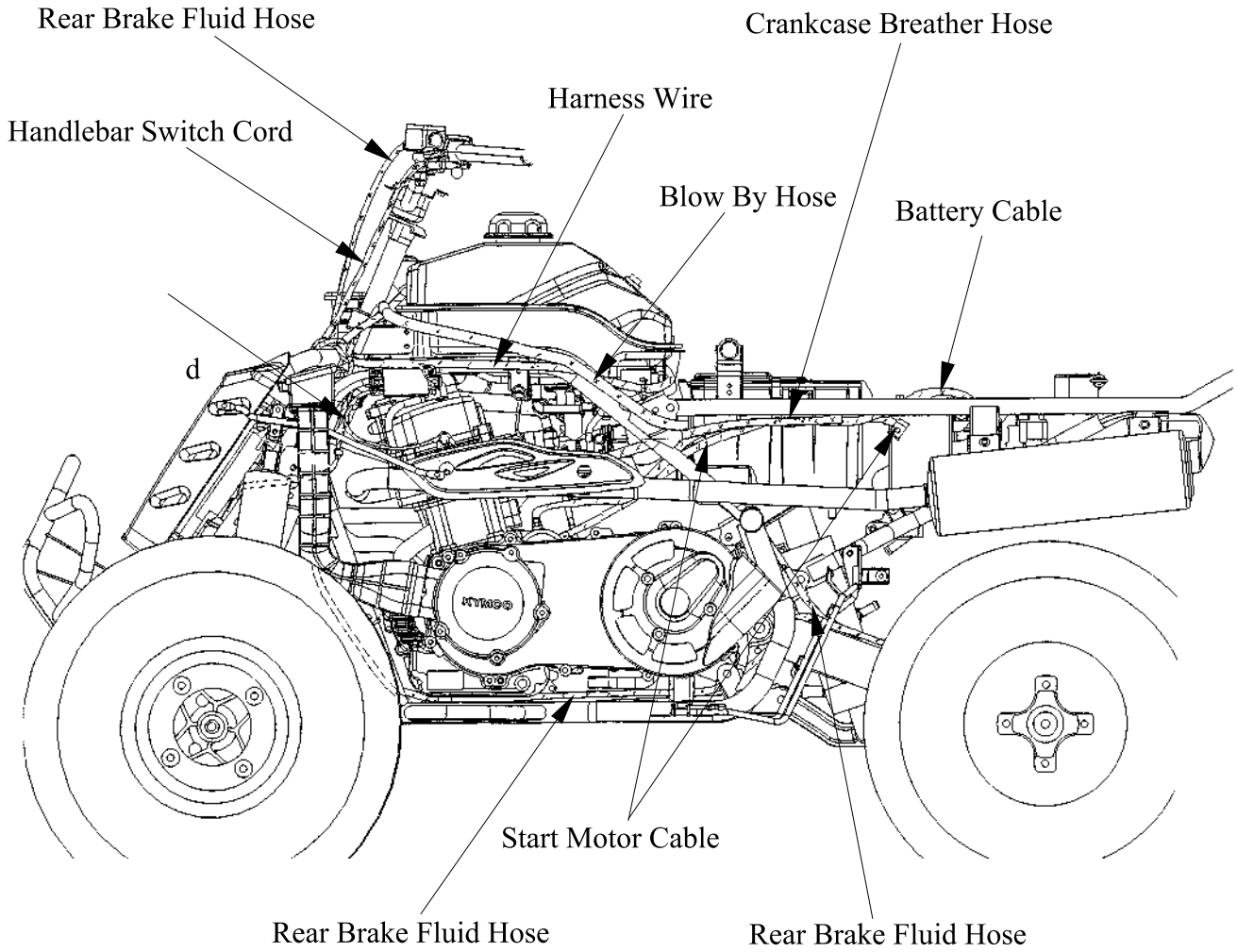

# 1. GENERAL INFORMATION

## WIRING DIAGRAM (OFF ROAD)

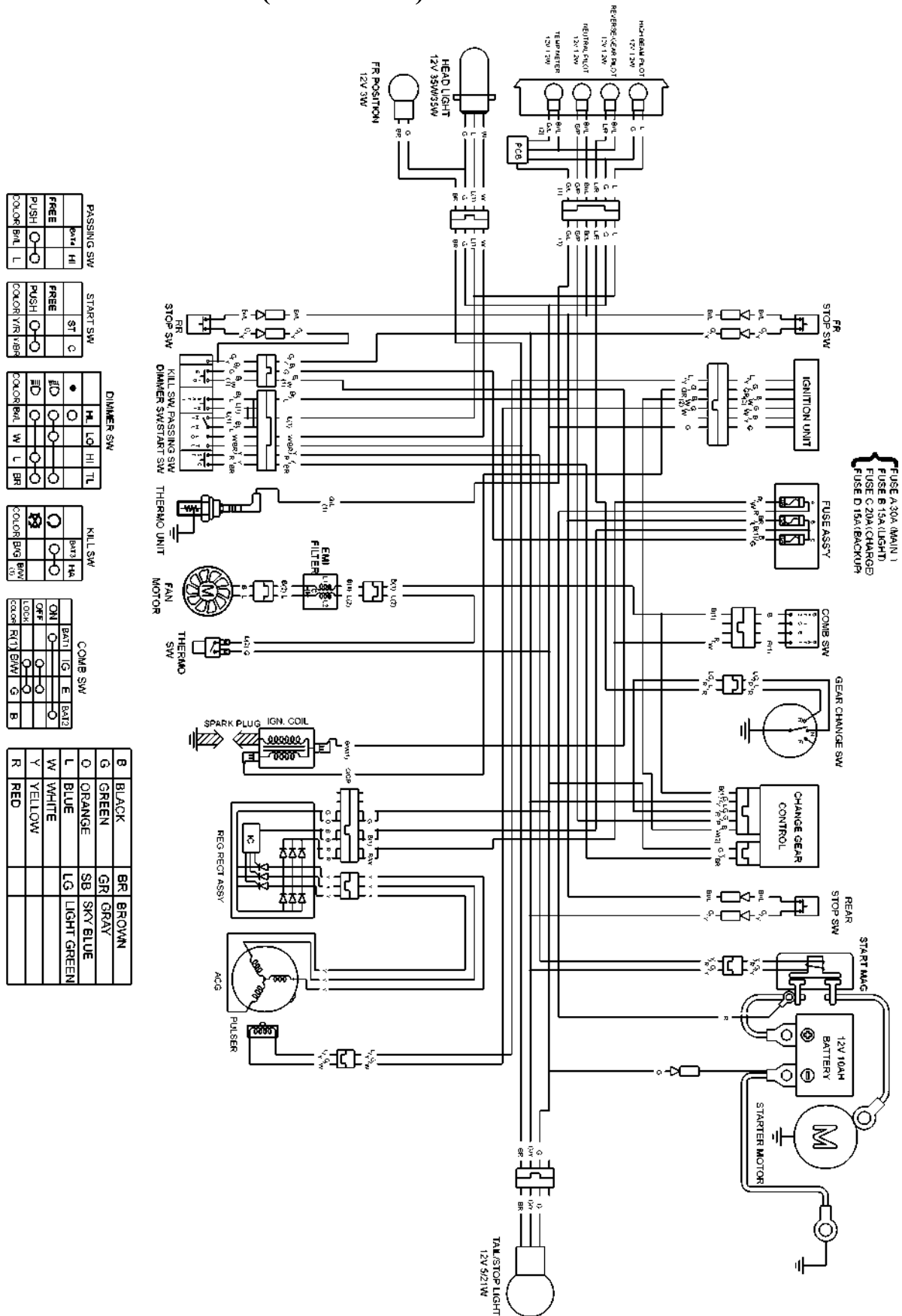

# 1. GENERAL INFORMATION

## WIRING DIAGRAM (ON ROAD)

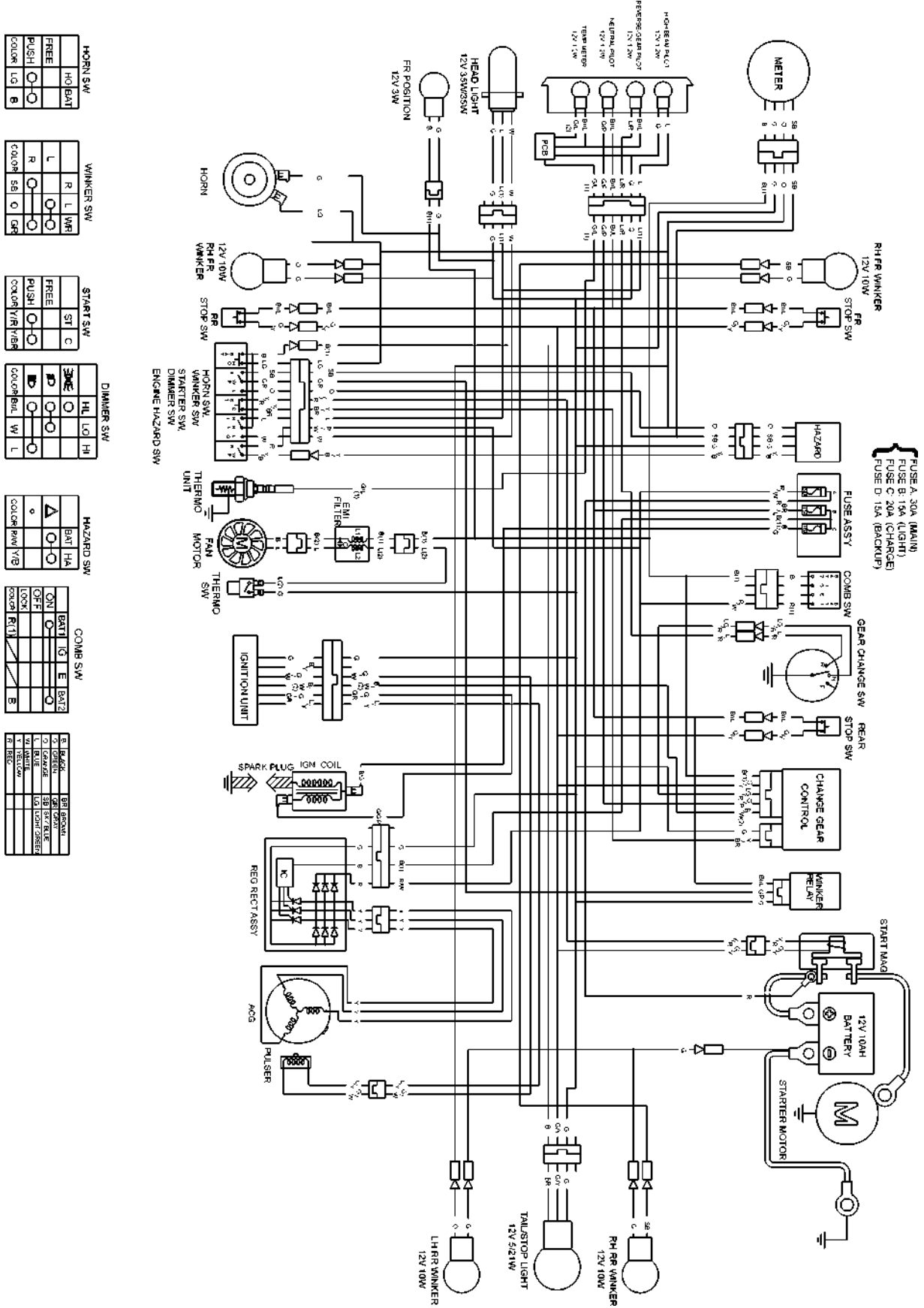

**HORN SW**

HO	BAT
FREE	○
PUSH	○
COLOR	LG
	<b>B</b>

**WINKER SW**

R	L	W/R
○	○	○
○	○	○
COLOR	SB	GR

**START SW**

ST	C
FREE	○
PUSH	○
COLOR	Y/R
	<b>W/B</b>

**DIMMER SW**

HL	LO	HI
○	○	○
○	○	○
COLOR	B/L	W
		<b>L</b>

**HAZARD SW**

BAT	HA
○	○
○	○
COLOR	P/W
	<b>Y/B</b>

**COMB SW**

BAT1	G	E	BAT2
○	○	○	○
○	○	○	○
LOCK	RT1		
			<b>B</b>

**IGNITION UNIT**

B	IGN	IGN	IGN
○	○	○	○
○	○	○	○
COLOR	W	W	W
			<b>REC</b>

FUSE A 30A (MAIN)  
 FUSE B 15A (LIGHT)  
 FUSE C 20A (CHARGE)  
 FUSE D 15A (BACKUP)

# 1. GENERAL INFORMATION

## TROUBLESHOOTING

### ENGINE WILL NOT START OR IS HARD TO START

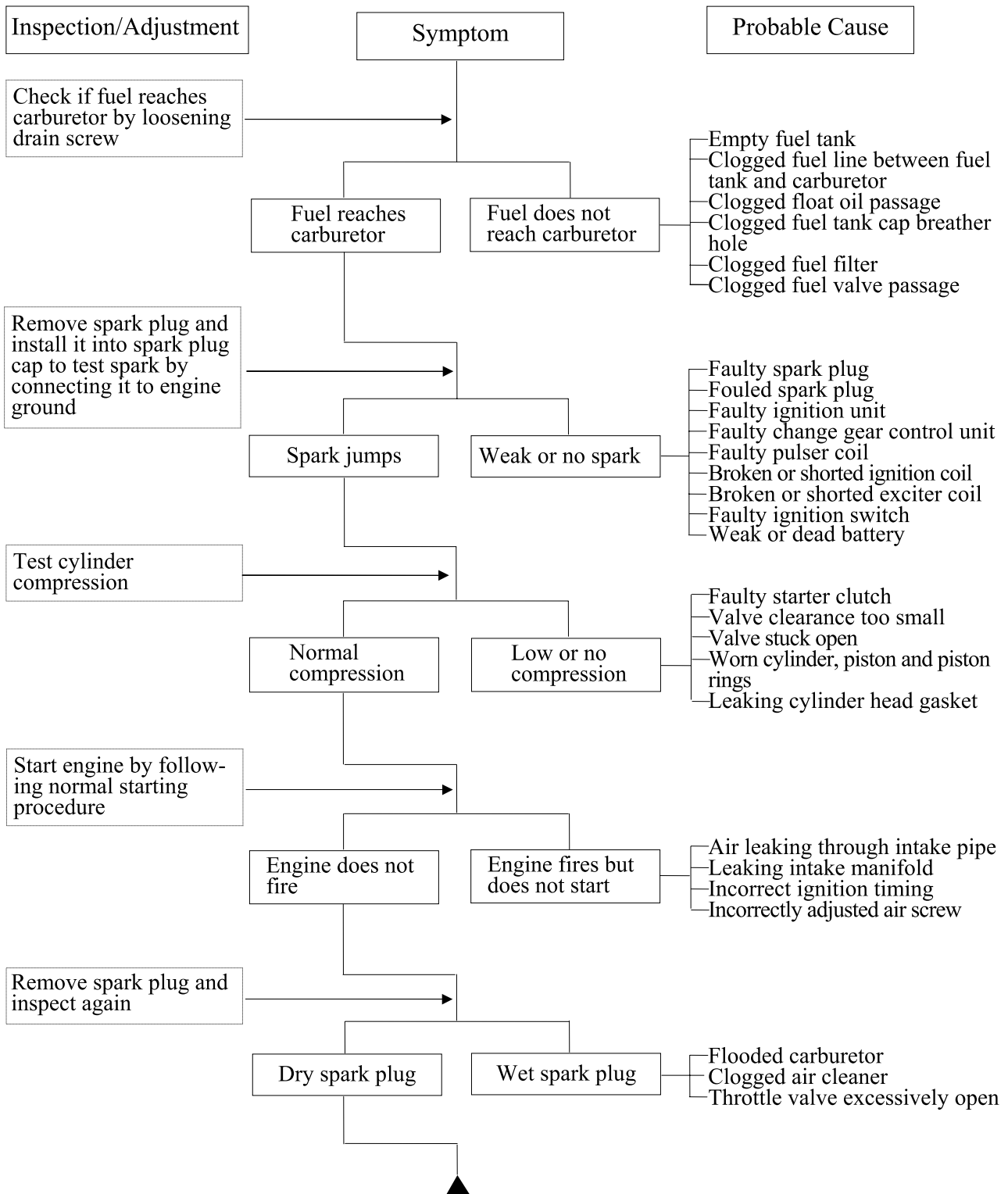



# 1. GENERAL INFORMATION

## ENGINE LACKS POWER

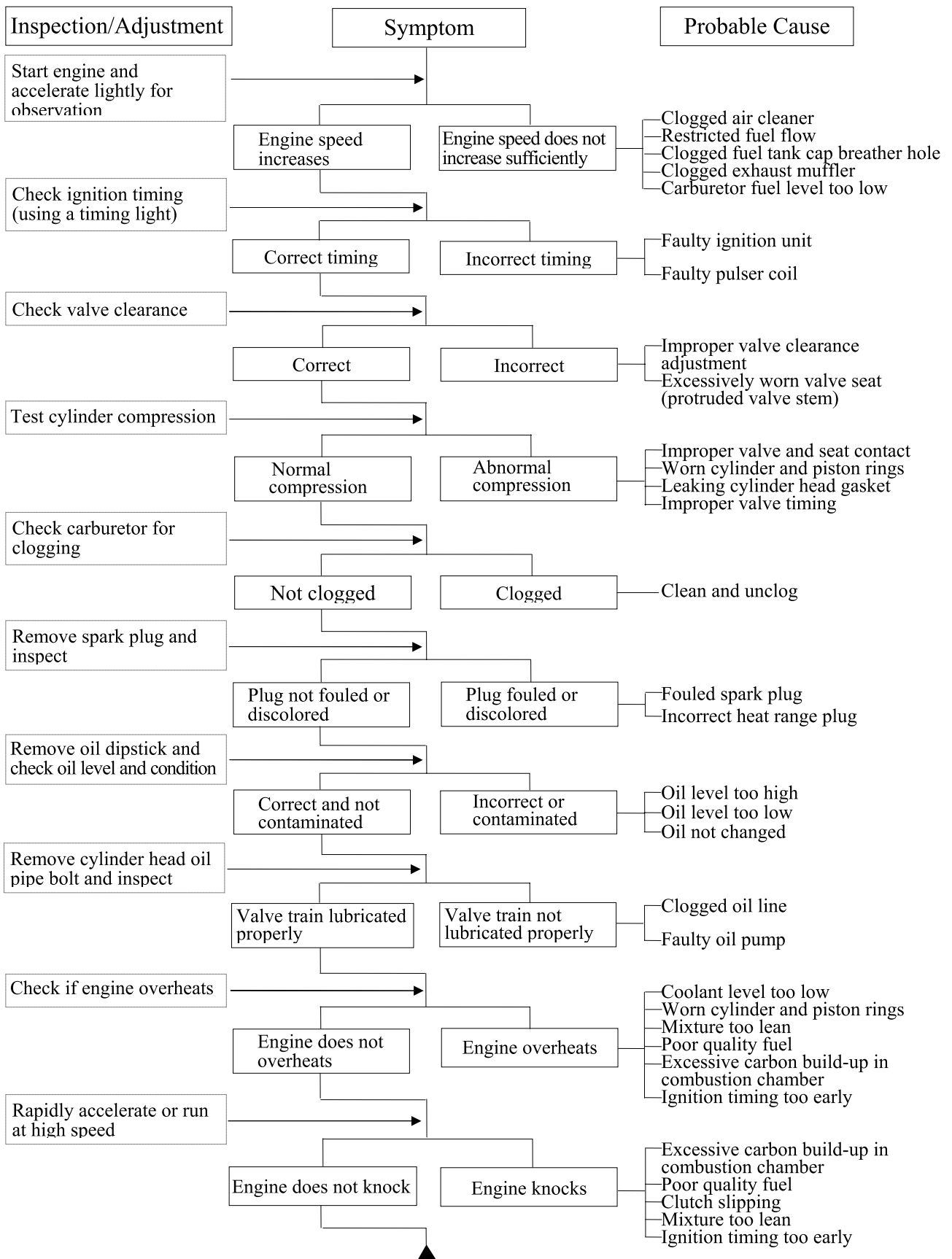

# 1. GENERAL INFORMATION

## POOR PERFORMANCE (ESPECIALLY AT IDLE AND LOW SPEEDS)

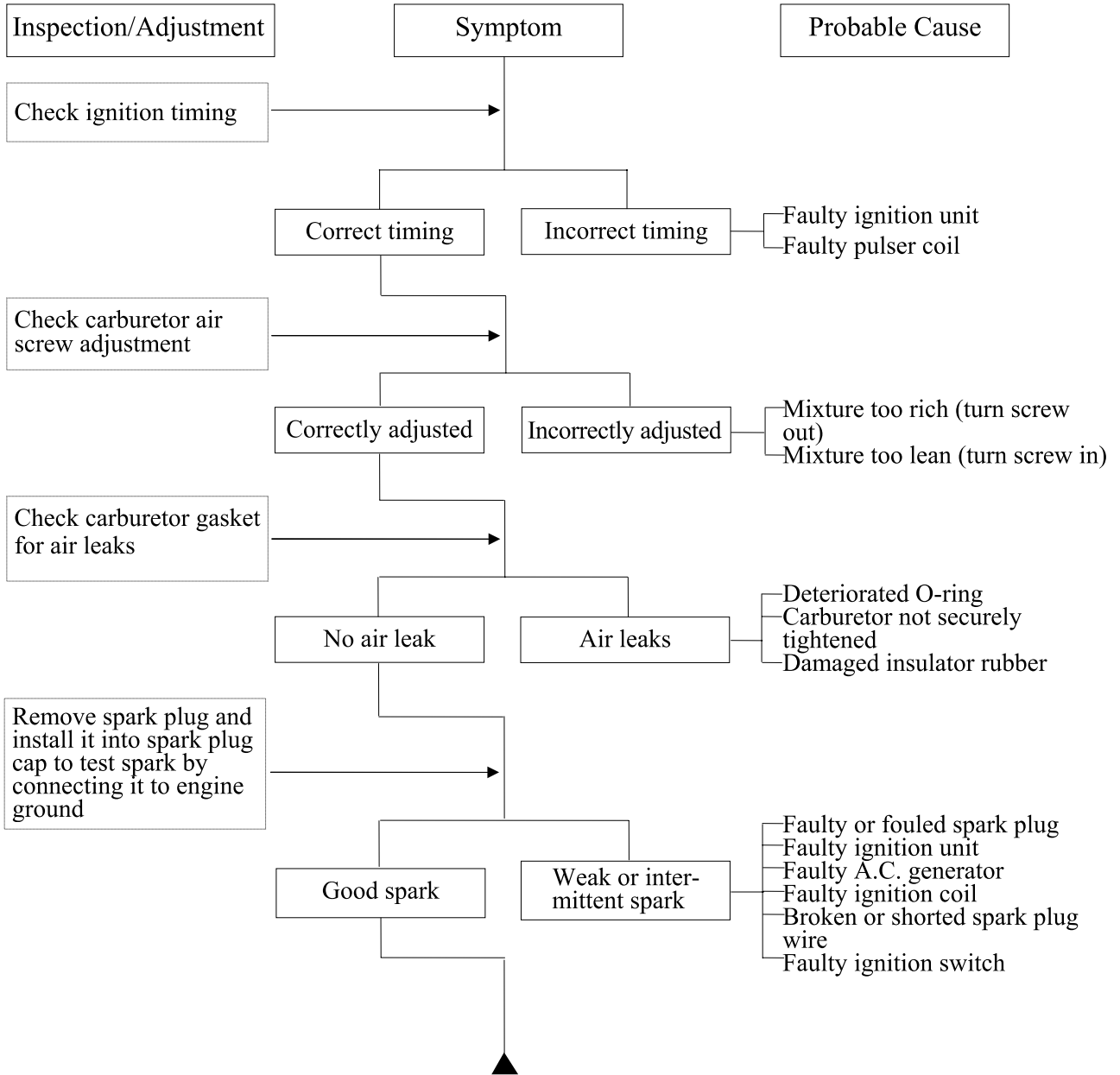

# 1. GENERAL INFORMATION

## POOR PERFORMANCE (AT HIGH SPEED)

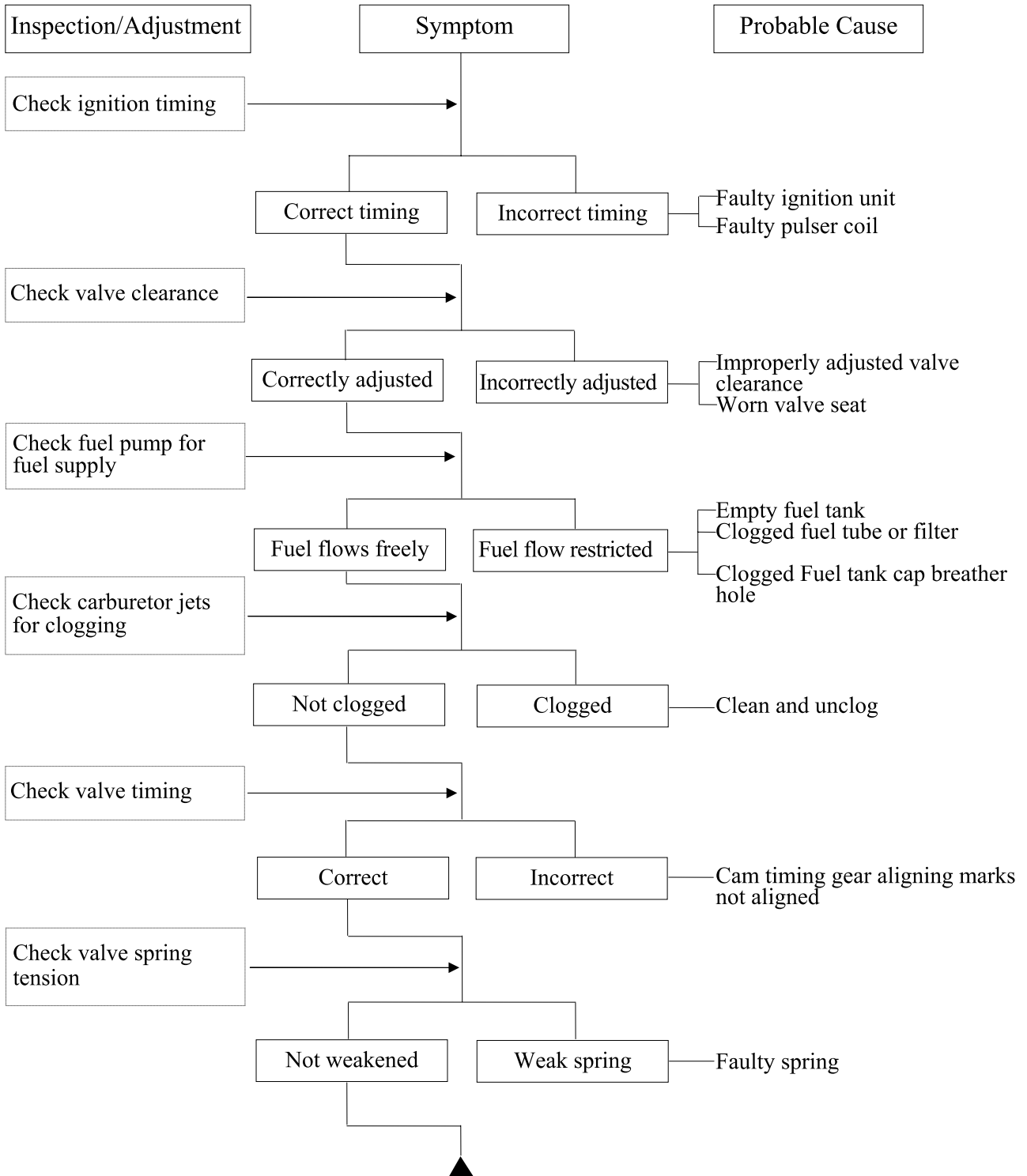

# 1. GENERAL INFORMATION

## POOR CHARGING (BATTERY OVER DISCHARGING OR OVERCHARGING)

### Undercharging

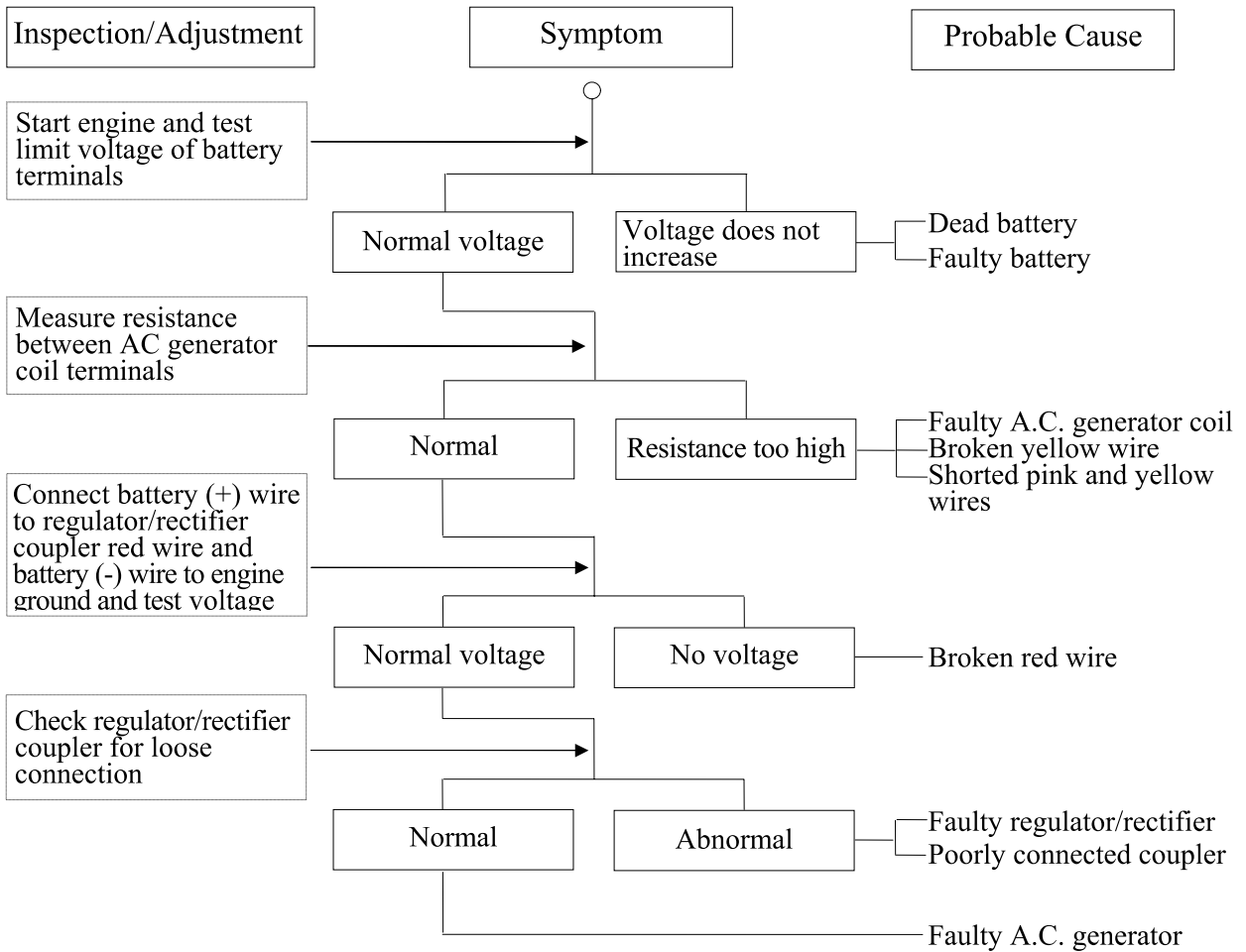

### Overcharging

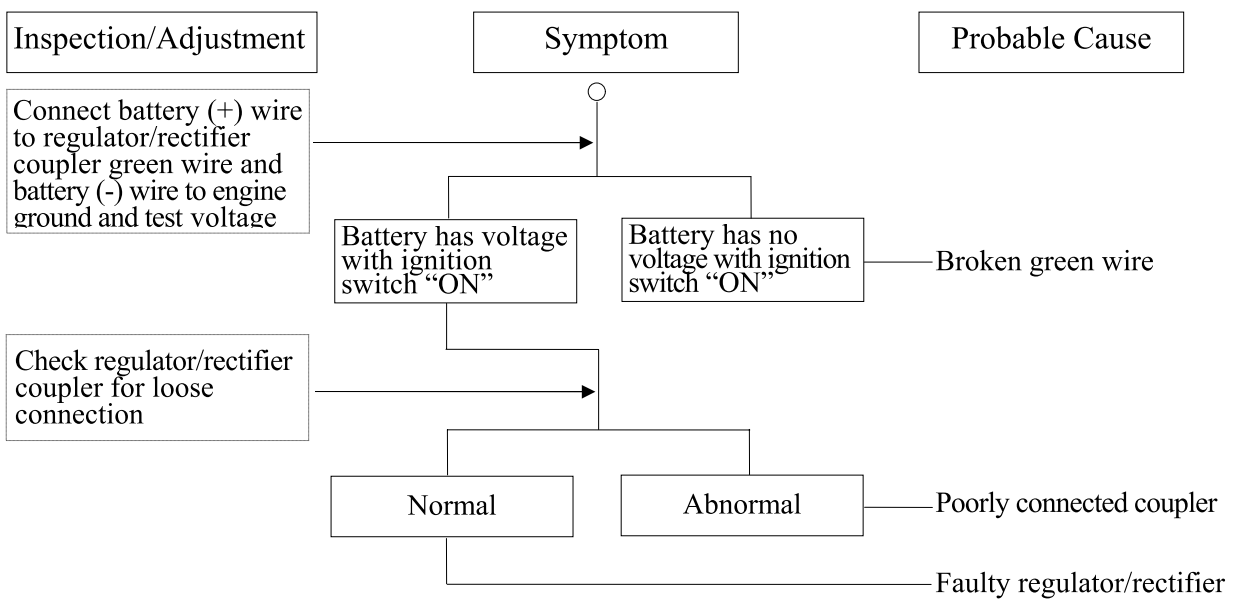

# 1. GENERAL INFORMATION

## NO SPARK AT SPARK PLUG

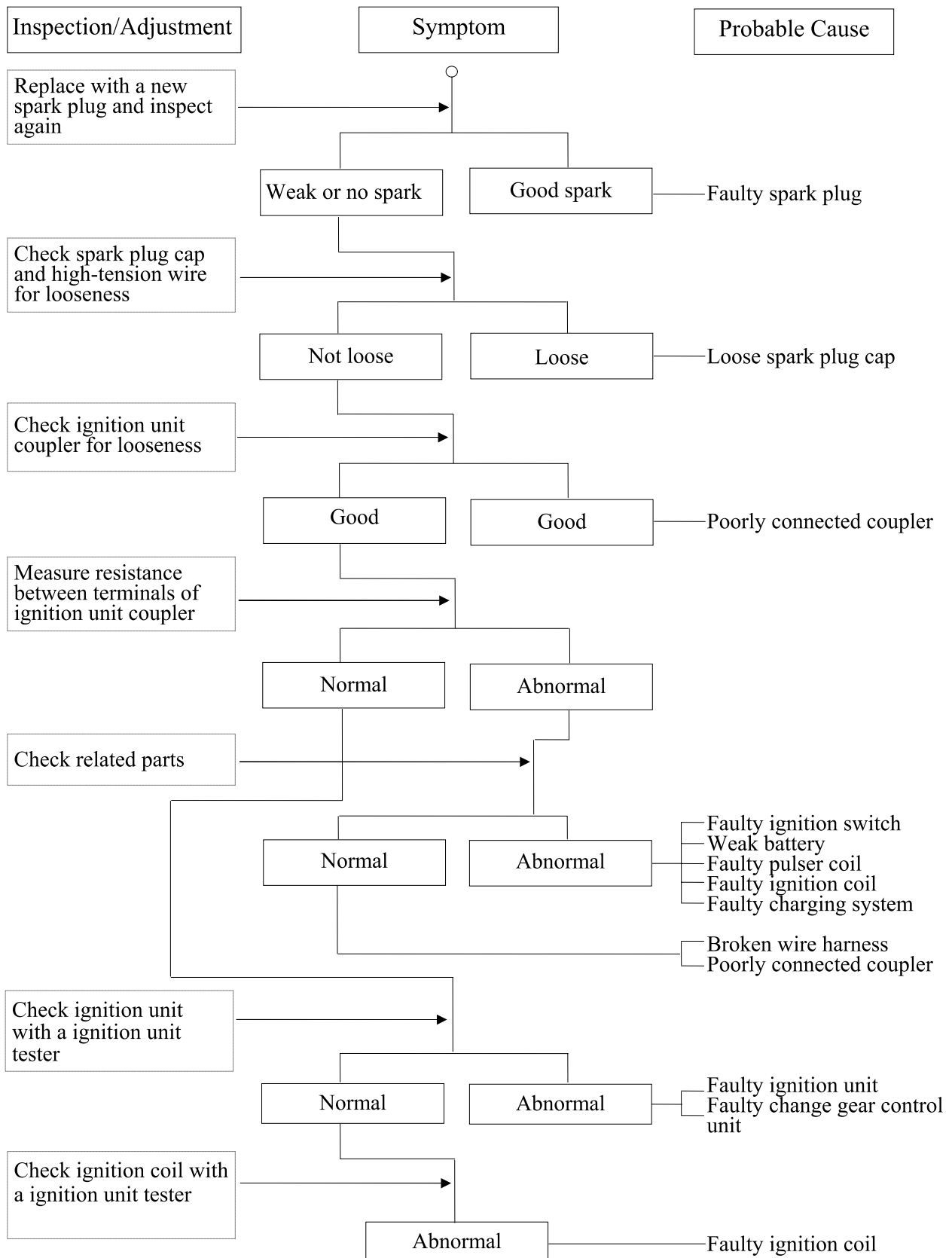

## **2. FRAME COVERS/EXHAUST MUFFLER**

---

## 2. FRAME COVERS/EXHAUST MUFFLER

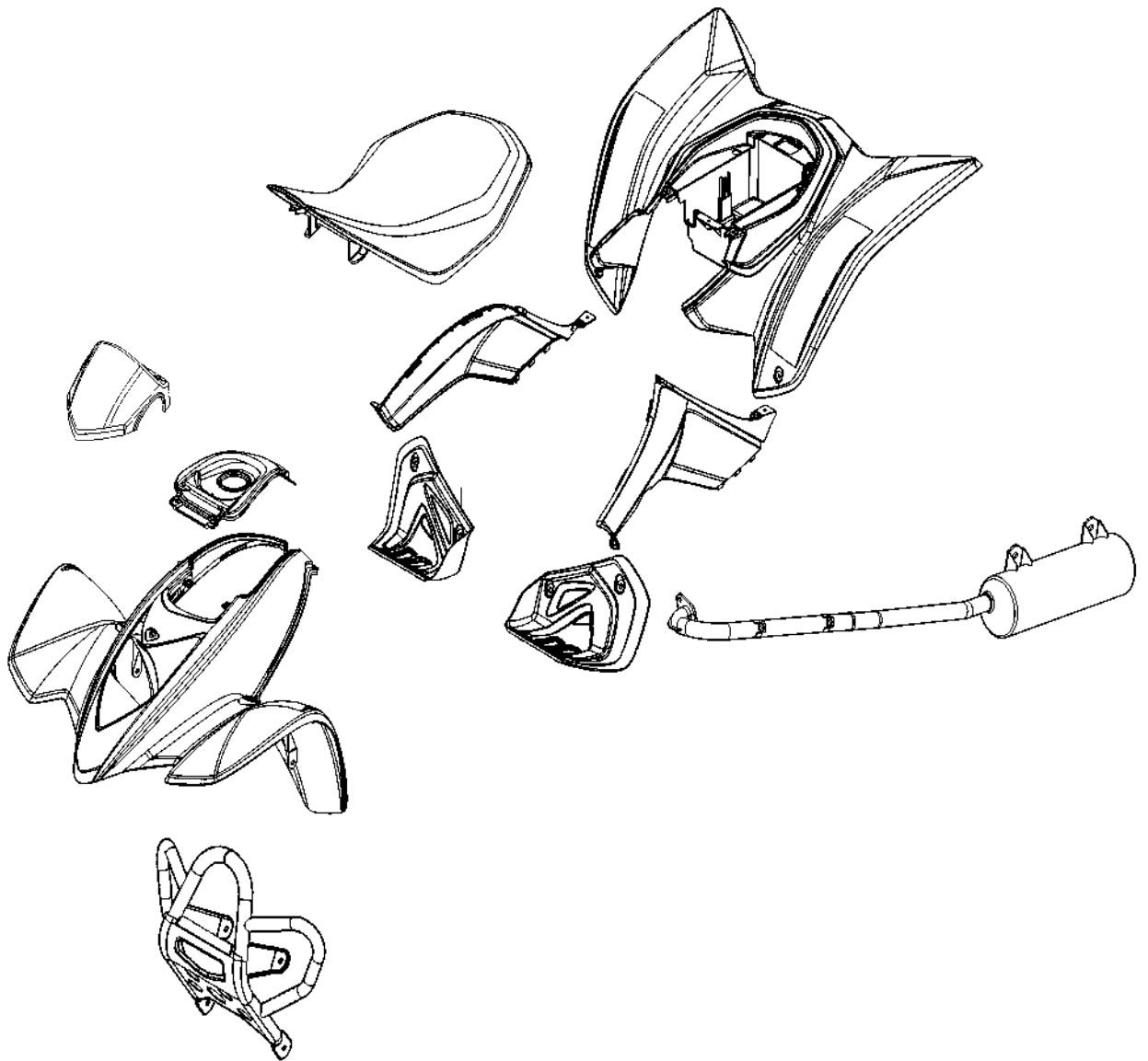

## **2. FRAME COVERS/EXHAUST MUFFLER**

---



## 2. FRAME COVERS/EXHAUST MUFFLER

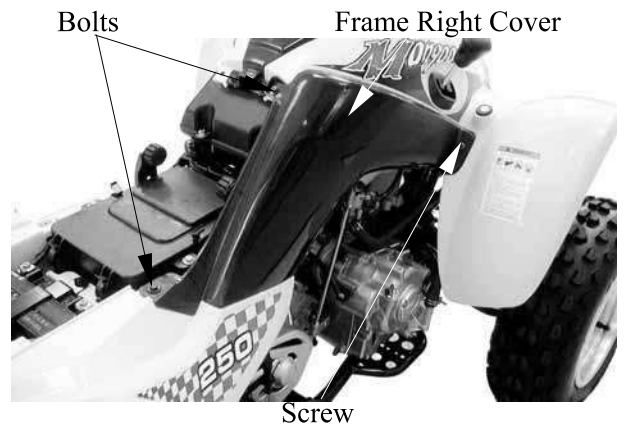
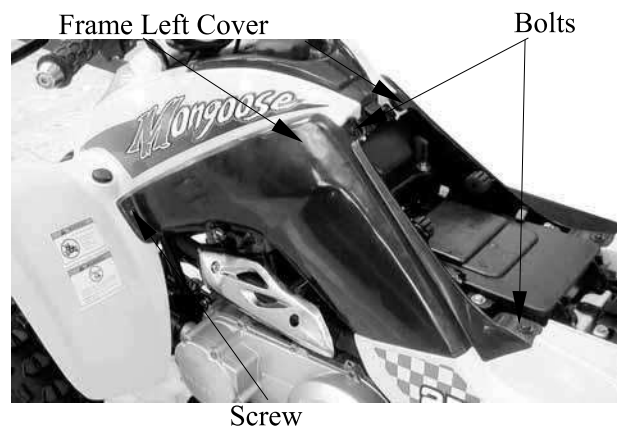
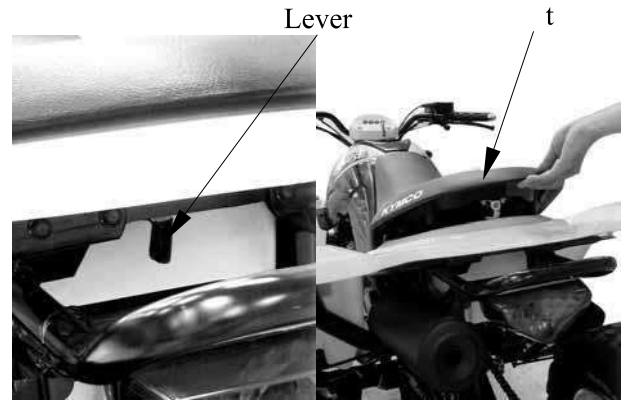

\* During removal, do not pull the joint claws forcedly to avoid damage.

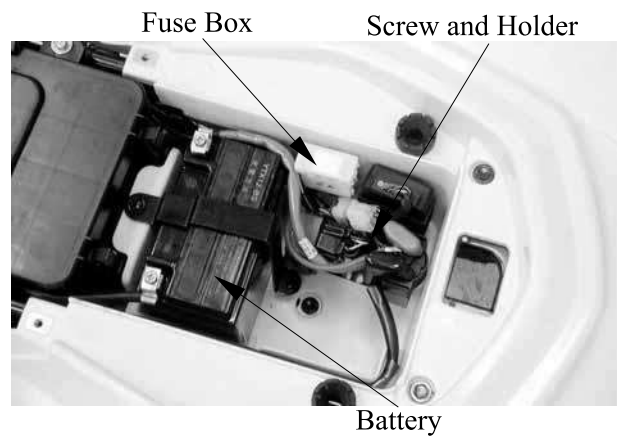

## 2. FRAME COVERS/EXHAUST MUFFLER



\*

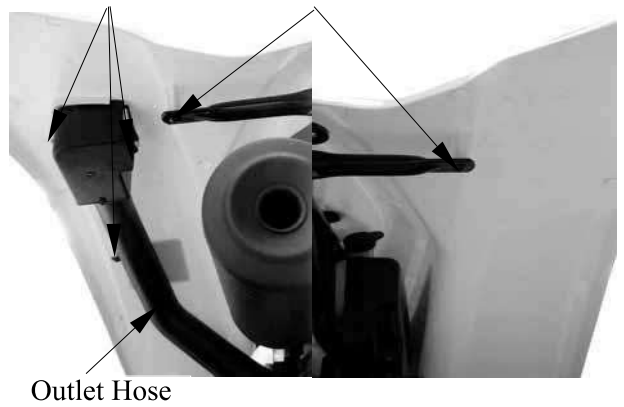

Outlet Hose

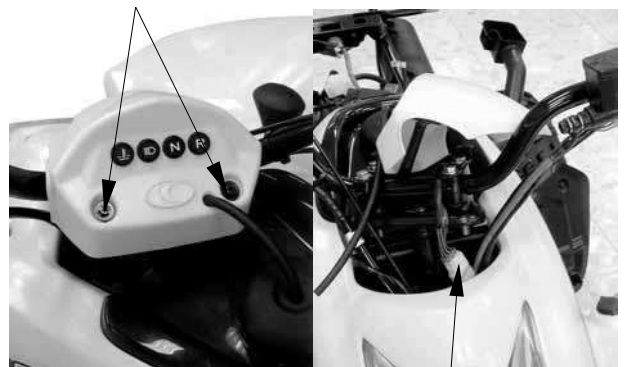

Indicator Lamp coupler

## 2. FRAME COVERS/EXHAUST MUFFLER

\* After remove, be sure to tighten the fuel fill cap.

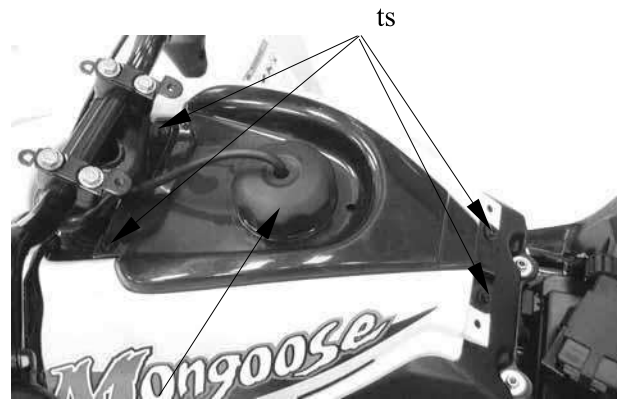

Fuel Fill Cap

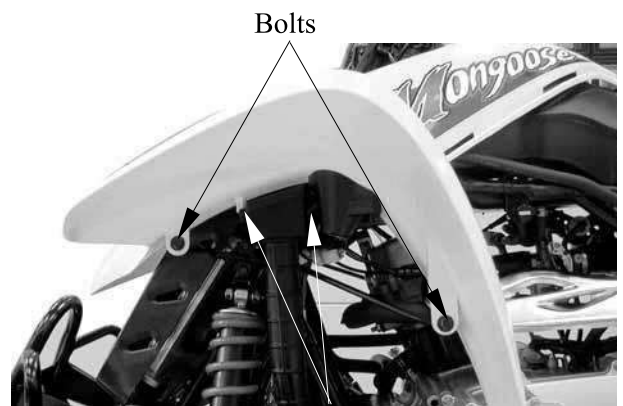

Screws



Bolts

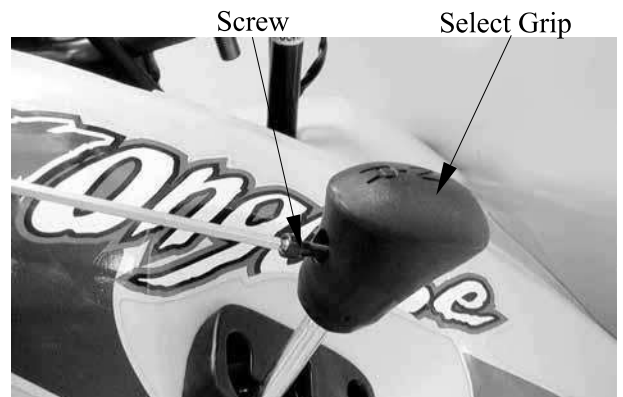

Screw

Select Grip

## 2. FRAME COVERS/EXHAUST MUFFLER

---



Ignition Coupler

Headlight Coupler



Screws

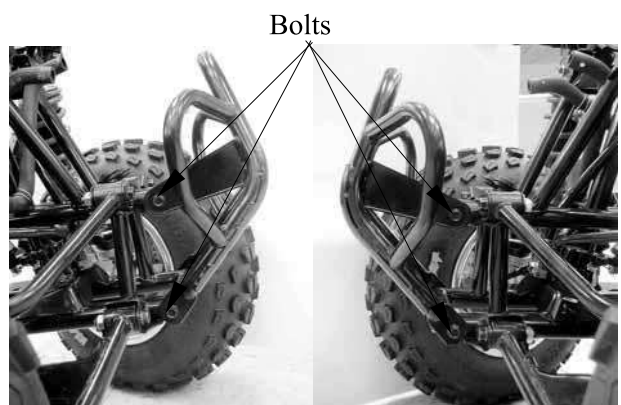

Bolts

## 2. FRAME COVERS/EXHAUST MUFFLER

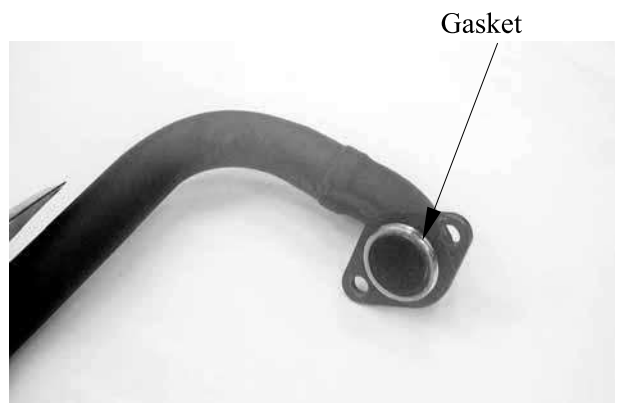
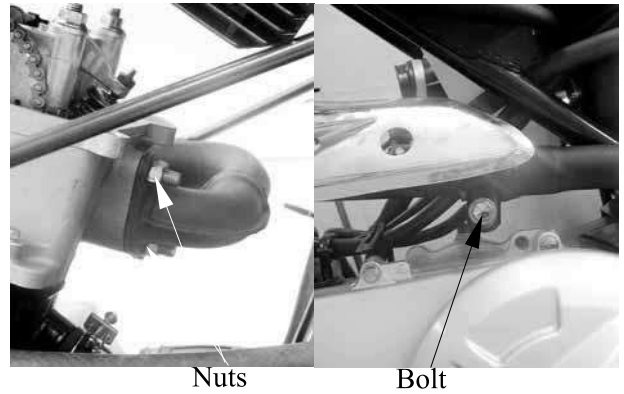

\* Be sure to install a new exhaust gasket.

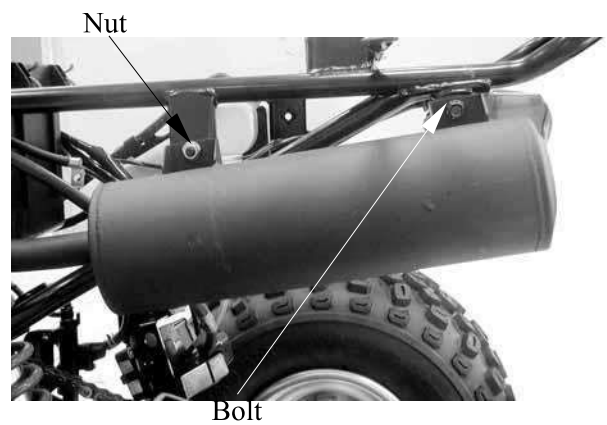

### **3. INSPECTION/ADJUSTMENT**

---

### **3. INSPECTION/ADJUSTMENT**

---

### 3. INSPECTION/ADJUSTMENT

						year
<b>Valves</b>	Check valve clearance. Adjust if necessary.	<input type="radio"/>		<input type="radio"/>	<input type="radio"/>	<input type="radio"/>
<b>Spark plug</b>	Check condition. Adjust gap and clean. Replace if necessary.	<input type="radio"/>	<input type="radio"/>	<input type="radio"/>	<input type="radio"/>	<input type="radio"/>
<b>Air filter element (for engine and drive belt compartment)</b>	Clean. Replace if necessary.	Every 20~40 hours (more often in wet or dusty areas.)				
<b>Carburetor</b>	Check idle speed/starter operation. Adjust if necessary.		<input type="radio"/>	<input type="radio"/>	<input type="radio"/>	<input type="radio"/>
<b>Fuel line</b>	Check fuel hose for cracks or damage. Replace if necessary.			<input type="radio"/>	<input type="radio"/>	<input type="radio"/>
<b>Engine oil</b>	Replace (Warm engine before draining).	<input type="radio"/>		<input type="radio"/>	<input type="radio"/>	<input type="radio"/>
<b>Coolant</b>	Check coolant leakage. Replace if necessary. Replace coolant every 24 months.	<input type="radio"/>	<input type="radio"/>	<input type="radio"/>	<input type="radio"/>	<input type="radio"/>
<b>Oil strainer</b>	Clean. Replace if necessary.	<input type="radio"/>		<input type="radio"/>		<input type="radio"/>
<b>Drive chain</b>	Check and adjust slack/alignment/clean/lube.	<input type="radio"/>	<input type="radio"/>	<input type="radio"/>	<input type="radio"/>	<input type="radio"/>
<b>Transmission oil</b>	Check oil leakage. Replace every 12 months.	<input type="radio"/>				<input type="radio"/>
<b>Brake system</b>	Check operation and brake fluid. Replace brake pad if necessary.	<input type="radio"/>	<input type="radio"/>	<input type="radio"/>	<input type="radio"/>	<input type="radio"/>
<b>Drive belt</b>	Check operation/replace if damage or excessive wear.	<input type="radio"/>				<input type="radio"/>
<b>Wheels</b>	Check balance/damage/runout. Replace if necessary.	<input type="radio"/>		<input type="radio"/>	<input type="radio"/>	<input type="radio"/>
<b>Wheel bearings</b>	Check bearing assembly for looseness/damage. Replace if damaged.	<input type="radio"/>		<input type="radio"/>	<input type="radio"/>	<input type="radio"/>
<b>Steering system</b>	Check operation/replace if damage. Check toe-in/adjust if necessary.	<input type="radio"/>	<input type="radio"/>	<input type="radio"/>	<input type="radio"/>	<input type="radio"/>
<b>Rear swing arm shafts</b>	Lubricate every 6 months.			<input type="radio"/>	<input type="radio"/>	<input type="radio"/>
<b>Fitting/Fasteners</b>	Check all chassis fittings and fasteners. Correct if necessary.	<input type="radio"/>	<input type="radio"/>	<input type="radio"/>	<input type="radio"/>	<input type="radio"/>

- In the interest of safety, we recommend these items should be serviced only by an authorized KYMCO motorcycle dealer.



### 3. INSPECTION/ADJUSTMENT

---

\*

Fuel Filter



Fuel tubes

Lock nut

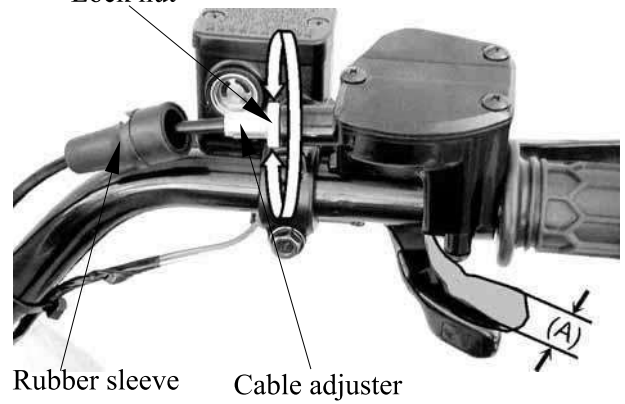

Rubber sleeve

Cable adjuster

Air Cleaner Housing Cover

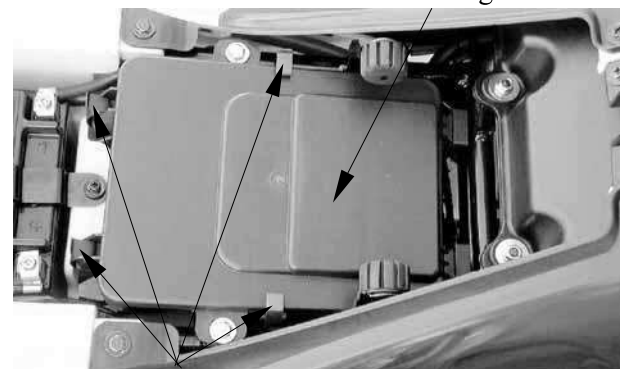

Retainer Clips

### 3. INSPECTION/ADJUSTMENT

---

Screw

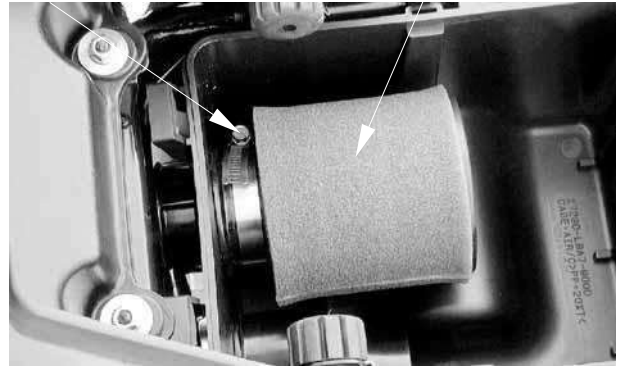

Screw

Air Cleaner Holder

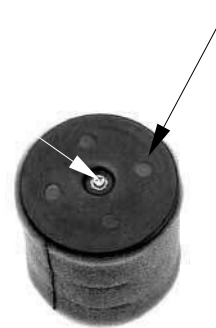

Air Cleaner

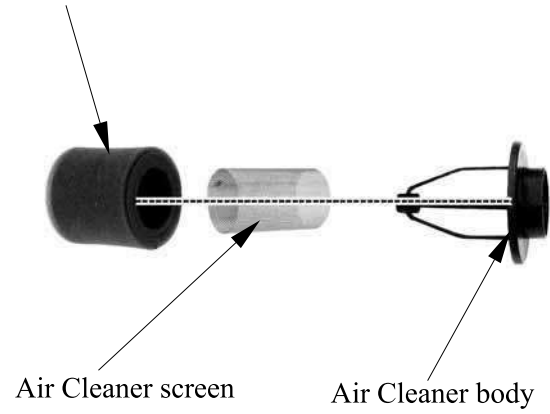

Air Cleaner screen

Air Cleaner body

### 3. INSPECTION/ADJUSTMENT

---

\* <sup>r</sup>  
use gasoline or low flash point solvents  
which may lead to a fire or explosion.

\* Do not twist or wring out the foam  
element. This could damage the foam  
material.

\* The element should be wet but not  
dripping.

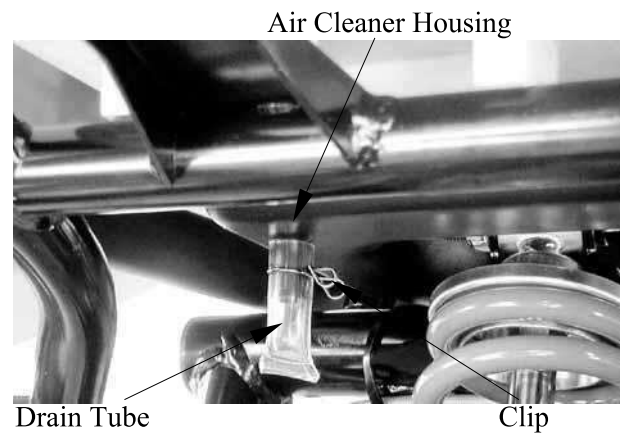
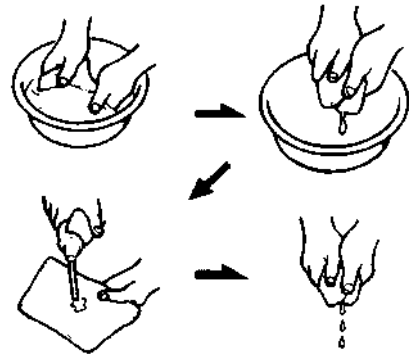

### 3. INSPECTION/ADJUSTMENT

#### AIR FILTER FOR DRIVE BELT

To clean the air filter:

Remove the two screws attaching front fender and remove air filter housing.  
Remove the two screws and remove air filter housing cover.

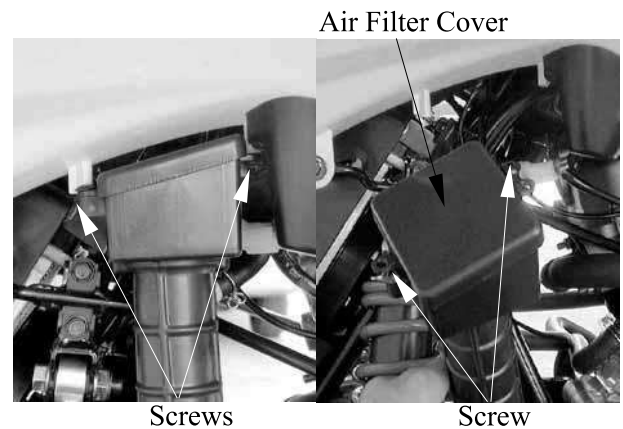

Remove the air filter from the housing.  
Tap the air filter lightly to remove most of the dust and dirt.  
Blow out the remaining dirt with compressed air.  
If the element is damaged, replace it.

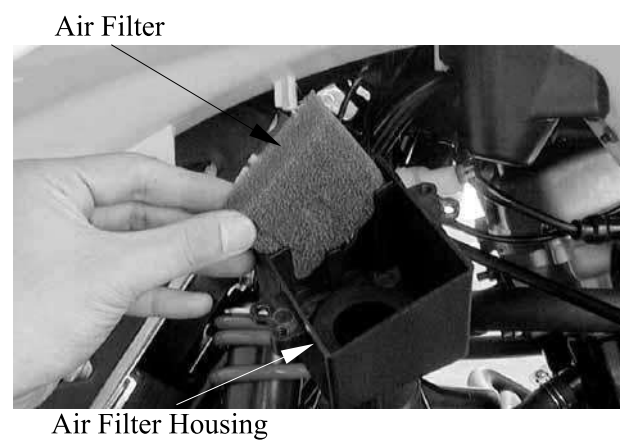

Reassemble by reversing the disassembly sequence.

#### SPARK PLUG

Remove ignition coil cap and spark plug.  
Check the spark plug for wear and fouling deposits.  
Clean any fouling deposits with a spark plug cleaner or a wire brush.

**Specified Spark Plug:** DPR7EA-9

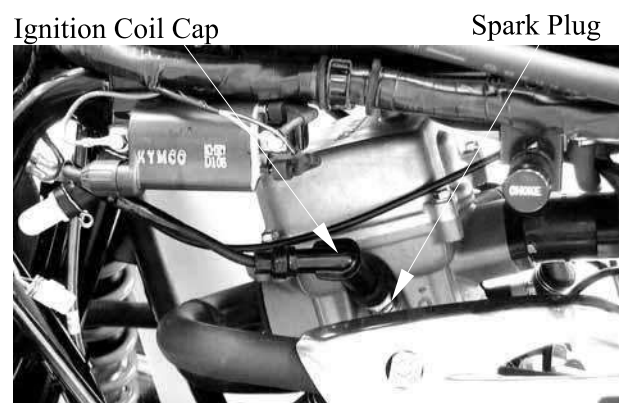

Measure the spark plug gap.

**Spark Plug Gap:** 0.6~0.7mm

\* When installing, first screw in the spark plug by hand and then tighten it with a spark plug wrench.

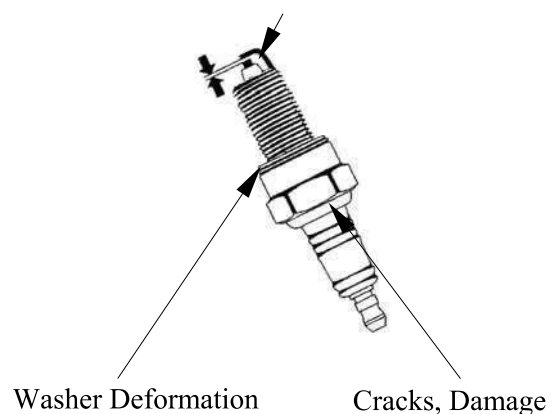

### 3. INSPECTION/ADJUSTMENT

\*

Cylinder Head Cover

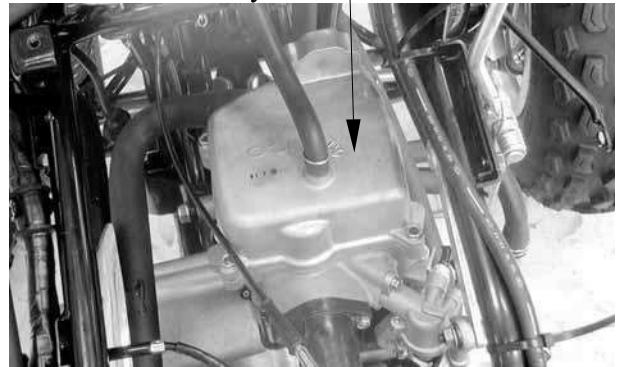

Index Mark

“T” Mark



- \* Check the valve clearance again after the lock nut is tightened.

Valve Wrench

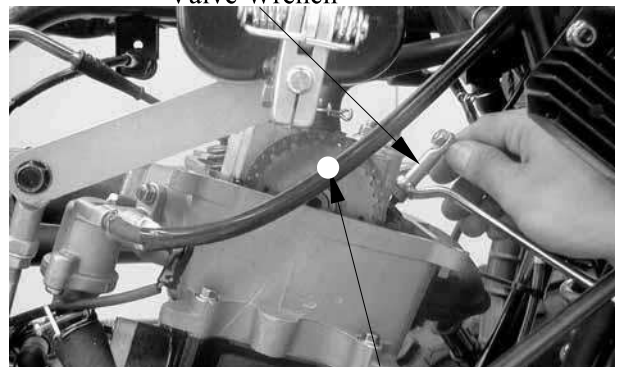

Round Hole

- \* The engine must be warm for accurate idle speed inspection and adjustment.

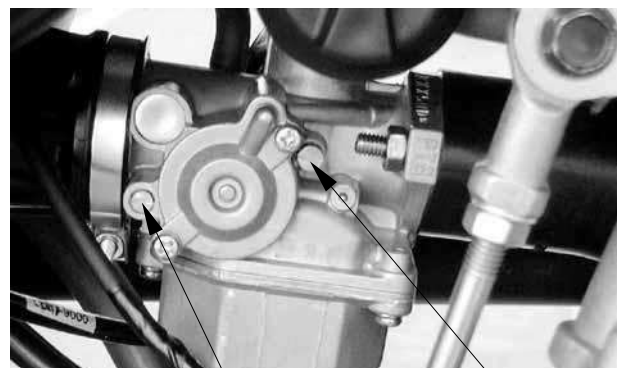

Air Screw

Throttle Stop Screw

### 3. INSPECTION/ADJUSTMENT

---

\*

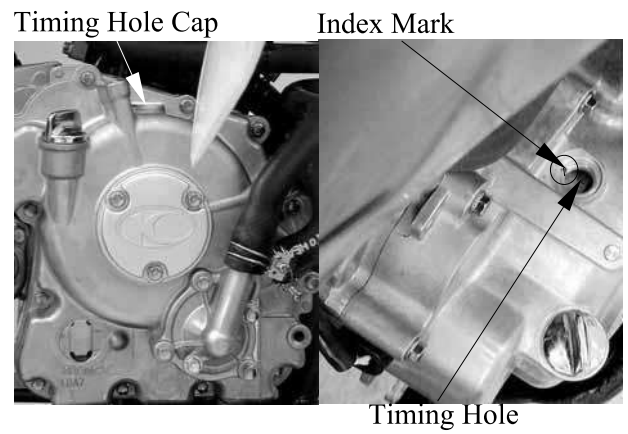

### 3. INSPECTION/ADJUSTMENT

\* Run the engine for 2~3 minutes and check the oil level after the engine is stopped for 2~3 minutes.

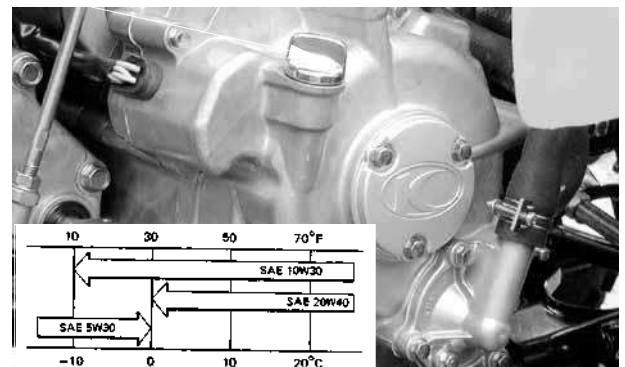
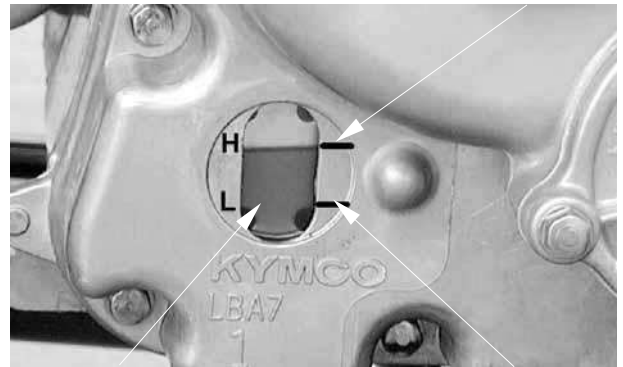

\* The engine oil will drain more easily while the engine is warm.

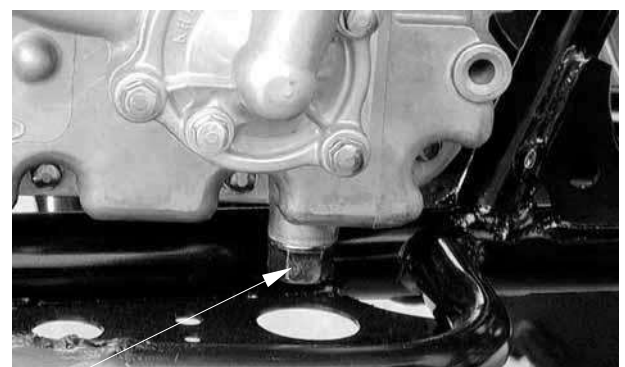

g

### 3. INSPECTION/ADJUSTMENT

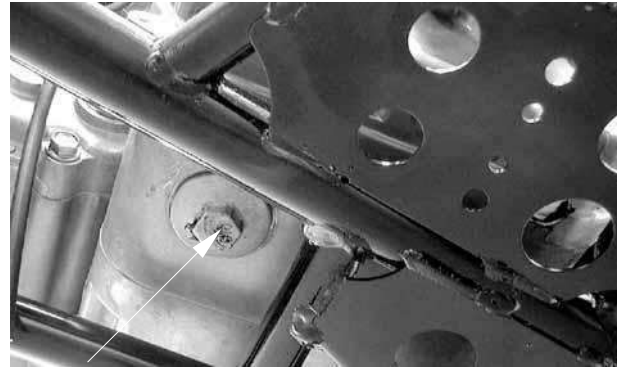

p

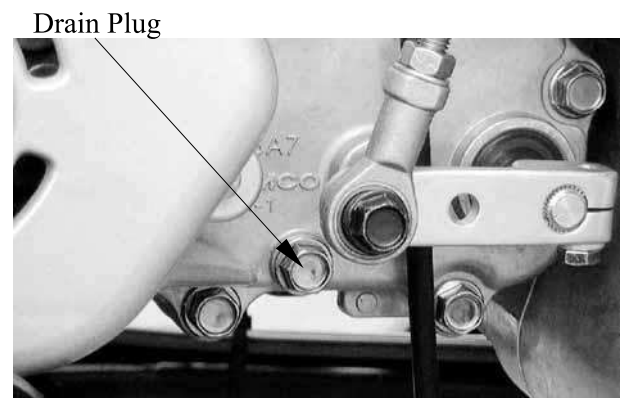
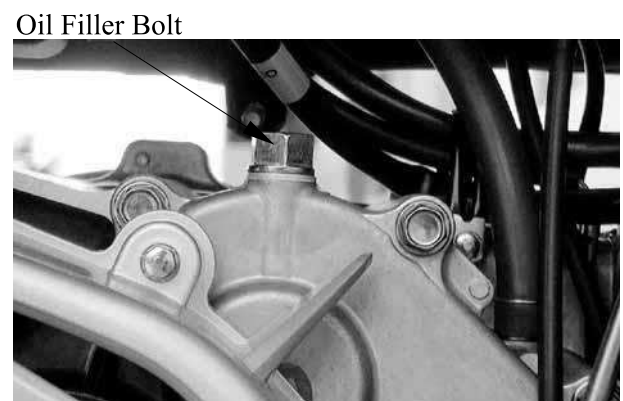
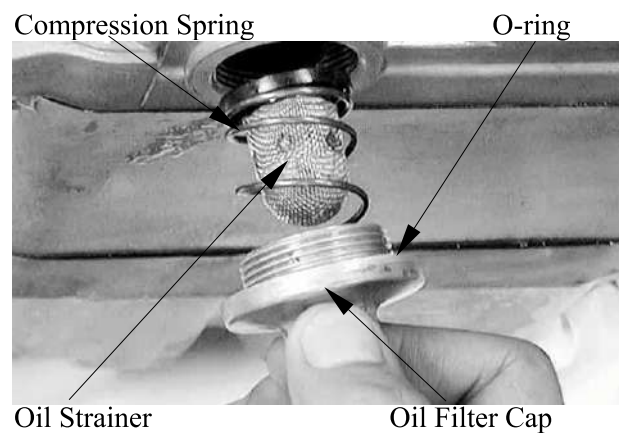

\* Make sure that the sealing washer is in good condition.



### 3. INSPECTION/ADJUSTMENT

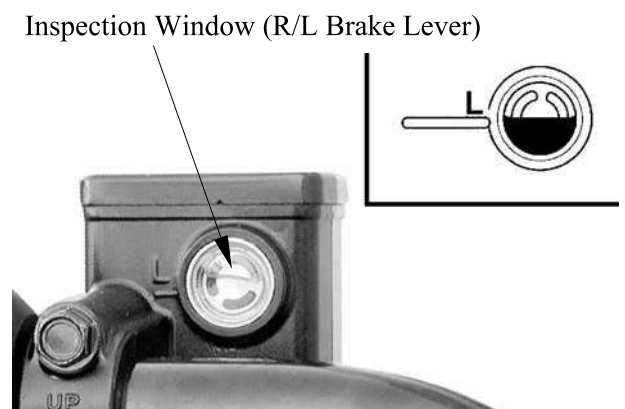
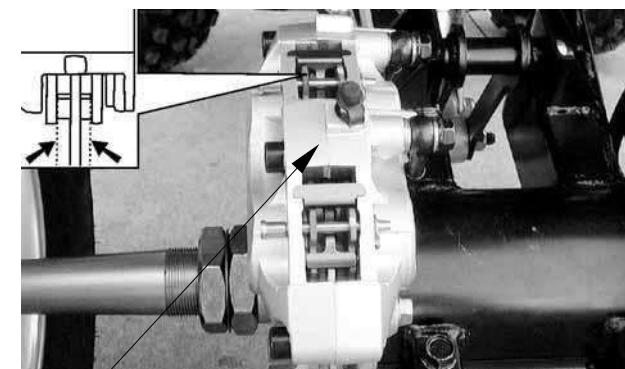
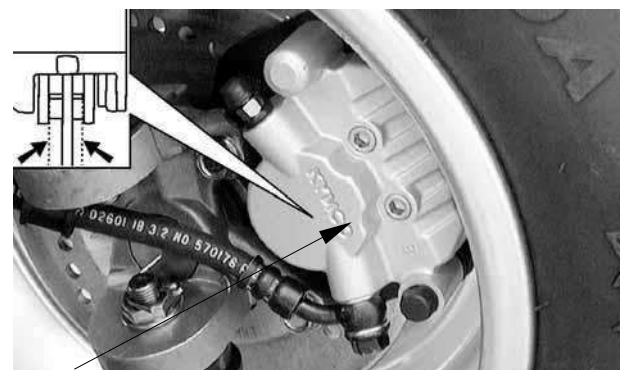
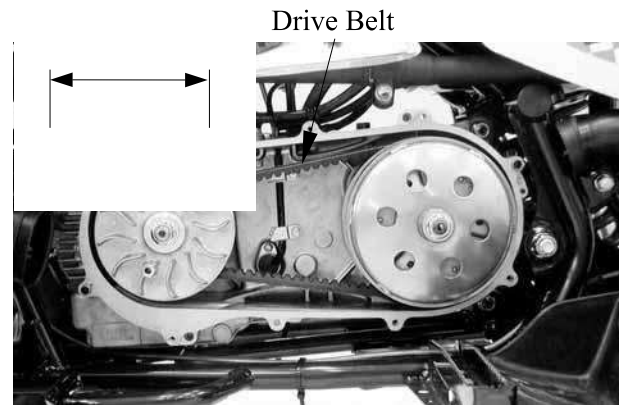

### 3. INSPECTION/ADJUSTMENT

---

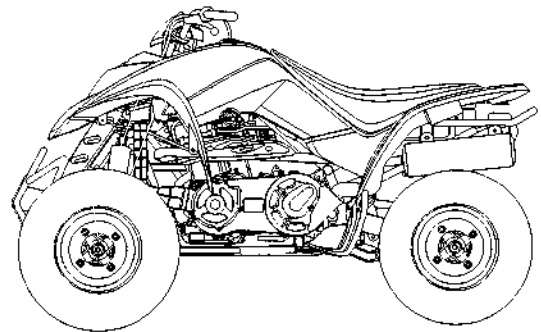
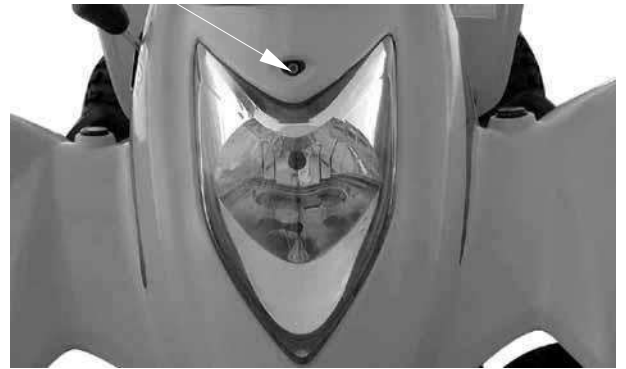

### 3. INSPECTION/ADJUSTMENT

---

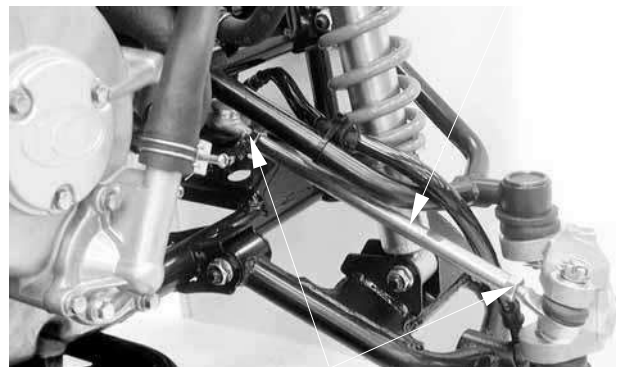
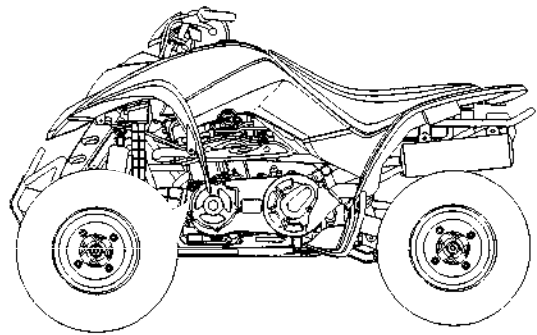
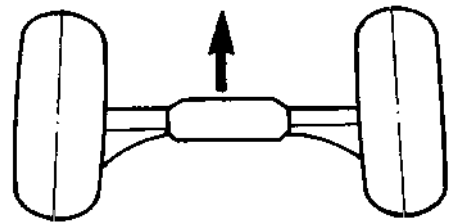

### 3. INSPECTION/ADJUSTMENT

- \* Be sure that both tie-rod are turned the same amount. If not, the machine will drift tight or left even though the handlebar is positioned straight which may lead to mishandling and accident.
- After setting the toe-in to specification, run the machine slowly for some distance with hands placed lightly on the handlebar and check that the handlebar responds correctly. If not, turn either the right or left tie-rod within the toe-in specification.

Tie-rod End Nuts

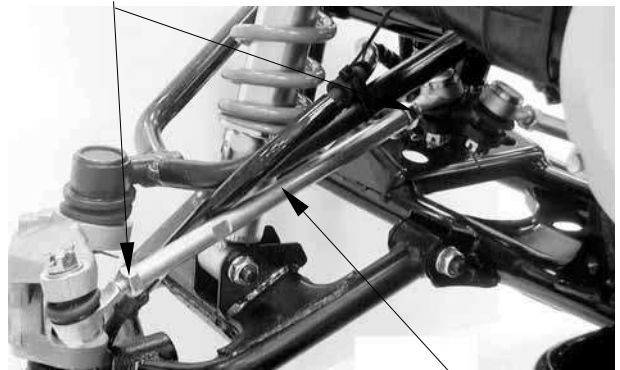

Tie-rod

- \* Tire pressure should be checked when tires are cold.



Rear Axle Nut



t



### 3. INSPECTION/ADJUSTMENT

---

- \* It is dangerous to ride with a worn out tire. When a tire wear is out of specification, replace the tire immediately.

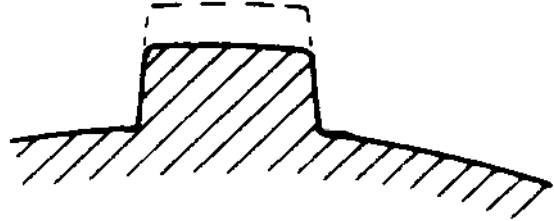

\*

### 3. INSPECTION/ADJUSTMENT

---

\* Too little of chain slack will overload the engine and other vital parts; keep the slack within the specified limits.

\* Wheels should be on the ground without the rider on it.

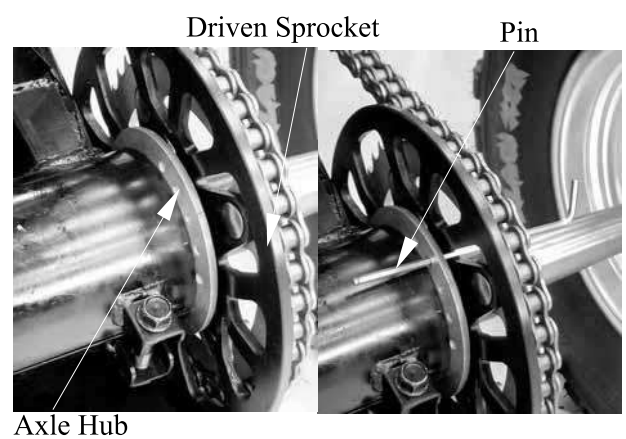
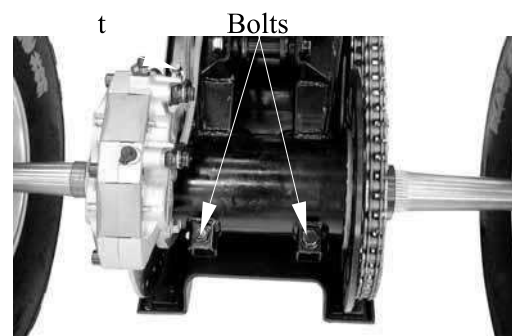
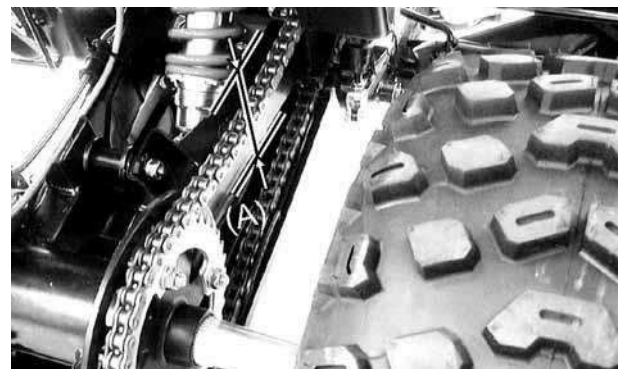

### 3. INSPECTION/ADJUSTMENT

---

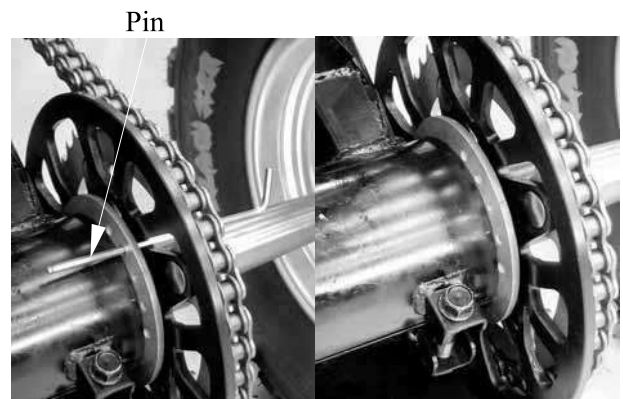
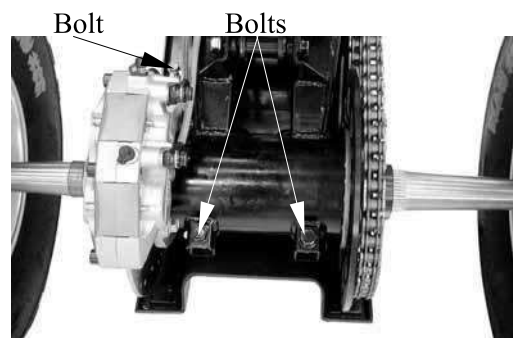
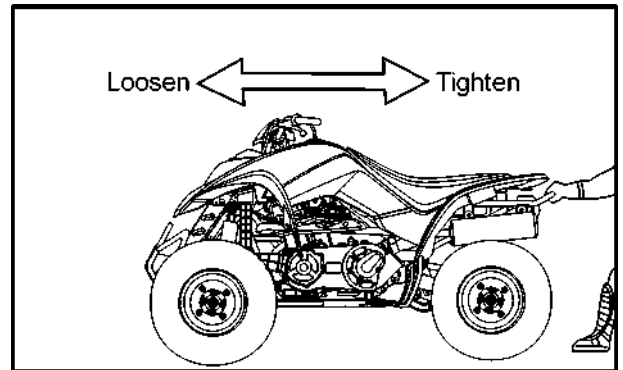

### 3. INSPECTION/ADJUSTMENT

---

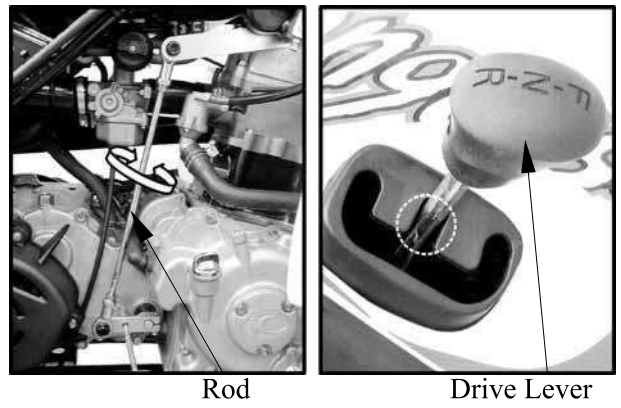
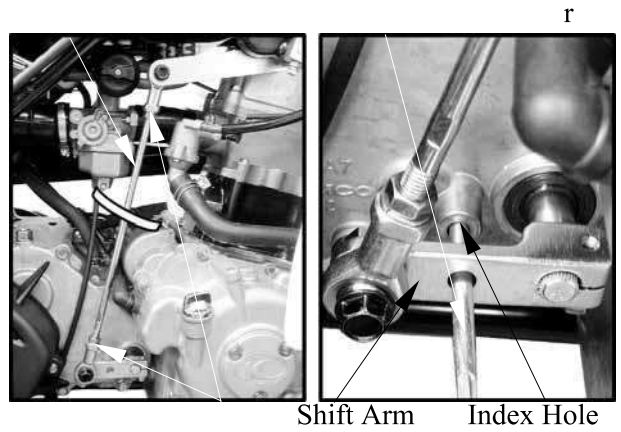



### 3. INSPECTION/ADJUSTMENT

---

\* Damaged cable sheath may cause corrosion and interfere with the cable movement. An unsafe condition may result so replace such cable as soon as possible.

\* Hold cable end high and apply several drops of lubricant to cable.

\* Wipe off the excess grease.



Nipple

### 3. INSPECTION/ADJUSTMENT

---

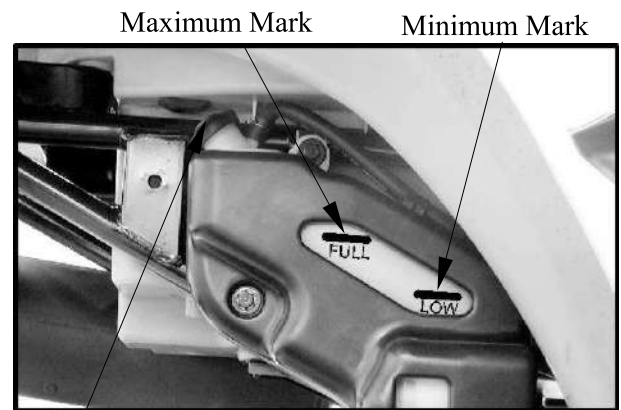

Coolant Reservoir Cap

\*

\* Perform this operation when the engine is cold.

\* The coolant freezing point should be 5 °C lower than the temperature of the riding area.

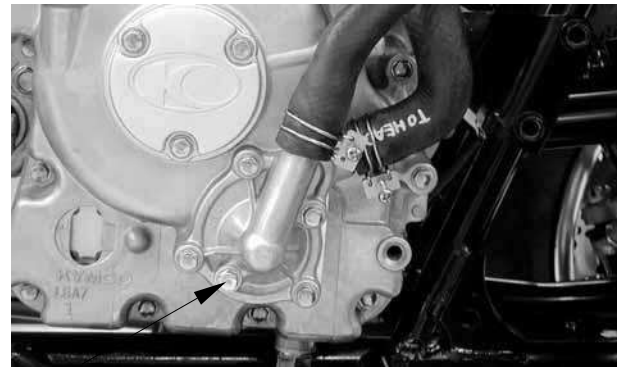

Drain Bolt

## 4. LUBRICATION SYSTEM

---

---

---

---

---

---

---

---

---

---

### LUBRICATION SYSTEM

---

SERVICE INFORMATION-----	4- 2
TROUBLESHOOTING-----	4- 2
ENGINE OIL/OIL FILTER -----	4- 3
OIL PUMP-----	4- 3

## 4. LUBRICATION SYSTEM

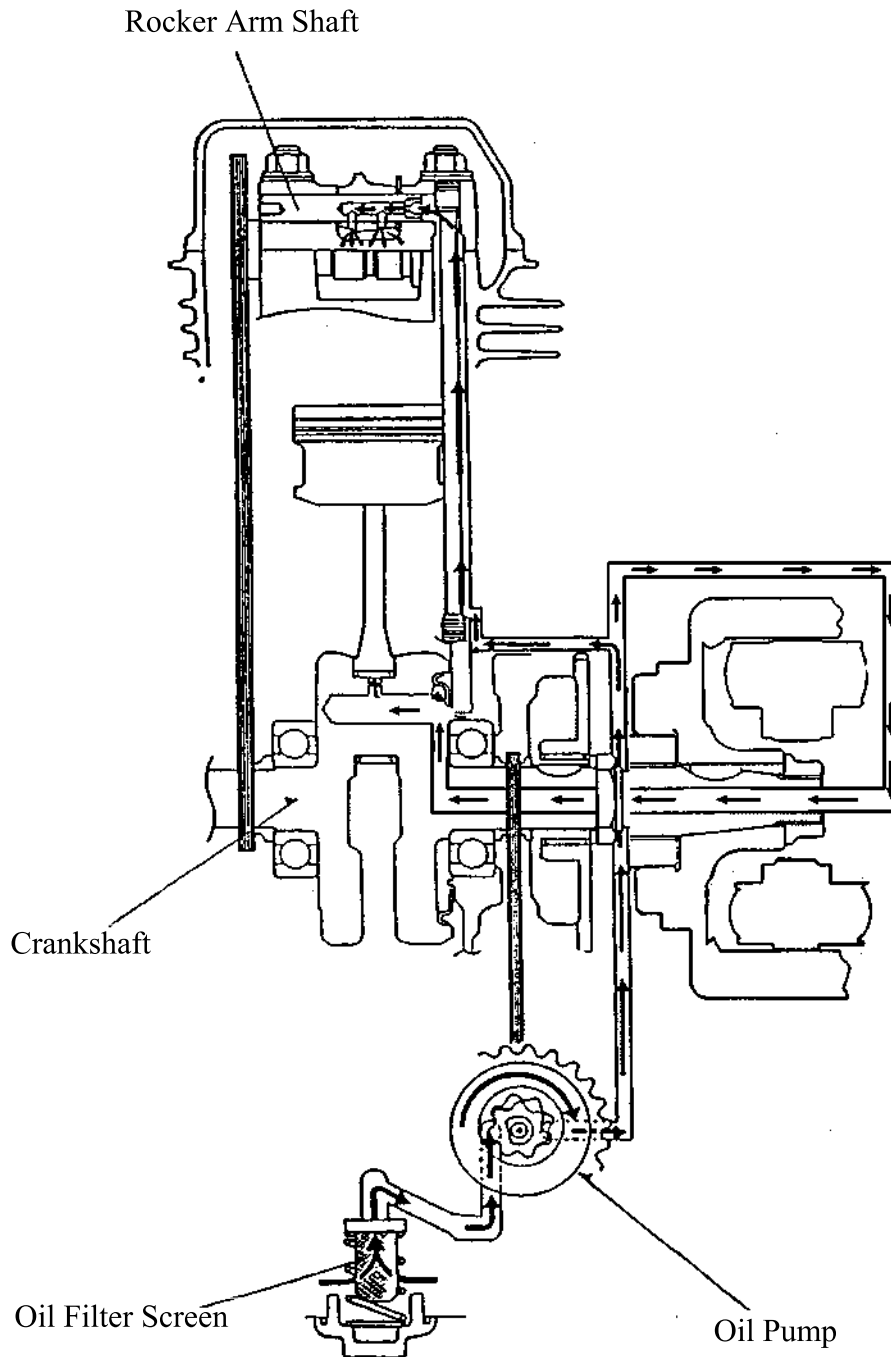

## 4. LUBRICATION SYSTEM

### SERVICE INFORMATION

#### GENERAL INSTRUCTIONS

- The maintenance of lubrication system can be performed with the engine installed in the frame.
- Use care when removing and installing the oil pump not to allow dust and foreign matters to enter the engine and oil line.
- Do not attempt to disassemble the oil pump. The oil pump must be replaced as a set when it reaches its service limit.
- After the oil pump is installed, check each part for oil leaks.

#### SPECIFICATIONS

Item		Standard (mm)	Service Limit (mm)
Oil pump	Inner rotor-to-outer rotor clearance	0.15	0.20
	Outer rotor-to-pump body clearance	0.15~0.20	0.25
	Rotor end-to-pump body clearance	0.04~0.09	0.12

#### TROUBLESHOOTING

##### Oil level too low

- Natural oil consumption
- Oil leaks
- Worn or poorly installed piston rings
- Worn valve guide or seal

##### Poor lubrication pressure

- Oil level too low
- Clogged oil filter or oil passages
- Not use the specified oil

## 4. LUBRICATION SYSTEM

### ENGINE OIL/OIL FILTER

#### OIL LEVEL AND OIL CHANGE

Refer to the “ENGINE OIL” section in the chapter 3 to check the oil level and replacement and oil filter cleaning.

### OIL PUMP

#### REMOVAL

Remove the right crankcase cover and the A.C. generator flywheel. (Refer to the “A.C. GENERATOR/FLYWHEEL” section in the chapter 16)

Remove the starter clutch gear. (Refer to the “STARTER CLUTCH” section in the chapter 18)

Remove the two bolts and oil separator cover.

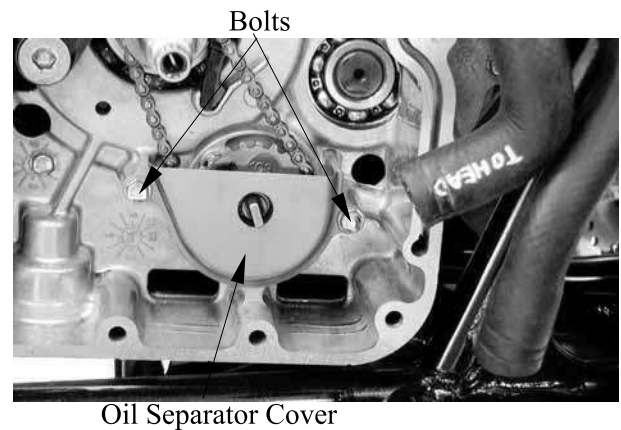

Pry the circlip off and remove the oil pump driven gear, then remove the oil pump drive chain and oil driven sprocket.

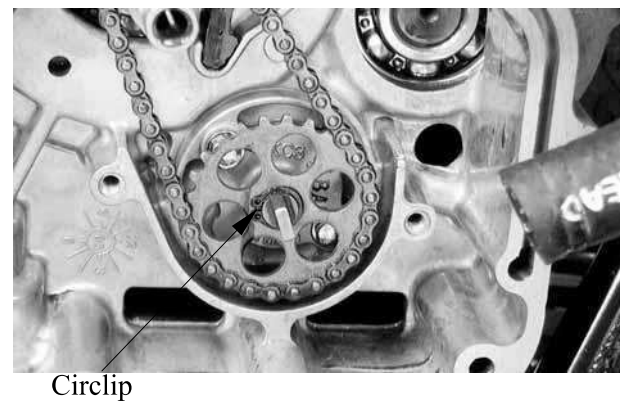

## 4. LUBRICATION SYSTEM

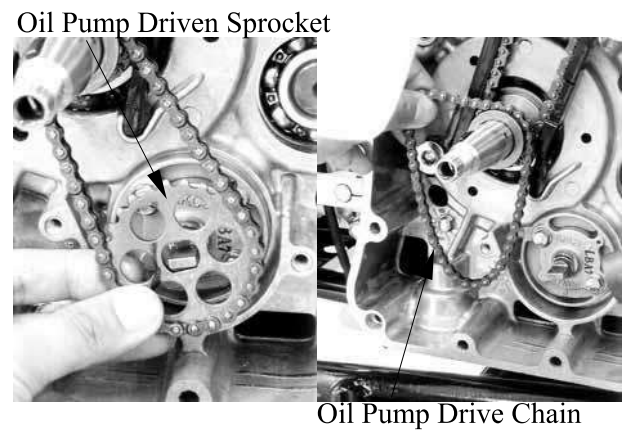

Remove the two oil pump bolts for remove the oil pump.

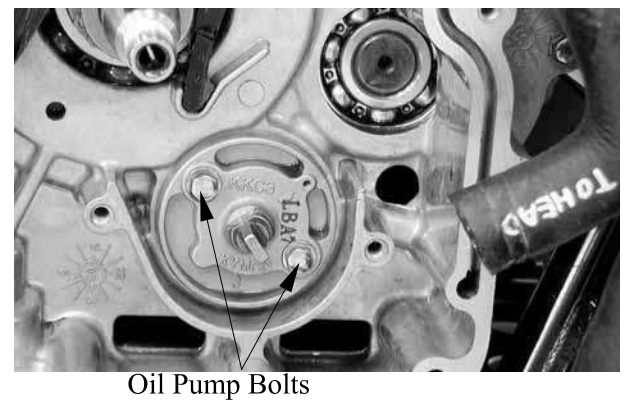

### OIL PUMP DISASSEMBLY

Remove the screw and disassemble the oil pump.

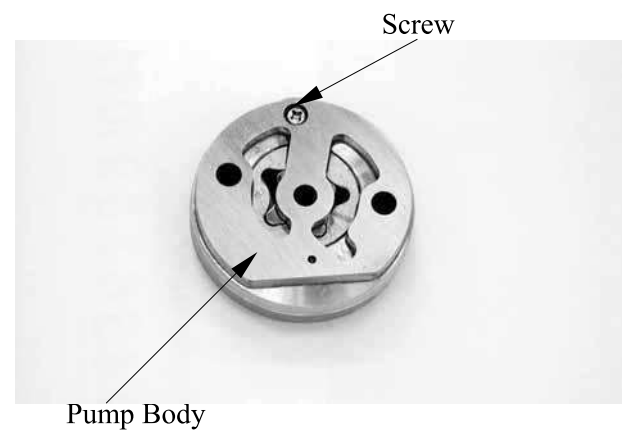

### INSPECTION

Measure the rotor end-to-pump body clearance.

**Service Limit:** 0.12mm

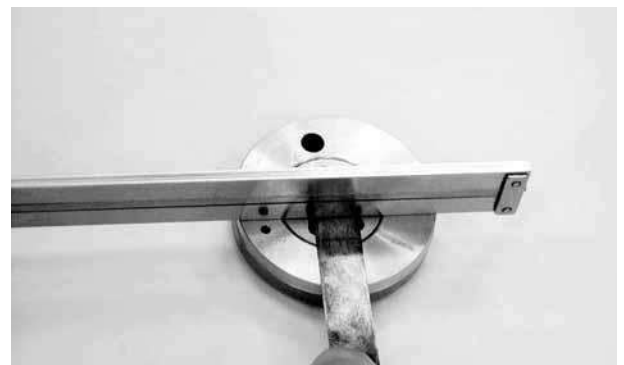

## 4. LUBRICATION SYSTEM

Measure the inner rotor-to-outer rotor clearance.

**Service Limit:** 0.2mm

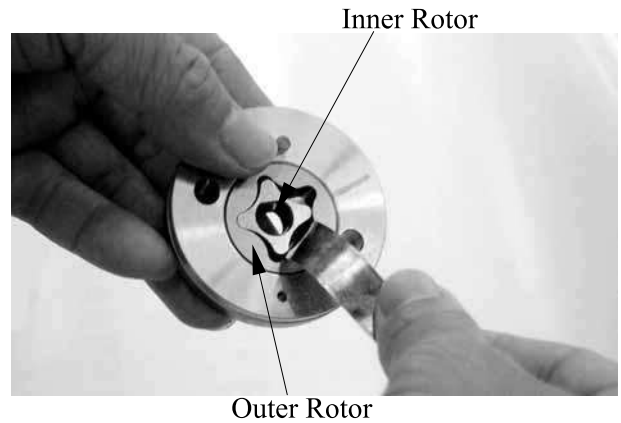

Measure the pump body-to-outer rotor clearance.

**Service Limit:** 0.25mm

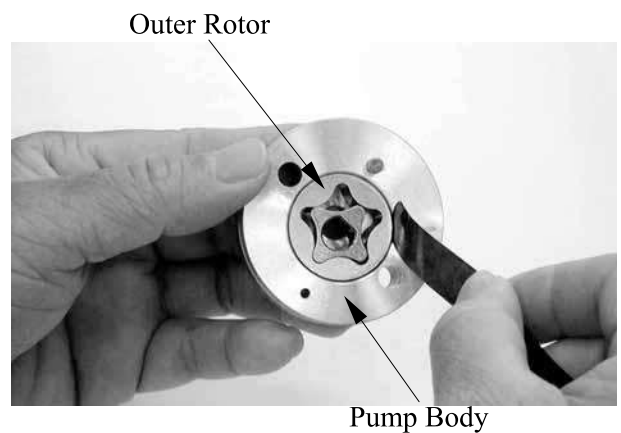

### ASSEMBLY

Install the outer rotor, inner rotor and pump shaft into the pump body.

- \* Insert the pump shaft by aligning the flat on the shaft with the flat in the inner rotor.

Install the dowel pin.

Install the pump cover by aligning the hole in the cover with the dowel pin.

Tighten the screw to secure the pump cover.

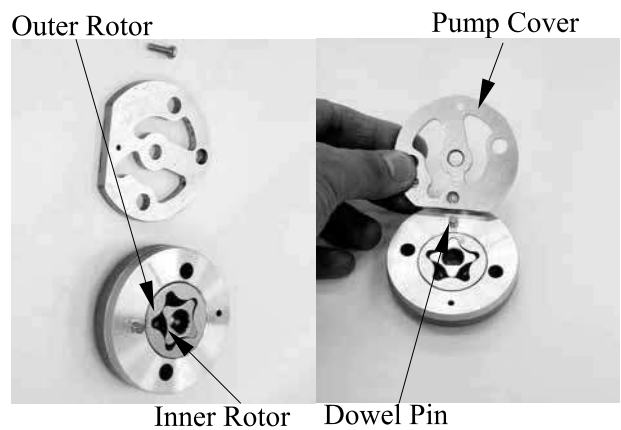

### INSTALLATION

Reverse the "OIL PUMP REMOVAL" procedures.

- \* Install the oil pump with the arrow on the pump body facing up and fill the oil pump with engine oil before installation.

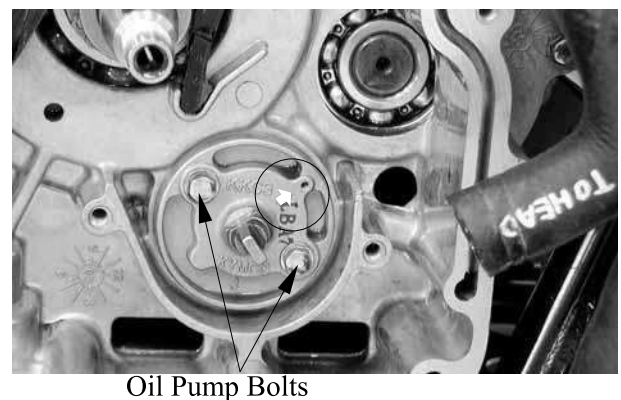



## 4. LUBRICATION SYSTEM

Make sure that the pump shaft rotates freely without binding.

Pump Shaft

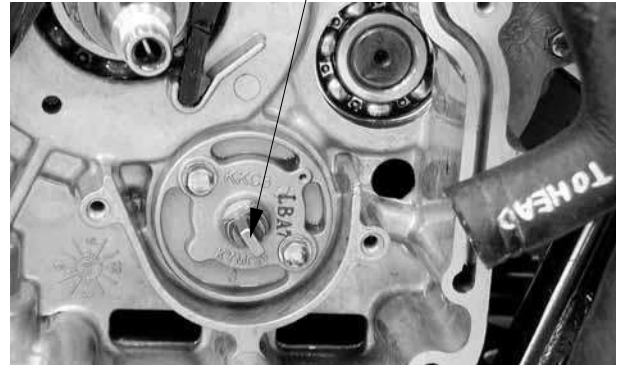

Install oil pump driven sprocket and drive chain, circlip and oil separator cover.



## 5. FUEL SYSTEM

---

---

---

---

---

---

---

---

**5**

### FUEL SYSTEM

---

SERVICE INFORMATION-----	5- 2
TROUBLESHOOTING-----	5- 3
FUEL TANK -----	5- 4
FUEL VALVE REMOVAL -----	5- 4
THROTTLE VALVE-----	5- 7
CARBURETOR-----	5- 8
AIR CLEANER -----	5-12

# 5. FUEL SYSTEM

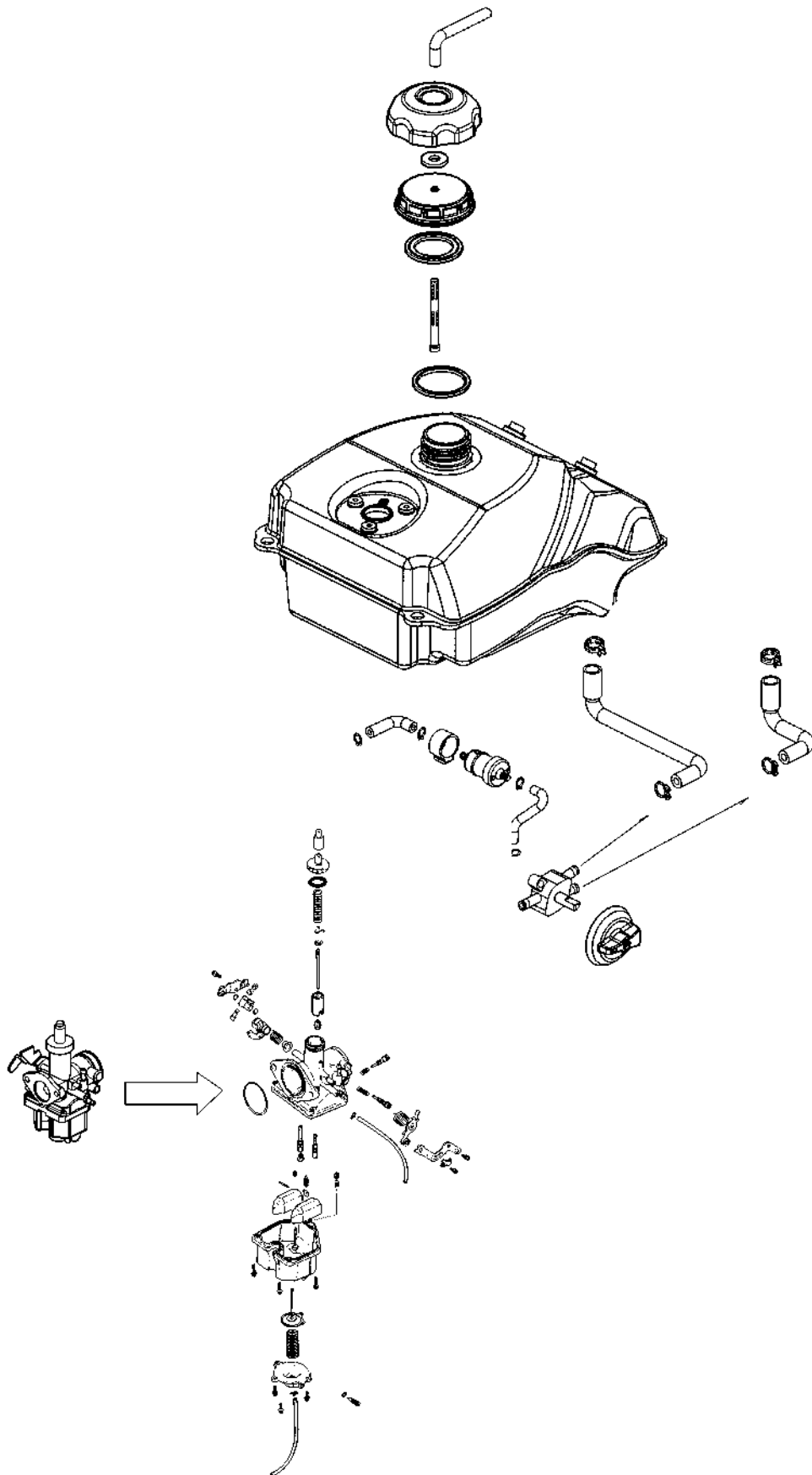

## 5. FUEL SYSTEM

### SERVICE INFORMATION

#### GENERAL INSTRUCTIONS



Gasoline is very dangerous. When working with gasoline, keep sparks and flames away from the working area.  
Gasoline is extremely flammable and is explosive under certain conditions. Be sure to work in a well-ventilated area.

- Do not bend or twist control cables. Damaged control cables will not operate smoothly.
- When disassembling fuel system parts, note the locations of O-rings. Replace them with new ones during reassembly.
- Before float chamber disassembly, loosen the drain screw to drain the residual gasoline into a clean container.
- After the carburetor is removed, plug the intake manifold side with a clean shop towel to prevent foreign matters from entering.
- When cleaning the carburetor air and fuel jets, the O-rings and diaphragm must be removed first to avoid damage. Then, clean with compressed air.
- When the motorcycle is not used for over one month, drain the residual gasoline from the float chamber to avoid erratic idling and clogged slow jet due to deteriorated fuel.

#### SPECIFICATIONS

Item	Standard
Type	PD
Venturi dia.	φ22
Float level	14.8mm
Main jet No.	98
Adjust method	Piston
Idle speed	1500±100rpm
Throttle grip free play	1 ~ 4mm
Air screw opening	1 1/8±1/2

## 5. FUEL SYSTEM

---

### **SPECIAL TOOL**

Float level gauge

### **TROUBLESHOOTING**

#### **Engine cranks but won't start**

- No fuel in tank
- No fuel to carburetor
- Cylinder flooded with fuel
- No spark at plug
- Clogged air cleaner
- Intake air leak
- Improper throttle operation

#### **Engine idles roughly, stalls or runs poorly**

- Excessively used choke
- Ignition malfunction
- Faulty carburetor
- Poor quality fuel
- Lean or rich mixture
- Incorrect idle speed

#### **Misfiring during acceleration**

- Faulty ignition system
- Faulty carburetor

#### **Backfiring at deceleration**

- Float level too low
- Incorrectly adjusted carburetor
- Faulty exhaust muffler

#### **Engine lacks power**

- Clogged air cleaner
- Faulty carburetor
- Faulty ignition system

#### **Lean mixture**

- Clogged carburetor fuel jets
- Float level too low
- Intake air leak
- Clogged fuel tank cap breather hole
- Kinked or restricted fuel line

#### **Rich mixture**

- Float level too high
- Clogged air jets
- Clogged air cleaner

## 5. FUEL SYSTEM

### FUEL TANK

#### REMOVAL



- Keep sparks and flames away from the work area.
- Wipe off any spilled gasoline.

Remove the seat, right and left side frame cover (See page 2-3) and center frame cover (See page 2-5).

Switch the fuel valve “OFF”.  
Disconnect the fuel tube from carburetor and remove two screws at the fuel valve holder.

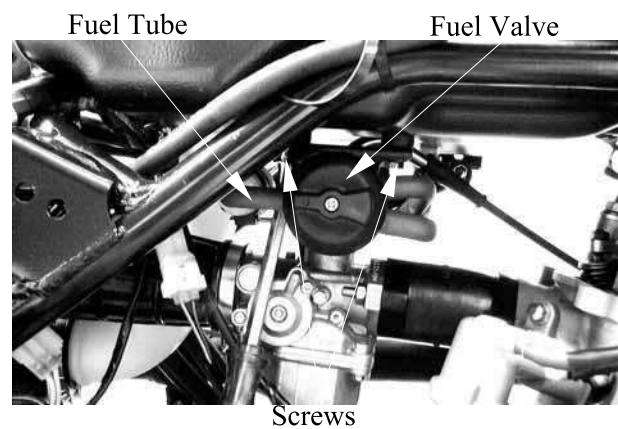

Remove the two bolts and two nuts at the fuel tank, then remove the fuel tank.

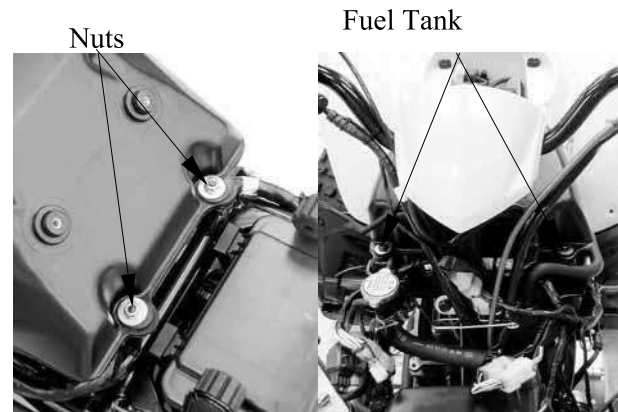

#### INSTALLATION

Reverse the “FUEL TANK REMOVAL” procedures.

### FUEL VALVE REMOVAL

- \*
- Keep sparks and flames away from the work area.
  - Drain gasoline into a clean container.

Remove the screw and then remove control switch.  
Disconnect all fuel tubes and remove the two screws, then remove fuel valve.

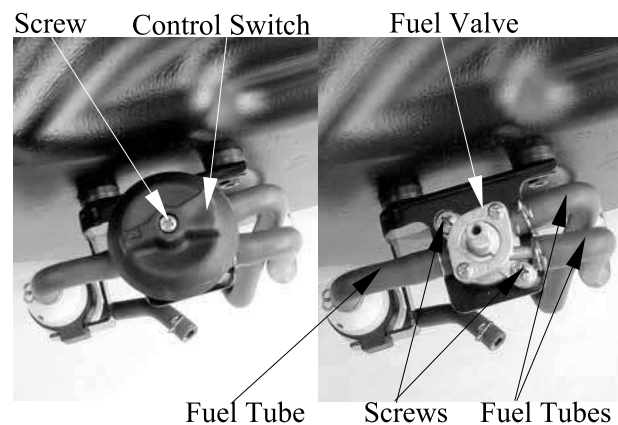

## 5. FUEL SYSTEM

### DISASSEMBLY

Remove the two screws on the retaining ring and then remove retaining ring.  
Remove the washer and control shaft.

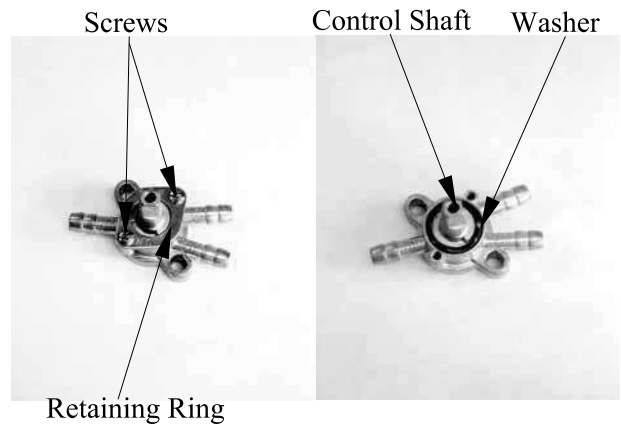

Remove the rubber gasket from the fuel valve body.

### INSPECTION

Inspect the fuel valve body for dirt and clog.  
Clean if necessary.

Replace the rubber gasket with new ones if they are damaged or deteriorated.

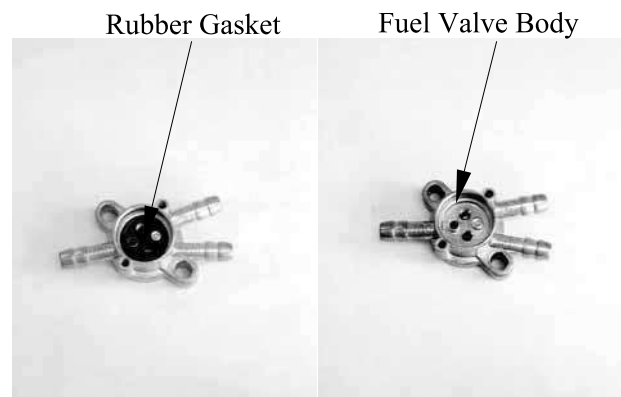

Replace the O-rings with new ones if they are damaged or deteriorated.

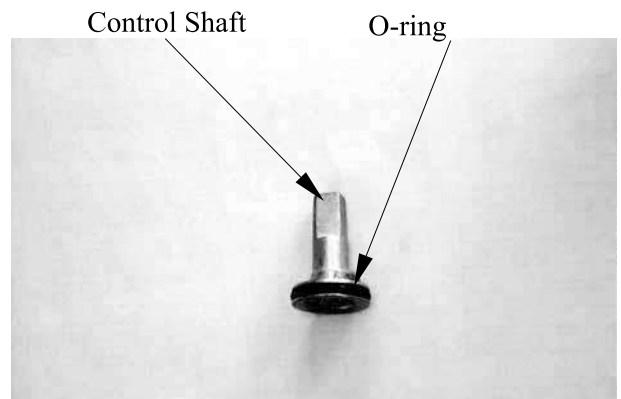

### ASSEMBLY

Reverse the "DISASSEMBLY" procedures.  
Install rubber gasket, control shaft, washer and retaining ring.

- \*
- Aligning the tab on the control shaft with the outlet duct in the fuel valve body.
  - Aligning the tab on the retaining ring with the outlet duct in the fuel valve body.

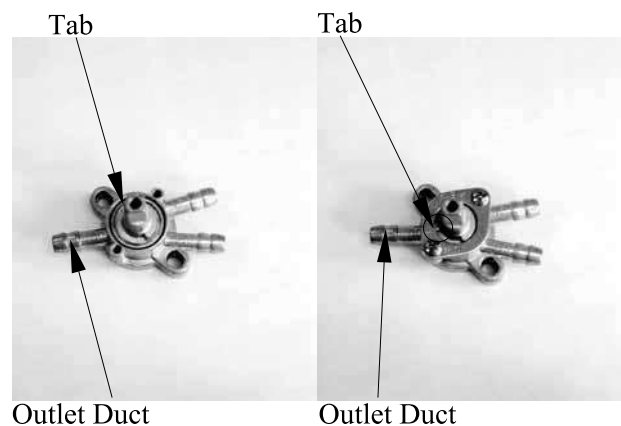

## 5. FUEL SYSTEM

---

### INSTALLATION

Reverse the “FUEL VALVE REMOVEAL”  
procedures.

Connect all fuel tube.

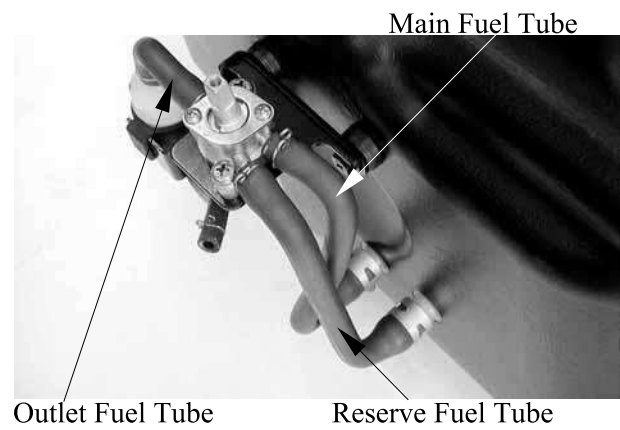



## 5. FUEL SYSTEM

### THROTTLE VALVE

#### DISASSEMBLY

Remove the fuel tank. (Refer to “FUEL TANK” section in the chapter 5)

Remove the carburetor cap.

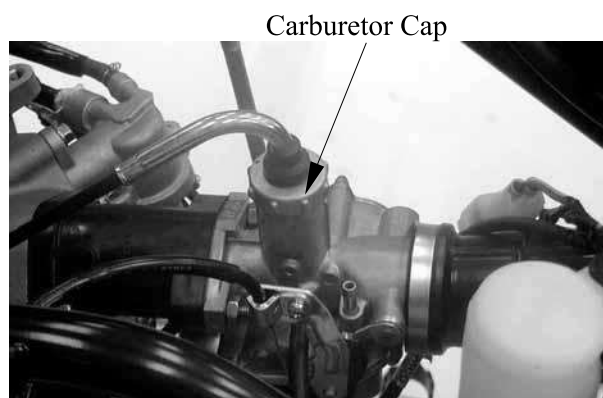

Pull out the throttle valve.

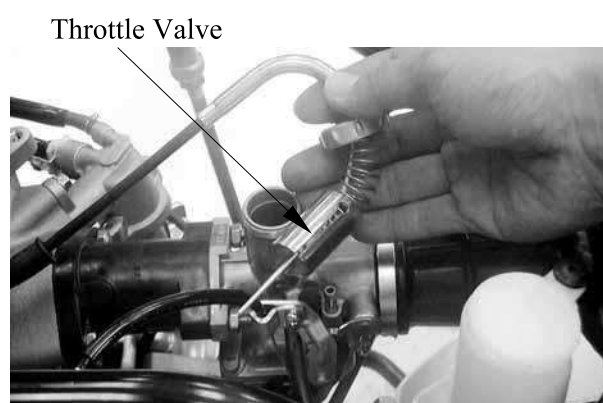

Compress the spring to disconnect the throttle cable by hand.



Remove the spring from the throttle valve

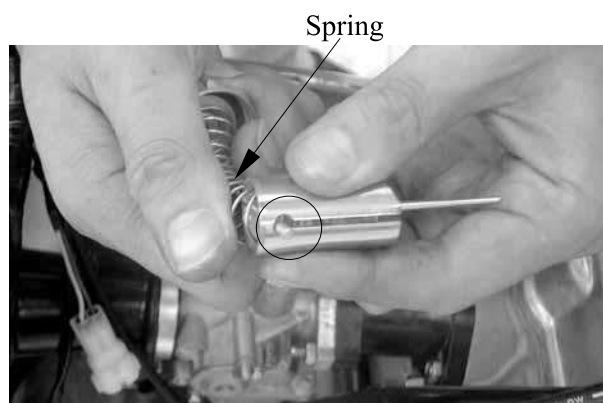

## 5. FUEL SYSTEM

Pry off the needle retainer and remove the jet needle.  
Check the throttle valve and jet needle for wear or damage.

### ASSEMBLY

Reverse the “DISASSEMBLY” procedures.

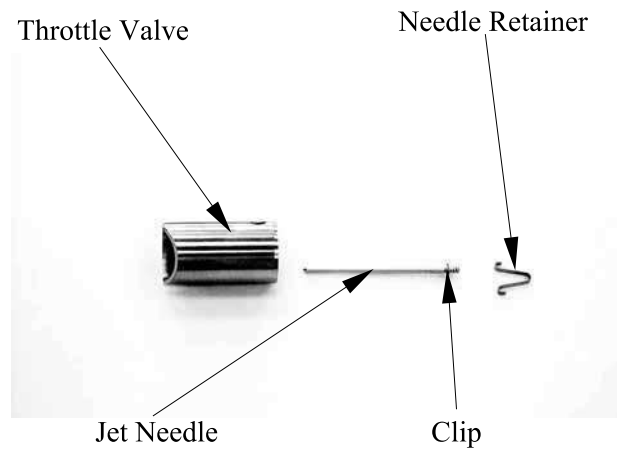

Install the throttle valve into the carburetor body.

- \* Align the groove in the throttle valve with the throttle stop screw on the carburetor body.

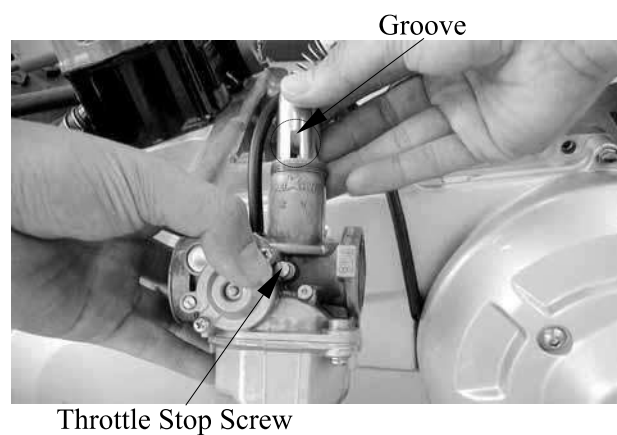

## CARBURETOR

### REMOVAL

Remove the fuel tank and carburetor cap.  
(Refer to “FUEL TANK” and “THROTTLE VALVE DISASSEMBLY” section in the chapter 5)  
Loosen the drain screw to drain the gasoline from the float chamber.

- \* • Keep sparks and flames away from the work area.  
• Drain gasoline into a clean container.

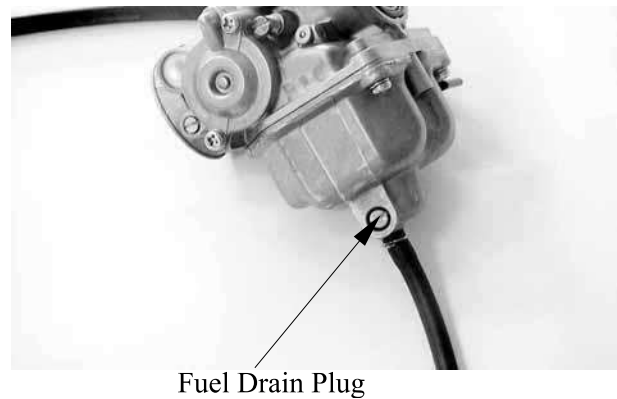

Loosen the screw on the lock plate for disconnect the choke cable.

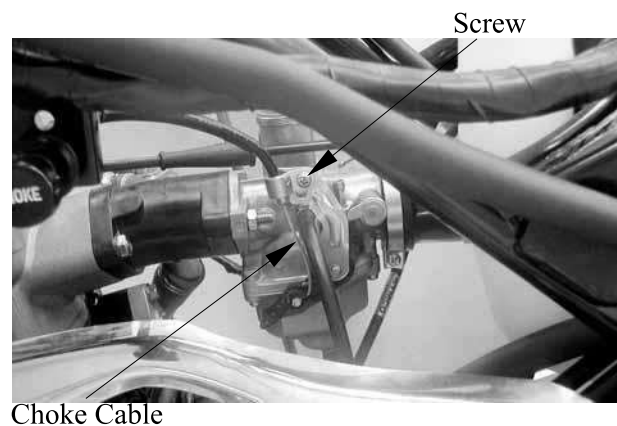

## 5. FUEL SYSTEM

Remove the two bolts at the air cleaner case.  
Loosen the air cleaner connecting tube band screw.  
Remove the two carburetor lock nuts attaching the inlet pipe.  
Remove the carburetor

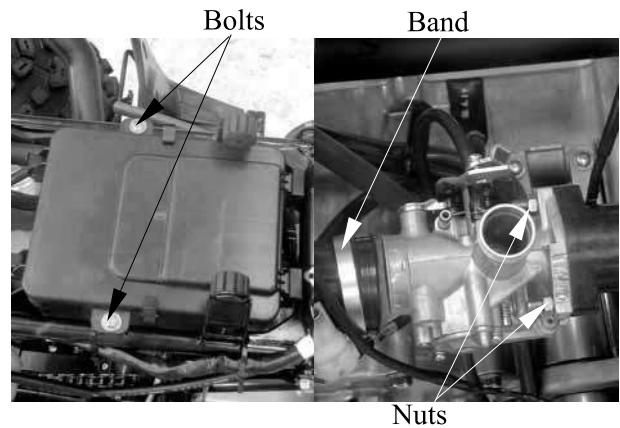

### DISASSEMBLY

Remove the float chamber attaching three screws and remove the float chamber.

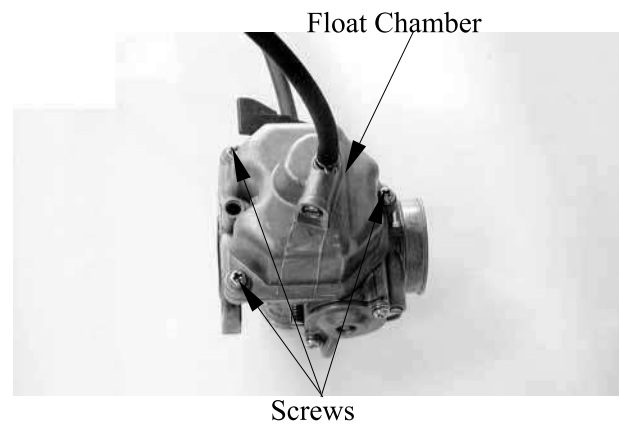

Remove the jet holder.

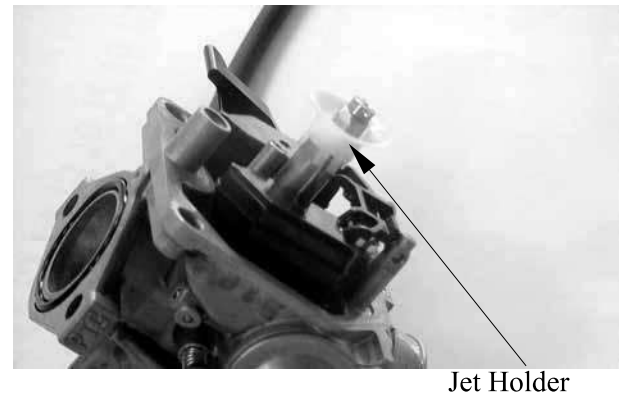

Pull out the float pin, then remove float and float valve.

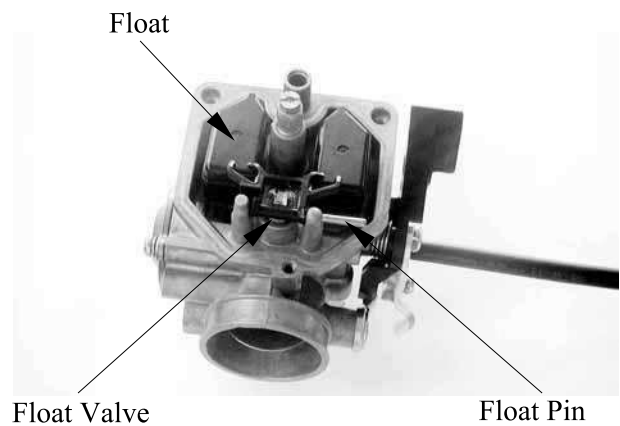

## 5. FUEL SYSTEM

Remove the main jet, needle jet holder, and needle jet.  
Remove the slow jet.  
Remove the air screw and throttle stop screw.

### CAUTIONS!

- \* • Be careful not to damage the jets and jet holder when removing them.
- Before removal, turn the throttle stop screw and air screw in and count the number of turns until they seat lightly and then make a note of this.
- Do not force the screw against its seat to avoid seat damage.
- Be sure to install the O-ring in the reverse order of removal.

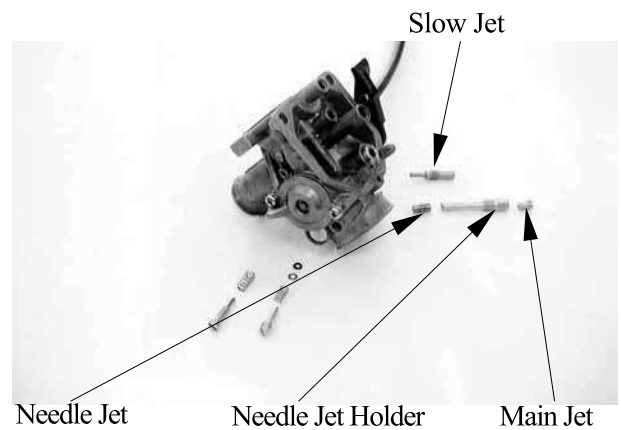
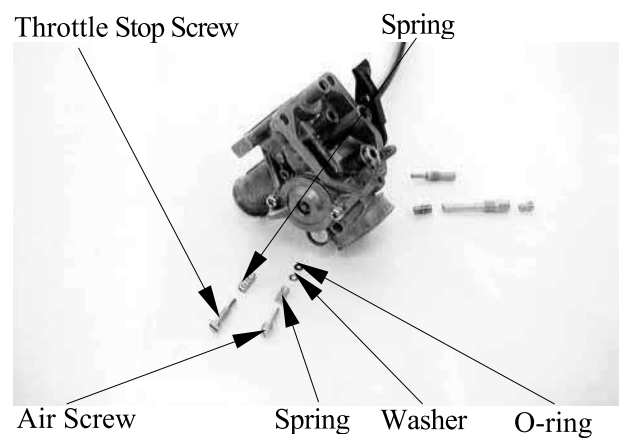
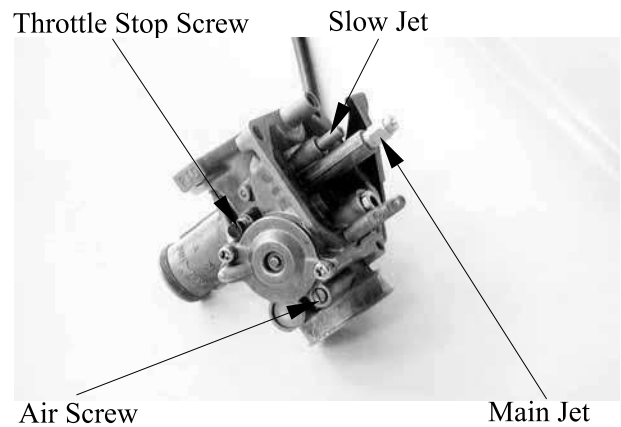

Remove the two screws and the air cut-off valve cover.

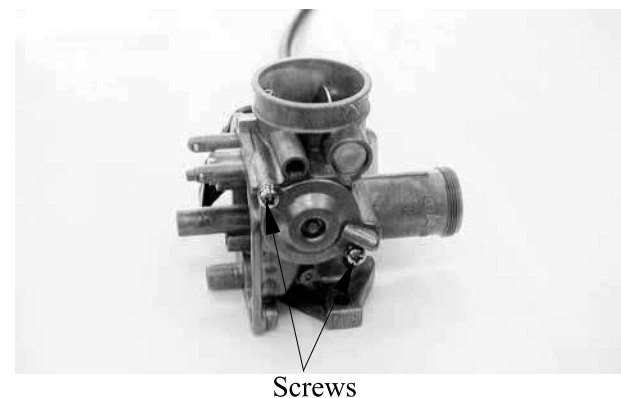

## 5. FUEL SYSTEM

Remove the spring, diaphragm and O-rings. Inspect the diaphragm and spring for wear or damage.

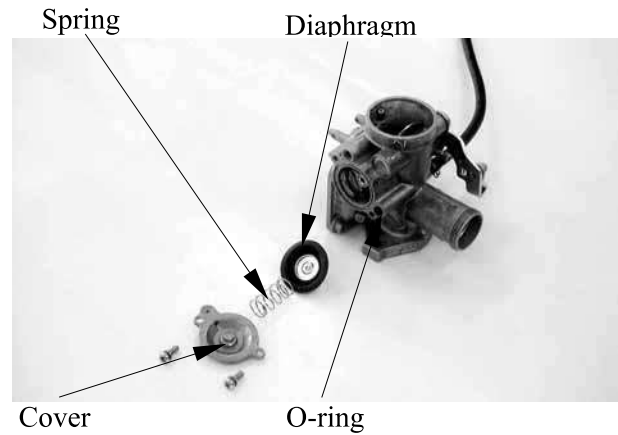

### CARBURETOR CLEANING

Blow compressed air through all passages of the carburetor body.

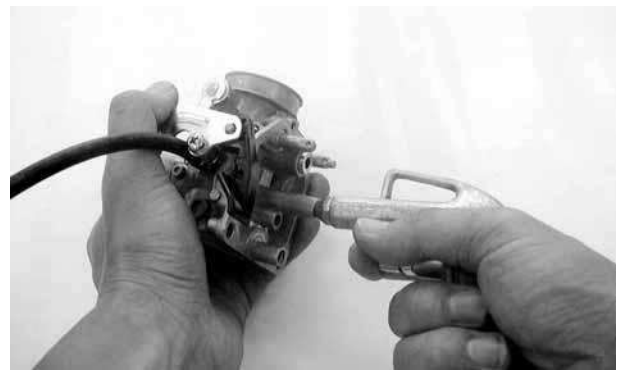

### FLOAT/FLOAT VALVE INSPECTION

Inspect the float valve seat for wear or damage.  
Inspect the float for damage or fuel level inside the float chamber.

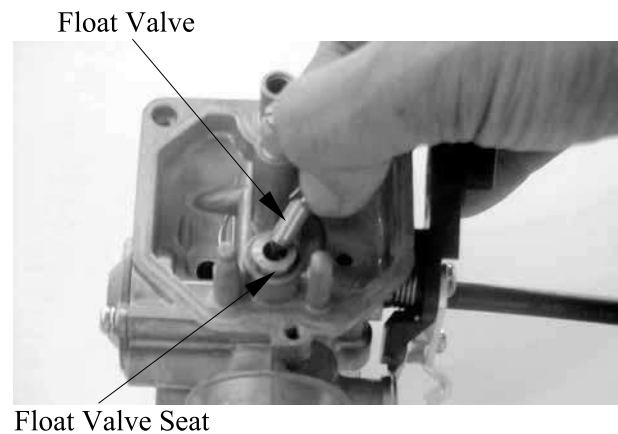

### FUEL RESERVOIR O-RING CHECK

Remove the O-ring.

#### INSPECTION

Inspect the check the O-ring for damage. Replace with new ones if necessary

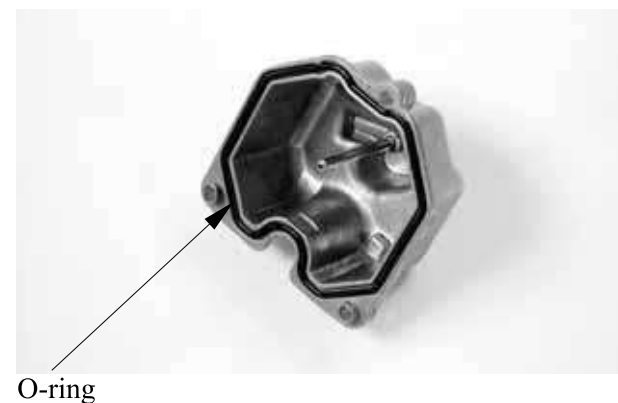

## 5. FUEL SYSTEM

### ASSEMBLY

Install the slow jet.

Install the needle jet, needle jet holder and main jet.

Install the throttle stop screw and air screw

Install the spring, diaphragm and O-rings.

- \* 

<ul style="list-style-type: none"><li>• When installing the air screw, return it to the original position as noted during removal</li><li>• After the carburetor is installed, be sure to perform the Exhaust Emission</li></ul>
--

Install the float valve, float and float pin.

### FLOAT LEVEL INSPECTION

Turn the carburetor upside down so that the float will go down to make the float valve contact the float valve seat.

Then slowly tilt the carburetor and measure the float level with the float level gauge while the float pin just contacts with float valve.

**Float Level:** 14.8mm

When adjusting, carefully bend the float pin.

Check the float for proper operation.

Install the jet holder, aligning the jet holder groove with the carburetor tab and then install the float chamber.

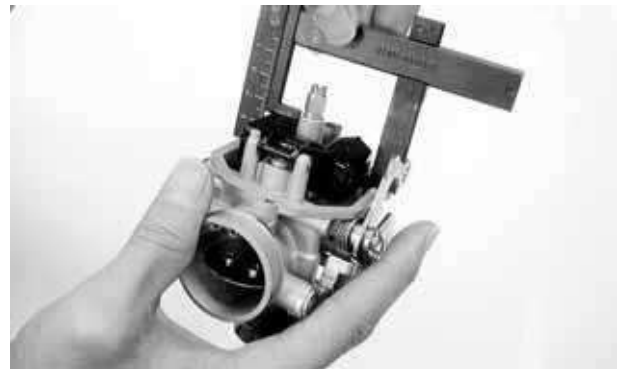

Jet Holder

### INSTALLATION

Reverse the “CARBURETOR REMOVAL” procedures.

### AIR CLEANER

Refer to the “AIR CLEANER” section in the chapter 3 for air cleaner replacement and cleaning.

---

---

---

---

---

---

---

---

---

## ENGINE REMOVAL

---



SERVICE INFORMATION-----	6- 1
ENGINE REMOVAL -----	6- 2

## **6. ENGINE REMOVAL/INSTALLATION**

---

### **SERVICE INFORMATION**

#### **GENERAL INSTRUCTIONS**

- A floor jack or other adjustable support is required to support and maneuver the engine.  
Be careful not to damage the machine body, cables and wires during engine removal.
- Use shop towels to protect the machine body during engine removal.
- Parts requiring engine removal for servicing:
  - Crankcase
  - Crankshaft



## 6. ENGINE REMOVAL

### ENGINE REMOVAL

Drain engine oil and transmission oil.  
(Refer to chapter 3)  
Remove frame covers and exhaust pipe.  
(Refer chapter 2)  
Remove the carburetor. (Refer to chapter 5)

Disconnect the oil recycle tube at the  
cylinder head cover.

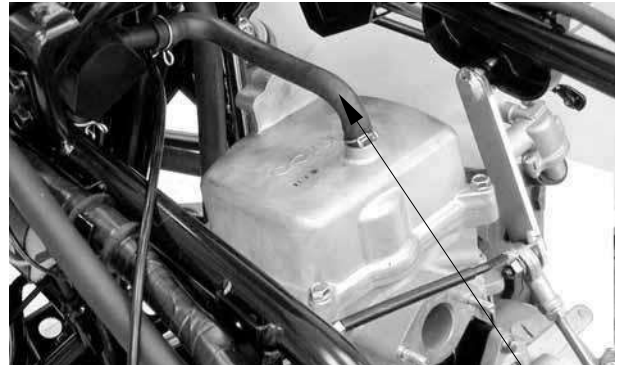

Oil Recycle Tube

Disconnect the water hose from water pump  
cover.

Water Hose



Remove the bolt at the thermostat and  
disconnect the thermosensor wire, then  
disconnect the thermostat from the cylinder  
head.

Thermostat Bolt

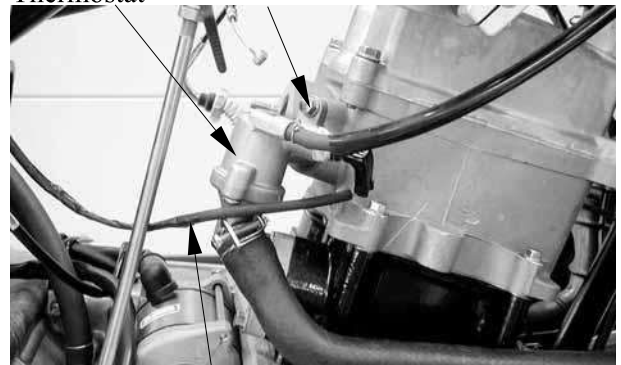

Thermosensor Wire

Remove the bolt at the drive select arm,  
then disconnect the drive select arm from  
engine assembly.

Drive Select Arm

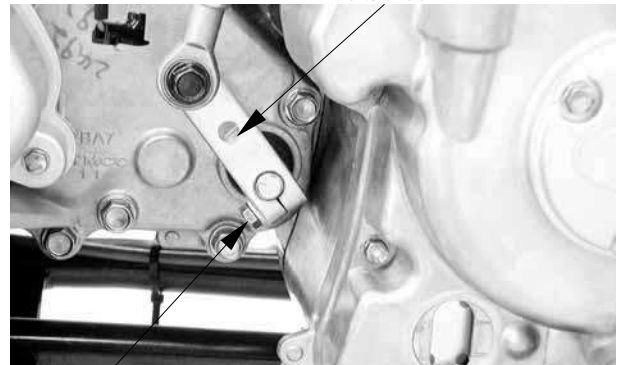

Bolt

## 6. ENGINE REMOVAL/INSTALLATION

Disconnect the speedometer cable (ON ROAD only).

Speedometer Cable



Remove the three bolts at the drive sprocket cover and then remove the drive sprocket cover.

Remove the two bolts on the drive sprocket. Remove the drive sprocket and washer.

Drive Sprocket Cover Bolts

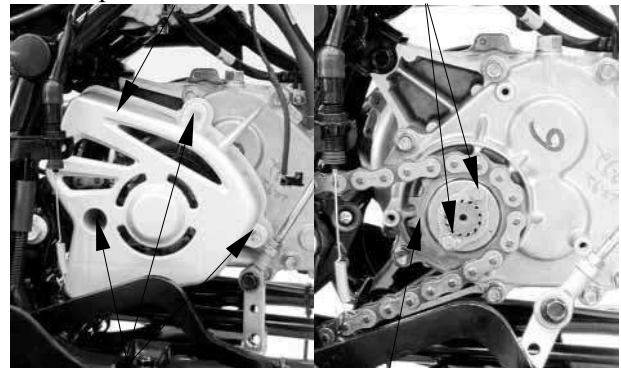

Bolts Drive Sprocket

Slide the rubber sleeve back to expose the starter motor wire nut.

Remove the starter motor wire nut for disconnect the starter motor wire.

Rubber Sleeve Nut



Remove the bolt at the starter motor for disconnect the ground wire lead.

Ground Wire Bolt



## 6. ENGINE REMOVAL

Remove the A.C. Generator, pulser and gear change switch couplers.

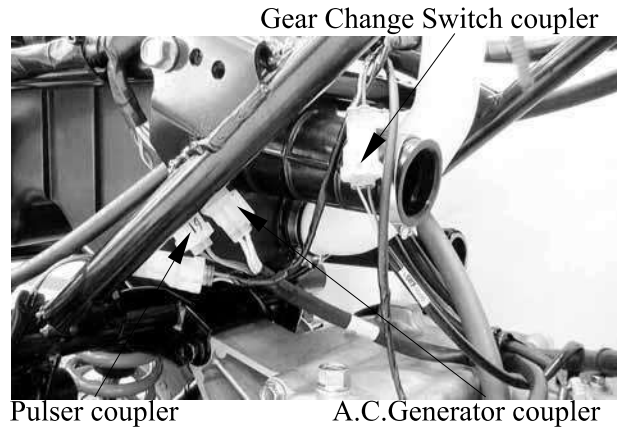

Disconnect the spark plug cap.

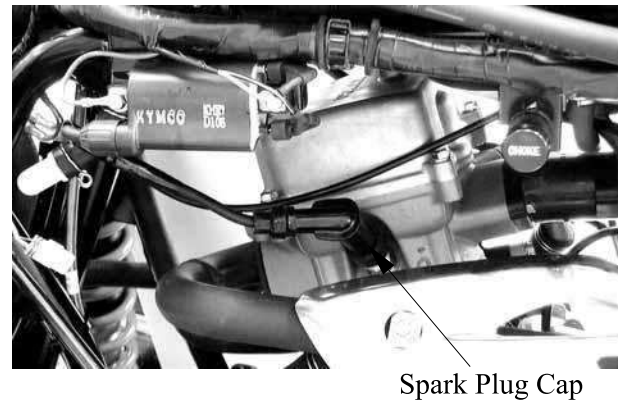

Remove the three bolts and remove the outlet hose cover.

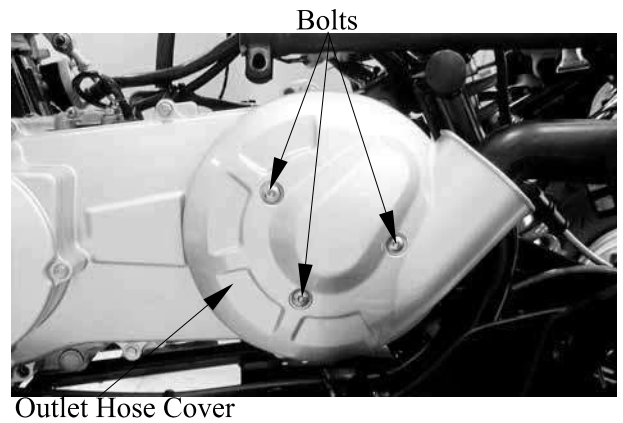

Unscrew the clamp and then disconnect the outlet hose from the left crankcase cover.

Unscrew the clamp and then disconnect the inlet hose from the left crankcase cover.

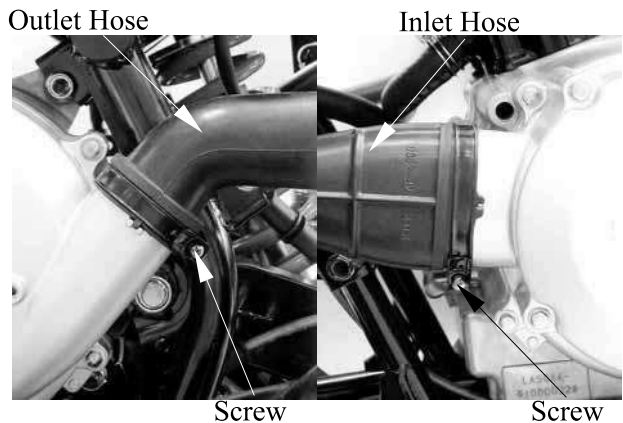

## 6. ENGINE REMOVAL/INSTALLATION

Remove the two bolts at the left foot peg attaching the left floor board holder and remove the nut at the left floor board holder, then remove the left floor board holder.

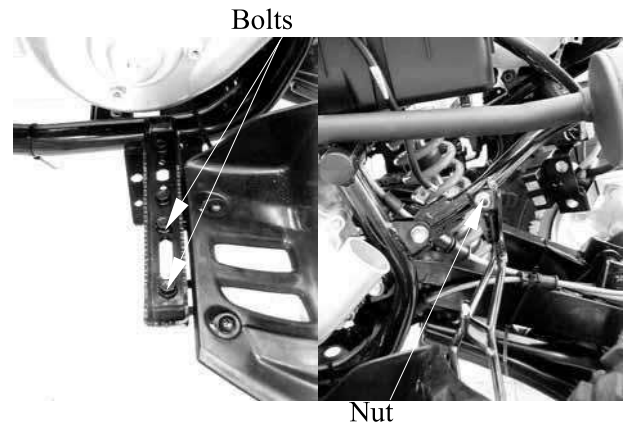

Remove the two bolts at the right foot peg attaching the right floor board holder. Remove the nut at the right floor board holder and bolt attaching the reservoir protection cover, then remove the right floor board holder.

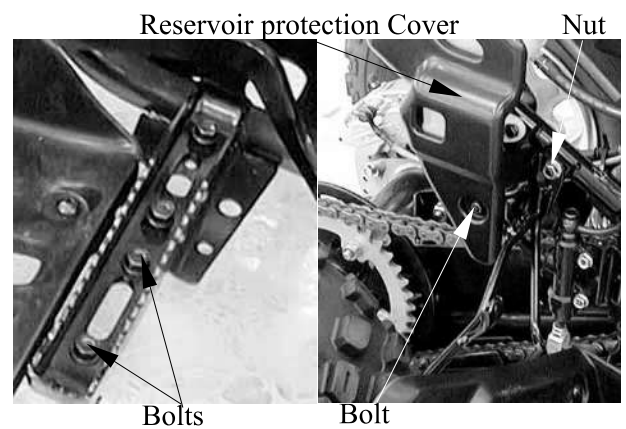

Remove the two nuts and then remove the drive select lever.

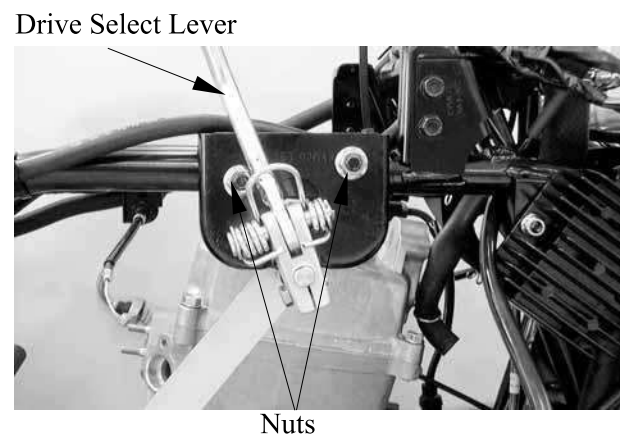

Remove the two bolts at the left front fender holder for remove the left front fender holder.

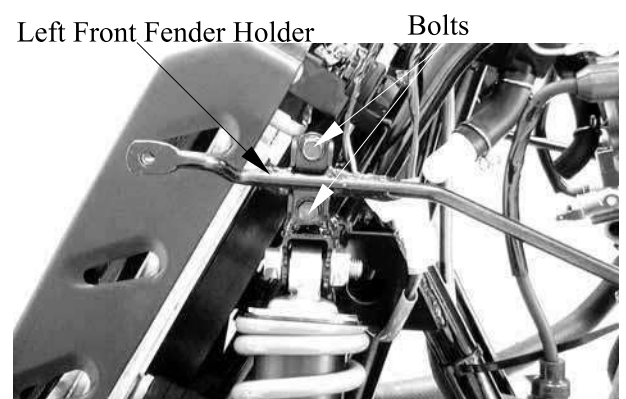

## 6. ENGINE REMOVAL

Remove the rear lower mounting bolt and nut.  
Remove the rear upper mounting bolt and nut.  
Remove the front mounting bolts and nuts.

Mounting Bolt and Nut



Mounting Bolt and Nut      Mounting Bolt and Nut

Remove the four bolts for remove the left and right engine brackets.

Brackets

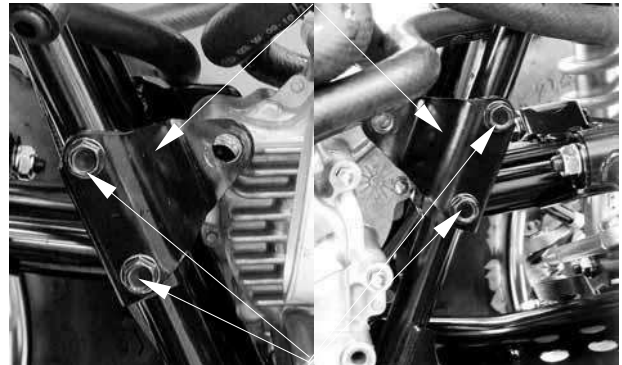

Bolts

Remove the engine assembly to the left side of the machine.

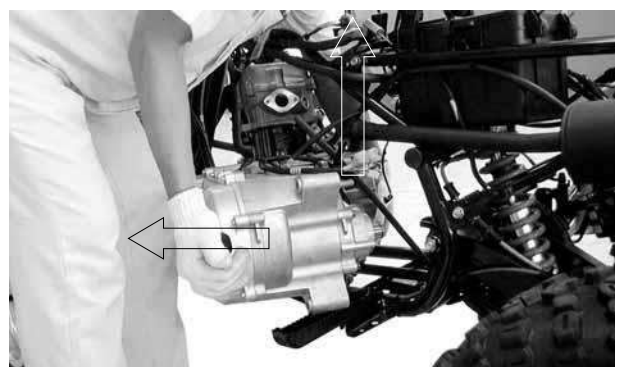
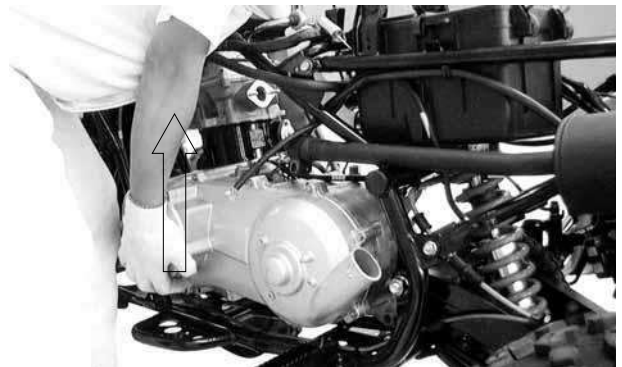

## 6. ENGINE REMOVAL/INSTALLATION

---



## 7. CYLINDER HEAD/VALVES

---

---

---

---

---

---

---

---

### CYLINDER HEAD/VALVES

---

SERVICE INFORMATION-----	7- 2
TROUBLESHOOTING-----	7- 3
CYLINDER HEAD COVER-----	7- 4
CAMSHAFT/CAMSHAFT HOLDER-----	7- 4
CYLINDER HEAD-----	7- 9



## 7. CYLINDER HEAD/VALVES

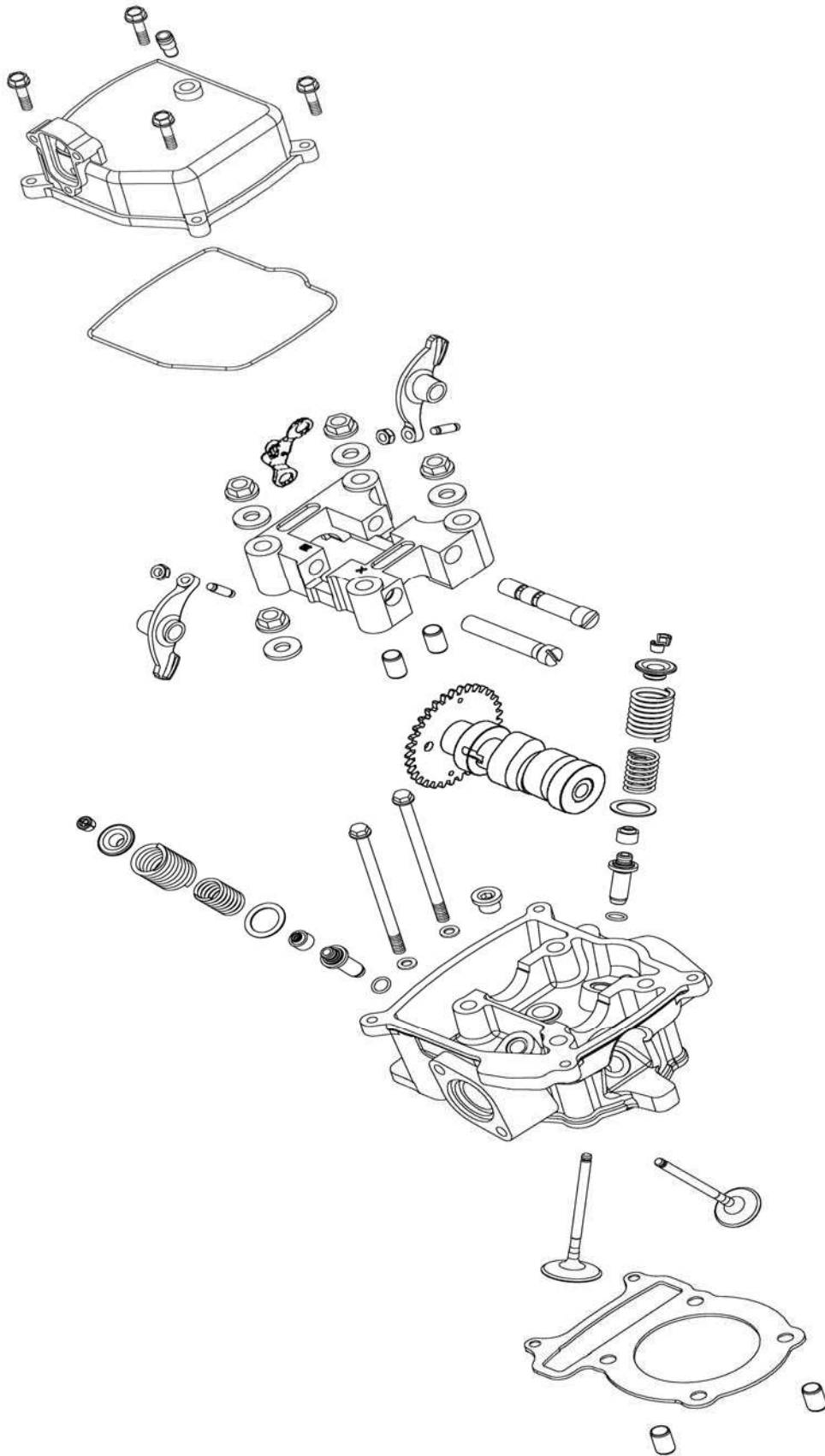



## 7. CYLINDER HEAD/VALVES

### SERVICE INFORMATION

#### GENERAL INSTRUCTIONS

- The cylinder head can be serviced with the engine installed in the frame.
- When assembling, apply molybdenum disulfide grease or engine oil to the valve guide movable parts, valve arm and camshaft sliding surfaces for initial lubrication.
- The camshaft is lubricated by engine oil through the cylinder head engine oil passages. Clean and unclog the oil passages before assembling the cylinder head.
- After disassembly, clean the removed parts and dry them with compressed air before inspection.
- After removal, mark and arrange the removed parts in order. When assembling, install them in the reverse order of removal.

#### SPECIFICATIONS

Item		Standard (mm)	Service Limit (mm)
Valve clearance (cold)	IN	0.1	—
	EX	0.1	—
Cylinder head compression pressure		15±2kg/cm <sup>2</sup>	
Cylinder head warpage		—	0.05
Camshaft cam height	IN	34.287	34.15
	EX	34.1721	34.05
Valve rocker arm to shaft clearance		0.034~0.09	0.1
Valve stem-to-guide clearance	IN	0.010~0.037	0.06
	EX	0.025~0.052	0.08
Valve spring free length	IN	30.9	29.4
	EX	41	39
Valve spring compressed force	IN	10.20~11.84kg(at 18.05mm)	—
	EX	19.14~22.02kg(at 21.5mm)	—
Valve spring tilt	IN	0.8	—
	EX	1.07	—

## 7. CYLINDER HEAD/VALVES

---

### TORQUE VALUES

Cylinder head cover bolt	0.8~1.2kgf-m	
Cam shaft hold nut	2.3~2.7kgf-m	Apply engine oil to threads
Tappet adjusting nut	0.7~1.1kgf-m	

### SPECIAL TOOLS

Valve spring compressor	E040
Tappet adjuster	E012

### TROUBLESHOOTING

- The poor cylinder head operation can be diagnosed by a compression test or by tracing engine top-end noises.

#### Poor performance at idle speed

- Compression too low

#### Compression too low

- Incorrect valve clearance adjustment
- Burned or bent valves
- Incorrect valve timing
- Broken valve spring
- Poor valve and seat contact
- Leaking cylinder head gasket
- Warped or cracked cylinder head
- Poorly installed spark plug

#### Compression too high

- Excessive carbon build-up in combustion chamber

#### White smoke from exhaust muffler

- Worn valve stem or valve guide
- Damaged valve stem seal

#### Abnormal noise

- Incorrect valve clearance adjustment
- Sticking valve or broken valve spring
- Damaged or worn camshaft
- Worn cam chain guide
- Worn camshaft and rocker arm

## 7. CYLINDER HEAD/VALVES

### CYLINDER HEAD COVER

#### REMOVAL

Remove fuel tank. (Refer to the chapter 5)

Disconnect the oil recycle tube at the cylinder head cover.

Remove the four bolts at the cylinder head cover, then remove the cylinder head cover.

Oil Recycle Tube

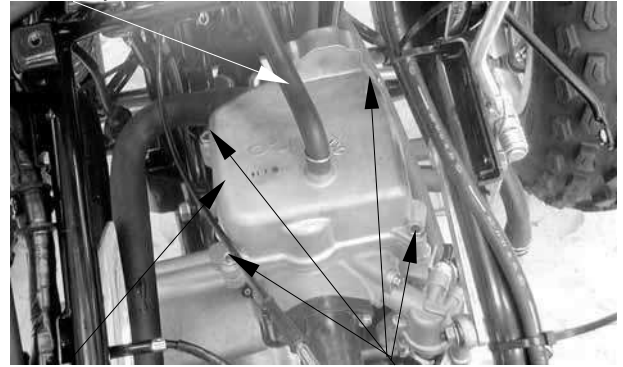

Cylinder Head Cover

Bolts

#### INSTALLATION

Install a new cylinder head cover O-ring and install the cylinder head cover. Install and tighten the cylinder head cover bolts.

**Torque:** 0.8~1.2kgf-m

\* Be sure to install the O-ring into the groove properly.

O-ring

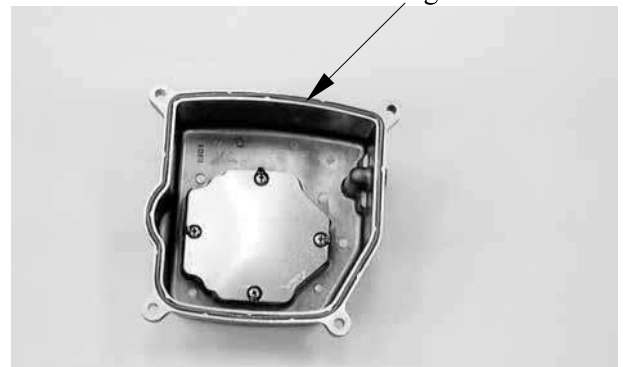

### CAMSHAFT/CAMSHAFT HOLDER

#### REMOVAL

Remove the cylinder head cover. (Refer to the cylinder head cover removal)

Remove the cam chain tensioner cap bolt and the O-ring.

Bolt

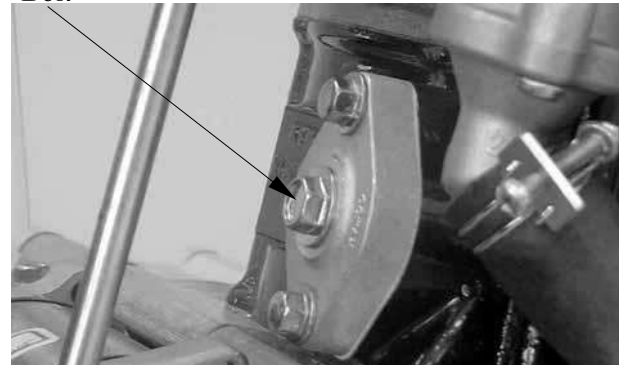

Turn the cam chain tensioner screw clockwise to tighten it.

Tensioner Screw

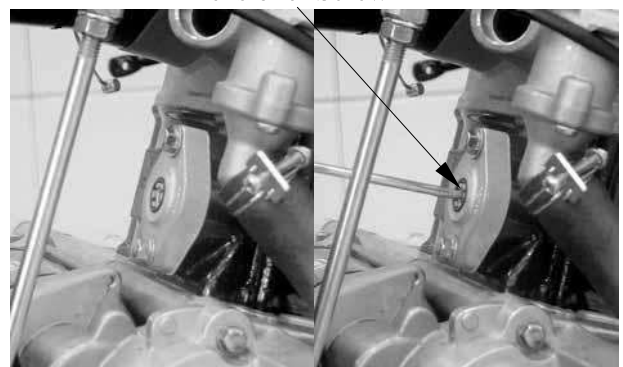

## 7. CYLINDER HEAD/VALVES

Remove the four camshaft holder nuts and washers.

\* Diagonally loosen the cylinder head nuts in 2 or 3 times.

Remove the camshaft holder and dowel pins.

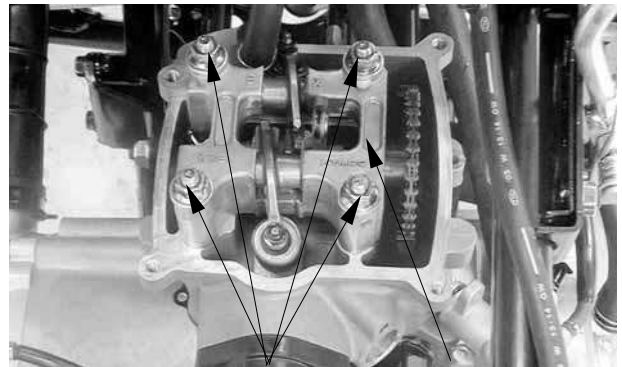

Nuts and Washers    Camshaft Holder

Remove the camshaft gear from the cam chain and remove the camshaft.



Camshaft

### **CAMSHAFT HOLDER DISASSEMBLY**

Take out the valve rocker arm shafts. Remove the valve rocker arms, arm shafts and stop plate.

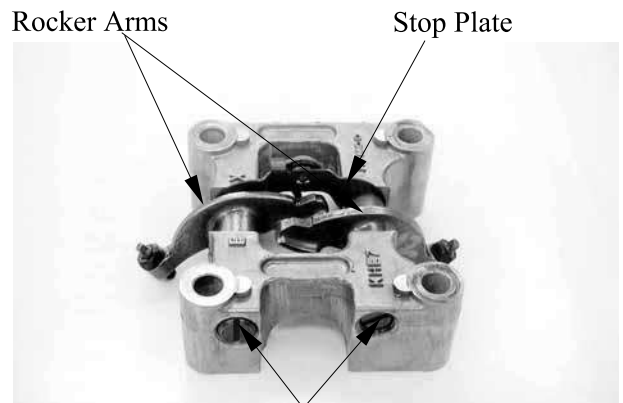

Rocker Arms

Stop Plate

Rocker Arm Shafts

## 7. CYLINDER HEAD/VALVES

### CAMSHAFT HOLDER INSPECTION

Inspect the camshaft holder for wear or damage.

Inspect the rocker arm shaft for blue discoloration or grooves.

If any defects are found, replace the rocker arm shaft with a new one, then inspect lubrication system.

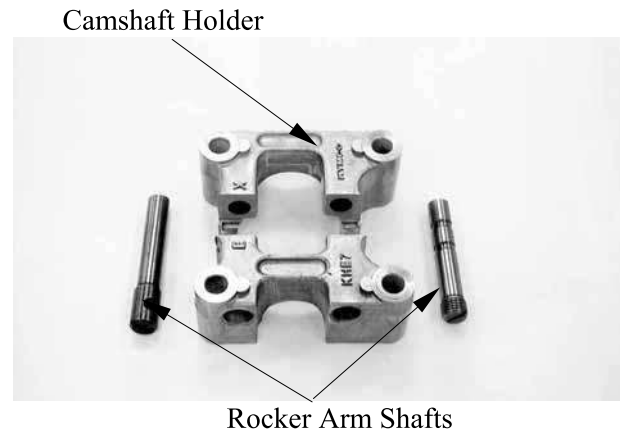

Inspect the rocker arm bore, cam lobe contact surface and adjuster surface for wear/pitting/scratches/blue discoloration.

If any defects are found, replace the rocker arm shaft with a new one, then inspect lubrication system.

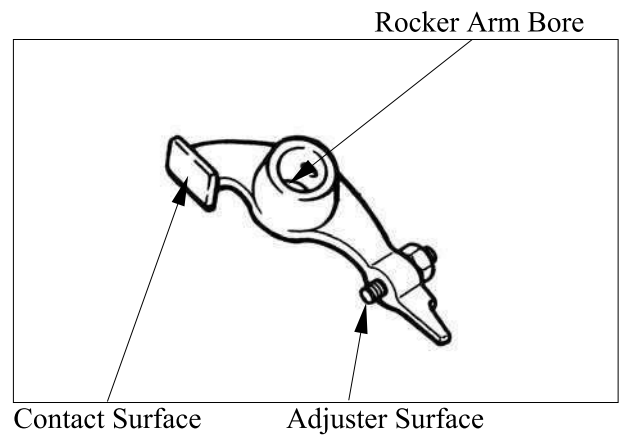

Measure each rocker arm shaft O.D.  
Measure the I.D. of each valve rocker arm.  
Measure arm to shaft clearance.  
Replace as a set if out of specification.

**Service limits:** 0.10mm

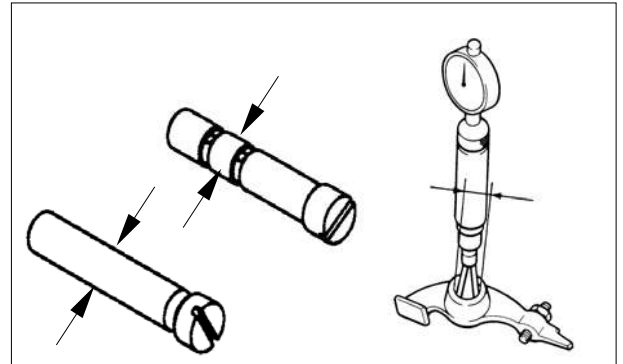

## 7. CYLINDER HEAD/VALVES

### CAMSHAFT HOLDER ASSEMBLY

Reverse the “CAMSHAFT HOLDER DISASSEMBLY” procedures.

- \* Align the cross cutout on the exhaust valve rocker arm shaft with the bolt of the camshaft holder.

### CAMSHAFT INSPECTION

Check each camshaft bearing for play or damage. Replace the camshaft assembly with a new one if the bearings are noisy or have excessive play.

Camshaft Bearings

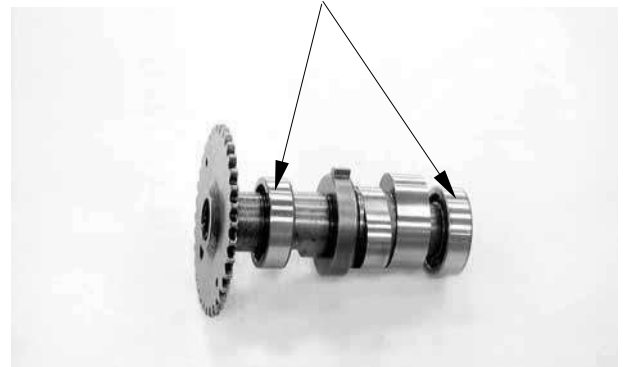

Inspect camshaft lobes for pitting/scratches/blue discoloration.

Measure the cam lobe height.

#### Service Limits:

IN : 34.15mm replace if below

EX: 34.05mm replace if below

If any defects are found, replace the camshaft with a new one, then inspect lubrication system.

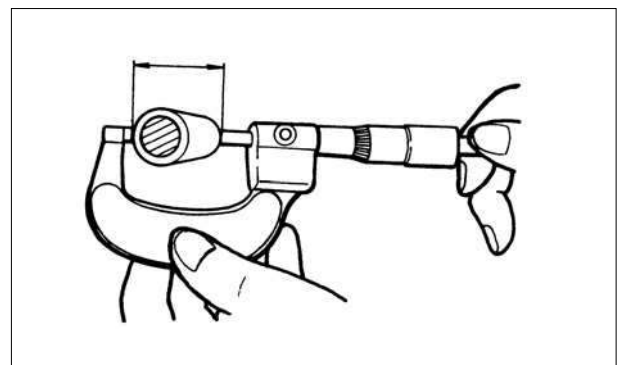

## 7. CYLINDER HEAD/VALVES

### INSTALLATION

Reverse the “CAMSHAFT REMOVAL” procedures.

Note the following points:

1. Turn the flywheel so that the “T” mark on the flywheel aligns with the index mark on the crankcase.

Keep the round hole on the camshaft gear facing up and align the punch marks on the camshaft gear with the cylinder head surface (Position the intake and exhaust cam lobes down.) and install the camshaft onto the cylinder head. (Refer to the “VALVE CLEARANCE” section in the chapter 3)

Install the camshaft dowel pins and holder.

- \* Apply engine oil to the threads of the cylinder head nuts.
- \* Diagonally tighten the cylinder head nuts in 2~3 times.

#### Torque:

Cam shaft hold nut: 2.3~2.7kgf-m

2. Turn the cam chain tensioner screw counter-clockwise to release it.  
Apply engine oil to a new O-ring and install it.  
Tighten the cam chain tensioner cap bolt.

- \* Be sure to install the O-ring into the groove properly.

3. Adjust the valve clearance. (Refer to the “VALVE CLEARANCE” section in the chapter 3)



Dowel Pins



## 7. CYLINDER HEAD/VALVES

### CYLINDER HEAD

#### REMOVE

Remove the camshaft. (Refer to the “camshaft remove” section in the chapter 7)  
 Remove the carburetor. (Refer to the “carburetor remove” section in the chapter 5)  
 Remove the exhaust muffler. (Refer to the “exhaust muffler remove” section in the chapter 2)

Remove the two bolts and then remove the carburetor intake manifold.

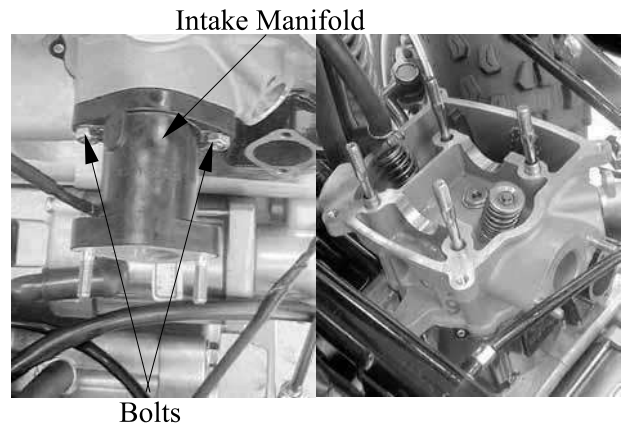

Remove the bolt and disconnect the thermostat.

Remove the two cylinder head bolts.  
 Remove the cylinder head.

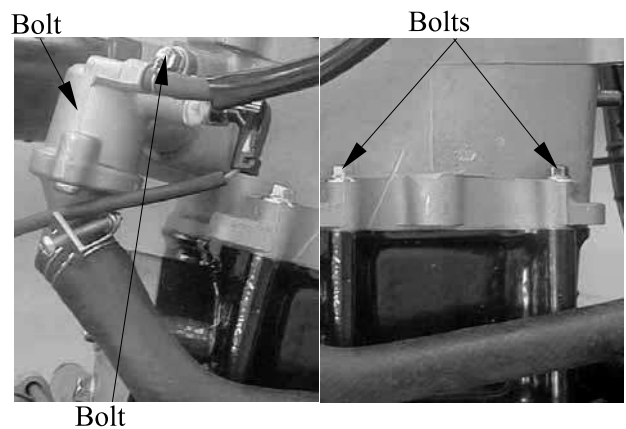

### CYLINDER HEAD DISASSEMBLY

Remove the valve spring cotters, retainers, springs, spring seats, oil seals and valves using a valve spring compressor.

- \* 
 • Be sure to compress the valve springs with a valve spring compressor.  
 • Mark all disassembled parts to ensure correct reassembly.



Valve Spring Compressor E040

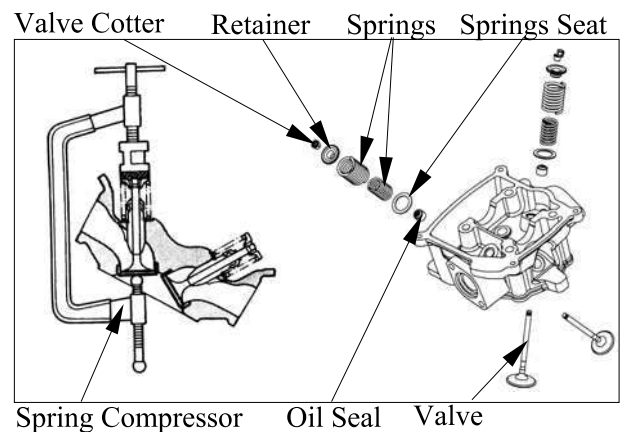



## 7. CYLINDER HEAD/VALVES

### VALVE /VALVE GUIDE INSPECTION

Inspect each valve for bending, burning, scratches or abnormal stem wear.  
If any defects are found, replace the valve with a new one.

Check valve movement in the guide.

Measure each valve stem O.D.

Measure each valve guide I.D.

Subtract each valve stem O.D. from the corresponding guide I.D. to obtain the stem-to-guide clearance.

**Service limits:** IN : 0.06mm replace if over  
EX: 0.08mm replace if over

\* If the stem-to-guide clearance exceeds the service limits, replace the cylinder head as necessary.

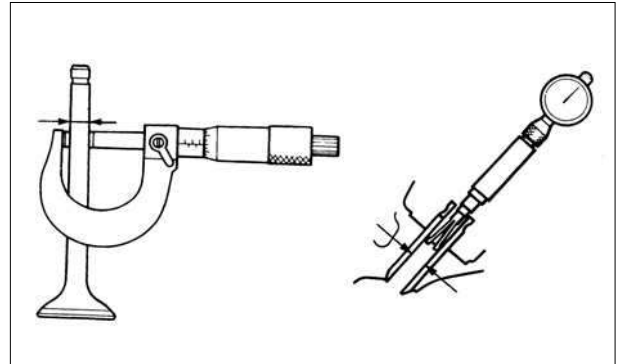

### CYLINDER HEAD INSPECTION

Check the spark plug hole and valve areas for cracks.

Check the cylinder head for warpage with a straight edge and feeler gauge.

**Service Limit:** 0.05mm repair or replace if over

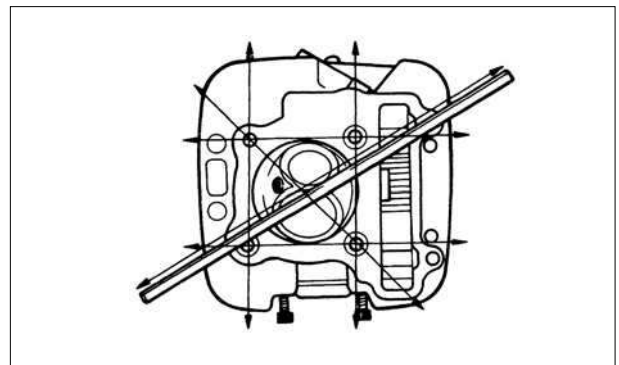

### VALVE SPRING INSPECTION

Measure the free length of the inner and outer valve springs.

**Service Limit:**

Inner: 29.4mm replace if below

Outer: 39mm replace if below

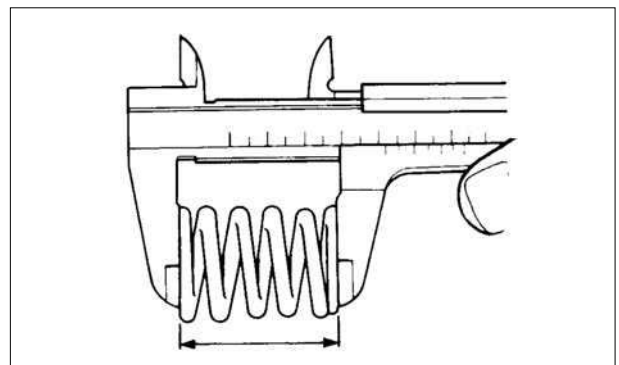

## 7. CYLINDER HEAD/VALVES

---

Measure compressed force (valve spring)  
and installed length.

Replace if out of specification.

**Service limits:**

IN : 10.20~11.84kg(at 18.05mm)

EX : 19.14~22.02kg(at 21.5mm)

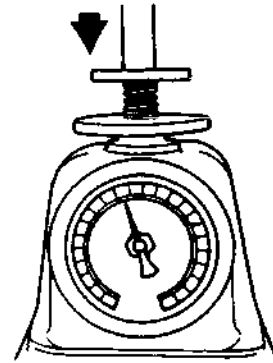

Measure the spring tilt.

Replace if out of specification.

**Service limits:** IN : 0.8mm

EX : 1.07mm

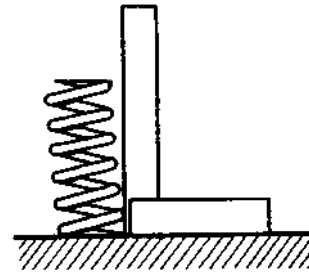

## 7. CYLINDER HEAD/VALVES

### ASSEMBLY

Install the valve spring seats and oil seal.

\*

Lubricate each valve with engine oil and insert the valves into the valve guides.

Install the valve springs and retainers.

Compress the valve springs using the valve spring compressor, then install the valve cotters.

- \*
- When assembling, a valve spring compressor must be used.
  - Install the cotters with the pointed ends facing down from the upper side of the cylinder head.



Valve Spring Compressor E040

Tap the valve stems gently with a plastic hammer for 2~3 times to firmly seat the cotters.

- \*
- Be careful not to damage the valves.

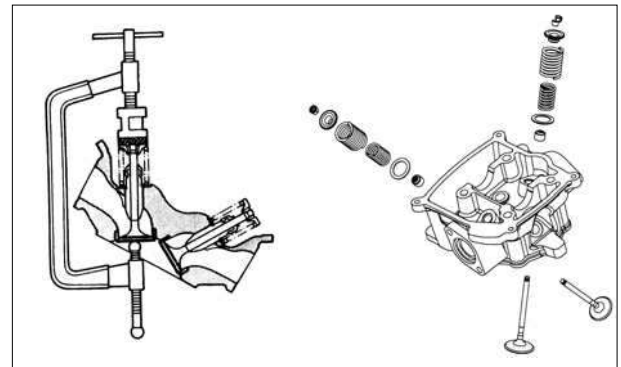

### INSTALLATION

Install the dowel pins and a new cylinder head gasket.

Reverse the “CYLINDER HEAD REMOVAL” procedures.

#### Torque:

Cylinder head bolt: 0.8~1.2kgf-m

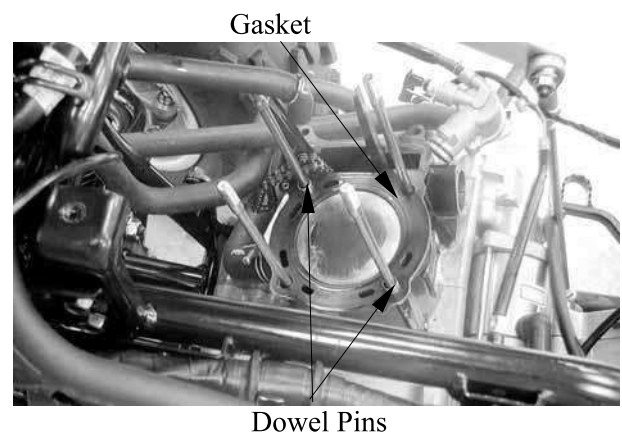

---

---

---

---

---

---

---

---

## CYLINDER /PISTON

SERVICE INFORMATION-----	8- 2
TROUBLESHOOTING-----	8- 2
CYLINDER/PISTON -----	8- 4



# 8. CYLINDER/PISTON

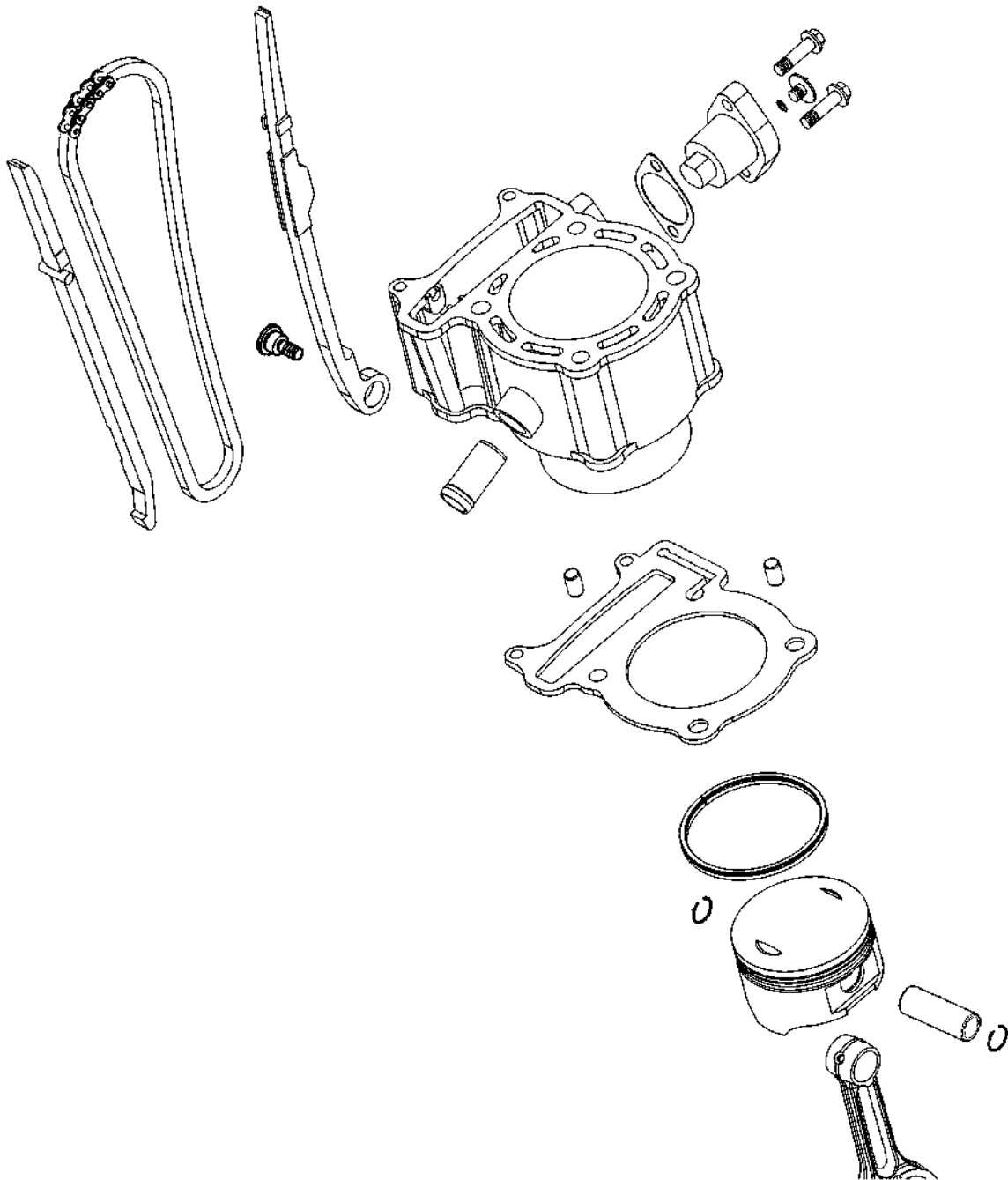

## 8. CYLINDER/PISTON

---

### SERVICE INFORMATION

#### GENERAL INSTRUCTIONS

- The cylinder and piston can be serviced with the engine installed in the frame.
- After disassembly, clean the removed parts and dry them with compressed air before inspection.

### TROUBLESHOOTING

- When hard starting or poor performance at low speed occurs, check the crankcase breather for white smoke. If white smoke is found, it means that the piston rings are worn, stuck or broken.

#### **Compression too low or uneven compression**

- Worn, stuck or broken piston rings
- Worn or damaged cylinder and piston

#### **Compression too high**

- Excessive carbon build-up in combustion chamber or on piston head

#### **Excessive smoke from exhaust muffler**

- Worn or damaged piston rings
- Worn or damaged cylinder and piston

#### **Abnormal noisy piston**

- Worn cylinder, piston and piston rings
- Worn piston pin hole and piston pin

## 8. CYLINDER/PISTON

### SPECIFICATIONS

		Standard (mm)	Service Limit (mm)	
Cylinder	I.D.	72.705~72.715	72.8	
	Warpage	—	0.05	
	Cylindricity	—	0.05	
	True roundness	—	0.05	
Piston, piston ring	Ring-to-groove clearance	Top	0.015~0.055	0.09
		Second	0.015~0.055	0.09
	Ring end gap	Top	0.15~0.3	0.5
		Second	0.3~0.45	0.65
		Oil ring	0.2~0.7	0.9
	Piston O.D.		72.67~72.69	72.6
	Piston O.D. measuring position		10mm from bottom of skirt	—
	Piston-to-cylinder clearance		0.010~0.040	0.1
Piston pin hole I.D.		17.002~17.008	17.04	
Piston pin O.D		16.994~17.000	16.96	
Piston-to-piston pin clearance		0.002~0.014	0.02	
Connecting rod small end I.D. bore		17.016~17.034	17.06	

## 8. CYLINDER/PISTON

### CYLINDER/PISTON

#### REMOVAL

Remove the cylinder head. (Refer to the chapter 7)

Remove the two dowel pins, cylinder head gasket and cam chain guide.

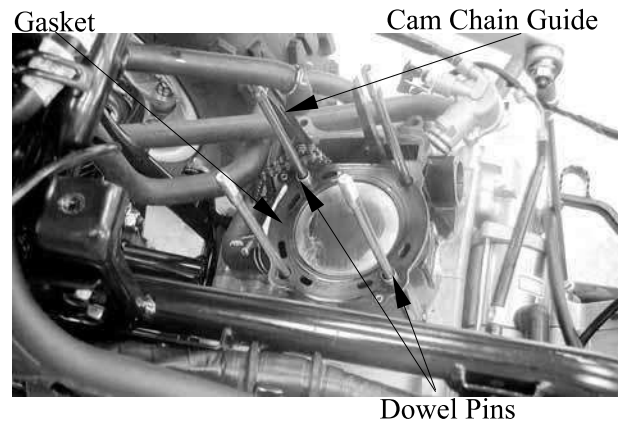

Unscrew the clamp and disconnect the water hose.  
Remove the cylinder

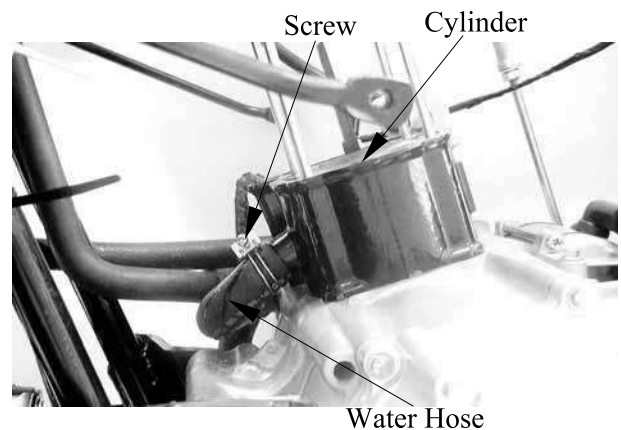

Remove the cylinder gasket and dowel pins.  
Clean any gasket material from the cylinder surface.

\* Be careful not to drop foreign matters into the crankcase.

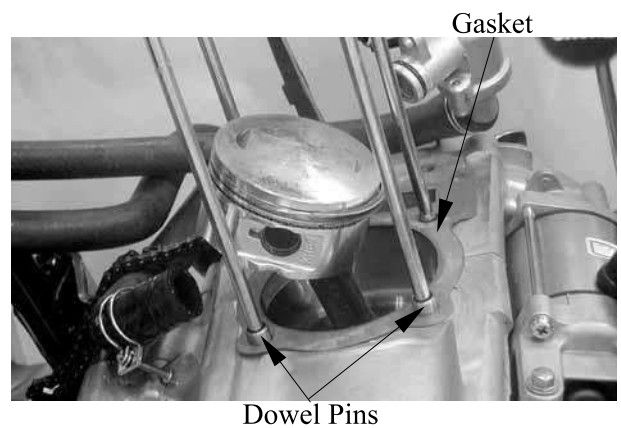

Remove the piston pin clip.

\* Place a clean shop towel in the crankcase to keep the piston pin clip from falling into the crankcase.

Press the piston pin out of the piston and remove the piston.

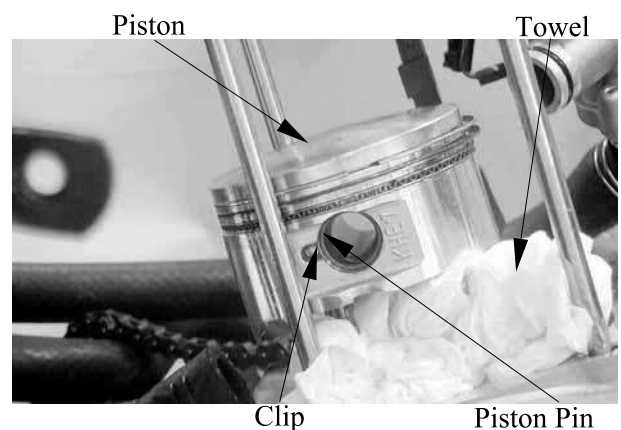



## 8. CYLINDER/PISTON

### INSPECTION

Inspect the piston, piston pin and piston rings.

Remove the piston rings.

\*

Clean carbon deposits from the piston ring grooves.

Inspect the piston wall for wear/scratches/damage.

If any defects are found, replace the piston with a new one.

Install the piston rings onto the piston and measure the piston ring-to-groove clearance.

**Service Limits: Top:** 0.09mm replace if over  
over  
**2nd:** 0.09mm replace if over  
over

Remove the piston rings and insert each piston ring into the cylinder bottom.

\* Use the piston head to push each piston ring into the cylinder.

Measure the piston ring end gap.

**Service Limit: Top:** 0.5mm replace if over  
2nd: 0.65mm replace if over  
Oil ring: 0.9mm replace if over  
over

Measure the piston pin hole I.D.

**Service Limit:** 17.04mm replace if over

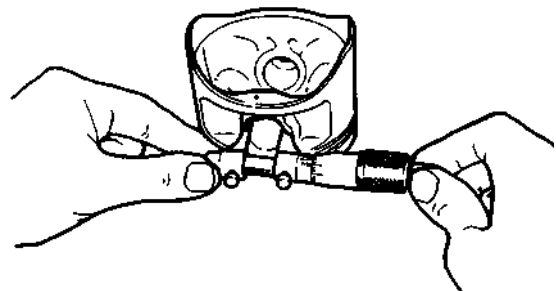
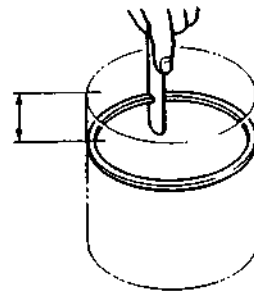
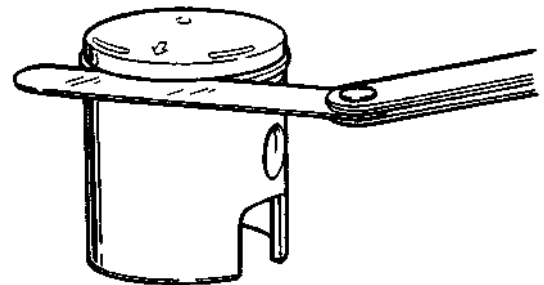

## 8. CYLINDER/PISTON

Measure the piston pin O.D.

**Service Limit:** 16.96mm replace if below

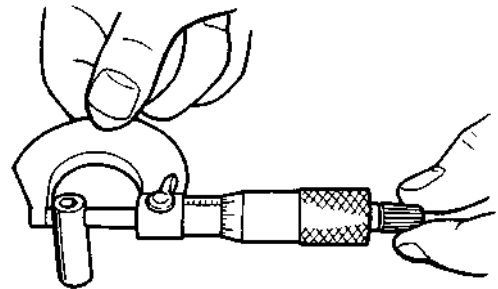

Measure the piston O.D.

\*

**Service Limit:** 72.6mm replace if below

Measure the piston-to-piston pin clearance.

**Service Limit:** 0.02mm replace if over

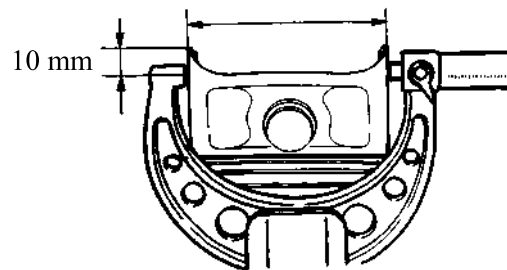

### CYLINDER INSPECTION

Inspect the cylinder bore for wear or damage. Measure the cylinder I.D. at three levels of top, middle and bottom at 90° to the piston pin (in both X and Y directions).

Cylinder I.D.:

**Service Limit:** 72.8mm replace if over

Measure the cylinder-to-piston clearance.

**Service Limit:** 0.1mm repair or replace if over

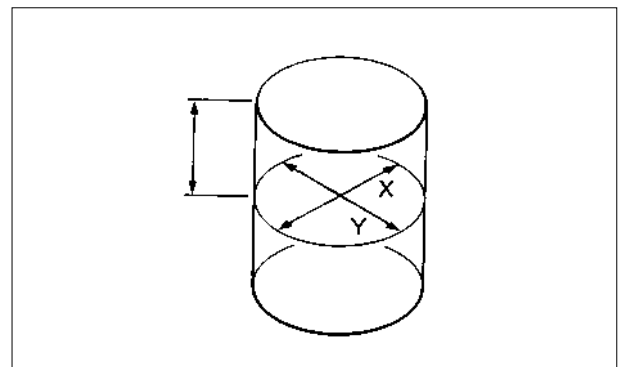

The true roundness is the difference between the values measured in X and Y directions. The cylindricity (difference between the values measured at the three levels) is subject to the maximum value calculated.

**Service Limits:**

**True Roundness:** 0.05mm repair or replace if over

**Cylindricity:** 0.05mm repair or replace if over

## 8. CYLINDER/PISTON

### PISTON RING INSTALLATION

Install the piston rings onto the piston.  
Apply engine oil to each piston ring.

- \*
- Be careful not to damage or break the piston and piston rings.
  - All rings should be installed with the markings facing up.
  - After installing the rings, they should rotate freely without sticking.

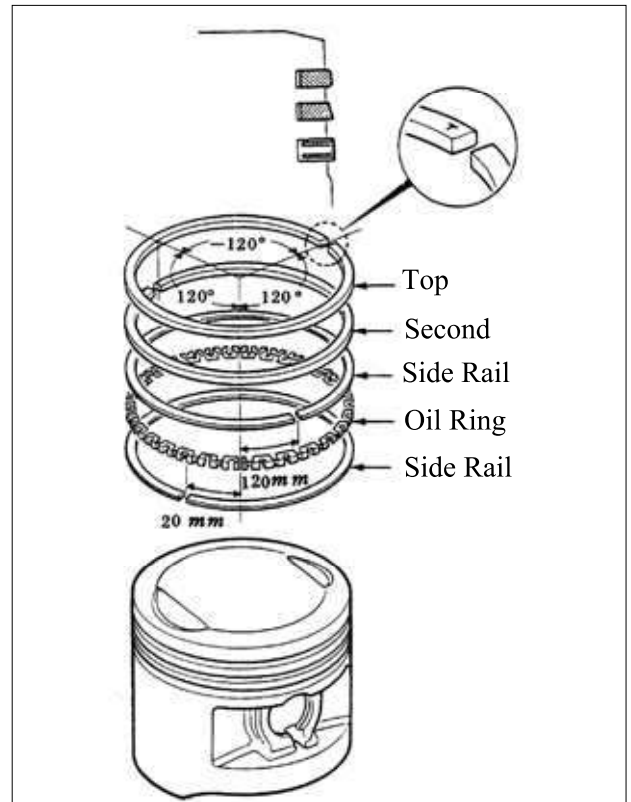

Measure the connecting rod small end I.D.

**Service Limit:** 17.06mm replace if over

Measure the connecting rod to piston pin clearance.

**Service Limit:** 0.06mm replace if over



Inspect the exhaust side and intake side chain guides.

Wear/Damage → Replace.

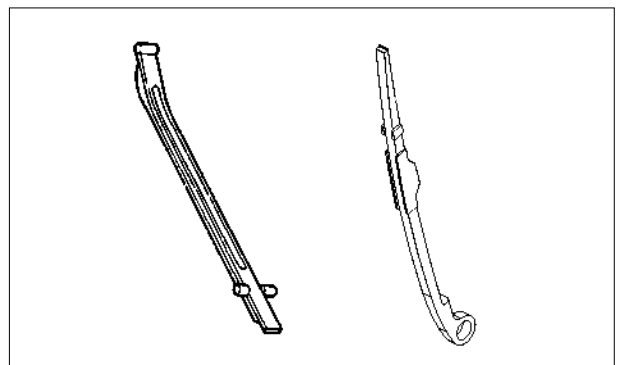

## 8. CYLINDER/PISTON

### PISTON INSTALLATION

Remove any gasket material from the crankcase surface.

- \* Be careful not to drop foreign matters into the crankcase.

Install the piston, piston pin and a new piston pin clip.

- \*
  - Position the piston “IN” mark on the intake valve side.
  - Place a clean shop towel in the crankcase to keep the piston pin clip from falling into the crankcase.



### CYLINDER INSTALLATION

Install the dowel pins and a new cylinder gasket on the crankcase.

Coat the cylinder bore, piston and piston rings with clean engine oil.

Carefully lower the cylinder over the piston by compressing the piston rings.

- \*
  - Apply proper clean engine oil around cylinder wall.
  - Be careful not to damage or break the piston rings.
  - Stagger the ring end gaps at 120° to the piston pin.

## **9. DRIVE AND DRIVEN PULLEYS**

---

---

---

---

---

---

---

---

---

### **DRIVE AND DRIVEN PULLEYS**

---

SERVICE INFORMATION.....	9-2
TROUBLESHOOTING.....	9-2
LEFT CRANKCASE COVER .....	9-3
DRIVE PULLEY .....	9-4
CLUTCH/DRIVEN PULLEY .....	9-7



# 9. DRIVE AND DRIVEN PULLEYS

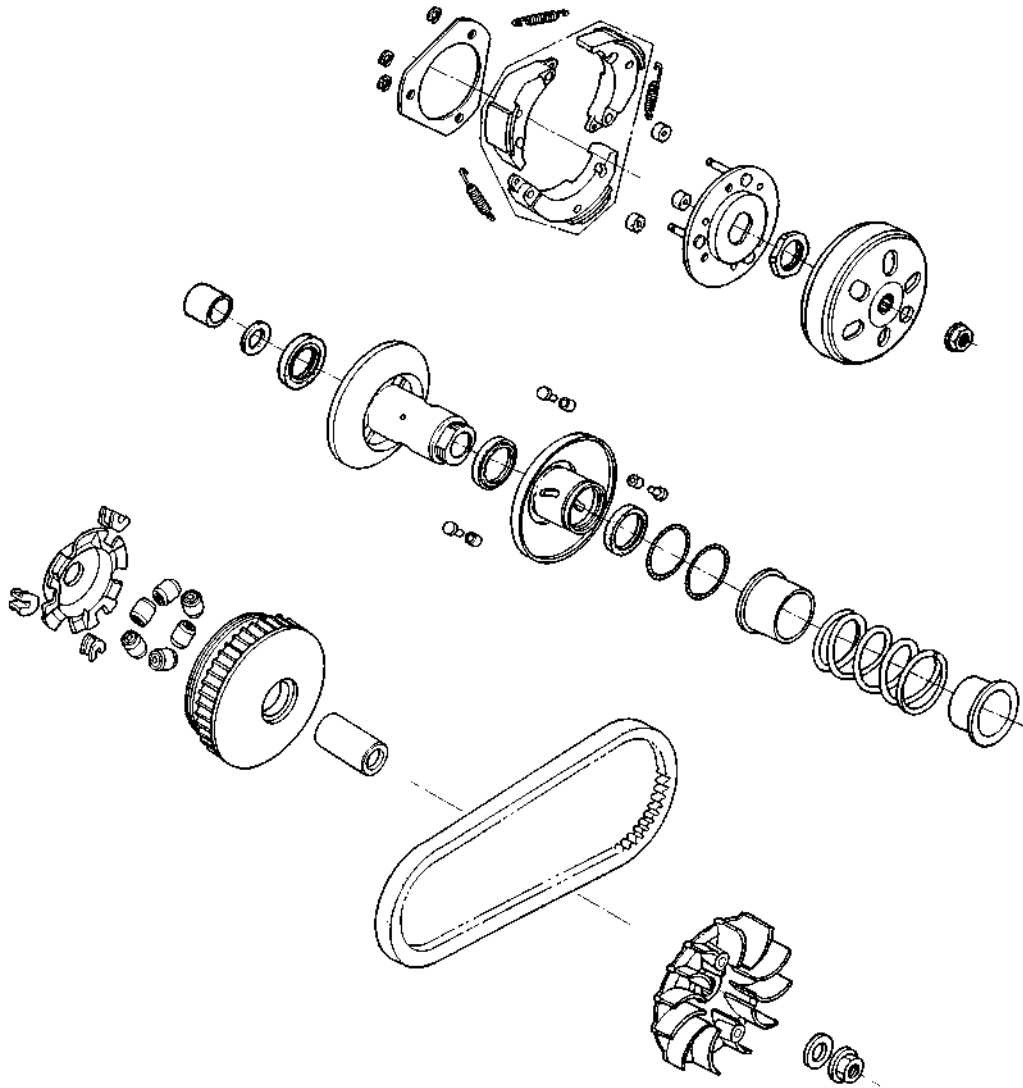

## 9. DRIVE AND DRIVEN PULLEYS

### SERVICE INFORMATION

#### GENERAL INSTRUCTIONS

- The drive pulley, clutch and driven pulley can be serviced with the engine installed in the frame.
- Avoid getting grease and oil on the drive belt and pulley faces. Remove any oil or grease from them to minimize the slipping of drive belt and drive pulley.

#### SPECIFICATIONS

Item	Standard (mm)	Service Limit (mm)
Movable drive face bushing I.D.	26.989~27.052	27.06
Drive face collar O.D.	26.96~26.974	26.94
Drive belt width	23.6~24.4	22
Clutch lining thickness	—	0.5
Clutch outer I.D.	153.0~153.2	153.5
Driven face spring free length	—	131
Driven face O.D.	39.965~39.985	39.94
Movable driven face I.D.	40.000~40.025	40.06
Weight roller O.D.	22.92~23.08	22.8

#### TORQUE VALUES

Drive face nut	9.0~10.0kgf-m
Clutch outer nut	5.0~6.0kgf-m
Drive plat nut	5.0~6.0kgf-m

#### SPECIAL TOOLS

Universal holder	E017	Clutch spring compressor	E027
Bearing puller	E008	Oil seal and bearing install	E014

#### TROUBLESHOOTING

##### Engine starts but motorcycle won't move

- Worn drive belt
- Broken ramp plate
- Worn or damaged clutch lining
- Broken driven face spring

##### Lack of power

- Worn drive belt
- Weak driven face spring
- Worn weight roller
- Fouled drive face

##### Engine stalls or motorcycle creeps

- Broken clutch weight spring

## 9. DRIVE AND DRIVEN PULLEYS

### LEFT CRANKCASE COVER

#### REMOVAL

Remove the five bolts.  
Remove the starting cover.

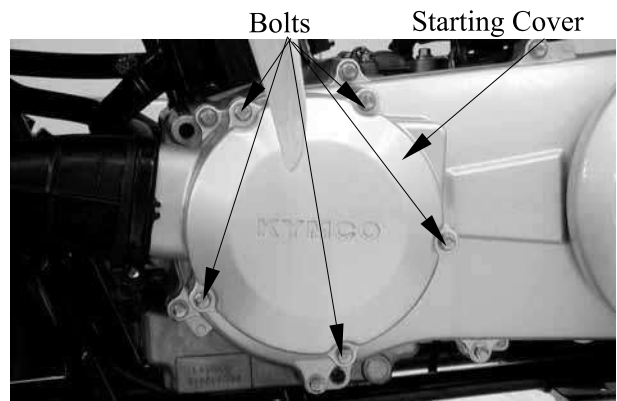

Remove the dowel pins and gasket.

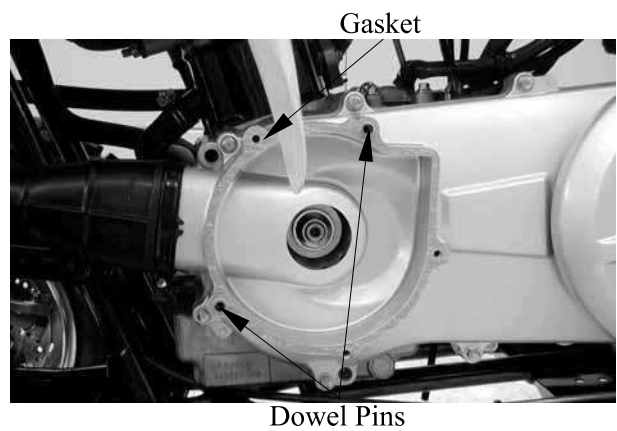

Remove the three bolts.  
Remove the outlet hose cover.

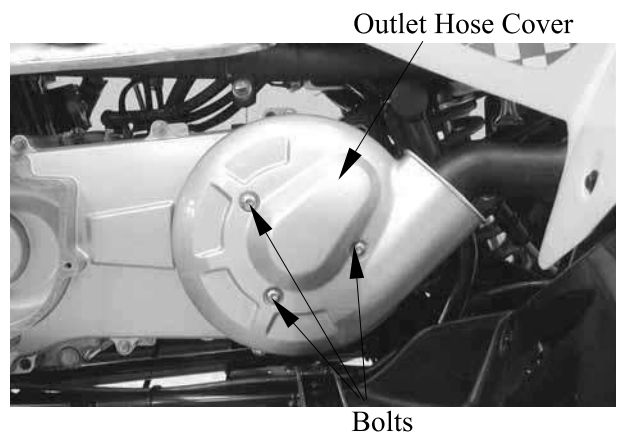

Loosen the drive belt air inlet and outlet hose band screws and disconnect them from the left crankcase cover.

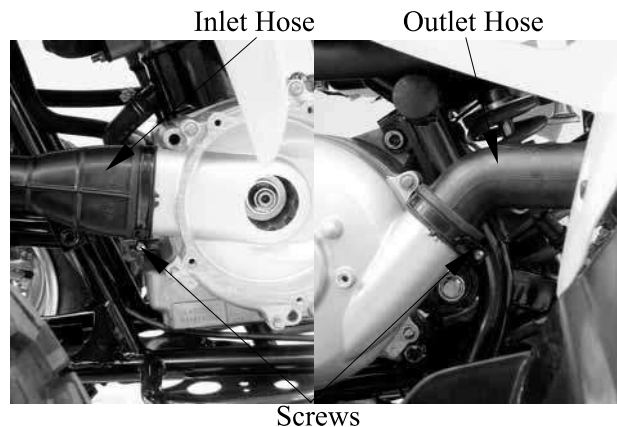



## 9. DRIVE AND DRIVEN PULLEYS

Remove the left crankcase cover bolts and left crankcase cover.  
Remove the gasket and dowel pins.

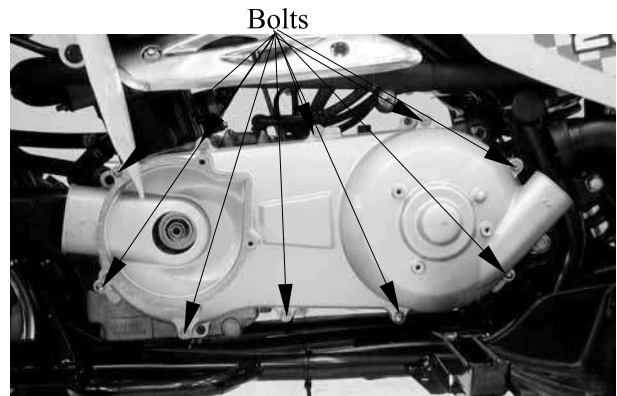

### INSPECTION

Inspect the bearing for allow play in the left crankcase cover or the bearing turns roughly  
→ Replace.

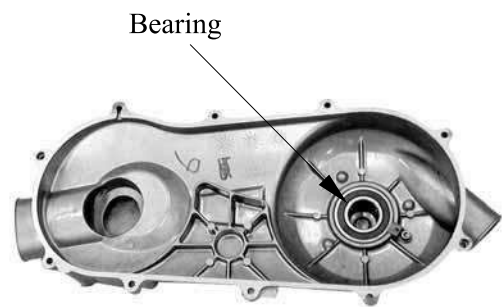

### INSTALLATION

Install the dowel pins and new gasket.  
Reverse the “LEFT CRANKCASE COVER REMOVAL” procedures.  
Install the left crankcase cover and tighten the bolts.  
Connect the drive belt air inlet and outlet hose and tighten band screws.  
Install the starting cover and outlet hose cover.

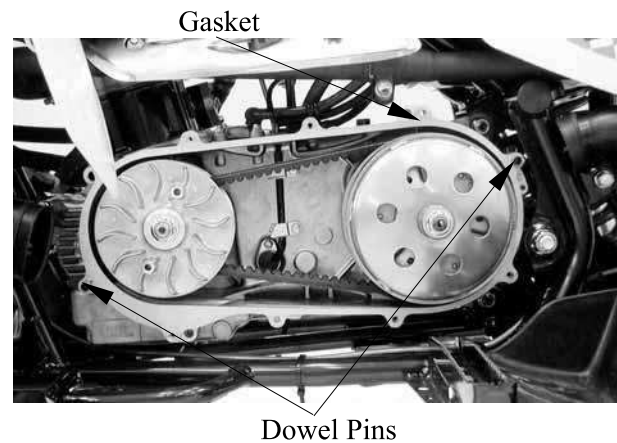

### DRIVE PULLEY

#### REMOVAL

Remove the left crankcase cover. (Refer to the “LEFT CRANKCASE COVER REMOVAL” section in the chapter 9)

Hold the drive pulley using a universal holder and remove the drive face nut and washer.  
Remove the drive pulley.

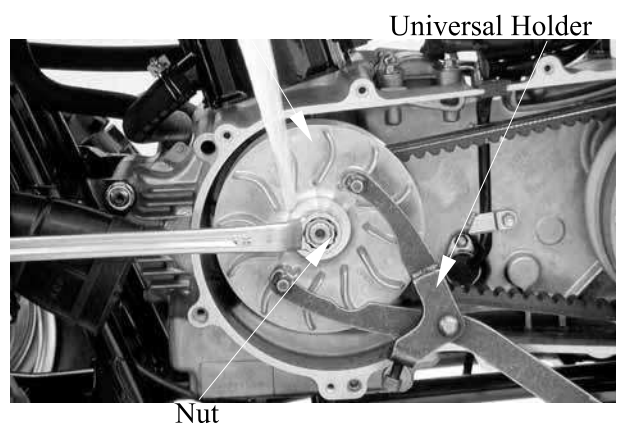

Universal Holder E017

## 9. DRIVE AND DRIVEN PULLEYS

Remove the movable drive face assembly and drive pulley collar.

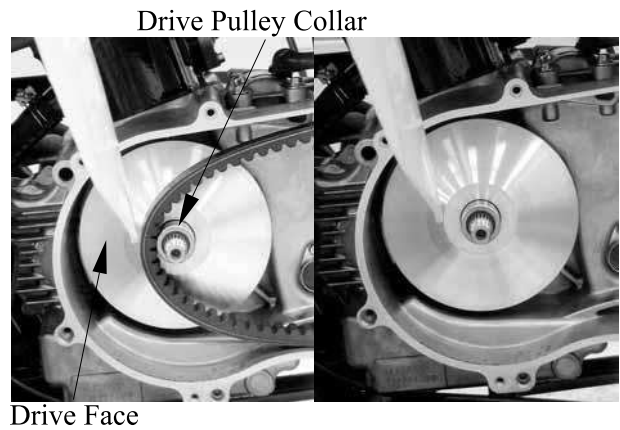

### DISASSEMBLY

Remove the ramp plate.

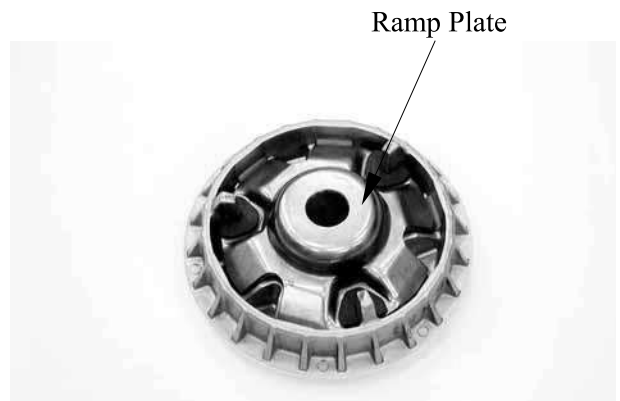

Remove the six weight rollers.

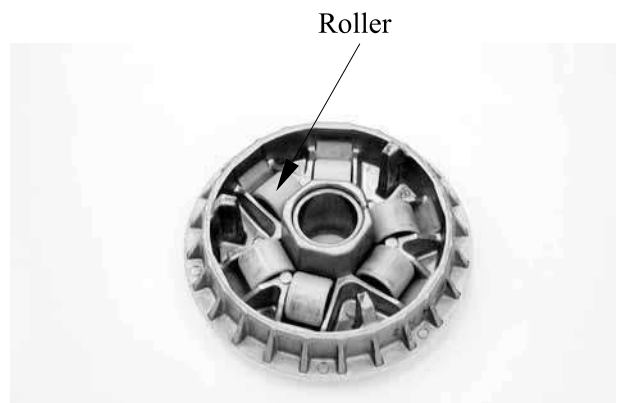

### INSPECTION

Check each weight roller for wear or damage.  
Measure each weight roller O.D.

**Service Limit:** 22.8mm replace if below.

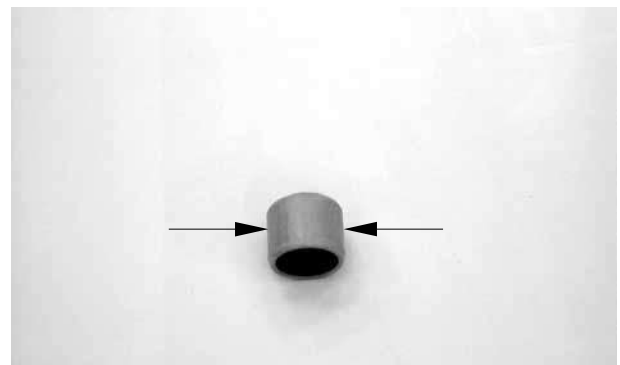

## 9. DRIVE AND DRIVEN PULLEYS

Measure the movable drive face bushing I.D.

**Service Limit:** 27.06mm replace if over

### ASSEMBLY

Install the weight rollers into the movable drive face.

Install the ramp plate.

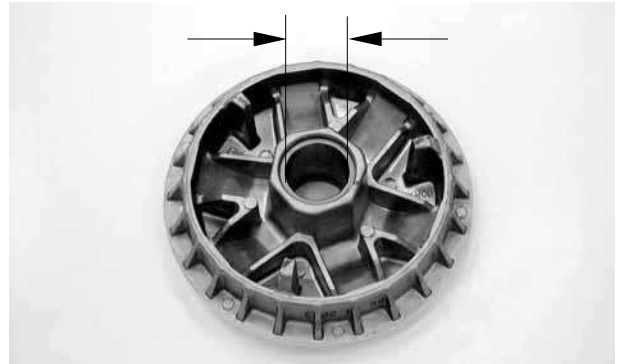

Check the drive pulley collar for wear or damage.

Measure the O.D. of the drive pulley collar sliding surface.

**Service Limit:** 26.94mm replace if below



### INSTALLATION

Install the drive pulley face assembly and collar.

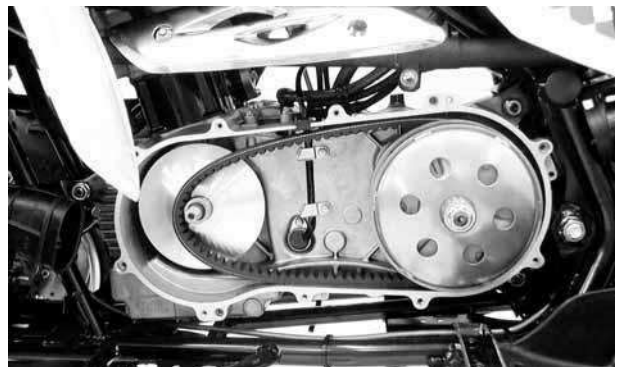

Install the drive pulley, wash and nut.

- \* When installing the drive pulley face, compress it to let the drive belt move downward to the lowest position so that the drive pulley can be tightened. Install the washer with the "OUT SIDE" mark facing out. Do not get oil or grease on the drive belt or pulley faces.

Washer

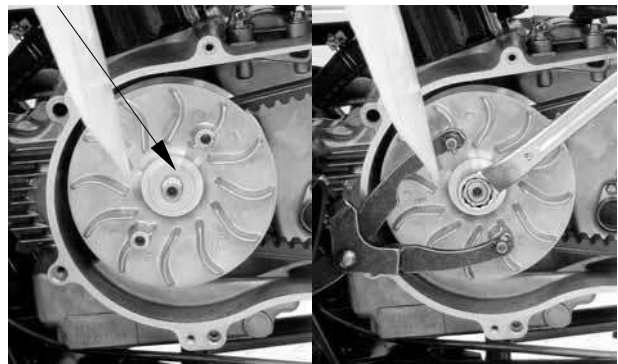

**Torque:** 9.0~10.0kgf-m

# 9. DRIVE AND DRIVEN PULLEYS

## CLUTCH/DRIVEN PULLEY

### REMOVAL

Remove the left crankcase cover. (Refer to the "LEFT CRANKCASE COVER REMOVAL" section in the chapter 9)  
 Remove the drive pulley. (Refer to the "DRIVE PULLEY REMOVAL" section in the chapter 9)

Hold the clutch outer with the universal holder and remove the clutch outer nut.

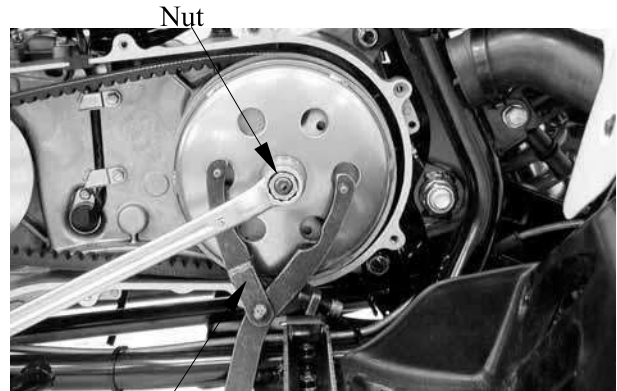

Universal Holder



Universal Holder E017

Remove the wash, collar and clutch outer.

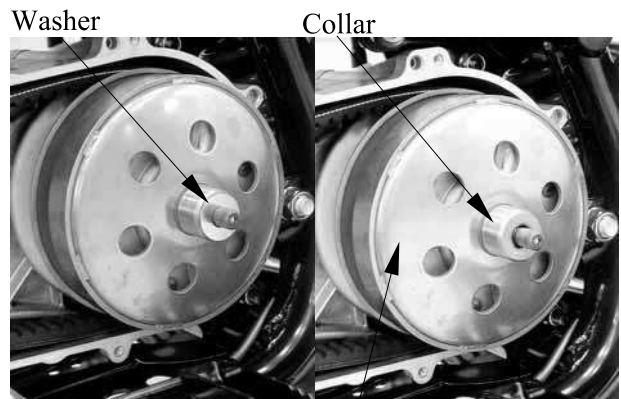

Washer

Collar

Clutch Outer

Remove the clutch/driven pulley and drive belt.



Clutch/Driven Pulley

Drive Belt

### DRIVE BELT INSPECTION

Check the drive belt for cracks, separation or abnormal or excessive wear.  
 Measure the drive belt width.

**Service Limit:** 22.0mm replace if below

\*

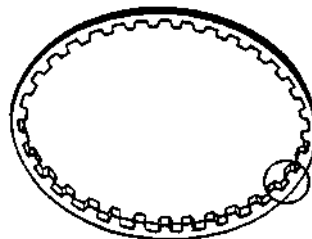

## 9. DRIVE AND DRIVEN PULLEYS

### CLUTCH OUTER INSPECTION

Inspect the clutch outer for wear or damage.  
Measure the clutch outer I.D.

**Service Limit:** 153.5mm replace if over

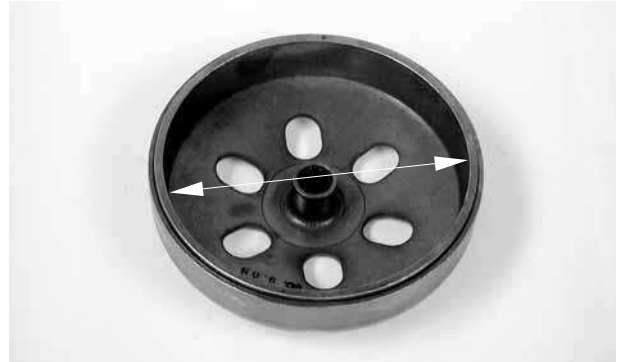

### CLUTCH/DRIVEN PULLEY DISASSEMBLY

Hold the clutch/driven pulley assembly with the clutch spring compressor.

\* Be sure to use a clutch spring compressor to avoid spring damage.

**Special**

Clutch Spring Compressor E027

Set the clutch spring compressor in a vise and remove the clutch drive plate nut.

Loosen the clutch spring compressor and disassemble the clutch/driven pulley assembly. Remove the seal collar.

Pull out the guide roller pins and guide rollers. Remove the movable driven face from the driven face.

Clutch Spring Compressor

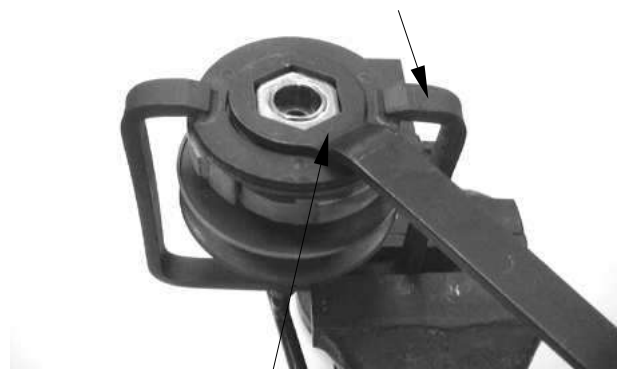

Lock Nut Wrench

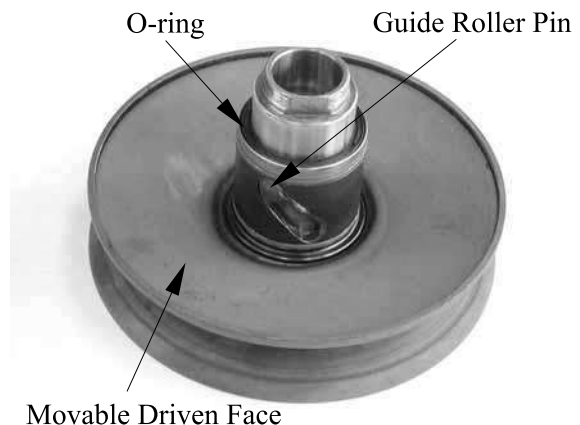

## 9. DRIVE AND DRIVEN PULLEYS

Remove the oil seal from the movable driven face.



Measure the clutch lining thickness.  
**Service Limit:** 0.5mm replace if below



### INSPECTION

Measure the driven face spring free length.  
**Service Limit:** 131mm replace if below

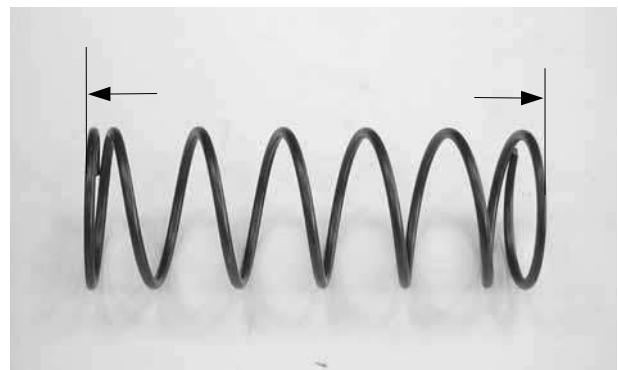

Check the driven face for wear or damage.  
Measure the driven face O.D.  
**Service Limit:** 39.94mm replace if below



## 9. DRIVE AND DRIVEN PULLEYS

Check the movable driven face for wear or damage.

Measure the movable driven face I.D.

**Service Limit:** 40.06mm replace if over

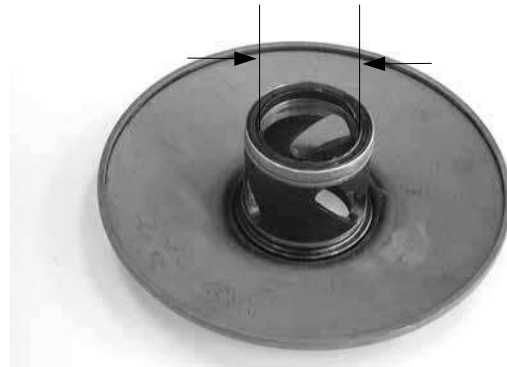

### DRIVEN PULLEY FACE BEARING REPLACEMENT

Drive the inner needle bearing out of the driven pulley face.

- \* Discard the removed bearing and replace with a new one.

Inner Bearing



Remove the snap ring and drive the outer bearing out of the driven face.

- \* Discard the removed bearing and replace with a new one.

Outer Bearing



Apply grease to the outer bearing.  
Drive a new outer bearing into the driven face with the sealed end facing up.

**Special**

Bearing Puller E008

Seat the snap ring in its groove.  
Apply grease to the driven face bore areas.

- \* Pack all bearing cavities with proper grease.  
Specified grease: Heat resistance 230°C

Press a new needle bearing into the driven face.

**Special**

Oil Seal And Bearing Install E014

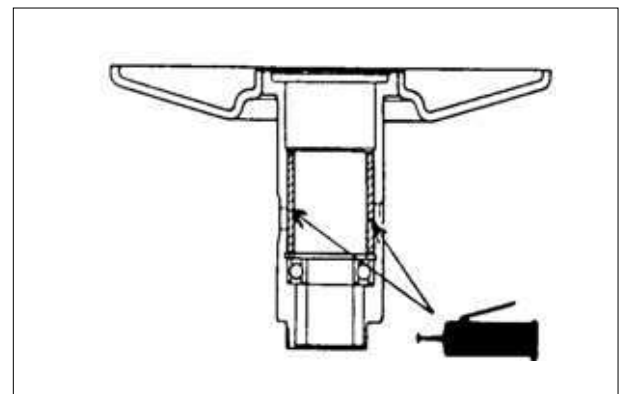

## 9. DRIVE AND DRIVEN PULLEYS

### CLUTCH DISASSEMBLY

Remove the circlips and retainer plate to disassemble the clutch.

\* Keep grease off the clutch linings.

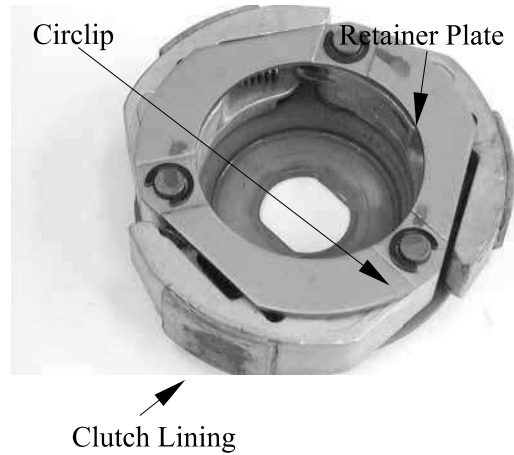

### CLUTCH / DRIVEN PULLEY ASSEMBLY

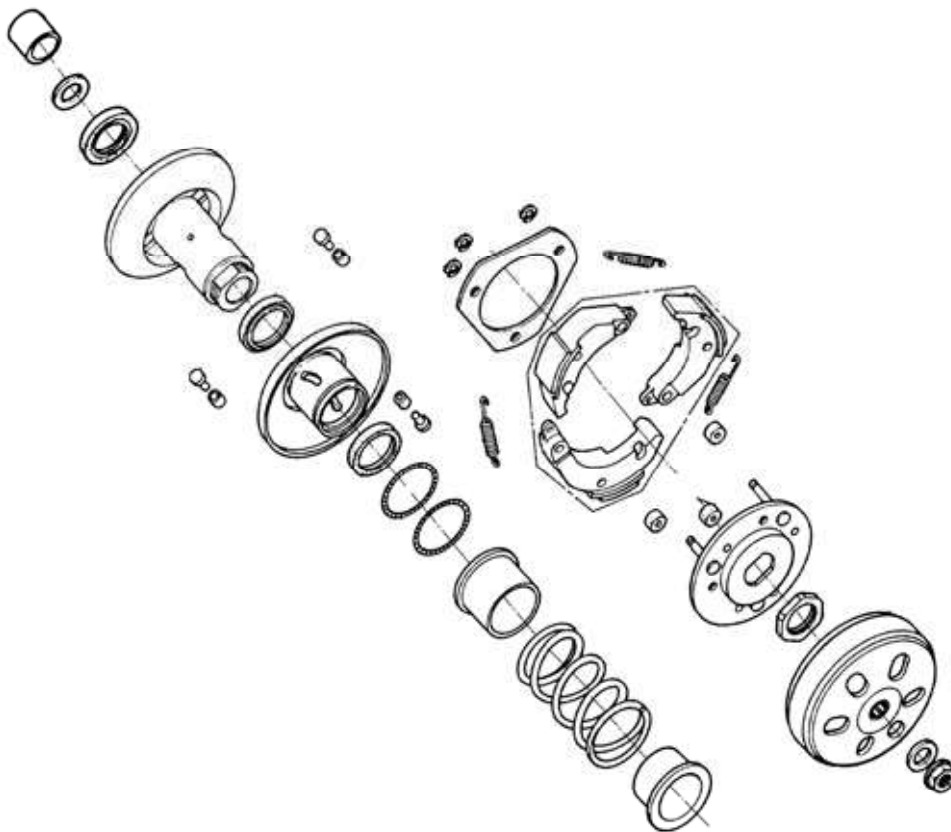



## 9. DRIVE AND DRIVEN PULLEYS

---

Install the damper rubbers on the drive plate pins.

Install the clutch weights/shoes and clutch springs onto the drive plate.

Install the retainer plate and secure with the circlips.

Clean the driven pulley faces and remove any grease from them.

Install the oil seal onto the moveable driven face.

Apply grease to the Oil seal and install them onto the moveable driven face.

Install the movable driven face onto the driven face.

Apply grease to the guide rollers and guide roller pins and then install them into the holes of the driven face.

Install the seal collar.

Remove any excessive grease.

\* Be sure to clean the driven face off any grease.

Set the driven pulley assembly, driven face spring and clutch assembly onto the clutch spring compressor.

\* Align the flat surface of the driven face with the flat on the clutch drive plate.

Compress the clutch spring compressor and install the drive plate nut.

Set the clutch spring compressor in a vise and tighten the drive plate nut to the specified torque.

**Torque:** 5.0~6.0kgf-m

\* Be sure to use a clutch spring compressor to avoid spring damage.

 Special

Clutch Spring Compressor E027

## 9. DRIVE AND DRIVEN PULLEYS

### INSTALLATION

Install the clutch/driven pulley and driven belt onto the drive shaft.

\* Keep grease off the drive shaft.

Install the clutch outer, collar and washer.  
Hold the clutch outer with the flywheel holder.

Install and tighten the clutch outer nut.

**Torque:** 5.0~6.0kg-m

**Special**

Universal Holder E017

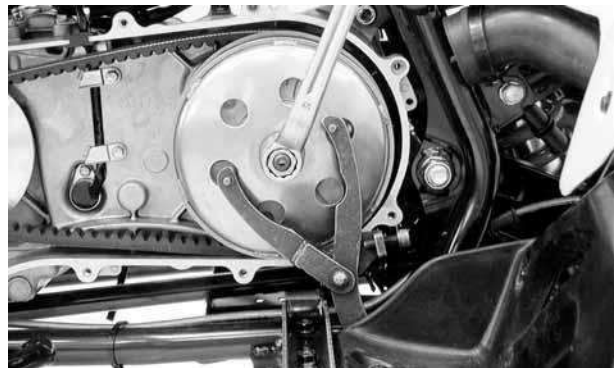

---

**FINAL REDUCTION/TRANSMISSION SYSTEM**

---

SERVICE INFORMATION-----	10- 2
TROUBLESHOOTING-----	10- 2
TRANSMISSION CASE COVER-----	10- 3
TRANSMISSION-----	10- 5

# 10.FINAL REDUCTION/ TRANSMISSION SYSTEM

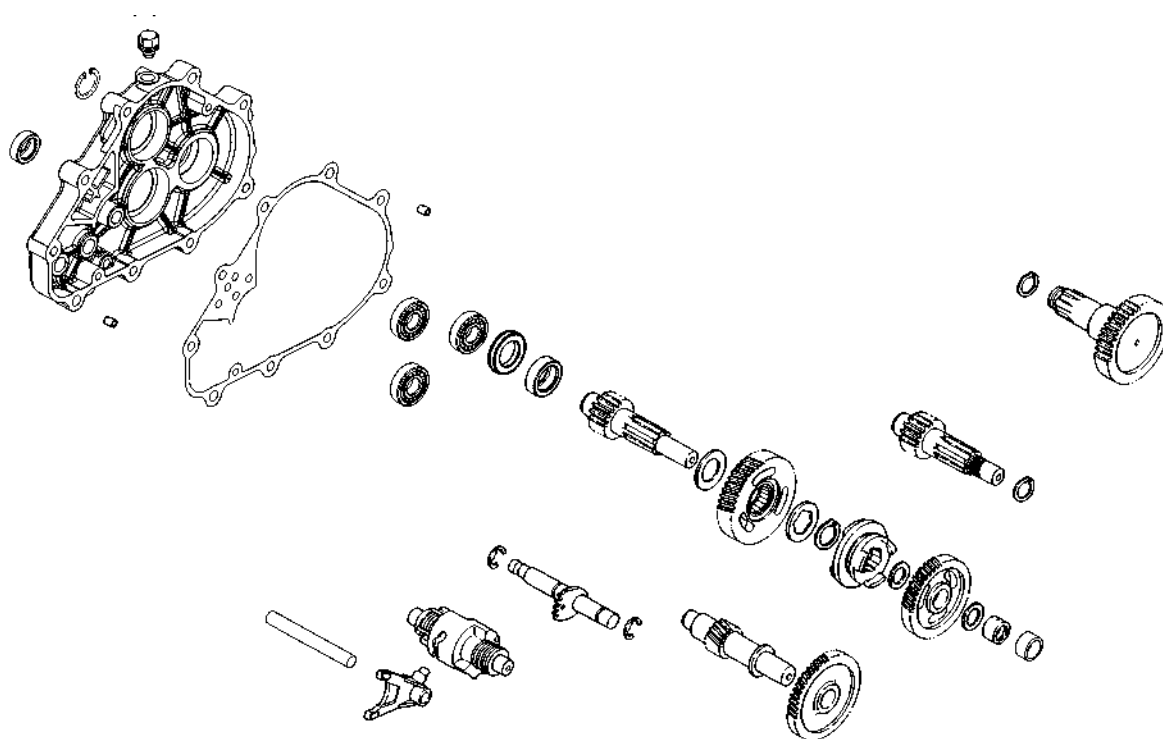

## SERVICE INFORMATION

### GENERAL INSTRUCTIONS

- The transmission system can be serviced with the engine installed in the frame.
- When replacing the drive shaft, use a special tool to hold the bearing inner race for this operation.

### SPECIFICATIONS

Specified Oil: GEAR OIL SAE 90#

Oil Capacity:       At change       : 0.3 liter  
                          At disassembly : 0.4 liter

### TORQUE VALUES

Transmission case cover bolt   2.4~3.0kgf-m

### TROUBLESHOOTING

#### Engine starts but motorcycle won't move

- Damaged transmission
- Seized or burnt transmission

#### Oil leaks

- Oil too rich
- Worn or damaged oil seal

# 10.FINAL REDUCTION/ TRANSMISSION SYSTEM

## TRANSMISSION CASE COVER REMOVAL

Drain transmission gear oil into a clean container. (Refer to the “TRANSMISSION OIL REPLACEMENT” section in the chapter 3)

Remove the three and then remove the drive sprocket cover.

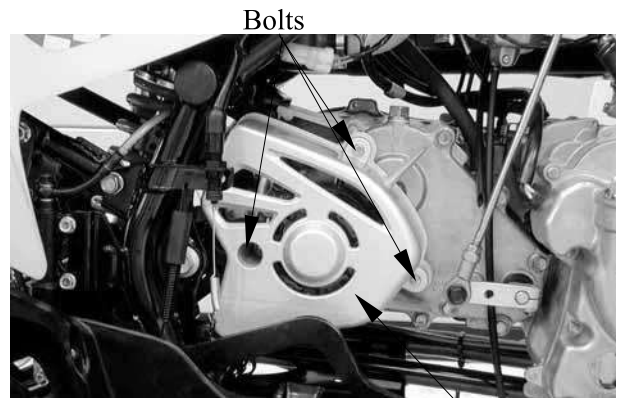

Drive Sprocket Cover

Remove the two bolts and then remove the washer and drive sprocket.

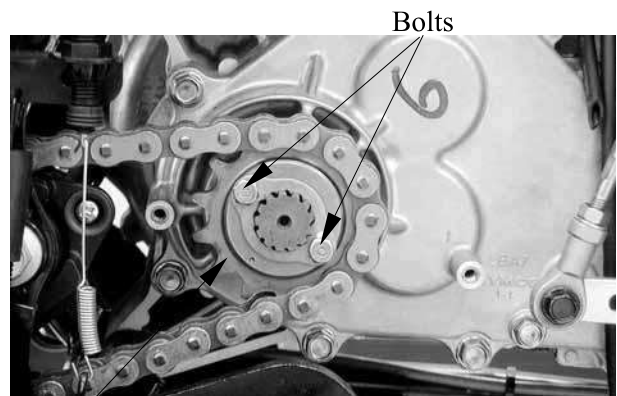

Drive Sprocket

Remove the bolt and then disconnect the drive shift arm from the shift shaft.

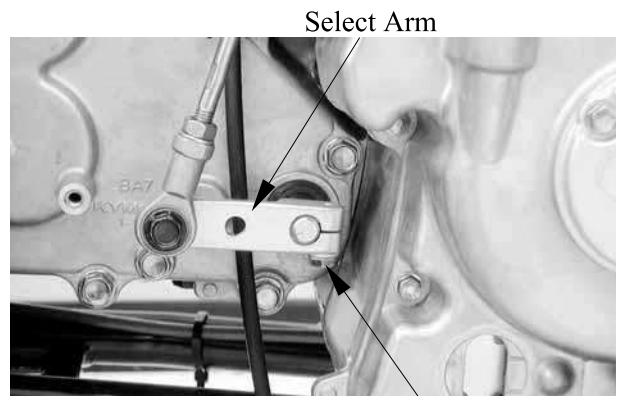

Select Arm

Remove the transmission case cover attaching bolts.



Bolts

# 10.FINAL REDUCTION/ TRANSMISSION SYSTEM

Remove the transmission case cover, dowel pins and gasket.

Inspect the bearings for allow play in the transmission case cover or the bearings turn roughly.

If any defects are found, replace the bearing with a new one.

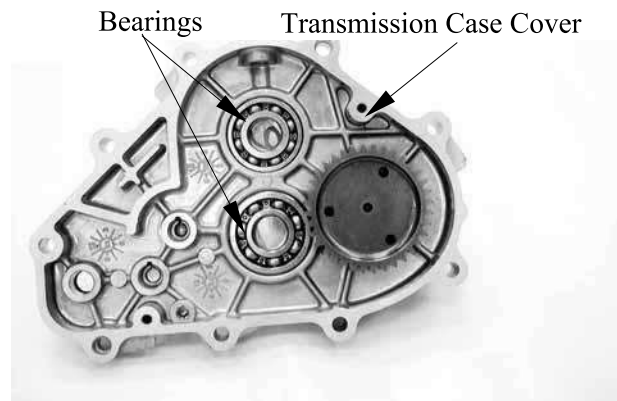

## TRANSMISSION CASE COVER DISASSEMBLY

Remove the drive axle circlip.

Remove the drive axle from the transmission case cover.

Remove the bearing circlip for remove the bearing.

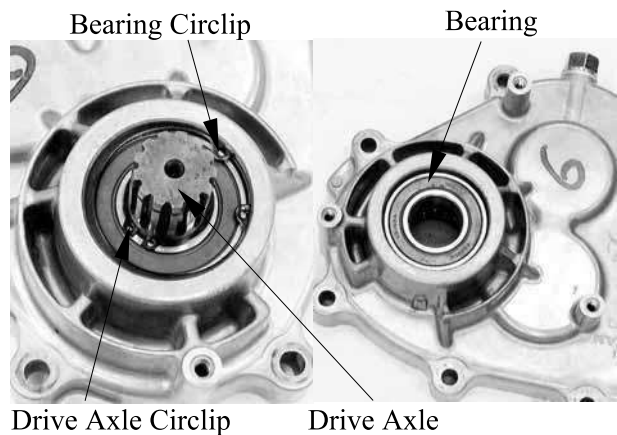

Inspect the bearing for allow play in the transmission case cover or the bearing turns roughly .

If any defects are found, replace the bearing with a new one.

Inspect the drive axle gear teeth for wear or damage.



Remove the bearing to expose the oil seal.

Inspect the oil seal for wear or damage.

If any defects are found, replace the oil seal with a new one.

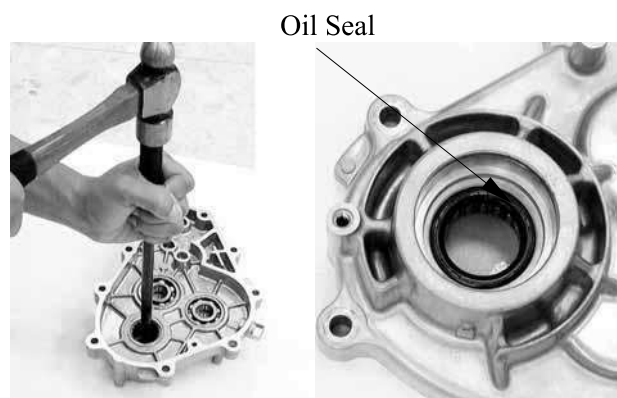

# 10.FINAL REDUCTION/ TRANSMISSION SYSTEM

Inspect the needle bearing for allow play in the transmission case cover or the bearing turns roughly.  
If any defects are found, replace the bearing with a new one.

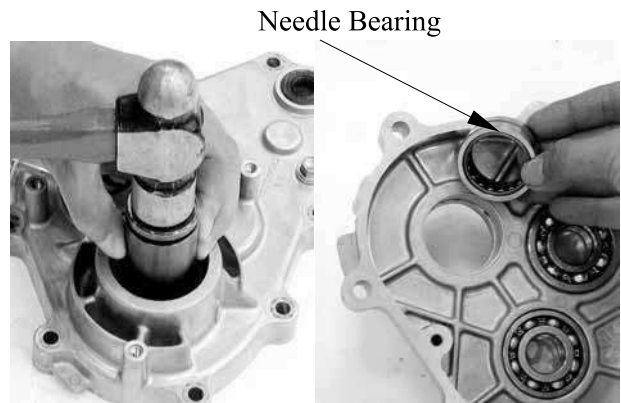

## ASSEMBLY

Install the needle bearing.  
Install the oil seal and bearing.  
Install the bearing circlip.  
Install the drive axle and drive axle circlip.

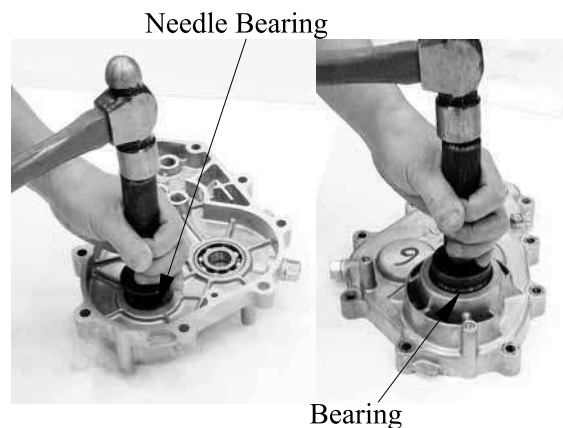

## TRANSMISSION REMOVAL

Remove the transmission cover. (Refer to the "TRANSMISSION CASE COVER REMOVAL" in the chapter 10)

Check the transmission operation.  
Unsmooth operation → Repair.

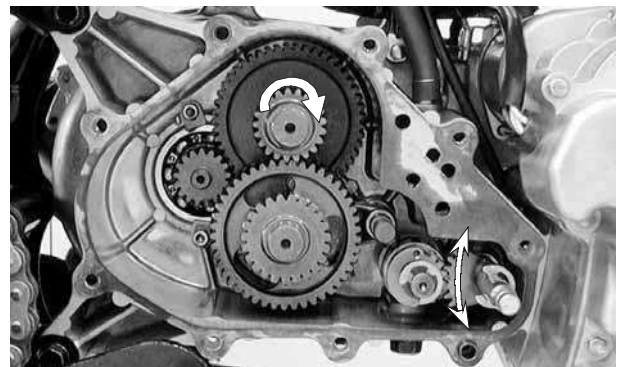

Remove the shift shaft.

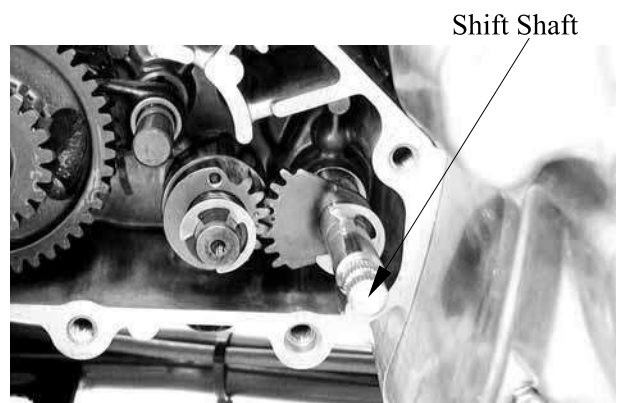



# 10.FINAL REDUCTION/ TRANSMISSION SYSTEM

Remove the stopper plug.

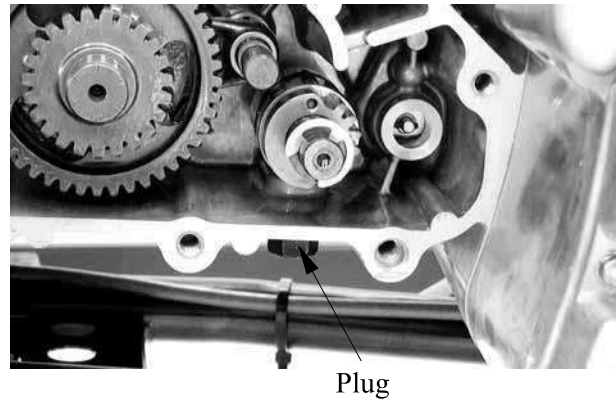

Remove spring, washer and shift cam stopper.

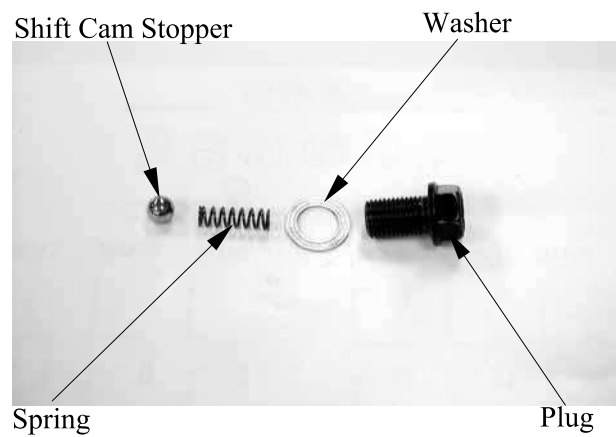

Remove the transmission guide bar.



Remove shift cam.

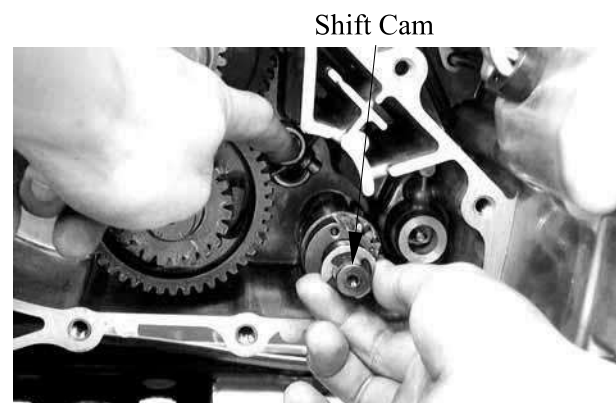

# 10.FINAL REDUCTION/ TRANSMISSION SYSTEM

Remove the shift fork.

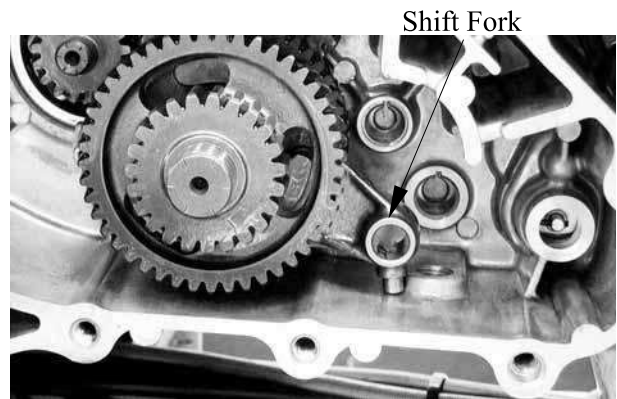

Measure the guide bar runout.  
Out of specification → Replace.

**Service Limit:** Less than 0.03 mm

\* Do not attempt to straighten a bent guide bar.

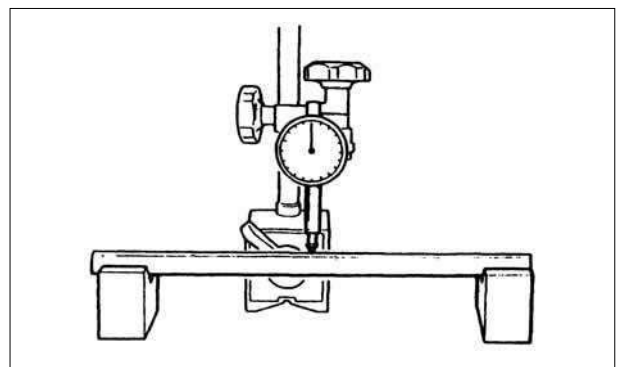

Inspect the shift fork cam follower and shift fork pawl.  
Scoring/beads/wear → Replace.

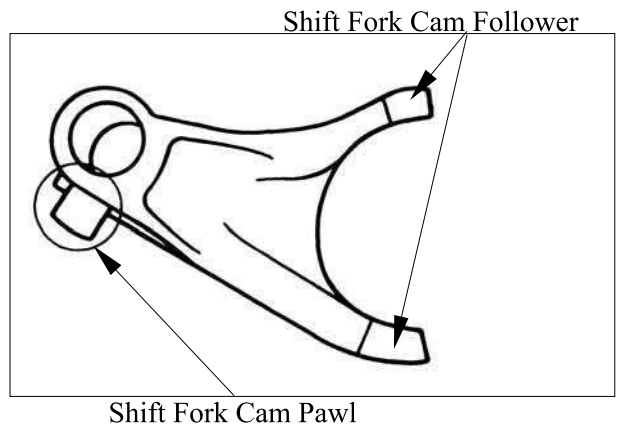

Check the shift cam groove and shift cam gear.  
Wear or damage → Replace.



# 10.FINAL REDUCTION/ TRANSMISSION SYSTEM

Inspect shift shaft gear.  
Damage → Replace.  
Inspect shift shaft.  
Damage/bends/wear → Replace.

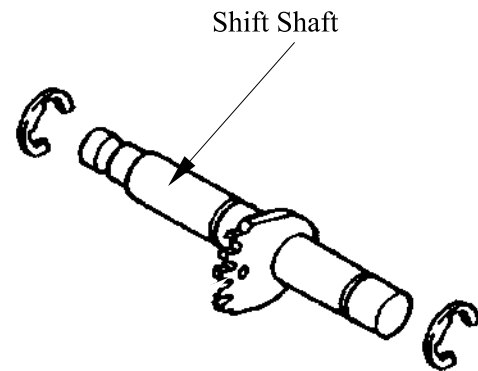

r

Remove the main axle.

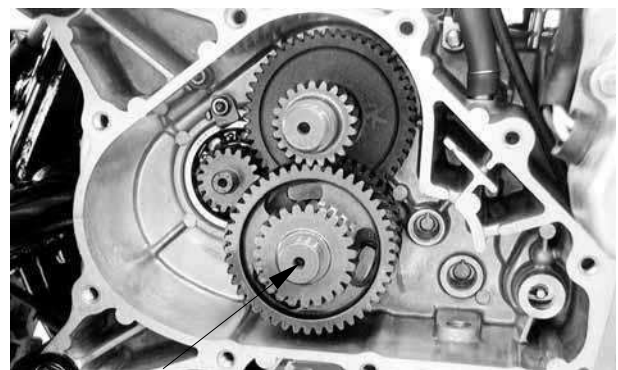

Main Axle

**MAIN AXLE DISASSEMBLY**  
Remove the washers, collar, primary driven gear, bush and clutch dog.

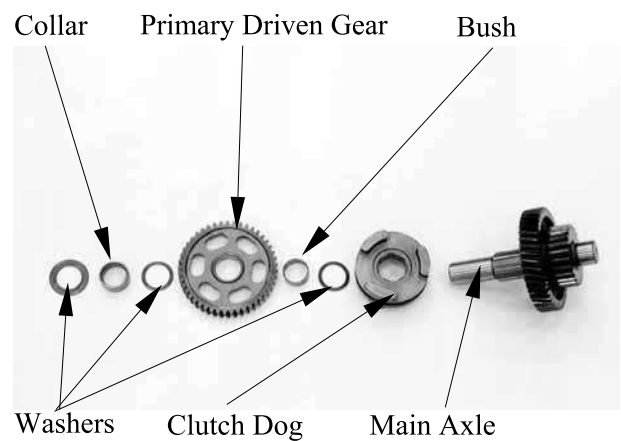
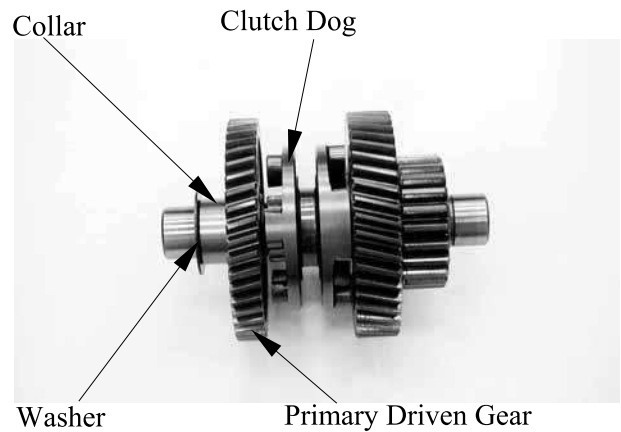

# 10.FINAL REDUCTION/ TRANSMISSION SYSTEM

Remove the circlip and then remove the washers, reverse wheel gear and needle bearing.

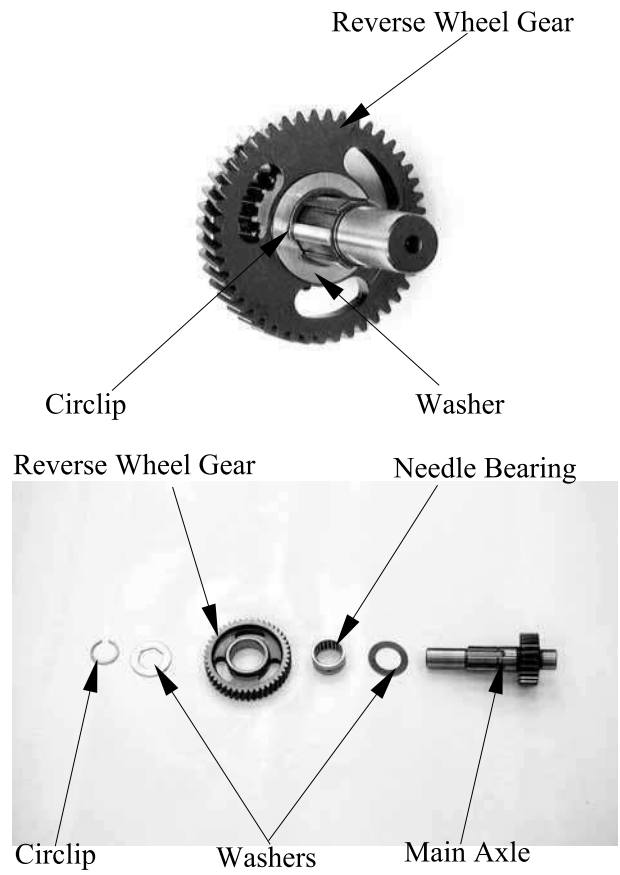

Inspect the gear teeth.  
Blue discoloration/pitting/wear → Replace.

Inspect the mated dogs.  
Rounded edges/cracks/missing portions  
→ Replace.

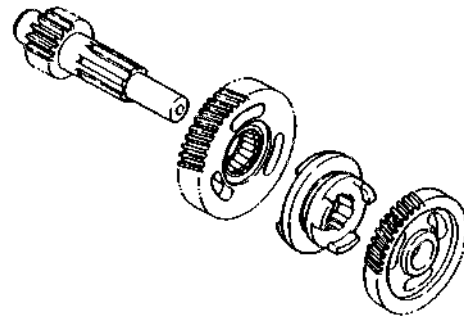

# 10.FINAL REDUCTION/ TRANSMISSION SYSTEM

## MAIN AXLE ASSEMBLY

Reverse the "MAIN AXLE  
DISASSEMBLY" procedures.

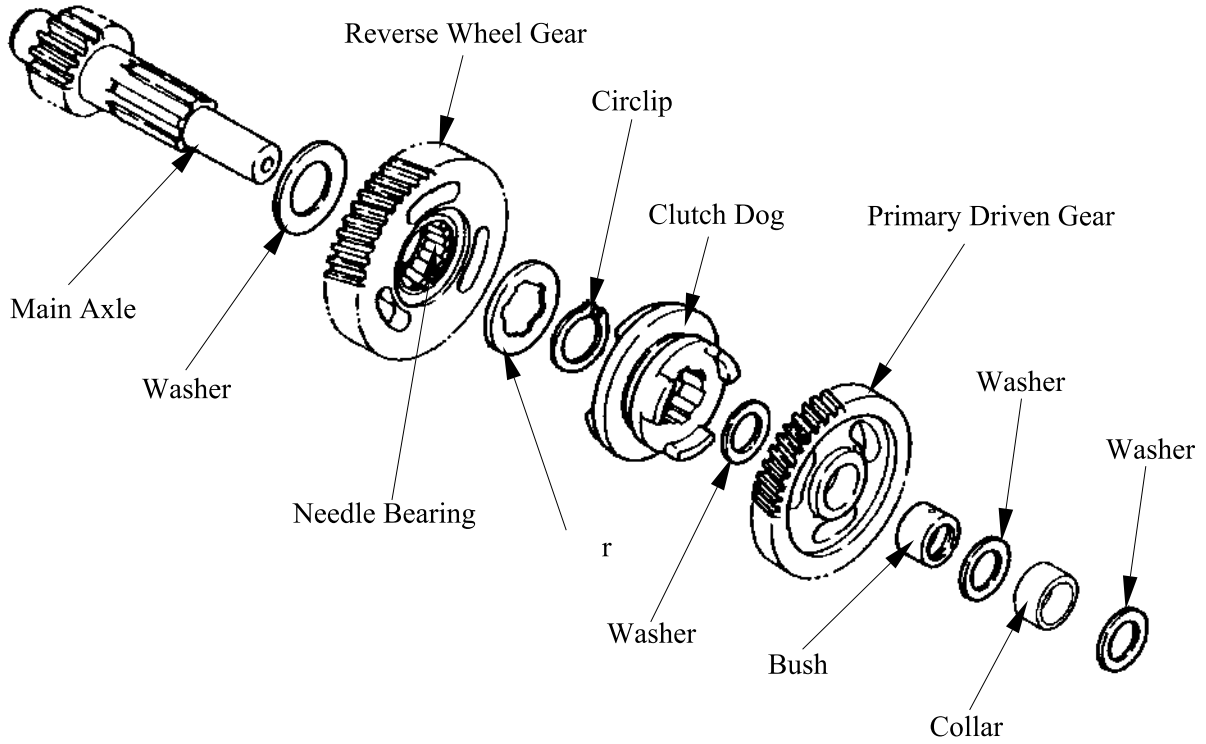

Remove the counter axle.

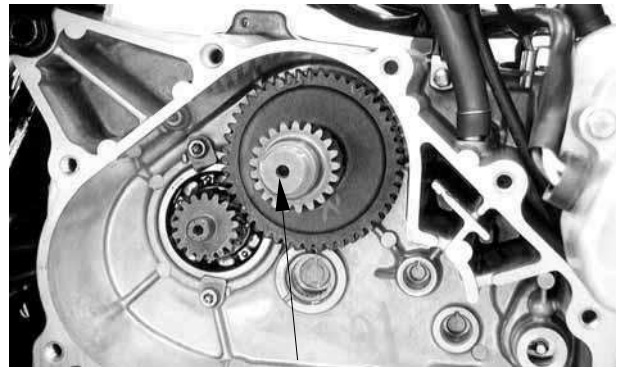

Counter Axle

Inspect the gear teeth.  
Blue discoloration/pitting/wear → Replace.



t

Primary Drive Axle

Oil Seal

### PRIMARY DRIVE AXLE REMOVAL

Remove the clutch/driven pulley. (Refer to the chapter 9)

Remove the oil seal, circlip, screw and plate.  
Remove the primary drive axle.

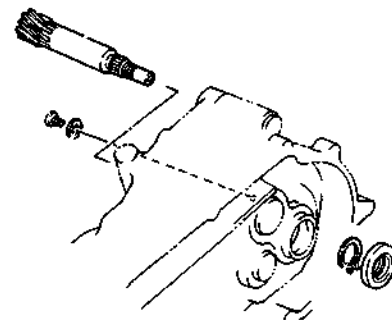

Plate

Circlip

Inspect the bearings for allow play in the transmission case cover or the bearing turns roughly.

If any defects are found, replace the bearing with a new one.

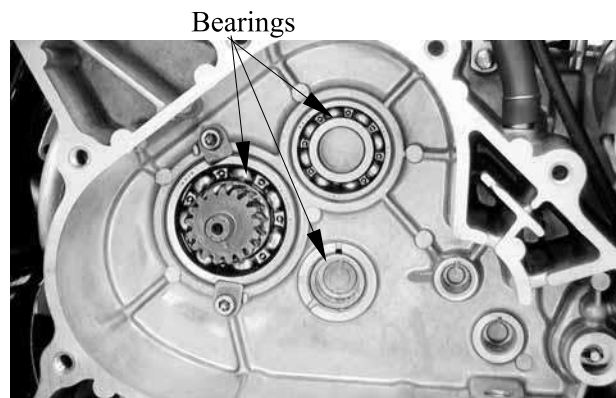

Bearings

# 10.FINAL REDUCTION/ TRANSMISSION SYSTEM

## INSTALLATION

Reverse the “TRANSMISSION REVOVAL” section procedures.

Install the primary drive axle. (Reverse the “PRIMARY DRIVE AXLE” procedures.)

Install the counter axle.

Install the main axle.

Install the shift cam.

Install the shift fork.

Install the guide bar.

Install the shift shaft.

- \* Make sure that the lever on the gear change switch correctly engages with the locating slot on the shift shaft.  
Align the mark on the shift shaft gear with the mark on the shift cam gear.

Install the shift cam stopper and tighten the plug.

**Torque:** 4.5~5.0kgf-m

Install the dowel pins and a new gasket onto the right crankcase.

Install the transmission case cover and tighten the transmission case cover bolt.

**Torque:** 2.4~3.0kgf-m

Fill the engine with oil and install the oil filler bolt. (Refer to the “TRANSMISSION OIL REPLACEMENT” section in the chapter 3)

### Specified Gear Oil:

KYMCO SIGMA GEAR OIL 90#

### Oil Capacity:

At disassembly : 0.4 liter

At change : 0.3liter

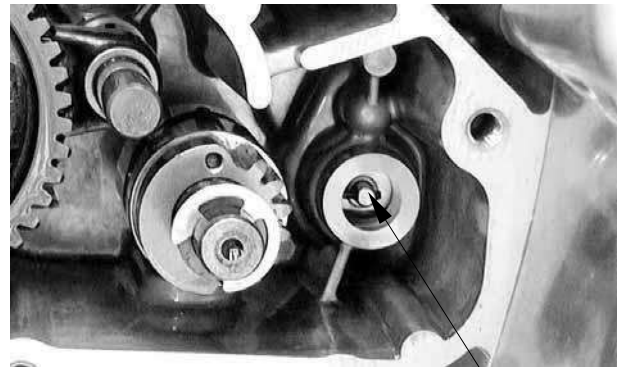

Gear Change Switch

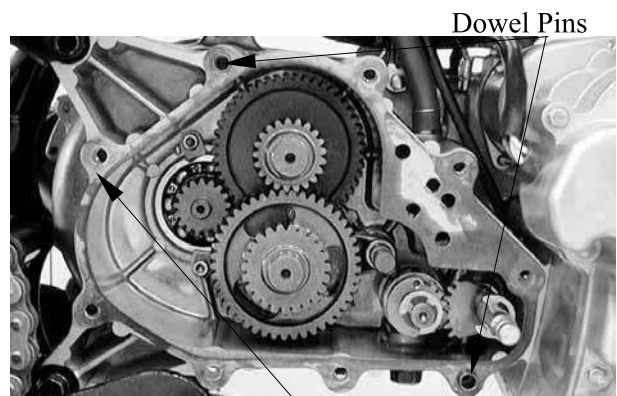
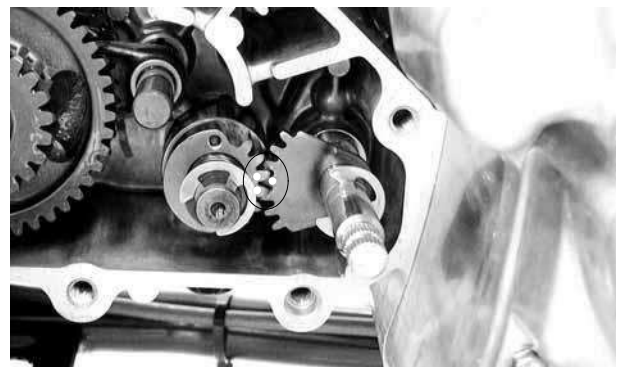

Dowel Pins

Gasket

# **11.CRANKSCASE/CRANKSHAFT/ BALANCE SHAFT**

---

Mongoose/KXR 250

---

---

---

---

---

---

---

---

---

---

## **CRANKCASE/CRANKSHAFT/BALANCE SHAFT**

---

SERVICE INFORMATION-----	11- 2
TROUBLESHOOTING-----	11- 2
CRANKCASE/CRANKSHAFT/BALANCE SHAFT-----	11- 3



# 11. CRANKCASE/CRANKSHAFT/ BALANCE SHAFT

---

Mongoose/KXR 250

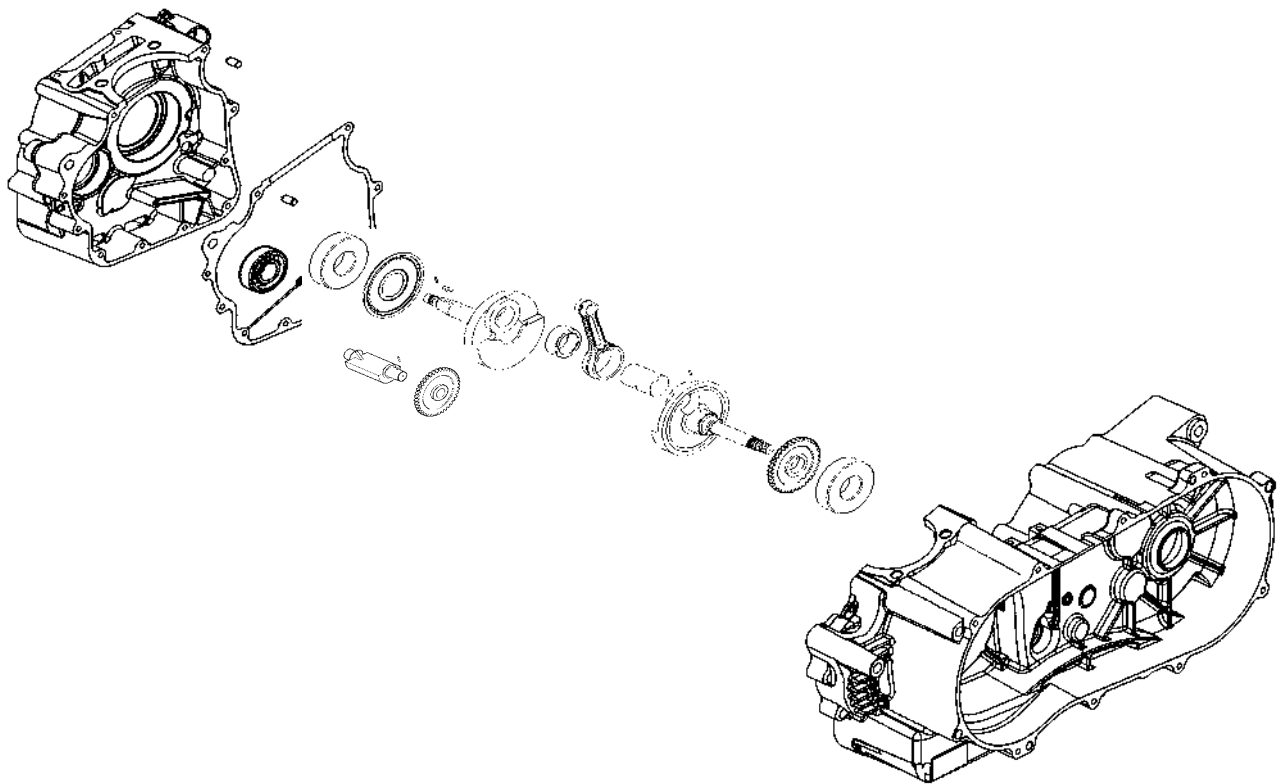

# 11. CRANKCASE/CRANKSHAFT/ BALANCE SHAFT

**Mongoose/KXR 250**

## SERVICE INFORMATION

### GENERAL INSTRUCTIONS

- This section covers crankcase separation to service the crankshaft. The engine must be removed for this operation.
- The following parts must be removed before separating the crankcase.
  - Cylinder head (⇒Chapter 7)
  - Cylinder/piston (⇒Chapter 8)
  - Drive and driven pulleys (⇒Chapter 9)
  - A.C. generator (⇒Chapter 16)
  - Starter clutch (⇒Chapter 18)
  - Oil pump (⇒Chapter 4)

### SPECIFICATIONS

	Item	Standard (mm)	Service Limit (mm)
Crankshaft	Connecting rod big end side clearance	0.05~0.4	0.6
	Connecting rod big end radial clearance	0~0.008	0.05
	Run out	—	0.10

### TORQUE VALUES

Crankcase bolt	0.8~1.2kgf-m
Cam chain tensioner slipper bolt	0.8~1.2kgf-m
Cam chain cover bolt	0.8~1.2kgf-m

### TROUBLESHOOTING

Excessive engine noise  
Excessive bearing play

# 11. CRANKCASE/CRANKSHAFT/ BALANCE SHAFT

Mongoose/KXR 250

## CRANKCASE/CRANKSHAFT/BA LANCE SHAFT

### REMOVAL

Remove the timing chain from right crankcase.

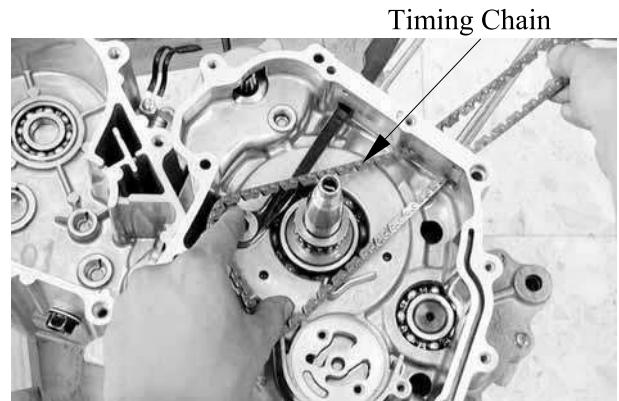

Remove the left and right crankcase attaching bolts.  
Separate the left and right crankcase halves.

\* Do not damage the crankcase gasket surface.

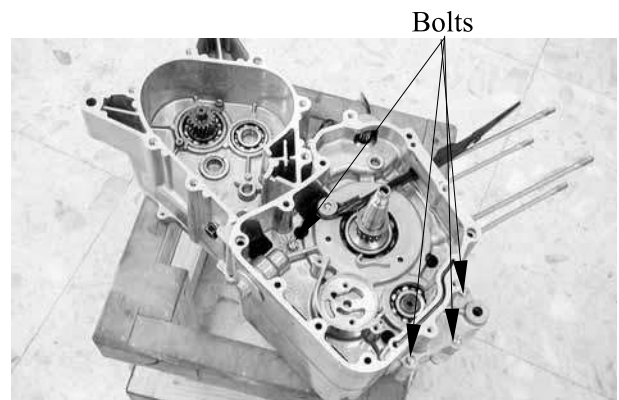

Remove the gasket and dowel pins.

Remove the crankshaft from the left crankcase.

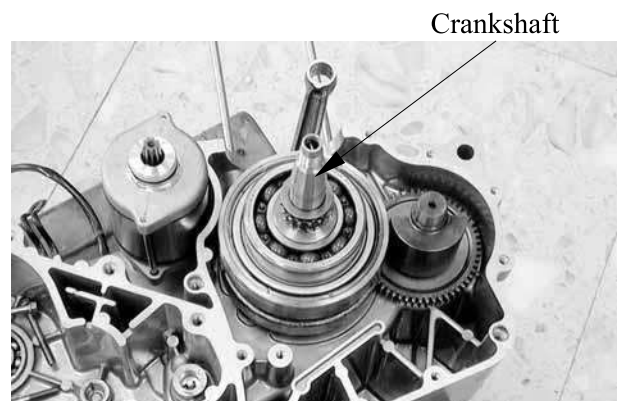

# 11. CRANKCASE/CRANKSHAFT/ BALANCE SHAFT

Mongoose/KXR 250

Remove balance shaft from the left crankcase.

Balance Shaft

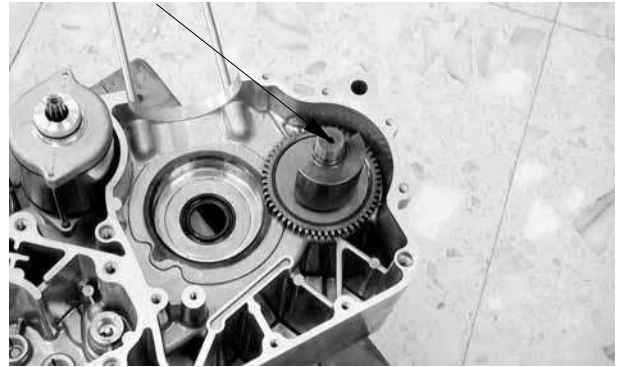

Clean off all gasket material from the crankcase mating surfaces.

\* Avoid damaging the crankcase mating surfaces.



Inspect the balance shaft gear teeth.  
Burr/chips/roughness/wear → Replace.



## CRANKSHAFT INSPECTION

Inspect the crankshaft gear teeth.  
Burr/chips/roughness/wear → Replace.

Measure the connecting rod small end I.D.  
**Service Limit:** 17.06 mm replace if over



# 11. CRANKCASE/CRANKSHAFT/ BALANCE SHAFT

Mongoose/KXR 250

Measure the connecting rod small end free play (A).

Out of specification (0.8 ~ 1.0 mm) →  
Replace the crankshaft.

Measure the crankshaft run out (B).

**Service Limit:** 0.10mm replace if over

Measure the connecting rod big end side clearance (C).

**Service Limit:** 0.6mm replace if over

Measure the crank width (D).

Out of specification (55.15 ~ 55.2 mm) →  
Replace the crankshaft.

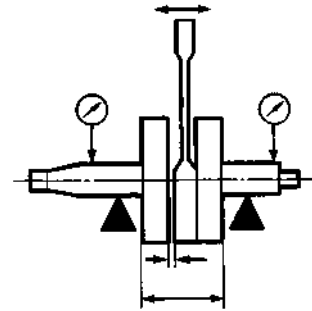

Turn the crankshaft bearings and check for excessive play.

Measure the crankshaft bearing play.

**Service Limit:**

Axial : 0.20mm replace if over

Radial : 0.05mm replace if over

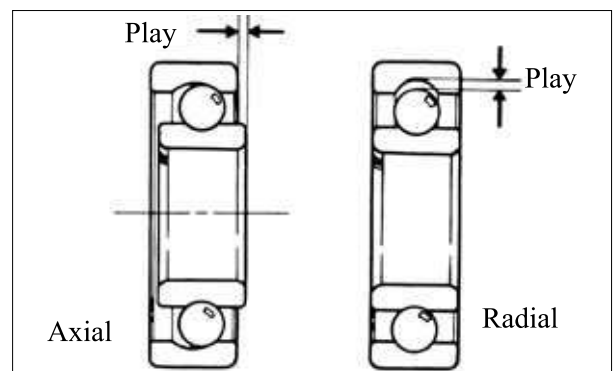

# 11. CRANKCASE/CRANKSHAFT/ BALANCE SHAFT

Mongoose/KXR 250

## CRANKCASE/BALANCER INSTALLATION

Install the balance shaft and crankshaft into the left crankcase.

- \* Align the mark on the balance shaft with the mark on the crankshaft.

Install the dowel pins and new gasket.  
Install the right crankcase and tighten the crankcase attach bolts.  
Install the timing chain.

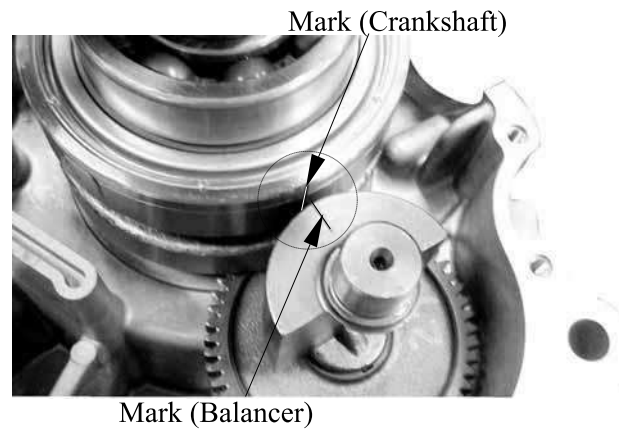

# 12. COOLING SYSTEM

---

---

## COOLING SYSTEM

---

SERVICE INFORMATION-----	12- 1
TROUBLESHOOTING-----	12- 1
COOLING SYSTEM TESTING-----	12- 3
RADIATOR -----	12- 4
WATER PUMP -----	12- 6
THERMOSENSOR-----	12-10
THERMOSTAT-----	12-11

## 12. COOLING SYSTEM

---

### SERVICE INFORMATION

#### GENERAL INSTRUCTIONS

- The water pump must be serviced after removing the engine.  
Other cooling system service can be done with the engine installed in the frame.
- The engine must be cool before servicing the cooling system.  
When the coolant temperature is over 100°C, never remove the radiator cap to release the pressure because the boiling coolant may cause danger.
- Avoid spilling coolant on painted surfaces because the coolant will corrode the painted surfaces.  
Wash off any spilled coolant with fresh water as soon as possible.
- After servicing the system, check for leaks with a cooling system tester.

#### SPECIAL TOOL

Mechanical seal driver

#### TORQUE VALUES

Water pump impeller	1.0~1.4kgf-m
Water pump cover bolt	0.8~1.2kgf-m

#### TROUBLESHOOTING

##### Engine temperature too high

- Faulty temperature gauge or thermosensor
- Faulty radiator cap
- Faulty thermostat
- Insufficient coolant
- Passages blocked in hoses or water jacket
- Clogged radiator fins
- Passages blocked in radiator
- Faulty water pump

##### Coolant leaks

- Faulty pump mechanical (water) seal
- Deteriorated O-rings
- Damaged or deteriorated water hoses

##### Temperature gauge pointer does not register the correct coolant temperature

- Faulty temperature gauge or thermosensor
- Faulty thermostat



# 12. COOLING SYSTEM

## SPECIFICATIONS

Radiator cap relief pressure		075~1.05kg/cm <sup>2</sup>	
Thermostat temperature	Begins to open	80±2°C	
	Full-open	90°C	
	Valve lift	3.5~4.5mm	
Coolant capacity		Total system 1400±20cc	Radiator: 1100±20cc Reserve tank: 300±20cc

## COOLANT GRAVITY

Temp. °C Coolant concentration	0	5	10	15	20	25	30	35	40	45	50
5%	1.009	1.009	1.008	1.008	1.007	1.006	1.005	1.003	1.001	0.009	0.997
10%	1.018	1.107	1.017	1.016	1.015	1.014	0.013	1.011	1.009	1.007	1.005
15%	1.028	1.027	1.026	1.025	1.024	1.022	1.020	1.018	1.016	1.014	1.012
20%	1.036	1.035	1.034	1.033	1.031	1.029	1.027	1.025	1.023	1.021	1.019
25%	1.045	1.044	1.043	1.042	1.040	1.038	1.036	1.034	1.031	1.028	1.025
30%	1.053	1.051	1.051	1.049	1.047	1.045	1.043	1.041	1.038	1.035	1.032
35%	1.063	1.062	1.060	1.058	1.056	1.054	1.052	1.049	1.046	1.043	1.040
40%	1.072	1.070	1.068	1.066	1.064	1.062	1.059	1.056	1.053	1.050	1.047
45%	1.080	1.078	1.076	1.074	1.072	1.069	1.056	1.063	1.062	1.057	1.054
50%	1.086	1.084	1.082	1.080	1.077	1.074	1.071	1.068	1.065	1.062	1.059
55%	1.095	1.093	1.091	1.088	1.085	1.082	1.079	1.076	1.073	1.070	1.067
60%	1.100	1.098	1.095	1.092	1.089	1.086	1.083	1.080	1.077	1.074	1.071

## COOLANT MIXTURE (WITH ANTI-RUST AND ANTI-FREEZING EFFECTS)

Freezing Point	Mixing Rate	KYMCO SIGMA Coolant Concentrate	Distilled Water
-9°C	20%		
-15°C	30%	425cc	975cc
-25°C	40%		
-37°C	50%		
-44.5°C	55%		

### Cautions for Using Coolant:

- Use coolant of specified mixing rate. (The mixing rate of 425cc KYMCO SIGMA coolant concentrate + 975cc distilled water is 30%.)
- Do not mix coolant concentrate of different brands.
- Do not drink the coolant which is poisonous.
- The freezing point of coolant mixture shall be 5°C lower than the freezing point of the riding area.

## 12. COOLING SYSTEM

### COOLING SYSTEM TESTING

#### RADIATOR CAP INSPECTION

Install the radiator cap onto the radiator tester and apply specified pressure to it. It must hold specified pressure for at least six seconds.

- \* Apply water to the cap sealing surface before testing.

#### Radiator Cap Relief Pressure:

0.75~1.05kg/cm<sup>2</sup>

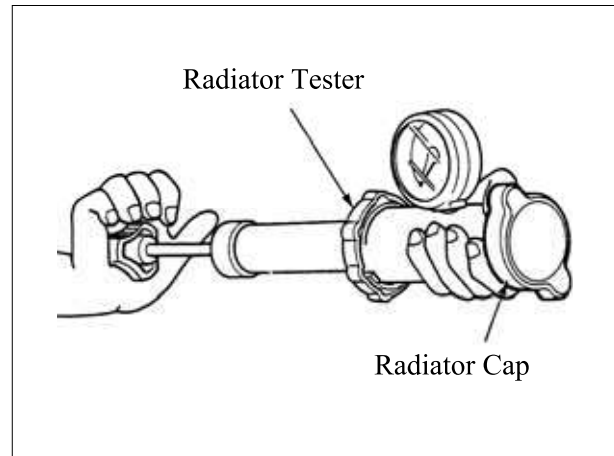

Install the radiator tester onto the radiator and apply specified pressure to it. It must hold specified pressure for at least six seconds.

Check the water hoses and connectors for leaks.

- \* The test pressure should not exceed 1.05 kg/cm<sup>2</sup>. Excessive pressure can damage the radiator and its hose

# 12. COOLING SYSTEM

## RADIATOR

### RADIATOR INSPECTION

Remove the front fender. (⇒2-5)  
 Inspect the radiator soldered joints and seams for leaks.  
 Blow dirt out from between core fins with compressed air. If insects, etc., are clogging the radiator, wash them off.  
 Carefully straighten any bent fins.

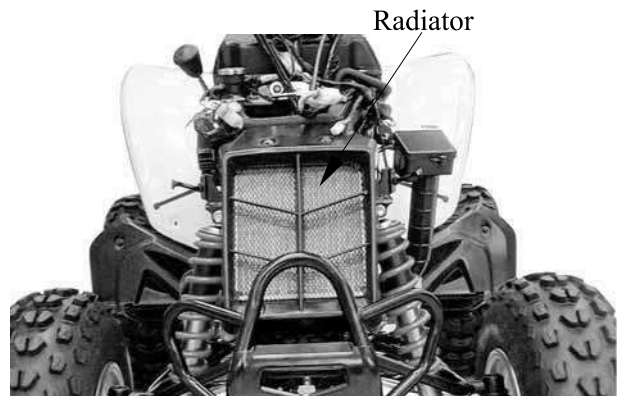

### RADIATOR REMOVAL

Drain the coolant. (⇒3-20)  
 Remove the front fender. (⇒2-5)

Disconnect the air vent tube from the radiator filler.  
 Remove the overflow tube clamp and disconnect the overflow tube.  
 Disconnect the fan motor wire coupler.

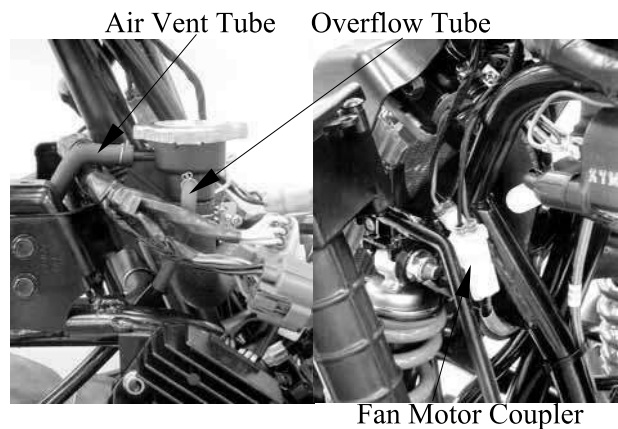

Remove the two bolts on the radiator filler hold plate.  
 Remove the two bolts on the radiator.

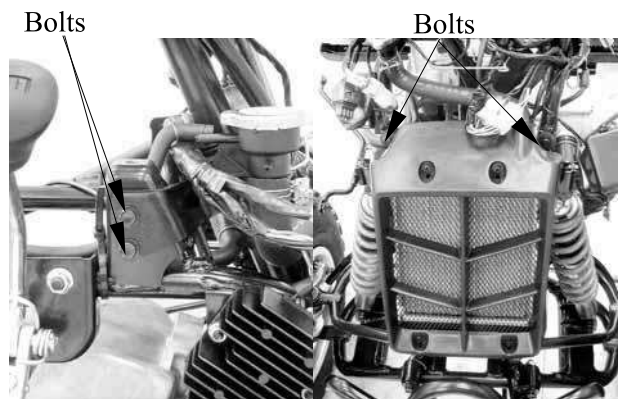

Disconnect the thermostatic switch wire leads.  
 Loosen the hose bands and disconnect the upper hose and lower hose from the radiator.  
 Pull the radiator upward to remove the radiator.

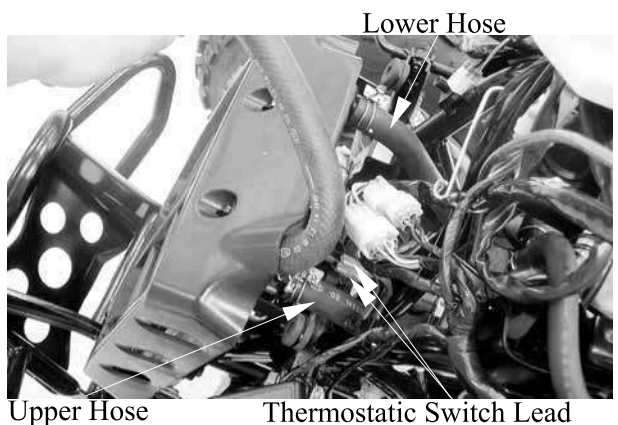

## 12. COOLING SYSTEM

### RADIATOR DISASSEMBLY

Remove the three bolts and then remove the fan/shroud from the radiator.

Check fan motor by battery.

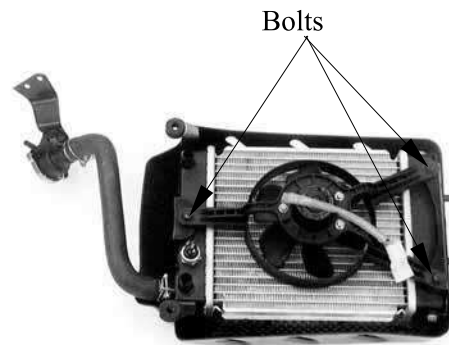

### CHECK THERMOSTATIC SWITCH

When coolant temperature lower than 85~90°C the thermostatic switch OFF.  
When coolant temperature over 85~90°C the thermostatic switch ON.

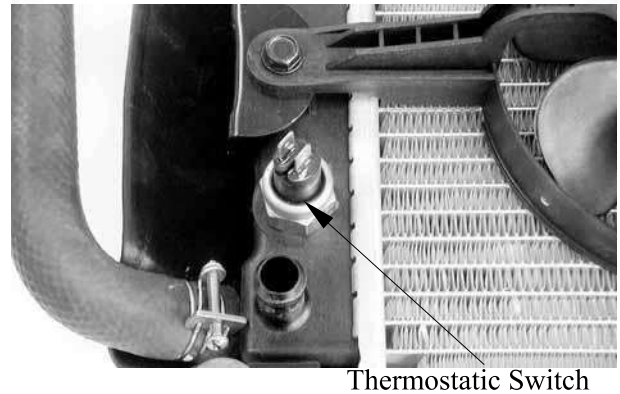

### RADIATOR ASSEMBLY

Install the fan shroud on the radiator with the three bolts.

### RADIATOR INSTALLATION

Reverse the "RADIATOR REMOVAL" procedures.

Fill the radiator with coolant. (⇒3-20)

Connect the vent tube to the radiator filler.

After installation, check for coolant leaks.

\*

If you want to refill the coolant, the following procedure must be checked.

1. Please make the radiator filler and the air vent tube to be separated.
2. Then start the engine, filled in the coolant till the coolant flowed out from the air vent tube.
3. Put the air vent tube on.

# 12. COOLING SYSTEM

## WATER PUMP

### MECHANICAL SEAL (WATER SEAL) INSPECTION

Inspect the telltale hole for signs of mechanical seal coolant leakage.  
If the mechanical seal is leaking, remove the right crankcase cover and replace the mechanical seal.

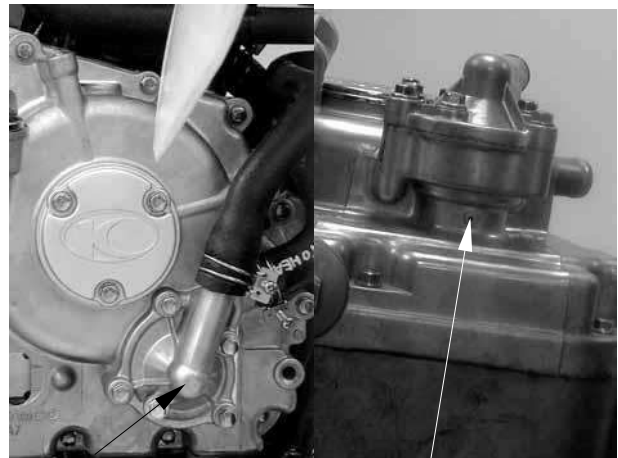

Water Pump

Telltale Hole

### WATER PUMP/IMPELLER REMOVAL

Drain the coolant. (⇒3-20)

Loosen the screw and disconnect the coolant inlet hose.

Remove the four bolts and the water pump cover.

Water Pump Cover

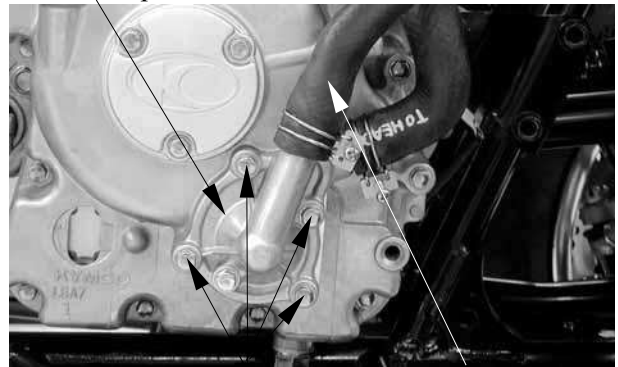

Bolts

Inlet Hose

Remove the gasket and 2 dowel pins

Remove the water pump impeller, washer and seal washer (porcelain).

\* The impeller has left hand threads.

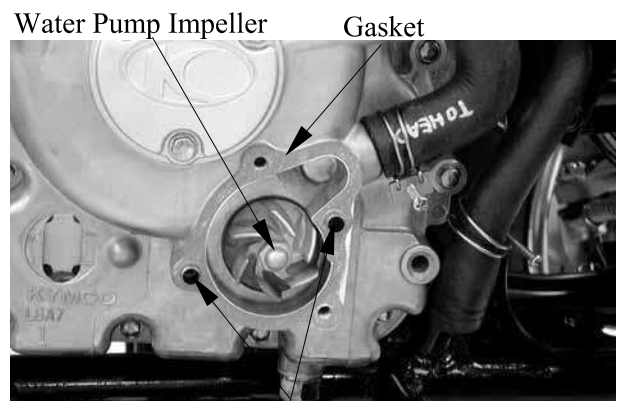

Water Pump Impeller

Gasket

Dowel Pins

## 12. COOLING SYSTEM

Inspect the mechanical (water) seal and seal washer for wear or damage.

\* The mechanical seal and seal washer must be replaced as a set.

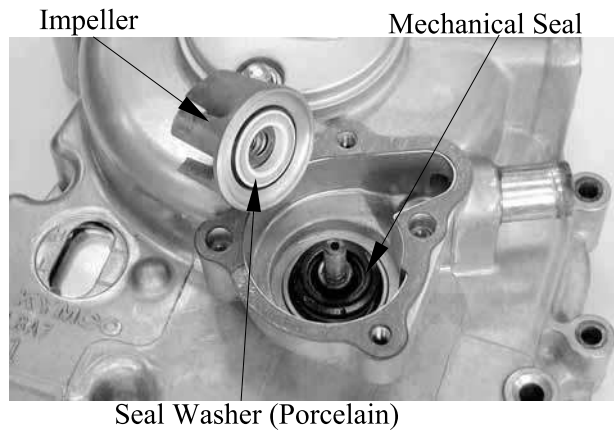

### WATER PUMP SHAFT REMOVAL

Remove the water pump impeller. (⇒ 12-6)

Disconnect the water hose from the right crankcase cover.

Remove the twelve bolts attaching the right crankcase cover.

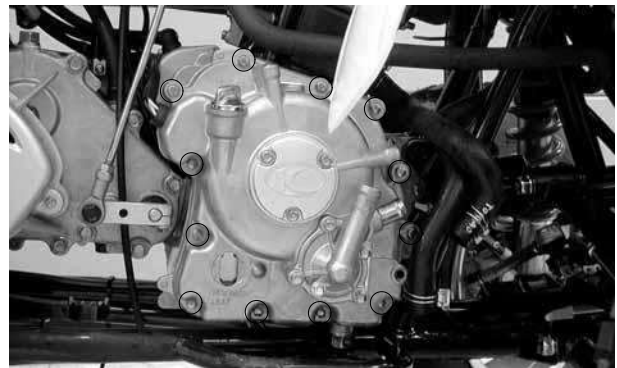

Remove the water pump bearing snap ring from the water pump assembly.

Remove the water pump shaft and inner bearing.

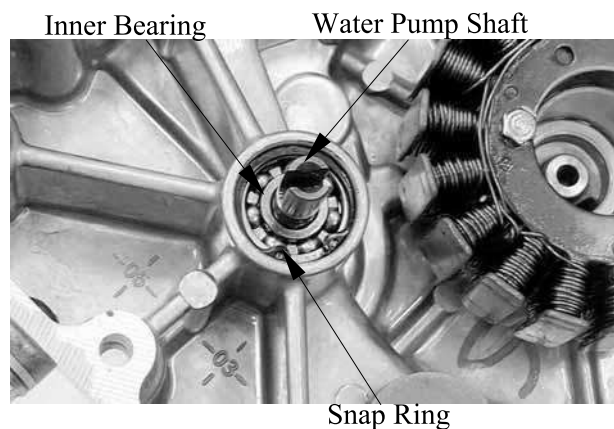

## 12. COOLING SYSTEM

Remove the water pump shaft outer bearing.

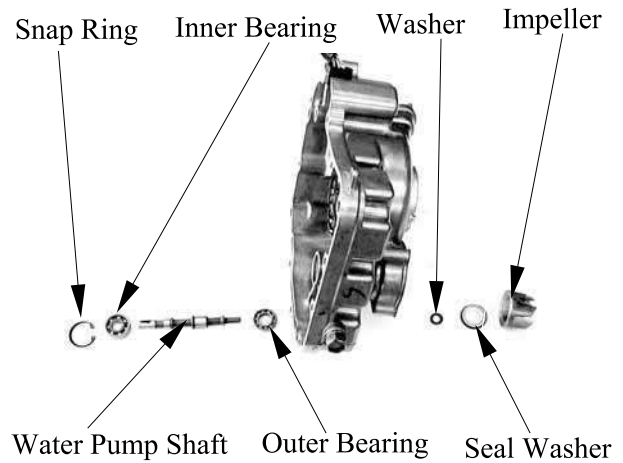

### MECHANICAL SEAL REPLACEMENT

Drive the mechanical seal out of the water pump assembly from the inside.

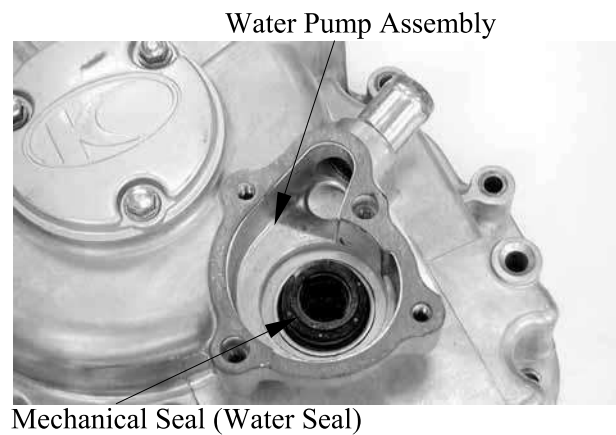

Drive in a new mechanical seal using a mechanical seal driver.

\* Apply sealant to the right crankcase cover fitting surface of a new mechanical seal and then drive in the mechanical seal.

## 12. COOLING SYSTEM

### WATER PUMP SHAFT INSTALLATION

Drive a new water pump shaft outer bearing into the water pump assembly from the inside.



Install the water pump shaft and shaft inner bearing into the water pump assembly. Install the snap ring to secure the inner bearing properly.

Install the dowel pins and a new gasket and then install the water pump assembly to the right crankcase cover.

Tighten the twelve bolts to secure the right crankcase cover.

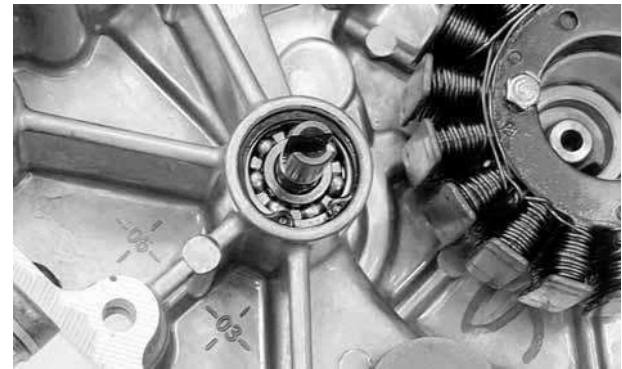

\* When installing the water pump assembly, aligning the groove on the water pump shaft with the tab on the oil pump shaft.

### WATER PUMP/IMPELLER INSTALLATION

When the mechanical seal is replaced, a new seal washer must be installed to the impeller.

Install the impeller onto the water pump shaft.

**Torque:** 1.0~1.4kgf-m

\* The impeller has left hand threads.



Install the two dowel pins and a new gasket. Install the water pump cover and tighten the four bolts.

**Torque:** 0.8~1.2 kgf-m



# 12. COOLING SYSTEM

## THERMOSENSOR

### THERMOSENSOR REMOVAL

Drain the coolant. (⇒3-20)  
 Disconnect the thermosensor wire.  
 Remove the thermosensor from the thermostat.

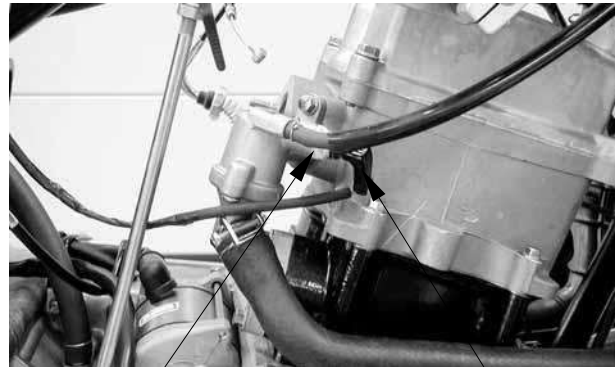

Thermosensor

Thermosensor Wire

### THERMOSENSOR INSPECTION

Suspend the thermosensor in a pan of water over a burner and measure the resistance through the sensor as the water heats up.

Temperature(°C)	50	80	100	120
Resistance(Ω)	154	52	27	16

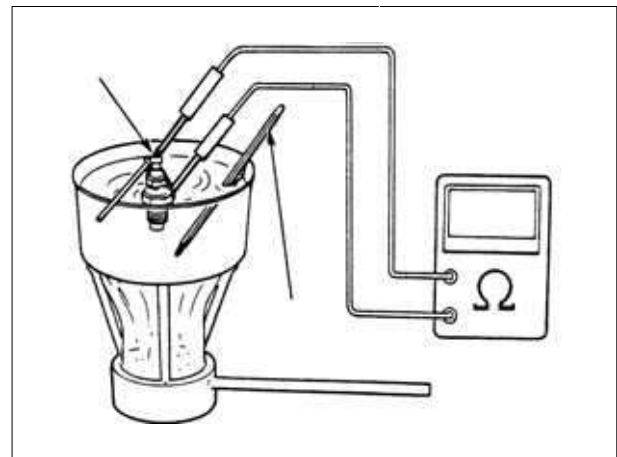

### THERMOSENSOR INSTALLATION

Apply 3-BOND No. 1212 sealant or equivalent to the thermosensor threads and install it into the thermostat housing.  
 Connect the thermosensor wire.  
 Fill the radiator with coolant. (⇒3-20)

\* Be sure to bleed air from the cooling system.

## 12. COOLING SYSTEM

### THERMOSTAT

#### THERMOSTAT REMOVAL

Drain the coolant. (⇒3-20)  
Disconnect the thermosensor wire from the thermosensor.  
Disconnect the water hose from the thermostat housing.  
Disconnect the air vent tube from the thermostat housing.  
Remove the mounting bolt and the thermostat housing from the cylinder head.

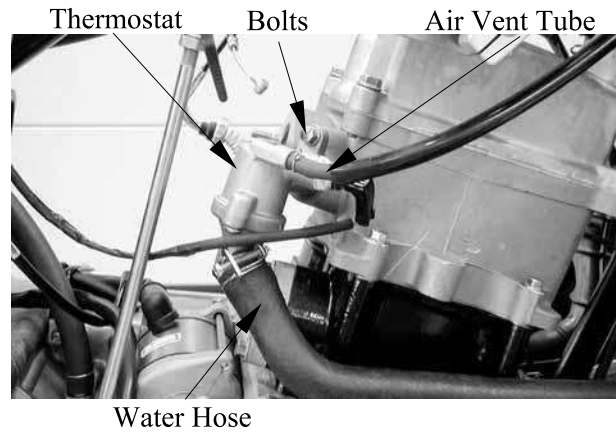

Remove the two screws and separate the thermostat housing halves.

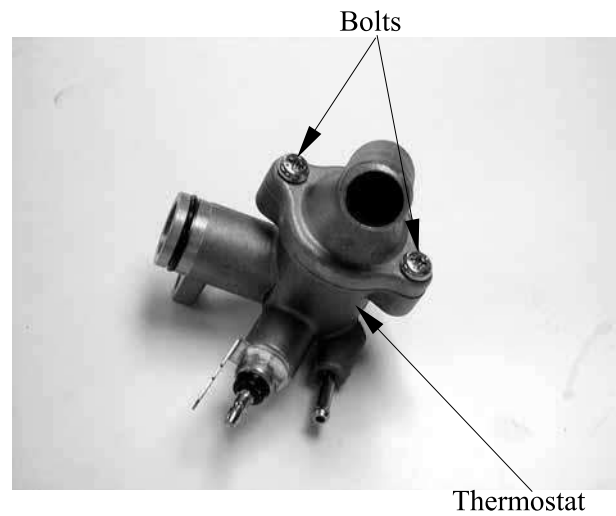

Remove the thermostat from the thermostat housing.

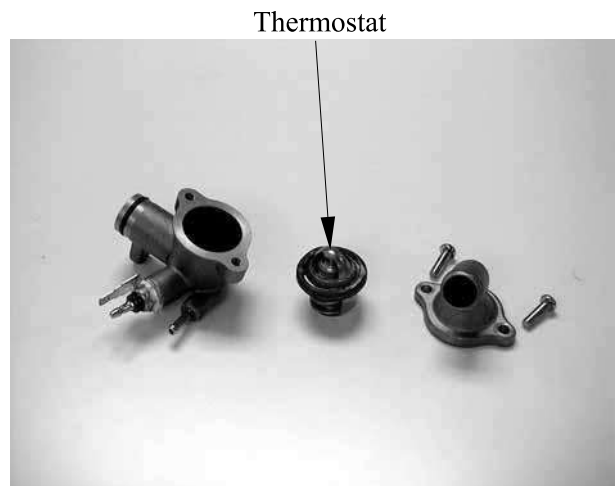

## 12. COOLING SYSTEM

### THERMOSTAT INSPECTION

Suspend the thermostat in a pan of water over a burner and gradually raise the water temperature to check its operation.

#### Technical Data

Begins to open	80±2°C
Full-open	90°C
Valve lift	3.5~4.5mm

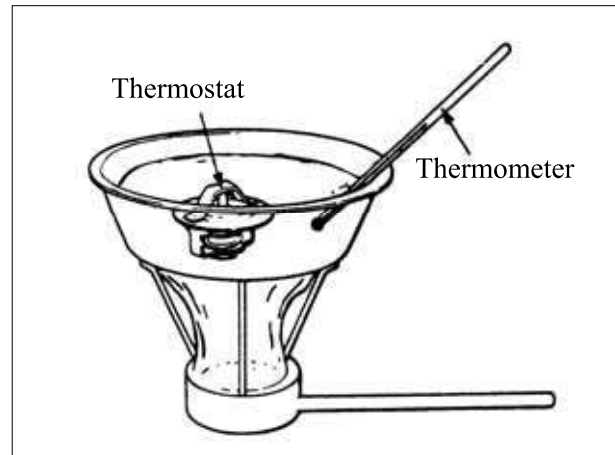

- \* Do not let the thermostat touch the pan as it will give a false reading.
- \* Replace the thermostat if the valve stays open at room temperature.
- \* Test the thermostat after it is opened for about 5 minutes and holds the temperature at 70°C.

### THERMOSTAT INSTALLATION

The installation sequence is the reverse of removal.

- \* Replace the O-ring with a new one and apply grease to it.

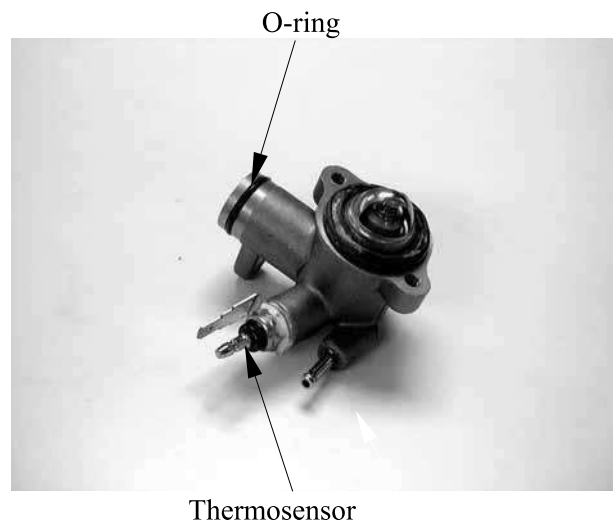

Fill the cooling system with the specified coolant. (⇒3-20)

## **13. BRAKE SYSTEM**

---

# 13. BRAKE SYSTEM

---

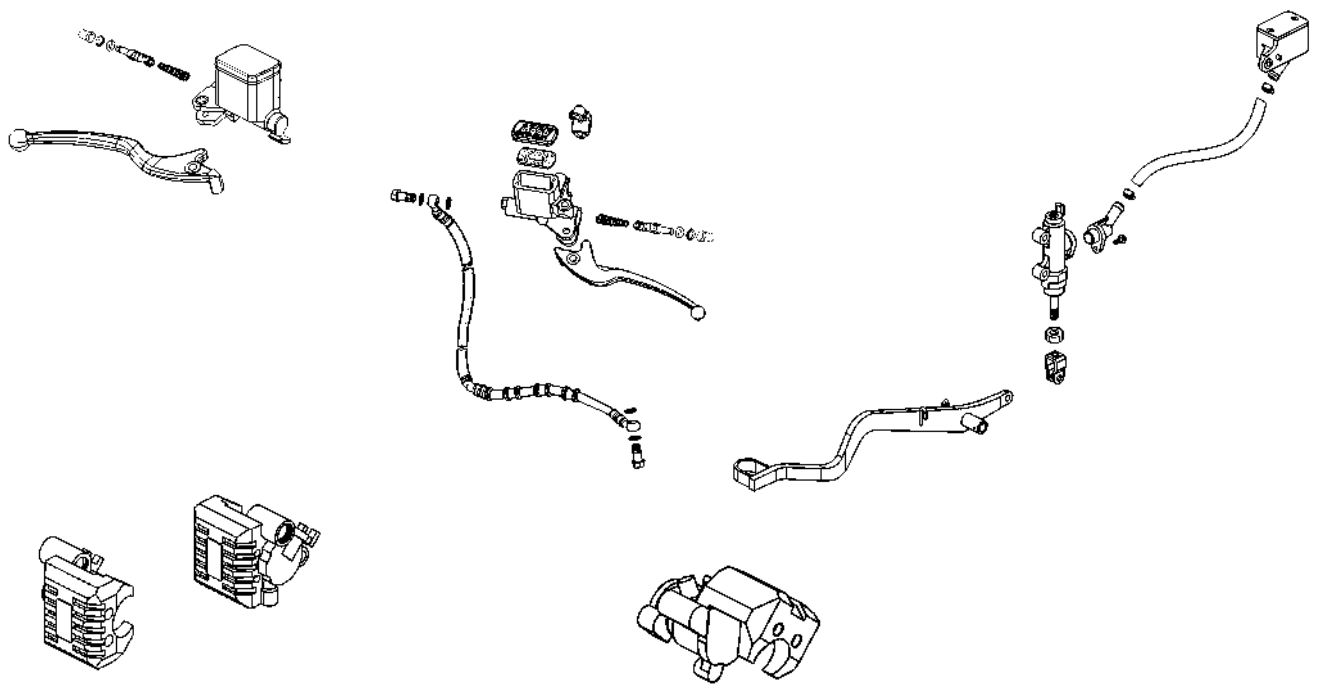

# 13. BRAKE SYSTEM

---

m	Standard (mm)	Service Limit (mm)
Brake disk thickness	3.8~4.2	3.0
Brake disk runout	—	0.30

## TROUBLESHOOTING

### Loose brake lever

- Air in hydraulic brake system
- Brake fluid level too low
- Hydraulic brake system leakage

### Poor brake performance

- Air in brake system
- Deteriorated brake fluid
- Contaminated brake pads and brake disk
- Worn brake pads
- Worn brake master cylinder piston oil seal
- Clogged brake fluid line
- Deformed brake disk
- Unevenly worn brake caliper

### Tight brake lever

- Seized piston
- Clogged hydraulic brake system
- Smooth or worn brake pad

### Brake noise

- Contaminated brake pad surface
- Excessive brake disk run out
- Incorrectly installed caliper
- Brake disk or wheel not aligned

### Hard braking

- Seized hydraulic brake system
- Seized piston

# 13. BRAKE SYSTEM

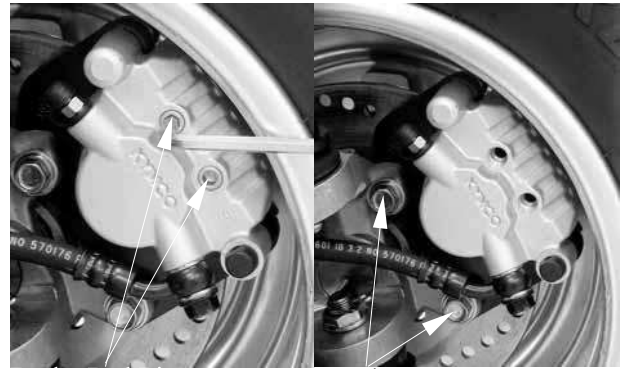

Bolts

Brake Caliper Holder

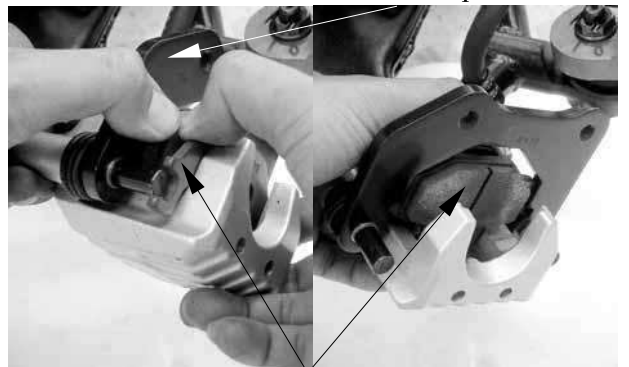

Brake Pads

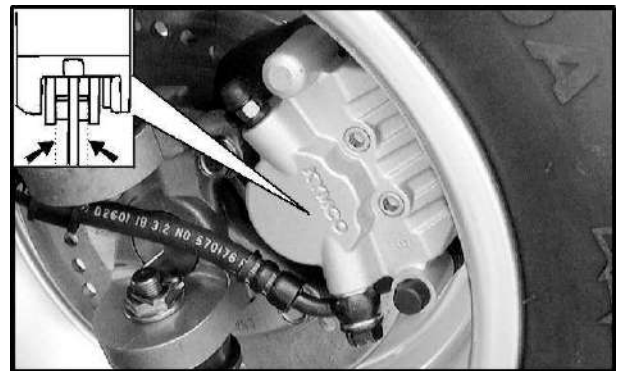

## 13. BRAKE SYSTEM

---

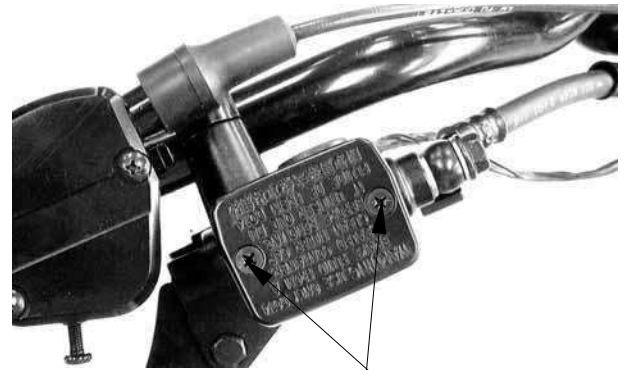

Screws



Bleed Valve

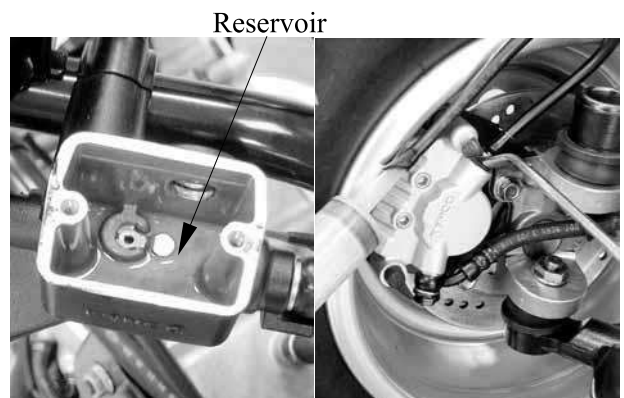

Reservoir

- When drawing brake fluid with the syringe, the brake fluid level should be kept over 1/2 of the brake reservoir height.
- Use only the recommended brake fluid.



## 13. BRAKE SYSTEM

When bleeding air from the brake system, the brake fluid level should be kept over 1/2 of the brake reservoir height.

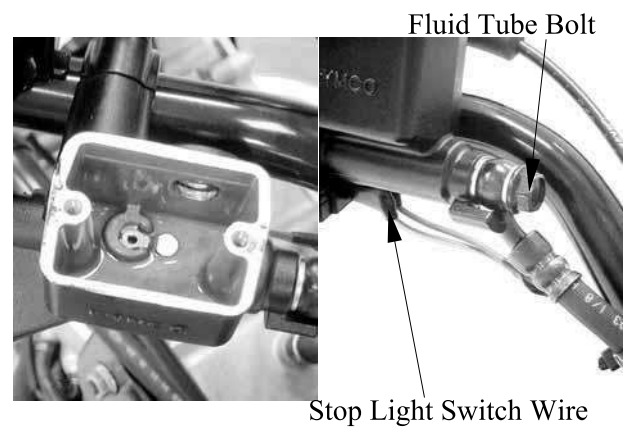

When removing the brake fluid tube bolt, be sure to place towels under the tube and plug the tube end to avoid brake fluid leakage and contamination.

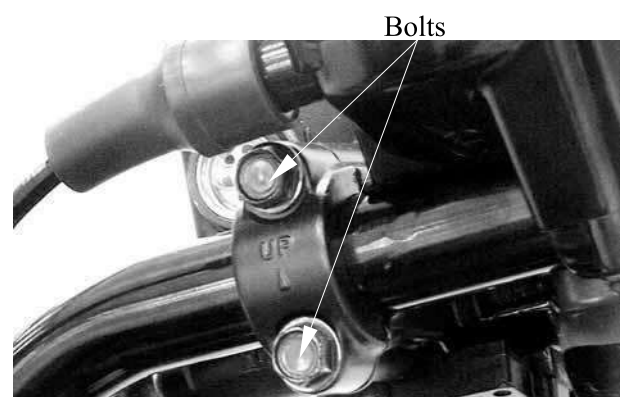

# 13. BRAKE SYSTEM

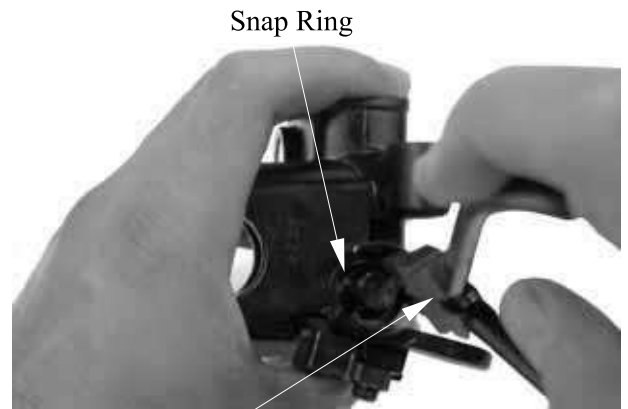

Snap Ring

Snap Ring Pliers (Close)

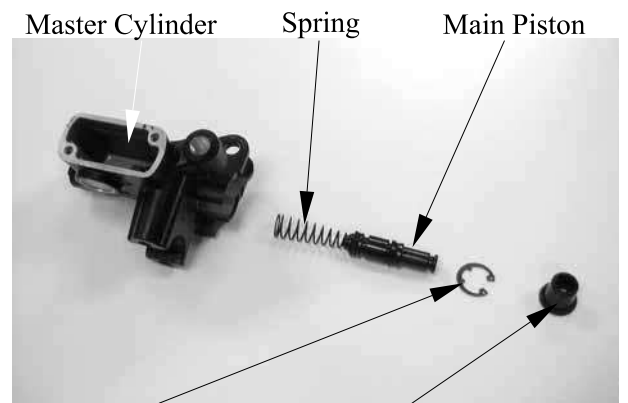

Master Cylinder

Spring

Main Piston

Snap Ring

r



## 13. BRAKE SYSTEM

---

\*

d

spring must be installed as a unit without exchange.

- When assembling the piston, soak the cups in brake fluid for a while.
- Install the cups with the cup lips facing the correct direction.

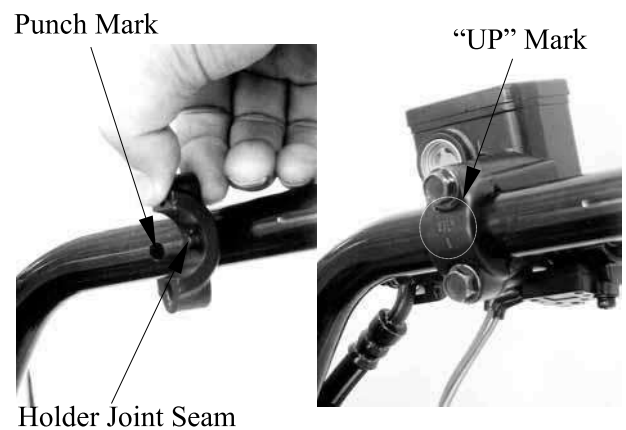

# 13. BRAKE SYSTEM

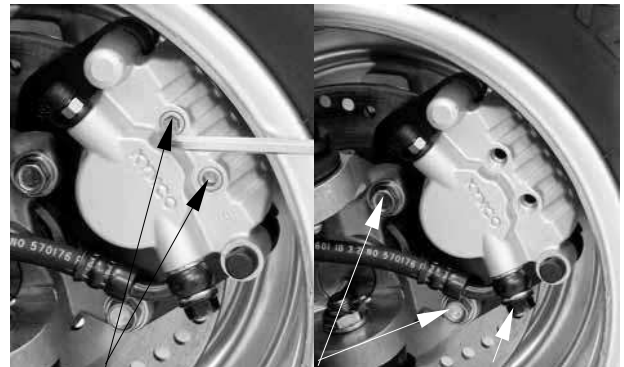

Brake Pad Pins      Bolts      Fluid Tube Bolt

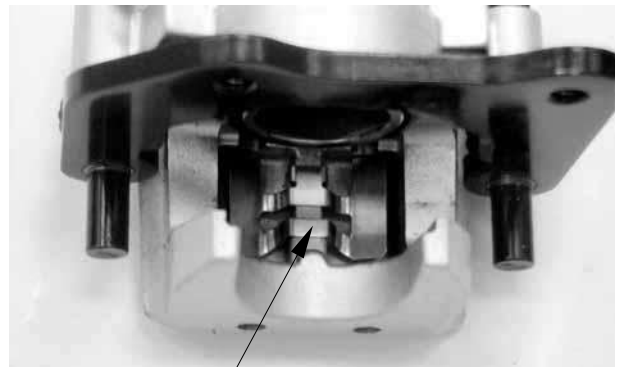

Spring Plate



Dust Seal

# 13. BRAKE SYSTEM

Inner Oil Seal

\*



\* Install the piston with its outer end protruding 3 ~ 5mm beyond the brake caliper.



## 13. BRAKE SYSTEM

---

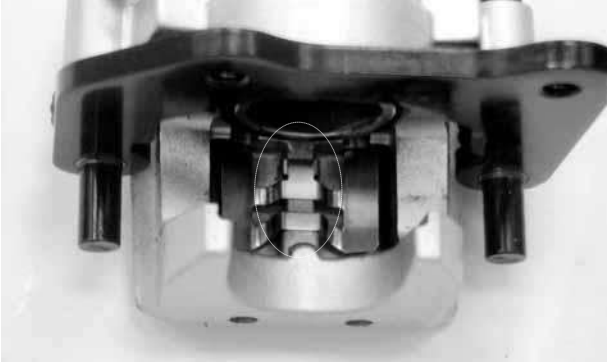
- \*  correctly engages with the locating slot on the caliper spring plate.

- \* When installing the brake caliper, be sure to position the brake disk between the two brake pads.

- \* When installing the brake fluid tube, be sure to install the two sealing washers.

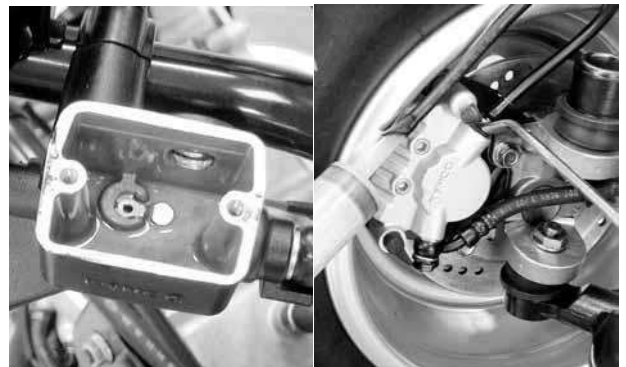

# 13. BRAKE SYSTEM

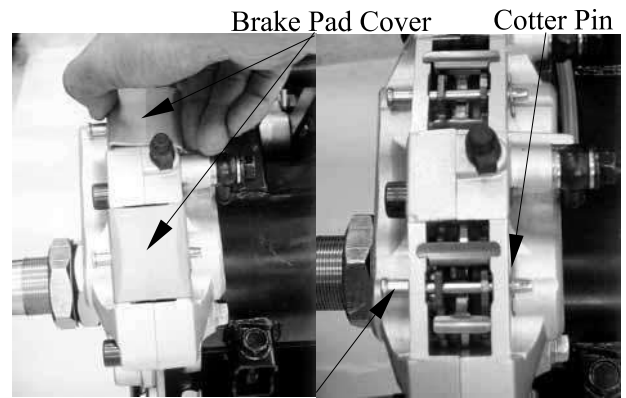

Brake Pad Pin

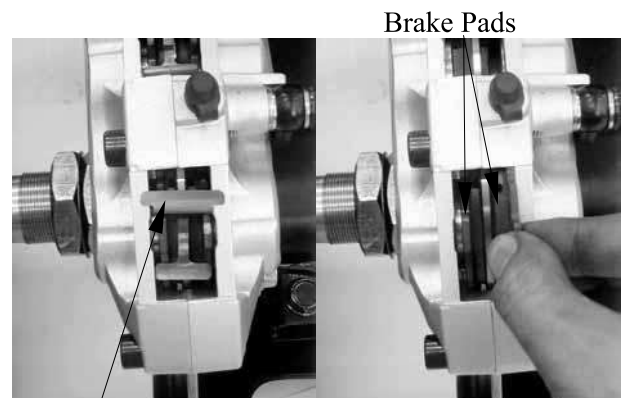

Spring Plate

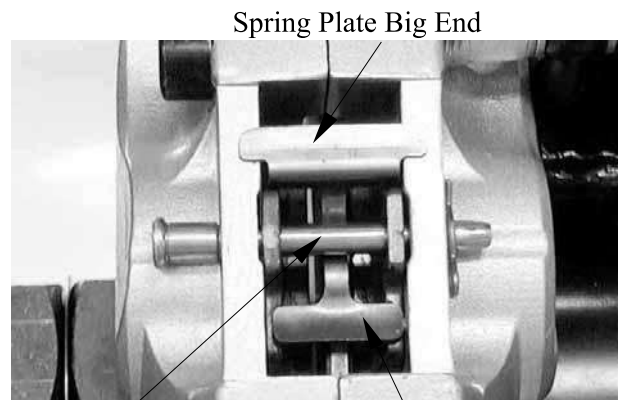

Brake Pad Pin

Spring Plate Small End

- \*
- Make sure put the spring plate big end on the rear caliper.
  - Make sure put the spring plate small end on the rear pads.
  - Make sure brake pad pin over the spring plate.

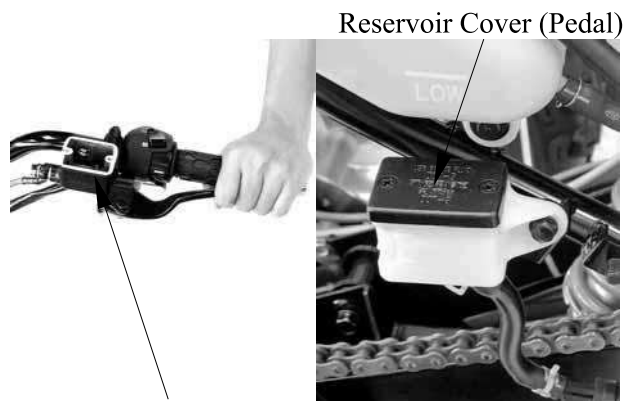

Reservoir (Front Left Lever)

# 13. BRAKE SYSTEM

Bleed Valve (Front Left Lever)

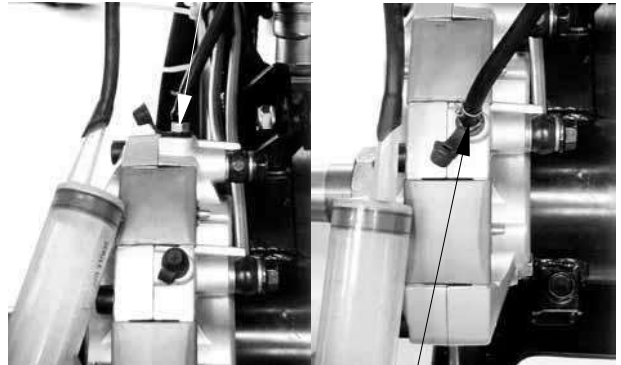

Bleed Valve (Pedal)

Bleed Valve (Front Left Lever)

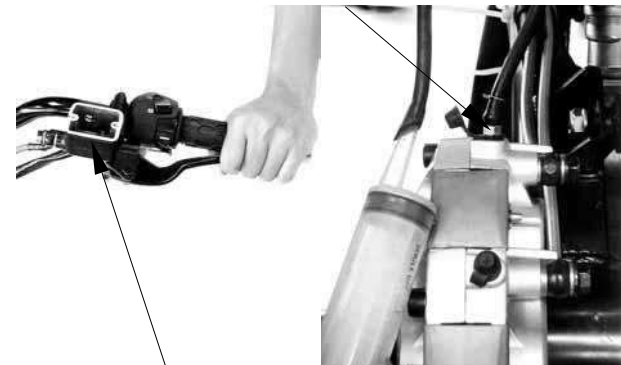

Reservoir (Front Left Lever) Bleed Valve (Pedal)

Reservoir Cover (Pedal)



Reservoir (Pedal) Reservoir Protection Cover

- When drawing brake fluid with the syringe, the brake fluid level (pedal) should be kept over 1/2 of the brake reservoir height.
- Use only the recommended brake fluid.



Brake Pedal

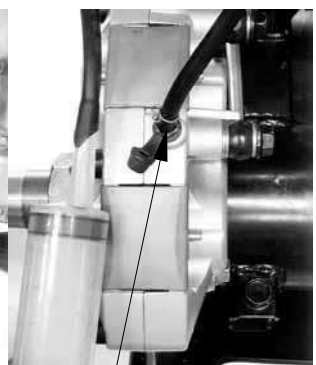

Bleed Valve (Pedal)



# 13. BRAKE SYSTEM

---

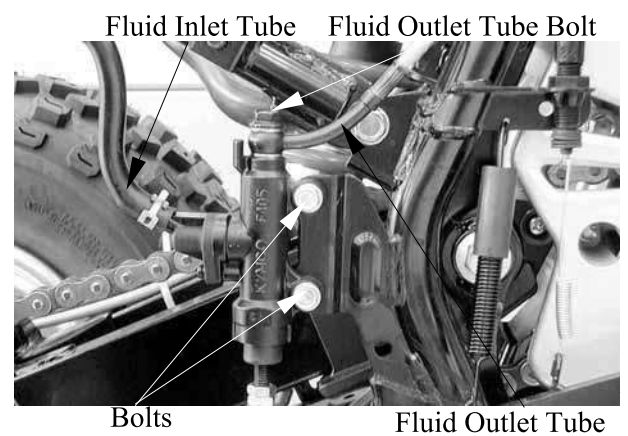
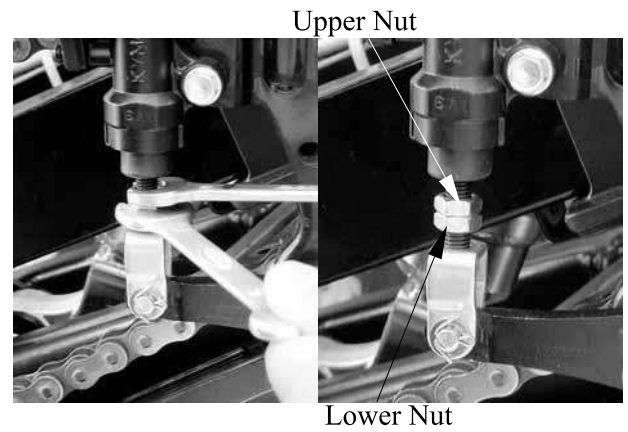

# 13. BRAKE SYSTEM

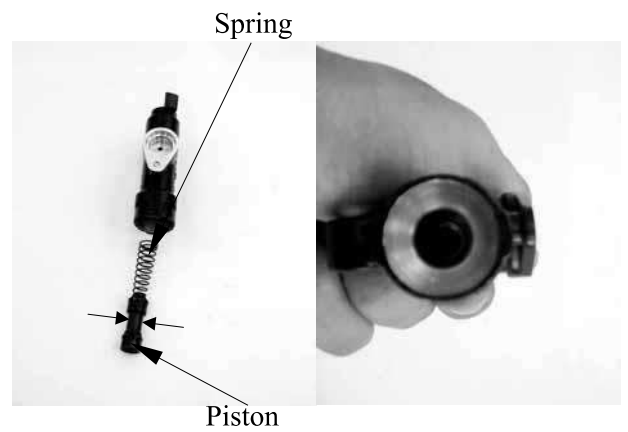
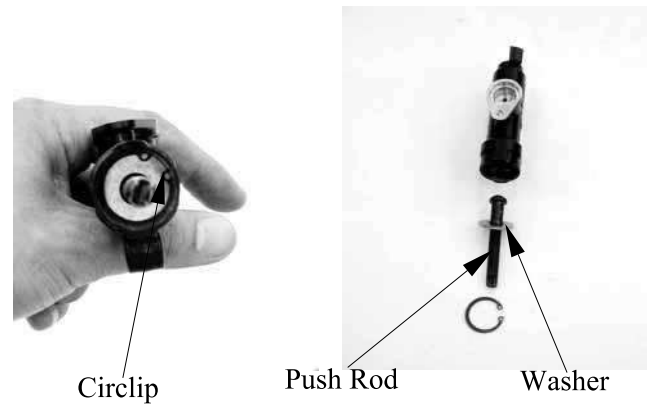
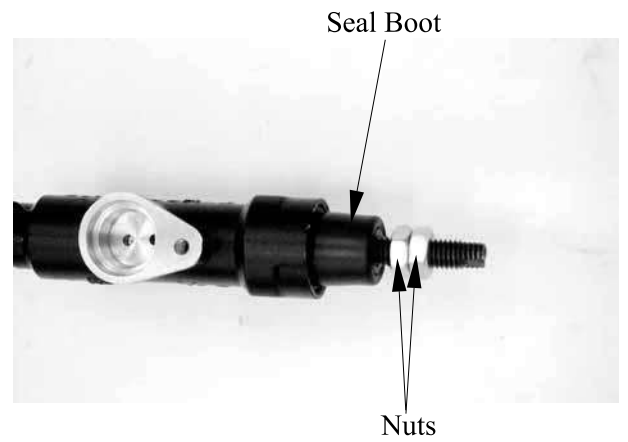
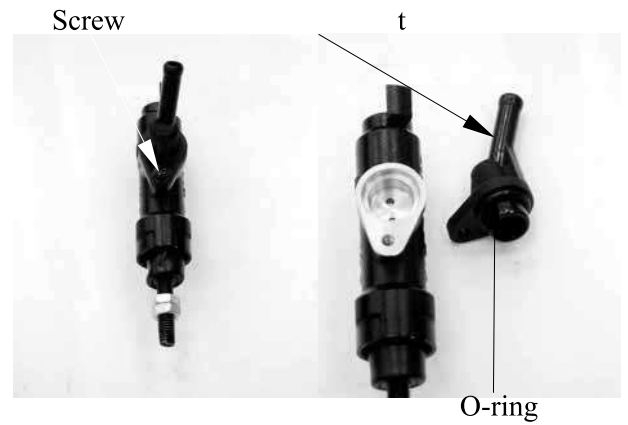

# 13. BRAKE SYSTEM

---

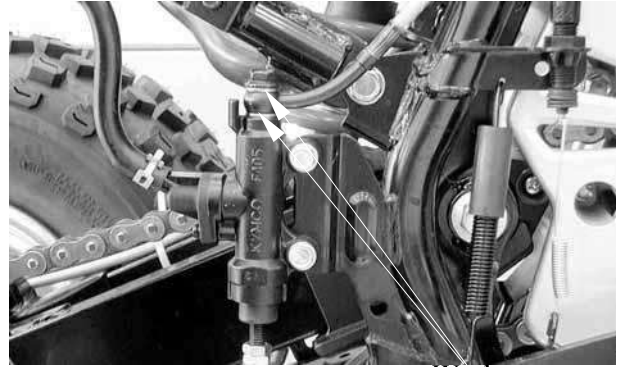

Washers

# 13. BRAKE SYSTEM

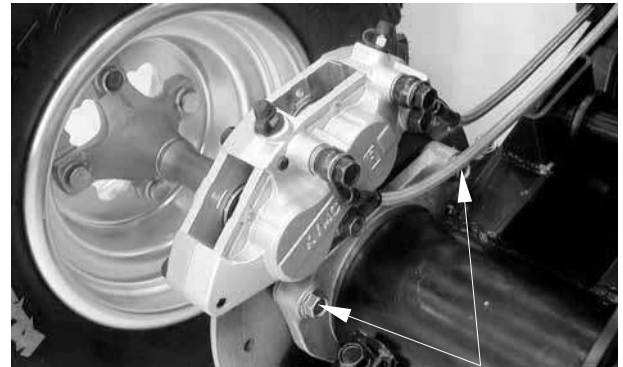

Bolts

Slightly loosen the caliper housing bolts before removing the caliper mounting bolts to facilitate later disassembly.



Bolts

Place a rag over the piston to prevent it from popping out and flying and keep hand off the piston.  
 Be careful of brake fluid which can possibly splash.  
 Do not use high pressure air but increase the pressure gradually.



Use care not to cause scratch on the cylinder bore.  
 Do not reuse the piston seal and dust seal that have been removed.

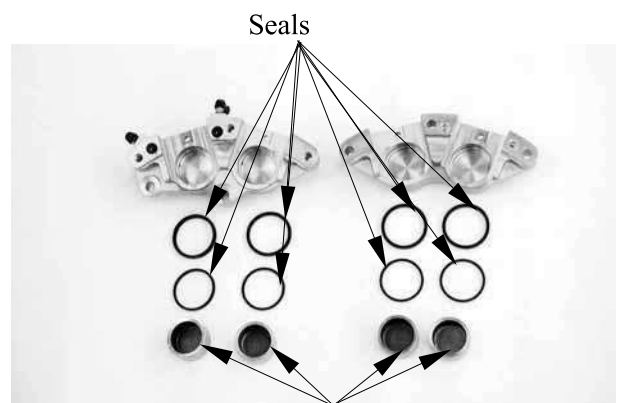

Seals

Piston

## 13. BRAKE SYSTEM

---

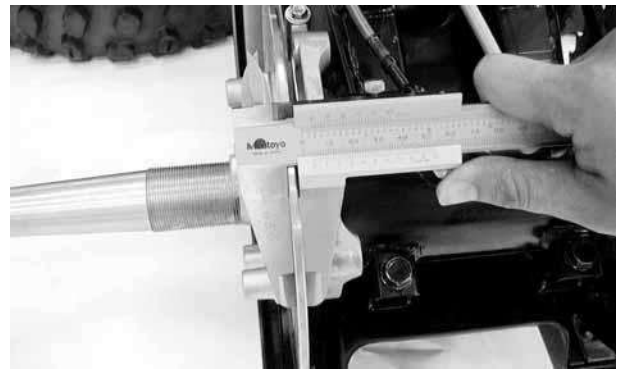
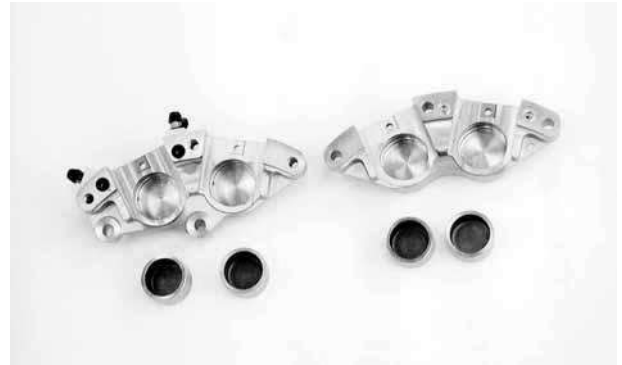

Wash the caliper components with fresh brake fluid before assembly. Do not wipe off brake fluid after washing the components.

Replace the piston seal and dust seal with new ones with brake fluid applied.

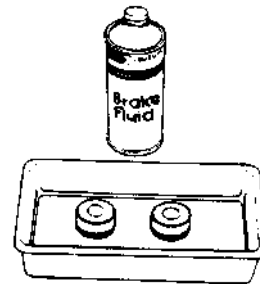

# 13. BRAKE SYSTEM

---



Washers

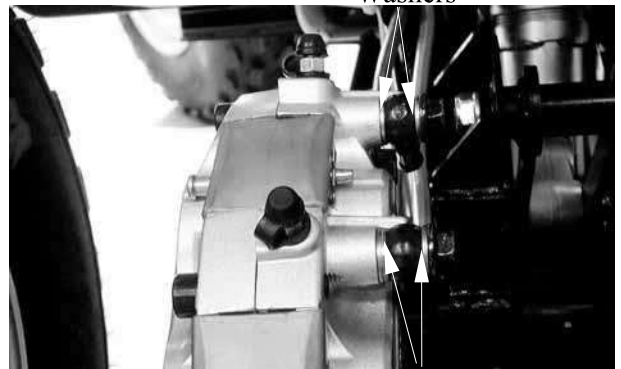

# 14. FRONT WHEEL/FRONT SUSPENSION/ STEERING SYSTEM

---



14

# 14. FRONT WHEEL/FRONT SUSPENSION/ STEERING SYSTEM

---

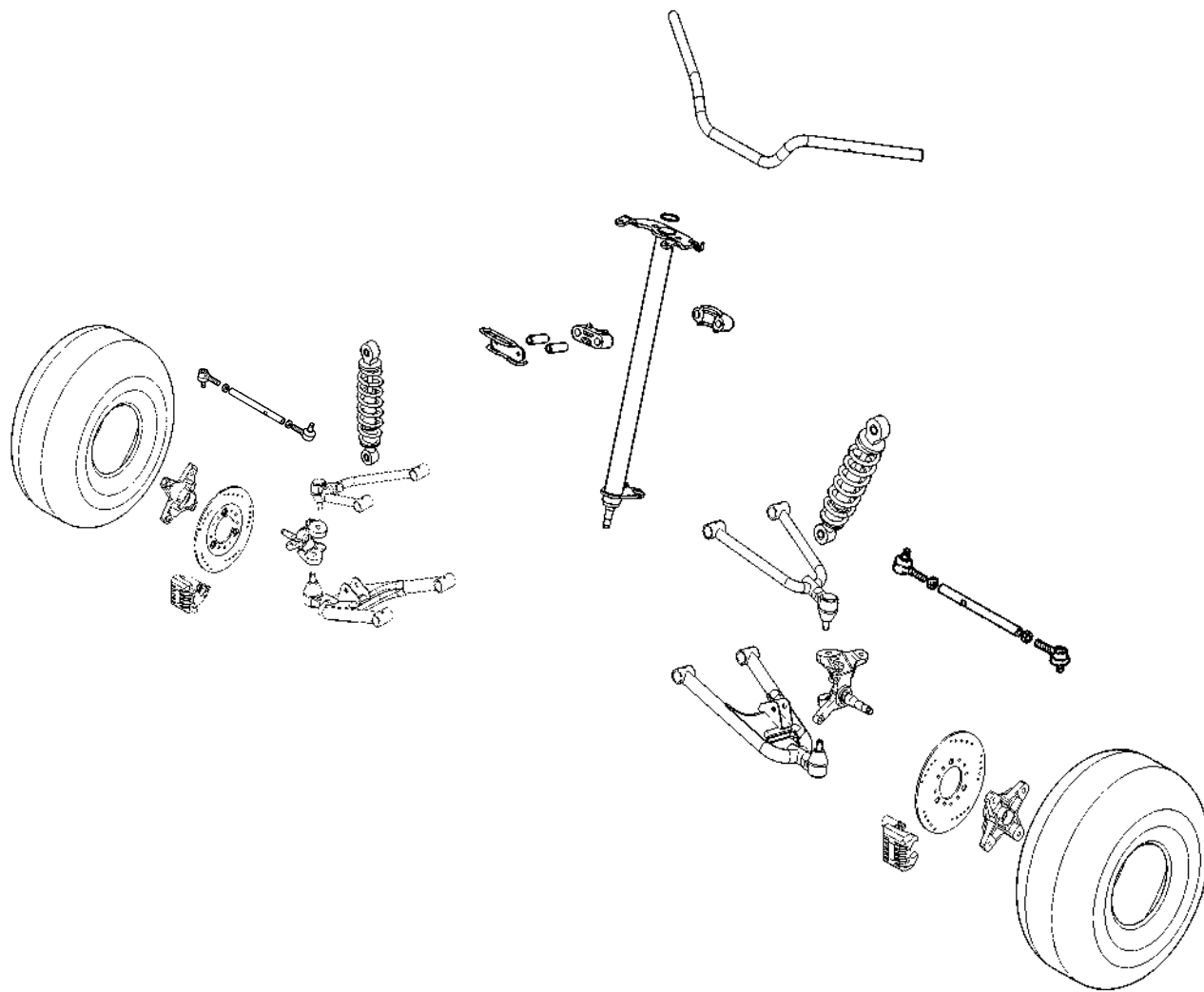



# 14. FRONT WHEEL/FRONT SUSPENSION/ STEERING SYSTEM



m		Standard (mm)	Service Limit (mm)
Front wheel rim run out	Radial	—	2.0
	Axial	—	2.0
Tie rod length		299.5±0.5	—
Rod-end (tie rod) angle		180°	—

## TORQUE VALUES

Steering stem nut	6.0~8.0kgf-m
Front swing arm nut	4.0~5.0kgf-m
Front wheel nut	4.0~5.0kgf-m
Front wheel hub nut	6.0~8.0kgf-m
Steering knuckle nut	3.0~4.0kgf-m
Front shock absorber upper mount bolt	3.5~4.5kgf-m
Front shock absorber lower mount bolt	3.5~4.5kgf-m

## SPECIAL TOOLS

Oil seal and bearing install E014

## TROUBLESHOOTING

### Hard steering (heavy)

- Insufficient tire pressure

### Steers to one side or does not track straight

- Uneven front shock absorbers
- Bent front arm
- Bent steering knuckle

### Front shock absorber noise

- Slider bending
- Loose arm fasteners
- Lack of lubrication

### Front wheel wobbling

- Bent rim
- Excessive wheel bearing play
- Bent spoke plate
- Faulty tire
- Improperly tightened axle nut

### Soft front shock absorber

- Weak shock springs
- Insufficient damper oil

# 14. FRONT WHEEL/FRONT SUSPENSION/ STEERING SYSTEM



\*

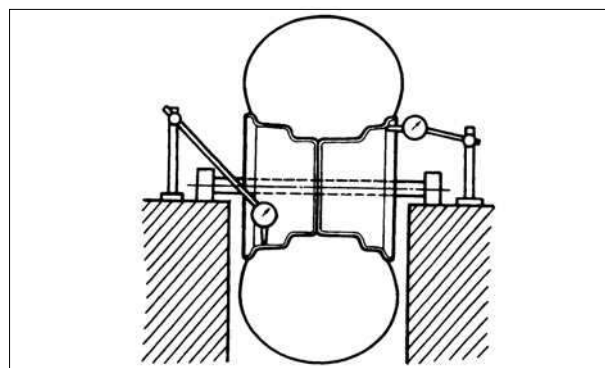
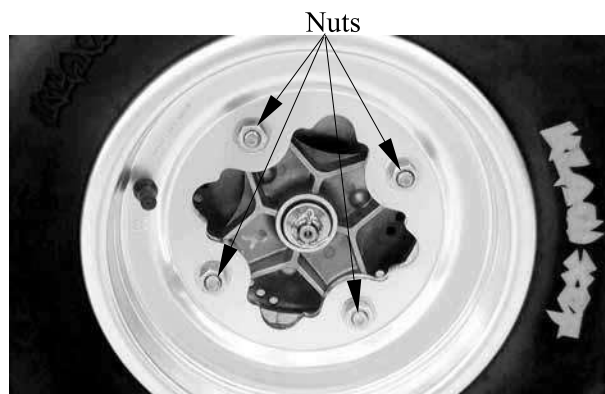

\* Be sure the tapered side of the wheel nuts face the wheel rim.

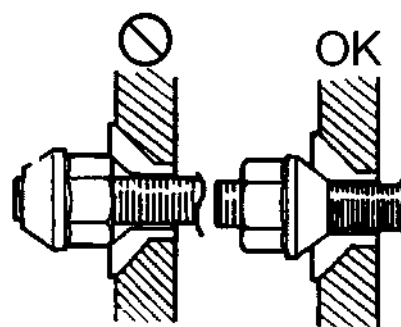

# 14. FRONT WHEEL/FRONT SUSPENSION/ STEERING SYSTEM



\*

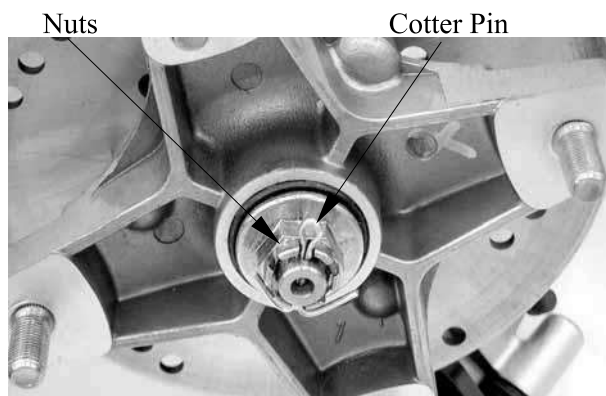

\* Place a wood block against the outer edge to protect this edge.

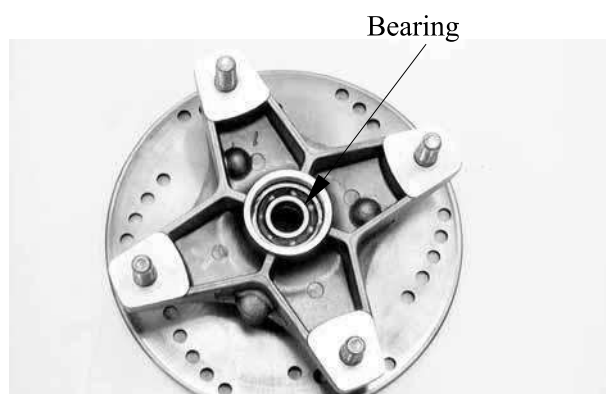
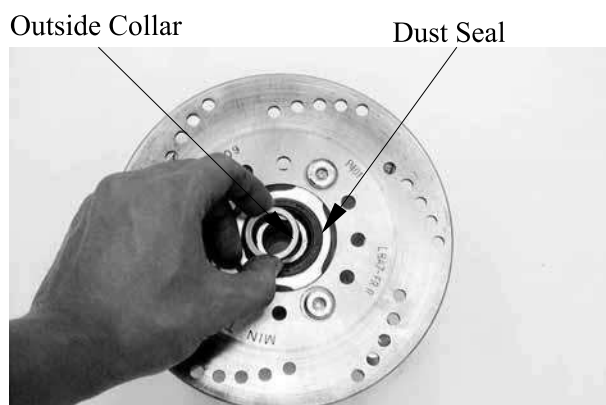
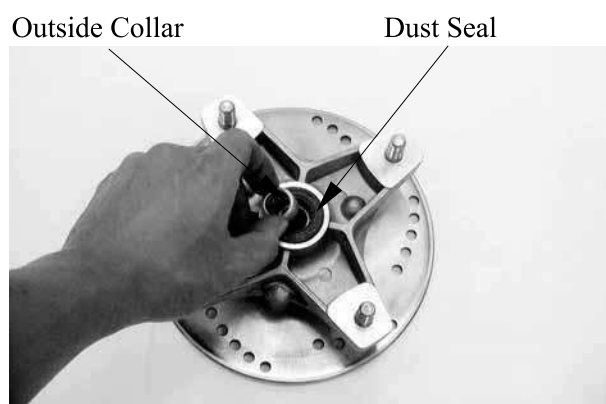

# 14. FRONT WHEEL/FRONT SUSPENSION/ STEERING SYSTEM

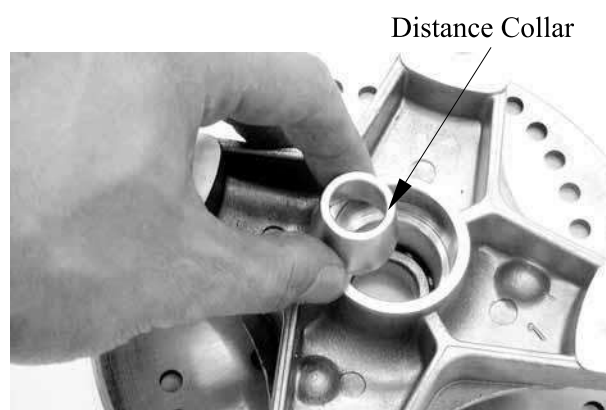
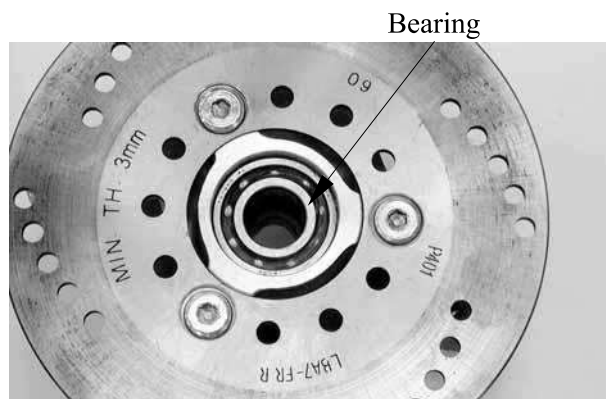

\*

# 14. FRONT WHEEL/FRONT SUSPENSION/ STEERING SYSTEM



\*

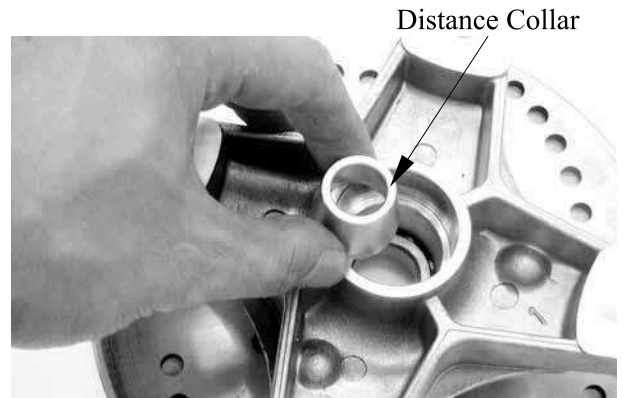

\* Apply the grease onto the oil seal lips, bearing.



- \*
  - Do not allow the bearings to tilt while driving them in.
  - Do not strike the center race or balls of the bearing. Contact should be made only with the outer race.
  - Pack all bearing cavities with grease.
  - Drive in the bearing squarely with the sealed end facing out.



\*

# 14. FRONT WHEEL/FRONT SUSPENSION/ STEERING SYSTEM

---



\*

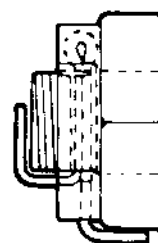
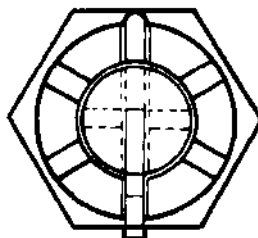

\*

# 14. FRONT WHEEL/FRONT SUSPENSION/ STEERING SYSTEM



\* Support the machine securely so there is no danger of it falling over.

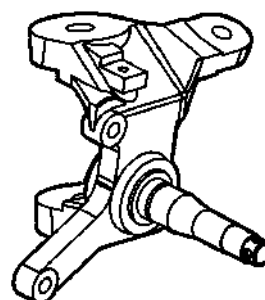
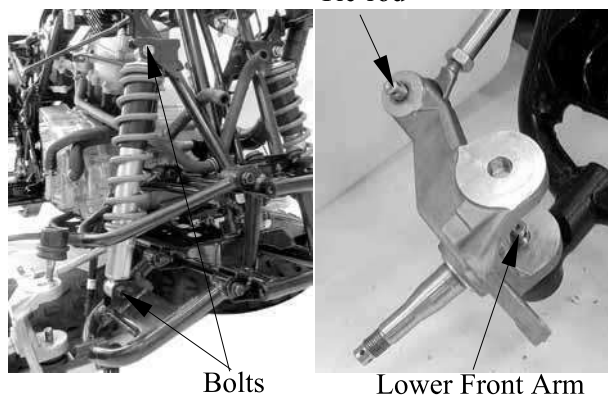
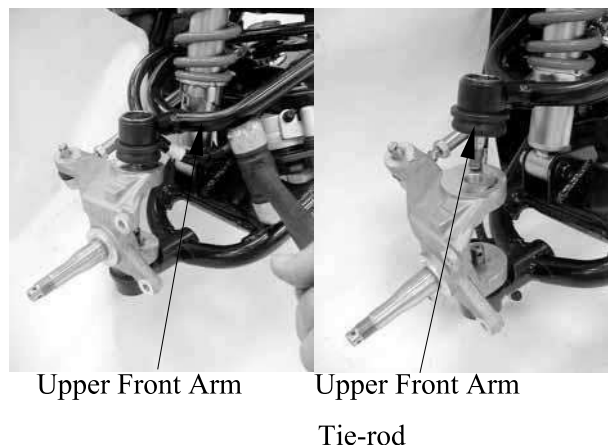
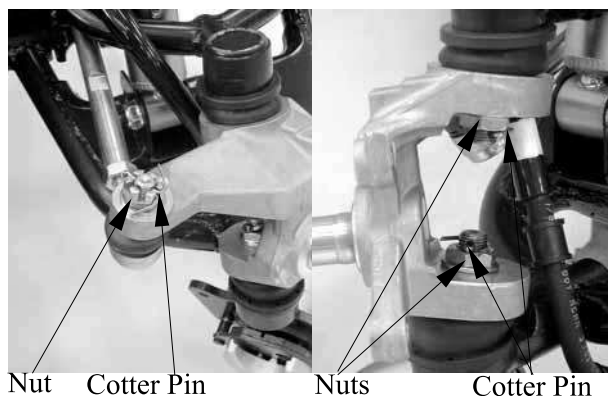

# 14. FRONT WHEEL/FRONT SUSPENSION/ STEERING SYSTEM

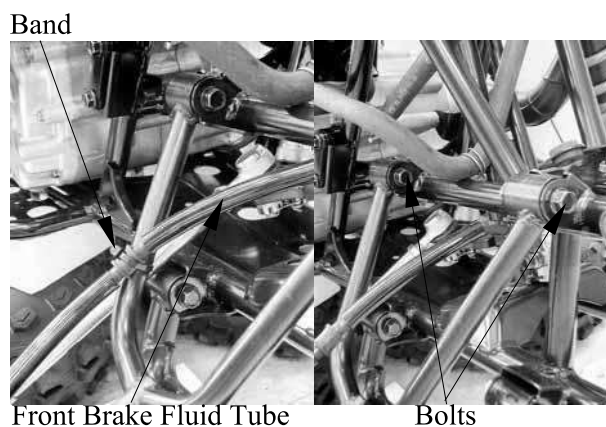
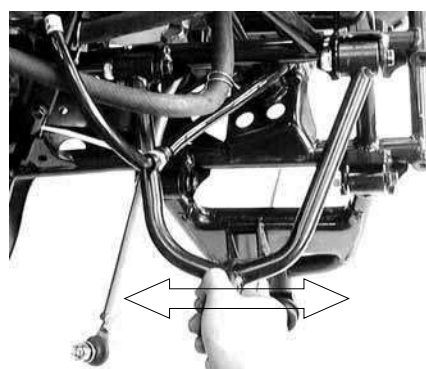
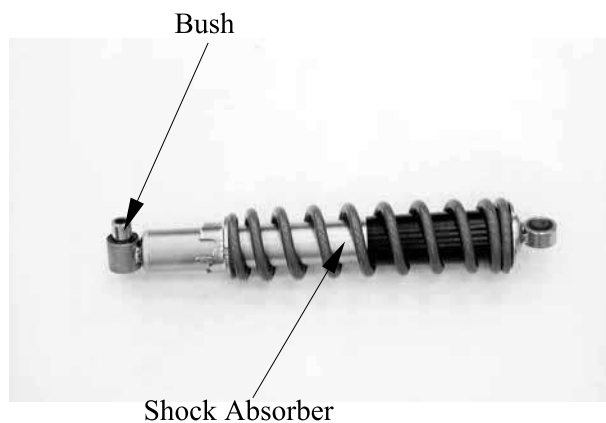



# 14. FRONT WHEEL/FRONT SUSPENSION/ STEERING SYSTEM



\*

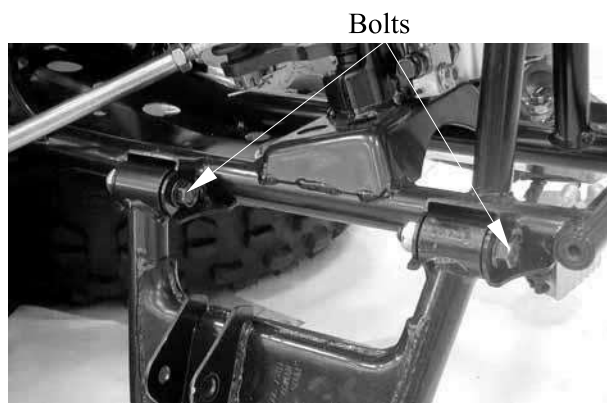
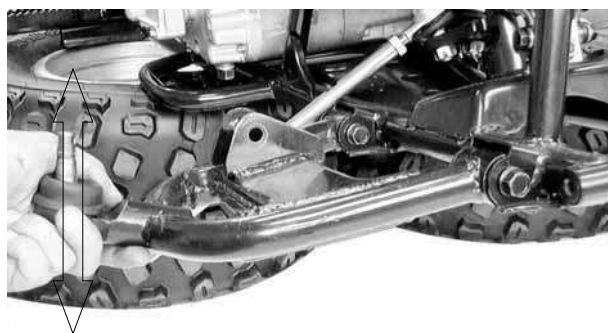
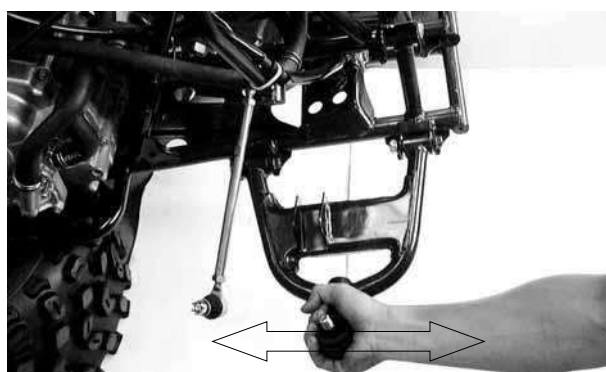
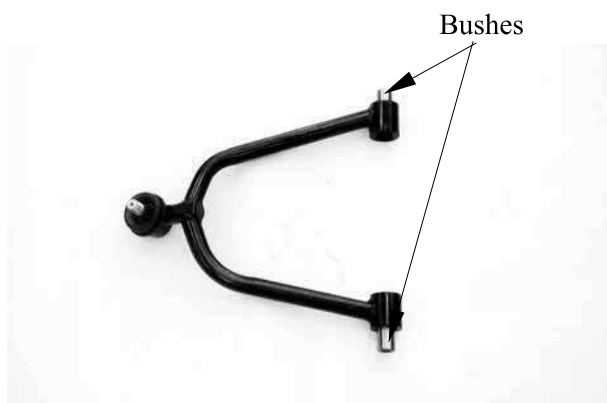

## 14. FRONT WHEEL/FRONT SUSPENSION/ STEERING SYSTEM

---



\*

y dangerously weaken the arm.

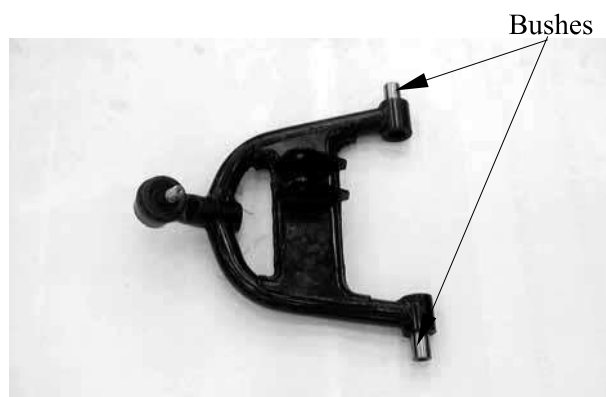

\*

Apply the grease onto the bushes and inner collars

\*

Always use a new cotter pin.

# 14. FRONT WHEEL/FRONT SUSPENSION/ STEERING SYSTEM

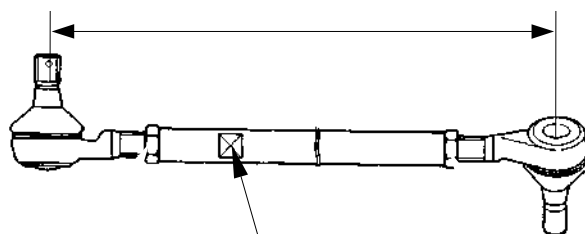
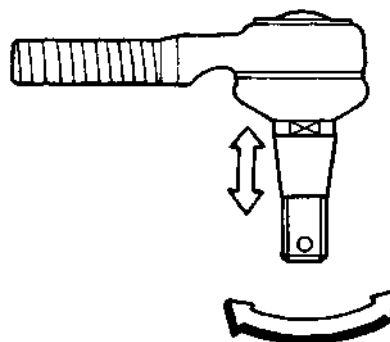
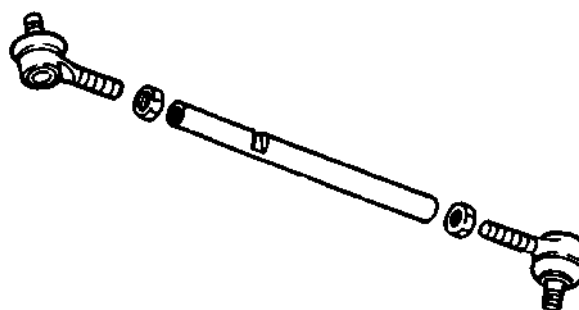
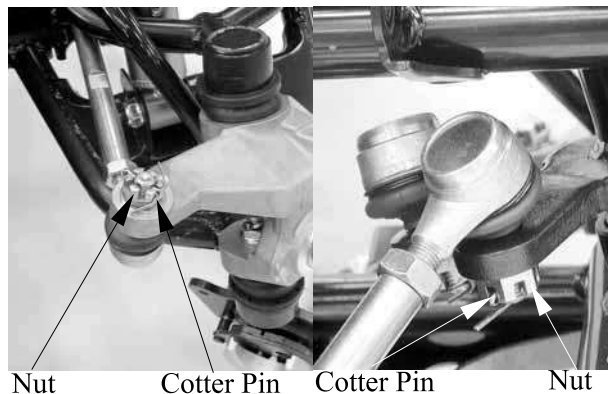

t      Indentation Surface      Lock Nut

# 14. FRONT WHEEL/FRONT SUSPENSION/ STEERING SYSTEM

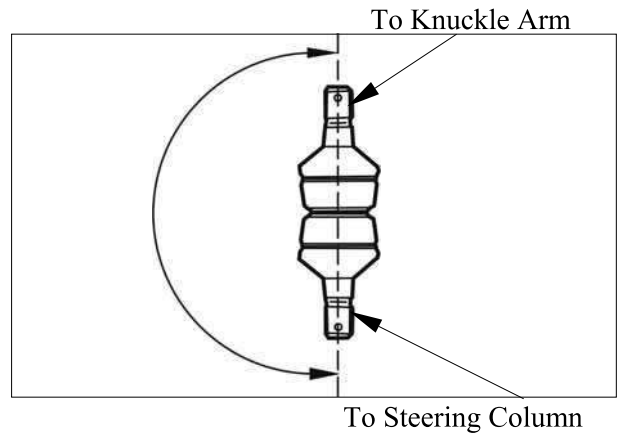

\*

identification.

\*

The threads on both rod-end must be of the same length.

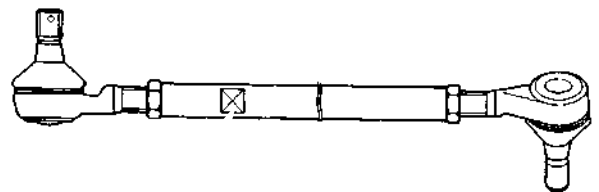
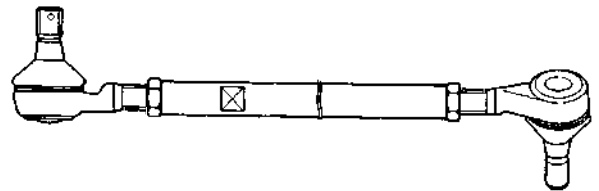

\*

Be sure that the rod-end on the indentation surface side is connected to the steering knuckle.

\*

# 14. FRONT WHEEL/Front SUSPENSION/ STEERING SYSTEM

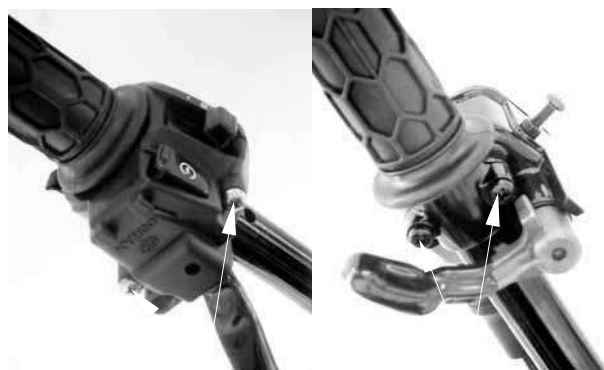

# 14. FRONT WHEEL/FRONT SUSPENSION/ STEERING SYSTEM



\*

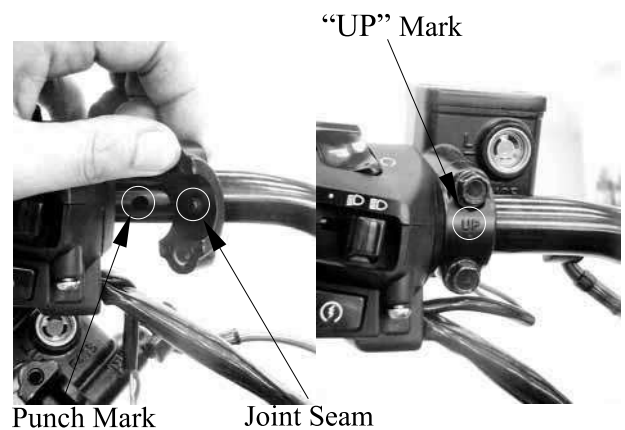
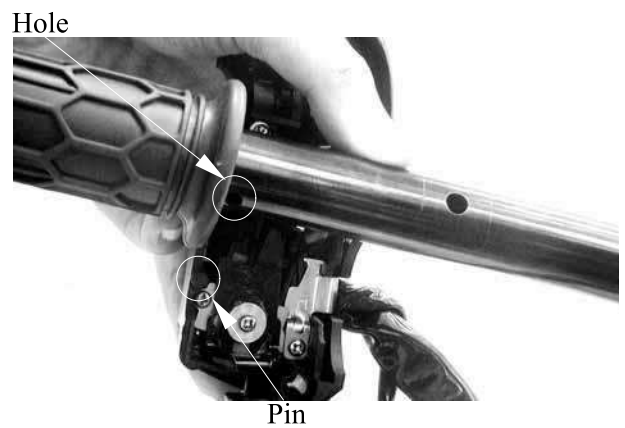
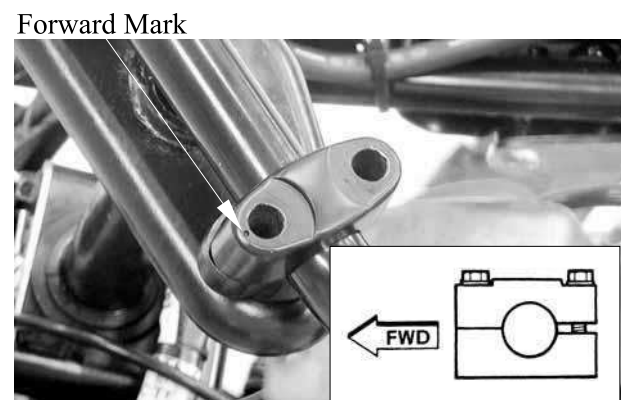
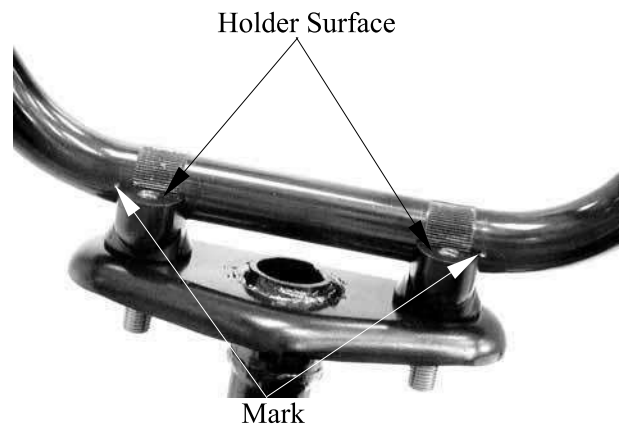

# 14. FRONT WHEEL/FRONT SUSPENSION/ STEERING SYSTEM

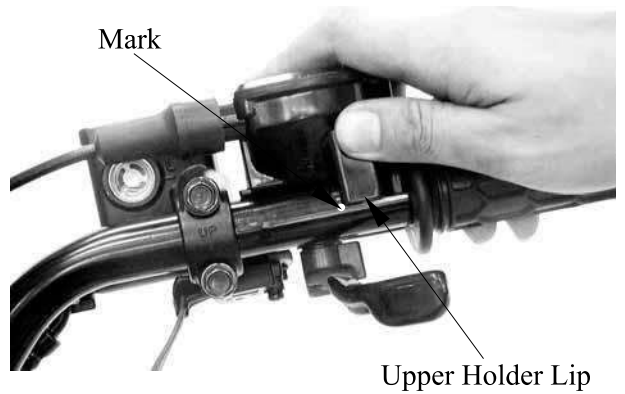

Steering Bracket

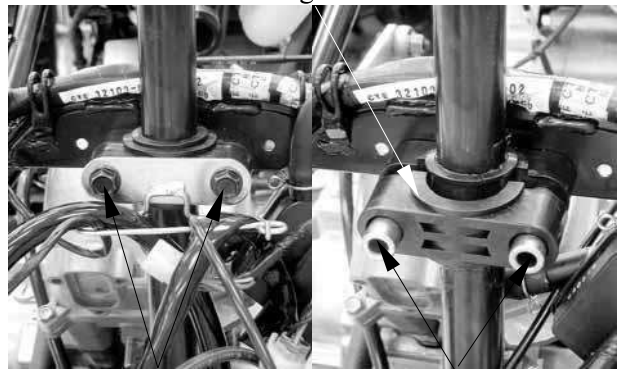

Bolts

Collars

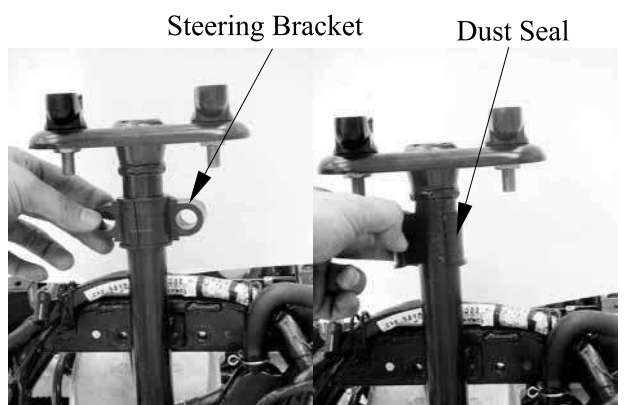

Steering Bracket

Dust Seal

# 14. FRONT WHEEL/FRONT SUSPENSION/ STEERING SYSTEM

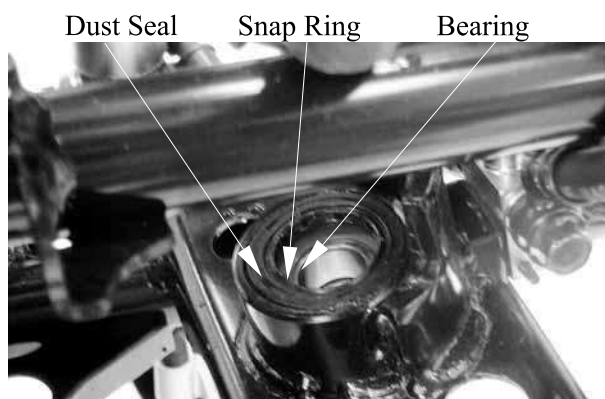
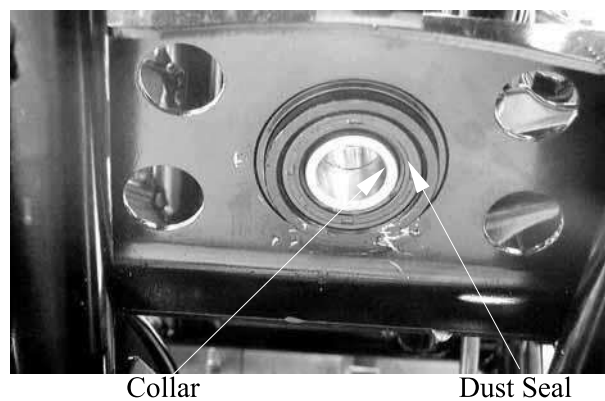
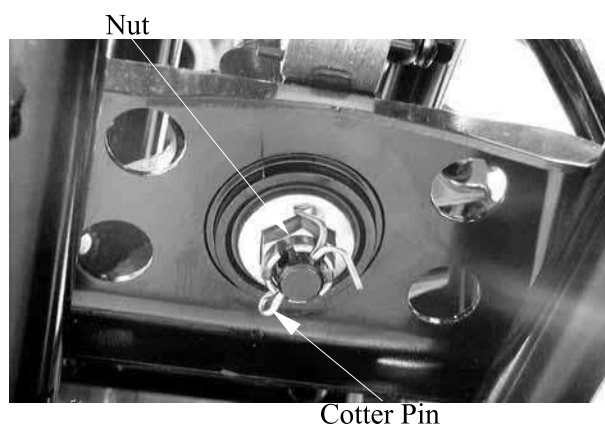
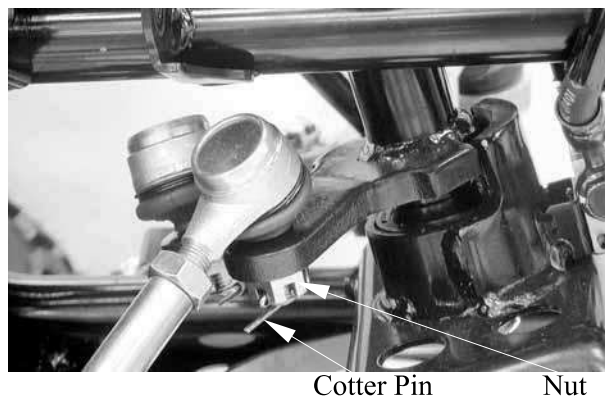



## 14. FRONT WHEEL/FRONT SUSPENSION/ STEERING SYSTEM



- \* Do not attempt to straighten a bent shaft, this may dangerously weaken the shaft.



- \* Apply the grease onto the collar, dust seals, and bearing.



- \* Always use a new cotter pin.



- \* Always use a new cotter pin.

# **15. REAR WHEEL/AXLE/SUSPENSION**

---

---

## **REAR WHEEL/AXLE/SUSPENSION**

---

SERVICE INFORMATION-----	15- 2
TROUBLESHOOTING-----	15- 3
REAR WHEEL/AXLE/AXLE HUB -----	15- 3
REAR FORK/SWIM ARM/SHOCK ABSORBER -----	15- 12

**15. REAR WHEEL/AXLE/SUSPENSION**

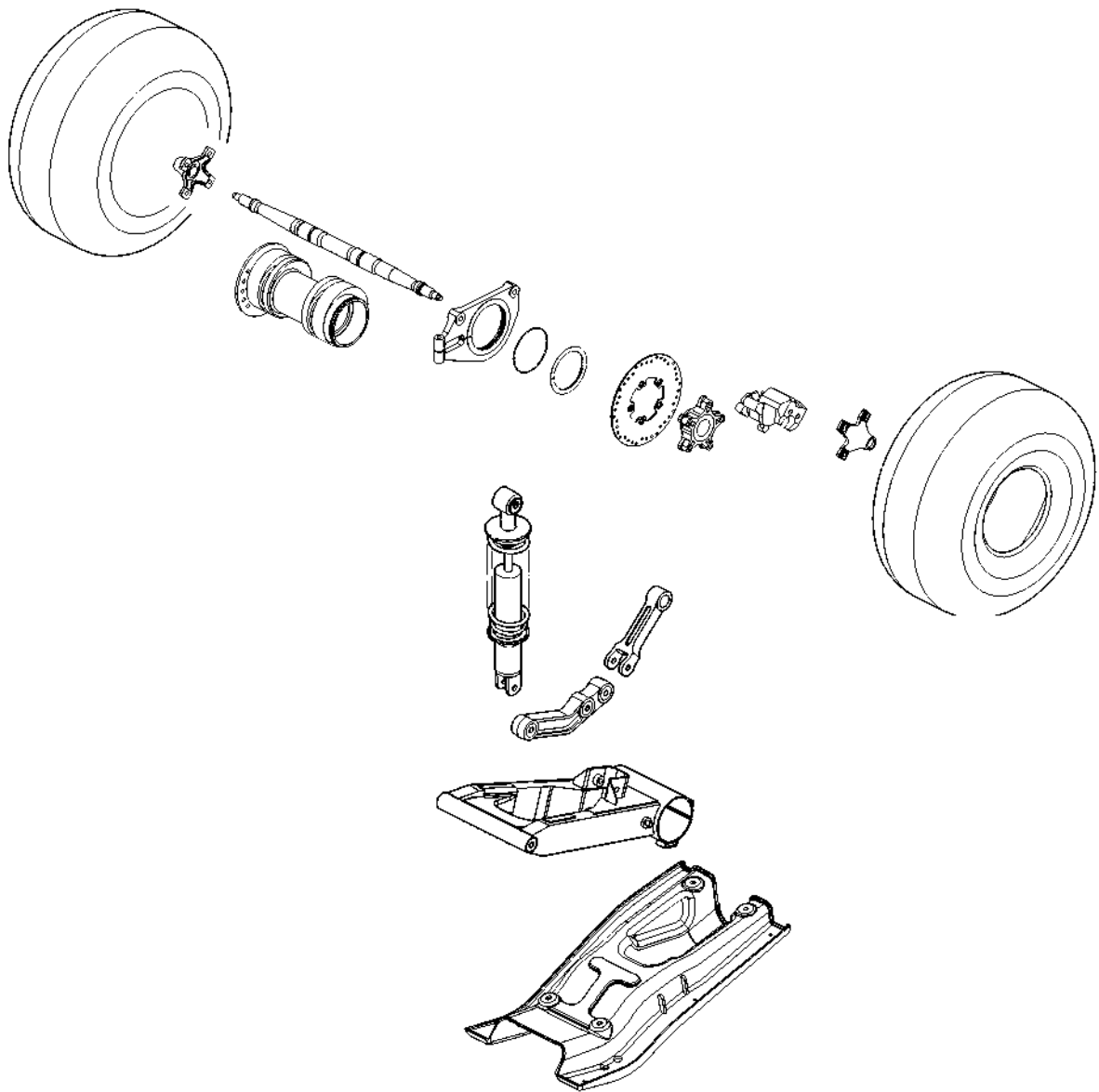

# 15. REAR WHEEL/AXLE/SUSPENSION

## SERVICE INFORMATION

### GENERAL INSTRUCTIONS

- Jack the machine front wheel off the ground and be careful to prevent the machine from falling down.
- During servicing, keep oil or grease off the brake disk
- Inspect the brake system before riding.

### SPECIFICATIONS

Item		Standard (mm)	Service Limit (mm)
Rear wheel	Rim run out	Radial	—
		Axial	—
			2.0
			2.0

### TORQUE VALUES

Rear wheel nut	4.0~5.0kgf-m
Rear shock absorber upper mount bolt	3.5~4.5kgf-m
Rear shock absorber lower mount bolt	3.5~4.5kgf-m
Rear fork axle	6.0~8.0kgf-m
Rear wheel hub nut	9.0~11.0kgf-m
Rear wheel shaft nut	11.0~13.0kgf-m
Caliper holder bolt	1.8~2.5kgf-m

### SPECIAL TOOLS

Nut wrench F010

## TROUBLESHOOTING

### Rear wheel wobbling

- Bent rim
- Faulty tire
- Axle not tightened properly

### Soft rear shock absorber

- Weak shock absorber spring
- Faulty damper

# 15. REAR WHEEL/AXLE/SUSPENSION

## REAR WHEEL/AXLE/AXLE HUB

### REMOVAL AND INSPECTION

Place the machine on a level place.  
Remove the rear caliper. (Refer to the “REAR BRAKE CALIPER REMOVAL” section in chapter 13)

Use the nut wrench to loosen two rear axle nuts (inner and outer) of the rear axle.

\*



Nut wrench F010

Remove four nuts attaching the rear wheel hub of the both rear wheels, then remove the both rear wheels.

\*

Elevate the rear wheels by placing a suitable stand under the rear of frame. Support the machine securely so there is no danger of it falling over.

Remove the cotter pin and then remove nut.

Remove the rear wheel hub.

Inspect the rear wheel hub.  
Cracks/damage → Replace.

Inspect the rear wheel hub splines.  
Wear/damage → Replace.

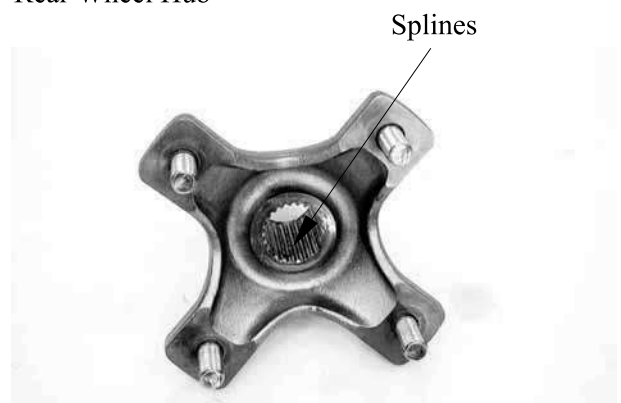
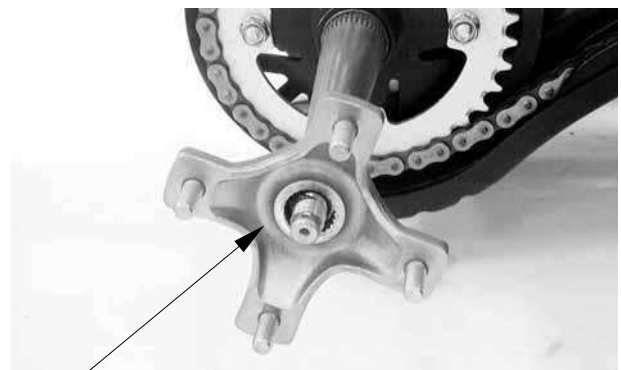
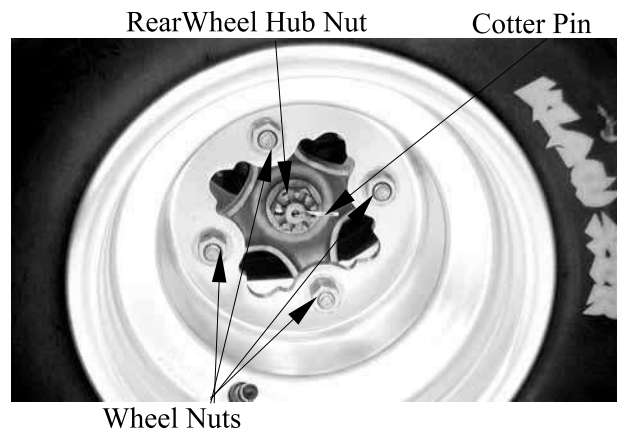
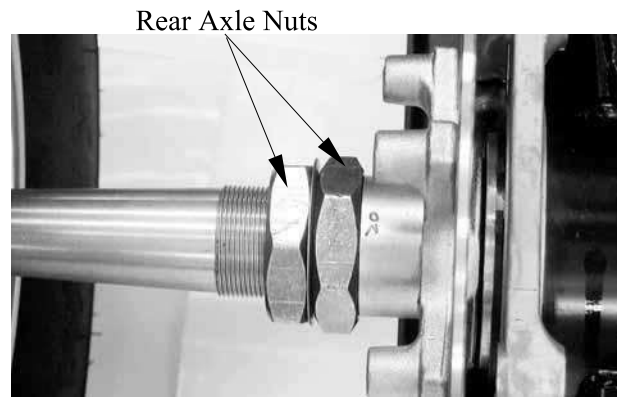

# 15. REAR WHEEL/AXLE/SUSPENSION

Measure the wheel runout.

**Service Limit:**

Vertical: 2.0 mm

Lateral: 2.0mm

Out of specification → Replace wheel.

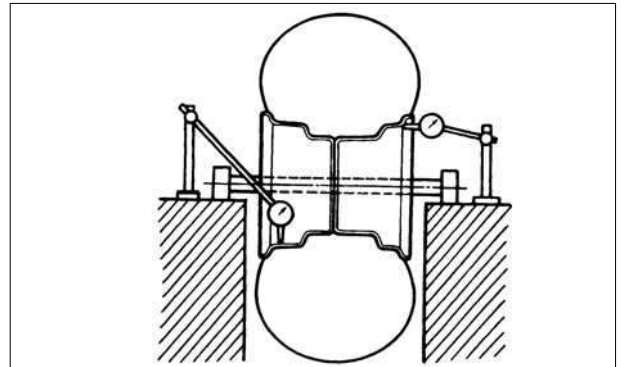

Remove the two rear axle nuts (outer and inner), washer and collar.

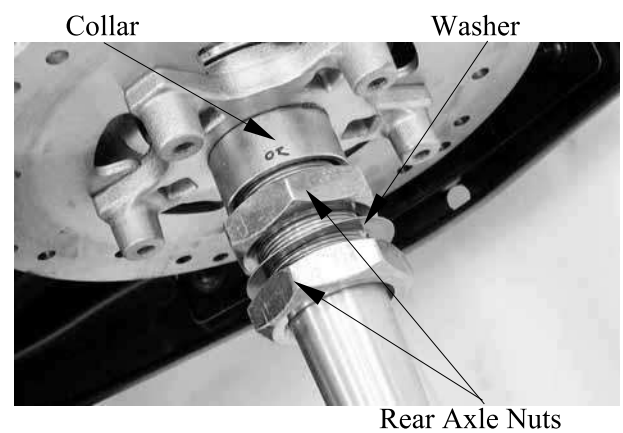

Remove the rear brake disk.

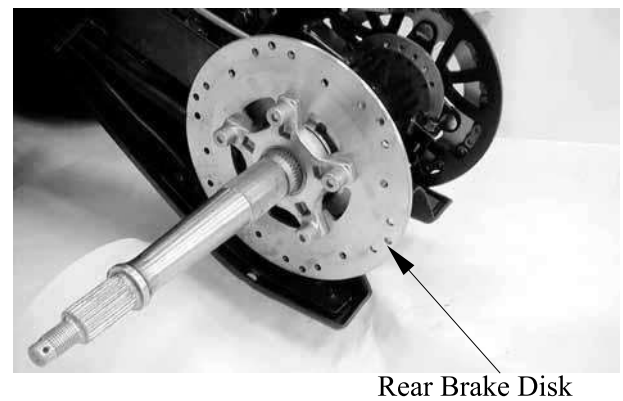

## 15. REAR WHEEL/AXLE/SUSPENSION

Inspect the brake disk  
Cracks/damage → Replace.  
Inspect the brake disk splines.  
Wear/damage → Replace.

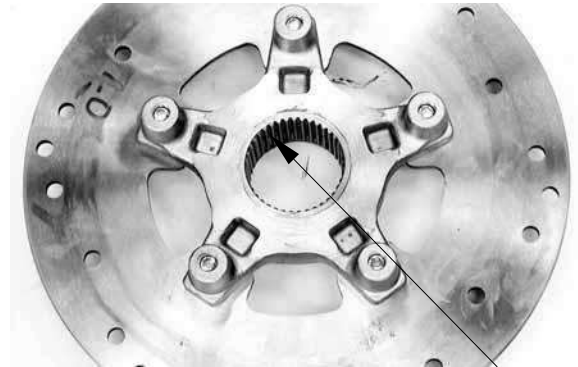

Splines

Loosen the driven chain (refer to the “DRIVE CHAIN SLACK ADJUSTMENT” section in the chapter 3) and remove the two bolts at the drive sprocket (refer to the chapter 6), then disconnect the drive chain from the driven sprocket.

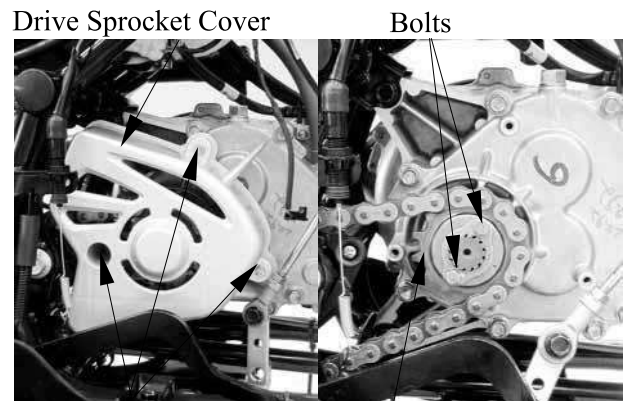

Drive Sprocket Cover

Bolts

Bolts

Drive Sprocket



Driven Sprocket

Remove the rear axle from right side.

\* Tap the axle and with a rubber hammer, this will avoid damage the axle thread.

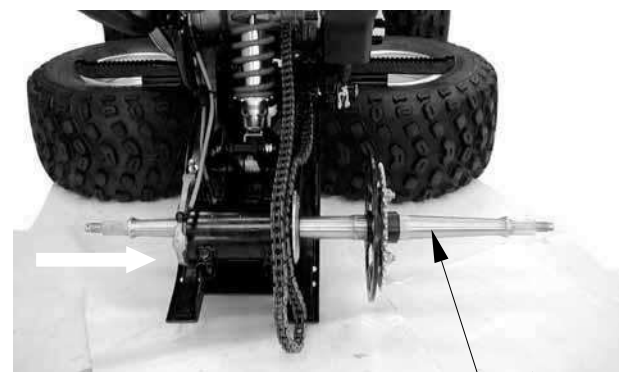

Rear Axle

# 15. REAR WHEEL/AXLE/SUSPENSION

## REAR AXLE DISASSEMBLY



Remove the driven sprocket clip at the rear axle and then remove the driven sprocket.



Remove the four nuts attaching the driven sprocket holder at the driven sprocket and then remove driven sprocket.



Nuts

Inspect the drive sprocket and driven sprocket.

More than 1/4 teeth wear → Replace.

Bent teeth → Replace.

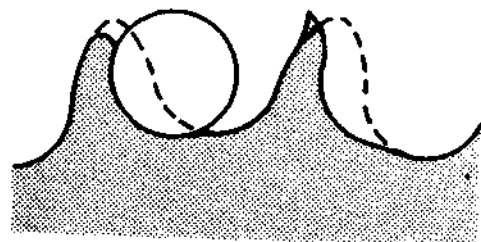



## 15. REAR WHEEL/AXLE/SUSPENSION

Inspect the driven sprocket holder splines.  
Wear/damage → Replace.



Splines

Inspect the rear axle.  
Scratched (excessively)/damage → Replace.  
Inspect the splines and threads of the rear axle  
Wear/damage → Replace.



Measure the rear axle run out.  
**Service limit:** less than 1.5mm  
Out of specification → Replace.

\*



### REAR AXLE ASSEMBLY

Reverse the “REAR AXLE DISASSEMBLY” procedures.

\*

Apply grease onto the rear axle splines.

Remove the bolt at the rear caliper holder.  
Remove the two bolts attaching the rear axle hub at the rear fork.

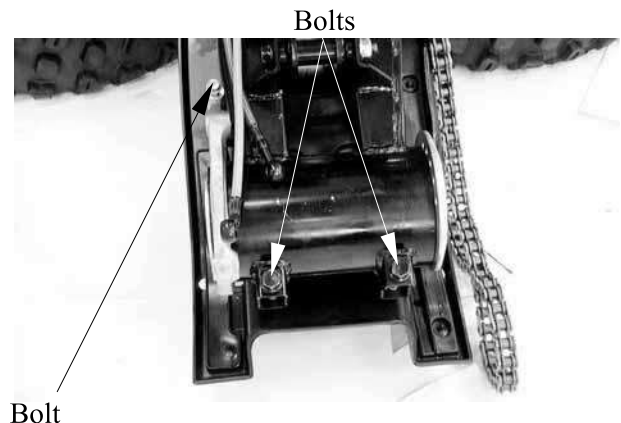

## 15. REAR WHEEL/AXLE/SUSPENSION

Remove the circlip at the caliper holder and then remove the caliper holder and collar.

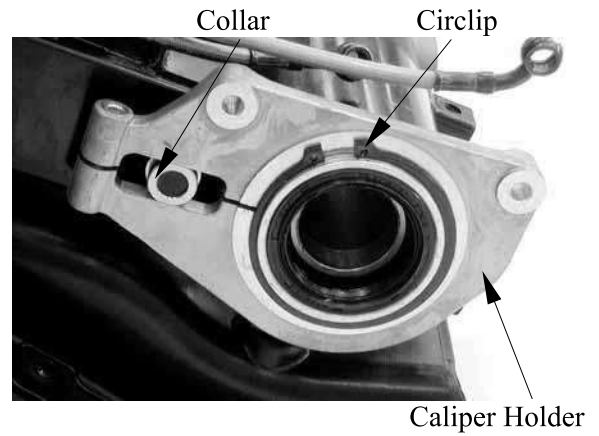

Remove the rear axle hub from right side.

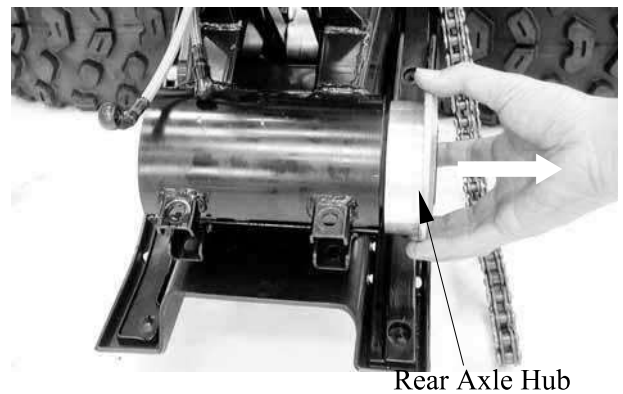

## 15. REAR WHEEL/AXLE/SUSPENSION

Inspect rear axle hub.

Bearings allow play in the axle hub or the bearing turns roughly → Replace.

Oil seals is wear/damage → Replace.

Axle hub is cracks/bend/damage →  
Replace.



### REAR AXLE HUB DISASSEMBLY

Bearing and dust seal replacement steps:

Clean the outside of the rear axle hub.

Remove the dust seal by a flat-head screw driver.

\*

Place a wood block against the outer edge to protect this edge.

Remove the bearing by a general bearing puller.



### REAR AXLE HUB ASSEMBLY

Install the new bearing and dust seal by reversing the previous steps.

\*

Do not strike the center race or balls of the bearing.  
Contact should be made only with the outer race.  
Make sure install the distance collar into the rear axle hub

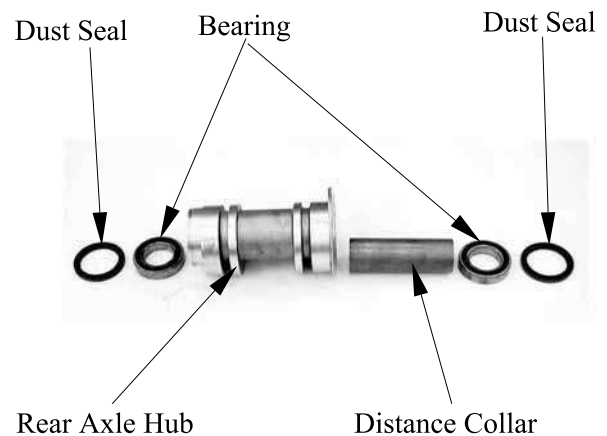

## 15. REAR WHEEL/AXLE/SUSPENSION

### INSTALLATION

Reverse the “REAR WHEEL/AXLE/AXLE HUB REMOVAL AND INSPECTION” procedures.

\*

Apply grease onto the dust seal lips and bearings.

Install the rear axle hub.

\*

Install the rear axle.

Connect the drive chain.

Install the rear brake disk, collar inner nut, washer and outer nut.

\*

At this time, the nuts should not be tightened completely.

Install the rear wheel hub and tighten the nut.

**Torque:** 9.0~11.0kgf-m

Install cotter pin (new)

\*

Do not loosen the wheel hub nut after torque tightening. If the wheel hub nut groove is not aligned with the cotter pin hole, align groove with the hole by tightening up on the wheel hub nut.  
Always use a new cotter pin.

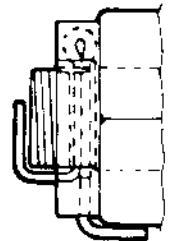
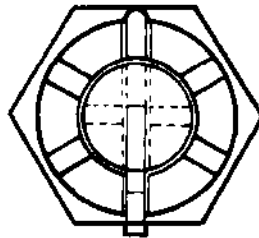

## 15. REAR WHEEL/AXLE/SUSPENSION

Install the rear wheel and tighten the four nuts.

**Torque:** 4.0~5.0kgf-m

\*

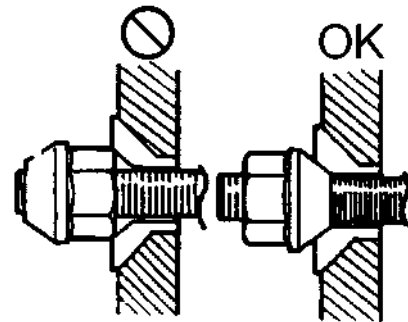

Tighten the two rear axle nuts (inner and outer).

\*



Nut wrench F010

**Torque:** 11.0~13.0kgf-m

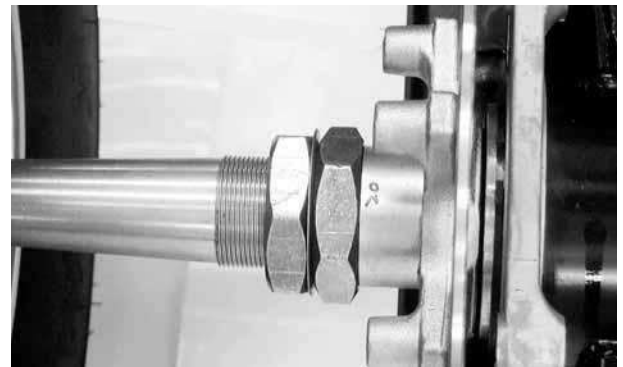

Adjust drive chain slack. (Refer to the “DRIVE CHAIN SLACK ADJUSTMENT” section in the CHAPTER 3.)

**Drive chain slack:** 30 ~ 40mm

## 15. REAR WHEEL/AXLE/SUSPENSION

### REAR FORK/SWIM ARM/SHOCK ABSORBER REMOVAL AND INSPECTION

Place the machine on a level place.  
Elevate the rear wheels by placing a suitable  
stand under the rear of frame.

\* Support the machine securely so there is  
no danger of it falling over.

Remove the rear wheels, rear axle and rear  
hub.

Refer to the “REAR WHEEL/AXLE/AXLE  
HUB REMOVAL AND INSPECTION”  
section in chapter 15.

Remove the two bolts at the air cleaner case.  
(Refer to the “CARBURETOR  
REMOVAL” section in chapter 5.)

Elevate the air cleaner case and remove the  
upper mount bolt at the rear shock absorber

Remove the four bolts at the lower guard  
and then remove the lower guard.

\* When removing the lower guard, hold  
the swing arm so that it does not drop  
downwards when the lower guard is  
removed.



Air Cleaner Case

Bolt

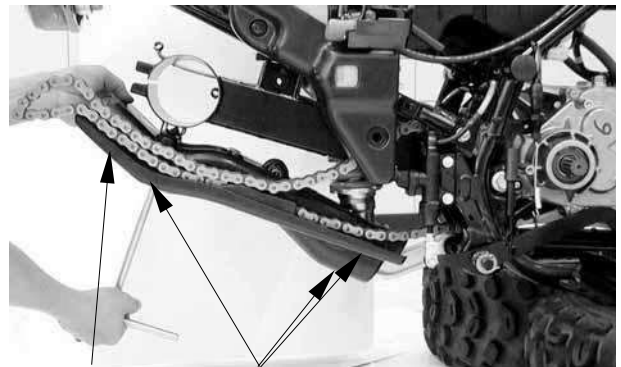

Lower Guard

Bolts

Remove the lower mount bolt at the rear  
shock absorber and then remove the shock  
absorber and bush.



Lower Bolt

## 15. REAR WHEEL/AXLE/SUSPENSION

Remove the two bolts attaching the rear swing arm at the rear fork and then remove the rear swing arm.

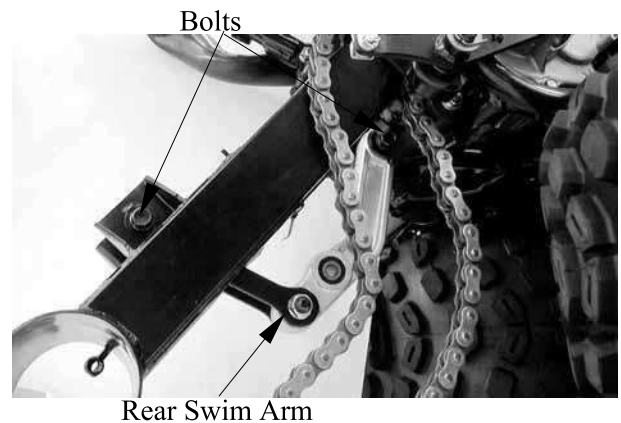

Inspect the shock absorber rod.  
Bends/damage → Replace the shock absorber assembly.  
Inspect the shock absorber.  
Oil leaks → Replace the shock absorber assembly.  
Inspect the spring.  
Fatigue → Replace the shock absorber assembly.  
Move the spring up and down.  
Inspect the bush.  
Wear/damage → Replace.

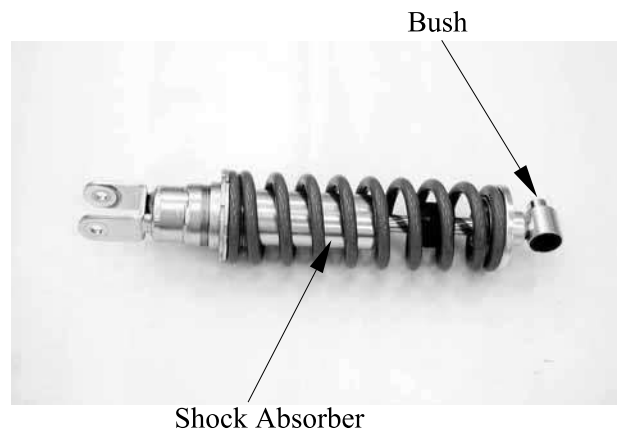

### REAR SWING ARM DISASSEMBLY

Remove the bolt attaching the lower rear swing arm at the upper rear swing arm and then disconnect the upper rear swing arm from the lower rear swing arm.

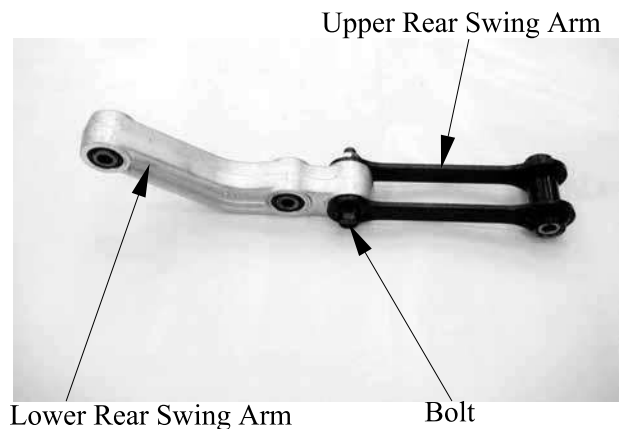

Inspect the upper rear swing arm.  
Bends/damage → Replace.  
Inspect the bush.  
Wear/damage → Replace.

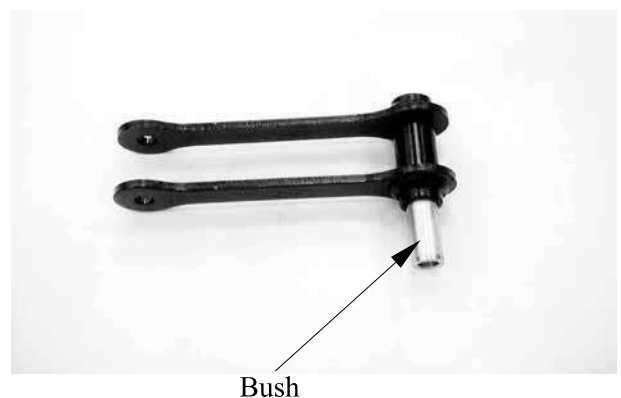

## 15. REAR WHEEL/AXLE/SUSPENSION

Remove the dust seals and the bushes from the lower rear swing arm.

Inspect the lower rear swing arm.

Wear/damage → Replace.

Inspect the bush.

Wear/damage → Replace.

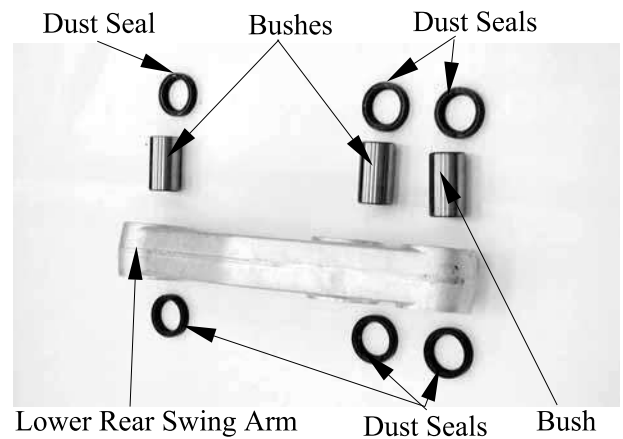

Inspect the needle bearings.

Bring allow play in the lower rear swing arm or bearing turns roughly → Replace.

### REAR SWING ARM ASSEMBLY

Reverse the “REAR SWING ARM DISASSEMBLY” procedures.

\* Apply grease onto the oil seal lips, needle bearing and bushes.

Install the upper rear swing arm and tighten the bolt.

**Torque:** 3.5~4.5kgf-m

Check the tightening torque of the pivot shaft (rear fork) securing nut.

**Torque:** 6.0~8.0kgf-m

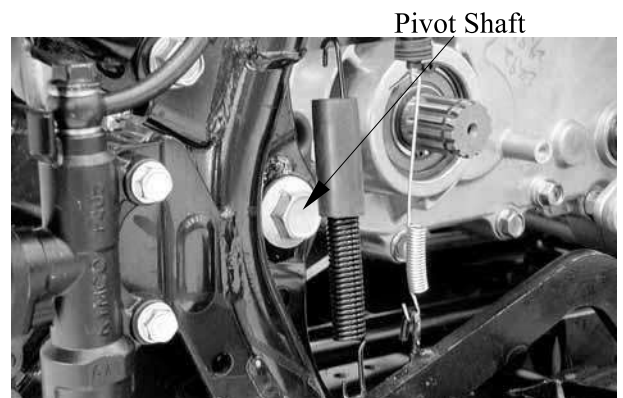
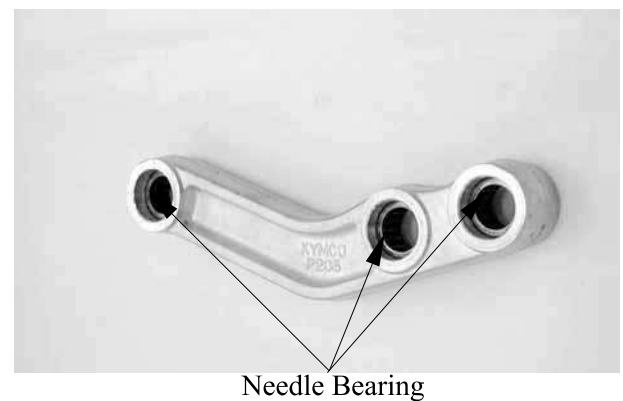

Check the rear fork side play by moving it from side to side.

If side play noticeable, check the inner collar, bearing, bushing and thrust cover, or adjust the shim.





## 15. REAR WHEEL/AXLE/SUSPENSION

Check the rear fork vertical movement by moving it up and down.

If vertical movement is tight, binding or rough, check the inner collar, bearing, bushing and thrust cover, or adjust the shim.

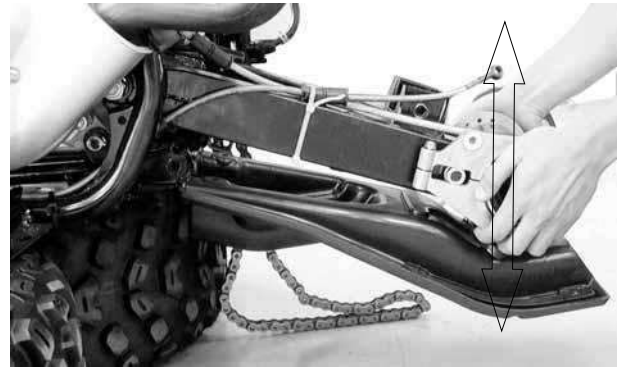

Remove the band and then disconnect the rear brake fluid tubes from the rear fork.

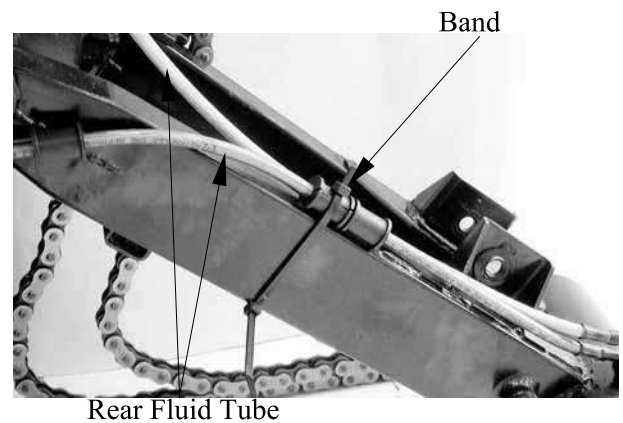

Remove the nut and pivot shaft, then remove rear fork and drive chain.

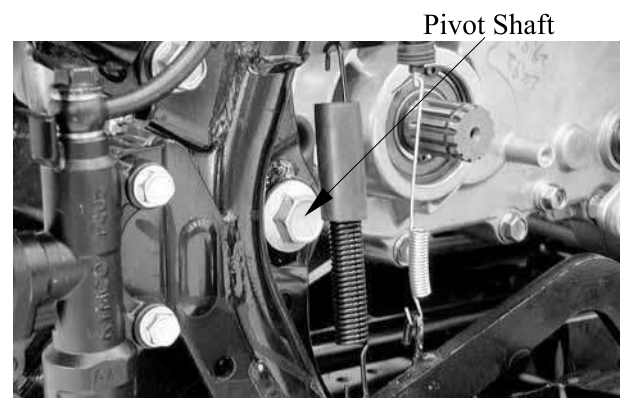

Remove the thrust covers.

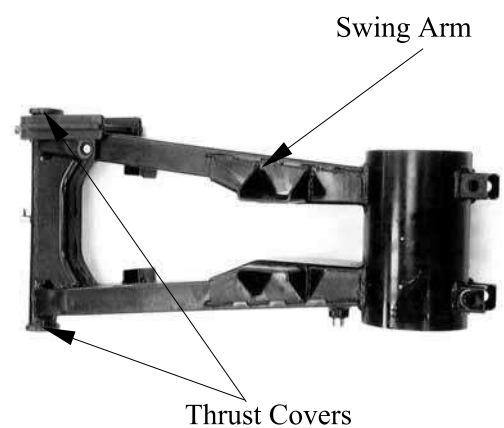

## 15. REAR WHEEL/AXLE/SUSPENSION

Inspect the rear fork.

Crack/bend/damage → Replace.

Roll the axle on a flat surface to inspect the pivot shaft.

Bends → Replace.

\* Do not attempt to straighten a bent axle.

Inspect the thrust covers, collar and bushes.

Wear/damage → Replace.



r

Inspect the drive chain stiffness.

Stiff → Clean and lubricate or replace.

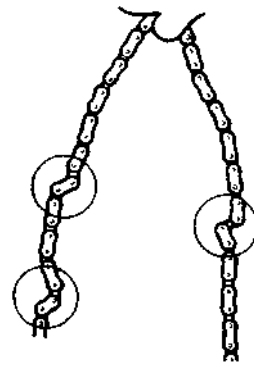

## **15. REAR WHEEL/AXLE/SUSPENSION**

### **INSTALLATION**

Reverse the “REAR FORK/SWIM ARM/SHOCK ABSORBER REMOVAL AND INSPECTION” procedure.

Apply grease onto the collar, bush, pivot shaft and thrust cover.



Install the rear fork and tightening the nut and pivot shaft.

**Torque:** 6.0 ~ 8.0kgf-m



Install the rear swing arm and tightening the bolts.

**Torque:** 3.5 ~ 4.5kgf-m



Install the shock absorber and tightening the bolts.

**Torque:** 3.5 ~ 4.5kgf-m

Install the rear hub and rear wheels.

Refer to the “REAR WHEEL INSTALLATION” section.

Adjust the drive chain slack.

Refer to the “DRIVE CHAIN SLACK ADJUSTMENT” section in the CHAPTER 3.

**Drive chain slack:** 30 ~ 40mm

**BATTER/CHARGING SYSTEM/  
A.C. GENERATOR**

SERVICE INFORMATION-----	16- 2
TROUBLESHOOTING-----	16- 3
BATTERY REMOVAL -----	16- 4
CHARGING SYSTEM -----	16- 6
REGULATOR/RECTIFIER-----	16- 7
A.C. GENERATOR CHARGING COIL -----	16- 8

# 16. BATTERY/CHARGING SYSTEM/ A.C. GENERATOR

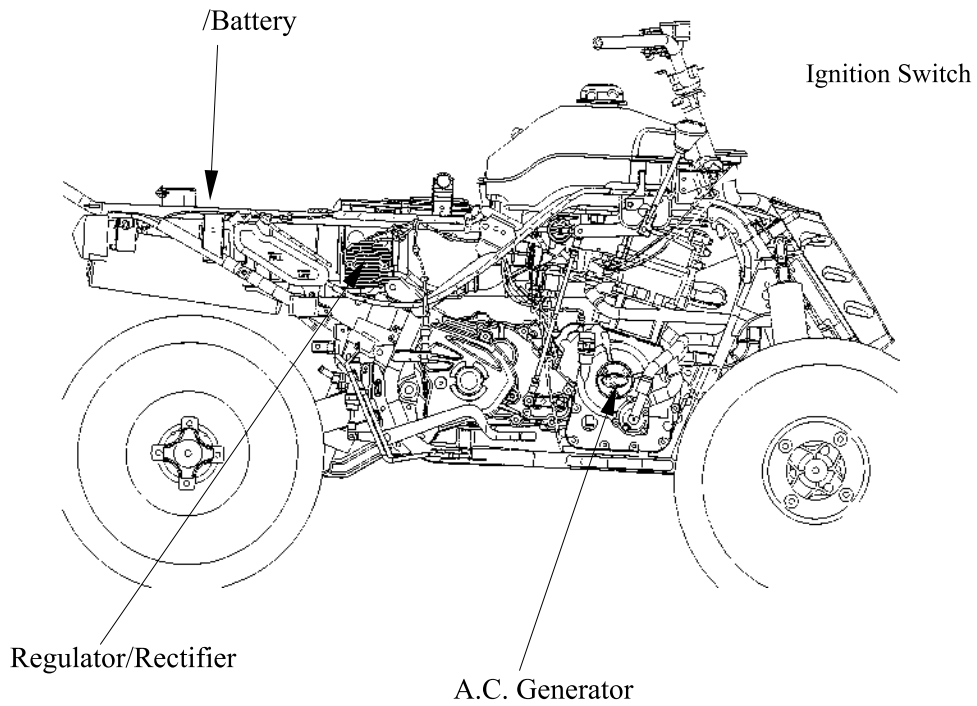

## CHARGING CIRCUIT

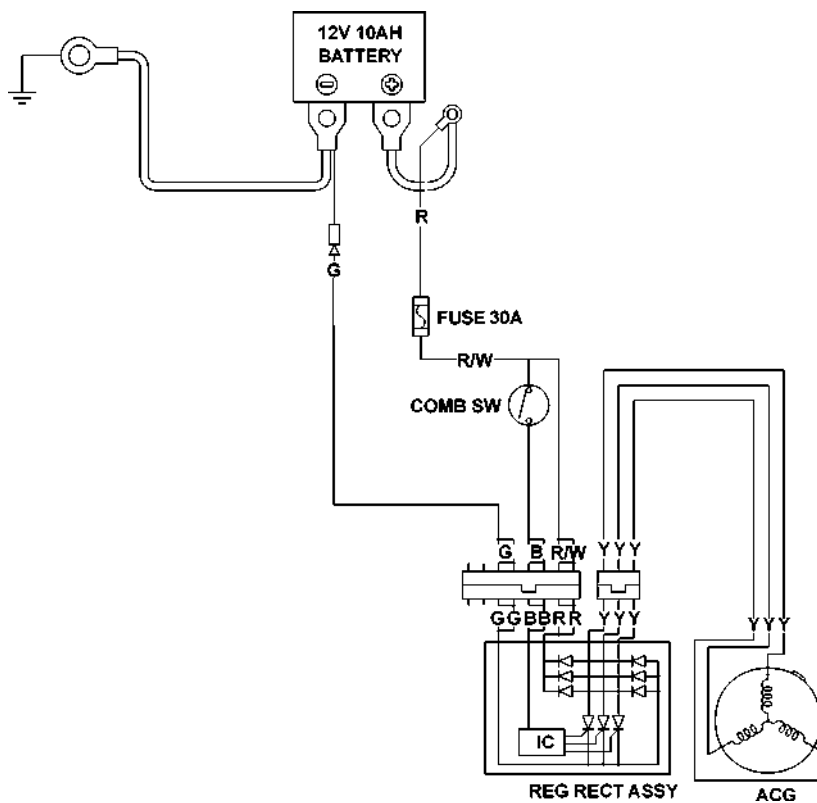

## SERVICE INFORMATION

### GENERAL INSTRUCTIONS

The battery electrolyte (sulfuric acid) is poisonous and may seriously damage the skin and eyes. Avoid contact with skin, eyes, or clothing. In case of contact, flush with water and get prompt medical attention

- The battery can be charged and discharged repeatedly. If a discharged battery is not used for a long time, its service life will be shortened. Generally, the capacity of a battery will decrease after it is used for 2~3 years. A capacity-decreased battery will resume its voltage after it is recharged but its voltage decreases suddenly and then increases when a load is added.
- When a battery is overcharged, some symptoms can be found. If there is a short circuit inside the battery, no voltage is produced on the battery terminals. If the rectifier won't operate, the voltage will become too high and shorten the battery service life.
- If a battery is not used for a long time, it will discharge by itself and should be recharged every 3 months.
- A new battery filled with electrolyte will generate voltage within a certain time and it should be recharged when the capacity is insufficient. Recharging a new battery will prolong its service life.
- Inspect the charging system according to the sequence specified in the Troubleshooting.
- Do not disconnect and soon reconnect the power of any electrical equipment because the electronic parts in the regulator/rectifier will be damaged. Turn off the ignition switch before operation.
- It is not necessary to check the MF battery electrolyte or fill with distilled water.
- Check the load of the whole charging system.
- Do not quick charge the battery. Quick charging should only be done in an emergency.
- Remove the battery from the motorcycle for charging.
- When replacing the battery, do not use a traditional battery.
- When charging, check the voltage with a voltmeter.

### SPECIFICATIONS

Item		Standard	
Battery	Capacity/Model	12V-12AH	
	Voltage (20°C)	Fully charged	13.1V
		Undercharged	12.3V
	Charging current	STD: 1.2A Quick: 3.0A	
	Charging time	STD: 5~10hr Quick: 30min	
A.C. Generator	Capacity	150W	
Regulator/Rectifier	Limit voltage	Lighting	12.0~14.0V
		Charging	10~13.0V 13.5~15.5V

## TESTING INSTRUMENTS

Electric tester

## TROUBLESHOOTING

### No power

- Dead battery
- Disconnected battery cable
- Fuse burned out
- Faulty ignition switch

### Low power

- Weak battery
- Loose battery connection
- Charging system failure
- Faulty regulator/rectifier

### Intermittent power

- Loose battery cable connection
- Loose charging system connection
- Loose connection or short circuit in lighting system

### Charging system failure

- Loose, broken or shorted wire or connector
- Faulty regulator/rectifier
- Faulty A.C. generator

# 16. BATTERY/CHARGING SYSTEM/ A.C. GENERATOR

## BATTERY REMOVAL

Pull right the lock lever and pull up the seat at the rear.

Remove the battery holder, by removing the mount bolts. (Make sure the ignition switch is OFF)

Remove the battery by removing the bolt. First disconnect the battery negative (-) cable and then the positive (+) cable.

 When disconnecting the battery positive (+) cable, do not touch the frame with tool; otherwise it will cause short circuit and sparks to fire the fuel.

The installation sequence is the reverse of removal.

 First connect the positive (+) cable and then negative (-) cable to avoid short circuit.

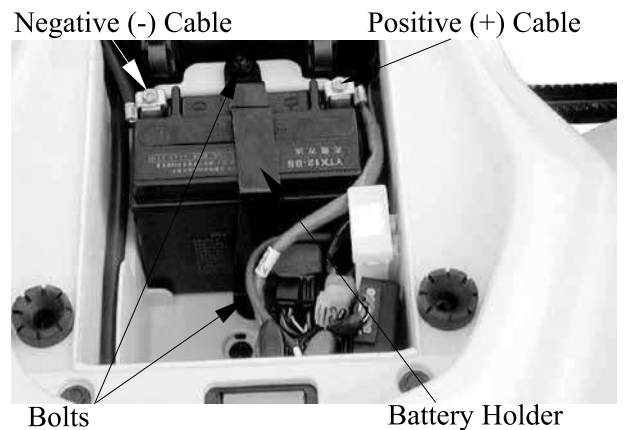
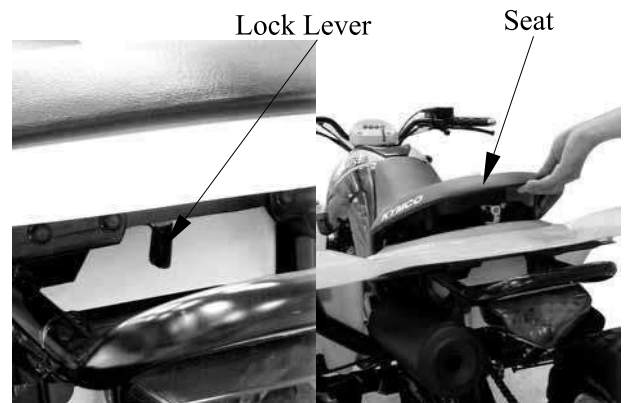

## BATTERY VOLTAGE (OPEN CIRCUIT VOLTAGE) INSPECTION

Remove the seat.

Disconnect the battery cables.

Measure the voltage between the battery terminals.

**Fully charged** : 13.1V

**Undercharged** : 12.3V max

\* Battery charging inspection must be performed with a voltmeter.





# 16. BATTERY/CHARGING SYSTEM/ A.C. GENERATOR

## CHARGING

Connect the charger positive (+) cable to the battery positive (+) terminal.

Connect the charger negative (-) cable to the battery negative (-) terminal.



- Keep flames and sparks away from a charging battery.
- Turn power ON/OFF at the charger, not at the battery terminals to prevent sparks near the battery to avoid explosion.
- Charge the battery according to the



- Quick charging should only be done in an emergency.
- Measure the voltage 30 minutes after the battery is charged.



Charging current: Standard : 1.2A  
Quick : 3.0A  
Charging time : Standard : 5~10 hours  
Quick : 30 minutes  
After charging: Open circuit voltage: 12.8V min.

## CHARGING SYSTEM

### SHORT CIRCUIT TEST

Disconnect the ground wire from the battery and connect an ammeter across the battery negative (-) terminal and the ground wire. Turn the ignition switch OFF and check for short circuit.

\* Connect the electric tester positive (+) terminal to ground wire and the tester negative (-) terminal to the battery negative (-) terminal.

If any abnormality is found, check the ignition switch and wire harness for short circuit.

### CURRENT TEST

This inspection must be performed with an electric tester when the battery is fully charged.

Warm up the engine for inspection.

Connect the electric tester across the battery terminals. Disconnect the red wire from the fuse terminal and connect an ammeter between the red wire lead and the fuse terminal as shown.

Attach a tachometer to the engine.

Start the engine and gradually increase the engine speed to measure the limit voltage and current.

**Limit Voltage/Current:** 13.5~15.5V/0.5A  
max.

If the limit voltage is not within the specified range, check the regulator/rectifier.

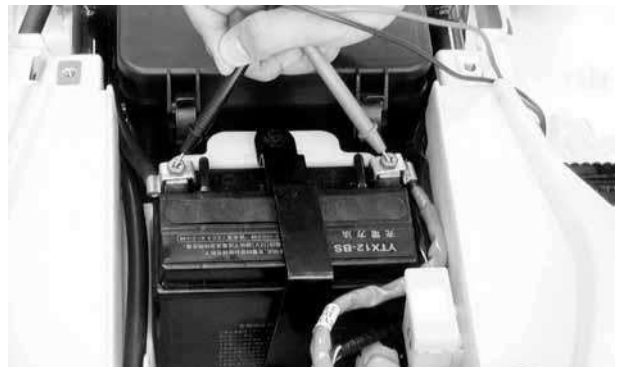

# 16. BATTERY/CHARGING SYSTEM/ A.C. GENERATOR

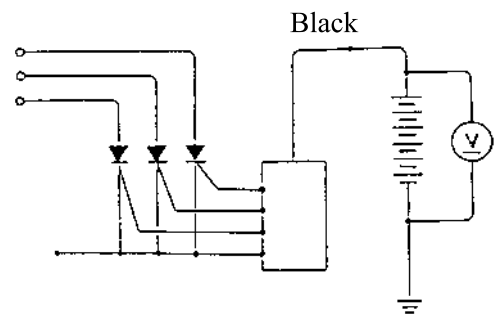
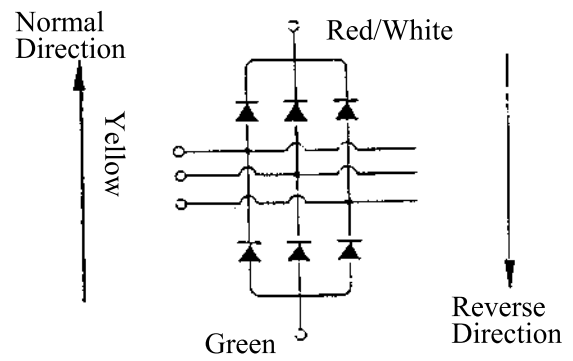
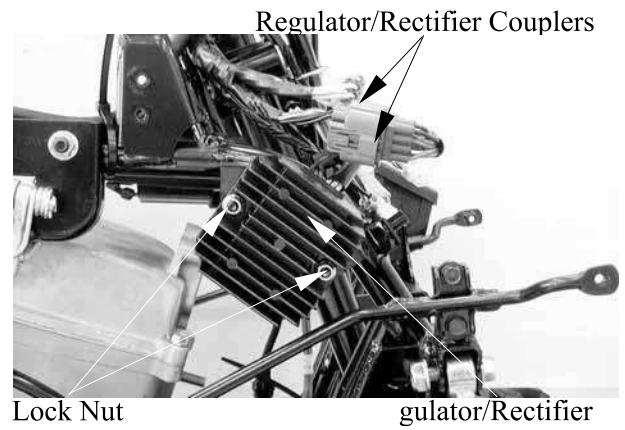

## A.C. GENERATOR INSPECTION

\* This test can be made without removing the stator from the engine.

Disconnect the A.C. generator connector. Check the continuity between the yellow wires and ground.

There should be continuity between the yellow wires and no continuity between each yellow wire and ground.

**Resistance** (at 20°C):

Yellow~Yellow	1.6~2.5Ω
---------------	----------



## A.C. GENERATOR/FLYWHEEL REMOVAL

Remove the right crankcase cover. (Refer to the “WATER PUMP SHAFT REMOVAL” section in the chapter 12)

Remove the pulser coil screws and then remove the A.C. generator wire set plate. Remove the A.C. generator bolts and then remove A.C. generator and pulser coil from right crankcase cover.

\* When removing the pulser coil and stator, be careful not to damage them to avoid shorted or broken wire.

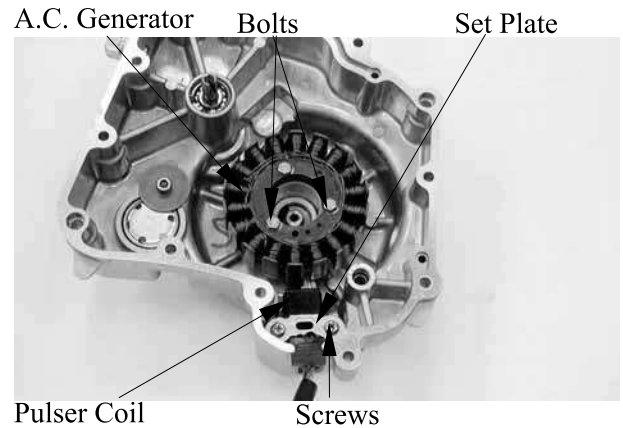

Remove the oil through guide and spring.



Hold the flywheel with a flywheel holder and remove flywheel nut and wash.



Flywheel holder E021

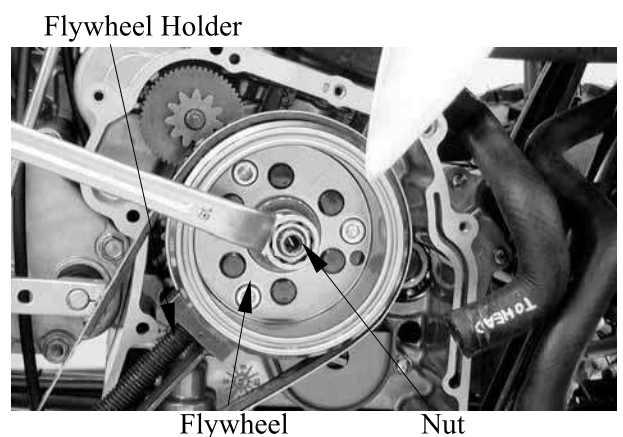

# 16. BATTERY/CHARGING SYSTEM/ A.C. GENERATOR

Remove the flywheel with a flywheel puller.



Flywheel puller E003

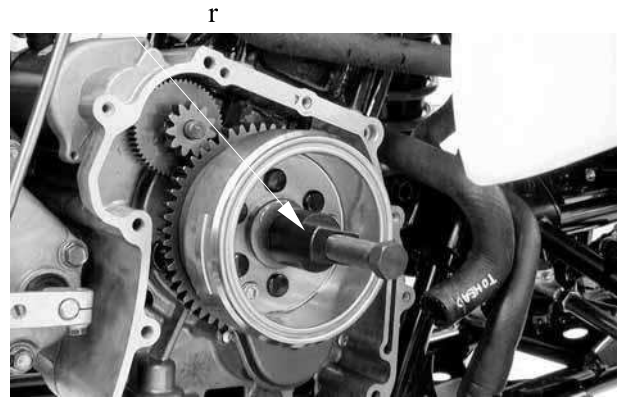

## INSTALLATION

Reverse the “REMOVAL” procedures.  
Install the flywheel, washer and tighten the nut.

**Torque:** 5.5~6.5kgf-m

\*

- Before installation, check and make sure that the inside of the flywheel is not contaminated.
- Make sure install the flywheel onto the crankshaft by aligning the key on the crankshaft with the groove in the flywheel.

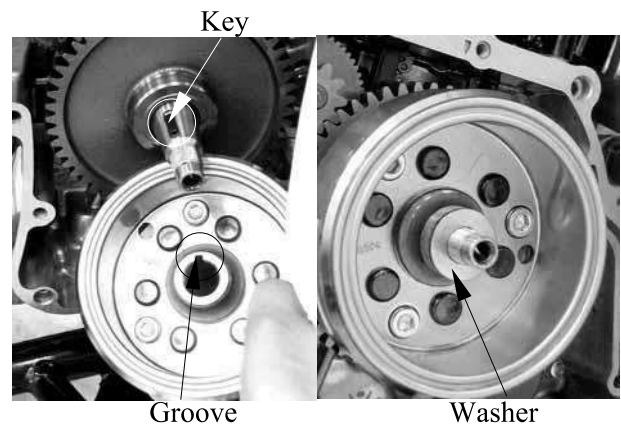

Install the oil through guide and spring.

Install the A.C. generator onto the right crankcase cover and tighten the bolts.

**Torque:** 0.8~1.0kgf-m

Install the right crankcase cover.

## IGNITION SYSTEM

SERVICE INFORMATION-----	17- 2
TROUBLESHOOTING-----	17- 3
IGNITION UNIT /CHANGE GEAR CONTROL INSPECTION-----	17- 4
IGNITION COIL INSPECTION-----	17- 6
PULSER COIL -----	17- 7

# 17. IGNITION SYSTEM

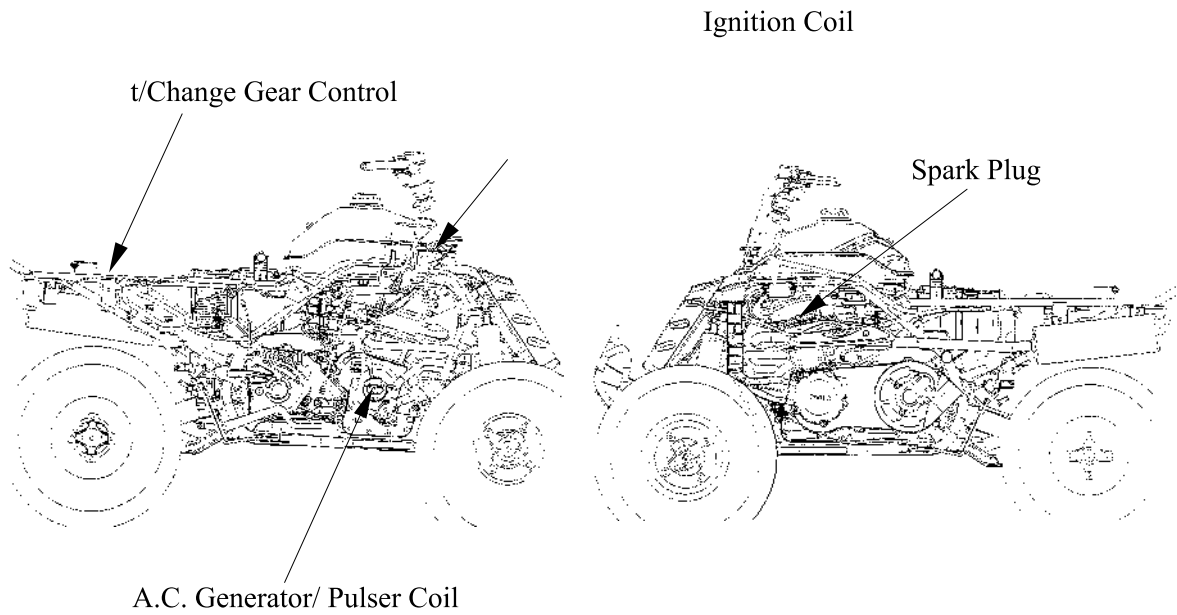

## IGNITION CIRCUIT

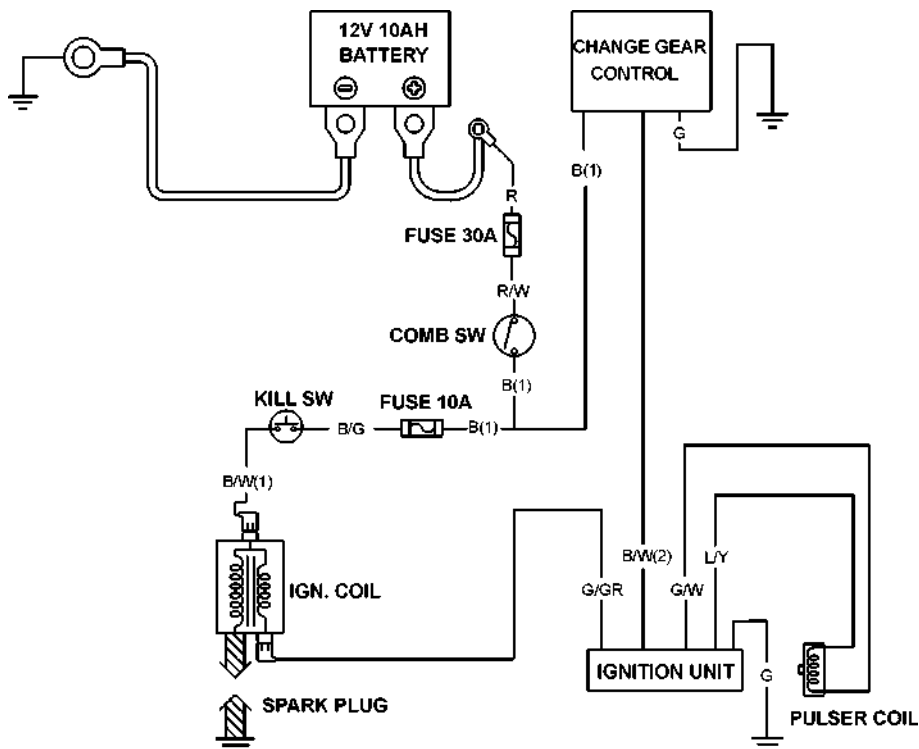

## SERVICE INFORMATION

### GENERAL INSTRUCTIONS

- Check the ignition system according to the sequence specified in the Troubleshooting.
- The ignition system adopts ignition unit, change gear control and the ignition timing cannot be adjusted.
- If the timing is incorrect, inspect the ignition unit, A.C. generator, change gear control and replace any faulty parts. Inspect the ignition unit with a ignition unit tester
- Loose connector and poor wire connection are the main causes of faulty ignition system. Check each connector before operation.
- Use of spark plug with improper heat range is the main cause of poor engine performance.
- The inspections in this section are focused on maximum voltage. The inspection of ignition coil resistance is also described in this section.
- Inspect the spark plug referring to chapter 3.

### SPECIFICATIONS

Item		Standard
Spark plug	Standard type	DPR7EA-9
Spark plug gap		0.6~0.7mm
Ignition timing	“F” mark Full advance	5°±1°BTDC/2000RPM
Ignition coil resistance (20°C)	Primary coil	3.4~4.1Ω
	Secondary coil	without plug cap
		with plug cap
Pulser coil resistance (20°C)		105~110Ω
Ignition coil primary side max. voltage		14V
Pulser coil max. voltage		1.6V
Exciter coil max. voltage		14V

### TESTING INSTRUMENT

Commercially available electric tester with resistance over 10MΩ/CDV.



# 17. IGNITION SYSTEM

---

## TROUBLESHOOTING

### High voltage too low

- Weak battery or low engine speed
- Loose ignition system connection
- Faulty ignition unit

- Faulty ignition coil
- Faulty pulser coil

### Normal high voltage but no spark at plug

- Faulty spark plug
- Electric leakage in ignition secondary circuit
- Faulty ignition coil

### Good spark at plug but engine won't start

- Faulty ignition unit or incorrect ignition timing
- Faulty change gear control unit
- Improperly tightened A.C. generator flywheel

### No high voltage

- Faulty ignition switch
- Faulty ignition unit
- Poorly connected or broken ignition unit ground wire
- Dead battery or faulty regulator/rectifier
- Faulty ignition coil connector
- Faulty pulser coil

# 17. IGNITION SYSTEM

## IGNITION UNIT /CHANGE GEAR CONTROL INSPECTION

Remove the seat. (Refer to the chapter 2)  
 Disconnect the ignition unit coupler and remove the ignition unit.  
 Disconnect the change gear control coupler and remove the change gear control.  
 Measure the resistance between the terminals using the electric tester.

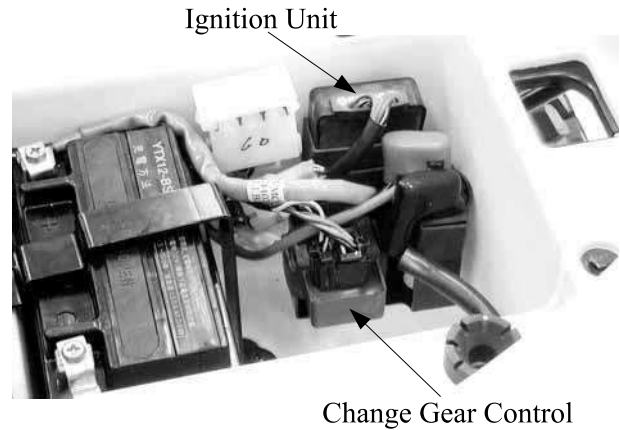

- \*
- Due to the semiconductor in circuit, it is necessary to use a specified tester for accurate testing. Use of an improper tester in an improper range may give false readings.
  - Use a YF-3501 Electric Tester.
  - In this table, “Needle swings then returns” indicates that there is a charging current applied to a condenser. The needle will then remain at “∞” unless the condenser is discharged.

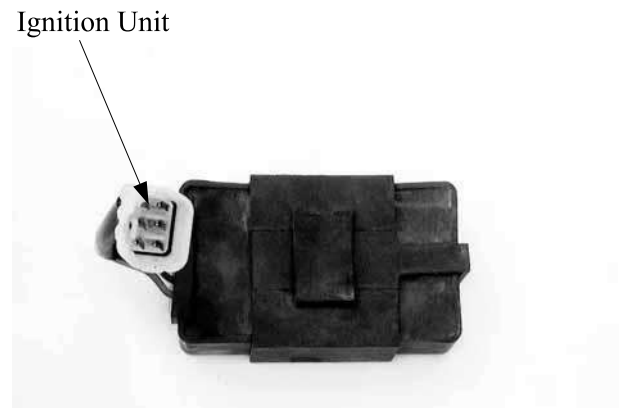

## IGNITION UNIT INSPECTION

Testing Range (at 20°C)

Unit: Ω

Probe⊕ (-)Probe	Blue/ Yellow	Green / Gray	Black / White	Green/ White	Black/ Yellow	Green
Blue/ Yellow		∞	10.56M	90.4K	10.56M	46K
Green / Gray	12.73M		∞	12.73M	∞	12.73M
Black / White	∞	∞		∞	999	∞
Green/ White	90.4K	∞	10.56M		10.56M	46K
Black/ Yellow	∞	∞	999	∞		∞
Green	44.4K	∞	10.56M	44.4K	10.56M	

Note: The readings in this table are taken with a YF-3501 Tester.

# 17. IGNITION SYSTEM

Test the ignition unit using the ignition unit tester.

\* Operate the ignition unit tester by following the manufacturer's instructions.

Connect the special connector to the ignition unit coupler and ignition unit tester.

Switch Range	Good CDI	Faulty CDI
1. OFF	No spark	—
2. P	No spark	—
3. EXT	No spark	Good spark
4. ON1	Good spark	No spark
5. ON2	Good spark	No spark

If the ignition unit is faulty, replace it with a new one.

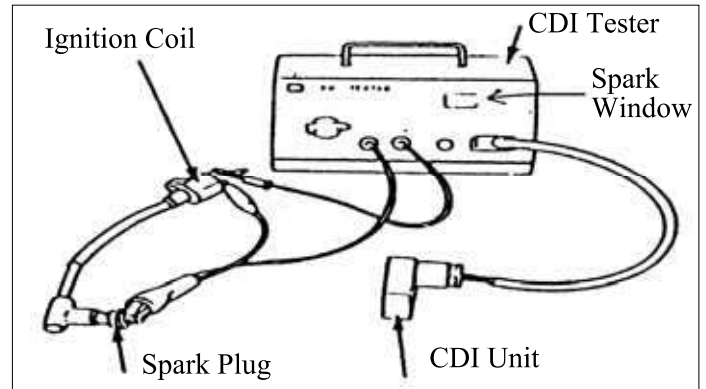

Change Gear Control

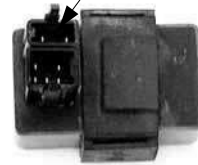

## CHANGE REAR CONTROL INSPECTION

Testing Range(at 20°C)

Unit: Ω

Probe⊕ (-)Probe	Green	Yellow/ Brown	Light Green/ Red	Green/ Pink	Green/ Yellow	Black/ White	Black
Green		14	∞	∞	7.85M	7.85M	10K
Yellow/ Brown	18		∞	∞	7.85M	7.85M	10K
Light Green/ Red	7.85M	7.85M		11	∞	∞	7.85M
Green/ Pink	7.85M	7.85M	9		∞	∞	7.85M
Green/ Yellow	∞	∞	∞	∞			∞
Black/ White	∞	∞	∞	∞	11		∞
Black	10K	10K	∞	∞	7.85M	7.85M	

Note: The readings in this table are taken with a YF-3501 Tester.

## IGNITION COIL INSPECTION CONTINUITY TEST

Remove the front fender. (Refer to the chapter 2)  
Remove the spark plug cap. (Refer to the chapter 6)  
Disconnect the ignition coil wires.

\* This test is to inspect the continuity of ignition coil.

Measure the resistance between the ignition coil primary coil terminals.

**Resistance:**  $3.4 \sim 4.1\Omega/20^{\circ}\text{C}$

Remove the spark plug cap and measure the secondary coil resistance between the spark plug wire and the primary coil terminal.

**Resistance:**

(with plug cap):  $19.8\text{K}\Omega/20^{\circ}\text{C}$

(without plug cap):  $14.45\text{K}\Omega/20^{\circ}\text{C}$

\* This test is for reference only. Accurate test should be performed with a CDI tester.



Ignition Coil



Measure the spark plug cap resistance.

Remove the spark plug cap and measure the spark plug resistance.

**Resistance:**  $4.2 \sim 5.2\text{K}\Omega/20^{\circ}\text{C}$

\* Measure the resistance in the  $\text{XK}\Omega$  range of the electric tester.



## PERFORMANCE TEST

Test the performance with a ignition unit tester.

- \* • Operate the ignition unit tester by following the manufacturer's instructions.
- Use the special connector to connect the ignition unit.

If the spark is weak, inspect the spark plug and CDI unit. If both of them are normal, replace the ignition coil with a new one.

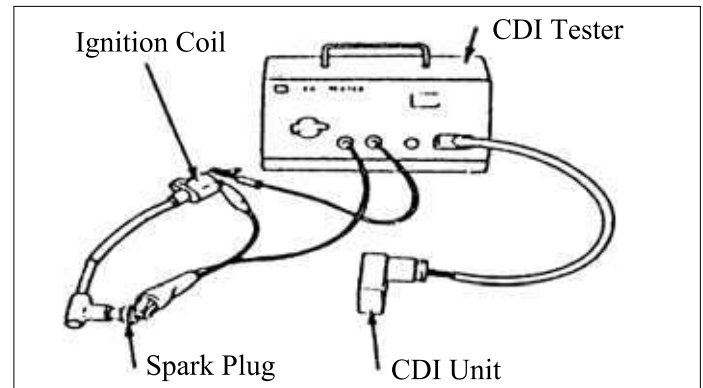

## PULSER COIL

### INSPECTION

Remove the front fender. (Refer to the chapter 2)

Disconnect the pulser coil wire coupler and measure the resistance between the blue/yellow and green/white wire terminals.

**Resistance:** 105 ~ 110Ω/20°C



Refer to the "A.C. GENERATOR/FLYWHEEL" section in the chapter 16 to remove or install.

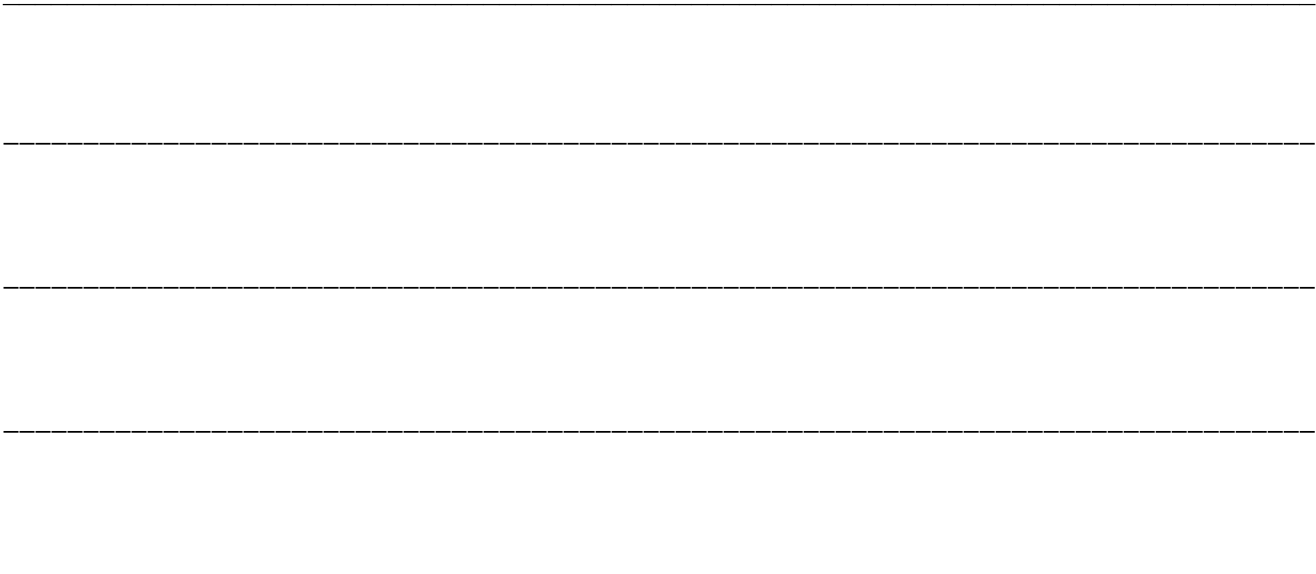

## STARTING SYSTEM

# 18

SERVICE INFORMATION-----	18- 2
TROUBLESHOOTING-----	18- 2
STARTER MOTOR -----	18- 3
STARTER RELAY -----	18- 6
STARTER CLUTCH-----	18- 7

# 18. STARTING SYSTEM

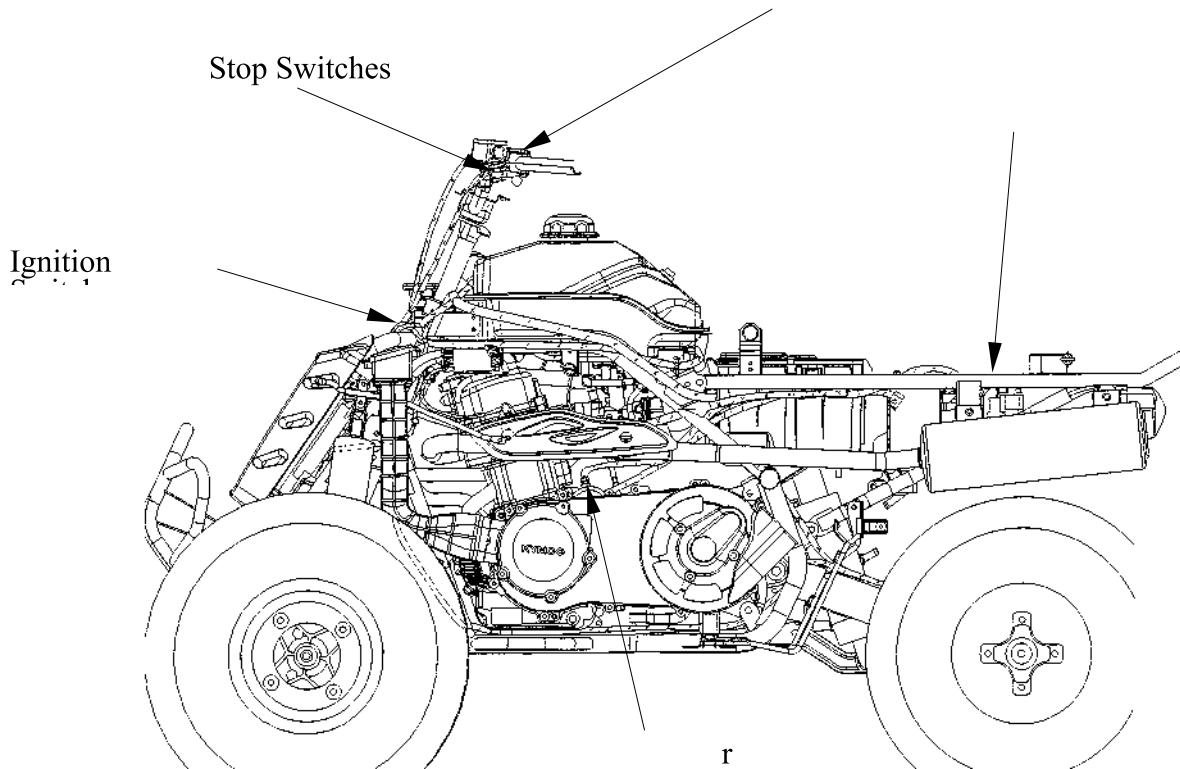

## STARTING CIRCUIT

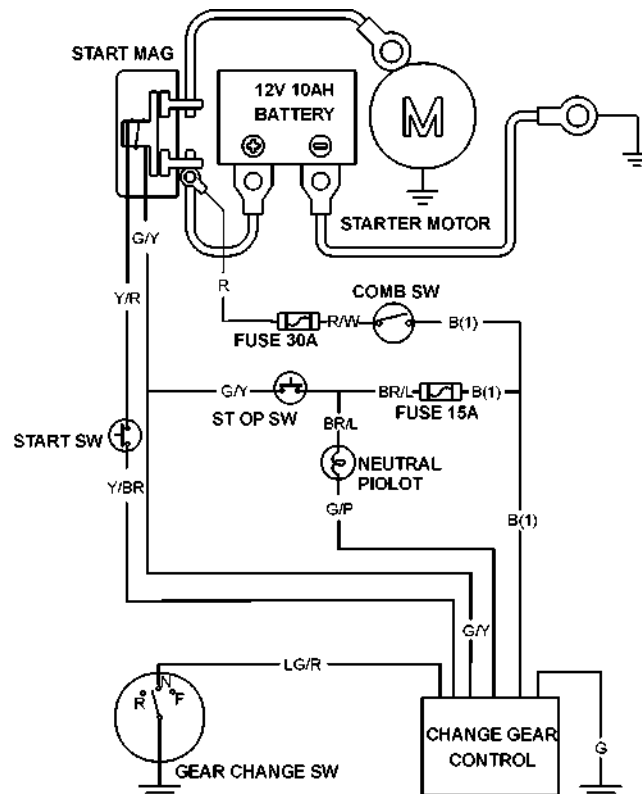

## SERVICE INFORMATION

### GENERAL INSTRUCTIONS

- The removal of starter motor can be accomplished with the engine installed.

## TROUBLESHOOTING

### **Starter motor won't turn**

- Fuse burned out
- Weak battery
- Faulty ignition switch
- Faulty starter clutch
- Faulty front or rear stop switch
- Faulty starter relay
- Poorly connected, broken or shorted wire
- Faulty starter motor
- Faulty change gear control unit

### **Lack of power**

- Weak battery
- Loose wire or connection
- Foreign matter stuck in starter motor or gear

### **Starter motor rotates but engine does not start**

- Faulty starter clutch
- Starter motor rotates reversely
- Weak battery



## 18. STARTING SYSTEM

### STARTER MOTOR

#### REMOVAL

- \* Before removing the starter motor, turn the ignition switch OFF and remove the battery ground. Then, turn on the ignition switch and push the starter button to see if the starter motor operates properly.

Remove the waterproof rubber jacket and remove nut to disconnect the starter motor cable connector.

Remove the two starter motor mounting bolts and the motor.

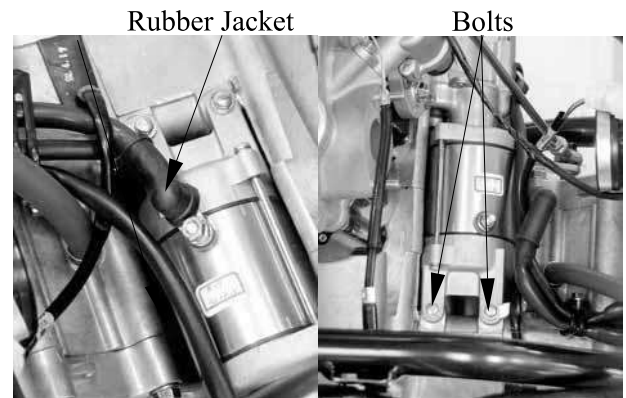

#### DISASSEMBLY

Remove the two starter motor case screws, front cover, motor case and other parts.

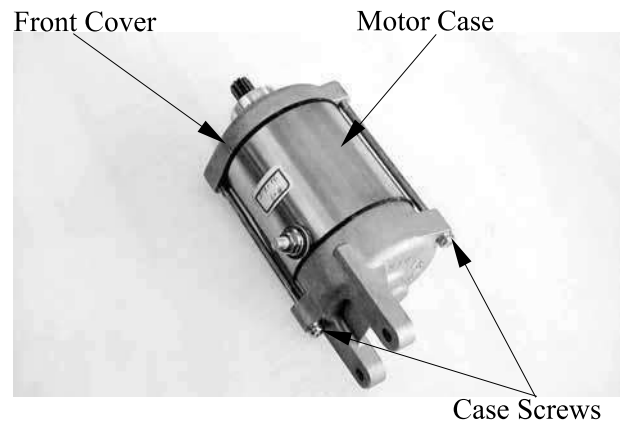

#### INSPECTION

Inspect the removed parts for wear, damage or discoloration and replace if necessary. Clean the commutator if there is metal powder between the segments.



Check for continuity between pairs of the commutator segments and there should be continuity.

Also, make a continuity check between individual commutator segments and the armature shaft. There should be no continuity.

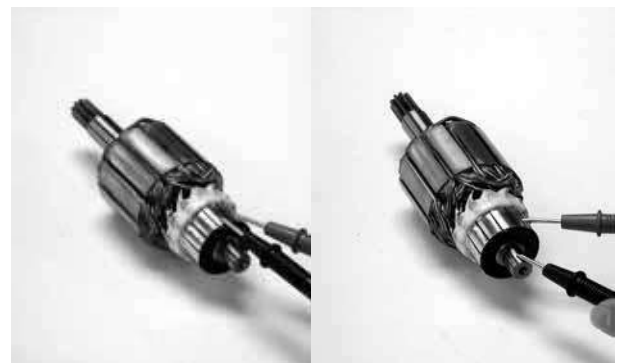

# 18. STARTING SYSTEM

## STARTER MOTOR CASE CONTINUITY CHECK

Check to confirm that there is no continuity between the starter motor wire terminal and the motor front cover.

Also check for the continuity between the wire terminal and each brush.

Replace if necessary.

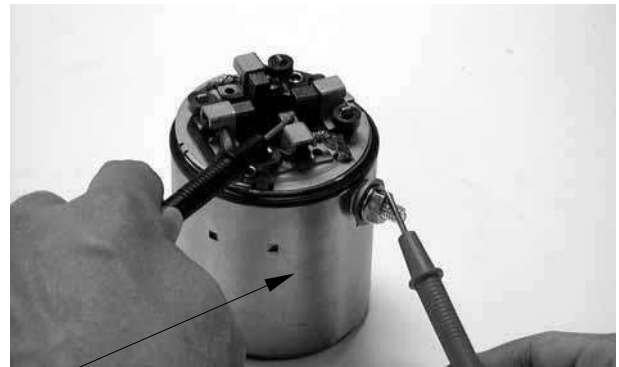

Wire Terminal

Measure the length of the brushes.

**Service Limit:** 8.5mm replace if below



Check for continuity between the brushes. If there is continuity, replace with new ones.



Check if the needle bearing in the front cover turns freely and has no excessive play.

Replace if necessary.

Check the dust seal for wear or damage.

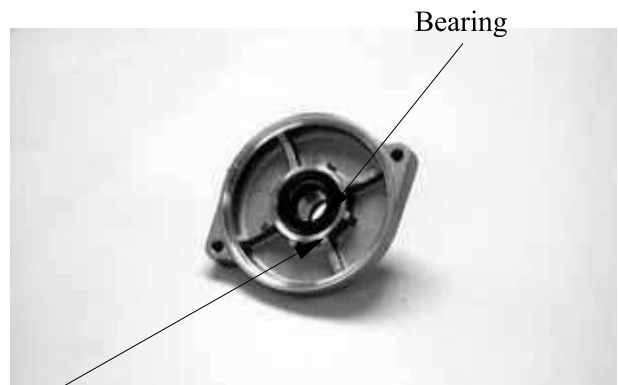

Dust Seal

## 18. STARTING SYSTEM

### ASSEMBLY

Apply grease to the dust seal in the front cover.  
Install the brushes onto the brush holders.  
Apply a thin coat of grease to the two ends of the armature shaft.  
Insert the commutator into the front cover.

- \* Be careful not to damage the brush and armature shaft mating surfaces.
- \* When installing the commutator, the armature shaft should not damage the dust seal lip.

Install a new O-ring to the front cover.  
Install the starter motor case, aligning the tab on the motor case with the groove on the front cover.  
Tighten the starter motor case screws.

- \* When assembling the front cover and motor case, slightly press down the armature shaft to assemble them.

### STARTER MOTOR INSTALLATION

Connect the starter motor cable connector and properly install the waterproof rubber jacket.  
Check the O-ring for wear or damage and replace if necessary.  
Apply grease to the O-ring and install the starter motor.  
Tighten the two mounting bolts.  
**Torque: 0.8~1.2kgf-m**

- \* The starter motor cable connector must be installed properly.

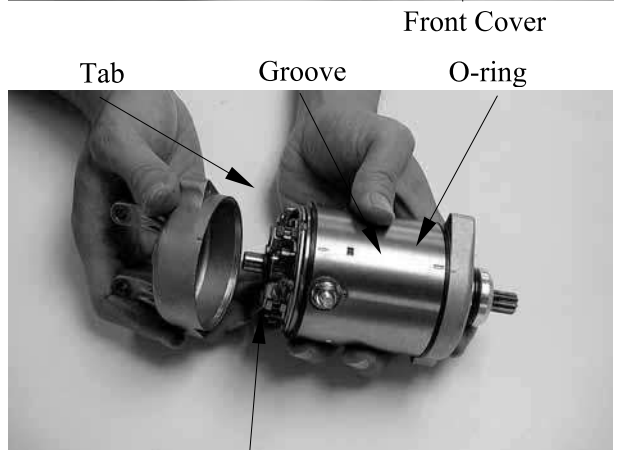
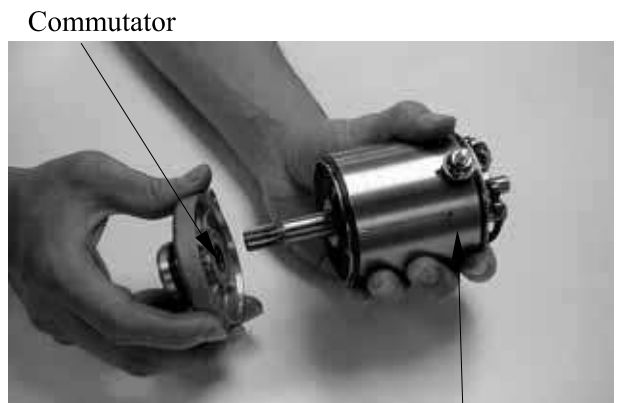

Motor Case



## STARTER RELAY

### INSPECTION

Remove the seat. (Refer to the chapter 2)  
Turn the ignition switch ON and the starter relay is normal if you hear a click when the starter button is depressed.

If there is no click sound:

- Inspect the starter relay voltage
- Inspect the starter relay ground circuit
- Check for continuity between the starter relay yellow/red and green/red wire terminals



### STARTER RELAY VOLTAGE INSPECTION

Connect a 12V battery across the starter relay yellow/red and green/red wire terminals.

Connect an electric tester between the starter relay large terminals and check for continuity between the two terminals.  
The relay is normal if there is continuity.  
Replace the starter relay with a new one if there is no continuity.

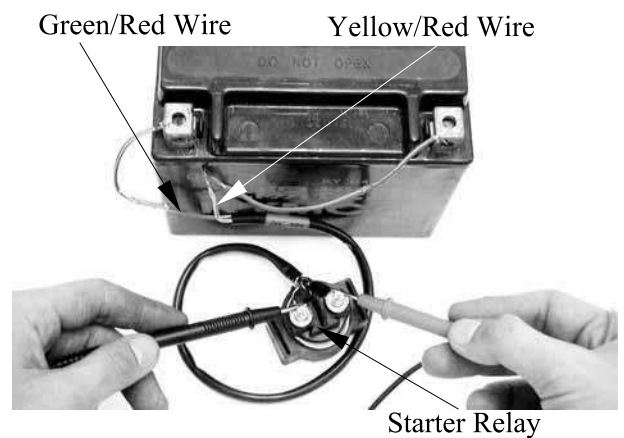

## 18. STARTING SYSTEM

### STARTER CLUTCH REMOVAL

Remove the right crankcase cover. (Refer to the “WATER PUMP SHAFT REMOVAL” section in the chapter 12)

Remove the flywheel. (Refer to the “A.C. GENERATOR/FLYWHEEL REMOVAL” section in the chapter 16)

Inspect the starter one-way clutch for wear or damage.

Remove the starter driven gear.



Starter Relay

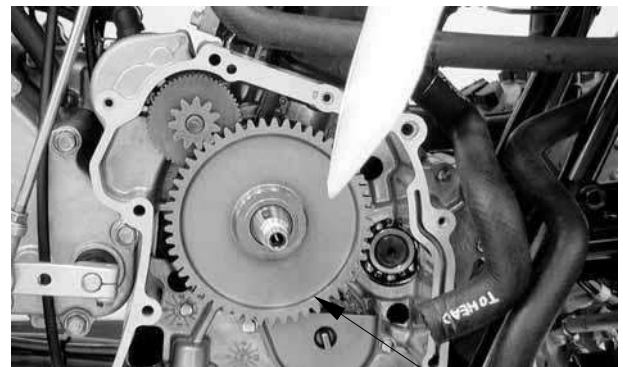

Starter Driven Gear

Inspect the starter driven gear for wear or damage.



Remove the starter idle gear and shaft.



Starter Idle Gear

Starter Idle Gear Shaft

## 18. STARTING SYSTEM

Inspect the starter idle gear and shaft for wear or damage.

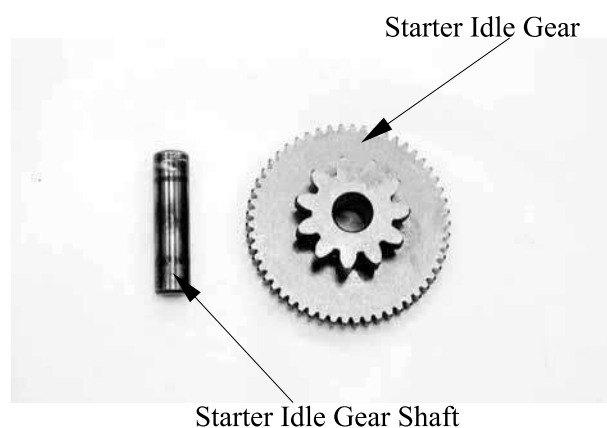

### INSTALLATION

Reverse the “REMOVAL” procedures.  
Install the starter idle gear and shaft.  
Install the starter driven gear.

Install flywheel and right crankcase cover.  
(Refer to the “A.C.  
GENERATOR/FLYWHEEL  
INSTALLATION” section in the chapter  
16)

---

---

---

---

---

---

---

---

**BULBS REMOVAL/INSTRUMENT/HORN**

BULBS REMOVAL-----	19- 1
INSTRUMENT (ON ROAD ONLY) -----	19- 4
HORN (ON ROAD ONLY)-----	19- 4

## BULBS REMOVAL

### HEADLIGHT

Remove the front fender. (See page 2-5)

Disconnect the headlight wire coupler.

Remove the rubber boot from the bulb socket.

Relax the lock clip to remove the bulb and replace with a new one.

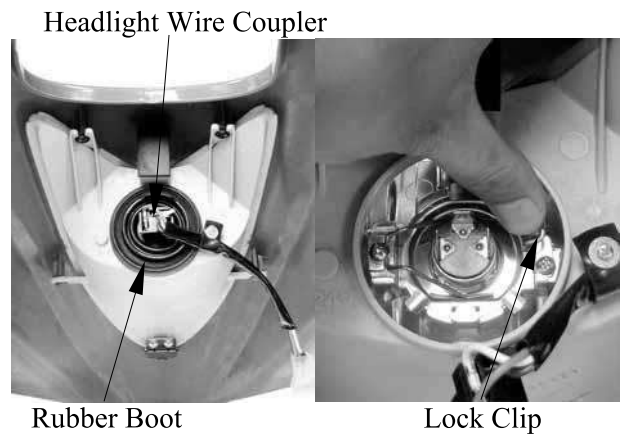

Install the bulb, aligning the bulb socket groove with the bulb tab and set the lock clip.

Install the rubber boot.

Install the front fender in the reverse order of removal.

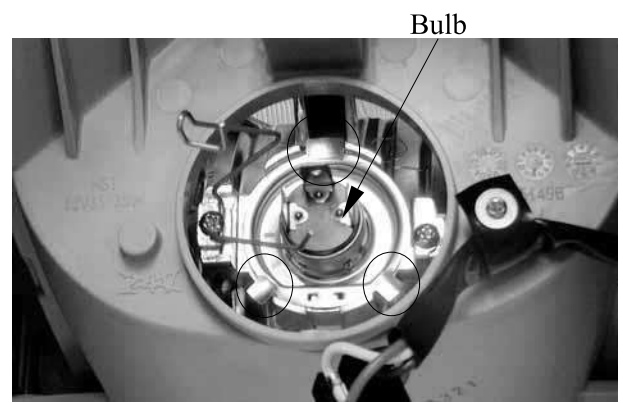

### TAIL/BRAKE LIGHT

Remove the bulb socket by turning it counterclockwise.

Remove the bulb.

Install the bulb in the reverse order of removal.

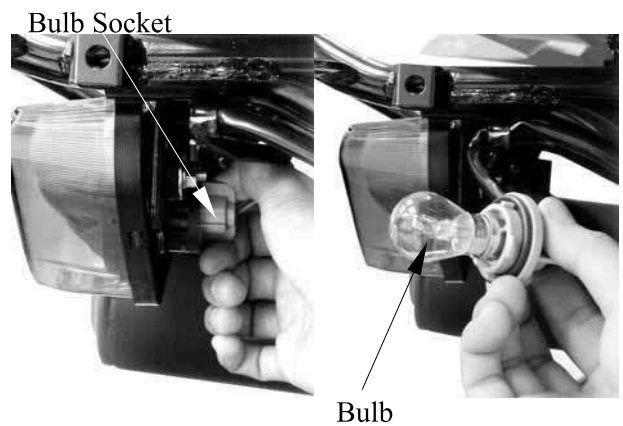



## 19. BULBS REMOVAL/INSTRUMENT/HORN

### INDICATOR LIGHT

Remove the handlebar cover. (See page 2-4)

Remove the bulb sockets by pulling them out.

Remove the bulb.

Install the bulb in the reverse order of removal.

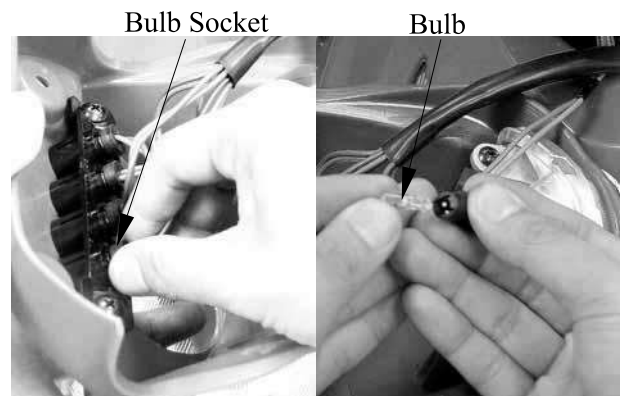

### POSITION LIGHT (ON ROAD ONLY)

Remove the handlebar cover. (See page 2-4)

Remove the bulb socket by pulling it out.

Remove the bulb.

Install the bulb in the reverse order of removal.

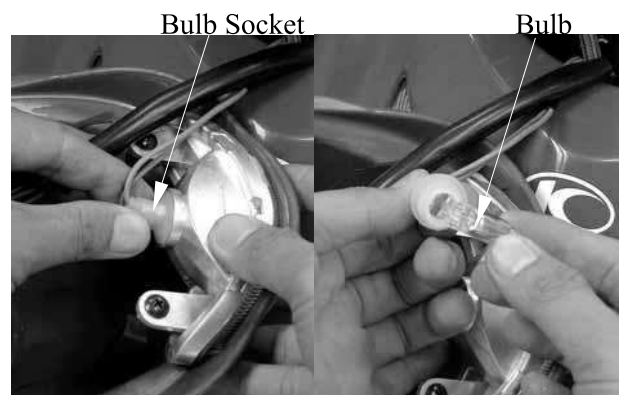

### FRONT TURN SIGNAL LIGHT (ON ROAD ONLY)

Remove the turn signal light lens by a standard screwdriver.

Pull the bulb socket out from the signal light case and remove bulb.

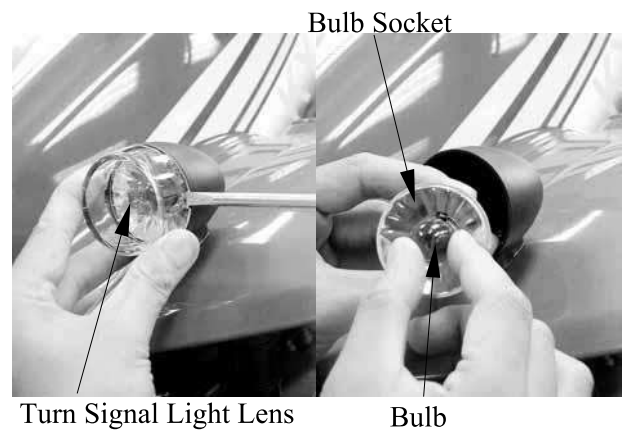

Install the bulb, aligning the bulb socket groove with the bulb tab.



# 19. BULBS REMOVAL/INSTRUMENT/HORN

Install the bulb socket, aligning the bulb socket groove with the turn signal case tab.  
Install the turn signal lens, aligning the turn signal lens groove with the turn signal case tab.

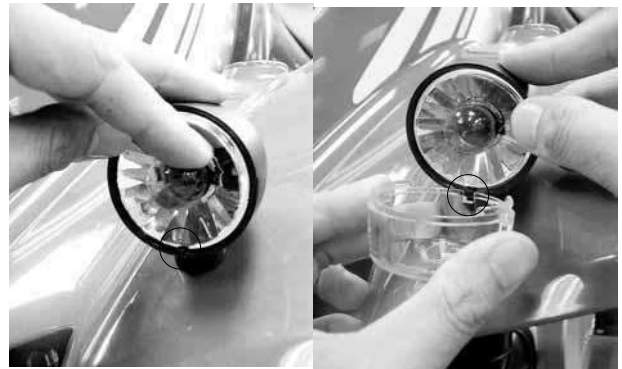

## REAR TURN SIGNAL LIGHT (ON ROAD ONLY)

Remove the screw and remove the turn signal light lens.  
Pull the bulb socket outside from the signal light case and remove bulb.

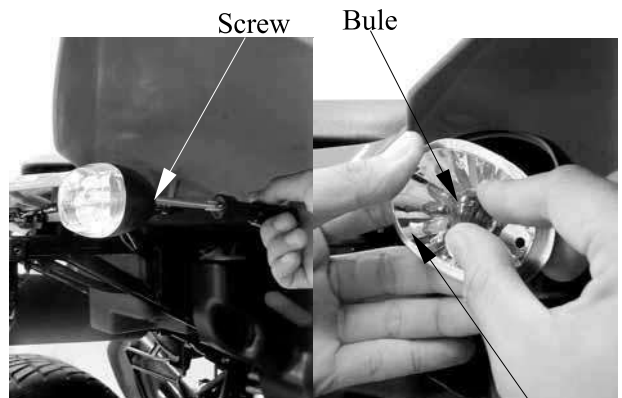

Install the bulb, aligning the bulb socket groove with the bulb tab.

Install the bulb in the reverse order of removal.



# 19. BULBS REMOVAL/INSTRUMENT/HORN

## INSTRUMENT (ON ROAD) REMOVAL

Remove the handlebar cover. (See page 2-4)  
Disconnect the meter wire coupler and speedometer cable.  
Remove the two nuts and then remove the instrument.

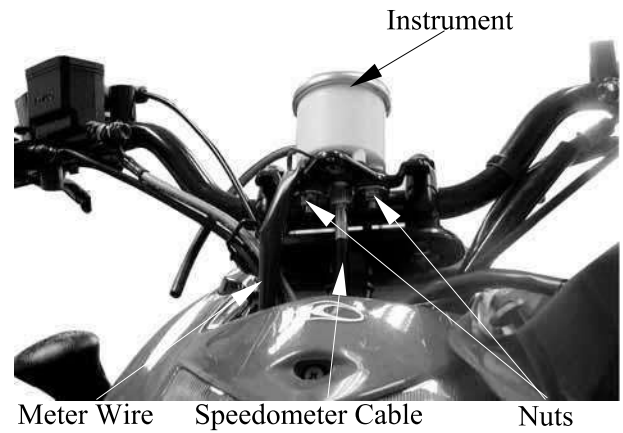

Pull the bulb socket out and then remove the instrument bulb.

Install the instrument in the reverse order of removal.

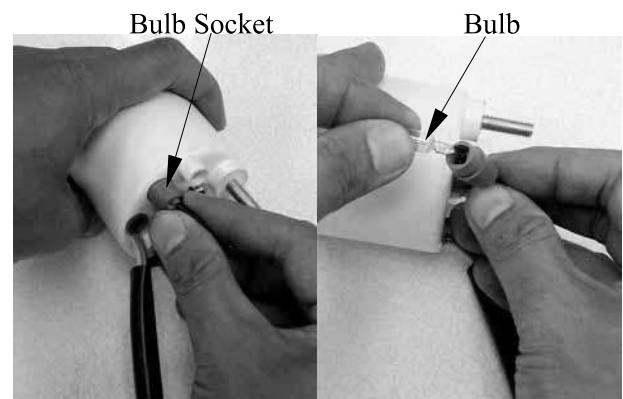

## HORN (ON ROAD)

### REMOVAL

Disconnect the horn wire leads.  
Remove the bolt and remove horn.

### INSTALLATION

The installation sequence is the reverse of removal.

