

**TABLE OF CONTENTS**

<b>SPECIFICATIONS.....</b>	<b>1</b>
<b>GENERAL INFORMATION.....</b>	<b>2</b>
<b>INSPECTION/ADJUSTMENT.....</b>	<b>3</b>
<b>LUBRICATION SYSTEM.....</b>	<b>4</b>
<b>ENGINE REMOVAL/INSTALLATION.....</b>	<b>5</b>
<b>CYLINDER HEAD/CYLINDER/PISTON.....</b>	<b>6</b>
<b>A.C. GENERATOR.....</b>	<b>7</b>
<b>KICK STARTER/DRIVE PULLEY/CLUTCH/DRIVEN PULLEY.....</b>	<b>8</b>
<b>FINAL REDUCTION.....</b>	<b>9</b>
<b>CRANKCASE/CRANKSHAFT.....</b>	<b>10</b>
<b>FUEL SYSTEM.....</b>	<b>11</b>
<b>FRAME COVERS.....</b>	<b>12</b>
<b>STEERING HANDLEBAR/FRONT WHEEL/FRONT BRAKE/ FRONT SHOCK ABSORBER/FRONT FORK.....</b>	<b>13</b>
<b>REAR WHEEL/REAR BRAKE/REAR SHOCK ABSORBER.....</b>	<b>14</b>
<b>ELECTRICAL EQUIPMENT.....</b>	<b>15</b>
<b>INSTRUMENT/SWITCHES/LIGHTS.....</b>	<b>16</b>
<b>EXHAUST EMISSION CONTROL SYSTEM.....</b>	<b>17</b>

# 1.SPECIFICATIONS

LIKE50/125

## SPECIFICATIONS

Name & Model		LIKE 50/125	
Overall length (mm)		1915	
Overall width (mm)		690	
Overall height (mm)		1115	
Wheel base (mm)		1315/1325	
Engine type		Air cooled 2/4-stroke	
Fuel Used		92# or 95 nonleaded gasoline	
Displacement (cc)		50 cc/125 cc	
Net weight (kg)	Front wheel	40	
	Rear wheel	60	
	Total	100	
1 Person 70KG Gross weight(kg)	Front wheel	71	
	Rear wheel	112	
	Total	183	
Tires	Front wheel	120/70-12	
	Rear wheel	130/70-12	
Ground clearance (mm)		120	
Braking distance (m) (Initial speed Km/h)		4.4m (30km/h)	
Min. turning radius (mm)R/L		1900/1900	
Starting system		Starting motor & kick starter	
Fuel type		Gasoline, 2-stroke motor oil	
Cylinder arrangement		Single cylinder, flat	
Combustion chamber type		Semi-sphere	
Valve arrangement		Reed valve & piston	
Bore x stroke (mm)		39 x 41.4/52.4 x57.8	
Compression ratio		11 / 13	
Compression pressure (kg/cm <sup>2</sup> rpm)		11.8kg/cm <sup>2</sup> ±2	
Max. output		2.4/7500 kw/rpm 6.5/7500 kw/rpm	
Max. torque (kg m/rpm)		3.2/7000 N.m/rpm 9.1/7000 N.m/rpm	
Port timing	Intake	Open	Automatic controlled
		Close	Automatic controlled
	Exhaust	Open	—
		Close	—
	Scavenging	Open	—
		Close	—
Idle speed (rpm)		1700/2000 ±100	
Lubrication type		Separate type	

Lubrication oil capacity (liter)		0.8/0.9	
Air cleaner type & No.		Wet, single	
Fuel capacity (liter)		6	
Carburetor	Type	Plunger type	
	Piston dia. (mm)	—	
	Venturi dia. (mm)	16/22	
Ignition system type		CDI electromagnetic Ignition	
Ignition timing F mark		13.5°±1°BTDC/2000 rpm	
Spark plug		NGK	CR7HSA
Spark plug gap (mm)		0.6~0.7	
Battery capacity		12V7AH	
Power to transmission gear		Power-transmission gear-clutch	
Reduction ratio of power to transmission		—	
Clutch type		Dry multi-disc clutch	
Transmission gear operation type		Automatic centrifugal type	
Transmission ratio		1 speed	—
Reduction gear	Type	Two-stage reduction	
	1st reduction ratio	3.1~0.9	
	2nd reduction ratio	12.69	
Transmission gear type		Non-stage	
Tire pressure (kg/cm <sup>2</sup> )	Front wheel	1.75 kg/cm <sup>2</sup>	
	Rear wheel	2.25 kg/cm <sup>2</sup>	
Turning angle		Right & left 45°	
Brake system type	Front wheel	hydraulic	
	Rear wheel	Expanding	
Suspension type	Front wheel	Telescope	
	Rear wheel	Unit swing	
Shock absorber type	Front wheel	Telescope	
	Rear wheel	Unit swing	
Frame type		Pipe under bone	

---

**GENERAL INFORMATION**

---

ENGINE SERIAL NUMBER/IDENTIFICATION.....2- 1

SERVICE PRECAUTIONS..... 2- 2

SERVICE INFORMATION.....2- 10

TORQUE VALUES..... 2- 12

SPECIAL TOOLS..... 2- 13

LUBRICATION POINTS..... 2- 15

WIRING DIAGRAM.....2- 16

CABLE & HARNESS ROUTING.....2- 17

TROUBLESHOOTING.....2- 21

### ENGINE SERIAL NUMBER/IDENTIFICATION

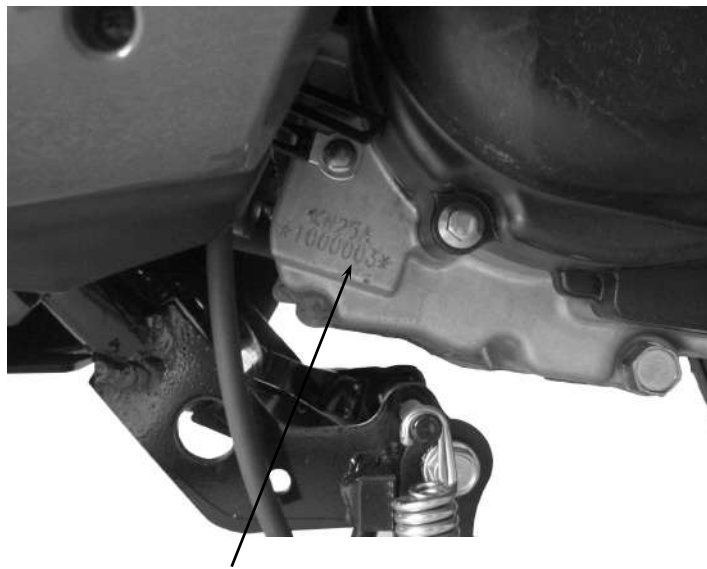

Location of Engine Serial Number

## 2. GENERAL INFORMATION

LIKE 50/125

### SERVICE PRECAUTIONS

- Make sure to install new gaskets, O-rings, circlips, cotter pins, etc. when reassembling.

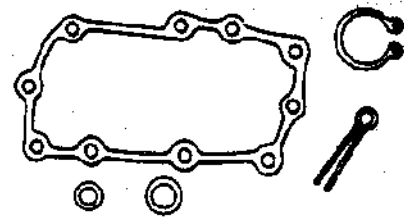

- When tightening bolts or nuts, begin with larger-diameter to smaller ones at several times, and tighten to the specified torque diagonally.

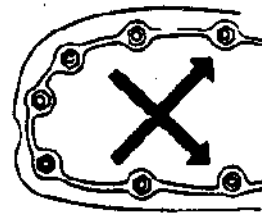

- Use genuine parts and lubricants.

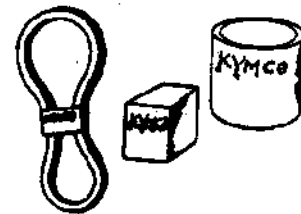

- When servicing the motorcycle, be sure to use special tools for removal and installation.



- After disassembly, clean removed parts. Lubricate sliding surfaces with engine oil before reassembly.

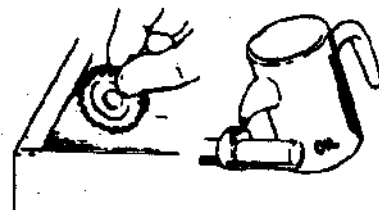

- Apply or add designated greases and lubricants to the specified lubrication points.

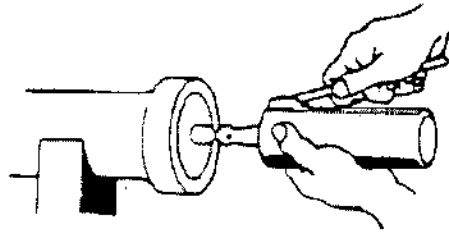

- After reassembly, check all parts for proper tightening and operation.

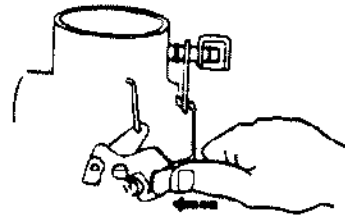

- When two persons work together, pay attention to the mutual working safety.



- Disconnect the battery negative (-) terminal before operation.
- When using a spanner or other tools, make sure not to damage the motorcycle surface.

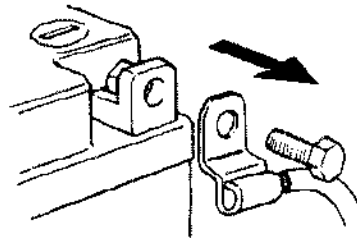

- After operation, check all connecting points, fasteners, and lines for proper connection and installation.
- When connecting the battery, the positive (+) terminal must be connected first.
- After connection, apply grease to the battery terminals.
- Terminal caps shall be installed securely.

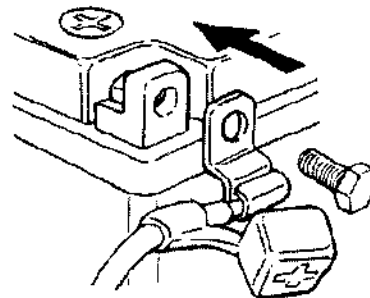

## 2. GENERAL INFORMATION

LIKE 50/125

- If the fuse is burned out, find the cause and repair it. Replace it with a new one according to the specified capacity.

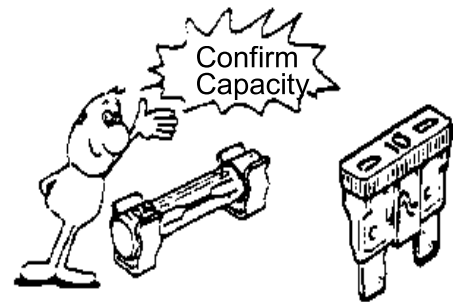

- After operation, terminal caps shall be installed securely.



- When taking out the connector, the lock on the connector shall be released before operation.

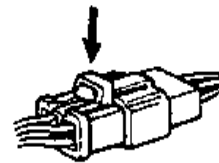

- Hold the connector body when connecting or disconnecting it.
- Do not pull the connector wire.

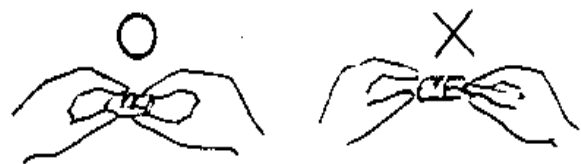

- Check if any connector terminal is bending, protruding or loose.

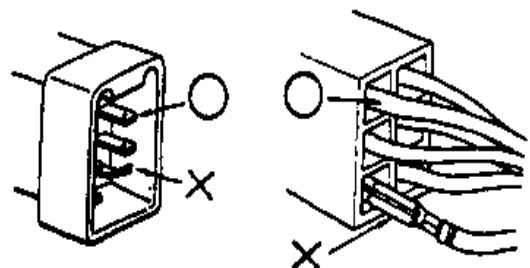

## 2. GENERAL INFORMATION

LIKE 50/125

- The connector shall be inserted completely.
- If the double connector has a lock, lock it at the correct position.
- Check if there is any loose wire.

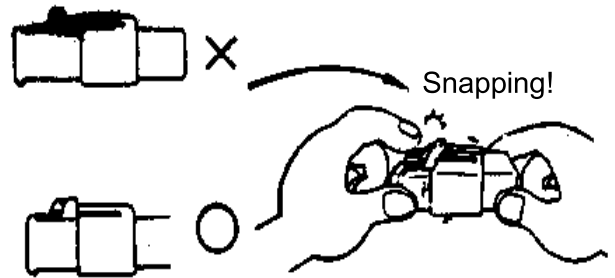

- Before connecting a terminal, check for damaged terminal cover or loose negative terminal.

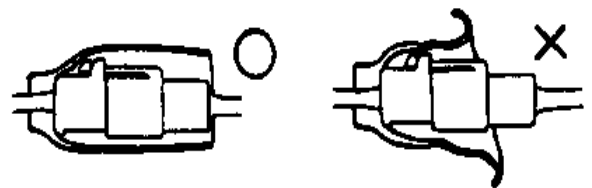

- Check the double connector cover for proper coverage and installation.

- Insert the terminal completely.
- Check the terminal cover for proper coverage.
- Do not make the terminal cover opening face up.

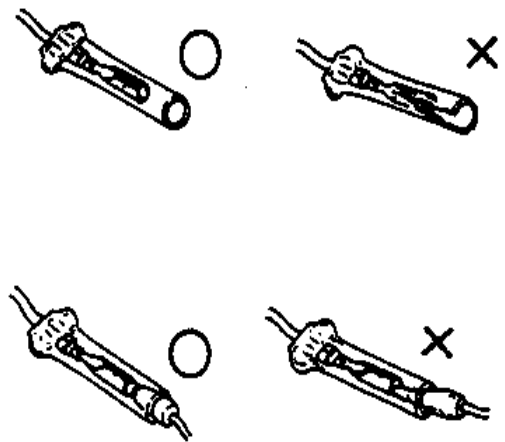

- Secure wire harnesses to the frame with their respective wire bands at the designated locations. Tighten the bands so that only the insulated surfaces contact the wire harnesses.

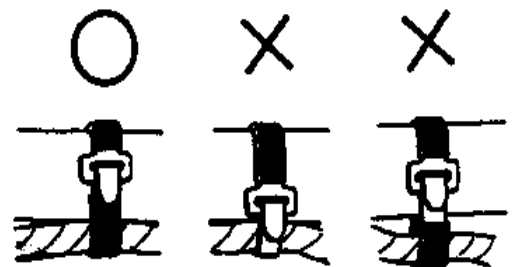



## 2. GENERAL INFORMATION

LIKE 50/125

- After clamping, check each wire to make sure it is secure.

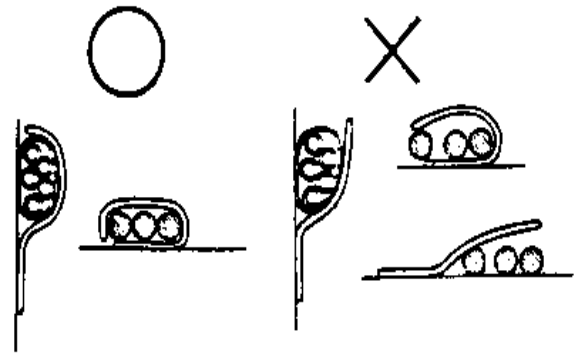

- Do not squeeze wires against the weld or its clamp.



- After clamping, check each harness to make sure that it is not interfering with any moving or sliding parts.

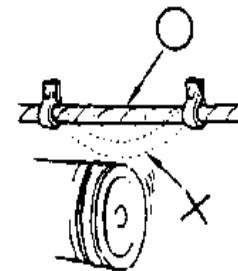

- When fixing the wire harnesses, do not make it contact the parts which will generate high heat.

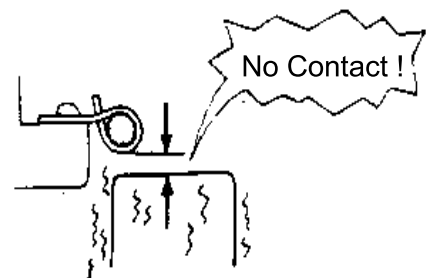

- Route wire harnesses to avoid sharp edges or corners. Avoid the projected ends of bolts and screws.
- Route wire harnesses passing through the side of bolts and screws. Avoid the projected ends of bolts and screws.

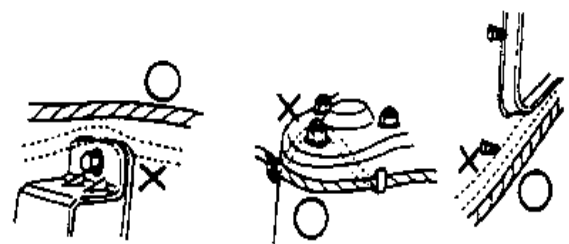

## 2. GENERAL INFORMATION

LIKE 50/125

- Route harnesses so they are neither pulled tight nor have excessive slack.

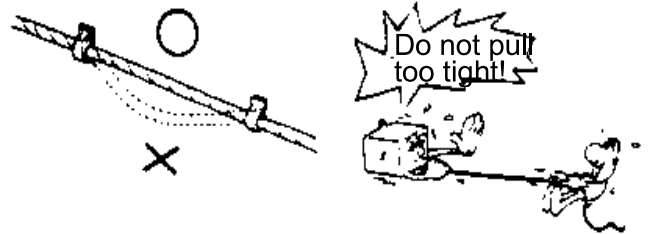

- Protect wires and harnesses with electrical tape or tube if they contact a sharp edge or corner.

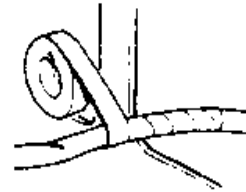

- When rubber protecting cover is used to protect the wire harnesses, it shall be installed securely.

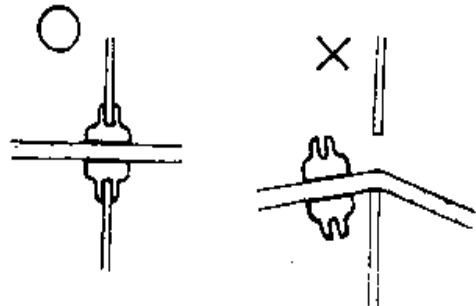

- Do not break the sheath of wire.
- If a wire or harness is with a broken sheath, repair by wrapping it with protective tape or replace it.

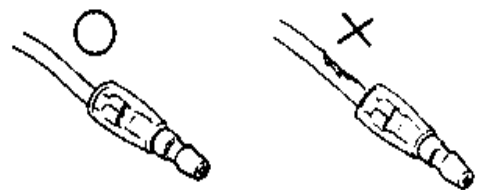

- When installing other parts, do not press or squeeze the wires.

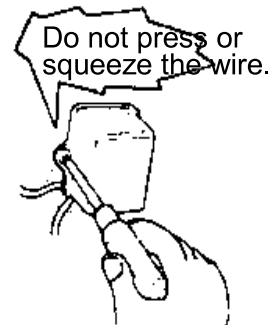

## 2. GENERAL INFORMATION

LIKE 50/125

- After routing, check that the wire harnesses are not twisted or kinked.

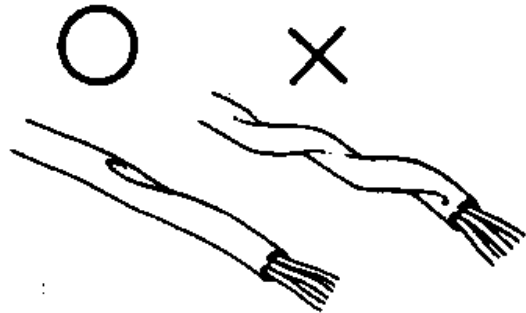

- Wire harnesses routed along with handlebar should not be pulled tight, have excessive slack or interfere with adjacent or surrounding parts in all steering positions.

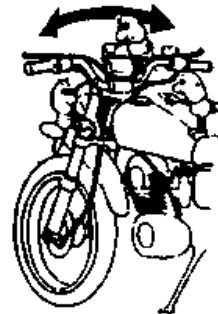

- When a testing device is used, make sure to understand the operating methods thoroughly and operate according to the operating instructions.

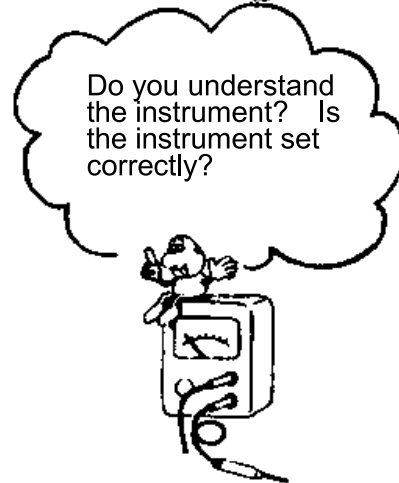

- Be careful not to drop any parts.



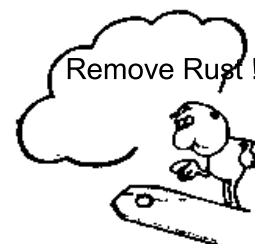

- When rust is found on a terminal, remove the rust with sand paper or equivalent before connecting.



■ Symbols:

The following symbols represent the servicing methods and cautions included in this service manual.

 : Apply engine oil to the specified points. (Use designated engine oil for lubrication.)  
Engine Oil

 : Apply grease for lubrication.  
Grease

 : Use special tool.  
Special

\* : Caution

 : Warning

## 2. GENERAL INFORMATION

LIKE 50/125

### SERVICE INFORMATION

ENGINE Item	Standard (mm)	Service Limit (mm)
	LIKE 50/125	LIKE 50/125
Cylinder head warp	—	0.10
Piston O.D.(5mm from bottom of piston skirt)	38.970~38.955	38.90
Cylinder-to- piston clearance		0.10
Piston pin hole I.D.	12.002~12.008	12.03
Piston pin O.D.	11.994~12.0	11.98
Piston-to-piston pin clearance	←	←
Piston ring end gap (top/second)	0.10~0.25	0.40
Connecting rod small end I.D.	17.005~17.017	17.03
Cylinder bore	39.0~39.025	39.05
Drive belt width	18	17
Drive pulley collar O.D.	20.01~20.025	←
Movable drive face ID.	20.035~20.085	19.97
Weight roller O.D.	13.0	12.4
Clutch outer I.D.	107~107.2	107.5
Driven face spring free length	87.9	82.6
Driven face O.D.	←	←
Movable driven face I.D.	←	←
Connecting rod big end side clearance	←	←
Connecting rod big end radial	←	←
Crankshaft runout A/B	—	←

CARBURETOR	LIKE 50	LIKE 125
Venturi dia.	16mm	22mm
Identification number	PB	PB
Float level	8.6mm	8.6mm
Main jet	#78	#98
Slow jet	#35	#35
Air screw opening	$2\frac{1}{4} \pm \frac{1}{2}$	$2\frac{1}{4} \pm \frac{1}{2}$
Idle speed	2000±100rpm	1700±100rpm
Throttle grip free play	2~6mm	2~6mm
Jet needle clip notch	1st notch	1st notch

## 2. GENERAL INFORMATION

**SUPER8 50 2T**

FRAME		Standard (mm)	Service Limit (mm)
Item		LIKE 50/125	LIKE 50/125
Axle shaft runout		—	0.2
Front wheel rim runout	Radial		
	Axial		
Front shock absorber spring free length		200.0	182.8
Rear wheel rim runout			2.0
Brake drum I.D.	Front/rear	110	111
Brake lining thickness	Front/rear	5.7/4.0	2.0/2.0
Brake disk runout	Front/rear	—	0.30
Rear shock absorber spring free length		235.7	218.7

ELECTRICAL EQUIPMENT			LIKE 50/125
Battery	Capacity		12V7AH
	Voltage		13.0~13.2V
	Charging current	Standard	0.4A/5H
		Quick	4A/0.5H
Spark plug	(NGK)		CR9HSA
Spark plug gap			0.6~0.7mm
Ignition coil resistance	Primary coil		0.153~0.187Ω
	Secondary coil (with plug cap)		6.99~10.21KΩ
	Secondary coil (without plug cap)		3.24~3.96KΩ
Pulser coil resistance (20°C)			80~160Ω
Ignition timing			13°±1°BTDC/2000rpm

## 2. GENERAL INFORMATION

LIKE 50/125

### TORQUE VALUES

#### ENGINE

Item	Thread dia. (mm)	Torque (kg-m)	Remarks
Cylinder head bolt	BF7x115	1.5~1.7	(cold)
Clutch drive plate nut	10	3.5~4.0	
Clutch outer nut	NH10	3.5~4.5	
Drive face nut	NH12	5.0~6.0	
Oil check bolt	10	1.0~1.5	
Engine mounting bolt	BF10x95	4.5~5.5	
Engine hanger bracket bolt	BF10x50	3.5~4.5	
Exhaust muffler joint lock nut	M8mm	1.8~2.2	
Exhaust muffler lock bolt	BF8x35	3.0~3.6	
Spark plug		1.1~1.7	(cold)

#### FRAME

Item	Thread dia. (mm)	Torque (kg-m)	Remarks
Handlebar lock nut	10	4.5~5.0	Flange bolt/U-nut
Steering stem lock nut	25.4	7.0~8.0	
Steering top cone race	25.4	0.5~1.3	
Front axle nut	12	5.0~7.0	Flange U-nut
Rear axle nut	16	11.0~13.0	Flange U-nut
Rear brake arm bolt			Flange nut
Front shock absorber:			
upper mount bolt	8	2.4~3.0	Flange bolt/U-nut
lower mount bolt			Cross head
hex bolt		1.5~3.0	Apply locking agent
Front damper nut	8	1.5~3.0	
Front pivot arm bolt			Flange screw/U-nut
Rear shock absorber:			
upper mount bolt	10	3.5~4.5	Flange nut
lower mount bolt	8	2.4~3.0	
lower joint nut	8	1.8~2.2	

Torque specifications listed above are for important fasteners. Others should be tightened to standard torque values below.

#### STANDARD TORQUE VALUES

SH bolt: 8mm

Flange 6mm bolt

Item	Torque (kg-m)	Item	Torque (kg-m)
5mm bolt, nut	0.45~0.6	5mm screw	0.35~0.5
6mm bolt, nut	0.8~1.2	6mm screw, SH bolt	0.7~1.1
8mm bolt, nut	1.8~2.5	6mm flange bolt, nut	1.0~1.4
10mm bolt, nut	3.0~4.0	8mm flange bolt, nut	2.4~3.0
12mm bolt, nut	5.0~6.0	10mm flange bolt, nut	3.5~4.5

### SPECIAL TOOLS

Tool Name	Tool No.	Remarks
Universal bearing puller		Crankshaft bearing removal
Lock nut wrench, 39mm		Drive pulley disassembly/assembly
Lock nut socket wrench		Top cone race holding
Lock nut wrench,		Stem lock nut tightening
Crankcase puller		Crankcase disassembly
Bearing remover set, 12mm (Spindle assy, 15mm) (Remover weight)		Drive shaft bearing removal/installation
Bearing remover set, 15mm (Spindle assy, 15mm) (Remover head, 15mm) (Remover shaft, 15mm)		Drive shaft bearing removal/installation
Bearing outer driver, 28x30mm		Bearing installation
Bearing remover		Driven pulley outer bearing installation
Clutch spring compressor		Driven pulley disassembly/assembly
Crankcase assembly collar		Driven shaft, crankshaft & crankcase assembly
Crankcase assembly tool		Crankshaft & crankcase assembly
Rear shock absorber remover		Front shock absorber disassembly/assembly
Ball race remover		Steering stem bearing races
Rear shock absorber compressor		Rear shock absorber disassembly/assembly
Float level gauge		Carburetor fuel level check
Lock nut socket wrench, 32mm		One-way clutch lock nut removal/installation
Universal holder		Flywheel holding
Flywheel puller		Flywheel removal
Pilot, 12mm		Drive shaft bearing installation
Bearing outer driver, 32x35mm		Drive shaft bearing installation Final shaft bearing installation



## 2. GENERAL INFORMATION

LIKE 50/125

Tool Name	Tool No.	Remarks
Bearing outer driver, 37x40mm		Drive shaft bearing installation Final shaft bearing installation Crankshaft bearing installation
Outer driver, 24x26mm		Driven pulley bearing installation
Pilot, 10mm		Front wheel bearing installation
Bearing driver pilot, 17mm		Drive shaft bearing installation
Snap ring pliers (close)		Circlip removal/installation
Bearing outer driver, 42x47mm		Crankshaft bearing installation
Pilot, 20mm		Crankshaft bearing installation
Bearing outer driver handle A		Bearing installation Drive in ball race
Bearing puller head, 10mm		Front wheel bearing removal
Universal bearing puller		Crankshaft bearing removal
Bearing puller		Front wheel bearing removal
Pressure tester set		Cylinder compression gauge

## LUBRICATION POINTS

### ENGINE

NO.	Lubrication Points	Lubricant	Remarks
1	Crankcase sliding & movable	JASO-FC or API-TC	
2	Cylinder movable parts		
3	Transmission gear (final gear)	SAE-90#	
4	Kick starter spindle bushing	Grease	
5	Drive pulley movable parts	Grease	
6	Starter pinion movable parts	Grease	

### FRAME

Apply clean engine oil or grease to cables and movable parts not specified. This will avoid abnormal noise and rise the durability of the motorcycle.

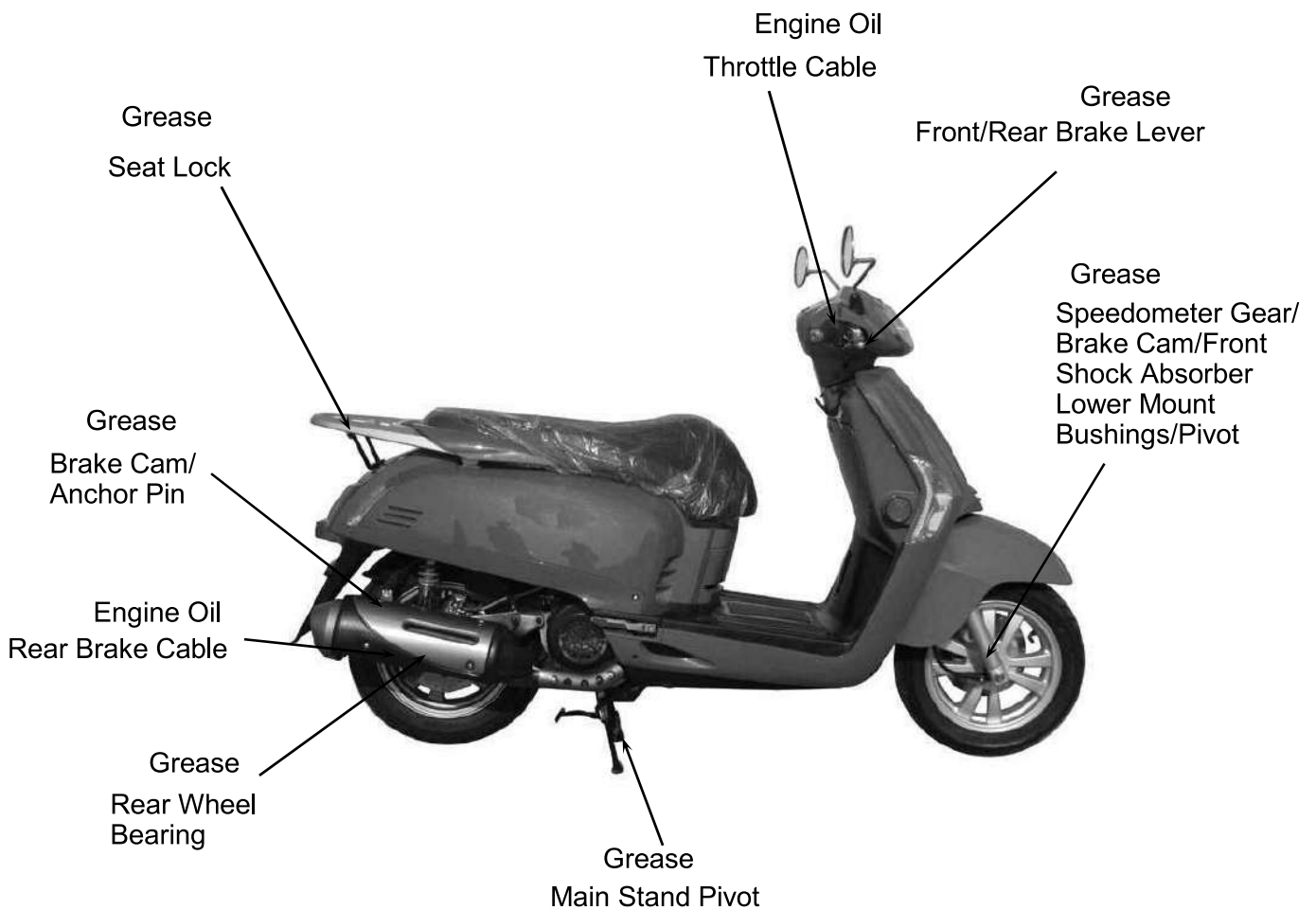



### CABLE & HARNESS ROUTING

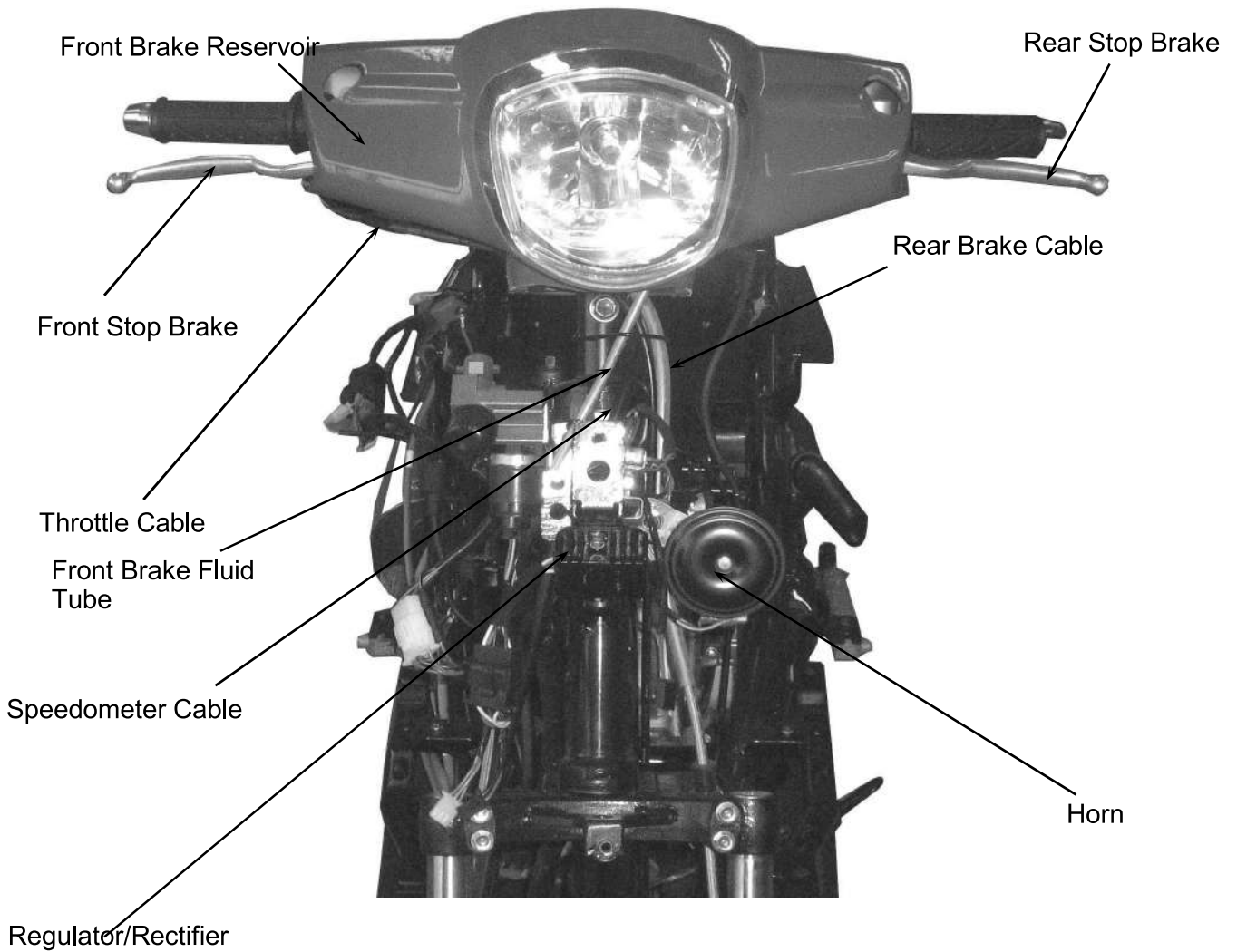

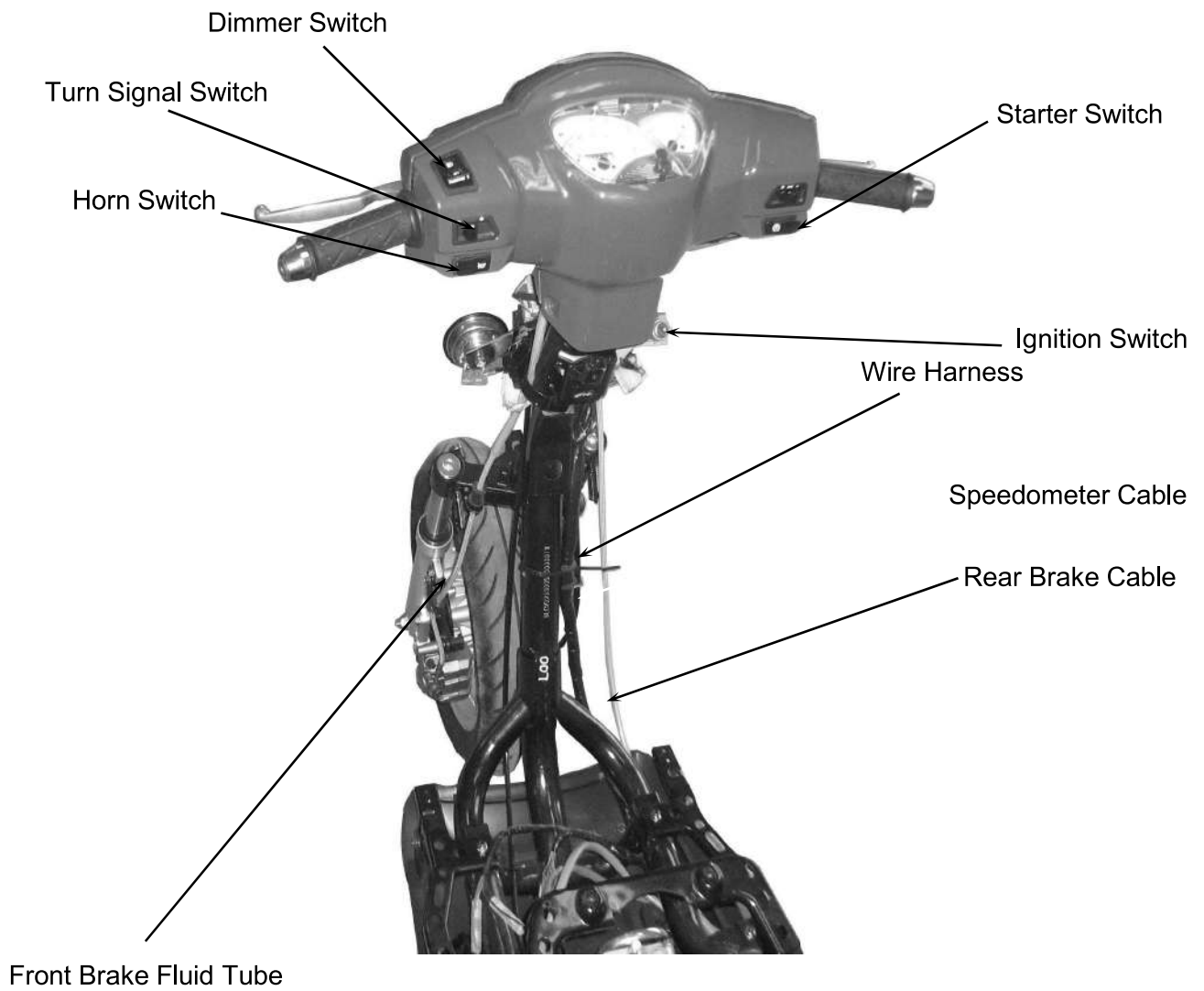

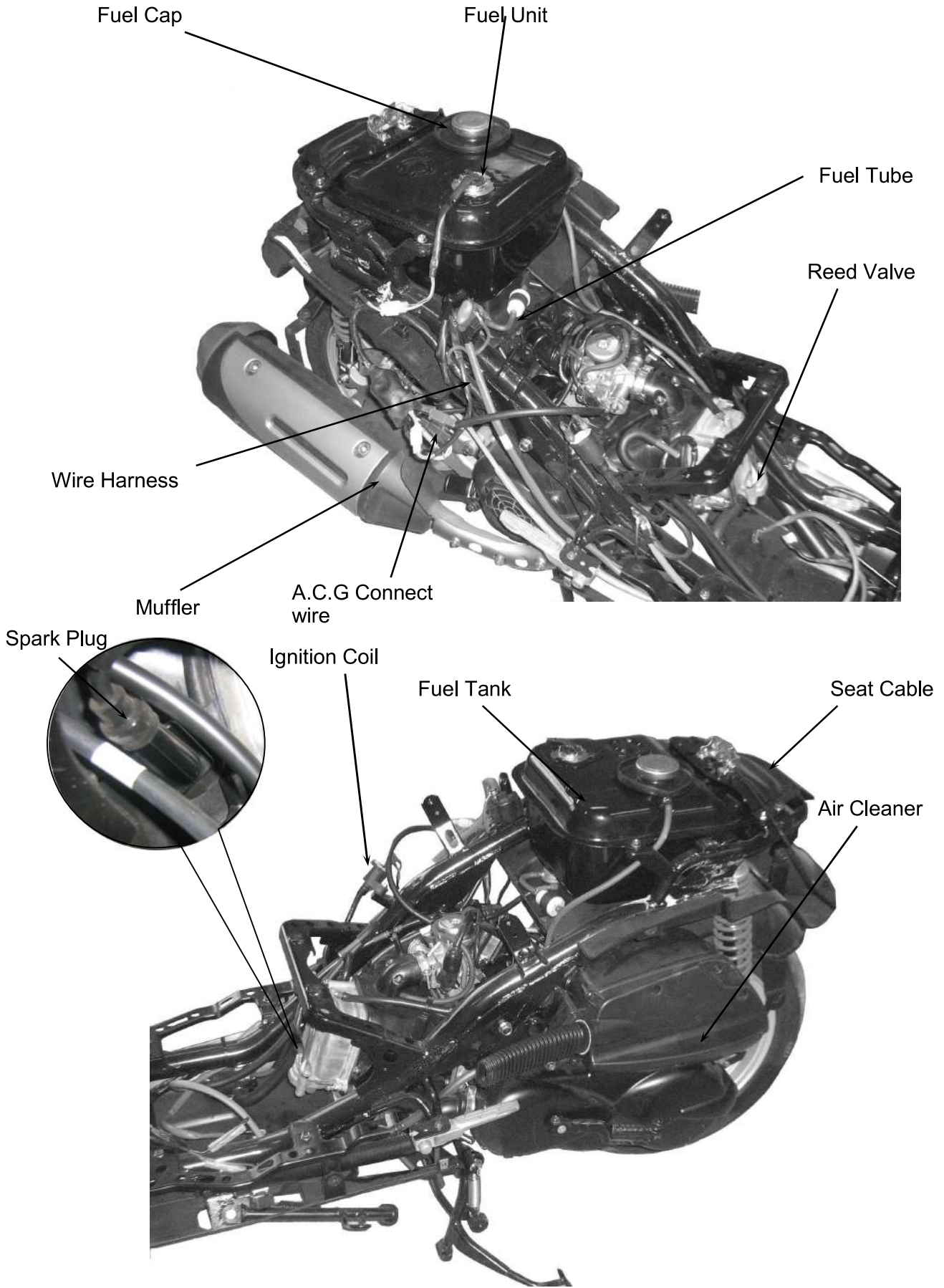

## 2. GENERAL INFORMATION

LIKE 50/125

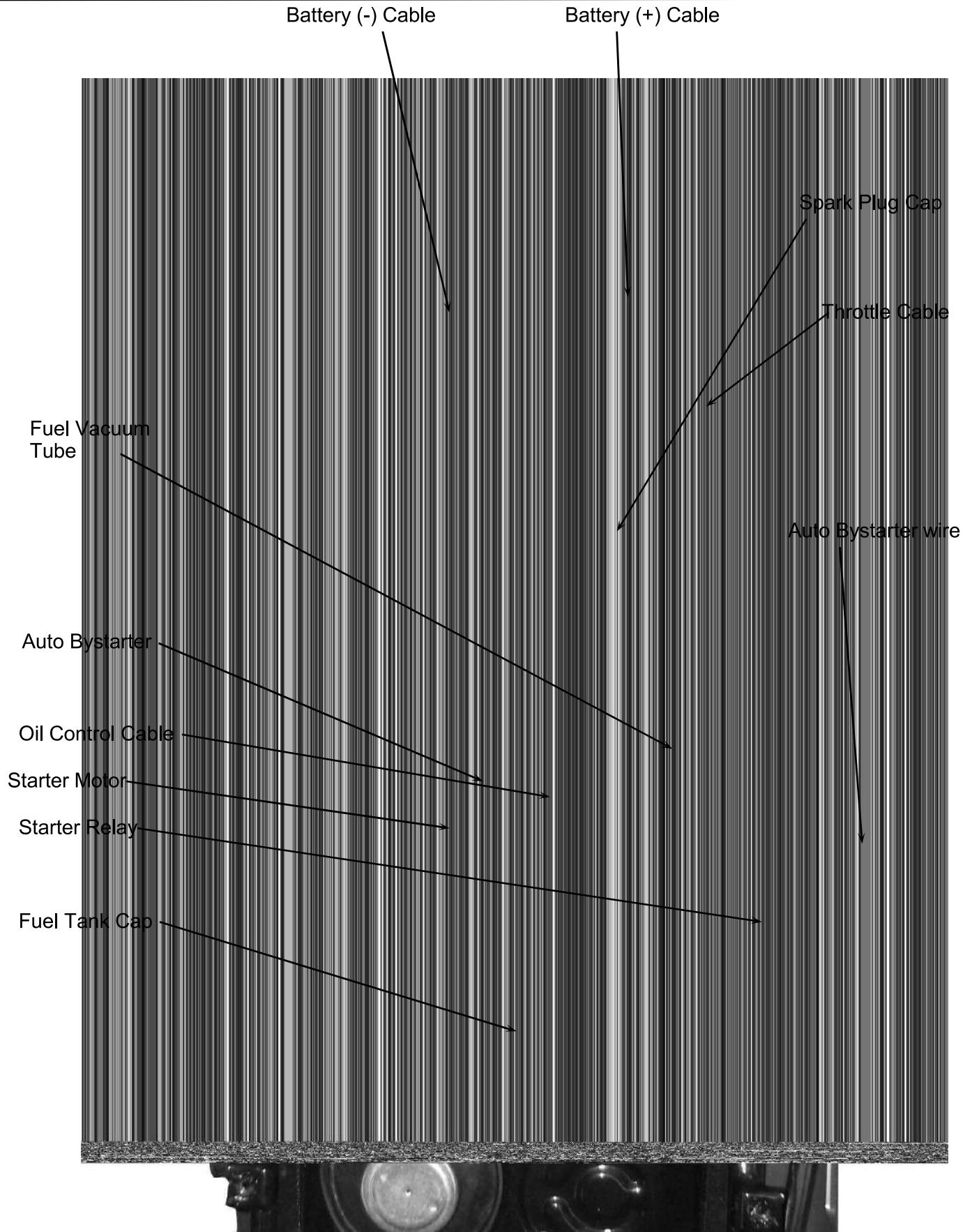

## TROUBLESHOOTING

### ENGINE WILL NOT START OR IS HARD TO START

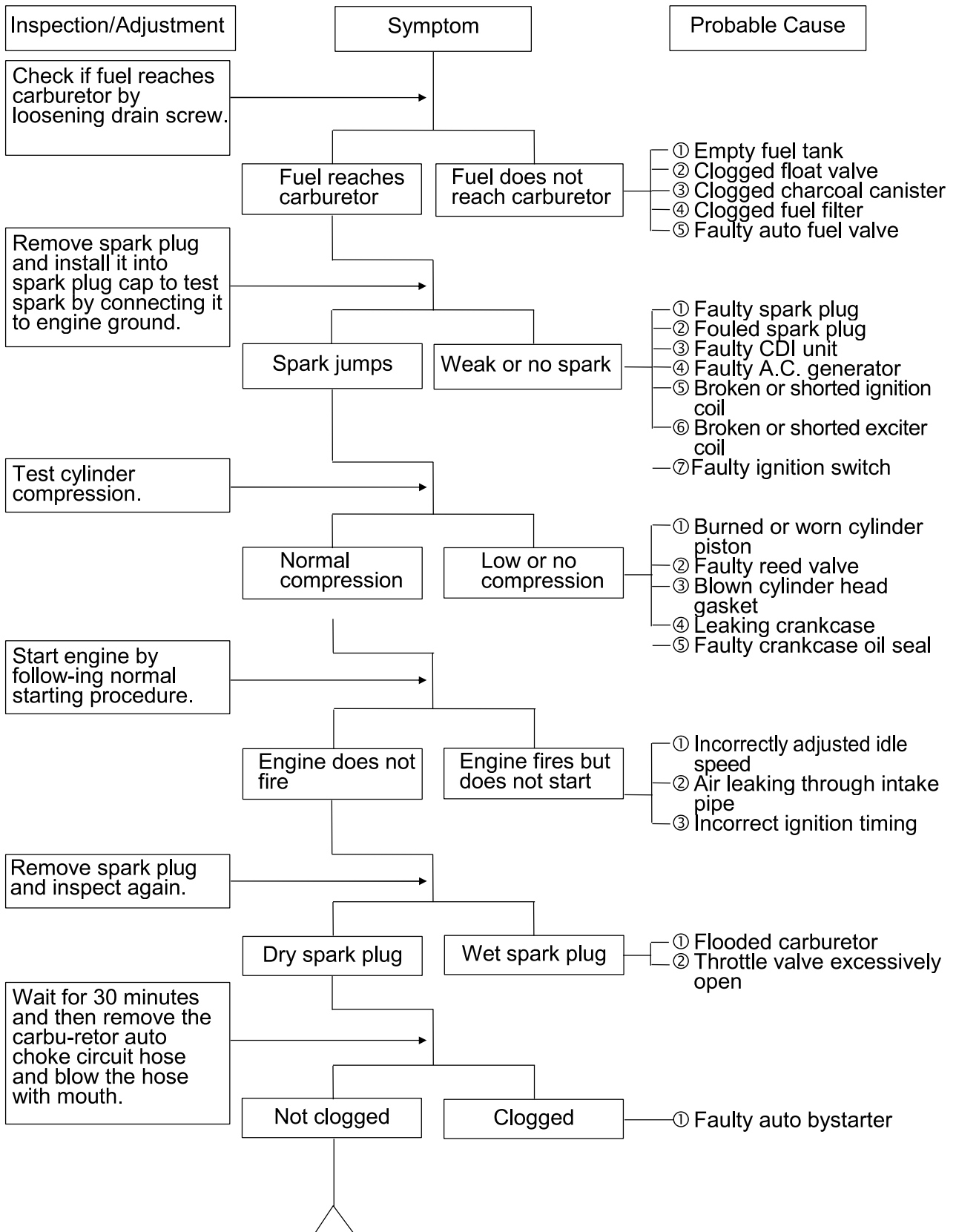



## ENGINE STOPS IMMEDIATELY AFTER IT STARTS

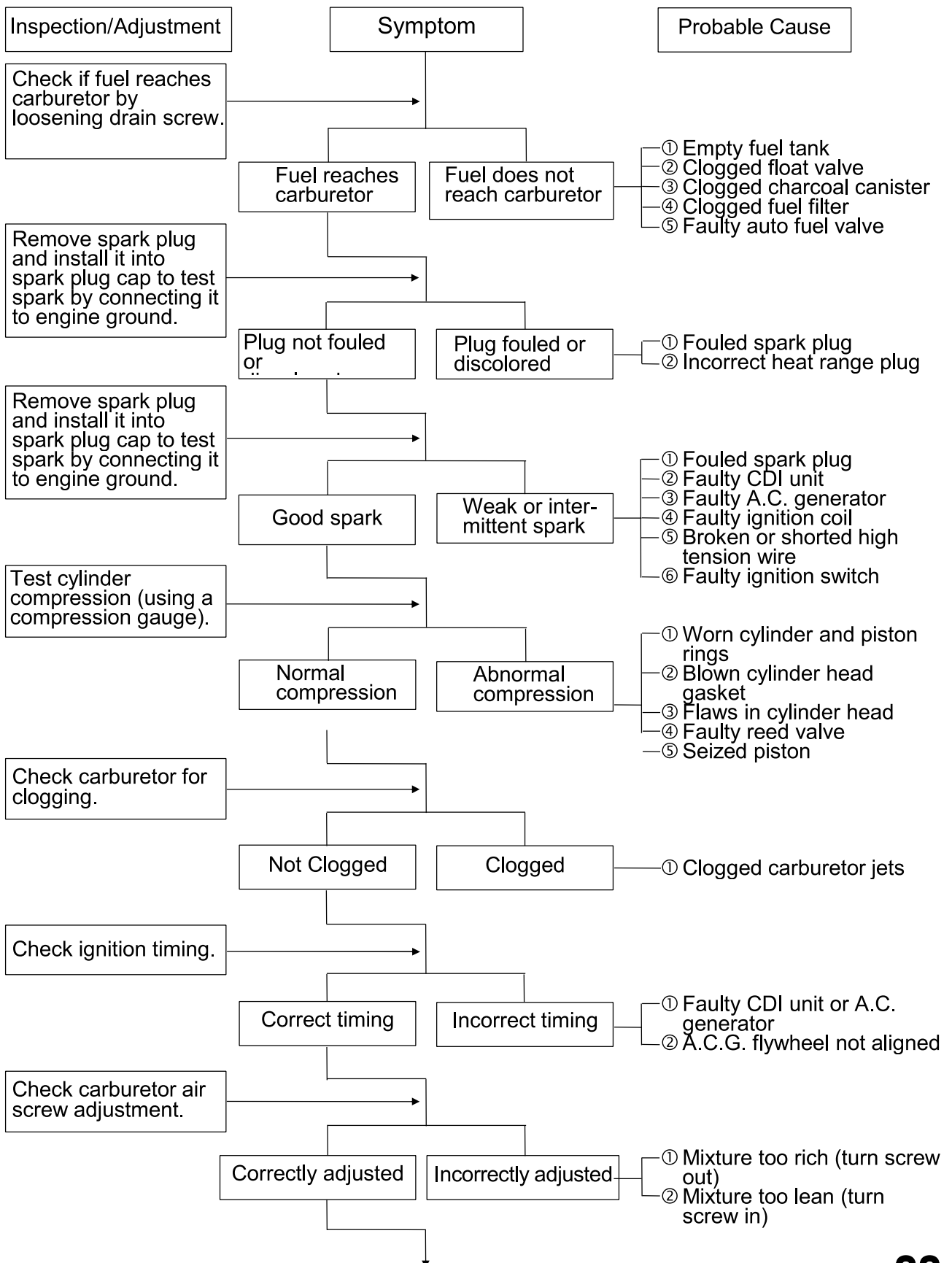

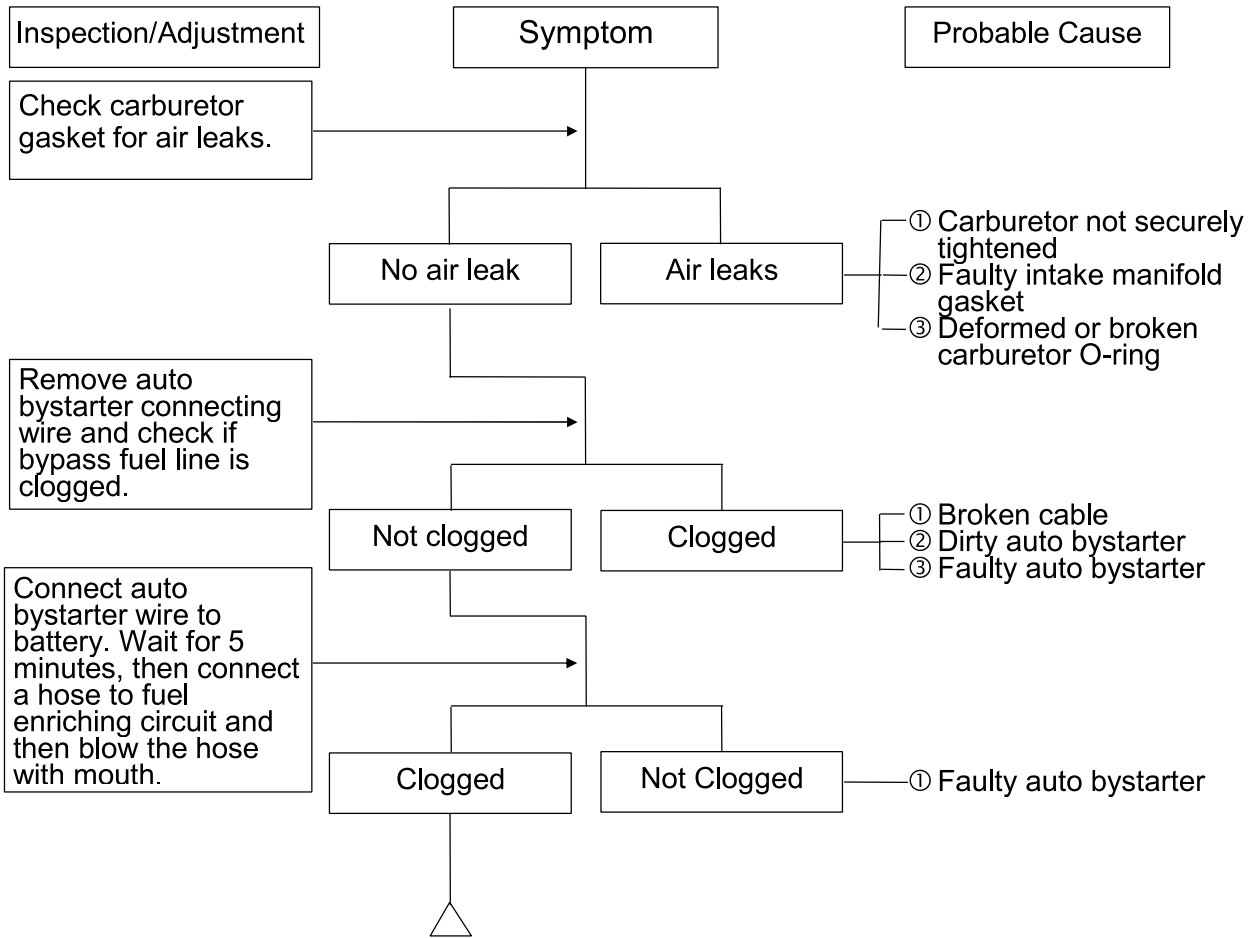

## ENGINE LACKS POWER

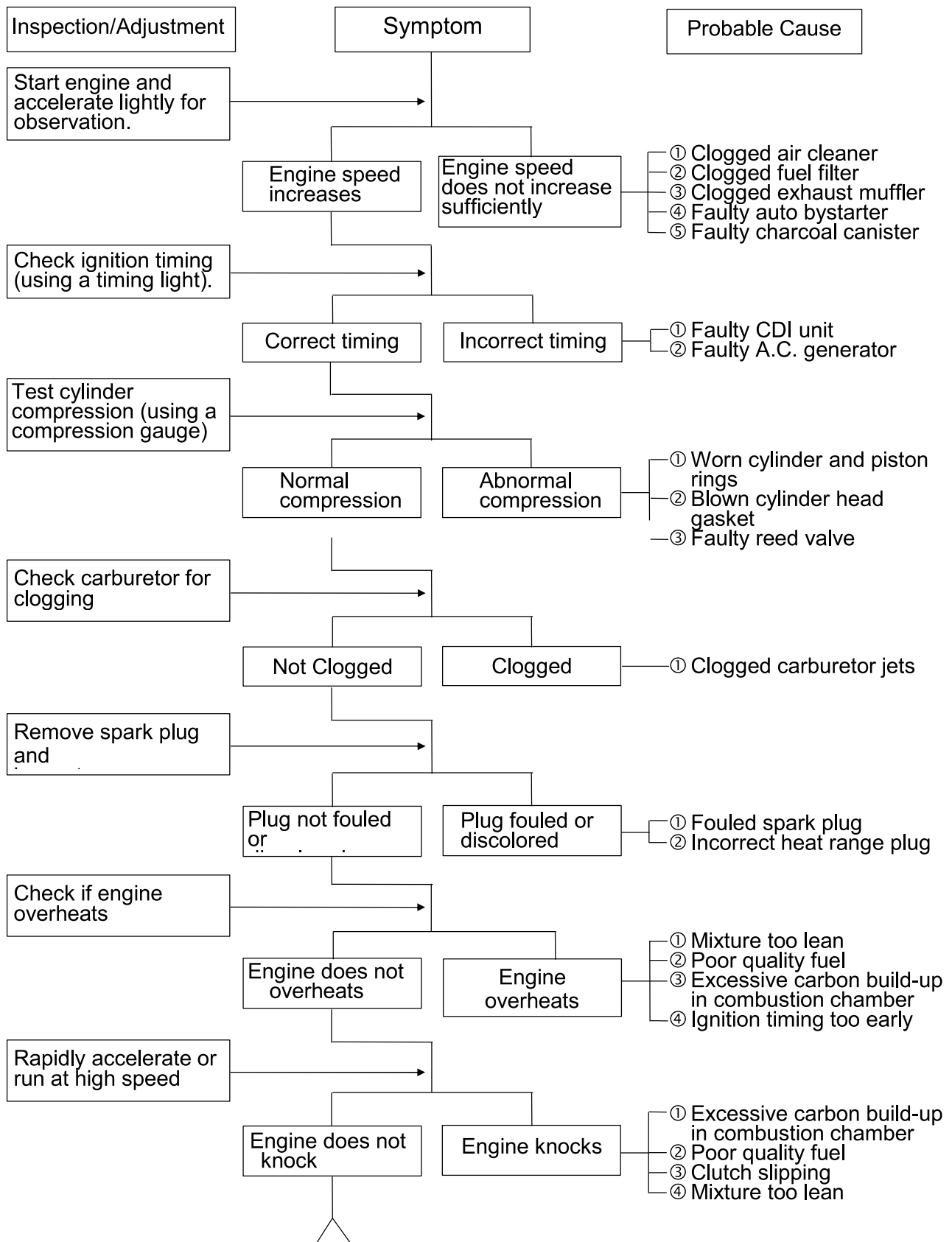

## POOR PERFORMANCE (ESPECIALLY AT IDLE AND LOW SPEEDS)

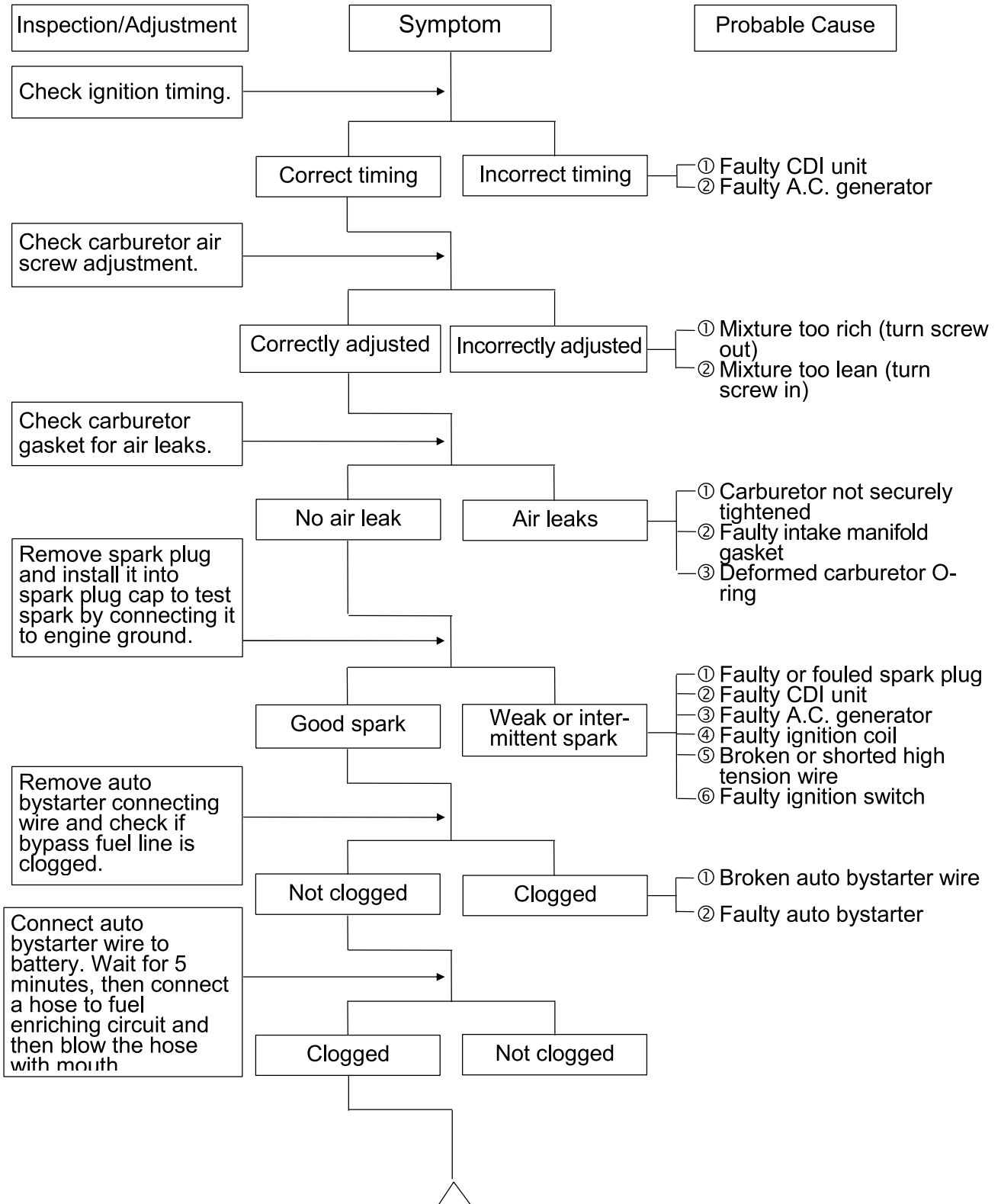

## POOR PERFORMANCE (AT HIGH SPEED)

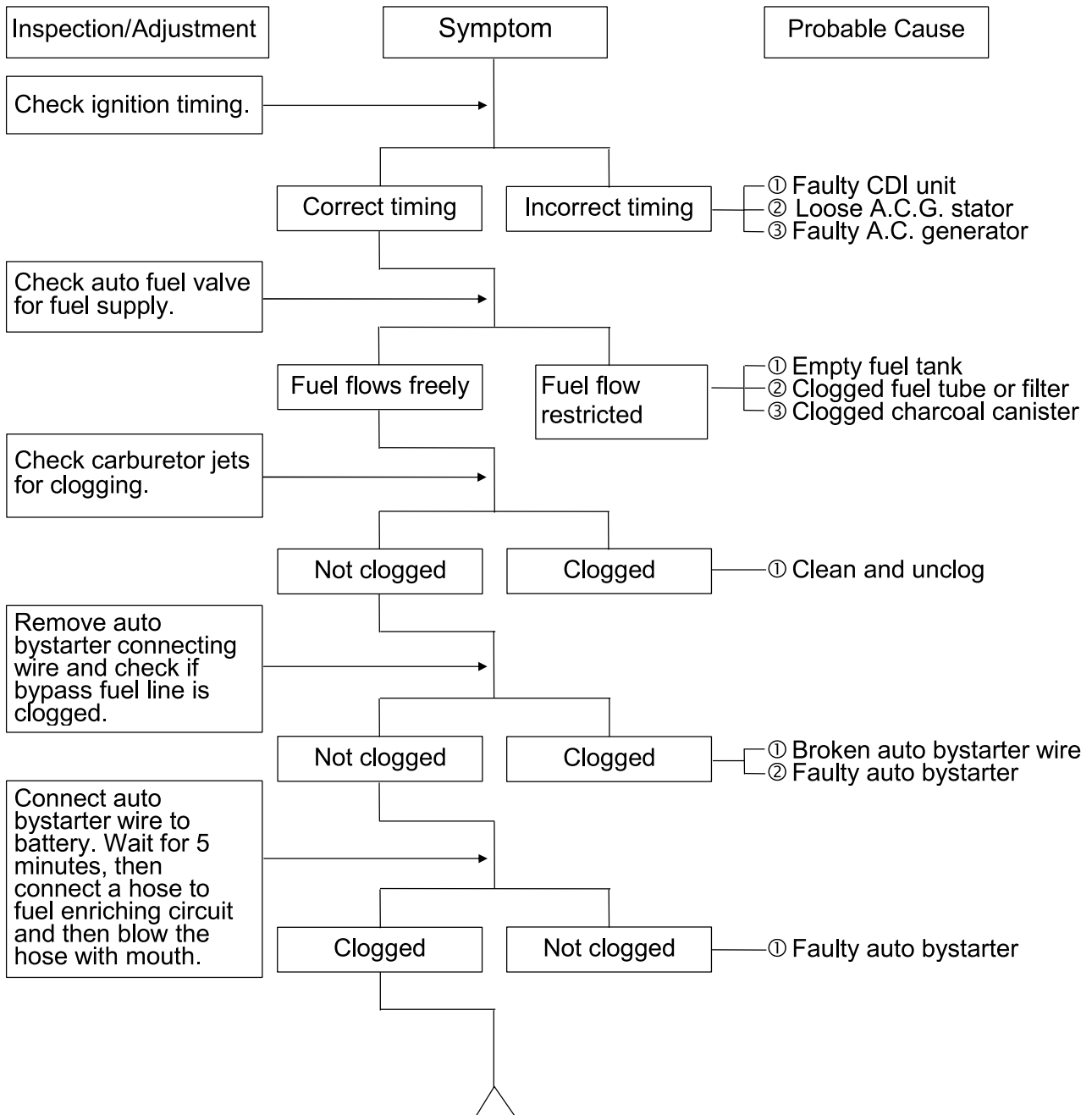

## CLUTCH, DRIVE AND DRIVEN PULLEYS

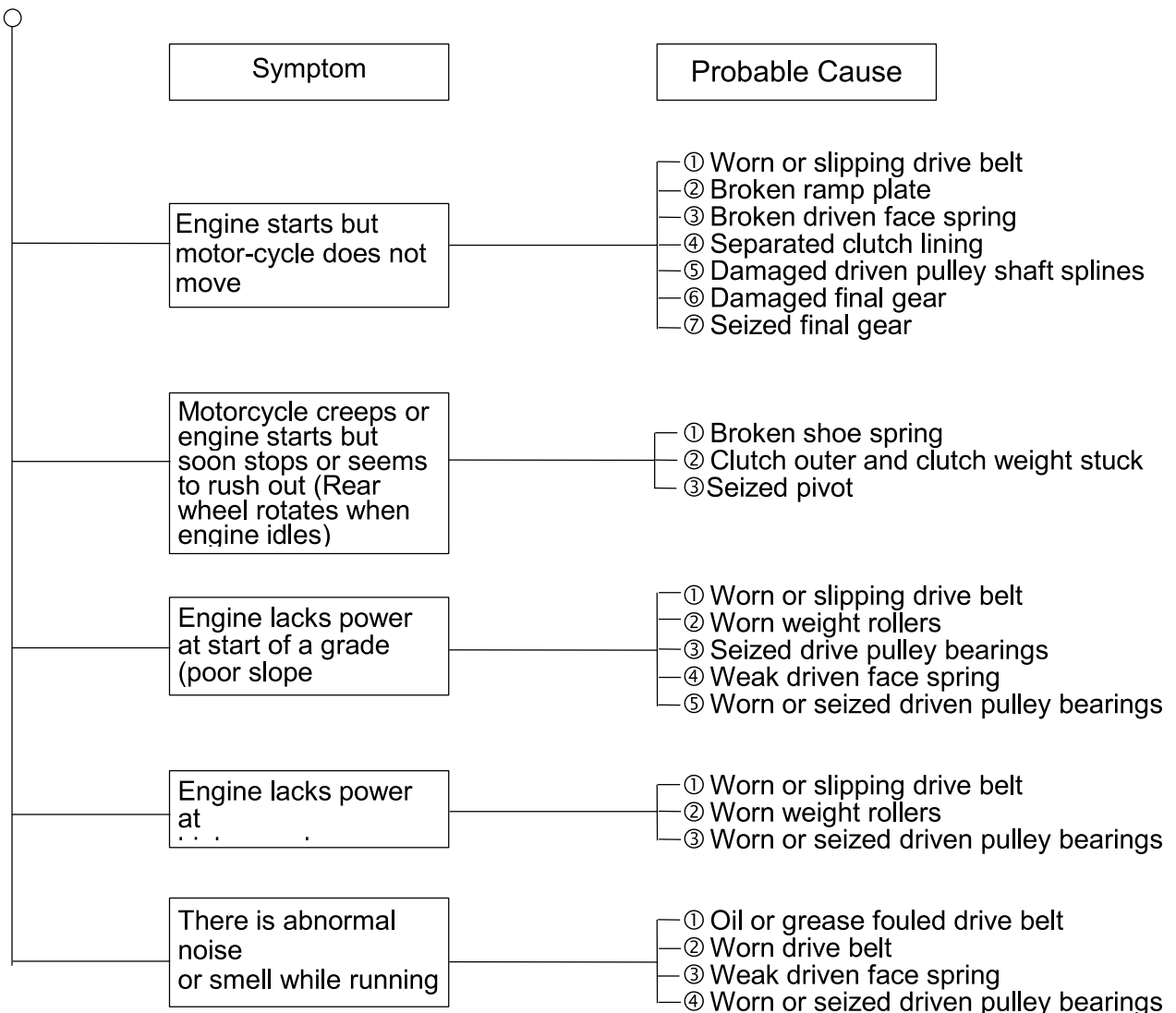

## STEERING HANDLEBAR DOES NOT TRACK STRAIGHT

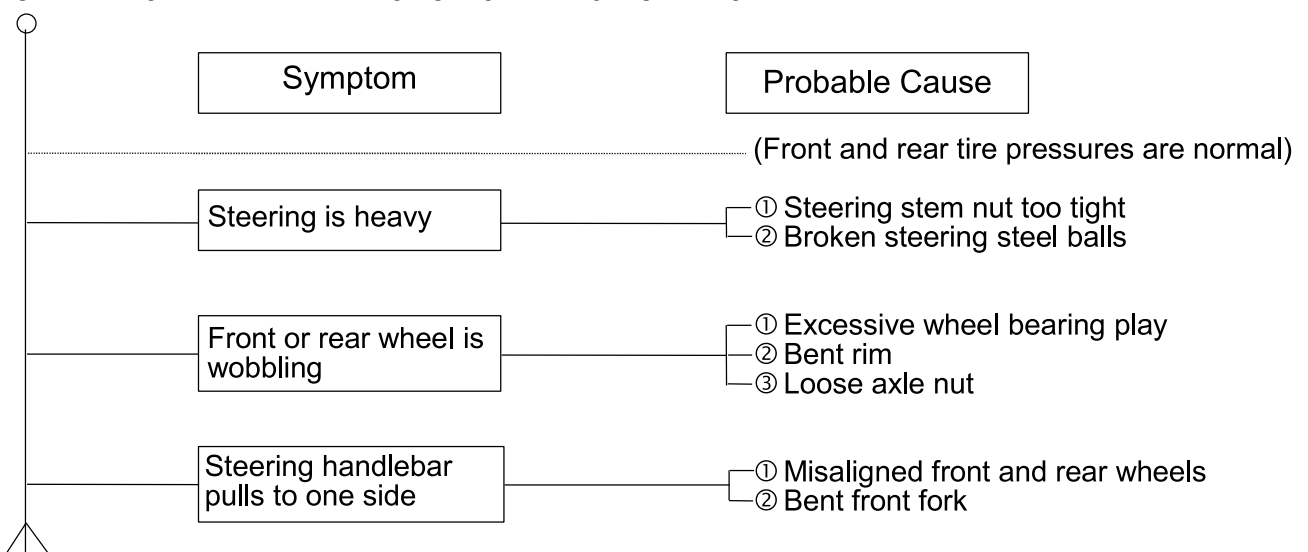

### POOR SUSPENSION PERFORMANCE

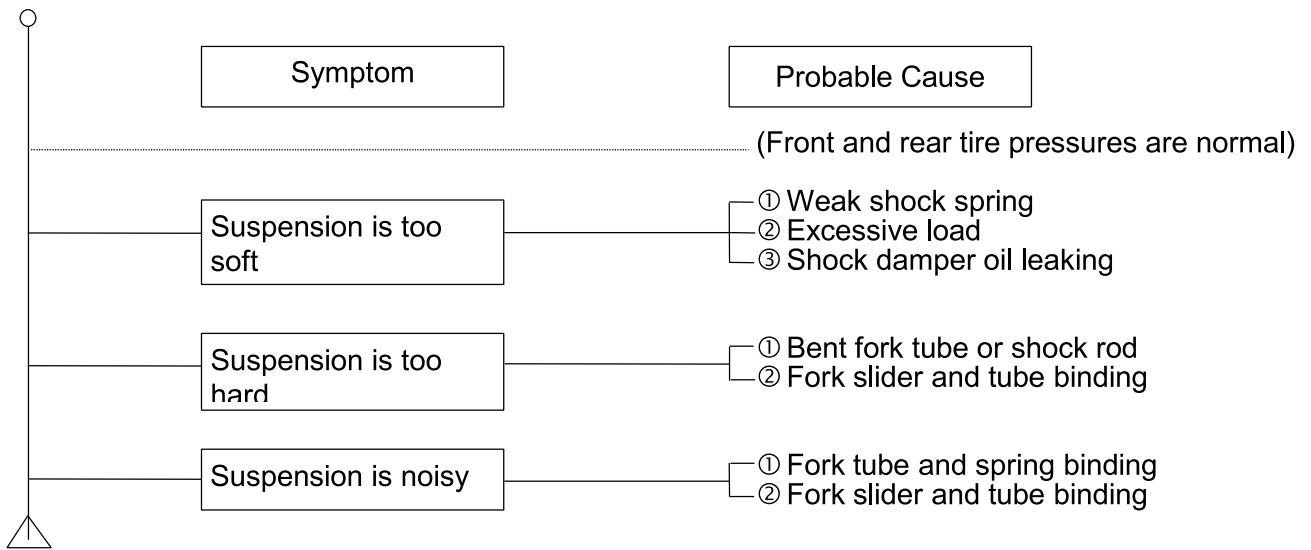

### POOR BRAKE PERFORMANCE

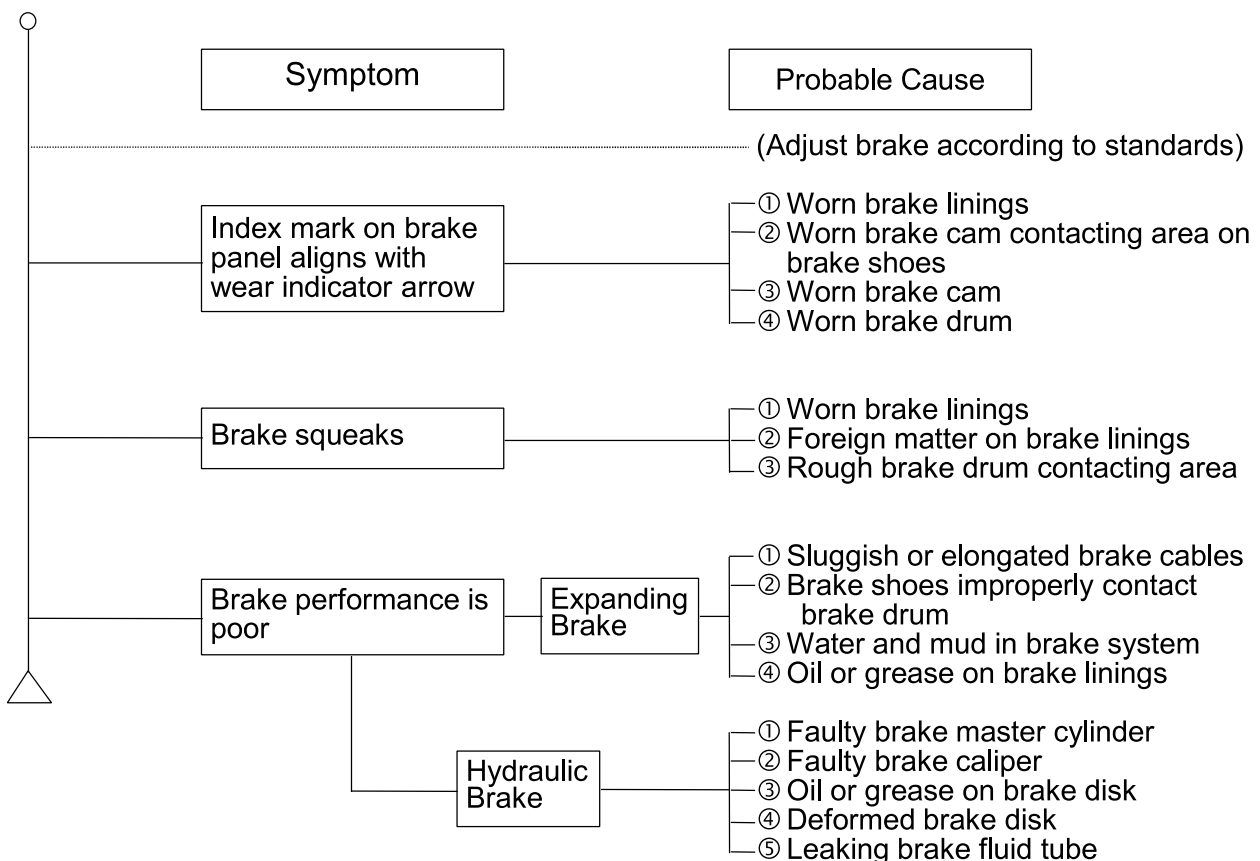

## FUEL GAUGE

1. Pointer does not register correctly (Ignition switch ON)

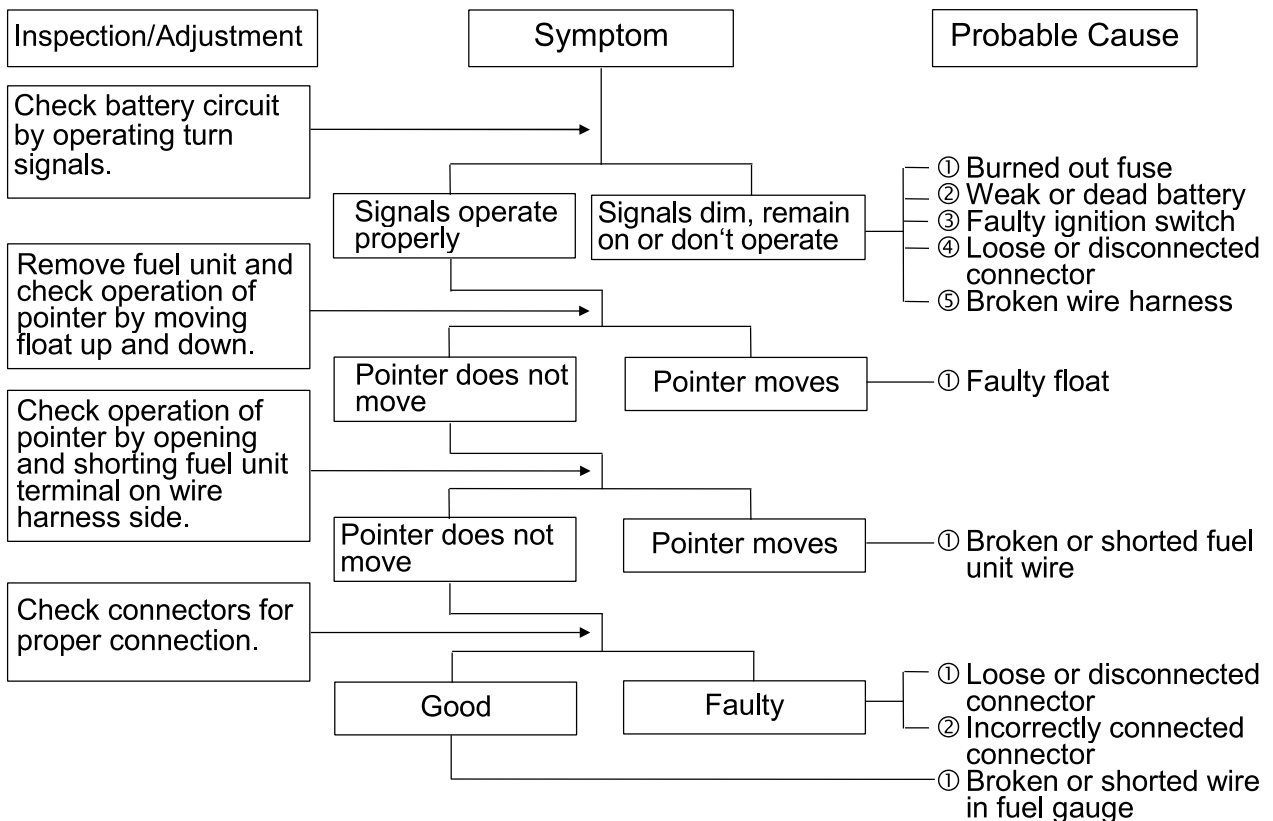

2. Pointer fluctuates or swings (Ignition switch ON)

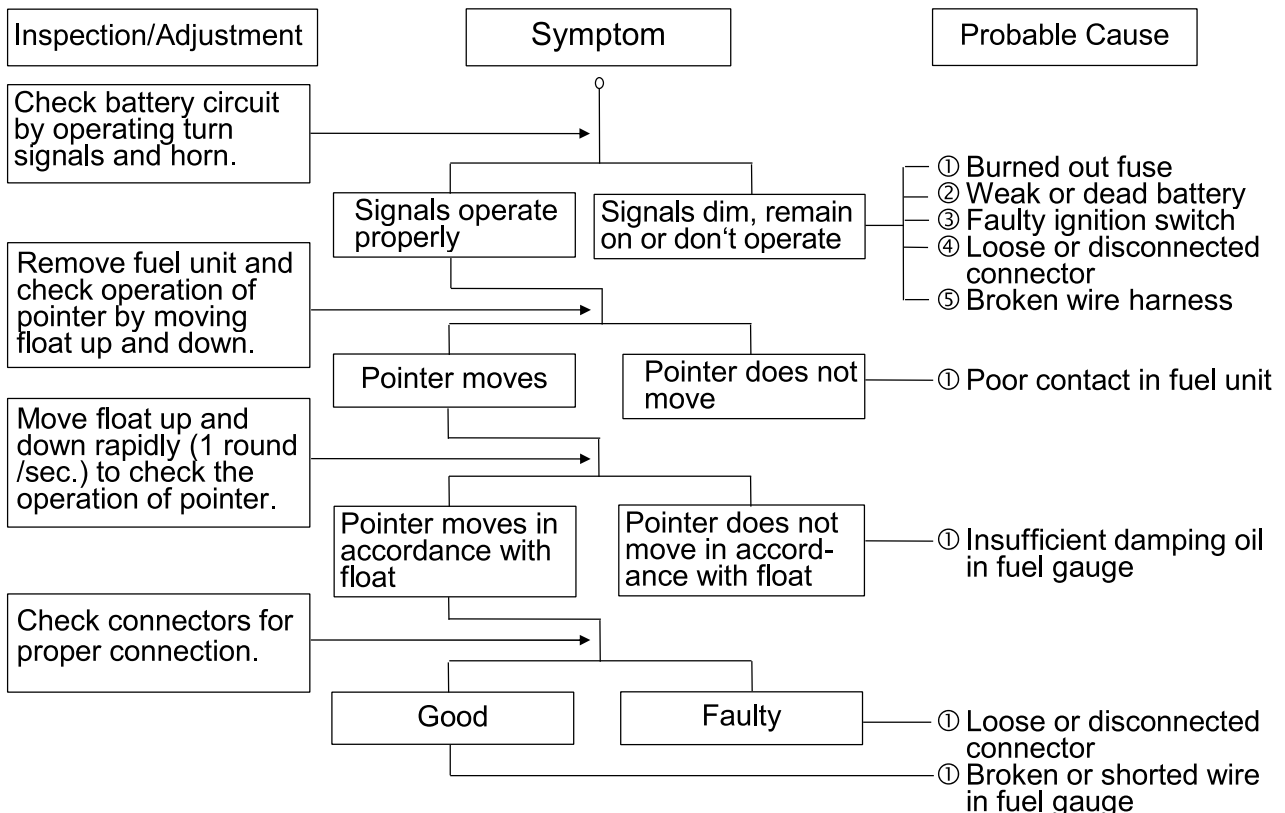



## STARTER MOTOR

### 1. Starter motor won't turn

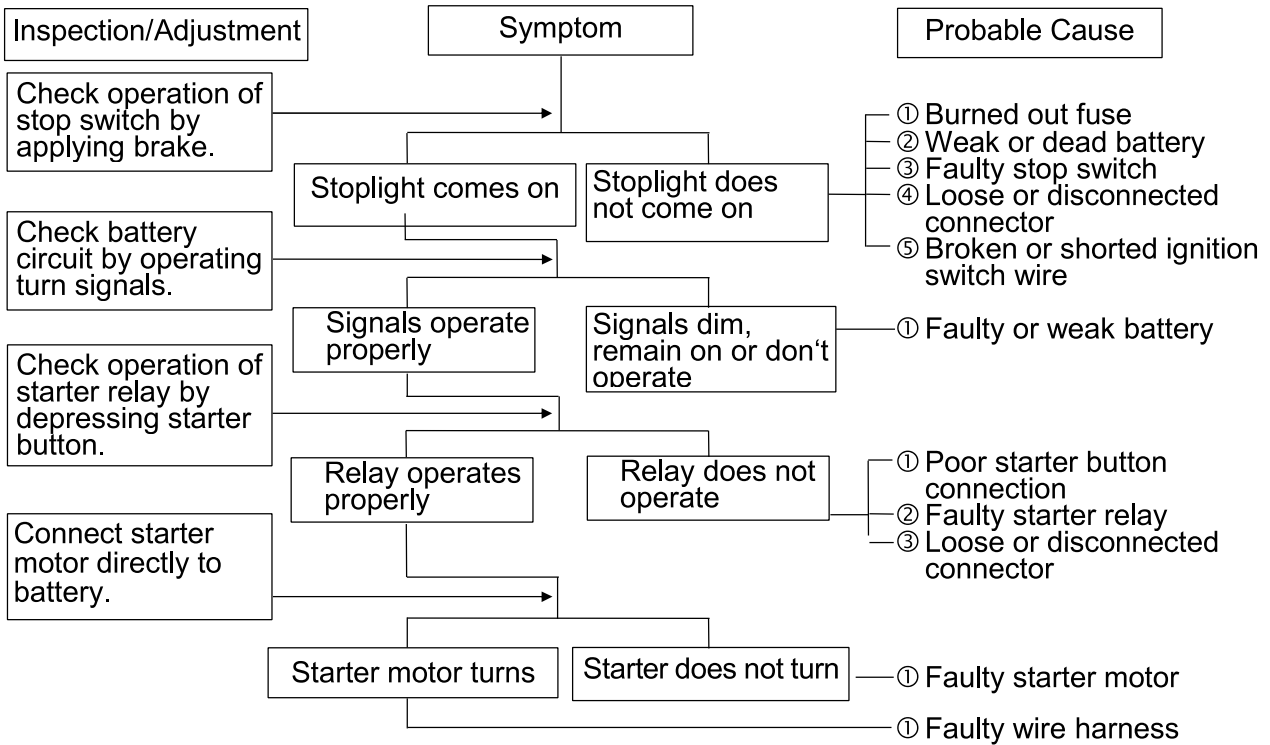

### 2. Starter motor turns slowly or idles

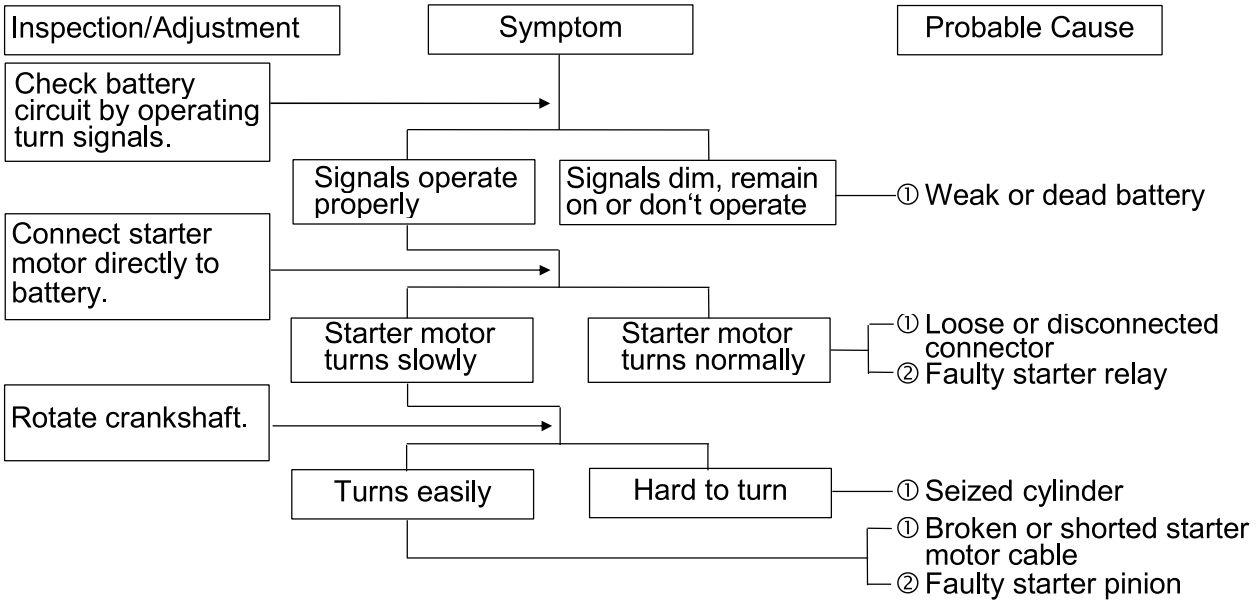

### 3. Starter motor does not stop turning

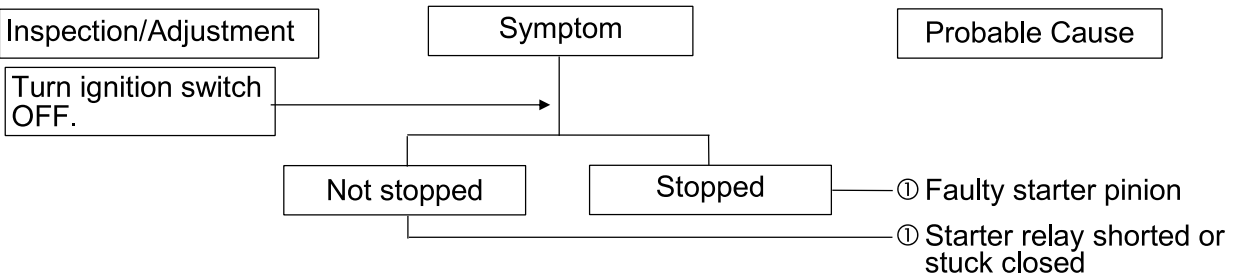

---

**INSPECTION/ADJUSTMENT**

---

INSPECTION AND MAINTENANCE SCHEDULE..... 3- 1  
BRAKE SYSTEM..... 3- 4  
MOVING DEVICE..... 3- 6  
DAMPING DEVICE.....3- 7  
POWER DRIVE SYSTEM.....3- 7  
ELECTRICAL EQUIPMENT..... 3- 8  
ENGINE..... 3- 9  
OTHERS..... 3-12

### 3. INSPECTION/ADJUSTMENT

LIKE 50/125

#### INSPECTION AND MAINTENANCE SCHEDULE

(Note) 1. ○ means time for inspection.

2. ☆ means regular replacement for the specified parts.

This inspection and maintenance schedule is based upon average riding conditions. Machines subjected to severe use, or ridden in unusually dusty areas, require more frequent servicing.

Inspection & Maintenance Item			Frequency				Judgment Standards	Remarks								
			Prior	1st month	Every 6 months	Every 12 months										
Suspension	Steering handlebar	Check for looseness and vertical play				○										
		Operating performance	○			○										
		Right/left turning angle				○										
	Front fork	Damage			○	○										
		Check for front fork pivot installation			○	○		Check steering stem								
Check front fork pivot for looseness and abnormal noise					○		Check steering stem									
Brake System	Brake Lever	Front/rear brake lever free play			○	○	Free play: 10~20mm									
		Brake lever operation	○													
		Brake performance		○	○	○										
	Lever/Cable	Looseness, abnormal noise and damage		○		○										
	Brake drum/ shoe	Drum-to-lining clearance			○	○										
		Brake shoe and lining wear				☆		Indicator type								
Brake drum wear and damage					○	Standard: Rear : 110 mm Service Limits: Rear : 111 mm										
Moving Device	Tire	Tire pressure	○		○	○	<table border="1"> <thead> <tr> <th></th> <th>Front</th> <th>Rear</th> </tr> </thead> <tbody> <tr> <td>1 rider</td> <td>1.75 kg/cm<sup>2</sup></td> <td>2.25 kg/cm<sup>2</sup></td> </tr> <tr> <td>Tire Size</td> <td>100/80-16</td> <td>110/70-16</td> </tr> </tbody> </table>		Front	Rear	1 rider	1.75 kg/cm <sup>2</sup>	2.25 kg/cm <sup>2</sup>	Tire Size	100/80-16	110/70-16
	Front	Rear														
1 rider	1.75 kg/cm <sup>2</sup>	2.25 kg/cm <sup>2</sup>														
Tire Size	100/80-16	110/70-16														

### 3. INSPECTION/ADJUSTMENT

LIKE 50/125

Inspection & Maintenance Item			Frequency				Judgment Standards	Remarks
			Prior	1st month	Every 6 months	Every 12 months		
Moving Device	Motor-cycle	Tire crack and damage	<input type="radio"/>		<input type="radio"/>	<input type="radio"/>		
		Tire groove and abnormal wear	<input type="radio"/>		<input type="radio"/>	<input type="radio"/>	Groove Depth: Front: 0.8mm Rear : 0.8mm	
		Imbedded objects, gravel, etc.	<input type="radio"/>		<input type="radio"/>	<input type="radio"/>		
		Axle nut looseness			<input type="radio"/>	<input type="radio"/>	Torque Values: Front axle nut 5.0~7.0kg-m Rear axle nut 11.0~13.0kg-m	Axle nut torque
		Check wheel rim, rim edge and spoke plate for damage		<input type="radio"/>		<input type="radio"/>	Rim runout at rim end: Front: Axial 2.0mm Radial 2.0mm Rear: Axial 2.0mm Radial 2.0mm	
		Check front wheel bearing for excessive play and abnormal noise				<input type="radio"/>		
		Check front wheel bearing for excessive play and abnormal noise				<input type="radio"/>		
Damping Device	Frame Spring	Damage					Shock spring free length	
	Suspension arm	Connecting parts looseness and arm damage				<input type="radio"/>		
	Shock absorber	Oil leakage and damage				<input type="radio"/>		
		Assembly parts looseness abnormal noise				<input type="radio"/>		
Power Drive System	Clutch	Operation		<input type="radio"/>	<input type="radio"/>	<input type="radio"/>		
	Transmission case	Oil leakage and oil level			<input type="radio"/>	<input type="radio"/>	Oil level: Oil check bolt hole at lower hole edge Rear wheel transmission case	
Electrical Equipment	Ignition device	Spark plug condition			<input type="radio"/>	<input type="radio"/>	Plug gap: 0.6~0.7mm	
	Battery	Terminal connection				<input type="radio"/>		
	Wires	Loose connection and damage				<input type="radio"/>		

### 3. INSPECTION/ADJUSTMENT

LIKE 50/125

Inspection & Maintenance Item		Frequency				Judgment Standards	Remarks
		Prior	1st month	Every 6 months	Every 12 months		
Engine	Body	Performance and abnormal noise			<input type="radio"/>	<input type="radio"/>	
		Conditions at low and high speeds		<input type="radio"/>	<input type="radio"/>	<input type="radio"/>	
		Exhaust smoke			<input type="radio"/>	<input type="radio"/>	
		Air cleaner			<input type="radio"/>	<input type="radio"/>	
	Lubrication system	Oil quality and quantity			<input type="radio"/>	<input type="radio"/>	<input type="checkbox"/> Oil level indicator Indicator light comes on when oil is insufficient
		Oil leakage			<input type="radio"/>	<input type="radio"/>	
		Oil level	<input type="radio"/>				
		Check oil filter for clogging				<input type="radio"/>	
	Fuel System	Fuel leakage					
		Carburetor, throttle valve and auto bystarter				<input type="radio"/>	
		Check fuel filter for clogging				<input type="radio"/>	
		Fuel level	<input type="radio"/>				
		Fuel tube replacement					☆Every 4 years
	Lights & Winker	Operation					
Winking action, dirt and damage		<input type="radio"/>					
Buzzer & Steering Lock	Operation				<input type="radio"/>		
Rearview Mirror & Reflector	Rearview mirror position	<input type="radio"/>				Rearview Mirror	
Reflector & License Plate	Dirt and damage	<input type="radio"/>					
Counter	Operation				<input type="radio"/>		
Exhaust Muffler	Joint looseness and damage				<input type="radio"/>		
	Exhaust muffler performance				<input type="radio"/>		
Body & Frame	Looseness and damage				<input type="radio"/>		
Abnormal Conditions Happened Last Time	Check if the abnormal conditions occur again	<input type="radio"/>					
Others	Lubrication points			<input type="radio"/>	<input type="radio"/>		
	Remove carbon deposits on combustion chamber, breather hole and exhaust muffler				<input type="radio"/>		

#### BRAKE SYSTEM

Inspect the brake fluid level.  
Recommend brake fluid: DOT4

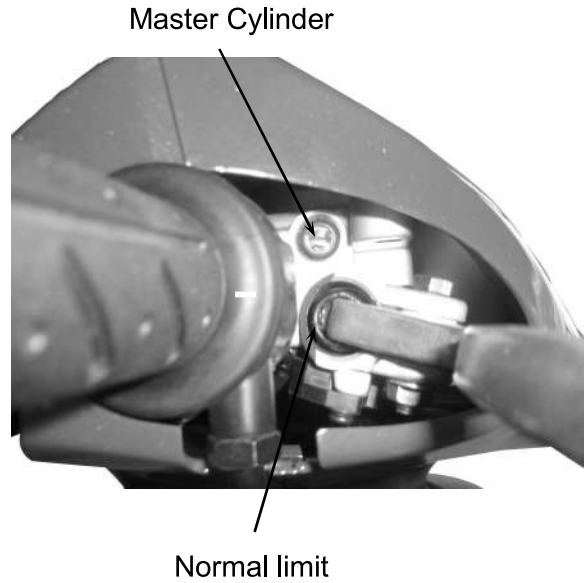

#### BRAKE LEVER

Measure the front and rear brake lever free plays.

**Free Play:** Rear: 10~20mm

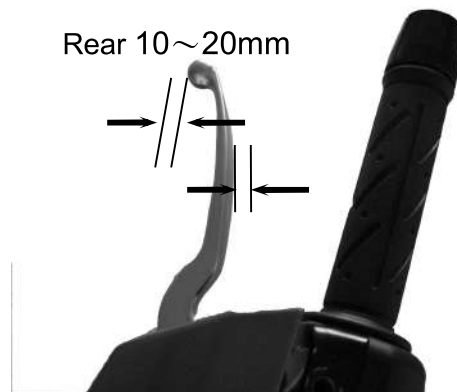

If the free plays do not fall within the limits, turn the right and left adjusting nuts for adjustment.



#### BRAKE DRUM/SHOE

##### 《 Brake Shoe Wear 》

Replace the brake shoes if the arrow on the brake arm aligns with reference mark“△” on the brake panel when the brake is fully applied.

##### 《 Brake Drum Wear/Damage 》

Check the brake drum appearance for damage. Check if the brake lining wear is within the specified service limit. Check the brake operation for abnormal noise and brake drum inside for wear or damage.

<Rear> “△” Marks

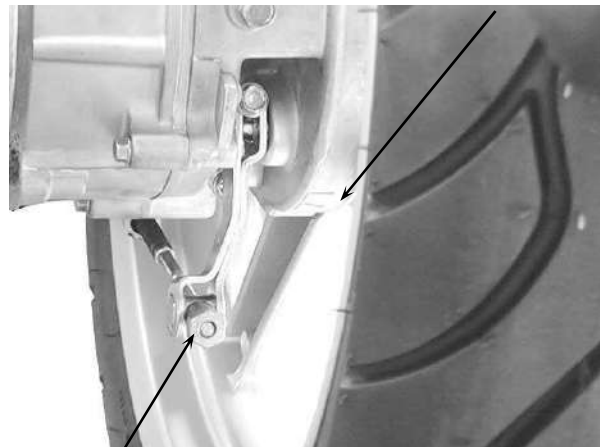

Adjusting Nuts

#### BRAKE DISK/LINING

##### 《 Brake Disk Surface and Brake Pad Wear 》

Check the brake disk surface for scratch. Check if the brake pad wear is within the specified service limit.

##### 《 Brake Disk Run-out Inspection 》

Stand the motorcycle wheels off the ground and check if the brake disk run-out is within the specified service limit.



Brake Disk

#### BRAKE FLUID LEVEL INSPECTION

##### 《 Brake Master Cylinder Fluid Level Inspection 》

Turn the steering handlebar upright and check if the front brake fluid level is within the specified limits through the front brake master cylinder check hole.

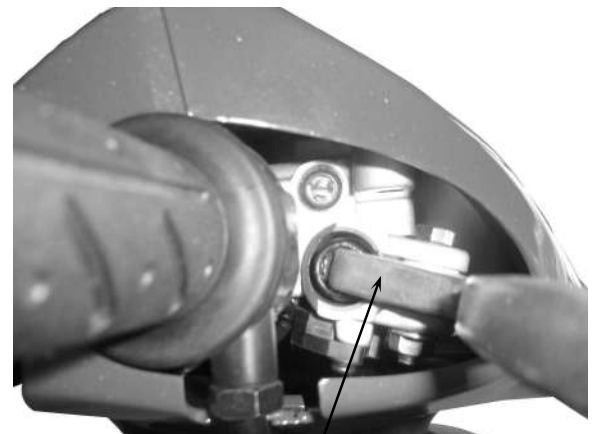

Brake Master Cylinder

## MOVING DEVICE

### TIRES

#### 《Tire Pressure》

Check the tire pressure.

\* 

Tire pressure should be checked when tires are cold.
--

Tire Pressure (one rider)

**Front:** 1.75 kg/cm<sup>2</sup>

**Rear:** 2.25 kg/cm<sup>2</sup>

Tire Size

Front	120/70 – 12
Rear	130/70 – 12

#### 《Axle Nut/Axle Shaft Looseness》

Check the front and rear axle nuts for looseness.

If the axle nuts are loose, tighten them to the specified torques.

#### Torques:

**Front:** 5.0~7.0kg-m

**Rear:** 11.0~13.0kg-m

#### 《Wheel Rim/Spoke Plate Damage》

Check the wheel rim and spoke plate for wear or damage and measure the rim runout.



Front Wheel



Axle Nut

Rear Wheel



Axle Nut



#### DAMPING DEVICE

##### SHOCK ABSORBERS

###### 《Oil Leak/Damage》

Fully apply the front brake and check the action of the front shock absorber by compressing it several times.

Check the entire shock absorber assembly for looseness or damage.

Check the action of the rear shock absorber by compressing it several times.

Check the entire shock absorber assembly for looseness or damage.



#### POWER DRIVE SYSTEM

##### TRANSMISSION CASE

Check the rear wheel transmission case surrounding area for oil leaks.

Stop the engine and remove the oil check bolt.

\* Place the motorcycle on its main stand on level ground.

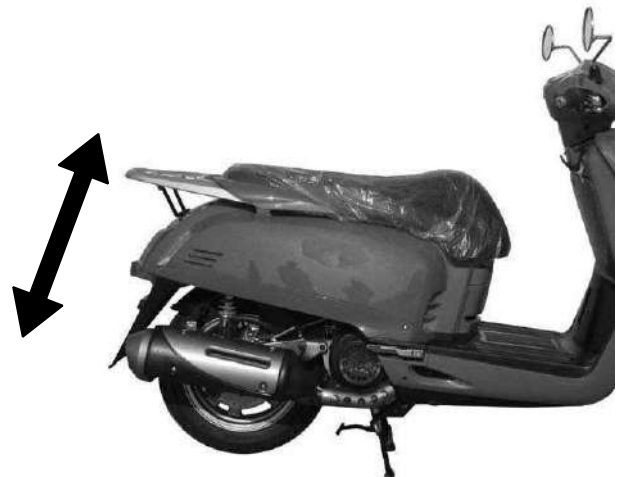

The gear oil level shall be at the oil check bolt hole. If the oil level is low, add the specified oil to the proper level.

**Specified Gear Oil:** SAE 90#

Install and tighten the oil check bolt.

**Torque:** 1.0~1.5kg-m

Start the engine and check for oil leaks.

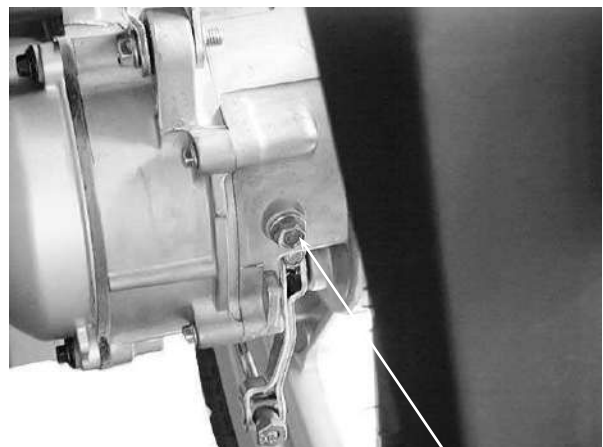

Oil Check Bolt

## ELECTRICAL EQUIPMENT

### IGNITION APPARATUS

#### 《 Spark Plug 》

Remove the frame center cover.  
 Remove the spark plug cap and spark plug.  
 Check the spark plug for wear, fouling and carbon deposits.  
 Remove the fouling and carbon deposits with a spark plug cleaner or wire brush.

#### Specified Spark Plug

NGK
SF10JA
CR7HSA

**Spark Plug Gap:** 0.6~0.7mm

#### 《 Ignition Apparatus 》

\* The CDI ignition timing is not adjustable. If the timing is incorrect, check the CDI unit, ignition coil and A.C. generator and replace any faulty parts.

Remove the right side rail. (⇒12-4)  
 Remove the A.C. generator fan cover.  
 (⇒7-3)  
 Remove the three bolts attaching the fan cover and then remove the fan cover.  
 Warm up the engine and check the ignition timing with a timing light.

When the engine is running at the specified rpm, the ignition timing is correct if the "F" mark on the flywheel aligns with the index mark on the crankcase within  $\pm 1.5^\circ$ .

#### Ignition Timing:

$13.5^\circ \pm 1^\circ$  BTDC/2000rpm

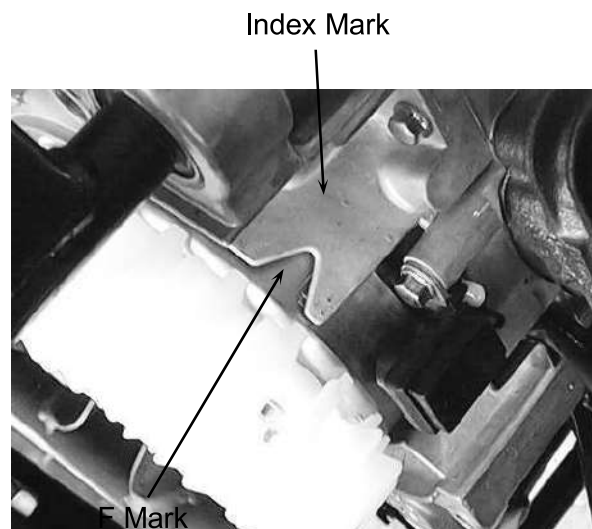
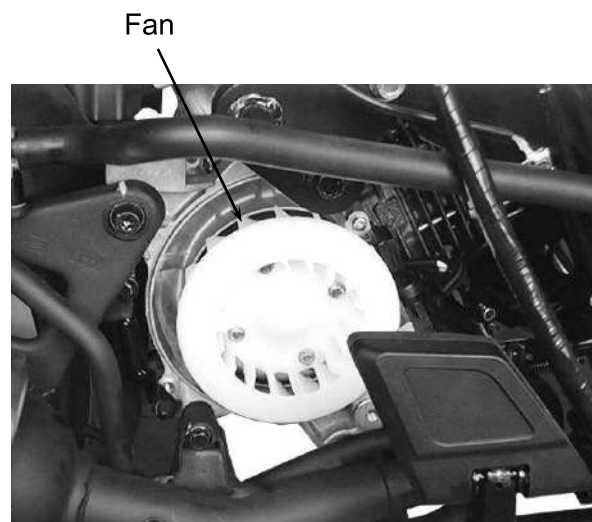
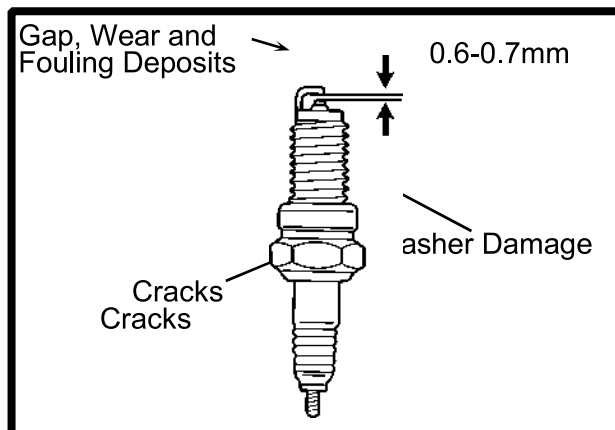

## ENGINE

### BODY

#### 《At High and Low Speeds》

\* The engine must be warm for accurate idle speed adjustment.

Adjust the idle speed to the specified range by turning the throttle stop screw and air screw.

#### Idle Speed:

50cc: 1700±100rpm

125cc: 2000±100rpm



#### 《Air Cleaner》

Remove the air cleaner cover by removing the seven bolts cleaner cover screws.

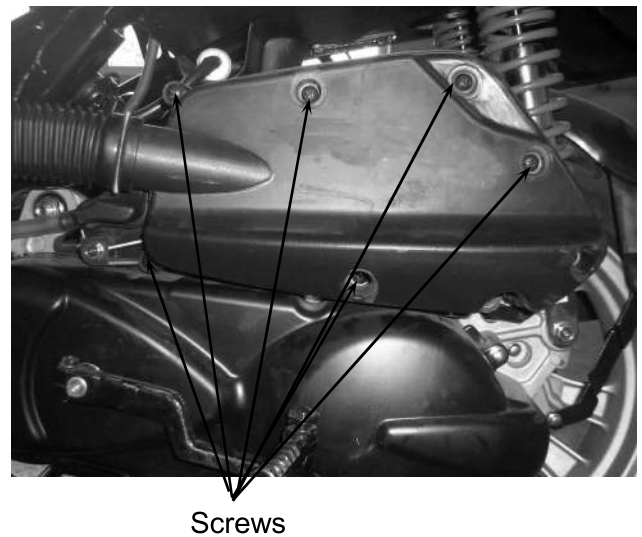

Remove the air cleaner element.



Wash the air cleaner element in detergent oil, squeeze out and allow to dry.

\* Never use gasoline or organic vaporable oil with acid or alkali for washing.

After washing, soak the element in clean engine oil SAE 10W-30# and squeeze out excess oil. Reinstall the element.

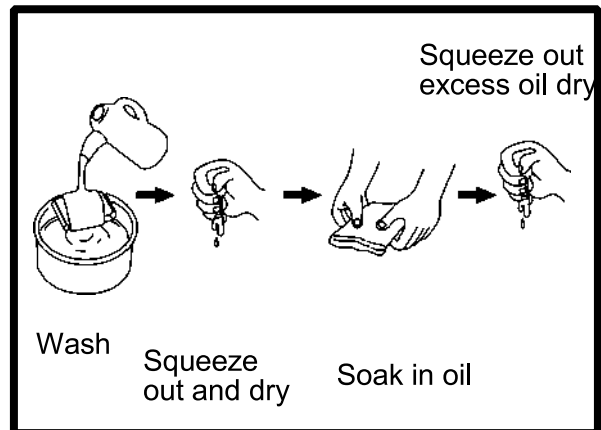

#### 《Cylinder Compression》

\* Warm up the engine before compression test.

Remove the spark plug and insert a compression gauge.

Open the throttle valve fully and push the starter button for 7 ~ 8 seconds to test the compression.

Compression:

11.8kg/cm<sup>2</sup>

If the compression is low, check for the following:

- Leaking cylinder head gasket
- Worn piston/cylinder

If the compression is high, it indicates that carbon deposits have accumulated on the combustion chamber and the piston head.



#### FUEL SYSTEM

##### 《Throttle Grip Free Play》

Measure the throttle grip free play.

**Free Play:** 2~6mm

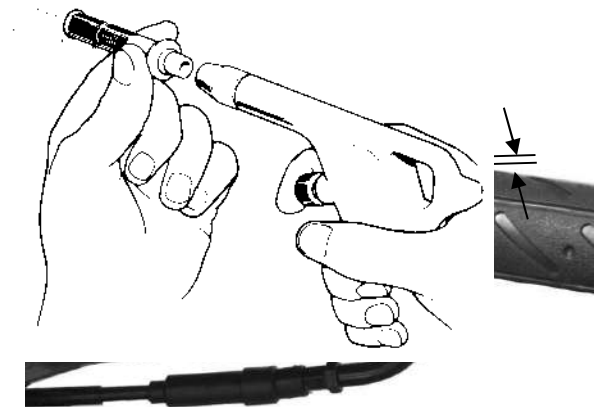

If the throttle grip free play does not fall within the specified range, adjust by loosening the lock nut and turning the adjusting nut.

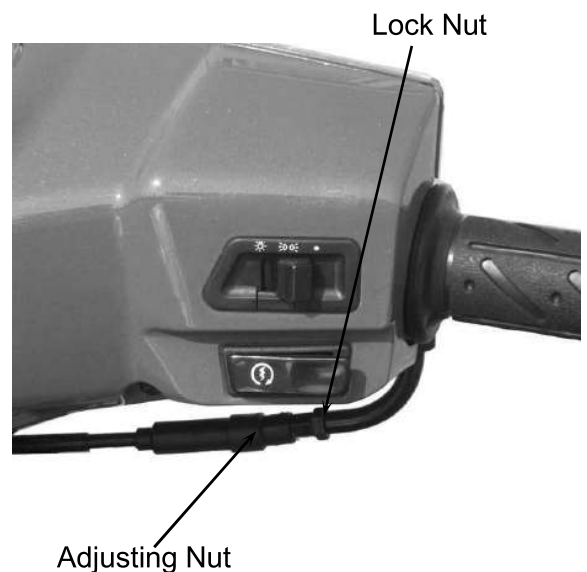

#### OTHERS

##### LIGHTS

##### 《Headlight》

**Front upper cover remove. (12⇒5)**

Adjust the headlight beam by loosening the headlight adjusting bolt and moving the adjusting bolt forward and backward to a proper position. Tighten the adjusting bolt.



**LUBRICATION SYSTEM**

**SERVICE INFORMATION..... 4-2**  
**TROUBLESHOOTING ..... 4-2**  
**ENGINE OIL/OIL FILTER ..... 4-3**  
**OIL PUMP ..... 4-3**

## LUBRICATION SYSTEM

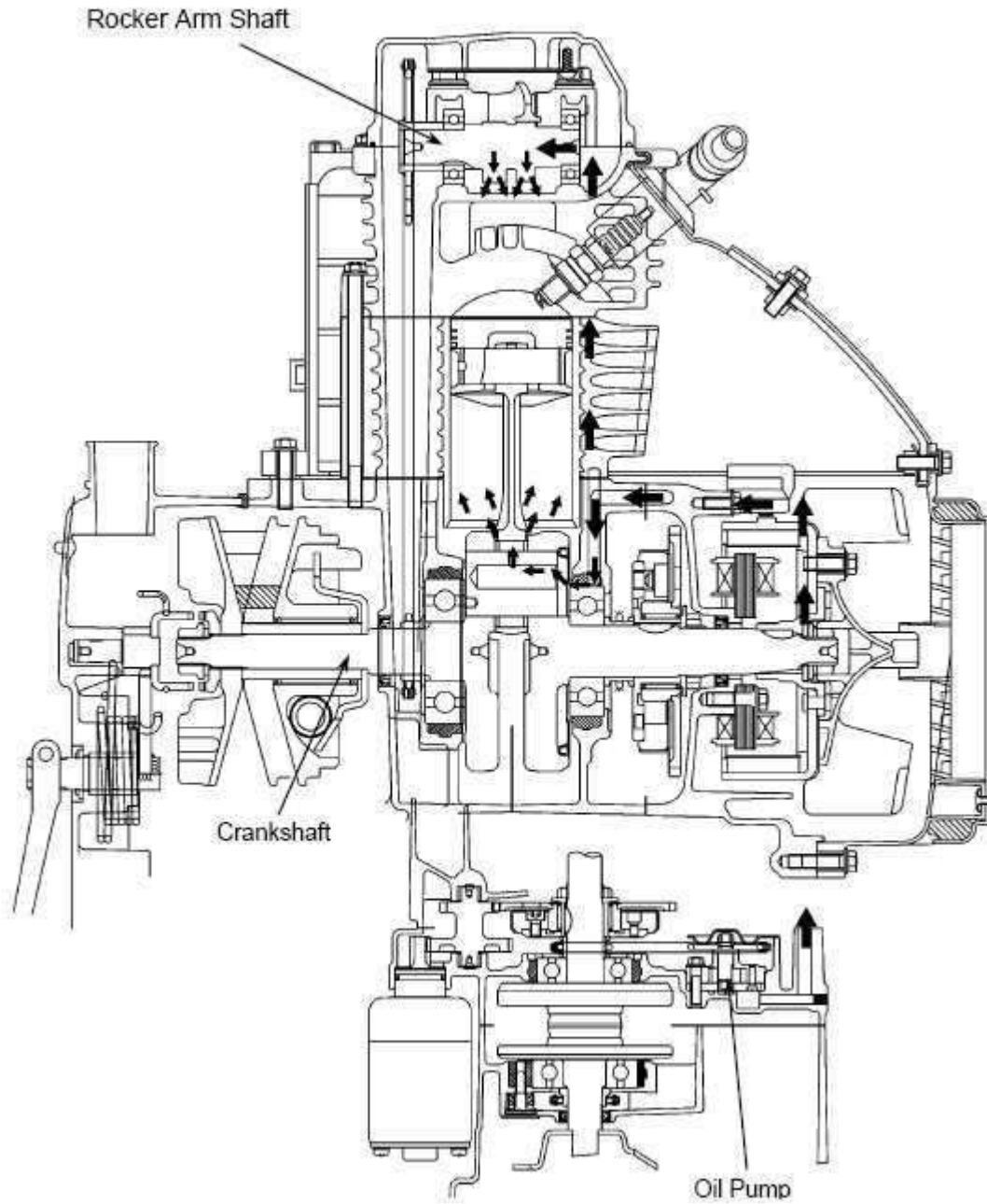

## SERVICE INFORMATION

### GENERAL INSTRUCTIONS

- The maintenance of lubrication system can be performed with the engine installed in the frame.
- Use care when removing and installing the oil pump not to allow dust and foreign matters to enter the engine and oil line.
- Do not attempt to disassemble the oil pump. The oil pump must be replaced as a set when it reaches its service limit.
- After the oil pump is installed, check each part for oil leaks.

## SPECIFICATIONS

	Item	Standard (mm)	Service Limit (mm)
Oil pump	Inner rotor-to-outer rotor clearance	—	0.12
	Outer rotor-to-pump body clearance	—	0.12
	Rotor end-to-pump body clearance	0.05~0.10	0.2

## TROUBLESHOOTING

### Oil level too low

- Natural oil consumption
- Oil leaks
- Worn or poorly installed piston rings
- Worn valve guide or seal

### Poor lubrication pressure

- Oil level too low
- Clogged oil filter or oil passages
- Not use the specified oil



## ENGINE OIL OIL LEVEL

- \* 
  - Place the motorcycle upright on level ground for engine oil level check.
  - Run the engine for 2~3 minutes and check the oil level after the engine is stopped for 2~3 minutes.

Remove the oil dipstick and check the oil level with the oil dipstick.  
If the level is near the lower level, fill to the upper level with the specified engine oil.

## OIL CHANGE

- \* 
 The engine oil will drain more easily while the engine is warm.

Remove the oil filter screen cap located on the bottom of the engine to drain the engine oil thoroughly.

After the oil has been completely drained, check the filter screen O-ring for damage and replace if necessary. Install the oil filter screen, spring and filter screen cap.

**Torque:** 1.5kg-m

Fill with the specified SAE15W40#, API: SG/CD engine oil to the proper level.

Oil Capacity: At disassembly : 0.90 liter  
                   At change : 0.80 liter  
                   (50cc 0.85/0.7 liter)

Check for oil leaks and then start the engine and let it idle for few minutes. Recheck the oil level.

## OIL PUMP REMOVAL

Remove the A.C. generator flywheel.  
 (⇒7-3)

Remove the nine right crankcase cover bolts and the right crankcase cover.

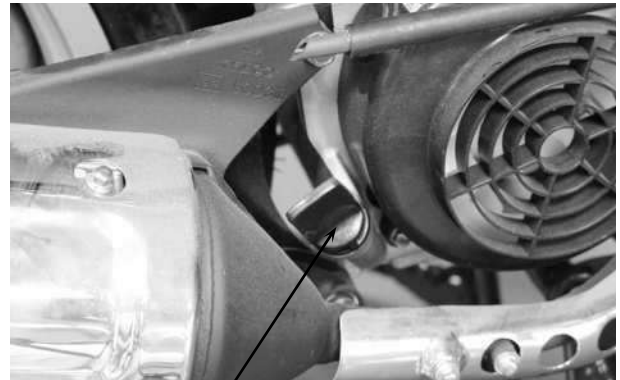

Oil Dipstick

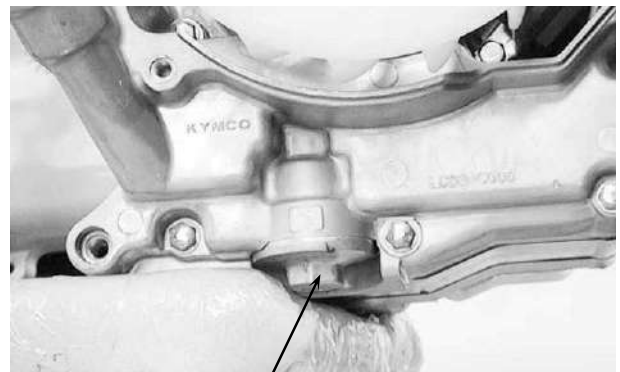

Oil Filter Screen Cap



Bolts

Pulser Coil



Stator

Right Crankcase Cover

## 4. LUBRICATION SYSTEM

LIKE 50/125

Remove the gasket and dowel pins.  
Remove the starter idle gear and starter clutch.

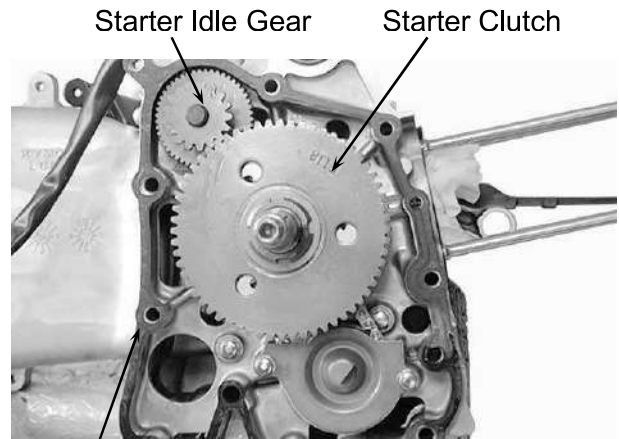

Remove the two bolts and oil separator cover.

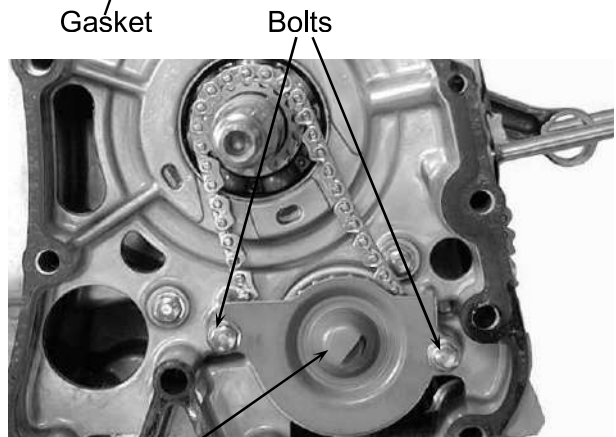

Remove the oil pump driven gear nut to  
remove the oil pump driven gear and  
drive chain.



Remove the oil pump mounting two bolts  
and the oil pump.

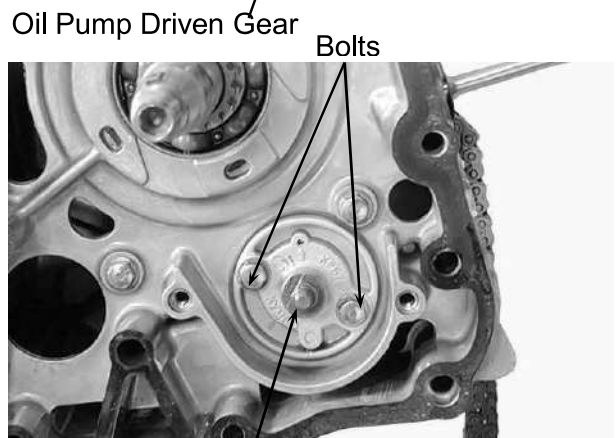

## 4. LUBRICATION SYSTEM

LIKE 50/125

### DISASSEMBLY

Remove the screw and disassemble the oil pump.

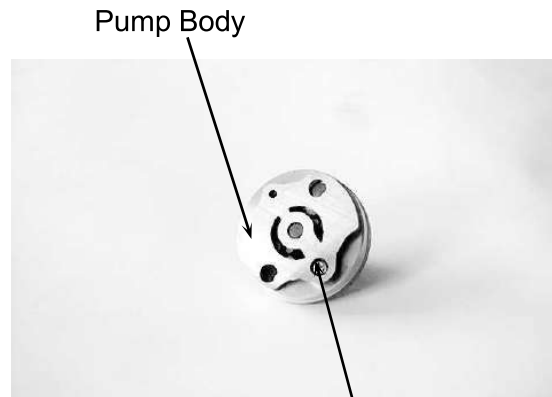

### INSPECTION

Measure the pump body-to-outer rotor clearance.

**Service Limit:** 0.12mm

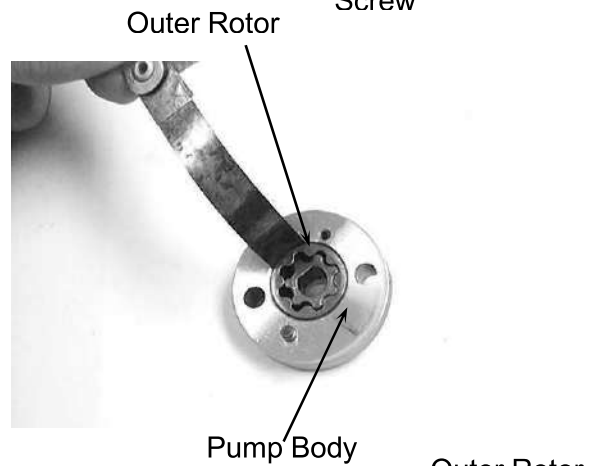

Measure the inner rotor-to-outer rotor clearance.

**Service Limit:** 0.12mm

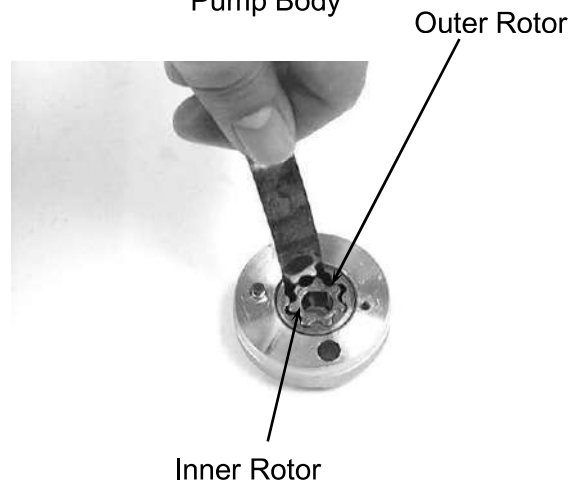

Measure the rotor end-to-pump body clearance.

**Service Limit:** 0.2mm

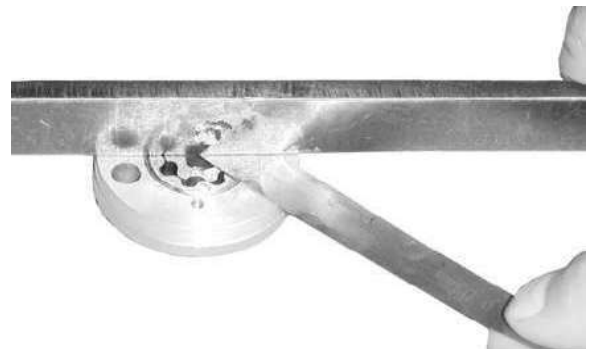

## 4. LUBRICATION SYSTEM

LIKE 50/125

### ASSEMBLY

Install the outer rotor, inner rotor and pump shaft into the pump body.

\*

Insert the pump shaft by aligning the flat on the shaft with the flat in the inner rotor.

Install the dowel pin.

Install the pump cover by aligning the hole in the cover with the dowel pin.

Tighten the screw to secure the pump cover.

Make sure that the pump shaft rotates freely without binding.

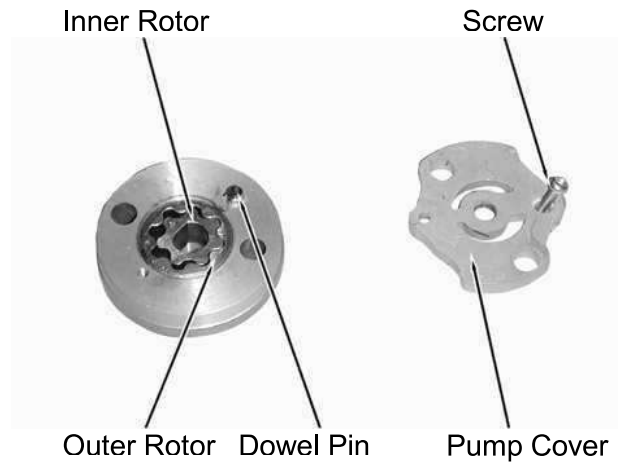

Oil Pump Screw Arrow



### INSTALLATION

Install the oil pump into the crankcase.

\*

Install the oil pump with the arrow on the pump body facing up and fill the oil pump with engine oil before installation.

After the oil pump is installed, tighten the two mounting bolts.

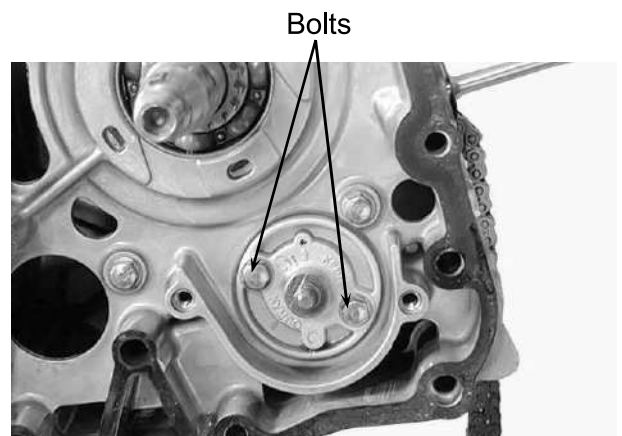

## 4. LUBRICATION SYSTEM

LIKE 50/125

Install the pump driven gear and drive chain by aligning the pump driven gear with the cutout in the pump shaft.  
Install and tighten the pump driven gear nut.

**Torque:** 1.0kg-m

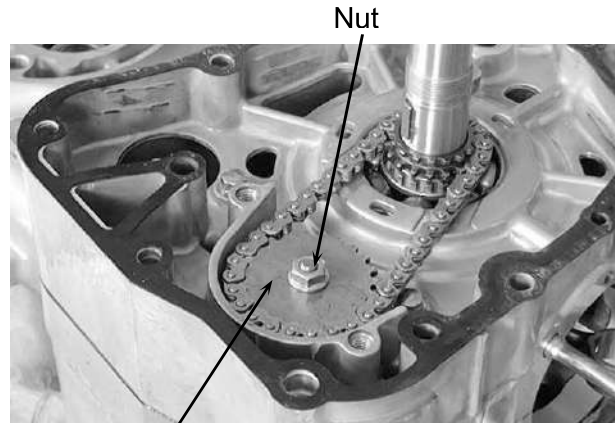

Pump Driven Gear Bolts

Install the oil separator cover and tighten the bolts.

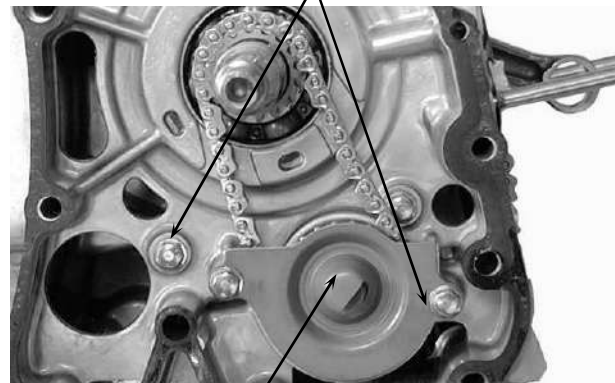

Oil Separator Cover

Install the starter idle gear and starter clutch.  
Install the gasket and dowel pins.

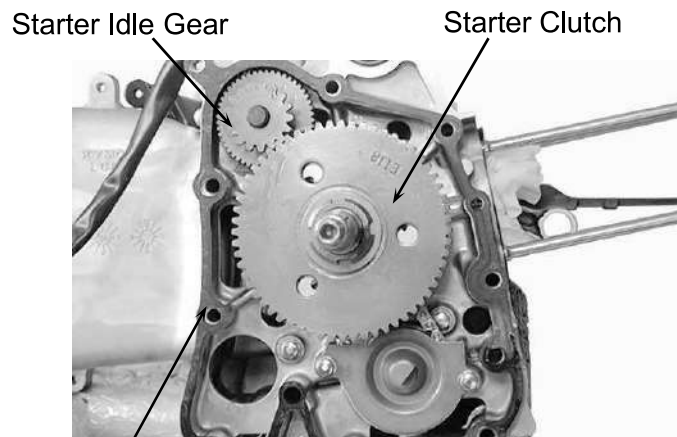

Gasket Bolts

Install the right crankcase cover and tighten the nine bolts.

**Torque:** 0.9kg-m

\* Diagonally tighten the bolts in 2~3 times.

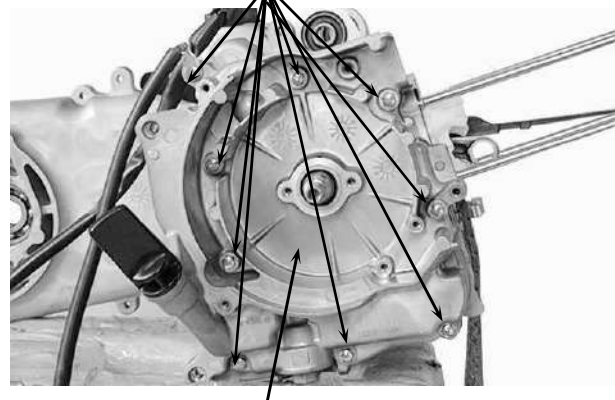

Right Crankcase Cover

**ENGINE REMOVAL/INSTALLATION**

SERVICE INFORMATION.....5-1  
ENGINE REMOVAL..... 5-3  
ENGINE INSTALLATION..... 5-5

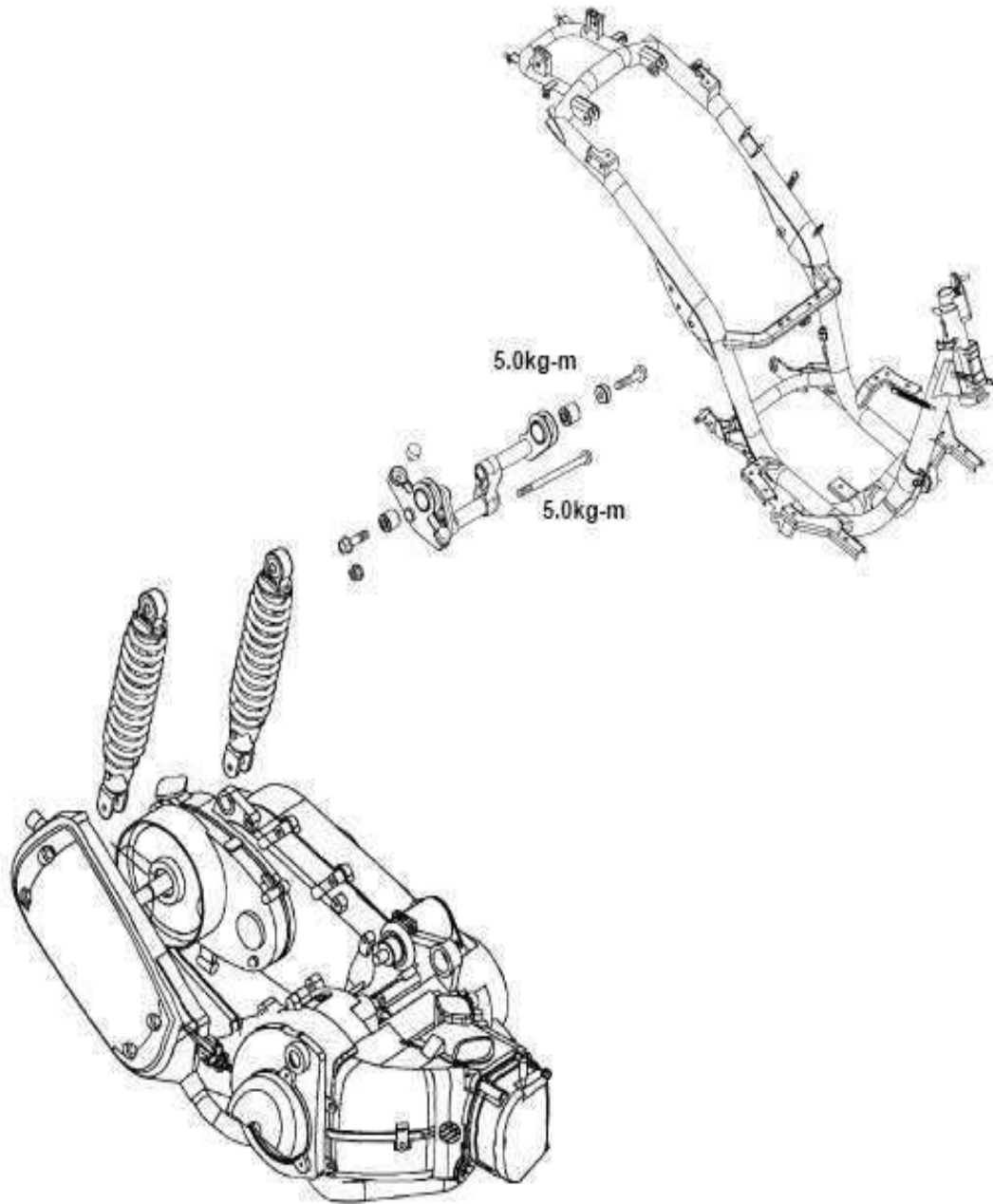

## SERVICE INFORMATION

### GENERAL INSTRUCTIONS

- A floor jack or other adjustable support is required to support and maneuver the engine. Be careful not to damage the motorcycle body, cables and wires during engine removal.
- Use shop towels to protect the motorcycle body during engine removal.
- Parts requiring engine removal for servicing:
  - Crankcase
  - Crankshaft

### TORQUE VALUES

Engine mounting bolt	4.5~5.5kg-m
Rear shock absorber lower mount bolt	2.4~3.0kg-m
Engine hanger bracket bolt	3.5~4.5kg-m



## 5. ENGINE REMOVAL/INSTALLATION

LIKE 50/125

### ENGINE REMOVAL

Disconnect the battery negative cable.  
Remove the frame body cover. (⇒12)  
Disconnect the engine negative cable.  
Disconnect the spark plug high tension wire.  
Disconnect the auto bystarter wire connector.  
Disconnect the A.C.G. wire connector.

Disconnect the starter motor cable from the starter relay.  
Remove the spark plug cap.

Disconnect the fuel tube at the carburetor side.  
Disconnect the auto fuel valve vacuum tube from the tee tube.  
Disconnect the throttle cable from the carburetor.

Loosen the secondary air cleaner / A.I.C.V. connecting tube band clip and remove the connecting tube.

Auto Bystarter Wire



A.C.G. Wire Connector



Throttle Cable

Starter Relay



Connecting Tube

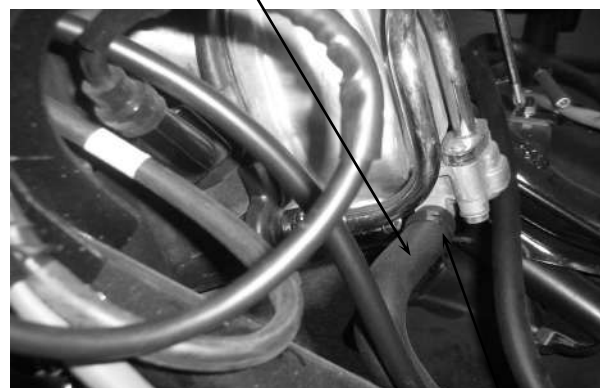

Clip

## 5. ENGINE REMOVAL/INSTALLATION

LIKE 50/125

Remove the air cleaner bolts.  
Remove the rear brake adjusting nut,  
connecting pin and rear brake cable.

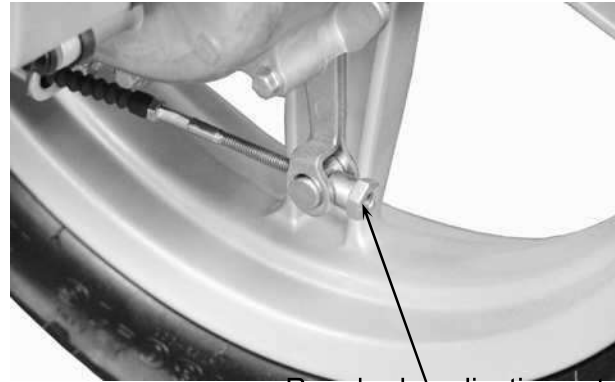

Rear brake adjusting nut

Remove the battery connection wire.



Wirer

Remove the rear shock absorbers  
mounting bolts.



Rear Shock Absorber Bolts

Remove the engine mounting bolt and  
pull out the engine with the engine  
hanger bracket backward.

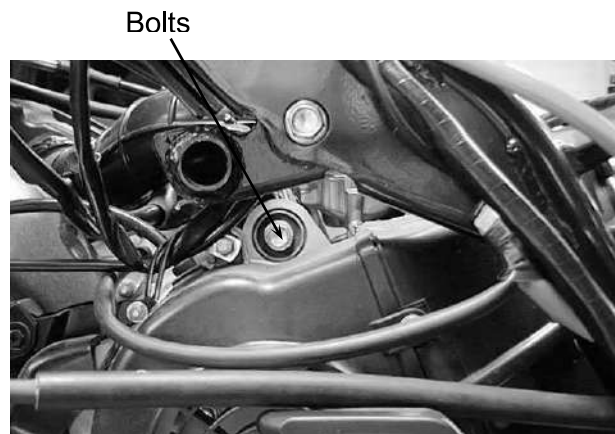

Bolts

### ENGINE HANGER BRACKET REMOVAL

Remove the ignition coil from the engine hanger.  
Remove the engine hanger bracket bolt and nut.  
Remove the engine.

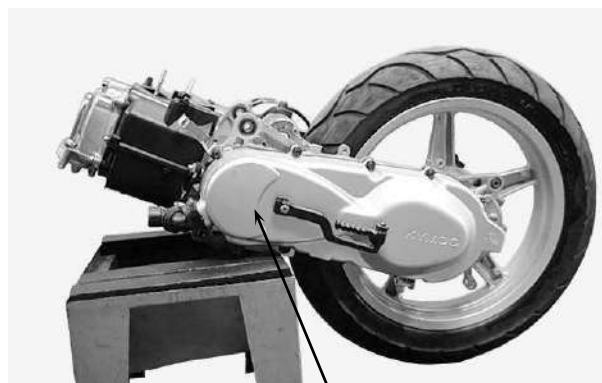

Engine

Remove the engine hanger bracket.  
Inspect the engine hanger bushings and stopper rubbers for wear or damage.



### ENGINE HANGER BRACKET INSTALLATION

Install the engine hanger bracket to the engine.  
Install and tighten the engine hanger bracket bolts.

Engine Hanger Bracket Bolt Bushings

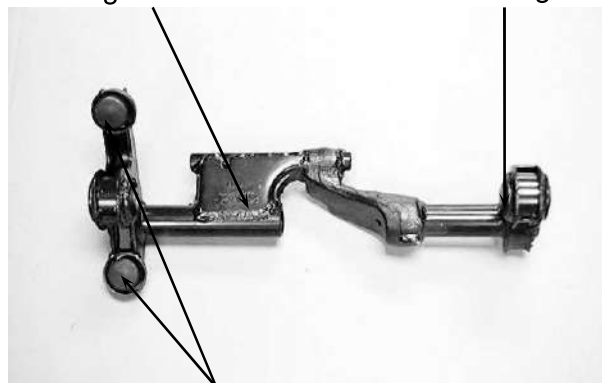

### ENGINE INSTALLATION

Install the engine and tighten the engine mounting bolts.

**Torque:** 5.0kg-m

Tighten the rear shock absorbers mounting bolts.

**Torque:** Up side 4.0kg-m

Down side 2.5kg-m

Install the removed parts in the reverse order of removal.

Stopper Rubbers

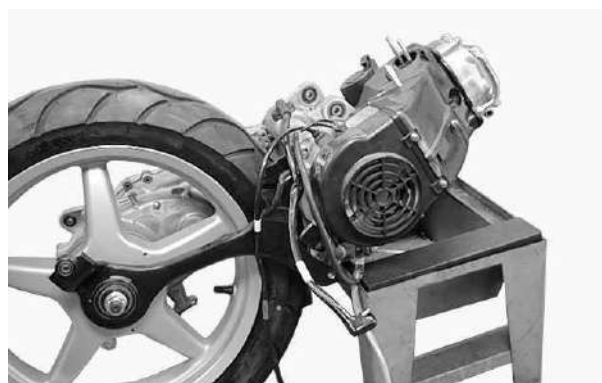

\*

**Tire pressure should be checked when tires are cold.**

After installation, inspect and adjust the following:

- Throttle grip free play (⇒3-3)
- Rear brake adjustment (⇒3-8)

**CYLINDER HEAD/CYLINDER/PISTON**

**SERVICE INFORMATION..... 6-2**  
**TROUBLESHOOTING ..... 6-2**  
**CAMSHAFT REMOVAL..... 6-3**  
**CYLINDER HEAD REMOVAL ..... 6-5**  
**CYLINDER HEAD DISASSEMBLY ..... 6-6**  
**CYLINDER HEAD ASSEMBLY ..... 6-8**  
**CYLINDER HEAD INSTALLATION..... 6-9**  
**CYLINDER/PISTON ..... 6-11**

# 6. CYLINDER HEAD/CYLINDER/PISTON

LIKE 50/125

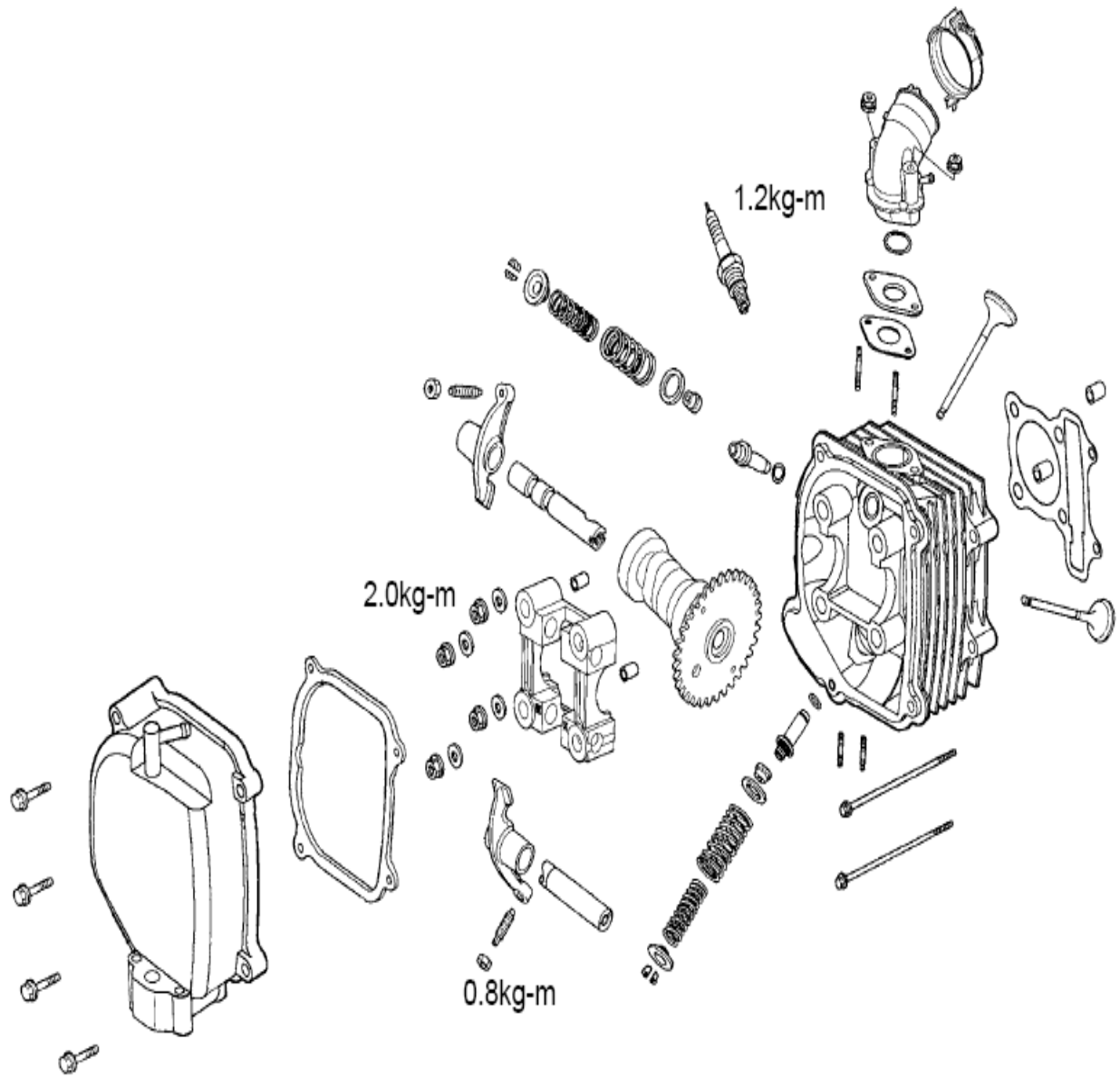

## SERVICE INFORMATION

### GENERAL INSTRUCTIONS

- The cylinder head, cylinder and piston can be serviced with the engine installed in the frame.
- Before disassembly, clean the engine to prevent dust from entering the engine.
- Remove all gasket material from the mating surfaces.
- Do not use a driver to pry between the cylinder and cylinder head, cylinder and crankcase.
- Do not damage the cylinder inside and the piston surface.
- After disassembly, clean the removed parts before inspection. When assembling, apply the specified engine oil to movable parts.

### SPECIFICATIONS

Item	Standard (mm)	Service Limit (mm)
	LIKE 50/125	LIKE 50/125
Cylinder head warpage	—	0.10
Piston O.D.(5mm from bottom of piston skirt)	38.970~38.955	38.90
Cylinder-to- piston clearance		0.10
Piston pin hole I.D.	12.002~12.008	12.03
Piston pin O.D.	11.994~12.0	11.98
Piston-to-piston pin clearance	←	←
Piston ring end gap (top/second)	0.10~0.25	0.40
Connecting rod small end I.D.	17.005~17.017	17.03
Cylinder bore	39.0~39.025	39.05

### TORQUE VALUES

Cylinder head bolt	1.5~1.7kg-m
Exhaust muffler joint lock nut	1.8~2.2kg-m
Exhaust muffler lock bolt	3.0~3.6kg-m
Spark plug	1.1~1.7kg-m

### ●TROUBLESHOOTING

#### Compression too low, hard starting or poor performance at low speed

- Leaking cylinder head gasket
- Loose spark plug
- Worn, stuck or broken piston and piston rings
- Worn or damaged cylinder and piston

#### Compression too high, overheating or knocking

- Excessive carbon build-up in cylinder head or on piston head

#### Abnormal noisy piston

- Worn cylinder and piston
- Worn piston pin or piston pin hole
- Worn connecting rod small end bearing

#### Abnormal noisy piston rings

- Worn, stuck or broken piston rings
- Worn or damaged cylinder

## 6. CYLINDER HEAD/CYLINDER/PISTON

LIKE 50/125

### CAMSHAFT REMOVAL

Remove the center cover.  
Remove the four cylinder head cover bolts and secondary air inlet tube bolts to remove the cylinder head cover.

Remove the cam chain tensioner cap screw and the O-ring.

Turn the cam chain tensioner screw clockwise to tighten it.

Turn the flywheel counterclockwise so that the "T" mark on the flywheel aligns with the index mark on the crankcase to bring the round hole on the camshaft gear facing up to the top dead center on the compression stroke.

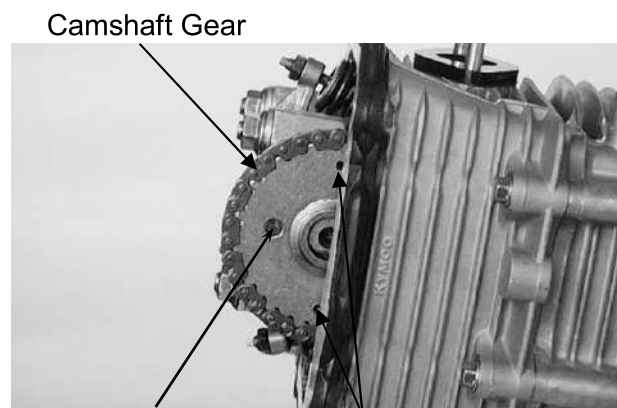
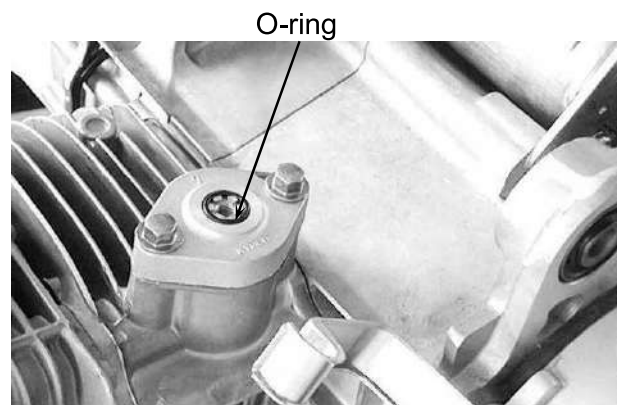
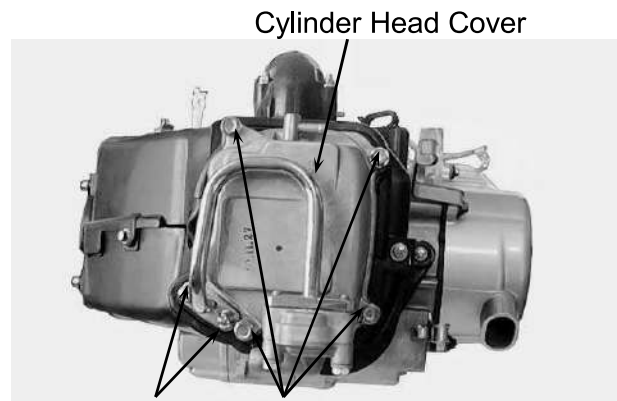

## 6. CYLINDER HEAD/CYLINDER/PISTON

LIKE 50/125

Remove the four cylinder head nuts and washers.

\* Diagonally loosen the cylinder head nuts in 2 or 3 times.

Remove the camshaft holder and dowel pins.

Remove the camshaft gear from the cam chain and remove the camshaft.

### CAMSHAFT INSPECTION

Check each cam lobe for wear or damage.

Measure the cam lobe height.

#### Service Limits:

( 50 cc )

IN : 25.30mm replace if below

EX: 25.20mm replace if below

( 125 cc )

IN : 29.30/29.40mm replace if below

EX: 29.15/ 29.05mm replace if below

Camshaft Bearings

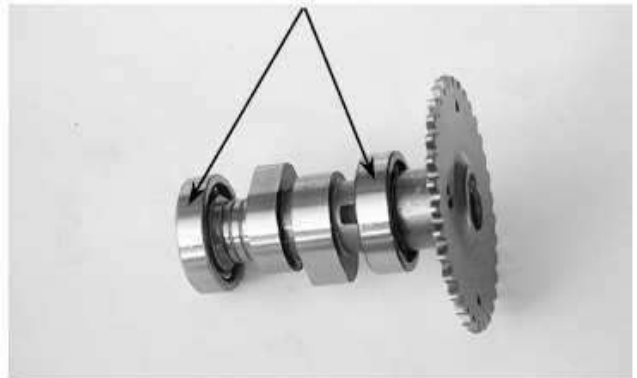

5mm Bolt

Rocker Arm



Camshaft Holder

Rocker Arm Shaft

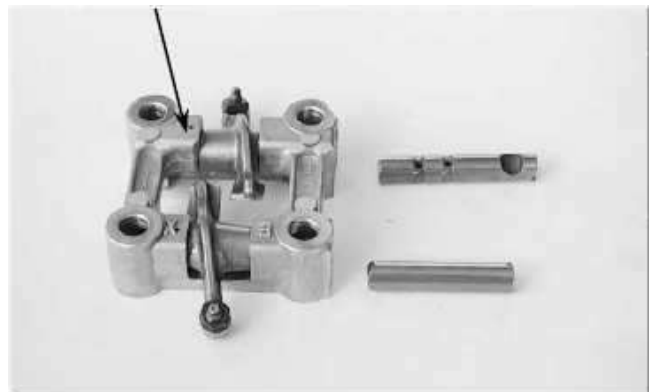

Rocker Arm Shafts



## 6. CYLINDER HEAD/CYLINDER/PISTON

LIKE 50/125

### CYLINDER HEAD REMOVAL

- Remove the camshaft. (⇒7)
- Remove the carburetor. (⇒5)
- Remove the exhaust muffler.
- Remove the carburetor intake manifold.



- Remove the cooling fan cover.
- Remove the engine cover bolts and screws.
- Separate the engine cover joint claws.

## 6. CYLINDER HEAD/CYLINDER/PISTON

LIKE 50/125

Remove the two cylinder head bolts.  
Remove the cylinder head.

Cylinder Head

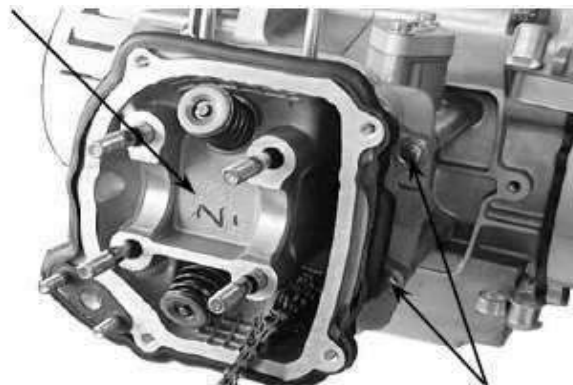

Remove the dowel pins and cylinder head gasket.  
Remove the cam chain guide.

Dowel Pins

Cylinder Head Gasket



Remove all gasket remnants from the cylinder surface.

\*

- Avoid damaging the cylinder contact surface.
- Be careful not to drop any gasket remnants into the engine.

Cam Chain Guide

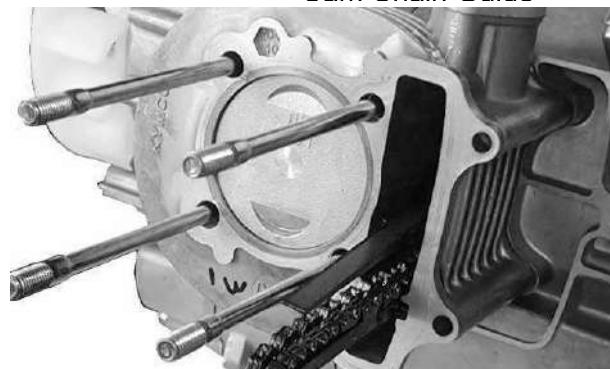

### CYLINDER HEAD DISASSEMBLY

Remove the valve spring cotters, retainers, springs, spring seats and valve stem seals using a valve spring compressor.

\*

- Be sure to compress the valve springs with a valve spring compressor.
- Mark all disassembled parts to ensure correct reassemble.

Valve Spring Compressor



Valve Spring Compressor Attachment

Valve Spring Compressor  
Valve Spring Compressor Attachment

## 6. CYLINDER HEAD/CYLINDER/PISTON

LIKE 50/125

Remove carbon deposits from the combustion chamber.  
Clean off any gasket remnants from the cylinder head contact surface.

\* Be careful not to damage the cylinder head mating surface.



### INSPECTION

#### CYLINDER HEAD

Check the spark plug hole and valve hole areas for cracks.

Check the cylinder head for warpage with a straight edge and feeler gauge.

**Service Limit:** 0.05mm repair or replace if over.

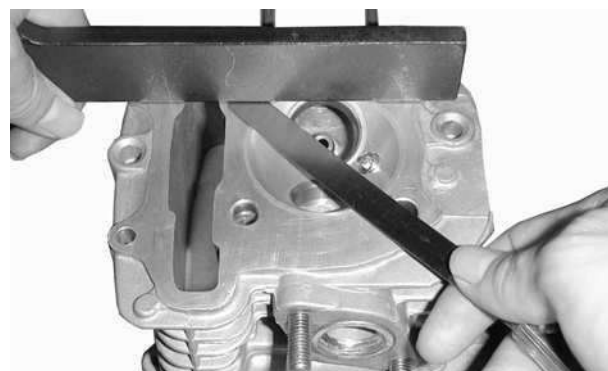

#### VALVE SPRING FREE LENGTH

Measure the free length of the inner and outer valve springs.

**Service Limits:**

Inner : 31.2mm replace if below

Outer : 34.1mm replace if below



#### VALVE /VALVE GUIDE

Inspect each valve for bending, burning, or abnormal stem wear.

Check valve movement in the guide.

Measure each valve stem O.D.

**Service Limits:** IN : 4.90mm replace if below

EX: 4.90mm replace if below



### CYLINDER HEAD ASSEMBLY

Install the valve spring seats and valve stem seals.  
Lubricate each valve stem with engine oil and insert the valves into the valve guides.  
Be sure to install new valve stem seals.  
Tap the valve stems gently with a plastic hammer for 2~3 times to firmly seat the cotters.

\* Be careful not to damage the valves.

### CYLINDER HEAD INSTALLATION

Install the dowel pins and a new cylinder head gasket.  
Install the cam chain guide.

Install the cylinder head.

### CAMSHAFT HOLDER ASSEMBLY

Install the exhaust valve rocker arm to the "EX" mark side of the camshaft holder.  
Install the intake valve rocker arm and the rocker arm shafts.

\* 

- Align the cutout on the front end of the intake valve rocker arm shaft with the bolt of the camshaft holder.
- Align the cross cutout on the exhaust valve rocker arm shaft with the bolt of the camshaft holder.

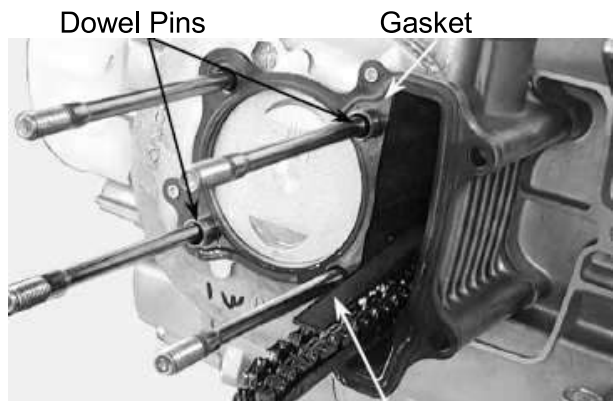

Cam Chain Guide

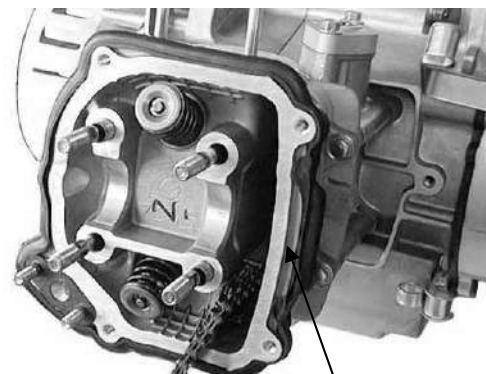

Cylinder Head



Valve Rocker Arm

## CAMSHAFT INSTALLATION

Turn the flywheel so that the "T" mark on the flywheel aligns with the index mark on the crankcase.

Keep the round hole on the camshaft gear facing up and align the punch marks on the camshaft gear with the cylinder head surface (Position the intake and exhaust cam lobes down.) and install the camshaft onto the cylinder head.

Install the cam chain over the camshaft gear.

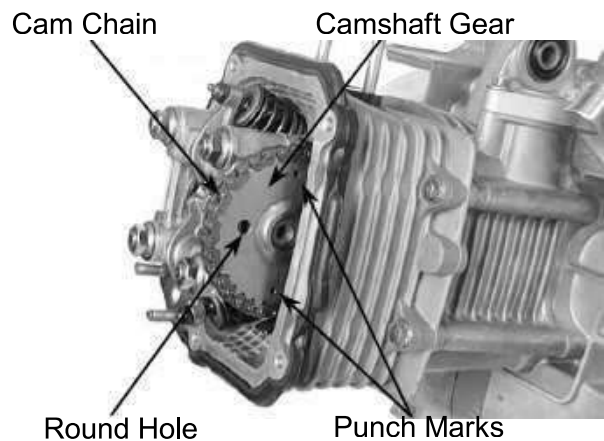

Install the dowel pins.

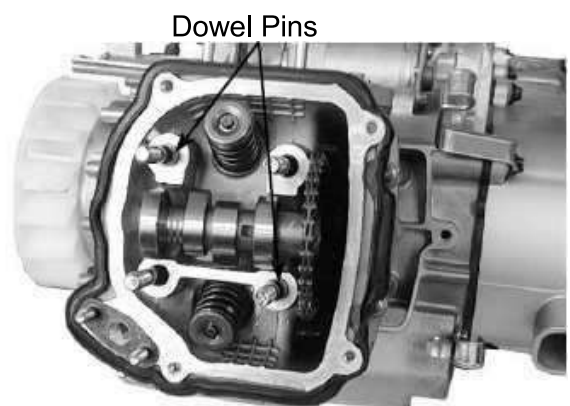

Install the camshaft holder, washers and nuts on the cylinder head.

Tighten the four cylinder head nuts and two bolts.

**Torque:** Cylinder head nut: 2.0kg-m

\*

- Apply engine oil to the threads of the cylinder head nuts.
- Diagonally tighten the cylinder head nuts in 2~3 times.



Adjust the valve clearance. (⇒3-5)  
Turn the cam chain tension screw counter-clockwise to release it.

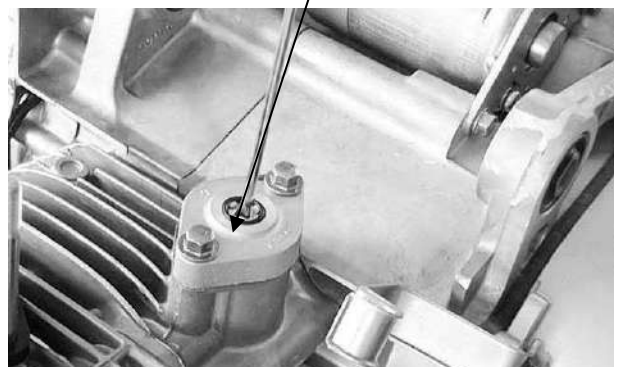

Apply engine oil to a new O-ring and install it.  
Tighten the cam chain tension cap screw.

\* Be sure to install the O-ring into the groove properly.

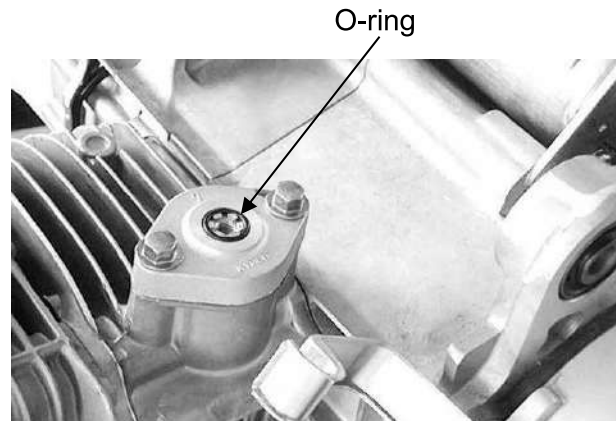

Install a new cylinder head cover gasket and install the cylinder head cover.  
Install and tighten the cylinder head cover bolts.

\* Be sure to install the gasket into the groove properly.

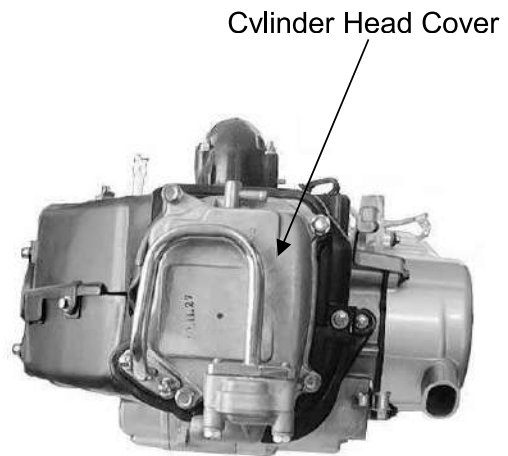

## CYLINDER/PISTON

### CYLINDER REMOVAL

Turn the cam chain tension screw clockwise to tighten it.  
Remove the two bolts on the cam chain tension.

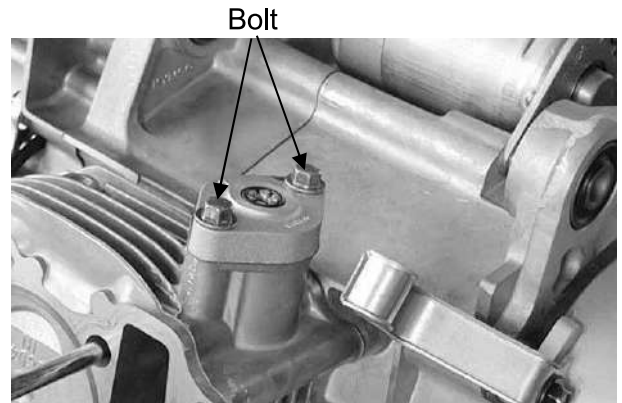

Remove the cylinder head.  
Remove the cam chain guide.  
Remove the cylinder base bolts.  
Remove the cylinder.

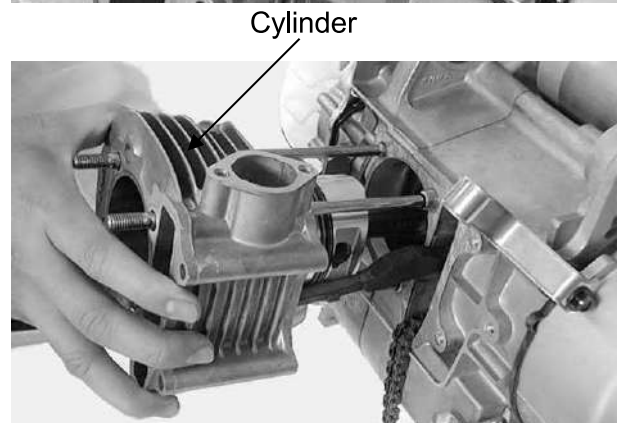

Remove the cylinder gasket and dowel pins.  
Clean any gasket remnant from the cylinder surface.

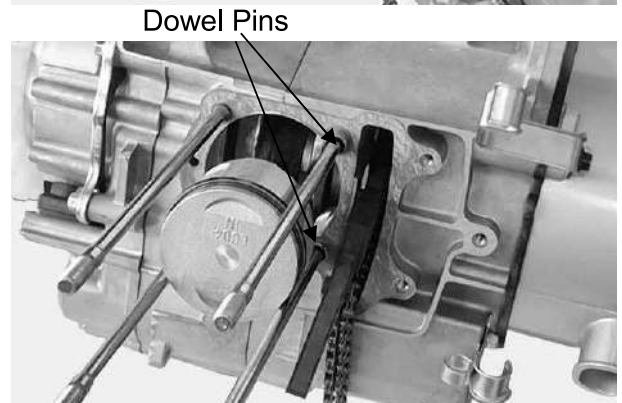

### PISTON REMOVAL

Remove the piston pin clip.

\* Place a clean shop towel in the crankcase to keep the piston pin clip from falling into the crankcase.

Press the piston pin out of the piston and remove the piston.

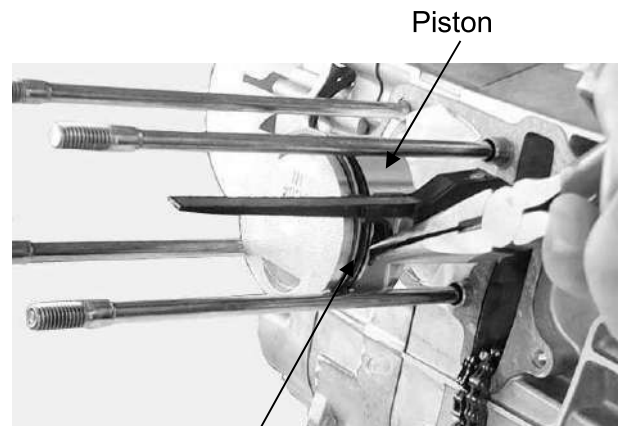

Inspect the piston, piston pin and piston rings.

Remove the piston rings.

\*

Take care not to damage or break the piston rings during removal.

Clean carbon deposits from the piston ring grooves.



Install the piston rings onto the piston and measure the piston ring-to-groove clearance.

**Service Limits: Top:** 0.09mm replace if over

**2nd:** 0.09mm replace if over



Remove the piston rings and insert each piston ring into the cylinder bottom.

\*

Use the piston head to push each piston ring into the cylinder.

Measure the piston ring end gap.

**Service Limit:** 0.5mm replace if over



Measure the piston pin hole I.D.

**Service Limit:** 15.04mm replace if over  
(50cc 13.04mm replace if over)





over

Measure the piston pin O.D.

**Service Limit:** 14.96mm replace if below  
(50cc 12.96mm replace if below)

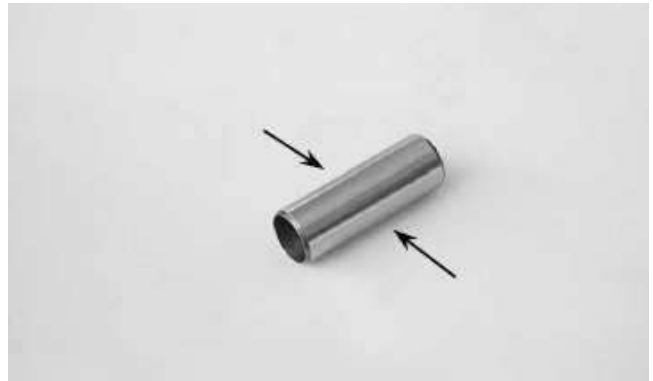

Measure the piston O.D.

\* Take measurement at 9mm from the bottom and 90° to the piston pin hole.

**(125cc) Service Limit:** 52.3mm replace if below

**(50cc) Service Limit:** 39.9mm replace if below

Measure the piston-to-piston pin clearance.

**Service Limit:** 0.02mm replace if over



### CYLINDER INSPECTION

Inspect the cylinder bore for wear or damage.

Measure the cylinder I.D. at three levels of top, middle and bottom at 90° to the piston pin (in both X and Y directions).

**(125cc) Service Limit:** 52.50mm repair or replace if over

**(50cc) Service Limit:** 39.10mm repair or replace if over

Measure the cylinder-to-piston clearance.



The true roundness is the difference between the values measured in X and Y directions.

The cylindricity (difference between the values measured at the three levels) is subject to the maximum value calculated.

**Service Limits:**

**True Roundness:** 0.05mm repair or replace if over

**Cylindricity:** 0.05mm repair or replace if

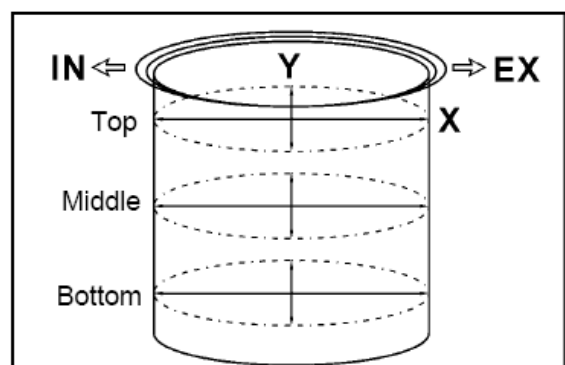

Inspect the top of the cylinder for warpage.

**Service Limit:** 0.05mm repair or replace if over

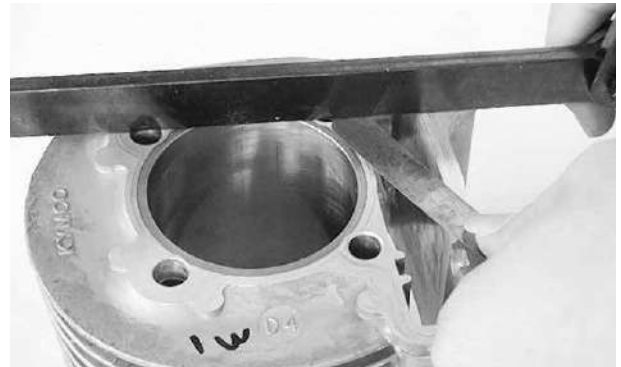

Measure the connecting rod small end I.D.

**Service Limit:** 15.06mm replace if over (50cc 13.04mm replace if over)



### PISTON RING INSTALLATION

Install the piston rings onto the piston. Apply engine oil to each piston ring.

\*

- Be careful not to damage or break the piston and piston rings.
- All rings should be installed with the markings facing up.
- After installing the rings, they should rotate freely without sticking.

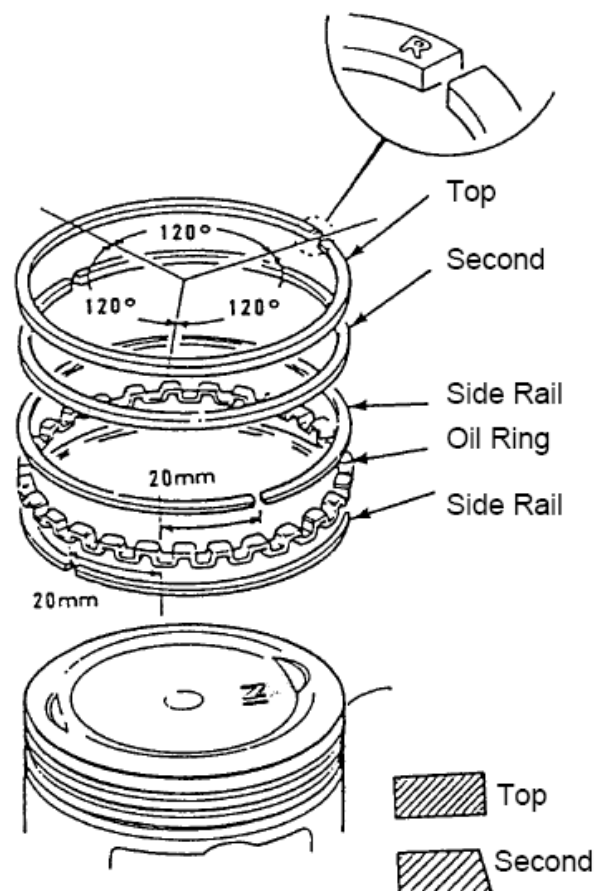

### PISTON INSTALLATION

Remove any gasket remnant from the crankcase surface.

- \* Be careful not to drop foreign matters into the crankcase.



Piston Pin

Install the piston, piston pin and a new piston pin clip.

- \*
  - Position the piston "IN" mark on the intake valve side.
  - Place a clean shop towel in the crankcase to keep the piston pin clip from falling into the crankcase.

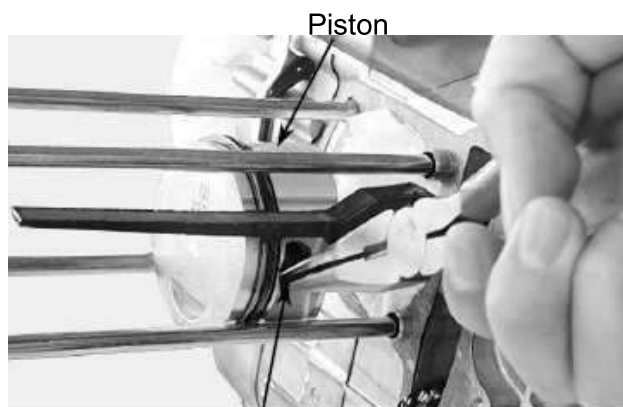

Piston

Piston Pin Clip

Cylinder

### CYLINDER INSTALLATION

Install the dowel pins and a new cylinder gasket on the crankcase. Coat the cylinder bore, piston and piston rings with clean engine oil. Carefully lower the cylinder over the piston by compressing the piston rings.

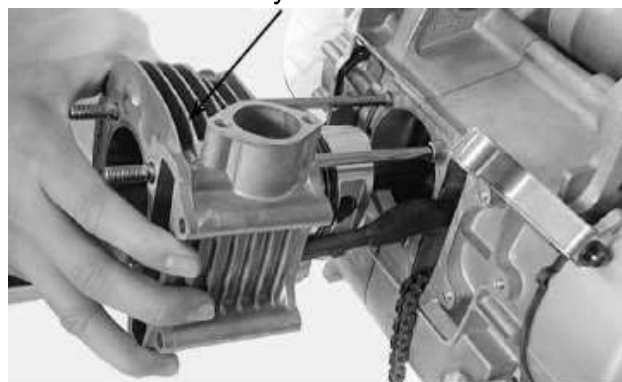

Bolts

- \*
  - Be careful not to damage or break the piston rings.
  - Stagger the ring end gaps at 120° to the piston pin.

Loosely install the cylinder base bolts. Install the cam chain guide. Install the cam chain tension. Tighten the cam chain tension bolts.

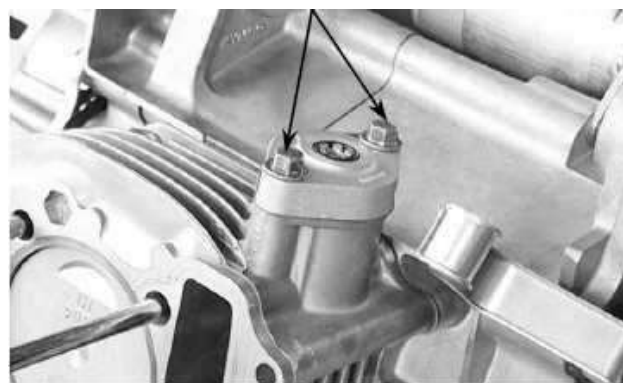

---

## A.C. GENERATOR

---

SERVICE INFORMATION.....	7-2
A.C. GENERATOR REMOVAL.....	7-3
A.C. GENERATOR INSTALLATION.....	7-4

# 7. A.C. GENERATOR

LIKE 50/125

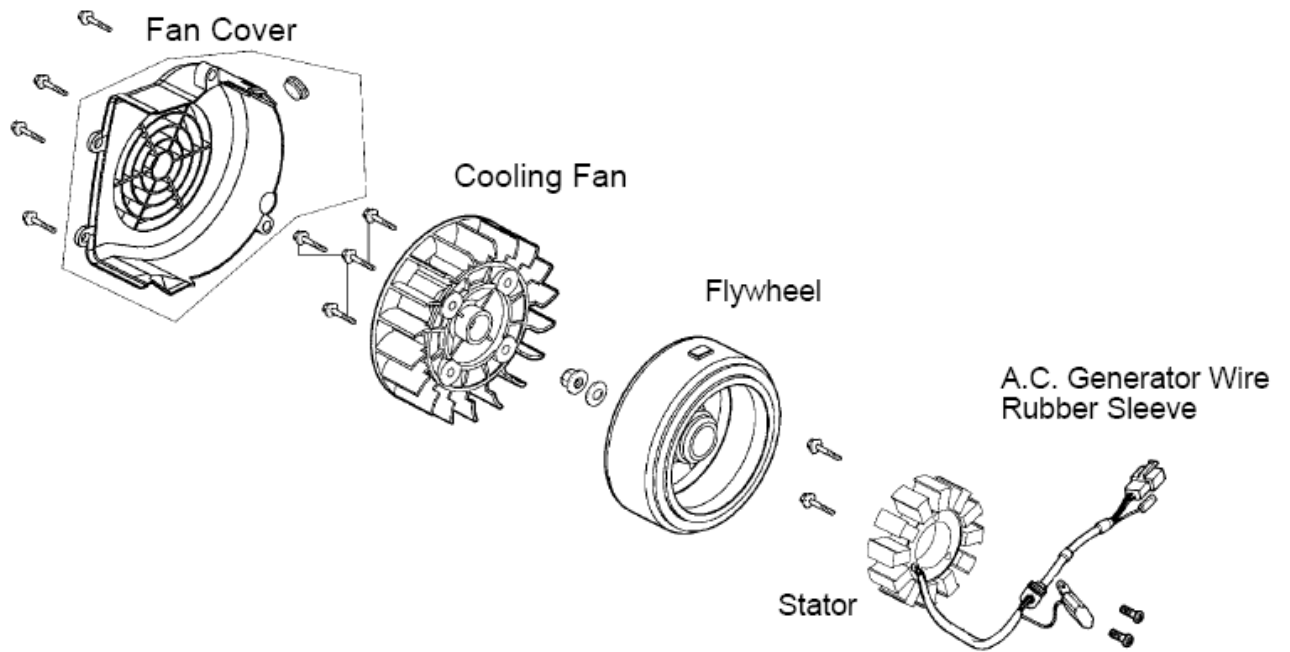

## SERVICE INFORMATION

### GENERAL INSTRUCTIONS

- All A.C. generator maintenance and inspection can be made with the engine installed.
- Refer to Section 15 for A.C. generator inspection.

### TORQUE VALUE

Flywheel nut : 3.5~4.0kg-m

### SPECIAL TOOLS

Flywheel puller  
Universal holder

# 7. A.C. GENERATOR

LIKE 50/125

## A.C. GENERATOR

### REMOVAL

Remove the rear right side cover. (⇒12)  
Remove the four bolts attaching the cooling fan cover to remove the fan cover.

Remove the cooling fan by removing the cooling fan attaching four bolts.

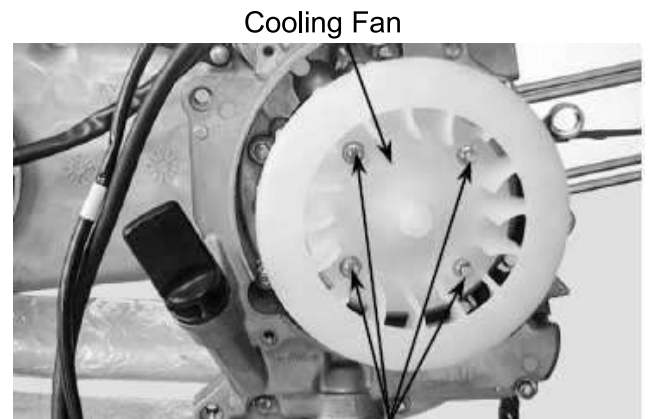

Cooling Fan

Bolts

Hold the flywheel with an universal holder.  
Remove the flywheel nut.

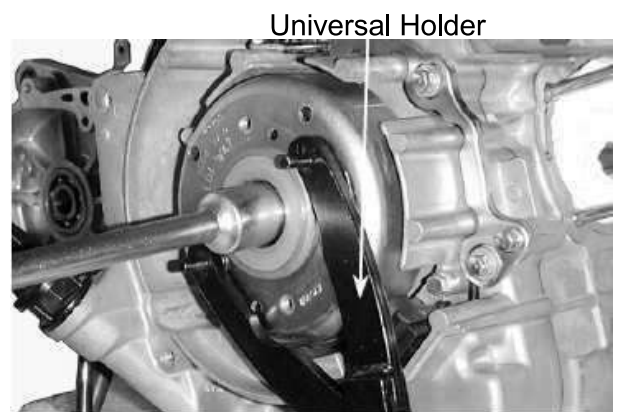

Universal Holder

Remove the A.C. generator flywheel using the flywheel puller.  
Remove the woodruff key.

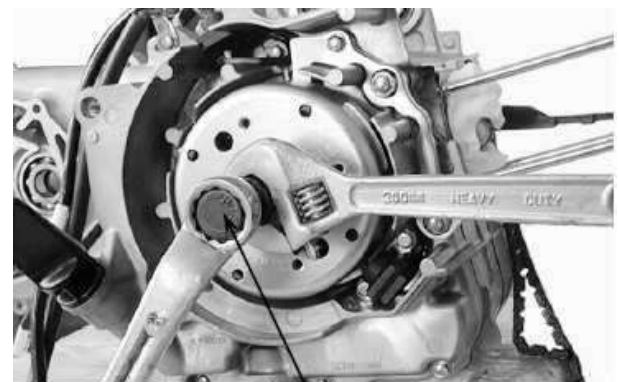

Flywheel Puller

# 7. A.C. GENERATOR

LIKE 50/125

Remove the A.C. generator wire connector.

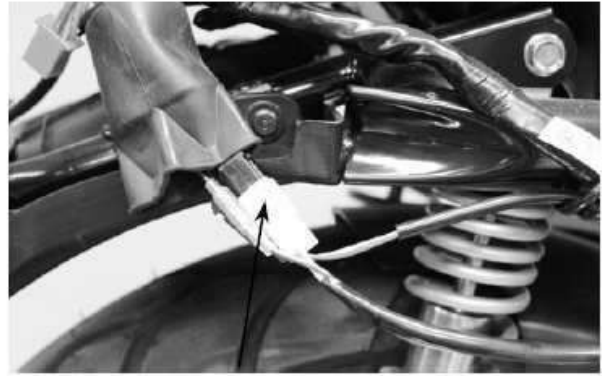

A.C. Generator Wire Connector

Remove the A.C. generator wire set plate.

Remove the pulser coil bolts.

Remove the A.C. generator wire rubber sleeve and pulser coil from the right crankcase.

Remove the two bolts and A.C. generator stator.

Wire Set Plate



Bolts

## INSTALLATION

Install the A.C. generator stator and pulser coil onto the right crankcase.

Tighten the stator and pulser coil bolts.

**Torques: Pulser Coil** : 0.5kg-m

**Stator** : 0.9kg-m

Install the A.C. generator wire rubber sleeve and A.C. generator wire set plate.

Stator



Pulser Coil Set Plate

Woodruff Key

Connect the A.C. generator wire connector.

Clean the taper hole in the flywheel off any burrs and dirt.

Install the woodruff key in the crankshaft keyway.





## 7. A.C. GENERATOR

LIKE 50/125

Install the flywheel onto the crankshaft with the flywheel hole aligned with the crankshaft woodruff key.



Install the cooling fan.

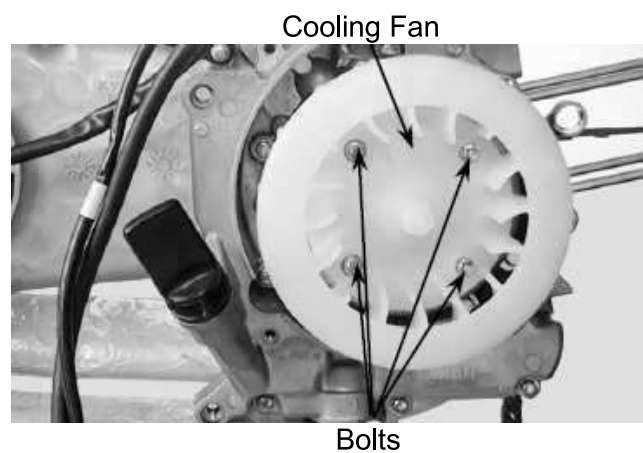

Install the fan cover.  
Install the rear right side cover. (⇒ 12)

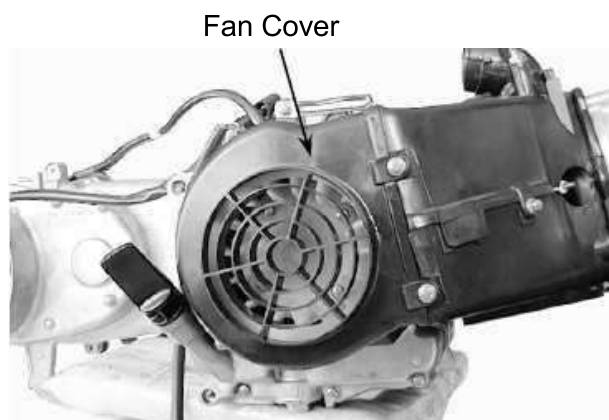

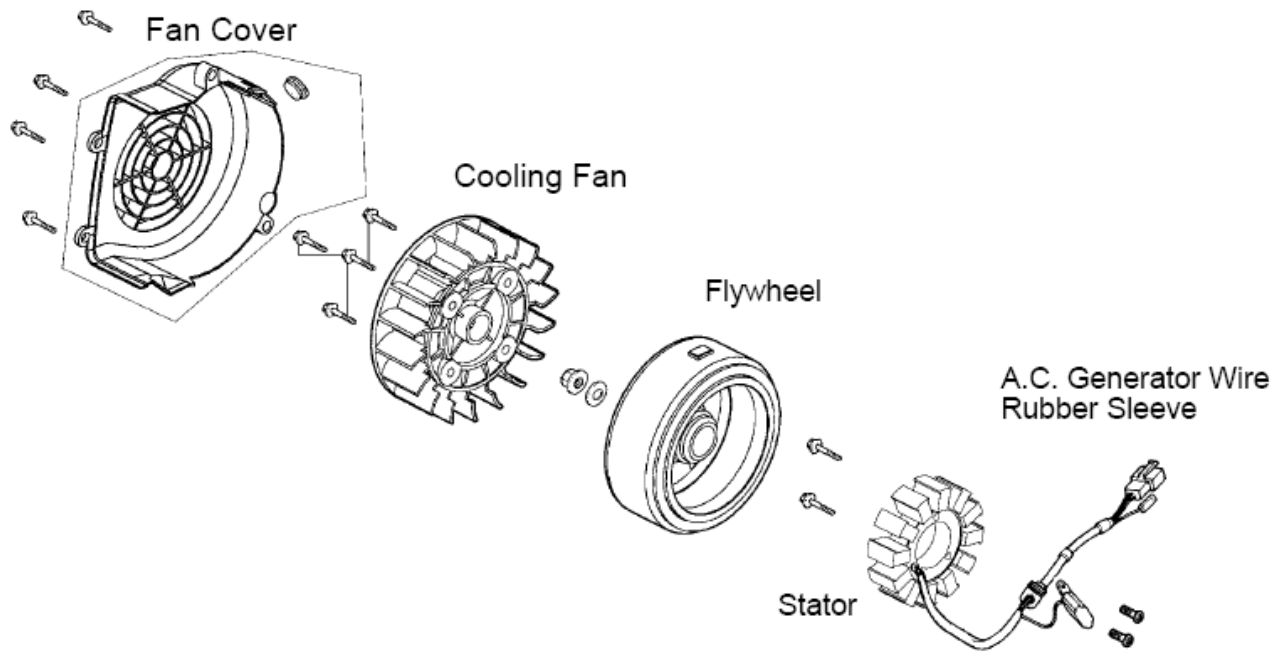

**KICK STARTER/DRIVE PULLEY/  
CLUTCH/DRIVEN PULLEY**

<b>SERVICE INFORMATION .....</b>	<b>8-2</b>
<b>TROUBLESHOOTING.....</b>	<b>8-2</b>
<b>LEFT CRANKCASE COVER.....</b>	<b>8-3</b>
<b>DRIVE PULLEY .....</b>	<b>8-3</b>
<b>CLUTCH/DRIVEN PULLEY.....</b>	<b>8-7</b>
<b>KICK STARTER.....</b>	<b>8-14</b>

# 8. KICK STARTER/DRIVE PULLEY/ CLUTCH/DRIVEN PULLEY

LIKE 50/125

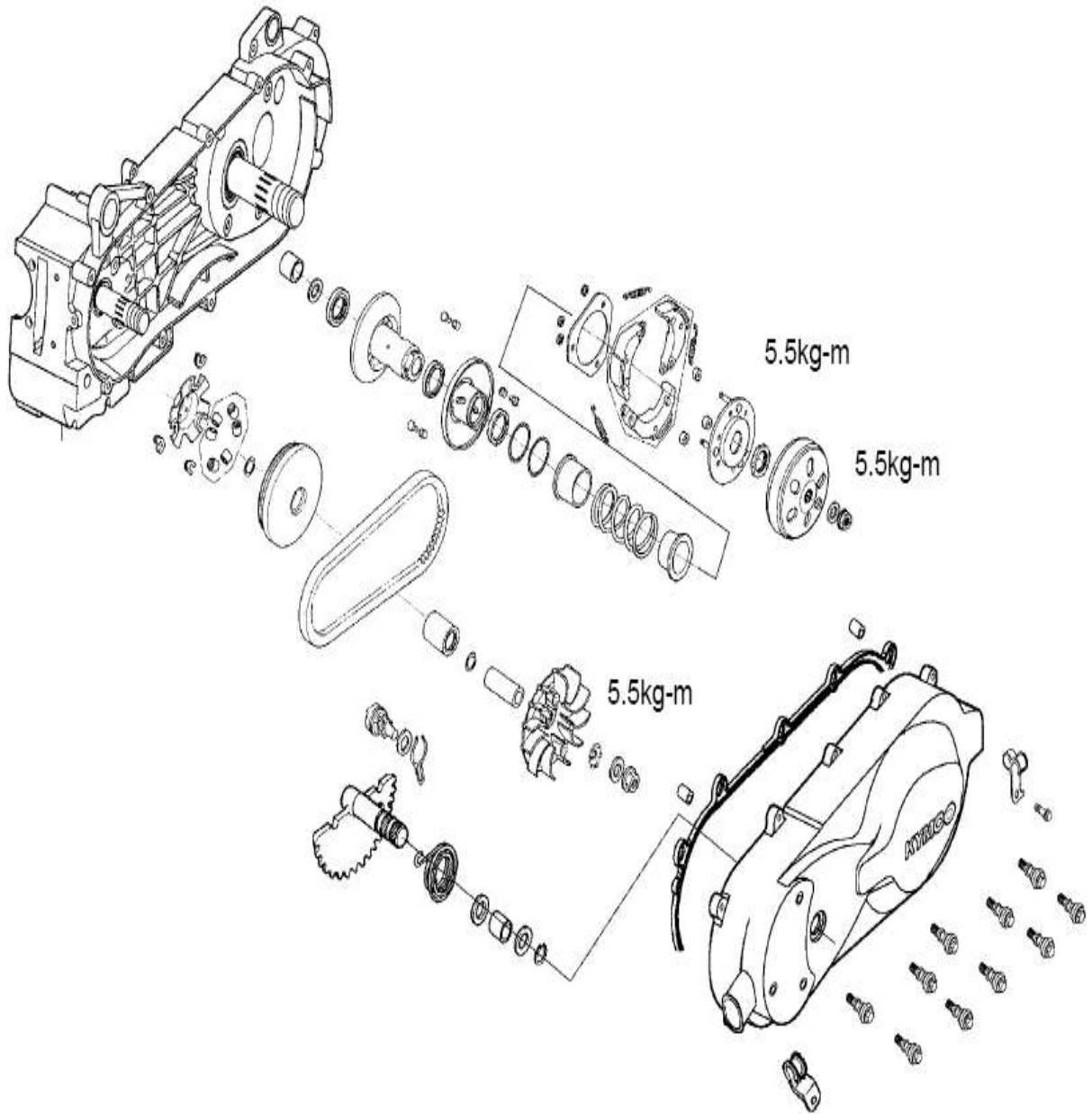

AMZGO

# 8. KICK STARTER/DRIVE PULLEY/ CLUTCH/DRIVEN PULLEY

LIKE 50/125

## SERVICE INFORMATION

### GENERAL INSTRUCTIONS

- Avoid getting grease and oil on the drive belt and pulley faces.

### SPECIFICATIONS

Item	LIKE 50/125	
	Standard (mm)	Service Limit (mm)
Drive pulley collar O.D.	20.01~20.025	24.24
Movable drive face I.D.	20.035~20.085	19.97
Weight roller O.D.	13.0	12.4
Clutch outer I.D.	107~107.2	107.5
Driven face spring free length	87.9	82.6
Driven face O.D.	33.965~33.985	33.94
Movable driven face I.D.	34.0~34.25	34.06
Drive belt width	18	17

### TORQUE VALUES

Drive face nut	3.5~4.0kg-m
Clutch outer nut	3.5~4.5kg-m
Clutch drive plate nut	5.0~6.0kg-m

### SPECIAL TOOLS

Lock nut wrench, 39mm	Universal holder
Clutch spring compressor	Lock nut socket wrench, 32mm
Bearing outer driver 37x40mm	Bearing driver pilot, 17mm
One-way clutch puller	Outer driver, 24x26mm

### TROUBLESHOOTING

#### Engine starts but motorcycle won't move

- Worn drive belt
- Broken ramp plate
- Worn or damaged clutch lining

#### Engine stalls or motorcycle creeps

- Broken clutch weight spring

#### Poor performance at high speed or lack of power

- Worn drive belt
- Weak driven face spring
- Worn weight roller
- Faulty driven face

## 8. KICK STARTER/DRIVE PULLEY/ CLUTCH/DRIVEN PULLEY

LIKE 50/125

### LEFT CRANKCASE COVER REMOVAL

Remove the bar assembly right rear step.

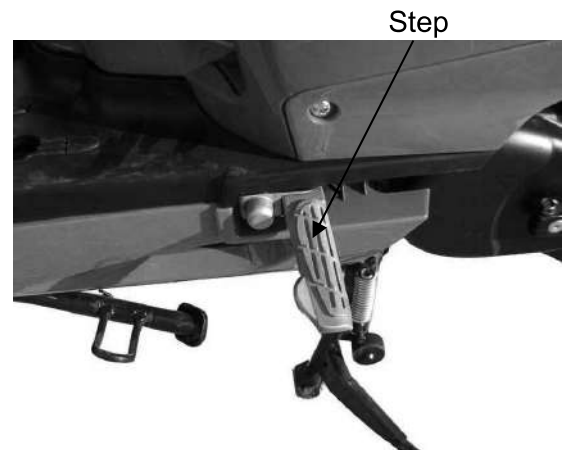

Left Crankcase Cover

Remove the left crankcase cover bolts  
and left crankcase cover.  
Remove the seal rubber and dowel pins.

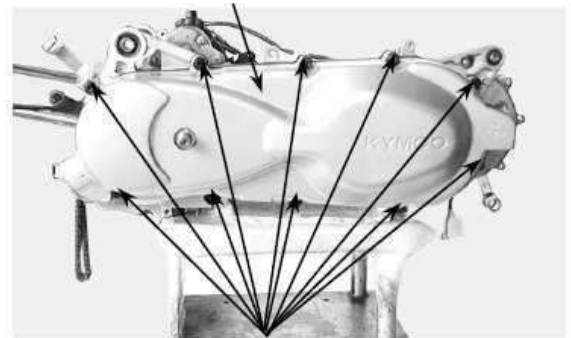

### DRIVE PULLEY REMOVAL

Hold the drive pulley using an universal  
holder and remove the drive face nut and  
starting ratchet.

Remove the drive pulley face.

Special

Universal Holder

Starting Ratchet      Blots      Drive Pulley Face

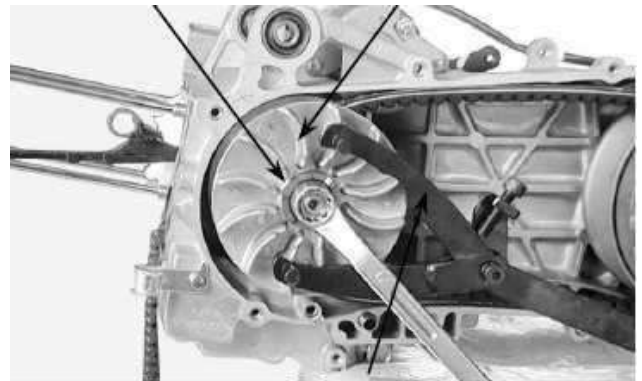

Universal Holder

### CLUTCH/DRIVEN PULLEY

Remove the drive pulley and drive belt.  
Hold the clutch outer with the flywheel  
holder and remove the clutch outer nut.  
Remove the clutch outer.  
Remove the clutch/driven pulley and  
drive belt.

Special

Flywheel Holder

Clutch Outer

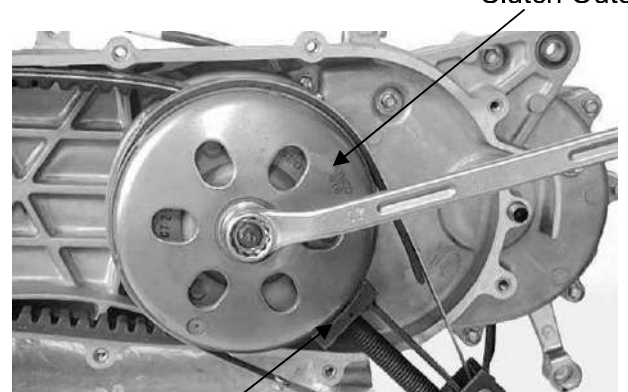

Flywheel Holder

## 8. KICK STARTER/DRIVE PULLEY/ CLUTCH/DRIVEN PULLEY

LIKE 50/125

### INSPECTION

Check the drive belt for cracks, separation or abnormal or excessive wear. Measure the drive belt width.

**Service Limit:** 19.0mm replace if below (50cc 17.0mm replace if below)

\*

Use specified genuine parts for replacement.

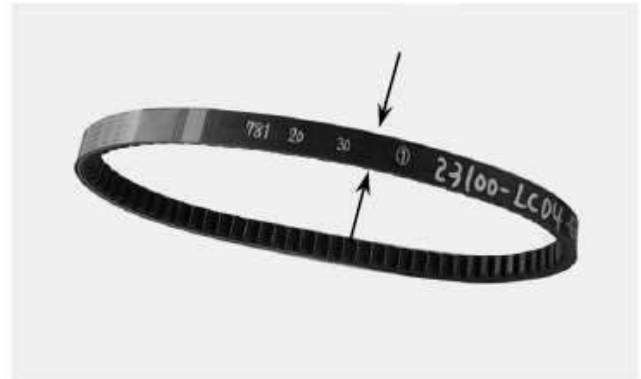

Drive Pulley Collar

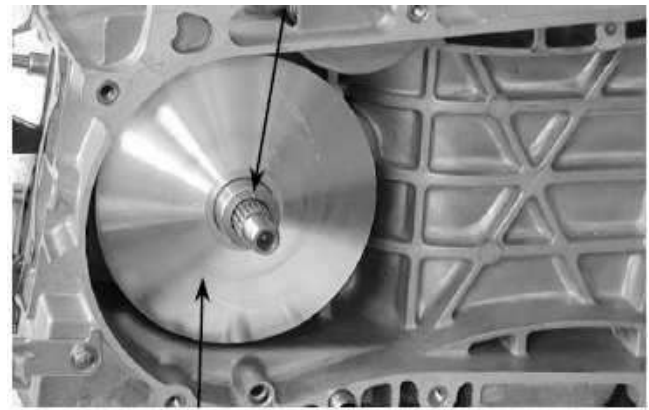

Movable Drive Face Assembly

Remove the movable drive face assembly.  
Remove the drive pulley collar.

Ramp Plate



### DISASSEMBLY

Remove the ramp plate.

Weight Rollers



Remove the weight rollers.

## 8. KICK STARTER/DRIVE PULLEY/ CLUTCH/DRIVEN PULLEY

LIKE 50/125

### INSPECTION

Check each weight roller for wear or damage.

Measure each weight roller O.D.

**Service Limit:** 17.4mm replace if below  
(50cc 15.4mm replace if below)

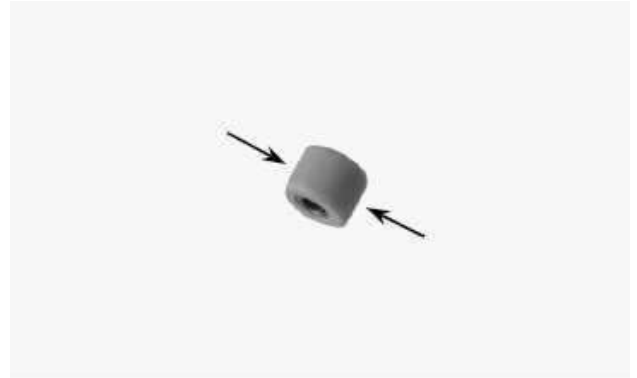

Measure the movable drive face bushing I.D.

**Service Limit:** 24.06mm replace if over



Check the drive pulley bushing for wear or damage.

Measure the O.D. of the drive pulley bushing sliding surface.

**Service Limit:** 23.94mm replace if below

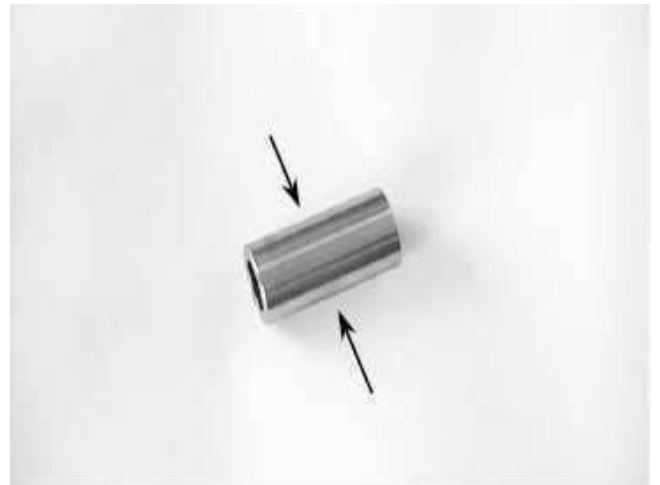



# 8. KICK STARTER/DRIVE PULLEY/ CLUTCH/DRIVEN PULLEY

LIKE 50/125

## ASSEMBLY

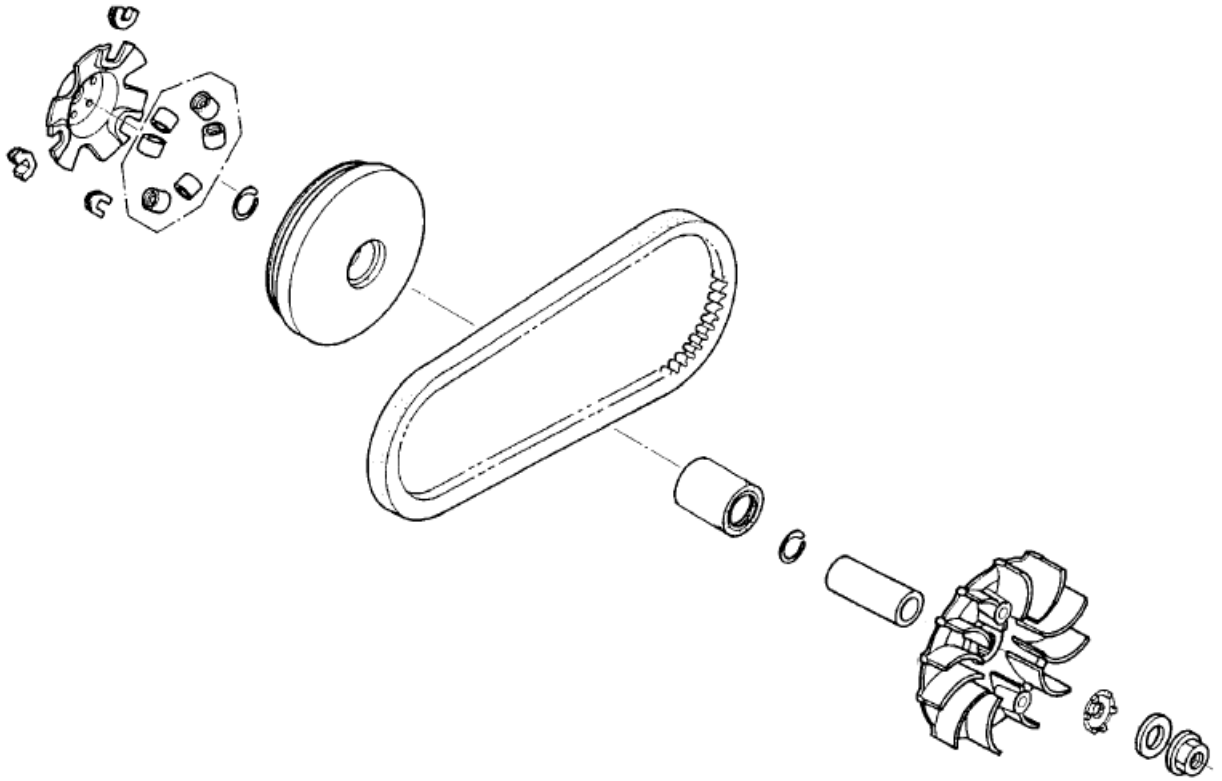

Install the weight rollers into the movable drive face.



Weight Roller

Install the ramp plate.



Ramp Plate

## 8. KICK STARTER/DRIVE PULLEY/ CLUTCH/DRIVEN PULLEY

LIKE 50/125

Insert the drive pulley collar into the movable drive face.

Drive Pulley Collar



### INSTALLATION

Install the movable drive face onto the crankshaft.



Movable Drive Face Assembly

### INSPECTION

Inspect the clutch outer for wear or damage.

Measure the clutch outer I.D.

**Service Limit:** 125.5mm replace if over  
(50cc 112.5mm replace if over)

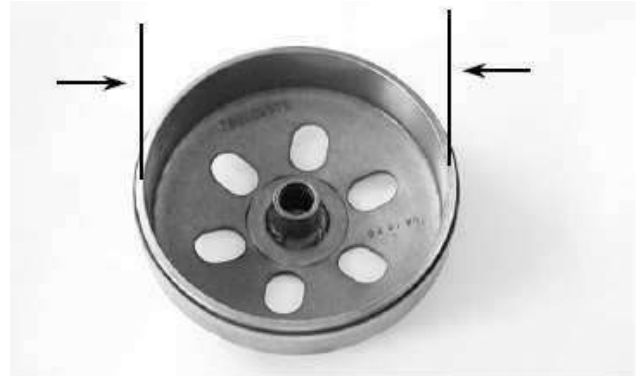

### CLUTCH/DRIVEN PULLEY DISASSEMBLY

Clutch



Driven Pulley

## 8. KICK STARTER/DRIVE PULLEY/ CLUTCH/DRIVEN PULLEY

LIKE 50/125

Hold the clutch/driven pulley assembly with the clutch spring compressor.

\*

Be sure to use a clutch spring compressor to avoid spring damage.

Special

Clutch Spring Compressor

Set the clutch spring compressor in a vise and remove the clutch drive plate nut.

Special

Lock Nut Wrench, 39mm

Loosen the clutch spring compressor and disassemble the clutch/driven pulley assembly.

Remove the seal collar.

Check the driven face for wear or damage.

Measure the clutch lining thickness.

**Service Limit:** 33.94mm replace if below

Pull out the guide roller pins and guide rollers.

Remove the movable driven face from the driven face.

Clutch Spring Compressor



Lock Nut Wrench



O-ring

Guide Roller Pin



Movable Driven Face

## 8. KICK STARTER/DRIVE PULLEY/ CLUTCH/DRIVEN PULLEY

LIKE 50/125

Remove the oil seal from the movable driven face.



### INSPECTION

Measure the driven face spring free length.

**Service Limit:** 163.7mm replace if below  
(50cc 154.6mm replace if below)

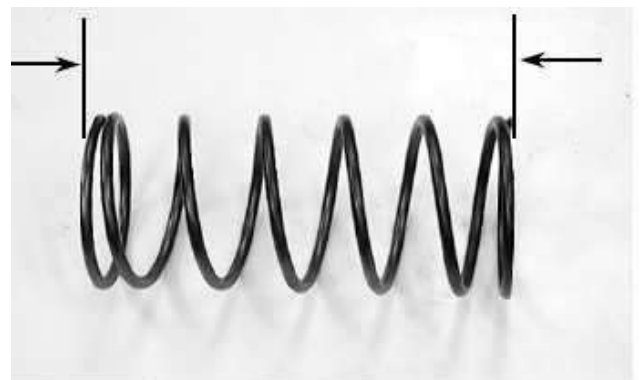

Check the driven face for wear or damage.

Measure the driven face O.D.

**Service Limit:** 33.94mm replace if below



Check the movable driven face for wear or damage.

Measure the movable driven face I.D.

**Service Limit:** 34.06mm replace if over

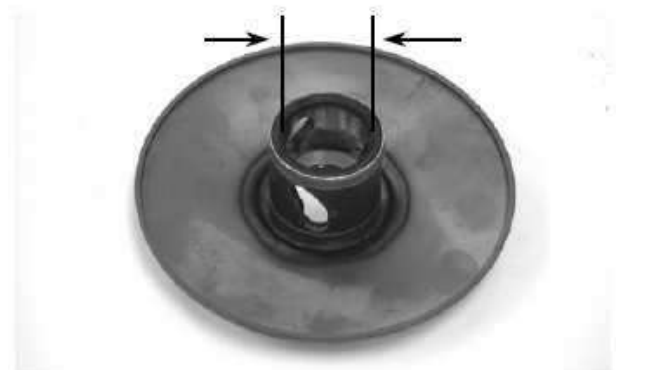

## 8. KICK STARTER/DRIVE PULLEY/ CLUTCH/DRIVEN PULLEY

LIKE 50/125

### DRIVEN PULLEY FACE BEARING REPLACEMENT

Drive the inner needle bearing out of the driven pulley face.

- \* Discard the removed bearing and replace with a new one.

Remove the snap ring and drive the outer bearing out of the driven face.

- \* Discard the removed bearing and replace with a new one.

Apply grease to the outer bearing. Drive a new outer bearing into the driven face with the sealed end facing up.

Special  
Bearing Driver

Seat the snap ring in its groove. Apply grease to the driven face bore areas.

- \* Pack all bearing cavities with 9~9.5g grease.  
Specified grease: Heat resistance 230° C

Press a new needle bearing into the driven face.

Special  
Bearing Driver  
Pilot, 20mm

### CLUTCH DISASSEMBLY

Remove the circlips and retainer plate to disassemble the clutch.

- \* Keep grease off the clutch linings.

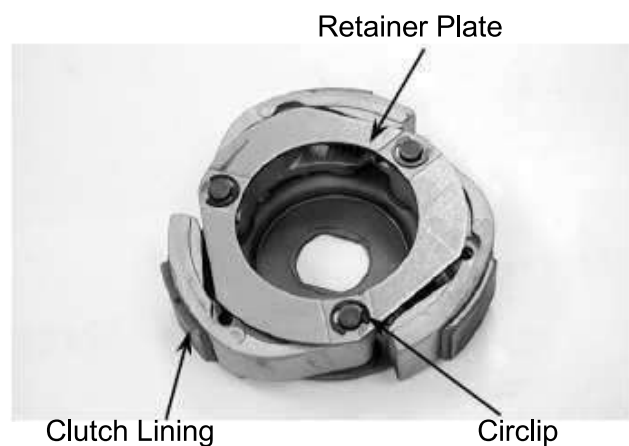
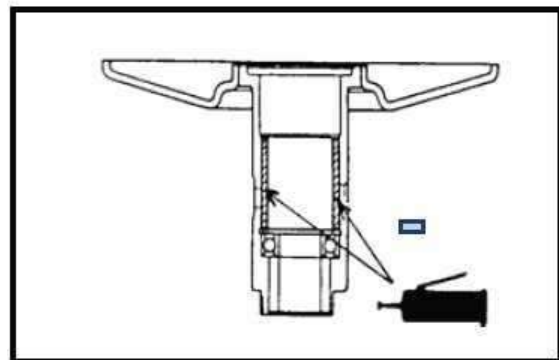
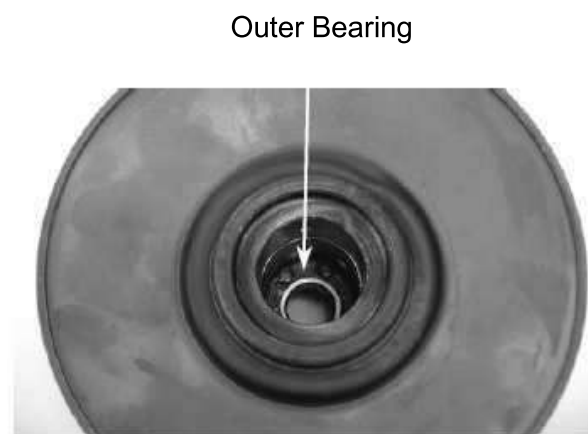
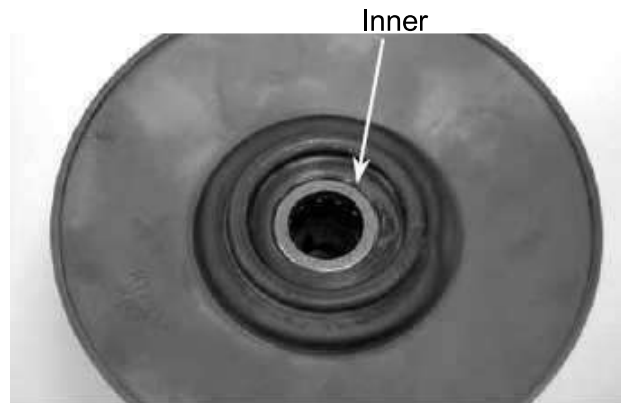

# 8. KICK STARTER/DRIVE PULLEY/ CLUTCH/DRIVEN PULLEY

LIKE 50/125

## CLUTCH / DRIVEN PULLEY ASSEMBLY

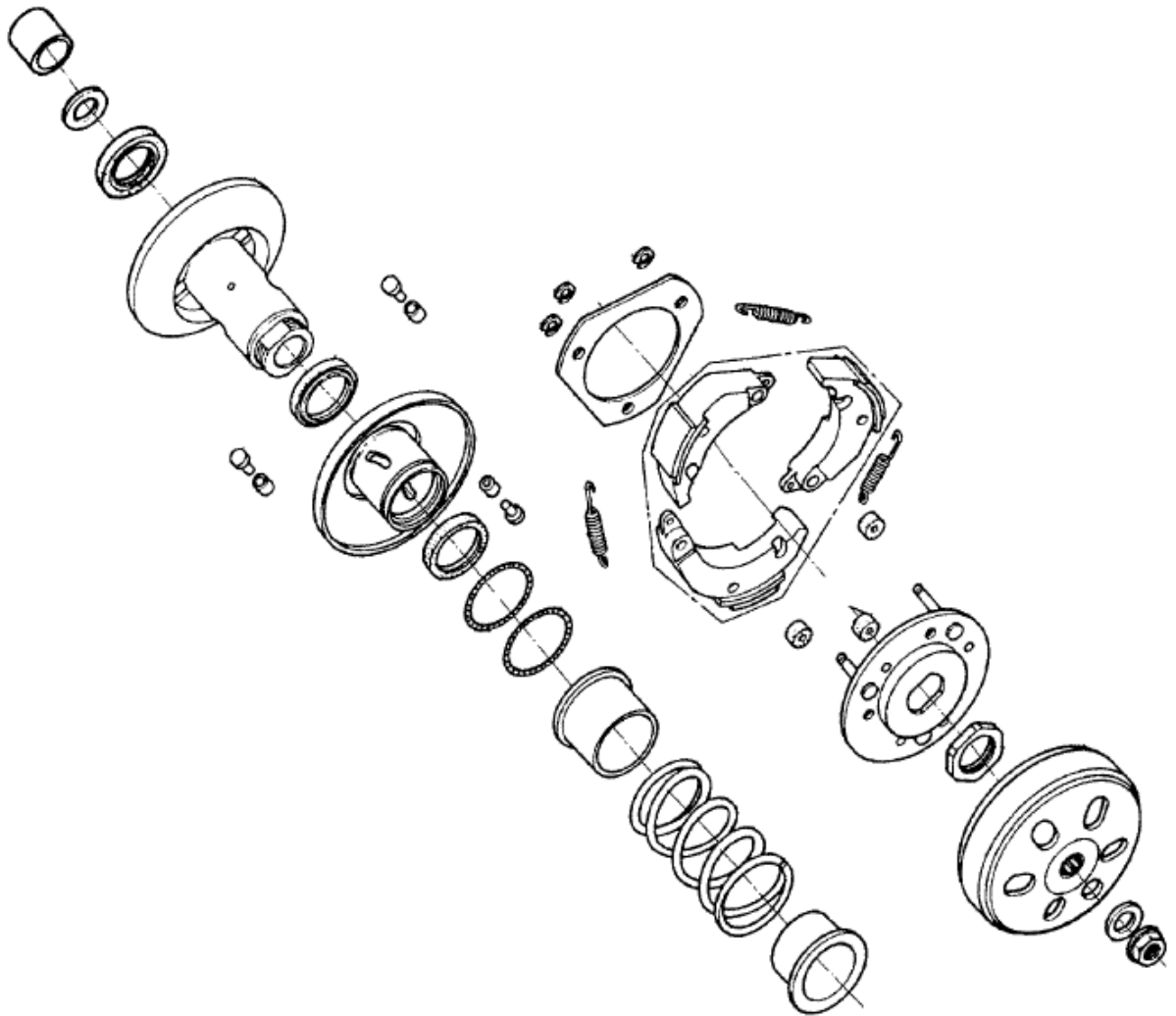

## 8. KICK STARTER/DRIVE PULLEY/ CLUTCH/DRIVEN PULLEY

LIKE 50/125

Install the damper rubbers on the drive plate pins.  
Install the clutch weights/shoes and clutch springs onto the drive plate.  
Install the retainer plate and secure with the circlips.

Retainer Plate      Clutch Weights/Shoes

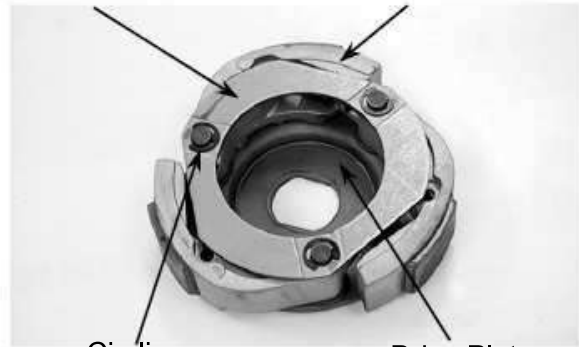

Movable Driven Face

**CLUTCH/DRIVEN PULLEY ASSEMBLY**  
Clean the driven pulley faces and remove any grease from them.  
Install the oil seal onto the moveable driven face.  
Apply grease to the O-rings and install them onto the moveable driven face.



Install the movable driven face onto the driven face.  
Apply grease to the guide rollers and guide roller pins and then install them into the holes of the driven face.



Install the seal collar.  
Remove any excessive grease.

\* Be sure to clean the driven face off any grease.

Set the driven pulley assembly, driven face spring and clutch assembly onto the clutch spring compressor.

Driven Face

\* Align the flat surface of the driven face with the flat on the clutch drive plate.



Movable Driven Face

## 8. KICK STARTER/DRIVE PULLEY/ CLUTCH/DRIVEN PULLEY

LIKE 50/125

Compress the clutch spring compressor and install the drive plate nut. Set the clutch spring compressor in a vise and tighten the drive plate nut to the specified torque.

**Torque:** 5.5kg-m

\* Be sure to use a clutch spring compressor to avoid spring damage.

Special  
Clutch Spring Compressor

### INSTALLATION

Install the clutch/driven pulley onto the drive shaft.

\* Keep grease off the drive shaft.

Install the clutch outer. Hold the clutch outer with the flywheel holder. Install and tighten the clutch outer nut.

**Torque:** 5.5kg-m  
Special  
Flywheel Holder  
Install the drive belt.

Install the drive pulley face, starting ratchet and drive face nut.

\* When installing the drive pulley face, compress it to let the drive belt move downward to the lowest position so that the drive pulley can be tightened. Install the starting ratchet by aligning the starting ratchet teeth with the crankshaft teeth. Do not get oil or grease on the drive belt or pulley faces.

**Torque:** 5.5kg-m

Clutch Spring Compressor

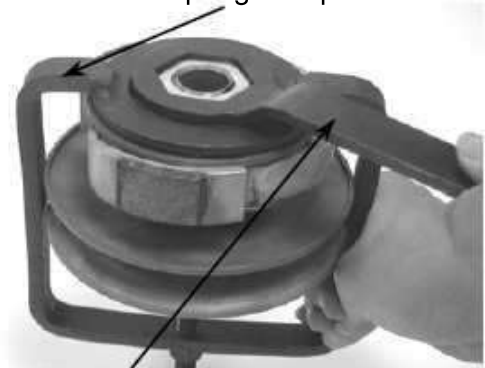

Lock Nut Wrench

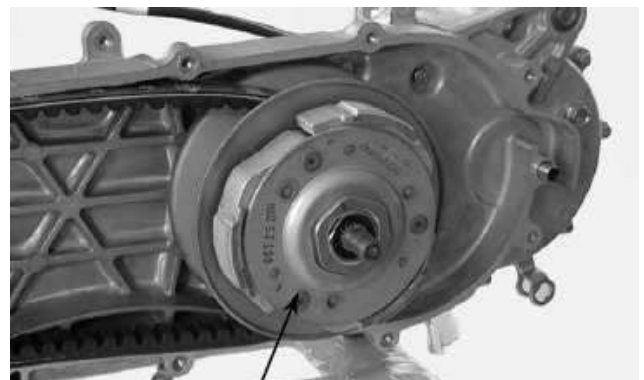

Clutch/Driven Pulley

Clutch Outer

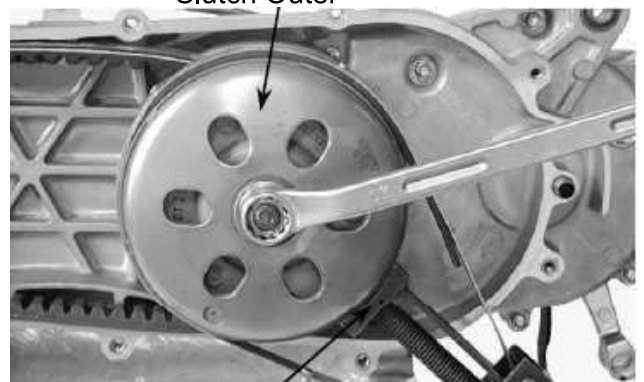

Flywheel Holder

Drive Pulley

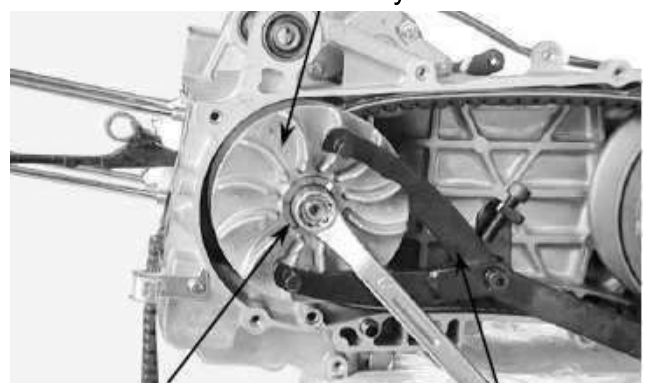

Starting Ratchet

Universal Holder



## 8. KICK STARTER/DRIVE PULLEY/ CLUTCH/DRIVEN PULLEY

LIKE 50/125

### KICK STARTER REMOVAL

Remove the left crankcase cover.  
Remove the seal rubber and dowel pins.  
Remove the kick lever.  
Remove the circlip and washer from the  
kick starter spindle.

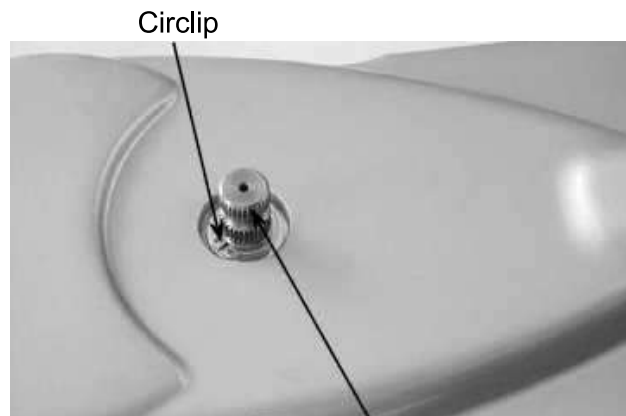

Gently turn the kick starter spindle to  
remove the starter driven gear together  
with the friction spring.



Remove the kick starter spindle and  
return spring from the left crankcase  
cover.  
Remove the kick starter spindle bushing.

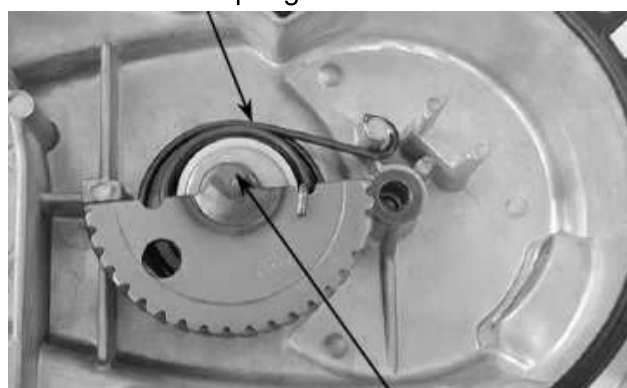

### INSPECTION

Inspect the kick starter spindle and gear  
for wear or damage.  
Inspect the return spring for weakness or  
damage.  
Inspect the kick starter spindle bushings  
for wear or damage.

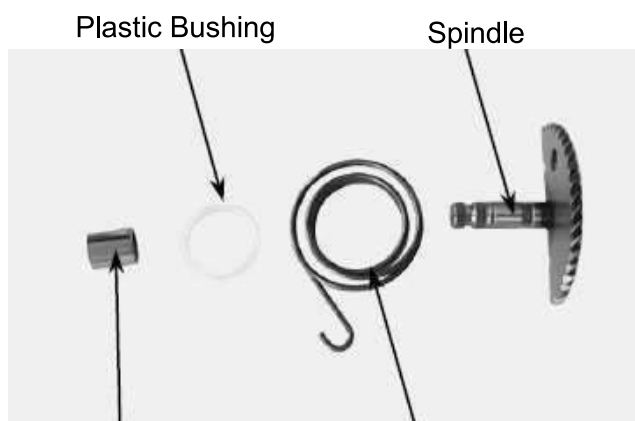

## 8. KICK STARTER/DRIVE PULLEY/ CLUTCH/DRIVEN PULLEY

LIKE 50/125

Inspect the starter driven gear for wear or damage.  
Inspect the friction spring for wear or damage.

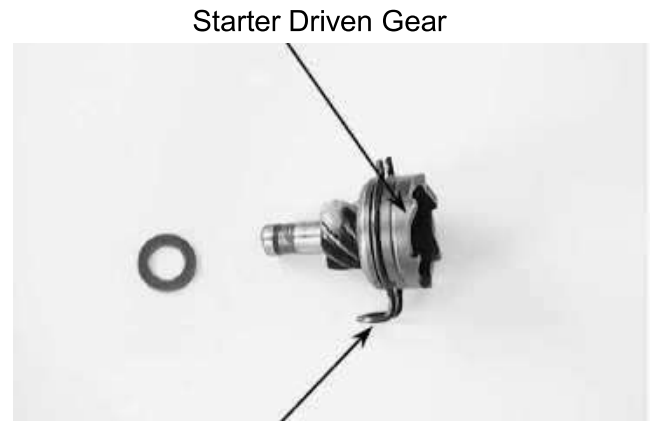

Inspect the kick starter spindle and starter driven gear forcing parts for wear or damage.

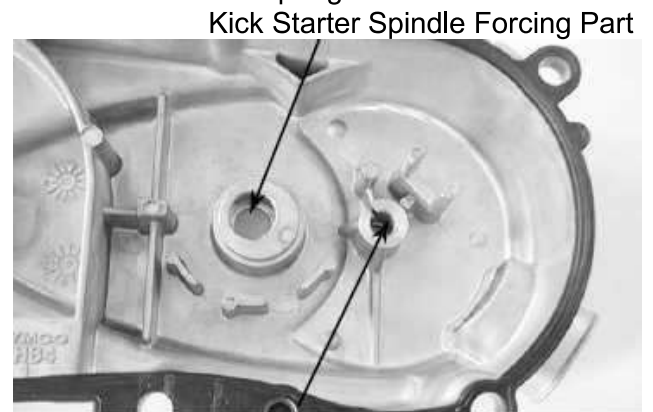

### INSTALLATION

Install the kick starter spindle bushings and return spring onto the left crankcase cover.

\*

When installing the return spring, use a screw driver to press the inward and outward return spring hooks into their original positions respectively.

Install the starter driven gear and friction spring as the figure shown.

Install the kick lever.  
Install the left crankcase cover and tighten the cover bolts diagonally.

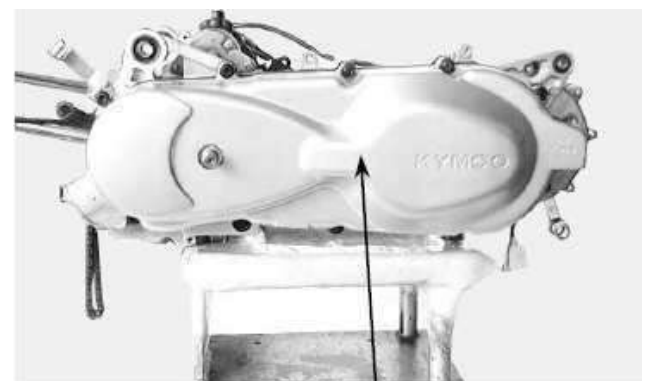
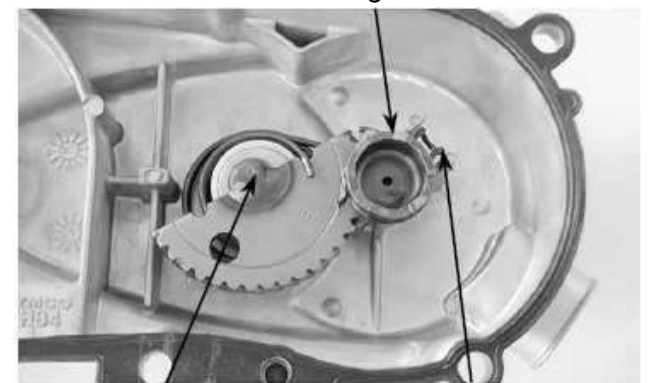

---

**FINAL REDUCTION**

---

SERVICE INFORMATION..... 9-2

TROUBLESHOOTING..... 9-2

FINAL REDUCTION DISASSEMBLY..... 9-3

FINAL REDUCTION INSPECTION..... 9-3

FINAL REDUCTION ASSEMBLY..... 9-5

# 9. FINAL REDUCTION

LIKE 50/125

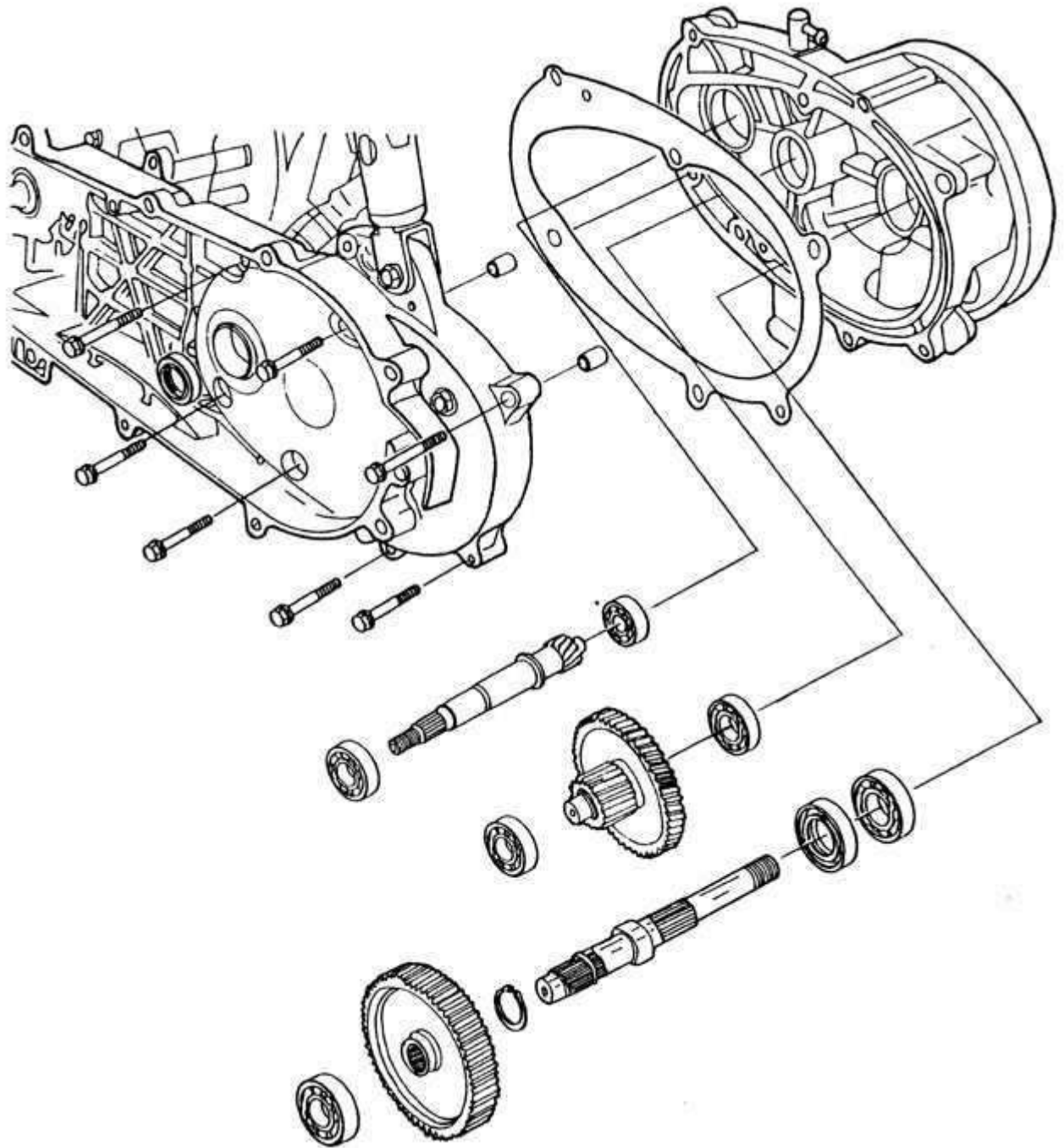

## SERVICE INFORMATION GENERAL INSTRUCTIONS

- When replacing the drive shaft, use a special tool to hold the bearing inner race for this operation.

## SPECIFICATIONS

Specified Oil: GEAR OIL SAE 90#

Oil Capacity: At change : 0.181 liter

At disassembly : 0.21 liter

## TORQUE VALUES

Transmission case cover bolt 1.2kg-m

## SPECIAL TOOLS

Driver handle A

Outer driver, 32x35mm

Outer driver, 37x40mm

Outer driver, 42x47mm

Pilot, 15mm

Pilot, 17mm

Pilot, 20mm

Crankcase assembly tool

– Assembly shaft

– Assembly collar

## TROUBLESHOOTING

### Engine starts but motorcycle won't move

- Damaged transmission
- Seized or burnt transmission

### Oil leaks

- Oil level too high
- Worn or damaged oil seal

## 9. FINAL REDUCTION

LIKE 50/125

### FINAL REDUCTION DISASSEMBLY

Remove the exhaust muffler.  
Remove the rear wheel. (⇒14)  
Remove the rear brake cable. (⇒14)  
Remove the left crankcase cover. (⇒8)  
Remove the clutch/driven pulley. (⇒8)  
Drain the transmission gear oil into a clean container.  
Remove the transmission case cover attaching bolts.  
Remove the transmission case cover.  
Remove the gasket and dowel pins.

Remove the final gear and countershaft.

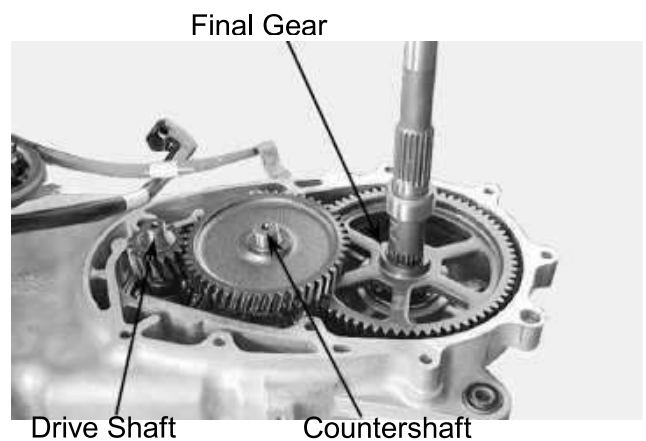
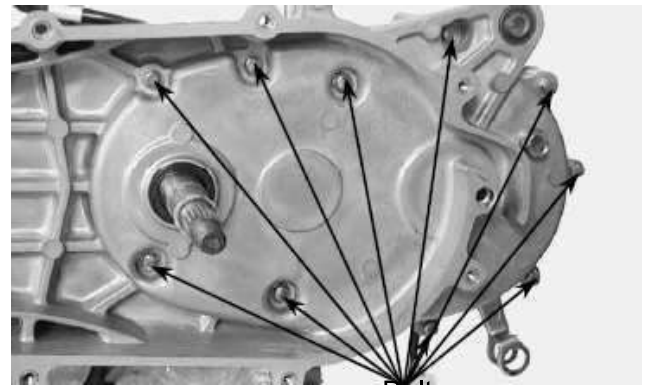

### FINAL REDUCTION INSPECTION

Inspect the countershaft and gear for wear or damage.

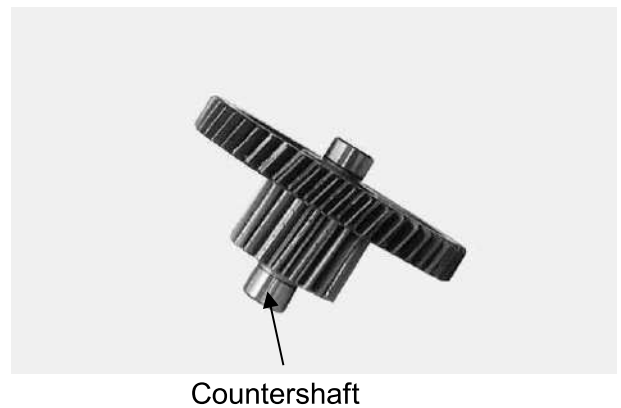

Inspect the final gear and final shaft for wear, damage or seizure.



Check the left crankcase bearings for excessive play and inspect the oil seal for wear or damage.

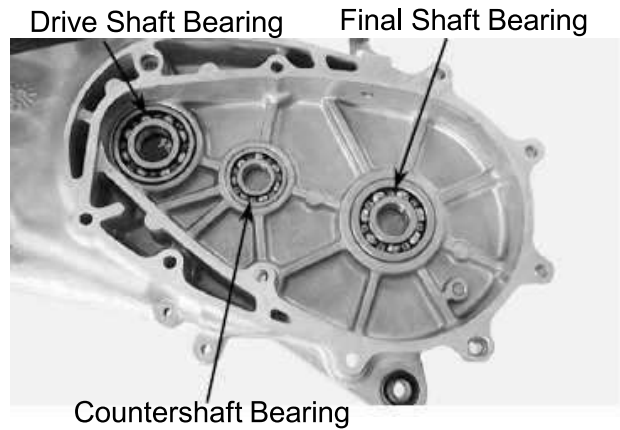

Check the transmission case cover bearings for excessive play and inspect the final shaft bearing oil seal for wear or damage.

\* Do not remove the transmission case cover except for necessary part replacement. When replacing the drive shaft, also replace the bearing and oil seal.

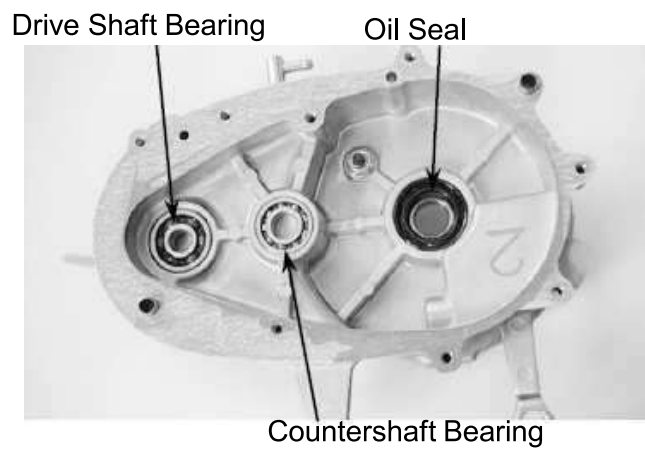

### BEARING REPLACEMENT (TRANSMISSION CASE COVER)

Remove the transmission case cover bearings using a bearing remover.  
Remove the final shaft oil seal.



Drive new bearings into the transmission case cover.



## 9. FINAL REDUCTION

LIKE 50/125

### BEARING REPLACEMENT (LEFT CRANKCASE)

Remove the drive shaft.  
Remove the drive shaft oil seal.  
Remove the left crankcase bearings using a bearing remover.

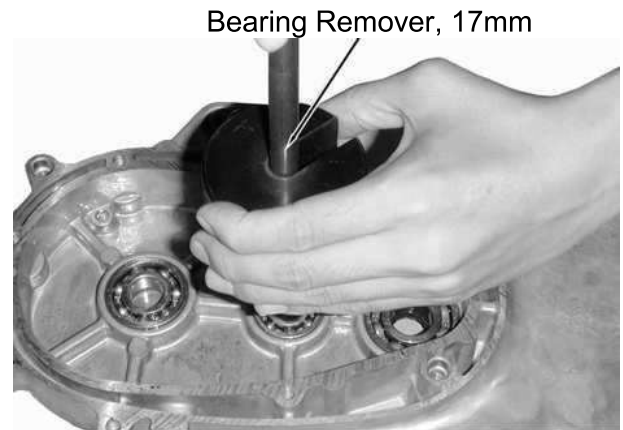

Drive new bearings into the left crankcase.  
Install a new drive shaft oil seal.

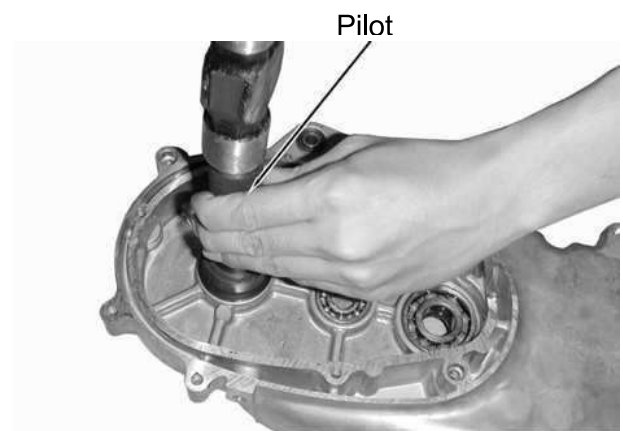

### FINAL REDUCTION ASSEMBLY

Install the drive shaft into the left crankcase.  
Inspect the drive shaft and gear for wear or damage.

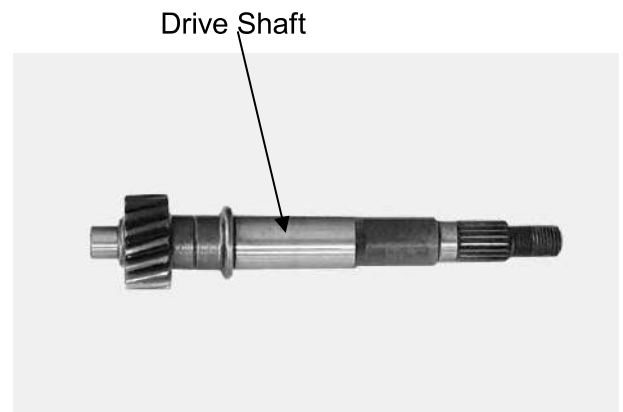

Install the final gear and final shaft into the left crankcase.  
Install the countershaft and gear into the left crankcase.  
Install the washer onto the countershaft.  
Install the dowel pins and a new gasket.

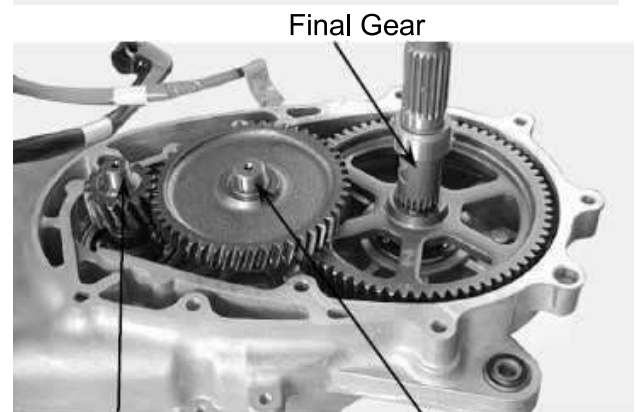

Drive Shaft

Countershaft



## 9. FINAL REDUCTION

LIKE 50/125

Install the transmission case cover.

Install and tighten the transmission case cover bolts.  
Install the clutch/driven pulley. (⇒8)  
Install the rear wheel. (⇒14)  
Install the rear brake cable. (⇒14)

After installation, fill the transmission case with the specified oil. (⇒3)

\*

- Place the motorcycle on its main stand on level ground.
- Check the oil sealing washer for wear or damage.

### Specified Gear Oil:

KYMCO SIGMA GEAR OIL SAE 90#

### Oil Capacity:

At disassembly : 0.21 liter

At change : 0.181 liter

Install and tighten the oil check bolt.

**Torque:** 1.0~1.5kg-m

Start the engine and check for oil leaks.  
Check the oil level from the oil check bolt hole and add the specified oil to the proper level if the oil level is low.

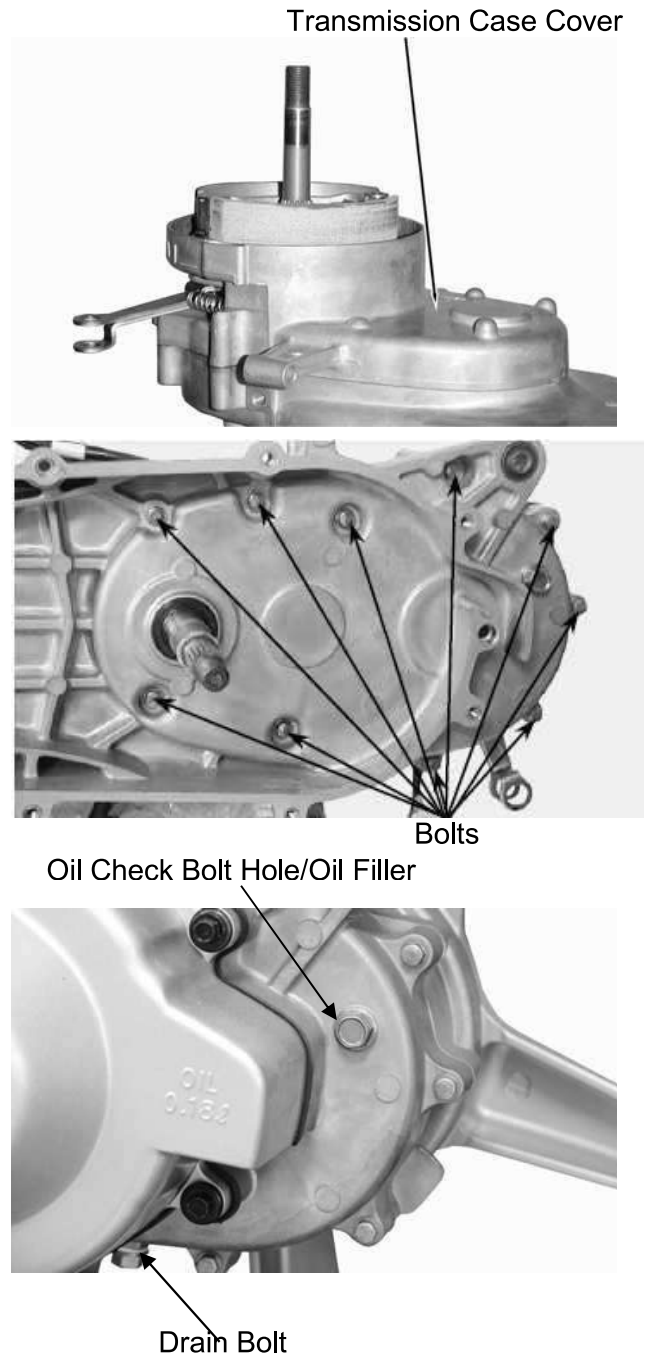

**CRANKCASE/CRANKSHAFT**

SERVICE INFORMATION.....	10-2
TROUBLESHOOTING.....	10-2
CRANKCASE SEPARATION.....	10-3
CRANKSHAFT INSPECTION.....	10-4
CRANKCASE ASSEMBLY.....	10-4

# 10. CRANKCASE/CRANKSHAFT

LIKE 50/125

Torque: 0.8~1.2kg-m

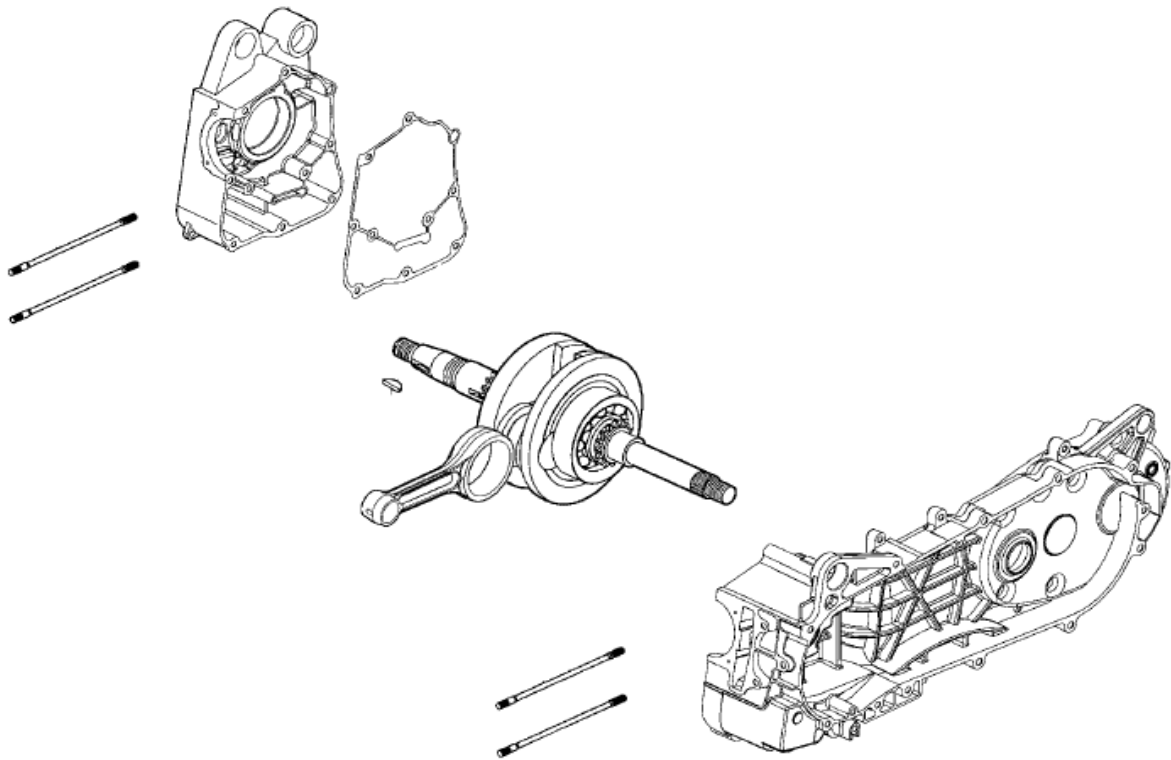

## SERVICE INFORMATION

### GENERAL INSTRUCTIONS

- This section covers crankcase separation to service the crankshaft.
- The following parts must be removed before separating the crankcase.
 

Engine (⇒Section 5)	Driven pulley (⇒Section 9)
Carburetor (⇒Section 11)	A.C. generator (⇒Section 7)
Oil pump (⇒Section 4)	Cylinder head/cylinder (⇒Section 6)
Reed valve (⇒Section 11)	
- When the left crankcase must be replaced, remove the following part in addition to the above.  
Final reduction removal
- Special tools must be used for crankshaft and crankcase assembly. When separating the crankcase, the bearing will remain in the crankcase and it should be removed. When assembling, drive a new bearing into the crankcase and install a new oil seal.

### SPECIFICATIONS

Item	LIKE 50/125	
	Standard (mm)	Service Limit (mm)
Connecting rod big end side clearance	—	0.60
Connecting rod big end radial clearance	—	0.04
Crankshaft runout A/B	—	0.15/0.10

### SPECIAL TOOLS

Crankcase puller	Bearing outer driver handle A
Universal bearing puller	Bearing outer driver, 42x47mm
Crankcase assembly collar	Bearing driver pilot, 20mm
Crankcase assembly tool	Bearing outer driver, 37x40mm
	Bearing driver pilot, 17mm

### TROUBLESHOOTING

#### Abnormal engine noise

- Excessive crank journal bearing play
- Excessive crankpin bearing play
- Excessive transmission bearing play

# 10. CRANKCASE/CRANKSHAFT

LIKE 50/125

## CRANKCASE SEPARATION

Remove the crankcase attaching two bolts.  
Separate the left and right crankcase halves.

\* Do not damage the crankcase gasket surface.

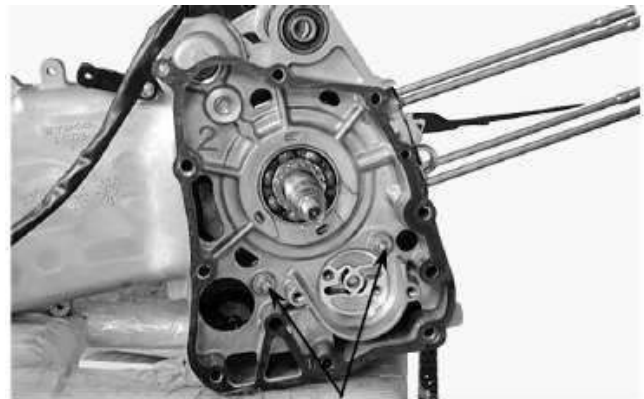

Crankcase Bolts

Dowel Pins

Remove the gasket and dowel pins.



Gasket

Remove the crankshaft from the left crankcase.

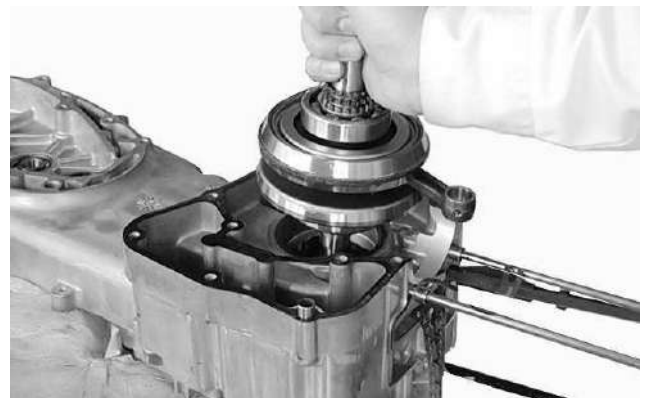

Clean off all gasket material from the crankcase mating surfaces.

\* Avoid damaging the crankcase mating surfaces.



# 10. CRANKCASE/CRANKSHAFT

LIKE 50/125

Remove the oil seal from the right crankcase.  
Check the oil seal lip for wear or deterioration.

The installation sequence is the reverse of removal.



## CRANKSHAFT INSPECTION

Measure the connecting rod big end side clearance.

**Service Limit:** 0.55mm replace if over

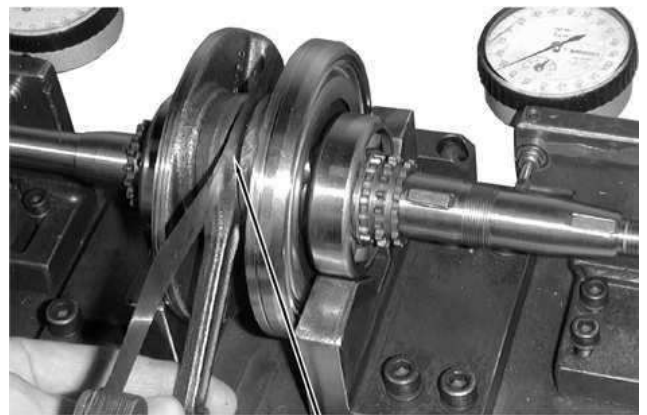

Connecting Rod Big End

Turn the crankshaft bearings and check for excessive play.

If they do not turn smoothly, quietly or if they fit loosely in the crankshaft, replace the crankshaft as a set.

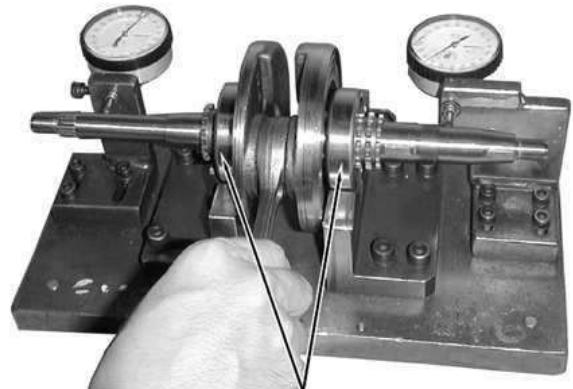

Crankshaft Bearings

## CRANKCASE ASSEMBLY

Install the crankshaft into the left crankcase.

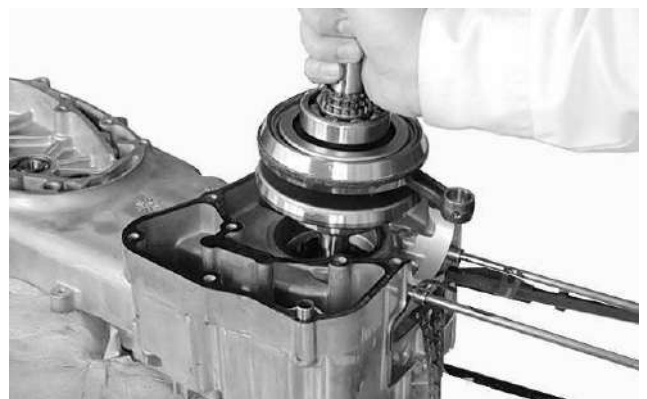

## 10. CRANKCASE/CRANKSHAFT

LIKE 50/125

Install the dowel pins and a new gasket onto the left crankcase.

\* Place the right crankcase over the crankshaft and onto the left crankcase.

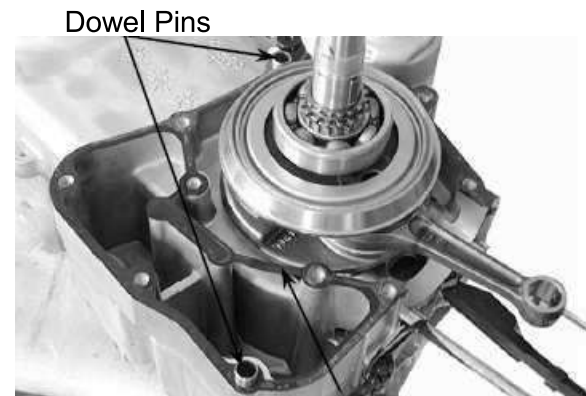

Gasket

Tighten the crankcase attaching two bolts.

**Torque:** 0.9kg-m

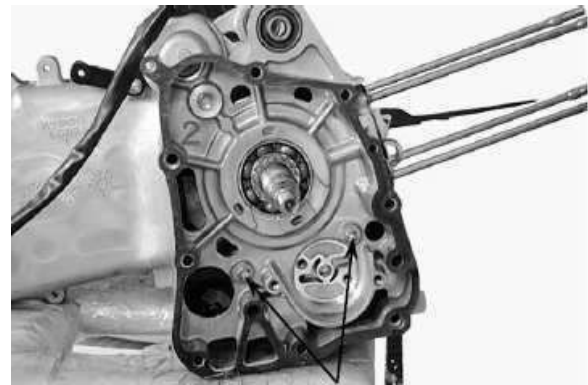

Crankcase Bolts

## FUEL SYSTEM

SERVICE INFORMATION.....	11-2
TROUBLESHOOTING .....	11-3
CARBURETOR REMOVAL .....	11-4
AUTO BYSTARTER.....	11-4
AIR CUT-OFF VALVE.....	11-6
VACUUM CHAMBER.....	11-6
FLOAT CHAMBER .....	11-7
CARBURETOR INSTALLATION.....	11-10
FUEL TANK .....	11-11
FUEL UNIT.....	11-11
AUTO FUEL VALVE .....	11-12
AIR CLEANER .....	11-13



# 11. FUEL SYSTEM

LIKE 50/125

## FUEL SYSTEM

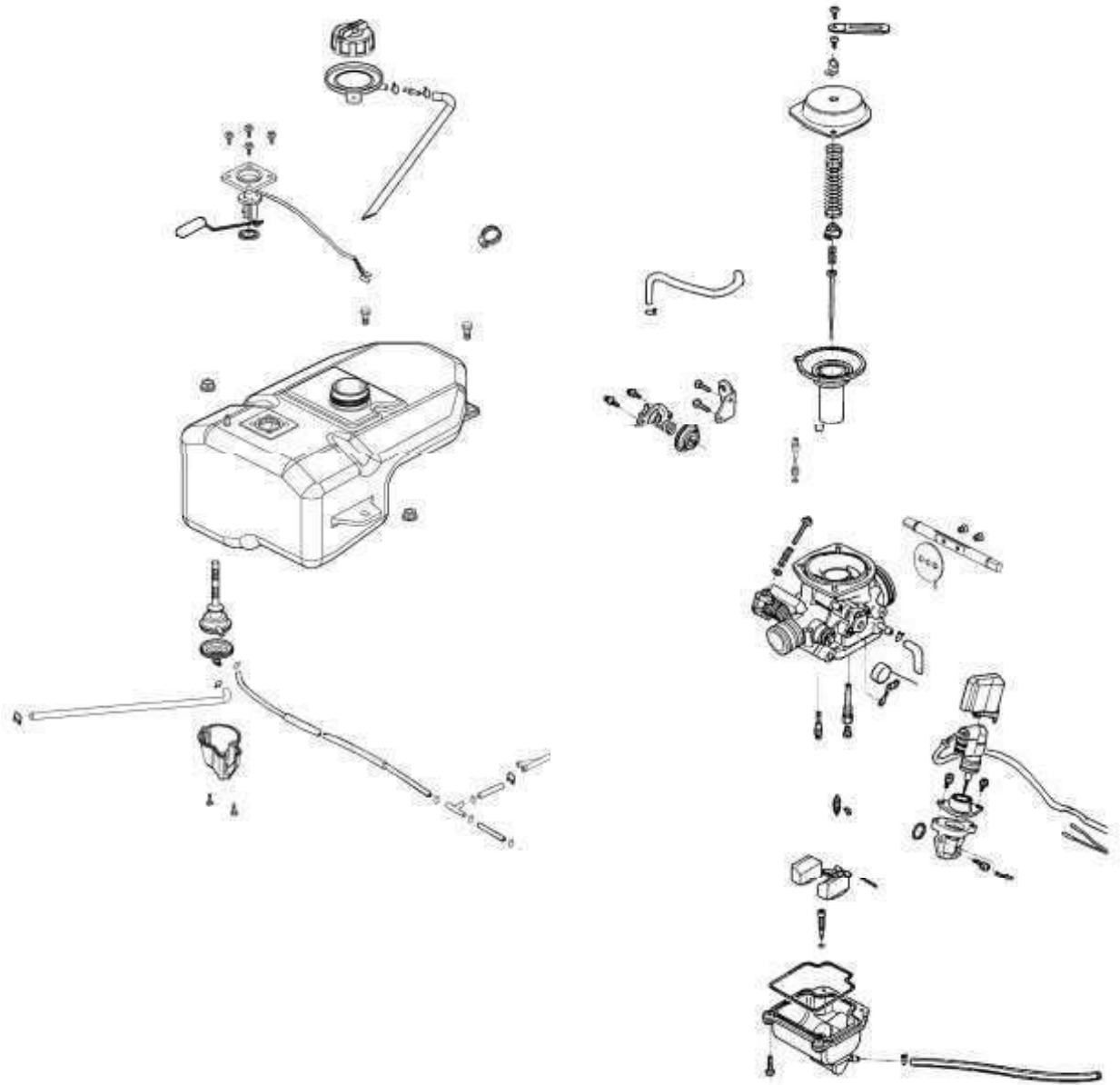

# 11. FUEL SYSTEM

LIKE 50/125

## SERVICE INFORMATION

### GENERAL INSTRUCTIONS

\*

Gasoline is very dangerous. When working with gasoline, keep sparks and flames away from the working area.  
Gasoline is extremely flammable and is explosive under certain conditions. Be sure to work in a well-ventilated area.

- Do not bend or twist control cables. Damaged control cables will not operate smoothly.
- When disassembling fuel system parts, note the locations of O-rings. Replace them with new ones during assembly.
- Before float chamber disassembly, loosen the drain screw to drain the residual gasoline into a clean container.
- After the carburetor is removed, plug the intake manifold side with a clean towel to prevent foreign matters from entering.
- Remove the vacuum diaphragm before cleaning the carburetor air and fuel passages with compressed air to avoid damaging the vacuum diaphragm.
- When the motorcycle is not used for over one month, drain the residual gasoline from the float chamber to avoid erratic idling and clogged slow jet due to deteriorated fuel.
- The pilot screw is factory pre-set and no adjustment is necessary. During carburetor disassembly, note the number of turns of the pilot screw and use as a reference when reinstalling it.
- A tachometer must be used when adjusting the engine speed.
- Turn the pilot screw in or out slowly to obtain the highest engine speed.

### SPECIFICATIONS

Item	125 cc	50cc
	Standard	Standard
Venturi dia. (mm)	22	16
Identification type	VE	CVK
Float level (mm)	19.0	17.0
Main jet	#98	#78
Slow jet	#35	#35
Idle speed	1700±100rpm	2000±100rpm
Throttle grip free play	2~6mm	2~6mm
Pilot screw opening	2 3/8±3/4	2 3/4±1/2

## SPECIAL TOOL

Float level gauge

## TROUBLESHOOTING

### Engine does not start

- No fuel in tank
- Too much fuel getting to cylinder
- Clogged fuel filter
- Clogged air cleaner

### Lean mixture

- Clogged fuel jets
- Clogged fuel cap vent
- Clogged fuel filter
- Bent, kinked or restricted fuel line

- Faulty float valve
- Float level too low
- Clogged air cleaner

### Engine idles roughly, stalls or runs poorly

- Incorrect idle speed
- Ignition malfunction
- Compression too low
- Incorrectly adjusted air screw
- Incorrect float level

- Clogged air cleaner
- Intake air leaks
- Fuel contaminated
- Faulty reed valve
- Clogged fuel jets

### Rich mixture

- Faulty float valve
- Float level too high
- Clogged air jets

# 11. FUEL SYSTEM

LIKE 50/125

## CARBURETOR REMOVAL

Remove the frame body cover. (⇒12)  
Disconnect the auto bystarter wire connector.

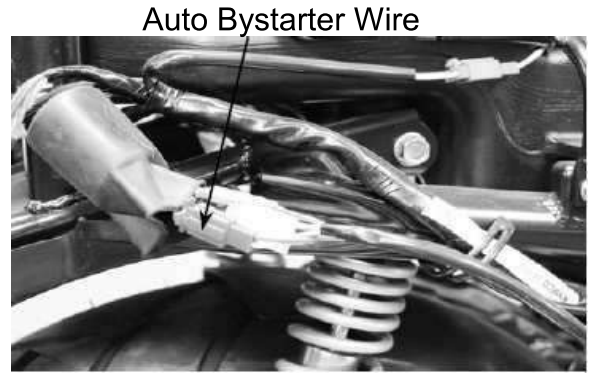

Loosen the drain screw and drain the fuel from the float chamber.  
Disconnect the fuel tube and vacuum tube at the carburetor.

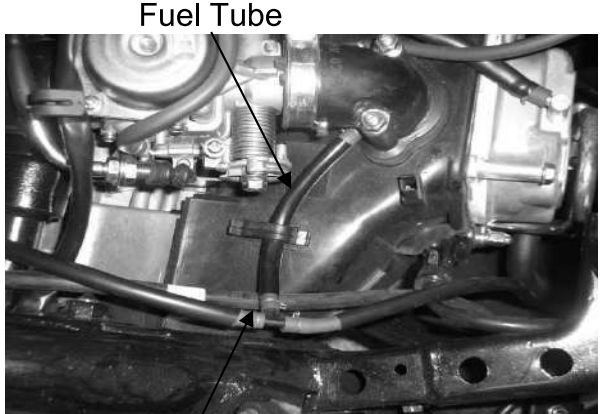

Vacuum Tube  
Adjusting Nut Lock Nut

Loosen the throttle cable adjusting nut and lock nut, and disconnect the throttle cable from the carburetor.  
Loosen the carburetor intake manifold band and air cleaner connecting tube band screws and then remove the carburetor.



Air Cleaner  
Connecting Tube Band

Intake Manifold Band

## AUTO BYSTARTER OPERATION INSPECTION

Measure the resistance between the auto bystarter wire terminals.

**Resistance:** 15  $\Omega$  max. (10 minutes minimum after stopping the engine)(50cc 5  $\Omega$ )

If the reading is not within the limit, replace the auto bystarter with a new one.



# 11. FUEL SYSTEM

LIKE 50/125

Connect a hose to the fuel enriching circuit of the carburetor. Connect the auto by starter yellow wire to the positive (+) terminal of a battery and green wire to the negative (-) terminal. Wait 5 minutes and blow the hose with mouth or vacuum pump. If the passage is blocked, the auto bystarter is normal.

Disconnect the auto bystarter from the battery. Wait 30 minutes and blow the hose with mouth or vacuum pump. If air can be blown into the hose, the auto bystarter is normal.

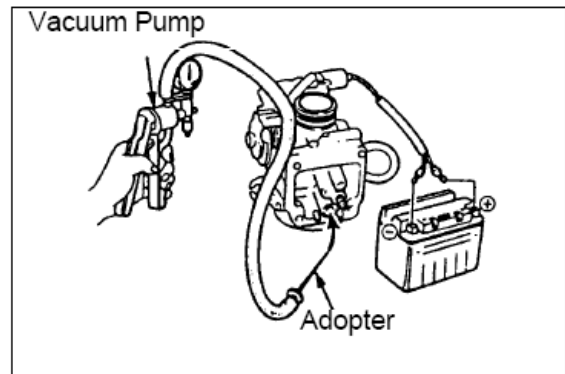

Auto Bystarter

## REMOVAL

Remove the set plate screws and set plate.

Remove the auto bystarter from the carburetor.



Bystarter Valve

## AUTO BYSTARTER INSPECTION

Check the auto bystarter valve and needle for nicks, wear or damage. If any faulty part is found, replace the auto bystarter as a set.



Bystarter Needle  
Auto Bystarter

## INSTALLATION

Insert the auto bystarter into the carburetor body until it bottoms. Position the set plate into the groove in the auto bystarter and tighten the screws.



Set Plate

\*

- Be sure to install the auto bystarter and set plate properly.
- Install the set plate with its bottom face facing down.

### AIR CUT-OFF VALVE DISASSEMBLY

Disconnect the vacuum tube from the air cut-off valve.  
Remove the two screws to remove the air cut-off valve cover, spring and vacuum diaphragm.

### ASSEMBLY

Install the vacuum diaphragm onto the carburetor.  
Install the spring and air cut-off valve cover and then tighten the two screws.

\*

- Be sure to set the vacuum diaphragm lip into the groove on the carburetor.
- When installing the air cut-off valve cover, make sure that the vacuum diaphragm is properly installed.

### VACUUM CHAMBER DISASSEMBLY

Remove the two vacuum chamber cover screws and the cover.

Remove the spring and vacuum diaphragm/piston.

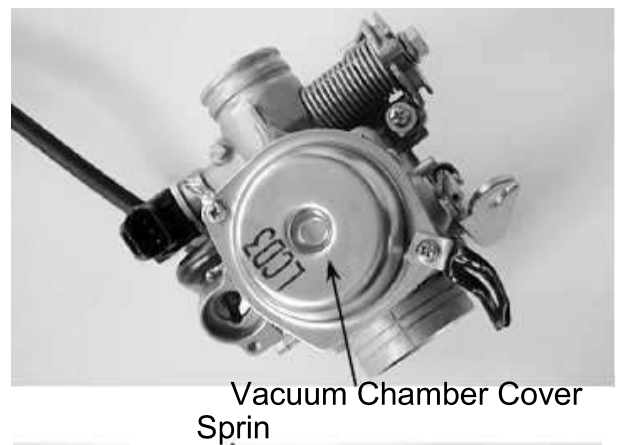
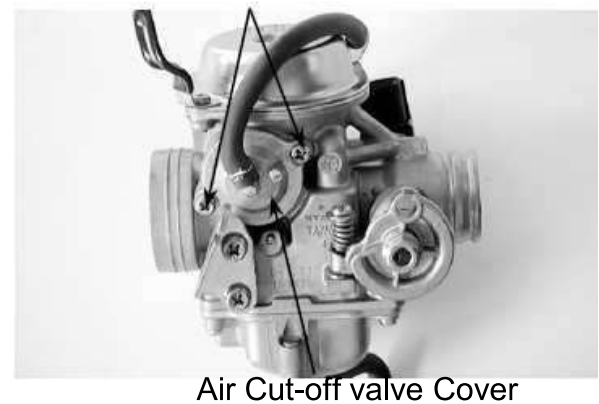
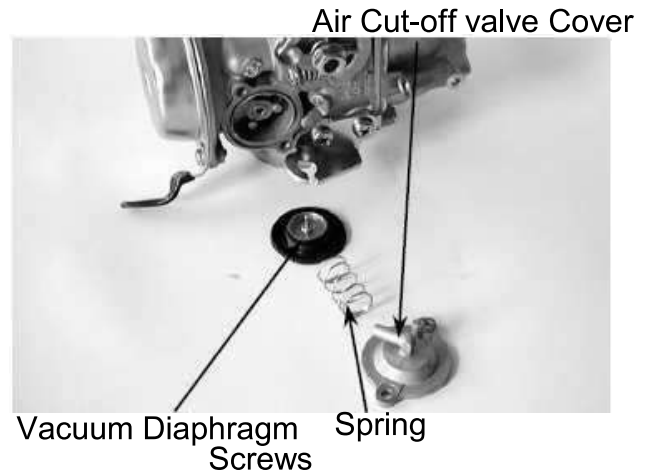

Push the needle holder in and turn it left to remove the needle holder.  
Remove the spring and jet needle from the piston.

\* Be careful not to damage the vacuum diaphragm.

### INSPECTION

Inspect the needle for stepped wear.  
Inspect the vacuum piston for wear or damage.  
Inspect the diaphragm for deterioration and tears.

### ASSEMBLY

Install the vacuum piston/diaphragm in the carburetor body and align the tab on the diaphragm with the groove in the carburetor body.  
Install the spring.  
Install the vacuum chamber cover and tighten it with the two screws.

\* Be careful not to damage the diaphragm.

### FLOAT CHAMBER DISASSEMBLY

Remove the four float chamber screws and the float chamber.

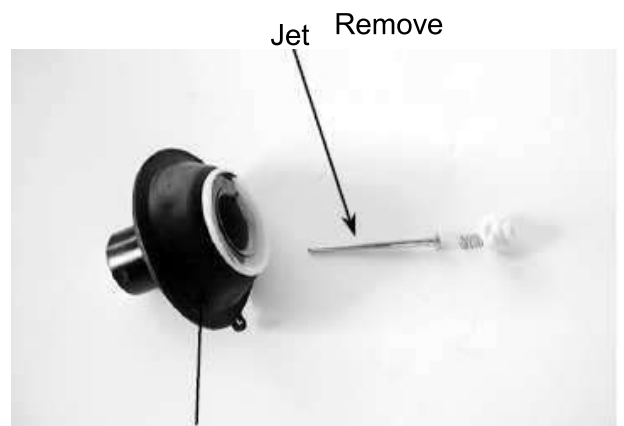
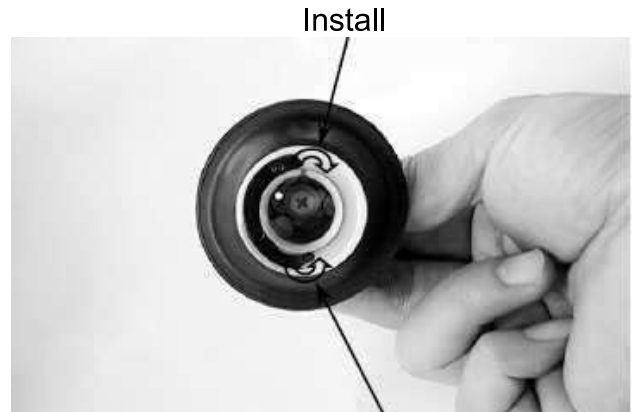

Vacuum Diaphragm Vacuum Chamber Cover



Vacuum Diaphragm Float Chamber

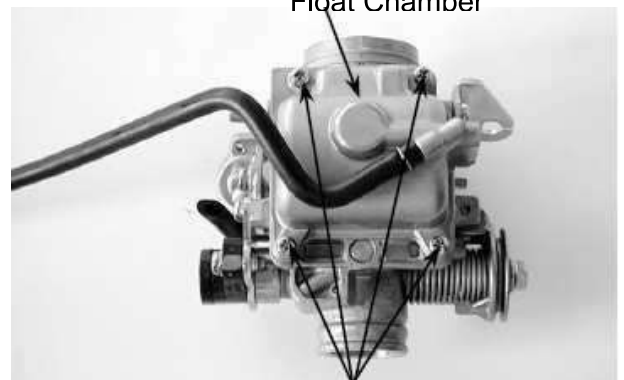

Screw

# 11. FUEL SYSTEM

LIKE 50/125

Remove the float pin, float and float valve.

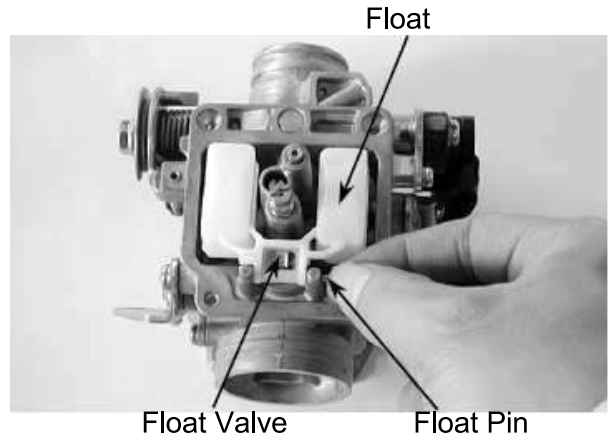

## INSPECTION

Inspect the float valve and valve seat for damage or clogging.

Inspect the float valve and valve seat contact area for stepped wear or contamination.

\*

Worn or contaminated float valve and valve seat must be replaced because it will result in float level too high due to incomplete airtightness.



Valve Seat

Remove the main jet, needle jet holder, needle jet, slow jet and pilot screw.

\*

- Be careful not to damage the fuel jets and pilot screw.
- Before removing, turn the pilot screw in and carefully count the number of turns until it seats lightly and then make a note of this.
- Do not force the pilot screw against its seat to avoid seat damage.

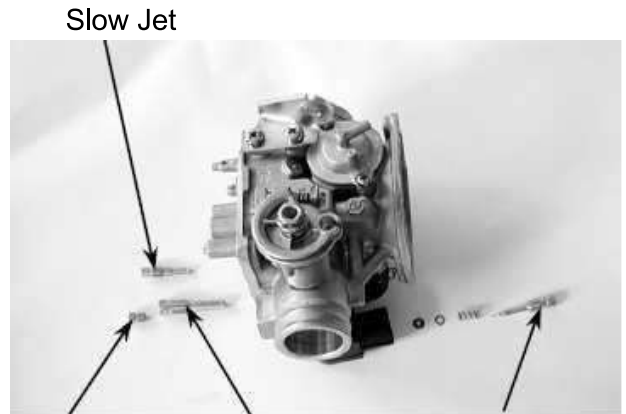

Main Jet

Needle Jet

Pilot Screw

Clean the removed fuel jets with detergent oil and blow them open with compressed air.

Blow compressed air through all passages of the carburetor body.

\*

Also remove and clean the vacuum chamber and air cut-off valve.





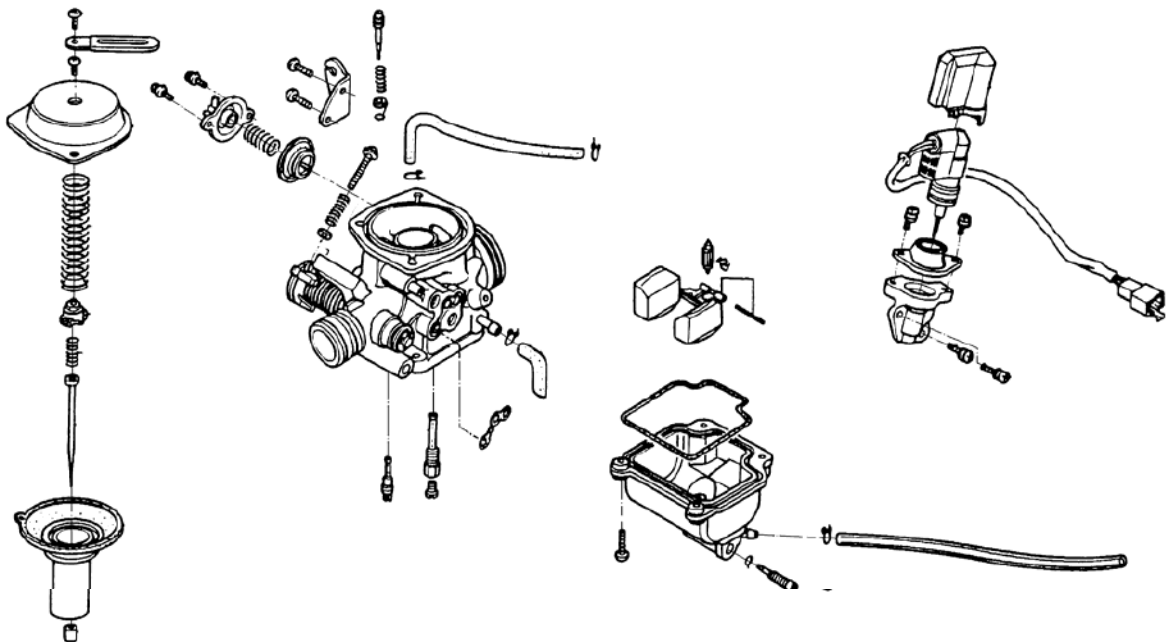

### ASSEMBLY

Install the slow jet, needle jet, needle jet holder, main jet and pilot screw.

\* Return the pilot screw to the original position as noted during removal.

**Standard Opening:** 3 3/8 turns

Install the float valve, float and float pin.

Slow Jet

Pilot Screw

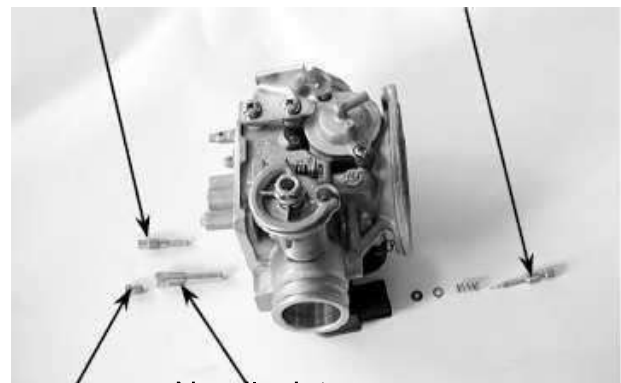

Main Jet Needle Jet



Float Valve Float Pin

## FLOAT LEVEL INSPECTION

\*

- Check the operation of the float valve and float before float level inspection.
- Measure the float level by placing the float level gauge on the float chamber face parallel with the main jet.

Measure the float level.

**Float Level:** 19.0mm

## CARBURETOR INSTALLATION

Tighten the drain screw.

Install the carburetor onto the intake manifold, aligning the tab on the carburetor with the cutout in the intake manifold. Tighten the band screw.

Install the air cleaner connecting tube and tighten the band screw.

Connect the throttle cable to the throttle wheel on the carburetor.

Connect the fuel tube and vacuum tube to the carburetor.

Connect the auto bystarter wire connector.

Perform the following inspections and adjustments:

- Throttle grip free play (⇒3-3)
- Carburetor idle speed (⇒3-6)

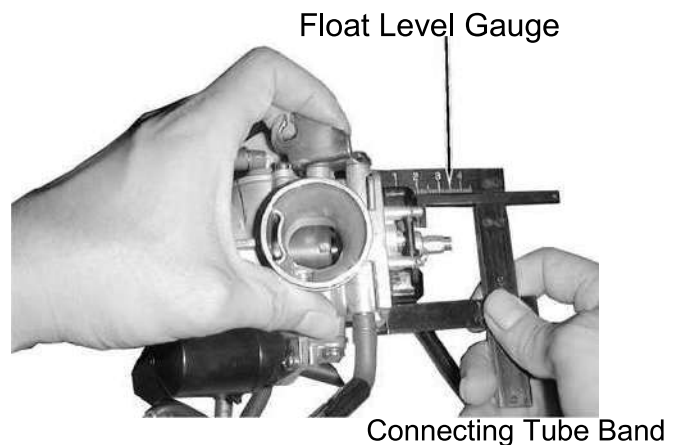

Throttle Cable

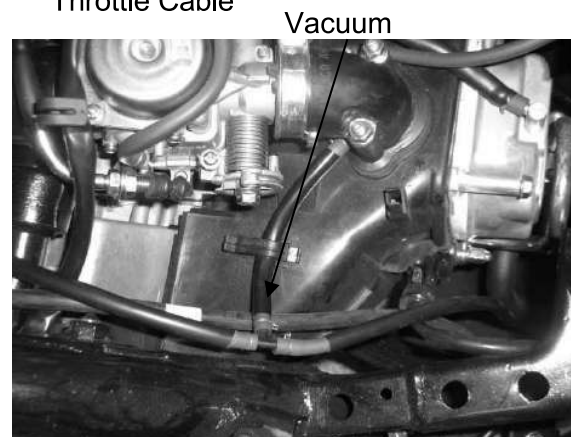

Vacuum

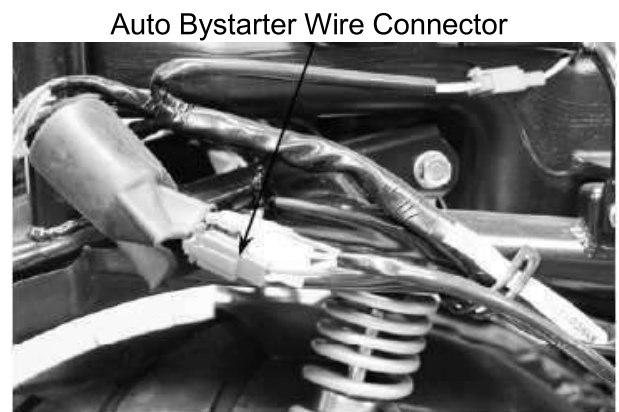

## FUEL TANK REMOVAL

Remove the frame body cover.  
Disconnect the fuel unit wire connector.

Fuel Unit Wire Connector

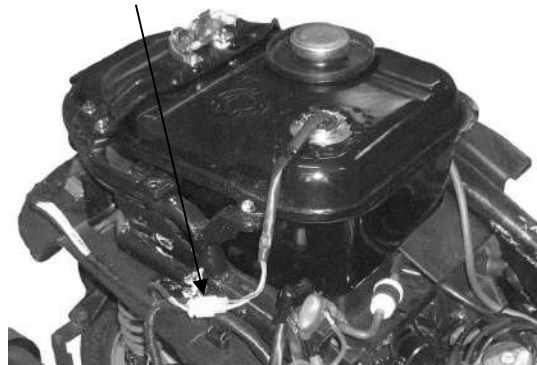

Auto Fuel Valve



Disconnect the fuel tube and vacuum tube at the auto fuel valve.

Remove the fuel tank frame mounting bolts and fuel tank frame.  
Remove the fuel tank mounting bolts and fuel tank.

Fuel Tank

Vacuum Tube

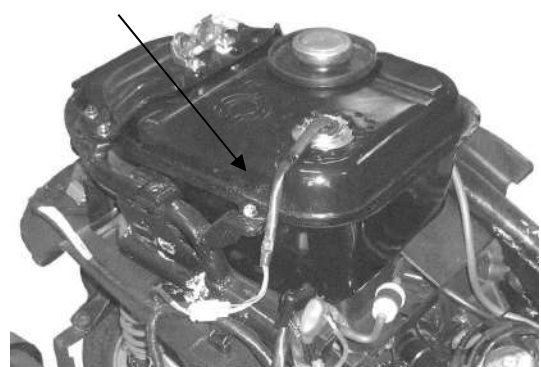

## INSTALLATION

Install the fuel tank in the reverse order of removal.

## FUEL UNIT

\*

Tire pressure should be checked when tires are cold.

## REMOVAL

Disconnect the fuel unit wire connector.

\*

Do not bend the fuel unit float arm; otherwise, the fuel unit metering values will be incorrect.



Install the fuel unit.

- \* Make sure the fuel unit wire on the connect position.

Connect the fuel unit wire connector.

### INSTALLATION

Inspect the fuel unit gasket for damage.

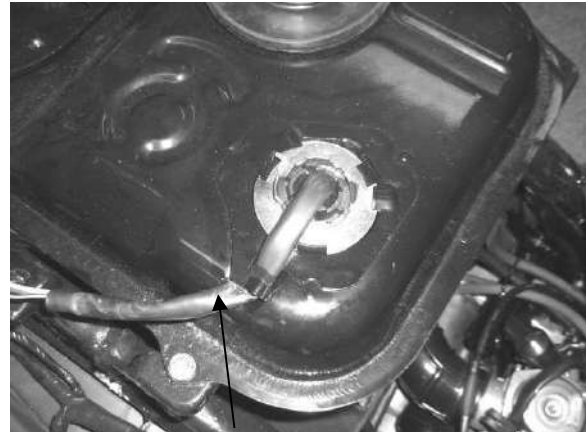

Fuel Unit Wire

### AUTO FUEL VALVE

- \* No Smoking!

- \* First clean the fuel tube.

Disconnect the fuel tube and vacuum tube from the carburetor.  
Connect a vacuum pump to the vacuum tube and apply vacuum. Check if fuel flows out.

- The valve is operating normally if fuel flows out of the fuel tube when the vacuum is applied.
- The fuel shall stop flowing out when the vacuum pump is disconnected.

If the fuel valve does not operate normally, Check the vacuum diaphragm for poor installation or damage and inspect the fuel tube for clogging.

Auto Fuel Valve

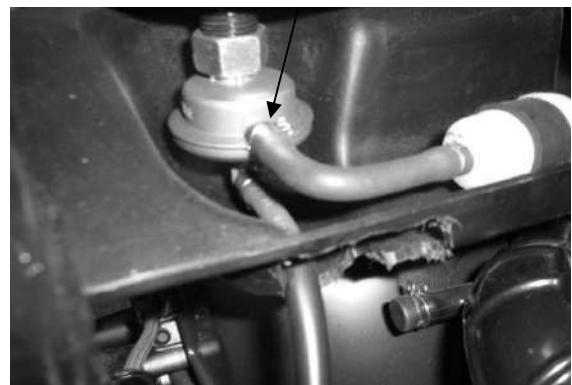

## AIR CLEANER

Loosen the air cleaner connecting tube band screw.

Disconnect the transmission case breather tube from the air cleaner case.

Remove the two bolts and air cleaner cas

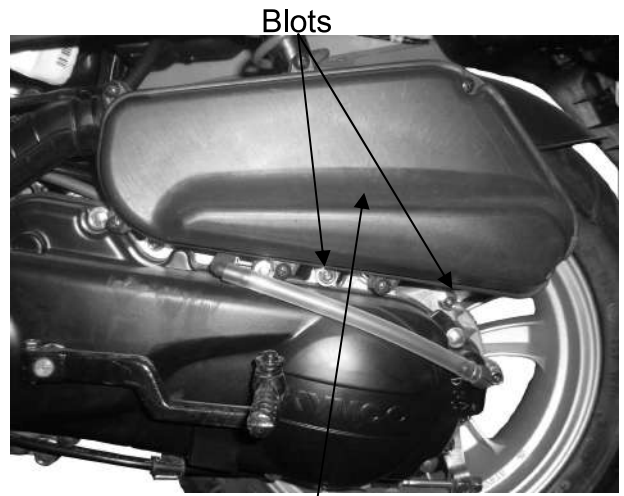

Air Cleaner Case

The installation sequence is the reverse of removal.

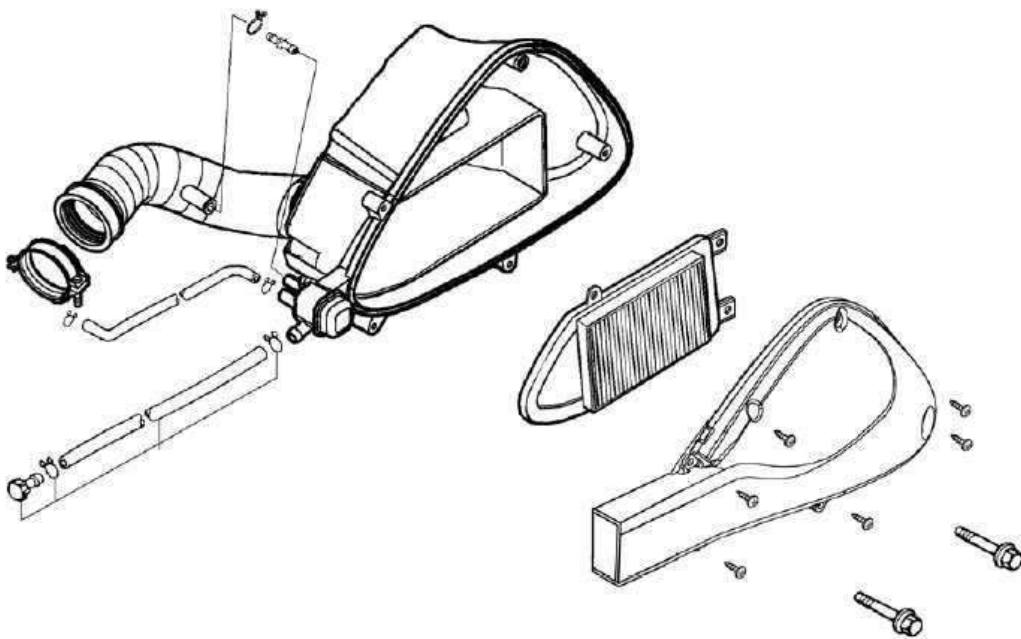

## FRAME COVERS

SCHEMATIC DRAWING .....	12-1
SERVICE INFORMATION .....	12-2
TROUBLESHOOTING.....	12-2
FRAME COVERS REMOVAL.....	12-3
EXHAUST MUFFLER REMOVAL .....	12-6

# 12. FRAME COVERS

ASSEMBLY DRAWING

SUPER8 50 2T

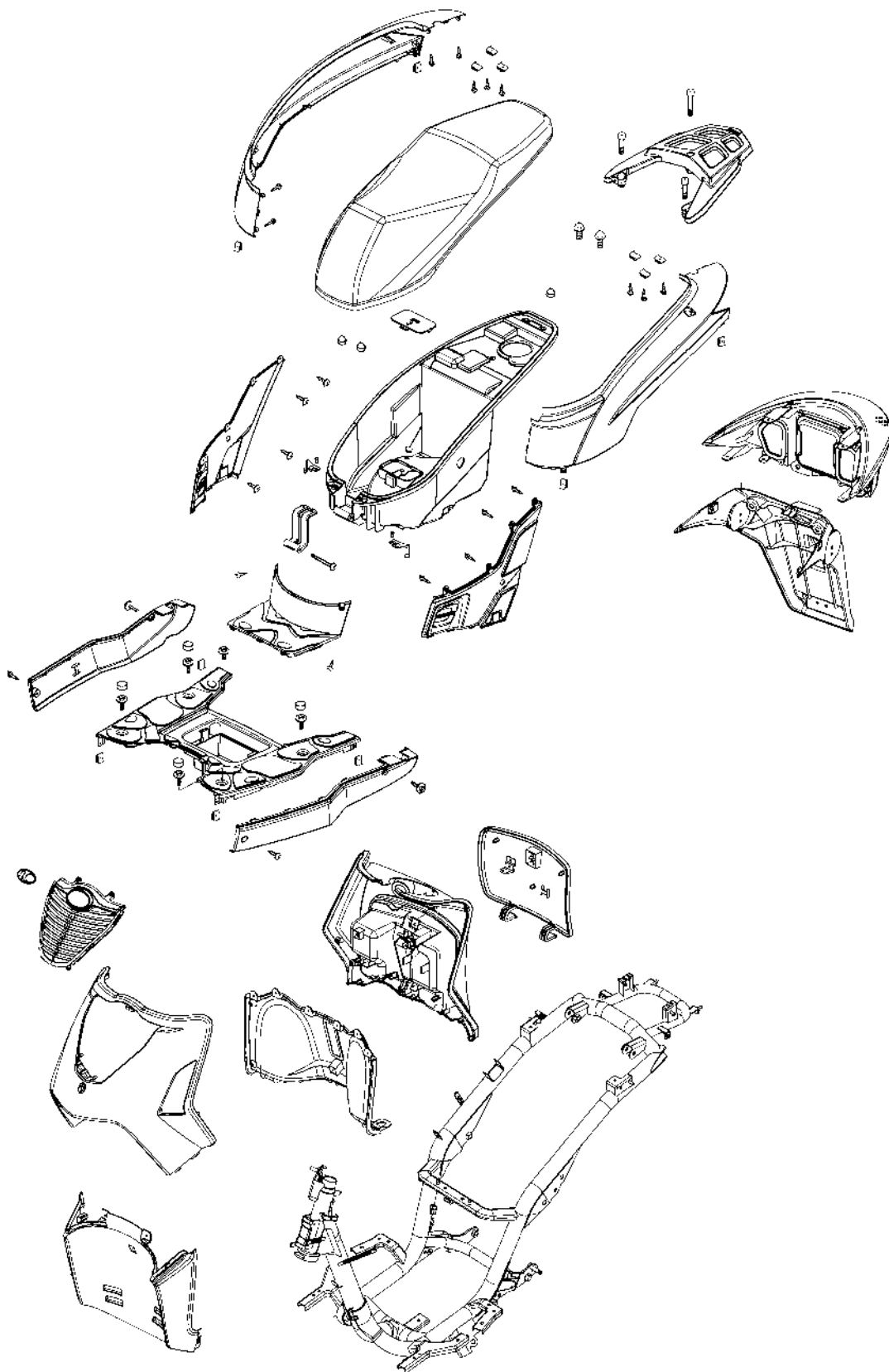

## SERVICE INFORMATION

- When removing frame covers, use care not to pull them by force because the cover joint claws may be damaged.

## Items Related for Removal

- Handlebar front cover ——— Headlight wire
- Front cover ———
- Handlebar rear cover ——— Speedometer cable and instrument light wire connectors, etc.
- Frame body cover ——— Met-in box, rear carrier, rear fender.
- Floor board ——— frame body cover.
- Front tool box ——— Front cover, battery, floor board .



# 12. FRAME COVERS

LIKE 50/125

## FRAME COVERS REMOVAL

### REAR CARRIER

Remove the met-in box.  
First remove the seven nuts attaching the met-in box.  
Remove the met-in box.

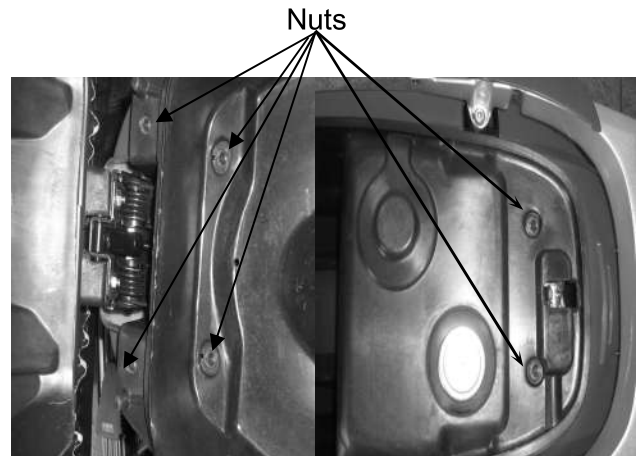

Remove the two bolts and two nuts attaching the rear carrier.  
Remove the rear carrier.

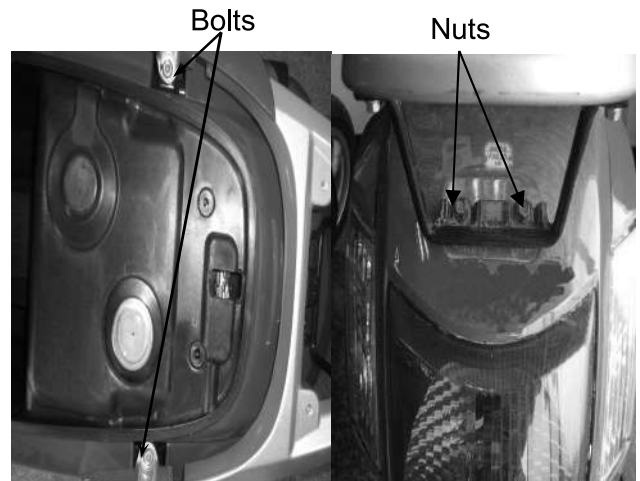

### FRAME BODY COVER REMOVAL

Remove the two nuts attaching the rear protective cover.  
Remove the rear protective cover

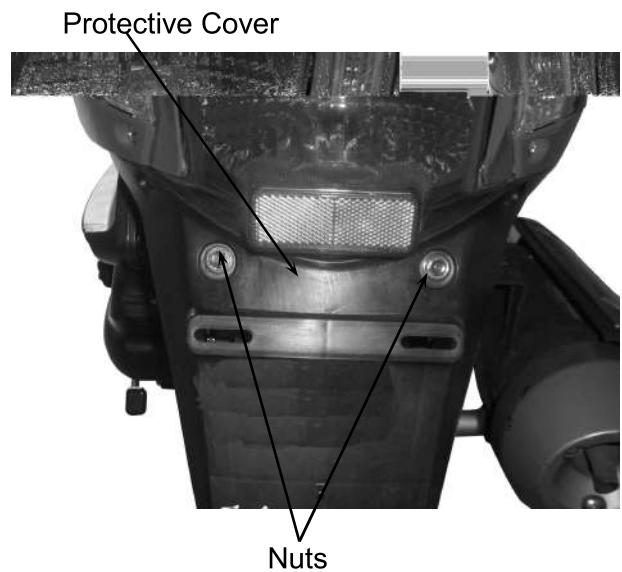

## 12. FRAME COVERS

LIKE 50/125

Remove the two screws on the bottom of the center cover.  
Remove the center cover.  
Remove the body cover.

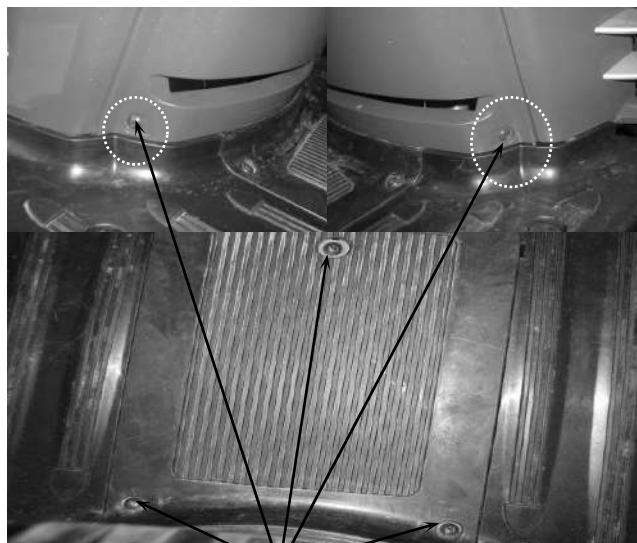

Screws  
Screws

### FLOOR-FOOT REMOVAL

Remove the screws attaching the right and left side covers.  
Remove the right and left side covers by pulling them outward.



Side Cover  
Battery Wire

Disconnect the battery wire.  
Remove the battery.



Battery

## 12. FRAME COVERS

LIKE 50/125

Remove the floor mat.  
Remove the center cover. (⇒12-3)  
Remove the screws and bolts attaching the front right and left side covers.  
Remove the five bolts attaching the floor-foot.  
Remove the floor-foot.  
The installation sequence is the reverse of removal.

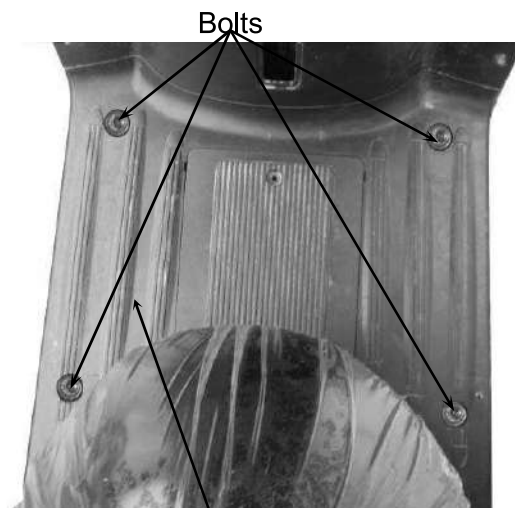

Floor-Foot  
Screws

### LEG SHIELD LOW REMOVAL

Remove the met-in box.  
Remove the body cover.  
Remove the floor-foot.  
Remove the front upper cover.  
Remove the four screws attaching the leg shield low.  
Disconnect the leg shield low with the cowl under cover.  
The installation sequence is the reverse of removal.

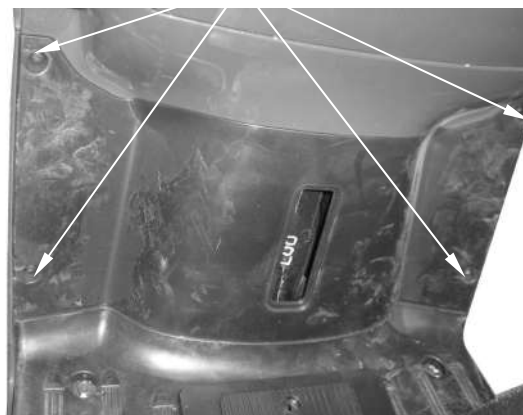

Leg Shield Low

Bolts

### FRONT UPPER COVER REMOVAL

Remove the eight screws on the back of the front upper cover.  
Remove the bolt on the front of the front upper cover.  
Disconnect the signal light wire connector.  
Remove the front upper cover.  
The installation sequence is the reverse of removal.

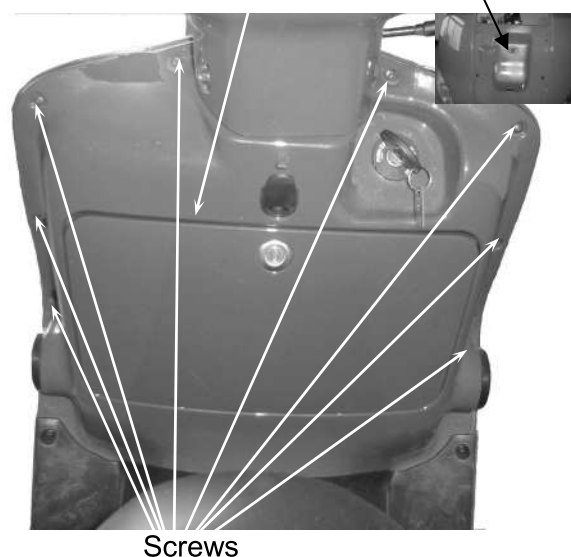

Screws

# 12. FRAME COVERS

LIKE 50/125

## HANDLEBAR COVER REMOVAL

First remove the windshield.  
Remove the two screws and two bolts attaching the handlebar rear cover.  
Remove the handlebar rear cover.  
The installation sequence is the reverse of removal.

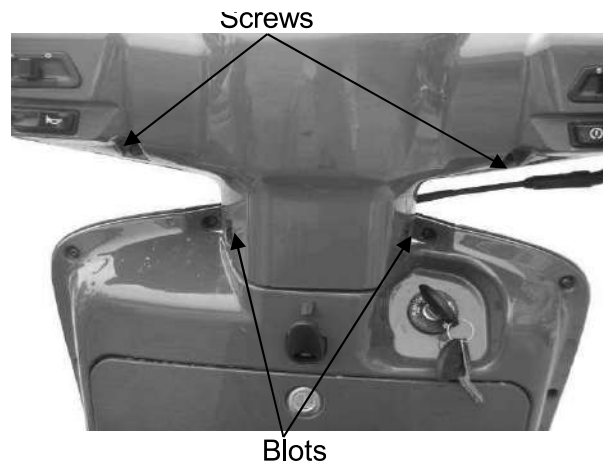

Remove the two screws attaching the handlebar cover  
Remove the handlebar cover.  
The installation sequence is the reverse of removal.

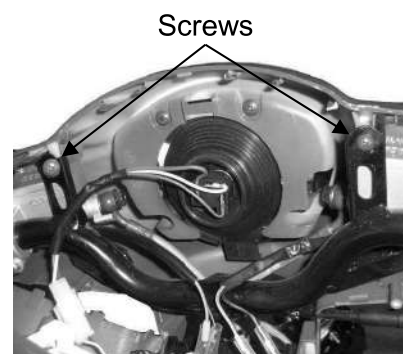

## BOTTOM COVER REMOVAL

Remove the four bolts attaching the bottom cover.  
Remove the bottom cover.

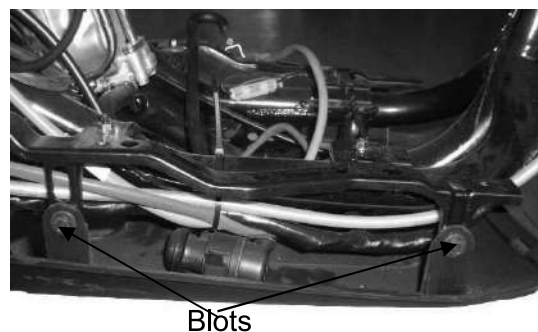

## EXHAUST MUFFLER REMOVAL

Remove two lock nuts from joint in the exhaust muffler.  
Remove the exhaust muffler two lock bolts to remove the exhaust muffler.  
Remove the exhaust muffler joint packing collar.  
The installation sequence is the reverse of removal.

### Torque:

Exhaust muffler joint lock nut: 2.2kg-m  
Exhaust muffler lock bolt: 3.3kg-m

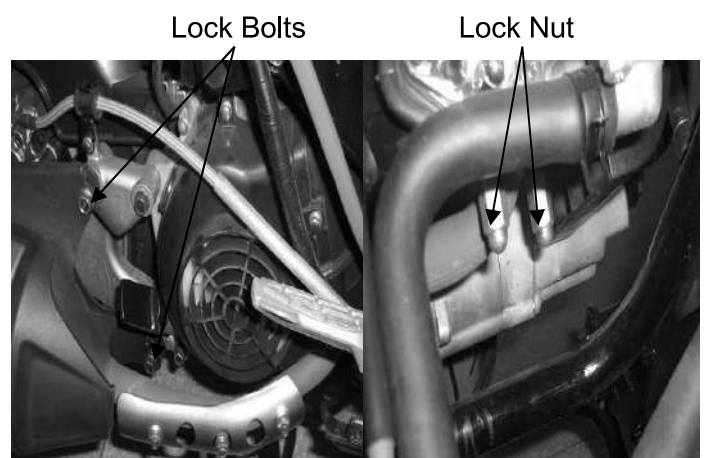

---

**FRONT WHEEL/FRONT BRAKE/FRONT SUSPENSION**

---

**SERVICE INFORMATION..... 13-2**

**TROUBLESHOOTING..... 13-3**

**FRONT WHEEL..... 13-4**

**HYDRAULIC BRAKE DRAWING..... 13-7**

**HYDRAULIC BRAKE..... 13-8**

**FRONT SHOCK ABSORBER..... 13-13**

**STEERING HANDLEBAR..... 13-14**

**STEERING STEM..... 13-15**

# 13. STEERING HANDLEBAR/FRONT WHEEL/FRONT BRAKE/FRONT SHOCK ABSORBER/FRONT FORK

LIKE 50/125

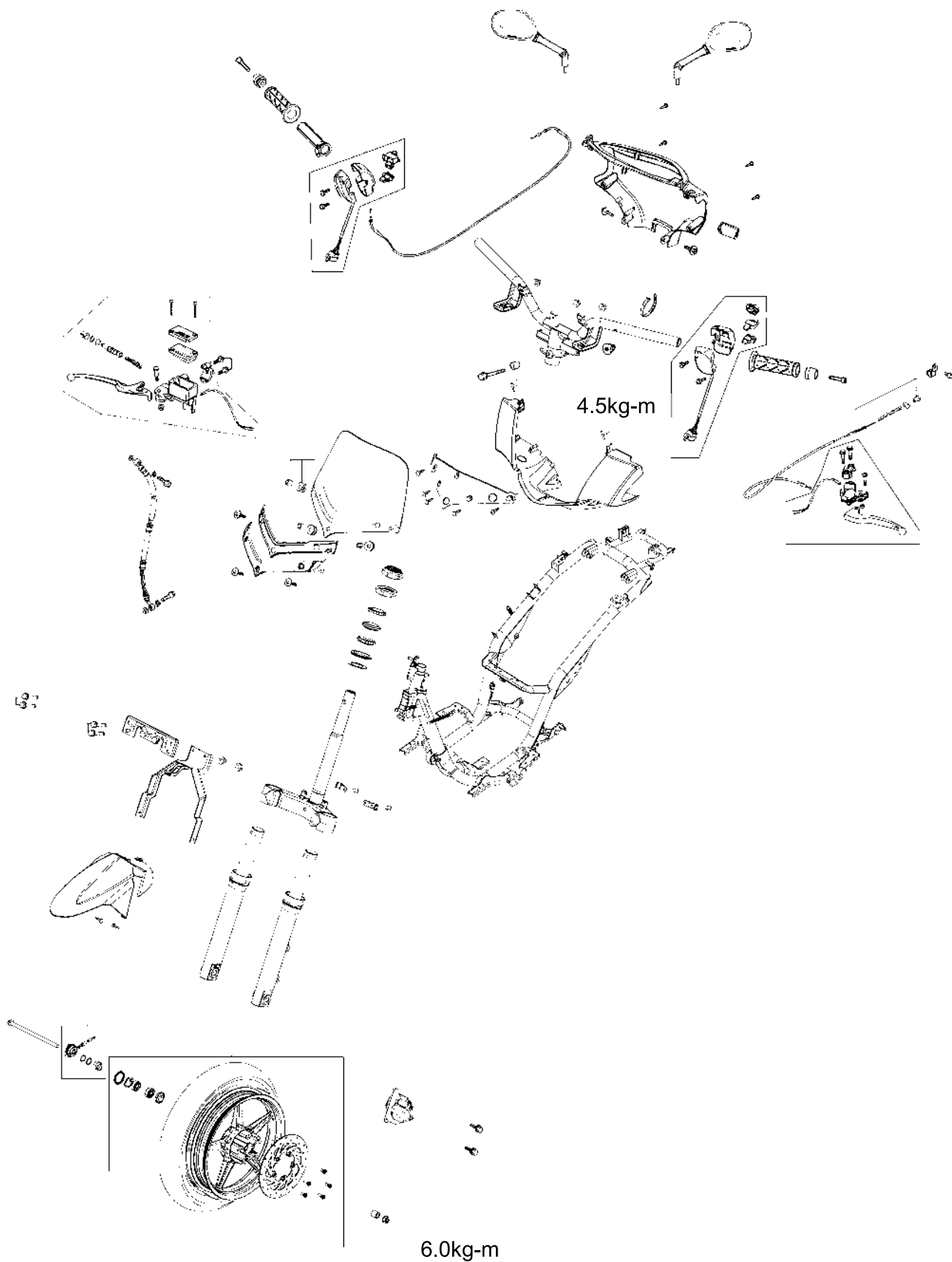

# 13. STEERING HANDLEBAR/FRONT WHEEL/FRONT BRAKE/FRONT SHOCK ABSORBER/FRONT FORK LIKE 50/125

---

## SERVICE INFORMATION

### GENERAL INSTRUCTIONS

- Remove the motorcycle front wheel off the ground and be careful to prevent the motorcycle from falling down.
- During servicing, keep oil or grease off the brake drum and brake linings.
- Contaminated brake disk or brake pads reduce stopping power. Clean the contaminated brake disk with high-performance brake degreaser and replace the brake pads.
- Do not use brake fluid for cleaning.
- Bleed air from the brake system if the brake system is removed or the brake is soft.
- Do not allow any foreign matters to enter the brake system when filling it with brake fluid.
- Brake fluid will damage painted surfaces and plastic parts. When servicing the brake system, use shop towels to cover and protect rubber, plastic parts and coated surfaces. Wipe off any spilled brake fluid with a clean shop towel.
- Inspect the brake system before riding.

### SPECIFICATIONS

Item		Standard (mm)	Service Limit (mm)
Axle shaft runout		—	0.2
Front wheel rim runout	Radial	—	2.0
	Axial	—	2.0
Front brake lining thickness		5.5	2.75
Front shock absorber spring free length		260	252
Brake disk thickness		3.2~3.5	3.0
Brake disk runout		—	0.25
Brake master cylinder I.D.		12.700~12.743	12.75
Brake master cylinder piston O.D.		12.657~12.684	12.64
Brake caliper piston O.D.		33.910~33.934	33.901
Brake caliper cylinder I.D.		33.90~33.990	34.01

### TORQUE VALUES

Steering stem bolt	4.0~5.0kg-m	Brake caliper bleed valve	0.6kg-m
Steering stem lock nut	7.0~8.0kg-m	Brake fluid tube bolt	3.0~4.0kg-m
Steering top cone race	0.5~1.3kg-m	Brake pad pin bolt	1.5~2.0kg-m
Front shock absorber bolt	2.0~2.5kg-m	Brake caliper bolt	2.9~3.5kg-m
Front axle nut	5.0~7.0kg-m	Brake master cylinder bolt	1.0~1.4kg-m

# 13. STEERING HANDLEBAR/FRONT WHEEL/FRONT BRAKE/FRONT SHOCK ABSORBER/FRONT FORK

## LIKE 50/125

---

### SPECIAL TOOLS

Lock nut wrench

Outer driver, 28x30mm

Ball race remover

Pliers (close)

Bearing remover head, 10mm

Driver handle A

Pilot, 10mm

Outer driver, 37x40mm

Bearing remover

### TROUBLESHOOTING

#### Hard steering (heavy)

- Excessively tightened steering stem top cone race
- Broken steering balls
- Insufficient tire pressure

#### Steers to one side or does not track straight

- Uneven front shock absorbers
- Bent front fork
- Bent front axle or uneven tire

#### Poor brake performance

- Incorrectly adjusted brake
- Worn brake linings
- Contaminated brake lining surface
- Worn brake shoes at cam contacting area
- Worn brake drum
- Poorly connected brake arm

#### Poor brake performance (Disk Brake)

- Air in brake system
- Deteriorated brake fluid
- Contaminated brake pads and brake disk
- Worn brake pads
- Worn brake master cylinder piston oil seal
- Clogged brake fluid line
- Deformed brake disk
- Unevenly worn brake caliper

#### Front wheel wobbling

- Bent rim
- Excessive wheel bearing play
- Bent spoke plate
- Faulty tire
- Improperly tightened axle nut

#### Soft front shock absorber

- Weak shock springs
- Insufficient damper oil

#### Front shock absorber noise

- Slider bending
- Loose fork fasteners
- Lack of lubrication



# 13. STEERING HANDLEBAR/FRONT WHEEL/FRONT BRAKE/FRONT SHOCK ABSORBER/FRONT FORK LIKE 50/125

## FRONT WHEEL

### REMOVAL

Remove the motorcycle front wheel off the ground.  
Disconnect the speedometer cable.



Speedometer Cable

Remove the front axle nut and pull out the axle.  
Remove the front wheel.  
Remove the front brake panel.



Axle Shaft

### INSPECTION

#### AXLE RUNOUT

Set the axle in V blocks and measure the runout using a dial gauge.  
The actual runout is 1/2 of the total indicator reading.

**Service Limit:** 0.2mm replace if over

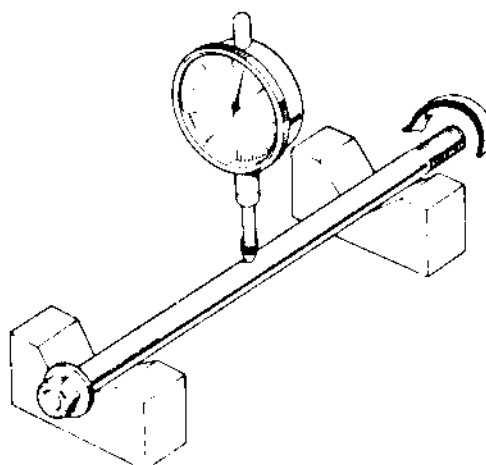

#### WHEEL RIM

Check the wheel rim run-out.

**Service Limits:**

**Radial:** 2.0mm replace if over

**Axial:** 2.0mm replace if over

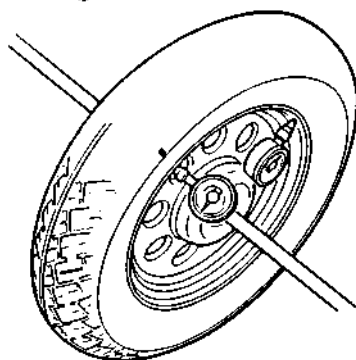

# 13. STEERING HANDLEBAR/FRONT WHEEL/FRONT BRAKE/FRONT SHOCK ABSORBER/FRONT FORK LIKE 50/125

## FRONT WHEEL BEARING

Remove the side collar and dust seal.

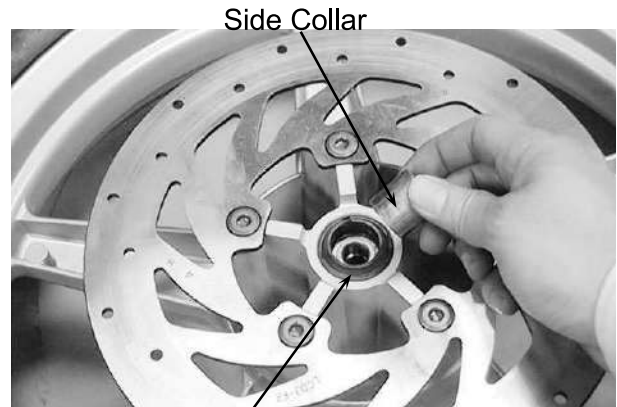

Dust Seal

Turn the inner race of each bearing with your finger to see if they turn smoothly and quietly. Also check if the outer race fits tightly in the hub.

Replace the bearings if the races do not turn smoothly, quietly, or if they fit loosely in the hub.



Wheel Bearing

## BEARING REPLACEMENT

Remove the front wheel bearings and distance collar.

**Special**

Bearing Remover

Bearing Remover Head, 12mm

Pack all bearing cavities with grease.

Drive in the left bearing.

Install the distance collar.

Drive in the right bearing.

- \* Do not allow the bearings to tilt while driving them in.  
• Drive in the bearing squarely with the sealed end facing out.



Bearing Remover

**Special**

Driver handle A



Driver Handle A

# 13. STEERING HANDLEBAR/FRONT WHEEL/FRONT BRAKE/FRONT SHOCK ABSORBER/FRONT FORK LIKE 50/125

Apply grease to a new dust seal lip and install the dust seal.  
Install the side collar.



## INSTALLATION

Apply grease to the brake panel dust seal lip.  
Apply grease to the speedometer gear engaging and sliding parts.  
Install the brake panel by aligning the speedometer retaining pawls with the hub cutouts.

\* If not aligned, the retaining pawl will be deformed when the axle nut is tightened.  
After installing the axle, turn the wheel to make sure that the speedometer drive shaft rotates freely.

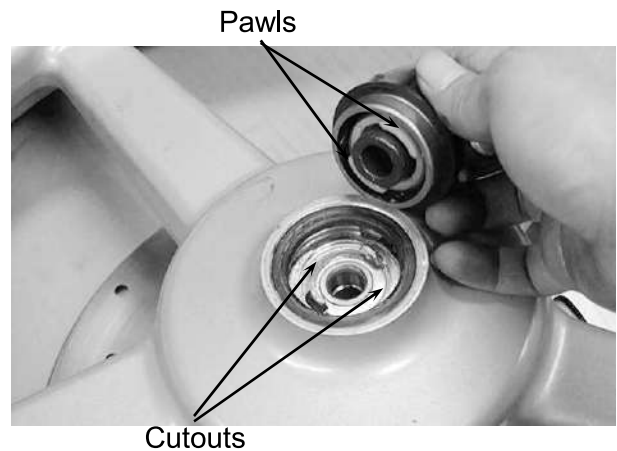

Apply a thin coat of grease to the axle shaft.  
Install the front wheel by aligning the brake panel groove with the front fork tab.  
Insert the axle shaft.  
Install and tighten the axle nut.

**Torque:** 5.0~7.0kg-m

Install the front brake cable and rotate the front tire to check the speedometer if performed.

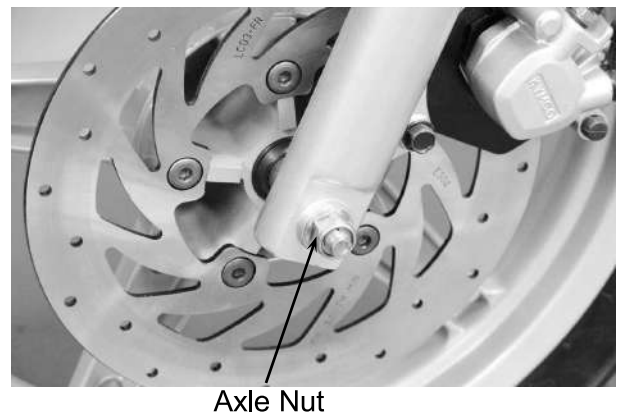

Connect the speedometer cable.

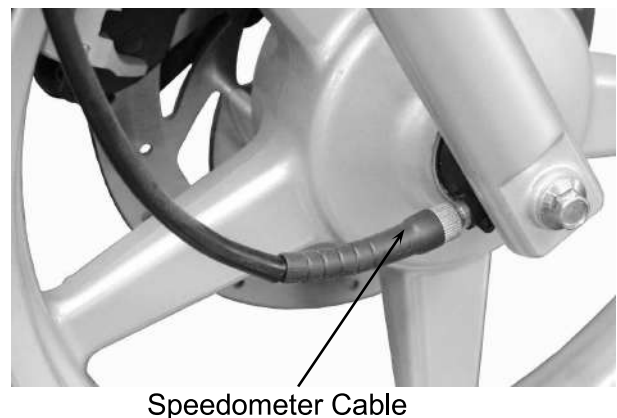

# 13. STEERING HANDLEBAR/FRONT WHEEL/FRONT BRAKE/FRONT SHOCK ABSORBER/FRONT FORK

---

## HYDRAULIC BRAKE DRAWING

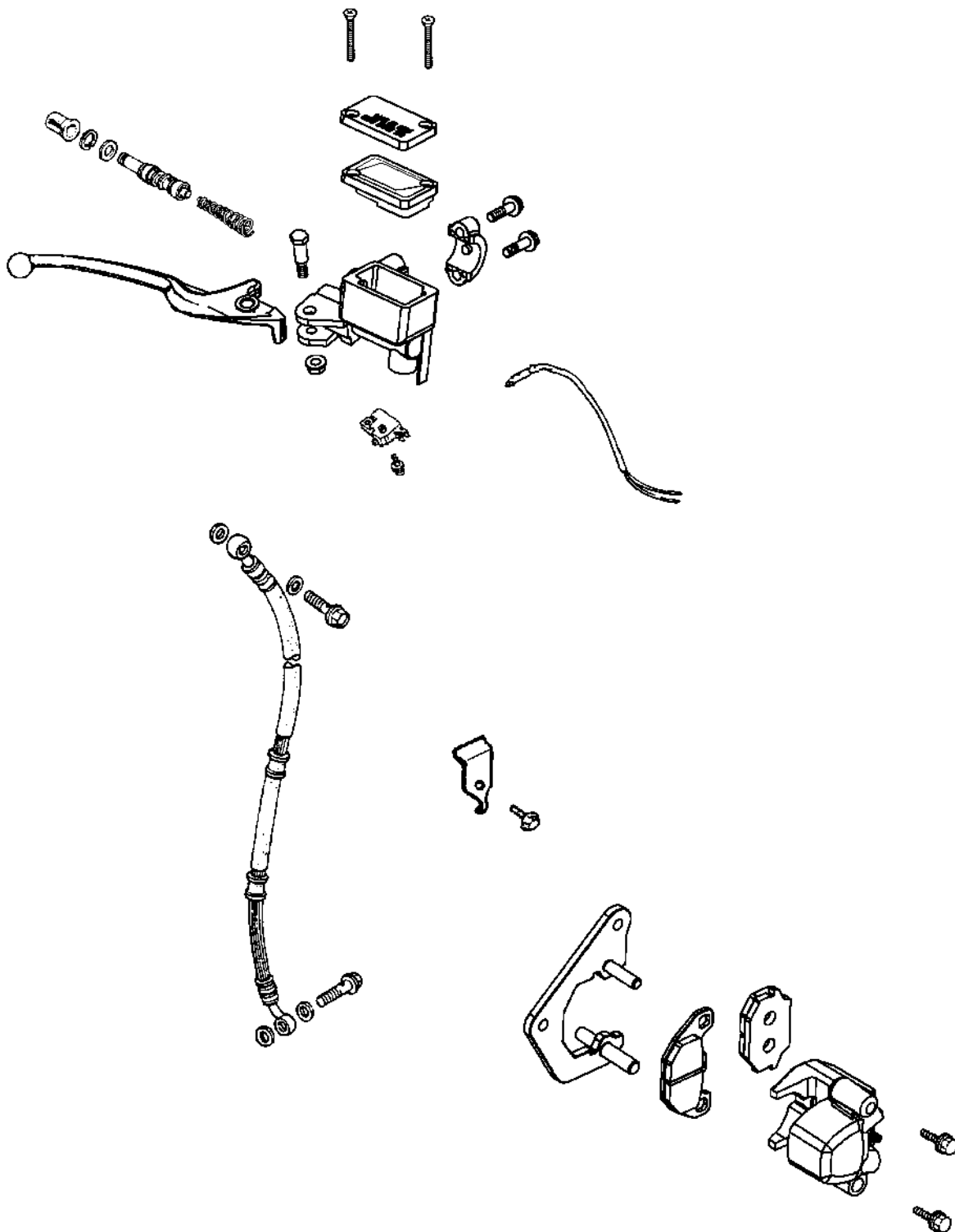

# 13. STEERING HANDLEBAR/FRONT WHEEL/FRONT BRAKE/FRONT SHOCK ABSORBER/FRONT FORK

## LIKE 50/125

### HYDRAULIC BRAKE (FRONT BRAKE)

#### BRAKE FLUID REPLACEMENT/AIR BLEEDING

Check the brake fluid level on level ground.

\*

- When operating the brake lever, the brake reservoir cap must be tightened securely to avoid splash of brake fluid.
- When servicing the brake system, use shop towels to cover plastic parts and coated surfaces to avoid damage caused by splash of brake fluid.



### BRAKE FLUID BLEEDING

In order to avoid spilling brake fluid, connect a transparent hose to the bleed valve.



#### Warning

Spilled brake fluid on brake pads or brake disk reduces stopping power. Clean the brake pads and brake disk with a high-performance brake

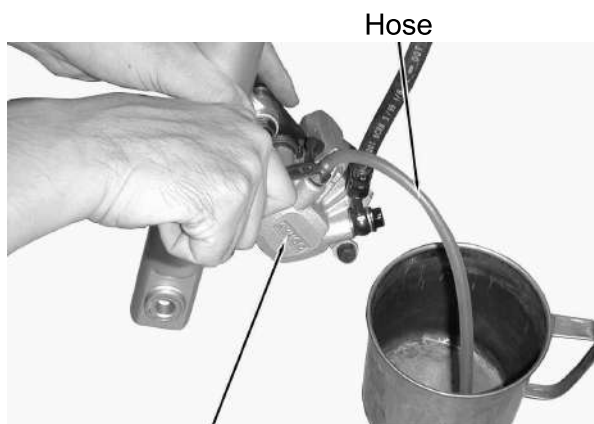

Front Brake Caliper Reservoir

Fully apply the brake lever and then loosen the brake caliper bleed valve to drain the brake fluid until there is no air bubbles in the brake fluid. Then, tighten the bleed valve. Repeat these steps until the brake system is free of air.

### BRAKE FLUID REFILLING

Add DOT-3 brake fluid to the brake reservoir.

\*

- When bleeding, be careful not to allow air in the brake reservoir flowing into the brake system.
- Never use dirty or unspecified brake fluid or mix different brake fluids because it will damage the brake system.



Make sure to bleed air from the brake system.

### BRAKE PAD/DISK REPLACEMENT

\*

The brake pads must be replaced as a set to ensure the balance of the brake disk.

Remove the two bolts attaching the brake caliper.

Remove the brake caliper.

Compress the brake caliper seat, and press down the fixed-reed to take out the brake pads.

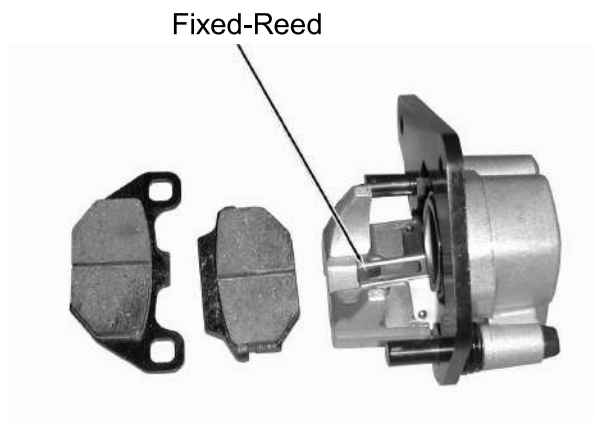

# 13. STEERING HANDLEBAR/FRONT WHEEL/FRONT BRAKE/FRONT SHOCK ABSORBER/FRONT FORK

---

Install the brake pads in the reverse order of removal.

Tighten the brake pad pin bolt.

**Torque:** 1.5~2.0kg-m

\* Keep grease or oil off the brake pads to avoid brake failure.

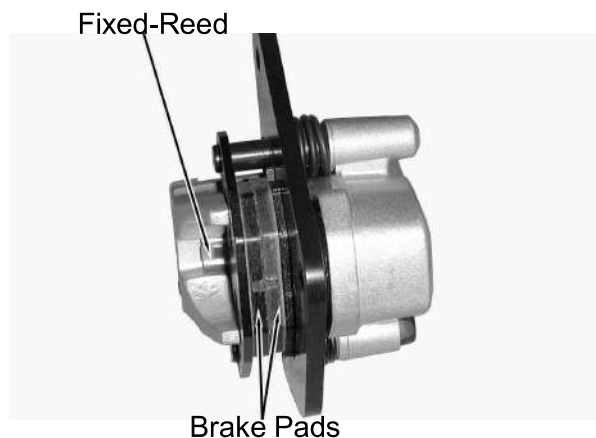

## BRAKE DISK

Measure the brake disk thickness.

**Service Limit:** 3.0mm

Measure the brake disk runout.

**Service Limit:** 0.3mm



## BRAKE MASTER CYLINDER

### REMOVAL

First drain the brake fluid from the hydraulic brake system.

- \* 
  - When servicing the brake system, use shop towels to cover rubber and plastic parts and coated surfaces to avoid being contaminated by brake fluid.
  - When removing the brake fluid tube bolt, be sure to plug the tube end to avoid brake fluid leakage.

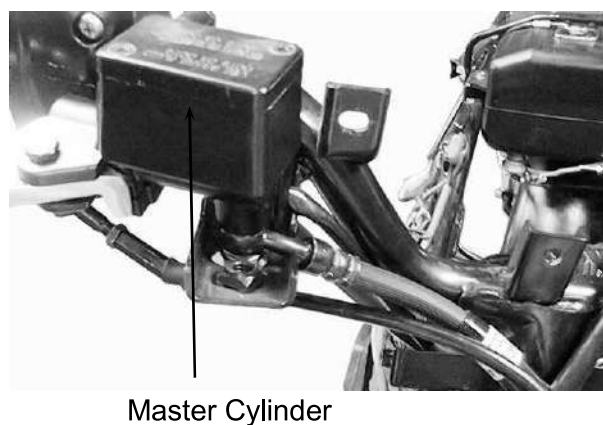

### DISASSEMBLY

Remove the piston rubber cover and snap ring from the brake master cylinder.

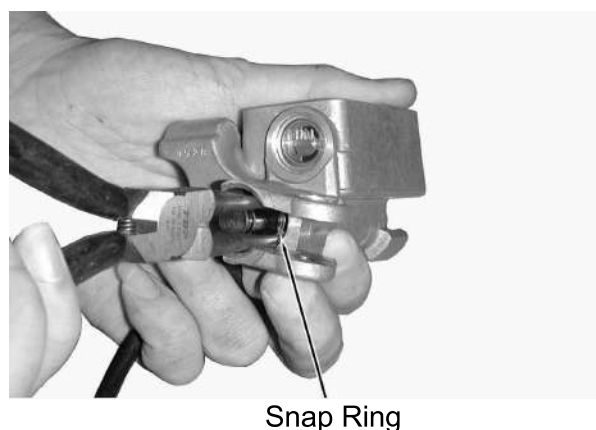

# 13. STEERING HANDLEBAR/FRONT WHEEL/FRONT BRAKE/FRONT SHOCK ABSORBER/FRONT FORK LIKE 50/125

Remove the main piston and spring from the brake master cylinder.  
Clean the inside of the master cylinder and brake reservoir with brake fluid.

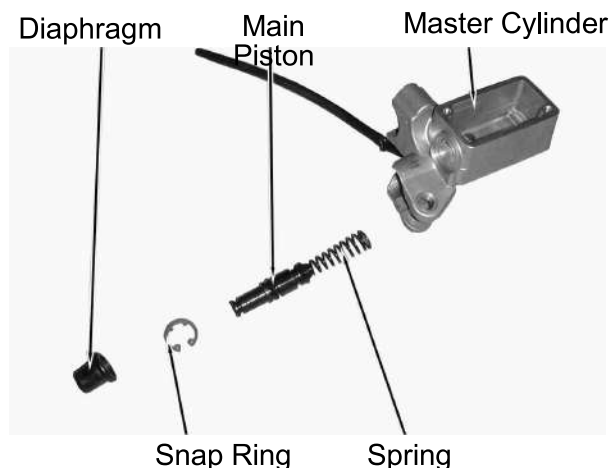

## INSPECTION

Measure the brake master cylinder I.D.  
Inspect the master cylinder for scratches or cracks.

**Service Limit:** 12.75mm



Measure the brake master cylinder piston O.D.

**Service Limit:** 12.75mm

Before assembly, inspect the 1st and 2nd rubber cups for wear or damage.

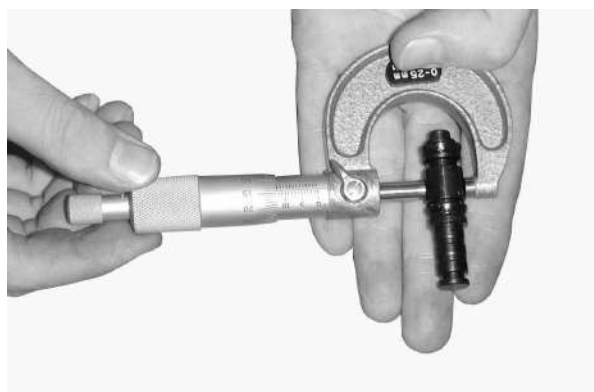

## ASSEMBLY

Before assembly, apply brake fluid to all removed parts.

Install the spring together with the 1st rubber cup.

\*

- During assembly, the main piston and spring must be installed as a unit without exchange.
- When assembling the piston, soak the cups in brake fluid for a while.
- Install the cups with the cup lips facing the correct direction.

Install the main piston, spring and snap ring.  
Install the diaphragm.  
Install the brake lever.

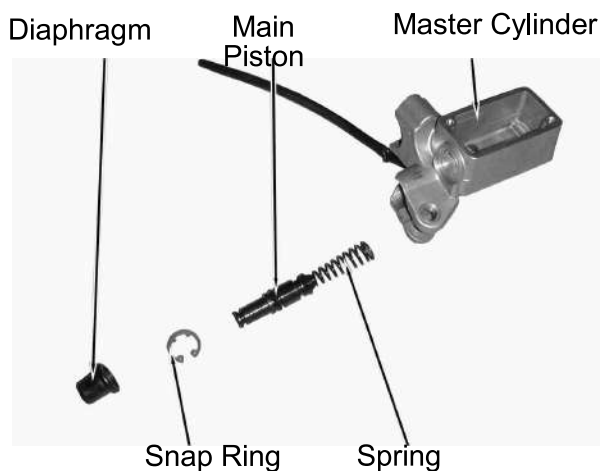

# 13. STEERING HANDLEBAR/FRONT WHEEL/FRONT BRAKE/FRONT SHOCK ABSORBER/FRONT FORK LIKE 50/125

Place the brake master cylinder on the handlebar and install the holder with the “up” mark facing up. Also align the punch mark with the holder joint seam.

First tighten the upper bolt and then tighten the lower bolt.

**Torque:** 1.0~1.4kg-m

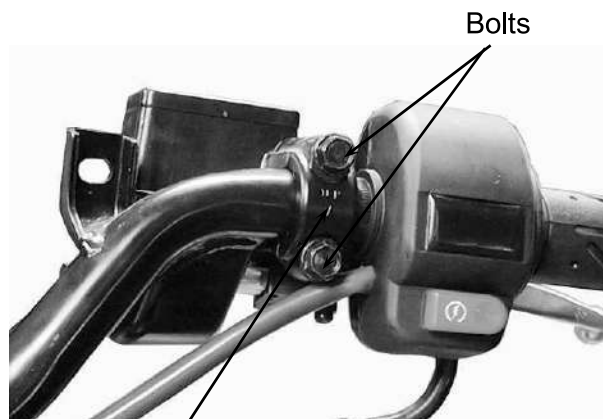

“Up” Mark

Install the brake fluid tube with the attaching bolt and two sealing washers. Install the handlebar covers. Connect the front and rear stop switch wire connectors. Fill the brake reservoir with recommended brake fluid to the upper limit and bleed air according to the method stated in page 12-8.

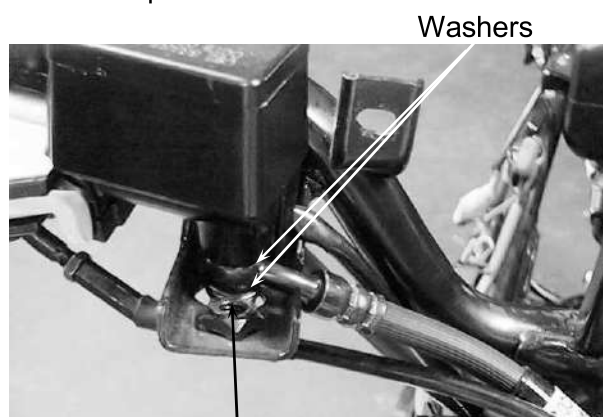

Fluid Tube Bolt

## BRAKE CALIPER (FRONT)

### REMOVAL

Remove the brake caliper and brake pad springs.

Place a clean container under the brake caliper and disconnect the brake fluid pipe from the caliper.

\* Do not spill brake fluid on any coated surfaces.



Bolt

### DISASSEMBLY

Remove the brake caliper seat from the brake caliper.

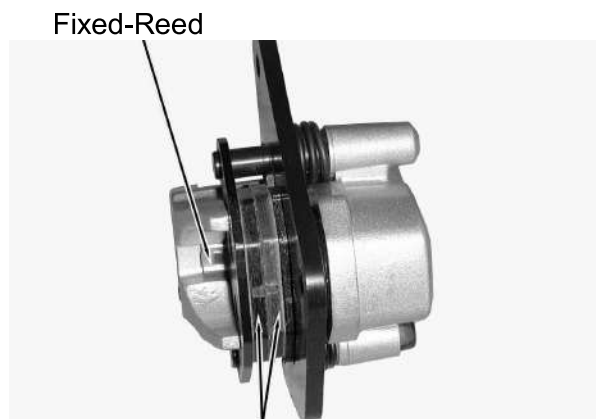

Brake Pads



# 13. STEERING HANDLEBAR/FRONT WHEEL/FRONT BRAKE/FRONT SHOCK ABSORBER/FRONT FORK LIKE 50/125

Remove the pistons from the brake caliper. If necessary, use compressed air to squeeze out the pistons through the brake fluid inlet opening and place a shop towel under the caliper to avoid contamination caused by the removed pistons. Check each piston cylinder for scratches or wear and replace if necessary.

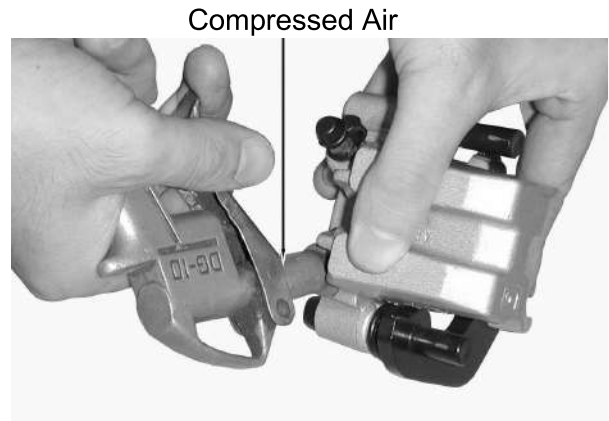

Push the piston oil seals outward to remove them. Clean each oil seal groove with brake fluid.

\* Be careful not to damage the piston surface.



Check each piston for scratches or wear. Measure each piston O.D. with a micrometer gauge.

**Service Limit:** 33.90mm



Check each caliper cylinder for scratches or wear and measure the cylinder bore.

**Service Limit:** 33.45mm



# 13. STEERING HANDLEBAR/FRONT WHEEL/FRONT BRAKE/FRONT SHOCK ABSORBER/FRONT FORK LIKE 50/125

## ASSEMBLY

Clean all removed parts.  
Apply silicon grease to the pistons and oil seals. Lubricate the brake caliper cylinder inside wall with brake fluid.  
Install the brake caliper piston with grooved side facing out.

\* Install the piston with its outer end protruding 3~5mm beyond the brake caliper cylinder.



Wipe off excessive brake fluid with a clean shop towel. Apply silicon grease to the brake caliper seat pin and caliper inside. Install the brake caliper seat.

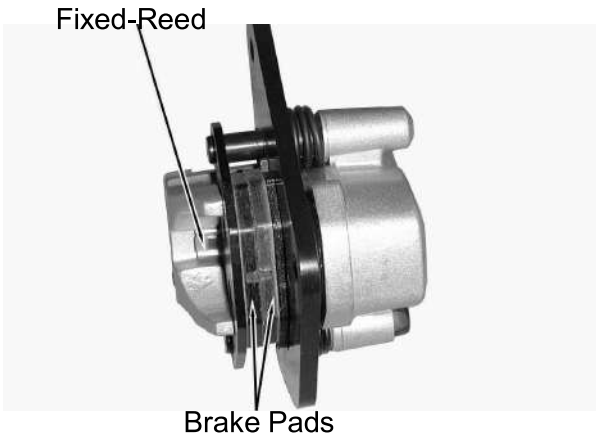

## INSTALLATION

Install the brake caliper and tighten the two bolts.

**Torque:** 2.9~3.5kg-m

Connect the brake fluid tube to the brake caliper and tighten the fluid tube bolt.

**Torque:** 3.0~4.0kg-m

Fill the brake reservoir with recommended brake fluid and bleed air from the brake system.

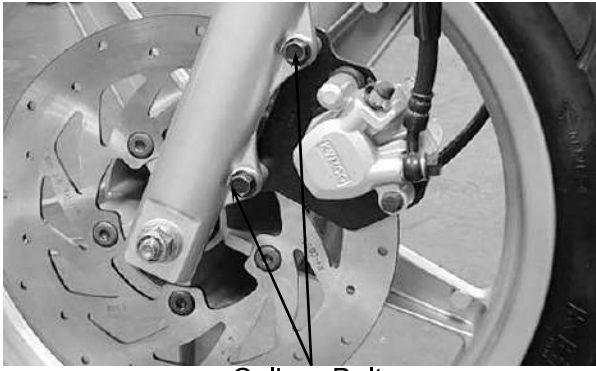

## FRONT SHOCK ABSORBER

### REMOVAL

Remove the front cover. (⇒12)  
Remove the front wheel.  
Remove the front shock absorber upper mount bolts.  
Loosen the lower mount bolts to remove the front shock absorbers.

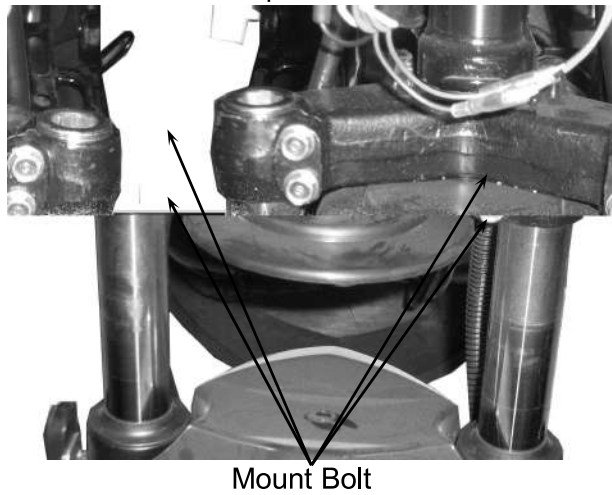

# 13. STEERING HANDLEBAR/FRONT WHEEL/FRONT BRAKE/FRONT SHOCK ABSORBER/FRONT FORK LIKE 50/125

## INSPECTION

Inspect the following items and replace if necessary.

- Front shock absorber tube bending or damage.
- Weak front shock absorber spring.
- Damper and damper rod bending.
- Oil seal damage or wear.

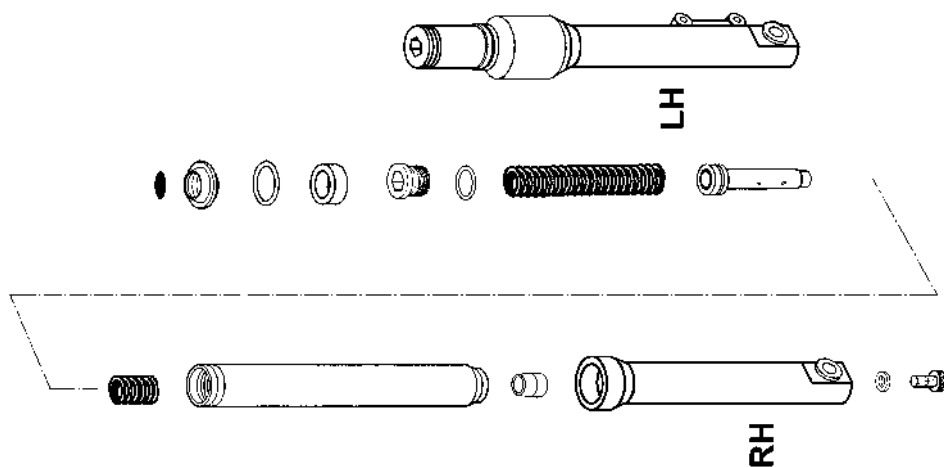

## INSTALLATION

Install the front shock absorbers onto the steering stem.  
Install and tighten the front shock absorber upper mount bolts.  
Tighten the lower mount bolts.

\* Align the upper mount bolt hole with the groove on the front fork.  
Front shock absorbers are installed at the same altitude.

Install the front wheel.

## STEERING HANDLEBAR

### REMOVAL

Remove the handlebar covers. (⇒ 12)  
Remove the rear brake lever holder bolt to remove the holder.  
Remove the front brake master cylinder holder bolts to remove the brake master cylinder.

Mount Boot

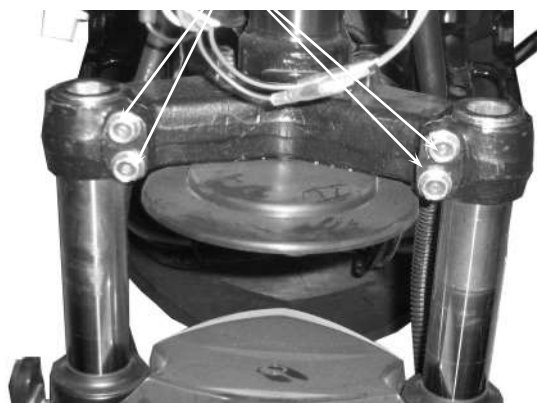

Brake Master Cylinder



Blots

# 13. STEERING HANDLEBAR/FRONT WHEEL/FRONT BRAKE/FRONT SHOCK ABSORBER/FRONT FORK LIKE 50/125

Remove the throttle seat screw.

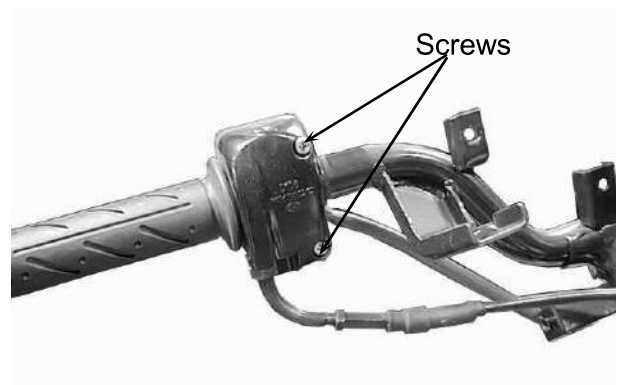

Remove the throttle seat from the handlebar and disconnect the throttle cable from the throttle pipe.  
Remove the throttle pipe from the handlebar.

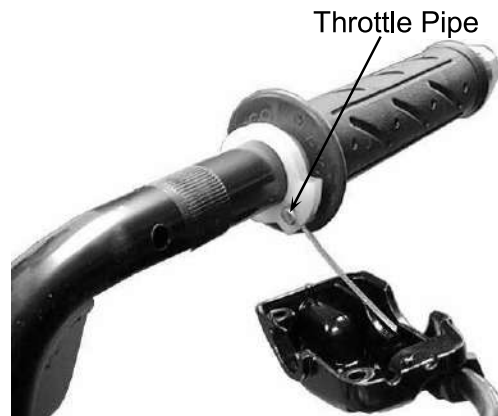

Remove the steering stem lock bolt, collar, nut and the handlebar.



## STEERING STEM

### REMOVAL

Remove the steering stem lock nut.

 Special

Steering Stem Lock Nut Wrench

Lock Nut wrench

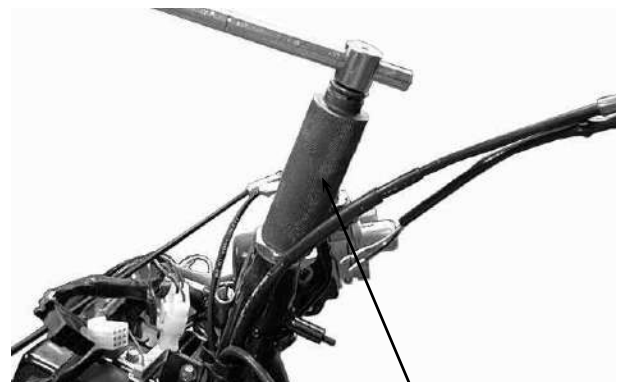

Steering Stem Lock Nut Wrench

# 13. STEERING HANDLEBAR/FRONT WHEEL/FRONT BRAKE/FRONT SHOCK ABSORBER/FRONT FORK LIKE 50/125

Remove the top cone race.

\*

- Be careful not to lose the steel balls (20 on top race and 15 on bottom race).
- Clean the openings of frame covers with clean shop towels.

Remove the front fork.

Top Cone Race

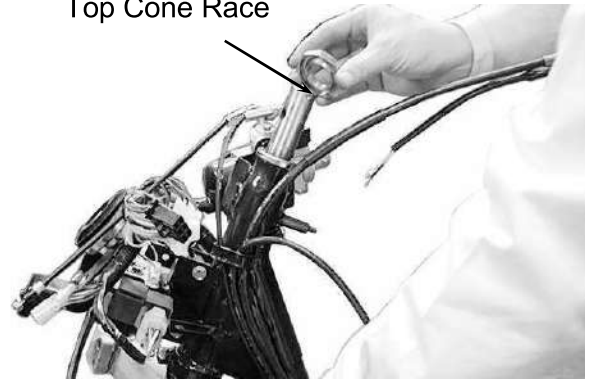

## BOTTOM CONE RACE REPLACEMENT

Remove the bottom cone race using a chisel.

\*

- Be careful not to damage the steering stem and front fork.

Drive a new bottom cone race into place with a proper driver.



Bottom Cone Race  
Ball Race Remover

## BALL RACE REPLACEMENT

Drive out the top and bottom ball races.

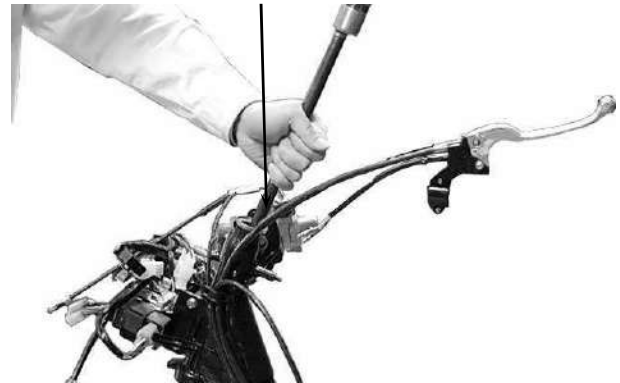

Drive new top and bottom ball races into the steering head using the outer driver.

Special

Outer Driver

Outer Driver

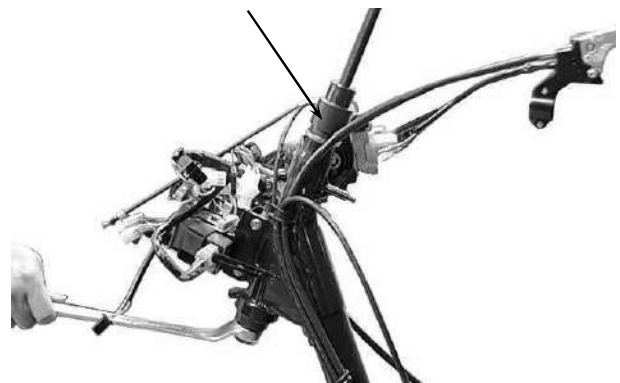

# 13. STEERING HANDLEBAR/Front WHEEL/Front BRAKE/Front SHOCK ABSORBER/Front FORK LIKE 50/125

## INSTALLATION

Install the top and bottom steel balls.  
Apply grease to the top and bottom ball races and install 20 steel balls on the top ball race and 15 steel balls on the bottom ball race.

Apply grease to the ball races and install the front fork.  
Apply grease to the top cone race and install it.  
Tighten the top cone race and then turn the steering stem right and left several times to make steel balls contact each other closely.

\* Check that the steering stem rotates freely without vertical play.

Install the steering stem lock nut and tighten it while holding the top cone race.  
**Torque:** 7.0~8.0kg-m  
Install the front wheel. (⇒12)

## HANDLEBAR INSTALLATION

Install the handlebar onto the steering stem tube and then install and tighten the bolt.  
**Torque:** 4.5kg-m  
Install the front wheel. (⇒12)  
Install the brake levers. (⇒12)  
Install the handlebar covers.

Top Steel Ball



Top Cone Race

Top Cone Race Lock Nut Wrench



Steering Stem Lock Nut Wrench



Nut

**REAR WHEEL/REAR BRAKE/REAR SHOCK ABSORBER**

SERVICE INFORMATION..... 14-2  
TROUBLESHOOTING..... 14-2  
REAR WHEEL..... 14-3  
REAR BRAKE..... 14-4  
REAR SHOCK ABSORBER..... 14-6

# 14. REAR WHEEL/REAR BRAKE/REAR SHOCK ABSORBER

LIKE 50/125

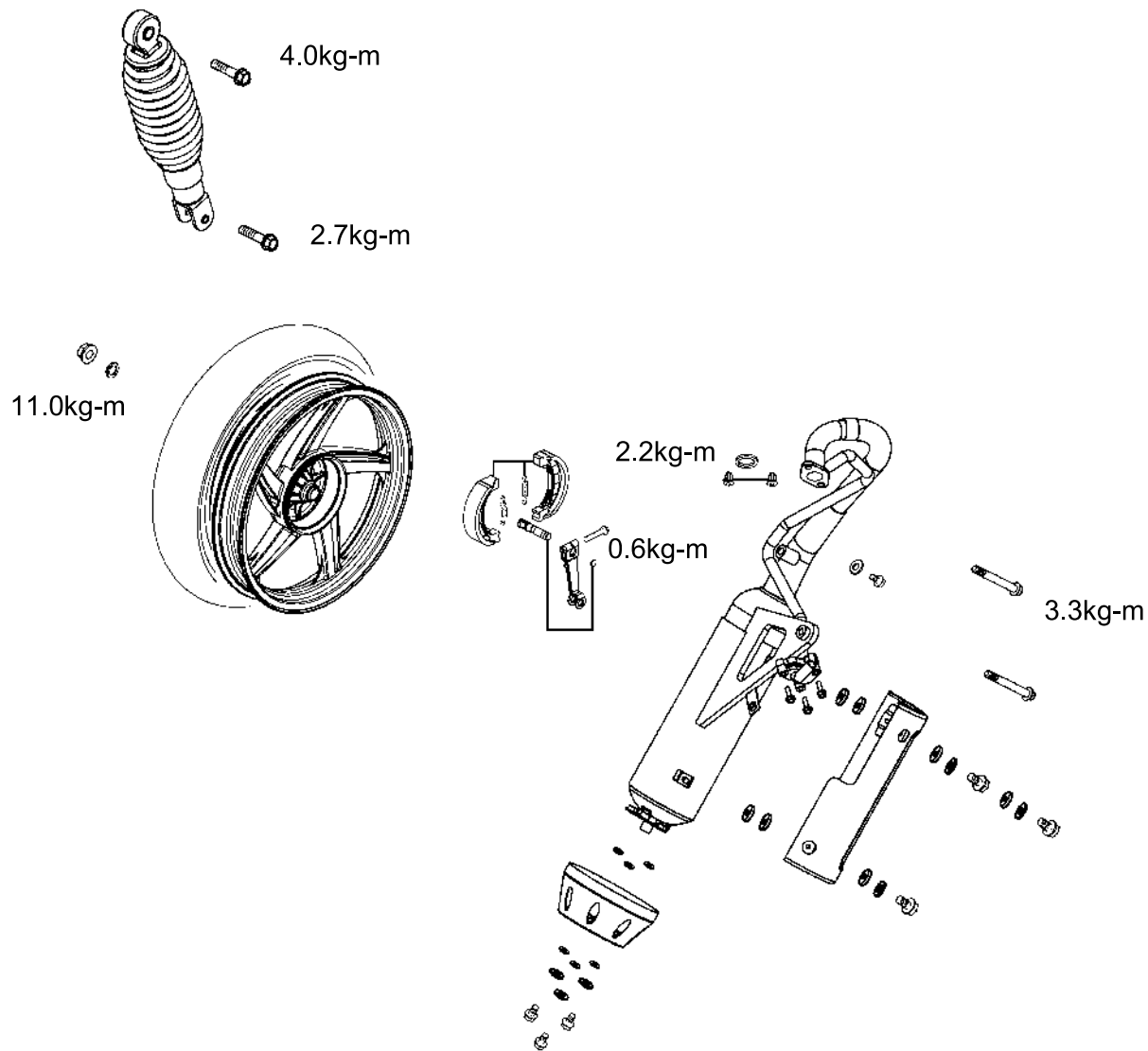



# 14. REAR WHEEL/REAR BRAKE/REAR SHOCK ABSORBER

LIKE 50/125

## SERVICE INFORMATION

### SPECIFICATIONS

Item	Standard (mm)	Service Limit (mm)
Rear wheel rim runout		2.0
Rear brake drum I.D.	110	111
Rear brake lining thickness	4.0	2.0
Rear shock absorber spring free length	235.7	218.7

### TORQUE VALUES

Rear axle nut 11.0~13.0kg-m  
Rear shock absorber upper mount bolt 3.5~4.5kg-m  
Rear shock absorber lower mount bolt 2.4~3.0kg-m

### SPECIAL TOOL

Rear shock absorber remover  
Rear shock absorber compressor

### TROUBLESHOOTING

#### Rear wheel wobbling

- Bent rim
- Faulty tire
- Axle not tightened properly

#### Soft rear shock absorber

- Weak shock absorber spring

#### Poor brake performance

- Brake not adjusted properly
- Contaminated brake linings
- Worn brake linings
- Worn brake shoes at cam contacting area
- Worn brake cam
- Improper engagement between brake arm and wear indicator plate

# 14. REAR WHEEL/REAR BRAKE/REAR SHOCK ABSORBER

LIKE 50/125

## REAR WHEEL

### REMOVAL

Remove the two exhaust muffler joint lock nuts.  
Remove the two exhaust muffler lock bolts.  
Remove the exhaust muffler.  
Remove the rear axle nut to remove the rear wheel.

Rear Axle Nut



### INSPECTION

Measure the rear wheel rim runout.

#### Service Limits:

Radial : 2.0mm replace if over

Axial : 2.0mm replace if over

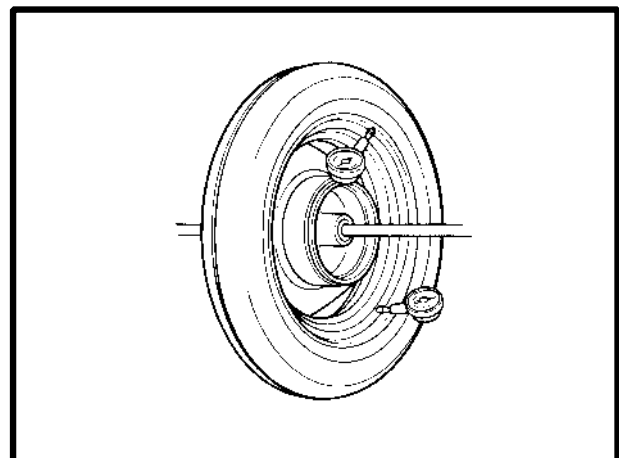

### INSTALLATION

Install the rear wheel and apply SAE30# engine oil to the axle threads. Then, tighten the rear axle nut.

#### Torque values:

Rear axle nut: 11.0~13.0kg-m

Rear Axle Nut



# 14. REAR WHEEL/REAR BRAKE/REAR SHOCK ABSORBER

LIKE 50/125

## REAR BRAKE

Remove the rear wheel. (⇒14-3)  
Inspect the rear brake drum.  
Measure the rear brake drum I.D.

**Service Limit:** 95.5mm replace if over



## BRAKE LINING INSPECTION

Measure the brake lining thickness.

**Service Limit:** 2.0mm replace if below

\* Keep oil or grease off the brake linings.

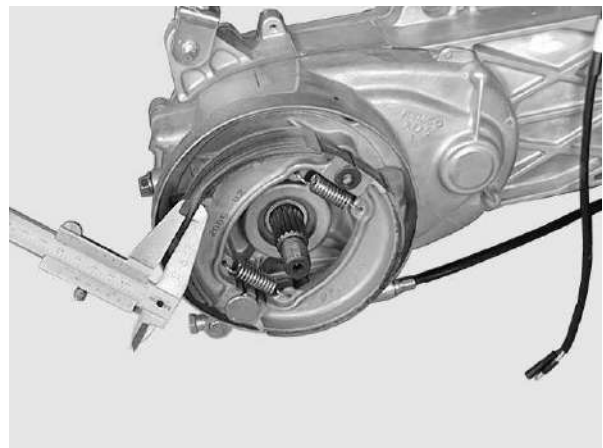

## REAR BRAKE DISASSEMBLY

Remove the rear brake adjusting nut and disconnect the rear brake cable.  
Remove the rear brake shoes.

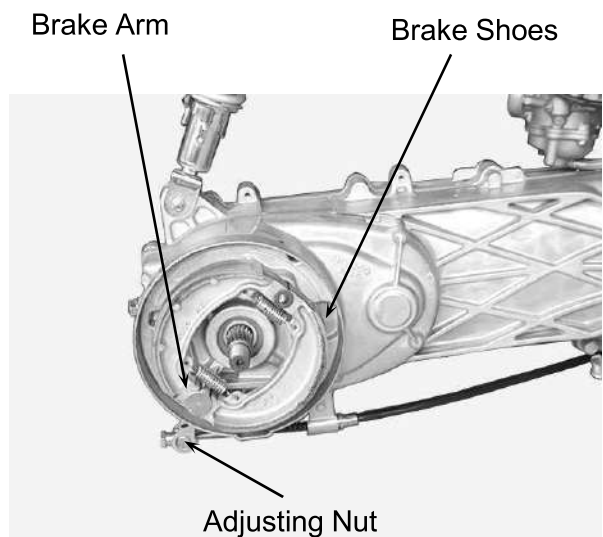

# 14. REAR WHEEL/REAR BRAKE/REAR SHOCK ABSORBER

LIKE 50/125

Remove the brake cam bolt to remove the brake arm, wear indicator plate and felt seal.

Remove the brake arm.

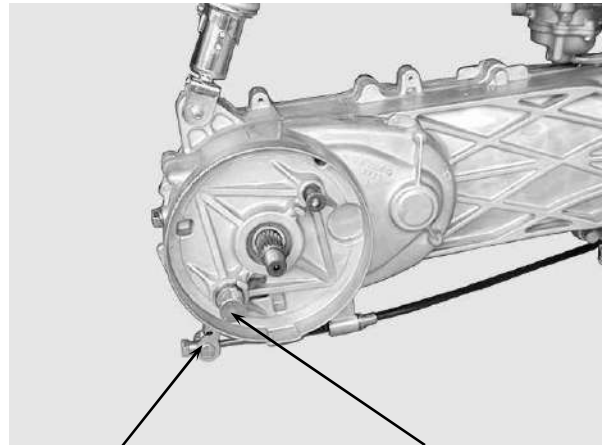

Brake Arm

Brake Cam

## REAR BRAKE ASSEMBLY

Apply grease to the anchor pin and brake shoe moving parts.

Apply grease to the brake cam and install it.



Grease

Apply engine oil to the felt seal and install it to the brake cam.

Install the wear indicator plate.

\* Align the wide tooth of the wear indicator plate with the wide groove on the brake cam.

Install the brake arm onto the brake cam.

\* Align the punch mark on the brake arm with the scribed line on the brake cam.

Install and tighten the brake arm bolt.

Install the brake arm return spring.

Install the brake shoes.

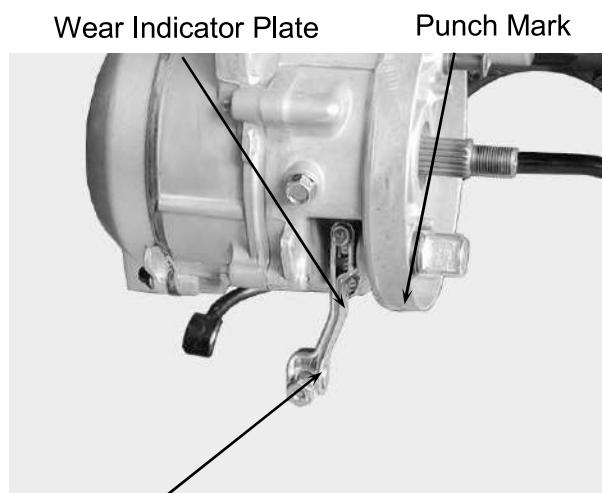

Wear Indicator Plate

Punch Mark

Brake Arm

# 14. REAR WHEEL/REAR BRAKE/REAR SHOCK ABSORBER

LIKE 50/125

Install the brake arm pin.  
Connect the brake cable and install the adjusting nut.  
Install the rear wheel. (⇒14-3)  
Adjust the rear brake lever free play. (⇒3-4)

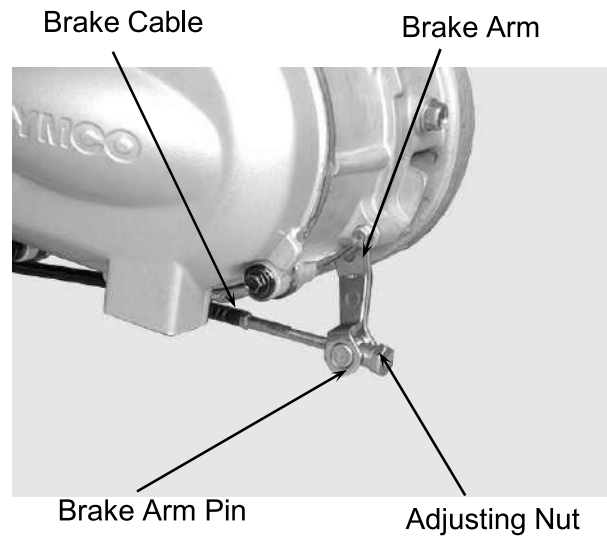

## REAR SHOCK ABSORBER

### REMOVAL

Remove the front cover. (⇒12)  
Remove the met-in box. (⇒12)  
Remove the air cleaner case.  
Remove the rear shock absorber upper and lower mount bolts to remove the rear shock absorber.

Upper Mount Bolt



Lower Mount Bolt

### INSTALLATION

Install the rear shock absorber.  
Install the rear shock absorber upper mount bolt and then install the lower mount bolt.

#### Torque:

**Upper Mount Bolt:** 3.5~4.5kg-m

**Lower Mount Bolt:** 2.4~3.0kg-m

Install the frame body cover. (⇒12)

Rear Shock Absorber



**ELECTRICAL EQUIPMENT**

SERVICE INFORMATION ..... 15- 1

TROUBLESHOOTING..... 15- 1

CHARGING SYSTEM..... 15- 3

BATTERY ..... 15- 4

IGNITION SYSTEM ..... 15- 7

STARTING SYSTEM ..... 15- 11

## SERVICE INFORMATION

### GENERAL INSTRUCTIONS

- It is not necessary to check the battery electrolyte or fill with distilled water.
- Remove the battery from the motorcycle for charging. Do not remove the electrolyte cap..
- Do not quick charge the battery. Quick charging should only be done in an emergency..
- Charge the battery according to the charging current and time specified on the battery.
- When charging, check the voltage (open voltage) with an electric tester.
- When replacing the battery, do not use a traditional battery.

### SPECIFICATIONS

SPECIFICATIONS		LIEK 50/125	
Battery	Capacity	12V7AH	
	Voltage	13.0~13.2V	
	Charging current	Standard	0.4A/5H
		Quick	4A/0.5H
Spark plug	(NGK)	CR7HSA	
Spark plug gap		0.6~0.7mm	
Ignition coil resistance	Primary coil	0.2~0.3Ω	
	Secondary coil (with plug cap)	7.0~8.4KΩ	
	Secondary coil (without plug cap)	2.5~3.2KΩ	
Pulser coil resistance (20°C)		80~160Ω	
Ignition timing		13.5°±1°BTDC/2000rpm	

## TROUBLESHOOTING

### CHARGING SYSTEM

#### No power

- Dead battery
- Disconnected battery cable
- Fuse burned out
- Faulty ignition switch

#### Low power

- Weak battery
- Loose battery connection
- Charging system failure
- Faulty regulator/rectifier

#### Intermittent power

- Loose battery cable connection
- Loose charging system connection
- Loose connection or short circuit in ignition system
- Loose connection or short circuit in lighting system

#### Charging system failure

- Loose, broken or shorted wire or connector
- Faulty regulator/rectifier
- Faulty A.C. generator

## IGNITION SYSTEM

### No spark at plug

- Faulty spark plug
- Poorly connected, broken or shorted wire
  - Between A.C. generator and CDI unit
  - Between CDI unit and ignition coil
  - Between CDI unit and ignition switch
  - Between ignition coil and spark plug
- Faulty ignition switch
- Faulty ignition coil
- Faulty CDI unit
- Faulty A.C. generator

### Engine starts but turns poorly

- Ignition primary circuit
  - Faulty ignition coil
  - Poorly connected wire or connector
- Ignition secondary circuit
  - Faulty ignition coil
  - Faulty spark plug
  - Poorly insulated plug cap
- Improper ignition timing
  - Battery voltage too low (6V max.)
  - Faulty CDI unit

## STARTING SYSTEM

### Starter motor won't turn

- Fuse burned out
- Weak battery
- Faulty ignition switch
- Faulty starter switch
- Faulty front or rear stop switch
- Faulty starter relay
- Poorly connected, broken or shorted wire
- Faulty starter motor

### Lack of power

- Weak battery
- Loose wire or connection
- Foreign matter stuck in starter motor or pinion

### Starter motor rotates but engine does not start

- Faulty starter pinion
- Starter motor rotates reversely
- Faulty starter clutch
- Weak battery



## CHARGING SYSTEM

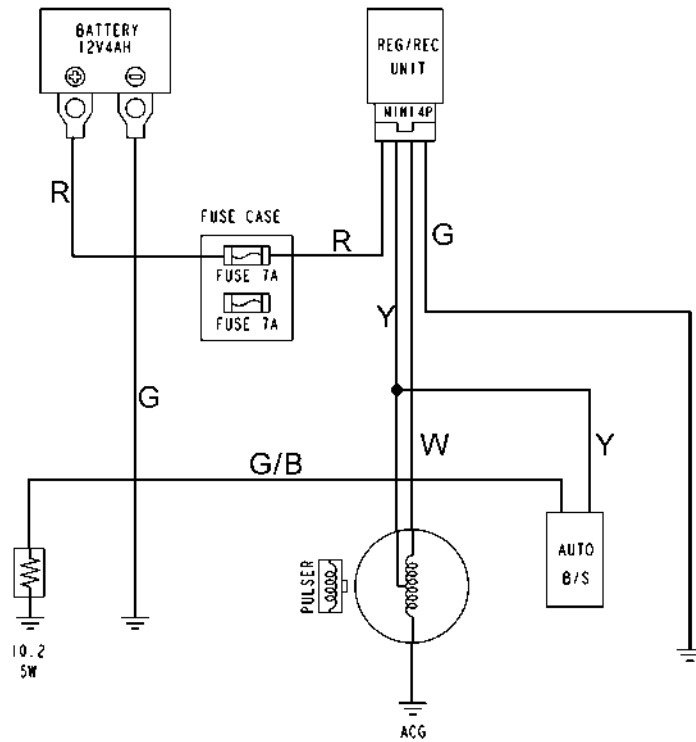
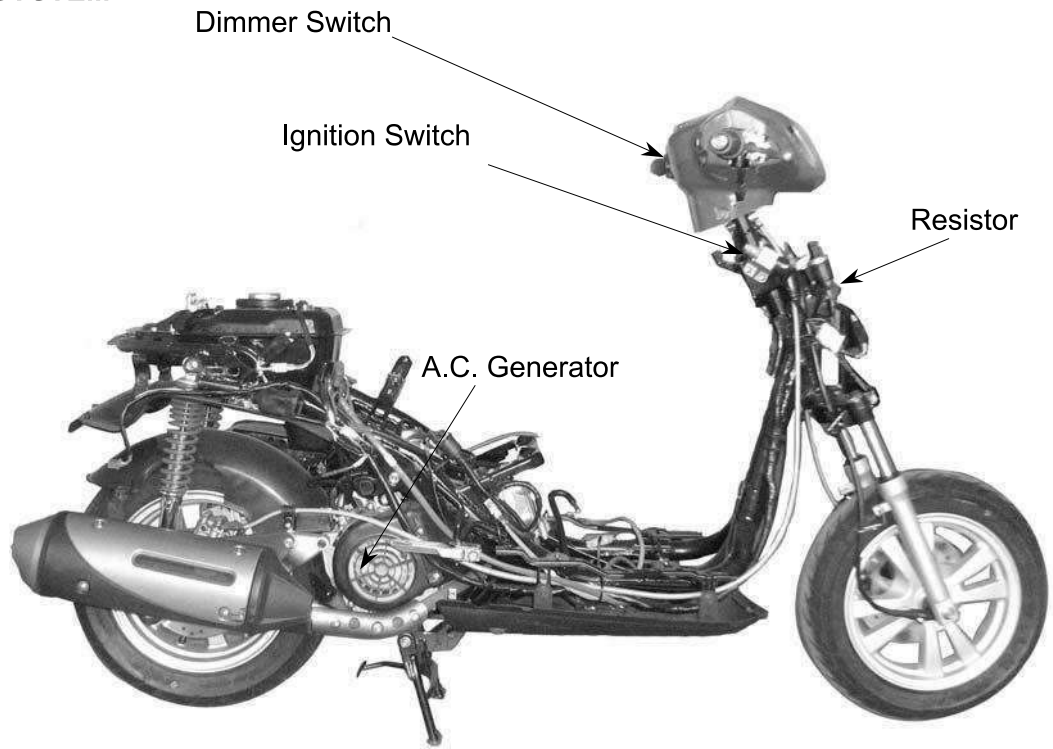

## BATTERY REMOVAL

Remove the battery cover.  
Disconnect the battery cables .

- \* First disconnect the battery negative (-) cable and then the positive (+) cable.

Remove the battery.  
The installation sequence is the reverse of removal.

## BATTERY CHARGING (OPEN CIRCUIT VOLTAGE) INSPECTION

Remove the battery cover and disconnect the battery cables.

Measure the voltage between the battery terminals.

Fully charged : 13.0V~13.2V

Undercharged : 12.3V max.

- \* Battery charging inspection must be performed with an electric tester.

## CHARGING METHOD

Connect the charger positive (+) cable to the battery positive (+) cable.

Connect the charger negative (-) cable to the battery negative (-) cable.

- \* 
  - Keep flames and sparks away from a charging battery.
  - Turn power ON/OFF at the charger, not at the battery terminals to prevent sparks near the battery.
  - Charge the battery according to the current specified on the battery surface.

Charging current: Standard: 0.4A

Quick : 4A

Charging time : Standard: 5 hours

Quick : 0.5 HOUR

After charging: Open circuit voltage: 12.8V min.

- \* 
  - Quick charging should only be done in an emergency.
  - During quick charging, the battery temperature should not exceed 45°C.
  - Measure the voltage 30 minutes after the battery is charged.



Battery Cover

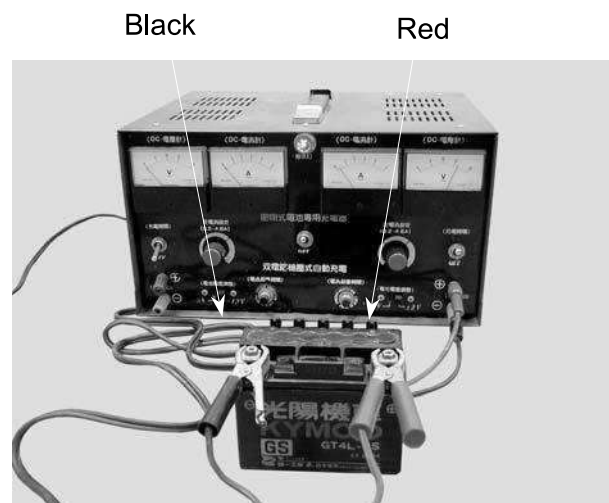

# 15. ELECTRICAL EQUIPMENT

LIKE 50/125

## PERFORMANCE TEST

Warm up the engine.  
Remove the floor mat and front tool box cover.

\* Use a fully charged battery to check the charging system output.

Stop the engine and open the fuse box. Disconnect the wire lead from the fuse terminal. Connect an ammeter between the wire lead and fuse terminal as shown. Connect the battery positive (+) terminal to the voltmeter positive (+) probe and battery negative (-) terminal to the voltmeter negative (-) probe. Start the engine, gradually increase engine speed to test the output:

Position \ RPM	Day	Night
2500	1.3A min.	1.0A min.
6000	2.0A min.	2.0A min.

**Charging Limit Voltage:**  $14.5 \pm 0.5V/8000rpm$   
If the limit voltage is not within the specified range, check the regulator/ rectifier.

## A.C. GENERATOR (CHARGING COIL) INSPECTION

\* Inspect with the engine installed.

Remove the met-in box. ( $\Rightarrow$  12)  
Disconnect the A.C. generator connector. Measure the resistances between the charging coil terminals (white-green) and lighting coil terminals (yellow-green).

**Resistances:**

Charging coil	white-green	$0.4 \sim 2\Omega$
Lighting coil	yellow-green	$0.3 \sim 2\Omega$

Refer to 7-3 for A.C. generator removal.

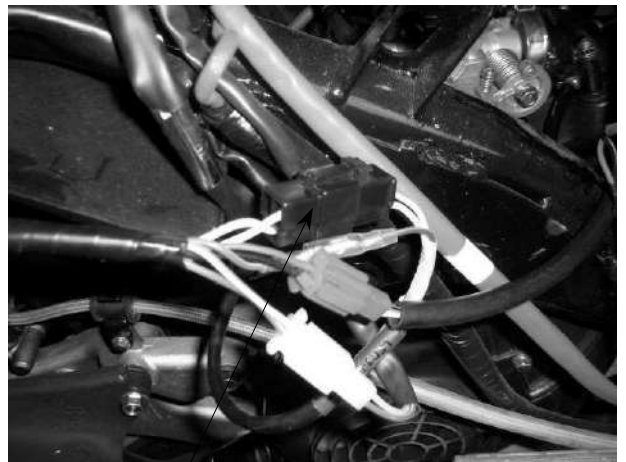
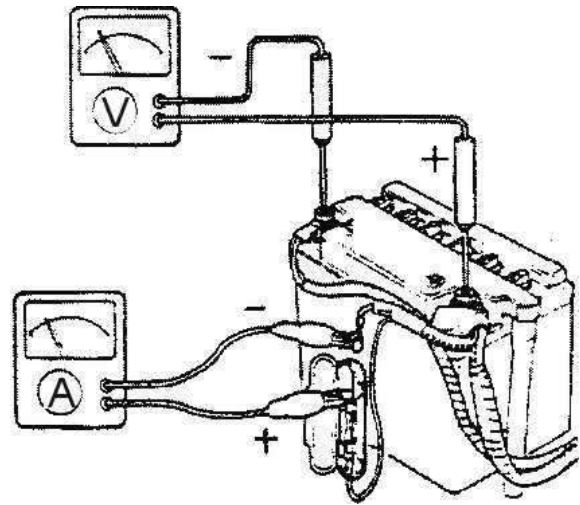

A.C. Generator Connector



## RESISTOR INSPECTION

Remove the frame front cover. (⇒12)  
 Measure the resistance between the resistor with ground.

**Resistances:**  
 Resistor: 4.5~5.5Ω

\* Faulty resistor is the cause of faulty operation of the auto bystarter.

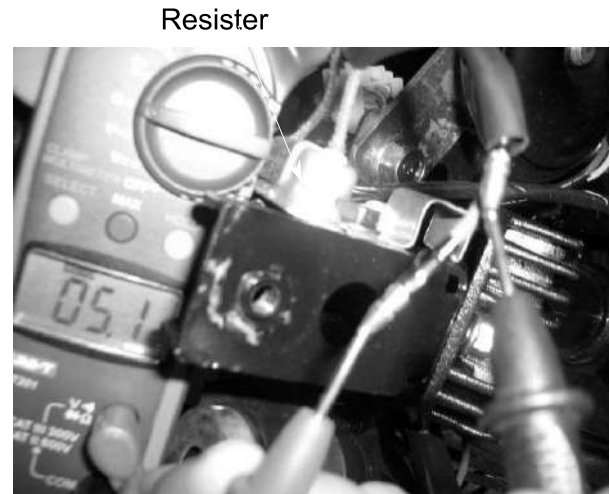

## REGULATOR/RECTIFIER INSPECTION

Remove the front cover. (⇒12)  
 Disconnect the regulator/rectifier wire coupler and remove the bolt to remove the regulator/rectifier.

Measure the resistances between the terminals.  
 Replace the regulator/rectifier if the readings are not within the specifications in the table below.

\* 

- Due to the semiconductor in circuit, it is necessary to use a specified tester for accurate testing. Use of an improper tester in an improper range may give false readings.
- Use a Sanwa Electric Tester (07208-0020000) or Kowa Electric Tester (TH-5H). The proper range for testing is listed below.

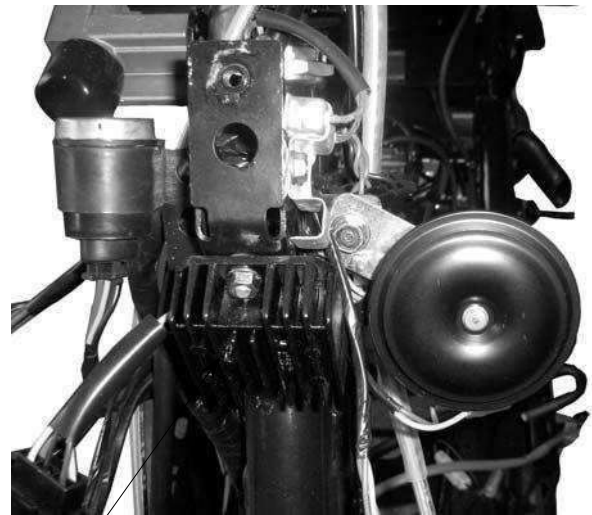

Regulator/Rectifier

Model	Brand	Range
SP-10D	Sanwa	KΩ
TH-5H	Kowa	100Ω

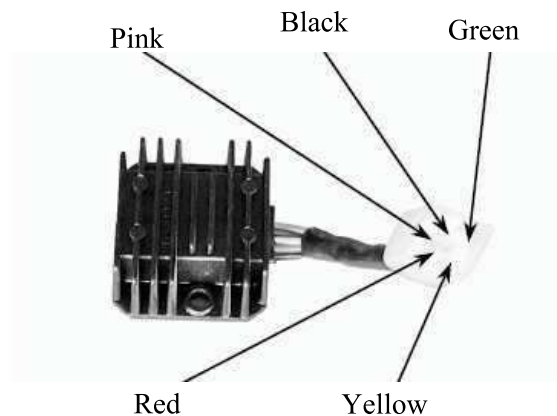

(+)Probe	(-)Probe	Peach	Yellow	Red	Green	Black
Peach			∞	4-7K	∞	∞
Yellow		∞		4-7K	∞	∞
Red		∞	∞		∞	∞
Green		4-6K	4-6K	13-17K		1-2K
Black		4-7K	4-7K	13-17K	1-2K	

# 15. ELECTRICAL EQUIPMENT

LIKE 50/125

## IGNITION SYSTEM

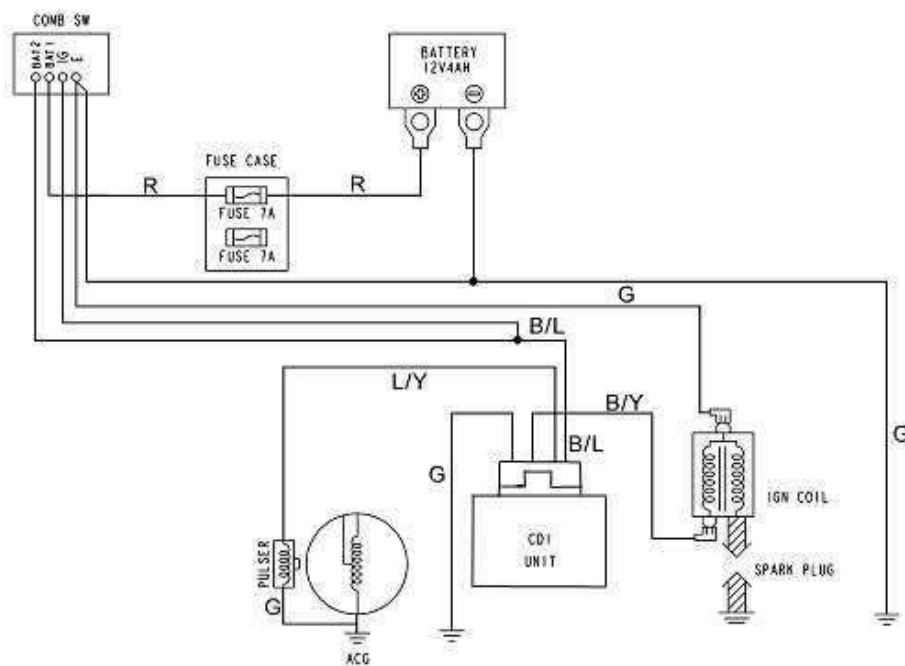
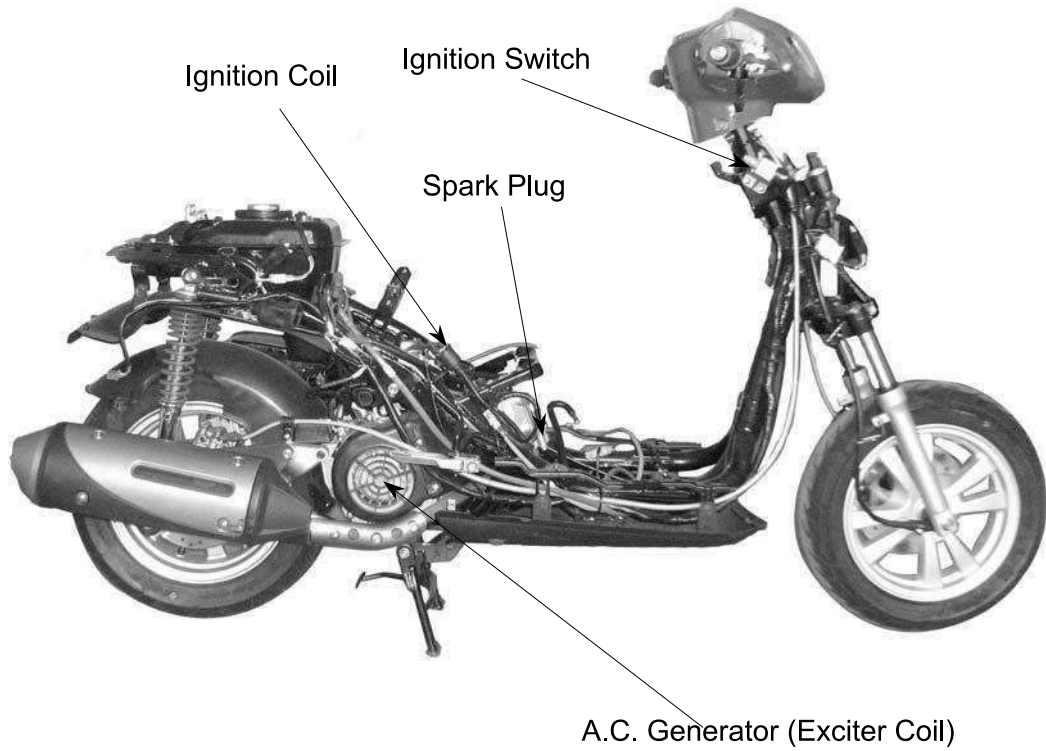

\*

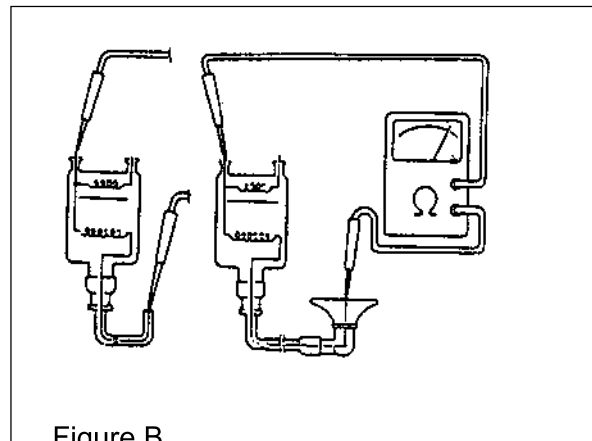
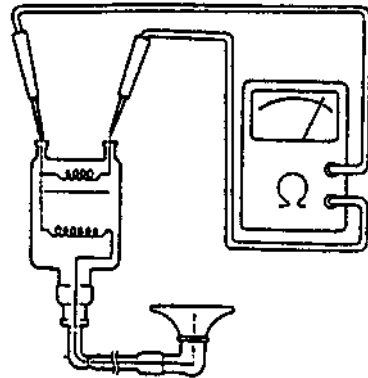

Figure B

Figure A



Ignition Coil

## Performance Test

Remove the ignition coil.

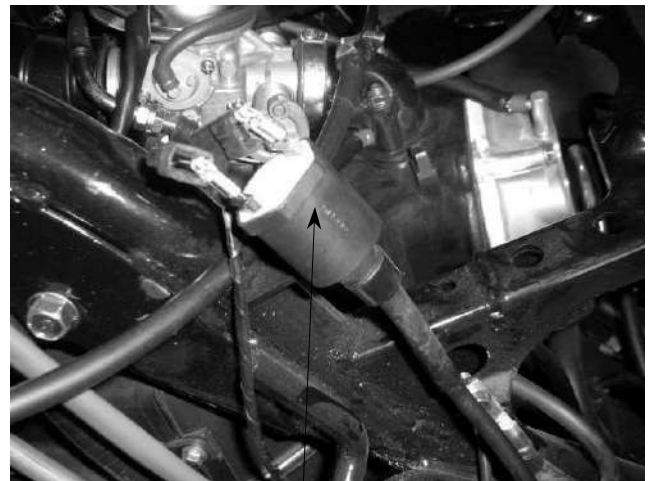

Ignition Coil

Inspect the ignition coil with an ignition coil tester.

\* Follow the ignition coil tester manufacturer's instructions.

1. Turn the changeover switch to 12V and connect the ignition coil to the tester.
2. Turn the power switch ON and check the spark from the watch window.
  - Good : Normal and continuous spark
  - Faulty: Weak or intermittent spark

\* The test is performed at both conditions that the ignition coil is cold and hot.

## A.C. GENERATOR

### Exciter Coil/Pulser Coil Inspection

\* This test is performed with the stator installed in the engine.

Remove the met-in box. (⇒12)  
Disconnect the A.C. generator wire connector.  
Measure the pulser coil resistance between the blue/yellow wire and ground.

**Resistance** (20°C): 100~150Ω



## CDI UNIT INSPECTION

Remove the front cover.  
 Disconnect the CDI coupler and remove the CDI unit.



CDI Unit

## CDI CIRCUIT INSPECTION

Measure the resistance between the terminals.  
 Replace the CDI unit if the readings are not within the specifications in the table below.

- \*
- Due to the semiconductor in circuit, it is necessary to use a specified tester for accurate testing. Use of an improper tester in an improper range may give false readings.
  - Use a Sanwa Electric Tester or Kowa Electric Tester (TH-5H).
  - In this table, "Needle swings then returns" indicates that there is a charging current applied to a condenser. The needle will then remain at "∞" unless the condenser is discharged.

Blue/ Yellow

Black/Blue

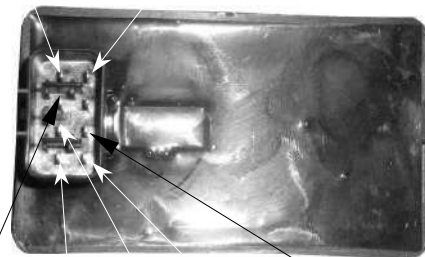

Violet/ Black  
 Green

Black / Blue  
 Violet/Red

Green/ Black

Use the x KΩ range for the Sanwa Tester.  
 Use the x 100Ω range for the Kowa Tester.

Unit: Ω

Probe⊕ (-)Probe	Black	Blue/ Yellow	Green	Black/ Yellow
Black		4~7MΩ	4~7MΩ	2~3MΩ
Blue/ Yellow	15~20KΩ		600~900Ω	1000~1500KΩ
Green	15~20MΩ	600~900Ω		4~7MΩ
Black/ Yellow	∞	∞	∞	



## STARTING SYSTEM

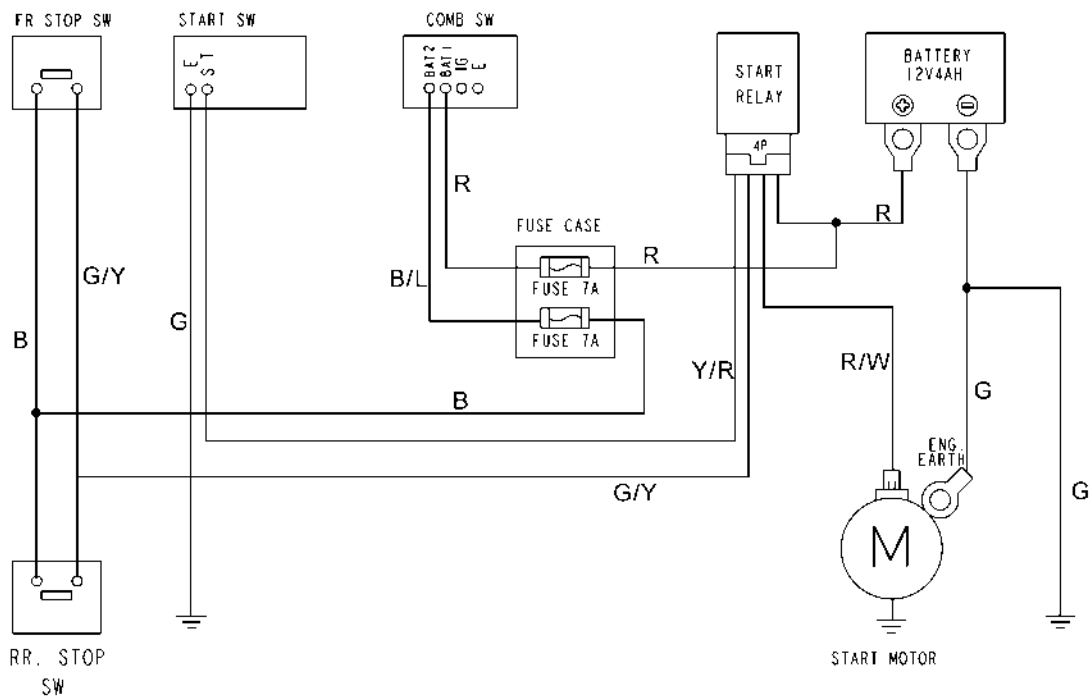
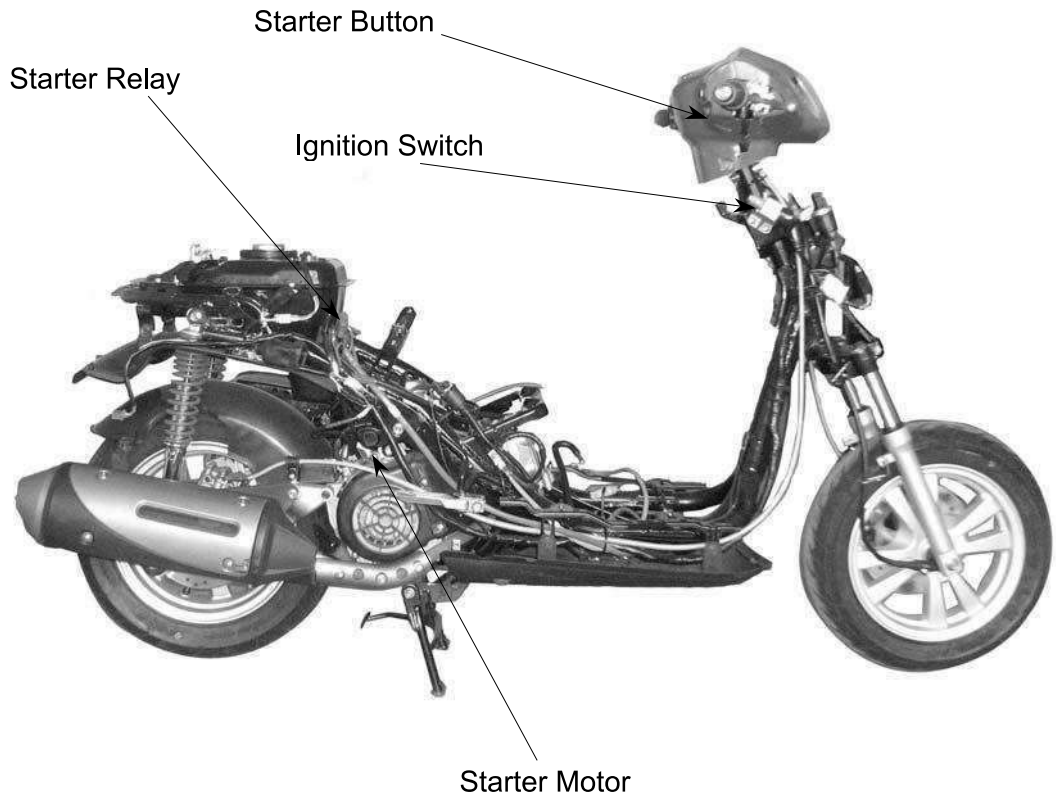

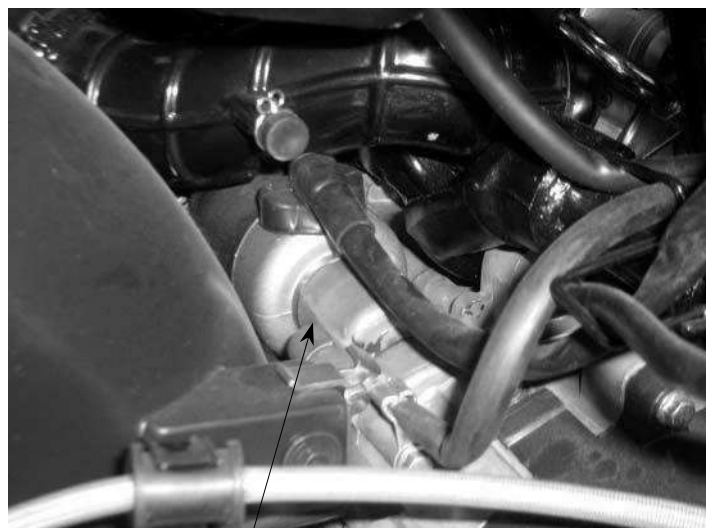
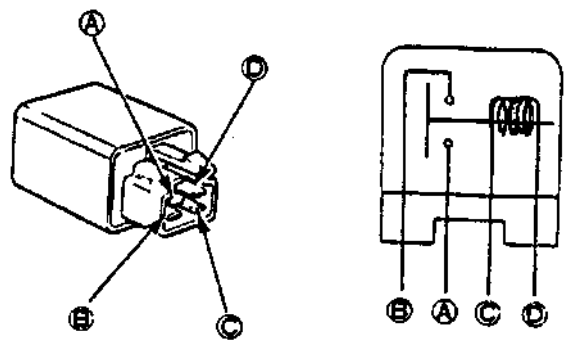

\*

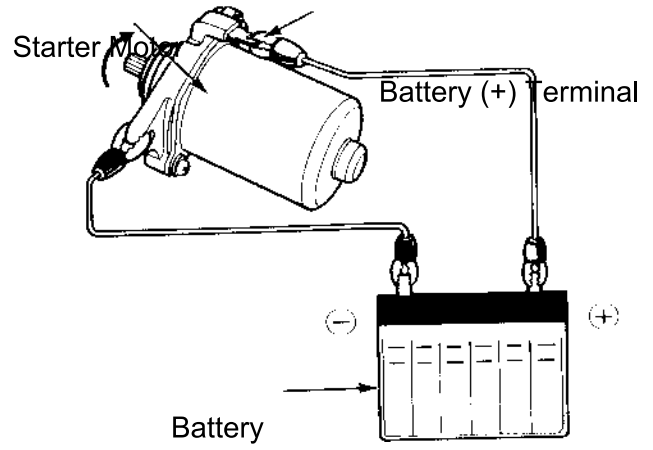

**INSTRUMENT/SWITCHES/LIGHTS**

SERVICE INFORMATION..... 16-1  
TROUBLESHOOTING..... 16-1  
FUEL UNIT..... 16-2  
SWITCHES..... 16-4  
STOP SWITCH INSPECTION/HORN..... 16-6  
FRONT TURN SIGNAL LIGHT REPLACEMENT..... 16-7  
INSTRUMENT/HEADLIGHT..... 16-8

## SERVICE INFORMATION

### GENERAL INSTRUCTIONS

- Wires should be connected to other wires of the same color. Couplers must be connected to other couplers of the same color.
- All plastic plugs have locking tabs that must be released before disconnecting, and must be aligned when reconnecting.
- After installation of each switch, a continuity check must be performed.

### TROUBLESHOOTING

#### Lights do not come on when ignition switch is "ON"

- Burned bulb
- Faulty switch
- Broken or shorted wire
- Fuse burned out
- Weak battery
- Poorly connected wire
- Faulty winker

#### Light dims

- Faulty ignition coil
- Wire or switch resistance too high
- Faulty regulator/rectifier

#### Headlight does not change when dimmer switch is turn to Hi or Lo

- Faulty or burned bulb
- Faulty dimmer switch

#### Motor oil indicator light does not come on (when motor oil is insufficient)

- Fuse burned out
- Dead battery
- Faulty ignition switch
- Faulty instrument
- Faulty oil meter

#### Motor oil indicator light winks

- Loose wire connection
- Broken wire
- Faulty oil meter

#### Fuel gauge pointer does not register correctly

- Disconnected wire or connector
- Broken wire
- Faulty float
- Faulty fuel unit
- Faulty instrument

#### Fuel gauge pointer fluctuates or swings

- Loose wire connection
- Faulty fuel unit
- Faulty instrument

## FUEL UNIT

\* No Smoking!

### REMOVAL

Remove the seat.  
Remove the body cover.  
Disconnect the fuel unit wire connectors.

\* Do not damage the fuel unit wire.

Remove the fuel unit.

\* Be careful not to bend or damage the fuel unit float arm.

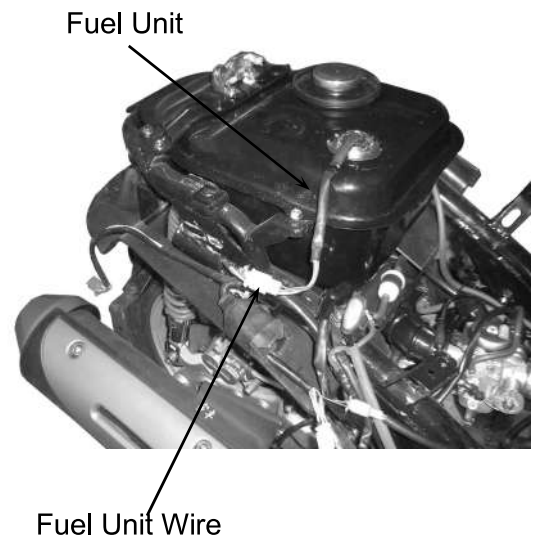

### INSPECTION

Remove the fuel unit.  
Measure the resistance between the fuel unit wire terminals with the float at upper and lower positions.

RESISTANCES Unit:  $\Omega$

Wire Terminals	Upper	Lower
G~Y/W	20~40	560~580



### FUEL GAUGE INSPECTION

Connect the fuel unit wire connectors and turn the ignition switch "ON".

\* Before performing the following test, operate the turn signals to determine that the battery circuit is normal.

Check the fuel gauge needle for correct indication by moving the fuel unit float up and down.

Float Position	Needle Position
Upper	"F" (Full)
Lower	"E" (Empty)

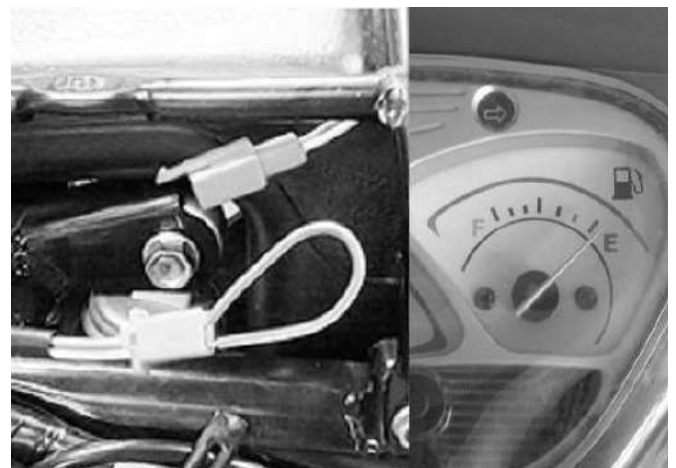

## INSTALLATION

The installation sequence is the reverse of removal.

\*

- Install the fuel unit at the connect position.

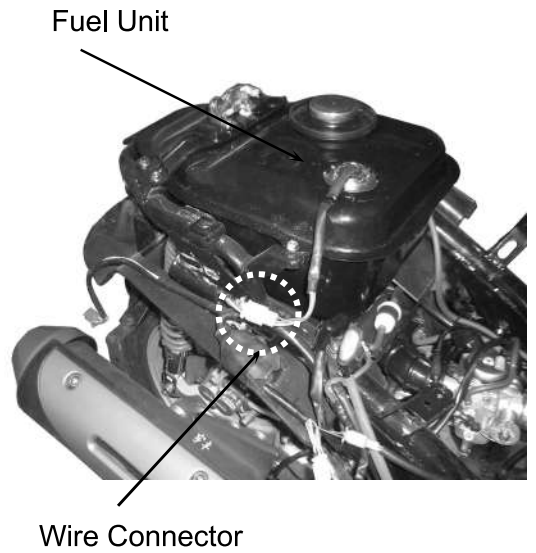

## SWITCHES

### IGNITION SWITCH INSPECTION

Remove the front cover. (⇒ 12)  
 Disconnect the ignition switch wire couplers and check for continuity between the wire terminals.

Color	Red	Black/White	Green	Black
Symbol	BAT1	IG	E	BAT2
LOCK		○ — ○	○	
OFF		○	○	
ON	○			○



### IGNITION SWITCH REPLACEMENT

Remove the front cover. (⇒ 12)  
 Disconnect the ignition switch wire couplers.  
 Remove the two mounting bolts and remove the ignition switch.  
 The installation sequence is the reverse of removal.

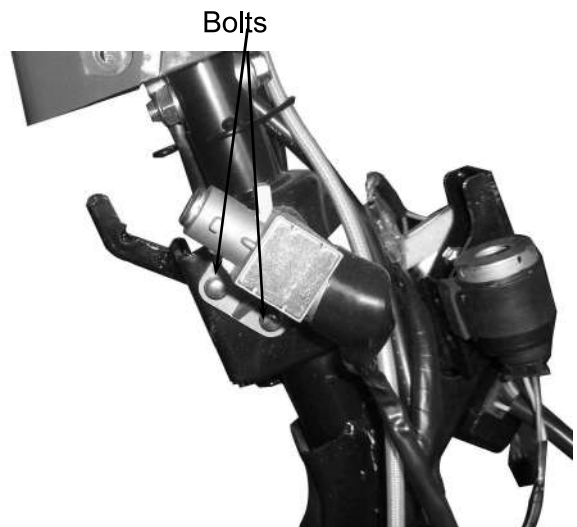



### DIMMER SWITCH INSPECTION

Check for continuity between wire terminals.

Color	W/L	L	We	Y
Symbol	HL	HI	LO	BAT
HI	○	○		
LO	○		○	
PASSING		○		○

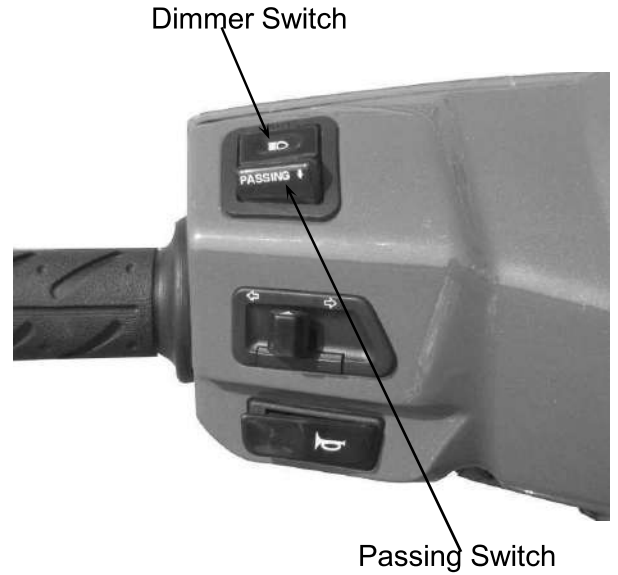

### TURN SIGNAL SWITCH INSPECTION

Check for continuity between the wire terminals.

Color	SB	O	GR
Symbol	R	L	WR
R	○		○
L		○	○

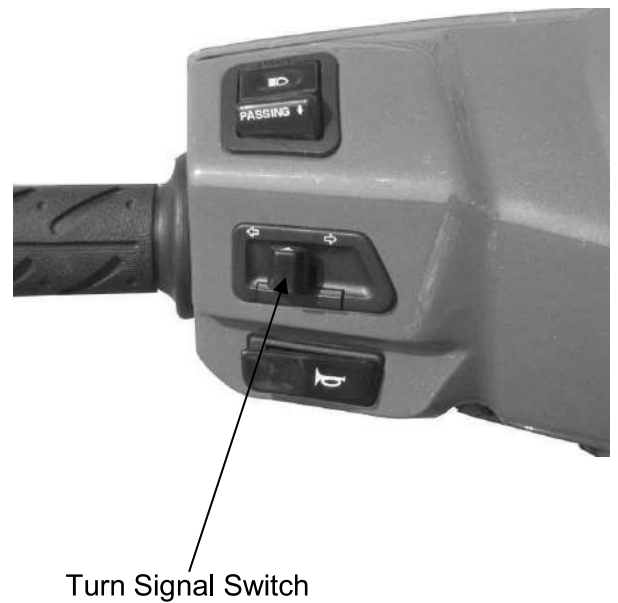

### STARTER SWITCH INSPECTION

Check for continuity between wire terminals.  
Push the starter button when measuring.

Color	Y/R	G
Symbol	ST	E
FREE		
PUSH	○ ———	○ ———



Starter Switch

### HORN SWITCH INSPECTION

Check for continuity between wire terminals.  
Push the horn button when measuring.

Color	Light Green	Brown / Blue
Symbol	HO	BAT
FREE		
PUSH	○ ———	○ ———



Horn Switch

Stop Switch Wire

### STOP SWITCH INSPECTION

Remove the handlebar front cover. (⇒ 12)  
Disconnect the front and rear stop switch wire couplers.  
Check for continuity between the wire terminals when the front/rear brake lever is applied.



## HORN INSPECTION

Remove the frame front cover. (⇒12)  
Disconnect the horn wire couplers. The horn is normal if it sounds when a 12V battery is connected across the horn wire terminals.



## FRONT TURN SIGNAL LIGHT REPLACEMENT

Remove three screws attaching the turn signal light set and remove the light set.

\* Replace with new set of the same specifications.

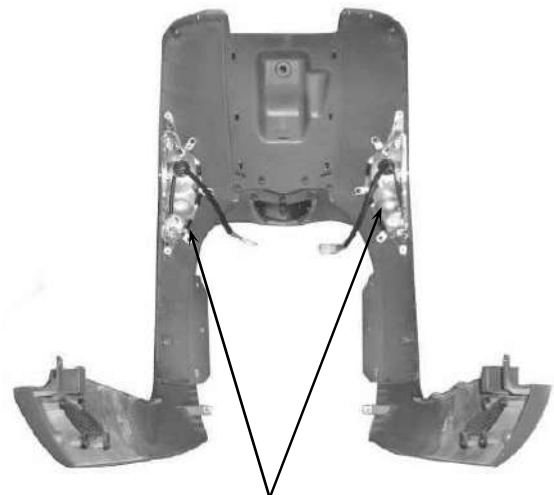

Turn Signal Light Set

## TAILLIGHT/STOPLIGHT/REAR TURN SIGNAL LIGHT BULB REPLACEMENT

Taillight Base Removal:  
Remove the rear protective cover.  
Remove the seat.  
Remove the body cover.  
Remove the taillight base.  
The installation sequence is the reverse of remove.



Taillight Base

## INSTRUMENTS

### BULB REPLACEMENT

Remove the handlebar rear cover. (⇒12)  
 Remove the bulb socket and replace the bulb.  
 The installation sequence is the reverse of removal.

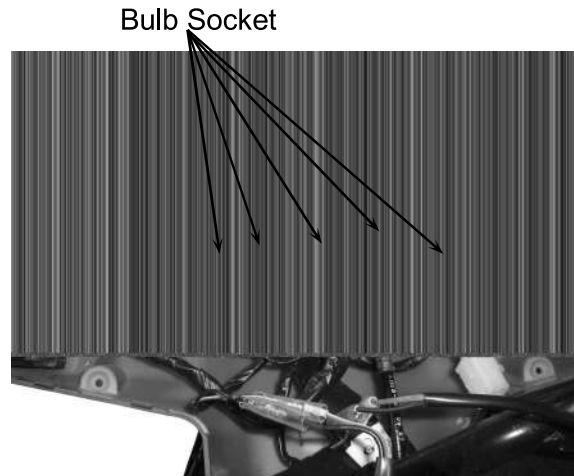

### INSTRUMENTS REPLACEMENT

Remove the handlebar rear cover. (⇒12)  
 Disconnect the right and left handlebar switches wire couplers.  
 Disconnect the speedometer cable.  
 Remove the instrument bulb sockets  
 Disconnect the two fuel gauge wires.  
 Remove the instrument wire clamp screw.  
 Remove the three screws attaching the instruments to the handlebar rear cover.  
 Remove the instruments.

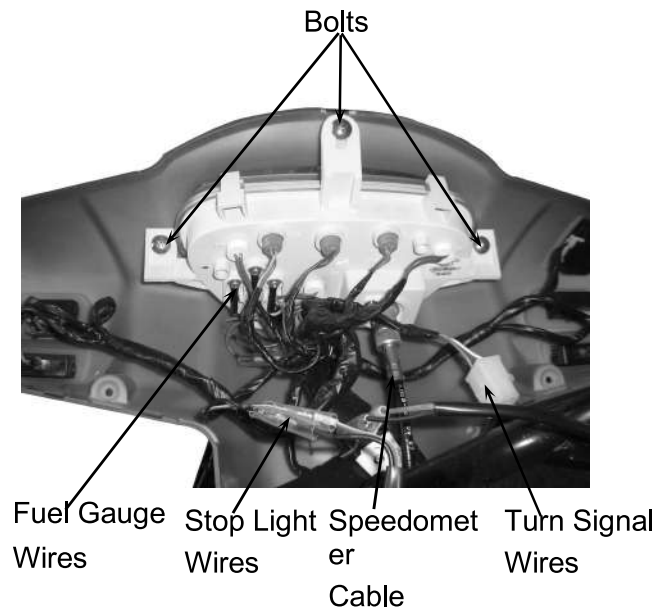

## HEADLIGHT

### REMOVAL/BULB REPLACEMENT

Remove the handlebar rear cover. (⇒12)  
 Remove the bulb sockets and bulbs.

- \* 
 • The model adopts krypton gas bulb. When installing, do not directly touch the bulb glass with fingers.  
 • Use bulbs of the same specifications for replacement.

The installation sequence is the reverse of removal.

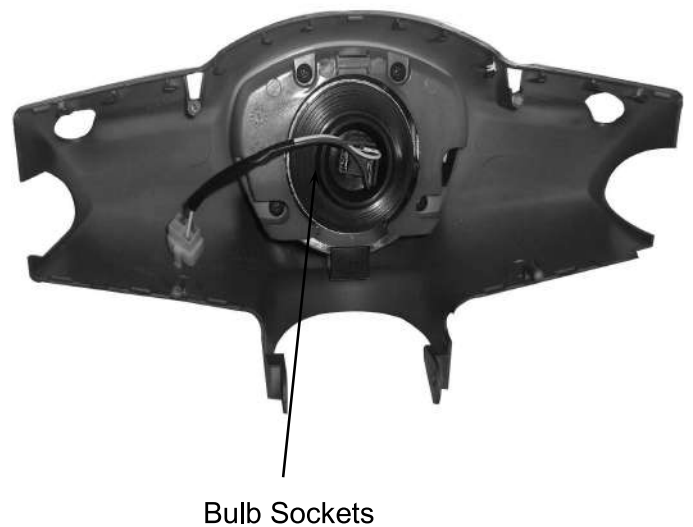

## EXHAUST EMISSION CONTROL SYSTEM

SCHEMATIC DRAWING.....	17-1
EXHAUST EMISSION CONTROL SYSTEM .....	17-1
TROUBLESHOOTING.....	17-2
SERVICE INFORMATION.....	17-2
SECONDARY AIR CLEANER.....	17-3
AIR INJECTION CUT-OFF VALVE (A.I.C.V.).....	17-3
REED VALVE.....	17-4

# 17. EXHAUST EMISSION CONTROL SYSTEM

LIKE 50/125

## SCHEMATIC DRAWING

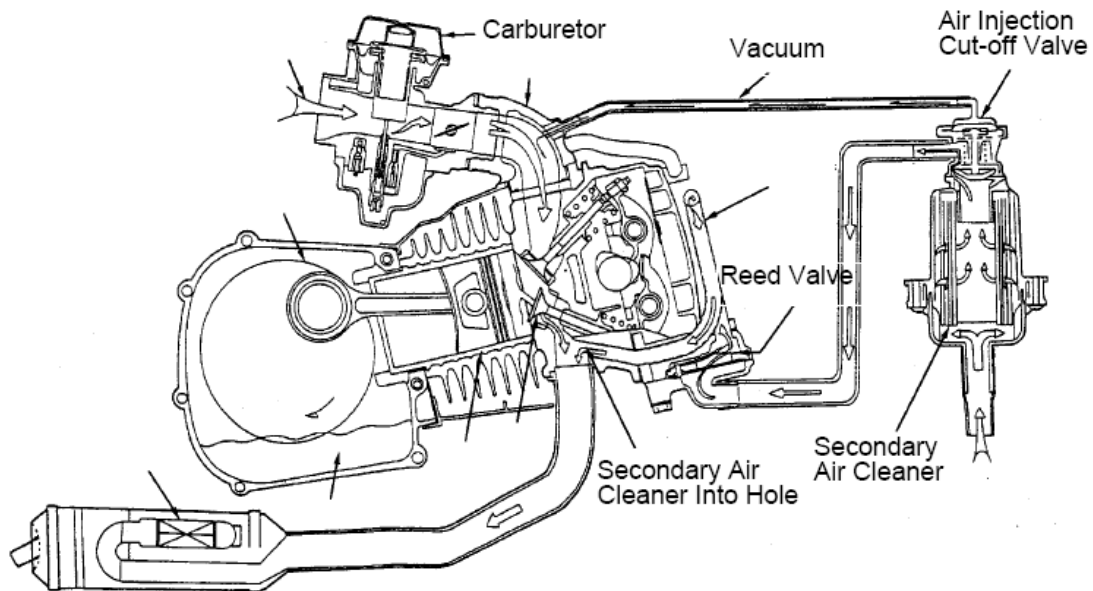

## EXHAUST EMISSION CONTROL SYSTEM

The exhaust emission control system adopted in this model utilizes the reed valve to draw secondary air into the exhaust system for re-combustion by means of exhaust pulsation so as to minimize the exhaust emission.

## FUNCTION

Item	Purpose	Function
Secondary Air Cleaner	Filter secondary air.	It filters the fresh air drawn for re-burning to prevent dirt or dust from affecting the operation of the air injection cut-off valve.
Air Injection Cut-off Valve	Prevent exhaust muffler noise and backfiring at sudden deceleration.	The air injection cut-off valve usually opens to lead air into the exhaust muffler in which air is re-burned to reduce CO. When the throttle valve closes suddenly, the air injection cut-off valve is actuated by vacuum to close and cut off secondary air in order to prevent exhaust muffler backfiring due to air in the exhaust system.
Reed Valve	Control the secondary air inlet to reduce CO.	When the motorcycle speed is less than 50km per hour, the reed valve operates to draw secondary air into the exhaust system for re-combustion.

# 17. EXHAUST EMISSION CONTROL SYSTEM

LIKE 50/125

---

## TROUBLESHOOTING

### High CO at idle speed

1. Damaged or clogged reed valve
2. Damaged or clogged air injection cut-off valve
3. Clogged air cleaner

### Backfiring at sudden deceleration

1. Damaged reed valve (malfunction)
2. Faulty air injection cut-off valve (unable to close)
3. Carburetor incorrectly adjusted
4. Faulty air cut-off valve
5. Leaking vacuum tube

### Exhaust muffler noise

1. Faulty air injection cut-off valve
2. Broken vacuum tube
3. Faulty reed valve

## SERVICE INFORMATION

### GENERAL INSTRUCTIONS

- During operation, be careful to avoid scalding caused by the exhaust muffler.
- Note the locations of tubes for proper installation.
- Replace any damaged tube with a new one.
- Make sure to tighten the connector of each tube securely

### TOOLS

- Vacuum pump

### SPECIFICATIONS

Air injection cut-off valve actuating pressure —  
250mm/Hg — 30 liter/min.  
Reed valve stopper clearance — 4.6mm

# 17. EXHAUST EMISSION CONTROL SYSTEM

LIKE 50/125

## SECONDARY AIR CLEANER / AIR INJECTION CONTROL VALVE (A.I.C.V.)

### REMOVAL

Remove the seat. (⇒ 12)  
Remove the body cover.  
Disconnect the secondary air cleaner / (A.I.C.V) connecting tube.

### INSPECTION

Remove two screws on the air cleaner/air injection control valve.  
Replace new one when the filter elements obstruct considerable dirt.

### INSTALLATION

The installation sequence is the reverse of removal.

\*

- The secondary air cleaner must be assembled and installed properly to avoid dust entering the air cleaner.
- When installing, be careful not to bend or twist the tubes and check for proper installation.
- The tube length is very important to its performance, use the tube of same specification for replacement.

Secondary Air Cleaner / A.I.C.V.

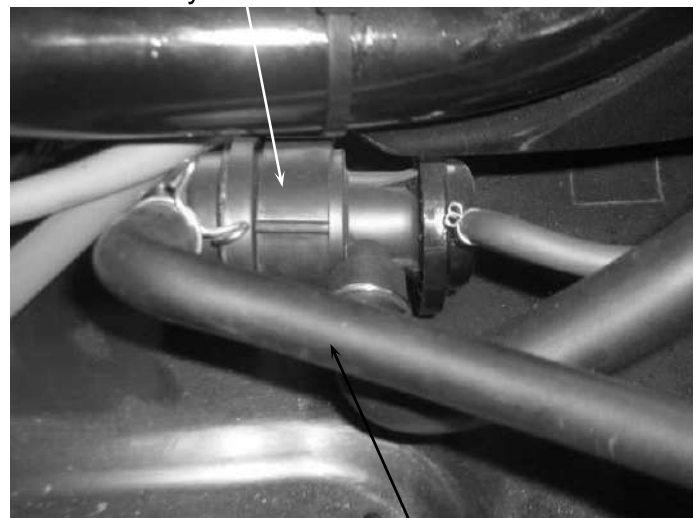

Air Inlet Tube Bolt

Air Outlet Tube



Air Inlet Tube

Vacuum Tube





# 17. EXHAUST EMISSION CONTROL SYSTEM

LIKE 50/125

## REED VALVE

### REMOVAL

Disconnect the secondary air inlet tube connector.  
Remove the reed valve cover three bolts.

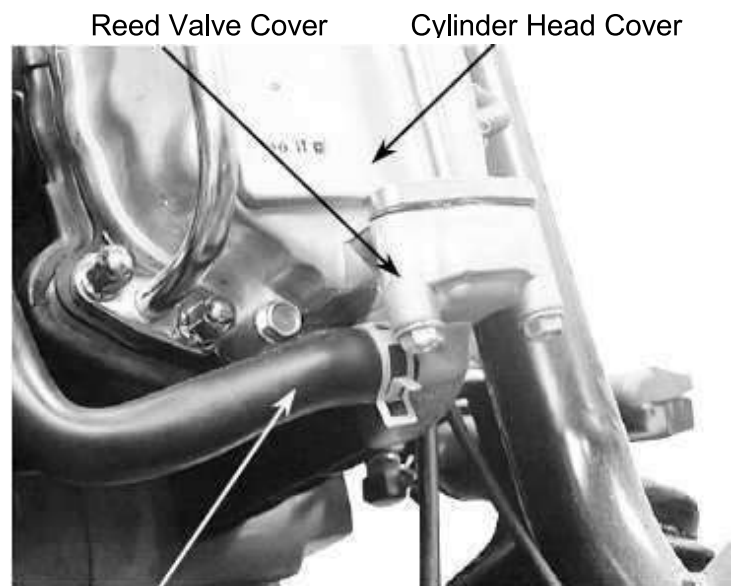

Secondary Air Inlet Tube

Remove the three bolts attaching the reed valve cover and the reed valve.



Reed Valve

### INSPECTION

Check the reed valve for cracks, damage, big clearance or weak reeds. Replace if necessary.  
Check the gasket and O-ring for damage or deterioration and replace if necessary.  
Reed valve stopper clearance: 4.6mm

### INSTALLATION

Install the reed valve in the reverse order of removal.

\*

- When installing, be careful not to bend or twist the tubes and check for proper installation.



Reed Stopper