**By KWANG YANG Motor Co., Ltd.
First Edition, Apr 2005
All rights reserved. Any reproduction or
unauthorized use without the written permission of
KWANG YANG Motor Co., Ltd.
is expressly prohibited.
4121-LCA5/LDE9-S00**

PREFACE

This Service Manual describes the technical features and servicing procedures for the KYMCO *MXU 300/250*.

Section 1 contains the precautions for all operations stated in this manual. Read them carefully before starting any operation.

Section 2 is the removal/installation procedures for the frame covers which are subject to higher removal/installation frequency during maintenance and servicing operations.

Section 3 describes the inspection/adjustment procedures, safety rules and service information for each part, starting from periodic maintenance.

Sections 4 through 19 give instructions for disassembly, assembly and inspection of engine, chassis frame and electrical equipment.

Most sections start with an assembly or system illustration and troubleshooting for the section. The subsequent pages give detailed procedures for the section.

The information and contents included in this manual may be different from the vehicle in case specifications are changed.
--

TABLE OF CONTENTS

GENERAL INFORMATION		1
FRAME COVERS/EXHAUST MUFFLER		2
INSPECTION/ADJUSTMENT		3
LUBRICATION SYSTEM		4
FUEL SYSTEM		5
ENGINE	ENGINE REMOVAL	6
	CYLINDER HEAD/VALVES	7
	CYLINDER/PISTON	8
	DRIVE AND DRIVEN PULLEYS	9
	FINAL REDUCTION/TRANSMISSION SYSTEM	10
	CRANKCASE/CRANKSHAFT/BALANCE SHAFT	11
COOLING SYSTEM		12
BRAKE SYSTEM		13
CHASSIS	FRONT WHEEL/FRONT SUSPENSION/STEERING SYSTEM	14
	REAR WHEEL/AXLE/SUSPENSION/DRIVING MECHANISM	15
ELECTRICAL EQUIPMENT	BATTERY/CHARGING SYSTEM/A.C. GENERATOR	16
	IGNITION SYSTEM	17
	STARTING SYSTEM	18
	LIGHTS/SWITCHES	19

KWANG YANG MOTOR CO., LTD.
OVERSEAS SALES DEPARTMENT
OVERSEAS SERVICE SECTION

GENERAL INFORMATION

SERIAL NUMBER----- 1- 1
SPECIFICATIONS ----- 1- 2
SERVICE PRECAUTIONS ----- 1- 4
TORQUE VALUES ----- 1-12
SPECIAL TOOLS ----- 1-14
LUBRICATION POINTS ----- 1-15
CABLE & HARNESS ROUTING ----- 1-18
WIRING DIAGRAM (OFF ROAD) ----- 1-22
TROUBLESHOOTING----- 1-26

1. GENERAL INFORMATION

SERIAL NUMBER

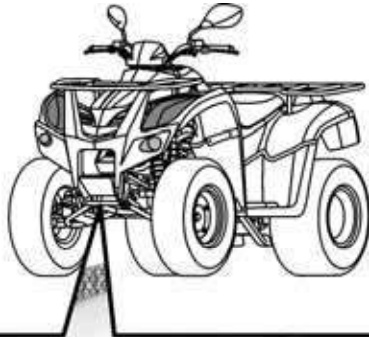

(1) Location of Frame Serial Number

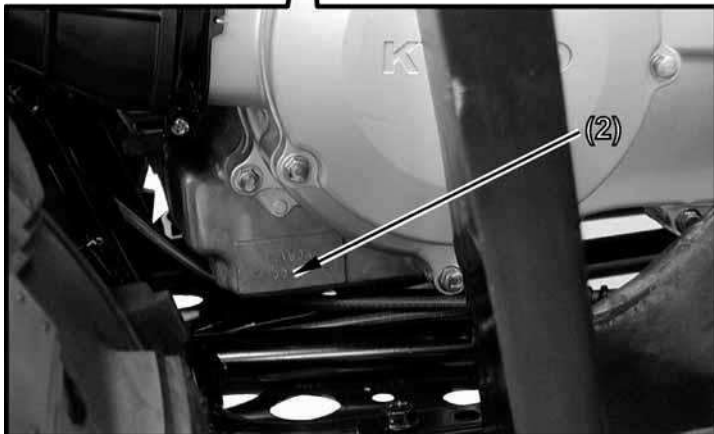
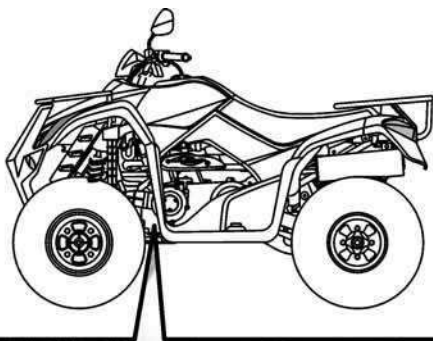

(2) Location of Engine Serial Number

1. GENERAL INFORMATION

SPECIFICATIONS (MXU 250)

Model No.		LB50		
Name & Type		MXU 250		
Overall length		1810 mm (72.4 in)		
Overall width		1050 mm (42 in)		
Overall height		1110 mm (44.4 in)		
Wheel base		1170 mm (46.8 in)		
Engine type		O.H.C.		
Displacement		249 cm ³ (15.2 cu-in)		
Fuel Used		92# nonleaded gasoline		
Dry weight	Front wheel	112 kg (246 lbs)		
	Rear wheel	102 kg (224 lbs)		
	Total	214 kg (471 lbs)		
Curb weight	Front wheel	116 kg (255 lbs)		
	Rear wheel	110 kg (242 lbs)		
	Total	226 kg (497 lbs)		
Tires	Front wheel	22*7-10		
	Rear wheel	22*10-10		
Ground clearance		125 mm (5 in)		
Min. turning radius		2900 mm (116 in)		
Engine	Starting system		Electric/Recoil starter	
	Type		Gasoline, 4-stroke	
	Cylinder arrangement		Single cylinder	
	Combustion chamber type		Semi-sphere	
	Valve arrangement		O.H.C., chain drive	
	Bore x stroke		72.7 x 60 mm (2.9 x 2.4 in)	
	Compression ratio		10.3:1	
	Compression pressure		15 kgf/cm ² (1500kPa, 213 psi)	
	Intake valve (at 1 mm lift)	Open	8.1° BTDC	
		Close	41° ABDC	
	Exhaust valve (at 1 mm lift)	Open	37° BBDC	
		Close	7.9° ATDC	
	Valve clearance (cold)	Intake	0.1 mm (0.004 in)	
		Exhaust	0.1 mm (0.004 in)	
	Idle speed (rpm)		1500rpm	
	Lubrication System	Lubrication type		Forced pressure & Wet sump
		Oil pump type		Trochoid
		Oil filter type		Full-flow filtration
		Oil capacity		1.6 L (1.4 Imp qt, 1.7 Us qt)
		Oil exchanging capacity		1.4 L (1.23 Imp qt, 1.48 Us qt)
Cooling Type		Liquid cooled		
Fuel System	Air cleaner type & No		Wet type element	
	Fuel capacity		12.5 L (2.63 Imp gal, 3.25 US gal)	
	Carburetor	Type	PTG	
		Main jet NO.	98	
Venturi dia.		φ22 mm (φ0.88 in)		
Throttle type		PISTON		
Electrical Equipment	Ignition System	Type	Full transistor digital ignition	
		Ignition timing	5°BTDC/1000rpm	
		Spark plug	DPR7EA-9	
		Spark plug gap	0.6~0.7mm (0.002 ~0.003 in)	
Battery	Capacity	12V12AH		
Drive Train	Clutch type		Dry, centrifugal automatic	
	Clutch operation system		Automatic (V-belt)	
	Primary reduction system		Helical gear/spur gear	
	Secondary reduction system		Chain drive	
	Primary reduction ratio		26.5	
	Secondary reduction ratio		10.02	
Reverse ratio		50.9		
Moving Device	FR/RR tire rolling circumference		1759/1759 mm (71.8/71.8 in)	
	Tire pressure	Front	0.28 kg/cm ² (28 Kpa, 3.2 psi)	
		Rear		
Turning angle	Left	40°		
	Right	40°		
Brake system type	Front	Disk brake		
	Rear	Disk brake		
Suspension type	Front	Double wishbone		
	Rear	Link suspension		
Frame type		Double cradle		

1. GENERAL INFORMATION

SPECIFICATIONS (MXU 300)

Model No.		LA60		
Name & Type		MXU 300		
Overall length		1810 mm (72.4 in)		
Overall width		1030 mm (41.2 in)		
Overall height		1100 mm (44 in)		
Wheel base		1170 mm (46.8 in)		
Engine type		O.H.C.		
Displacement		270 cm ³ (16.2 cu-in)		
Fuel used		92# nonleaded gasoline		
Dry weight	Front wheel	110 kg (242 lbs)		
	Rear wheel	110 kg (242 lbs)		
	Total	220 kg (484 lbs)		
Curb weight	Front wheel	115 kg (253 lbs)		
	Rear wheel	110 kg (242 lbs)		
	Total	225 kg (495 lbs)		
Tires	Front wheel	22*7-10		
	Rear wheel	22*10-10		
Ground clearance		250 mm (10 in)		
Min. turning radius		2900 mm (116 in)		
Engine	Starting system		Electric/Recoil starter	
	Type		Gasoline, 4-stroke	
	Cylinder arrangement		Single cylinder	
	Combustion chamber type		Semi-sphere	
	Valve arrangement		O.H.C., chain drive	
	Bore x stroke		72.7 x 65.2 mm (2.9 x 2.608 in)	
	Compression ratio		10.3:1	
	Compression pressure		16 kgf/cm ² (1600kPa, 227 psi)	
	Intake valve (at 1mm lift)	Opens	5° BTDC	
		Closes	41° ABDC	
	Exhaust valve (at 1mm lift)	Opens	37° BBDC	
		Closes	5° ATDC	
	Valve clearance (cold)	Intake	0.1 mm (0.004 in)	
		Exhaust	0.1 mm (0.004 in)	
	Idle speed (rpm)		1600 rpm	
	Lubrication System	Lubrication type		Forced pressure & Wet sump
		Oil pump type		Trochoid
		Oil filter type		Full-flow filtration
		Oil capacity		1.6 L (1.4 Imp qt, 1.7 Us qt)
		Oil exchanging capacity		1.4 L (1.23 Imp qt, 1.48 Us qt)
Cooling Type		Liquid cooled		

Fuel System	Air cleaner type & No		Wet type element	
	Fuel capacity		12.5 L (2.63 Imp gal, 3.25 US gal)	
	Carburetor	Type		PTG
		Main jet NO.		98
Venturi dia.		φ22 mm (φ0.88 in)		
Throttle type		PISTON		
Electrical Equipment	Ignition System	Type		Full transistor digital ignition
		Ignition timing		5° BTDC/1500 rpm
		Spark plug		DPR7EA-9
		Spark plug gap		0.6~0.7mm (0.002 ~0.003 in)
Battery		Capacity	12V12AH	
Drive Train	Clutch type		Dry, centrifugal automatic	
	Clutch operation system		Automatic (V-belt)	
	Primary reduction system		Helical gear/spur gear/bevel gear	
	Secondary reduction system		Driven mechanism	
	High reduction ratio		2.01	
	Low reduction ratio		3.84	
Moving Device	Reverse ratio		3.23	
	FR/RR tire rolling circumference		1756/1756 mm (70.24/70.24 in)	
	Tire pressure	Front	0.28 kg/cm ² (28 Kpa, 3.2 psi)	
		Rear		
	Turning angle	Left	40°	
		Right	40°	
Brake system type		Front	Disk brake	
		Rear	Disk brake	
Suspension type		Front	Double wishbone	
		Rear	Link suspension	
Frame type		Double cradle		

1. GENERAL INFORMATION

SERVICE PRECAUTIONS

- Make sure to install new gaskets, O-rings, circlips, cotter pins, etc. when reassembling.

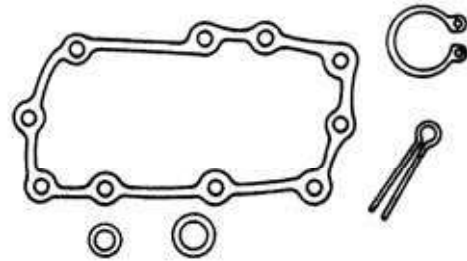

- When tightening bolts or nuts, begin with larger-diameter to smaller ones at several times, and tighten to the specified torque diagonally.

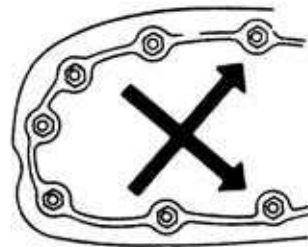

- Use genuine parts and lubricants.

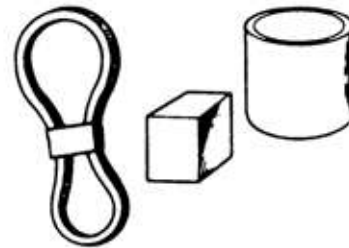

- When servicing the motorcycle, be sure to use special tools for removal and installation.



- After disassembly, clean removed parts. Lubricate sliding surfaces with engine oil before reassembly.

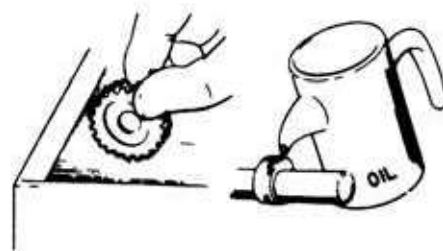

1. GENERAL INFORMATION

- Apply or add designated greases and lubricants to the specified lubrication points.

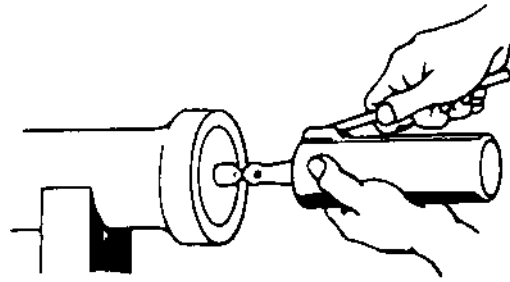

- After reassembly, check all parts for proper tightening and operation.

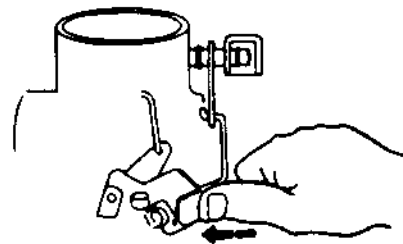

- When two persons work together, pay attention to the mutual working safety.

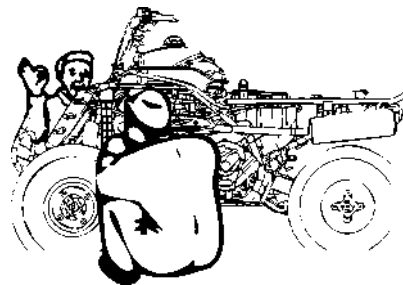

- Disconnect the battery negative (-) terminal before operation.
- When using a spanner or other tools, make sure not to damage the motorcycle surface.

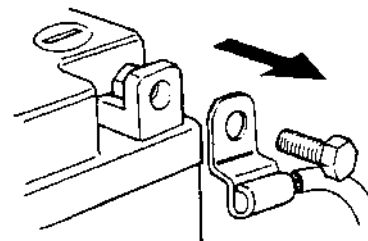

- After operation, check all connecting points, fasteners, and lines for proper connection and installation.
- When connecting the battery, the positive (+) terminal must be connected first.
- After connection, apply grease to the battery terminals.
- Terminal caps shall be installed securely.

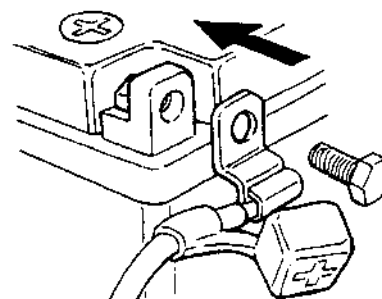

1. GENERAL INFORMATION

- If the fuse is burned out, find the cause and repair it. Replace it with a new one according to the specified capacity.

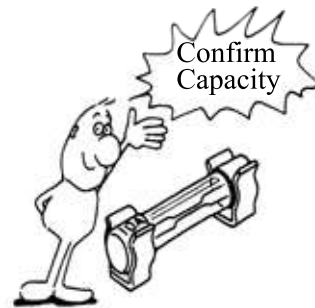

- After operation, terminal caps shall be installed securely.



- When taking out the connector, the lock on the connector shall be released before operation.

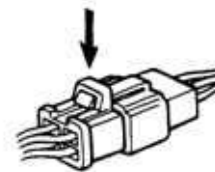

- Hold the connector body when connecting or disconnecting it.
- Do not pull the connector wire.

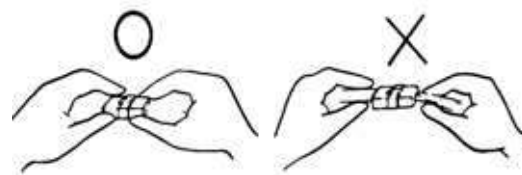

- Check if any connector terminal is bending, protruding or loose.

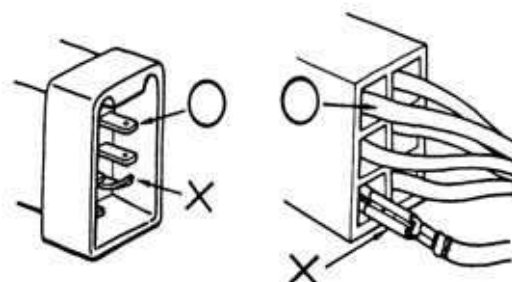

1. GENERAL INFORMATION

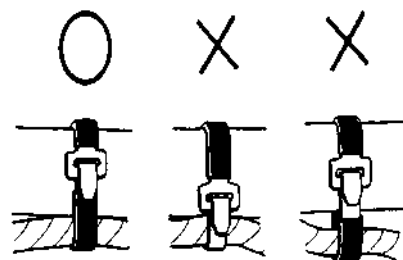
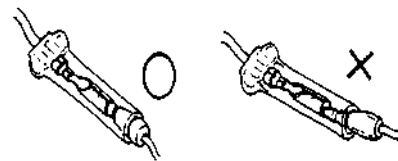
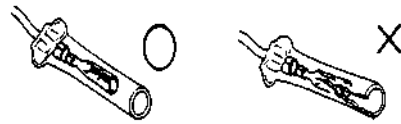
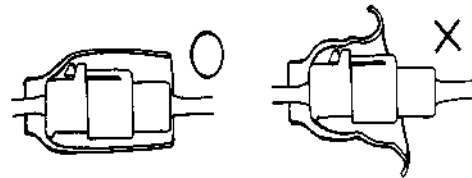
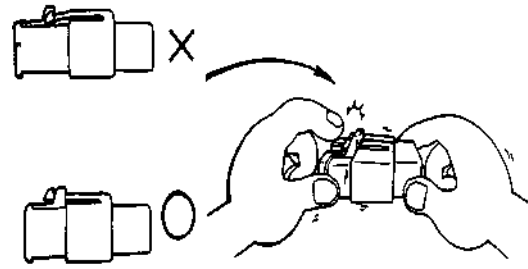

1. GENERAL INFORMATION

- After clamping, check each wire to make sure it is secure.

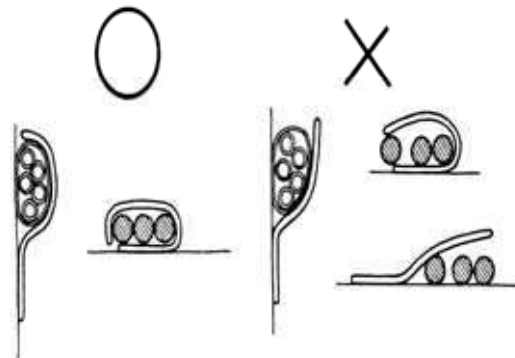

- Do not squeeze wires against the weld or its clamp.



- After clamping, check each harness to make sure that it is not interfering with any moving or sliding parts.

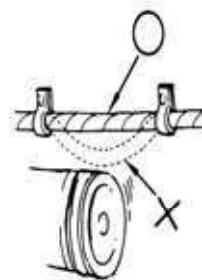

- When fixing the wire harnesses, do not make it contact the parts which will generate high heat.

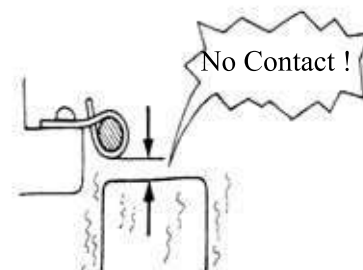

- Route wire harnesses to avoid sharp edges or corners. Avoid the projected ends of bolts and screws.
- Route wire harnesses passing through the side of bolts and screws. Avoid the projected ends of bolts and screws.

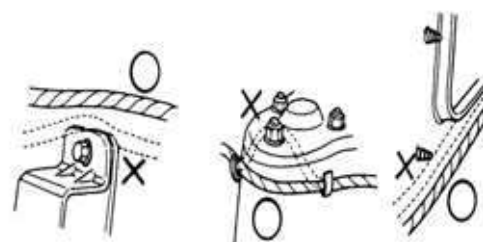

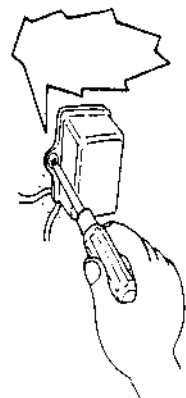
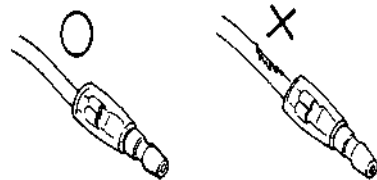
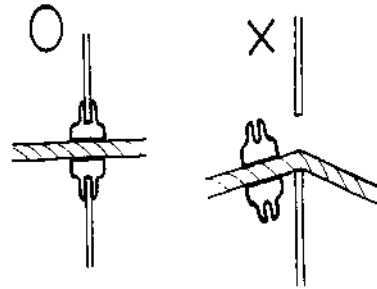
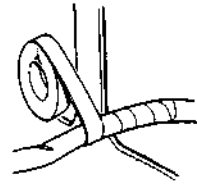
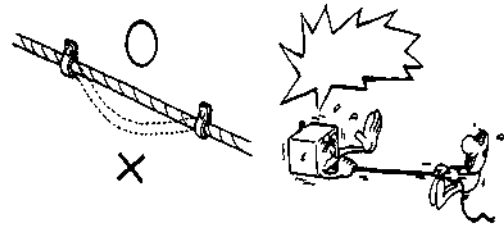

1. GENERAL INFORMATION

- After routing, check that the wire harnesses are not twisted or kinked.

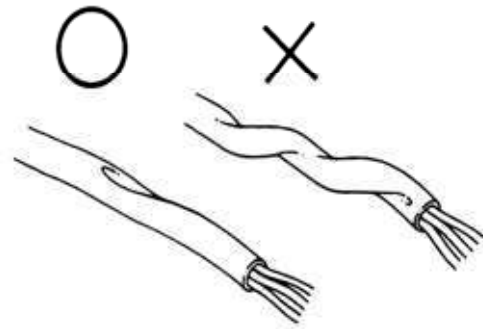

- Wire harnesses routed along with handlebar should not be pulled tight, have excessive slack or interfere with adjacent or surrounding parts in all steering positions.

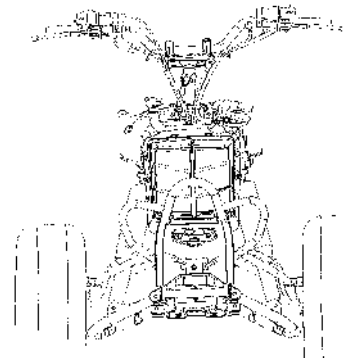

- When a testing device is used, make sure to understand the operating methods thoroughly and operate according to the operating instructions.

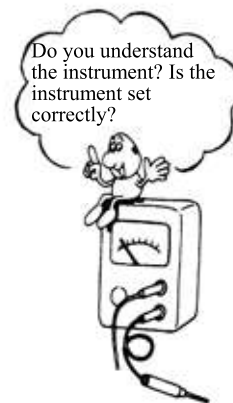

- Be careful not to drop any parts.



- When rust is found on a terminal, remove the rust with sand paper or equivalent before connecting.



1. GENERAL INFORMATION

■ Symbols:

The following symbols represent the servicing methods and cautions included in this service manual.



: Apply engine oil to the specified points. (Use designated engine oil for lubrication.)



: Apply grease for lubrication.



: Transmission Gear Oil (90#)



: Caution



: Warning

1. GENERAL INFORMATION

TORQUE VALUES

STANDARD TORQUE VALUES

Item	Torque kgf-m (N-m, lbf-ft)	Item	Torque kgf-m (N-m, lbf-ft)
5mm bolt and nut	0.5 (5, 3.6)	4mm screw	0.3 (3, 2.2)
6mm bolt and nut	1 (10, 7.2)	5mm screw	0.4 (4, 2.9)
8mm bolt and nut	2.2 (22, 16)	6mm screw, SH bolt	0.9 (9, 6.5)
10mm bolt and nut	3.5 (35, 25)	6mm flange bolt and nut	1.2 (12, 9)
12mm bolt and nut	5.5 (55, 40)	8mm flange bolt and nut	2.7 (27, 20)
14mm bolt and nut	7 (70, 50)	10mm flange bolt and nut	4 (40, 29)

Torque specifications listed below are for important fasteners.

ENGINE

Item	Q'ty	Thread dia. (mm)	Torque kgf-m (N-m, lbf-ft)	Remarks
Stud bolt	4	8	0.9 (9, 6.5)	
Oil filter screen cap	1	30	1.5 (15, 11)	
Seat ball stopper bolt	1	14	4.8 (48, 35)	
L cover bolt	10	6	1.2 (12, 8.6)	
Cam shaft holder nut	4	8	2.5 (25, 18)	Apply oil
Tappet ADJ nut	2	5	0.9 (9, 6.5)	Apply oil
Pivot tensioner bolt	1	8	1 (10, 7.2)	
Lifter tensioner bolt	2	6	1.2 (12, 8.6)	
Lifter tensioner cap	1	6	0.4 (4, 2.9)	
Mission case bolt	9	8	2.7 (27, 20)	
Mission fill and drain bolt	2	12	2 (20, 15)	
Driver face nut	1	14	9.5 (95, 68)	Apply oil
Clutch outer nut	1	12	5.5 (55, 40)	
Drive plate nut	1	28	5.5 (55, 40)	
ACG flywheel nut	1	14	6 (60, 43)	
Spark plug	1	12	1.8 (18, 13)	
Water pump impeller	1	7	1.2 (12, 8.6)	Left thread
Oil drain plug	1	12	2.5 (25, 18)	
Oil pump screw	1	3	0.2 (2, 1.5)	
Head CYL stud bolt (IN pipe)	2	6	0.9 (9, 6.5)	
Head CYL stud bolt (EX pipe)	2	8	0.9 (9, 6.5)	
A.C.G Startor	3	5	0.9 (9, 6.5)	
Drive bevel gear nut (MXU 300)	1	18	10 (100, 72)	
Driven bevel gear nut (MXU 300)	1	16	10 (100, 72)	

1. GENERAL INFORMATION

FRAME

Item	Q'ty	Thread dia. (mm)	Torque Kgf-m (N-m, lbf-ft)	Remarks
Steering stem nut	1	14	7 (70, 50)	
Front swing arm nut	8	10	4.5 (45, 32)	
Knuckle ball joint nut	4	12	3 (30, 22)	Castle nut
Tie-rod ball joint nut	4	10	2 (20, 15)	Castle nut
Front wheel nut	8	12	4.5 (45, 32)	
Rear wheel nut	8	12	4.5 (45, 32)	
Front wheel hub nut	2	14	7 (70, 50)	Castle nut
Rear wheel hub nut	2	16	10 (100, 72)	Castle nut
Front shock absorber upper mount bolt	2	10	4 (40, 29)	
Front shock absorber lower mount bolt	2	10	4 (40, 29)	
Rear shock absorber upper mount bolt	1	10	4 (40, 29)	
Rear shock absorber lower mount bolt	1	10	4 (40, 29)	
Right pivot bolt (MXU 300)	1	30	11.8 (118, 85)	
Left pivot bolt (MXU 300)	1	30	1.1 (11, 8)	
Left pivot lock nut (MXU 300)	1	30	11.8 (118, 85)	
Final gear case mounting bolt	8	10	5.5 (55, 40)	
Axle hub holding bolt (MXU 250)	1	10	4 (40, 29)	
Caliper holder bolt (MXU 250)	1	6	1 (10, 7.2)	
Rear wheel shaft nut (MXU 250)	2	40	12 (120, 86)	
Rear swingarm pivot bolt (MXU 250)	1	14	7 (70, 50)	
Rear engine upper mounting bolt	1	10	4 (40, 29)	
Rear engine lower mounting bolt	1	10	4 (40, 29)	
Front engine mounting bolt	1	10	4 (40, 29)	
Exhaust muffler lock bolt (frame)	2	8	3.5 (35, 25)	
Exhaust muffler lock nut (engine)	2	8	3.5 (35, 25)	
Brake caliper mounting bolt	8	8	3.2 (32, 24)	
Brake hose oil bolt	10	10	3.5 (35, 25)	
Master cylinder holder bolt	4	6	1.2 (12, 8.6)	

1. GENERAL INFORMATION

SPECIAL TOOLS

Tool Name	Tool No.	Remarks
Flywheel puller	E003	Flywheel removal
Valve adjuster	E012	Valve clearance adjustment
Valve spring compressor	E040	Cylinder head disassembly
Oil seal and bearing install	E014	
Universal holder	E017	Drive face/Clutch outer removal/installation
Flywheel holder	E021	Flywheel removal
Clutch spring compressor	E034	Driven pulley disassembly
Bearing puller	E037	
Nut wrench (MXU 300)	F013	Left pivot lock nut removal/installation
Pinion puller set (MXU 300)	F014	Pinion/Bearing removal
Lock nut wrench (MXU 300)	F015	Pinion bearing nut removal
Nut wrench (MXU 250)	F010	Rear axle nut removal/installation
Ball joint remover	F012	Knuckle removal

LUBRICATION POINTS

ENGINE

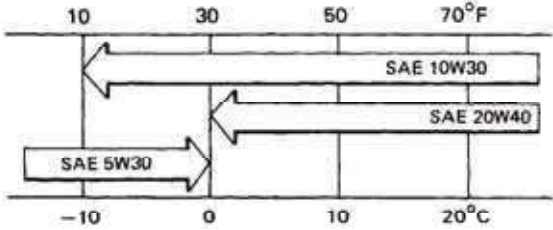
Lubrication Points	Lubricant
Valve guide/valve stem movable part Cam lobes Valve rocker arm friction surface Cam chain Cylinder lock bolt and nut Piston surroundings and piston ring grooves Piston pin surroundings Cylinder inside wall Connecting rod/piston pin hole Connecting rod big end Crankshaft right side oil seal Crankshaft one-way clutch movable part Oil pump drive chain Balance gear A.C. generator Starter one-way clutch Bearing movable part O-ring face Oil seal lip	<ul style="list-style-type: none"> •Genuine KYMCO Engine Oil (SAE10W-30) •API SG Engine Oil 
Transmission gear and rear driving mechanism	Gear oil: SAE90#

1. GENERAL INFORMATION

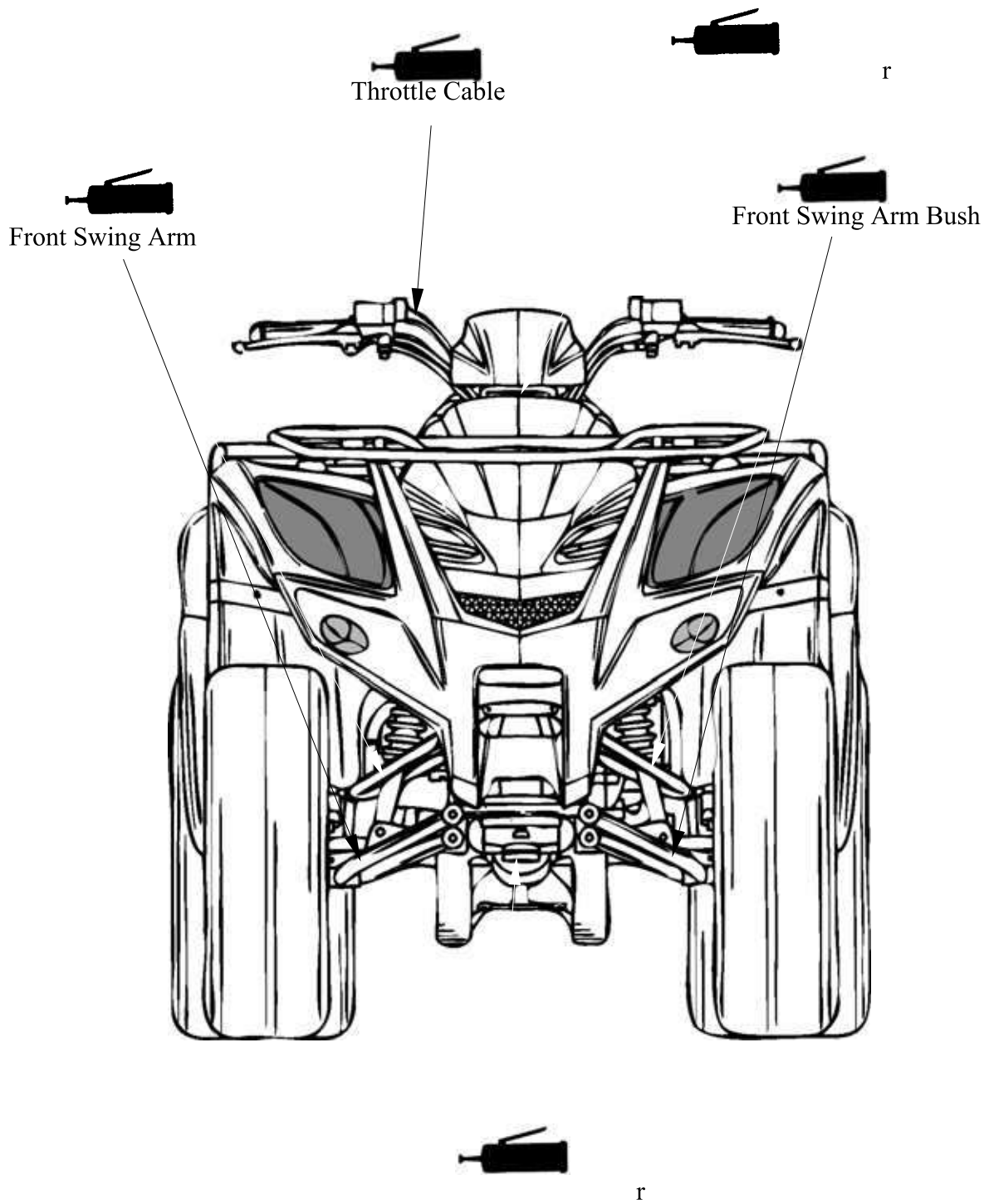

1. GENERAL INFORMATION

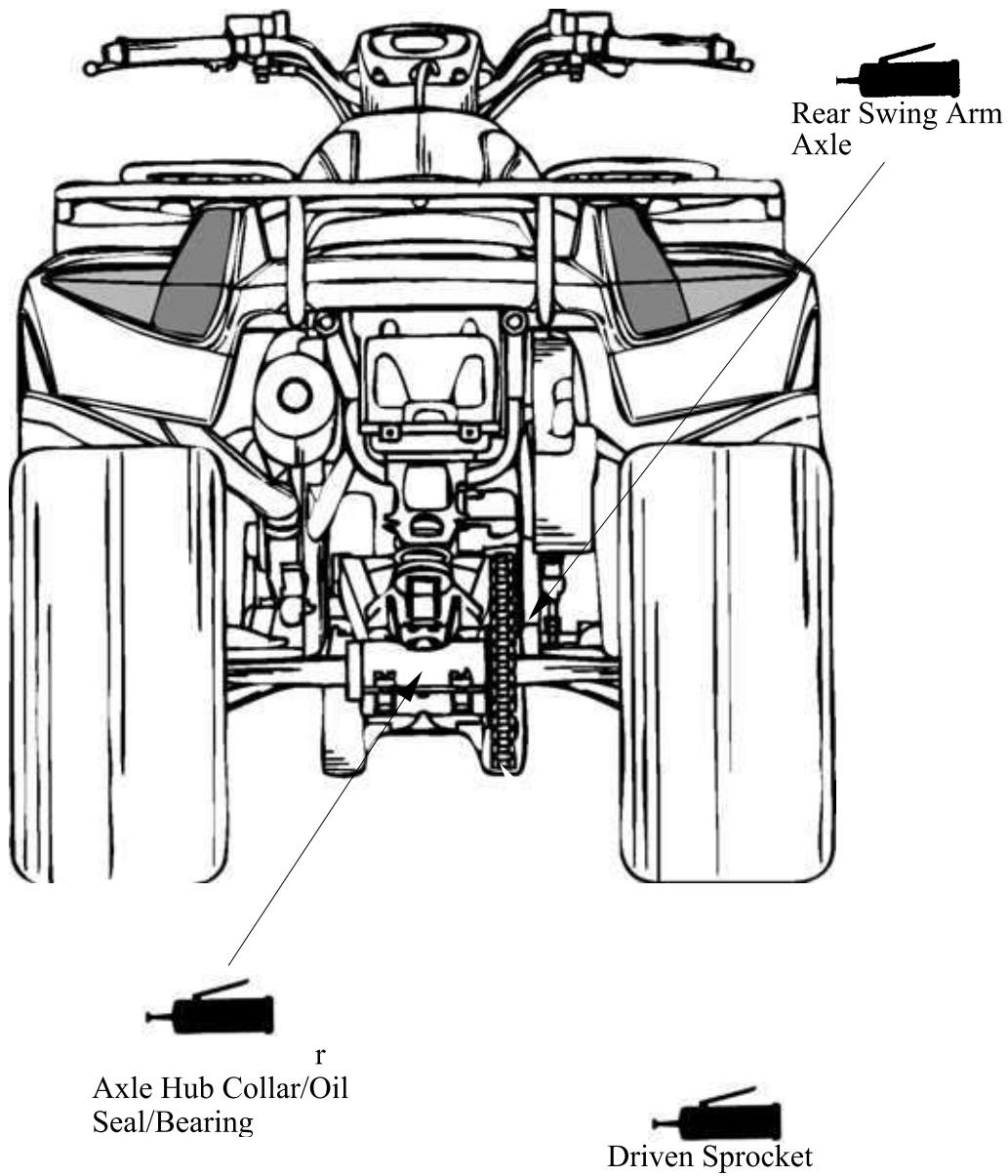

1. GENERAL INFORMATION

CABLE & HARNESS ROUTING

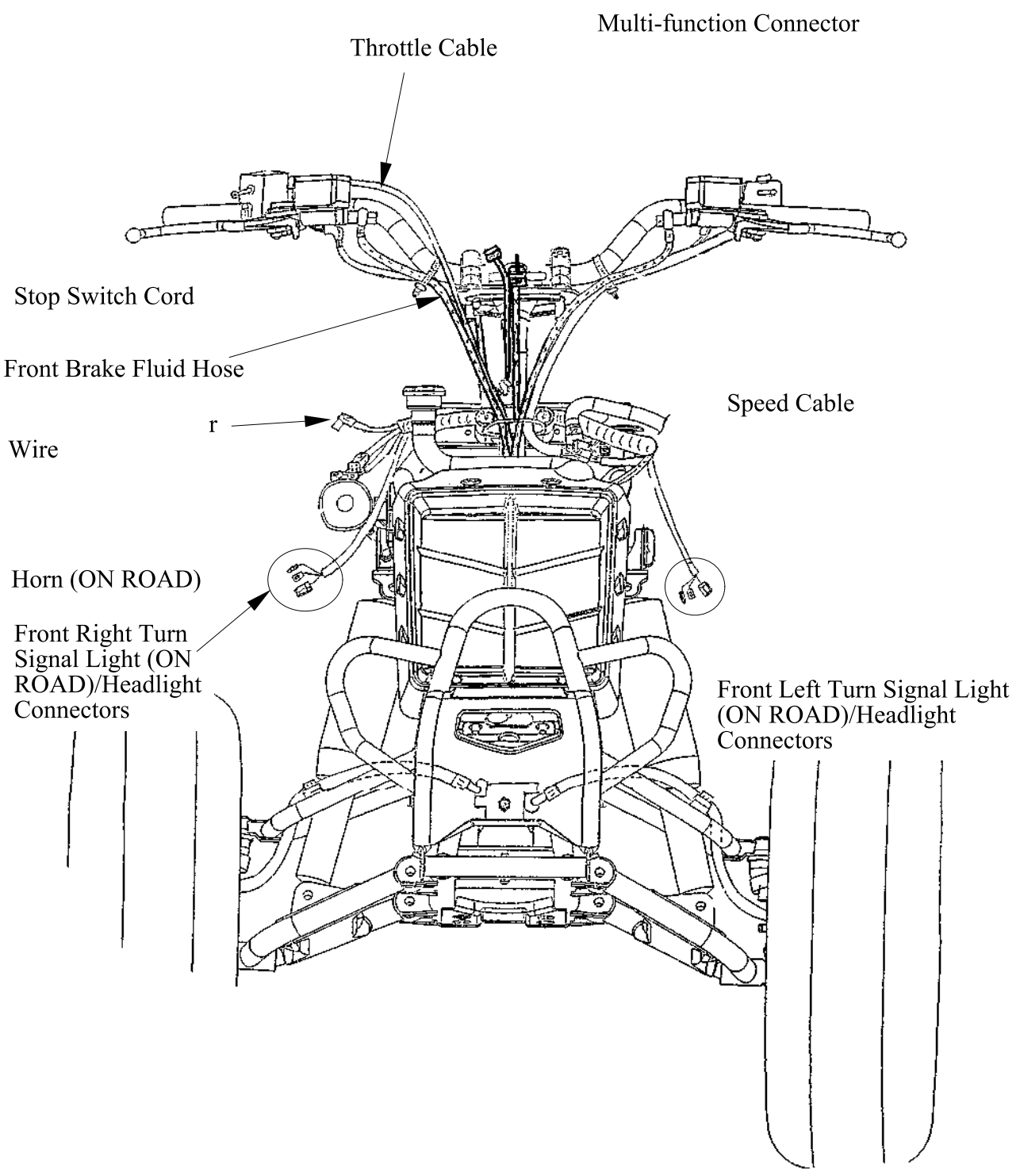

1. GENERAL INFORMATION

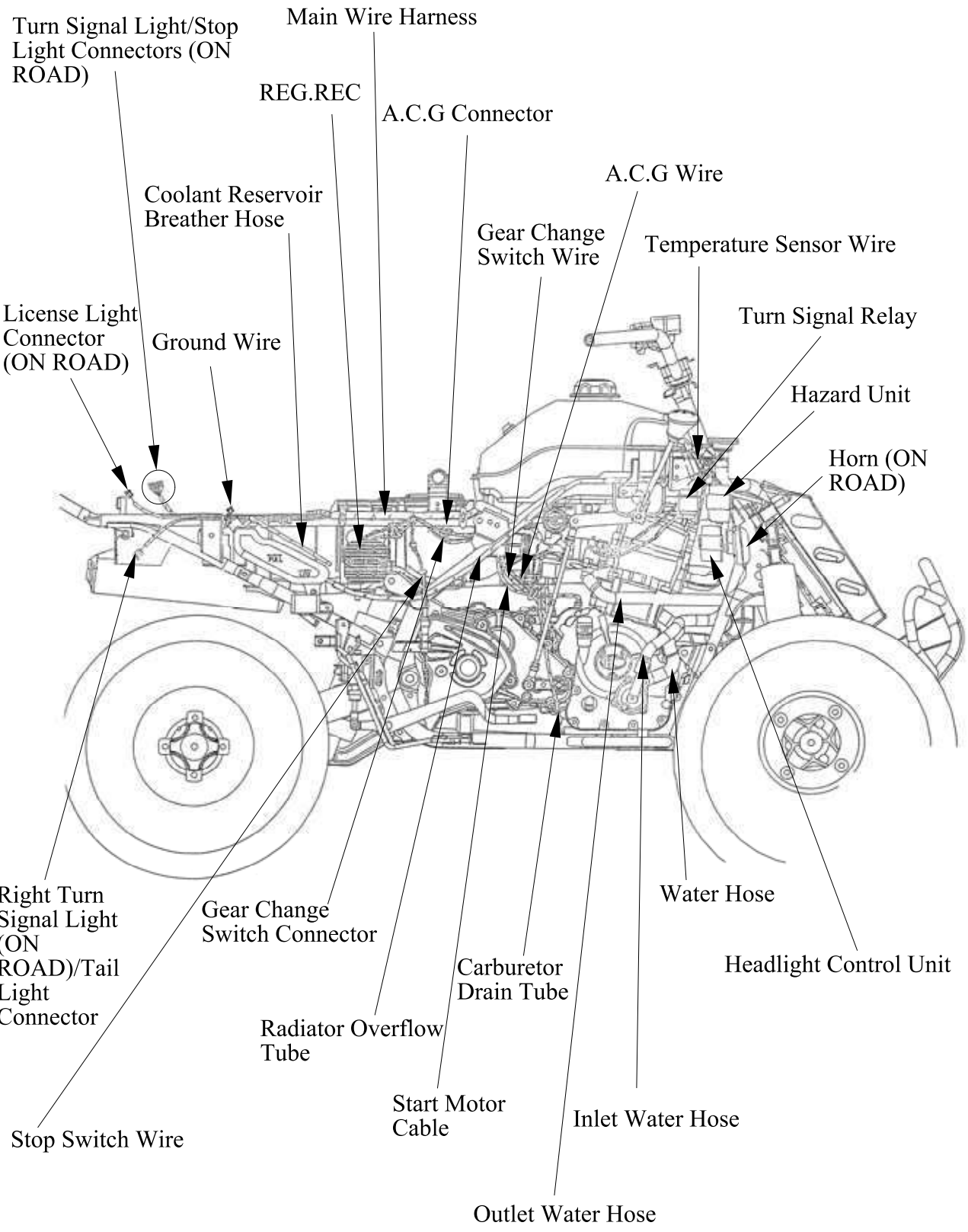

1. GENERAL INFORMATION

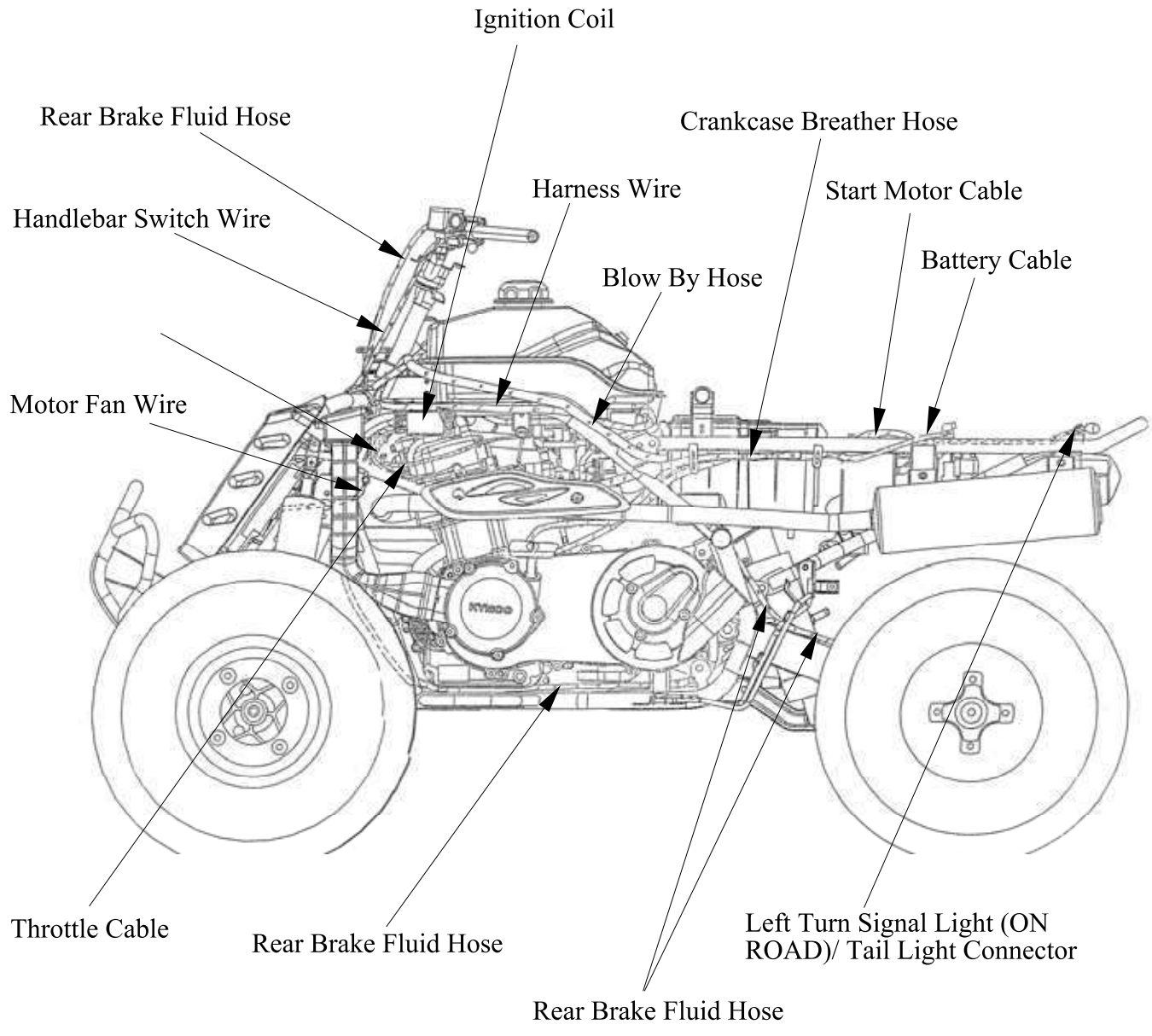

1. GENERAL INFORMATION

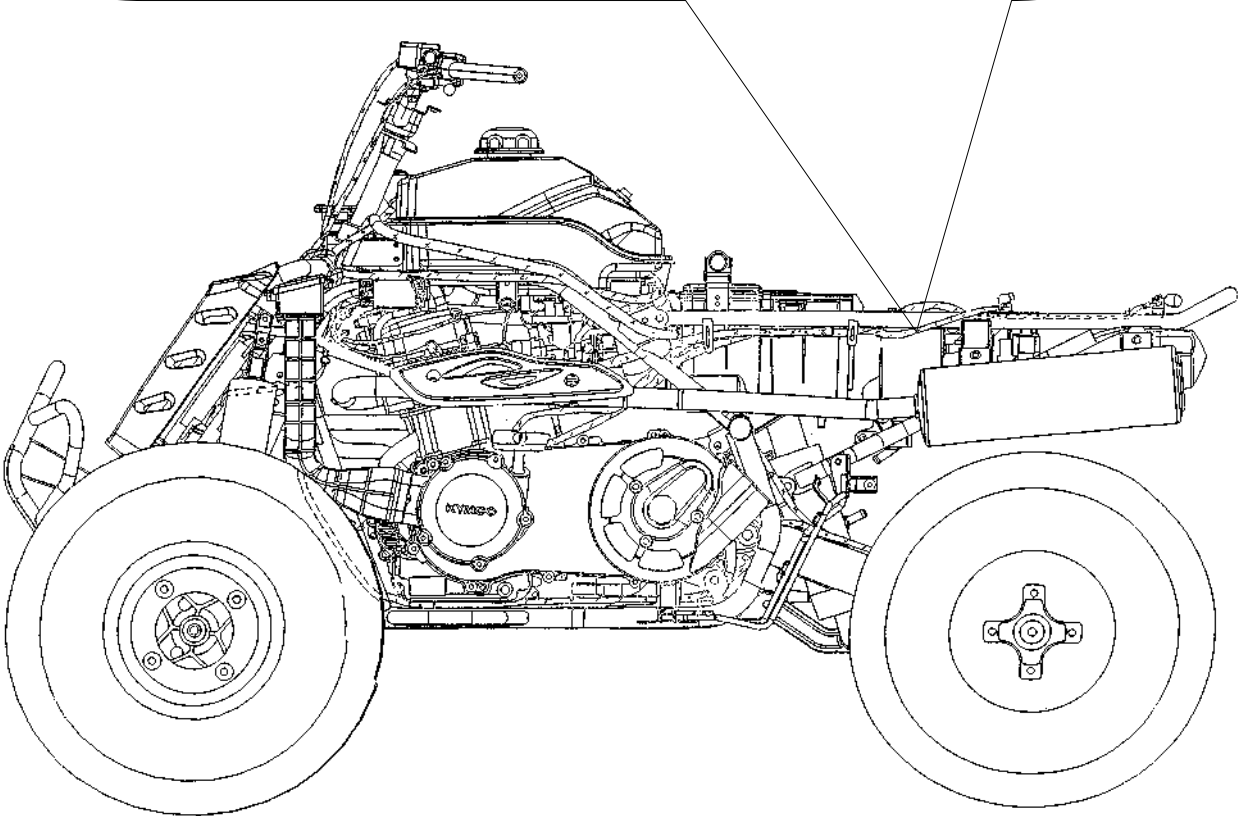
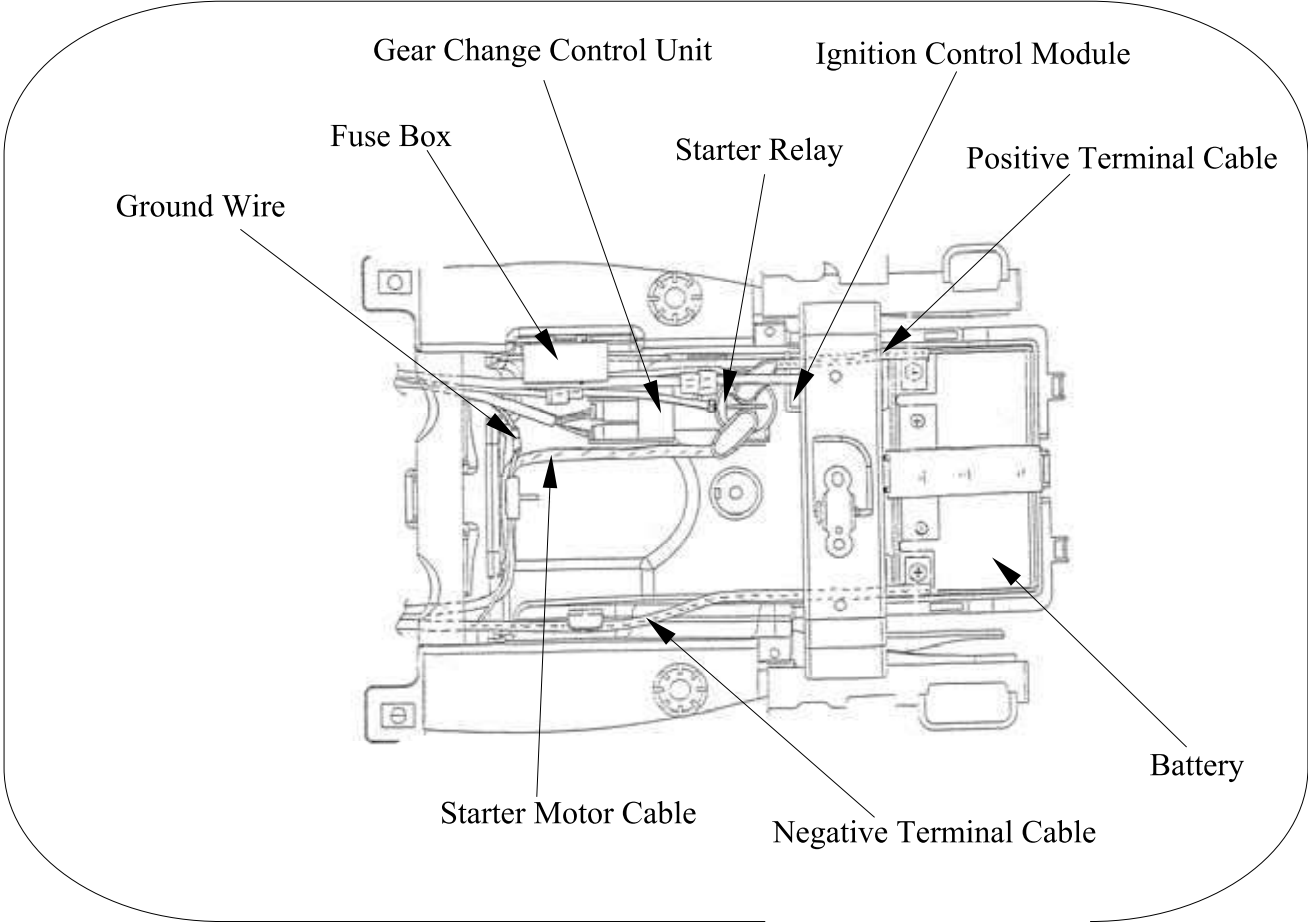

1. GENERAL INFORMATION

WIRING DIAGRAM (MXU 300 OFF ROAD)

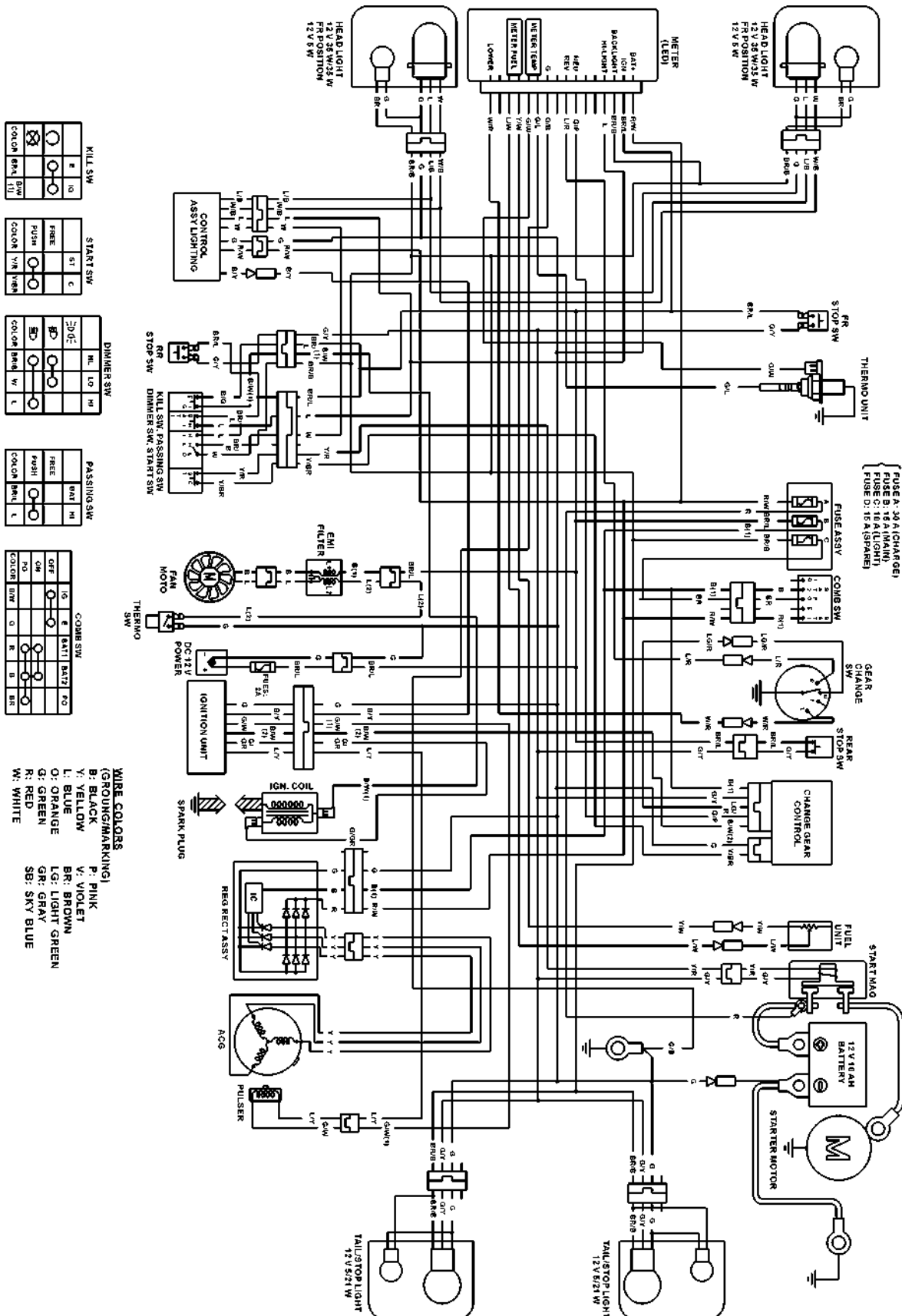

KILL SW	E	IG
COLOR	RED	BLACK

START SW	FR	ST	C
COLOR	RED	BLACK	GREEN

DIMMER SW	HL	LO	HI
COLOR	RED	BLACK	WHITE

PASSING SW	FR	HI
COLOR	RED	BLACK

GEAR SW	IG	BA1	BA2	PO
COLOR	BLACK	RED	BLACK	ORANGE

- WIRE COLORS (GROUND/MARKING)**
- B: BLACK
 - Y: YELLOW
 - L: BLUE
 - O: ORANGE
 - G: GREEN
 - R: RED
 - W: WHITE
 - P: PINK
 - V: VIOLET
 - BR: BROWN
 - LG: LIGHT GREEN
 - GR: GRAY
 - SB: SKY BLUE

1. GENERAL INFORMATION

WIRING DIAGRAM (MXU 300 ON ROAD)

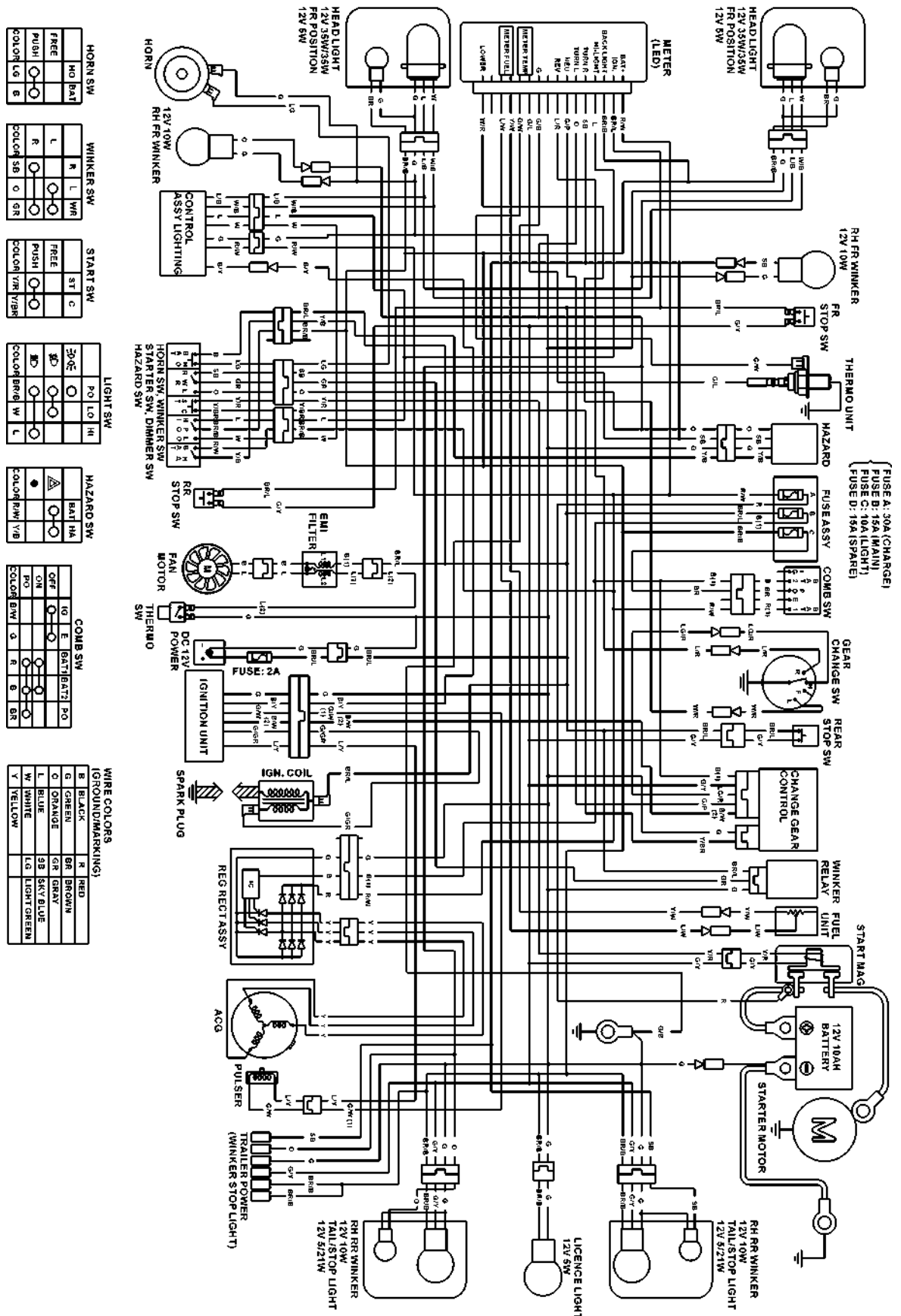

1. GENERAL INFORMATION

TROUBLESHOOTING

ENGINE WILL NOT START OR IS HARD TO START

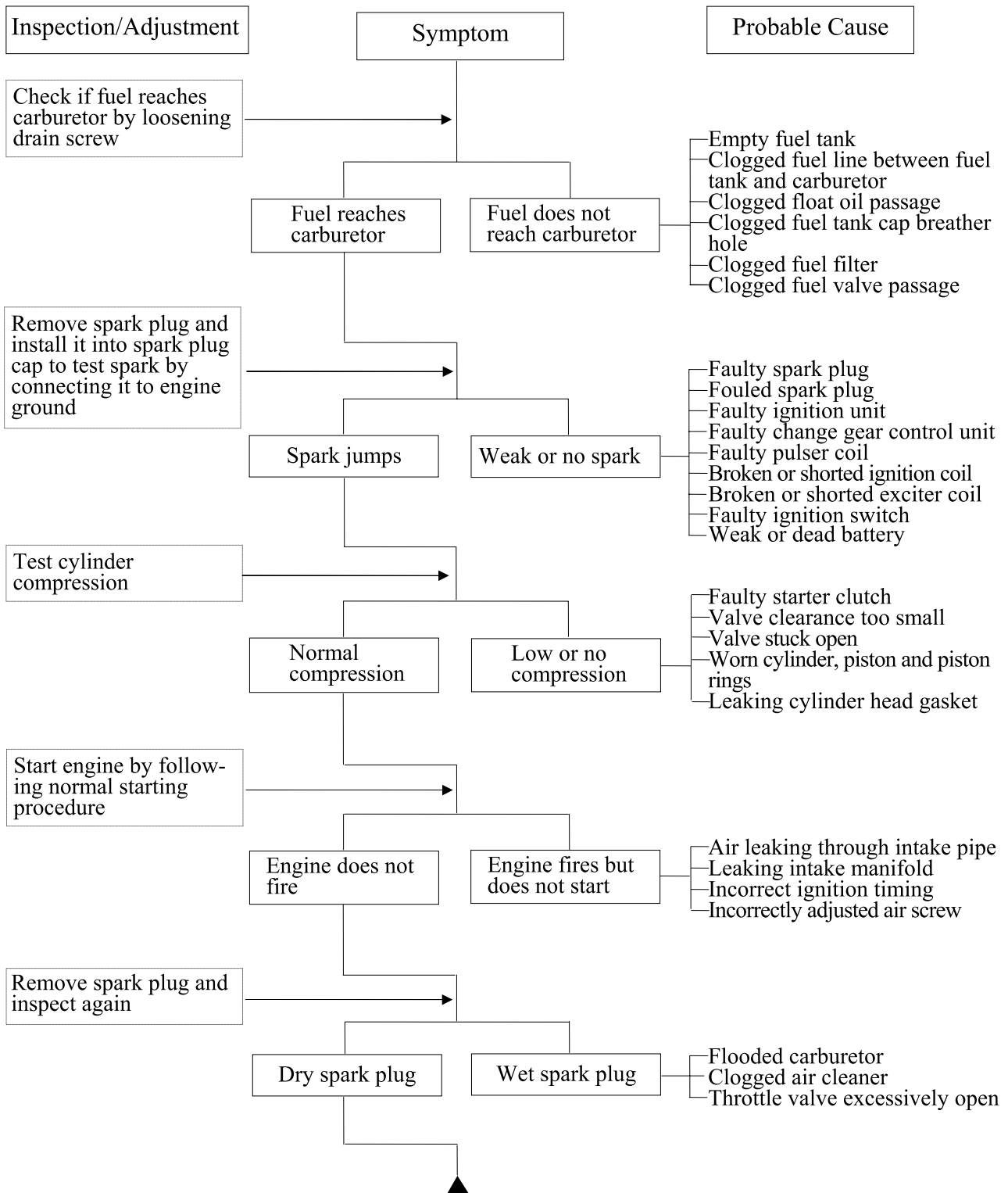

1. GENERAL INFORMATION

ENGINE LACKS POWER

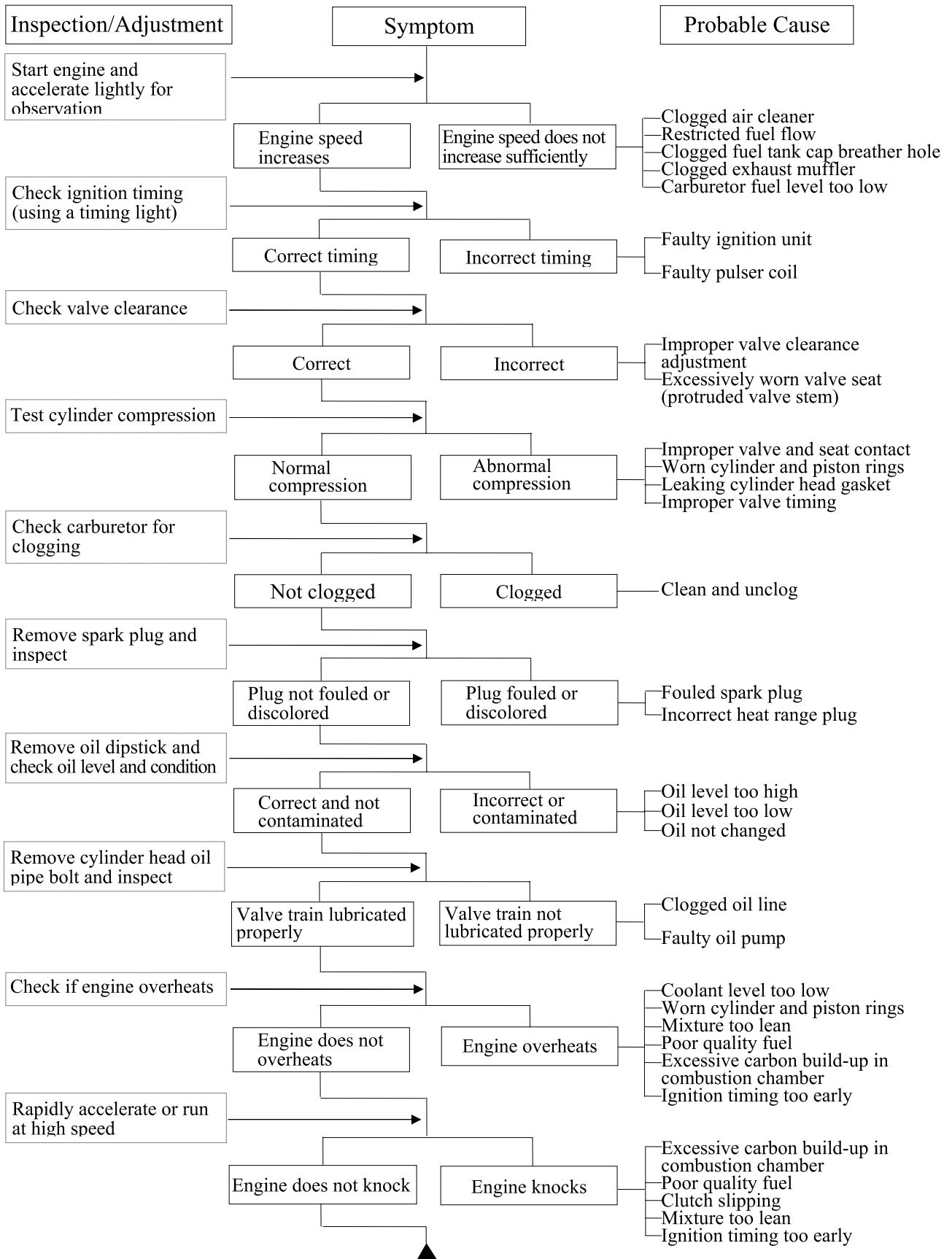

1. GENERAL INFORMATION

POOR PERFORMANCE (ESPECIALLY AT IDLE AND LOW SPEEDS)

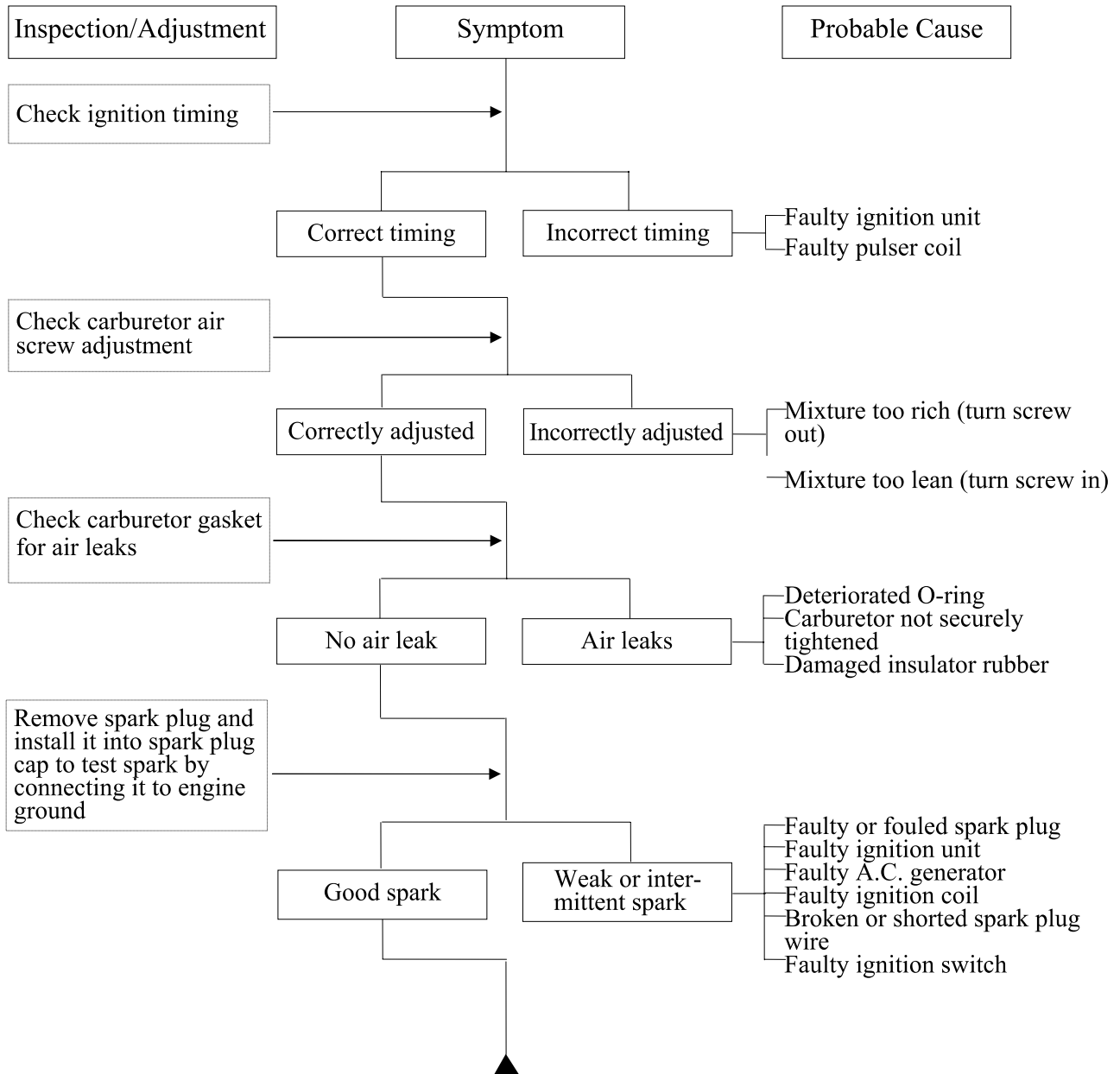

1. GENERAL INFORMATION

POOR PERFORMANCE (AT HIGH SPEED)

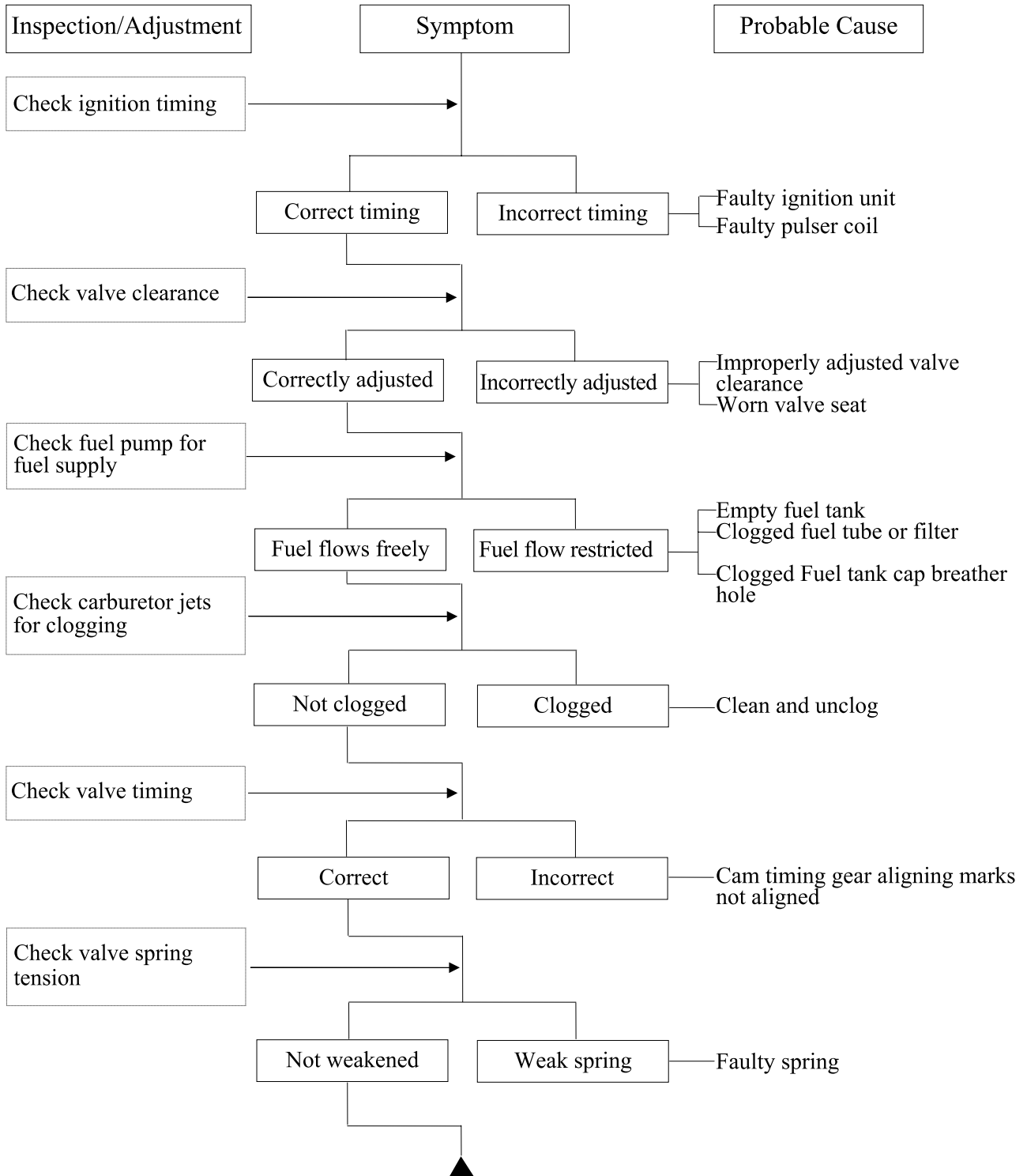

1. GENERAL INFORMATION

POOR CHARGING (BATTERY OVER DISCHARGING OR OVERCHARGING)

Undercharging

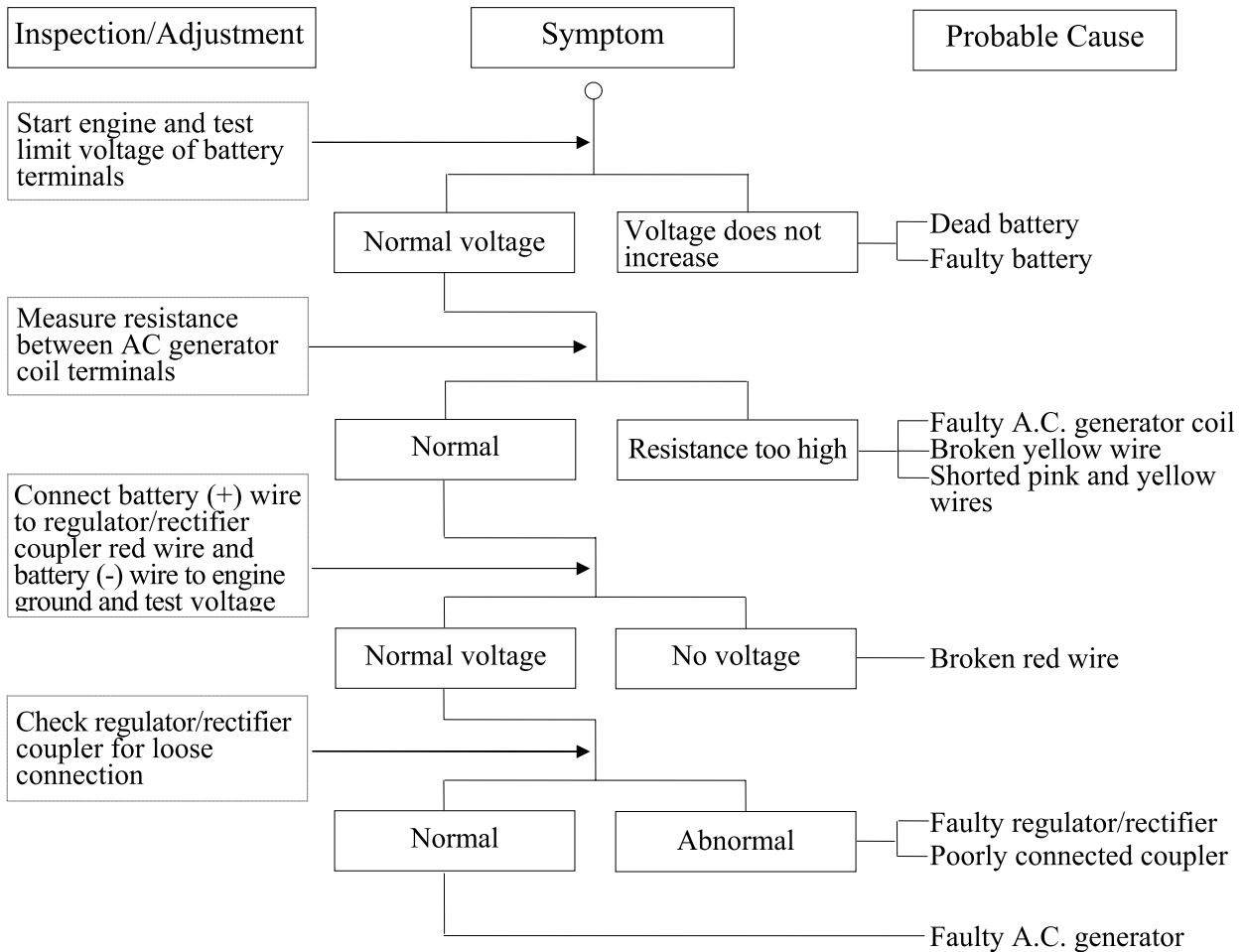

Overcharging

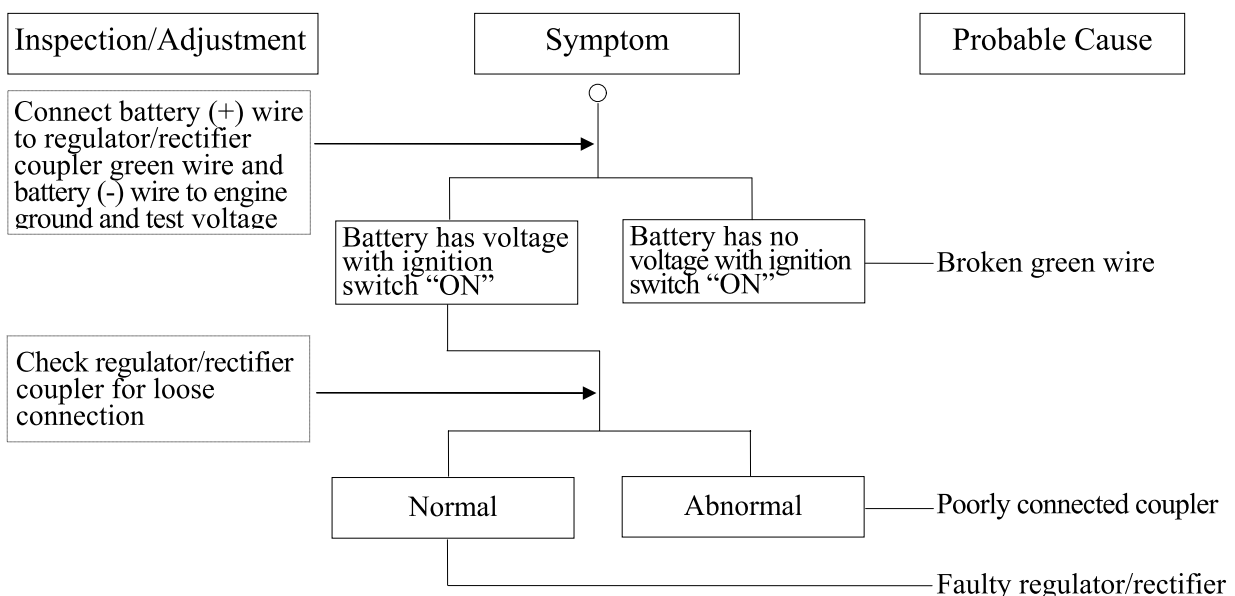

1. GENERAL INFORMATION

NO SPARK AT SPARK PLUG

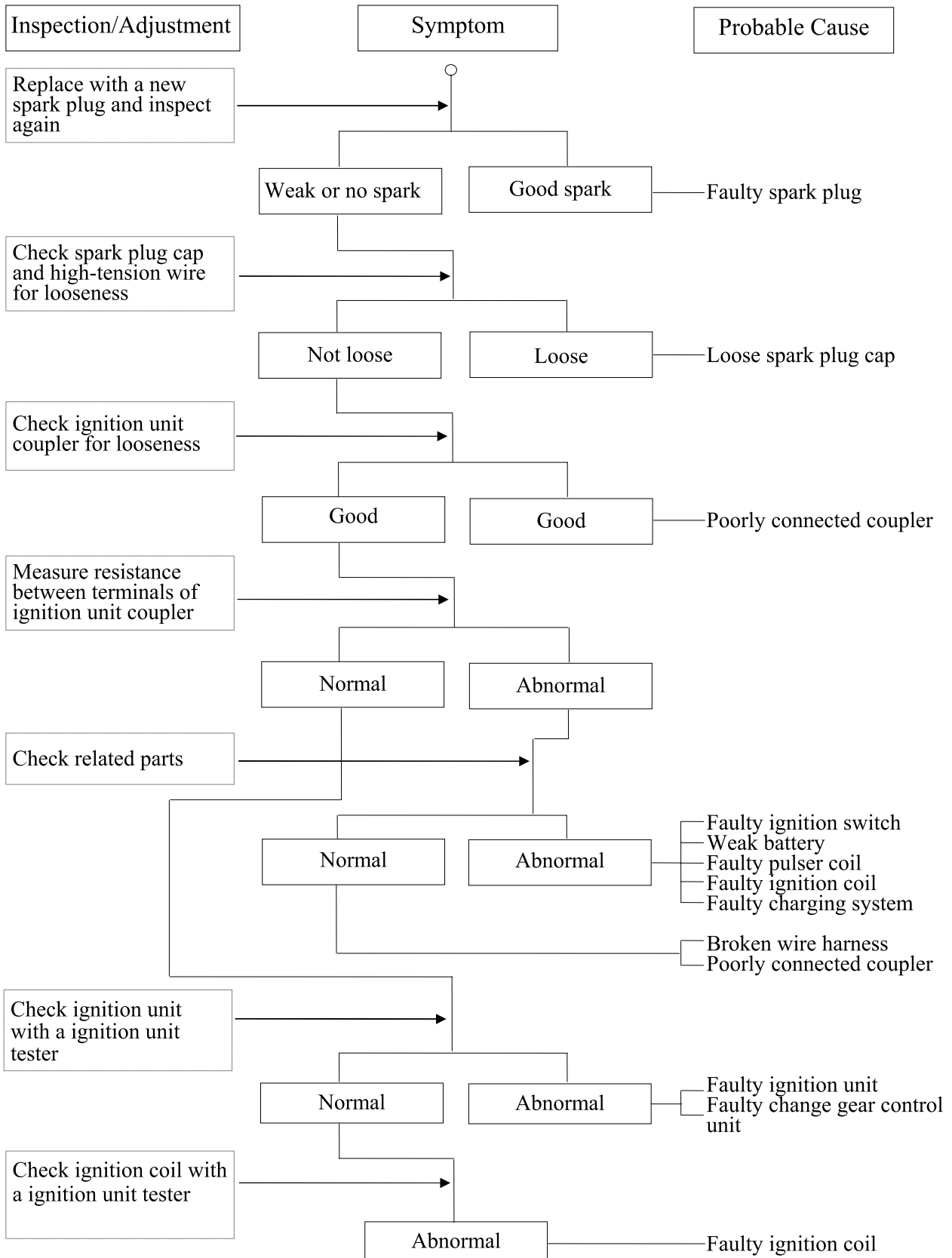

2. FRAME COVERS/EXHAUST MUFFLER

2. FRAME COVERS/EXHAUST MUFFLER

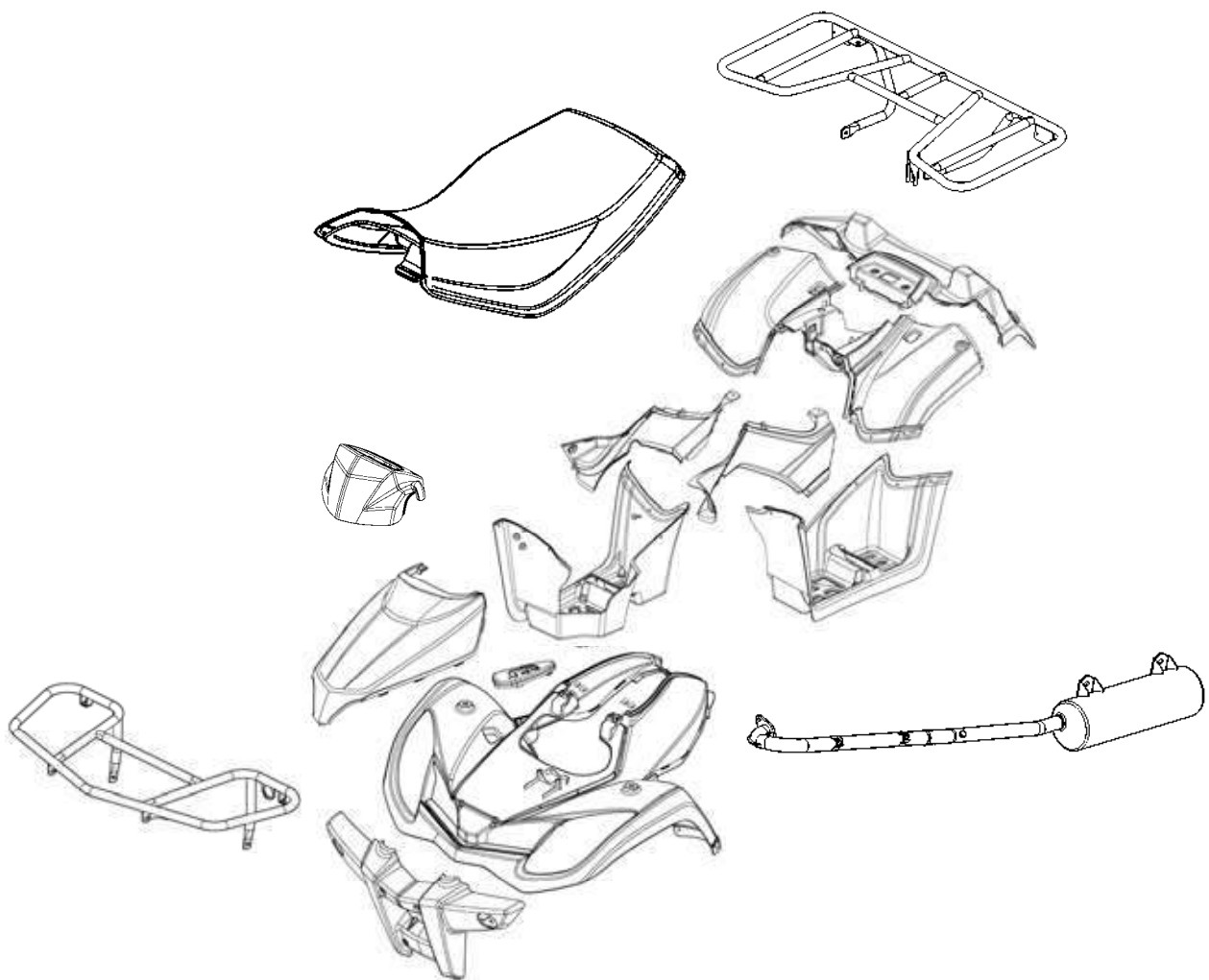

2. FRAME COVERS/EXHAUST MUFFLER

2. FRAME COVERS/EXHAUST MUFFLER

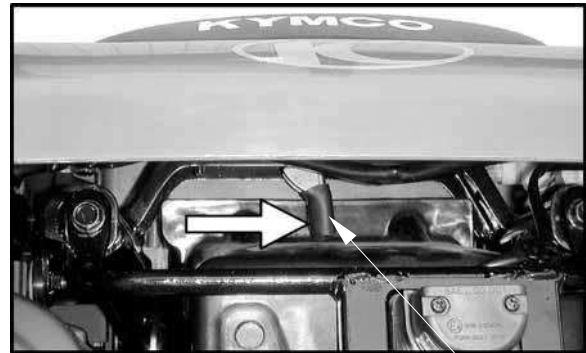

Lever

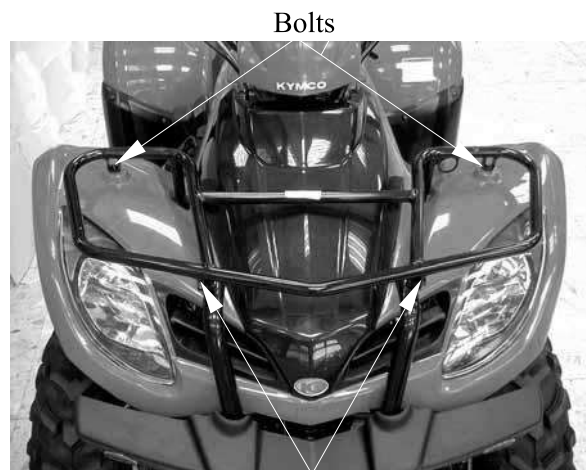
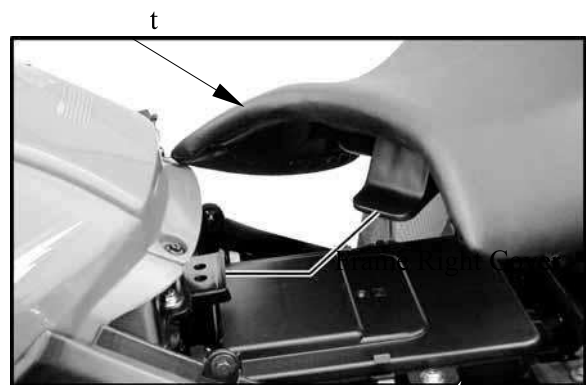

Bolts

Mounting Bolts

2. FRAME COVERS/EXHAUST MUFFLER

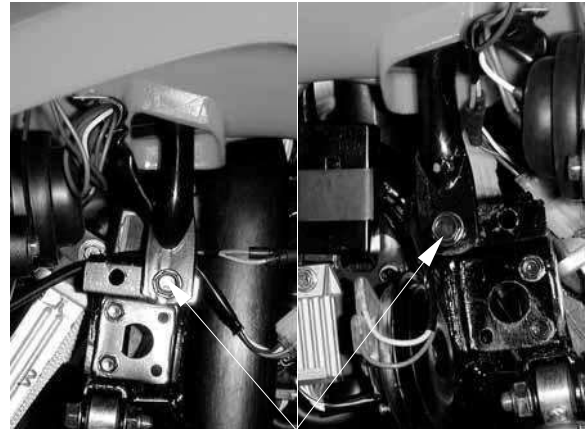

Right Signal Light Connectors

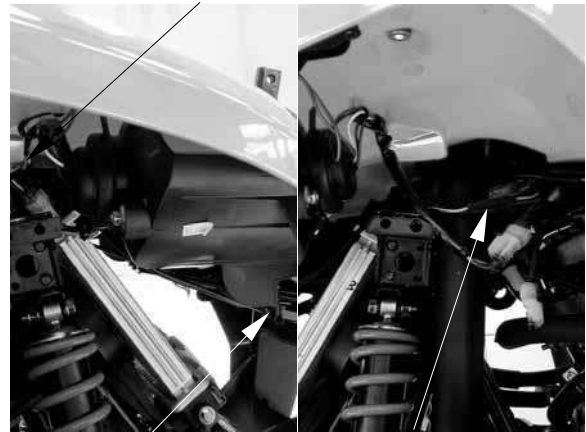

Bolt Left Signal Light Connectors

Bolt



Mounting Bolts

2. FRAME COVERS/EXHAUST MUFFLER

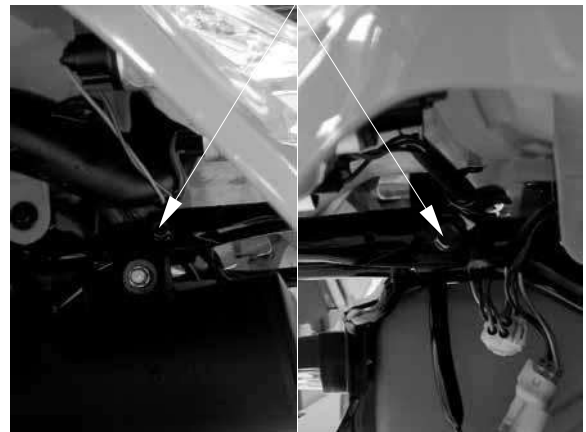

2. FRAME COVERS/EXHAUST MUFFLER

During removal, do not pull the joint claws forcedly to avoid damage.

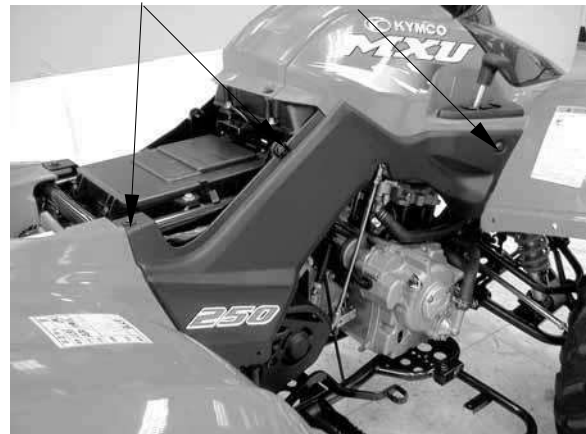
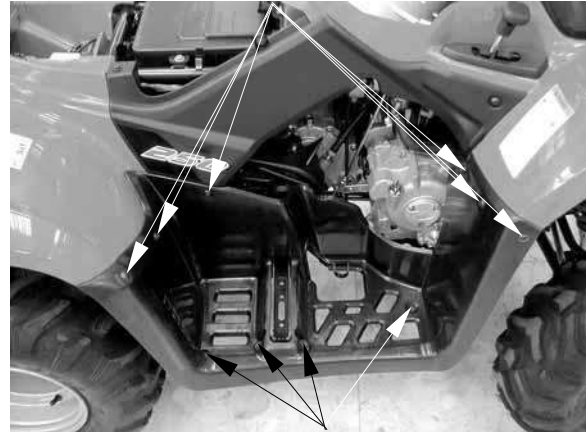

During removal, do not pull the joint claws forcedly to avoid damage.



2. FRAME COVERS/EXHAUST MUFFLER

During removal, do not pull the joint claws forcedly to avoid damage.



Fuel Tank Breather tube Speedometer Cable

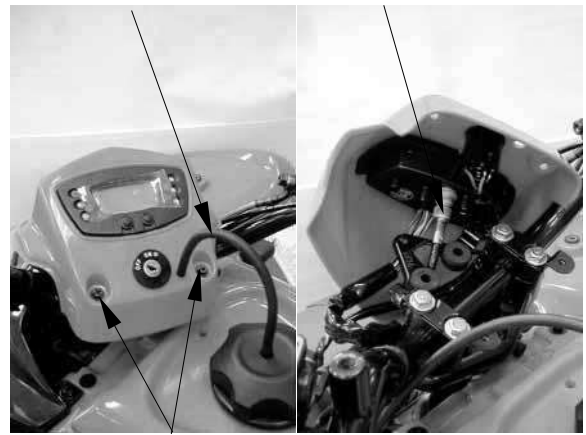

Screws

Ignition Switch Connector

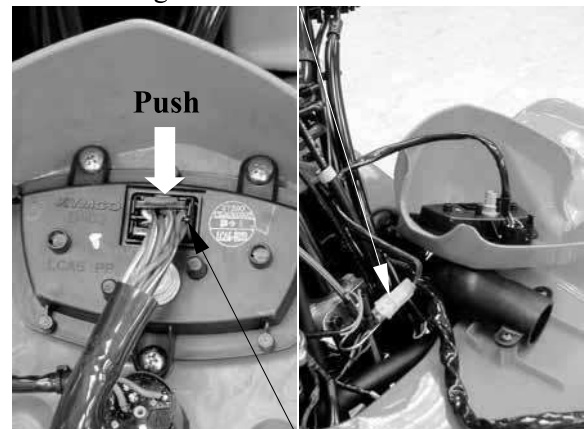

Instrument Connector

2. FRAME COVERS/EXHAUST MUFFLER

Put on the fuel tank cap after removing the cover to prevent duct, mud, etc. from entering the fuel tank

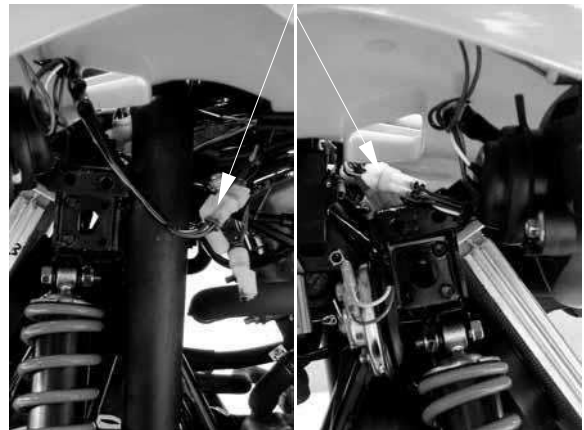
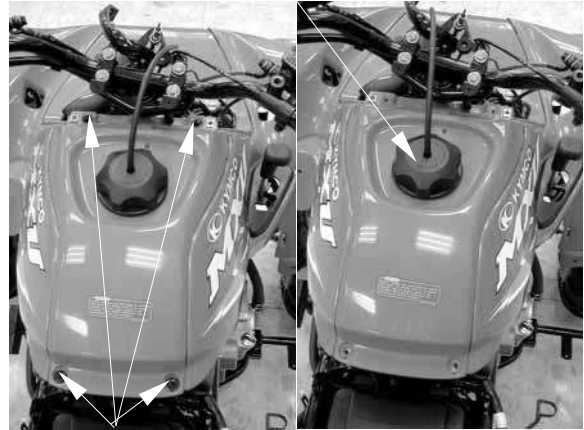

Drive Select Lever Grip

Air Inlet Hose

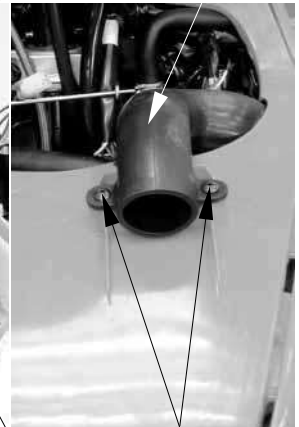

Bolt

Screws

2. FRAME COVERS/EXHAUST MUFFLER

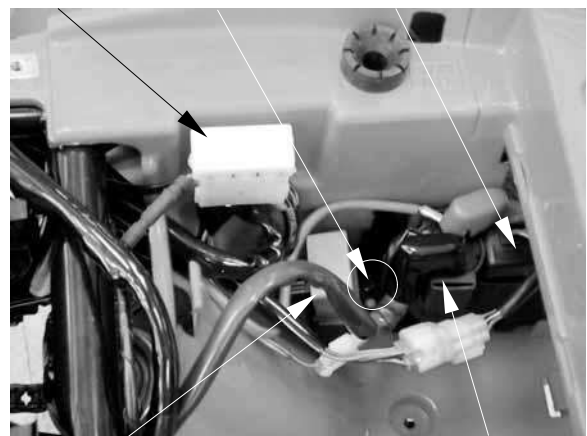
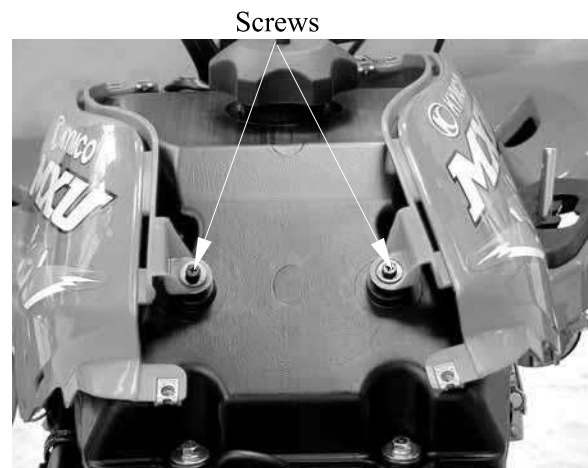

2. FRAME COVERS/EXHAUST MUFFLER

Bolts



Bolts

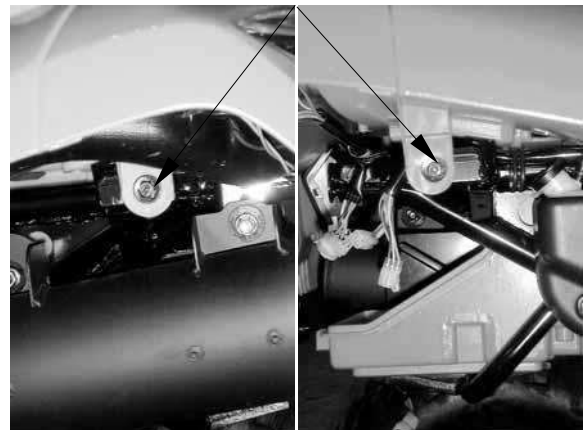

2. FRAME COVERS/EXHAUST MUFFLER

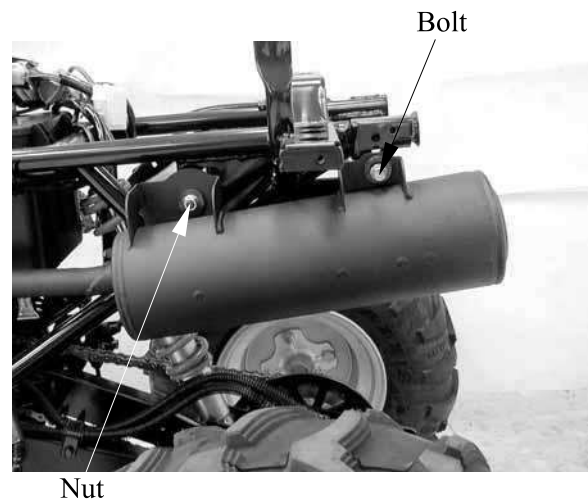
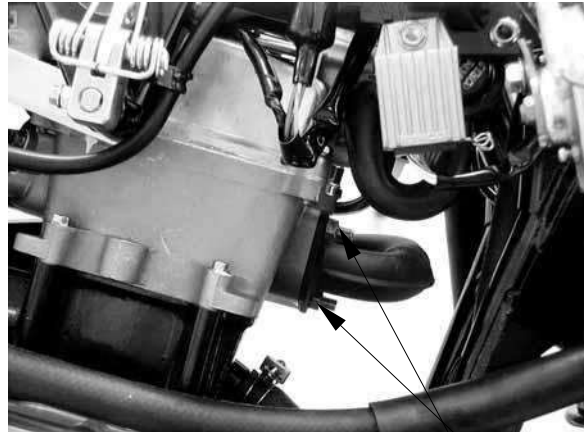

Be sure to install a new exhaust gasket.

t

3. INSPECTION/ADJUSTMENT

3

REAR FINAL GEAR CASE OIL REPLACEMENT (MXU 300)----	3-14
DRIVE BELT/BRAKE PADS INSPECTION -----	3-15
BRAKE FLUID INSPECTION/ HEADLIGHT AIM-----	3-16
STEERING SYSTEM INSPECTION-----	3-17
TOE-IN ADJUSTMENT -----	3-18
WHEELS/TIRES -----	3-19
DRIVE CHAIN SLACK ADJUSTMENT (MXU 250)-----	3-21
DRIVE SELECT LEVER ADJUSTMENT -----	3-23
CABLE INSPECTION AND LUBRICATION-----	3-24
REAR SUSPENSION LUBRICATION (MXU 250)-----	3-24
COOLING SYSTEM-----	3-25
SPARK ARRESTER CLEANING (OFF ROAD)-----	3-26

3. INSPECTION/ADJUSTMENT

3. INSPECTION/ADJUSTMENT

3. INSPECTION/ADJUSTMENT

ITEM	WHICHEVER COMES FIRST ROUTINE	INITIAL		EVERY	
		mi	100	600	1200
		Km	150	1000	2000
		MONTH	1	6	12
Engine oil	•Replace (Warm engine before draining).		<input type="radio"/>	<input type="radio"/>	<input type="radio"/>
Oil strainer	•Clean. •Replace if necessary.		<input type="radio"/>	<input type="radio"/>	<input type="radio"/>
Transmission oil	•Check oil level/oil leakage •Replace every 12 months.		<input type="radio"/>		<input type="radio"/>
Rear final gear case oil	•Check oil level/oil leakage •Replace every 12 months.		<input type="radio"/>		<input type="radio"/>
V-belt	•Check operation. •Replace if damage or excessive wear.		<input type="radio"/>		<input type="radio"/>
Air filter element (for engine and *V-belt compartment)	•Clean. •Replace if necessary.	Every 20~40 hours (150~300km, 100~200mi) (More often in wet or dusty areas.)			
Carburetor	•Check idle speed/starter operation. •Adjust if necessary.		<input type="radio"/>	<input type="radio"/>	<input type="radio"/>
Cylinder head cover breather system	•Check breather hose for cracks or damage. •Replace if necessary.			<input type="radio"/>	<input type="radio"/>
Spark plug	•Check condition. •Adjust gap and clean. •Replace if necessary.		<input type="radio"/>	<input type="radio"/>	<input type="radio"/>
Fuel line	•Check fuel hose for cracks or damage. •Replace if necessary.			<input type="radio"/>	<input type="radio"/>
Valves	•Check valve clearance. •Adjust if necessary.		<input type="radio"/>	<input type="radio"/>	<input type="radio"/>
Brake	•Check operation and brake fluid. •Replace brake pad if necessary.		<input type="radio"/>	<input type="radio"/>	<input type="radio"/>
Spark arresster (OFF ROAD)	•Clean			<input type="radio"/>	<input type="radio"/>
Coolant	•Check coolant leakage. •Replace if necessary. •Replace coolant every 24 months.		<input type="radio"/>	<input type="radio"/>	<input type="radio"/>
Battery	•Check specific gravity. •Check breather hose for proper operation. •Correct if necessary.		<input type="radio"/>	<input type="radio"/>	<input type="radio"/>
Exhaust system	•Check leakage. •Retighten if necessary. •Replace gasket if necessary.			<input type="radio"/>	<input type="radio"/>
Drive chain	•Check and adjust slack/alignment/clean/lube.		<input type="radio"/>	<input type="radio"/>	<input type="radio"/>
Wheels	•Check balance/damage/runout. •Replace if necessary.		<input type="radio"/>	<input type="radio"/>	<input type="radio"/>
Wheel bearings	•Check bearing assembly for looseness/damage. •Replace if damaged.		<input type="radio"/>	<input type="radio"/>	<input type="radio"/>
Steering system	•Check operation. •Replace if damaged. •Check toe-in. •Adjust if necessary.		<input type="radio"/>	<input type="radio"/>	<input type="radio"/>
Knuckle shafts/ Steering shaft	•Lubricate every 6 months.			<input type="radio"/>	<input type="radio"/>
Fittings and Fasteners	•Check all chassis fittings and fasteners. •Correct if necessary.		<input type="radio"/>	<input type="radio"/>	<input type="radio"/>

3. INSPECTION/ADJUSTMENT

*

Fuel Filter



Fuel tubes

Lock nut

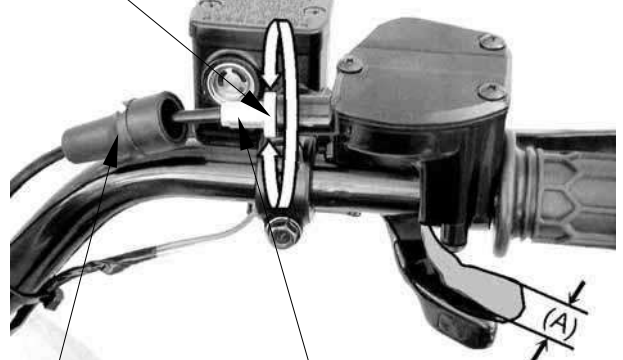

Rubber sleeve

Cable adjuster

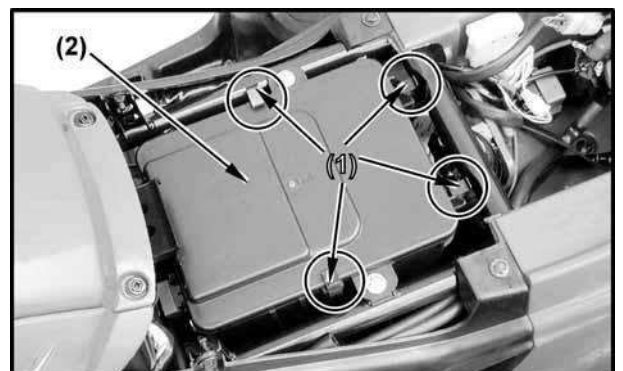

3. INSPECTION/ADJUSTMENT

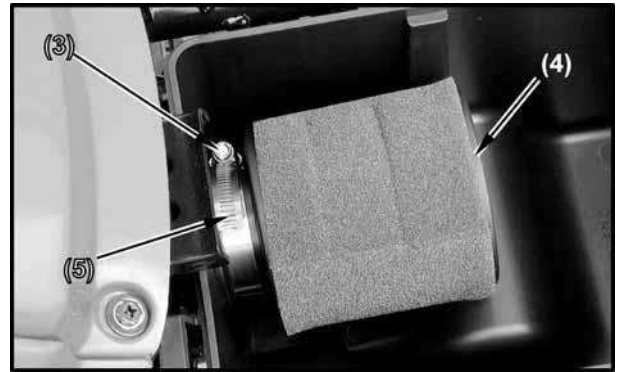

r

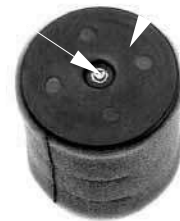

Air Cleaner



Air Cleaner screen

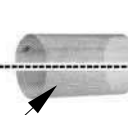

Air Cleaner body



3. INSPECTION/ADJUSTMENT

* Do not use gasoline or low flash point solvents which may lead to a fire or explosion.

* Do not twist or wring out the foam element. This could damage the foam material.

* The element should be wet but not dripping.

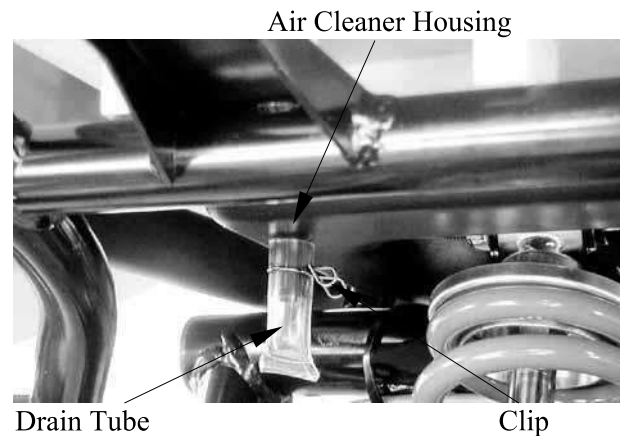
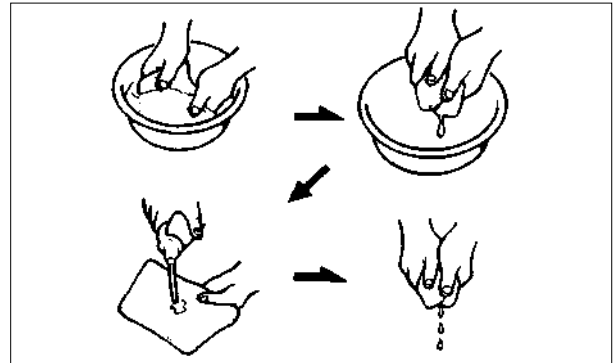

3. INSPECTION/ADJUSTMENT

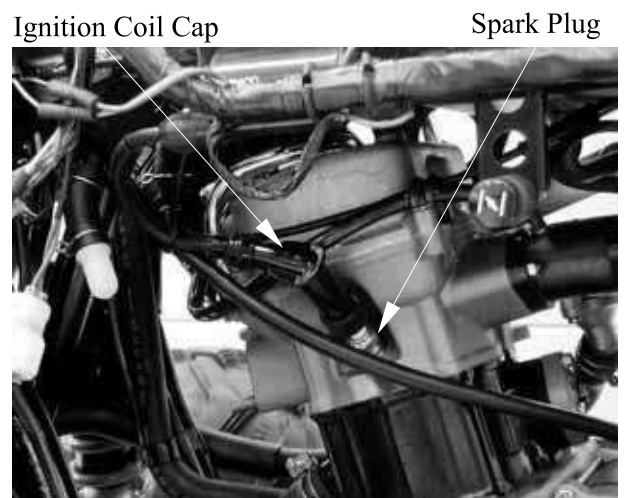
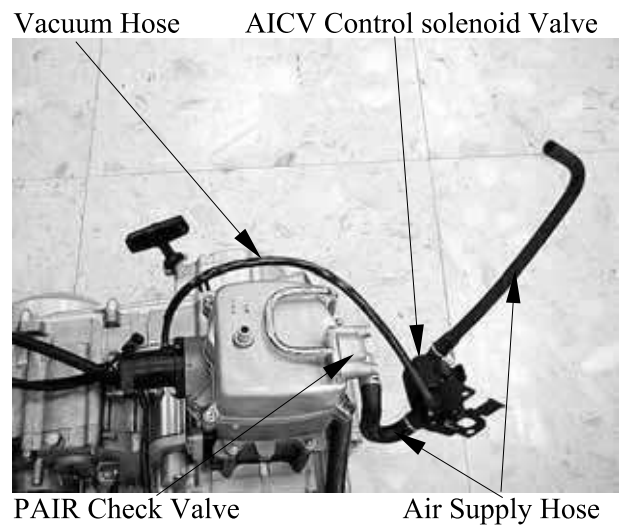

3. INSPECTION/ADJUSTMENT

* plug by hand and then tighten it with a spark plug wrench.^k

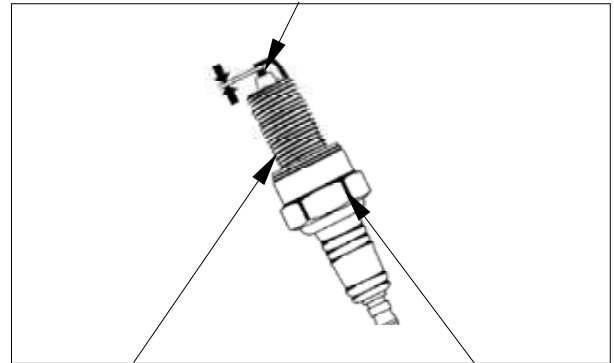

Washer Deformation

Cracks, Damage

* Inspect and adjust valve clearance while the engine is cold (below 35°C).

Cylinder Head Cover

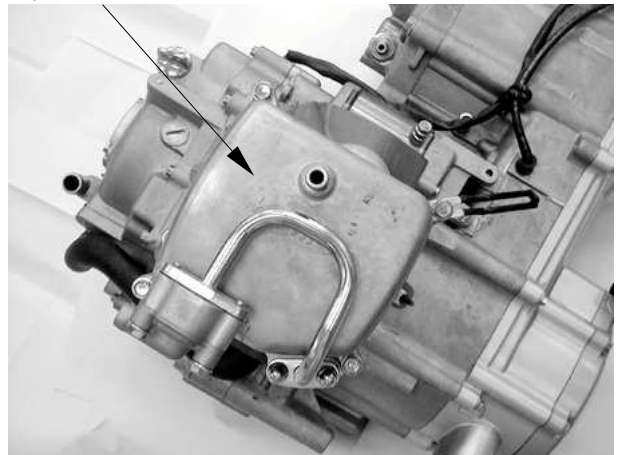

Index Mark

“T” Mark

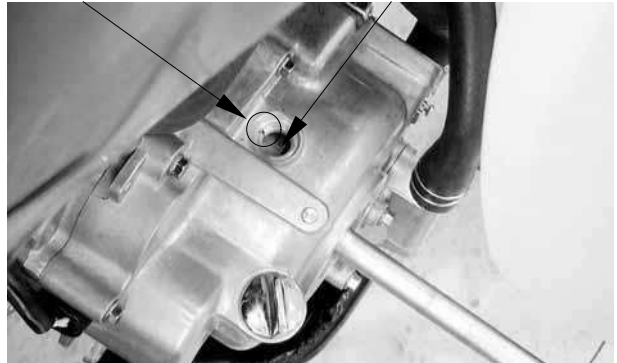

3. INSPECTION/ADJUSTMENT

- * • Check the valve clearance again after the lock nut is tightened.

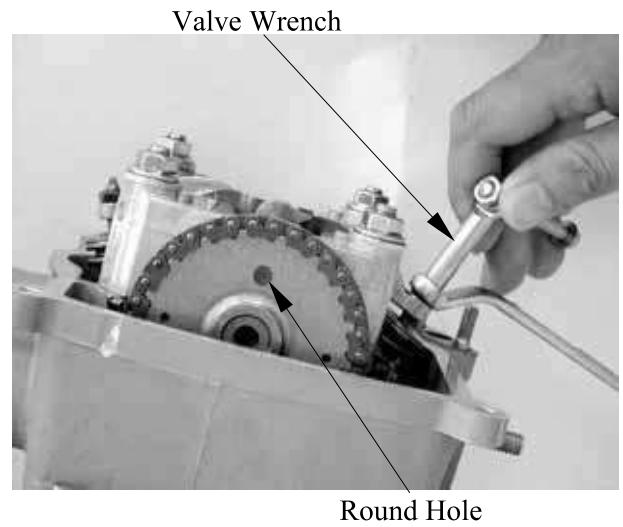

- * • The engine must be warm for accurate idle speed inspection and adjustment.

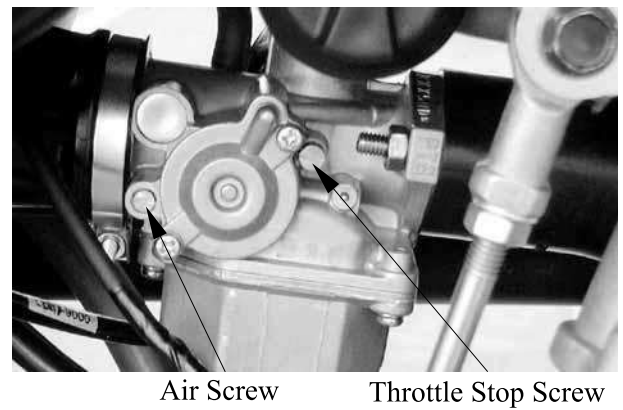

*

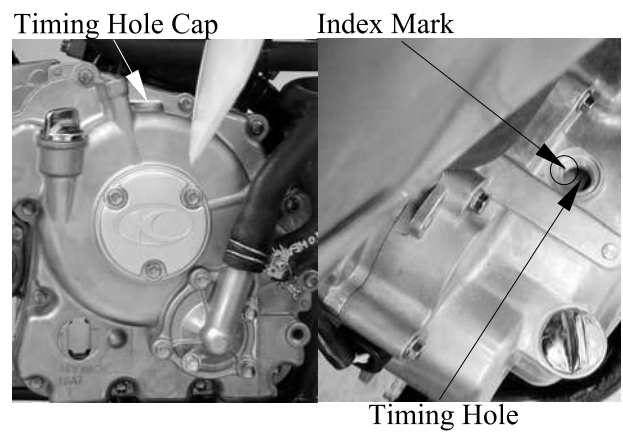

3. INSPECTION/ADJUSTMENT

Compression Gauge



* Run the engine for 2~3 minutes and check the oil level after the engine is stopped for 2~3 minutes.

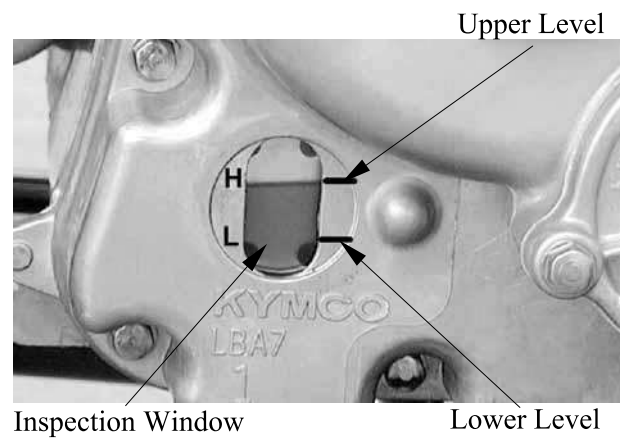

3. INSPECTION/ADJUSTMENT

Oil Fill Cap

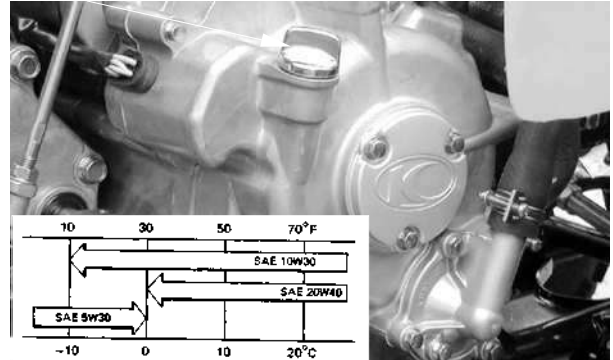

* The engine oil will drain more easily while the engine is warm.

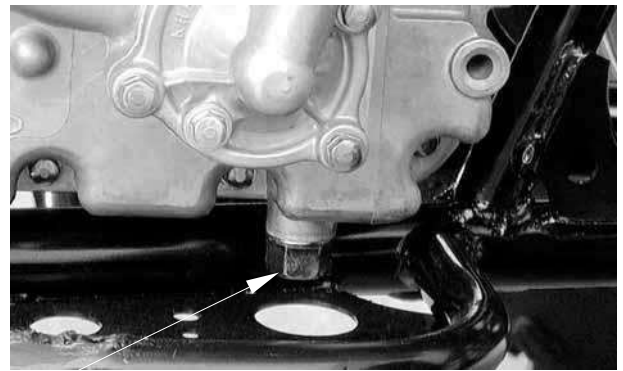

Drain Plug

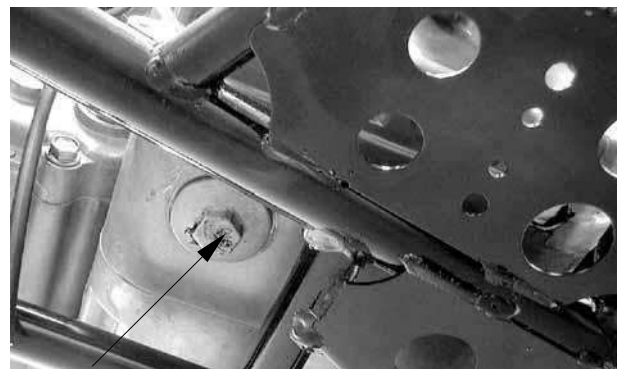

Oil Filter Cap

3. INSPECTION/ADJUSTMENT



r Oil Filter Cap

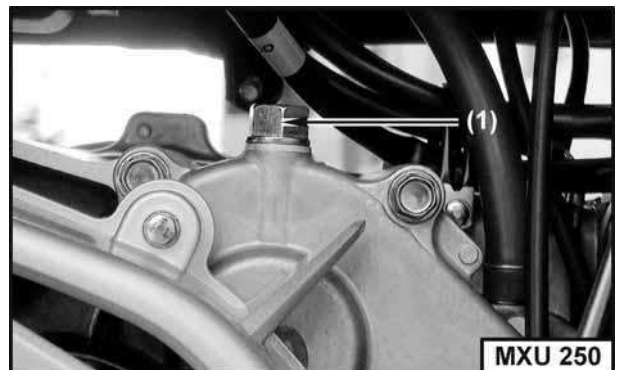

3. INSPECTION/ADJUSTMENT

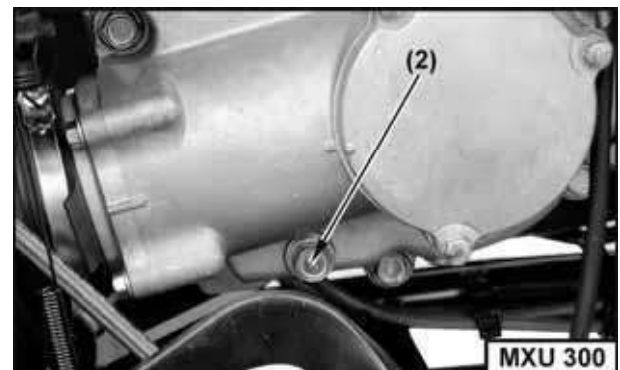
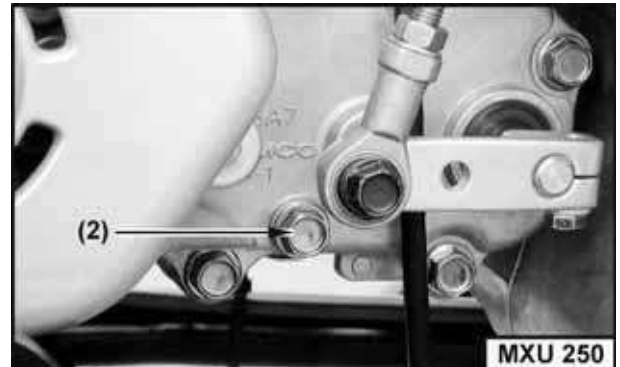

Make sure that the sealing washer is in good condition.

3. INSPECTION/ADJUSTMENT

REAR FINAL GEAR CASE OIL REPLACEMENT (MXU 300)

Change the oil with the final gear case warm, and the ATV on level ground to assure complete and rapid draining.

Rear final gear oil replacement

To drain the oil, first place an oil drain pan under the oil drain plug (1).



Remove the oil filler cap (2).

Remove the drain plug.

After the oil has completely drained, reinstall and tighten the drain plug to specified torque.

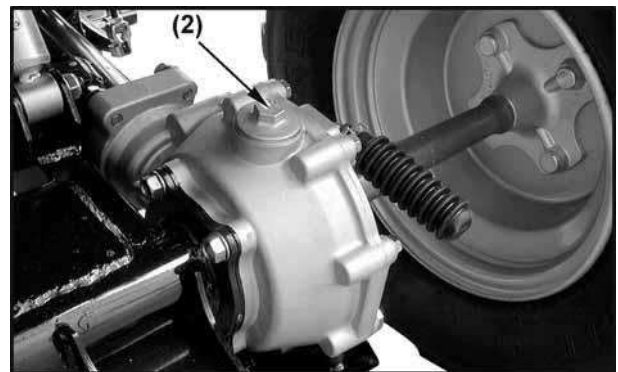

Torque: 2 kgf-m (20 Nm, 15 lbf-ft)

Fill the gear case with the recommended oil (SAE #90).

Oil Capacity (MXU 300):

At disassembly : 0.15 L (5.33 Imp oz,
5 US oz)

At change : 0.1 L (3.56 Imp oz,
3.33 US oz)

Remove the oil level check bolt (3).

Make sure the oil level reaches the oil level check hole.

Install and tighten the oil level check bolt to the specified torque.

Torque: 2 kgf-m (20 Nm, 15 lbf-ft)

Install and tighten the oil filler cap to the specified torque.

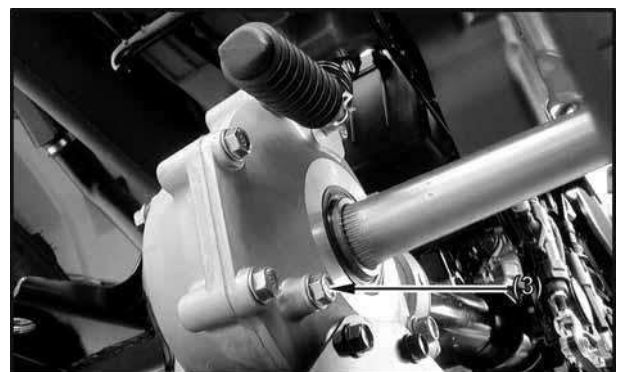

Torque: 1.5 kgf-m (15 Nm, 11 lbf-ft)

3. INSPECTION/ADJUSTMENT

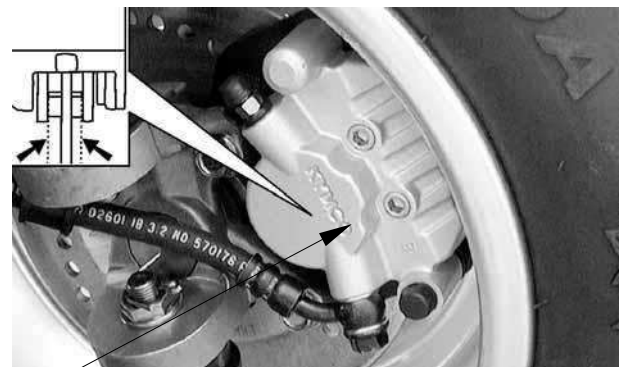
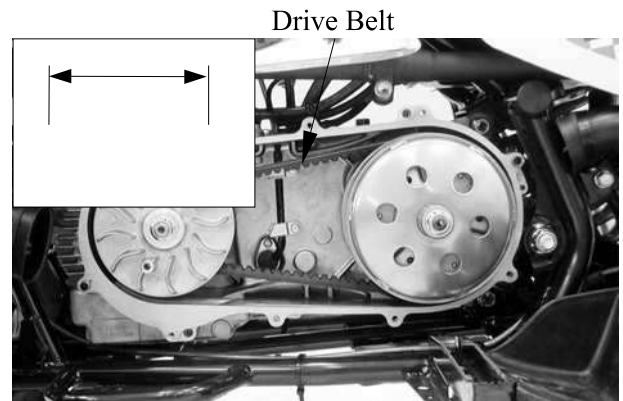

Front Caliper

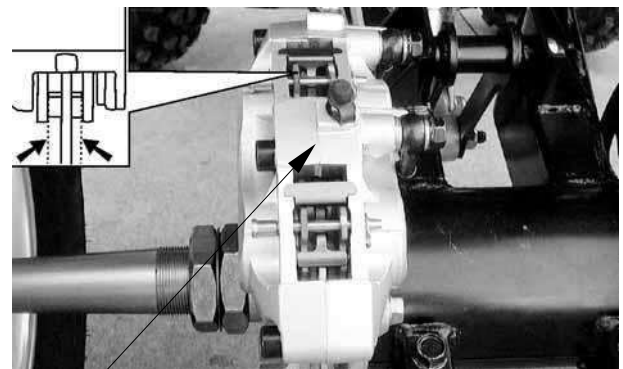

Rear Caliper

3. INSPECTION/ADJUSTMENT

Inspection Window (R/L Brake Lever)

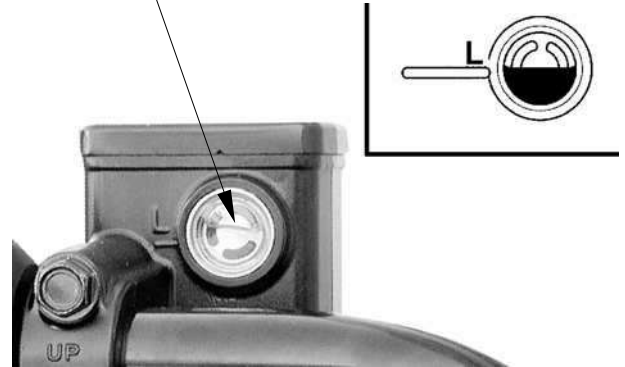

Inspection Window (Rear Brake Pedal)

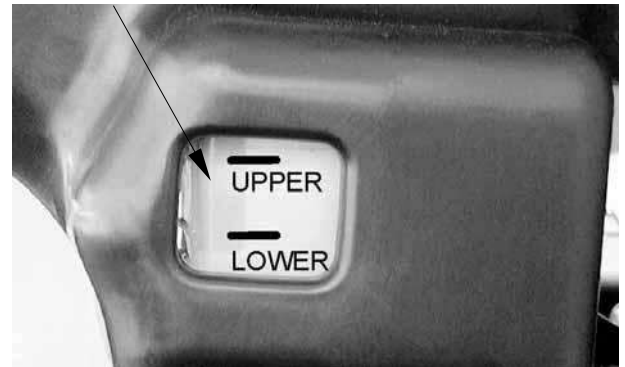

Adjust Screws

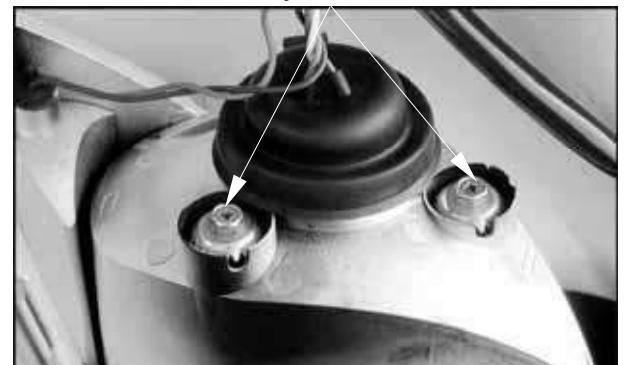

3. INSPECTION/ADJUSTMENT

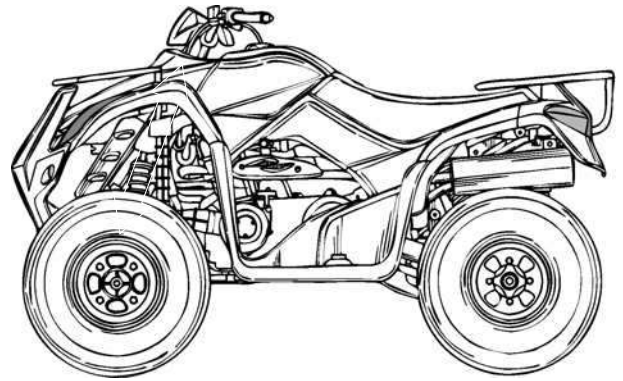

3. INSPECTION/ADJUSTMENT

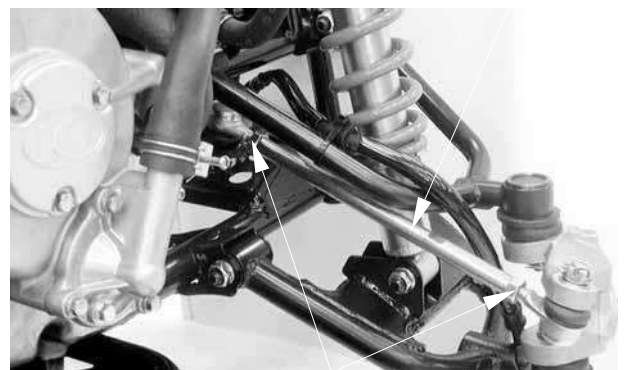
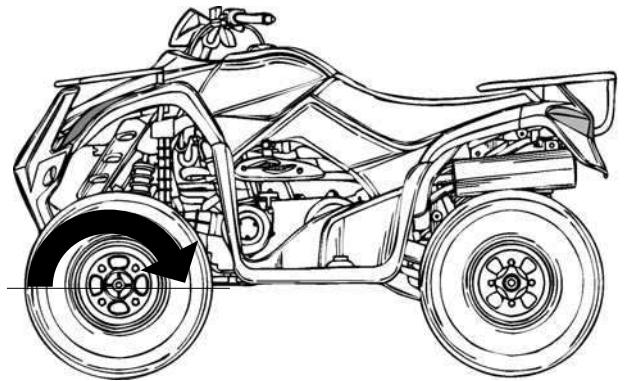
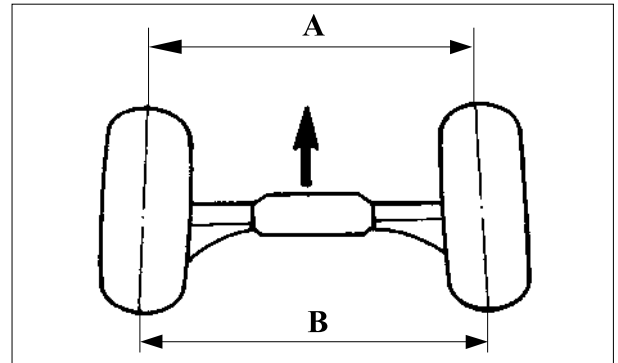

3. INSPECTION/ADJUSTMENT

*

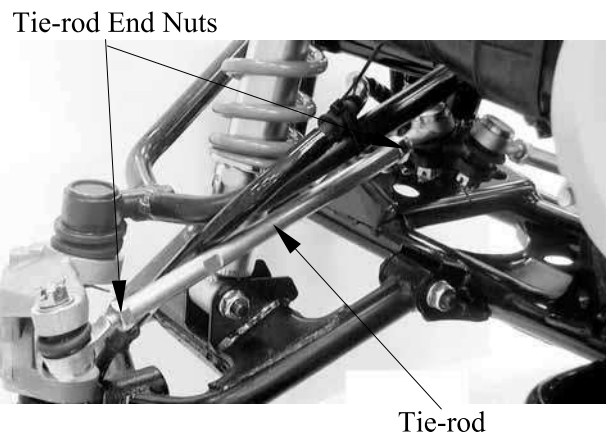

* Tire pressure should be checked when tires are cold.



3. INSPECTION/ADJUSTMENT

Rear Axle Nut



* It is dangerous to ride with a worn out tire. When a tire wear is out of specification, replace the tire immediately.

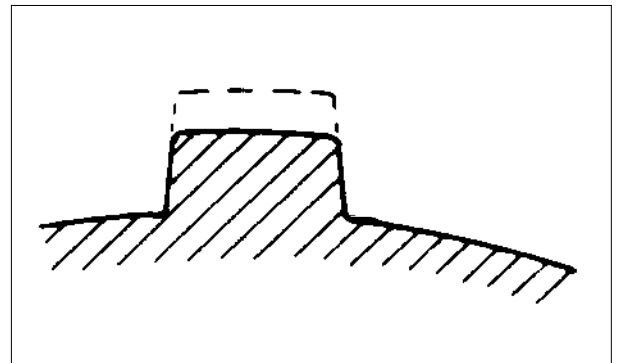

- *
- Never attempt even small repairs to the wheel.
 - Ride conservatively after installing a tire to allow it to seat itself properly on the rim.

3. INSPECTION/ADJUSTMENT

* Too little of chain slack will overload the engine and other vital parts; keep the slack within the specified limits.

* Wheels should be on the ground without the rider on it.

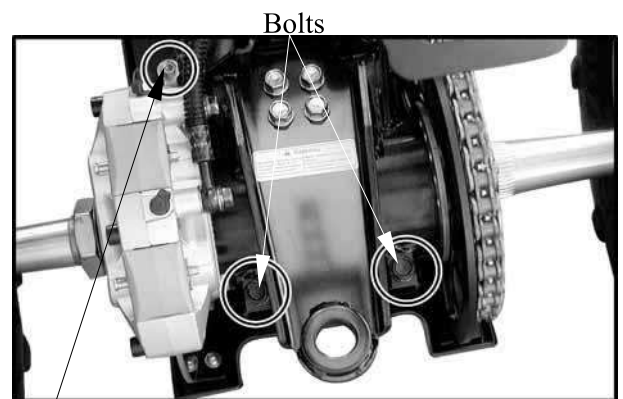
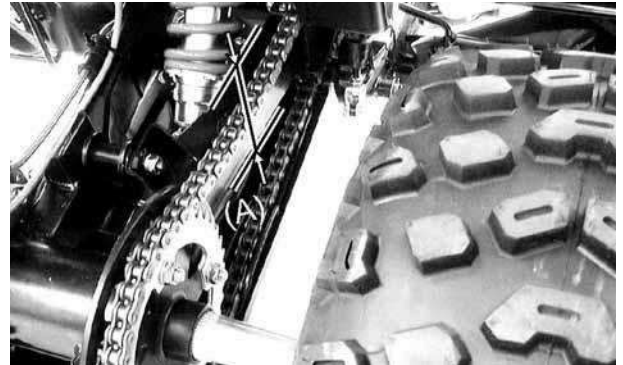

t

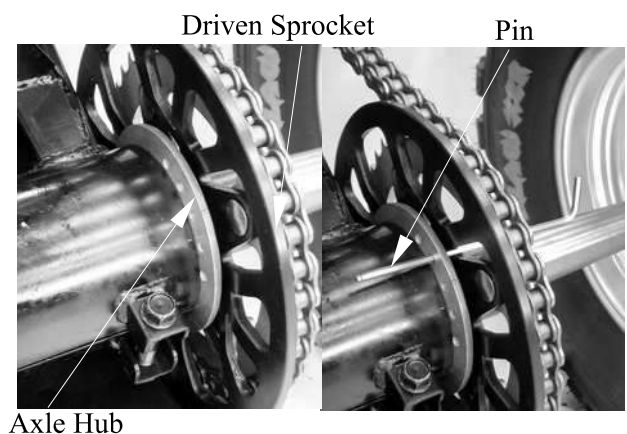

3. INSPECTION/ADJUSTMENT

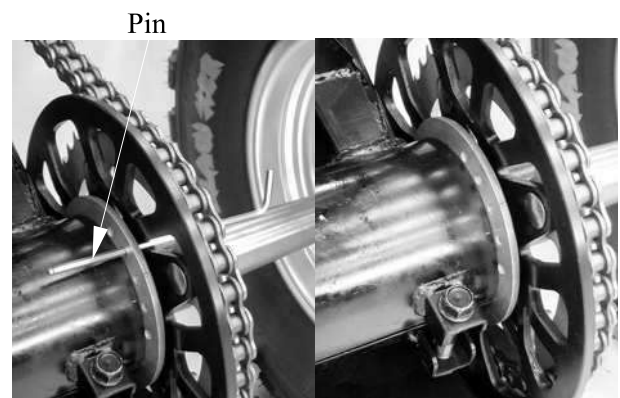
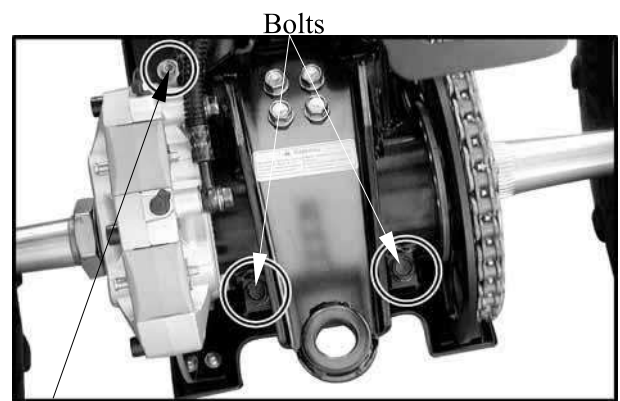
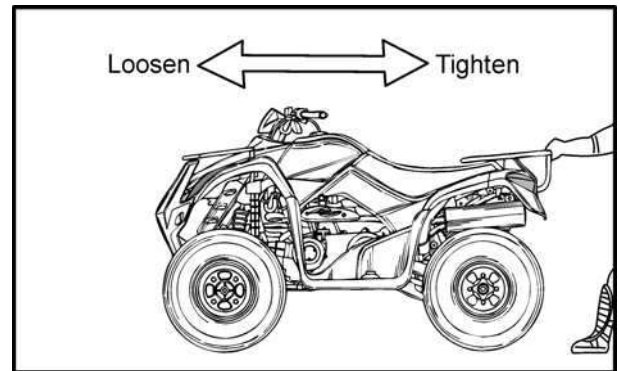

3. INSPECTION/ADJUSTMENT

Provide standard/phillips screwdriver and pass the standard/phillips screwdriver through the shift arm into the index hole at the transmission case cover.

Turn the rod clockwise or counterclockwise until the drive select lever into the "N" position of the shift guide and tighten the lock nuts, then pull out the standard/phillips screwdriver.

After adjustment, start the engine and test to ride the ATV to be sure the drive select lever is operating properly.

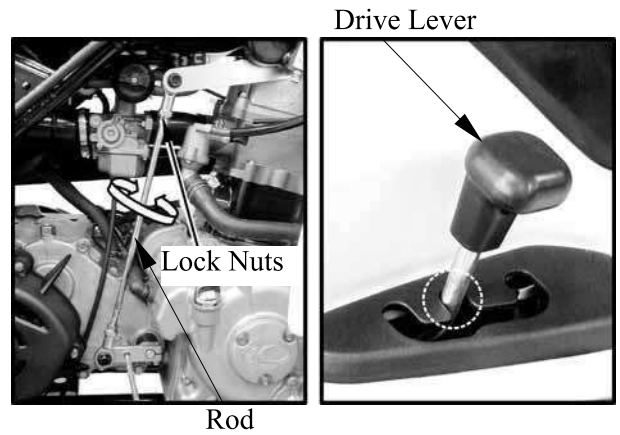
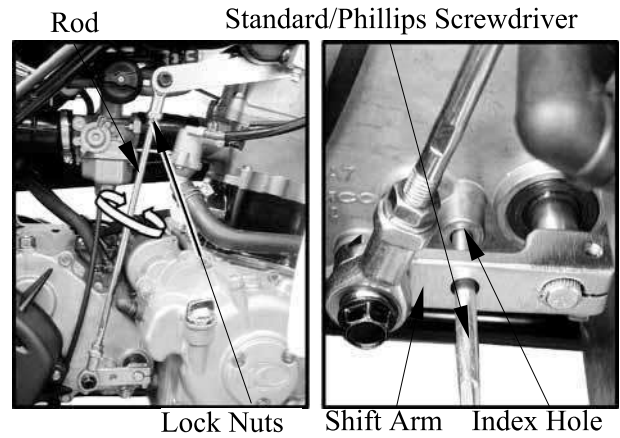

3. INSPECTION/ADJUSTMENT

* Damaged cable sheath may cause corrosion and interfere with the cable movement. An unsafe condition may result so replace such cable as soon as possible.

* Hold cable end high and apply several drops of lubricant to cable.

* Wipe off the excess grease.



Nipple

3. INSPECTION/ADJUSTMENT

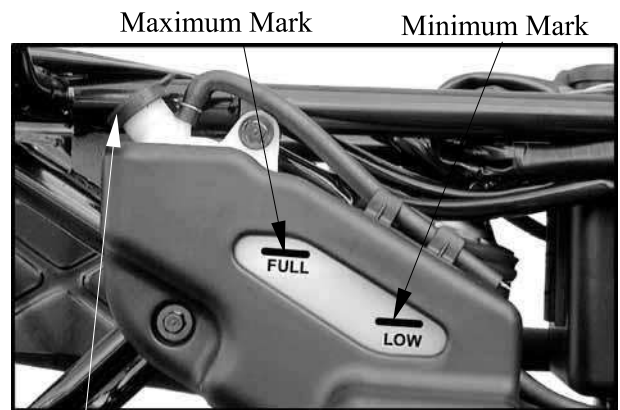

Coolant Reservoir Cap

*

* Perform this operation when the engine is cold.

* The coolant freezing point should be 5 °C lower than the temperature of the riding area.

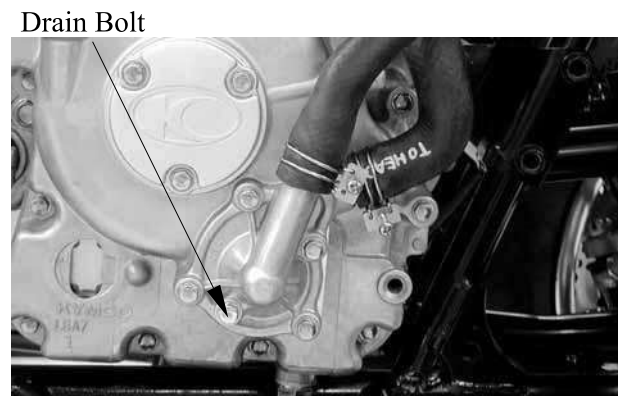

3. INSPECTION/ADJUSTMENT



4. LUBRICATION SYSTEM

4

LUBRICATION SYSTEM

SERVICE INFORMATION-----	4- 2
TROUBLESHOOTING-----	4- 2
ENGINE OIL/OIL FILTER -----	4- 3
OIL PUMP-----	4- 3

4. LUBRICATION SYSTEM

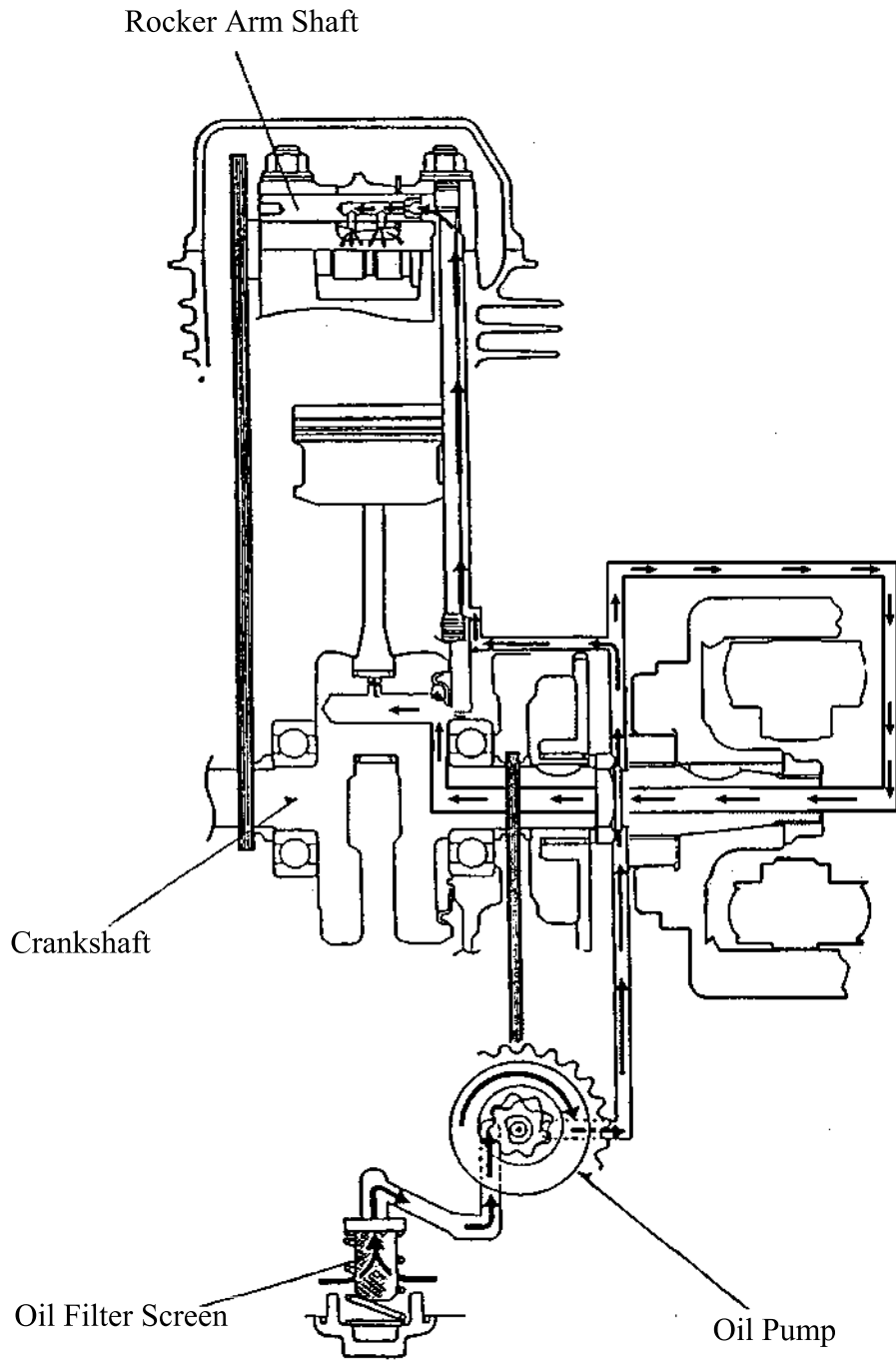

4. LUBRICATION SYSTEM

SERVICE INFORMATION

GENERAL INSTRUCTIONS

- The maintenance of lubrication system can be performed with the engine installed in the frame.
- Use care when removing and installing the oil pump not to allow dust and foreign matters to enter the engine and oil line.
- Do not attempt to disassemble the oil pump. The oil pump must be replaced as a set when it reaches its service limit.
- After the oil pump is installed, check each part for oil leaks.

SPECIFICATIONS

Unit: mm (in)

Item		Standard	Service Limit
Oil pump	Inner rotor-to-outer rotor clearance	0.15 (0.006)	0.2 (0.008)
	Outer rotor-to-pump body clearance	0.15~0.2 (0.006~0.008)	0.25 (0.01)
	Rotor end-to-pump body clearance	0.04~0.09 (0.0016~0.0036)	0.12 (0.0048)

TROUBLESHOOTING

Oil level too low

- Natural oil consumption
- Oil leaks
- Worn or poorly installed piston rings
- Worn valve guide or seal

Poor lubrication pressure

- Oil level too low
- Clogged oil filter or oil passages
- Not use the specified oil

4. LUBRICATION SYSTEM

ENGINE OIL/OIL FILTER

OIL LEVEL AND OIL CHANGE

Refer to the “ENGINE OIL” section in the chapter 3 to check the oil level and replacement and oil filter cleaning.

OIL PUMP

REMOVAL

Remove the right crankcase cover and the A.C. generator flywheel. (Refer to the “A.C. GENERATOR/FLYWHEEL” section in the chapter 16)

Remove the starter clutch gear. (Refer to the “STARTER CLUTCH” section in the chapter 18)

Remove the two bolts and oil separator cover.

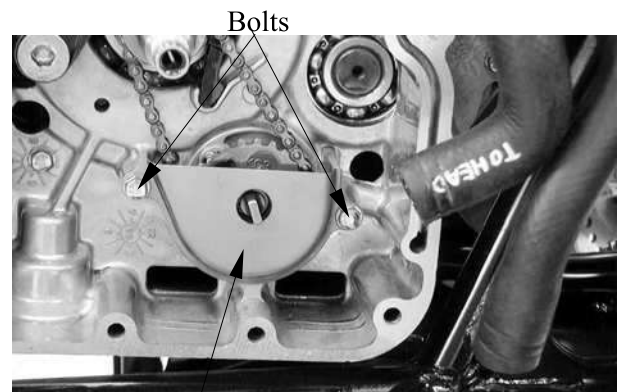

Oil Separator Cover

Pry off and remove the circlip from oil driven sprocket.



Circlip

4. LUBRICATION SYSTEM

Remove the oil pump drive chain and oil driven sprocket.

Oil Pump Driven Sprocket

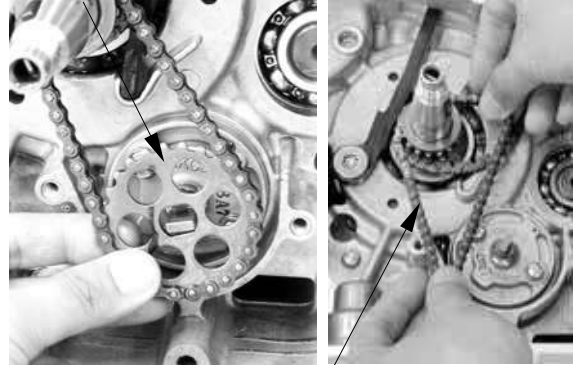

Oil Pump Drive Chain

Remove the two oil pump bolts for remove the oil pump.

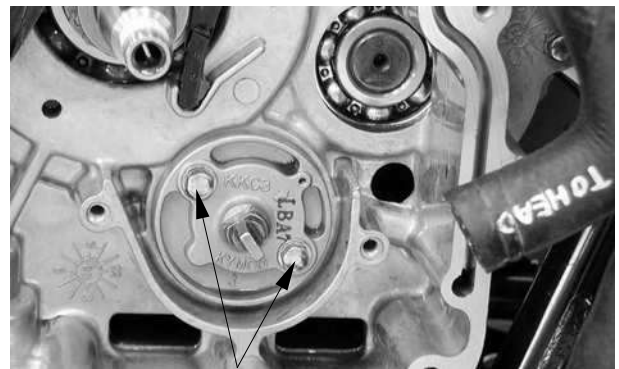

Oil Pump Bolts

OIL PUMP DISASSEMBLY

Remove the screw and disassemble the oil pump.



Pump Body

INSPECTION

Measure the rotor end-to-pump body clearance.

Service Limit: 0.12 mm (0.0048 in)



4. LUBRICATION SYSTEM

Measure the inner rotor-to-outer rotor clearance.

Service Limit: 0.2 mm (0.008 in)

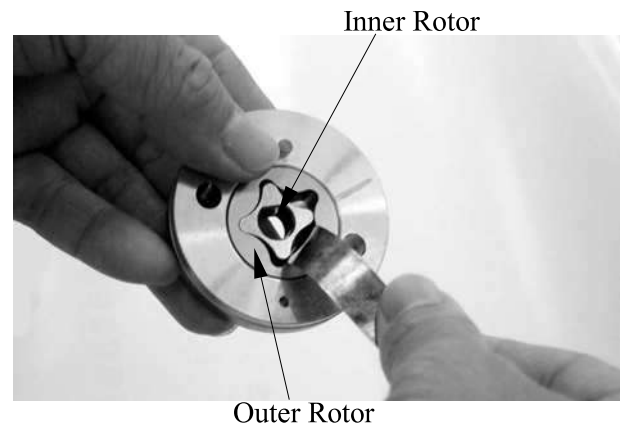

Measure the pump body-to-outer rotor clearance.

Service Limit: 0.25 mm (0.01 in)

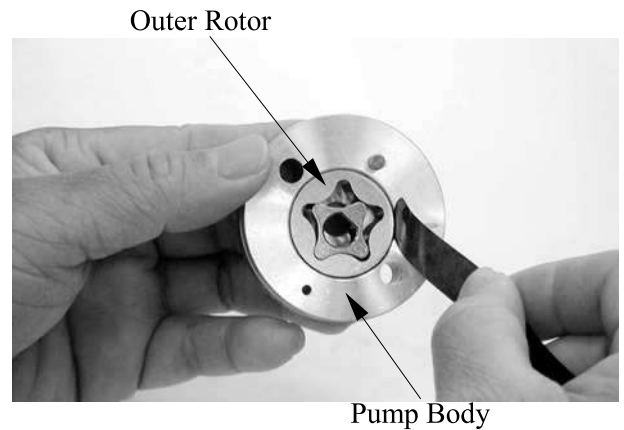

ASSEMBLY

Install the outer rotor, inner rotor and pump shaft into the pump body.

- * Insert the pump shaft by aligning the flat on the shaft with the flat in the inner rotor.

Install the dowel pin.

Install the pump cover by aligning the hole in the cover with the dowel pin.

Tighten the screw to the specified torque.

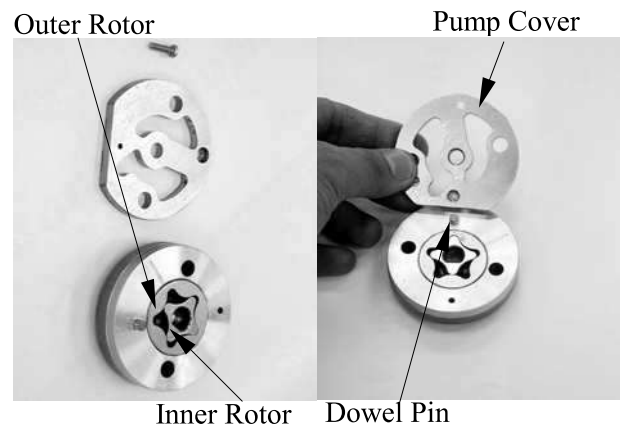

Torque : 0.2 kgf-m (2 Nm, 1.5 lbf-ft)

INSTALLATION

Reverse the "OIL PUMP REMOVAL" procedures.

- * Install the oil pump with the arrow on the pump body facing up and fill the oil pump with engine oil before installation.

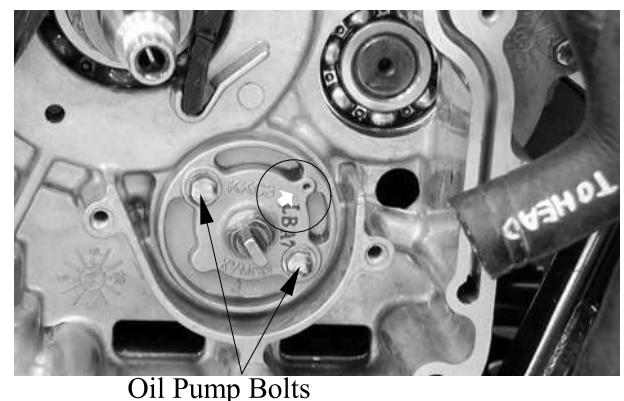

4. LUBRICATION SYSTEM

Make sure that the pump shaft rotates freely without binding.

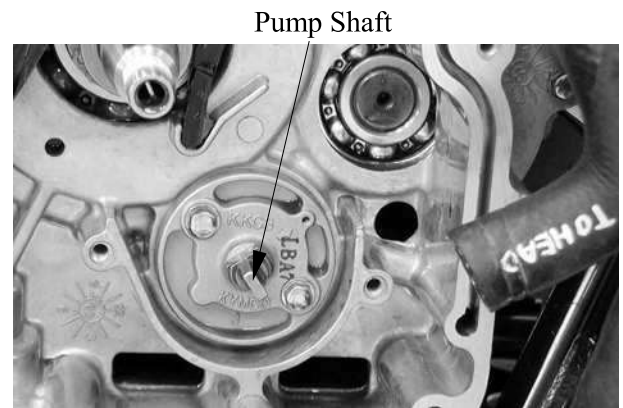

Install oil pump driven sprocket and drive chain, circlip and oil separator cover.



5. FUEL SYSTEM

5

FUEL SYSTEM

SERVICE INFORMATION-----	5- 2
TROUBLESHOOTING-----	5- 3
FUEL TANK -----	5- 4
FUEL VALVE -----	5- 4
THROTTLE VALVE-----	5- 7
CARBURETOR-----	5- 9
AIR CLEANER HOUSING-----	5-15
PAIR SOLENOID VALVE -----	5-16

5. FUEL SYSTEM

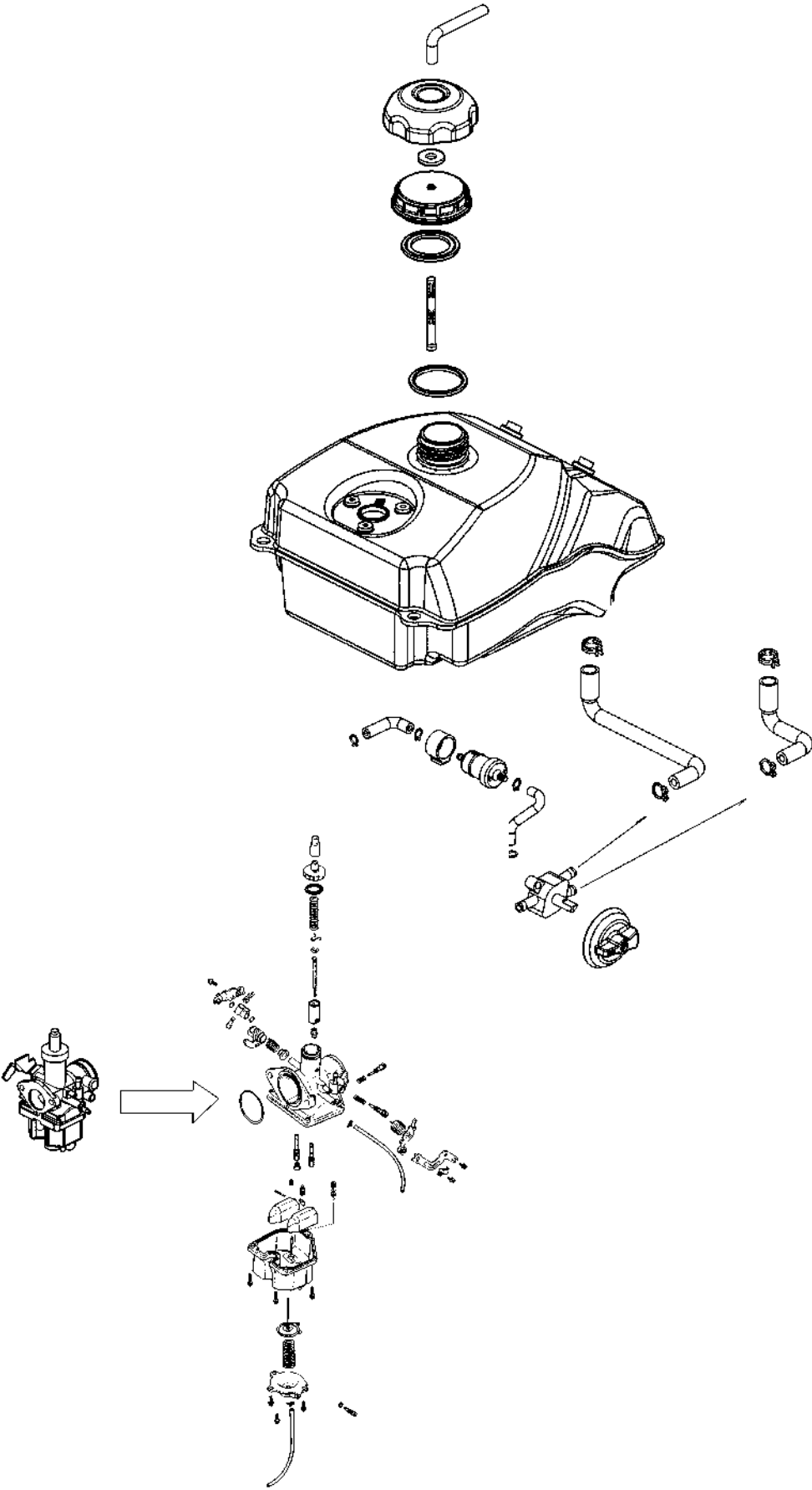

5. FUEL SYSTEM

SERVICE INFORMATION

GENERAL INSTRUCTIONS



Gasoline is very dangerous. When working with gasoline, keep sparks and flames away from the working area.
Gasoline is extremely flammable and is explosive under certain conditions. Be sure to work in a well-ventilated area.

- Do not bend or twist control cables. Damaged control cables will not operate smoothly.
- When disassembling fuel system parts, note the locations of O-rings. Replace them with new ones during reassembly.
- Before float chamber disassembly, loosen the drain screw to drain the residual gasoline into a clean container.
- After the carburetor is removed, plug the intake manifold side with a clean shop towel to prevent foreign matters from entering.
- When cleaning the carburetor air and fuel jets, the O-rings and diaphragm must be removed first to avoid damage. Then, clean with compressed air.
- When the motorcycle is not used for over one month, drain the residual gasoline from the float chamber to avoid erratic idling and clogged slow jet due to deteriorated fuel.

SPECIFICATIONS

Item		Standard
Type		PTG
Venturi dia.		φ22
Float level		14.8mm
Main jet No.		98
Adjust method		Piston
Idle speed	MXU 250	1500±100rpm
	MXU 300	1600±100rpm
Throttle grip free play		1 ~ 4mm
Air screw opening		1 1/8 ± 1/2

5. FUEL SYSTEM

TROUBLESHOOTING

Engine cranks but won't start

- No fuel in tank
- No fuel to carburetor
- Cylinder flooded with fuel
- No spark at plug
- Clogged air cleaner
- Intake air leak
- Improper throttle operation

Engine idles roughly, stalls or runs poorly

- Excessively used choke
- Ignition malfunction
- Faulty carburetor
- Poor quality fuel
- Lean or rich mixture
- Incorrect idle speed

Misfiring during acceleration

- Faulty ignition system
- Faulty carburetor

Backfiring at deceleration

- Float level too low
- Incorrectly adjusted carburetor
- Faulty exhaust muffler

Engine lacks power

- Clogged air cleaner
- Faulty carburetor
- Faulty ignition system

Lean mixture

- Clogged carburetor fuel jets
- Float level too low
- Intake air leak
- Clogged fuel tank cap breather hole
- Kinked or restricted fuel line

Rich mixture

- Float level too high
- Clogged air jets
- Clogged air cleaner

5. FUEL SYSTEM

FUEL TANK

REMOVAL



- Keep sparks and flames away from the work area.
- Wipe off any spilled gasoline.

Remove the seat (See page 2-3), right and left side frame cover (See page 2-6) and fuel tank cover (See page 2-8).

Switch the fuel valve “OFF”.

Disconnect the fuel tube from carburetor.

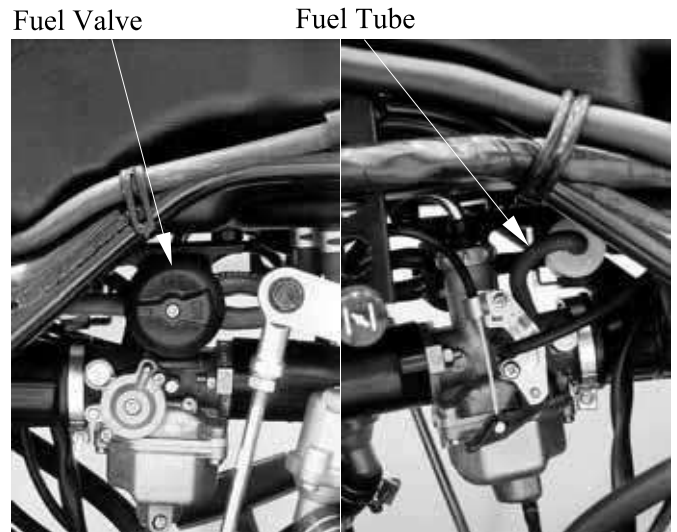

Disconnect the fuel unit connectors.

Remove the two bolts and two nuts from the fuel tank, then remove the fuel tank.

INSTALLATION

Reverse the “FUEL TANK REMOVAL” procedures.

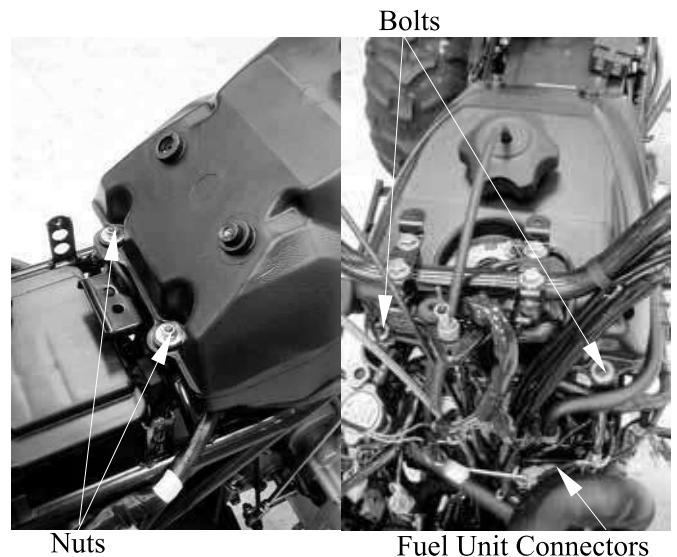

FUEL VALVE

REMOVAL

- * Keep sparks and flames away from the work area.
- Drain gasoline into a clean container.

Remove the screw and then remove control switch.

Disconnect all fuel tubes and remove the two screws, then remove fuel valve.

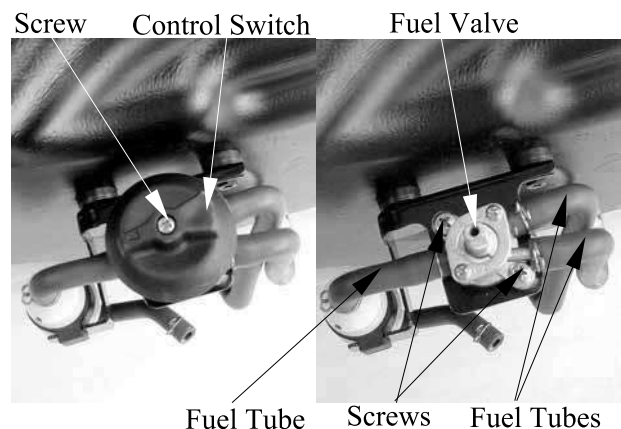

5. FUEL SYSTEM

DISASSEMBLY

Remove the two screws on the retaining ring and then remove retaining ring.
Remove the washer and control shaft.

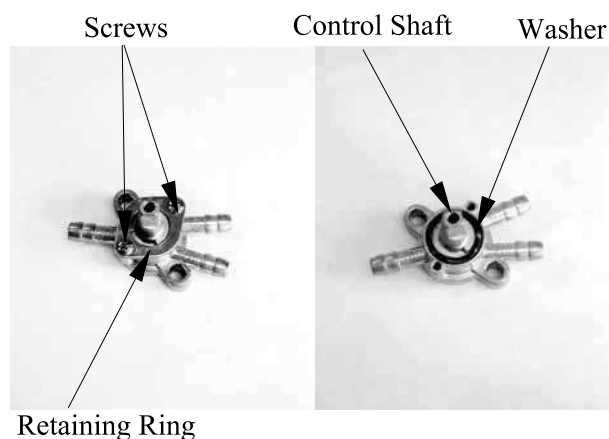

Remove the rubber gasket from the fuel valve body.

INSPECTION

Inspect the fuel valve body for dirt and clog.
Clean if necessary.

Replace the rubber gasket with new ones if they are damaged or deteriorated.

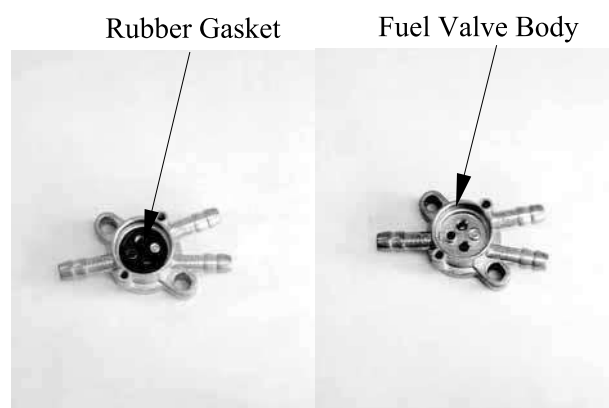

Replace the O-rings with new ones if they are damaged or deteriorated.

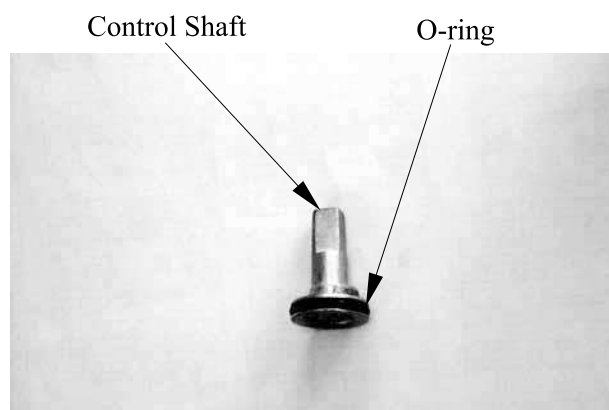

5. FUEL SYSTEM

ASSEMBLY

Reverse the “DISASSEMBLY” procedures.
Install rubber gasket, control shaft, washer
and retaining ring.

- * • Aligning the tab on the control shaft with the outlet duct in the fuel valve body.
- Aligning the tab on the retaining ring with the outlet duct in the fuel valve body.

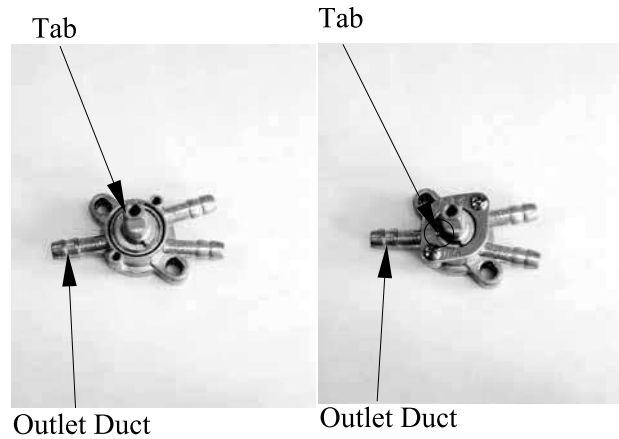

INSTALLATION

Reverse the “FUEL VALVE REMOVEAL”
procedures.

Connect all fuel tube.

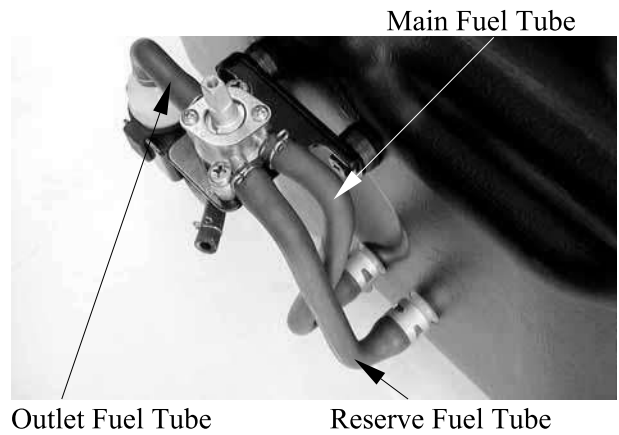

5. FUEL SYSTEM

THROTTLE VALVE

DISASSEMBLY

Remove the fuel tank. (Refer to “FUEL TANK” section in the chapter 5)

Remove the carburetor cap.

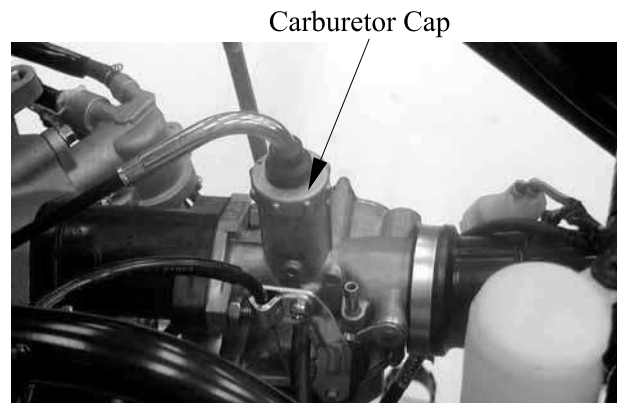

Pull out the throttle valve.

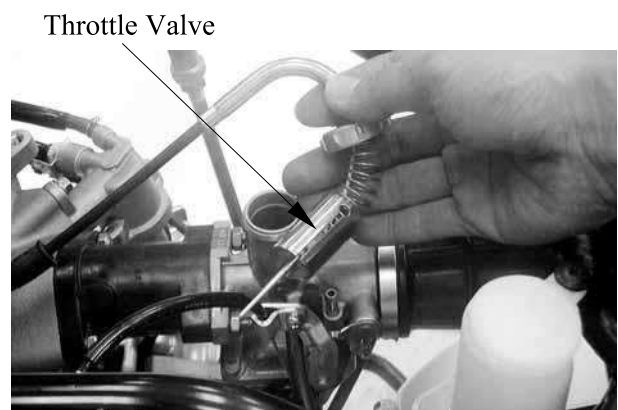

Compress the spring to disconnect the throttle cable by hand.

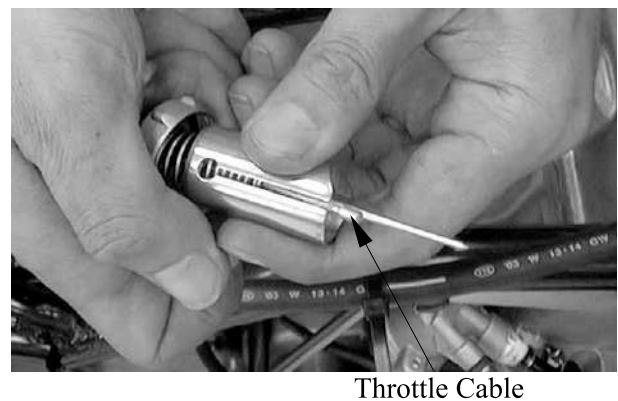

5. FUEL SYSTEM

Remove the spring from the throttle valve

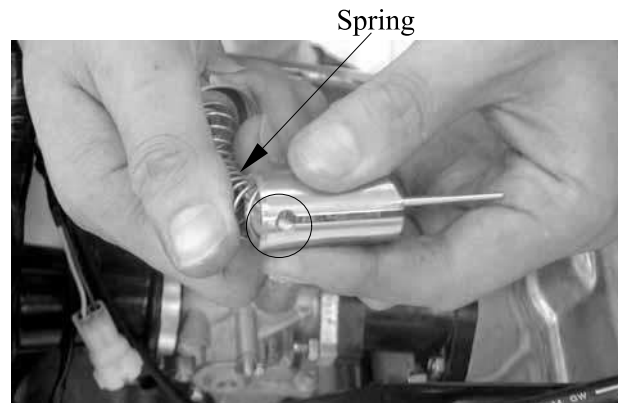

Pry off the needle retainer and remove the jet needle.
Check the throttle valve and jet needle for wear or damage.

ASSEMBLY

Reverse the “DISASSEMBLY” procedures.

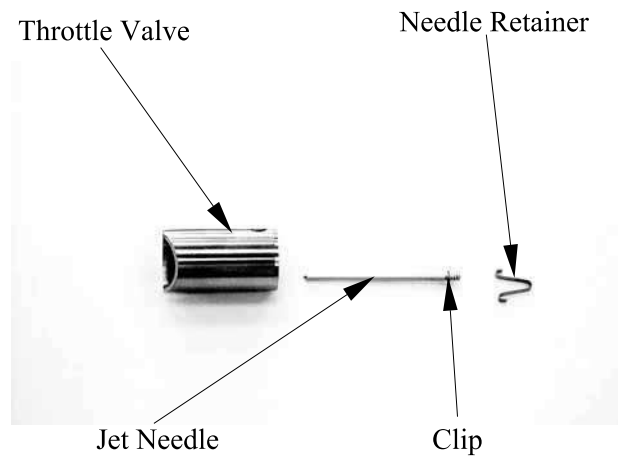

Install the throttle valve into the carburetor body.

* Align the groove in the throttle valve with the throttle stop screw on the carburetor body.

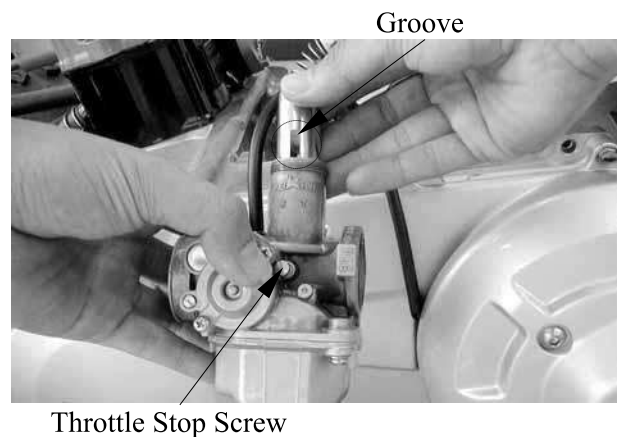

5. FUEL SYSTEM

CARBURETOR

REMOVAL

Remove the fuel tank and carburetor cap.
(Refer to “FUEL TANK” and “THROTTLE VALVE DISASSEMBLY” section in the chapter 5)

Loosen the drain screw to drain the gasoline from the float chamber.

- * • Keep sparks and flames away from the work area.
• Drain gasoline into a clean container.

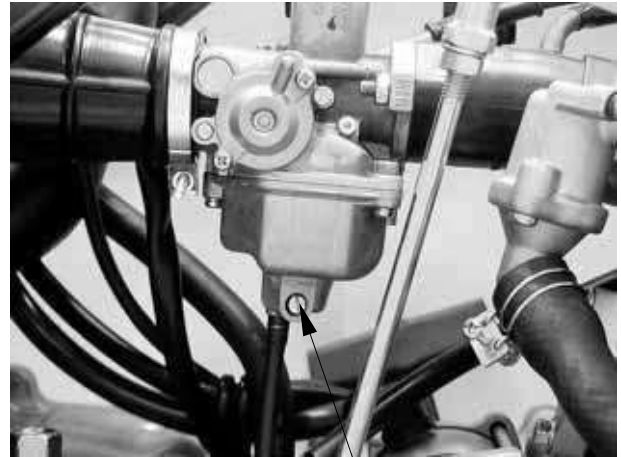

Fuel Drain Plug

Loosen the screw on the lock plate for disconnect the choke cable

Loosen the air cleaner connecting tube band screw.

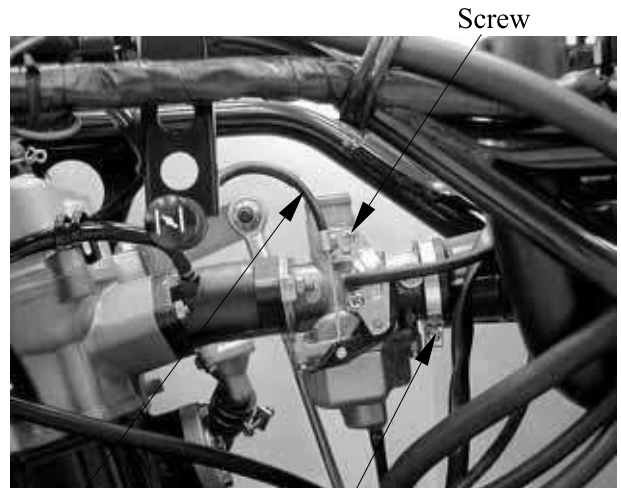

Choke Cable

Band Screw

Remove the two bolts at the air cleaner case.
Disconnect the air cleaner connecting tube from the carburetor.
Remove the two carburetor mounting nuts and carburetor body.
Remove the carburetor.

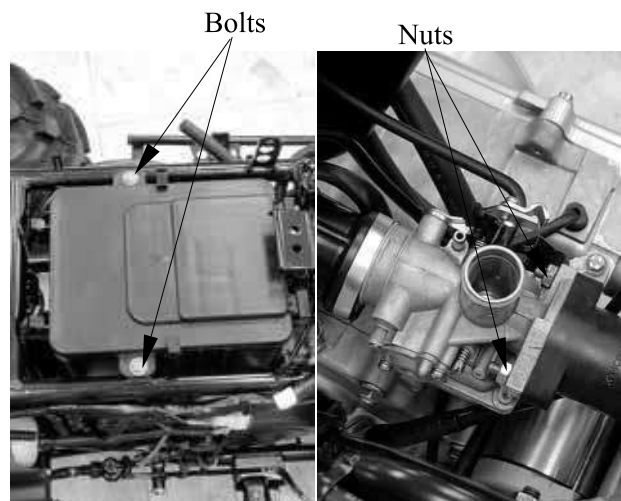

Bolts

Nuts

5. FUEL SYSTEM

Check the O-ring for damage.
Replace with new ones if necessary.

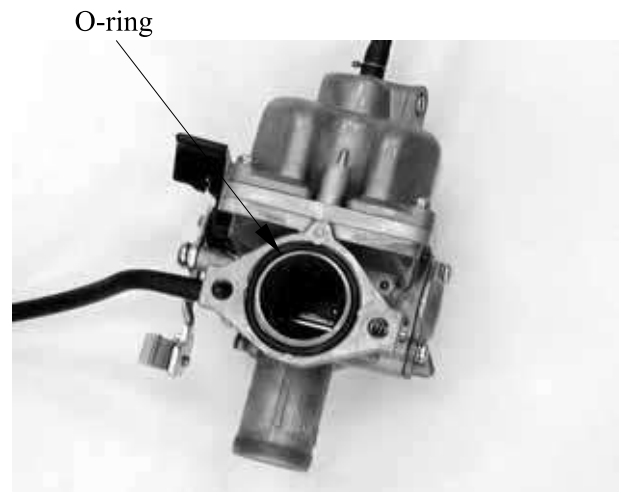

DISASSEMBLY

Remove the float chamber attaching three screws and remove the float chamber.

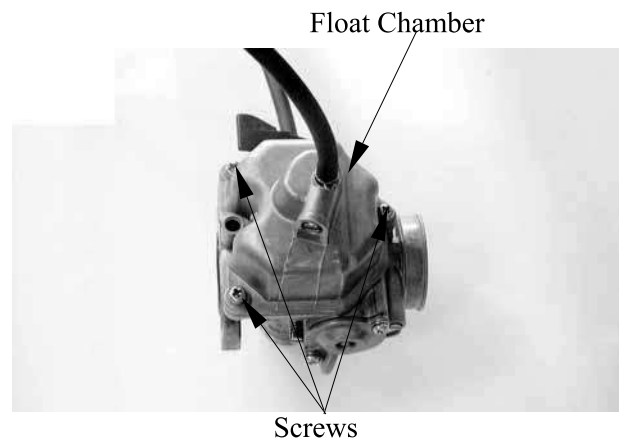

Remove the baffle plate.

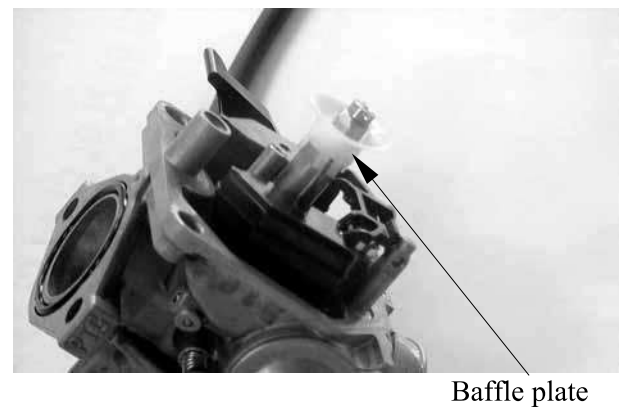

5. FUEL SYSTEM

Pull out the float pin, then remove float and float valve.

Inspect the float for deformation or damage.

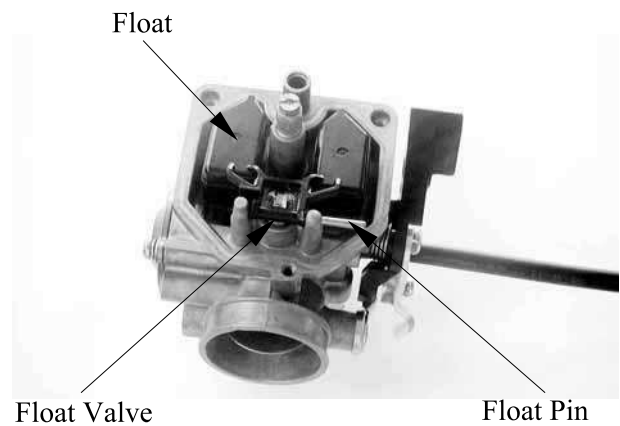

Remove the main jet, needle jet holder, and needle jet.
Remove the slow jet.
Remove the air screw and throttle stop screw.

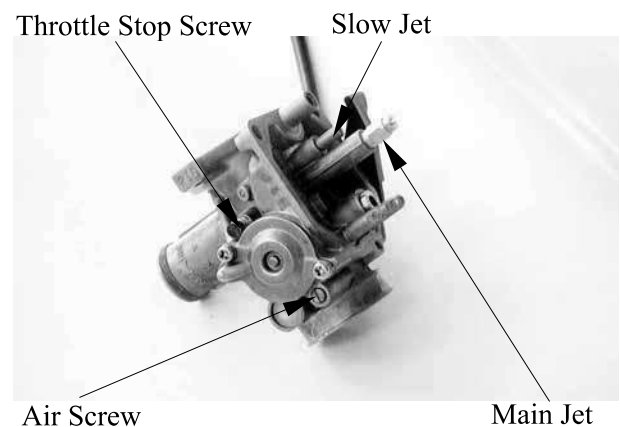

CAUTIONS!

- * • Be careful not to damage the jets and jet holder when removing them.
- Before removal, turn the throttle stop screw and air screw in and count the number of turns until they seat lightly and then make a note of this.
- Do not force the screw against its seat to avoid seat damage.
- Be sure to install the O-ring in the reverse order of removal.

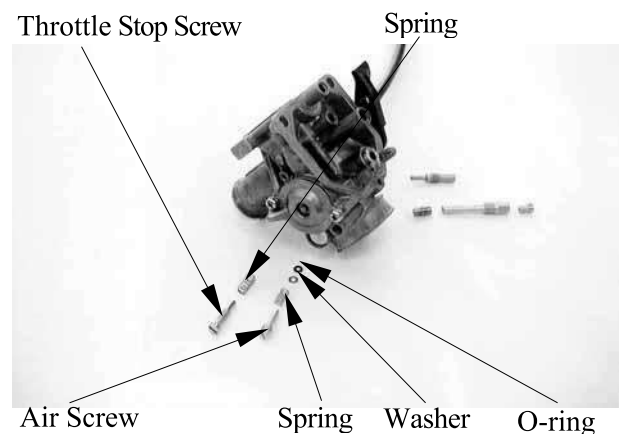

5. FUEL SYSTEM

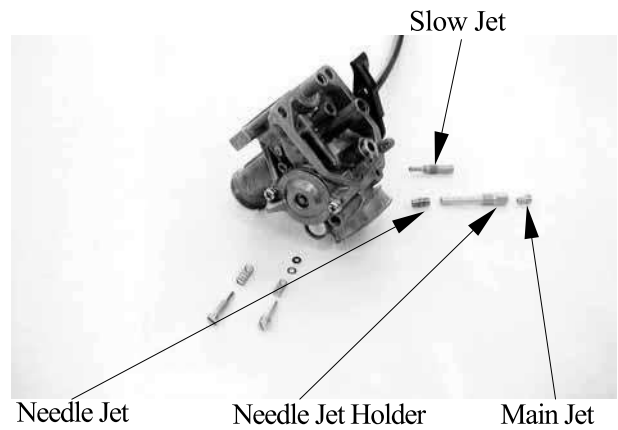

Remove the two screws and the air cut-off valve cover.

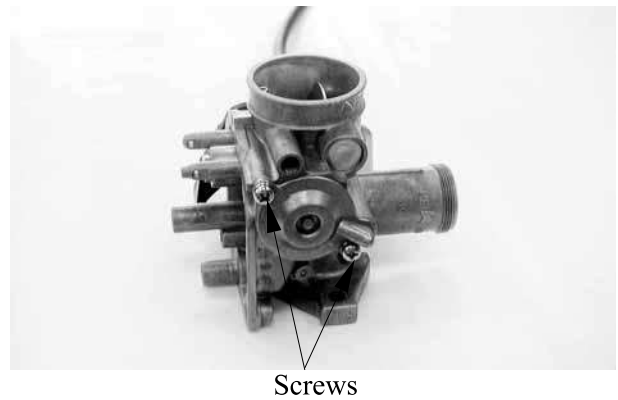

Remove the spring, diaphragm and O-rings. Inspect the diaphragm and spring for wear or damage.

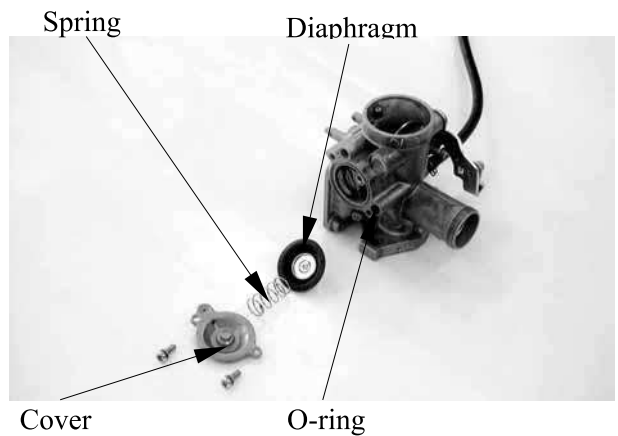

5. FUEL SYSTEM

CARBURETOR CLEANING

Blow compressed air through all passages of the carburetor body.

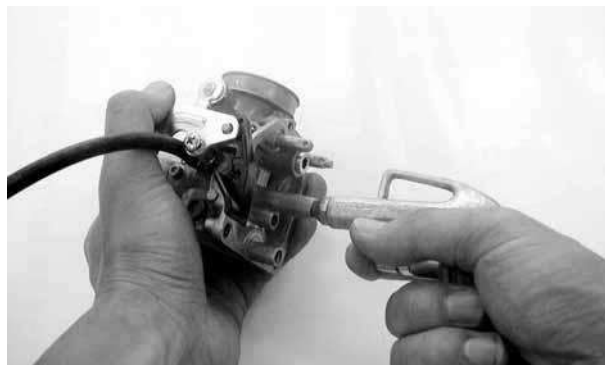

FLOAT/FLOAT VALVE INSPECTION

Inspect the float valve seat for wear or damage.
Inspect the float for damage or fuel level inside the float chamber.

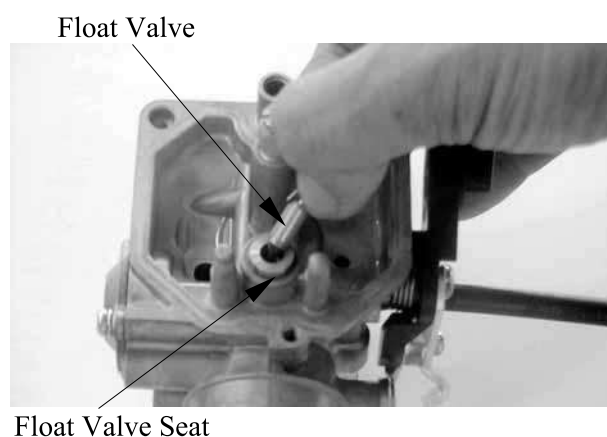

FUEL RESERVOIR O-RING CHECK

Remove the O-ring.

INSPECTION

Inspect the check the O-ring for damage.
Replace with new ones if necessary



5. FUEL SYSTEM

ASSEMBLY

Install the slow jet.

Install the needle jet, needle jet holder and main jet.

Install the throttle stop screw and air screw

Install the spring, diaphragm and O-rings.

- *

<ul style="list-style-type: none">• When installing the air screw, return it to the original position as noted during removal• After the carburetor is installed, be sure to perform the Exhaust Emission
--

Install the float valve, float and float pin.

FLOAT LEVEL INSPECTION

Turn the carburetor upside down so that the float will go down to make the float valve contact the float valve seat.

Then slowly tilt the carburetor and measure the float level with the float level gauge while the float pin just contacts with float valve.

Float Level: 14.8mm



When adjusting, carefully bend the float pin.

Check the float for proper operation.

Install the jet holder, aligning the baffle plate groove with the carburetor tab and then install the float chamber.



Baffle Plate

INSTALLATION

Reverse the “CARBURETOR REMOVAL” procedures.

AIR CLEANER

Refer to the “AIR CLEANER” section in the chapter 3 for air cleaner replacement and cleaning.

5. FUEL SYSTEM

AIR CLEANER HOUSING REMOVAL/INSTALLATION

Remove the seat (see page 2-3).
Remove the side covers (see page 2-6).

Remove the clip and disconnect the
crankcase breather hose from the crankcase.
Loosen the carburetor-to-air cleaner
connecting tube band screw.

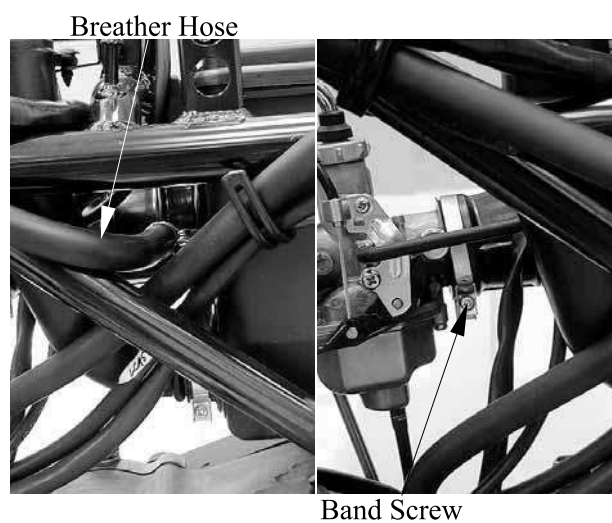

Remove the intake air duct trim clip.
Remove the mounting bolts and then remove
the air cleaner housing from the carburetor
and the intake duct.

Installation is in the reverse order of
removal.

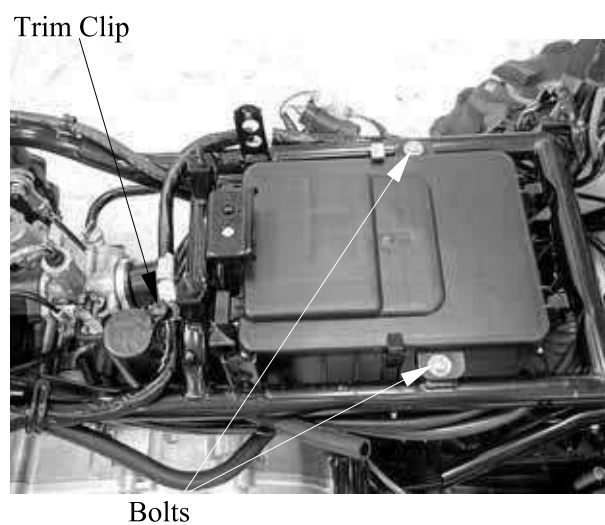

5. FUEL SYSTEM

PAIR SOLENOID VALVE REMOVAL/INSTALLATION

Remove the two nuts and electrical holder.
Disconnect air supply hose and vacuum hose
from the air solenoid valve, then remove the
air solenoid valve.

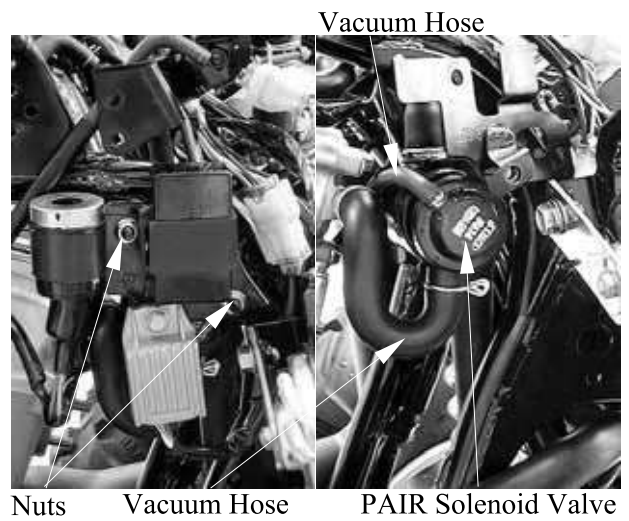

Installation is in the reverse order of
removal.





ENGINE REMOVAL



SERVICE INFORMATION-----	6- 1
ENGINE REMOVAL (MXU 250) -----	6- 2
ENGINE INSTALLATION (MXU 250) -----	6- 7
ENGINE REMOVAL (MXU 300) -----	6- 8
ENGINE INSTALLATION (MXU 300) -----	6-17

6. ENGINE REMOVAL/INSTALLATION

SERVICE INFORMATION

GENERAL INSTRUCTIONS

- A floor jack or other adjustable support is required to support and maneuver the engine.
Be careful not to damage the machine body, cables and wires during engine removal.
- Use shop towels to protect the machine body during engine removal.
- Parts requiring engine removal for servicing:
 - Crankcase
 - Crankshaft

6. ENGINE REMOVAL

ENGINE REMOVAL (MXU 250)

Drain engine oil and transmission oil.
(Refer to chapter 3).
Remove frame covers and exhaust pipe.
(Refer chapter 2).
Remove the air cleaner housing and carburetor.
(Refer to chapter 5).
Remove the air solenoid valve (refer to chapter 5).
Remove the spark coil (refer to chapter 17).

Disconnect the crankcase breather from the cylinder head cover.
Disconnect the vacuum hose from the inlet pipe.

Disconnect the water hose from water pump cover.

Remove the bolt at the thermostat and disconnect the thermosensor wire, then disconnect the thermostat from the cylinder head.

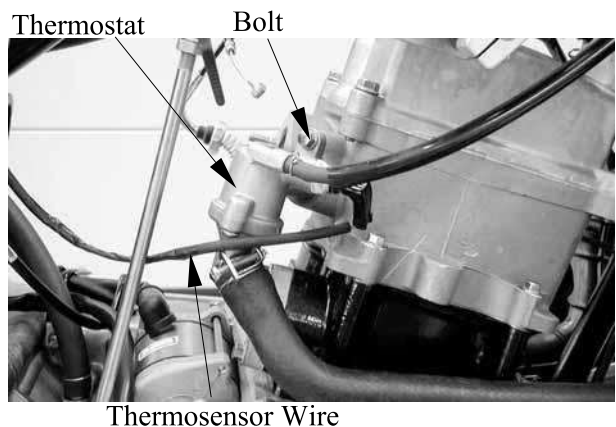
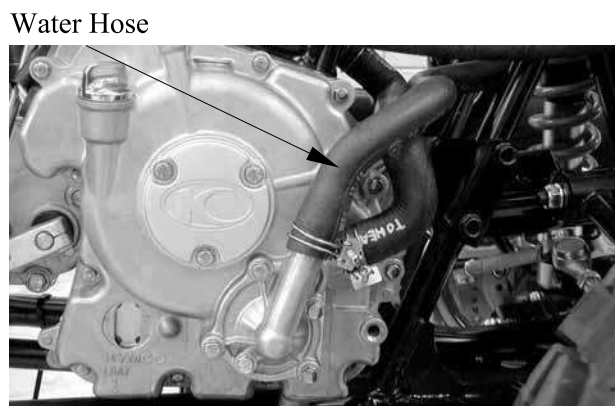
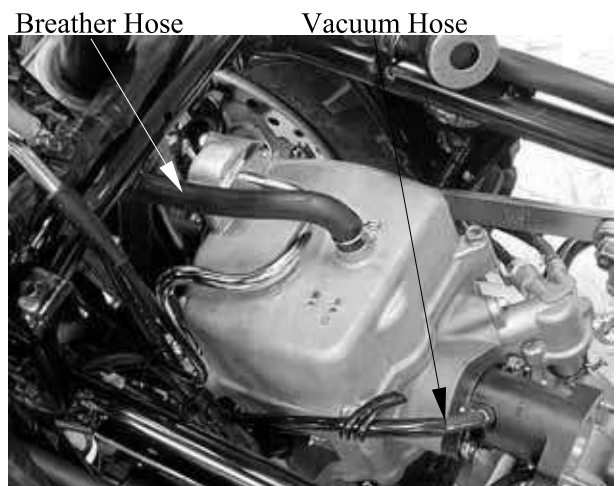

6. ENGINE REMOVAL/INSTALLATION

Remove the drive select shift to drive select arm connecting bolt and nut.

Remove the two mounting nuts and drive select shift.

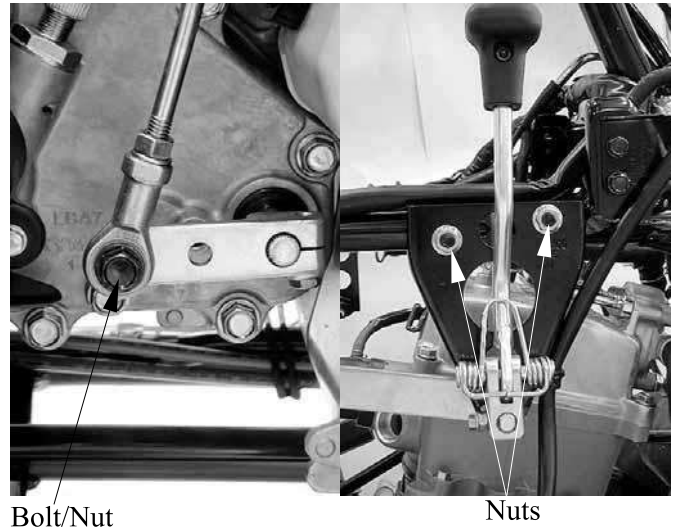

Disconnect the speedometer cable.

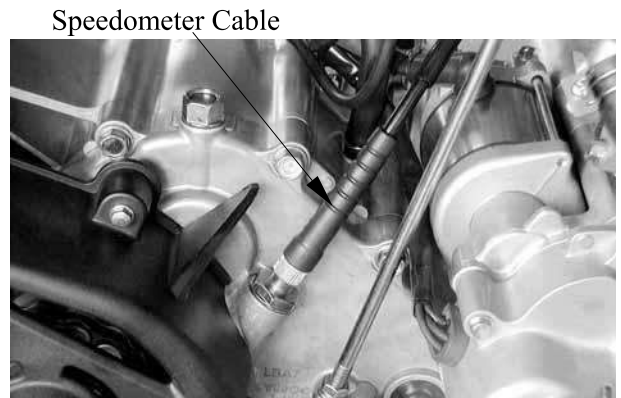

Remove the three bolts at the drive sprocket cover and then remove the drive sprocket cover.

Remove the two bolts on the drive sprocket.
Remove the drive sprocket and washer.

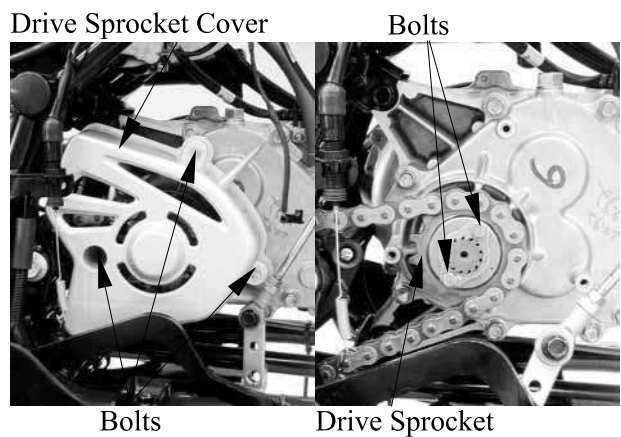

6. ENGINE REMOVAL

Slide the rubber sleeve back to expose the starter motor wire nut.

Remove the starter motor wire nut for disconnect the starter motor wire.



Remove the bolt at the starter motor for disconnect the ground wire lead.

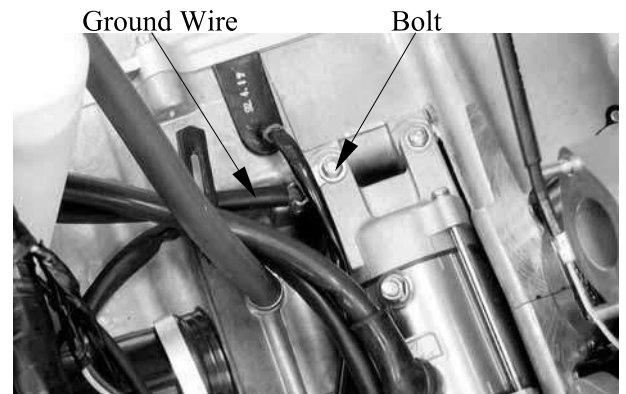

Remove the A.C. Generator, ignition pulse generator and gear change switch connectors.

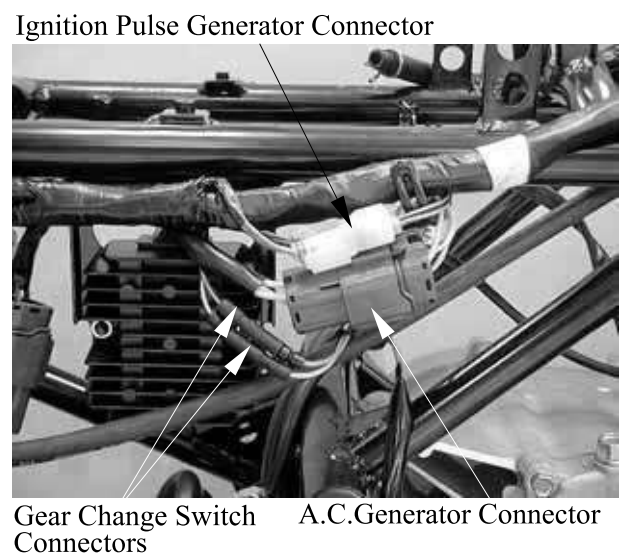

6. ENGINE REMOVAL/INSTALLATION

Loosen the inlet hose band screw and then disconnect the inlet hose from the left crankcase cover.
Loosen the outlet hose band screw and then disconnect the outlet hose from the left crankcase cover.

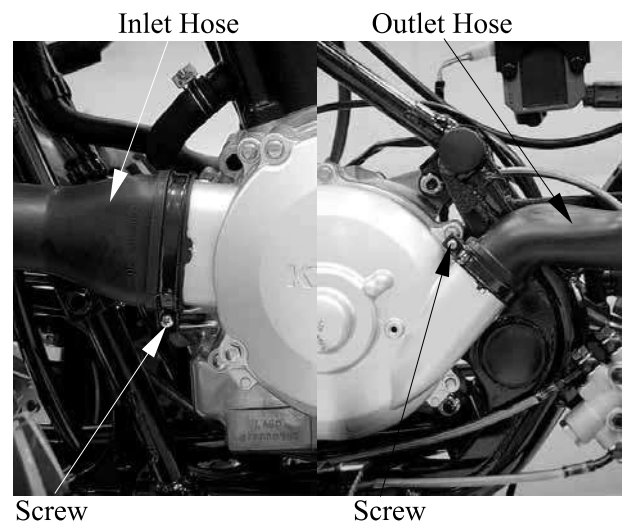

Remove the rear lower mounting bolt and nut.
Remove the rear upper mounting bolt and nut.
Remove the front mounting bolts and nuts.

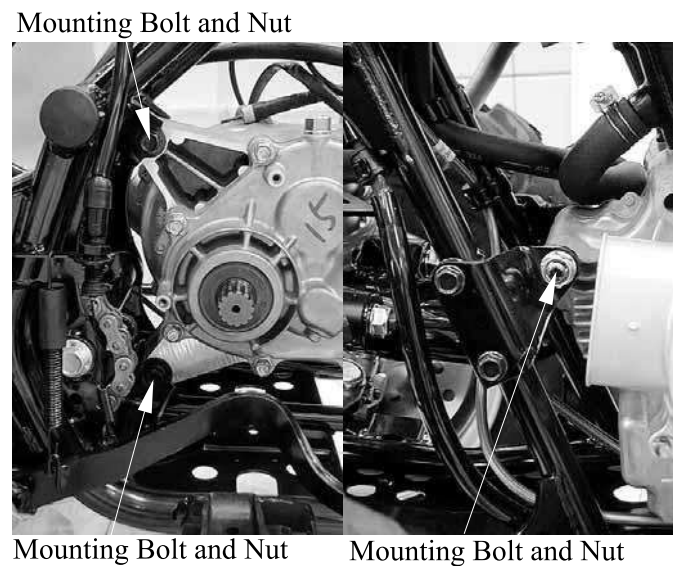

Remove the four bolts for remove the left and right engine brackets.

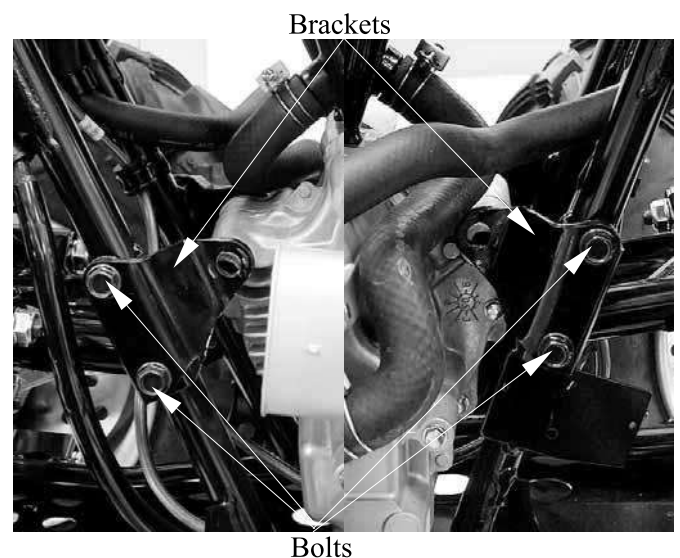

6. ENGINE REMOVAL

Remove the engine assembly to the left side of the machine.

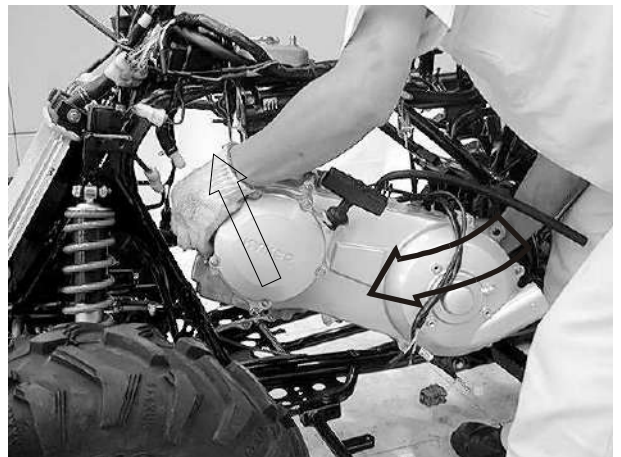
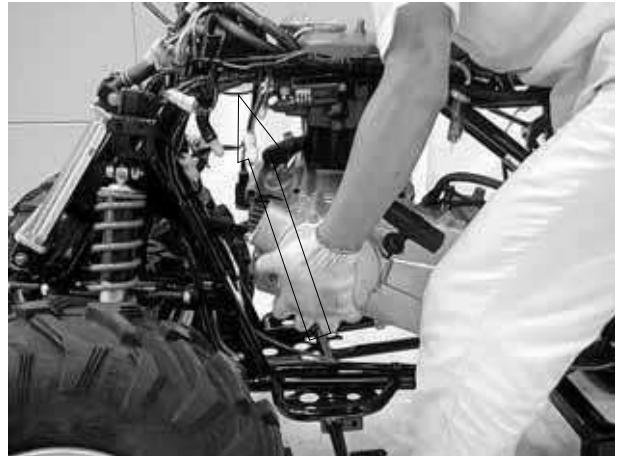

6. ENGINE REMOVAL/INSTALLATION

ENGINE INSTALLATION (MXU 250)

Installation is in the reverse order of removal.

The rear upper and lower engine mounting bolts and nuts loosely install, then tighten the engine mounting nuts to the specified torque.

Torque: 40 N-m (4 kgf-m, 29 lbf-ft)

The brackets, bolts, front engine mounting bolt and loosely install, then tighten the bolts on the brackets to the specified torque.

Torque: 22 N-m (2.2 kgf-m, 16 lbf-ft)

Tighten the front engine mounting bolt and nut to the specified torque.

Torque: 40 N-m (4 kgf-m, 29 lbf-ft)

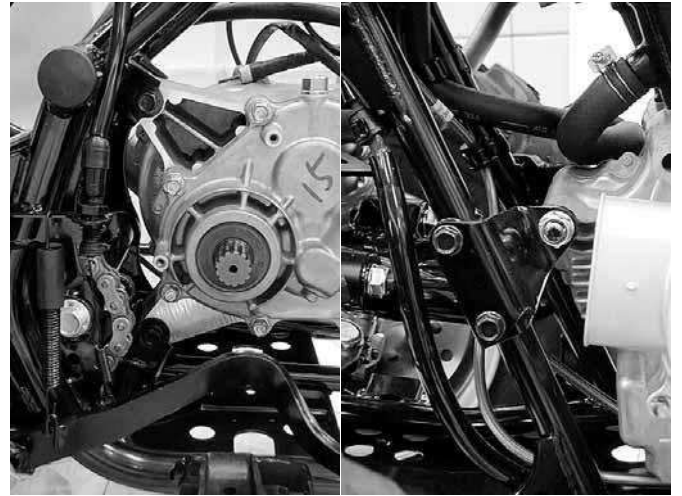

6. ENGINE REMOVAL

ENGINE REMOVAL (MXU 300)

Drain engine oil and transmission oil.
(Refer to chapter 3).
Remove frame covers and exhaust pipe.
(Refer chapter 2).
Remove the air cleaner housing and carburetor.
(Refer to chapter 5).

Disconnect the spark plug from the cylinder head.

Disconnect the spark coil connectors from the spark coil, then remove the two bolts and spark coil.

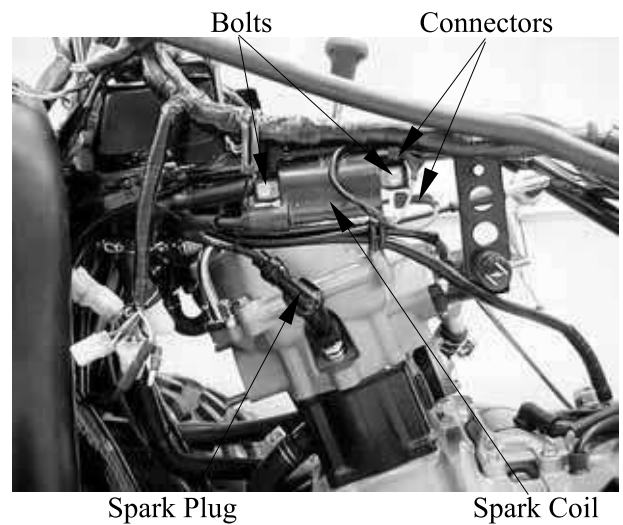

Disconnect the speedometer cable.

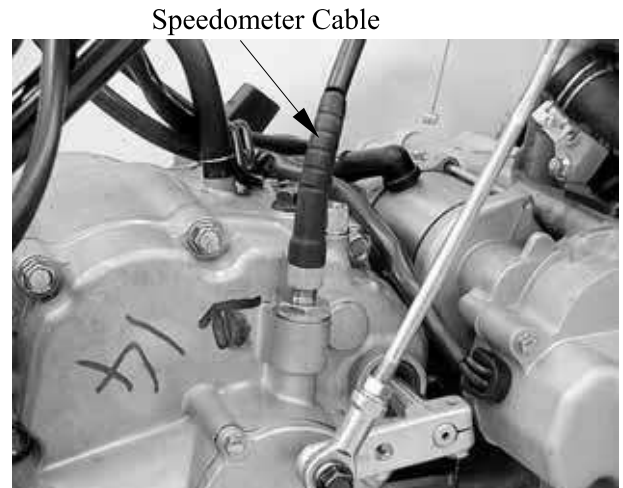

Disconnect the crankcase breather from the cylinder head cover.
Disconnect the vacuum hose from the inlet pipe.

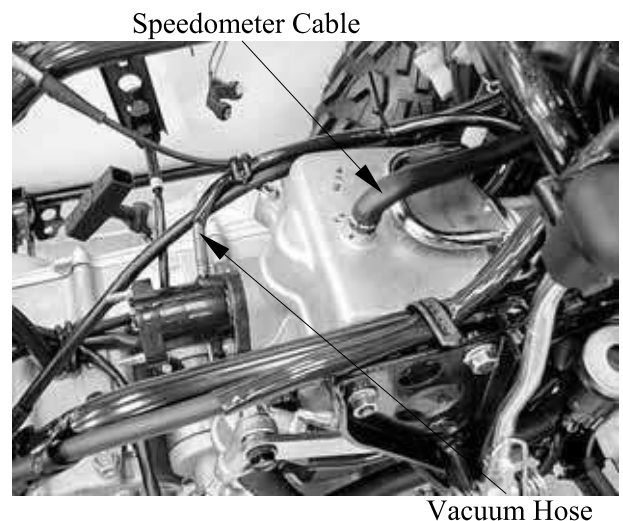

6. ENGINE REMOVAL/INSTALLATION

Remove the drive select shift to drive select arm connecting bolt and nut.

Remove the two mounting nuts and drive select shift.

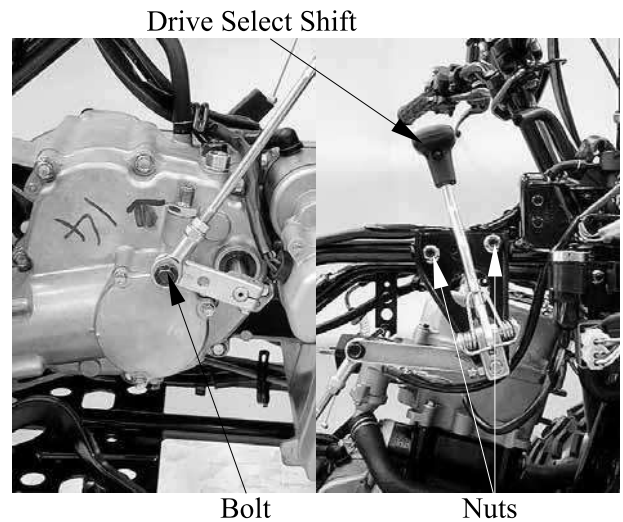

Remove the bolt and thermostat.

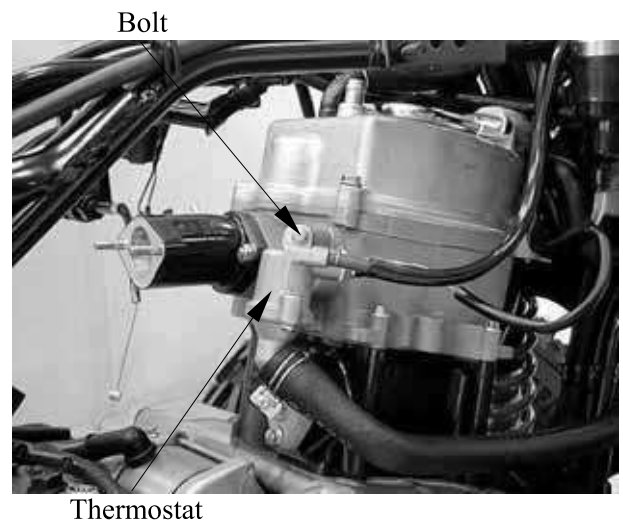

Remove the two nuts and electrical holder. Disconnect air supply hose and vacuum hose from the air solenoid valve, then remove the air solenoid valve.

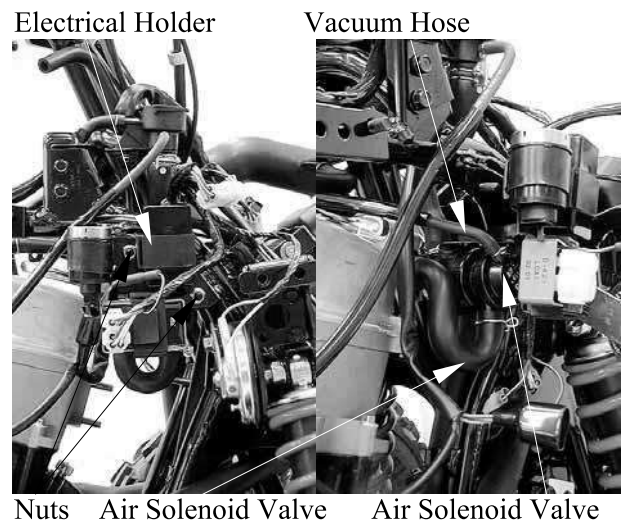

6. ENGINE REMOVAL

Loosen the hose band and disconnect the water hose from the water pump.

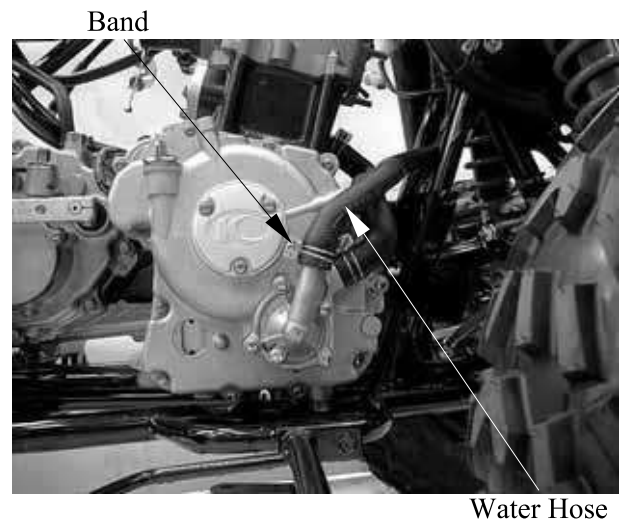

Remove the A.C. Generator, ignition pulse generator and gear change switch connectors.

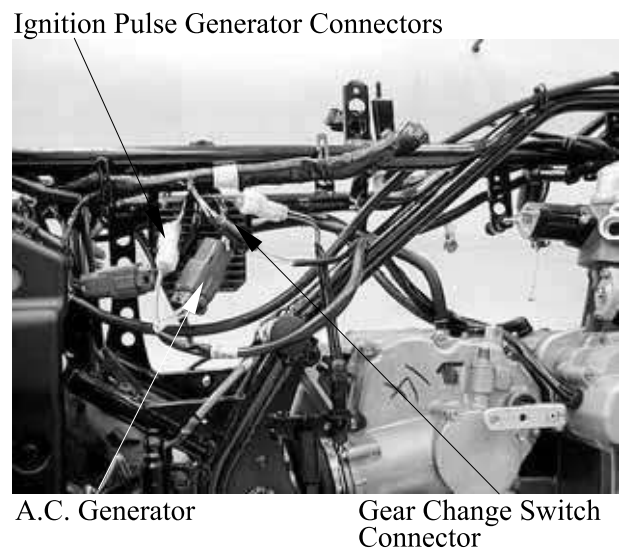

Straighten the clamp and remove the bolt, then disconnect the engine ground cable.

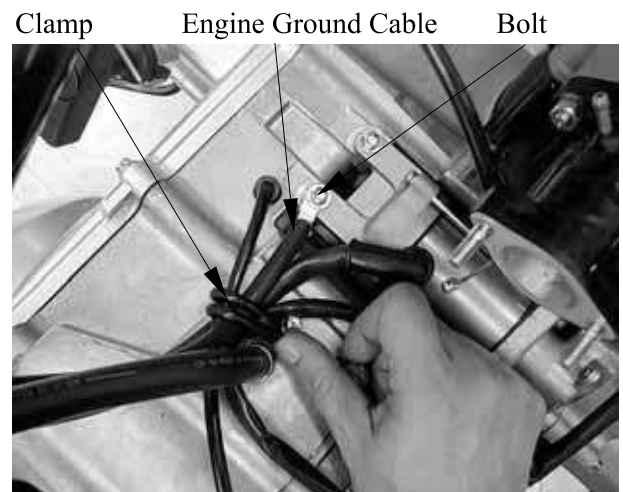

6. ENGINE REMOVAL/INSTALLATION

Slide the rubber sleeve back to expose the starter motor wire nut.

Remove the starter motor wire nut for disconnect the starter motor wire.

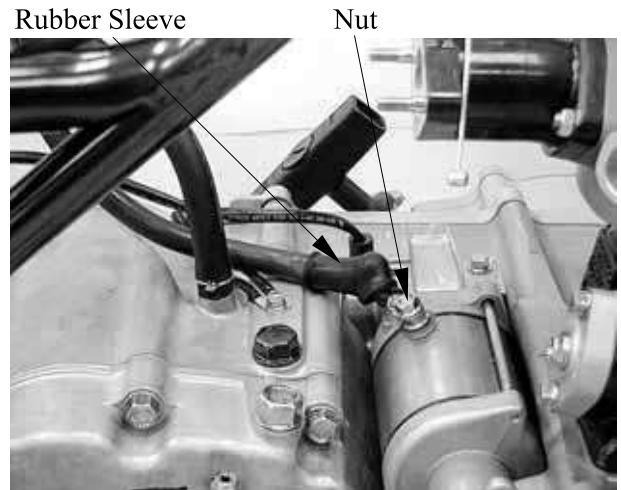

Loosen the inlet hose band screw and then disconnect the inlet hose from the left crankcase cover.

Loosen the outlet hose band screw and then disconnect the outlet hose from the left crankcase cover.

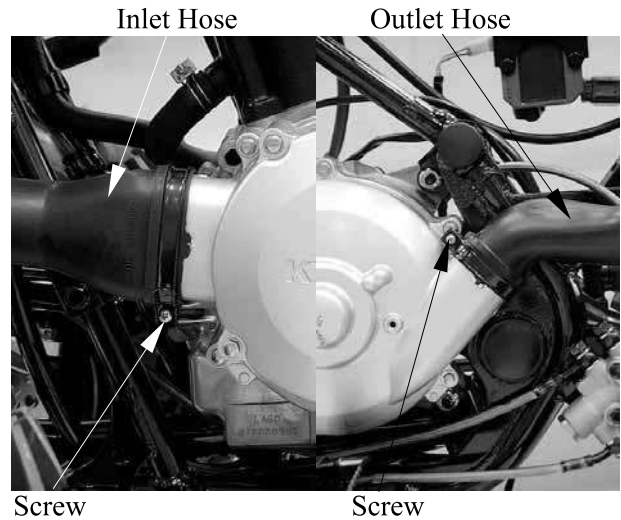

Remove the front mounting bolt and nut.

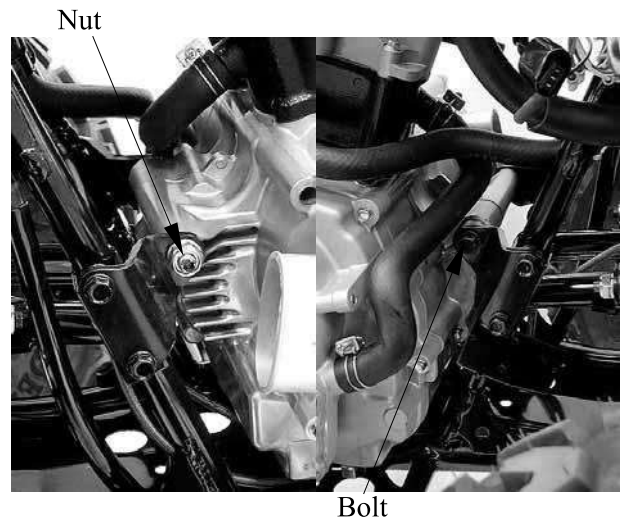

6. ENGINE REMOVAL

Remove the four bolts for remove the left and right engine brackets.

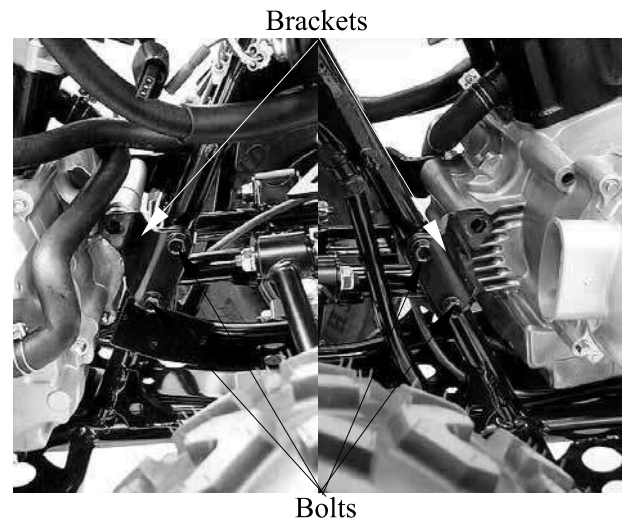

Remove the rear upper mounting bolt and nut.

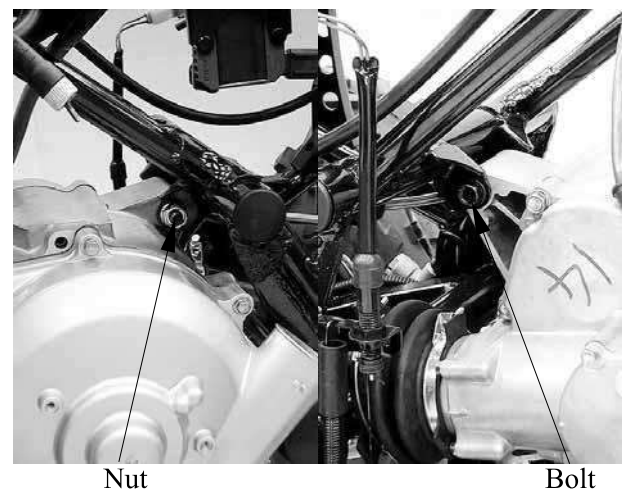

Remove the rear lower mounting bolt and nut.

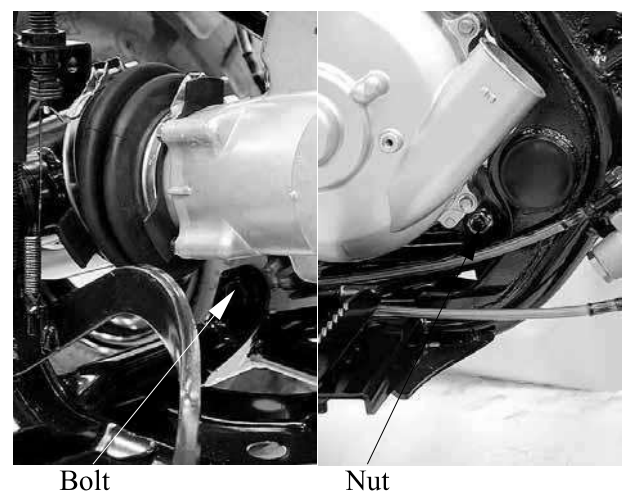

6. ENGINE REMOVAL/INSTALLATION

Loosen the joint boot band screw on the swingarm side. Remove the joint boot from the swingarm.

Screw (Only swingarm side) Joint Boot



Rise the engine front side and move the engine forward, then remove the engine from the frame by disengaging the countershaft from the universal joint in the swing arm.

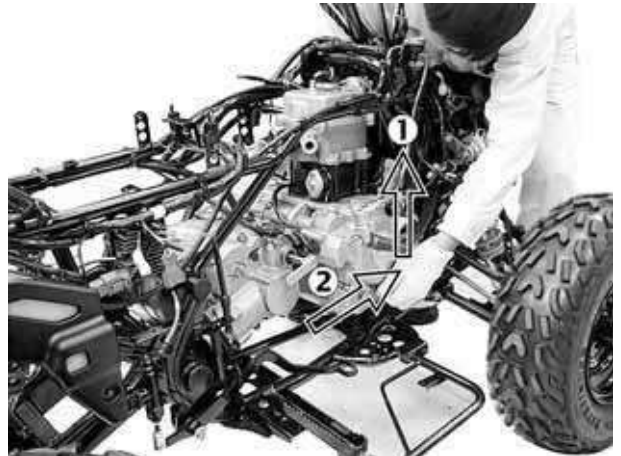

6. ENGINE REMOVAL

Turn the engine rear side to frame left side.

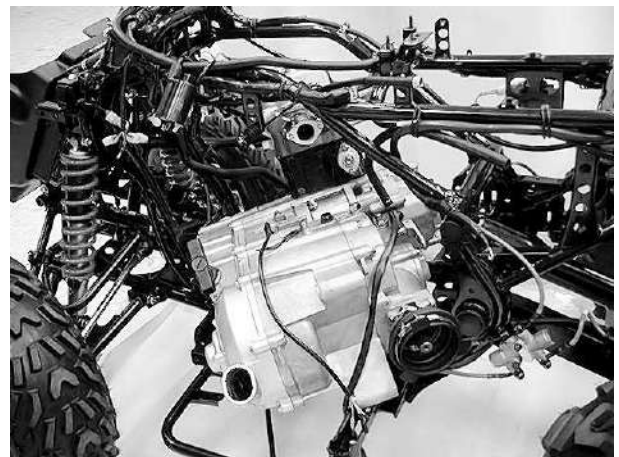

Lower the cylinder head to turn the cylinder head to frame left side.



6. ENGINE REMOVAL/INSTALLATION



Move the engine to a rubber mat.

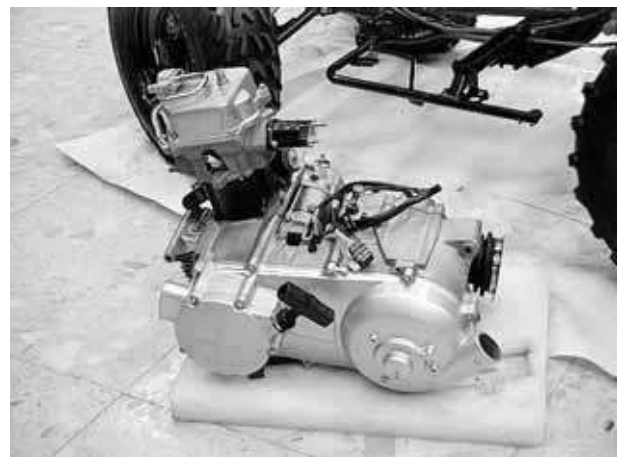

6. ENGINE REMOVAL

Remove the two bolts and intake manifold may more easy to move engine.

Bolts



Intake Manifold

Be careful not to damage choke knob cable and holder plate when the engine is moved.

Holder Plate



Choke Knob Cable

6. ENGINE REMOVAL/INSTALLATION

ENGINE INSTALLATION (MXU 300)

Installation is in the reverse order of removal.

Check the joint boot for tears or other damage.

Check the secondary driven bevel gear shaft splines and universal joint splines for wear or damage.

Be sure to install the joint onto the secondary driven bevel gear shaft case.

Apply molybdenum disulfide grease to the universal joint splines and the secondary driven bevel gear shaft splines.

Slide the joint boot front to expose the secondary driven bevel gear shaft.

Install the engine the frame.

Move the engine rearward and engage the secondary driven bevel gear shaft into the universal joint.

The rear upper and lower engine mounting bolts and nuts loosely install, then tighten the engine mounting nuts to the specified torque.

Torque: 40 N-m (4 kgf-m, 29 lbf-ft)

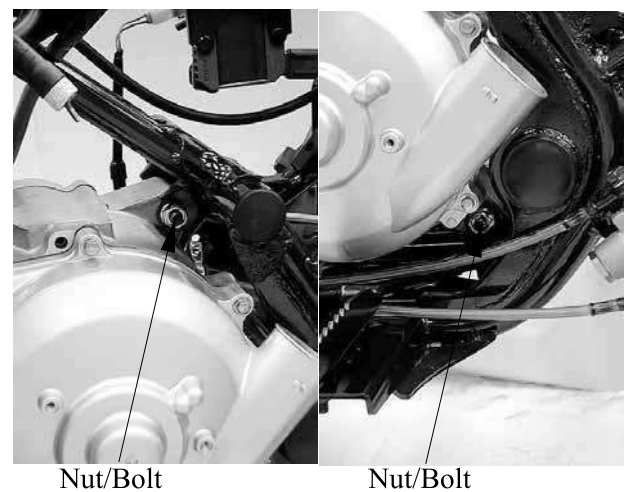
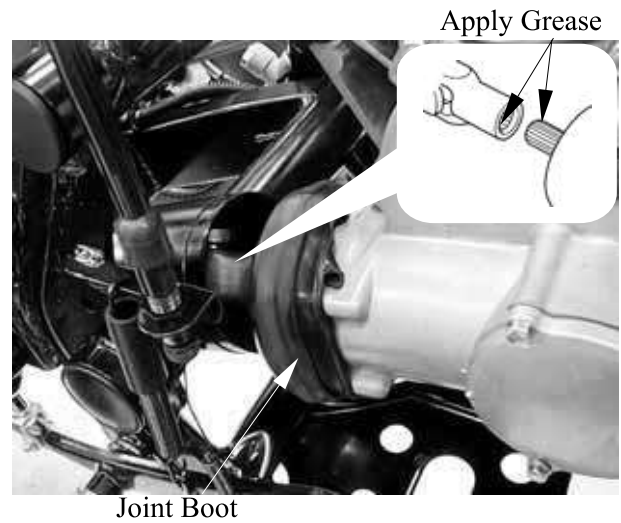

6. ENGINE REMOVAL

The brackets, bolts, front engine mounting bolt and loosely install, then tighten the bolts on the brackets to the specified torque.

Torque: 22 N-m (2.2 kgf-m, 16 lbf-ft)

Tighten the front engine mounting bolt and nut to the specified torque.

Torque: 40 N-m (4 kgf-m, 29 lbf-ft)

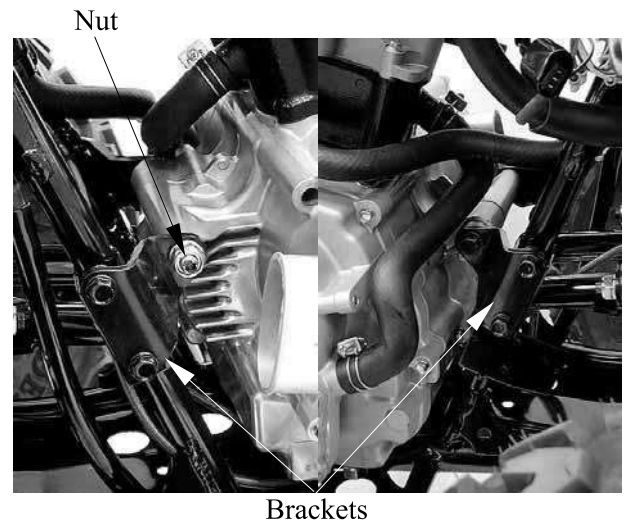

7. CYLINDER HEAD/VALVES

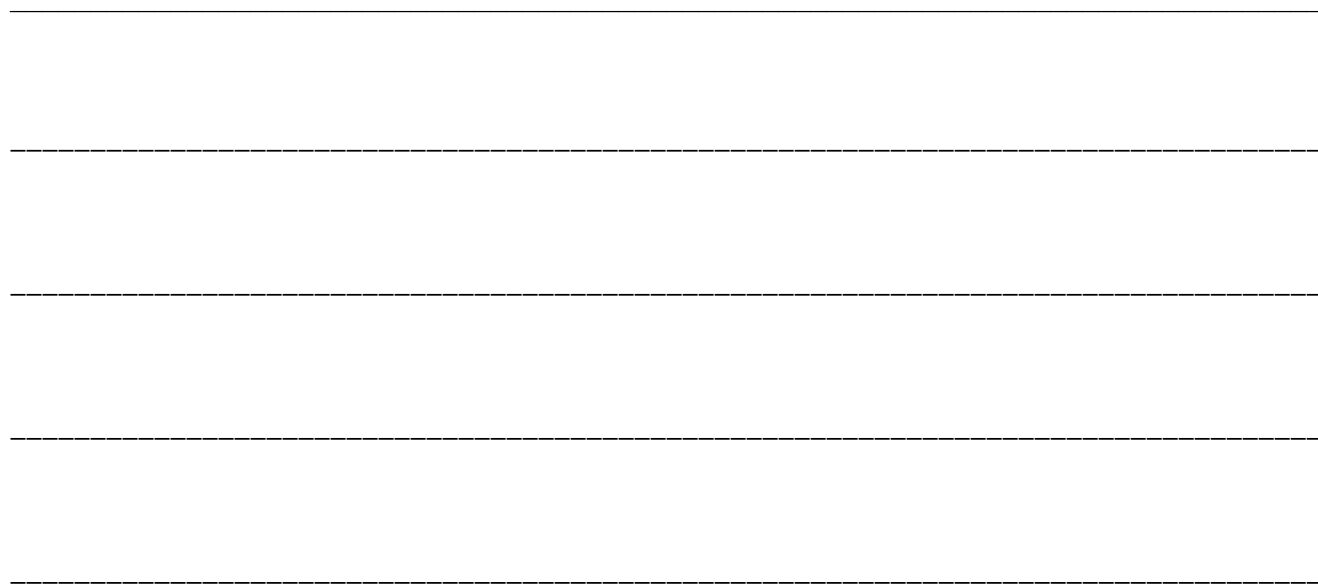

CYLINDER HEAD/VALVES

SERVICE INFORMATION-----	7- 2
TROUBLESHOOTING-----	7- 3
CYLINDER HEAD COVER-----	7- 4
CAMSHAFT/CAMSHAFT HOLDER-----	7- 4
CYLINDER HEAD-----	7-10



7. CYLINDER HEAD/VALVES

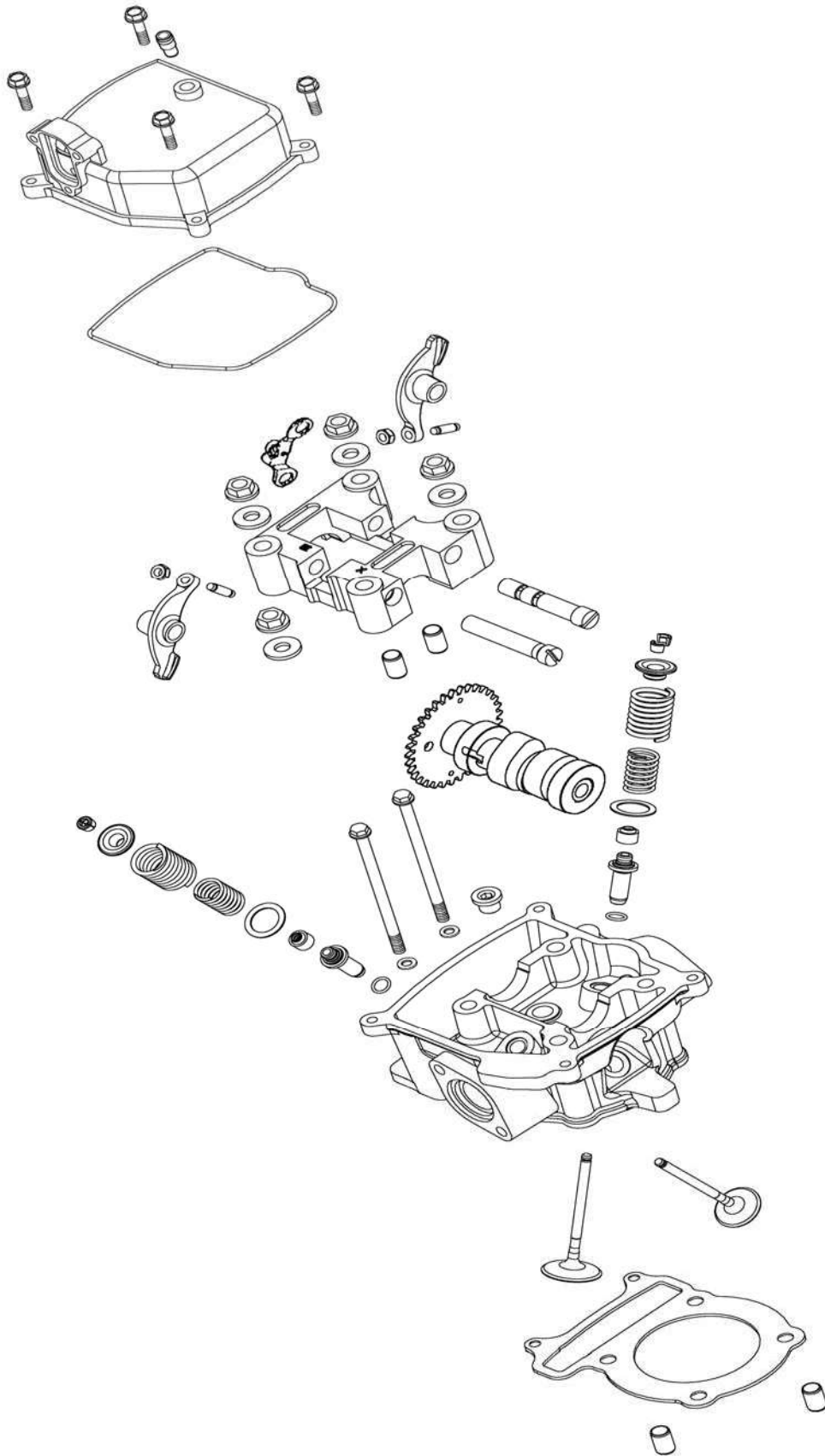

7. CYLINDER HEAD/VALVES

SERVICE INFORMATION

GENERAL INSTRUCTIONS

- The cylinder head can be serviced with the engine installed in the frame.
- When assembling, apply molybdenum disulfide grease or engine oil to the valve guide movable parts, valve arm and camshaft sliding surfaces for initial lubrication.
- The camshaft is lubricated by engine oil through the cylinder head engine oil passages. Clean and unclog the oil passages before assembling the cylinder head.
- After disassembly, clean the removed parts and dry them with compressed air before inspection.
- After removal, mark and arrange the removed parts in order. When assembling, install them in the reverse order of removal.

SPECIFICATIONS

Unit mm (in)

Item		Standard	Service Limit
Valve clearance (cold)	IN	0.1 (0.004)	—
	EX	0.1 (0.004)	—
Cylinder head compression	MXU 250	15±2 kgf/cm ² (1500 kPa, 213 psi)	—
	MXU 300	16±2 kgf/cm ² (1600 kPa, 227 psi)	—
Cylinder head warpage		—	0.05 (0.0002)
Camshaft cam height	IN	34.287 (1.3715)	34.15 (1.366)
	EX	34.1721 (1.3669)	34.05 (1.362)
Valve rocker arm to shaft clearance		0.034~0.09 (0.0014~0.0036)	0.1 (0.004)
Valve stem-to-guide Clearance	IN	0.01~0.037 (0.004~0.0015)	0.06 (0.0024)
	EX	0.025~0.052 (0.001~0.0021)	0.08 (0.0032)
Valve spring free length	IN	30.9 (1.236)	29.4 (1.176)
	EX	41 (1.64)	39 (1.56)
Valve spring compressed force	IN	10.20~11.84kg(at 18.05mm)	—
	EX	19.14~22.02kg(at 21.5mm)	—
Valve spring tilt	IN	0.8 (0.032)	—
	EX	1.07 (0.0428)	—

TORQUE VALUES

Cylinder head cover bolt	1 kgf-m (10 Nm, 7.2 lbf-ft)	Apply engine oil to threads
Cam shaft hold nut	2.5 kgf-m (25 Nm, 18 lbf-ft)	
Tappet adjusting nut	0.9 kgf-m (9 Nm, 6.5 lbf-ft)	

SPECIAL TOOLS

Valve spring compressor	E040
Tappet adjuster	E012

7. CYLINDER HEAD/VALVES

TROUBLESHOOTING

- The poor cylinder head operation can be diagnosed by a compression test or by tracing engine top-end noises.

Poor performance at idle speed

- Compression too low

Compression too low

- Incorrect valve clearance adjustment
- Burned or bent valves
- Incorrect valve timing
- Broken valve spring
- Poor valve and seat contact
- Leaking cylinder head gasket
- Warped or cracked cylinder head
- Poorly installed spark plug

Compression too high

- Excessive carbon build-up in combustion chamber

White smoke from exhaust muffler

- Worn valve stem or valve guide
- Damaged valve stem seal

Abnormal noise

- Incorrect valve clearance adjustment
- Sticking valve or broken valve spring
- Damaged or worn camshaft
- Worn cam chain guide
- Worn camshaft and rocker arm

7. CYLINDER HEAD/VALVES

CYLINDER HEAD COVER

REMOVAL

Remove fuel tank. (Refer to the chapter 5)
Disconnect the crankcase breather hose and pair control valve hose from the cylinder head cover. (Refer to the chapter 6)

Remove the four bolts at the cylinder head cover, then remove the cylinder head cover.

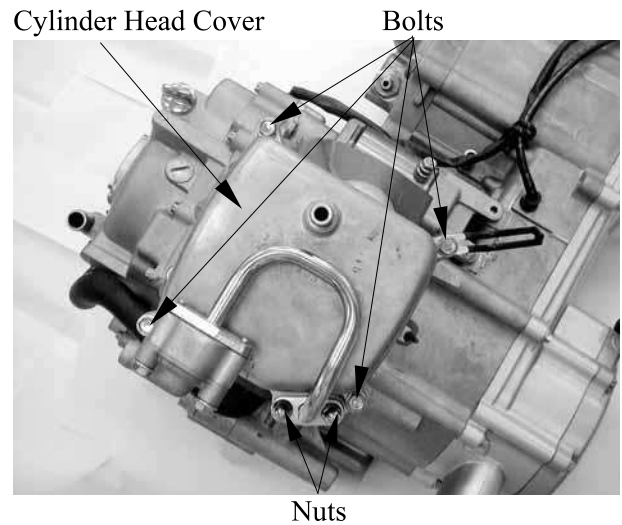

INSTALLATION

Install a new cylinder head cover O-ring and install the cylinder head cover.
Install and tighten the cylinder head cover bolts.

Torque: 1 kgf-m (10 Nm, 7.2 lbf-ft)

* Be sure to install the O-ring into the groove properly.

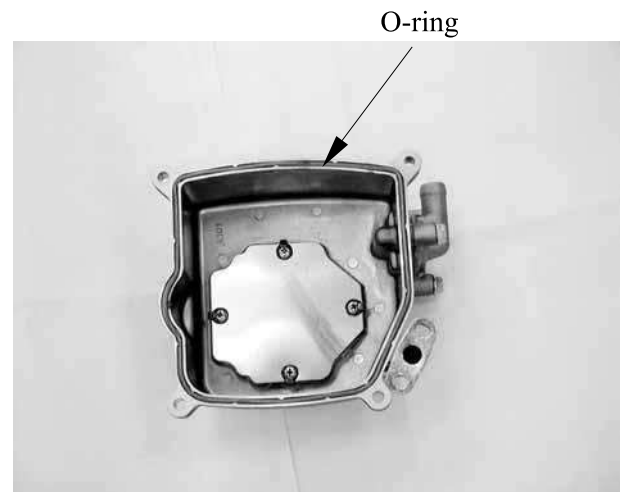

CAMSHAFT/CAMSHAFT HOLDER

REMOVAL

Remove the cylinder head cover. (Refer to the cylinder head cover removal)

Remove the cam chain tensioner cap bolt and the O-ring.

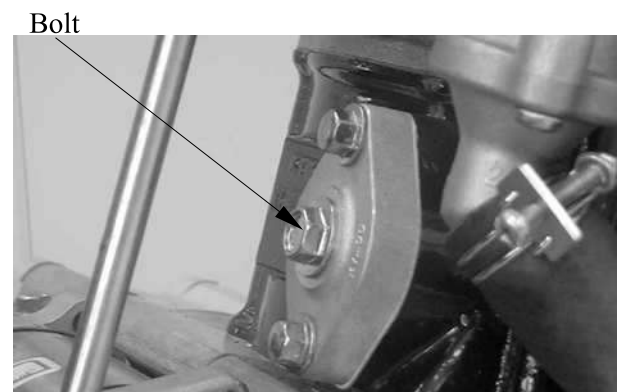

7. CYLINDER HEAD/VALVES

Turn the cam chain tensioner screw clockwise to tighten it.

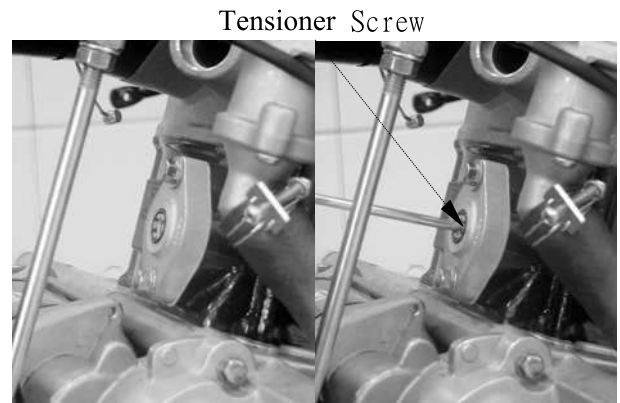

Remove the four camshaft holder nuts and washers.

* Diagonally loosen the cylinder head nuts in 2 or 3 times.

Remove the camshaft holder and dowel pins.

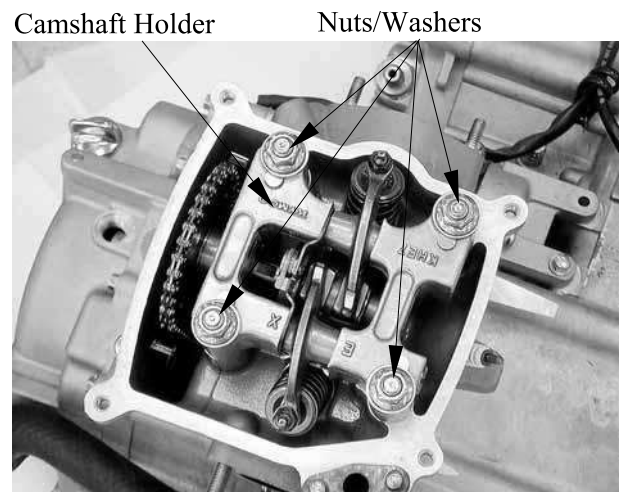

Remove the camshaft gear from the cam chain and remove the camshaft.

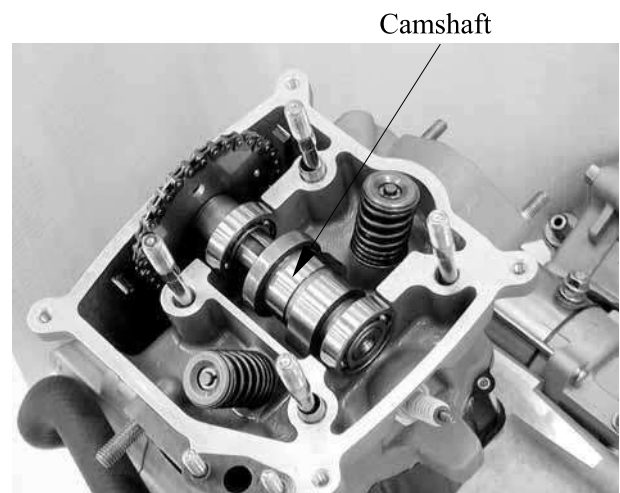

7. CYLINDER HEAD/VALVES

CAMSHAFT HOLDER DISASSEMBLY

Take out the valve rocker arm shafts.
Remove the valve rocker arms, arm shafts and stop plate.

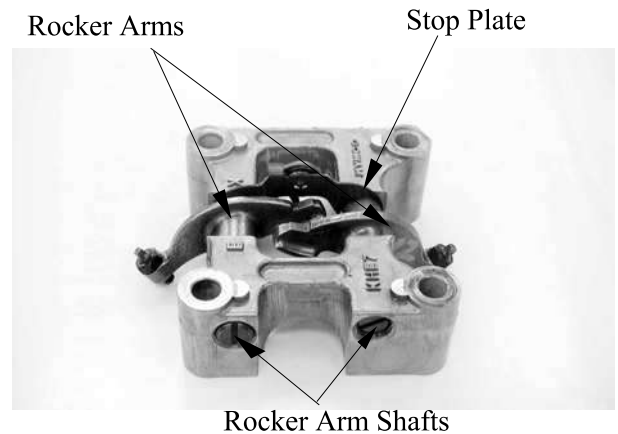

CAMSHAFT HOLDER INSPECTION

Inspect the camshaft holder for wear or damage.

Inspect the rocker arm shaft for blue discoloration or grooves.

If any defects are found, replace the rocker arm shaft with a new one, then inspect lubrication system.

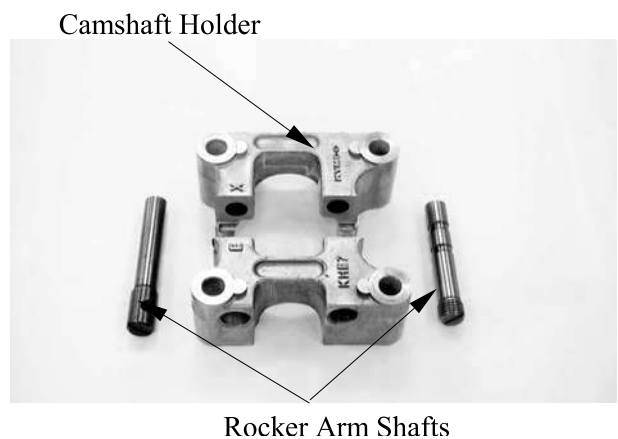

Inspect the rocker arm bore, cam lobe contact surface and adjuster surface for wear/pitting/scratches/blue discoloration.

If any defects are found, replace the rocker arm shaft with a new one, then inspect lubrication system.

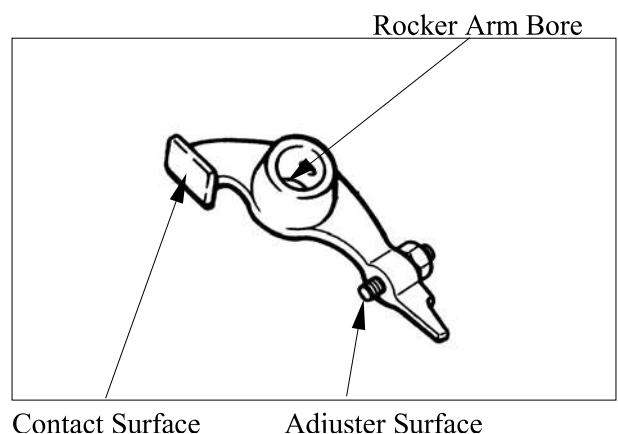

7. CYLINDER HEAD/VALVES

Measure each rocker arm shaft O.D.
 Measure the I.D. of each valve rocker arm.
 Measure arm to shaft clearance.
 Replace as a set if out of specification.

Service limits: 0.1 mm (0.004 in)

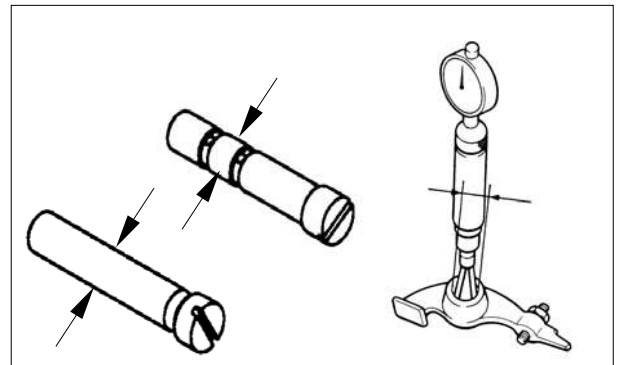

Check the stop plate spring for damage.
 Replace the stop plate assembly with a new one if the spring is damaged.

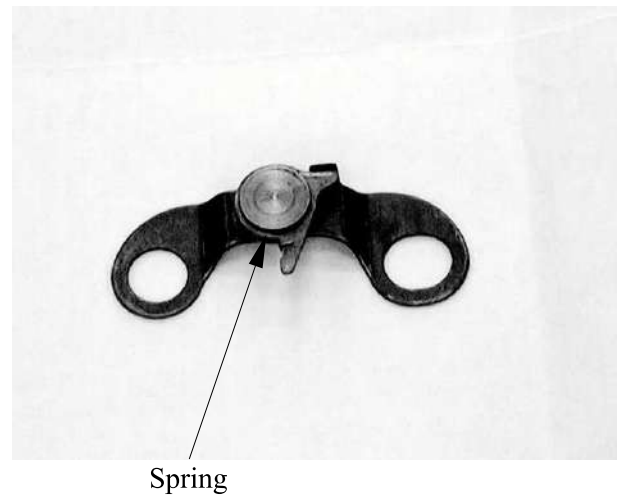

CAMSHAFT HOLDER ASSEMBLY
 Reverse the “CAMSHAFT HOLDER DISASSEMBLY” procedures.

* Align the cross cutout on the exhaust valve rocker arm shaft with the bolt of the camshaft holder.

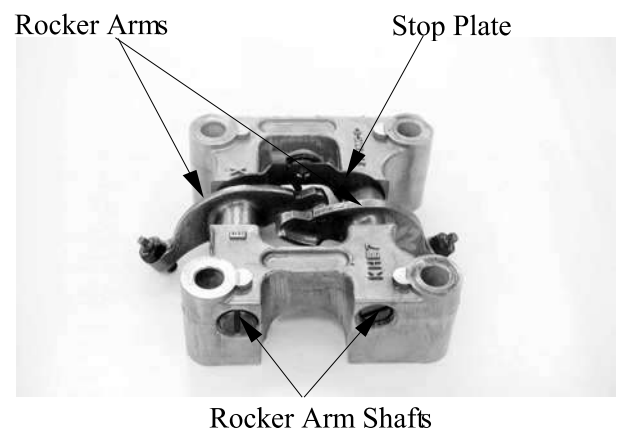

7. CYLINDER HEAD/VALVES

CAMSHAFT INSPECTION

Check each camshaft bearing for play or damage. Replace the camshaft assembly with a new one if the bearings are noisy or have excessive play.

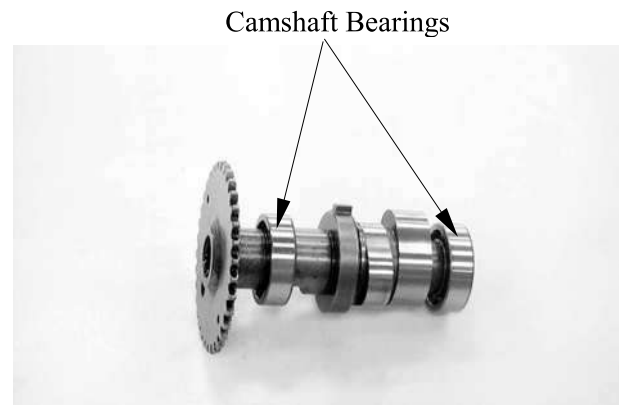

Inspect camshaft lobes for pitting/scratches/blue discoloration.

Measure the cam lobe height.

Service Limits (replace if below):

IN : 34.15 mm (1.366 in)

EX: 34.05mm (1.362 in)

If any defects are found, replace the camshaft with a new one, then inspect lubrication system.

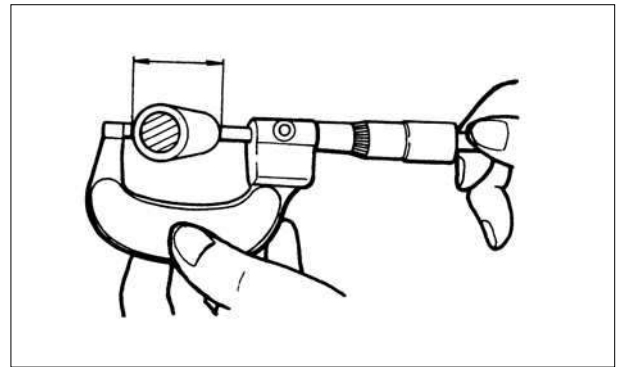

INSTALLATION

Reverse the “CAMSHAFT REMOVAL” procedures.

Note the following points:

1. Turn the flywheel so that the “T” mark on the flywheel aligns with the index mark on the crankcase.

Keep the round hole on the camshaft gear facing up and align the punch marks on the camshaft gear with the cylinder head surface (Position the intake and exhaust cam lobes down.) and install the camshaft onto the cylinder head. (Refer to the “VALVE CLEARANCE” section in the chapter 3)

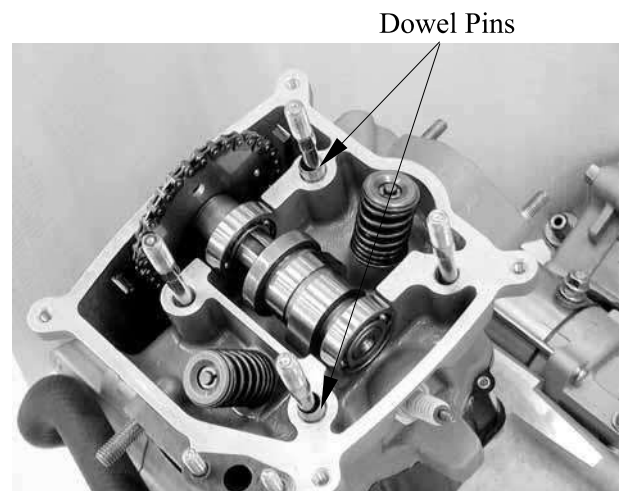

7. CYLINDER HEAD/VALVES

Install the camshaft dowel pins and holder.
Install the washers and nuts and tighten the nuts.

- *
 - Apply engine oil to the threads of the cylinder head nuts.
 - Diagonally tighten the cylinder head nuts in 2~3 times.

Torque:

Cam shaft hold nut (Apply engine oil to threads): 2.5 kgf-m (25 Nm, 18 lbf-ft)

2. Turn the cam chain tensioner screw counter-clockwise to release it.
Apply engine oil to a new O-ring and install it.
Tighten the cam chain tensioner cap bolt.

- * Be sure to install the O-ring into the groove properly.

3. Adjust the valve clearance. (Refer to the “VALVE CLEARANCE” section in the chapter 3)

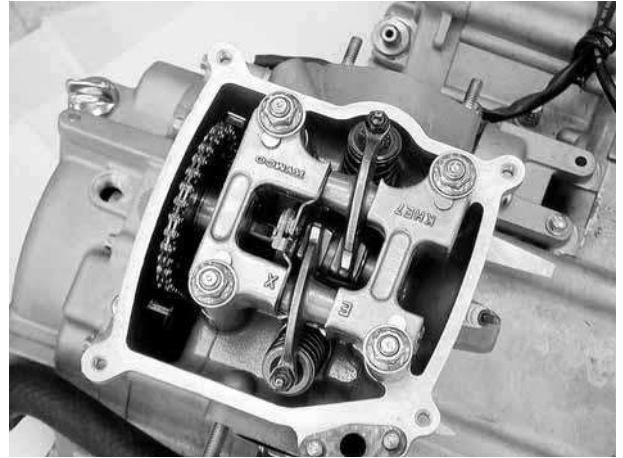

7. CYLINDER HEAD/VALVES

CYLINDER HEAD

REMOVE

Remove the camshaft (page 7-4).
Remove the carburetor. (Refer to the "carburetor remove" section in the chapter 5)
Remove the exhaust muffler (page 2-11).

Remove the two bolts and then remove the carburetor intake manifold.

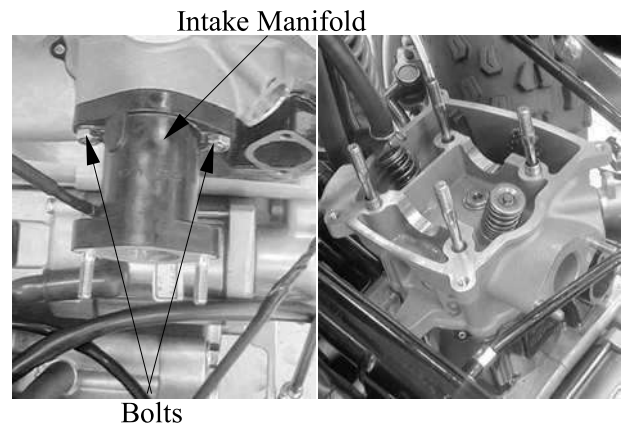

Remove the bolt and disconnect the thermostat.

Remove the two cylinder head bolts.
Remove the cylinder head.

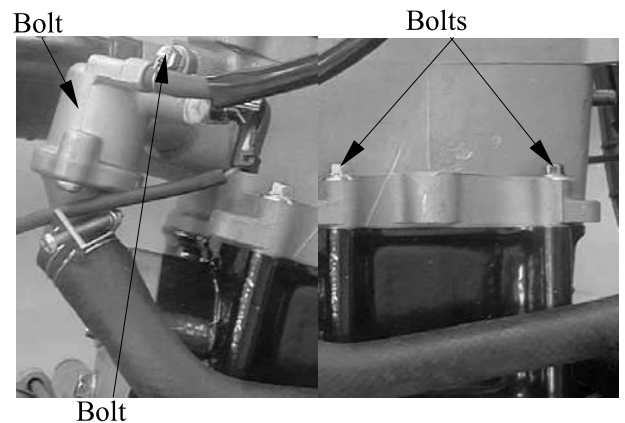

CYLINDER HEAD DISASSEMBLY

Remove the valve spring cotters, retainers, springs, spring seats, oil seals and valves using a valve spring compressor.

- *
- Be sure to compress the valve springs with a valve spring compressor.
 - Mark all disassembled parts to ensure correct reassembly.

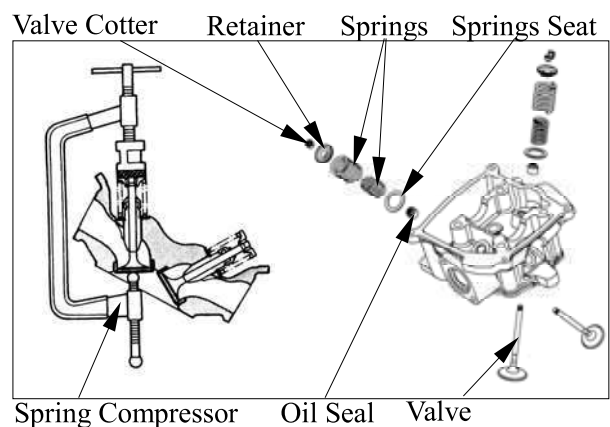

Special tool:
Valve Spring Compressor E040

7. CYLINDER HEAD/VALVES

VALVE /VALVE GUIDE INSPECTION

Inspect each valve for bending, burning, scratches or abnormal stem wear.
 If any defects are found, replace the valve with a new one.

Check valve movement in the guide.

Measure each valve stem O.D.

Measure each valve guide I.D.

Subtract each valve stem O.D. from the corresponding guide I.D. to obtain the stem-to-guide clearance.

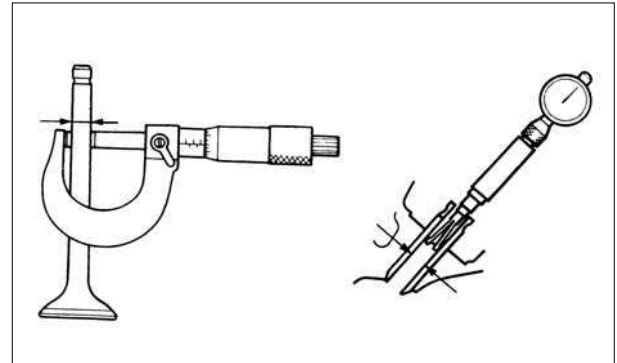

Service limits (replace if over):

IN : 0.06 mm (0.0024 in)

EX: 0.08 mm (0.0032 in)

* If the stem-to-guide clearance exceeds the service limits, replace the cylinder head is necessary.

CYLINDER HEAD INSPECTION

Check the spark plug hole and valve areas for cracks.

Check the cylinder head for warpage with a straight edge and feeler gauge.

Service Limit: 0.05mm repair or replace if over.

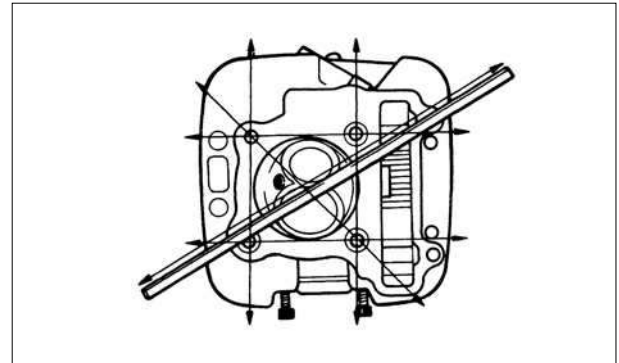

VALVE SPRING INSPECTION

Measure the free length of the inner and outer valve springs.

Service Limit (replace if below):

Inner: 29.4 mm (1.176 in)

Outer: 39 mm (1.56 in)

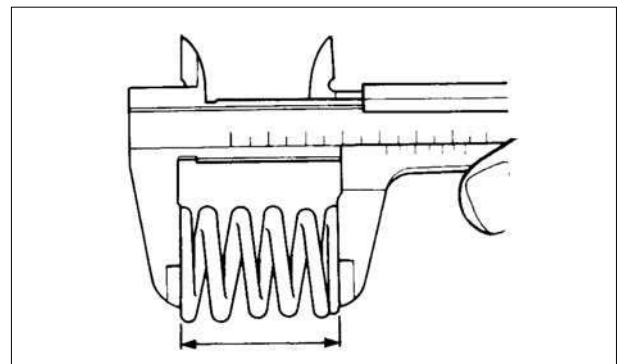

7. CYLINDER HEAD/VALVES

Measure compressed force (valve spring)
and installed length.
Replace if out of specification.

Standard:

IN : 10.20 ~ 11.84kg(at 18.05mm)

EX : 19.14 ~ 22.02kg(at 21.5mm)

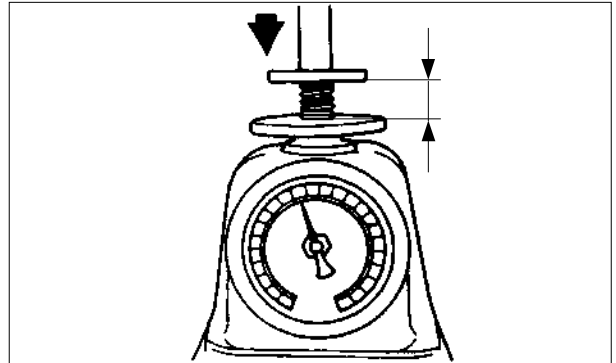

Measure the spring tilt.
Replace if out of specification.

Standard: IN : 0.8mm (0.032)

EX : 1.07mm (0.0428)

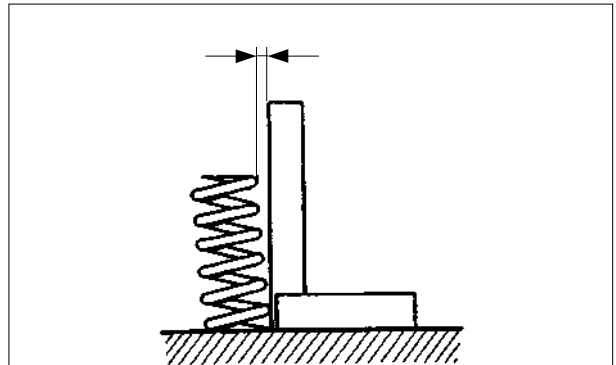

7. CYLINDER HEAD/VALVES

ASSEMBLY

Install the valve spring seats and oil seal.

- * Be sure to install new oil seal.

Lubricate each valve with engine oil and insert the valves into the valve guides.

Install the valve springs and retainers.

Compress the valve springs using the valve spring compressor, then install the valve cotters.

- * • When assembling, a valve spring compressor must be used.
 • Install the cotters with the pointed ends facing down from the upper side of the cylinder head.

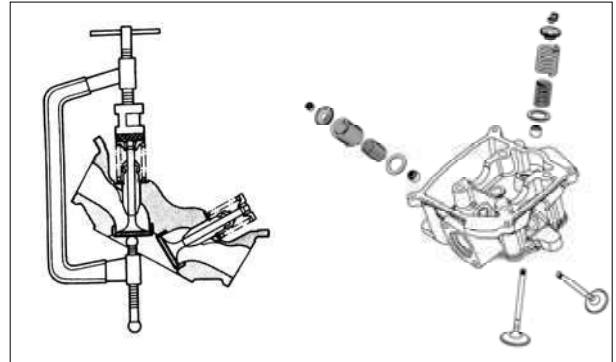

Special tool:

Valve Spring Compressor E040

Tap the valve stems gently with a plastic hammer for 2~3 times to firmly seat the cotters.

- * Be careful not to damage the valves.

INSTALLATION

Install the dowel pins and a new cylinder head gasket.

Reverse the “CYLINDER HEAD REMOVAL” procedures.

After camshaft holder is installed and tighten the nuts, then tighten cylinder head bolts.

Torque:

Cylinder head bolt:

1 kgf-m (10 Nm, 7.2 lbf-ft)

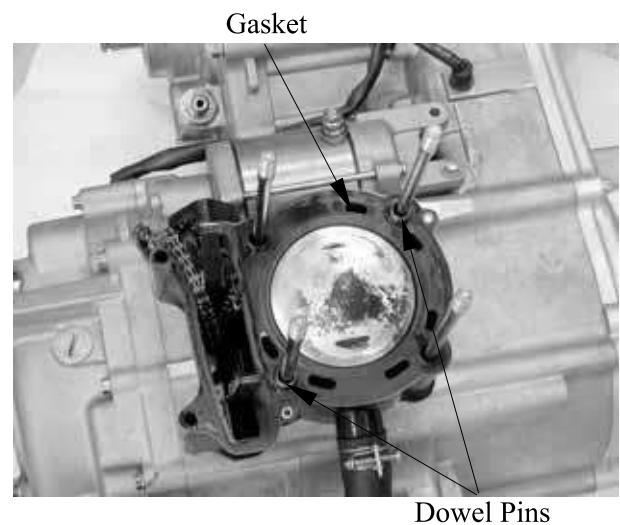

CYLINDER /PISTON

SERVICE INFORMATION-----	8- 2
TROUBLESHOOTING-----	8- 2
CYLINDER/PISTON -----	8- 4



8. CYLINDER/PISTON

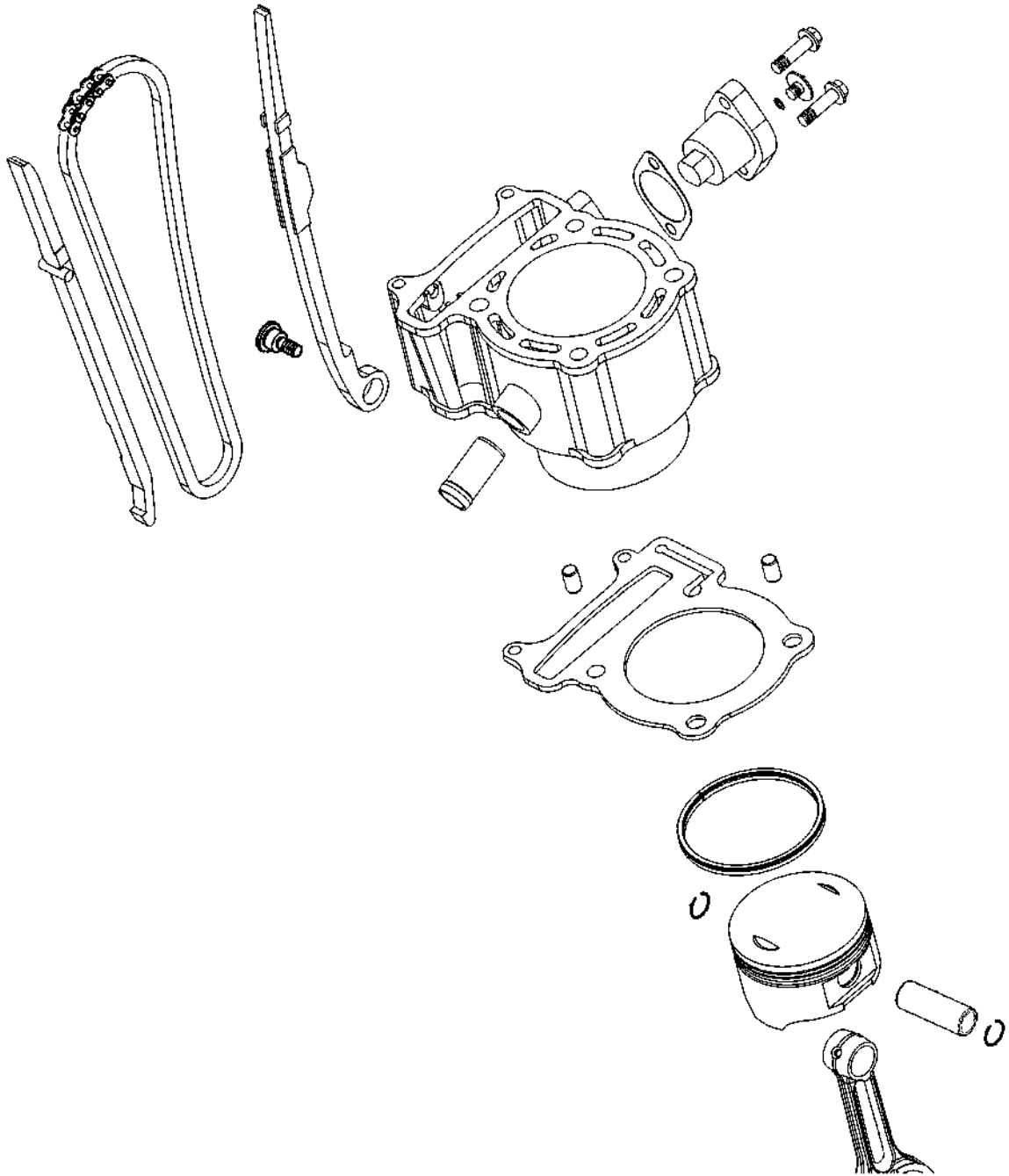

8. CYLINDER/PISTON

SERVICE INFORMATION

GENERAL INSTRUCTIONS

- The cylinder and piston can be serviced with the engine installed in the frame.
- After disassembly, clean the removed parts and dry them with compressed air before inspection.

TROUBLESHOOTING

- When hard starting or poor performance at low speed occurs, check the crankcase breather for white smoke. If white smoke is found, it means that the piston rings are worn, stuck or broken.

Compression too low or uneven compression

- Worn, stuck or broken piston rings
- Worn or damaged cylinder and piston

Compression too high

- Excessive carbon build-up in combustion chamber or on piston head

Excessive smoke from exhaust muffler

- Worn or damaged piston rings
- Worn or damaged cylinder and piston

Abnormal noisy piston

- Worn cylinder, piston and piston rings
- Worn piston pin hole and piston pin

8. CYLINDER/PISTON

SPECIFICATIONS

Unit: mm (in)

Item		Standard	Service Limit	
Cylinder	I.D.	72.705~72.715 (2.9082~2.9086)	72.8 (2.912)	
	Warpage	—	0.05 (0.002)	
	Cylindricity	—	0.05 (0.002)	
	True roundness	—	0.05 (0.002)	
Piston, Piston ring	Ring-to-groove clearance	Top	0.015~0.055 (0.0006~0.0022)	0.09 (0.0036)
		Second	0.015~0.055 (0.0006~0.0022)	0.09 (0.0036)
	Ring end gap	Top	0.15~0.3 (0.006~0.012)	0.5 (0.02)
		Second	0.3~0.45 (0.012~0.018)	0.65 (0.026)
		Oil ring	0.2~0.7 (0.008~0.028)	0.9 (0.036)
	Piston O.D.	72.67~72.69 (2.9068~2.9076)	72.6 (2.904)	
	Piston O.D. measuring position	10mm from bottom of skirt	—	
	Piston-to-cylinder clearance	0.01~0.04 (0.0004~0.0016)	0.1 (0.004)	
Piston pin hole I.D.	17.002~17.008 (0.68008~0.68032)	17.04 (0.6816)		
Piston pin O.D		16.994~17 (0.67976~0.68)	16.96 (0.6784)	
Piston-to-piston pin clearance		0.002~0.014 (0.00008~0.00056)	0.02 (0.0008)	
Connecting rod small end I.D. bore		17.016~17.034 (0.68064~0.68136)	17.06 (0.6824)	

8. CYLINDER/PISTON

CYLINDER/PISTON

REMOVAL

Remove the cylinder head. (Refer to the chapter 7)

Remove the two dowel pins, cylinder head gasket and cam chain guide.

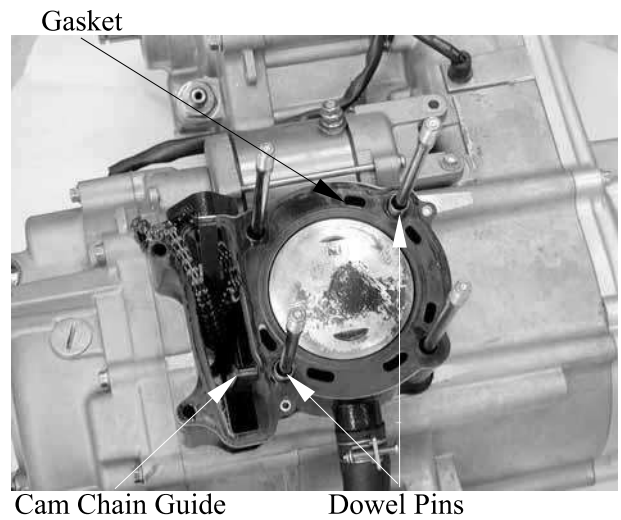

Unscrew the clamp and disconnect the water hose.
Remove the cylinder.

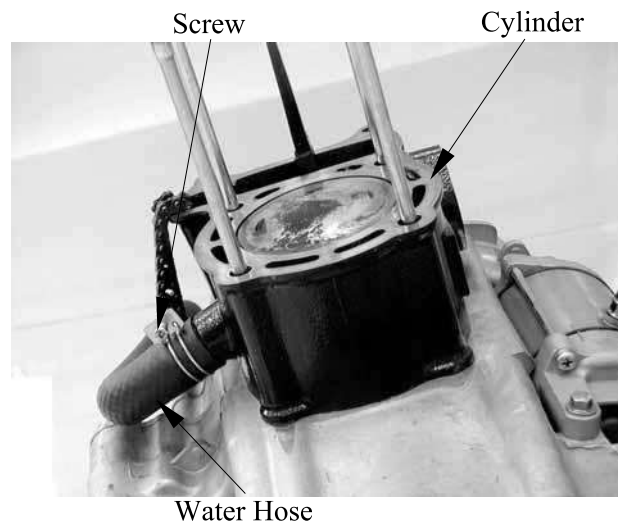

Remove the cylinder gasket and dowel pins.
Clean any gasket material from the cylinder surface.

* Be careful not to drop foreign matters into the crankcase.

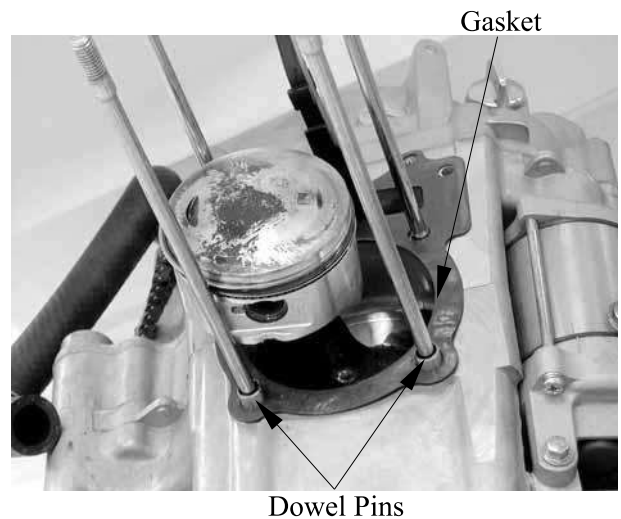

8. CYLINDER/PISTON

Remove the piston pin clip.

- * Place a clean shop towel in the crankcase to keep the piston pin clip from falling into the crankcase.

Press the piston pin out of the piston and remove the piston.

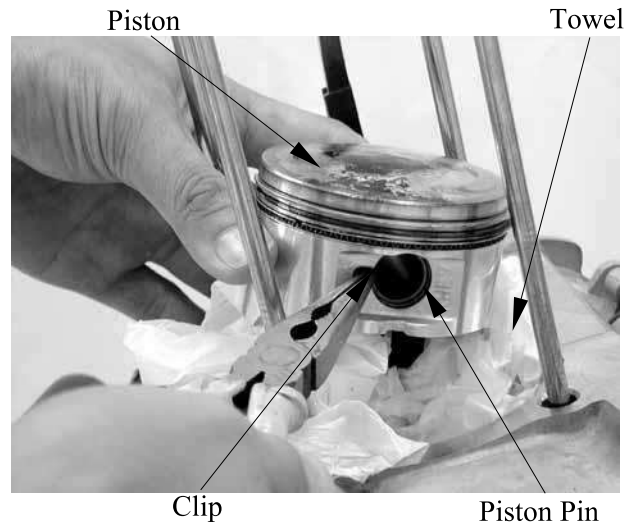

INSPECTION

Inspect the piston, piston pin and piston rings.

Remove the piston rings.

- * Take care not to damage or break the piston rings during removal.

Clean carbon deposits from the piston ring grooves.



Inspect the piston wall for wear/scratches/damage.

If any defects are found, replace the piston with a new one.

Install the piston rings onto the piston and measure the piston ring-to-groove clearance.

Service Limits (replace if over):

Top: 0.09 mm (0.0036 in)

2nd: 0.09 mm (0.0036 in)

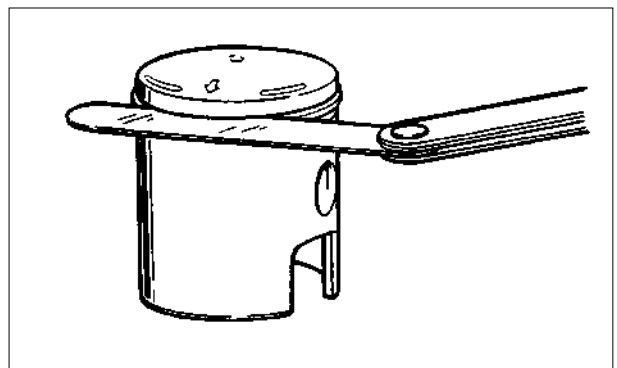

8. CYLINDER/PISTON

Remove the piston rings and insert each piston ring into the cylinder bottom.

* Use the piston head to push each piston ring into the cylinder.

Measure the piston ring end gap.

Service Limit (replace if over):

Top: 0.5 mm (0.02 in)

2nd: 0.65 mm (0.026 in)

Oil ring: 0.9 mm (0.036 in)

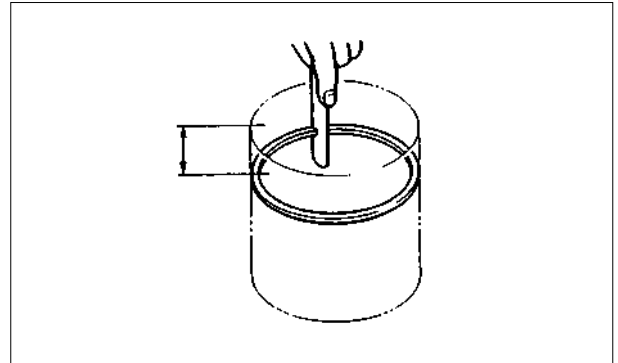

Measure the piston pin hole I.D.

Service Limit (replace if over):

17.04 mm (0.6816 in)

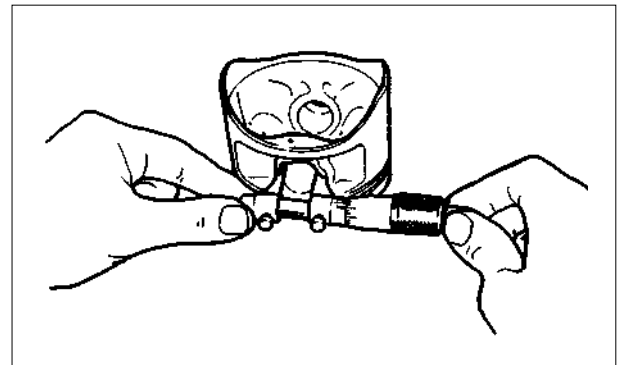

Measure the piston pin O.D.

Service Limit (replace if below):

16.96 mm (0.6784 in)

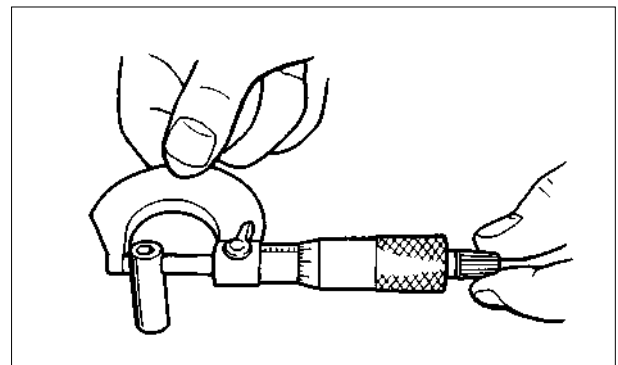

8. CYLINDER/PISTON

Measure the piston O.D.

* Take measurement at 10mm from the bottom and 90° to the piston pin hole.

Service Limit (replace if below):
72.6 mm (2.904 in)

Measure the piston-to-piston pin clearance.

Service Limit (replace if over):
0.02 mm (0.0008 in)

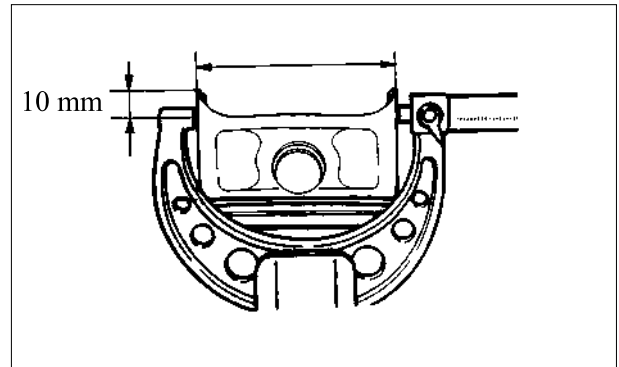

CYLINDER INSPECTION

Inspect the cylinder bore for wear or damage. Measure the cylinder I.D. at three levels of top, middle and bottom at 90° to the piston pin (in both X and Y directions).

Cylinder I.D.:

Service Limit (replace if over):
72.8 mm (2.912 in)

Measure the cylinder-to-piston clearance.

Service Limit (repair or replace if over):
0.1 mm (0.004 in)

The true roundness is the difference between the values measured in X and Y directions. The cylindricity (difference between the values measured at the three levels) is subject to the maximum value calculated.

Service Limits (repair or replace if over):
True Roundness: 0.05 mm (0.002 in)
Cylindricity: 0.05 mm (0.002 in)

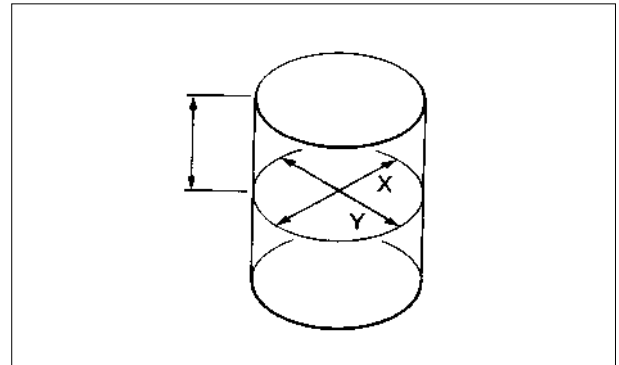

8. CYLINDER/PISTON

PISTON RING INSTALLATION

Install the piston rings onto the piston.
Apply engine oil to each piston ring.

- *
- Be careful not to damage or break the piston and piston rings.
 - All rings should be installed with the markings facing up.
 - After installing the rings, they should rotate freely without sticking.

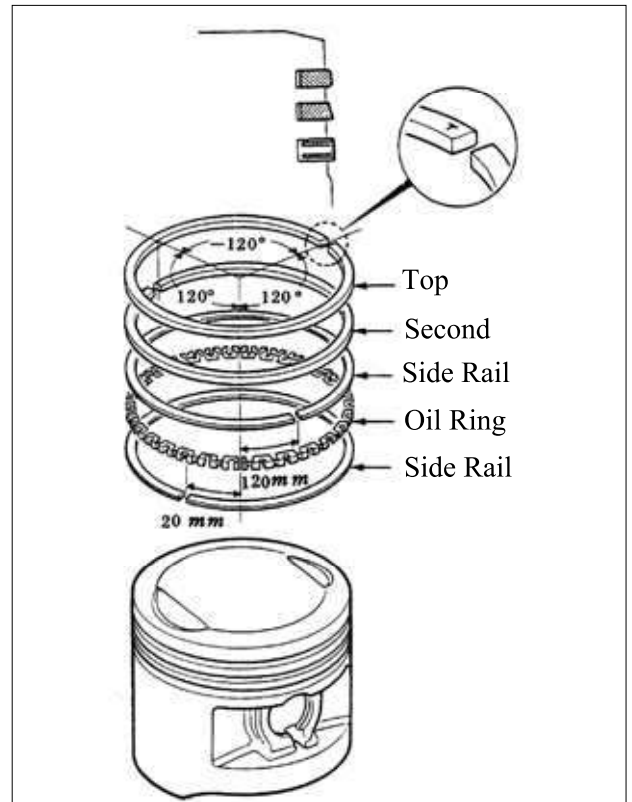

Measure the connecting rod small end I.D.

Service Limit (replace if over):
17.06 mm (0.6824 in)

Measure the connecting rod to piston pin clearance.

Service Limit (replace if over):
0.06 mm (0.0024 in)

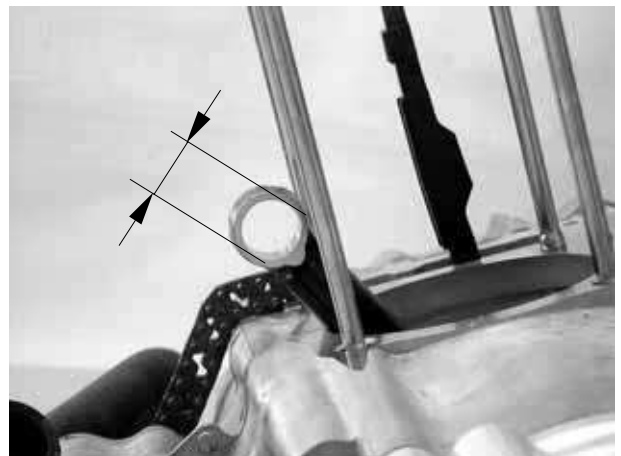

8. CYLINDER/PISTON

Inspect the exhaust side and intake side chain guides.

Wear/Damage → Replace.

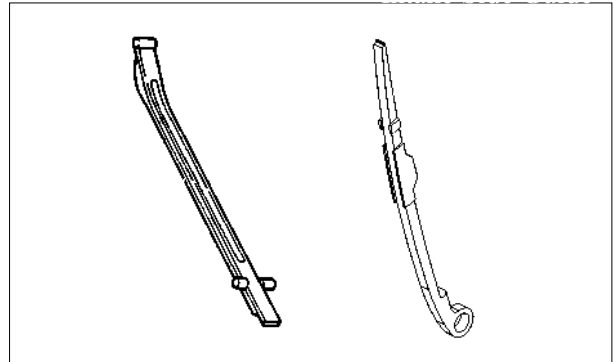

PISTON INSTALLATION

Remove any gasket material from the crankcase surface.

- * Be careful not to drop foreign matters into the crankcase.

Install the piston, piston pin and a new piston pin clip.

- *
 - Position the piston “IN” mark on the intake valve side.
 - Place a clean shop towel in the crankcase to keep the piston pin clip from falling into the crankcase.



CYLINDER INSTALLATION

Install the dowel pins and a new cylinder gasket on the crankcase.

Coat the cylinder bore, piston and piston rings with clean engine oil.

Carefully lower the cylinder over the piston by compressing the piston rings.

*

9. DRIVE AND DRIVEN PULLEYS

DRIVE AND DRIVEN PULLEYS

SERVICE INFORMATION..... 9-2
TROUBLESHOOTING..... 9-2
LEFT CRANKCASE COVER 9-3
DRIVE PULLEY/DRIVEN PULLEY 9-4



9. DRIVE AND DRIVEN PULLEYS

MXU 300/250

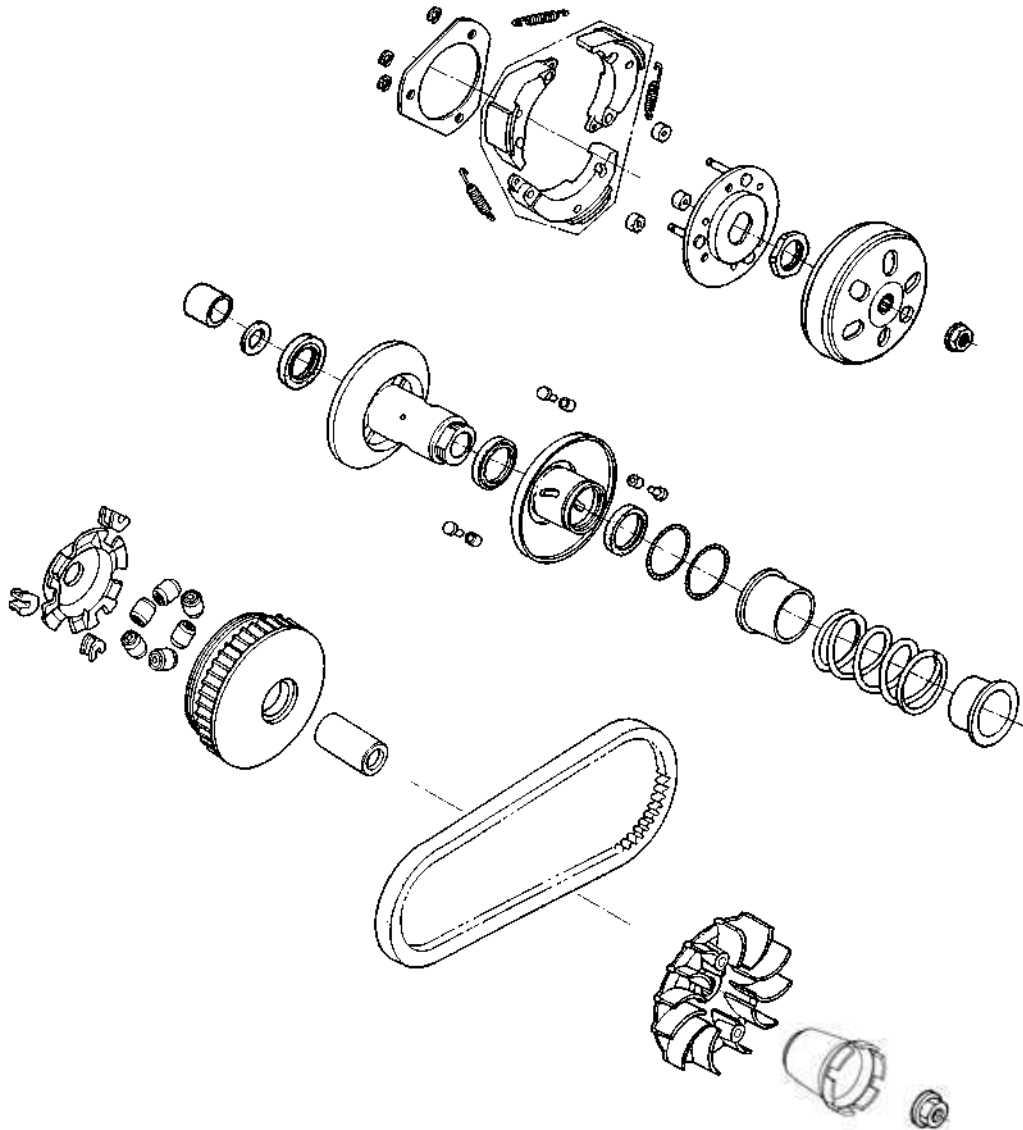

SERVICE INFORMATION

GENERAL INSTRUCTIONS

- The drive pulley, clutch and driven pulley can be serviced with the engine installed in the frame.
- Avoid getting grease and oil on the drive belt and pulley faces. Remove any oil or grease from them to minimize the slipping of drive belt and drive pulley.

SPECIFICATIONS

Unit: mm (in)

Item	Standard	Service Limit
Movable drive face bushing I.D.	26.989~27.052 (1.07956~1.08208)	27.06 (1.0824)
Drive face collar O.D.	26.96~26.974 (1.0784~1.07896)	26.94 (1.0776)
Drive belt width	23.6~24.4 (0.944~0.976)	22 (0.88)
Clutch lining thickness	—	0.5 (0.02)
Clutch outer I.D.	153~153.2 (6.12~6.128)	153.5 (6.14)
Driven face spring free length	—	131 (5.24)
Driven face O.D.	39.965~39.985 (1.5986~1.5994)	39.94 (1.5976)
Movable driven face I.D.	40~40.025 (1.6~1.601)	40.06 (1.6024)
Weight roller O.D.	22.92~23.08 (0.9168~0.9232)	22.8 (0.912)

TORQUE VALUES

Drive face nut	9.5 kgf-m (95 Nm, 68 lbf-ft)
Clutch outer nut	5.5 kgf-m (55 Nm, 40 lbf-ft)
Drive plat nut	5.5 kgf-m (55 Nm, 40 lbf-ft)

SPECIAL TOOLS

Universal holder	E017	Clutch spring compressor	E027
Bearing puller	E008	Oil seal and bearing install	E014

TROUBLESHOOTING

Engine starts but motorcycle won't move

- Worn drive belt
- Broken ramp plate
- Worn or damaged clutch lining
- Broken driven face spring

Engine stalls or motorcycle creeps

- Broken clutch weight spring

Lack of power

- Worn drive belt
- Weak driven face spring
- Worn weight roller
- Fouled drive face

9. DRIVE AND DRIVEN PULLEYS

MXU 300/250

LEFT CRANKCASE COVER

REMOVAL

Remove the five bolts.

Remove the recoil starter cover.

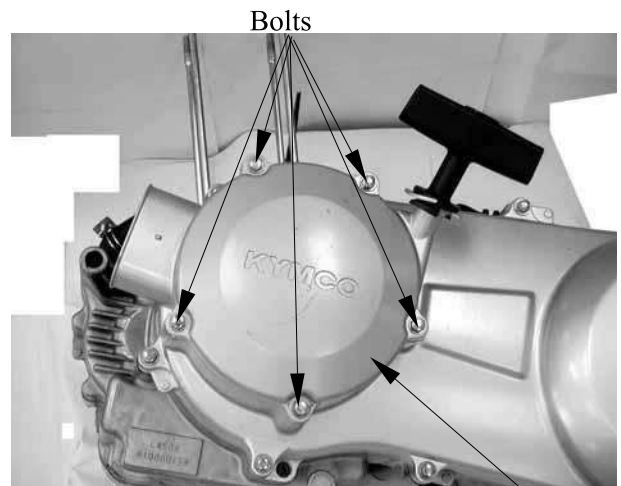

Recoil Starter Cover

Remove the dowel pins and gasket.



Dowel Pins

Disconnect drive belt air inlet and outlet hose from left crankcase cover (see page 6-5).

Remove the left crankcase cover bolts and left crankcase cover.

Remove the gasket and dowel pins.

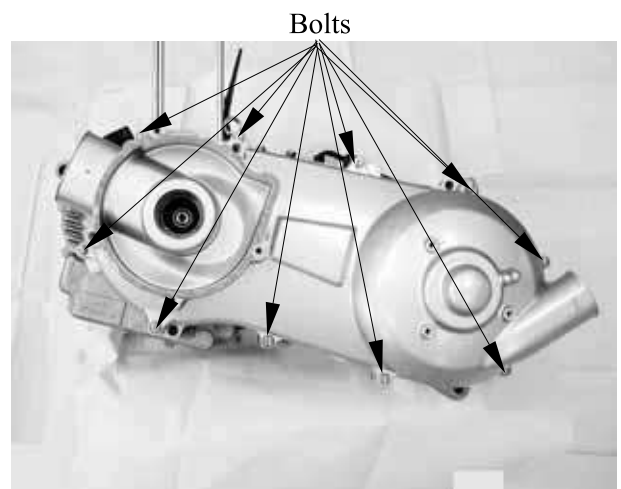

9. DRIVE AND DRIVEN PULLEYS

INSPECTION

Inspect the bearing for allow play in the left crankcase cover or the bearing turns roughly
→ Replace.

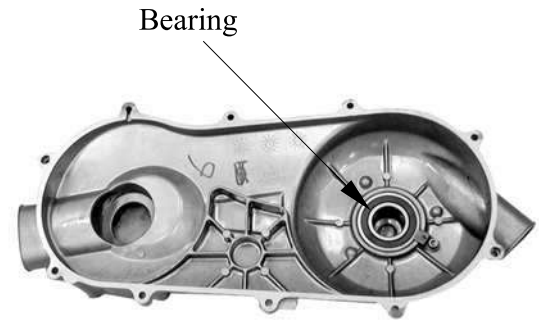

INSTALLATION

Install the dowel pins and new gasket.
Reverse the “LEFT CRANKCASE COVER REMOVAL” procedures.
Install the left crankcase cover and tighten the bolts.
Connect the drive belt air inlet and outlet hose and tighten band screws.
Install the recoil starter cover and outlet hose cover.

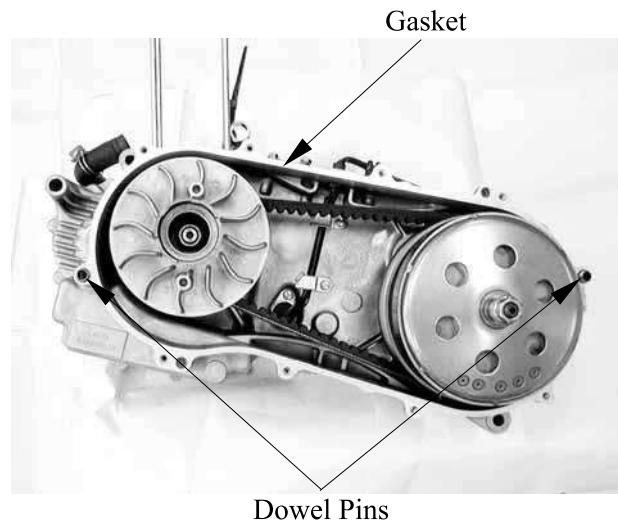

DRIVE PULLEY/DRIVEN PULLEY

REMOVAL

Remove the left crankcase cover. (Refer to the “LEFT CRANKCASE COVER REMOVAL” section in the chapter 9)

Hold the drive pulley using a universal holder and remove the drive face nut and ratchet.
Remove the drive pulley.

Special tool: Universal Holder E017

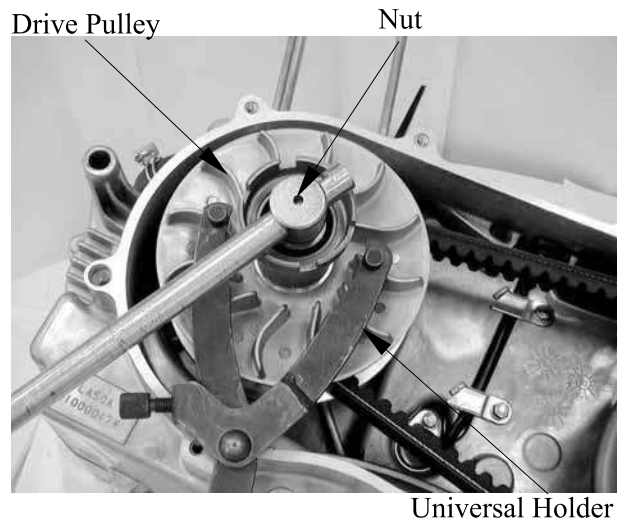

9. DRIVE AND DRIVEN PULLEYS

Remove the left crankcase cover. (Refer to the “LEFT CRANKCASE COVER REMOVAL” section in the chapter 9)
 Remove the drive pulley. (Refer to the “DRIVE PULLEY REMOVAL” section in the chapter 9)

Hold the clutch outer with the universal holder and remove the clutch outer nut.

Special tool: Universal Holder E017

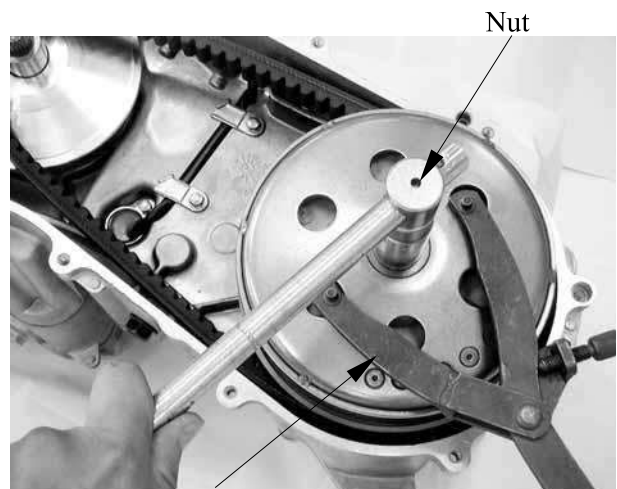

Universal Holder

Remove the collar and clutch outer.

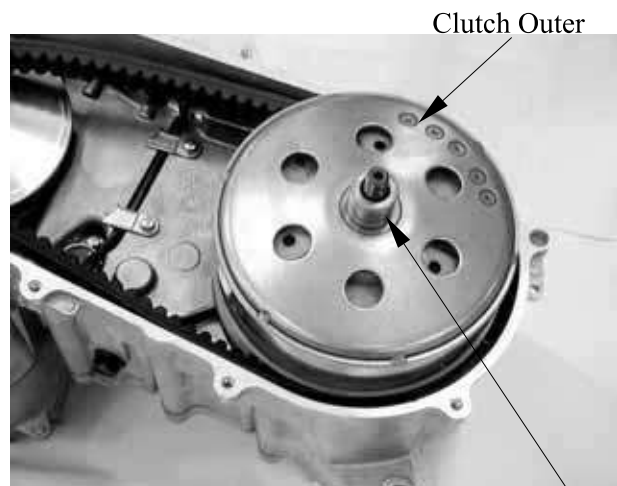

Collar

Remove the clutch/driven pulley and drive belt.

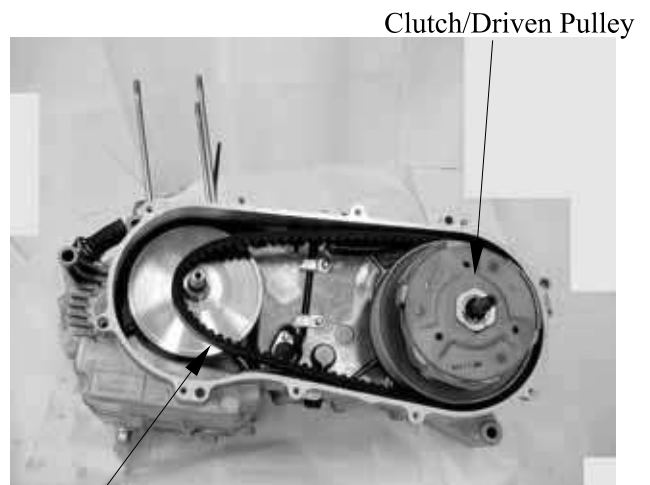

Drive Belt

9. DRIVE AND DRIVEN PULLEYS

Remove the movable drive face assembly and drive pulley collar.

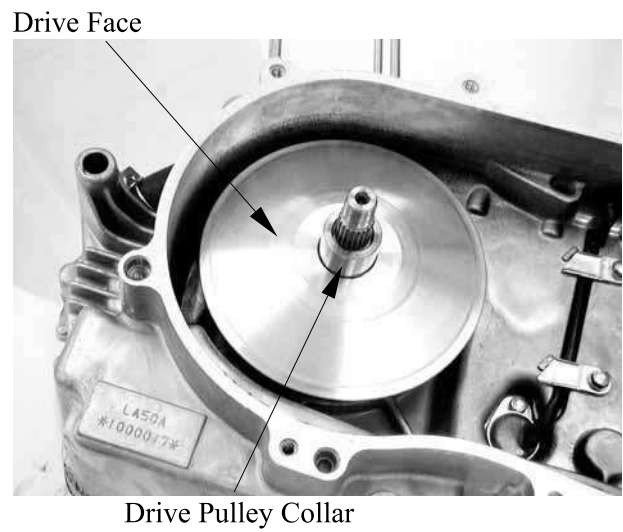

DISASSEMBLY

Remove the ramp plate.

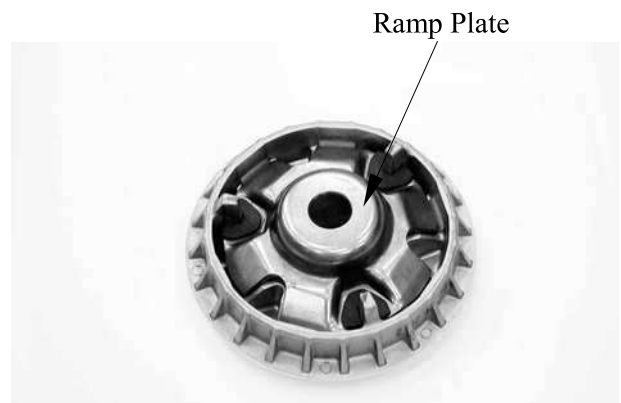

Remove the six weight rollers.

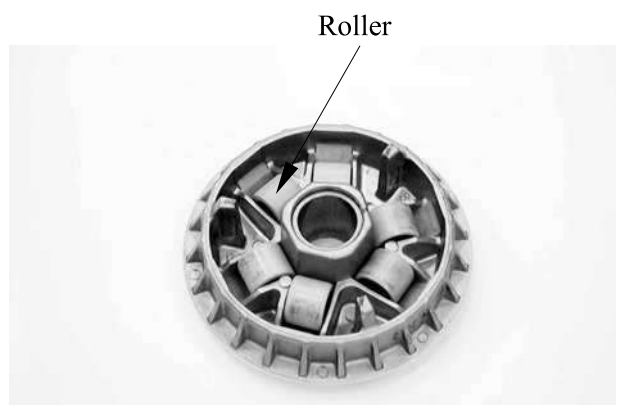

9. DRIVE AND DRIVEN PULLEYS

MXU 300/250

INSPECTION

Check each weight roller for wear or damage.
Measure each weight roller O.D.

Service Limit (replace if below):

22.8 mm (0.912 in)

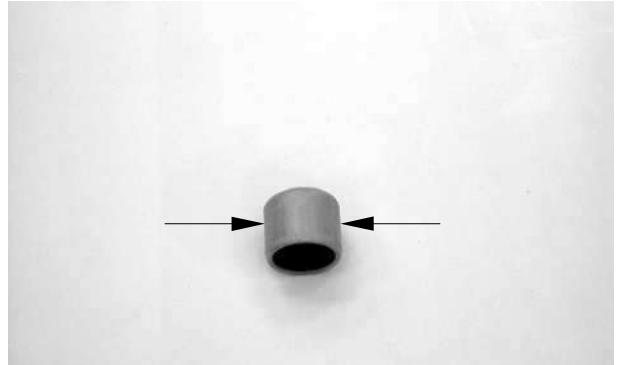

Measure the movable drive face bushing I.D.

Service Limit (replace if over):

27.06 mm (1.0824 in)

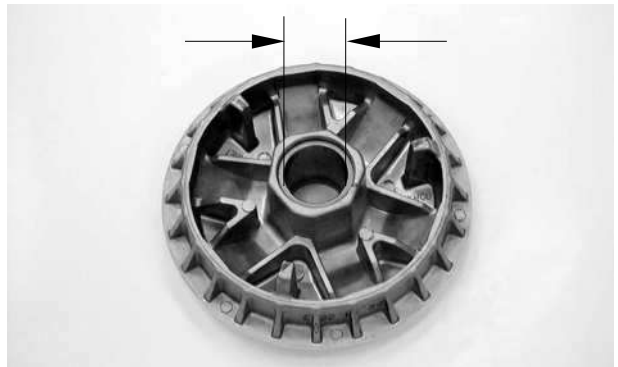

ASSEMBLY

Install the weight rollers into the movable
drive face.

Install the ramp plate.

Check the drive pulley collar for wear or
damage.
Measure the O.D. of the drive pulley collar
sliding surface.

Service Limit (replace if below):

26.94 mm (1.0776 in)

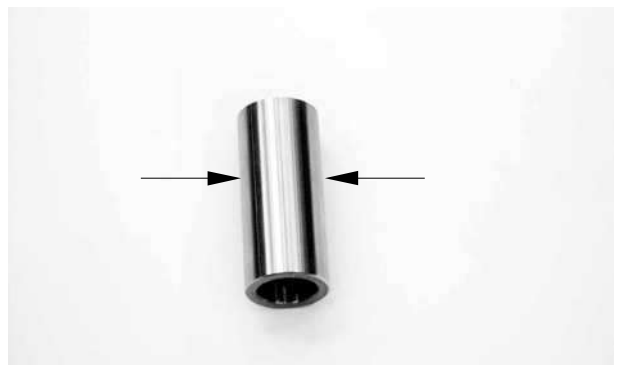

9. DRIVE AND DRIVEN PULLEYS

DRIVE BELT INSPECTION

Check the drive belt for cracks, separation or abnormal or excessive wear.
Measure the drive belt width.

Service Limit (replace if below):
22 mm (0.88 in)

* Use specified genuine parts for replacement.

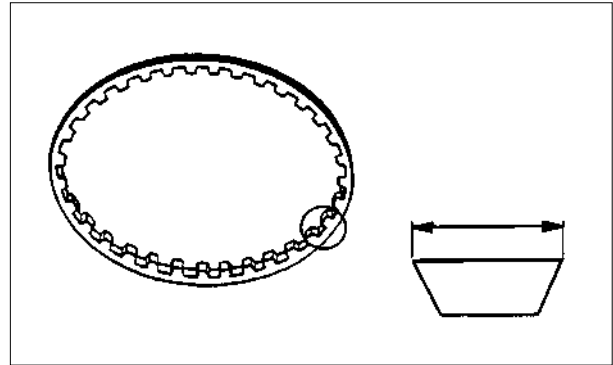

CLUTCH OUTER INSPECTION

Inspect the clutch outer for wear or damage.
Measure the clutch outer I.D.

Service Limit (replace if over):
153.5 mm (6.14 in)



CLUTCH/DRIVEN PULLEY DISASSEMBLY

Hold the clutch/driven pulley assembly with the clutch spring compressor.

* Be sure to use a clutch spring compressor to avoid spring damage.

Special tool:
Clutch Spring Compressor E027

Set the clutch spring compressor in a vise and remove the clutch drive plate nut.



9. DRIVE AND DRIVEN PULLEYS

Loosen the clutch spring compressor and disassemble the clutch/driven pulley assembly. Remove the seal collar.



Pull out the guide roller pins and guide rollers. Remove the movable driven face from the driven face.

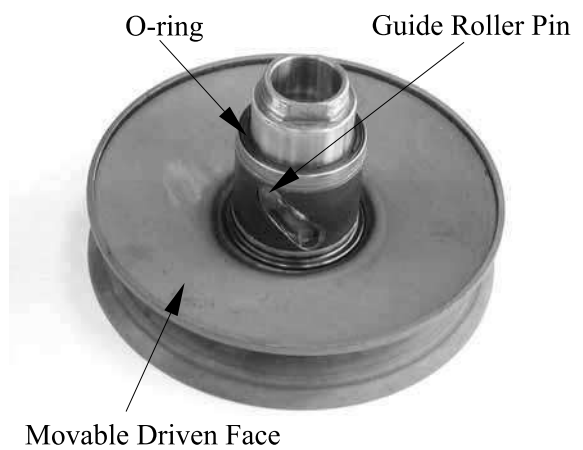

Remove the oil seal from the movable driven face.



9. DRIVE AND DRIVEN PULLEYS

Measure the clutch lining thickness.

Service Limit (replace if below):

0.5 mm (0.02 in)



INSPECTION

Measure the driven face spring free length.

Service Limit (replace if below):

131 mm (5.24 in)

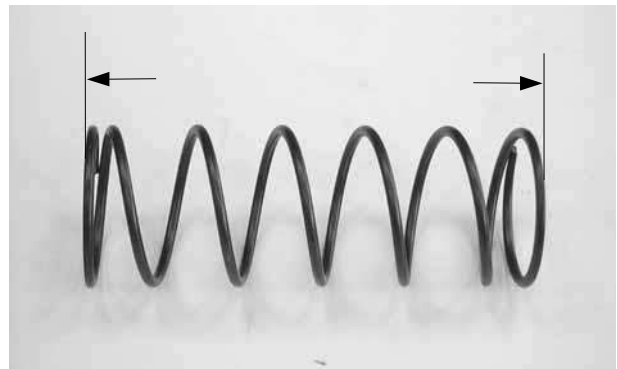

Check the driven face for wear or damage.
Measure the driven face O.D.

Service Limit (replace if below):

39.94 mm (1.5976 in)



9. DRIVE AND DRIVEN PULLEYS

MXU 300/250

Check the movable driven face for wear or damage.
Measure the movable driven face I.D.

Service Limit (replace if over):
40.06 mm (1.6024 in)

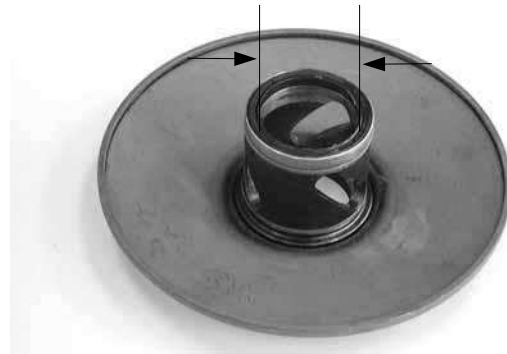

DRIVEN PULLEY FACE BEARING REPLACEMENT

Drive the inner needle bearing out of the driven pulley face.

* Discard the removed bearing and replace with a new one.



Remove the snap ring and drive the outer bearing out of the driven face.

* Discard the removed bearing and replace with a new one.

Apply grease to the outer bearing.
Drive a new outer bearing into the driven face with the sealed end facing up.

Special tool: Bearing Puller E008



9. DRIVE AND DRIVEN PULLEYS

Seat the snap ring in its groove.
Apply grease to the driven face bore areas.

- * Pack all bearing cavities with proper grease.
Specified grease: Heat resistance 230°C

Press a new needle bearing into the driven face.

Special tool:

Oil Seal And Bearing Install E014

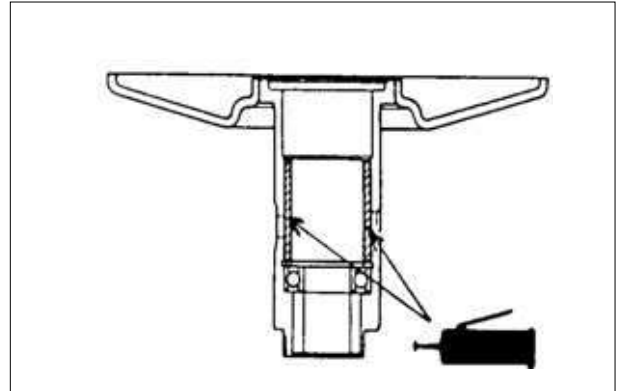

CLUTCH DISASSEMBLY

Remove the circlips and retainer plate to disassemble the clutch.

- * Keep grease off the clutch linings.

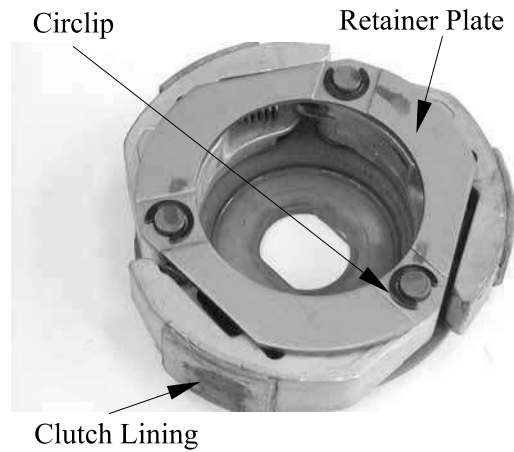

CLUTCH / DRIVEN PULLEY ASSEMBLY

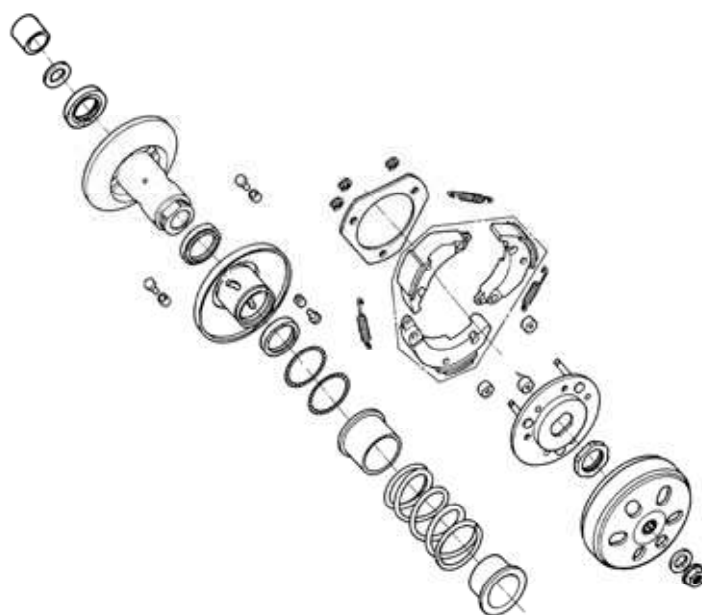

9. DRIVE AND DRIVEN PULLEYS

Install the damper rubbers on the drive plate pins.
Install the clutch weights/shoes and clutch springs onto the drive plate.
Install the retainer plate and secure with the circlips.

Clean the driven pulley faces and remove any grease from them.
Install the oil seal onto the moveable driven face.
Apply grease to the Oil seal and install them onto the moveable driven face.

Install the movable driven face onto the driven face.
Apply grease to the guide rollers and guide roller pins and then install them into the holes of the driven face.

Install the seal collar.
Remove any excessive grease.

* Be sure to clean the driven face off any grease.

Set the driven pulley assembly, driven face spring and clutch assembly onto the clutch spring compressor.

* Align the flat surface of the driven face with the flat on the clutch drive plate.

Compress the clutch spring compressor and install the drive plate nut.
Set the clutch spring compressor in a vise and tighten the drive plate nut to the specified torque.

Torque: 5.5 kgf-m (55Nm, 40lbf-ft)

* Be sure to use a clutch spring compressor to avoid spring damage.

Special tool:
Clutch Spring Compressor E027

9. DRIVE AND DRIVEN PULLEYS

INSTALLATION

Install the drive pulley face assembly and collar.



Install the clutch/driven pulley and driven belt onto the drive shaft.

* Keep grease off the drive shaft.

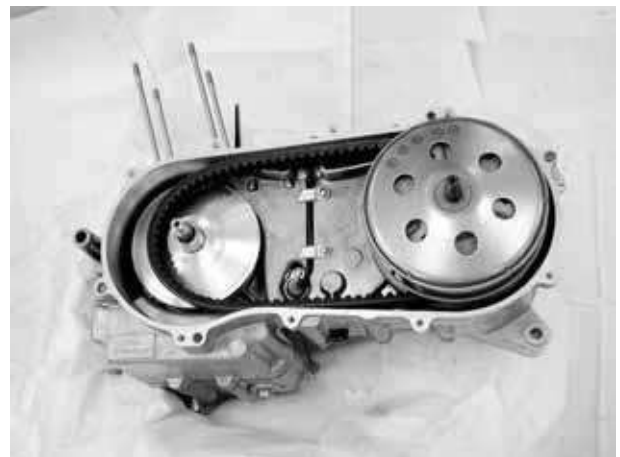

Install the clutch outer, collar.
Hold the clutch outer with the flywheel holder.
Install and tighten the clutch outer nut.

Torque: 5.5 kgf-m (55 Nm, 40 lbf-ft)

Special tool: Universal Holder E017

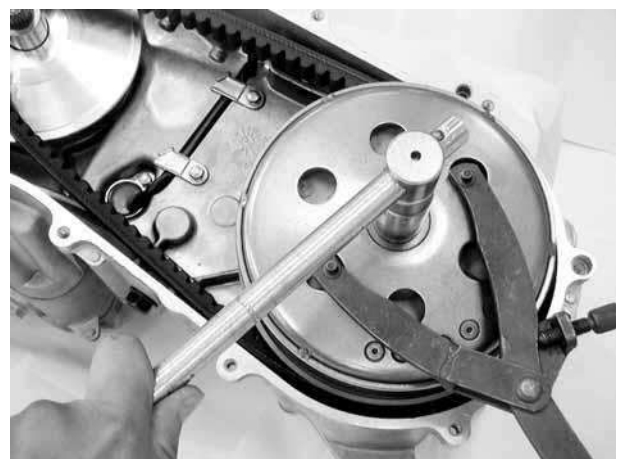

9. DRIVE AND DRIVEN PULLEYS

MXU 300/250

Install the drive pulley and ratchet.

*

When installing the drive pulley face, compress it to let the drive belt move downward to the lowest position so that the drive pulley can be tightened. Make sure the ratchet into the splines on the crankshaft when the ratchet is installed. Do not get oil or grease on the drive belt or pulley faces.

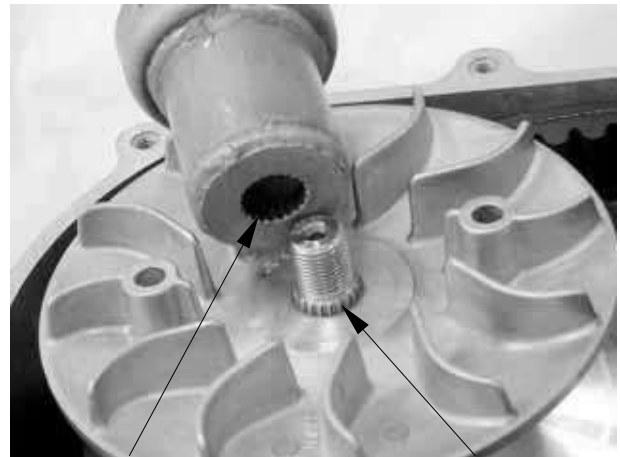

Splines

Splines

Install and tighten the nut.

Torque: 9.5 kgf-m (95 Nm, 68 lbf-ft)



FINAL REDUCTION/TRANSMISSION SYSTEM

SERVICE INFORMATION-----	10- 3
TROUBLESHOOTING-----	10- 3
TRANSMISSION CASE COVER (MXU 250)-----	10- 4
TRANSMISSION (MXU 250)-----	10- 6
SPEEDOMETER GEAR -----	10-16
TRANSMISSION CASE COVER/SECONDARY DRIVEN BEVEL GEAR ASSEMBLY (MXU 300)-----	10-18
TRANSMISSION (MXU 300)-----	10-29
SECONDARY GEAR SHIMS (MXU 300)-----	10-39

10.FINAL REDUCTION/ TRANSMISSION SYSTEM

MXU 250

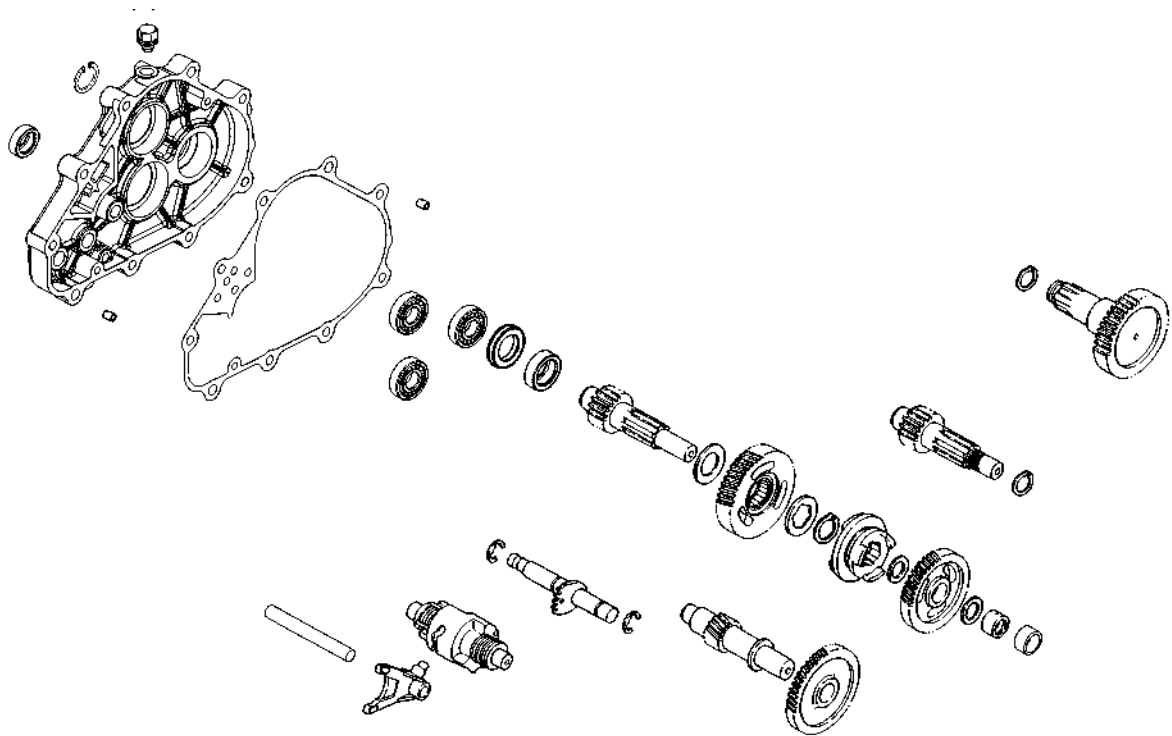

10.FINAL REDUCTION/ TRANSMISSION SYSTEM

MXU 300

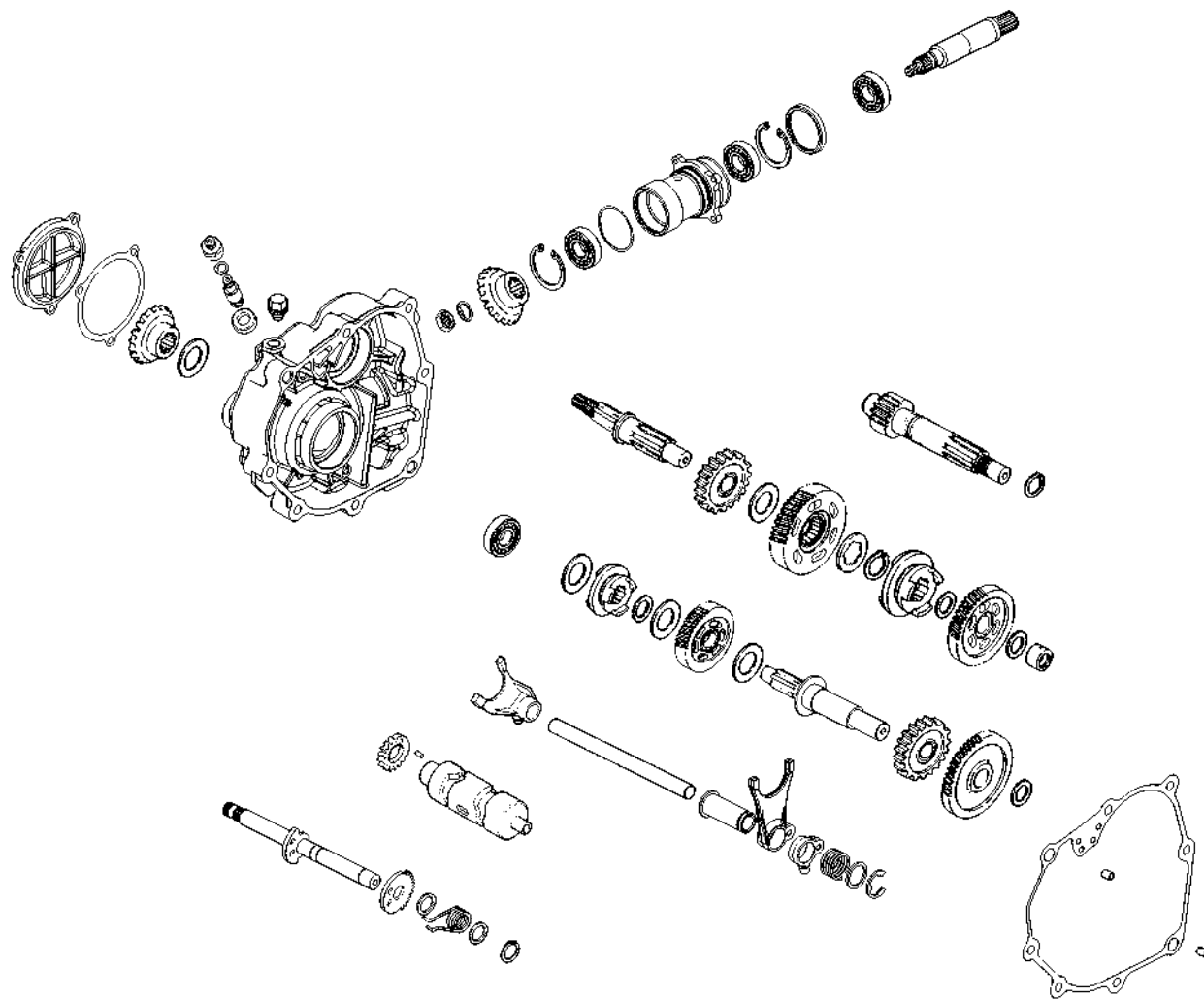

SERVICE INFORMATION

GENERAL INSTRUCTIONS

- The MXU 250 transmission system can be serviced with the engine installed in the frame.
- The MXU 300 transmission system can be serviced with the engine removed from the frame.
- When replacing the drive shaft, use a special tool to hold the bearing inner race for this operation.

SPECIFICATIONS

Specified Oil: GEAR OIL SAE 90#

Oil Capacity (MXU 250): At change : 0.3 liter (0.264 imp qt, 0.318 US qt)
At disassembly : 0.4 liter (0.352 imp qt, 0.424 US qt)

Oil Capacity (MXU 300): At change : 0.5 liter (0.44 imp qt, 0.53 US qt)
At disassembly : 0.6 liter (0.528 imp qt, 0.636 US qt)

TORQUE VALUES

Transmission case cover bolt 2.7 kgf-m (27 Nm, 20 lbf-ft)
Drive bevel gear nut 10 kgf-m (100 Nm, 72 lbf-ft)
Driven bevel gear nut 10 kgf-m (100 Nm, 72 lbf-ft)

TROUBLESHOOTING

Engine starts but motorcycle won't move

- Damaged transmission
- Seized or burnt transmission

Oil leaks

- Oil too rich
- Worn or damaged oil seal

TRANSMISSION CASE COVER (MXU 250)

REMOVAL

Drain transmission gear oil into a clean container. (Refer to the “TRANSMISSION OIL REPLACEMENT” section in the chapter 3)

Remove the three bolts and then remove the drive sprocket cover (see page 6-3).

Remove the two bolts and then remove the washer and drive sprocket (see page 6-3).

Remove the bolt and then disconnect the drive shift arm from the shift shaft (see page 6-3).

Disconnect the speedometer cable (see page 6-3).

Remove the transmission case cover attaching bolts.

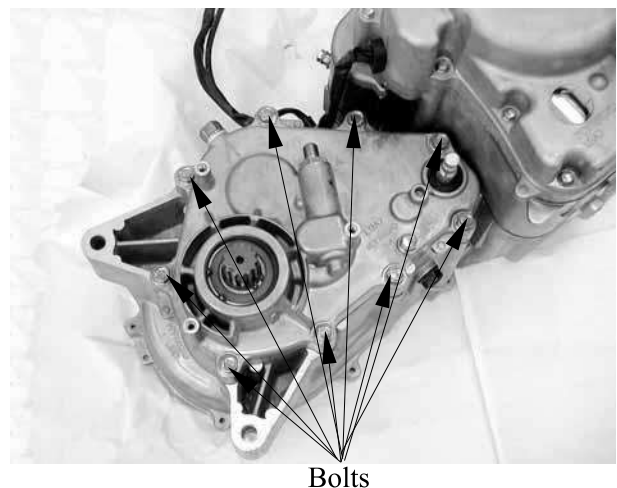

Remove the transmission case cover, dowel pins and gasket.

Inspect the bearings for allow play in the transmission case cover or the bearings turn roughly.

If any defects are found, replace the bearing with a new one.

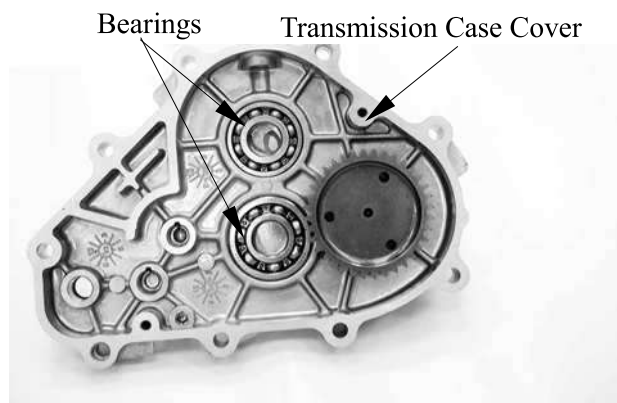

10.FINAL REDUCTION/ TRANSMISSION SYSTEM

TRANSMISSION CASE COVER DISASSEMBLY

Remove the drive axle circlip.
Remove the drive axle from the transmission case cover.
Remove the bearing circlip for remove the bearing.

Inspect the bearing for allow play in the transmission case cover or the bearing turns roughly.
If any defects are found, replace the bearing with a new one.

Inspect the drive axle gear teeth for wear or damage.

Remove the bearing to expose the oil seal.

Inspect the oil seal for wear or damage.
If any defects are found, replace the oil seal with a new one.

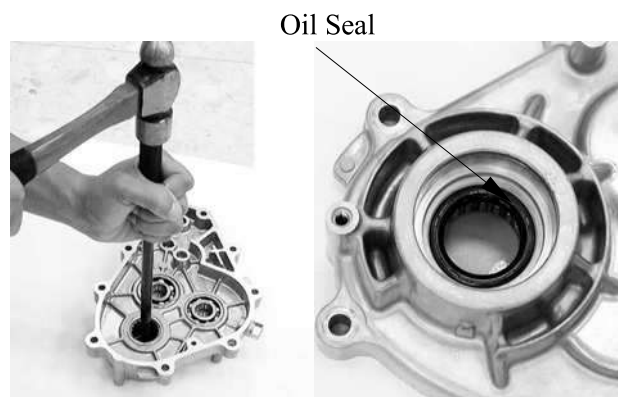
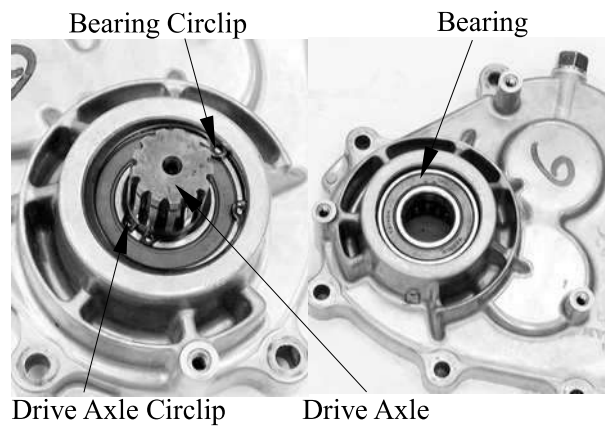

10.FINAL REDUCTION/ TRANSMISSION SYSTEM

Inspect the needle bearing for allow play in the transmission case cover or the bearing turns roughly.
If any defects are found, replace the bearing with a new one.

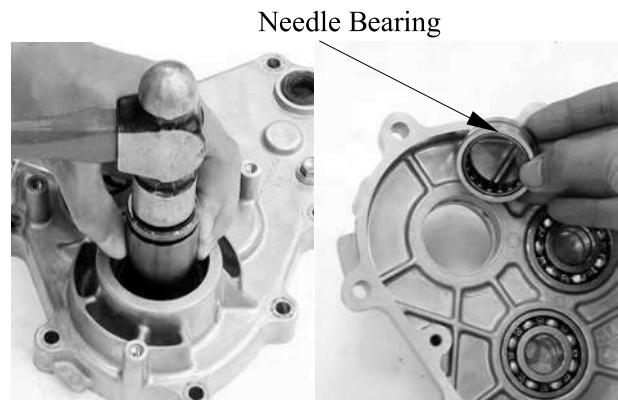

ASSEMBLY

Install the needle bearing.
Install the oil seal and bearing.
Install the bearing circlip.
Install the drive axle and drive axle circlip.

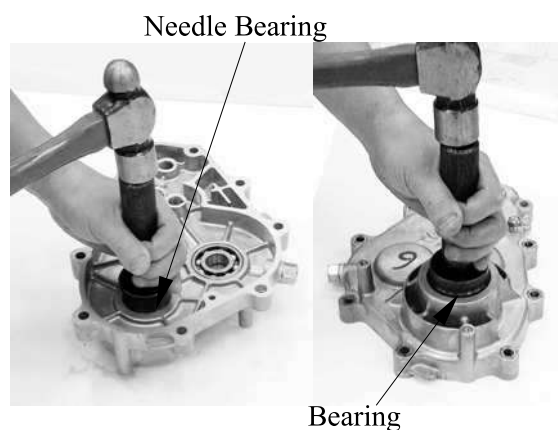

TRANSMISSION (MXU 250) REMOVAL

Remove the transmission cover. (Refer to the "TRANSMISSION CASE COVER REMOVAL" in the chapter 10)

Check the transmission operation.
Unsmooth operation → Repair.

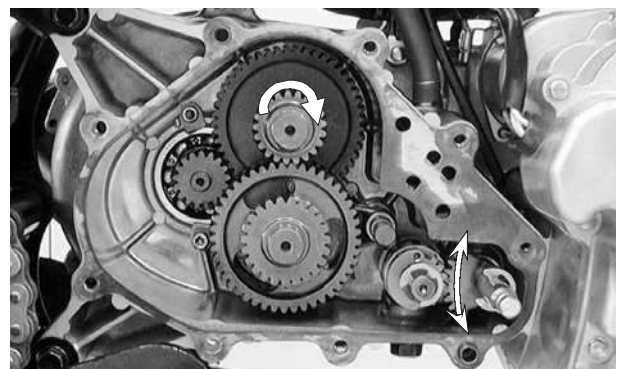

10.FINAL REDUCTION/ TRANSMISSION SYSTEM

Remove the shift shaft.

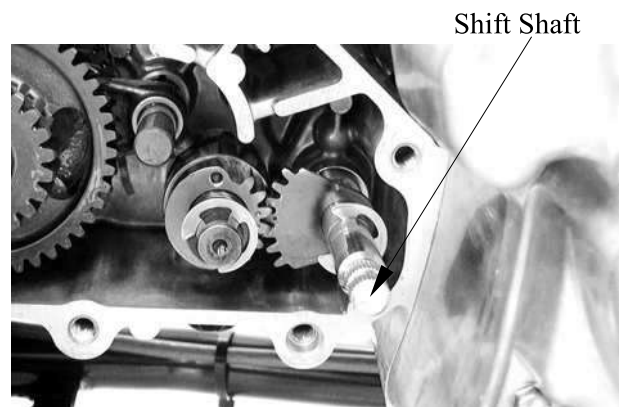

Remove the stopper plug.

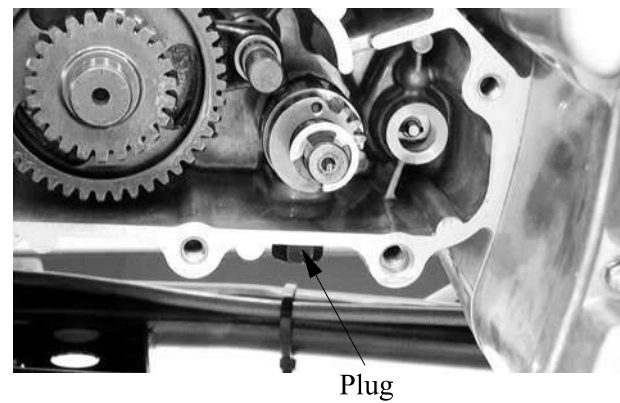

Remove spring, washer and shift cam stopper.

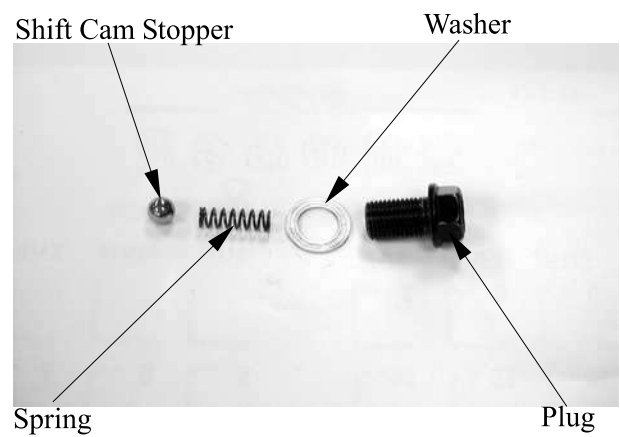

10.FINAL REDUCTION/ TRANSMISSION SYSTEM

Remove the transmission guide bar.



Remove shift cam.

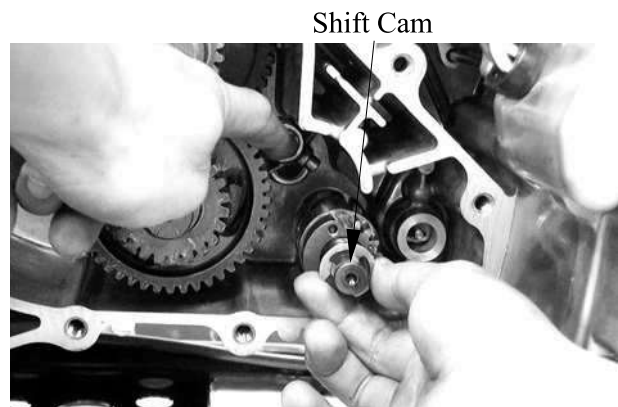

Remove the shift fork.

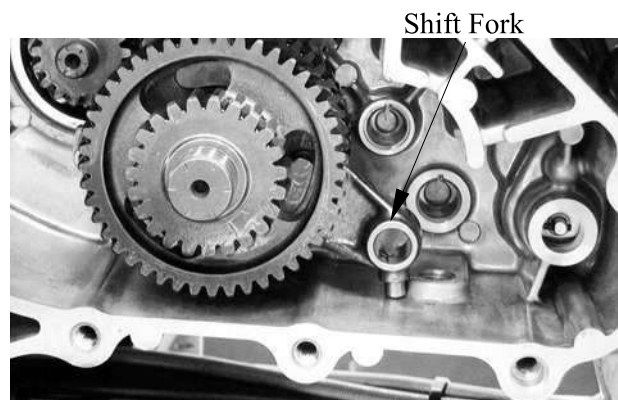

10.FINAL REDUCTION/ TRANSMISSION SYSTEM

Measure the guide bar runout.
Out of specification → Replace.

Service Limit:

Less than 0.03 mm (0.0012 in)

Do not attempt to straighten a bent guide bar.

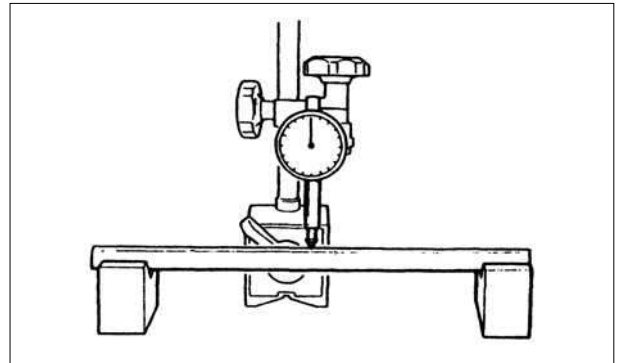

Inspect the shift fork cam follower and shift fork pawl.
Scoring/beads/wear → Replace.

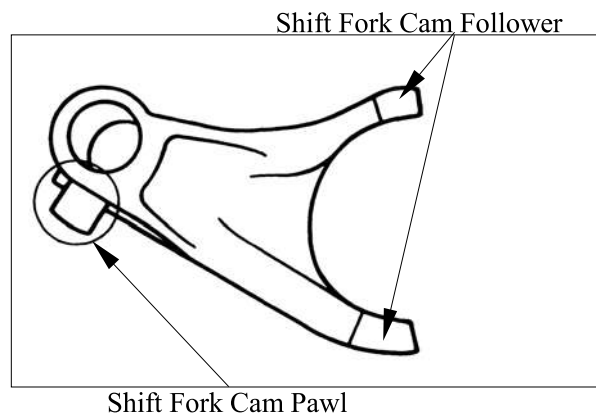

Check the shift cam groove and shift cam gear.
Wear or damage → Replace.



10.FINAL REDUCTION/ TRANSMISSION SYSTEM

Inspect shift shaft gear.
Damage → Replace.
Inspect shift shaft.
Damage/bends/wear → Replace.

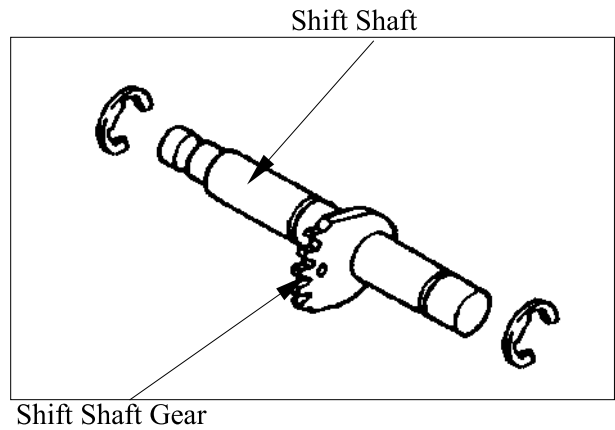

Remove the main axle.

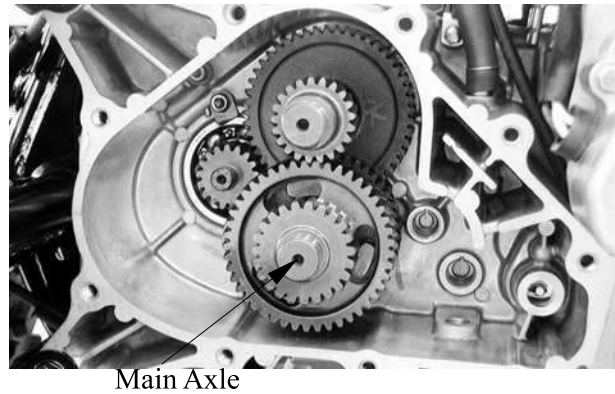

MAIN AXLE DISASSEMBLY

Remove the washers, collar, primary driven gear, bush and clutch dog.

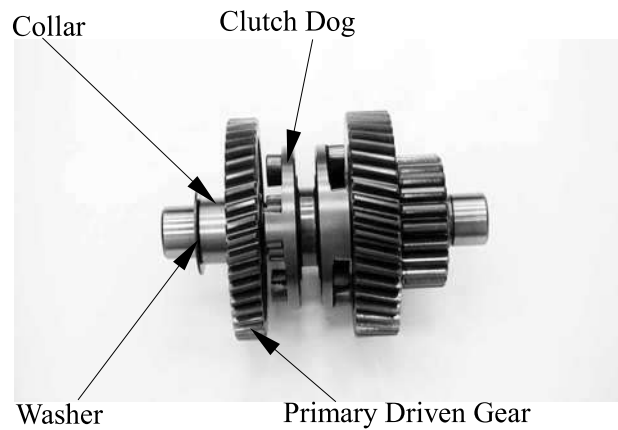

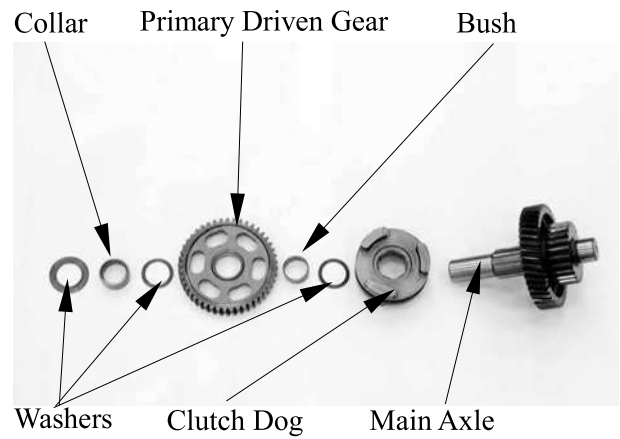

Remove the circlip and then remove the washers, reverse wheel gear and needle bearing.

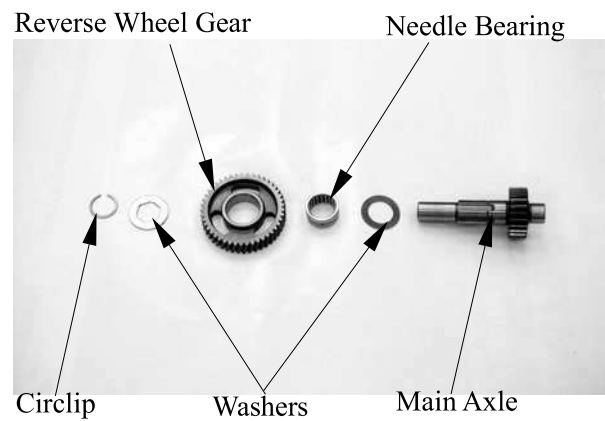
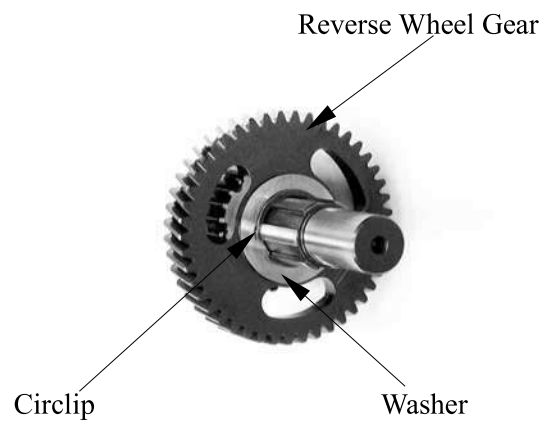

10.FINAL REDUCTION/ TRANSMISSION SYSTEM

Inspect the gear teeth.
Blue discoloration/pitting/wear → Replace.

Inspect the mated dogs.
Rounded edges/cracks/missing portions
→ Replace.

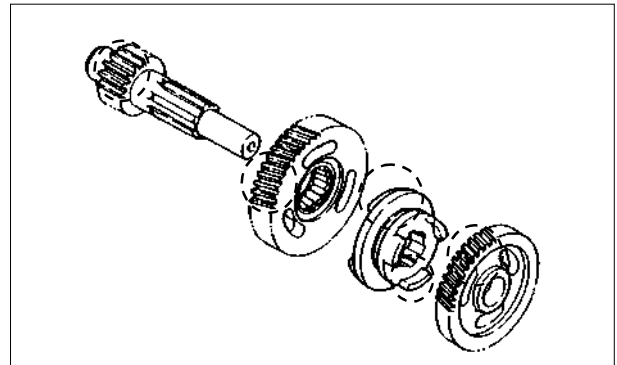

MAIN AXLE ASSEMBLY

Reverse the “MAIN AXLE
DISASSEMBLY” procedures.

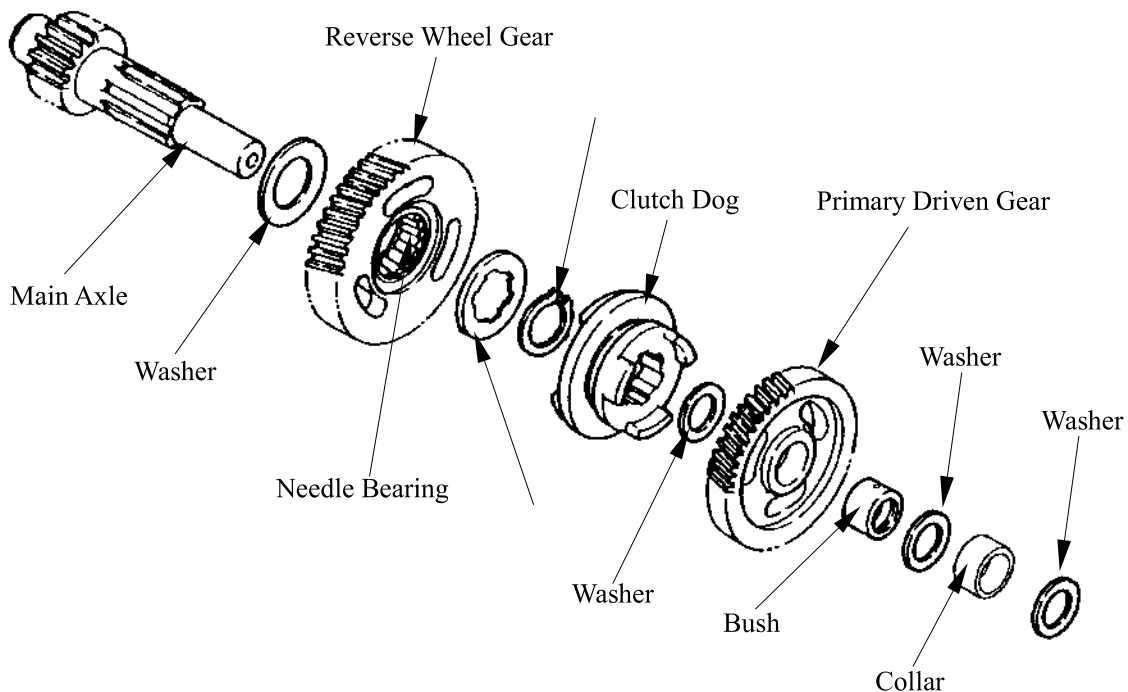

10.FINAL REDUCTION/ TRANSMISSION SYSTEM

Remove the counter axle.

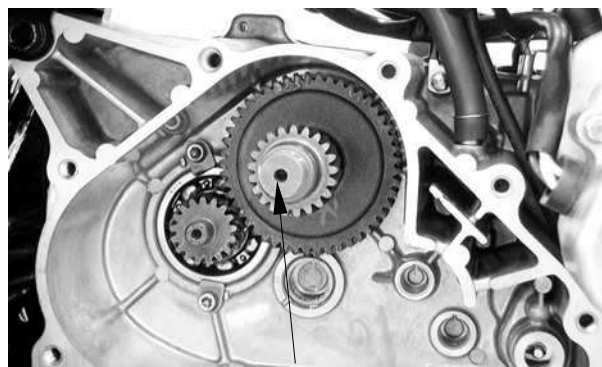

Counter Axle

Inspect the gear teeth.
Blue discoloration/pitting/wear → Replace.



PRIMARY DRIVE AXLE REMOVAL

Remove the clutch/driven pulley. (Refer to the chapter 9)

Remove the oil seal, circlip, bolts and plates.
Remove the primary drive axle.

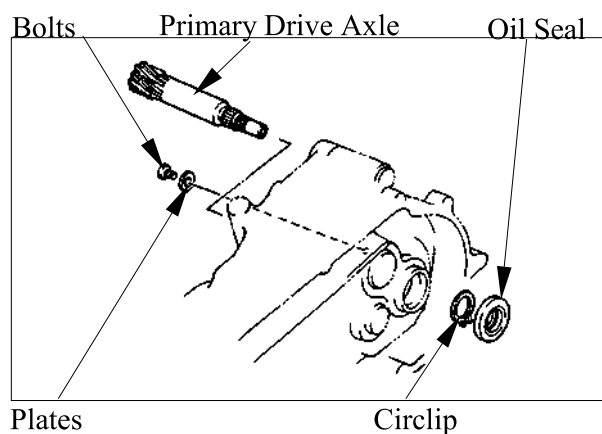

10.FINAL REDUCTION/ TRANSMISSION SYSTEM

Inspect the bearings for allow play in the transmission case cover or the bearing turns roughly.

If any defects are found, replace the bearing with a new one.

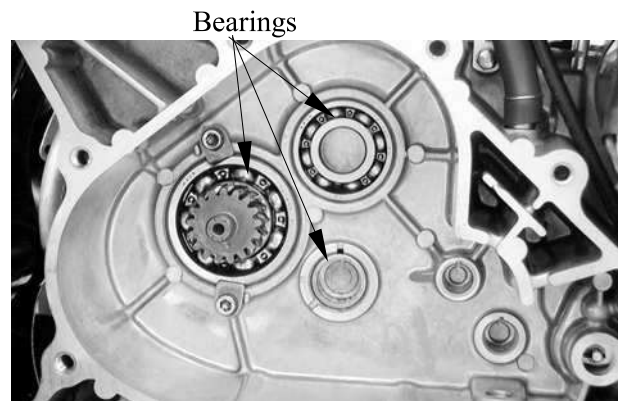

INSTALLATION

Reverse the "TRANSMISSION REVOVAL" section procedures.

Install the main drive axle. (Reverse the "MAIN DRIVE AXLE" procedures.)

Install the counter axle.

Install the main axle washer.

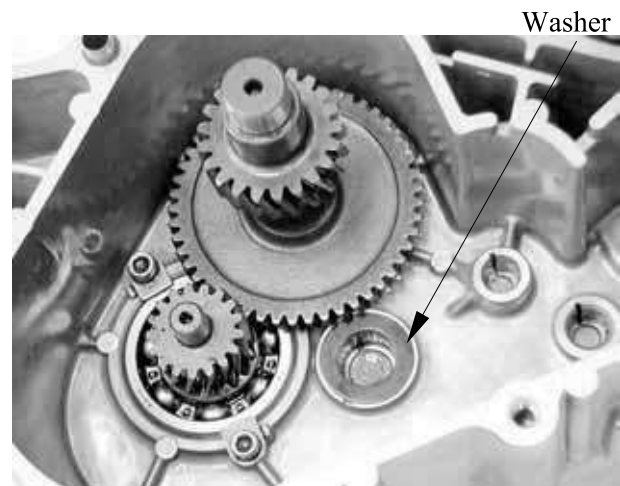

Install the main axle.



10.FINAL REDUCTION/ TRANSMISSION SYSTEM

Install the shift cam.
Install the shift fork.
Install the guide bar.
Install the shift shaft.

Make sure that the lever on the gear change switch correctly engages with the locating slot on the shift shaft.
Align the mark on the shift shaft gear with the mark on the shift cam gear.

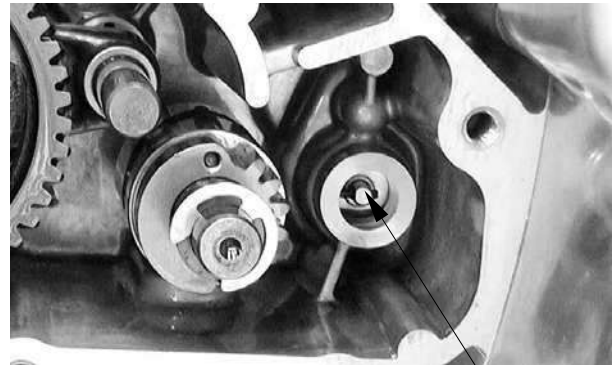

Gear Change Switch

Install the shift cam stopper and tighten the plug.

Torque: 4.8 kgf-m (48 Nm, 35 lbf-ft)

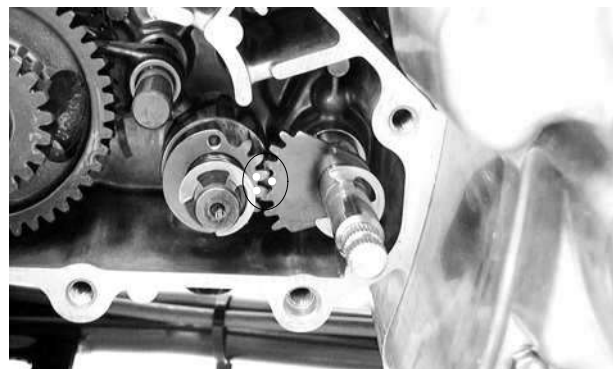

Install the dowel pins and a new gasket onto the right crankcase.

Install the transmission case cover and tighten the transmission case cover bolt.

Torque: 2.7 kgf-m (27 Nm, 20 lbf-ft)

Fill the engine with oil and install the oil filler bolt. (Refer to the “TRANSMISSION OIL REPLACEMENT” section in the chapter 3)

Specified Gear Oil:

KYMCO SIGMA GEAR OIL 90#

Oil Capacity (MXU 250):

At disassembly:

0.4 liter (0.352 Imp qt, 0.424 US qt)

At change:

0.3 liter (0.264 Imp qt, 0.318 US qt)

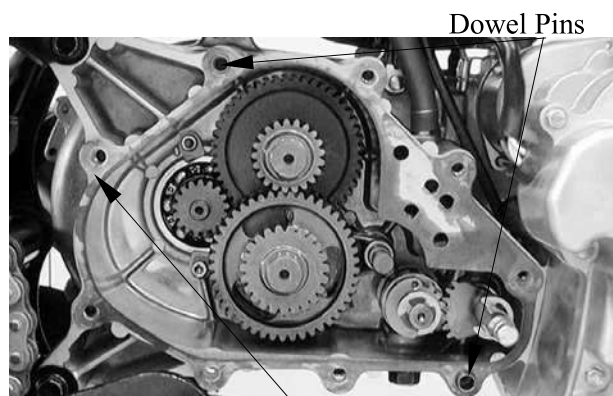

Dowel Pins

Gasket

SPEEDOMETER GEAR REMOVAL

Disconnect the speedometer cable (see page 6-3).

Remove the speedometer gear plug, washer and speedometer gear shaft.

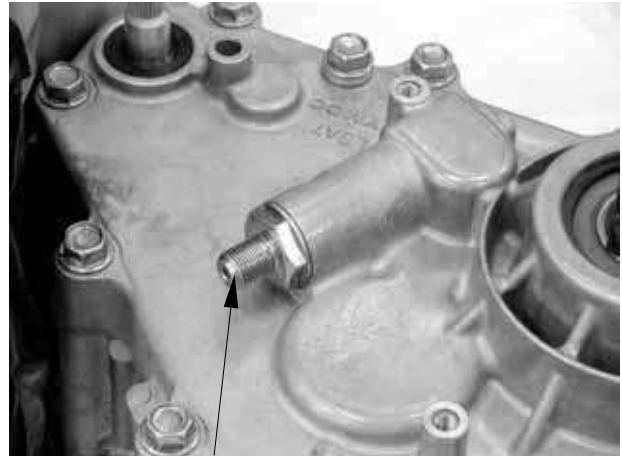

Plug

INSPECTION

Inspect the speedometer gear teeth.
pitting/wear → Replace.

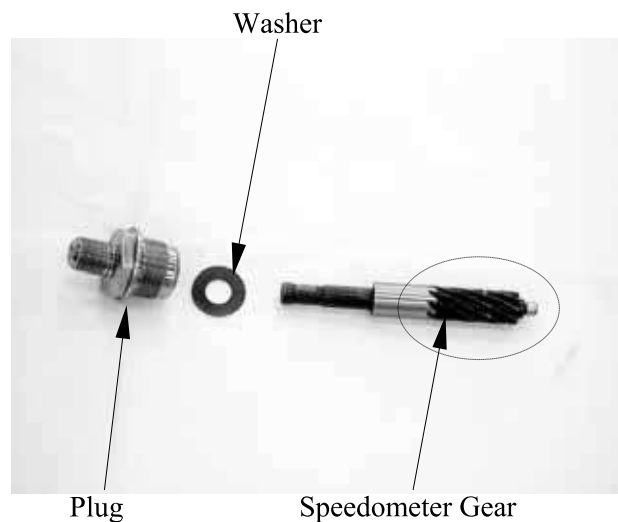

Plug

Speedometer Gear

Remove the transmission case cover (see page 10-4).

Inspect the speedometer driver gear teeth on the main axle.

Pitting/wear → Replace.



10.FINAL REDUCTION/ TRANSMISSION SYSTEM

Inspect the oil seal for wear or damage.
If any defects are found, replace the oil seal
with a new one.



Oil Seal

INSTALLATION

Reverse the “REMOVAL” procedures.

10.FINAL REDUCTION/ TRANSMISSION SYSTEM

TRANSMISSION CASE COVER / SECONDARY DRIVEN BEVEL GEAR ASSEMBLY (MXU 300) REMOVAL

Drain transmission gear oil into a clean container. (Refer to the “TRANSMISSION OIL REPLACEMENT” section in the chapter 3)

Remove the engine assembly (Refer to the “ENGINE REMOVAL” section in the chapter 6) or remove the rear swingarm (page 15-21).

Loosen the joint boot band screw and remove the joint boot from the secondary driven bevel gear.

Remove the four bolts and secondary driven bevel gear assembly.



Joint Boot

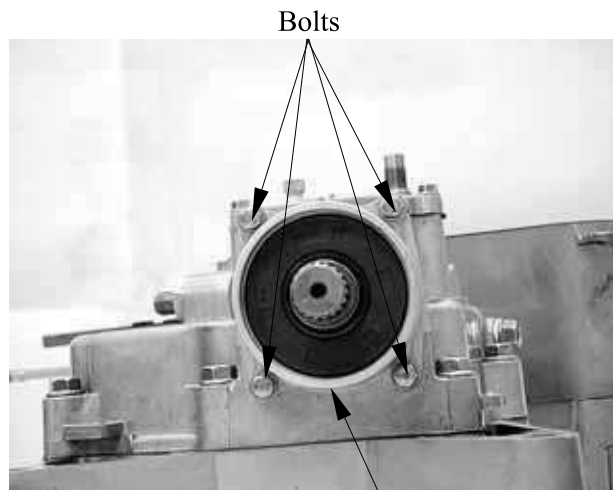

Secondary Driven Bevel Gear Assembly



Secondary Driven Bevel Gear Assembly

10.FINAL REDUCTION/ TRANSMISSION SYSTEM

Remove the three bolts and secondary drive bevel gear cover.

Secondary Drive Bevel Gear Cover

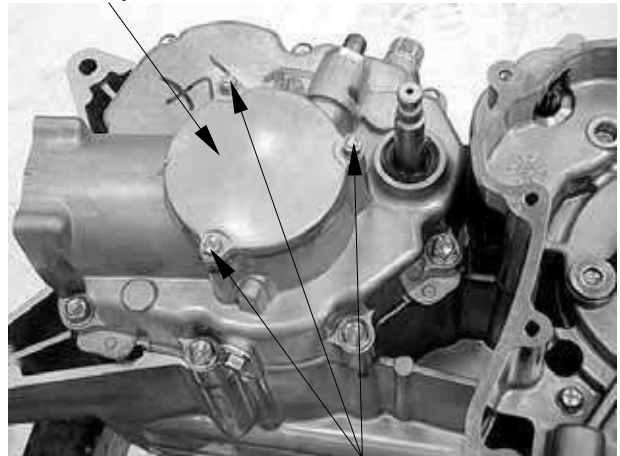

Bolts

Remove the speedometer gear plug, washer and speedometer gear.

Speedometer Gear

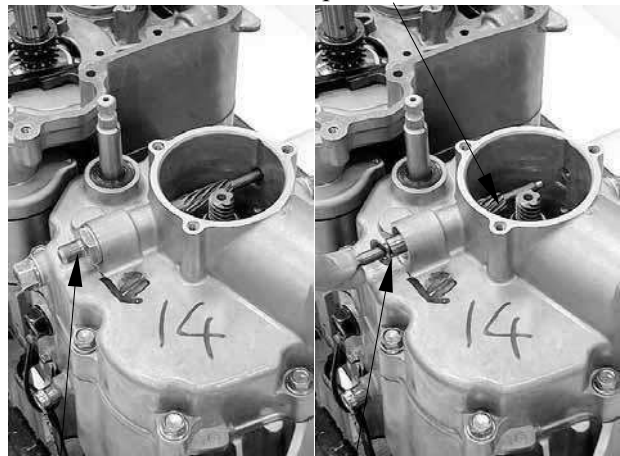

Plug

Washer

Using a chisel, unlock the nut.

Hold the clutch outer (see page 9-3 to remove the left crankcase cover) with the universal holder and remove the secondary drive bevel gear nut.

Special tool: **Universal holder E017**

Clutch Outer

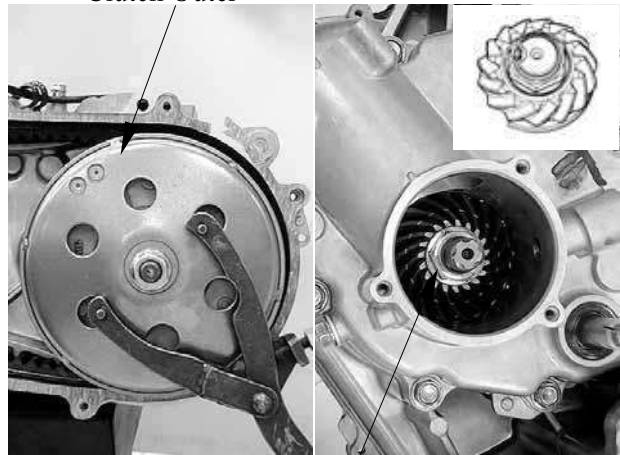

Nut

10.FINAL REDUCTION/ TRANSMISSION SYSTEM

Remove the eight bolts, then remove the transmission case cover, gasket and secondary drive bevel gear/shim.

Secondary Drive Bevel Gear/Shim

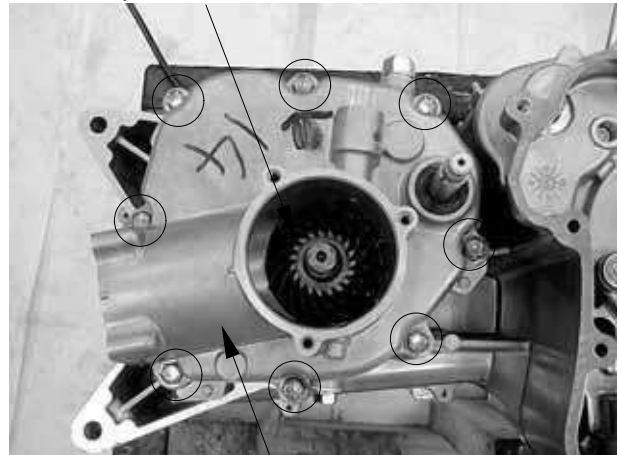

Transmission Case Cover/Gasket

Remove the two dowel pins.



Dowel Pins

SECONDARY DRIVEN BEVEL GEAR CASE DISASSEMBLY

Using a chisel, unlock the nut.

Fit the universal joint onto the driven bevel gear shaft.

Remove the driven bevel gear shaft nut by holding the universal joint with a vise.

Driven Bevel Gear Shaft Nut

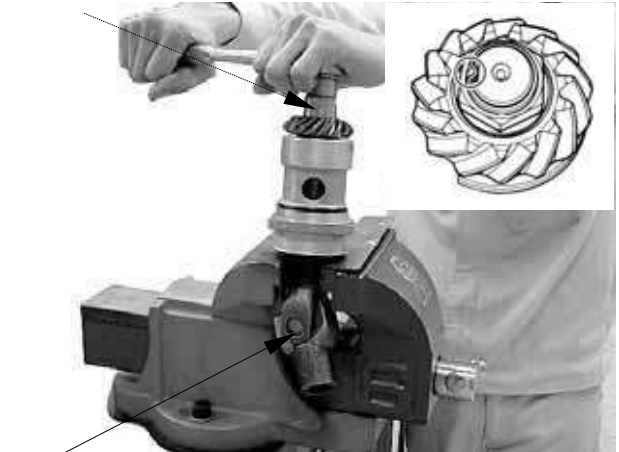

Universal Joint

10.FINAL REDUCTION/ TRANSMISSION SYSTEM

Remove the secondary driven bevel gear and shim.

Secondary Driven Bevel Gear Shim

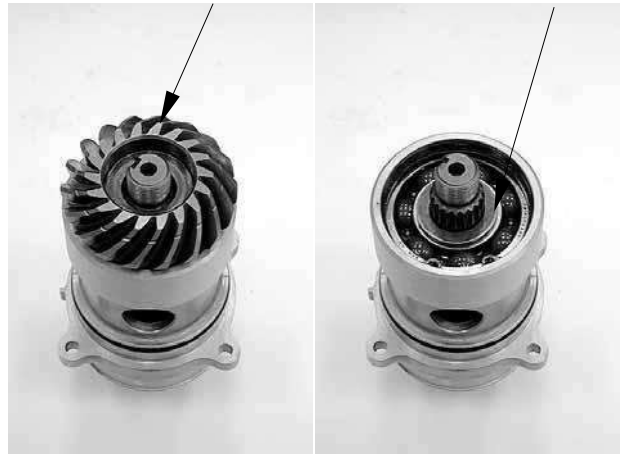

Remove the secondary driven bevel gear shaft from case.

Secondary Driven Bevel Gear Shaft

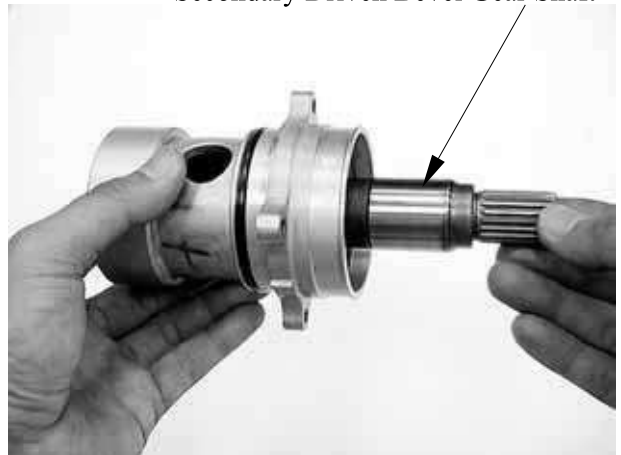

TRANSMISSION CASE COVER BEARING/OIL SEAL REPLACEMENT

Inspect the shift shaft oil seal and speedometer gear oil seal for wear or damage. If any defects are found, replace the oil seal with a new one.

Shift Shaft Oil Seal

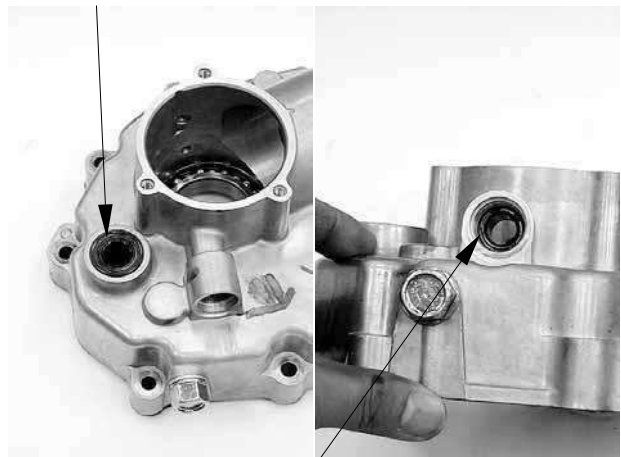

Speedometer Gear Oil Seal

10.FINAL REDUCTION/ TRANSMISSION SYSTEM

Remove the two bolts and driveshaft bearing set plate.

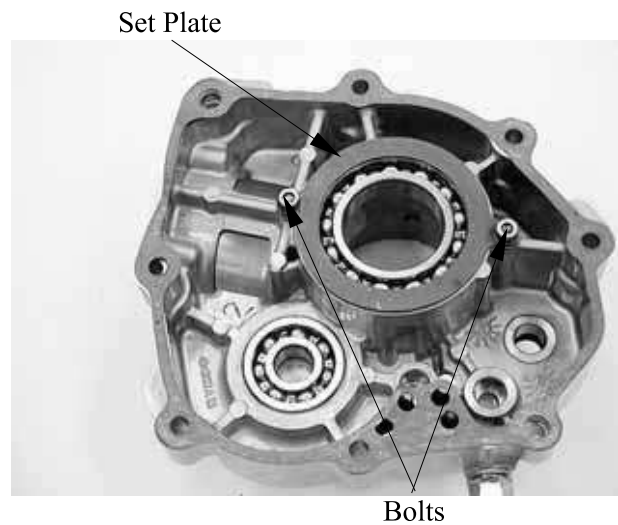

Remove the countershaft bearing and driveshaft bearing with special tools.

Special tools:

Bearing puller E037

Bearing/Oil seal install E014

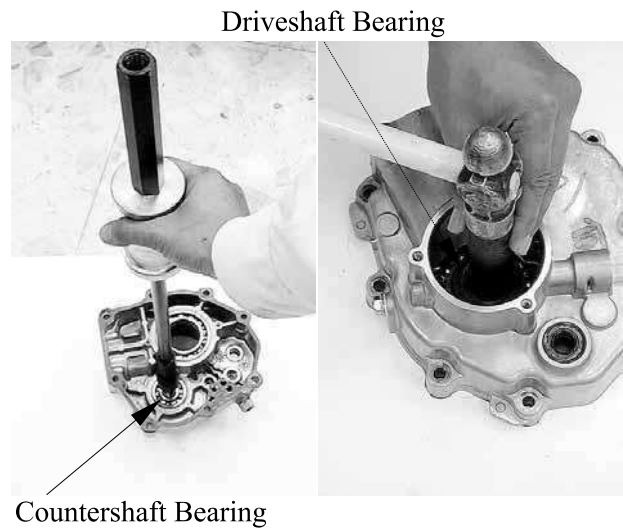

Install a new driveshaft bearing and a new countershaft bearing with special tool.

Special tools:

Bearing/Oil seal install E014

Install the bearing set plate.

Install and tighten the two new bolts (replace the new bolts).

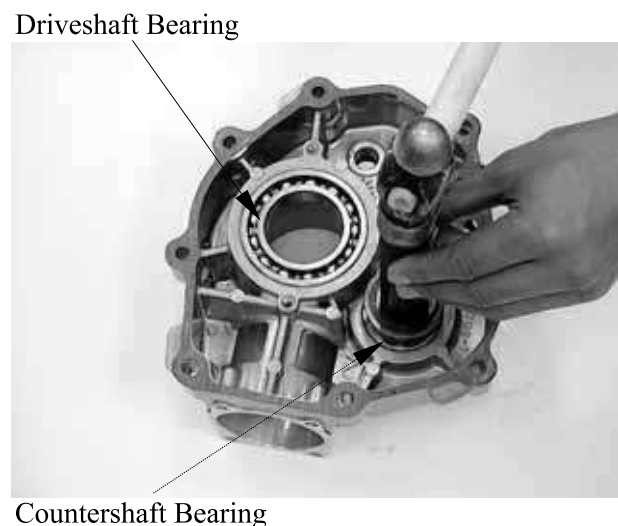

10.FINAL REDUCTION/ TRANSMISSION SYSTEM

SECONDARY DRIVEN BEVEL GEAR SHAFT CASE BEARING/OIL SEAL REPLACEMENT

Remove the secondary driven bevel gear shaft oil seal.

Remove the snap ring.

Oil Seal



Snap Ring



Remove the outer bearing.

Outer Bearing



Remove the snap ring.

Remove the inner bearing.

Snap Ring



Inner Bearing



10.FINAL REDUCTION/ TRANSMISSION SYSTEM

Install a new inner bearing with the special tool.

Special tools:
Bearing/Oil seal install E014

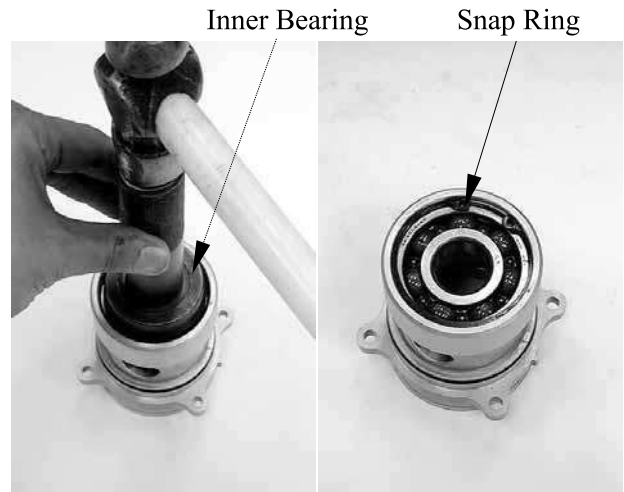

Install a new outer bearing with special tool.

Special tools:
Bearing/Oil seal install E014

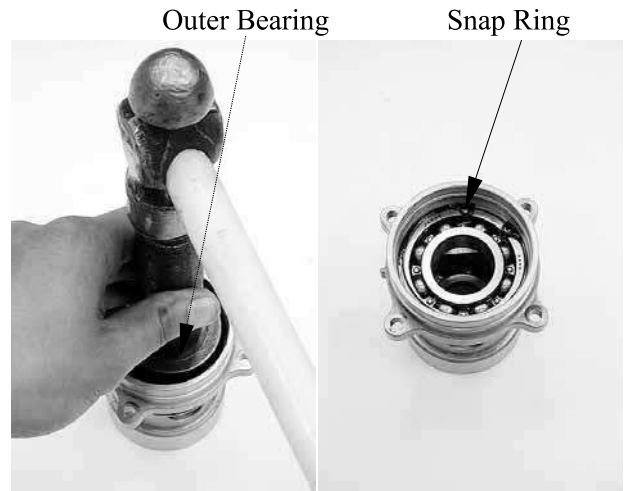

Apply the oil to a new oil seal lip and then install the oil seal with the special tool.

Special tools:
Bearing/Oil seal install E014



10.FINAL REDUCTION/ TRANSMISSION SYSTEM

INSPECTION

Inspect the secondary driven bevel gear shaft splines for wear or damage.

Inspect the secondary driven bevel gear shaft for blue discoloration, pitting or wear.



Inspect the bevel gears and speedometer gear for blue discoloration, pitting or wear.

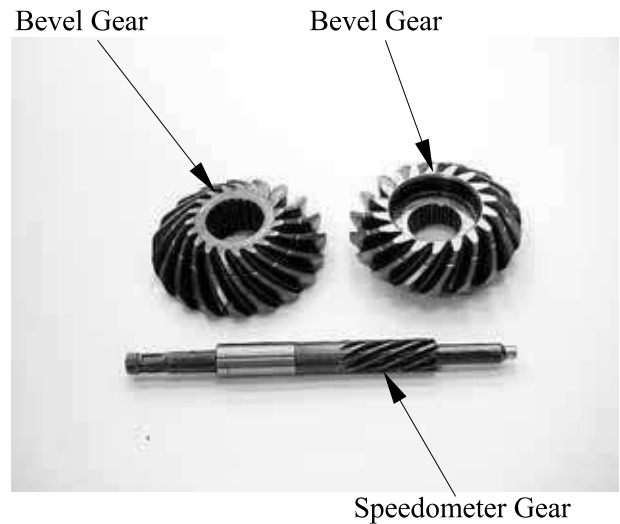

SECONDARY DRIVEN BEVEL GEAR ASSEMBLY

Apply engine oil to the secondary driven bevel gear shaft.

Install the secondary driven bevel gear shaft into the case.

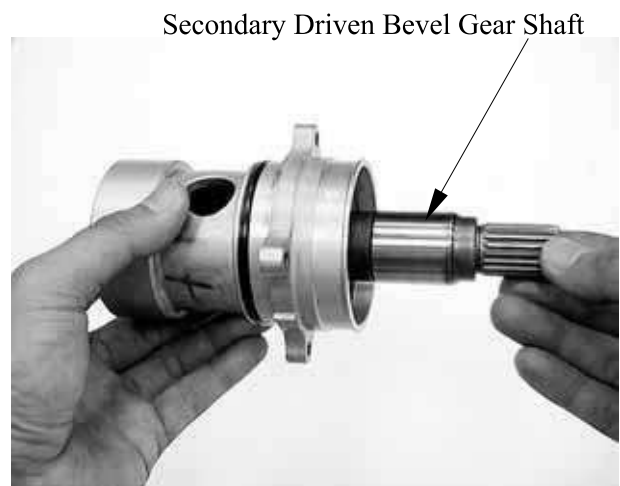

10.FINAL REDUCTION/ TRANSMISSION SYSTEM

Apply engine oil to the driven bevel gear.

Install the shim and driven bevel gear.

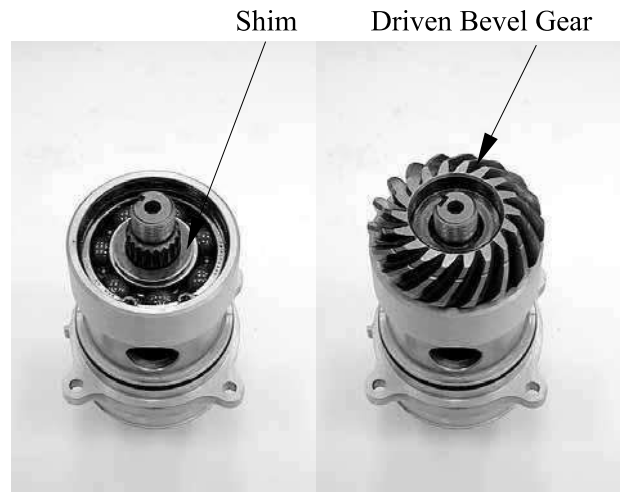

Fit the universal joint onto the driven bevel gear shaft.

Tighten the driven bevel gear nut to the specified torque.

Torque: 100 N-m (10 kgf-m, 72.5 lb-ft)

Stake the nut with a center punch.

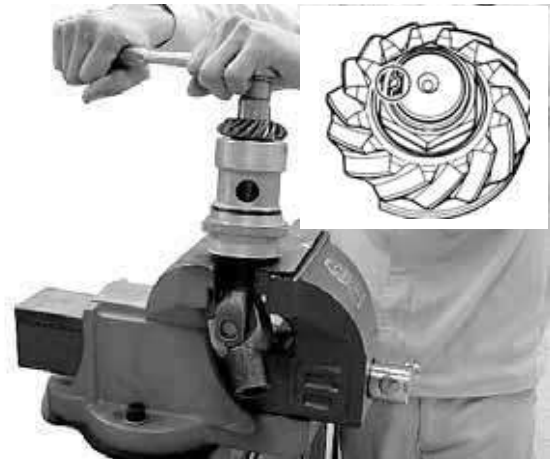

INSTALLATION

Install the two dowel pins.



10.FINAL REDUCTION/ TRANSMISSION SYSTEM

Install the gasket and transmission case cover.
Install and tighten the bolts to the specified torque.

Torque: 2.7 kgf-m (27 Nm, 20 lbf-ft)

Transmission Cover/Gasket

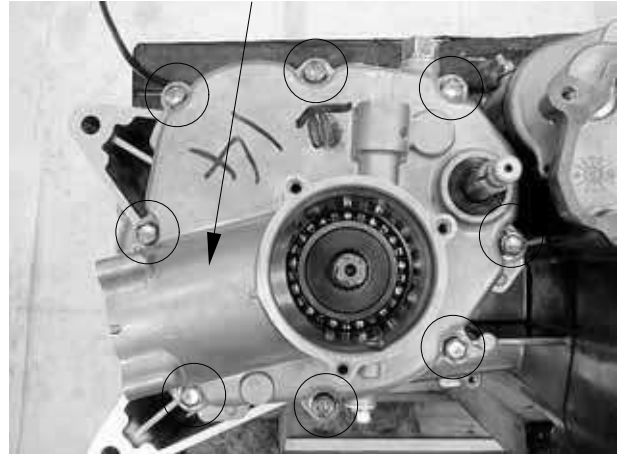

Install the shim and drive bevel gear.

Shim

Drive Bevel Gear

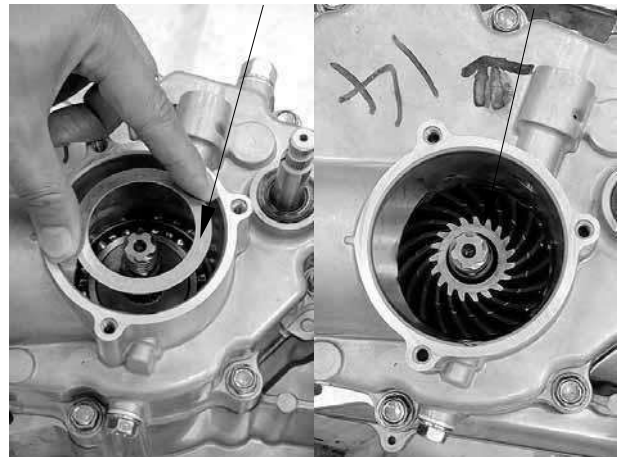

Hold the clutch out and tighten the drive bevel gear nut to the specified torque.

Torque: 100 N-m (10 kgf-m, 72.5 lb-ft)

Stake the nut with a center punch.

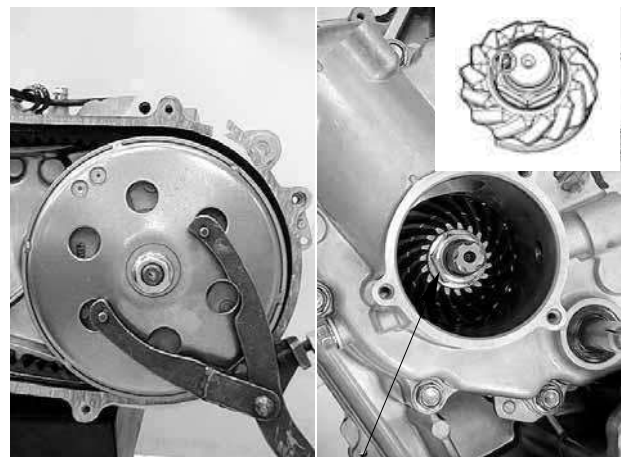

Nut

10.FINAL REDUCTION/ TRANSMISSION SYSTEM

Replace a new O-ring and apply engine oil to the O-ring.

Install the secondary driven bevel gear into the transmission case cover.

Align the mark on the secondary bevel driven gear shaft case with the index mark on the transmission case cover.

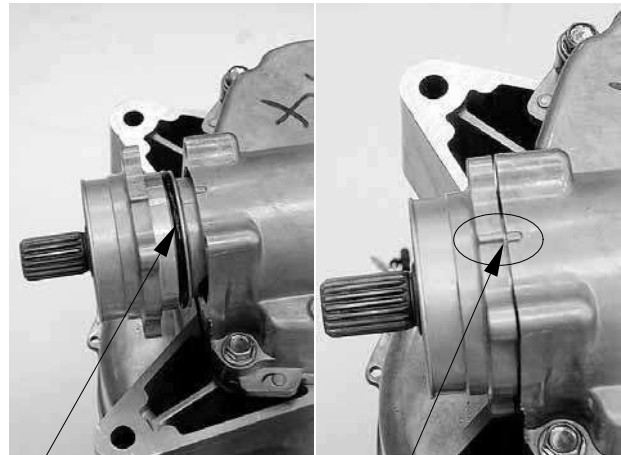

O-ring

Marks

Shift the shift shaft to neutral.

Install and tighten the four bolts in several steps until the driven bevel gear shaft case evenly touches the transmission case cover.

Then, while rotating the driven bevel gear shaft, tighten the bolts in a crisscross pattern in several steps.

It is important to turn the driven bevel gear shaft while tightening the bolts. If the bevel gear shim is too thick, the gears will lock after only light tightening.

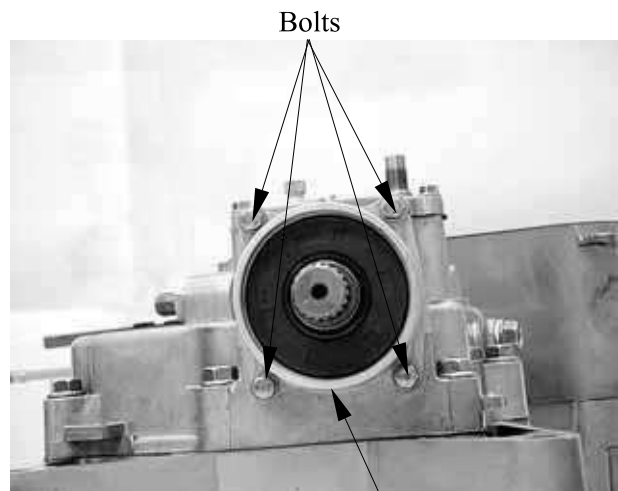

Driven Bevel Gear Shaft Case

Install the speedometer gear and washer.
Install the plug and tighten it.

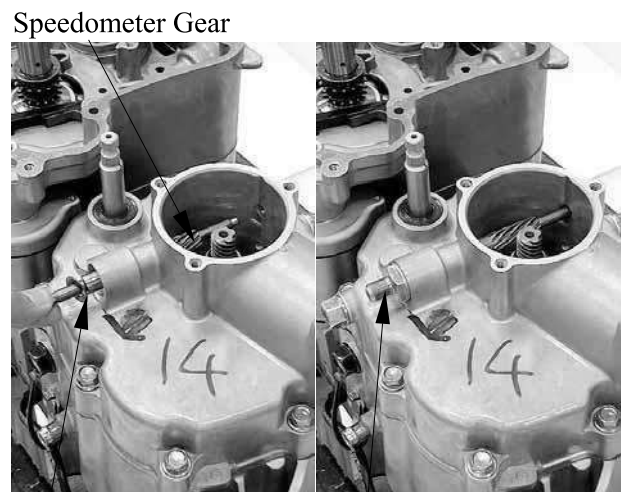

Washer

Plug

10.FINAL REDUCTION/ TRANSMISSION SYSTEM

Install the drive bevel gear cover and tighten the three bolts.

Align the mark on the drive bevel gear cover with the index mark on the transmission case cover.

Fill the engine with oil and install the oil filler bolt. (Refer to the "TRANSMISSION OIL REPLACEMENT" section in the chapter 3)

Specified Gear Oil:

KYMCO SIGMA GEAR OIL 90#

Oil Capacity (MXU 300):

At disassembly:

0.6 liter (0.528 Imp qt, 0.636 US qt)

At change:

0.5 liter (0.44 Imp qt, 0.53 US qt)

TRANSMISSION (MXU 300) REMOVAL

Remove the shift shaft.

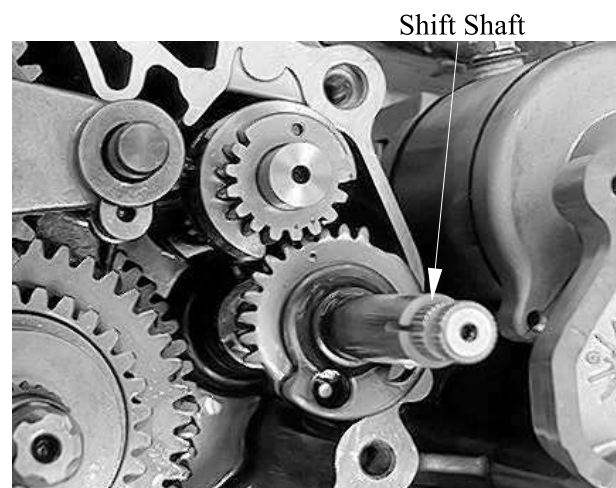
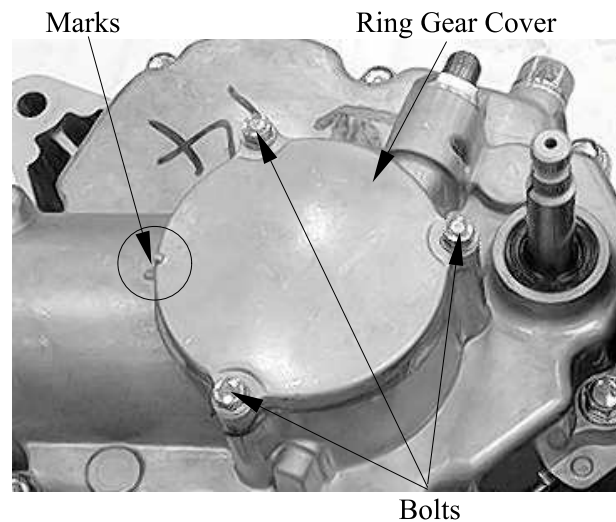

Remove the stopper plug and washer, then remove the spring and shift cam stopper.

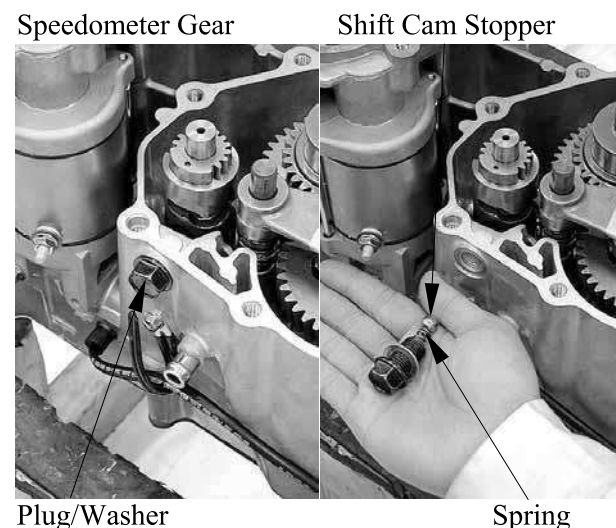

10.FINAL REDUCTION/ TRANSMISSION SYSTEM

Remove the transmission guide bar.
Remove the upper shift fork.

Guide Bar

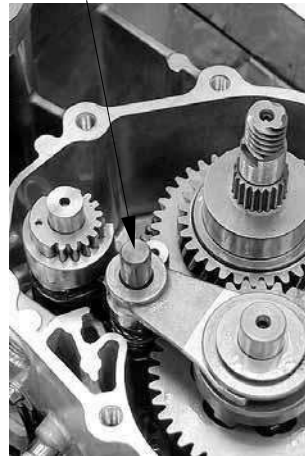

Upper Shift Fork

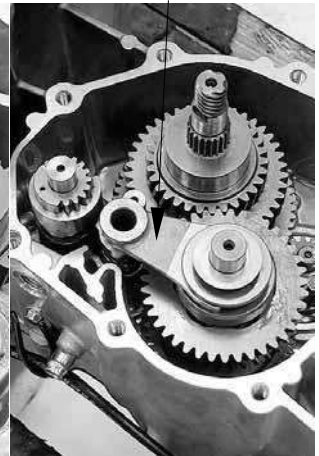

Remove the shift cam.
Remove the lower shift fork.

Shift Cam

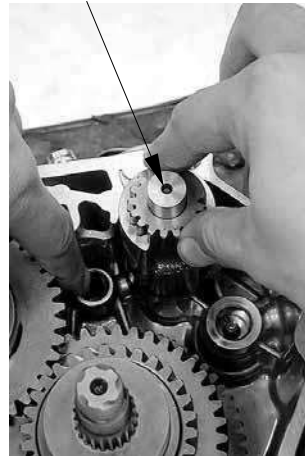

Lower Shift Fork

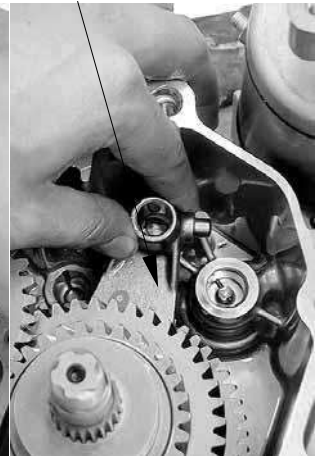

Washer



Plug

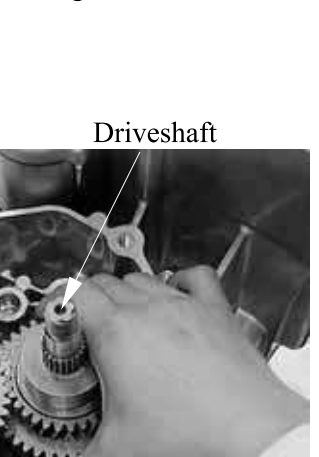

Remove the countershaft and driveshaft as an assembly.

Disassemble the countershaft and the driveshaft.

Keep track of the disassembled parts (gears, washer and clip) by stacking them on a tool or slipping them onto a piece of wire.

Countershaft



Driveshaft



10.FINAL REDUCTION/ TRANSMISSION SYSTEM

INSPECTION

Measure the guide bar runout.
Out of specification → Replace.

Service Limit:

Less than 0.03 mm (0.0012 in)

Do not attempt to straighten a bent guide bar.

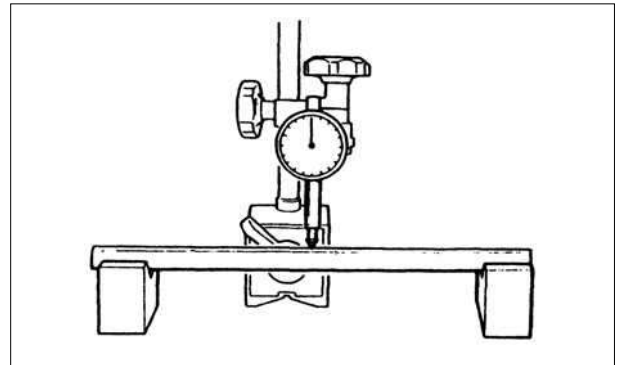

Inspect the shift fork cam follower and shift fork pawl.
Scoring/beads/wear → Replace.

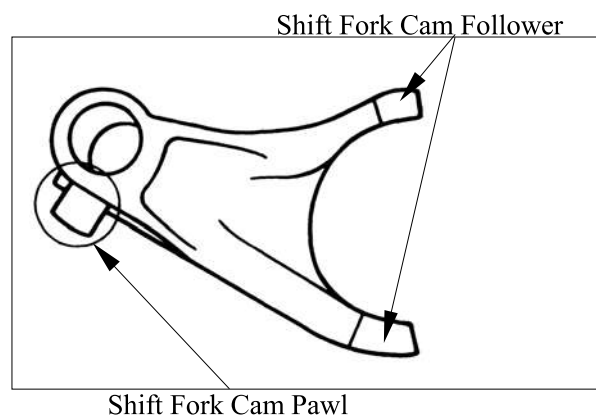

Check the shift cam groove and shift cam gear.
Wear or damage → Replace.



Inspect shift shaft gear.
Damage → Replace.
Inspect shift shaft.
Damage/bends/wear → Replace.
Check the return spring for fatigue or damage.



10.FINAL REDUCTION/ TRANSMISSION SYSTEM

COUNTERSHAFT DISASSEMBLY/INSPECTION

Remove the washer and high gear clutch dog.

Clutch dog

Check the gear dogs, gearshifter groove for wear or damage.

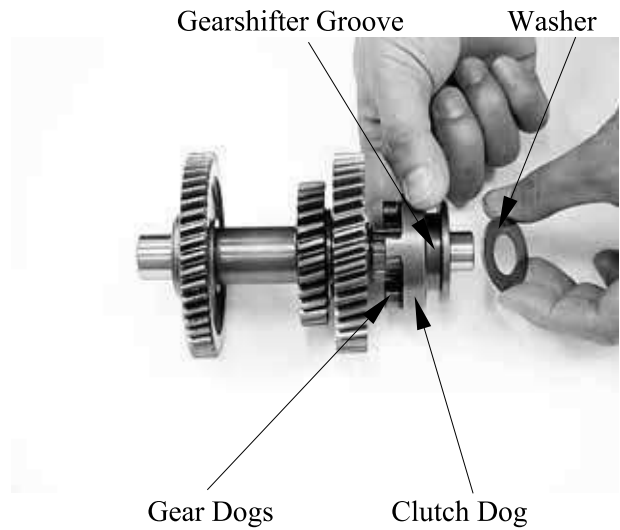

Remove the snap ring, then remove washer

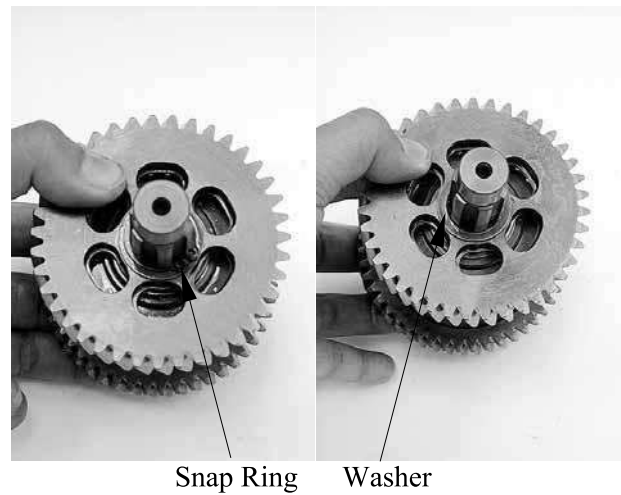

Remove the high drive gear, then remove washer.

High drive gear

Inspect the dog holes and teeth for damage or wear.

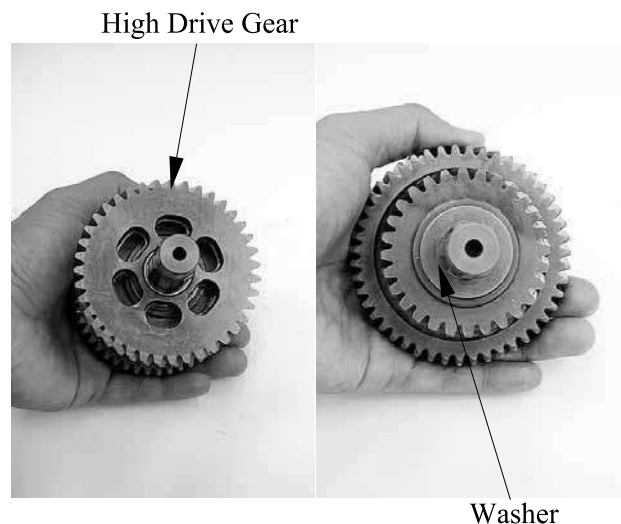

10.FINAL REDUCTION/ TRANSMISSION SYSTEM

Remove the washer.

Countershaft

Inspect the teeth, spline grooves and sliding surfaces for abnormal wear or damage.

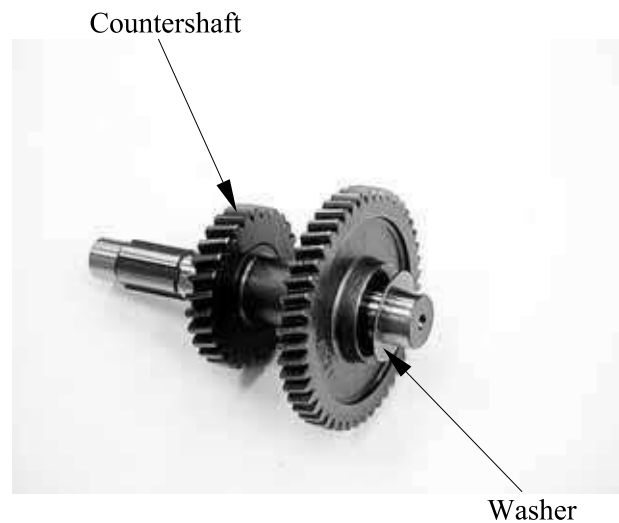

ASSEMBLY

Clean all parts in solvent.

Apply molybdenum oil solution to the gear and sliding surface and shift fork grooves to ensure initial lubrication.

Reverse the “COUNTERSHAFT DISASSEMBLY” procedures to assemble all parts into their original positions.

- Check the gears for freedom of movement or rotation of the countershaft.
- Install the snap rings with the chamfered edges facing the thrust load side. Do not reuse a worn snap ring which could easily spin in the groove.
- Check that the snap ring are seated in the grooves and align their end gaps with the grooves of the spline.

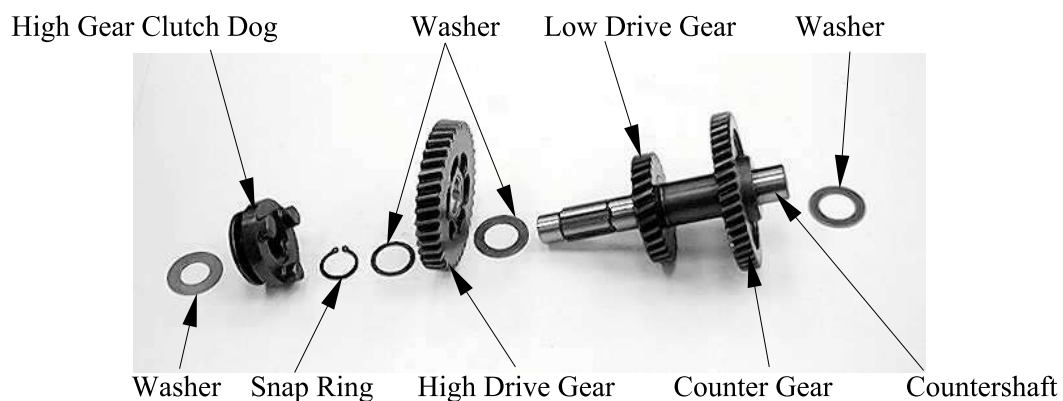

10.FINAL REDUCTION/ TRANSMISSION SYSTEM

DRIVESHAFT DISASSEMBLY/INSPECTION

Remove the washer.

Remove the reverse gear.

Reverse gear

Inspect the dog holes and teeth for damage or wear.

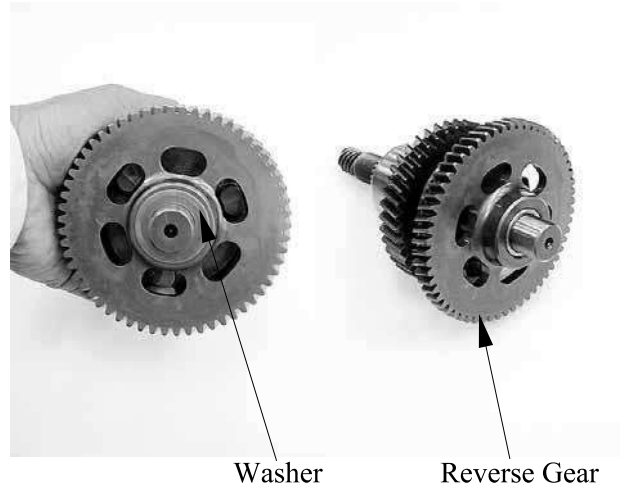

Remove the washer.

Remove the reverse/low gear clutch dog.

Clutch dog

Check the gear dogs, gearshifter groove for wear or damage.

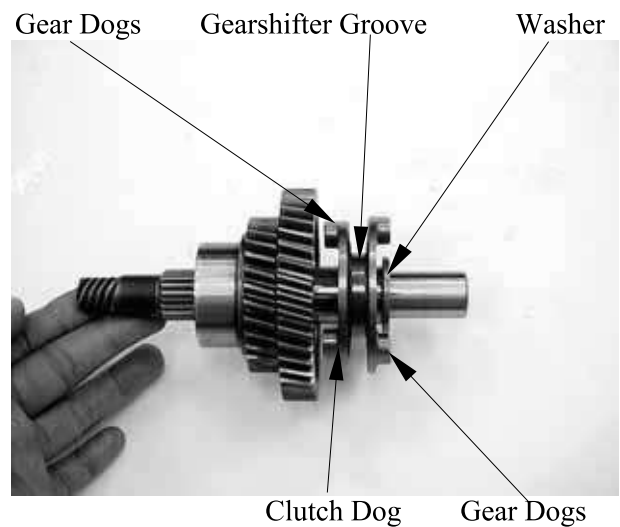

Remove the snap ring, then remove the washer.

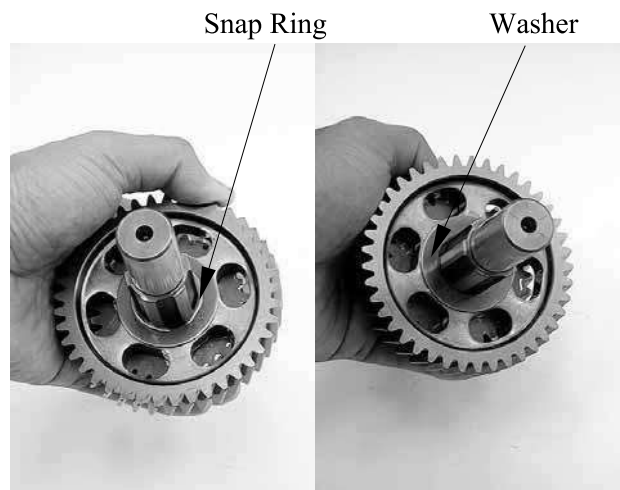

10.FINAL REDUCTION/ TRANSMISSION SYSTEM

Remove the low driven gear, then remove the washer.

Low driven gear

Inspect the dog holes and teeth for damage or wear.

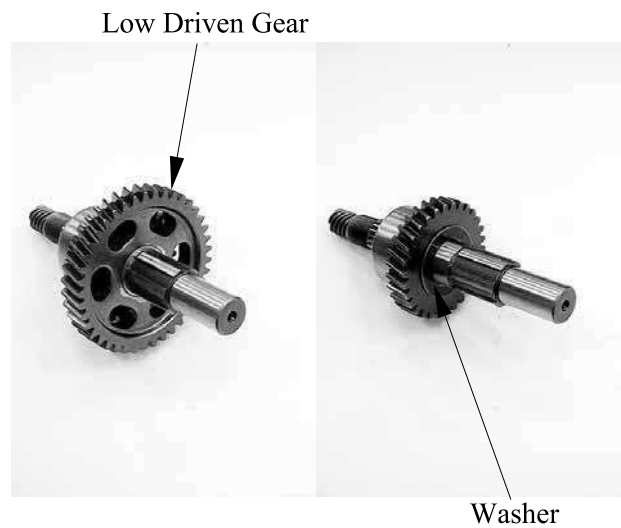

ASSEMBLY

Clean all parts in solvent.

Apply molybdenum oil solution to the gear and sliding surface and shift fork grooves to ensure initial lubrication.

Reverse the “DRIVESHAFT DISASSEMBLYN” procedures to assemble all parts into their original positions.

- Check the gears for freedom of movement or rotation of the driveshaft.
- Install the snap rings with the chamfered edges facing the thrust load side. Do not reuse a worn snap ring which could easily spin in the groove.
- Check that the snap ring are seated in the grooves and align their end gaps with the grooves of the spline.

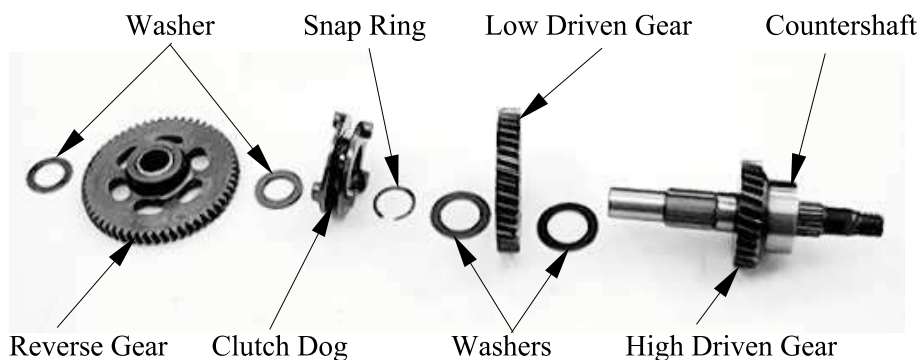

10.FINAL REDUCTION/ TRANSMISSION SYSTEM

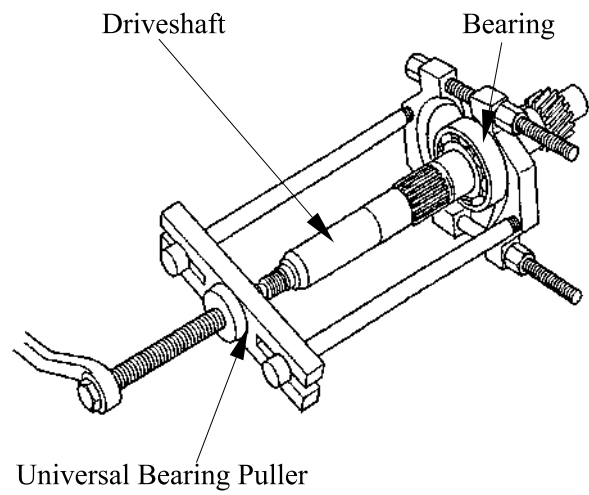
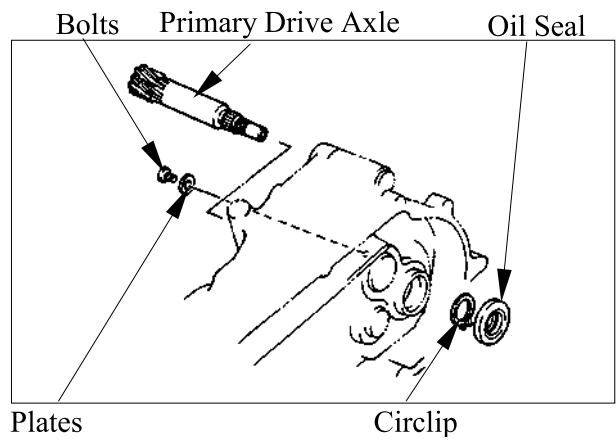

Bearings

10.FINAL REDUCTION/ TRANSMISSION SYSTEM

Install the new bearings with special tool.

Special tools:

Bearing/Oil seal install E014

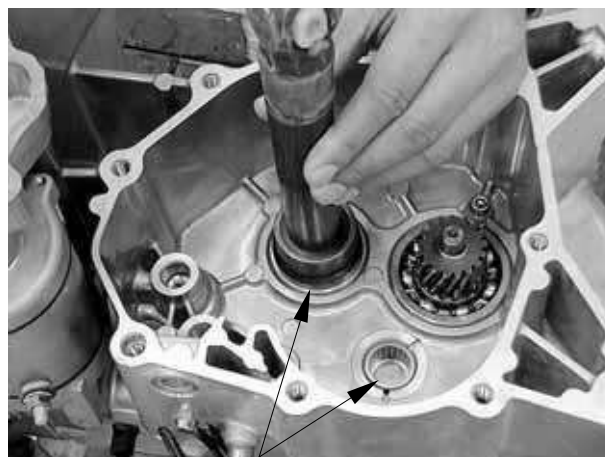

Bearings

INASTALLATION

Apply engine oil to the following parts:

Countershaft.

Driveshaft.

Gear teeth.

Assemble the countershaft and driveshaft.



Install the countershaft, driveshaft assemblies as a set into the transmission case.

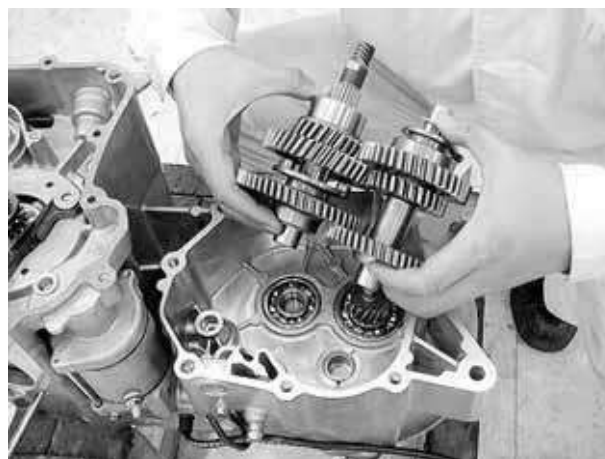

10.FINAL REDUCTION/ TRANSMISSION SYSTEM

Apply engine oil to the gearshift fork, sliding surfaces and gearshift fork pawl.

Install the lower gearshift fork into the clutch dog (counter axle) groove with its "LCD9L" mark facing down.

Install the shift cam into the transmission case, then install the lower gearshift fork pawl into the shift cam groove.

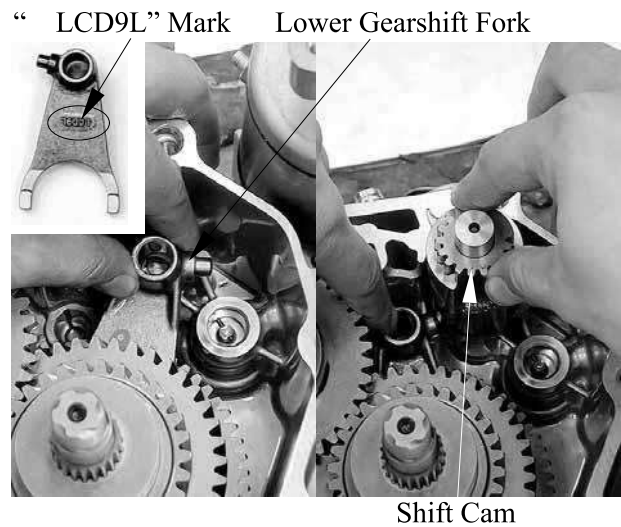

Apply engine oil to the gearshift fork, sliding surfaces and gearshift fork pawl.

Install the upper gearshift fork into the clutch dog (main axle) groove and install the upper gearshift fork pawl into the shift cam groove with its "LCD9R" mark facing down.

Install the guide bar.

Install the shift cam stopper/spring/washer/plug and tighten plug to specified torque.

Torque: 48 N-m (4.8 kgf-m, 35 lbf-ft)

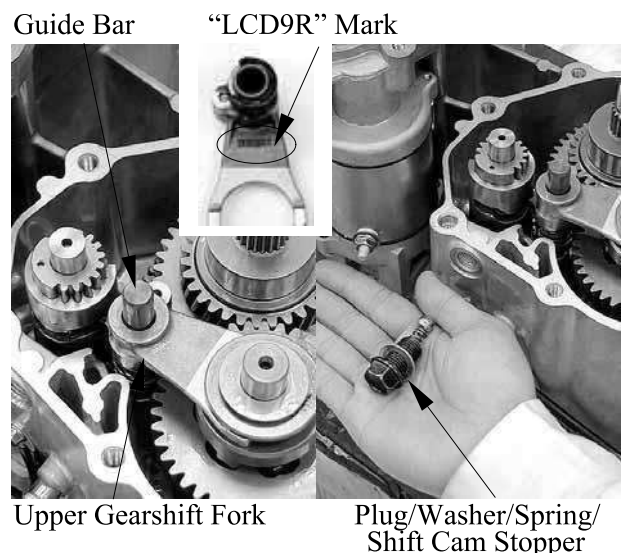

Install the shift shaft.

Make sure that the lever on the gear change switch correctly engages with the locating slot on the shift shaft.
Align the mark on the shift shaft gear with the mark on the shift cam gear.

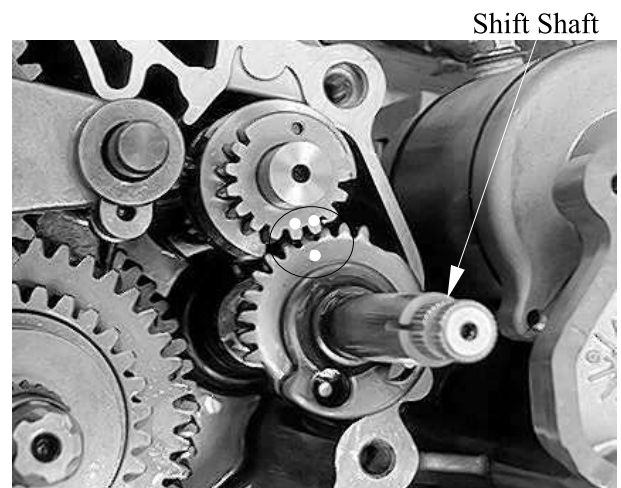

SECONDARY GEAR SHIMS (MXU 300)

Remove the four bolts and secondary drive bevel gear cover.

Secondary Drive Bevel Gear Cover

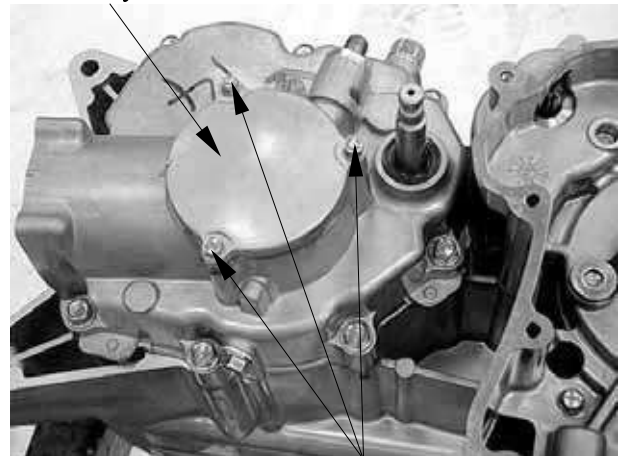

Bolts

Set a dial gauge on the driven bevel gear as shown.

Measure the backlash by turning the driven bevel gear shaft in each direction, reading the total backlash on the dial gauge. If the backlash is not within specification, the shim must be changed and the backlash should be rechecked until correct. Refer to the chart (a) at the page 10-41 for appropriate shim thickness.

Drive Bevel Gear

Driven Bevel Gear

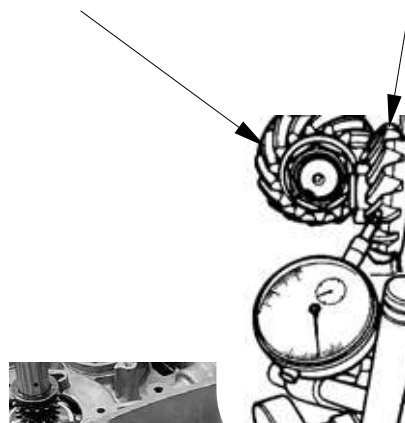

Bevel gear backlash

Standard: 0.03 - 0.15 mm (0.001 – 0.006 in)

- If the backlash is too small (under 0.03 mm, 0.001 in), replace the driven bevel gear side spacer with a thinner shim.
- If the backlash is too great (over 0.15 mm, 0.006 in), replace the driven bevel gear side spacer with a thicker shim.

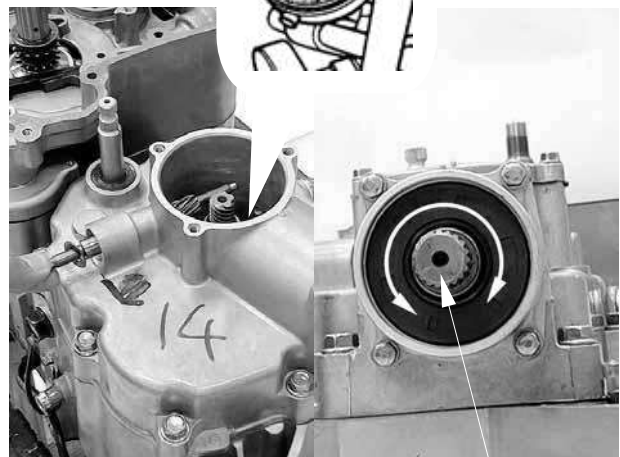

Driven Bevel Gear Shaft

TOOTH CONTACT

After backlash adjustment is carried out, the tooth contact must be checked. Pay attention to the following procedures:

- Remove the driven bevel gear.
- Clean and degrease several teeth of the drive and driven bevel gears.
Apply a coating of machinist's layout dye or paste to several teeth of the driven bevel gear.
- Install the driven bevel gear.
- Rotate the driven bevel gear several turns in both directions.
- Remove the driven bevel gear and inspect the coated teeth of the drive bevel gear. The tooth contact pattern should be as shown in (1), (2) and (3).
- If tooth contact is found to be correct (example (2)), then to complete installation.

(1): Incorrect (contact at tooth top)

(2): Correct

(3): Incorrect (contact at tooth root)

- If tooth contact is found to be incorrect (examples (1) and (3)), the shim thickness between the drive bevel gear and driven bevel gear must be changed and the tooth contact rechecked until correct.

Make sure to check the backlash after the tooth contact has been adjusted, since it may have changed. Adjust the tooth contact and backlash until they are both within specification. If the correct tooth contact cannot be maintained when adjusting the backlash, replace the drive and driven bevel gears.

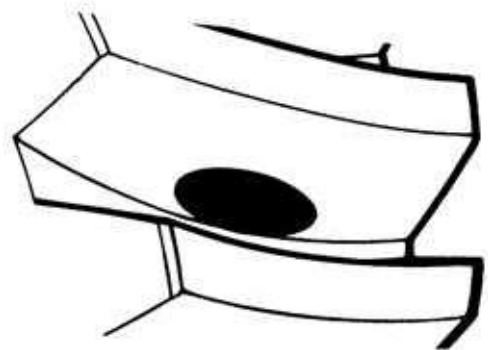
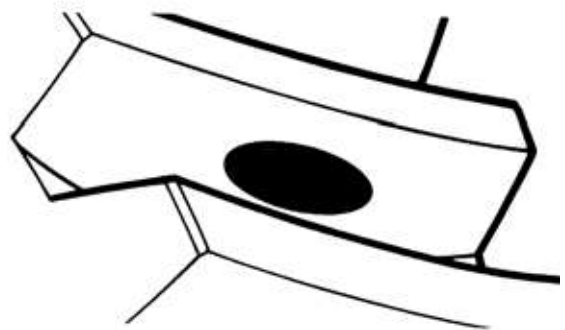

Tooth contact	Drive bevel gear shim adjustment	Driven bevel gear shim adjustment
Contact at tooth top	Increase shim thickness	Increase shim thickness
Contact at tooth root	Decrease shim thickness	Decrease shim thickness

10.FINAL REDUCTION/ TRANSMISSION SYSTEM

Drive bevel gear shims:

- A: 0.6 mm (0.024 in)**
- B: 0.65 mm (0.026 in)**
- C: 0.7 mm (0.028 in)**
- D: 0.75 mm (0.03 in)**
- E: 0.8 mm (0.032 in)**
- F: 0.85 mm (0.034 in)**
- G: 0.9 mm (0.036 in)**
- H: 0.95 mm (0.038 in)**
- I: 1 mm (0.04 in)**
- J: 1.05 mm (0.042 in)**
- K: 1.1 mm (0.044 in)**
- L: 1.15 mm (0.046 in)**

Driven bevel gear shims:

- A: 0.85 mm (0.034 in)**
- B: 0.9 mm (0.036 in)**
- C: 0.95 mm (0.038 in)**
- D: 1 mm (0.04 in)**
- E: 1.05 mm (0.042 in)**
- F: 1.1 mm (0.044 in)**
- G: 1.15 mm (0.046 in)**

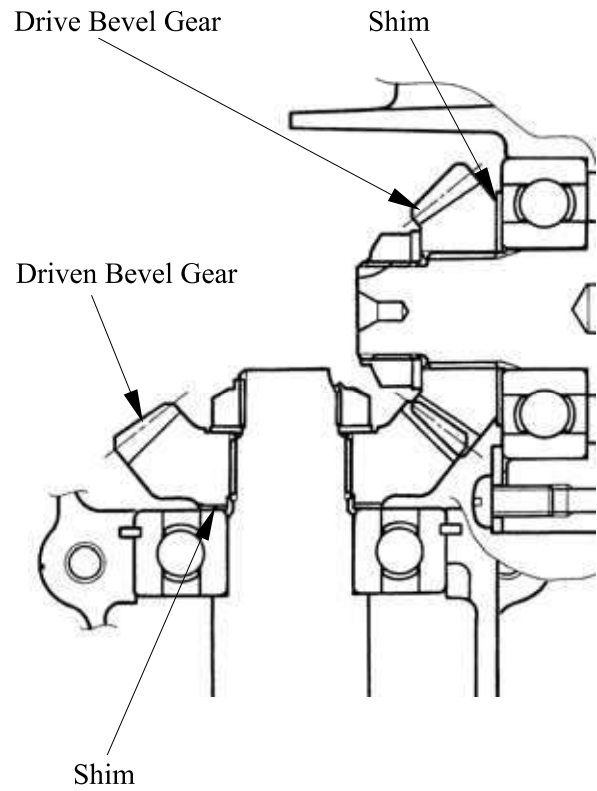

11. CRANKCASE/CRANKSHAFT/ BALANCE SHAFT

MXU 300/250

CRANKCASE/CRANKSHAFT/BALANCE SHAFT

SERVICE INFORMATION----- 11- 2
TROUBLESHOOTING----- 11- 2
CRANKCASE/CRANKSHAFT/BALANCE SHAFT----- 11- 3

11. CRANKCASE/CRANKSHAFT/ BALANCE SHAFT

MXU 300250

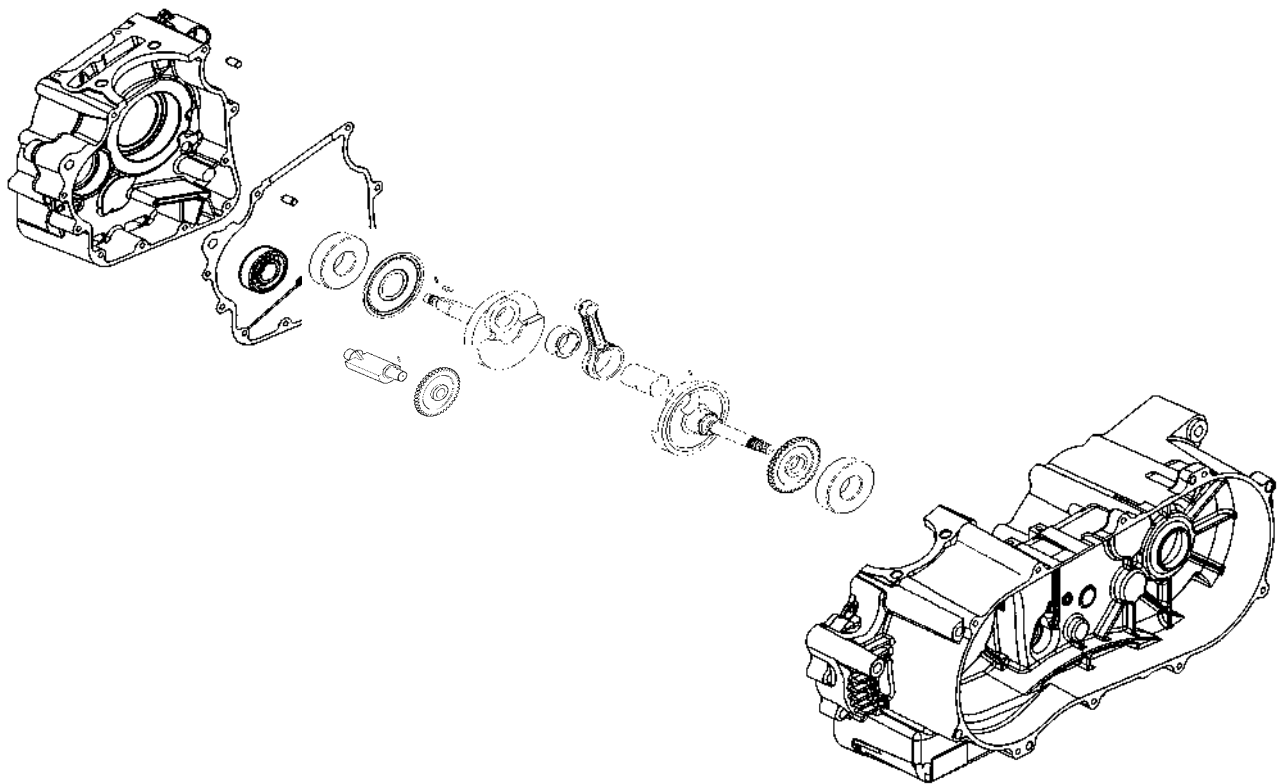

11. CRANKCASE/CRANKSHAFT/ BALANCE SHAFT

MXU 300/250

SERVICE INFORMATION

GENERAL INSTRUCTIONS

- This section covers crankcase separation to service the crankshaft. The engine must be removed for this operation.
- The following parts must be removed before separating the crankcase.
 - Cylinder head (⇒Chapter 7)
 - Cylinder/piston (⇒Chapter 8)
 - Drive and driven pulleys (⇒Chapter 9)
 - A.C. generator (⇒Chapter 16)
 - Starter clutch (⇒Chapter 18)
 - Oil pump (⇒Chapter 4)

SPECIFICATIONS

Unit: mm (in)

	Item	Standard	Service Limit
Crankshaft	Connecting rod big end side clearance	0.05 ~ 0.4 (0.002 ~ 0.016)	0.6 (0.024)
	Connecting rod big end radial clearance	0 ~ 0.008 (0 ~ 0.00032)	0.05 (0.002)
	Run out	—	0.1 (0.004)

TORQUE VALUES

Crankcase bolt	1 kgf-m (10 Nm, 7.2 lbf-ft)
Cam chain tensioner slipper bolt	1 kgf-m (10 Nm, 7.2 lbf-ft)
Cam chain cover bolt	1 kgf-m (10 Nm, 7.2 lbf-ft)

TROUBLESHOOTING

- Excessive engine noise
- Excessive bearing play

11. CRANKCASE/CRANKSHAFT/ BALANCE SHAFT

MXU 300250

CRANKCASE/CRANKSHAFT/BALANCE SHAFT

REMOVAL

Remove the timing chain from right crankcase.

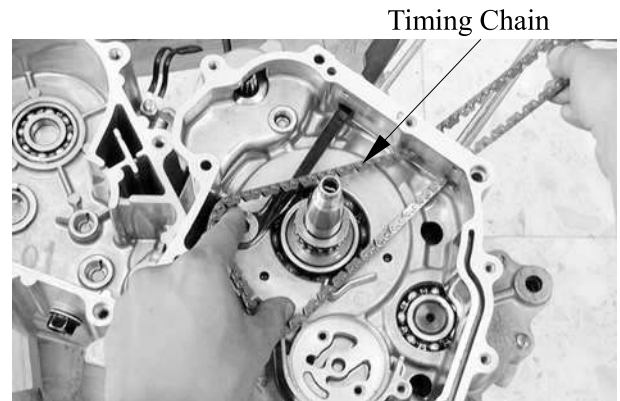

Remove the left and right crankcase attaching bolts.
Separate the left and right crankcase halves.

* Do not damage the crankcase gasket surface.

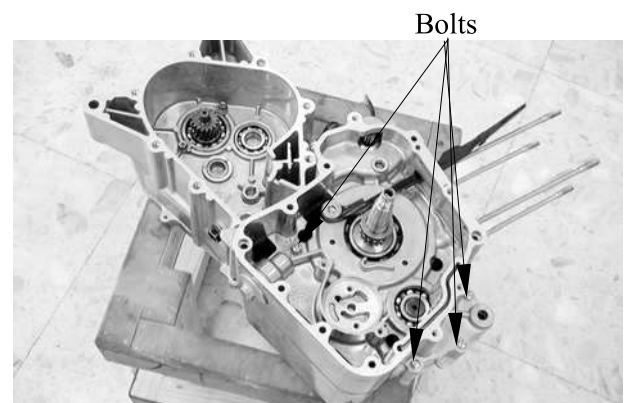

Remove the gasket and dowel pins.

Remove the crankshaft from the left crankcase.



11. CRANKCASE/CRANKSHAFT/ BALANCE SHAFT

MXU 300/250

Remove balance shaft from the left crankcase.

Balance Shaft

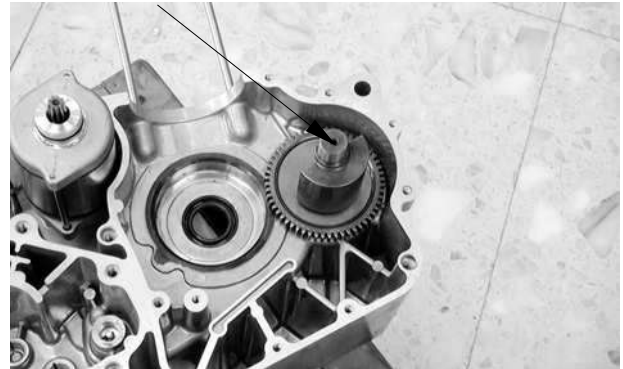

Clean off all gasket material from the crankcase mating surfaces.

* Avoid damaging the crankcase mating surfaces.



Inspect the balance shaft gear teeth.
Burrs/chips/roughness/wear → Replace.



11. CRANKCASE/CRANKSHAFT/ BALANCE SHAFT

MXU 300250

CRANKSHAFT INSPECTION

Inspect the crankshaft gear teeth.
Burr/chips/roughness/wear → Replace.

Measure the connecting rod small end I.D.

Service Limit (replace if over):
17.06 mm (0.6824 in)



Measure the connecting rod small end free play (A).

Out of specification:
0.8 ~ 1 mm (0.032 ~ 0.04 in)
→ Replace the crankshaft.

Measure the crankshaft run out (B).

Service Limit (replace if over):
0.1 mm (0.004 in)

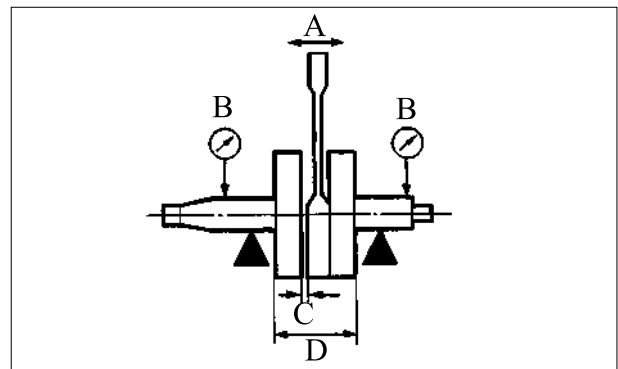

Measure the connecting rod big end side clearance (C).

Service Limit (replace if over):
0.6 mm (0.024 in)

Measure the crank width (D).

Out of specification:
55.15 ~ 55.2 mm (2.206 ~ 2.208 in)
→ Replace the crankshaft.

11. CRANKCASE/CRANKSHAFT/ BALANCE SHAFT

MXU 300/250

Turn the crankshaft bearings and check for excessive play.

Measure the crankshaft bearing play.

Service Limit (replace if over):

Axial : 0.2 mm (0.008 in)

Radial : 0.05 mm (0.002 in)

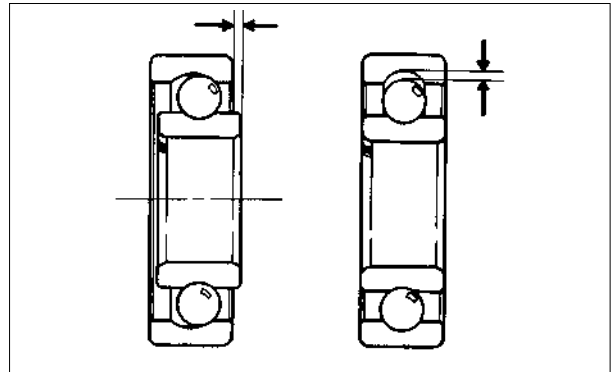

CRANKCASE/BALANCER

INSTALLATION

Install the balance shaft and crankshaft into the left crankcase.

- * Align the mark on the balance shaft with the mark on the crankshaft.

Install the dowel pins and new gasket.
Install the right crankcase and tighten the crankcase attach bolts.
Install the timing chain.

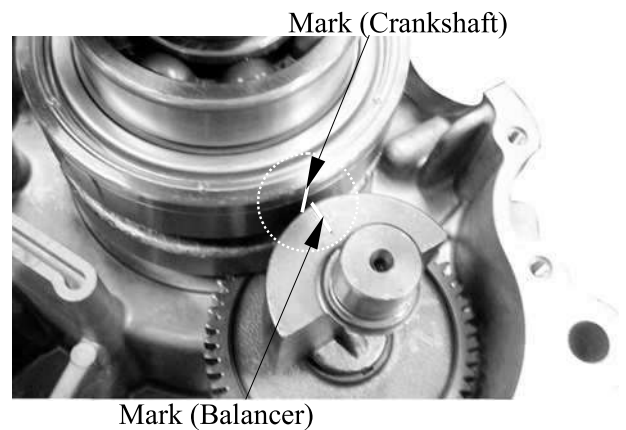

12. COOLING SYSTEM

COOLING SYSTEM

SERVICE INFORMATION-----	12- 1
TROUBLESHOOTING-----	12- 1
COOLING SYSTEM TESTING-----	12- 3
RADIATOR -----	12- 4
COOLANT REPLACEMENT -----	12- 7
WATER PUMP -----	12- 9
THERMOSENSOR-----	12-13
THERMOSTAT-----	12-14

12. COOLING SYSTEM

SERVICE INFORMATION

GENERAL INSTRUCTIONS

- The water pump must be serviced after removing the engine.
Other cooling system service can be done with the engine installed in the frame.
- The engine must be cool before servicing the cooling system.
When the coolant temperature is over 100°C, never remove the radiator cap to release the pressure because the boiling coolant may cause danger.
- Avoid spilling coolant on painted surfaces because the coolant will corrode the painted surfaces.
Wash off any spilled coolant with fresh water as soon as possible.
- After servicing the system, check for leaks with a cooling system tester.

SPECIAL TOOL

Mechanical seal driver

TORQUE VALUES

Water pump impeller	1.2 kgf-m (12 Nm, 8.6 lbf-ft)	Left thread
Water pump cover bolt	1 kgf-m (10 Nm, 7.2 lbf-ft)	

TROUBLESHOOTING

Engine temperature too high

- Faulty temperature gauge or thermosensor
- Faulty radiator cap
- Faulty thermostat
- Insufficient coolant
- Passages blocked in hoses or water jacket
- Clogged radiator fins
- Passages blocked in radiator
- Faulty water pump

Coolant leaks

- Faulty pump mechanical (water) seal
- Deteriorated O-rings
- Damaged or deteriorated water hoses

Temperature gauge pointer does not register the correct coolant temperature

- Faulty temperature gauge or thermosensor
- Faulty thermostat

12. COOLING SYSTEM

SPECIFICATIONS

Radiator cap relief pressure		0.75~1.05 kgf/cm ² (75~105 kPa, 10.65~14.91 psi)	
Thermostat temperature	Begins to open	80±2°C	
	Full-open	90°C	
	Valve lift	3.5~4.5 mm (0.14~0.18 in)	
Coolant capacity		Total system 1400±20cc	Radiator: 1100±20cc Reserve tank: 300±20cc

COOLANT GRAVITY

Temp. °C Coolant Concentration	0	5	10	15	20	25	30	35	40	45	50
5%	1.009	1.009	1.008	1.008	1.007	1.006	1.005	1.003	1.001	0.009	0.997
10%	1.018	1.107	1.017	1.016	1.015	1.014	0.013	1.011	1.009	1.007	1.005
15%	1.028	1.027	1.026	1.025	1.024	1.022	1.020	1.018	1.016	1.014	1.012
20%	1.036	1.035	1.034	1.033	1.031	1.029	1.027	1.025	1.023	1.021	1.019
25%	1.045	1.044	1.043	1.042	1.040	1.038	1.036	1.034	1.031	1.028	1.025
30%	1.053	1.051	1.051	1.049	1.047	1.045	1.043	1.041	1.038	1.035	1.032
35%	1.063	1.062	1.060	1.058	1.056	1.054	1.052	1.049	1.046	1.043	1.040
40%	1.072	1.070	1.068	1.066	1.064	1.062	1.059	1.056	1.053	1.050	1.047
45%	1.080	1.078	1.076	1.074	1.072	1.069	1.056	1.063	1.062	1.057	1.054
50%	1.086	1.084	1.082	1.080	1.077	1.074	1.071	1.068	1.065	1.062	1.059
55%	1.095	1.093	1.091	1.088	1.085	1.082	1.079	1.076	1.073	1.070	1.067
60%	1.100	1.098	1.095	1.092	1.089	1.086	1.083	1.080	1.077	1.074	1.071

COOLANT MIXTURE (WITH ANTI-RUST AND ANTI-FREEZING EFFECTS)

Freezing Point	Mixing Rate	KYMCO SIGMA Coolant Concentrate	Distilled Water
-9°C	20%		
-15°C	30%	425cc	975cc
-25°C	40%		
-37°C	50%		
-44.5°C	55%		

Cautions for Using Coolant:

- Use coolant of specified mixing rate. (The mixing rate of 425cc KYMCO SIGMA coolant concentrate + 975cc distilled water is 30%.)
- Do not mix coolant concentrate of different brands.
- Do not drink the coolant which is poisonous.
- The freezing point of coolant mixture shall be 5°C lower than the freezing point of the riding area.

12. COOLING SYSTEM

COOLING SYSTEM TESTING

RADIATOR CAP INSPECTION

Install the radiator cap onto the radiator tester and apply specified pressure to it. It must hold specified pressure for at least six seconds.

- * Apply water to the cap sealing surface before testing.

Radiator Cap Relief Pressure:

0.75~1.05 kgf/cm²

(75~105 kPa, 10.65~14.91 psi)

Install the radiator tester onto the radiator and apply specified pressure to it. It must hold specified pressure for at least six seconds.

Check the water hoses and connectors for leaks.

- * The test pressure should not exceed 1.05 kg/cm² (105kPa, 14.91 psi). Excessive pressure can damage the radiator and its hose connectors.

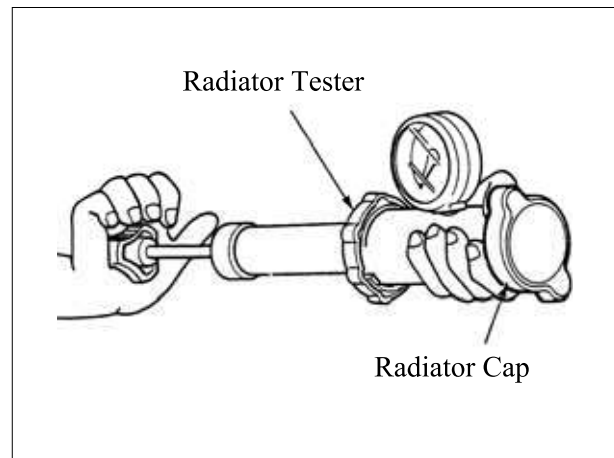

12. COOLING SYSTEM

RADIATOR

RADIATOR INSPECTION

Remove the front fender. (page 2-8)

Inspect the radiator soldered joints and seams for leaks.

Blow dirt out from between core fins with compressed air. If insects, etc., are clogging the radiator, wash them off.

Carefully straighten any bent fins.



Radiator

RADIATOR REMOVAL

Remove the front fender. (page 2-8)

Remove the radiator cap.

Remove the drain bolt and drain the coolant from the system.

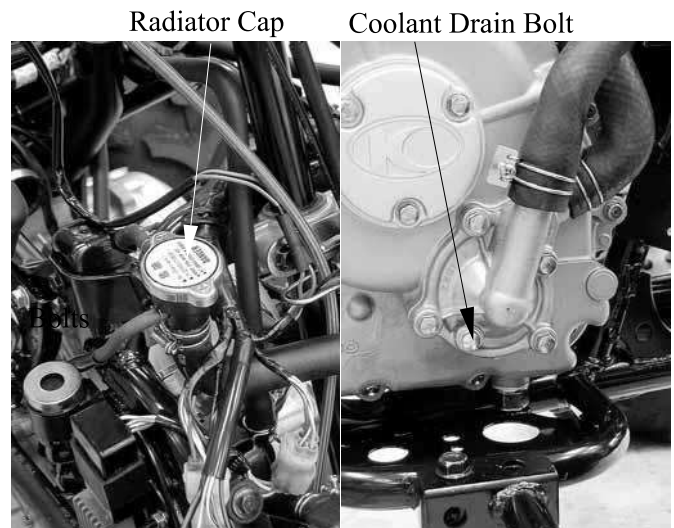

Radiator Cap

Coolant Drain Bolt

Disconnect the air bleed hose from the radiator filler.

Remove the siphon hose clamp and disconnect the siphon hose.

Remove the two bolts from filler neck hold plate.

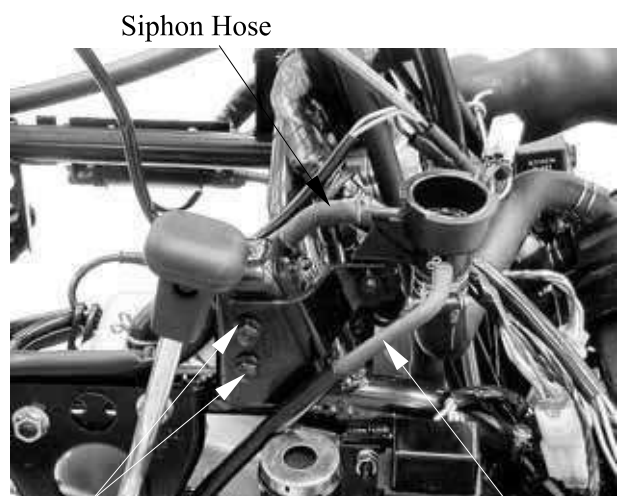

Siphon Hose

Bolts

Air Bleed Hose

12. COOLING SYSTEM

Remove the two bolts on the radiator.
Pull radiator forward and raise the radiator
from frame.

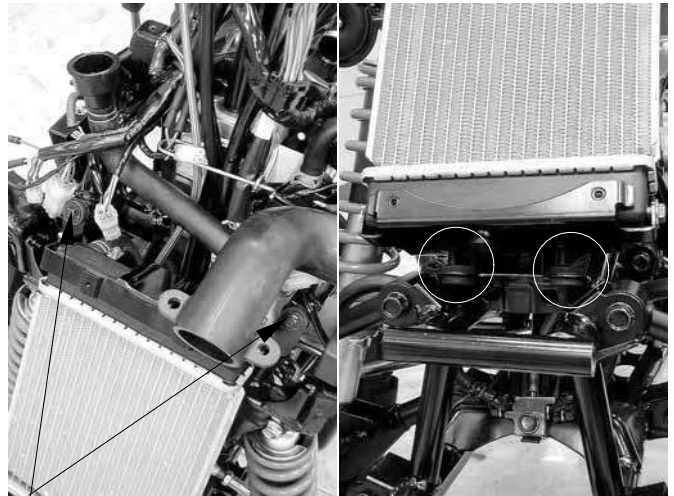

Bolts

Disconnect the thermostatic switch wire
connectors.

Disconnect the fan motor connector.

Loosen the hose bands and disconnect the
coolant hoses from the radiator.

Fan Motor Connector Radiator Hoses



Thermostatic Switch Connector

12. COOLING SYSTEM

RADIATOR DISASSEMBLY

Remove the three bolts and then remove the fan shroud from the radiator.

Check fan motor by battery.

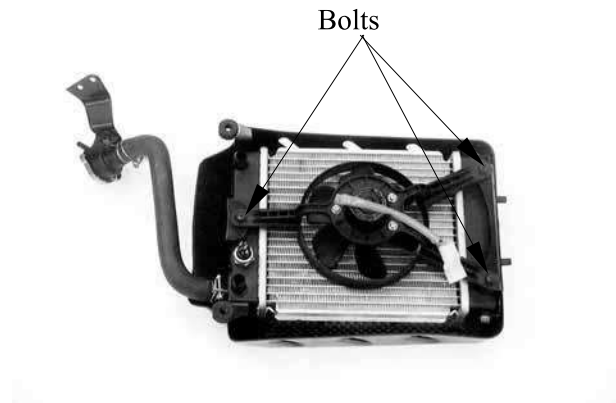

CHECK THERMOSTATIC SWITCH

When coolant temperature lower than 85~90°C the thermostatic switch OFF.
When coolant temperature over 85~90°C the thermostatic switch ON.

RADIATOR ASSEMBLY

Install the fan shroud on the radiator with the three bolts.

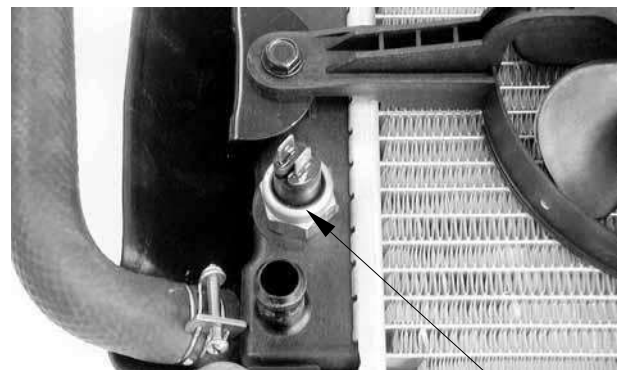

RADIATOR INSTALLATION

Reverse the "RADIATOR REMOVAL" procedures.

12. COOLING SYSTEM

COOLANT REPLACEMENT PREPARATION

- The effectiveness of coolant decreases with the accumulation of rust or if there is a change in the mixing proportion during usage. Therefore, for best performance change the coolant regularly as specified in the maintenance schedule.
- Mix only distilled, low mineral water with the antifreeze.

Mix only distilled, low mineral water with the antifreeze.

Recommended mixture:

1:1 (Distilled water and antifreeze)

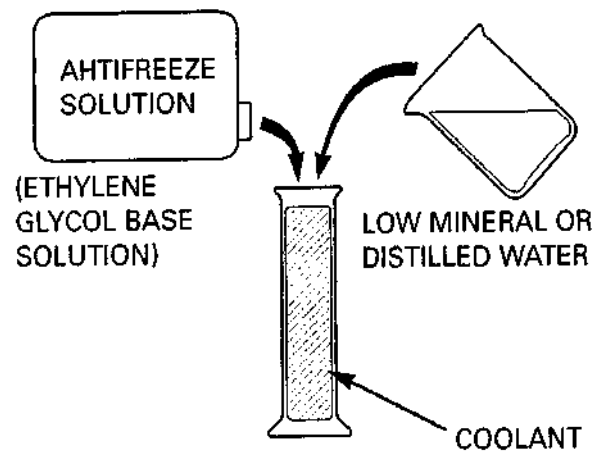

REPLACEMENT/AIR BLEEDING

- * When filling the system or reserve tank with coolant (checking the coolant level), place the vehicle in a vertical position on a flat, level surface.

Remove the radiator cap.

Remove the drain bolt and drain the coolant from the system.

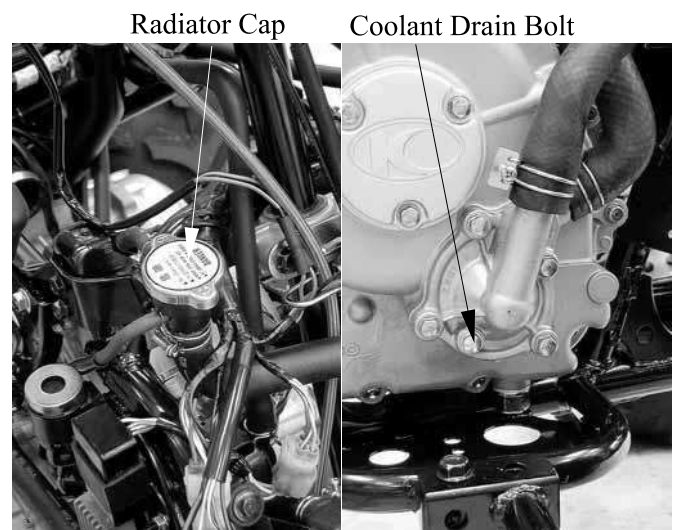

12. COOLING SYSTEM

Remove the reserve tank cap and drain the coolant from the reserve tank.

Reinstall the drain bolt with the new sealing washer securely.

Place the vehicle on a flat, level surface.
Fill the reserve tank to the upper level line.

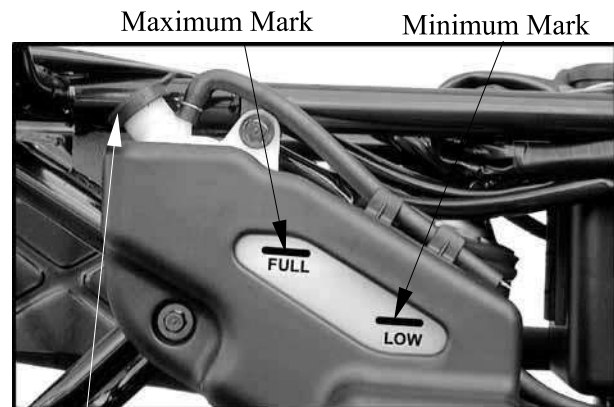

Coolant Reservoir Cap

Fill the system with the recommended coolant through the filler opening up to the filler neck.



Bleed air from the system as follow:

1. Start the engine and let it idle for 2 – 3 minutes.
2. Snap the throttle three to four times to bleed air from the system.
3. Stop the engine and add coolant to the proper level if necessary. Reinstall the radiator cap.
4. Check the level of coolant in the reserve tank and fill to the upper level if it is low.

12. COOLING SYSTEM

WATER PUMP

MECHANICAL SEAL (WATER SEAL) INSPECTION

Inspect the telltale hole for signs of mechanical seal coolant leakage. If the mechanical seal is leaking, remove the right crankcase cover and replace the mechanical seal.

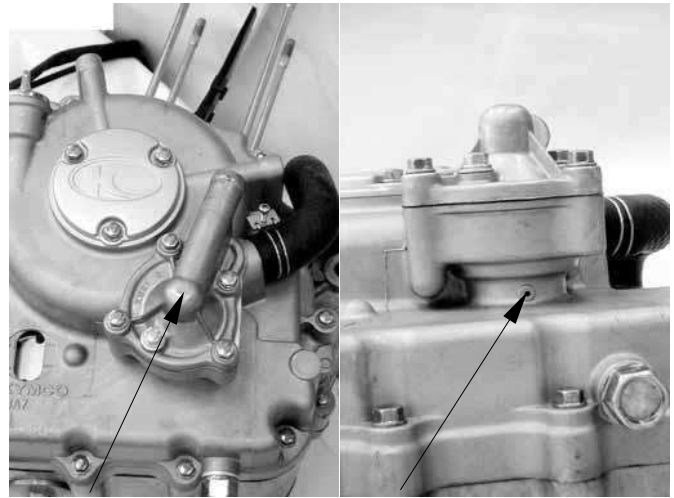

Water Pump

Telltale Hole

WATER PUMP/IMPELLER REMOVAL

Drain the coolant. (page 12-7)

Loosen the screw and disconnect the coolant inlet hose.

Remove the four bolts and the water pump cover.

Water Pump Cover

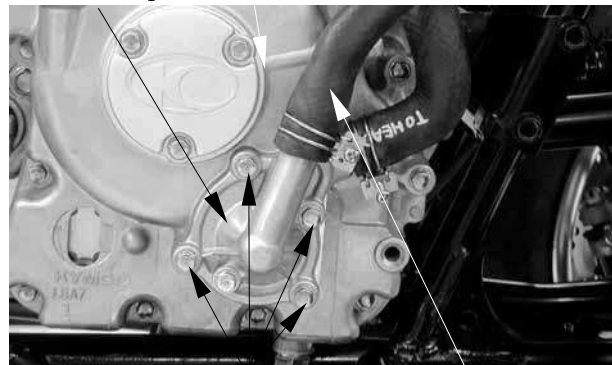

Bolts

Inlet Hose

Remove the gasket and 2 dowel pins

Remove the water pump impeller, washer and seal washer (porcelain).

* The impeller has left hand threads.

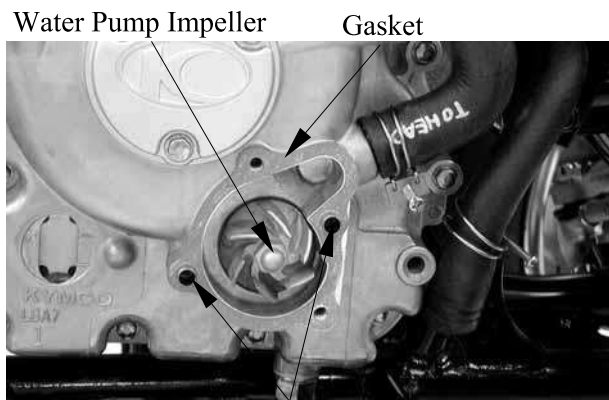

Water Pump Impeller

Gasket

Dowel Pins

12. COOLING SYSTEM

Inspect the mechanical (water) seal and seal washer for wear or damage.

* The mechanical seal and seal washer must be replaced as a set.

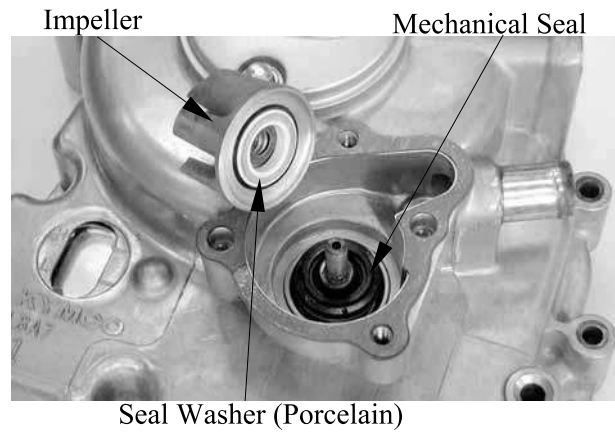

WATER PUMP SHAFT REMOVAL

Remove the water pump impeller. (page 12-9)

Disconnect the water hose from the right crankcase cover.

Remove the twelve bolts attaching the right crankcase cover.



Remove the water pump bearing snap ring from the water pump assembly.

Remove the water pump shaft and inner bearing.

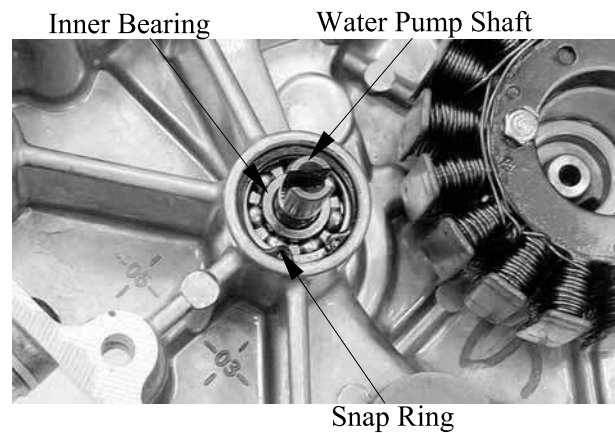

12. COOLING SYSTEM

Remove the water pump shaft outer bearing.

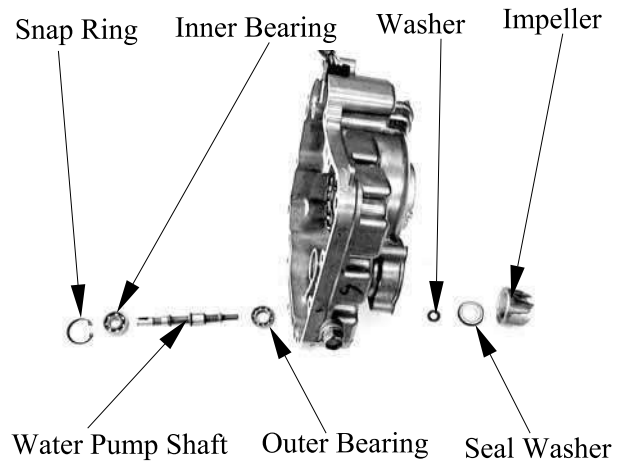

MECHANICAL SEAL REPLACEMENT

Drive the mechanical seal out of the water pump assembly from the inside.

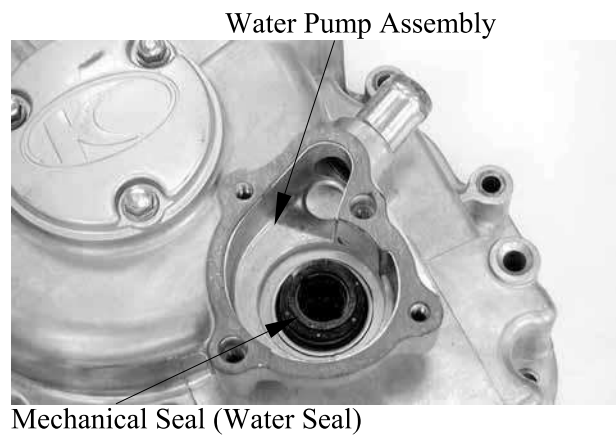

Drive in a new mechanical seal using a mechanical seal driver.

- * Apply sealant to the right crankcase cover fitting surface of a new mechanical seal and then drive in the mechanical seal.

12. COOLING SYSTEM

WATER PUMP SHAFT INSTALLATION

Drive a new water pump shaft outer bearing into the water pump assembly from the inside.

Outer Bearing



Water Pump Assembly

Install the water pump shaft and shaft inner bearing into the water pump assembly. Install the snap ring to secure the inner bearing properly.

Install the dowel pins and a new gasket and then install the water pump assembly to the right crankcase cover.

Tighten the twelve bolts to secure the right crankcase cover.

- * When installing the water pump assembly, aligning the groove on the water pump shaft with the tab on the oil pump shaft.

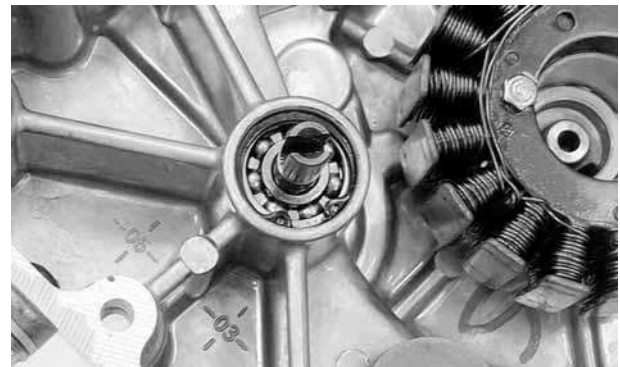

WATER PUMP/IMPELLER INSTALLATION

When the mechanical seal is replaced, a new seal washer must be installed to the impeller.

Install the impeller onto the water pump shaft.

Torque: 1.2 kgf-m (12 Nm, 8.64 lbf-ft)

- * The impeller has left hand threads.

Install the two dowel pins and a new gasket. Install the water pump cover and tighten the four bolts.

Torque: 1 kgf-m (10 Nm, 7.2 lbf-ft)



12. COOLING SYSTEM

THERMOSENSOR

THERMOSENSOR REMOVAL

Drain the coolant. (page 12-7)

Disconnect the thermosensor wire.
Remove the thermosensor from the thermostat.

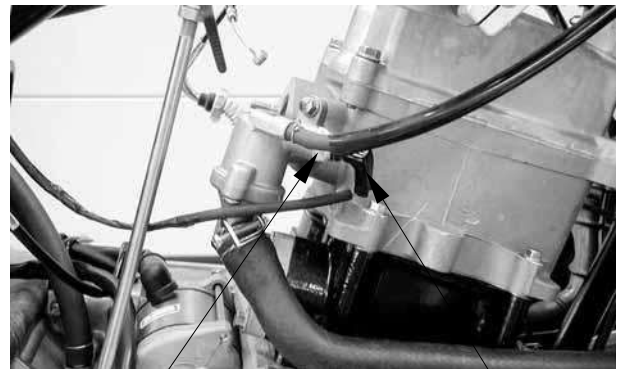

Thermosensor

Thermosensor Connector

THERMOSENSOR INSPECTION

Suspend the thermosensor in a pan of water over a burner and measure the resistance through the sensor as the water heats up.

Temperature(°C)	50	80	100	120
Resistance(Ω)	154	52	27	16

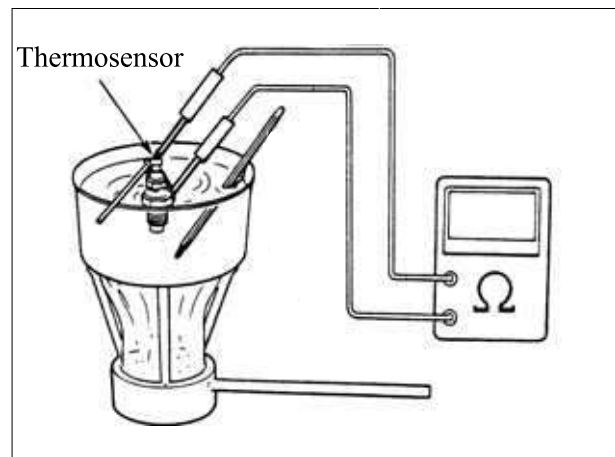

THERMOSENSOR INSTALLATION

Apply 3-BOND No. 1212 sealant or equivalent to the thermosensor threads and install it into the thermostat housing.

Connect the thermosensor wire.

Fill the radiator with coolant. (page 12-7)

* Be sure to bleed air from the cooling system.

12. COOLING SYSTEM

THERMOSTAT

THERMOSTAT REMOVAL

Drain the coolant. (page 12-7)

Disconnect the thermosensor wire from the thermosensor.

Disconnect the water hose from the thermostat housing.

Disconnect the air vent tube from the thermostat housing.

Remove the mounting bolt and the thermostat housing from the cylinder head.

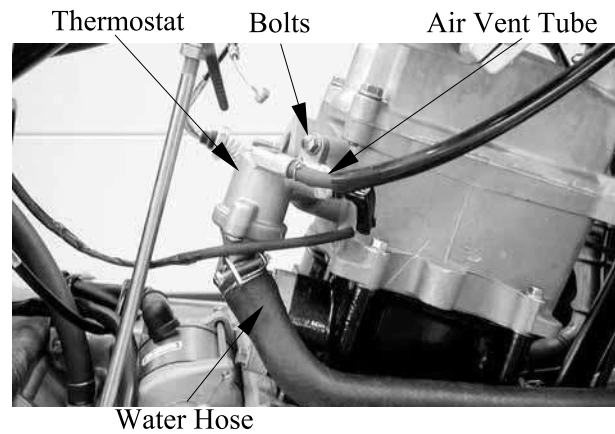

Remove the two screws and separate the thermostat housing halves.

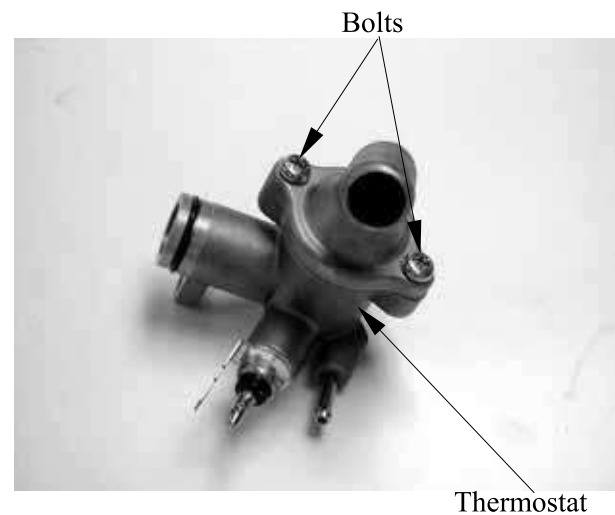

Remove the thermostat from the thermostat housing.

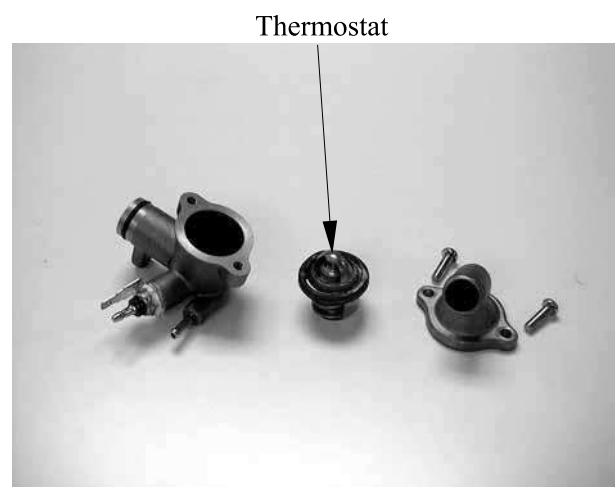

12. COOLING SYSTEM

THERMOSTAT INSPECTION

Suspend the thermostat in a pan of water over a burner and gradually raise the water temperature to check its operation.

Technical Data

Begins to open	$80 \pm 2^{\circ}\text{C}$
Full-open	90°C
Valve lift	3.5~4.5 mm

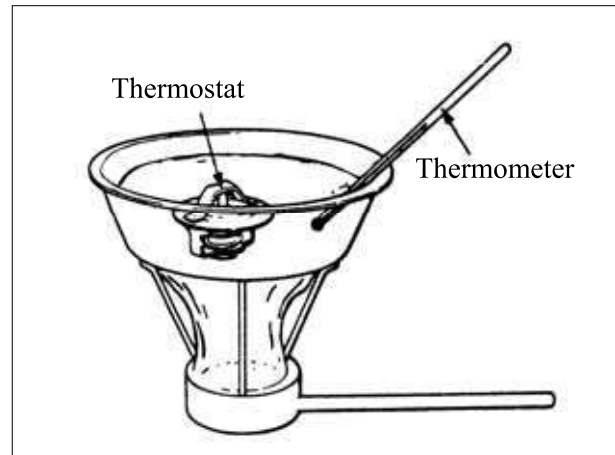

- * Do not let the thermostat touch the pan as it will give a false reading.
- * Replace the thermostat if the valve stays open at room temperature.
- * Test the thermostat after it is opened for about 5 minutes and holds the temperature at 70°C .

THERMOSTAT INSTALLATION

The installation sequence is the reverse of removal.

- * Replace the O-ring with a new one and apply grease to it.

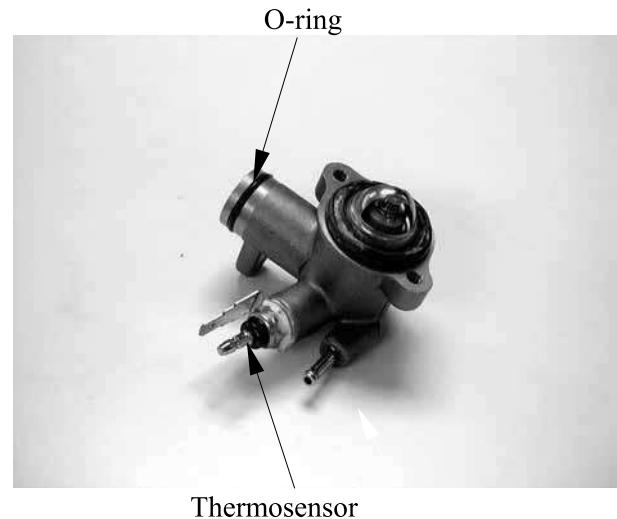

Fill the cooling system with the specified coolant. (page 12-7)

13. BRAKE SYSTEM

13. BRAKE SYSTEM

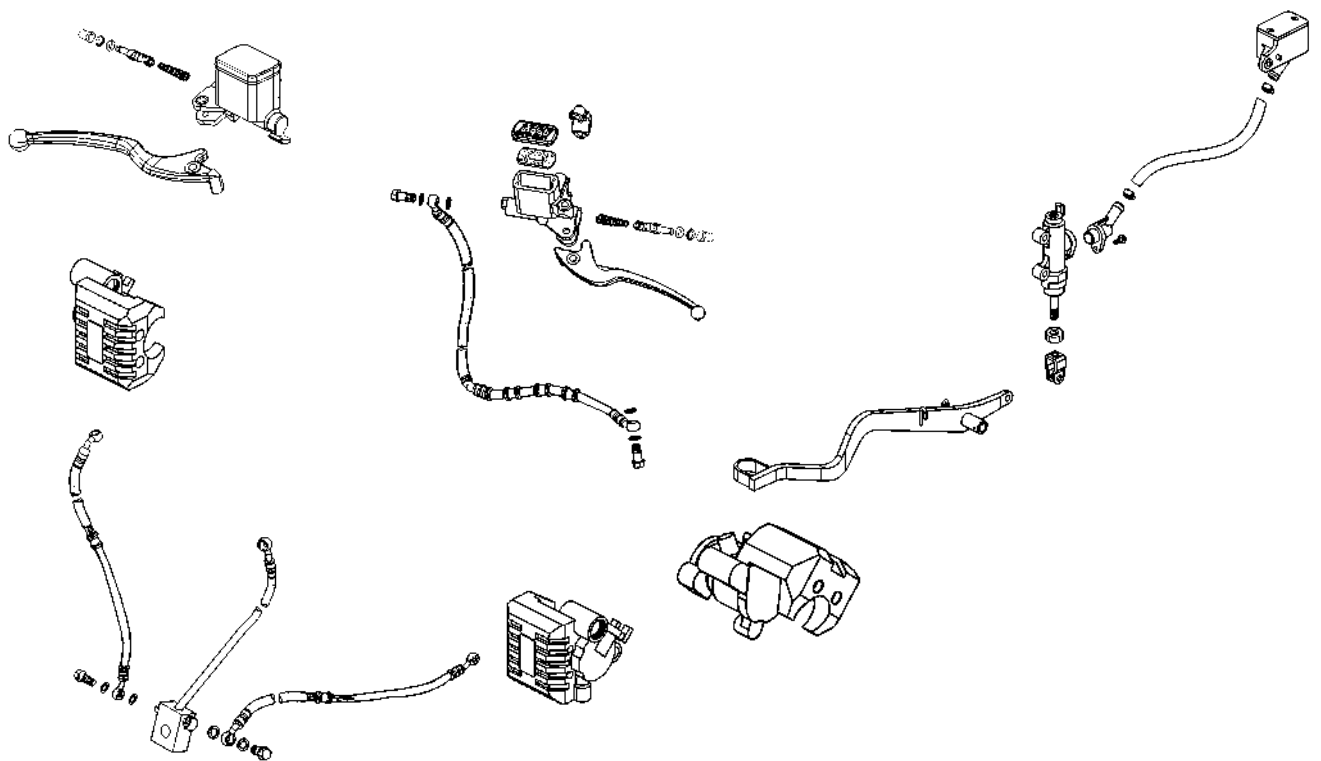

13. BRAKE SYSTEM

m	Standard	Service Limit
Brake disk thickness	3.8~4.2 (0.152~0.168)	3 (0.12)
Brake disk runout	—	0.3 (0.012)

TROUBLESHOOTING

Loose brake lever

- Air in hydraulic brake system
- Brake fluid level too low
- Hydraulic brake system leakage

Poor brake performance

- Air in brake system
- Deteriorated brake fluid
- Contaminated brake pads and brake disk
- Worn brake pads
- Worn brake master cylinder piston oil seal
- Clogged brake fluid line
- Deformed brake disk
- Unevenly worn brake caliper

Tight brake lever

- Seized piston
- Clogged hydraulic brake system
- Smooth or worn brake pad

Brake noise

- Contaminated brake pad surface
- Excessive brake disk run out
- Incorrectly installed caliper
- Brake disk or wheel not aligned

Hard braking

- Seized hydraulic brake system
- Seized piston

13. BRAKE SYSTEM

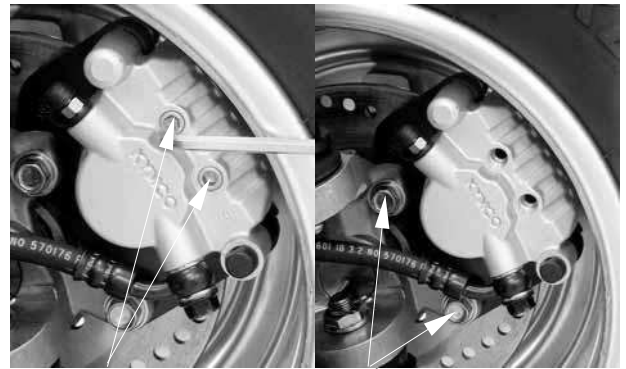

Bolts

Brake Caliper Holder

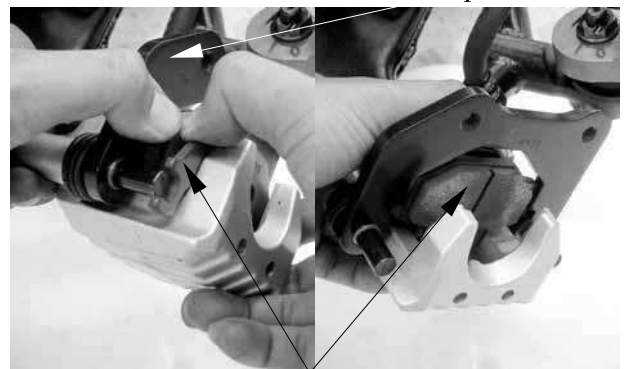

Brake Pads

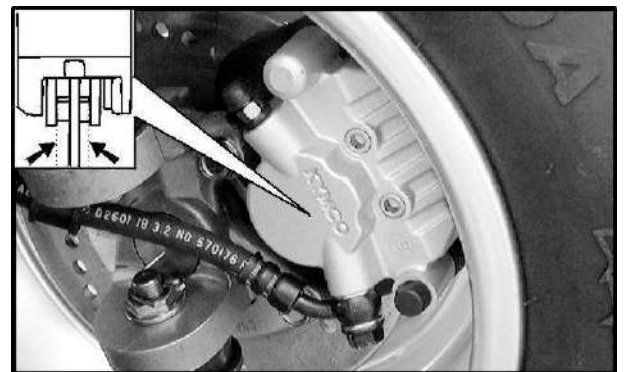

13. BRAKE SYSTEM

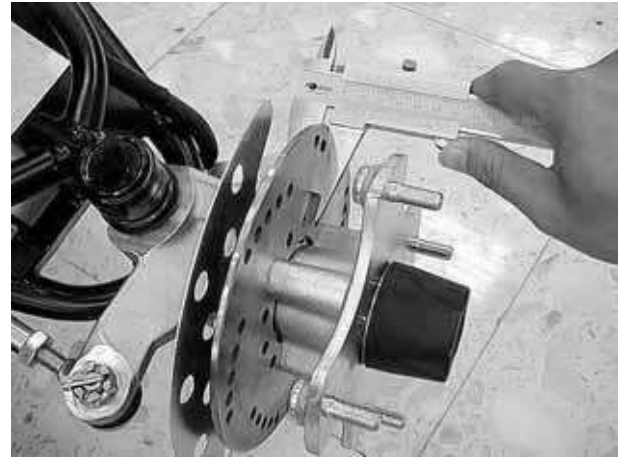

Screws



Bleed Valve

13. BRAKE SYSTEM

- When drawing brake fluid with the syringe, the brake fluid level should be kept over 1/2 of the brake reservoir height.
- Use only the recommended brake fluid.

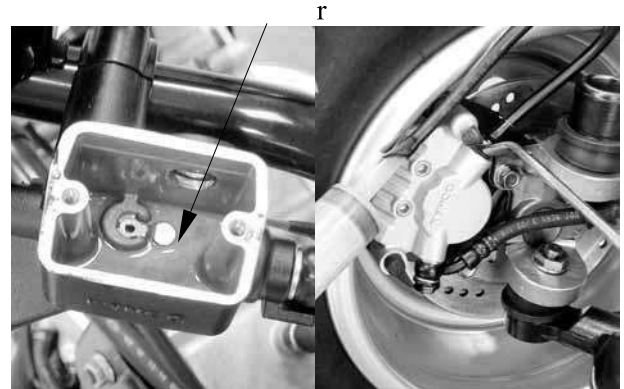

When bleeding air from the brake system, the brake fluid level should be kept over 1/2 of the brake reservoir height.

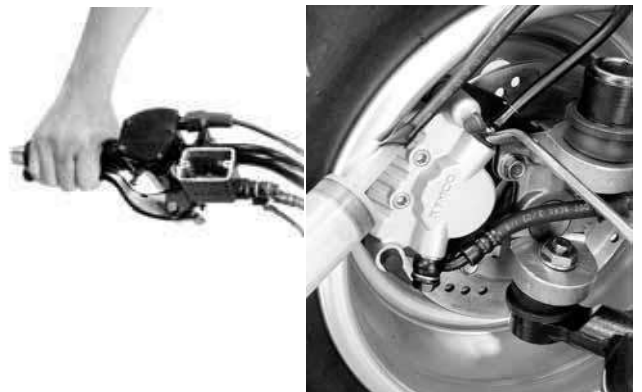

13. BRAKE SYSTEM

Do not splash brake fluid onto any rubber, plastic and coated parts. When working with brake fluid, use shop towels to cover these parts.

When removing the brake fluid tube bolt, be sure to place towels under the tube and plug the tube end to avoid brake fluid leakage and contamination.

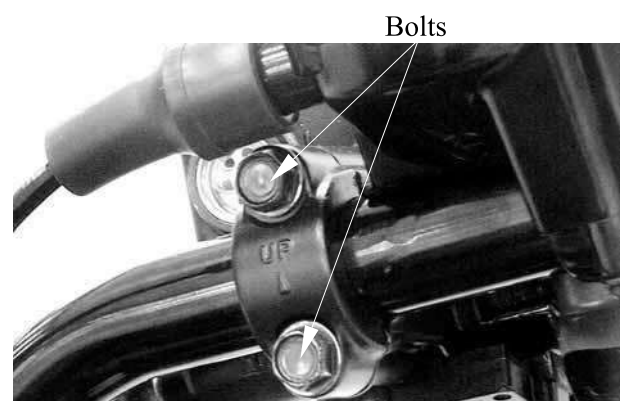
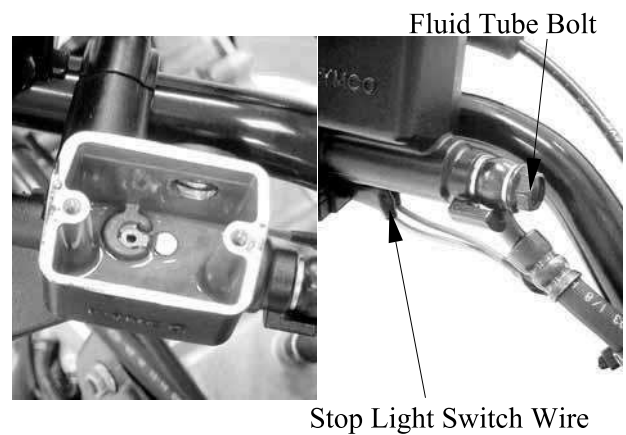

13. BRAKE SYSTEM

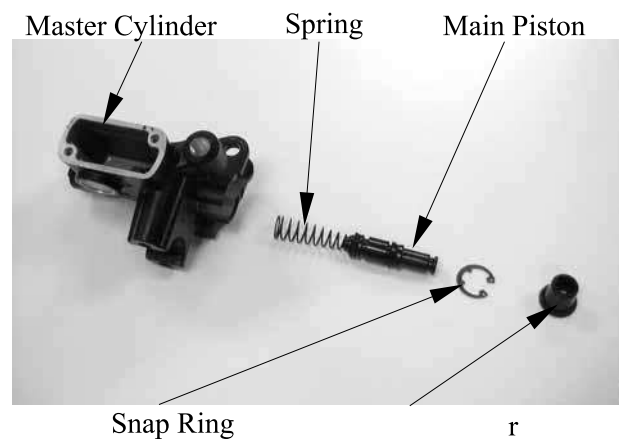

13. BRAKE SYSTEM

*

d

spring must be installed as a unit without exchange.

- When assembling the piston, soak the cups in brake fluid for a while.
- Install the cups with the cup lips facing the correct direction.

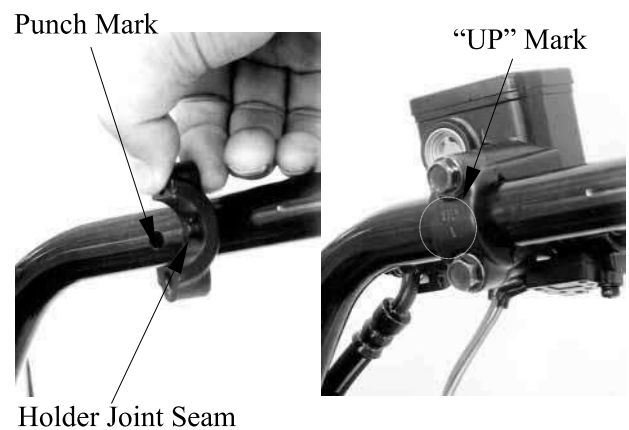

13. BRAKE SYSTEM

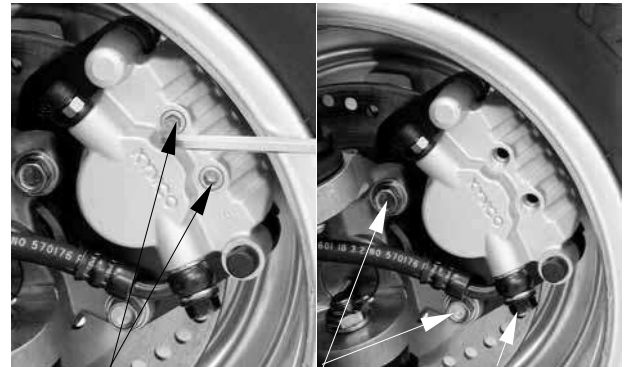

Brake Pad Pins

Bolts

Fluid Tube Bolt

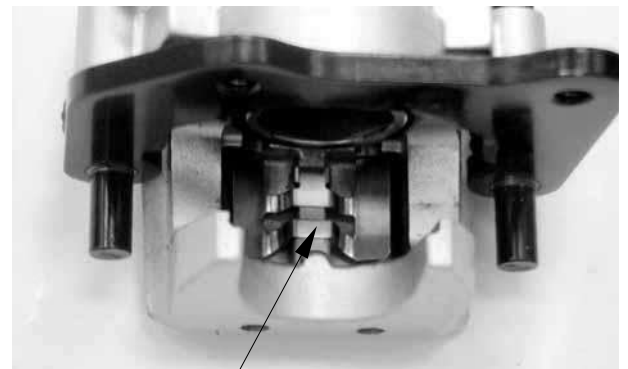

Spring Plate



13. BRAKE SYSTEM



*



* Install the piston with its outer end protruding 3 ~ 5 mm beyond the brake caliper.

13. BRAKE SYSTEM

- * Make sure that the boss on the caliper correctly engages with the locating slot on the caliper spring plate.

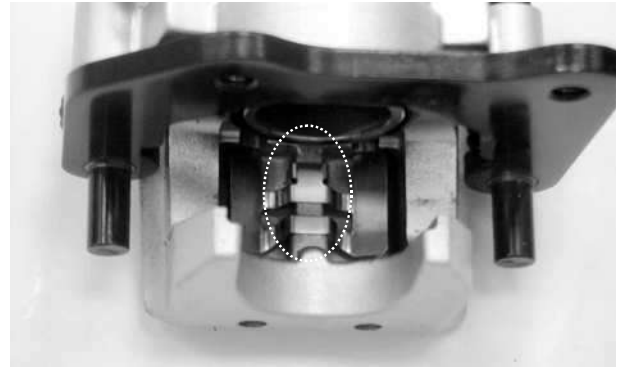

- * When installing the brake caliper, be sure to position the brake disk between the two brake pads.



- * When installing the brake fluid tube, be sure to install the two sealing washers.

13. BRAKE SYSTEM

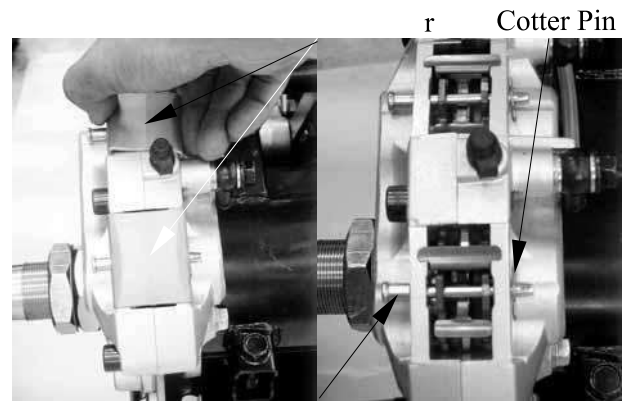

Brake Pad Pin

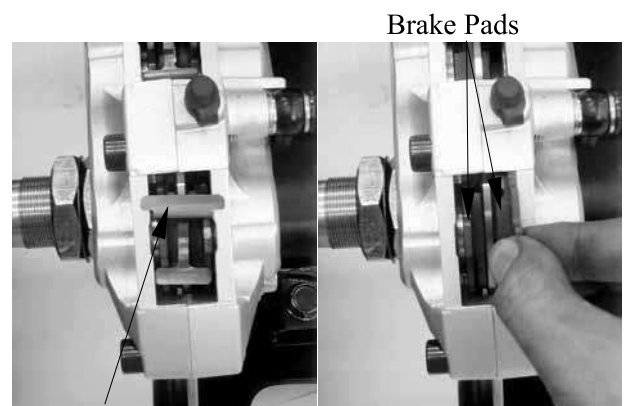

Spring Plate

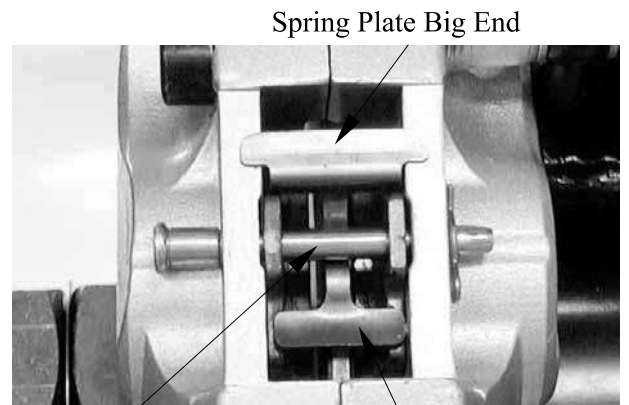

Brake Pad Pin

Spring Plate Small End

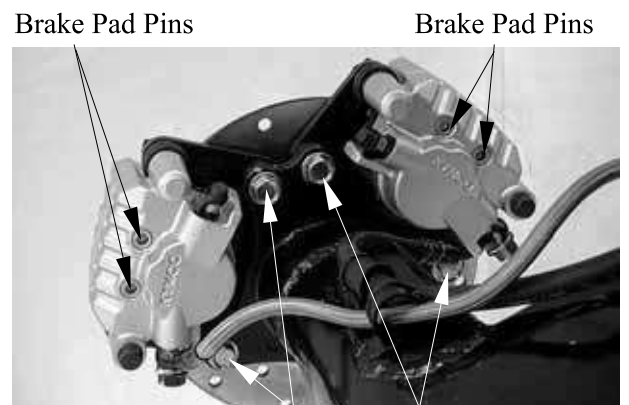

Brake Pad Pins

Bolts

- *
 - Make sure put the spring plate big end on the rear caliper.
 - Make sure put the spring plate small end on the rear pads.
 - Make sure brake pad pin over the spring plate.

13. BRAKE SYSTEM

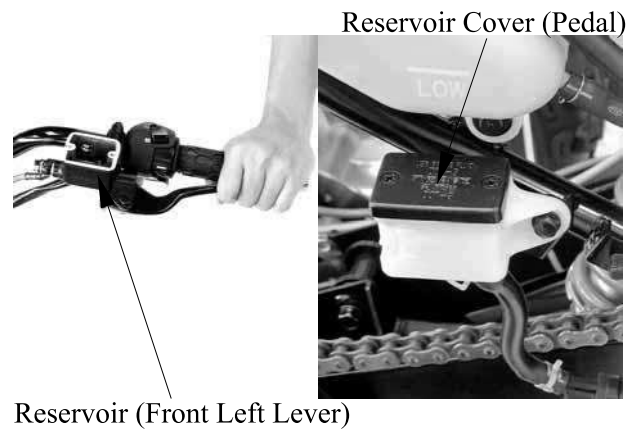

Bleed Valve (Front Left Lever)

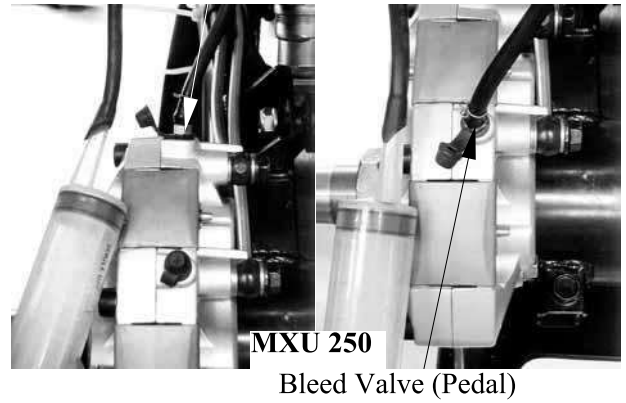

Bleed Valve (Front Left Lever)

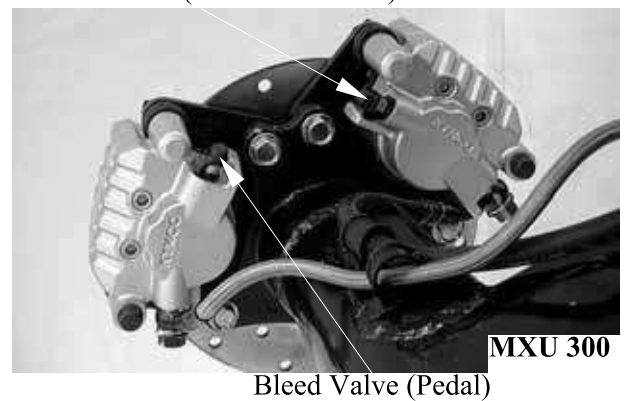

13. BRAKE SYSTEM

- When drawing brake fluid with the syringe, the brake fluid level (pedal) should be kept over 1/2 of the brake reservoir height.
- Use only the recommended brake fluid.

Bleed Valve (Front Left Lever)

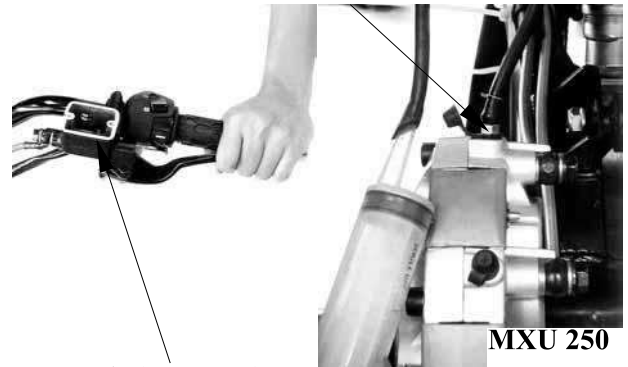

Reservoir (Front Left Lever)

Reservoir (Front Left Lever)



Bleed Valve (Front Left Lever)

Reservoir Cover (Pedal)



Reservoir (Pedal)

Reservoir Protection Cover

13. BRAKE SYSTEM

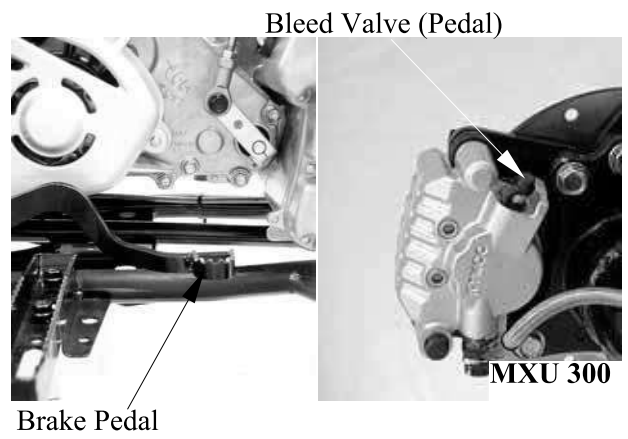
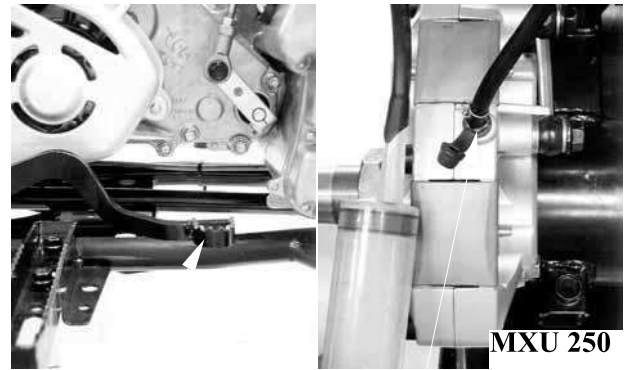

13. BRAKE SYSTEM

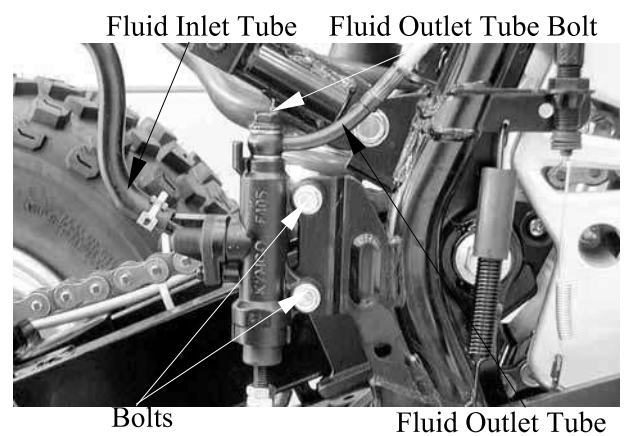
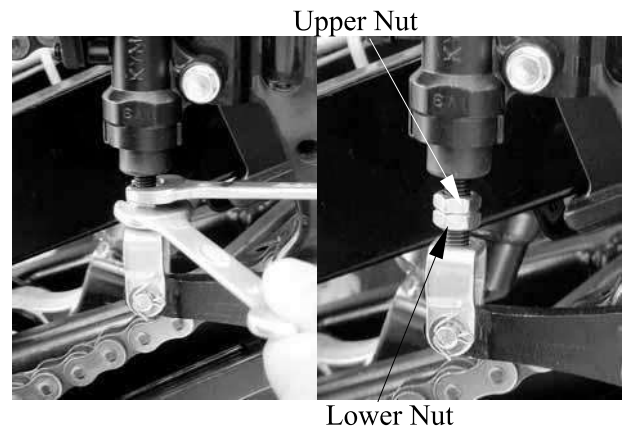

13. BRAKE SYSTEM

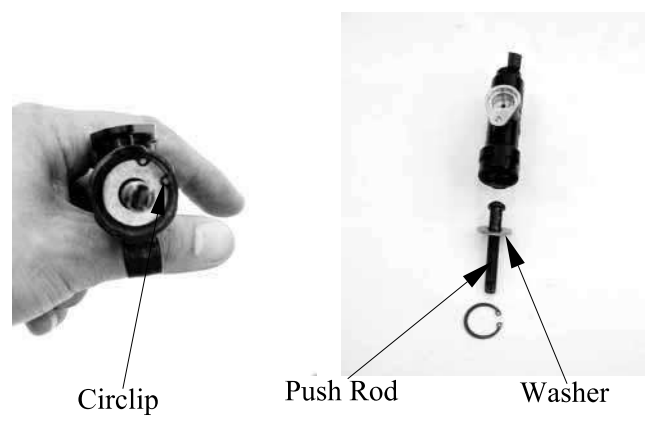
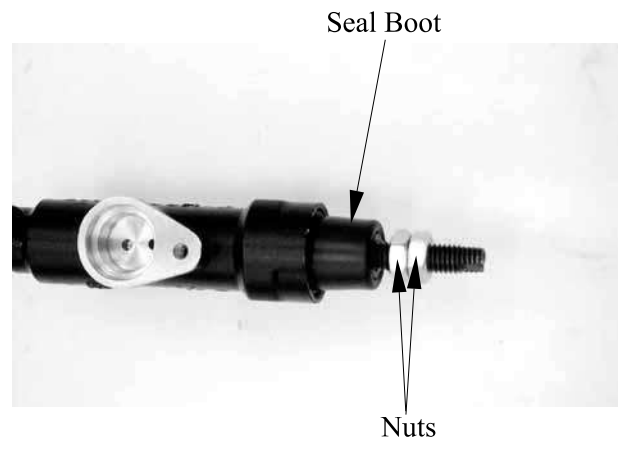
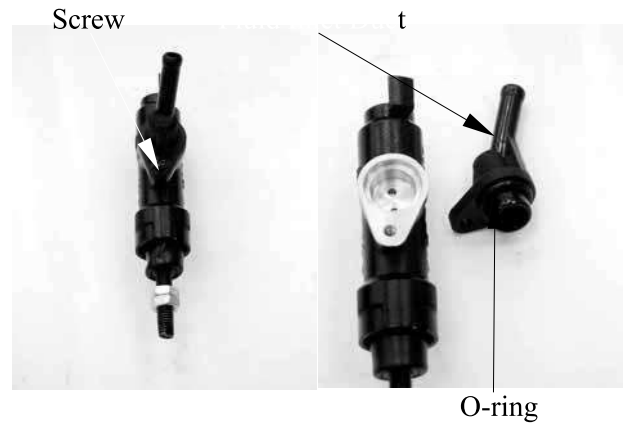

13. BRAKE SYSTEM

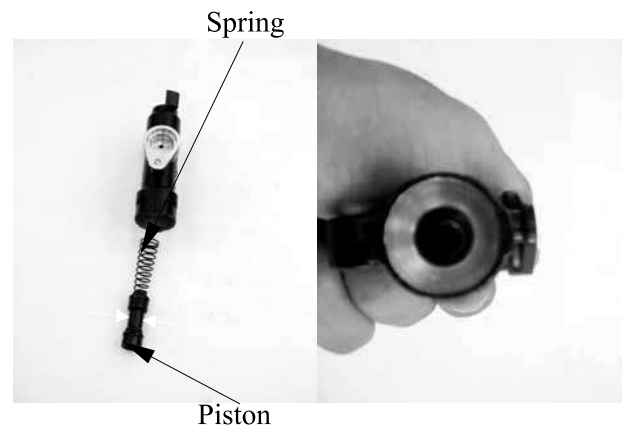

During assembly, the master cylinder, piston and spring must be installed as a unit without exchange.



13. BRAKE SYSTEM

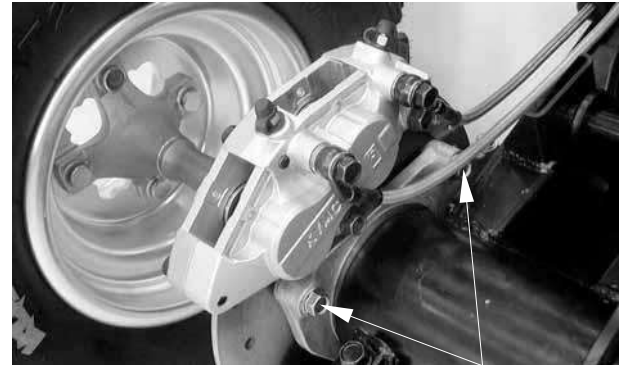

Bolts

Slightly loosen the caliper housing bolts before removing the caliper mounting bolts to facilitate later disassembly.



Bolts

Place a rag over the piston to prevent it from popping out and flying and keep hand off the piston.

Be careful of brake fluid which can possibly splash.

Do not use high pressure air but increase the pressure gradually.



13. BRAKE SYSTEM

Use care not to cause scratch on the cylinder bore.
Do not reuse the piston seal and dust seal that have been removed.

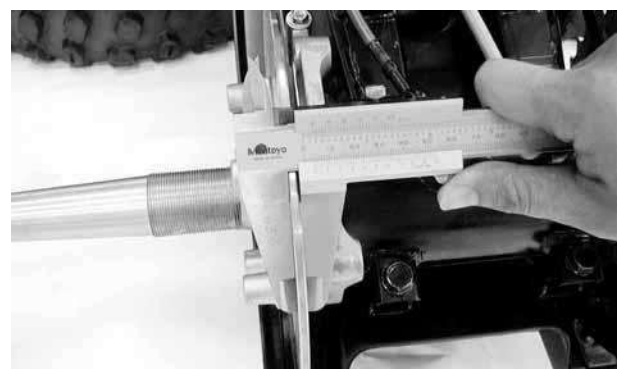
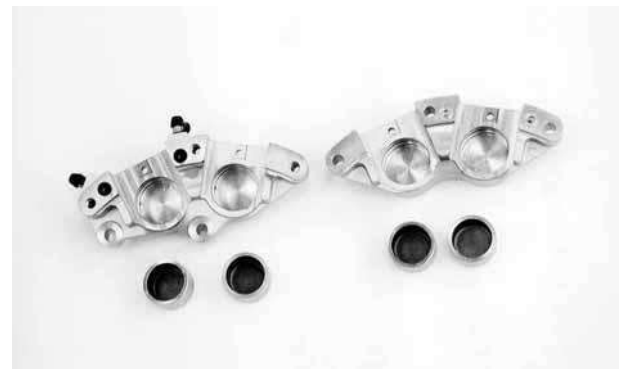
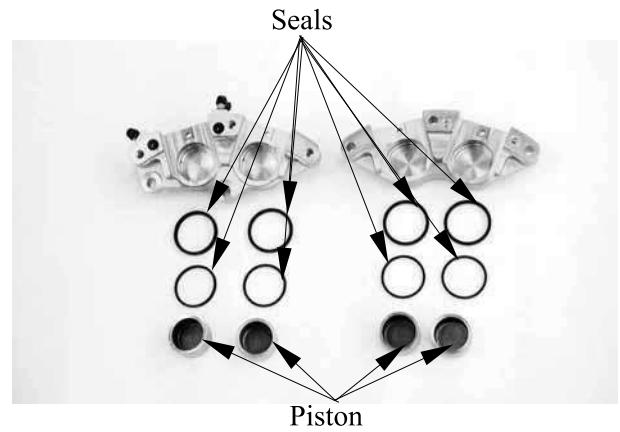

13. BRAKE SYSTEM

Wash the caliper components with fresh brake fluid before assembly. Do not wipe off brake fluid after washing the components.

Replace the piston seal and dust seal with new ones with brake fluid applied.

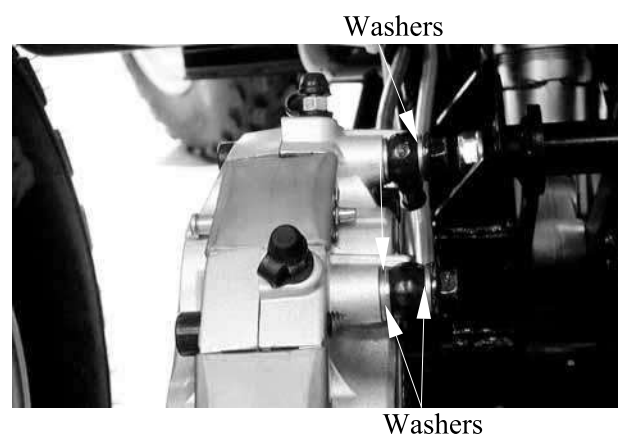
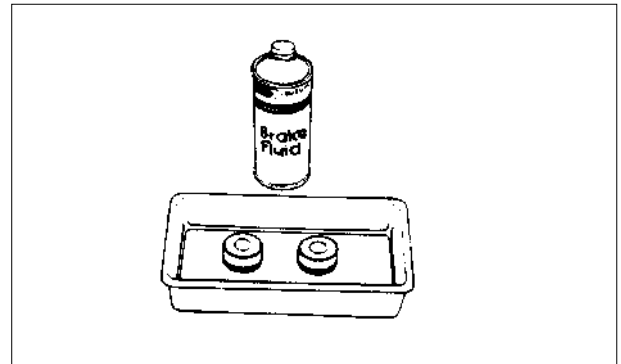

13. BRAKE SYSTEM

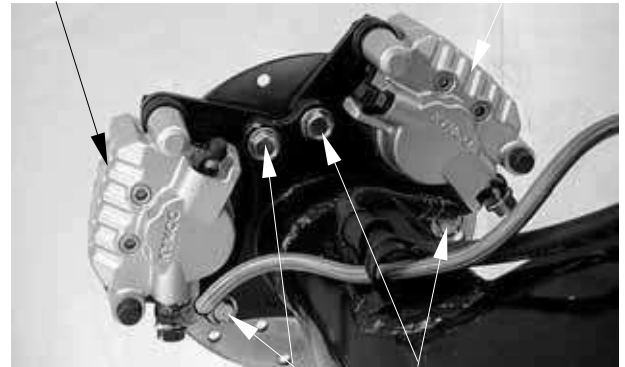

14. FRONT WHEEL/FRONT SUSPENSION/ STEERING SYSTEM



14

14. FRONT WHEEL/FRONT SUSPENSION/ STEERING SYSTEM

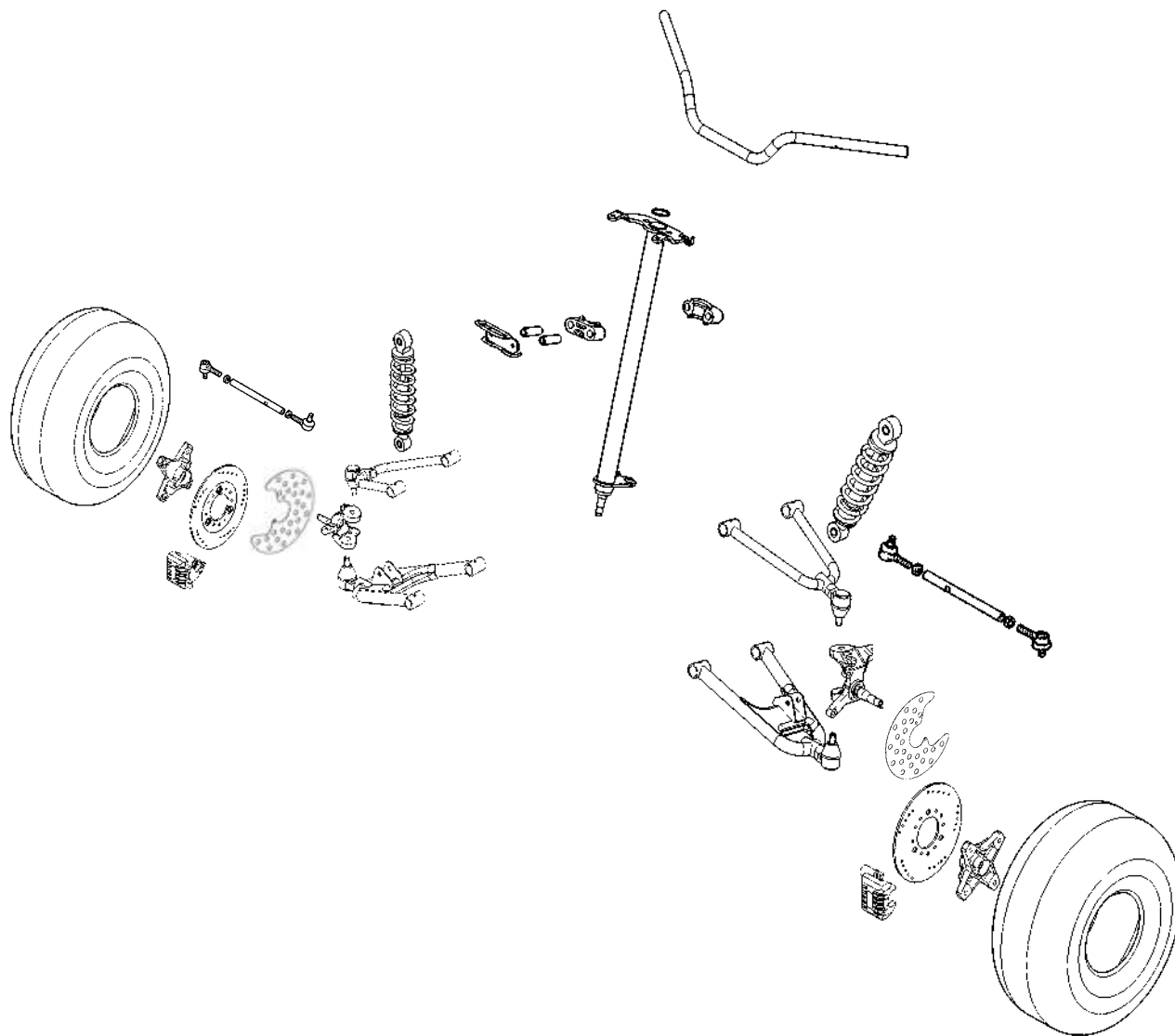

14. FRONT WHEEL/FRONT SUSPENSION/ STEERING SYSTEM



m		Standard	Service Limit
Front wheel rim run out	Radial	—	2 (0.08)
	Axial	—	2 (0.08)
Tie rod length		299.5±0.5 (11.98±0.02)	—
Rod-end (tie rod) angle		180°	—

TORQUE VALUES

Steering stem nut	7 kgf-m (70 Nm, 50 lbf-ft)	
Front swing arm nut	4.5 kgf-m (45 Nm, 32 lbf-ft)	
Front wheel nut	4.5 kgf-m (45 Nm, 32 lbf-ft)	
Front wheel hub nut	7 kgf-m (70 Nm, 50 lbf-ft)	Castle nut
Knuckle ball joint nut	3 kgf-m (30 Nm, 22 lbf-ft)	Castle nut
Tie-rod ball joint nut	2 kgf-m (20 Nm, 15 lbf-ft)	Castle nut
Front shock absorber mount bolt	4 kgf-m (40 Nm, 29 lbf-ft)	

SPECIAL TOOLS

Oil seal and bearing install	E014
Tie-rod ball joint remover	F011
Ball joint remover	F012

TROUBLESHOOTING

Hard steering (heavy)

- Insufficient tire pressure

Steers to one side or does not track straight

- Uneven front shock absorbers
- Bent front arm
- Bent steering knuckle

Front shock absorber noise

- Slider bending
- Loose arm fasteners
- Lack of lubrication

Front wheel wobbling

- Bent rim
- Excessive wheel bearing play
- Bent spoke plate
- Faulty tire
- Improperly tightened axle nut

Soft front shock absorber

- Weak shock springs
- Insufficient damper oil

14. FRONT WHEEL/FRONT SUSPENSION/ STEERING SYSTEM

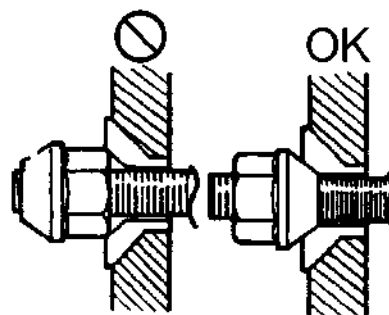
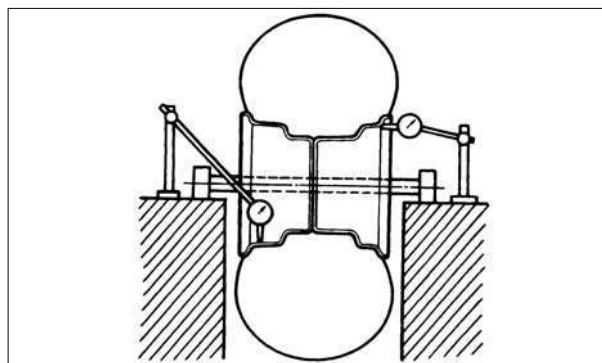
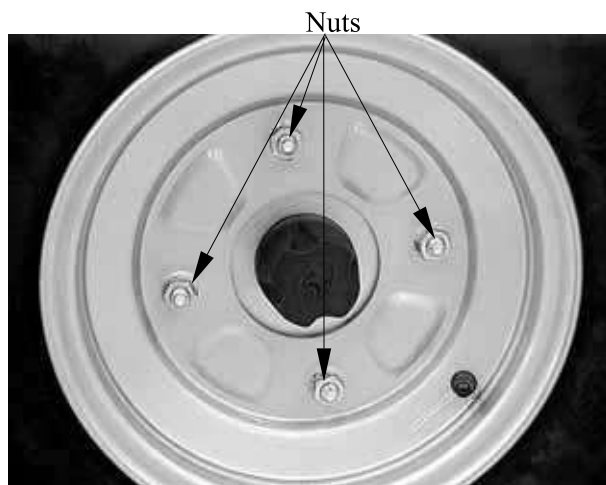

Be sure the tapered side of the wheel nuts face the wheel rim.

14. FRONT WHEEL/FRONT SUSPENSION/ STEERING SYSTEM

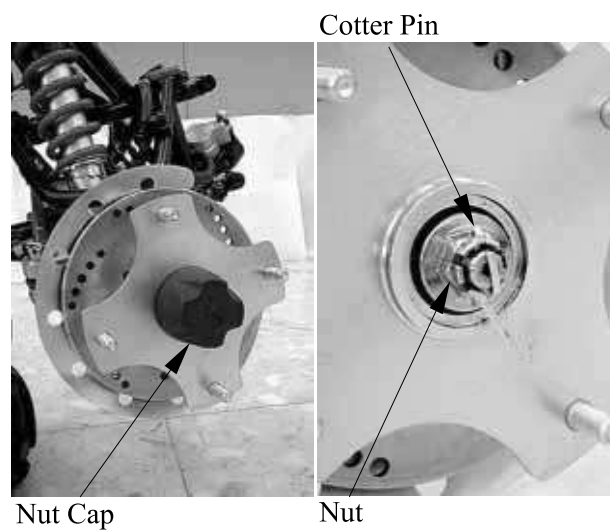

Place a wood block against the outer edge to protect this edge.

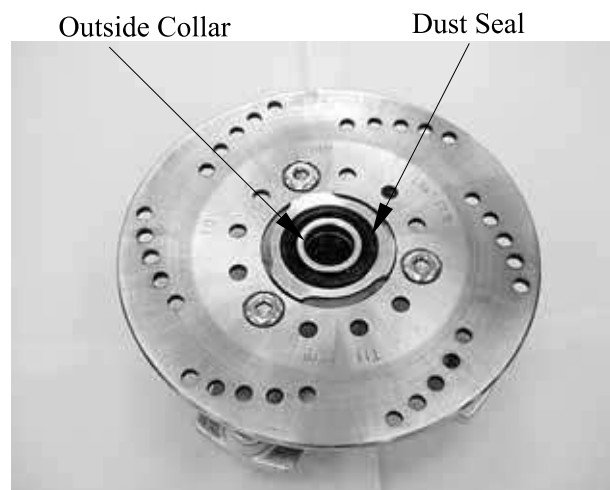
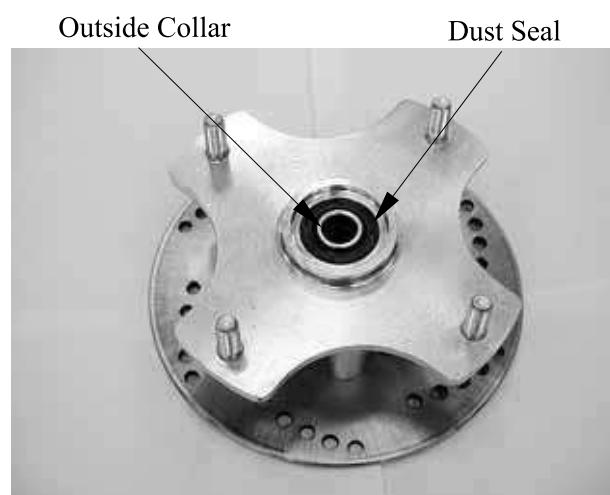

14. FRONT WHEEL/FRONT SUSPENSION/ STEERING SYSTEM



14. FRONT WHEEL/FRONT SUSPENSION/ STEERING SYSTEM



Distance Collar



Apply the grease onto the oil seal lips,
bearing.



Be sure the tapered side of the distance
collar face the wheel.



Distance Collar

14. FRONT WHEEL/FRONT SUSPENSION/ STEERING SYSTEM



Apply the grease onto the oil seal lips, bearing.

- Do not allow the bearings to tilt while driving them in.
- Do not strike the center race or balls of the bearing. Contact should be made only with the outer race.
- Pack all bearing cavities with grease.
- Drive in the bearing squarely with the sealed end facing out.

Apply grease onto the bearing and dust seal lips of the wheel panel.

Do not loosen the wheel hub nut after torque tightening. If the wheel hub nut groove is not aligned with the cotter pin hole, align groove with the hole by tightening up on the wheel hub nut. Always use a new cotter pin.

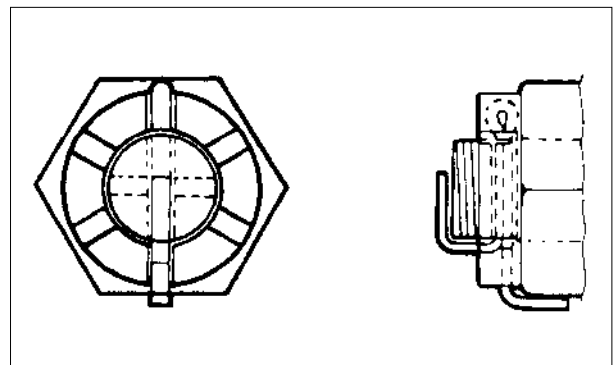

14. FRONT WHEEL/FRONT SUSPENSION/ STEERING SYSTEM



ger of it falling over.

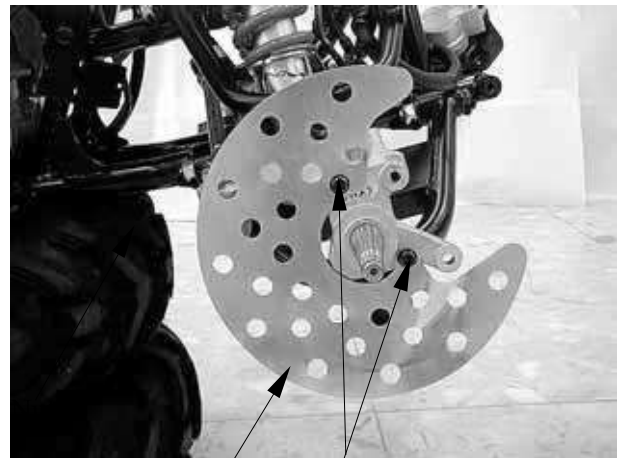
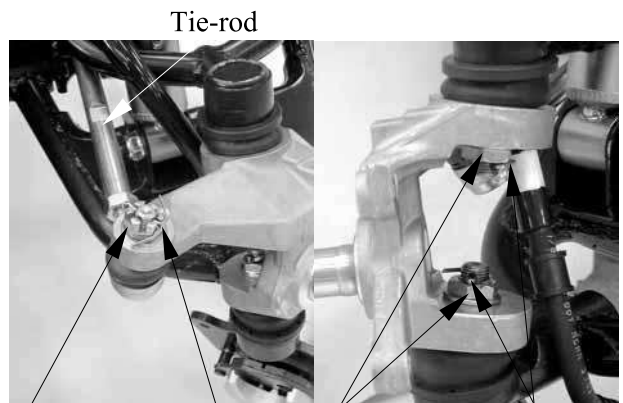
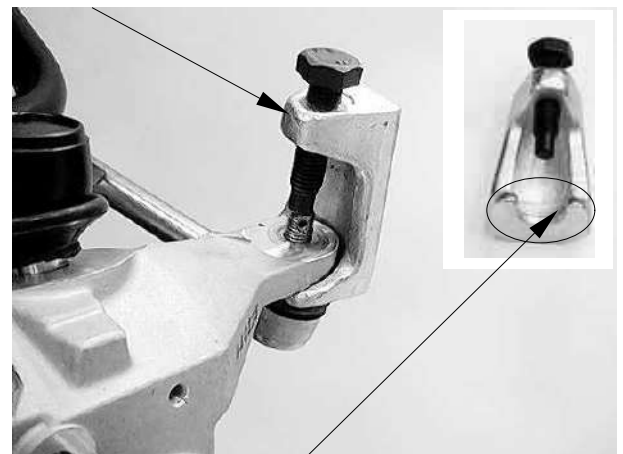

Plate Bolts



Tie-rod
Nut Cotter Pin Nuts Cotter Pin

Tie-rod Ball Joint Remover



Apply grease

14. FRONT WHEEL/FRONT SUSPENSION/ STEERING SYSTEM



Ball Joint Remover

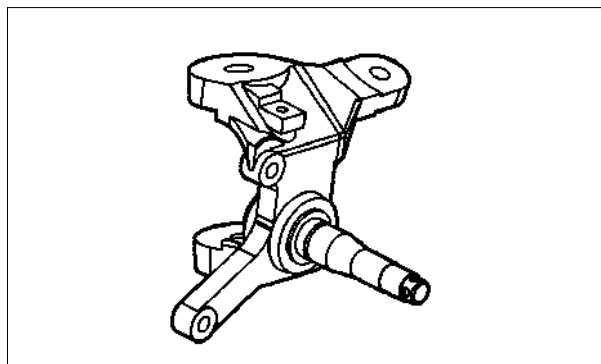

14. FRONT WHEEL/FRONT SUSPENSION/ STEERING SYSTEM



Bolts/Nuts

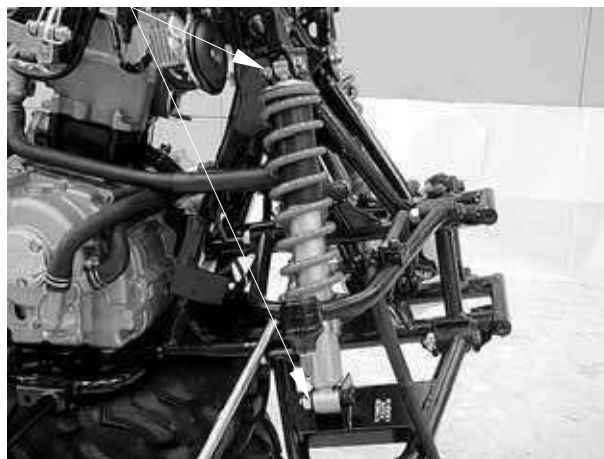

r

14. FRONT WHEEL/FRONT SUSPENSION/ STEERING SYSTEM

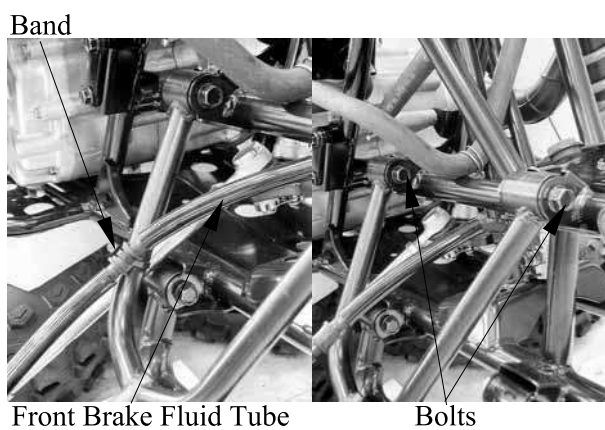
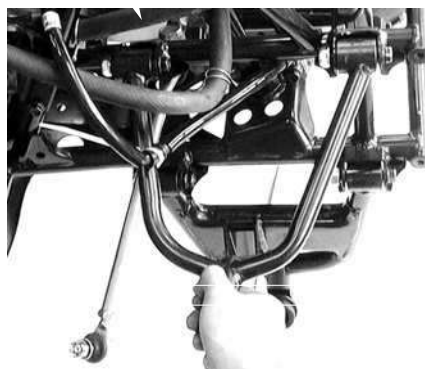

14. FRONT WHEEL/FRONT SUSPENSION/ STEERING SYSTEM

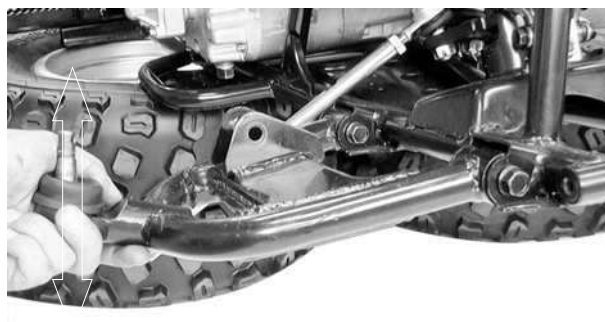
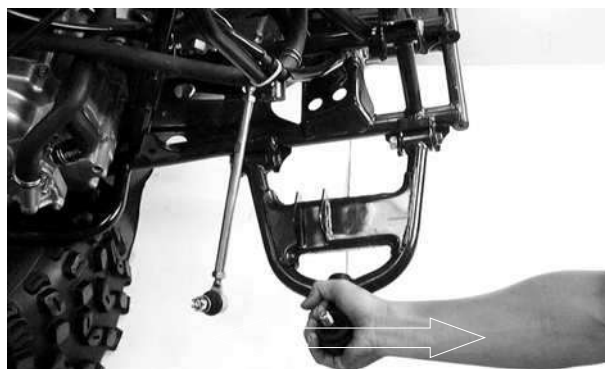
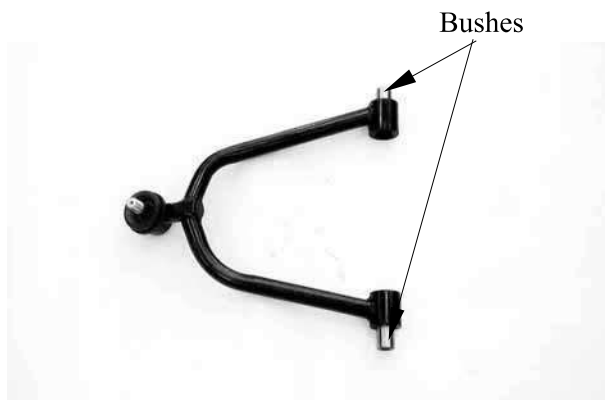

14. FRONT WHEEL/FRONT SUSPENSION/ STEERING SYSTEM

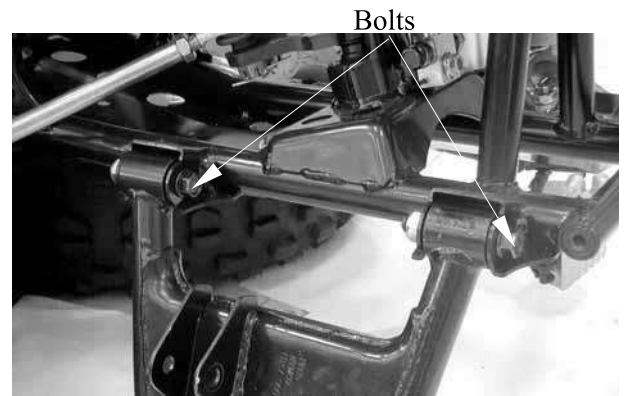

Do not attempt to straighten a bent arm,
this may dangerously weaken the arm.

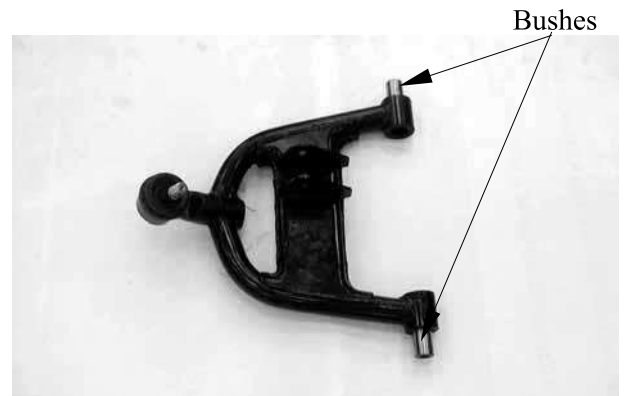

14. FRONT WHEEL/FRONT SUSPENSION/ STEERING SYSTEM



Always use a new cotter pin.

14. FRONT WHEEL/FRONT SUSPENSION/ STEERING SYSTEM

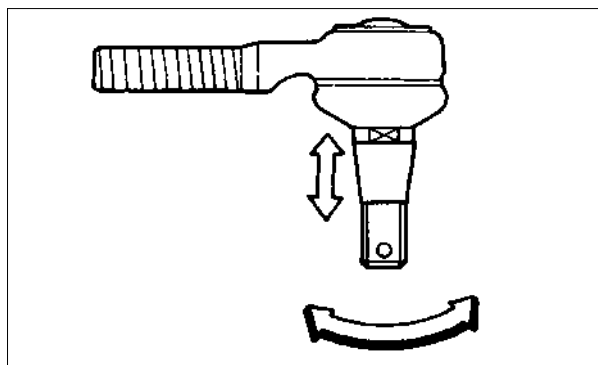
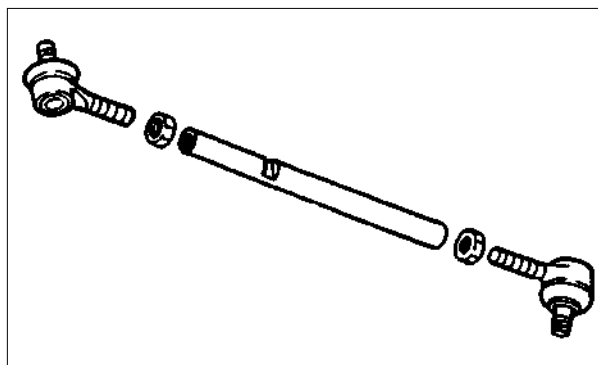
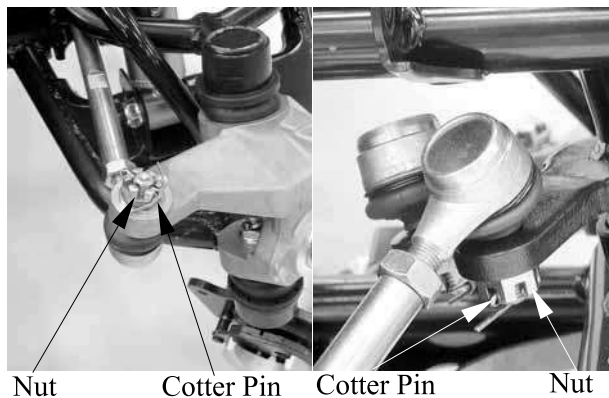

14. FRONT WHEEL/FRONT SUSPENSION/ STEERING SYSTEM

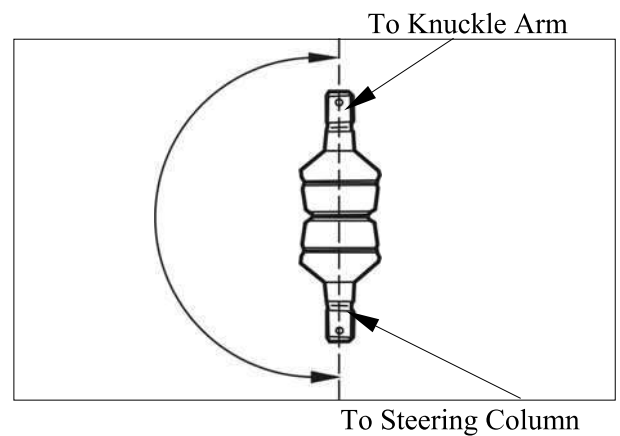
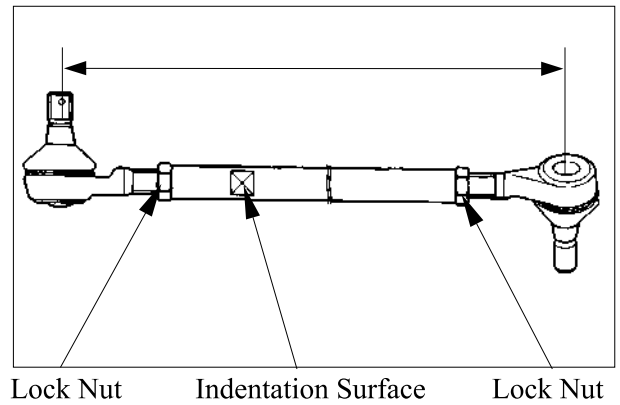

After making adjustment on both tie rods be sure to mark them R and L for identification.

The threads on both rod-end must be of the same length.

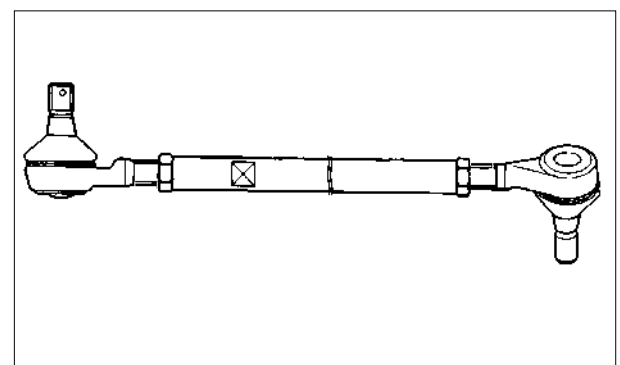

14. FRONT WHEEL/FRONT SUSPENSION/ STEERING SYSTEM

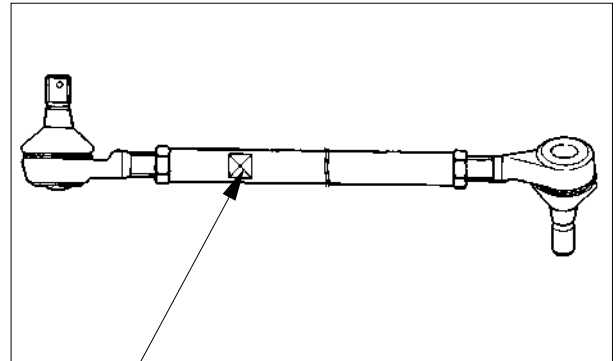

Indentation Surface

Be sure that the rod-end on the indentation surface side is connected to the steering knuckle.

Always use a new cotter pin.

14. FRONT WHEEL/FRONT SUSPENSION/ STEERING SYSTEM



Screws



Screws

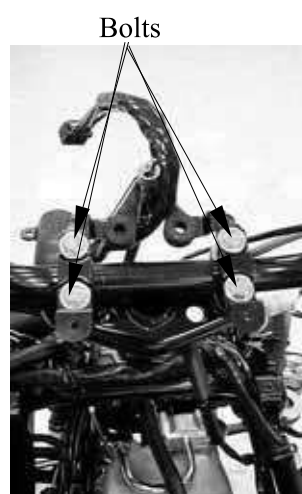

Bolts

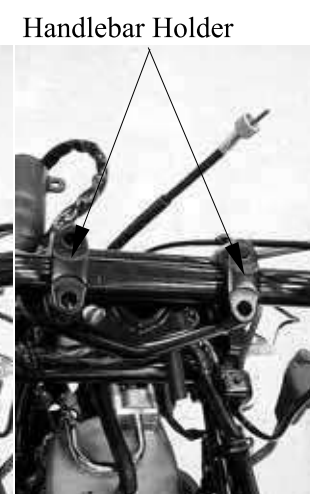

Handlebar Holder

14. FRONT WHEEL/FRONT SUSPENSION/ STEERING SYSTEM



Torque: 2.5 kgf-m (25 Nm, 18 lbf-ft)

Align the mark on the handlebar with the lower handlebar holder surface.

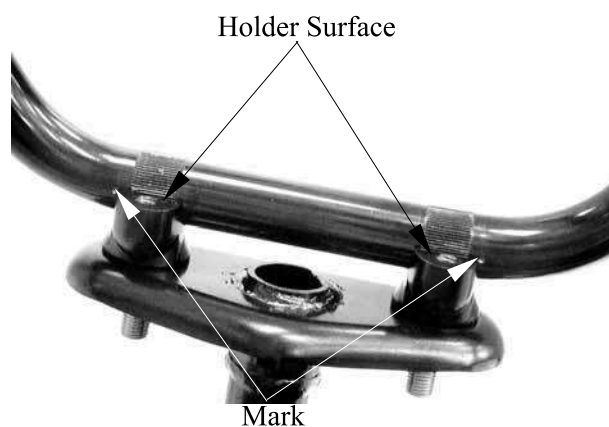

- Be sure the upper handlebar holder mark face to front.
- First tighten the bolts on the front side of the handlebar holder, and then tighten the bolts on the rear side.

Forward Mark

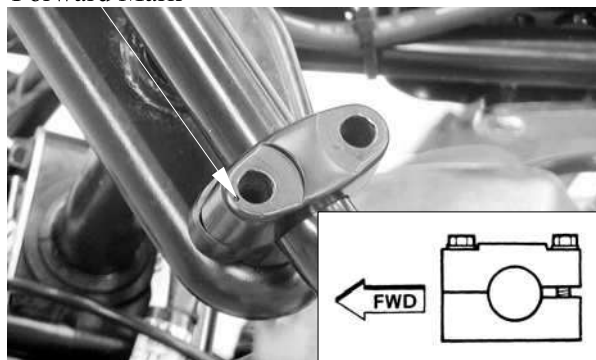

14. FRONT WHEEL/FRONT SUSPENSION/ STEERING SYSTEM

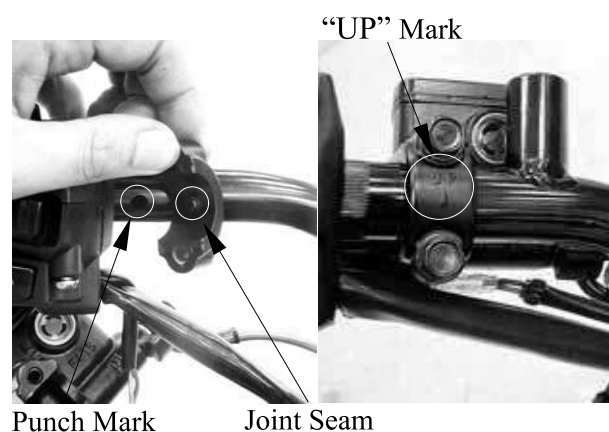

14. FRONT WHEEL/FRONT SUSPENSION/ STEERING SYSTEM

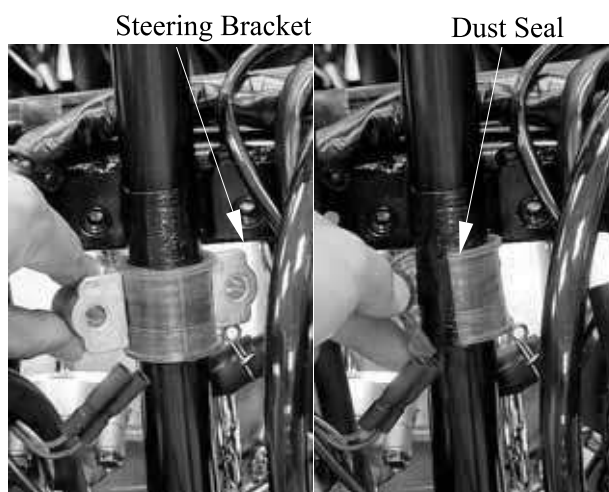
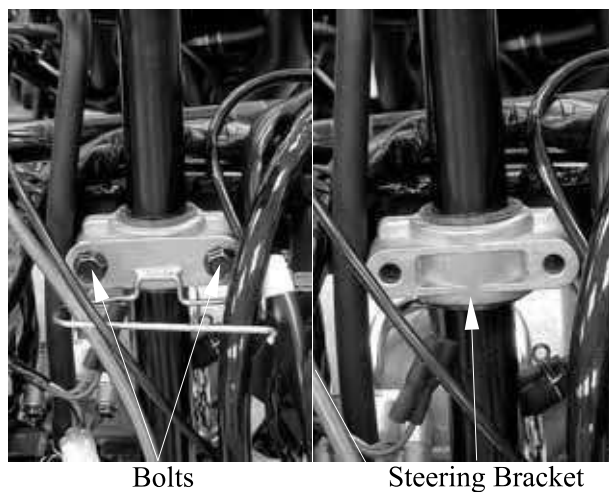
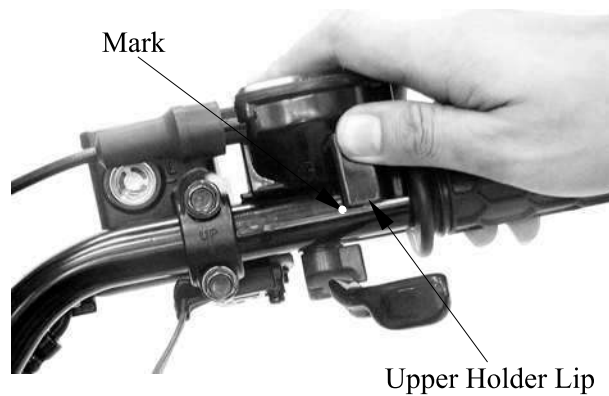

14. FRONT WHEEL/FRONT SUSPENSION/ STEERING SYSTEM

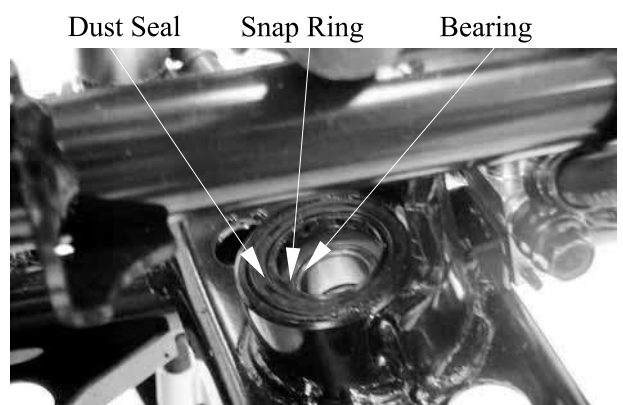
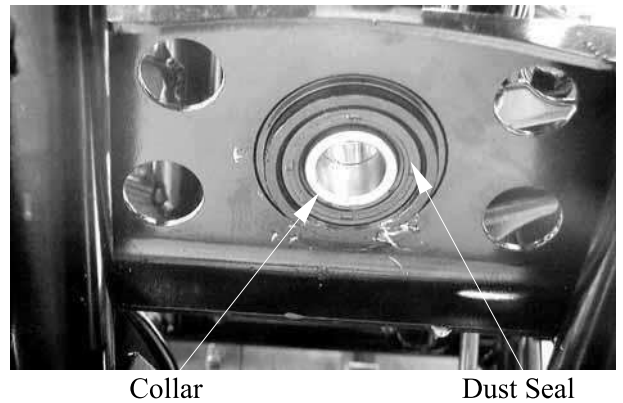
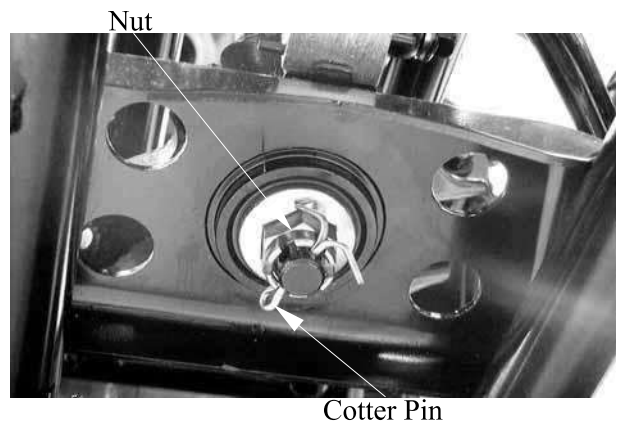

14. FRONT WHEEL/FRONT SUSPENSION/ STEERING SYSTEM



Do not attempt to straighten a bent shaft, this may dangerously weaken the shaft.



Apply the grease onto the collar, dust seals, and bearing.

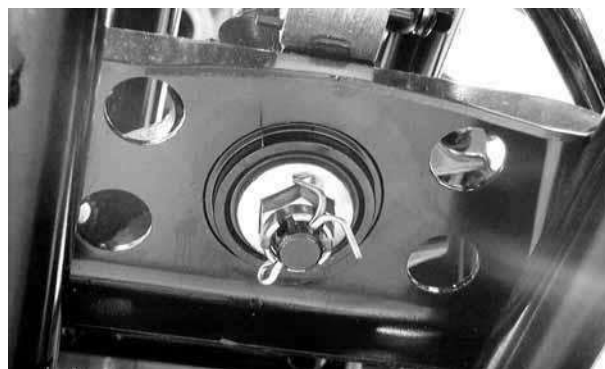

Always use a new cotter pin.

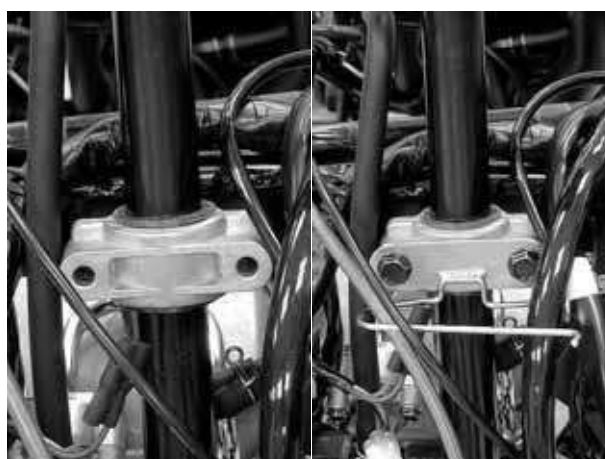

Always use a new cotter pin.

**REAR WHEEL/AXLE/SUSPENSION/
DRIVING MECHANISM**

SERVICE INFORMATION-----	15- 3
TROUBLESHOOTING-----	15- 3
REAR WHEEL/REAR WHEEL HUB-----	15- 4
REAR AXLE/AXLE HUB (MXU 250) -----	15- 6
REAR SHOCK ABSORBER -----	15- 15
SWINGARM (MXU 250) -----	15- 16
REAR DRIVING MECHANISM (MXU 300) REMOVAL AND INSPECTION -----	15- 21
FINAL DRIVE SHIM (MXU 300) ADJUSTMENT/FINAL GEAR CASE (MXU 300) DISASSEMBLY-----	15- 26
FINAL GEAR CASE (MXU 300) ASSEMBLY -----	15- 36
SWINGAEM (MXU300) -----	15- 38
REAR DRIVING MECHANISM (MXU 300) INSTALLATION ----	15- 40

15. REAR WHEEL/AXLE/SUSPENSION DRIVING MECHANISM

MXU 250

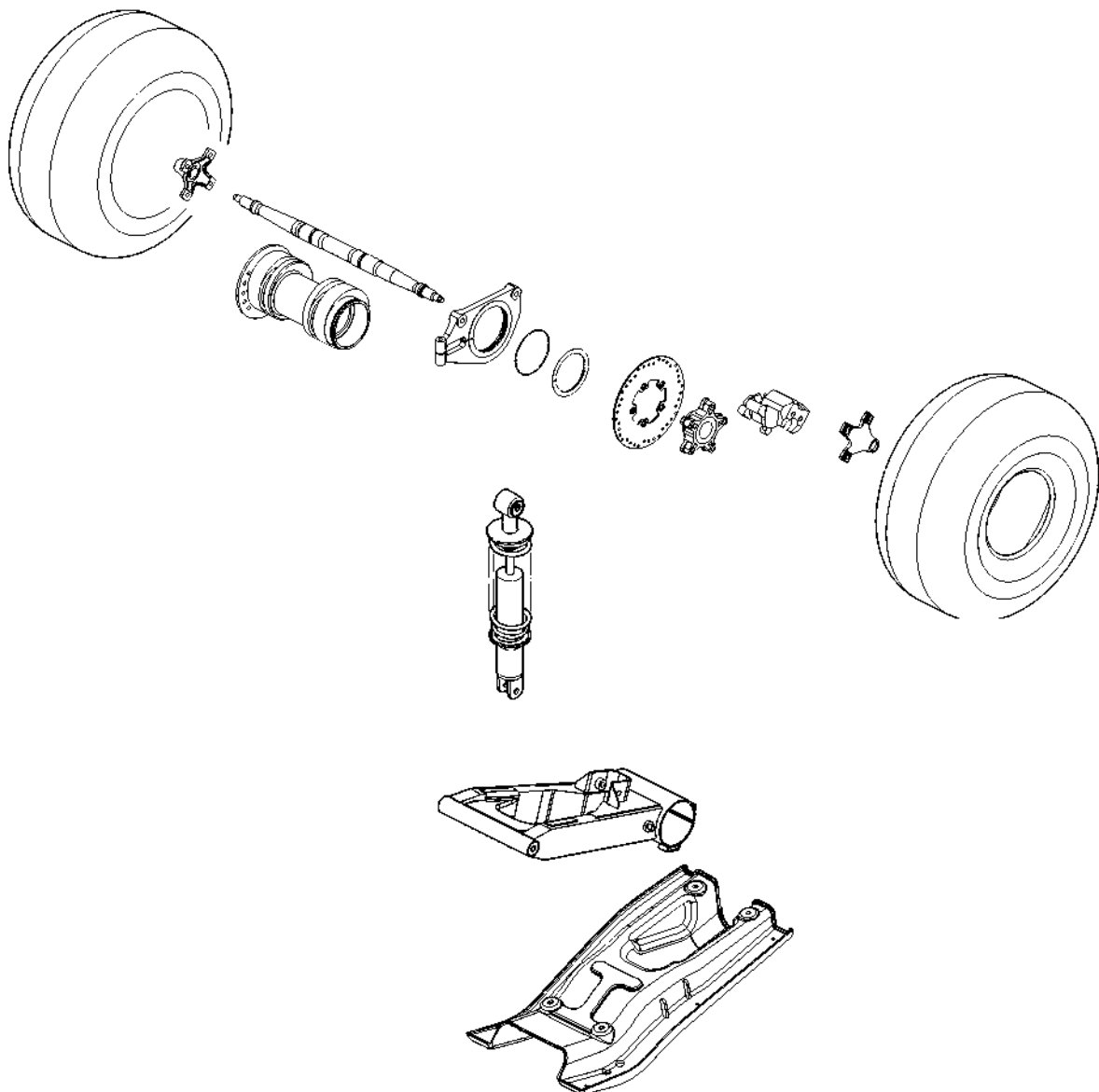

15. REAR WHEEL/AXLE/SUSPENSION/ DRIVING MECHANISM

MXU 300

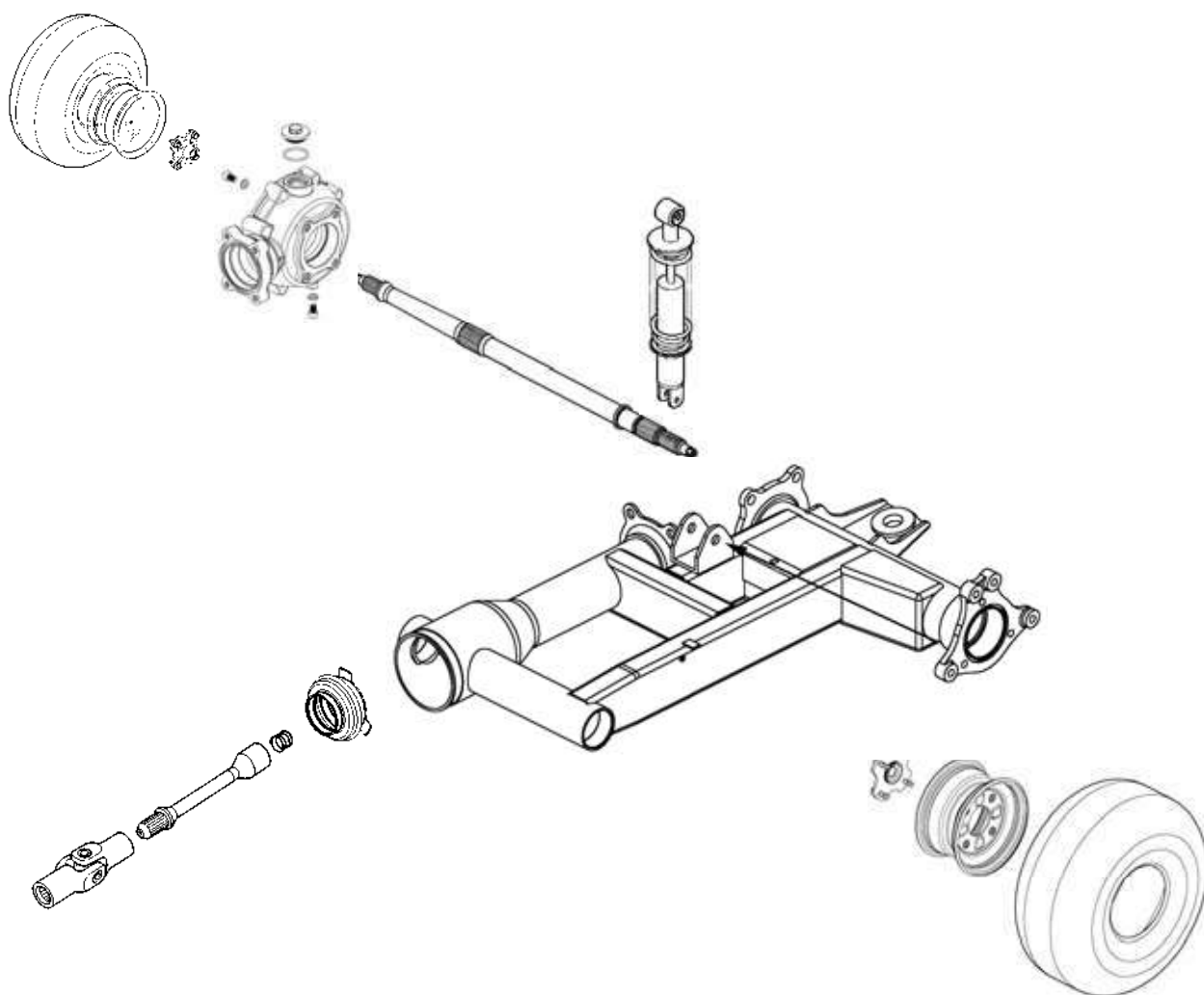

15. REAR WHEEL/AXLE/SUSPENSION DRIVING MECHANISM

SERVICE INFORMATION

GENERAL INSTRUCTIONS

- Jack the machine front wheel off the ground and be careful to prevent the machine from falling down.
- During servicing, keep oil or grease off the brake disk
- Inspect the brake system before riding.

SPECIFICATIONS

Unit: mm (in)

Item		Standard	Service Limit	
Rear wheel	Rim run out	Radial	—	2 (0.08)
		Axial	—	2 (0.08)

TORQUE VALUES

Rear wheel nut	4.5 kgf-m (45 N-m, 32 lbf-ft)
Rear shock absorber upper mount bolt	4 kgf-m (40 N-m, 29 lbf-ft)
Rear shock absorber lower mount bolt	4 kgf-m (40 N-m, 29 lbf-ft)
Rear swingarm pivot bolt (MXU 250)	7 kgf-m (70 N-m, 52 lbf-ft)
Rear wheel hub nut	10 kgf-m (100 N-m, 72 lbf-ft)
Rear wheel shaft nut (MXU 250)	12 kgf-m (120 N-m, 86 lbf-ft)
Caliper holder bolt (MXU 250)	1 kgf-m (10 N-m, 7.2 lbf-ft)
Right pivot bolt (MXU 300)	11.8 kgf-m (118 N-m, 85 lbf-ft)
Left pivot bolt (MXU 300)	1.1 kgf-m (11 N-m, 8 lbf-ft)
Left pivot lock nut (MXU 300)	11.8 kgf-m (118 N-m, 85 lbf-ft)
Final gear case mounting bolt (MXU 300)	5.5 kgf-m (55 N-m, 40 lbf-ft)
Final gear case cover bolt (MXU 300)	
10-mm bolt:	5 kgf-m (49 N-m, 36 lbf-ft)
8-mm bolt:	2.5 kgf-m (25 N-m, 19 lbf-ft)

SPECIAL TOOLS

Nut wrench	F010
Lock nut wrench	F013

TROUBLESHOOTING

Rear wheel wobbling

- Bent rim
- Faulty tire
- Axle not tightened properly

Soft rear shock absorber

- Weak shock absorber spring
- Faulty damper

15. REAR WHEEL/AXLE/SUSPENSION/ DRIVING MECHANISM

REAR WHEEL/REAR WHEEL HUB

REMOVAL AND INSPECTION

Remove four nuts attaching the rear wheel hub of the both rear wheels, then remove the both rear wheels.

Elevate the rear wheels by placing a suitable stand under the rear of frame. Support the machine securely so there is no danger of it falling over.



Wheel Nuts

Remove the nut cap.
Remove the cotter pin and then remove nut.
Remove the rear wheel hub.

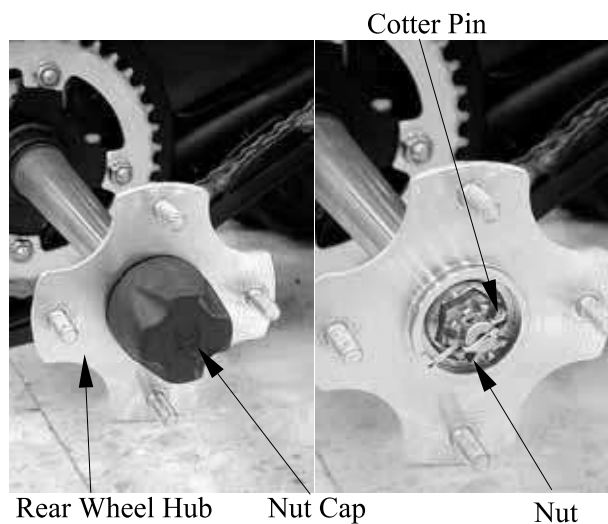

Rear Wheel Hub

Nut Cap

Nut

Inspect the rear wheel hub.
Cracks/damage → Replace.

Inspect the rear wheel hub splines.
Wear/damage → Replace.



Splines

15. REAR WHEEL/AXLE/SUSPENSION DRIVING MECHANISM

Measure the wheel runout.

Service Limit:

Vertical: 2 mm (0.08 in)

Lateral: 2 mm (0.08 in)

Out of specification → Replace wheel.

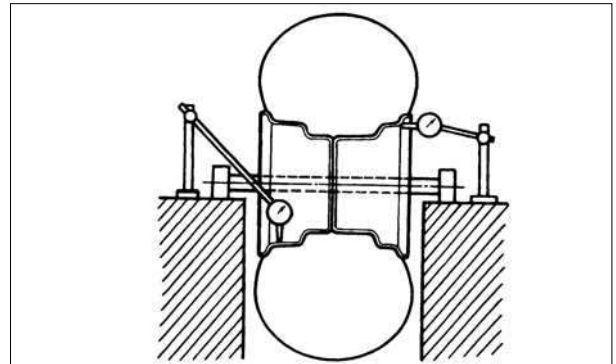

INSTALLATION

Apply molybdenum disulfide grease to axle shaft spline end (out side), so the spline groove is filled with grease.

Install the rear wheel hub onto the axle.

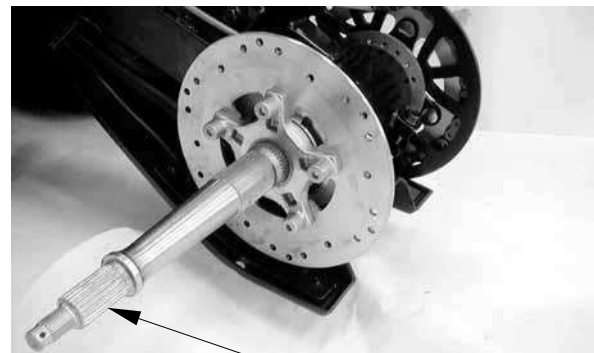

Apply grease

Apply grease to the rear wheel hub nut threads and setting surfaces.

Install the hub nut onto the axle and tighten the hub nut to the specified torque and further tighten until its grooves align with the cotter pin hole.

Torque: 10 kgf-m (100 Nm, 72 lbf-ft)

Install cotter pin (new).

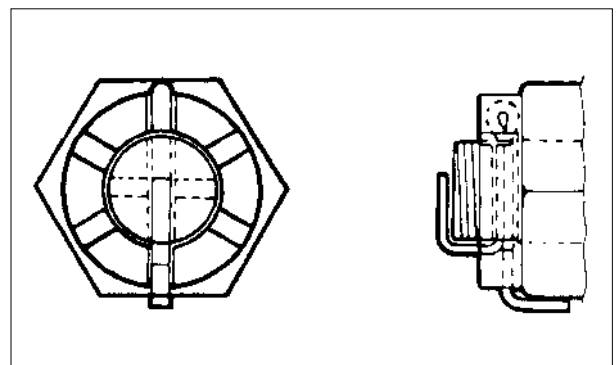

Do not loosen the wheel hub nut after torque tightening. If the wheel hub nut groove is not aligned with the cotter pin hole, align groove with the hole by tightening up on the wheel hub nut.
Always use a new cotter pin.

15. REAR WHEEL/AXLE/SUSPENSION/ DRIVING MECHANISM

Install the rear wheel and tighten the four nuts.

Torque: 4.5 kgf-m (45 Nm, 32 lbf-ft)

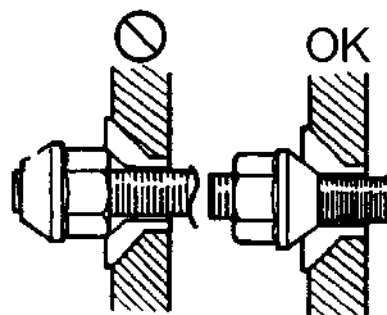

REAR AXLE/AXLE HUB (MXU 250)

REMOVAL AND INSPECTION

Place the machine on a level place.
Remove the rear caliper. (Refer to the “REAR BRAKE CALIPER REMOVAL” section in chapter 13)

Remove the rear wheels (page 15-4).

Use the nut wrench to loosen two rear axle nuts (inner and outer) of the rear axle.

Note that the rear axle nuts are left threaded.

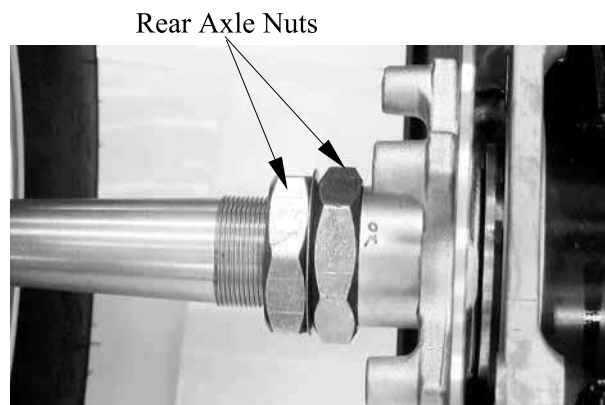

Special tool: Nut wrench F010

Remove the two rear axle nuts (outer and inner), washer and collar.

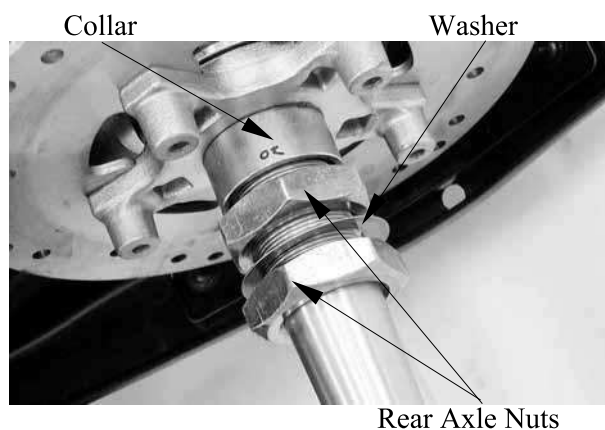

15. REAR WHEEL/AXLE/SUSPENSION DRIVING MECHANISM

Remove the rear brake disk.

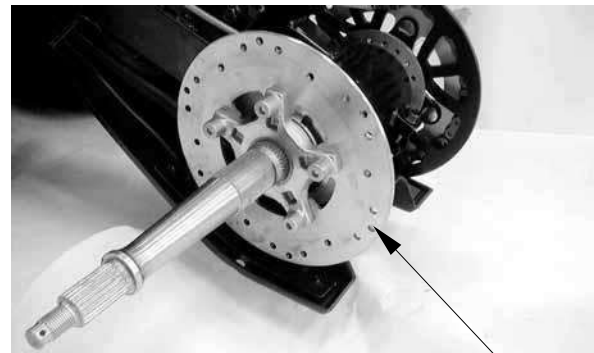

Rear Brake Disk

Inspect the brake disk
Cracks/damage → Replace.
Inspect the brake disk splines.
Wear/damage → Replace.



Splines

Loosen the driven chain (refer to the “DRIVE CHAIN SLACK ADJUSTMENT” section in the chapter 3) and remove the two bolts at the drive sprocket (refer to the chapter 6), then disconnect the drive chain from the driven sprocket.

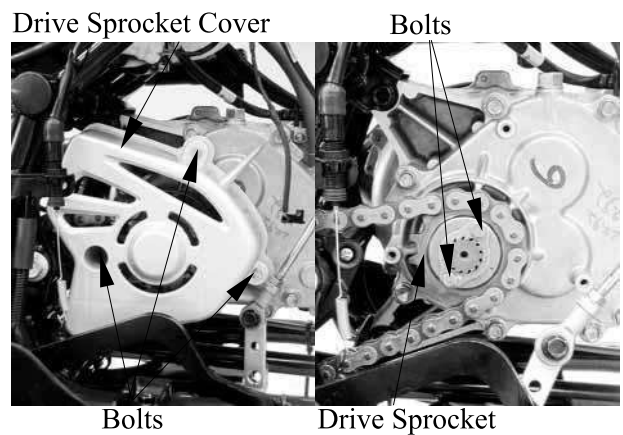

Drive Sprocket Cover

Bolts

Bolts

Drive Sprocket

15. REAR WHEEL/AXLE/SUSPENSION/ DRIVING MECHANISM

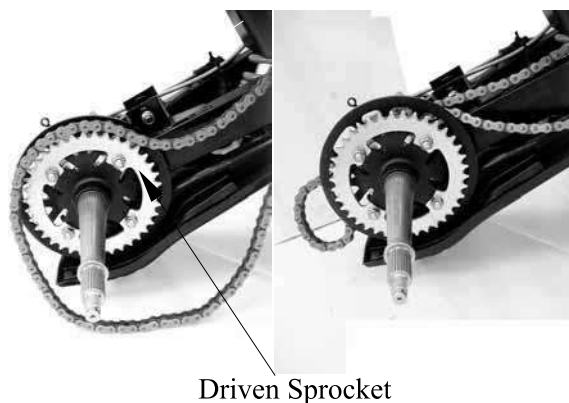

Remove the rear axle from right side.

Tap the axle and with a rubber hammer, this will avoid damage the axle thread.

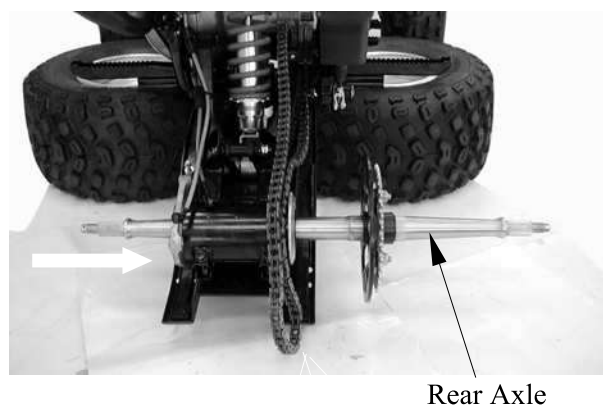

REAR AXLE DISASSEMBLY



15. REAR WHEEL/AXLE/SUSPENSION DRIVING MECHANISM

KYMCO
MXU 300/250

Remove the driven sprocket clip at the rear axle and then remove the driven sprocket.

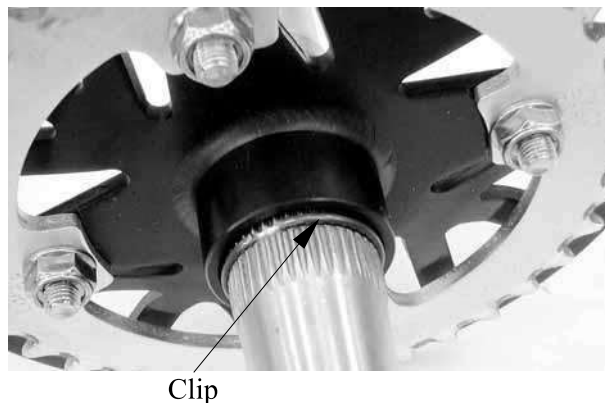

Remove the four nuts attaching the driven sprocket holder at the driven sprocket and then remove driven sprocket.



Inspect the drive sprocket and driven sprocket.

More than 1/4 teeth wear → Replace.

Bent teeth → Replace.

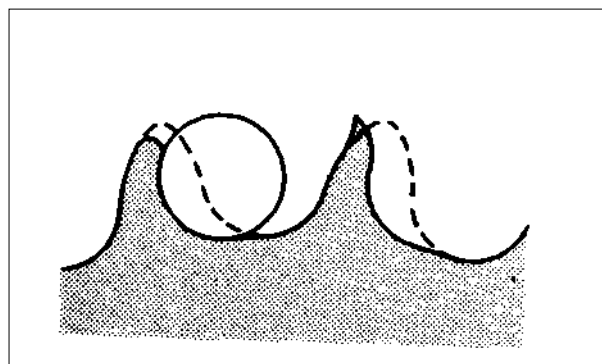

15. REAR WHEEL/AXLE/SUSPENSION/ DRIVING MECHANISM

Inspect the driven sprocket holder splines.
Wear/damage → Replace.

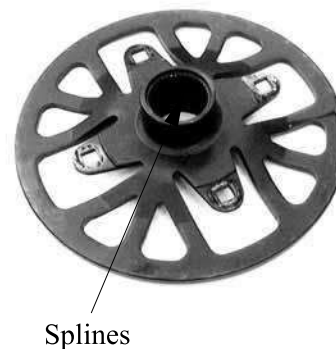

Inspect the rear axle.
Scratched (excessively)/damage → Replace.
Inspect the splines and threads of the rear axle
Wear/damage → Replace.



Measure the rear axle run out.

Service limit: less than 1.5 mm (0.06 in)
Out of specification → Replace.

Do not attempt to straighten a bent axle.

REAR AXLE ASSEMBLY

Reverse the “REAR AXLE
DISASSEMBLY” procedures.

Apply grease onto the rear axle splines.

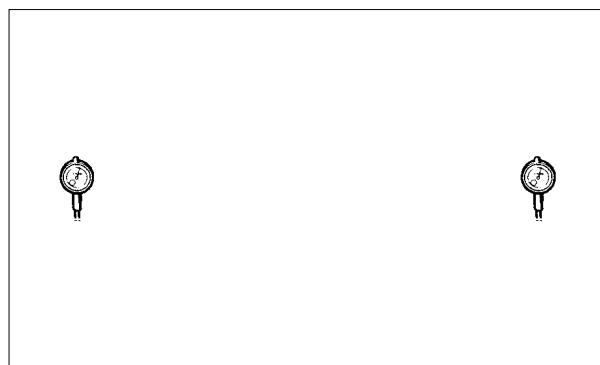

15. REAR WHEEL/AXLE/SUSPENSION DRIVING MECHANISM

Remove the bolt at the rear caliper holder.
Remove the two bolts attaching the rear
axle hub at the rear fork.

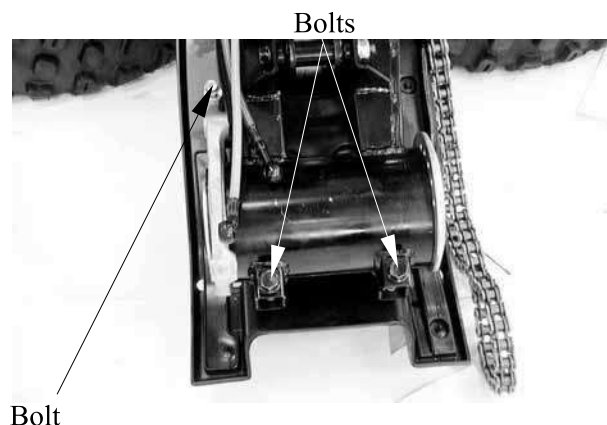

Remove the circlip at the caliper holder and
then remove the caliper holder and collar.

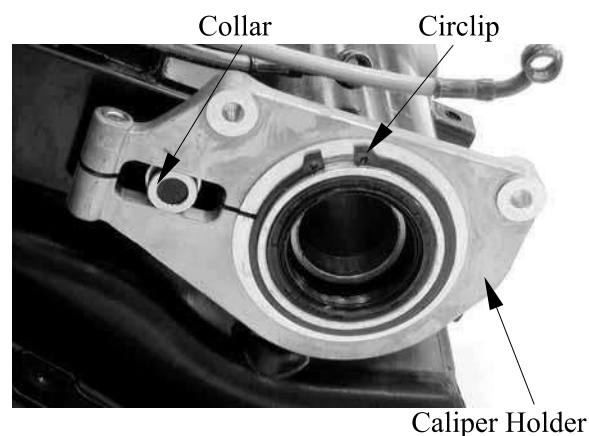

Inspect the O-ring for damage.
Apply grease to the O-ring before the
caliper holder is installed.

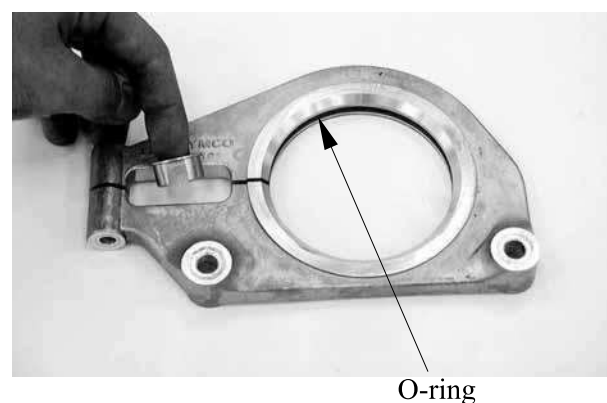

15. REAR WHEEL/AXLE/SUSPENSION/ DRIVING MECHANISM

Remove the rear axle hub from right side.

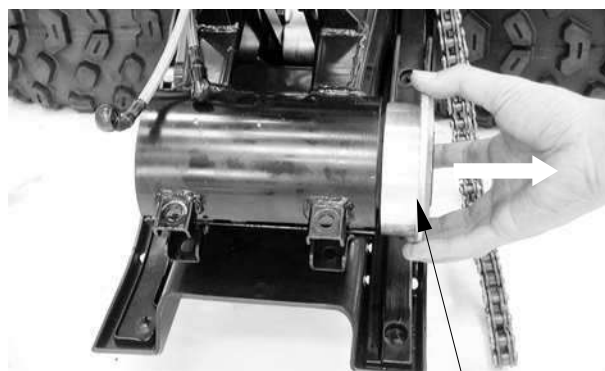

Rear Axle Hub

Inspect rear axle hub.

Bearings allow play in the axle hub or the bearing turns roughly → Replace.

Dust seals is wear/damage → Replace.

Axle hub is cracks/bend/damage →
Replace.



REAR AXLE HUB DISASSEMBLY

Bearing and dust seal replacement steps:

Clean the outside of the rear axle hub.

Remove the dust seal by a flat-head screw driver.

Place a wood block against the outer edge to protect this edge.

Remove the bearing by a general bearing puller.

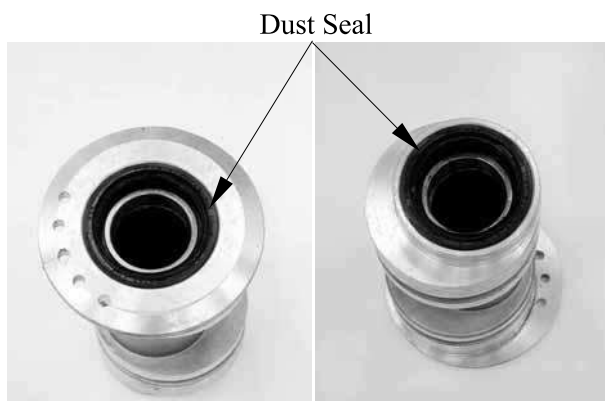

15. REAR WHEEL/AXLE/SUSPENSION DRIVING MECHANISM

REAR AXLE HUB ASSEMBLY

Install the new bearing and dust seal by reversing the previous steps.

Do not strike the center race or balls of the bearing.
Contact should be made only with the outer race.
Make sure install the distance collar into the rear axle hub

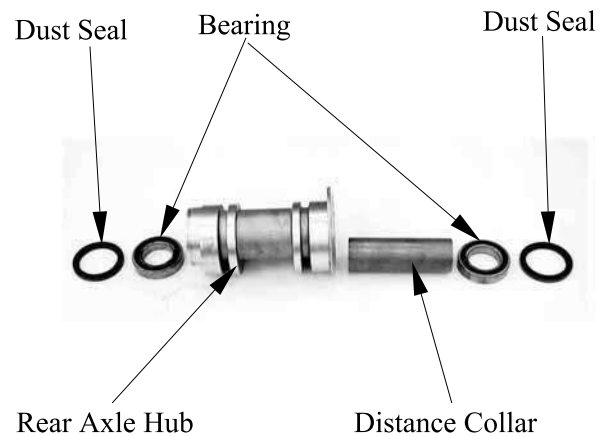

INSTALLATION

Reverse the “REAR WHEEL/AXLE/AXLE HUB REMOVAL AND INSPECTION” procedures.

Apply grease onto the dust seal lips and bearings.

Install the rear axle hub.

At this time, the rear axle hub should not be tightened completely.
Final tightening is done after the chain slack adjustment.

Install the rear axle.

Apply grease onto the rear axle splines.

Connect the drive chain.

Install the rear brake disk, collar inner nut, washer and outer nut.

At this time, the nuts should not be tightened completely.

15. REAR WHEEL/AXLE/SUSPENSION/ DRIVING MECHANISM

Tighten the two rear axle nuts (inner and outer).

Note that the rear axle nuts are left threaded.

Special tool: Nut wrench F010

Torque: 12 kgf-m (120 Nm, 86 lbf-ft)

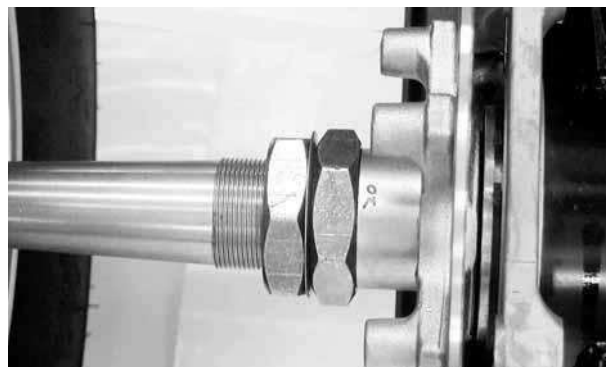

Adjust drive chain slack. (Refer to the “DRIVE CHAIN SLACK ADJUSTMENT” section in the CHAPTER 3.)

Drive chain slack: 30 ~ 40mm

15. REAR WHEEL/AXLE/SUSPENSION DRIVING MECHANISM

REAR SHOCK ABSORBER REMOVAL AND INSPECTION

Support the vehicle with a support block to raise the rear wheels off the ground.

Support the swingarm and remove the lower mounting bolt/nut.

Remove the upper mounting bolt/nut and nut and the shock absorber.



Bolts/Nuts

Inspect the shock absorber rod.

Bends/damage → Replace the shock absorber assembly.

Inspect the shock absorber.

Oil leaks → Replace the shock absorber assembly.

Inspect the spring.

Move the spring up and down.

Fatigue → Replace the shock absorber assembly.

Inspect the bushes.

Wear/damage → Replace.

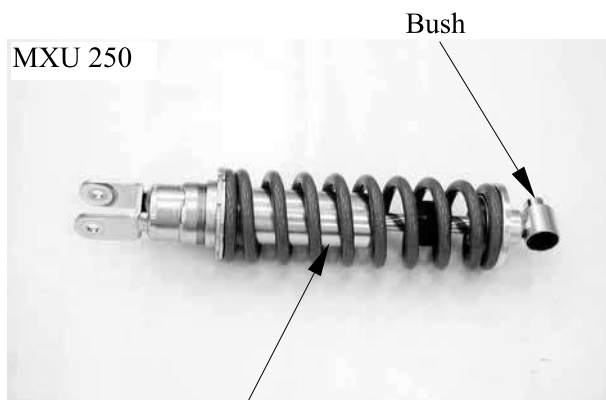

Shock Absorber

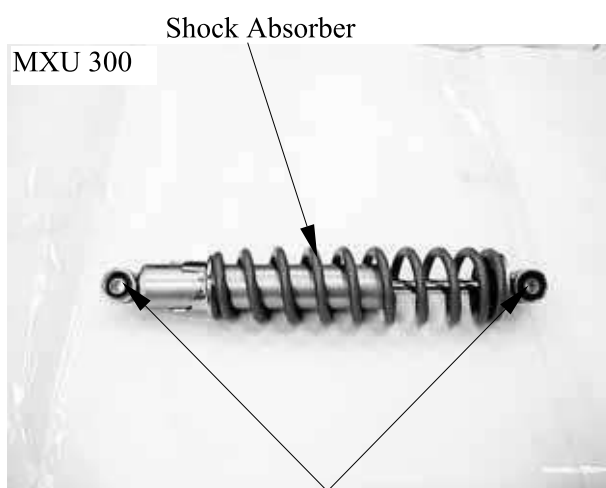

Bushes

15. REAR WHEEL/AXLE/SUSPENSION/ DRIVING MECHANISM

INSTALLATION

Install the shock absorber and tightening the bolts/nuts.

Torque: 4 kgf-m (40 Nm, 29 lbf-ft)

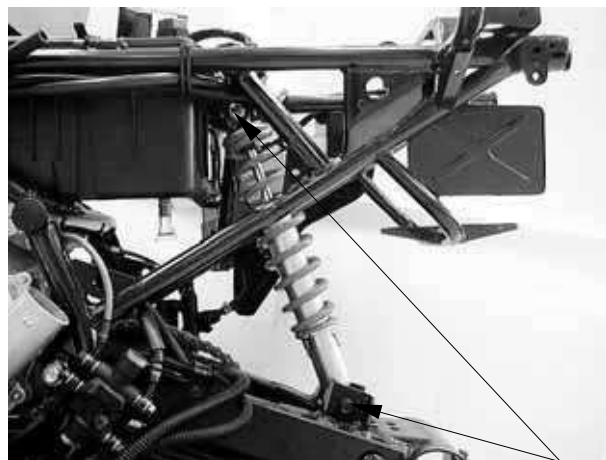

Bolts/Nuts

SWINGARM (MXU 250) REMOVAL AND INSPECTION

Place the machine on a level place.
Elevate the rear wheels by placing a suitable stand under the rear of frame.

Support the machine securely so there is no danger of it falling over.

Remove the rear wheels, rear axle and rear hub.

Refer to the “REAR AXLE HUB (MXU 250) REMOVAL AND INSPECTION” section in chapter 15.

Remove the rear shock absorber (page 15-15).

Check the tightening torque of the pivot bolt (swingarm) securing nut.

Torque: 7 kgf-m (70 Nm, 50 lbf-ft)

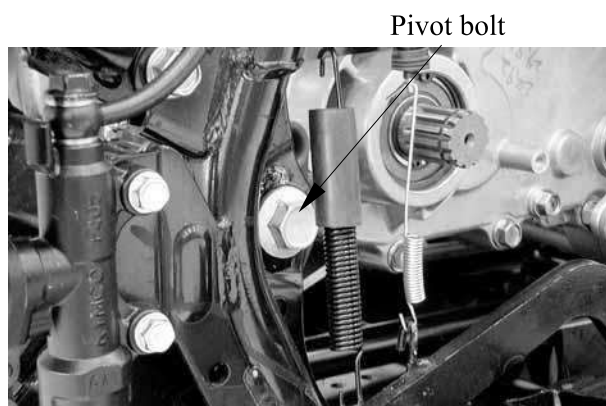

Pivot bolt

15. REAR WHEEL/AXLE/SUSPENSION DRIVING MECHANISM

Check the swingarm side play by moving it from side to side.

If side play noticeable, check the inner collar, bearing, bushing and thrust cover, or adjust the shim.

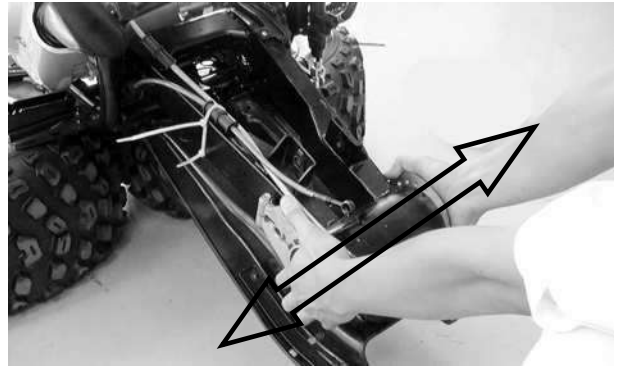

Check the swingarm vertical movement by moving it up and down.

If vertical movement is tight, binding or rough, check the inner collar, bearing, bushing and thrust cover, or adjust the shim.

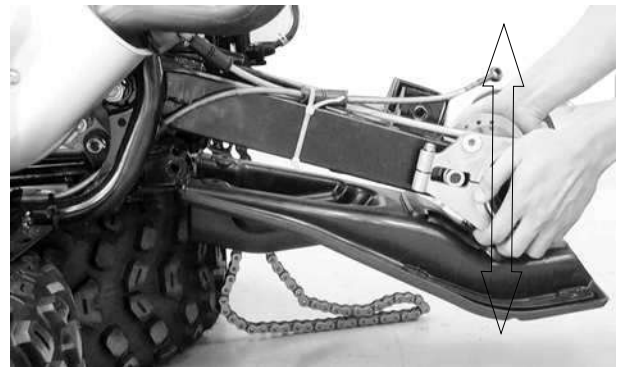

Remove the bolt and band, then disconnect the rear brake fluid hoses from the swingarm.

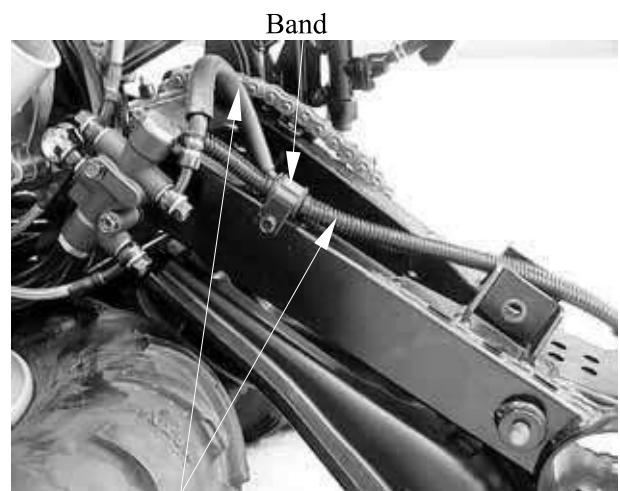

15. REAR WHEEL/AXLE/SUSPENSION/ DRIVING MECHANISM

KYMCO
MXU 300/250

Remove the nut and pivot bolt, then remove rear swingarm and drive chain.

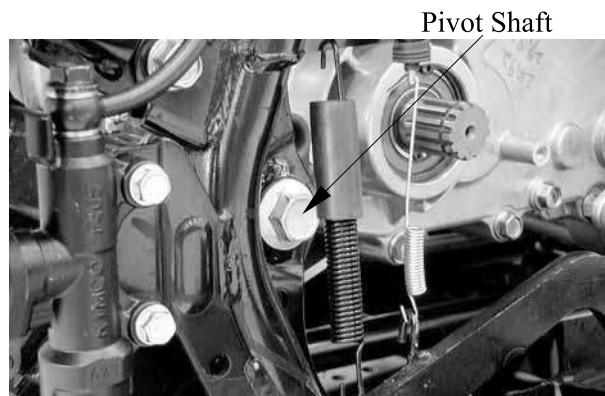

Remove the four bolts from the lower guard and then remove the lower guard.

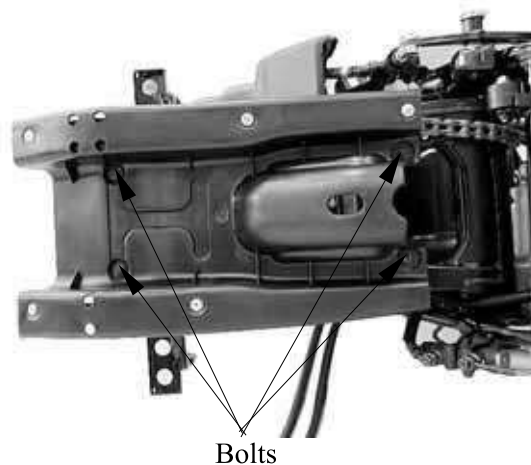

Remove the thrust covers.

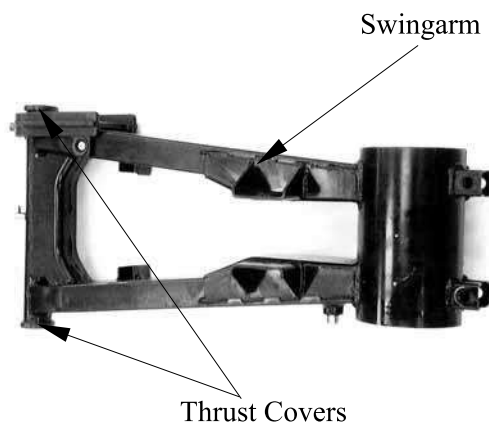

15. REAR WHEEL/AXLE/SUSPENSION DRIVING MECHANISM

Inspect the swingarm.
Crack/bend/damage → Replace.

Roll the pivot bolt on a flat surface to
inspect the pivot shaft.
Bends → Replace.

Do not attempt to straighten a bent bolt.

Inspect the thrust covers, collar and bushes.
Wear/damage → Replace.

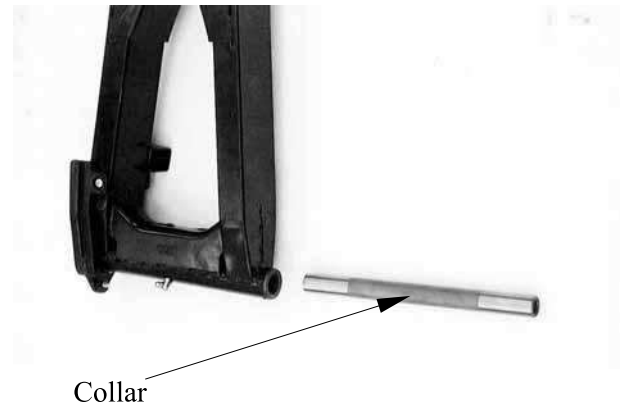
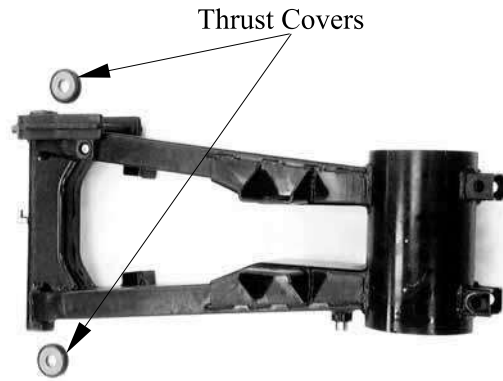

Inspect the drive chain stiffness.
Stiff → Clean and lubricate or replace.

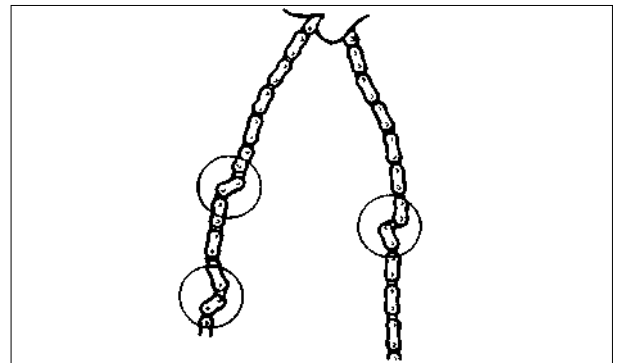

15. REAR WHEEL/AXLE/SUSPENSION/ DRIVING MECHANISM

INSTALLATION

Reverse the “SWIMARM (MXU 250)
REMOVAL AND INSPECTION”
procedure.

Apply grease onto the collar, bush, pivot
bolt and thrust cover.



Install the swingarm and drive chain.
Install the pivot bolt and tightening the nut
and pivot bolt.

Torque: 7 kgf-m (70 Nm, 50 lbf-ft)

Install the shock absorber (page 15-15).

Install the rear hub and rear wheels.
Refer to the “REAR WHEEL
INSTALLATION” section.

Adjust the drive chain slack.
Refer to the “DRIVE CHAIN SLACK
ADJUSTMENT” section in the CHAPTER
3.

Drive chain slack: 30 ~ 40mm

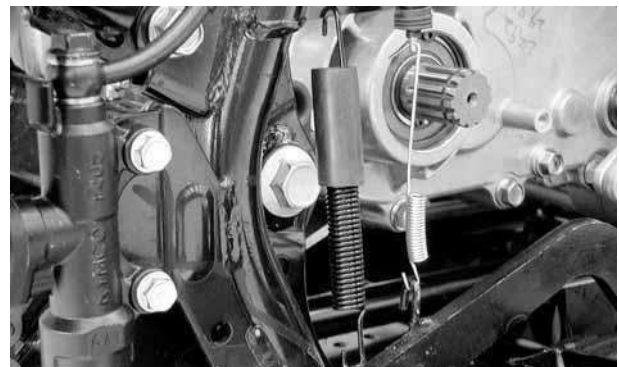

15. REAR WHEEL/AXLE/SUSPENSION DRIVING MECHANISM

REAR DRIVING MECHANISM (MXU 300) REMOVAL AND INSPECTION

Place the machine on a level place.
Elevate the rear wheels by placing a suitable
stand under the rear of frame.

Support the machine securely so there is
no danger of it falling over.

Remove the rear wheels and rear hubs (page
15-4).

Drain the final gear case oil (page 3-13)

Remove the rear brake calipers (page 13-
12).

Remove the rear brake disk.

Inspect the brake disk
Cracks/damage → Replace.
Inspect the brake disk splines.
Wear/damage → Replace.

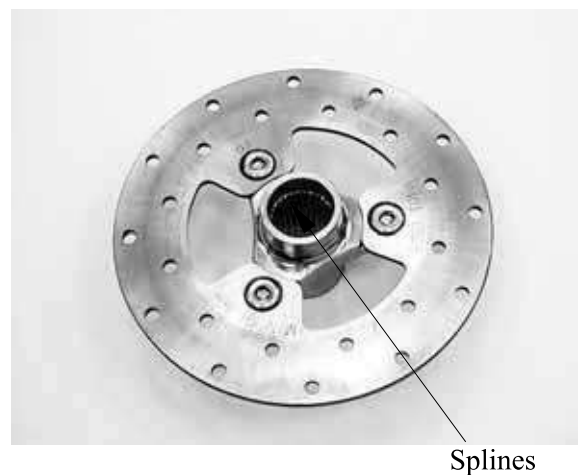
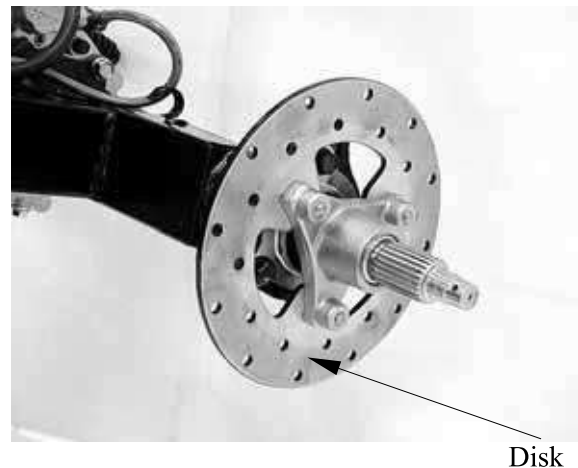

15. REAR WHEEL/AXLE/SUSPENSION/ DRIVING MECHANISM

Loosen the joint boot band screw of the swingarm side. Remove the joint boot from the swingarm.

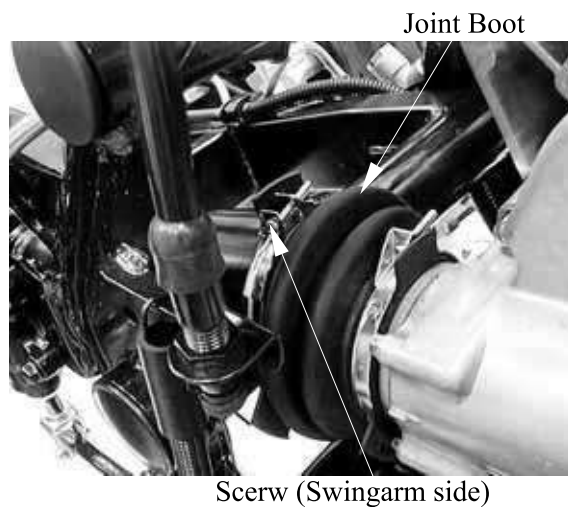

Remove the rear shock absorber (page 15-15).

Remove the bolt and band, then disconnect the rear brake fluid hoses from the swingarm.

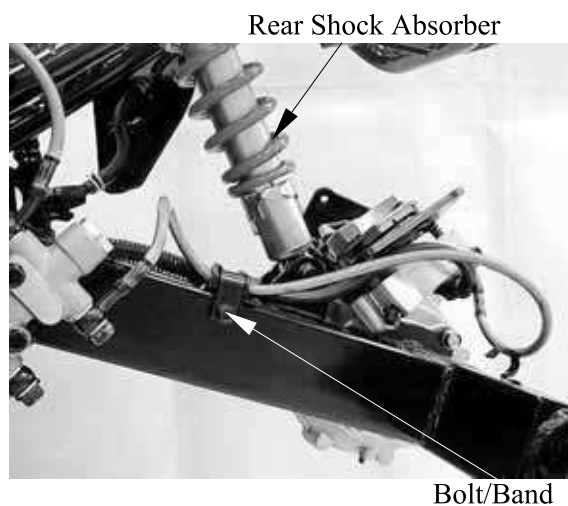

Remove the swingarm pivot bolt cap.
Remove the right pivot bolt.

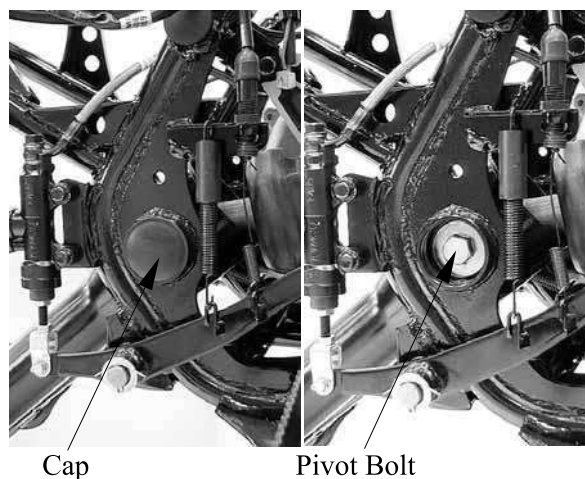

15. REAR WHEEL/AXLE/SUSPENSION DRIVING MECHANISM

Remove the swingarm pivot bolt cap.
Remove the left pivot lock nut using the special tool.

Special tool: Lock nut wrench F013

Remove the left pivot adjusting bolt.

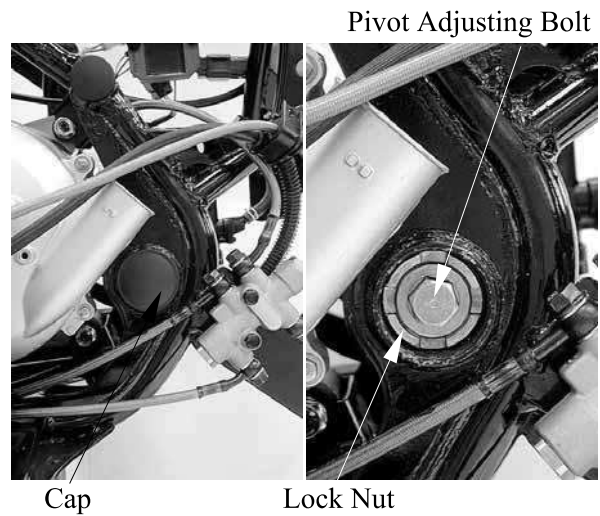

Remove the swingarm, then take spring out from the swingarm.

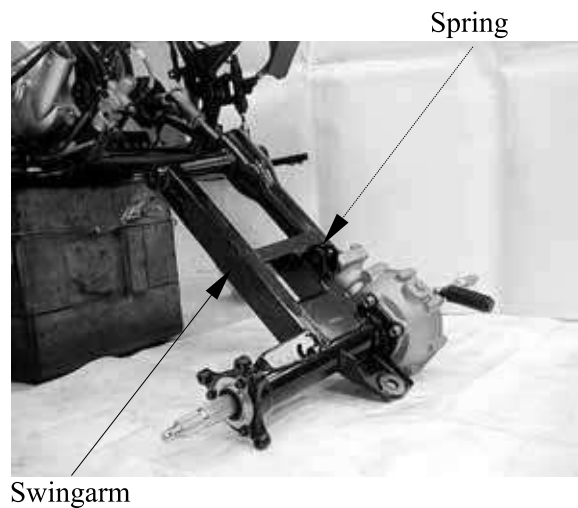

Disengage the universal joint from the secondary driven bevel gear shaft splines.



15. REAR WHEEL/AXLE/SUSPENSION/ DRIVING MECHANISM

Disengage the universal joint from the drive shaft splines.

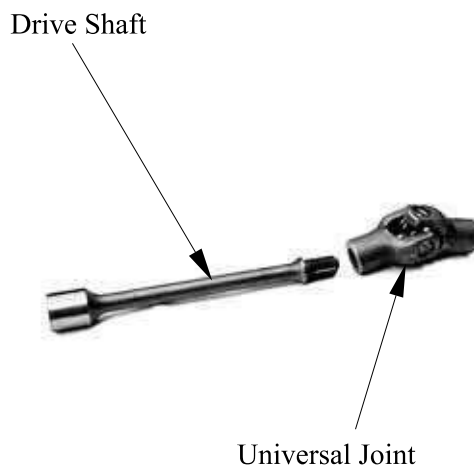

UNIVERSAL JOINT INSPECTION:

If the splines are damaged, check the pinion and universal joint splines also.



DRIVE SHAFT INSPECTION:

Check the splines of the drive shaft wear or damage.

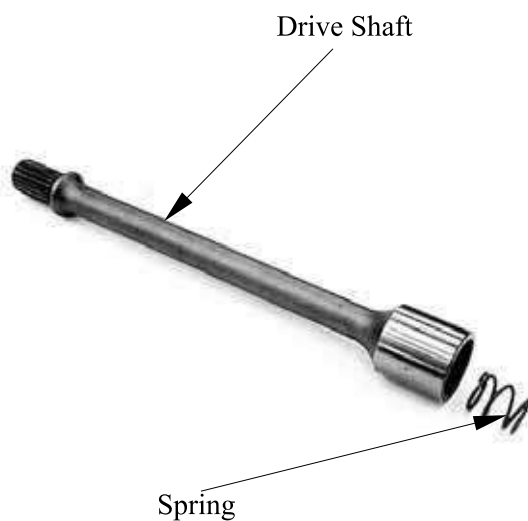

15. REAR WHEEL/AXLE/SUSPENSION DRIVING MECHANISM

Remove the eight mounting bolts (front/left) and then remove the rear driving mechanism.

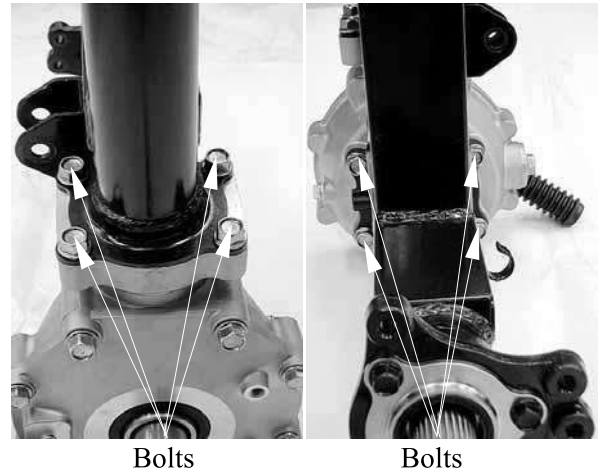

Support the swingarm with a support block and place a rubber mat under the rear axle right side end.

Remove the final gear case assembly and rear axle by driving them from the left side using a rubber mallet.

Place the rear axle right side end on the rubber mat.

Remove the final gear case assembly from right side.

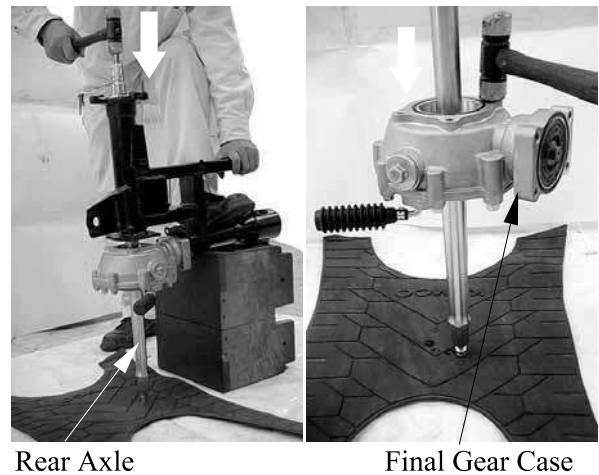

Tap the final gear case using a diagonal pattern and with a rubber hammer, this will avoid damage the final gear case.

Remove the O-rings from the final gear case grooves (front/rear).

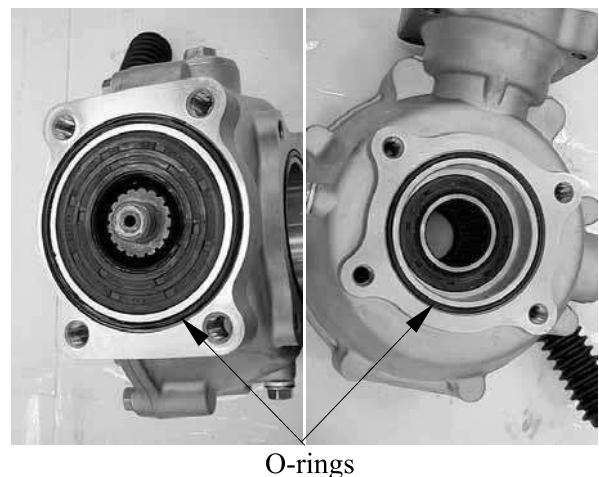

15. REAR WHEEL/AXLE/SUSPENSION/ DRIVING MECHANISM

REAR AXLE INSPECTION:

Check the axle splines for wear or damage.

Set the axle in V-blocks and measure the runout with a dial indicator.

Axle runout is 1/2 the total indicator reading.

Service limit: 3 mm (0.12 in)



FINAL GEAR CASE INSPECTION:

Turn the pinion gear and check that the gear turns smoothly and quietly without binding.

If the gears do not turn smoothly or quietly, the gears and/or bearing may be damaged or faulty. Replace the final gear case assembly if necessary.



FINAL DRIVE SHIM (MXU 300) ADJUSTMENT/FINAL GEAR CASE (MXU 300) DISASSEMBLY BACKLASH

Hold the pinion gear with the special tool.

Special tool:

Pinion puller set F014

Set the final gear into a jig or vise with soft jaws.



Pinion Puller Set

15. REAR WHEEL/AXLE/SUSPENSION DRIVING MECHANISM

Remove the oil cap and a horizontal type dial indicator on the ring gear through the filler hole.

Turn the ring gear back and forth to read backlash.

Standard:

0.05 – 0.25 mm (0.002 – 0.01 in)

Service limit: 0.4 mm (0.16 in)

Remove the dial indicator. Turn the ring gear 120° and measure backlash.

Repeat this procedure once more.

Compare the difference of the three measurements.

Service limit: 0.2 mm (0.08 in)

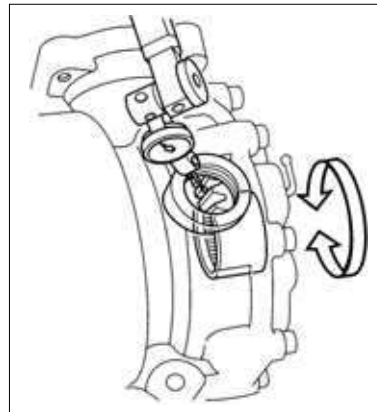

If the difference in measurements exceeds the service limit, it indicates that the bearing is not installed squarely, or the case is deformed.

Inspect the bearings and case.

If the backlash is too small, replace the ring gear right side spacer with a thicker one.

Backlash is changed by about 0.03 mm (0.0012 in) when thickness of the spacer is changed by 0.06 mm (0.0024 in).

Three shims (from A to C) are available in thickness increments of 0.03 mm (0.0012 in).

Right ring gear shims:

A: 1.53 mm (0.0612 in)

B: 1.5 mm (0.06 in)

C: 1.47 mm (0.0588 in)

Left ring gear shims:

A: 1.53 mm (0.0612 in)

B: 1.5 mm (0.06 in)

C: 1.47 mm (0.0588 in)

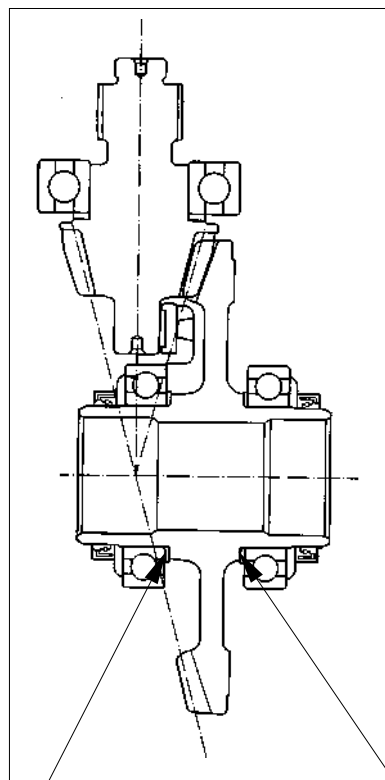

m

15. REAR WHEEL/AXLE/SUSPENSION/ DRIVING MECHANISM

Change the right side shim an equal thickness and opposite amount of what the left side shim was changed; if the left shim was replaced with a 0.03 mm (0.0012 in) thicker shim, replace the right shim with one that is 0.03 mm (0.0012 in) thinner.

FINAL GEAR CASE DISASSEMBLY

Check the oil seal for wear or damage; replace it if necessary.

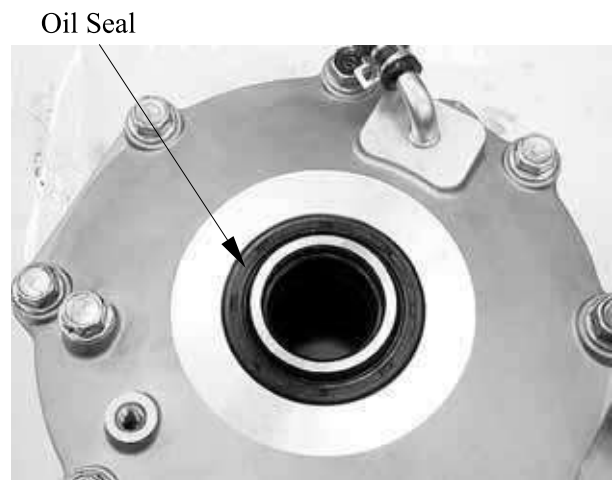

Remove the cover bolts in a crisscross pattern in several steps.

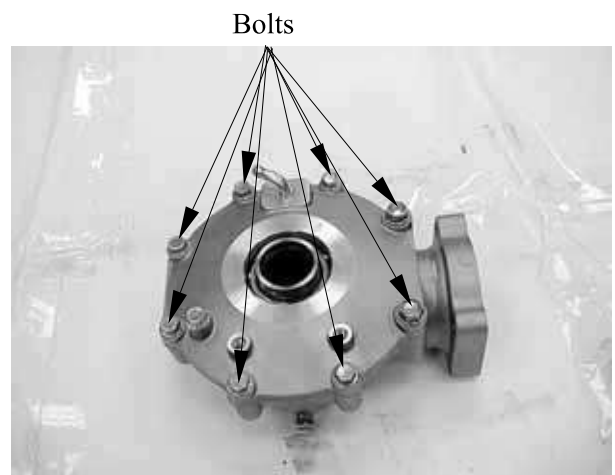

15. REAR WHEEL/AXLE/SUSPENSION DRIVING MECHANISM

Pry the cover at the prying point using a screwdriver.

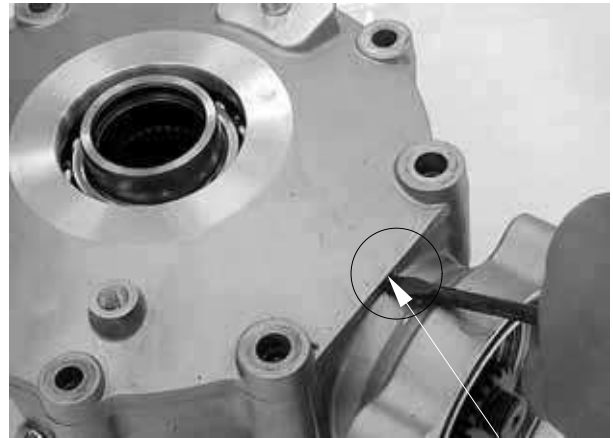

Prying Point

Remove the case cover and right ring gear shim.

Remove the ring gear and left ring gear shim.

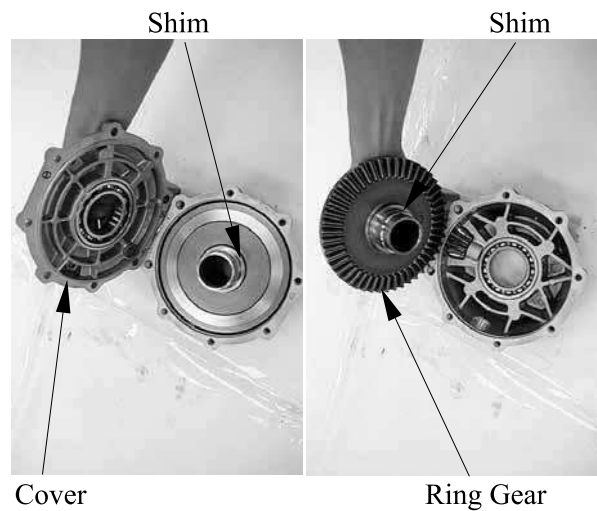

BEARING INSPECTION

Turn the inner race of each bearing in the gear case and case cover with your finger. The bearings should turn smoothly and quietly. Also check that the bearing outer race fits tightly in the case or cover.

For ring gear case and case cover bearing replacement (page 15-34).

For pinion gear removal and bearing replacement (page 15-32).

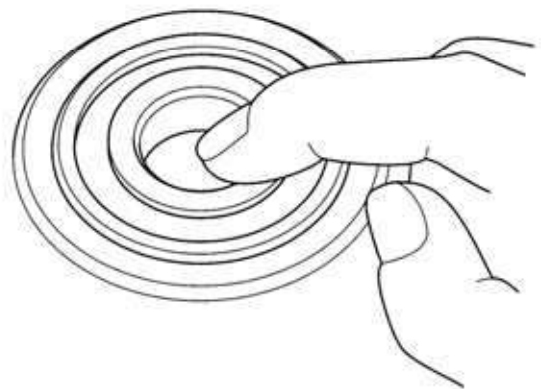

15. REAR WHEEL/AXLE/SUSPENSION/ DRIVING MECHANISM

GEAR TOOTH CONTACT CHECK

Clean sealing material off the mating surfaces of the gear case and cover, being careful not to damage them.

Keep dust and dirt out of the case and cover.

Clean and degrease several teeth on the ring gear and pinion gear, and then apply a coating of machinist's layout dye or paste to several teeth of the pinion gear.

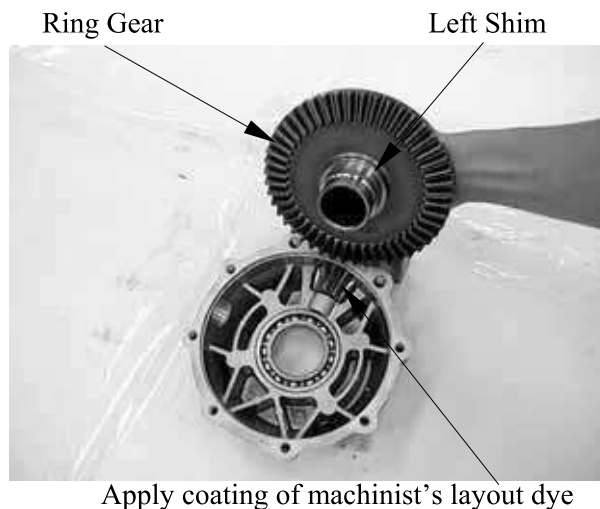

Install the ring gear with the shims into the gear case.

Install the case cover.



Install and tighten the case cover bolts in several steps until the cover evenly touches the gear case. Then, while rotating the pinion gear, tighten the bolts to the specified torque in a crisscross pattern in several steps.

Torque:

10-mm bolt: 49 N-m (5 kgf-m, 36 lbf-ft)

8-mm bolt: 25 N-m (2.6 kgf-m, 19 lbf-ft)

It is important to turn the pinion while tightening the bolts. If the ring gear shim is too thick, the gears will lock after only light tightening.

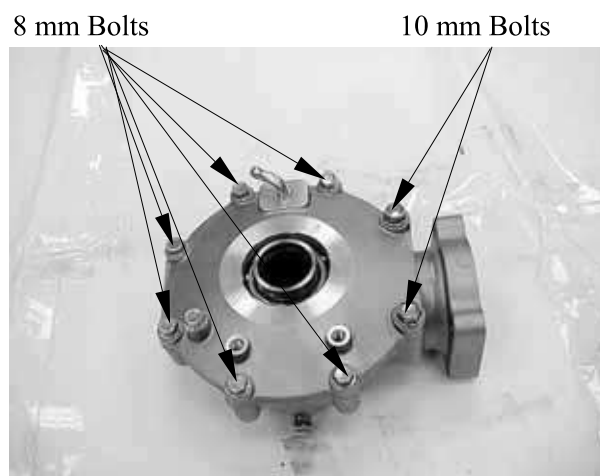

15. REAR WHEEL/AXLE/SUSPENSION DRIVING MECHANISM

Remove the oil cap.

Rotate ring gear several turns in each direction.

Check the gear tooth contact pattern through the oil filler hole.

This will provide a contact pattern on the coated teeth of the gear.

Compare the coated teeth to the examples shown in (1), (2) and (3).

Contact is normal if the machinist's layout dye to the approximate center of each tooth (example (2)).

If tooth contact is found to be incorrect (example (1) and (3)), the shim between the pinion gear bearing and pinion gear must be changed and the tooth contact re-checked until correct.

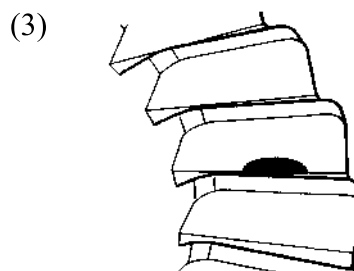
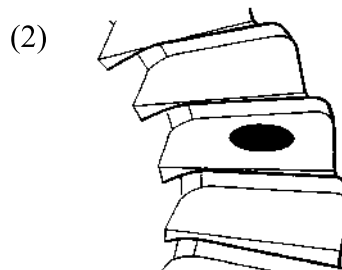
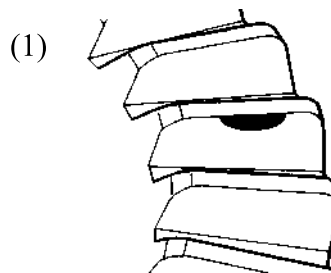

Tooth contact	Shim adjustment
Contact at tooth top (1)	Decrease shim thickness
Contact at tooth root (3)	Increase shim thickness

Make sure to check the backlash and shim thickness after the tooth contact has been adjusted, since it may have changed. Adjust the tooth contact and backlash until they are both within specification. If the correct tooth contact cannot be maintained when adjusting the backlash, replace the pinion gear and ring gear as a set.

Pinion gear shims:

A: 2.03 mm (0.0812 in)

B: 2 mm (0.08 in)

C: 1.97 mm (0.0788 in)

For pinion shim replacement, see next page.

15. REAR WHEEL/AXLE/SUSPENSION/ DRIVING MECHANISM

PINION GEAR REMOVAL

Check the oil seal for wear or damage; replace it if necessary.

Remove the oil seal from the gear case.

Oil Seal



Remove the lock nut using the special tool.

Special tool:

Lock nut wrench F015

Lock Nut

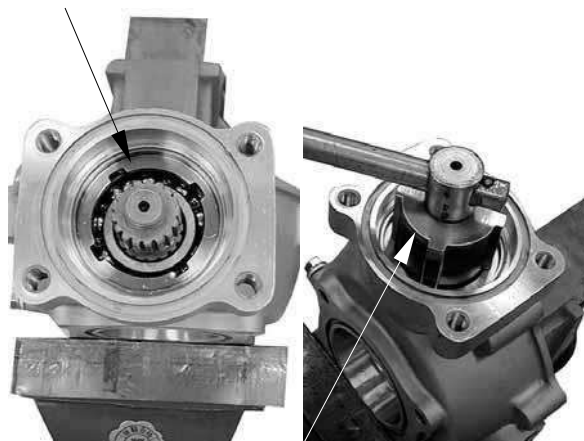

Lock Nut Wrench

Install the special tools onto the pinion gear shaft and gear case.

Special tool:

Pinion puller set F014

Pull the pinion assembly out from the case.

Pinion Puller Set

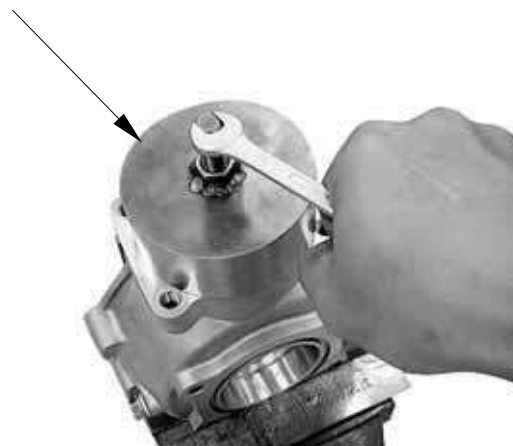

15. REAR WHEEL/AXLE/SUSPENSION DRIVING MECHANISM

PINION GEAR BEARING AND SHIM REPLACEMENT

Pull the pinion bearing from the shaft with a commercially available bearing puller.

Remove the pinion shim.

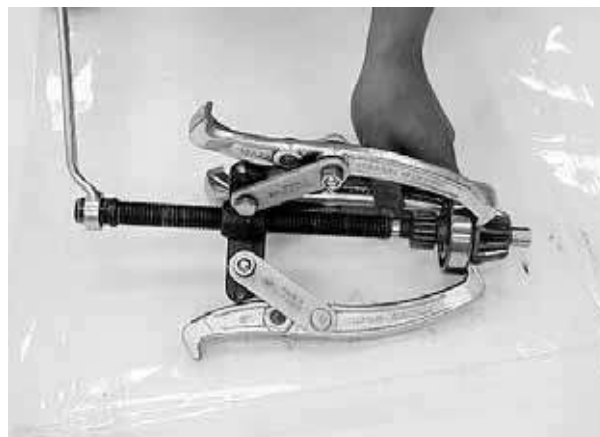

Install the shim and bearing onto the pinion gear.

When the gear set, ring gear bearing, and/or gear case has been replaced, use a 2 mm (0.08 in) thick shim for initial reference.

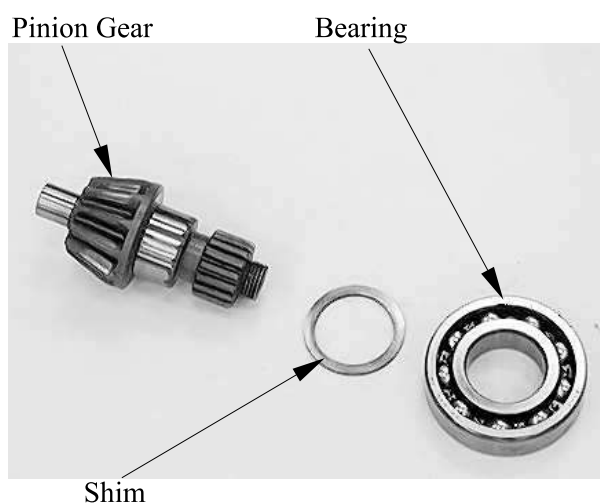

Drive the bearing with the marked side facing up.



15. REAR WHEEL/AXLE/SUSPENSION/ DRIVING MECHANISM

FINAL GEAR CASE BEARING REPLACEMENT

CASE BEARING:
Remove the oil seal.

Drive the ring gear bearing out of the case.

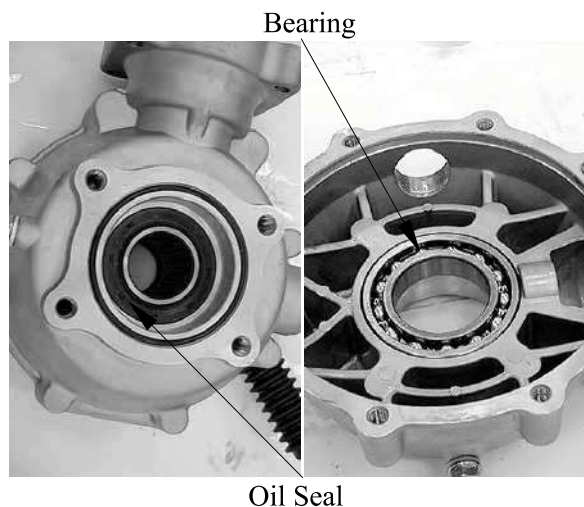

CASE COVER BEARING:
Remove the oil seal.

Drive the ring gear bearing out of the case
cover.

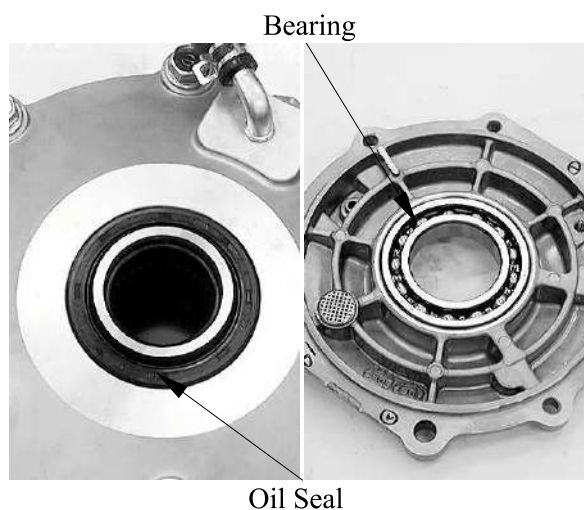

Drive each bearing into the case and cover.

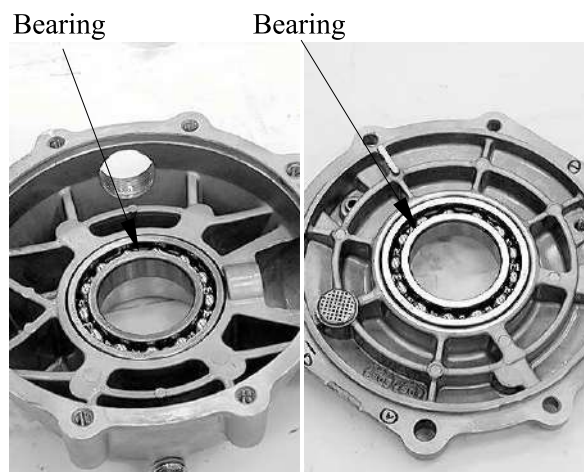

15. REAR WHEEL/AXLE/SUSPENSION DRIVING MECHANISM

Apply grease to new oil seal lips.
Install each oil seal with the flat side facing out until it is flush with the case or cover.

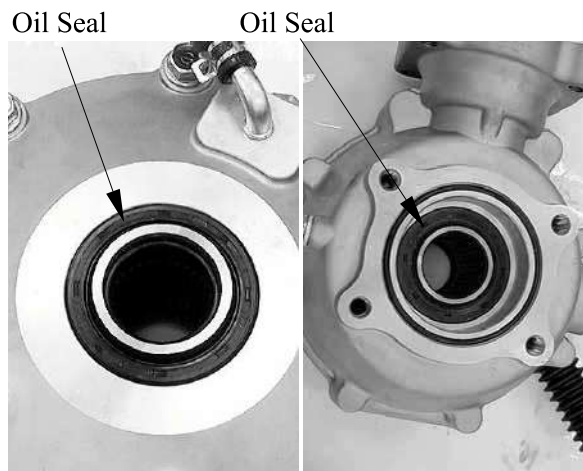

PINION NEEDLE BEARING

Remove the pinion gear (page 15-32).

Remove the snap ring.

Heat the gear case to 80° (176°F) and remove needle bearing.

Be sure to wear heavy gloves to avoid burns when handling the heated case cover.

Using a torch to heat the case cover may cause warpage.



Snap Ring/Needle Bearing

Drive the needle bearing into the case.
Install the snap ring.

Apply molybdenum disulfide grease to the needle bearing.

PINION GEAR INSTALLATION

Drive the pinion assembly into the gear case.

Keep the driver centered with the bearing outer race during installation.



15. REAR WHEEL/AXLE/SUSPENSION/ DRIVING MECHANISM

Install a new lock nut and tighten it to the specified torque using the special tools.

Special tool:

Lock nut wrench F015

Torque: 100 N-m (10 kgf-m, 72 lbf-ft)

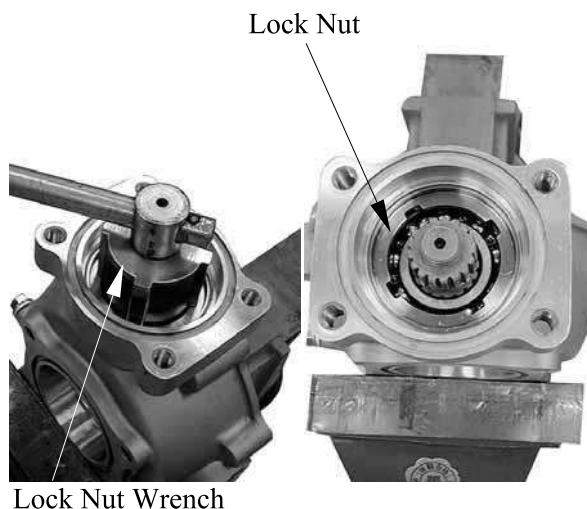

Apply grease to a new oil seal lips and install it into the gear case until it is fully seated.



FINAL GEAR CASE (MXU 300) ASSEMBLY

When the gear set, bearing, and/or gear case has been replaced, check the tooth contact pattern (page 15-30) and gear backlash (page 15-26).

Clean the mating surface of the gear case and cover, being careful not to damage them.

Keep dust and dirt out of the case and cover.

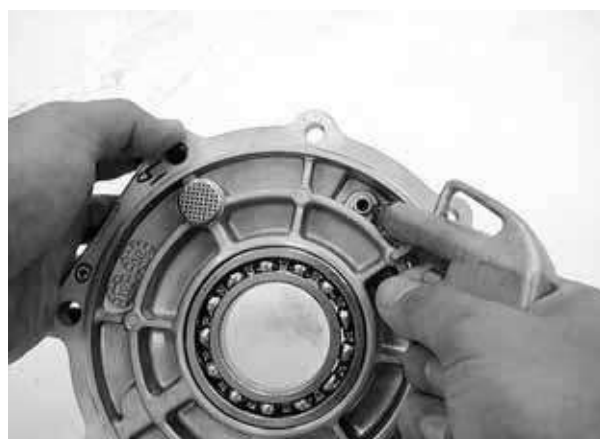

Blow compressed air through the breather hole in the gear case.

15. REAR WHEEL/AXLE/SUSPENSION DRIVING MECHANISM

Install the proper ring gear shims onto the ring gear and install them into the gear case.

Apply liquid sealant to the mating surface of the case cover.

Install the case cover over the gear case.

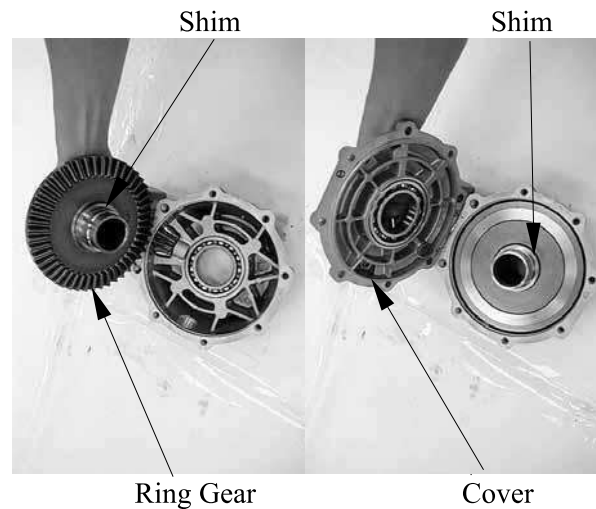

Apply locking agent to the threads of the two 10 mm bolts.

Install and tighten the case cover bolts in several steps until the cover evenly touches the gear case. Then, while rotating the pinion gear, tighten the bolts to the specified torque in a crisscross pattern in several steps.

Torque:

10-mm bolt: 49 N-m (5 kgf-m, 36 lbf-ft)

8-mm bolt: 25 N-m (2.6 kgf-m, 19 lbf-ft)

8 mm Bolts 10 mm Bolts

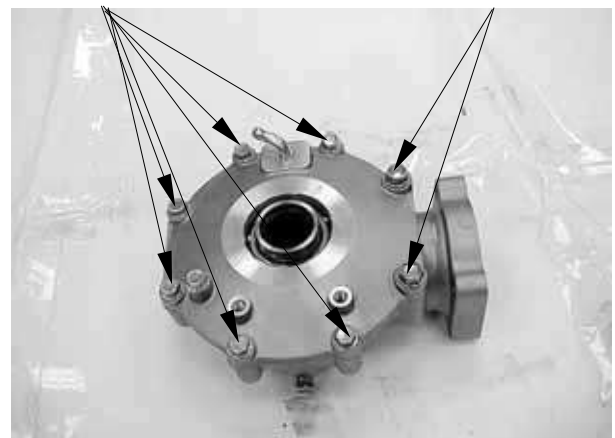

It is important to turn the pinion while tightening the bolts. If the ring gear shim is too thick, the gears will lock after only light tightening.

15. REAR WHEEL/AXLE/SUSPENSION/ DRIVING MECHANISM

Make sure that the gear assembly rotates smoothly without binding.



SWINGARM (MXU 300) SWINGARM INSPECTION/BEARING REPLACEMENT

Inspect the dust seal for wear or damage.
If any damages are found, replace them with
new ones.

Remove the dust seals.
Remove the swingarm bearing.

Dust Seal



Bearing

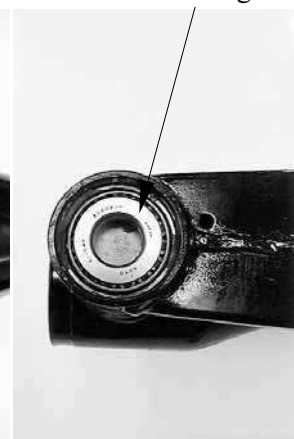

Inspect the swingarm bearing, outer race
and bearing plate, if any damages are found,
replace the swingarm bearing with a new
one.

Bearing



Outer Race

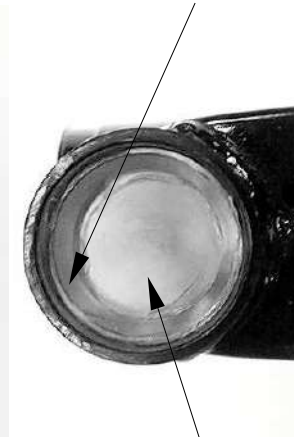

Bearing Plate

15. REAR WHEEL/AXLE/SUSPENSION DRIVING MECHANISM

Remove the swingarm bearing race and bearing plate by using the special tool.

Special tool: Bearing puller E037

The removed bearing and dust seal must be replaced with new ones.

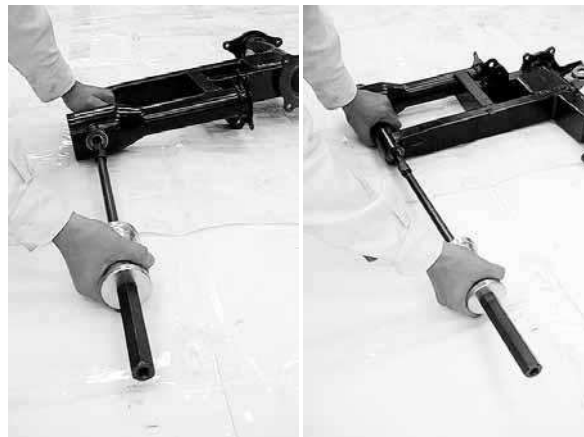

Install the new swingarm bearing race and its new plate to the swingarm by using the special tool.

Special tool:

Oil seal & bearing installer E014

When installing the bearing plate, make sure that the bulge of bearing plate faces inside.

Apply grease to the swingarm bearing and lips of dust seals, then install them into the swingarm with the special tool.

Special tool:

Oil seal & bearing installer E014



Bearing/Dust Seal

Remove the three bolts and dust plate.

Check the dust seal for wear or damage.

Remove the O-ring.

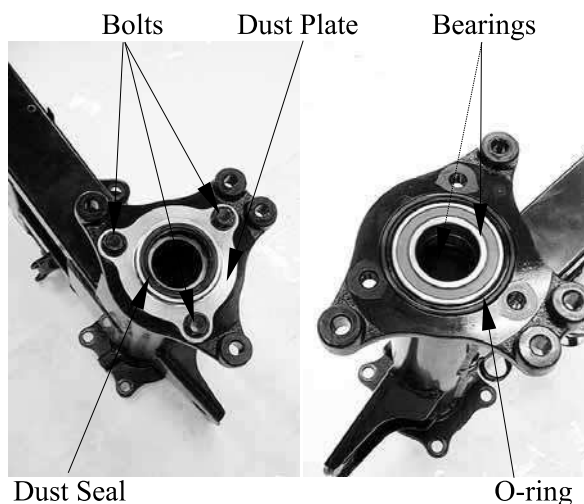

15. REAR WHEEL/AXLE/SUSPENSION/ DRIVING MECHANISM

Drive the rear axle bearing out of the left axle housing.

Drive in the new bearings squarely until it is fully seated.

Special tool:
Oil seal & bearing installer E014

Pack 3 g (0.1 oz) of grease into bearing cavity.



REAR DRIVING MECHANISM (MXU 300) INSTALLATION

Apply grease to new O-ring and install it into the groove in the swingarm.

Install the dust plate and tighten the three bolts securely.

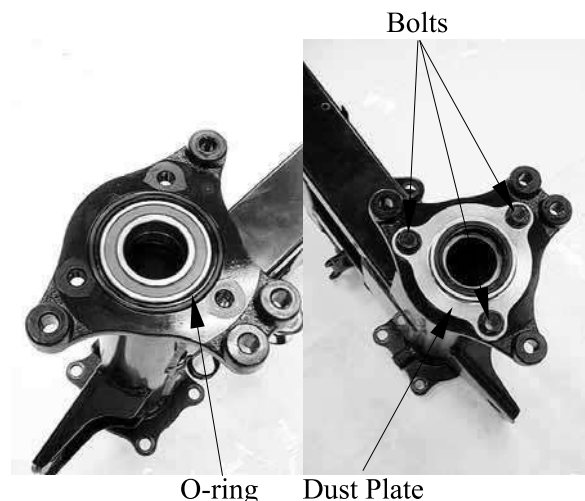

Clean the mating surfaces of the gear case and swingarm.

Coat new O-rings with grease and install them into the grooves in the gear case.

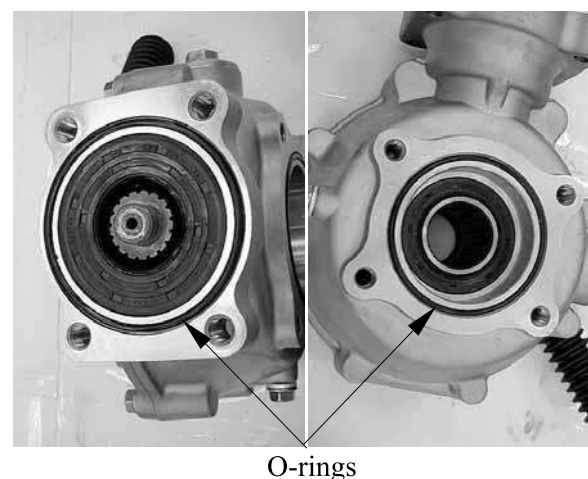

15. REAR WHEEL/AXLE/SUSPENSION DRIVING MECHANISM

Apply molybdenum disulfide grease to the center splines of the rear axle.

Install the rear axle into the final gear case from left side until it is fully seated.

Apply Grease

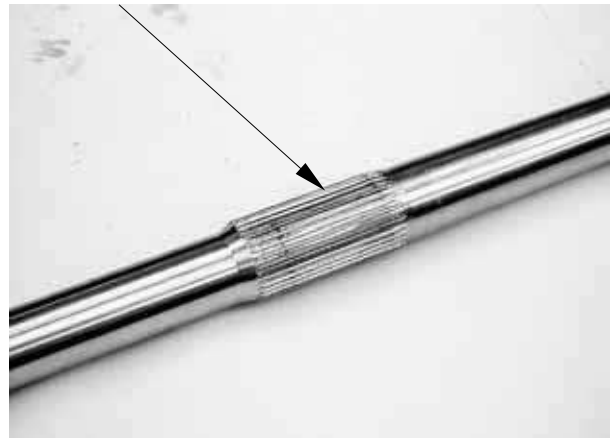

Install the rear axle into the axle housing from swingarm right side and install final gear case.

Install and tighten the mounting bolts in several steps to the specified torque.

Torque: 55 N-m (5.5 kgf-m, 40 lbf-ft)

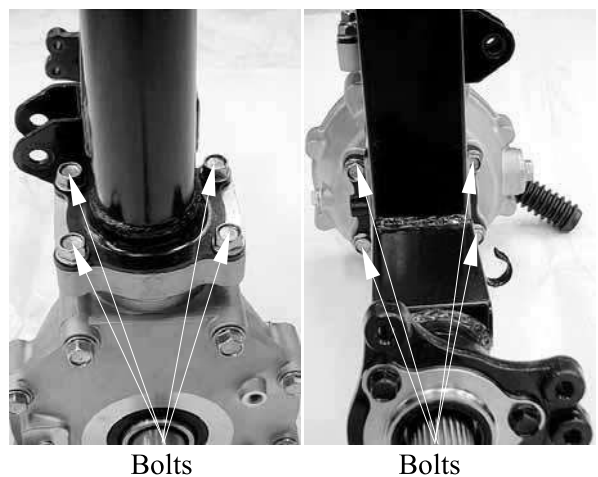

Apply molybdenum disulfide grease to the universal joint splines and the drive shaft splines.

Apply molybdenum disulfide grease to the drive shaft splines.

Install the spring into the drive shaft

Apply Grease

Spring



Apply Grease

15. REAR WHEEL/AXLE/SUSPENSION/ DRIVING MECHANISM

Set the drive shaft assembly into the swingarm, then secure drive shaft and spring onto the pinion gear shaft in the final gear case.

Drive Shaft/Spring



Pack 3 g (0.1 oz) of grease into each bearing cavity.

Apply grease to the new dust seal lips and install them into the swingarm pivot until they are flush.

Apply Grease



Apply Grease

Apply molybdenum disulfide grease to the universal joint splines and the secondary driven bevel gear shaft splines.

Set the swingarm into the frame and engage the universal joint onto the secondary driven bevel gear shaft.

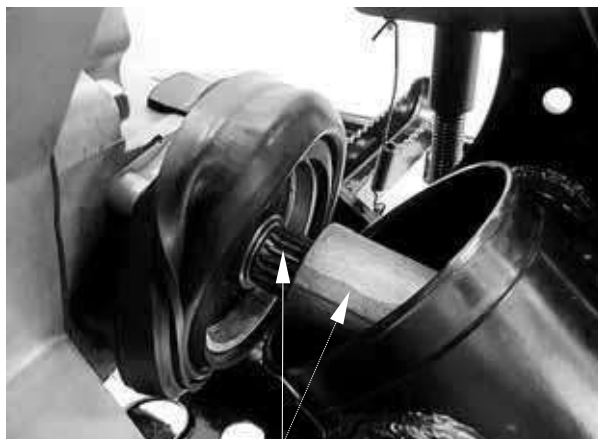

Apply Grease

15. REAR WHEEL/AXLE/SUSPENSION DRIVING MECHANISM

Install the right pivot bolt and the left pivot adjusting bolt.

Tighten the right pivot bolt to the specified torque.

Actual: 11.8 kgf-m (118 N-m, 85 lbf-ft)

Tighten the left pivot adjusting bolt to the specified torque.

Torque: 1.1 kgf-m (11 N-m, 8 lbf-ft)

Move the swingarm up and down several times to seat the pivot bearings.
Retighten the pivot bolts to the same torque.

Install the left pivot lock nut.
Tighten the lock nut while holding the left pivot adjusting bolt to the specified torque.

Special tool: Lock nut wrench F013

Torque:
Actual: 11.8 kgf-m (118 N-m, 85 lbf-ft)
Special tool indicated:
10.5 kgf-m (105 N-m, 76 lbf-ft)

Install the shock absorber (page 15-16).

Install the brake fluid hose band and tighten the bolt securely.

Fill the final gear case with recommended oil (page 3-13)

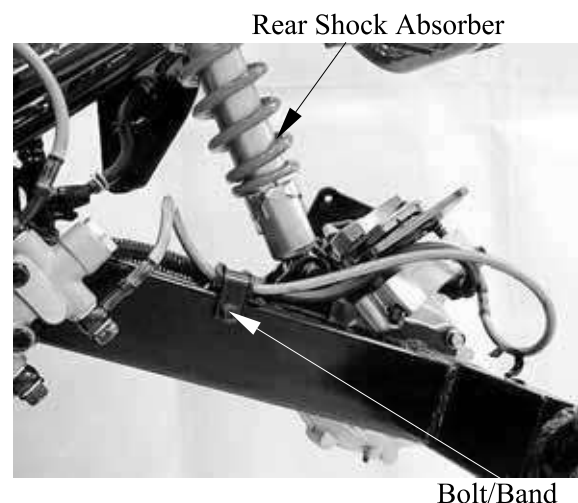
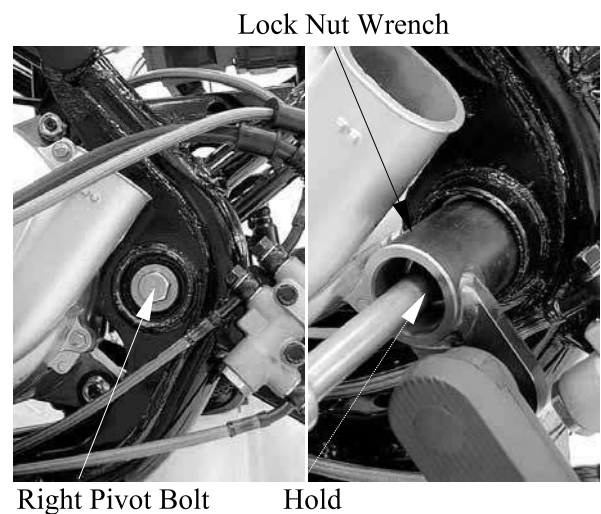

15. REAR WHEEL/AXLE/SUSPENSION/ DRIVING MECHANISM

Apply molybdenum disulfide grease to the disk holder splines and the rear axle splines.

Install the rear brake disk.

Install the brake calipers (page 13-22).

Install the rear wheel hubs and wheels (15-5).

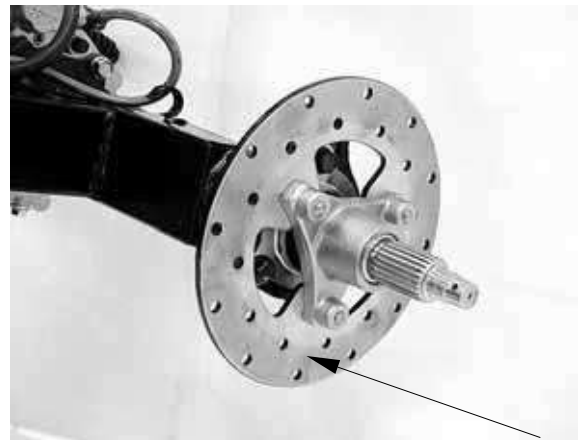

Disk

**BATTER/CHARGING SYSTEM/
A.C. GENERATOR**

SERVICE INFORMATION-----	16- 2
TROUBLESHOOTING-----	16- 3
BATTERY -----	16- 4
CHARGING SYSTEM -----	16- 7
REGULATOR/RECTIFIER-----	16- 8
A.C. GENERATOR INSPECTION -----	16- 9

16. BATTERY/CHARGING SYSTEM/ A.C. GENERATOR

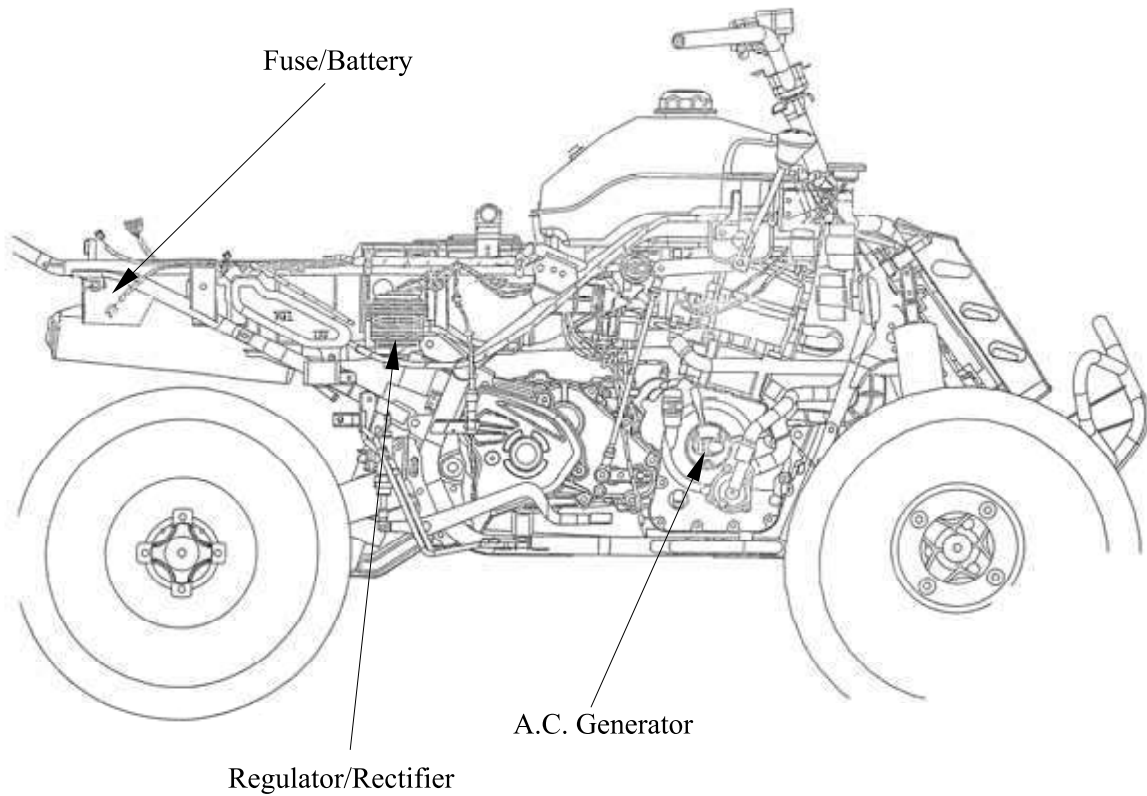

CHARGING CIRCUIT

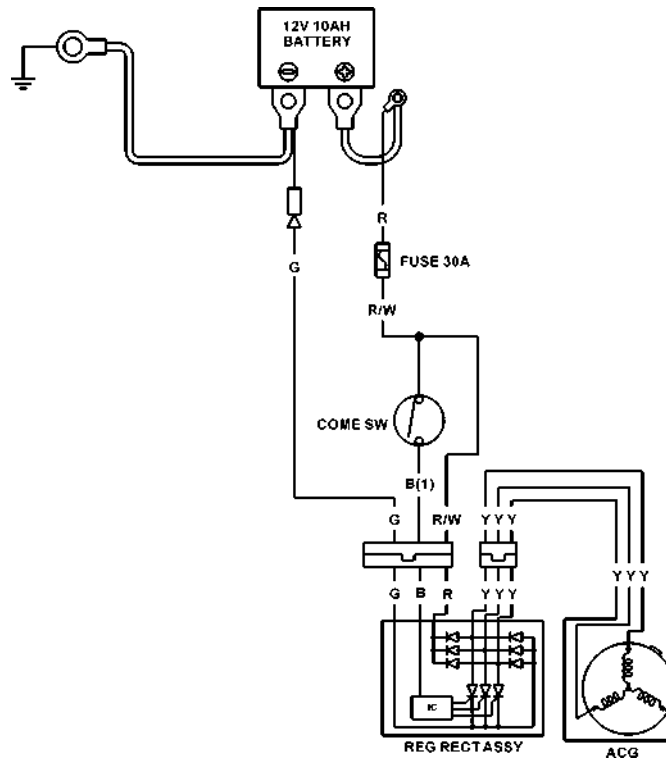

SERVICE INFORMATION

GENERAL INSTRUCTIONS

The battery electrolyte (sulfuric acid) is poisonous and may seriously damage the skin and eyes. Avoid contact with skin, eyes, or clothing. In case of contact, flush with water and get prompt medical attention

- The battery can be charged and discharged repeatedly. If a discharged battery is not used for a long time, its service life will be shortened. Generally, the capacity of a battery will decrease after it is used for 2~3 years. A capacity-decreased battery will resume its voltage after it is recharged but its voltage decreases suddenly and then increases when a load is added.
- When a battery is overcharged, some symptoms can be found. If there is a short circuit inside the battery, no voltage is produced on the battery terminals. If the rectifier won't operate, the voltage will become too high and shorten the battery service life.
- If a battery is not used for a long time, it will discharge by itself and should be recharged every 3 months.
- A new battery filled with electrolyte will generate voltage within a certain time and it should be recharged when the capacity is insufficient. Recharging a new battery will prolong its service life.
- Inspect the charging system according to the sequence specified in the Troubleshooting.
- Do not disconnect and soon reconnect the power of any electrical equipment because the electronic parts in the regulator/rectifier will be damaged. Turn off the ignition switch before operation.
- It is not necessary to check the MF battery electrolyte or fill with distilled water.
- Check the load of the whole charging system.
- Do not quick charge the battery. Quick charging should only be done in an emergency.
- Remove the battery from the machine for charging.
- When replacing the battery, do not use a traditional battery.
- When charging, check the voltage with a voltmeter.

SPECIFICATIONS

Item		Standard	
Battery	Capacity/Model	12V-12AH	
	Voltage (20°C)	Fully charged	13.1V
		Undercharged	12.3V
	Charging current	STD: 1.2A Quick: 3.0A	
	Charging time	STD: 5~10hr Quick: 30min	
A.C. Generator	Capacity	MXU 300	200 W/5000 RPM
		MXU 250	150 W/5000 RPM
	Charging Limit voltage		13.5~15.5V

TORQUE VALUES

A.C.G. flywheel nut 6 kgf-m (60 Nm, 43 lbf-ft)

SPECIAL TOOLS

Flywheel holder E021
 Flywheel puller E003

TESTING INSTRUMENTS

Electric tester

TROUBLESHOOTING

No power

- Dead battery
- Disconnected battery cable
- Fuse burned out
- Faulty ignition switch

Low power

- Weak battery
- Loose battery connection
- Charging system failure
- Faulty regulator/rectifier

Intermittent power

- Loose battery cable connection
- Loose charging system connection
- Loose connection or short circuit in lighting system

Charging system failure

- Loose, broken or shorted wire or connector
- Faulty regulator/rectifier
- Faulty A.C. generator

16. BATTERY/CHARGING SYSTEM/ A.C. GENERATOR

BATTERY

REMOVAL/INSTALLATION

1. Make sure the ignition switch is OFF.
2. Pull right the lock lever and pull up the seat at the rear.

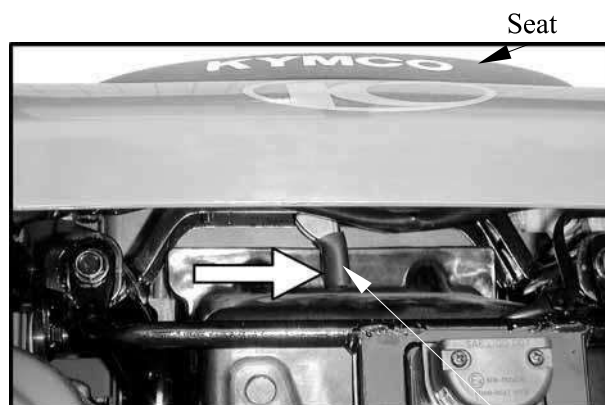

Lock Lever

3. ON ROAD:
Hang license light holder (1), by removing the left mount bolt (2) and loosen the right mount bolt (3)

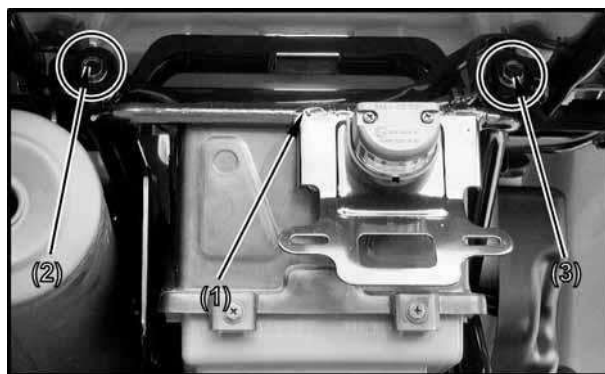

4. Remove the battery cover (4) by removing the screws (5).



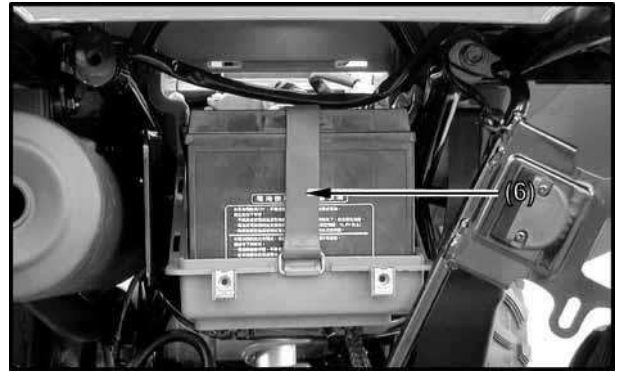

16. BATTERY/CHARGING SYSTEM/ A.C. GENERATOR

5. Release the rings and remove the rubber band (6).

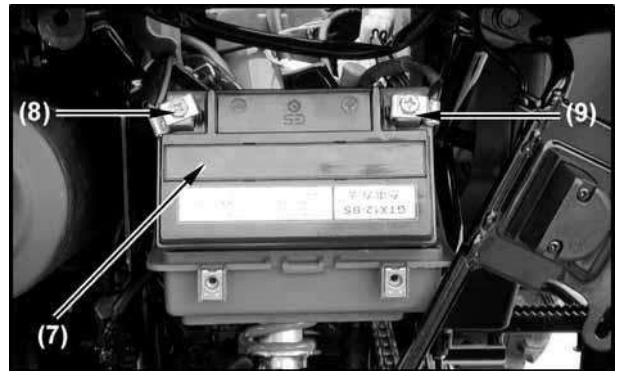

6. Shift the battery (7) and the terminal leads face you.
7. Disconnect the negative (-) terminal lead (8) from the battery first, then disconnect the positive (+) terminal lead (9).
8. Remove the battery.



 When disconnecting the battery positive (+) cable, do not touch the frame with tool; otherwise it will cause short circuit and sparks to fire the fuel.

INSTALLATION

1. Installation is in the reverse order of removal.

 First connect the positive (+) cable and then negative (-) cable to avoid short circuit.

2. Make sure the battery is installed upright as shown
3. Check all bolts and other fasteners are secure.
4. After installing the battery, check to see if the battery cables are routed correctly.



BATTERY VOLTAGE (OPEN CIRCUIT VOLTAGE) INSPECTION

Remove the seat.
Disconnect the battery cables.
Measure the voltage between the battery terminals.

Fully charged : 13.1V

Undercharged : 12.3V max

* Battery charging inspection must be performed with a voltmeter.



CHARGING

Connect the charger positive (+) cable to the battery positive (+) terminal.
Connect the charger negative (-) cable to the battery negative (-) terminal.

- Keep flames and sparks away from a charging battery.
- Turn power ON/OFF at the charger, not at the battery terminals to prevent sparks near the battery to avoid explosion.
- Charge the battery according to the current specified on the battery.

* Quick charging should only be done in an emergency.
• Measure the voltage 30 minutes after the battery is charged.

Charging current: Standard : 1.2A

Quick : 3.0A

Charging time : Standard : 5 ~ 10 hours

Quick : 30 minutes

After charging: Open circuit voltage: 12.8V min.



CHARGING SYSTEM

CURRENT LEAKAGE TEST

Remove the seat (see page 2-3).
Turn the ignition switch “OFF”, and disconnect the negative (-) cable from the battery.
Connect the ammeter (+) probe to the negative (-) cable and the ammeter (-) probe to the battery (-) terminal.
With the ignition switch “OFF”, check for current leakage.



- * ● When measuring current using a tester, set it to a high range, and then bring the range down to an appropriate level. Current flow higher than the range selected may blow out the fuse in the tester.
- While measuring current, do not turn the ignition switch “ON”. A sudden surge of current may blow out the fuse in the tester.

Specified current leakage:

1 mA maximum

If current leakage exceeds the specified value, a shorted circuit is likely.

Locate the short by disconnecting connections one by one and measuring the current.

CHARGING VOLTAGE INSPECTION

Start the engine and warm it up to operating temperature; stop the engine.

Connect the multi-meter between the positive and negative terminals of the battery.

- * ● Make sure the battery is in good condition before performing this test.
- To prevent a short, make absolutely certain which are the positive and negative terminals or cable.



With the headlight on high beam, restart the engine. Measure the voltage on the multimeter when the engine runs at 5000 rpm.

Limit Voltage/Current: 13.5~15.5V/0.5A
max.

16. BATTERY/CHARGING SYSTEM/ A.C. GENERATOR

REGULATOR/RECTIFIER

INSPECTION

Remove the right side cover. (Refer to chapter 2)
Remove the regulator/rectifier wire connectors.
Check the continuity between the wire terminals.

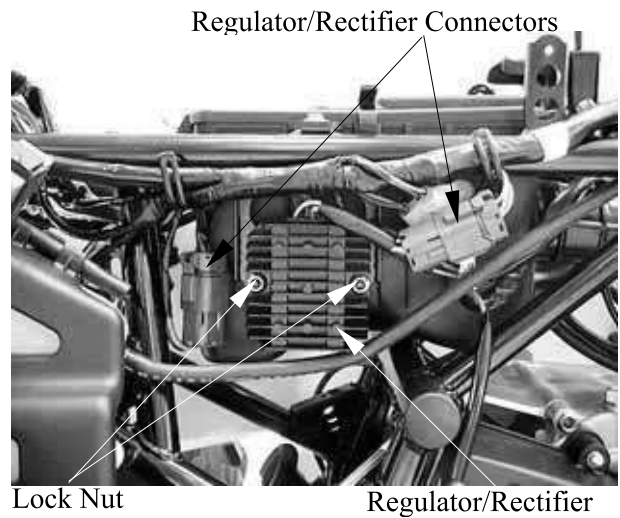

Normal Direction: Continuity

	(+) Probe	(-) Probe
I	Yellow	Green
II	Red/White	Yellow

Reverse Direction: No Continuity

	(+) Probe	(-) Probe
I	Green	Yellow
II	Yellow	Red/White

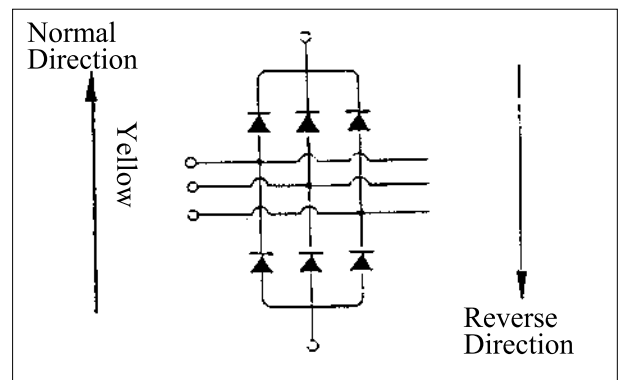

VOLTAGE REGULATION TEST

Connect a voltmeter across the battery terminals.
Start the engine and gradually increase the engine speed.
The battery terminal voltage should be within 14.0~15.0V.

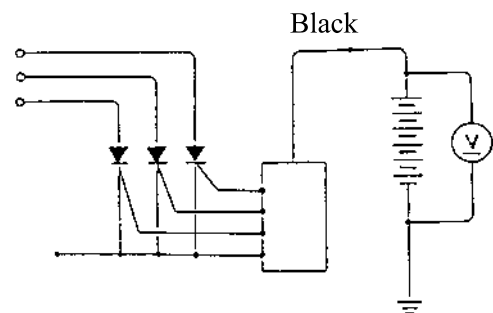

A.C. GENERATOR INSPECTION

* This test can be made without removing the stator from the engine.

Disconnect the A.C. generator connector. Check the continuity between the yellow wires and ground.

There should be continuity between the yellow wires and no continuity between each yellow wire and ground.

Resistance (at 20°C):

Yellow~Yellow	1.6~2.5Ω
---------------	----------



A.C. GENERATOR/FLYWHEEL REMOVAL

Remove the right crankcase cover. (Refer to the “WATER PUMP SHAFT REMOVAL” section in the chapter 12)

Remove the pulser coil screws and then remove the A.C. generator wire set plate. Remove the A.C. generator bolts and then remove A.C. generator and pulser coil from right crankcase cover.

* When removing the pulser coil and stator, be careful not to damage them to avoid shorted or broken wire.

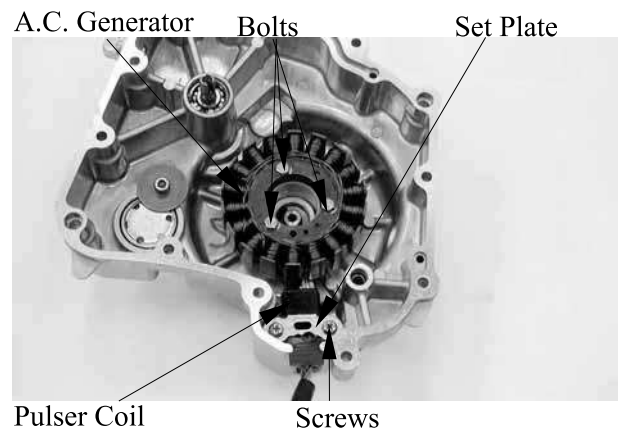

Remove the oil through guide and spring.



16. BATTERY/CHARGING SYSTEM/ A.C. GENERATOR

Hold the flywheel with a flywheel holder and remove flywheel nut and wash.

Special tool:

Flywheel holder E021

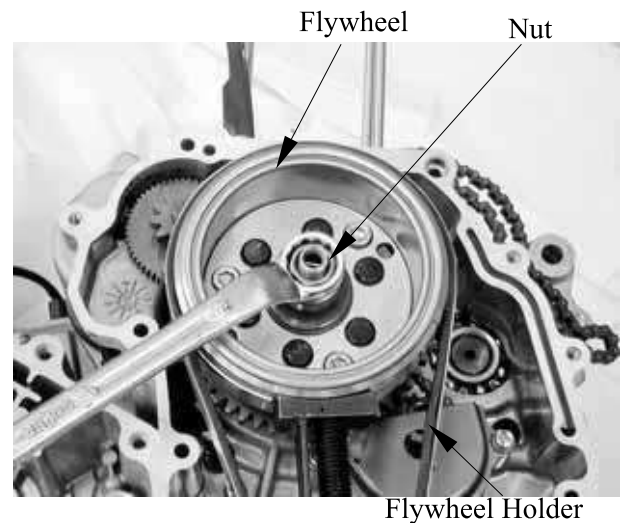

Remove the flywheel with a flywheel puller.

Special tool:

Flywheel puller E003



INSTALLATION

Reverse the “REMOVAL” procedures.
Install the flywheel, washer and tighten the nut.

Torque: 6 kgf-m (60 Nm, 43 lbf-ft)

*

- Before installation, check and make sure that the inside of the flywheel is not contaminated.
- Make sure install the flywheel onto the crankshaft by aligning the key on the crankshaft with the groove in the flywheel.

Install the oil through guide and spring.
Install the A.C. generator onto the right crankcase cover and tighten the bolts.

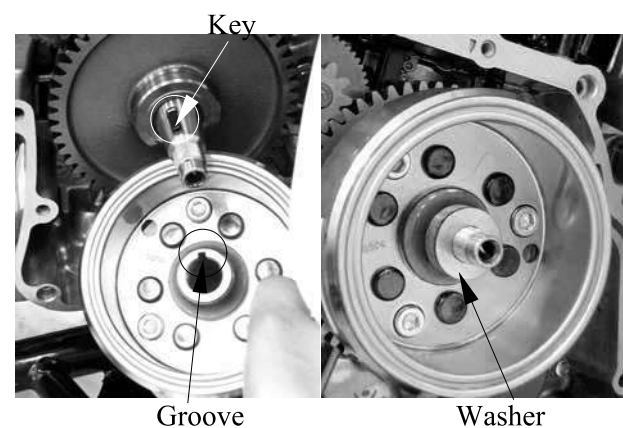

Torque: 0.9 kgf-m (9 Nm, 6.5 lbf-ft)

Install the right crankcase cover.

IGNITION SYSTEM

SERVICE INFORMATION-----	17- 2
TROUBLESHOOTING-----	17- 3
IGNITION UNIT /CHANGE GEAR CONTROL INSPECTION-----	17- 4
IGNITION COIL INSPECTION-----	17- 6
PULSER COIL -----	17- 7

17. IGNITION SYSTEM

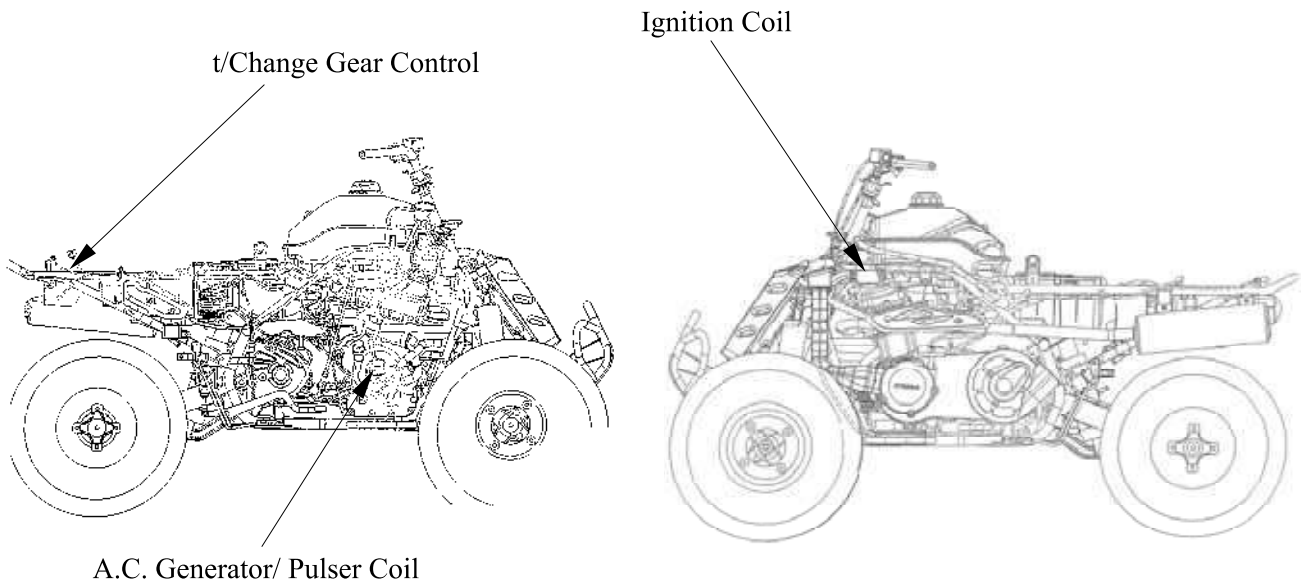

IGNITION CIRCUIT (ON ROAD)

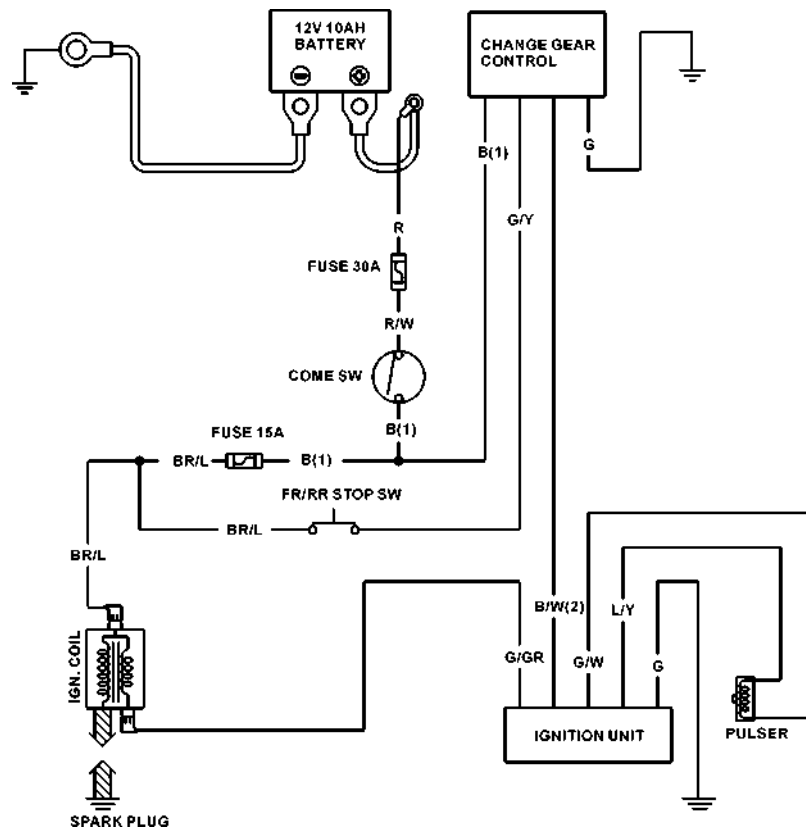

IGNITION CIRCUIT (OFF ROAD)

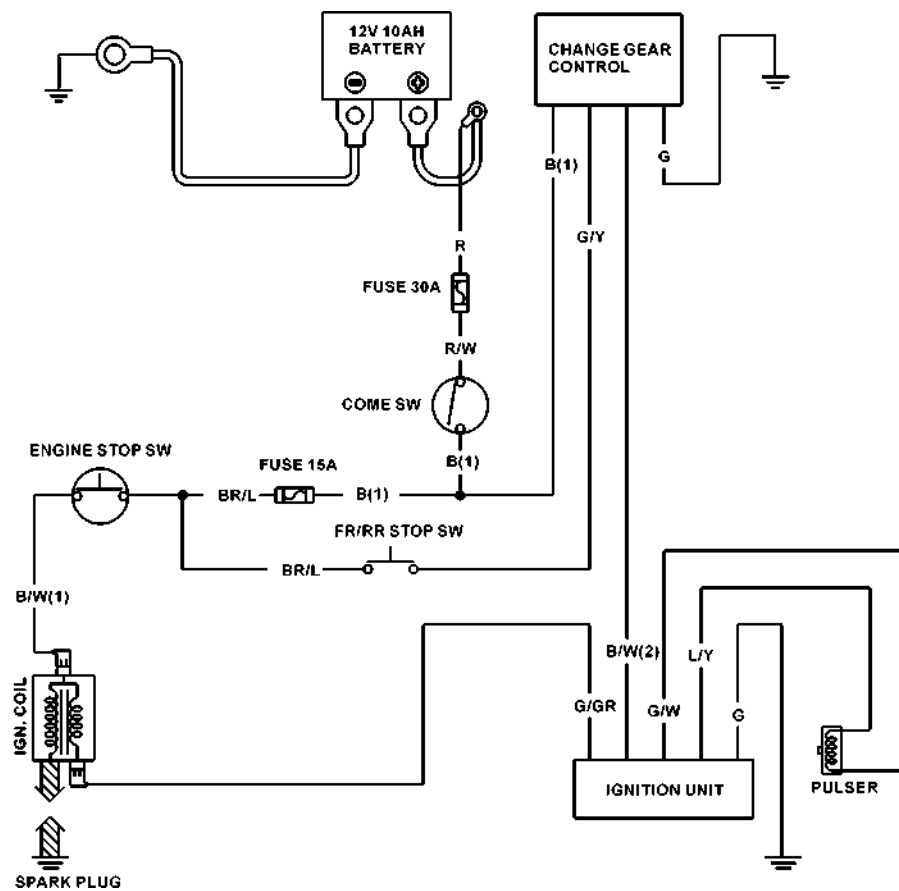

SERVICE INFORMATION

GENERAL INSTRUCTIONS

- Check the ignition system according to the sequence specified in the Troubleshooting.
- The ignition system adopts ignition unit, change gear control and the ignition timing cannot be adjusted.
- If the timing is incorrect, inspect the ignition unit, A.C. generator, change gear control and replace any faulty parts. Inspect the ignition unit with a ignition unit tester
- Loose connector and poor wire connection are the main causes of faulty ignition system. Check each connector before operation.
- Use of spark plug with improper heat range is the main cause of poor engine performance.
- The inspections in this section are focused on maximum voltage. The inspection of ignition coil resistance is also described in this section.
- Inspect the spark plug referring to chapter 3.

17. IGNITION SYSTEM

SPECIFICATIONS

Item		Standard	
Spark plug	Standard type	DPR7EA-9	
Spark plug gap		0.6~0.7mm	
Ignition timing	“F” mark Full advance	5°±1°BTDC/1000RPM	
Ignition coil resistance (20°C)	Primary coil	3.4~4.1Ω	
	Secondary coil	without plug cap	14.45KΩ
		with plug cap	19.8KΩ
Pulser coil resistance (20°C)		105~110Ω	
Ignition coil primary side max. voltage		14V	
Pulser coil max. voltage		1.6V	
Exciter coil max. voltage		14V	

TESTING INSTRUMENT

Commercially available electric tester with resistance over 10MΩ/CDV.

TROUBLESHOOTING

High voltage too low

- Weak battery or low engine speed
- Loose ignition system connection
- Faulty ignition unit

- Faulty ignition coil

- Faulty pulser coil

Normal high voltage but no spark at plug

- Faulty spark plug
- Electric leakage in ignition secondary circuit
- Faulty ignition coil

Good spark at plug but engine won't start

- Faulty ignition unit or incorrect ignition timing
- Faulty change gear control unit
- Improperly tightened A.C. generator flywheel

No high voltage

- Faulty ignition switch
- Faulty ignition unit
- Poorly connected or broken ignition unit ground wire
- Dead battery or faulty regulator/rectifier
- Faulty ignition coil connector
- Faulty pulser coil

17. IGNITION SYSTEM

IGNITION UNIT /CHANGE GEAR CONTROL INSPECTION

Remove the seat. (Refer to the chapter 2)
 Disconnect the ignition unit coupler and remove the ignition unit.
 Disconnect the change gear control coupler and remove the change gear control.
 Measure the resistance between the terminals using the electric tester.

- *
- Due to the semiconductor in circuit, it is necessary to use a specified tester for accurate testing. Use of an improper tester in an improper range may give false readings.
 - Use a YF-3501 Electric Tester.
 - In this table, “Needle swings then returns” indicates that there is a charging current applied to a condenser. The needle will then remain at “∞” unless the condenser is discharged.

Change Gear Control



Ignition Unit

Ignition Unit



IGNITION UNIT INSPECTION

Testing Range (at 20°C)

Unit: Ω

Probe⊕ (-)Probe	Blue/ Yellow	Green / Gray	Black / White	Green/ White	Black/ Yellow	Green
Blue/ Yellow		∞	10.56M	90.4K	10.56M	46K
Green / Gray	12.73M		∞	12.73M	∞	12.73M
Black / White	∞	∞		∞	999	∞
Green/ White	90.4K	∞	10.56M		10.56M	46K
Black/ Yellow	∞	∞	999	∞		∞
Green	44.4K	∞	10.56M	44.4K	10.56M	

Note: The readings in this table are taken with a YF-3501 Tester.

17. IGNITION SYSTEM

Test the ignition unit using the ignition unit tester.

* Operate the ignition unit tester by following the manufacturer's instructions.

Connect the special connector to the ignition unit coupler and ignition unit tester.

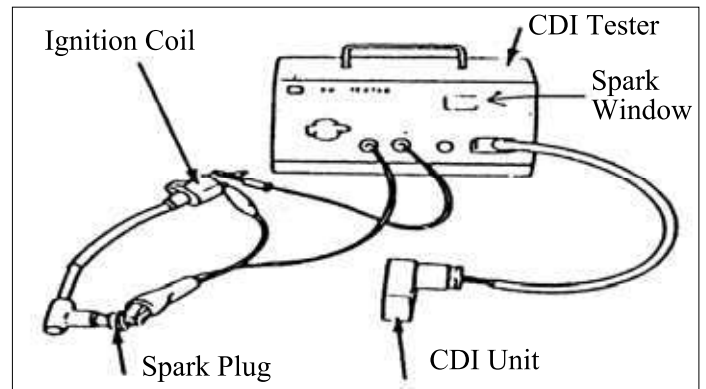

Switch Range	Good CDI	Faulty CDI
1. OFF	No spark	—
2. P	No spark	—
3. EXT	No spark	Good spark
4. ON1	Good spark	No spark
5. ON2	Good spark	No spark

If the ignition unit is faulty, replace it with a new one.

Change Gear Control



CHANGE REAR CONTROL INSPECTION

Testing Range(at 20°C)

Unit: Ω

Probe⊕ (-)Probe	Green	Yellow/ Brown	Light Green/ Red	Green/ Pink	Green/ Yellow	Black/ White	Black
Green		14	∞	∞	7.85M	7.85M	10K
Yellow/ Brown	18		∞	∞	7.85M	7.85M	10K
Light Green/ Red	7.85M	7.85M		11	∞	∞	7.85M
Green/ Pink	7.85M	7.85M	9		∞	∞	7.85M
Green/ Yellow	∞	∞	∞	∞			∞
Black/ White	∞	∞	∞	∞	11		∞
Black	10K	10K	∞	∞	7.85M	7.85M	

Note: The readings in this table are taken with a YF-3501 Tester.

17. IGNITION SYSTEM

IGNITION COIL INSPECTION CONTINUITY TEST

Remove the front fender. (Refer to the chapter 2)
Remove the spark plug cap. (Refer to the chapter 6)
Disconnect the ignition coil wires.

* This test is to inspect the continuity of ignition coil.

Measure the resistance between the ignition coil primary coil terminals.

Resistance: 3.4~4.1Ω/20°C



Ignition Coil

Remove the spark plug cap and measure the secondary coil resistance between the spark plug wire and the primary coil terminal.

Resistance:

(with plug cap): 19.8KΩ/20°C

(without plug cap): 14.45KΩ/20°C

* This test is for reference only. Accurate test should be performed with a CDI tester.



17. IGNITION SYSTEM

Measure the spark plug cap resistance.
Remove the spark plug cap and measure the spark plug resistance.
Resistance: 4.2~5.2K Ω /20°C

- * Measure the resistance in the XK Ω range of the electric tester.



PERFORMANCE TEST

Test the performance with a ignition unit tester.

- *
- Operate the ignition unit tester by following the manufacturer's instructions.
 - Use the special connector to connect the ignition unit.

If the spark is weak, inspect the spark plug and ignition unit. If both of them are normal, replace the ignition coil with a new one.

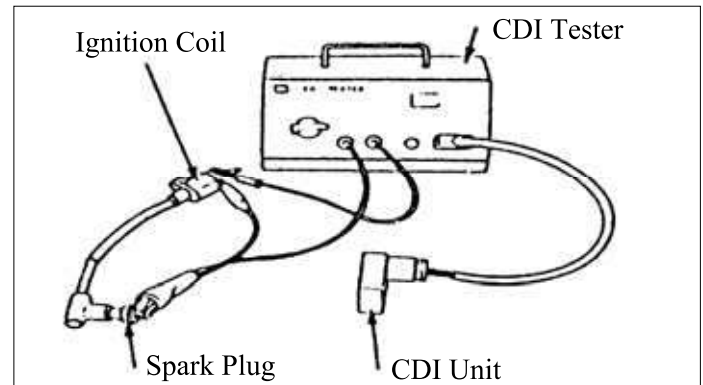

PULSER COIL

INSPECTION

Remove the front fender. (Refer to the chapter 2)

Disconnect the pulser coil wire coupler and measure the resistance between the blue/yellow and green/white wire terminals.

Resistance: 105~110 Ω /20°C

Refer to the "A.C. GENERATOR/FLYWHEEL" section in the chapter 16 to remove or install.

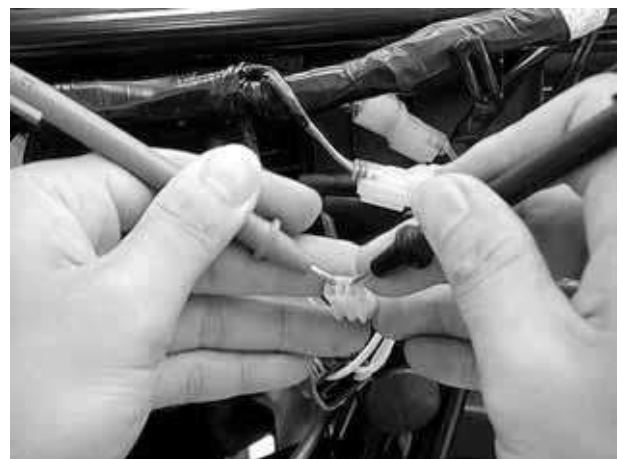

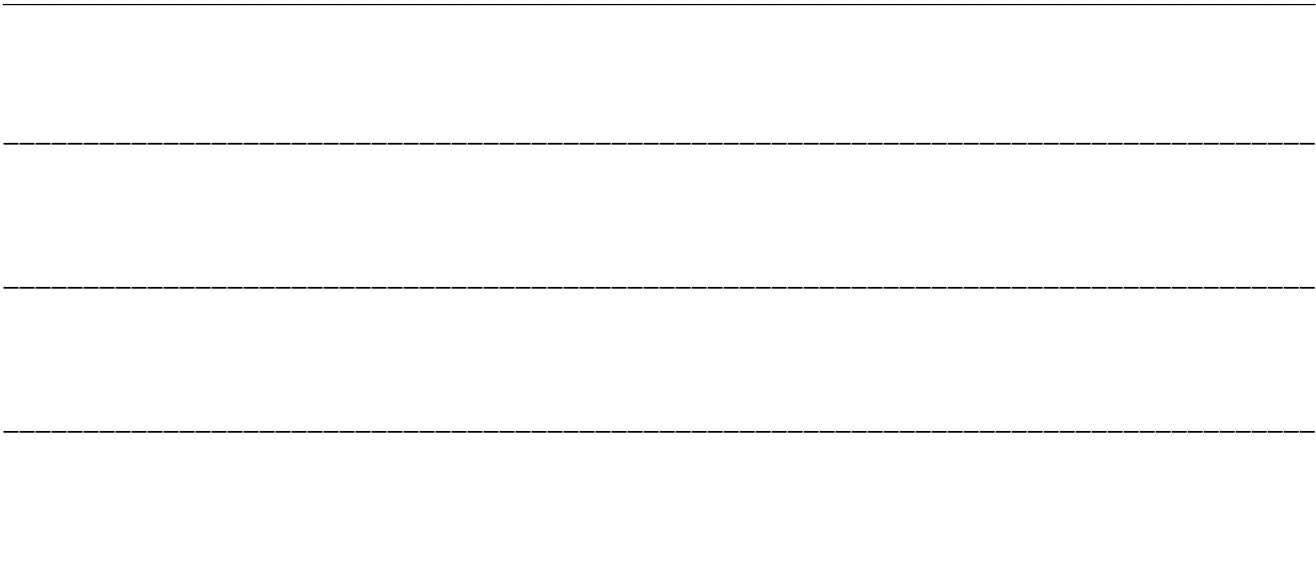

STARTING SYSTEM

18

SERVICE INFORMATION-----	18- 2
TROUBLESHOOTING-----	18- 2
STARTER MOTOR -----	18- 3
STARTER RELAY -----	18- 7
STARTER CLUTCH-----	18- 8
RECOIL STARTER -----	18-10

18. STARTING SYSTEM

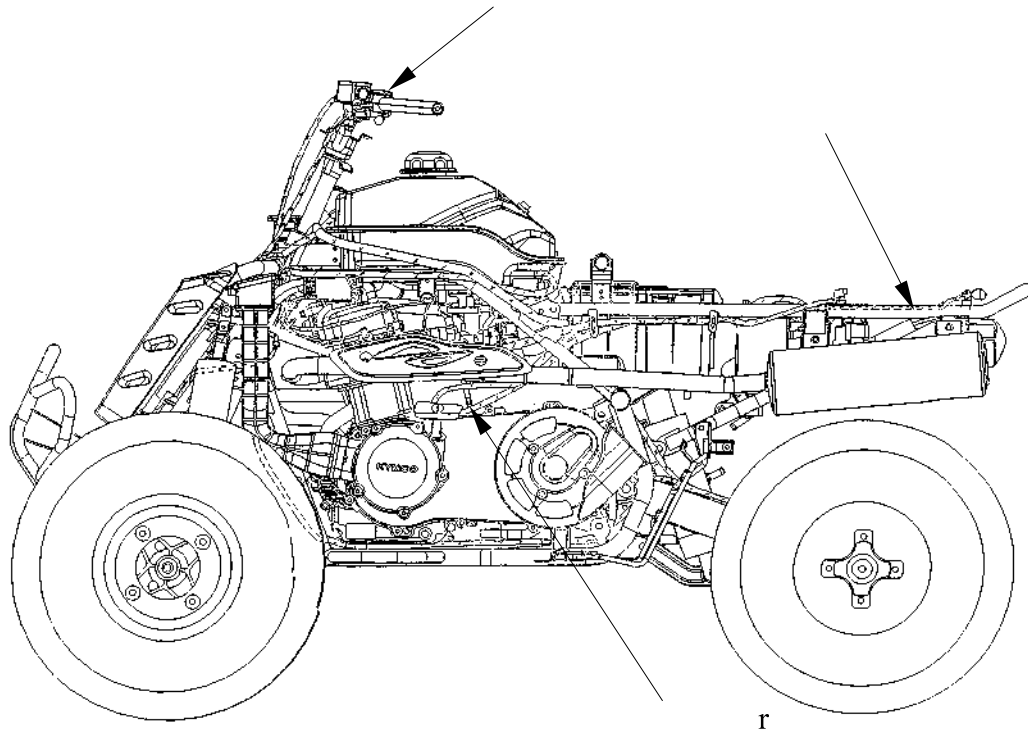

STARTING CIRCUIT

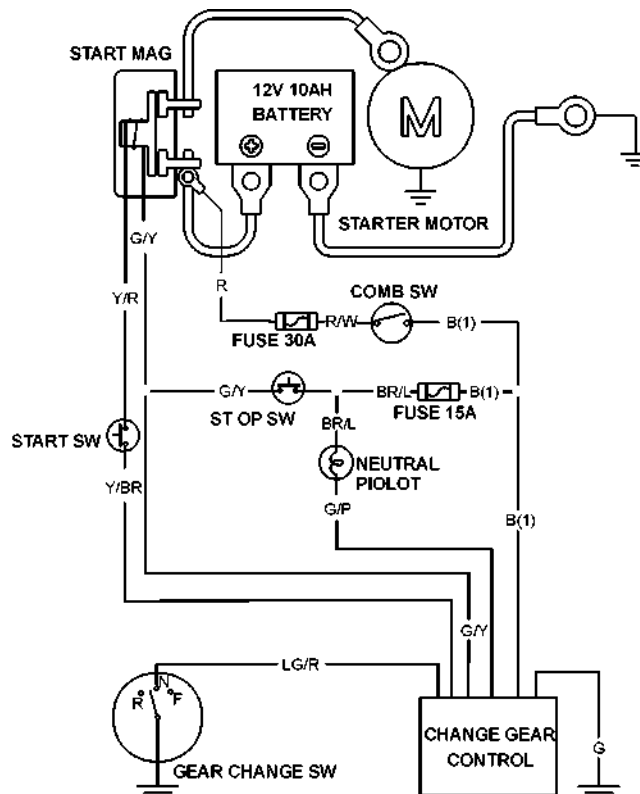

18. STARTING SYSTEM

SERVICE INFORMATION

GENERAL INSTRUCTIONS

- The removal of starter motor can be accomplished with the engine installed.

TROUBLESHOOTING

Starter motor won't turn

- Fuse burned out
- Weak battery
- Faulty ignition switch
- Faulty starter clutch
- Faulty front or rear stop switch
- Faulty starter relay
- Poorly connected, broken or shorted wire
- Faulty starter motor
- Faulty change gear control unit

Lack of power

- Weak battery
- Loose wire or connection
- Foreign matter stuck in starter motor or gear

Starter motor rotates but engine does not start

- Faulty starter clutch
- Starter motor rotates reversely
- Weak battery

18. STARTING SYSTEM

STARTER MOTOR

REMOVAL

- * Before removing the starter motor, turn the ignition switch OFF and remove the battery ground. Then, turn on the ignition switch and push the starter button to see if the starter motor operates properly.

Remove the waterproof rubber jacket and remove nut to disconnect the starter motor cable connector.

Remove the two starter motor mounting bolts and the motor.

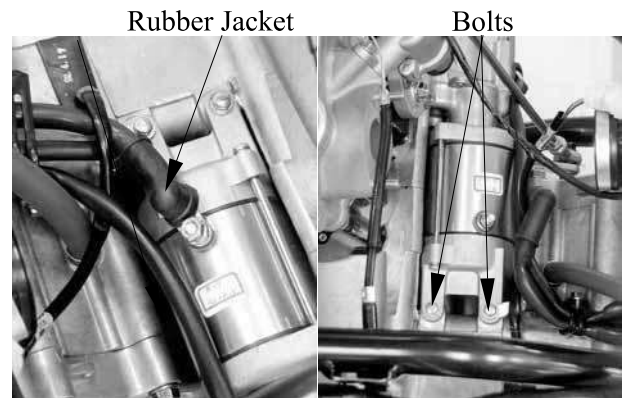

DISASSEMBLY

Remove the two starter motor case screws, front cover, motor case and other parts.

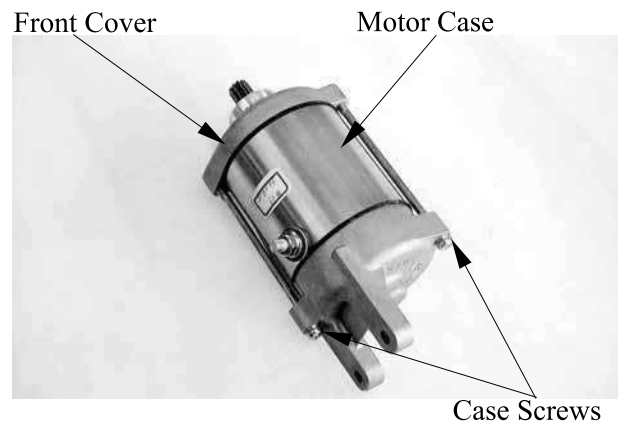

INSPECTION

Inspect the removed parts for wear, damage or discoloration and replace if necessary. Clean the commutator if there is metal powder between the segments.



18. STARTING SYSTEM

Check for continuity between pairs of the commutator segments and there should be continuity.

Also, make a continuity check between individual commutator segments and the armature shaft. There should be no continuity.

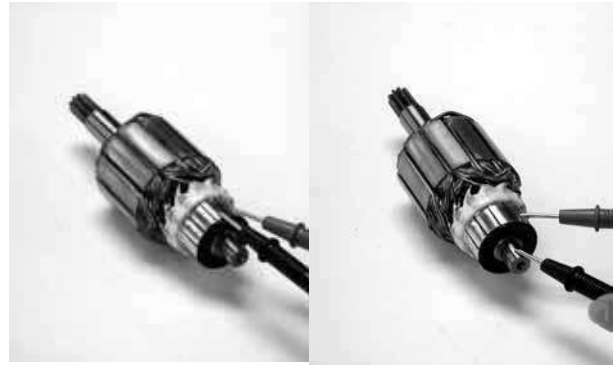

STARTER MOTOR CASE CONTINUITY CHECK

Check to confirm that there is no continuity between the starter motor wire terminal and the motor front cover.

Also check for the continuity between the wire terminal and each brush.
Replace if necessary.

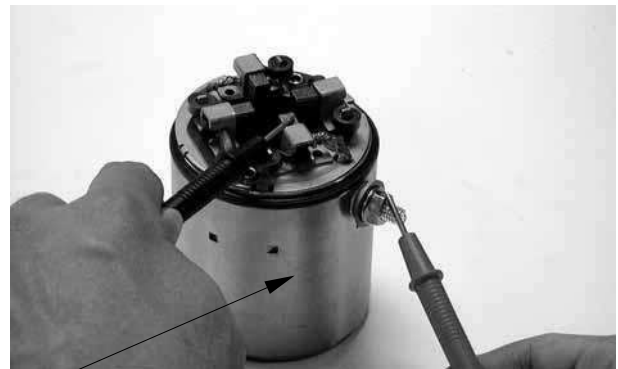

Wire Terminal

Measure the length of the brushes.

Service Limit (replace if below):

8.5 mm (0.34 in)



18. STARTING SYSTEM

Check for continuity between the brushes. If there is continuity, replace with new ones.



Check if the needle bearing in the front cover turns freely and has no excessive play.
Replace if necessary.
Check the dust seal for wear or damage.

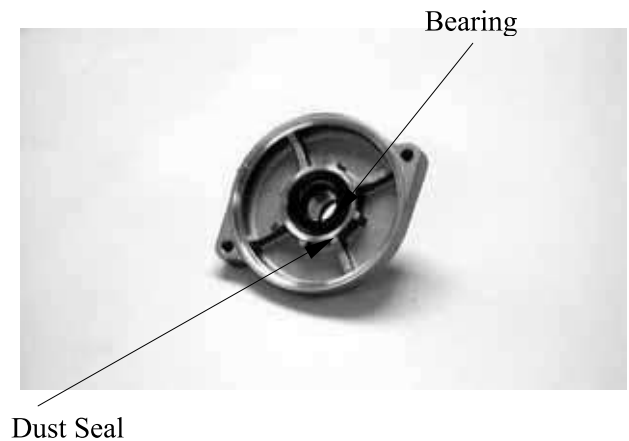

ASSEMBLY

Apply grease to the dust seal in the front cover.
Install the brushes onto the brush holders.
Apply a thin coat of grease to the two ends of the armature shaft.
Insert the commutator into the front cover.

- *
- Be careful not to damage the brush and armature shaft mating surfaces.
 - When installing the commutator, the armature shaft should not damage the dust seal lip.

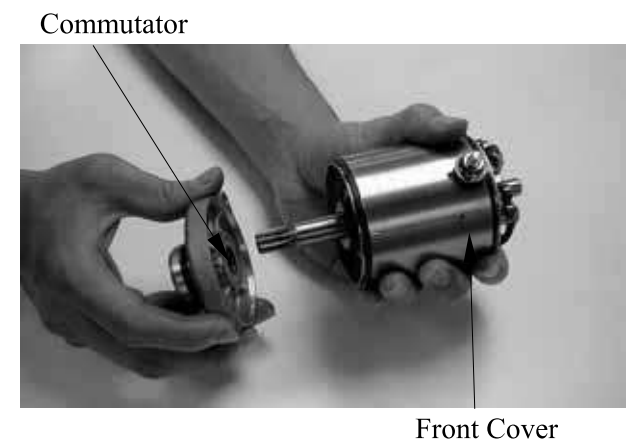

18. STARTING SYSTEM

Install a new O-ring to the front cover.
Install the starter motor case, aligning the tab on the motor case with the groove on the front cover.
Tighten the starter motor case screws.

* When assembling the front cover and motor case, slightly press down the armature shaft to assemble them.

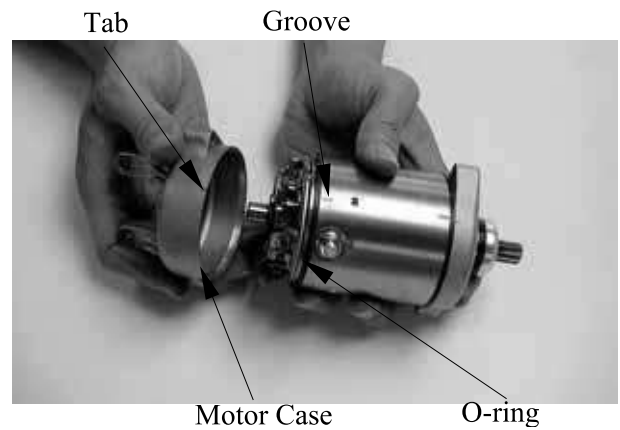

STARTER MOTOR INSTALLATION

Connect the starter motor cable connector and properly install the waterproof rubber jacket.

Check the O-ring for wear or damage and replace if necessary.

Apply grease to the O-ring and install the starter motor.

Tighten the two mounting bolts.

Torque: 0.8~1.2kgf-m

* The starter motor cable connector must be installed properly.



18. STARTING SYSTEM

STARTER RELAY

INSPECTION

Remove the seat. (Refer to the chapter 2)
Turn the ignition switch ON and the starter relay is normal if you hear a click when the starter button is depressed.

If there is no click sound:

- Inspect the starter relay voltage
- Inspect the starter relay ground circuit
- Check for continuity between the starter relay yellow/red and green/red wire terminals



STARTER RELAY VOLTAGE INSPECTION

Connect a 12V battery across the starter relay yellow/red and green/red wire terminals.

Connect an electric tester between the starter relay large terminals and check for continuity between the two terminals.
The relay is normal if there is continuity.
Replace the starter relay with a new one if there is no continuity.

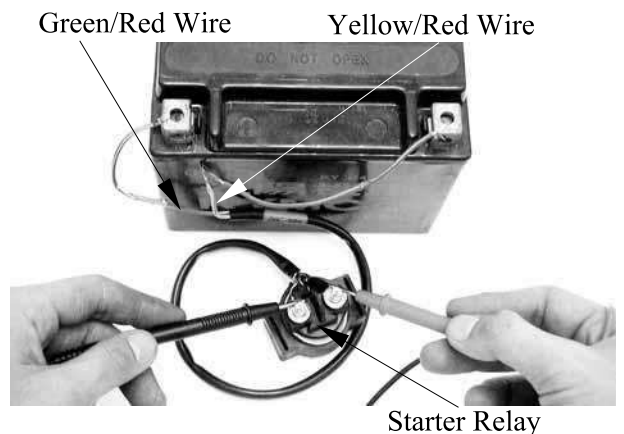

18. STARTING SYSTEM

STARTER CLUTCH REMOVAL

Remove the right crankcase cover. (Refer to the “WATER PUMP SHAFT REMOVAL” section in the chapter 12)

Remove the flywheel. (Refer to the “A.C. GENERATOR/FLYWHEEL REMOVAL” section in the chapter 16)

Inspect the starter one-way clutch for wear or damage.



Starter One-way Clutch

Remove the starter driven gear.



Starter Driven Gear

Inspect the starter driven gear for wear or damage.



18. STARTING SYSTEM

Remove the starter idle gear and shaft.

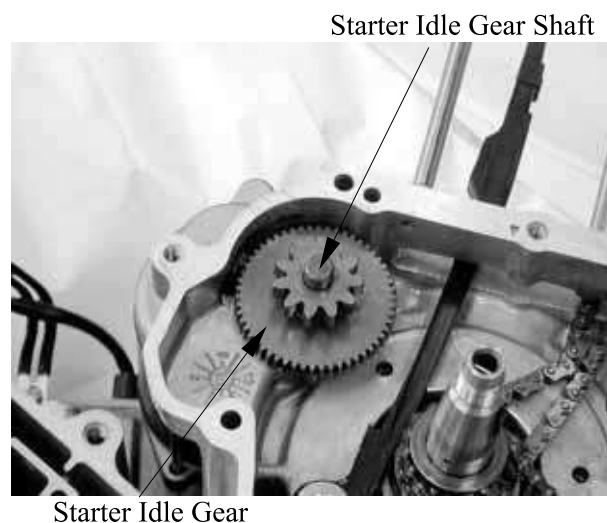

Inspect the starter idle gear and shaft for wear or damage.

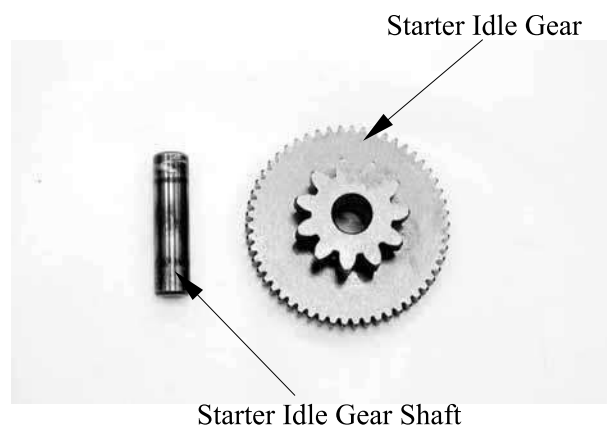

INSTALLATION

Reverse the "REMOVAL" procedures.
Install the starter idle gear and shaft.
Install the starter driven gear.

Install flywheel and right crankcase cover.
(Refer to the "A.C.
GENERATOR/FLYWHEEL
INSTALLATION" section in the chapter
16)

18. STARTING SYSTEM

RECOIL STARTER

Refer to the chapter 9 to remove recoil starter.

* Do not disassembly that the recoil starter would not be assembly.

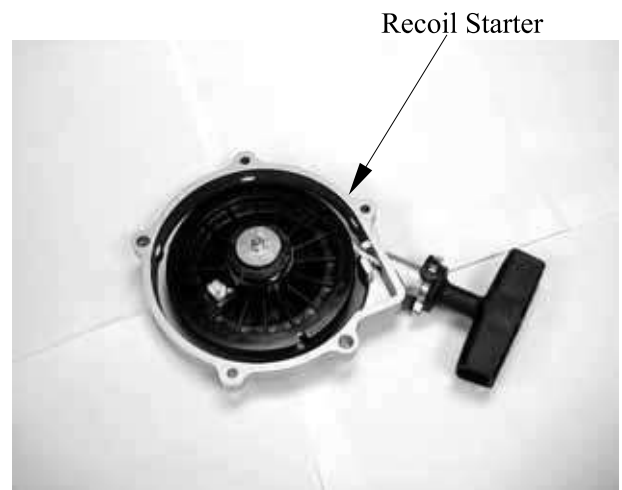

ROPE REPLACE

Insert the rope into the hook part of the friction plate, reel the rope clockwise five times with the rope, then cut the rope.



Rope

Hook the rope onto the groove of the recoil starter case.

Remove the plug of the recoil starter grip.

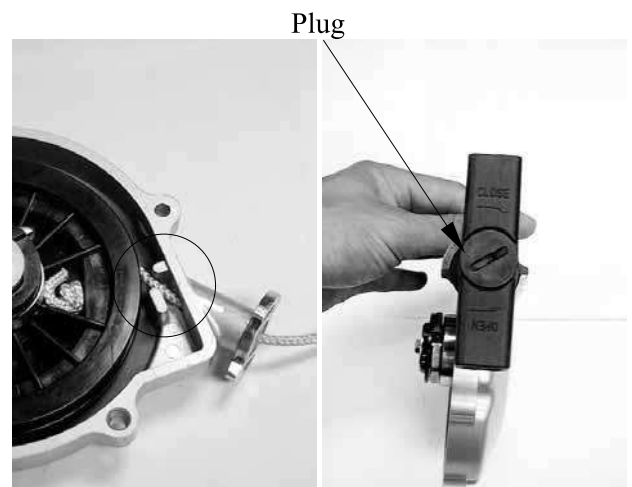

18. STARTING SYSTEM

Insert the rope into recoil starter grip and washer.

Reinstall the cap.

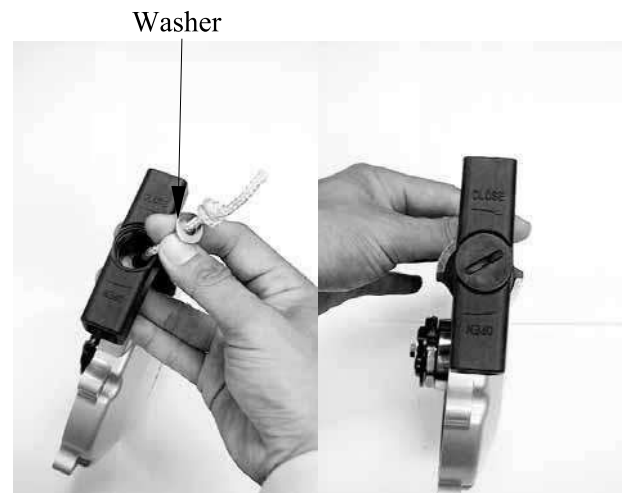

Pull the rope and check that the ratchet is pushed out

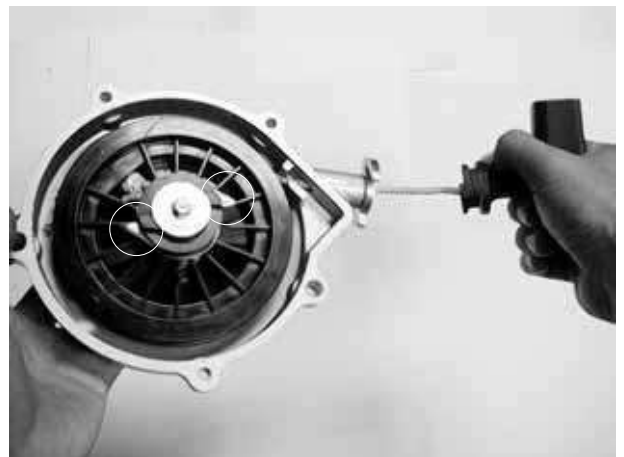

Refer to the chapter 9 to remove ratchet.
Inspect the ratchet splines.
Wear/damage → Replace.

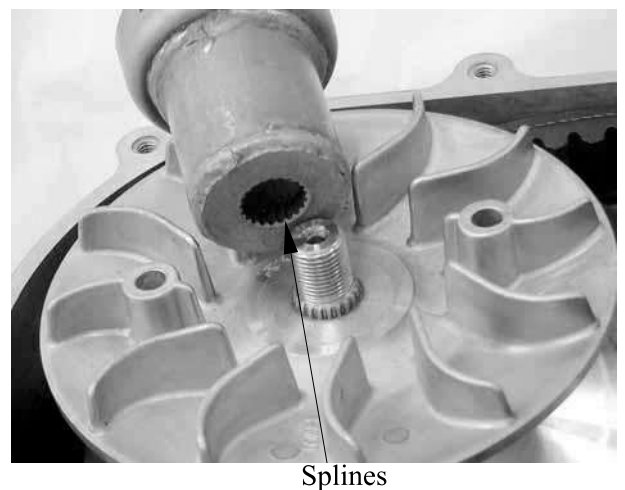

LIGHTS/SWITCHES

SERVICE INFORMATION-----	19- 1
BULBS REMOVAL-----	19- 2
HORN (ON ROAD)-----	19- 4
IGNITION SWITCH-----	19- 5
HANDLEBAR SWITCH-----	19- 5
NEUTRAL/REVESE SWITCH-----	19- 7

19. LIGHTS/SWITCHES

SERVICE INFORMATION

- A continuity test can be made with the switches installed on the vehicle.
- All plastic connectors have locking tabs that must be released before disconnecting, and must be aligned when reconnecting.
- To isolate an electrical failure, check the continuity of the electrical path through the part. A continuity check can usually be made without removing the part from the vehicle. Simply disconnect the connectors and connect a continuity tester to the terminals or connections.

BULBS REMOVAL

HEADLIGHT

Remove the front fender. (See page 2-8)

Remove the rubber boot from the headlight case.

Disconnect the headlight wire connector.

Rubber Boot



Headlight Connector

Relax the lock clips to remove the bulb and replace with a new one.

Install the bulb, aligning the bulb socket groove with the bulb tab and set the lock clips.

Connect headlight wire connector.

Install the rubber boot.

Install the front fender in the reverse order of removal.

Lock Clips



Lock Clip

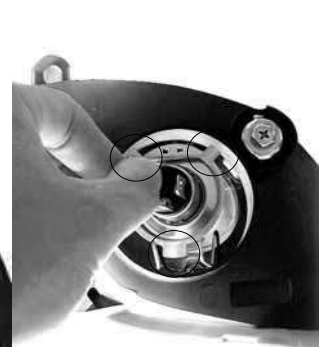

POSITION LIGHT

Remove the bulb socket by pulling it out.

Remove the bulb.

Install the bulb in the reverse order of removal



Bulb Socket

19. LIGHTS/SWITCHES

TAIL/BRAKE LIGHT

Remove the bulb socket by turning it counterclockwise.
Remove the bulb.

Install the bulb in the reverse order of removal.



TURN SIGNAL LIGHT (ON ROAD)

FRONT

Remove the rubber boot from the turn signal light case.
Remove the bulb socket by turning it counterclockwise.

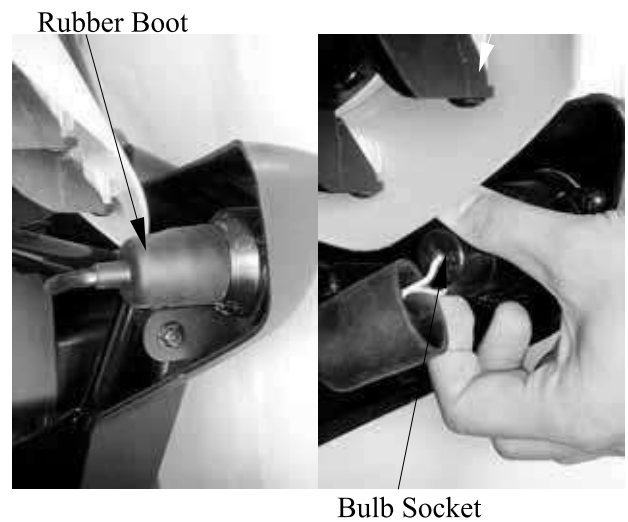

Remove the bulb.

Install the bulb in the reverse order of removal.

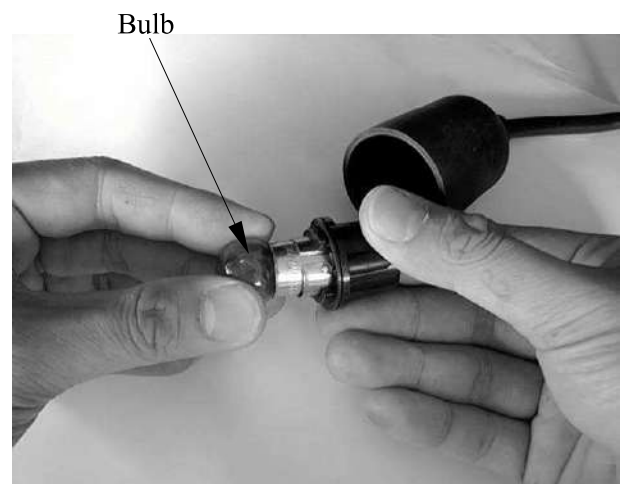

19. LIGHTS/SWITCHES

REAR

Remove the bulb socket by turning it counterclockwise.

Remove the bulb.

Install the bulb in the reverse order of removal.

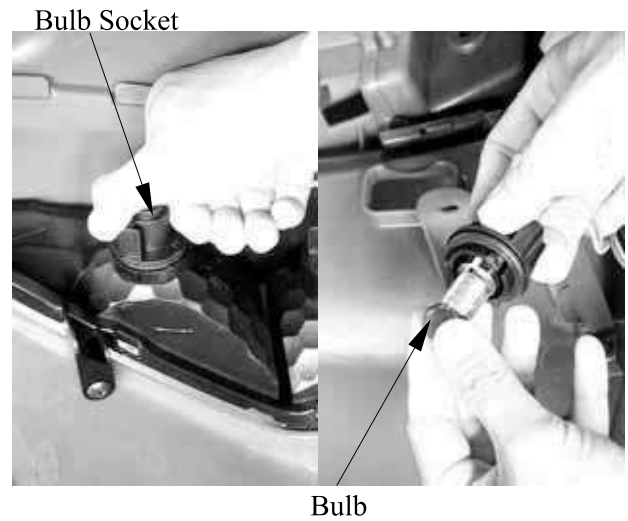

LICENCE LIGHT BULB (ON ROAD)

Remove the two screws and licence light cover.

Remove the bulb.

Install the bulb in the reverse order of removal

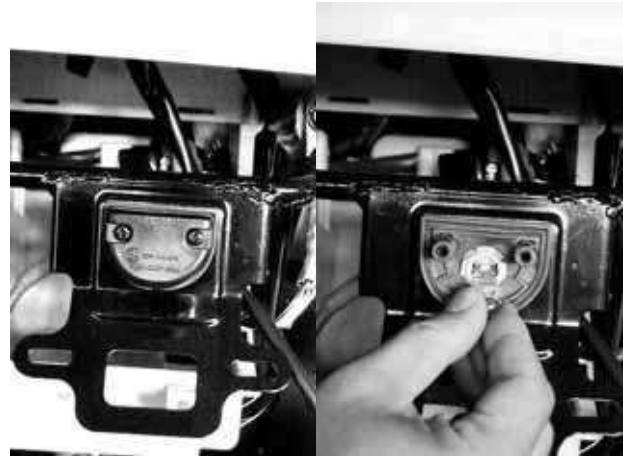

HORN (ON ROAD)

REMOVAL

Disconnect the horn wire leads.

Remove the bolt and remove horn.

INSTALLATION

The installation sequence is the reverse of removal.

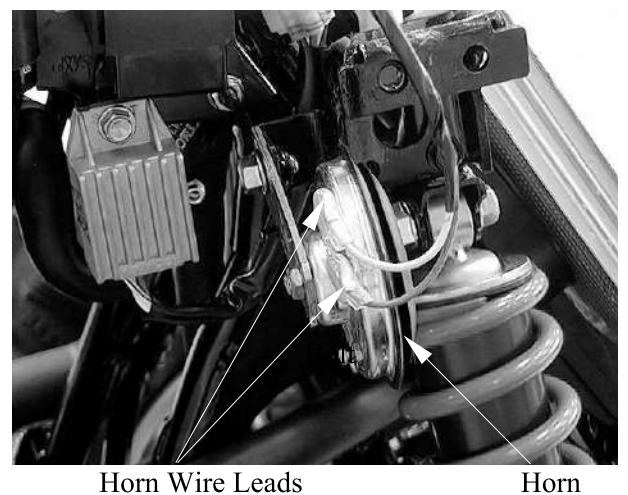

19. LIGHTS/SWITCHES

IGNITION SWITCH

INSPECTION

Disconnect the ignition switch connectors. (Refer to the "HANDLEBAR COVER REMOVAL" section in chapter 2.)

Check for continuity between the switch side connector terminals in each switch position.

Continuity should exist between the color coded wires as right:

	IG	E	BAT1	BAT2	PO
OFF	○—○				
ON			○—○	○—○	
PO			○—○	○—○	○—○
COLOR	B/W	G	R	B	BR

REPLACEMENT

Release the switch wire from the wire clips on the steering shaft holder frame pipe.

Remove the handlebar cover (see page 2-7).
Remove the ignition switch from the cover while pushing in the two stoppers.

Install a new ignition switch by aligning the locating tab with the groove in the cover.

Install the removed parts in the reverse order of removal.

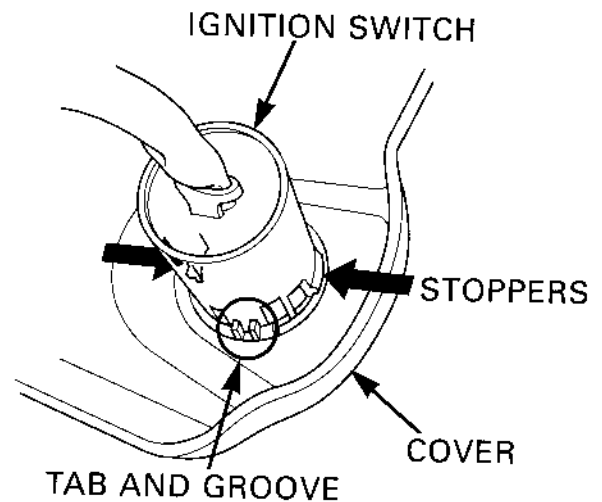

HANDLEBAR SWITCH

INSPECTION

Remove front center cover. (See page 2-7)

Disconnect the connectors.

Check for continuity between the switch side connector terminals in each switch position.

Continuity should exist between the color coded wires as next page:

19. LIGHTS/SWITCHES

(ON ROAD)

HORN SW

	HO	BAT
FREE		
PUSH	○	○
COLOR	LG	B

WINKER SW

	R	L	WR
L		○	○
R	○		○
COLOR	SB	O	GR

START SW

	ST	C
FREE		
PUSH	○	○
COLOR	Y/R	Y/BR

LIGHT SW

	PO	LO	HI
☰	○		
☷	○	○	
☷	○		○
COLOR	BR/B	W	L

HAZARD SW

	BAT	HA
△	○	○
●		
COLOR	R/W	Y/B



(OFF ROAD)

KILL SW

	E	IG
○	○	○
⊗		
COLOR	BR/L	B/W(1)

START SW

	ST	C
FREE		
PUSH	○	○
COLOR	Y/R	Y/BR

DIMMER SW

	HL	LO	HI	PO
☰				○
☷	○	○		
☷	○		○	
COLOR	BR/B	W	L	BR

PASSING SW

	BAT	HI
FREE		
PUSH	○	○
COLOR	BR/B	L

Dimmer Switch



Start Switch

Pass Switch



19. LIGHTS/SWITCHES

NEUTRAL/REVERSE SWITCHES

INSPECTION

Disconnect the neutral/reverse switch wire connector. (See page 6-4 or 6-10)

Check for continuity between the switch side connector terminal and engine ground.

NEUTRAL SWITCH

There should be continuity with the transmission in neutral and no continuity with it in any gear except neutral.

REVERSE SWITCH

There should be continuity with the transmission in reverse and no continuity with it in any gear except reverse.

REPLACEMENT

Remove drive and driven pulley. (Refer to chapter 9)

Remove the two bolts and set plates.
Remove neutral/reverse switch.

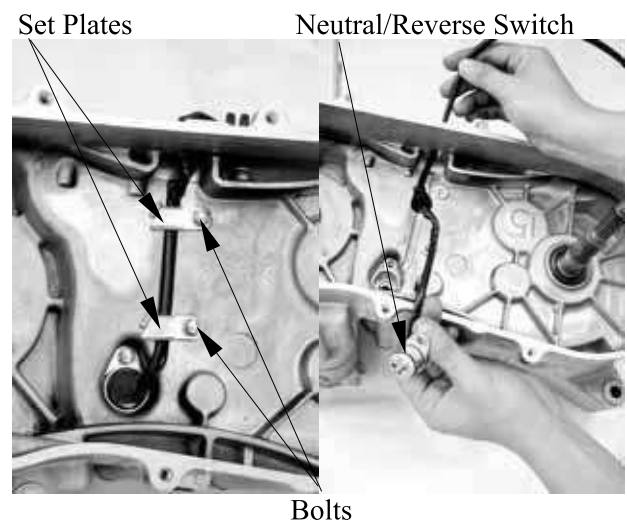

Install a new switch with a new O-ring (apply engine oil to O-ring).

Make sure that the lever on the neutral/reverse switch correctly engages with the locating slot on the shift shaft.

