

---

# PREFACE

This Service Manual describes the technical features and servicing procedures for the KYMCO **MOVIE SYSTEM** 125/150.

Section 1 contains the precautions for all operations stated in this manual. Read them carefully before starting any operation.

Section 2 is the removal/installation procedures for the frame covers which are subject to higher removal/installation frequency during maintenance and servicing operations.

Section 3 describes the inspection/adjustment procedures, safety rules and service information for each part, starting from periodic maintenance.

Sections 4 through 17 give instructions for disassembly, assembly and inspection of engine, chassis frame and electrical equipment.

Most sections start with an assembly or system illustration and troubleshooting for the section. The subsequent pages give detailed procedures for the section.

The information and contents included in this manual may be different from the motorcycle in case specifications are changed.
---

## TABLE OF CONTENTS

ENGINE	GENERAL INFORMATION	1
	FRAME COVERS/EXHAUST MUFFLER	2
	INSPECTION/ADJUSTMENT	3
	LUBRICATION SYSTEM	4
	FUEL SYSTEM	5
	ENGINE REMOVAL/INSTALLATION	6
	CYLINDER HEAD/VALVES	7
	CYLINDER/PISTON	8
	DRIVE AND DRIVEN PULLEYS/KICK STARTER	9
	FINAL REDUCTION	10
	CRANKCASE/CRANKSHAFT	11
CHASSIS	FRONT WHEEL/FRONT BRAKE/ FRONT SUSPENSION	12
	REAR WHEEL /REAR BRAKE /REAR SUSPENSION	13
ELECTRICAL EQUIPMENT	BATTERY/CHARGING SYSTEM/A.C. GENERATOR	14
	IGNITION SYSTEM	15
	STARTING SYSTEM	16
	LIGHTS/ INSTRUMENTS/SWITCHES	17

**KWANG YANG MOTOR CO., LTD.**  
**OVERSEAS SALES DEPARTMENT**  
**OVERSEAS SERVICE SECTION**

---

---

## GENERAL INFORMATION

---

SERIAL NUMBER-----	1- 1
SPECIFICATIONS-----	1- 2
SERVICE PRECAUTIONS-----	1- 3
TORQUE VALUES-----	1-11
SPECIAL TOOLS-----	1-12
LUBRICATION POINTS-----	1-13
CABLE & HARNESS ROUTING-----	1-15
WIRING DIAGRAM-----	1-20
TROUBLESHOOTING-----	1-21

# 1. GENERAL INFORMATION

## SERIAL NUMBER

SD25GB

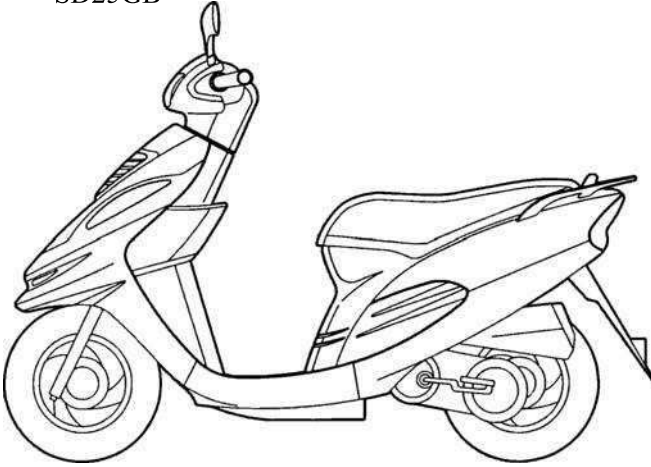

SD25GC

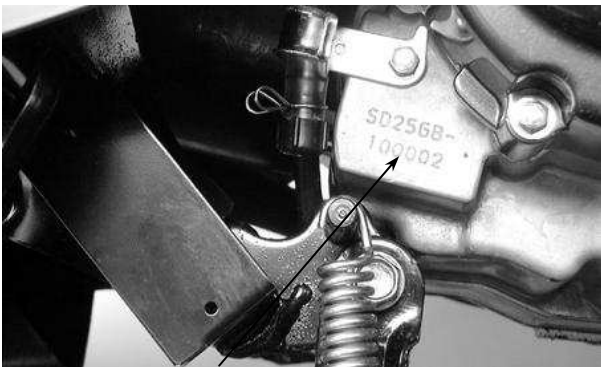
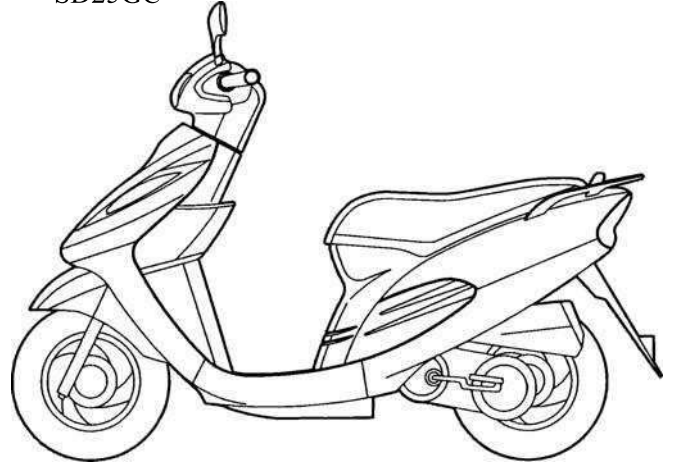

Location of Engine Serial Number



Vehicle Identification Serial Number



Location of Frame Serial Number

# 1. GENERAL INFORMATION

## SPECIFICATIONS

Name & Model No.		SD25GB	SD25GC	
Motorcycle Name & Type		Jockey 125		
Overall length (mm)		1745		
Overall width (mm)		690		
Overall height (mm)		1140	1110	
Wheel base (mm)		1220		
Engine type		O.H.C.		
Displacement (cc)		124.6		
Fuel Used		92# nonleaded gasoline		
Net weight (kg)	Front wheel	38		
	Rear wheel	64		
	Total	102		
Gross weight(kg)	Front wheel	40.5		
	Rear wheel	69		
	Total	109.5		
Tires	Front wheel	100/90-10		
	Rear wheel	100/90-10		
Ground clearance (mm)		116		
Performance	Braking distance (m)	7.9m(Initial speed 40km/h 1 rider)		
	Min. turning radius (m)	1.866		
Engine	Starting system		Starting motor & kick starter	
	Type		Gasoline, 4-stroke	
	Cylinder arrangement		Single cylinder	
	Combustion chamber type		Semi-sphere	
	Valve arrangement		O.H.C., chain drive	
	Bore x stroke (mm)		52.4 x 57.8	
	Compression ratio		9.6:1	
	Compression pressure (kg/cm <sup>2</sup> )		13.0	
	Max. output (ps/rpm)		9.6/7500	
	Max. torque (kg m/rpm)		0.99/6500	
	Port timing	Intake (1mm)	Open	6° BTDC
			Close	30° ABDC
		Exhaust (1mm)	Open	30° BBDC
			Close	8° ATDC
	Valve clearance (cold) (mm)	Intake	0.12	
		Exhaust	0.12	
	Idle speed (rpm)		1700rpm	
	Lubrication System	Lubrication type		Forced pressure & wet sump
		Oil pump type		Inner/outer rotor type
		Oil filter type		Full-flow filtration
Oil capacity		0.9 liter		
Cooling Type		Forced air cooling		
Fuel System	Air cleaner type & No		Paper element, wet	
	Fuel capacity		5.5 liters	
	Carburetor	Type	VE	
		Piston dia. (mm)	22	
		Venturi dia.(mm)	24 equivalent	
Throttle type		Butterfly type		
Electrical Equipment	Type		CDI	
	Ignition timing		13°BTDC/1700rpm	
	Contact breaker		Non-contact point type	
	Spark plug		NGK CR7HSA	
	Spark plug gap		0.6 0.7mm	
Battery	Capacity		12V8AH	
Power Drive System	Clutch	Type	Dry multi-disc clutch	
	Transmission Gear	Type	Non-stage transmission	
		Operation	Automatic centrifugal type	
	Reduction Gear	Type	Two-stage reduction	
		Reduction ratio	1st	2.64
2nd			8.615	
Moving Device	Front Axle	Caster angle		
		Trail length		
	Tire pressure (kg/cm <sup>2</sup> )	Front	1.75	
		Rear	2.00 (2.25)	
	Turning angle	Left	45°	
Right		45°		
Brake system type		Front	Disk brake   Drum brake	
		Rear	Drum brake	
Damping Device	Suspension type	Front	Telescope	
		Rear	Swing arm	
	Shock type	Front	Telescope	
		Rear	Swing arm	
Frame type		Steel pipe		

# 1. GENERAL INFORMATION

## SPECIFICATIONS

Name & Model No.		SN25AA		
Motorcycle Name & Type		Movie XL 125		
Overall length (mm)		1885		
Overall width (mm)		695		
Overall height (mm)		1150		
Wheel base (mm)		1280		
Engine type		O.H.C.		
Displacement (cc)		124.6		
Fuel Used		92# nonleaded gasoline		
Net weight (kg)	Front wheel	44		
	Rear wheel	66		
	Total	110		
Gross weight(kg)	Front wheel	48		
	Rear wheel	71		
	Total	119		
Tires	Front wheel	120/70-12		
	Rear wheel	130/70-12		
Ground clearance (mm)		165		
Performance	Braking distance (m)	7.9m(Initial speed 30km/h 1 rider)		
	Min. turning radius (m)	1.9		
Engine	Starting system		Starting motor & kick starter	
	Type		Gasoline, 4-stroke	
	Cylinder arrangement		Single cylinder	
	Combustion chamber type		Semi-sphere	
	Valve arrangement		O.H.C., chain drive	
	Bore x stroke (mm)		52.4 x 57.8	
	Compression ratio		9.6:1	
	Compression pressure (kg/cm <sup>2</sup> )		13.0	
	Max. output (ps/rpm)		9.8/7500	
	Max. torque (kg m/rpm)		1.0/6500	
	Port timing	Intake (1mm)	Open	7.3° BTDC
			Close	33° ABDC
		Exhaust (1mm)	Open	32° BBDC
			Close	6.9° ATDC
	Valve clearance (cold) (mm)	Intake	0.12	
		Exhaust	0.12	
	Idle speed (rpm)		1700rpm	
	Lubrication System	Lubrication type		Forced pressure & wet sump
		Oil pump type		Inner/outer rotor type
		Oil filter type		Full-flow filtration
Oil capacity		0.9 liter		
Cooling Type		Forced air cooling		

Fuel System	Air cleaner type & No		Paper element, wet		
	Fuel capacity		7.5 liters		
	Carburetor	Type		VE	
		Piston dia. (mm)		22	
Venturi dia.(mm)		24 equivalent			
Throttle type		Butterfly type			
Electrical Equipment	Type		CDI		
	Ignition timing		15°BTDC/1700rpm		
	Contact breaker		Non-contact point type		
	Spark plug		NGK CR7HSA		
	Spark plug gap		0.6 0.7mm		
Power Drive System	Battery	Capacity		12V8AH	
	Clutch	Type		Dry multi-disc clutch	
		Type		Non-stage transmission	
	Transmission Gear	Operation		Automatic centrifugal type	
		Reduction Gear	Type		Two-stage reduction
Reduction ratio			1st	2.64	
		2nd	8.6		
Moving Device	Front Axle	Caster angle			
		Trail length			
	Tire pressure (kg/cm <sup>2</sup> )	Front	1.75		
		Rear	2.00 (2.25)		
Turning angle	Left	45°			
	Right	45°			
Brake system type		Front	Disk brake	Drum brake	
		Rear	Drum brake		
Damping Device	Suspension type		Front	Telescope	
			Rear	Swing arm	
Shock type	Front		Telescope		
	Rear		Swing arm		
Frame type		Steel pipe			

# 1. GENERAL INFORMATION

## SPECIFICATIONS

Name & Model No.		SN30AA		
Motorcycle Name & Type		Movie 150		
Overall length (mm)		1885		
Overall width (mm)		695		
Overall height (mm)		1150		
Wheel base (mm)		1280		
Engine type		O.H.C.		
Displacement (cc)		149.4		
Fuel Used		92# nonleaded gasoline		
Net weight (kg)	Front wheel	44		
	Rear wheel	66		
	Total	110		
Gross weight(kg)	Front wheel	48		
	Rear wheel	71		
	Total	119		
Tires	Front wheel	120/70-12		
	Rear wheel	130/70-12		
Ground clearance (mm)		165		
Performance	Braking distance (m)	7.9m(Initial speed 30km/h 1 rider)		
	Min. turning radius (m)	1.9		
Engine	Starting system		Starting motor & kick starter	
	Type		Gasoline, 4-stroke	
	Cylinder arrangement		Single cylinder	
	Combustion chamber type		Semi-sphere	
	Valve arrangement		O.H.C., chain drive	
	Bore x stroke (mm)		57.4 x 57.8	
	Compression ratio		9.2:1	
	Compression pressure (kg/cm <sup>2</sup> )		15.0	
	Max. output (ps/rpm)		10.5/7500	
	Max. torque (kg m/rpm)		1.1/6500	
	Port timing	Intake (1mm)	Open	7.3° BTDC
			Close	33° ABDC
		Exhaust (1mm)	Open	32° BBDC
			Close	6.9° ATDC
	Valve clearance (cold) (mm)	Intake	0.12	
		Exhaust	0.12	
	Idle speed (rpm)		1700rpm	
	Lubrication System	Lubrication type		Forced pressure & wet sump
		Oil pump type		Inner/outer rotor type
		Oil filter type		Full-flow filtration
Oil capacity		0.9 liter		
Cooling Type		Forced air cooling		

Fuel System	Air cleaner type & No		Paper element, wet		
	Fuel capacity		7.5 liters		
	Carburetor	Type		VE	
		Piston dia. (mm)		22	
Venturi dia.(mm)		24 equivalent			
Throttle type		Butterfly type			
Electrical Equipment	Type		CDI		
	Ignition timing		15°BTDC/1700rpm		
	Contact breaker		Non-contact point type		
	Spark plug		NGK CR7HSA		
	Spark plug gap		0.6 0.7mm		
Power Drive System	Battery	Capacity		12V8AH	
	Clutch	Type		Dry multi-disc clutch	
		Type		Non-stage transmission	
	Transmission Gear	Operation		Automatic centrifugal type	
		Reduction Gear	Type		Two-stage reduction
Reduction ratio			1st	2.8	
		2nd	8.89		
Moving Device	Front Axle	Caster angle			
		Trail length			
	Tire pressure (kg/cm <sup>2</sup> )	Front	1.75		
		Rear	2.00 (2.25)		
Turning angle	Left	45°			
	Right	45°			
Brake system type		Front	Disk brake	Drum brake	
		Rear	Drum brake		
Damping Device	Suspension type	Front	Telescope		
		Rear	Swing arm		
	Shock type	Front	Telescope		
		Rear	Swing arm		
Frame type		Steel pipe			

## SERVICE PRECAUTIONS

- Make sure to install new gaskets, O-rings, circlips, cotter pins, etc. when reassembling.

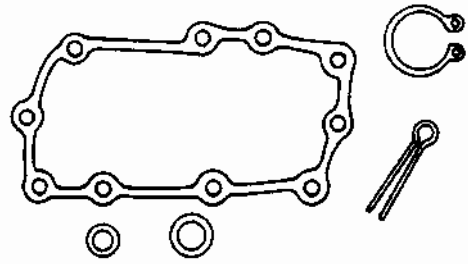

- When tightening bolts or nuts, begin with larger-diameter to smaller ones at several times, and tighten to the specified torque diagonally.

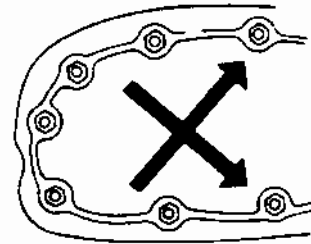

- Use genuine parts and lubricants.

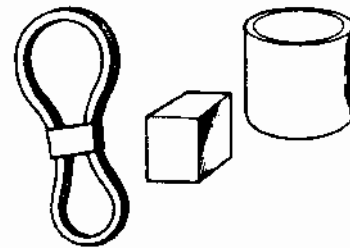

- When servicing the motorcycle, be sure to use special tools for removal and installation.



- After disassembly, clean removed parts. Lubricate sliding surfaces with engine oil before reassembly.

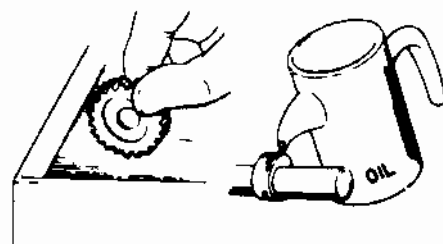

# 1. GENERAL INFORMATION

- Apply or add designated greases and lubricants to the specified lubrication points.

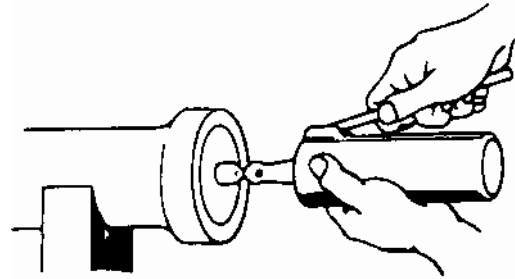

- After reassembly, check all parts for proper tightening and operation.

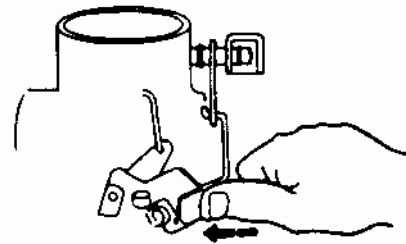

- When two persons work together, pay attention to the mutual working safety.

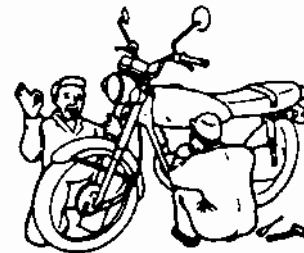

- Disconnect the battery negative (-) terminal before operation.
- When using a spanner or other tools, make sure not to damage the motorcycle surface.

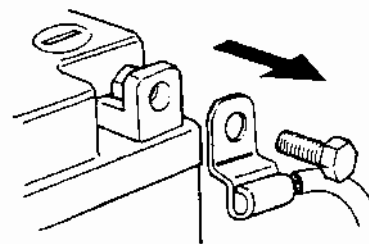

- After operation, check all connecting points, fasteners, and lines for proper connection and installation.
- When connecting the battery, the positive (+) terminal must be connected first.
- After connection, apply grease to the battery terminals.
- Terminal caps shall be installed securely.

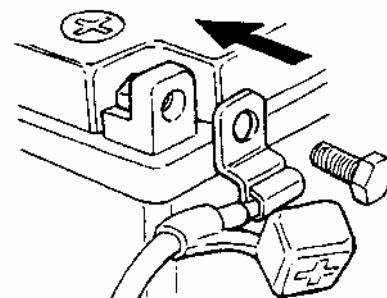



# 1. GENERAL INFORMATION

- If the fuse is burned out, find the cause and repair it. Replace it with a new one according to the specified capacity.

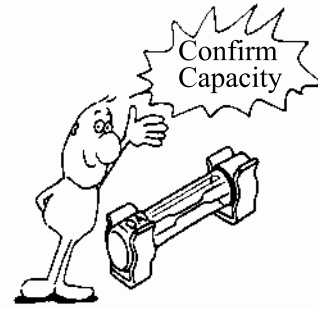

- After operation, terminal caps shall be installed securely.

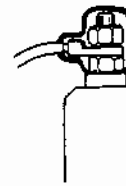

- When taking out the connector, the lock on the connector shall be released before operation.

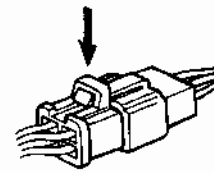

- Hold the connector body when connecting or disconnecting it.
- Do not pull the connector wire.



- Check if any connector terminal is bending, protruding or loose.

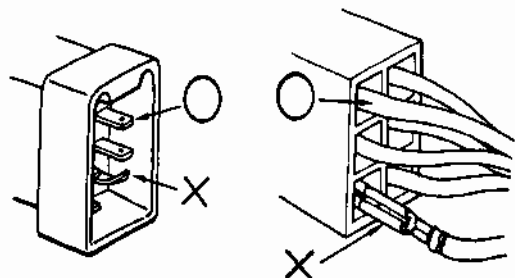

# 1. GENERAL INFORMATION

- The connector shall be inserted completely.
- If the double connector has a lock, lock it at the correct position.
- Check if there is any loose wire.

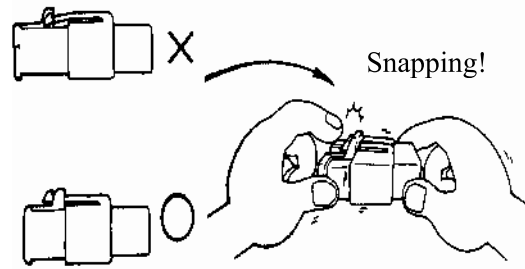

- Before connecting a terminal, check for damaged terminal cover or loose negative terminal.

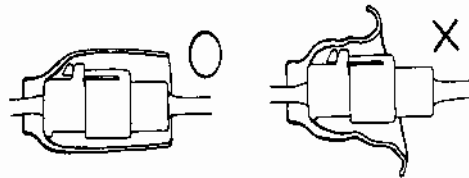

- Check the double connector cover for proper coverage and installation.

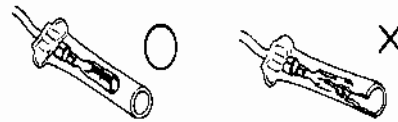

- Insert the terminal completely.
- Check the terminal cover for proper coverage.
- Do not make the terminal cover opening face up.

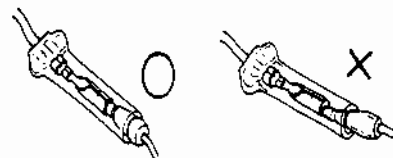

- Secure wire harnesses to the frame with their respective wire bands at the designated locations. Tighten the bands so that only the insulated surfaces contact the wire harnesses.

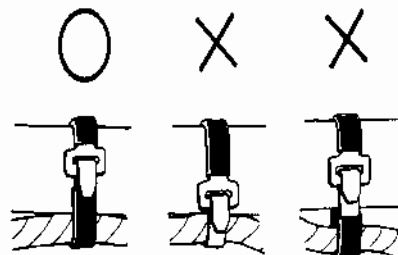

# 1. GENERAL INFORMATION

- After clamping, check each wire to make sure it is secure.

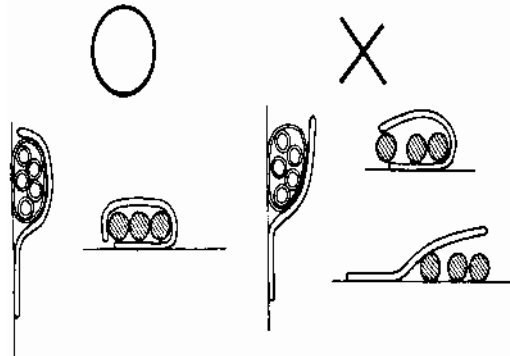

- Do not squeeze wires against the weld or its clamp.

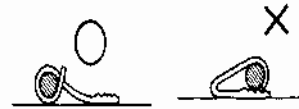

- After clamping, check each harness to make sure that it is not interfering with any moving or sliding parts.

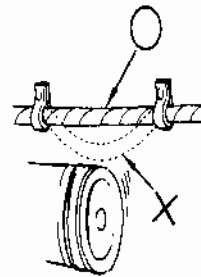

- When fixing the wire harnesses, do not make it contact the parts which will generate high heat.

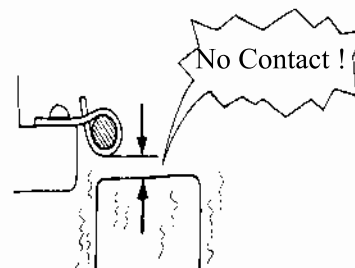

- Route wire harnesses to avoid sharp edges or corners. Avoid the projected ends of bolts and screws.
- Route wire harnesses passing through the side of bolts and screws. Avoid the projected ends of bolts and screws.

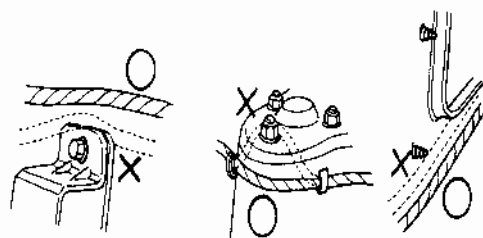

# 1. GENERAL INFORMATION

- Route harnesses so they are neither pulled tight nor have excessive slack.

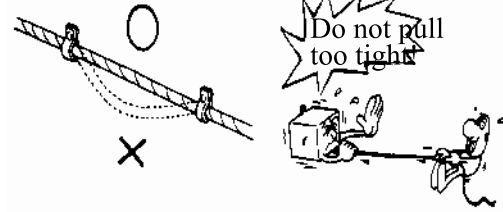

- Protect wires and harnesses with electrical tape or tube if they contact a sharp edge or corner.

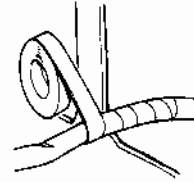

- When rubber protecting cover is used to protect the wire harnesses, it shall be installed securely.

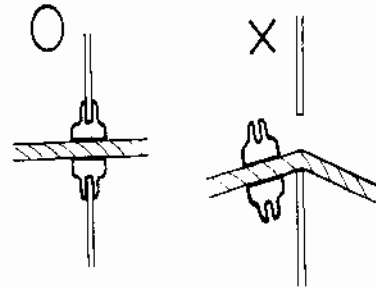

- Do not break the sheath of wire.
- If a wire or harness is with a broken sheath, repair by wrapping it with protective tape or replace it.

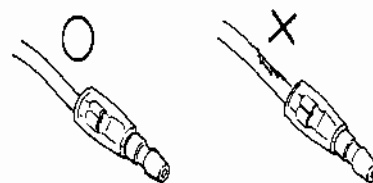

- When installing other parts, do not press or squeeze the wires.

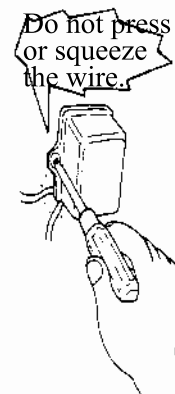

# 1. GENERAL INFORMATION

- After routing, check that the wire harnesses are not twisted or kinked.

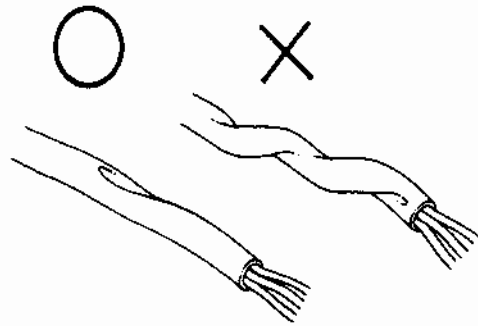

- Wire harnesses routed along with handlebar should not be pulled tight, have excessive slack or interfere with adjacent or surrounding parts in all steering positions.

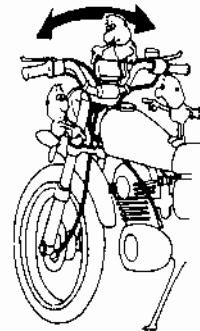

- When a testing device is used, make sure to understand the operating methods thoroughly and operate according to the operating instructions.

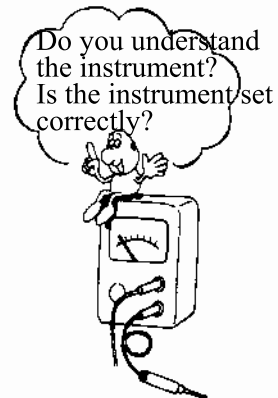

- Be careful not to drop any parts.



- When rust is found on a terminal, remove the rust with sand paper or equivalent before connecting.



# 1. GENERAL INFORMATION

## ■ Symbols:

The following symbols represent the servicing methods and cautions included in this service manual.



: Apply engine oil to the specified points. (Use designated engine oil for lubrication.)



: Apply grease for lubrication.



: Transmission Gear Oil (90#)



: Use special tool.



: Caution



: Warning

(⇒12-3) : Refer to page 12-3.

# 1. GENERAL INFORMATION

## TORQUE VALUES

### STANDARD TORQUE VALUES

Item	Torque (kg-m)	Item	Torque (kg-m)
5mm bolt, nut	0.5	5mm screw	0.4
6mm bolt, nut	1.0	6mm screw, SH bolt	0.9
8mm bolt, nut	2.2	6mm flange bolt, nut	1.2
10mm bolt, nut	3.5	8mm flange bolt, nut	2.7
12mm bolt, nut	5.5	10mm flange bolt, nut	4.0

Torque specifications listed below are for important fasteners.

### ENGINE

Item	Q'ty	Thread dia.(mm)	Torque (kg-m)	Remarks
Cylinder head bolt A	2	8	0.9	Double end bolt
Cylinder head bolt B	4	8	0.9	
Oil filter screen cap	1	30	1.5	
Exhaust muffler joint lock nut	2	6	1.2	Double end bolt
Cylinder head nut	4	8	2.0	Apply oil to threads
Valve adjusting lock nut	2	5	0.9	
Cam chain tensioner slipper bolt	1	6	1.0	
Oil bolt	1	8	1.3	
Clutch outer nut	1	12	5.5	
Clutch drive plate nut	1	12	5.5	
Drive face seal cover bolt	3	4	0.3	
Starter clutch cap bolt	3	6	1.2	
Drive face nut	1	12	5.5	
Spark plug	1	10	1.2	
Starter clutch lock nut	1	22	9.5	Left hand threads
Cam chain tensioner screw	1	6	0.4	

### FRAME

Item	Q'ty	Thread dia.(mm)	Torque (kg-m)	Remarks
Steering stem lock nut	1	10	12.0	U-nut
Front axle nut	1	12	6.0	U-nut
Rear axle nut	1	14	11.0	U-nut
Rear shock absorber upper mount bolt	1	10	4.0	
Rear shock absorber lower mount bolt	1	8	2.5	
Speedometer cable set screw	1	5	0.45	
Front shock absorber tube bolt	1	5	0.45	
Front shock absorber upper mount bolt	2	8	0.1	
Front shock absorber lower mount bolt	2	8	1.8	
Front shock absorber hex bolt	1	8	3.0	
Rear shock absorber lower joint lock nut	1	8	3.5	Apply locking agent

# 1. GENERAL INFORMATION

## SPECIAL TOOLS

Tool Name	Tool No.	Remarks	Ref. Page
Valve adjuster Valve guide driver Valve guide reamer Valve spring compressor Lock nut wrench, 39mm Bearing driver Bearing driver Bearing remover, 12mm Remover set, 12mm Remover head, 12mm Remover shaft Remover weight Bearing remover set, 15mm Driver set, 15mm Driver shaft, 15mm Driver head, 15mm Driver weight Bearing driver Driver handle Driver weight Clutch spring compressor Outer extension Crankshaft assembly tool Crankshaft assembly collar Crankshaft assembly shaft Attachment Lock nut wrench Lock nut wrench Ball race remover extension Ball race remover Spring compressor Spring compressor attachment Spring compressor attachment Spring compressor attachment Lock nut wrench Driver outer extension Float level gauge Valve spring compressor Valve seat cutter, 24.5mm Valve seat cutter, 25mm Valve seat cutter, 22mm Valve seat cutter, 26mm Cutter clip, 5mm Universal holder Outer driver, 32x35mm Outer driver, 37x40mm Outer driver, 42x47mm Pilot, 12mm Pilot, 15mm Pilot, 17mm Pilot, 20mm Driver handle A Bearing remover shaft Bearing remover head, 12mm Flywheel puller		45° IN/EX Plane cutter 32° IN Plane cutter 32° EX Plane cutter 60° IN/EX	



# 1. GENERAL INFORMATION

## LUBRICATION POINTS

### ENGINE

Lubrication Points	Lubricant
Valve guide/valve stem movable part Cam lobes Valve rocker arm friction surface Cam chain Cylinder lock bolt and nut Piston surroundings and piston ring grooves Piston pin surroundings Cylinder inside wall Connecting rod/piston pin hole Connecting rod big end Crankshaft right side oil seal Crankshaft one-way clutch movable part Oil pump drive chain Starter reduction gear engaging part Countershaft gear engaging part Final gear engaging part Bearing movable part O-ring face Oil seal lip	<ul style="list-style-type: none"> <li>•Genuine KYMCO Engine Oil (SAE15W-40)</li> <li>•API SG Engine Oil</li> </ul>
Starter idle gear Friction spring movable part/shaft movable part Shaft movable grooved part Starter spindle movable part	High-temperature resistant grease
Starter one-way clutch threads	Thread locking agent
A.C. generator connector Transmission case breather tube	Adhesive

# 1. GENERAL INFORMATION

## FRAME

The following is the lubrication points for the frame.

Use general purpose grease for parts not listed.

Apply clean engine oil or grease to cables and movable parts not specified. This will avoid abnormal noise and rise the durability of the motorcycle.

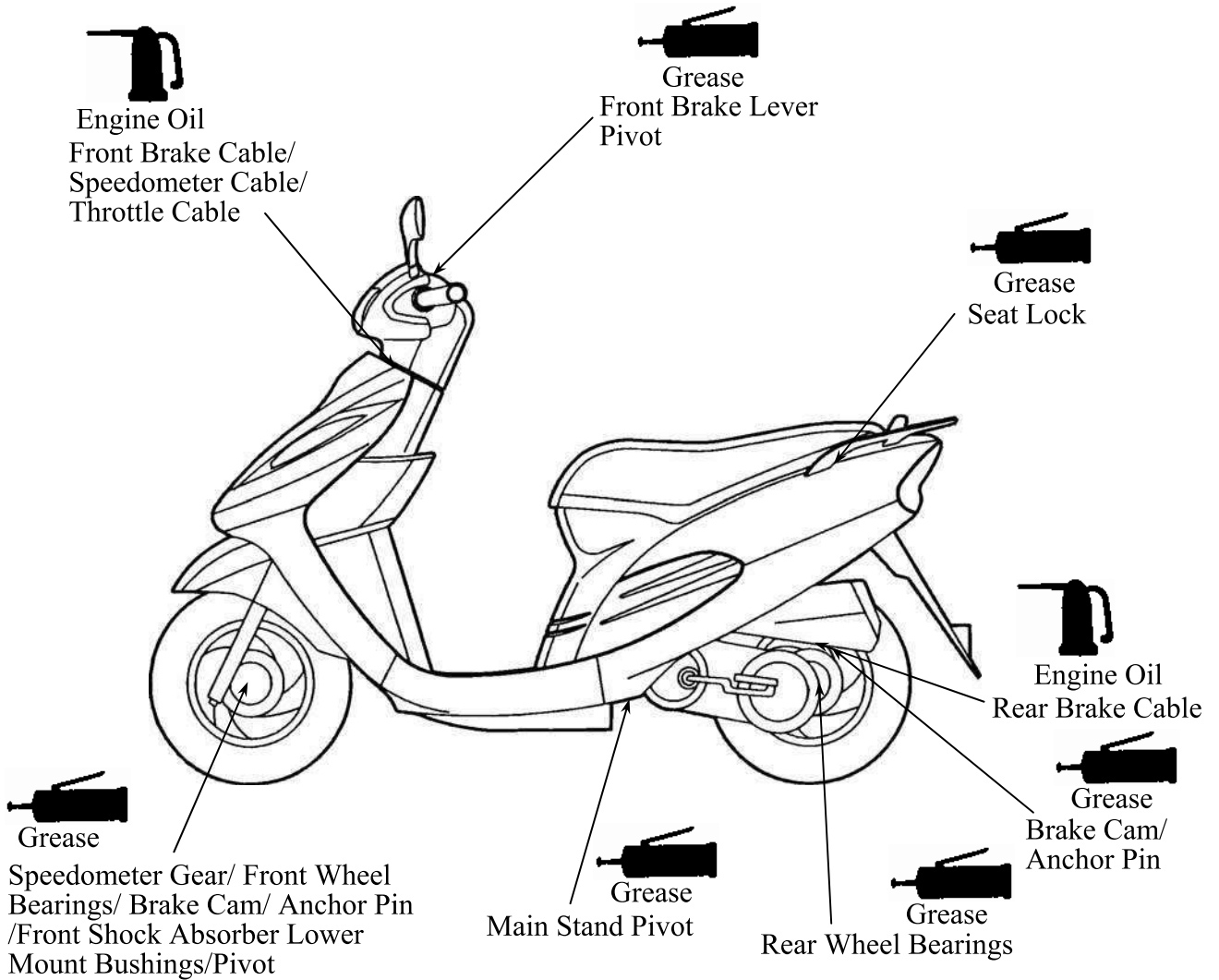

# 1. GENERAL INFORMATION

## CABLE & HARNESS ROUTING

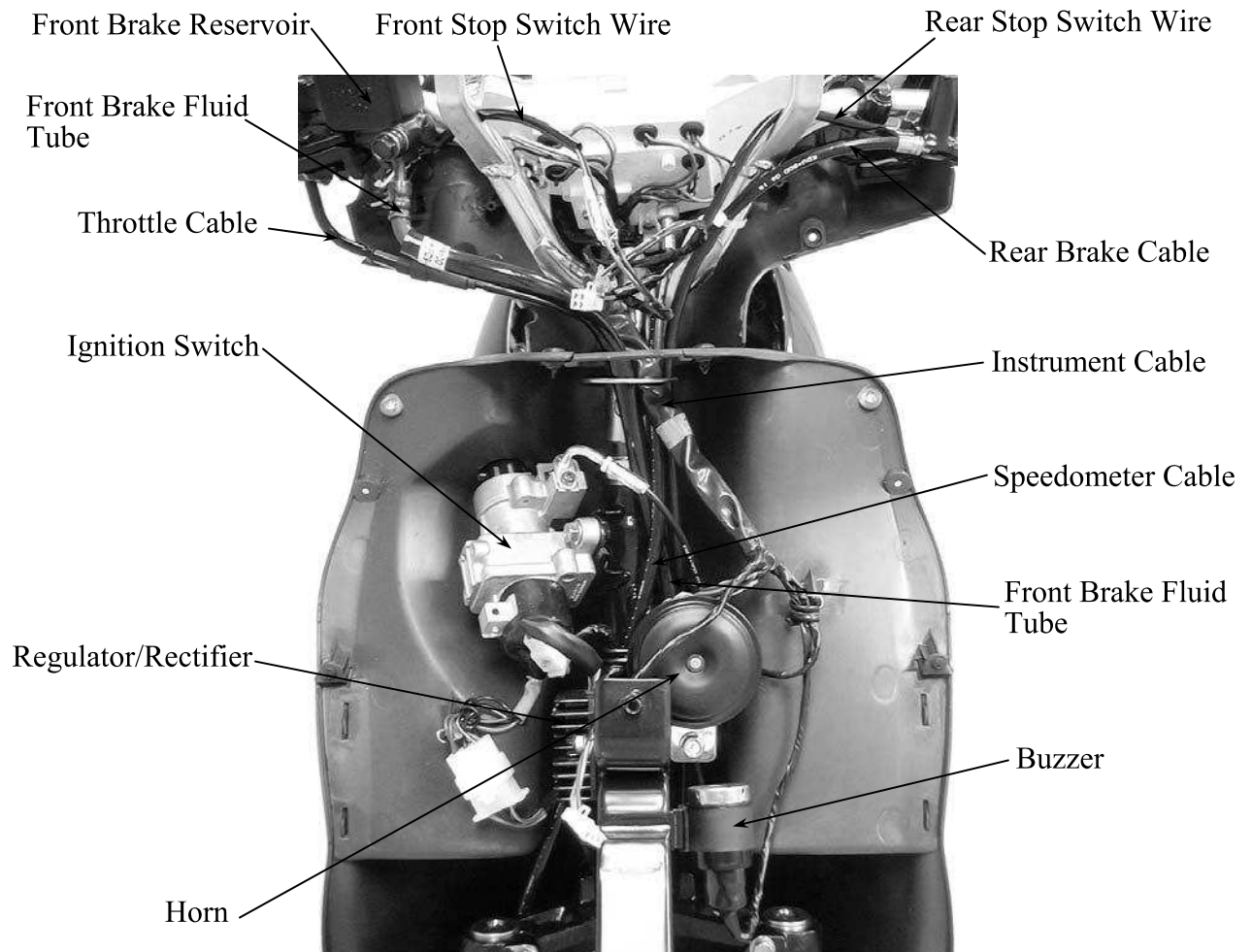

# 1. GENERAL INFORMATION

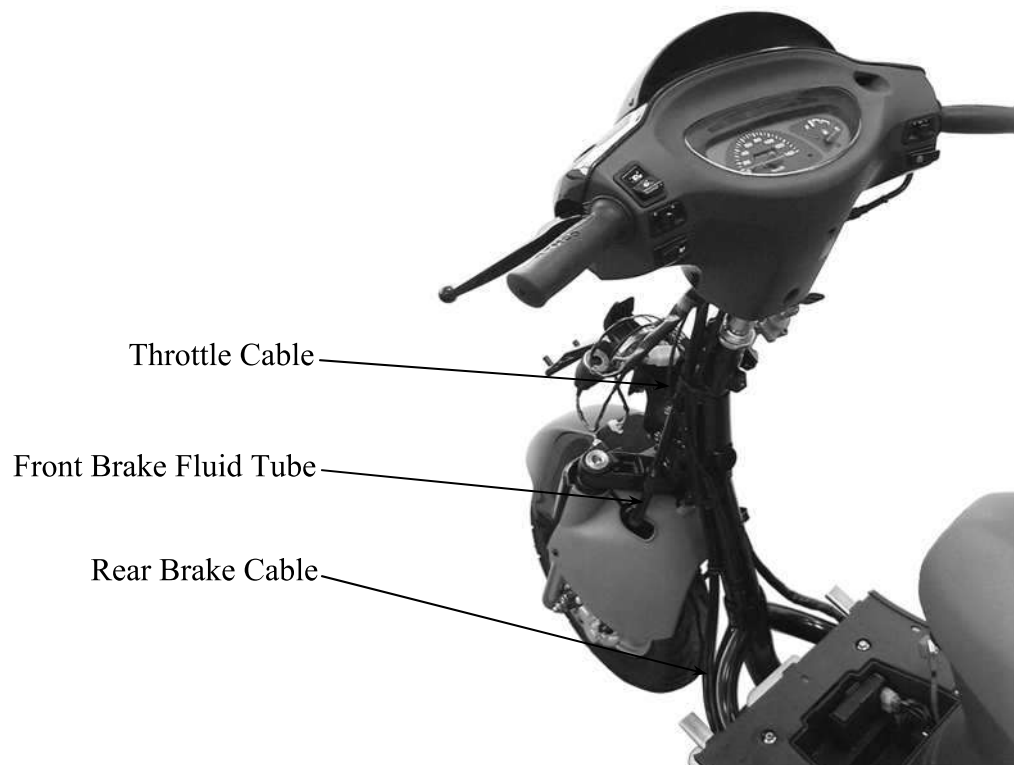
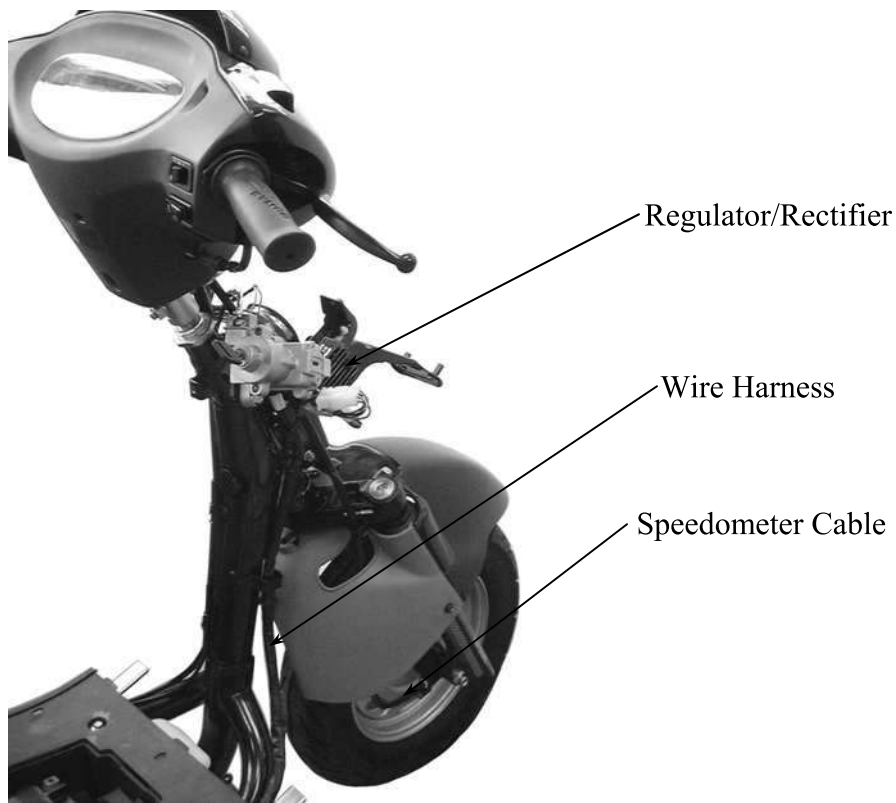

# 1. GENERAL INFORMATION

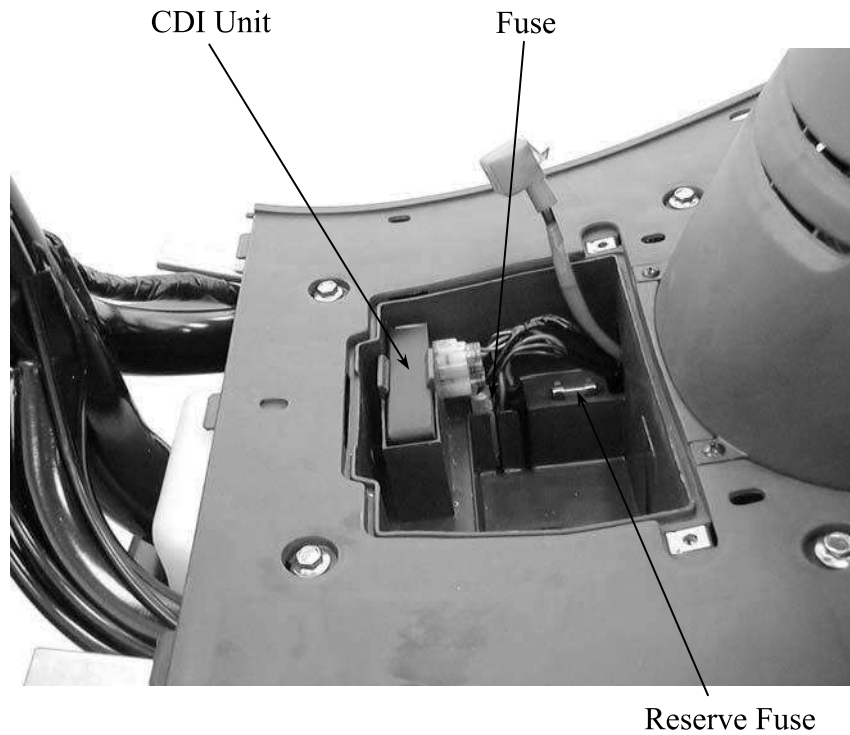
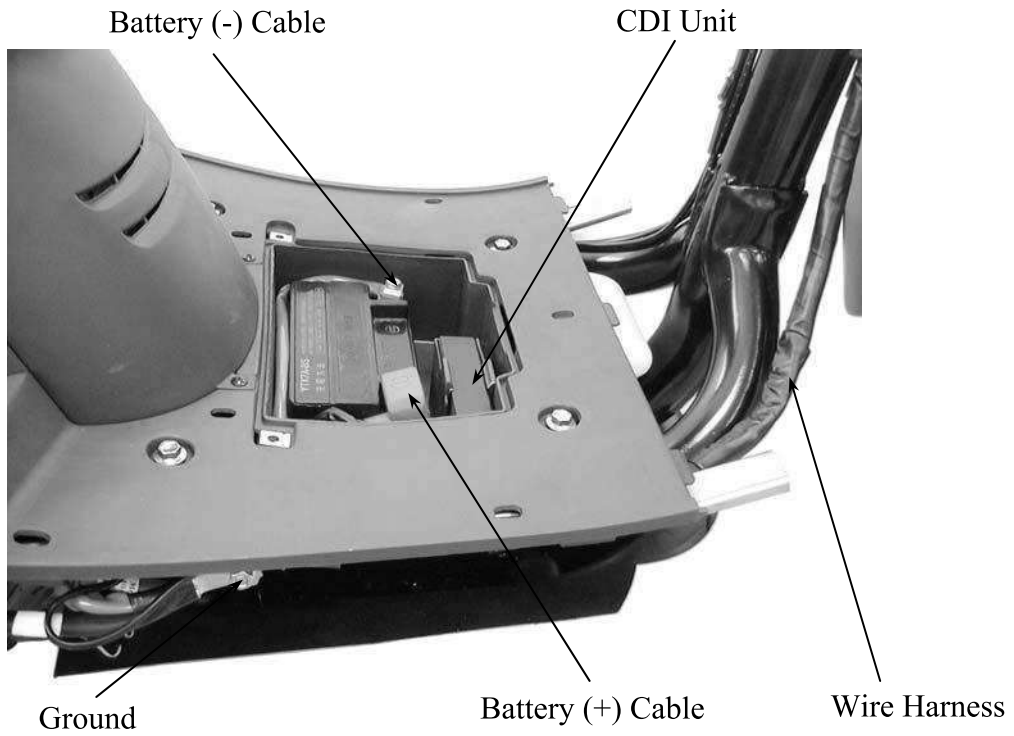

# 1. GENERAL INFORMATION

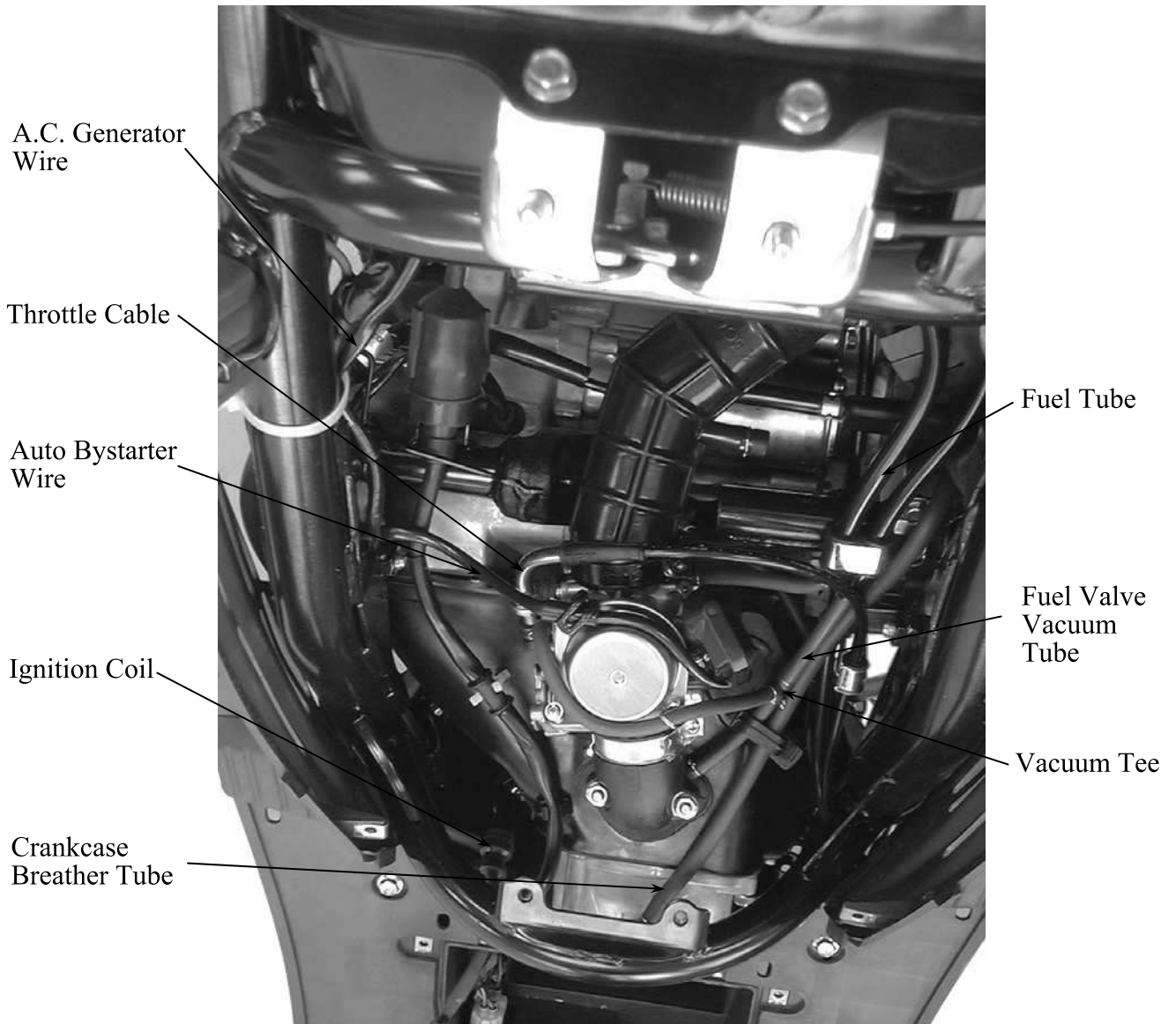

# 1. GENERAL INFORMATION

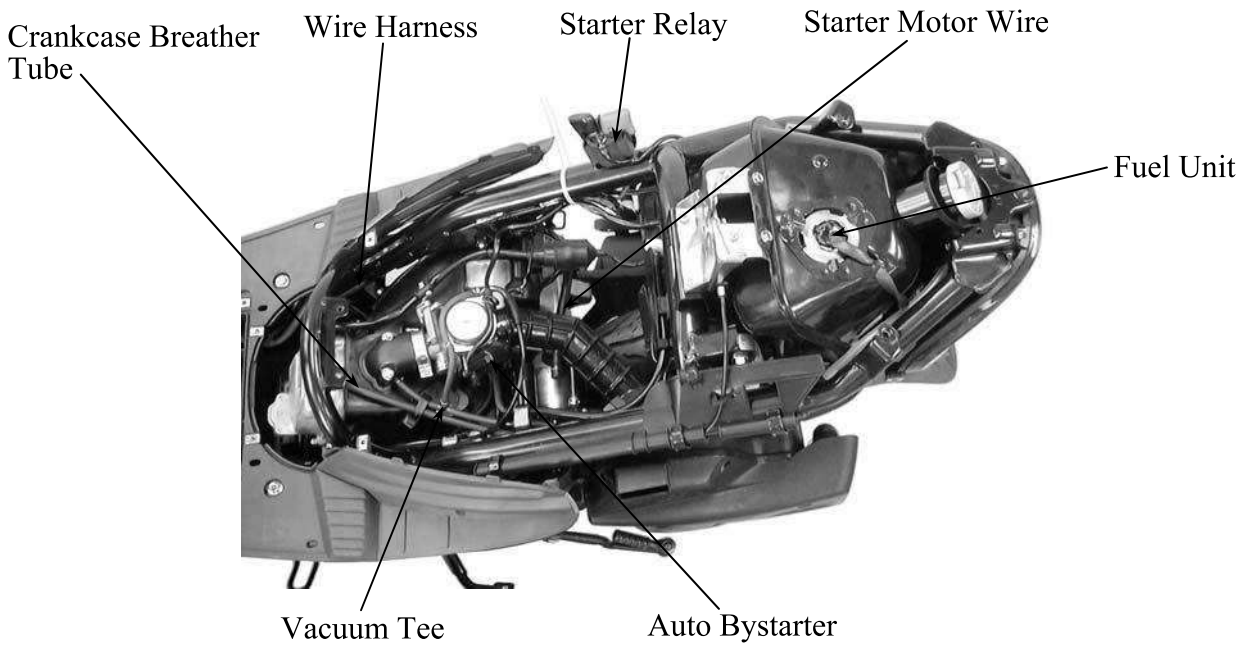
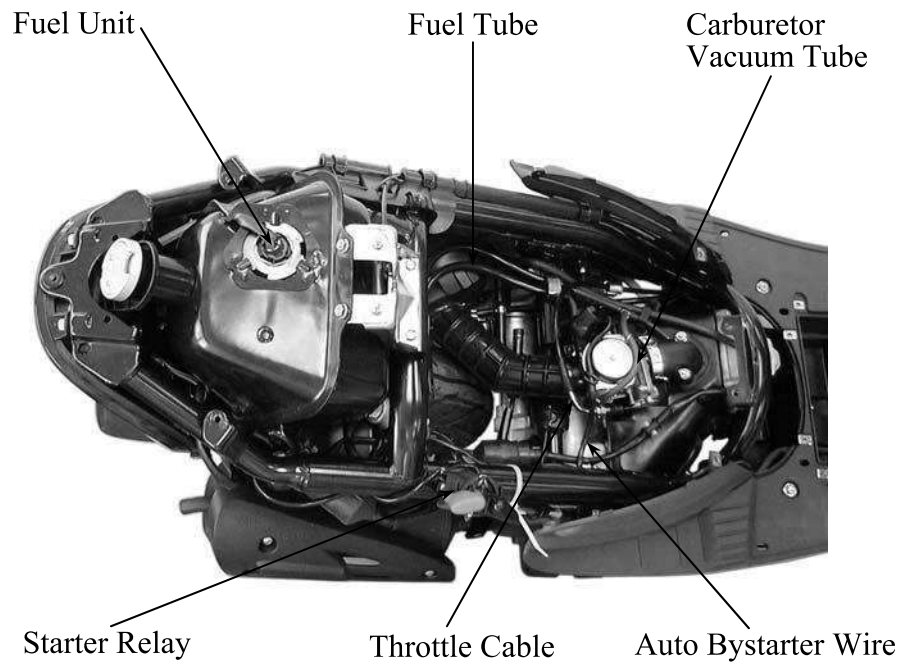





# 1. GENERAL INFORMATION

## TROUBLESHOOTING

### ENGINE WILL NOT START OR IS HARD TO START

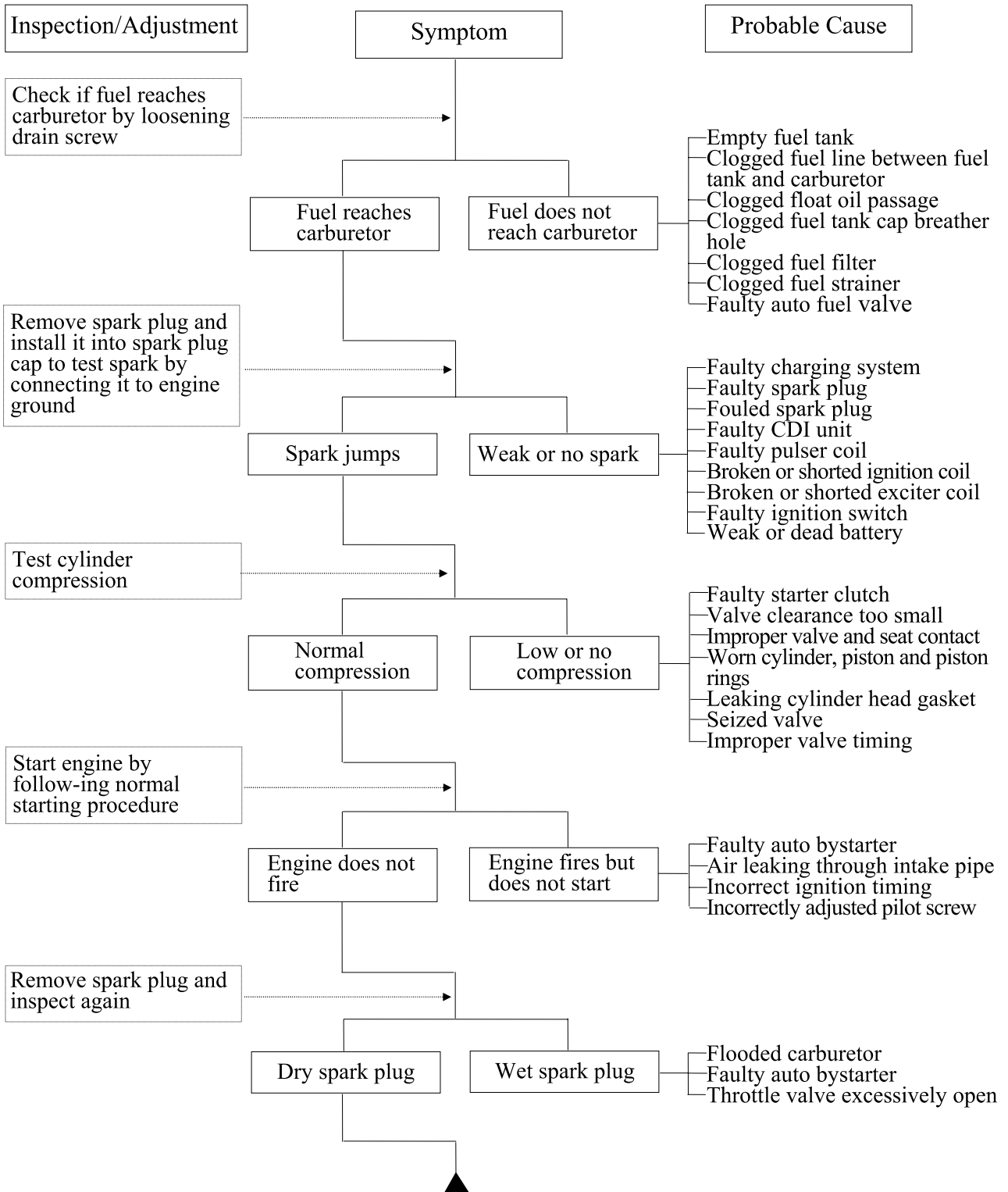

# 1. GENERAL INFORMATION

## ENGINE LACKS POWER

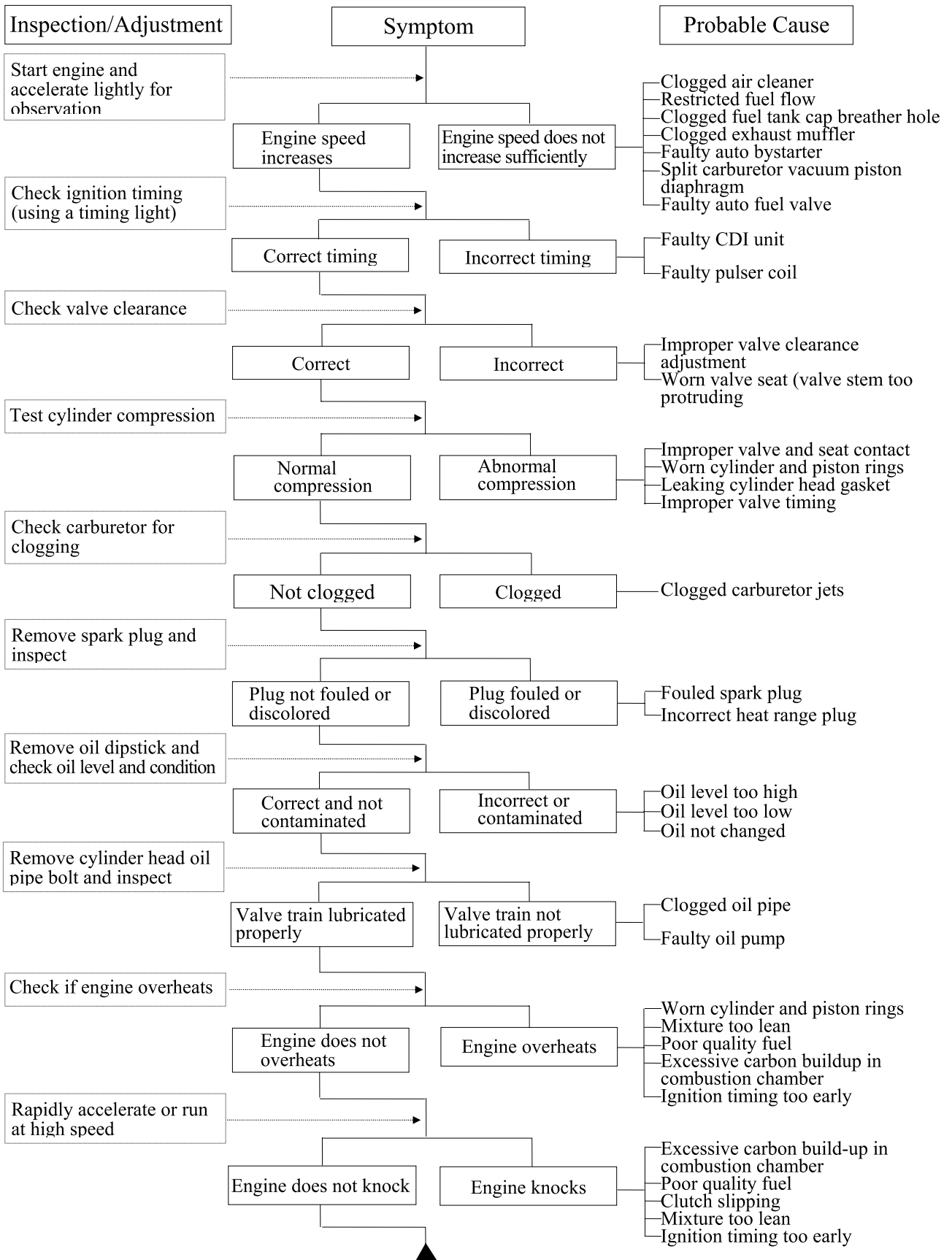

# 1. GENERAL INFORMATION

## POOR PERFORMANCE (ESPECIALLY AT IDLE AND LOW SPEEDS)

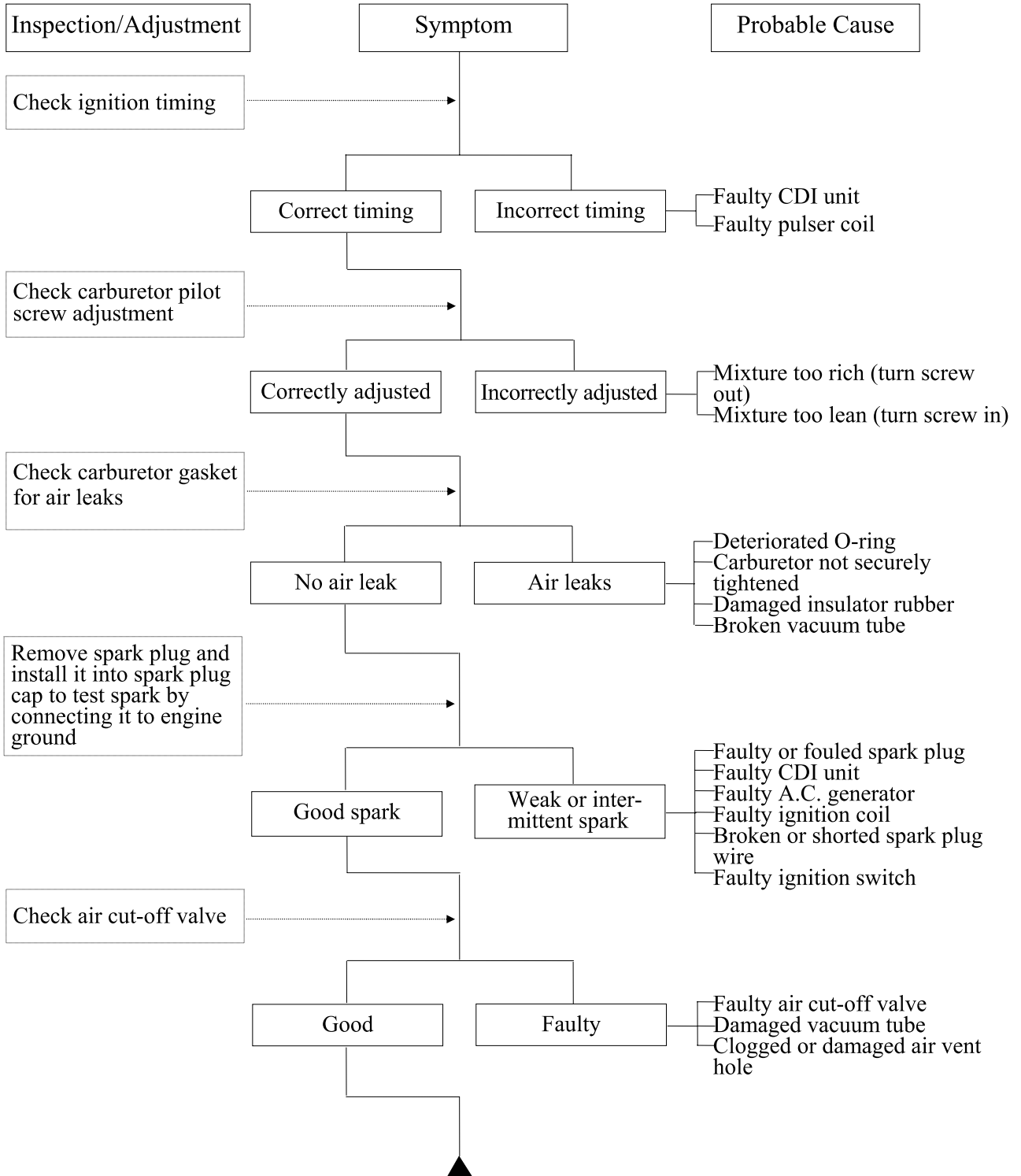

# 1. GENERAL INFORMATION

## POOR PERFORMANCE (AT HIGH SPEED)

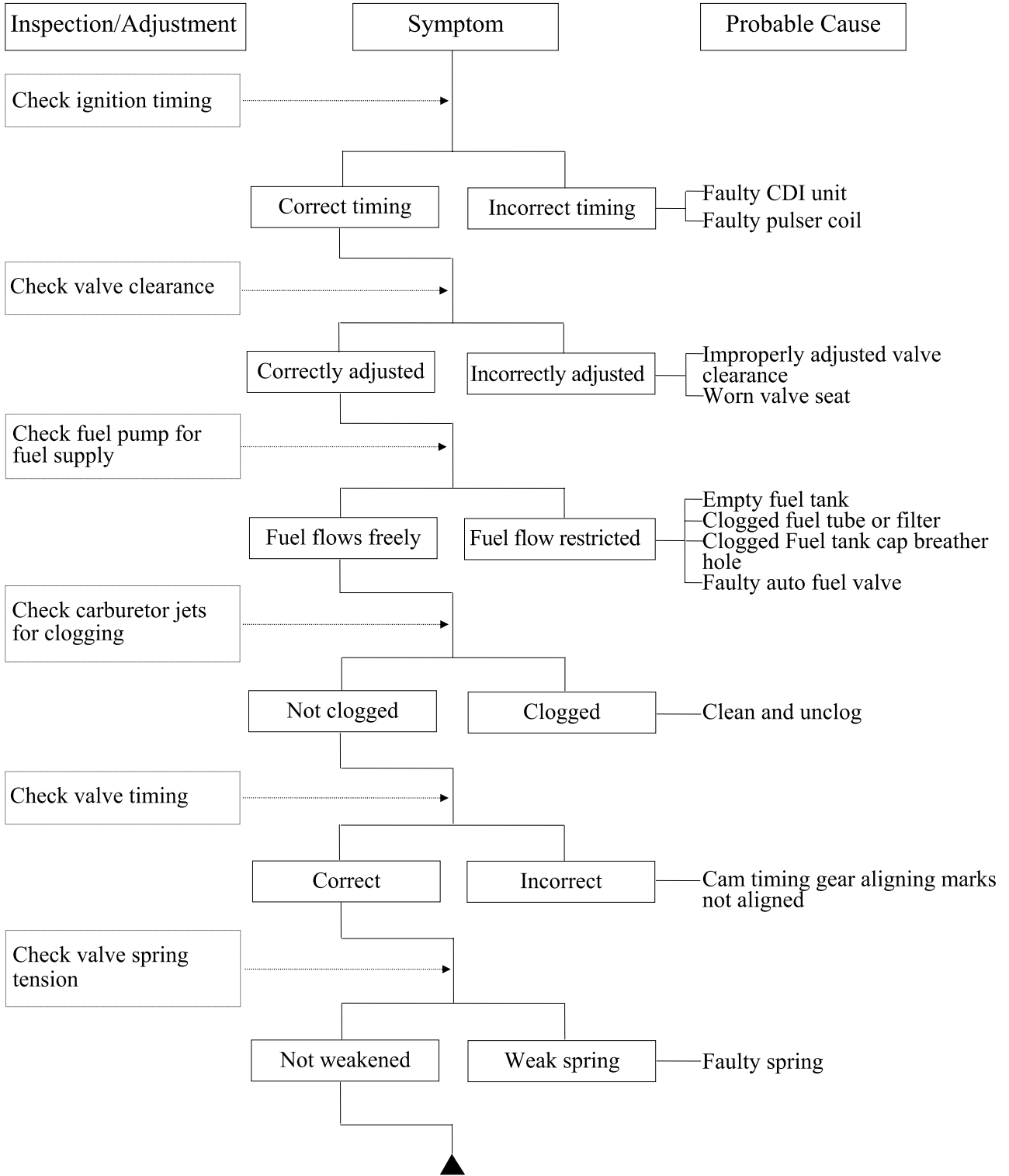

# 1. GENERAL INFORMATION

## POOR CHARGING (BATTERY OVER DISCHARGING OR OVERCHARGING)

### Undercharging

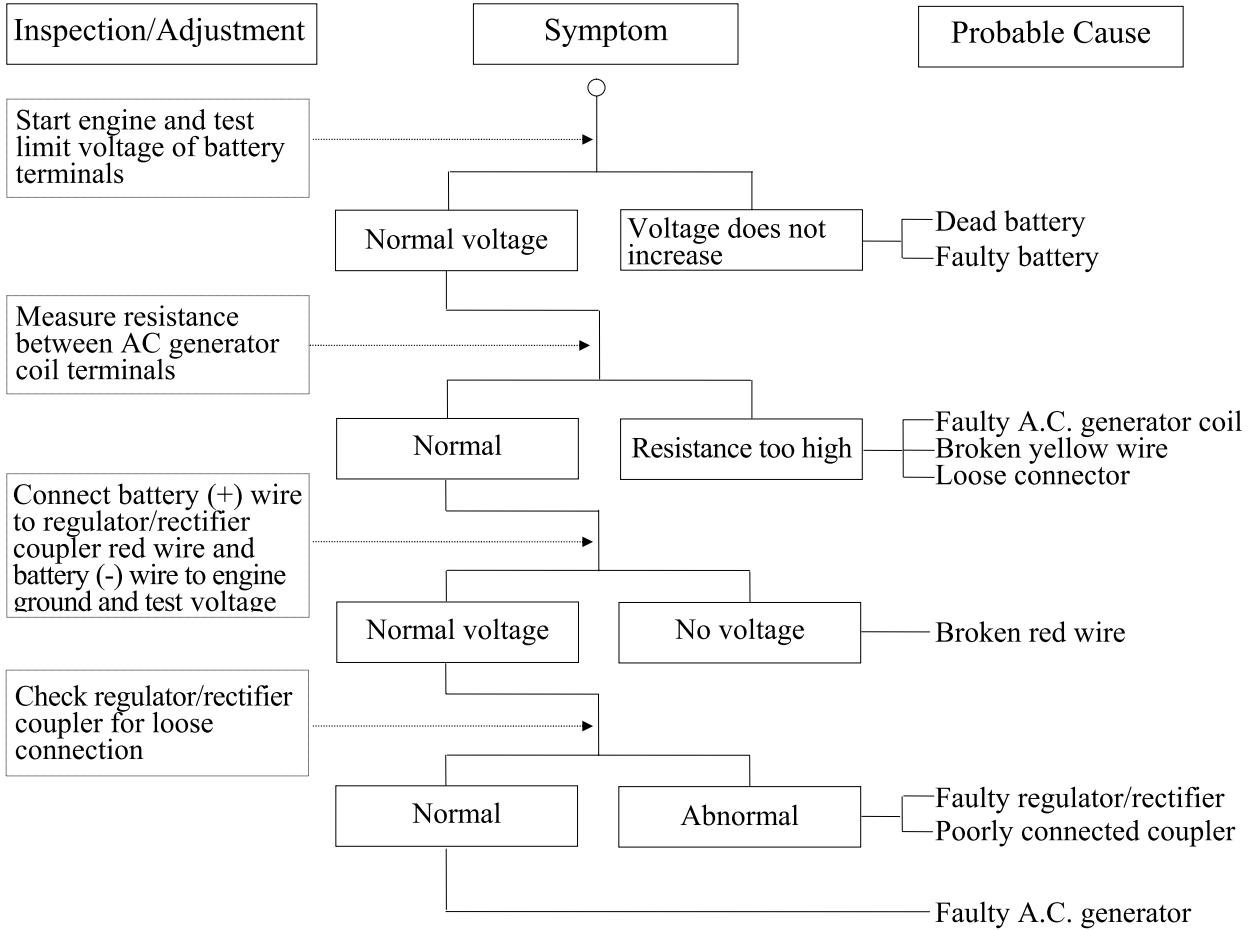

### Overcharging

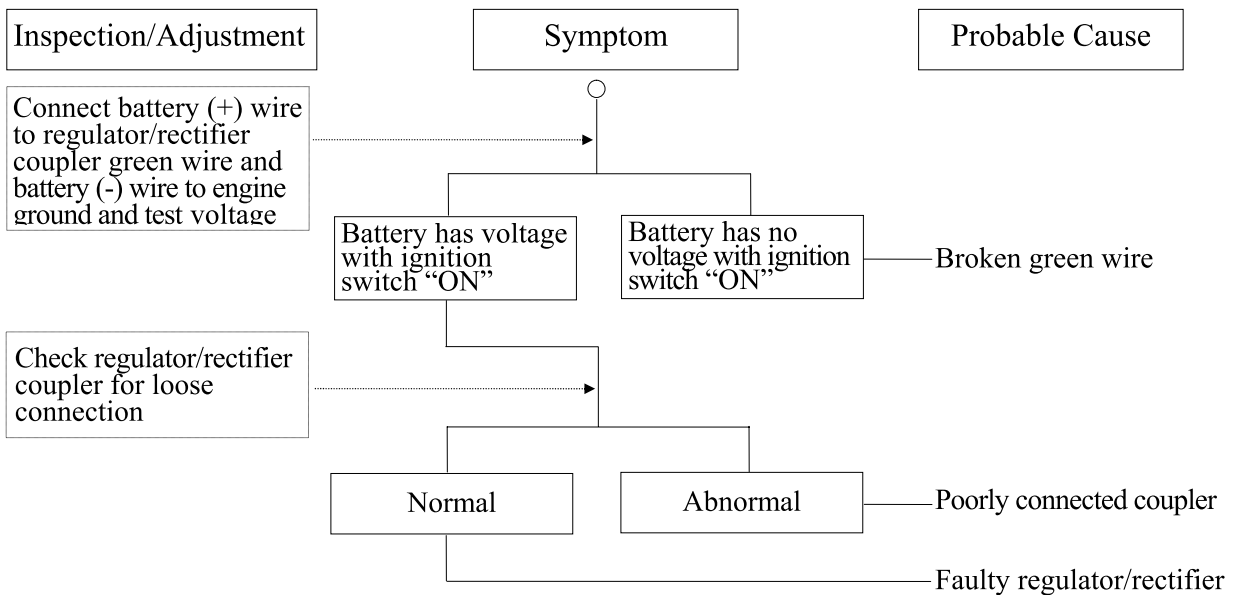

# 1. GENERAL INFORMATION

## NO SPARK AT SPARK PLUG

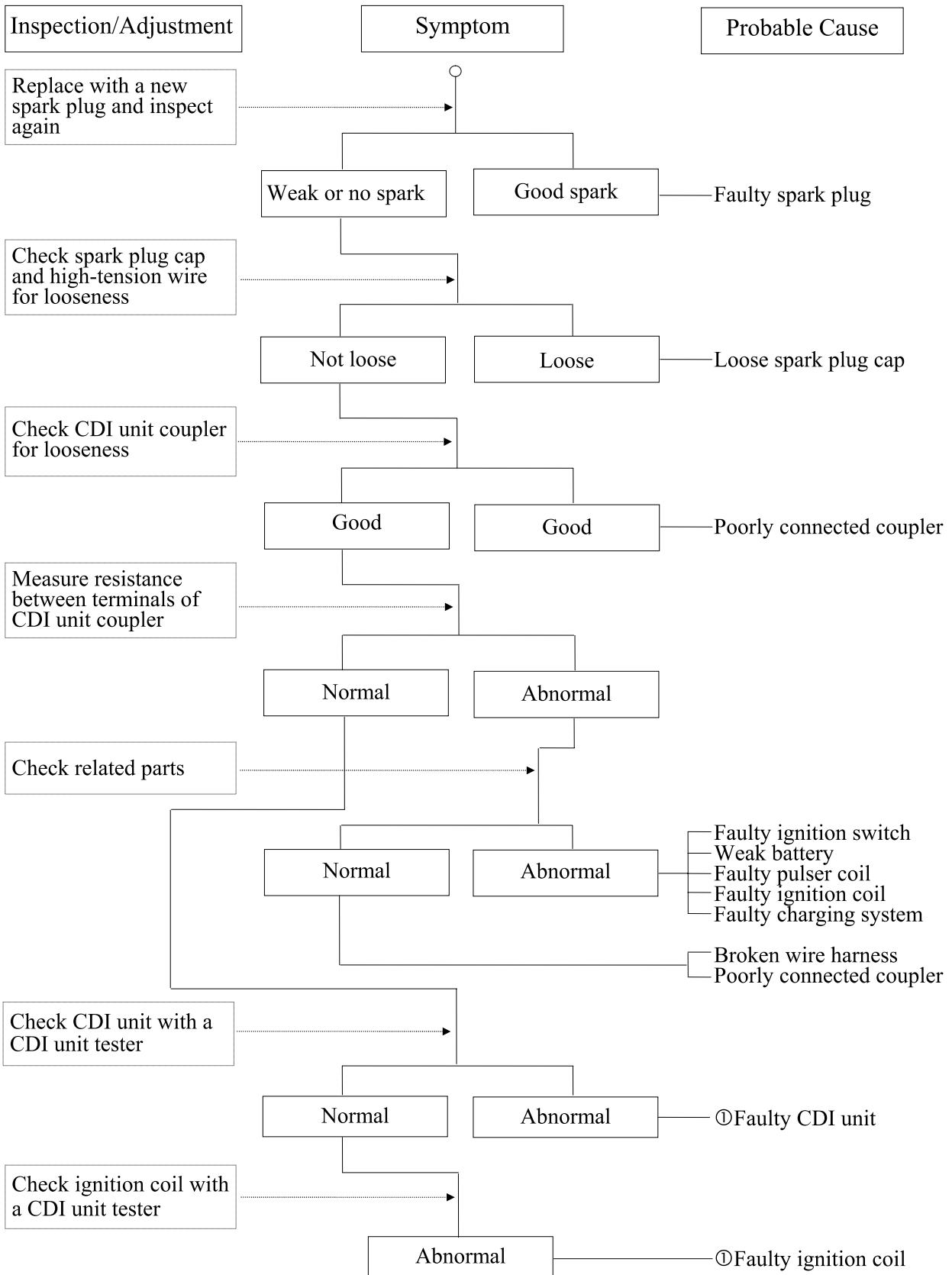

---

**FRAME COVERS/EXHAUST MUFFLER**

---

SERVICE INFORMATION-----	2- 1
TROUBLESHOOTING-----	2- 1
FRAME COVERS-----	2- 2
EXHAUST MUFFLER REMOVAL-----	2- 5

## **2. FRAME COVERS/EXHAUST MUFFLER**

---

### **SERVICE INFORMATION**

#### **GENERAL INSTRUCTIONS**

- When removing frame covers, use special care not to pull them by force because the cover joint claws may be damaged.
- Make sure to route cables and harnesses according to the Cable & Harness Routing.

#### **TORQUE VALUES**

Exhaust muffler lock bolt	3.5kg-m
Exhaust muffler joint lock nut	1.2kg-m

### **TROUBLESHOOTING**

#### **Noisy exhaust muffler**

- Damaged exhaust muffler
- Exhaust muffler joint air leaks

#### **Lack of power**

- Caved exhaust muffler
- Exhaust muffler air leaks
- Clogged exhaust muffler



### FRAME COVERS

#### REAR HAND GRIP REMOVAL

Remove the three bolts attaching the rear hand grip.  
Remove the rear hand grip.  
The installation sequence is the reverse of removal.

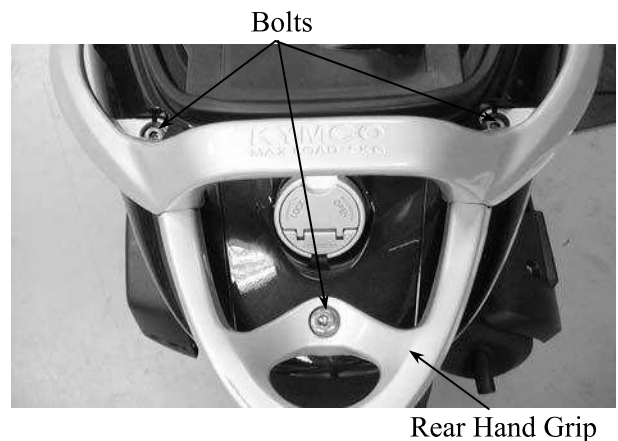

#### FRAME REAR COVER REMOVAL

Remove the two screws attaching the frame rear cover.  
Remove the frame rear cover.  
The installation sequence is the reverse of removal.

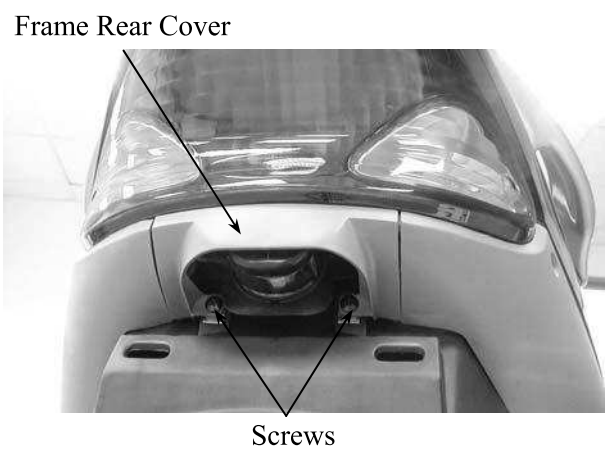

#### REAR SIDE COVERS REMOVAL

Remove the two screws on the rear end of each of the rear right and left side covers.  
Remove the one bolt on the front end of each of the rear right and left side covers.  
Remove the rear right and left side covers by pulling them backward.  
The installation sequence is the reverse of removal.

During removal, do not pull the joint claws forcibly to avoid damage.

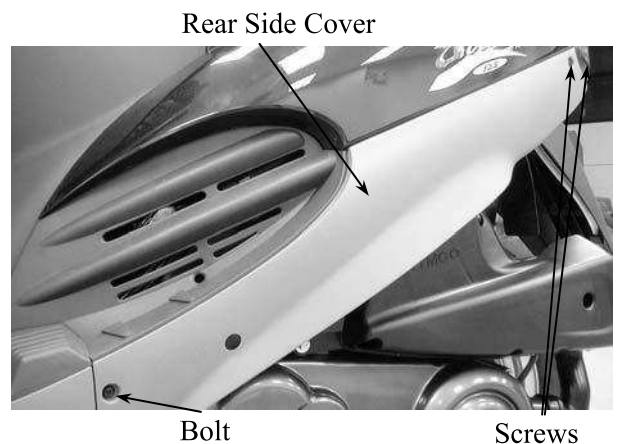

Remove the two bolts and nuts attaching the met-in box.  
Remove the met-in box.  
The installation sequence is the reverse of removal.

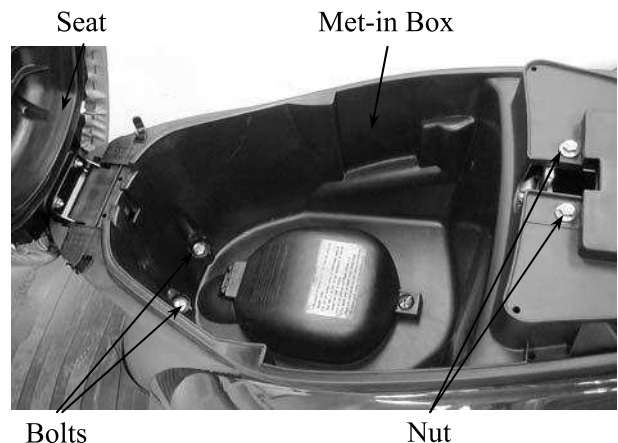

## 2. FRAME COVERS/EXHAUST MUFFLER

Remove the fuel tank cap.  
 Remove the six screws inside the frame body cover on the joint between the floor board and the frame body cover.  
 Remove the frame body cover.



Frame Body Cover

### FRAME CENTER COVER REMOVAL

Remove the two screws on the bottom of the frame center cover.  
 Remove the frame center cover.

Frame Center Cover

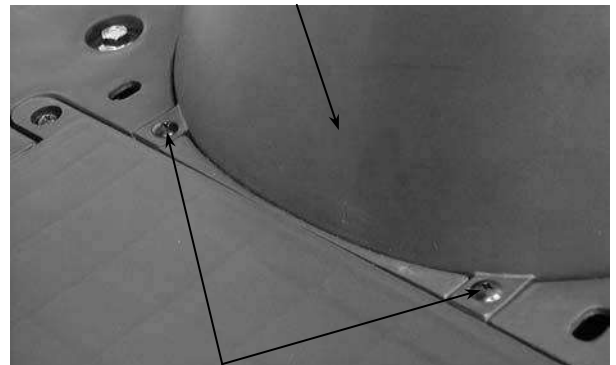

Screws

### FRONT SIDE COVERS REMOVAL

Remove the front cover.  
 Remove the bolt and five screws attaching each of the front right and left side covers.  
 Remove the front side covers by pulling them outward.  
 The installation sequence is the reverse of removal.



Front Side Cover

Screws

### FRONT COVER REMOVAL

Remove the three bolts on the front of the front cover.  
 Remove the six screws that combine the front cover with the front tool box.  
 Remove the front cover and disconnect the turn signal light wire connector.  
 The installation sequence is the reverse of removal.

Front Cover

Screws



Bolt

Screws Back Cover

## 2. FRAME COVERS/EXHAUST MUFFLER

### HANDLEBAR FRONT/REAR COVER REMOVAL

#### HANDLEBAR REAR COVER REMOVAL

Remove the right and left rearview mirrors.  
Remove the handlebar rear cover bolt.  
Disconnect all of the wire connectors, couplers and the speedometer cable.  
Remove the handlebar rear cover.

During removal, be careful not to damage the joint claws.

Handlebar Front Cover      Handlebar Rear Cover

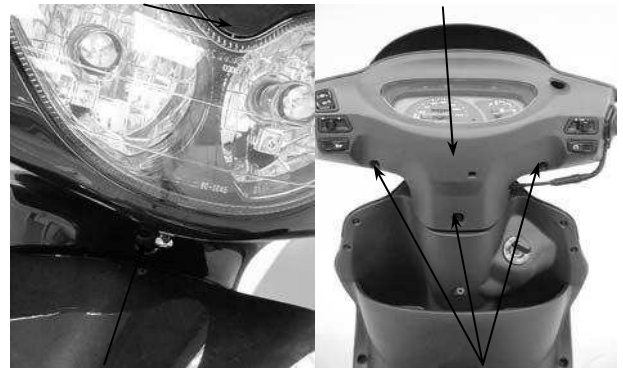

Bolt

Screws

#### HANDLEBAR FRONT COVER REMOVAL

Remove the two screws attaching the handlebar front cover.  
Remove the handlebar front cover.  
The installation sequence is the reverse of removal.

Speedometer Cable

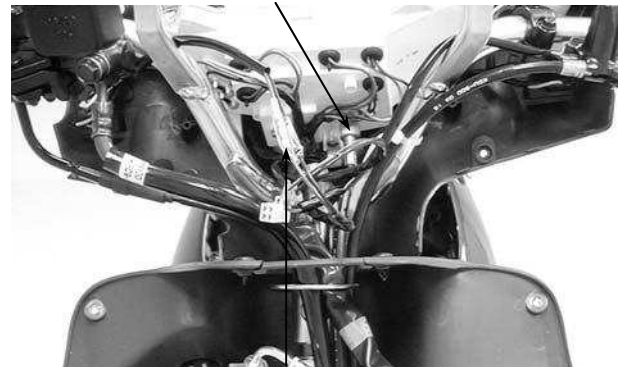

Wire Connectors

Handlebar Rear Cover



#### FLOOR BOARD REMOVAL

Remove the battery cover.  
Remove the battery cables.  
Remove the battery.  
Remove the CDI unit.

- When removing, first disconnect the battery negative (-) cable and then the positive (+) cable.
- When installing, first connect the positive (+) cable and then the negative (-) cable.

CDI Unit

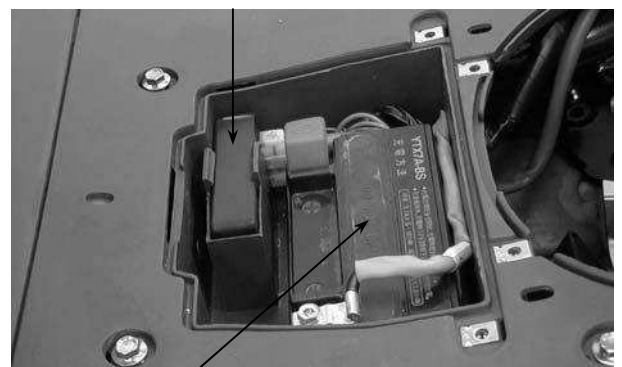

Battery

## 2. FRAME COVERS/EXHAUST MUFFLER

Remove the rear right and left side covers.  
 Remove the frame body cover.  
 Remove the front right and left side covers.  
 Remove the four bolts attaching the floor board.  
 Remove the screw on the bottom of the battery case.  
 Remove the floor board.  
 The installation sequence is the reverse of removal.

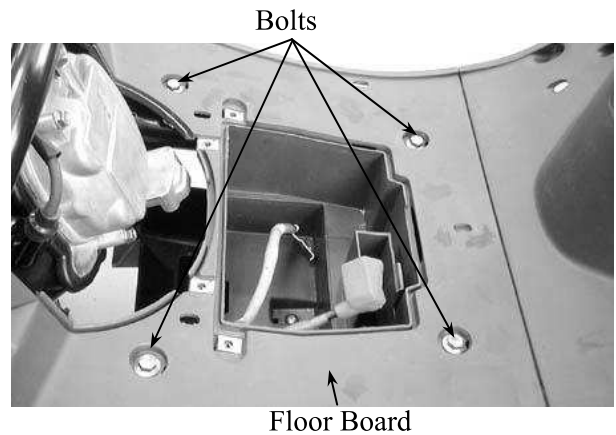

### FRONT TOOL BOX REMOVAL

Remove the bolt attaching the front tool box.  
 Remove the front tool box.  
 The installation sequence is the reverse of removal.

Front Tool Box



### BOTTOM COVER REMOVAL

Remove the four bolts attaching the bottom cover.  
 Remove the bottom cover.  
 The installation sequence is the reverse of removal.

Bolt

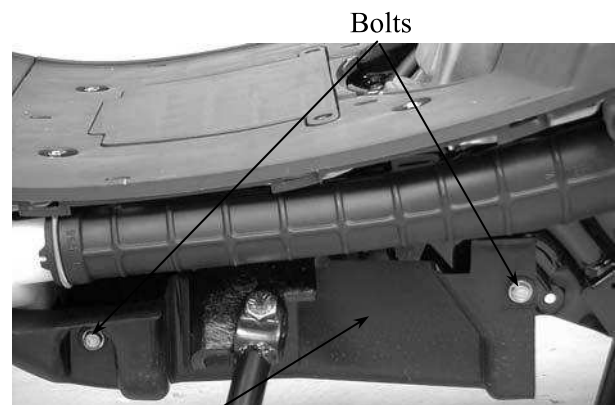

When installing, the edge of the bottom cover must be insert into the front side covers.

### EXHAUST MUFFLER REMOVAL

Remove the two exhaust muffler joint lock nuts.  
 Remove the two exhaust muffler lock bolts to remove the exhaust muffler.  
 Remove the exhaust muffler joint packing collar.  
 When installing, first install the exhaust muffler packing collar onto the engine and then install the exhaust muffler.

#### Torques:

Exhaust muffler lock bolt: 3.5kg-m  
 Exhaust muffler joint lock nut: 1.2kg-m

Be sure to install a new exhaust muffler packing collar.



### 3. INSPECTION/ADJUSTMENT

### INSPECTION/ADJUSTMENT

SERVICE INFORMATION-----	3- 1
MAINTENANCE SCHEDULE-----	3- 2
FUEL LINE-----	3- 3
THROTTLE OPERATION-----	3- 3
AIR CLEANER -----	3- 4
SPARK PLUG-----	3- 4
VALVE CLEARANCE -----	3- 5
CARBURETOR IDLE SPEED -----	3- 5
IGNITION TIMING-----	3- 6
CYLINDER COMPRESSION -----	3- 6
FINAL REDUCTION GEAR OIL -----	3- 7
DRIVE BELT -----	3- 7
BRAKE SHOE -----	3- 8
BRAKE SYSTEM -----	3- 8
HEADLIGHT AIM-----	3- 9
SUSPENSION-----	3- 9
NUTS/BOLTS/FASTENERS -----	3-10
WHEELS/TIRES -----	3-10
STEERING HANDLEBAR -----	3-10

### 3. INSPECTION/ADJUSTMENT

#### SERVICE INFORMATION

##### GENERAL

 <b>WARNING</b>
--

- Before running the engine, make sure that the working area is well-ventilated. Never run the engine in a closed area. The exhaust contains poisonous carbon monoxide gas which may cause death to people.
- Gasoline is extremely flammable and is explosive under some conditions. The working area must be well-ventilated and do not smoke or allow flames or sparks near the working area or fuel storage area.

##### SPECIFICATIONS

###### ENGINE

- Throttle grip free play : 2-6mm
- Spark plug gap : 0.6-0.7mm
- Spark plug: Standard : NGK: CR7HSA
- Valve clearance : IN: 0.12mm  
EX: 0.12mm
- Idle speed : 1700±100rpm
- Engine oil capacity:
  - At disassembly : 0.9 liter
  - At change : 0.8 liter
- Gear oil capacity :
  - At disassembly : 200cc
  - At change : 180cc
- Cylinder compression : 13kg/cm<sup>2</sup>
- Ignition timing : BTDC 13±3°/1700±100rpm

###### CHASSIS

- Front brake free play: 10-20mm
- Rear brake free play: 10-20mm

###### TIRE PRESSURE

	1 Rider	2 Riders
Front	1.75kg/cm <sup>2</sup>	1.75kg/cm <sup>2</sup>
Rear	2.00kg/cm <sup>2</sup>	2.25kg/cm <sup>2</sup>

###### TIRE SIZE:

- Front : 100/90-10
- Rear : 100/90-10

###### TORQUE VALUES

- Front axle nut : 6.0kg-m
- Rear axle nut : 11.0kg-m

### 3. INSPECTION/ADJUSTMENT

#### MAINTENANCE SCHEDULE

Perform the periodic maintenance at each scheduled maintenance period.

I: Inspect, and Clean, Adjust, Lubricate or Replace if necessary.

A: Adjust C: Clean R: Replace T: Tighten

Item	Frequency	Whichever comes first ⇨ ↓	Regular Service Mileage (km)											
			1000	200	300	400	500	600	700	800	900	1000	1100	1200
			0	0	0	0	0	0	0	0	0	0	0	0
Engine oil		R New motorcycle 300km	R		R		R		R		R		R	
Engine oil filter screen					C				C					
Fuel filter screen											R			
Gear oil	Note 3	R New motorcycle 300km				R					R			
Valve clearance			A		A				A				A	
Carburetor					I				I				C	
Air Cleaner	Note 2,3	Replace at every 3000km												
Spark plug		Clean at every 3000km and replace if necessary												
Brake system			I	I	I	I	I	I	I	I	I	I	I	
Drive belt									I					
Suspension					I				I				I	
Nut, bolt, fastener									I					
Tire					I				I				I	
Steering head bearing			I					I					I	

- In the interest of safety, we recommend these items should be serviced only by an authorized KYMCO motorcycle dealer.

Note: 1. For higher odometer readings, repeat at the frequency interval established here.

2. Service more frequently when riding in dusty or rainy areas.

3. Service more frequently when riding in rain or at full throttle.

### 3. INSPECTION/ADJUSTMENT

#### FUEL LINE

Remove the met-in box.  
Check the fuel lines and replace any parts which show signs of deterioration, damage or leakage.

Do not smoke or allow flames or sparks in your working area.

Fuel Line



Fuel Filter

#### THROTTLE OPERATION

Check the throttle grip for smooth movement.

Measure the throttle grip free play.

**Free Play:** 2 6mm



Major adjustment of the throttle grip free play is made at the carburetor side. Adjust by loosening the lock nut and turning the adjusting nut.



Adjusting Nut

Lock Nut

Minor adjustment is made with the adjusting nut at the throttle grip side. Slide the rubber cover out and adjust by loosening the lock nut and turning the adjusting nut.



Adjusting Nut

Lock Nut



### 3. INSPECTION/ADJUSTMENT

#### AIR CLEANER

##### AIR CLEANER REPLACEMENT

Remove the rear side covers.  
Remove the five air cleaner case cover screws and the cover.

Remove the air cleaner element by removing the two screws.  
Check the element and replace it if it is excessively dirty or damaged.

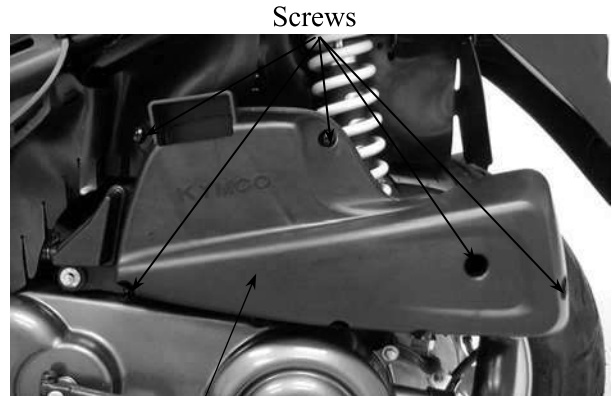

Air Cleaner Case Cover

Air Cleaner Element



Screws

##### CHANGE INTERVAL

More frequent replacement is required when riding in unusually dusty or rainy areas.

- The air cleaner element has a viscous type paper element. Do not clean it with fuel.
- Be sure to install the air cleaner element and cover securely.

#### SPARK PLUG

Remove the spark plug.  
Check the spark plug for wear and fouling deposits.  
Clean any fouling deposits with a spark plug cleaner or a wire brush.

**Specified Spark Plug:** NGK: CR7HSA



Measure the spark plug gap.

**Spark Plug Gap:** 0.6 0.7mm

When installing, first screw in the spark plug by hand and then tighten it with a spark plug wrench.

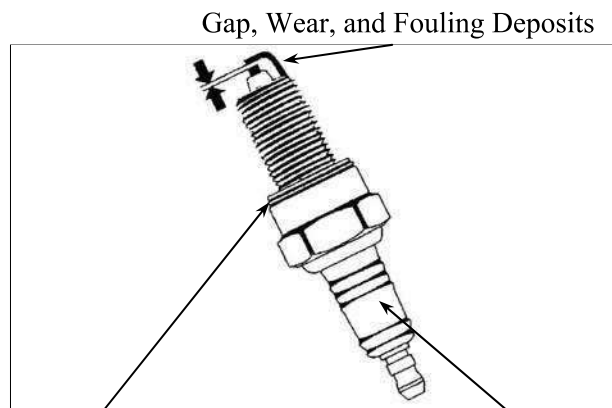

Washer Deformation

Cracks, Damage

### 3. INSPECTION/ADJUSTMENT

#### VALVE CLEARANCE

Inspect and adjust valve clearance while the engine is cold (below 35 °C).

Remove the center cover.  
Remove the cylinder head cover.



Turn the flywheel counterclockwise so that the “T” mark on the flywheel aligns with the index mark on the crankcase to bring the round hole on the camshaft gear facing up to the top dead center on the compression stroke.

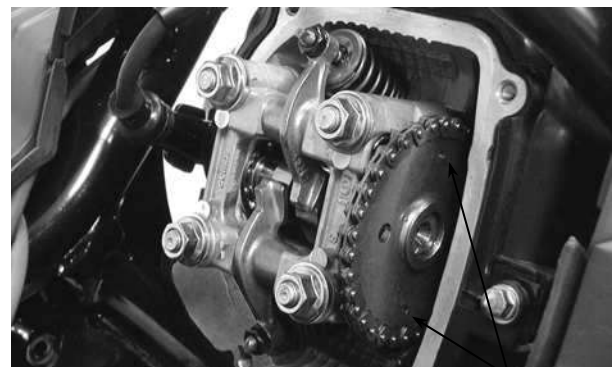

Inspect and adjust the valve clearance.

**Valve Clearance:** IN: 0.12mm  
EX: 0.12mm

Loosen the lock nut and adjust by turning the adjusting nut

Special

Valve Wrench

- Check the valve clearance again after the lock nut is tightened.

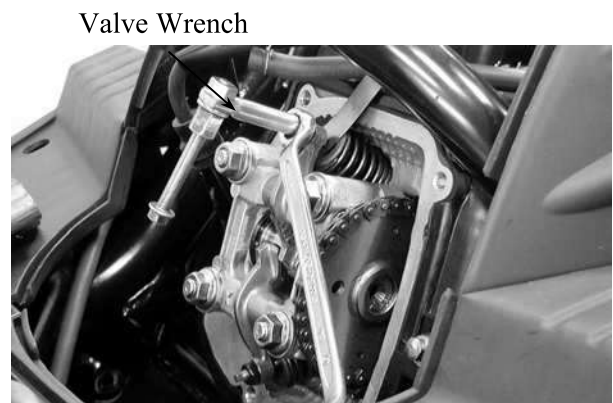

#### CARBURETOR IDLE SPEED

- The engine must be warm for accurate idle speed inspection and adjustment.

Remove the inspection cover.  
Warm up the engine before this operation.  
Start the engine and connect a tachometer.  
Turn the throttle stop screw to obtain the specified idle speed.

**Idle Speed:** 1700±100rpm

When the engine misses or run erratic, adjust the pilot screw.

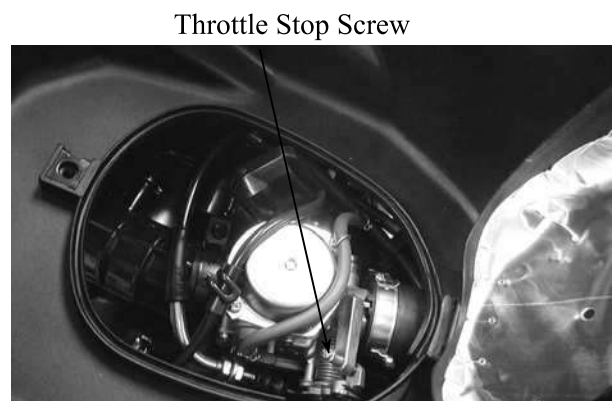

### 3. INSPECTION/ADJUSTMENT

#### IGNITION TIMING

The CDI unit is not adjustable. If the ignition timing is incorrect, check the ignition system.

Remove the rear right side cover.  
Remove the timing hole cap.

Timing Hole Cap



Check the ignition timing with a timing light.  
When the engine is running at idle speed, the ignition timing is correct if the "F" mark on the flywheel aligns with the index mark on the crankcase.

Timing Light



Also use a timing light to check the advance. Raise the engine speed to 5,000rpm and the index mark on the crankcase should be aligned with the advance mark on the flywheel.

Advance Mark

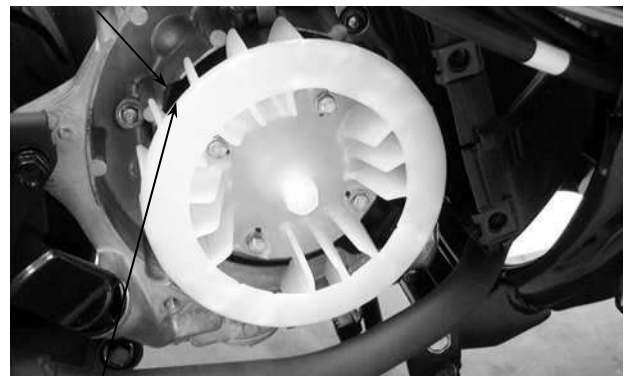

"F" Mark

#### CYLINDER COMPRESSION

Warm up the engine before compression test.  
Remove the met-in box and frame center cover.  
Remove the spark plug .  
Insert a compression gauge.  
Open the throttle valve fully and push the starter button to test the compression.

**Compression:** 13kg/cm<sup>2</sup>

If the compression is low, check for the following:

- Leaky valves
- Valve clearance to small
- Leaking cylinder head gasket
- Worn piston rings
- Worn piston/cylinder

If the compression is high, it indicates that carbon deposits have accumulated on the combustion chamber and the piston head.

Compression Gauge



### 3. INSPECTION/ADJUSTMENT

#### FINAL REDUCTION GEAR OIL OIL LEVEL CHECK

Place the motorcycle on its main stand on level ground for oil level check.

Stop the engine and remove the oil check bolt.  
The oil level shall be at the oil check bolt hole.  
If the oil level is low, add the recommended oil to the proper level.

**Recommended Oil:** GEAR OIL SAE90#

Install the oil check bolt.

Make sure that the sealing washer is in good condition.

Oil Check Bolt/Sealing Washer



Oil Check Bolt Hole



#### OIL CHANGE

Remove the oil check bolt.  
Remove the oil drain bolt and drain the oil thoroughly.  
Install the oil drain bolt.

**Torque:** 1.0kg-m

Make sure that the sealing washer is in good condition.

Fill with the recommended oil.

**Oil Capacity:** At disassembly : 200cc  
At change : 180cc

Reinstall the oil check bolt and check for oil leaks.

**Torque:** 1.2kg-m



Oil Drain Bolt/ Sealing Washer

#### DRIVE BELT

Remove the left crankcase cover.  
Inspect the drive belt for cracks or excessive wear.  
Replace the drive belt with a new one if necessary and in accordance with the Maintenance Schedule.

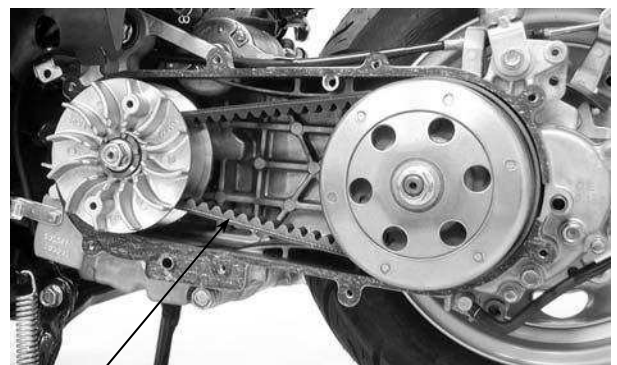

Drive Belt

### 3. INSPECTION/ADJUSTMENT

#### BRAKE SHOE

Replace the brake shoes if the arrow on the wear indicator plate aligns with the punch mark on the brake panel when the brake is fully applied.

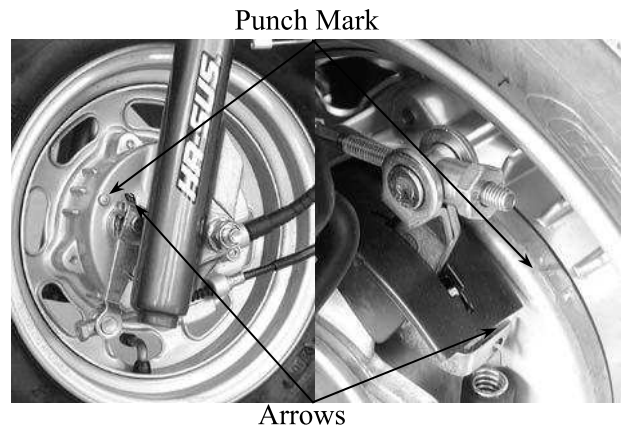

#### BRAKE SYSTEM

##### FRONT BRAKE

Measure the front brake lever free play.

**Free Play:** 10 20mm



If the free play do not fall within the limit, adjust by turning the adjusting nut.



Adjusting Nut

##### REAR BRAKE

Measure the rear brake lever free play.

**Free Play:** 10 20mm



### 3. INSPECTION/ADJUSTMENT

If the free play do not fall within the limit, adjust by turning the adjusting nut.

Adjusting Nut



#### HEADLIGHT AIM

Turn the ignition switch ON and start the engine.

Turn on the headlight switch.

Adjust the headlight aim by turning the headlight aim adjusting screw.



Adjusting Screw

#### SUSPENSION

##### FRONT

Fully apply the front brake lever and check the action of the front shock absorbers by compressing them several times.

Check the entire shock absorber assembly for oil leaks, looseness or damage.



##### REAR

Check the action of the rear shock absorber by compressing it several times.

Check the entire shock absorber assembly for oil leaks, looseness or damage.

Jack the rear wheel off the ground and move the rear wheel sideways with force to see if the engine hanger bushings are worn.



### 3. INSPECTION/ADJUSTMENT

#### NUTS/BOLTS/FASTENERS

Check all important chassis nuts and bolts for looseness.  
Tighten them to their specified torque values if any looseness is found.

#### WHEELS/TIRES

Check the tires for cuts, imbedded nails or other damages.  
Check the tire pressure.

Tire pressure should be checked when tires are cold.



#### TIRE PRESSURE

	1 Rider	2 Riders
Front	1.75kg/cm <sup>2</sup>	1.75kg/cm <sup>2</sup>
Rear	2.00kg/cm <sup>2</sup>	2.25kg/cm <sup>2</sup>

#### TIRE SIZE

**Front :** 100-90-10  
**Rear :** 100-90-10

Check the front axle nut for looseness.  
Check the rear axle nut for looseness.  
If the axle nuts are loose, tighten them to the specified torques.

**Torques: Front :** 6.0kg-m  
**Rear :** 11.0kg-m

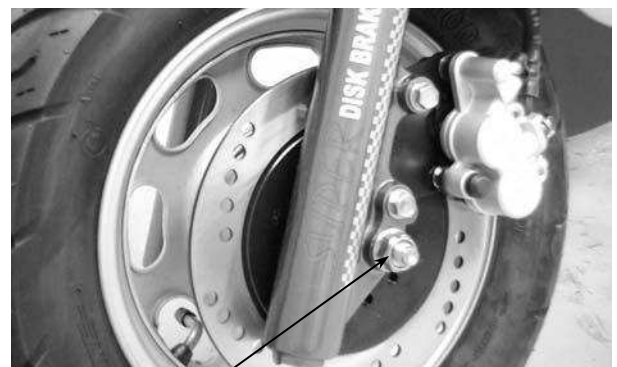

Front Axle Nut

#### STEERING HANDLEBAR

Raise the front wheel off the ground and check that the steering handlebar rotates freely.  
If the handlebar moves unevenly, binds, or has vertical movement, adjust the steering head bearing.



## 4. LUBRICATION SYSTEM

---

---

---

---

---

---

---

---

**4**

### LUBRICATION SYSTEM

---

SERVICE INFORMATION-----	4- 1
TROUBLESHOOTING-----	4- 1
ENGINE OIL/OIL FILTER -----	4- 2
OIL PUMP-----	4- 2



# 4. LUBRICATION SYSTEM

## SERVICE INFORMATION

### GENERAL INSTRUCTIONS

- The maintenance of lubrication system can be performed with the engine installed in the frame.
- Use care when removing and installing the oil pump not to allow dust and foreign matters to enter the engine and oil line.
- Do not attempt to disassemble the oil pump. The oil pump must be replaced as a set when it reaches its service limit.
- After the oil pump is installed, check each part for oil leaks.

### SPECIFICATIONS

Item		Standard (mm)	Service Limit (mm)
Oil pump	Inner rotor-to-outer rotor clearance	—	0.12
	Outer rotor-to-pump body clearance	—	0.12
	Rotor end-to-pump body clearance	0.05 0.10	0.2

### TROUBLESHOOTING

#### Oil level too low

- Natural oil consumption
- Oil leaks
- Worn or poorly installed piston rings
- Worn valve guide or seal

#### Poor lubrication pressure

- Oil level too low
- Clogged oil filter or oil passages
- Not use the specified oil

## 4. LUBRICATION SYSTEM

### ENGINE OIL/OIL FILTER

#### OIL LEVEL

- Place the motorcycle upright on level ground for engine oil level check.
- Run the engine for 2-3 minutes and check the oil level after the engine is stopped for 2-3 minutes.

Remove the oil dipstick and check the oil level with the oil dipstick. If the level is near the lower level, fill to the upper level with the specified engine oil.

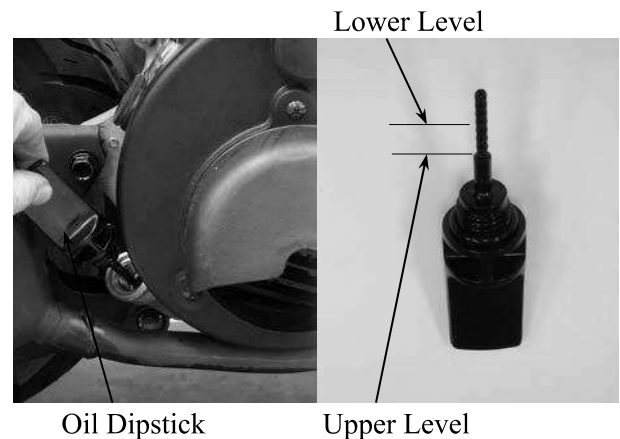

Oil Dipstick

Upper Level

#### OIL CHANGE

The engine oil will drain more easily while the engine is warm.

Remove the oil filter screen cap located on the bottom of the engine to drain the engine oil thoroughly.



Oil Filter Screen Cap

After the oil has been completely drained, check the filter screen O-ring for damage and replace if necessary. Install the oil filter screen, spring and filter screen cap.

**Torque:** 1.5kg-m

Fill with the specified SAE15W40#, API: SG engine oil to the proper level.

Oil Capacity: At disassembly : 0.90 liter  
At change : 0.80 liter

Check for oil leaks and then start the engine and let it idle for few minutes.

Recheck the oil level.



O-ring

Bolts

Pulser Coil

### OIL PUMP

#### REMOVAL

Remove the A.C. generator flywheel. Remove the nine right crankcase cover bolts and the right crankcase cover.



Stator

Right Crankcase Cover

## 4. LUBRICATION SYSTEM

Remove the gasket and dowel pins.  
Remove the starter idle gear and starter clutch.



Gasket

Remove the two bolts and oil separator cover.

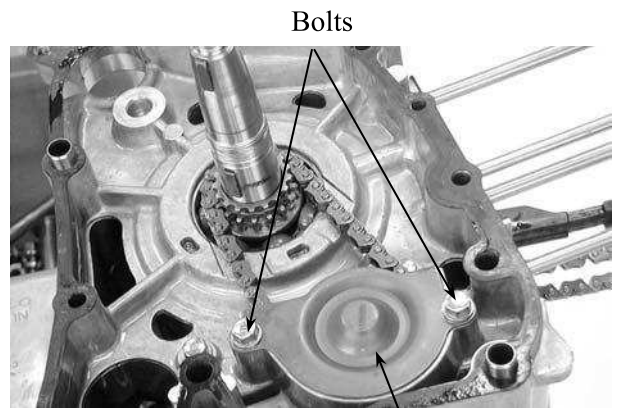

Bolts

Oil Separator Cover

Remove the oil pump driven gear nut to  
remove the oil pump driven gear and drive  
chain.

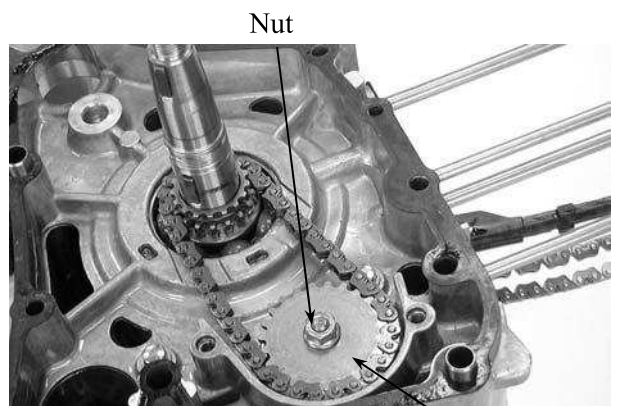

Nut

Oil Pump Driven Gear

Remove the two oil pump mounting bolts  
and the oil pump.

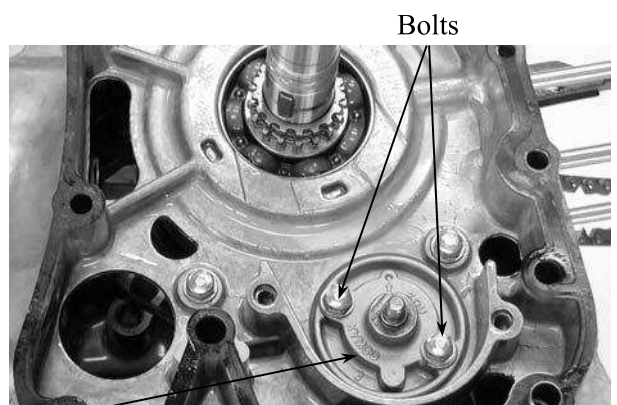

Bolts

Oil Pump

## 4. LUBRICATION SYSTEM

### DISASSEMBLY

Remove the screw and disassemble the oil pump.

Screw

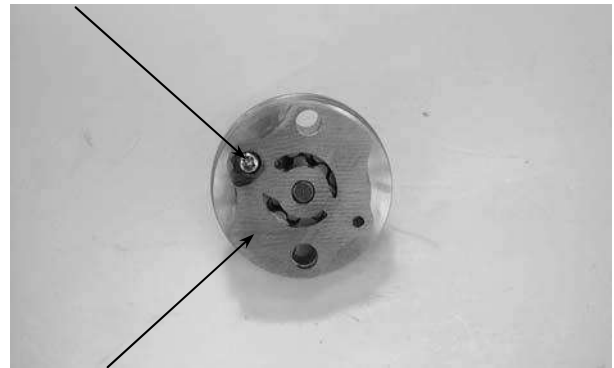

Pump Body

### INSPECTION

Measure the pump body-to-outer rotor clearance.

**Service Limit:** 0.12mm

Outer Rotor

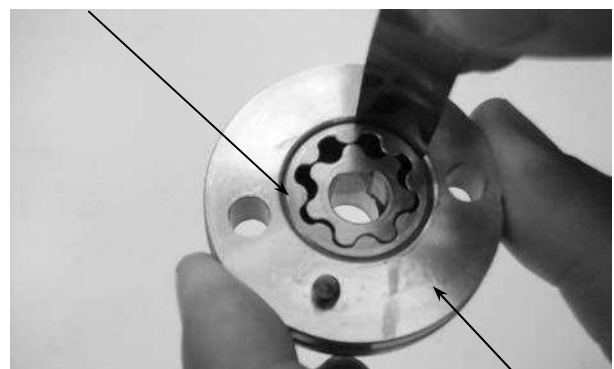

Pump Body

Measure the inner rotor-to-outer rotor clearance.

**Service Limit:** 0.12mm

Outer Rotor

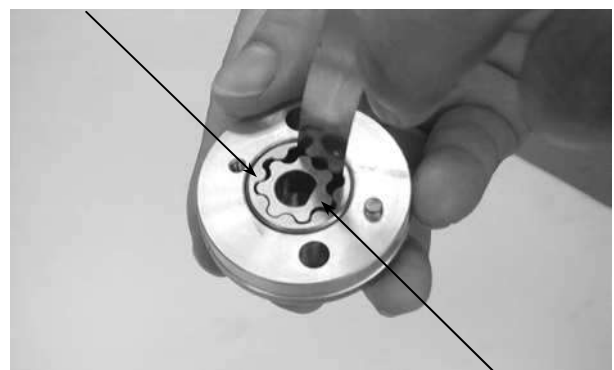

Inner Rotor

Measure the rotor end-to-pump body clearance.

**Service Limit:** 0.2mm

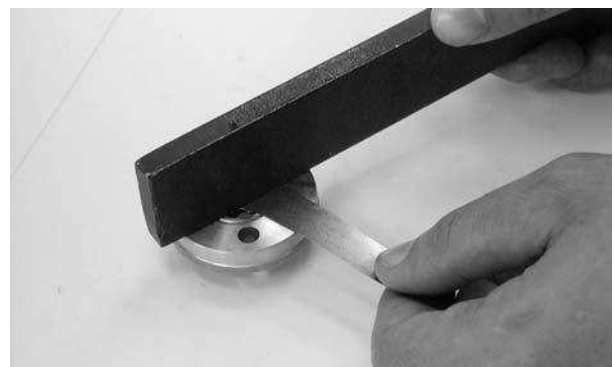

## 4. LUBRICATION SYSTEM

### ASSEMBLY

Install the outer rotor, inner rotor and pump shaft into the pump body.

Insert the pump shaft by aligning the flat on the shaft with the flat in the inner rotor.

Install the dowel pin.  
Install the pump cover by aligning the hole in the cover with the dowel pin.

Tighten the screw to secure the pump cover.  
Make sure that the pump shaft rotates freely without binding.

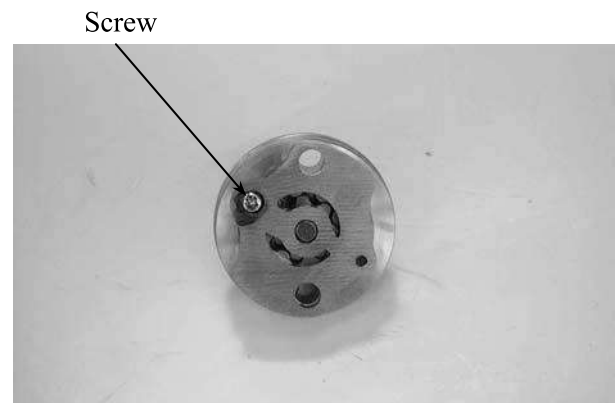
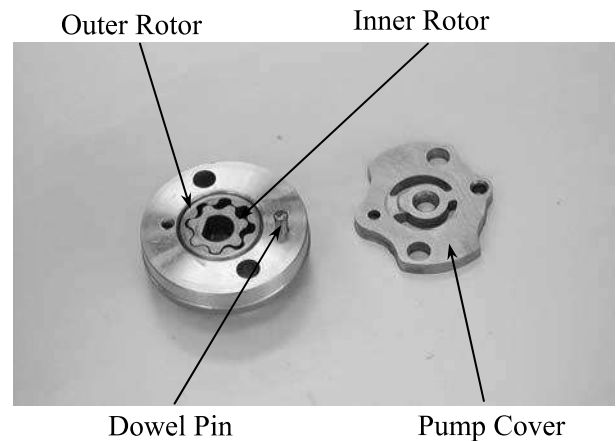

### INSTALLATION

Install the oil pump into the crankcase.

Install the oil pump with the arrow on the pump body facing up and fill the oil pump with engine oil before installation.

After the oil pump is installed, tighten the two mounting bolts.

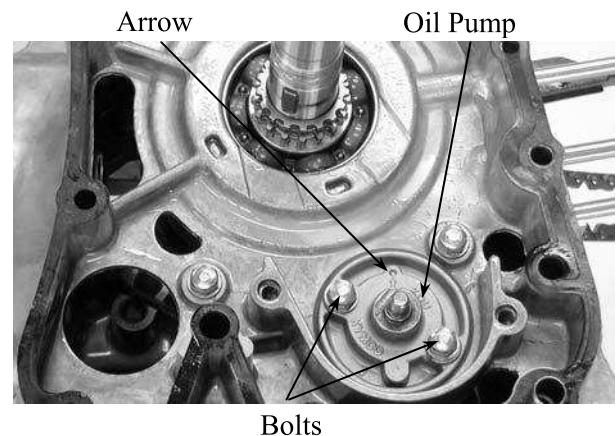

Install the pump driven gear and drive chain by aligning the pump driven gear with the cutout in the pump shaft.  
Install and tighten the pump driven gear nut.

**Torque:** 1.0kg-m

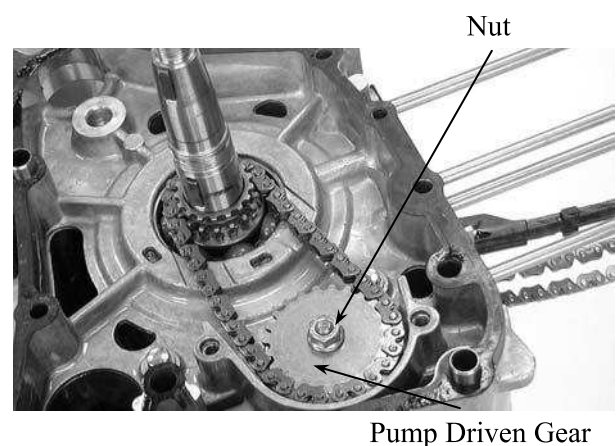

## 4. LUBRICATION SYSTEM

Install the oil separator cover and tighten the bolts.

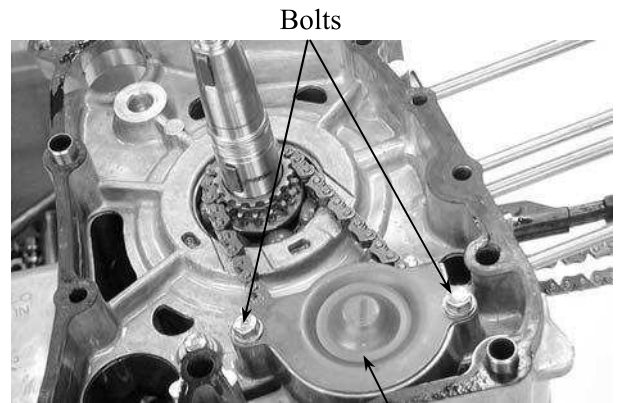

Oil Separator Cover

Install the starter idle gear and starter clutch.  
Install the gasket and dowel pins.

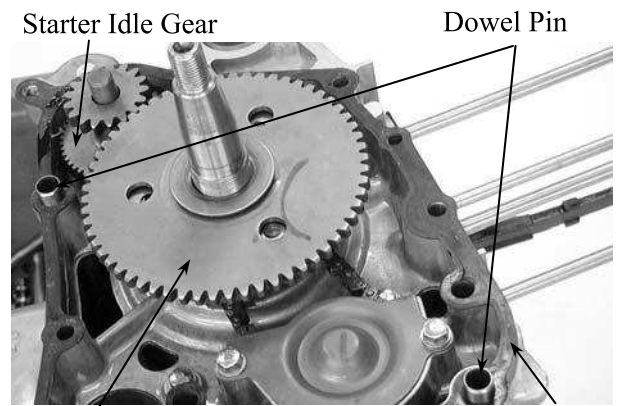

Starter Clutch

Gasket

Install the right crankcase cover and tighten the nine bolts.

**Torque:** 0.9kg-m

Diagonally tighten the bolts in 2 3 times.

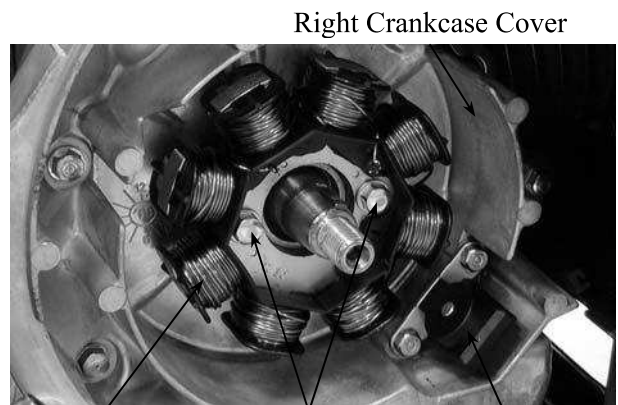

Right Crankcase Cover

Stator

Bolts

Pulser Coil

## FUEL SYSTEM

SERVICE INFORMATION-----	5- 1
TROUBLESHOOTING-----	5- 2
CARBURETOR REMOVAL -----	5- 3
AUTO BYSTARTER -----	5- 3
AIR CUT-OFF VALVE-----	5- 5
VACUUM CHAMBER -----	5- 5
FLOAT CHAMBER-----	5- 6
CARBURETOR INSTALLATION -----	5- 8
PILOT SCREW ADJUSTMENT -----	5- 9
FUEL TANK -----	5-10
AUTO FUEL VALVE -----	5-11
FUEL UNIT -----	5-11
AIR CLEANER -----	5-12

## SERVICE INFORMATION

### GENERAL INSTRUCTIONS

Gasoline is very dangerous. When working with gasoline, keep sparks and flames away from the working area.  
 Gasoline is extremely flammable and is explosive under certain conditions. Be sure to work in a well-ventilated area.

- When disassembling the carburetor, be sure to service the vacuum piston and float chamber.
- Do not bend or twist control cables. Damaged control cables will not operate smoothly.
- When disassembling fuel system parts, note the locations of O-rings. Replace them with new ones during assembly.
- Before float chamber disassembly, loosen the drain screw to drain the residual gasoline into a clean container.
- After the carburetor is removed, plug the intake manifold side with a clean shop towel to prevent foreign matters from entering.
- Remove the vacuum diaphragm before cleaning the carburetor air and fuel passages with compressed air to avoid damaging the vacuum diaphragm.
- When the motorcycle is not used for over one month, drain the residual gasoline from the float chamber to avoid erratic idling and clogged slow jet due to deteriorated fuel.

### SPECIFICATIONS

Name & Model	Jockey
Venturi dia. (mm)	24
Identification number	VE028 C
Float level (mm)	17.5
Main jet	#105
Slow jet	#35
Idle speed	1700±100rpm
Throttle grip free play	2□6mm
Pilot screw opening	3±½

Name & Model	Movie XL
Venturi dia. (mm)	φ22.1
Identification number	VE070A
Float level (mm)	17.5
Main jet	#102
Slow jet	#35
Idle speed	1700±100rpm
Throttle grip free play	2□6mm
Pilot screw opening	2¼□2¾



## 5. FUEL SYSTEM

---

### TROUBLESHOOTING

#### Engine is hard to start

- No spark at plug
- Compression too low
- No fuel to carburetor
  - Clogged fuel filter
  - Restricted fuel line
  - Faulty float valve
  - Incorrectly adjusted float level
- Engine flooded with fuel
  - Clogged air cleaner
  - Fuel overflowing
- Intake air leak
- Contaminated fuel
- Faulty auto bystarter
- Clogged idle system or auto bystarter passages

#### Rich mixture

- Faulty auto bystarter
- Faulty float valve
- Float level too high
- Clogged air jets
- Dirty air cleaner
- Flooded carburetor

#### Backfiring at deceleration

- Improper air cut-off valve operation
- Lean mixture in idle system

#### Misfiring during acceleration

- Faulty ignition system
- Lean mixture

#### Engine idles roughly, stalls or runs poorly

- Clogged fuel system
- Ignition malfunction
- Rich or lean mixture
- Contaminated fuel
- Intake air leak
- Incorrect idle speed
- Incorrectly adjusted pilot screw
- Clogged idle system or auto bystarter passages
- Incorrectly adjusted float level

#### Lean mixture

- Clogged fuel jets
- Faulty float valve
- Float level too low
- Clogged fuel system
- Intake air leak
- Improper vacuum piston operation
- Improper throttle operation

## 5. FUEL SYSTEM

### CARBURETOR REMOVAL

Remove the frame body cover.  
Disconnect the auto bystarter wire connector.



Auto Bystarter Wire

Loosen the drain screw and drain the fuel from the float chamber.  
Disconnect the fuel tube and vacuum tube at the carburetor.

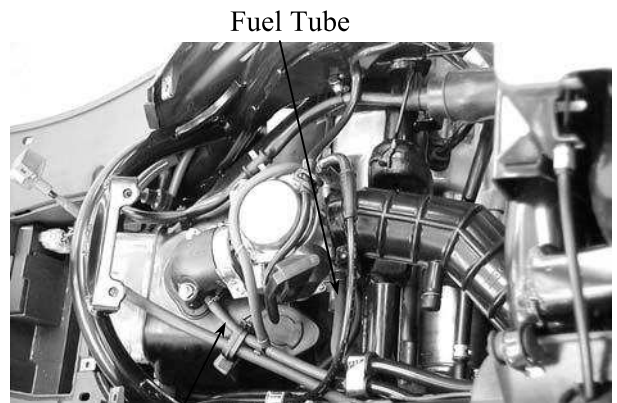

Fuel Tube

Vacuum Tube

Loosen the throttle cable adjusting nut and lock nut, and disconnect the throttle cable from the carburetor.  
Loosen the carburetor intake manifold band and air cleaner connecting tube band screws and then remove the carburetor.

Air Cleaner Connecting Tube Band      Adjusting Nut      Lock Nut

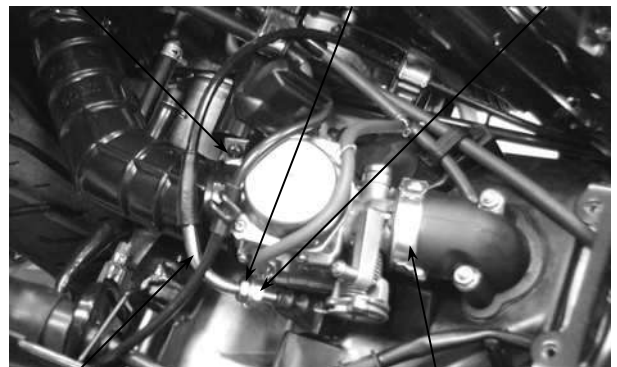

Throttle Cable

Intake Manifold Band

### AUTO BYSTARTER

#### OPERATION INSPECTION

Measure the resistance between the auto bystarter wire terminals.

**Resistance:** 10Ω max. (10 minutes minimum after stopping the engine)

If the reading is not within the limit, replace the auto bystarter with a new one.



## 5. FUEL SYSTEM

Connect a hose to the fuel enriching circuit of the carburetor. Connect the auto bystarter yellow wire to the positive (+) terminal of a battery and green wire to the negative (-) terminal. Wait 5 minutes and blow the hose with mouth or vacuum pump. If the passage is blocked, the auto bystarter is normal.

Disconnect the auto bystarter from the battery. Wait 30 minutes and blow the hose with mouth or vacuum pump. If air can be blown into the hose, the auto bystarter is normal.

### REMOVAL

Remove the set plate screws and set plate. Remove the auto bystarter from the carburetor.

### AUTO BYSTARTER INSPECTION

Check the auto bystarter valve and needle for nicks, wear or damage. If any faulty part is found, replace the auto bystarter as a set.

### INSTALLATION

Insert the auto bystarter into the carburetor body until it bottoms. Position the set plate into the groove in the auto bystarter and tighten the screws.

- Be sure to install the auto bystarter and set plate properly.
- Install the set plate with its bottom face facing down.

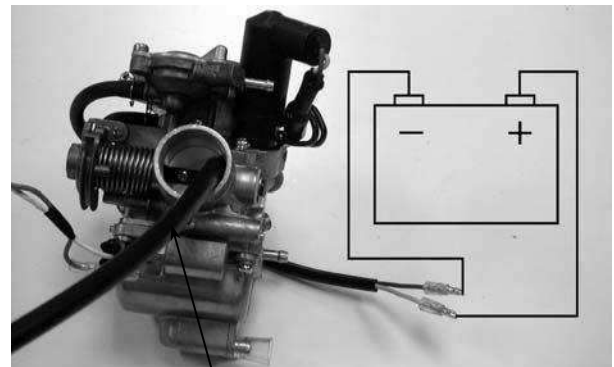

Adopter

Auto Bystarter



Set Plate

Screws

Bystarter Valve



Bystarter Needle

Auto Bystarter



Set Plate

Screws

## 5. FUEL SYSTEM

### AIR CUT-OFF VALVE

#### DISASSEMBLY

Disconnect the vacuum tube from the air cut-off valve.  
Remove the two screws to remove the air cut-off valve cover, spring and vacuum diaphragm.

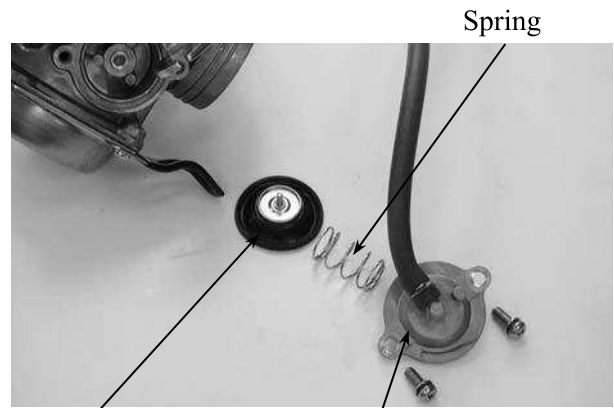

Vacuum Diaphragm    Air Cut-off valve Cover

#### ASSEMBLY

Install the vacuum diaphragm onto the carburetor.  
Install the spring and air cut-off valve cover and then tighten the two screws.

- Be sure to set the vacuum diaphragm lip into the groove on the carburetor.
- When installing the air cut-off valve cover, make sure that the vacuum diaphragm is properly installed.

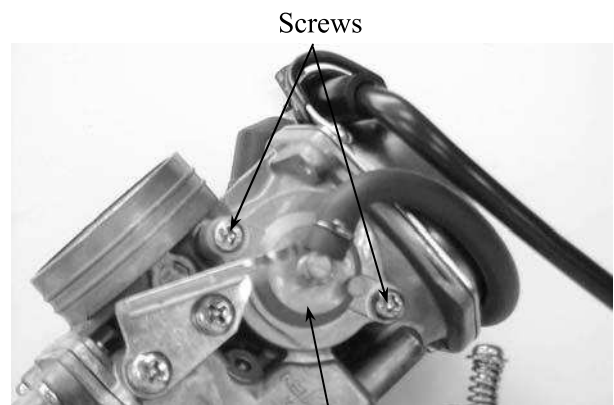

Air Cut-off valve Cover

### VACUUM CHAMBER

#### DISASSEMBLY

Remove the two vacuum chamber cover screws and the cover.



Vacuum Chamber Cover

Remove the spring and vacuum diaphragm/piston.

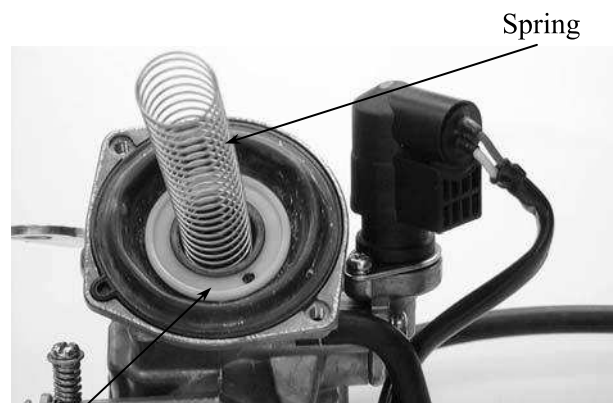

Vacuum Diaphragm/Piston

## 5. FUEL SYSTEM

Push the needle holder in and turn it left to remove the needle holder.  
Remove the spring and jet needle from the piston.

Be careful not to damage the vacuum diaphragm.



### INSPECTION

Inspect the needle for stepped wear.  
Inspect the vacuum piston for wear or damage.  
Inspect the diaphragm for deterioration and tears.

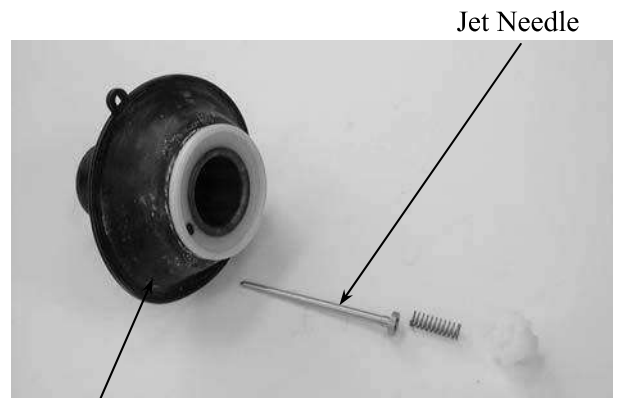

Vacuum Diaphragm

### ASSEMBLY

Install the vacuum piston/diaphragm in the carburetor body and align the tab on the diaphragm with the groove in the carburetor body.  
Install the spring.  
Install the vacuum chamber cover and tighten it with the two screws.

- Be careful not to damage the diaphragm.
- Hold the vacuum piston while tightening the vacuum chamber cover.

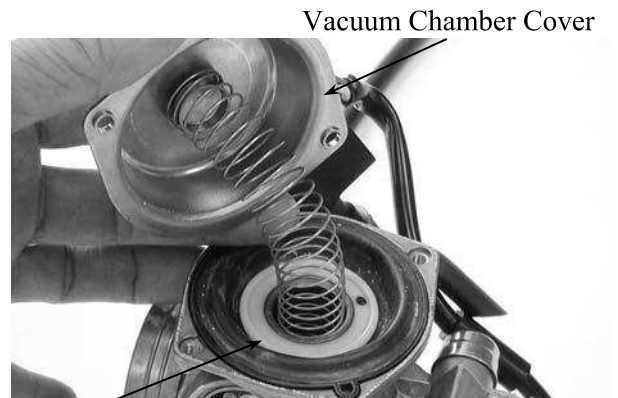

Vacuum Diaphragm

### FLOAT CHAMBER

#### DISASSEMBLY

Remove the four float chamber screws and the float chamber.

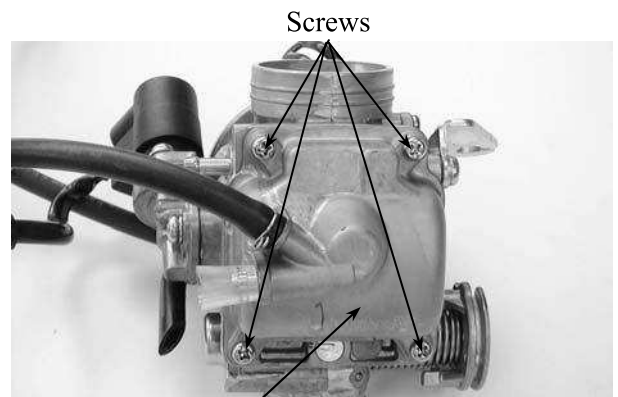

Float Chamber

## 5. FUEL SYSTEM

Remove the float pin, float and float valve.

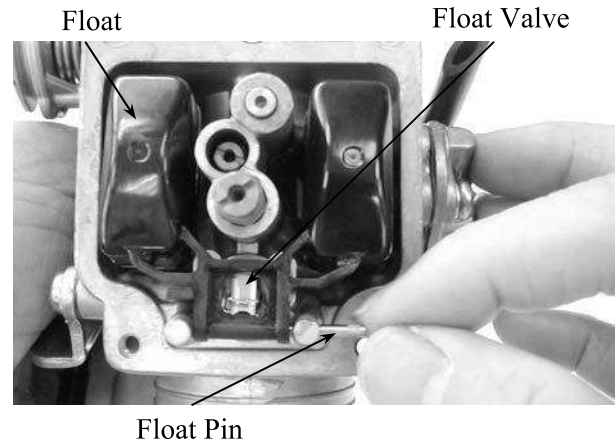

### INSPECTION

Inspect the float valve and valve seat for damage or clogging.  
Inspect the float valve and valve seat contact area for stepped wear or contamination.

Worn or contaminated float valve and valve seat must be replaced because it will result in float level too high due to incomplete airtightness.

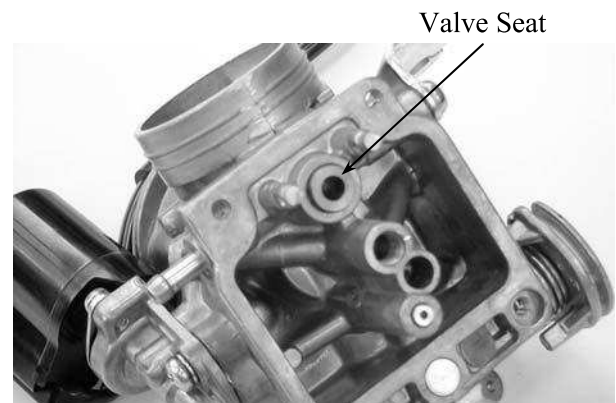

Remove the main jet, needle jet holder, needle jet, slow jet and pilot screw.

- Be careful not to damage the fuel jets and pilot screw.
- Before removing, turn the pilot screw in and carefully count the number of turns until it seats lightly and then make a note of this.
- Do not force the pilot screw against its seat to avoid seat damage.

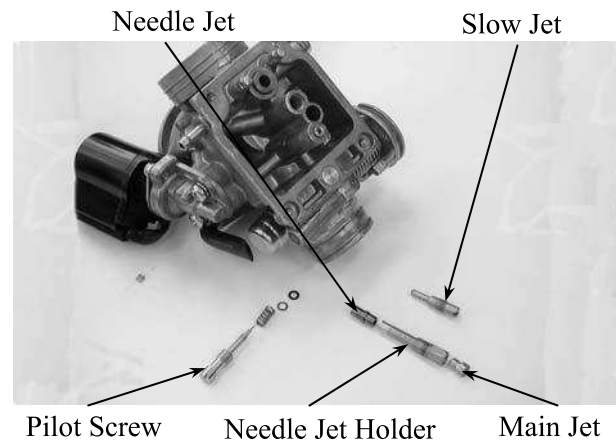

Clean the removed fuel jets with detergent oil and blow them open with compressed air.  
Blow compressed air through all passages of the carburetor body.

Also remove and clean the vacuum chamber and air cut-off valve.

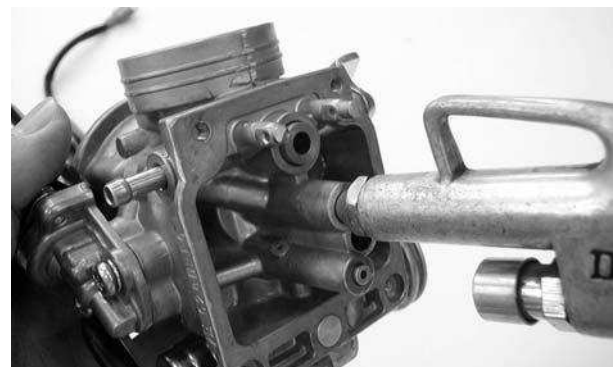

# 5. FUEL SYSTEM

### ASSEMBLY

Install the slow jet, needle jet, needle jet holder, main jet and pilot screw.

Return the pilot screw to the original position as noted during removal.

**Standard Opening:** 3±½ turns

Install the float valve, float and float pin.

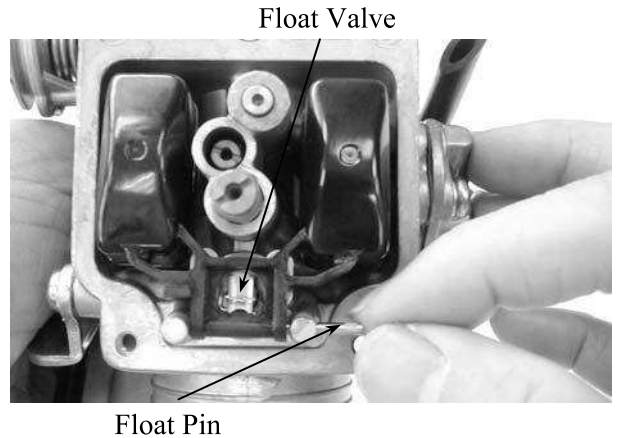
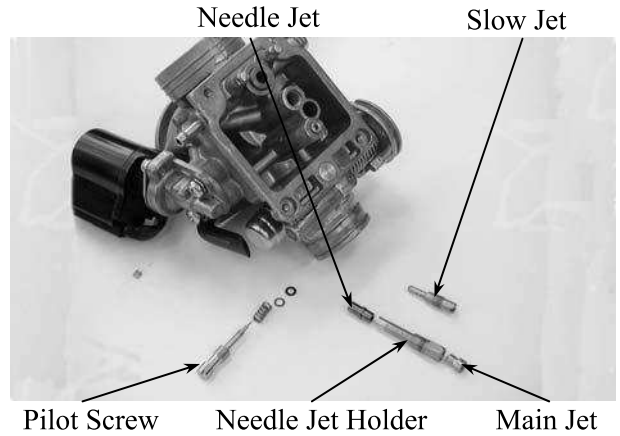

### FLOAT LEVEL INSPECTION

- Check the operation of the float valve and float before float level inspection.
- Measure the float level by placing the float level gauge on the float chamber face parallel with the main jet.

Measure the float level.

**Float Level:** 17.5mm

Special

Float Level Gauge

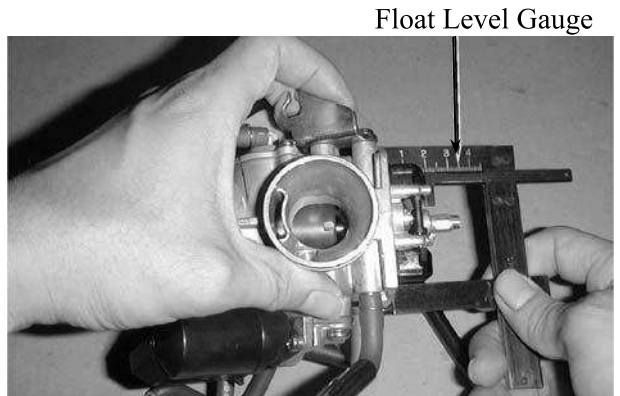

### CARBURETOR INSTALLATION

Tighten the drain screw.  
Install the carburetor onto the intake manifold, aligning the tab on the carburetor with the cutout in the intake manifold.  
Tighten the band screw.  
Install the air cleaner connecting tube and tighten the band screw.  
Connect the throttle cable to the throttle wheel on the carburetor.

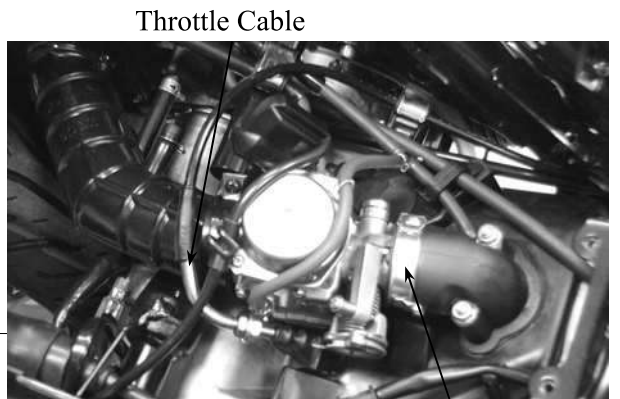

## 5. FUEL SYSTEM

lightly and back it out to the specification given.

**Standard Opening:**  $3\pm\frac{1}{2}$  turns

### Connecting Tube Band

Connect the fuel tube and vacuum tube to the carburetor.

Vacuum Tube

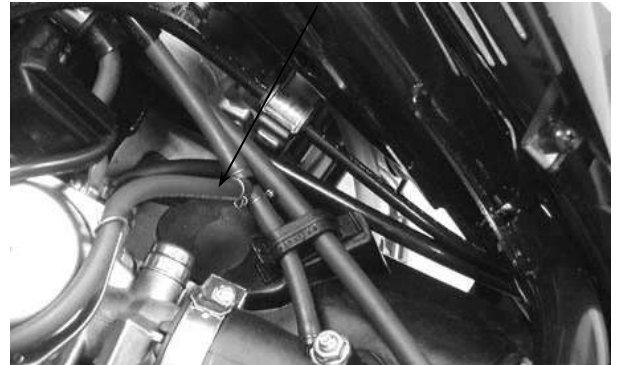

Connect the auto bystarter wire connector. Perform the following inspections and adjustments:

- Throttle grip free play
- Carburetor idle speed



Auto Bystarter Wire Connector

## PILOT SCREW ADJUSTMENT

### \* ADJUSTMENT

- The pilot screw is factory pre-set and no adjustment is necessary. During carburetor disassembly, note the number of turns of the pilot screw and use as a reference when reinstalling it.
- Place the motorcycle on its main stand on level ground for this operation.

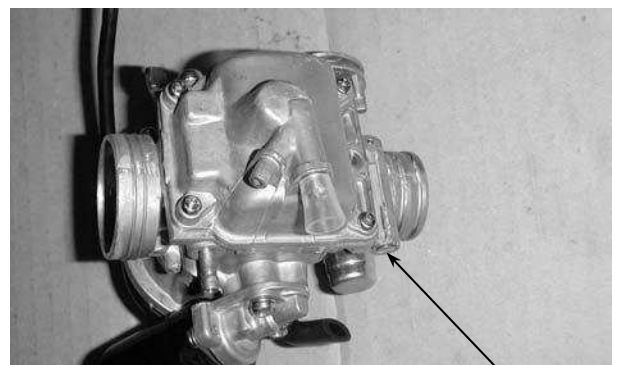

Pilot Screw

A tachometer must be used when adjusting the engine speed.  
Turn the pilot screw clockwise until it seats



## 5. FUEL SYSTEM

### \* CAUTION

Do not force the pilot screw against its seat to prevent damage.

Warm up the engine and adjust the throttle stop screw to obtain the specified idle speed.

**Idle Speed:** 1700±100rpm

Turn the pilot screw in or out slowly to obtain the highest engine speed.

Slightly accelerate several times to make sure that the idle speed is within the specified range.

If the engine misses or runs erratic, repeat the above steps.

### FUEL TANK

#### REMOVAL

Remove the frame body cover.  
Disconnect the fuel unit wire connector.



Fuel Unit Wire Connector

Disconnect the fuel tube and vacuum tube at the auto fuel valve.

Auto Fuel Valve



Vacuum Tube

Remove the five fuel tank mounting bolts and fuel tank.

#### INSTALLATION

Install the fuel tank in the reverse order of removal.



## 5. FUEL SYSTEM

### Fuel Tank

#### AUTO FUEL VALVE

**No Smoking!**

First clean the fuel tube.

Disconnect the fuel tube and vacuum tube from the carburetor. Connect a vacuum pump to the vacuum tube and apply vacuum. Check if fuel flows out.

- The valve is operating normally if fuel flows out of the fuel tube when the vacuum is applied.
- The fuel shall stop flowing out when the vacuum pump is disconnected.

If the fuel valve does not operate normally, Check the vacuum diaphragm for poor installation or damage and inspect the fuel tube for clogging.

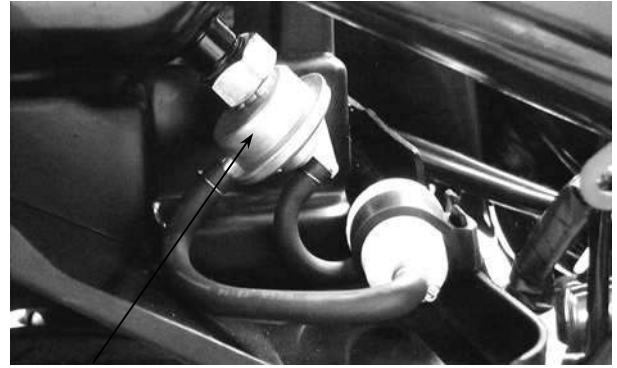

Auto Fuel Valve

#### FUEL UNIT

Refer to Section 17 for the fuel unit inspection.

#### REMOVAL

Disconnect the fuel unit wire connector. Turn the fuel unit retainer counterclockwise and remove the fuel unit.

Do not bend the fuel unit float arm; otherwise, the fuel unit metering values will be incorrect.

Fuel Unit



#### INSTALLATION

Inspect the fuel unit gasket for damage. Install the fuel unit by aligning the groove in the fuel unit with the tab on the fuel tank.

Mark



## 5. FUEL SYSTEM

Retainer

Install the fuel unit retainer and turn the retainer clockwise to secure it.

Make sure that the arrow on the retainer is aligned with the arrow on the fuel tank.

Connect the fuel unit wire connector.

The installation sequence is the reverse of removal.

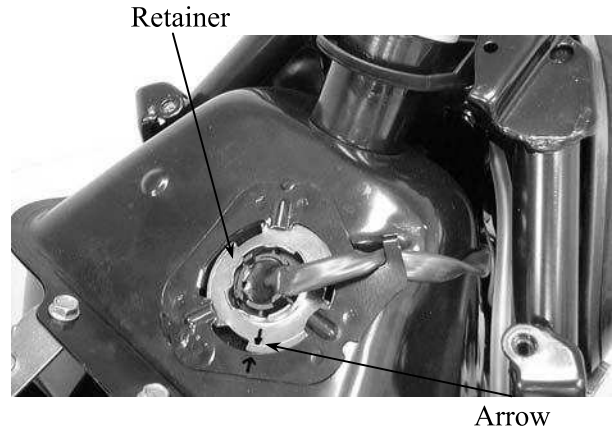

### AIR CLEANER

Loosen the air cleaner connecting tube band screw.

Disconnect the transmission case breather tube from the air cleaner case.

Remove the two bolts and air cleaner case.

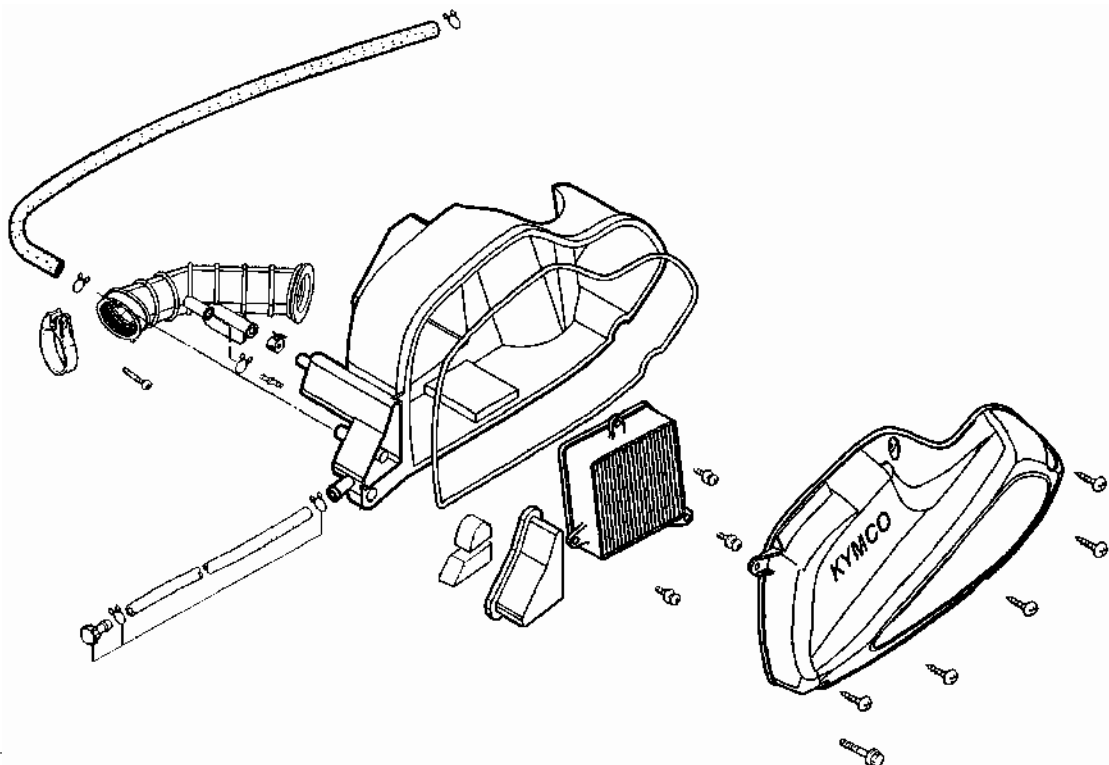
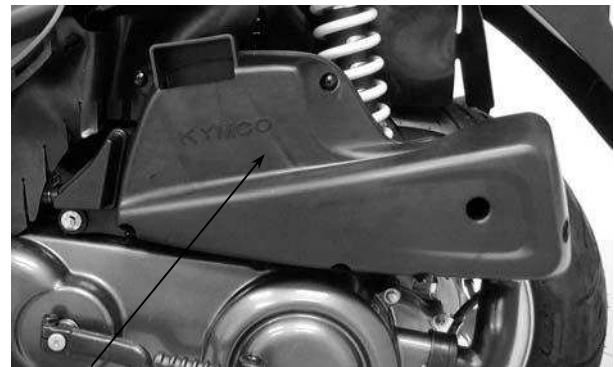

---

## ENGINE REMOVAL/INSTALLATION



**6**

---

SERVICE INFORMATION-----	6- 1
ENGINE REMOVAL -----	6- 2
ENGINE INSTALLATION -----	6- 4

## **6. ENGINE REMOVAL/INSTALLATION**

---

### **SERVICE INFORMATION**

#### **GENERAL INSTRUCTIONS**

- A floor jack or other adjustable support is required to support and maneuver the engine. Be careful not to damage the motorcycle body, cables and wires during engine removal.
- Use shop towels to protect the motorcycle body during engine removal.
- Parts requiring engine removal for servicing:
  - Crankcase
  - Crankshaft

## 6. ENGINE REMOVAL/INSTALLATION

### ENGINE REMOVAL

Disconnect the battery negative cable.  
 Remove the frame body cover.  
 Disconnect the engine negative cable.  
 Disconnect the spark plug high tension wire.  
 Disconnect the auto bystarter wire connector.

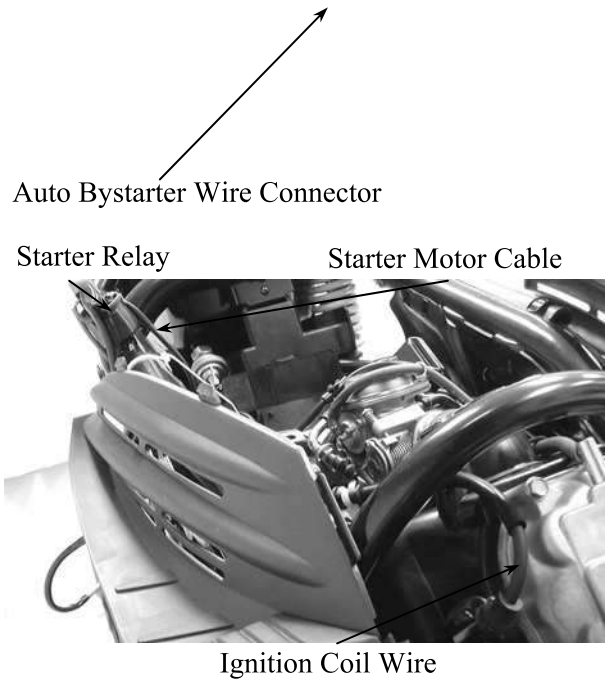

Disconnect the starter motor cable from the starter relay.  
 Remove the spark plug cap and disconnect the ignition coil wire from the set plate.

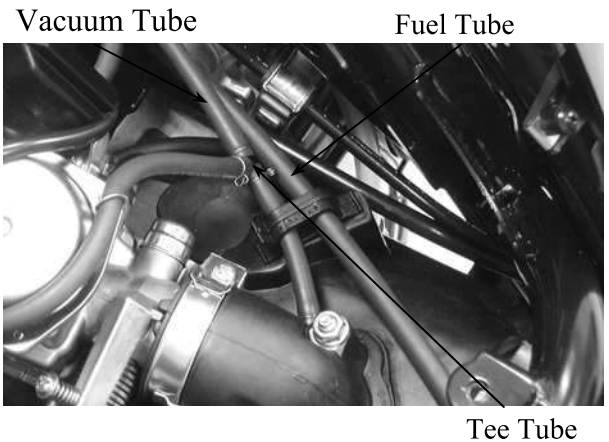

Disconnect the fuel tube at the carburetor side.  
 Disconnect the auto fuel valve vacuum tube from the tee tube.  
 Disconnect the throttle cable from the carburetor.

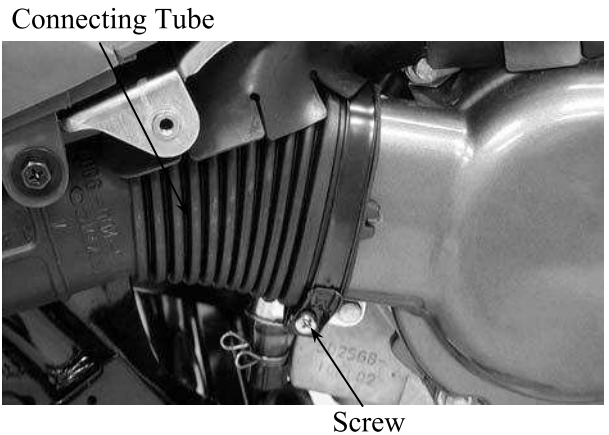

Loosen the drive belt air cleaner connecting tube band screw and remove the connecting tube.



## 6. ENGINE REMOVAL/INSTALLATION

Remove the air cleaner bolts.  
Remove the rear brake adjusting nut,  
connecting pin and rear brake cable.

Remove the rear shock absorber lower  
mount bolt.

Rear Shock Absorber Lower Mount Bolt



Remove the four A.C. generator cooling fan  
cover bolts and cooling fan cover.  
Remove the engine mounting bolt and pull  
out the engine with the engine hanger  
bracket backward.

Engine Mounting Bolt



### ENGINE HANGER BRACKET REMOVAL

Remove the ignition coil from the engine  
hanger.  
Remove the engine hanger bracket bolt and  
nut.  
Remove the engine hanger bracket.

Engine Hanger Bracket

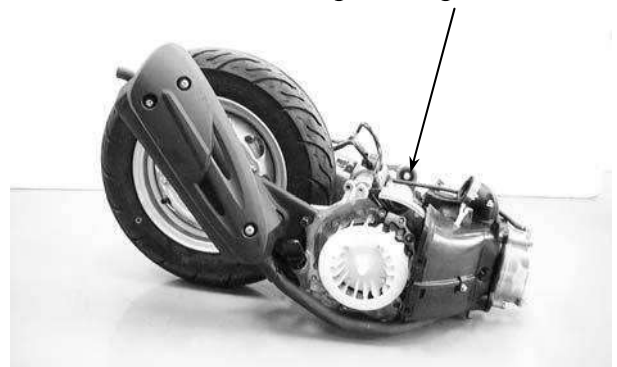

Brake Adjusting Nut



Inspect the engine hanger bushings and

## 6. ENGINE REMOVAL/INSTALLATION

stopper rubbers for wear or damage.

### ENGINE HANGER BRACKET INSTALLATION

Install the engine hanger bracket to the engine.  
Install the engine hanger bracket bolt and tighten the nut.

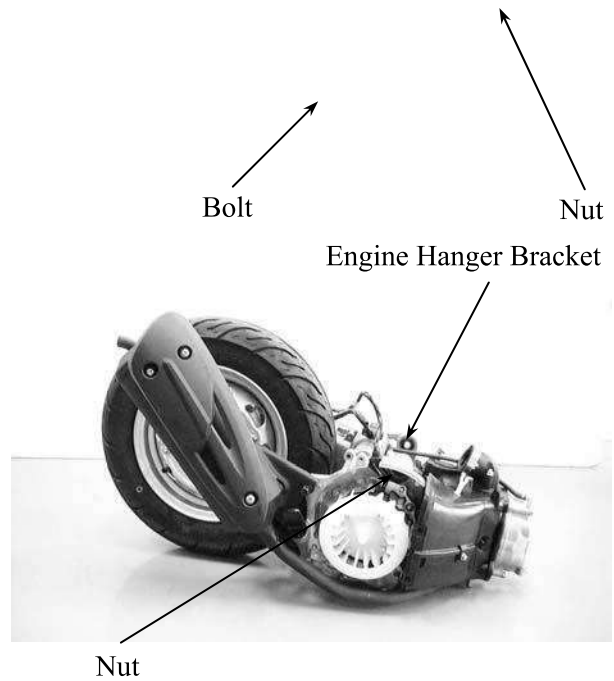

### ENGINE INSTALLATION

Install the engine and tighten the engine mounting bolt.

**Torque:** 7.0kg-m

Tighten the rear shock absorber upper mount bolt.

**Torque:** 4.0kg-m

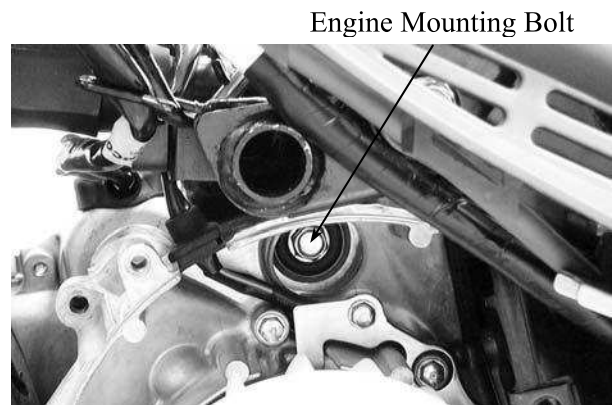

Install the removed parts in the reverse order of removal.

Route the wires and cables properly.

After installation, inspect and adjust the following:

- Throttle grip free play.
- Rear brake adjustment.

Rear Shock Absorber Lower Mount Bolt



Bushings

Stopper Rubbers





## 7. CYLINDER HEAD/VALVES

---

---

---

---

---

---

---

---

### CYLINDER HEAD/VALVES

---

SERVICE INFORMATION-----	7- 1
TROUBLESHOOTING-----	7- 2
CAMSHAFT REMOVAL -----	7- 3
CYLINDER HEAD REMOVAL -----	7- 6
CYLINDER HEAD DISASSEMBLY -----	7- 7
CYLINDER HEAD ASSEMBLY -----	7- 8
CYLINDER HEAD INSTALLATION -----	7- 9
CAMSHAFT INSTALLATION -----	7-10

## 7. CYLINDER HEAD/VALVES

### SERVICE INFORMATION

#### GENERAL INSTRUCTIONS

- The cylinder head can be serviced with the engine installed in the frame.
- When assembling, apply molybdenum disulfide grease or engine oil to the valve guide movable parts, valve arm and camshaft sliding surfaces for initial lubrication.
- The camshaft is lubricated by engine oil through the cylinder head engine oil passages. Clean and unclog the oil passages before assembling the cylinder head.
- After disassembly, clean the removed parts and dry them with compressed air before inspection.
- After removal, mark and arrange the removed parts in order. When assembling, install them in the reverse order of removal.

#### SPECIFICATIONS

Item		Standard (mm)	Service Limit (mm)
Valve clearance (cold)	IN	0.12	—
	EX	0.12	—
Cylinder head compression pressure		13kg/cm <sup>2</sup>	
Cylinder head warpage		—	
Camshaft cam height	IN	29.803	29.40
	EX	29.5637	29.16
Valve rocker arm I.D.	IN	10.000 10.015	10.10
	EX	10.000 10.015	10.10
Valve rocker arm shaft O.D.	IN	9.972 9.987	9.91
	EX	9.972 9.987	9.91
Valve seat width	IN	1.0	1.8
	EX	1.0	1.8
Valve stem O.D.	IN	4.975 4.990	4.90
	EX	4.955 4.970	4.90
Valve guide I.D.	IN	5.000 5.012	5.03
	EX	5.000 5.012	5.03
Valve stem-to-guide clearance	IN	0.010 0.037	0.08
	EX	0.030 0.057	0.10

## 7. CYLINDER HEAD/VALVES

### TORQUE VALUES

Cylinder head nut	2.0kg-m	Apply engine oil to threads
Valve clearance adjusting nut	0.9kg-m	Apply engine oil to threads
Stud bolt	0.9~1.1kg-m	

### SPECIAL TOOLS

Valve spring compressor	
Valve seat cutter, 24.5mm	45° IN/EX
Valve seat cutter, 25mm	Plane cutter 32° IN
Valve seat cutter, 22mm	Plane cutter 32° EX
Valve seat cutter, 26mm	Plane cutter 60° IN/EX
Cutter clip, 5mm	
Valve spring compressor attachment	
Valve wrench	
Valve guide driver	
Valve guide reamer	

### TROUBLESHOOTING

- The poor cylinder head operation can be diagnosed by a compression test or by tracing engine top-end noises.

#### Poor performance at idle speed

- Compression too low

#### Compression too low

- Incorrect valve clearance adjustment
- Burned or bend valves
- Incorrect valve timing
- Broken valve spring
- Poor valve and seat contact
- Leaking cylinder head gasket
- Warped or cracked cylinder head
- Poorly installed spark plug

#### Compression too high

- Excessive carbon build-up in combustion chamber

#### White smoke from exhaust muffler

- Worn valve stem or valve guide
- Damaged valve stem seal

#### Abnormal noise

- Incorrect valve clearance adjustment
- Sticking valve or broken valve spring
- Damaged or worn camshaft
- Worn cam chain guide
- Worn camshaft and rocker arm

## 7. CYLINDER HEAD/VALVES

### CAMSHAFT REMOVAL

Remove the center cover.  
Remove the four cylinder head cover bolts to remove the cylinder head cover.  
Remove the two nuts attaching the secondary air inlet tube.

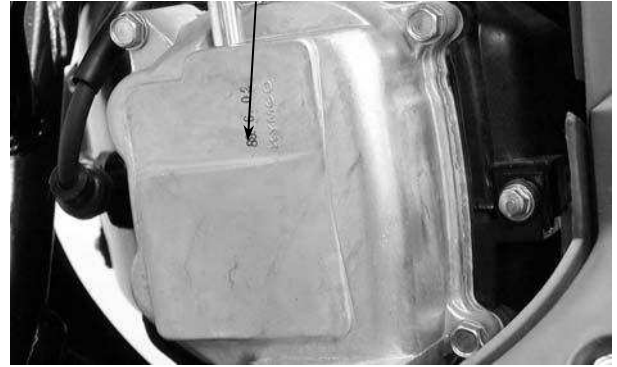

Remove the cam chain tensioner cap screw and the O-ring.

O-ring

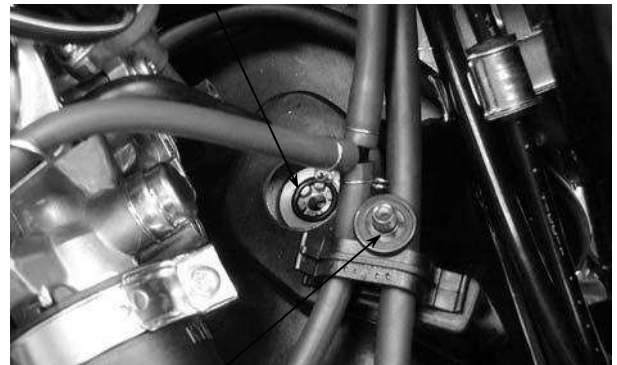

Screw

Turn the cam chain tensioner screw clockwise to tighten it.

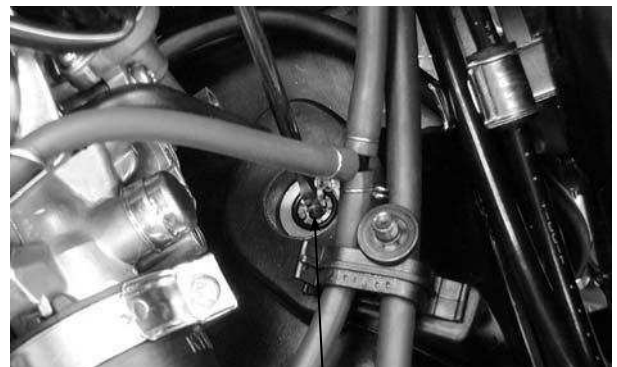

Tensioner Screw

Turn the flywheel counterclockwise so that the "T" mark on the flywheel aligns with the index mark on the crankcase to bring the round hole on the camshaft gear facing up to the top dead center on the compression stroke.

Camshaft Gear



Round Hole

Punch Marks

Cylinder Head Cover

## 7. CYLINDER HEAD/VALVES

Remove the two cylinder head bolts.  
Remove the four cylinder head nuts and washers.

Diagonally loosen the cylinder head nuts in 2 or 3 times.

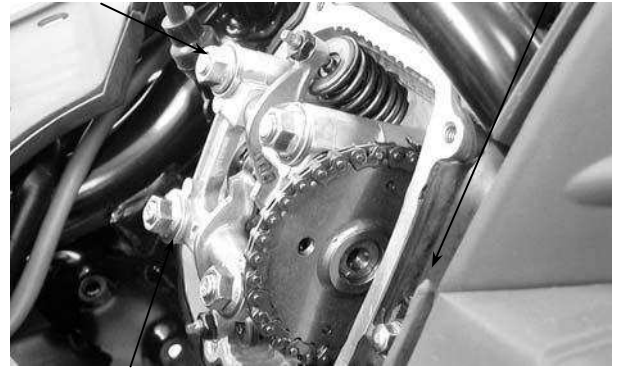

Washer

Remove the camshaft holder and dowel pins.

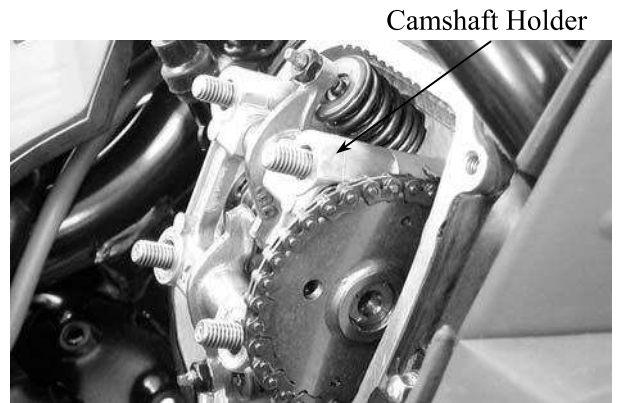

Camshaft Holder

Remove the camshaft gear from the cam chain and remove the camshaft.

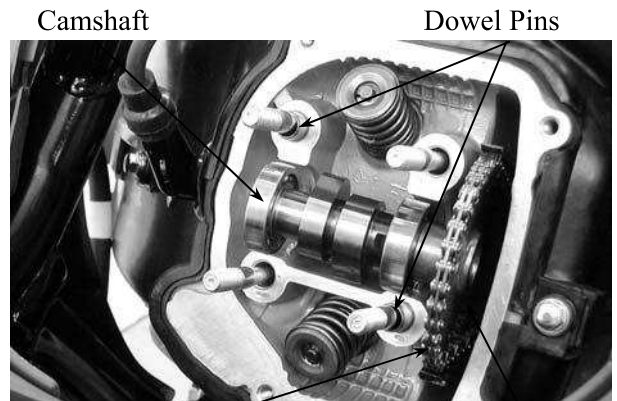

Camshaft

Dowel Pins

Cam Chain

Camshaft Gear

### CAMSHAFT INSPECTION

Check each cam lobe for wear or damage.  
Measure the cam lobe height.

#### Service Limits:

IN : 29.40mm replace if below

EX: 29.16mm replace if below



## 7. CYLINDER HEAD/VALVES

Check each camshaft bearing for play or damage. Replace the camshaft assembly with a new one if the bearings are noisy or have excessive play.

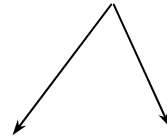

### CAMSHAFT HOLDER DISASSEMBLY

Take out the valve rocker arm shafts using a 5mm bolt.  
Remove the valve rocker arms.

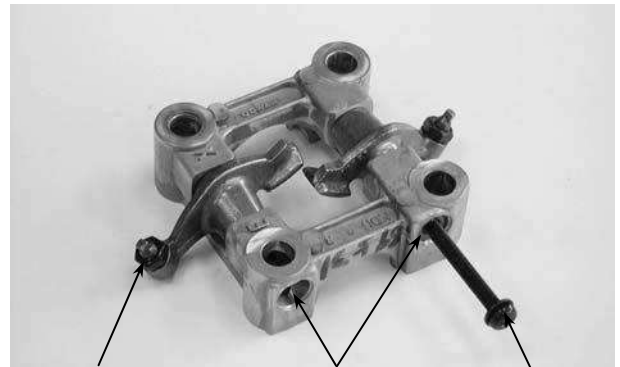

Rocker Arm    Rocker Arm Shaft    5mm Bolt

### CAMSHAFT HOLDER INSPECTION

Inspect the camshaft holder, valve rocker arms and rocker arm shafts for wear or damage.

If the valve rocker arm contact surface is worn, check each cam lobe for wear or damage.

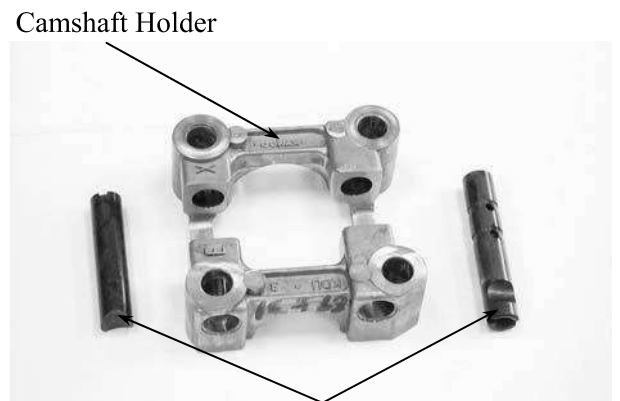

Rocker Arm Shafts

Measure the I.D. of each valve rocker arm.

**Service Limits:** IN: 10.10mm replace if over

EX: 10.10mm replace if over

Measure each rocker arm shaft O.D.

**Service Limits:** IN: 9.91mm replace if over

EX: 9.91mm replace if over



## 7. CYLINDER HEAD/VALVES

### CYLINDER HEAD REMOVE

Remove the camshaft.  
Remove the carburetor.  
Remove the exhaust muffler.  
Remove the carburetor intake manifold.  
Remove the cooling fan cover.  
Remove the engine cover bolts and screws.  
Separate the engine cover joint claws.

Remove the cylinder head.

Remove the dowel pins and cylinder head gasket.  
Remove the cam chain guide.

Remove all gasket material from the cylinder mating surface.

- Avoid damaging the cylinder mating surface.
- Be careful not to drop any gasket material into the engine.

Intake Manifold

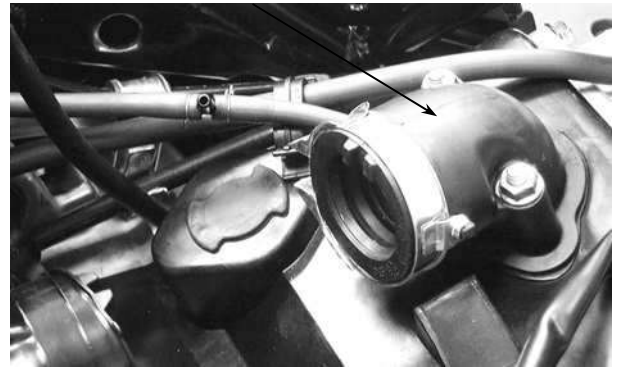

Cylinder Head

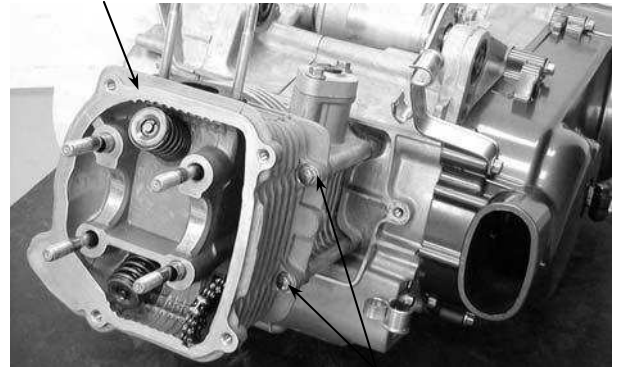

Bolts

Dowel Pins

Cylinder Head Gasket

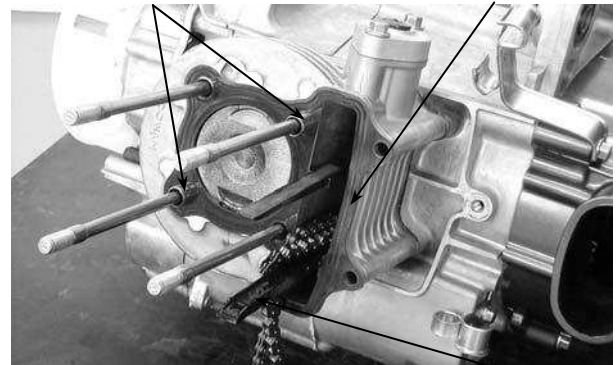

Cam Chain Guide

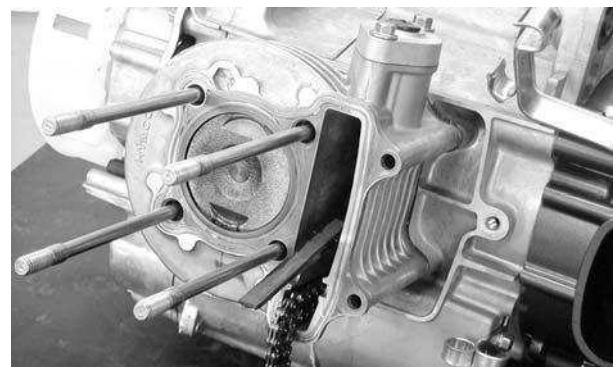

## 7. CYLINDER HEAD/VALVES

### CYLINDER HEAD DISASSEMBLY

Remove the valve spring cotters, retainers, springs, spring seats and valve stem seals using a valve spring compressor.

- Be sure to compress the valve springs with a valve spring compressor.
- Mark all disassembled parts to ensure correct reassembly.

Special

Valve Spring Compressor

Valve Spring Compressor Attachment

Remove carbon deposits from the combustion chamber.  
Clean off any gasket material from the cylinder head mating surface.

Be careful not to damage the cylinder head mating surface.

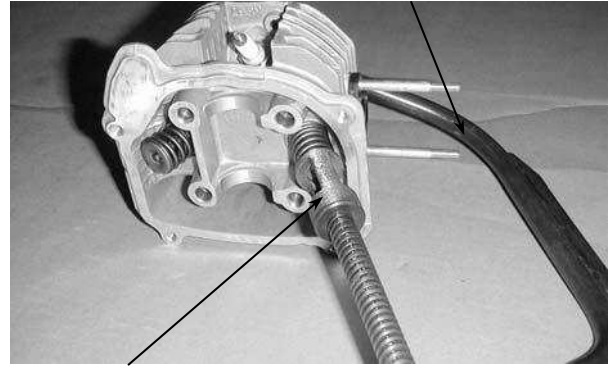

Valve Spring Compressor Attachment

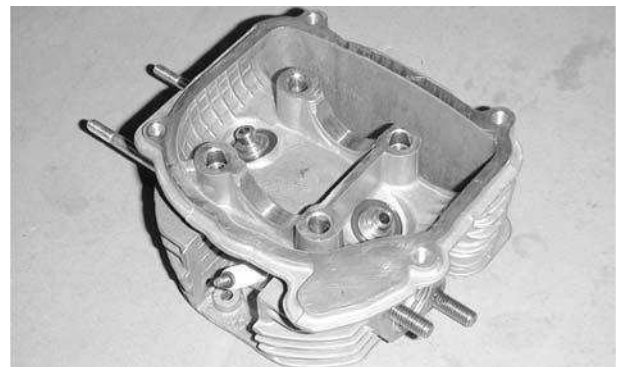

### INSPECTION CYLINDER HEAD

Check the spark plug hole and valve areas for cracks.  
Check the cylinder head for warpage with a straight edge and feeler gauge.

**Service Limit:** 0.05mm repair or replace if over

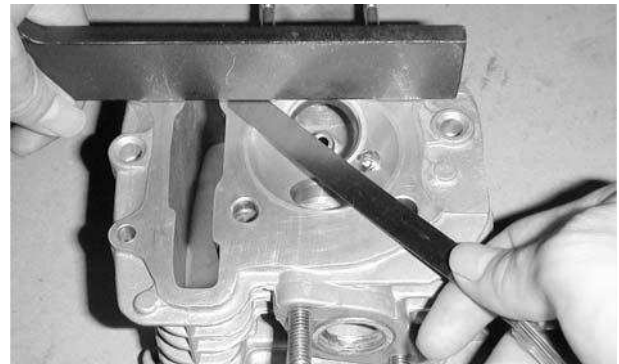

### VALVE SPRING FREE LENGTH

Measure the free length of the inner and outer valve springs.

**Service Limits:**

Inner: 32.3mm replace if below

Outer : 35.0mm replace if below

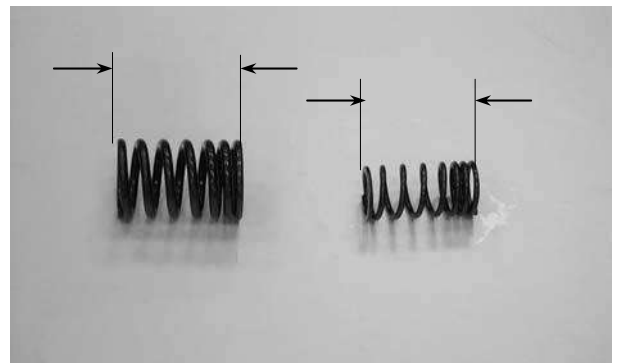



## 7. CYLINDER HEAD/VALVES

### VALVE /VALVE GUIDE

Inspect each valve for bending, burning, scratches or abnormal stem wear.  
Check valve movement in the guide.

Measure each valve stem O.D.

**Service Limits:** IN : 4.90mm replace if below  
EX: 4.90mm replace if below

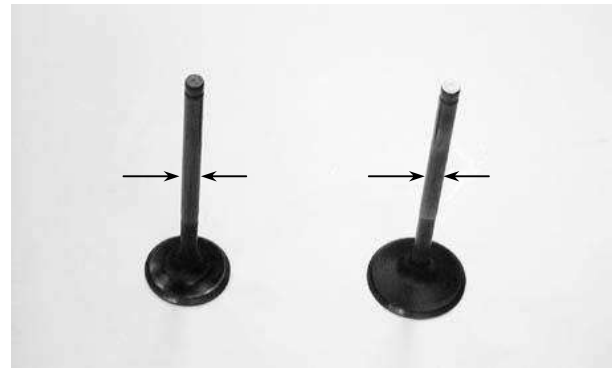

Measure each valve guide I.D.

**Service Limits:** IN : 5.03mm replace if over  
EX: 5.03mm replace if over

Subtract each valve stem O.D. from the corresponding guide I.D. to obtain the stem-to-guide clearance.

**Service Limits:** IN : 0.08mm replace if over  
EX: 0.10mm replace if over

If the stem-to-guide clearance exceeds the service limits, replace the cylinder head as necessary.

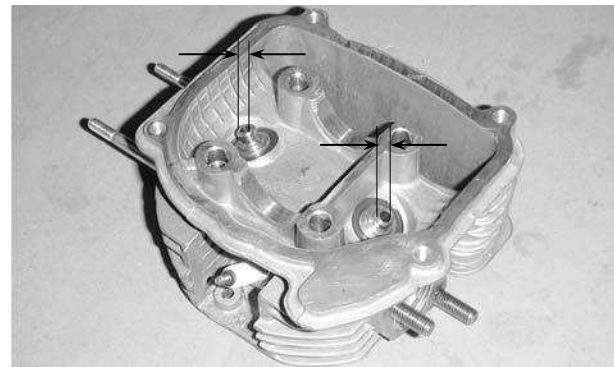

### CYLINDER HEAD ASSEMBLY

Install the valve spring seats and valve stem seals.

Be sure to install new valve stem seals.

Lubricate each valve stem with engine oil and insert the valves into the valve guides.  
Install the valve springs and retainers.

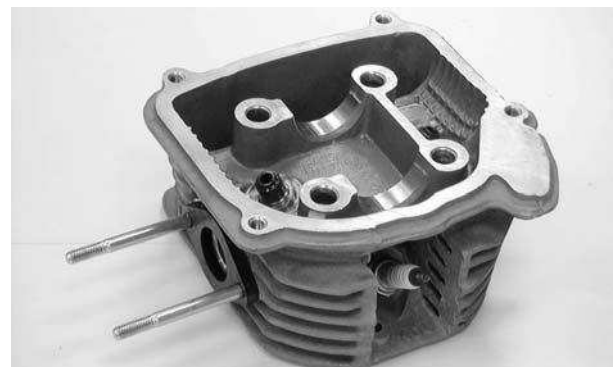

Compress the valve springs using the valve spring compressor, then install the valve cotters.

- When assembling, a valve spring compressor must be used.
- Install the cotters with the pointed ends facing down from the upper side of the cylinder head.

Special

Valve Spring Compressor

Valve Spring Compressor Attachment

Valve Spring Compressor



Valve Spring Compressor Attachment

## 7. CYLINDER HEAD/VALVES

Tap the valve stems gently with a plastic hammer for 2-3 times to firmly seat the cotters.

Be careful not to damage the valves.

### CYLINDER HEAD INSTALLATION

Tighten the four stud bolts.  
Install the dowel pins and a new cylinder head gasket.  
Install the cam chain guide.

**Torque:** Stud Bolts :0.7-1.1kg-m

Install the cylinder head.

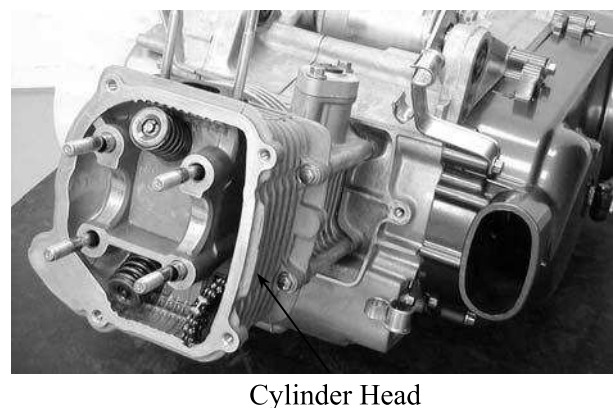
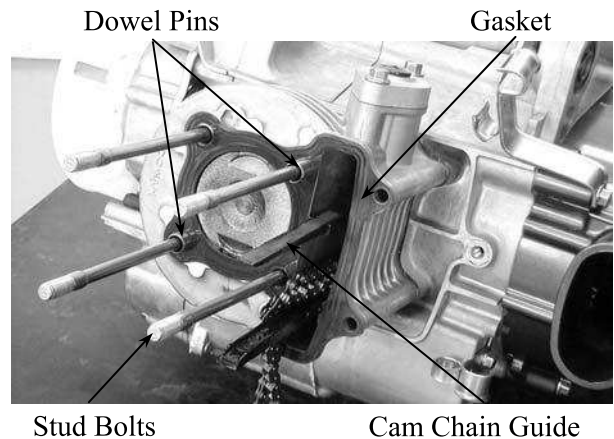

### CAMSHAFT HOLDER ASSEMBLY

Install the exhaust valve rocker arm to the "EX" mark side of the camshaft holder.  
Install the intake valve rocker arm and the rocker arm shafts.

- Align the cutout on the front end of the intake valve rocker arm shaft with the bolt of the camshaft holder.
- Align the cross cutout on the exhaust valve rocker arm shaft with the bolt of the camshaft holder.

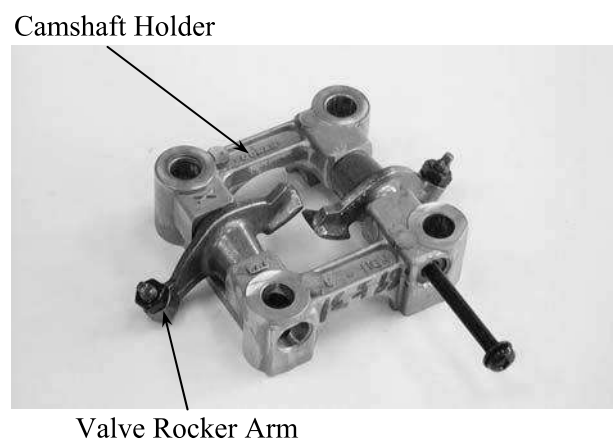

### CAMSHAFT INSTALLATION



## 7. CYLINDER HEAD/VALVES

Turn the flywheel so that the “T” mark on the flywheel aligns with the index mark on the crankcase.

Keep the round hole on the camshaft gear facing up and align the punch marks on the camshaft gear with the cylinder head surface (Position the intake and exhaust cam lobes down.) and install the camshaft onto the cylinder head.

Install the cam chain over the camshaft gear.

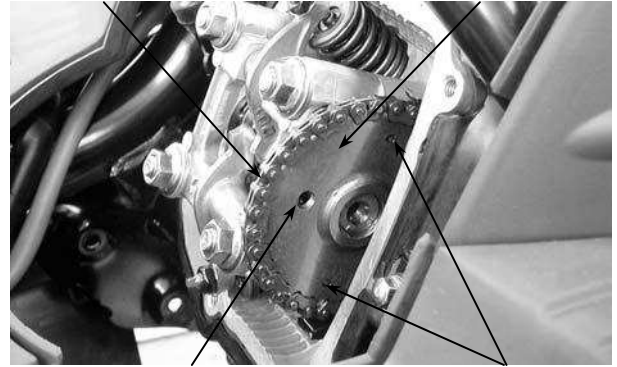

Round Hole

Punch Marks

Install the dowel pins.

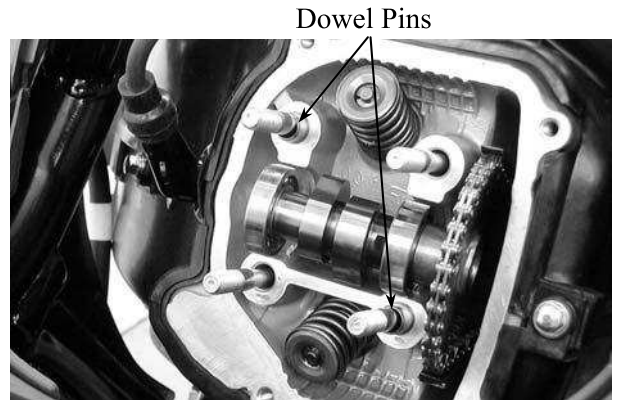

Dowel Pins

Install the camshaft holder, washers and nuts on the cylinder head.

Tighten the four cylinder head nuts and two bolts.

**Torque:** Cylinder head nut: 2.0kg-m

- Apply engine oil to the threads of the cylinder head nuts.
- Diagonally tighten the cylinder head nuts in 2 3 times.

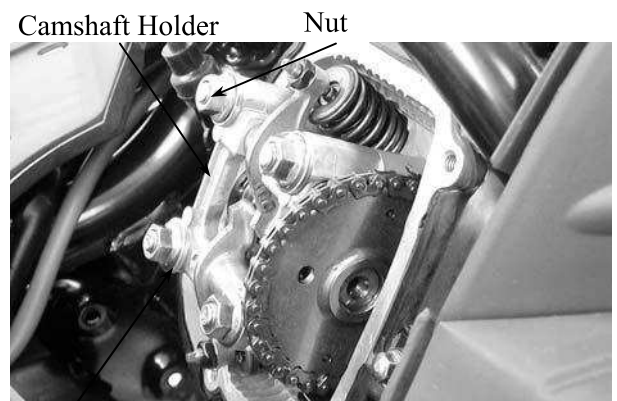

Camshaft Holder

Nut

Washer

Adjust the valve clearance.

Turn the cam chain tensioner screw counter-clockwise to release it.

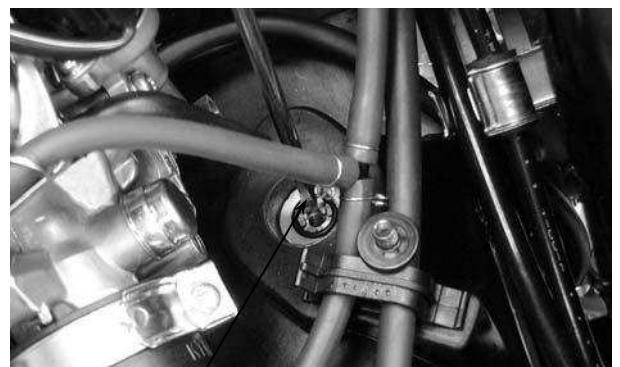

Tensioner Screw

## 7. CYLINDER HEAD/VALVES

Apply engine oil to a new O-ring and install it.

Tighten the cam chain tensioner cap screw.

Be sure to install the O-ring into the groove properly.

Install a new cylinder head cover O-ring and install the cylinder head cover. Install and tighten the cylinder head cover bolts.

Be sure to install the O-ring into the groove properly.

O-ring

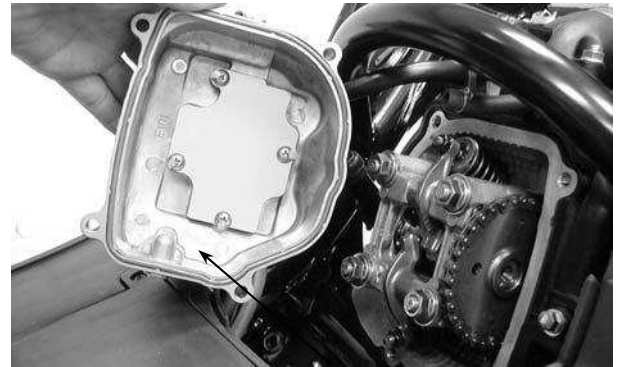

Cylinder Head Cover



---

## CYLINDER /PISTON

---

SERVICE INFORMATION-----	8- 1
TROUBLESHOOTING-----	8- 1
CYLINDER REMOVAL -----	8- 2
PISTON REMOVAL -----	8- 2
PISTON INSTALLATION-----	8- 6
CYLINDER INSTALLATION -----	8- 6



## 8. CYLINDER/PISTON

---

### SERVICE INFORMATION

#### GENERAL INSTRUCTIONS

- The cylinder and piston can be serviced with the engine installed in the frame.
- After disassembly, clean the removed parts and dry them with compressed air before inspection.

### TROUBLESHOOTING

- When hard starting or poor performance at low speed occurs, check the crankcase breather for white smoke. If white smoke is found, it means that the piston rings are worn, stuck or broken.

#### **Compression too low or uneven compression**

- Worn, stuck or broken piston rings
- Worn or damaged cylinder and piston

#### **Excessive smoke from exhaust muffler**

- Worn or damaged piston rings
- Worn or damaged cylinder and piston

#### **Compression too high**

- Excessive carbon build-up in combustion chamber or on piston head

#### **Abnormal noisy piston**

- Worn cylinder, piston and piston rings
- Worn piston pin hole and piston pin

## 8. CYLINDER/PISTON

### SPECIFICATIONS

Movie 125			Standard (mm)	Service Limit (mm)
Cylinder	I.D.		52.400 52.410	52.50
	Warpage		—	0.05
	Cylindricity		—	0.05
	True roundness		—	0.05
Piston, piston ring	Ring-to-groove clearance	Top	0.015 0.055	0.09
		Second	0.015 0.055	0.09
	Ring end gap	Top	0.10 0.25	0.5
		Second	0.10 0.25	0.5
		Oil side rail	0.2 0.7	—
	Piston O.D.		52.370 52.390	52.3
	Piston O.D. measuring position		9mm from bottom of skirt	—
	Piston-to-cylinder clearance		0.010 0.040	0.1
	Piston pin hole I.D.		15.002 15.008	15.04
Piston pin O.D		14.994 15.000	14.96	
Piston-to-piston pin clearance		0.002 0.014	0.02	
Connecting rod small end I.D. bore		15.016 15.034	15.06	

Movie 150			Standard (mm)	Service Limit (mm)
Cylinder	I.D.		57.400 57.410	57.50
	Warpage		—	0.05
	Cylindricity		—	0.05
	True roundness		—	0.05
Piston, piston ring	Ring-to-groove clearance	Top	0.015 0.055	0.09
		Second	0.015 0.055	0.09
	Ring end gap	Top	0.10 0.25	0.5
		Second	0.10 0.25	0.5
		Oil side rail	0.2 0.7	—
	Piston O.D.		57.370 57.390	57.3
	Piston O.D. measuring position		9mm from bottom of skirt	—
	Piston-to-cylinder clearance		0.010 0.040	0.1
	Piston pin hole I.D.		15.002 15.008	15.04
Piston pin O.D		14.994 15.000	14.96	
Piston-to-piston pin clearance		0.002 0.014	0.02	
Connecting rod small end I.D. bore		15.016 15.034	15.06	

## 8. CYLINDER/PISTON

### CYLINDER REMOVAL

Remove the cylinder head.  
Remove the cam chain guide.  
Remove the cylinder base bolts.  
Remove the cylinder.

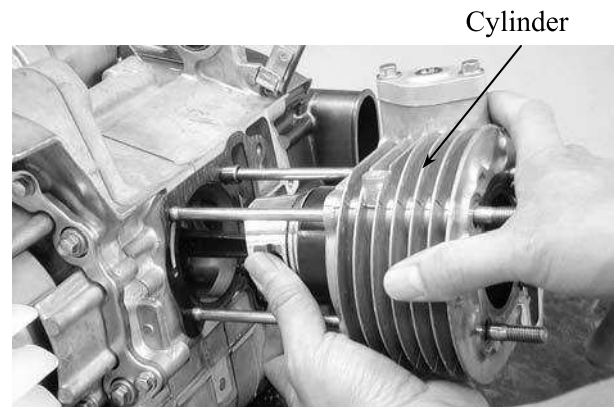

Remove the cylinder gasket and dowel pins.  
Clean any gasket material from the cylinder surface.

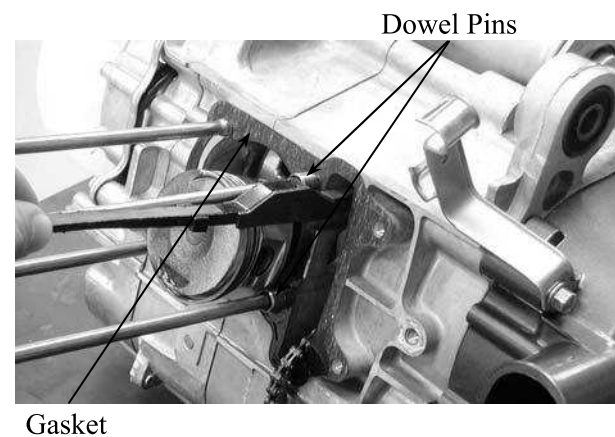

### PISTON REMOVAL

Remove the piston pin clip.

Place a clean shop towel in the crankcase to keep the piston pin clip from falling into the crankcase.

Press the piston pin out of the piston and remove the piston.





## 8. CYLINDER/PISTON

Inspect the piston, piston pin and piston rings.

Remove the piston rings.

Take care not to damage or break the piston rings during removal.

Clean carbon deposits from the piston ring grooves.



Install the piston rings onto the piston and measure the piston ring-to-groove clearance.

**Service Limits:** **Top:** 0.09mm replace if over  
**2nd:** 0.09mm replace if over



Remove the piston rings and insert each piston ring into the cylinder bottom.

Use the piston head to push each piston ring into the cylinder.

Measure the piston ring end gap.

**Service Limit:** 0.5mm replace if over

Gap



Measure the piston pin hole I.D.

**Service Limit:** 15.04mm replace if over

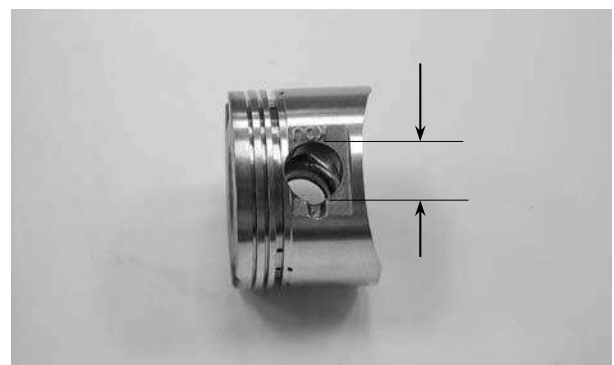

## 8. CYLINDER/PISTON

Measure the piston pin O.D.

**Service Limit:** 14.96mm replace if below



Measure the piston O.D.

Take measurement at 9mm from the bottom and 90° to the piston pin hole.

**Service Limit:** 52.3mm replace if below

Measure the piston-to-piston pin clearance.

**Service Limit:** 0.02mm replace if over

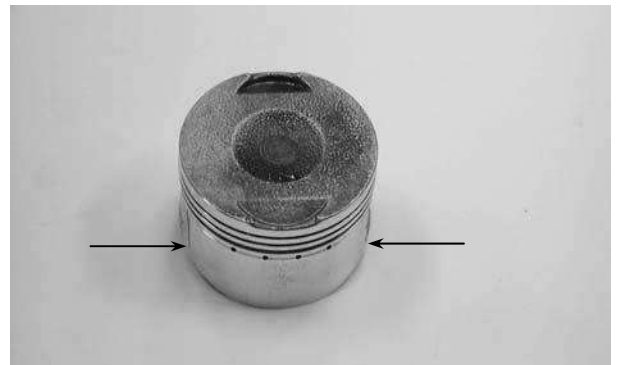

### CYLINDER INSPECTION

Inspect the cylinder bore for wear or damage. Measure the cylinder I.D. at three levels of top, middle and bottom at 90° to the piston pin (in both X and Y directions).

**Service Limit:** 52.50mm repair or replace if over

Measure the cylinder-to-piston clearance.

**Service Limit:** 0.1mm repair or replace if over



The true roundness is the difference between the values measured in X and Y directions. The cylindricity (difference between the values measured at the three levels) is subject to the maximum value calculated.

**Service Limits:**

**True Roundness:** 0.05mm repair or replace if over

**Cylindricity:** 0.05mm repair or replace if over

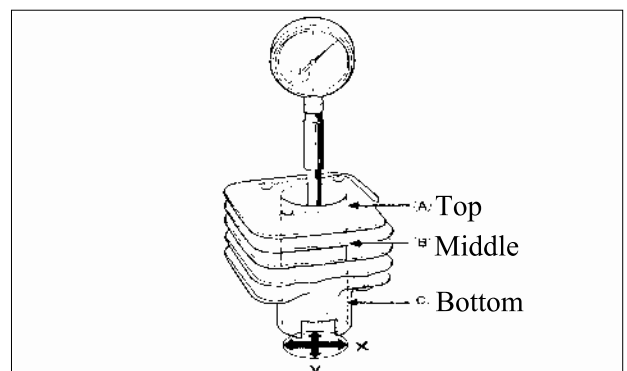

## 8. CYLINDER/PISTON

Inspect the top of the cylinder for warpage.  
**Service Limit:** 0.05mm repair or replace if over



Measure the connecting rod small end I.D.  
**Service Limit:** 15.06mm replace if over

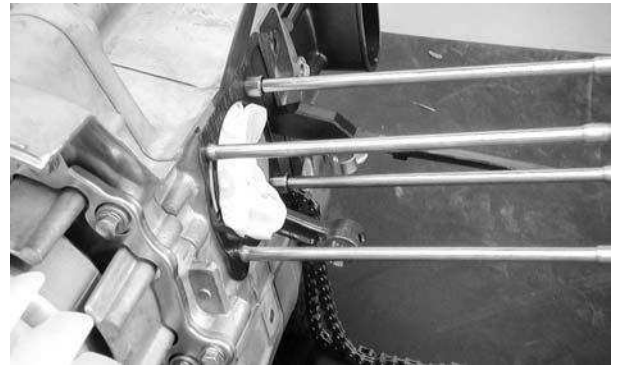

### PISTON RING INSTALLATION

Install the piston rings onto the piston.  
 Apply engine oil to each piston ring.

- Be careful not to damage or break the piston and piston rings.
- All rings should be installed with the markings facing up.
- After installing the rings, they should rotate freely without sticking.

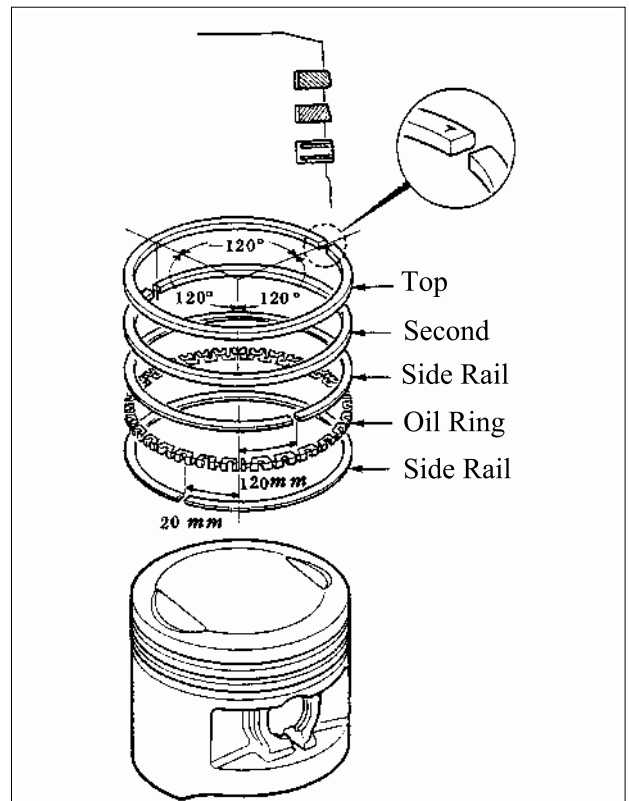

## 8. CYLINDER/PISTON

### PISTON INSTALLATION

Remove any gasket material from the crankcase surface.

Be careful not to drop foreign matters into the crankcase.

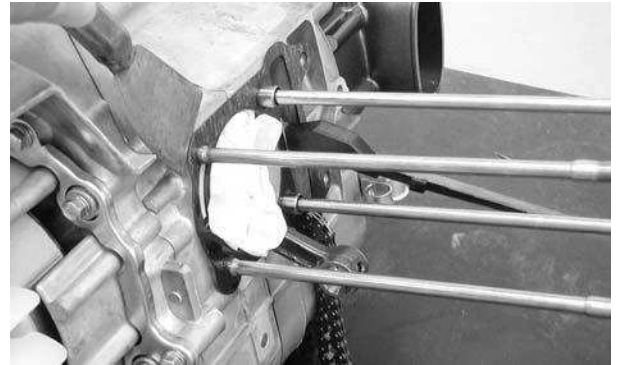

Install the piston, piston pin and a new piston pin clip.

- Position the piston “IN” mark on the intake valve side.
- Place a clean shop towel in the crankcase to keep the piston pin clip from falling into the crankcase.



Piston Pin Clip      Piston Pin      Piston

### CYLINDER INSTALLATION

Install the dowel pins and a new cylinder gasket on the crankcase.

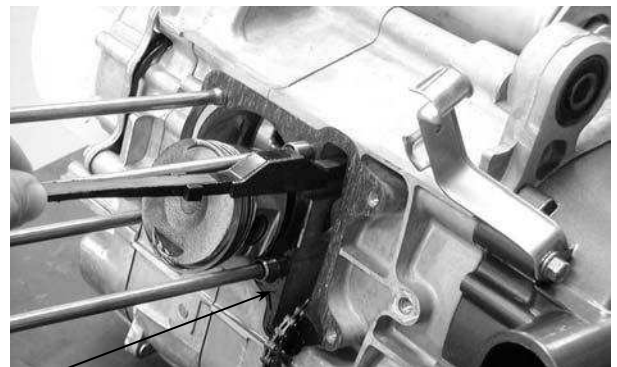

Gasket

Coat the cylinder bore, piston and piston rings with clean engine oil. Carefully lower the cylinder over the piston by compressing the piston rings.

- Be careful not to damage or break the piston rings.
- Stagger the ring end gaps at 120° to the piston pin.

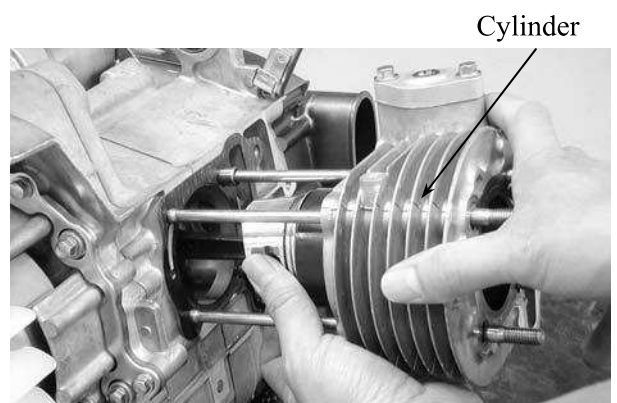

Cylinder

## 8. CYLINDER/PISTON

Loosely install the cylinder base bolts.

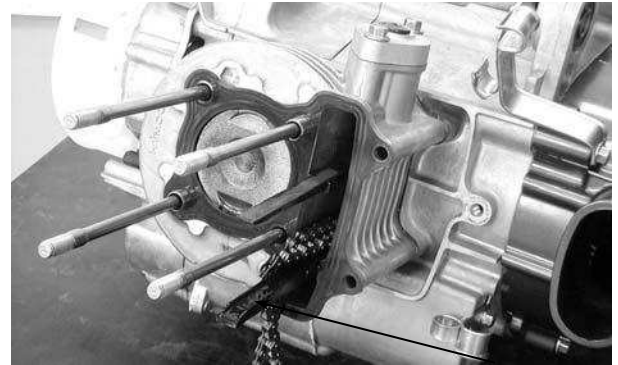

Cam Chain Guide

Install the cam chain guide.

Insert the tab on the cam chain guide into the cylinder groove.

Install the cylinder head.  
Tighten the cylinder base bolts.

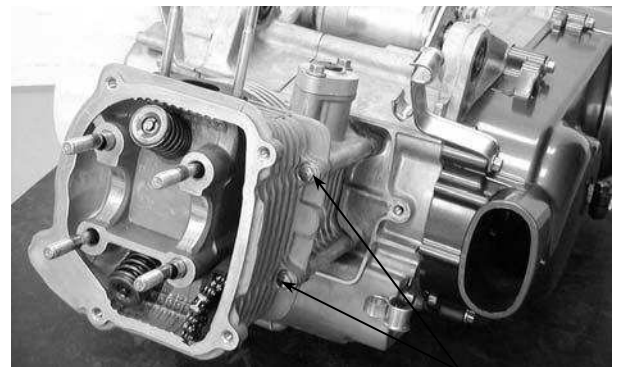

Cylinder Base Bolt

---

---

---

---

---

---

**DRIVE AND DRIVEN PULLEYS/  
KICK STARTER**

---

SERVICE INFORMATION-----	9- 1
TROUBLESHOOTING-----	9- 1
LEFT CRANKCASE COVER-----	9- 2
DRIVE PULLEY -----	9- 3
CLUTCH/DRIVEN PULLEY-----	9- 7
KICK STARTER -----	9-13



# 9. DRIVE AND DRIVEN PULLEYS/ KICK STARTER

## SERVICE INFORMATION

### GENERAL INSTRUCTIONS

- The drive pulley, clutch and driven pulley can be serviced with the engine installed.
- Avoid getting grease and oil on the drive belt and pulley faces. Remove any oil or grease from them to minimize the slipping of drive belt and drive pulley.

### SPECIFICATIONS

Item	Standard (mm)	Service Limit (mm)
Movable drive face bushing I.D.	23.989 24.052	24.06
Drive face collar O.D.	23.960 23.974	23.94
Drive belt width	19.6 20.4	19.0
Clutch lining thickness	—	1.5
Clutch outer I.D.	125.0 125.2	125.5
Driven face spring free length	154.6	147.6
Driven face O.D.	33.965 33.985	33.94
Movable driven face I.D.	34.000 34.025	34.06
Weight roller O.D.	17.920 18.080	17.40

### TORQUE VALUES

Drive face nut	5.5kg-m
Clutch outer nut	5.5kg-m
Clutch drive plate nut	5.5kg-m

### SPECIAL TOOLS

Universal holder	Clutch spring compressor
Driver handle A	Lock nut wrench, 39mm
Outer driver, 32x35mm	Bearing driver
Pilot, 20mm	Bearing driver

### TROUBLESHOOTING

#### Engine starts but motorcycle won't move

- Worn drive belt
- Broken ramp plate
- Worn or damaged clutch lining
- Broken driven face spring

#### Engine stalls or motorcycle creeps

- Broken clutch weight spring

#### Lack of power

- Worn drive belt
- Weak driven face spring
- Worn weight roller
- Fouled drive face

# 9. DRIVE AND DRIVEN PULLEYS/ KICK STARTER

## LEFT CRANKCASE COVER

### REMOVAL

Loosen the drive belt air tube band screw.

Remove the left crankcase cover bolts and left crankcase cover.  
Remove the seal rubber and dowel pins.

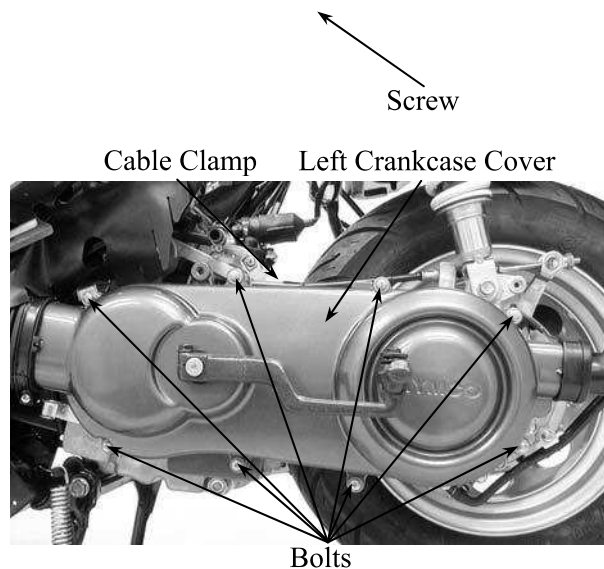

### INSTALLATION

Install the dowel pins and seal rubber.

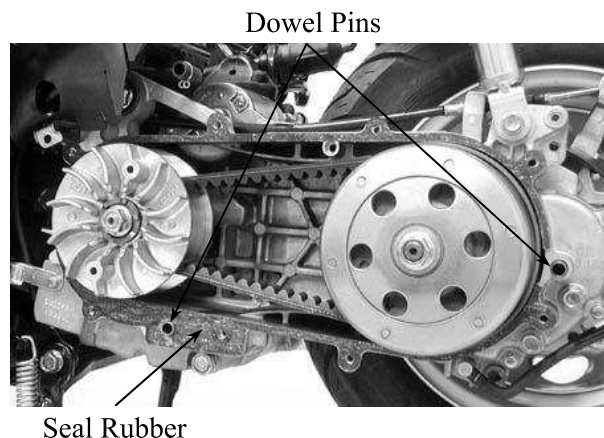

Install the left crankcase cover and tighten the left crankcase cover bolts.  
Install the cable clamp to the specified location and tighten the bolt.

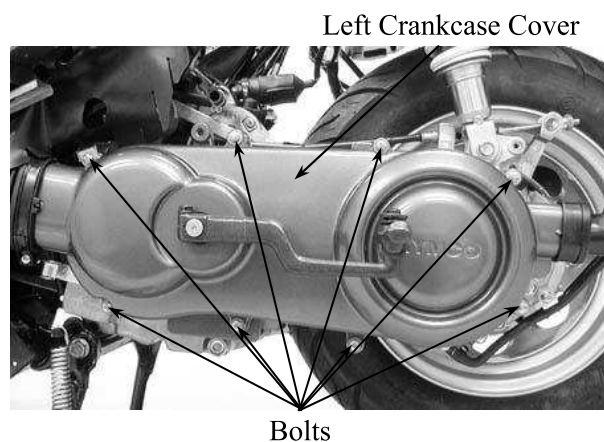

Air Tube Band



Install the drive belt air tube and tighten the



# 9. DRIVE AND DRIVEN PULLEYS/ KICK STARTER

tube band screw.

## DRIVE PULLEY

### REMOVAL

Remove the left crankcase cover.  
Hold the drive pulley using an universal holder and remove the drive face nut and starting ratchet.  
Remove the drive pulley face.

Special

Universal Holder

Hold the clutch outer with the universal holder and remove the clutch outer nut.  
Remove the clutch/driven pulley and drive belt.

### INSPECTION

Check the drive belt for cracks, separation or abnormal or excessive wear.  
Measure the drive belt width.

**Service Limit:** 19.0mm replace if below

Use specified genuine parts for replacement.

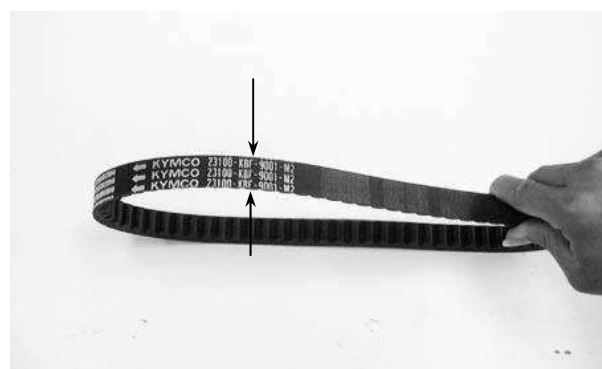
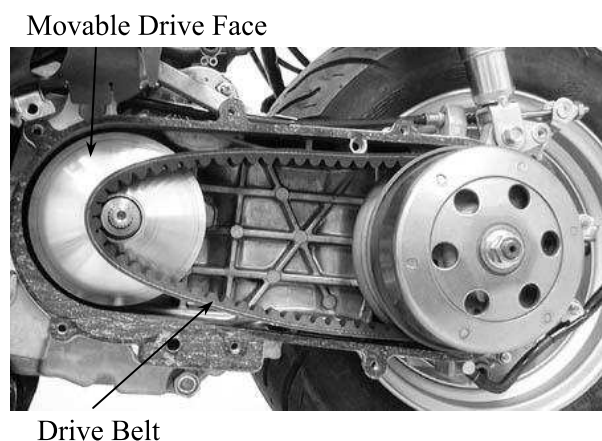
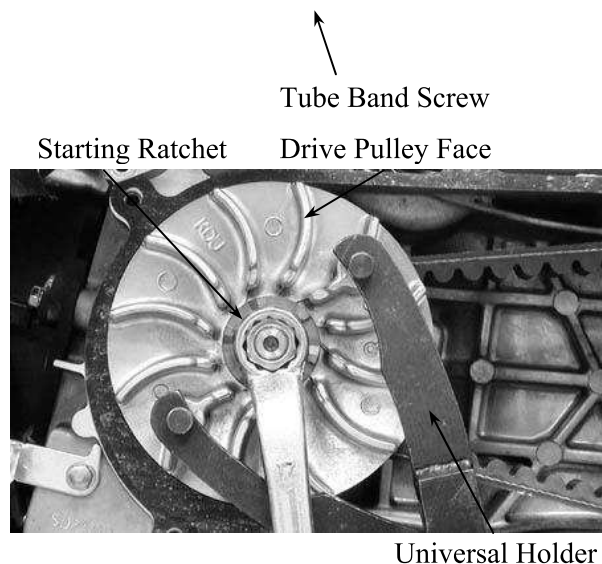

Intake Cover



Remove the movable drive face assembly.

# 9. DRIVE AND DRIVEN PULLEYS/ KICK STARTER

Remove the drive pulley collar.

### DISASSEMBLY

Remove the ramp plate.

Movable Drive Face Assembly  
Ramp Plate



Remove the weight rollers.



Weight Roller

### INSPECTION

Check each weight roller for wear or damage.

Measure each weight roller O.D.

**Service Limit:** 17.4mm replace if below

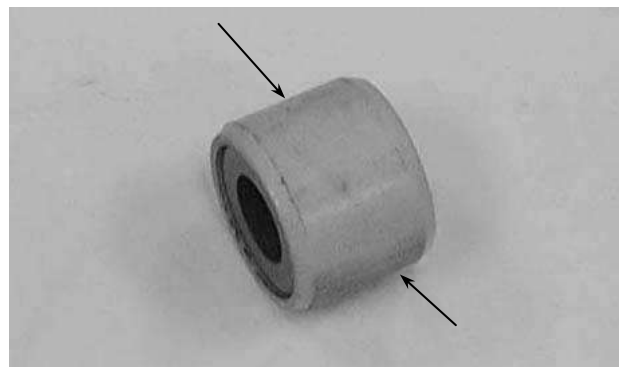

Drive Pulley Collar



Measure the movable drive face bushing

# 9. DRIVE AND DRIVEN PULLEYS/ KICK STARTER

I.D.

**Service Limit:** 24.06mm replace if over

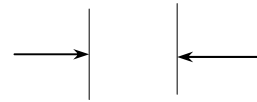

Check the drive pulley collar for wear or damage.  
Measure the O.D. of the drive pulley collar sliding surface.

**Service Limit:** 23.94mm replace if below

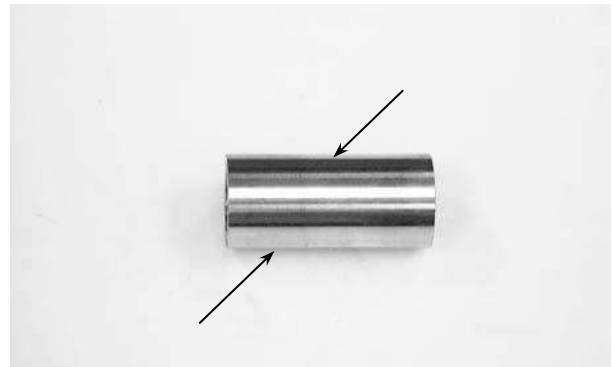

## ASSEMBLY

Install the weight rollers into the movable drive face.



Weight Roller

Install the ramp plate.

Ramp Plate



## 9. DRIVE AND DRIVEN PULLEYS/ KICK STARTER

Insert the drive pulley collar into the movable drive face.



### INSTALLATION

Install the movable drive face onto the crankshaft.

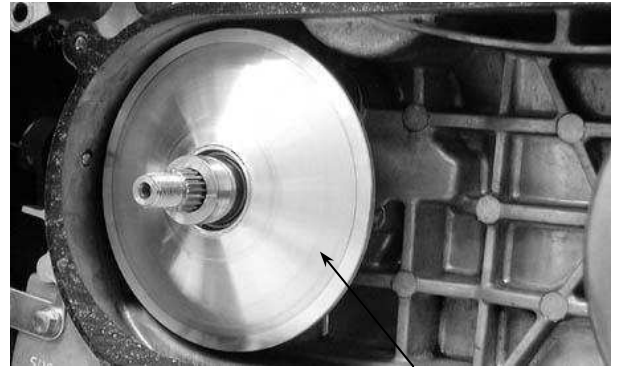

Movable Drive Face Assembly

Lay the drive belt on the driven pulley.  
Set the drive belt on the drive pulley collar.

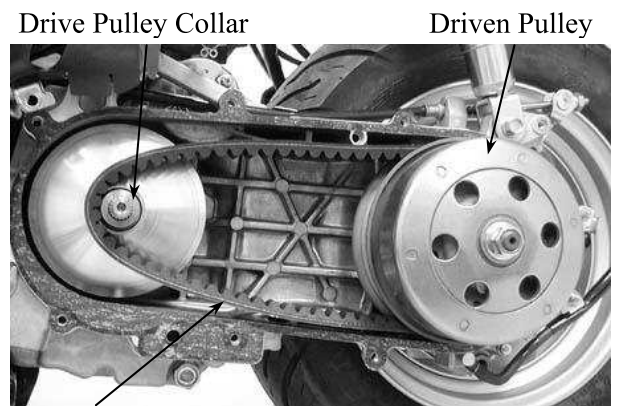

Drive Belt

## 9. DRIVE AND DRIVEN PULLEYS/ KICK STARTER

Install the drive pulley face, starting ratchet and drive face nut.

- When installing the drive pulley face, compress it to let the drive belt move downward to the lowest position so that the drive pulley can be tightened.
- Install the starting ratchet by aligning the starting ratchet teeth with the crankshaft teeth.

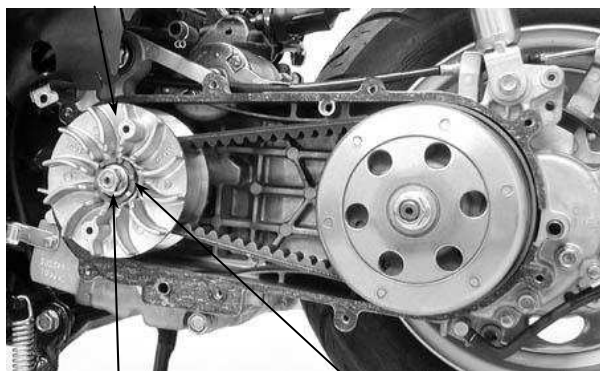

Drive Face Nut Starting Ratchet

Hold the drive pulley with the universal holder and tighten the drive face nut.

**Torque:** 5.5kg-m

Special

Universal Holder

Do not get oil or grease on the drive belt or pulley faces.

Drive Pulley

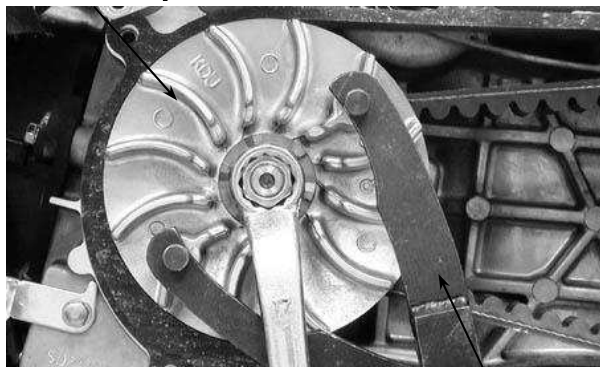

Universal Holder

### CLUTCH/DRIVEN PULLEY

Remove the left crankcase cover.  
Remove the drive pulley and drive belt.  
Hold the clutch outer with the universal holder and remove the clutch outer nut.

Special

Universal Holder

Remove the clutch outer.

Clutch Outer

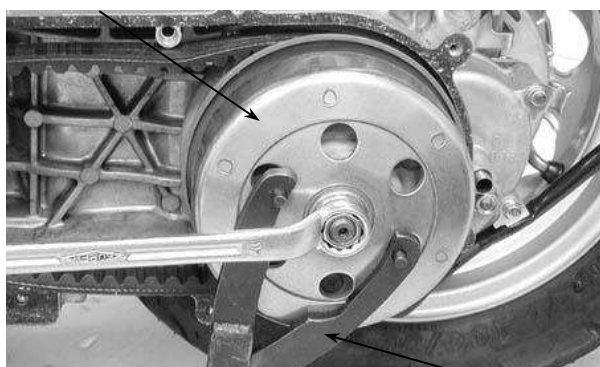

Universal Holder

### INSPECTION

Inspect the clutch outer for wear or damage.  
Measure the clutch outer I.D.

**Service Limit:** 125.5mm replace if over



Drive Pulley Face

## 9. DRIVE AND DRIVEN PULLEYS/ KICK STARTER

Check the clutch shoes for wear or damage.  
Measure the clutch lining thickness.

**Service Limit:** 1.5mm replace if below

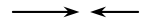

### CLUTCH/DRIVEN PULLEY DISASSEMBLY

Clutch/Driven Pulley

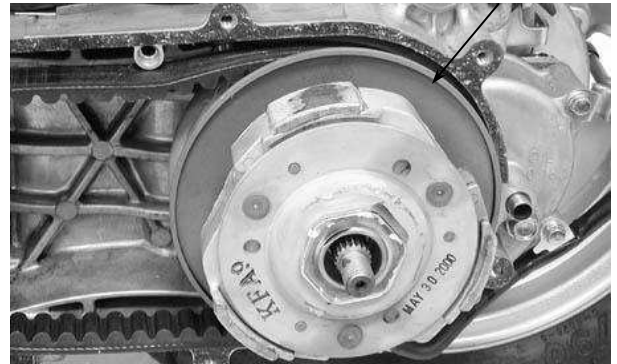

Hold the clutch/driven pulley assembly with the clutch spring compressor.

Be sure to use a clutch spring compressor to avoid spring damage.

Special

Clutch Spring Compressor  
Outer Driver, 32x35mm

Set the clutch spring compressor in a vise and remove the clutch drive plate nut.

Lock Nut Wrench, 39mm

Special

Loosen the clutch spring compressor and disassemble the clutch/driven pulley assembly.

Remove the seal collar.

Clutch Spring Compressor

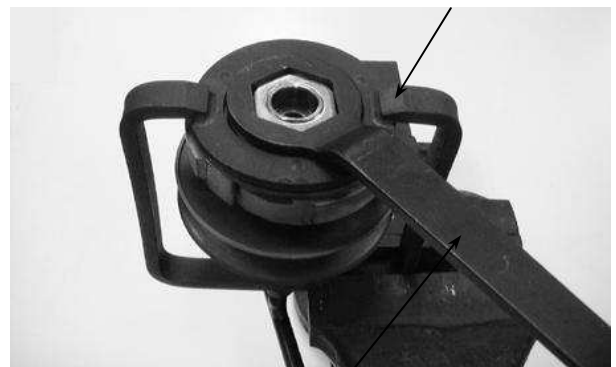

Lock Nut Wrench



## 9. DRIVE AND DRIVEN PULLEYS/ KICK STARTER

Pull out the guide roller pins and guide rollers. Remove the movable driven face from the driven face.

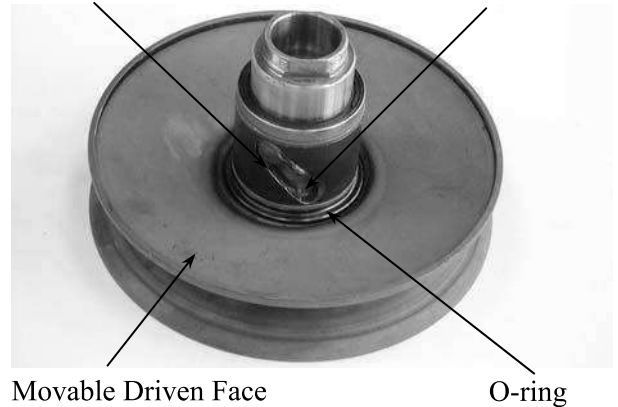

Remove the oil seal from the movable driven face.



### INSPECTION

Measure the driven face spring free length.

**Service Limit:** 147.6mm replace if below

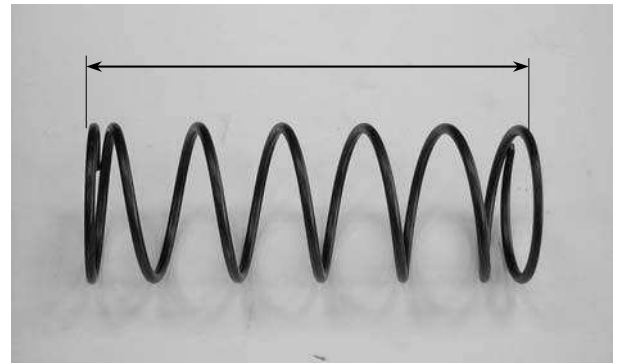

Check the driven face for wear or damage. Measure the driven face O.D.

**Service Limit:** 33.94mm replace if below

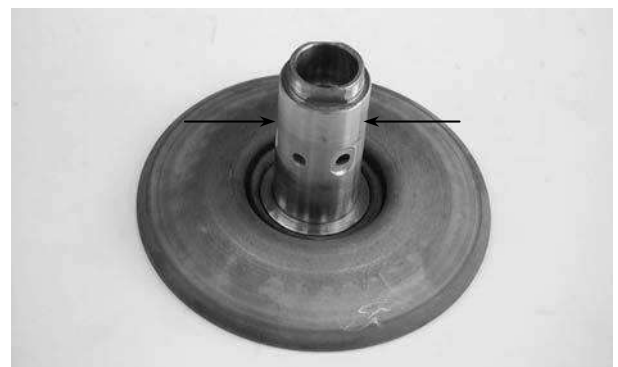

## 9. DRIVE AND DRIVEN PULLEYS/ KICK STARTER

Check the movable driven face for wear or damage.

Measure the movable driven face I.D.

**Service Limit:** 34.06mm replace if over

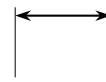

### DRIVEN PULLEY FACE BEARING REPLACEMENT

Drive the inner needle bearing out of the driven pulley face.

Discard the removed bearing and replace with a new one.

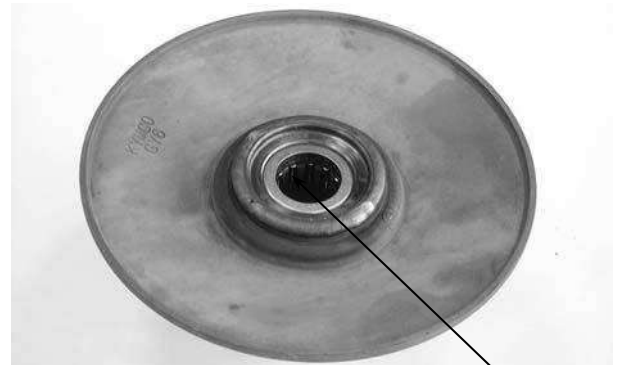

Inner Bearing

Remove the drive the outer bearing out of the driven face.

Discard the removed bearing and replace with a new one.

Apply grease to the outer bearing.  
Drive a new outer bearing into the driven face with the sealed end facing up.

Special

Bearing Driver



Outer Bearing

Apply grease to the driven face bore areas.

Pack all bearing cavities with 9 9.5g grease.

Specified grease: Heat resistance 230°C





## 9. DRIVE AND DRIVEN PULLEYS/ KICK STARTER

Press a new needle bearing into the driven face.

Special

Bearing Driver  
Pilot, 20mm



### CLUTCH DISASSEMBLY

Remove the circlips and retainer plate to disassemble the clutch.

Keep grease off the clutch linings.

### CLUTCH ASSEMBLY

Install the damper rubbers on the drive plate pins.  
Install the clutch weights/shoes and clutch springs onto the drive plate.  
Install the retainer plate and secure with the circlips.

### CLUTCH/DRIVEN PULLEY ASSEMBLY

Clean the driven pulley faces and remove any grease from them.  
Install the oil seal onto the moveable driven face.  
Apply grease to the O-rings and install them onto the moveable driven face.

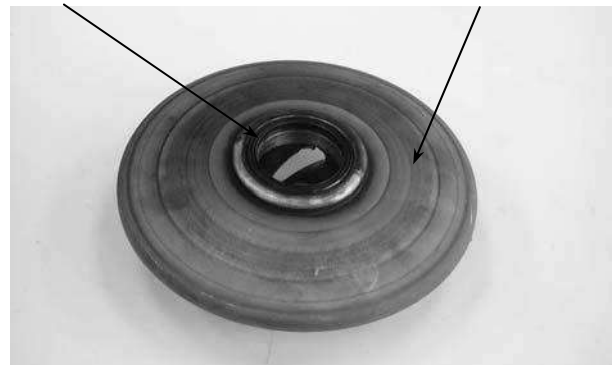
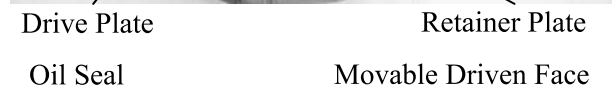
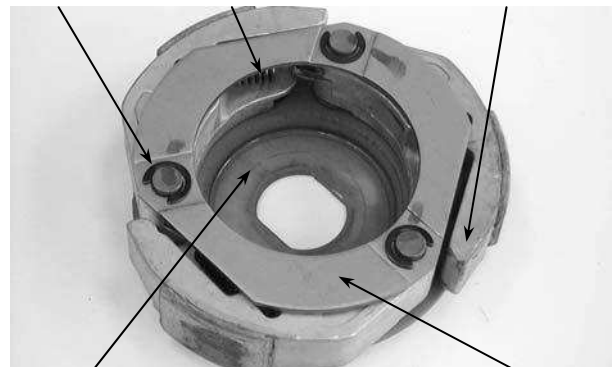
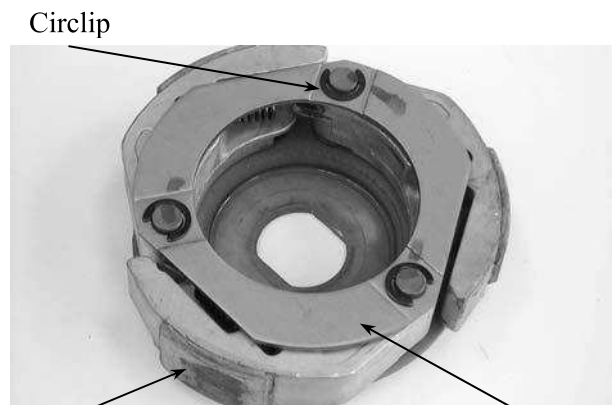

## 9. DRIVE AND DRIVEN PULLEYS/ KICK STARTER

Install the movable driven face onto the driven face.

Apply grease to the guide rollers and guide roller pins and then install them into the holes of the driven face.

Install the seal collar.

Remove any excessive grease.

Be sure to clean the driven face off any grease.



Set the driven pulley assembly, driven face spring and clutch assembly onto the clutch spring compressor.

Align the flat surface of the driven face with the flat on the clutch drive plate.



Compress the clutch spring compressor and install the drive plate nut.

Set the clutch spring compressor in a vise and tighten the drive plate nut to the specified torque.

**Torque:** 5.5kg-m

Be sure to use a clutch spring compressor to avoid spring damage.

Special

Clutch Spring Compressor  
Outer Driver, 32x35mm

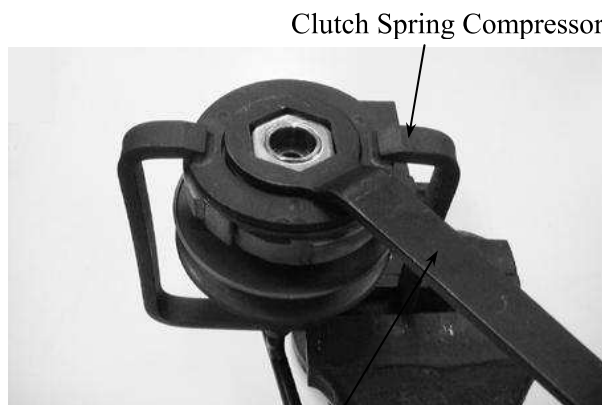

### INSTALLATION

Install the clutch/driven pulley onto the drive shaft.

Keep grease off the drive shaft.



Guide Roller                      Guide Roller Pin



Install the clutch outer.

## 9. DRIVE AND DRIVEN PULLEYS/ KICK STARTER

Hold the clutch outer with the universal holder.

Install and tighten the clutch outer nut.

**Torque:** 5.5kg-m

Special

Universal Holder

Install the drive belt.

Install the left crankcase cover.

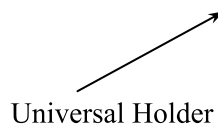

### KICK STARTER

#### REMOVAL

Remove the left crankcase cover.

Remove the seal rubber and dowel pins.

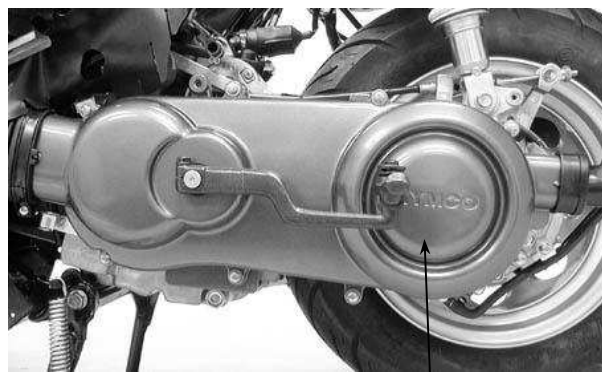

Left Crankcase Cover

Remove the kick lever.

Remove the circlip and washer from the kick starter spindle.

Kick Starter Spindle

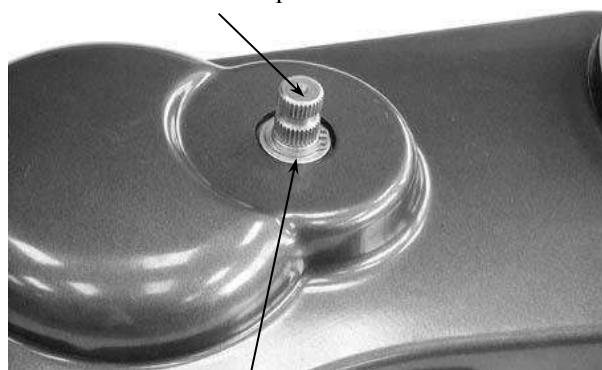

Circlip

Gently turn the kick starter spindle to remove the starter driven gear together with the friction spring.

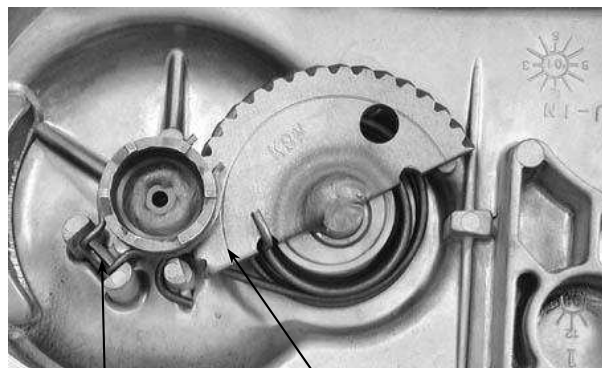

Friction Spring Starter Driven Gear

Clutch Outer



Remove the kick starter spindle and return

# 9. DRIVE AND DRIVEN PULLEYS/ KICK STARTER

spring from the left crankcase cover.  
Remove the kick starter spindle bushing.

### INSPECTION

Inspect the kick starter spindle and gear for wear or damage.  
Inspect the return spring for weakness or damage.  
Inspect the kick starter spindle bushings for wear or damage.

Inspect the starter driven gear for wear or damage.  
Inspect the friction spring for wear or damage.

Inspect the kick starter spindle and starter driven gear forcing parts for wear or damage.

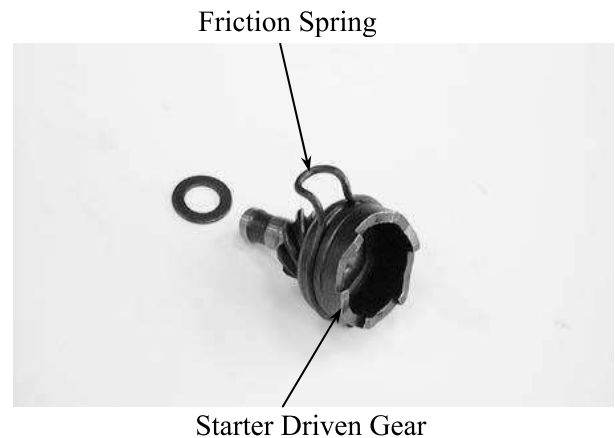
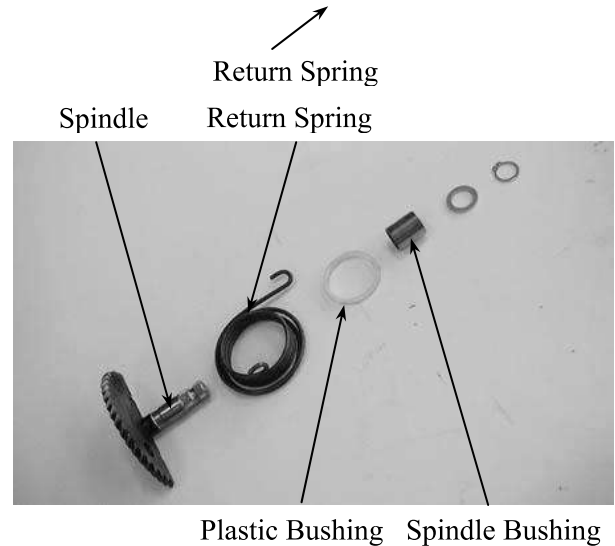

Kick Starter Spindle Forcing Part

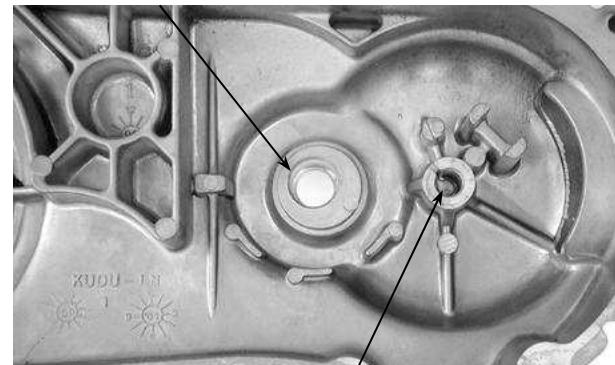

Kick Starter Spindle

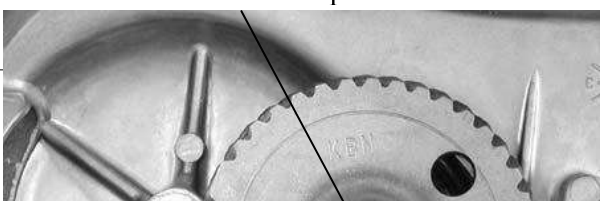

### INSTALLATION

## 9. DRIVE AND DRIVEN PULLEYS/ KICK STARTER

Install the kick starter spindle bushings and return spring onto the left crankcase cover.

When installing the return spring, use a screw driver to press the inward and outward return spring hooks into their original positions respectively.

Install the starter driven gear and friction spring as the figure shown.

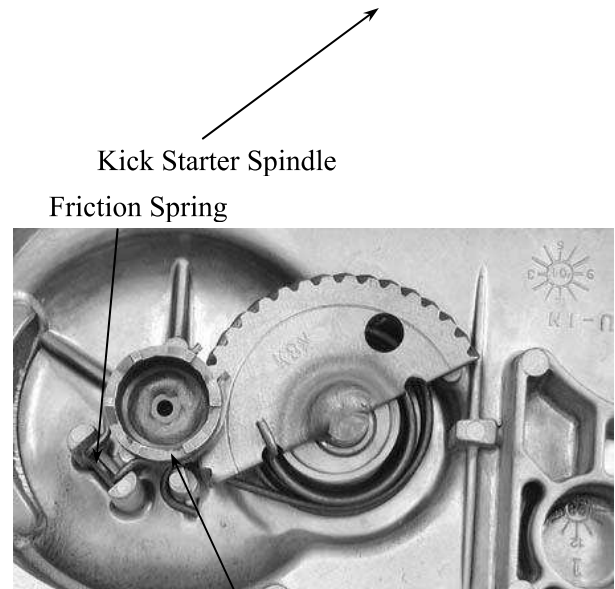

Kick Starter Spindle

Friction Spring

Starting Ratchet

Install the kick lever.  
Install the left crankcase cover and tighten the cover bolts diagonally.  
Connect the drive belt air tube and tighten the band screw.

For drum brake, be sure to install the rear brake cable clamp to the specified location and install the brake cable into the brake cable holder.

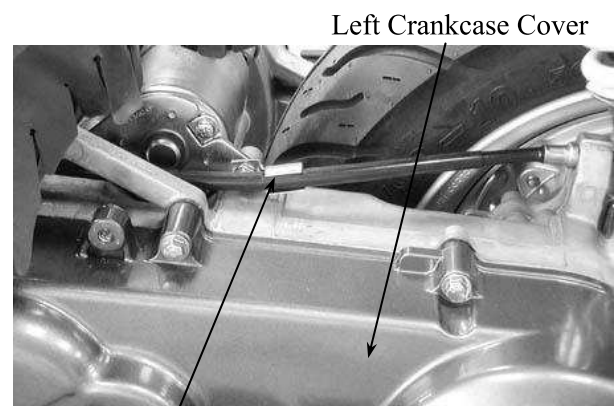

Left Crankcase Cover

Rear Brake Cable Clamp



---

## FINAL REDUCTION

---

SERVICE INFORMATION-----	10- 1
TROUBLESHOOTING-----	10- 1
FINAL REDUCTION DISASSEMBLY -----	10- 2
FINAL REDUCTION INSPECTION-----	10- 2
BEARING REPLACEMENT -----	10- 3
FINAL REDUCTION ASSEMBLY -----	10- 4

# 10. FINAL REDUCTION

## SERVICE INFORMATION

---

### GENERAL INSTRUCTIONS

- When replacing the drive shaft, use a special tool to hold the bearing inner race for this operation.

### SPECIFICATIONS

Specified Oil: GEAR OIL SAE 90#

Oil Capacity:           At change           : 0.2 liter  
                                  At disassembly : 0.18 liter

### TORQUE VALUES

Transmission case cover bolt   1.2kg-m

### SPECIAL TOOLS

Driver handle A

Outer driver, 32x35mm

Outer driver, 37x40mm

Outer driver, 42x47mm

Pilot, 15mm

Pilot, 17mm

Pilot, 20mm

Crankcase assembly tool

– Assembly shaft

– Assembly collar

### TROUBLESHOOTING

#### Engine starts but motorcycle won't move

- Damaged transmission
- Seized or burnt transmission

#### Oil leaks

- Oil level too high
- Worn or damaged oil seal

**FINAL REDUCTION DISASSEMBLY**

Remove the exhaust muffler.

## 10. FINAL REDUCTION

Remove the rear wheel.  
 Remove the rear brake cable.  
 Remove the left crankcase cover.  
 Remove the clutch/driven pulley.  
 Drain the transmission gear oil into a clean container.  
 Remove the transmission case cover attaching bolts.

Remove the transmission case cover.  
 Remove the gasket and dowel pins.  
 Remove the final gear and countershaft.

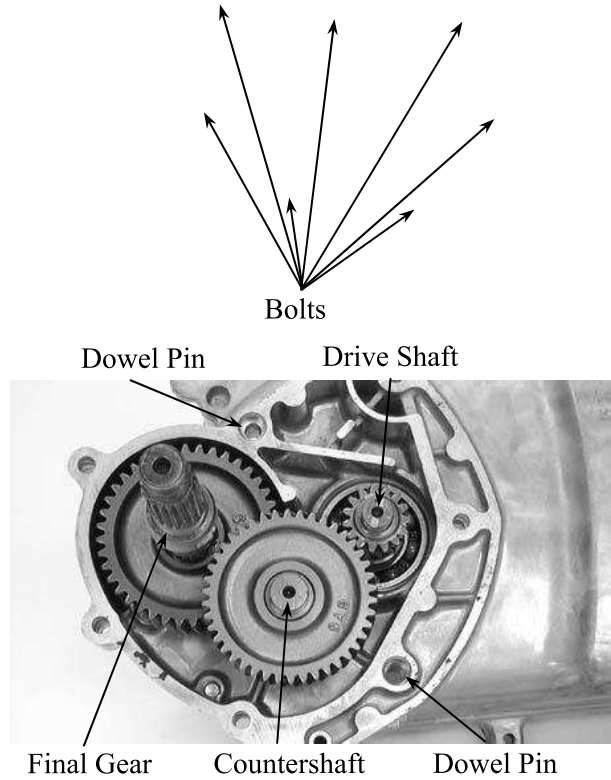

### FINAL REDUCTION INSPECTION

Inspect the countershaft and gear for wear or damage.

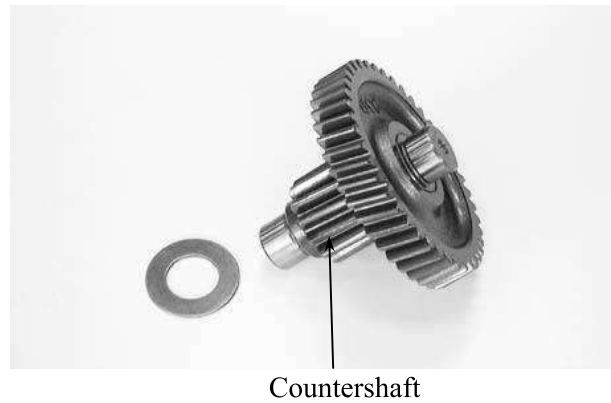

Inspect the final gear and final shaft for wear, damage or seizure.

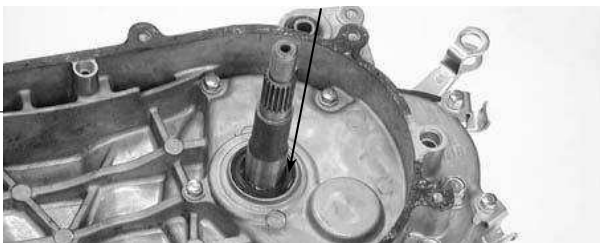

Check the left crankcase bearings for excessive play and inspect the oil seal for



# 10. FINAL REDUCTION

wear or damage.

Inspect the drive shaft and gear for wear or damage.  
Check the transmission case cover bearings for excessive play and inspect the final shaft bearing oil seal for wear or damage.

Do not remove the transmission case cover except for necessary part replacement. When replacing the drive shaft, also replace the bearing and

## BEARING REPLACEMENT (TRANSMISSION CASE COVER)

Remove the transmission case cover bearings using a bearing remover.  
Remove the final shaft oil seal.

Drive new bearings into the transmission case cover.

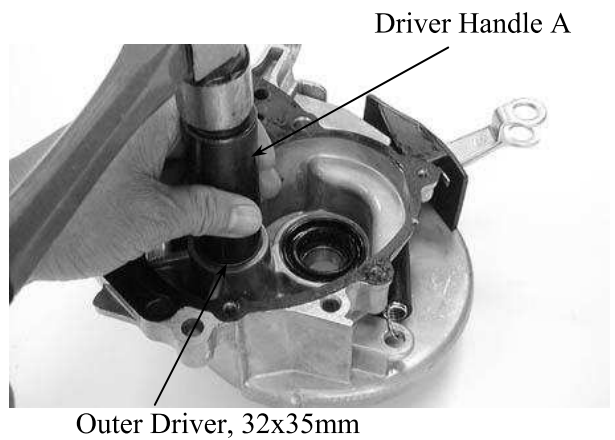
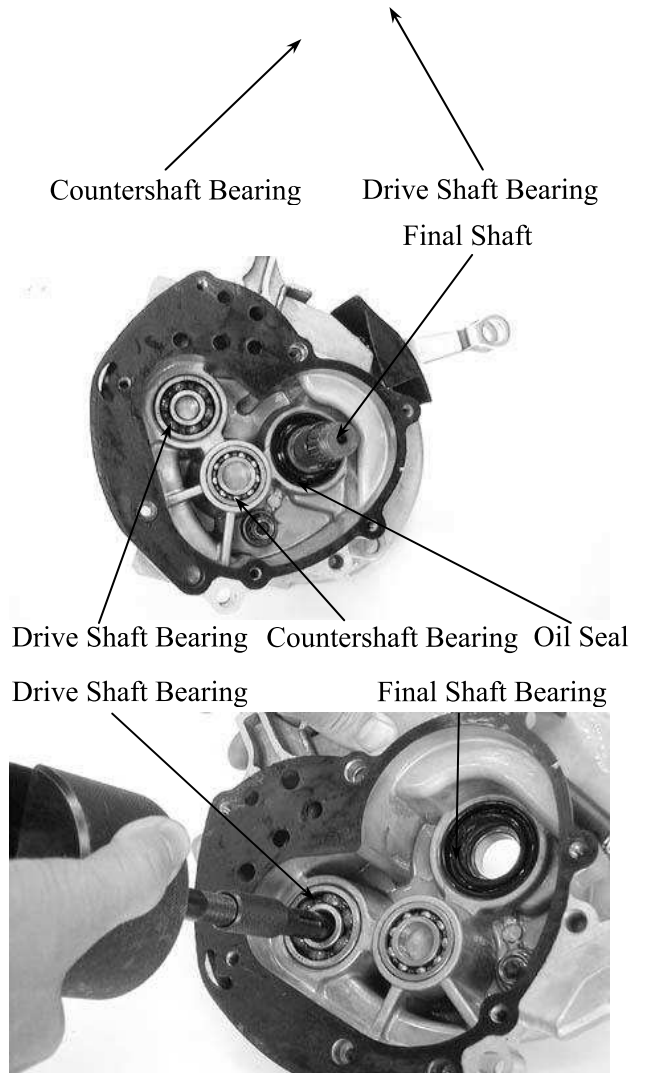

Final Shaft Bearing



## BEARING REPLACEMENT (LEFT CRANKCASE)

## 10. FINAL REDUCTION

Remove the drive shaft.  
Remove the drive shaft oil seal.  
Remove the left crankcase bearings using a bearing remover.

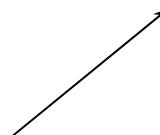
  
Bearing Remover, 12mm

Drive new bearings into the left crankcase.  
Install a new drive shaft oil seal.

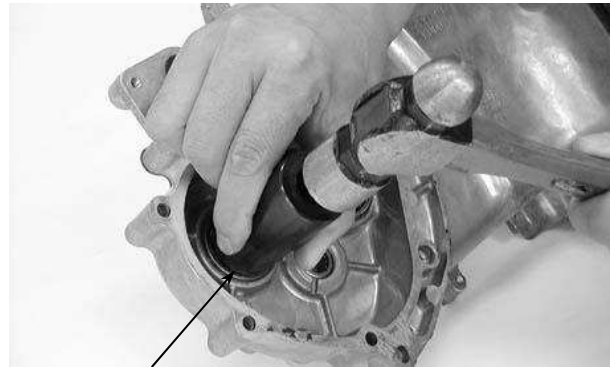

Pilot

### FINAL REDUCTION ASSEMBLY

Install the drive shaft into the left crankcase.

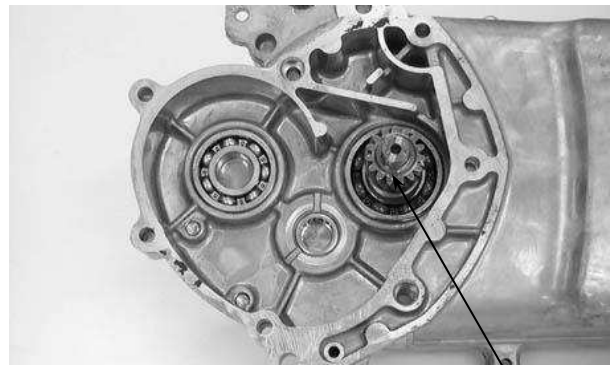

Drive Shaft

Install the final gear and final shaft into the left crankcase.

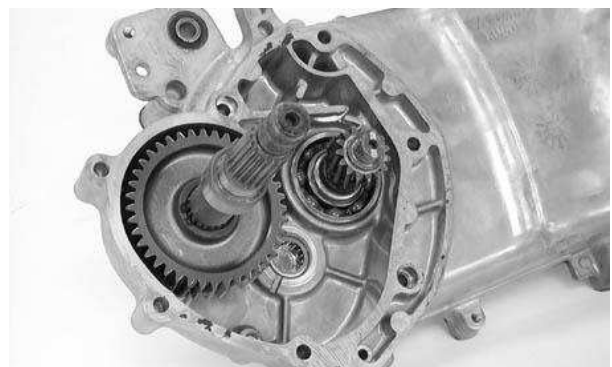

Install the countershaft and gear into the left crankcase.



# 10. FINAL REDUCTION

Install the countershaft.  
 Install the dowel pins and a new gasket.

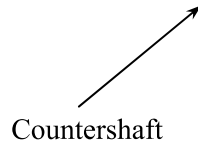

Install the transmission case cover.

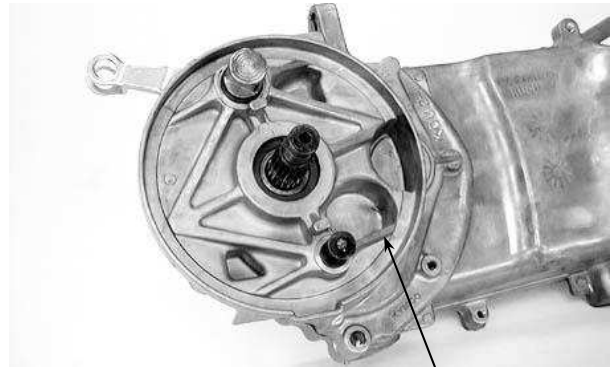

Transmission Case Cover

Install and tighten the transmission case cover bolts.  
 Install the clutch/driven pulley.  
 Install the rear wheel.  
 Install the rear brake cable.

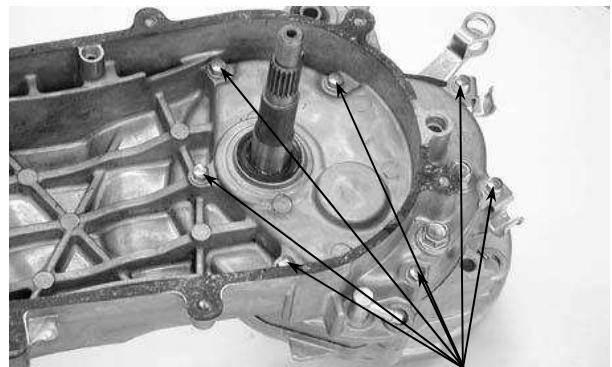

Bolts

After installation, fill the transmission case with the specified oil.

- Place the motorcycle on its main stand on level ground.
- Check the oil sealing washer for wear or damage.

**Specified Gear Oil:**

KYMCO SIGMA GEAR OIL 90#

**Oil Capacity:**

At disassembly : 0.2 liter  
 At change : 0.18 liter

Install and tighten the oil check bolt.

**Torque:** 1.0 1.5kg-m

Start the engine and check for oil leaks.  
 Check the oil level from the oil check bolt hole and add the specified oil to the proper level if the oil level is low.



Drain Bolt Oil Check Bolt Hole/Oil Filler



---

## CRANKCASE/CRANKSHAFT

---

SERVICE INFORMATION-----	11- 1
TROUBLESHOOTING-----	11- 1
CRANKCASE SEPARATION -----	11- 2
CRANKSHAFT INSPECTION-----	11- 3
CRANKCASE ASSEMBLY -----	11- 4

# 11. CRANKCASE/CRANKSHAFT

## SERVICE INFORMATION

### GENERAL INSTRUCTIONS

- This section covers crankcase separation to service the crankshaft. The engine must be removed for this operation.
- The following parts must be removed before separating the crankcase.
  - Cylinder head (⇒Section 7)
  - Cylinder/piston (⇒Section 8)
  - Drive and driven pulleys (⇒Section 9)
  - A.C. generator (⇒Section 14)
  - Carburetor/air cleaner (⇒Section 4)
  - Rear wheel/rear shock absorber (⇒Section 13)
  - Starter motor (⇒Section 16)
  - Oil pump (⇒Section 4)

### SPECIFICATIONS

	Item	Standard (mm)	Service Limit (mm)
Crankshaft	Connecting rod big end side clearance	0.10 0.35	0.55
	Connecting rod big end radial clearance	0 0.008	0.05
	Runout	—	0.10

### TORQUE VALUES

Crankcase bolt	0.9kg-m
Cam chain tensioner slipper bolt	1.0kg-m
Cam chain cover bolt	0.9kg-m

### SPECIAL TOOL

Gear remover

### TROUBLESHOOTING

#### Excessive engine noise

- Excessive bearing play
- Excessive crankpin bearing play

### CRANKCASE SEPARATION

Remove the two crankcase attaching bolts.

# 11. CRANKCASE/CRANKSHAFT

Separate the left and right crankcase halves.

Do not damage the crankcase gasket surface.

Remove the gasket and dowel pins.

Gasket



Remove the crankshaft and cam chain from the left crankcase.

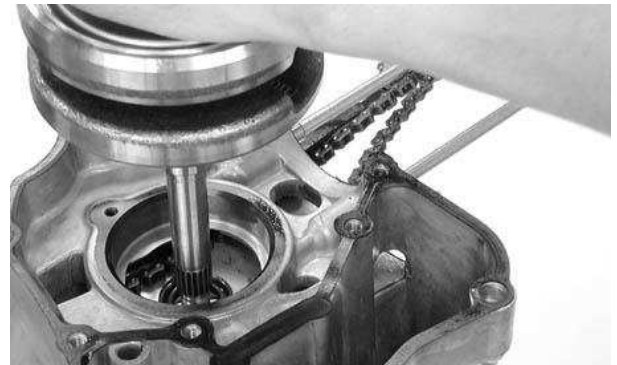

Clean off all gasket material from the crankcase mating surfaces.

Avoid damaging the crankcase mating surfaces.

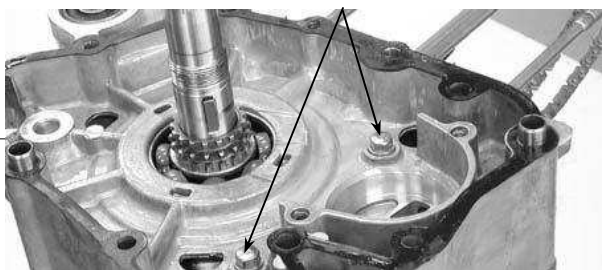
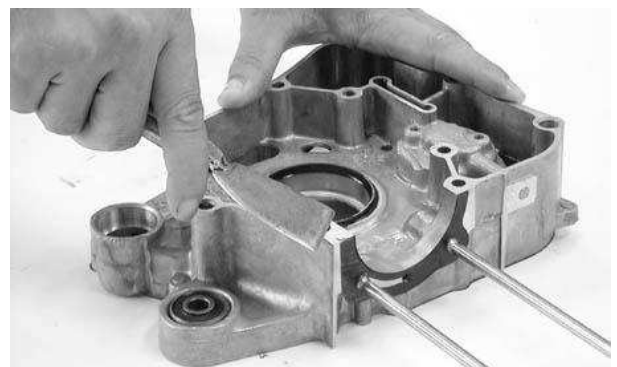

Remove the oil seal from the right crankcase.  
 Check the oil seal lip for wear or deterioration.

# 11. CRANKCASE/CRANKSHAFT

The installation sequence is the reverse of removal.

## CRANKSHAFT INSPECTION

Measure the connecting rod big end side clearance.

**Service Limit:** 0.55mm replace if over



Connecting Rod Big End

Measure the connecting rod big end radial clearance at two points at right angles to the shaft.

**Service Limit:** 0.05mm replace if over

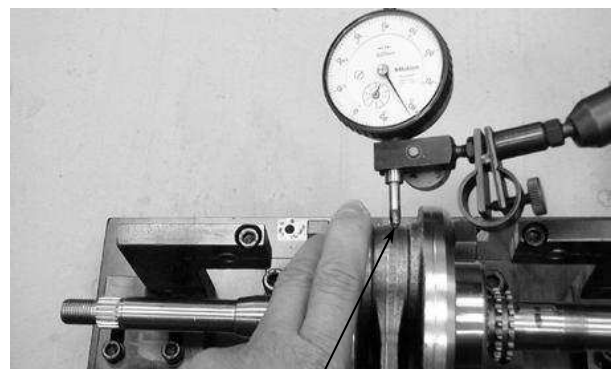

Measuring Location

Measure the crankshaft runout.

**Service Limit:** 0.10mm replace if over

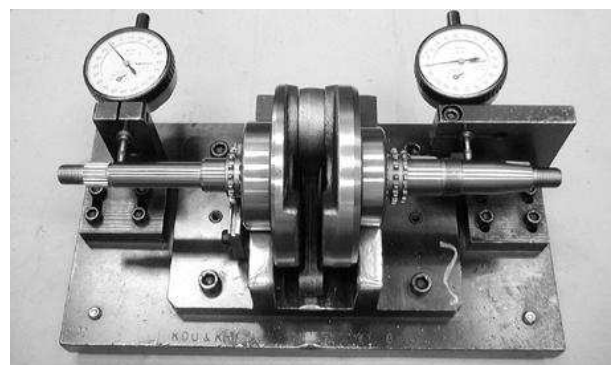

Turn the crankshaft bearings and check for excessive play.  
If they do not turn smoothly, quietly or if they fit loosely in the crankshaft, replace the

# 11. CRANKCASE/CRANKSHAFT

crankshaft as a set.

## CRANKCASE ASSEMBLY

Install the cam chain into the left crankcase.



Cam Chain

Install the crankshaft into the left crankcase.

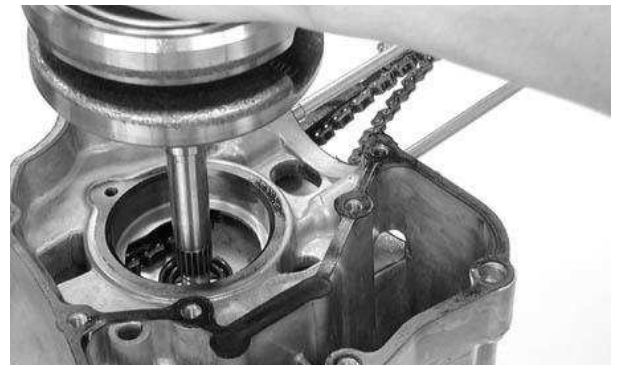

Install the dowel pins and a new gasket onto the left crankcase.

Place the right crankcase over the crankshaft and onto the left crankcase.

Gasket

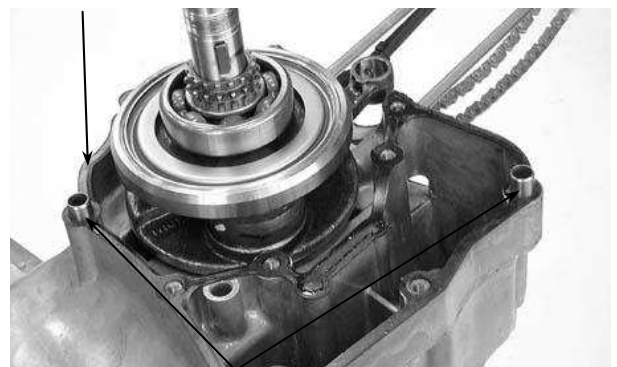

Dowel Pins

Tighten the two crankcase attaching bolts.  
**Torque: 0.9kg-m**

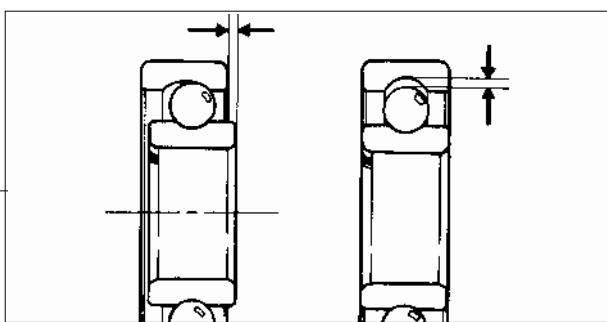



# 11. CRANKCASE/CRANKSHAFT

---

Crankcase Bolts

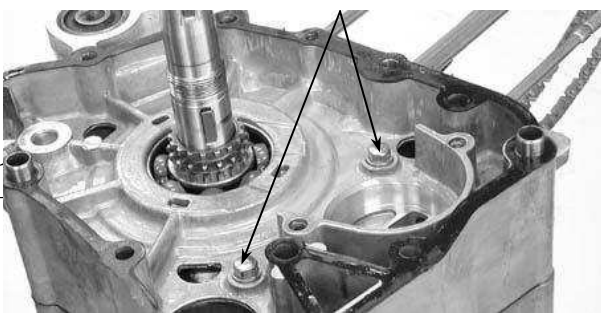

---

---

---

---

---

---

---

**FRONT WHEEL/FRONT BRAKE/  
FRONT SUSPENSION**

---

SERVICE INFORMATION-----	12- 1
TROUBLESHOOTING-----	12- 2
FRONT WHEEL-----	12- 3
FRONT BRAKE-----	12- 6
HYDRAULIC BRAKE-----	12- 8
FRONT SHOCK ABSORBER-----	12-13
STEERING HANDLEBAR-----	12-16
STEERING STEM-----	12-17

# 12. FRONT WHEEL/FRONT BRAKE/ FRONT SUSPENSION



## SERVICE INFORMATION

### GENERAL INSTRUCTIONS

- Remove the motorcycle frame covers before removing the front wheel. Jack the motorcycle front wheel off the ground and be careful to prevent the motorcycle from falling down.
- During servicing, keep oil or grease off the brake drum and brake linings.
- Contaminated brake disk or brake pads reduce stopping power. Clean the contaminated brake disk with high-performance brake degreaser and replace the brake pads.
- Do not use brake fluid for cleaning.
- Bleed air from the brake system if the brake system is removed or the brake is soft.
- Do not allow any foreign matters to enter the brake system when filling it with brake fluid.
- Brake fluid will damage painted surfaces and plastic parts. When servicing the brake system, use shop towels to cover and protect rubber, plastic parts and coated surfaces. Wipe off any spilled brake fluid with a clean shop towel.
- Inspect the brake system before riding.

### SPECIFICATIONS

Item	Standard (mm)	Service Limit (mm)
Axle shaft runout	—	0.2
Front wheel rim runout	Radial	2.0
	Axial	2.0
Front brake drum I.D	110	111
Front brake lining thickness	6.2	1.5
Front shock absorber spring free length	259	251
Brake disk thickness	3.8	3.0
Brake disk runout	—	0.30
Brake master cylinder I.D.	12.700 12.743	12.75
Brake master cylinder piston O.D.	12.657 12.684	12.64
Brake caliper piston O.D.	25.335 25.368	25.330
Brake caliper cylinder I.D.	25.40 25.45	25.460

### TORQUE VALUES

Steering stem bolt	4.0 5.0kg-m	Brake caliper bleed valve	0.6kg-m
Steering stem lock nut	8.0 12.0kg-m	Brake fluid tube bolt	2.5 3.5kg-m
Steering top cone race	0.5 1.3kg-m	Brake pad pin bolt	1.5 2.0kg-m
Front shock absorber bolt	2.0 2.5kg-m	brake caliper bolt	2.9 3.5kg-m
Front axle nut	6.0kg-m	Brake master cylinder bolt	1.0 1.4kg-m

## 12. FRONT WHEEL/FRONT BRAKE/ FRONT SUSPENSION

### SPECIAL TOOLS

- |                                |                            |
|--------------------------------|----------------------------|
| Lock nut wrench                | Driver handle A            |
| Lock nut wrench                | Outer driver, 37x40mm      |
| Outer driver, 28x30mm          | Pilot, 10mm                |
| Rear shock absorber attachment | Bearing remover            |
| Shock absorber compressor      | Bearing remover head, 10mm |
| Ball race remover              | Damper compressor          |
| Pliers (close)                 |                            |

### TROUBLESHOOTING

#### Hard steering (heavy)

- Excessively tightened steering stem top cone race
- Broken steering balls
- Insufficient tire pressure

#### Steers to one side or does not track straight

- Uneven front shock absorbers
- Bent front fork
- Bent front axle or uneven tire

#### Poor brake performance

- Incorrectly adjusted brake
- Worn brake linings
- Contaminated brake lining surface
- Worn brake shoes at cam contacting area
- Worn brake drum
- Poorly connected brake arm

#### Poor brake performance (Disk Brake)

- Air in brake system
- Deteriorated brake fluid
- Contaminated brake pads and brake disk
- Worn brake pads
- Worn brake master cylinder piston oil seal
- Clogged brake fluid line
- Deformed brake disk
- Unevenly worn brake caliper

#### Front wheel wobbling

- Bent rim
- Excessive wheel bearing play
- Bent spoke plate
- Faulty tire
- Improperly tightened axle nut

#### Soft front shock absorber

- Weak shock springs
- Insufficient damper oil

#### Front shock absorber noise

- Slider bending
- Loose fork fasteners
- Lack of lubrication

# 12. FRONT WHEEL/FRONT BRAKE/ FRONT SUSPENSION

## FRONT WHEEL

### REMOVAL

Jack the motorcycle front wheel off the ground.  
Remove the speedometer cable set screw and disconnect the speedometer cable.  
Remove the front brake cable.

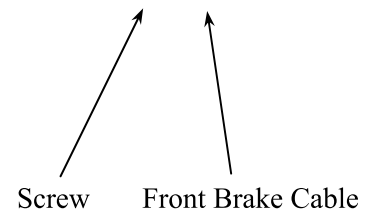

Remove the front axle nut and pull out the axle.  
Remove the front wheel.  
Remove the front brake panel.



### INSPECTION

#### AXLE RUNOUT

Set the axle in V blocks and measure the runout using a dial gauge.  
The actual runout is  $\frac{1}{2}$  of the total indicator reading.

**Service Limit:** 0.2mm replace if over

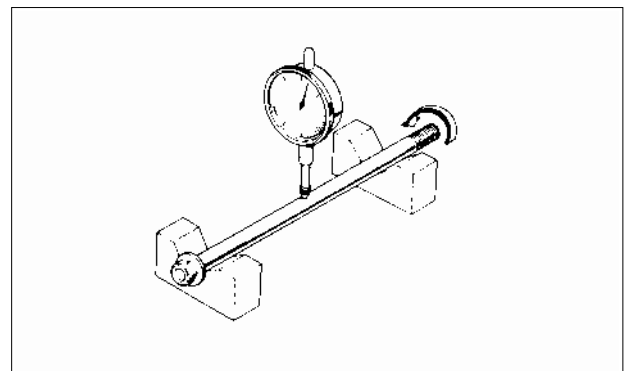

#### WHEEL RIM

Check the wheel rim runout.

**Service Limits:**

**Radial:** 2.0mm replace if over

**Axial:** 2.0mm replace if over

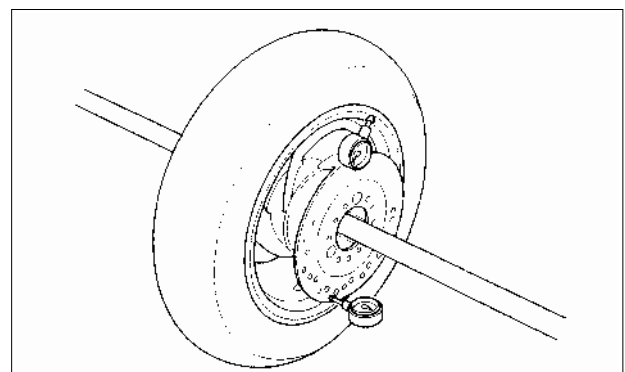

Speedometer Cable



## FRONT WHEEL BEARING

# 12. FRONT WHEEL/FRONT BRAKE/ FRONT SUSPENSION

Remove the side collar and dust seal.

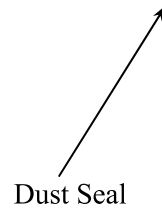

Turn the inner race of each bearing with your finger to see if they turn smoothly and quietly. Also check if the outer race fits tightly in the hub.  
Replace the bearings if the races do not turn smoothly, quietly, or if they fit loosely in the hub.

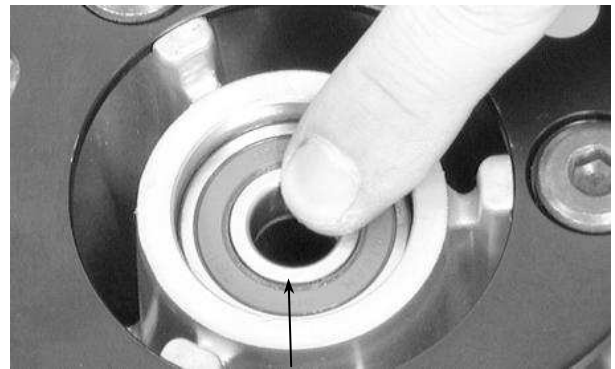

### BEARING REPLACEMENT

Remove the front wheel bearings and distance collar.

Special

Bearing Remover

Bearing Remover Head, 12mm

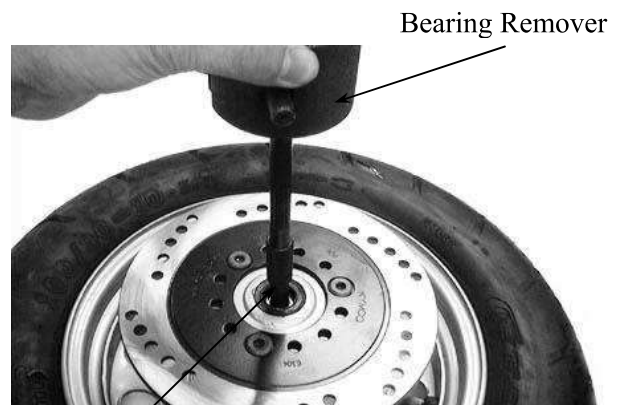

Bearing Remover Head

Pack all bearing cavities with grease.  
Drive in the left bearing.  
Install the distance collar.  
Drive in the right bearing.

- Do not allow the bearings to tilt while driving them in.
- Drive in the bearing squarely with the sealed end facing out.

Special

Outer driver, 32x35mm

Driver handle A

Pilot, 12mm



Pilot

Side Collar



Apply grease to a new dust seal lip and

## 12. FRONT WHEEL/FRONT BRAKE/ FRONT SUSPENSION

install the dust seal.  
Install the side collar.

### INSTALLATION

Apply grease to the brake panel dust seal lip.  
Apply grease to the speedometer gear engaging and sliding parts.  
Install the brake panel by aligning the speedometer retaining pawls with the hub cutouts.

If not aligned, the retaining pawl will be deformed when the axle nut is tightened.  
After installing the axle, turn the wheel to make sure that the speedometer drive shaft rotates freely.

Apply a thin coat of grease to the axle shaft.  
Install the front wheel by aligning the brake panel groove with the front fork tab.  
Insert the axle shaft.  
Connect the speedometer cable and secure it with the screw.

Install and tighten the axle nut.

**Torque:** 6.0kg-m

Install the front brake cable and adjust the front brake lever free play.

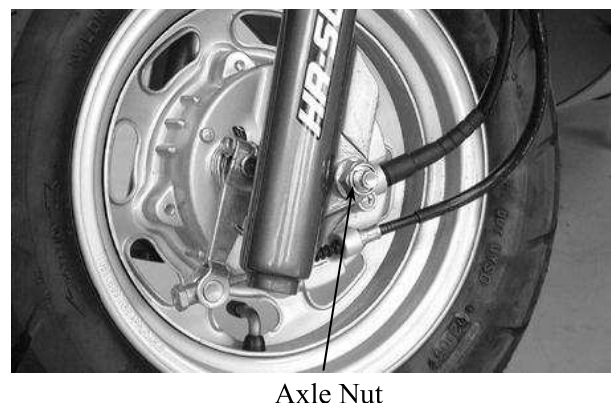
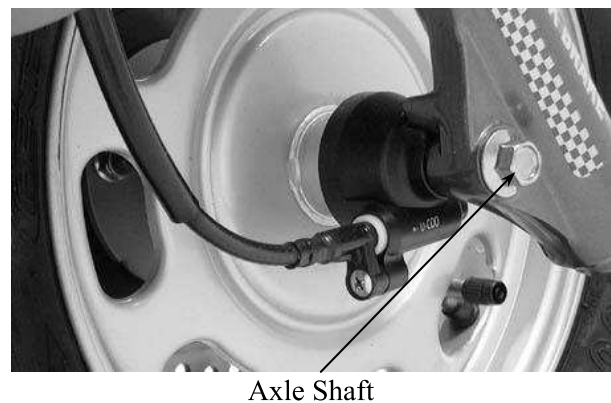
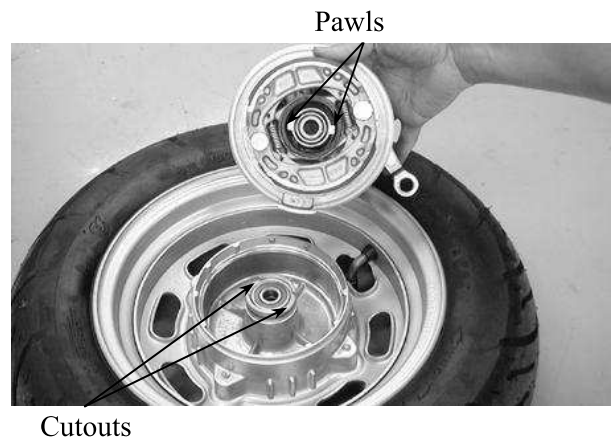
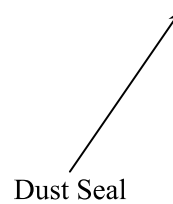

Side Collar

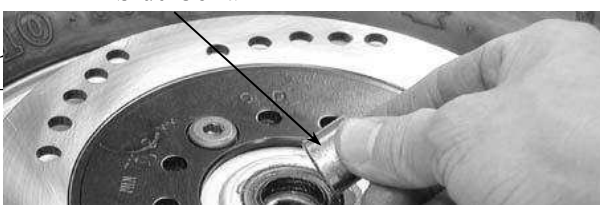

### FRONT BRAKE

## 12. FRONT WHEEL/FRONT BRAKE/ FRONT SUSPENSION

Remove the front wheel.  
Remove the front brake panel.

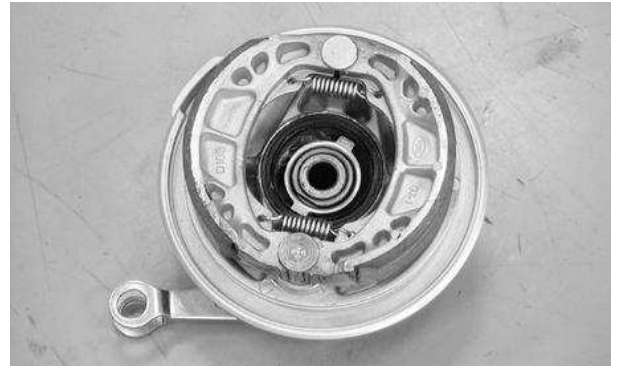

### INSPECTION

Measure the brake drum I.D.

**Service Limit:** 111mm replace if over

Remove the brake shoes and springs, and replace the brake shoes.

Keep oil or grease off the brake linings.

Inspect the brake panel dust seal for damage and replace if necessary.

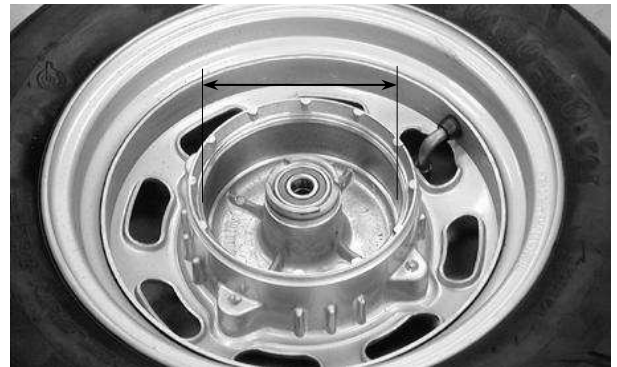

### BRAKE PANEL DISASSEMBLY

Remove the brake shoes.

Remove the brake arm and return spring.  
Remove the wear indicator plate and felt seal.

Remove the brake cam.

Remove the speedometer gear and brake panel collar.

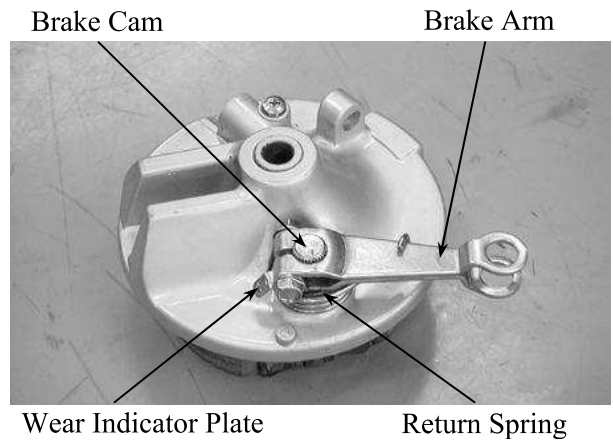

### ASSEMBLY

Apply grease to the anchor pin and brake cam.

Install the brake cam.



Install the return spring by aligning the



## 12. FRONT WHEEL/FRONT BRAKE/ FRONT SUSPENSION

spring hook end with the hole in the brake panel.

Apply engine oil to the felt seal and install it to the brake panel.

Install the wear indicator plate on the brake cam by aligning the tooth on the plate with the groove on the brake cam.

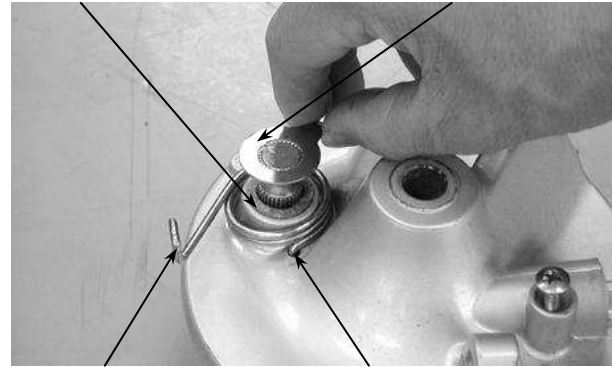

Return Spring      Hole

Install the brake arm on the brake cam by aligning the punch marks on the brake arm and brake cam.

Install and tighten the brake arm bolt.

**Torque:** 1.0kg-m

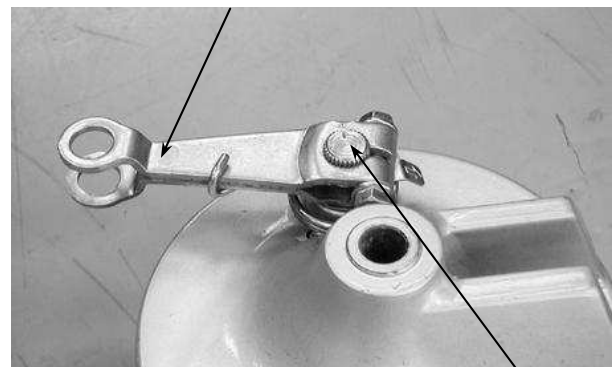

Brake Arm

Brake Cam

Apply grease to the brake panel collar and install it into the brake panel.

Apply grease to the speedometer gear and then install it into the brake panel.

Install the brake shoe springs to the brake shoes and then install the brake shoes into the brake panel.

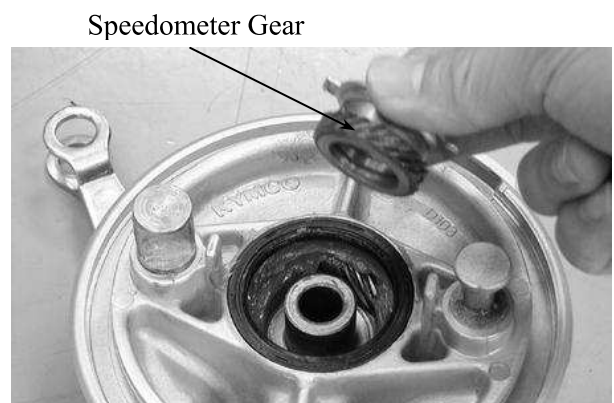

Speedometer Gear

### INSTALLATION

Install the brake panel onto the front wheel.

Install the front wheel.

Adjust the front brake lever free play.

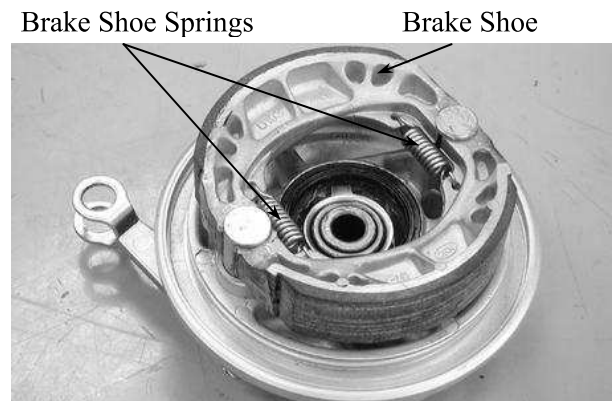

Brake Shoe Springs

Brake Shoe

Felt Seal

Wear Indicator Plate

## 12. FRONT WHEEL/FRONT BRAKE/ FRONT SUSPENSION

### HYDRAULIC BRAKE (FRONT BRAKE)

#### BRAKE FLUID REPLACEMENT/AIR BLEEDING

Check the brake fluid level on level ground.

- When operating the brake lever, the brake reservoir cap must be tightened securely to avoid splash of brake fluid.
- When servicing the brake system, use shop towels to cover plastic parts and coated surfaces to avoid damage caused by splash of brake fluid.

#### BRAKE FLUID BLEEDING

In order to avoid spilling brake fluid, connect a transparent hose to the bleed valve.



#### Warning

Spilled brake fluid on brake pads or brake disk reduces stopping power. Clean the brake pads and brake disk with a high-performance brake degreaser.

Fully apply the brake lever and then loosen the brake caliper bleed valve to drain the brake fluid until there is no air bubbles in the brake fluid. Then, tighten the bleed valve.

Repeat these steps until the brake system is free of air.

#### BRAKE FLUID REFILLING

Add DOT-3 brake fluid to the brake reservoir.

- When bleeding, be careful not to allow air in the brake reservoir flowing into the brake system.
- When using a brake bleeder, follow the manufacturer's instructions.
- Never use dirty or unspecified brake fluid or mix different brake fluids because it will damage the brake

Make sure to bleed air from the brake system.

#### BRAKE PAD/DISK REPLACEMENT

The brake pads must be replaced as a set to ensure the balance of the brake disk.

Remove the two bolts attaching the brake caliper.

Remove the brake caliper.

Remove the brake pad pin to remove the brake pads.

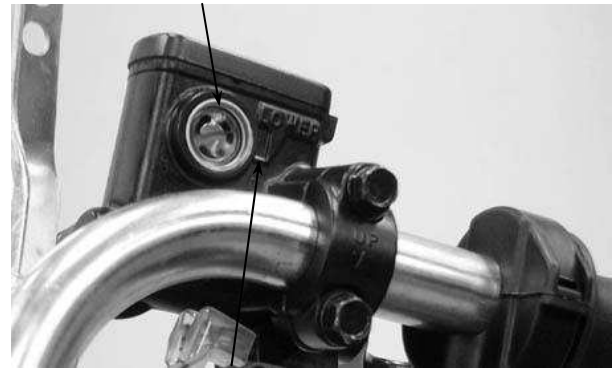

Lower Limit

Front Brake Caliper



Bleed Valve

Brake Pad Pins



Front Brake Caliper

Upper Limit

## 12. FRONT WHEEL/FRONT BRAKE/ FRONT SUSPENSION

Install the brake pads in the reverse order of removal.

Tighten the brake pad pin bolt.

**Torque:** 1.5 2.0kg-m

Keep grease or oil off the brake pads to avoid brake failure.

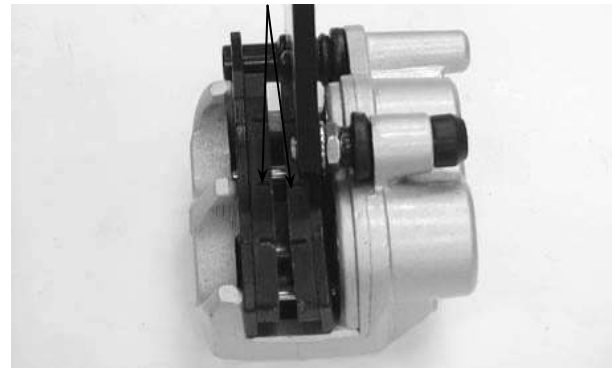

### BRAKE DISK

Measure the brake disk thickness.

**Service Limit:** 3.0mm

Measure the brake disk runout.

**Service Limit:** 0.3mm



### BRAKE MASTER CYLINDER

#### REMOVAL

First drain the brake fluid from the hydraulic brake system.

- When servicing the brake system, use shop towels to cover rubber and plastic parts and coated surfaces to avoid being contaminated by brake fluid.
- When removing the brake fluid tube bolt, be sure to plug the tube end to avoid brake fluid leakage.

Master Cylinder

Bolts



Snap Ring



#### DISASSEMBLY

Remove the piston rubber cover and snap ring from the brake master cylinder.

## 12. FRONT WHEEL/FRONT BRAKE/ FRONT SUSPENSION

Remove the rubber cover, main piston and spring from the brake master cylinder.  
Clean the inside of the master cylinder and brake reservoir with brake fluid.

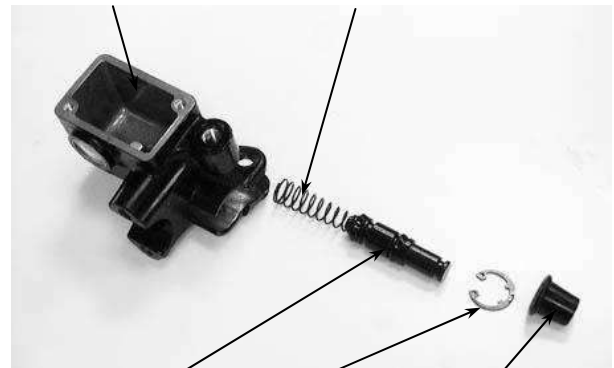

Main Piston   Snap Ring   rubber cover

### INSPECTION

Measure the brake master cylinder I.D.  
Inspect the master cylinder for scratches or cracks.

**Service Limit:** 12.75mm



Measure the brake master cylinder piston O.D.

**Service Limit:** 12.64mm

Before assembly, inspect the 1st and 2nd rubber cups for wear or damage.



### ASSEMBLY

Before assembly, apply brake fluid to all removed parts.

Install the spring together with the 1st rubber cup.

- During assembly, the main piston and spring must be installed as a unit without exchange.
- When assembling the piston, soak the cups in brake fluid for a while.
- Install the cups with the cup lips facing the correct direction.

Install the main piston, spring and snap ring.  
Install the rubber cover.  
Install the brake lever.



Master Cylinder   Spring

## 12. FRONT WHEEL/FRONT BRAKE/ FRONT SUSPENSION

Place the brake master cylinder on the handlebar and install the holder with the “up” mark facing up. Also align the punch mark with the holder joint seam. First tighten the upper bolt and then tighten the lower bolt.

**Torque:** 1.0 1.4kg-m

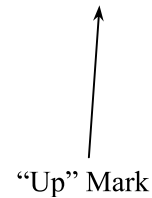

Install the brake fluid tube with the attaching bolt and two sealing washers. Install the handlebar covers. Connect the front and rear stop switch wire connectors. Fill the brake reservoir with recommended brake fluid to the upper limit and bleed air according to the method stated in page 12-8.

### **BRAKE CALIPER (FRONT)**

#### REMOVAL

Remove the brake caliper and brake pad springs. Place a clean container under the brake caliper and disconnect the brake fluid pipe from the caliper.

Do not spill brake fluid on any coated surfaces.



Bolt

Brake Caliper Seat



#### DISASSEMBLY

Remove the brake caliper seat from the brake caliper.

Fluid Tube Bolt      Punch Mark

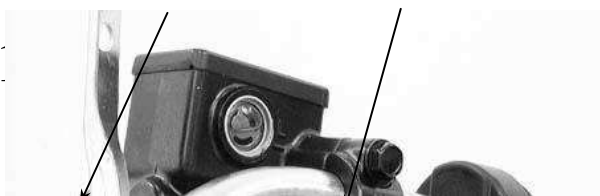

Remove the pistons from the brake caliper.

## 12. FRONT WHEEL/FRONT BRAKE/ FRONT SUSPENSION

If necessary, use compressed air to squeeze out the pistons through the brake fluid inlet opening and place a shop towel under the caliper to avoid contamination caused by the removed pistons.

Check each piston cylinder for scratches or wear and replace if necessary.

Push the piston oil seals outward to remove them.

Clean each oil seal groove with brake fluid.

Be careful not to damage the piston surface.

Check each piston for scratches or wear. Measure each piston O.D. with a micrometer gauge.

**Service Limit:** 25.33mm

Check each caliper cylinder for scratches or wear and measure the cylinder bore.

**Service Limit:** 25.46mm

↑  
Compressed Air



## 12. FRONT WHEEL/FRONT BRAKE/ FRONT SUSPENSION

Clean all removed parts.

Apply silicon grease to the pistons and oil seals. Lubricate the brake caliper cylinder inside wall with brake fluid.

Install the brake caliper piston with grooved side facing out.

Install the piston with its outer end protruding 3-5mm beyond the brake caliper cylinder.

Wipe off excessive brake fluid with a clean shop towel. Apply silicon grease to the brake caliper seat pin and caliper inside. Install the brake caliper seat.

### INSTALLATION

Install the brake caliper and tighten the two bolts.

**Torque:** 2.9-3.5kg-m



Bolts

Connect the brake fluid tube to the brake caliper and tighten the fluid tube bolt.

**Torque:** 2.5-3.5kg-m

Fill the brake reservoir with recommended brake fluid and bleed air from the brake system.



Fluid Tube Bolt

### FRONT SHOCK ABSORBER

#### REMOVAL

Remove the front cover.

Remove the front inner fender.

Remove the front wheel.

Remove the front shock absorber upper mount bolts.

Loosen the lower mount bolts to remove the front shock absorbers.

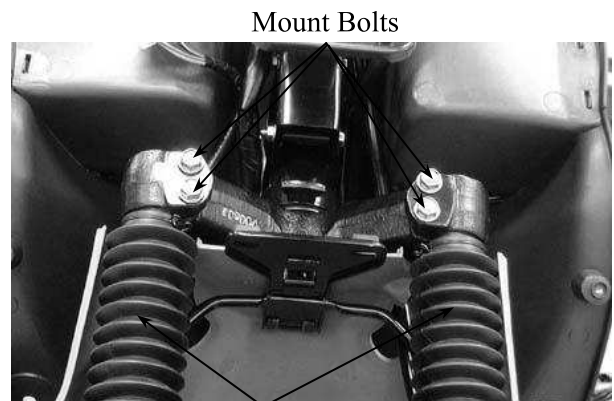

Shock Absorbers

#### DISASSEMBLY

Remove the dust boot.



# 12. FRONT WHEEL/FRONT BRAKE/ FRONT SUSPENSION

Remove the circlip.

Set the front shock absorber in a vise.  
Remove the damper rod, hex bolt and  
copper washer.  
Pull out the front shock absorber tube.

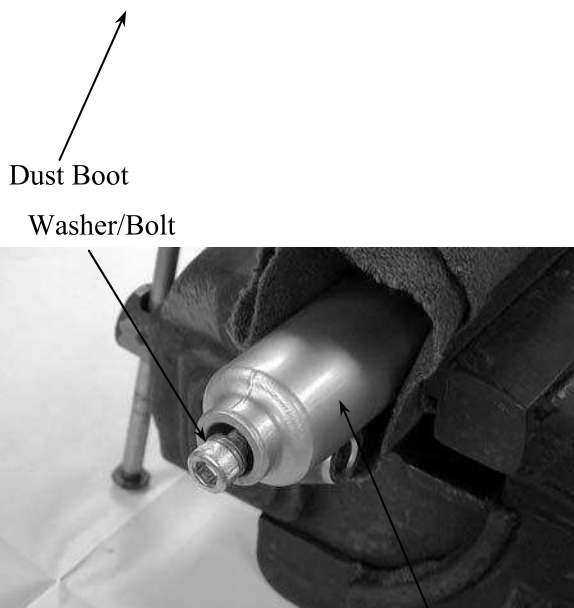

Front Shock Absorber

Set the front shock absorber tube in a vise.  
Remove the lock bolt on the front shock  
absorber tube.

- When holding the shock absorber tube, place a shop towel to protect it and do not apply too much force.
- Place a container under the front shock absorber to drain the engine oil from it.

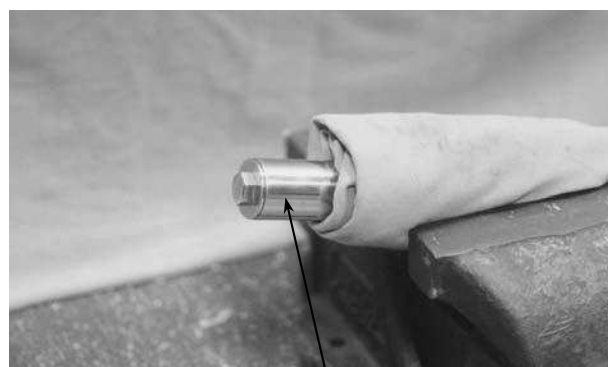

Shock Absorber Tube

Take out the front shock absorber spring,  
damper and damper spring.

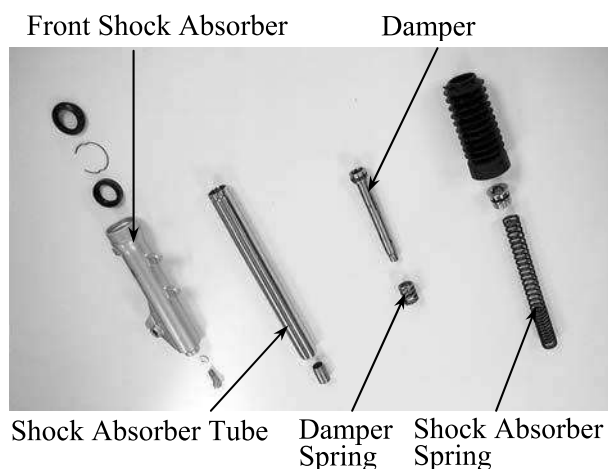

Shock Absorber Tube    Damper Spring    Shock Absorber Spring

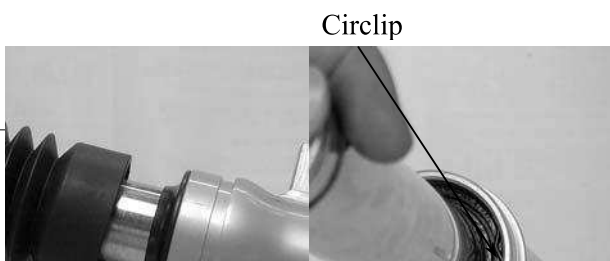

## INSPECTION



## 12. FRONT WHEEL/FRONT BRAKE/ FRONT SUSPENSION

Inspect the following items and replace if necessary.

- Front shock absorber tube bending or damage
- Weak front shock absorber spring
- Damper and damper rod bending
- Oil seal damage or wear

Measure the front shock absorber spring free length.

**Service Limits:** Right : 251mm  
Left : 251mm



### ASSEMBLY

Install the damper spring onto the damper rod and then install them into the front shock absorber tube.

Install the shock absorber spring onto the front shock absorber tube and tighten the lock bolt on the top.

Install the front shock absorber spring with the closely wound coils facing down.

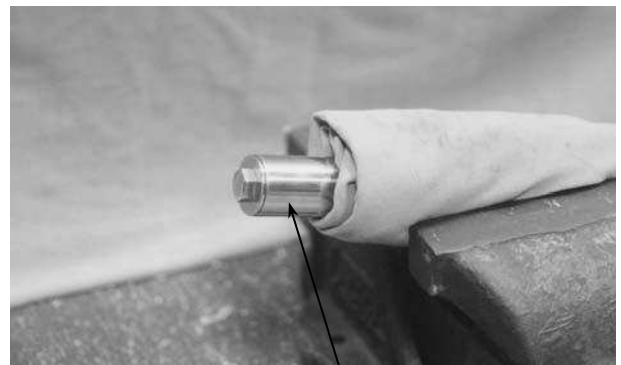

Shock Absorber Tube

Front Shock Absorber

Set the front shock absorber in a vise. Insert the shock absorber tube into the shock absorber and tighten the hex bolt. (Apply locking agent to the washer and install it together with the hex bolt.)

**Torque:** 1.5 3.0kg-m

Add engine oil into the front shock absorber.

**Specified Oil:** SS#8

**Oil Capacity:** 55±1cc



Hex Bolt/Washer

Install the circlip.

# 12. FRONT WHEEL/FRONT BRAKE/ FRONT SUSPENSION

Install the dust boot.

## INSTALLATION

Install the front shock absorbers onto the steering stem.  
Install and tighten the front shock absorber upper mount bolts.  
Tighten the lower mount bolts.

Align the upper mount bolt hole with the groove on the front fork.

Install the front wheel.

## STEERING HANDLEBAR

### REMOVAL

Remove the handlebar covers.  
Remove the rear brake lever holder bolt to remove the holder.  
Remove the front brake master cylinder holder bolts to remove the brake master cylinder.

Remove the throttle seat screw.

Dust Boot

Mount Bolts



Front Shock Absorbers

Bolts

Bolts



Brake Master Cylinder

Rear Brake Lever

Throttle Pipe

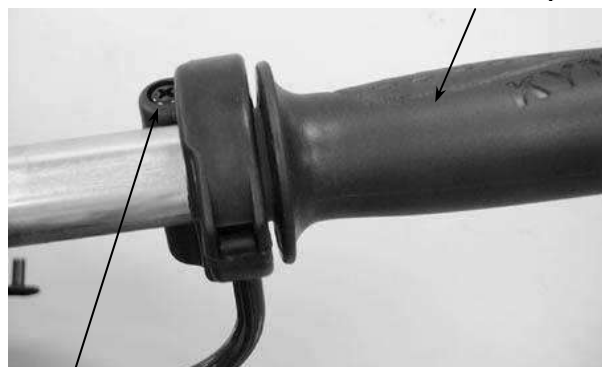

Screw

Remove the throttle seat from the handlebar



## 12. FRONT WHEEL/FRONT BRAKE/ FRONT SUSPENSION

and disconnect the throttle cable from the throttle pipe.  
Remove the throttle pipe from the handlebar.

Remove the steering stem lock bolt, collar, nut and the handlebar.

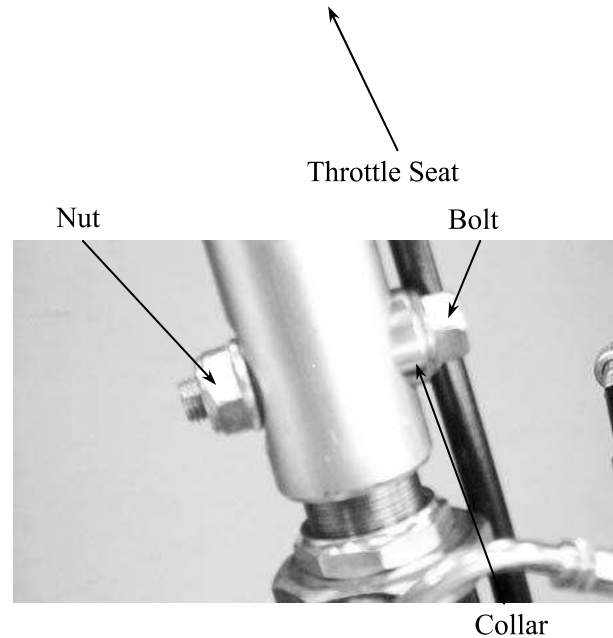

### STEERING STEM

#### REMOVAL

Remove the steering stem lock nut.

Special

Steering Stem Lock Nut Wrench  
Lock Nut wrench

Steering Stem Lock Nut Wrench

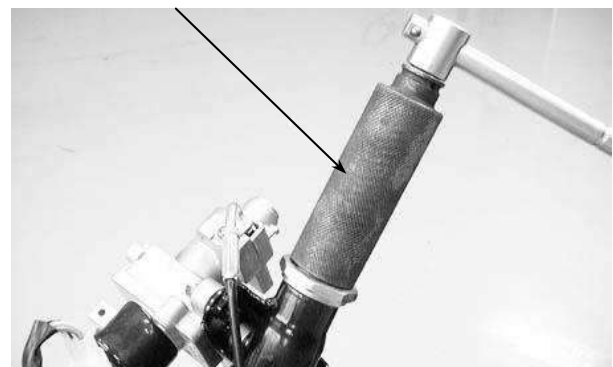

Remove the top cone race.

- Be careful not to lose the steel balls (26 on top race and 19 on bottom race).
- Clean the openings of frame covers with clean shop towels.

Remove the front fork.

Top Cone Race



Throttle Pipe



### BOTTOM CONE RACE REPLACEMENT

## 12. FRONT WHEEL/FRONT BRAKE/ FRONT SUSPENSION

Remove the bottom cone race using a  
isel.

Be careful not to damage the steering  
stem and front fork.

Drive a new bottom cone race into place  
with a proper driver.

Bottom Cone Race

### BALL RACE REPLACEMENT

Drive out the top and bottom ball races.



Ball Race Remover

Outer Driver, 37x40mm

Drive new top and bottom ball races into the  
steering head using the outer driver.

Special

Outer Driver 37x40mm

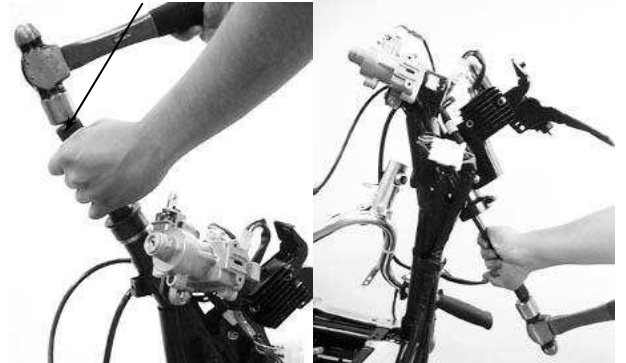

### INSTALLATION

Apply grease to the top and bottom ball  
races and install 26 steel balls on the top  
ball race and 19 steel balls on the bottom  
ball race.

Apply grease to the ball races and install the  
front fork.

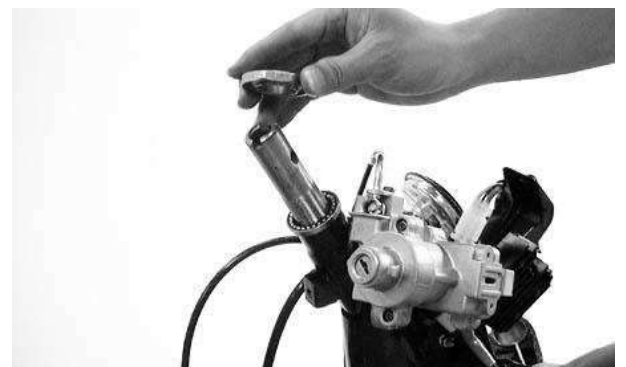

Apply grease to the top cone race and install  
it.



## 12. FRONT WHEEL/FRONT BRAKE/ FRONT SUSPENSION

Tighten the top cone race and then turn the steering stem right and left several times to make steel balls contact each other closely.

Check that the steering stem rotates freely without vertical play.

Install the steering stem lock nut and tighten it while holding the top cone race.

**Torque:** 8.0 12.0kg-m

Install the front wheel.

Top Cone Race  
Steering Stem Lock Nut Wrench

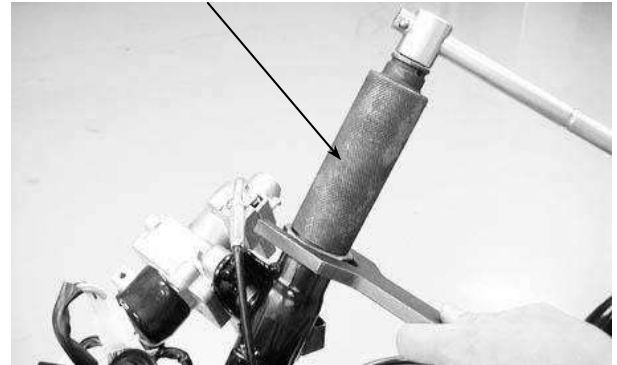

### HANDLEBAR INSTALLATION

Install the handlebar onto the steering stem tube and then install and tighten the bolt.

**Torque:** 4.5kg-m

Install the front wheel.

Install the brake levers.

Install the handlebar covers.

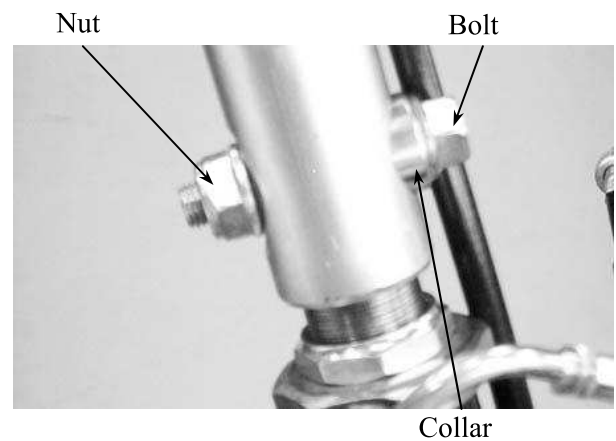

---

---

---

---

---

---

**REAR WHEEL/REAR BRAKE/  
REAR SUSPENSION**

---

SERVICE INFORMATION-----	13- 1
TROUBLESHOOTING-----	13- 1
REAR WHEEL-----	13- 2
REAR BRAKE -----	13- 2
REAR SHOCK ABSORBER -----	13- 5

# 13. REAR WHEEL/REAR BRAKE/ REAR SUSPENSION

## SERVICE INFORMATION

### GENERAL INSTRUCTIONS

- During servicing, keep oil or grease off the brake drum and brake linings.

### SPECIFICATIONS

Item		Standard (mm)	Service Limit (mm)
Rear wheel	Rim runout	Radial	2.0
		Axial	2.0
	Rear brake drum I.D	130	131
Rear brake lining thickness		4.5	2.0
Rear shock absorber spring free length		227	220

### TORQUE VALUES

Rear axle nut	11.0 13.0kg-m
Rear shock absorber upper mount bolt	4.0kg-m
Rear shock absorber lower mount bolt	2.5kg-m
Exhaust muffler joint lock nut	1.2kg-m
Exhaust muffler lock bolt	3.5kg-m
Brake arm bolt	1.0kg-m

### TROUBLESHOOTING

#### Rear wheel wobbling

- Bent rim
- Faulty tire
- Axle not tightened properly

#### Soft rear shock absorber

- Weak shock absorber spring
- Faulty damper

#### Poor brake performance

- Brake not adjusted properly
- Worn brake linings
- Worn brake shoes at cam contacting area
- Worn brake cam
- Worn brake drum

# 13. REAR WHEEL/REAR BRAKE/ REAR SUSPENSION

## REAR WHEEL

### REMOVAL

Remove the exhaust muffler joint lock nuts and exhaust muffler lock bolts.  
Remove the exhaust muffler.  
Remove the rear axle nut to remove the rear wheel.

### INSPECTION

Measure the rear wheel rim runout.

#### Service Limits:

**Radial:** 2.0mm replace if over

**Axial:** 2.0mm replace if over

If the rim runout exceeds the specified service limits, check the final shaft bearing for excessive play and the final shaft for bending. Inspect the rear wheel and wheel rim for runout.

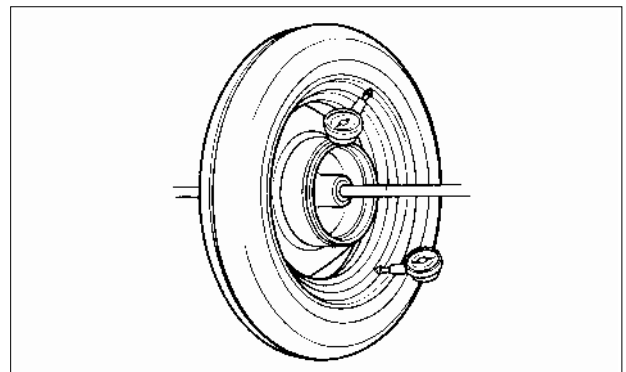

### INSTALLATION

Install the rear wheel and apply SAE30# engine oil to the axle shaft threads. Then, tighten the rear axle nut.

**Torque:** 11.0 13.0kg-m

Install the exhaust muffler.  
Tighten the exhaust muffler joint lock nuts and exhaust muffler lock bolt.

#### Torque:

Exhaust muffler joint lock nut: 1.2kg-m

Exhaust muffler lock bolt: 3.5kg-m

Rear Axle Nut



### REAR BRAKE

Remove the rear wheel.  
Inspect the rear brake drum.  
Measure the rear brake drum I.D.

**Service Limits:** 131mm replace if over

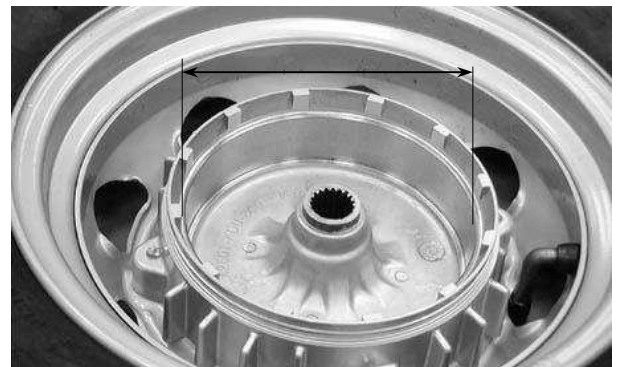

Rear Axle Nut



### BRAKE LINING INSPECTION



# 13. REAR WHEEL/REAR BRAKE/ REAR SUSPENSION

Measure the brake lining thickness.

**Service Limit:** 2.0mm replace if below

Keep oil or grease off the brake linings.

## REAR BRAKE DISASSEMBLY

Remove the rear brake adjusting nut and disconnect the rear brake cable.  
Remove the rear brake shoes.

Remove the brake arm bolt to remove the brake arm, wear indicator plate and felt seal.  
Remove the brake cam.

## REAR BRAKE ASSEMBLY

Apply grease to the anchor pin.  
Apply grease to the brake cam and install it.  
Install the brake shoes.

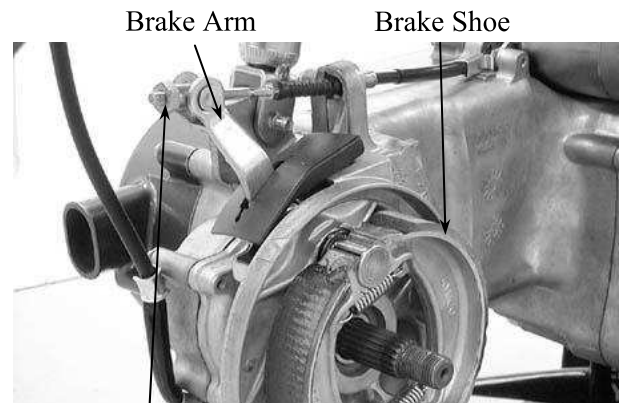
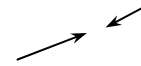

Adjusting Nut

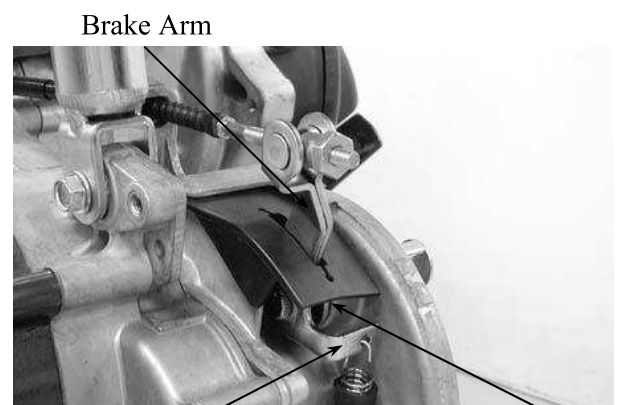

Wear Indicator Plate

Bolt

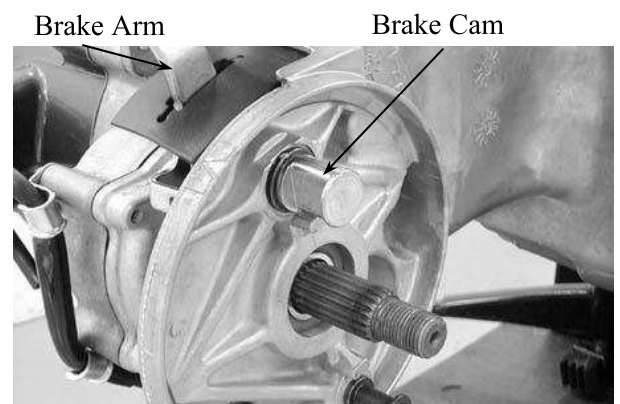

Brake Arm

Brake Cam



Apply engine oil to the felt seal and install it

# 13. REAR WHEEL/REAR BRAKE/ REAR SUSPENSION

to the brake cam.  
Install the wear indicator plate and brake arm.

Align the wide groove on the wear indicator plate with the wide tooth of the brake cam.

Install and tighten the brake arm bolt.

Align the scribed line on the brake arm with the punch mark on the brake cam.

**Torque:** 1.0kg-m

Install the brake arm return spring.

Install the brake arm pin.  
Connect the brake cable and install the adjusting nut.  
Install the rear wheel.  
Adjust the rear brake lever free play.

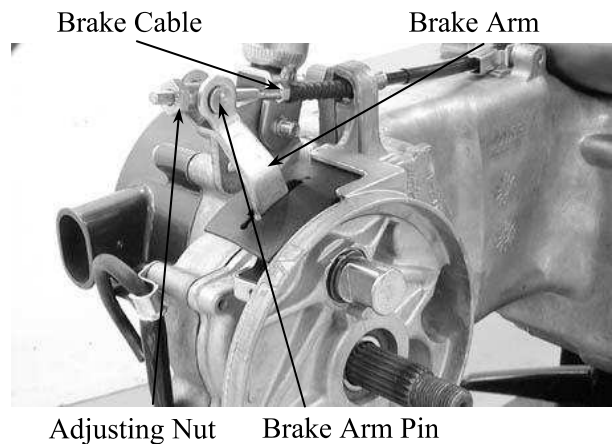
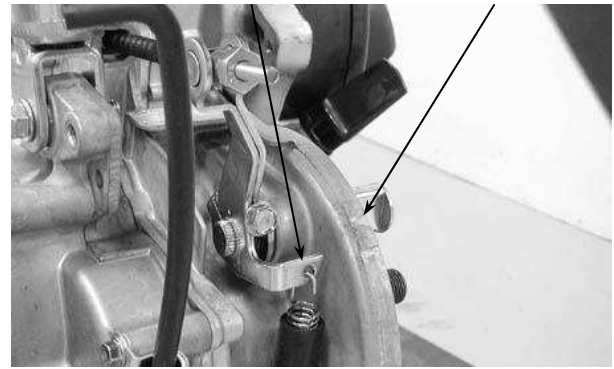

# 13. REAR WHEEL/REAR BRAKE/ REAR SUSPENSION

## REAR SHOCK ABSORBER

### REMOVAL

Remove the frame body cover.  
Remove the air cleaner case.

Remove the rear shock absorber upper and lower mount bolts.  
Remove the rear shock absorber.

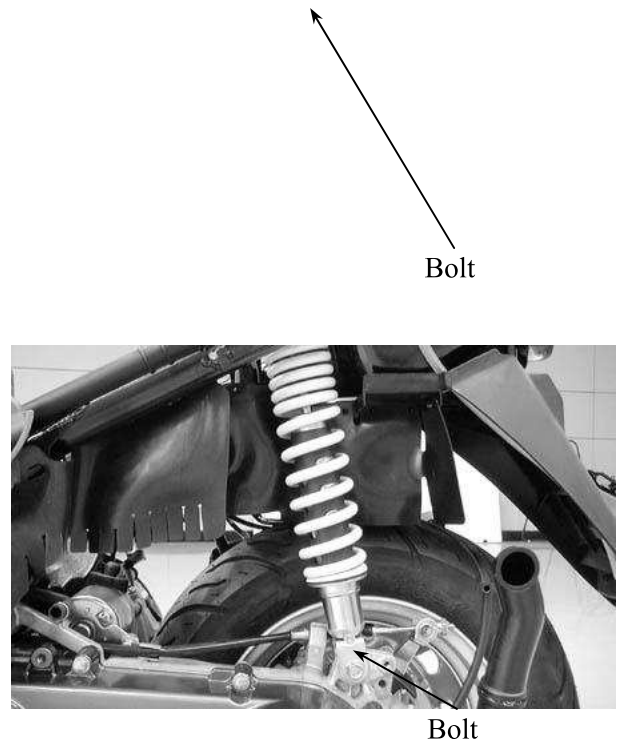

### DISASSEMBLY

Install the rear shock absorber compressor as the figure shown.

Install the rear shock absorber lower joint into the rear shock absorber compressor.

Compress the rear shock absorber spring.

Loosen the lower joint lock nut.  
Remove the lower joint.  
Remove the lock nut, rubber and damper.

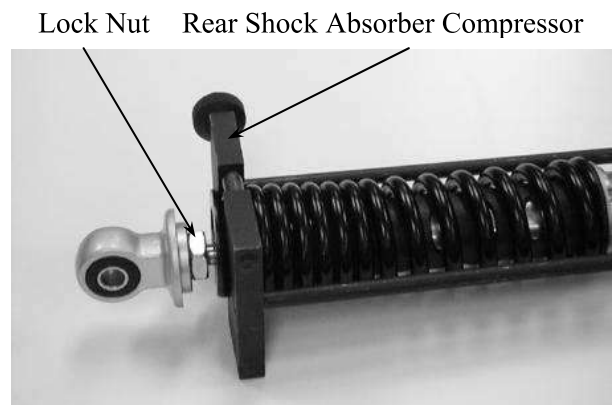

# 13. REAR WHEEL/REAR BRAKE/ REAR SUSPENSION

## INSPECTION

Inspect the damper rod for bending or damage.  
Inspect the damper for oil leaks.  
Inspect the damper rubber for deterioration or damage.

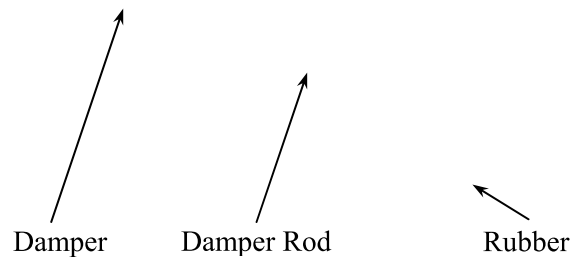

Measure the front shock absorber spring free length.

**Service Limit:** 220mm replace if below

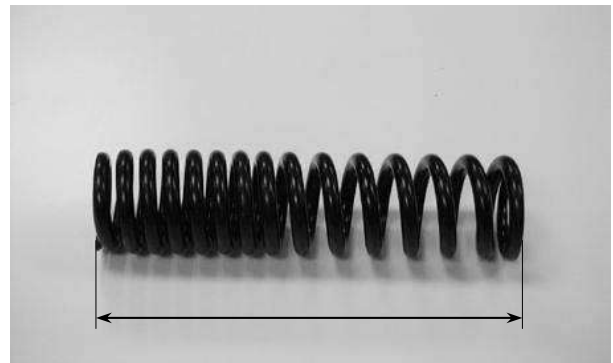

## ASSEMBLY

Assemble the rear shock absorbers in the reverse order of disassembly.

- Install the shock absorber spring with loosely wound coils facing down.
- Apply locking agent to the lock nut threads and tighten the lock nut.



Tighten the lock nut.

**Torque:** 3.5 4.8kg-m

## INSTALLATION

Install the rear shock absorber. First install the upper mount bolt and then the lower mount bolts and tighten them. Install the air cleaner case and tighten the two bolts.

Install the frame body cover.

**Torque:**

Upper Mount Bolt: 4.0kg-m

Lower Mount Bolt: 2.5kg-m



Lower Mount Bolt



---

**BATTER/CHARGING SYSTEM/  
A.C. GENERATOR**

---

SERVICE INFORMATION-----	14- 2
TROUBLESHOOTING-----	14- 3
BATTERY REMOVAL -----	14- 4
CHARGING SYSTEM -----	14- 5
REGULATOR/RECTIFIER-----	14- 6
A.C. GENERATOR CHARGING COIL -----	14- 7
A.C. GENERATOR -----	14- 7

# 14. BATTERY/CHARGING SYSTEM/ A.C. GENERATOR

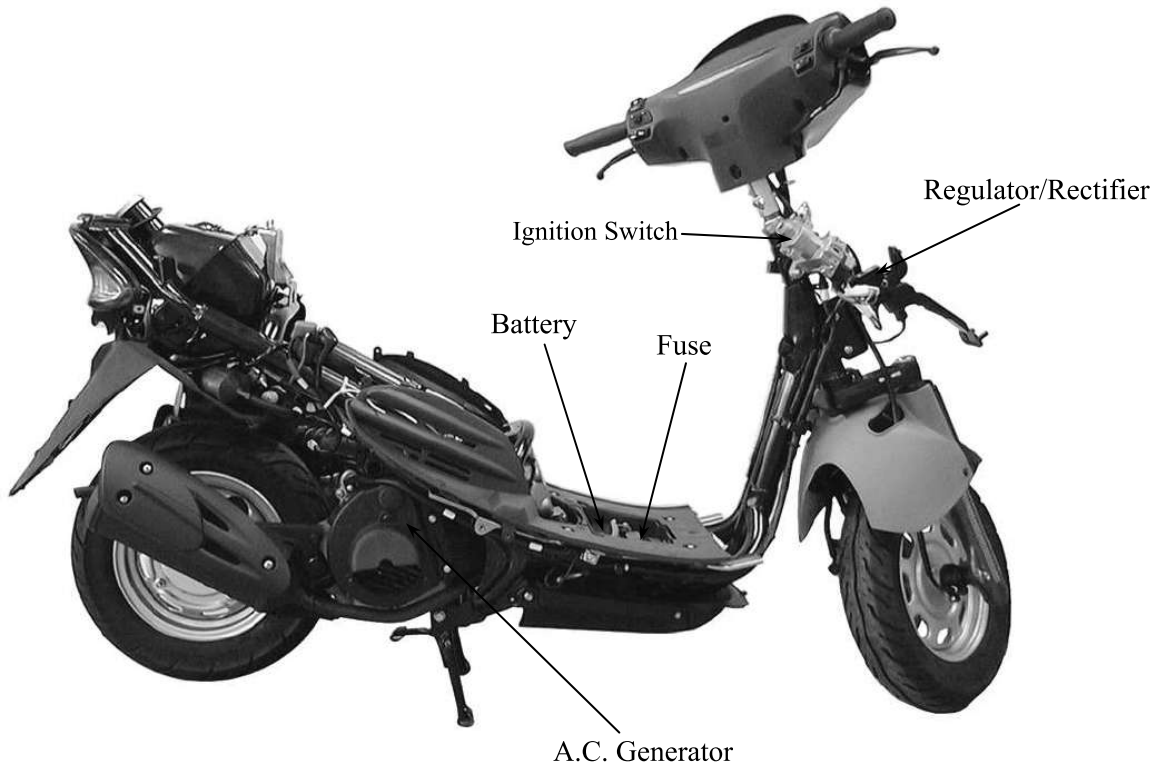

## CHARGING CIRCUIT

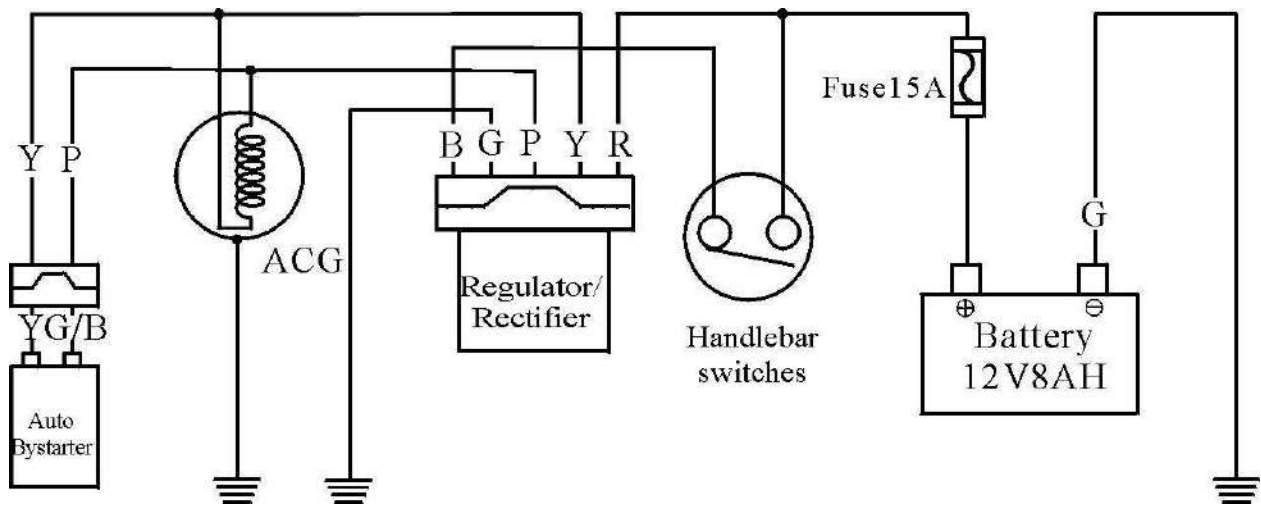

# 14. BATTERY/CHARGING SYSTEM/ A.C. GENERATOR

## SERVICE INFORMATION

### GENERAL INSTRUCTIONS

The battery electrolyte (sulfuric acid) is poisonous and may seriously damage the skin and eyes. Avoid contact with skin, eyes, or clothing. In case of contact, flush with water and get prompt medical attention

- The battery can be charged and discharged repeatedly. If a discharged battery is not used for a long time, its service life will be shortened. Generally, the capacity of a battery will decrease after it is used for 2-3 years. A capacity-decreased battery will resume its voltage after it is recharged but its voltage decreases suddenly and then increases when a load is added.
- When a battery is overcharged, some symptoms can be found. If there is a short circuit inside the battery, no voltage is produced on the battery terminals. If the rectifier won't operate, the voltage will become too high and shorten the battery service life.
- If a battery is not used for a long time, it will discharge by itself and should be recharged every 3 months.
- A new battery filled with electrolyte will generate voltage within a certain time and it should be recharged when the capacity is insufficient. Recharging a new battery will prolong its service life.
- Inspect the charging system according to the sequence specified in the Troubleshooting.
- Do not disconnect and soon reconnect the power of any electrical equipment because the electronic parts in the regulator/rectifier will be damaged. Turn off the ignition switch before operation.
- It is not necessary to check the MF battery electrolyte or fill with distilled water.
- Check the load of the whole charging system.
- Do not quick charge the battery. Quick charging should only be done in an emergency.
- Remove the battery from the motorcycle for charging.
- When replacing the battery, do not use a traditional battery.
- When charging, check the voltage with an voltmeter.

### SPECIFICATIONS

Item		Standard	
Battery	Capacity/Model	12V-8AH	
	Voltage (20°C)	Fully charged	13.1V
		Undercharged	12.3V
	Charging current	STD: 0.9A Quick: 3.0A	
	Charging time	STD: 5-10hr Quick: 30min	
A.C. Generator	Capacity	0.114KW/5000rpm	
	Charging coil resistance (20°C)	Yellow-Pink	
Regulator/Rectifier	Type	Single-phase half-wave SCR	
	Limit voltage	Lighting	12.0-14.0V/5000rpm (Electric tester, tachometer)
		Charging	10-13.0V/5000rpm 13.5-15.5V/5000rpm
Resistor	Resistance (20°C) 20W5.9Ω	5.0-7.0Ω	
	Resistance (20°C) 20W5.9Ω	4.0-6.0Ω	

# 14. BATTERY/CHARGING SYSTEM/ A.C. GENERATOR

## TORQUE VALUES

Pulser coil bolt	0.5kg-m
Coil lock bolt	0.9kg-m
Flywheel nut	5.5kg-m
Cooling fan bolt	0.9kg-m

## SPECIAL TOOLS

Universal holder  
Flywheel puller

## TESTING INSTRUMENTS

Kowa electric tester  
Sanwa electric tester

## TROUBLESHOOTING

### No power

- Dead battery
- Disconnected battery cable
- Fuse burned out
- Faulty ignition switch

### Low power

- Weak battery
- Loose battery connection
- Charging system failure
- Faulty regulator/rectifier

### Intermittent power

- Loose battery cable connection
- Loose charging system connection
- Loose connection or short circuit in lighting system

### Charging system failure

- Loose, broken or shorted wire or connector
- Faulty regulator/rectifier
- Faulty A.C. generator



# 14. BATTERY/CHARGING SYSTEM/ A.C. GENERATOR

## BATTERY REMOVAL

Remove the battery cover screws on the floor board.

Open the battery cover and remove the battery by removing the bolt and band. First disconnect the battery negative (-) cable and then the positive (+) cable.

 When disconnecting the battery positive (+) cable, do not touch the frame with tool; otherwise it will cause short circuit and sparks to fire the fuel.

The installation sequence is the reverse of removal.

 First connect the positive (+) cable and then negative (-) cable to avoid short circuit.

## BATTERY VOLTAGE (OPEN CIRCUIT VOLTAGE) INSPECTION

Remove the floor board.

Open the battery cover and disconnect the battery cables.

Measure the voltage between the battery terminals.

Fully charged : 13.1V

Undercharged : 12.3V max.

Battery charging inspection must be performed with a voltmeter.

## CHARGING

Connect the charger positive (+) cable to the battery positive (+) terminal.

Connect the charger negative (-) cable to the battery negative (-) terminal.

-  • Keep flames and sparks away from a charging battery.
- Turn power ON/OFF at the charger, not at the battery terminals to prevent sparks near the battery to avoid explosion.
  - Charge the battery according to the

- Quick charging should only be done in an emergency.
- Measure the voltage 30 minutes after the battery is charged.

Charging current: Standard : 0.9A

Quick : 3.0A

Charging time : Standard : 5□10 hours

Quick : 30 minutes

After charging: Open circuit voltage: 12.8V min.

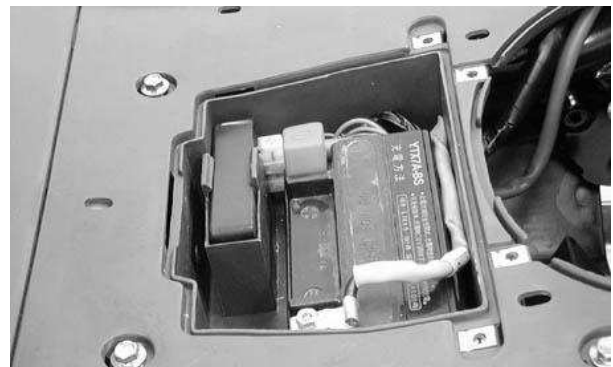

# 14. BATTERY/CHARGING SYSTEM/ A.C. GENERATOR

## CHARGING SYSTEM

### SHORT CIRCUIT TEST

Disconnect the ground wire from the battery and connect an ammeter across the battery negative (-) terminal and the ground wire. Turn the ignition switch OFF and check for short circuit.

Connect the electric tester positive (+) terminal to ground wire and the tester negative (-) terminal to the battery negative (-) terminal.

If any abnormality is found, check the ignition switch and wire harness for short circuit .

### CURRENT TEST

This inspection must be performed with an electric tester when the battery is fully charged.

Warm up the engine for inspection.

Connect the electric tester across the battery terminals. Disconnect the red wire from the fuse terminal and connect an ammeter between the red wire lead and the fuse terminal as shown.

Attach a tachometer to the engine.

Start the engine and gradually increase the engine speed to measure the limit voltage and current.

**Limit Voltage/Current:** 13.5□15.5V/0.5A  
max. (5000rpm max.)

If the limit voltage is not within the specified range, check the regulator/rectifier.

### LIGHTING SYSTEM LIMIT VOLTAGE INSPECTION

Remove the front cover.

Measure the voltage with the electric tester in the DC range.

**Limit Voltage:** 12□14V/5000rpm

If the limit voltage is not within the specified range, check the regulator/rectifier.

### PERFORMANCE TEST

RPM	2500	6000
Day	1.0A min.	2.0A min.
Night	1.0A min.	2.0A min.

Perform this test with a fully charged battery



(-) Terminal



Headlight Wire Coupler



# 14. BATTERY/CHARGING SYSTEM/ A.C. GENERATOR

readings are not within the specifications in the table.

## REGULATOR/RECTIFIER

### MAIN HARNESS CIRCUIT INSPECTION

Remove the front cover.  
Remove the regulator/rectifier 5P coupler and check for continuity between the wire harness terminals according to the following :

Item (Wire Color)	Judgement
Between battery (red) and engine ground	Battery has voltage
Between ground (green) and engine ground	Continuity exists
Between lighting wire and engine ground (Remove the resistor coupler and auto bystarter coupler and turn the lighting switch OFF for inspection)	Battery has voltage
Between charging coil (pink) and engine ground	A.C. generator coil has resistance

Regulator/Rectifier

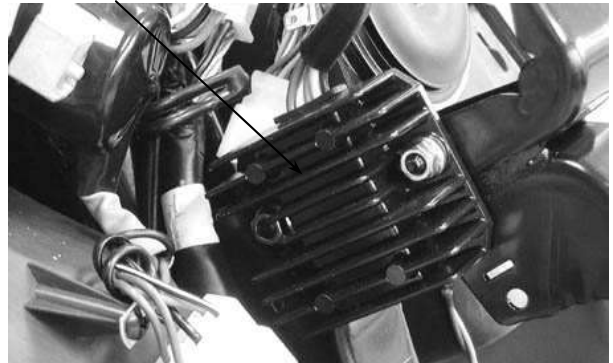

### REGULATOR/RECTIFIER INSPECTION

If the main harness terminals are normal, check the regulator/rectifier coupler for loose connection and measure the resistances between the regulator/rectifier terminals.

- Do not touch the tester probes with your finger because human body has resistance.
- Use the following specified testers for accurate testing. Use of an improper tester in an improper range may give false readings.
  - Kowa Electric Tester
  - Sanwa Electric Tester
  - Kowa Electric Tester TH-5H
- Proper range for testing:
  - Use XKΩ range for Sanwa Tester
  - Use X100Ω range for Kowa Tester
- If the dry battery in the tester is weak, the readings will be incorrect. In this case, check the dry battery.
- The Kowa tester readings are 100 times the actual values. Be careful during testing.

Pink Black Green

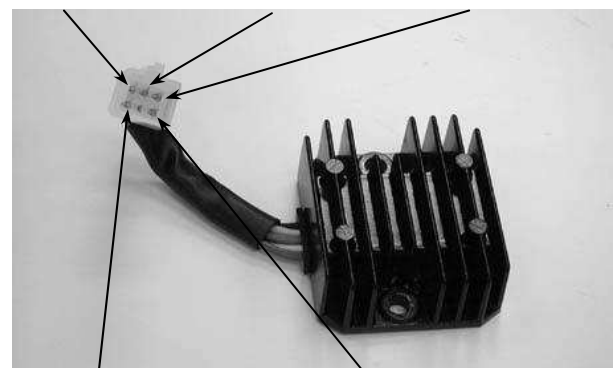

Red Yellow

Probe⊕ Probe(-)	Black	Pink	Red	Yellow	Green
Black		4	8.5	4	0.5
Pink	∞		3.5	∞	∞
Red	∞	∞		∞	∞
Yellow	∞	∞	3.5		
Green	0.5	5K-100K	8	3.5	

Replace the regulator/rectifier if the

## A.C. GENERATOR CHARGING COIL

The inspection of A.C. generator charging coil can be made with the engine installed.

### INSPECTION

Disconnect the A.C. generator 2P connector.  
Measure the resistance between the A.C. generator pink wire and engine ground with an electric tester.

**Standard:**  $0.2 \sim 1.2 \Omega$  (at  $20 \sim$ )

Replace the A.C. generator charging coil if the reading is not within the specifications.

Charging Coil Wire

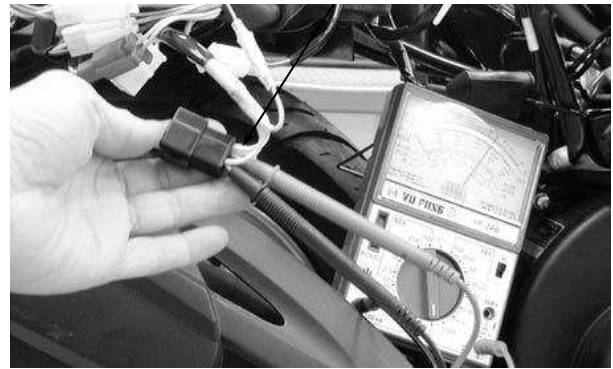

## A.C. GENERATOR REMOVAL

Remove the rear right side cover.  
Remove the four bolts attaching the cooling fan cover to remove the fan cover.



Fan Cover

Remove the cooling fan by removing the four cooling fan attaching bolts.

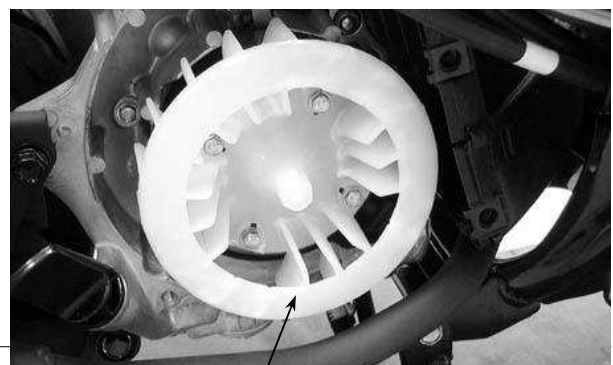

# 14. BATTERY/CHARGING SYSTEM/ A.C. GENERATOR

## Cooling Fan

Hold the flywheel with an universal holder.  
Remove the flywheel nut.

Special

Universal Holder

Universal Holder

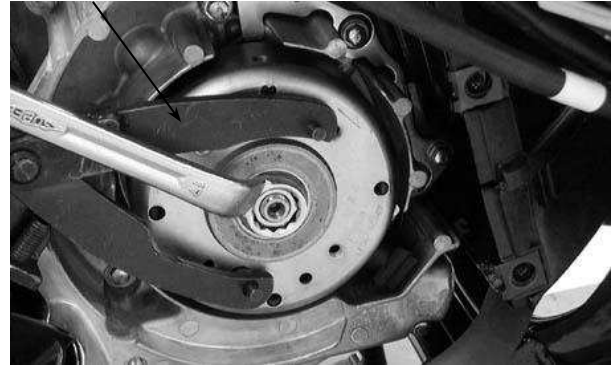

Remove the A.C. generator flywheel using  
the flywheel puller.  
Remove the woodruff key.

Special

Flywheel Puller



Flywheel Puller

Remove the A.C. generator wire connector.

A.C. Generator Wire Connector



Remove the A.C. generator wire set plate.  
Remove the pulser coil bolts.

Remove the A.C. generator wire rubber  
sleeve and pulser coil from the right  
crankcase.

Remove the two bolts and A.C. generator  
stator.

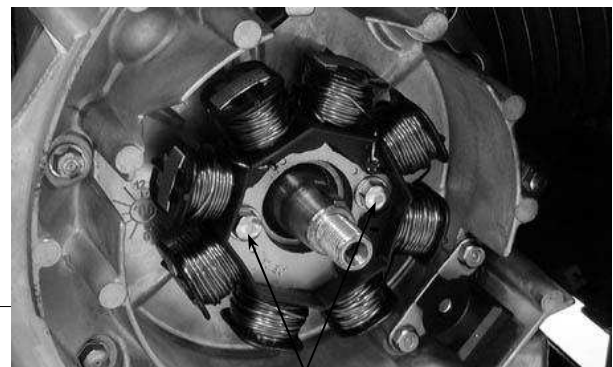

# 14. BATTERY/CHARGING SYSTEM/ A.C. GENERATOR

Bolts

## INSTALLATION

Install the A.C. generator stator and pulser coil onto the right crankcase.

Tighten the stator and pulser coil bolts.

**Torques: Pulser Coil** : 0.5kg-m

**Stator** : 0.9kg-m

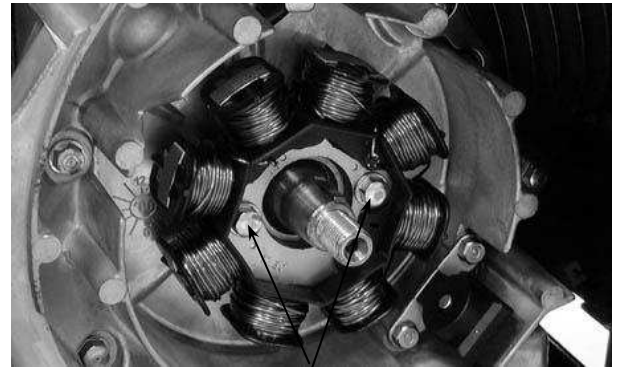

Bolts

Install the A.C. generator wire rubber sleeve and A.C. generator wire set plate.

Connect the A.C. generator wire connector.

A.C. Generator Wire Connector



Clean the taper hole in the flywheel off any burrs and dirt.

Install the woodruff key in the crankshaft keyway.

Woodruff Key

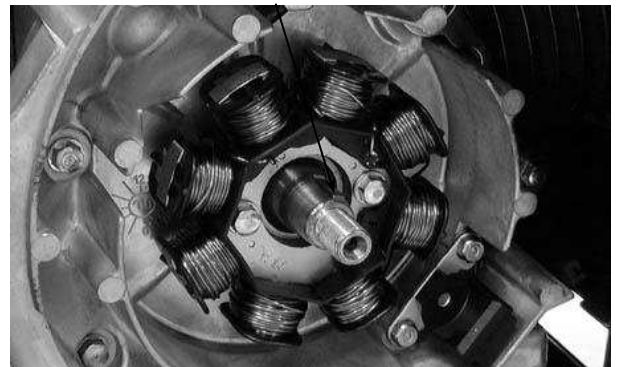

Install the flywheel onto the crankshaft with the flywheel hole aligned with the crankshaft woodruff key.

The inside of the flywheel is magnetic. Make sure that there is no bolt or nut before installation.

Universal Holder



# 14. BATTERY/CHARGING SYSTEM/ A.C. GENERATOR

Hold the flywheel with the universal holder and tighten the flywheel nut.

**Torque:** 5.5kg-m

Special

Universal Holder

Install the cooling fan.

**Torque:** 0.9kg-m

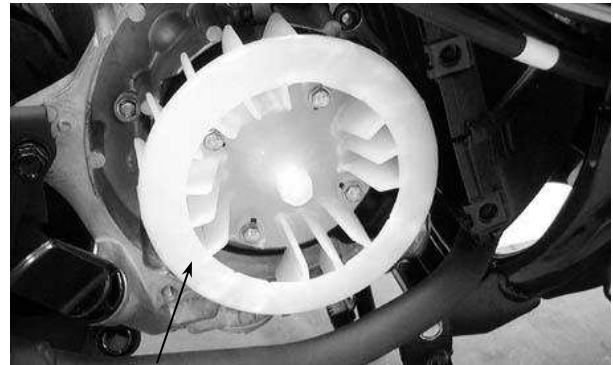

Cooling Fan

Install the fan cover.

Install the rear right side cover.



Fan Cover

# 14. BATTERY/CHARGING SYSTEM/ A.C. GENERATOR

---





---

## IGNITION SYSTEM

---

SERVICE INFORMATION-----	15- 2
TROUBLESHOOTING-----	15- 3
CDI UNIT INSPECTION-----	15- 4
IGNITION COIL-----	15- 5
PULSER COIL -----	15- 6

# 15. IGNITION SYSTEM

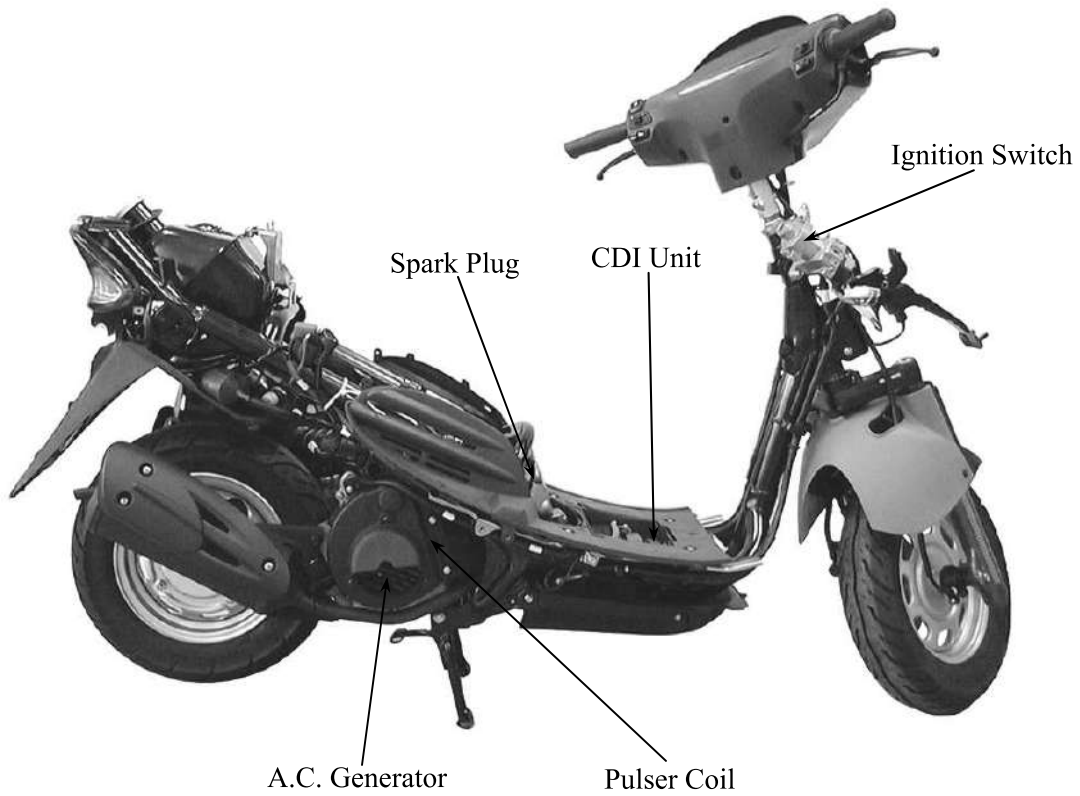

## IGNITION CIRCUIT

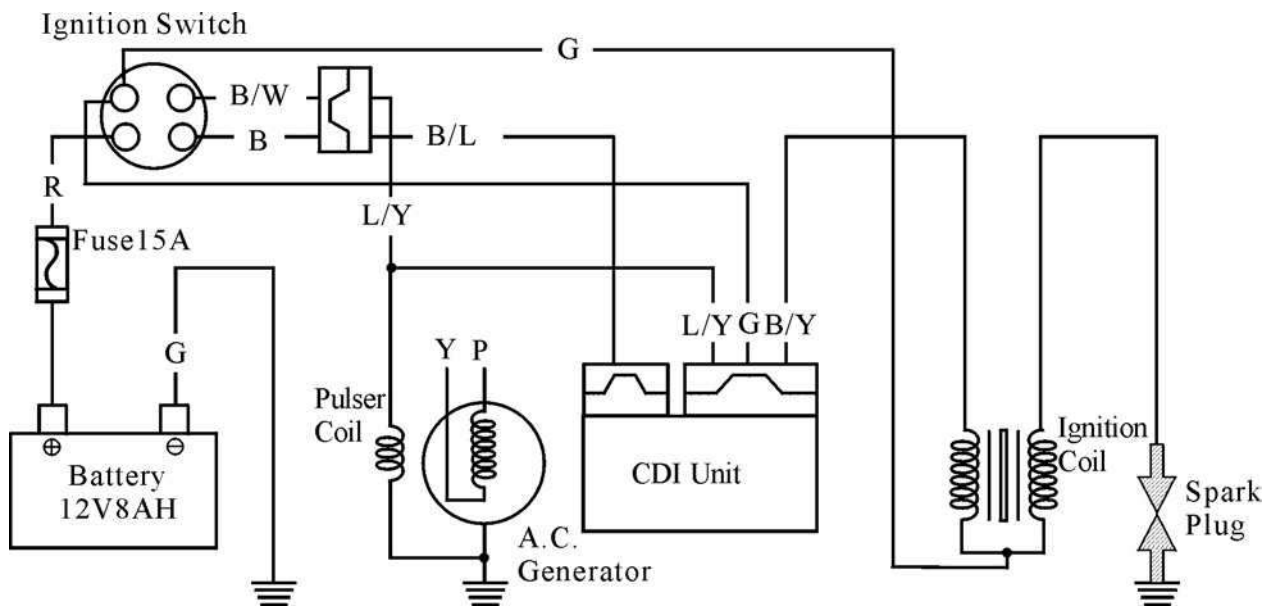

# 15. IGNITION SYSTEM

## SERVICE INFORMATION

### GENERAL INSTRUCTIONS

- Check the ignition system according to the sequence specified in the Troubleshooting.
- The ignition system adopts CDI unit and the ignition timing cannot be adjusted.
- If the timing is incorrect, inspect the CDI unit and A.C. generator and replace any faulty parts. Inspect the CDI unit with a CDI tester
- Loose connector and poor wire connection are the main causes of faulty ignition system. Check each connector before operation.
- Use of spark plug with improper heat range is the main cause of poor engine performance.
- The inspections in this section are focused on maximum voltage. The inspection of ignition coil resistance is also described in this section.
- Inspect the ignition switch according to the continuity table specified in page 20-3.
- Inspect the spark plug referring to Section 3.
- Remove the A.C. generator and pulser coil referring to Section 10.

### SPECIFICATIONS

Item		Standard	
Spark plug	Standard type	CR7HSA(NGK)	
	Hot type		
	Cold type		
Spark plug gap		0.6□0.7mm	
Ignition timing	“F” mark Full advance	13°BTDC/1,700±100rpm 27°BTDC/5,000±100rpm	
Ignition coil resistance (20□)	Primary coil		
	Secondary coil	with plug cap	7□12KΩ
		without plug cap	3□5KΩ
Pulser coil resistance (20□)		50□150Ω	
Ignition coil primary side max. voltage		12V min.	
Pulser coil max. voltage		2.1V min.	

### TESTING INSTRUMENT

Kowa Electric Tester

or commercially available electric tester with resistance over 10MΩ/CDV

# 15. IGNITION SYSTEM

## TROUBLESHOOTING

### High voltage too low

- Weak battery or low engine speed
- Loose ignition system connection
- Faulty CDI unit
- Faulty ignition coil
- Faulty pulser coil

### Normal high voltage but no spark at plug

- Faulty spark plug
- Electric leakage in ignition secondary circuit
- Faulty ignition coil

### Good spark at plug but engine won't start

- Faulty CDI unit or incorrect ignition timing
- Improperly tightened A.C. generator flywheel

### No high voltage

- Faulty ignition switch
- Faulty CDI unit
- Poorly connected or broken CDI ground wire
- Dead battery or faulty regulator/rectifier
- Faulty ignition coil connector
- Faulty pulser coil

## CDI UNIT INSPECTION

Remove the two battery cover screws.  
Disconnect the CDI coupler and remove the

# 15. IGNITION SYSTEM

CDI unit.

Measure the resistance between the terminals using the electric tester..

- Due to the semiconductor in circuit, it is necessary to use a specified tester for accurate testing. Use of an improper tester in an improper range may give false readings.
- Use a Sanwa Electric Tester or Kowa Electric Tester.
- In this table, “Needle swings then returns” indicates that there is a charging current applied to a condenser. The needle will then remain at “∞” unless the condenser is discharged.

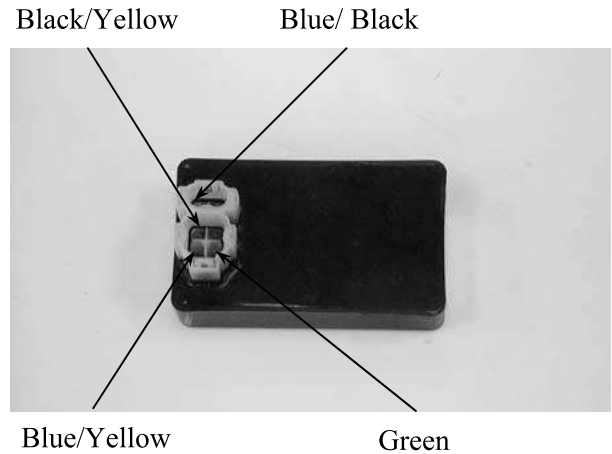

Unit: KΩ

Probe⊕ (-)Probe	Blue/ Black	Black/ Yellow	Blue/ Yellow	Green
Blue/ Black		∞	1k~∞	20~60
Black/ Yellow	30~80		150~400	5~15
Blue/ Yellow	100~250	∞		40~90
Green	10~30	∞	60~200	

CDI Unit

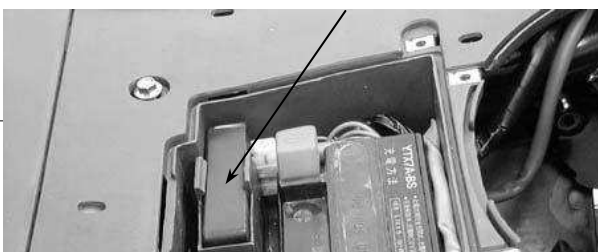

## IGNITION COIL REMOVAL

# 15. IGNITION SYSTEM

Remove the frame body cover.  
 Remove the spark plug cap.  
 Disconnect the ignition coil wires and  
 remove the ignition coil bolt and ignition  
 coil.

## INSPECTION CONTINUITY TEST

This test is to inspect the continuity of  
 ignition coil.

Measure the resistance between the ignition  
 coil primary coil terminals.

**Resistance:** 0.1□1.0Ω/20□

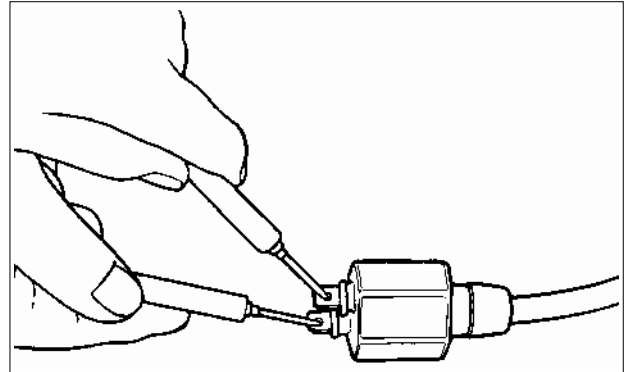

Measure the secondary coil resistances with  
 and without the spark plug cap.

**Resistances:**

(with plug cap): 7□12KΩ/20□

(without plug cap): 3□5KΩ/20□

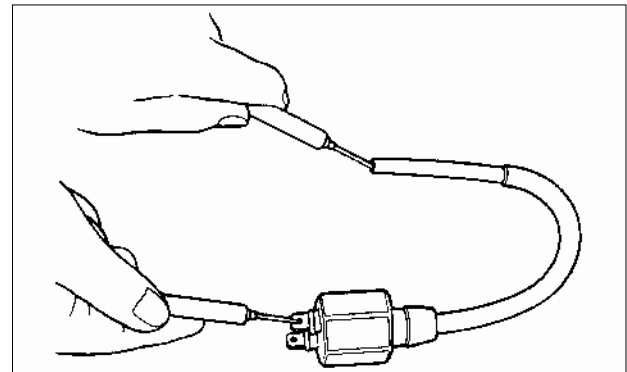

Correctly operate the tester following the  
 manufacturer's instructions.

1. Turn the ignition coil tester changeover  
 switch to 12V and connect the ignition  
 coil to the tester.
2. Turn the tester power switch ON and  
 check the spark from the watch window.

□ Good : Normal and continuous spark

□ Faulty : Weak or intermittent spark

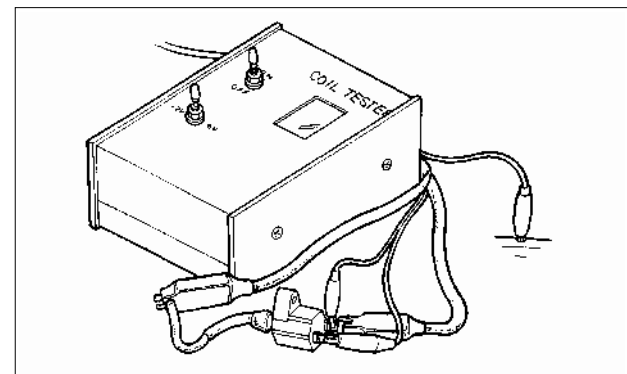

Ignition Coil



## PULSER COIL INSPECTION

## 15. IGNITION SYSTEM

This test is performed with the stator installed in the engine.

Remove the frame body cover.  
Disconnect the A.C. generator connector.

Measure the pulser coil resistance between the blue/yellow and green wire terminals.

**Resistance:**  $50 \square 150 \Omega / 20 \square$

A.C. generator removal.

### IGNITION TIMING INSPECTION

The CDI unit is not adjustable. If the ignition timing is incorrect, inspect the CDI unit, pulser coil and A.C. generator and replace any faulty parts.

Remove the timing hole cap.



Timing Hole Cap

Warm up the engine and check the ignition timing with a timing light.  
When the engine is running at 1700rpm, the ignition timing is correct if the "F" mark aligns with the index mark within  $\pm 3^\circ$ .

**Ignition Timing:**  $13^\circ$  BTDC/1700rpm







# 16. STARTING SYSTEM

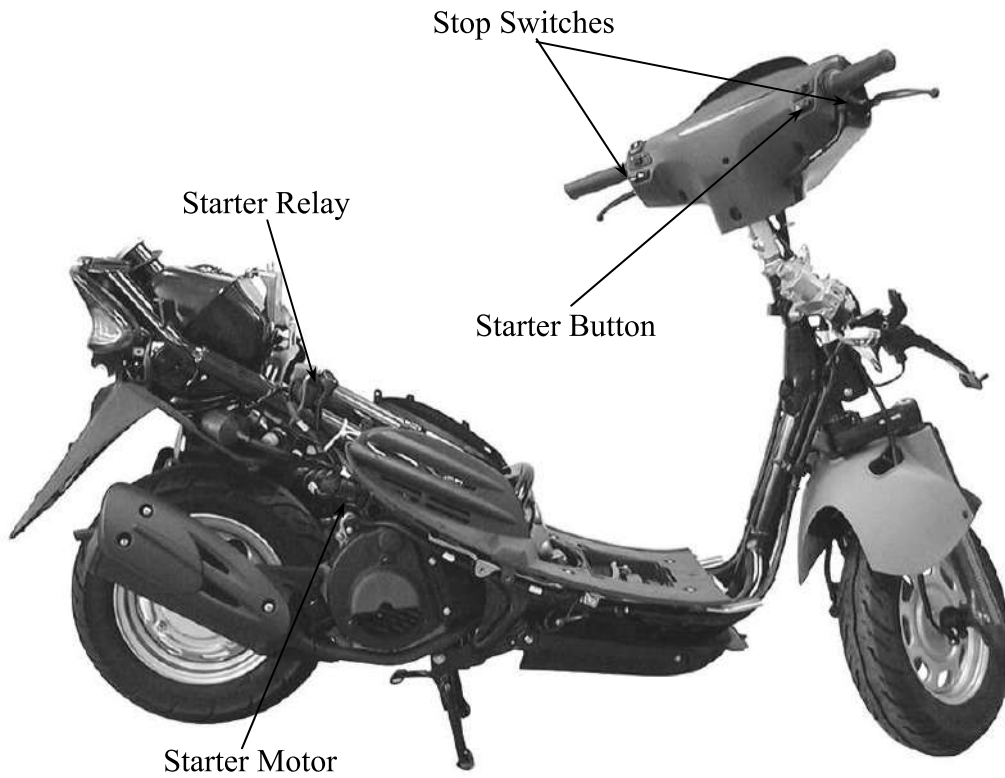

## STARTING CIRCUIT

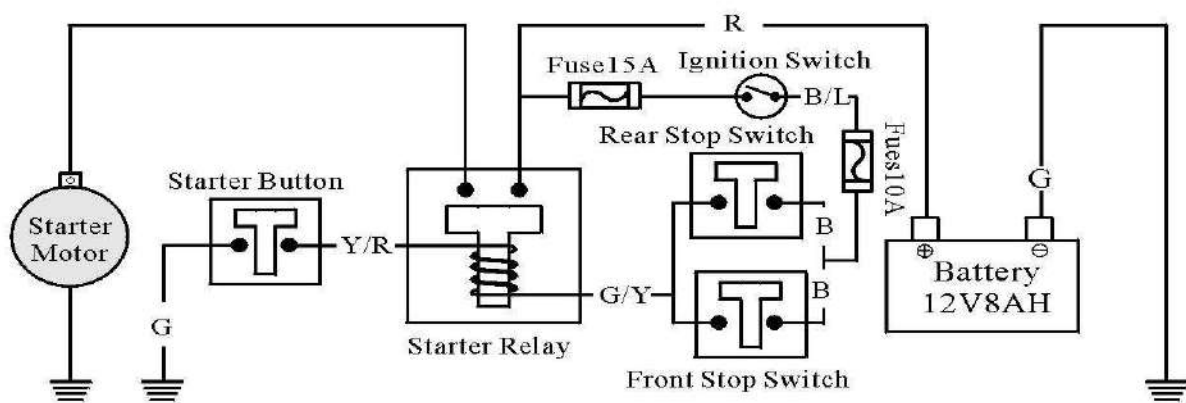

# 16. STARTING SYSTEM

## SERVICE INFORMATION

### GENERAL INSTRUCTIONS

- The removal of starter motor can be accomplished with the engine installed.
- For the starter clutch removal, refer to Section 4.

### SPECIFICATIONS

Item	Standard (mm)	Service Limit (mm)
Starter motor brush length	12.5	8.5

### TORQUE VALUES

Starter clutch cover socket bolt	1.2kg-m
Starter clutch lock nut	9.5kg-m

### SPECIAL TOOLS

Lock nut wrench  
 Universal holder

## TROUBLESHOOTING

### Starter motor won't turn

- Fuse burned out
- Weak battery
- Faulty ignition switch
- Faulty starter clutch
- Faulty front or rear stop switch
- Faulty starter relay
- Poorly connected, broken or shorted wire
- Faulty starter motor

### Lack of power

- Weak battery
- Loose wire or connection
- Foreign matter stuck in starter motor or gear

### Starter motor rotates but engine does not start

- Faulty starter clutch
- Starter motor rotates reversely
- Weak battery

# 16. STARTING SYSTEM

## REMOVAL

Before removing the starter motor, turn the ignition switch OFF and remove the battery ground. Then, turn on the ignition switch and push the starter button to see if the starter motor operates properly.

Remove the two starter motor mounting bolts and the motor.

Remove the waterproof rubber jacket and disconnect the starter motor cable connector.

## DISASSEMBLY

Remove the two starter motor case screws, front cover, motor case and other parts.

## INSPECTION

Inspect the removed parts for wear, damage or discoloration and replace if necessary. Clean the commutator if there is metal powder between the segments.

Check for continuity between pairs of the commutator segments and there should be continuity.

Also, make a continuity check between individual commutator segments and the armature shaft. There should be no continuity.

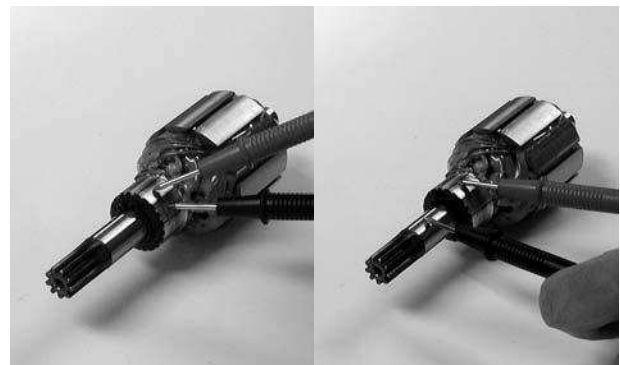
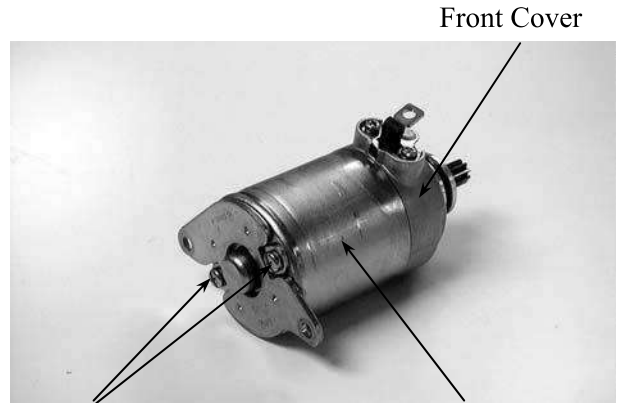
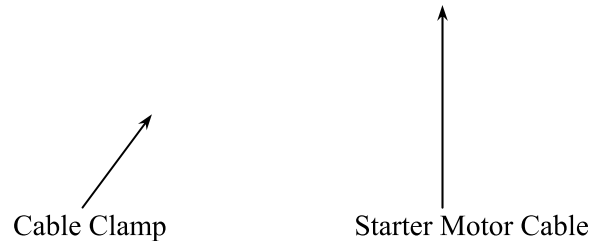

Bolts



STARTER MOTOR CASE CONTINUITY

## 16. STARTING SYSTEM

### CHECK

Check to confirm that there is no continuity between the starter motor wire terminal and the motor front cover.

Also check for the continuity between the wire terminal and each brush.

Replace if necessary.

Wire Terminal

Measure the length of the brushes.

**Service Limit:** 8.5mm replace if below



Check for continuity between the brushes. If there is continuity, replace with new ones.



Check if the needle bearing in the front cover turns freely and has no excessive play.

Replace if necessary.

Check the dust seal for wear or damage.

Bearing



Dust Seal



# 16. STARTING SYSTEM

## ASSEMBLY

Apply grease to the dust seal in the front cover.  
 Install the brushes onto the brush holders.  
 Apply a thin coat of grease to the two ends of the armature shaft.  
 Insert the commutator into the front cover.

- Be careful not to damage the brush and armature shaft mating surfaces.
- When installing the commutator, the armature shaft should not damage the dust seal lip.

Install a new O-ring to the front cover.  
 Install the starter motor case, aligning the tab on the motor case with the groove on the front cover.  
 Tighten the starter motor case screws.

When assembling the front cover and motor case, slightly press down the armature shaft to assemble them.

Commutator

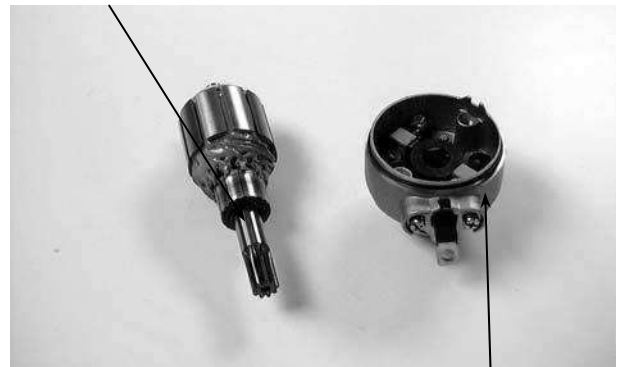

Front Cover

Tab Groove O-ring

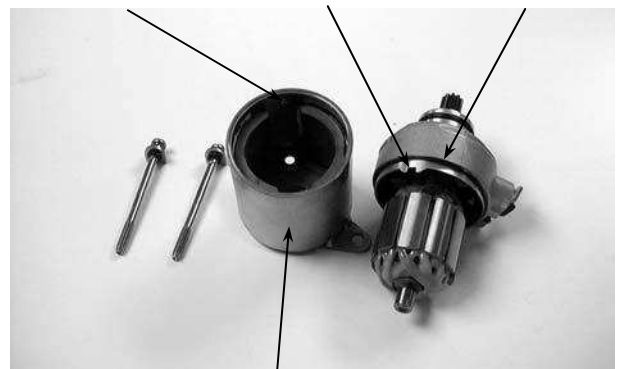

Motor Case

Starter Relay



## STARTER RELAY

### INSPECTION

Remove the frame body cover.  
 Turn the ignition switch ON and the starter relay is normal if you hear a click when the starter button is depressed.  
 If there is no click sound:

- Inspect the starter relay voltage
- Inspect the starter relay ground circuit
- Inspect the starter relay operation

Green/Yellow Wire

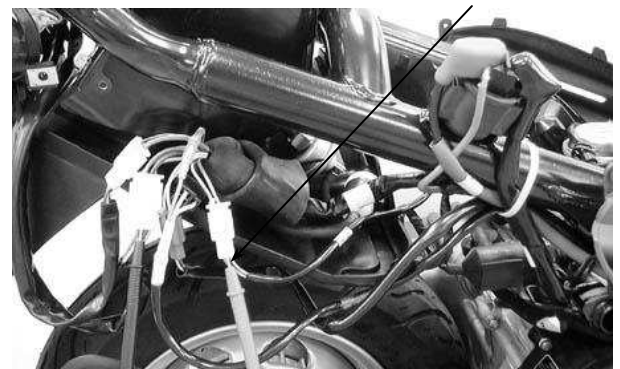

### STARTER RELAY VOLTAGE INSPECTION

Place the motorcycle on its main stand.  
 Measure the voltage between the starter relay connector green/yellow wire (-) and engine ground.  
 Turn the ignition switch ON and the battery voltage should be normal when the brake lever is fully applied.  
 If the battery has no voltage, inspect the stop switch continuity and cable.

# 16. STARTING SYSTEM

## STARTER RELAY GROUND CIRCUIT INSPECTION

Disconnect the starter relay wire connector. Check for continuity between the yellow/red wire terminal and ground. There should be continuity when the starter button is depressed. If there is no continuity, check the starter button for continuity and inspect the wire.

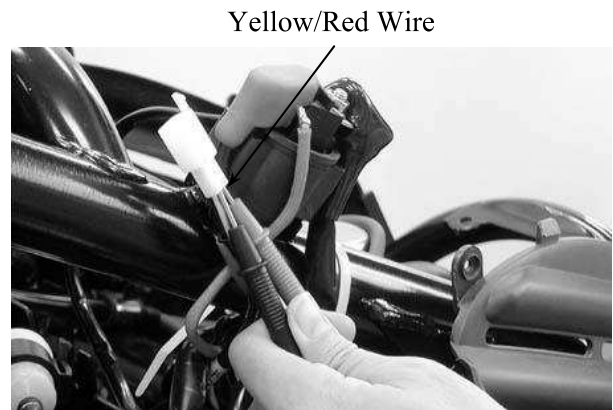

## OPERATION TEST

Connect the electric tester to the starter relay larger terminals that connect to the battery positive cable and the starter motor cable. Connect a fully charged battery across the starter relay yellow/red and green/yellow wire terminals. Check for continuity between the starter relay large terminals. The relay is normal if there is continuity.



Starter Relay

## INSTALLATION

Connect the starter motor cable connector and properly install the waterproof rubber jacket. Check the O-ring for wear or damage and replace if necessary. Apply grease to the O-ring and install the starter motor. Tighten the two mounting bolts.

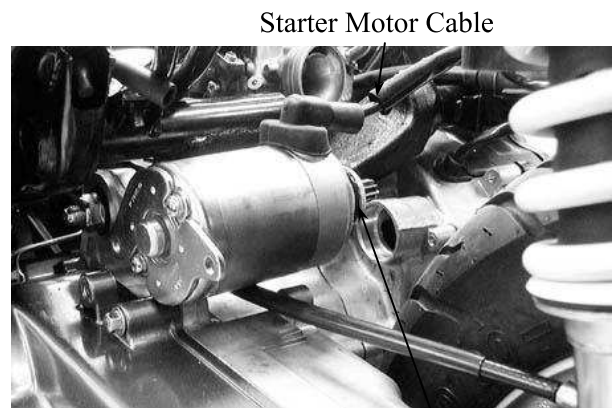

Starter Motor Cable

O-ring

The starter motor cable connector must be installed properly.

## STARTER CLUTCH

### REMOVAL

Remove the A.C. generator.  
Remove the right crankcase cover.

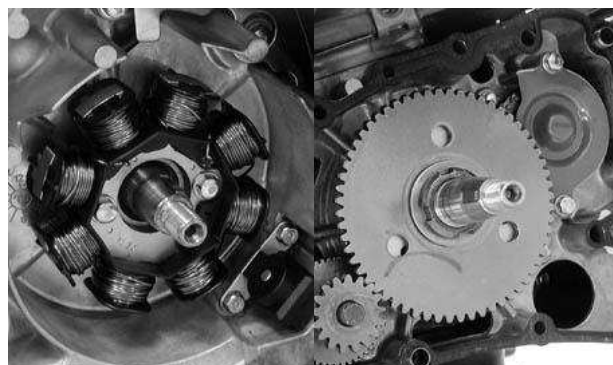

# 16. STARTING SYSTEM

Remove the starter clutch lock nut.

Special

Lock Nut Wrench

Note that the lock nut is left threaded.

Remove the starter clutch.

Remove the starter idle gear and shaft.

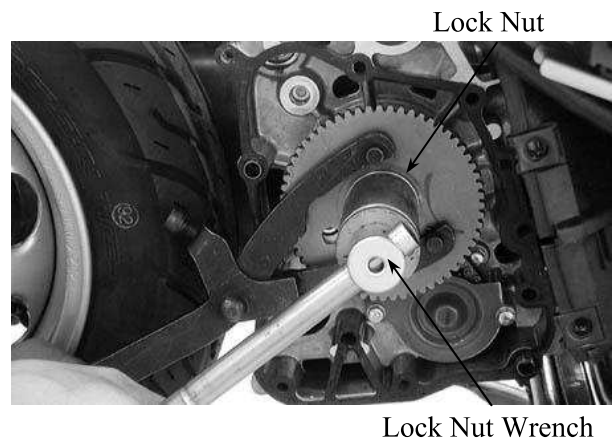

## INSPECTION

Inspect the operation of the starter drive gear when it is assembled on the clutch. The starter drive gear should turn clockwise freely and should not turn counterclockwise.



## STARTER CLUTCH DISASSEMBLY

Inspect the starter drive gear for wear or damage and replace if necessary. Measure the starter drive gear I.D.

**Service Limit:** 32.06mm replace if over  
Inspect the needle bearing for wear or damage and replace if necessary.

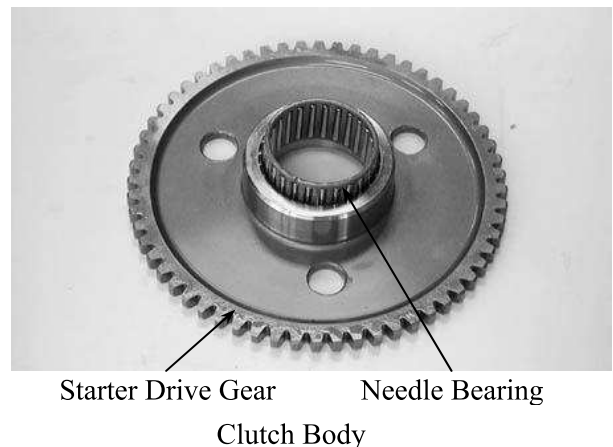

## CLUTCH BODY DISASSEMBLY

Remove the rollers, plungers and springs from the clutch body. Inspect the clutch body for wear or damage and replace if necessary. Inspect each roller and plunger for wear or damage and check for weak spring. Replace if necessary.

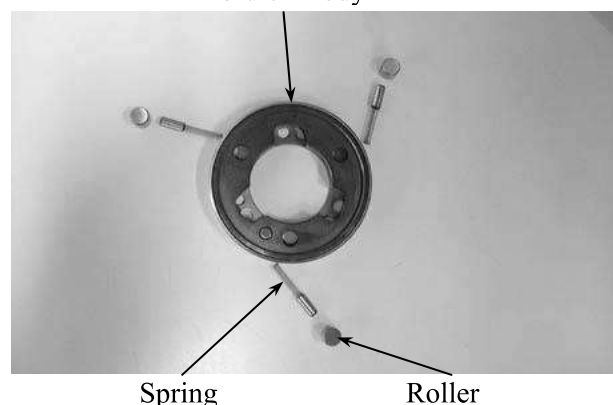

# 16. STARTING SYSTEM

Measure the clutch cover O.D.

**Service Limit:** 27.94mm replace if over

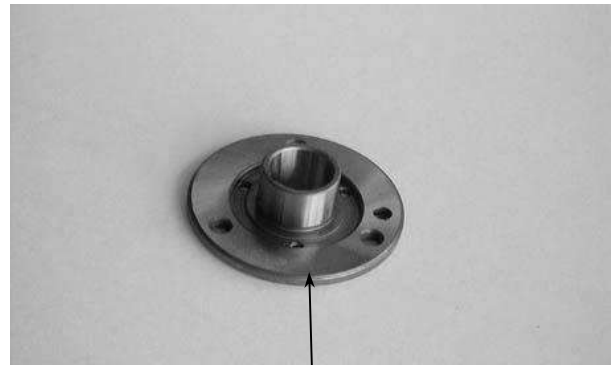

Clutch Cover

Measure the starter idle gear I.D.

**Service Limit:** 10.05mm replace if over

Starter Idle Gear

Measure the starter idle gear shaft O.D.

**Service Limit:** 9.94mm replace if below

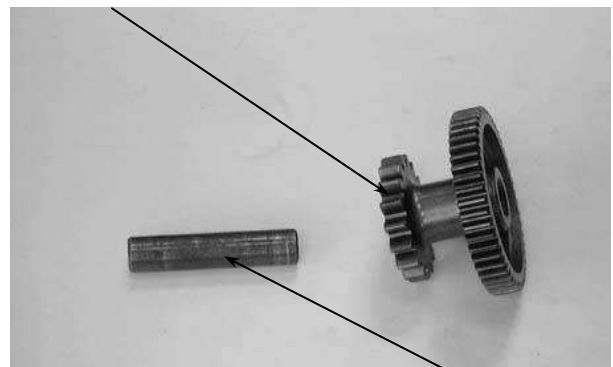

Idle Gear Shaft

## ASSEMBLY

Install the springs, plungers and rollers onto the clutch body.

Install the clutch cover by aligning the clutch cover anchor pin with the hole in the clutch body. Apply locking agent to the threads of the clutch cover bolts and tighten them.

**Torque:** 1.2kg-m

Apply engine oil to the needle bearing and starter drive gear and then install them to the clutch body.

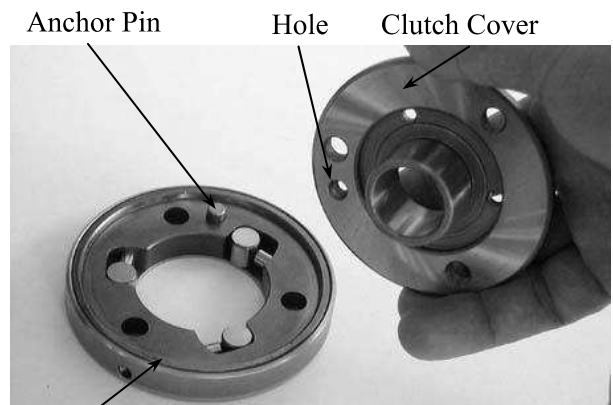

Clutch Body

## INSTALLATION

Install the starter clutch onto the crankshaft. Apply engine oil to the starter idle gear and shaft and then install them.

Hold the starter drive gear with the universal holder and tighten the starter clutch lock nut.

**Torque:** 9.5kg-m

Special

Universal Holder

Note that the lock nut is left threaded.

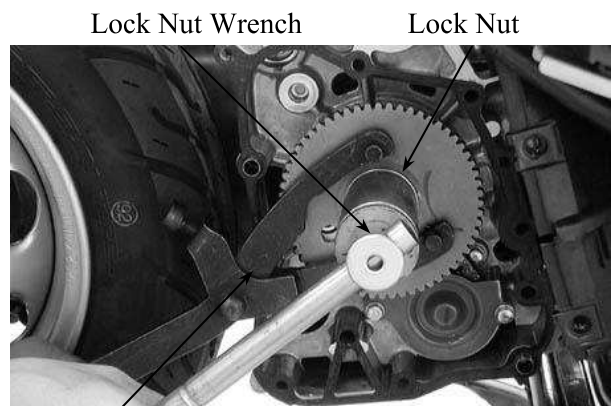

Universal Holder

Install the right crankcase cover.



## LIGHTS/INSTRUMENTS/SWITCHES

SERVICE INFORMATION-----	17- 2
TROUBLESHOOTING-----	17- 2
HEADLIGHT -----	17- 3
FRONT TURN SIGNAL LIGHT-----	17- 3
POSITION/REAR TURN SIGNAL LIGHT -----	17- 3
IGNITION SWITCH -----	17- 4
HANDLEBAR SWITCHES-----	17- 4
STOP SWITCH -----	17- 6
HORN -----	17- 6
FUEL GAUGE -----	17- 6
FUEL UNIT -----	17- 6
AUTO BYSTARTER -----	17- 7
INSTRUMENTS -----	17- 8

## ELECTRICAL EQUIPMENT LAYOUT

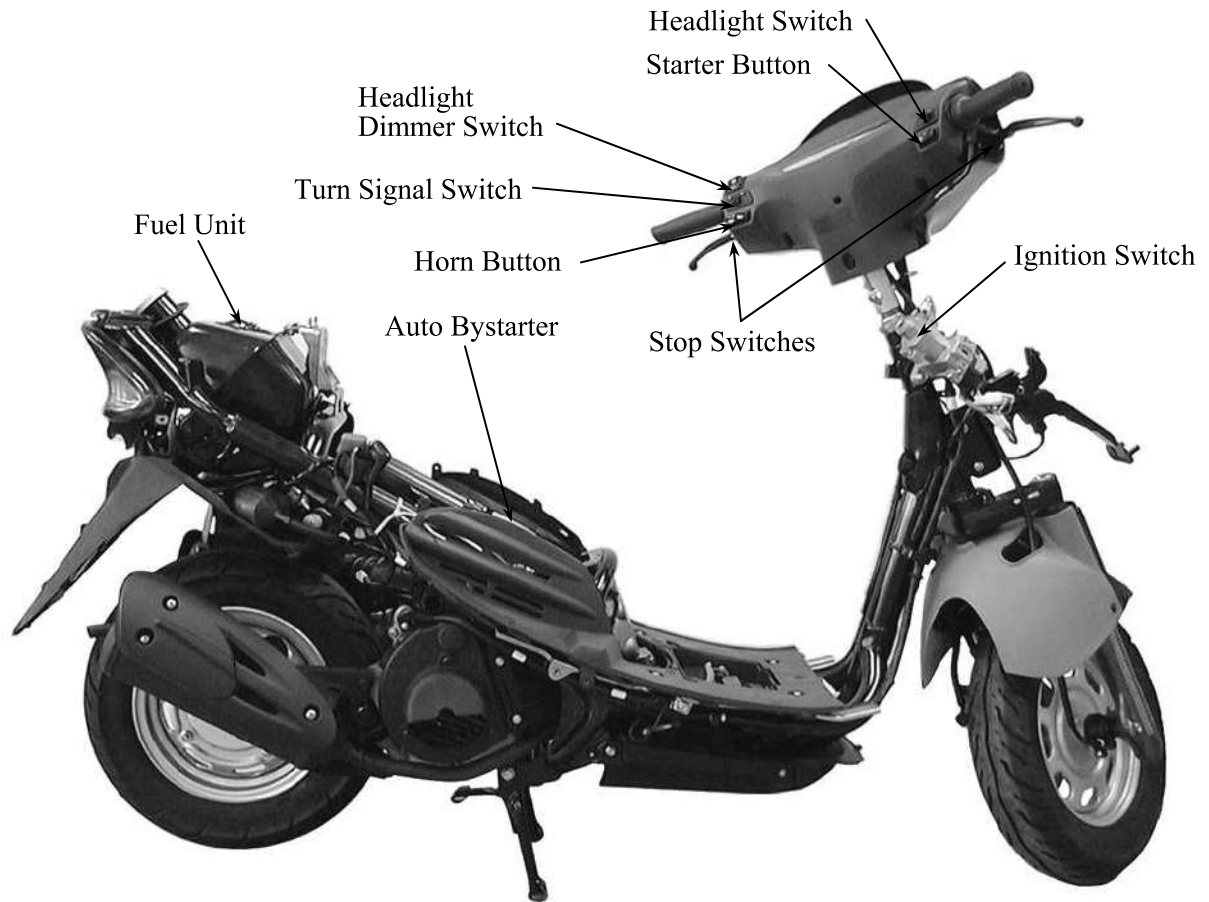

## SERVICE INFORMATION

### GENERAL INSTRUCTIONS

- An electric tester is needed to measure or test the electric equipment.
- Be sure to use fuses and bulbs of the same specifications to avoid damage of electrical equipment.
- After installation of each switch, a continuity check must be performed. A continuity check can usually be made without removing the part from the motorcycle.

## TROUBLESHOOTING

### Lights do not come on and horn does not sound when ignition switch is "ON"

- Faulty ignition switch
- Fuse burned out
- Weak battery
- Burned bulb
- Faulty switch
- Faulty horn
- Poorly connected, broken or shorted wire

### Fuel gauge pointer does not move

- Faulty fuel gauge
- Faulty fuel unit
- Poorly connected, broken or shorted wire

### Engine starts but stalls during idling

- Faulty auto bystarter
- Faulty auto bystarter resistor
- Poorly connected or broken wire
- Clogged carburetor

### Fuel gauge pointer does not register correctly

- Faulty fuel gauge
- Faulty fuel unit
- Faulty fuel unit float

## HEADLIGHT

### BULB REPLACEMENT

Remove the front cover.  
Remove the rubber boot from the bulb socket.  
Remove the bulb socket by turning it counter-clockwise.  
Remove the bulb for replacement.  
Install a new bulb, aligning the groove on the bulb socket with the tab on the bulb.  
Install the bulb socket.  
Install the rubber boot.  
Install the front cover.

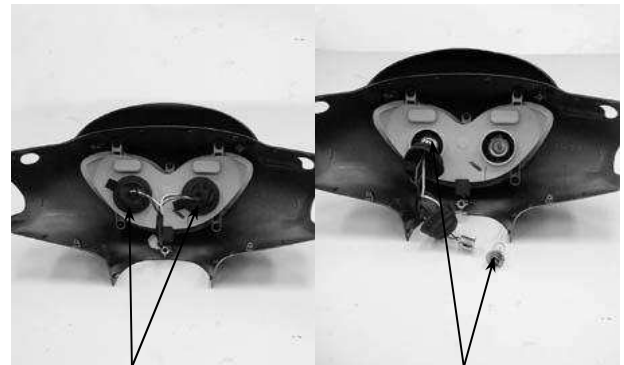

Rubber Boot

Bulb Socket

### HEADLIGHT REMOVAL

Remove the front cover.  
Remove the six screws attaching the headlight.  
Remove the headlight.  
The installation sequence is the reverse of removal.  
After installation, adjust the headlight beam.

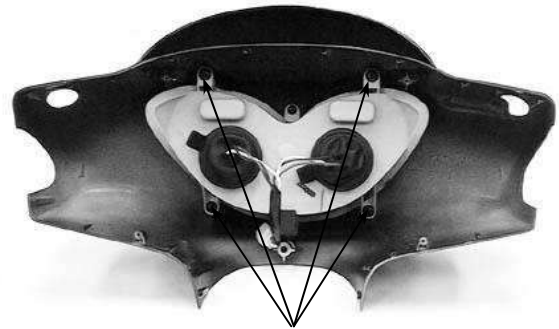

Screws

### FRONT TURN SIGNAL LIGHT

Remove the front cover.  
Remove the front turn signal bulb socket and replace the bulb.  
The installation sequence is the reverse of removal.

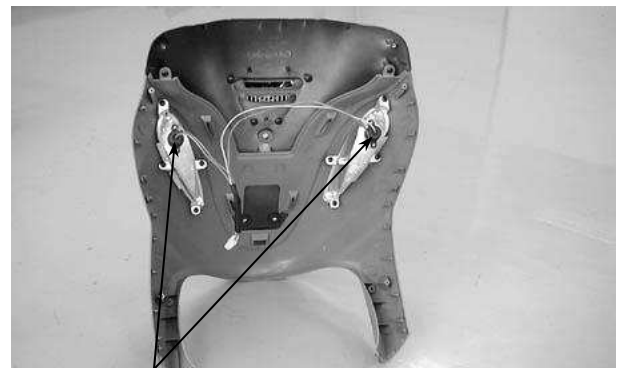

Turn Signal Bulb Sockets

### POSITION LIGHT/REAR TURN SIGNAL LIGHT

#### BULB REPLACEMENT

Remove the rear cover.  
Remove the two screws to remove the position light/rear turn signal light shell.  
Remove the bulb sockets and replace the bulb.  
The installation sequence is the reverse of removal.

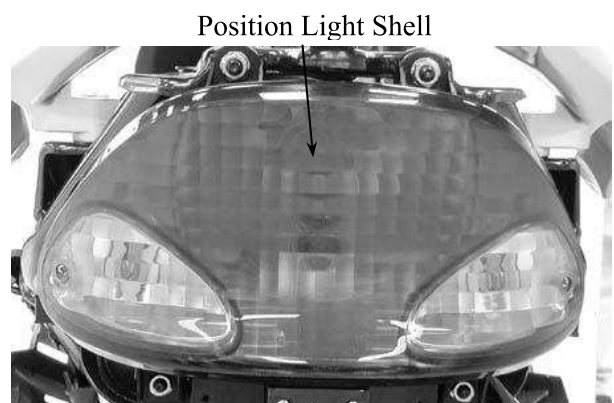

Position Light Shell



## IGNITION SWITCH

### INSPECTION

Remove the front cover.  
 Disconnect the ignition switch wire coupler.  
 Check for continuity between the wire terminals.

Color Position	Black	Red	Black/ White	Green
LOCK			○ — ○	○
OFF			○ — ○	○
ON	○ — ○			

### Replacement

Remove the two mounting bolts to remove the ignition switch holder.  
 Remove the two screws to remove the ignition switch for replacement.

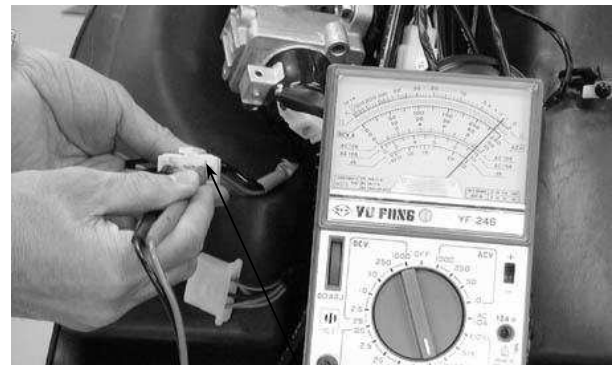

Ignition Switch Coupler



Ignition Switch Holder

## HANDLEBAR SWITCHES

### HEADLIGHT SWITCH INSPECTION

Remove the handlebar front and rear covers.  
 Disconnect the headlight switch wire couplers. Check for continuity between the wire terminals.

	HL	CL	TL	RE
OFF		○ — ○		○
N		○ — ○		
P		○ — ○		
N	○ — ○			
H	○ — ○			
Color	White/ Blue	Black	Brown	

Headlight Switch

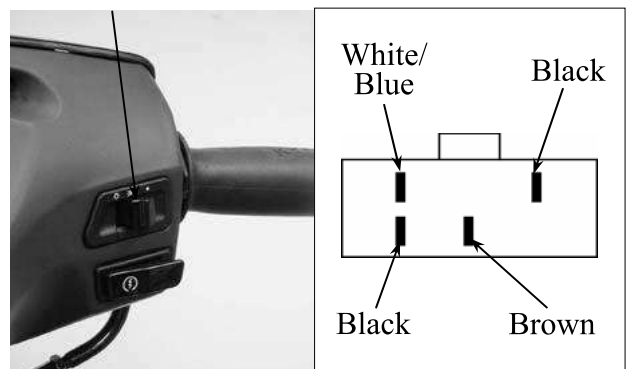

# 17. LIGHTS/INSTRUMENTS/SWITCHES

HI	○	○		
Color	White/Blue	Blue	White	Black

## STARTER SWITCH

	ST	E
FREE		
PUSH	○	○
Color	Yellow/Red	Green

Headlight Switch

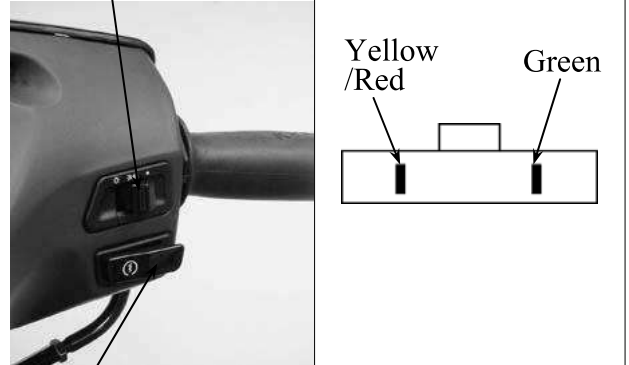

Starter Switch

## HORN SWITCH

	HO	BATZ
FREE		
PUSH	○	○
Color	Light Green	Black

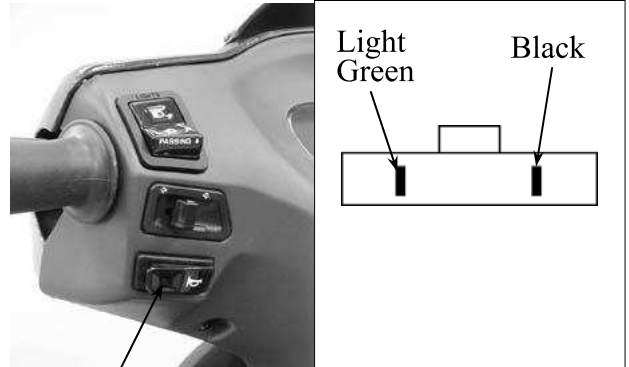

Horn Button

## TURN SIGNAL SWITCH

	R	L	WR
L		○	○
N			
R	○		○
Color	Light Blue	Orange	Gray

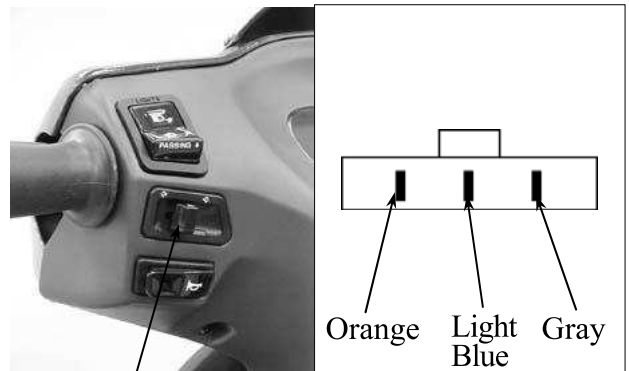

Turn Signal Switch

## DIMMER SWITCH

	HL	HI	LO	PASS
PASS		○		○
LO	○		○	
N	○	○	○	

Dimmer Switch

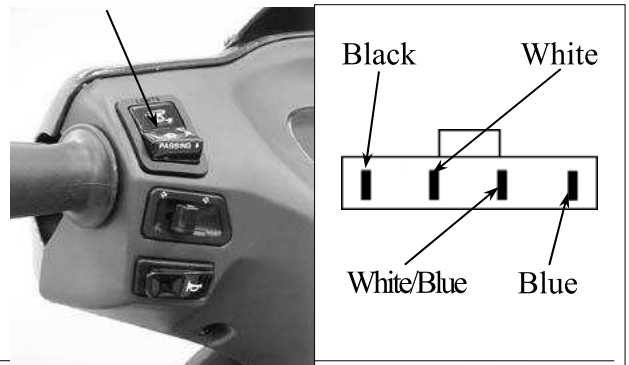

## STOP SWITCH

### INSPECTION

Remove the handlebar front cover.  
Disconnect the front stop switch wire coupler.  
Check for continuity between the wire terminals when the front brake lever is applied. The switch is normal if there is continuity.

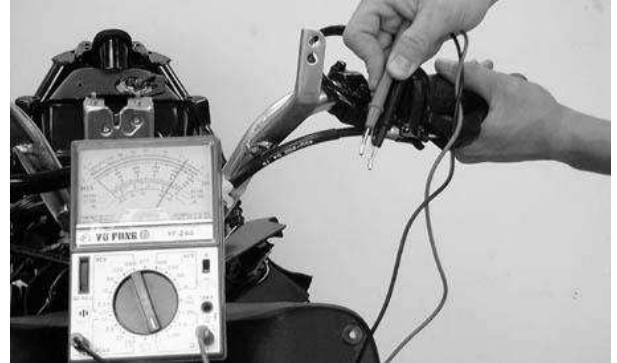

## HORN INSPECTION

Remove the front cover.  
Disconnect the horn wire coupler.  
The horn is normal if it sounds when a 12V battery is connected across the horn wire terminals.



## FUEL GAUGE

### INSPECTION

Remove the rear right side cover.  
Disconnect the fuel gauge wire connector.  
Turn the ignition switch ON.  
Connect the green and yellow/white wires and the fuel gauge needle should move from E to F.  
Connect the green and blue/white wires and the fuel gauge needle should move from F to E.



## FUEL UNIT

### REMOVAL

Remove the met-in box.  
Remove the rear right side cover.  
Disconnect the fuel unit wire connector.  
Remove the fuel unit.



Be careful not to bend or damage the fuel unit float arm.

## Fuel Unit Connector

### INSPECTION

Measure the resistance between the fuel unit wire terminals with the float at upper and lower positions.

### RESISTANCES

Unit:  $\Omega$

Color	Float	Upper	Lower
	G Y/W	35 45	480 520
G L/W	480 520	35 45	
Y/W L/W	480 520	480 520	

The installation sequence is the reverse of removal.

- Install the fuel unit by aligning the groove on the fuel unit with the tab on the fuel tank.
- Align the arrow on the fuel unit retainer with the arrow on the fuel tank.



## AUTO BYSTARTER

### AUTO BYSTARTER INSPECTION

Remove the rear right side cover.  
Disconnect the auto bystarter wire connector.

Measure the resistance between the yellow and green/black wire terminals.

**Resistance:** 10 $\Omega$  max.

- Perform this operation when the engine is cold.



Auto Bystarter Connector

## INSTRUMENTS

### BULB REPLACEMENT

Remove the front cover.

Remove the bulb socket and replace the bulb.

The installation sequence is the reverse of removal.

Instruments





# 17. LIGHTS/INSTRUMENTS/SWITCHES

Bulb Socket

## INSTRUMENTS REPLACEMENT

Remove the handlebar front cover.  
Remove the handlebar rear cover.  
Disconnect the right and left handlebar switches wire couplers.  
Disconnect the speedometer cable.  
Remove the instrument bulb sockets  
Disconnect the three fuel gauge wires.  
Remove the instrument wire clamp screw.

Switch Couplers Bulb Socket Switch Couplers

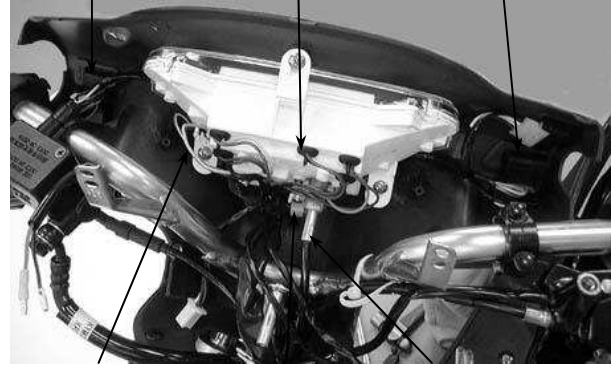

Fuel Gauge Wires Clamp Speedometer Cable

Remove the three screws attaching the instruments to the handlebar rear cover.  
Remove the instruments.

Handlebar Rear Cover

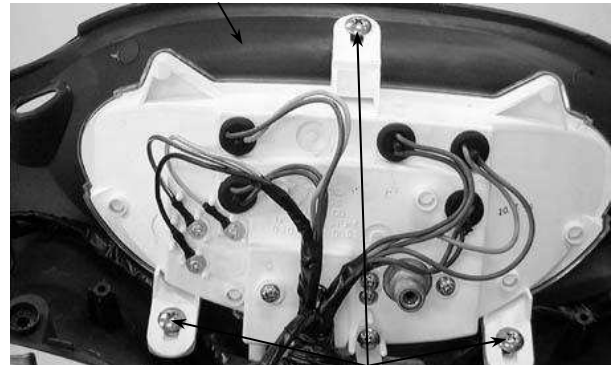

Screws

## DISASSEMBLY

Remove the screws to disassemble the instruments.

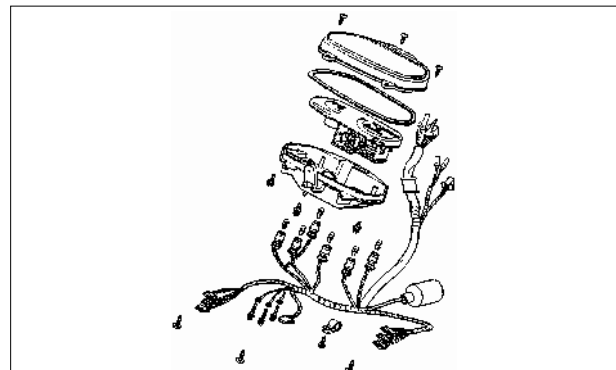

## ASSEMBLY/INSTALLATION

The assembly and installation sequence is the reverse of removal.

Bulb Socket

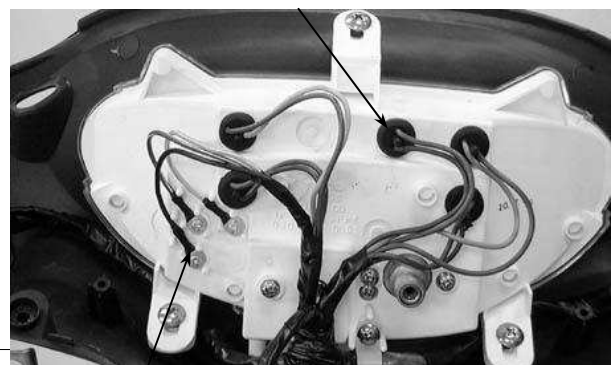

# 17. LIGHTS/INSTRUMENTS/SWITCHES

---



Fuel Gauge Wires

←  
Clamp

# TEXT

---

A.C.GENERATOR CHARGING COIL	14 - 7	CYLINDER REMOVAL	8 - 2
A.C.GENERATOR	14 - 7	DRIVE BELT	3 - 7
AERIAL NUMBER	1 - 1	DRIVE PULLEY	9 - 3
AIR CLEANER	3 - 4	ENGINE INSTALLATION	6 - 4
AIR CLEANER	5 -12	ENGINE OIL/OIL FILTER	4 - 2
AIR CUT-OFF VALVE	5 - 5	ENGINE REMOVAL	6 - 2
AUTO BYSTARTER	17 - 7	EXHAUST MUFFLER REMOVAL	2 - 5
AUTO BYSTARTER	5 - 3	FINAL REDUCTION ASSEMBLY	10 - 4
AUTO FUEL VALVE	5 -11	FINAL REDUCTION DISASSEMBLY	10 - 2
BATTERY	14 - 4	FINAL REDUCTION GEAR OIL	3 - 7
BEAR BRAKE	13 - 2	FINAL REDUCTION INSPECTION	10 - 2
BEARING REPLACEMENT	10 - 3	FLOAT CHAMBER	5 - 6
BRAKE SHOE	3 - 8	FRAME COVERS	2 - 2
BRAKE SYSTEM	3 - 8	FRONT BRAKE	12 - 6
CABLE&HARNES ROUTING	1 -15	FRONT SHOCK ABSORBER	12 -13
CAMSHAFT INSTALLATION	7 -10	FRONT TURN SIGNAL LIGHT	17 - 3
CAMSHAFT REMOVAL	7 - 3	FRONT WHEEL	12 - 3
CARBURETOR IDLE SPEED	3 - 5	FUEL GAUGE	17 - 6
CARBURETOR INSTALLATION	5 - 8	FUEL LINE	3 - 3
CARBURETOR REMOVAL	5 - 3	FUEL TANK	5 -10
CDI UNIT INSPECTION	15 - 4	FUEL UNIT	17 - 6
CHARGING SYSTEM LAYOUT	14 - 1	FUEL UNIT	5 -11
CHARGING SYSTEM	14 - 5	HANDLEBAR SWITCHES	17 - 4
CLUTCH/DRIVEN PULLEY	9 - 7	HEADLIGHT AIM	3 - 9
CRANKCASE ASSEMBLY	11 - 4	HEADLIGHT	17 - 3
CRANKCASE INSPECTION	11 - 3	HORN	17 - 6
CRANKCASE SEPARATION	11 - 2	HYDRAULIC BRAKE	12 - 8
CYLINDER COMPRESSION	3 - 6	IGNITION COIL	15 - 5
CYLINDER HEAD ASSEMBLY	7 - 8	IGNITION SWITCH	17 - 4
CYLINDER HEAD DISASSEMBLY	7 - 7	IGNITION TIMING	3 - 6
CYLINDER HEAD INSTALLATION	7 - 9	INSTRUMENTS	17 - 8
CYLINDER HEAD REMOVAL	7 - 6	KICK STARTER	9 -13
CYLINDER INSTALLATION	8 - 6	LEFT CRANKCASE COVER	9 - 2

---

# TEXT

---

LUBRICATION POINTS	1 -13	STARTER MOTOR	16 - 3
MAINTENANCE SCHEDULE	3 - 2	STARTER RELAY	16 - 5
NUTS/BOLTS/FASTENERS	3 -10	STEERING HANDLEBAR	3 -10
OIL PUMP	4 - 2	STEERING HYDRAULIC	12 -16
PILOT SCREW ADJUSTMENT	5 - 9	STEERING STEM	12 -17
PISTON INSTALLATION	8 - 6	STOP SWITCHES	17 - 6
PISTON REMOVAL	8 - 2	SUSPENSION	3 - 9
POSITION/REAR TURN SIGNAL LIGHT	17 - 3	THROTTLE OPERATION	3 - 3
PULSER COIL	15 - 6	TORQUE VALUES	1 -11
REAR SHOCK ABSORBER	13 - 5	TROUBLESHOOTING	1 -21
REAR WHEEL	13 - 2	TROUBLESHOOTING	10 - 1
REGULATOR/RECTIFIER	14 - 6	TROUBLESHOOTING	11 - 1
SERVICE INFORMATION	10 - 1	TROUBLESHOOTING	12 - 2
SERVICE INFORMATION	11 - 1	TROUBLESHOOTING	13 - 1
SERVICE INFORMATION	12 - 1	TROUBLESHOOTING	14 - 3
SERVICE INFORMATION	13 - 1	TROUBLESHOOTING	15 - 3
SERVICE INFORMATION	14 - 2	TROUBLESHOOTING	16 - 2
SERVICE INFORMATION	15 - 2	TROUBLESHOOTING	17 - 2
SERVICE INFORMATION	16 - 2	TROUBLESHOOTING	2 - 1
SERVICE INFORMATION	17 - 2	TROUBLESHOOTING	4 - 1
SERVICE INFORMATION	2 - 1	TROUBLESHOOTING	5 - 2
SERVICE INFORMATION	3 - 1	TROUBLESHOOTING	7 - 2
SERVICE INFORMATION	4 - 1	TROUBLESHOOTING	8 - 1
SERVICE INFORMATION	5 - 1	TROUBLESHOOTING	9 - 1
SERVICE INFORMATION	6 - 1	VACUUM CHAMBER	5 - 5
SERVICE INFORMATION	7 - 1	VALVE CLEARANCE	3 - 5
SERVICE INFORMATION	8 - 1	WHEELS/TIRES	3 -10
SERVICE INFORMATION	9 - 1	WIRING DIAGRAM	1 -20
SERVICE PRECAUTIONS	1 - 3		
SPARK PLUG	3 - 4		
SPECIAL TOOLS	1 -12		
SPECIFICATIONS	1 - 2		
STARTER CLUTCH	16 - 6		

---

# KYMCO TECHNICAL INFORMATION

Model □ ALL MODEL (For EURO 2)  
Subject □ KYMCO Clean Air System (For EURO 2)

Date: 8.JAN.04

NO.: KTI-04002

## KYMCO Clean Air System (For EURO 2)

The KYMCO Clean Air System is a secondary air suction system that helps the exhaust gases to burn more completely. When the spent fuel charge is released into the exhaust system, it is still hot enough to burn. The system allows extra air into the exhaust system so that the spent fuel charge can continue to burn. This continued burning action tends to burn up a great deal of the normally unburned gases, as well as changing a significant portion of the poisonous carbon monoxide into harmless carbon dioxide.

### Secondary Air Suction System Diagram (4-stroke)

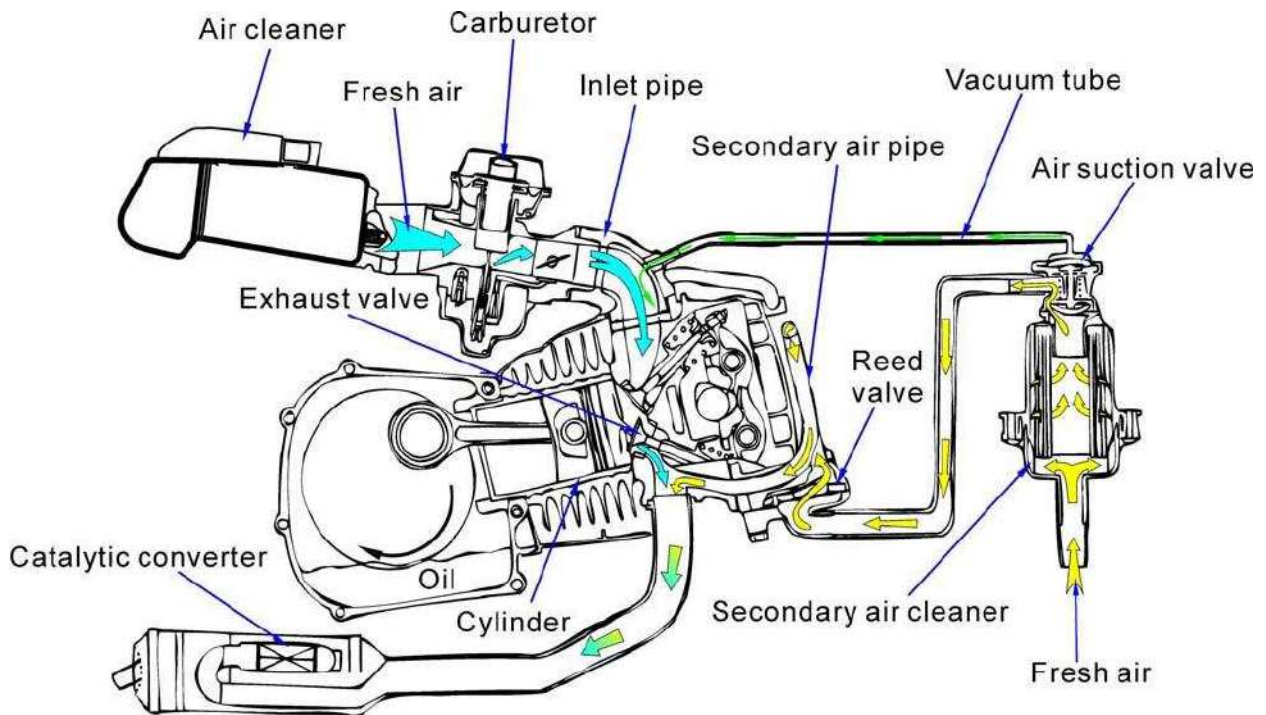

# KYMCO TECHNICAL INFORMATION

Model □ ALL MODEL (For EURO 2)  
Subject □ KYMCO Clean Air System (For EURO 2)

Date: 8.JAN.04

NO.: KTI-04002

## Secondary Air Suction System Diagram (2-stroke)

