

**By KWANG YANG Motor Co., Ltd.
First Edition, FEB. 2011
All rights reserved. Any reproduction or
unauthorized use without the written permission of
KWANG YANG Motor Co., Ltd.
is expressly prohibited.
4122-KKE5-S00**

PREFACE

This Service Manual describes the technical features and servicing procedures for the **KYMCO XCITING 700**.

Section 1 contains the precautions for all operations stated in this manual. Read them carefully before any operation is started.

Section 2 is the removal/installation procedures for the frame covers which are subject to higher removal/installation frequency during maintenance and servicing operations.

Section 3 describes the inspection/adjustment procedures, safety rules and service information for each part, starting from periodic maintenance.

Sections 8 through 14 give instructions for disassembly, assembly and adjustment of engine parts. Section 15 through 17 is the removal/ installation of chassis. Section 18 through 21 states the testing and measuring methods of electrical equipment.

Most sections start with an assembly or system illustration and troubleshooting for the section. The subsequent pages give detailed procedures for the section.

The information and contents included in this manual may be different from the motorcycle in case specifications are changed.

KYMCO reserves the right to make changes at any time without notice and without incurring any obligation.

TABLE OF CONTENTS

	GENERAL INFORMATION	1
	FRAME COVERS /EXHAUST MUFFLER	2
	INSPECTION/ADJUSTMENT	3
ENGINE	LUBRICATION SYSTEM	4
	CABLE & HARNESS ROUTING	5
	AFI (AUTOMATIC FUEL INJECTION)	6
	COOLING SYSTEM	7
	ENGINE REMOVAL/INSTALLATION	8
	CYLINDER HEAD/VALVES	9
	CYLINDER/PISTON	10
	DRIVE AND DRIVEN PULLEY	11
	FINAL REDUCTION	12
	A.C. GENERATOR/STARTER CLUTCH	13
	CRANKCASE/CRANKSHAFT	14
CHASSIS	STEERING HANDLEBAR/FRONT WHEEL/FRONT SHOCK ABSORBER	15
	REAR FORK/REAR WHEEL/REAR SHOCK ABSORBER`	16
	BRAKE SYSTEM	17
ELECTRICAL EQUIPMENT	BATTERY/CHARGING SYSTEM	18
	IGNITION SYSTEM	19
	ELECTRIC STARTER	20
	LIGHTS/METERS/SWITCHES	21
	ANTI-LOCK BRAKE SYSTEM(ABS)	22

KWANG YANG MOTOR CO., LTD.
OVERSEAS SALES DEPARTMENT
OVERSEAS SERVICE SECTION

1. GENERAL INFORMATION



GENERAL INFORMATION

SERIAL NUMBER-----	1 - 1
SPECIFICATIONS -----	1 - 2
SERVICE PRECAUTIONS -----	1 - 3
TORQUE VALUES -----	1 - 7
SPECIAL TOOLS -----	1 - 9
LUBRICATION POINTS -----	1-10
TROUBLESHOOTING-----	1-12

1. GENERAL INFORMATION

SERIAL NUMBER

FRAME NUMBER(VIN):



VEHICLE IDENTIFICATION NUMBER(VIN):



Location of Engine Serial Number

1. GENERAL INFORMATION

SPECIFICATIONS

ITEM		SPECIFICATIONS		
Name		MYROAD 700i		
Overall length		2330 mm		
Overall width		830 mm		
Overall height		1510 mm		
Wheel base		1615 mm		
Engine type		D.O.H.C.		
Displacement		699.5 cc		
Fuel Used		92# nonleaded gasoline		
Dry weight	Front wheel	108 kg		
	Rear wheel	160 kg		
	Total	268 kg		
Curb weight	Front wheel	116 kg		
	Rear wheel	168 kg		
	Total	284 kg		
Tires	Front wheel	120/70-R15		
	Rear wheel	160/60-R14		
Ground clearance		135 mm		
Min. turning radius		2700 mm		
Engine	Starting system		Electric starter motor	
	Type		Gasoline, 4-stroke	
	Cylinder arrangement		Twin cylinder	
	Combustion chamber type		ROOF	
	Valve arrangement		O.H.C.	
	Bore x stroke		76.9X75.3 mm	
	Compression ratio		10.5:1	
	Compression pressure		13 kgf/cm ²	
	Intake valve	Open	7° BTDC	
		Close	40° ABDC	
	Exhaust valve	Open	40° BBDC	
		Close	10° ATDC	
	Valve clearance (cold)	Intake	0.16 mm	
		Exhaust	0.22 mm	
	Idle speed		Rpm	
	Lubrication System	Lubrication type		Forced pressure & Wet sump
		Oil pump type		Trochoid
		Oil filter type		Full-flow filtration
		Oil capacity		3 L
		Final reduction oil capacity		0.4 L
	Cooling Type		Liquid cooled	

ITEM		SPECIFICATIONS		
Fuel System	Air cleaner type & No		Wet paper type element	
	Fuel capacity		14 L	
	Throttle Body Venturi dia		φ 38 mm	
Electrical Equipment	Ignition System	Type	Full transistor ignition	
		Spark plug	DR8E	
		Ignition timing	ECU	
		Spark plug gap	0.6~0.7 mm	
Battery	Capacity	12V12AH		
Power Drive System	Clutch	Type	Dry, centrifugal automatic	
		Transmission Gear	Type	Helical gear/spur gear
	Operation		Automatic centrifugal Type	
	Reduction Ratio	Type	CVT	
		Preliminary	0.99	
		Final	5.58	
Moving Device	FR/RR tire rolling circumference		mm	
	Tire pressure (rider only/60 kg)	Front	2 kg/cm ²	
		Rear	2.25 kg/cm ²	
	Turning angle	Left	40°	
Right		40°		
Brake system type		Rear	Disk brake	
		Front	Disk brake	
Damping Device	Suspension type	Front	Telescopic fork	
		Rear	Unit swing	
Frame type		Double cradle		

1. GENERAL INFORMATION

SERVICE PRECAUTIONS

- Make sure to install new gaskets, O-rings, circlips, cotter pins, etc. when reassembling.

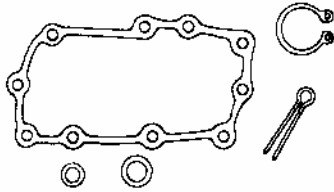

- When tightening bolts or nuts, begin with larger-diameter to smaller ones at several times, and tighten to the specified torque diagonally.

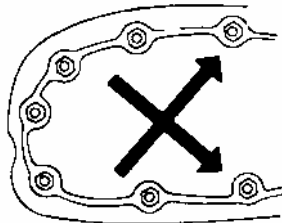

- Use genuine parts and lubricants.

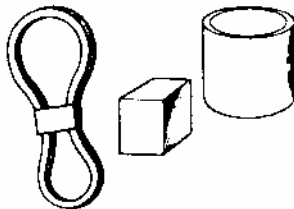

- When servicing the motorcycle, be sure to use special tools for removal and installation.



- After disassembly, clean removed parts. Lubricate sliding surfaces with engine oil before reassembly.

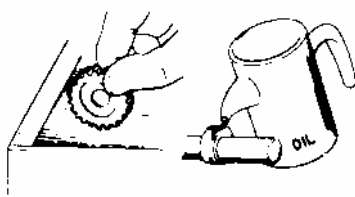

- Apply or add designated greases and lubricants to the specified lubrication points.

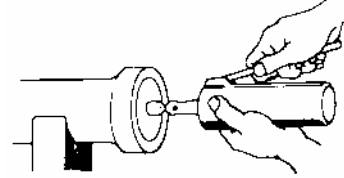

- After reassembly, check all parts for proper tightening and operation.

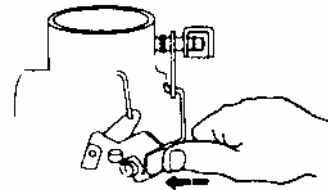

- When two persons work together, pay attention to the mutual working safety.

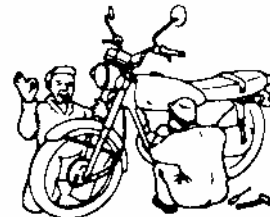

- Disconnect the battery negative (-) terminal before operation.
- When using a spanner or other tools, make sure not to damage the motorcycle surface.

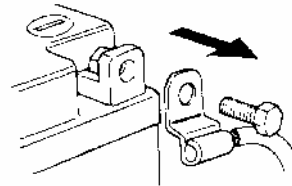

- After operation, check all connecting points, fasteners, and lines for proper connection and installation.
- When connecting the battery, the positive (+) terminal must be connected first.
- After connection, apply grease to the battery terminals.
- Terminal caps shall be installed securely.

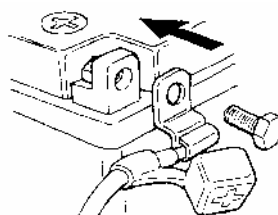

1. GENERAL INFORMATION

- If the fuse is burned out, find the cause and repair it. Replace it with a new one according to the specified capacity.

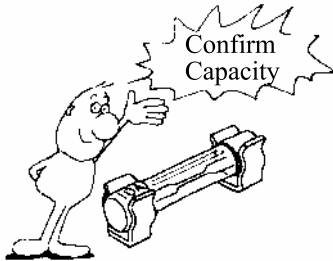

- After operation, terminal caps shall be installed securely.

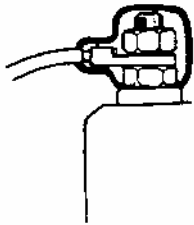

- When taking out the connector, the lock on the connector shall be released before operation.

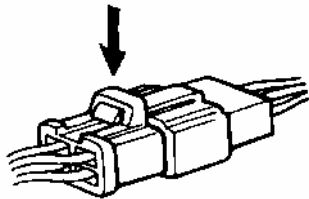

- Hold the connector body when connecting or disconnecting it.
- Do not pull the connector wire.

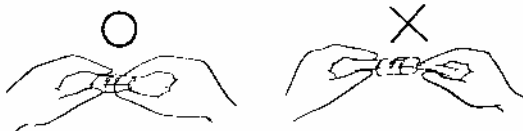

- Check if any connector terminal is bending, protruding or loose.

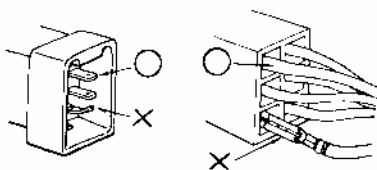

- The connector shall be inserted completely.
- If the double connector has a lock, lock it at the correct position.
- Check if there is any loose wire.



- Before connecting a terminal, check for damaged terminal cover or loose negative terminal.

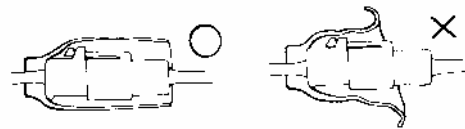

- Check the double connector cover for proper coverage and installation.

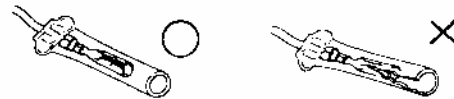

- Insert the terminal completely.
- Check the terminal cover for proper coverage.
- Do not make the terminal cover opening face up.

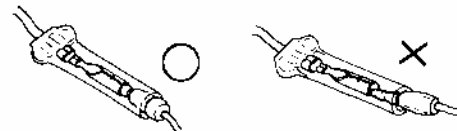

- Secure wire harnesses to the frame with their respective wire bands at the designated locations. Tighten the bands so that only the insulated surfaces contact the wire harnesses.

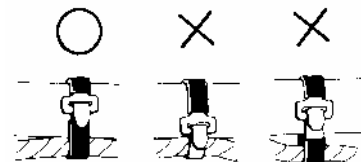

1. GENERAL INFORMATION

- After clamping, check each wire to make sure it is secure.

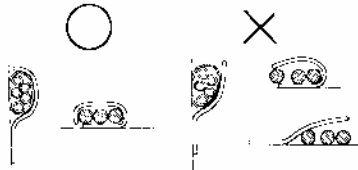

- Do not squeeze wires against the weld or its clamp.

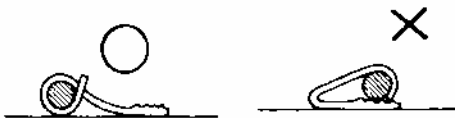

- After clamping, check each harness to make sure that it is not interfering with any moving or sliding parts.

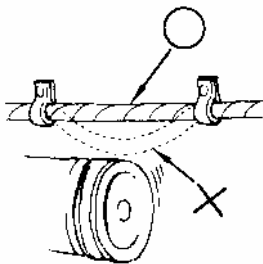

- When fixing the wire harnesses, do not make it contact the parts which will generate high heat.

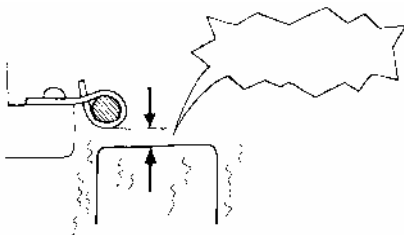

- Route wire harnesses to avoid sharp edges or corners. Avoid the projected ends of bolts and screws.

- Route wire harnesses passing through the side of bolts and screws. Avoid the projected ends of bolts and screws.



- Route harnesses so they are neither pulled tight nor have excessive slack.



- Protect wires and harnesses with electrical tape or tube if they contact a sharp edge or corner.

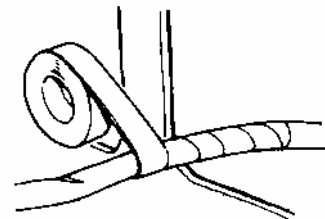

- When rubber protecting cover is used to protect the wire harnesses, it shall be installed securely.

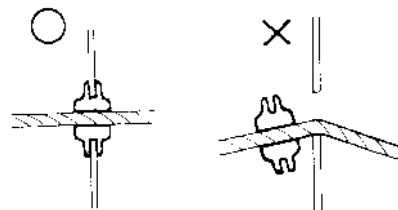

- Do not break the sheath of wire.
- If a wire or harness is with a broken sheath, repair by wrapping it with protective tape or replace it.

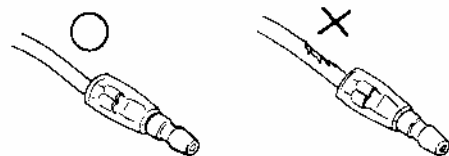

- When installing other parts, do not press or squeeze the wires.



1. GENERAL INFORMATION

- After routing, check that the wire harnesses are not twisted or kinked.

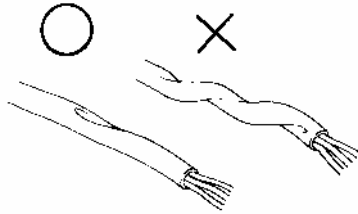

- Wire harnesses routed along with handlebar should not be pulled tight, have excessive slack or interfere with adjacent or surrounding parts in all steering positions.

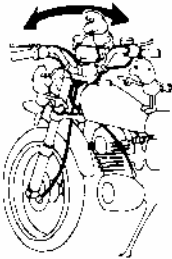

- When a testing device is used, make sure to understand the operating methods thoroughly and operate according to the operating instructions.

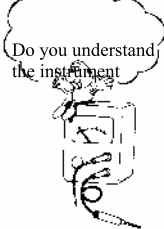

- Be careful not to drop any parts.

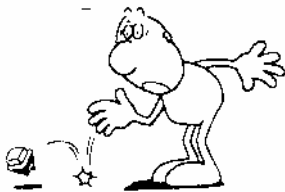

- When rust is found on a terminal, remove the rust with sand paper or equivalent before connecting.

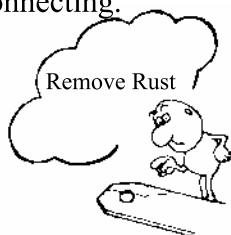

- Symbols:

The following symbols represent the servicing methods and cautions included in this service manual.



Engine Oil

: Apply engine oil to the specified points. (Use designated engine oil for lubrication.)



Grease

: Apply grease for lubrication.



Gear Oil

: Transmission Gear Oil (90#)

: Note

1. GENERAL INFORMATION

TORQUE VALUES STANDARD TORQUE VALUES

Item	Torque Kg-m	Item	Torque Kgf-m
5mm bolt and nut	0.5	5mm screw	0.4
6mm bolt and nut	1.0	6mm screw, SH bolt	0.9
8mm bolt and nut	2.2	6mm flange bolt and nut	1.2
10mm bolt and nut	3.5	8mm flange bolt and nut	2.7
12mm bolt and nut	5.5	10mm flange bolt and nut	4.0

Torque specifications listed below are for important fasteners.

ENGINE

NO	ITEM	THREAD DWG. NO	DWG. NAME	THREAD SIZE AND TYPE	TORQUE		PR VALUES N-m	PR VALUES Kgf.cm	REMARKS
					N-m	Kgf-m			
1	HEAD COVER	90017-KKE5-E000	BOLT HEAD COVER	M6X1.0	7.8 ~11.8	0.8~1.2	9.8	100	NONE
2	CAM SPROCKET	90083-KED9-9000	BOLT KNOCK 6MM	M6X1.0	7.8 ~11.8	0.8~1.2	9.8	100	APPLY THREAD LOCK
3	CYLINDER HEAD	90007-KKE5-E000	BOLT WASHER 10X160	M10X1.25	47.1 ~51.0	4.8~5.2	49.1	500	APPLY OIL
4	CYLINDER HEAD	90008-KKE5-E000	BOLT WASHER 10X170	M10X1.25	47.1 ~51.0	4.8~5.2	49.1	500	APPLY OIL
5	HEAD	98059-58916-00	SPARK PLUG CR8E	M10X1.0	9.8 ~13.7	1~1.4	11.8	120	NONE
6	CAM SHAFT HOLDER	96001-06045-08	BOLT FLANGE SH 6*45	M6X1.0	7.8~11.8	0.8~1.2	9.8	100	APPLY OIL
7	HEAD	12205-KE8-3000	BOLT SEALING 12MM	M12X1.0	14.7 ~19.6	1.5~2	17.2	175	APPLY THREAD LOCK
8	OIL PUMP SHAFT	94050-10080	NUT FLANGE 10MM (C)	M10X1.25	19.6 ~29.4	2~3	24.5	250	APPLY Loctite 243
9	TENSIONER	14531-KED9-9000	PIVOT TENSION GUIDE	M8X1.25	17.7 ~21.6	1.8~2.2	19.6	200	APPLY OIL
10	CONROD	13213-KKE5-E000	BOLT CONN ROD	M10X1.0	58.0~62.7	6.0~6.4	60.8	620	APPLY OIL 10W/30
11	CRANK SHAFT	90015-KED9-9000	BOLT UBS 10X35	M10X1.0	73.5~83.4	7.5 ~8.5	78.4	800	APPLY OIL ACG/CRANKSHAFT TAPPER AREA APPLY Loctite 648
12	CRANK SHAFT	90241-KKE5-E000	NUT M30X1.0	M30X1.0(L.H.)	127.5~147.1	13~15	137.3	1400	APPLY Loctite 243
13	ONE WAY/ ACG	96600-08015-10	SOCKET BOLT 8X15(B)	M8X1.5	24.5 ~34.3	2.5~3.5	29.4	300	APPLY THREAD LOCK
14	R/L CRANK CASE	90084-KKE5-E000	CAP OIL CHANNEL	M14X1.5	11.8 ~17.7	1.2~1.8	14.7	150	NONE
15	L CRANK CASE	9052A-GFY6-9500	BOLT ASSY DRAIN PLUG	M12X1.5	19.6 ~29.4	2~3	24.5	250	NONE
16	R CASE	35500-KED9-9000	SW ASSY OIL PRESSURE	PT 1/8	9.8 ~13.7	1~1.4	11.8	120	APPLY SEAL
17	L CRANK CASE	12361-GFY6-9010	HOLE CAP TAPPET ADJUSTING	M30X1.5	9.8 ~19.6	1~2	14.7	150	NONE
18	L CRANK CASE	15421-LBA2-E000	BOLT, OIL COOLER	M20X1.5	11.8 ~17.7	1.2~1.8	14.7	150	NONE
19	L CRANK CASE	1541A-LBA2-E000	ELEMENT COMP., OIL FILTER	M20X1.5	23.5 ~29.4	2.4~3	26.5	270	NONE
20	OIL PUMP	95701-06025-08	BOLT FLANGE 6X25	M6X1.0	7.8 ~11.8	0.8~1.2	9.8	100	NONE
21	BALANCER SHAFT	90231-KEC2-9000	NUT HEX 16MM.L H	M16X1.0	39.2 ~49.1	4~5	44.1	450	APPLY Loctite 243
22	MAIN SHAFT	90242-KKE5-E000	NUT LOCK 22 MM (R,H)	M22X1.0	127.5~147.1	13~15	137.3	1400	APPLY Loctite 243
23	COUNTER SHAFT	90023-KKE5-E000	BOLT 12X45	M12X1.25	107.9~127.5	11~13	122.3	1200	APPLY OIL
24	DRIVE SHAFT	90201-KKE5-E000	NUT,FLANGE 16MM	M16X1.0	78.5 ~ 88.3	8 ~ 9	86.6	850	APPLY OIL
25	MISSION COVER	95701-08035-08 95701-08045-08	BOLT FLANGE 8*35 (C) BOLT FLANGE 8*45 (C)	M8X1.25	24.5~28.4	2.5~2.9	26.5	270	NONE
26	FLANGE, SWING ARM CASE	90010-KKE5-E000	SPOCKET BOLT 8x22 (B)	M8X1.25	24.5 ~34.3	2.5~3.5	29.4	300	APPLY THREAD LOCK NYLOK BLUE PATCH
27	PIVOT, R SWING ARM	90010-KKE5-E000	SPOCKET BOLT 8x22 (B)	M8X1.25	24.5 ~34.3	2.5~3.5	29.4	300	APPLY THREAD LOCK NYLOK BLUE PATCH
28	FLANGE, SWING ARM CASE	90010-KKE5-E100	SPOCKET BOLT 8x30 (B)	M8X1.25	24.5 ~34.3	2.5~3.5	29.4	300	APPLY THREAD LOCK NYLOK BLUE PATCH
29	ENCODER PLATE, PHASE	94050-06080	NUT FLANGE 6MM(C)	M6X1.0	7.8 ~11.8	0.8~1.2	9.8	100	NONE
30	MAIN GEAR A ASSY. (SPRING)	23115-KKE5-7000	BOLT M8X1.25	M8X1.25	31.4~35.3	3.2~3.6	33.3	340	APPLY THREAD LOCK NYLOK BLUE PATCH
31	CASE ASSY. LIFTER TENSIONER	90005-KKE5-E000	BOLT SPECIAL M18X1.0	M18X1.0	17.7 ~21.6	1.8~2.2	19.6	200	NONE
32	HEAD COMP.	90018-KKE5-E000	BOLT ,HEAD	M6X1.0	7.8 ~11.8	0.8~1.2	9.8	100	NONE

1. GENERAL INFORMATION

FRAME

No.	ITEM	THREAD SIZE AND TYPE	TORQUE		PR値 Kg f-m	REMARK	THREAD DWG.No.
			Kg f-m	N-m			
1	STEERING						
	HANDLE BOLT	M8X1.25	2.4~3.0	24~30	2.7	FLANGE BOLT	95701-08035-07
	TOP BRIDGE BOLT	M8X1.25	2.4~3.0	24~30	2.7	——	96600-08025-07
	BOT BRIDGE BOLT	M8X1.25	2.4~3.0	24~30	2.7	FLANGE BOLT	95801-08040-06
	STEM(TOP BRIDGE)	M22x1.5	6.5~7.5	65~75	7.0	——	90201-LBA2-E000
	STEM LOCK	BC1	5.0~6.0	50~60	5.5	——	50306-196-0010
	RACE NUT(HEAD)	BC1	1.8~2.3	18~23	2.0	——	53220-LBA2-E000
	F/C TOP SCREW	M5X0.8	0.1~0.2	1~2	1.5	——	93891-05012-06
2	WHEEL						
	FR.AXLE	M18X1.5	3.0~3.6	30~36	3.3	——	44301-LBA2-E000
	RR.AXLE NUT	M20X1.5	12~14	120~140	13	U NUT	90306-LBA2-9000
3	SUSPENSION						
	FR AXLE PINCH BOLT	M8x1.25	2.0~2.6	20~26	2.3	——	96600-08035-07
	RR. CUSH	M10X1.25	3.5~4.5	35~45	4.0	FLANGE BOLT	95801-10040-00
4	BRAKE						
	FR.CALIPER	M8X1.25	2.4~3.0	24~30	2.7	——	90122-KEC8-9000
	RR.CALIPER	M8X1.25	2.4~3.0	24~30	2.7	——	90131-KUCU-9000
	BRK.OIL BOLT	M10X1.25	3.0~4.0	30~40	3.5	——	90145-MS9-6110-MI
	M/C HOLDER	M6X1.0	1.0~1.4	10~14	1.2	FLANGE BOLT	95701-06022-07
	C/P BLEEDER	M8X1.25	0.4~0.7	4~7	0.55	——	43352-KKD6-E000-HL
	MASTER CYLINDER CAP	M4X1.0	0.12~0.2	1.2~2	0.16	SCREW ,FLAT	93600-04012-1G
	BRK. OIL BOLT (Modulator, ABS)	M10x1.0	3.0~4.0	30~40	3.5	FLANGE BOLT	90145-LFHI-E000
	MODULATOR, ABS	M6X1.0	0.77~0.83	7.7~8.3	0.8	NUT	#
5	ENG. MOUNT						
	FRAME SIDE	M12X1.25	7.5~8.5	75~85	8.0	FLANGE BOLT	95801-12175-08
	FRAME SIDE	M12X1.25	7.5~8.5	75~85	8.0	NUT	90306-KLFO-004
	FRAME SIDE	M12X1.25	7.5~8.5	75~85	8.0	NUT	90306-KLFO-004
6	MUFFLER						
	EXH. PIPE	M6x1.0	1.0~1.4	10~14	1.2	NUT	90301-KGBG-9000
	MUFF.BRKT.	M10x1.25	3.2~3.8	32~38	3.5	FLANGE BOLT	95801-10050-07
7	REAR FORK	M10X1.25	3.5~4.5	35~45	4.0	SOCKET BOLT	96600-KKE5-E000
	BOLT,RR FORK PIVOT	M22X1.5	1.0~1.2	10~12	1.1	——	52106-KKE5-E100
	NUT FLANGE	M22X1.5	10~11	100~110	10.5	NUT	52108-KKE5-E100
8							
	START RELAY BOLT	M6X1.0	0.25~0.35	2.5~3.5	0.3	——	94050-06080
	SPDMT.SENSOR CABLE	M6X1.0	1.0~1.4	10~14	1.2	——	96001-06020-07
	RR. CARRIER	M8X1.25	2.0~2.8	20~28	2.4	WASHER BOLT	90105-KHB4-9000
	FUEL PUMP	M5X0.8	0.6~0.8	6~8	0.7	——	90302-LBF2-9000
	BRKT. MAIN STAND	M8x1.25	2.4~3.0	24~30	2.7	FLANGE BOLT	95701-08025-08
	SW ASSY. THERMO	M16X1.5	2.0~2.5	20~25	2.25	——	37760-LBB5-E000
	O2 SENSOR	M18X1.5	4.0~5.0	40~50	4.5	——	39450-LBF2-800
9	SET START MAG.	M6X1.0	0.25~0.35	2.5~3.5	0.3	——	94050-06080

1. GENERAL INFORMATION

SPECIAL TOOLS

Tool Name	Tool No.	Remarks
Lock nut socket wrench	A120F00007	Steering stem removal or install
Oil seal & bearing installers	A120E00014	Oil seal & bearing install
Universal holder	A120E00017	Holding clutch for removal
Flywheel holder	A120E00021	A.C. generator flywheel holding
Bearing pullers	A120E00030	Bearing removal
Tappet adjuster	A120E00036	Tappet adjustment
Bearing pullers	A120E00037	Bearing removal
Valve spring compressor	A120E00040	Valve removal
Oil filter cartridge wrench	A120E00052	Cartridge removal or install
Clutch spring compressor	A120E00053	Clutch disassembly
Flywheel puller	A120E00061	A.C. generator flywheel removal
Clutch fixed bolt	A120E00038	Clutch
Balancer gear nut wrench	A120F00080	Balancer gear
Connecting rod bolts wrench	A120F00081	Connecting rod

1. GENERAL INFORMATION

LUBRICATION POINTS

ENGINE

Lubrication Points	Lubricant
Valve guide/valve stem movable part Camshaft protruding surface Valve rocker arm friction surface Camshaft drive chain Cylinder lock bolt and nut Piston surroundings and piston ring grooves Piston pin surroundings Cylinder inside wall Connecting rod/piston pin hole Connecting rod big end Crankshaft Balancer shaft Crankshaft one-way clutch movable part Oil pump drive chain Starter reduction gear engaging part O-ring face Oil seal lip	<ul style="list-style-type: none"> •Genuine KYMCO Engine Oil (SAE 5W-50) •API SJ Engine Oil
Drive gear shaft Countershaft Final gear Final gear shaft Transmission gearshaft bearing part	Transmission oil: SAE 90
A.C. generator connector	Adhesive

1. GENERAL INFORMATION

FRAME

The following is the lubrication points for the frame.

Use general purpose grease for parts not listed.

Apply clean engine oil or grease to cables and movable parts not specified. This will avoid abnormal noise and rise the durability of the motorcycle.

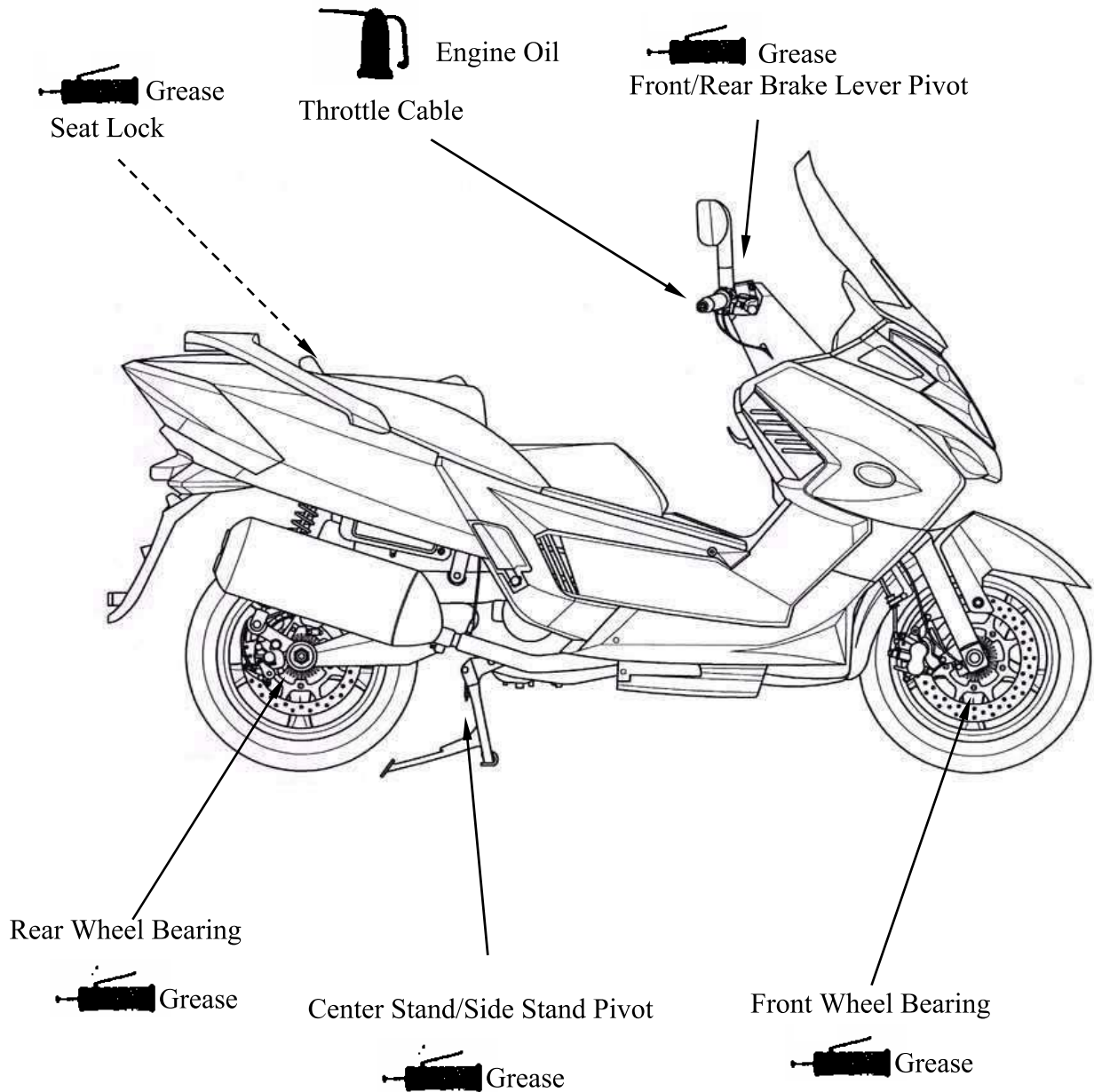

1. GENERAL INFORMATION

TROUBLESHOOTING

ENGINE WILL NOT START OR IS HARD TO START

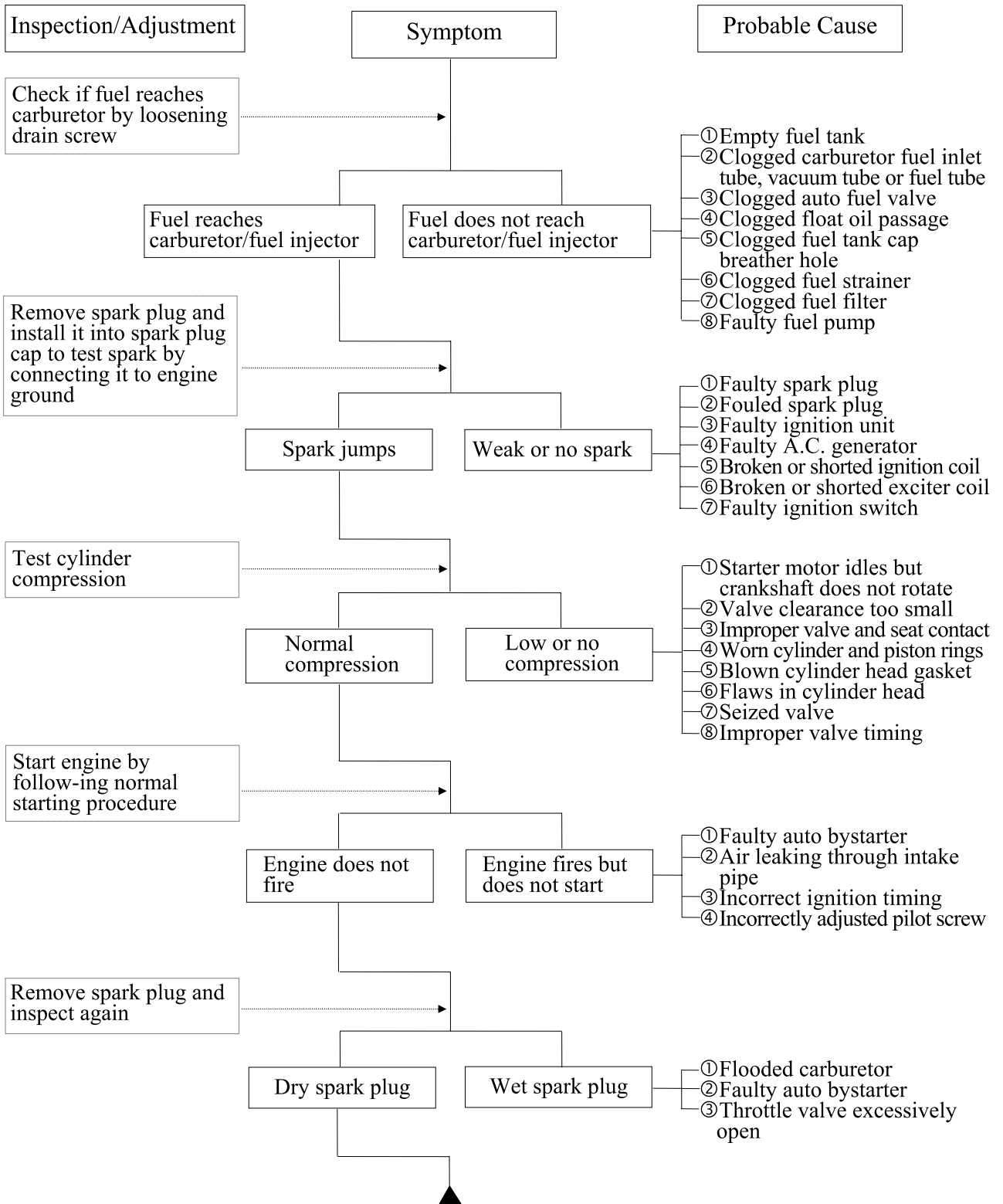

1. GENERAL INFORMATION

ENGINE LACKS POWER

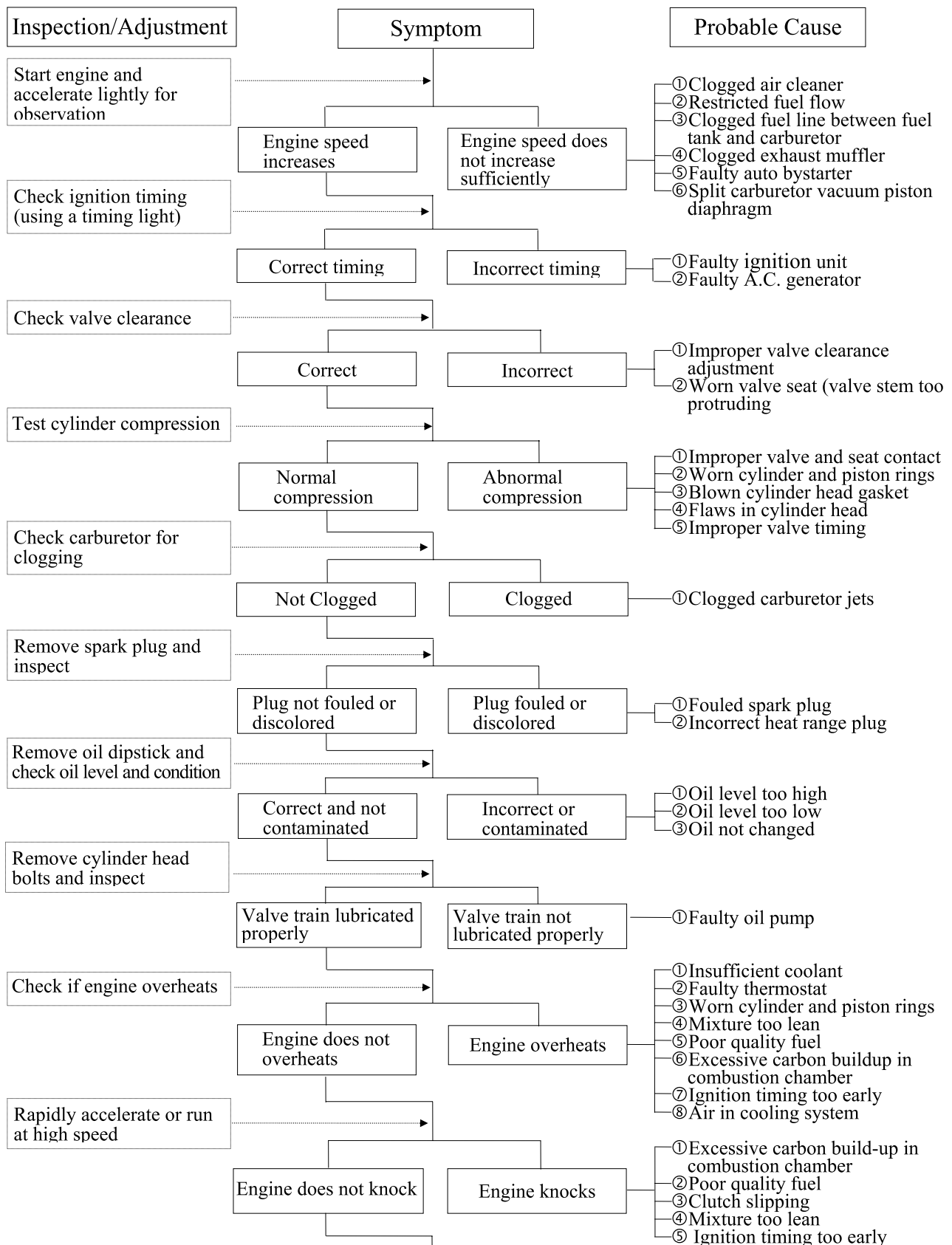

1. GENERAL INFORMATION

POOR PERFORMANCE (ESPECIALLY AT IDLE AND LOW SPEEDS)

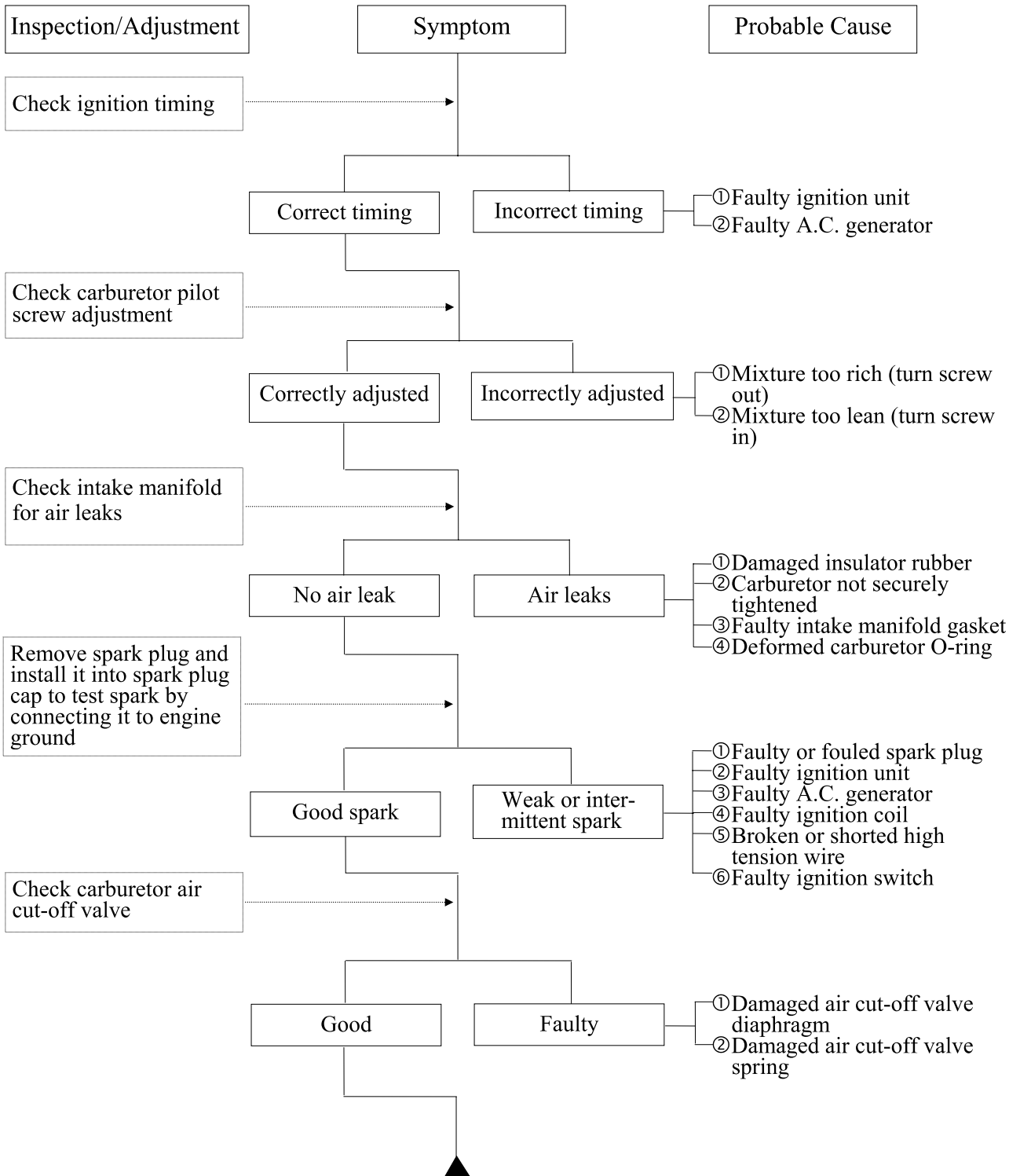

1. GENERAL INFORMATION

POOR PERFORMANCE (AT HIGH SPEED)

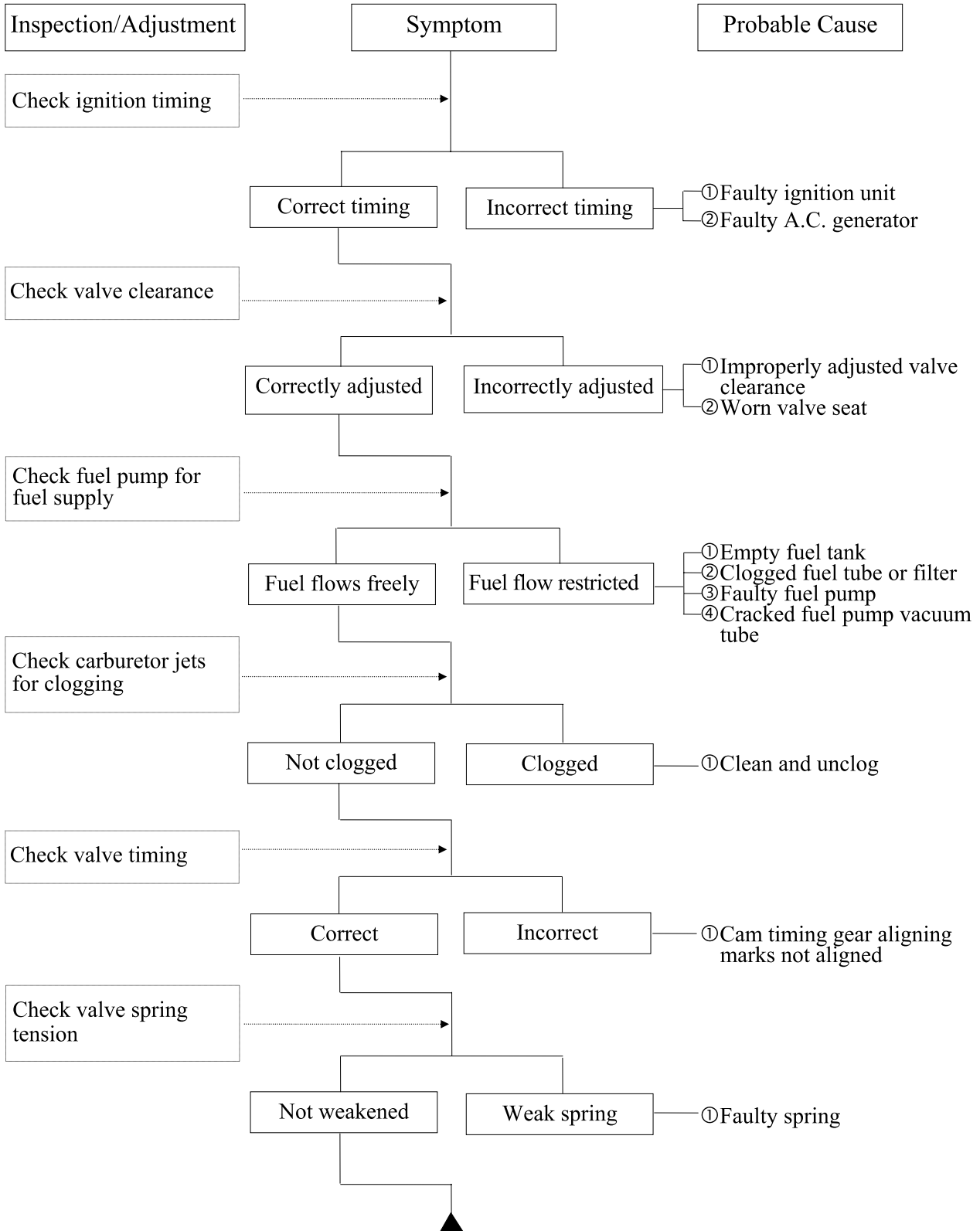

1. GENERAL INFORMATION

ENGINE NOISE

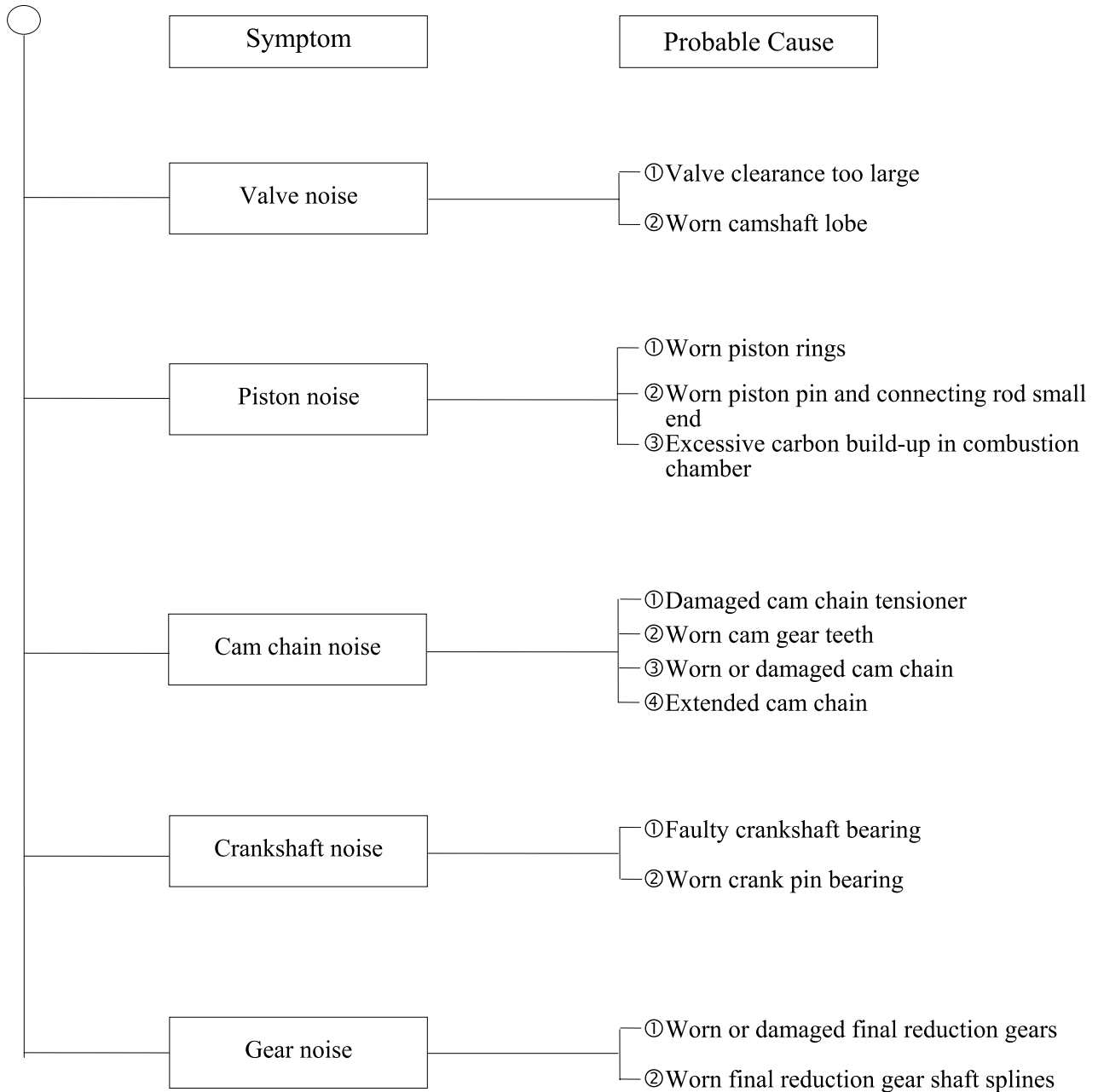

1. GENERAL INFORMATION

CLUTCH, DRIVE AND DRIVEN PULLEYS

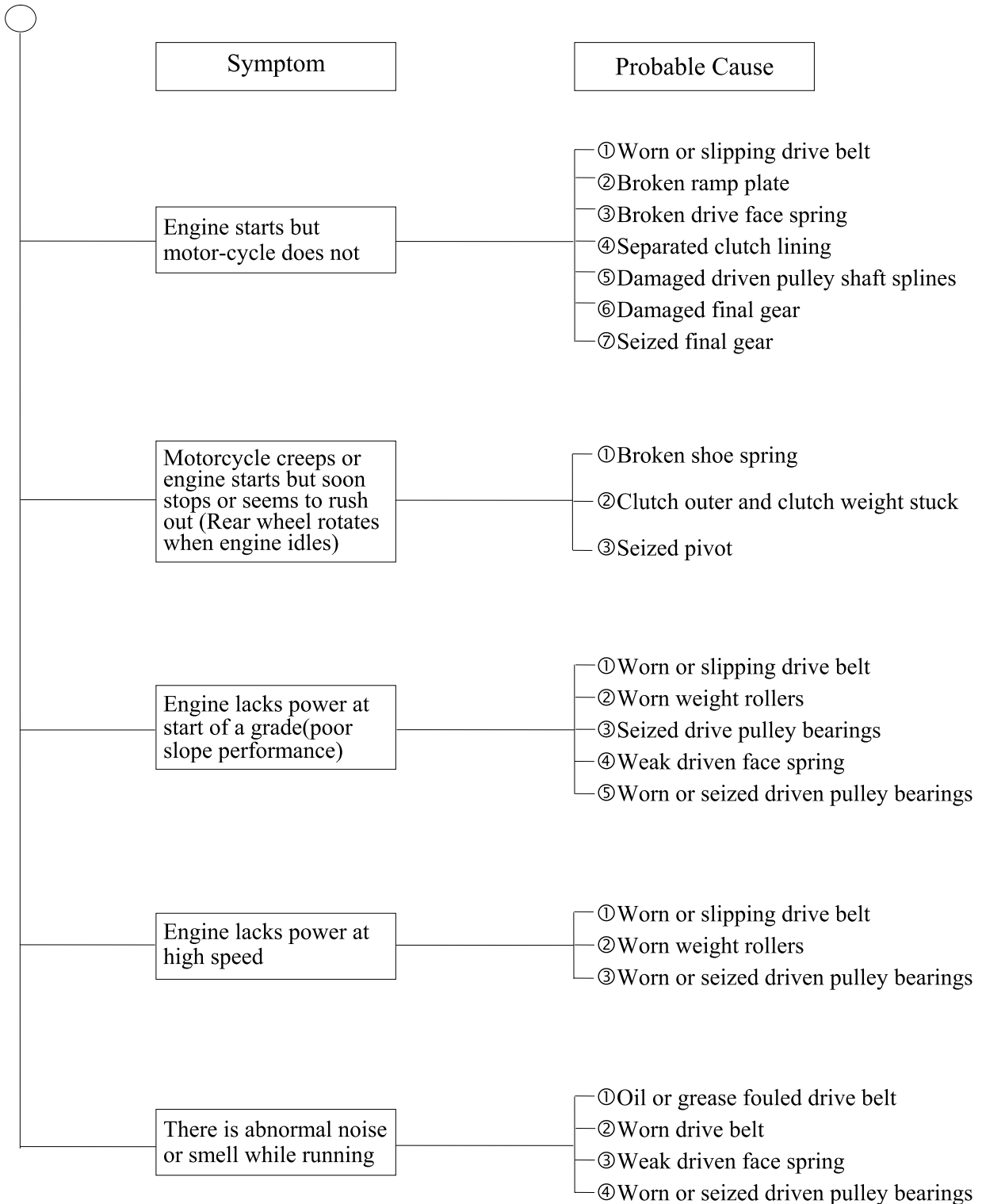

1. GENERAL INFORMATION

STARTER MOTOR

1. Starter motor won't turn

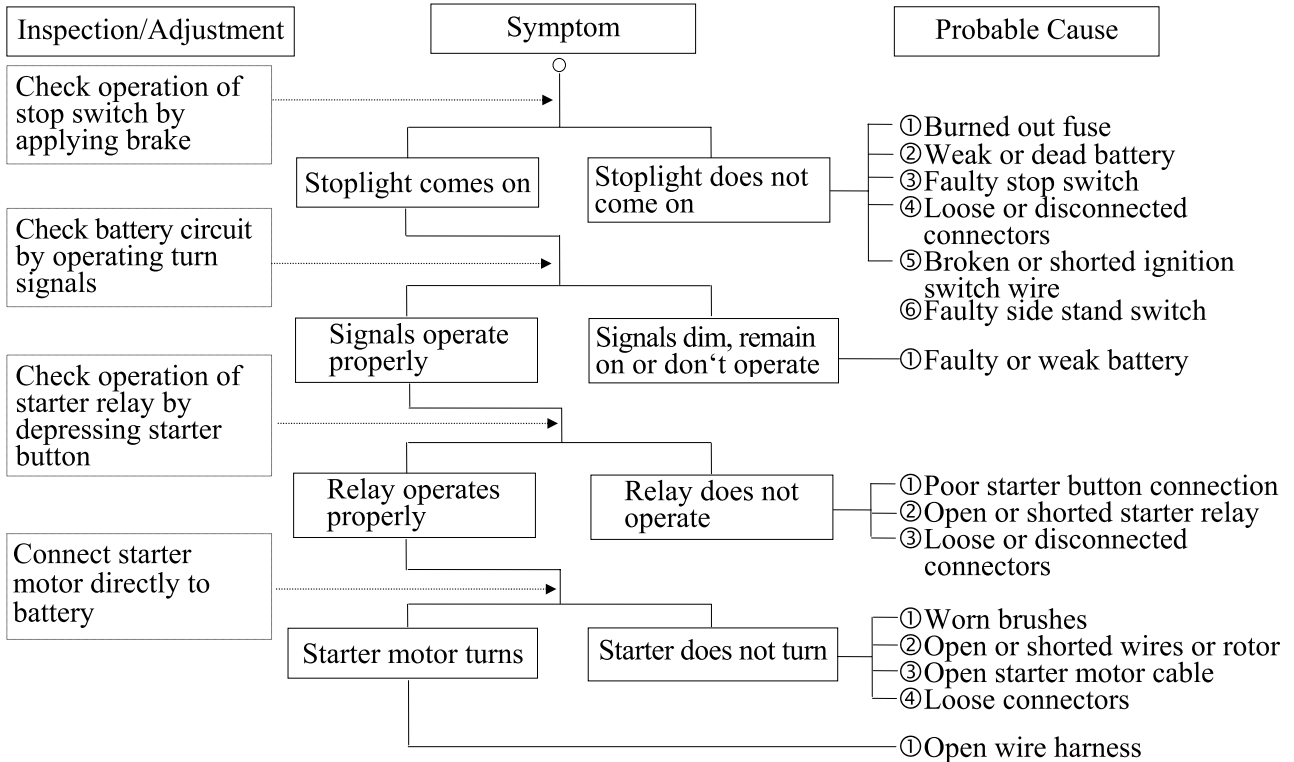

2. Starter motor turns slowly or idles

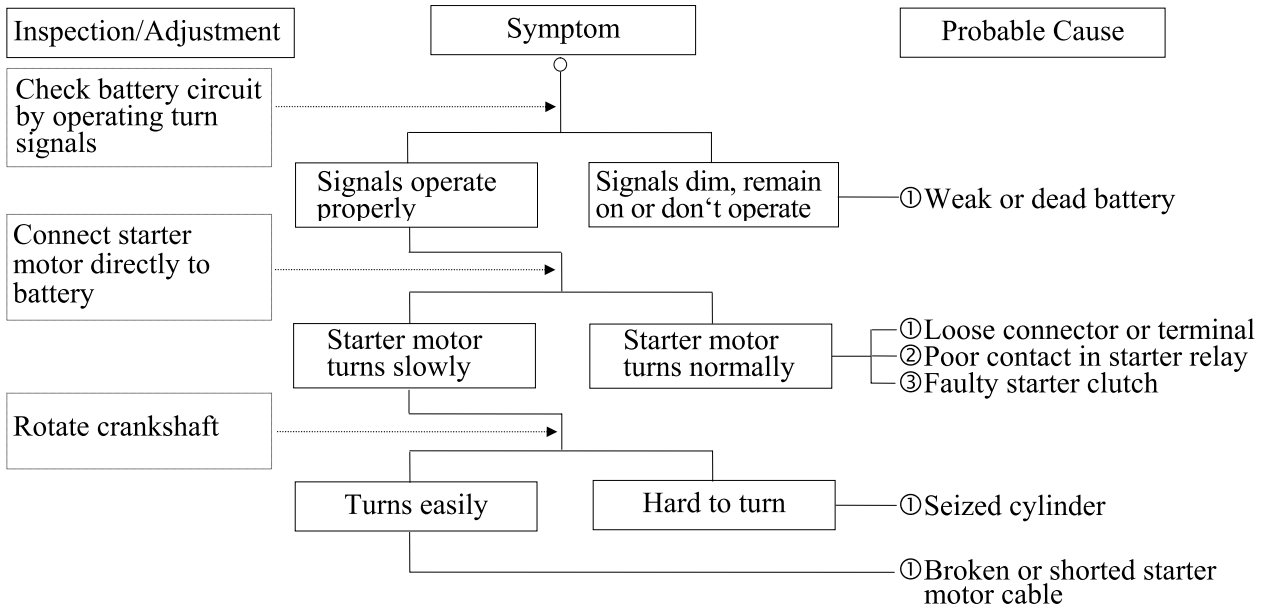

3. Starter motor does not stop turning

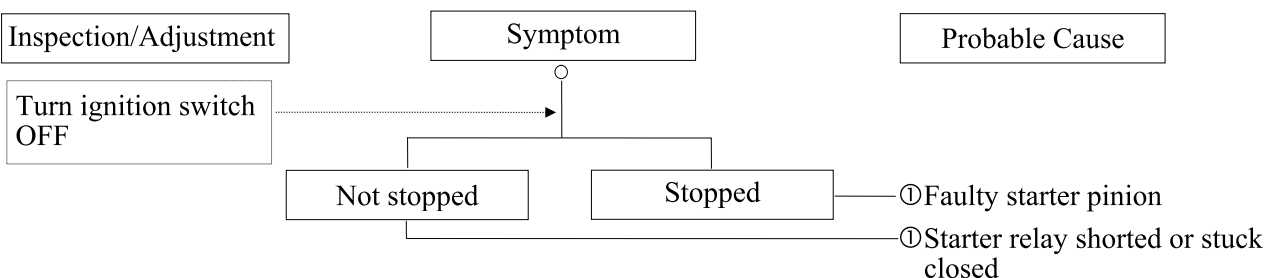

1. GENERAL INFORMATION

NO SPARK AT SPARK PLUG

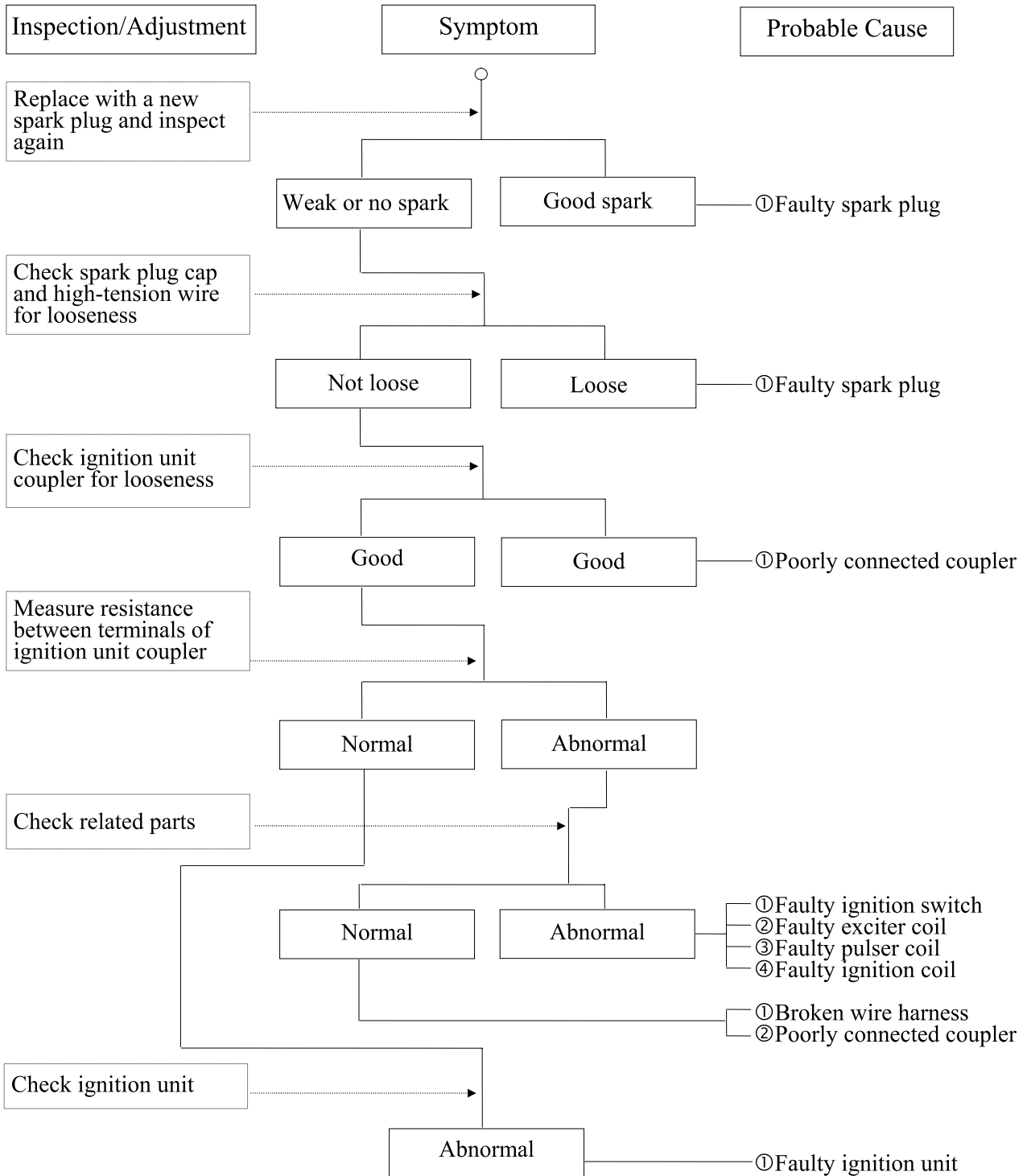

1. GENERAL INFORMATION

POOR CHARGING (BATTERY OVER DISCHARGING OR OVERCHARGING)

Undercharging

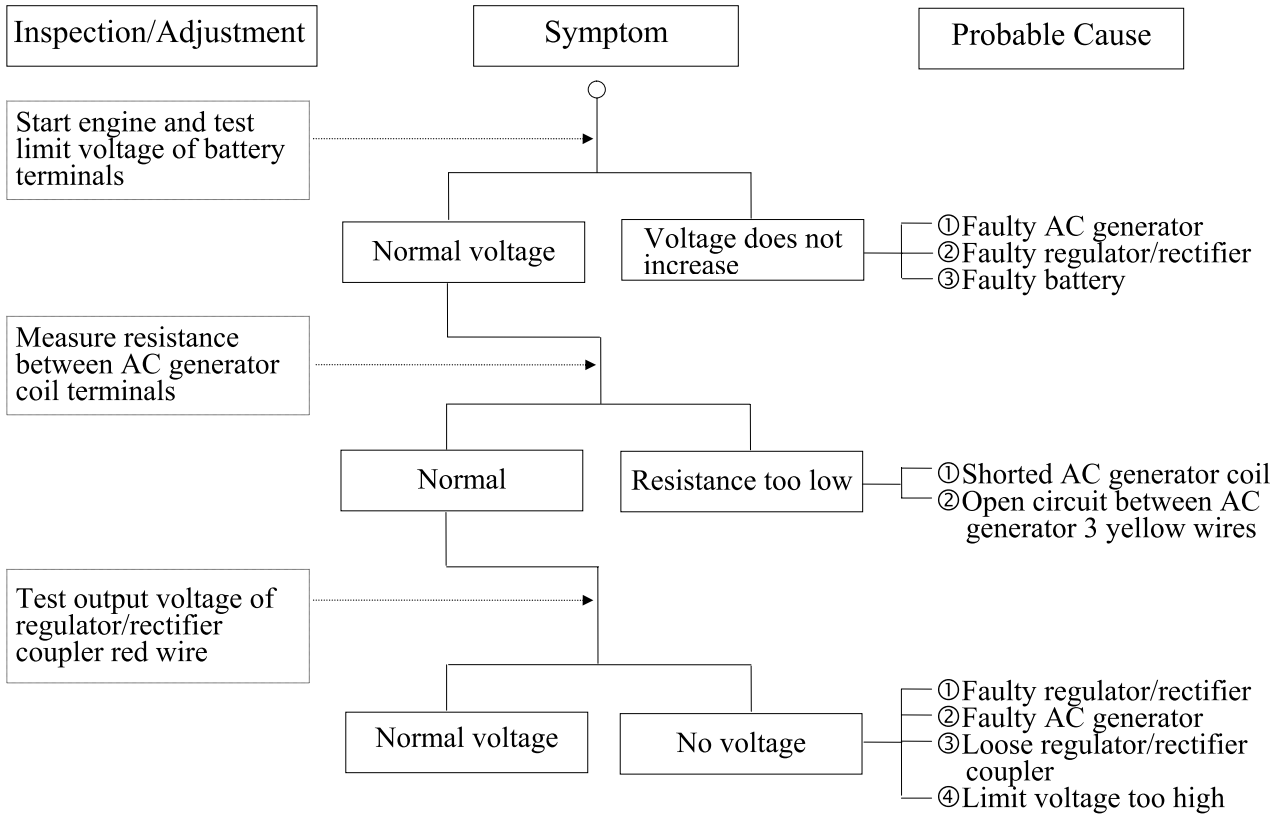

Overcharging

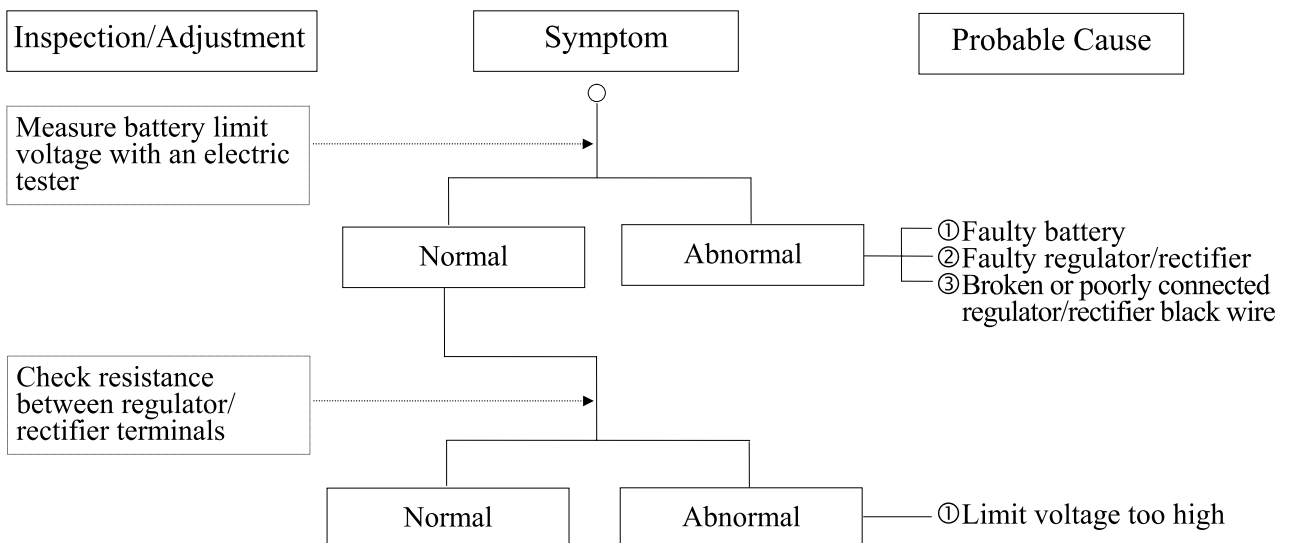

1. GENERAL INFORMATION

FUEL GAUGE

1. Pointer does not register correctly (Ignition switch ON)

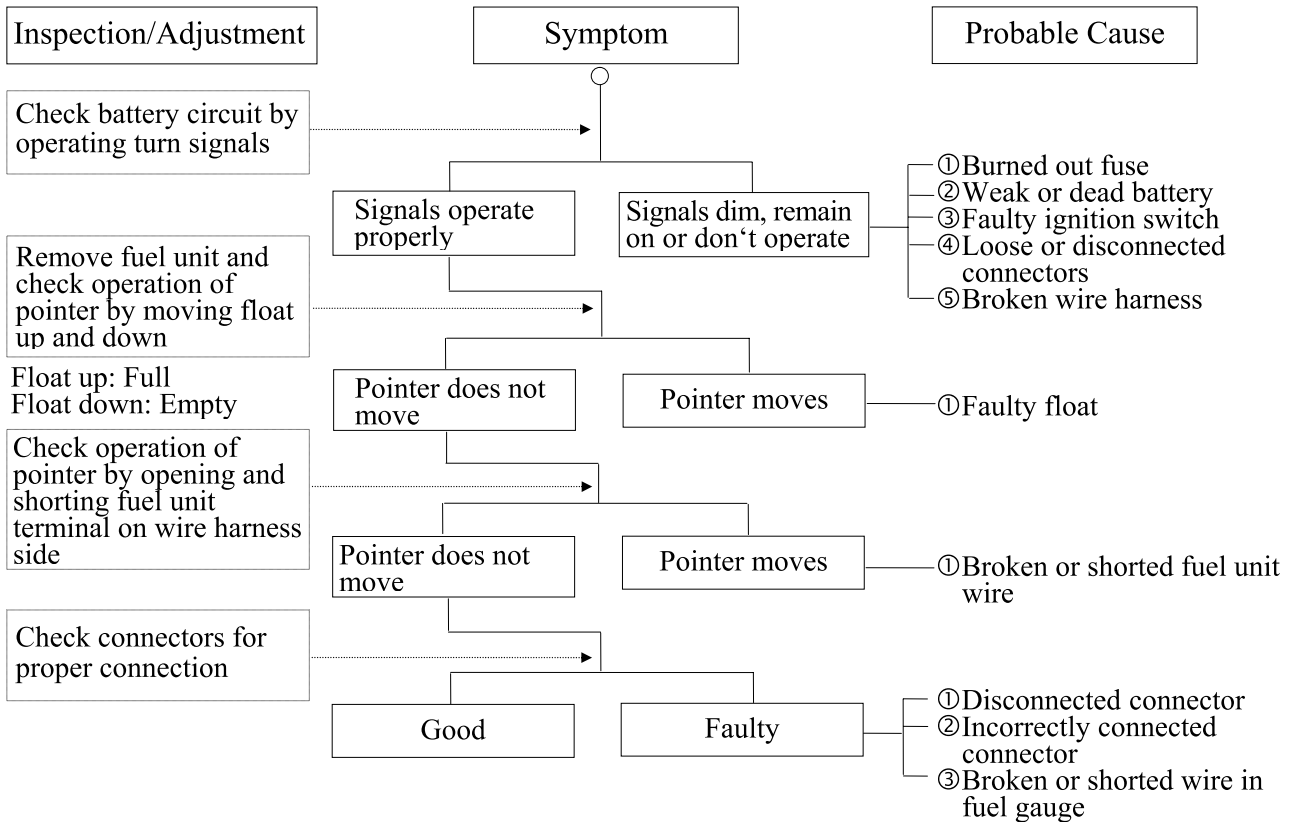

2. Pointer fluctuates or swings (Ignition switch ON)

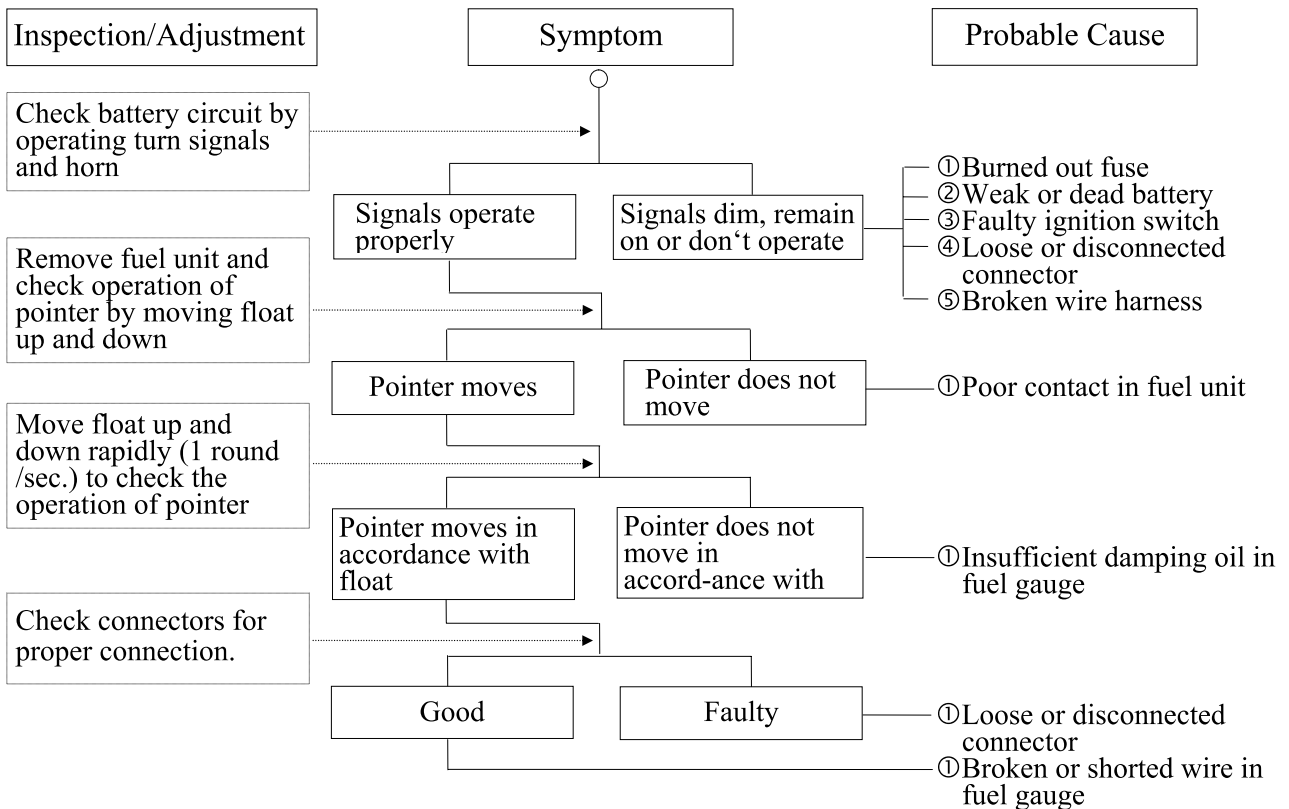

1. GENERAL INFORMATION

STEERING HANDLEBAR DOES NOT TRACK STRAIGHT

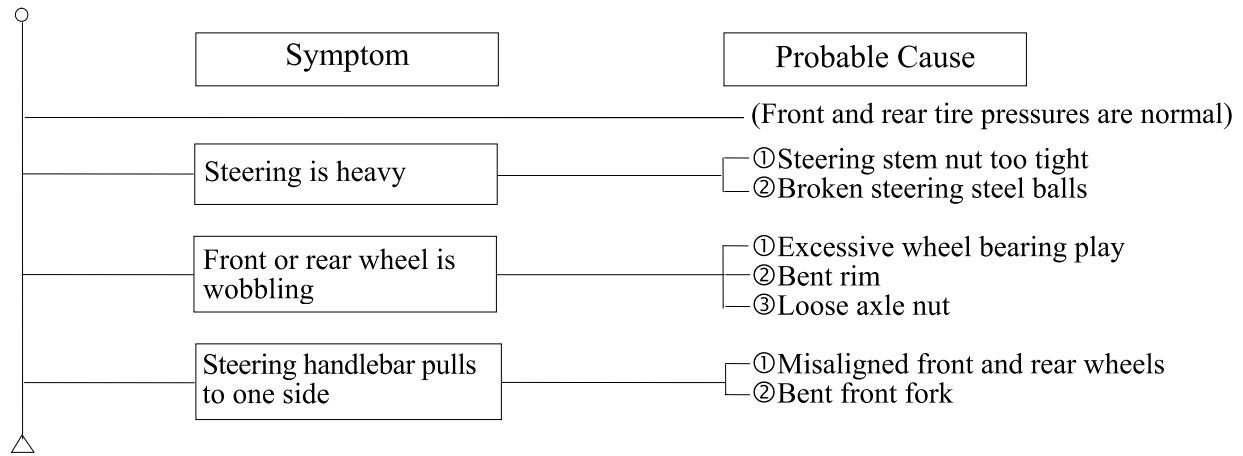

POOR SUSPENSION PERFORMANCE

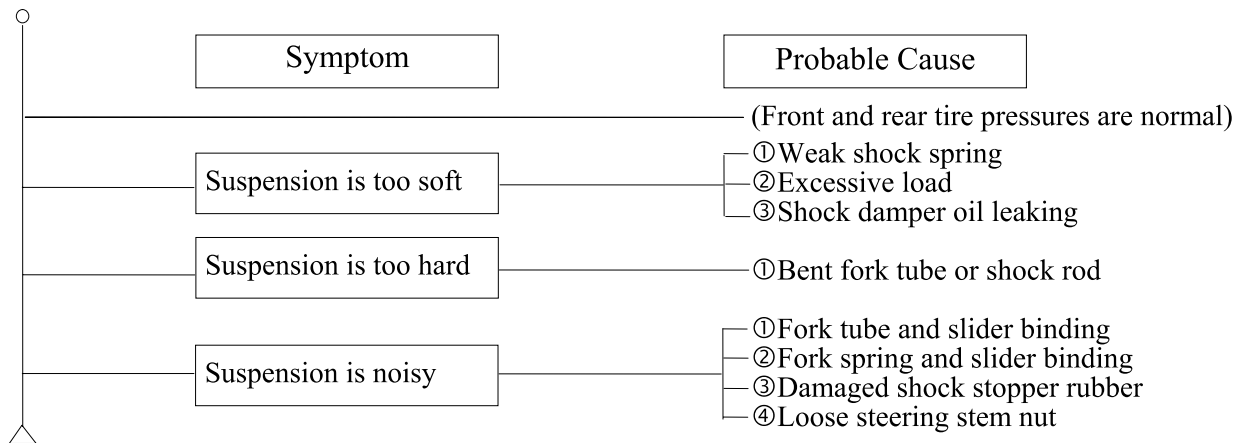

POOR BRAKE PERFORMANCE

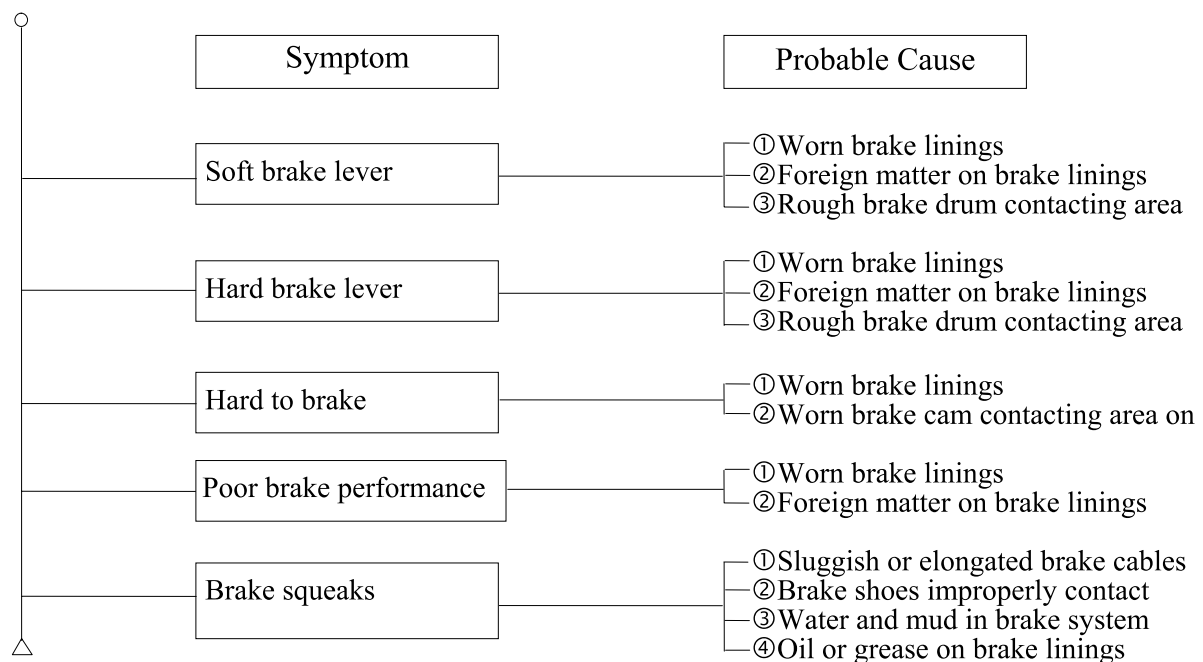

1. GENERAL INFORMATION

TROUBLESHOOTING (XCITING 250 AFI)

ENGINE WILL NOT START OR IS HARD TO START

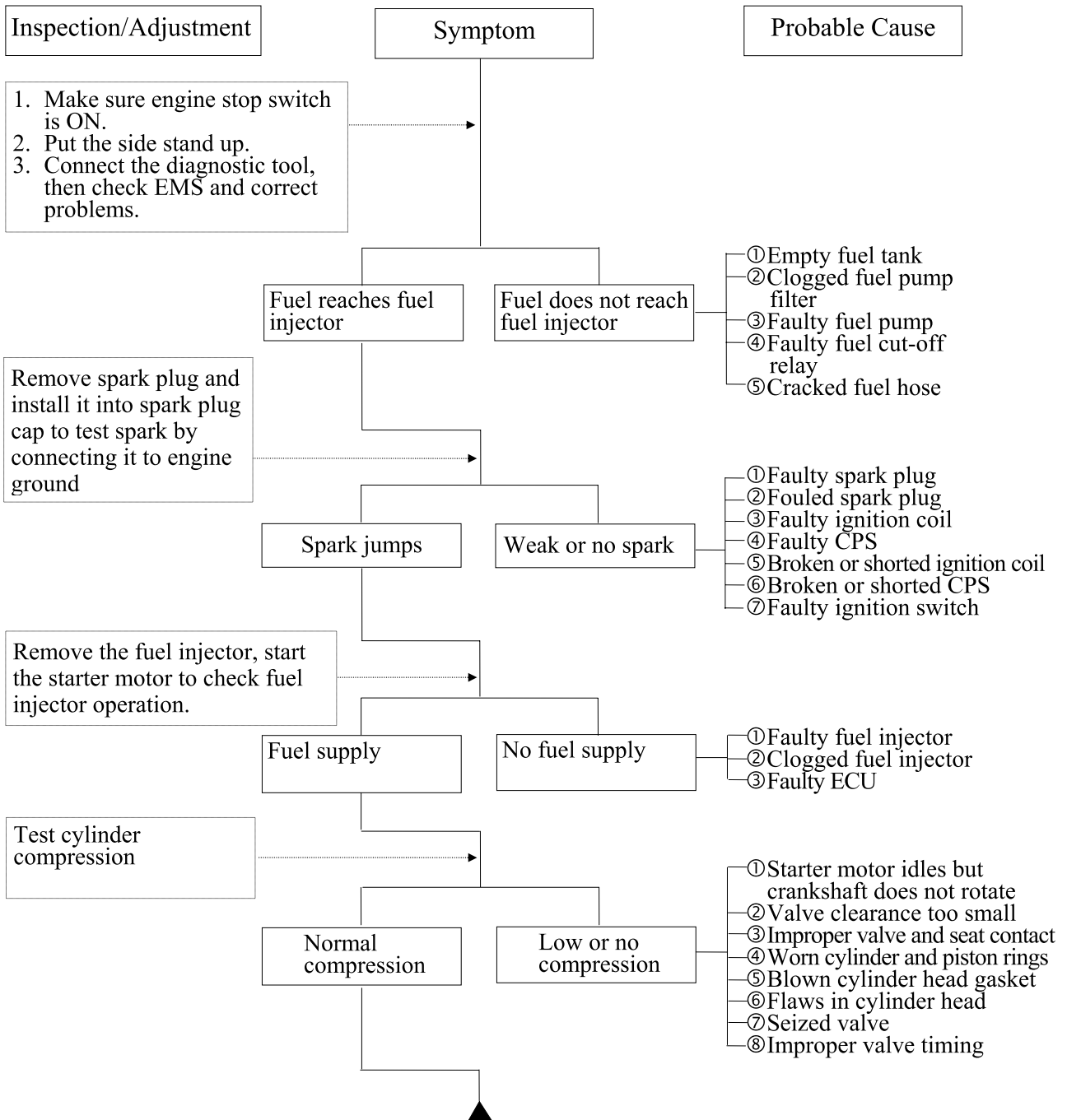

1. GENERAL INFORMATION

ENGINE LACKS POWER

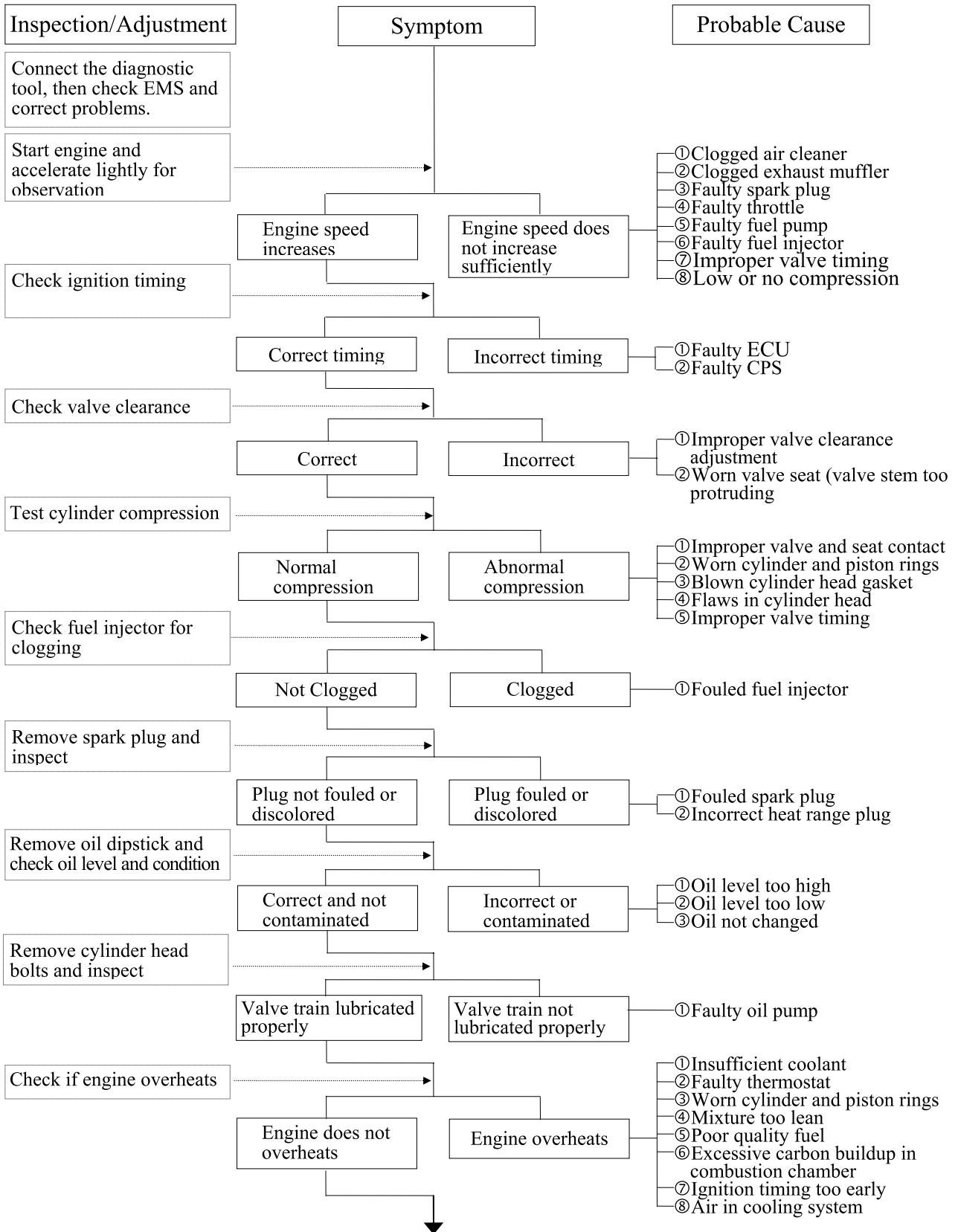

1. GENERAL INFORMATION

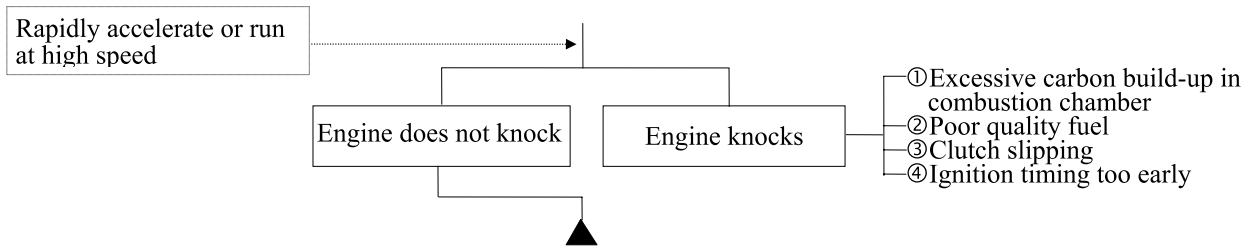

1. GENERAL INFORMATION

POOR PERFORMANCE (ESPECIALLY AT IDLE AND LOW SPEEDS)

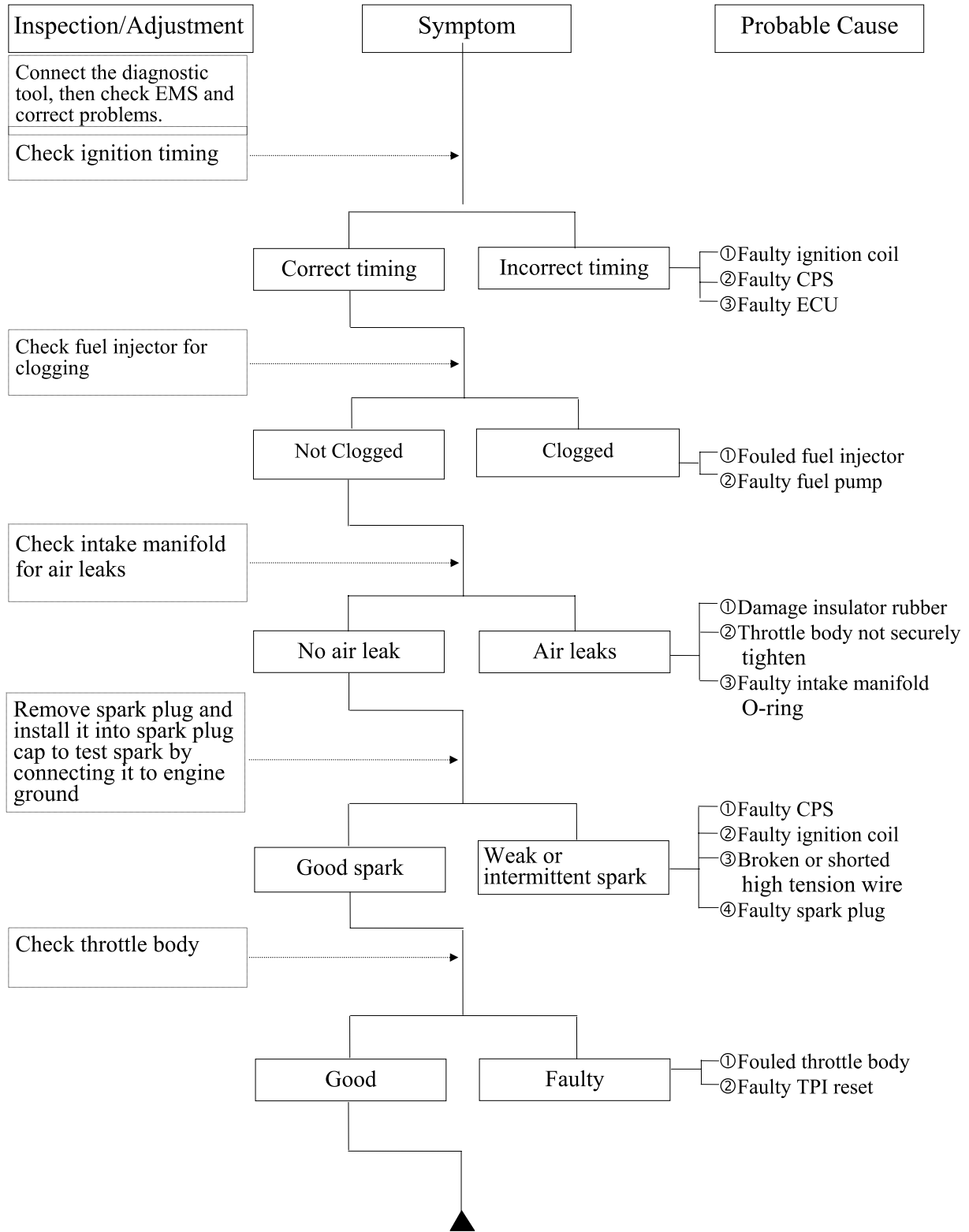

1. GENERAL INFORMATION

POOR PERFORMANCE (AT HIGH SPEED)

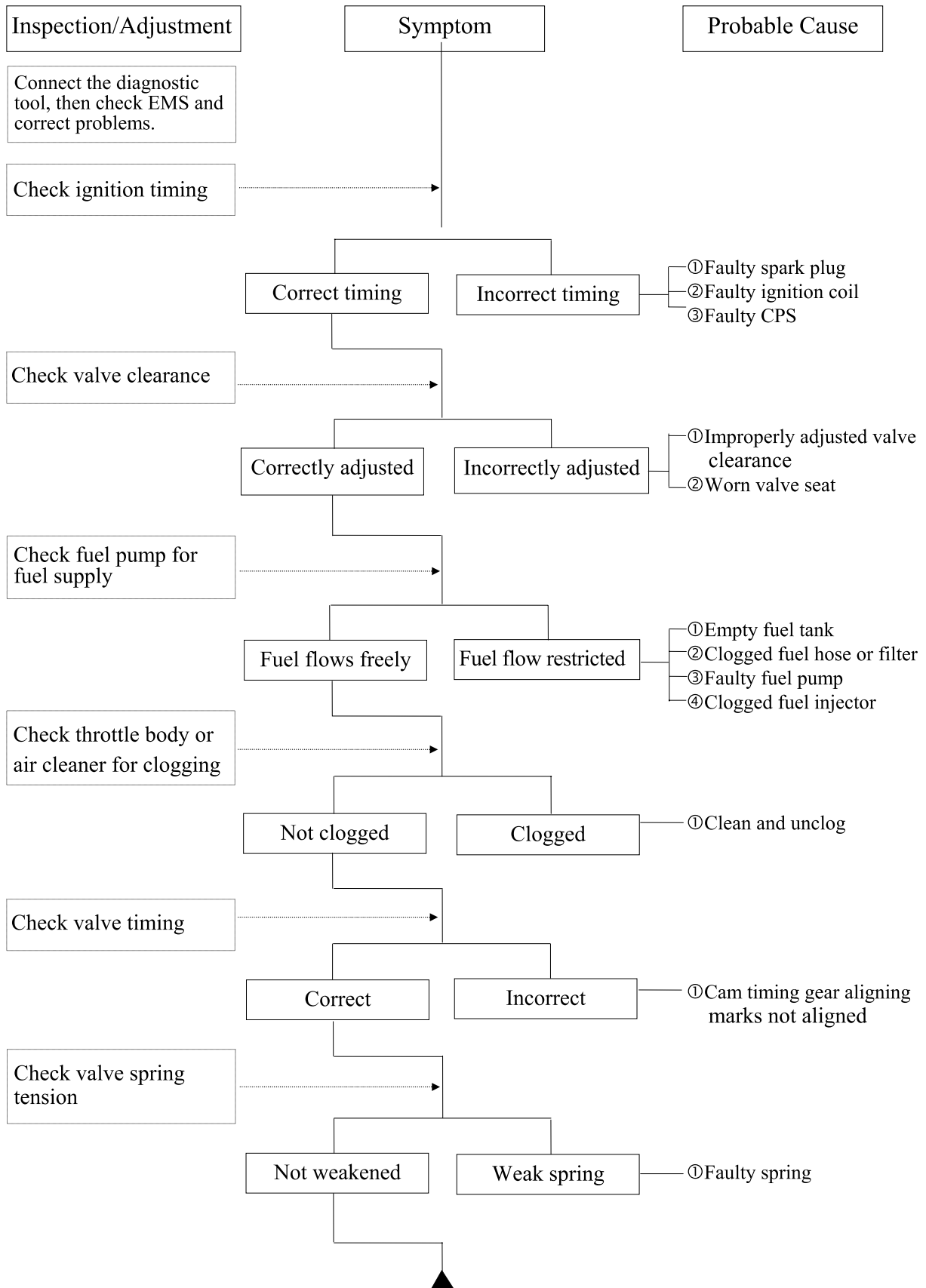

1. GENERAL INFORMATION

ENGINE NOISE

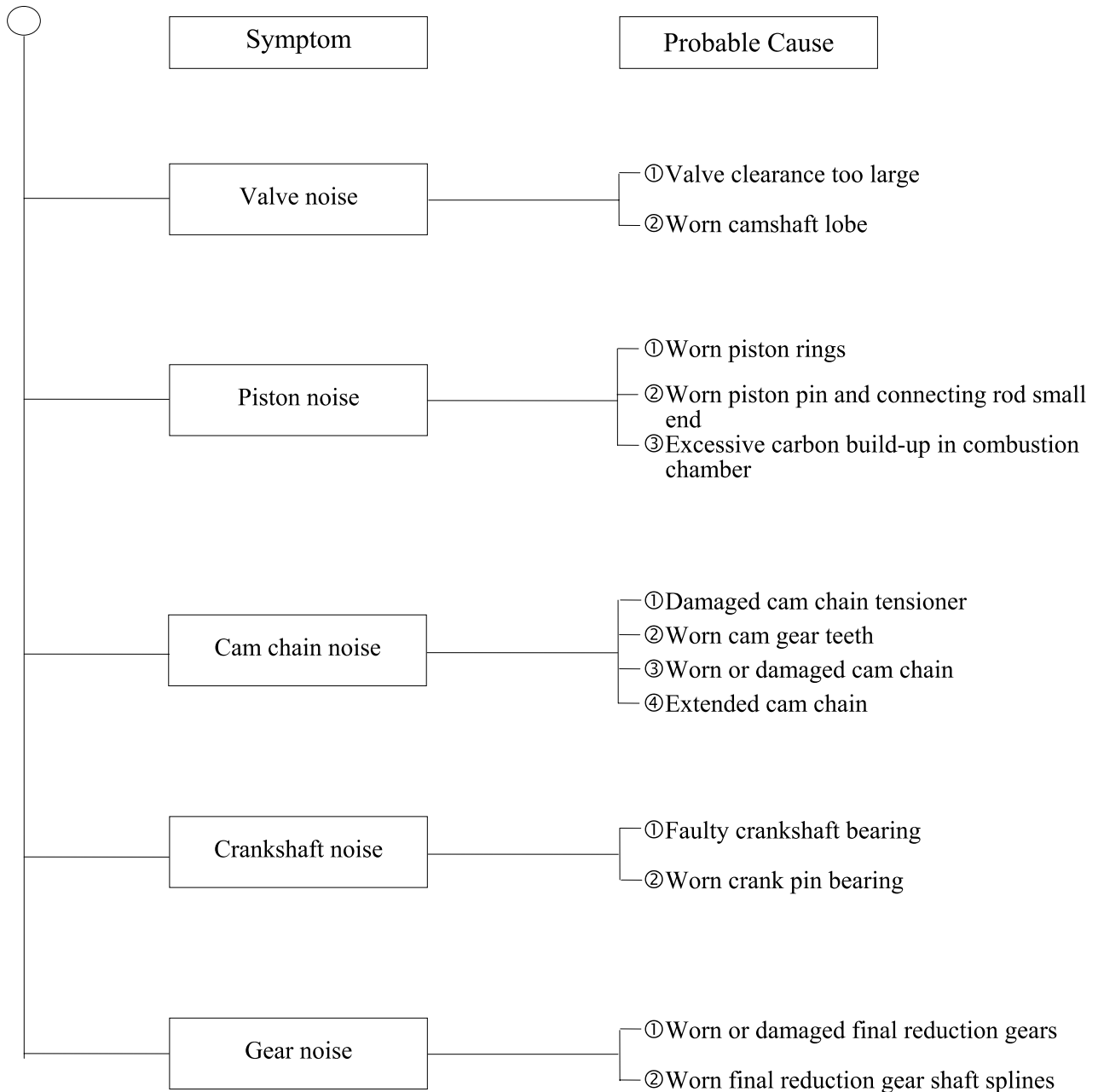

1. GENERAL INFORMATION

CLUTCH, DRIVE AND DRIVEN PULLEYS

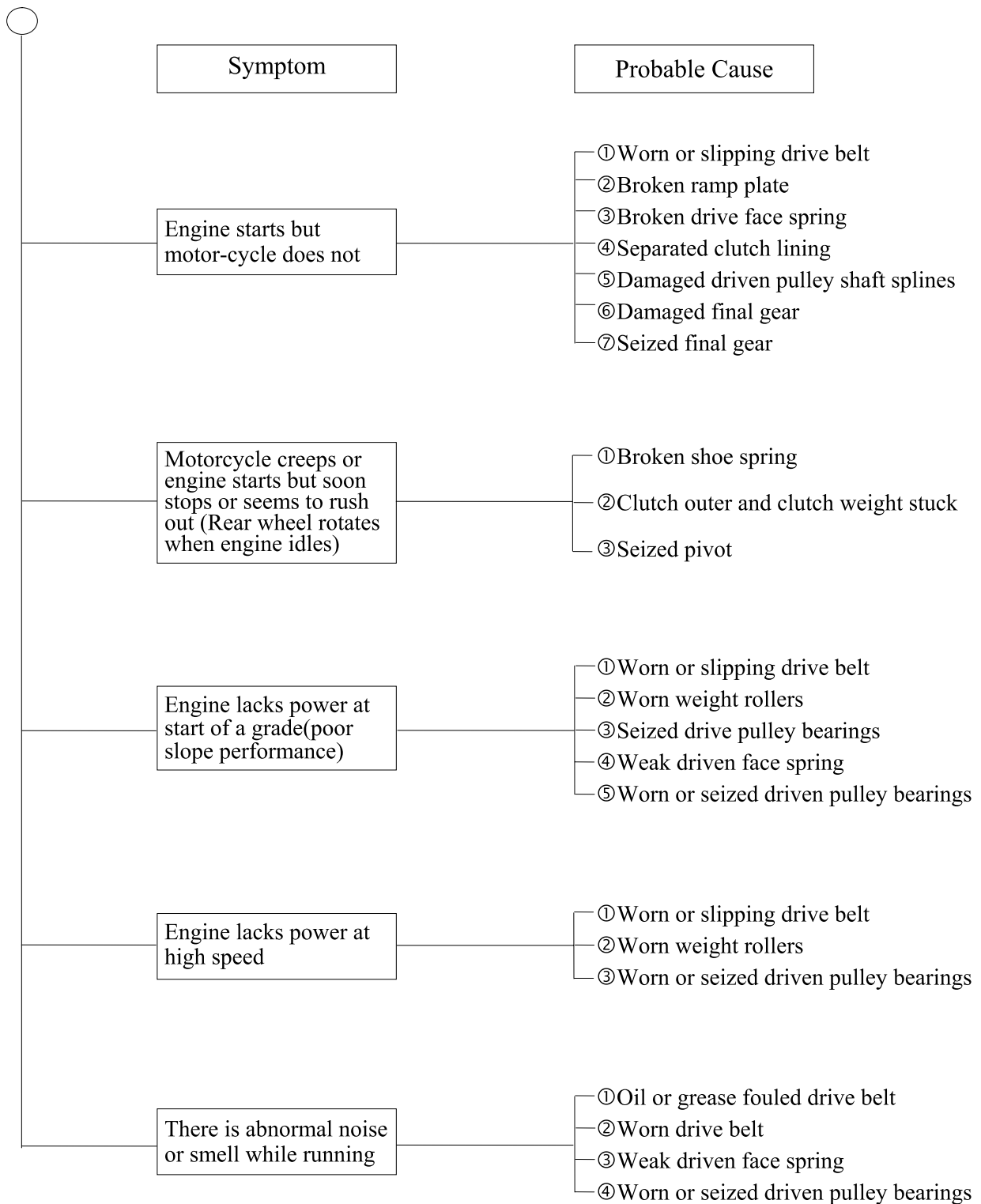

1. GENERAL INFORMATION

STARTER MOTOR

1. Starter motor won't turn

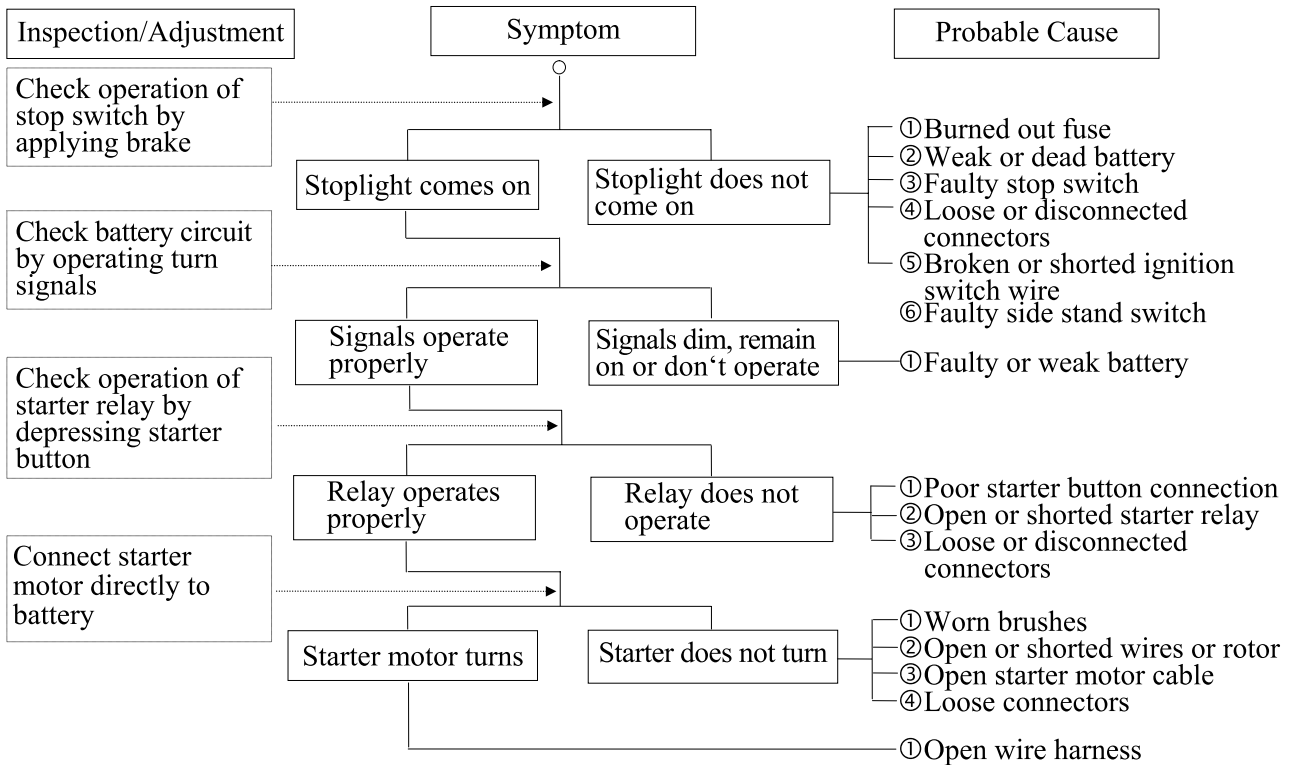

2. Starter motor turns slowly or idles

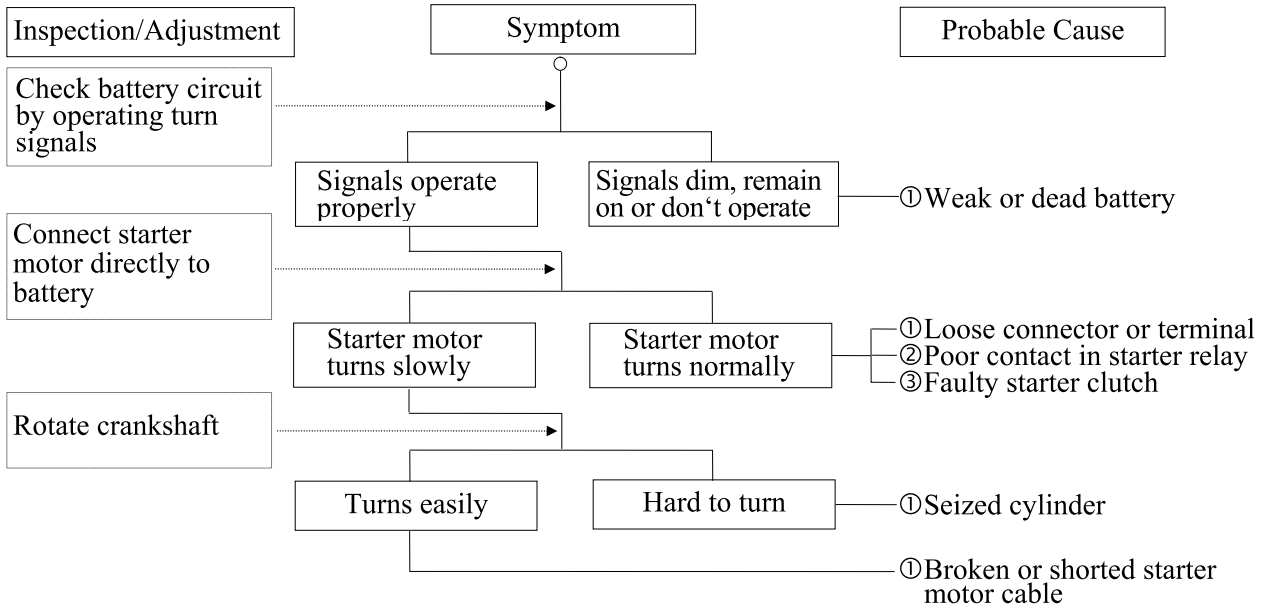

3. Starter motor does not stop turning

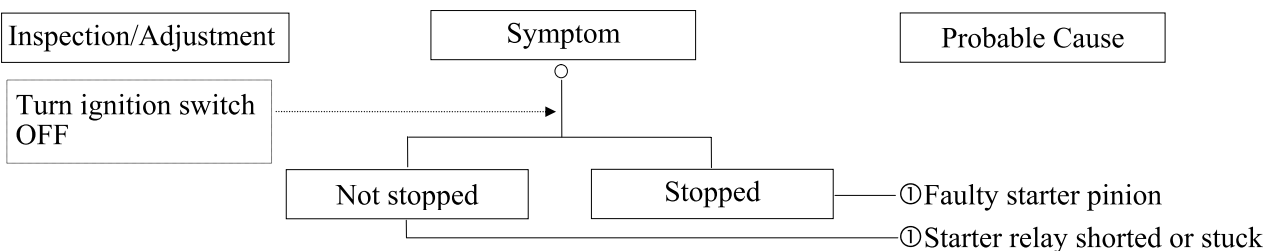

1. GENERAL INFORMATION

closed

NO SPARK AT SPARK PLUG

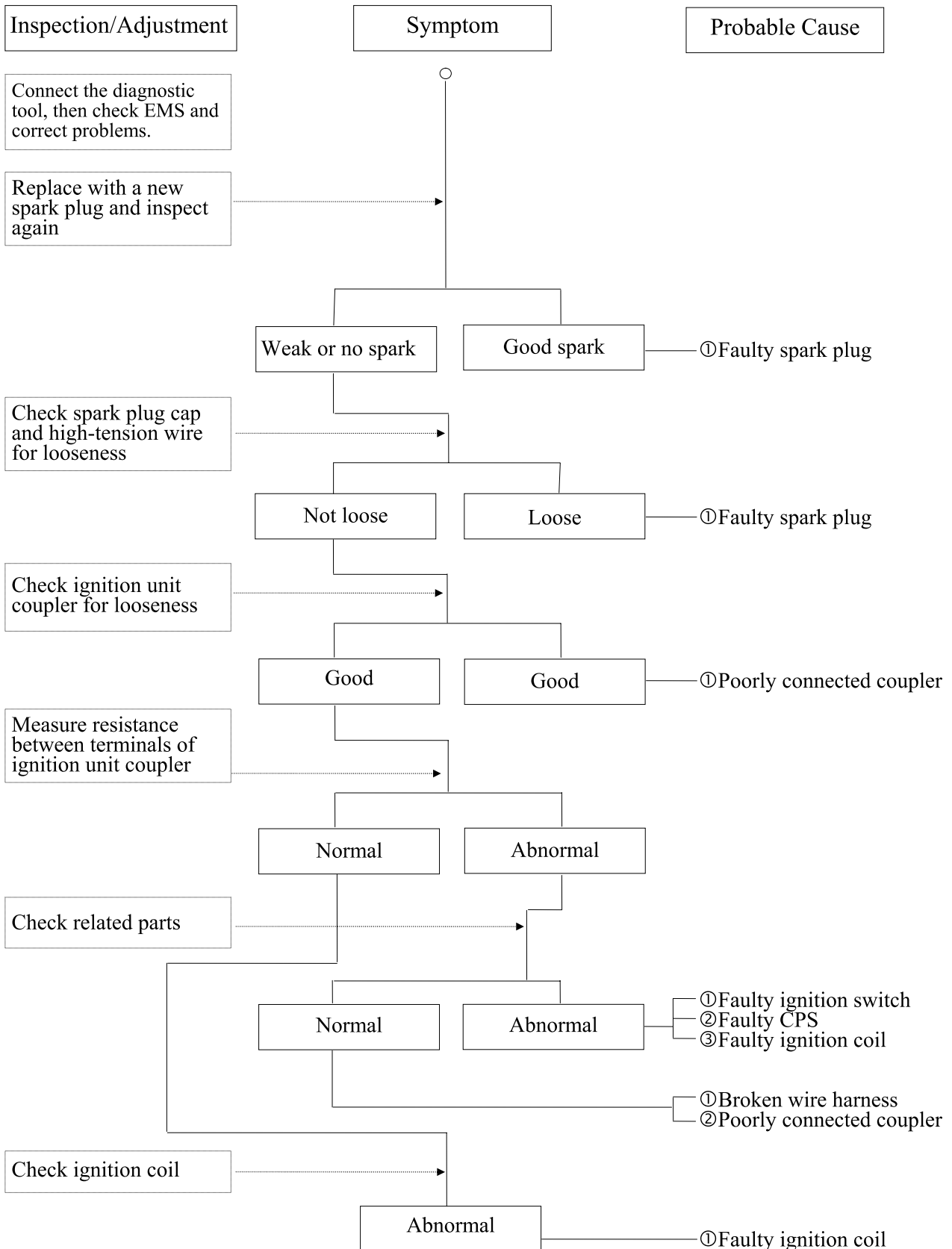

1. GENERAL INFORMATION

POOR CHARGING (BATTERY OVER DISCHARGING OR OVERCHARGING)

Undercharging

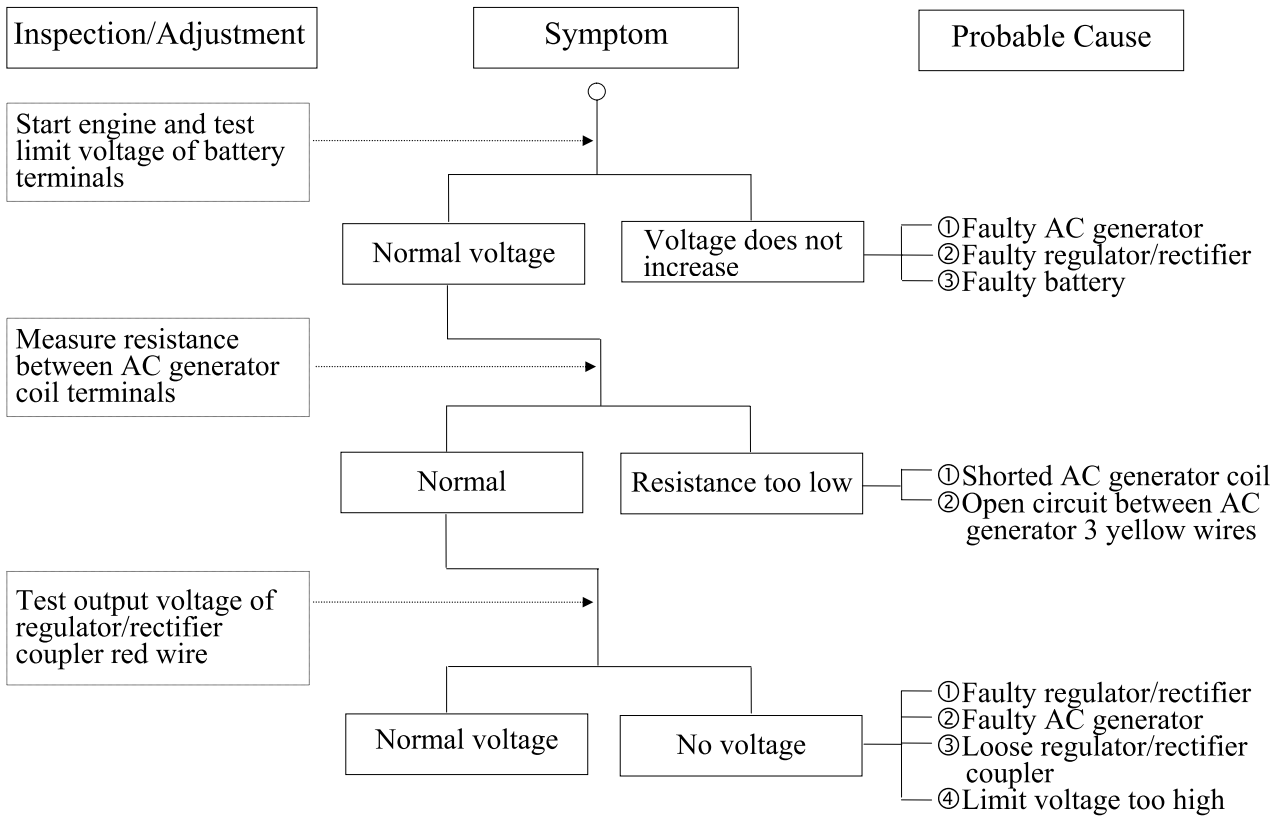

Overcharging

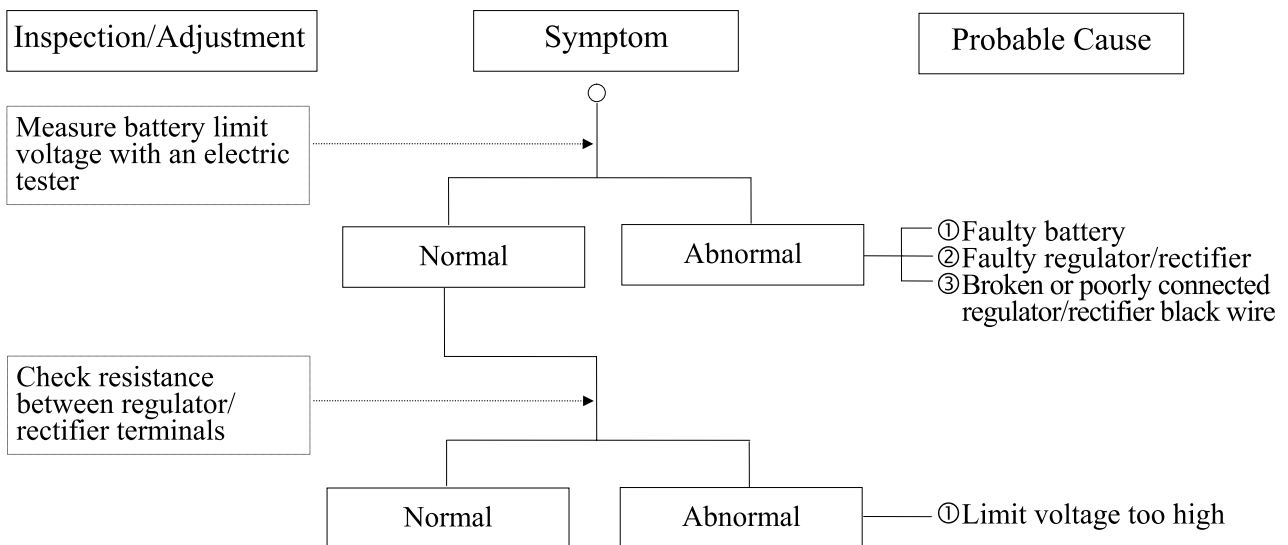

1. GENERAL INFORMATION

FUEL GAUGE

1. Pointer does not register correctly (Ignition switch ON)

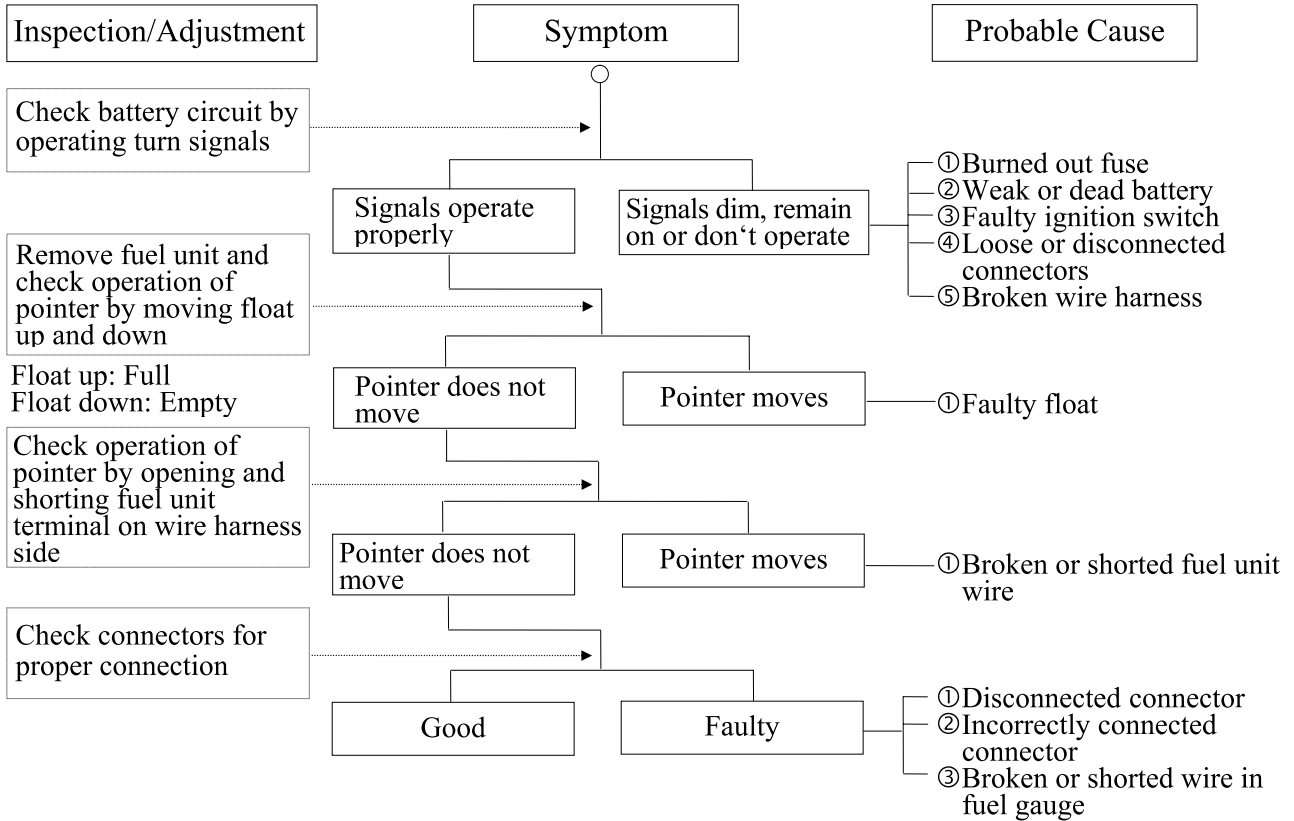

2. Pointer fluctuates or swings (Ignition switch ON)

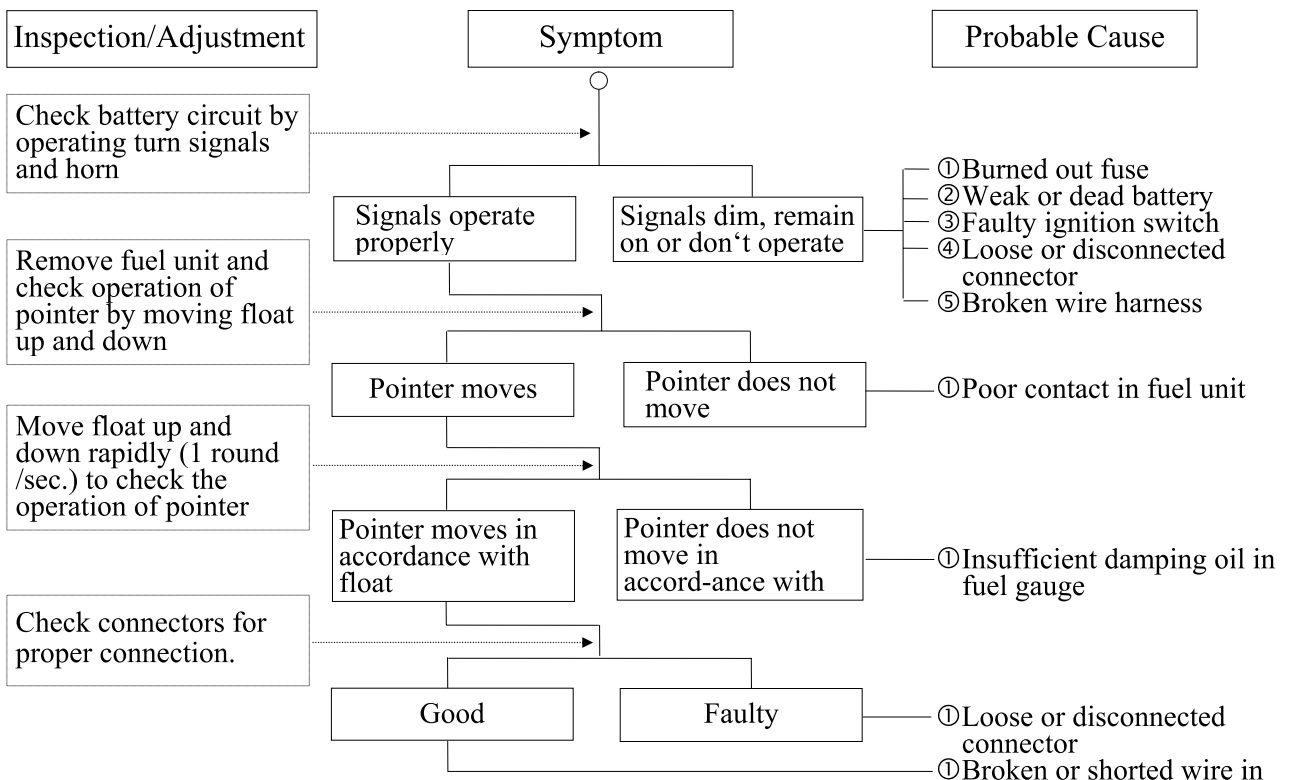

1. GENERAL INFORMATION

fuel gauge

STEERING HANDLEBAR DOES NOT TRACK STRAIGHT

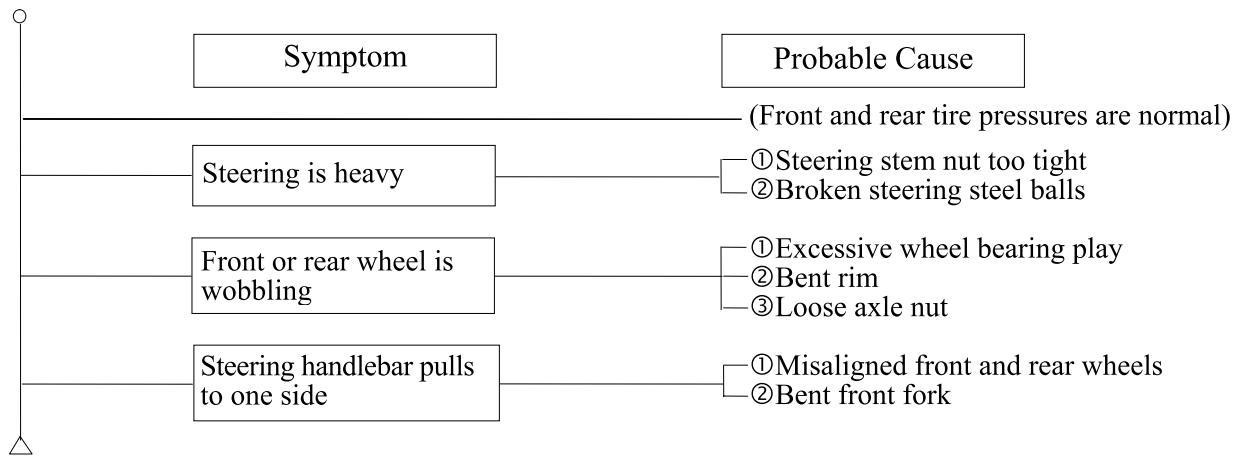

POOR SUSPENSION PERFORMANCE

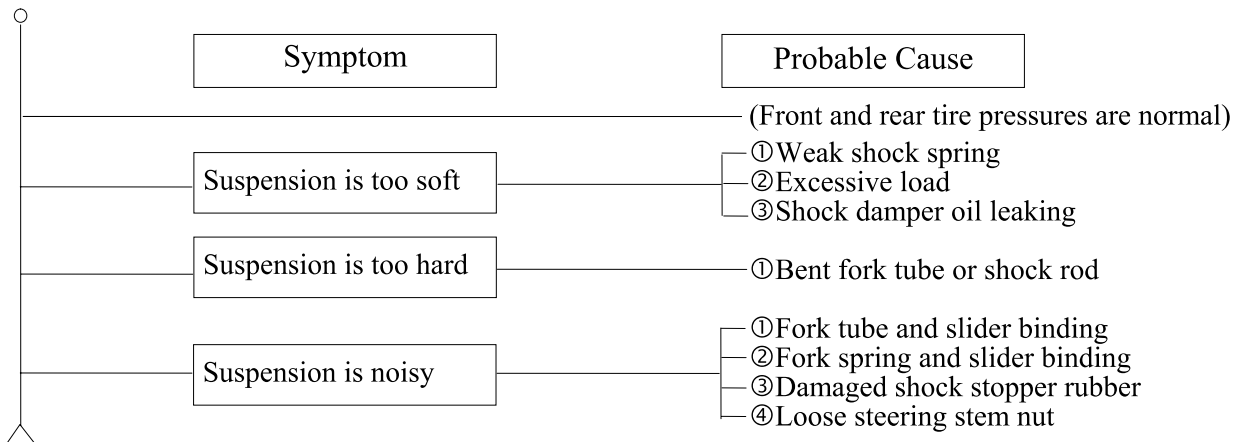

POOR BRAKE PERFORMANCE

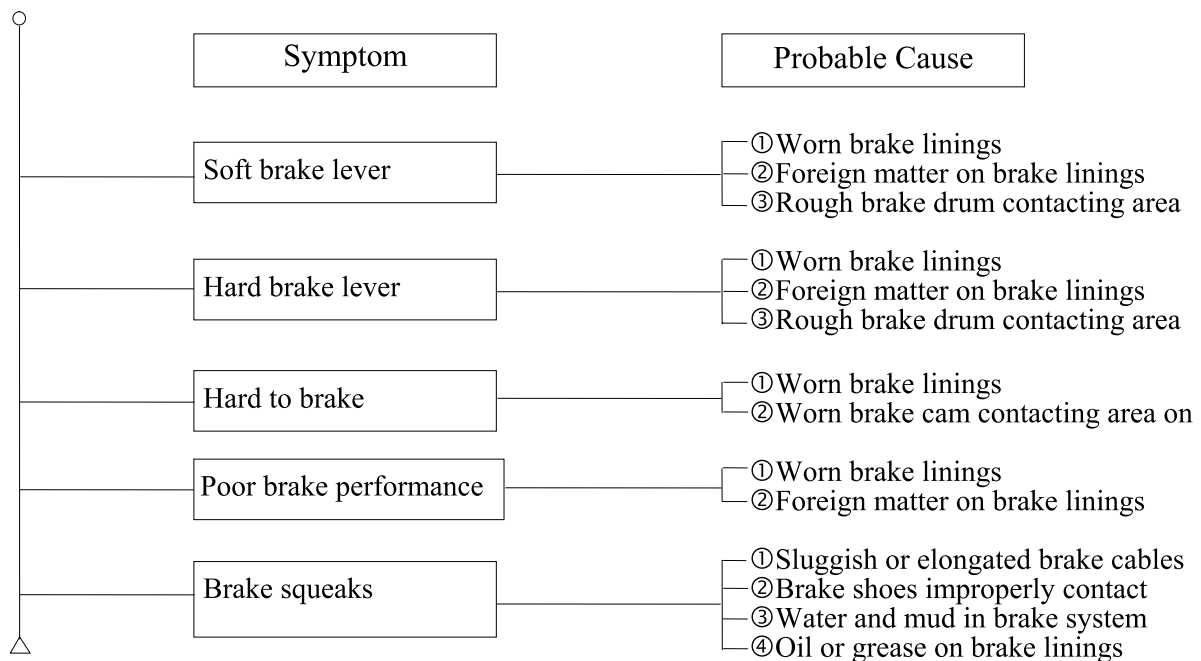

1. GENERAL INFORMATION

2. FRAME COVERS/ EXHAUST MUFFLER

2

FRAME COVERS/EXHAUST MUFFLER

SCHEMATIC DRAWING -----	2- 1
SERVICE INFORMATION-----	2- 2
TROUBLESHOOTING-----	2- 2
FRAME COVERS REMOVAL -----	2- 3
EXHAUST MUFFLER -----	2-17

2. FRAME COVERS/ EXHAUST MUFFLER

MYROAD 700i

SCHEMATIC DRAWING

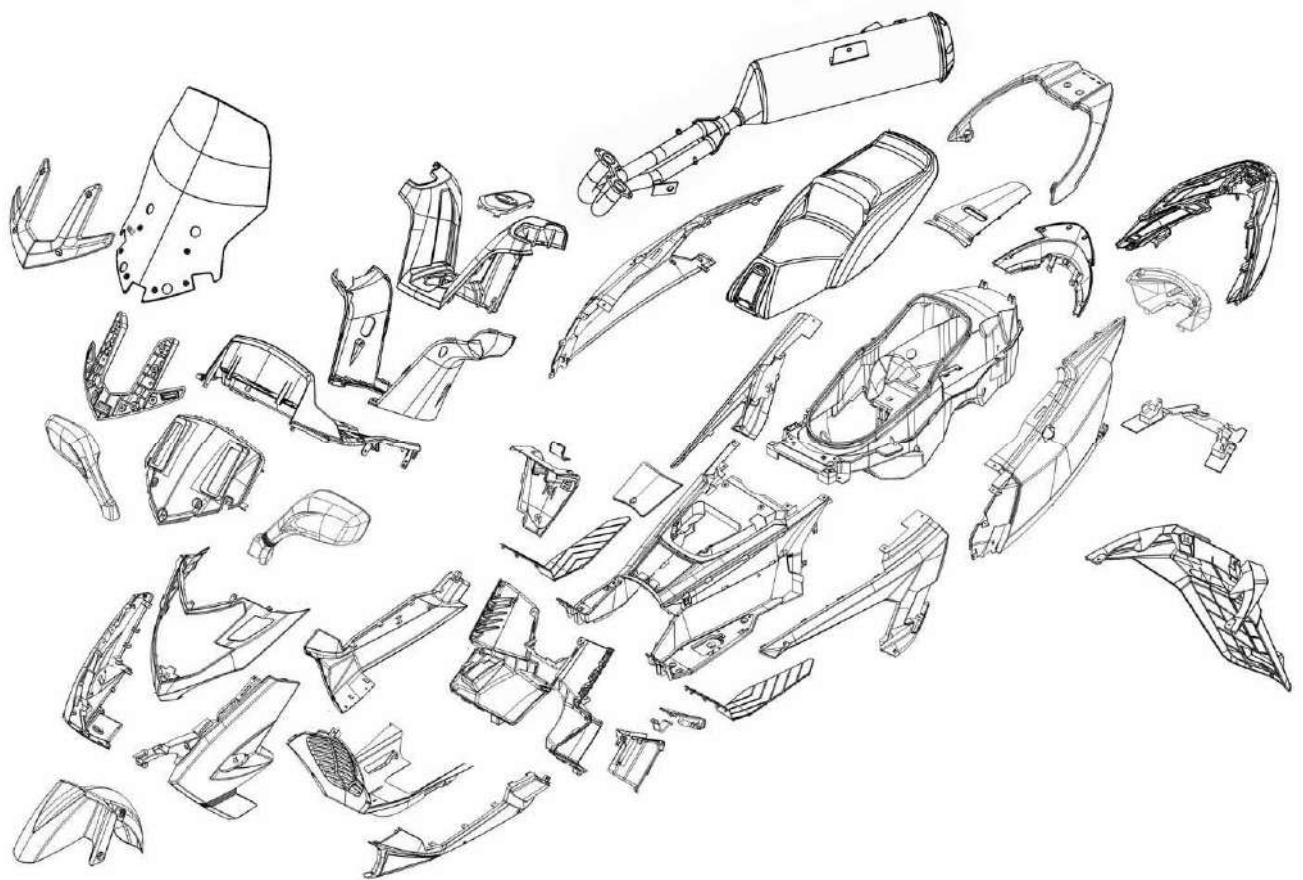

2. FRAME COVERS/ EXHAUST MUFFLER

MYROAD 700i

SERVICE INFORMATION

GENERAL INSTRUCTIONS

- When removing frame covers, use care not to pull them by force because the cover joint claws may be damaged.
- Make sure to route cables and harnesses according to the Cable & Harness Routing.

TORQUE VALUES

Muffler mount bolt	3.2~3.8 kg-m
Exhaust pipe joint nut	1.0~1.4 kg-m
Exhaust pipe band bolt	1.0~1.4 kg-m

TROUBLESHOOTING

Noisy exhaust muffler

- Damaged exhaust muffler
- Exhaust muffler joint air leaks

Lack of power

- Caved exhaust muffler
- Clogged exhaust muffler
- Exhaust muffler air leaks

2. FRAME COVERS/ EXHAUST MUFFLER

FRAME COVERS REMOVAL

SEAT

REMOVAL

Unlock the seat with the ignition key.
Open the seat.

Remove the two nuts and seat damper unit.

Remove the two nuts and the seat.

INSTALLATION

Installation is in the reverse order of the removal.

After installation, check the seat installation by moving the seat.

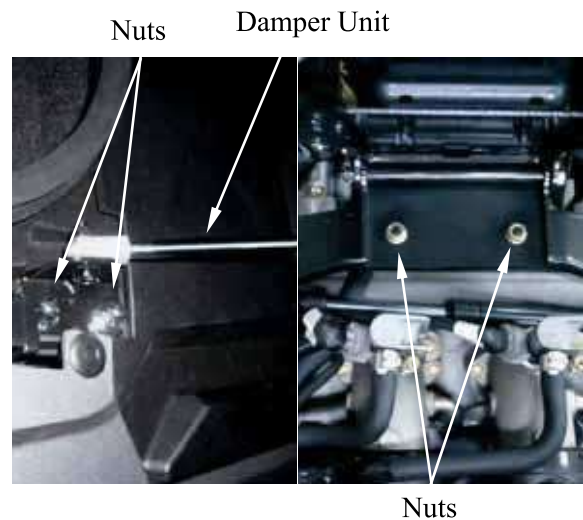

LUGGAGE BOX REMOVAL

After removal the seat, side cover, carrier, body cover, then you can remove the luggage box.

Remove the screws and bolts.

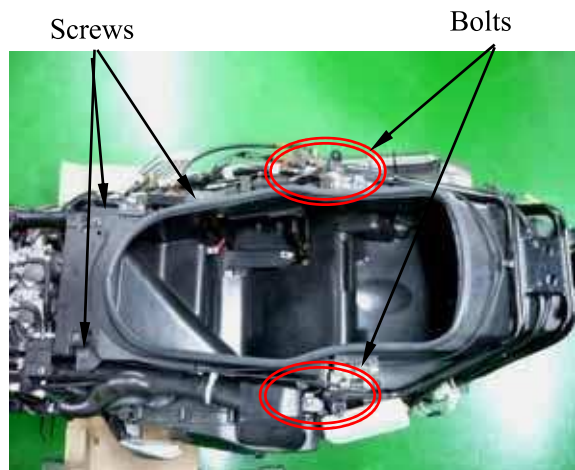

Raise the luggage box, disconnect the luggage box light and accessory socket connectors.

INSTALLATION

Installation is in the reverse order of removal.



Luggage box light Connector

2. FRAME COVERS/ EXHAUST MUFFLER

FUEL PUMP LID

REMOVAL

Remove the bolt and lid.

INSTALLATION

Installation is in the reverse order of removal.



Fuel pump Lid

REAR SPOILER

REMOVAL

Unlock the seat with the ignition key.
Open the seat.

Remove the rubber cap.

Remove four bolts and rear spoiler.

INSTALLATION

Installation is in the reverse order of removal.

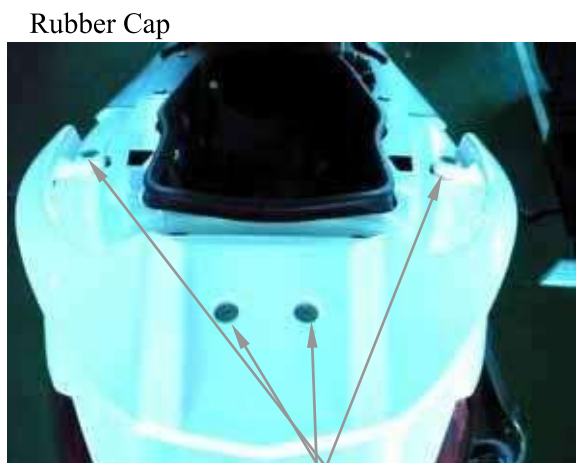

Bolts

FRONT FENDER

REMOVAL

Remove the six bolts and front fender.

INSTALLATION

Installation is in the reverse order of removal.



Bolts

2. FRAME COVERS/ EXHAUST MUFFLER

UPPER HANDLEBAR COVER

REMOVAL

Remove four screws and upper handlebar cover.

INSTALLATION

Installation is in the reverse order of removal.



Screws

RIGHT/LEFT SIDE COVERS REMOVAL

After removing seat, the priority you should remove would be side covers, there are some screws and bolts hiding in these parts.

Remove the two bolts and side covers



Bolts

Side Cover

Remove the hex bolt and foot step.



Hex Bolt

Foot step

2. FRAME COVERS/ EXHAUST MUFFLER

Remove the side cover following the way of picture showing.

Specially notice not to damage the tabs on the side covers, especially the hook structures on the end of side covers.



Be careful not to damage the tabs on the side covers.



Floor Mat

RIGHT/LEFT FLOOR SKIRT REMOVAL

Remove the floor mat.

Remove the right and left center body cover .



2. FRAME COVERS/ EXHAUST MUFFLER

Remove the seven screws.

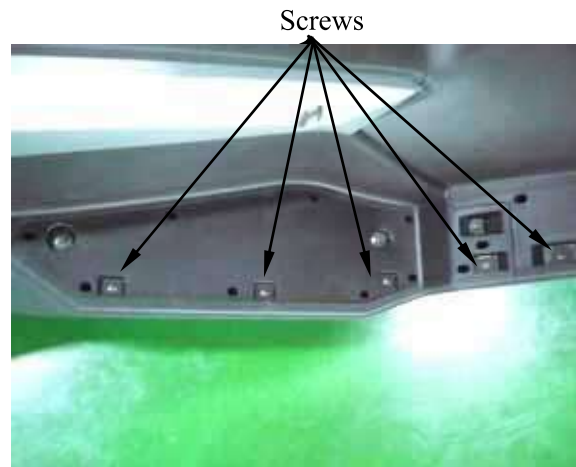

Remove two screws.

Remove the floor skirt.

Be careful not to damage the tabs on the floor skirt.

INSTALLATION

Installation is in the reverse order of removal.



FLOORBOARD

REMOVAL

Remove right and left center body cover.

Remove the right and left floor skirt.

Remove the luggage box.

Remove six bolts, four screws and floorboard.

INSTALLATION

Installation is in the reverse order of removal.

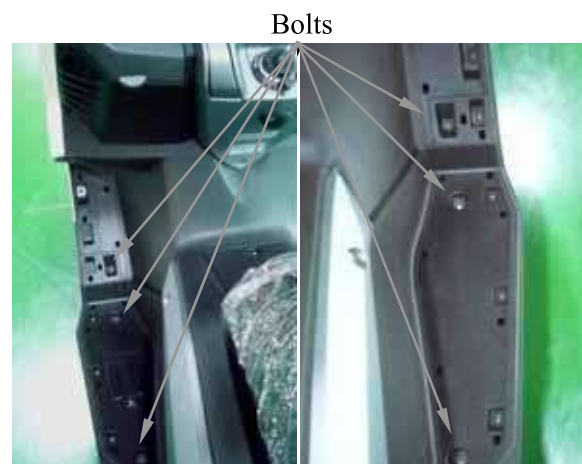

2. FRAME COVERS/ EXHAUST MUFFLER

LICENCE LIGHT REMOVAL

Remove two screws.
Disconnect the license light connector and
remove the license light.

INSTALLATION

Installation is in the reverse order of removal.



Screws



Connector

REAR FENDER REMOVAL

Remove the licence light.

Remove two screws.



Screws

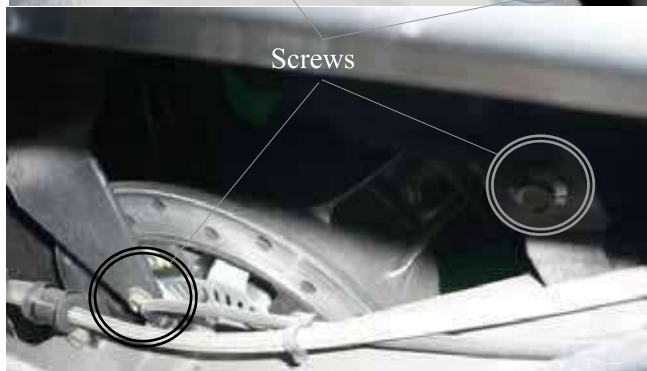

Remove two nuts and rear fender.

INSTALLATION

Installation is in the reverse order of removal.

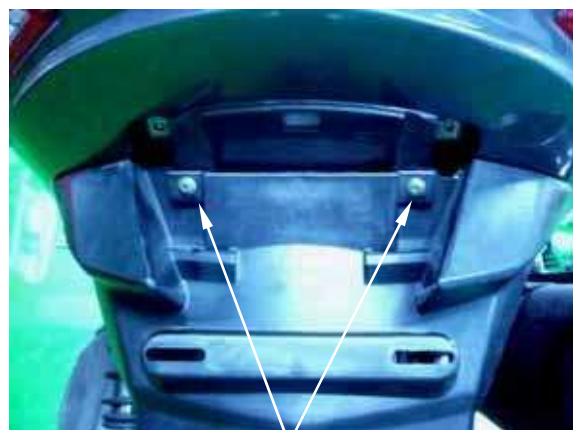

Screws

2. FRAME COVERS/ EXHAUST MUFFLER

RIGHT/LEFT SIDE BODY COVER REMOVAL

Remove the luggage box.
Remove the rear spoiler.

Remove two bolts.



Taillight/Rear Turn Signal Light Connector

Raise the side body cover, disconnect the taillight/rear turn signal light connector and remove the side body cover.

INSTALLATION

Installation is in the reverse order of removal



Body cover

REAR BODY COVER REMOVAL

Remove the luggage box.
Remove the rear spoiler.

Remove two screws and rear body cover.

Be careful not to damage the tabs on the rear body cover.

INSTALLATION

Installation is in the reverse order of removal.



2. FRAME COVERS/ EXHAUST MUFFLER

TAILLIGHT/REAR TURN SIGNAL LIGHT

REMOVAL

Remove the side and rear body cover.

Remove bolts and taillight/rear turn signal light.

INSTALLATION

Installation is in the reverse order of removal.

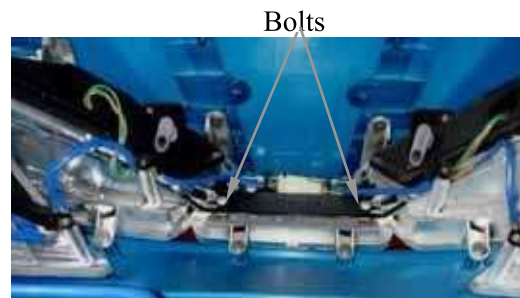

Bolts

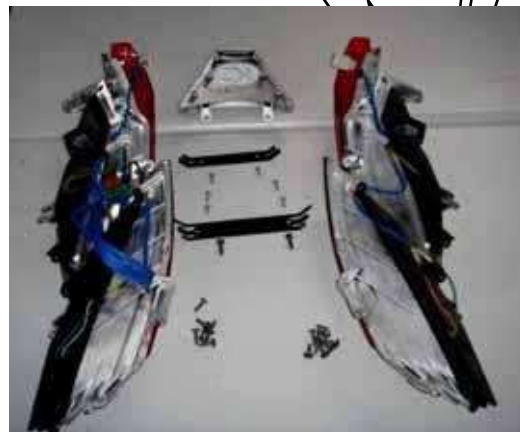

REAR LOWER COVER

REMOVAL

Remove the side body cover.

Remove the rear lower cover.



Rear Lower Cover

REARVIEW MIRROR

REMOVAL

Remove bolts lid.

Remove three bolts and rearview mirror.



Bolts

2. FRAME COVERS/ EXHAUST MUFFLER

Remove the two bolts, rearview mirror holder and seat.

INSTALLATION

Installation is in the reverse order of removal

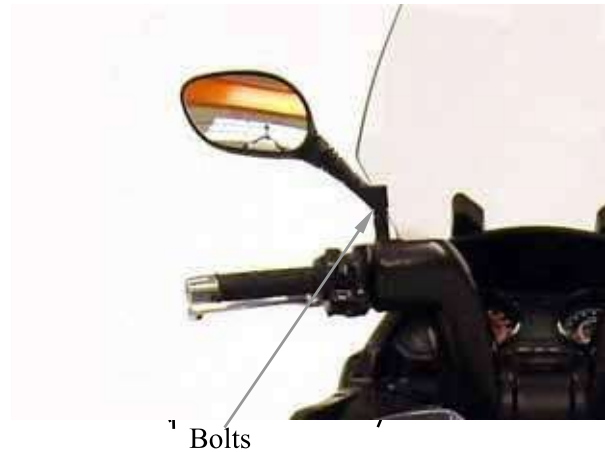

WINDSHIELD

REMOVAL

Remove four screws and windshield garnish.



Remove 6 bolts and windshield.

Be careful not to scratch or damage the windshield surface.

INSTALLATION

Installation is in the reverse order of removal.



2. FRAME COVERS/ EXHAUST MUFFLER

FRONT COVER REMOVAL

The priority to remove is front cover (with head lights, then tunnel leg shield (81141-KKE5), there are some bolts and screws hide inside.

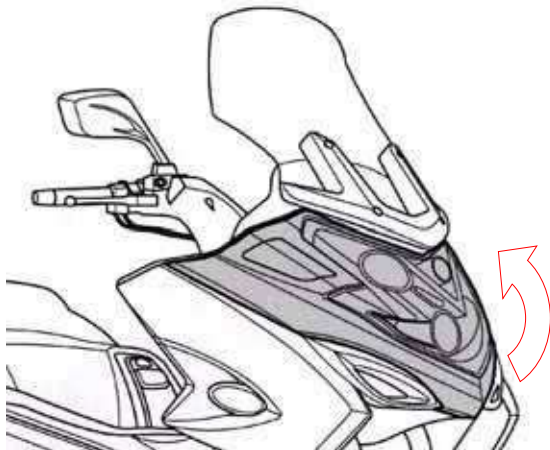

Remove six screws.



Remove two screws.

Remove one screw.

Disconnect headlight and turn signal light connectors.

INSTALLATION

Installation is in the reverse order of removal.

Screws



Screws



Turn Signal Light Connectors

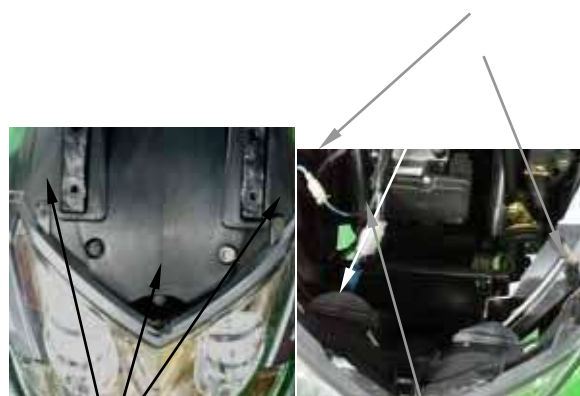

Screw

Headlight Connector

2. FRAME COVERS/ EXHAUST MUFFLER

HEADLIGHT

REMOVAL

Remove the front cover.

Remove 8 screws and headlight.

INSTALLATION

Installation is in the reverse order of removal.



TURN SIGNAL LIGHT

REMOVAL

Remove the front cover.

Remove three screws and turn signal light.

INSTALLATION

Installation is in the reverse order of removal.



FRONT METER VISOR

REMOVAL

Remove the windshield.

Remove the front cover.

Remove four bolts and windshield holder.

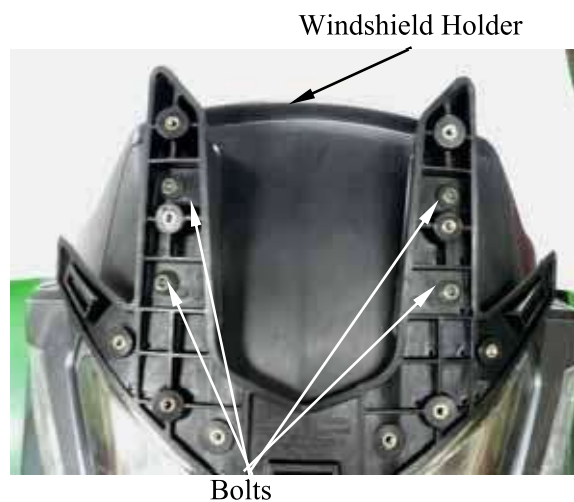

2. FRAME COVERS/ EXHAUST MUFFLER

Remove two screws and front meter visor.

INSTALLATION

Installation is in the reverse order of removal.

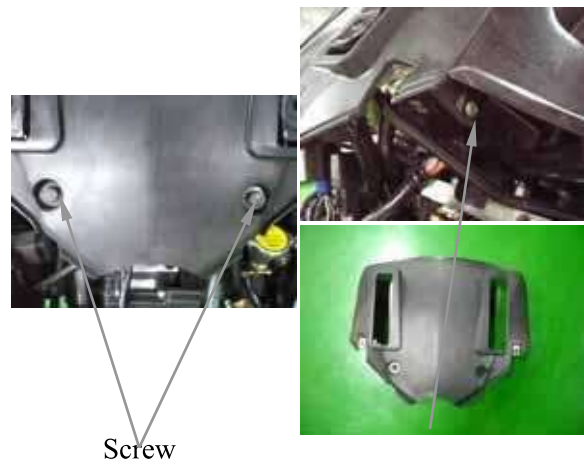

METER PANEL

REMOVAL

Remove the front cover.

Remove the front meter visor.

Remove the tunnel leg shield.

Remove screws from instrument.



Meter Panel

Speedometer Connector

Disconnect the speedometer connector and remove meter panel.

INSTALLATION

Installation is in the reverse order of removal.

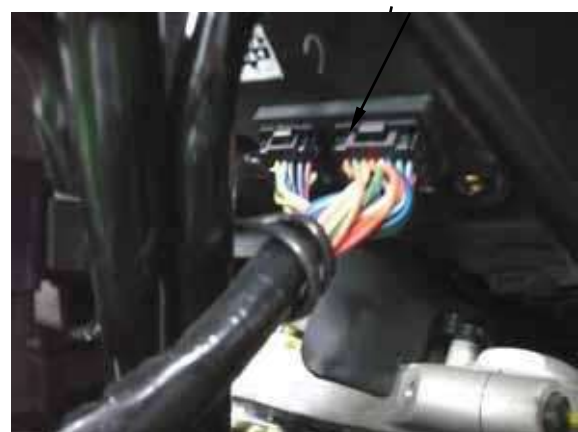

2. FRAME COVERS/ EXHAUST MUFFLER

METER

REMOVAL

Remove the meter panel.

Remove two screws and meter.



INNER COVER

REMOVAL

Remove the front cover.

Remove the floorboard.

Remove the meter panel.

Remove the shutter screw and shutter.

Turn the fuel fill cap garnish counterclockwise and remove it.

Remove three screws and disconnect the fuel fill duct.



2. FRAME COVERS/ EXHAUST MUFFLER

Remove 2 bolts from front panel floor.

INSTALLATION

Installation is in the reverse order of removal.



FRONT LOWER COVER

REMOVAL

Remove the panel floor.

Remove the screws from lower cover.

Remove the lower cover.

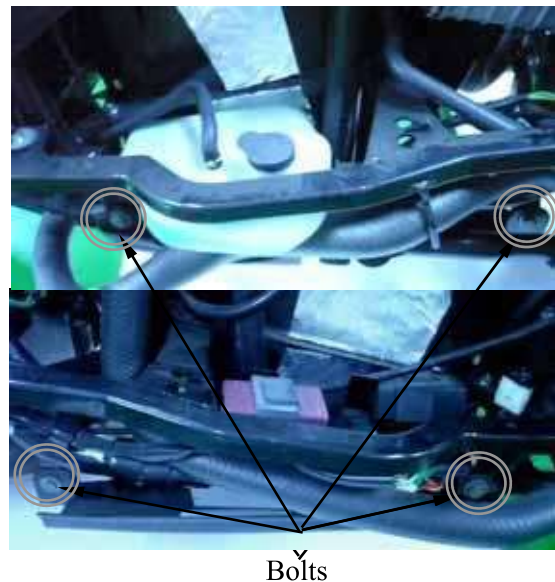

2. FRAME COVERS/ EXHAUST MUFFLER

EXHAUST MUFFLER

REMOVAL

Disconnect the connector with O2 heater/O2 sensor.

Remove screws from muffler protector.

Loosen the rear muffler cover screws.

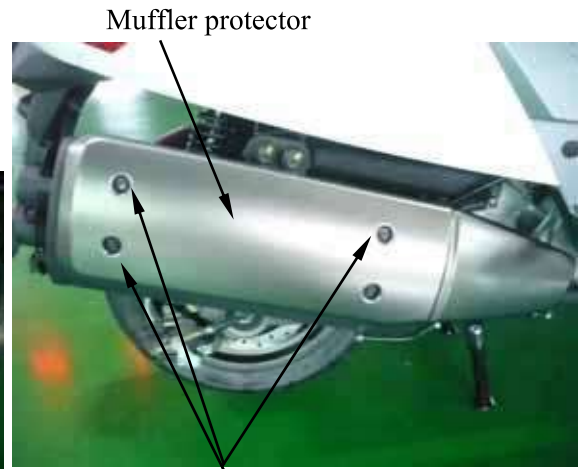

Muffler protector

Screws

Remove the exhaust pipe joint nuts and exhaust pipe.

Remove the muffler.



Bolt



Bolt

INSTALLATION

Replace the gaskets with new ones.

Install the exhaust pipe and tighten the joint nuts.

Torque: 1.0~1.4 kg-m

Install the muffler and tighten the mount bolts.

Torque: 3.2~3.8 kg-m

Install and tighten the band bolts.

Torque: 2.1 kg-m



3. INSPECTION/ADJUSTMENT

3

INSPECTION/ADJUSTMENT

SERVICE INFORMATION-----	3-1
MAINTENANCE SCHEDUL -----	3- 3
FUEL LINE-----	3- 5
THROTTLE OPERATION-----	3- 5
AIR CLEANER -----	3-7
CRANKCASE BREATHER -----	3- 8
SPARK PLUG-----	3- 8
VALVE CLEARANCE -----	3-10
ENGINE OIL -----	3-13
ENGINE OIL FILTER CARTRIDGE -----	3-15
RADIATOR COOLANT -----	3-16
COOLING SYSTEM-----	3-17
TRANSMISSION OIL -----	3-18
BRAKE FLUED -----	3-19
BRAKE PAD WEAR -----	3-20
BRAKE SYSTEM -----	3-20
BRAKE LOCK OPERATION -----	3-21
HEADLIGHT AIM -----	3-22
SIDE STAND-----	3-23
SUSPENSION-----	3-24
WHEELS/TIRES-----	3-24
STEERING HEAD BEARINGS-----	3-25

3. INSPECTION/ADJUSTMENT

SERVICE INFORMATION

GENERAL

- Place the scooter on a level ground before starting any work.
- Gasoline is extremely flammable and is explosive under certain conditions.
- Work in a well ventilated area. Smoking or allowing flames or sparks in the work area or where the gasoline is stored can cause a fire or explosion.
- If the engine must be running to do some work, make sure the area is well ventilated. Never run the engine in an enclosed area.
- The exhaust contains poisonous carbon monoxide gas that may cause loss of consciousness and may lead to death. Run the engine in an open area or with an exhaust evacuation system in an enclosed area.

SPECIFICATIONS

ITEM		SPECIFICATIONS	
Throttle free play		2-6 mm (1/16 – 1/4 in)	
Spark plug		NGK	DR8E
Spark plug gap		0.6~0.7 mm	
Valve clearance	IN	0.16 mm	
	EX	(0.22 mm)	
Engine oil capacity	At draining	2.75 liter	
	Total amount	3.0 liter	
Recommended engine oil		KYMCO 4-stroke oil or equivalent motor oil API service classification: SJ Viscosity: 5W50	
Engine idle speed		1250±100 rpm	
Final reduction oil capacity	At draining	0.36 liter	
	Total amount	0.4 liter	
Recommended final reduction oil		SAE 90	
Recommended brake fluid		DOT 4	
Tire size	Front	120/70-R15	
	Rear	160/60-R14	
Tire air pressure	Solo riding	Front	2 kgf/cm ²
		Rear	2.25 kgf/cm ²
	Two up riding	Front	2 kgf/cm ²
		Rear	2.5 kgf/cm ²
Minimum tire tread depth	Front	1.6 mm (0.06 in)	
	Rear	2.0 mm (0.08 in)	

3. INSPECTION/ADJUSTMENT

TORQURE VALUES

Engine oil drain plug	2.5 kgf•m
Oil strainer screen cap	1.2~1.8 kgf•m
	Apply oil to the threads and seating surface.
Oil filter cartridge	1~2 kgf•m
	Apply oil to the threads and seating surface.
Transmission oil drain bolt	2~3 kgf•m
Transmission oil filler bolt	1.2~1.8 kgf•m

SPECIAL TOOLS

Oil filter cartridge wrench	A120E00061
-----------------------------	------------

3. INSPECTION/ADJUSTMENT

MAINTENANCE SCHEDULE

Perform the pre-ride inspection in the owner's manual at each scheduled maintenance period. This interval should be judged by odometer reading or months, whichever comes first.

I: INSPECT AND CLEAN, ADJUST, LUBRICATE OR REPLACE IF NECESSARY

C: CLEAN R: REPLACE A: ADJUST L: LUBRICATE

ITEM	FREQUENCY	WHICHEVER COMES	ODOMETER READING [NOTE (1)]					
	NOTE	MONTH	6	12	18	24	30	36
AIR CLEANER	NOTE 2		R	R	R	R	R	R
SPARK PLUGS				R		R		R
THROTTLE OPERATION				I		I		I
VALVE CLEARANCE						I		
FUEL LINE				I		I		I
CRANKCASE BREATHER	NOTE 3		C	C	C	C	C	C
ENGINE OIL			R	R	R	R	R	R
ENGINE OIL FILTER			R	R	R	R	R	R
ENGINE OIL STRAINER SCREEN			C	C	C	C	C	C
ENGINE IDLE SPEED			I	I	I	I	I	I
RADIATOR COOLANT	NOTE 6			I		I		R
COOLING SYSTEM				I		I		I
SECONDARY AIR SUPPLY SYSTEM				I		I		I
TRANSMISSION OIL	NOTE 5		R					
DRIVE BELT	NOTE 4					I		I
CLUTCH SHOE WEAR				I	I	I	I	I
BRAKE FLUID	NOTE 7			I	I	I	R	I
BRAKE PAD WEAR				I	I	I	I	I
BRAKE SYSTEM			I		I		I	I
BRAKE LIGHT SWITCH					I		I	I
BRAKE LOCK OPERATION			I	I	I	I	I	I
SIDE STAND					I		I	I
SUSPENSION					I		I	I
HEADLIGHT AIM					I		I	I
NUTS, BOLTS, FASTENERS			I		I		I	I
WHEELS/TIRES					I		I	I
STEERING BEARINGS			I		I		I	I

3. INSPECTION/ADJUSTMENT

NOTE:

- 1 At higher odometer readings, repeat at the frequency interval established here.
- 2 Service more frequently if the scooter is ridden in unusually wet or dusty areas.
- 3 Service more frequently when riding in rain or at full throttle.
- 4 Inspect every 18000 km (12000 mi) after replacement.
- 5 Replace every 1 year, or every 10000km (6000mi), whichever comes first.
- 6 Replace every 2 year, or at indicated odometer interval, whichever comes first.
- 7 Replace every 2 years. Replacement requires mechanical skill.

3. INSPECTION/ADJUSTMENT

- * • Do not smoke or allow flames or sparks in your working area.

FUEL FILTER

Visually check the fuel filter. If accumulation of sediment or clogging is found, replace the fuel filter with a new one.



r

THROTTLE OPERATION

Check for smooth throttle grip full opening and automatic full closing in all steering positions.

Check the throttle cables and replace them if they are deteriorated, kinked or damaged. Lubricate the throttle cables, if throttle operation is not smooth.

Measure the throttle grip free play.

Free Play: 2~6 mm (1/16~1/4 in)

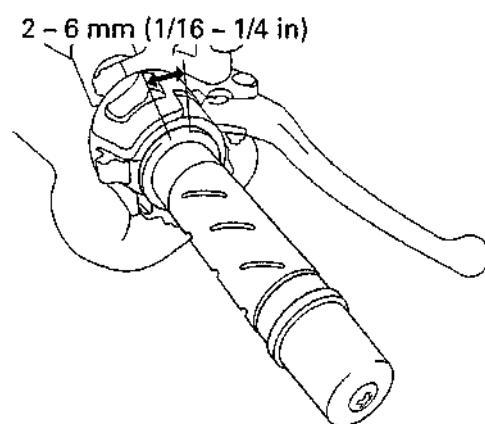

3. INSPECTION/ADJUSTMENT

Throttle grip free play can be adjusted at either end of the throttle cable.

Minor adjustment is made with the upper adjuster.

Slide the rubber sleeve back to expose the throttle cable adjuster.

Adjust the free play by loosening the lock nut and turning the adjuster.

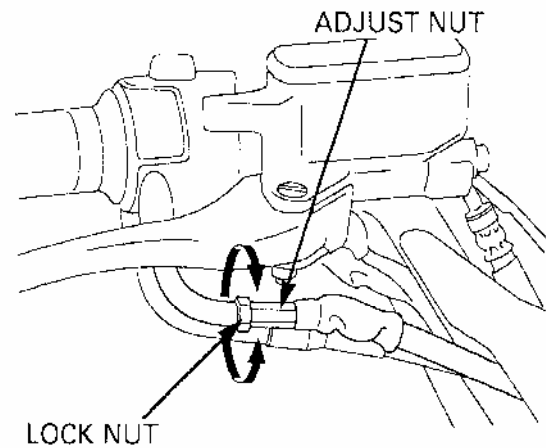

3. INSPECTION/ADJUSTMENT

AIR CLEANER

The air cleaner should be serviced at regular intervals. Service more frequently when riding in unusually wet or dusty areas.

Install a new air cleaner element. Use the KYMCO genuine air cleaner element or an equivalent air cleaner element specified for your model. Using the wrong KYMCO air cleaner element or a non-KYMCO air cleaner which is not of equivalent quality may cause premature engine wear or performance problems.

Air cleaner element removal/installation



Remove the screws and air cleaner housing cover

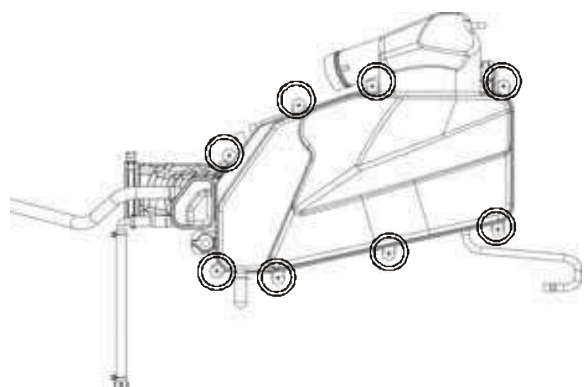

3. INSPECTION/ADJUSTMENT

Remove the air cleaner element.
Check the cleaner element.

Install the removed parts in the reverse order of removal.

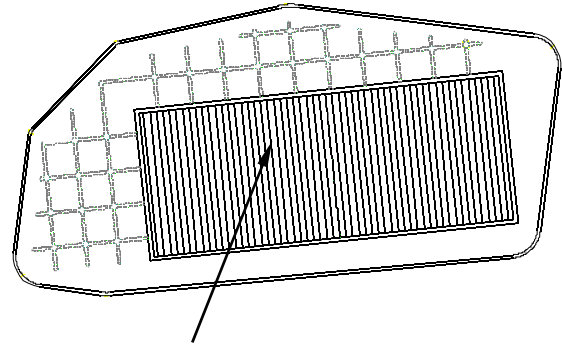

Air Cleaner Element

Air cleaner element removal/installation

Remove the luggage box.

Remove the six screws and air cleaner cover.

CRANKCASE BREATHER

Remove the crankcase breather tube plug from the tube and drain deposits into a suitable container.

Reinstall the crankcase breather tube plug.

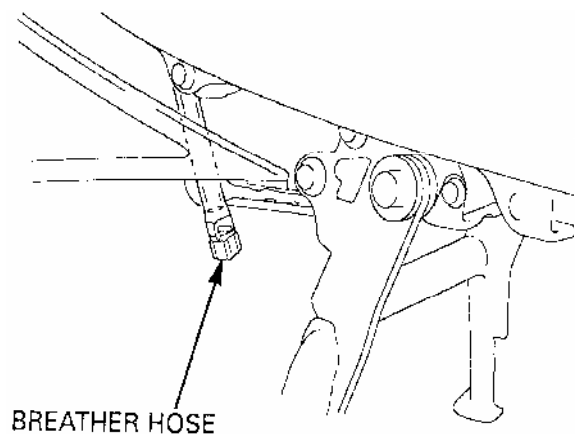

BREATHER HOSE

Service more frequently when riding in rain, at full throttle, or after the scooter is washed or overturned. Service if the deposit level can be seen in the transparent section of the drain tube.

SPARK PLUG

REMOVAL

Remove the spark plug maintenance lid



Spark plug lid

3. INSPECTION/ADJUSTMENT

Remove the spark plug using an equipped spark plug wrench or an equivalent tool.

Inspect or replace as described in the maintenance schedule.



Spark Plug

INSPECTION

Remove the carbon deposits from the spark plug with a small wire brush or a spark plug cleaning machine.

The spark plug should be replaced periodically. Whenever removing the carbon deposits, be sure to observe the operational color of the spark plug's porcelain tip. This color tells you whether or not the standard spark plug is suitable for your type of usage. A normal operating spark plug should be light brown or tan color. If the spark plug is very white or glazed appearing, then it has been operating much too hot. This spark plug should be replaced with the colder plug.

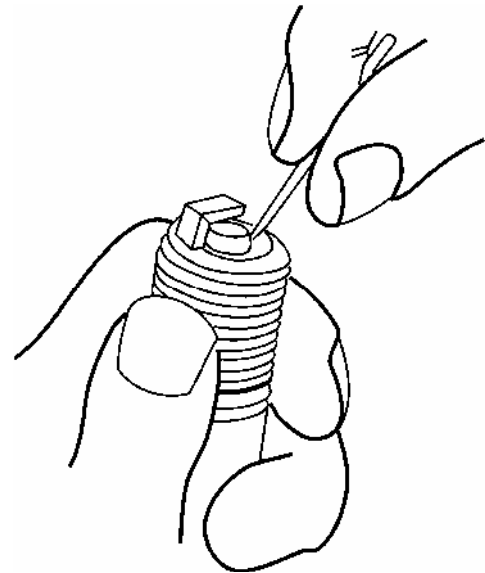

Recommended spark plug: DR8E

Measure the spark plug gap between the center and side electrodes with the feeler gauge.

If necessary, adjust the gap by bending the side electrode carefully.

Spark plug gap:
0.6–0.7 mm (0.024–0.028 in)

Install the spark plug in the cylinder head and hand tighten, then torque to the specification.

Torque: 1.0~1.4 kg·m

Install the spark plug cap.

Install the removed parts in the reverse order of removal.

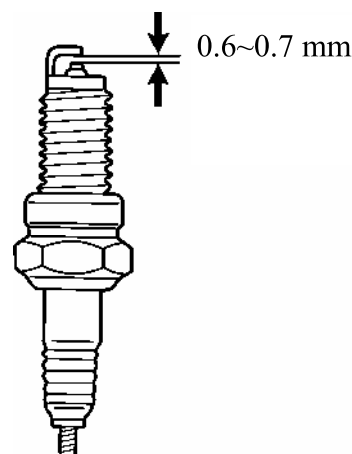

3. INSPECTION/ADJUSTMENT

VALVE CLEARANCE

* Inspect and adjust the valve clearance while the engine is cold (Below 35°C/95°F).

Inspection and adjust

Remove the cylinder head cover.

Remove the timing hole cap and O-ring.
Remove the crankshaft hole cap and O-ring.

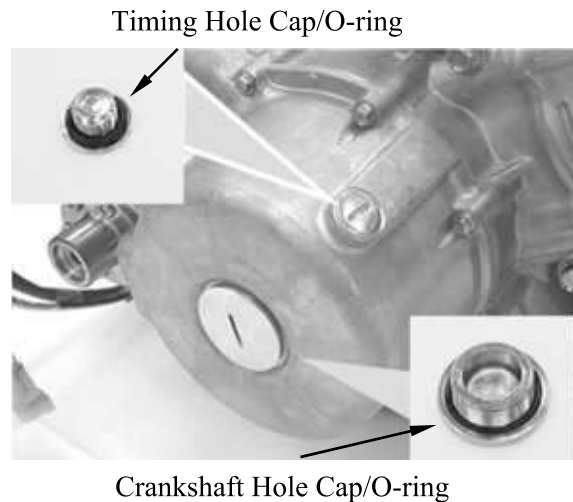

Turn the crankshaft clockwise and align the "T" mark on the flywheel with the index mark on the right crankcase cover.

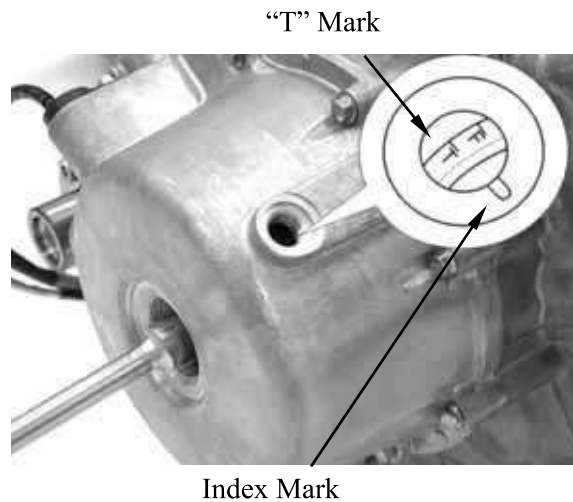

The punch marks "in" and "ex" on the camshaft should be aligned with the boundary of cylinder head as shown.

If the punch marks on the camshaft are facing downward, turn the crankshaft clockwise one full turn (360°) and the punch marks are facing upward.

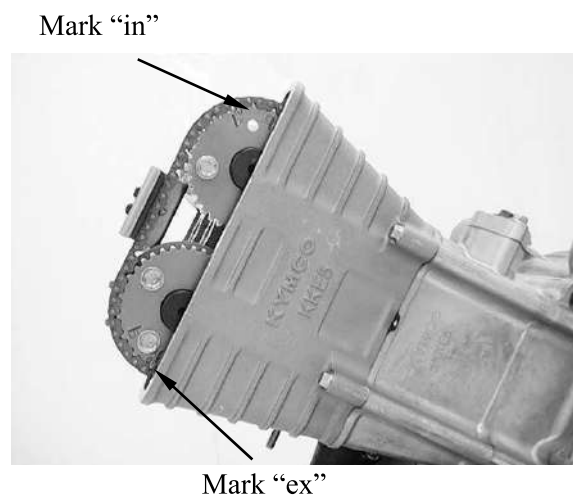

3. INSPECTION/ADJUSTMENT

Insert the feeler gauge between the valve lifter and the cam lobe.
Check the valve clearance for the valves using a feeler gauge.

Valve Clearance

IN:0.16 mm(0.006 in)

EX:0.22 mm(0.009in)

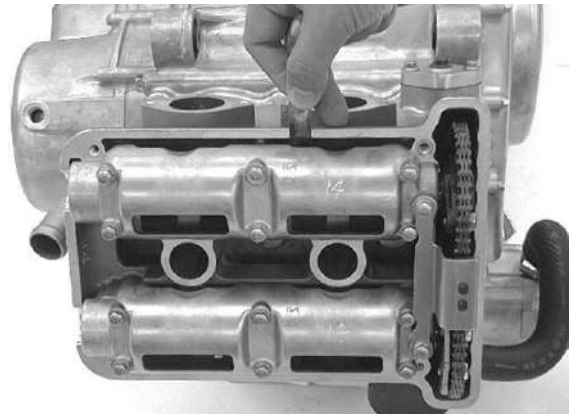

Remove the camshaft.

Remove the valve lifters and shims.

The shims may stick to the inside of the valve lifter. Don't allow the shims to fall into the crankcase.

Mark all of shims and valve lifters to ensure correct reassembly in original locations.

The valve lifter can be easily removed with a valve lapping tool or magnet.

The shims can be easily removed with tweezers or magnet.

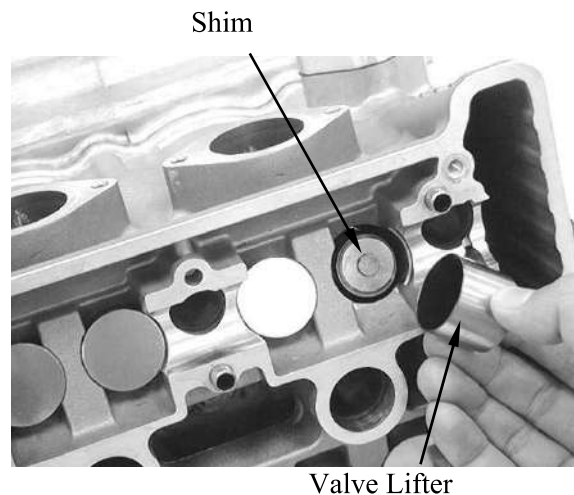

Clean the valve shim contact area in the valve lifter with compressed air.

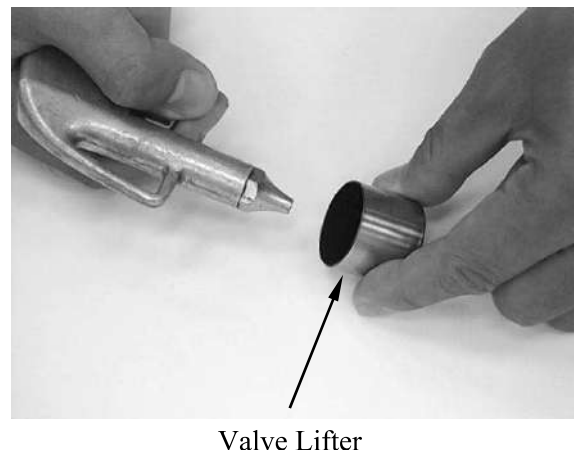

3. INSPECTION/ADJUSTMENT

Measure the shim thickness and record it.
Calculate the new shims thickness using the equation below.

$$A+C=B+D$$

- A: New shim thickness
- B: Record valve clearance
- C: Specified valve clearance
- D: Old shim thickness

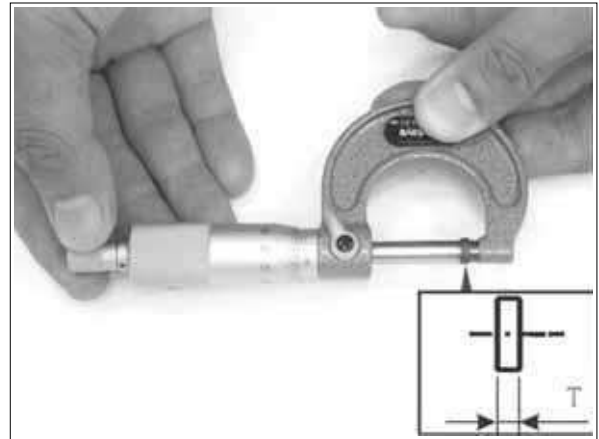

Grade number	"T" Thickness	Mark
01	1.80	180
02	1.85	185
03	1.90	190
04	1.95	195
05	2.00	200
06	2.05	205
07	2.10	210
08	2.15	215
09	2.20	220
10	2.25	225
11	2.30	230
12	2.35	235
13	2.40	240
14	2.45	245
15	2.50	250
16	2.55	255
17	2.60	260
18	2.65	265
19	2.70	270
20	2.75	275
21	2.80	280
22	2.85	285
23	2.90	290
24	2.95	295
25	3.00	300

Make sure the correct shim is selected by measuring it with a micrometer.

Reface the valve seat if carbon deposits result in a clearance of over 2.8mm

Install the removed parts in the reverse order of removal.

3. INSPECTION/ADJUSTMENT

ENGINE OIL

OIL LEVEL INSPECTION

Start the engine and let it idle for 2 – 3 minutes.

Turn off the engine and support the scooter level surface.

Check the engine oil level. The level must be maintained between the upper H (1) and lower level L (2) marks on the oil inspection screen (3).

If the oil level is below or near the lower level line, add the recommended engine oil until the oil level is to the upper level.

Change the engine oil with the engine at normal operating temperature and the scooter on its center stand to assure complete and rapid draining.

Remove the oil filler cap from the right crankcase cover.

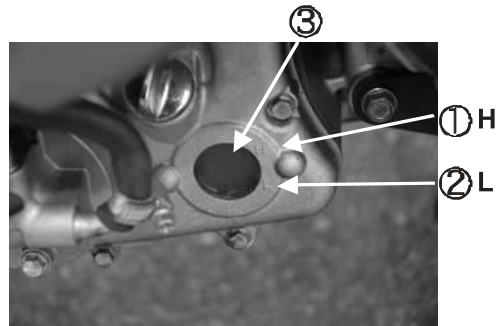

Engine oil capacity: 3.0 L
Engine oil exchanging capacity: 2.6 L

Recommended engine oil:

KYMCO 4-stroke oil or equivalent motor oil API service classification: SJ
 Viscosity: SAE 5W50

* Other viscosities shown in the chart may be used when the average temperature in your riding area is within the indicated range.

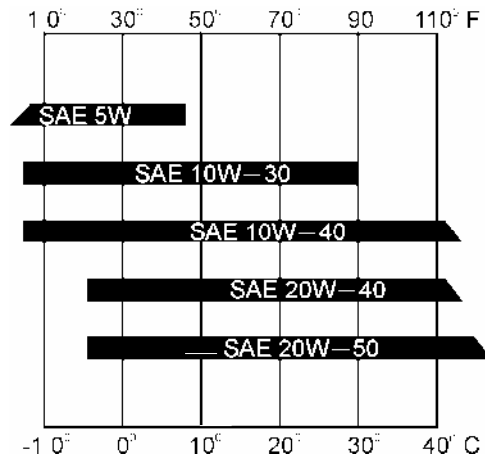

ENGINE OIL & STARINER SCREEN

When running in very dusty conditions, oil changes should be performed more frequently than specified in the maintenance schedule.

Please dispose of used engine oil in a manner that is compatible with the environment. We suggest you take it in a sealed container to your local recycling center or service station for reclamation. Do not throw it in the trash or pour it on the ground or down a drain.

Used engine oil may cause skin cancer if repeatedly left in contact with the skin for prolonged periods. Although this is unlikely unless you handle used oil on a daily basis, it is still advisable to thoroughly wash your hands with soap and water as soon as possible after handling used oil.

3. INSPECTION/ADJUSTMENT

Place a drain pan under the crankcase and remove the oil strainer cap.

The setting spring and oil strainer screen will come out when the oil strainer cap is removed.

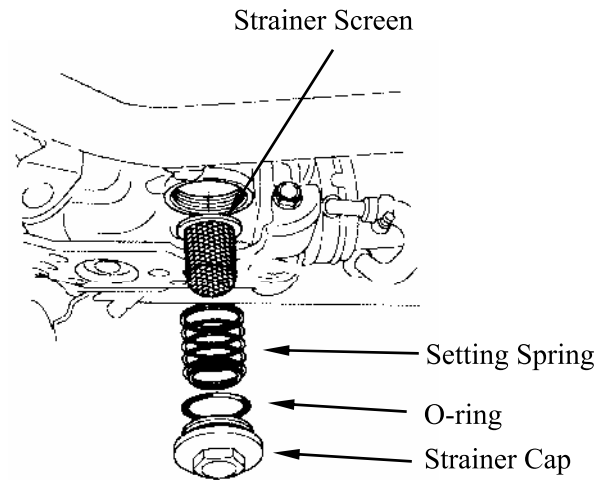
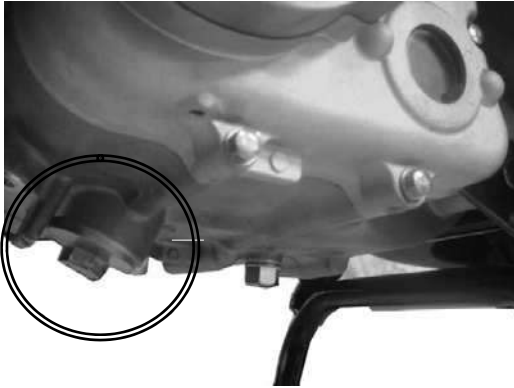

Clean the oil strainer screen.

After draining the oil completely, install the strainer screen and setting spring into the engine.

Oil Strainer Screen

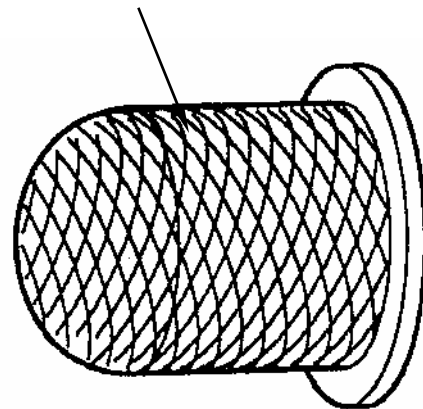

Strainer Screen

Apply clean engine oil to the strainer cap threads, flange surface and a new O-ring. Install and tighten the strainer cap with a new O-ring.

Torque: 1~2 kgf•m

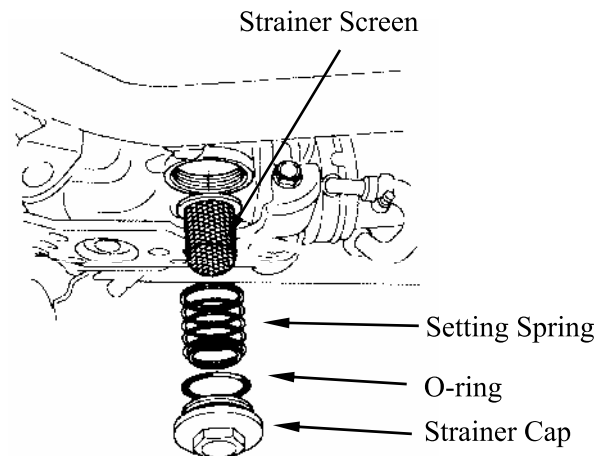

3. INSPECTION/ADJUSTMENT

Fill the crankcase with the recommended engine oil.

Engine oil capacity: 3.0 L
Engine oil exchanging capacity: 2.6 L

Install the oil filler cap.
Check the engine oil level.
Make sure there are no oil leaks



ENGINE OIL FILTER CARTRIDGE REPLACEMENT

Drain the engine oil.

Remove and discard the oil filter cartridge using the special tool.

Tool:
Oil filter wrench: A120E00061

Apply clean engine oil to the new oil filter cartridge threads, flange surface and a new O-ring.

Install the new oil filter cartridge and tighten it to the specified torque.

O-ring

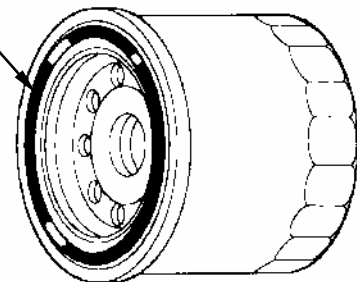

Torque: 2.4~3 kgf•m

Refill the engine oil

3. INSPECTION/ADJUSTMENT

RADIATOR COOLANT

Place the scooter on its center stand.

The reserve tank is under left footboard.

Check the coolant level through the inspection window (1) at the left side skirt while the engine is at the normal operating

temperature with the scooter in an upright position. If the coolant level is below the LOWER level mark (3), remove the left floor

mat, remove the lid screw and reserve tank lid and the

Reserve tank cap (4) and add coolant mixture until it reaches the upper level mark (2).

Remove the left floor mat and remove screw and reserve tank lid.

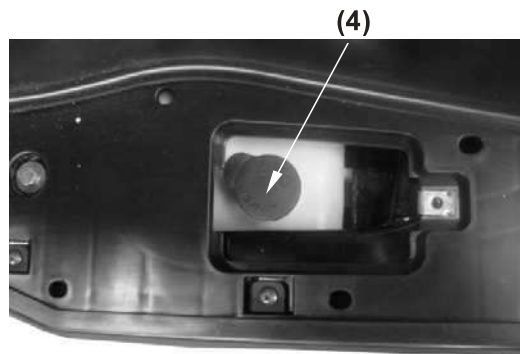
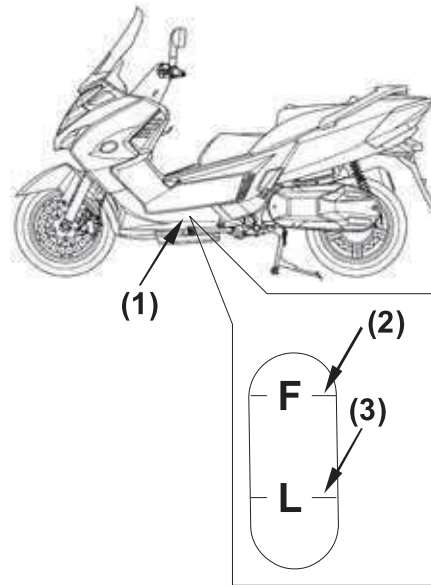

Remove reserve tank cap.

Check to see if there are any coolant leaks when the coolant level decrease very rapidly.

If reserve tank becomes completely empty, there is a possibility of air getting into the cooling system.

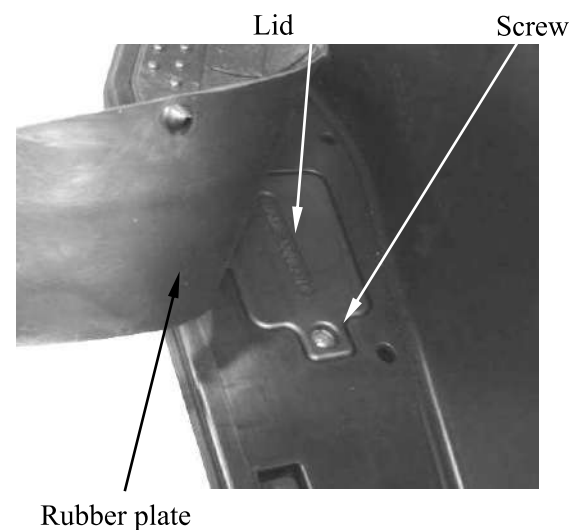

Be sure to remove all air from the cooling system.

Reinstall the filler cap.

3. INSPECTION/ADJUSTMENT

COOLING SYSTEM

Check for any coolant leakage from the water pump, radiator hoses and hose joints.
Check the radiator hoses for cracks or deterioration and replace if necessary.
Check that all hose clamps are tight.

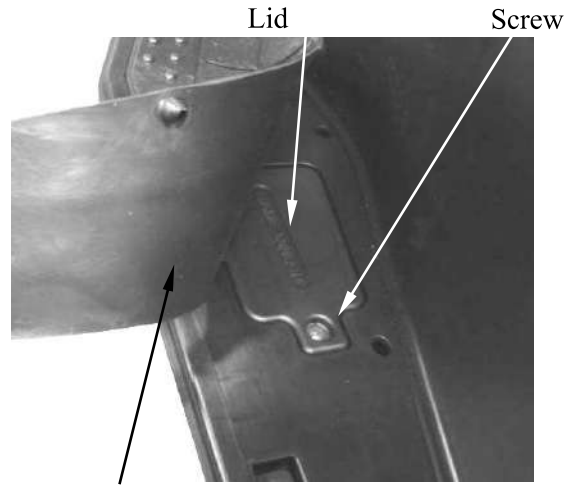

Check the radiator air passages for clogs or damage.
Straighten any bent fins, and remove insects, mud or other obstructions with compressed air or low water pressure.
Replace the radiator if the air flow is restricted over more than 20% of the radiating surface.

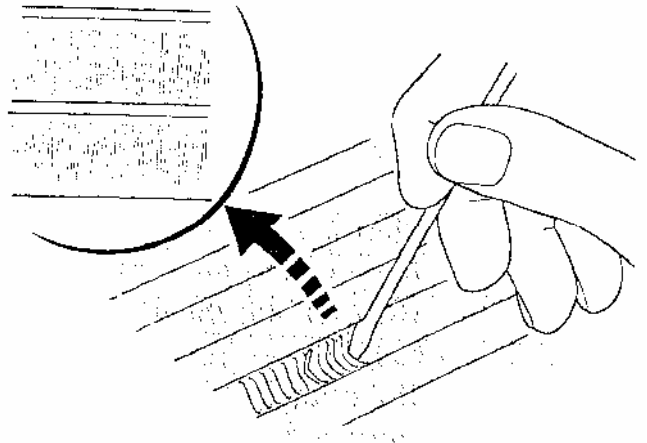

3. INSPECTION/ADJUSTMENT

TRANSMISSION OIL OIL CHANGE

Place the scooter in its center stand.

Remove the transmission oil drain bolt (1) and the transmission oil filler bolt (2), slowly turn the rear wheel and drain the oil.

After draining the oil completely, install the oil drain bolt with a new sealing washer and tighten it.

Torque: 2~3 kgf•m



oil drain bolt (1)

Fill the transmission case with recommended oil.

Recommended transmission oil: SAE 90

Oil capacity: 0.40 L

Oil exchanging capacity: 0.32L

Install the transmission oil filler bolt with a new sealing washer and tighten it.

oil filler bolt (2)

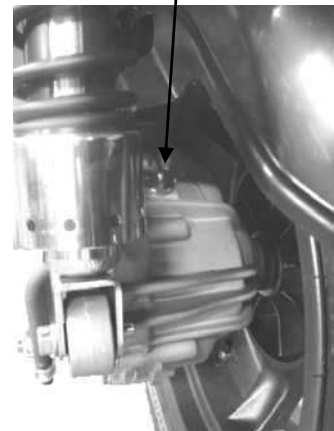

3. INSPECTION/ADJUSTMENT

BRAKE FLUID

- *
 - ♦ Do not mix different type of fluid, as they are not compatible with each other.
 - ♦ Do not allow foreign material to enter the system when filling the reservoir.
 - ♦ Avoid spilling fluid on painted, plastic or rubber parts. Place a rag over these parts whenever the system is serviced.



Brake fluid level inspection:

With the scooter in an upright position, check the front and rear fluid level. The level should be above the lower level mark. If the level is at or below the lower level mark "L", check the brake pads for wear.

Worn break pads should be replaced immediately. If the pads are not worn, have your brake system inspected for leaks. Do not ride your scooter unless the brakes are in perfect working order.

Brake fluid type: DOT 4 (from a sealed container)

Note: Other checks- Make sure there are no fluid leaks. Check for deterioration or cracks in the hoses and fittings.

3. INSPECTION/ADJUSTMENT

BRAKE PAD WEAR

Brake pad wear depends upon the severity of usage, the type of riding, and road conditions. (Generally, the pads will wear faster on wet and dirty roads.) Inspect the pads at each regular maintenance interval.

Front/Rear brake

Check the cutout in each brake pad, the cutout should be visible, indicating that brake pad is not worn down to the brake rotor. If either pad is worn to the cutout, replace both pads as a set.

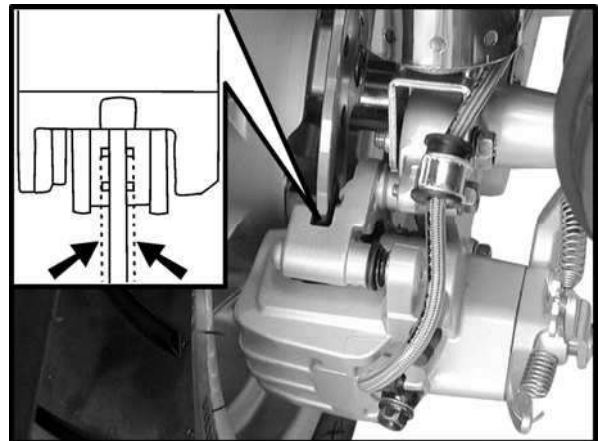

BRAKE SYSTEM

INSPECTION

Check the free play of front/rear brake lever.

Standard of free play: 10~20 mm

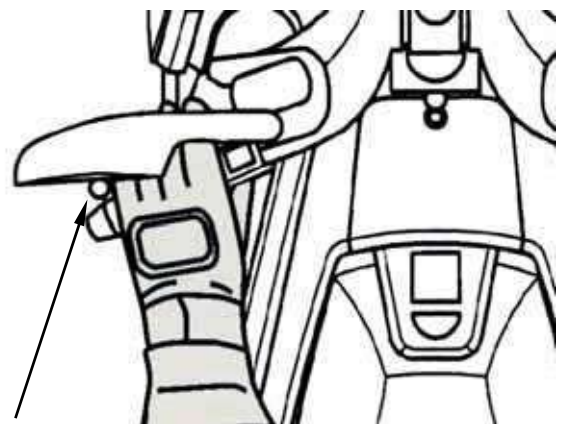

Rear Brake Lever

3. INSPECTION/ADJUSTMENT

Operate the rear brake lever.
 Make sure the front wheel does not turn while the brake lever is operated.

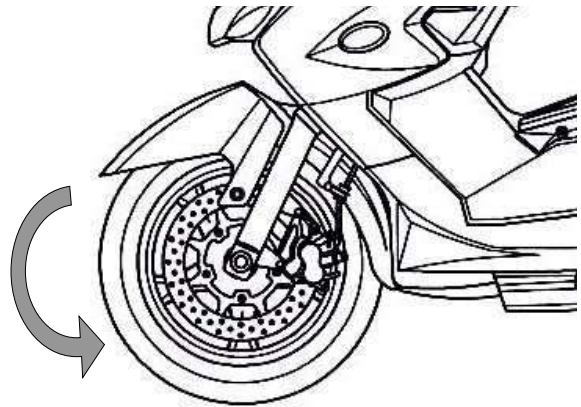

Firmly apply the brake lever and check that no air has entered the system.
 If the lever feels soft or spongy when operated, bleed the air from the system.

Inspect the brake hose and fittings for deterioration, cracks and signs of leakage.
 Tighten any loose fittings.
 Replace hoses and fittings as required.

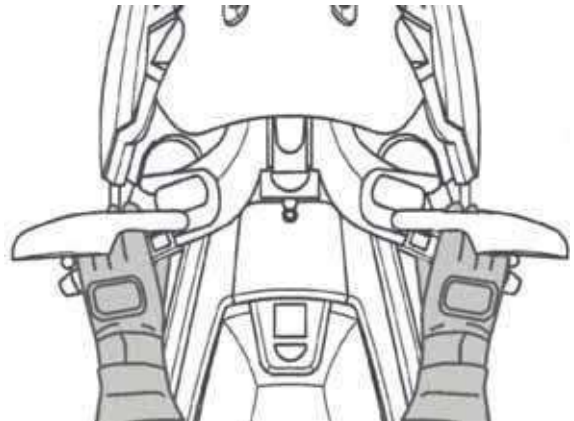

BRAKE LOCK OPERATION

INSPECTION

Stop the engine and put the scooter on its center stand on level ground.

Pull up the parking brake lever slowly and check the parking brake lever stroke.

Parking brake lever stroke: 3 – 6 cm

If out of specification, adjust the parking brake lever.



3. INSPECTION/ADJUSTMENT

ADJUSTMENT

Place the scooter on its center stand.
Release the parking brake lever lock.
Pull up the parking brake lever.

Loosen the lock nut.
Turn the adjust bolt until you feel resistance when turn the rear wheel by your hand.
Hold the adjust bolt and tighten the lock nut securely.

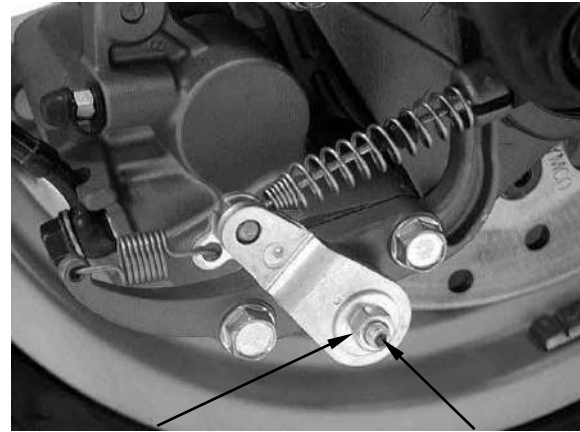

Nut

Bolt

Release the parking brake lever.
Make sure the rear wheel turns smoothly.

Pull the parking brake lever slowly and check the lever stroke.

Standard: 3 – 6 notches

HEADLIGHT AIM

Place the scooter on a level surface.

Adjust the headlight beam vertically by turning the vertical beam adjuster.
A clockwise rotation moves the beam up and counterclockwise rotation moves the beam down.

Adjust the headlight beam horizontally by turning the horizontal beam adjuster.
A clockwise rotation moves the beam toward the right side of the rider.

Horizontally Adjusting Screw

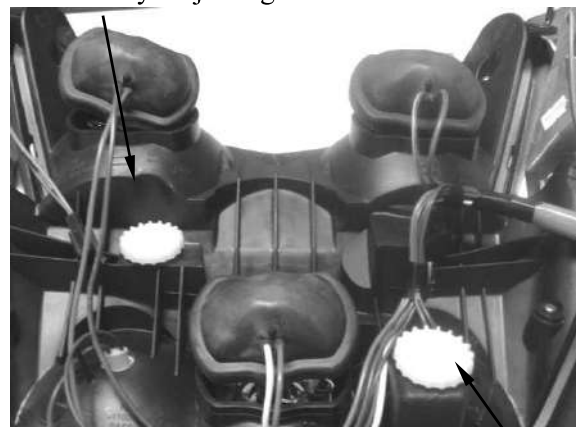

Vertically Adjusting Screw

* Adjust the headlight beam as specified by local laws and regulations.

3. INSPECTION/ADJUSTMENT

SIDE STAND

Support the scooter on a level surface.

Check the side stand spring for fatigue or damage.

Check the side stand assembly for smooth movement and lubricate the side stand pivot if necessary.

Check the side stand ignition cut-off system:

- ✓ Start the engine.
- ✓ Fully lower the side stand while running the engine.
- ✓ The engine should stop as the side stand is lowered.

If there is a problem with the system, check the side stand switch.

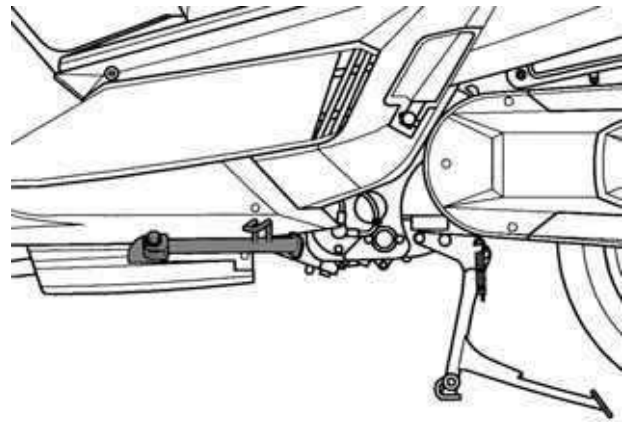

SUSPENSION

FRONT SUSPENSION INSPECTION

Check the action of the forks by operating the front brakes and compressing the front suspension several times.

Check the entire assembly for signs of leaks, damage or loose fasteners.

Replace damaged components which cannot be repaired.

Tighten all nuts and bolts.

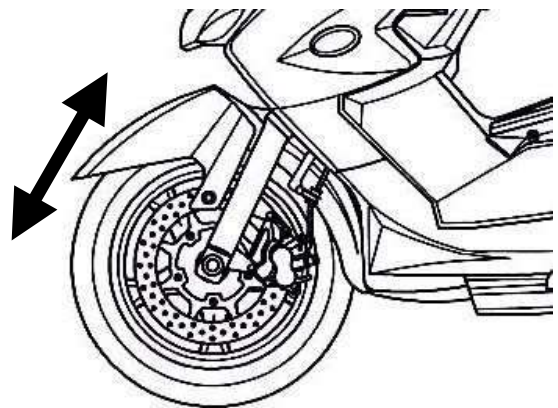

3. INSPECTION/ADJUSTMENT

REAR SUSPENSION INSPECTION

Check the action of the shock absorber by compressing it several times.

Check the entire shock absorber assembly for signs of leaks, damage or loose fasteners.

Replace damaged components which cannot be repaired.

Tighten all nuts and bolts.

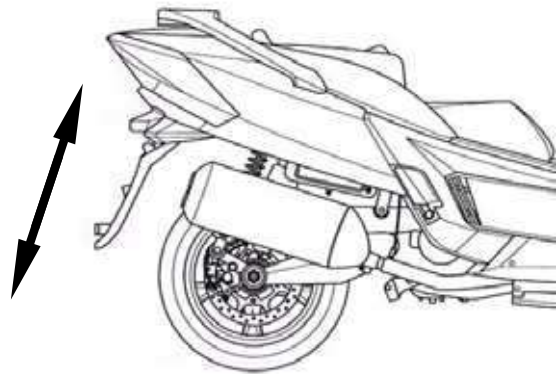

NUTS, BOLTS, FASTENERS

Check that all chassis nuts and bolts are tightened to their correct torque values (page 1-9).

Check that all safety clips, hose clamps and cable stays are in place and properly secured.

WHEELS/TIRES

Tire pressure should be checked when the tires are cold.

3. INSPECTION/ADJUSTMENT

Recommended tire size:

Tire size: front120/70-R15
Tire size: rear.....160/60-R14

Check the tires for cuts, embedded nails, or other damage.
Check the front and rear wheels for trueness.

Measure the tread depth at the center of the tires.
Replace the tires when the tread depth reaches the following limits.

Minimum tread depth:
Front: 1.6 mm
Rear: 2.2 mm

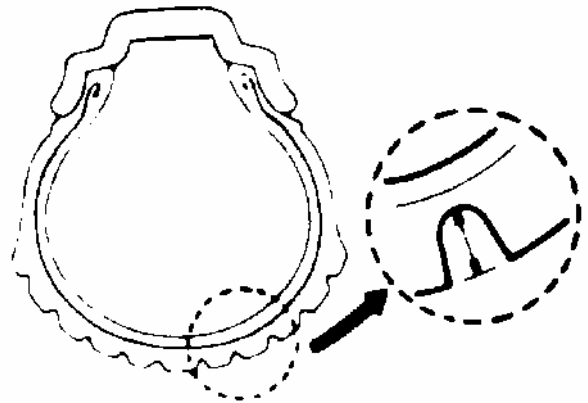

STEERING HEAD BEARINGS

Check that the control cables do not interfere with handlebar rotation.

Support the scooter securely and raise the front wheel off the ground.
Check that the handlebar moves freely from side to side.
If the handlebar moves unevenly, binds, or has vertical movement, inspect the steering head bearings.

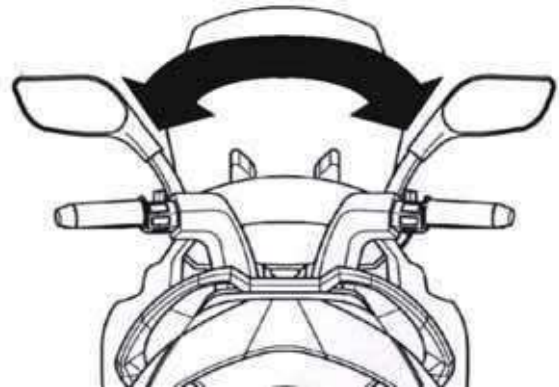

4. LUBRICATION SYSTEM

4

LUBRICATION SYSTEM

SERVICE INFORMATION-----	4- 2
TROUBLESHOOTING-----	4- 3
OIL PRESSURE SWITCH-----	4- 4
OIL PRESSURE RELIEF VALVE-----	4- 4
OIL PUMP-----	4- 5
OIL COOLER-----	4-8

4. LUBRICATION SYSTEM

4. LUBRICATION SYSTEM

SERVICE INFORMATION

GENERAL INSTRUCTIONS

- The oil pump service may be done with the engine installed in the frame.
- When removing and installing the oil pump use care not to allow dust or dirt to enter the engine.
- If any portion of the oil pump is worn beyond the specified service limits, replace the oil pump as an assembly.
- After the engine has been installed check that there are no oil leaks and that oil pressure is correct.
- For oil pressure indicator inspection, refer to section 20 of this manual.

SPECIFICATIONS

Unit: mm

ITEM		STANDARD	SERVICE LIMIT
Engine oil capacity	At draining	2.6 liter	—
	At disassembly	3.0 liter	—
Recommended engine oil		KYMCO 4-stroke oil or equivalent motor oil API service classification SJ Viscosity: SAE 5W-50	—
Oil pump rotor	Tip clearance	0.15 mm	0.2 mm
	Body clearance	0.15 – 0.2 mm	0.25 mm
	Side clearance	0.04 – 0.09 mm	0.12 mm

TORQUE VALUES

Oil pump bolt	0.8~1.2 kgf•m
Oil cooler bolt	1.2~1.8 kgf•m
Oil pressure switch	1~1.4 kgf•m
Oil filter cartridge	2.0~3.0 kgf•m

TOOLS

Oil filter wrench A120E00061

4. LUBRICATION SYSTEM

TROUBLESHOOTING

Oil level low

- Oil consumption
- External oil leak
- Worn piston ring
- Incorrect piston ring installation
- Worn valve guide or seal

Oil contamination (White appearance)

- From coolant mixing with oil
 - Faulty water pump mechanical seal
 - Faulty head gasket
 - Water leak in crankcase

No oil pressure

- Oil level too low
- Oil pump drive chain broken
- Oil pump drive sprocket broken
- Oil pump damaged (pump shaft)
- Internal oil leak

Low oil pressure

- Pressure relief valve stuck open
- Clogged oil filter and strainer screen
- Oil pump worn or damaged
- Internal oil leak
- Incorrect oil being used
- Oil level too low

High oil pressure

- Pressure relief valve stuck closed
- Plugged oil filter, gallery, or metering orifice
- Faulty oil pump

Seized engine

- No or low oil pressure
- Clogged oil orifice/passage
- Internal oil leak
- Non-recommended oil used

Oil contamination

- Deteriorated oil
- Faulty oil filter
- Worn piston ring (White appearance with water or moisture)
 - Damaged water pump mechanical seal
 - Damaged head gasket
 - Oil relief not frequent enough

Oil pressure warning indicator does not work

- Faulty oil pressure switch
- Short circuit in the indicator wire
- Low or no oil pressure

4. LUBRICATION SYSTEM

OIL PRESSURE SWITCH

CHECK

Start the engine.
Check the oil pressure indicator goes out after one or two seconds. If the oil pressure indicator stay on, stop the engine immediately and determine the cause.

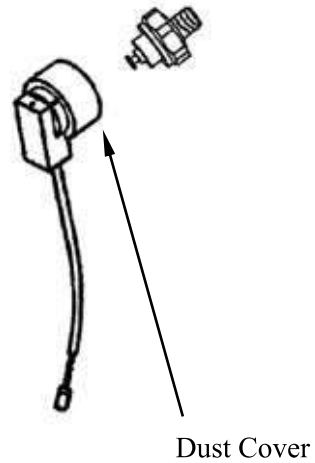

OIL PRESSURE RELIEF VALVE / OIL PUMP

REMOVAL

Remove the right crankcase cover.

Remove the pressure relief valve and O-ring from the right crankcase

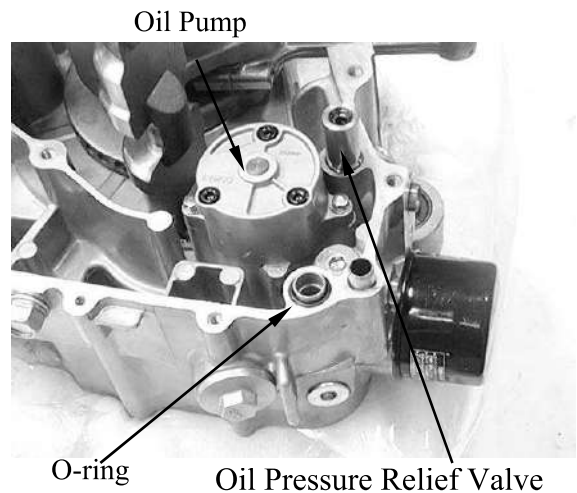

INSPECTION

Check the operation of the pressure relief valve by pushing on the piston.

INSTALLATION

Apply oil to a new O-ring and install the pressure relief valve groove, and install the relief valve to the right crankcase.

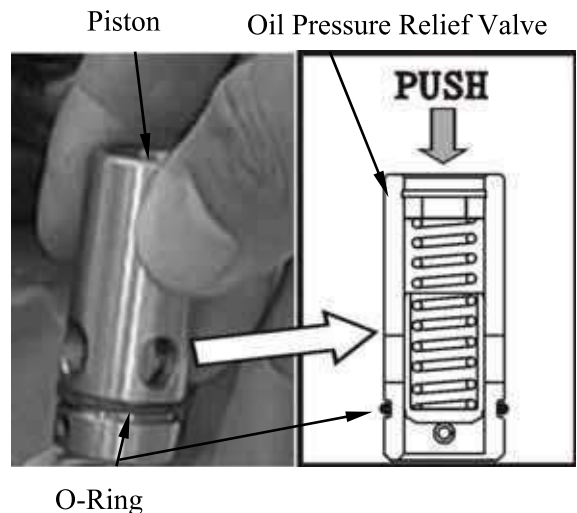

4. LUBRICATION SYSTEM

OIL PUMP

DISASSEMBLY

Remove bolts and oil pump cover.

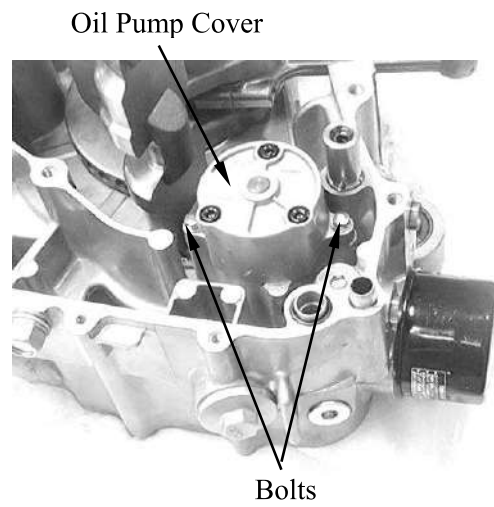

Remove the dowel pin, pin, oil pump shaft, oil pump outer rotor and inner rotor.

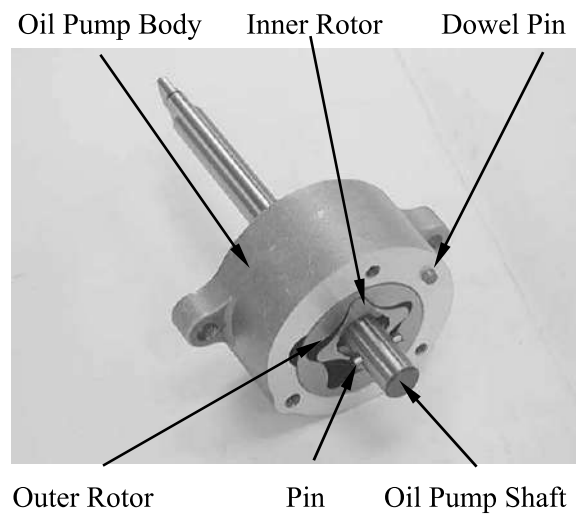

4. LUBRICATION SYSTEM

INSPECTION

Temporarily install the oil pump shaft.
Install the outer and inner rotors into the oil pump body.

Measure the tip clearance.

Service limit: 0.2 mm (0.008 in)

Measure at several points and use the largest reading to compare the service limit.

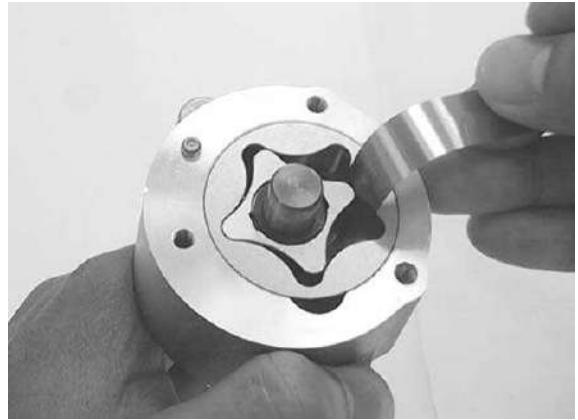

Measure the pump body clearance.

Service limit: 0.25 mm (0.01 in)



Measure the side clearance with the straight edge and feeler gauge.

Service limit: 0.12 mm (0.0048 in)



4. LUBRICATION SYSTEM

ASSEMBLY

Dip all parts in clean engine oil.

Install the outer rotor into the oil pump body.

Install the inner rotor into the outer rotor.

Install the oil pump shaft.

Install the pin onto the oil pump body.

Install the oil pump cover onto the oil pump body by aligning the dowel pin.

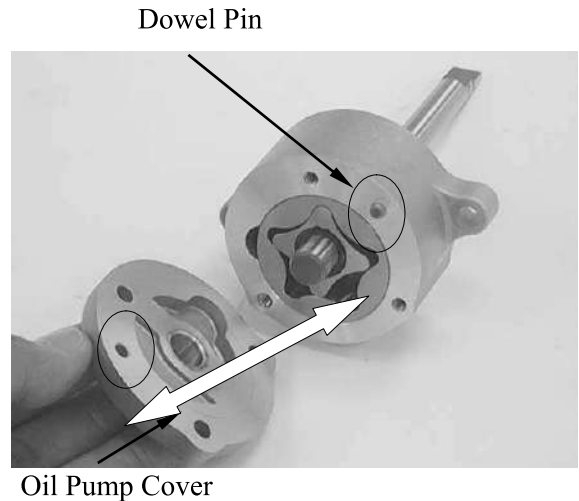

Install and tighten the bolts to the specified torque.

Torquor: 1.2 kgf•m

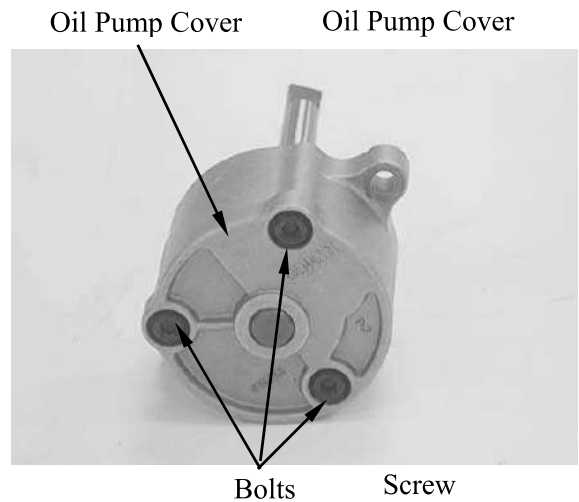

INSTALLATION

Install the oil pump and tighten the two bolts securely.

Make sure the pump shaft rotates freely and arrow on the oil pump is upside.

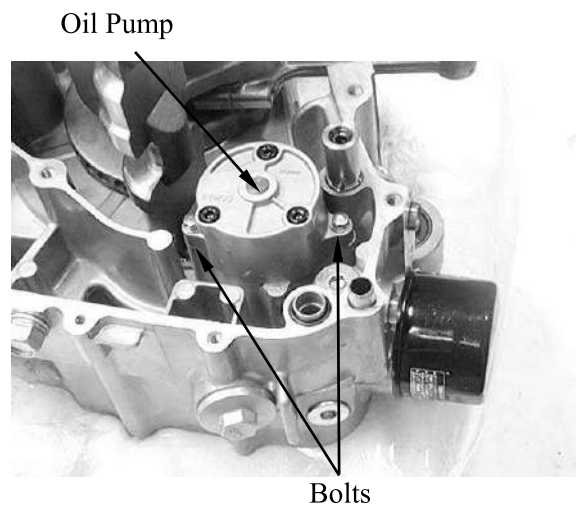
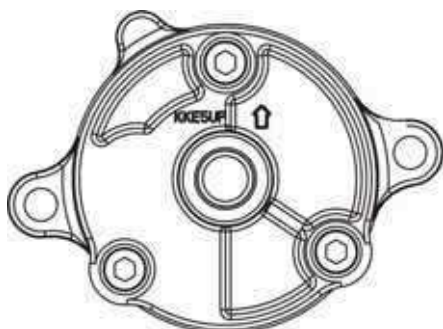

4. LUBRICATION SYSTEM

OIL COOLER

REMOVAL

Drain the engine oil and remove the oil filter cartridge.

Drain the coolant from the system.

Loosen the hose bands and disconnect the oil cooler hoses from the cooler.



Hose

Remove the oil cooler mounting bolts, oil cooler.

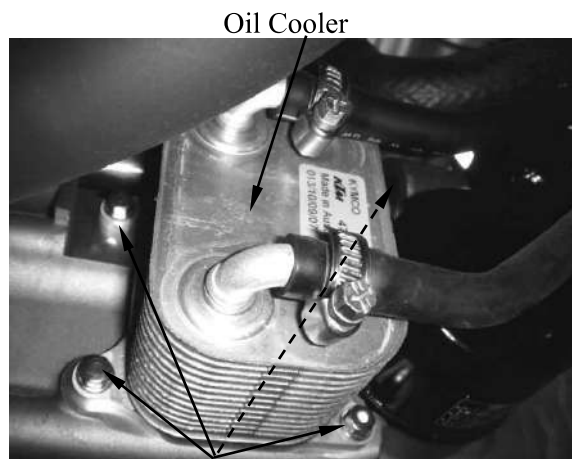

Oil Cooler

Bolts

INSPECTION

Check the cooler for damage.

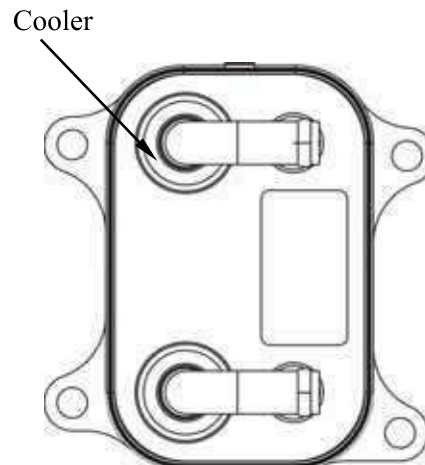

Cooler

4. LUBRICATION SYSTEM

INSTALLATION

Install the removed parts in the reverse order of removal.

Install the oil cooler bolts with the specified torque.

Torque: 0.8~1.2 kgf•m

Remember to install the dowel pin(15x10)
And O-ring (14.8x2.4)

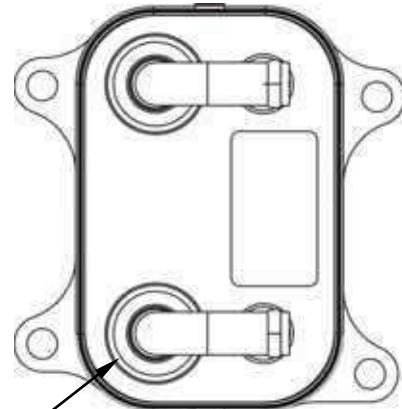

Oil Cooler



4. LUBRICATION SYSTEM

Installation of oil filter cartridge

Standard Torque:

Oil filter cartridge 1.2~1.8 kgf•m



5. Cable, Wire and Hose Routing.

MYROAD 700i



F1

F2

FRONT VIEW

L1

L2

L3

L4

L5

L5

D

TOP VIEW

R2

R1

R3

R4

R5

0

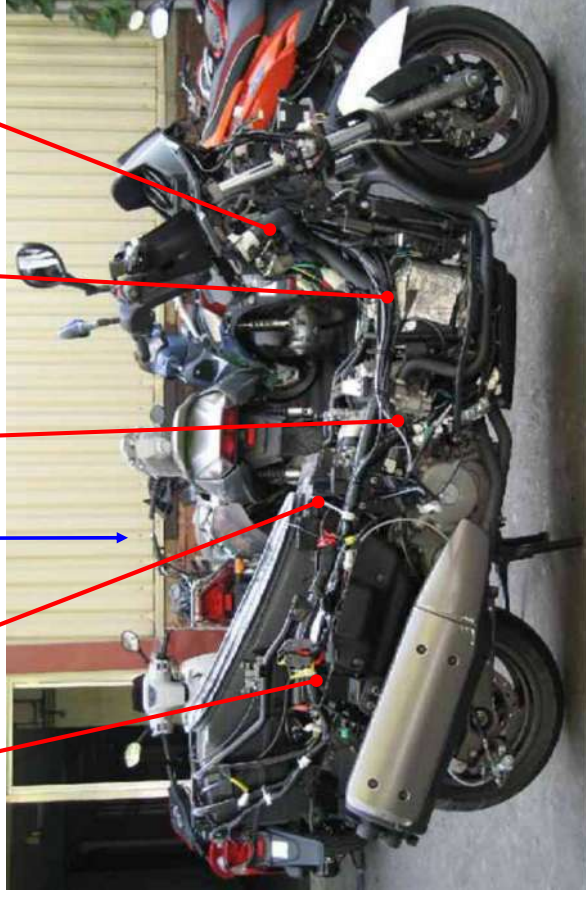

Notice for assembly:

1. Do not fold or squeeze the wires, cables or hoses.
2. Ensure to connect the couplers or connectors in correct position tightly.
3. Do not force to pull or squeeze any wire, cable or hose, that way would damage parts.
To organize wires, cables and hoses in correct position before assembling.
4. O2 sensor is a very expensive but fragile part, be more careful while assembling.
 - a. Be sure to disconnect the coupler before dismantling the exhaust pipe while maintaining, prevent from damage the wire and O2 sensor.
 - b. Do not heat the O2 sensor or coupler when maintaining it would cause malfunction.
5. When dismantle the ECU coupler, do not pull or squeeze the fixed rod or wire, it would cause malfunction.

FRNOT VIEW-1

F1

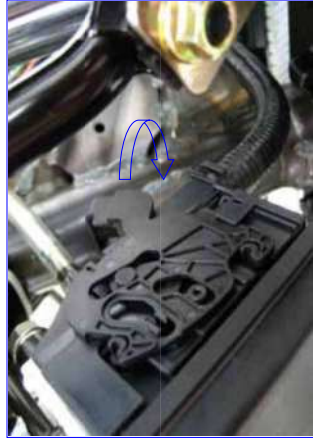

ABS controller's coupler need to be in correct position.



Fixed band

Fixed hook

Notice for assembly:

1. Ensure the wires, cables or hoses in correct routes.
2. Replace the wires, cables or hoses in correct routes if any damage found.

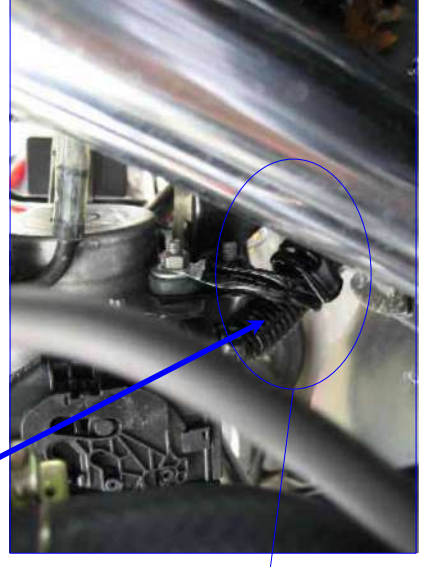

Fix ABS wire by soft hook.

FRONT VIEW-2

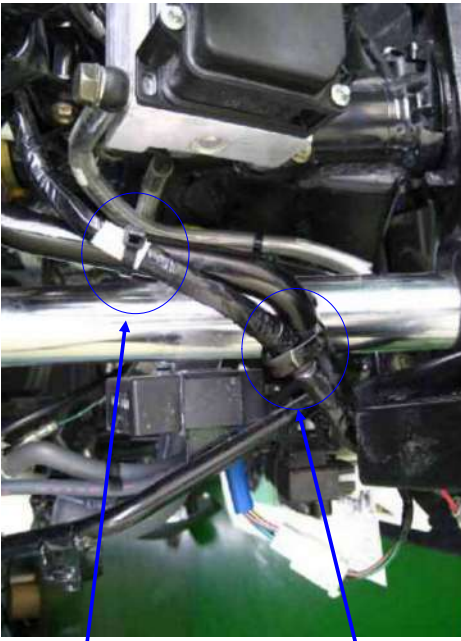

Fixed band

Fixed hook

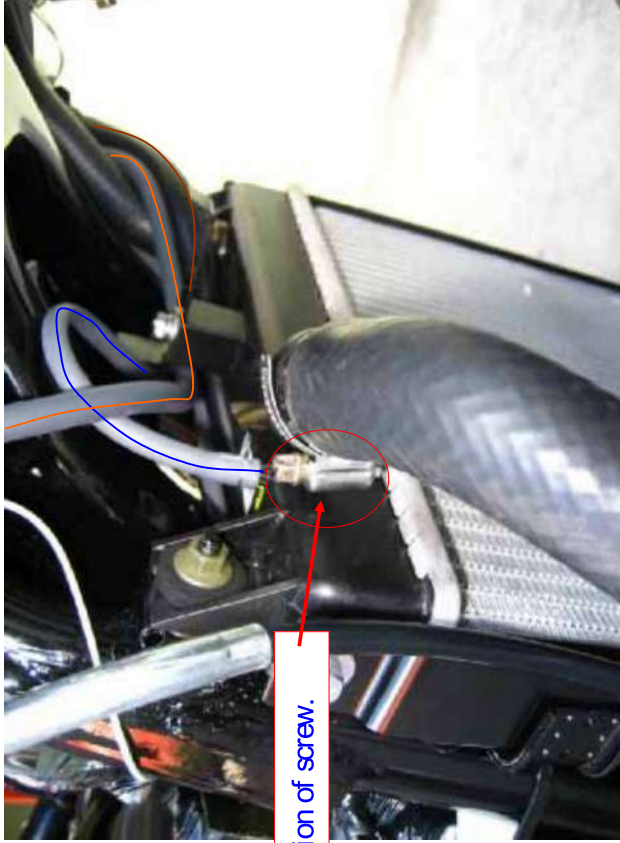

Direction of screw.

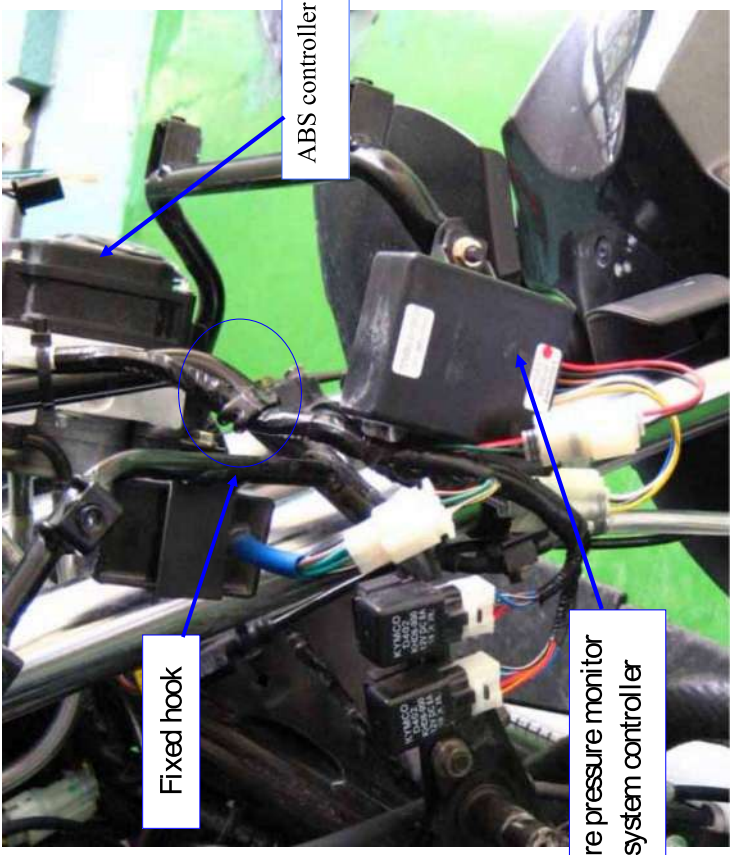

Fixed hook

ABS controller

Tire pressure monitor system controller

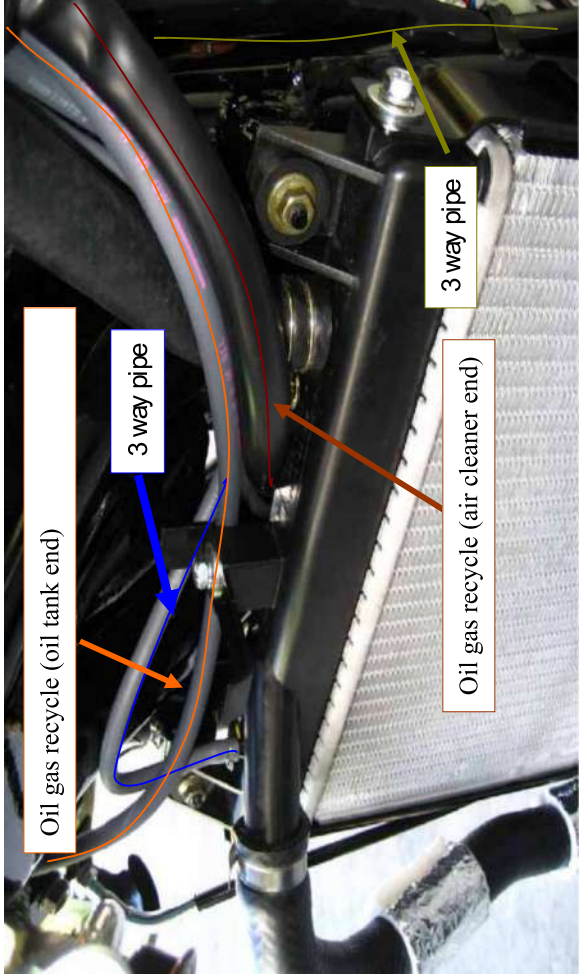

Oil gas recycle (oil tank end)

3 way pipe

3 way pipe

Oil gas recycle (air cleaner end)

LEFT VIEW-1

L1



METER wire fixed hook

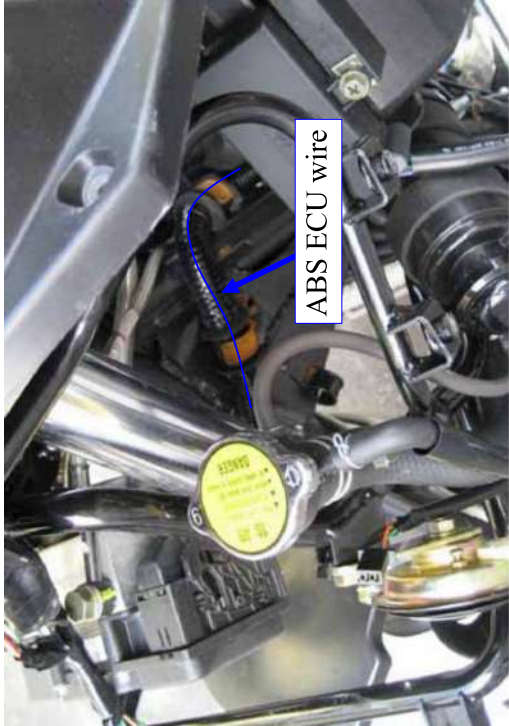

ABS ECU wire

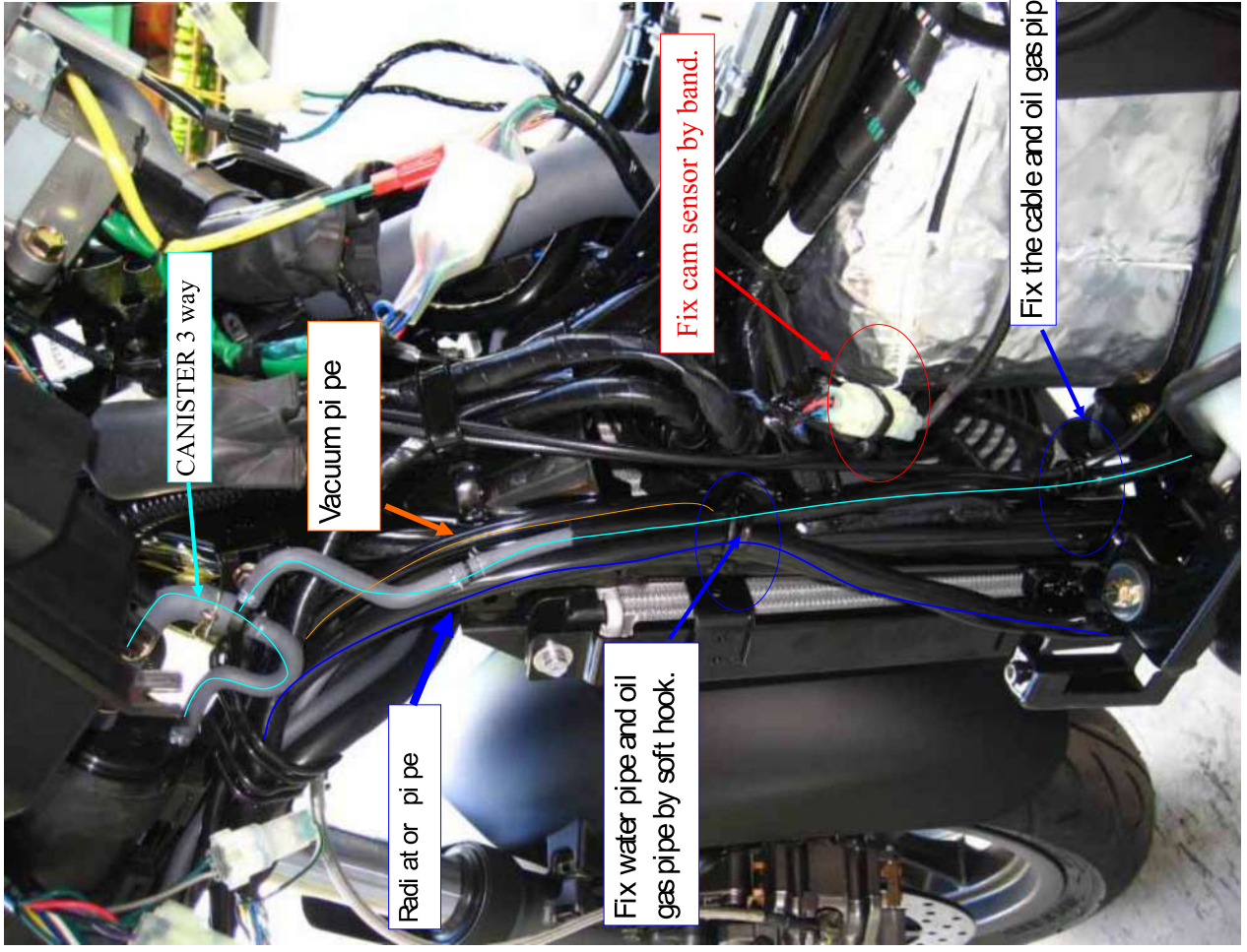

CANISTER 3 way

Vacuum pi pe

Radi at or pi pe

Fix water pipe and oil gas pi pe by soft hook.

Fix cam sensor by band.

Fix the cable and oil gas pip by soft hook.



LEFT VIEW-2

Notice for assembly:

1. Radiator pipe and air pipe can not be twisted or squeezed.

L2

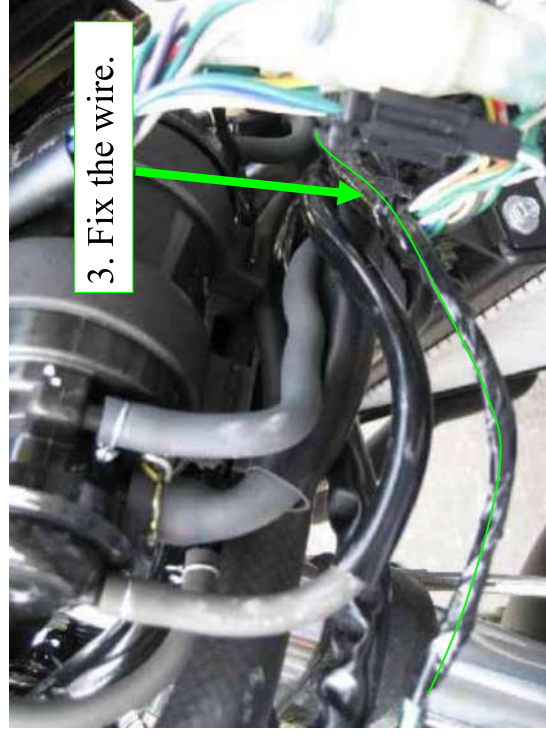
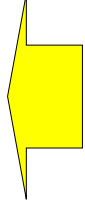
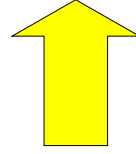
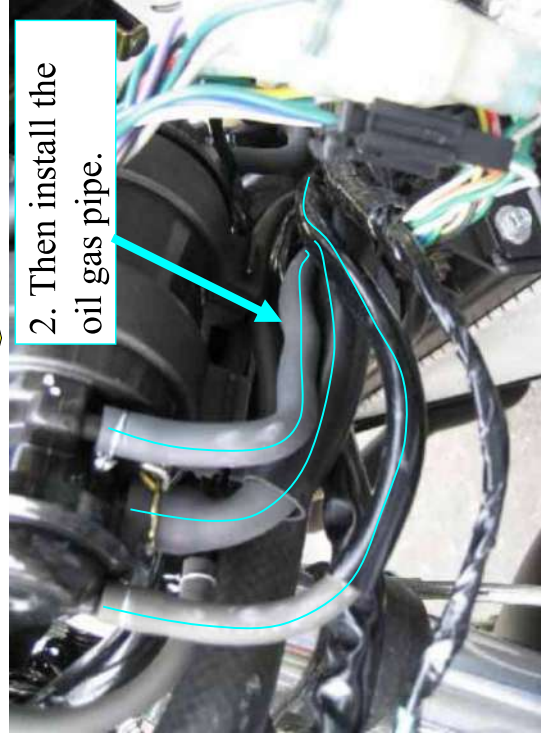
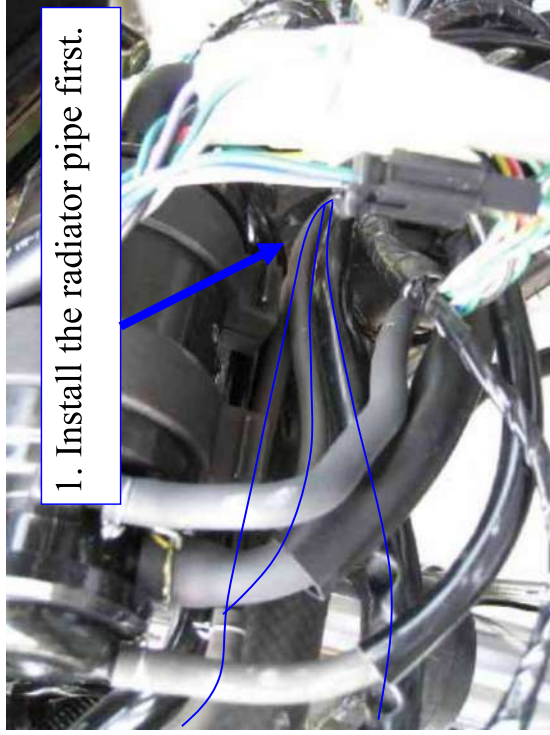

Locate all the cables and wires under stay.

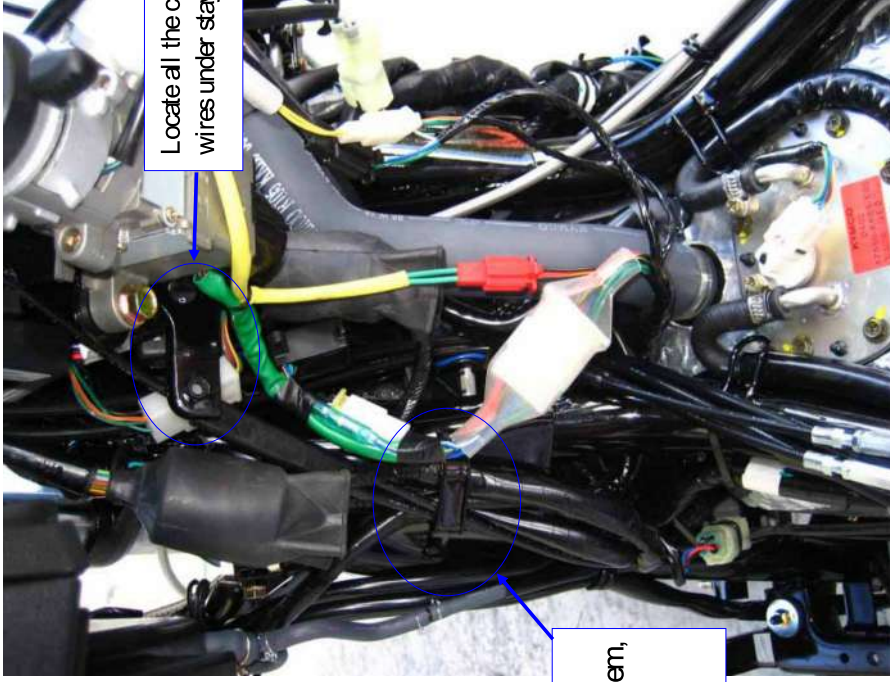

Locate all the wires and cables in hook and fix them, except throttle cable and seat-lock cable.

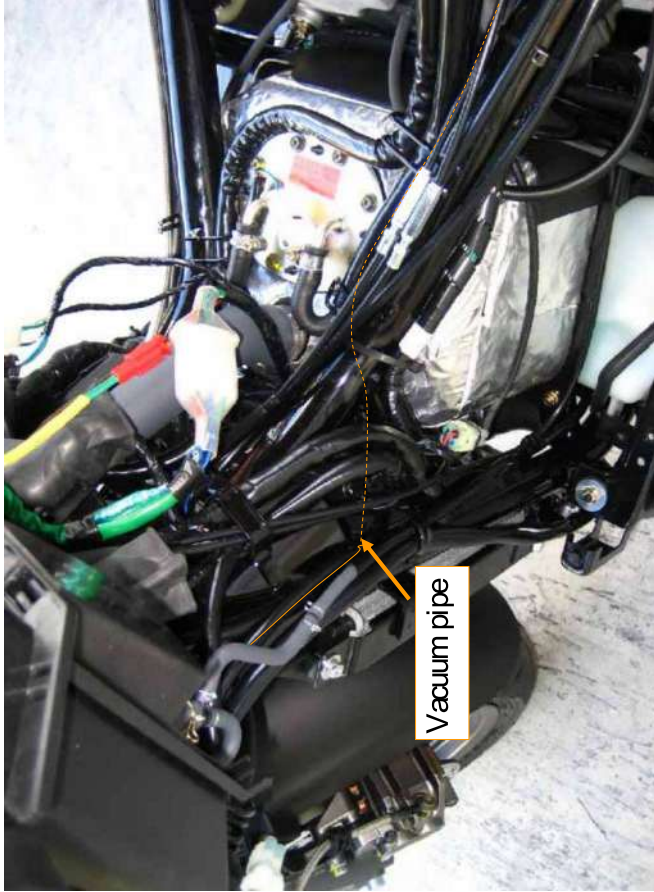

Vacuum pipe

LEFT VIEW-3



The route of vacuum pipe

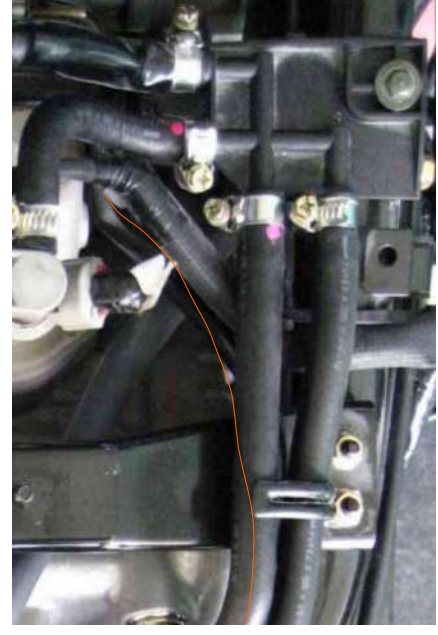

LEFT VIEW -4

L4

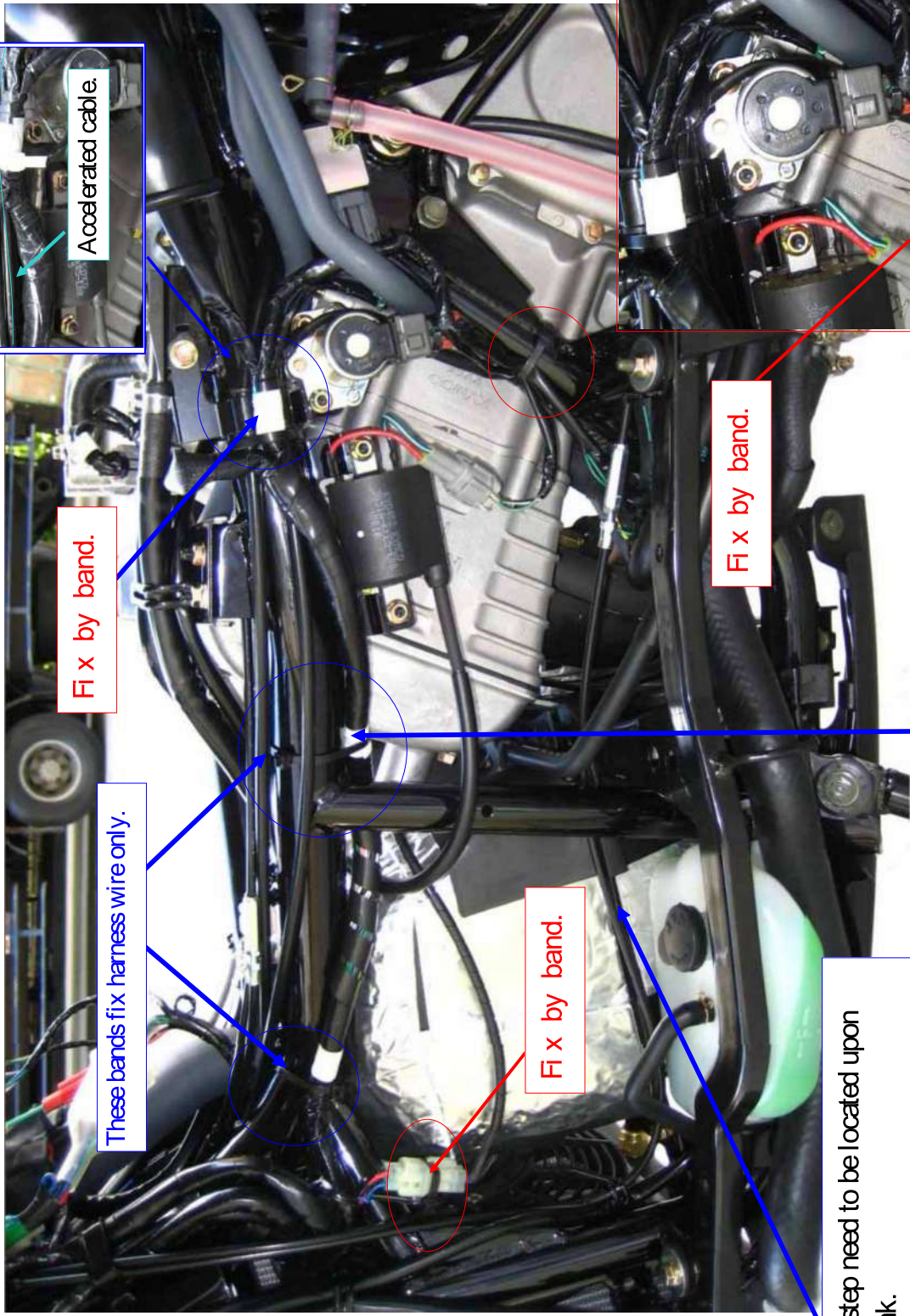
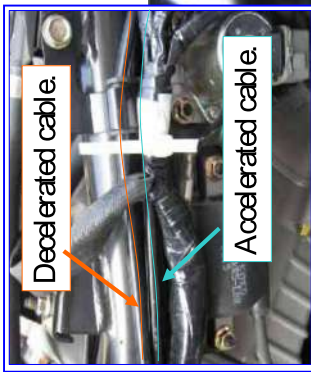

The cable of rear foot step need to be located upon the secondary water tank.

The harness wire should be located behind the frame.

LEFT VIEW-5-Notice for route of radiator pipe.

L5



- Oil coolant cycle loop which conducts to oil filter loop.
- Small cycle loop.
- Coolant outs from engine.
- The pipe of radiator cap.
- Coolant gets into engine by this pipe.

Confirmation:

1. Ensure those G-type hooks to be fixed firmly.
2. Do not assemble both oil coolant pipe in the wrong position.



Both oil coolant pipes should not be assembled by the wrong position.

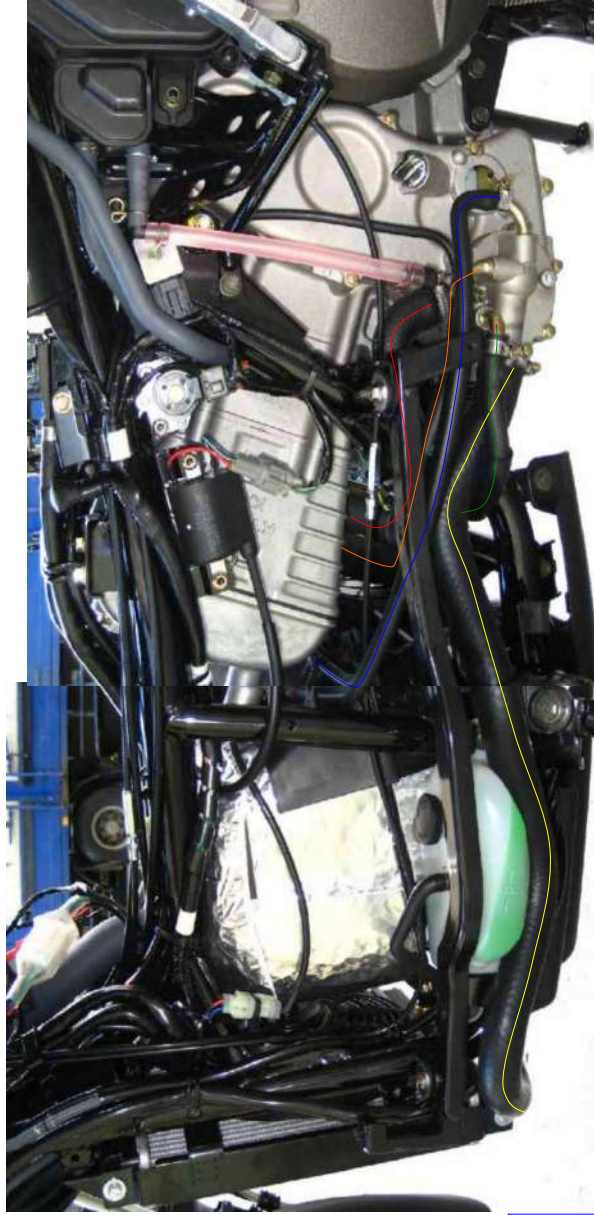

LEFT VIEW-6

L6

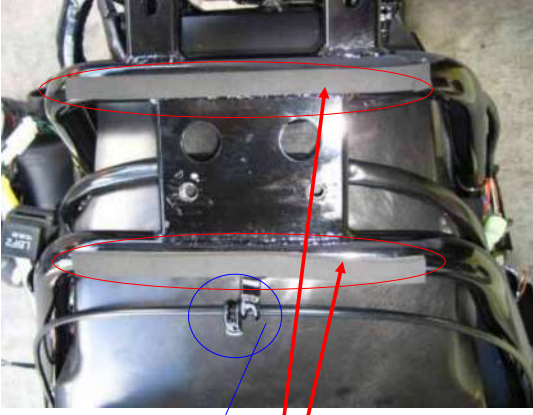

The cable should not be tightened, it should be installed with tolerance.

Sponge patches.

Fix by band.

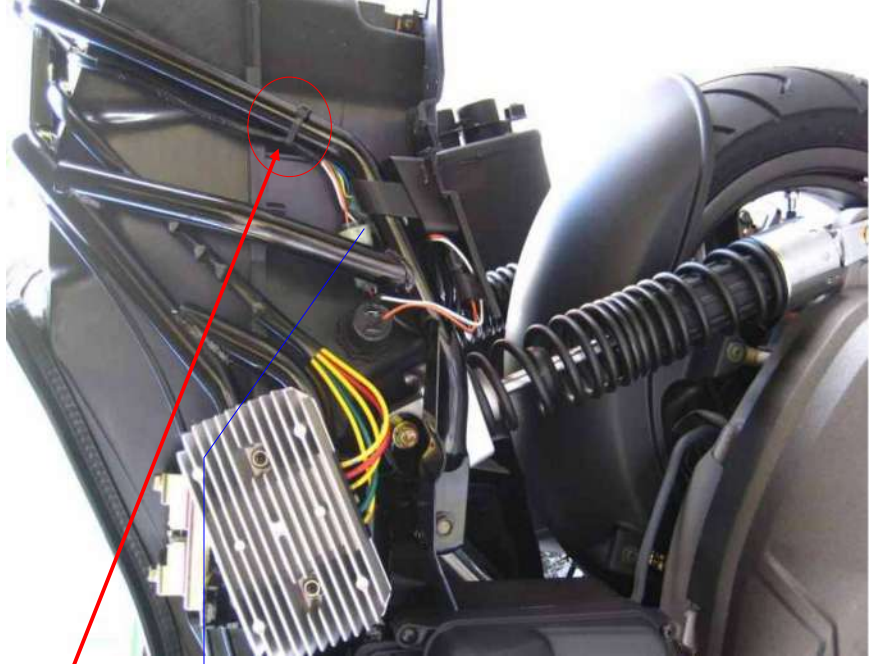

The coupler of suspension motor.

The terminals should be installed upon the battery contacts.



Seat lock route





RIGHT VIEW-1

R1

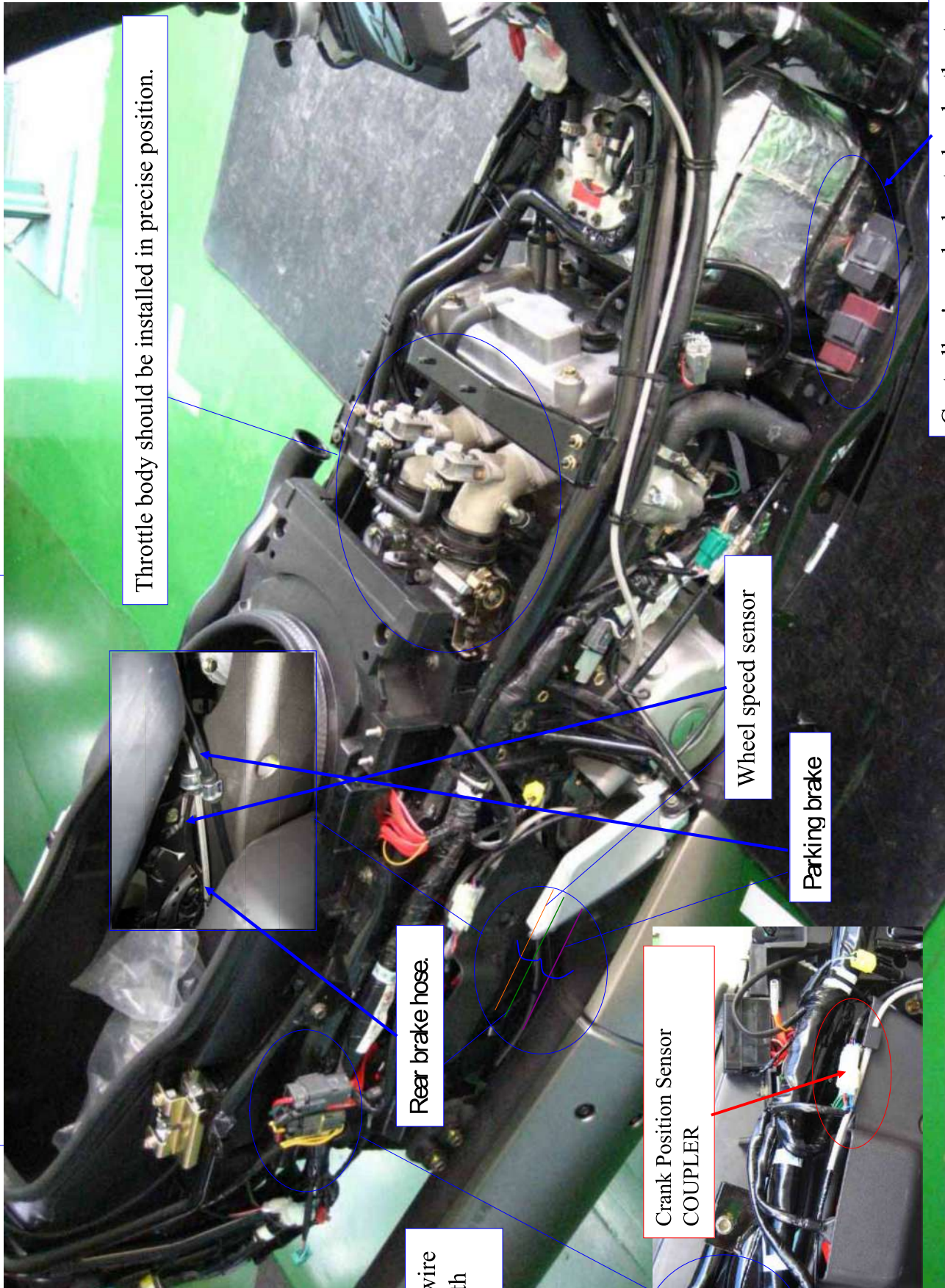

Throttle body should be installed in precise position.



Rear brake hose.

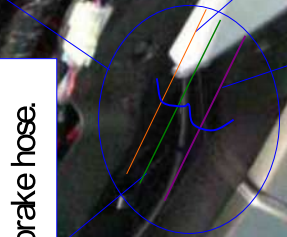

Locate the wire between both couplers.

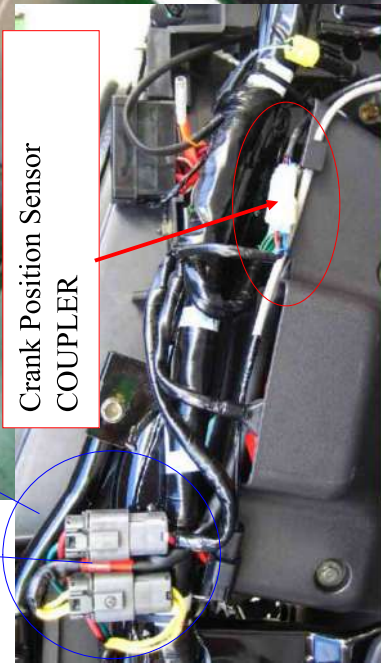

Crank Position Sensor COUPLER

Wheel speed sensor

Parking brake

Controllers' coupler located under the stay.



ECU coupler need to be fixed in correct position firmly.

RIGHT VIEW-2

R2



O2 sensor's coupler need to be located on the cover.

Condenser's position.

Fix by band.

Fix the cable by soft hook.



The route of rear brake cable.

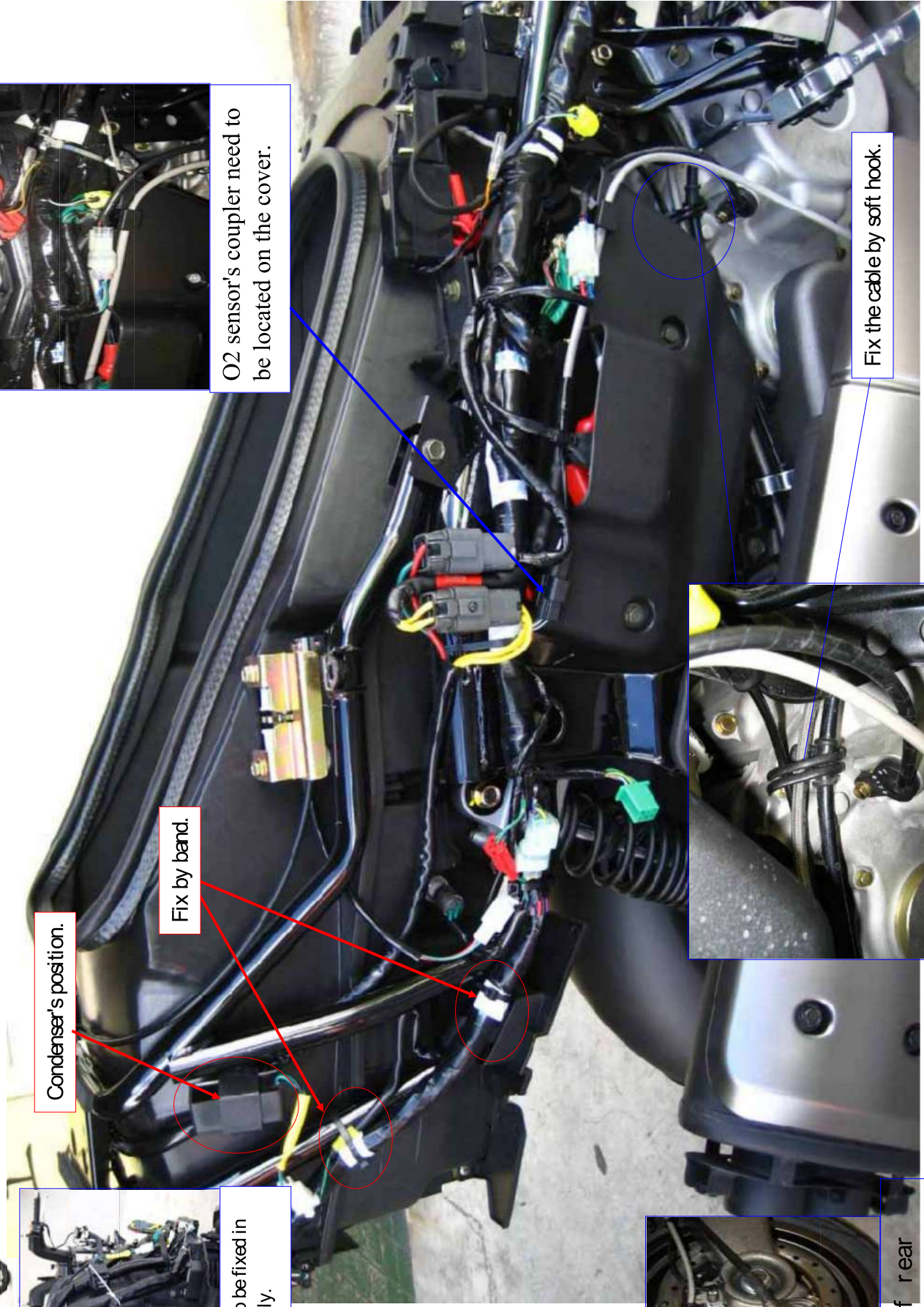

RIGHT VIEW-3

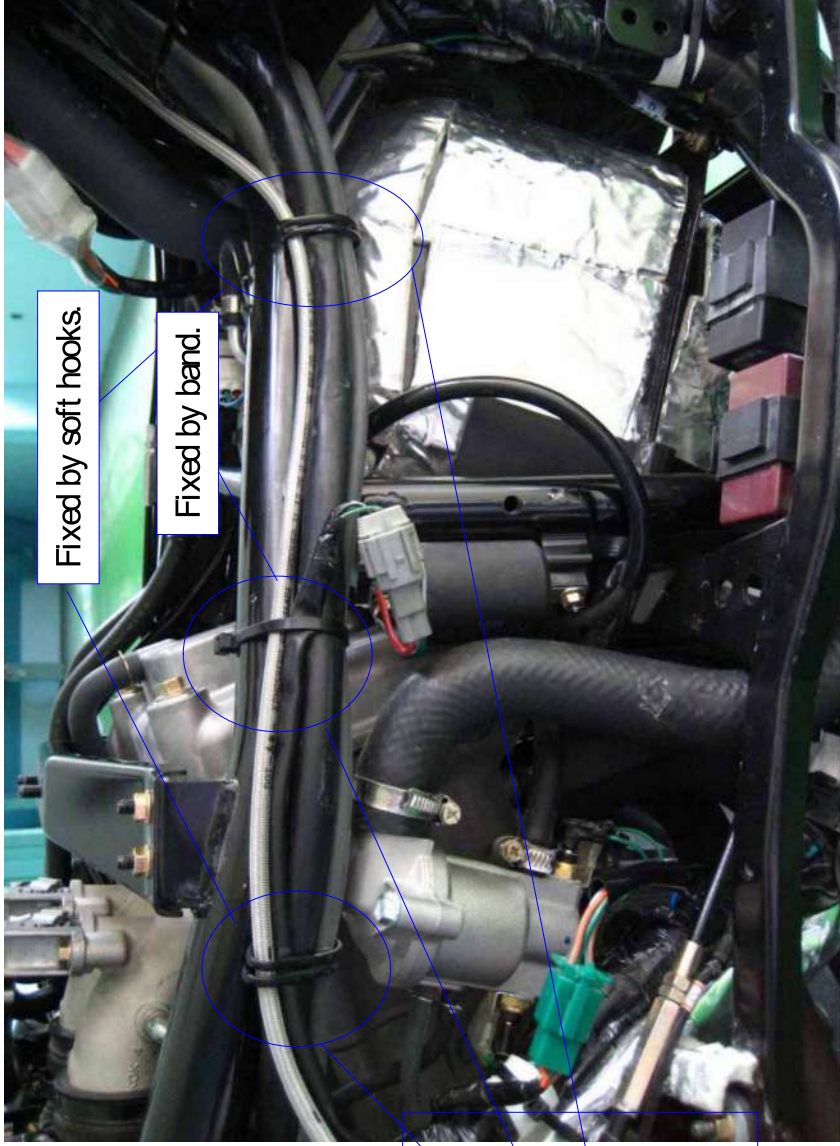

Fixed by soft hooks.

Fixed by band.

The fixed order as following,
 1. Brake oil pipe
 2. Oil wire
 3. Air cleaner pipe
 4. The pipe of small circle

Heat insulating by paste the aluminum foil on the frame pipe.

Locate the parking brake cable under the stay.



Fan cable and harness wire coupler



Fixed by band.

Paste with aluminum foil.



RIGHT VIEW-4

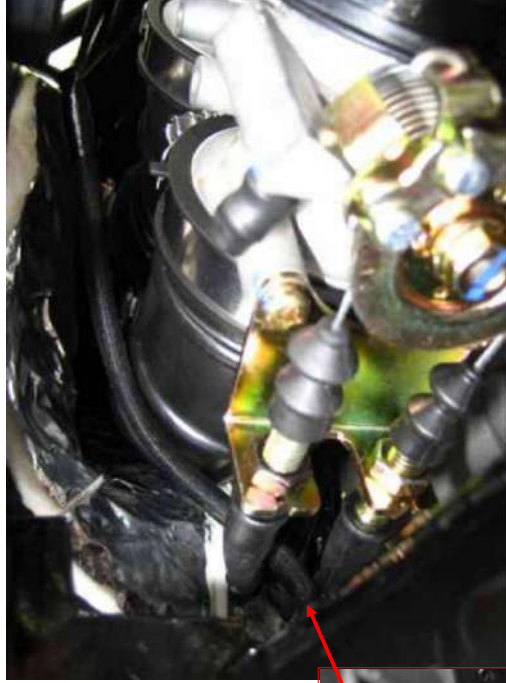

Pressure sensor wire's route.

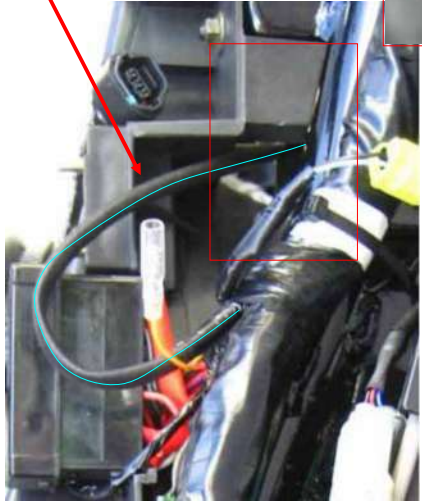

Fix the pipe by 8-type ring.

Fix the hazard controller wire by soft hook.

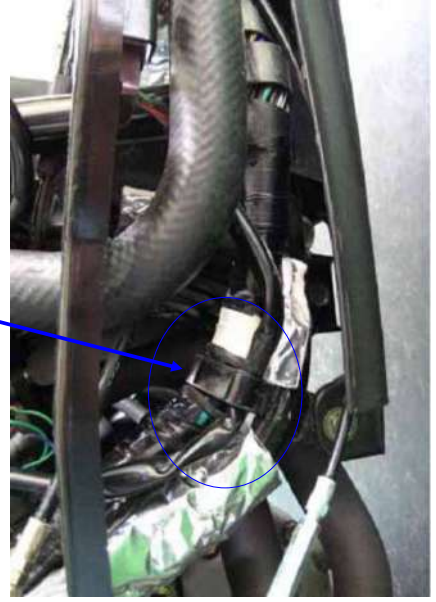

Oil gas recycle(CAP end)



RIGHT VIEW-5



Parking brake switch terminal.

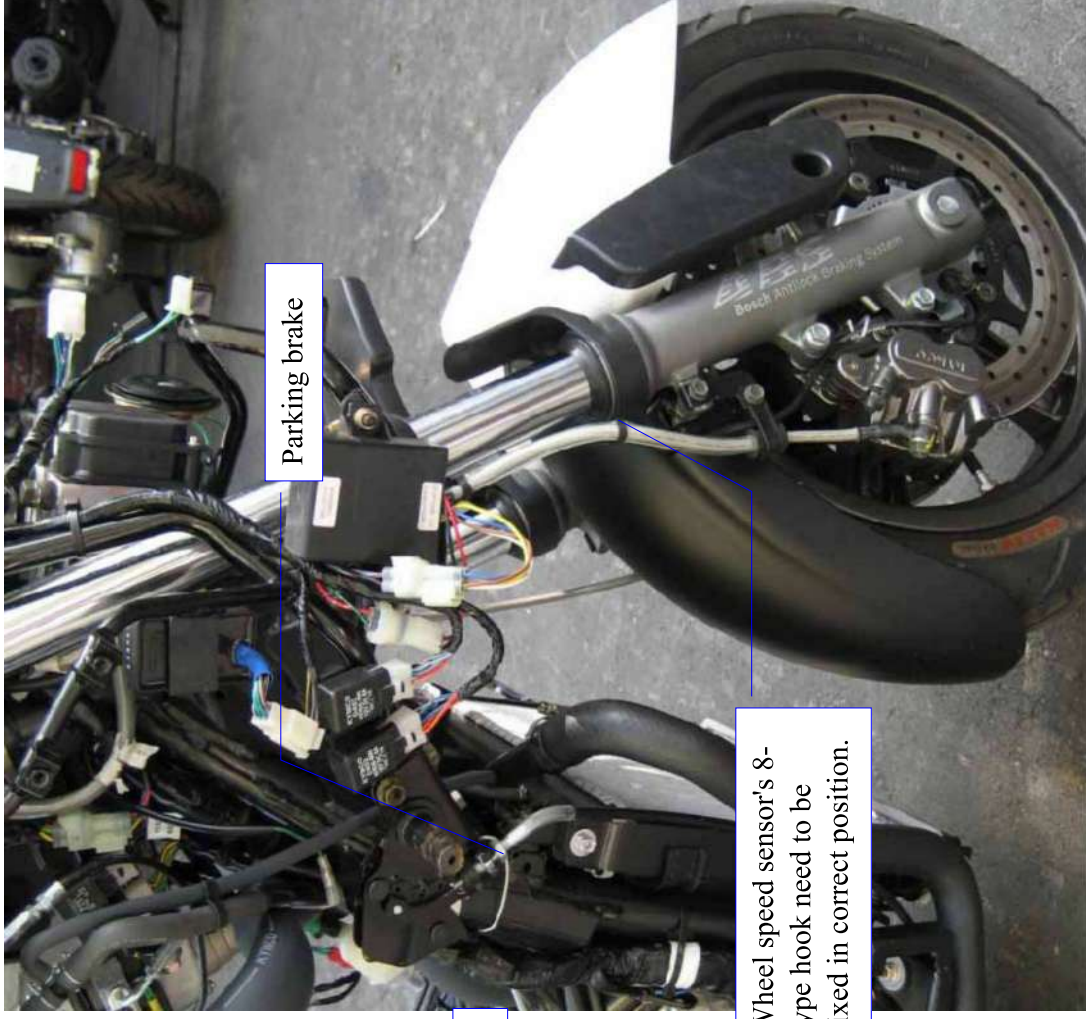

Parking brake

Wheel speed sensor's 8-type hook need to be fixed in correct position.



Fix position the brake oil pipe.

RIGHT VIEW-6

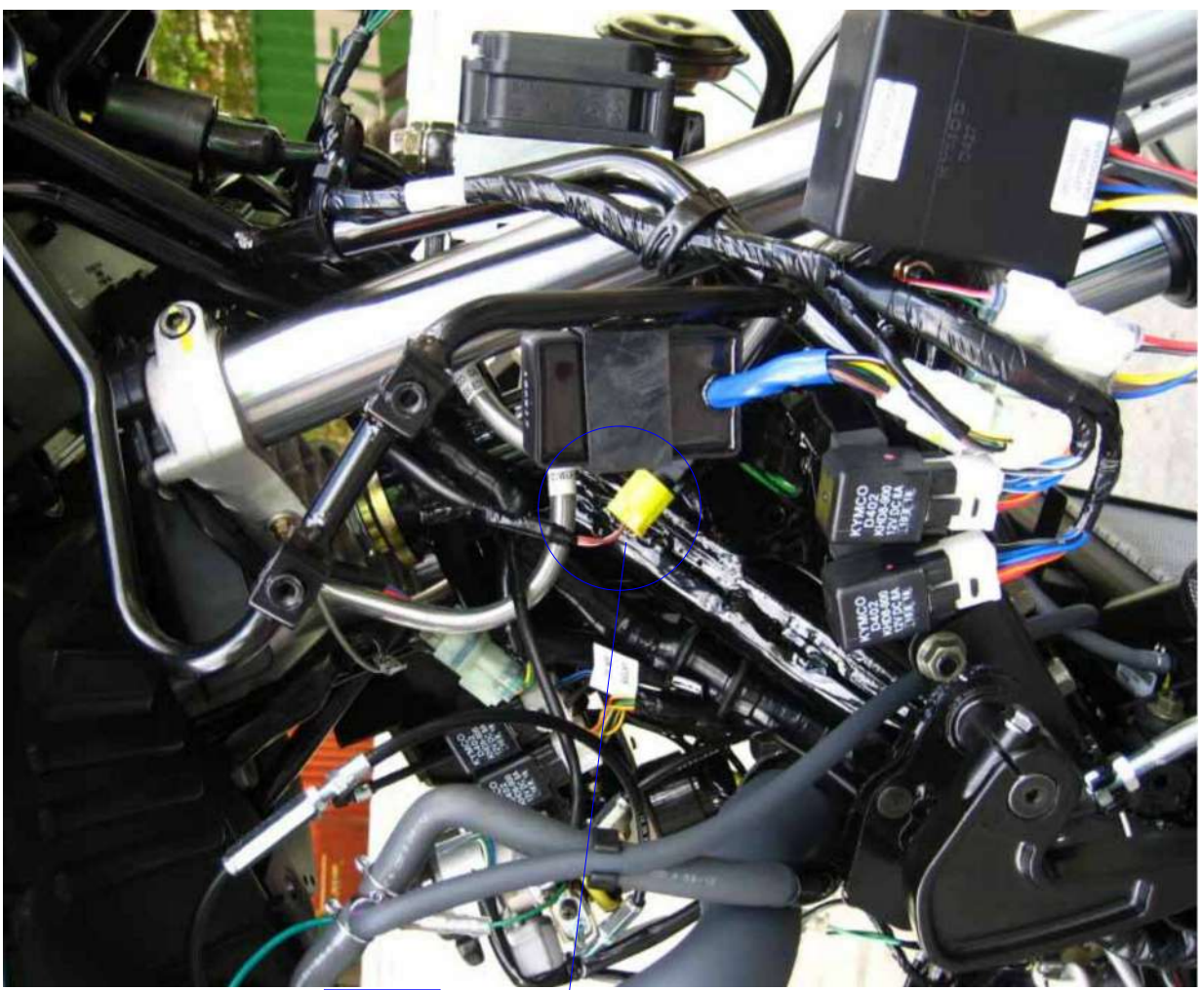

Fix the wheel speed sensor by band.



Fix the harness wire by hook.



TOP VIEW-1

D1

The screws mount inside.



Fix the fuel pump pipes as picture's

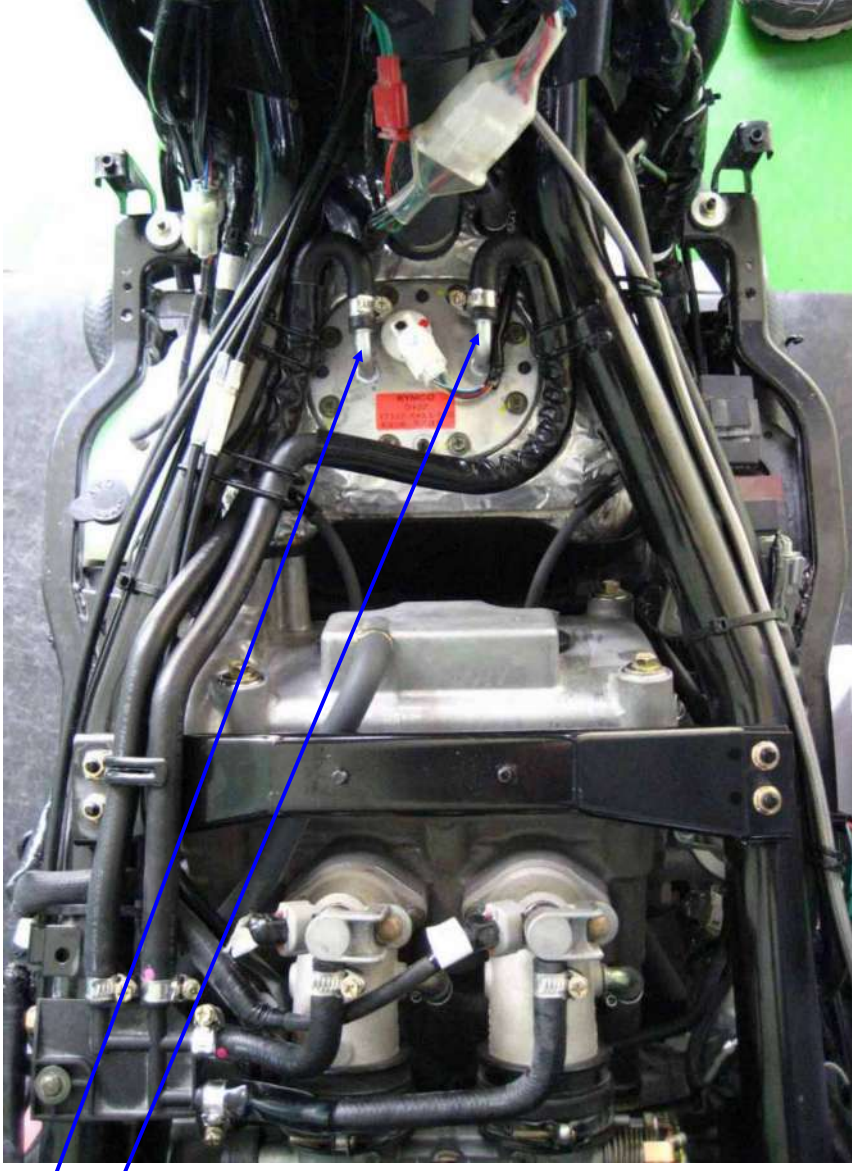

Notice for assembly:

1. Injectors' wires have been marked in R(right) and L(left) for your reference, do not assemble in wrong position.

TOP VIEW-2

Notic for oil pipes' routes

The routes of pipes:

Oil gas recycle pipe

Oil tank cap pipe

The routes of injectors' pipes.

The route of ISC pipe.

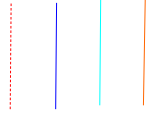

Mounting the oil pipes' screws follow the picture.

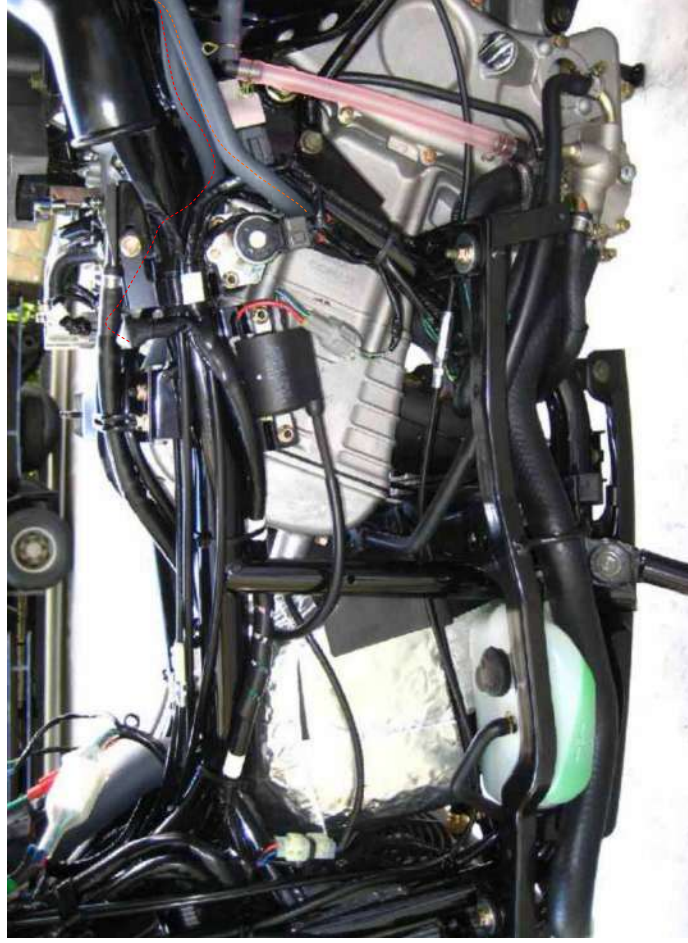

TOP VIEW-3

Left oil pipe

Right handle bar wire

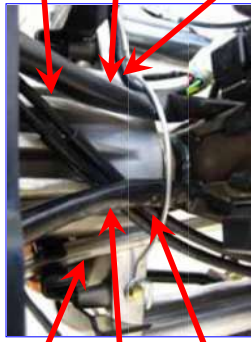

Right oil pipe
Right handle bar wire
Electric suspension

2 Throttle cables

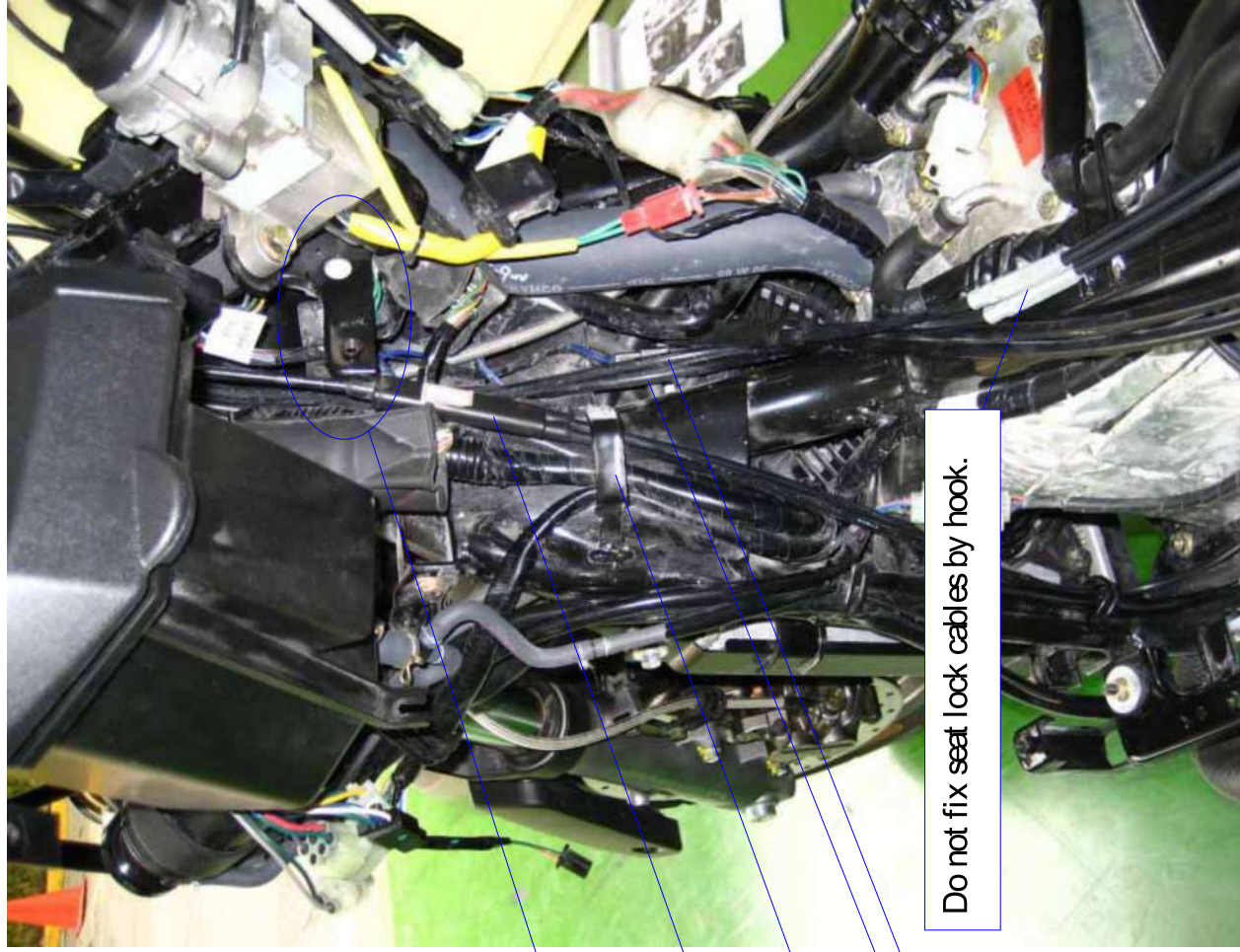

Wires and pipes locate under stay.

Rear foot step's cable.

Fix by hook.

Do not fix seat lock cables by hook.

Do not fix seat lock cables by hook.

TOP VIEW -4



Brake cable

Handle bar switch wire



Brake cable

Throttle cable

Handle bar switch wire

AFI (AUTOMATIC FUEL INJECTION)

SERVICE INFORMATION-----	6- 1
SYSTEM DIAGRAM-----	6- 2
SYSTEM LOCATION-----	6- 3
TROUBLESHOOTING-----	6- 6
SELF-DIAGNOSTIC PROCEDURES WITHOUT DIAGNOSTIC TOOL-----	6- 7
EFI SELF-DIAGNOSIS CHECK ENGINE LAMP (CELP) FAILURE CODES-----	6- 7
CELP FAILURE CODES CHART-----	6- 9
SELF-DIAGNOSTIC PROCEDURES USING DIAGNOSTIC TOOL-----	6-11
DIANOSTIC REPORT -----	6-17
MAINTAINING BY CHECKING COMPONENT -----	6-18
EMS PARTS INSPECTION SPECIFICATIONS -----	6-23



6. AFI (AUTOMATIC FUEL INJECTION)

SERVICE INFORMATION

GENERAL INSTRUCTIONS

- This section covers service of the fuel system.
- These services can be done with the engine installed in the frame.
- Be sure to relieve the fuel pressure before fuel pump or fuel hose removal.
- Bending or twisting the control cables will impair smooth operation and could cause the cables to stick or bind, resulting in loss of vehicle control.
- Work in a well ventilated area. Smoking or allowing flames or sparks in the work area or where gasoline is stored can cause a fire or explosion.
- Do not apply commercially available carburetor cleaners to the inside of the throttle bore, which is coated with molybdenum.
- Do not snap the throttle valve from fully open to fully close after the throttle cable has been removed; it may cause incorrect idle operation.
- Do not loosen or tighten the painted bolts and screws of the throttle body. Loosening or tighten them can cause throttle and idle valve synchronization failure.
- Seal the cylinder head intake ports with tape or a clean cloth to keep dirt and debris from entering the intake ports after the throttle body has been removed.
- Do not damage the throttle body. It may cause incorrect throttle and idle valve synchronization.
- Do not push the fuel pump base under the fuel tank when the fuel tank is stored.
- Always replace the packing when the fuel pump is removed.
- The electronic fuel injection system is equipped with the self-diagnostic system. If the Check Engine Lamp “CELP” illuminate while riding, follow the self-diagnostic procedures to remedy the problem.
- A faulty EFI system is often related to poorly connected or corroded connectors. Check those connections before proceeding.
- When disassembling the fuel injection parts, note the location of the O-rings. Replace them with new ones upon reassembly.
- Do not disconnect the battery negative or positive cable while engine is running, it may cause ECU damage.
- Connect the battery cables mistook may cause ECU damage.
- Do not disconnect or connect the ECU connector during the ignition switch “ON”; it may cause the ECU damage.

6. AFI (AUTOMATIC FUEL INJECTION)

SYSTEM DIAGRAM

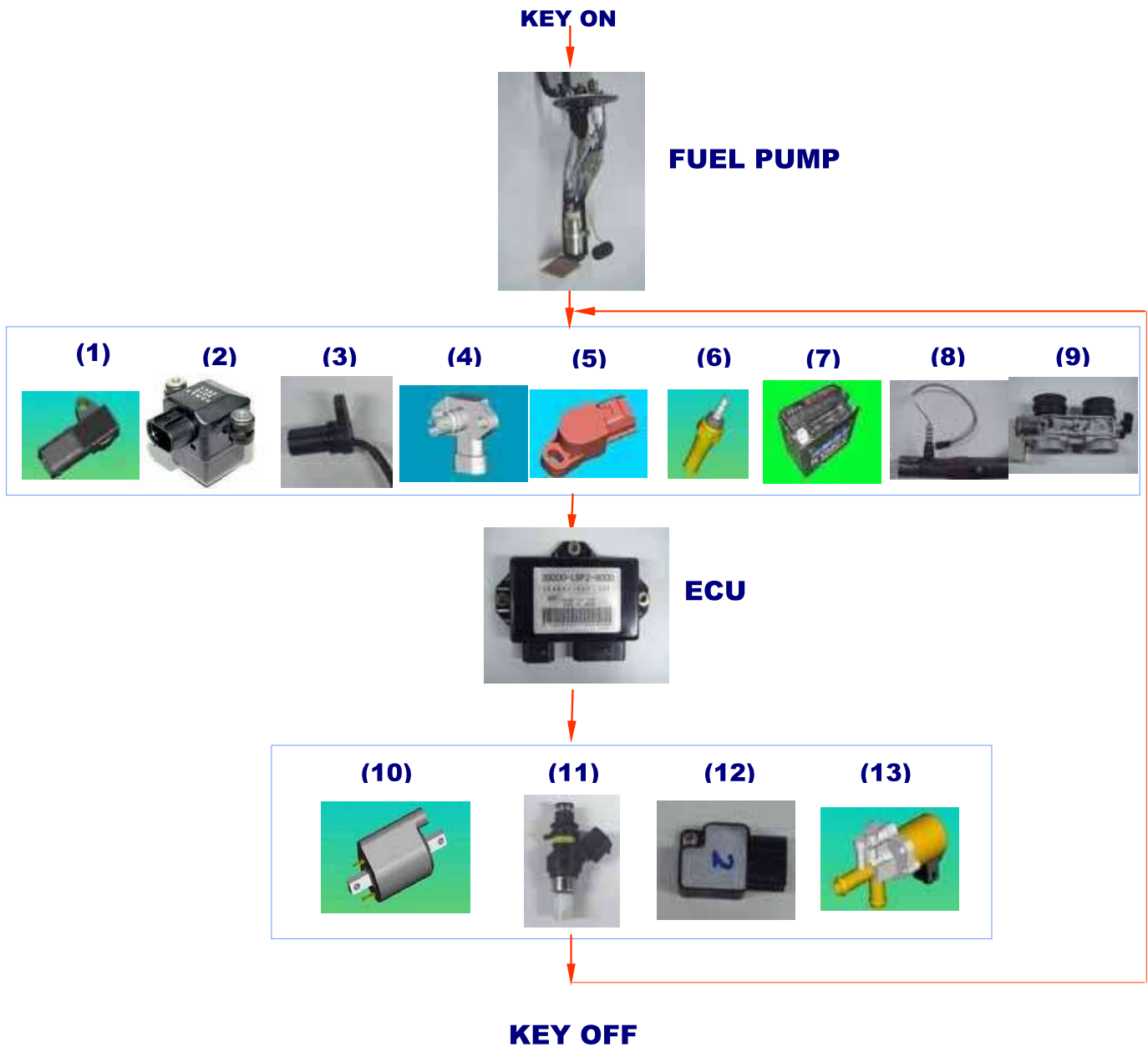

- (1)MAP(Manifold Air Pressure) sensor
- (2)Tilt switch CPS
- (3)CPS(Crank Position Sensor)
- (4)T-MAP Sensor
- (5)TPS(Throttle Position Sensor)
- (6)WTS(Water Temperature Sensor)
- (7)Battery voltage

- (8)O2 Sensor
- (9)Throttle body
- (10)Inductive ignition coil
- (11)Fuel injector
- (12)Ignition driver
- (13)ISC(Idle Speed Control) unit

6. AFI (AUTOMATIC FUEL INJECTION)

SYSTEM LOCATION



ECU



T-MAP sensor



O₂ sensor

CPS (Crank Position Sensor)

6. AFI (AUTOMATIC FUEL INJECTION)

Fuel injector (left)

CPS

Fuel pump



Fuel injector (right)

ISC

Ignition driver

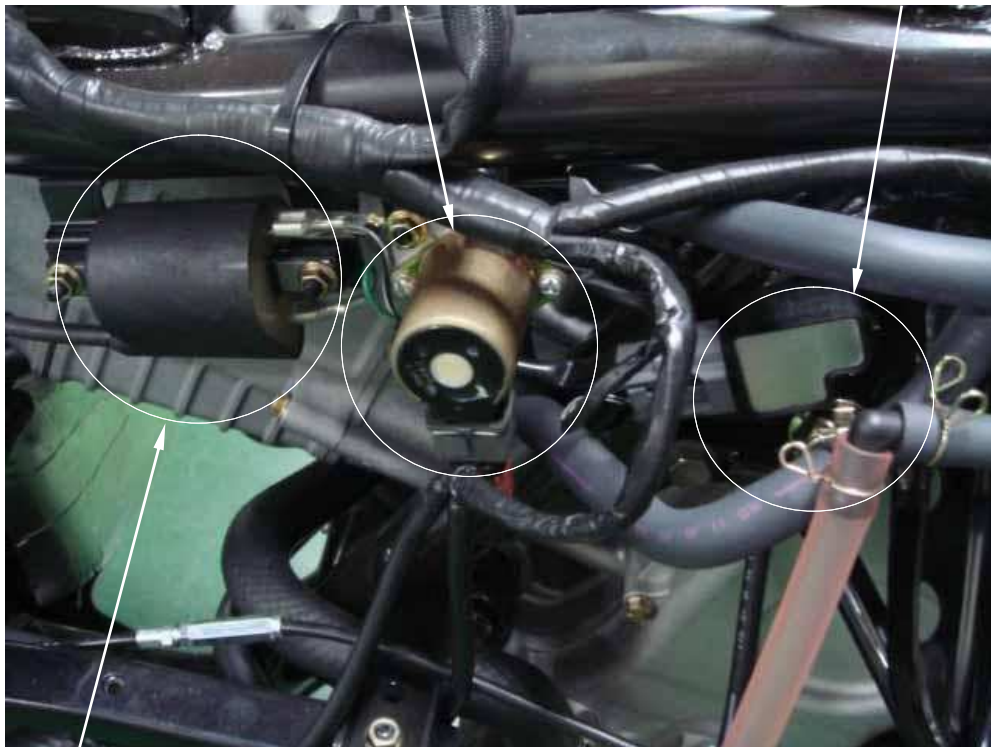

Inductive ignition coil

6. AFI (AUTOMATIC FUEL INJECTION)



Tilt sensor

Water temperature sensor



MAP sensor

6. AFI (AUTOMATIC FUEL INJECTION)

TROUBLESHOOTING

Engine would not start

- Intake air leak
- Fuel contaminated/deteriorated
- Pinched or clogged fuel hose
- Faulty fuel pump
- Clogged fuel filter
- Sticking fuel injector needle
- Faulty fuel pump operating system

Backfiring or misfiring during acceleration

- Ignition system malfunction

Engine stall, hard to start, rough idling

- Intake air leak
- Fuel contaminated/deteriorated
- Pinched or clogged fuel hose
- Idle speed misadjustment
- Fail to perform TPS/ISC reset

Poor performance (drive ability) and poor fuel economy

- Pinched or clogged fuel hose
- faulty injector

6. AFI (AUTOMATIC FUEL INJECTION)

SELF-DIAGNOSIS PROCEDURES WITHOUT DIAGNOSTIC TOOL

SELF-DIAGNOSTIC FUNCTION

Without diagnostics program can be performed condition.

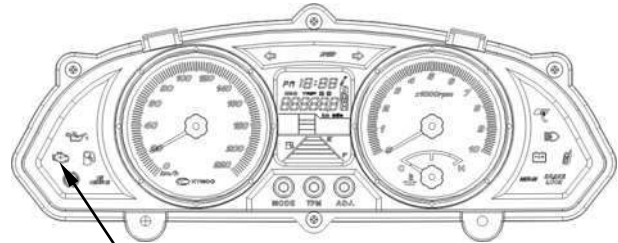

CELP lamp

SELF-DIAGNOSIS

“key ON ” →the CELP lamp will light for two second then off.

If there is any injection system malfunction the CELP lamp will show the failure code to let you know which part got problem.

When more than one failure occurs, the CELP lamp shows the codes in the order of lowest number to highest number.

CLEAR- FAILURE CODES

When you have solved the problems, key on and wait for 4 cycles of failure code running, the ECU will clear failure code automatically, but if the problem is still there, the failure code would not be cleared.

6. AFI (AUTOMATIC FUEL INJECTION)

CELP lamp show as a model

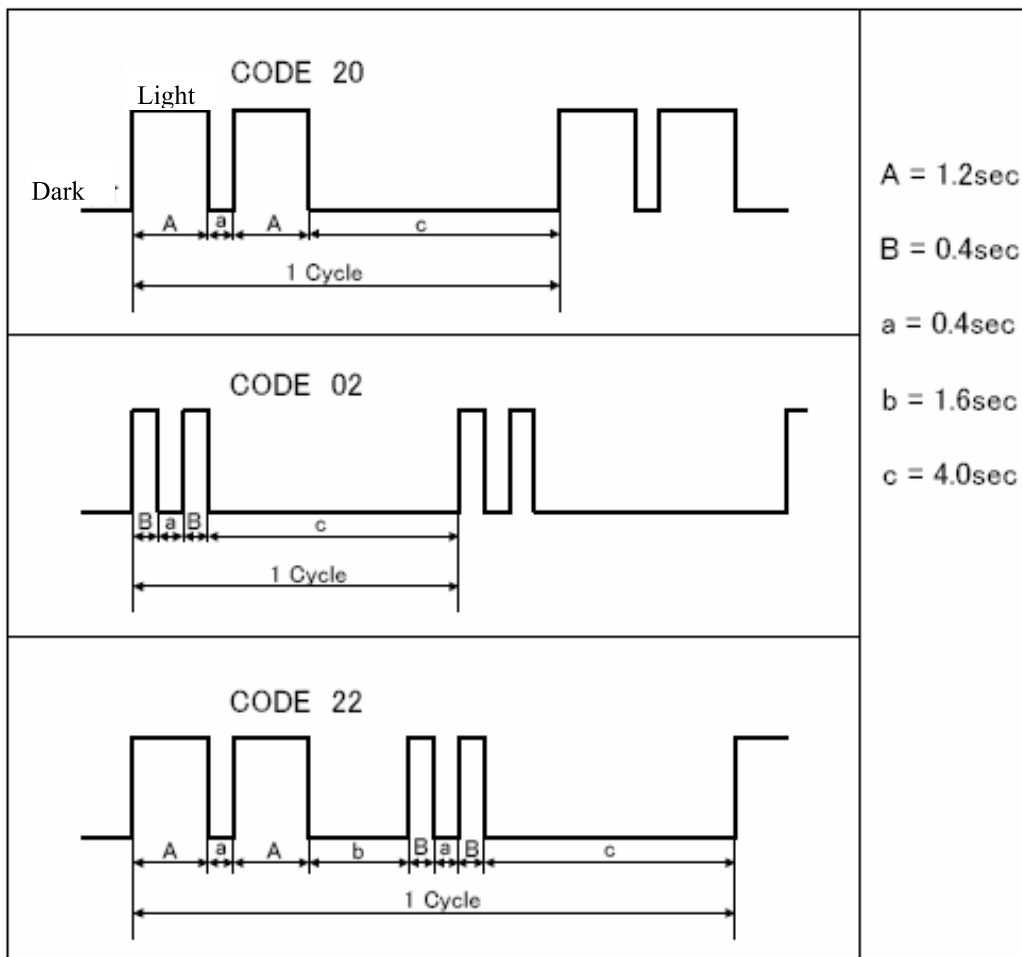

6. AFI (AUTOMATIC FUEL INJECTION)

MALFUNCTION INDICATOR LAMP (CLEP) FAILURE CODES

Blinks	Failure codes (PC and PDA)	Contents	Inspection	Priority
02	P0335	Faulty CPS(ACG)	CPS sensor(ACG)	2
03	P0340	Faulty CPS(Camshaft)	CPS sensor(Camshaft)	2
04	P1560	Sensor don't receive power source from ECU	ECU	2
05	P1120	TPS setting value problem	Throttle Body	2
06	P1122	TPS movement speed problem	Throttle Body	2
08	P0217	Engine water temperature overheat	Check lubrication and cooling system	1
09	P0115	WTS sensor or electric malfunction	WTS sensor	2
10	P0560	Battery voltage malfunction	Check battery charge system and AC generator	1
11	P0110	T-MAP sensor or electric malfunction	T-MAP sensor(temperature)	2
12	P1121	TPS output voltage malfunction	TPS	2
13	P0106	Map sensor or electric malfunction	MAP sensor	2
14	P0105	T-MAP sensor or electric malfunction	T-MAP sensor(Pressure)	2
15	P0134	O2 sensor or electric circuit malfunction	O2 sensor	2

6. AFI (AUTOMATIC FUEL INJECTION)

17	P1169	O2 sensor feedback signal or electric circuit malfunction	O2 sensor	2
21	P1110	Roll sensor or electric circuit malfunction	Roll sensor	2
22	P0219	Engine speed is over than top speed	CVT	2
23	P0700	Engine starting speed exceed CVT Speed limited	CVT	2
31	P0230	Fuel pump relay or electric circuit malfunction	Fuel pump relay	2
33	P0505	ISC learning or electric circuit malfunction	ISC	2
34	P0410	ISC or electric circuit malfunction	ISC	2
37	P0480	Coolant fan relay or electric circuit malfunction	Coolant fan relay	2
38	P0135	O2 sensor heater malfunction	O2 sensor	2
51	P0350	LH ignition coil or electric circuit malfunction	LH ignition coil and LH driver	2
52	P0351	RH ignition coil or electric circuit malfunction	RH ignition coil and RH driver	2
61	P0251	LH injector or electric circuit problem	LH injector or wire	2
62	P0252	RH injector or electric circuit problem	RH injector or wire	2

6. AFI (AUTOMATIC FUEL INJECTION)

SELF-DIAGNOSTIC PROCEDURES USING DIAGNOSTIC TOOL

SELF-DIAGNOSTIC PROCEDURES

1. Connect the diagnostic tool to connector which under the seat.
2. Put the side stand up and engine stop switch is at "RUN".
3. Turn the ignition switch to "ON".
4. Turn on the main switch.
5. To press the enter button and get into the fuction.



Diagnostic Tool Connector

6. AFI (AUTOMATIC FUEL INJECTION)



**Press ENTER
button**



ECU version

6. AFI (AUTOMATIC FUEL INJECTION)



Press ENTER
button



Loading DTC



Press ENTER
button

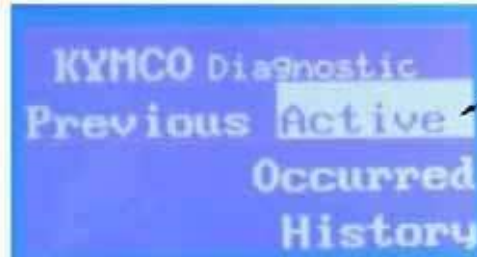

Active DTC



Press ENTER
button



NO Active DTC



Press ENTER
button



Loading DTC



Press ENTER
button



History DTC



Press ENTER
button



DTC 38

6. AFI (AUTOMATIC FUEL INJECTION)



Press ENTER
button

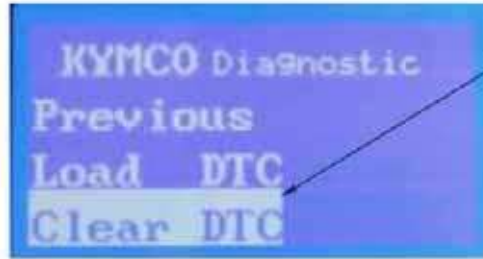

Clear DTC



Press ENTER
button



Completed

Page 01



Press ENTER
button



Page 02



6. AFI (AUTOMATIC FUEL INJECTION)

Page 03



KYMCO Diagnosis 03
Air temperature 25 °C
Atom. pressure 101.9 KPa
Manifold pressure 65.5 KPa

Page 05



02 FR RE
Volt 0.9 0.9 mV
Heater ON ON

Page 04

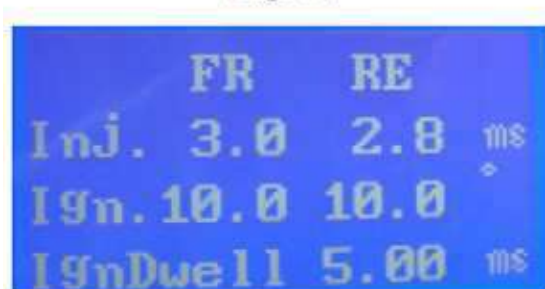

FR RE
Inj. 3.0 2.8 ms
Ign. 10.0 10.0
IgnDwell 5.00 ms

Page 06



KYMCO Diagnosis 06
ECU counter 0 H
Cut Out volt 3.94 V

6. AFI (AUTOMATIC FUEL INJECTION)

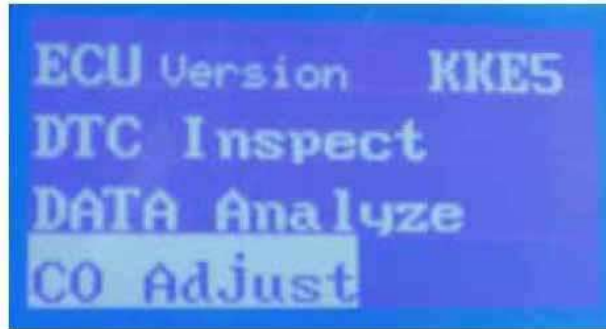

Press ENTER
button

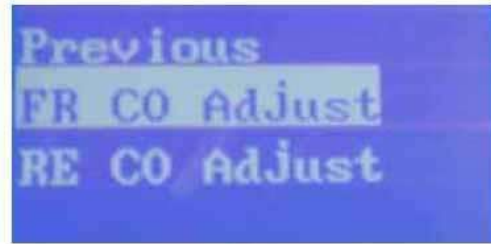

Press ENTER
button



UP
button:+0.01

DOWN
button:-0.01

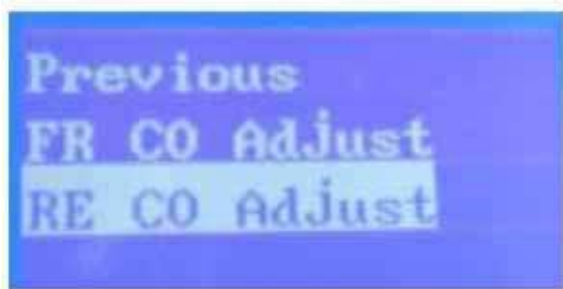

Press ENTER
button



UP
button:+0.01

DOWN
button:-0.01

6. AFI (AUTOMATIC FUEL INJECTION)

KYMCO Diagnostic Report
KKE5
SF :
Production
Date :
Customer :
Service
Date :
Eng. No:
Mileage :

 Reason of repair: maintenance breakdown

	Item	Date	Reference	Memo
ECU Version	ECU No		---	
	Hardware Ver		---	
	Software Ver		K6i188G1000	
	Calibration Ver		8G100000	
	Model Name		KYMCO-KKE5	
DTC	Active			
	Occurred			
	History			
(Cool Engine) Engine Stop	Atom. Temp. (°C)		environ.temp ± 2 °C	
	Engine Temp. (°C)		environ.temp ± 2 °C	
	Atom. Pressure(Kpa)		101.3 ± 3 kPa	Decreasing 12 kpa as the altitude raising per 1000m
	Throttle Position(%)		0%	Full Throttle: >80%
	Throttle Position Voltage (V)		0.68±0.05 V	
	Battery Voltage(V)		>12.6 V	
	Target r.p.m		---	
	ISC adapteion		---	
	Roll Sensor State		3.5 ~ 4.7V(stand)	0.4 ~ 1.44V (Fall down)
	ECU functioning(time)		---	
(Hot Engine) Before Repair	Engine speed (rpm)(idle)		1250 ± 100 rpm	engine warming up condition: above 80°C
	Engine Temp. (°C)		80 ~ 95 °C	engine warming up condition: above 80°C
	Atom. Temp. (°C)		environ.temp ± 2 °C	
	Intake Pressure(Kpa)		60~75 kpa	
	Fuel Inject Interval(front cylinder)		2.2 ~ 3.2 ms	could be higher than 3.2 ms when the engine has not
	Fuel Inject Interval(rear cylinder)		2.2 ~ 3.2 ms	finished to warm up.
	Ignition Timing (°)(front cylinder)		5 ~ 12 BTDC	
	Ignition Timing (°)(rear cylinder)		5 ~ 12 BTDC	
	Charging Interval(ms) during ignition		6 ~ 8 ms	
	ISC Opening Angle		25 ~ 50%	
	O2 Sensor Voltage(V)(front cylinder)		0~1 V	
	O2 Sensor Voltage(V)(rear cylinder)		0~1 V	
	O2 Sensor Heater Performance		ON	
	O2 correction rate		-20% ~ +10%	
	Before catalyst CO% (front cylinder)		0.5 ~ 3.0%	
Before catalyst CO% (rear cylinder)		0.5 ~ 3.0%		
(Hot Engine) After Repair	Engine speed (rpm)(idle)		1250 ± 100 rpm	engine warming up condition: above 80°C
	Engine Temp. (°C)		80 ~ 95 °C	engine warming up condition: above 80°C
	Atom. Temp. (°C)		environ.temp ± 2 °C	
	Intake Pressure(Kpa)		60~75 kpa	
	Fuel Inject Interval(front cylinder)		2.2 ~ 3.2 ms	could be higher than 3.2 ms when the engine has not
	Fuel Inject Interval(rear cylinder)		2.2 ~ 3.2 ms	finished to warm up.
	Ignition Timing (°)(front cylinder)		5 ~ 12 BTDC	
	Ignition Timing (°)(rear cylinder)		5 ~ 12 BTDC	
	Charging Interval(ms) during ignition		6 ~ 8 ms	
	ISC Opening Angle		25 ~ 50%	
	O2 Sensor Voltage(V)(front cylinder)		0~1 V	
	O2 Sensor Voltage(V)(rear cylinder)		0~1 V	
	O2 Sensor Heater Performance		ON	
	O2 correction rate		-20% ~ +10%	
	Before catalyst CO% (front cylinder)		0.5 ~ 3.0%	
Before catalyst CO% (rear cylinder)		0.5 ~ 3.0%		
Repair description		Repair Process		

Report ID=

6. AFI (AUTOMATIC FUEL INJECTION)

Maintaining By Checking Component

FUEL PUMP

Measure the resistance of the fuel pump.

Standard (25°C): 1.9 - 3.0Ω



Float down



Float up

T-MAP (Manifold Air Temperature Pressure) Sensor

Measure the resistance (pin 1, 2)

Standard (20~30 °C) : 1500 ~ 2650 Ω



-20°C: 14260 ~ 16022 Ω ◦
 20°C: 2353 ~ 2544 Ω ◦
 20°C ~ 30°C: 1500 ~ 2650 Ω ◦
 60°C: 568.9 ~ 597.4 Ω



6. AFI (AUTOMATIC FUEL INJECTION)

ISC (Idle Speed Control Motor)



Measure the resistance of the ISC

Standard : $9.6\ \Omega$ --- 20°C



TPS (Throttle Position Sensor)

Measure the resistance of the TPS (Throttle Position Sensor).

Standard : $5\text{K}\ \Omega \pm 40\%$ ($3000\ \Omega \sim 7000\ \Omega$)

1,3 PIN = $7000\ \Omega \sim 1200\ \Omega$

1,2 PIN = $3000\ \Omega \sim 7000\ \Omega$

2,3 PIN = $1200\ \Omega \sim 7000\ \Omega$



Measure the 1,3 PIN 



6. AFI (AUTOMATIC FUEL INJECTION)

WTS (Water Temperature Sensor)

Measure the resistance of the WTS

+50°C :153 Ω

+80°C :52 Ω

+100°C :27.5 Ω

+120°C : 16 Ω

25°C (Estimate):200 Ω±10%



IG (INDUCTIVE IGNITION COIL)

Measure the resistance of the IG



Primary: 3.57 ~ 4.83 Ω



Secondary: 10.7~14.49 KΩ

INJECTOR

Measure the resistance

Standard (20°C/68°F): 10.6~15.9 Ω



O2 SENSOR

The sensor can't work until the exhaust temperature over 350 centigrade, There's a heater inside when turning on the switch it will heat the sensor to work temperature.

For prevent from seize the thread while high temperature, to be sure that the mount screw it in stand torque.

All spare part are equip anti-seize oil, so you don't have to apply any oil on the thread.

Torque: 4.5 ± 0.5kgf-m

Measure the resistance of the O2 sensor heater.

(Connect the meter (+) probe to the white wire and the meter (-) probe to the white wire to measure the resistance

Standard : 10 ~15 Ω



6. AFI (AUTOMATIC FUEL INJECTION)

TILT SWITCH

The engine should be stall when the vehicle incline over 65° for safety. When you place the vehicle back to normal situation, you have to key-off and key-on the switch, then it can be restarted.



Standard:





Normal: 3.5~4.7 V

OVER 65°: 0.4~1.4V











6. AFI (AUTOMATIC FUEL INJECTION)

EMS Parts inspection specifications

NO.	Part name	Inspection way			Item	Specification	Remark	Temperature
		Darwing	PDA	Multimeter				
1.	ECU				1. Outlook checking 2. Performance confirmed 3. Voltage inspection 4. Map content (edition issue NO.)	1. Confirm by drawing chart code 2. Connection for Harness and wire connector 3. Voltage(5V±0.1V) 4. Follow the diagnosis record list		-30°C~75°C
2.	IDLE AIR BYPASS VALVE or ISC				1. Opening setting 2. Confirm if performance is smooth 3. Outlook (with joint)	1. IDLE opening: 0.6V±0.02V WOT opening: 3.77V 3. Confirm if performance is smooth? 4. Outlook (with joint)?	resistance: 9.6Ω~20°C Voltage : 0°~105° (0.3~4.5V) 5KΩ±30%	-40°C~130°C
3.	MAP SENSOR				1. MAP Pattern	1. 13.332kpaABS(1V) ~119.990kpaABS(4.2V)		-15°C~60°C
4.	TPS, THROTTLE POSITION SENSOR				1. TPS Output voltage 2. Resistance range	1. IDLE opening: 0.68 ± 0.05V WOT opening : 4.1 ± 0.1V 2. 5KΩ±40% (3000Ω~7000Ω)	1,3 PIN=7000Ω~1200Ω (Ohm is decreasing by rotating TPS) 1,2 PIN=3000Ω~7000Ω (Constant resistance) 2,3 PIN=1200Ω~7000Ω (Ohm is increasing by rotating TPS)	-30°C~110°C

6. AFI (AUTOMATIC FUEL INJECTION)

5.	FUEL PUMP		V	V	1. Leakage test 2. Outlook(with joint) 3. Insulation resistance 4. Leakage test for fuel tube 5. Noisy 6. Fuel level resistance.	2. No rust and damaged. 3. >1MΩ 5. Noisy? 6. FUEL LEVEL resistance :F:1100 Ω±20 E:100Ω±5	Pump coil about 1.9 Ω	-15℃~+60℃
6.	FUEL INJECTOR		V	V	1. Flow rate 2. Resistance Value	1. Follow the KTW final inspection list. 2. 10.6Ω~15.9Ω	13.25Ω±20%	-15℃~+60℃
7.	WTS,WATER TEMPERATURE SENSOR		V	V	1. Resistance Value 2. Insulation resistance	When+50℃--153Ω When+80℃--52Ω When+100℃--27.5Ω When+120℃-- 16Ω	25℃: About 200Ω±10%	-40℃~+120℃
8.	INDUCTIVE IGNITION COIL		V	V	1. Resistance	Primary side: 3.57~4.83Ω Secondary: 10.7~14.49KΩ	4.2Ω±15% 12.6KΩ±15%	-15℃~+60℃
9.	OXYGEN SENSOR		V	V	1. Resistance 2. Output voltage 3. Out look 4. Confirm length of protect tube	1. Heater resistance : 10Ω~15Ω 2. Sensor output voltage : A/F: <when>0.8V(RICH) A/F: >when14.7,<0.18V(LEAN) 3. Confirm outlook no rust and damaged. 4. Confirm length of protect tube	Measure after the engine is warm	-40℃~+900℃(Central electrode)
10.	CPS ,CRANK POSITION SENSOR		V	V		Output voltage=10.4V±0.2V		-30℃~+140℃
12.	TILT SWITCH		V	V	Output voltage at normal Output voltage when	Normal=3.5~4.7V Fall down =0.3~1.4V	Measure with PDA	-20℃~+80℃
13.	IGNITION DRIVER		V	V	1.Voltage	Connect with ecu and coil wire measure Primary side: 3.57~4.83Ω Secondary: 10.7~14.49KΩ	Need with ecu and coil wire measure	-30℃~+100℃
14.	T-MAP SENSOR		V	V	1. Temperature and resistance range 2. Atmospheric pressure and voltage	1. When -20℃ Resistance rang= 14260 ~ 16022 Ω * When 20℃ Resistance ran= 2353~2544 Ω * When 20℃~30℃ (About)=1500~2650 Ω * When 60℃ Resistance ran= 568.9~597.4 Ω *	Inspect the Atmospheric pressure with PDA	-15℃~60℃

7. COOLING SYSTEM

COOLING SYSTEM

7

SERVICE INFORMATION-----	7- 2
TROUBLESHOOTING-----	7- 4
COOLING SYSTEM TESTING-----	7- 5
COOLANT REPLACEMENT -----	7- 6
THERMOSTAT-----	7- 8
WATER PUMP -----	7-11
RADIATOR -----	7-14
FAN MOTOR SWITCH -----	7-16
WATER TEMPERATURE SENSOR -----	7-17
RAIDATOR RESERVE TANK -----	7-18

7. COOLING SYSTEM

7. COOLING SYSTEM

SERVICE INFORMATION

GENERAL INSTRUCTIONS

WARNING:

Removing the radiator cap while the engine is hot can allow the coolant to spray out, seriously scalding you. Always let the engine and radiator cool down before removing the radiator cap.

CAUTION:

Radiator coolant is toxic. Keep it away from eyes, mouth, skin and clothes.

- If any coolant gets in your eyes, rinse them with water and consult a physician immediately.
- If any coolant is swallowed, induce vomiting, gargle and consult a physician immediately.
- If any coolant gets on your skin or clothes, rinse thoroughly with plenty of water.

NOTE:

Use coolant with silicate inhibitors may cause premature wear of water pump seals or blockage of radiator passages. Using tap water may cause engine damage.

- This section covers service of the cooling system.
- These services can be done with the engine installed in the frame.
- Add coolant at the reserve tank. Do not remove the radiator cap except to refill or drain the system.
- All cooling system services can be done with the engine in the frame.
- Avoid spilling coolant on painted surfaces.
- After servicing the system, check for leaks with a cooling system tester.

7. COOLING SYSTEM

SPECIFICATIONS

ITEM		SPECIFICATIONS
Coolant capacity	Radiator and engine	2.2 liter
	Reserve tank	0.8 liter
Radiator cap relief pressure		108 kPa
Thermostat	Begin to open	80 - 84°C
	Fully open	95°C
	Valve lift	8 mm
Standard coolant concentration		1:3 mixture with soft water

COOLANT GRAVITY CHART

Temp. Coolant concentration	0	5	10	15	20	25	30	35	40	45	50
5%	1.009	1.009	1.008	1.008	1.007	1.006	1.005	1.003	1.001	0.999	0.997
10%	1.018	1.107	1.017	1.016	1.015	1.014	0.013	1.011	1.009	1.007	1.005
15%	1.028	1.027	1.026	1.025	1.024	1.022	1.020	1.018	1.016	1.014	1.012
20%	1.036	1.035	1.034	1.033	1.031	1.029	1.027	1.025	1.023	1.021	1.019
25%	1.045	1.044	1.043	1.042	1.040	1.038	1.036	1.034	1.031	1.028	1.025
30%	1.053	1.051	1.051	1.049	1.047	1.045	1.043	1.041	1.038	1.035	1.032
35%	1.063	1.062	1.060	1.058	1.056	1.054	1.052	1.049	1.046	1.043	1.040
40%	1.072	1.070	1.068	1.066	1.064	1.062	1.059	1.056	1.053	1.050	1.047
45%	1.080	1.078	1.076	1.074	1.072	1.069	1.056	1.063	1.062	1.057	1.054
50%	1.086	1.084	1.082	1.080	1.077	1.074	1.071	1.068	1.065	1.062	1.059
55%	1.095	1.093	1.091	1.088	1.085	1.082	1.079	1.076	1.073	1.070	1.067
60%	1.100	1.098	1.095	1.092	1.089	1.086	1.083	1.080	1.077	1.074	1.071

COOLANT MIXTURE (WITH ANTI-RUST AND ANTI-FREEZING EFFECTS)

Freezing Point	Mixing Rate	KYMCO SIGMA Coolant Concentrate	Distilled Water
-9	20%		
-15	30%	425cc	975cc
-25	40%		
-37	50%		
-44.5	55%		

Cautions for Using Coolant:

- Use coolant of specified mixing rate. (The mixing rate of 425cc KYMCO SIGMA coolant concentrate + 975cc distilled water is 30%.)
- Do not mix coolant concentrate of different brands.
- Do not drink the coolant which is poisonous.
- The freezing point of coolant mixture shall be 5 ° lower than the freezing point of the riding area.

7. COOLING SYSTEM

TORQUE VALUES

Water pump bolt	1.3 kgf•m
Fan motor bolt	0.53 kgf•m
Radiator shroud mounting nut	0.9 kgf•m

TROUBLESHOOTING

Engine temperature too high

- Faulty radiator cap
- Faulty temperature gauge or thermosensor
- Air in system
- Thermostat stuck closed
- Insufficient coolant
- Passages blocked in radiator, hoses or water jacket
- Faulty cooling fan motor
- Faulty fan motor switch
- Faulty water pump

Engine temperature too low

- Faulty temperature gauge or thermosensor
- Thermostat stuck open
- Faulty fan motor switch

Coolant leak

- Faulty water pump mechanical seal
- Deteriorated O-rings
- Faulty radiator cap
- Damaged or deteriorated cylinder head gasket
- Loose hose connection or clamp
- Damaged or deteriorated hoses

7. COOLING SYSTEM

COOLING SYSTEM TESTING

RADIATOR CAP INSPECTION

Remove the radiator cap.

Pressure test the radiator cap.

Replace the radiator cap if it does not hold pressure, or if relief pressure is too high or too low.

It must hold the specified pressure for at least six seconds.

Before installing the cap in the tester, wet the sealing surface.

Radiator Cap Relief Pressure:

1.1 kg/cm²

Pressurize the radiator, engine and hoses, and check for leaks.

Excessive pressure can damage the cooling system components.
Do not exceed 1.4 kg/cm².

Repair or replace components if the system will not hold the specified pressure for at least six seconds.

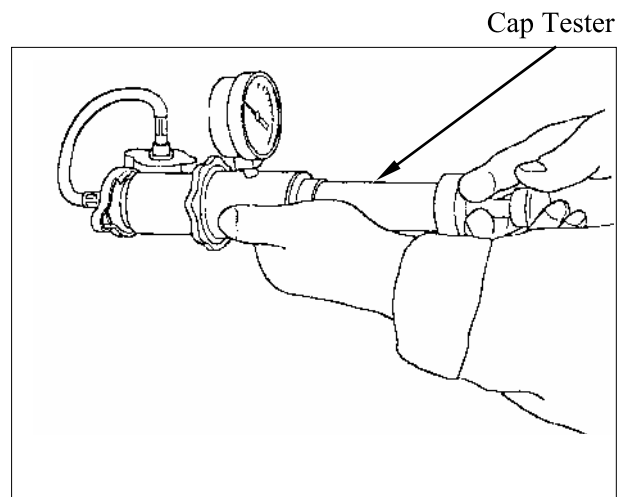
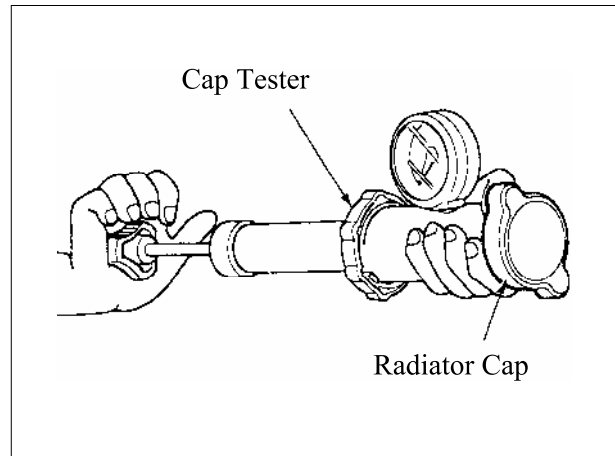

COOLANT REPLACEMENT PREPARATION

- The effectiveness of coolant decreases with the accumulation of rust or if there is a change in the mixing proportion during usage. Therefore, for best performance change the coolant regularly as specified in the maintenance schedule.
- Mix only distilled, low mineral water with the antifreeze.

Recommended mixture:

1:1 (Distilled water and antifreeze)

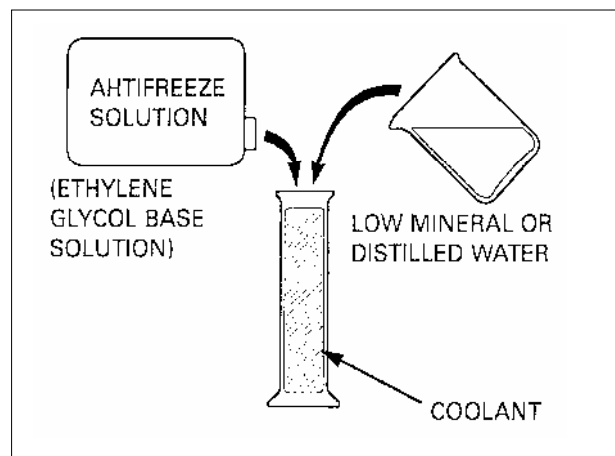

7. COOLING SYSTEM

REPLACEMENT/AIR BLEEDING

Remove the front cover.

When filling the system or reserve tank with coolant (checking the coolant level), place the scooter in a vertical position on a flat, level surface.

Remove the radiator cap.

Radiator Cap



Disconnect the water hose and drain the coolant from the system.

Remove the water drain bolt and drain the coolant from the system.



Water Hose

Clamp

Remove the floor mat.

Remove the screw and reserve tank lid.

Reserve Tank Lid

Screw

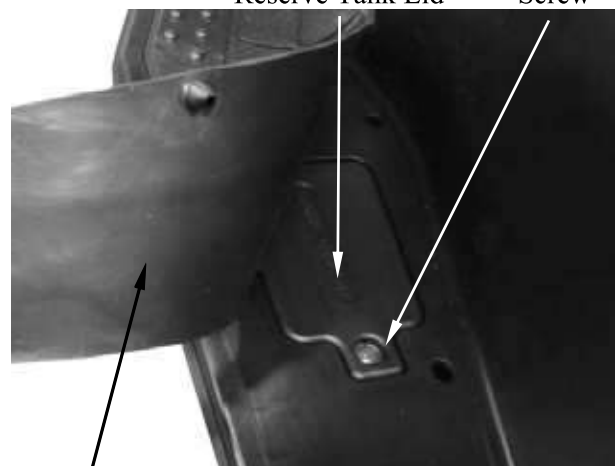

Floor Mat

7. COOLING SYSTEM

Remove the reserve tank cap and drain the coolant from the reserve tank.

Reconnect the water hose securely.

Reserve Tank Cap

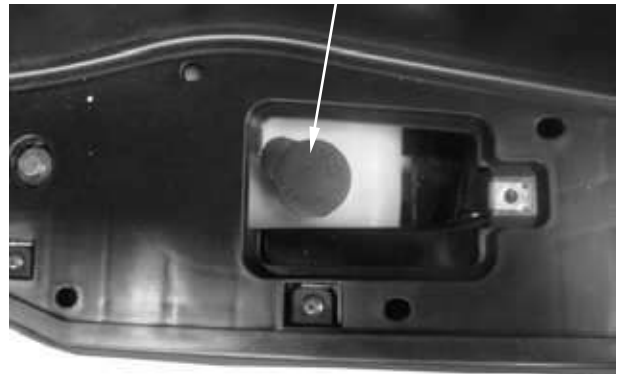

Place the scooter on its center stand on a flat, level surface.
Fill the reserve tank to the upper level line.

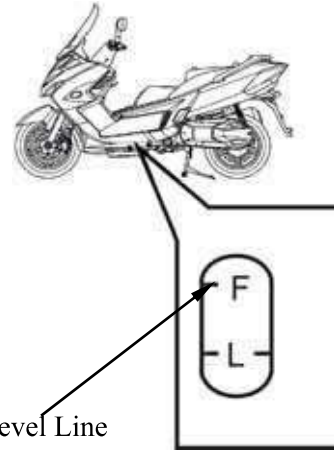

Upper Level Line

Fill the system with the recommended coolant through the filler opening up to the filler neck.

Filler Neck



7. COOLING SYSTEM

Bleed air from the system as follow:

1. Start the engine and let it idle for 2–3 minutes.
2. Snap the throttle three to four times to bleed air from the system.
3. Stop the engine and add coolant to the proper level if necessary. Reinstall the radiator cap.
4. Check the level of coolant in the reserve tank and fill to the upper level if it is low.

THERMOSTAT REMOVAL

Remove the floorboard.
Remove bolts of housing cover.

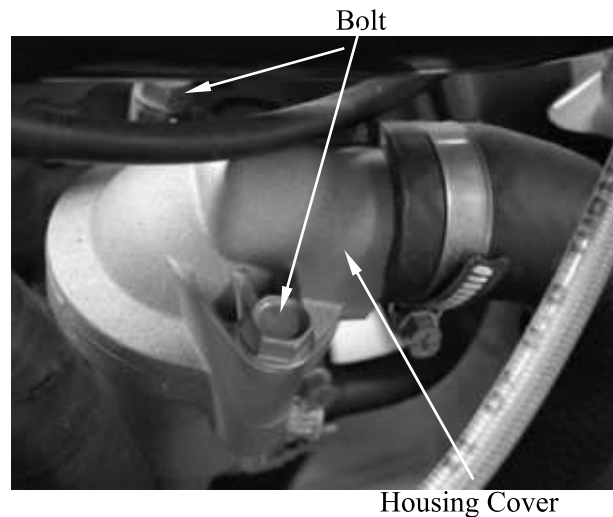

Remove the housing cover.
Remove the thermostat.



7. COOLING SYSTEM

INSPECTION

Visually inspect the thermostat for damage.

Heat the water with an electric heating element to operating temperature for five minutes.

Suspend the thermostat in heated water to check its operation.

- Keep flammable materials away from the electric heating element.
- Do not let the thermostat or thermometer touch the pan, or you will get false readings.

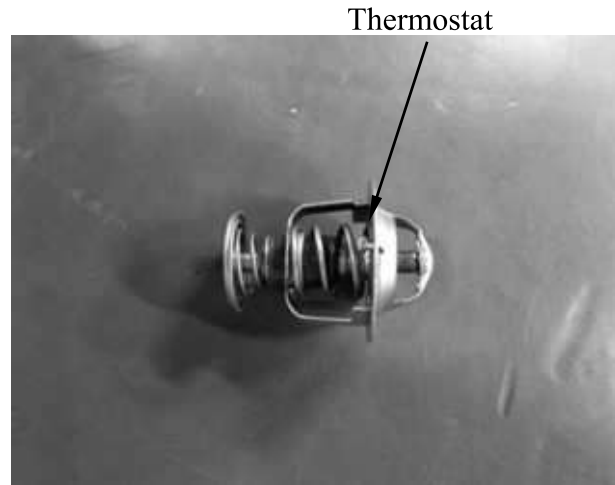

Replace the thermostat if the valve stays open at room temperature, or if it responds at temperatures other than those specified.

**Thermostat begin to open:
80–84°C**

**Valve lift:
8 mm at 95°C**

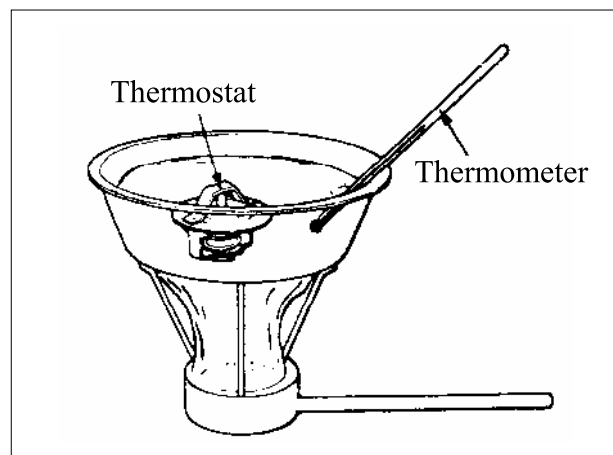

7. COOLING SYSTEM

INSTALLATION

Install the thermostat into the housing with its air bleed hole facing up and aligning bleed hole with the tab in the housing.

Air Bleed Hole

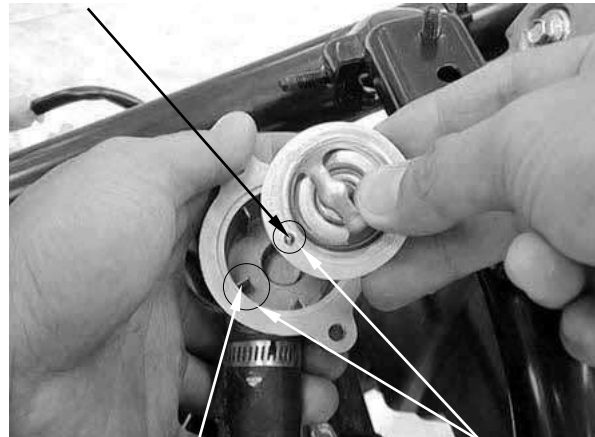

Tab

Align

Install housing cover.



Install housing cover.
Tighten the fixed bolts.

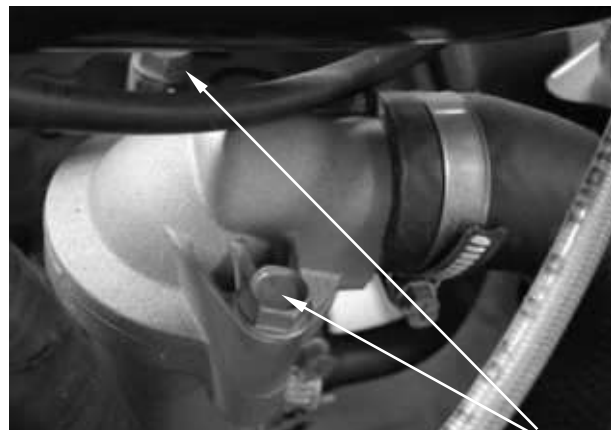

bolts

7. COOLING SYSTEM

WATER PUMP REMOVAL

Drain the coolant.

Loosen the hose bands and disconnect the water hoses from the water pump.

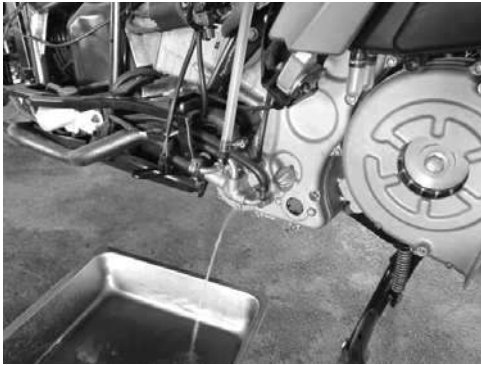

Water Hoses

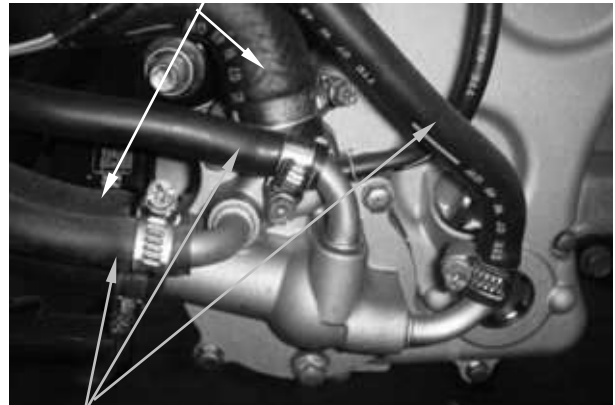

Hoses

Remove 4 bolts from the water pump cover.

Water pump cover

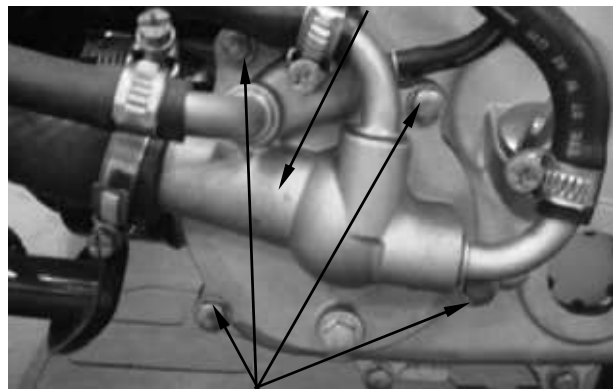

Bolts

7. COOLING SYSTEM

Remove the water pump cover.

Water Pump Cover



Gasket

Remove the crankcase.
Remove the water pump impeller.

Water pump impeller

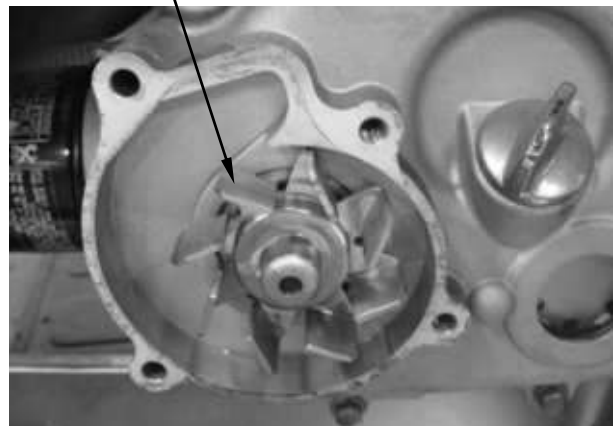

INSTALLATION

Apply engine oil to a new gasket and install it onto the stepped portion of the water pump.

Install the water pump into the crankcase while aligning the water pump shaft groove with oil pump shaft end.

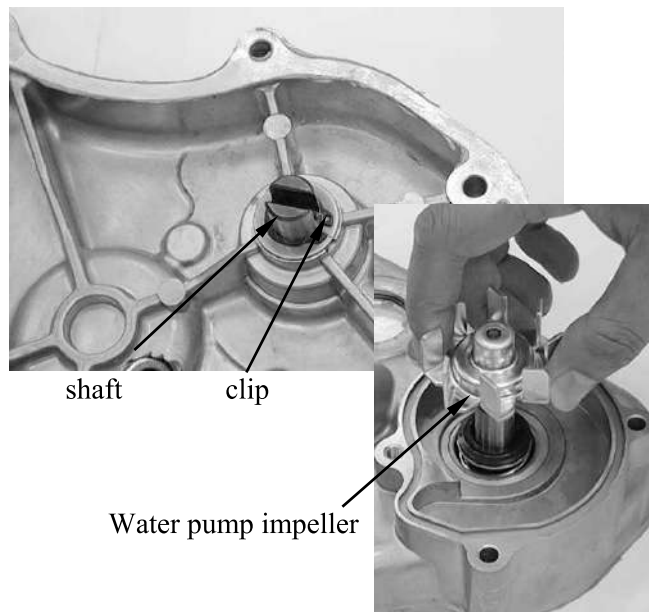

7. COOLING SYSTEM

Install 4 bolts of water pump, water pipes and clamp.

Install the water pump cover and tighten the bolts to the specified torque.

Torque: 1.3 kgf•m

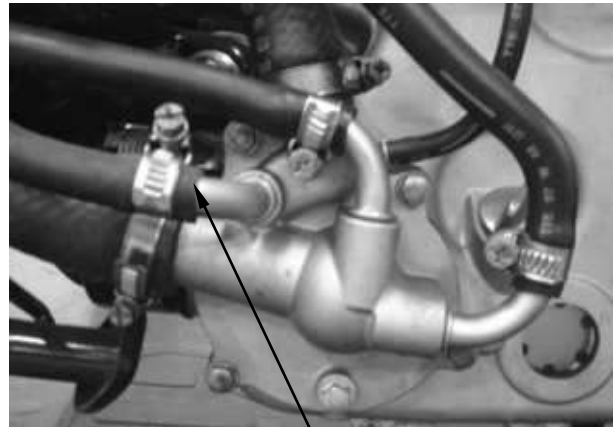

Clamp

7. COOLING SYSTEM

RADIATOR REMOVAL

Drain the coolant.

Disconnect the fan motor connector.



Fan Motor Connector

Loosen the hose clamp and disconnect the radiator lower hose from the radiator.

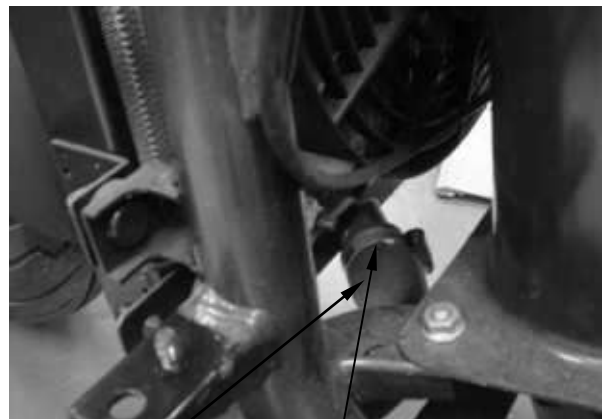

Lower Hose Clamp

Loosen the hose clip and disconnect the coolant filler hose from the radiator. Loosen the clamp of upper hose and disconnect the upper hose.

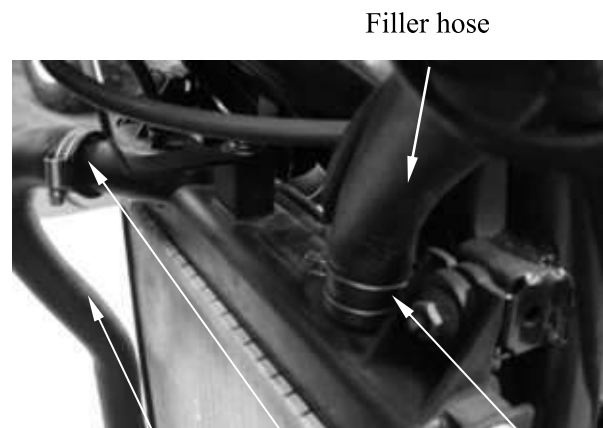

Upper Hose Clamp Clip Filler hose

7. COOLING SYSTEM

Disconnect the air bleed hose.



Air Bleed Hose

Remove the four bolts and radiator from the frame.

Be careful not to damage the radiator.

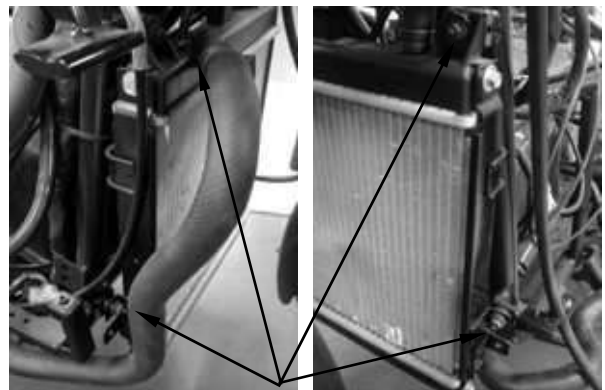

Bolts

7. COOLING SYSTEM

FAN MOTOR DISSASSEMBLY

Remove the four bolts and fan motor.

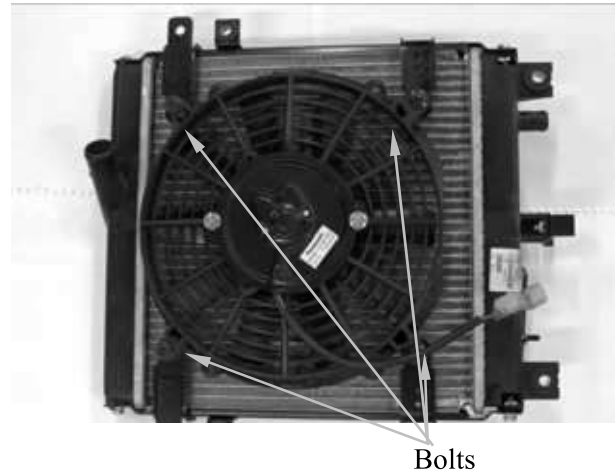

Check the fan motor to operate using an available battery.

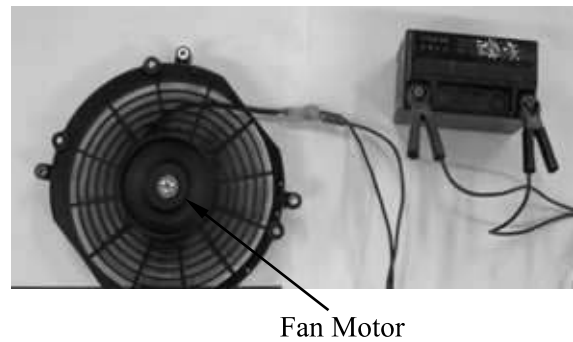

ASSEMBLY

Install the fan motor/shroud assembly to the radiator with the fan motor wire facing up.
Install and tighten the bolts securely.



7. COOLING SYSTEM

WATER TEMPERATURE SENSOR

REMOVAL

Remove the side body cover

Disconnect the water temperature sensor connector.

Remove the water temperature sensor from the water joint.



Connector

Water Temperature Sensor

INSPECTION

Connect the water temperature sensor to the ohmmeter and dip it in oil contained in a pan which is placed on an electric heater.

Gradually raise oil temperature while reading the thermometer in the pan and the ohmmeter connected. If the resistance measured is out of specification, replace the temperature gauge with a new one.

Temperature	Standard resistance
50	140– 310 Ω
100	24.1– 28.2 Ω

- Handle the water temperature sensor carefully as it is vulnerable to impact.
- Do not allow the water temperature sensor and the thermometer to come in contact with the bottom of the pan.

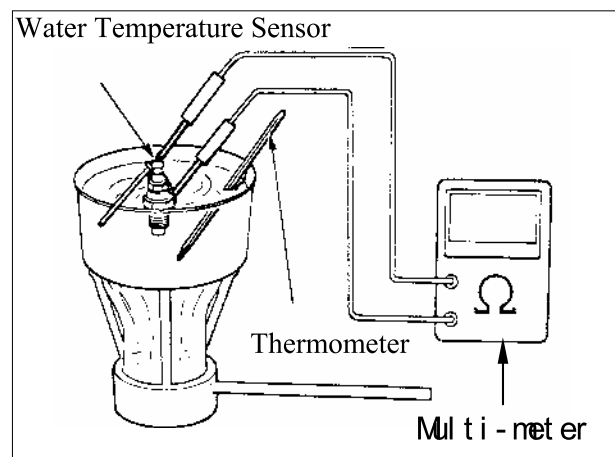

After the water temperature sensor has been installed, fill coolant and perform air bleeding.

INSTALLATION

Tighten the water temperature sensor.

Torque: 0.8~1.2 kgf•m

7. COOLING SYSTEM

RADIATOR RESERVE TANK

REMOVAL

Remove the floorboard.

Remove the two nuts and radiator reserve tank from the frame.

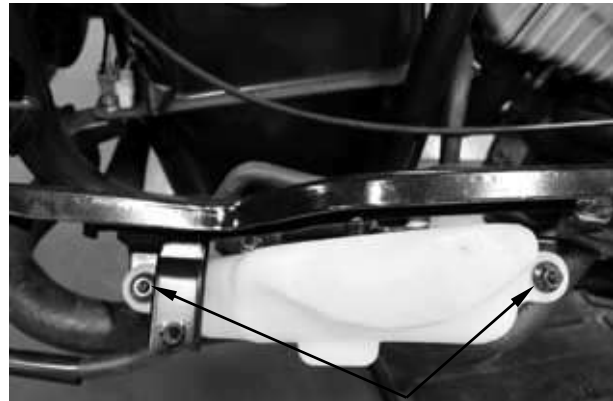

Nuts

Open the reserve tank cap and drain the coolant from the reserve tank.

Disconnect the hoses.

INSTALLATION

Installation is in the reverse order of removal.

Check the hoses for damage, replace them if necessary.

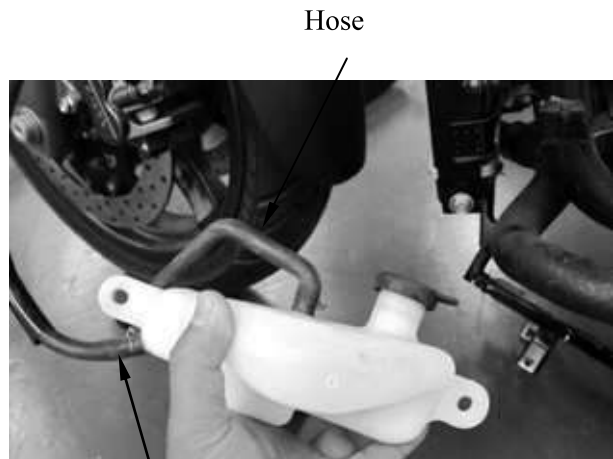

Hose

8.ENGINE REMOVAL/ INSTALLATION

ENGINE REMOVAL/INSTALLATION

SERVICE INFORMATION-----	8- 1
ENGINE REMOVAL -----	8- 2
ENGINE INSTALLATION -----	8- 8



8.ENGINE REMOVAL/ INSTALLATION

SERVICE INFORMATION

GENERAL INSTRUCTIONS

- During engine removal and installation, support the scooter on its main stand.
- Support the frame using a jack or other adjustable support to ease of engine hanger bolt removal.
- The following components require engine removal for serviced with the engine installed in the frame.

™ Oil pump

™ Water pump

™ Cylinder head

™ Cylinder/Piston

™ Drive and driven pulleys/clutch

™ Final reduction

™ Alternator/Starter clutch

- The following components require engine removal for service.

™ Crankshaft/Crankcase/Balancer

SPECIFICATIONS

ITEM		SPECIFICATIONS
Engine dry weight		65kg
Engine oil capacity	At draining	3.0 L
	At disassembly	2.6 L

TORQUE VALUES

Engine mounting bolt	8 kgf•m
Engine mounting nut	8 kgf•m
Rear shock absorber mounting bolt	4 kgf•m
Rear/parking brake caliper mounting bolt	2.7 kgf•m

8.ENGINE REMOVAL/ INSTALLATION

ENGINE REMOVAL

Remove the following:

- Luggage box
- Floorboard
- Rear fender
- Side/rear body cover
- Exhaust muffler

Drain the coolant.
Support the scooter on its main stand.



Disconnect the water temperature sensor connector and cooler pipe.

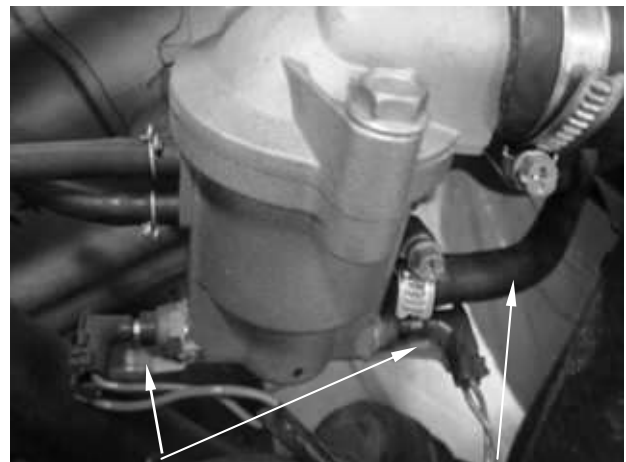

Connector

cooler pipe

Disconnect the spark plug caps.
Disconnect the crankcase breather hose.
Disconnect the crank position sensor's connector.

Crankcase breather hose



Spark plug cap

8.ENGINE REMOVAL/ INSTALLATION

Remove the bolt and thermostat housing.

Release the rubber cap and remove the terminal nut to disconnect the starter motor cable.

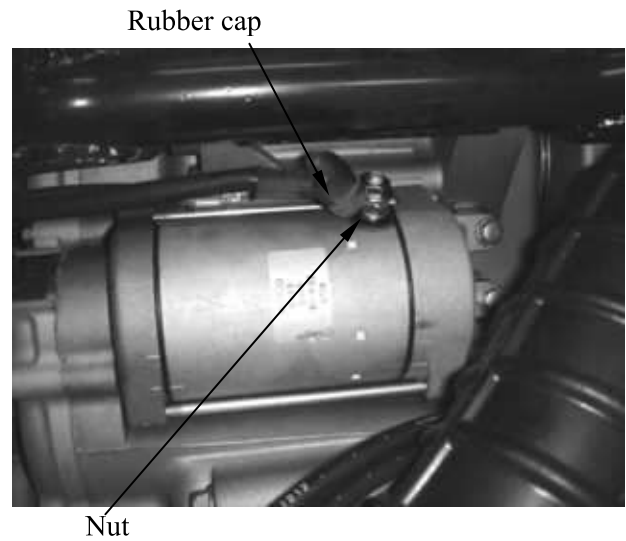

Disconnect the air bleed hoses.

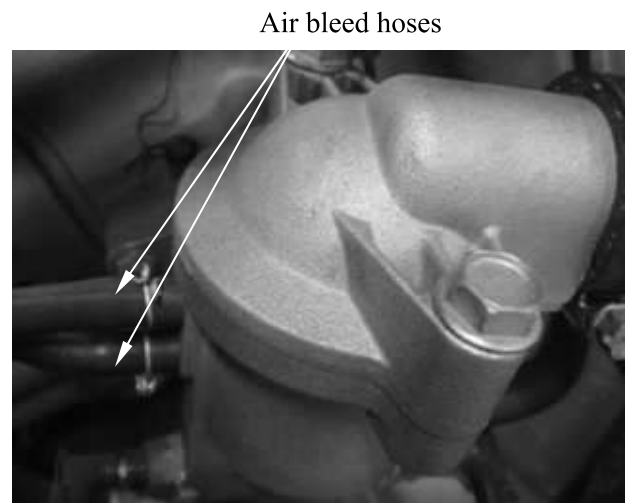

Remove the bolt and remove the thermostat.



8.ENGINE REMOVAL/ INSTALLATION

Remove the A.C.G. connector.

A.C.G. connector

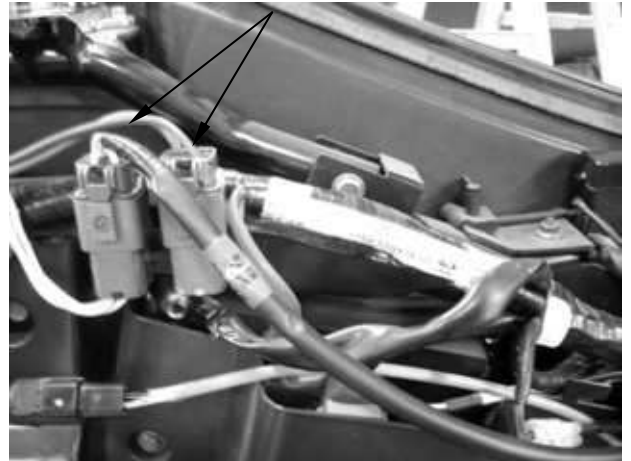

Disconnect the engine ground cable.

Engine ground cable

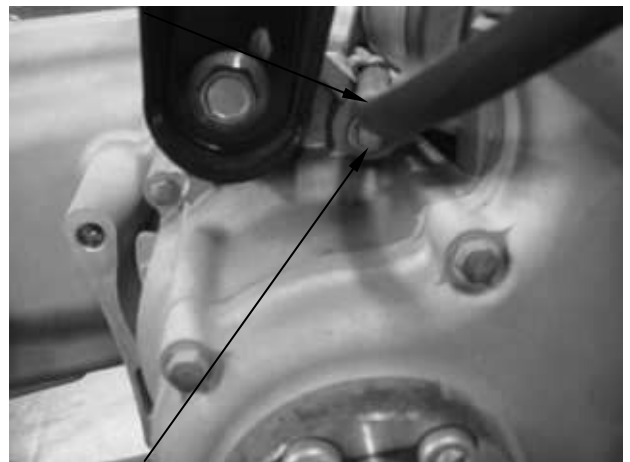

bolt

Disconnect the cooler's tubes and water pipe.

Cooler's tubes

water pipe

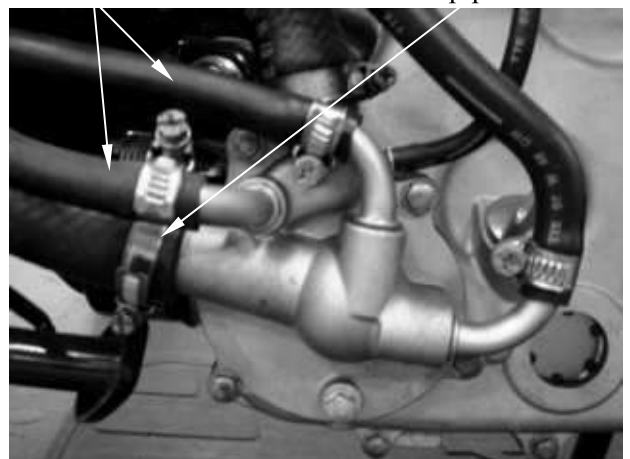

8.ENGINE REMOVAL/ INSTALLATION

Disconnect the oil pressure switch connector.

Oil pressure switch connector

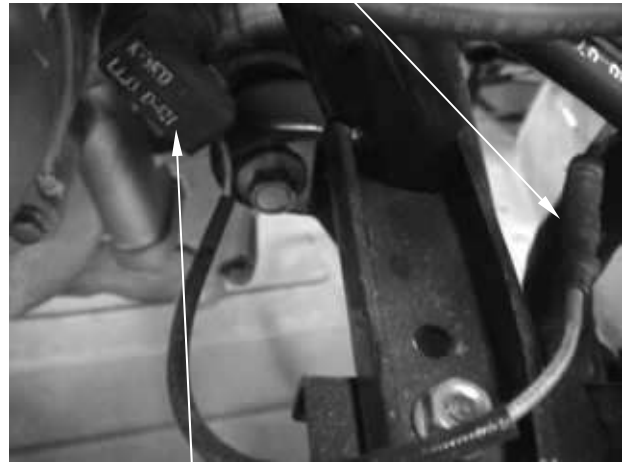

Oil pressure switch

Remove the bolts and rear/parking brake caliper.
Remove the brake hose from clamps.

Bolt



Remove the nut.
Pull out the engine mounting bolt, then
removes the engine from the frame.



ISC TUBE

8.ENGINE REMOVAL/ INSTALLATION

Remove the air cleaner bolts, remove T-MAP sensor connector and air cleaner.

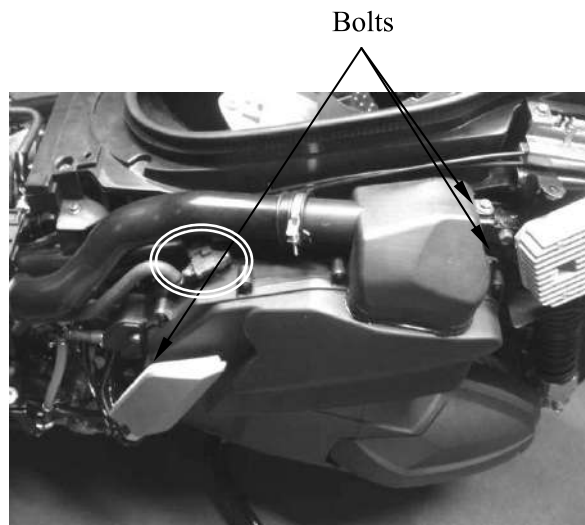

Remove the rear cushion lower bolts.

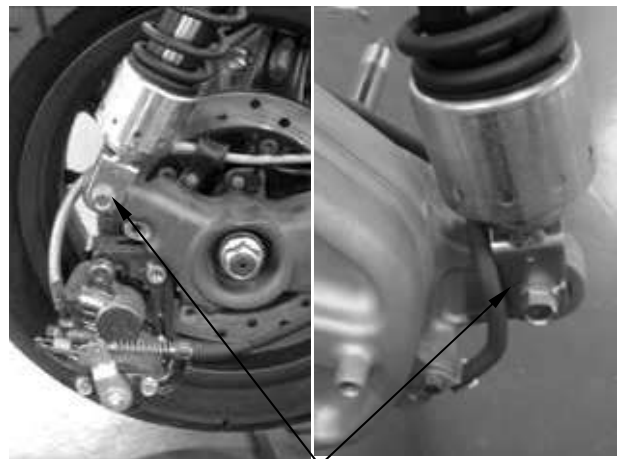

Remove the engine fixed bolt.

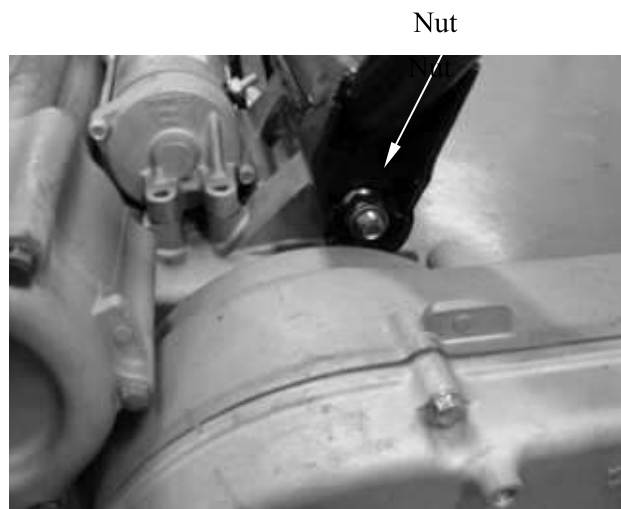

8.ENGINE REMOVAL/ INSTALLATION

Turn the engine mount bolt counterclockwise and loosen it.

Pull out the engine mount bolt then removes the engine from the frame.



Nut

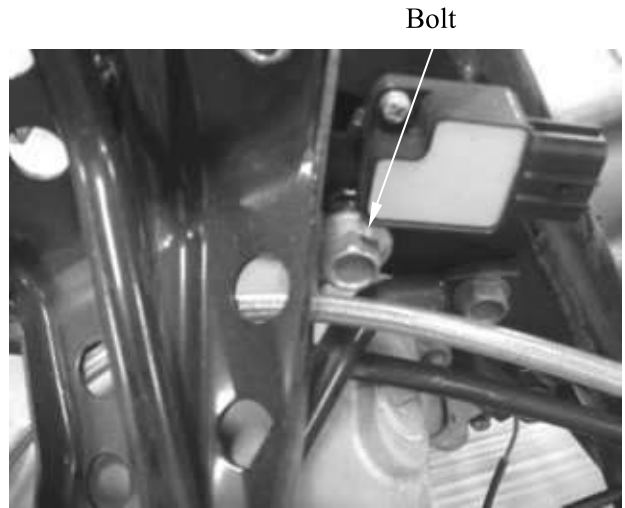

Bolt

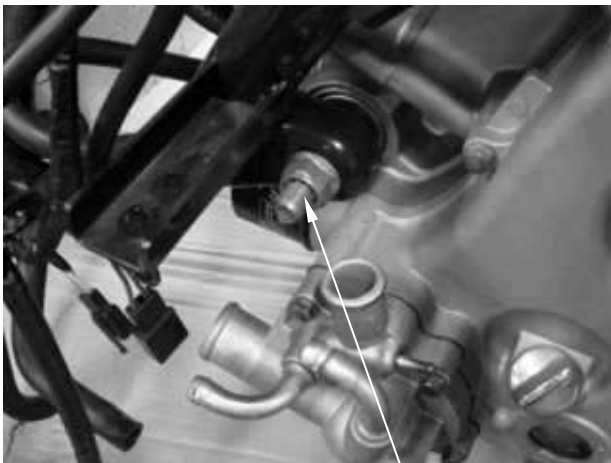

Nut



Bolt



Picture 1

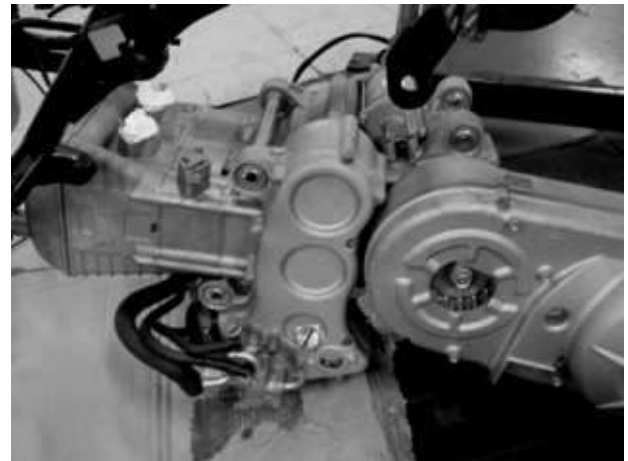

Picture 2

8.ENGINE REMOVAL/ INSTALLATION

MYROAD 700i

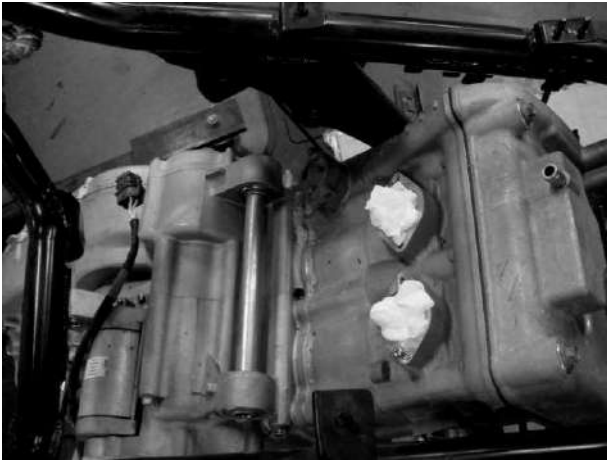

Picture 3

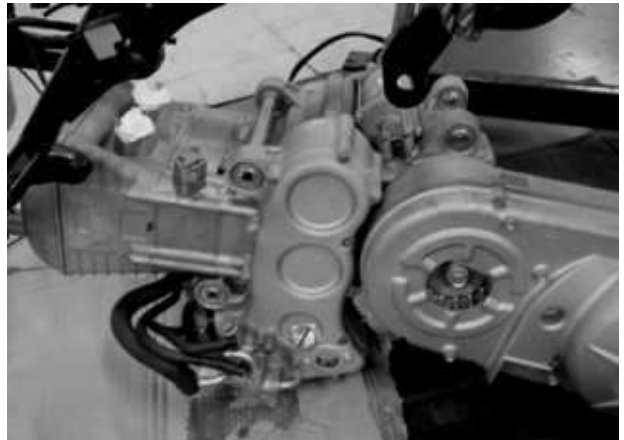

Picture 4

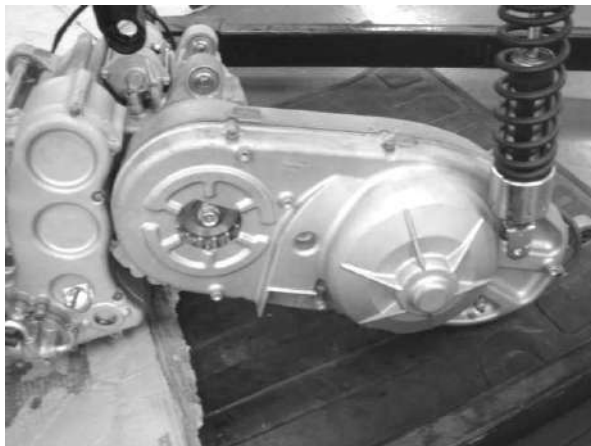

Picture 5

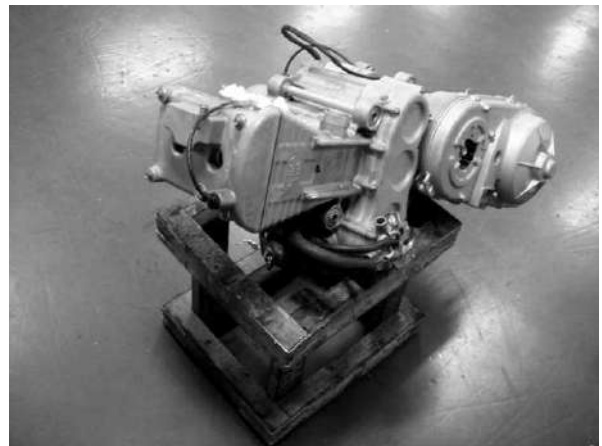

Picture 6

INSTALLATION

Installation is in the reverse order of removal.

- At installing the engine, be careful not to catch your hand or finger between the engine hanger and crankcase.
- Check for leakage of the engine oil and engine coolant.

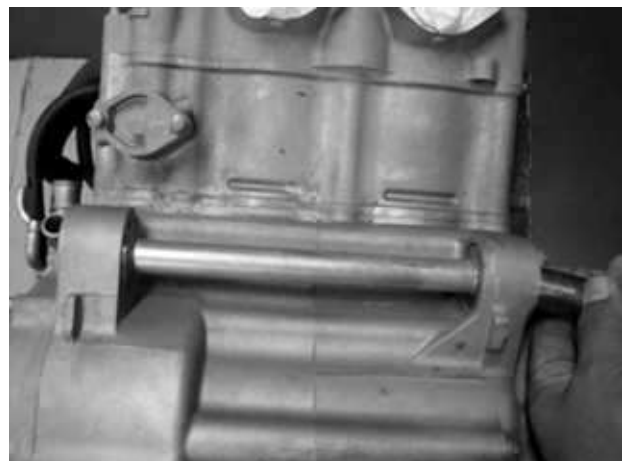

8.ENGINE REMOVAL/ INSTALLATION

Check the engine fixed bolts.
Replace with new parts if necessary.

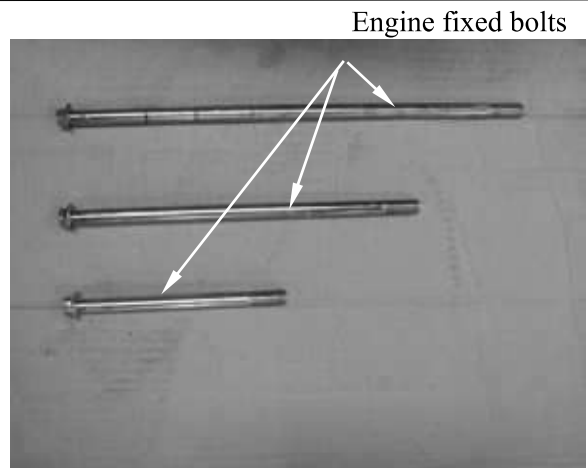

Check the collars.
Replace with new parts if necessary.

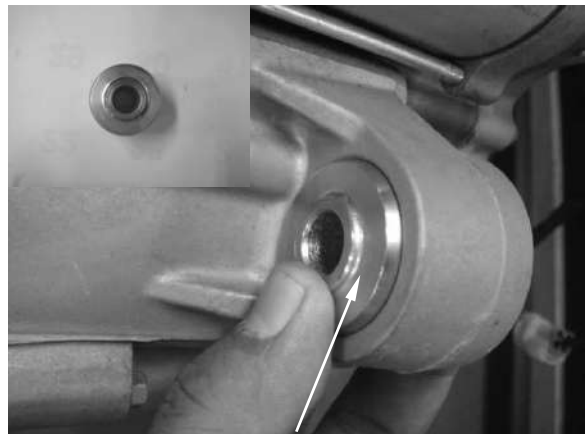

Collar

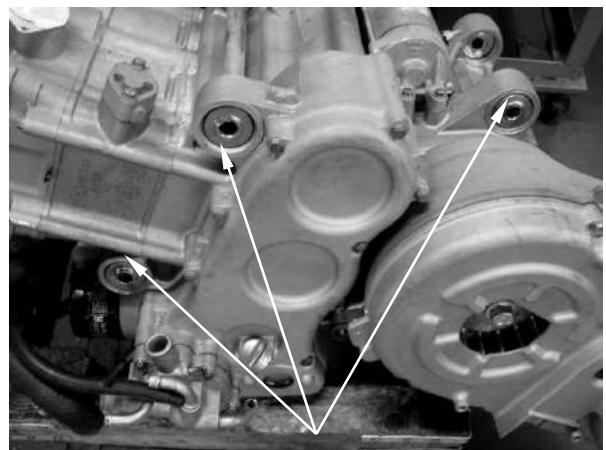

Collar

9. CYLINDER HEAD/VALVES

CYLINDER HEAD/VALVES

SCHEMATIC DRAWING	9-1
SERVICE INFORMATION.....	9-2
TROUBLESHOOTING.....	9-3
CYLINDER COMPRESSION TEST	9-4
CYLINDER HEAD COVER	9-5
CAMSHAFT	9-7
CYLINDER HEAD.....	9-11



9. CYLINDER HEAD/VALVES

SCHEMATIC DRAWING

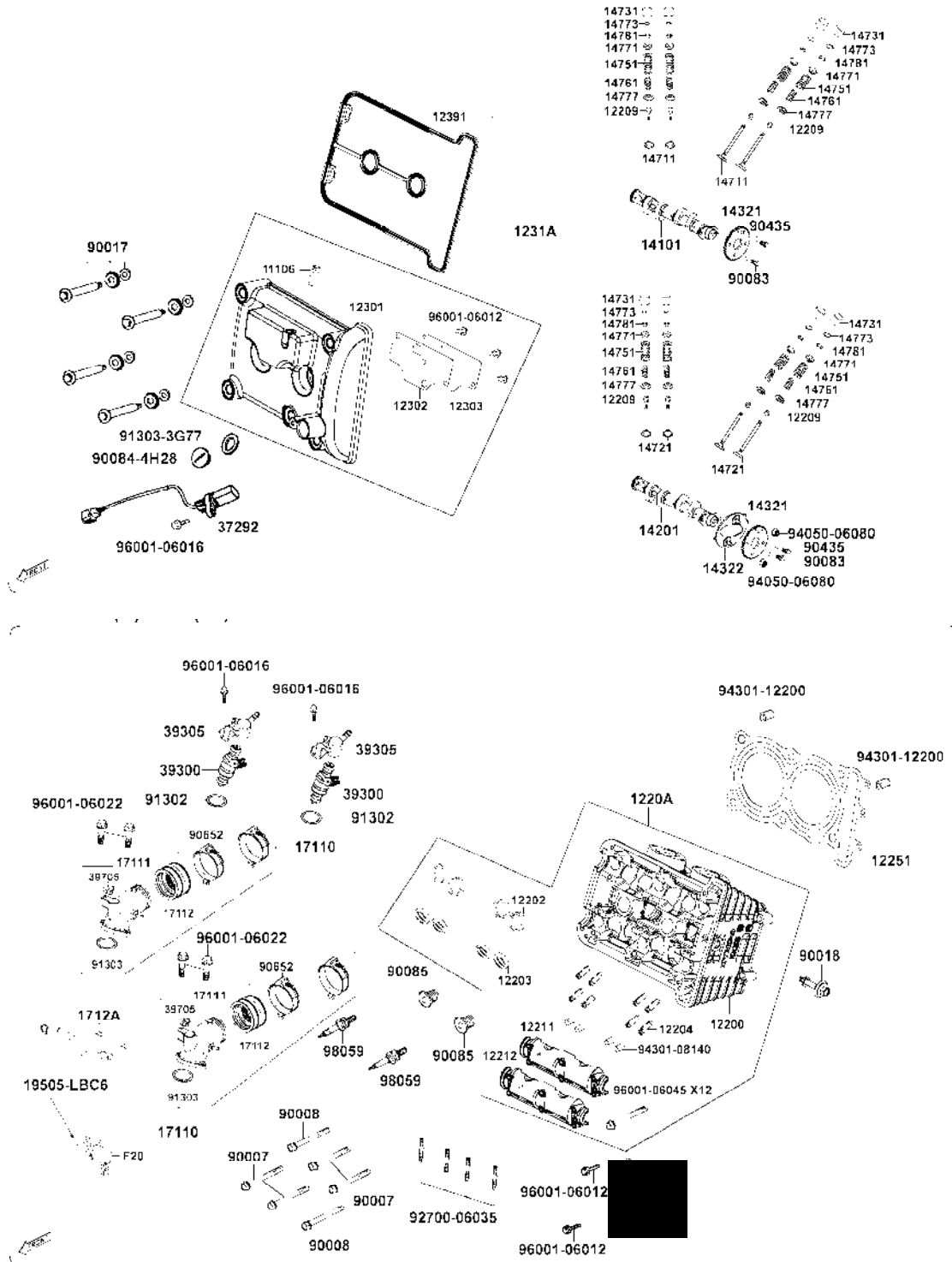

9. CYLINDER HEAD/VALVES

SERVICE INFORMATION

GENERAL INSTRUCTIONS

- The cylinder head can be serviced with the engine installed in the frame. Coolant in the radiator and water jacket must be drained first.
- When assembling, apply molybdenum disulfide grease or engine oil to the valve guide movable parts and valve arm sliding surfaces for initial lubrication.
- After disassembly, clean the removed parts and dry them with compressed air before inspection.
- After removal, mark and arrange the removed parts in order. When assembling, install them in the reverse order of removal.

SPECIFICATIONS

Unit: mm

Item		Standard	Service Limit
Cylinder head compression pressure		13 kg/cm ²	—
Valve clearance (cold)	IN	0.16±0.03	—
	EX	0.22±0.03	—
Valve Stem O.D.	IN	4.475~4.490	4.465
	EX	4.455~4.470	4.445
Valve Guide I.D.	IN	5.000~5.012	4.532
	EX	5.000~5.012	4.532
Valve stem-to-guide clearance	IN	0.010~0.037	0.08
	EX	0.030~0.057	0.1
Valve lifter O.D.		27.965~27.98	27.91
Camshaft cam height	IN	36.6	36.5
	EX	36.6	36.5

TORQUE VALUES

Cylinder head cover bolt	0.8~1.2 kgf•m	Apply engine oil to threads
Breather separator bolt	0.8~1.2 kgf•m	Apply engine oil to threads
Cam chain holder bolt	0.8~1.2 kgf•m	
Cylinder bolt	0.8~1.2 kgf•m	
Cam chain tensioner bolt	0.8~1.2 kgf•m	
Cylinder head bolt	4.8~5.2 kgf•m	Apply engine oil to threads

9. CYLINDER HEAD/VALVES

SPECIAL TOOLS

Valve spring compressor A120E00040

TROUBLESHOOTING

- The poor cylinder head operation can be diagnosed by a compression test or by tracing engine top-end noises.

Poor performance at idle speed

- Compression too low

Compression too low

- Incorrect valve clearance adjustment
- Burned or bent valves
- Incorrect valve timing
- Broken valve spring
- Poor valve and seat contact
- Leaking cylinder head gasket
- Warped or cracked cylinder head
- Poorly installed spark plug

Compression too high

- Excessive carbon build-up in combustion chamber

White smoke from exhaust muffler

- Worn valve stem or valve guide
- Damaged valve stem oil seal

Abnormal noise

- Incorrect valve clearance adjustment
- Sticking valve or broken valve spring
- Damaged or worn camshaft
- Worn cam chain tensioner
- Worn camshaft and rocker arm

9. CYLINDER HEAD/VALVES

CYLINDER COMPRESSION TEST

Warm up the engine to normal operating temperature.
Stop the engine and remove the spark plug cap and remove the spark plug.

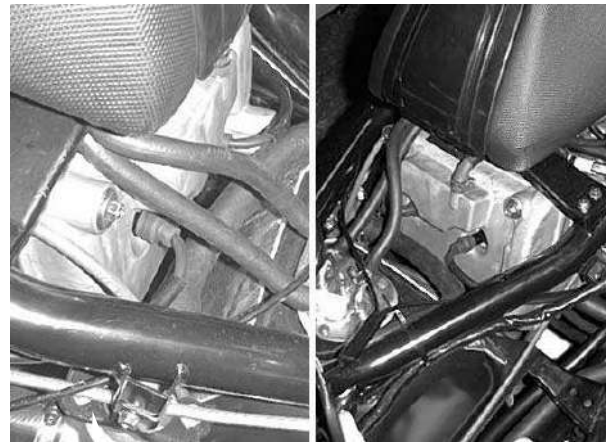

Install a compression gauge into the spark plug hole.

Open the throttle all the way and crank the engine with the starter motor until the gauge reading stops rising.

The maximum reading is usually reached 4 – 7 seconds.

* To avoid discharging the battery, do not operate the starter motor for more than seven seconds.

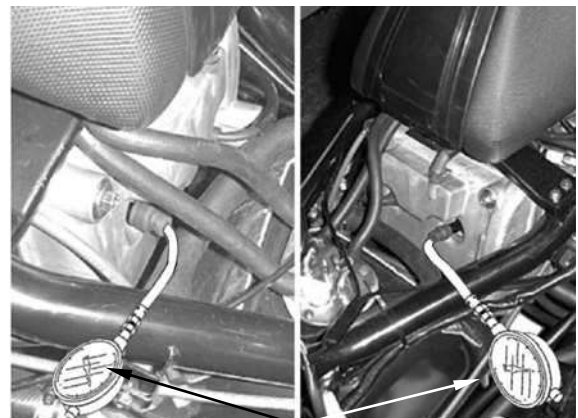

Compression Gauge

Compression pressure:

13 kg/cm²

Low compression can be caused by:

- ♦ Blown cylinder head gasket
- ♦ Improper valve adjustment
- ♦ Valve leakage
- ♦ Worn piston ring or cylinder

High compression can be caused by:

- ♦ Carbon deposits in combustion chamber or on piston head

9. CYLINDER HEAD/VALVES

CYLINDER HEAD COVER

DISASSEMBLY

Remove the luggage box.
Remove the floorboard.

Remove the four bolts and cylinder head cover.

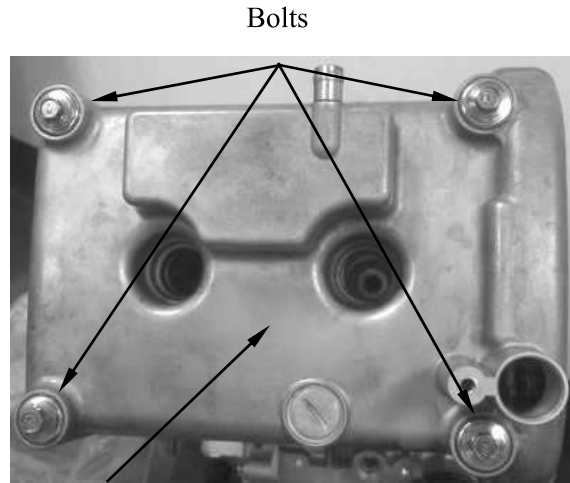

Cylinder Head Cover

Remove the cylinder head cover packing.

Cylinder Head Cover Packing

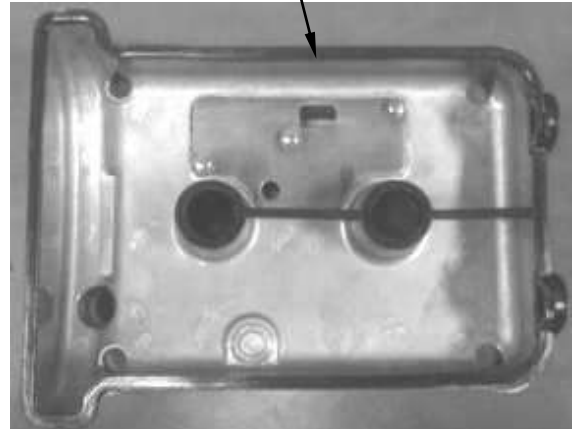

Remove the bolts and breather separator.

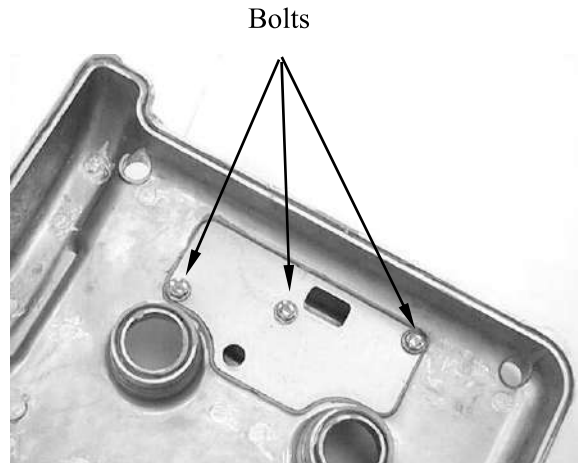

9. CYLINDER HEAD/VALVES

Remove the gasket.

ASSEMBLY

Assembly is in the reverse order of disassembly.

Torque:

Breather separator bolt:

0.8~1.2 kgf•m

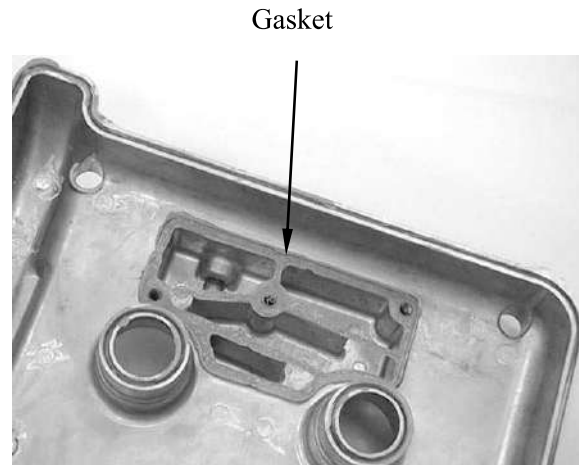

9. CYLINDER HEAD/VALVES

CAMSHAFT

REMOVAL

Remove the cylinder head cover.

Turn the A.C. generator flywheel so that the "T" mark on the flywheel aligns with the index mark on the right crankcase cover.

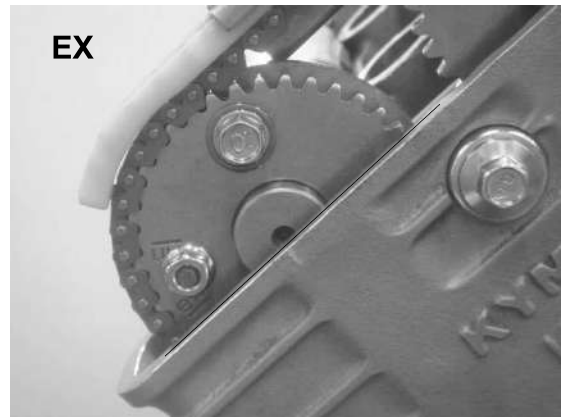

Remove two bolts and the tensioner.



Remove the two bolts and cam chain guide.

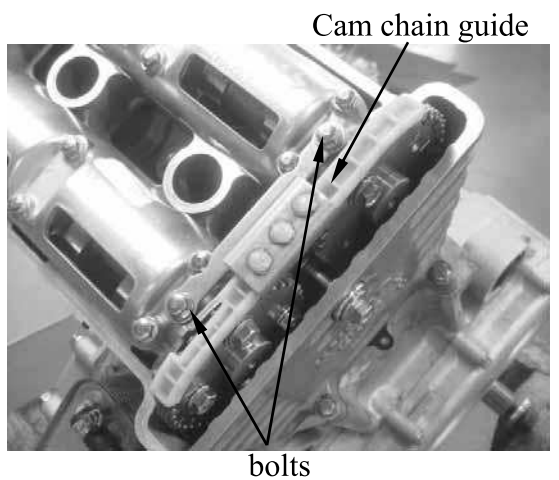

9. CYLINDER HEAD/VALVES

Loosen and remove the camshaft holder bolts in a crisscross pattern in several steps, then remove the camshaft holders.

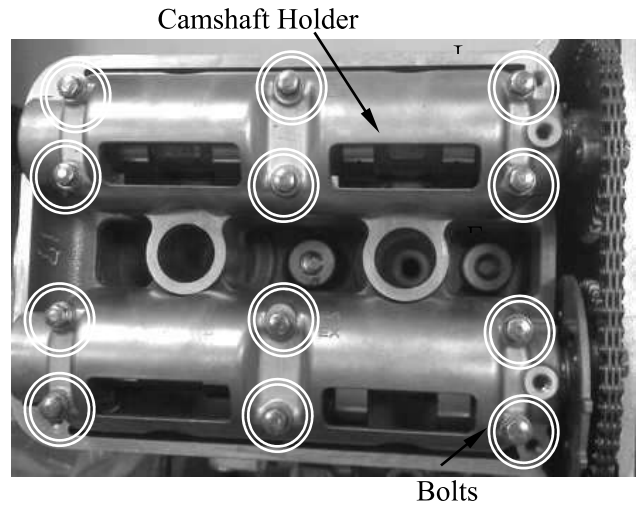

Remove the camshaft from the cam chain.

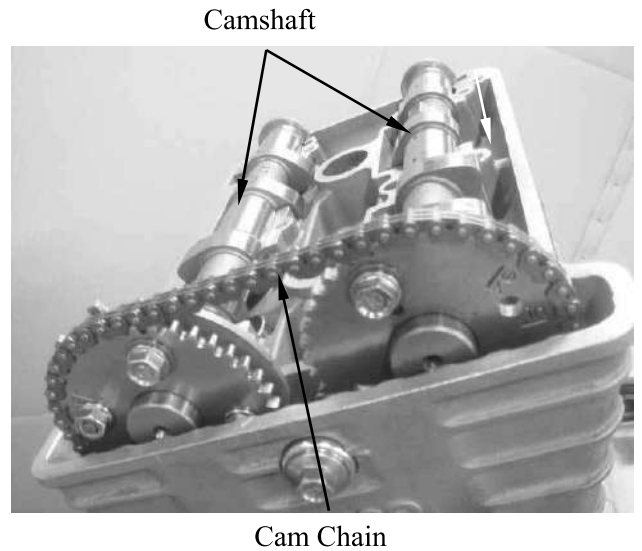
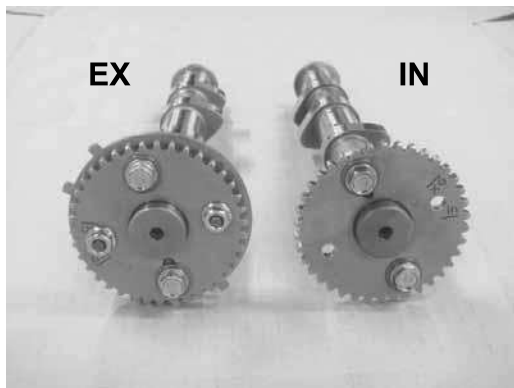

Inspection of the camshaft chain guide.

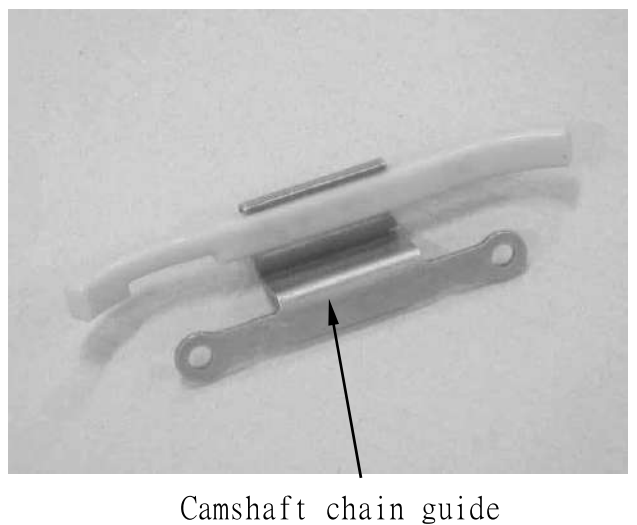

9. CYLINDER HEAD/VALVES

INSPECTION

Camshaft Holder

* Always replace the camshaft holders and cylinder head in pairs to ensure the coaxial function. The code should be the same.

Inspect the bearing surface of each camshaft holder for scoring, scratches, or evidence of insufficient lubrication.

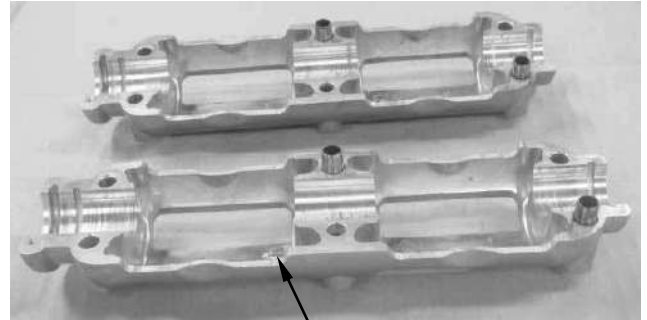

Camshaft Holder



Intake camshaft holder code



Cylinder head code

Camshaft

Support both ends of the camshaft with V-blocks and check the camshaft with a dial gauge. Check each cam lobe for wear or damage.

Service Limit: 0.05mm

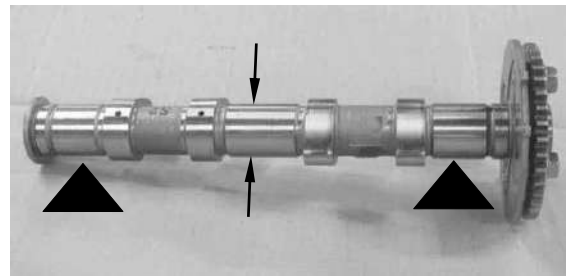

Cam Lobe Height

Using a micrometer to measure the cam lobe height.

Service Limits: IN : 36.6 mm

EX: 36.6 mm

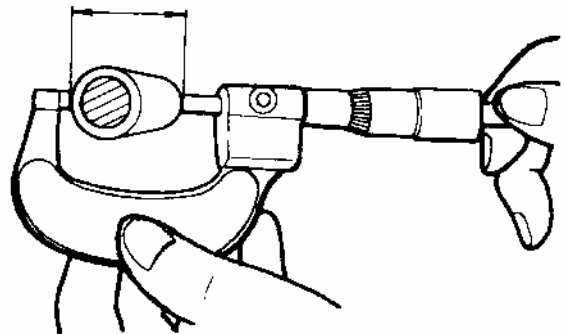

9. CYLINDER HEAD/VALVES

Cam chain guide

Inspect the cam chain slipper surface of the cam chain guide for wear or damage.

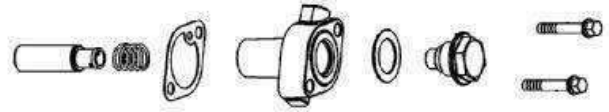

Remove the valve lifter

Remove the valve lifters and shims.
Remove the valve lifters.
Do not remove the valve lifters by using any magnetic material.

Valve Lifter

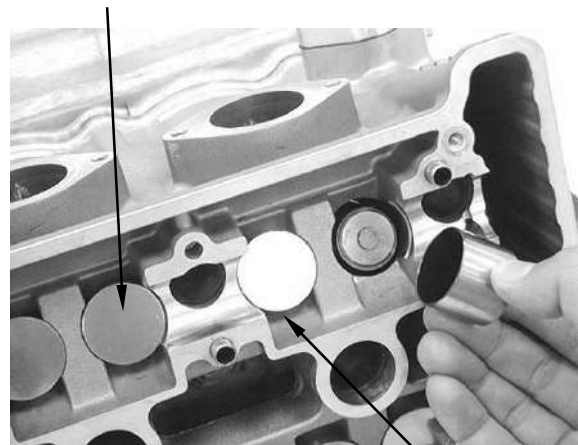

Valve Lifter

Inspection and clean the valve lifter

Inspect each valve lifter for scratches or abnormal wear.
Measure the each valve lifter O.D.

Service Limit: 27.91 mm

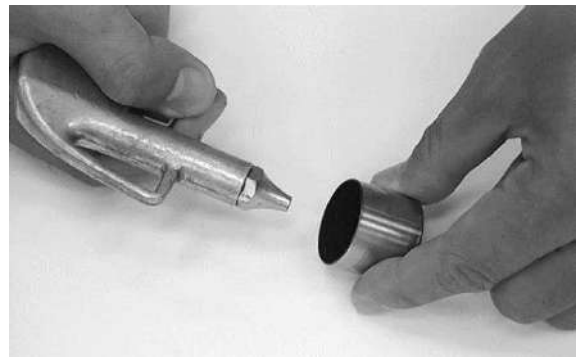

9. CYLINDER HEAD/VALVES

CYLINDER HEAD REMOVAL

* Always replace the camshaft holder and cylinder head in pairs

Remove the two bolts, intake pipe.
Remove the bolt, water joint, gasket and water stop collar.

Remove the bolts from the cylinder head.
Remove the cylinder head.

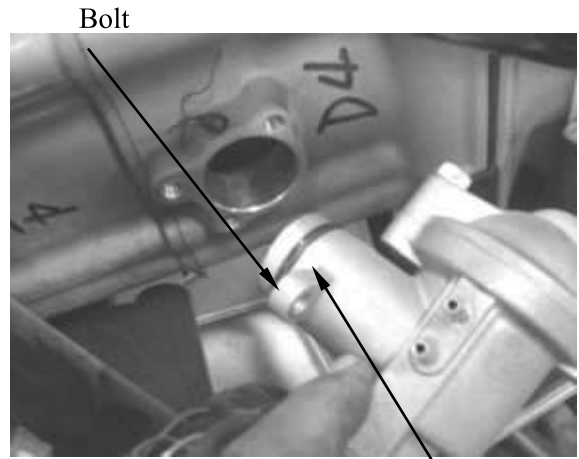

Water Joint/Gasket/Water Stop Collar

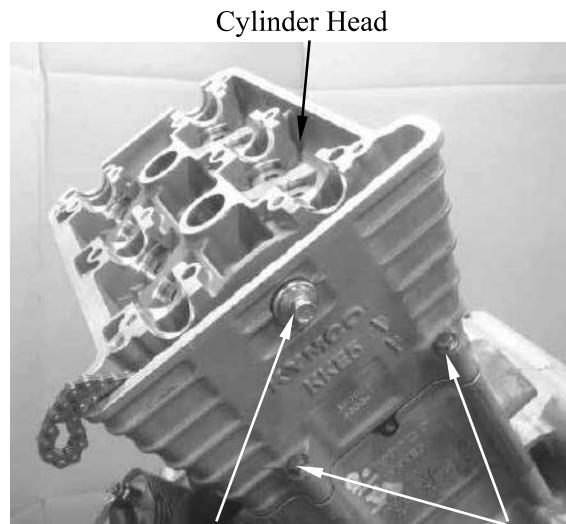
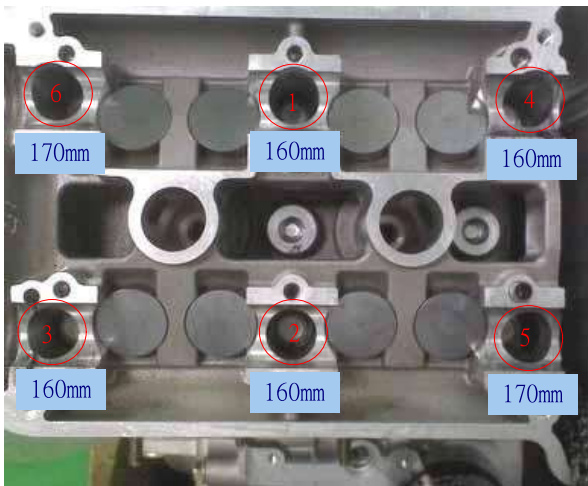

Bolt Bolts

Remove the dowel pins and cylinder head gasket

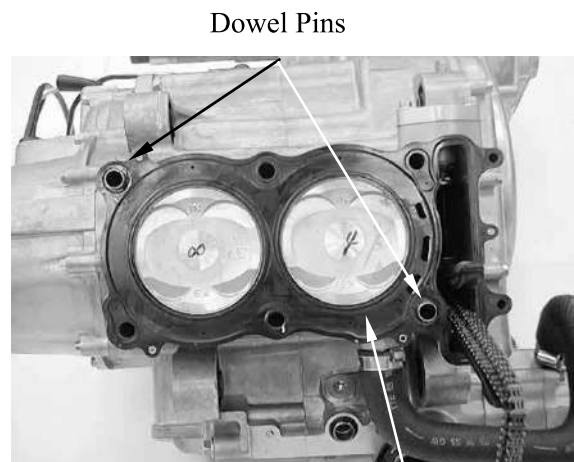

Cylinder Head Gasket

9. CYLINDER HEAD/VALVES

Remove the valve spring cotters, retainers, springs, spring seats, oil seals and valves using a valve spring compressor.

- *
- Be sure to compress the valve springs with a valve spring compressor.
 - Mark all disassembled parts to ensure correct reassembly.

Special tool:
Valve Spring Compressor A120E00040

Valve Spring Compressor

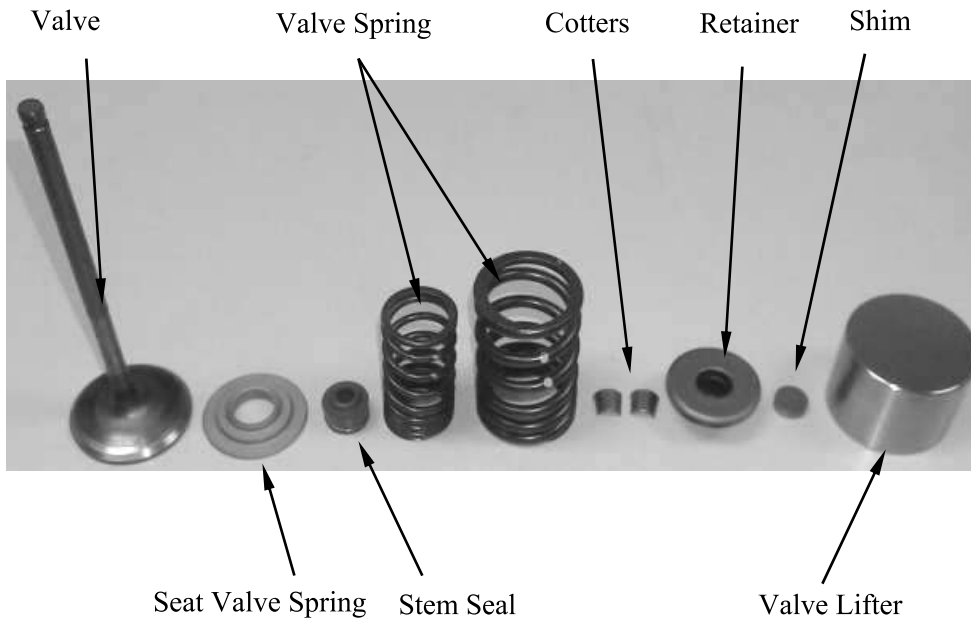
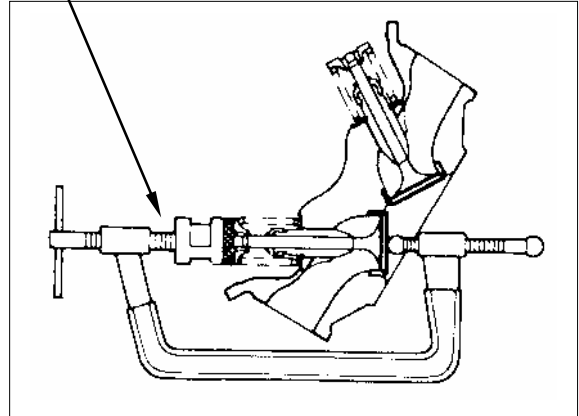

9. CYLINDER HEAD/VALVES

VALVE /VALVE GUIDE INSPECTION

Inspect each valve for bending, burning, scratches or abnormal stem wear.
If any defects are found, replace the valve with a new one.

Check valve movement in the guide.

Measure each valve stem O.D.

Measure each valve guide I.D.

Subtract each valve stem O.D. from the corresponding guide I.D. to obtain the stem-to-guide clearance.

Service limits:

IN: 0.08 mm

EX: 0.1 mm

* If the stem-to-guide clearance exceeds the service limits, replace the cylinder head is necessary.

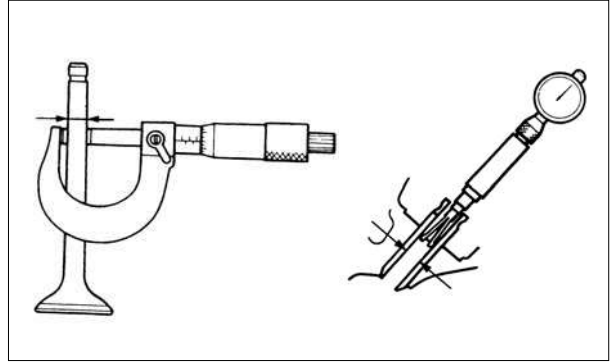

CYLINDER HEAD INSPECTION

CYLINDER

Remove the carbon deposits from the combustion chambers.
Check the spark plug hole and valve areas for cracks.

Check the cylinder head for warpage with a straight edge and feeler gauge.

Service Limit: 0.05 mm

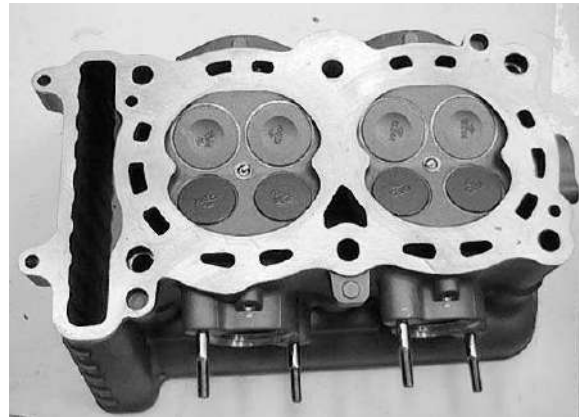

VALVE SPRING INSPECTION

Measure the free length of the inner and outer valve springs.

Service Limit:

Inner: 36.4 mm

Outer: 39.4 mm

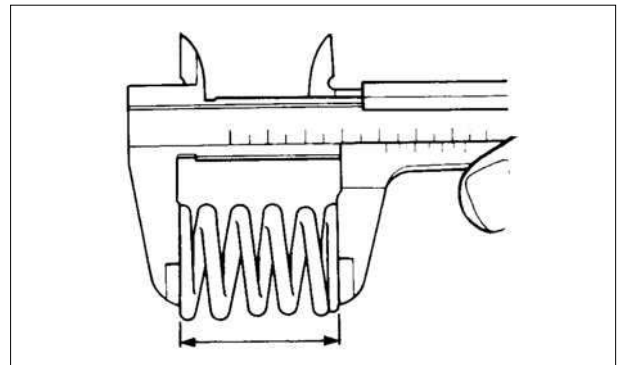

9. CYLINDER HEAD/VALVES

Measure compressed force (valve spring) and installed length.

Replace if out of specification.

Standard:

Inner: 2.9 kg/32 mm

Outer: 12.4 kg/35 mm

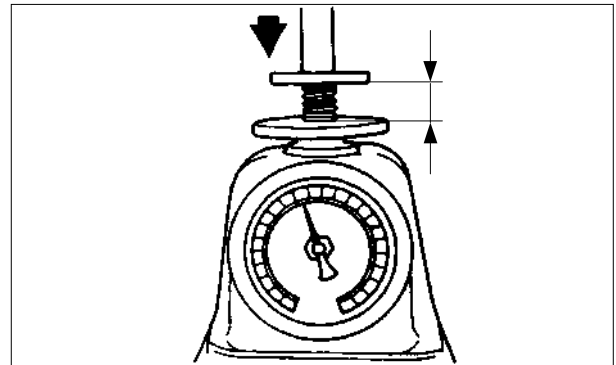

Measure the spring tilt.

Replace if out of specification.

Standard:

Inner: 1.2 mm

Outer: 1.2 mm

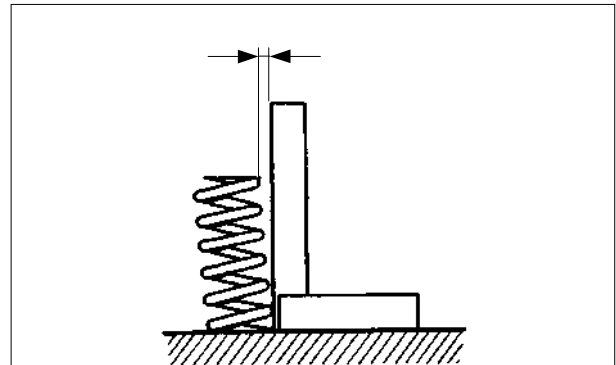

ASSEMBLY

Install the valve spring seats and oil seal.

* Be sure to install new oil seal.

Install the seat valve spring.

Install the new stem seals

Lubricate each valve with engine oil or molybdenum disulfide oil and insert the valves into the valve guides.

To avoid damage the stem seal, turn the valve slowly when inserting.

Install the valve springs and retainers.

Install the valve cotters using the special tools as shown.

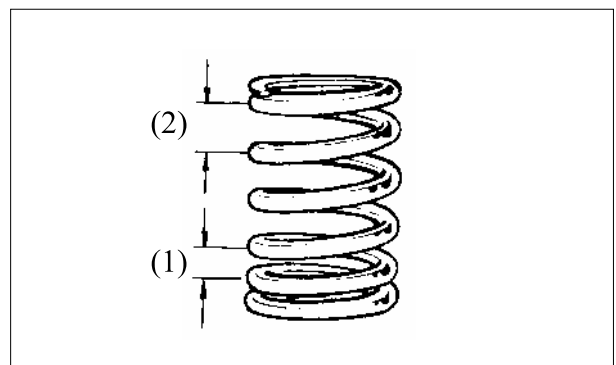

* • When assembling, a valve spring compressor must be used.
• Install the cotters with the pointed ends facing down from the upper side of the cylinder head.

Special tool:

Valve Spring Compressor A120E00040

Valve Spring Compressor

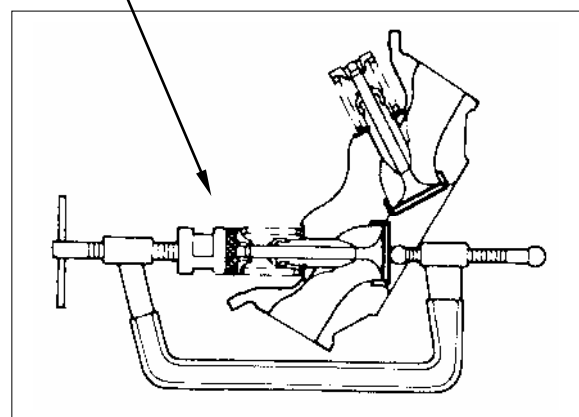

9. CYLINDER HEAD/VALVES

Tap the valve stems gently with two plastic hammers for 2~3 times as shown to seat the cotters firmly.

* Be careful not to damage the valves.

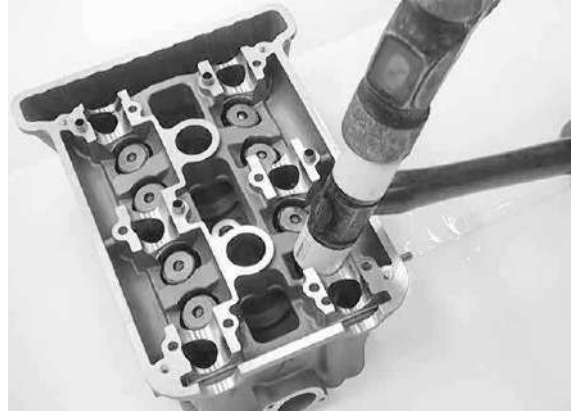

INSTALLATION

Install the dowel pins and new cylinder head gasket as shown.



Dowel Pins

Cylinder Head Gasket

Install the cylinder head.

Apply engine oil to the cylinder head bolt threads.
Install the cylinder bolts and cylinder head bolt.

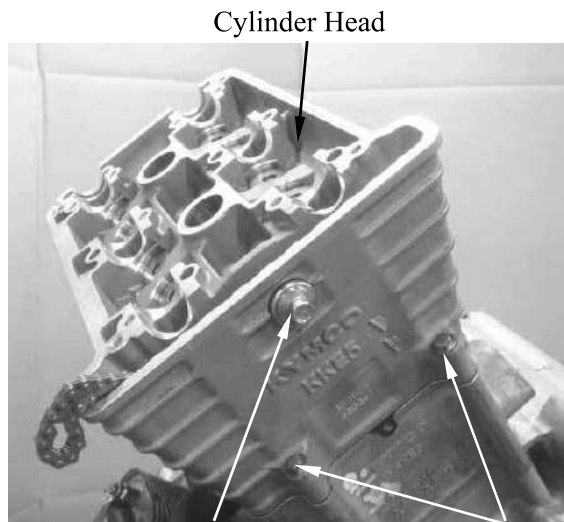

Cylinder Head

Bolt

Bolts

9. CYLINDER HEAD/VALVES



NO 2, 3	STUD BOLT
	1->2->3->4->5->6
1ST	300kg-cm
2ND	400kg-cm
3RD	500kg-cm

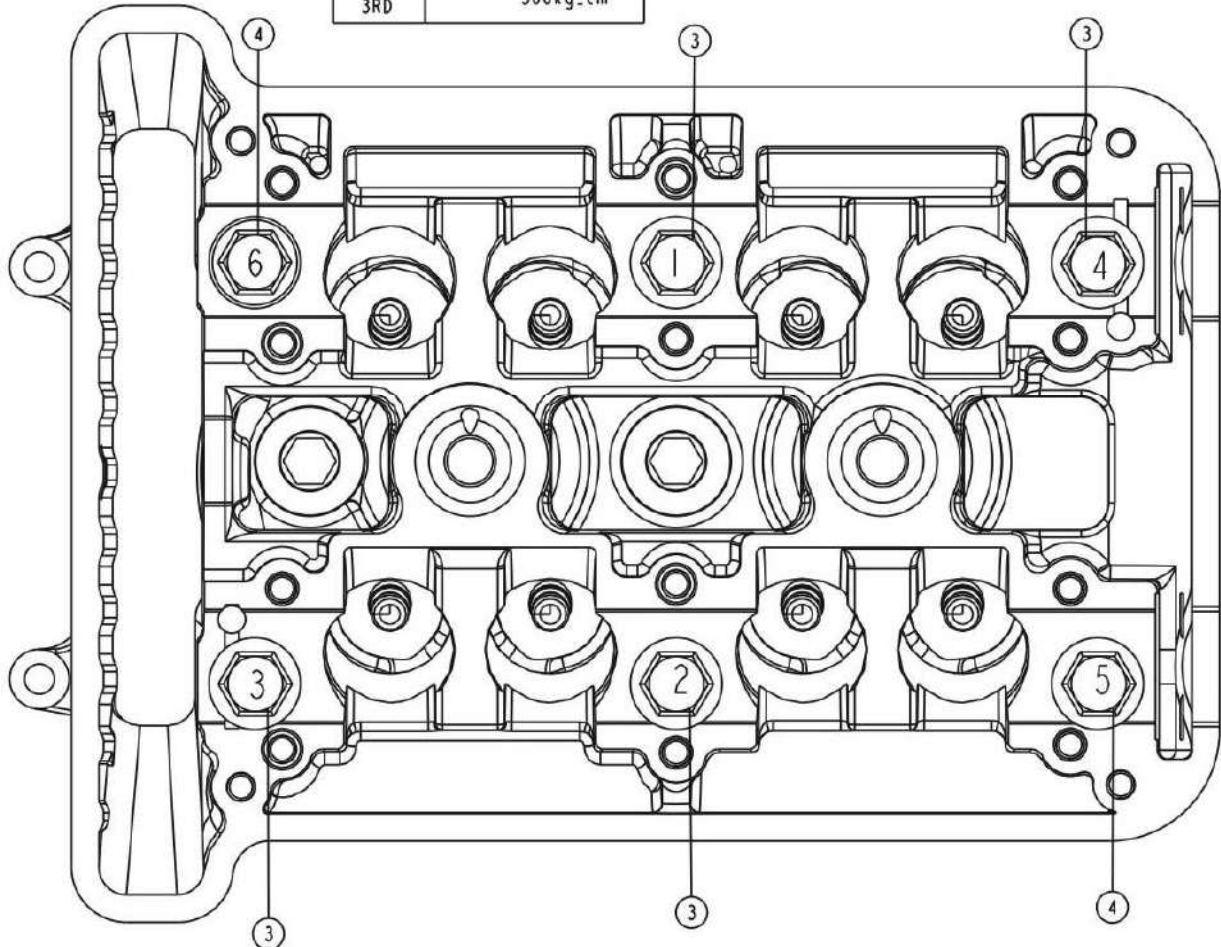

9. CYLINDER HEAD/VALVES

Install the water stop collar, gasket and water joint.
Install and tighten the two bolts to the specified torque.

Torque: 0.8~1.2 kgf•m



Water Joint

the new O-rings onto the intake pipe.



O-ring

Install the intake pipe.
Install and tighten the four bolts securely.

Torque: 0.8~1.2 kgf•m

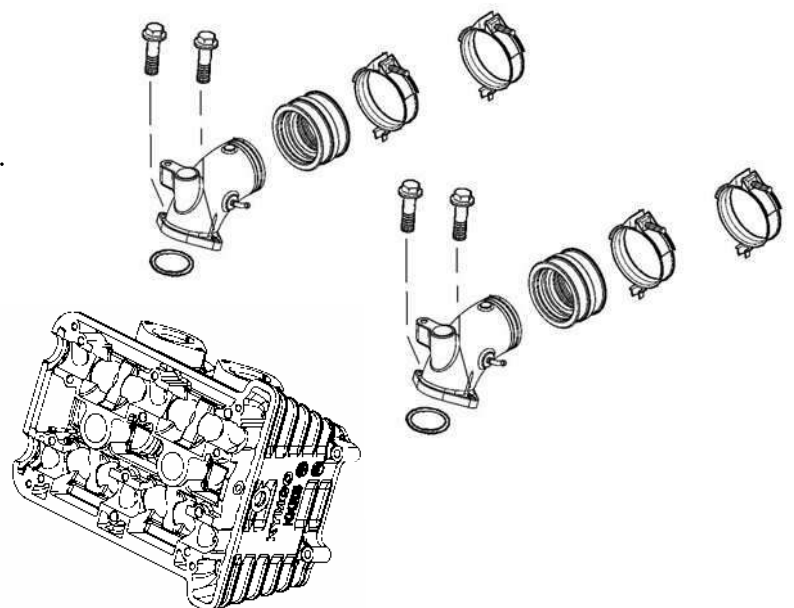

9. CYLINDER HEAD/VALVES

Install the valve lifter.

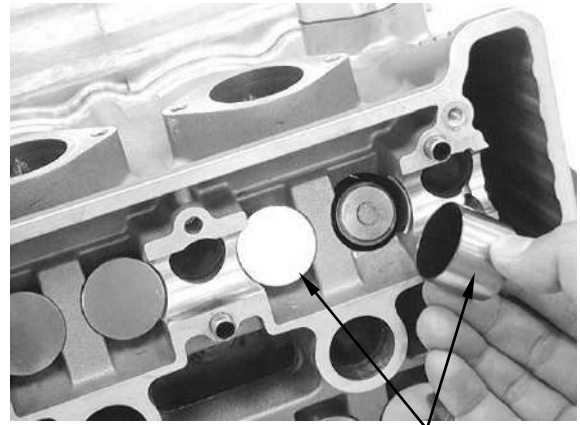

Valve Lifter

CAMSHAFT INSTALLATION

Turn the crankshaft counterclockwise, align the "T" mark on the flywheel with the index on the right crankcase cover.

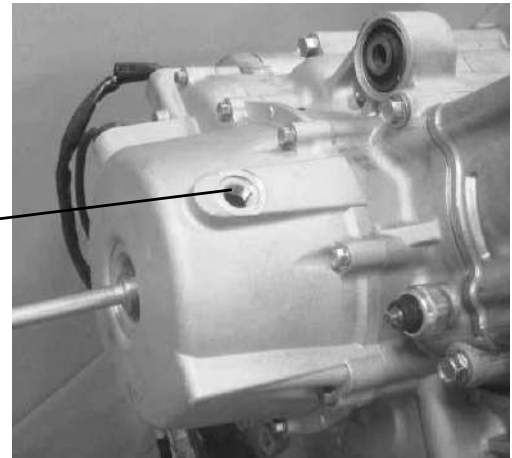
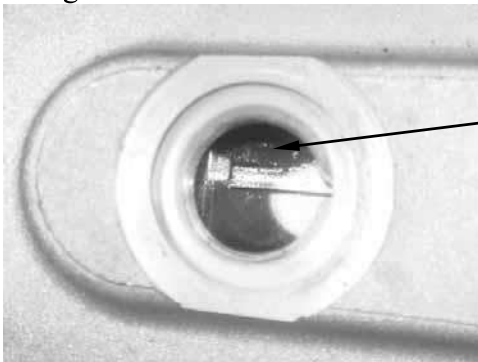

Apply molybdenum disulfide oil to the camshaft and the camshaft holder for lubrication.

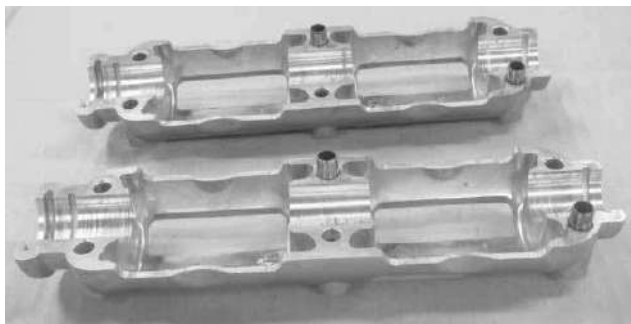

9. CYLINDER HEAD/VALVES

Install intake and exhaust camshaft holders to the correct locations.

Install and tighten the holder bolts in a crisscross pattern way.

First stage: 0.4 kgf.m

Second stage: 0.6 kgf.m

Third stage: 1.0 kgf.m

Inspect the valve clearances if those are in the standard, replace the shim if necessary.

Valve clearance (cold)

IN: 0.16±0.03mm

EX:0.22±0.03mm

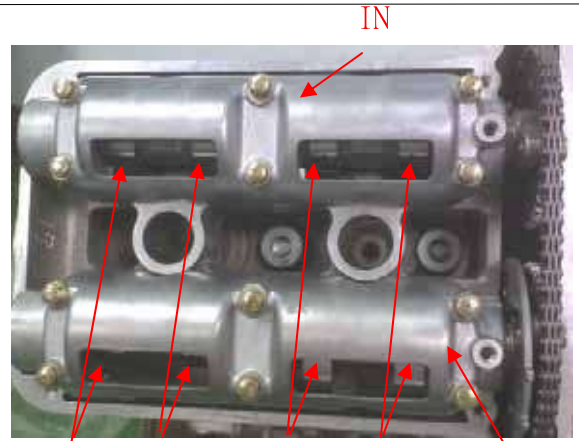

Inspect valve clearances IN EX

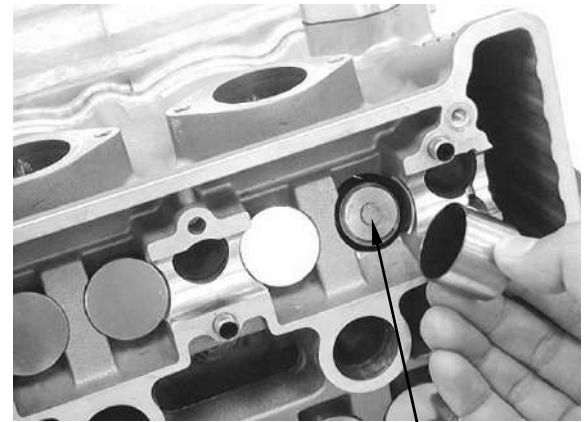

Shim

Unit: mm		
14773-KKE5-E00-180	14773-KKE5-E00-180	SHIM T=1.80
14773-KKE5-E00-185	14773-KKE5-E00-185	SHIM T=1.85
14773-KKE5-E00-190	14773-KKE5-E00-190	SHIM T=1.90
14773-KKE5-E00-195	14773-KKE5-E00-195	SHIM T=1.95
14773-KKE5-E00-200	14773-KKE5-E00-200	SHIM T=2.00
.		
.		
14773-KKE5-E00-300	14773-KKE5-E00-300	SHIM T=3.00

NO 6	INLET	EX
	1->2->3->4->5->6	1->2->3->4->5->6
1ST	40kg.cm	40kg.cm
2ND	60kg.cm	60kg.cm
3RD	100kg.cm	100kg.cm

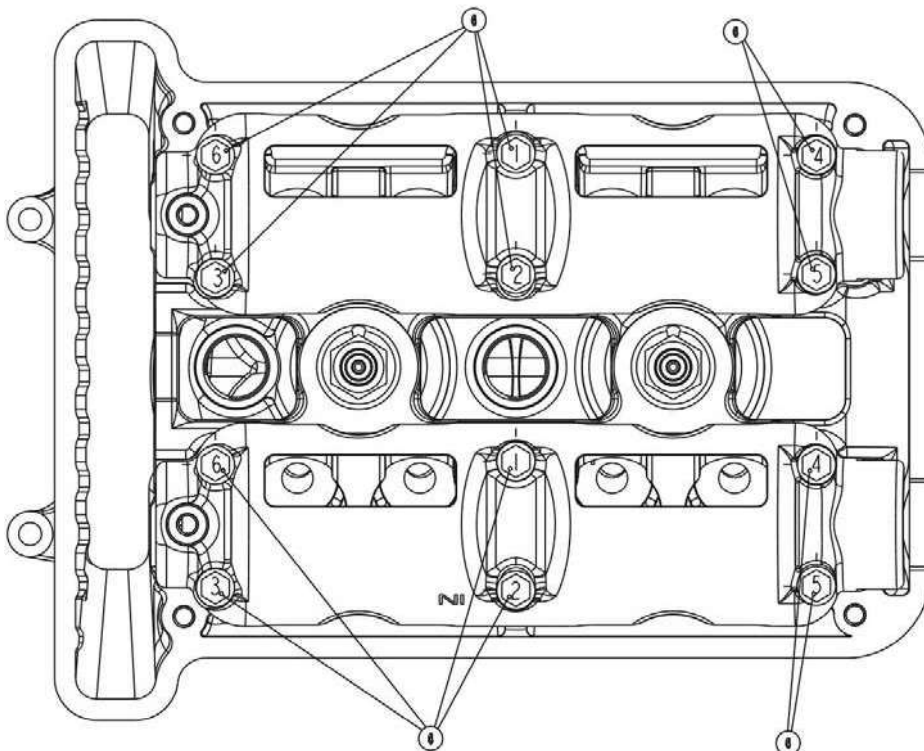

9. CYLINDER HEAD/VALVES

Install the cam sprocket bolts and tighten them.

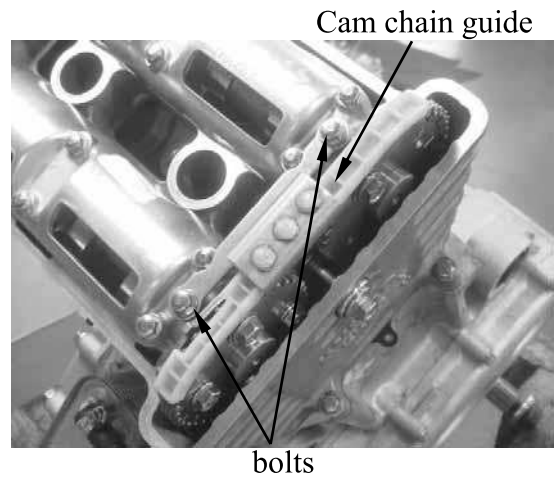

Install the tensioner with a new gasket onto the cylinder.

* There is the passage of oil inside, do not install with incorrect direction.

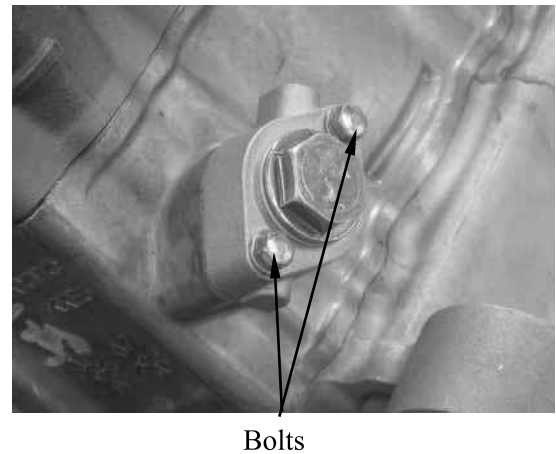

Install the head cover.



9. CYLINDER HEAD/VALVES

Tighten 4 bolts on head cover.
Torque: 0.8~1.2 kgf•m



Tighten the bolt of cam sensor.



10. CYLINDER/PISTON

CYLINDER/PISTON

SCHEMATIC DRAWING -----	10-1
SERVICE INFORMATION-----	10-2
TROUBLESHOOTING-----	10-3
CYLINDER/PISTON -----	10-4

10. CYLINDER/PISTON

SCHEMATIC DRAWING

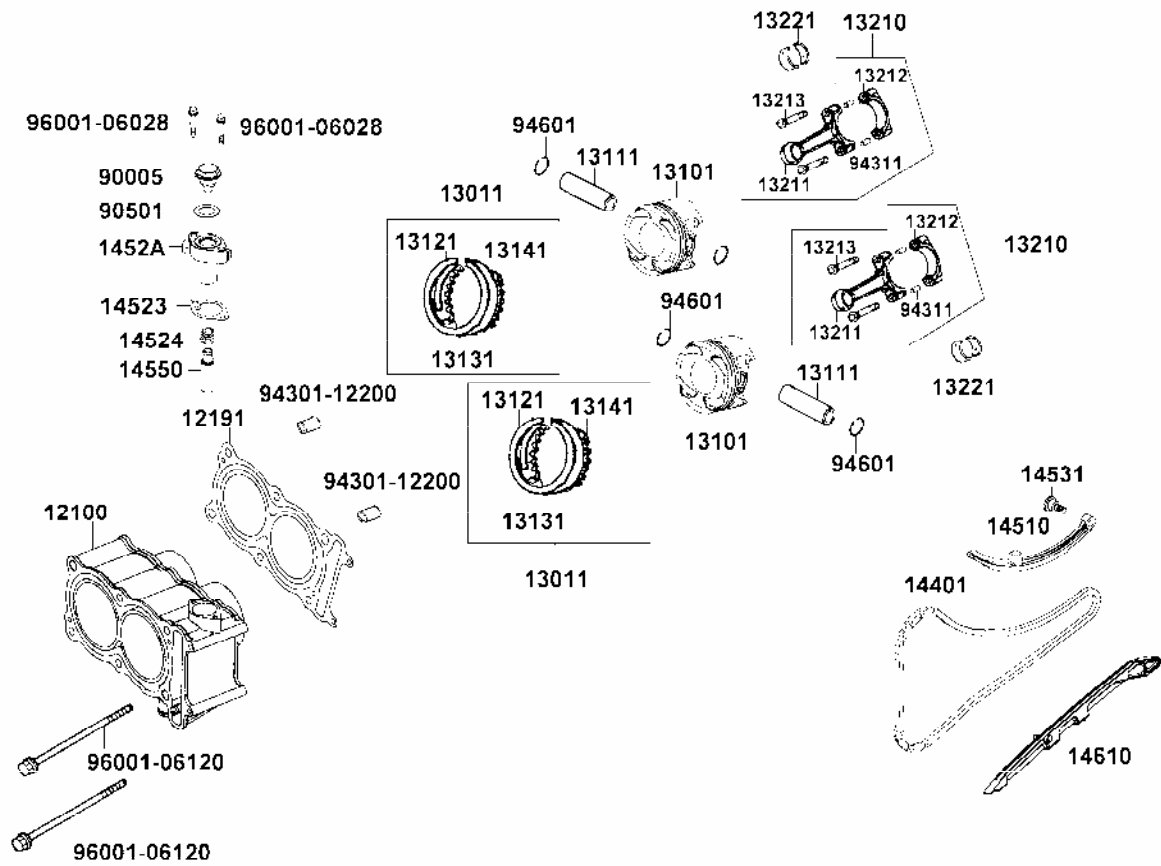

10. CYLINDER/PISTON

SERVICE INFORMATION

GENERAL INSTRUCTIONS

- The cylinder and piston can be serviced with the engine installed in the frame.
- When installing the cylinder, use a new cylinder gasket and make sure that the dowel pins are correctly installed.
- After disassembly, clean the removed parts and dry them with compressed air before inspection.

SPECIFICATIONS (XCITING 250/250 AFI)

Unit: mm

Item		Standard	Service Limit		
Cylinder	I.D.	76.9+0.015~76.9+0.005	76.965		
	Cylindricity	0.01	0.05		
	True roundness	0.01	0.05		
	Ring-to-groove clearance				
Piston, piston ring		top	0.03~0.07	0.1	
		Second	0.03~0.07	0.1	
	Ring end gap		top	0.25~0.35	0.65
			Second	0.3~0.5	0.65
			Oil side rail	0.2~0.7	0.85
	Piston O.D.		76.895+0~76.895-0.02	76.825	
	Piston O.D. measuring position		10 mm from bottom of skirt	—	
	Piston-to-cylinder clearance		0.01~0.04	0.14	
	Piston pin hole I.D.		18.002~18.008	18.018	
Piston pin O.D		18~17.994	17.984		
Piston-to-piston pin clearance		0.002~0.014	0.044		
Connecting rod small end I.D. bore		18.034~18.016	18.044		

10. CYLINDER/PISTON

TROUBLESHOOTING

- When hard starting or poor performance at low speed occurs, check the crankcase breather for white smoke. If white smoke is found, it means that the piston rings are worn, stuck or broken.

Compression too low or uneven compression

- Worn or damaged cylinder and piston rings
- Worn, stuck or broken piston rings

Compression too high

- Excessive carbon build-up in combustion chamber or on piston head

Excessive smoke from exhaust muffler

- Worn or damaged piston rings
- Worn or damaged cylinder and piston

Abnormal noisy piston

- Worn cylinder, piston and piston rings
- Worn piston pin hole and piston pin
- Incorrectly installed piston

10. CYLINDER/PISTON

CYLINDER/PISTON

REMOVAL

Remove the cylinder head.

Remove the cam chain guide.

Cam Chain Guide



Remove the water hose from the cylinder.
Remove the cylinder head gasket and dowel pins.

Remove the cylinder.

Remove the cylinder gasket and dowel pins.
Clean any gasket material from the cylinder surface.

Cylinder

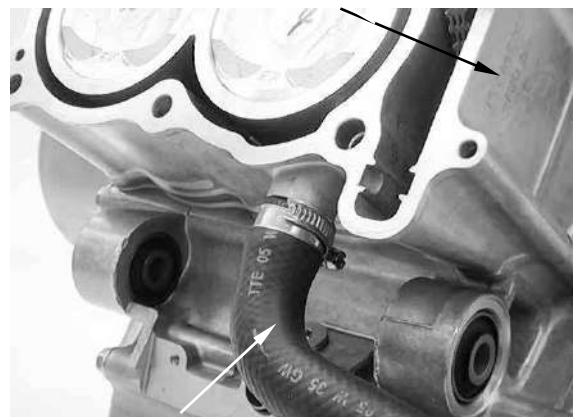

Water Hose

Remove the piston pin clip.

* Arrange a rag blocking the cylinder bores, prevent clips from falling into the crankcase.

Piston Pin Clip

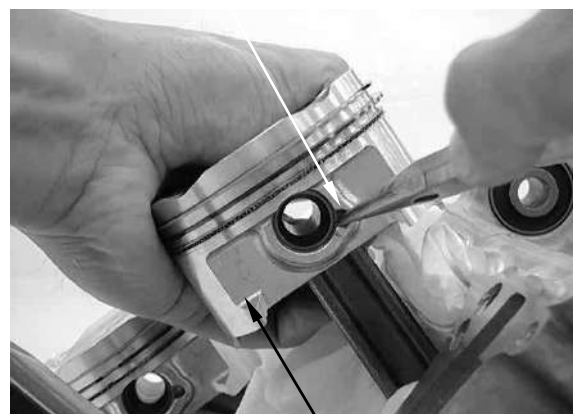

Piston

Press the piston pin out of piston and remove the piston.

10. CYLINDER/PISTON

PISTON RING REMOVAL

Spread each piston ring and remove it by lifting up at a point opposite the gap

- * Do not damage the piston ring by spreading the ends too far.

Clean carbon deposits from the piston ring grooves.

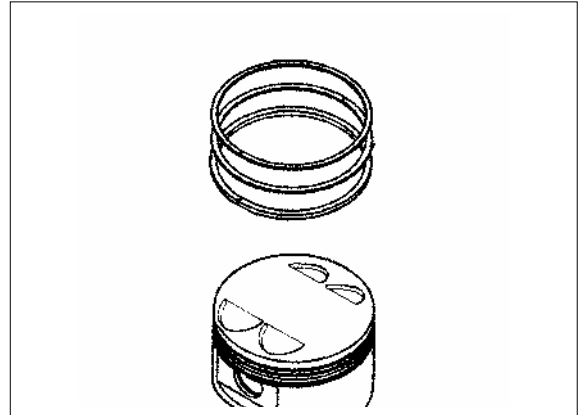

INSPECTION

Piston ring

Inspect the piston rings for movement by rotating the rings. The rings should be able to move in their grooves without catching.

Push the ring until the outer surface of the piston ring is nearly flush with the piston and measure the ring-to-groove clearance.

Service Limits: Top: 0.1 mm
2nd: 0.1 mm

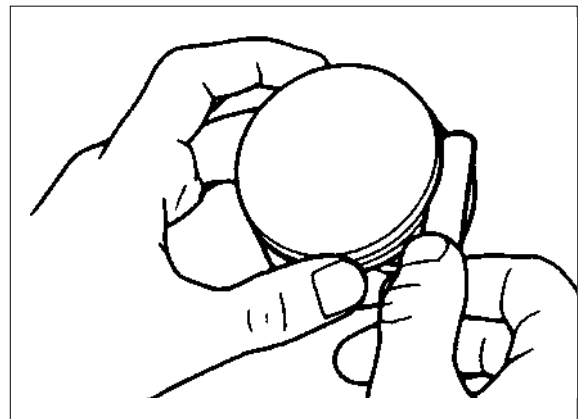

Insert each piston ring into the bottom of the cylinder squarely.

- * Use the piston head to push each piston ring into the cylinder.

Measure the piston ring end gap.

Service Limit:

Top: 0.65 mm
2nd: 0.65 mm
Oil ring: 0.85 mm

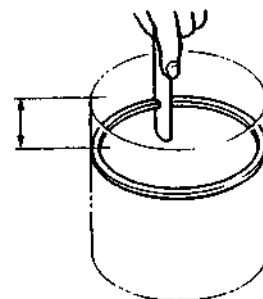

10. CYLINDER/PISTON

Piston/Piston pin

Measure the piston O.D. at the point (A) from the bottom and 90° to the piston pin hole.

Service Limit :

76.825 mm at (A): 10 mm

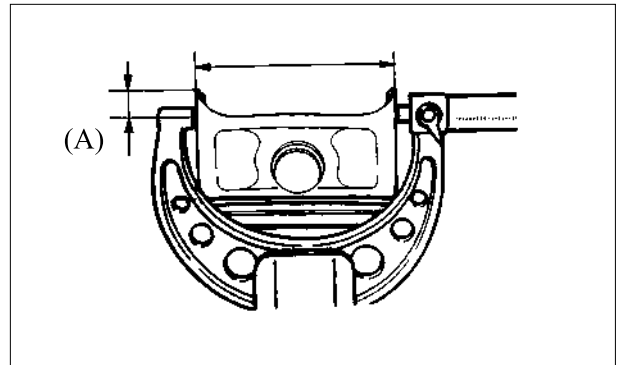

Measure the piston pin hole. Take the maximum reading to determine the I.D..

Service Limit:
18.018 mm

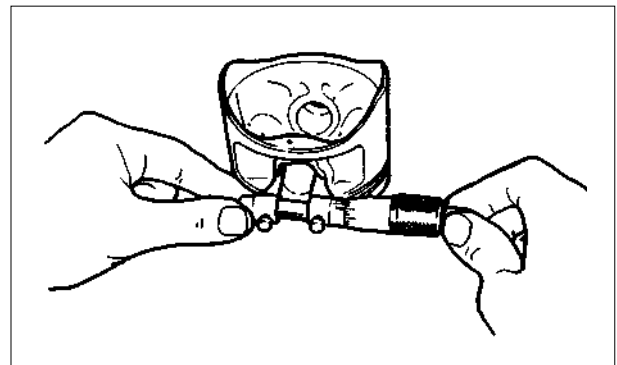

Measure the piston pin O.D. at piston and connecting rod sliding areas.

Service Limit:
17.894 mm

Measure the piston-to-piston pin clearance.

Service Limit: 0.044 mm

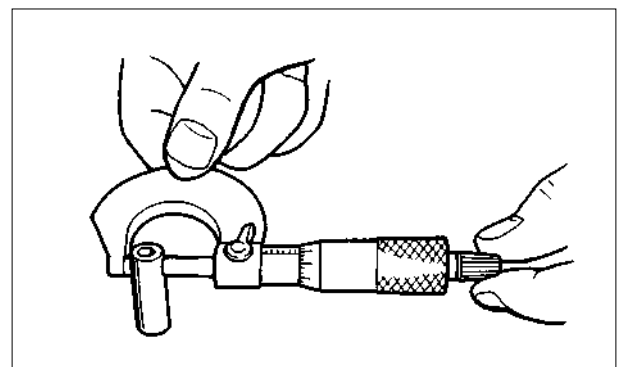

10. CYLINDER/PISTON

Cylinder

Check the cylinder for warp with a straight edge and feeler gauge in the directions shown.

Service Limit: 0.05 mm

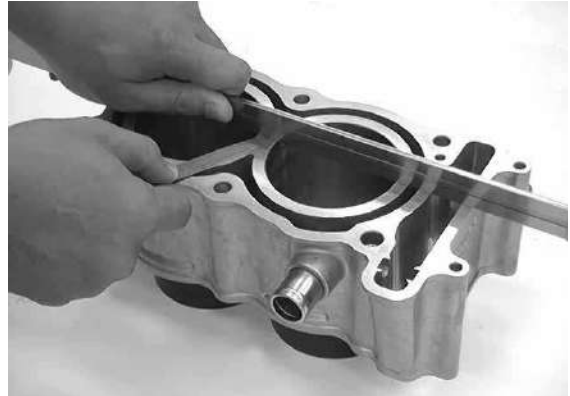

Check the cylinder wall for wear or damage. Measure and record the cylinder I.D. at three levels in an X and Y axis. Take the maximum reading to determine the cylinder wear.

Service Limit:
76.965 mm

Calculate the piston-to-cylinder clearance. Take a maximum reading to determine the clearance.

Service Limit: 0.14 mm

Calculate the taper and out-of-round at three levels in an X and Y axis. Take the maximum reading to determine them.

Service Limit:

Taper: 0.1 mm

Out-of-round: 0.1 mm

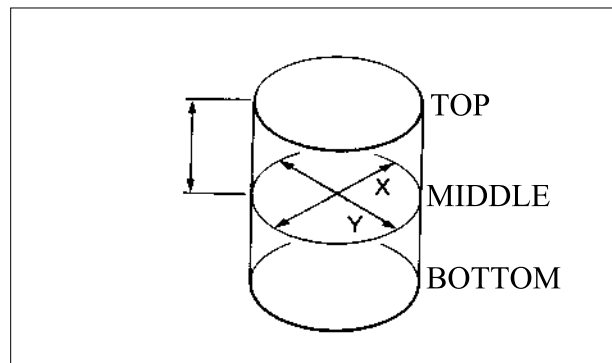

10. CYLINDER/PISTON

Measure the connecting rod small end I.D..

Service Limit: 18.044 mm

Calculate the connecting rod-to-piston pin clearance.

Service Limit: 0.06 mm



PISTON RING INSTALLATION

Carefully install the piston rings into the piston ring grooves with the markings facing up.

* Be careful not to damage the piston and rings.

- ♦ Do not confuse the top and second rings.
- ♦ To install the oil ring, install the oil ring, then install the side rails.

Stagger the piston ring end gaps 120° degrees apart from each other.

Stagger the side rail end gaps as shown.

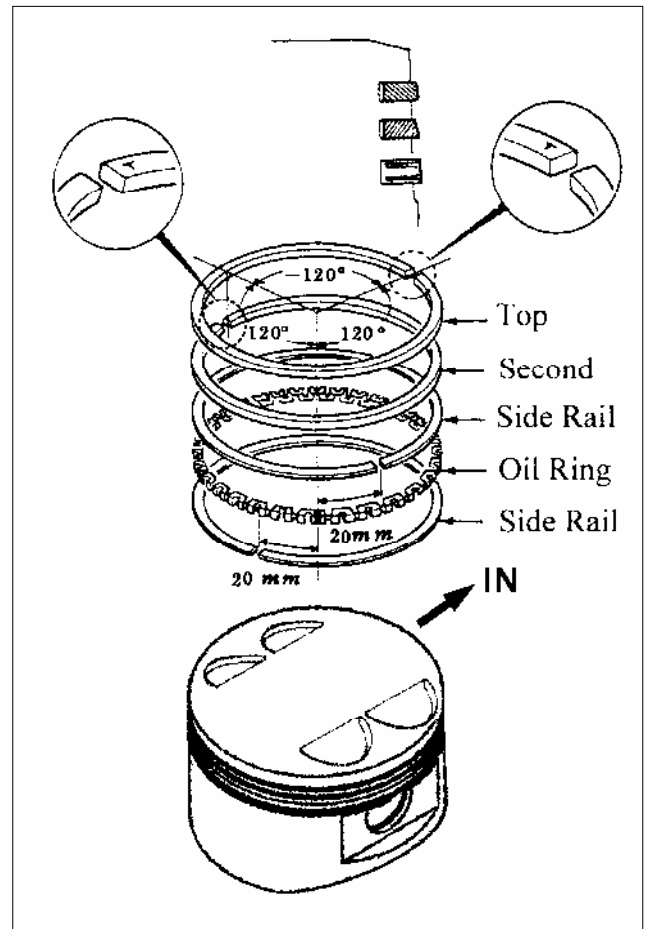

10. CYLINDER/PISTON

CYLINDER/PISTON INSTALLATION

Remove any gasket material from the crankcase surface.

- * • Be careful not to drop foreign matters into the crankcase.



Install the piston, piston pin and a new piston pin clip.

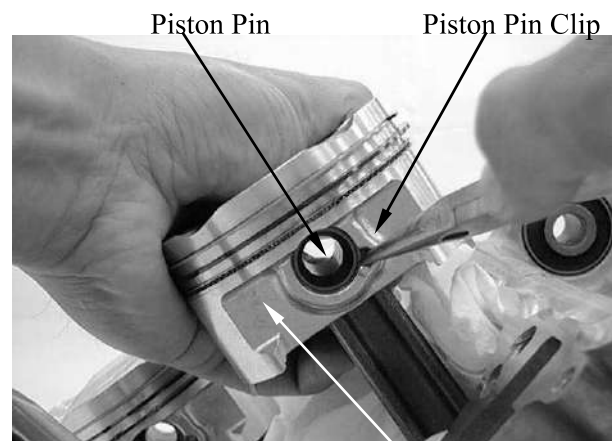

Piston

Install the dowel pins and a new cylinder gasket on the crankcase.

- * • Position the piston "IN" mark on the intake valve side.
• Place a clean shop towel in the crankcase to keep the piston pin clip from falling into the crankcase.

Dowel Pin Gasket

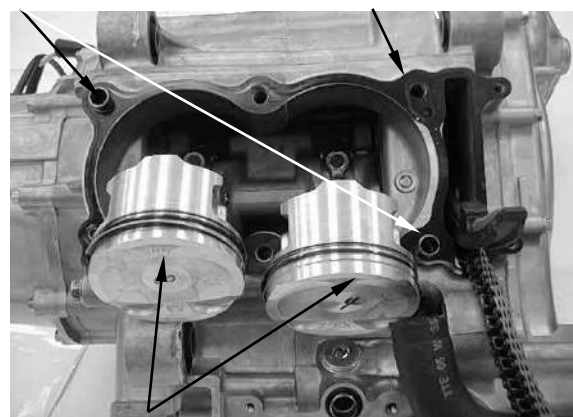

"IN" Mark

Cylinder

10. CYLINDER/PISTON

Coat the cylinder bore, piston and piston rings with clean engine oil.
Carefully lower the cylinder over the piston by compressing the piston rings.

- * Be careful not to damage or break the piston rings.
- * The piston ring end gaps should not be parallel with or at 90° to the piston pin.

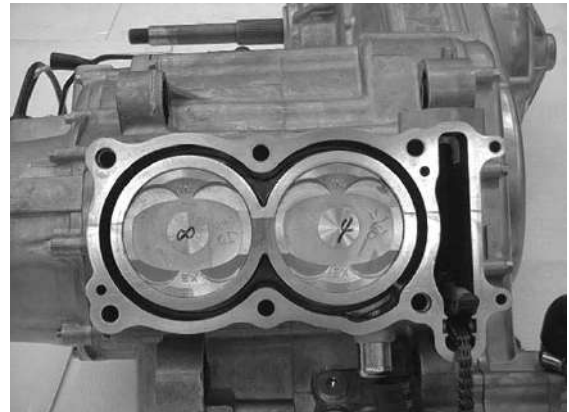

Install the cam chain guide.

- * Insert the tab on the cam chain guide into the cylinder groove.

Cam Chain Guide



Install the cylinder gasket and dowel pins.
Connect the water hose to the cylinder.

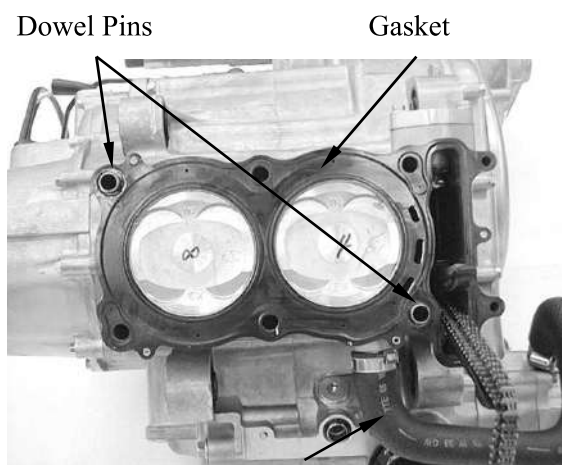

Water Hose

11. DRIVE AND DRIVEN PULLEY

DRIVE AND DRIVEN PULLEY

SCHEMATIC DRAWING -----	11- 1
SERVICE INFORMATION-----	11- 2
TROUBLESHOOTING-----	11- 2
LEFT CRANKCASE COVER -----	11- 3
DRIVE PULLEY -----	11- 10
CLUTCH/DRIVEN PULLEY-----	11-13

11. DRIVE AND DRIVEN PULLEY

SCHEMATIC DRAWING

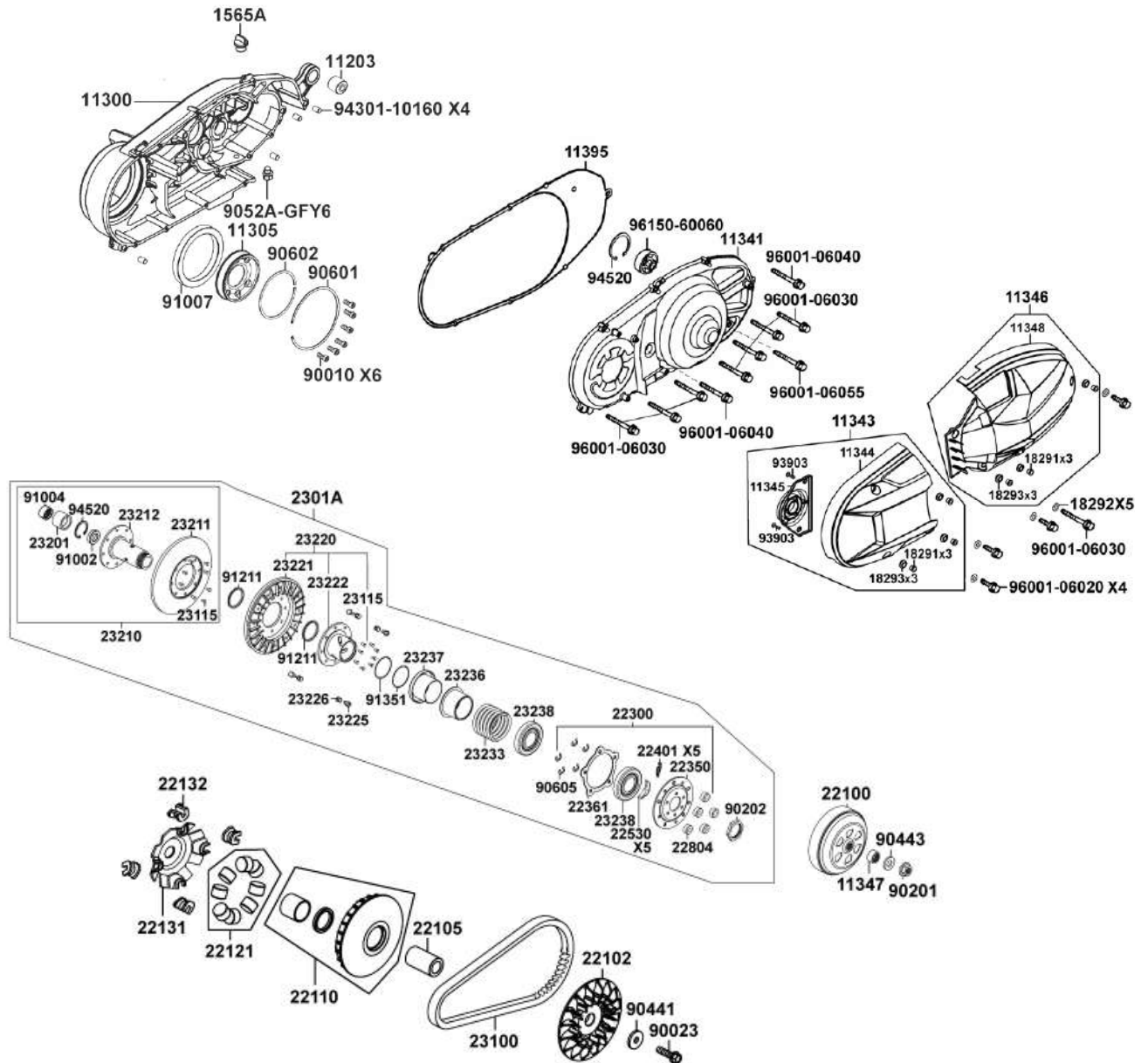

11. DRIVE AND DRIVEN PULLEY

SERVICE INFORMATION

GENERAL INSTRUCTIONS

- The drive pulley, clutch and driven pulley can be serviced with the engine installed.
- Avoid getting grease and oil on the drive belt and pulley faces. Remove any oil or grease from them to minimize the slipping of drive belt and drive pulley.
- Do not apply grease to the movable drive face and weight rollers.

SPECIFICATIONS

Unit: mm

Item	Standard	Service Limit
Movable driven face bushing I.D.	47.965 ~ 47.985	
Driven face collar O.D.	48 ~ 48.025	
Drive belt width	25.8 ~ 26.6	
Clutch lining thickness	4.5	
Clutch outer I.D.	170 ~ 170.2	
Drive pulley collar O.D.	39.96 ~ 39.974	
Weight roller O.D.	29.92 ~ 30.08	

TORQUE VALUES

Drive face nut	10~12 kgf•m
Clutch outer nut	8~9 kgf•m
Clutch drive plate nut	7~8 kgf•m

SPECIAL TOOLS

Universal holder	A120E00017
Clutch spring compressor	A120E00053
Oil seal & bearing install	A120E00014

TROUBLESHOOTING

Engine starts but motorcycle won't move

- Worn drive belt
- Broken ramp plate
- Worn or damaged clutch lining
- Broken driven face spring

Lack of power

- Worn drive belt
- Weak driven face spring
- Worn weight roller
- Faulty driven face

Engine stalls or motorcycle creeps

- Broken clutch weight spring

11. DRIVE AND DRIVEN PULLEY

LEFT CRANKCASE COVER REMOVAL

Remove the 3 bolts and the Left Front Cover.



Remove 2 bolts and the Left Rear Cover.

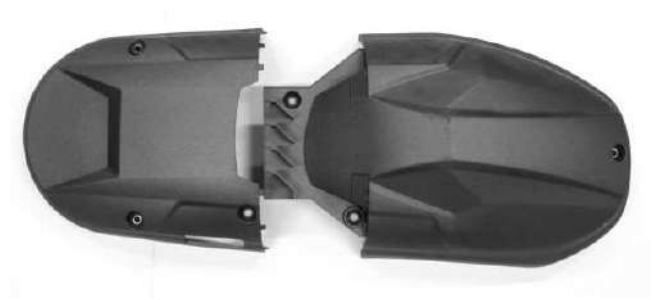

Remove 9 bolts and the Left Cover.

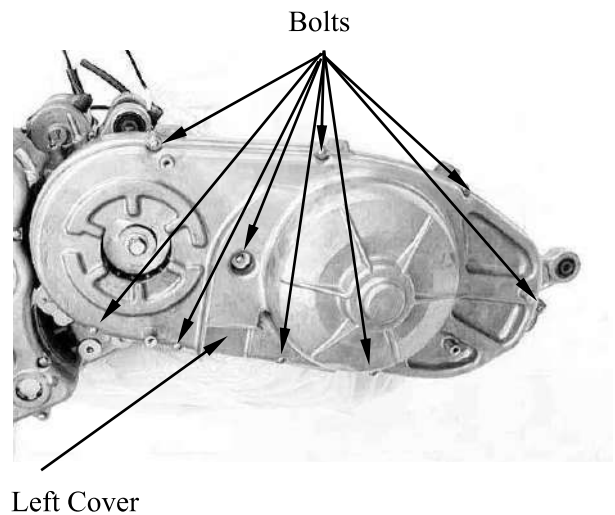

11. DRIVE AND DRIVEN PULLEY

Remove the dowel pins and gasket from the left crankcase.

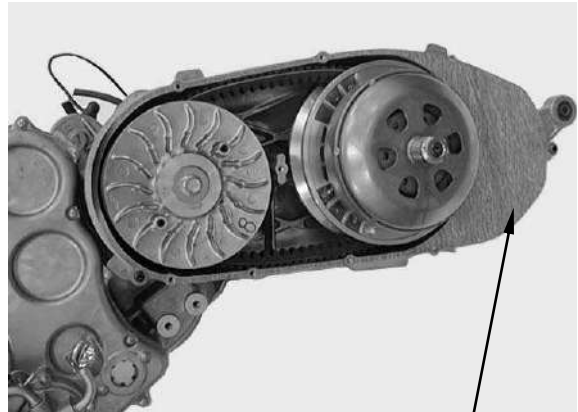

Gasket

11. DRIVE AND DRIVEN PULLEY

DRIVESHAFT BEARING REPLACEMENT

Remove the snap ring.

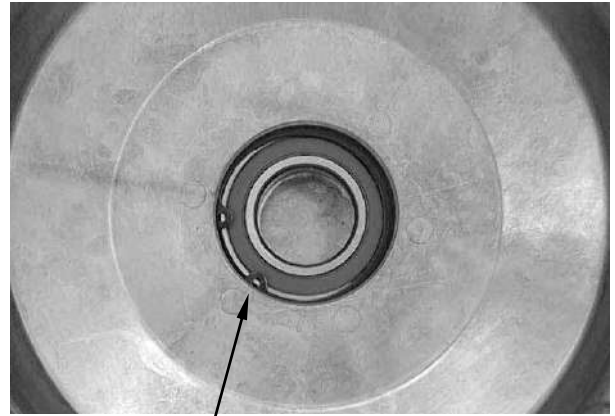

Clip

Heat the left crankcase cover around the driveshaft bearing with industrial dryer.
Remove the driveshaft bearing from the left crankcase cover.

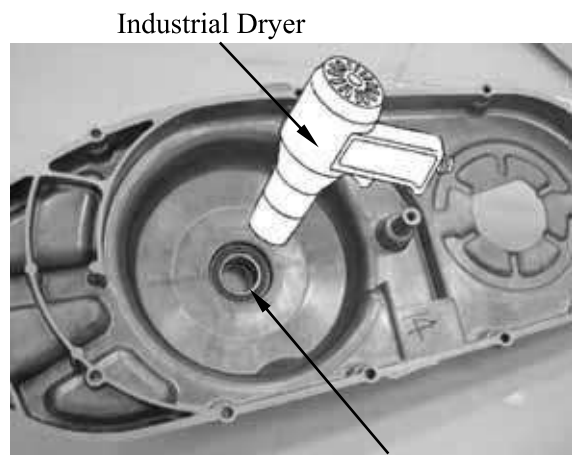

Industrial Dryer

Bearing

Install the new driveshaft bearing into the left crankcase cover using a special tool.

Special tool:

Oil seal & bearing install A120E00014

INSTALLATION

Installation is in the reverse order of removal.

* Clean the gasket on the left crankcase before installation.

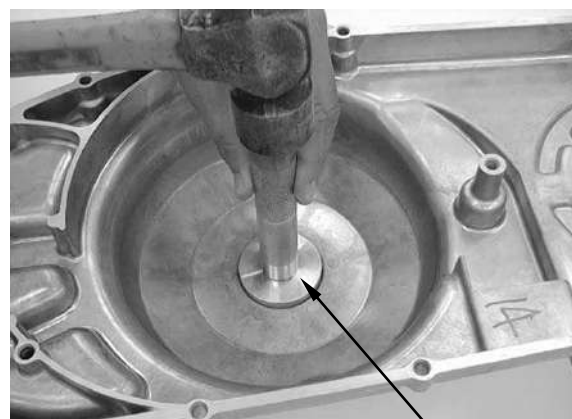

Bearing Install

11. DRIVE AND DRIVEN PULLEY

DRIVE PULLEY REMOVAL

Remove the left crankcase cover
Hold the drive pulley face with the special
tool and loosen the drive pulley face nut.

Special tool:
Universal holder A120E00017

Remove the nut, washer and drive pulley
face.

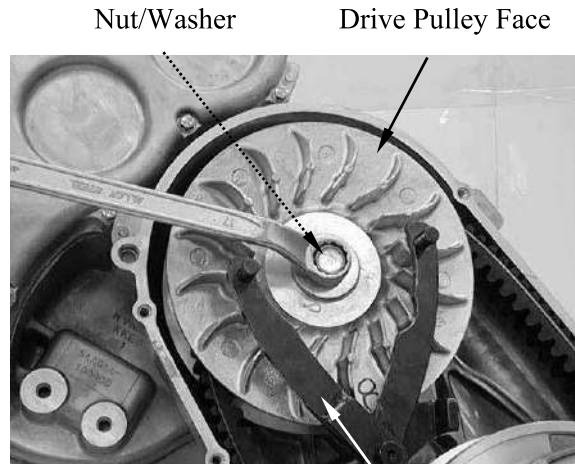

Universal Holder

Hold the clutch outer with the special tool as
shown.

Special tool:
Universal holder A120E00017

Remove the nut, collar and clutch outer.

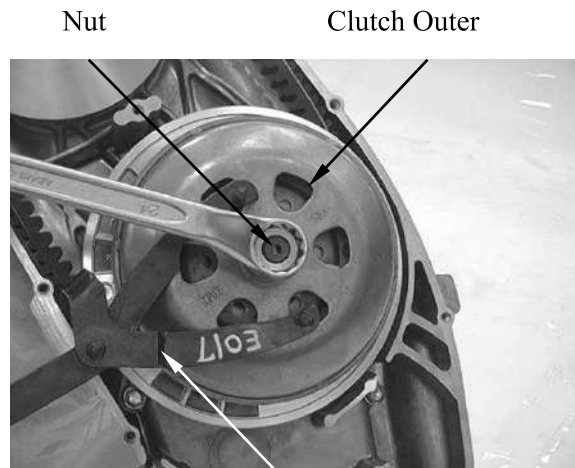

Universal Holder

Remove the clutch assembly and drive belt.

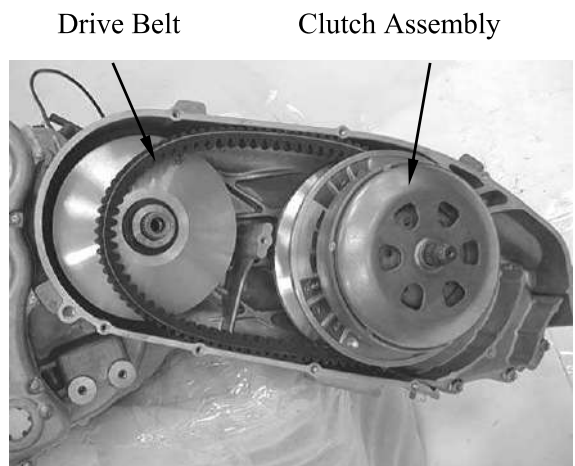

11. DRIVE AND DRIVEN PULLEY

Remove the movable drive face assembly.

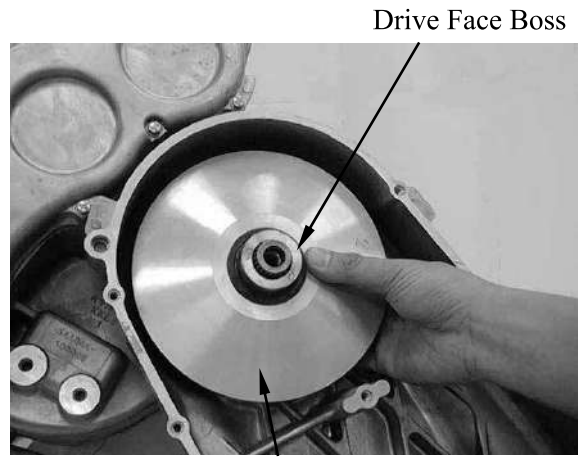

Movable Drive Face

Remove the collar.

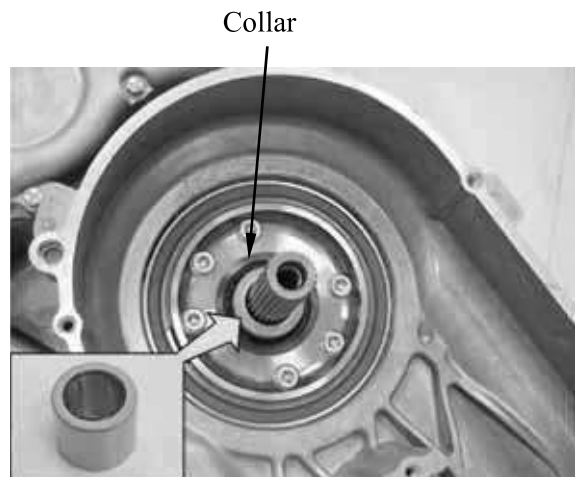

11. DRIVE AND DRIVEN PULLEY

DISASSEMBLY

Drive pulley

Remove the ramp plate and slide pieces.

Ramp Plate

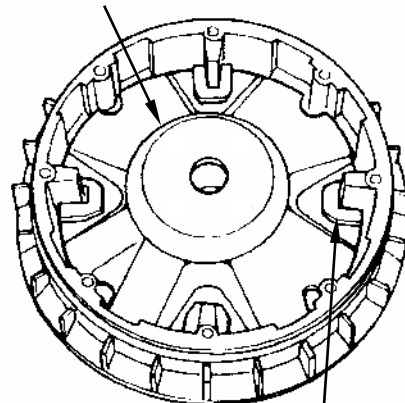

Slide Pieces

Remove the weight rollers.

Weight Rollers

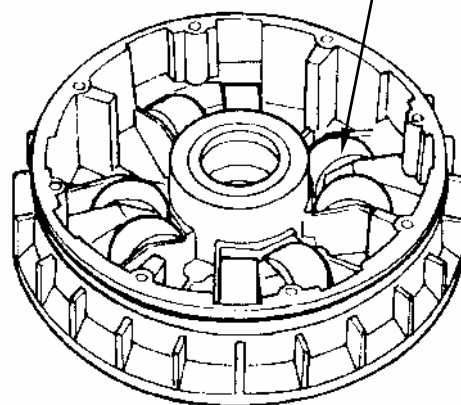

Remove the drive face boss from the movable drive face.

Drive Face Boss



11. DRIVE AND DRIVEN PULLEY

INSPECTION

Drive face boss

Check the drive face boss for wear or damage.

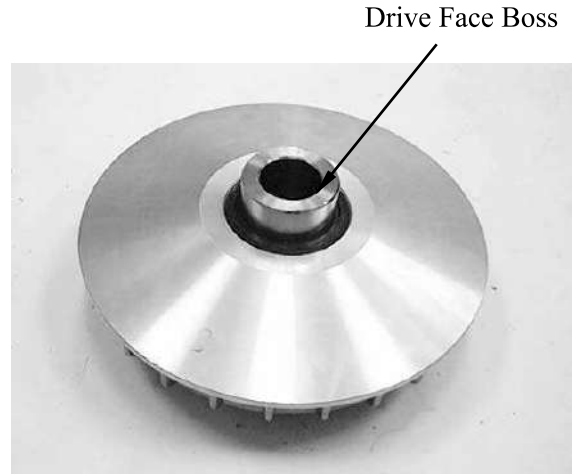

Weight roller

Check the roller for wear or damage.

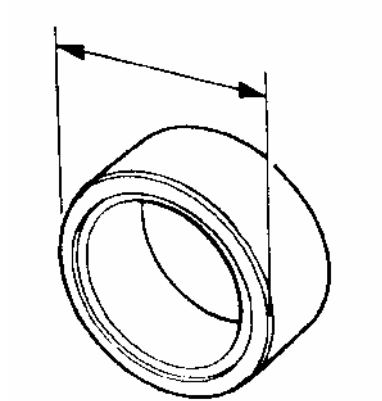

Weight roller

Check the dust seal for wear or damage.

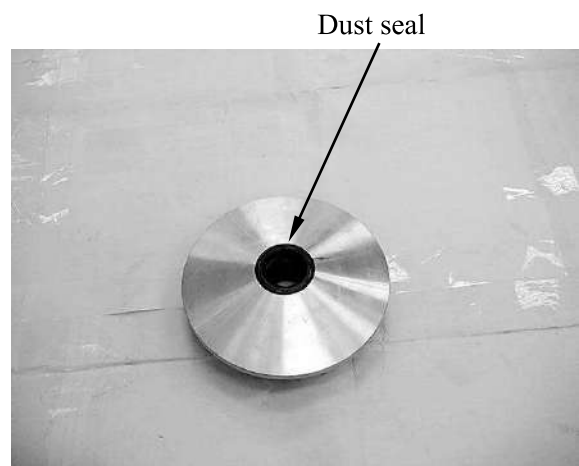

11. DRIVE AND DRIVEN PULLEY

ASSEMBLY

Drive pulley

Clean the movable drive face, drive pulley face, weight rollers, slide pieces, ramp plate and drive face boss.

* Remove any excess grease.

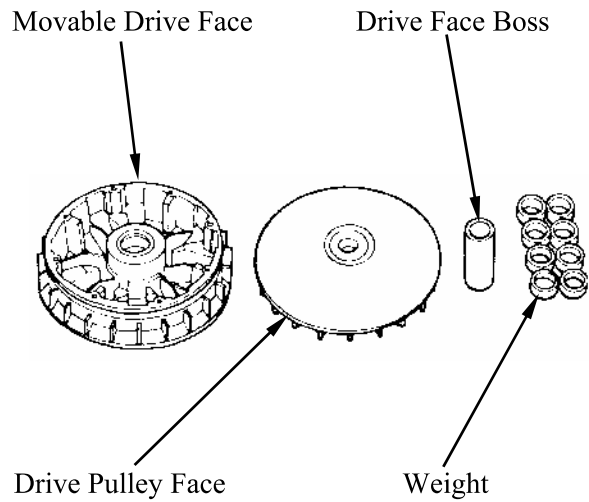

Install the weight rollers to the movable drive face.

* The direction of all weight rolls is the same. The thin side is towards to clockwise.

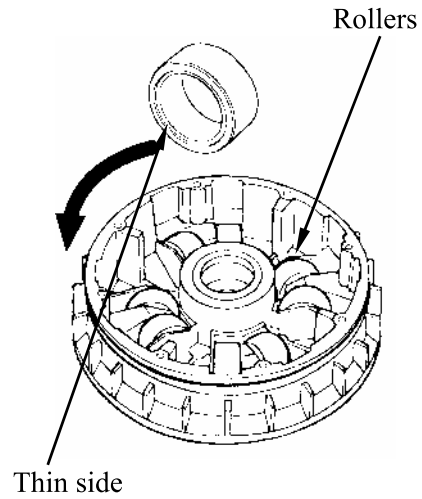

Install the ramp plate and slide pieces.

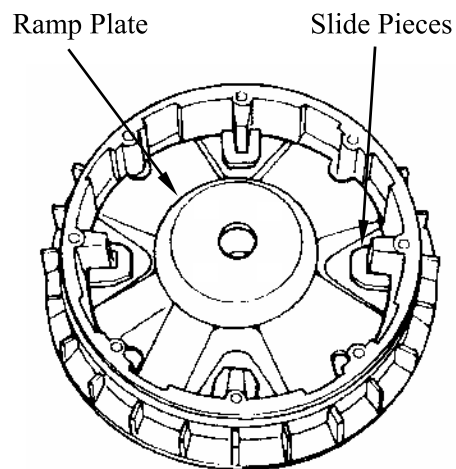

11. DRIVE AND DRIVEN PULLEY

INSTALLATION

Install the collar.

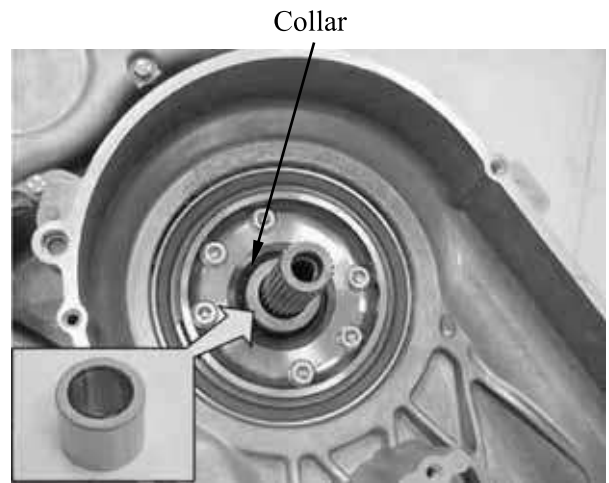

Clean any oil and grease from the pulley faces and the drive belt.

Install the movable drive face assembly onto the crankshaft.

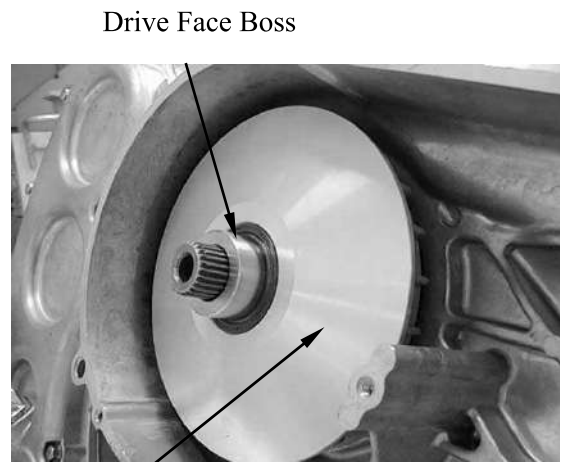

Movable Drive Face Assembly

Install the drive belt and clutch/driven pulley assembly.

* Install the drive belt with the arrow mark facing the direction.

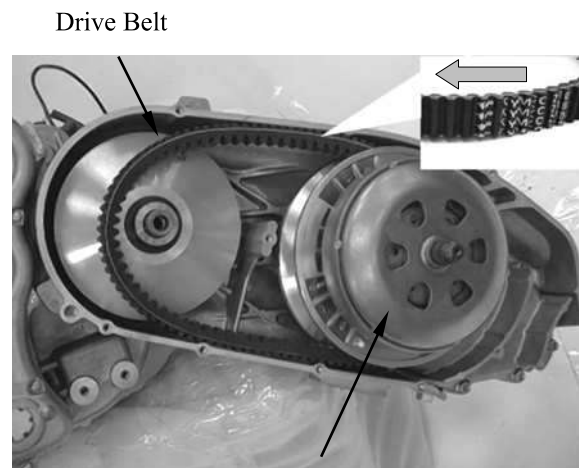

Clutch/Driven Pulley Assembly

11. DRIVE AND DRIVEN PULLEY

Hold the clutch outer with the special tool as shown.

Special tool:

Universal holder A120E00017

Install and tighten the nut to the specified torque.

Torque:

8~9 kgf•m

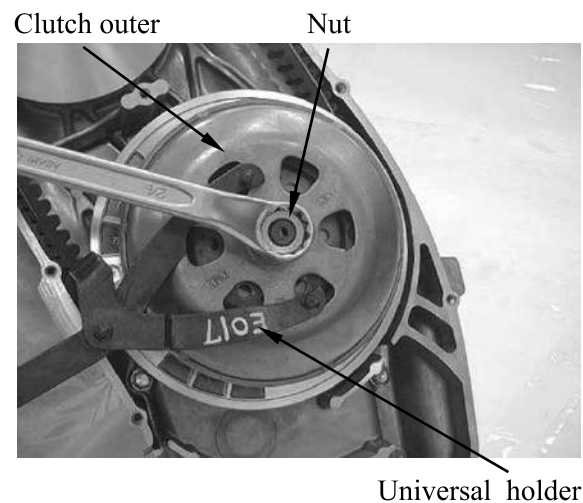

Install the drive pulley face and washers.
Apply oil to the drive pulley face bolt threads.

Hold the drive face with the special tool and tighten the bolt to the specified torque.

Torque: 10~12 kgf•m

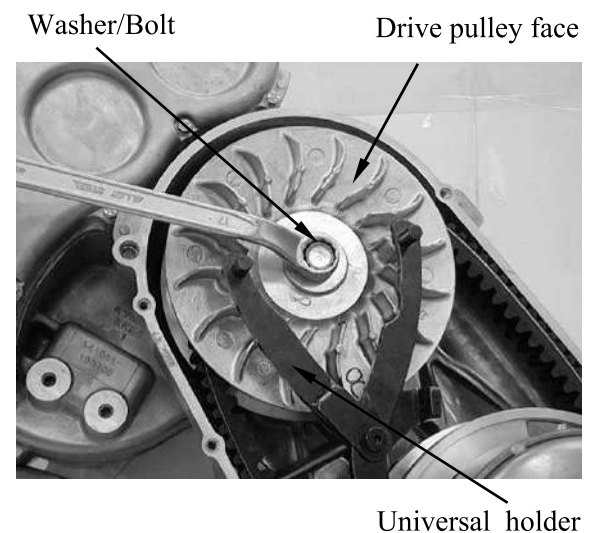

11. DRIVE AND DRIVEN PULLEY

DISASSEMBLY Clutch/Driven Pulley

Hold the clutch/driven pulley assembly with the clutch spring compressor.

* Be sure to use a clutch spring compressor to avoid spring damage.

Special tool:

Clutch Spring Compressor A120E00053

Set the tool in a vise and remove the clutch drive plate nut.

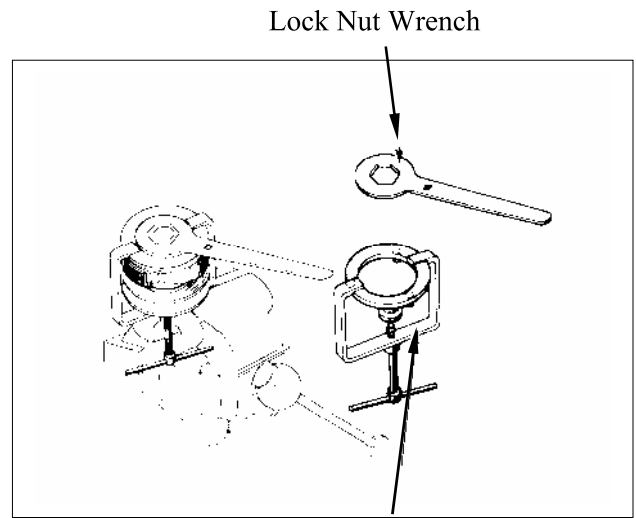

Clutch spring compressor

Remove the spring compressor and disassemble the following:

- Clutch assembly
- Driven face spring
- Driven pulley

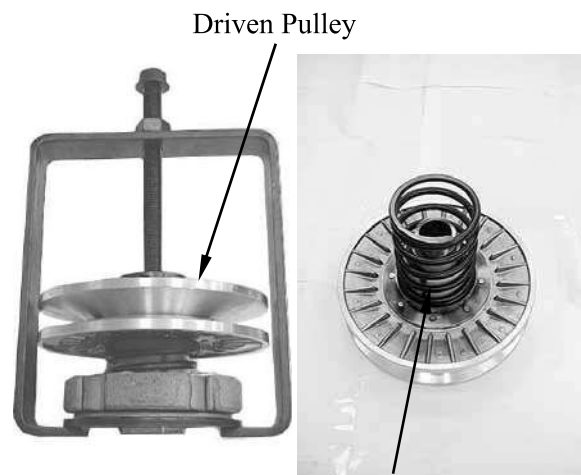

Driven Face Spring

Remove the spring collar.

Remove the seal collar.

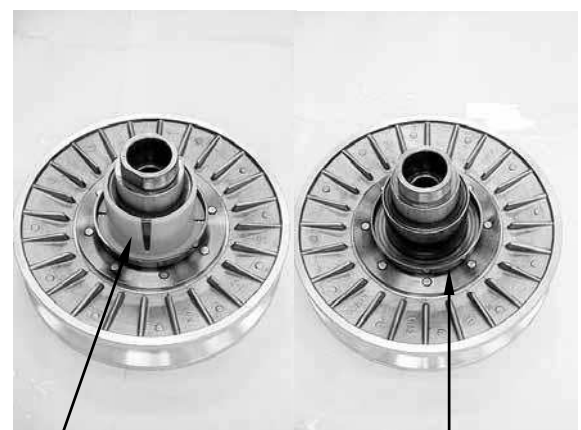

Spring Collar

Seal Collar

11. DRIVE AND DRIVEN PULLEY

Remove the guide roller pins, guide rollers and the movable driven face.

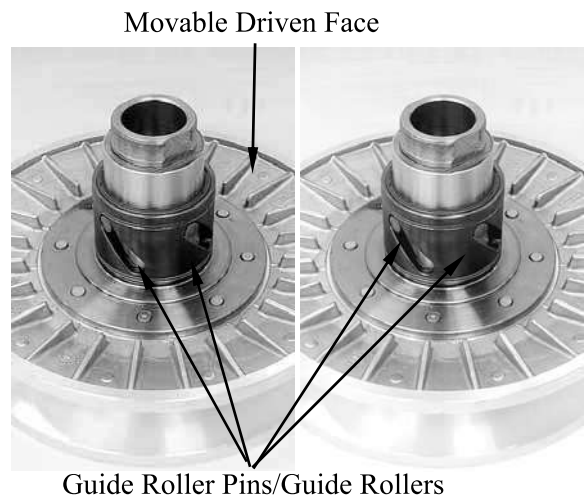

Remove the O-rings and oil seals from the movable driven face.

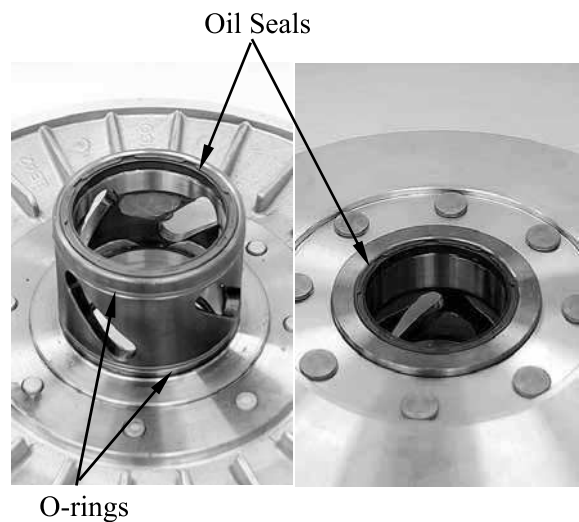

Driven Face Bearing Replacement

Remove the driven face needle bearing.

Remove the snap ring, then remove the ball bearing.

Apply grease to new ball bearing.

Install the ball bearing into the driven face.
Install the snap ring to groove in the driven face securely.

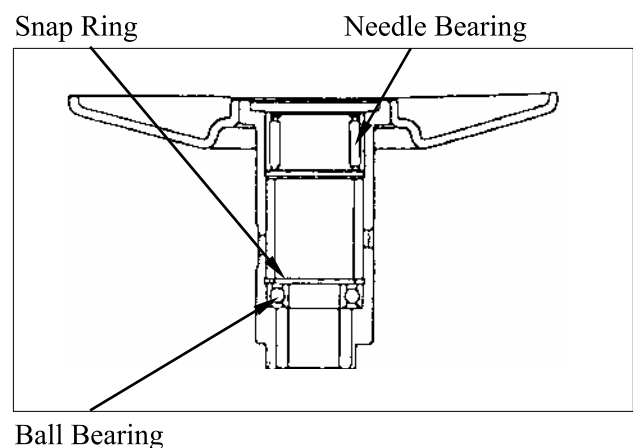

11. DRIVE AND DRIVEN PULLEY

Filling 25 g of grease to the driven face inner surface.

Apply grease to new needle bearing.
Press the needle bearing into the driven.

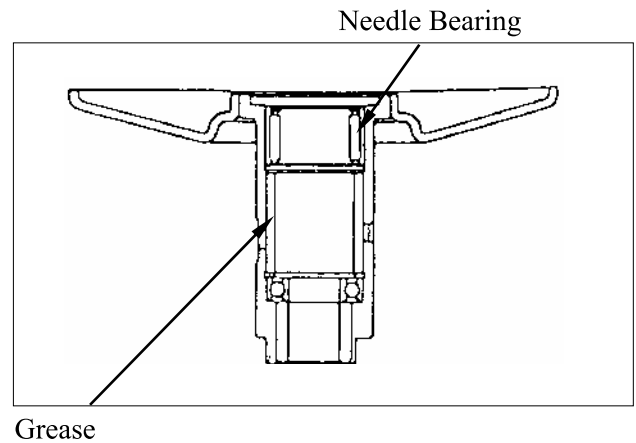

INSPECTION

Clutch Outer

Check the clutch outer for wear or damage.



11. DRIVE AND DRIVEN PULLEY

Clutch Shoe Lining

Check the clutch shoe for wear or damage.
Measure the thickness of each shoe.

Service limit: 2.5 mm

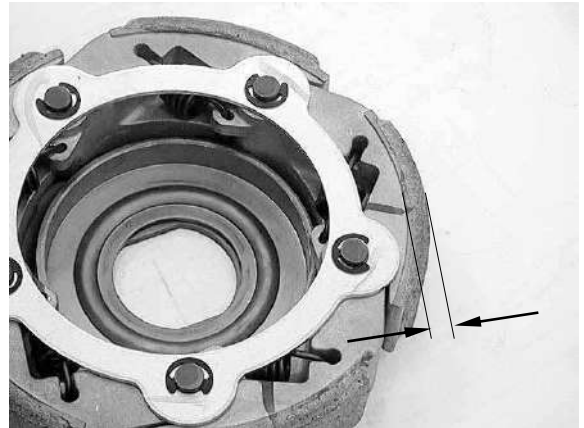

Driven Face Spring

Check the driven face spring for wear or damage.

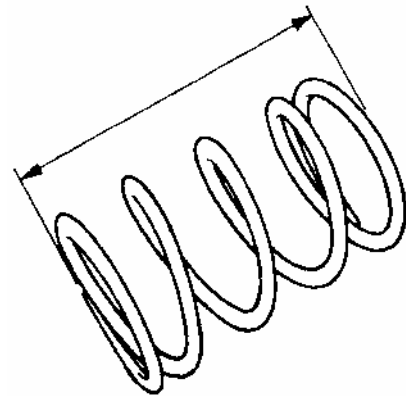

Driven Face

Check the driven face for scratches, scoring or damage.



11. DRIVE AND DRIVEN PULLEY

Movable Driven Face

Check the movable driven face for scratches, scoring or damage.

Check the guide grooves for stepped wear or damage.



Drive Belt

Check the drive belt for cracks, separation or abnormal or excessive wear.

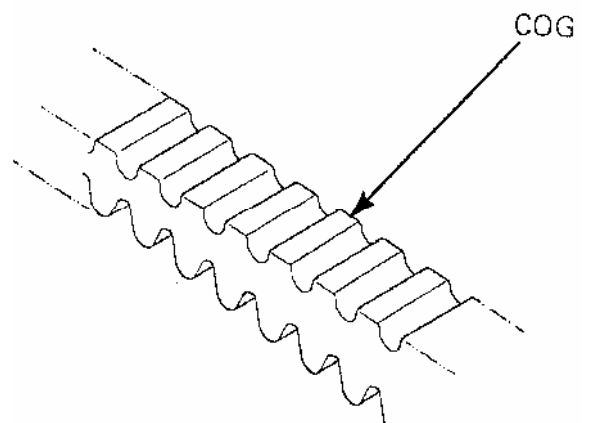

Remove the clutch/driven pulley, then replace the drive belt if necessary.

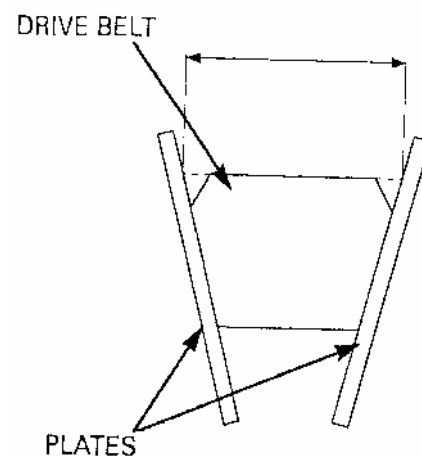

11. DRIVE AND DRIVEN PULLEY

ASSEMBLY

Clean any oil from the drive belt sliding surfaces on the driven face.

Apply grease to new oil seal lips and install into the movable driven face.

Coat new O-rings with grease and install them into the movable driven face grooves.



O-rings

Install the movable driven face onto the driven face.

Install the guide rollers and guide roller pins.

Filling 6~7g of grease to each guide groove.

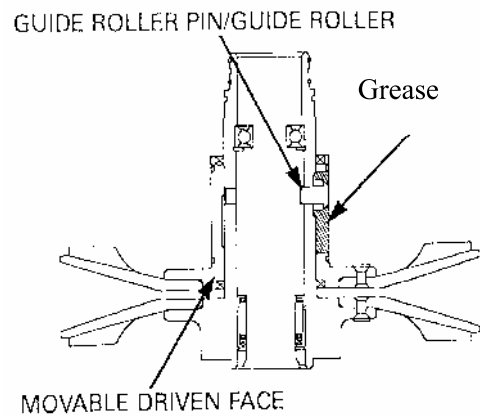

Install the seal collar.

Install spring collar .

Install driven face spring.

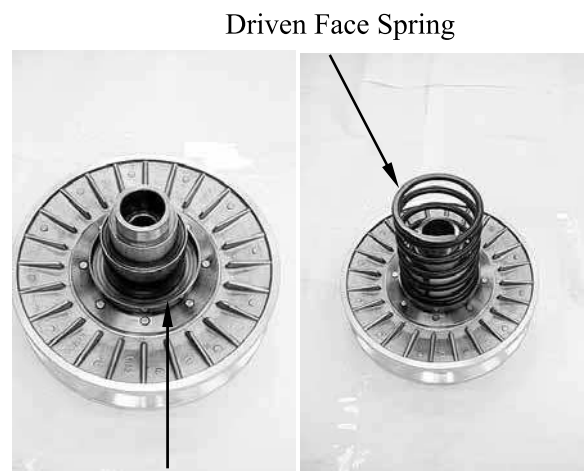

Seal Collar

11. DRIVE AND DRIVEN PULLEY

Install the drive belt into the driven pulley.
Squeeze and hold the drive belt by your hand.

Set the clutch spring compressor over the clutch/driven pulley assembly and hold the spring compressor in a vice.

Special tool:

Clutch Spring Compressor A120E00053

Compress the driven face spring.
Install and tighten the clutch drive plate nut to the specified torque.

Torque:

7~8 kgf•m

Install the drive belt and clutch/driven pulley assembly.

* Install the drive belt with the arrow mark facing the direction.

Lock Nut Wrench

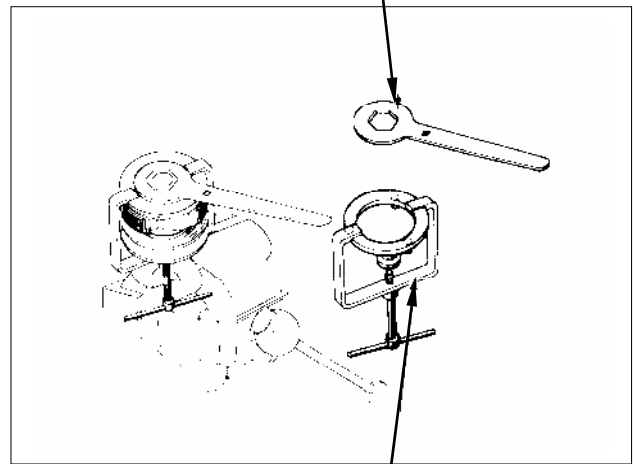

Clutch spring compressor

Drive Belt

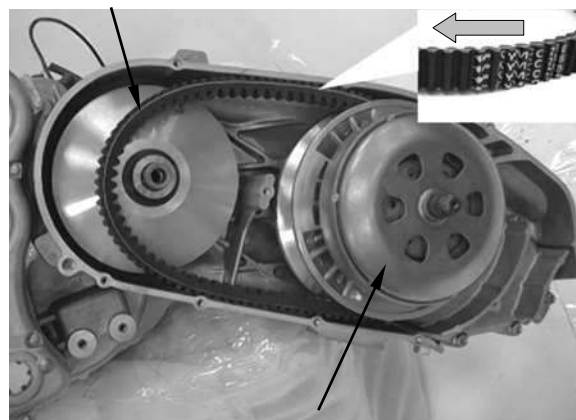

Clutch/Driven Pulley Assembly

Hold the clutch outer with the special tool as shown.

Special tool:

Universal holder A120E00017

Install the collar and nut.
Tighten the nut to the specified torque.

Torque:

8~9 kgf•m

Clutch outer Nut

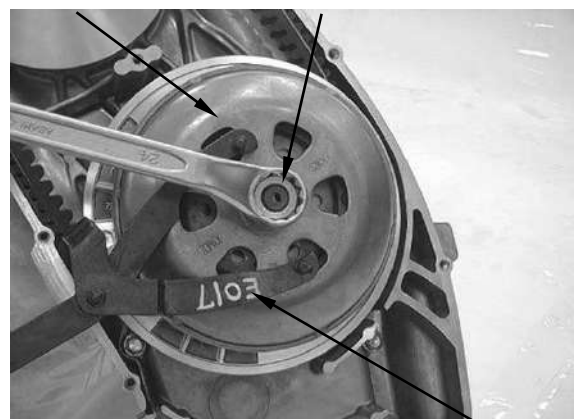

Universal holder

11. DRIVE AND DRIVEN PULLEY

Install the drive pulley face and washers.

Apply oil to the drive pulley face bolt threads.

Hold the drive face with the special tool and tighten the bolt to the specified torque.

Torque: 10~12 kgf•m

Special tool:

Universal holder

A120E00017

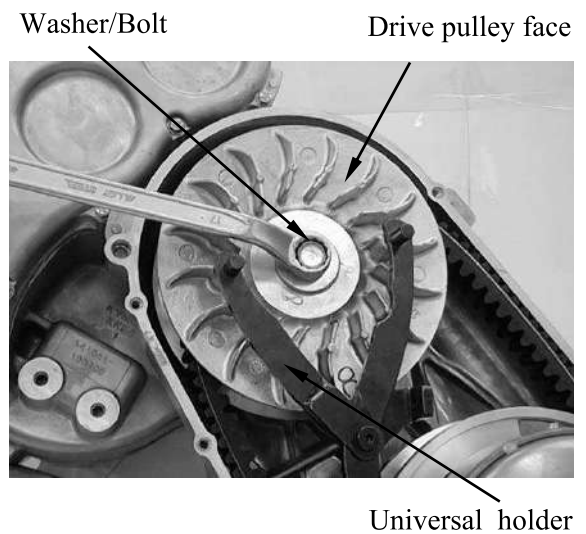

12. FINAL REDUCTION

12

FINAL REDUCTION

SCHEMATIC DRAWING -----	12-1
SERVICE INFORMATION-----	12-2
TROUBLESHOOTING-----	12-2
FINAL REDUCTION DISASSEMBLY -----	12-3
FINAL REDUCTION INSPECTION-----	12-6
FINAL REDUCTION ASSEMBLY -----	12-6

12. FINAL REDUCTION

SCHEMATIC DRAWING

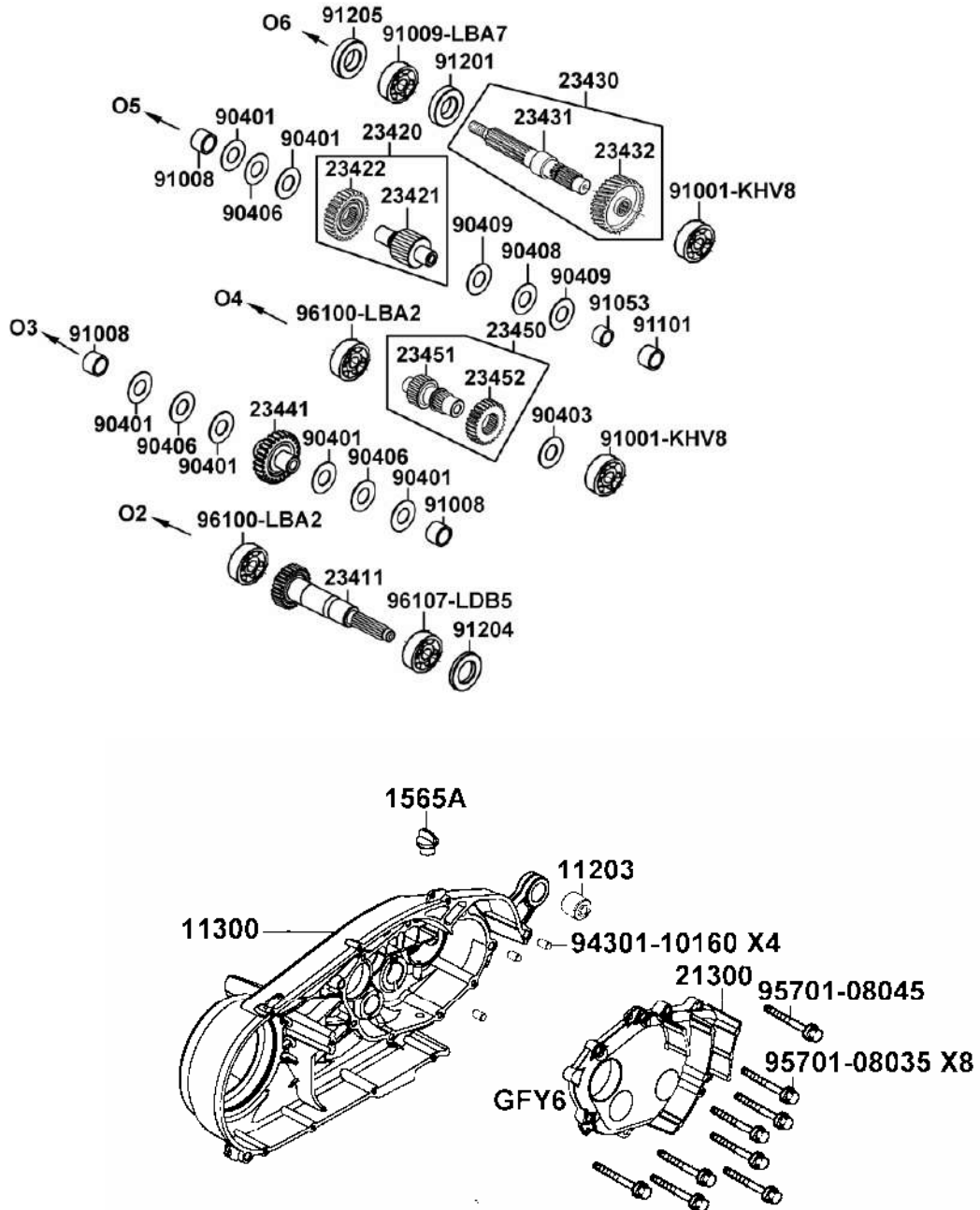

12. FINAL REDUCTION

SERVICE INFORMATION

GENERAL INSTRUCTIONS

- The servicing operations of this section can be made with the engine installed.
- When replacing the drive shaft, use a special tool to hold the bearing inner race for this operation.

SPECIFICATIONS

Specified Oil: SAE 90#

Oil Capacity:

At disassembly:	0.4 L
At change:	0.32 L

TORQUE VALUES

Transmission case cover bolt	2.5~2.9 kgf•m
Oil drain bolt	2.4 kgf•m
Oil filler bolt	2.4 kgf•m

SPECIAL TOOLS

Bearing puller	A120E00037
Oil seal & bearing driver	A120E00014
Universal bearing puller	A120E00030

TROUBLESHOOTING

Engine starts but motorcycle won't move

- Damaged transmission
- Seized or burnt transmission
- Faulty drive and driven pulleys/clutch

Abnormal noise

- Worn, seized or chipped gears
- Worn bearing

Oil leaks

- Oil level too high
- Worn or damaged oil seal
- Cracked crankcase

12. FINAL REDUCTION

FINAL REDUCTION DISASSEMBLY

TRANSMISSION DISASSEMBLY

Remove the exhaust muffler.
Remove the rear brake caliper.
Remove the right rear shock absorber.
Remove the rear fork .
Remove the rear wheel.

Drain the transmission gear oil into a clean container.

Remove the 9 bolts and transmission cover.

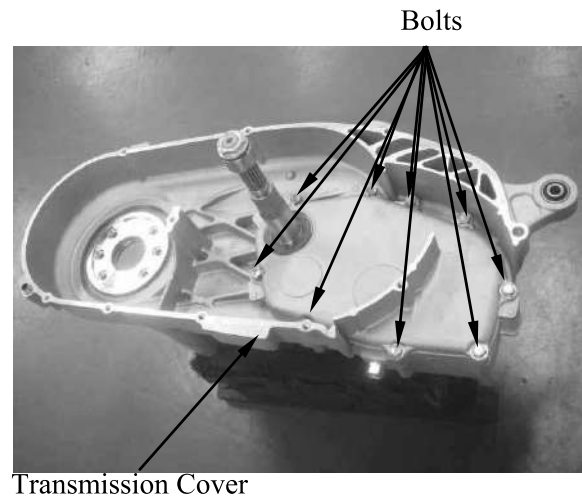

Remove the Dowel Pins.
Clean of the sealant from the swing arm case.

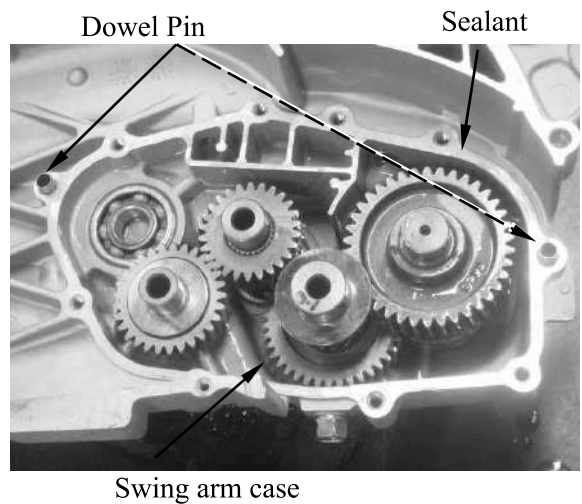

Remove the Shaft A Counter and Gear E Counter.

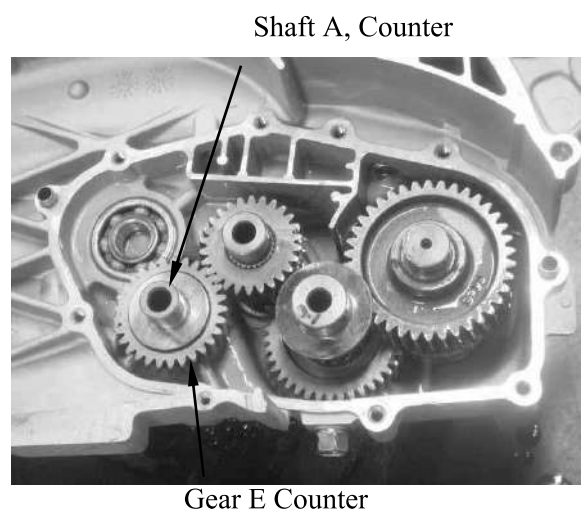

12. FINAL REDUCTION

Remove the Washer of Shaft A Counter

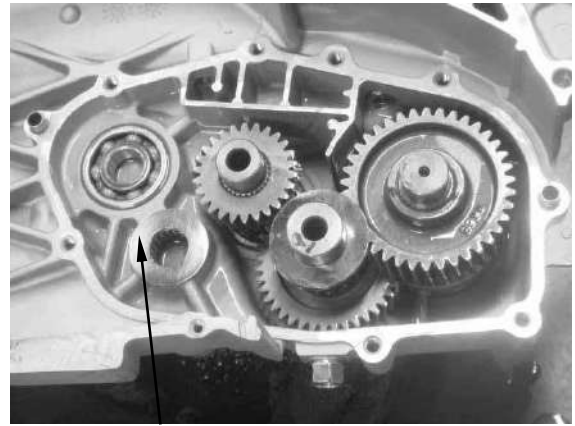

Washer of Shaft A Counter

Remove the Shaft B Counter and Gear F Counter.

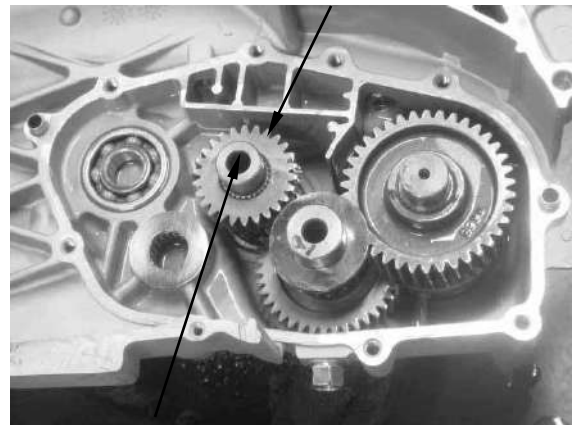

Shaft B Counter

Remove the Washers of Shaft C Counter.
Remove the Gear H Final from the Shaft Final.

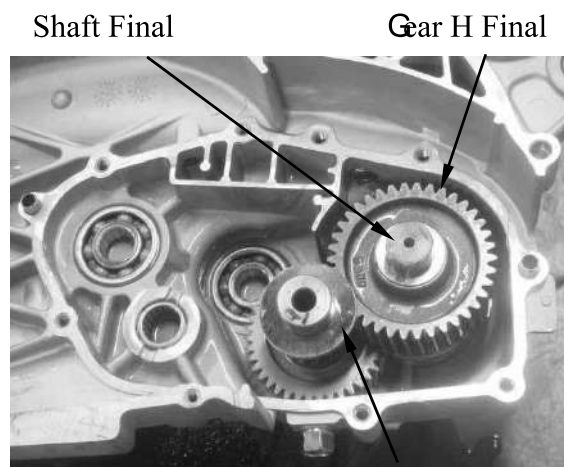

Washers of Shaft C Counter

12. FINAL REDUCTION

Remove the Shaft C Counter and Gear G Counter.

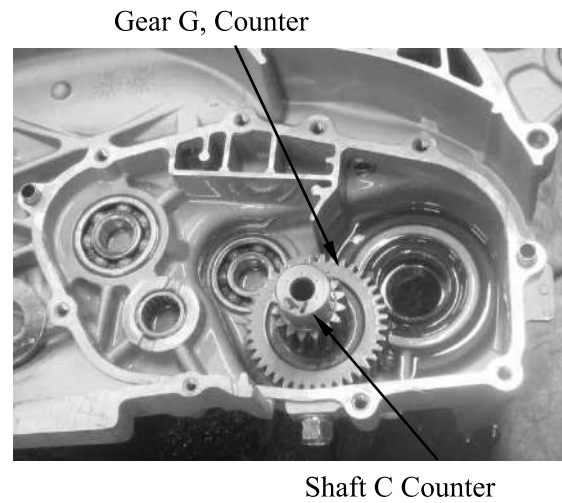

Remove the Washers of Shaft C Counter.

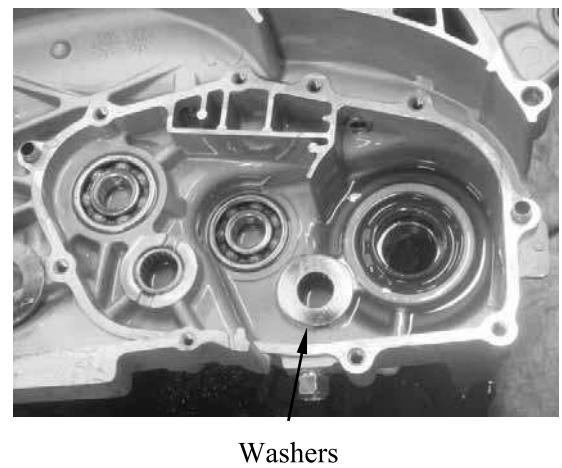

12. FINAL REDUCTION

FINAL REDUCTION INSPECTION

Check the oil seal and bearings for wear or damage.

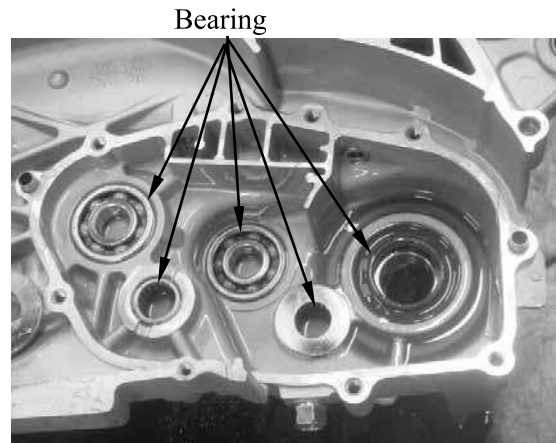

Check the shaft and gear for wear or damage.

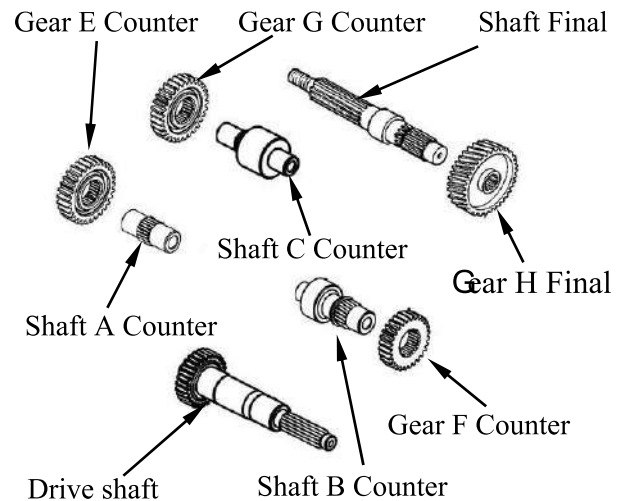

FINAL REDUCTION ASSEMBLY

Install the final gears and shaft to the transmission case.

Clean the mating surfaces of the transmission cover.

Apply sealant to the transmission cover mating surface.

Installation is in the reverse order of removal.

Install the bolts of transmission cover.

Torque: 2.5~2.9 kgf•m

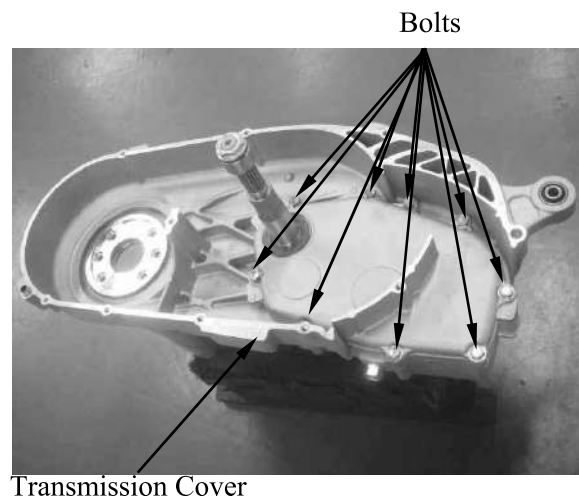

Transmission Cover

13. A.C. G/STARTER CLUTCH

13

A.C. G/STARTER CLUTCH

SCHEMATIC DRAWING -----	13-1
SERVICE INFORMATION-----	13-2
TROUBLESHOOTING-----	13-2
ALTERANTOR STATOR-----	13-3
FLYWHEEL/STARTER CLUTCH-----	13-4

13. A.C. G/STARTER CLUTCH

SCHEMATIC DRAWING

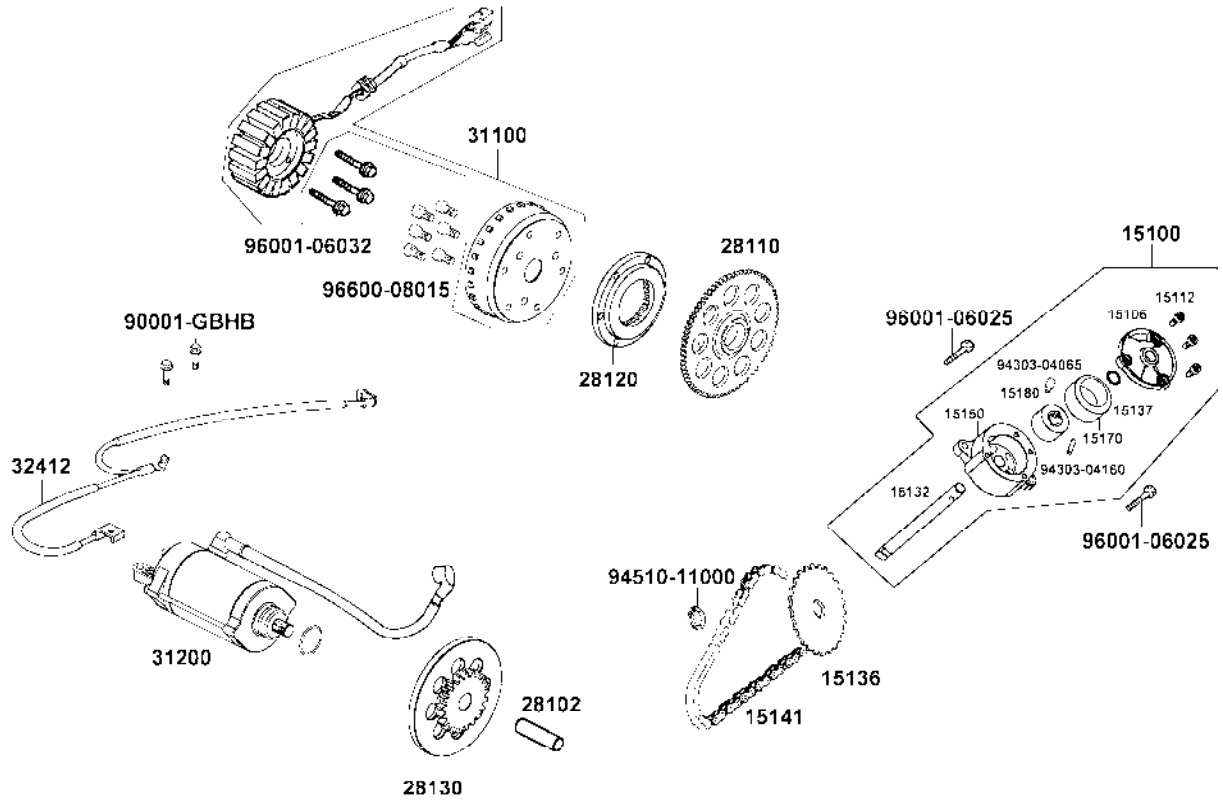

13. A.C. G/STARTER CLUTCH

SERVICE INFORMATION

GENERAL INSTRUCTIONS

- All servicing operations and inspections in this section can be made with the engine installed.
- Drain the coolant before removing the right crankcase cover.
- Be careful not to drain the coolant when the engine temperature is high. (Perform this operation when the engine is cold.)
- Drain the coolant into a clean container.
- Drain the engine oil into a clean container before removing the right crankcase cover.
- When the right crankcase cover is installed, fill with the recommended engine oil and coolant. Then, bleed air from the water jacket.

TROUBLESHOOTING

Starter motor turns, but engine does not turn

- Faulty starter clutch
- Damaged starter reduction gear

13. A.C. G/STARTER CLUTCH

ALTERNATOR STATOR RIGHT CRANKCASE COVER REMOVAL

Remove the exhaust muffler.
Remove water pump.
Remove bolts and right crankcase cover.

Tightened Torque: 0.8~1.2 kgf•m



Remove the two pulse coil mount bolts.
Remove the three stator mount bolts,
grommet and the stator from the right
crankcase cover.

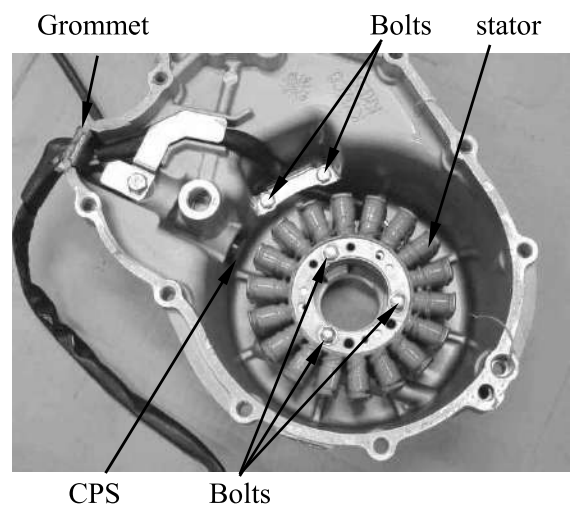

INSTALLATION

Install the stator and tighten the stator mount
bolts to the specified torque.

Torque: 0.8~1.2 kgf•m

Apply sealant to the grommet seating
surface and install it to the cover groove
properly.

Install the pulse coil and tighten mount bolts
to the specified torque.

Torque: 0.8~1.2 kgf•m

Clean the mating surfaces of the right
crankcase and cover.

Install the dowel pins Apply with liquid
gasket.

Install the right crankcase cover and tighten
the bolts in a crisscross pattern in 2 or 3
steps.

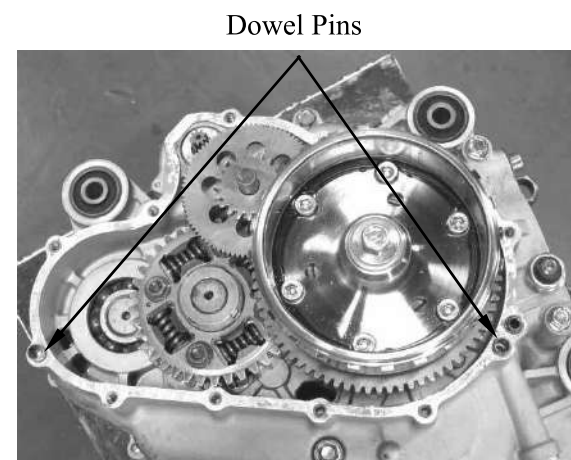

13. A.C. G/STARTER CLUTCH

FLYWHEEL/STARTER CLUTCH

REMOVAL

Hold the flywheel with the special tool and loosen the flywheel bolt.

Special tool:

Flywheel holder A120E00021

Remove the flywheel bolt and washer.

Tightened Torque: 7.5~8.5 kgf•m

Flywheel Bolt/Washer

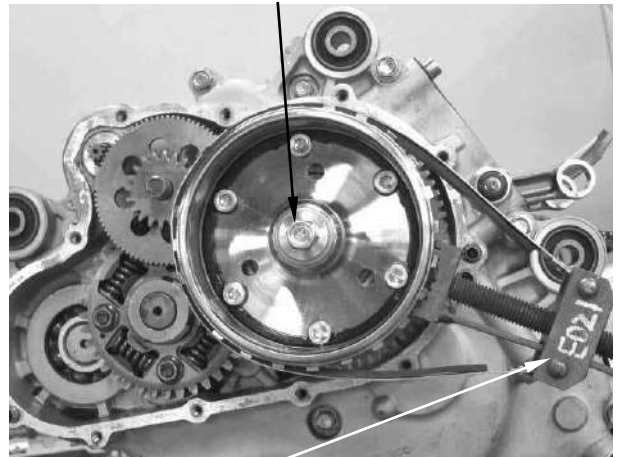

Flywheel Holder

Remove the flywheel/starter driven gear assembly using the special tool.

Special tool:

Flywheel puller A120E00084

Flywheel Puller

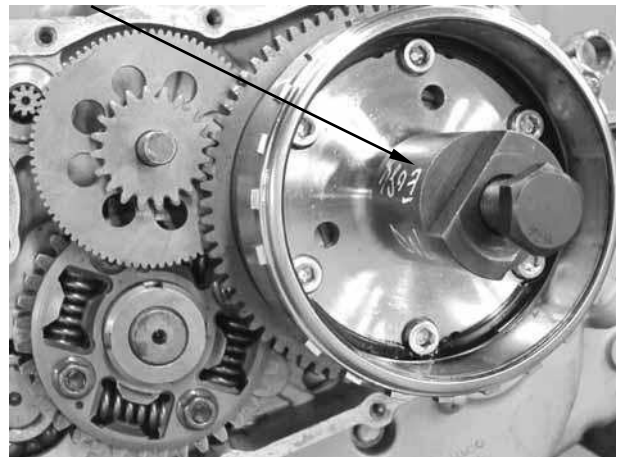

Remove the woodruff key.

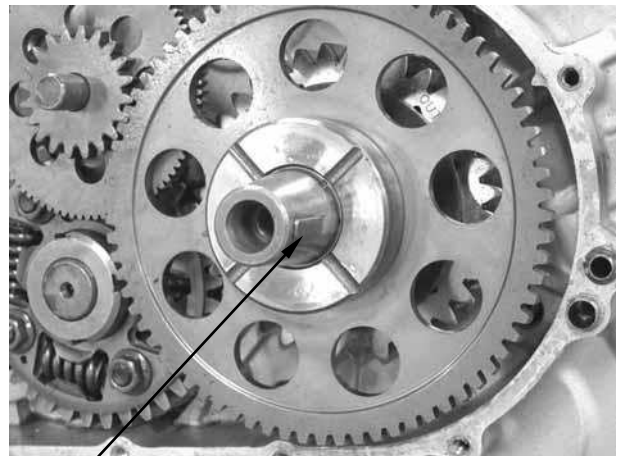

Woodruff Key

13. A.C. G/STARTER CLUTCH

Remove the reduction gear.

Reduction Gear



Remove the nut of drive gear assembly by using the special tool.

Tightened Torque: 14 kgf•m

Nut



Special tool:

Nut wrench A120E00087

Special tool



13. A.C. G/STARTER CLUTCH

Remove the drive gear set by using the special tool.

Drive Gear Set

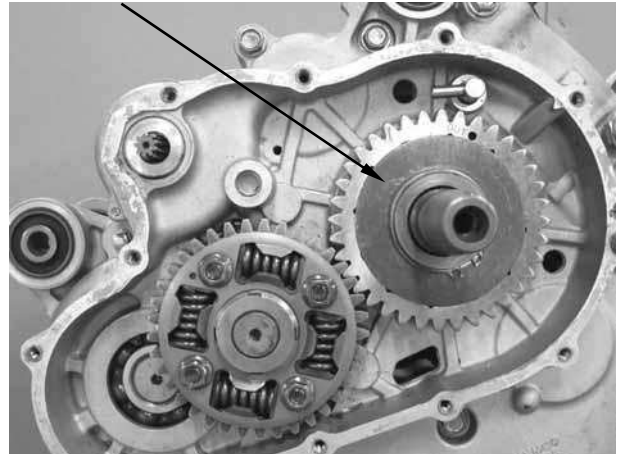

Special tool:

Crank drive gear puller A120E00086

Special tool

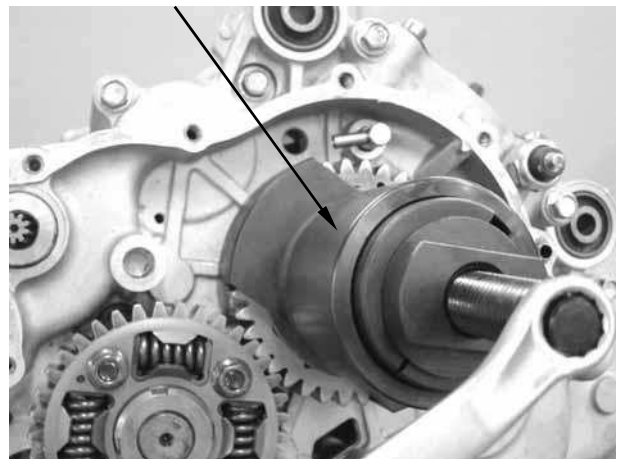

Remove the nut of main gear set by using special tool.

Tightened Torque: 14 kgf•m

Nut

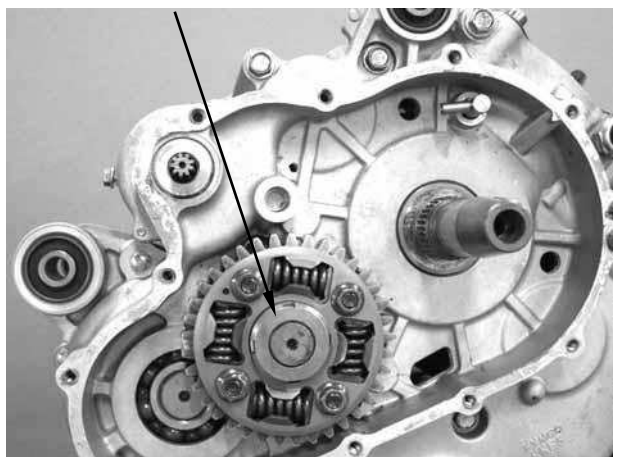

13. A.C. G/STARTER CLUTCH

Special tool:

Nut wrench A120E00082

Special tool

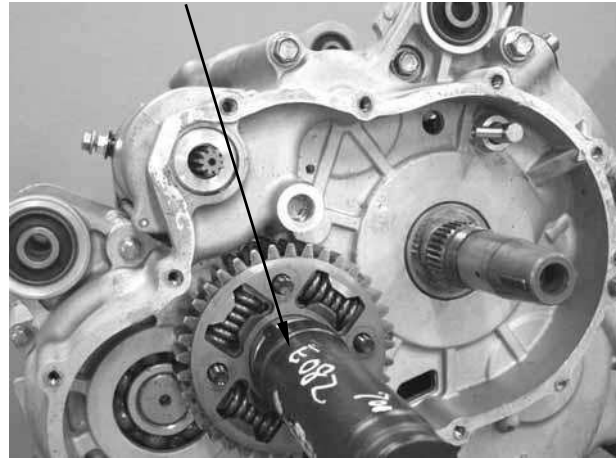

13. A.C. G/STARTER CLUTCH

INSPECTION

Check the operation of the clutch by turning the driven gear.

You should be able to turn the driven gear clockwise smoothly, but the gear should not turn counterclockwise.

Remove the starter driven gear by turning the driven gear.

Driven gear

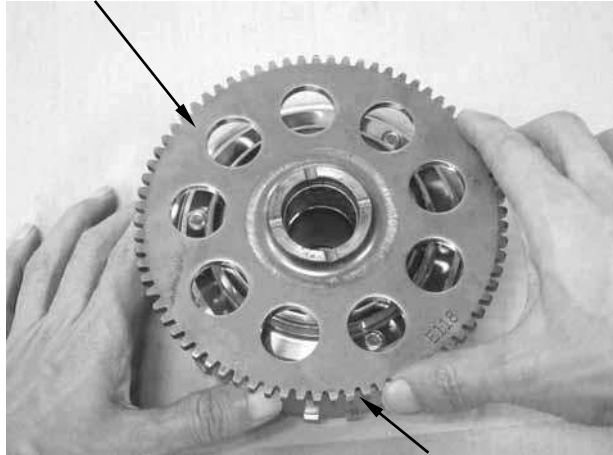

Fly Wheel

Check the starter driven gear teeth for wear or damage.



Installation would be the reverse order with the removal.

14. CRANKCASE/CRANKSHAFT

14

CRANKCASE/CRANKSHAFT/BALANCER

SCHEMATIC DRAWING -----	14- 1
SERVICE INFORMATION-----	14- 2
TROUBLESHOOTING-----	14- 3
LEFT CRANK CASE COVER -----	14- 4
WATER PUMP IMPELLER -----	14- 5
BALANCER GEAR/OIL PUMP CHAIN COMP-----	14- 6
BALANCER SUB-GEAR -----	14- 9
CRANKSHAFT/CRANKCASE SEPARATION-----	14-16
CRANKSHAFT /CONNECTING ROD-----	14-20
CRANKSHAFT/CRANKCASE INSTALLATION-----	14-23

14. CRANKCASE/CRANKSHAFT

SCHEMATIC DRAWING

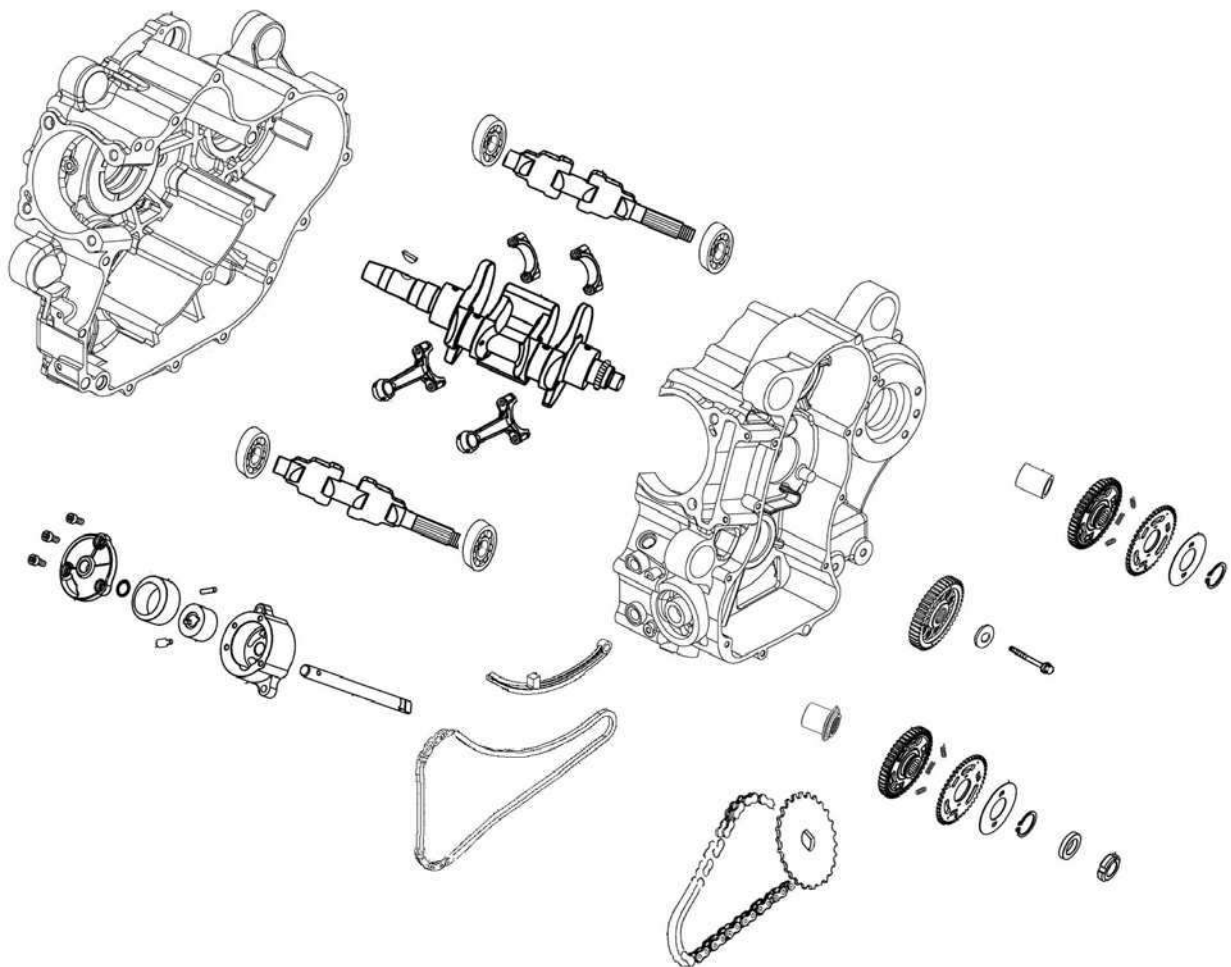

14. CRANKCASE/CRANKSHAFT

SERVICE INFORMATION

GENERAL INSTRUCTIONS

- This section covers crankcase separation to service the crankshaft and balancer. The engine must be removed for this operation.
- When separating the crankcase, never use a driver to pry the crankcase mating surfaces apart forcibly to prevent damaging the mating surfaces.
- When installing the crankcase, do not use an iron hammer to tap it.
- The following parts must be removed before separating the crankcase.
 - Cylinder head
 - Cylinder/piston
 - Drive and driven pulley
 - A.C. generator/starter clutch
 - Starter motor
 - Oil pump

SPECIFICATIONS

Unit: mm

	Item	Standard	Service Limit
Crankshaft	Connecting rod big end side clearance	0.1 ~ 0.35	0.4
	The clearance between crankshaft and crankcase	0.1 ~ 0.5	0.55

14. CRANKCASE/CRANKSHAFT

TORQUE VALUES (XCITING 500)

Crankcase bolt (M8)	2.1~2.5 kgf•m
Cam chain guide bolt	1.8~2.2 kgf•m

SPECIAL TOOLS

Bearing puller	A120E00037
Oil seal & bearing driver	A120E00014

TROUBLESHOOTING

Excessive engine noise

- Worn connecting to small end
- Worn or damaged crankshaft bearings

14. CRANKCASE/CRANKSHAFT

LEFT CRANK CASE COVER REMOVAL

Remove the parts required for crankcase separation.

Loosen the hose bands and disconnect the water hose and by pass hose from the water pump.

Remove the four bolts and water pump cover.

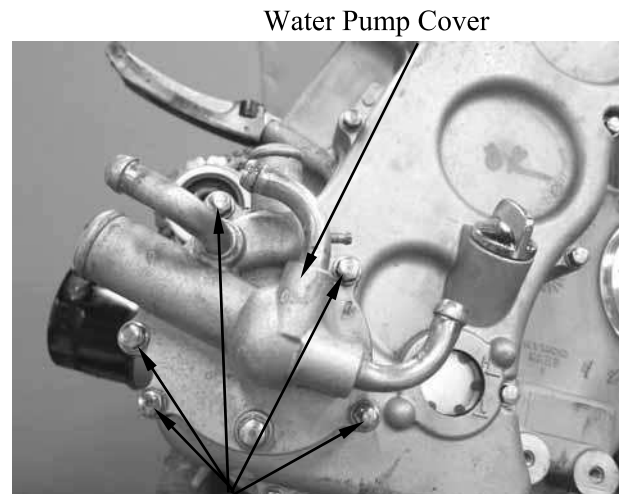

Bolts

Remove the ten bolts.

Remove the Left Crank Case Cover.

* Loosen the bolts in a crisscross pattern in several steps.

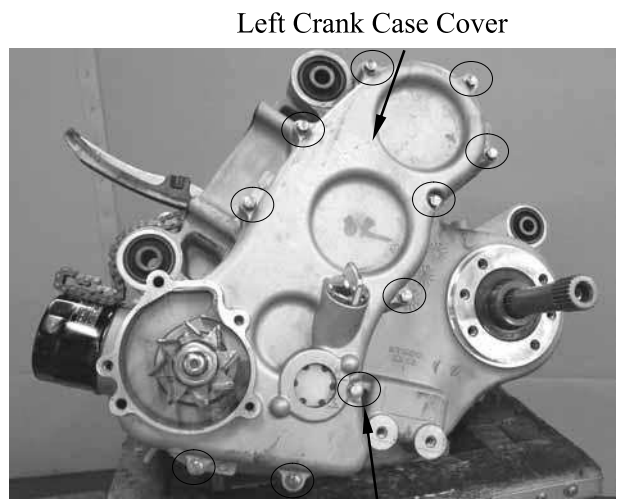

Bolts

Remove the dowel pins.

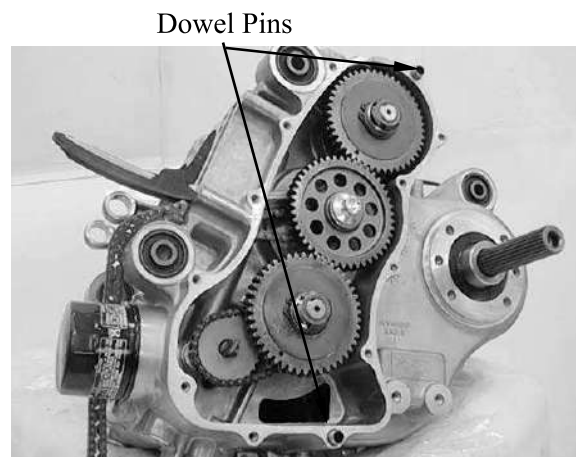

14. CRANKCASE/CRANKSHAFT

WATER PUMP IMPELLER REMOVAL

Remove the clip of Water Pump axle.

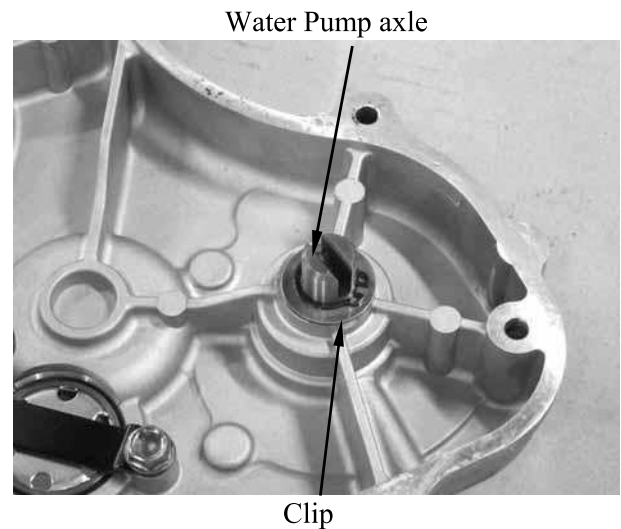

Remove the gasket and Water Pump Impeller.

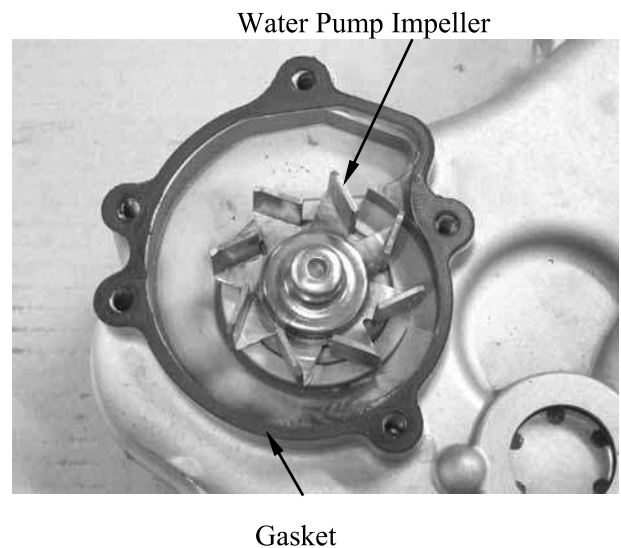

WATER PUMP IMPELLER INSTALLATION

Inspect all the gasket for unusual wear, damage or peeling and replace a new one if necessary.

Installation is in the reverse order of the removal.

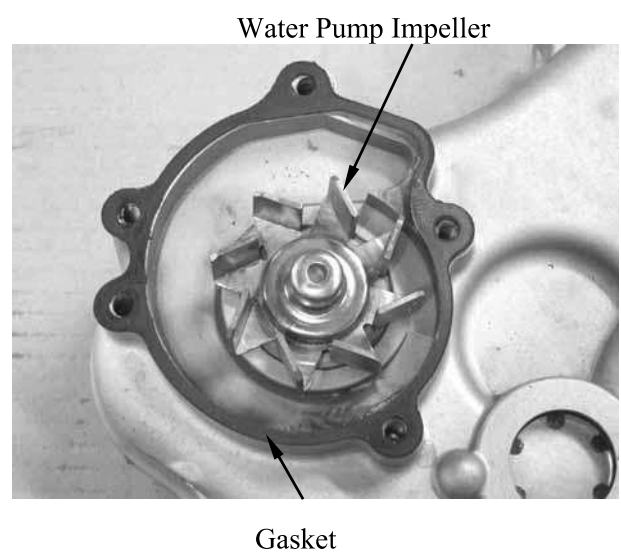

14. CRANKCASE/CRANKSHAFT

BALANCER GEAR/OIL PUMP CHAIN COMP REMOVAL

Hold the Balancer Drive Gear with the holder and loosen the lock nut of of Balancer Shaft Gear using the special tool clockwise.

Special tool:

- Flywheel Puller** **A120E00017**
- Lock Nut Wrench** **A120E00080**

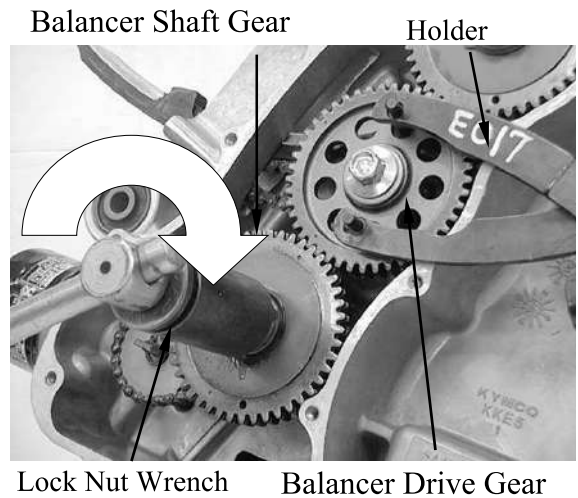

Remove the washer of Balancer Shaft Gear.

Remove the Balancer Shaft Gear clip.

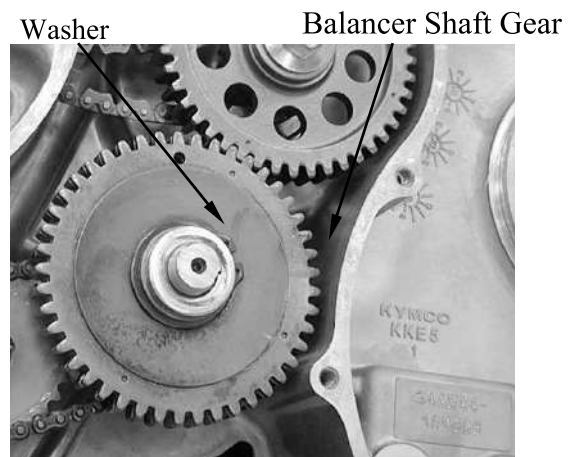

Hold the Balancer Drive Gear with the holder and loosen the lock nut of Balancer Shaft Gear using the special tool clockwise.

Remove the Balancer Shaft Gear clip.

Special tool:

- Universal Holder** **A120E00017**
- Lock Nut Wrench** **A120E00080**

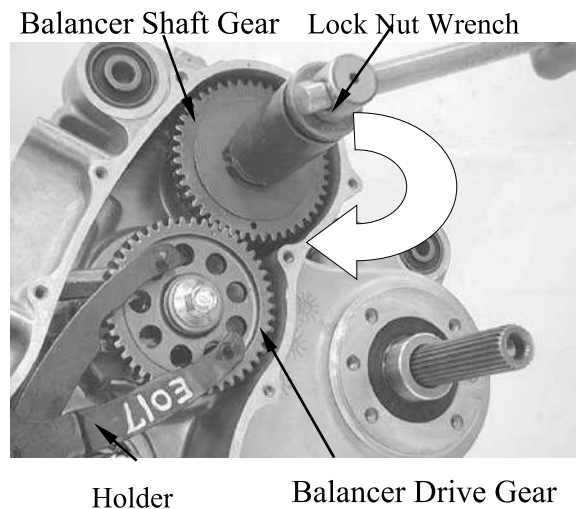

14. CRANKCASE/CRANKSHAFT

Hold the Balancer Drive Gear with the holder
Remove the bolt and washer attaching on the
Balancer Shaft Gear using the special tool.

Remove the Balancer Drive Gear.

Special tool:

Universal Holder A120E00017



Holder

Remove the nut attaching on the Sprocket.

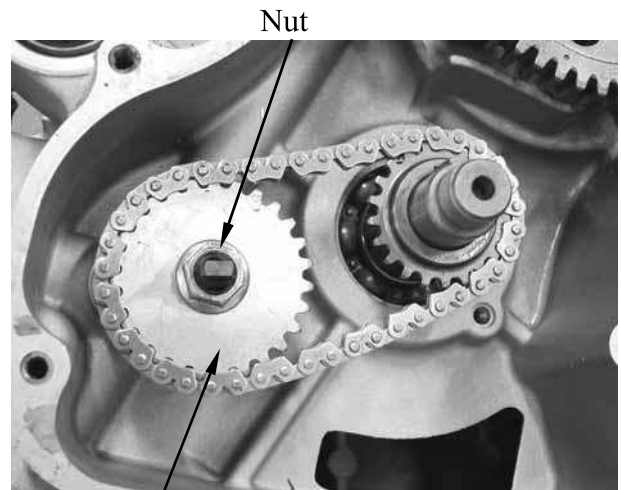

Sprocket Driven

Remove the Sprocket, Oil Pump Chain and
Sprocket Driven.

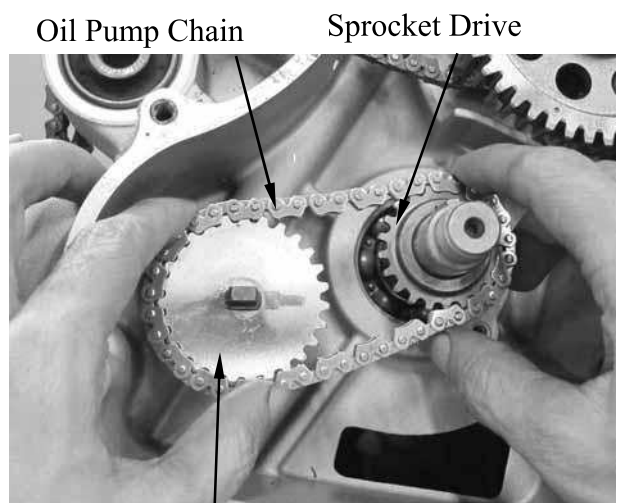

Sprocket Driven

14. CRANKCASE/CRANKSHAFT

Remove the bolt of Cam Chain Guide.

Remove the Cam Chain Guide and Cam Chain.

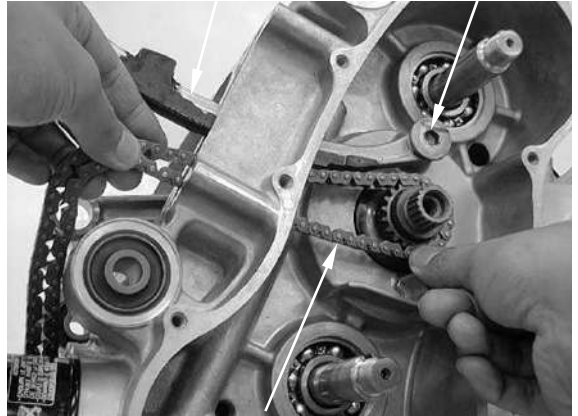

INSPECTION Cam Chain

Inspect the chain for cracks or stiff.

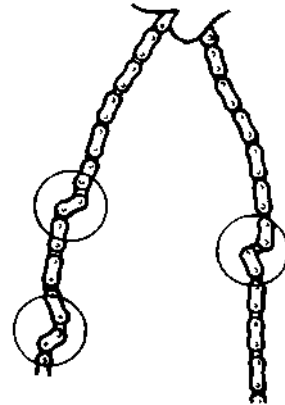

Balancer Gears

Check the teeth of Gear for wear or damage.

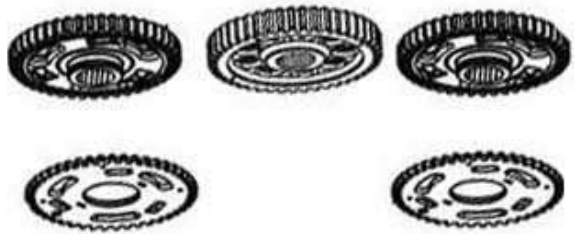

14. CRANKCASE/CRANKSHAFT

BALANCER SUB-GEAR REMOVAL

Remove the clip attaching on the Balancer Shaft Gear.

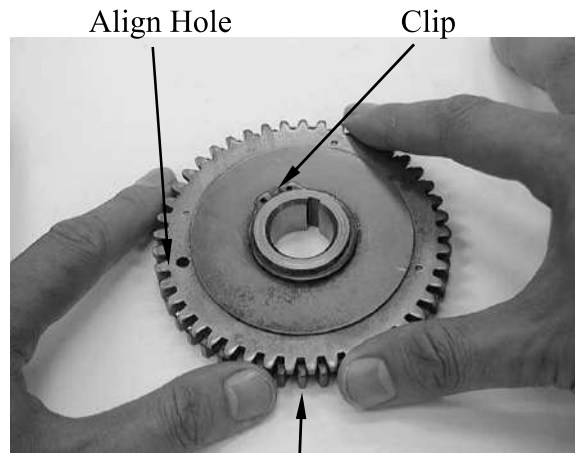

Balancer Shaft Gear/Sub Gear

Remove the Balance Gear Plate, Balancer Shaft Sub Gear and spring.

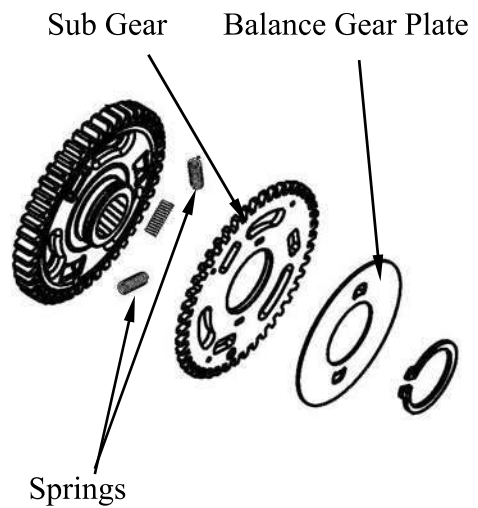

BALANCER SUB-GEAR INSTALLATION

Apply molybdenum disulfide oil to the sliding surface between Balancer Shaft Gear and Sub Gear.

* Inspect the gears for unusual wear or damage and replace a new one if necessary.

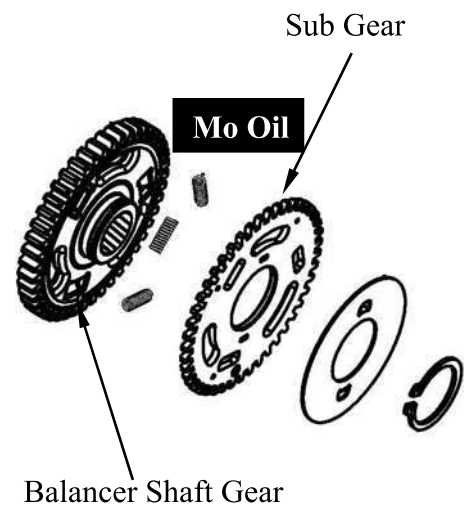

14. CRANKCASE/CRANKSHAFT

Install the springs into the Balancer Shaft Gear.

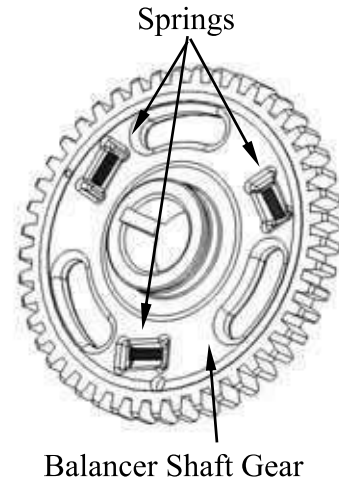

Assemble the Balancer Shaft Gear.

Align the hole of Balancer Shaft Gear and Sub Gear.

Install the Balance Gear Plate and Clip as shown.

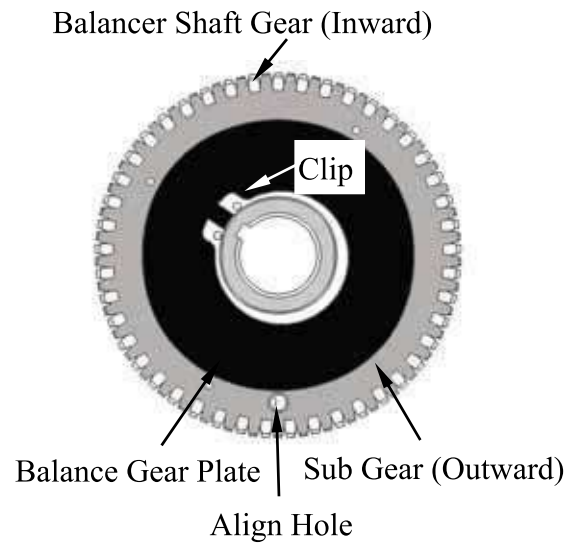

14. CRANKCASE/CRANKSHAFT

BALANCER GEAR/OIL PUMP CHAIN COMP INSTALLATION

Install the Cam Chain Guide and tighten the bolt.

Install the Cam Chain.

- * Inspect the cam chain slipper surface of the cam chain guide for wear or damage.

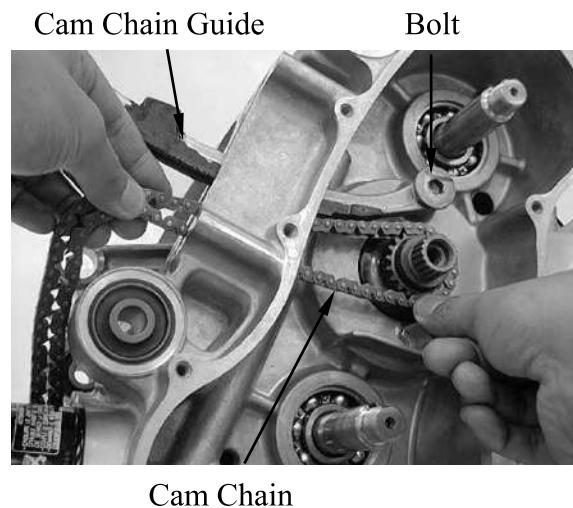

Install the Sprocket Drive, Oil Pump Chain and Sprocket Driven simultaneously.

- * Install the woodruff key in the groove of Sprocket Drive as shown.

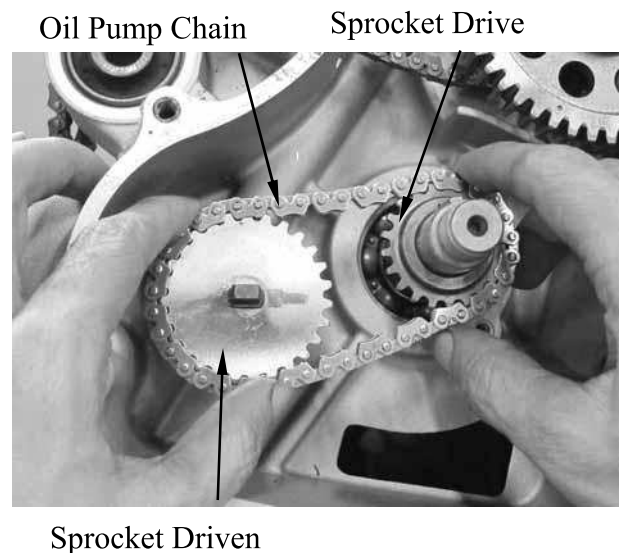

Install the nut attaching on the Sprocket Driven.

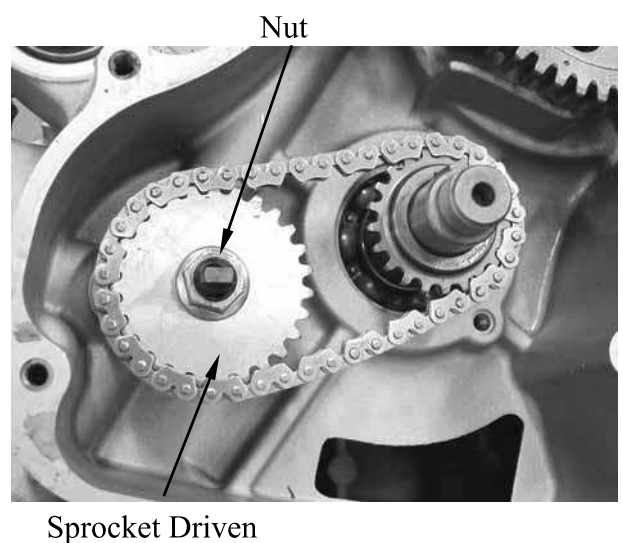

14. CRANKCASE/CRANKSHAFT

Install the Balancer Drive Gear with the mark on the crankshaft as shown.

Balancer Drive Gear



Install the washer and bolt of Balancer Drive Gear and tighten it using the special tool counterclockwise to the specified torque.

Special tool:

Universal Holder **A120E00017**

Torque: 7.5~8.5 kgf.m

Balancer Drive Gear

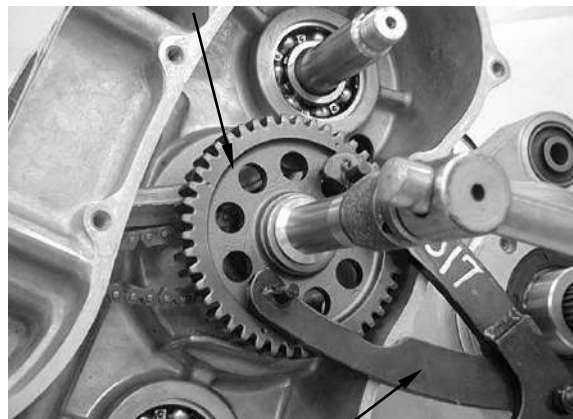

Holder

Install the collar.
Install the woodruff key into the groove of shaft before Balancer Shaft Gear installation.

woodruff Key



Collar

14. CRANKCASE/CRANKSHAFT

Install the both of the Balancer Shaft Gears to align the mark with the punch mark on the Balancer Drive Gear.

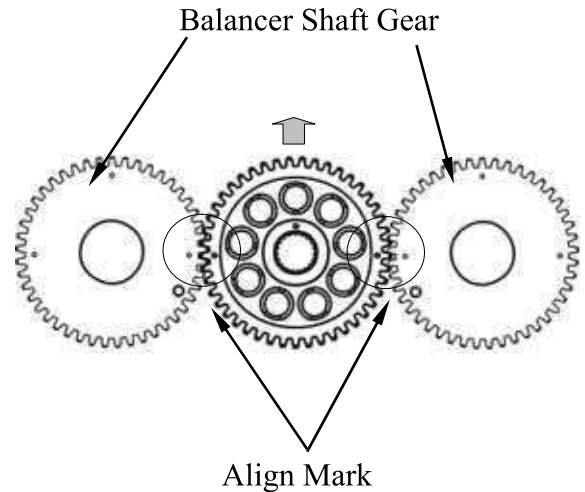

Install the washer to each Balancer Drive Gear.

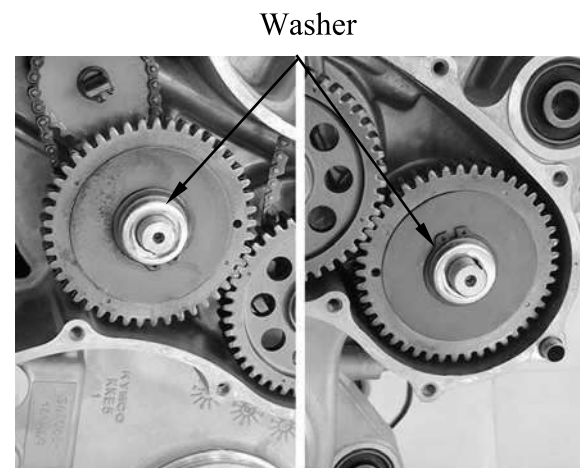

Hold the Balancer Drive Gear with the holder and tighten the lock nut of Balancer Shaft Gear using the special tool counterclockwise.

* Installation is in the reverse order of the removal.

Always keep the bigger chamfer of lock nut face to outside.

Special tool:

- Universal Holder** **A120E00017**
- Lock Nut Wrench** **A120E00080**

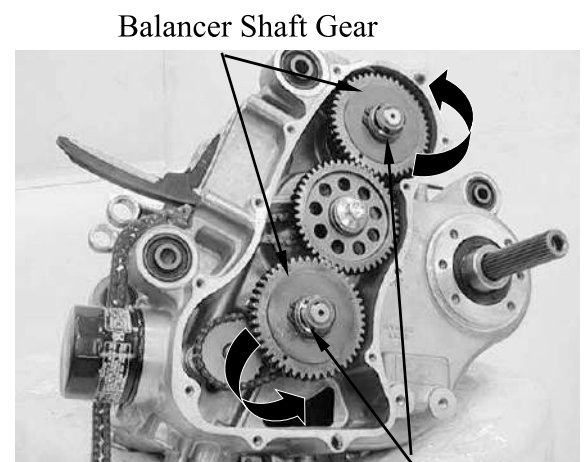

Lock Nut

14. CRANKCASE/CRANKSHAFT

Clean of the sealant from the left and right crankcase mating surfaces, being careful not to damage them.

Apply a coating of sealant to crankcase mating surfaces.

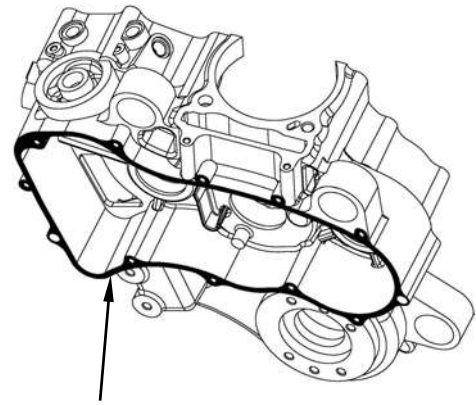

Sealant Area

Install the dowel pins.

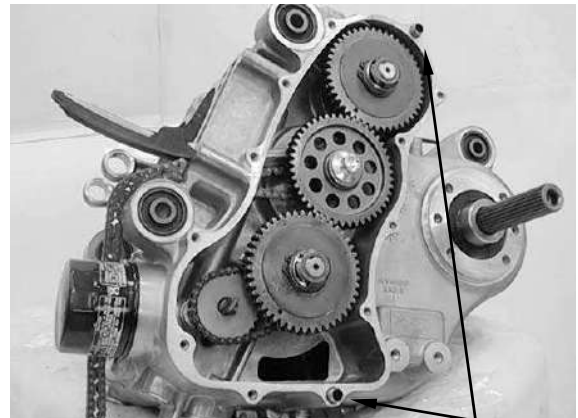

Dowel Pins

Install the left crankcase cover.

Left Crank Case Cover

Oil Pump Shaft

* Aligning the water pump shaft groove with oil pump shaft end when installation

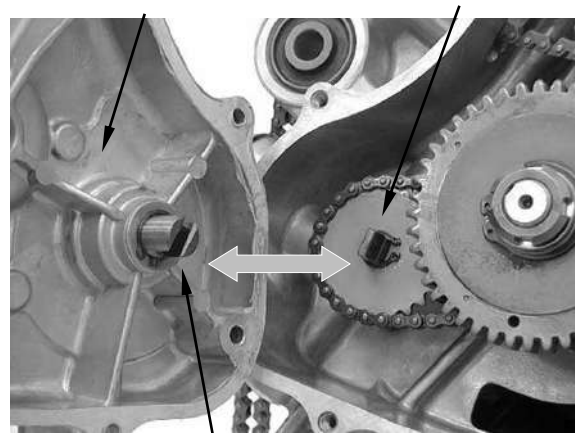

Water Pump Shaft

14. CRANKCASE/CRANKSHAFT

Tighten the ten bolts in a crisscross pattern in several steps.

Left Crank Case Cover

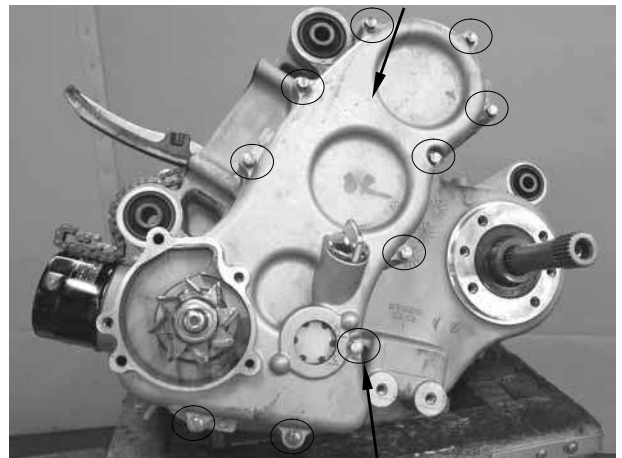

Bolts

*

Always replace the crankcases in pairs to ensure the coaxial function. The code should be the same. The set includes bolts as well, the part number is 1110A-KKE5-E00.



Crank case code

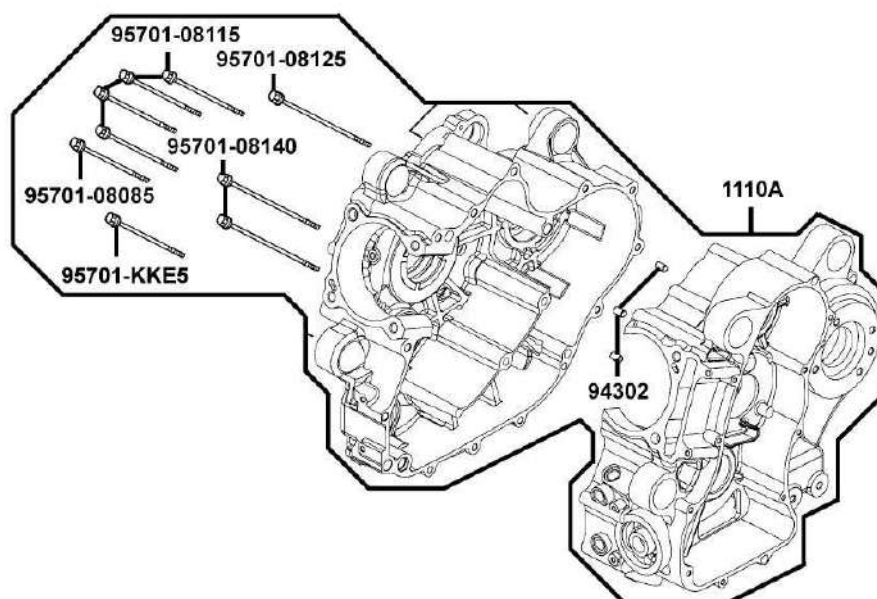

14. CRANKCASE/CRANKSHAFT

CRANKSHAFT/CRANKCASE SEPARATION REMOVAL

Remove the seventeen bolts in a crisscross pattern in several steps.

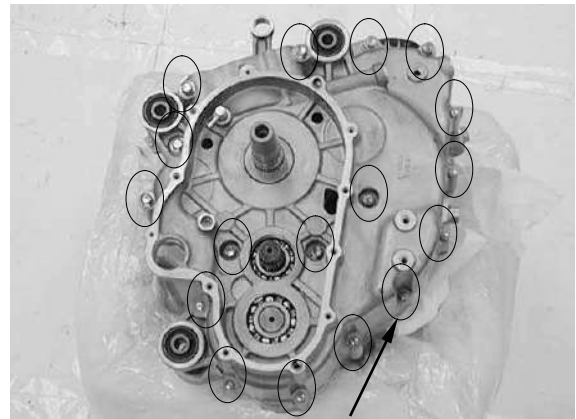

Bolts

Remove the Oil Pressure Relief Valve.

Remove the Dowel Pin/ O-Ring.



Oil Pressure Relief Valve

Dowel Pin/O-Ring

Remove the bolts attaching on the oil pump.

Remove the oil pump.

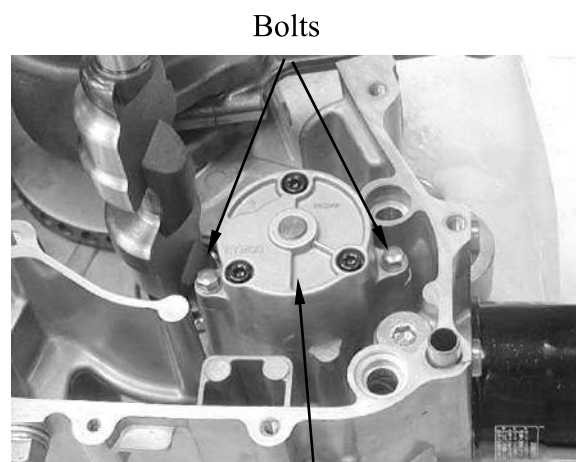

Bolts

Oil Pump

14. CRANKCASE/CRANKSHAFT

Remove the O-Rings.

O-Rings

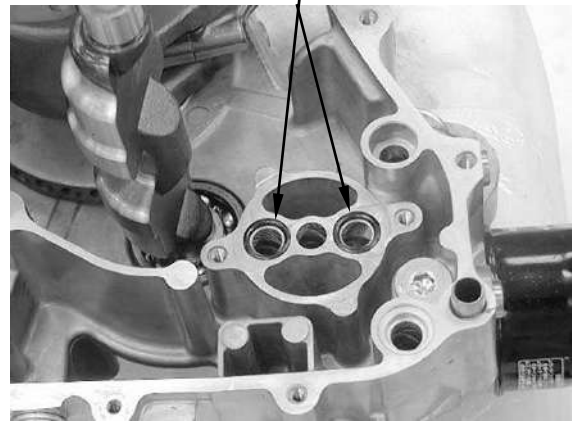

Remove the main shaft set and counter shaft set.

Main Shaft Set

Counter Shaft Set

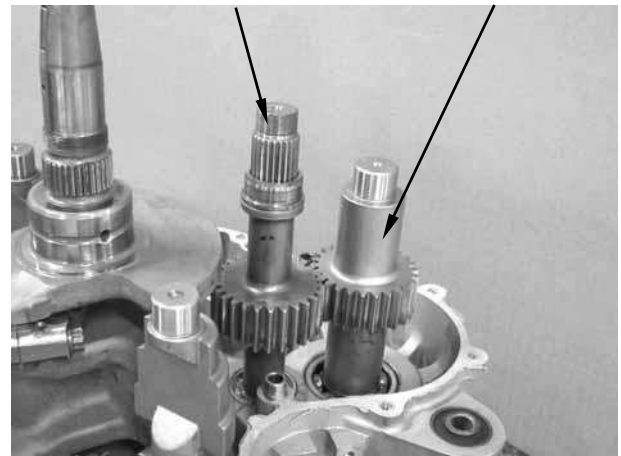

Remove the both Balancer Shafts.

Balancer Shafts

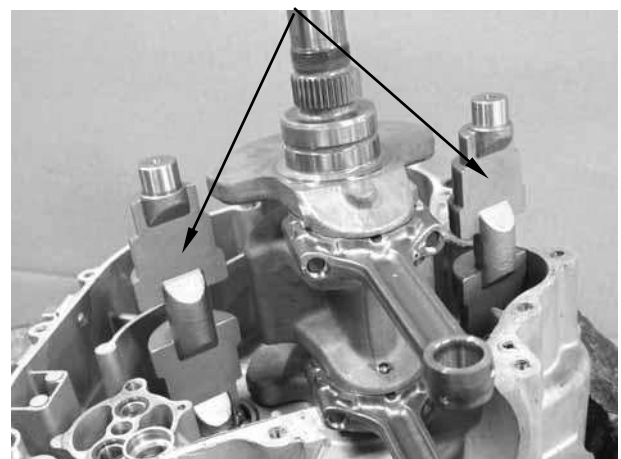

14. CRANKCASE/CRANKSHAFT

Remove the Crankshaft.

Crankshaft

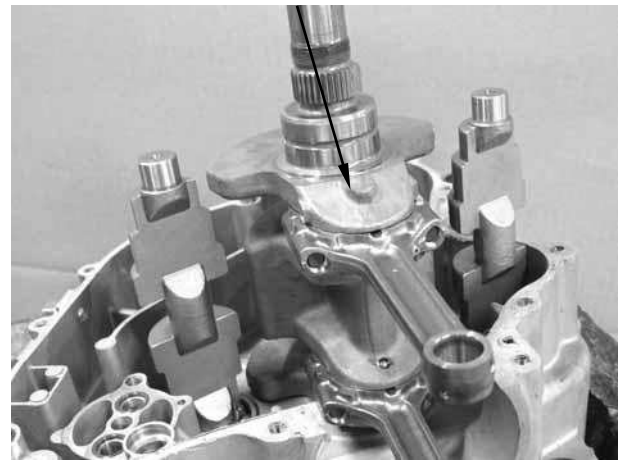

Turn the inner race of each bearing with your finger.
The bearings should turn smoothly and quietly. Also check that the bearing outer race fits tightly in the crankcase.

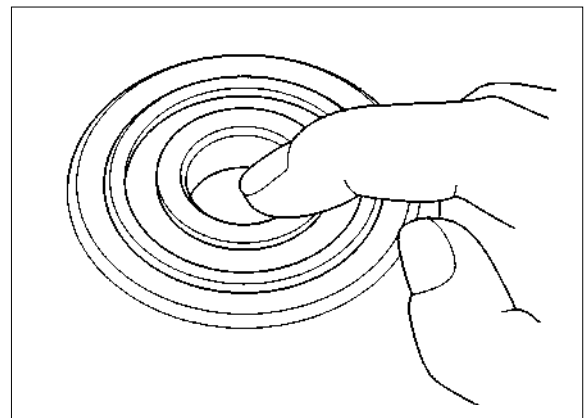

Replace the bearings if the races does not turn smoothly and quietly, or if they fit loosely in the crankcase.

Remove the Bearings from right crankcase using the special tool.

Bearings

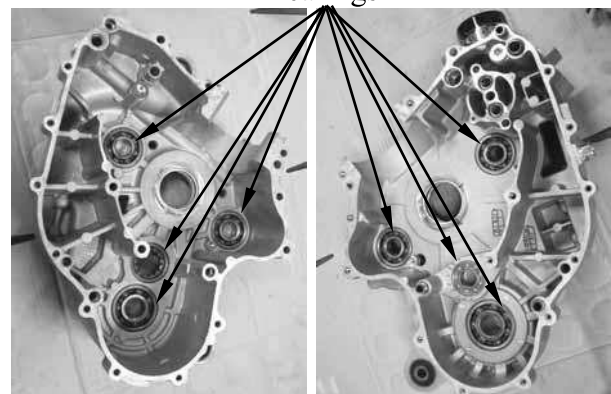

Special tool: Bearing puller A120E00037

14. CRANKCASE/CRANKSHAFT

CRANKSHAFT /CONNECTING ROD DISASSEMBLY

Remove the Crankshaft bolts using the special tool.

Special tool:A120E0081

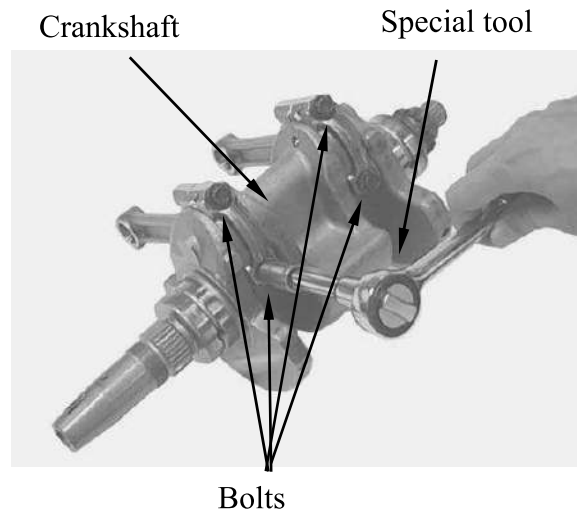

Mark the each part as you remove them to indicate the correct cylinder and position on the crank pins for reassembly.
Connecting rod small end inspection.



CONNECTING ROD BEARING INSPECTION

Inspect the bearing inserts for unusual wear, peeling or damage and replace if necessary.



14. CRANKCASE/CRANKSHAFT

CONNECTING ROD AND CRANK CASES BEARING INSERTS SELECTION

Select the proper bearing inserts for the replacement in accordance with the crank shaft mark.

*

Always apply the molybdenum disulfide to the inner surfaces of bearing inserts for installation. With wrong application of oil and grease could cause bearing damage.

CRANK SHAFT MARK

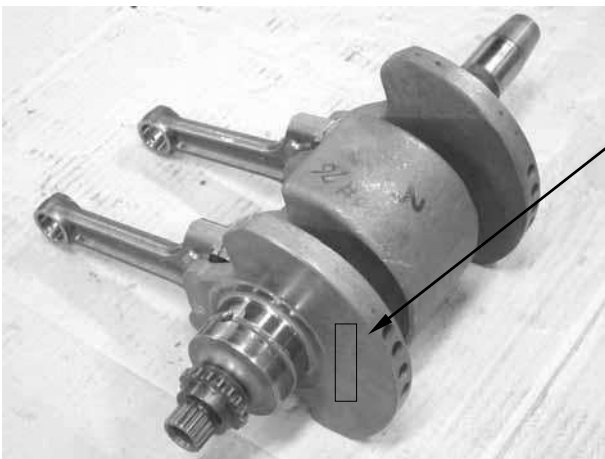
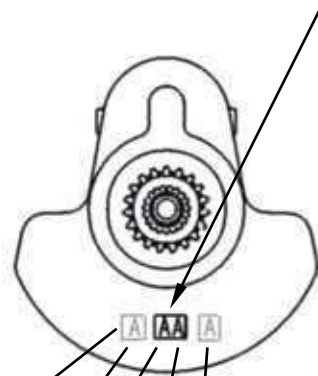

Left crankcase bearing inserts

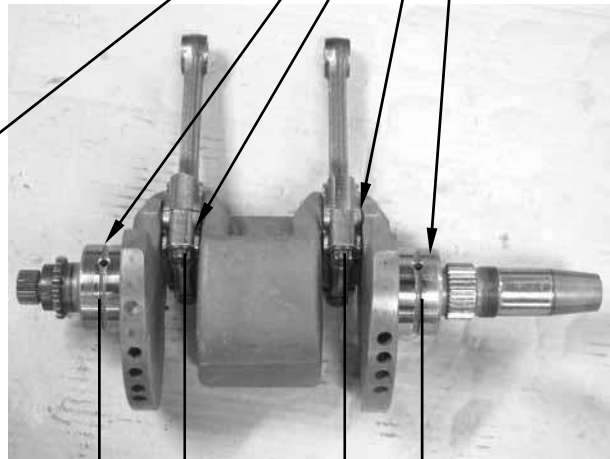

Right crankcase bearing inserts

Left connecting rod bearing inserts

Right connecting rod bearing inserts

Bearing inserts

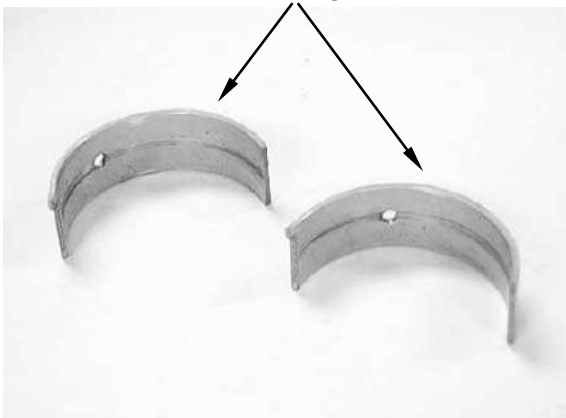

14. CRANKCASE/CRANKSHAFT

The connecting rods go with a grade number mark.

The mark will be a number “1” or “2” located on the side surface of rod as shown.

Determine the replacement bearing color by following fitting table.

Crank shaft Mark	Connecting Rod Mark	Bearing Inserts Color Choice
A	1	BLACK
A	2	GREEN
B	1	GREEN
B	2	RED

Bearing insert thickness:

A(Red):1.494~1.498mm
 13221-KKE5-E00 BEARING CONN ROD

B(Green):1.490~1.494mm
 13222-KKE5-E00 BEARING CONN ROD

C(Black):1.486~1.490mm
 13223-KKE5-E00 BEARING CONN ROD

CONNECTING ROD GRADE MARK

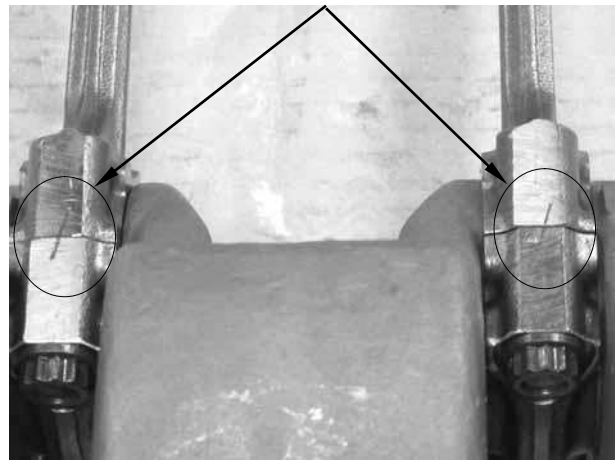

Bearing inserts

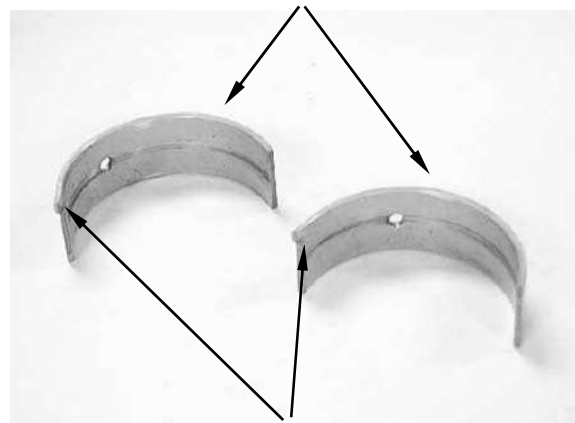

* Press the flange on the plate bearing into the connecting rod groove.

14. CRANKCASE/CRANKSHAFT

The crankcases go with a grade mark.

The mark will be “A” or “B” located on the side surface of case as shown.

Determine the replacement bearing color by following fitting table.

Crank shaft Mark	Crankcase Mark (Left/Right)	Bearing Inserts Color Choice
A	A	GREEN
A	B	YELLOW
B	A	BLACK
B	B	GREEN

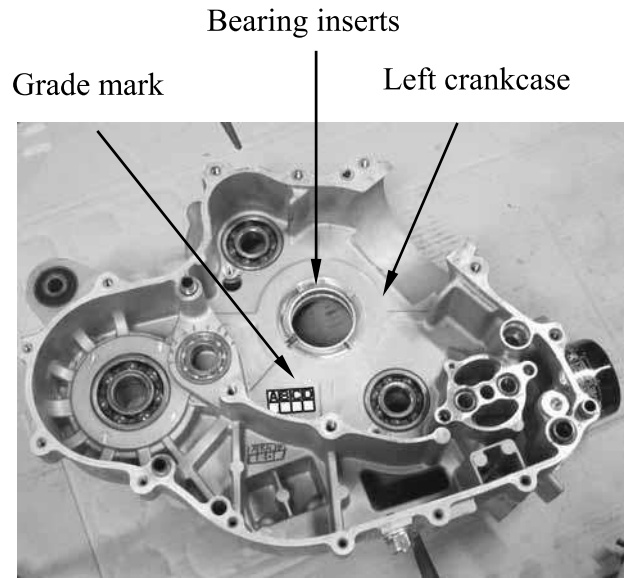

- 11314-KKE5-E00-A Bearing crankshaft**
- 11314-KKE5-E00-B Bearing crankshaft**
- 11314-KKE5-E00-C Bearing crankshaft**
- 11315-KKE5-E00-A Bearing crankshaft**
- 11315-KKE5-E00-B Bearing crankshaft**
- 11315-KKE5-E00-C Bearing crankshaft**

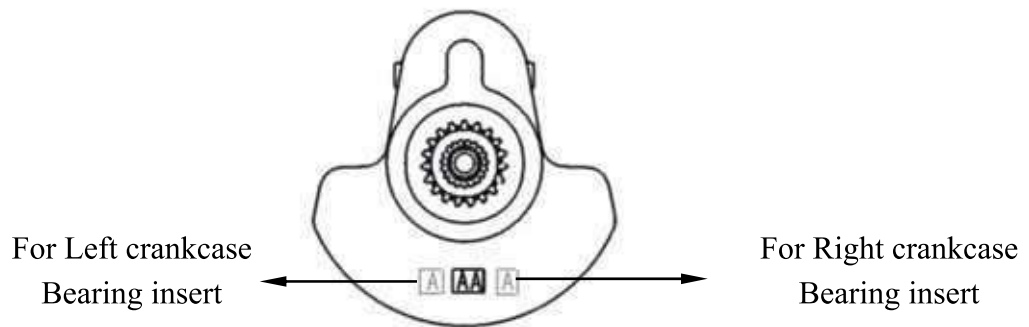
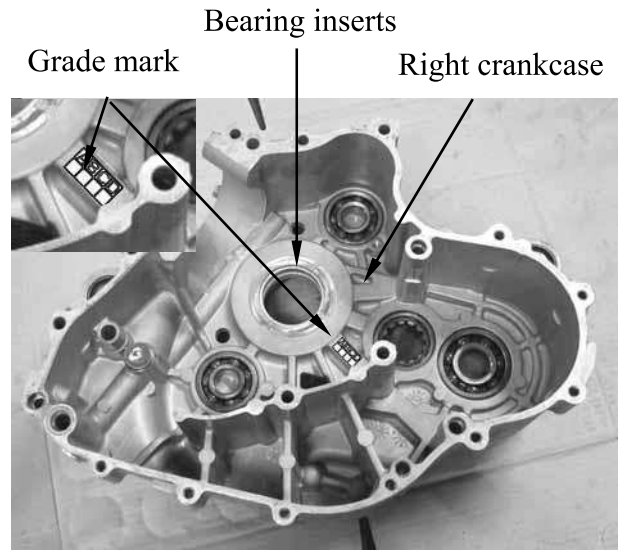

CRANK SHAFT MARK

14. CRANKCASE/CRANKSHAFT

CRANKSHAFT /CONNECTING ROD ASSEMBLY

Clean off oil from the main bearing.
 Before installing the bearing, apply molybdenum disulfide oil on the bearings.
 Install the bearing to the connecting rod and secure the bearing aligning the groove of connecting rod.

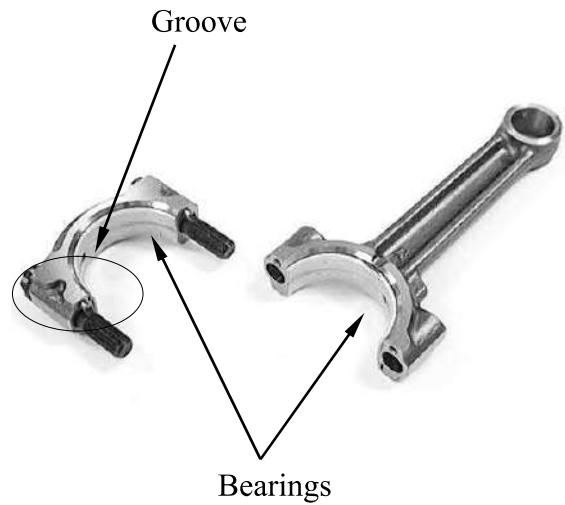

Install two of connecting rods with its oil holes facing intake side as shown.

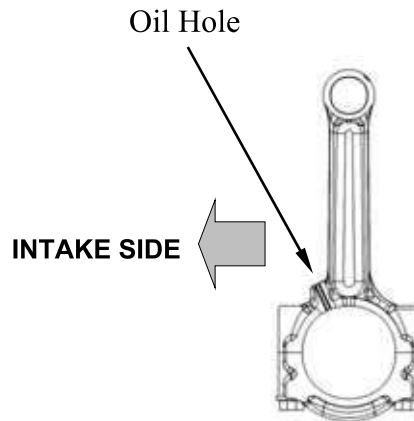

Install the connecting rod cap on the connecting rod.

Secure the pins of connecting rod cap align to the hole of connecting rod during installation.

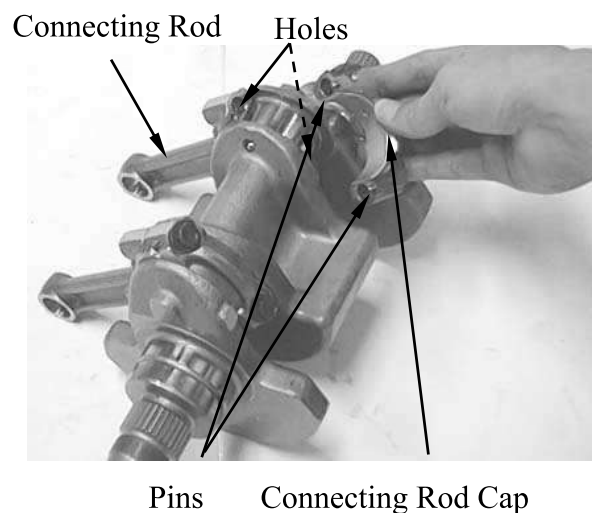

14. CRANKCASE/CRANKSHAFT

Apply oil to the bolt threads and flange surface.

Install and tighten the bolt to the specified torque in 3 steps.

Torque:

1st step : 3 kgf.m

2nd step: 5 kgf.m

3rd step : 6.2 kgf.m

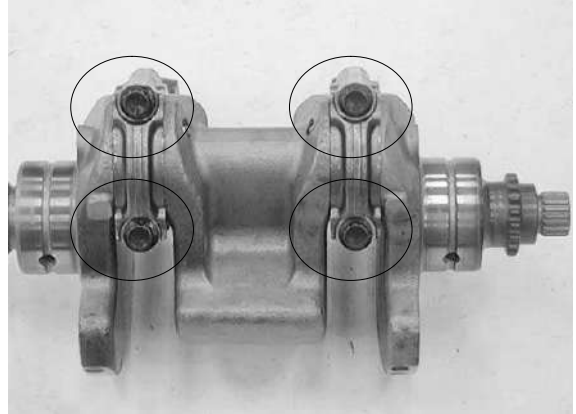

14. CRANKCASE/CRANKSHAFT

CRANKSHAFT/CRANKCASE

INSTALLATION

Install the new bearings to the right and left crankcase using special tool.

Special tool:
Oil seal & bearing driver A120E00014

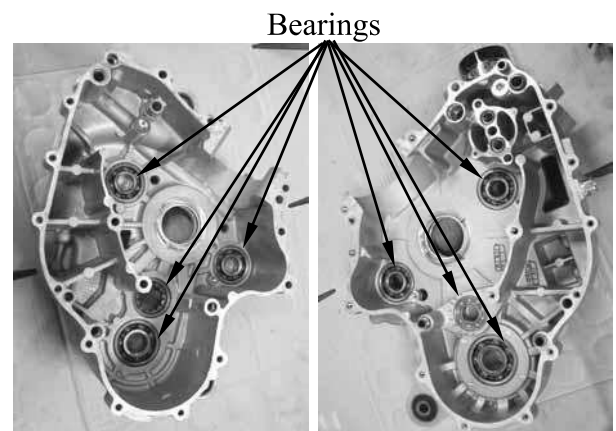

Install the Crankshaft.

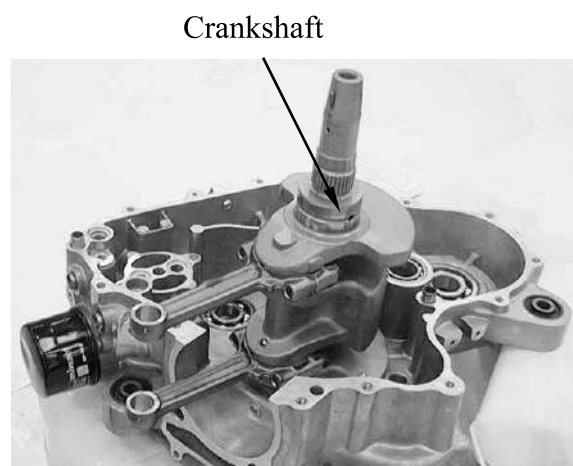

Install the both Balancer Shafts.

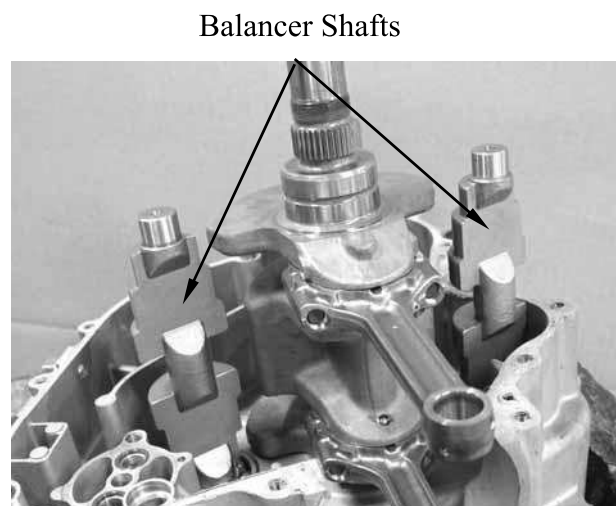

14. CRANKCASE/CRANKSHAFT

Install the main shaft and counter shaft.

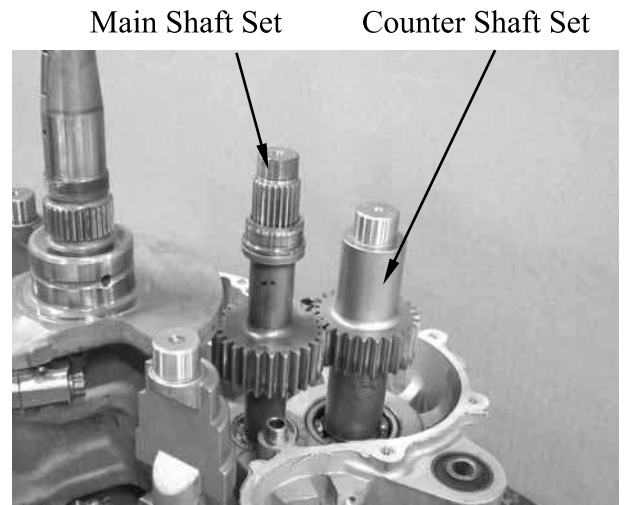

Install the O-Rings.

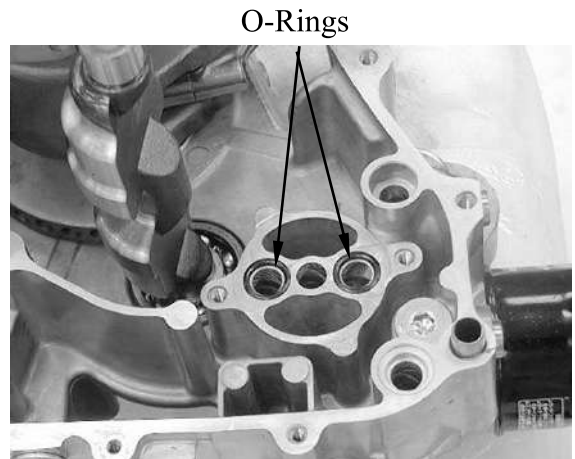

Install the oil pump.

Install the bolts on the oil pump.

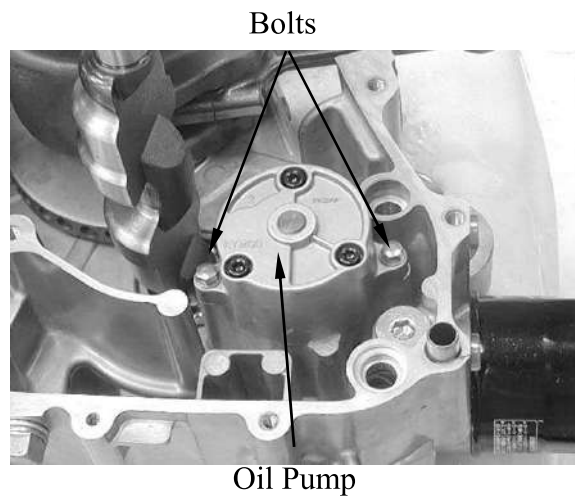

14. CRANKCASE/CRANKSHAFT

Install the Oil Pressure Relief Valve.

Install the Dowel Pin/ O-Ring.

Oil Pressure Relief Valve

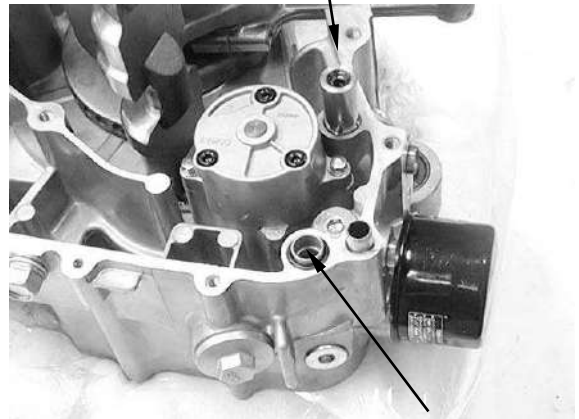

Dowel Pin/O-Ring

Apply a coating of sealant to crankcase mating surfaces.

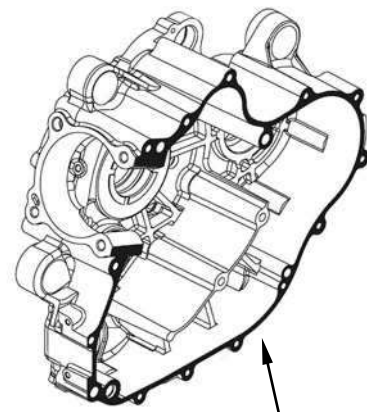

Sealant

Install the seventeen bolts in a crisscross pattern in several steps



Bolts

14. CRANKCASE/CRANKSHAFT

R SIDE BOLT

SEQUENCE	1	2	3	4	5	6	7	8	9
TORQUE kgf-m									
TIGHTENING	2.3±0.2kg-m								

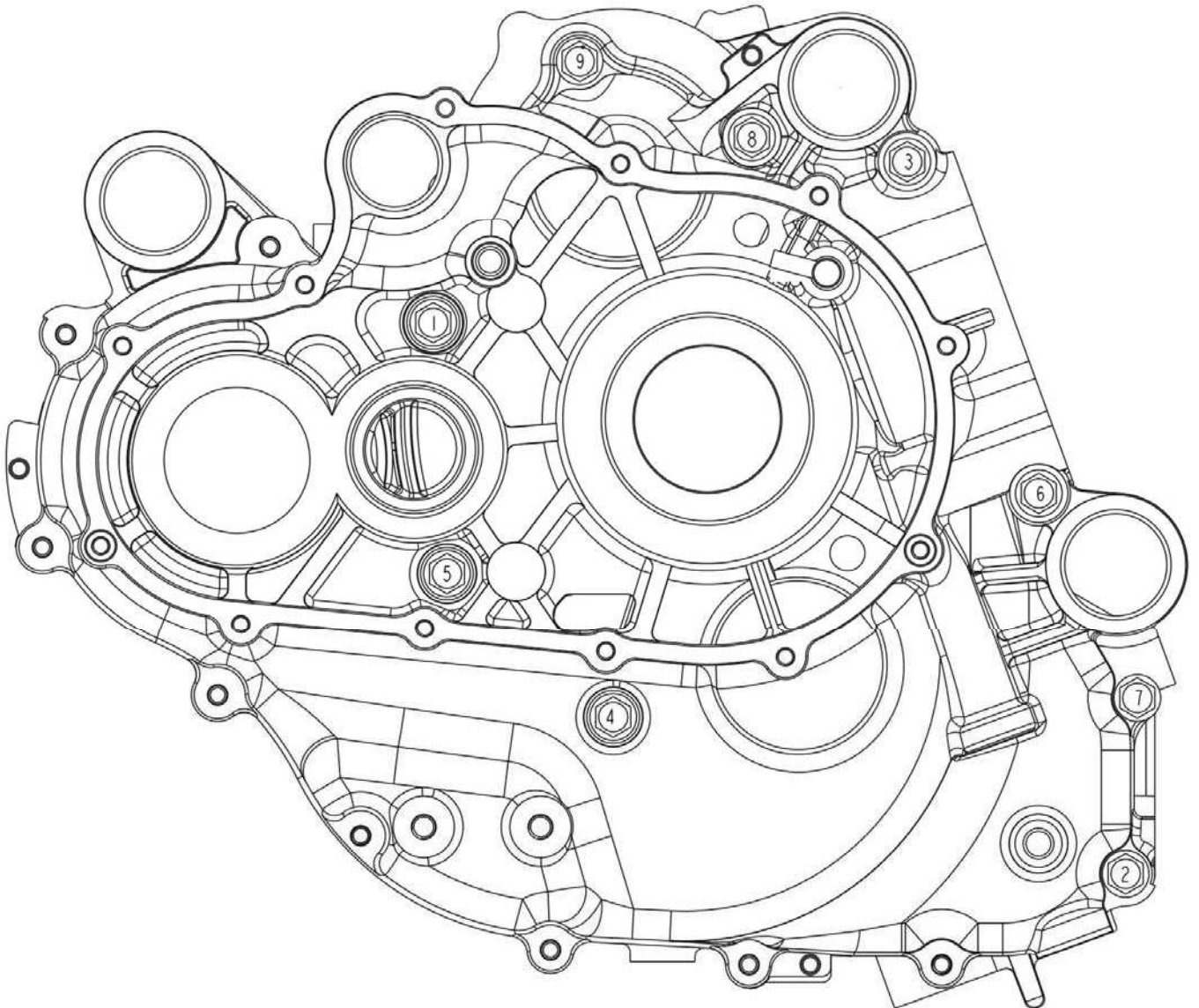

15. STEERING HANDLEBAR/FRONT WHEEL/ FRONT SHOCK ABSORBER

SCHEMATIC DRAWING

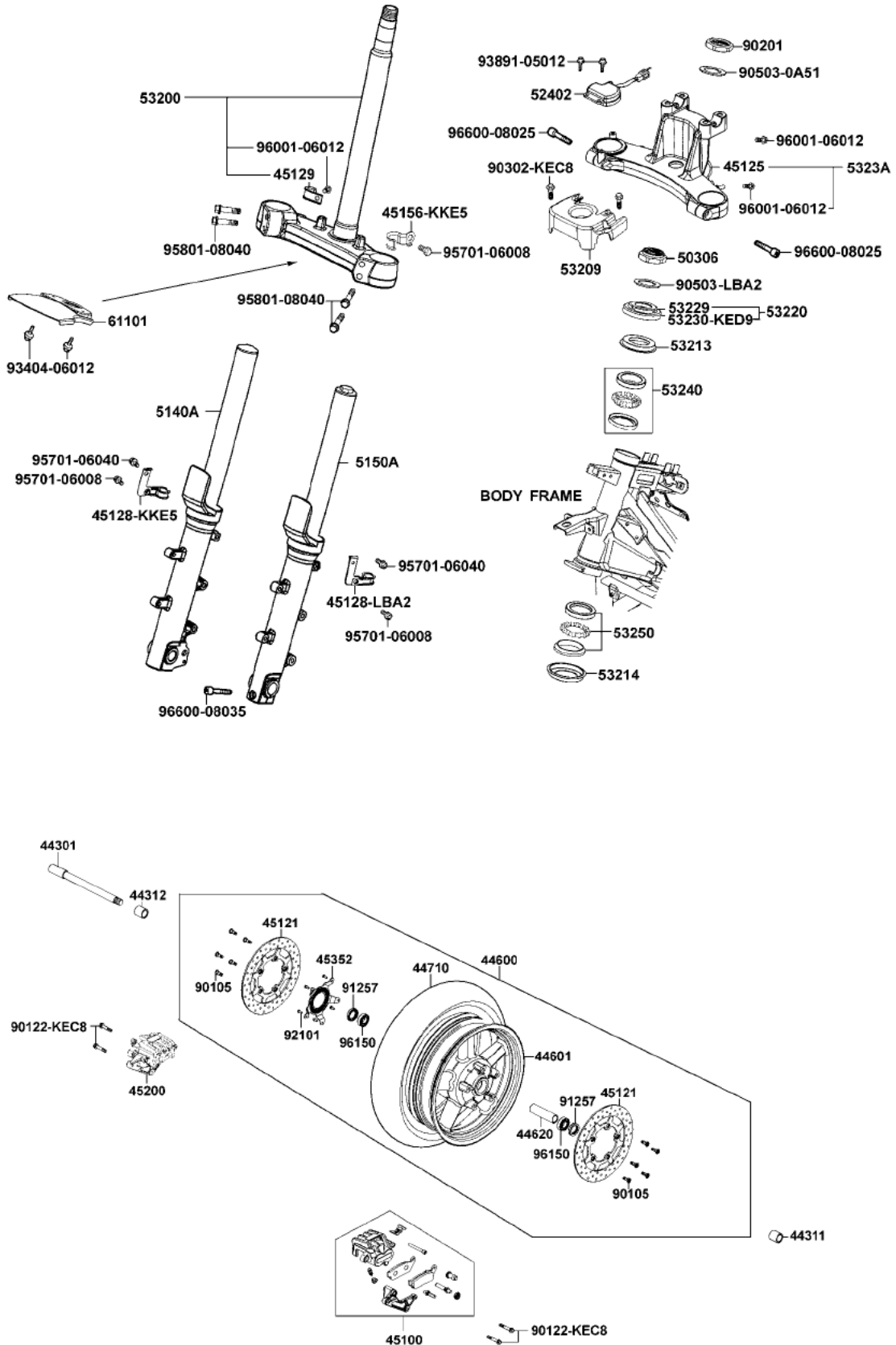

15. STEERING HANDLEBAR/FRONT WHEEL/ FRONT SHOCK ABSORBER

SERVICE INFORMATION

GENERAL INSTRUCTIONS

- A contaminated brake disc or pad reduces stopping power. Discard contaminated parts and clean a contaminated disc with a high quality brake degreasing agent.
- This section covers of the front wheel , fork, handlebar, and steering.
- A jack or other support is required to support the vehicle.
- Do not twist or bend the brake hose and pipe when servicing.
- Use genuine KYMCO replacement bolts and nuts for all suspension pivots and mounting points
- Refer to section 17 for brake system information.

SPECIFICATIONS

Unit: mm

ITEM		STANDARD	SERVICE LIMIT
Minimum tire tread depth		—	1.5
Cold tire pressure	Driver only	Front: 2, Rear: 2.5 kgf/ cm ²	—
	Driver and passenger	Front: 2, Rear: 2.5 kgf/ cm ²	—
Axle runout		—	0.2
Wheel rim runout	Radial	—	2
	Axial	—	2

TORQUE VALUES

Handlebar bolt	2.7 kgf•m
Steering stem nut	7.0 kgf•m
Steering stem lock nut	5.5 kgf•m
Steering top thread	2.7 kgf•m
Front axle bolt	3.3 kgf•m
Front brake disc bolt	4.3 kgf•m Lock bolt: replace with a new one.
Front fork bolt	2.3 kgf•m

SPECIAL TOOLS

Oil seal & bearing install driver	A120E00014
Lock nut socket wrench	A120E00023
Bearing remover	A120E00037
Long socket wrench	A120F00007

TROUBLESHOOTING

Hard steering

- Steering stem top thread too tight
- Worn or damaged steering bearings
- Worn or damaged steering bearing races
- Bent steering stem
- Insufficient tire pressure
- Faulty front tire

Steers to one side or does not track straight

- Damaged or loose steering bearings
- Bent fork
- Bent front axle: wheel installed incorrectly
- Bent frame
- Faulty front tire
- Worn or damaged front wheel bearings
- Worn or damaged engine mounting bushings

Front wheel wobbling

- Bent rim
- Worn or damaged front wheel bearings
- Faulty front tire
- Loose front axle fasteners

Wheel turns hard

- Faulty front wheel bearings
- Bent front axle
- Brake drag

Soft suspension

- Weak fork spring
- Insufficient fluid in fork
- Deteriorated fork fluid
- Incorrect fork fluid weight
- Low tire pressure

Hard suspension

- Bent fork tube
- Too much fluid in fork
- Incorrect fork fluid weight
- Clogged fork fluid passage
- High tire pressure

Front suspension noise

- Worn slider or fork tube bushing
- Insufficient fluid in fork
- Loose fork fastener

15. STEERING HANDLEBAR/FRONT WHEEL/ FRONT SHOCK ABSORBER

FRONT WHEEL

REMOVAL

Loosen the front axle holder bolt.

Holder bolt



Loosen the front axle bolt.

Support the scooter securely using a hoist or equivalent and raise the front wheel off the ground.

Front Axle



Remove the mount bolts and front brake calipers.

Pull off the front axle out and remove the front wheel.



Bolts

15. STEERING HANDLEBAR/FRONT WHEEL/ FRONT SHOCK ABSORBER

Remove the collar from the wheel hub.

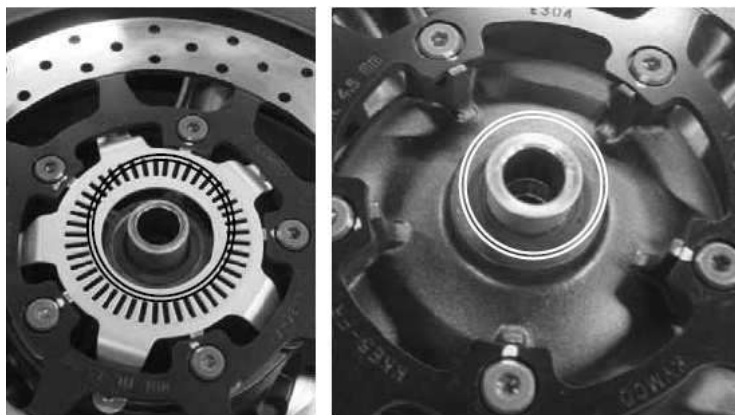

INSPECTION

Axle

Place the axle in V-blocks and measure the runout.

Actual runout is 1/2 the total indicator reading.

Service limit: 0.20 mm

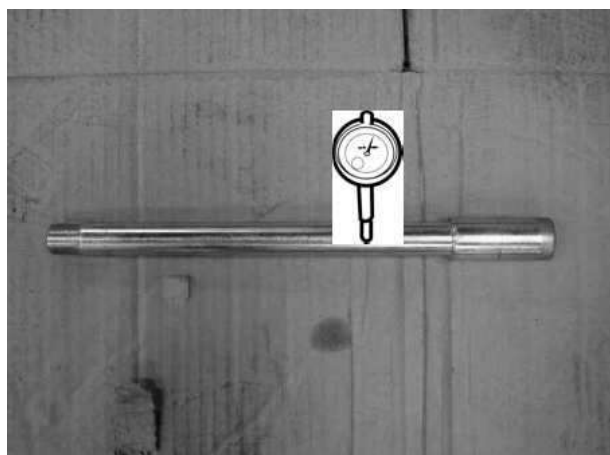

Wheel

Check the rim runout by placing the wheel in a truing stand.

Spin the wheel slowly and read the runout using a dial indicator.

Actual runout is 1/2 the total indicator reading.

Service limit: Radial: 0.2 mm

Axial: 0.2 mm

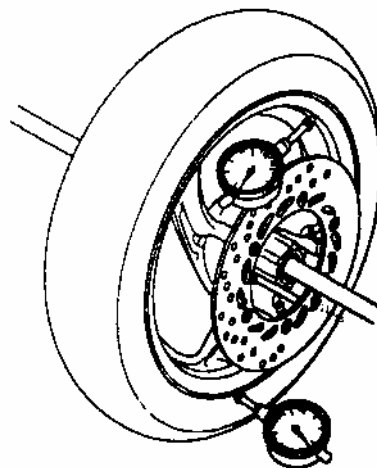

15. STEERING HANDLEBAR/FRONT WHEEL/ FRONT SHOCK ABSORBER

Wheel Bearing

Turn the inner race of each bearing with your finger.

The bearings should turn smoothly and quietly. Also check that the bearing outer race fits tightly in the hub.

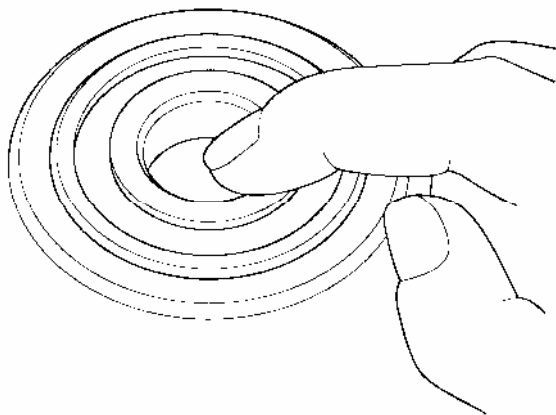

DIASSEMBLY

Remove the right and left disc bolts and brake discs.

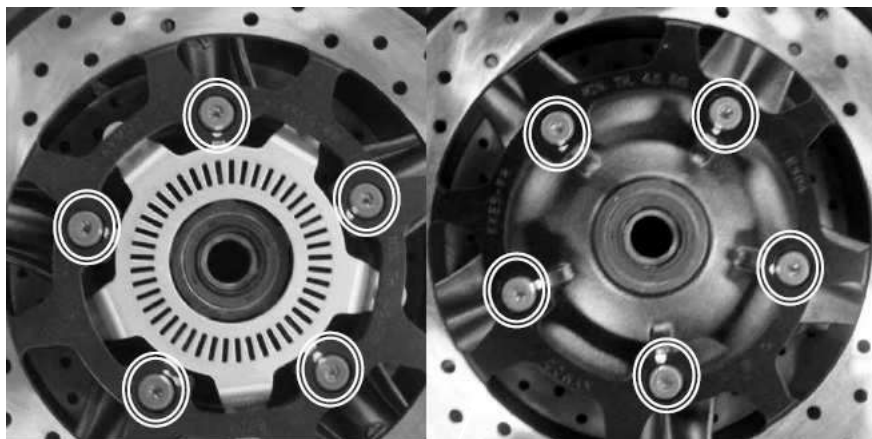

Remove the bolts and speed sensor guide.

Speed Sensor Guide



15. STEERING HANDLEBAR/FRONT WHEEL/ FRONT SHOCK ABSORBER

Remove the dust seals

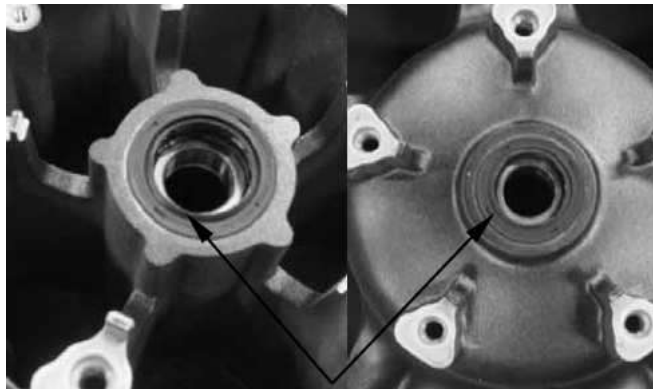

Dust Seals

Install the bearing remover into the bearing.
Drive the bearing out of the wheel hub.
Remove the distance collar and drive out the
other bearing.

Special tool:

Bearing remover A120E00037

NOTE:

**Replace the wheel bearings in pairs.
Do not reuse old bearings.**

Bearing remover



ASSEMBLY

Pack a new bearing cavities with grease.
Drive the new left bearing squarely with the
sealed side facing up until it is fully seated.

Special tool:

**Oil seal & bearing install driver
A120E00014**



15. STEERING HANDLEBAR/FRONT WHEEL/ FRONT SHOCK ABSORBER

Install the distance collar.

Bearing install driver



Pack a new bearing cavities with grease.
Drive the new right bearing squarely with the
sealed side facing up until it is fully seated.

Special tool:

Oil seal & bearing install driver

A120E00014

Apply grease to the new dust seal lips.
Install the dust seals into the wheel hub until
there are flush with the wheel hubs.

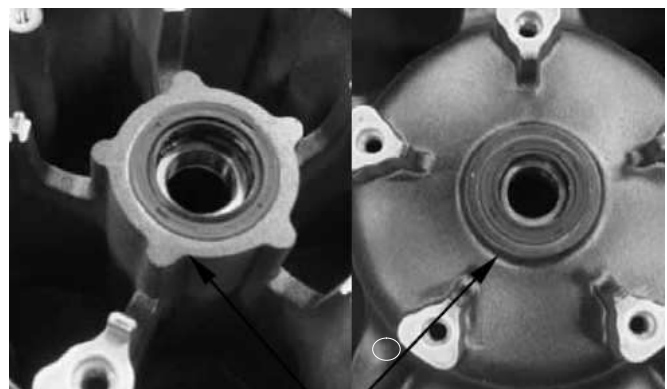

Dust Seals

15. STEERING HANDLEBAR/FRONT WHEEL/ FRONT SHOCK ABSORBER

Install the speed sensor guide.
Install the plate bolts and tighten them to the specified torque.

Torque: 1.0 kgf•m

Speed sensor guide



Install the brake discs into wheel hub.
Install new disc bolts and tighten them to the specified torque.

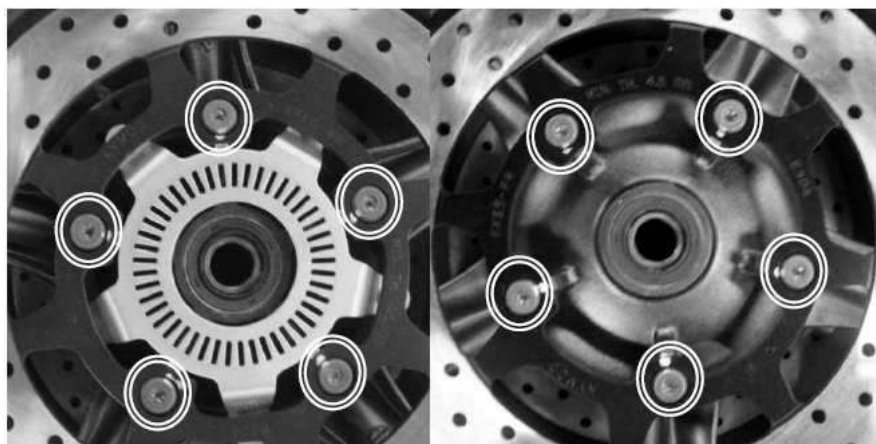

INSTALLATION

Install the side collars into the wheel hub.

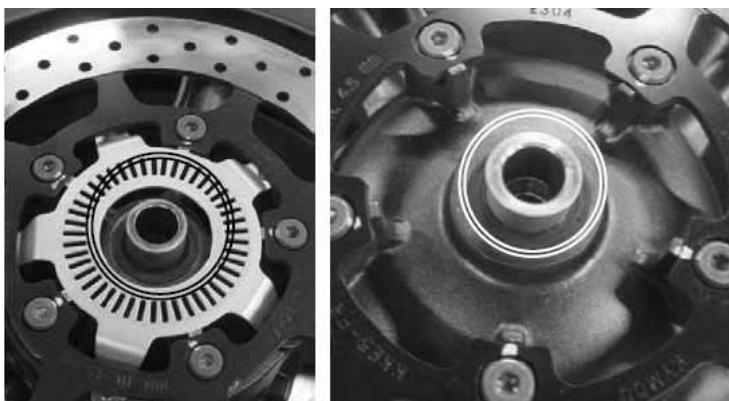

15. STEERING HANDLEBAR/FRONT WHEEL/ FRONT SHOCK ABSORBER

Install the front wheel between the fork leg.
Install the front axle front left side.
Tighten the axle bolt to the specified torque.

Torque: 3.3 kgf•m

Front Axle

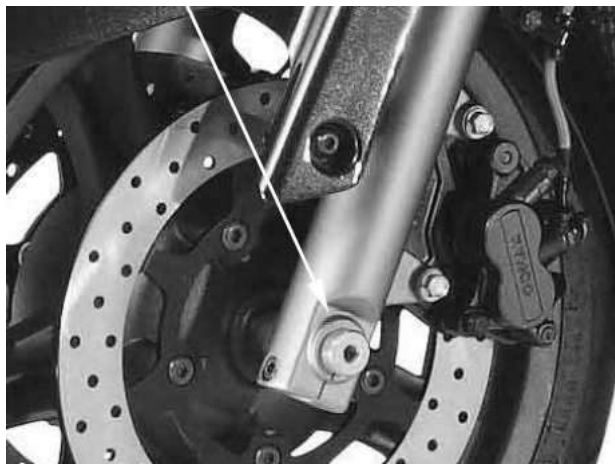

Tighten the front axle holder bolt to the specified torque.

Torque: 2.3 kgf•m

Holder Bolt

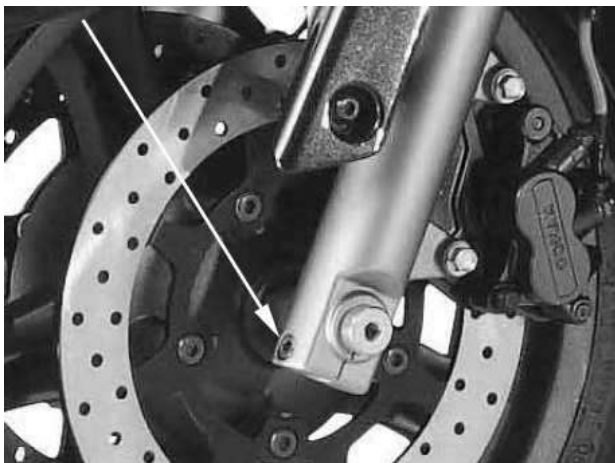

Install the right and left front calipers onto the fork leg.

Install and tighten the new front caliper mount bolts to the specified torque.

Torque: 2.7 kgf•m



Bolts

15. STEERING HANDLEBAR/FRONT WHEEL/ FRONT SHOCK ABSORBER

With the front brake applied, pump the fork up and down several times to seat the axle and check brake operation.



Check the brake operation by applying the brake lever.



Measure the speed sensor to speed sensor guide clearance.

Standard (A): 1.2 mm



Speed Sensor

15. STEERING HANDLEBAR/FRONT WHEEL/ FRONT SHOCK ABSORBER

FORK

REMOVAL

Remove the front wheel.
Remove the front fender.

Remove the bolt and hose clamp.
Remove the bolt and speed sensor.
Remove the upper fork pinch bolt.
Remove the lower fork pinch bolts.
Remove the fork from the handlebar post and steering stem.

Check the suspension.
Oil of shock absorber:
Standard: SS#8, 375 c.c.

INSTALLATION

Install the fork tube into steering stem and handlebar post and align the mark on the fork tube with the handlebar post surface as shown.

Install the cushion motor.
Install and tighten the upper pinch bolt to the specified.

Torque: 2.7 kgf•m



Connector of cushion motor

Lower Pinch Bolts



Upper Pinch Bolt

Lower Pinch Bolts

Lower fork pipe

Upper fork pipe

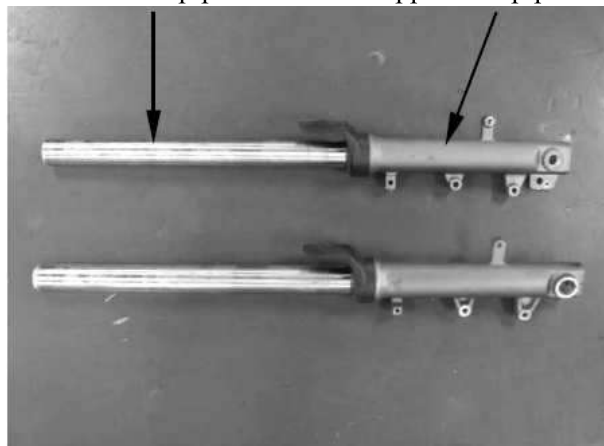

Bolt



Upper Pinch Bolt

15. STEERING HANDLEBAR/FRONT WHEEL/ FRONT SHOCK ABSORBER

Tighten the lower pinch bolts to specified torque.

Torque: 2.7 kgf•m

Install the brake caliper onto the fork leg with new mount bolts.

Torque: 2.7 kgf•m

Install the brake hose clamp onto the fork leg with the bolt.

Install the speed sensor onto the right fork leg and tighten the bolt.

Install the front fender.

Install the front wheel.

Connector of cushion motor

Lower Pinch Bolts

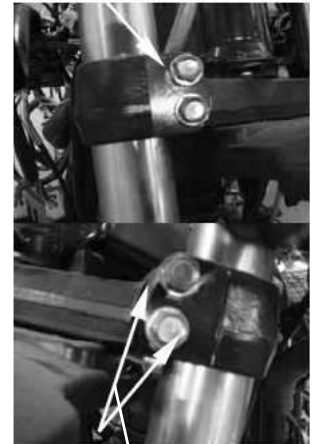

Upper Pinch Bolt

Lower Pinch Bolts

Remove the front cover.

Remove the connector of left handlebar switch.



Connector

Screw

Remove the bolts of steering handlebar.

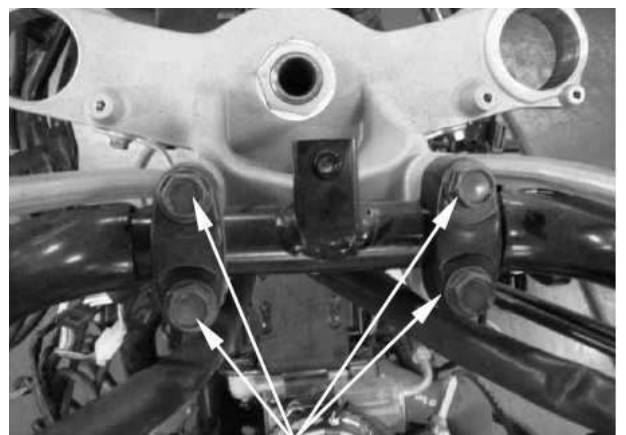

Bolt

15. STEERING HANDLEBAR/FRONT WHEEL/ FRONT SHOCK ABSORBER

STEERING HANDLEBAR

REMOVAL

Remove the front cover.

Remove the upper handlebar cover.

Remove the band bolt and disconnect the left handlebar switch connector.

Bolts



Rear Brake Light Switch Connectors

Remove the two bolts of master cylinder.
Dismantle the front brake light switch connectors.

Bolts



Front Brake Light Switch Connectors

Remove the screws and right handlebar switch.

Screws

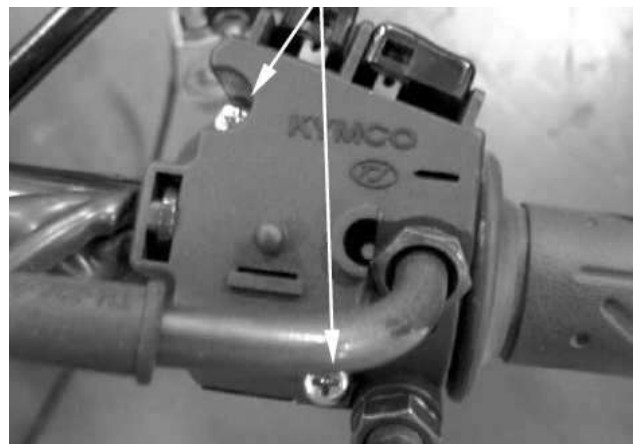

15. STEERING HANDLEBAR/FRONT WHEEL/ FRONT SHOCK ABSORBER

Remove the bolt/right handlebar weight and grip.

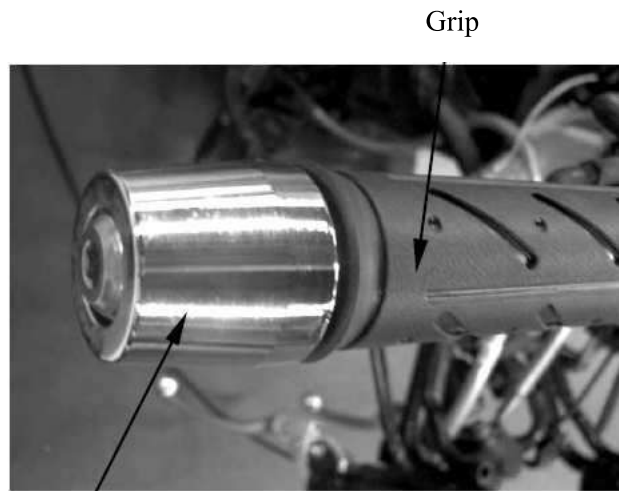

Bolt/Right Handlebar Weight

Remove the bolts and upper holders.

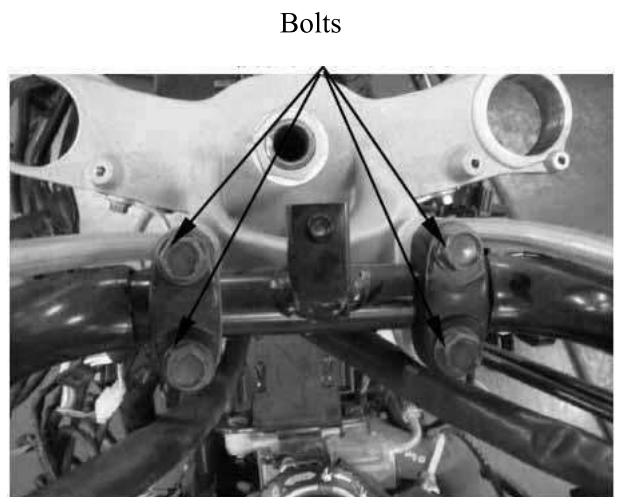

Bolts

Remove the handlebar from the handlebar post and right handlebar switch housing.



15. STEERING HANDLEBAR/FRONT WHEEL/ FRONT SHOCK ABSORBER

INSTALLATION

Install the right handlebar switch housing.



Align the holes on the handlebar with the pins on the handle post.

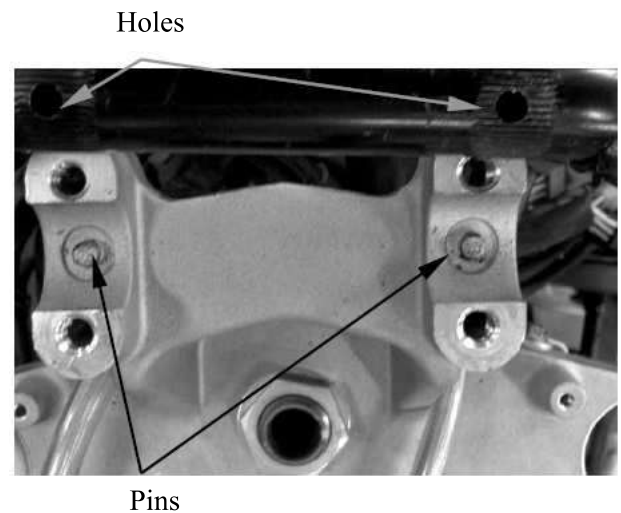

Install the handlebar to the handle post.

Install the upper holder bolts.

Tighten the front bolts first, then tighten the rear bolts.

Torque: 2.7 kgf•m

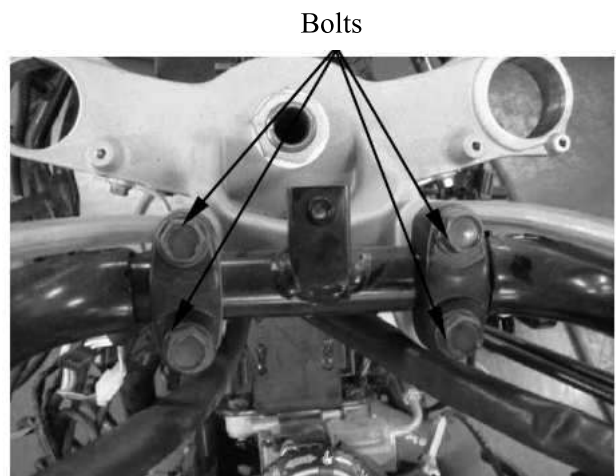

15. STEERING HANDLEBAR/FRONT WHEEL/ FRONT SHOCK ABSORBER

Install the throttle grip and bolt/right handlebar weight and tighten the bolt.

Throttle Grip

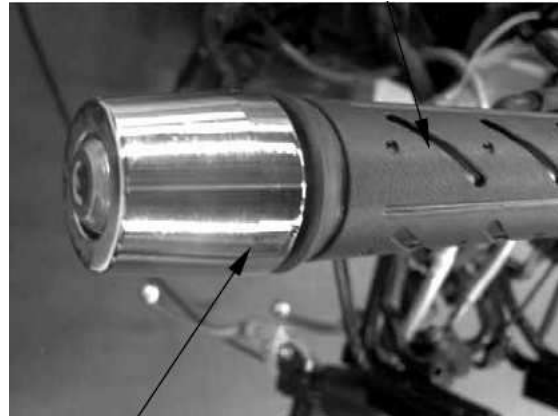

Bolt/Right Handlebar Weight

Align the pin on the right handlebar switch housing with the hole on the steering handle.

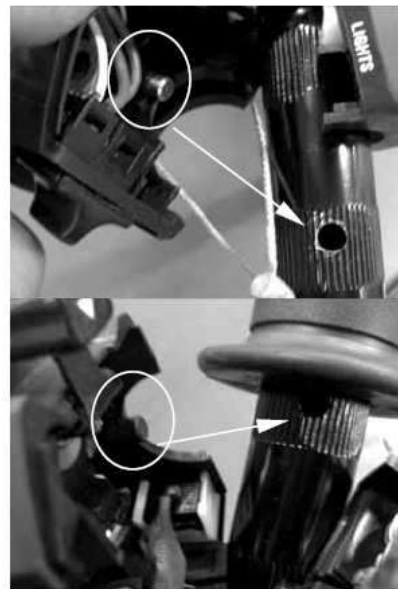

Install the screws and tighten the forward screw first, then tighten the rear screw.



15. STEERING HANDLEBAR/FRONT WHEEL/ FRONT SHOCK ABSORBER

Align the pin on the rear master cylinder holder with the hole on the handlebar.

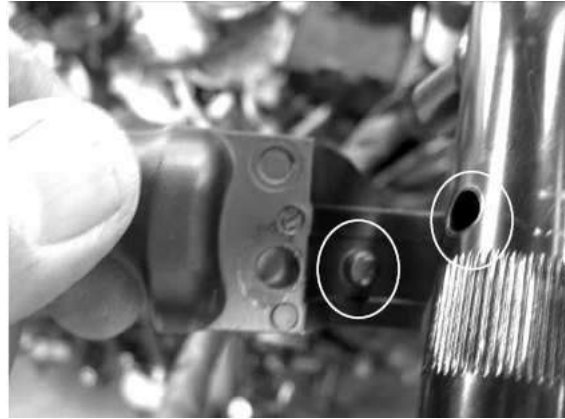

Install the front master cylinders and holder with the “UP” mark facing up.
Install the bolts and tighten the upper bolt first then tighten the lower bolt to the specified torque.

Torque: 1.2 kgf•m

“UP” Mark

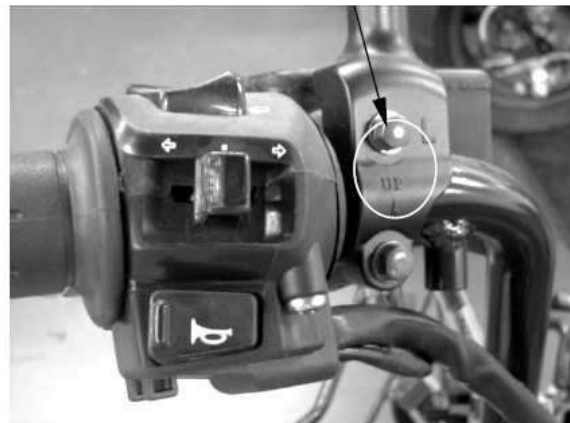

Connect the left handlebar switch connector and tighten the band bolt.



Left Handlebar Switch Connector

Bolt

15. STEERING HANDLEBAR/FRONT WHEEL/ FRONT SHOCK ABSORBER

STEERING STEM

REMOVAL

Remove the front fork.
Remove the steering handle.

Remove the bolts and brake hoses clamp.

Remove the nut, washer and handle post.

Special tool:

Long socket wrench 30mm

Remove the brake hoses from the clamps on the steering stem.

Clamp Bolts



Brake hoses

15. STEERING HANDLEBAR/FRONT WHEEL/ FRONT SHOCK ABSORBER

Remove the steering stem lock nut.

Special tool:

Long socket wrench A120F00007

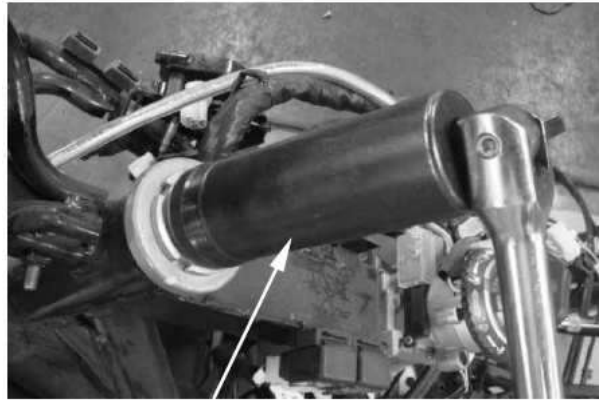

Long socket wrench

Remove the lock washer.

Lock Washer

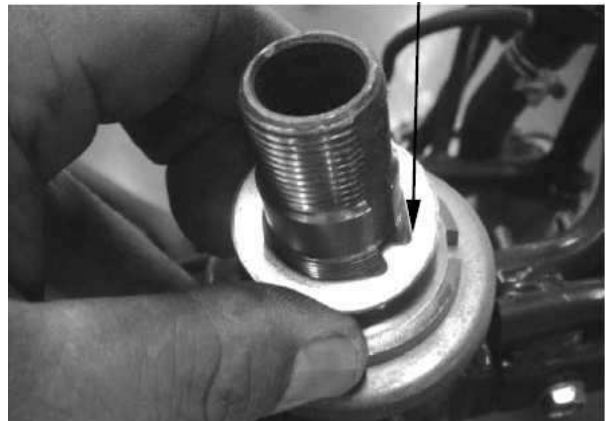

Loosen the steering top thread.
Hold the steering stem and remove the
steering stem top thread.

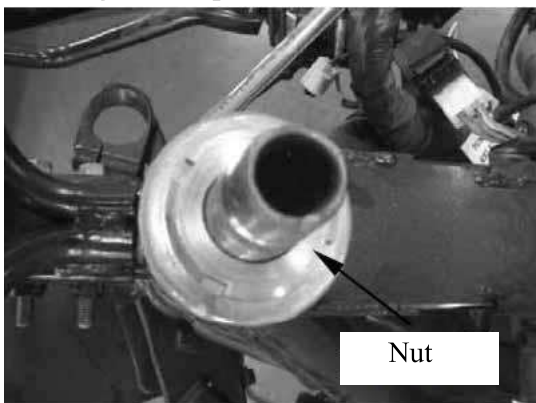

15. STEERING HANDLEBAR/FRONT WHEEL/ FRONT SHOCK ABSORBER

Remove the steering stem and lower bearing.

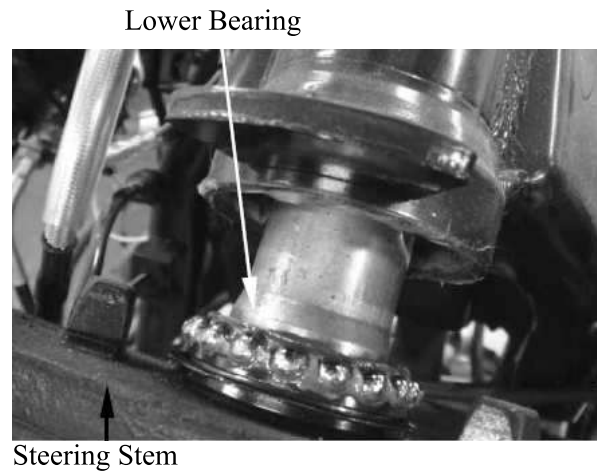

Remove the dust seal, upper inner race and upper bearing

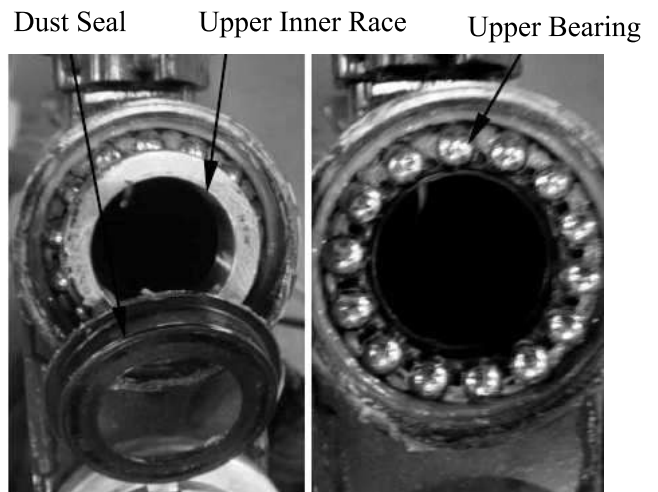

BEARING REPLACEMENT

Remove the upper bearing outer race.

NOTE:

Always replace the bearings and races as a set.

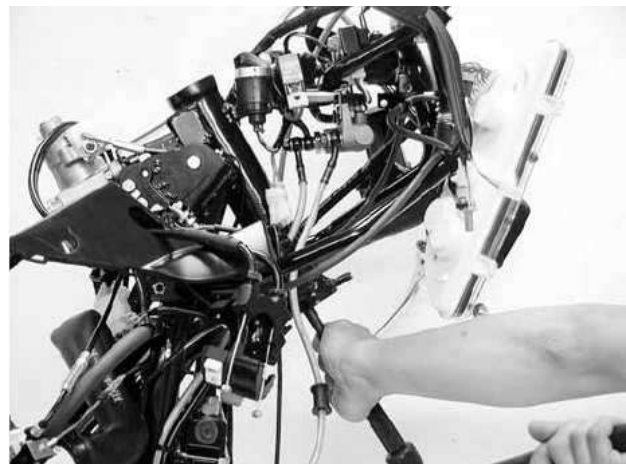

15. STEERING HANDLEBAR/FRONT WHEEL/ FRONT SHOCK ABSORBER

Remove the lower bearing outer race.

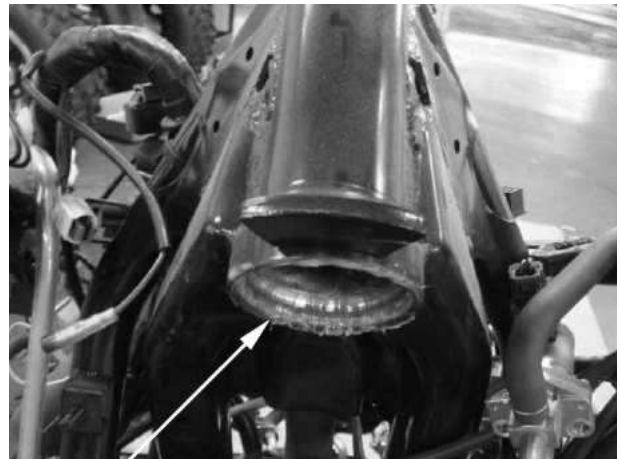

Lower Outer Race

Drive a new upper bearing race into the steering head pipe.



Upper Outer Race

Drive a new lower bearing race into the steering head pipe.

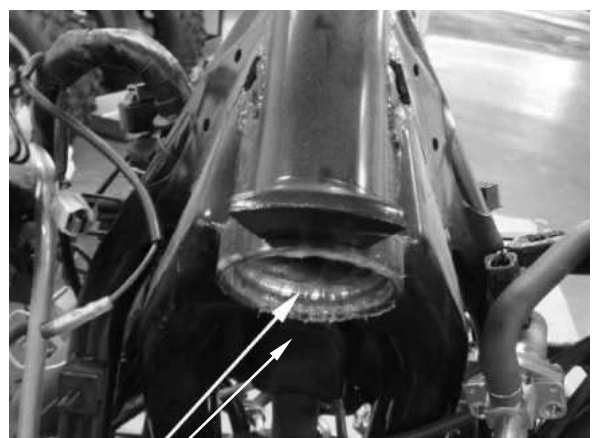

Lower Outer Race

15. STEERING HANDLEBAR/FRONT WHEEL/ FRONT SHOCK ABSORBER

Install the steering stem lock nut onto the steering to prevent the threads from being damaged when removing the lower bearing inner race from the steering stem.

Remove the lower bearing inner race with a chisel or equivalent tool, being careful not to damage the steering stem.

Remove the dust seal.

Lower Inner Race

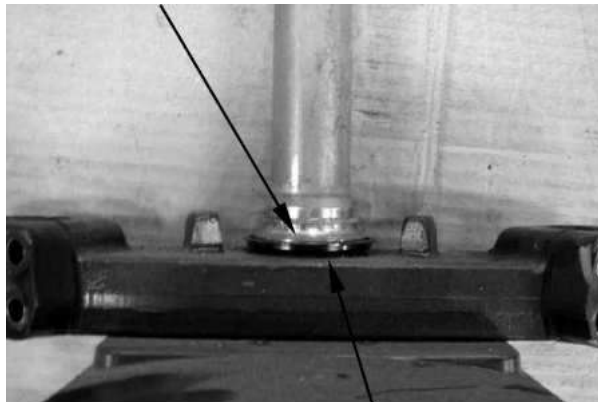

Dust Seal

Install the dust seal.

Apply grease to a new lower bearing inner race using a hydraulic press.

INSTALLATION

Apply grease to each new bearings and inner races.

Install the upper bearing, upper inner race and dust seal.

Dust Seal Upper Inner Race Upper Bearing

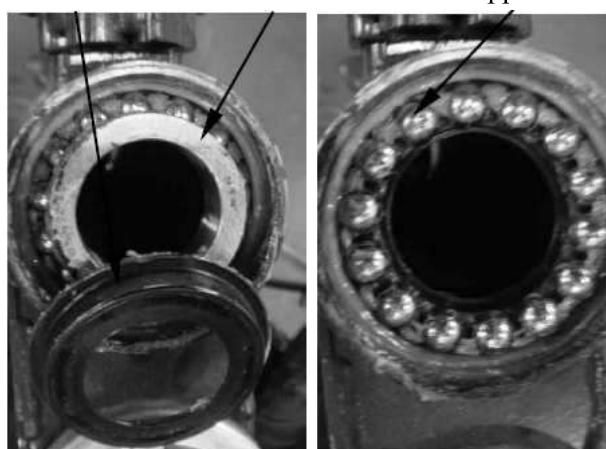

15. STEERING HANDLEBAR/FRONT WHEEL/ FRONT SHOCK ABSORBER

Install the lower bearing onto the stem.
Insert the steering stem into the steering head pipe.

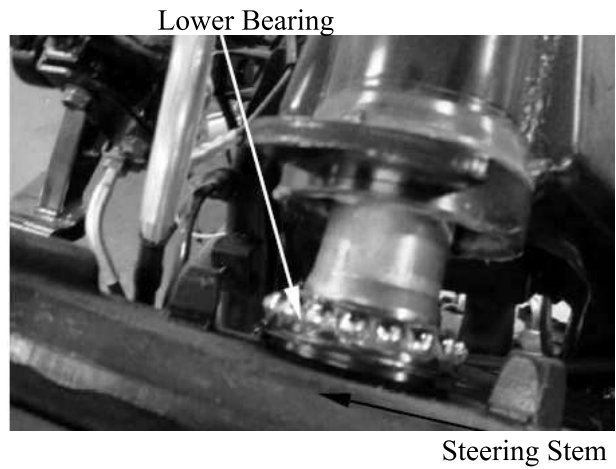

Install the steering top thread.

- Tighten the steering top thread to specified torque.

Torque: 2 kgf•m

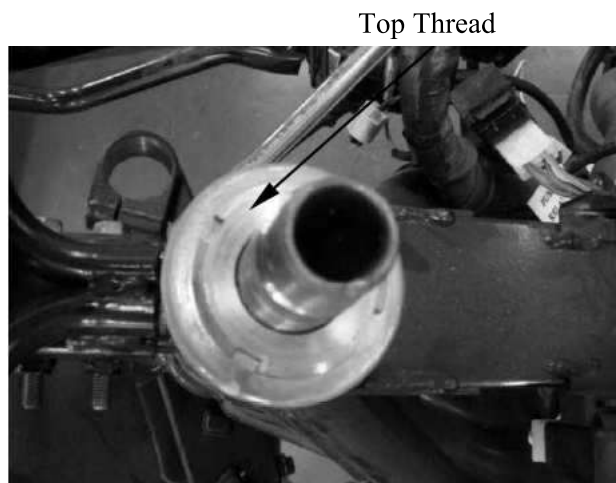

15. STEERING HANDLEBAR/FRONT WHEEL/ FRONT SHOCK ABSORBER

Install the lock washer aligning its tab into the groove on the steering stem.

Install the steering stem lock nut.
Hold the steering stem top thread and tighten the steering stem lock nut to the specified torque.

Special tool:

Long socket wrench A120F00007

Torque: 5.5 kgf•m

Make sure that the steering stem moves smoothly without play or binding.

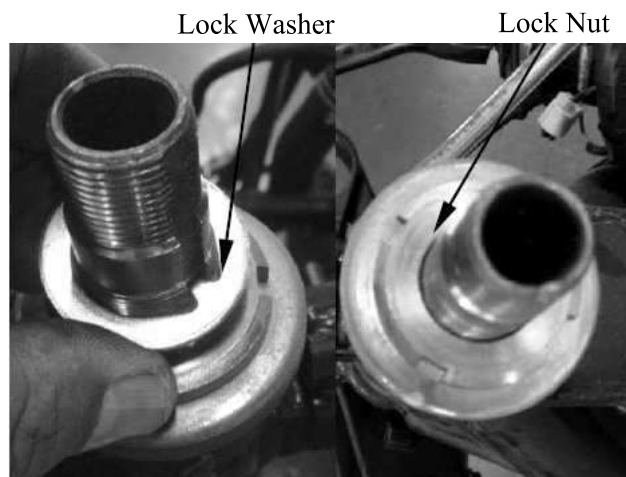

Install the handle post to the steering stem and front forks.

Install the washer and nut.

Tighten the handle post nut to the specified torque.

Torque: 7.0 kgf•m

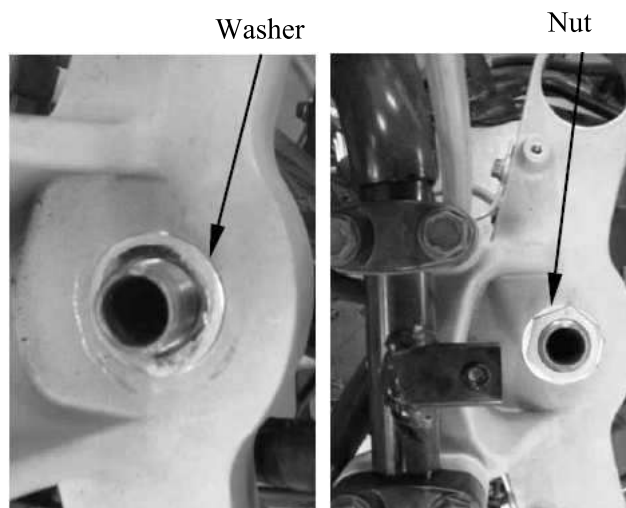

16. REAR FORK/REAR WHEEL/ REAR SHOCK ABSORBER

SCHEMATIC DRAWING

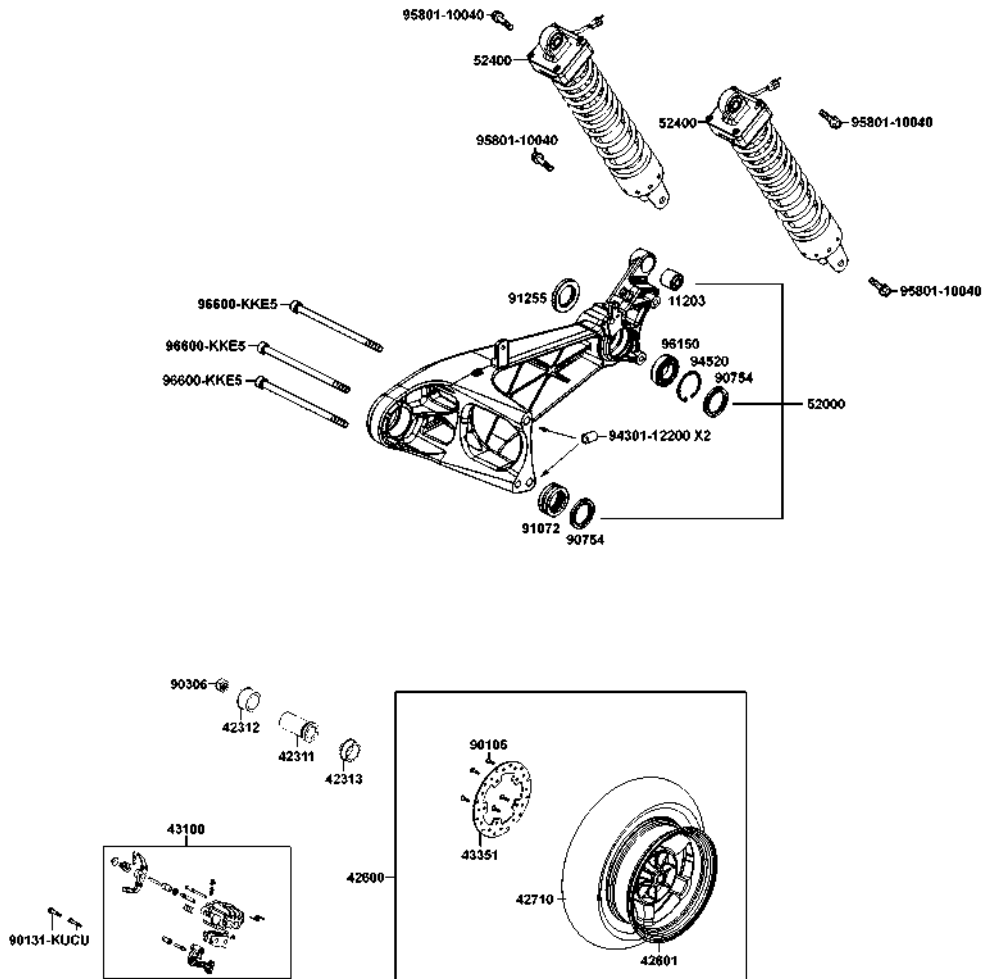

16. REAR FORK/REAR WHEEL/ REAR SHOCK ABSORBER

SERVICE INFORMATION

GENERAL INSTRUCTIONS

- A contaminated brake disc or pad reduces stopping power. Discard contaminated parts and clean a contaminated disc with a high quality brake degreasing agent.
- Riding on damaged rims impairs safe operation of the vehicle.
- This section covers of the rear wheel and rear suspension.
- A jack or other support is required to support the vehicle.
- Do not twist or bend the brake hose when servicing.
- Use genuine KYMCO replacement bolts and nuts for all suspension pivots and mounting points.

SPECIFICATIONS

Unit: mm

ITEM		STANDARD	SERVICE LIMIT
Minimum tire tread depth		—	2
Cold tire pressure	Rider only	Front: 2.0 Rear: 2.5 kgf-m	—
	Rider and passenger	Front: 2.0 Rear: 2.5 kgf-m	—
Wheel rim runout	Radial	—	2
	Axial	—	2

TORQUE VALUES

2	WHEEL						
	FR. AXLE	M18X1.5	3.0~3.6	30~36	3.3	—	44301-LBA2-E000
	RR. AXLE NUT	M20X1.5	12~14	120~140	13	U NUT	90306-LBA2-9000
3	SUSPENSION						
	FR AXLE PINCH BOLT	M8x1.25	2.0~2.6	20~26	2.3	—	96600-08035-07
	RR. CUSH	M10X1.25	3.5~4.5	35~45	4.0	FLANGE BOLT	95801-10040-00
4	BRAKE						
	FR. CALIPER	M8X1.25	2.4~3.0	24~30	2.7	—	90122-KEC8-9000
	RR. CALIPER	M8X1.25	2.4~3.0	24~30	2.7	—	90131-KUCU-9000
	BRK. OIL BOLT	M10X1.25	3.0~4.0	30~40	3.5	—	90145-MS9-6110-MI
	M/C HOLDER	M6X1.0	1.0~1.4	10~14	1.2	FLANGE BOLT	95701-06022-07
	C/P BLEEDER	M8X1.25	0.4~0.7	4~7	0.55	—	43352-KKD6-E000-HL
	MASTER CYLINDER CAP	M4X1.0	0.12~0.2	1.2~2	0.16	SCREW ,FLAT	93600-04012-IG
	BRK. OIL BOLT (Modulator, ABS)	M10x1.0	3.0~4.0	30~40	3.5	FLANGE BOLT	90145-LFHI-E000
	MODULATOR, ABS	M6X1.0	0.77~0.83	7.7~8.3	0.8	NUT	#

TROUBLESHOOTING

Rear wheel wobbling

- Bent rim
- Faulty tire
- Axle not tightened properly
- Engine mount bolt not tightened properly
- Loose or worn final gear shaft bearing
- Insufficient tire pressure
- Unbalanced tire and wheel

Soft suspension

- Weak rear shock absorber spring
- Oil leakage from damper unit

Rear wheel noise

- Worn rear wheel axle bearings
- Worn rear fork bearings
- Deformed rear fork

Hard suspension

- Bent damper rod
- Worn or damaged engine mount bushings
- High tire pressure

Rear suspension noisy

- Loose mounting fasteners
- Faulty shock absorber
- Weak rear suspension mount bushings

16. REAR FORK/REAR WHEEL/ REAR SHOCK ABSORBER

REAR WHEEL/REAR FORK

REMOVAL

Remove the muffler.
Remove the rear/parking brake caliper.

Loosen the rear axle nut.
Support the scooter securely on its main stand.

Axle Nut



Remove the bolts and brake hose/cable clamps from the rear fork.
Remove the rear shock absorber lower mount bolt.
Remove the rear axle nut.

Bolts



Bolt

Remove the rear fork mount bolts and rear fork.

Bolts



Rear Fork

16. REAR FORK/REAR WHEEL/ REAR SHOCK ABSORBER

Remove the inner side collar.



Inner Side Collar

Remove the rear wheel.



Rear Wheel

INSTECTION

Wheel

Check the wheel rim runout using dial indicator.

Service Limits:

Radial: 2 mm

Axial: 2 mm

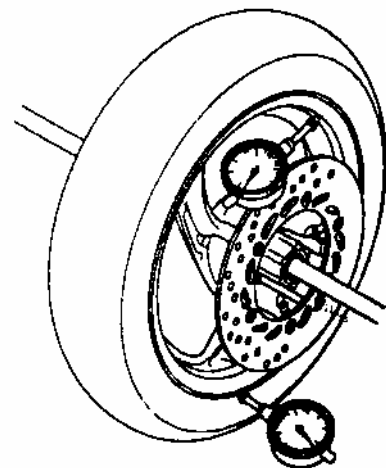

16. REAR FORK/REAR WHEEL/ REAR SHOCK ABSORBER

DISASSEMBLY

Wheel

Remove the brake disc bolts and rear brake disc.

Brake Disc



REAR FORK BEARING REPLACEMENT

Remove the outer side collar from the rear fork.

Outer Side Collar

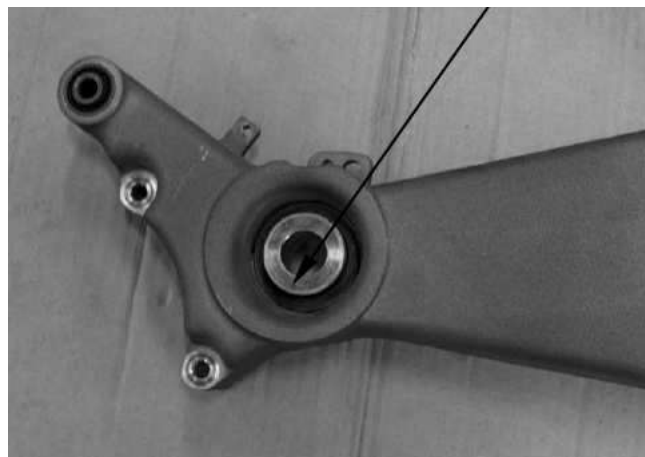

Remove the dust seal from the rear fork.

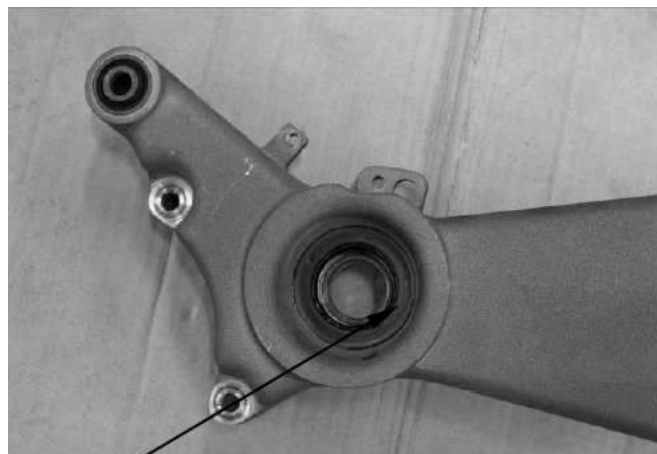

Dust Seal

16. REAR FORK/REAR WHEEL/ REAR SHOCK ABSORBER

Remove the snap ring.

Turn the inner race of the bearing with your finger.

The bearing should turn smoothly and quietly. Also check that the bearing outer race fits tightly in the rear fork.

Remove and discard the bearing if the race does not turn smoothly and quietly, or if it fits loosely in the rear fork.

Remove the bearing from the rear fork.

Drive in a new bearing squarely until it is fully seated, using the special tools.

Special tool:

Oil seal & bearing install A120E00014

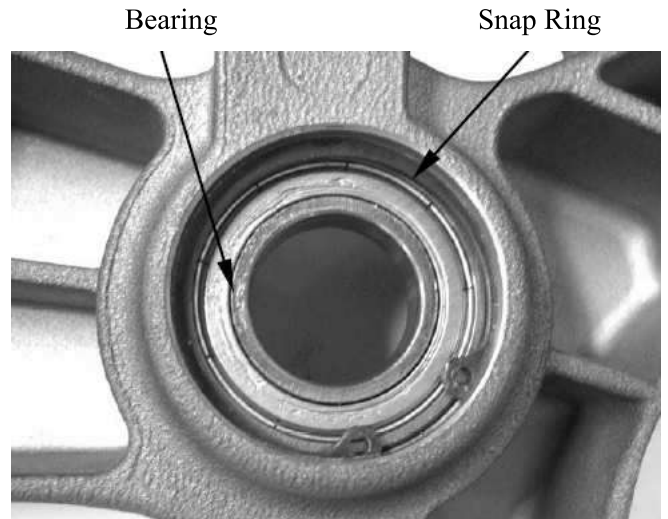

Install the snap ring to the groove of the rear fork securely.

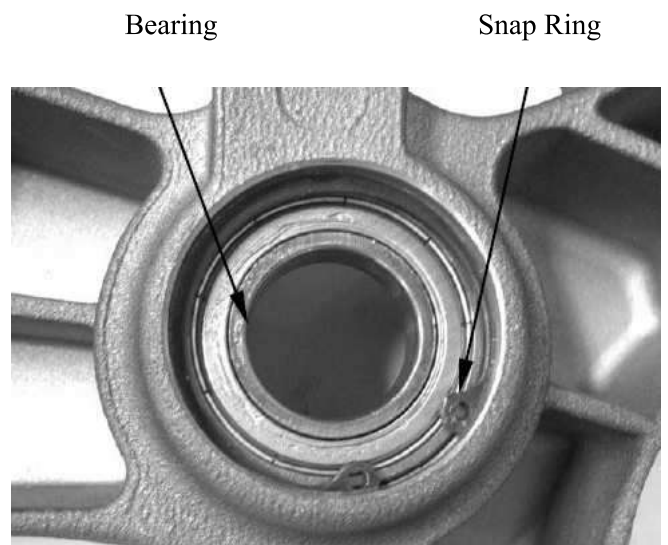

16. REAR FORK/REAR WHEEL/ REAR SHOCK ABSORBER

Apply grease to the new dust seal lip and install it to the rear fork.

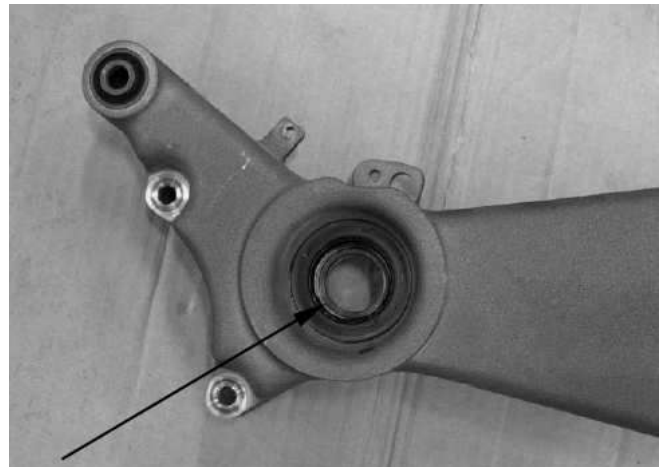

Dust Seal

Check the bushing for wear or damage.

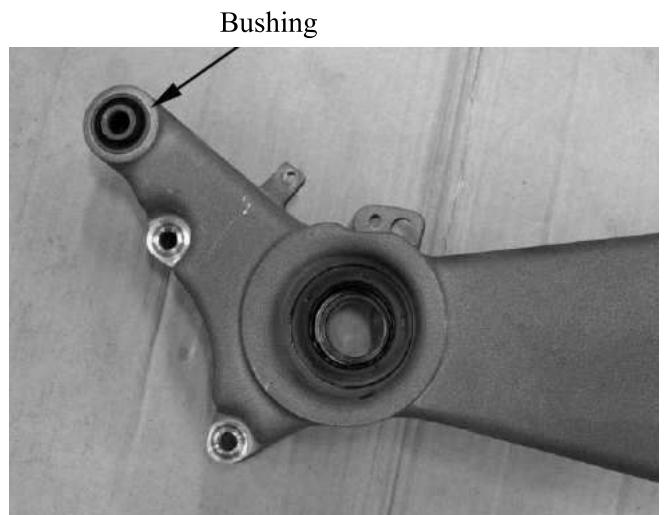

Bushing

ASSEMBLY

Wheel

Install the brake disc onto the wheel hub.

Install the new brake disc bolts and tighten them to the specified torque.

Torque: 4.3 kgf•m



Brake Disc

16. REAR FORK/REAR WHEEL/ REAR SHOCK ABSORBER

INSTALLATION

Install the rear wheel onto the final gear shaft, aligning the spline.



Install the inner side collar.
Apply grease to the final gear shaft.



Install the rear fork and tighten the bolts to the specified torque.

Torque: 4 kgf•m

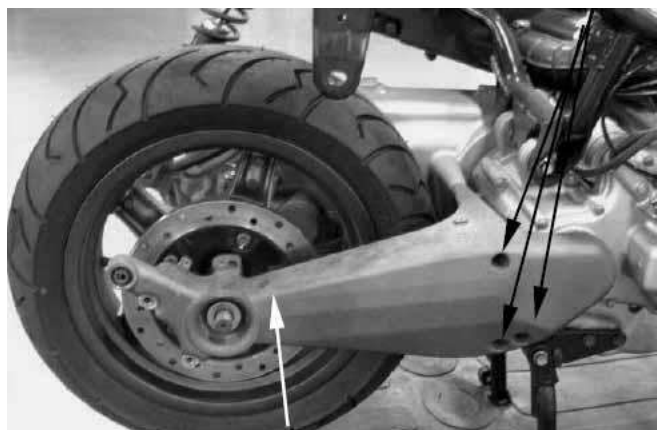

16. REAR FORK/REAR WHEEL/ REAR SHOCK ABSORBER

Install and tighten the rear axle nut to temporarily.

Install and tighten the rear shock absorber lower mount bolt to the specified torque.

Torque: 4.0 kgf•m

Install the brake hose/cable clamps to the rear fork and tighten the bolts securely.

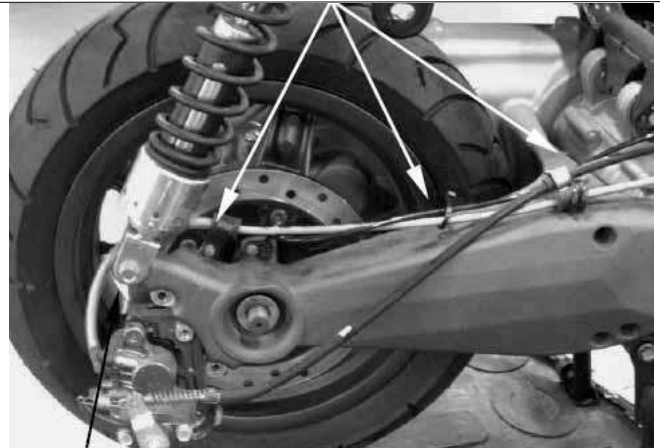

Tighten the rear axle nut to the specified torque.

Torque:
13 kgf•m

Install the rear/parking brake caliper

Install the muffler



REAR SHOCK ABSORBER

REMOVAL

Remove the luggage box.

Support the scooter securely on its center stand.

Support the engine securely with a hoist or equivalent.

Remove the rear shock absorber lower mount bolt.



Bolts/Clamps

Remove the rear shock absorber upper mount

16. REAR FORK/REAR WHEEL/ REAR SHOCK ABSORBER

bolt and shock absorber.

INSTECTION

Check the damper unit for leakage or other damage.

Check the upper joint bushing for wear or damage.

Replace the shock absorber assembly if necessary.

Bushing

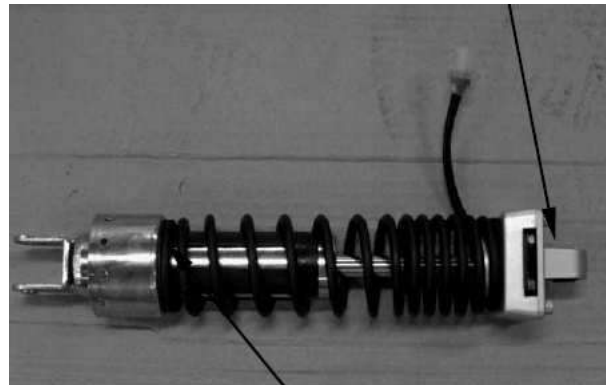

Damper Unit

Upper Mount Bolt



Lower Mount Bolt



INSTALLATION

Install the rear shock absorber tighten the upper mount bolt to the specified torque.

Torque: 4 kgf•m

Upper Mount Bolt



Install and tighten the lower mount bolt to the

16. REAR FORK/REAR WHEEL/ REAR SHOCK ABSORBER

specified torque.

Torque: 4 kgf•m



Needle Bearing



Dismantling



Mounting the bearing

17. BRAKE SYSTEM

BRAKE SYSTEM

SCHEMATIC DRAWING -----	17- 1
SERVICE INFORMATION -----	17- 2
TROUBLESHOOTING-----	17- 3
BRAKE FLUID -----	17- 4
BRAKE PAD-----	17- 8
BRAKE DISC INSPECTION-----	17-11
FRONT MASTER CYLINDER -----	17-12
REAR MASTER CYLINDER -----	17-16
FRONT BRAKE CALIPER-----	17-20
REAR/PARKING BRAKE CALIPER -----	17-22

17. BRAKE SYSTEM

SCHEMATIC DRAWING

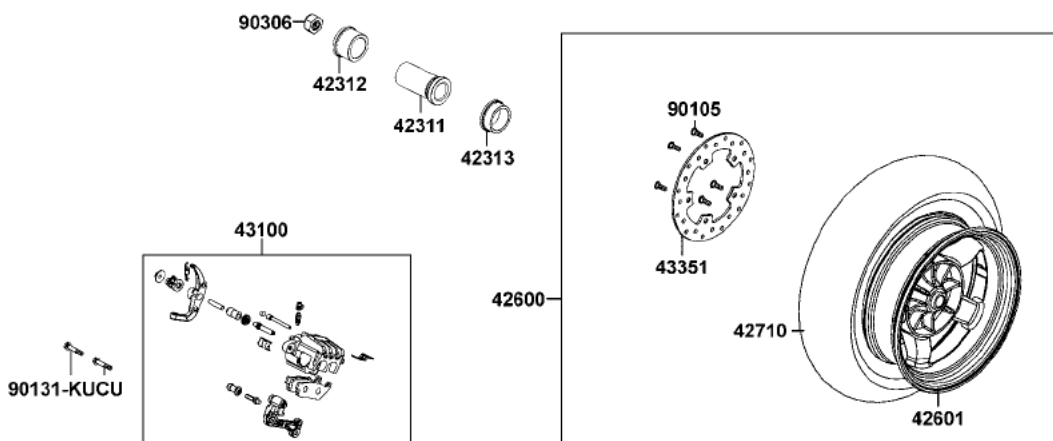
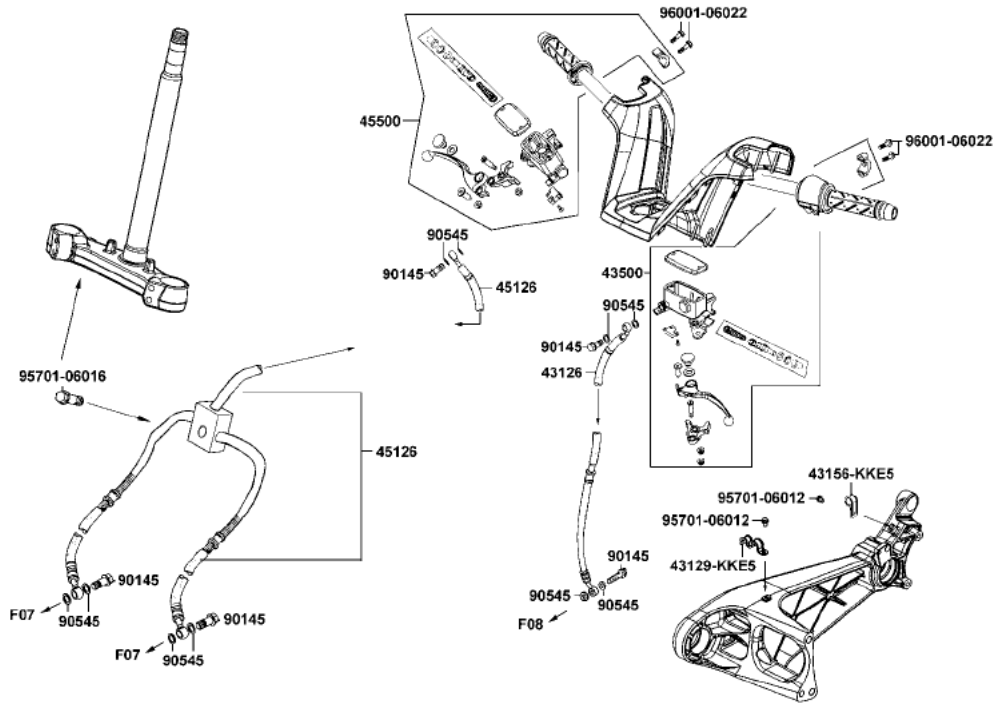

17. BRAKE SYSTEM

SERVICE INFORMATION

GENERAL

Frequent inhalation of brake pad dust, regardless of material composition could be hazardous to your health.

Avoid breathing dust particles.

- A contaminated brake disc or pad reduces stopping power. Discard contaminated parts and clean a contaminated disc with high quality brake degreasing agent.
- Avoid spilling brake fluid on painted, plastic or rubber parts. Place a rag over these parts whenever the system is serviced.
- This section covers maintenance of the front and rear hydraulic brake system.
- Never allow contamination (dirt, water, etc.) to get into and open reservoir.
- Once the hydraulic system has been opened, or if the brake feel spongy, the system must be bled.
- Always use fresh DOT 4 brake fluid from a sealed container when servicing the system. Do not mix different types of fluid as they may not be compatible.
- Always check brake operation before riding the vehicle.

SPECIFICATIONS

Unit: mm (in)

ITEM		STANDARD	SERVICE LIMIT
Front	Specified brake fluid	DOT 4	—
	Brake disc thickness	5.0	4.5
	Brake disc runout	—	0.03
Rear	Specified brake fluid	DOT 4	—
	Brake disc thickness	6.0	5.5
	Brake disc warpage	—	0.03

17. BRAKE SYSTEM

TORQUE VALUES

Master cylinder reservoir cover screw	0.15 kgf•m
Master cylinder holder bolt	1.2 kgf•m
Brake lever pivot bolt	0.6 kgf•m
Brake lever pivot nut	0.6 kgf•m
Brake light switch screw	0.12 kgf•m
Brake caliper mounting bolt	2.7 kgf•m
Brake caliper bleed screw	0.55 kgf•m
Brake hose oil bolt	3.5 kgf•m
Delay valve bleed screw	0.6 kgf•m

TROUBLESHOOTING

Brake lever soft or spongy

- Air in the hydraulic system
- Low brake fluid level
- Clogged fluid passage
- Contaminated brake disc/pad
- Warped/deformed brake disc
- Worn brake disc/pad
- Sticking/worn master cylinder piston
- Contaminated master cylinder
- Contaminated caliper
- Caliper not sliding properly
- Leaking hydraulic system
- Worn caliper piston seal
- Worn master cylinder piston cups
- Bent brake lever

Brake lever hard

- Clogged/restricted brake system
- Sticking/worn caliper piston
- Caliper not sliding properly
- Clogged/restricted fluid passage
- Worn caliper piston seal
- Sticking/worn master cylinder piston
- Bent brake lever

Brake drag

- Contaminated brake disc/pad
- Worn brake disc/pad
- Warped/deformed brake disc
- Caliper not sliding properly

17. BRAKE SYSTEM

BRAKE FLUID

Check

Brake fluid

Brake hose

Cracks/wear/damage → Replace.

Apply the brake lever several times.

Fluid leakage → Replace.

Brake hose clamp:

Loosen → Tighten

FLUID REPLACEMENT

Front brake

Avoid spilling brake fluid on painted, plastic or rubber parts and so on. Place a rag over these parts whenever the system is serviced.

Place the scooter on a level surface and keep the handlebar straight.

Remove the master cylinder reservoir cap and diaphragm.

Suck up the old brake fluid as much as possible.

Fill the reservoir with new brake fluid.

Specification and classification: DOT 4

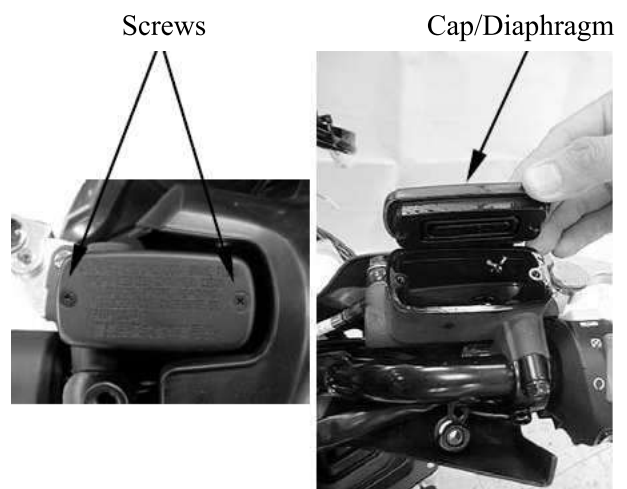

17. BRAKE SYSTEM

Connect a clear hose to the left front caliper air bleed screw and insert the other end of the hose into a container.

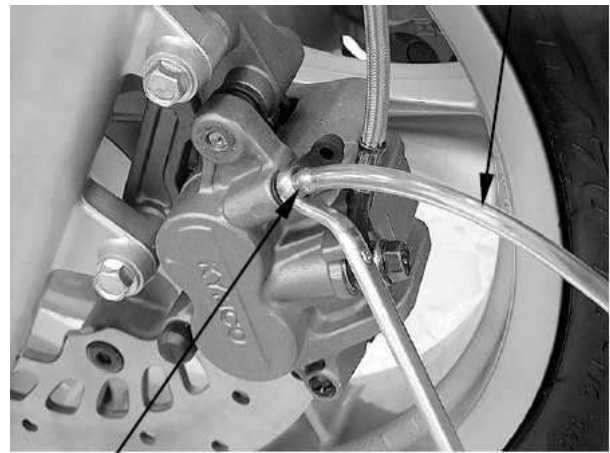

Clear Hose

Left Front Caliper Air Bleed Screw

Loosen the air bleed screw and pump the brake lever until the old brake fluid is completely out of the brake system.

Close the air bleed screw and disconnect the clear hose. Fill the reservoir with new brake fluid to the upper end of the inspection window.

Tighten the bleed screw to the specified torque.

Torque: 0.6 kgf•m



Brake Lever

Combination brake

Avoid spilling brake fluid on painted, plastic or rubber parts and so on. Place a rag over these parts whenever the system is serviced.

Place the scooter on a level surface and keep the handlebar straight.

17. BRAKE SYSTEM

Remove the master cylinder reservoir cap and diaphragm.

Suck up the old brake fluid as much as possible.

Fill the reservoir with new brake fluid.

Specification and classification: DOT 4

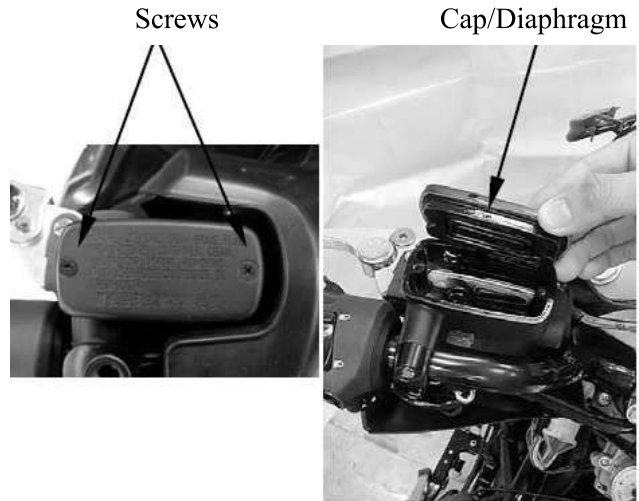

Rear brake:

The procedure of replacement is the same with front brake.

Relay Valve Air Bleed Screw

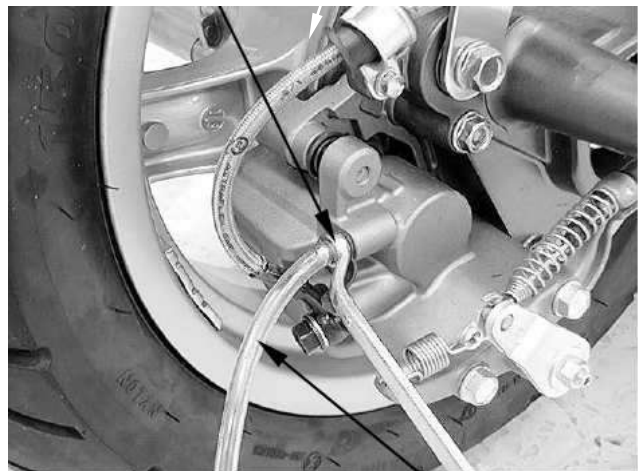

Clear Hose

17. BRAKE SYSTEM

BLEEDING THE HYDRAULIC BRAKE SYSTEM

Bleed the brake fluid circuit:

- The system has been disassembled.
 - A brake hose or brake pipe have been loosened or removed.
 - The brake fluid has been very low.
 - The brake operation has been faulty.
- A loss of braking performance may occur if the brake system is not properly bled.

Air bleeding steps (Front brake):

1. Add the proper brake fluid to the reservoir.
2. Install the diaphragm. Be careful not to spill any fluid or allow the reservoir to overflow.
3. Connect the clear plastic hose tightly to the left front caliper air bleed screw.
4. Place the other end of the hose into a container.
5. Slowly apply the brake lever several times.
6. Pull the lever in and hold it.
7. Loosen the bleed screw and allow the lever to travel towards its limit.
8. Tighten the bleed screw when the lever limit has been reached, then release the lever.
9. Repeat steps (5) to (7) until all the air bubbles have disappeared from the fluid.
10. Tighten the bleed screw.

Torque: 0.55 kgf•m

11. Add brake fluid to the proper level and install the master cylinder reservoir cap and diaphragm.

If bleeding is difficult, it may be necessary to let the brake fluid settle for a few hours.

Repeat the bleeding procedure when the tiny bubbles in the system have disappeared.

Check the operation of the brake after bleeding the brake system.

Clear Hose

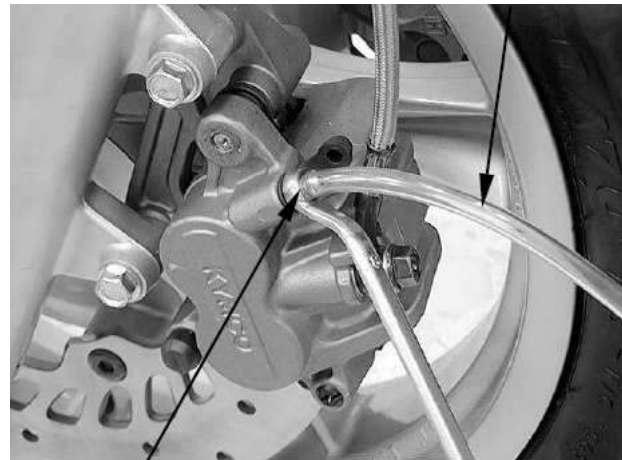

Left Front Caliper Air Bleed Screw

Rear Front Caliper Air Bleed Screw



Clear Hose

17. BRAKE SYSTEM

BRAKE PAD

BRAKE PAD REPLACEMENT

Front brake:

Push the caliper pistons all the way in by pushing the caliper body inward to provide clearance for new pads.

Always replace the brake pads in pairs to ensure even disc pressure. And be sure to use the genuine parts.

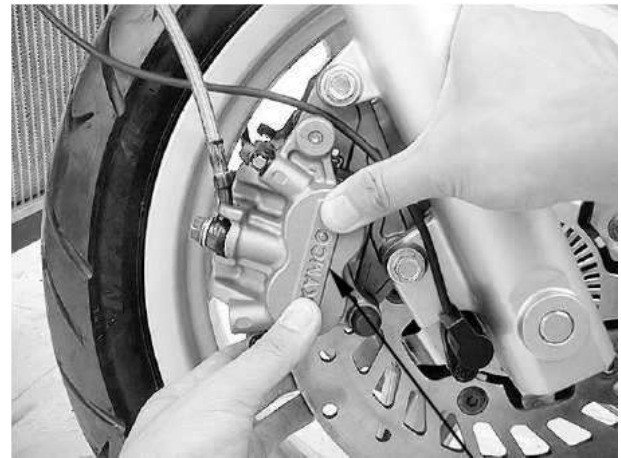

Caliper

Remove the pad pin plug and loosen the pad pin.



Pad Pin Plug

Pad Pin

Pad Pin

Remove the pad pin and the brake pads.

Make sure that the pad spring is installed in original position.

Install new pads so that their ends rest on the pad retainer on the bracket properly.

Install the pad pin by pushing the pads against the pad spring to align the pad pin holes in the pads and caliper.



Brake Pads

17. BRAKE SYSTEM

Tighten the pad pin to the specified torque.

Torque: 1.8 kgf•m

Install the pad pin plug.



Pad Pin

Pad Pin Plug

Rear/Parking brake:

Remove the pad pin plug and loosen the pad pin.

Always replace the brake pads in pairs to ensure even disc pressure. And be sure to use the genuine parts.

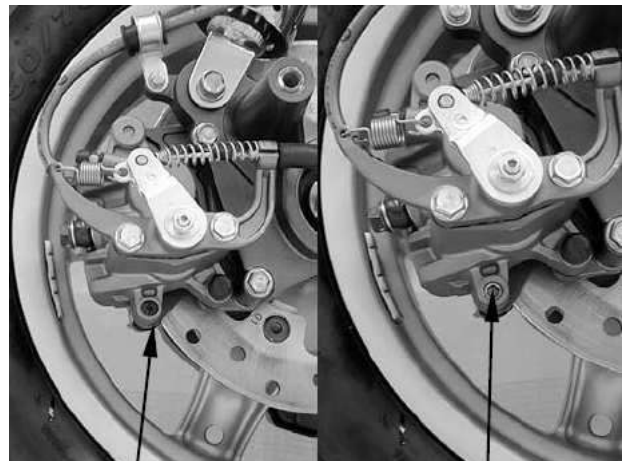

Pad Pin Plug

Pad Pin

Caliper

Bolts

Remove the mount bolts and rear/parking brake caliper from the rear fork.

Remove the pad pin and brake pads.

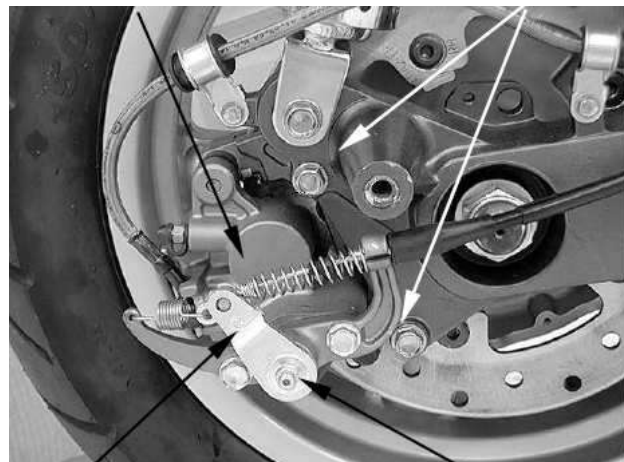

Brake Pads

Nut

17. BRAKE SYSTEM

Installation steps:

Turn the parking brake caliper piston clockwise and push it into the parking brake caliper.

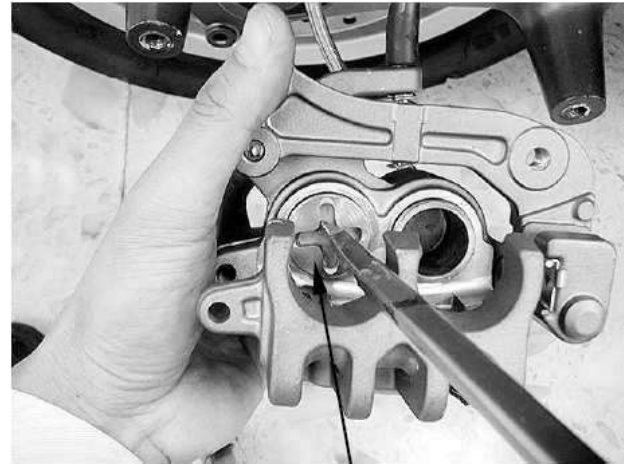

Parking Brake Caliper Piston

Pin

Install the pad pin by pushing the pads against the pad spring to align the pad pin holes in the pads and caliper.

Align the pin on the pad with the groove on the parking brake caliper piston.



Groove

Rear/Parking Caliper Body

Bolts

Install the rear/parking brake caliper to the rear fork.

Install and tighten the new rear/parking brake caliper mounting bolts to the specified torque.

Torque: 3.2 kgf•m



17. BRAKE SYSTEM

Tighten the pad pin to the specified torque.

Torque: 1.8 kgf•m

Install the pad pin plug to the specified torque.

Torque: 0.3 kgf•m

Rear brake :

The rear brake pads and front brake pads replacement are all the same.

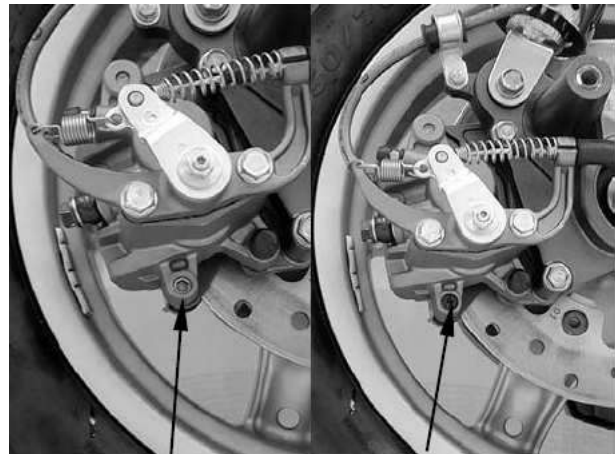

Pad Pin

Pad Pin Plug

BRAKE DISC INSPECTION

Visually inspect the brake disc for damage or cracks.

Measure the brake disc thickness.

Service limits:Front: 4.5 mm

Rear: 5.5 mm

Replace the brake disc if the smallest measurement is less than the service limit.

Measure the brake disc warpage.

Service limits:0.03 mm



17. BRAKE SYSTEM

FRONT MASTER CYLINDER

REMOVAL

When removing the brake hose bolt, cover the end of the hose to prevent contamination. Secure the hose to prevent fluid from leaking out.

Remove the upper handlebar cover.

Drain the front brake hydraulic system.

Remove the two screws and lower handlebar cover.

Disconnect the brake light connectors from front master cylinder.

Remove the brake hose oil bolt, sealing washers and brake hose eyelet.

Lower Handlebar Cover

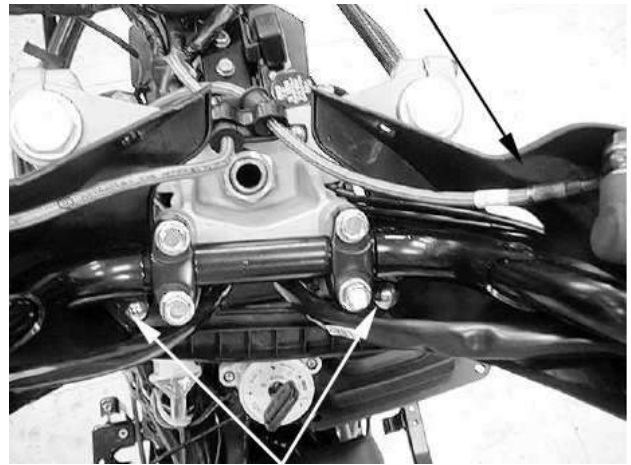

Screws



Brake Light Switch Connectors

Sealing Washers

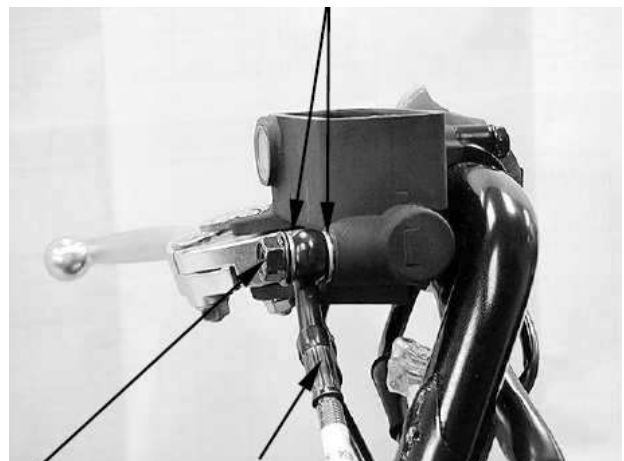

Bolt

Brake Hose

17. BRAKE SYSTEM

Remove the bolts from the master cylinder holder and remove the master cylinder assembly.

Master Cylinder

Bolts



Holder

DISASSEMBLY

Remove the brake lever pivot bolt and nut.
Remove the brake lever.

Nut

Brake Lever

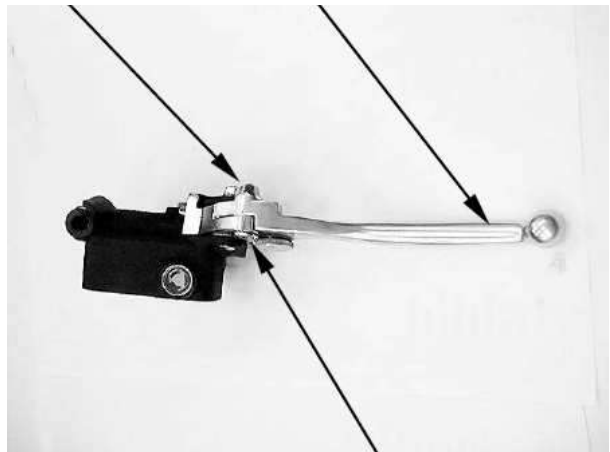

Pivot Bolt

Remove the screw and brake light switch.

Brake Light Switch



Screw

17. BRAKE SYSTEM

ASSEMBLY

Install the brake light switch and tighten the screw to the specified torque.

Torque: 0.12 kgf•m



Apply silicone grease to the master piston tip.
Install the brake lever.

Apply silicone grease to the brake lever pivot bolt sliding surface.
Install and tighten the pivot bolt to the specified torque.

Torque: 0.6 kgf•m

Install and tighten the pivot nut to the specified torque.

Torque: 0.6 kgf•m

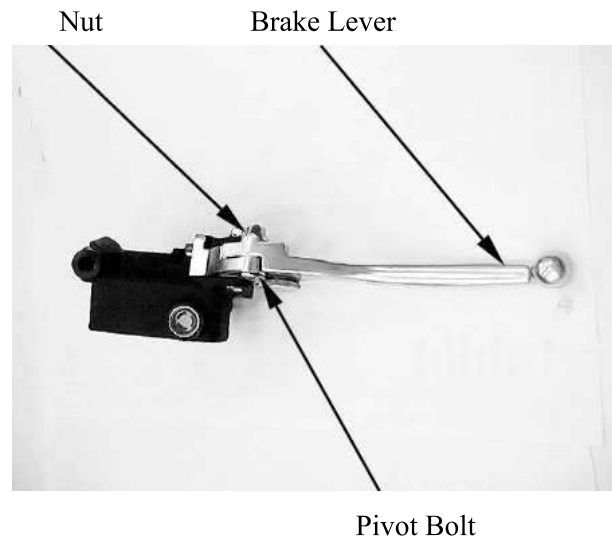

INSTALLATION

Align the pin on the master cylinder holder with the hole on the handlebar.

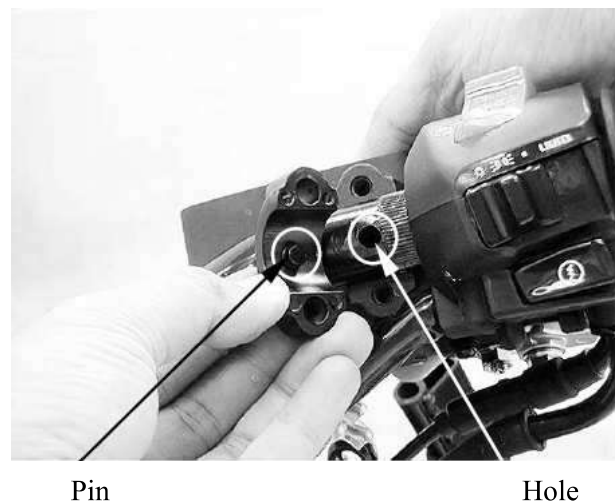

17. BRAKE SYSTEM

Install the front master cylinders and holders with the “UP” mark facing up.

Install the bolts and tighten the upper bolt first then tighten the lower bolt to the specified torque.

Torque: 1.2 kgf•m

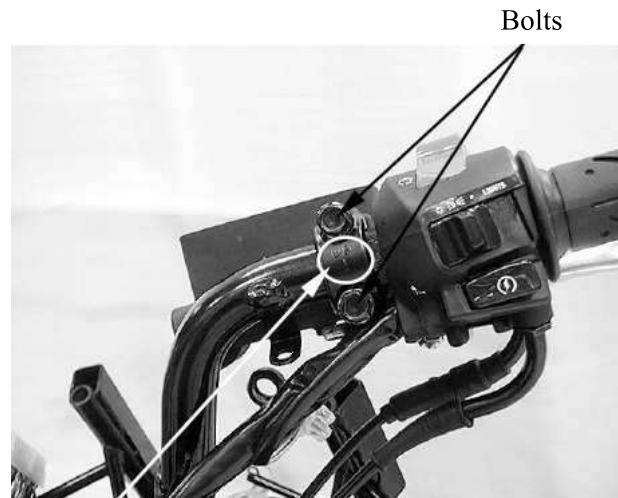

“UP” Mark

Rest the brake hose eyelet against the stopper. Install the brake hose eyelet with the oil bolt and new sealing washers. Tighten the oil bolt to the specified torque.

Torque: 3.5 kgf•m

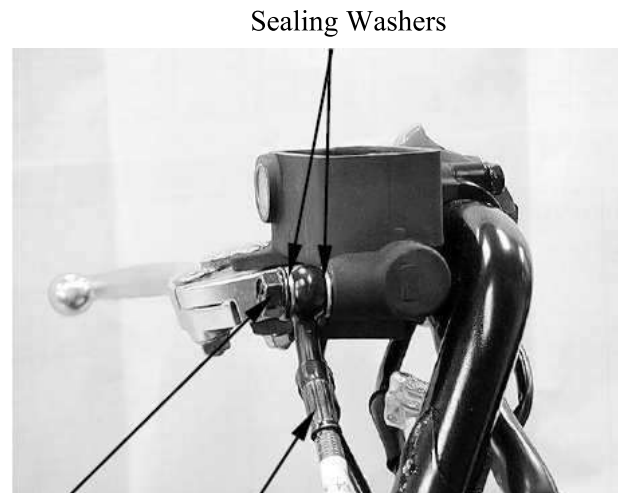

Bolt

Brake Hose

Connect the brake light switch connectors.

Fill the reservoir to the upper level and bleed the brake system.



Brake Light Switch Connectors

17. BRAKE SYSTEM

REAR MASTER CYLINDER

REMOVAL

When removing the brake hose bolt, cover the end of the hose to prevent contamination. Secure the hose to prevent fluid from leaking out.

Remove the upper handlebar cover.
Drain the combination brake hydraulic system.

Remove the two screws and lower handlebar cover.

Disconnect the brake light switch connectors from master cylinder.

Remove the brake hose oil bolt, sealing washers and brake hose eyelet.

Lower Handlebar Cover



Screws



Brake Light Switch Connectors

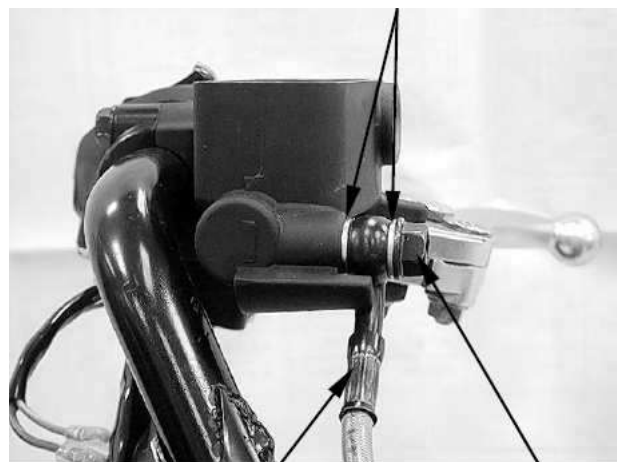

Brake Hose

Bolt

17. BRAKE SYSTEM

Remove the bolts from the master cylinder holder and remove the master cylinder assembly.

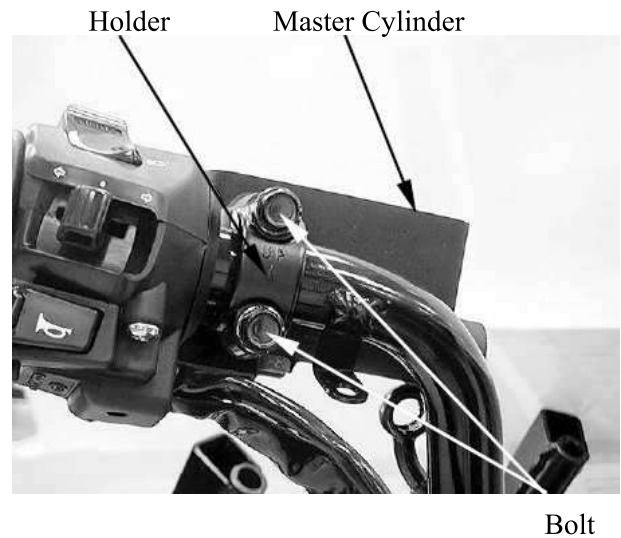

DISASSEMBLY

Remove the brake lever pivot bolt and nut.
Remove the brake lever.

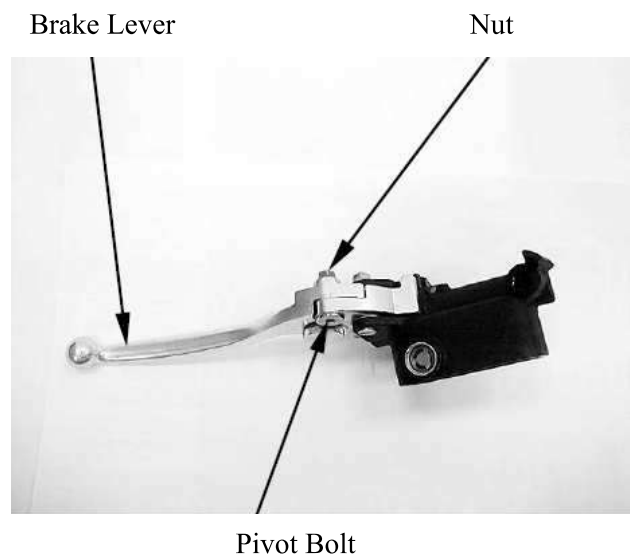

Remove the screw and brake light switch.

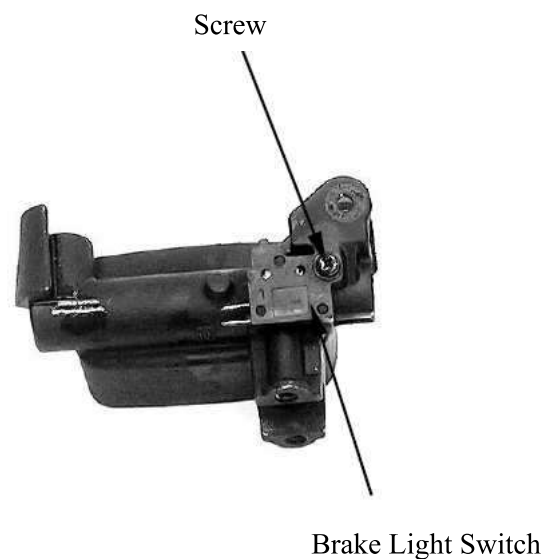

17. BRAKE SYSTEM

ASSEMBLY

Install the brake light switch and tighten the screw to the specified torque.

Torque: 0.12 kgf•m

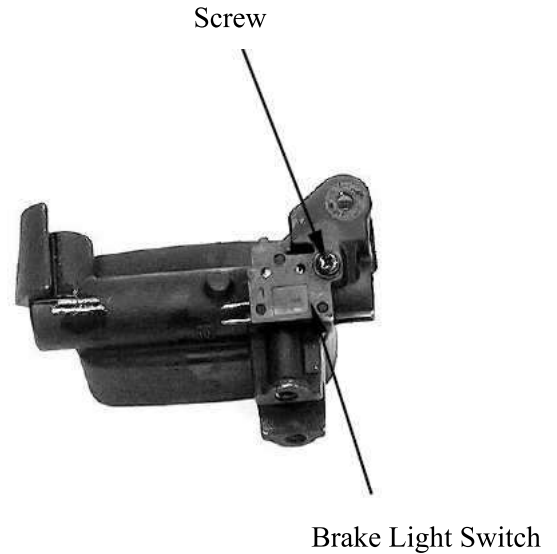

Apply silicone grease to the master piston tip.
Install the brake lever.

Apply silicone grease to the brake lever pivot bolt sliding surface.
Install and tighten the pivot bolt to the specified torque.

Torque: 0.6 kgf•m

Install and tighten the pivot nut to the specified torque.

Torque: 0.6 kgf•m

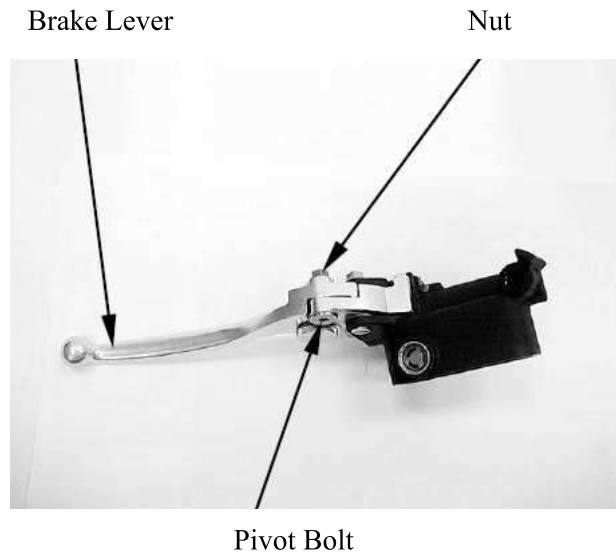

INSTALLATION

Align the pin on the master cylinder holder with the hole on the handlebar.

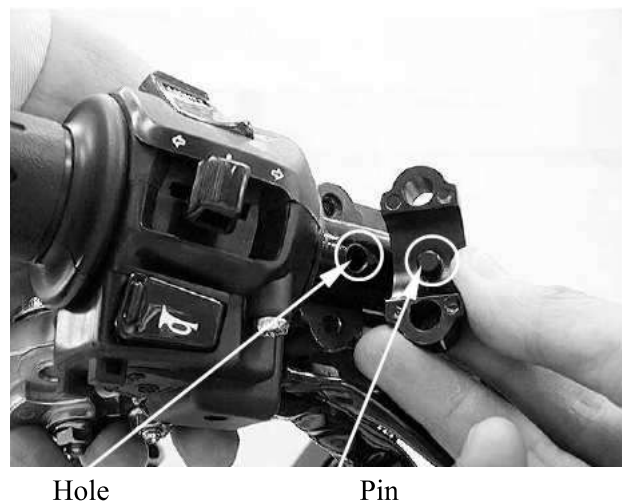

17. BRAKE SYSTEM

Install the rear master cylinders and holders with the “UP” mark facing up.

Install the bolts and tighten the upper bolt first then tighten the lower bolt to the specified torque.

Torque: 1.2 kgf•m

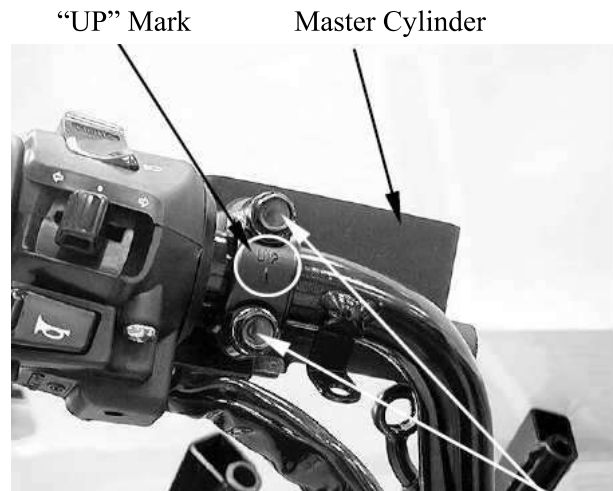

Bolt

Rest the brake hose eyelet against the stopper. Install the brake hose eyelet with the oil bolt and new sealing washers. Tighten the oil bolt to the specified torque.

Torque: 3.5 kgf•m

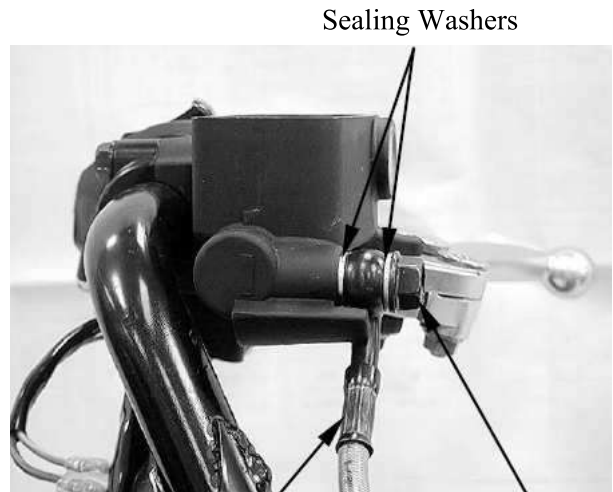

Brake Hose

Bolt

Connect the brake light switch connectors.

Fill the reservoir to the upper level and bleed the brake system.

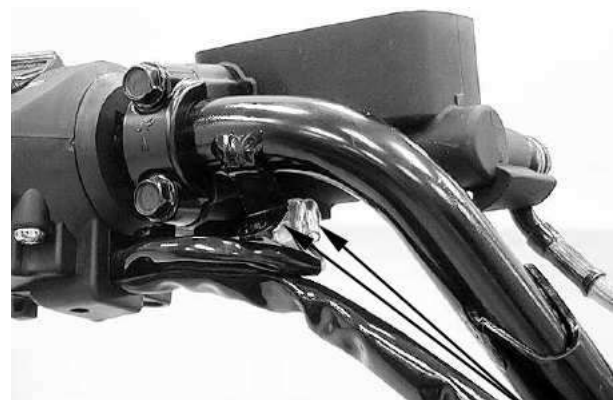

Brake Light Switch Connectors

17. BRAKE SYSTEM

FRONT BRAKE CALIPER REMOVAL

Drain the front brake hydraulic system or combination brake hydraulic system.

Remove the brake pads.

Remove the oil bolts, sealing washers and brake hose from the brake caliper.

Brake Hose

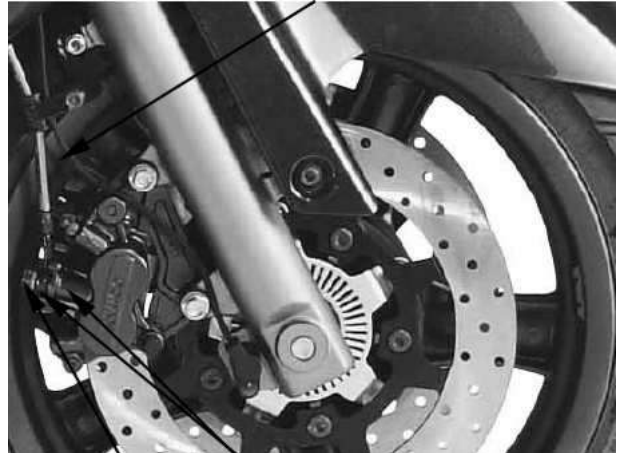

Bolts Sealing Washers

Remove the mount bolts and front brake caliper.

Bolts



Brake Caliper

DISASSEMBLY

Remove pad spring from the caliper body.

Do not remove the retainer from the bracket unless replacement.

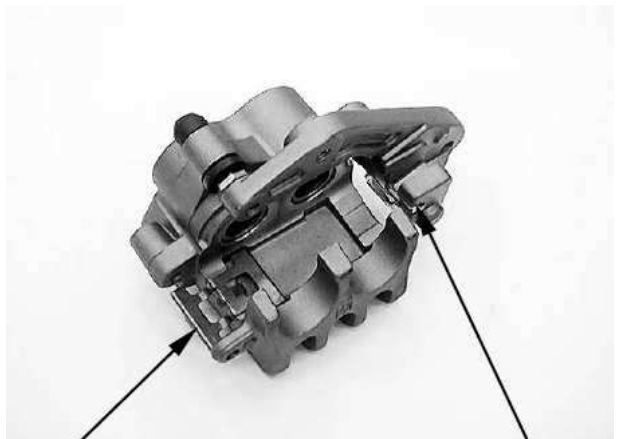

Pad Spring

Retainer

17. BRAKE SYSTEM

Remove the caliper bracket from the caliper body.

Do not remove the caliper and bracket pins unless replacement.

ASSEMBLY

Apply silicone grease to the boots inside.
Install the caliper bracket to the caliper.

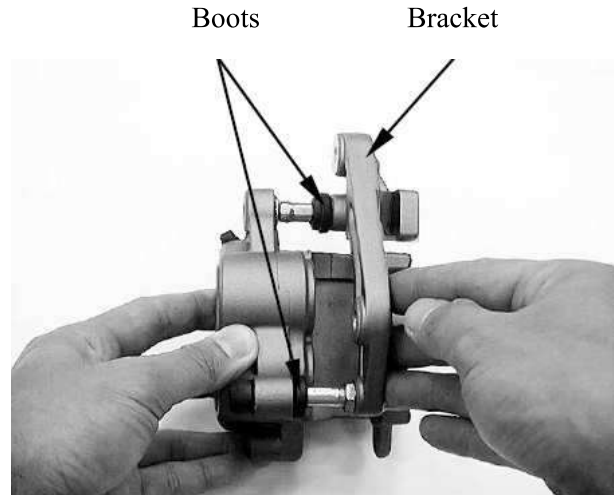

Install the pad spring into the caliper body as shown.

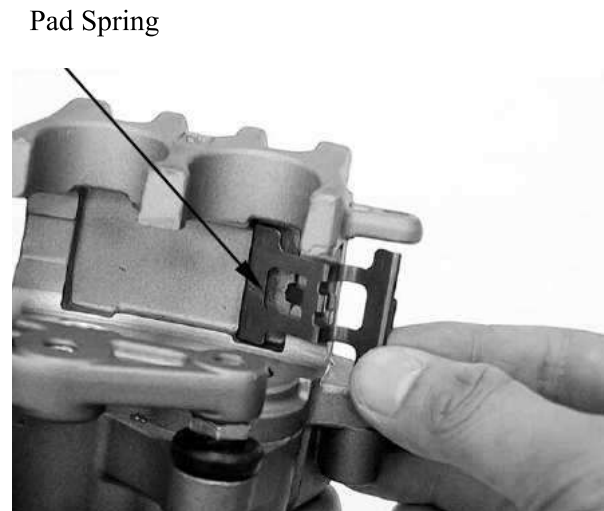

INSTALLATION

Install the front caliper onto the fork leg.
Install and tighten the new front caliper mount bolts to the specified torque.

Torque: 3.2 kgf•m

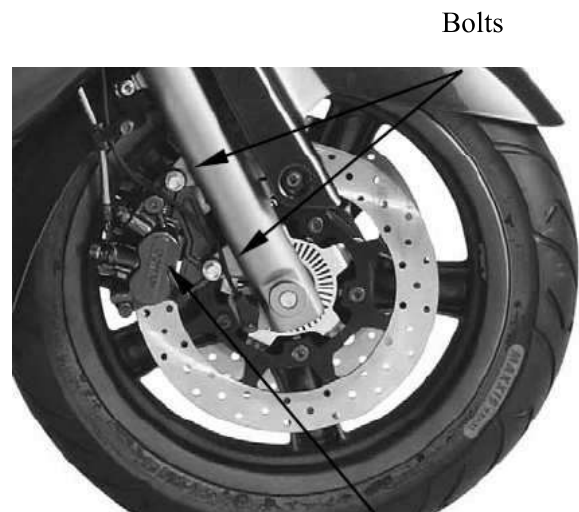

Brake Caliper

17. BRAKE SYSTEM

Install the brake hose eyelet to the caliper body with new sealing washers and oil bolts.
Push the brake hose eyelet to the stopper on the caliper, then tighten the oil bolts to the specified torque.

Torque: 3.5 kgf•m

Install the brake pads.
Fill and bleed the hydraulic system.

REAR/PARKING BRAKE CALIPER

REMOVAL

Remove the muffler.
Drain the rear brake hydraulic system.

Disconnect the parking brake cable from the brake arm.

Remove the pad pin plug and loosen the pad pin.
Remove the brake pad.

Remove the oil bolt, sealing washers and brake hose from the brake caliper.

Brake Hose



Bolts Sealing Washers

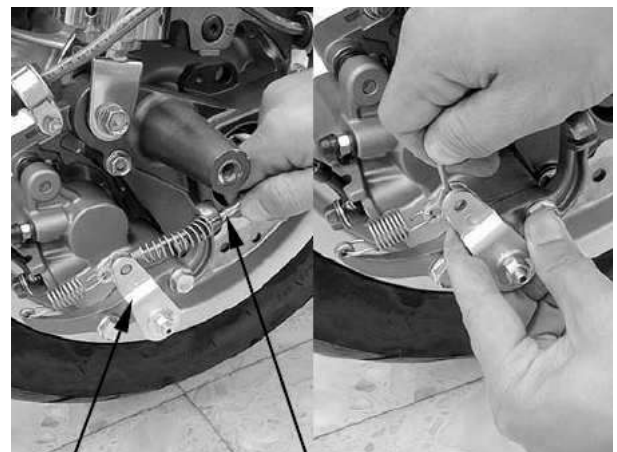

Arm Brake Cable

Brake Hose

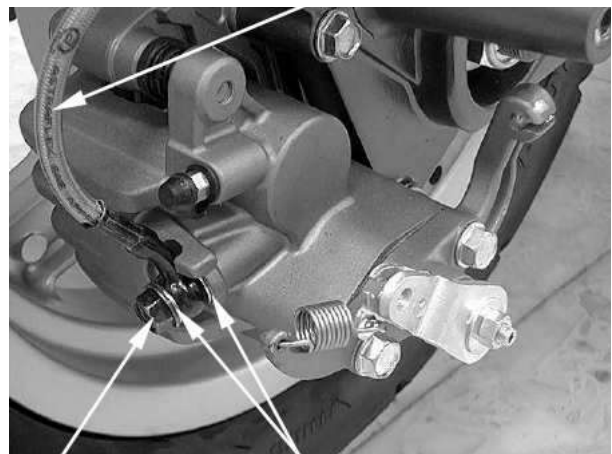

Bolts Sealing Washers

17. BRAKE SYSTEM

Remove the mount bolts and rear/parking brake caliper from the rear fork.

Rear/Parking Brake Caliper

Bolts

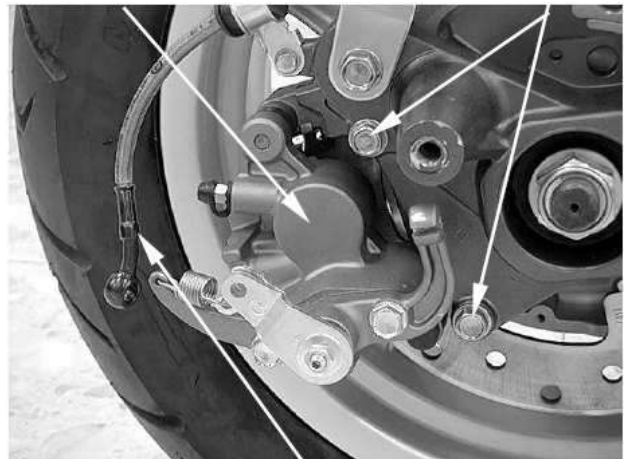

Brake hose

DISASSEMBLY

Remove the pad spring from the caliper body.

Do not remove the retainer from the bracket unless replacement.

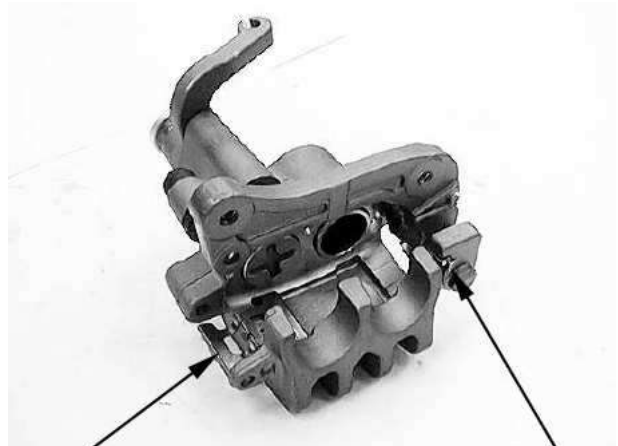

Pad Spring

Retainer

Remove the caliper bracket from the caliper body.

Do not remove the caliper and bracket pins unless replacement.

Bracket

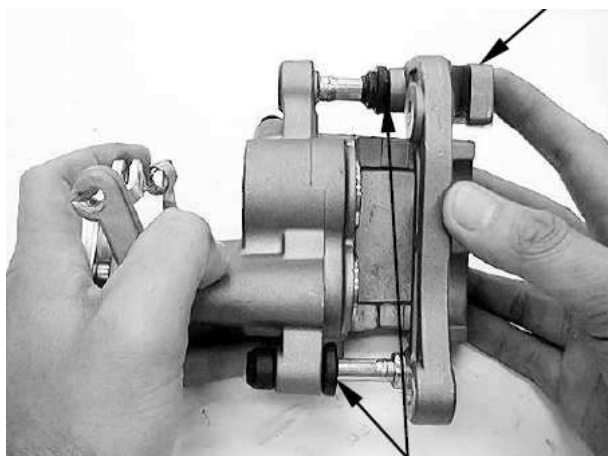

Boots

ASSEMBLY

Apply silicone grease to the boot inside.
Apply silicone grease to the boot inside.
Install the caliper bracket to the caliper.

17. BRAKE SYSTEM

Install the pad spring into the caliper body as shown.

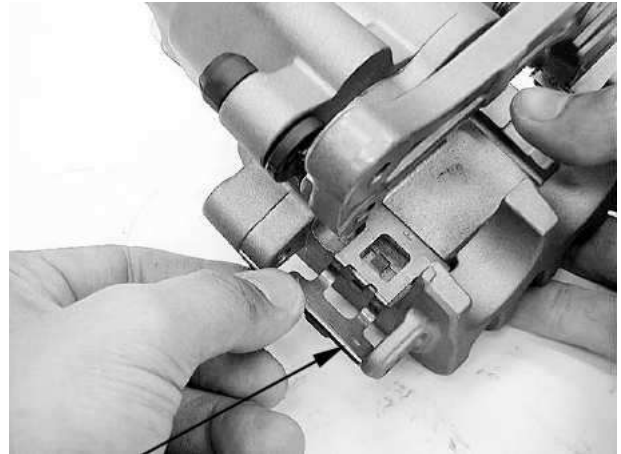

Pad Spring

PARKING BRAKE DISASSEMBLY

Remove the lock nut and parking brake arm.

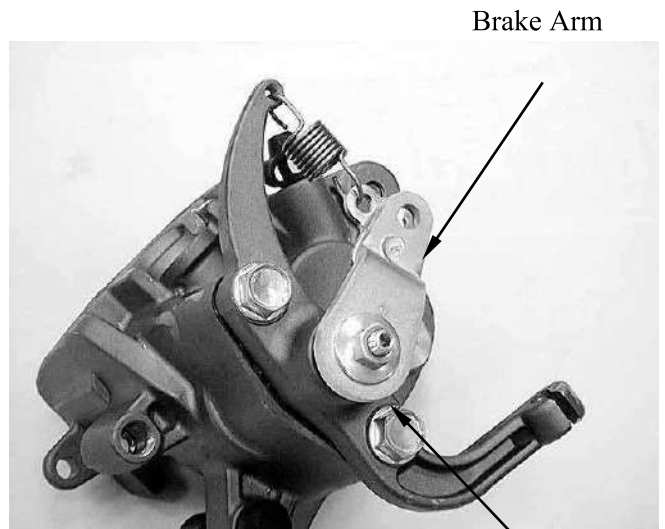

Brake Arm

Lock Nut

Remove the parking brake shaft and push rod.

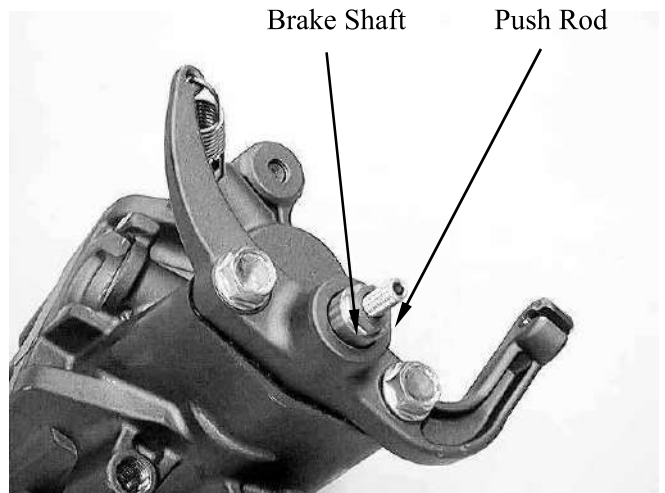

Brake Shaft

Push Rod

17. BRAKE SYSTEM

Removed the two bolts, gasket and parking brake bracket.

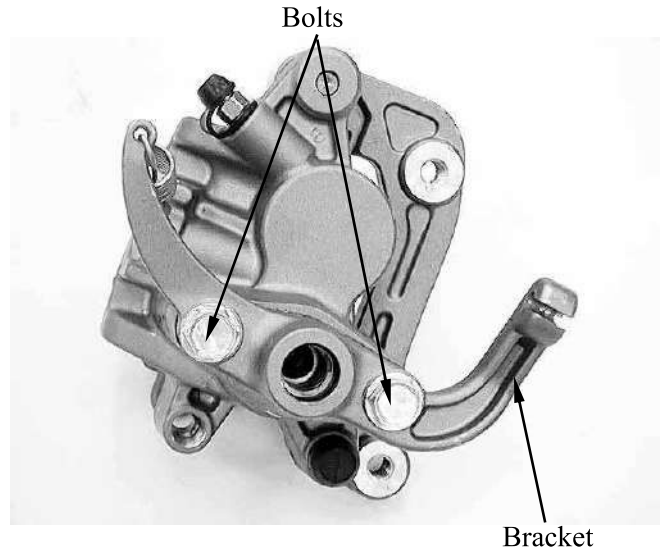

PARKING BRAKE ASSEMBLY

Install the gasket.

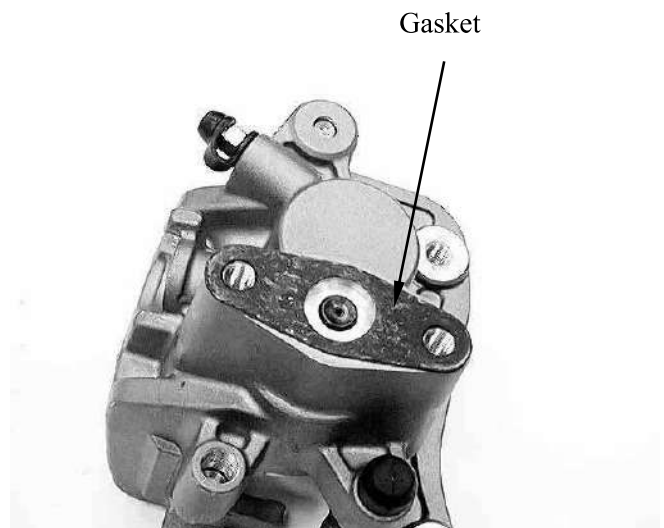

Install the parking brake bracket and tighten the bolts to the specified torque.

Torque: 3.2 kgf•m

Apply silicone grease to the parking brake shaft rolling surface.

Install the parking brake shaft.

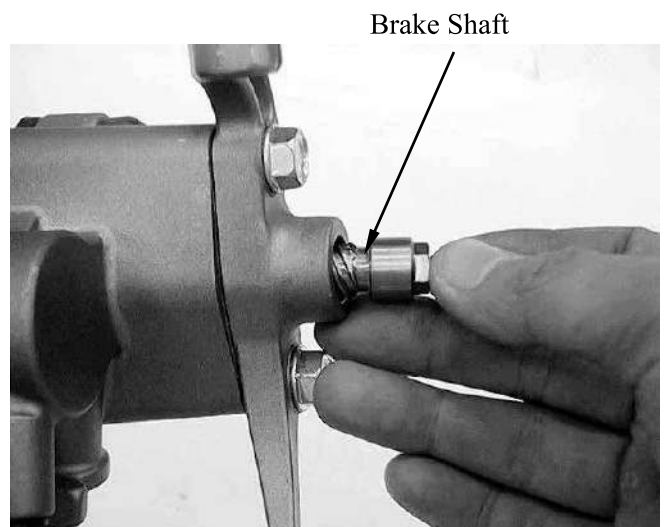

17. BRAKE SYSTEM

Temporarily install the brake arm and the lock nut.

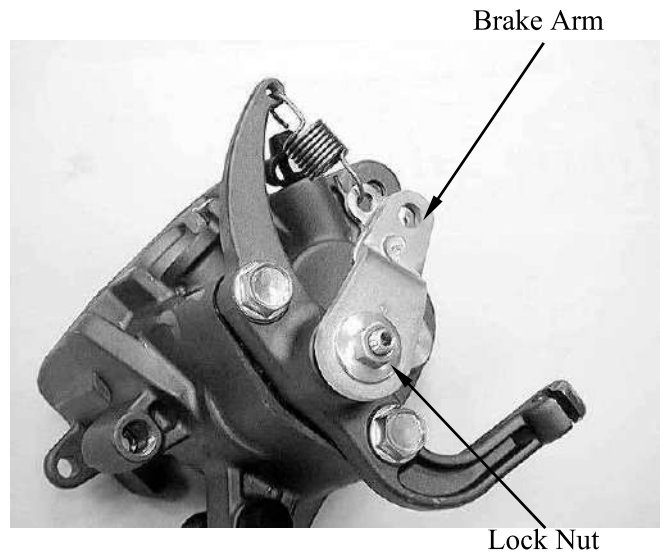

INSTALLATION

Install the brake pads.

Install the rear/parking brake caliper to the rear fork and tighten the new mount bolts to specified torque.

Torque: 3.2 kgf•m

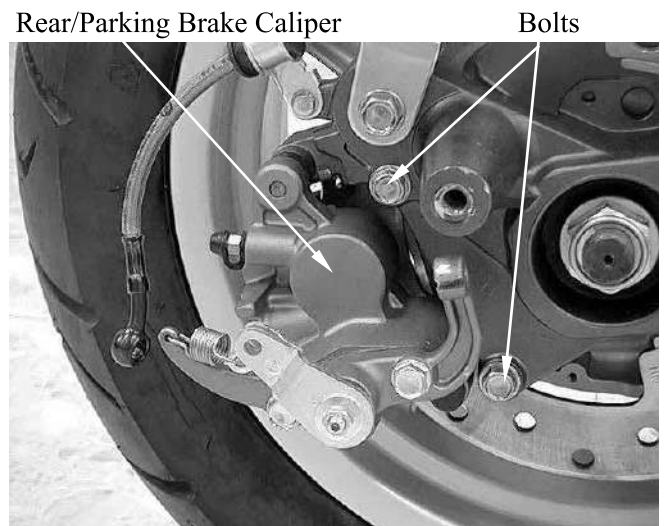

Install the brake hose eyelet to the caliper body with new sealing washers and oil bolts. Push the brake hose eyelet to the stopper on the caliper, then tighten the oil bolts to the specified torque.

Torque: 3.5 kgf•m

Fill and bleed the hydraulic system.

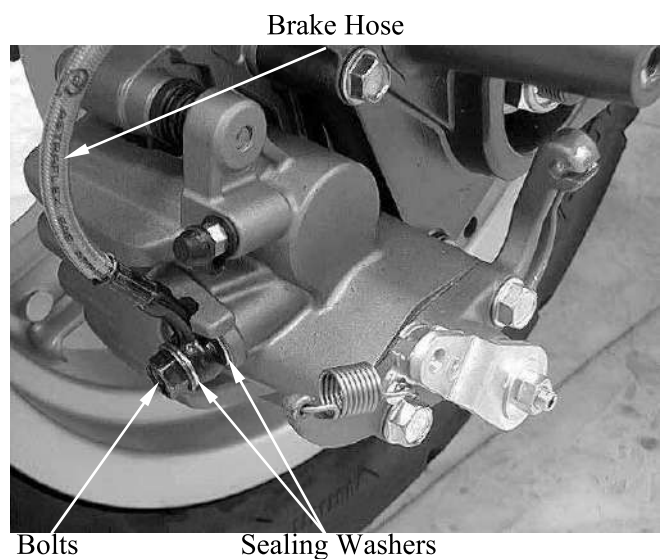

17. BRAKE SYSTEM

Connect the parking brake cable.

Adjust the parking brake.

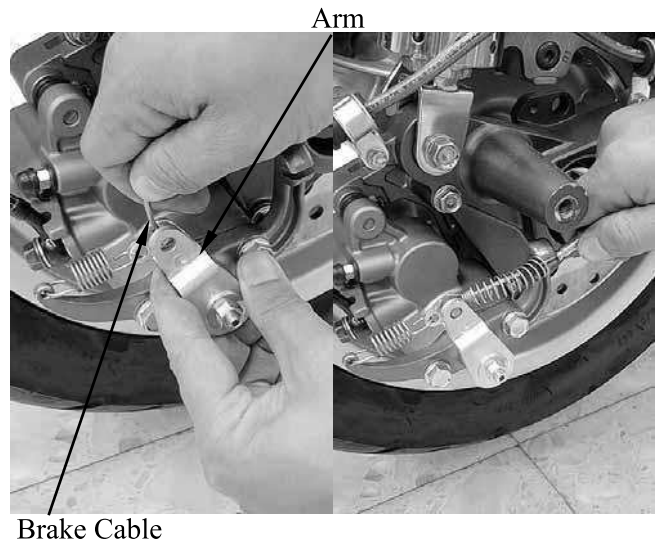

PARKING BRAKE LEVER LINK

REMOVAL

Remove the inner cover.

Loosen the lock nut and disconnect the parking brake cable from the parking braking brake lever link.



Lock Nut

Disconnect the parking brake switch connector.



17. BRAKE SYSTEM

Remove the two nuts and parking brake lever link.

Parking Brake Lever Link



Nuts

DISASSEMBLY

Remove the two screws and parking brake switch.

Parking Brake Switch

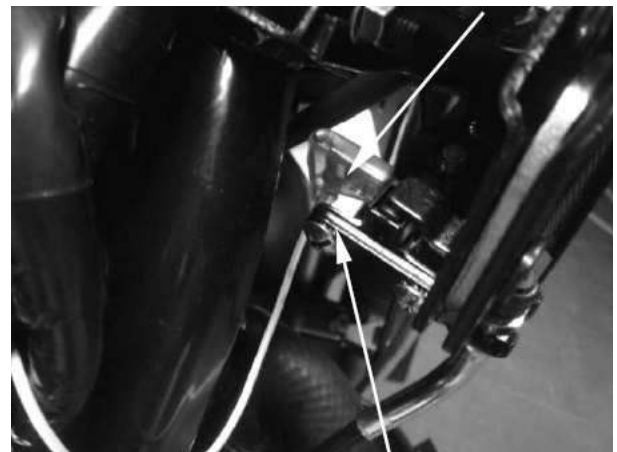

Screw

ASSEMBLY

Assembly is in the reverse order of disassembly.

INSTALLATION

Installation is in the reverse order of removal.

18. BATTERY/CHARGING SYSTEM

BATTERY/CHARGING SYSTEM

CHARGING SYSTEM LAYOUT -----	18-1
SERVICE INFORMATION-----	18-2
TROUBLESHOOTING-----	18-4
BATTERY -----	18-5
CHARGING SYSTEM INSPECTION -----	18-6
ALTERNATOR CHARGING COIL-----	18-7
REGULATOR/RECTIFIER-----	18-8

18. BATTERY/CHARGING SYSTEM

CHARGING SYSTEM LAYOUT



Regulator/Rectifier



Positive Terminal

Negative Terminal

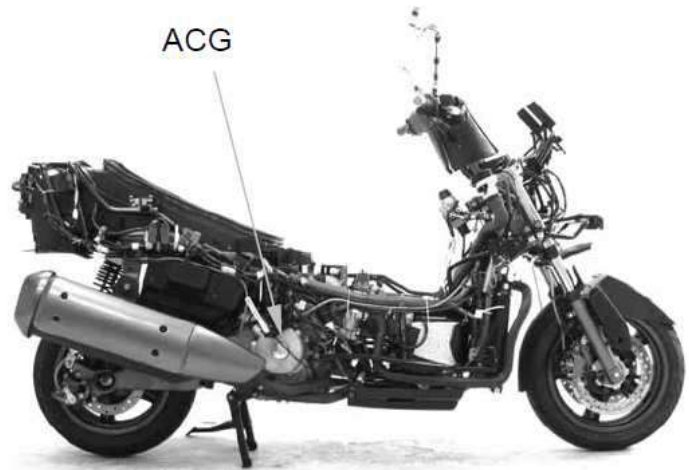

CHARGING CIRCUIT

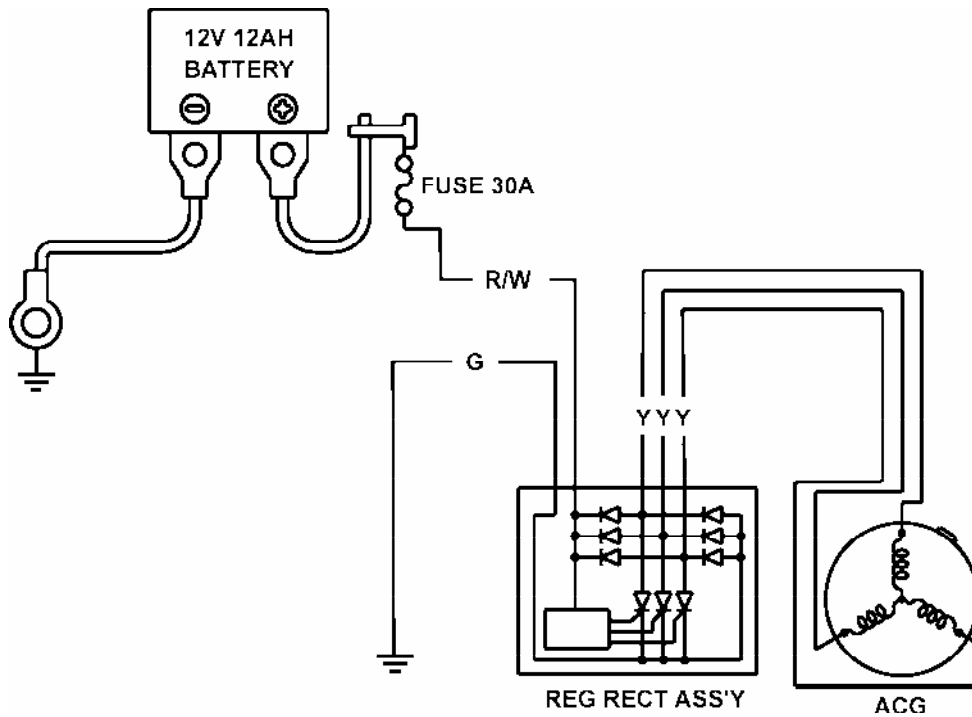

18. BATTERY/CHARGING SYSTEM

SERVICE INFORMATION

GENERAL

CAUTION

- The battery gives off explosive gases; keep sparks, flames and cigarettes away. Provide adequate ventilation when charging.
- The battery contains sulfuric acid (electrolyte). Contact with skin or eyes may cause severe burns. Wear protective clothing and a face shield.
 - If electrolyte gets on your skin, flush with water.
 - If electrolyte gets in your eyes, flush with water for at least 15 minutes and call a physician immediately.
- Electrolyte is poisonous.
 - If swallowed, drink large quantities of water or milk and call your local Poison Control Center or physician immediately, **KEEP OUT OF REACH OF CHILDREN.**

- Always turn off the ignition switch before disconnecting any electrical component.
- Some electrical components may be damaged if terminals or connectors are connected or disconnected while the ignition switch is turned to “ON” and current is present.
- For extended storage, remove the battery, give it a full charge, and store it in a cool, dry place.
- For a battery remaining in a shorted vehicle, disconnect the negative battery cable from the battery.
- The battery caps should not be removed. Attempting to remove the sealing caps from the cells may damage the battery.
- The maintenance free battery must be replaced when it reaches the end of its service life.
- The battery can be damaged if overcharged or undercharged, or if left to discharge for long period. These same conditions contribute to shortening the “life span” of the battery. Even under normal use, the performance of the battery deteriorates after 2-3 years.
- Battery voltage may recover after battery charging, but under heavy load, the battery voltage will drop quickly and eventually die out. For this reason, the charging system is often suspected as the problem. Battery overcharge often results from problems in the battery itself, which may appear to be an overcharging symptom. If one of the battery cells is shorted and battery voltage does not increase, the regulator/rectifier supplies excess voltage to the battery. Under these conditions, the electrolyte level goes down quickly.
- Before troubleshooting the charging system, check for proper use and maintenance of the battery. Check if the battery is frequently under heavy load, such as having the headlight and taillight on for long periods of time without riding the vehicle.
- The battery self-discharge when the vehicle is not in use, for this reason, charge the battery every 2 weeks to prevent sulfate from occurring.
- Filling a new battery with electrolyte will produce some voltage, but in order to achieve its maximum performance, always charge the battery. Also, the battery life is lengthened when it is initially charged.
- When checking the charging system, always follow the steps in the troubleshooting flow chart

18. BATTERY/CHARGING SYSTEM

BATTERY CHARGING

- This model comes with a maintenance free (MF) battery. Remember the following about MF batteries.
 - Use only the electrolyte that comes with the battery.
 - Use all of the electrolyte
 - Seal the battery properly
 - Never open the seals again
- For battery charging, do not exceed the charging current and time specified on the battery. Using excessive current or extending the charging time may damage the battery.

SPECIFICATIONS

ITEM		SPECIFICATIONS	
Battery	Capacity	12V – 12 Ah	
	Voltage (20°C/68°F)	Full charged	13.0 – 13.2 V
		Needs charging	Below 12.3 V
	Charging current	Normal	1.4 A/5 – 10 h
Quick		7 A/0.5 h	
Alternator	Capacity	300 W/5000 rpm	
	Charging coil resistance (20°C/68°F)	0.1 – 0.5Ω	

18. BATTERY/CHARGING SYSTEM

TROUBLESHOOTING

Battery is damaged or weak

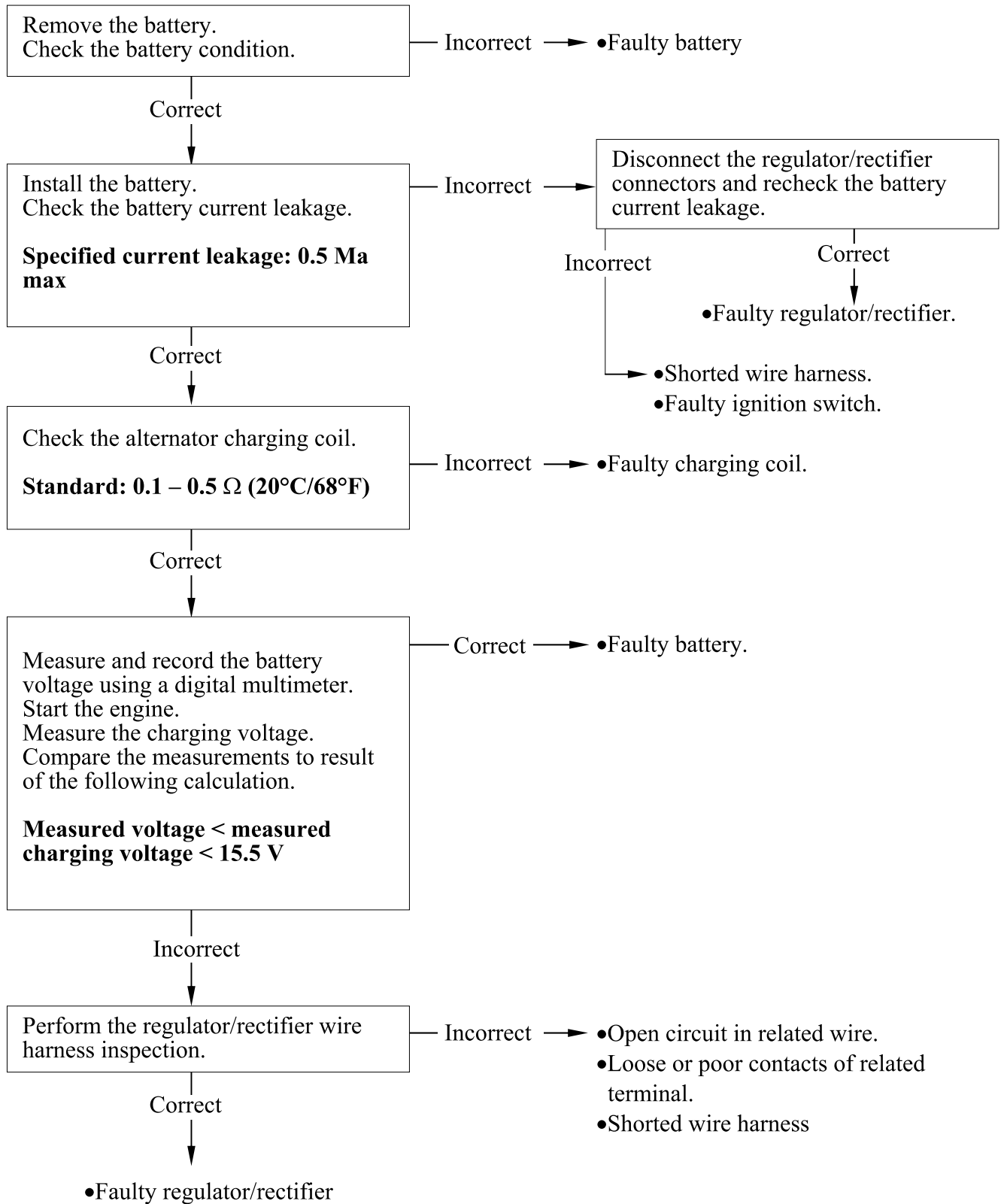

18. BATTERY/CHARGING SYSTEM

BATTERY

REMOVAL/INSTALLATION

Unlock and open the seat.
Turn ignition switch OFF.
Remove the screws and battery box cover.

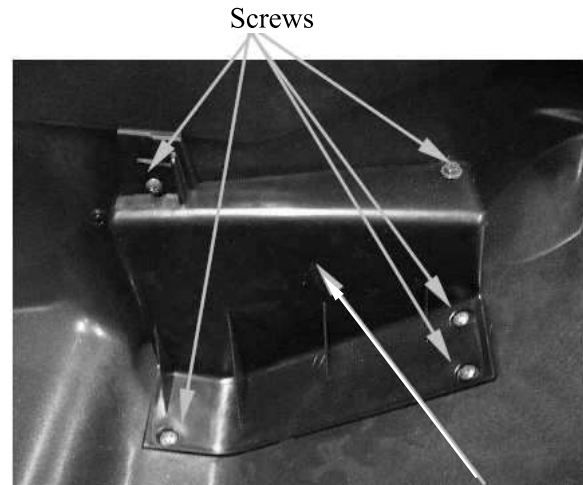

Battery Box Cover

Remove the battery retainer.
With the ignition switch to “OFF” disconnect the negative (-) terminal lead from the battery first, then disconnect the positive (+) terminal lead.
Pull out the battery from the battery box.

Installation is in the reverse order of removal.

After connecting the battery cables, coat the terminals with grease.

Positive Terminal

Negative Terminal

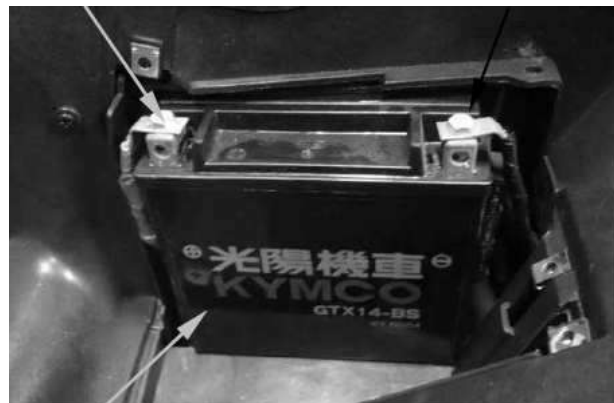

Battery

VOLTAGE INSPECTION

Remove the battery cover (see above).

Measure the battery voltage using a commercially available digital multimeter.

Voltage (20°C/68°C):

Fully charged: 13.0 13.2 V

Under charged: below 12.3 V



18. BATTERY/CHARGING SYSTEM

BATTERY CHARGING

Remove the battery (page 18-5).

Connect the charger positive (+) cable to the battery positive (+) terminal.

Connect the charger negative (-) cable to the battery negative (-) terminal.

Turn the power ON/OFF at the charger, not at the battery terminals.

Charging current time:

Standard: 1.4 A/5 10 hours

Quick: 7 A/0.5 hours

Quick charging should only be done in an emergency; slow charging is preferred. For battery charging, do not exceed the charging current and time specified on the battery. Using excessive current or extending the charging time may damage the battery.

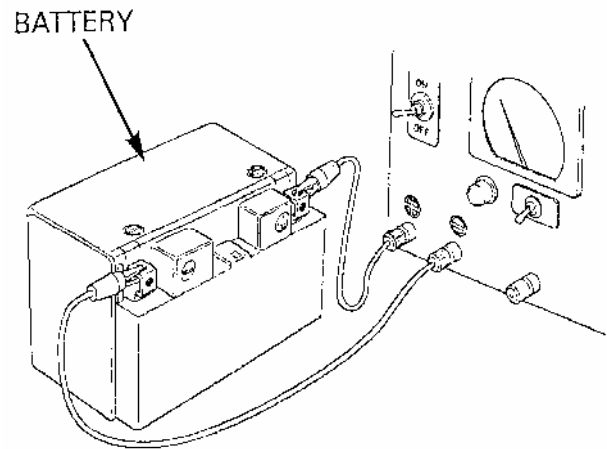

CHARGING SYSTEM INSPECTION

Remove the battery cover.

CURRENT LEAKAGE TEST

Turn the ignition switch OFF, disconnect the negative (-) cable from the battery.

Connect the ammeter (+) probe to the negative (-) cable and the ammeter (-) probe to the battery (-) terminal.

With the ignition switch OFF, check for current leakage.

When measuring current using a tester, set it to a high range, and then bring the range down to an appropriate level. Current flow higher than the range selected may blow out the fuse in the tester.

While measuring current, do not turn the ignition switch ON. A sudden surge of current may blow out the fuse in the tester.

Specified current leakage: 0.5 Ma max.

If current leakage exceeds the specified value, a shorted circuit is likely.

Locate the short by disconnecting connections one by one and measuring the current.



18. BATTERY/CHARGING SYSTEM

CHARGING VOLTAGE INSPECTION

Be sure that the battery is in good condition before performing this test.

Do not disconnect the battery or any cable in the charging system without first switching off the ignition switch. Failure to follow this precaution can damage the tester or electrical components.

Start the engine and warm it up to the operating temperature; stop the engine. Connect the multimeter between the positive and negative terminals of the battery.

To prevent short, make absolutely certain which are the positive and negative terminals or cable.

With the headlight on and turned to the high beam position, restart the engine.

Measure the voltage on the multimeter when the engine runs at 5000 rpm.

Standard:

Measured battery voltage
< Measure charging voltage
<15.5 V



ALTERNATOR CHARGING COIL INSPECTION

Remove the luggage box.

Disconnect the alternator connector.

Alternator Connector

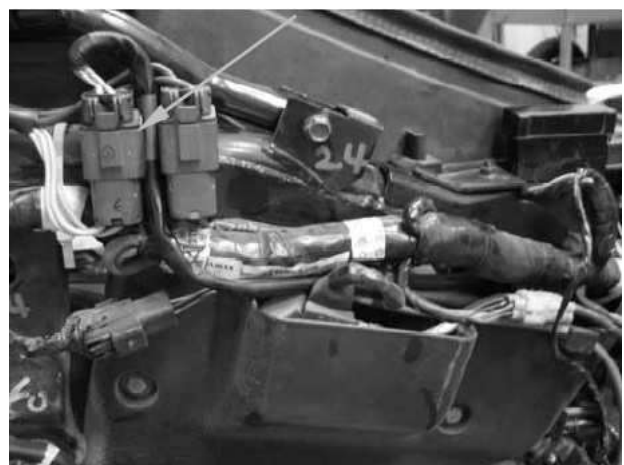

18. BATTERY/CHARGING SYSTEM

Measure the resistance between each Yellow wire terminals.

Standard: 0.1 – 0.5 Ω (20°C/68°F)

Check for continuity between each Yellow wire terminal of the alternator side connector and ground.

There should be continuity.

Replace the alternator stator if resistance is out of specification, or if any wire has continuity to ground.



Alternator Connector

REGULATOR/RECTIFIER WIRE HARNESS INSPECTION

Remove the luggage box.

Disconnect the regulator/rectifier connectors.
Check the connectors for loose contacts of corroded terminals.

Regulator/Rectifier

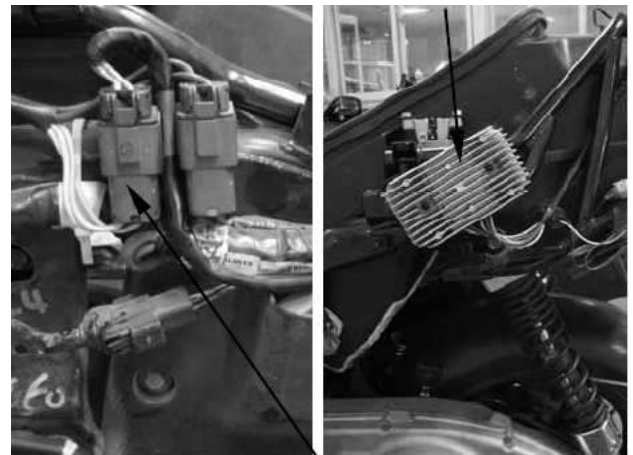

Regulator/Rectifier Connectors

Battery line

Measure the voltage between the Red/White wire terminal and ground.

There should be battery voltage at all times.

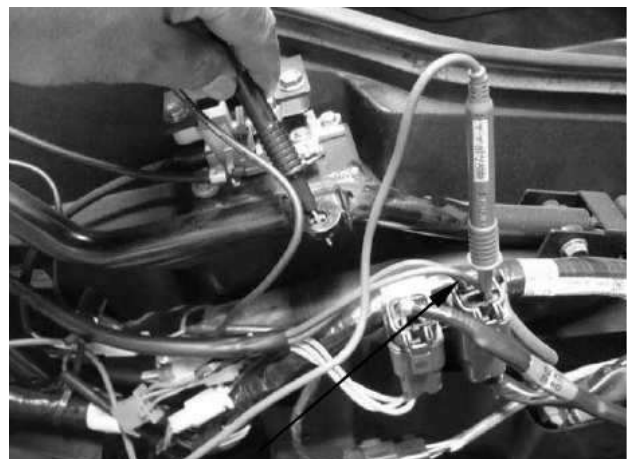

Regulator/Rectifier Connector

18. BATTERY/CHARGING SYSTEM

Ground line

Check the continuity between the Green wire terminal and ground.

There should be continuity at all times.

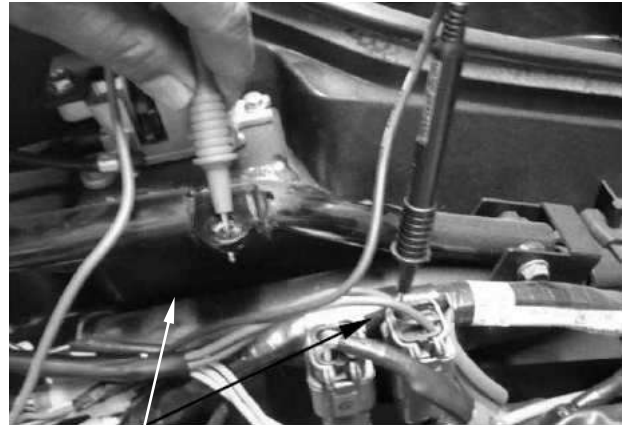

Regulator/Rectifier Connector

Charging coil line

Measure the resistance between each Yellow wire terminals.

Standard: 0.1 - 0.5 Ω (20°C/68°F)



Regulator/Rectifier Connector

Check for continuity between each Yellow wire terminal and ground.

There should be no continuity.

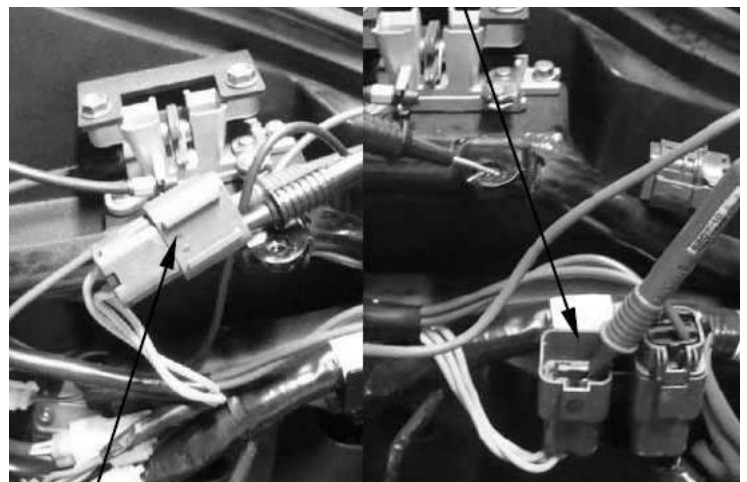

Regulator/Rectifier Connector

18. BATTERY/CHARGING SYSTEM

REMOVAL/INSTALLATION

Remove the side body cover.

Disconnect the regulator/rectifier connectors.

Remove the two bolts, regulator/rectifier and stay.

Installation is in the reverse order of removal.



19. IGNITION SYSTEM

IGNITION SYSTEM

SERVICE INFORMATION	19-1
TROUBLESHOOTING.....	19-2
IGNITION COIL INSPECTION	19-5
IGNITION PULSE GENERATOR INSPECTION	19-5

19. IGNITION SYSTEM

SERVICE INFORMATION

GENERAL INSTRUCTIONS

- Some electrical components may be damaged if terminals or connectors are connected or disconnected while the ignition switch is “ON” and current is present.
- When servicing the ignition system, always follow the steps in the troubleshooting on page 19-5.
- The ignition timing cannot be adjusted since the ignition control module is factory preset.
- The ignition control module or ECU may be damaged if dropped. Also, if the connector is disconnected when current is flowing, the excessive voltage may damage the ignition control module or ECU. Always turn off the ignition switch before servicing.
- A faulty ignition system is often related to poor connections. Check those connections before proceeding.
- Make sure the battery is adequately charged. Using the starter motor with a weak battery results in a slower engine cranking speed as well as no spark at the spark plug.
- Use a spark plug of the correct heat range. Using spark plug with an incorrect heat range can damage the engine.

SPECIFICATIONS

Item	Standard
Spark plug	NGK-CR8E
Spark plug gap	0.6~0.7 mm
Ignition system	Full transistor digital ignition
Ignition timing	Throttle position sensor

TROUBLESHOOTING

LOW PEAK VOLTAGE

- Cranking speed is too low (battery is undercharged).
- Poorly connected connectors or an open circuit in the ignition system.
- Faulty ignition-coil.
- Faulty ignition control module.

NO PEAK VOLTAGE

- Short circuit in engine stop switch or ignition switch wire.
- Faulty engine stop switch or ignition switch.
- Loose or poorly connected ignition control module connectors.
- Open circuit or poor connection in ground wire of the ignition control module.
- Faulty ignition pulse generator.
- Faulty ignition control module.

PEAK VOLTAGE IS NORMAL, BUT NO SPARK JUMPS AT THE PLUG

- Faulty spark plug or leaking ignition coil secondary current.
- Faulty ignition coil.

19. IGNITION SYSTEM

IGNITION COIL INSPECTION IGNITION COIL PRIMARY PEAK VOLTAGE

Remove the floorboard.

Check cylinder compression and check that the spark plug is installed correctly in the cylinder. Disconnect the spark plug cap from the spark plug.

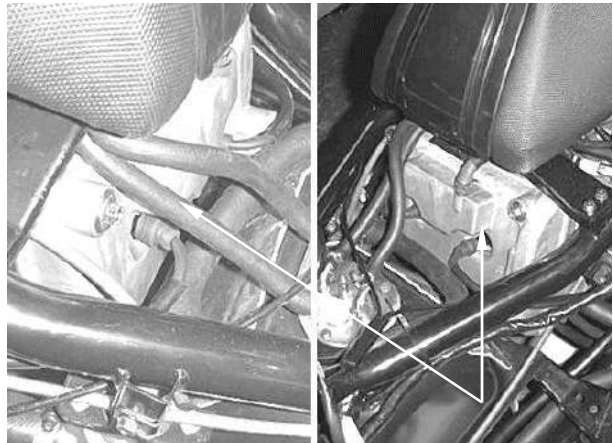

Spark Plug Cap

Connect to the spark tester to check the spark plug..



19. IGNITION SYSTEM

IGNITION PULSE GENERATOR INSPECTION

Remove the luggage box.

Disconnect the ignition pulse generator connector.

Measure the ignition pulse generator resistance between the Black wire and Blue wire.

Standard: $10.5 \pm 10\% \text{K}\Omega$ (20°C/68°F)



IGNITION COIL REMOVAL/INSTALLATION

Remove the floorboard.

Disconnect the spark plug cap from the spark plug.

Disconnect the ignition coil primary connectors.
Remove the two nuts and the ignition coil.

Installation is in the reverse order of removal.

Ignition coil inspection.

Standard: $3.57 \sim 4.83 \Omega$

$10.42 \sim 14.79 \text{K}\Omega$



Ignition Coil



20. ELECTRIC STARTER

ELECTRIC STARTER

STARTING SYSTEM LAYOUT	20-1
SERVICE INFORMATION.....	20-2
TROUBLESHOOTING.....	20-2
STARTER MOTOR	20-5
STARTER RELAY SWITCH.....	20-7

20. ELECTRIC STARTER

STARTING SYSTEM LAYOUT

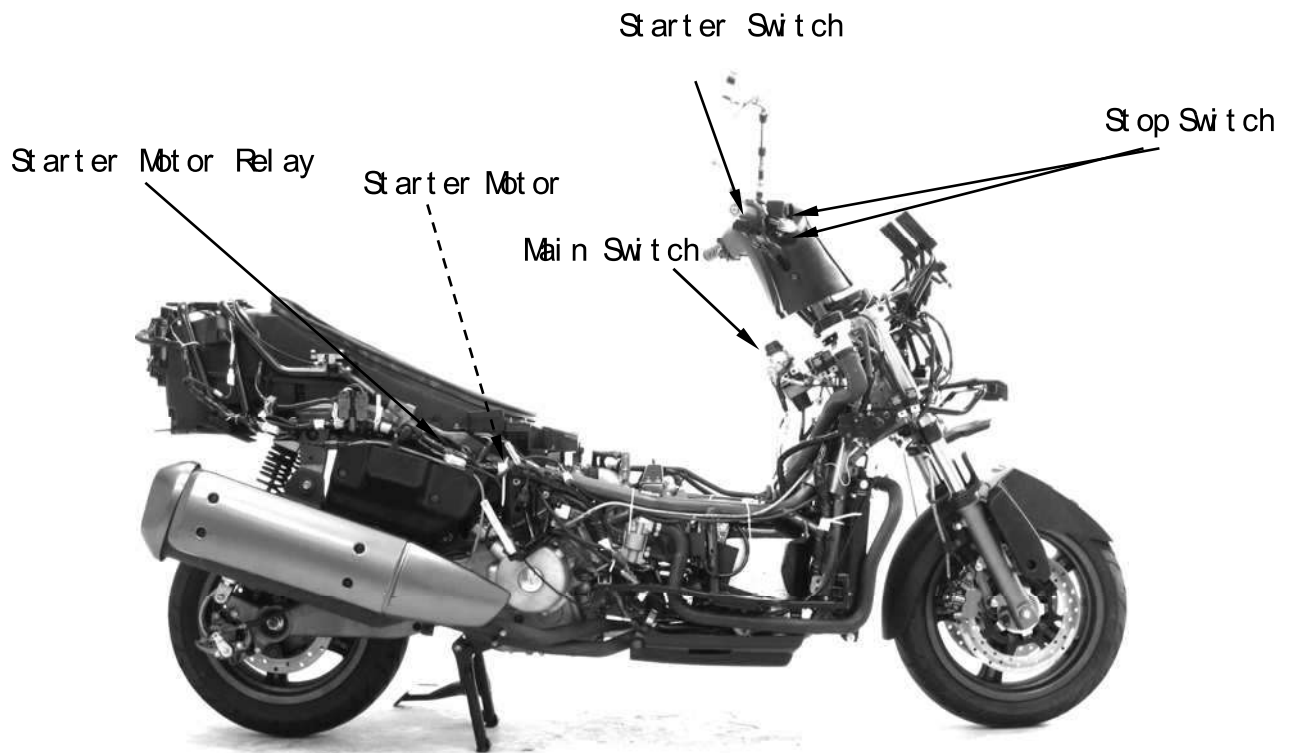

20. ELECTRIC STARTER

SERVICE INFORMATION

GENERAL

- Always turn the ignition switch to “OFF” before servicing the starter motor. The motor could suddenly start, causing serious injury.
- The starter motor can be serviced with the engine in the frame.
- When checking the starter system, always follow the steps in the troubleshooting flow chart.
- A weak battery may be unable to turn the starter motor quickly enough, or supply adequate ignition current.
- If the current is kept flowing through the starter motor to turn it while the engine is not cranking over, the starter motor may be damaged.

TROUBLESHOOTING

- Check for the following before troubleshooting:
 - Loose battery and starter motor cable
 - Discharged battery
- The starter motor can turn with the following conditions:
 - Ignition switch ON
 - Engine stop switch in RUN
 - Rear brake lever fully squeezed
 - Side stand retracted
 - Starter switch pushed

Starter motor will not turn

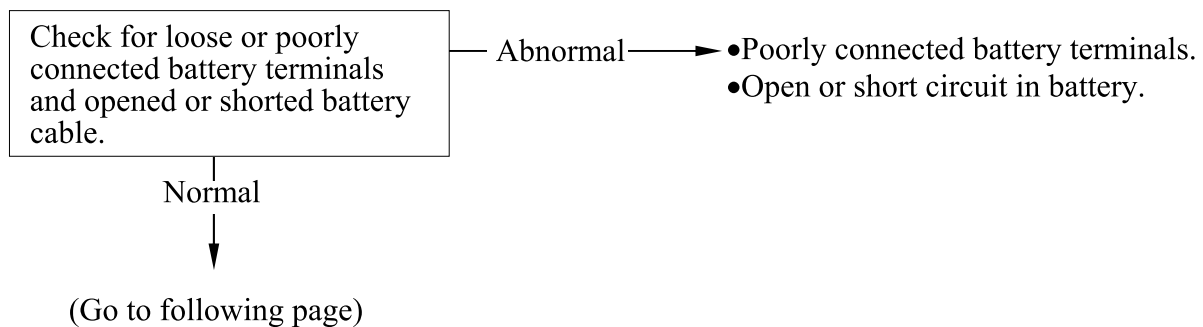

20. ELECTRIC STARTER

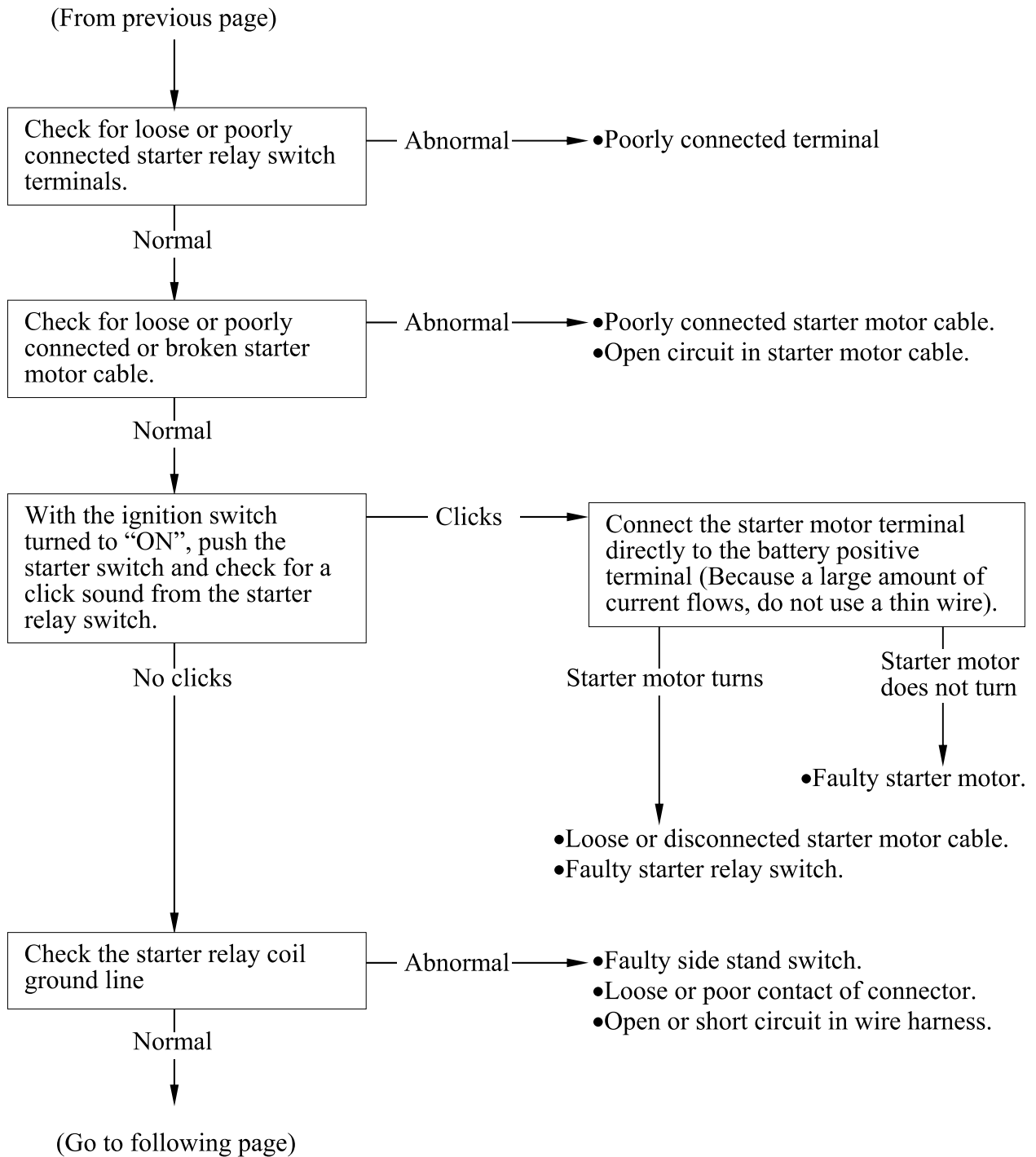

20. ELECTRIC STARTER

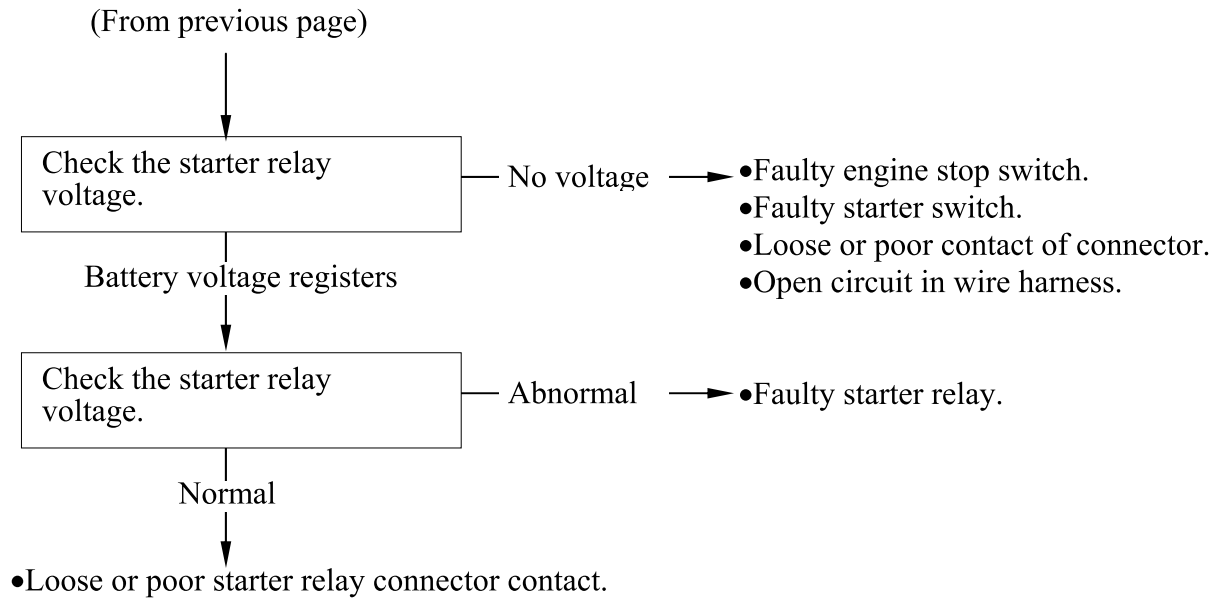

20. ELECTRIC STARTER

STARTER MOTOR

INSPECTION

Remove the luggage box.

Disconnect the starter motor cable from the starter relay switch.
Turn the ignition switch to “ON”.
Connect the starter motor cable directly to the battery positive terminal.
If the starter motor does not turn, the starter motor is faulty.

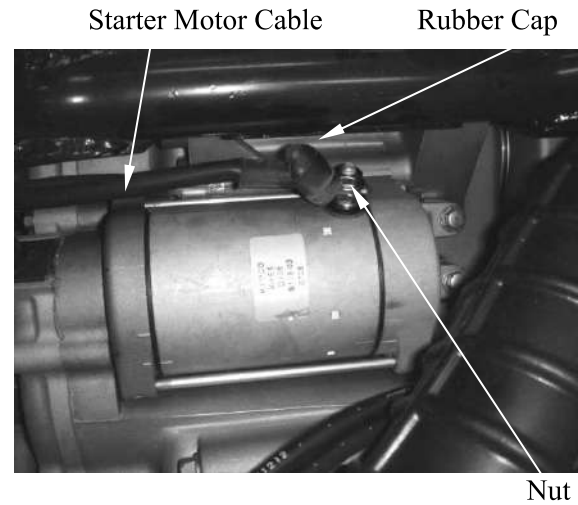

REMOVAL

Remove the throttle body.

Turn the ignition switch turned to “OFF”

Release the rubber cap and remove the terminal nut to disconnect the starter motor cable from the starter motor.

Remove the two bolts and starter motor.

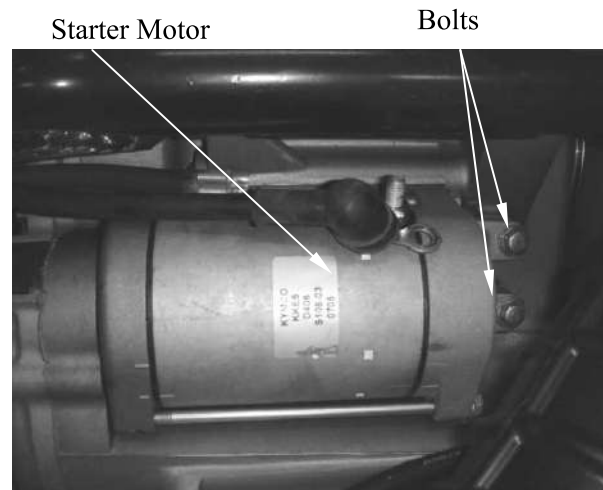

20. ELECTRIC STARTER

INSTALLATION

Coat a new O-ring with engine oil and install it into the starter motor groove.

Install the starter motor into the crankcase.

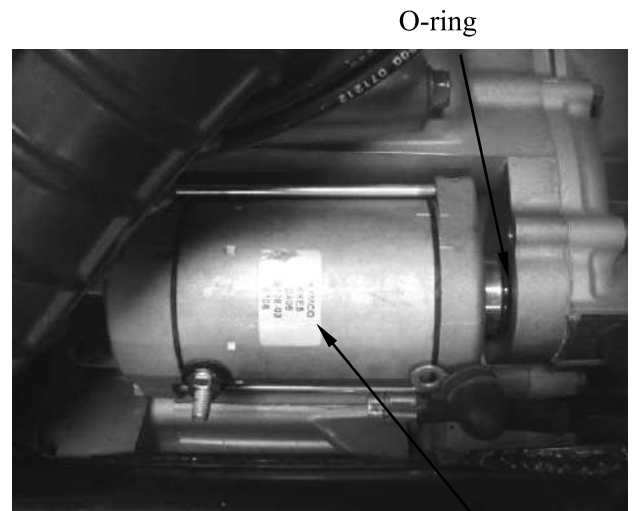

O-ring

Starter Motor

Install the two bolts and tighten them securely.

Connect the starter motor cable to motor terminal with the terminal nut and tighten it.

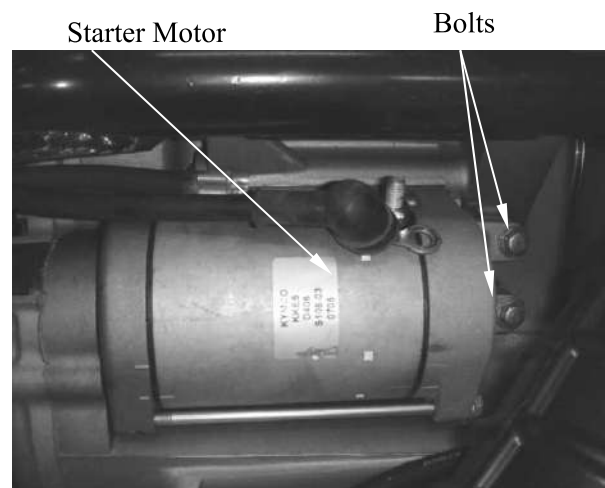

Starter Motor

Bolts

20. ELECTRIC STARTER

STARTER RELAY SWITCH

INSPECTION

Remove the luggage box.

Retracted the side stand.

Turn the ignition switch to “ON” and engine stop switch on.

Squeeze the rear brake lever fully and push the starter switch.

The coil is normal if the starter relay switch clicks.

If you do not hear the switch click. Inspect the relay switch using the procedure below.

GROUND LINE INSPECTION

Disconnect the starter relay switch connector. Check for continuity between the Green wire terminal and ground.

There should be continuity.

VOLTAGE INSPECTION

Connect the starter relay switch connector. Turn the ignition switch ON and engine stop switch to RUN.

Measure the starter relay switch Yellow/Red wire terminal and ground.

If the battery voltage appears only when the rear brake lever is squeezed fully and starter switch is pushed, the circuit is normal.

Starter Relay Switch

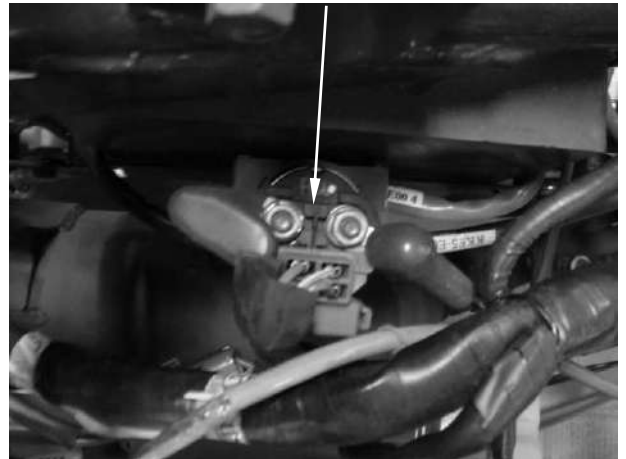

Starter Relay Connector



Starter Relay Switch

20. ELECTRIC STARTER

CONTINUITY INSPECTION

Disconnect the starter relay switch connector and cables.

Connect a fully charged 12 V battery positive wire to the relay switch Yellow/Red wire terminal and negative wire to the Green wire terminal.

There should be continuity between the cable terminals while the battery is connected, and no continuity when the battery is disconnected.

Starter Relay Switch

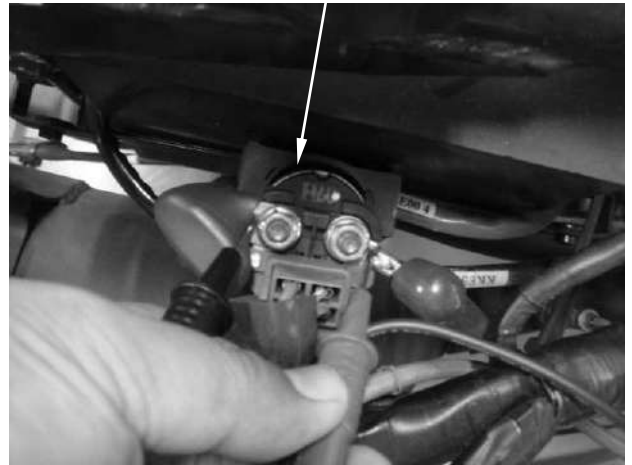

21. LIGHTS/METERS/SWITCHES

LIGHTS/METERS/SWITCHES

SERVICE INFORMATION-----	21- 1
BULB REPLACEMENT -----	21- 2
SPEED SENSOR -----	21- 5
BRAKE LIGHT SWITCH-----	21- 7
IGNITION SWITCH -----	21- 7
HANDLEBAR SWITCH -----	21- 8
PARKING SWITCH -----	21-10
LUGGAGE BOX LIGHT SWITCH -----	21-10
OIL PRESSURE SWITCH -----	21-10
FUEL UNIT -----	21-13
SIDE STAND SWITCH -----	21-13
HORN -----	21-14
BANK ANGLE SENSOR -----	21-15

21. LIGHTS/METERS/SWITCHES

SERVICE INFORMATION

GENERAL

A halogen head light bulb becomes very hot while the head light is on, and remains for a while after it is turned off. Be sure to let it cool down before servicing.

- Note the following when replacing the halogen headlight bulb
 - ™ Wear clean gloves while replacing the bulb. Do not put finger prints on the headlight bulb, as they may create hot spots on the bulb and cause it to fail.
 - ™ If you touch the bulb with your bare hands, clean it with a cloth moistened with alcohol to prevent its early failure.
 - ™ Be sure to install the dust cover after replacing the bulb.
- Check the battery condition before performing any inspection that requires proper battery voltage.
- A continuity test can be made with the switches installed on the scooter.
- Route the wires and cables properly after servicing each component.

21. LIGHTS/METERS/SWITCHES

BULB REPLACEMENT

HEADLIGHT

A halogen headlight bulb becomes very hot while the headlight is ON, and remain for a while after it is turned OFF. Be sure to let it cool down before servicing.

Remove the front cover

Disconnect the headlight connector from the headlight bulb and remove the dust cover.

Unhook the retainer and remove the bulb from the headlight case.

Avoid touching the halogen headlight bulb. Finger prints can create hot spots that cause a bulb to break.

Install a new bulb in the headlight case, by aligning the bulb tab with the case groove.

Hook the retainer.

Install the dust cover properly on to the headlight and connect the headlight connector

Headlight Connector



Dust Cover

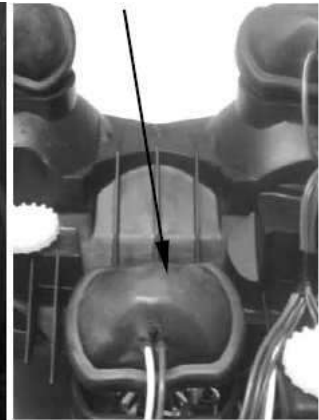

Retainer



Bulb

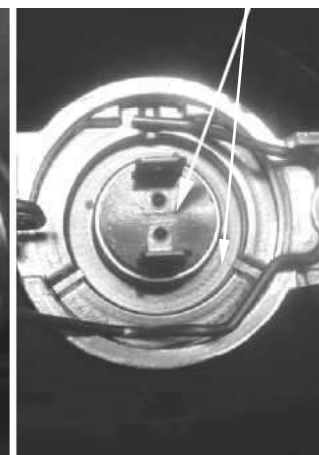

POSITION LIGHT

Remove the front cover.

Remove the bulb socket and position light bulb. Remove the bulb and replace with a new one.

Installation is in the reverse order of removal.

Socket

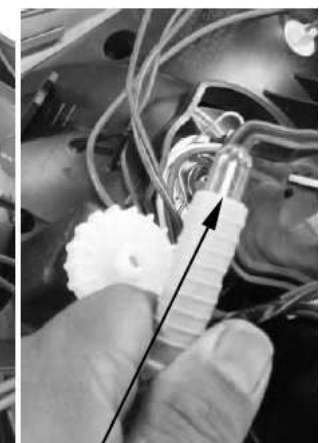

Bulb

21. LIGHTS/METERS/SWITCHES

FRONT TURN SIGNAL

Remove the front cover.

Turn the bulb socket counterclockwise to remove it.
Remove the bulb and replace with a new one.

Installation is in the reverse order of removal.

Socket



TAILLIGHT/BRAKE LIGHT, REAR TURN SIGNAL

Remove the six screws and lens.

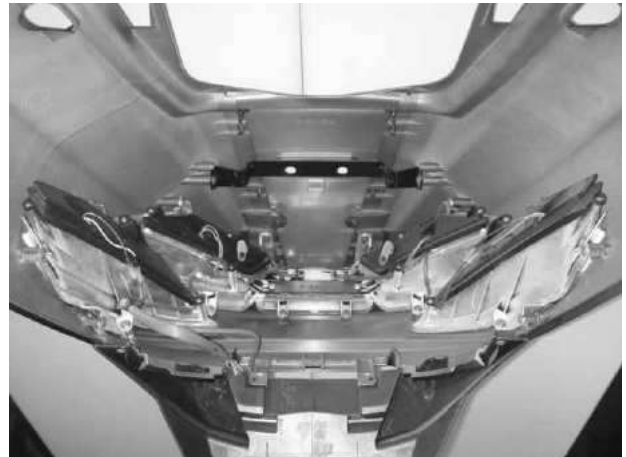

Taillight/Brake light

Remove the two screws and remove the taillight/brake light.



21. LIGHTS/METERS/SWITCHES

Disconnect the KYMCO logo assembly.

Installation is in the reverse order of removal.



LICENSE LIGHT

Remove two screws.
Disconnect the license light connector and
remove the license light.



Screws

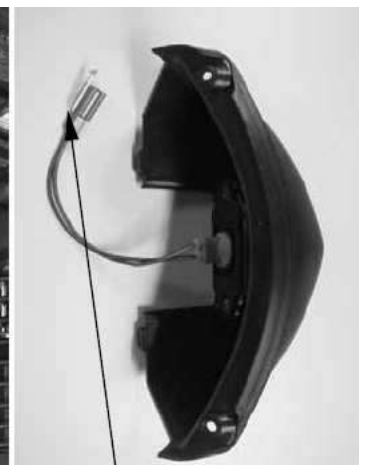

Connector

21. LIGHTS/METERS/SWITCHES

Remove the bulb socket and license light bulb.
Remove the bulb and replace with a new one.

Installation is in the reverse order of removal.

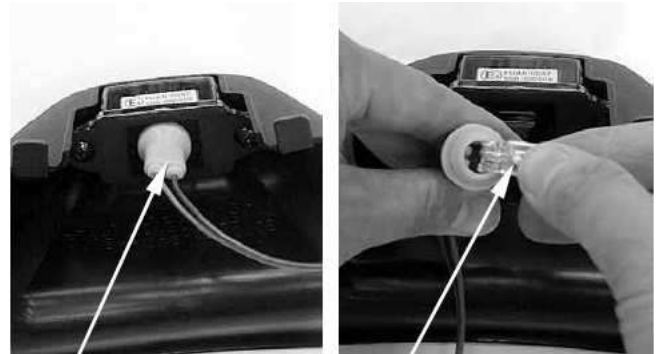

Socket

Bulb

Speed Sensor connector

SPEED SENSOR REMOVAL/INSTALLATION

Remove the front cover.

Disconnect the speed sensor connector.
Remove the bolt and speed sensor.

Installation is in the reverse order of removal.

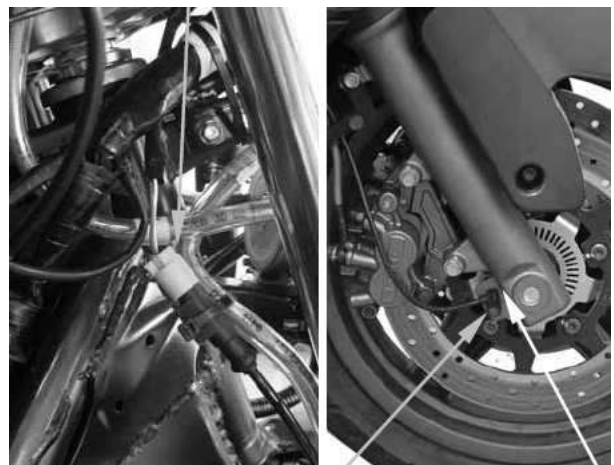

Bolt

Speed Sensor

INSPECTION

Measure the speed sensor to speed sensor guide clearance.

Standard: 0.3 – 1.2 mm

21. LIGHTS/METERS/SWITCHES

ADJUSTMENT

Remove the bolt and speed sensor.

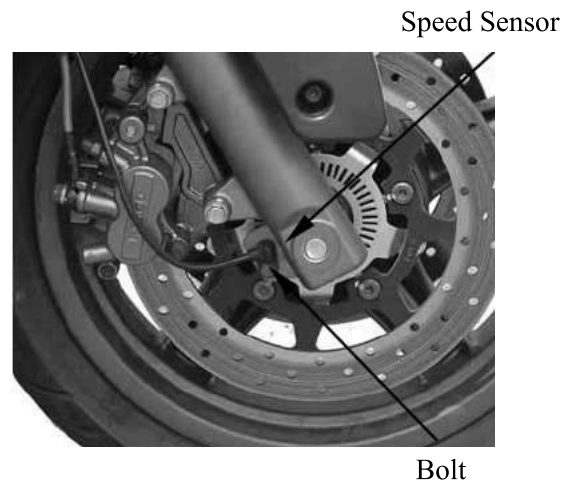

Remove the speed sensor.

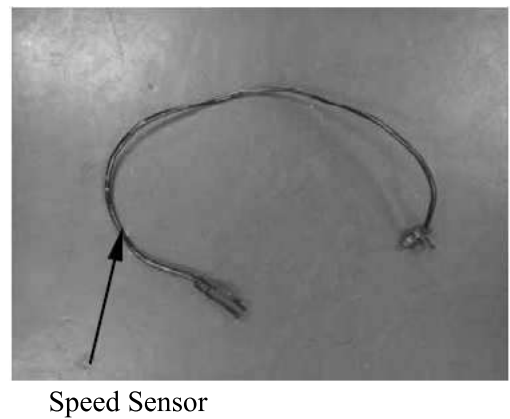

21. LIGHTS/METERS/SWITCHES

BRAKE LIGHT SWITCH

Remove the upper handlebar cover.

Disconnect front or rear light switch connector and check for continuity between the switch terminals.

There should be continuity with the front or rear brake lever squeezed, and there should be no continuity with the front or rear brake lever is released.

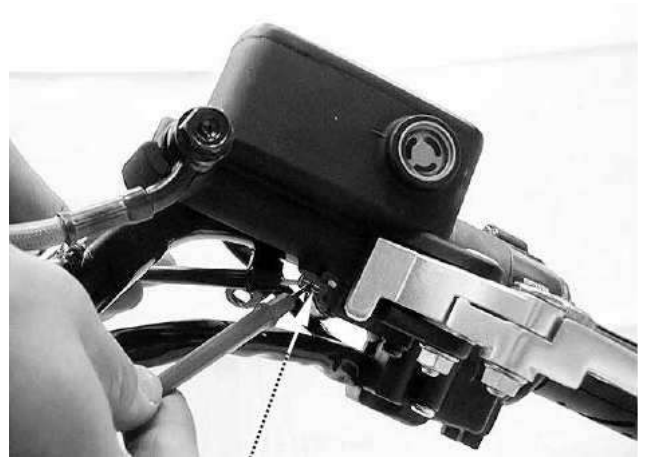

Brake Light Switch

MAIN SWITCH INSPECTION

Remove the front cover.

Disconnect the ignition switch connector and check for continuity at the switch side connector terminals.

Continuity should exist between the color code wires as follows:

	BAT2	BAT1	HA1	BAT3	HA2	IG	E
LOCK						●—●	●—●
OFF		●—●	●—●	●—●	●—●	●—●	●—●
ON	●—●	●—●	●—●	●—●	●—●		
	B	R	B/L1	R/W	B/L2	B/W	G

Connector



21. LIGHTS/METERS/SWITCHES

HANDLEBAR SWITCH

INSPECTION

Remove the front cover.

Right handlebar switch

Disconnect the right handlebar switch connector and check for continuity at switch side connector terminals.

Continuity should exist between the color code wires as follows:

	BAT3	PO	TL	HL
P	○	○	○	
H	○		○	○
COLOR	BR/L	BR/W	BR	W/L

Inspection of hazard switch and engine stop switch.

Check if hazard lamp lights when turning on the hazard switch.

ENGINE STOP SW

	IG	BAT3
OFF		
RUN	○	○
COLOR	B/W	B/G

Light Switch



Starter Switch

Hazard Switch



Engine Stop Switch

21. LIGHTS/METERS/SWITCHES

Left handlebar switch

Disconnect the left handlebar switch connector and check for continuity at switch side connector terminals.

Continuity should exist between the color code wires as follows:

WINKER SW

	WR	R	L
R	○—○		
N			
L	○—○		
COLOR	GR	SB	O

HORN SW

	BAT4	HO
FREE		
PUSH	○—○	
COLOR	BR/L	LG

PASSING SW

	BAT4	HI
FREE		
PUSH	○—○	
COLOR	BR/L	L

Turn Signal Switch (Winker Switch)



Horn Switch

Passing Switch



Dimmer Switch

DIMMER SW

	HL	HI	LO
LO	○—○		
(N)	○—○	○—○	○—○
HI	○—○		
COLOR	W/L	L	W

21. LIGHTS/METERS/SWITCHES

PARKING SWITCH INSPECTION

Remove the front cover.

Disconnect the parking switch connector and check for continuity between the switch terminals.

There should be continuity with the parking lever pull up, and there should be no continuity with the front brake lever is push down.



Parking Brake Switch Connector

Luggage Box Light Switch

LUGGAGE BOX LIGHT SWITCH INSPECTION

Remove the luggage box.

Disconnect the luggage box light switch connector and check for continuity between the switch terminals.

There should be no continuity with the luggage box light switch pushed, and there should be continuity with the luggage box light switch is released.



Luggage Box Light Switch Connector

OIL PRESSURE SWITCH INSPECTION

If the oil pressure warning indicator stays on while the engine running, check the engine oil level before inspection.

Make sure that the oil pressure warning indicator come on with the ignition switch ON.

Oil Pressure Warning Indicator

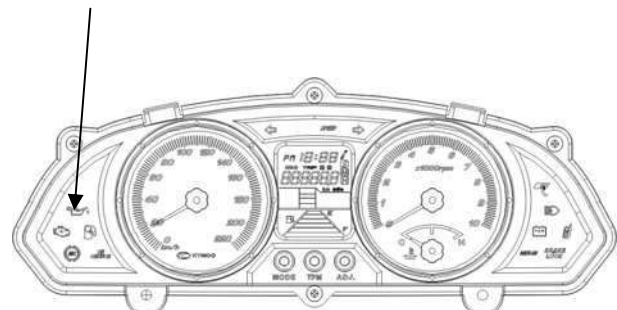

21. LIGHTS/METERS/SWITCHES

If the indicator does not come on, inspect as follow:

Remove the dust cover and disconnect oil pressure switch terminal.

Dust Cover



Short the oil pressure switch wire terminal with the ground using a jumper wire.

The oil pressure warning indicator comes on with the ignition switch is ON.

If the light does not comes on, check the fuse and wires for a loose connection or an open circuit.

Start the engine and make sure that the light goes out.

If the light does not go out, check the internal oil for leak.

If the engine oil does not leak, replace the oil pressure switch.

Oil Pressure Switch Terminal



Oil Pressure Switch

REMOVAL/INSTALLATION

Remove the dust cover and disconnect oil pressure switch terminal.

Remove the oil pressure switch from the crankcase.

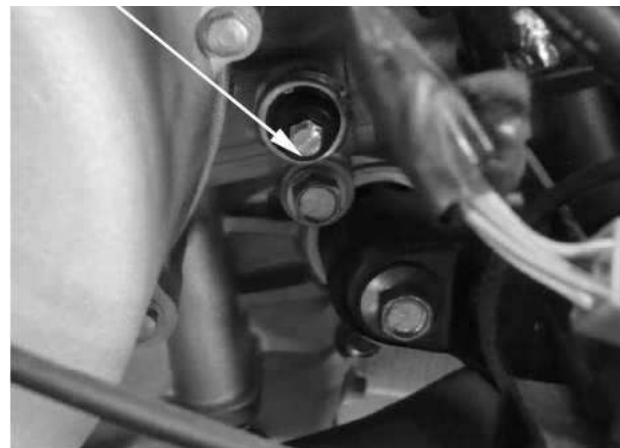

21. LIGHTS/METERS/SWITCHES

Apply sealant to the oil pressure switch threads as shown.

Install the oil pressure switch onto the crankcase, tighten it to the specified torque.

Torque: 1.2 kgf•m

Do not apply sealant to the thread head 3 – 4 mm (0.1 – 0.2 in)

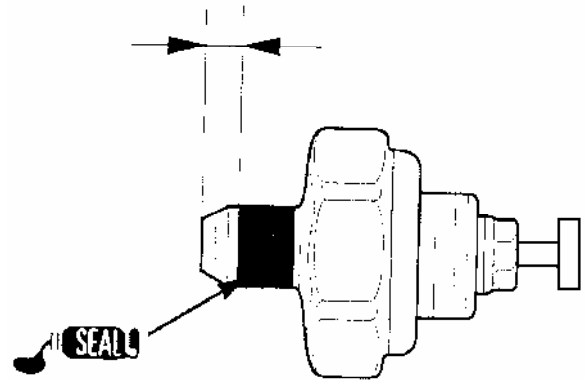

Oil Pressure Switch Terminal

Connect the oil pressure switch terminal to the switch.

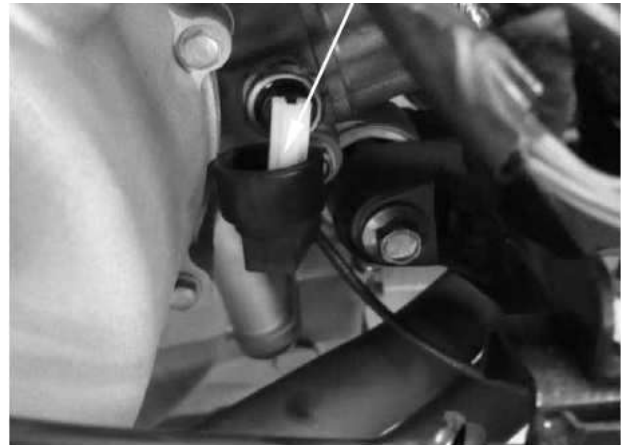

Dust Cover

Install the dust cover.



21. LIGHTS/METERS/SWITCHES

FUEL UNIT

REMOVAL

Remove the floorboard.

Disconnect the fuel unit connector.

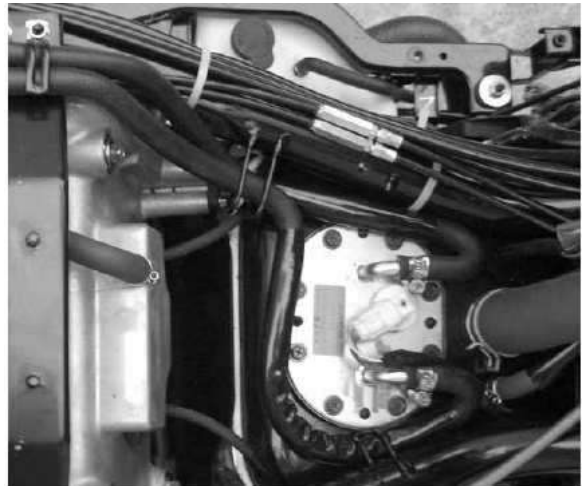

SIDE STAND SWITCH

INSPECTION

Remove the left floor skirt.

Disconnect the side stand switch connector.
There should be continuity between the Yellow/Green and Green with the side stand retracted.

There should be continuity between the Yellow/Black and Green with the side stand applied.

Side Stand Switch Connector

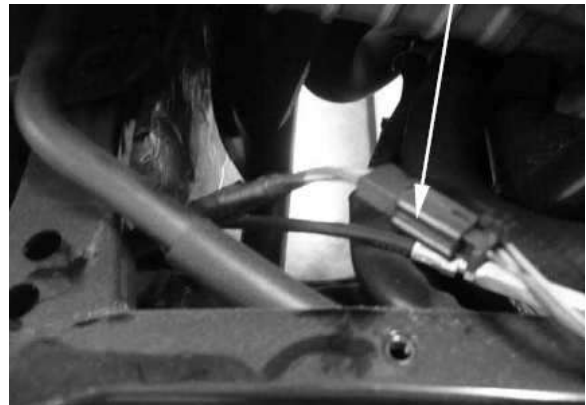

REMOVAL

Remove the left floor skirt.

Disconnect the side stand switch connector.
Remove the bolt and side stand switch from the side stand.



Bolt

21. LIGHTS/METERS/SWITCHES

Installs the side stand switch aligning the switch pin with the side stand hole.

Install and tighten the side stand switch bolt securely.

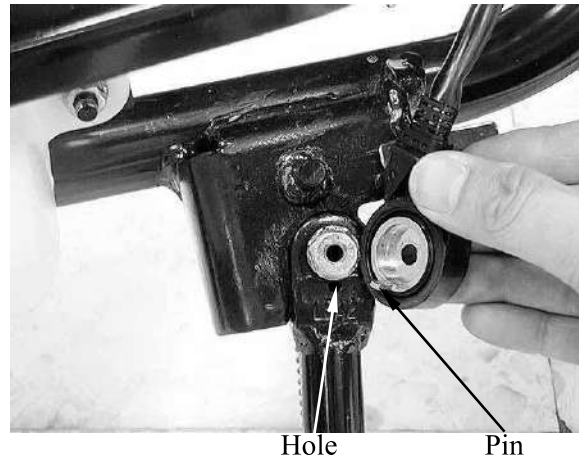

HORN INSPECTION

Remove the front cover

Disconnect the horn connectors from the horn.

Connect a 12 V battery to the horn terminals.
The horn is normal if it sounds when the 12 V battery is connected across the horn terminals.

Connector

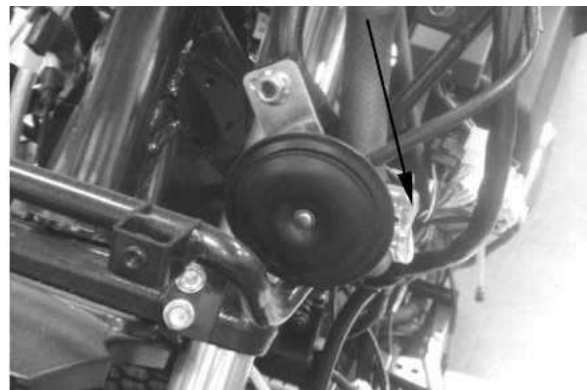

REMOVAL/INSTALLATION

Remove the front cover

Disconnect the horn connectors from the horn.
Remove the nut and horn.

Installation is in the reverse order of removal.

Horn

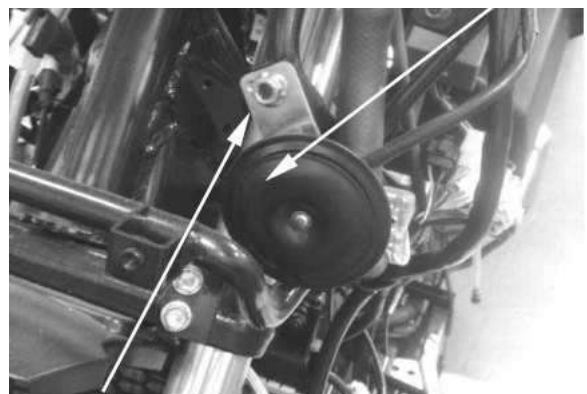

Nut

21. LIGHTS/METERS/SWITCHES

BANK ANGLE SENSOR INSPECTION

Support the scooter level surface.
Remove the meter panel.

Turn the ignition switch to “ON” and measure the voltage between the following terminals of the bank angle sensor connector with the connector connected.

TERMINAL	STANDARD
Bw/Green	3.7~4.4V
Black/Green	Battery voltage

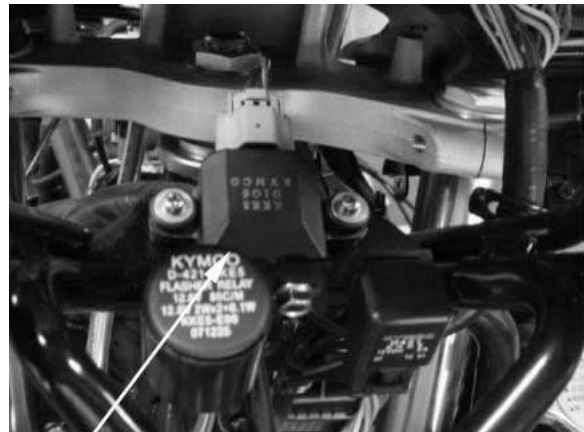

Bank Angle Sensor

The engine should stop as you incline the bank angle sensor approximately 60 degrees to the left or right.

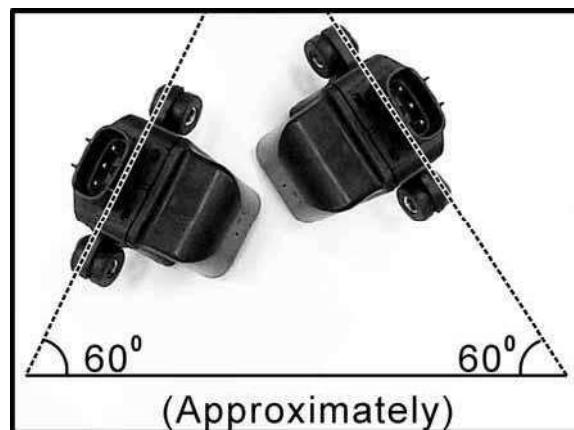

REMOVAL/INSTALLATION

Disconnect the bank angle sensor connector.
Remove the two screws, washers and bank angle sensor.

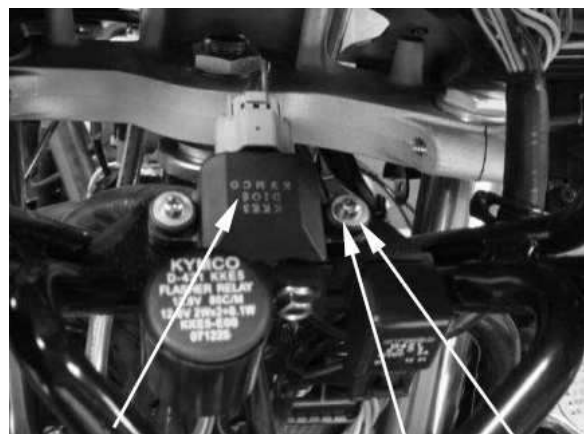

Bank Angle

Sensor Screws/Washers

21. LIGHTS/METERS/SWITCHES

Installation is in the reverse order of removal.

Install the bank angle sensor with its
“UP” mark facing up.

Tighten the mounting screws securely.



22. ANTI-LOCK BRAKE SYSTEM (ABS)

ANTI-LOCK BRAKE SYSTEM (ABS)

22

ABS Indicator Light-----	22	01
ABS Introduction-----	22	02
ABS Parts Location -----	22	03
Wheel Speed -----	22	04
ABS ECU & ABS Hydraulic Unit -----	22	06
ABS ECU GUARANTEE-----	22	07
Diagnostic Tool Operation -----	22	08
Bosch ABS8m DTC List -----	22	13

22-0

ABS Indicator Light

The ABS indicator light locates in the meter position as following picture show. This light will come on when the ignition switch being turned on and go off shortly after the vehicle starts

22. ANTI-LOCK BRAKE SYSTEM (ABS)

moving over 6km/hr speed.

If there is anything wrong with the ABS, the indicator will keep lighting. Even though the ABS has failed to be functioned, the brakes still can be applied normally.

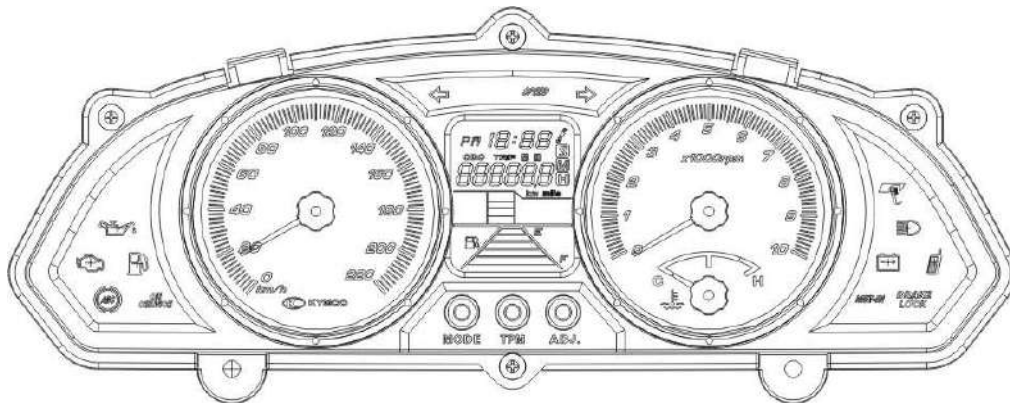

ABS indicator location

22. ANTI-LOCK BRAKE SYSTEM (ABS)

ABS Introduction

ABS is designed to help prevent the wheels from locking up when the brakes are applied hard while running straight. The ABS automatically regulates brake force.

Intermittently gaining gripping force and braking force helps prevent wheel lock-up and allows stable steering control while stopping.

Brake control function is identical to that of conventional vehicle. The brake lever is used for the front brake and rear brake.

Although the ABS provides stability while stopping by preventing wheel lock-up, remember the following characteristics:

- ABS can not compensate for adverse road conditions, misjudgment or improper application of brakes. You must take the same care as with vehicle not equipped with ABS.
- ABS isn't designed to shorten the braking distance. On loose, uneven or downhill surfaces, the stopping distance of a vehicle with ABS may be longer than that of an equivalent vehicle without ABS. Use special caution in such areas.
- ABS will help prevent wheel lock-up when braking in straight line but it cannot control wheel slip, which may be caused by braking during cornering. When turning a corner, it is better to limit braking to the light application of both brakes or not to brake at all. Reduce your speed before you get into the corner.
- The computer could inter-grade in the ABS compare vehicle speed with wheel speed. Since non-recommended tires can affect wheel speed, they may confuse, Which can extend distance.

Use of non-recommended tires may cause malfunctioning of ABS and lead to extended braking distance. The rider could have an accident as a result. Always use standard for this recommended vehicle.

NOTICE:

- When the ABS is functioning, you may feel a pulsing in the brake lever. This is normal. You need not suspend applying brakes.
- ABS does not function at speeds of approx. 10 km/h or below.
- ABS does not function if battery is discharged or battery power supply malfunction. (Light will come on)

22. ANTI-LOCK BRAKE SYSTEM (ABS)

Parts Location

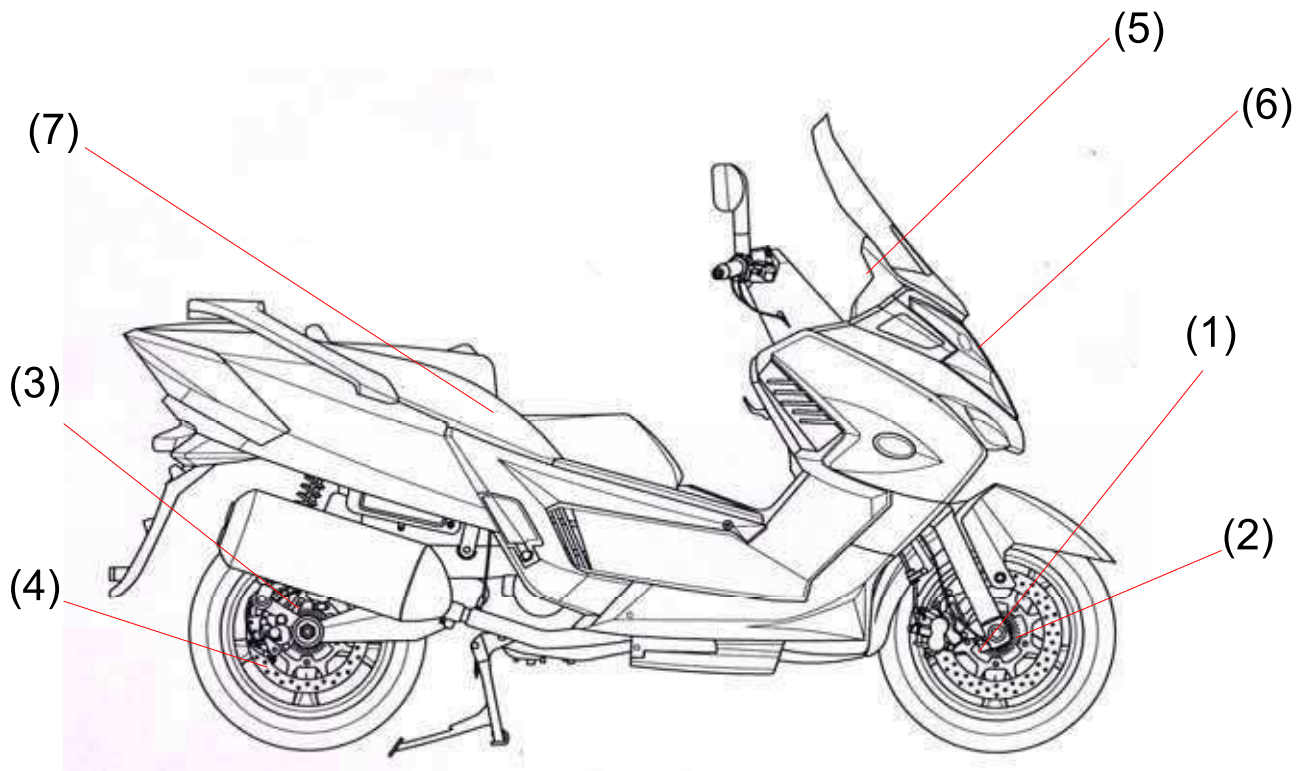

1. Front Wheel speed Sensor
2. Front Wheel speed Sensor Rotor
3. Rear Wheel speed Sensor
4. Rear Wheel speed Sensor Rotor
5. ABS indicator light
6. ABS ECU & ABS Hydraulic Unit
7. ABS diagnosis tool Connector

22. ANTI-LOCK BRAKE SYSTEM (ABS)

WHEEL SENSOR

REMOVAL & INSPECTION

Remove a bolt attaching to the front wheel speed sensor

Remove the front wheel speed sensor.

Install the front wheel speed sensor.



Remove the connector of front wheel speed sensor

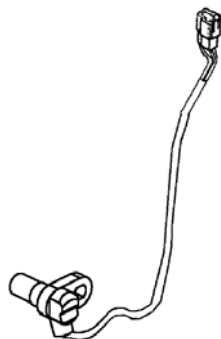

Front Wheel Speed Sensor

※ **Standard clearance:** Less than 1.2 mm between the Front wheel speed sensor and Front Wheel Speed Sensor Rotor

22. ANTI-LOCK BRAKE SYSTEM (ABS)

Remove the rear wheel speed sensor.
Remove a bolt attaching to the rear wheel speed sensor



Remove the connector of rear wheel speed sensor

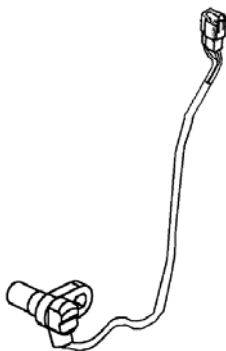

Rear Wheel Speed Sensor

※ **Standard clearance: Less than 1.2 mm between the Front wheel speed sensor and Front Wheel Speed Sensor Rotor**

22. ANTI-LOCK BRAKE SYSTEM (ABS)

ABS ECU REMOVAL & INSTALLATION

The coupler is used for automobile's waterproof. Please take care of operation.

Please keep a good ventilating about ECU in order to prevent the ABS ECU from high temperature.



(1) Push upward

(2) Take right out

(3) Finished

ABS ECU & ABS Hydraulic Unit



When replacing a new Hydraulic Unit, don't need to drain the brake fluid.

22. ANTI-LOCK BRAKE SYSTEM (ABS)

ABS ECU GUARANTEE:

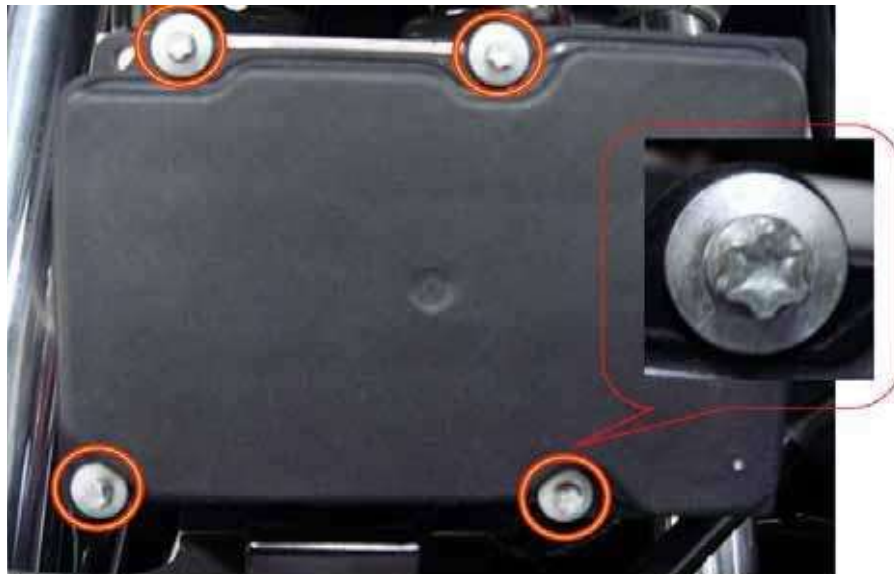

Don't remove four special bolts to take out the ABS ECU. If remove it during the guarantee period. KYMCO can not take a responsibility for it.

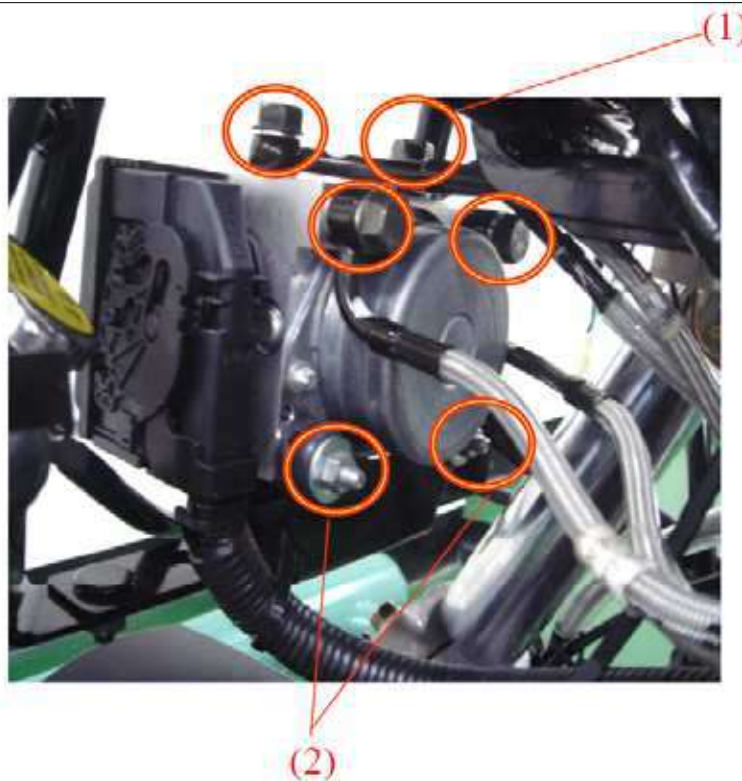

※ Don't need to drain the brake fluid if replace a new ECU Hydraulic unit.
(1) 4 oil tube bolts with torque 3.5 kgf.m (2) 2 fixed bolts with torque 0.8 kgf.m

DIAGNOSTIC TOOL OPERATION



1. Connect the KYMCO Fi Diagnostic tool
2. Put the side stand upward and ENG. stop switch is at "RUN" position.
3. Connect the diagnostic tool connector. (KYMCO Fi Diagnostic tool Power comes from vehicle's Battery)



Self-Diagnostic Tool Connector

22. ANTI-LOCK BRAKE SYSTEM (ABS)

4. Choose Fi ECU Version and then push down button for three times.

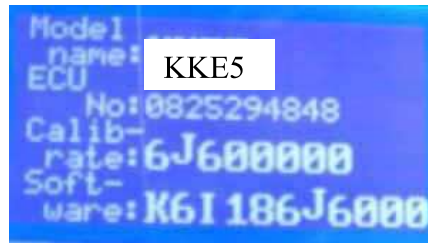

5. Choose No.2 ABS SYS ECU and then push up button to previous.

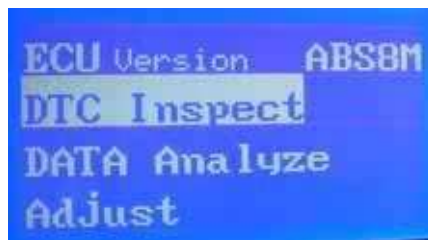
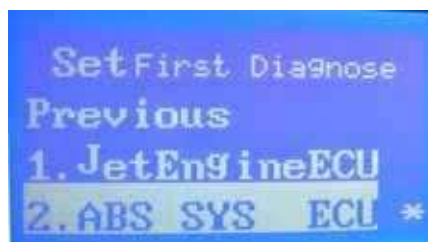

6. Confirming ECU Version and then enter ABS system.

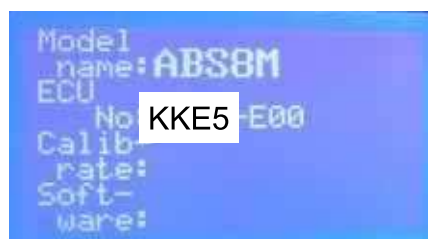

7. Choose ECU Version and then push "Enter" button.



22. ANTI-LOCK BRAKE SYSTEM (ABS)

8. Confirm ABS ECU Version if is KKE5-E00

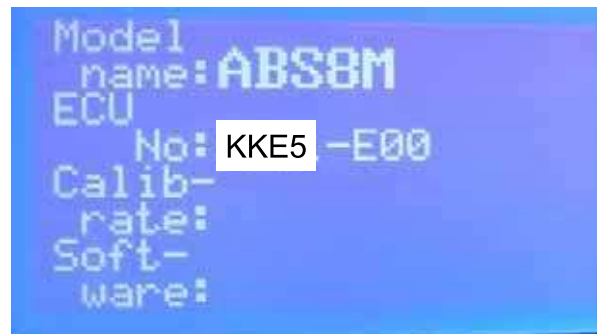

9. Choose DTC Inspect



10. Load DTC (Active Occurred History)

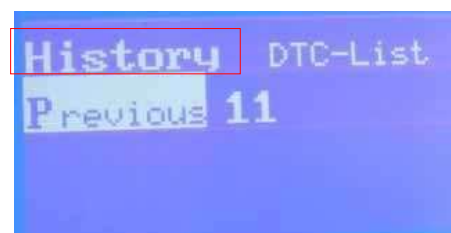
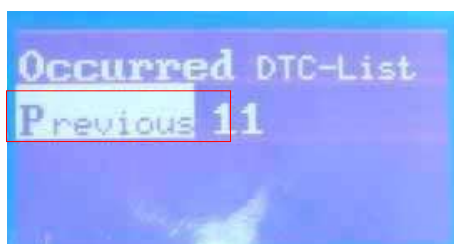
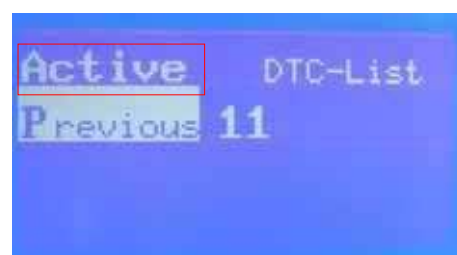
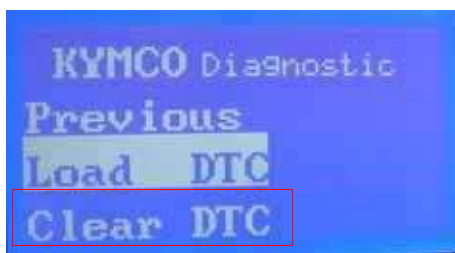

22. ANTI-LOCK BRAKE SYSTEM (ABS)

DTC DISPLAYED

1. Rear wheel speed sensor disconnect



2. Front wheel speed sensor disconnect



DTC CLEARED

1. Choose "Clear DTC" and then push "Enter" button.

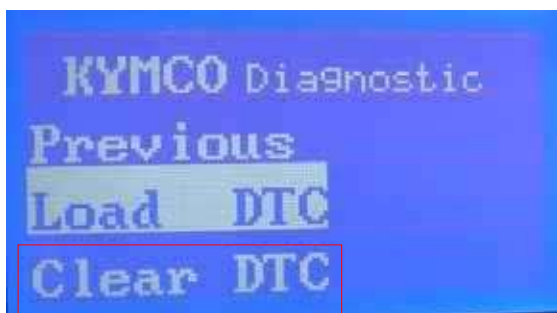

2. Clearing DTC completed until the DTC red lamp is off.



22. ANTI-LOCK BRAKE SYSTEM (ABS)

DATA ANALYZE

1. Choose "DATA Analyze" and then push "Enter" button

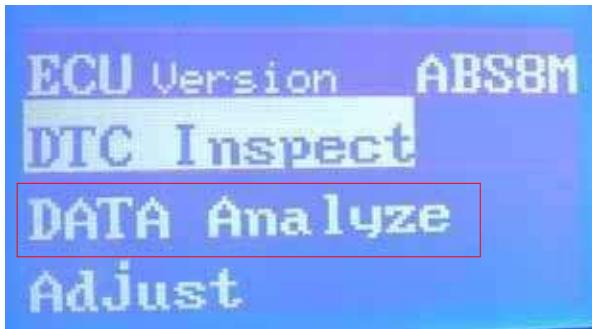

2. Front wheel speed & Rear wheel speed & Battery volt

Battery volt: Standard 9.6~16.7V

KYMCO Diagnosis 01

Fr Speed 5 km/hr

Re Speed 5 km/hr

Battery Volt 12.6V

You can turn the front or rear wheel to check if the wheel speed is figured.

Bosch ABS8m DTC List

Bosch ABS8m DTC LIST		
Code NO (Diagnostic Tool) 3620A-LEB2- E00	DTC (PDA)	description
01	5013	Rear Inlet Valve malfunction(EV)
02	5014	Rear Outlet Valve malfunction (AV)
03	5017	Front Inlet Valve malfunction (EV)
04	5018	Front Outlet Valve malfunction (AV)
05	5019	Valve Relay malfunction (Failsafe relay)
06	5025	Deviation between Wheel speeds (WSS_GENERIC)
07	5035	Pump Motor Malfunction
08	5042	Front wheel speed sensor malfunction-Plausibility
09	5043	Front wheel speed sensor Disconnection/gnd Short/Uz Short
10	5044	Rear wheel speed sensor malfunction – Plausibility
11	5045	Rear wheel speed sensor Disconnection/gnd Short/Uz Short
12	5052	Power Supply Malfunction (Under Voltage)
13	5053	Power Supply Malfunction (Over Voltage)
14	5055	ECU malfunction