

PREFACE

This Service Manual describes the technical features and servicing procedures for the KYMCO **LIKE II 125**.

Section 1 contains the precautions for all operations stated in this manual. Read them carefully before starting any operation.

Section 2 is the removal/installation procedures for the frame covers, which are subject to higher removal/installation frequency during maintenance and servicing operations.

Section 3 describes the inspection/adjustment procedures, safety rules and service information for each part, starting from periodic maintenance.

Sections 6 through 17 give instructions for disassembly, assembly and inspection of engine, chassis frame and electrical equipment.

Most sections start with an assembly or system illustration and troubleshooting for the section. The subsequent pages give detailed procedures for the section.

Our company reserves the right to make any alteration in the design.

The information and contents included in this manual may be different from the motorcycle in case specifications are changed.

TABLE OF CONTENTS

GENERAL INFORMATION	1
FRAME COVERS/EXHAUST MUFFLER	2
INSPECTION/ADJUSTMENT	3
LUBRICATION SYSTEM	4
FUEL SYSTEM	5
ENGINE REMOVAL/INSTALLATION	6
CYLINDER HEAD/VALVES/PISTON	7
DRIVE AND DRIVEN PULLEYS/KICK STARTER	8
FINAL REDUCTION	9
STEERING HANDLEBAR/FRONT WHEEL/FRONT BRAKE/FRONT SHOCK ABSORBER/FRONT FORK	10
REAR WHEEL /REAR BRAKE /REAR SUSPENSION	11
BATTERY /CHARGING SYSTEM	12
IGNITION SYSTEM	13
STARTING SYSTEM	14
LIGHTS/INSTRUMENTS/SWITCHES	15

KWANG YANG MOTOR CO., LTD.

QUALITY TECHNOLOGY DEPARTMENT

EDUCATION SECTION

1. GENERAL INFORMATION

1

ENGINE SERIAL NUMBER	1- 1	LUBRICATION POINTS.....	1-15
SPECIFICATIONS.....	1- 2	CABLE & HARNESS ROUTING.....	1-17
SERVICE PRECAUTIONS	1- 3	TROUBLESHOOTUNG.....	1-20
TORQUE VALUES	1-11		
SPECIAL TOOLS	1-12		

ENGINE SERIAL NUMBER

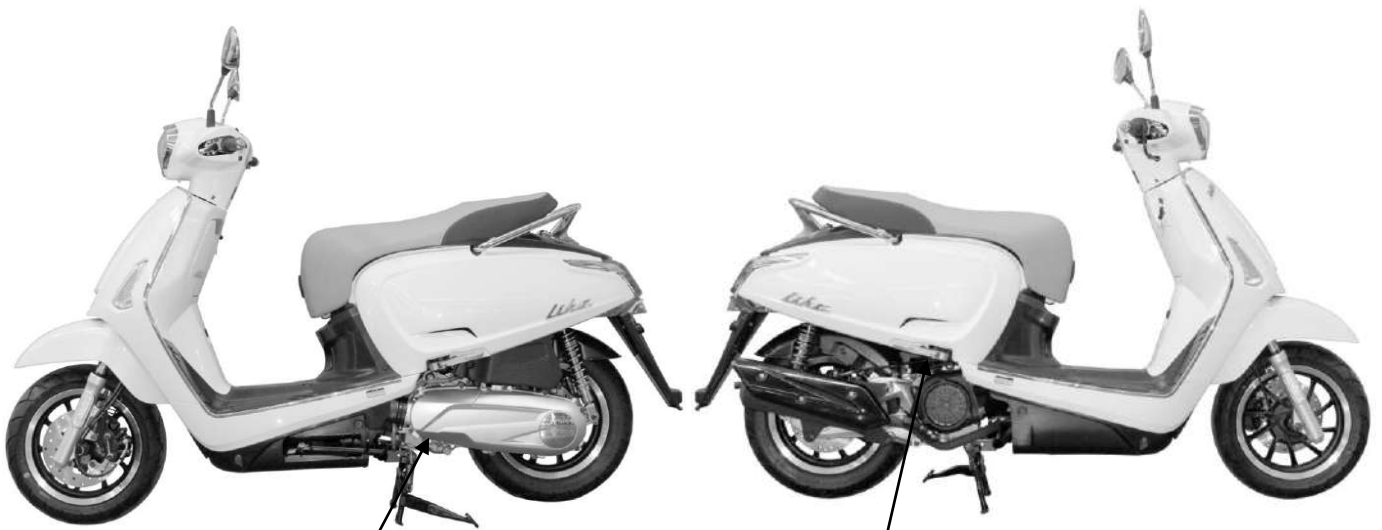

Location of Engine Serial Number



Location of Frame Serial Number

SPECIFICATIONS

Name & Model		LIKE 125	
Overall length (mm)		1935	
Overall width (mm)		690	
Overall height (mm)		1145	
Wheel base (mm)		1315	
Engine type		Air cooled 4-stroke	
Fuel Used		92# nonleaded gasoline	
Displacement (cc)		125cc	
Net weight (kg)	Front wheel	50	
	Rear wheel	79	
	Total	129	
Max weight Capacity (kg)	Front wheel	83	
	Rear wheel	196	
	Total	279	
Tires	Front wheel	110/70-12	
	Rear wheel	130/70-12	
Ground clearance (mm)		120	
Min. turning radius (mm)R/L		2010/2010	
Starting system		Starting motor	
Fuel type		Gasoline, 4-stroke motor oil	
Cylinder arrangement		Single cylinder, flat	
Combustion chamber type		Semi-sphere	
Valve arrangement		O.H.C.	
Bore x stroke (mm)		54 X 54.5	
Compression ratio		10.3±0.2	
Compression pressure (kg/cm ² rpm)		15kg/cm ² ±2	
Max. output		11.5ps/8500rpm	
Max. torque (NM/rpm)		10.2 N.M/6500rpm	
Port timing	Intake	Open	12°
		Close	27°
	Exhaust	Open	25°
		Close	0°
Valve clearance	Intake	0.12mm	
	Exhaust	0.12mm	
Idle speed (rpm)		1800±100	
Lubrication type		Separate type	
Lubrication oil capacity (liter)		0.9L	
Exchanging capacity		0.8L	
Air cleaner type & No.		Wet, single	
Gear Oil capacity		0.20cc	
Exchanging capacity		0.18cc	
Fuel capacity (liter)		6.8	
Carburetor	Type	—	
	Piston dia. (mm)	—	
	Venturi dia. (mm)	—	
Ignition system type		ECU	
Ignition timing F mark		—	
Spark plug	NGK	CR8E	
	Spark plug gap (mm)	0.7~0.8	
Battery capacity		12V 8AH	
Power to transmission gear		Power-transmission gear-clutch	
Reduction ratio of power to transmission		—	
Clutch type		Dry multi-disc clutch	
Transmission gear operation type		Automatic centrifugal type	
Transmission ratio		1 speed	
Reduction gear	Type	Two-stage reduction	
	1st reduction ratio	2.78~0.86	
	2nd reduction ratio	9.86	
Transmission gear type		Non-stage	
Tire pressure (kg/cm ²)	Front wheel	1.75/1.75 kg/cm ²	
	Rear wheel	2.0/2.25 kg/cm ²	
Turning angle		Right & left 45°	
Brake system type	Front wheel	Disk	
	Rear wheel	Disk	
Suspension type	Front wheel	Telescope	
	Rear wheel	Unit swing	
Shock absorber type	Front wheel	Telescope	
	Rear wheel	Unit swing	
Frame type		Pipe under bone	

1. GENERAL INFORMATION

SERVICE PRECAUTIONS

- Make sure to install new gaskets, O-rings, circlips, cotter pins, etc. when reassembling.

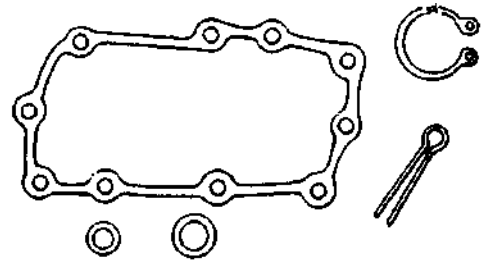

- When tightening bolts or nuts, begin with larger-diameter to smaller ones at several times, and tighten to the specified torque diagonally.

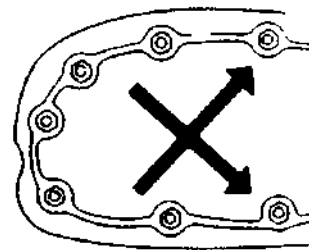

- Use genuine parts and lubricants

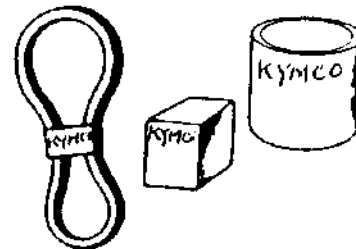

- When servicing the motorcycle, be sure to use special tools for removal and installation.



- After disassembly, clean removed parts. Lubricate sliding surfaces with engine oil before reassembly.

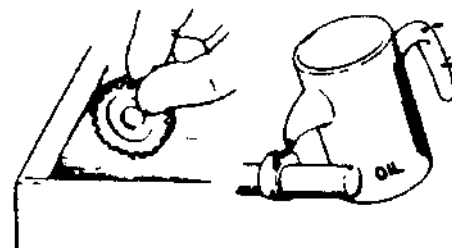

1. GENERAL INFORMATION

- Apply or add designated greases and lubricants to the specified lubrication points.

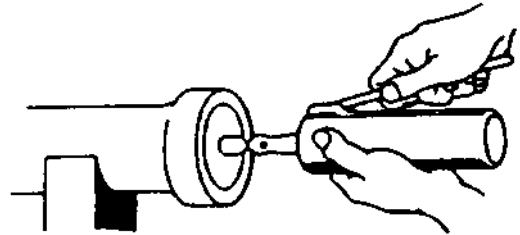

- After reassembly, check all parts for proper tightening and operation.

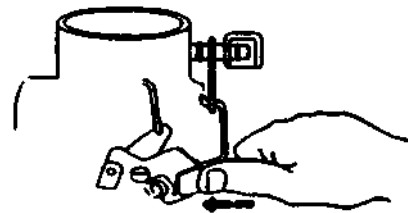

- When two persons work together, pay attention to the mutual working safety.



- Disconnect the battery negative (-) terminal before operation.
- When using a spanner or other tools, make sure not to damage the motorcycle surface.

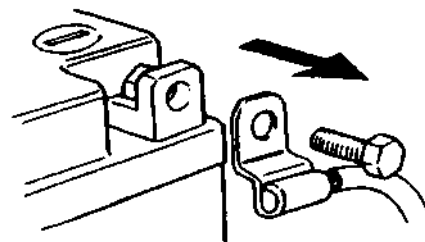

- After operation, check all connecting points, fasteners, and lines for proper connection and installation.
- When connecting the battery, the positive (+) terminal must be connected first.
- After connection, apply grease to the battery terminals.
- Terminal caps shall be installed securely.

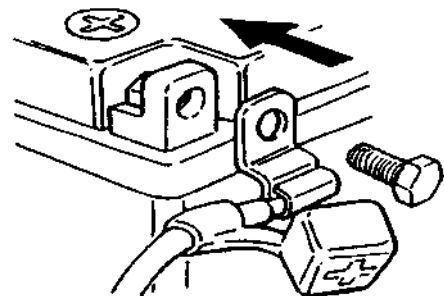

1. GENERAL INFORMATION

- If the fuse is burned out, find the cause and repair it. Replace it with a new one according to the specified capacity.

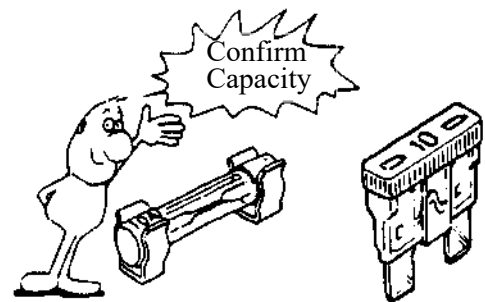

- After operation, terminal caps shall be installed securely.

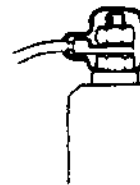

- When taking out the connector, the lock on the connector shall be released before operation.

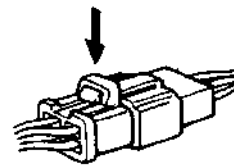

- Hold the connector body when connecting or disconnecting it.
- Do not pull the connector wire.



- Check if any connector terminal is bending, protruding or loose.

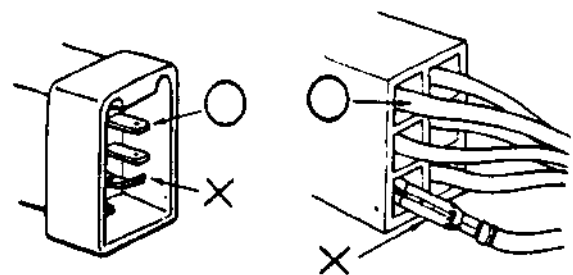

1. GENERAL INFORMATION

- The connector shall be inserted completely.
- If the double connector has a lock, lock it at the correct position.
- Check if there is any loose wire.

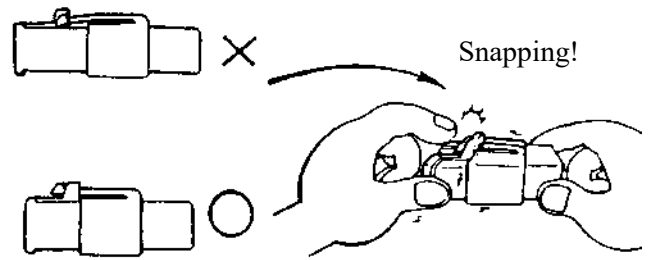

- Before connecting a terminal, check for damaged terminal cover or loose negative terminal.

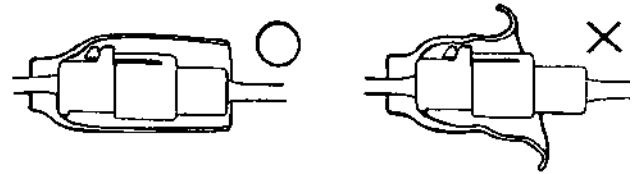

- Check the double connector cover for proper coverage and installation.

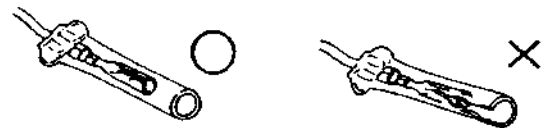

- Insert the terminal completely.
- Check the terminal cover for proper coverage.
- Do not make the terminal cover opening face up.

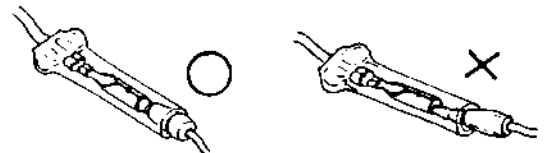

- Secure wire harnesses to the frame with their respective wire bands at the designated locations. Tighten the bands so that only the insulated surfaces contact the wire harnesses.

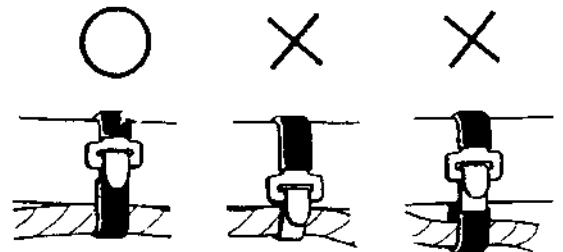

1. GENERAL INFORMATION

- After clamping, check each wire to make sure it is secure.

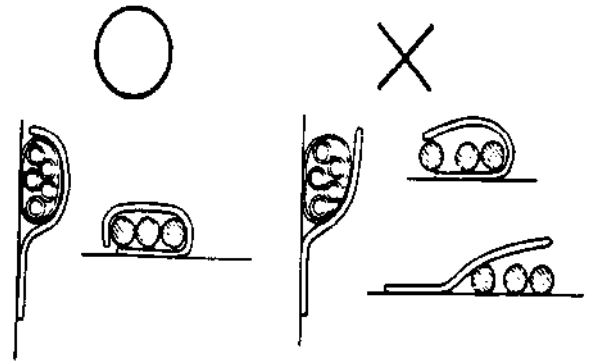

- Do not squeeze wires against the weld or its clamp

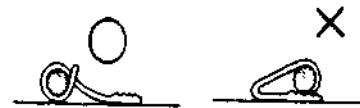

- After clamping, check each harness to make sure that it is not interfering with any moving or sliding parts.

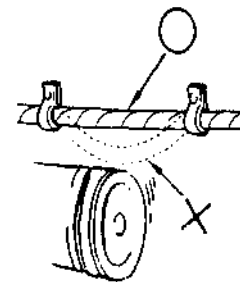

- When fixing the wire harnesses, do not make it contact the parts, which will generate high heat.

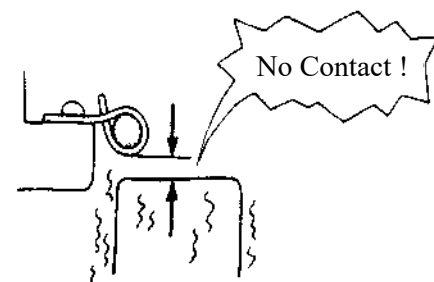

- Route wire harnesses to avoid sharp edges or corners. Avoid the projected ends of bolts and screws.
- Route wire harnesses passing through the side of bolts and screws. Avoid the projected ends of bolts and screws.

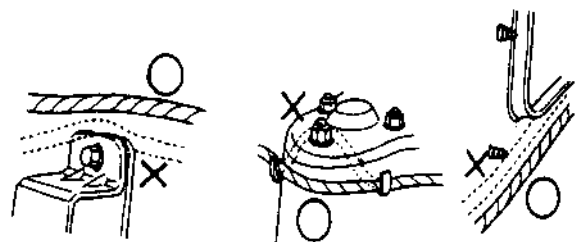

1. GENERAL INFORMATION

- Route harnesses so they are neither pulled tight nor have excessive slack.

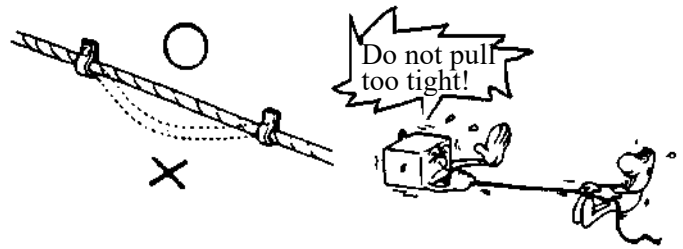

- Protect wires and harnesses with electrical tape or tube if they contact a sharp edge or corner.

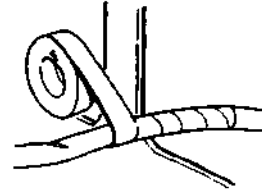

- When rubber protecting cover is used to protect the wire harnesses, it shall be installed securely.

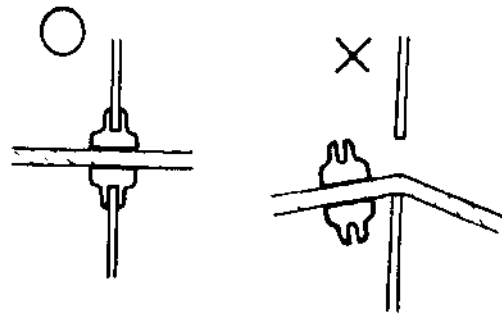

- Do not break the sheath of wire.
- If a wire or harness is with a broken sheath, repair by wrapping it with protective tape or replace it.

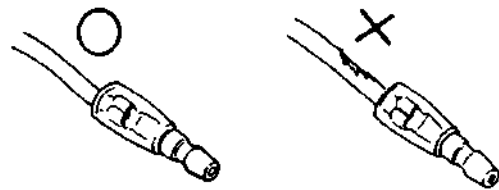

- When installing other parts, do not press or squeeze the wires.



1. GENERAL INFORMATION

- After routing, check that the wire harnesses are not twisted or kinked.

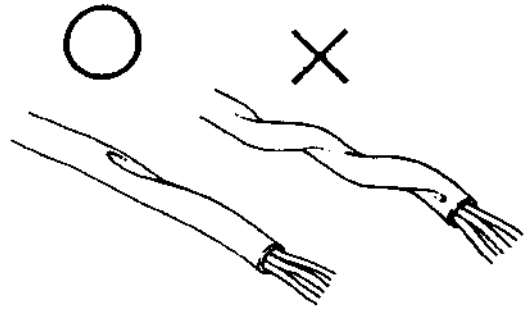

- Wire harnesses routed along with handlebar should not be pulled tight, have excessive slack or interfere with adjacent or surrounding parts in all steering positions.

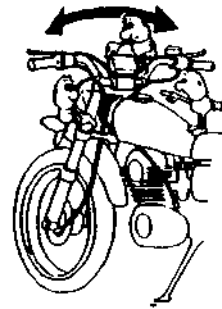

- When a testing device is used, make sure to understand the operating methods thoroughly and operate according to the operating instructions.

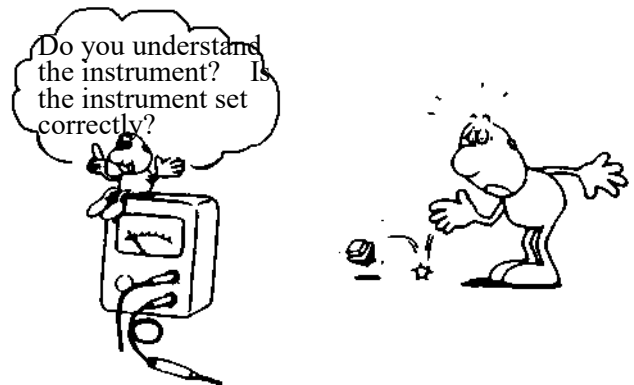

- Be careful not to drop any parts.

- When rust is found on a terminal, remove the rust with sand paper or equivalent before connecting.

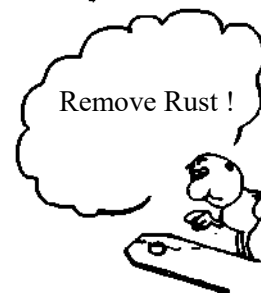

- Do not bend or twist control cables. Damaged control cables will not operate smoothly and may stick or bind.

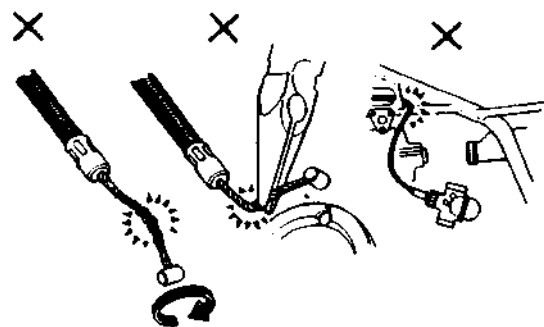

1. GENERAL INFORMATION

■ Symbols:

The following symbols represent the servicing methods and cautions included in this service manual.



Engine Oil

: Apply engine oil to the specified points. (Use designated engine oil for lubrication.)



Grease

: Apply grease for lubrication.



Gear Oil

: Transmission Gear Oil (90#)



: Use special tool.



: Caution



: Warning

1. GENERAL INFORMATION

Like II 125

TORQUE VALUES

STANDARD TORQUE VALUES

Item	Torque (kg-m)	Item	Torque (kg-m)
5mm bolt, nut	0.45-0.6	5mm screw	0.35-0.5
6mm bolt, nut	0.6-1.2	6mm screw, SH bolt	0.7-1.1
8mm bolt, nut	1.8-2.5	6mm flange bolt, nut	1.0-1.4
10mm bolt, nut	3.0-4.0	8mm flange bolt, nut	2.4-3.0
12mm bolt, nut	5.0-6.0	10mm flange bolt, nut	3.5-4.5

Torque specifications listed below are for important fasteners.

ENGINE

Item	Q'ty	Thread dia.(mm)	Torque (kg-m)	Remarks
Cylinder head bolt A	2	6	0.7-1.1	Double end bolt
Cylinder head bolt B	4	6	0.7-1.1	
Oil filter screen cap	1	30	1.0-2.0	
Exhaust muffler lock bolt	2	6	0.7-1.1	Double end bolt
Cylinder head flange nut	4	7	1.2-1.6	Apply oil to threads
Valve adjusting lock nut	2	3	0.07-0.09	
Cam chain tensioner slipper bolt	1	8	0.4-0.7	
Oil bolt	1	8	1.1-1.5	
Clutch outer nut	1	10	3.5-4.5	
Clutch drive plate nut	1	28	5.0-6.0	
Starter motor mounting bolt	2	6	0.8-1.2	
Oil pump bolt	3	4	0.1-0.3	
Drive face nut	1	10	5.5-6.5	
Spark plug	1	10	1.0-1.4	
A.C. generator stator bolt	2	6	0.8-1.2	
Cam chain tensioner bolt	1	6	0.8-1.2	

FRAME

Item	Q'ty	Thread dia.(mm)	Torque (kg-m)	Remarks
Steering stem lock nut	1	BC1	6.0-8.0	U-nut
Steering handle post nut	1	10	4.0-5.0	U-nut
Front axle nut	1	12	5.0-7.0	U-nut
Rear axle nut	1	16	11.0-13.0	U-nut
Rear shock absorber upper bolt	1	10	3.5-4.5	
Rear shock absorber lower bolt	1	8	2.4-3.0	
Muffler Bracket/ Rear Fork	1	8	3.0-3.6	
Rear Fork/Engine Case	1	8	2.4-3.0	Flange bolt
Engine Hanger---Frame side	2	10	4.5-5.5	
Engine Hanger---Engine side	2	10	4.5-5.5	U-nut

1. GENERAL INFORMATION

Like II 125

SPECIAL TOOLS

Description	Tool No.	Photo
Flywheel puller	A120E00002	
Oil seal and bearing installer	A120E00014	
Universal holder	A120E00017	
Flywheel holder	A120E00021	
Clutch spring compressor	A120E00034	
Valve adjuster	A120E00036	
Bearing puller	A120E00037	
Cylinder Compression Gauge	A120E00039	



1. GENERAL INFORMATION

Like II 125

Description	Tool No.	Photo
Valve spring compressor	A120E00040	
Fuel Pressure Gauge	A120E00048	
INJECTOR CLEANER for Synerjet	A120E00075	
Wires Injector Connector	A120E00090	
Lock nut wrench	A120F00002	
Lower/Upper Race Remover & Installer	A120F00008	
Steering Stem Top Thread Wrench (shoter type)	A120F00024	
Steering Stem Top Thread Wrench	A120F00029	
Band Remover/Installer	A120F00030	

1. GENERAL INFORMATION

Like II 125

Description	Tool No.	Photo
Pliers Fuel Pipe	A120F00031	
Electric Repair Kit	A120F00032	

1. GENERAL INFORMATION

Like II 125

LUBRICATION POINTS

ENGINE

Lubrication Points	Lubricant
Valve guide/valve stem movable part Cam lobes Valve rocker arm friction surface Cam chain Cylinder lock bolt and nut Piston surroundings and piston ring grooves Piston pin surroundings Cylinder inside wall Connecting rod/piston pin hole Connecting rod big end Crankshaft R/L side oil seal Starter reduction gear engaging part Countershaft gear engaging part Final gear engaging part Bearing movable part O-ring face Oil seal lip	<ul style="list-style-type: none"> •Genuine KYMCO Engine Oil (SAE15W-40) •API-SL Engine Oil
Starter idle gear Friction spring movable part/shaft movable part Shaft movable grooved part Kick starter spindle movable part	High-temperature resistant grease
A.C. generator connector Transmission case breather tube	Adhesive

1. GENERAL INFORMATION

Like II 125

FRAME

The following is the lubrication points for the frame.

Use a general purpose grease for parts not listed.

Apply clean engine oil or grease to cables and movable parts not specified.

This will avoid abnormal noise and rise the durability of the motorcycle.

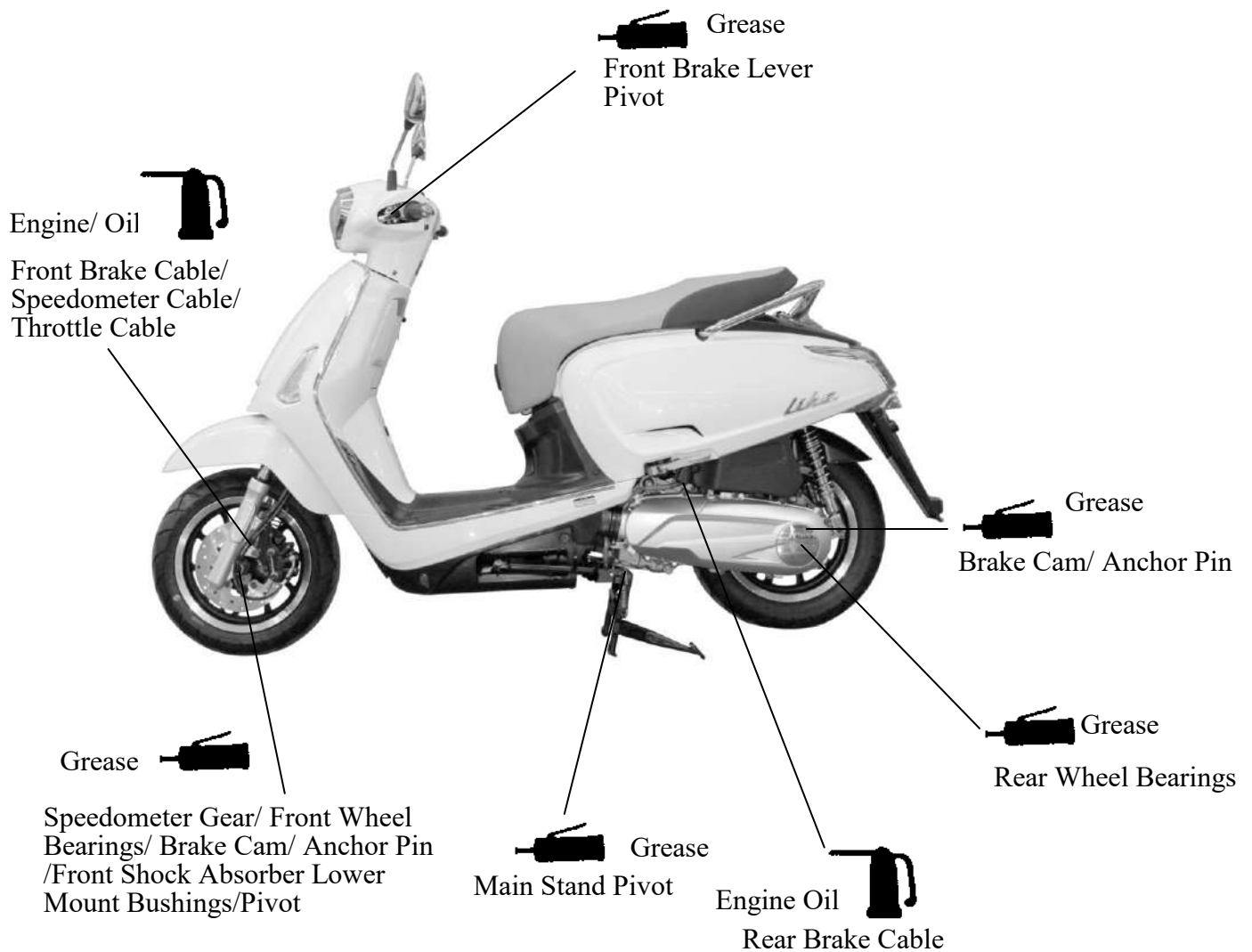

1. GENERAL INFORMATION

Like II 125

CABLE & HARNESS ROUTING

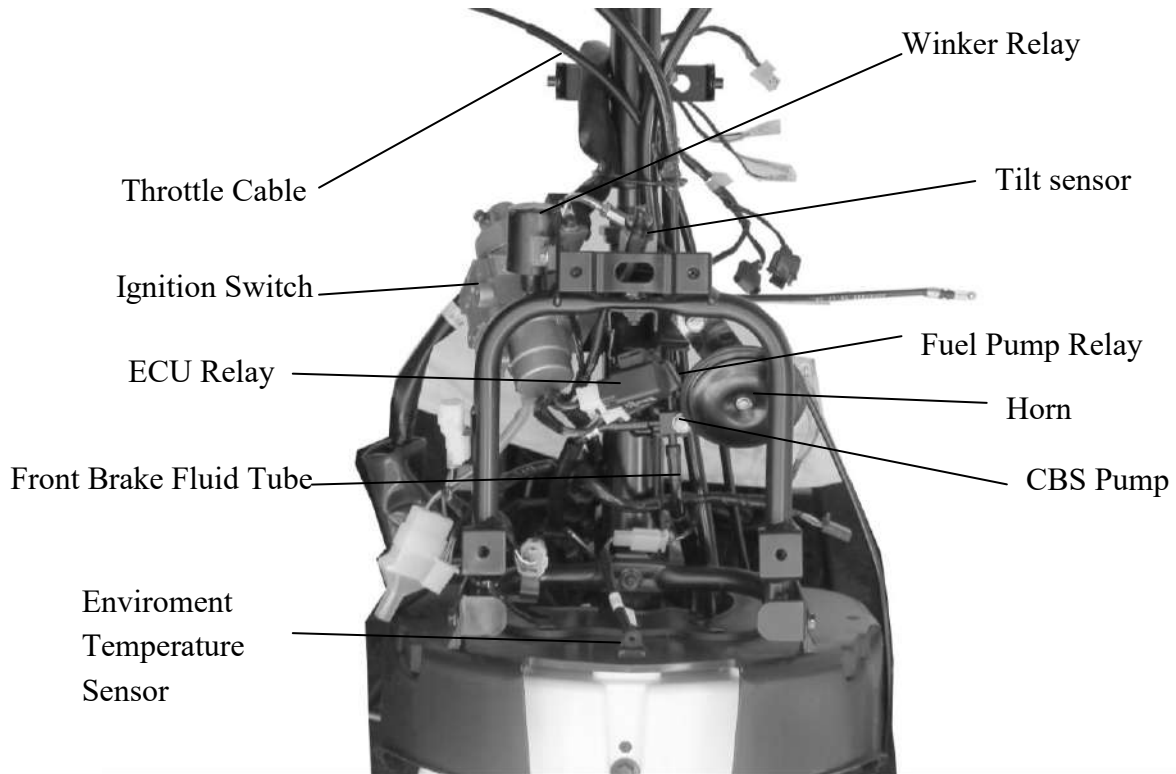

1. GENERAL INFORMATION

Like II 125

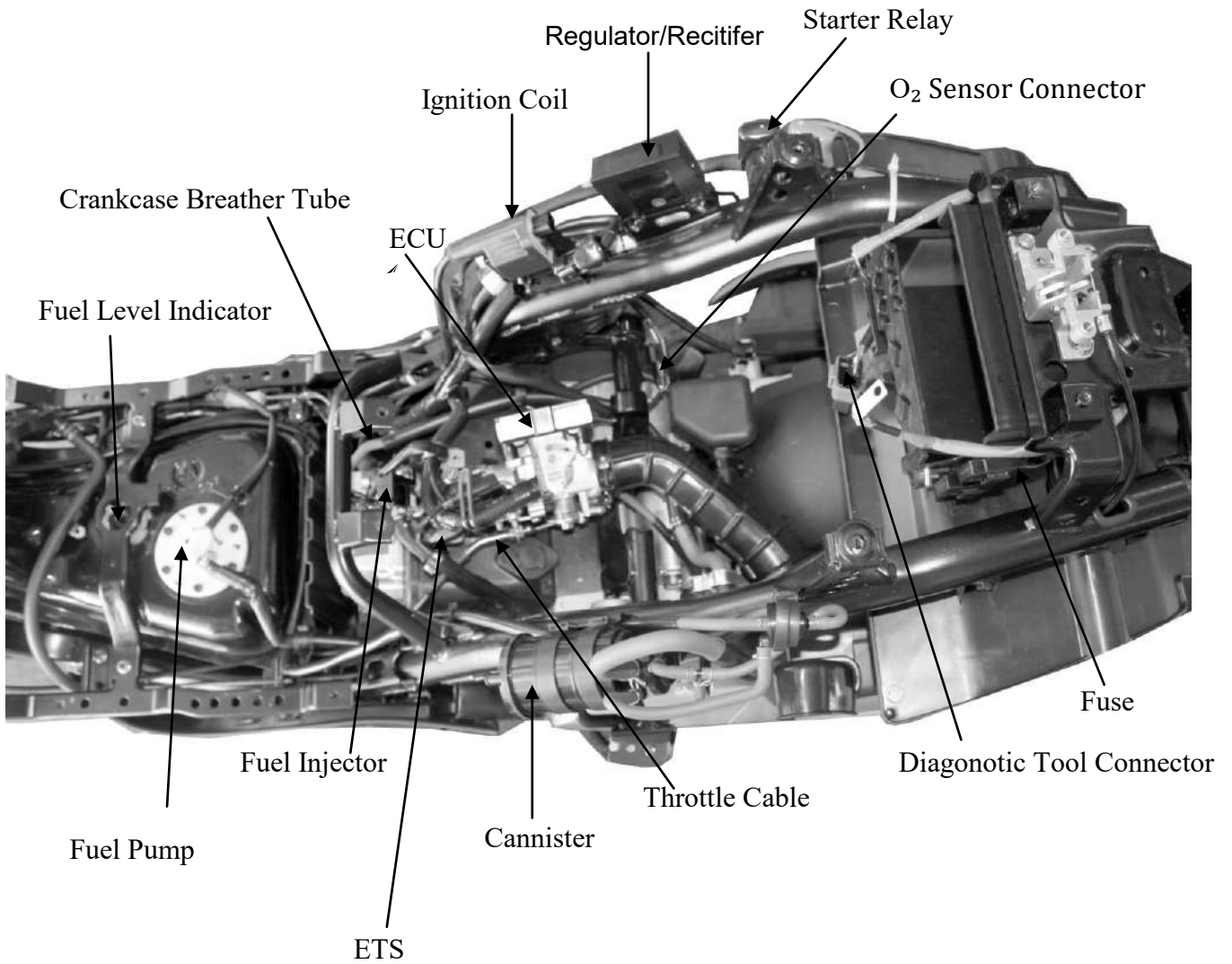

1. GENERAL INFORMATION

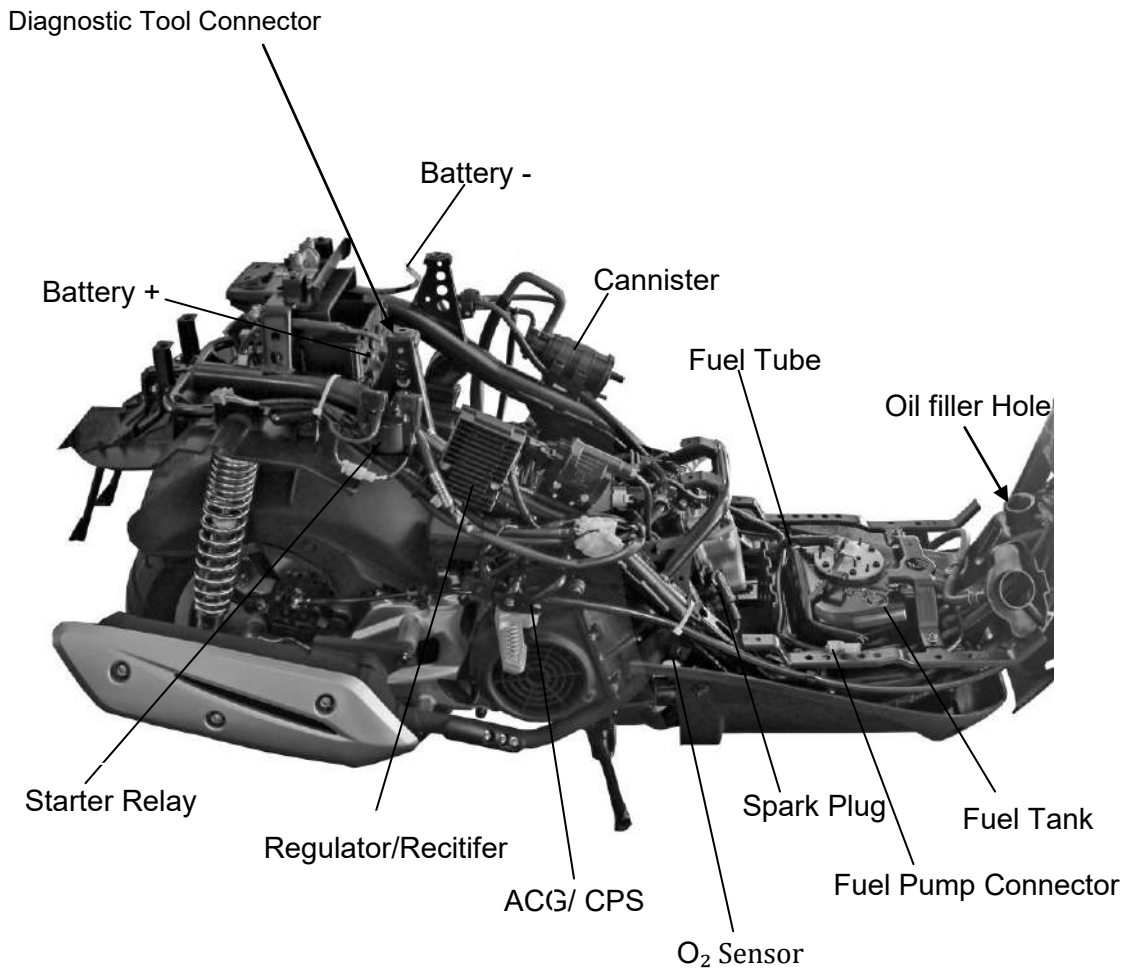

1 GENERAL INFORMATION

Troubleshooting

Vehicle can not be started

Preliminary 6 Step Inspection

1. Is the battery fully charged (12 V or higher). See the Battery topic for more information.
2. Key-On and listen for any action with Fuel Pump / Fuel Pump Relay (It will turn off automatically in 5-10 seconds)
3. Key-On to check for any failure lamp light up on dashboard. See the Self-Diagnosis topic for more information.
4. Is the Idle screw of Throttle Valve being changed or loose?
5. Has the vehicle under regular service? Is the gas station a good one?
6. Is the spark plug the correct model of specified by the vehicle builder?

1. GENERAL INFORMATION

Like II 125

General Troubleshooting

ENGINE WILL NOT START OR IS HARD TO START

Possible cause

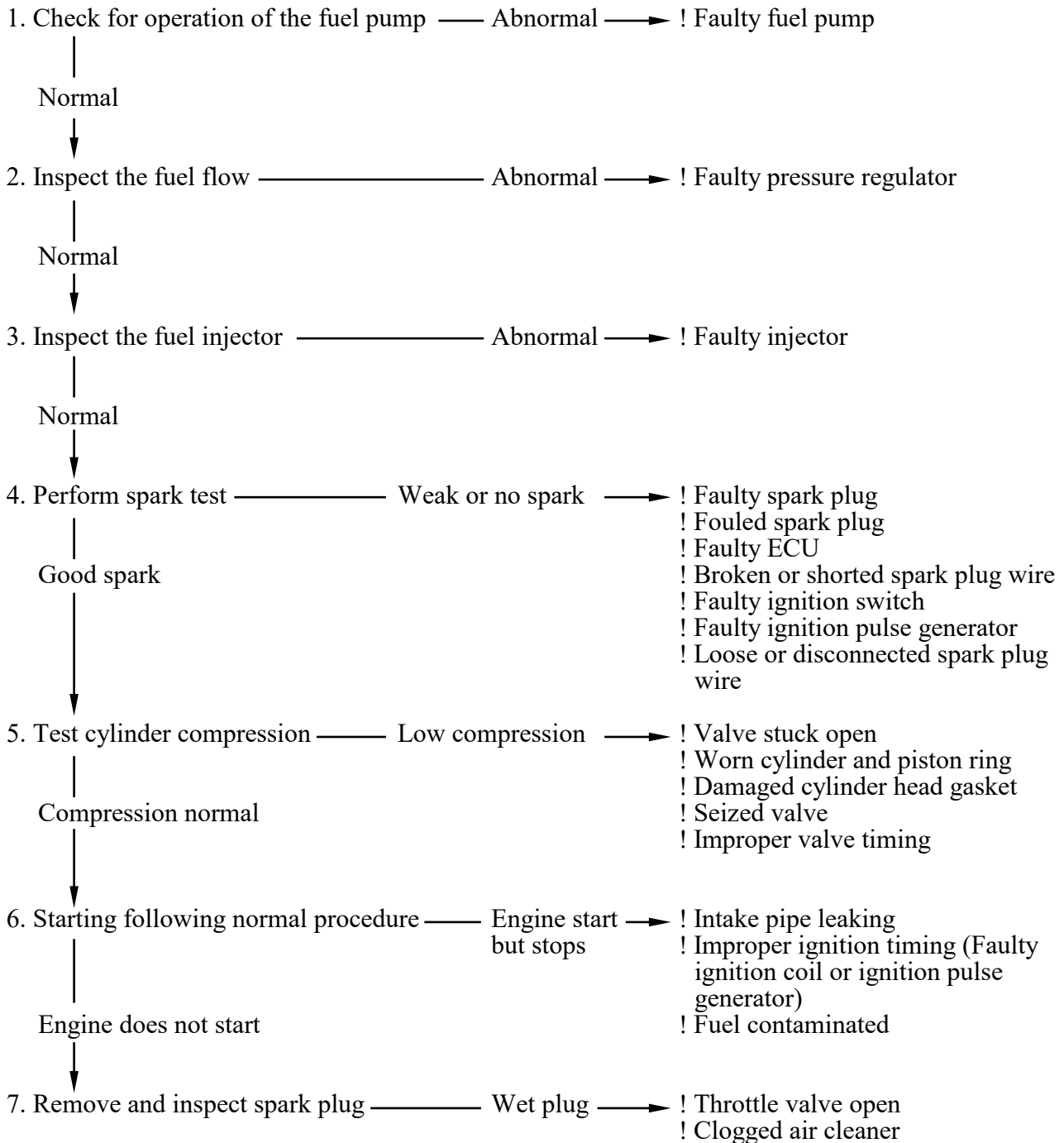

1 GENERAL INFORMATION

Like II 125

ENGINE LACKS POWER

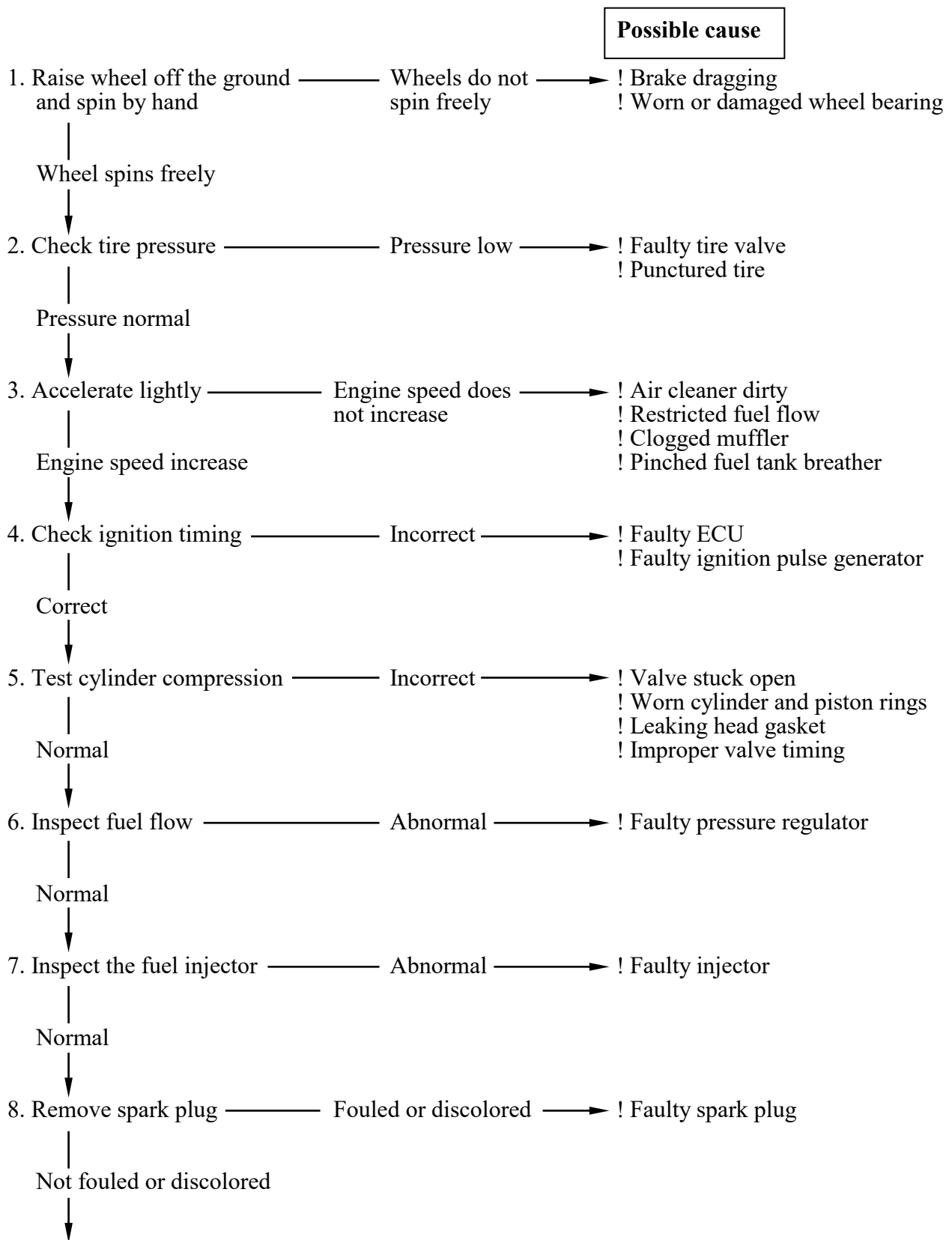

1. GENERAL INFORMATION

Like II 125

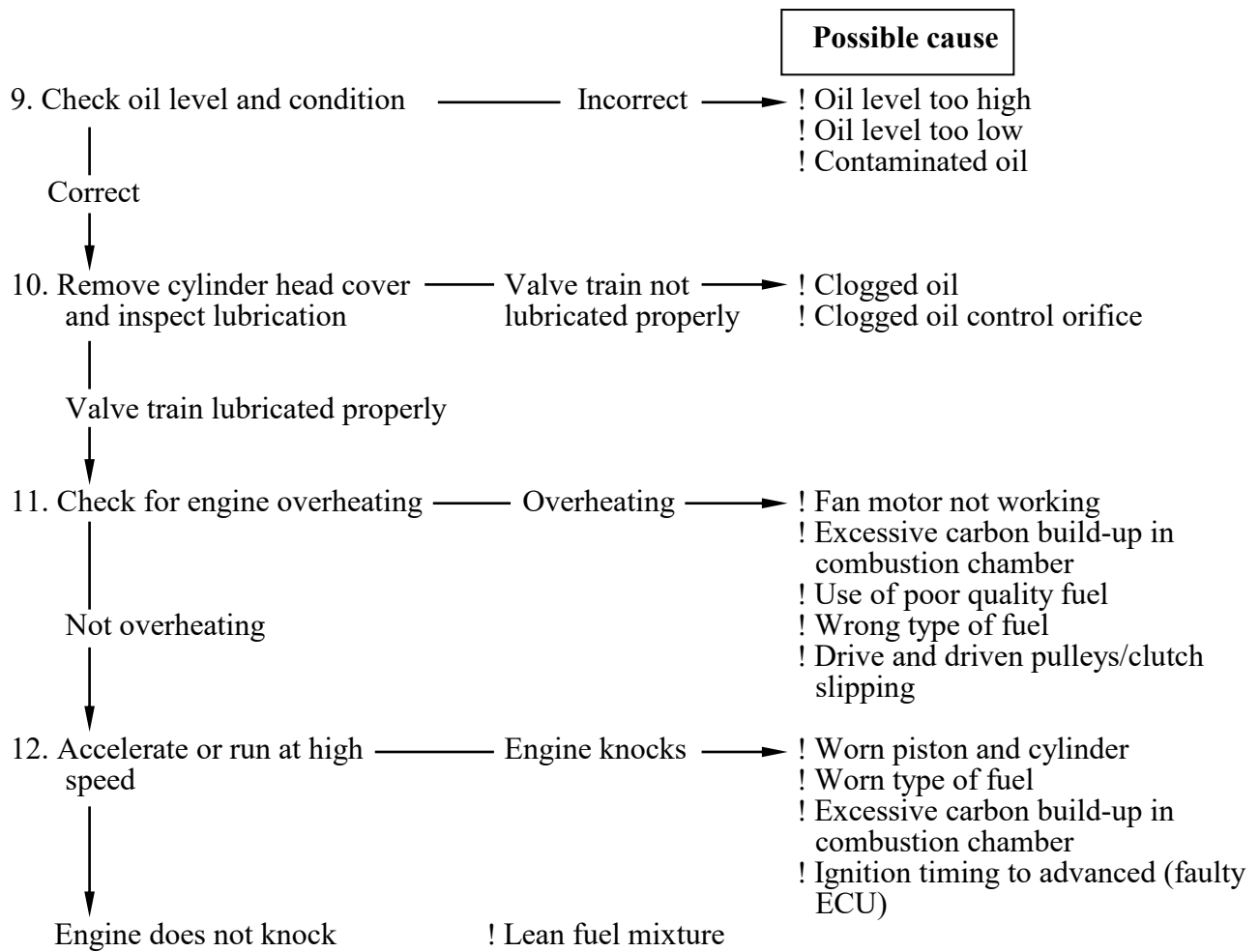

1 GENERAL INFORMATION

Like II 125

POOR PERFORMANCE AT LOW AND IDLE SPEED

Possible cause

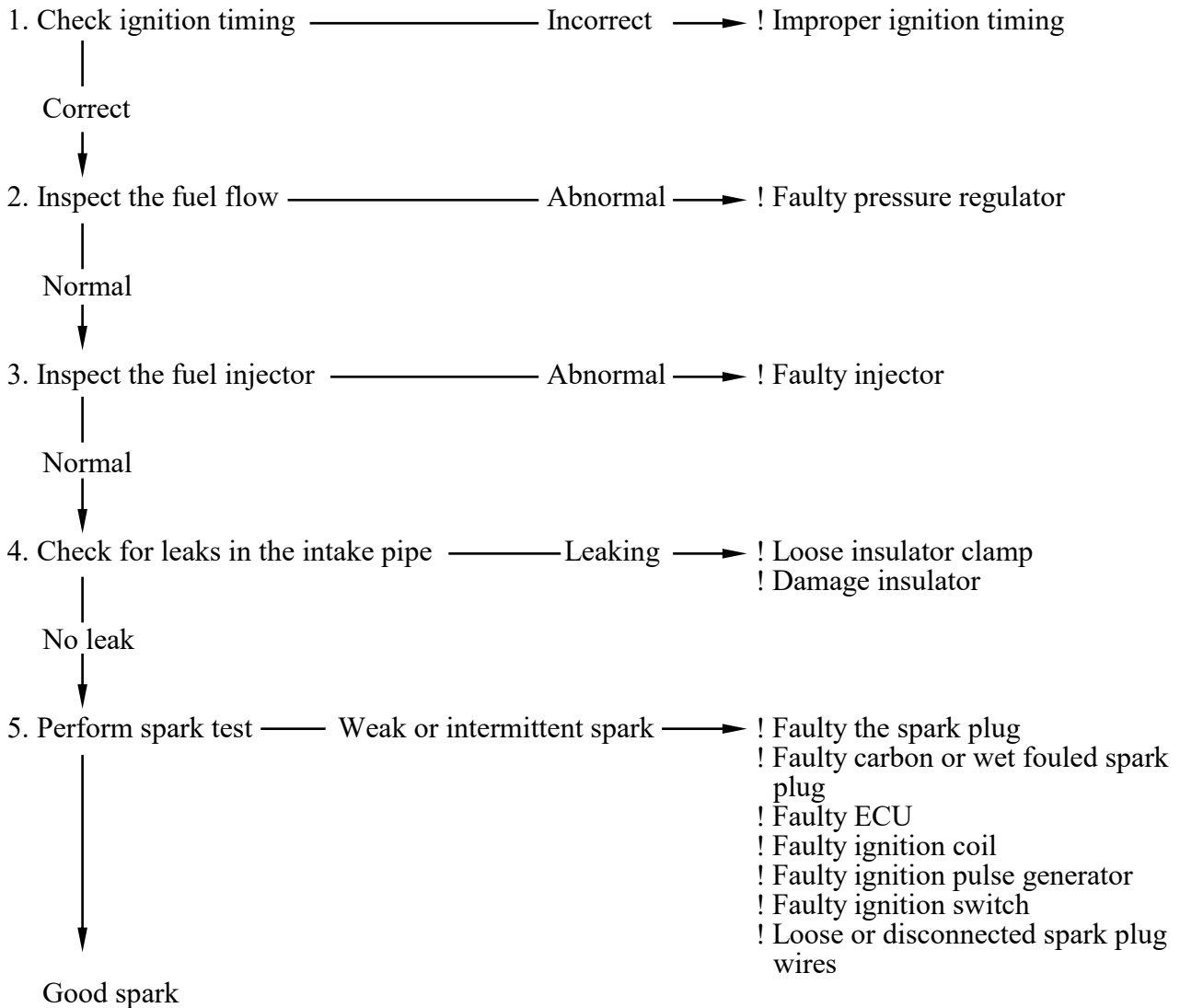

1. GENERAL INFORMATION

Like II 125

POOR PERFORMANCE AT HIGH SPEED

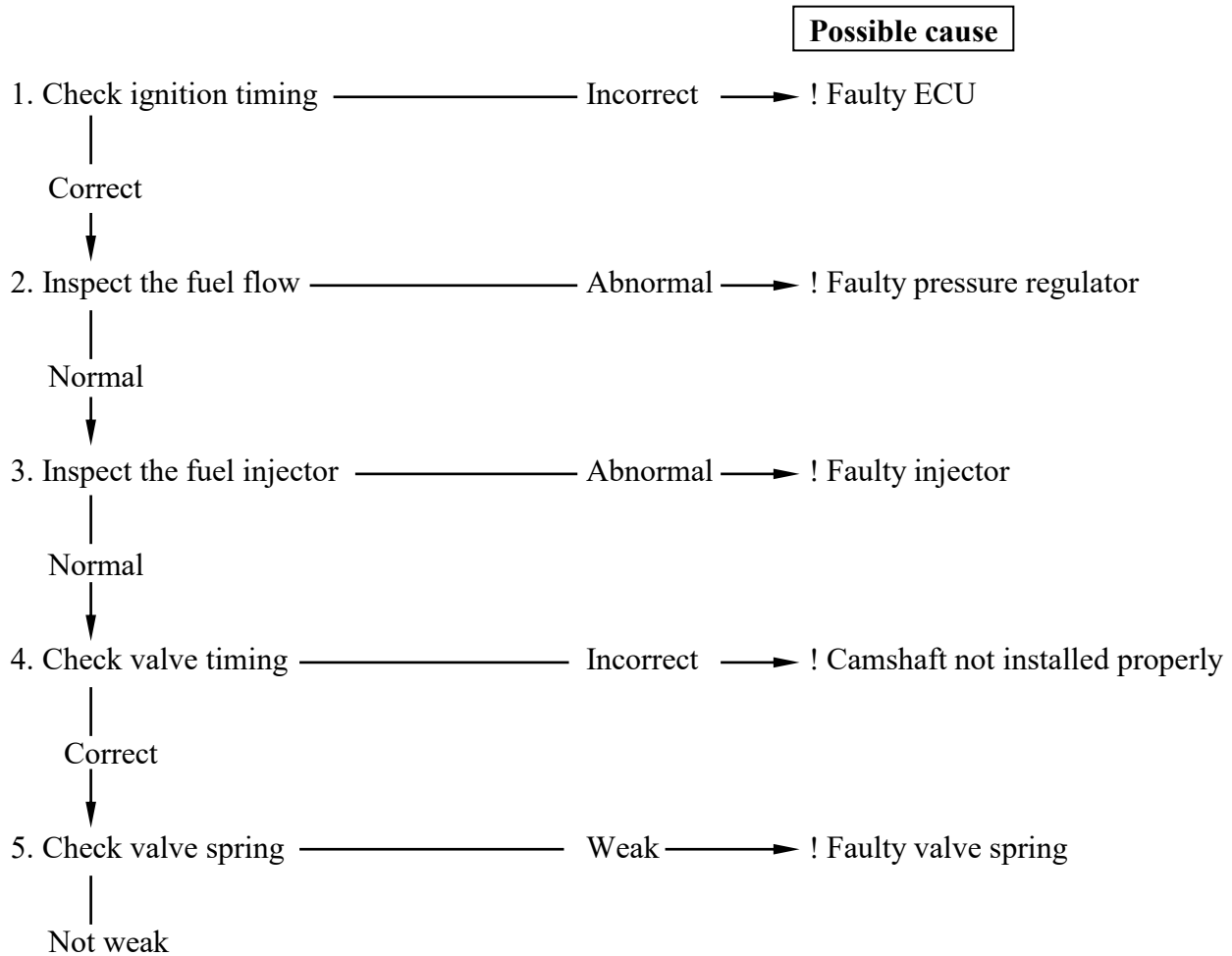

POOR HANDLING

	Possible cause
1. If steering is heavy —————→	! Steering stem adjusting nut too tight ! Damaged steering head bearings
2. If either wheel is wobbling —————→	! Excessive wheel bearing play ! Bent rim ! Improper installed wheel hub ! Swing arm pivot bearing excessively worn ! Bent frame
3. If the motorcycle pulled to one side —————→	! Faulty the shock absorber ! Front and rear wheel not aligned ! Bent fork ! Bent swing arm ! Bent axle

2. FRAME COVERS/EXHAUST MUFFLER

Like II 125

COVERS DISASSEMBLY

TE25AA(IT) F13

2

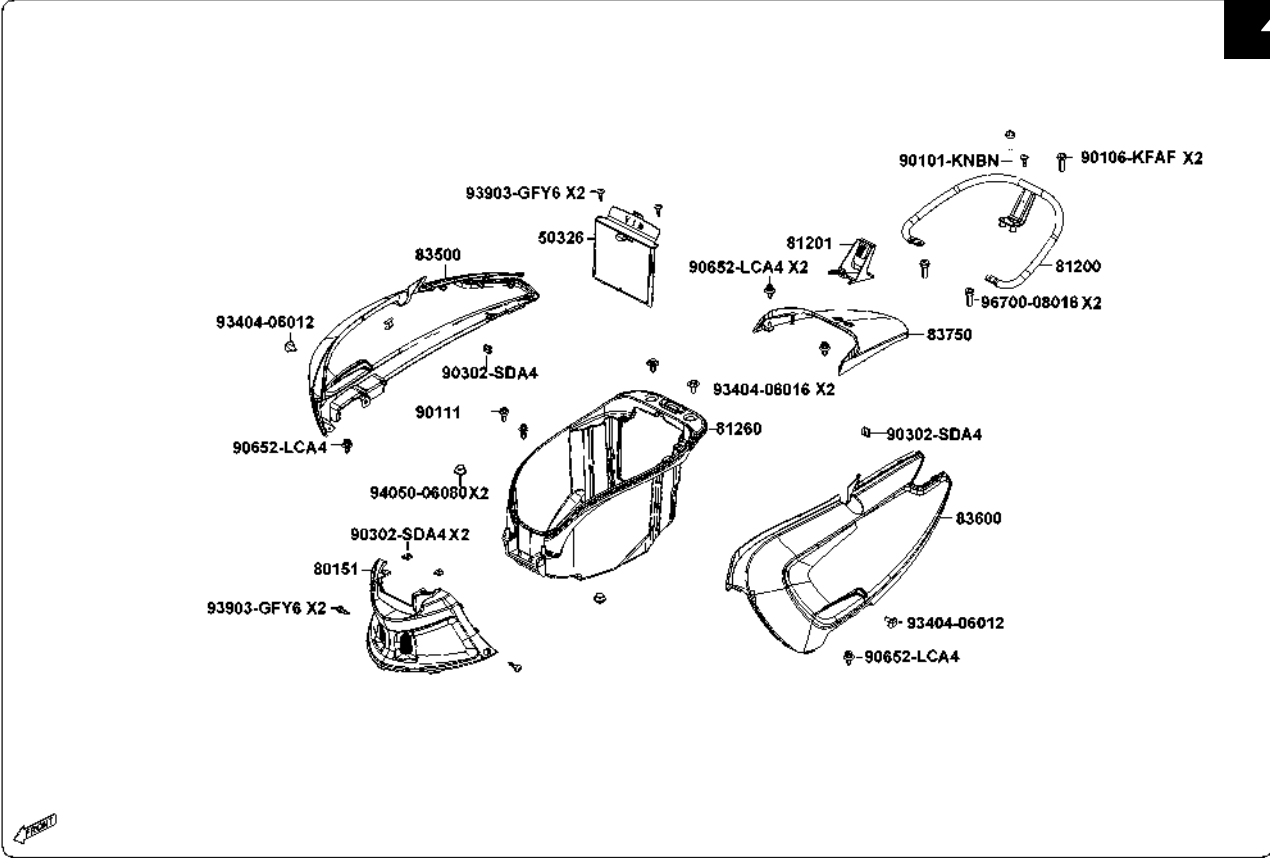

TE25AA(IT) F03

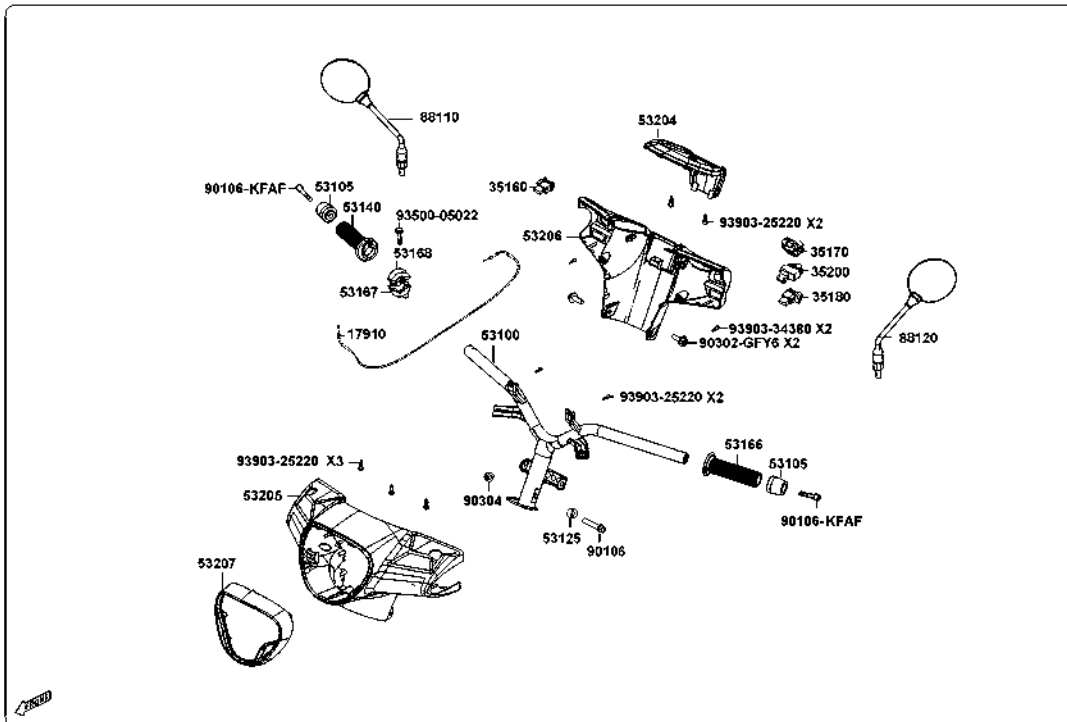

2. FRAME COVERS/EXHAUST MUFFLER

SERVICE INFORMATION	2-1	EXHAUST MUFFLER REMOVAL	2-7
FRAME COVERS	2-2		

SERVICE INFORMATION

GENERAL INSTRUCTIONS

- When removing frame covers, use special care not to pull them by force because the cover joint claws may be damaged.

Items Related for Removal

- Handlebar front cover ——— Handlebar rear cover
Headlight wire connector
- Handlebar rear cover ——— Speedometer cable and instrument light
wire connectors, etc.
- Frame body cover ——— Met-in box, rear grip, rear turn signal
lights, floor board
- Floor board ——— Frame body cover
- Front tool box ——— Front cover, floor board

TORQUE VALUES

- | | |
|--------------------------------|---------------|
| Exhaust muffler joint lock nut | 1.0~1.4 kgf-m |
| Exhaust muffler lock bolt | 3.0~3.6 kgf-m |

2. FRAME COVERS/EXHAUST MUFFLER

FRAME COVERS

FRONT COVER REMOVAL

Remove 1 screw and 2 plastic fasteners on the left side skirt and remove the left side skirt.

Remove 1 screw and 2 plastic fasteners on the right side skirt and remove the right side skirt.

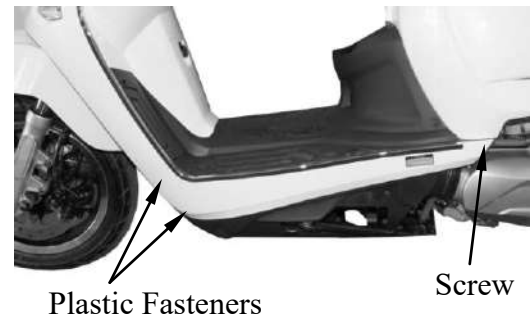

Remove 6 screws on the front cover and 3 screws in the front tool box.

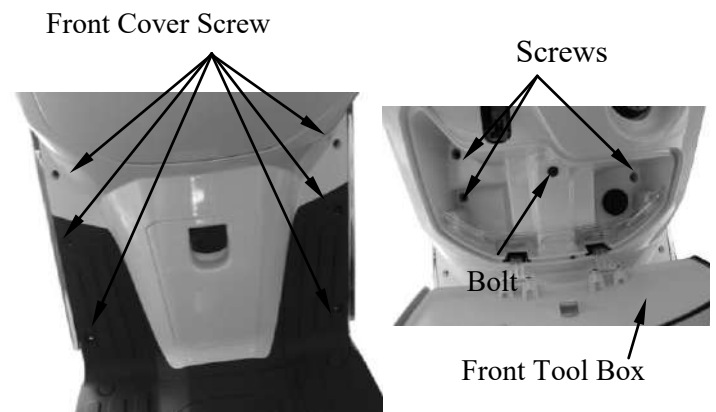

Remove 6 plastic clips on the mud fender

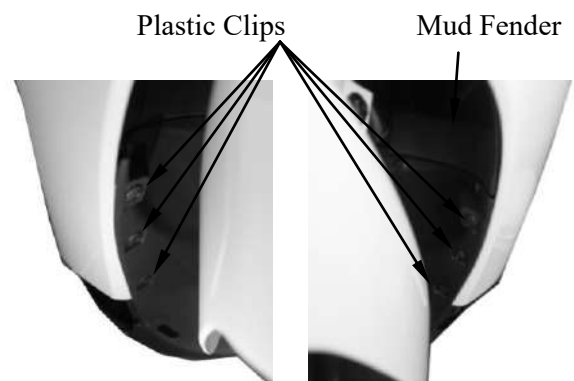

Remove 2 plastic fasteners beneath the handlebar cover.(turn the handlebar to the left end and right end,you will see them)

Disconnect the turn signal light connectors.
Remove the front cover(front part).

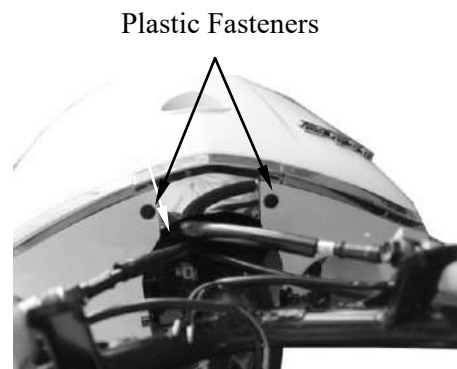

2. FRAME COVERS/EXHAUST MUFFLER

Like II 125

LEG SHIELD REMOVAL

Remove the bolt in the front tool box.
 Remove the fuel filler cap.
 Remove the front tool box lock cable.
 Disconnect the USB charger cable.
 Remove the decorative ring of the main switch.

The installation sequence is the reverse of removal.

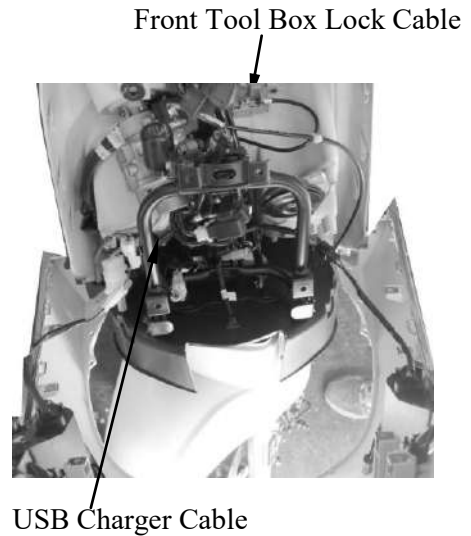

HANDLEBAR REAR COVER REMOVAL

Remove 4 screws on the handlebar rear cover .
 Separate 7 clips with a crowbar.
 Disconnect the speedometer cable, right and left handlebar switch couplers.
 Remove the handlebar rear cover.
 The installation sequence is the reverse of removal.

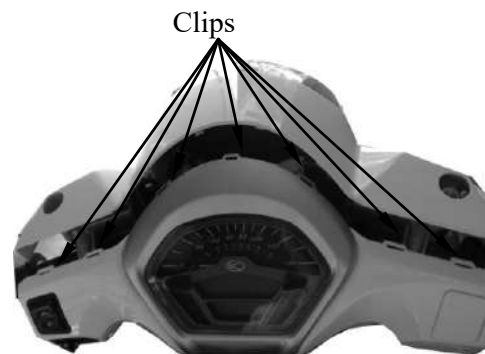

HANDLEBAR FRONT COVER REMOVAL

Remove the 2 screws attaching the handlebar front cover.
 Disconnect the headlight connector.
 Remove the handlebar front cover.

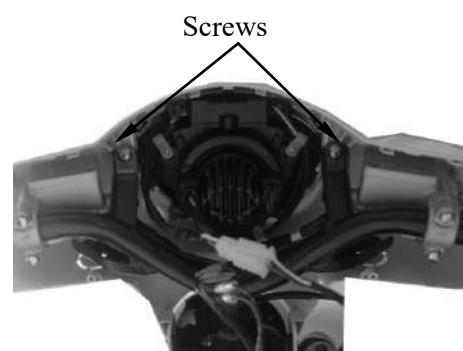

2. FRAME COVERS/EXHAUST MUFFLER

MET-IN BOX REMOVAL

Open the seat and remove 4 bolts and two screws attaching the met-in box.
Remove the met-in box .

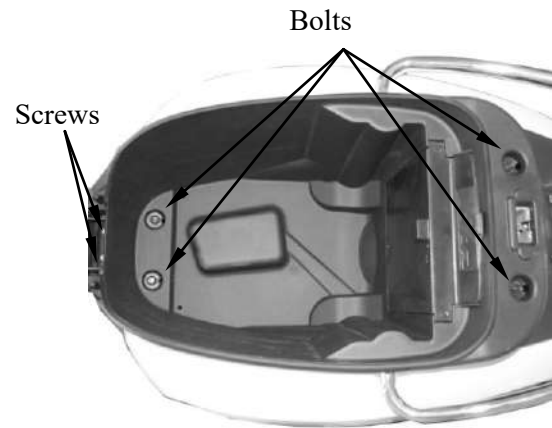

2. FRAME COVERS/EXHAUST MUFFLER

FRAME BODY COVER REMOVAL

Remove the 4 bolts attaching the rear carrier.

Remove the rear carrier.

Remove 2 plastic fasteners attaching the central rear cover.

Remove the central rear cover.

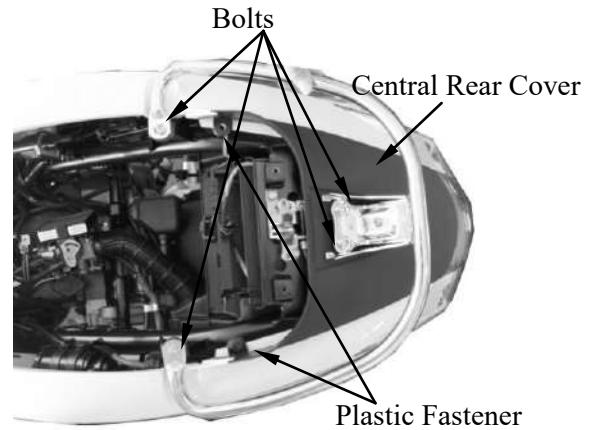

Remove 2 screws attaching the central cover

Remove the central cover.

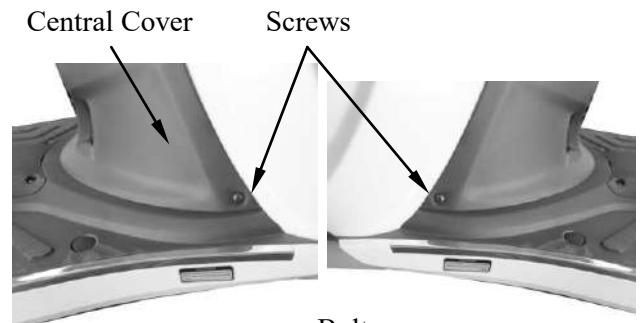

Remove 2 screws and 2 bolts attaching the rear fender.

Remove the rear fender.

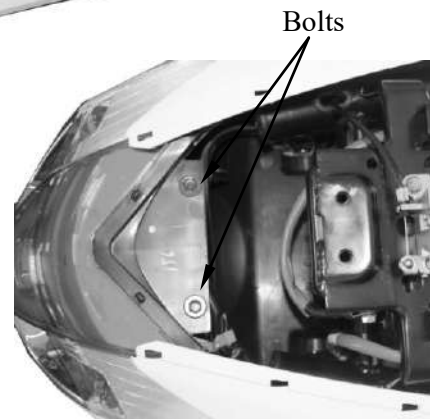

Remove 2 plastic fasteners attaching the frame body cover.

Remove 4 bolts attaching the frame body cover.

Disconnect the connectors of the taillight.

Remove the frame body cover.

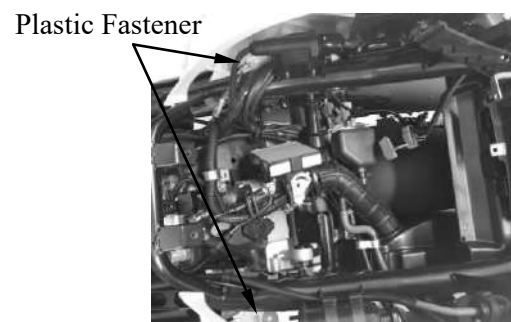
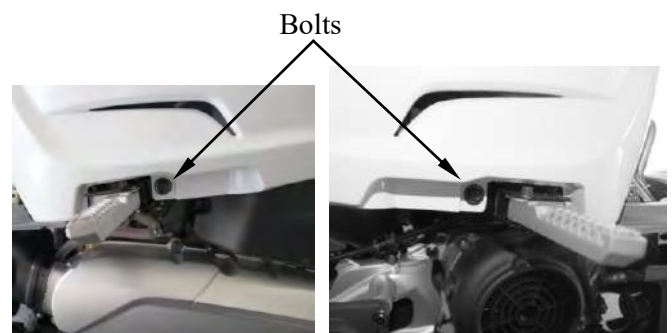

2. FRAME COVERS/EXHAUST MUFFLER

REAR FENDER REMOVAL

Remove 2 screws and 2 bolts attaching the rear fender.

Remove the rear fender.

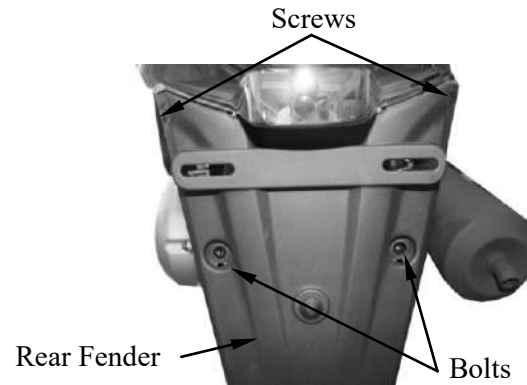

FRONT FENDER REMOVAL

Remove the L/R side bolts and middle bolt attaching the front fender

Remove 2 screws attaching the front fender

Remove the front fender.

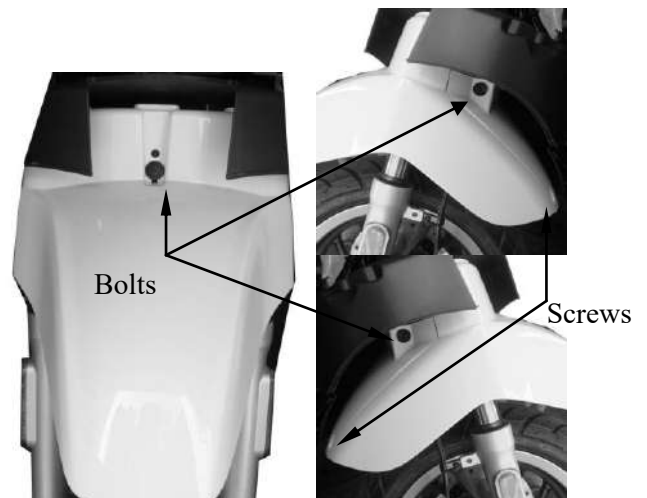

FLOOR BOARD REMOVAL

Remove the met-in box.

Remove the frame body cover.

Remove the 4 bolts and attaching the floor board.

Remove the floor board.

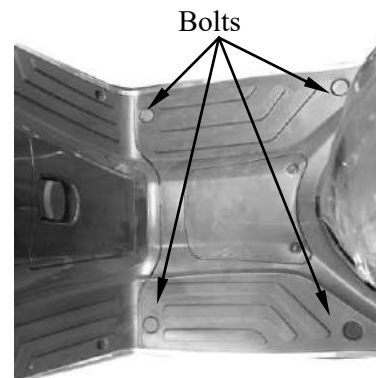

* During removal, do not pull the joint claws forcedly to avoid damage.
When installing, be sure to connect the seat lock wire.

2. FRAME COVERS/EXHAUST MUFFLER

EXHAUST MUFFLER REMOVAL

Disconnect the O₂ sensor.
Remove the 2 exhaust muffler joint lock nuts.
Remove the 3 exhaust muffler lock bolts.
Remove the exhaust muffler.
Remove the exhaust muffler joint packing collar.

When installing, first install the exhaust muffler packing collar and then install the exhaust muffler.

First install and tighten the exhaust muffler joint lock nuts.

Then, install and tighten the exhaust muffler lock bolts.

Torques:

Exhaust muffler lock bolt: 3.0~3.6kgf-m

Exhaust muffler joint lock nut: 1.0~1.4kgf-m

* Be sure to install a new exhaust muffler packing collar.

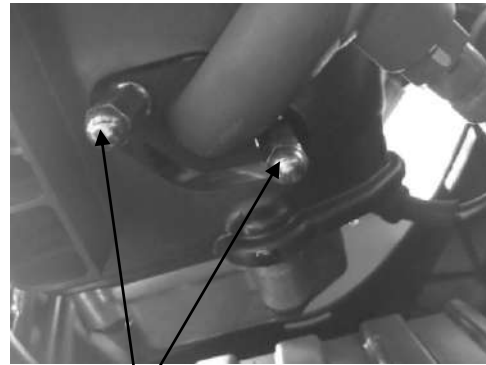

Lock Joint Nuts



Bolts

3. INSPECTION/ADJUSTMENT

3

INSPECTION/ADJUSTMENT

SERVICE INFORMATION-----	3-1
MAINTENANCE SCHEDULE-----	3-2
FUEL LINE-----	3-3
THROTTLE OPERATION-----	3-3
ENGINE OIL-----	3-4
TRANSMISSION OIL-----	3-4
AIR CLEANER-----	3-5
SPARK PLUG-----	3-5
VALVE CLEARANCE-----	3-6
CYLINDER COMPRESSION-----	3-7
DRIVE BELT-----	3-7
CLUTCH SHOE WEAR-----	3-7
HEADLIGHT AIM-----	3-8
BRAKE FLUID-----	3-8
BRAKE PAD WEAR-----	3-8
CBS-----	3-9

3. INSPECTION/ADJUSTMENT

Like II 125

SERVICE INFORMATION

GENERAL

 WARNING
--

- Before running the engine, make sure that the working area is well-ventilated. Never run the engine in a closed area. The exhaust contains poisonous carbon monoxide gas which may cause death to people.
- Gasoline is extremely flammable and is explosive under some conditions. The working area must be well-ventilated and do not smoke or allow flames or sparks near the working area or fuel storage area.

SPECIFICATIONS

Throttle grip free play : 2 ~6mm
 Spark plug : NGK : CR8E
 Spark plug gap : 0.7 ~0.8 mm
 Valve clearance : IN: 0.12mm EX: 0.12mm
 Idle speed : 1800±100 rpm

Engine oil capacity:

At disassembly : 0.9 Liter
 At change : 0.8 Liter

Ignition timing : ECU
 Coolant type : air-cooled

Gear oil capacity :

At disassembly : 0.20 Liter
 At change : 0.18 Liter

TIRE

	1Rider	2Riders
Front	1.75 kg/cm ²	1.75 kg/cm ²
Rear	2.0 kg/cm ²	2.25 kg/cm ²

TIRE SPECIFICATION:

Front : 110/70-12
 Rear : 130/70-12

TORQUE VALUES

Front axle nut : 65 N-m
 Rear axle nut : 120 N-m

3. INSPECTION/ADJUSTMENT

MAINTENANCE SCHEDULE

In order to have a safe riding, maintain good performance, prolong the scooter service life and reduce pollution, make sure to perform the periodic inspection and maintenance.

I: Inspect and clean, lubricate, refill, repair or replace if necessary.

A: Adjust C: Clean R: Replace T: Tighten D: Inspect with Diagnosis Instrument

M : Mintenance

FREQUENCY	ITEM	WHICHEVER COMES FIRST	ODOMETER READING (NOTE1)							
		→	1	3	5	7	9	11	13	REFER TO PAGE
		X 1000 km	0.6	2	3	4	5	6	7	
		↓								
		X 1000 mi								
		MONTH		3	6	9	12	15	18	
*	AIR CLEANER			R	R	R	R	R	R	
	SPARK PLUG				I		R		I	
*	THROTTLE OPERATION			I	I	I	I	I	I	
*	VALVE CLEARANCE		A				A			
*	FUEL LINE						I			
	CRANKCASE BREATHER		C	C	C	C	C	C	C	
	ENGINE OIL		R	R	R	R	R	R	R	
*	ENGINE OIL SCREEN		C	C	C	R	C	C	R	
*	ENGINE IDLE SPEED				I		I		I	
*	TRANSMISSION OIL		R		R		R		R	
*	DRIVE BELT		Inspect every 10000km,replace every 20000km							
**	RADIATOR COOLANT		None exist on this model							

**	CLUTCH SHOE WEAR				I		I		I	
	BRAKE FLUID		Replace at every 10000km or every year							
	BRAKE PAD WEAR			I	I	I	I	I	I	
	BRAKE SYSTEM			I	I	I	I	I	I	
*	BRAKE LIGHT SWITCH			I	I	I	I	I	I	
**	STEERING BEARINGS			I	I	I	I	I	I	
*	HEADLIGHT AIM			I	I	I	I	I	I	
*	NUTS,BOLTS,FASTENER			I	I	I	I	I	I	
**	WHEEL/TIRES			I	I	I	I	I	I	
*	CVT FILTER				C		C		C	
**	INJECTOR			D	D	C	D	D	C	

The above items are applicable to different models.Perform suitable itams for each model. When exceeding the listed mileages,perform maintenance accroding to the listed intervals.

The air cleaner requires more frequent cleaning or replacing when ridden in unusually dusty areas.

3. INSPECTION/ADJUSTMENT

FUEL LINE

Check the fuel lines and replace any parts, which show signs of deterioration, damage or leakage.

Check for dirty or clogged fuel injector and replace with a new one if it is clogged.

* Do not smoke or allow flames or sparks in your working area.

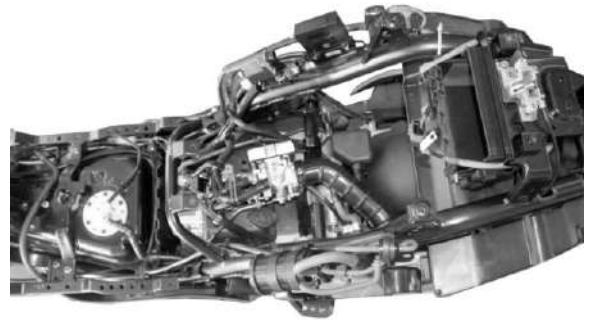

THROTTLE OPERATION

Check the throttle grip for smooth movement. Measure the throttle grip free play.

Free Play: 2~6 mm

Major adjustment of the throttle grip free play is made with the adjusting nut at the intake manifold side. Adjust by loosening the lock nut and turning the adjusting nut.

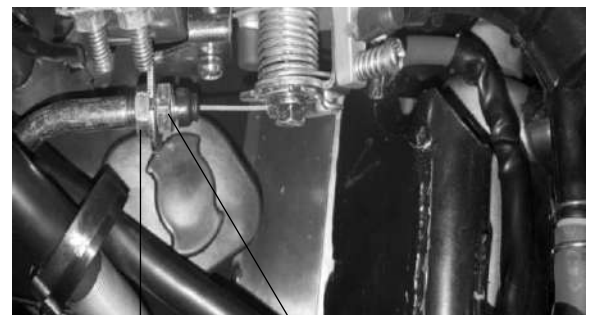

Lock Nut

Adjusting Nut

Minor adjustment is made with the adjusting nut at the throttle grip side.

Slide the rubber cover out and adjust by loosening the lock nut and turning the adjusting nut .



Lock Nut

Adjusting Nut

3. INSPECTION/ADJUSTMENT

ENGINE OIL

Engine oil recommendation

Use a premium quality 4-stroke motor oil to ensure longer service life of your scooter.

Use only oils which are rated, SL under the API service classification. The recommended viscosity is SAE 10W-40.

If SAE 10W-40 motor oil is not available, select an alternative according to the right chart.

Engine oil capacity:

At disassembly: 0.9 L

At change: 0.8 L

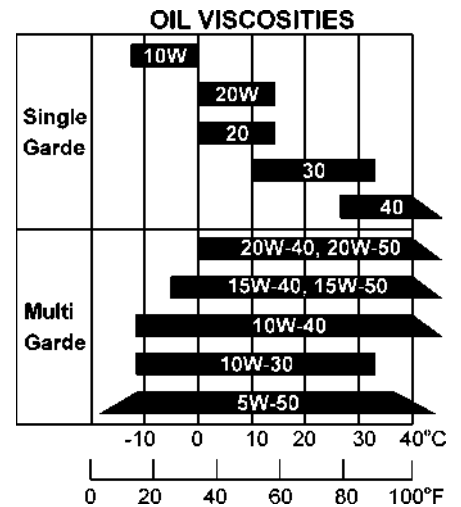

Oil strainer screen clean

Clean the oil strainer screen.

Check that the oil strainer screen, sealing rubber and drain plug O-ring are in good condition.

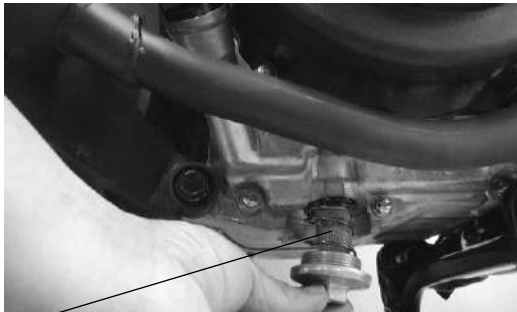

Oil strainer screen

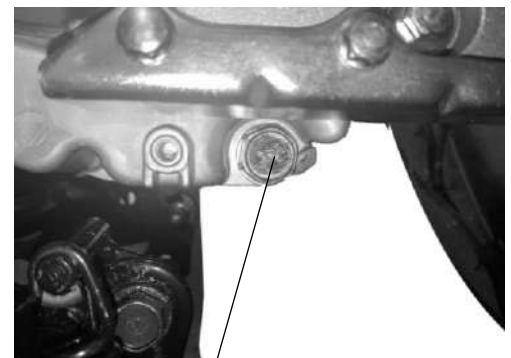

Oil drain bolt

TRANSMISSION OIL

Oil change

Fill the transmission case with recommended oil.

Recommended transmission oil: SAE 90

Oil capacity (at draining): 0.18L



fluid drain bolt

filler bolt

3. INSPECTION/ADJUSTMENT

AIR CLEANER

Air cleaner element replacement

1. Remove 6 screws from the air cleaner cover.
2. Remove the screws from the right side of the scooter.
3. Remove the air cleaner cap.
4. Replace the element with a new one

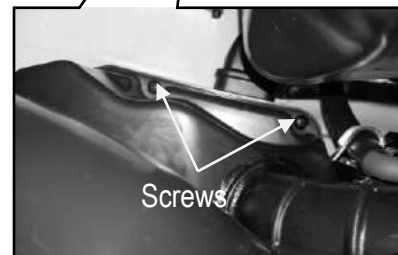
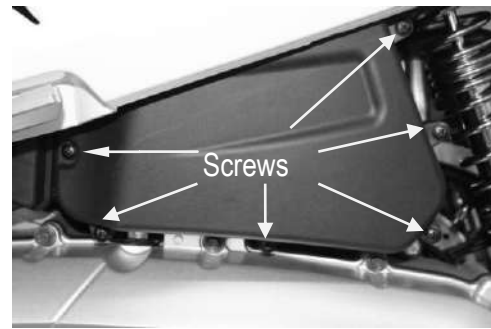

SPARK PLUG

Remove the spark plug cap and spark plug. Check the spark plug for wear and fouling deposits. Clean any fouling deposits with a spark plug cleaner or a wire brush.
 Specified Spark Plug: CR8E (NGK)
 Measure the spark plug gap.
 Spark Plug Gap: 0.7 – 0.8mm

* When installing, first screw in the spark plug by hand and then tighten it with a spark plug wrench.

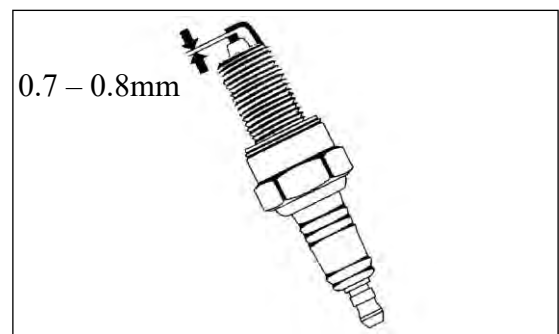

Torque: 0.9 kgf-m

3. INSPECTION/ADJUSTMENT

VALVE CLEARANCE

- * • Inspect and adjust valve clearance while the engine is cold (below 35°C).

Remove the four bolts on the cylinder head cover.
Remove the cylinder head cover.

Remove the fan cover.

Turn the A.C. generator flywheel clockwise to the top dead center (TDC) on the compression stroke so that the "T" mark on the flywheel aligns with the index mark on the right crankcase cover.

The punch mark on the camshaft should face Upward. If the punch mark on the camshaft are facing downward, turn the crankshaft clockwise one full turn (360°) and the punch mark are facing upward.

Adjust by loosening the valve adjusting screw lock-nut and turning the adjusting screw until there is a slight drag on the thickness gauge.

Valve Clearance: IN: 0.12 mm
EX: 0.12 mm

Apply oil to the valve adjusting screw lock-nut threads and seating surface.

Hold the adjusting screw and tighten the lock nut to the specified torque.

Torque: 0.9 kgf-m

Special tool:

Valve adjuster A120E00036

After tightening the lock-nut, recheck the valve clearance.

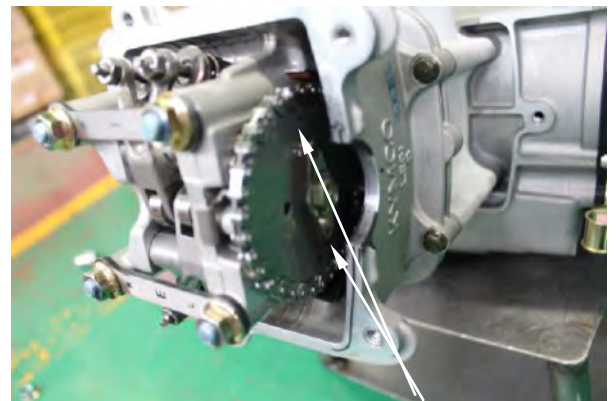

Round Hole

Valve adjuster



3. INSPECTION/ADJUSTMENT

CYLINDER COMPRESSION

Warm up the engine before compression test.
Remove the center cover and spark plug cap.
Remove the spark plug .
Insert a compression gauge.
Open the throttle valve fully and push the starter button to test the compression.

Compression: $15 \pm 2 \text{ kgf/cm}^2$

If the compression is low, check for the following:

- Leaky valves
- Valve clearance too small
- Leaking cylinder head gasket
- Worn pistons
- Worn piston/cylinder

If the compression is high, it indicates that carbon deposits have accumulated on the combustion chamber and the piston head.

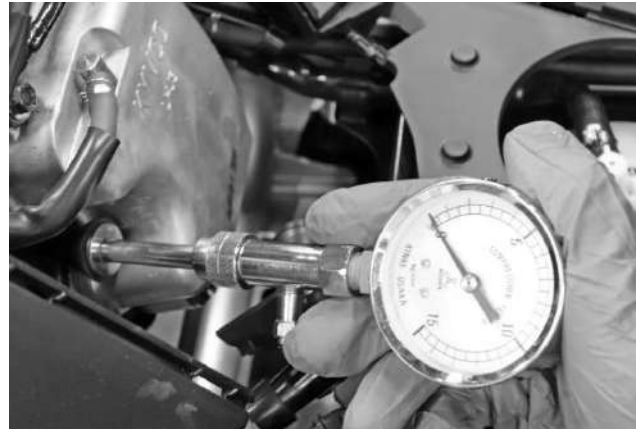

DRIVE BELT

Remove the left crankcase cover.
Inspect the drive belt for cracks or excessive wear.
Replace the drive belt with a new one if necessary and in accordance with the Maintenance Schedule.



drive belt

CLUTCH SHOE WEAR

Start the engine and check the clutch operation by increasing the engine speed gradually.
If the scooter tends to creep, or the engine stalls, check the clutch shoes for wear and replace if necessary.

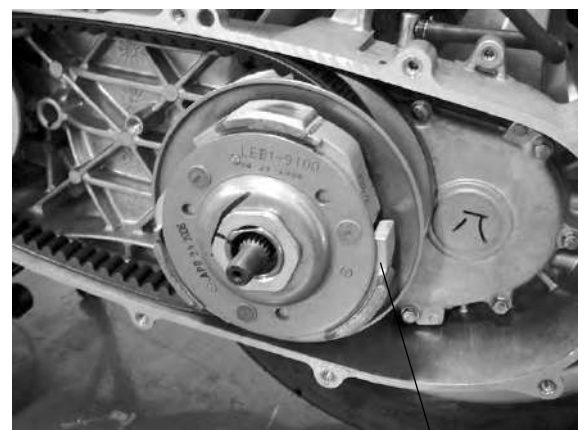

Clutch Shoes

3. INSPECTION/ADJUSTMENT

HEADLIGHT ADJUSTMENT

Headlight aim can be made by turning the screw in or out as necessary.

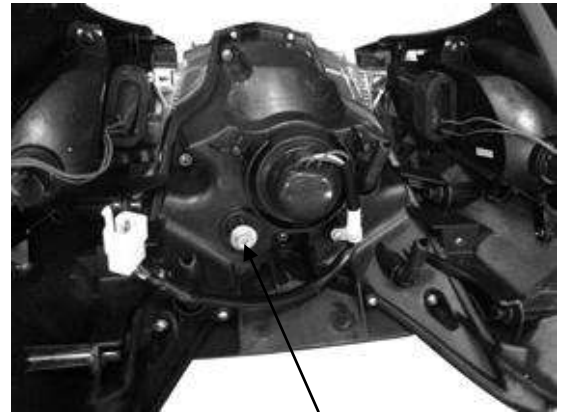

Adjustment Screw

BRAKE FLUID

Brake fluid level:

With the scooter in an upright position, check the front and rear fluid level. It should be above the lower level mark. If the level is at or below the lower level mark "L", check the brake pads for wear.

Worn pads should be replaced. If the pads are not worn, have your brake system inspected for leaks.

The recommended brake fluid is **DOT 4** brake fluid from a sealed container, or an equivalent.



Front brake

BRAKE PAD WEAR

Brake pad wear depends upon the severity of usage, the type of riding, and road conditions. (Generally, the pads will wear faster on wet and dirty roads.)

Check the cutout in each pad.

If either pad is worn to the cutout, replace both pads as a set.

Rear brake

Check the cutout in each pad.

If either pad is worn to the cutout, replace both pads as a set.

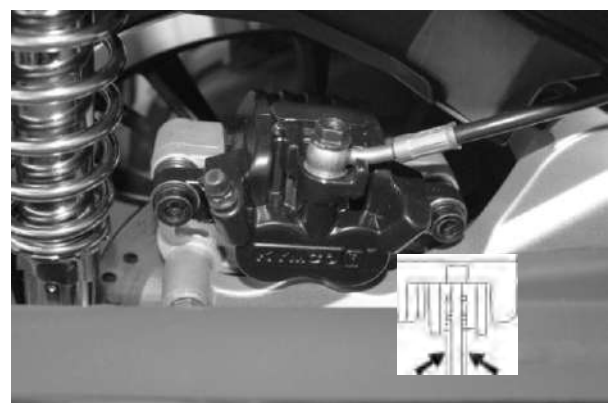

Rear brake

3. INSPECTION/ADJUSTMENT

Combination Braking System (CBS)

Combination Braking System , the rider's action of depressing the rear brake lever applies both front and rear brakes, The amount of each brake applied is determined by CBS pump.

Depressing the front brake lever only applies the front brake.

- ① Rear brake lever
- ② the master cylinder
- ③ the brake tubing
- ④ the brake caliper
- ⑤ the brake disc
- ⑥ CBS Pump

Three-limb Tube

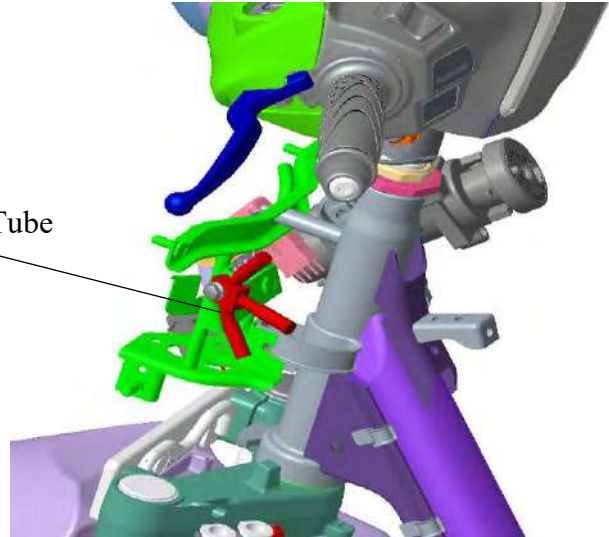

CBS Diagram

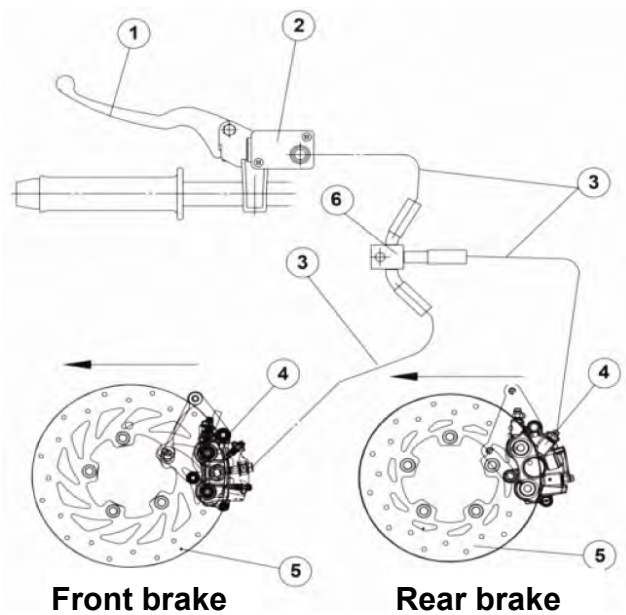

3. INSPECTION/ADJUSTMENT

Charging function detection instructions:

1. If the voltage display value is $\leq 12.25\text{V}$, the positive power is off and the USB symbol is not display
2. If the voltage display value $\geq 12.75\text{V}$, then the positive open, the instrument will determine whether there is a device in the charge:
 - 2.1 If no device is charging, the USB symbol is not displayed.
 - 2.2.1 If the device is charging and the battery voltage is $> 12.75\text{V}$, the USB symbol is displayed.
 - 2.2.2 If the device is charging and $12.75\text{V} > \text{battery voltage} > 12.25\text{V}$, the USB symbol is flashing.
 - 2.2.3 If the device is charging and the battery voltage is $\leq 12.25\text{V}$, the positive power is off and the USB symbol is not displayed.

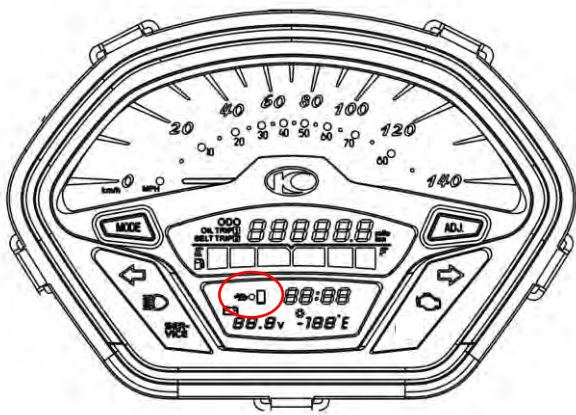

4. LUBRICATION SYSTEM

LUBRICATION SYSTEM

SERVICE INFORMATION	4-2
TROUBLESHOOTING	4-2
ENGINE OIL/OIL FILTER	4-3
OIL PUMP	4-4

4. LUBRICATION SYSTEM

LUBRICATION SYSTEM

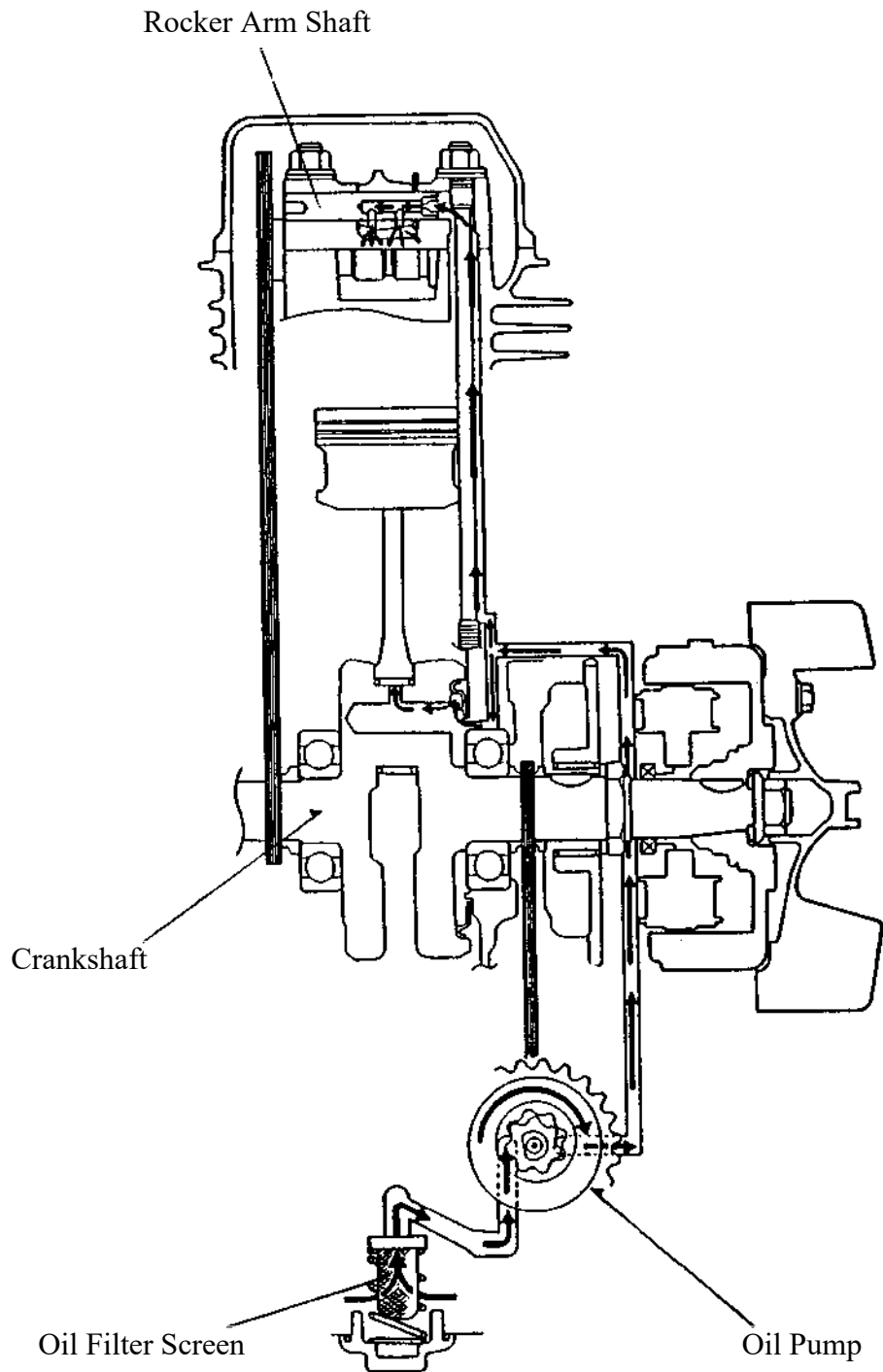

4. LUBRICATION SYSTEM

SERVICE INFORMATION

GENERAL INSTRUCTIONS

- The maintenance of lubrication system can be performed with the engine installed in the frame.
- Use care when removing and installing the oil pump not to allow dust and foreign matters to enter the engine and oil line.
- Do not attempt to disassemble the oil pump. The oil pump must be replaced as a set when it reaches its service limit.
- After the oil pump is installed, check each part for oil leaks.

SPECIFICATIONS

Item		Standard (mm)	Service Limit (mm)
Oil pump	Inner rotor-to-outer rotor clearance	—	0.12
	Outer rotor-to-pump body clearance	—	0.12
	Rotor end-to-pump body clearance	0.05~0.10	0.2

TROUBLESHOOTING

Oil level too low

- Natural oil consumption
- Oil leaks
- Worn or poorly installed piston rings
- Worn valve guide or seal

Poor lubrication pressure

- Oil level too low
- Clogged oil filter or oil passages
- Not use the specified oil

4. LUBRICATION SYSTEM

ENGINE OIL/OIL FILTER

OIL LEVEL

- *
 • Place the motorcycle upright on level ground for engine oil level check.
 • Run the engine for 2~3 minutes and check the oil level after the engine is stopped for 2~3 minutes.

Remove the oil dipstick and check the oil level with the oil dipstick.

If the level is near the lower level, fill to the upper level with the specified engine oil.



OIL CHANGE

Remove the oil filter screen cap located on the bottom of the engine to drain the engine oil thoroughly.

- *
 The engine oil will drain more easily while the engine is warm.

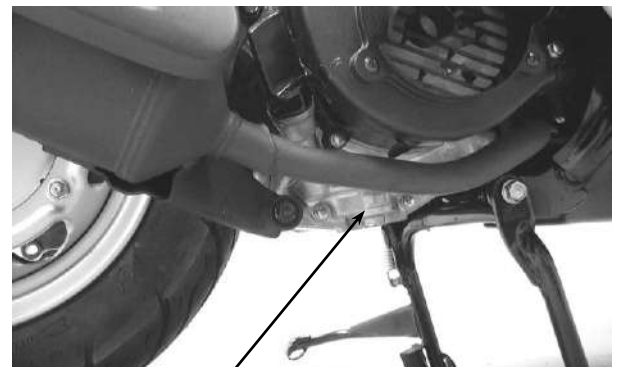

Oil Filter Screen Cap

After the oil has been completely drained, check the filter screen O-ring for damage and replace if necessary.

Install the oil filter screen, spring and filter screen cap.

Torque: 1.5kg-m

Fill with the specified SAE10W40#, API: SL engine oil to the proper level.

Oil Capacity: At disassembly : 0.90 liter
 At change : 0.8 liter



O-ring

Check for oil leaks and then start the engine and let it idle for few minutes.

Recheck the oil level.

4. LUBRICATION SYSTEM

OIL PUMP

REMOVAL

Remove the A.C. generator flywheel.
Remove the nine right crankcase cover bolts and the right crankcase cover.

Right Crankcase Cover

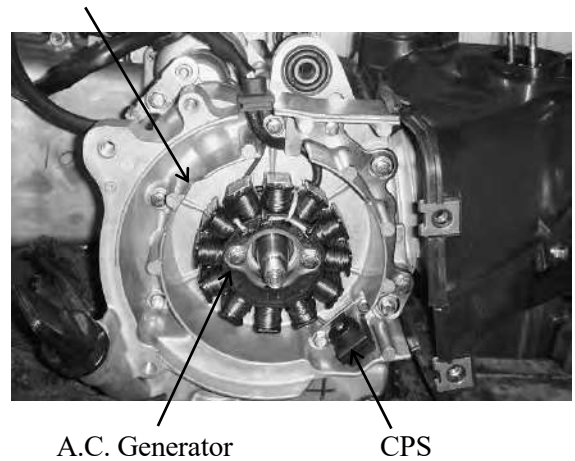

Remove the gasket and dowel pins.
Remove the starter idle gear and starter clutch.



Remove the two bolts and oil separator cover.

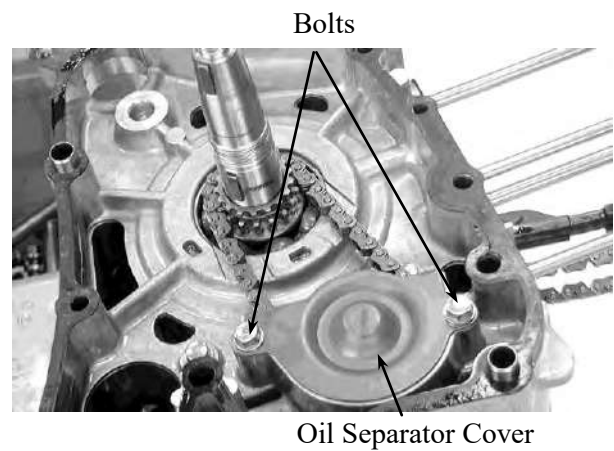

4. LUBRICATION SYSTEM

Remove the oil pump driven gear nut to remove the oil pump driven gear and drive chain.

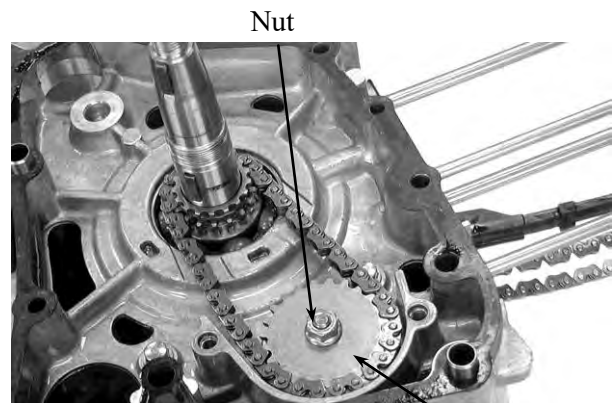

Nut

Oil Pump Driven Gear

Remove the two oil pump mounting bolts and the oil pump.

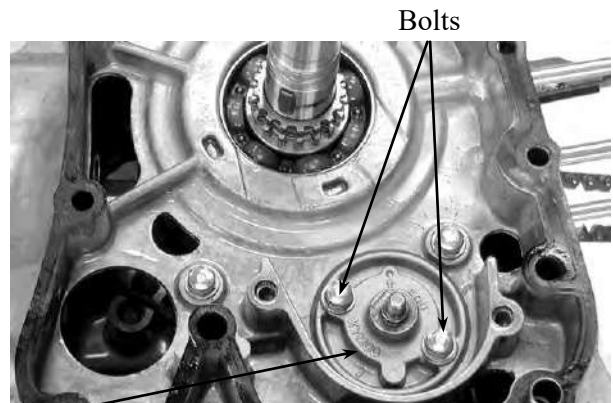

Bolts

Oil Pump

DISASSEMBLY

Remove the screw and disassemble the oil pump.

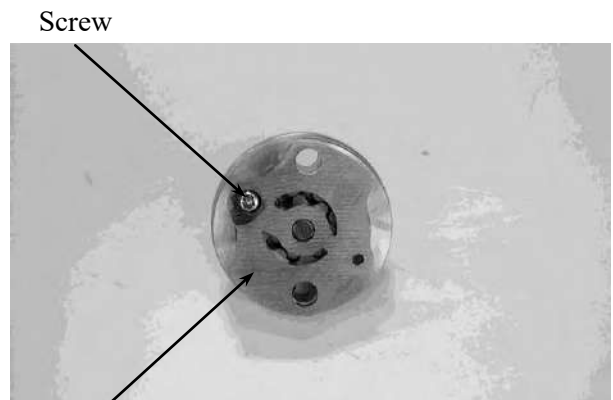

Screw

Pump Body

4. LUBRICATION SYSTEM

INSPECTION

Measure the pump body-to-outer rotor clearance.

Service Limit: 0.12mm

Outer Rotor

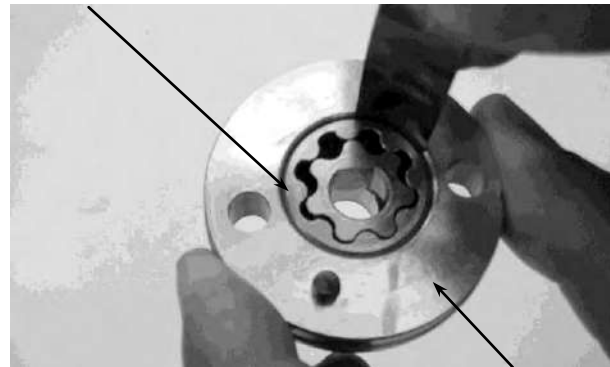

Pump Body

Measure the inner rotor-to-outer rotor clearance.

Service Limit: 0.12mm

Outer Rotor

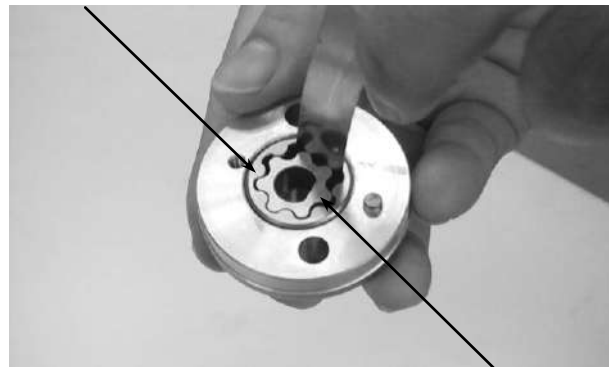

Inner Rotor

Measure the rotor end-to-pump body clearance.

Service Limit: 0.2mm

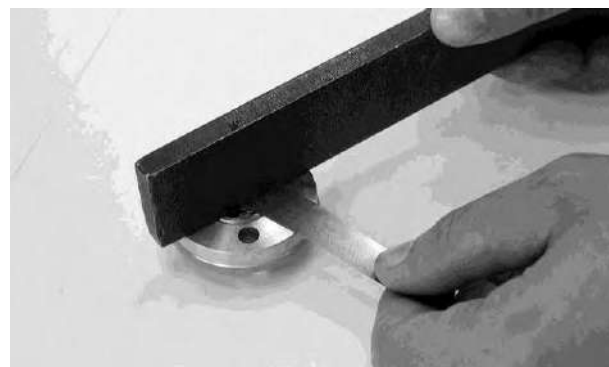

4. LUBRICATION SYSTEM

ASSEMBLY

Install the outer rotor, inner rotor and pump shaft into the pump body.

- * Insert the pump shaft by aligning the flat on the shaft with the flat in the inner rotor.

Install the dowel pin.

Install the pump cover by aligning the hole in the cover with the dowel pin.

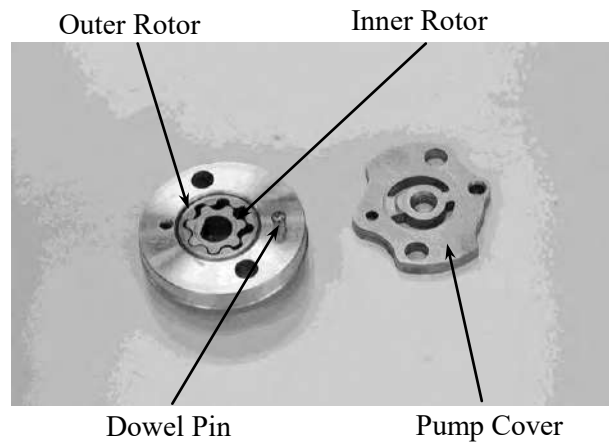

Tighten the screw to secure the pump cover. Make sure that the pump shaft rotates freely without binding.

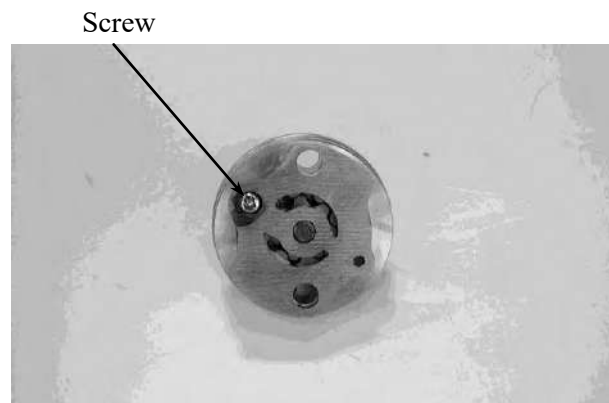

INSTALLATION

Install the oil pump into the crankcase.

- * Install the oil pump with the arrow on the pump body facing up and fill the oil pump with engine oil before installation.

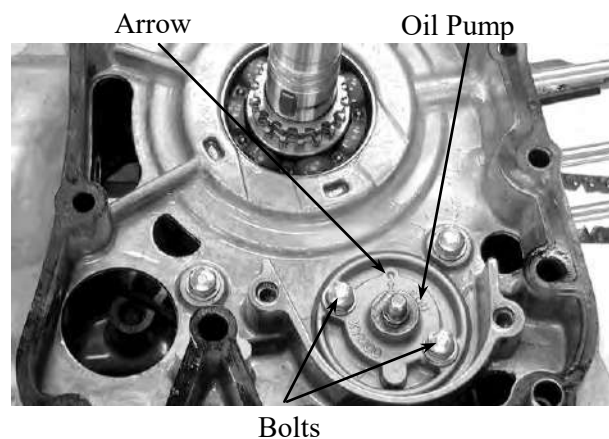

4. LUBRICATION SYSTEM

After the oil pump is installed, tighten the two mounting bolts.



Bolts

Install the pump driven gear and drive chain by aligning the pump driven gear with the cutout in the pump shaft.
Install and tighten the pump driven gear nut.

Torque: 1.0kg-m

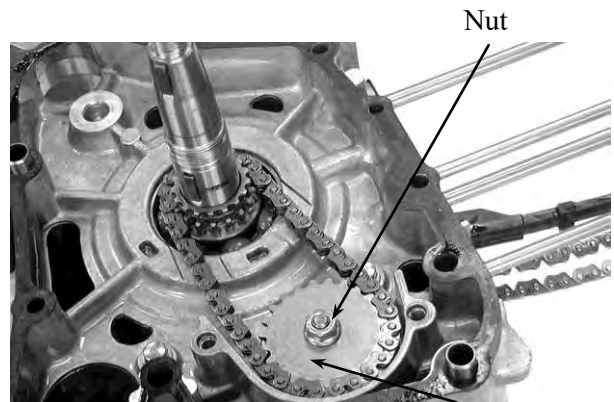

Pump Driven Gear

Install the oil separator cover and tighten the bolts.

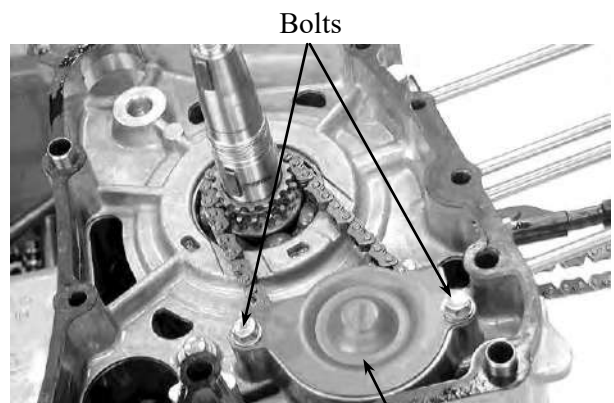

Oil Separator Cover

4. LUBRICATION SYSTEM

Install the starter idle gear and starter clutch.
Install the gasket and dowel pins.

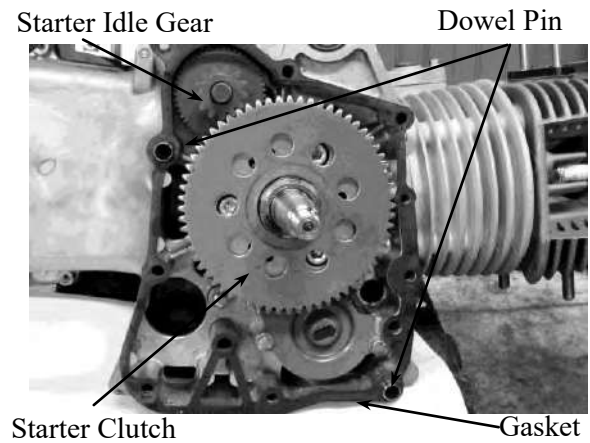

Install the right crankcase cover and tighten the nine bolts.

Torque: 0.9kg-m

* Diagonally tighten the bolts in 2 ~ 3 times.



A.C. Generator Right Crankcase Cover

5. FUEL INJECTION SYSTEM

FUEL INJECTION SYSTEM

SYSTEM DIAGRAM	5 - 1
SYSTEM LOCATION.....	5 - 2
SERVICE INFORMATION	5 - 3
TROUBLESHOOTING	5 - 4
CHECK ENGINE LAMP (CELP).....	5 - 5
HOW TO SHOW THE FAILURE CODE.....	5 - 6
FAILURE CODES CHART	5 - 7
ECU	5-11
FUEL PUMP	5-12
T-MAP & TPS.....	5-13
WTS.....	5-14
INJECTOR	5-14
O ² SENSOR	5-15
ROLL SENSOR	5-16

5. FUEL INJECTION SYSTEM

INJECTION SYSTEM

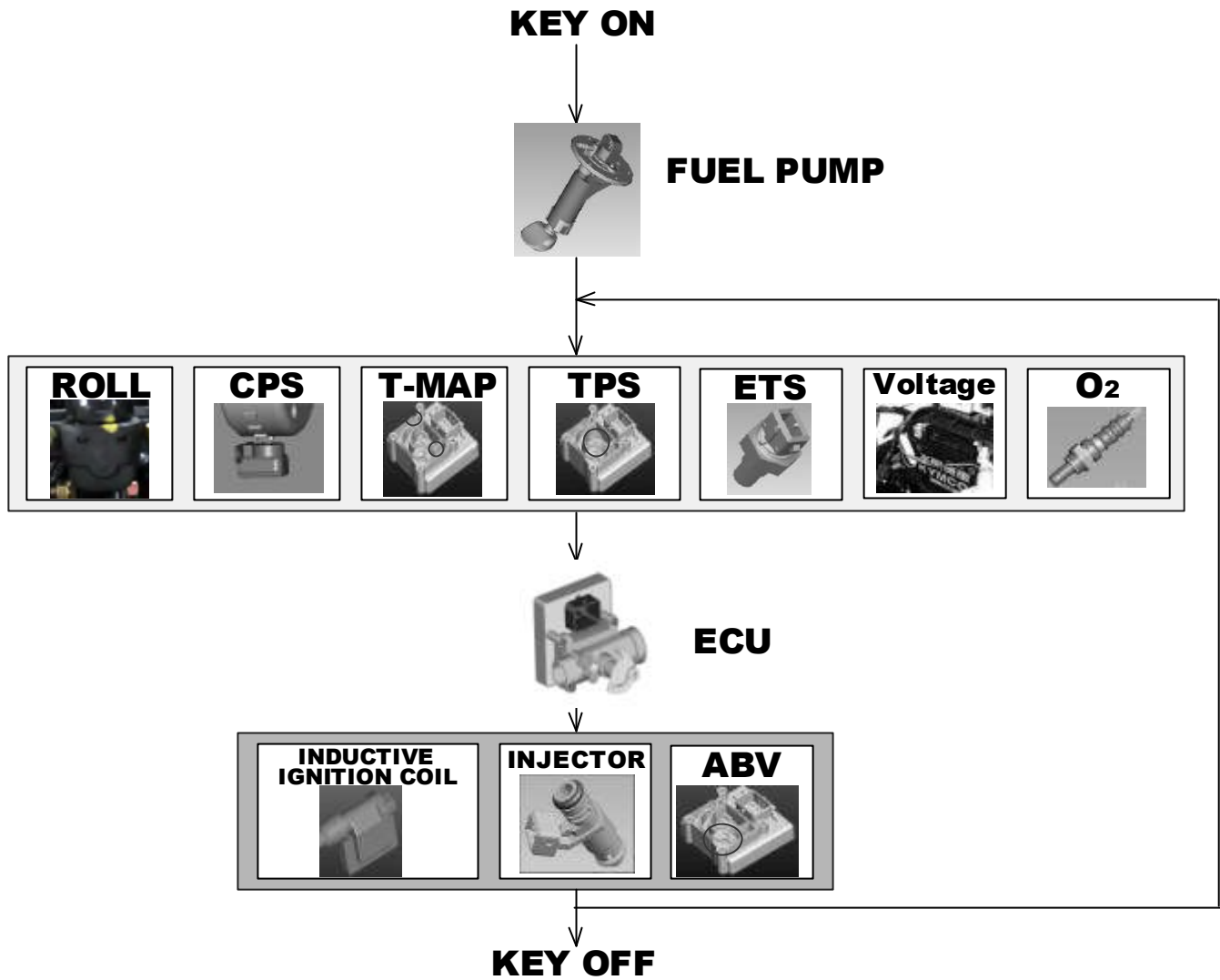

5. FUEL INJECTION SYSTEM

Parts I

- 01: Inductive ignition coil
- 02: Fuel pump
- 03: ECU
- 04: Fuel injector
- 05: ETS sensor
- 06: T-MAP sensor
- 07: ABV
- 08: TPS
- 09: Roll sensor
- 10: CPS
- 11: O2/O2 HT sensor

09

09

02
t sensor)

01

03

06

07

08

10

11

04

05

11



03

06

07

08

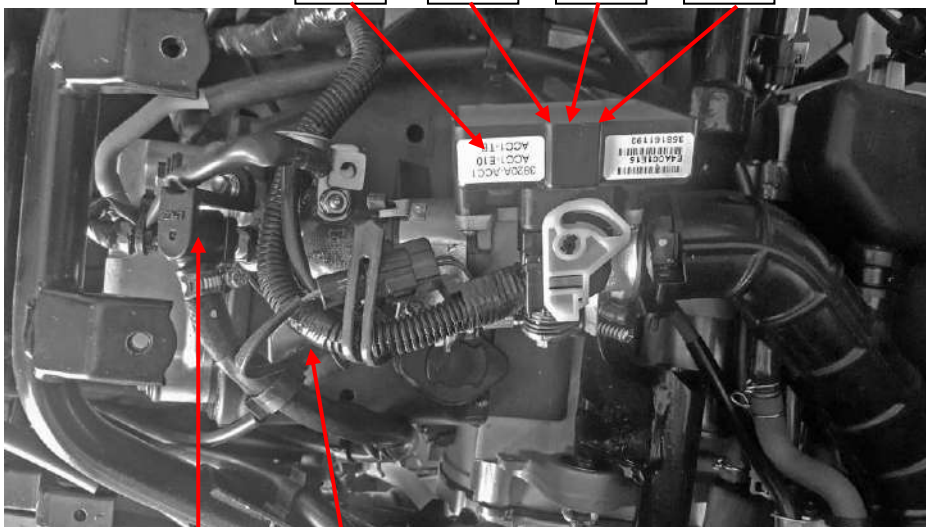

04

05

5. FUEL INJECTION SYSTEM

SERVICE INFORMATION

GENERAL INSTRUCTIONS

* Gasoline is very dangerous. When working with gasoline, keep sparks and flames away from the working area.
Gasoline is extremely flammable and is explosive under certain conditions. Be sure to work in a well-ventilated area.

- Disconnect the cables of the battery when the engine is running, which could lead to ECU damage.
- Connect the harness positive (+) cable to the battery negative (-) terminal or connect the harness negative (-) to the battery positive (+) terminal, which could lead to ECU damage.
- Always keep fuel over 750 cc in fuel tank.

SPECIFICATIONS

Item		Standard	
Charging voltage of battery		13.5 ~ 14.5V	
Voltage from the ECU to sensor		5±0.1V	
Fuel injector resistance (20°C/68°F)		10.6 ~ 15.9Ω	
Engine temperature sensor resistance		11.15±7.45% kΩ(25°C)	
Throttle position sensor voltage		Idle (0°) = 0.23±0.05V Throttle fully (90° /3.27V over)	
Fuel pump resistance (20°C/68°F)		F: about 120Ω E: about 1060Ω	
O2 sensor	O2 sensor heater resistance	6.7 ~ 9.5Ω	
	Voltage	Air/Fuel<14.7 (Rich)	>0.7V
		Air/Fuel>14.7 (Lean)	<0.18V
Crank position sensor (Pulser) resistance		96 ~ 144Ω	
Inductive ignition coil resistance (20°C/68°F)		0.55 ~ 0.75Ω	
Roll sensor voltage (diagnostics)		Normal: 0.4 ~ 1.4V Fall down (>65°): 3.5 ~ 4.7V	
Idle speed		1800 rpm	

5. FUEL INJECTION SYSTEM

TROUBLESHOOTING

Engine won't start

- Battery voltage too low
- Fuel level too low
- Pinched or clogged fuel hose
- Faulty fuel pump operating system
- Clogged fuel filter (fuel pump)
- Clogged fuel injector
- Faulty spark plug or wrong type
- Cut by ECU due to angle detect sensor or incorrect function

Backfiring or misfiring during acceleration

- Ignition system malfunction

Poor performance (drive ability) and poor fuel economy

- Pinched or clogged fuel hose
- Faulty fuel injector

Engine stall, hard to start, rough idling

- Intake air leak
- Fuel contaminated/deteriorated
- Pinched or clogged fuel hose
- Idle speed misadjusted

5. FUEL INJECTION SYSTEM

CHECK ENGINE LAMP (CEL)

- Open the Ignition switch, the CEL indicator will illuminate always. After starting it will crush out. If there is any malfunction, the CEL indicator will still illuminate, please take your scooter to a KYMCO dealer for service as soon as possible.

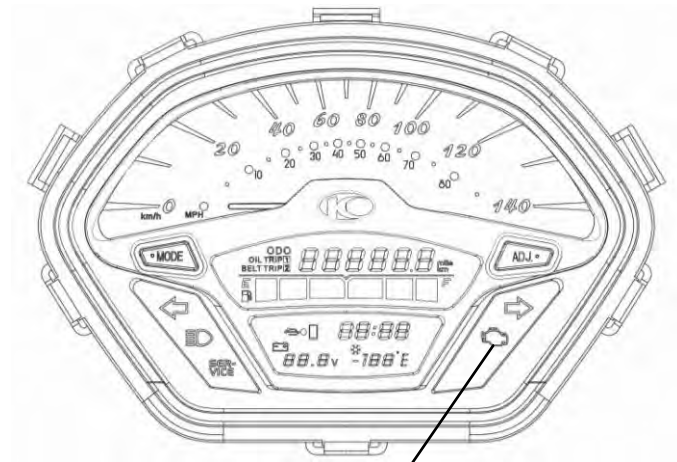

CEL

5. FUEL INJECTION SYSTEM**Failure Code Chart**

NO	Failure Code	Fault description	Remark
1	P0217	Engine over temperature condition	
2	P0335	Crankshaft position sensor circuit malfunction	
3	P0560	Battery voltage malfunction	
4	P0031	O2 sensor heater Voltage Low	
5	P0032	Lambda sensor heater Voltage High	
6	P0107	MAP sensor Voltage Low	
7	P0108	MAP sensor Voltage High	
8	P0112	Intake air temperature sensor Voltage Low	
9	P0117	Engine Temperature Sensor Voltage Low	
10	P0118	Engine Temperature Sensor Voltage High	
11	P0120	Throttle Position Sensor Malfunction or Voltage Lo	
12	P0122	Throttle Position Sensor Voltage Low	
13	P0123	Throttle Position Sensor Voltage High	
14	P0130	O2 sensor signal Malfunction	
15	P0131	O2 sensor signal Voltage Low	
16	P0132	O2 sensor signal Voltage High	
17	P0231	Fuel pump Voltage Low	
18	P0232	Fuel pump Voltage High	
19	P0261	Injection valve Voltage Low	
20	P0262	Injection valve Voltage High	
21	P0508	ISAV idle speed actuator valve Voltage Low	
22	P0509	ISAV idle speed actuator valve Voltage High	
23	P2300	Ignition Malfunction or Voltage Low	
24	P2301	Ignition Malfunction or Voltage High	
25	P0113	Intake air temperature sensor Voltage High	
26	B0099	Roll Over sensor (Open Circuit、 Voltage High、 Voltage Low)	

5. FUEL INJECTION SYSTEM

ECU

There are 36 pins attaching the ECU.

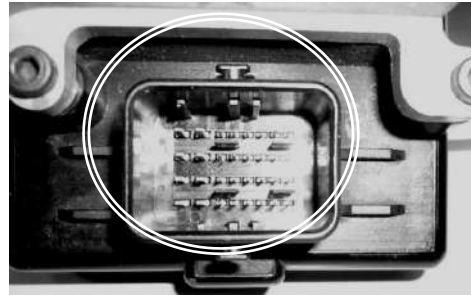

MAP content (edition issue no.)

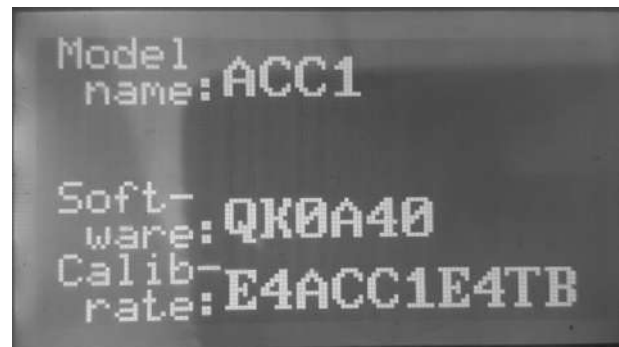

Prohibited to adjust and remove the throttle body idle screw

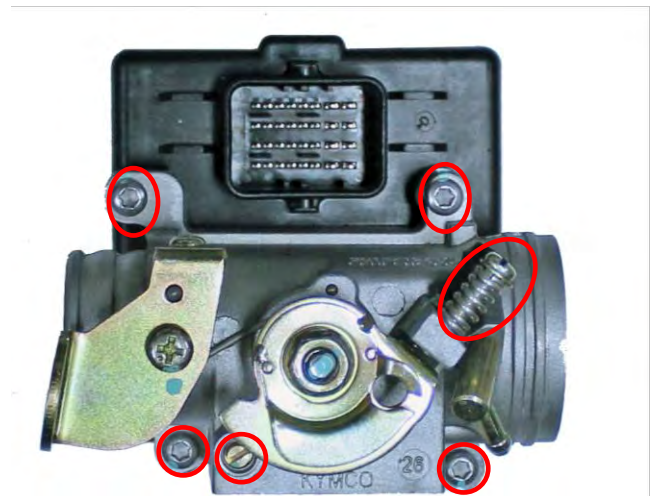

5. FUEL INJECTION SYSTEM

FUEL PUMP

Connect the meter (+) probe to the red/black wire and the meter (-) probe to the green wire to measure the voltage from the ECU input to fuel pump unit.

Standard : 8~16 V (Battery volt)

To measure the resistance of the fuel pump to see if it is short circuit or not.

Fuel Pump Inspection :

1. Fuel Pump Resistance:

>>>>About : 2Ω

2.If there is no continuity replace it

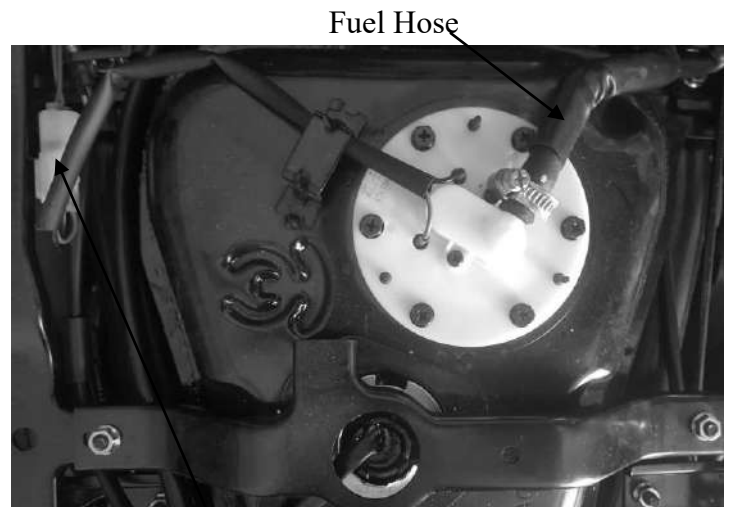

Connector

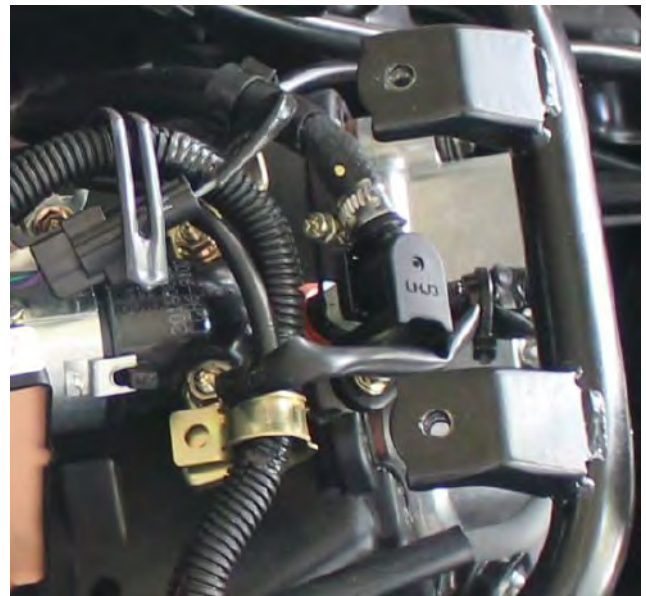

INJECTOR

Measure the resistance of the Injector

Standard (20°C/68°F): $10.6\sim 15.9\Omega$



5. FUEL INJECTION SYSTEM

T-MAP(Manifold Air Temperature Pressure) Sensor

Connect the Fi diagnostic tool.

Enter the Data Analyze

Check if the manifold pressure data is malfunction.

Turn the ignition switch to the “ON” position.

If data is incorrect, and the T-map sensor is problem.

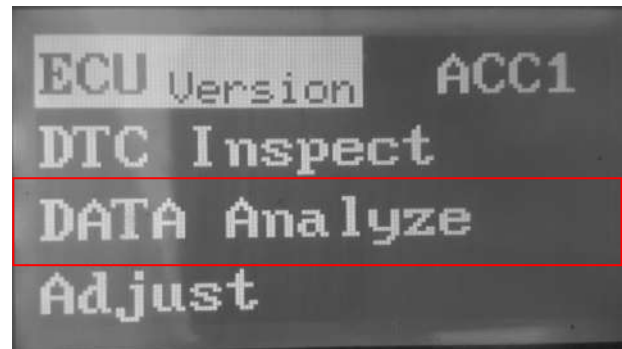

Standard : 101.3 ±3 kpa on sea altitude

The ambient pressure drop is about 12Kpa according to the altitude raises.

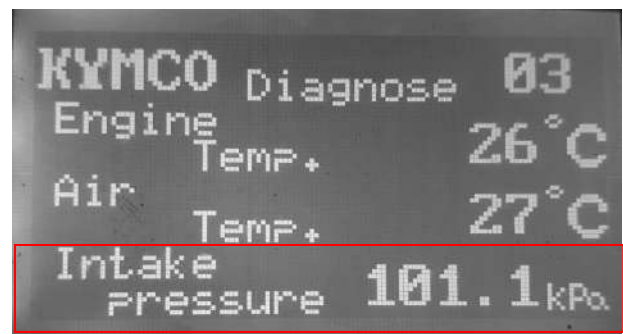

TPS (Throttle Position Sensor)

Enter the Data Analyze

Check if the TPS position data is malfunction.

Turn the ignition switch to the “ON” position.

If data is incorrect even the Idle and throttle fully, the TPS is problem.

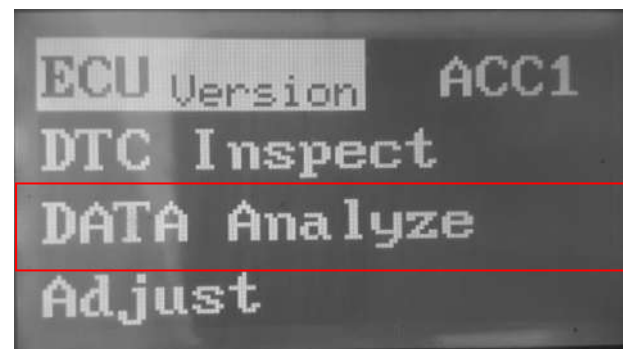

Standard :

Idle ~0° 0.23V ±0.05

Throttle fully ~90° > 3.27V

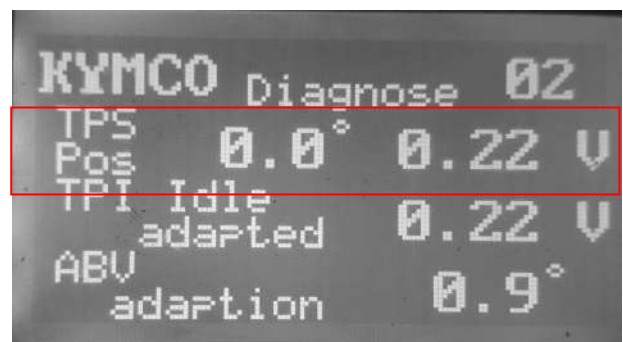

5. FUEL INJECTION SYSTEM

ETS (Engine Temperature Sensor)

Connect the meter (+) probe to the V/G wire and the meter (-) probe to the G/L wire to measure the voltage

Standard : 5 ± 0.25 V

Measure the resistance of the ETS

Standard $11.15\pm 7.45\%$ k Ω (25°C)



CPS

Measure the resistance of the Injector Measure the resistance between the blue/white and green/white wire terminals.

Standard : 96~144 Ω



5. FUEL INJECTION SYSTEM

O2 SENSOR

Measure the resistance of the O2 sensor heater.
(2 white wire pin)

Standard (20°C/68°F): 6.7 ~9.5Ω



Connect the KYMCO Fi diagnostic tool.
Enter the Data Analyze
Check Page 05
Turn the ignition switch to the “ON” position.
Starting engine till the O2 heater activation is ON.
If data is incorrect, the O2 sensor is problem.

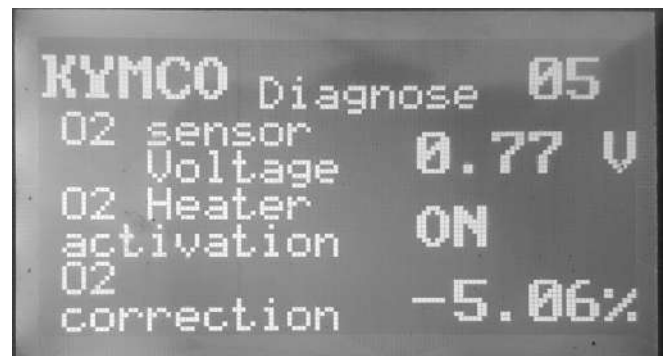

5. FUEL INJECTION SYSTEM

ROLL SENSOR

The engine should be stop when the vehicle incline over 65° for safety. When you place the vehicle back to normal position, you have to key-off and key-on the switch again, then it can be restarted.

Standard:

Normal: 0.4~1.4V

Fall down > 65°: 3.7~4.4 V

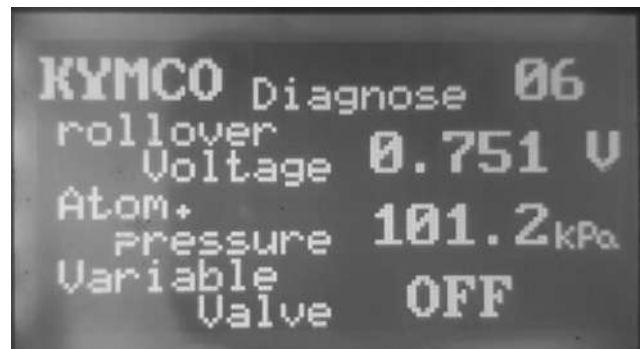
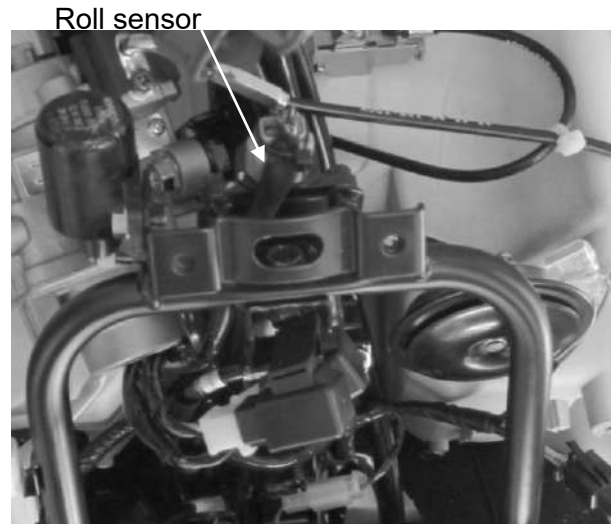

Fi Diagnostic Tool

Operation Instructions

Part No. 3620A-LEB2-E00

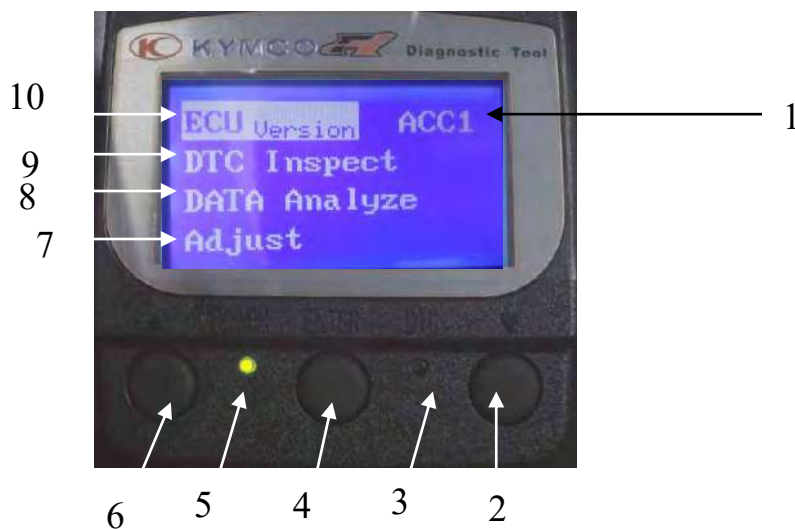

- | | |
|---------------------------------|--------------------------------------|
| 1 Model No. | 6 UP Button |
| 2 Down Button | 7 Adjust(TIP and ABV reset function) |
| 3 DTC indicator (Failure codes) | 8 DATA Analyze |
| 4 Enter or Exit | 9 DTC Inspect |
| 5 Power indicator | 10 ECU Version |

Note: For EURO 4 models

Use the Sub cord, OBD diagnostics, connector (part number:36205-LFA7- E00) to connect between vehicle and diagnostic tool.



To: Vehicle

To Diagnostic tool

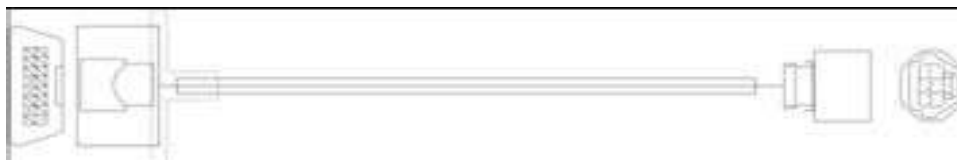

DTC INSPECTION

Connect Fi diagnostic tool with the connector of harness wire located beside the Battery.



Connector (OBD)

Press the "Enter" button



Check the software version

Press the "Enter" button and then turn to the first page.

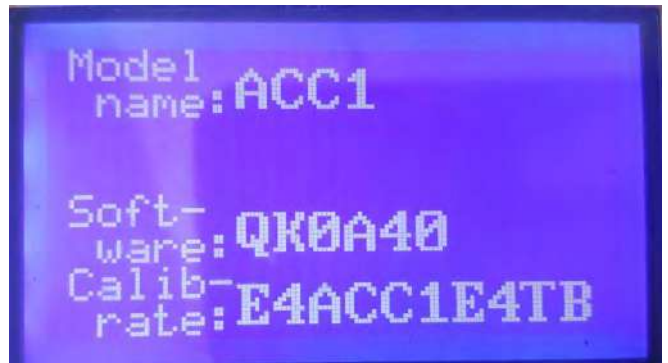

Press the "Down" button to enter the DTC Inspect.

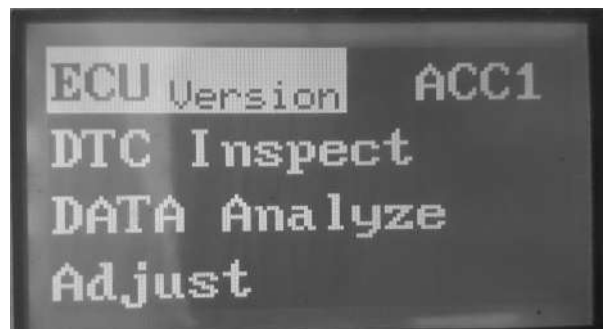

5. FUEL INJECTION SYSTEM

Press the "Enter" button to check the DTC number

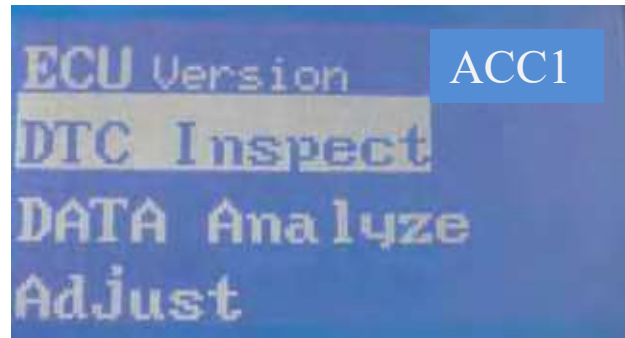

Press the "Enter" button

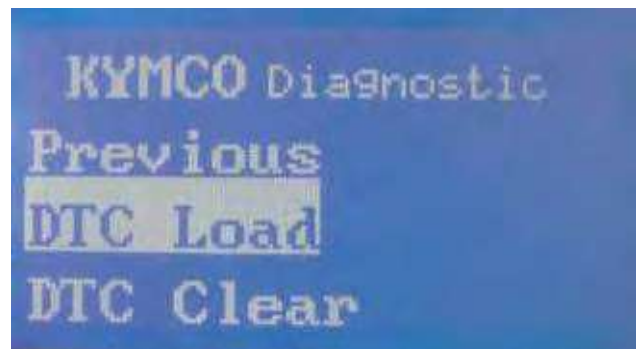

Press the "Enter" button

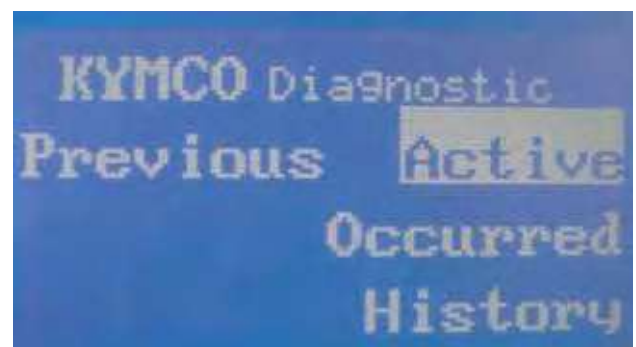

Display the DTC number of the DTC-List. Refer to DTC summary list.

Press the "Enter" button and then turn to the previous page

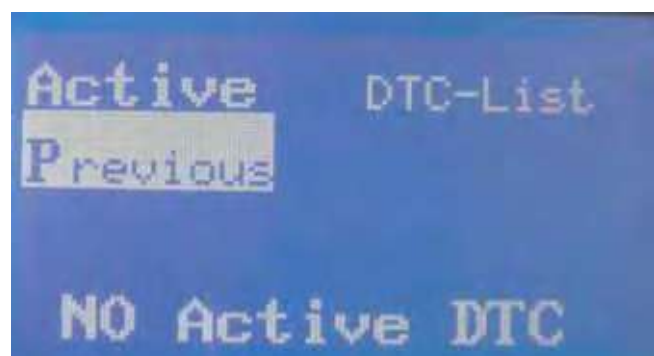

Press the "UP" button

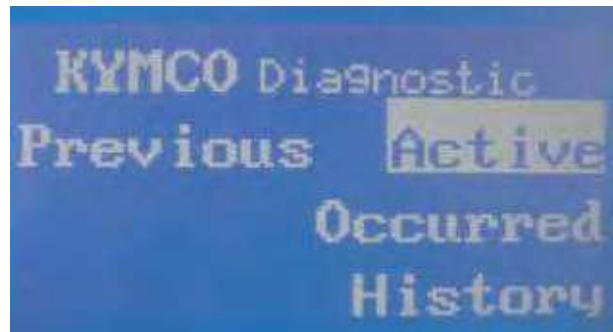

Press the "Enter" button and then turn to the previous page.

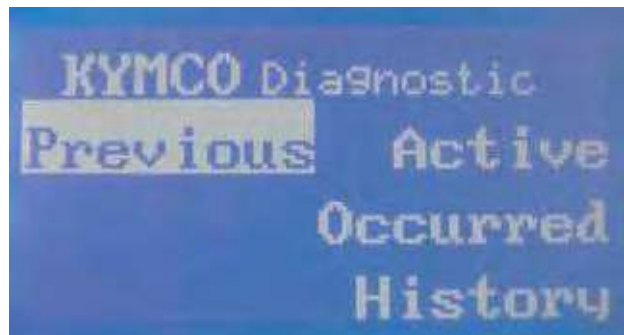

Press the "UP" button

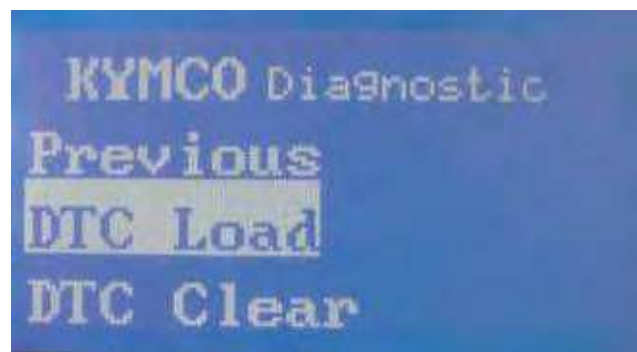

Press the "Enter" button and then turn to the first page.

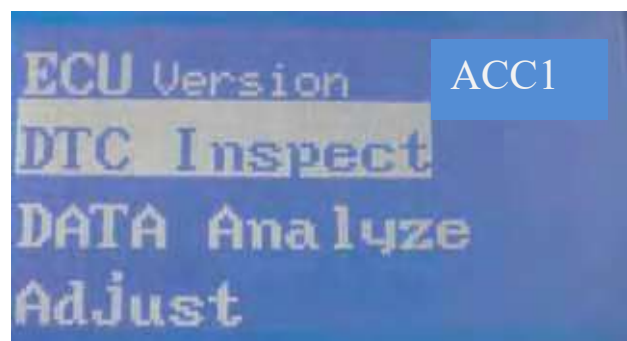

DTC CLEAR PROCEDURE

Choose "Load DTC"

Press the "Down" button

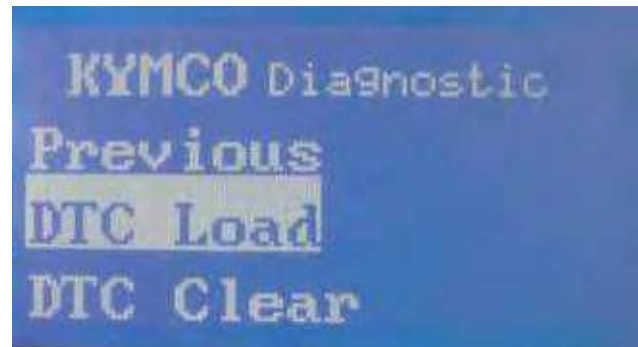

Press the "Enter" button

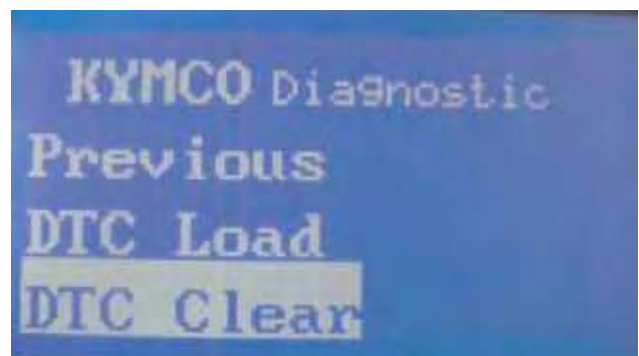

The DTC indicator is lighting at that time.



Clearing DTC until the DTC indicator is off.

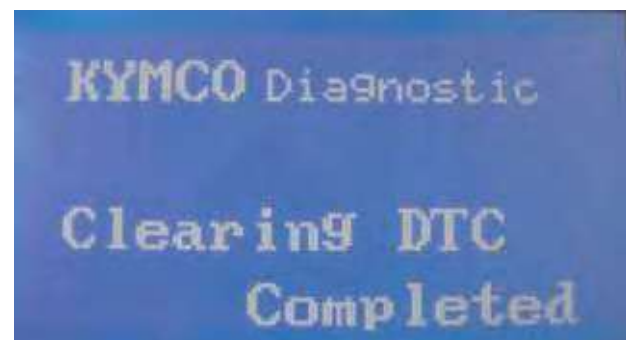

DATA ANALYSIS

Choose "Data Analyze"

Press the "Enter" button to enter page 01.

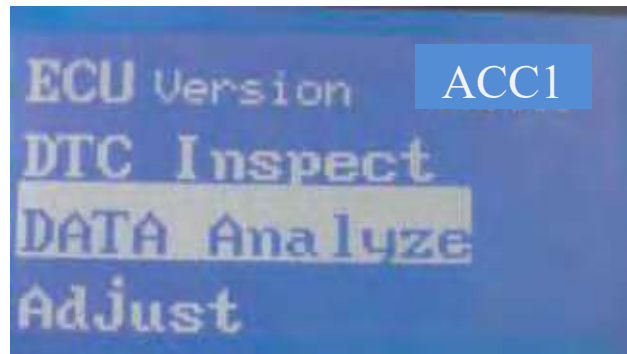

The figure includes the engine speed, idle speed and the battery voltage.

Refer to standard specification.

Press the "Down" button to enter page 02.



The figure includes TPS position, TPI idle adapted voltage and TPI WOT adapted (Throttle grip fully opened).

Refer to standard specification.

Press the "Down" button to enter page 03.

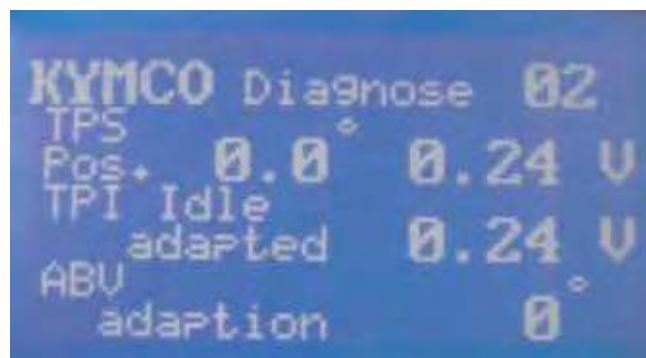

The figure includes engine working temperature, atmosphere pressure and Manifold pressure.

Refer to standard specifications on page 18-9.

Press the "Down" button to enter page 04.

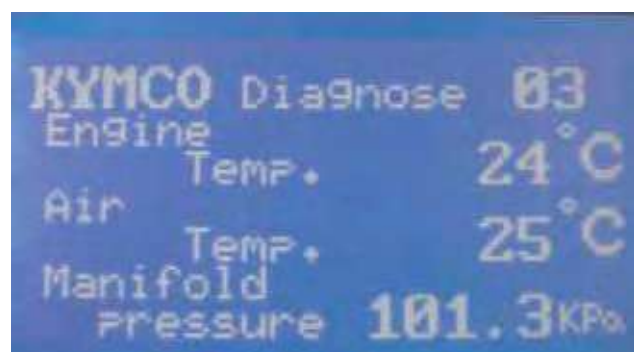

5. FUEL INJECTION SYSTEM

The figure includes fuel injector interval, ignition advance angle and ABV angle. Refer to standard specification. Press the "Down" button to enter page 05.

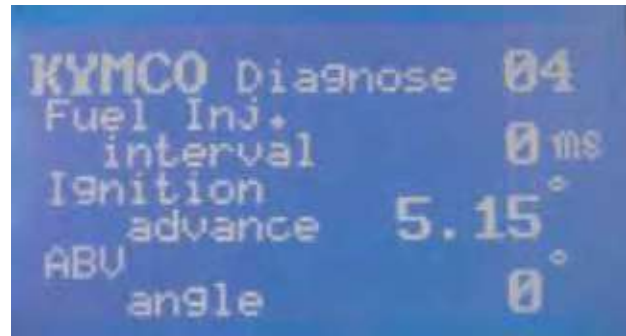

The figure includes O2 sensor voltage, O2 heater working condition and O2 correction.

Refer to standard specification.

Press the "Down" button to enter page 06.



The figure includes rollover voltage.

Refer to standard specification.

Press the "Down" button to enter page 07.

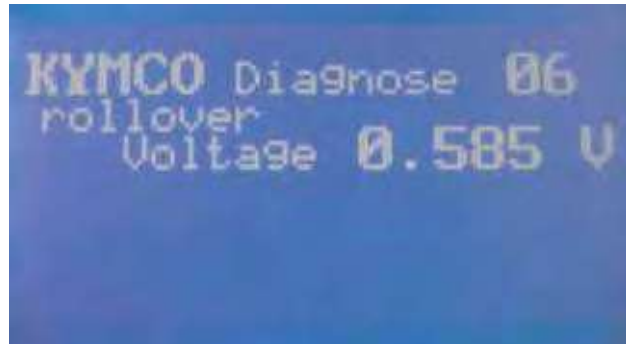

The figure includes ECU counter hours.

Press the "UP" button to the first page.

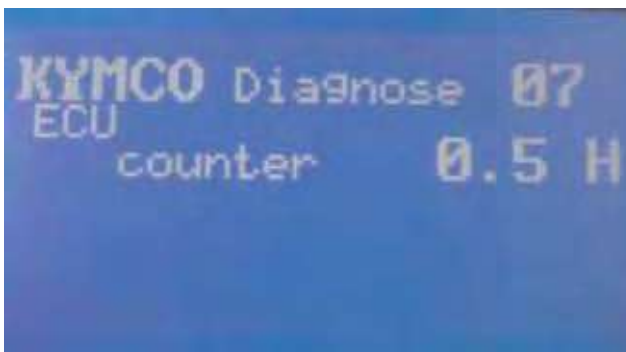

5. FUEL INJECTION SYSTEM

ADJUST

Need to process the TPI/ABV reset after replacing a new ECU or clean Throttle Body. To make ECU set up and set up initially

Choose "Adjust"

Press the "Enter" button to TPI/ABV Reset

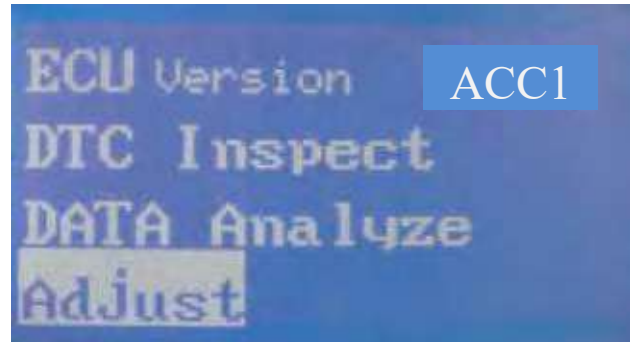

Press the "Enter" button

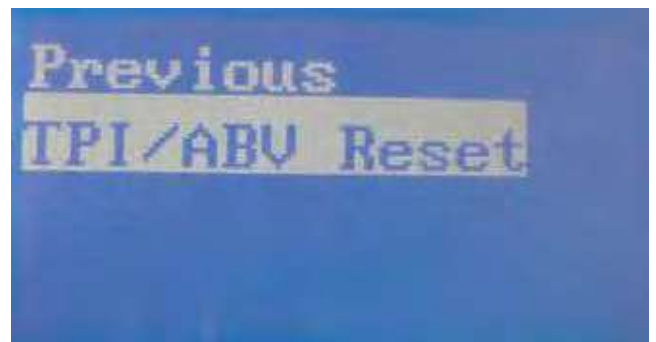

Please turn the ignition switch to the "OFF" position and then switch ON.

TPI/ABV reset is completed.

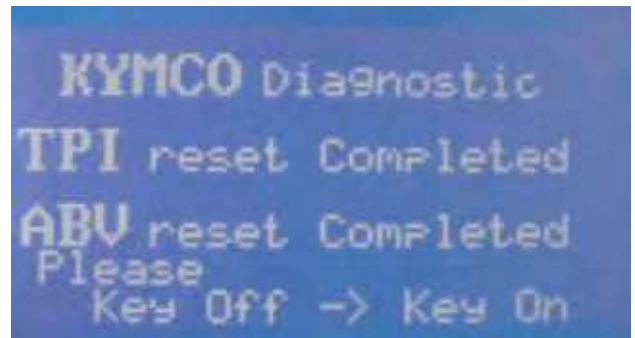

6. ENGINE REMOVAL/INSTALLATION



ENGINE REMOVAL/INSTALLATION

SERVICE INFORMATION	6-2
ENGINE REMOVAL.....	6-3
ENGINE INSTALLATION.....	6-6

6. ENGINE REMOVAL/INSTALLATION

TE25AA(IT) F21

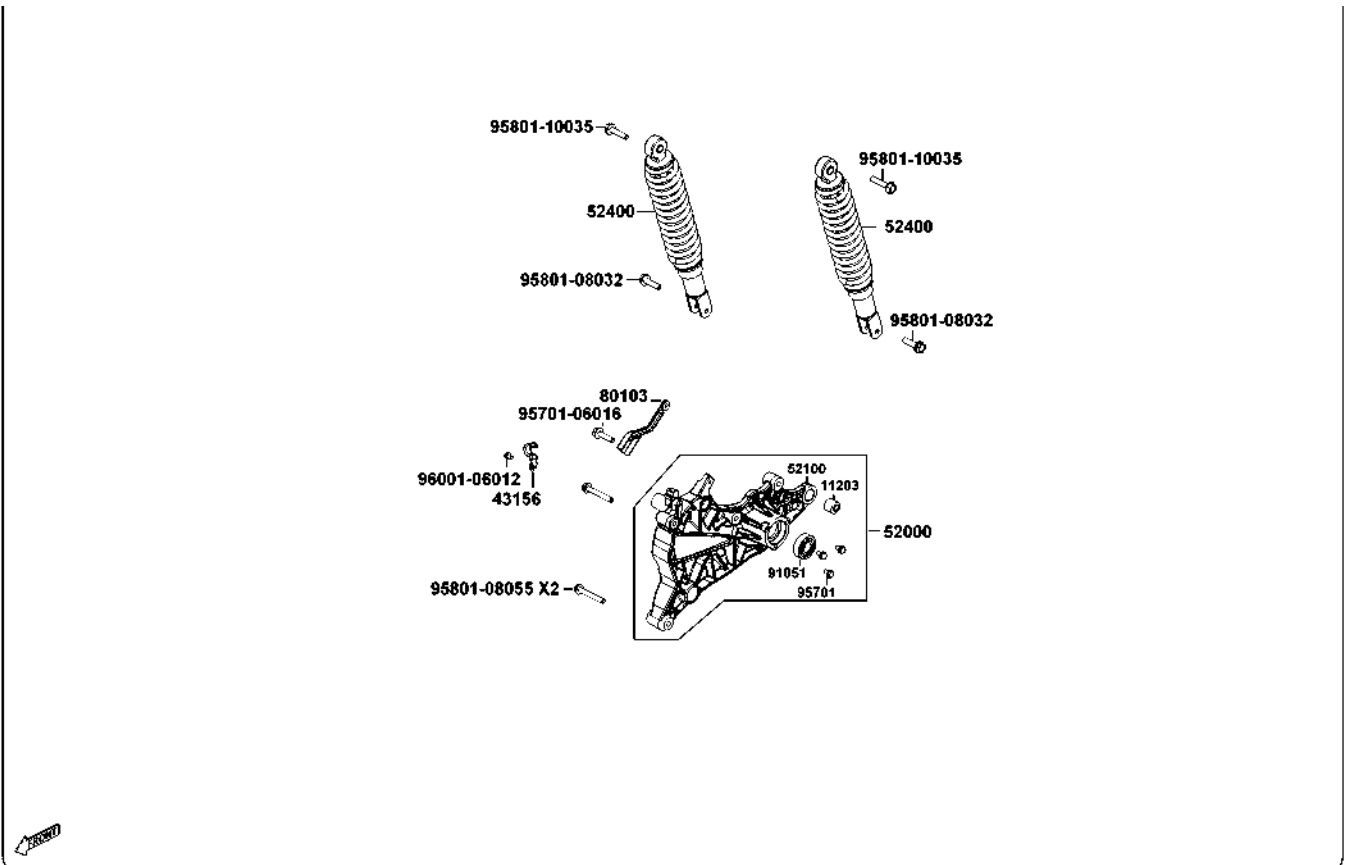
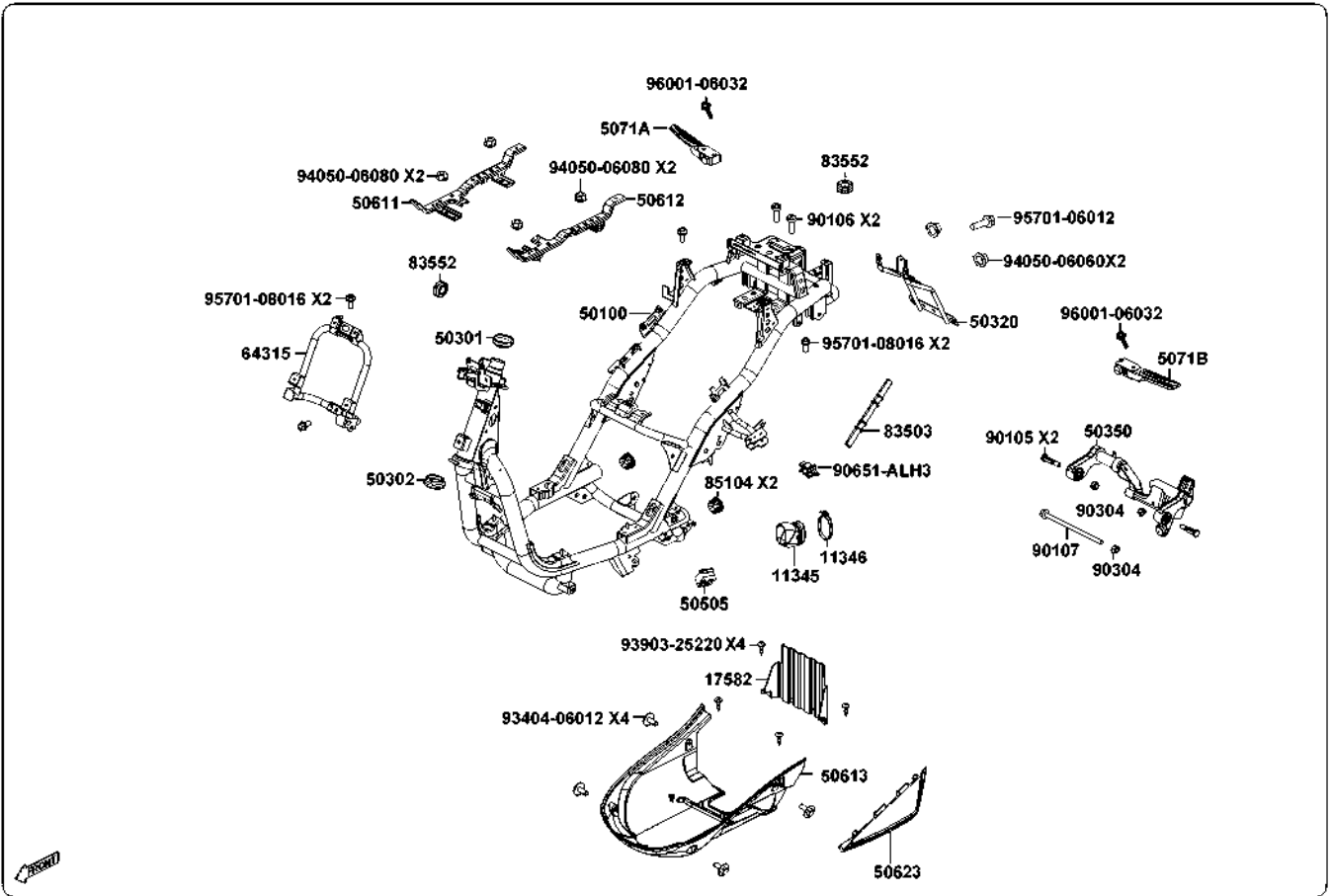

6. ENGINE REMOVAL/INSTALLATION

SERVICE INFORMATION

GENERAL INSTRUCTIONS

- A jack or other adjustable support is required to support and maneuver the engine. Be careful not to damage the motorcycle body, cables and wires during engine removal.
- Use towels to protect the motorcycle body during engine removal.
- Drain the coolant before removing the engine.
- After the engine is installed, fill the cooling system with coolant and be sure to bleed air. Start the engine to check for coolant leaks.
- Before removing the engine, the rear brake caliper must be removed first. Be careful not to bend or twist the brake fluid tube.

SPECIFICATIONS

Engine oil capacity: 0.9 Liter

TORQUE VALUES

Rear shock absorber upper mount bolt	40 N-m
Rear shock absorber lower mount bolt	40 N-m
Rear axle nut	120 N-n
Engine hanger bolt (frame side)	50 N-m
Engine hanger bolt (ENG. side)	50 N-m
Rear caliper holder bolt	27 N-m
Exhaust muffler pipe nut	20 N-m
Exhaust muffler bracket bolt (attached to RR Fork)	35 N-m
Rear fork bolt (attached to ENG case)	32 N-m

6. ENGINE REMOVAL/INSTALLATION

ENGINE REMOVAL

Remove the frame body cover(2-4/5).
 Disconnect the battery negative cable.
 Disconnect the engine negative cable.
 Disconnect the A.C. Generator wire connector.
 Disconnect the starter motor cable from the starter relay.

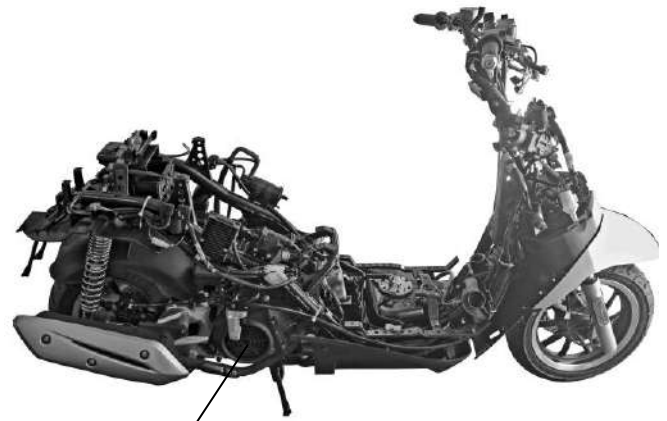

A.C.G wire connector

Remove the spark plug cap.
 Remove the ignition coil's wire.
 Remove the O2 sensor wire.

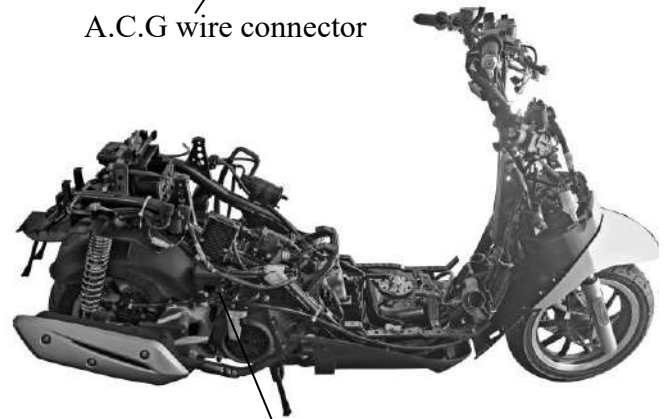

Starter relay.

Disconnect the ECU connector
 Disconnect the engine temperature sensor connector.
 Remove the injector's wire.
 Remove the throttle cable.
 Remove the vacuum tube.
 Remove the fuel tube attaching to injector.

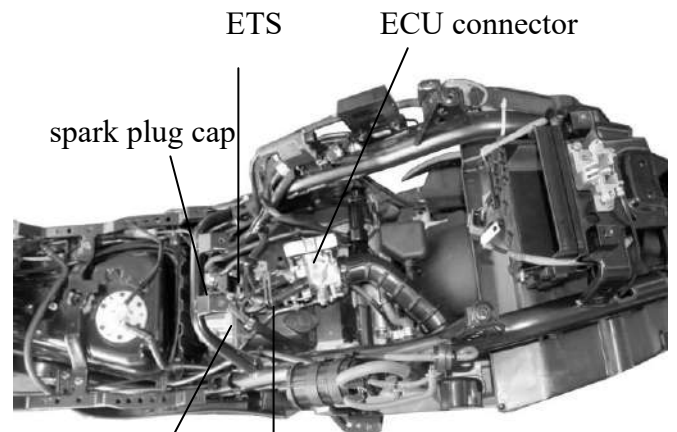

Fuel tube

Throttle Cable

6. ENGINE REMOVAL/INSTALLATION

- Remove the air cleaner
- Remove the exhaust muffler(2-6)

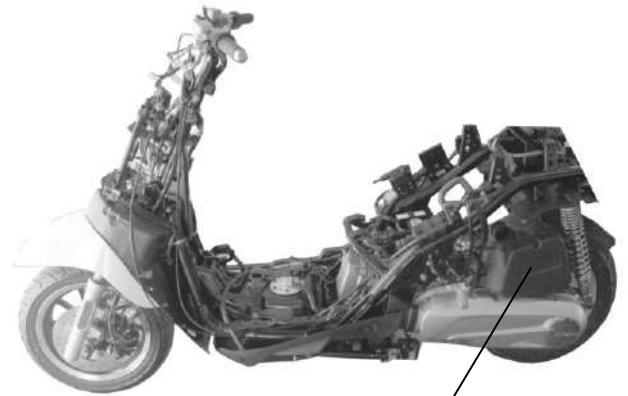

Air cleaner

- Remove the rear brake caliper.
- Remove one bolt attaching to rear brake hose clamps.

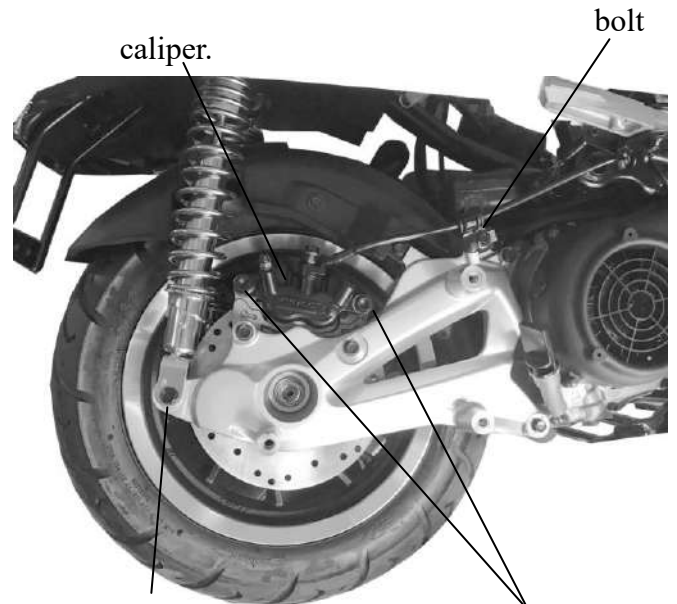

Rear Shock Absorber Bolts

Rear caliper bolts

- Remove the rear shock absorbers mounting bolts.



Rear Shock Absorber Bolts

6. ENGINE REMOVAL/INSTALLATION

Remove the engine mounting bolt and pull out the engine with the engine hanger bracket backward.

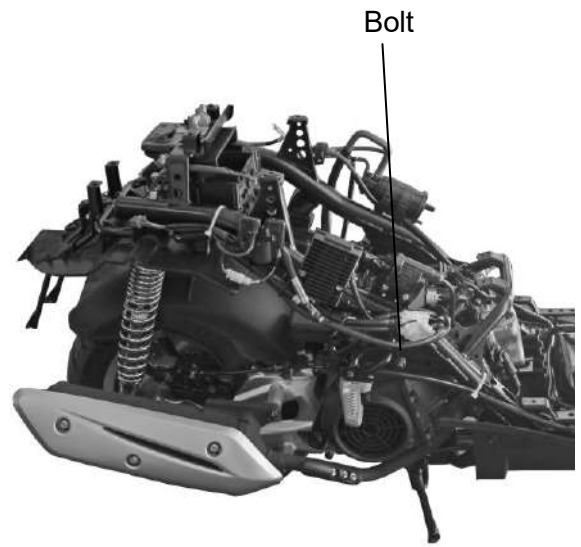

ENGINE HANGER BRACKET REMOVAL

Remove the engine hanger bracket bolt and nut.
Remove the engine.
Inspect the engine hanger bushings and stopper rubbers for wear or damage.

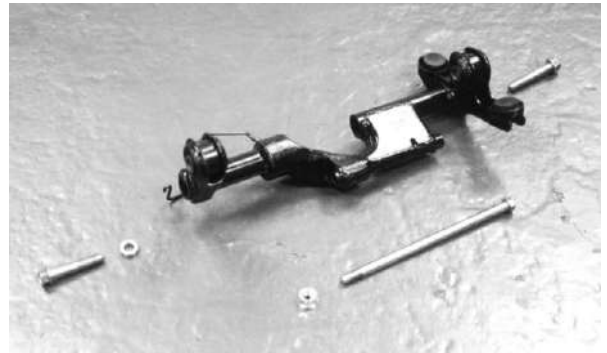

6. ENGINE REMOVAL/INSTALLATION

ENGINE HANGER BRACKET

INSTALLATION

Install the engine hanger bracket to the engine.
Install and tighten the engine hanger bracket bolts.

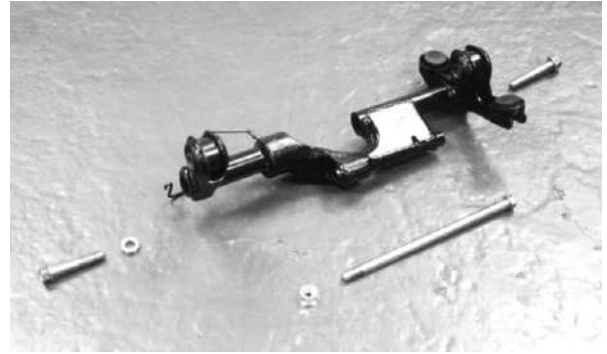

ENGINE INSTALLATION

Install the engine and tighten the engine mounting bolts.

Torque: 5.0kg-m

Tighten the rear shock absorbers mounting bolts.

Torque: Up side 4.0kg-m

Down side 2.5kg-m

Install the removed parts in the reverse order of removal.

*

Tire pressure should be checked when tires are cold.

Engine Hanger Bolts

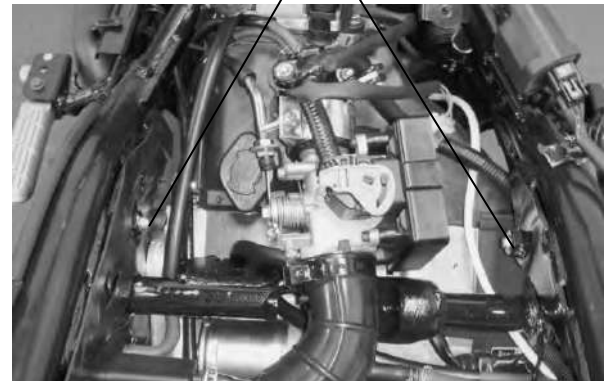

After installation, inspect and adjust the following:

Throttle grip free play (⇒3-3)

7. CYLINDER HEAD/VALVES CYLINDER / PISTON

TE25AA(IT) E03

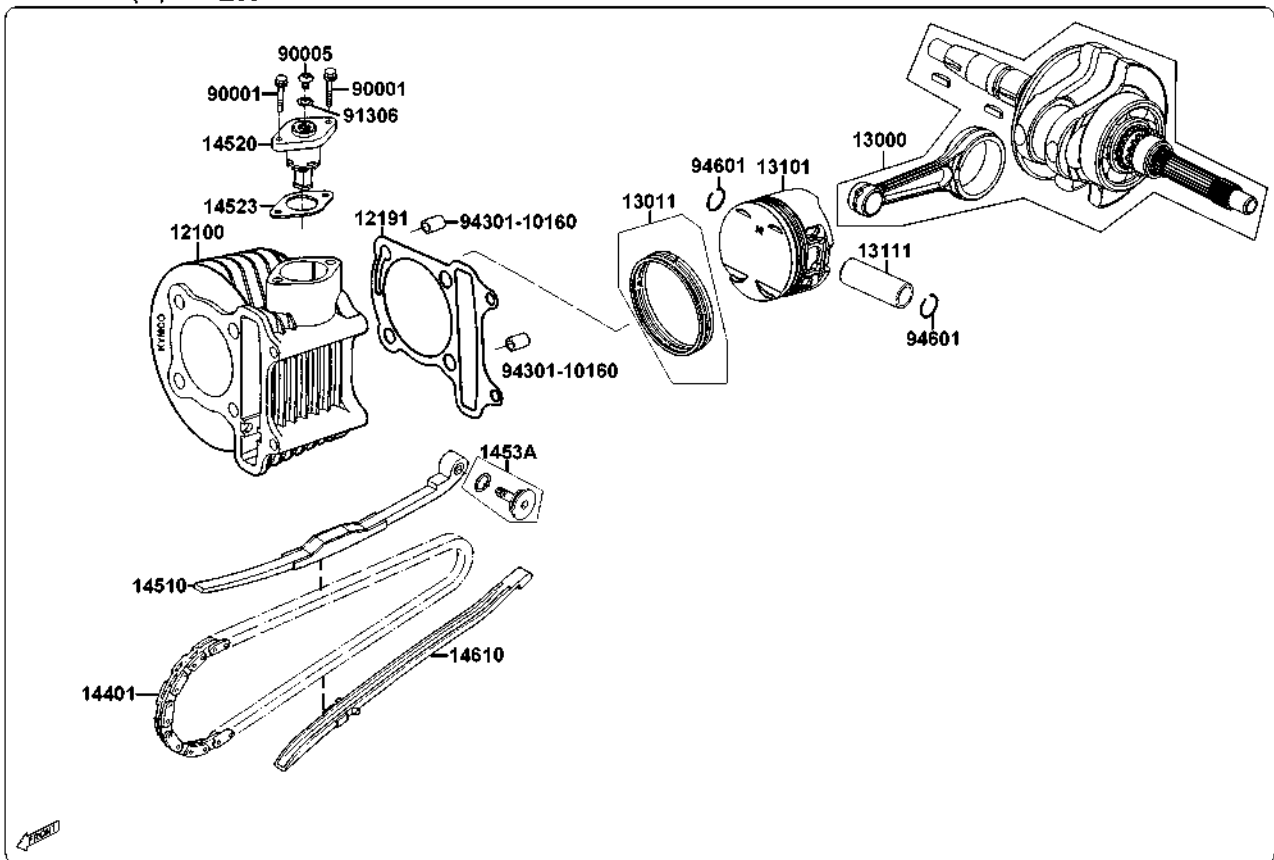

7. CYLINDER HEAD/VALVES CYLINDER / PISTON

SERVICE INFORMATION..... 7-1	CYLINDER HEAD DISASSEMBLY 7-7
TROUBLESHOOTING..... 7-2	CYLINDER HEAD ASSEMBLY 7-8
CAMSHAFT REMOVAL..... 7-3	CYLINDER HEAD INSTALLATION..... 7-8
CYLINDER HEAD REMOVAL 7-5	CAMSHAFT INSTALLATION 7-9

SERVICE INFORMATION

GENERAL INSTRUCTIONS

- The cylinder head can be serviced with the engine installed in the frame.
- When assembling, apply molybdenum disulfide grease or engine oil to the valve guide movable parts, valve arm and camshaft sliding surfaces for initial lubrication.
- The camshaft is lubricated by engine oil through the cylinder head engine oil passages. Clean and unclog the oil passages before assembling the cylinder head.
- After disassembly, clean the removed parts and dry them with compressed air before inspection.
- After removal, mark and arrange the removed parts in order. When assembling, install them in the reverse order of removal.

SPECIFICATIONS

Item		Standard (mm)	Service Limit (mm)
Valve clearance (cold)	IN	0.12	—
	EX	0.12	—
Cylinder head compression pressure		15kg/cm ²	

Item		Standard (mm)	Service Limit (mm)	
Cylinder	I.D.	54.0~54.10	54.10	
	Warpage	—	0.05	
	Cylindricity	—	0.05	
	True roundness	—	0.05	
Piston, piston ring	Ring-to-groove clearance	Top	0.025~0.005	0.09
		Second	0.025~0.005	0.09
	Ring end gap	Top	0.10~0.25	0.5
		Second	0.25~0.45	0.5
		Oil side rail	0.2~0.7	—
	Piston O.D.		53.49~53.51	53.4
	Piston O.D. measuring position		9mm from bottom of skirt	—
	Piston-to-cylinder clearance		0.010~0.040	0.1
Piston pin hole I.D.		14.002~14.008	14.04	
Piston pin O.D		13.994~14.000	13.96	
Piston-to-piston pin clearance		0.002~0.014	0.02	
Connecting rod small end I.D. bore		14.016~14.026	14.016	

7. CYLINDER HEAD/VALVES CYLINDER / PISTON

TORQUE VALUES

Cylinder head nut	2.0kg-m	Apply engine oil to threads
Valve clearance adjusting nut	0.9kg-m	Apply engine oil to threads
Stud bolt	0.9~1.1kg-m	

SPECIAL TOOLS

Valve spring compressor	A120E00040
Flywheel puller	A120E00002

TROUBLESHOOTING

- The poor cylinder head operation can be diagnosed by a compression test or by tracing engine top-end noises.

Poor performance at idle speed

- Compression too low

Compression too low

- Incorrect valve clearance adjustment
- Burned or bent valves
- Incorrect valve timing
- Broken valve spring
- Poor valve and seat contact
- Leaking cylinder head gasket
- Warped or cracked cylinder head
- Poorly installed spark plug

Compression too high

- Excessive carbon build-up in combustion chamber

White smoke from exhaust muffler

- Worn valve stem or valve guide
- Damaged valve stem seal

Abnormal noise

- Incorrect valve clearance adjustment
- Sticking valve or broken valve spring
- Damaged or worn camshaft
- Worn cam chain guide
- Worn camshaft and rocker arm

7. CYLINDER HEAD/VALVES CYLINDER / PISTON

7.1 CYLINDER HEAD REMOVAL

Remove 7 bolts
Remove the cover.

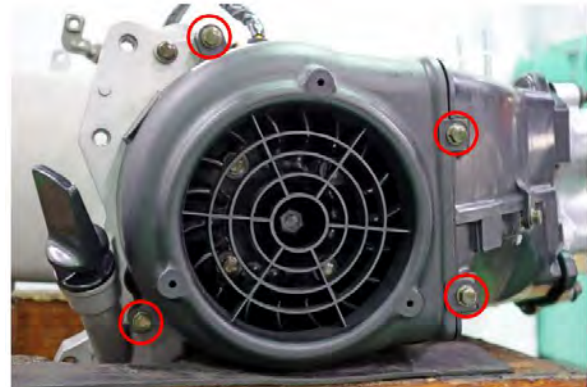

Remove 4 bolts and remove the cylinder head cover and gasket. Replace it with a new one when installation.



7. CYLINDER HEAD/VALVES CYLINDER / PISTON

7.2 CAMSHAFT REMOVAL

Safety first: Protective gloves and eyewear are recommended at this point.

Remove the spark plug, see the spark plug chapter.

Remove the cylinder head cover, see the cylinder head cover chapter.



The cam chain tensioner is located on top of the cylinder.

Remove the cam chain tensioner cap bolt with a 10mm socket.



Remove the cam chain tensioner out of the cylinder.



7. CYLINDER HEAD/VALVES CYLINDER / PISTON

Remove the camshaft sprocket bolt.

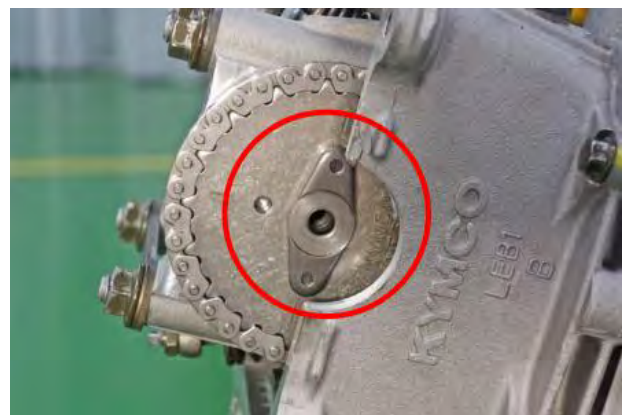

Remove the camshaft sprocket as shown,
Support the chain so it does not fall into the
cylinder head.

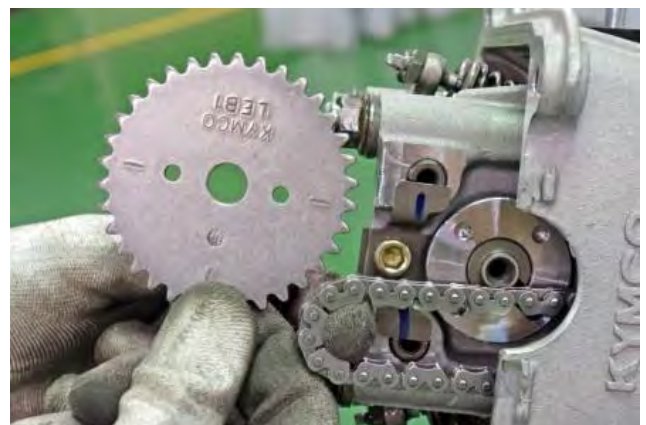

7. CYLINDER HEAD/VALVES CYLINDER / PISTON

Remove the set plate bolt.

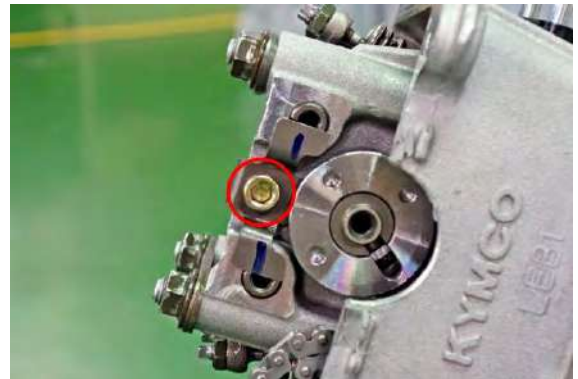

Remove the set plate.



Remove the 4 camshaft holder nuts with
a 14mm socket.

Loosen the nuts in crisscross pattern

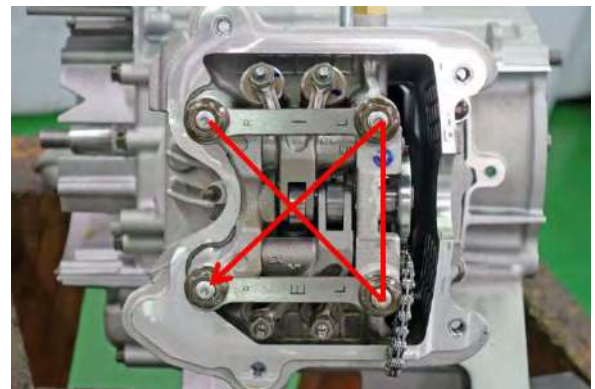

Remove the 2 camshaft holders.



7. CYLINDER HEAD/VALVES CYLINDER / PISTON

Thread a bolt into rocker arm shafts and pull the shafts out.



Lift the rocker arms as the shafts are removed.



Remove the camshaft from the cylinder head.



7. CYLINDER HEAD/VALVES CYLINDER / PISTON

7.3 INSPECTION

Inspect the camshaft cam heights for the intake and exhaust lobes.

Inspect the camshaft bearings for excessive play or roughness.

Replace the entire camshaft assembly if the bearings are rough or have excessive play.

Item		Standard(mm)
Camshaft cam height	IN	29.53±0.08
	EX	29.48±0.08



Inspect the rocker arm shaft outer diameter for the intake and exhaust valves.

Item		Standard(mm)
Valve rocker arm shaft O.D	IN	9.972-9.987
	EX	9.972-9.987



Inspect the rocker arm shaft inner diameter for the intake and exhaust valves.

Item		Standard(mm)
Valve rocker arm I.D	IN	10.00-10.015
	EX	10.00-10.015



7. CYLINDER HEAD/VALVES CYLINDER / PISTON

Inspect the camshaft bearing journals for scoring or scratches.



Inspect the camshaft sprocket for worn teeth or other signs of wear or damage



7. CYLINDER HEAD/VALVES CYLINDER / PISTON

7.4 INSTALLATION

The crankshaft must be rotated clockwise until the piston is at top dead center on the compression stroke



Position the piston at top dead center as right
The “T” mark should align with the index notch in the timing inspection hole. Support the chain if the crank must be turned to the correct position.



Lubricate the camshaft lobes and bearings with fresh engine oil.
Insert the camshaft into the camshaft holders with the lobes facing down.



Lubricate the inside diameters of the rocker arms and the roller with fresh engine oil.
Wipe the rocker arm shafts clean. Insert the rocker arm shafts into the camshaft holders and rocker arms.



7. CYLINDER HEAD/VALVES CYLINDER / PISTON

Install the 2 camshaft holders

Apply engine oil to the threads of the cylinder head nuts. Thread on the 4 cylinder head nuts and tighten in crisscross pattern over the course 2-3 rounds of tightening to reach specific torque.

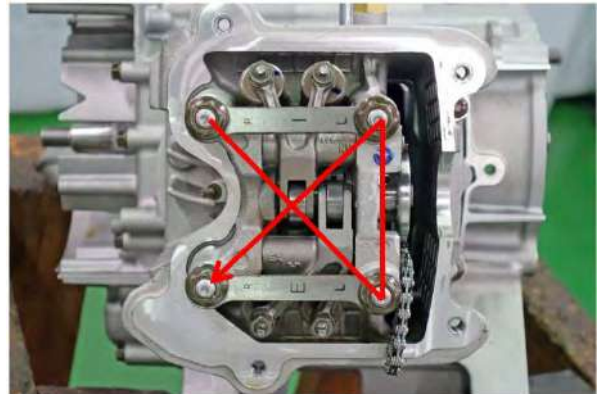

Install the set plate so it fits into the groove on the camshaft and between the projections on the rocker arm shafts.

Apply a small amount of blue Loctite (non-permanent) to the threads of the set plate bolt.

Thread in the bolt and tighten it to specification with a 5 mm Allen socket.



Install the camshaft sprocket onto the camshaft so the camshaft sprocket boss fits into the appropriate hole on the camshaft sprocket.

Make sure the camshaft sprocket boss is facing up so it is visible above the edge of the cylinder head as shown.

Align the horizontal marks on the camshaft sprocket with the top edge of the cylinder head as shown. Fit the camchain over the camshaft sprocket

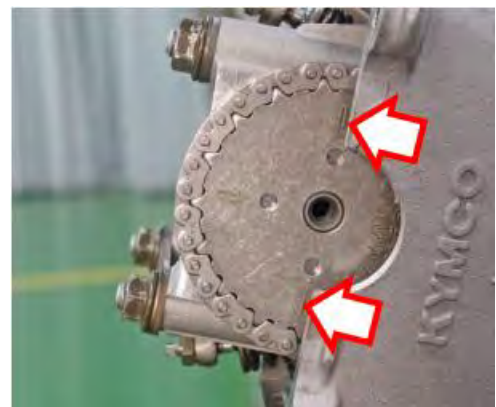

7. CYLINDER HEAD/VALVES CYLINDER / PISTON

For correct engine timing, the marks on the camshaft sprocket must be even with cylinder head mating surface. At the same time, the “T” mark is lined up with the index notch in the timing inspection hole. The camshaft lobes should be facing down and there should be slack in the rocker arms.

been installed.

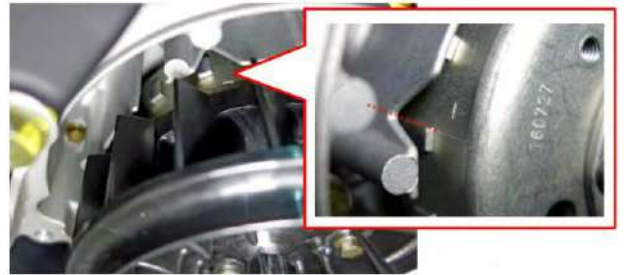

Apply a small amount of Loctite to threads of the camshaft sprocket bolts. Thread in the bolts and tighten to specification.

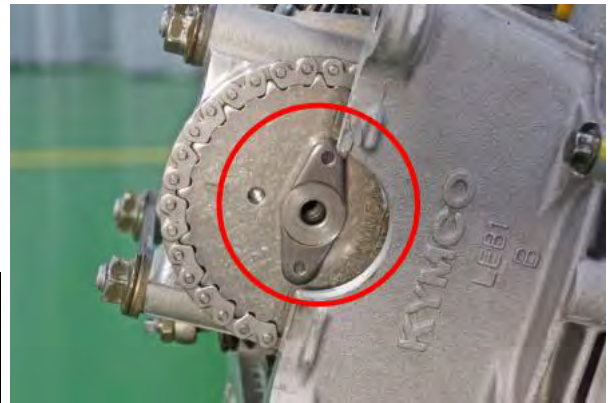

Item	Qty	Thread size (mm)	Torque	
			kgf-m	N-m
Cam sprocket bolt	1	8	1.8~2.5	18~25



Double check the engine timing

Use a small flat blade screwdriver bringing in the cam chain tensioner rod. Turn the screwdriver counter clockwise to retract the rod. The rod must be held in with the screwdriver until the cam chain tensioner has



7. CYLINDER HEAD/VALVES CYLINDER / PISTON

Install the cam chain tensioner with a new gasket. Insert the mounting bolts and tighten them evenly to specification with an 8mm socket. Release the cam chain tensioner rod.

Item	Qty	Thread size (mm)	Torque	
			kgf-m	N-m
Cam chain tensioner bolt	2	8	0.8~1.2	7.8~11.8

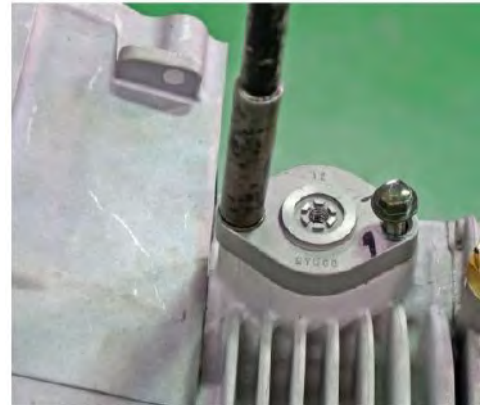

Rotate the crankshaft 360° clockwise and check the engine timing one more time.

Make sure the cam tensioner cap bolt O-ring is in good condition and install the cam chain tensioner cap bolt. Tighten the bolt securely.

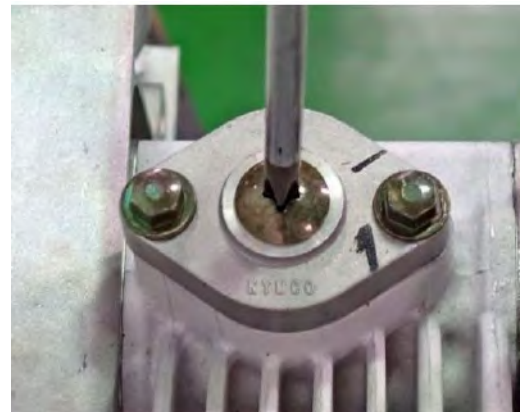

Install the fan cover and install the 4 bolts.



7. CYLINDER HEAD/VALVES CYLINDER / PISTON

7.5 CYLINDER HEAD

Remove the spark plug ,see the spark plug chapter.

Remove the cylinder head cover,see the cylinder head cover.

Remove the camshaft sprocket,see the camshaft chapter.

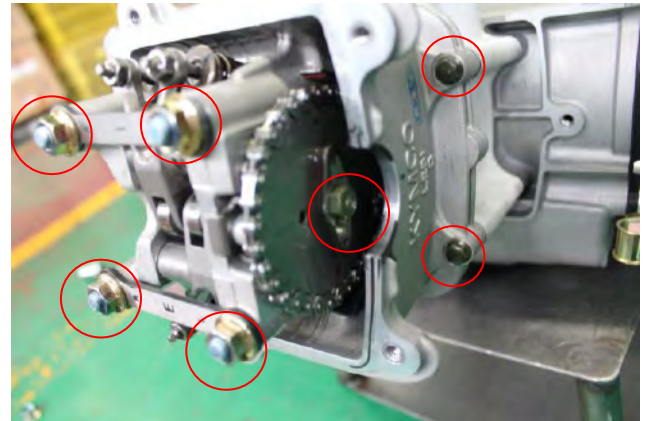

Item	Qty	Thread size (mm)	Torque	
			kgf-m	N-m
Cylinder head stud nut	4	10	1.8~2.2	18~22

Remove the 2 bolts.



Lift the cylinder head off the stud,guide the cam chain through the opening in the cylinder head ,but don't allow the cam chain to fall into the crankcase.



Remove the cylinder head gasket.

7. CYLINDER HEAD/VALVES CYLINDER / PISTON

Remove the 2 dowel pins from the left side of the cylinder head studs.



Remove the intake plate and gasket from the cylinder head.

remove the engine temperature sensor if needed.



Clean the combustion chamber with a contact cleaner, a plastic knife, brush .
Take care only to remove carbon and not scrape the head.



7. CYLINDER HEAD/VALVES CYLINDER / PISTON

To remove valves, see the valve chapter.
Place a straight edge across the bottom of the cylinder head and check for warp with a feeler gauge. You will need to check clearance readings from several places on the bottom of the cylinder head surface for warp.

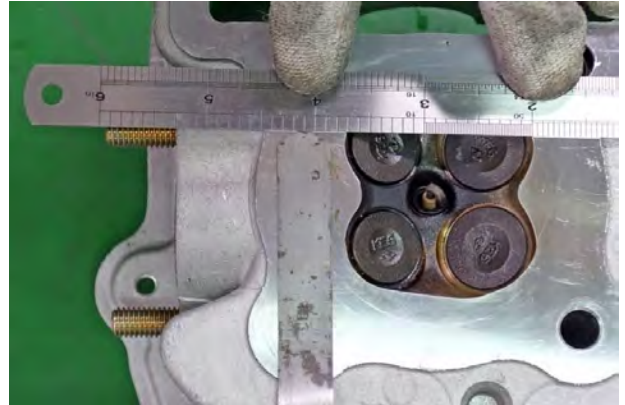

7.6 VALVES

SAFETY FIRST: Protective gloves and eyewear are recommended at this point.

Removal

Remove the camshaft, see the camshaft chapter

Remove the cylinder head, see the cylinder head chapter

Record the position of all parts so they can be returned to their proper place during reassembly.



Push down the valve springs with a valve spring compressor.

Special Tool: valve spring compressor, E040

Remove the split keepers, there are two per valve



7. CYLINDER HEAD/VALVES CYLINDER / PISTON

Remove the spring retainer.

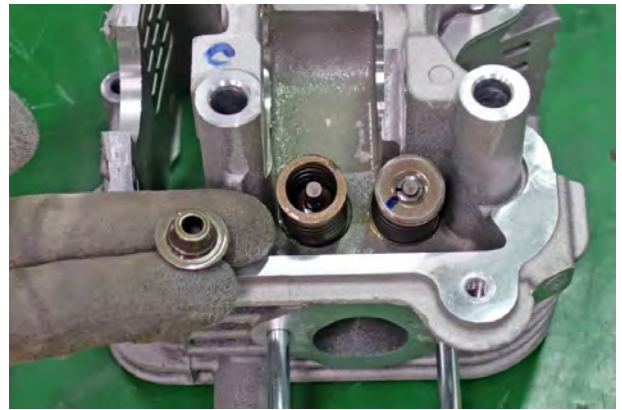

Remove the valve springs.



Push the valve stem down and remove the valve from the combustion chamber side of the cylinder head. Rotate the valve as it is removed



Remove the valve seal from the valve guide. The valve seal should be replaced if they are removed or you need to install new valves.



7. CYLINDER HEAD/VALVES CYLINDER / PISTON

Remove the spring seat.

Install in reverse order of removal.



7.7 INSPECTION

Inspect the spring for fatigue and damage.
Replace the springs if needed.



Inspect the valve for burning and damage.
Measure the stem diameter in several places
where the valve contact the guide,if the
measurement is below specification,replace
the valve.

Item		Standard(mm)
Valve stem O.D	IN	4.49~4.475
	EX	4.47~4.455



7. CYLINDER HEAD/VALVES CYLINDER / PISTON

Inspect the valve seat and the valve seat width. The valve seat should be centered on the valve face. If the seat is pitted, worn out, or fits poorly on the valve face, the valve seat must be resurfaced.

Item		Standard(mm)
Valve seat width	IN	1.2
	EX	1.2



Measure the inside diameter of the valve guides. Replace the guides if the measurement is beyond specification.

Calculate the valve stem-to-guide clearance. Replace the guide and valve if the clearance is beyond specification.



Item		Standard(mm)
Valve guide I.D	IN	4.5-4.512
	EX	4.5-4.512
Valve stem-to-guide Clearance	IN	0.040-0.037
	EX	0.040-0.037



7. CYLINDER HEAD/VALVES CYLINDER / PISTON

7.8 Cam Chain Guide

Slide out the lower cam chain guide. Inspect the guide for excessive wear and damage. Replace the guide as needed.



To remove the upper chain guide, remove the CVT, see the CVT chapter.

Remove the bolt with an 8mm Allen wrench.



Remove the upper chain guide.



7. CYLINDER HEAD/VALVES CYLINDER / PISTON

7.9 Cylinder and Piston

SAFETY FIRST: Protective gloves and eyewear are recommended at this point.

Cylinder Block Removal

Remove the engine from the frame, see the engine removal chapter.

Remove the cylinder head cover, see the cylinder head cover chapter.

Remove the camshaft sprocket, see the Camshaft chapter.

Remove the cylinder head, see the cylinder head chapter.

Remove the lower cam chain guide, see the cam chain guide chapter.

Slide the cylinder off the studs and piston.

Guide the cam chain through its opening and don't allow it to fall into the crankcase

Remove the cylinder.

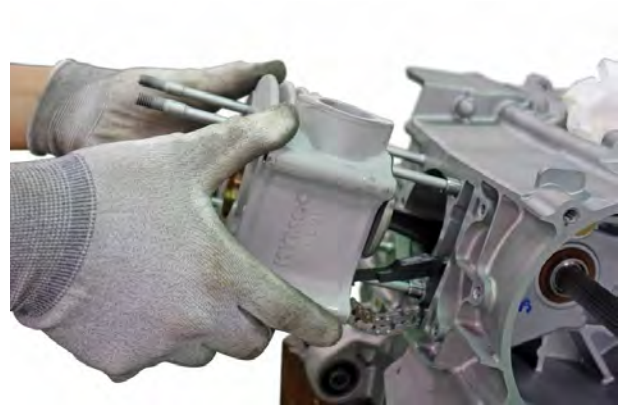

Remove the gasket.



Remove the 2 cylinder dowel pins from the left side of the studs



7. CYLINDER HEAD/VALVES CYLINDER / PISTON

Remove the piston pin clips with a pick or needle nose pliers. Discard the piston pin clips

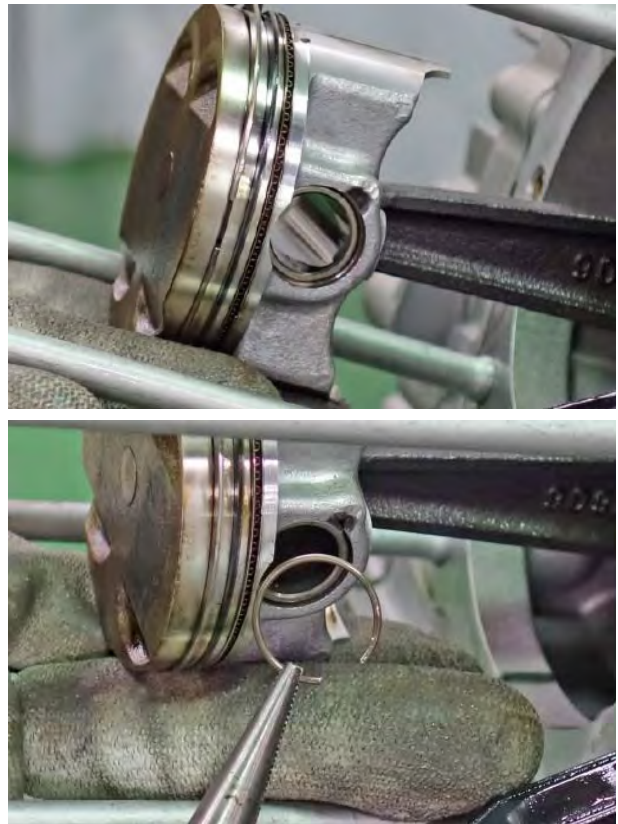

Remove the piston pin and the piston.
Clean off the cylinder mating surface, but take care to keep debris from falling into the crankcase.



7. CYLINDER HEAD/VALVES CYLINDER / PISTON

Spread the piston rings and lift them off opposite the gap. Spread the rings the minimum amount during removal. The rings can be easily damaged.

The two upper rings are each a single piece of metal. The oil ring consists of an expander ring and two side rails.

Clean off the carbon build up of the piston with a stiff bristled plastic brush or rag.
Never use a wire brush to clean a piston.

Also clean out the ring grooves. You can use an old ring to scrape.

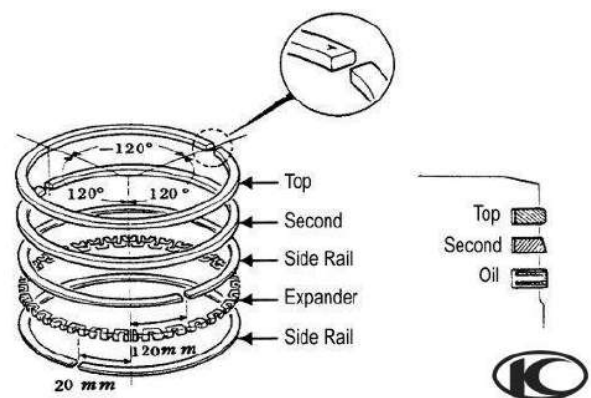

7. CYLINDER HEAD/VALVES CYLINDER / PISTON

7.10 INSPECTION

The cylinder and piston must be replaced as a set.

Inspect the cylinder bore for damage and abnormal wear.



Measure the cylinder diameter as below with a telescoping gauge.



Inspect the cylinder front to back and side to side at three different height levels with a dial bore gauge. Replace the cylinder and piston as a set if the cylinder is out of specification.

Calculate the cylinder taper. The taper is the maximum difference between either yellow and brown or blue and green.

Calculate the cylinder out of round. The out of round is greatest out of yellow, purple, or brown minus the smallest of blue, red or green.

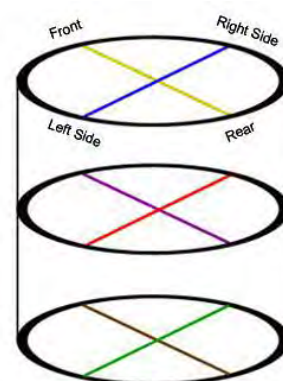

Measure the outer diameter of the piston at 8mm up from the bottom of the skirt at a 90° to the piston pin. Measure the piston with vernier caliper or a micrometer. Check the piston for wear, damage, and extreme discoloration.

Item	Standard mm
Piston-to-cylinder clearance.	-0.010-+0.010



7. CYLINDER HEAD/VALVES CYLINDER / PISTON

Measure the piston pin diameter with a micrometer. Measure the piston pin bore diameter with vernier calipers or a small bore Gauge. Measure at 3 different points for each. Replace the parts if any of the specifications are not met.

Item	Standard mm
Piston pin hole I.D.	14.002~14.008
Piston pin hole I.D.	13.994~14.000
Piston pin hole I.D.	0.002~0.014



Measure the inner diameter of the small end of the connecting rod with vernier calipers.

Item	Standard mm
Connecting rod small end I.D. Bore	14.016-14.026

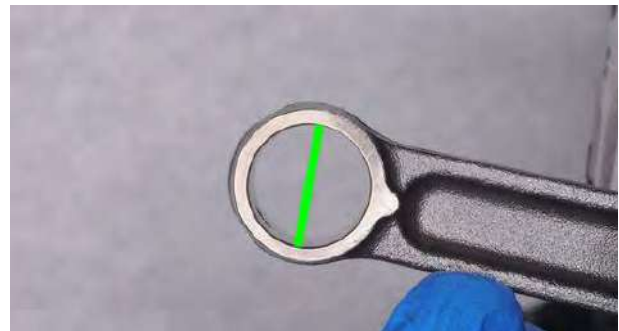

Measure the ring groove width and the ring-to-groove clearance with feeler gauge.

Item	Standard mm	
Connecting rod small end I.D. Bore	1st	0.025-0.005
	2nd	0.025-0.005



7. CYLINDER HEAD/VALVES CYLINDER / PISTON

Insert the top ring into the cylinder. Push the top Ring in the cylinder about an inch. Use the piston to push in the ring to keep it square with the cylinder.



Measure the ring gap with a feeler gauge. Repeat this procedure with second ring and the oil side Rails.

Item		Standard mm
Ring end gap	Top	0.10-0.25
	Second	0.25-0.45
	Oil side rail	0.2-0.7

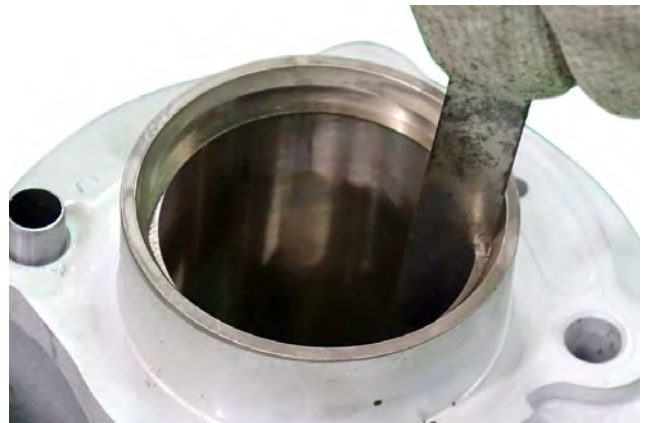

Assembly

Clean the piston ring grooves and apply fresh engine oil to the piston rings. Spread the rings the minimum amount possible to install them. Do not try and force them on the piston.



Install the top and second rings with their markings facing up. Install the rings to the piston as shown above so that no ring end gaps line up with the piston pin or perpendicular to the piston pin. The rings should turn easily on the piston without sticking or roughness.

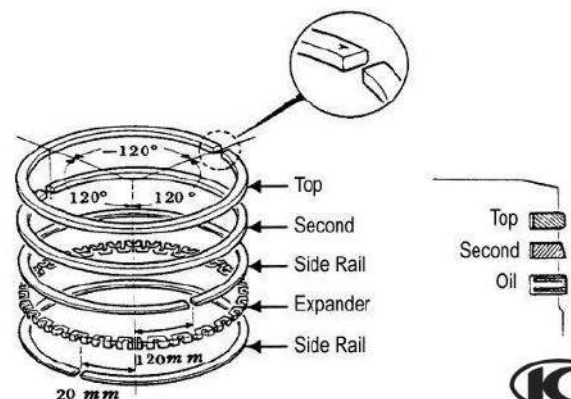

7. CYLINDER HEAD/VALVES CYLINDER / PISTON

Install the oil expander ring so that the ends are not overlapping. Install the steel rails above and below the oil ring.

Lubricate the piston pin and the small end of the connecting rod with fresh engine oil.



The “IN” mark should face the intake side of the engine.

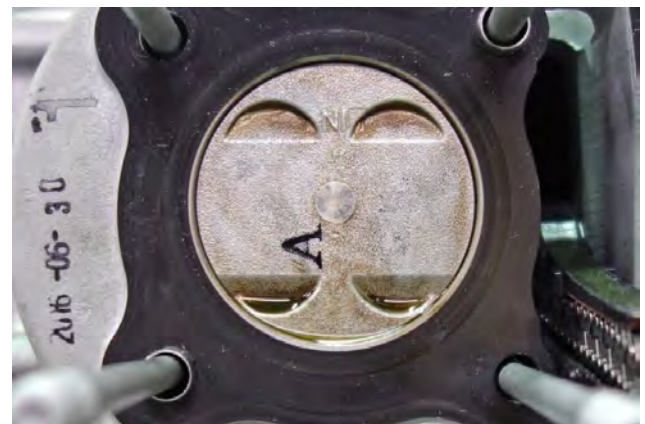

Place the piston over the connecting rod.
Insert the piston pin into the piston and rod.

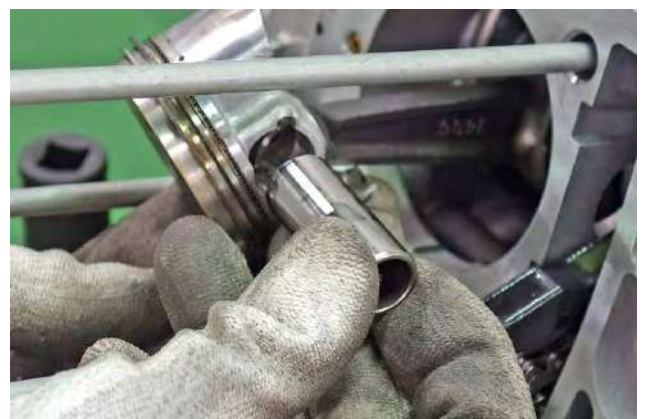

7. CYLINDER HEAD/VALVES CYLINDER / PISTON

Install a new piston pin clips securely into the grooves. Turn the gap in the clips away from the access gap.



Make sure the cylinder head mating surface is clean. Install the two dowel pins as shown.



Install a new base gasket onto the crankcase.



7. CYLINDER HEAD/VALVES CYLINDER / PISTON

Coat the inside of cylinder, piston rings, and piston with fresh engine oil. Lower the cylinder over the studs and guide the piston into the cylinder while you are compressing the rings with your fingers.

Be careful not to damage the rings during this step. Bring the cam chain and guide through the opening.



Insert the lower cam chain guide and make sure it is seated correctly.

Install the cylinder head, see the cylinder head chapter.

Install the camshaft, see the camshaft chapter

Install the cylinder head cover, see the cylinder head cover chapter.

Install the engine into the frame, see the engine installation chapter.

7. CYLINDER HEAD/VALVES CYLINDER / PISTON

7.11 A.C. Generator and Starter Clutch

SAFETY FIRST: Protective gloves and eyewear are recommended at this point.

Removal

Drain the engine oil and remove the oil filter.

See the engine oil chapter.

Remove the 7 cover bolts with an 8mm socket



Remove the 4 bolts, and remove the fan.



Remove the 17mm nut and washer.



7. CYLINDER HEAD/VALVES CYLINDER / PISTON

Item	Tool No
Flywheel puller	A120E00002



Apply grease to the threads of the flywheel puller tool before using it. Thread the puller onto the flywheel. Hold the tool with a large wrench and turn in the bolt until the pressure separates the flywheel from the crankshaft.



Remove the flywheel from the crankshaft.



7. CYLINDER HEAD/VALVES CYLINDER / PISTON

Stator and Pulsar Coil/ Crank Position Sensor

To inspect the stator, see the charging system chapter.

For crank position sensor inspection, see the Ignition system chapter

Remove the 2 bolts, and remove the ACG cord clamped.

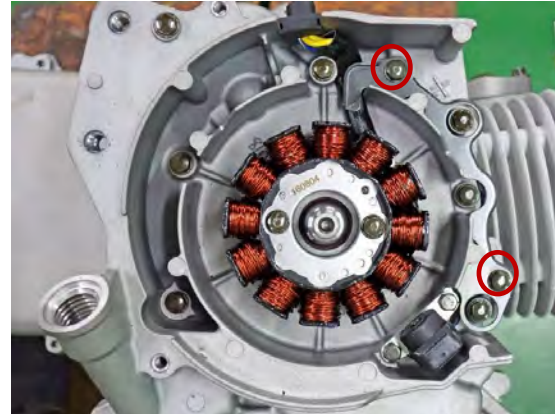

Remove the 2 bolts.

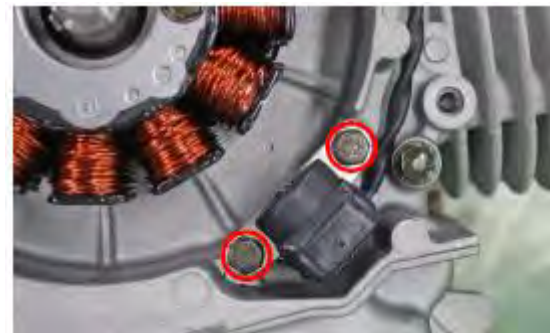

Free the rubber wire grommet from the right crankcase cover

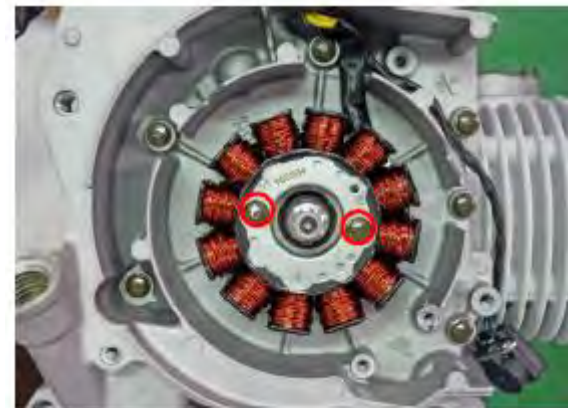

Remove the 3 stator mounting bolts and the 2 crank position sensor bolts with an 8mm socket. Remove the stator and the crank position sensor together.



7. CYLINDER HEAD/VALVES CYLINDER / PISTON

Starter Clutch

Remove the 10 bolts, and remove the crank case cover.

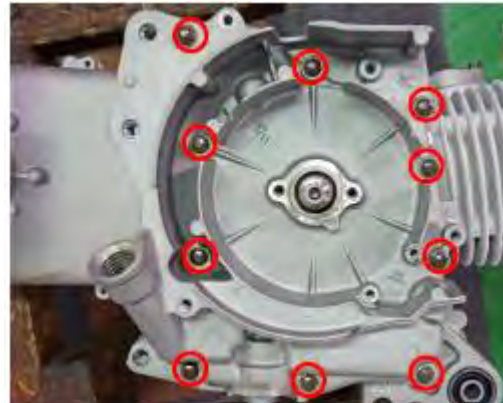

Use the special tool to remove the nut.
Special tool: A120E00010

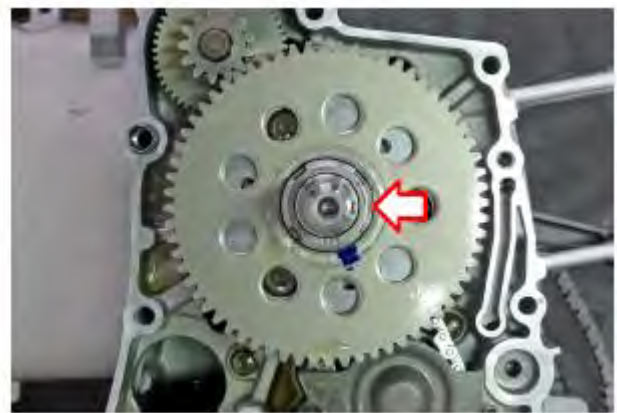

Remove the nut and washer, and then remove the starter clutch gear.



7. CYLINDER HEAD/VALVES CYLINDER / PISTON

Remove the starter clutch



Take the bearing out of the starter clutch.



Remove the starter idle gear and shaft from the crankcase.



7. CYLINDER HEAD/VALVES CYLINDER / PISTON

Inspect the starter idle gear and shaft for wear and damage. Replace the idle gear and shaft if needed.

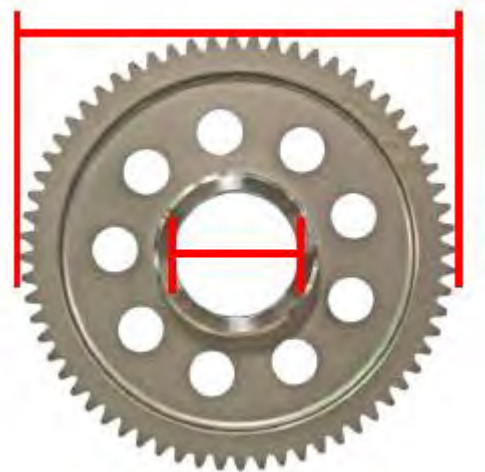

Inspect the starter driven gear for wear and damage. Measure the inside and outside diameter of the starter driven gear and replace if needed.

Item	Standard mm
Starter drive gear I.D	32(0~0.025)
Starter drive gear O.D	115.3(0~-0.35)



Fit the boss of the starter driven gear into the starter clutch. The Starter clutch should only allow the driven gear to turn in one direction. If the starter clutch allows turning both ways or will not let the driven gear rotate smoothly in one direction, the starter clutch must be replaced.



7. CYLINDER HEAD/VALVES CYLINDER / PISTON

Installation

Lubricate the starter idle gear shaft with fresh engine oil. Install the starter idle gear and shaft into the crankcase.

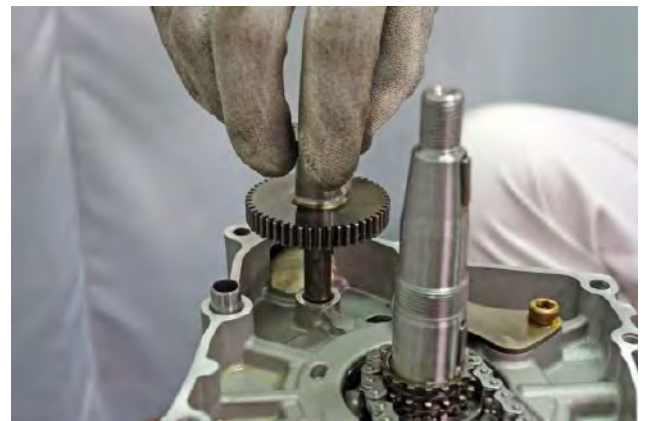

Put the bearing on the starter clutch.
Install the starter clutch



7. CYLINDER HEAD/VALVES CYLINDER / PISTON

Install the starter clutch gear
Put on the washer and nut, and tighten the nut.



Install the right crank case cover, and then tighten
the 10 bolts.

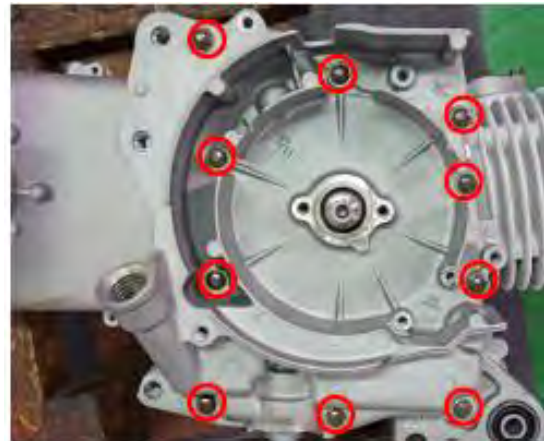

Stator and Crank Position Sensor

Fit the stator and the CPS into the generator
cover together as shown.



7. CYLINDER HEAD/VALVES CYLINDER / PISTON

Coat the rubber grommet in silicone sealant where it contacts the generator cover. Fit the rubber wire grommet into its cutout in the crankcase cover.

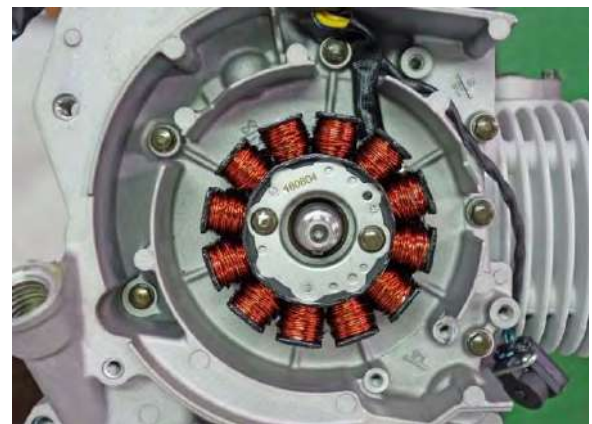

Install the 2 bolts

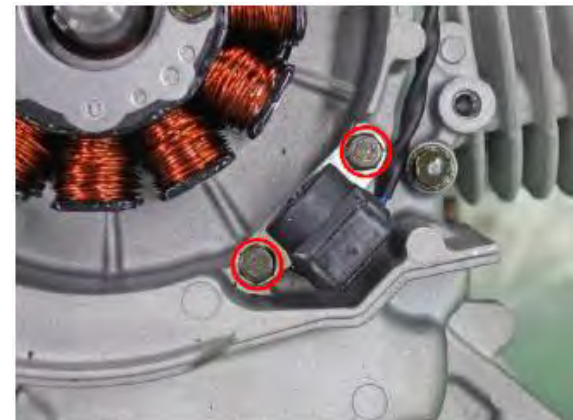

Install the 2 bolts and install the ACG cord clamber.

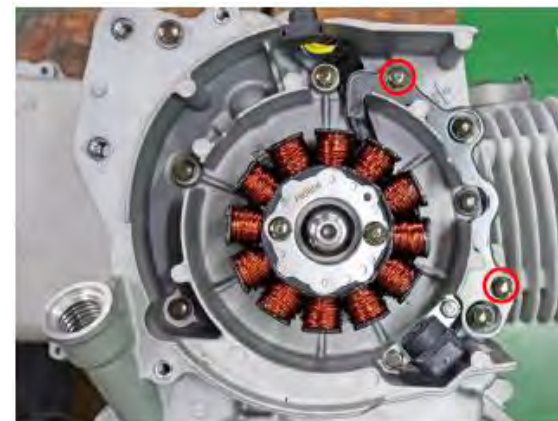

7. CYLINDER HEAD/VALVES CYLINDER / PISTON

Flywheel

Lubricate the inside of the starter driven gear with fresh engine oil. Slide the starter driven gear onto the flywheel as shown.

Clean off the tapered end of the crankshaft where the flywheel will ride and make sure the inside of the flywheel is oil free where it will contact the crankshaft.

Line up the groove in the flywheel with the key and fit the flywheel onto the crankshaft. Guide the starter driven gear into the starter clutch on the back of the flywheel.

Install the washer and flywheel nut.
Torque the flywheel nut to specification.



Item	Qty	Thread size (mm)	Torque	
			kgf-m	N-m
ACG flywheel nut	1	12	5.0~6.0	49~58.9

Install the fan, and tighten the 4 bolts.



Install the lower cover first, then the upper cover, the fan cover is the last.
Tighten the 7 bolts.



7. CYLINDER HEAD/VALVES CYLINDER / PISTON

7.12 Oil Pump

SAFETY FIRST: Protective gloves and eyewear are recommended at this point.

General Instructions

The maintenance of lubrication system can be performed with the engine installed in the frame
Use care when removing and installing the oil pump, do not allow dust and foreign matters to enter the engine and oil line.

Do not attempt to disassemble the oil pump. The oil pump must be replaced as a set when it reaches its service limit.

After the oil pump is installed, check each part for oil leaks.

Troubleshooting

Oil level too low

Natural oil consumption Oil leaks

Worn or poorly installed piston rings

Worn valve guide or seal

Poor lubrication pressure

Oil level too low

Clogged filter or oil passages

Not using the specified oil

Drain the engine oil, see the engine oil chapter
Remove the generator cover, flywheel, starter idle gear and starter driven gear. See the AC generator and starter clutch topic.

The oil pump is driven by a chain of the crankshaft.



Loosen the two oil pump cover bolts with an 8mm socket.

Remove the two oil pump cover bolts and oil pump cover.

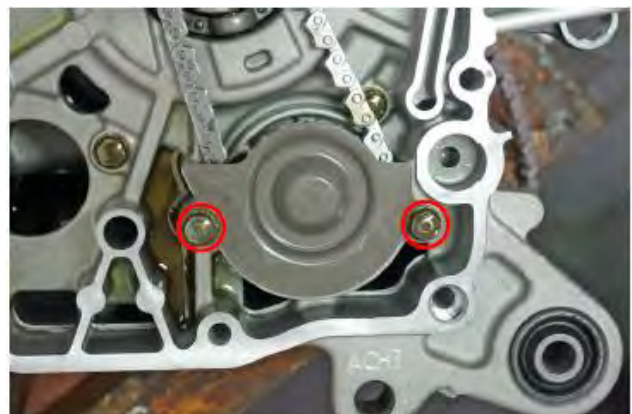

7. CYLINDER HEAD/VALVES CYLINDER / PISTON

Remove the nut.



Remove the oil pump drive chain and driven sprocket.
Inspect the oil pump drive chain and sprocket for wear and damage. Replace if needed.



Remove the oil pump shaft.



Remove the 2 oil pump screws with a #3 philips screwdriver.
Remove the oil pump.

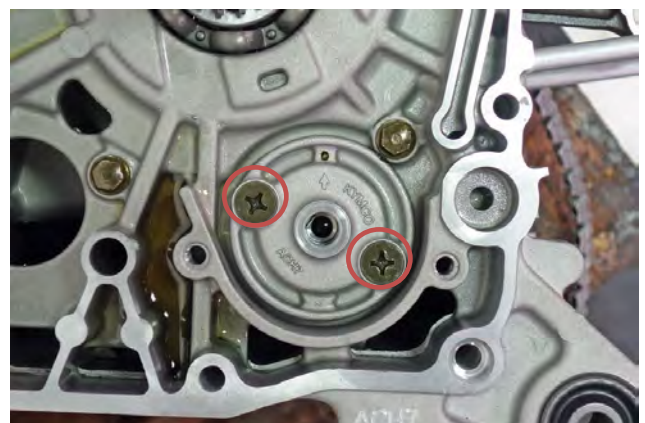

7. CYLINDER HEAD/VALVES CYLINDER / PISTON

Turn the oil pump shaft by hand and make sure it turns smoothly. If the oil pump shaft will not rotate smoothly the oil pump should be replaced with a new unit.

Install in the reverse order of work.

Note: Thoroughly clean the case mating surface, and then replace a new gasket before installation every time.



7. CYLINDER HEAD/VALVES CYLINDER / PISTON

7.12 Crankshaft

SAFETY FIRST: Protective gloves and eyewear are recommended at this point.

Removal

Drain the engine oil and remove the strainer screen. See the Engine Oil topic for more information.

Remove the engine. See the Engine Removal chapter.

Remove the cylinder head cover. See the Cylinder Head Cover chapter.

Remove the starter motor. See the Starter Motor chapter.

Remove the CVT pulleys and belt. See the CVT Removal chapter.

Remove the cylinder head. See the Cylinder Head chapter.

Remove the cylinder and piston. See the Cylinder and Piston chapter.

Remove the generator cover, flywheel, starter idle gear and starter driven gear. See the A.C. Generator and Starter clutch chapter.

Remove the oil pump drive chain, driven sprocket and the oil pump shaft. See the Oil Pump chapter.

7. CYLINDER HEAD/VALVES CYLINDER / PISTON

Loosen the two crankcase bolts in a crisscross pattern with an 8 mm socket. Remove the crankcase bolts from the left side of the engine.

Separate the halves of the crankcase. If needed gently tap the reinforced areas of the right crankcase half with a rubber mallet. Lift the right crankcase off of the left.

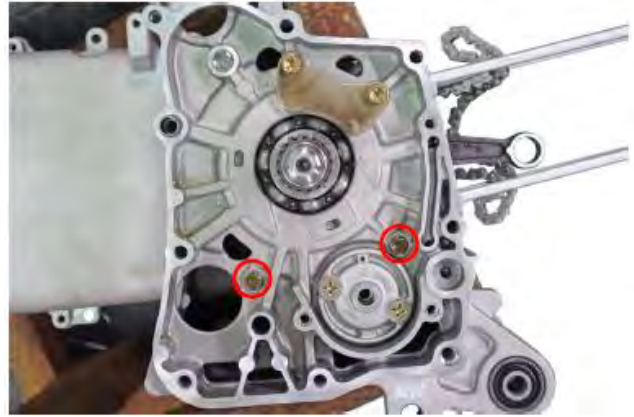

Lift the crankshaft out of the left crankcase half. Remove the cam chain from the crankshaft and crankcase. Inspect the cam chain for wear and damage. Replace the cam chain if needed.



Inspection

Check the side clearance of the big end of the connecting rod with a feeler gauge.

	Item	Standard mm
crankshaft	Connecting rod big end side clearance	38(+0.011/-0.003)

Grip the small end of the connecting rod and push the rod downwards and upwards, if there is definite play between the connecting rod and crank, the crankshaft should be replaced.



Inspect the crankshaft bearings for wear and damage. Replace the bearings if they show any kind of imperfection.

7. CYLINDER HEAD/VALVES CYLINDER / PISTON

Remove the left crankcase seal.



Remove the seal with a seal pick.



Drive a new seal into the left crankcase from outside with a suitable driver, which should have the same outside diameter with the seal.

Lubricate the new seal lips with fresh engine oil.



Put cam chain into the space between crankcase and the CVT case.

Make sure the cam chain would not interfere the

Item	Qty	Thread size (mm)	Torque	
			kgf-m	N-m
Can chain tensioner pivpt	1	6	0.8~1.2	7.8~11.8

Camshaft when installing the camshaft.



7. CYLINDER HEAD/VALVES CYLINDER / PISTON

Install the oil pump. See the Oil Pump chapter.

Install the starter idle gear^ driven gear, flywheel, and the generator cover. See the A.C. Generator and Starter clutch topic.

Install the starter motor. See the Starter Motor chapter.

Install the CVT pulleys and belt. See the CVT Installation chapter.

Install the cylinder and piston. See the Cylinder and Piston chapter.

Install the cylinder head. See the Cylinder Head topic.

Install the camshaft. See the Camshaft chapter.

Install the cylinder head cover. See the Cylinder Head Cover chapter.

Install the rear wheel. See the Rear Wheel chapter.

Install the engine into the frame. See the Engine Installation chapter.

8. DRIVEN PULLEYS/KICK STARTER

8

DRIVEN PULLEYS/KICK STARTER

SERVICE INFORMATION	8-1
TROUBLESHOOTING	8-1
LEFT CRANKCASE COVER	8-3
DRIVE PULLEY	8-3
CLUTCH/DRIVEN PULLEY	8-8

8. DRIVEN PULLEYS/KICK STARTER

LIKE II 125

TE25AA(IT) E07

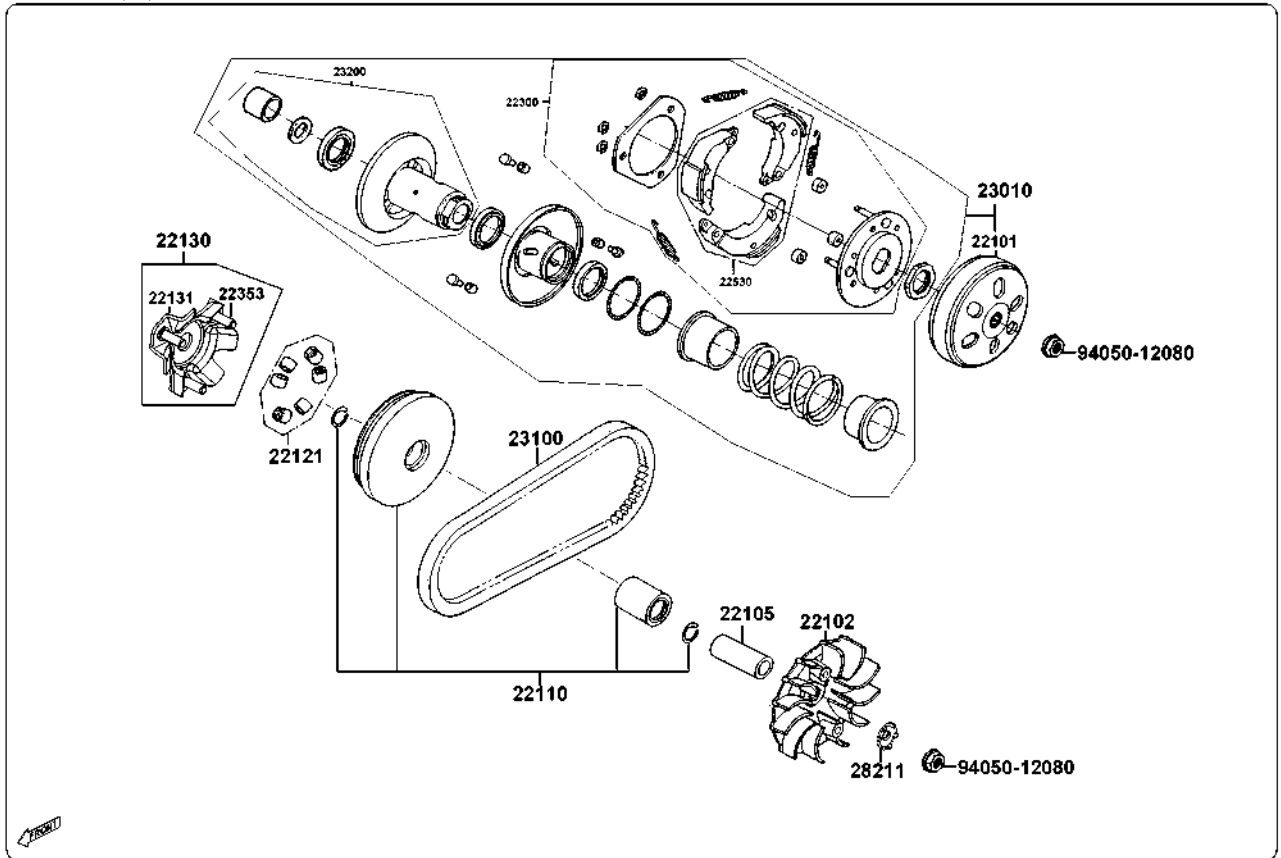

8. DRIVEN PULLEYS/KICK STARTER

SERVICE INFORMATION

GENERAL INSTRUCTIONS

The drive pulley, clutch and driven pulley can be serviced with the engine installed. Avoid getting grease and oil on the drive belt and pulley faces. Remove any oil or grease from them to minimize the slipping of drive belt and drive pulley.

SPECIFICATIONS

Item	Specification(mm)
Weight roller O.D(Drive pully)	18 ± 0.08
Clutch outer I.D	125-125.2
Clutch lining thickness	4.0

TORQUE VALUES

Drive face nut	5.5 kg-m
Clutch outer nut	5.5 kg-m
Clutch drive plate nut	5.5 kg-m

SPECIAL TOOLS

Universal holder	A120E00017
Outer driver, 32x35mm	A120E00015
Clutch spring compressor	A120E00027
Bearing driver	A120E00037

TROUBLESHOOTING

Engine starts but motorcycle won't move

- Worn drive belt
- Broken ramp plate
- Worn or damaged clutch lining
- Broken driven face spring

Lack of power

- Worn drive belt
- Weak driven face spring
- Worn weight roller
- Fouled drive face

Motorcycle scrape during riding

- Broken clutch weight spring

8. DRIVEN PULLEYS/KICK STARTER

LEFT CRANKCASE COVER

REMOVAL

Remove the drive belt air tube.
Remove 10 bolts attaching to left crankcase cover. Remove the gasket and dowel pins.



INSTALLATION

Install the dowel pins.
Install the gasket.
To install the left crankcase cover and tighten the left crankcase cover bolts diagonally. Connect the drive belt air tube and tighten the tube band screw.

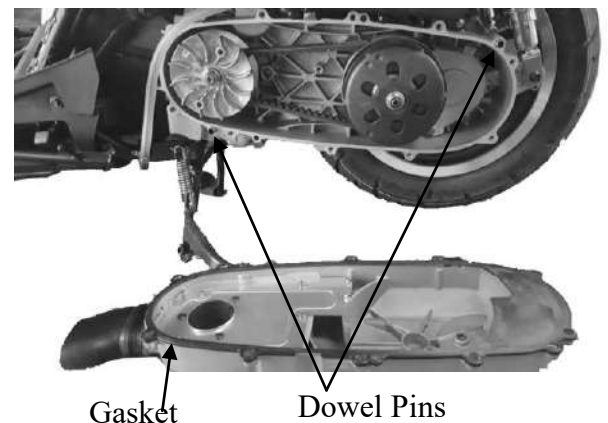

DRIVE PULLEY

REMOVAL

Remove the left crankcase cover.
Hold the drive pulley by using a universal holder and remove the drive face nut, starting ratchet and washer.
Remove the drive pulley face.

Special

Universal holder A120E00017

Hold the clutch outer with an universal holder and remove the clutch outer nut.
Remove the drive belt from the clutch/driven pulley.

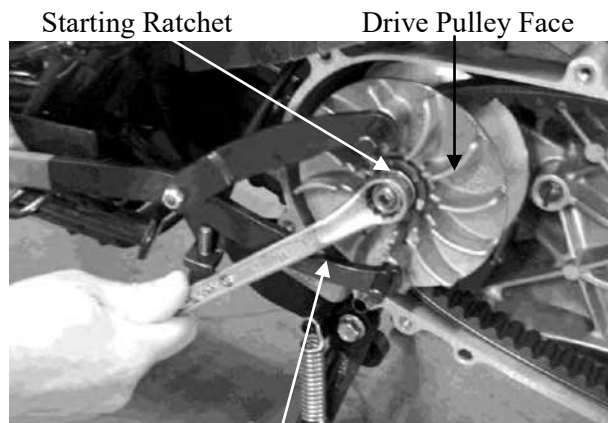

Universal Holder

Movable Drive Face Assembly

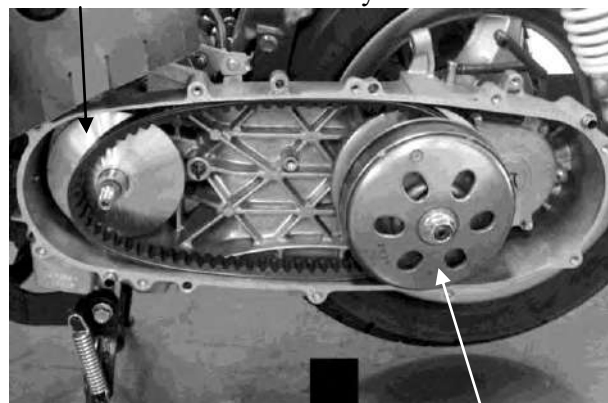

Clutch/Driven Pulley

8. DRIVEN PULLEYS/KICK STARTER

INSPECTION

Check the drive belt for cracks, separation or abnormal or excessive wear.

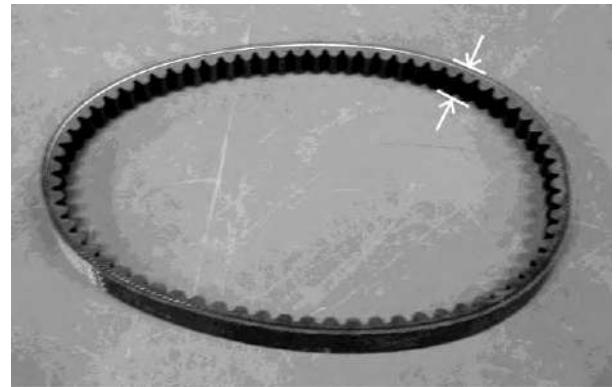

Remove the movable drive face assembly and drive pulley collar from the crankshaft.

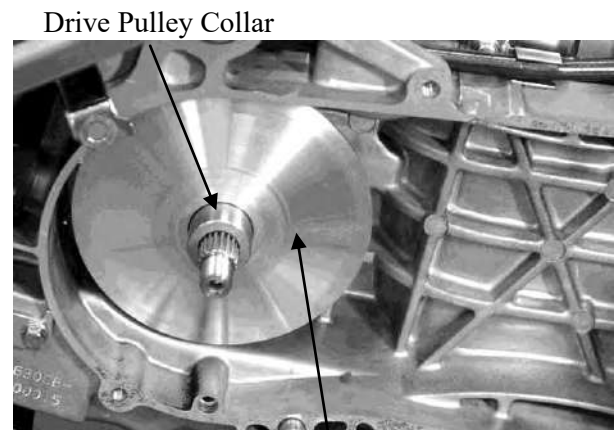

Drive Pulley Collar

Movable Drive Face Assembly

Remove the ramp plate.

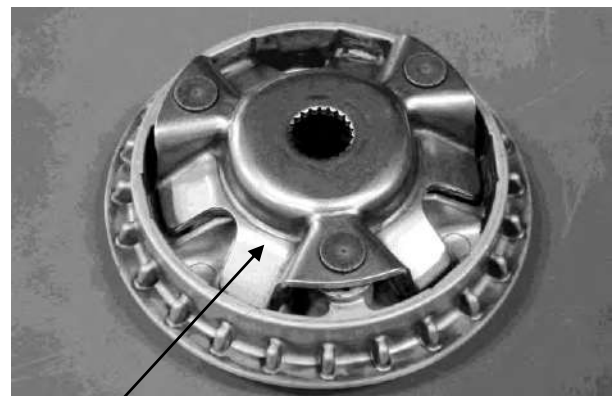

Ramp Plate

Remove the weight roller.



8. DRIVEN PULLEYS/KICK STARTER

INSPECTION

Check each weight roller for wear or damage.
Measure each weight roller O.D.

Service limit : 17.9mm replace if below



Measure the I.D. Of the movable drive face assembly



Check the drive pulley collar for wear or damage. Measure the O.D. of the drive pulley collar sliding surface.



8. DRIVEN PULLEYS/KICK STARTER

ASSEMBLY

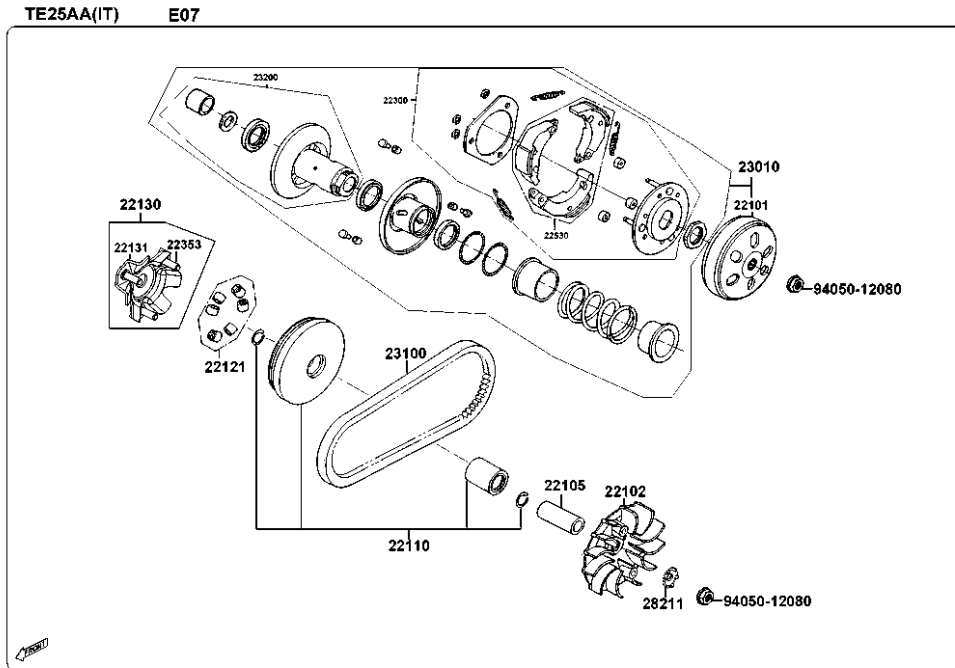

Install the weight rollers into the movable drive face.



Install the ramp plate

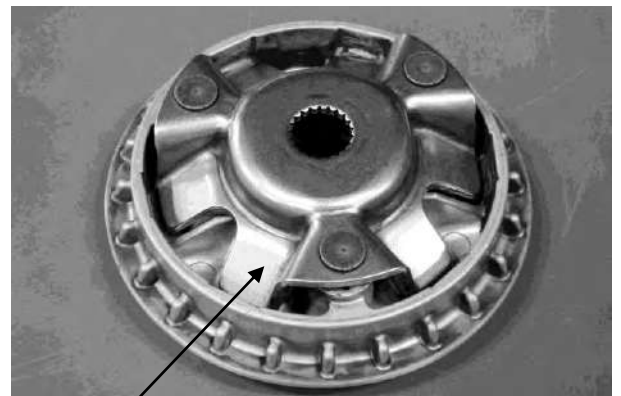

Ramp Plate

8. DRIVEN PULLEYS/KICK STARTER

Insert the drive pulley collar into the movable drive face.

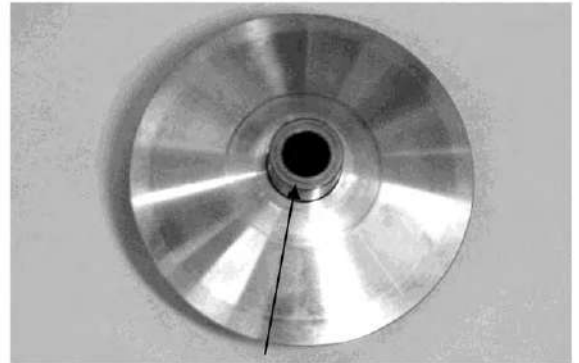

Drive Pulley Collar

INSTALLATION

Install the movable drive face onto the crankshaft.

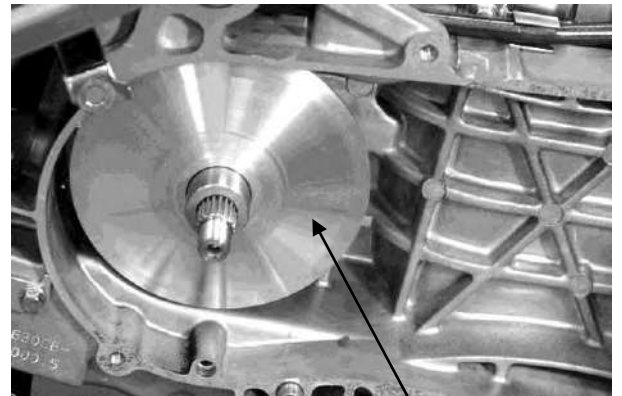

Movable Drive Face Assembly

Install the drive belt onto the clutch/driven pulley assembly and drive pulley collar.

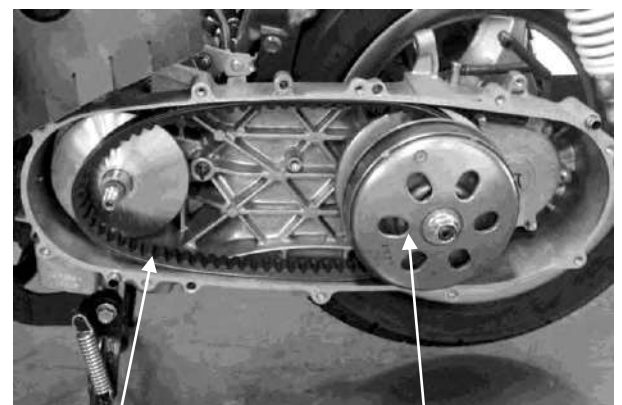

Drive Belt

Clutch/Driven Pulley

8. DRIVEN PULLEYS/KICK STARTER

Install the drive pulley, starting ratchet and nut.



Make sure to align to the crankshaft's gear when the starting ratchet installed.

Drive face nut torque: 5.0-6.0kg*m

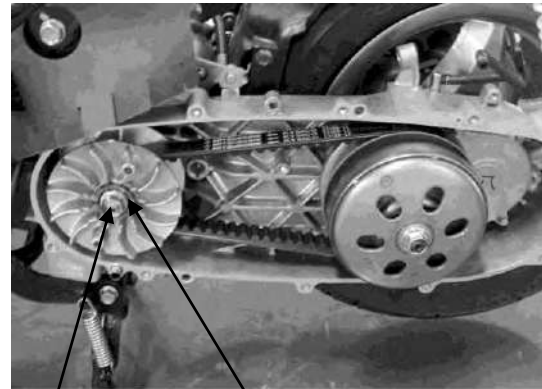

Nut Starting Ratchet

Universal Holder Drive Pulley Face

Hold the movable drive pulley's nut with the universal holder.

Special

Universal holder A120E00017



Be careful not make the lubricant applied on the drive belt and drive pulley.

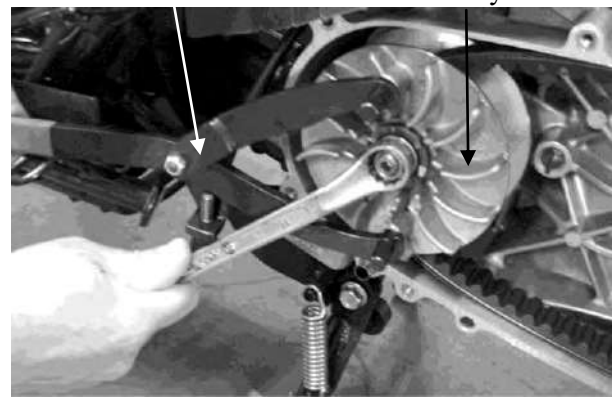

Clutch Outer

CLUTCH/DRIVEN PULLEY

Remove the left crankcase cover.

Remove the movable drive pulley and take off the drive belt.

Hold the clutch outer with the universal holder and remove the clutch outer nut.



INSPECTION

Inspect the clutch outer for wear or damage.

Measure the clutch outer I.D.

Service Limit: 125.0 mm replace if over



8. DRIVEN PULLEYS/KICK STARTER

Check the clutch lining for wear or damage.
Measure the clutch lining thickness.

Service Limit: 1.5 mm replace if below

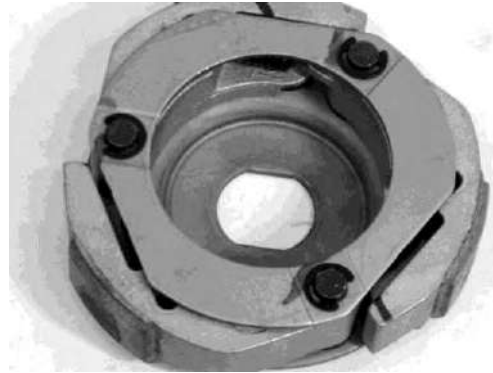

DISASSEMBLY



Be sure to use a clutch spring compressor to avoid spring damage.



Clutch / Driven pulley

Special

Clutch spring compressor A120E00027

Set the clutch spring compressor onto a vise and remove the clutch drive plate nut.

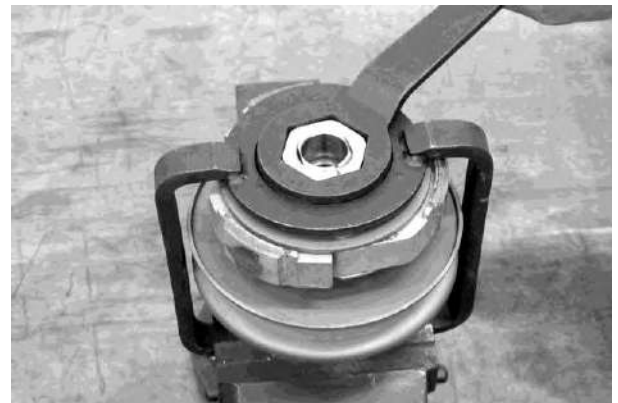

Loosen the clutch spring compressor and disassemble the clutch/driven pulley assembly.
Remove the seal collar.



8. DRIVEN PULLEYS/KICK STARTER

Pull out the guide roller pins and guide rollers.
Remove the movable driven face from the driven face.

Guide Roller Pins Guide Roller

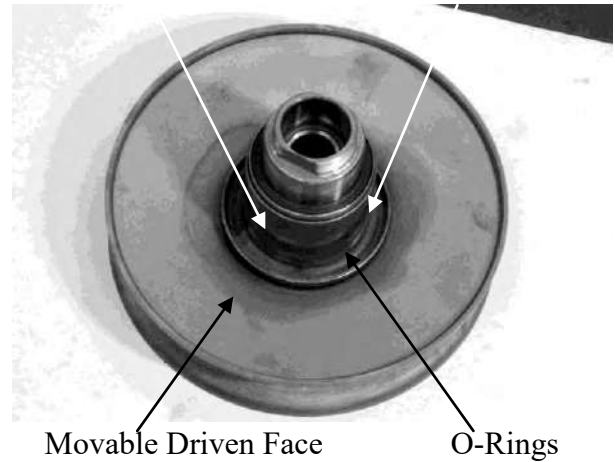

Remove the O-rings and oil seal from the movable driven face.

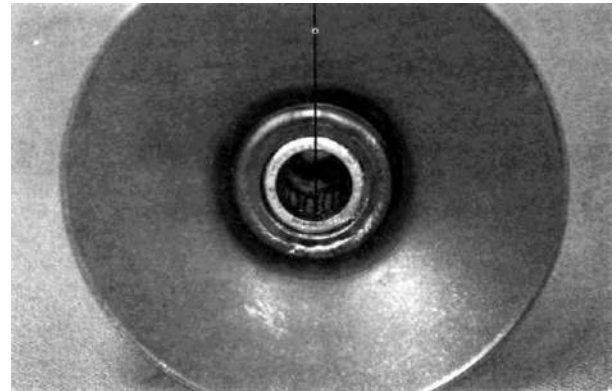

INSPECTION

Measure the driven face spring free length.
Replace with a new one if it is beyond service limit.

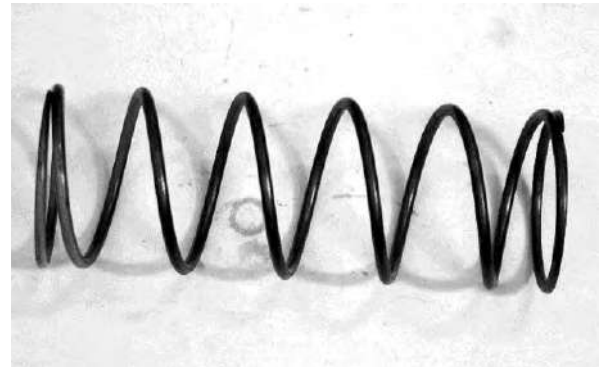

Check the driven face for wear or damage.
Measure the driven face O.D.



8. DRIVEN PULLEYS/KICK STARTER

Check the movable driven face for wear or damage. Measure the movable driven face I.D.

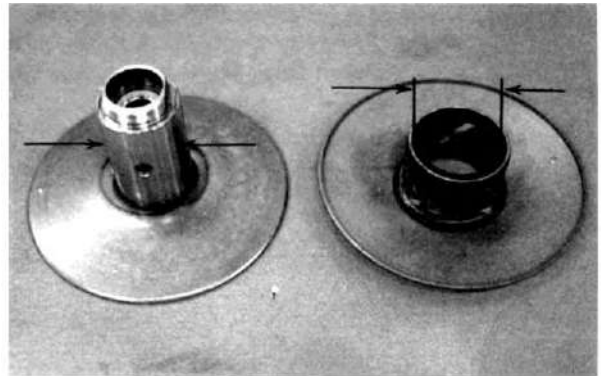

Inner Needle Bearing

Drive the inner needle bearing out of the driven pulley face.

Discard the removed bearing and replace with a new one.

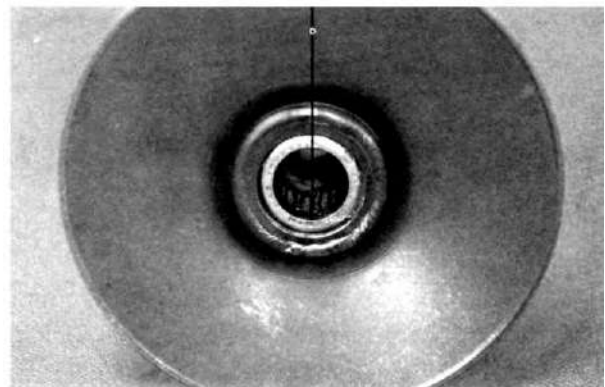

Remove the snap ring and drive the outer bearing out of the driven face.



Discard the removed bearing and replace with a new one.

Special

Bearing driver A120E00037

Apply grease to the outer bearing. Drive a new outer bearing into the driven face with the sealed end facing up. Seat the snap ring in its groove.



Pack all bearing cavities with 9.0~9.5g grease.
Specified grease: Heat resistance 230 °C

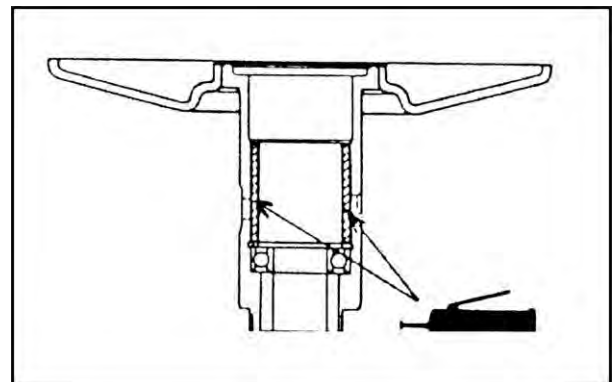

8. DRIVEN PULLEYS/KICK STARTER

Press a new needle bearing into the driven face.

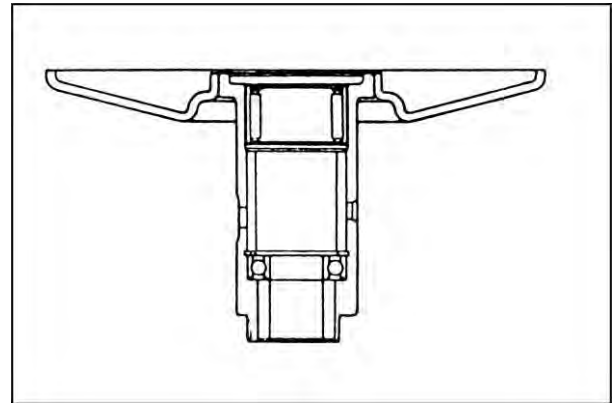

CLUTCH DISASSEMBLY

Remove the circlips and retainer plate to disassemble the clutch.



Keep grease off the clutch linings.

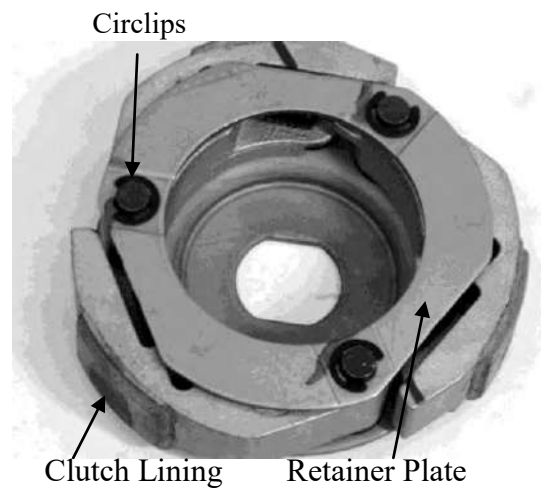

8. DRIVEN PULLEYS/KICK STARTER

CLUTCH / DRIVEN PULLEY ASSEMBLY

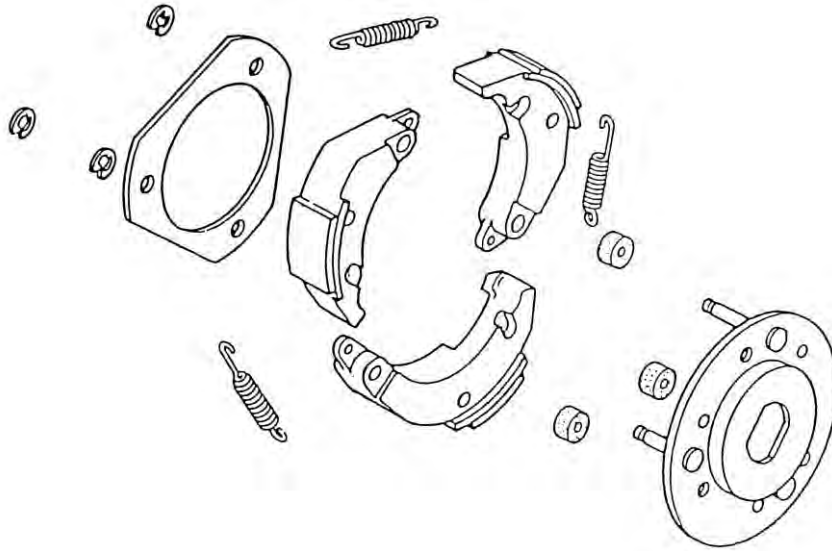

Install the damper rubbers on the drive plate pins.

Install the clutch weights/shoes and clutch springs onto the drive plate.

Install the retainer plate and secure with the circlips.

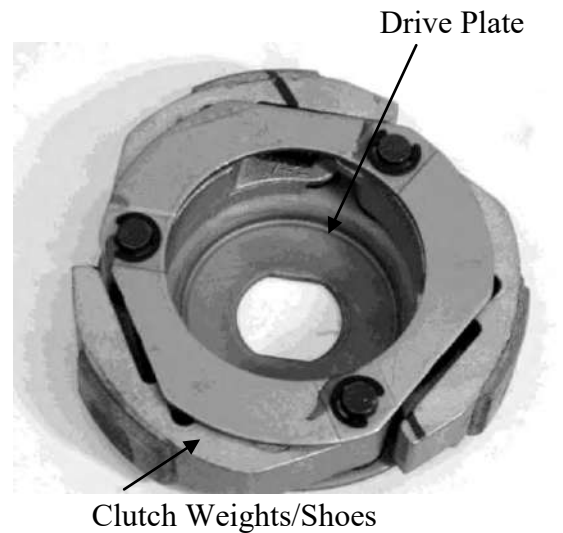

Clean the driven pulley faces and remove any grease from them.

Install the oil seal onto the moveable driven face.

Apply grease to the O-rings and install them onto the moveable driven face.



8. DRIVEN PULLEYS/KICK STARTER

Install the movable driven face onto the driven face.

Apply grease to the guide rollers and guide roller pins and then install them into the holes of the driven face.

Install the seal collar.

Remove any excessive grease.

* Be sure to clean the driven face off any grease.

* Align the flat surface of the driven face with the flat on the clutch drive plate.

Compress the clutch spring compressor and install the drive plate nut. Set the clutch spring compressor on a vise and tighten the drive plate nut to the specified torque.

Torque: 5.5 kg-m

* Be sure to use a clutch spring compressor to avoid spring damage.

Special

Clutch spring compressor A120E00027

INSTALLATION

Install the clutch/driven pulley onto the drive shaft

* Be sure to clean the driven face off any grease.

Guide Roller Pins

Guide Roller

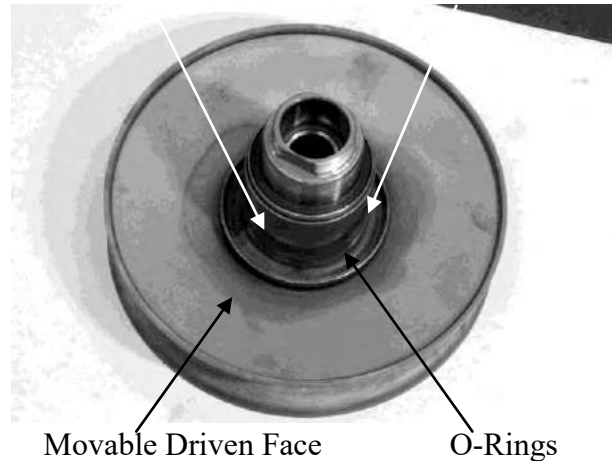

8. DRIVEN PULLEYS/KICK STARTER

Install the clutch outer.
Hold the clutch outer with the flywheel holder.
Install and tighten the clutch outer nut.

Torque: 5.0-6.0 kg-m

Special

Universal holder A120E00017

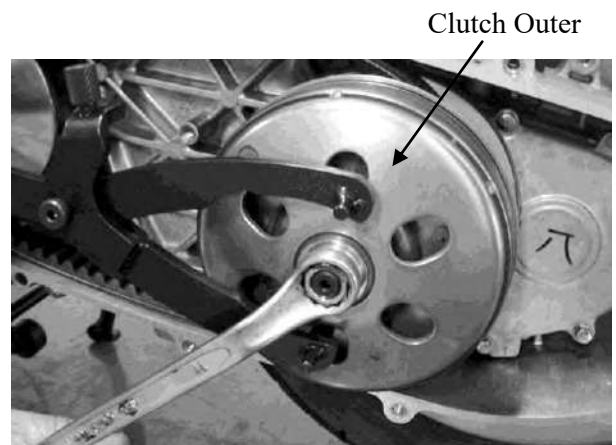

Install the drive belt.
Install the left crankcase cover.



9. FINAL REDUCTION

FINAL REDUCTION

SERVICE INFORMATION	9-2
TROUBLESHOOTING	9-2
FINAL REDUCTION DISASSEMBLY	9-3
FINAL REDUCTION INSPECTION	9-3
FINAL REDUCTION ASSEMBLY	9-5

9. FINAL REDUCTION

TE25AA(IT) E10

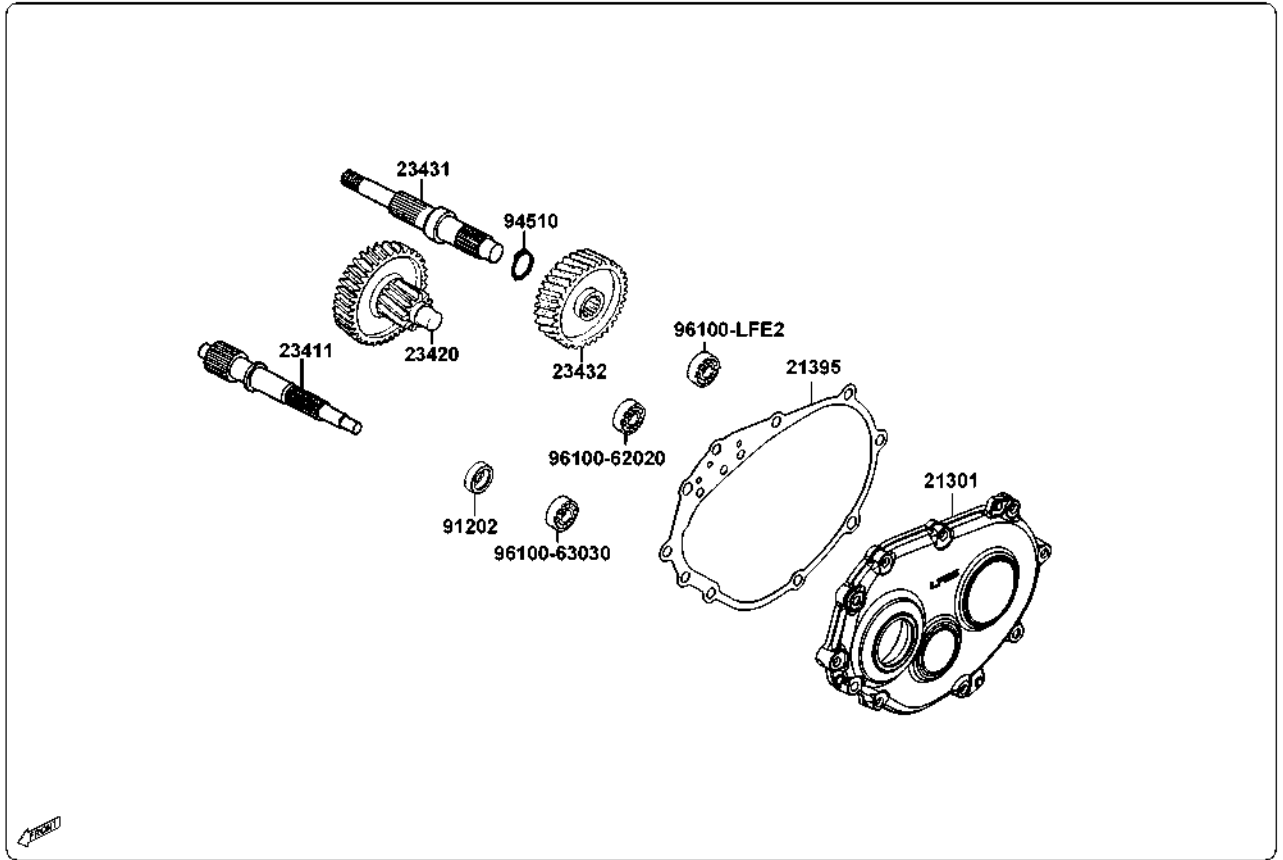

9. FINAL REDUCTION

SERVICE INFORMATION

GENERAL INSTRUCTIONS

- When replacing the drive shaft, use a special tool to hold the bearing inner race for this operation.

SPECIFICATIONS

Specified Oil: GEAR OIL SAE 90#

Oil Capacity: At change : 0.18 liter

At disassembly : 0.2liter

TORQUE VALUES

Transmission case cover bolt 1.2kg-m

SPECIAL TOOLS

Driver handle A

Outer driver, 32x35mm

Outer driver, 37x40mm

Outer driver, 42x47mm

Pilot, 15mm

Pilot, 17mm

Pilot, 20mm

Crankcase assembly tool

– Assembly shaft

– Assembly collar

TROUBLESHOOTING

Engine starts but motorcycle won't move

- Damaged transmission
- Seized or burnt transmission

Oil leaks

- Oil level too high
- Worn or damaged oil seal

9. FINAL REDUCTION

FINAL REDUCTION DISASSEMBLY

- Remove the exhaust muffler.
- Remove the rear wheel.
- Remove the left crankcase cover.
- Remove the clutch/driven pulley.
- Drain the transmission gear oil into a clean container.
- Remove the transmission case cover attaching bolts. (10bolts)
- Remove the transmission case cover.
- Remove the gasket and dowel pins.



Remove the final gear and countershaft.

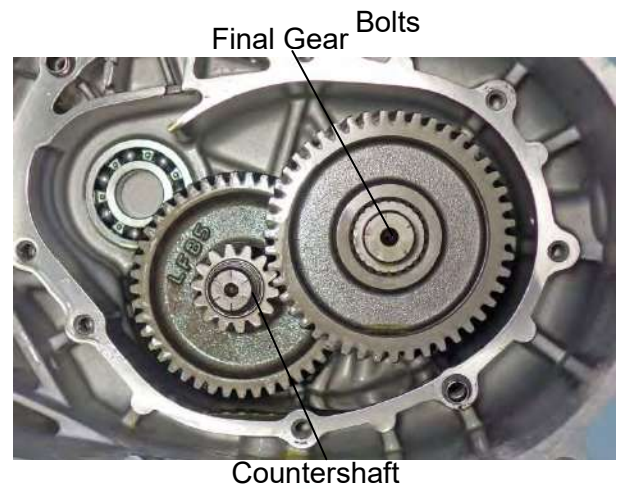

FINAL REDUCTION INSPECTION

Inspect the countershaft and gear for wear or damage.



Countershaft

Inspect the final gear and final shaft for wear, damage or seizure.



9. FINAL REDUCTION

Check the left crankcase bearings for excessive play and inspect the oil seal for wear or damage.

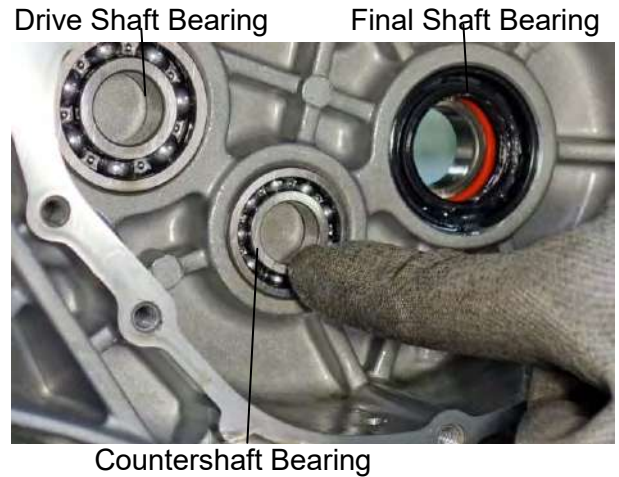

Check the transmission case cover bearings for excessive play and inspect the final shaft bearing oil seal for wear or damage.

*

Do not remove the transmission case cover except for necessary part replacement. When replacing the drive shaft, also replace the bearing and oil seal.

Drive Shaft Bearing

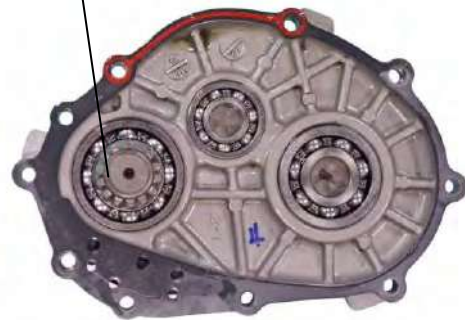

Check the transmission cover bearings for excessive play. Inspect the drive shaft, drive shaft bearing and oil seal for wear or damage.



Use a bearing puller to remove the crankcase or transmission cover.



9. FINAL REDUCTION

Use a seal pick to remove the oil seals.



Use a bearing driver to install any new bearings into the crankcase and transmission Case cover. The driver should have the same Outside diameter as the bearings. The bearings should go in square and have their marking facing out. Drive in a new seal in the same way if needed.



9. FINAL REDUCTION

Installation

Lubricate the final drive bearings with fresh final drive oil. Coat the lips of the seals with fresh final drive oil.

Press the drive shaft back into the transmission case cover as shown



Insert the final shaft through the oil seal and bearing.



Insert the countershaft into its bearing as shown



Install the final gear onto the final shaft as shown.



9. FINAL REDUCTION



Install the dowel pins. Install a new gasket onto the transmission case.



9. FINAL REDUCTION

Install the transmission case cover onto the transmission. Fit the drive into its bearing in the case and make sure the gear engages correctly with the countershaft gear. Turn the drive shaft and make sure the final shaft turns.



Insert the 10 transmission case cover bolts. Tighten the bolts to specification using a 8mm socket.



Item	Qty	Thread size(MM)	Torque	
			Kgf-m	N.M
Transmission case bolts	10	8	1.8-2.5	18-25

Install the rear wheel. See the rear wheel chapter.

Fill the final drive oil. See the final drive oil chapter.

Install the CVT belt and pulleys. See the CVT installation chapter.

Install the belt case. See the belt case chapter.

FRONT WHEEL/FRONT BRAKE/FRONT SUSPENSION

SERVICE INFORMATION..... 10-2

TROUBLESHOOTING 10-3

FRONT WHEEL 10-4

HYDRAULIC BRAKE DRAWING 10-7

HYDRAULIC BRAKE..... 10-8

FRONT SHOCK ABSORBER..... 10-13

STEERING HANDLEBAR..... 10-14

STEERING STEM 10-15

10. STEERING HANDLEBAR/FRONT WHEEL/ FRONT BRAKE/FRONT SHOCK ABSORBER/FRONT FORK

TE25AA(IT) F04

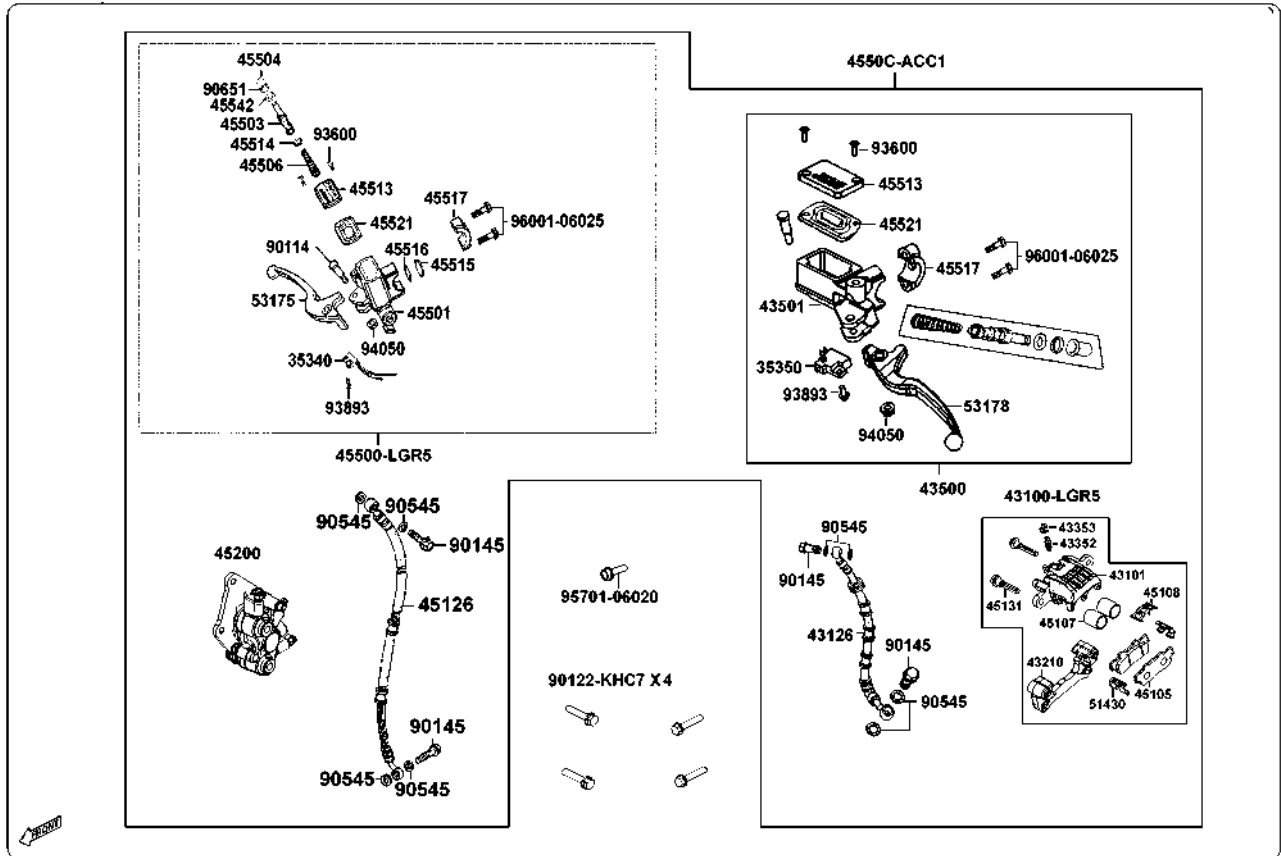

TE25AA(IT) F06

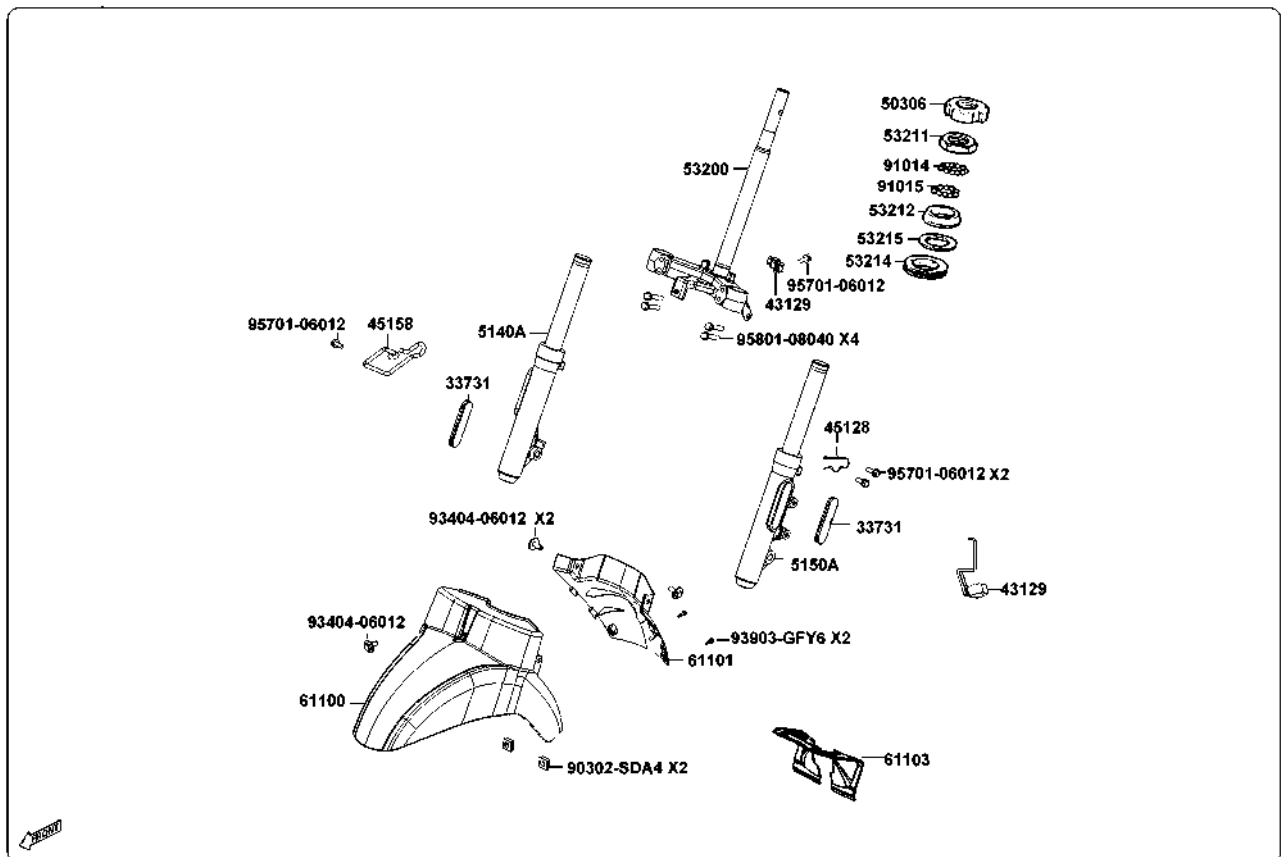

SERVICE INFORMATION

GENERAL INSTRUCTIONS

- Remove the motorcycle front wheel off the ground and be careful to prevent the motorcycle from falling down.
- During servicing, keep oil or grease off the brake drum and brake linings.
- Contaminated brake disk or brake pads reduce stopping power. Clean the contaminated brake disk with high-performance brake degreaser and replace the brake pads.
- Do not use brake fluid for cleaning.
- Bleed air from the brake system if the brake system is removed or the brake is soft.
- Do not allow any foreign matters to enter the brake system when filling it with brake fluid.
- Brake fluid will damage painted surfaces and plastic parts. When servicing the brake system, use shop towels to cover and protect rubber, plastic parts and coated surfaces. Wipe off any spilled brake fluid with a clean shop towel.
- Inspect the brake system before riding.

SPECIFICATIONS

Item		Standard (mm)	Service Limit (mm)
Axle shaft runout		—	0.2
Front wheel rim runout	Radial	—	2.0
	Axial	—	2.0
Front brake lining thickness		5	2.8
Front shock absorber spring free length		278.1	270
Brake disk thickness		4 ± 0.2	3.0
Brake disk runout		—	0.2
Brake master cylinder I.D.		12.700 ~ 12.743	12.75
Brake master cylinder piston O.D.		12.657 ~ 12.684	12.64
Brake caliper piston O.D.		21.93 ~ 22.96 / 25.33 ~ 25.3	21.90 / 25.30
Brake caliper cylinder I.D.		22.0 ~ 22.05 / 25.4 ~ 25.45	22.05 / 25.45

TORQUE VALUES

Steering stem bolt	4.0 ~ 5.0kg-m	Brake caliper bleed valve	0.6kg-m
Steering stem lock nut	7.0 ~ 8.0kg-m	Brake fluid tube bolt	3.0 ~ 4.0kg-m
Steering top cone race	0.5 ~ 1.3kg-m	Brake pad pin bolt	1.5 ~ 2.0kg-m
Front shock absorber bolt	2.0 ~ 2.5kg-m	Brake caliper bolt	2.9 ~ 3.5kg-m
Front axle nut	5.0 ~ 7.0kg-m	Brake master cylinder bolt	1.0 ~ 1.4kg-m

SPECIAL TOOLS

Lock nut wrench

Outer driver, 28x30mm

Ball race remover

Pliers (close)

Bearing remover head, 10mm

Driver handle A

Pilot, 10mm

Outer driver, 37x40mm

Bearing remover

TROUBLESHOOTING

Hard steering (heavy)

- Excessively tightened steering stem top cone race
- Broken steering balls
- Insufficient tire pressure

Steers to one side or does not track straight

- Uneven front shock absorbers
- Bent front fork
- Bent front axle or uneven tire

Poor brake performance

- Incorrectly adjusted brake
- Worn brake linings
- Contaminated brake lining surface
- Worn brake shoes at cam contacting area
- Worn brake drum
- Poorly connected brake arm

Poor brake performance (Disk Brake)

- Air in brake system
- Deteriorated brake fluid
- Contaminated brake pads and brake disk
- Worn brake pads
- Worn brake master cylinder piston oil seal
- Clogged brake fluid line
- Deformed brake disk
- Unevenly worn brake caliper

Front wheel wobbling

- Bent rim
- Excessive wheel bearing play
- Bent spoke plate
- Faulty tire
- Improperly tightened axle nut

Soft front shock absorber

- Weak shock springs
- Insufficient damper oil

Front shock absorber noise

- Slider bending
- Loose fork fasteners
- Lack of lubrication

FRONT WHEEL

REMOVAL

Remove the motorcycle front wheel off the ground.
Disconnect the speedometer cable.



Speedometer Cable

Remove the front axle nut and pull out the axle.
Remove the front wheel.
Remove the front brake panel.



Axle Shaft

INSPECTION

AXLE RUNOUT

Set the axle in V blocks and measure the runout using a dial gauge.
The actual runout is 1/2 of the total indicator reading.

Service Limit: 0.2mm replace if over

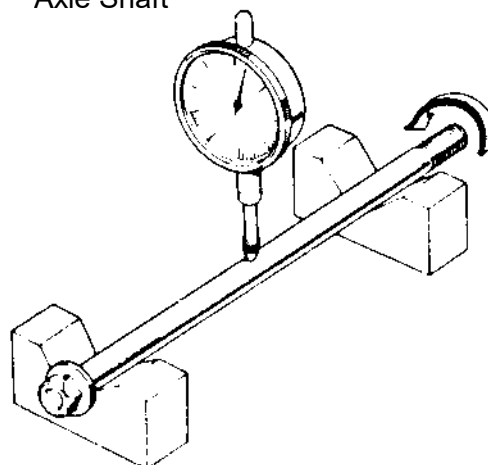

WHEEL RIM

Check the wheel rim run-out.

Service Limits:

Radial: 2.0mm replace if over

Axial: 2.0mm replace if over

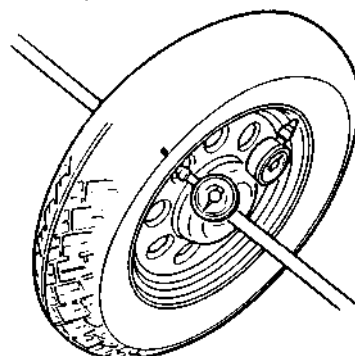

FRONT WHEEL BEARING

Remove the side collar and dust seal.

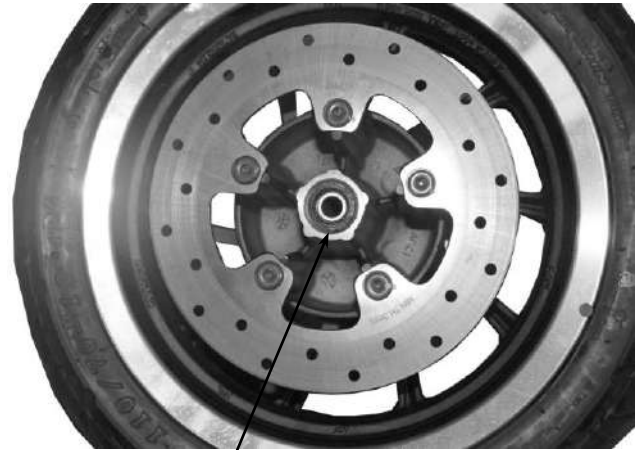

Dust Seal

Turn the inner race of each bearing with your finger to see if they turn smoothly and quietly. Also check if the outer race fits tightly in the hub.

Replace the bearings if the races do not turn smoothly, quietly, or if they fit loosely in the hub.



Wheel Bearing

BEARING REPLACEMENT

Remove the front wheel bearings and distance collar.

Special

Bearing Remover

Bearing Remover Head, 12mm

Pack all bearing cavities with grease.

Drive in the left bearing.

Install the distance collar.

Drive in the right bearing.

- ***
- Do not allow the bearings to tilt while driving them in.
 - Drive in the bearing squarely with the sealed end facing out.

Special

Driver handle A

Apply grease to a new dust seal lip and install the dust seal.
Install the side collar.

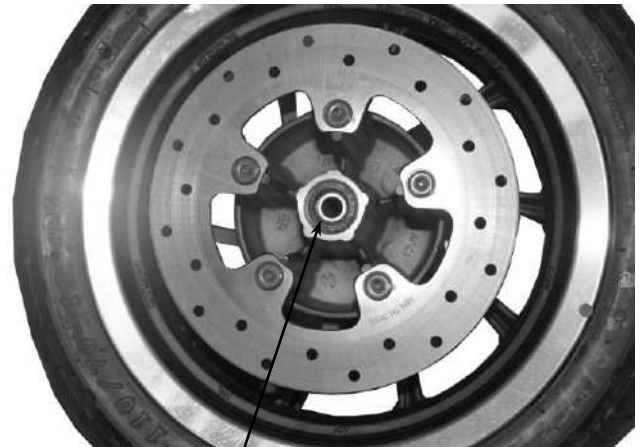

Dust Seal

INSTALLATION

Apply grease to the brake panel dust seal lip.
Apply grease to the speedometer gear engaging and sliding parts.
Install the brake panel by aligning the speedometer retaining pawls with the hub cutouts.

* If not aligned, the retaining pawl will be deformed when the axle nut is tightened.
After installing the axle, turn the wheel to make sure that the speedometer drive shaft rotates freely.

Apply a thin coat of grease to the axle shaft.
Install the front wheel by aligning the brake panel groove with the front fork tab.
Insert the axle shaft.
Install and tighten the axle nut.

Torque: 5.0~7.0kg-m

Install the front brake cable and rotate the front tire to check the speedometer if be performed.



Axle Nut

Connect the speedometer cable.



Speedometer Cable

HYDRAULIC BRAKE DRAWING

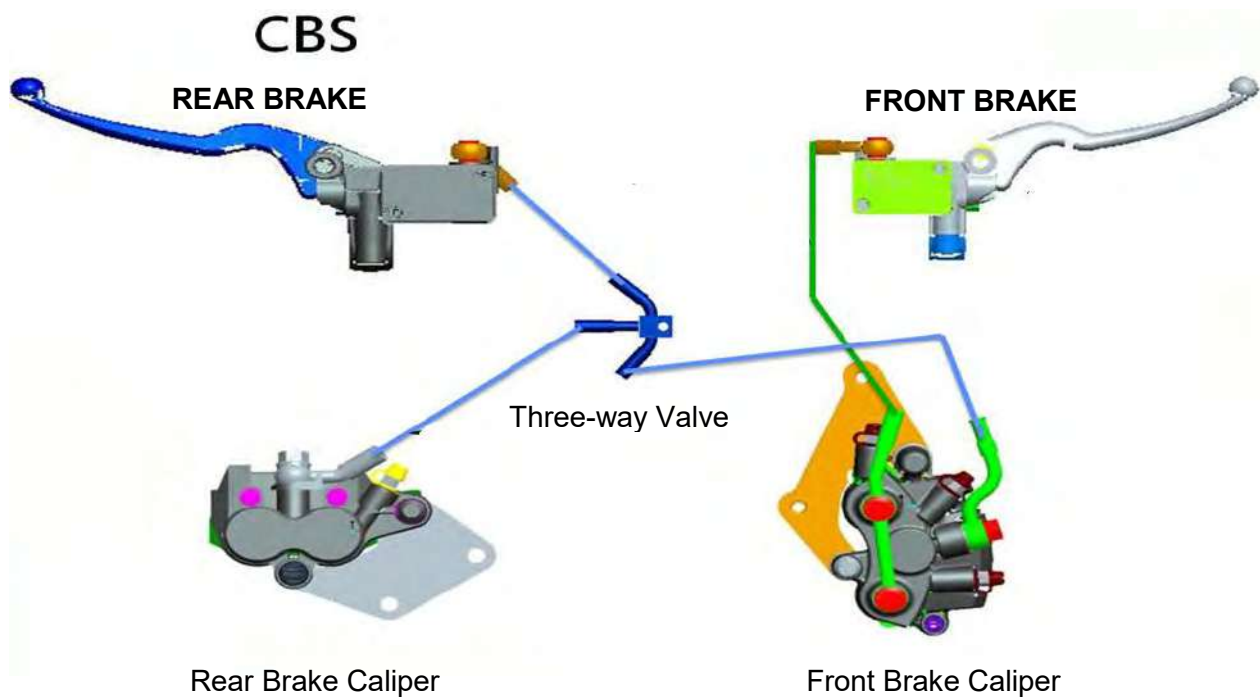

HYDRAULIC BRAKE

BRAKE FLUID REPLACEMENT/AIR BLEEDING

Check the brake fluid level on level ground.

- * When operating the brake lever, the brake reservoir cap must be tightened securely to avoid splash of brake fluid.
- * When servicing the brake system, use shop towels to cover plastic parts and coated surfaces to avoid damage caused by splash of brake fluid.



Lower Limit

Reservoir

BRAKE FLUID BLEEDING

In order to avoid spilling brake fluid, connect a transparent hose to the bleed valve.

Warning

Spilled brake fluid on brake pads or brake disk reduces stopping power. Clean the brake pads and brake disk with a high-performance brake

Fully apply the brake lever and then loosen the brake caliper bleed valve to drain the brake fluid until there is no air bubbles in the brake fluid. Then, tighten the bleed valve. Repeat these steps until the brake system is free of air.

BRAKE FLUID REFILLING

Add DOT-4 brake fluid to the brake reservoir.

- * When bleeding, be careful not to allow air in the brake reservoir flowing into the brake system.
- * Never use dirty or unspecified brake fluid or mix different brake fluids because it will damage the brake system.

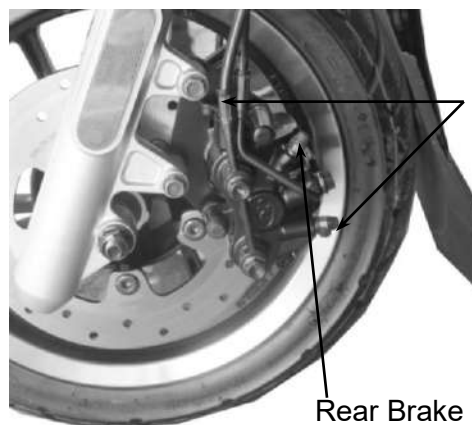

Front Brake Bleed Valve

Rear Brake Bleed Valve

Make sure to bleed air from the brake system.

BRAKE PAD/DISK REPLACEMENT

- * The brake pads must be replaced as a set to ensure the balance of the brake

Remove the two bolts attaching the brake caliper.
Remove the brake caliper.
Compress the brake caliper seat, and press down the fixed-reed to take out the brake pads.



Install the brake pads in the reverse order of removal.

Tighten the brake pad pin bolt.

Torque: 1.5~2.0kg-m

Keep grease or oil off the brake pads to avoid brake failure.



Brake Pads

BRAKE DISK

Measure the brake disk thickness.

Service Limit: 3.5mm

Measure the brake disk runout.

Service Limit: 0.3mm



BRAKE MASTER CYLINDER

REMOVAL

First drain the brake fluid from the hydraulic brake system.

- When servicing the brake system, use shop towels to cover rubber and plastic parts and coated surfaces to avoid being contaminated by brake fluid.
- When removing the brake fluid tube bolt, be sure to plug the tube end to avoid brake fluid leakage.

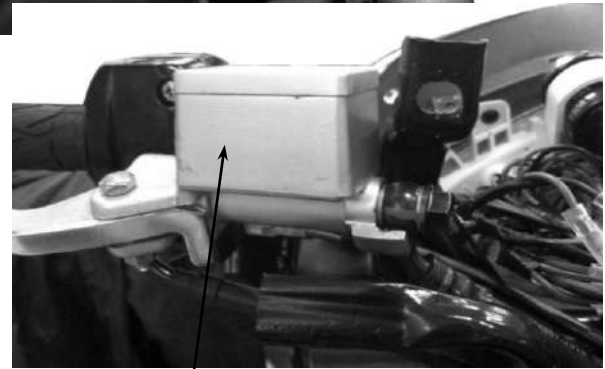

Master Cylinder

DISASSEMBLY

Remove the piston rubber cover and snap ring from the brake master cylinder.



Snap Ring

10. STEERING HANDLEBAR/FRONT WHEEL/ FRONT BRAKE/FRONT SHOCK ABSORBER/FRONT FORK

Remove the main piston and spring from the brake master cylinder.

Clean the inside of the master cylinder and brake reservoir with brake fluid.

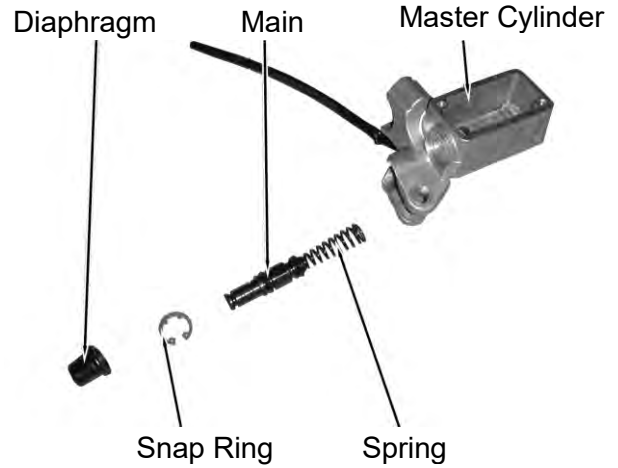

INSPECTION

Measure the brake master cylinder I.D.
Inspect the master cylinder for scratches or cracks.

Service Limit: 12.75mm



Measure the brake master cylinder piston O.D.

Service Limit: 12.64mm

Before assembly, inspect the 1st and 2nd rubber cups for wear or damage.

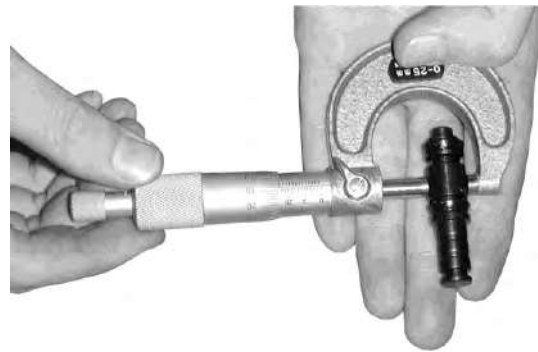

ASSEMBLY

Before assembly, apply brake fluid to all removed parts.

Install the spring together with the 1st rubber cup.

- * During assembly, the main piston and spring must be installed as a unit without exchange.
- * When assembling the piston, soak the cups in brake fluid for a while.
- * Install the cups with the cup lips facing the correct direction.

Install the main piston, spring and snap ring.
Install the diaphragm.
Install the brake lever.

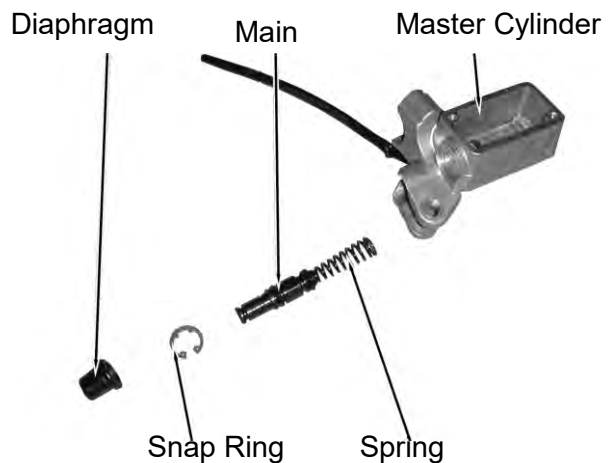

10. STEERING HANDLEBAR/FRONT WHEEL/ FRONT BRAKE/FRONT SHOCK ABSORBER/FRONT FORK

Place the brake master cylinder on the handlebar and install the holder with the “up” mark facing up. Also align the punch mark with the holder joint seam. First tighten the upper bolt and then tighten the lower bolt.

Torque: 1.0~1.4kg-m

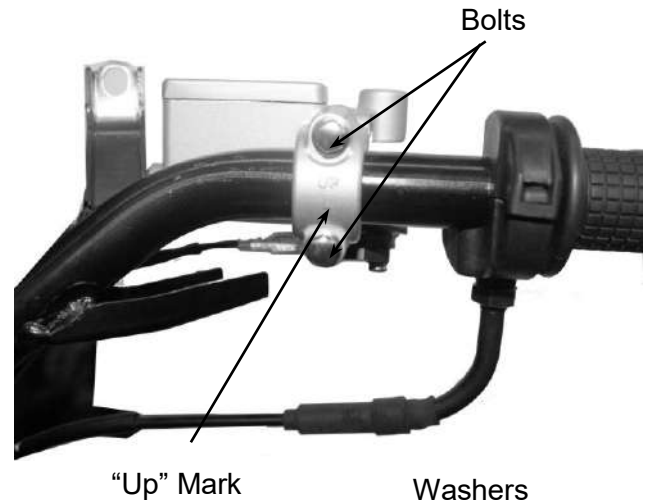

Install the brake fluid tube with the attaching bolt and two sealing washers. Install the handlebar covers. Connect the front and rear stop switch wire connectors. Fill the brake reservoir with recommended brake fluid to the upper limit and bleed air according to the method stated in page 12-8.

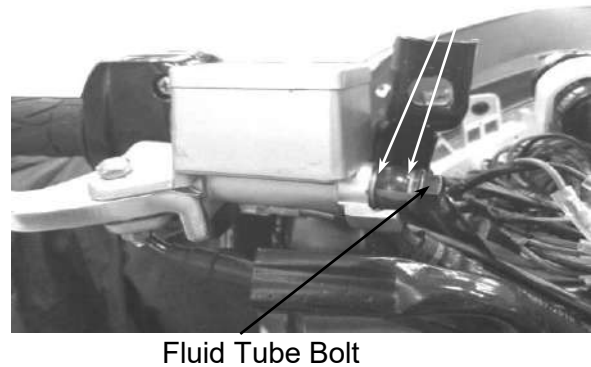

BRAKE CALIPER (FRONT)

REMOVAL

Remove the brake caliper and brake pad springs. Place a clean container under the brake caliper and disconnect the brake fluid pipe from the caliper.

* Do not spill brake fluid on any coated surfaces.



DISASSEMBLY

Remove the brake caliper seat from the brake caliper.



Remove the pistons from the brake caliper. If necessary, use compressed air to squeeze out the pistons through the brake fluid inlet opening and place a shop towel under the caliper to avoid contamination caused by the removed pistons. Check each piston cylinder for scratches or wear and replace if necessary.

* Be careful not to damage the piston surface.

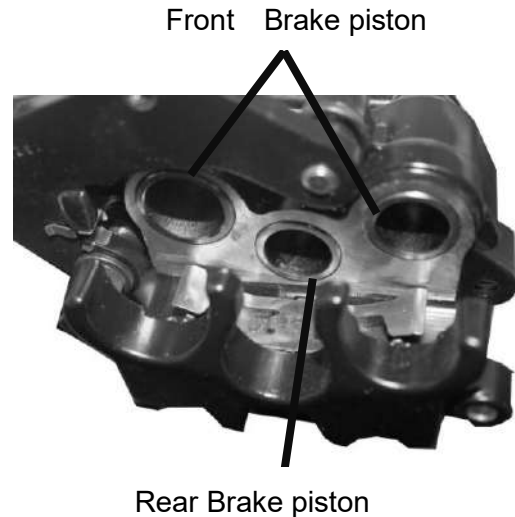

Check each piston for scratches or wear. Measure each piston O.D. with a micrometer gauge.

Service Limit:
25.35mm
21.95mm



Check each caliper cylinder for scratches or wear and measure the cylinder bore.



ASSEMBLY

Clean all removed parts.
Apply silicon grease to the pistons and oil seals. Lubricate the brake caliper cylinder inside wall with brake fluid.
Install the brake caliper piston with grooved side facing out.

* Install the piston with its outer end protruding 3~5mm beyond the brake caliper cylinder.

Wipe off excessive brake fluid with a clean shop towel. Apply silicon grease to the brake caliper seat pin and caliper inside. Install the brake caliper seat.



INSTALLATION

Install the brake caliper and tighten the two bolts.

Torque: 2.9~3.5kg-m

Connect the brake fluid tube to the brake caliper and tighten the fluid tube bolt.

Torque: 3.0~4.0kg-m

Fill the brake reservoir with recommended brake fluid and bleed air from the brake system.



FRONT SHOCK ABSORBER

REMOVAL

Remove the front cover.
Remove the front wheel.
Remove the front shock absorber upper mount bolts.
Loosen the lower mount bolts to remove the front shock absorbers.



INSPECTION

Inspect the following items and replace if necessary.

- Front shock absorber tube bending or damage.
- Weak front shock absorber spring.
- Damper and damper rod bending.
- Oil seal damage or wear.

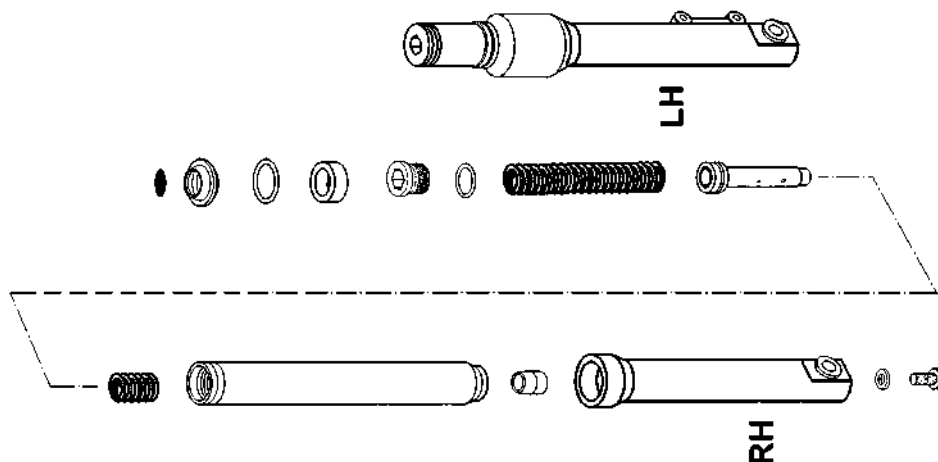

INSTALLATION

Install the front shock absorbers onto the steering stem.
Install and tighten the front shock absorber upper mount bolts.
Tighten the lower mount bolts.

* Align the upper mount bolt hole with the groove on the front fork.
Front shock absorbers are installed at the same altitude.

Install the front wheel.

Mount Bolt



Brake Master Cylinder

STEERING HANDLEBAR

REMOVAL

Remove the handlebar covers.
Remove the rear brake lever holder bolt to remove the holder.
Remove the front brake master cylinder holder bolts to remove the brake master cylinder.

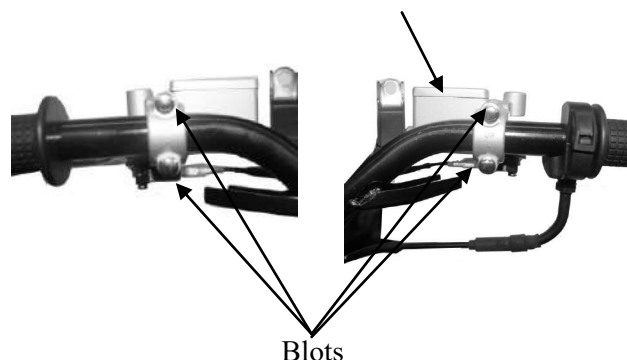

Blots

10. STEERING HANDLEBAR/FRONT WHEEL/ FRONT BRAKE/FRONT SHOCK ABSORBER/FRONT FORK

Remove the throttle seat screw.

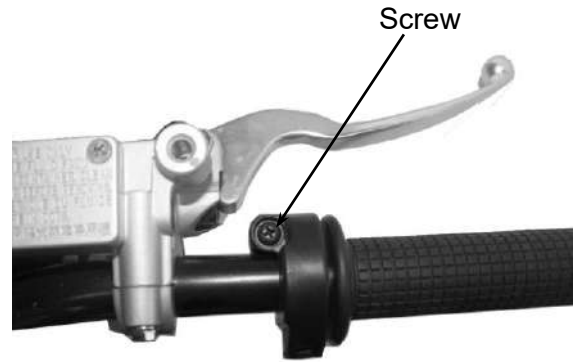

Remove the throttle seat from the handlebar and disconnect the throttle cable from the throttle pipe.
Remove the throttle pipe from the handlebar.

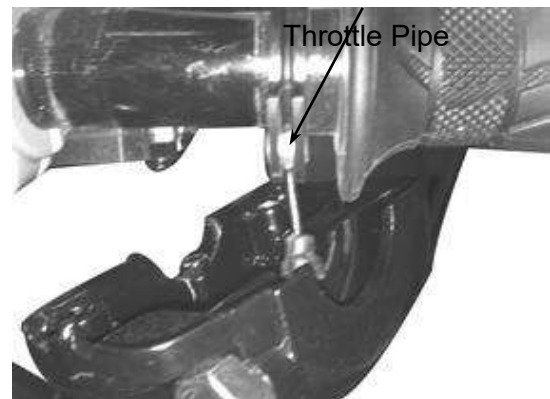

Remove the steering stem lock bolt, collar, nut and the handlebar.

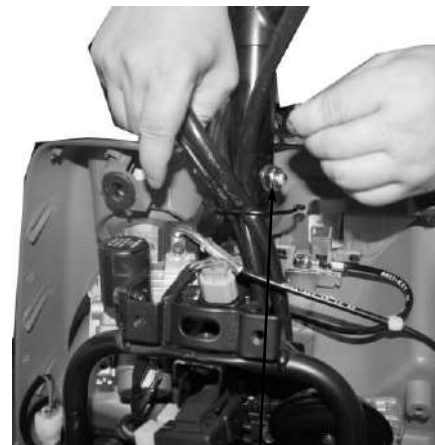

Nut

STEERING STEM

REMOVAL

Remove the steering stem lock nut.

Special

Steering Stem Lock Nut Wrench

Lock Nut wrench



Steering Stem Lock Nut Wrench

Remove the top cone race.

- * Be careful not to lose the steel balls (20 on top race and 15 on bottom race).
- * Clean the openings of frame covers with clean shop towels.

Remove the front fork.

Top Cone Race



BOTTOM CONE RACE REPLACEMENT

Remove the bottom cone race using a chisel.

- * Be careful not to damage the steering stem and front fork.

Drive a new bottom cone race into place with a proper driver.



Bottom Cone Race
Ball Race Remover

BALL RACE REPLACEMENT

Drive out the top and bottom ball races.



Drive new top and bottom ball races into the steering head using the outer driver.

Special

Outer Driver

Outer Driver

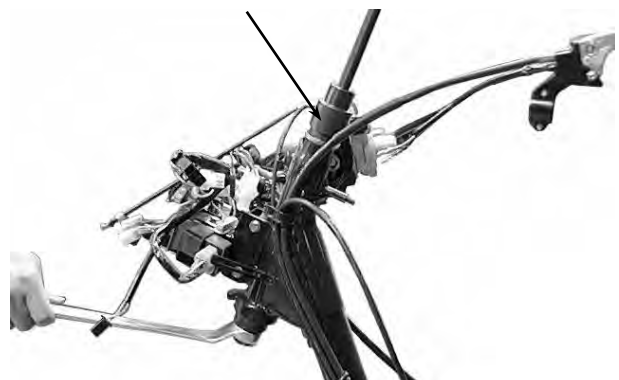

INSTALLATION

Install the top and bottom steel balls.
Apply grease to the top and bottom ball races and install 20 steel balls on the top ball race and 15 steel balls on the bottom ball race.

Top Steel Ball



Apply grease to the ball races and install the front fork.
Apply grease to the top cone race and install it.
Tighten the top cone race and then turn the steering stem right and left several times to make steel balls contact each other closely.

* Check that the steering stem rotates freely without vertical play.

Install the steering stem lock nut and tighten it while holding the top cone race.
Torque: 7.0~8.0kg-m
Install the front wheel.



Top Cone Race
Top Cone Race Lock Nut Wrench



Steering Stem Lock Nut Wrench

HANDLEBAR INSTALLATION

Install the handlebar onto the steering stem tube and then install and tighten the bolt.
Torque: 4.5kg-m
Install the front wheel.
Install the brake levers.
Install the handlebar covers.



Nut

11. REAR WHEEL/REAR BRAKE/REAR SHOCK ABSORBER



LIKE II 125

REAR WHEEL/REAR BRAKE/REAR SHOCK ABSORBER

SERVICE INFORMATION	11-2
TROUBLESHOOTING	11-2
REAR BRAKE.....	11-3
REAR WHEEL	11-7
REAR SHOCK ABSORBER	11-8

11. REAR WHEEL/REAR BRAKE/REAR SHOCK ABSORBER



LIKE II 125

TE25AA(IT) F17

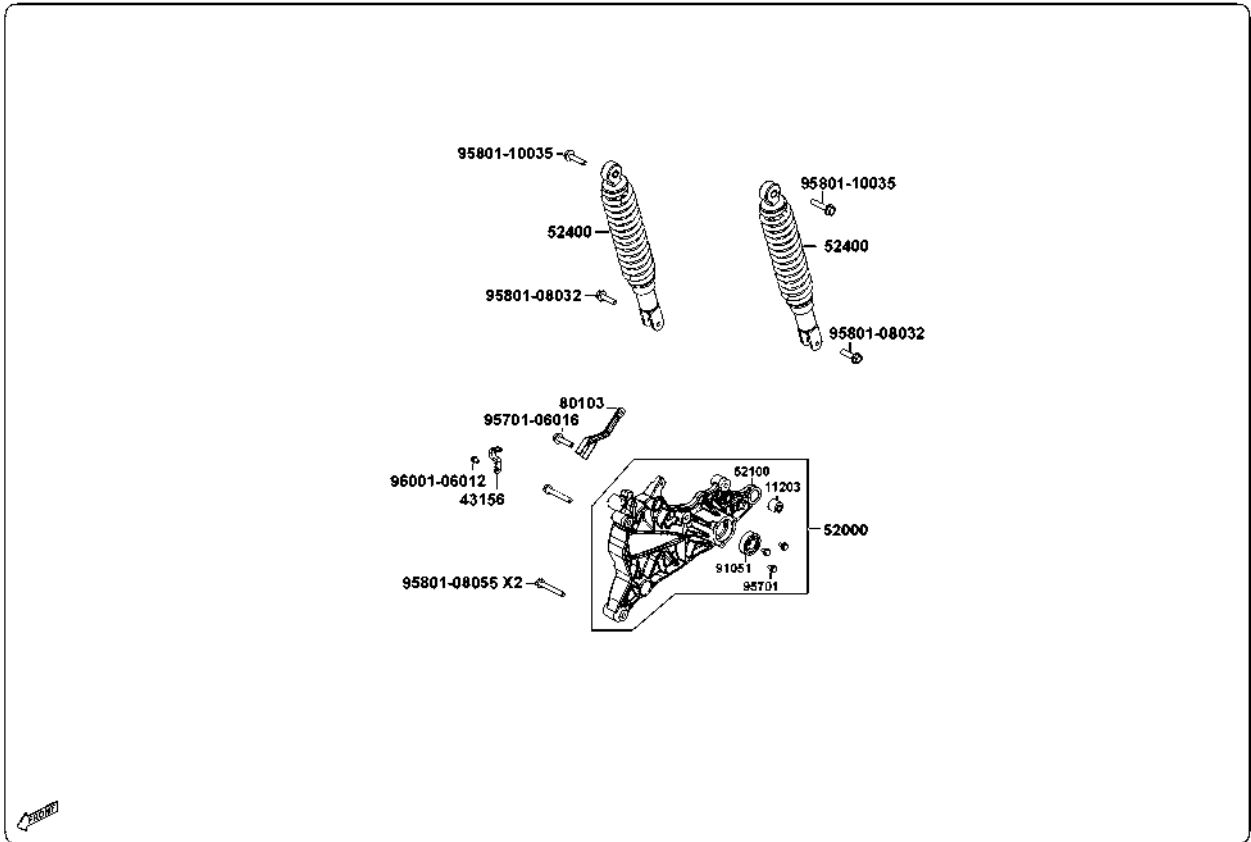

TE25AA(IT) F07

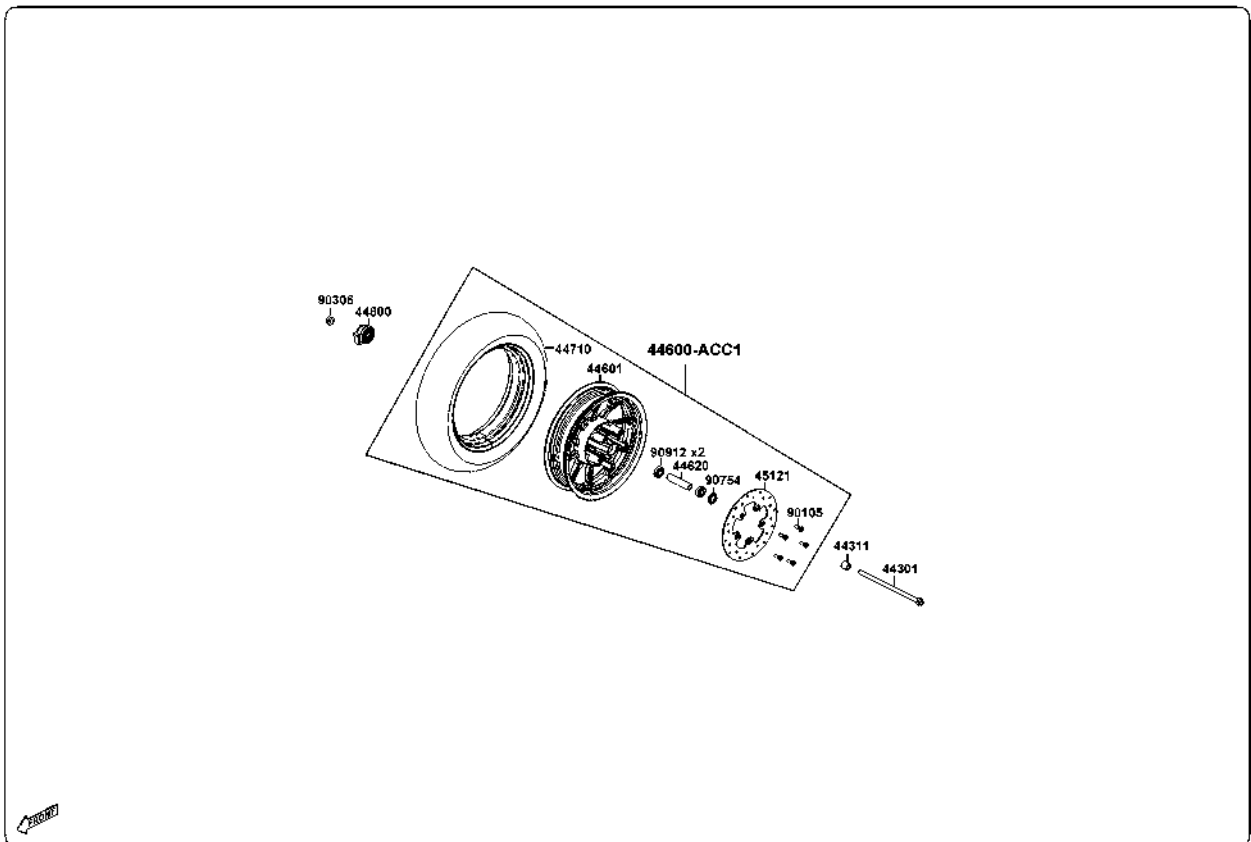

11. REAR WHEEL/REAR BRAKE/REAR SHOCK ABSORBER



LIKE II 125

SERVICE INFORMATION

GENERAL INSTRUCTIONS

- When performing the services stated in this section, the engine and exhaust muffler must be cold to avoid scalding.
- During servicing, keep oil or grease off the brake pads and brake disk.

SPECIFICATIONS

Item	Standard(mm)	Service Limit(mm)
Rear wheel rim runout	—	2.0
Rear brake disk thickness	4 ± 0.2	3.0
Rear brake disk runout	—	0.30
brake master cylinder I.D.	14.0~14.04	14.05
brake master cylinder piston O.D.	13.95~13.98	13.94
Brake caliper piston O.D.	25.33~25.36	25.30
Brake caliper cylinder I.D.	25.4~25.45	25.45

TORQUE VALUES

Exhaust muffler lock bolt	35 N-m
Exhaust muffler pipe nut	20 N-m
Rear axle nut	120 N-m
Rear shock absorber lower mount bolt	40 N-m
Rear shock absorber upper mount bolt	40 N-m
Rear brake caliper holder bolt	27 N-m

TROUBLESHOOTING

Rear wheel wobbling

- ◆ Bent rim
- ◆ Faulty tire
- ◆ Axle not tightened properly

Soft rear shock absorber

- ◆ Weak shock absorber spring
- ◆ Damper oil leaks

Rear wheel noise

- ◆ Worn rear wheel axle bearings
- ◆ Worn rear fork bearings
- ◆ Deformed rear fork

Poor brake performance

- ◆ Air in brake system
- ◆ Deteriorated brake fluid
- ◆ Contaminated brake pad surface
- ◆ Worn brake pads
- ◆ Clogged brake fluid line
- ◆ Deformed brake disk
- ◆ Unequal worn brake caliper

11. REAR WHEEL/REAR BRAKE/REAR SHOCK ABSORBER

REAR BRAKE

REAR BRAKE CALIPER REMOVAL

First remove the exhaust muffler
Remove the rear brake fluid tube bolt and disconnect the brake fluid tube.
Remove two bolts attaching the rear brake caliper.
Remove the rear brake caliper.

When removing the brake fluid tube, use shop towels to cover plastic parts and coated surfaces to avoid damage.

INSPECTION

Inspect the brake pads and brake disk.

Measure the brake disk thickness.

Service Limit: 3.0 mm replace if below

Visually check the brake pad thickness and it should not exceed the wear indicator mark.

DISASSEMBLY

Remove two brake pads dowel pins and three bolts from the brake caliper.
Remove the brake pads.

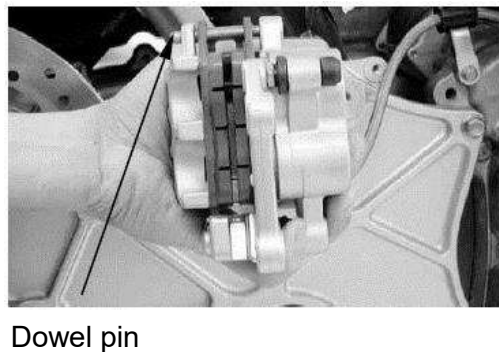
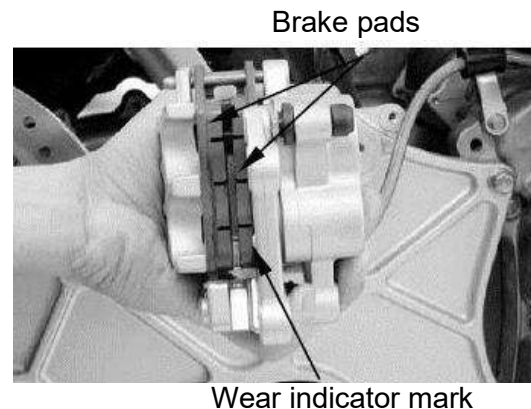
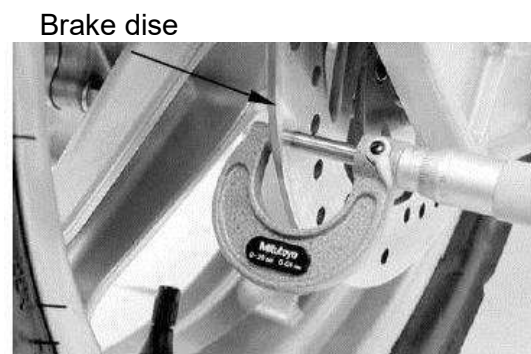
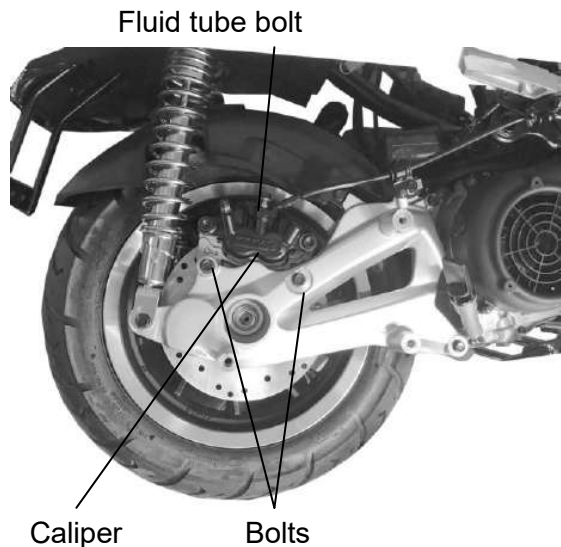

11. REAR WHEEL/REAR BRAKE/REAR SHOCK ABSORBER

Remove the piston from the brake caliper.

if necessary, use compressed air to squeeze out the piston through the brake fluid inlet opening and place a towel under the caliper to avoid contamination caused by the removed piston.

Check the piston cylinder for scratches or wear and replace if necessary.

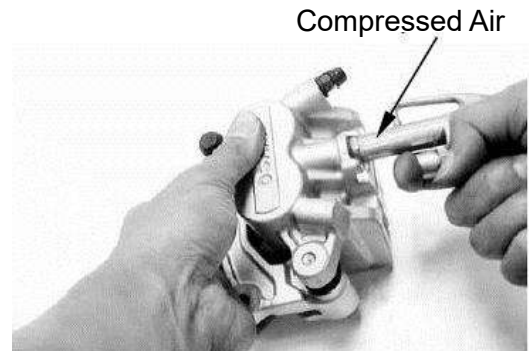

Push the piston oil seal outward to remove it. Clean the oil seal groove with brake fluid.

Be careful not to damage the piston Surface.



Check the piston for scratches or wear.

Measure the piston O.D. with a micrometer gauge.

Service Limit: 26.90 mm

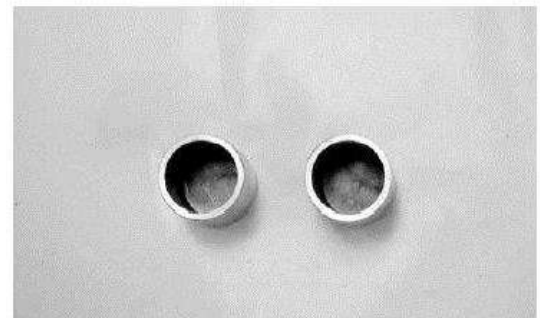

Check the caliper cylinder for scratches or wear and measure the cylinder bore.

Service Limit: 27.05 mm



11. REAR WHEEL/REAR BRAKE/REAR SHOCK ABSORBER



LIKE II 125

ASSEMBLY

Clean all removed parts.

Apply silicon grease to the piston and oil seal.
Lubricate the brake caliper cylinder inside wall with brake fluid.

Install the brake caliper piston with grooved side facing out.

Install the piston with its outer end protruding 3 ~5mm beyond the brake caliper.

Install the two spring plates onto the groove of the caliper.

Make sure the spring plate next to the brake pad dowel pin orientation.

Install two brake pads and brake pad dowel pin.

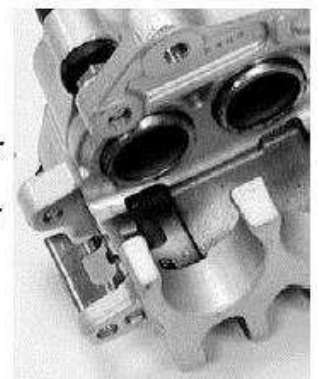
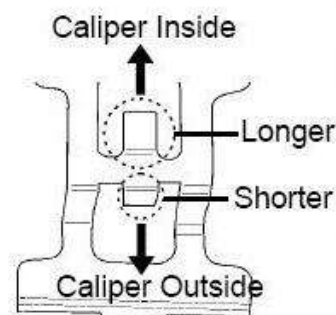
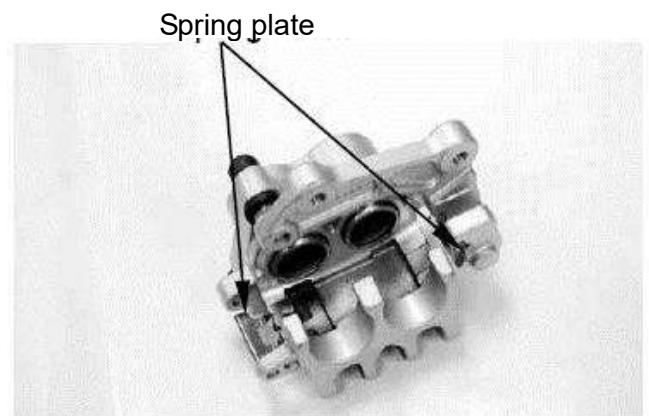

Dowel Pin

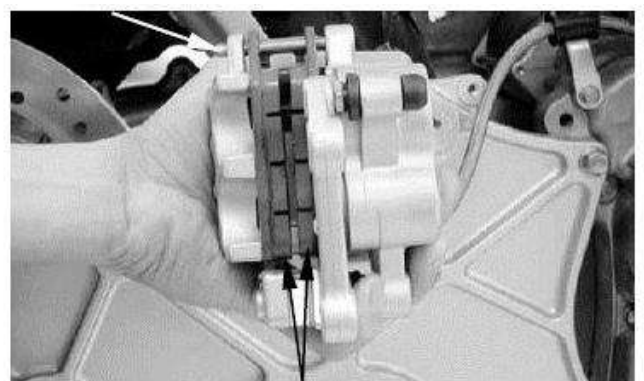

Brake pads

11. REAR WHEEL/REAR BRAKE/REAR SHOCK ABSORBER

INSTALLATION

Install the brake caliper to the rear fork and tighten the two bolts.

Torque: 27 N-m

Connect the brake fluid tube to the brake caliper and install fluid tube bolt, copper washers and tighten the fluid tube bolt.

Pill the brake reservoir with the specified brake fluid and bleed air from the brake system

When installing the brake fluid tube, be sure to install the two copper sealing washers.

REAR FORK REMOVAL

Remove the exhaust muffler

Remove the rear brake caliper

Remove the right rear shock absorber lower mount bolt.

Remove the rear axle nut and remove the collar.

Remove the rear fork.

The installation sequence is the reverse of removal.

Turn the inner race of each bearing with your finger to see if they turn smoothly and quietly.

Also check if the outer race fits tightly in the hub.

Replace the bearings if the race\$ do not turn smoothly, quietly, or if they fit loosely in the hub.

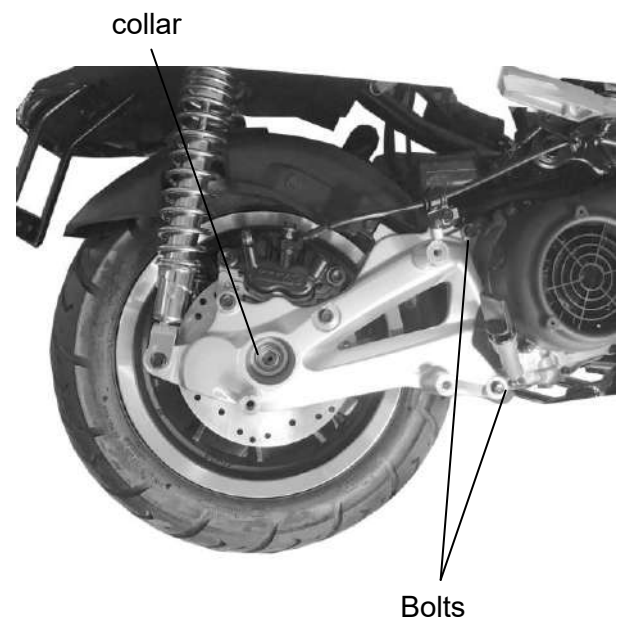
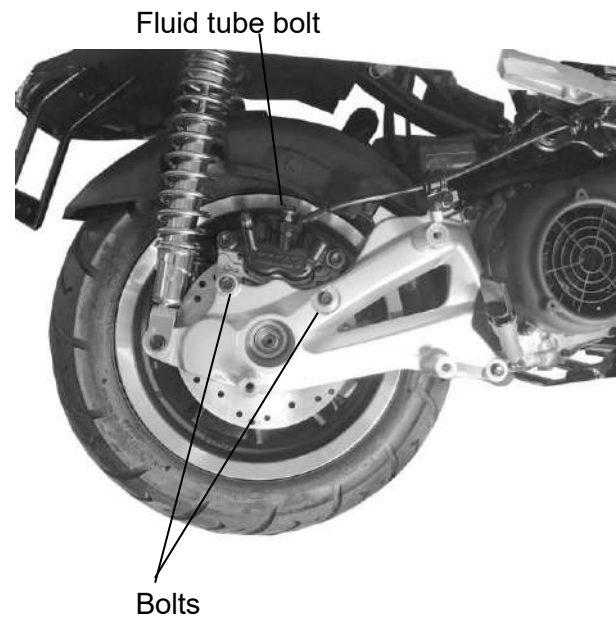

11. REAR WHEEL/REAR BRAKE/REAR SHOCK ABSORBER

REAR WHEEL REMOVAL

- Remove the exhaust muffler
- Remove the rear brake caliper
- Remove the rear fork
- Remove the rear axle collar.
- Remove the rear wheel.



Rear brake disk

Rear Axle collar

INSPECTION

Measure the rear wheel rim runout.

Service Limits:

- Radial:** 2.0mm replace if over
- Axial:** 2.0mm replace if over

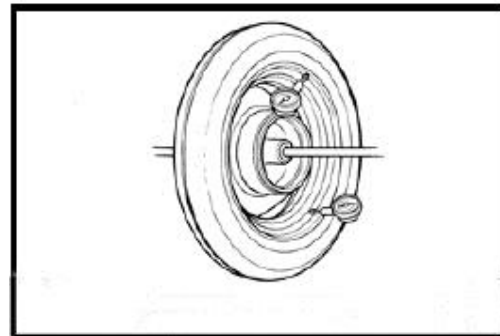

INSTALLATION

The installation sequence is the reverse of removal.

Torque:

- Rear shock absorber lower mount bolt: 35-45N-m
- Rear axle nut: 120 N-m

11. REAR WHEEL/REAR BRAKE/REAR SHOCK ABSORBER

REAR SHOCK ABSORBER

REMOVAL

Remove the front cover.
Remove the met-in box.
Remove the air cleaner case.
Remove the rear shock absorber upper and lower mount bolts to remove the rear shock absorber.

Upper Mount Bolt

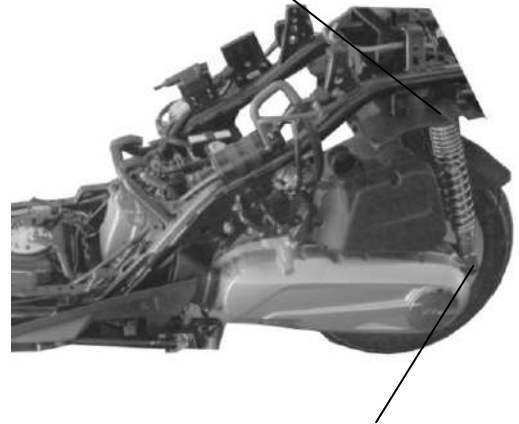

Lower Mount Bolt

Rear Shock Absorber

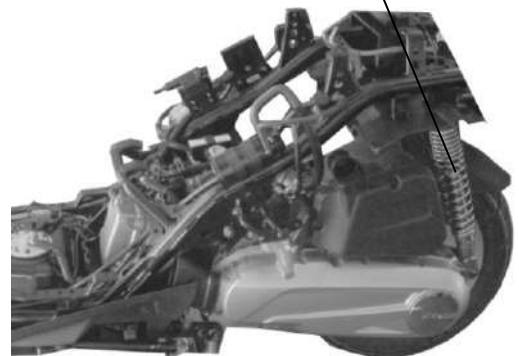

INSTALLATION

Install the rear shock absorber.
Install the rear shock absorber upper mount bolt and then install the lower mount bolt.

Torque:

Upper Mount Bolt: 3.5~4.5kg-m

Lower Mount Bolt: 2.4~3.0kg-m

Install the frame body cover.

12. BATTERY/CHARGING SYSTEM

12

BATTERY/CHARGING SYSTEM

CHARGING SYSTEM LAYOUT -----	12-1
CHARGING CIRCUIT -----	12-1
SERVICE INFORMATION-----	12-2
TROUBLESHOOTING-----	12-3
BATTERY CHARGING -----	12-5
REGULATOR/RECTIFIER -----	12-6

12. BATTERY/CHARGING SYSTEM

CHARGING SYSTEM LAYOUT

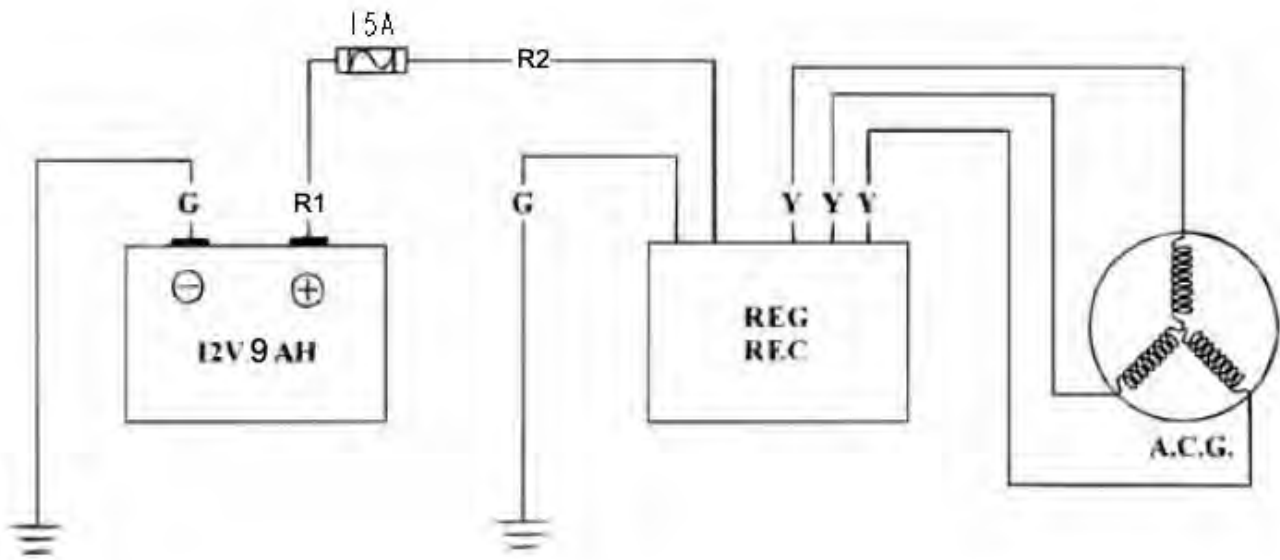
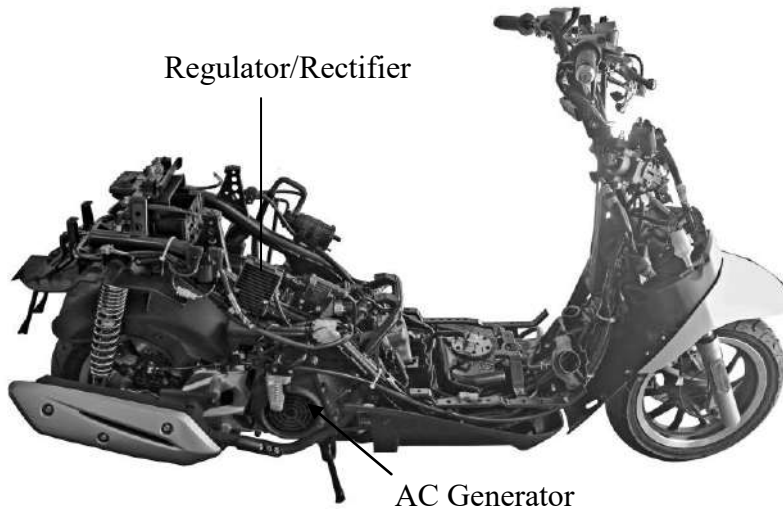

12. BATTERY/CHARGING SYSTEM

SERVICE INFORMATION

GENERAL INSTRUCTIONS

The battery electrolyte (sulfuric acid) is poisonous and may seriously damage the skin and eyes. Avoid contact with skin, eyes, or clothing. In case of contact, flush with water and get prompt medical attention

- The battery can be charged and discharged repeatedly. If a discharged battery is not used for a long time, its service life will be shortened. Generally, the capacity of a battery will decrease after it is used for 2~3 years. A capacity-decreased battery will resume its voltage after it is recharged but its voltage decreases suddenly and then increases when a load is added.
- When a battery is overcharged, some symptoms can be found. If there is a short circuit inside the battery, no voltage is produced on the battery terminals. If the rectifier won't operate, the voltage will become too high and shorten the battery service life.
- If a battery is not used for a long time, it will discharge by itself and should be recharged every 3 months.
- A new battery filled with electrolyte will generate voltage within a certain time and it should be recharged when the capacity is insufficient. Recharging a new battery will prolong its service life.
- Inspect the charging system according to the sequence specified in the Troubleshooting.
- Do not disconnect and soon reconnect the power of any electrical equipment because the electronic parts in the regulator/rectifier will be damaged. Turn off the ignition switch before operation.
- It is not necessary to check the MF battery electrolyte or fill with distilled water.
- Check the load of the whole charging system.
- Do not quick charge the battery. Quick charging should only be done in an emergency.
- Remove the battery from the motorcycle for charging.
- When replacing the battery, do not use a traditional battery.
- When charging, check the voltage with an electric tester.

SPECIFICATIONS

		Item	Standard
Battery	Capacity		12V9AH
	Voltage (20°C)	Fully charged	12.8V
		Insufficient charged	< 12V
	Charging current		0.6A* 5~10H

12. BATTERY/CHARGING SYSTEM

TROUBLESHOOTING

No power

- Dead battery
- Disconnected battery cable
- Fuse burned out
- Faulty ignition switch

Low power

- Weak battery
- Loose battery connection
- Charging system failure
- Faulty regulator/rectifier

Intermittent power

- Loose battery cable connection
- Loose charging system connection
- Loose connection or short circuit in ignition system

Charging system failure

- Loose, broken or shorted wire or connector
- Faulty regulator/rectifier
- Faulty A.C. generator

12. BATTERY/CHARGING SYSTEM

BATTERY REMOVAL

Remove the battery cover.
Disconnect the battery cables .

- * First disconnect the battery negative (-) cable and then the positive (+) cable.

Remove the battery.
The installation sequence is the reverse of removal.

BATTERY CHARGING (OPEN CIRCUIT VOLTAGE) INSPECTION

Remove the battery cover and disconnect the battery cables.

Measure the voltage between the battery terminals.

Fully charged : 13.0V ~ 13.2V

Undercharged : 12.3V max.

- * Battery charging inspection must be performed with an electric tester.

CHARGING METHOD

Connect the charger positive (+) cable to the battery positive (+) cable.

Connect the charger negative (-) cable to the battery negative (-) cable.

- *
 - Keep flames and sparks away from a charging battery.
 - Turn power ON/OFF at the charger, not at the battery terminals to prevent sparks near the battery.
 - Charge the battery according to the current specified on the battery surface.

Charging current : Standard: 0.4A
Quick: 4A

Charging time: Standard: 5 hours
Quick: 0.5 HOUR

After charging: Open circuit voltage: 12.8V min.

- *
 - Quick charging should only be done in an emergency.
 - During quick charging, the battery temperature should not exceed 45°C.
 - Measure the voltage 30 minutes after the battery is charged.

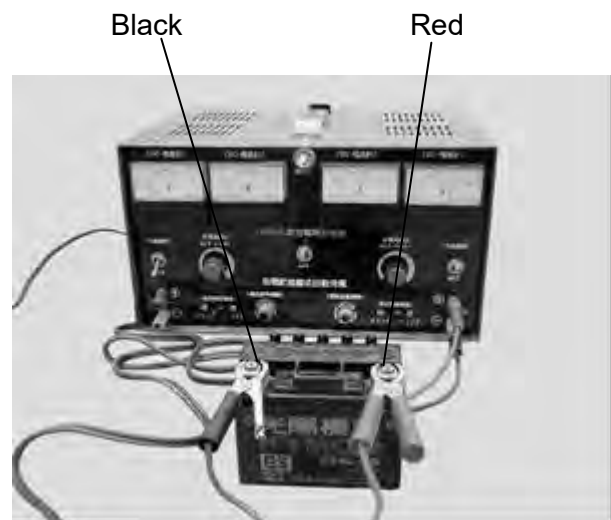
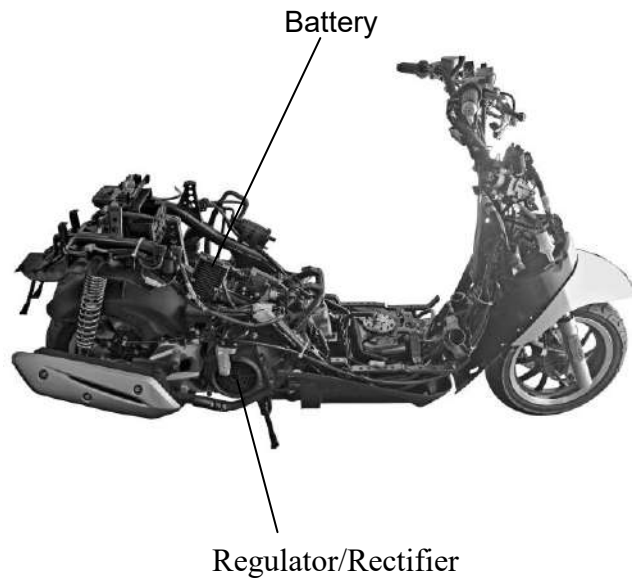

12. BATTERY/CHARGING SYSTEM

PERFORMANCE TEST

Warm up the engine.

Remove the floor mat and front tool box cover.

* Use a fully charged battery to check the charging system output.

Stop the engine and open the fuse box.

Disconnect the wire lead from the fuse terminal.

Connect an ammeter between the wire lead and fuse terminal as shown.

Connect the battery positive (+) terminal to the voltmeter positive (+) probe and battery negative (-) terminal to the voltmeter negative (-) probe.

Start the engine, gradually increase engine speed to test the output:

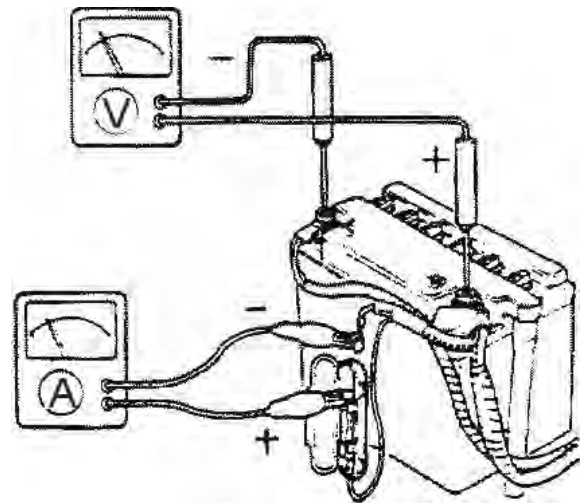

Position \ RPM	Day	Night
2500	1.3A min.	1.0A min.
6000	2.0A min.	2.0A min.

Charging Limit Voltage: 14.5 ± 0.5V/8000rpm

If the limit voltage is not within the specified range, check the regulator/ rectifier.

A.C GENERATOR INSPECTION

This test can be made without removing the stator from the engine. Disconnect the yellow wire from the auto-bystarter.

Remove the met-in box.

Disconnect the A.C. generator connector.

Check the continuity between the yellow wires and ground.

There should be continuity between the yellow wires and on continuity between each yellow wire and ground.

Resistance:

Yellow~Yellow	1~2.5 Ω
---------------	---------

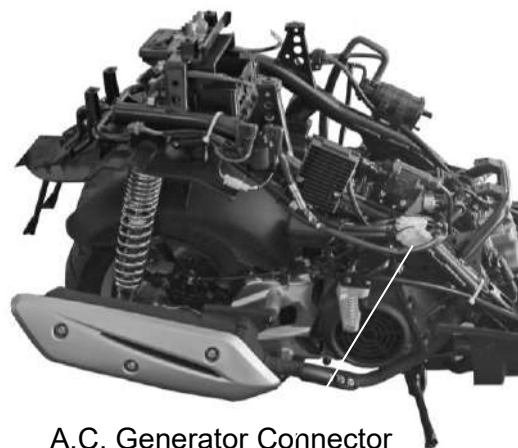

A.C. Generator Connector



12. BATTERY/CHARGING SYSTEM

A.C.GENERATOR REMOVAL

A.C.generator removal

A.C.generator installation

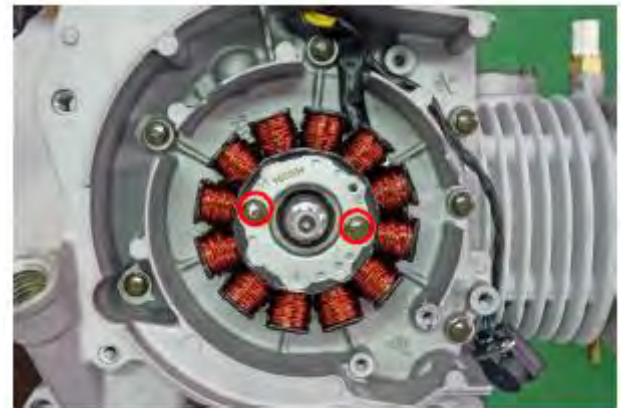

REGULATOR/RECTIFIER INSPECTION

Remove the met-in box.

Remove the regulator/rectifier wire coupler.

Check the continuity between the wire terminals.

Normal Direction:Continuity

	(+)Probe	(-)Probe
I	Yellow	Green
II	Red	Yellow

Reverse Direction: No Continuity

	(+)Probe	(-)Probe
I	Green	Yellow
II	Yellow	Red

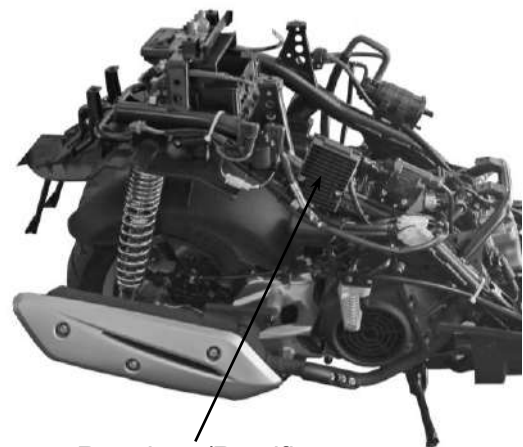

Regulator/Rectifier

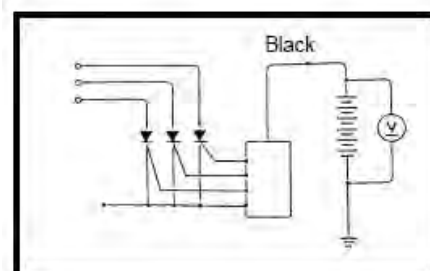
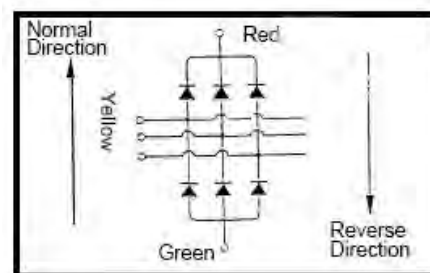

VOLTAGE REGULATION TEST

Connect a coltmeter across the battery terminals.

Start the engine and gradually increase the engine speed to 5500 rpm.

The battery terminal voltage should be within 13.5v~14.5V.

13. IGNITION SYSTEM

13

IGNITION SYSTEM

IGNITION SYSTEM LAYOUT	13-1
SERVICE INFORMATION	13-2
TROUBLESHOOTING	13-2
SPARK PLUG	13-3
IGNITION COIL INSPECTION	13-3
A.C. GENERATOR INSPECTION	13-4
ANGLE DETECT SENSOR	13-4

13. IGNITION SYSTEM

IGNITION SYSTEM LAYOUT

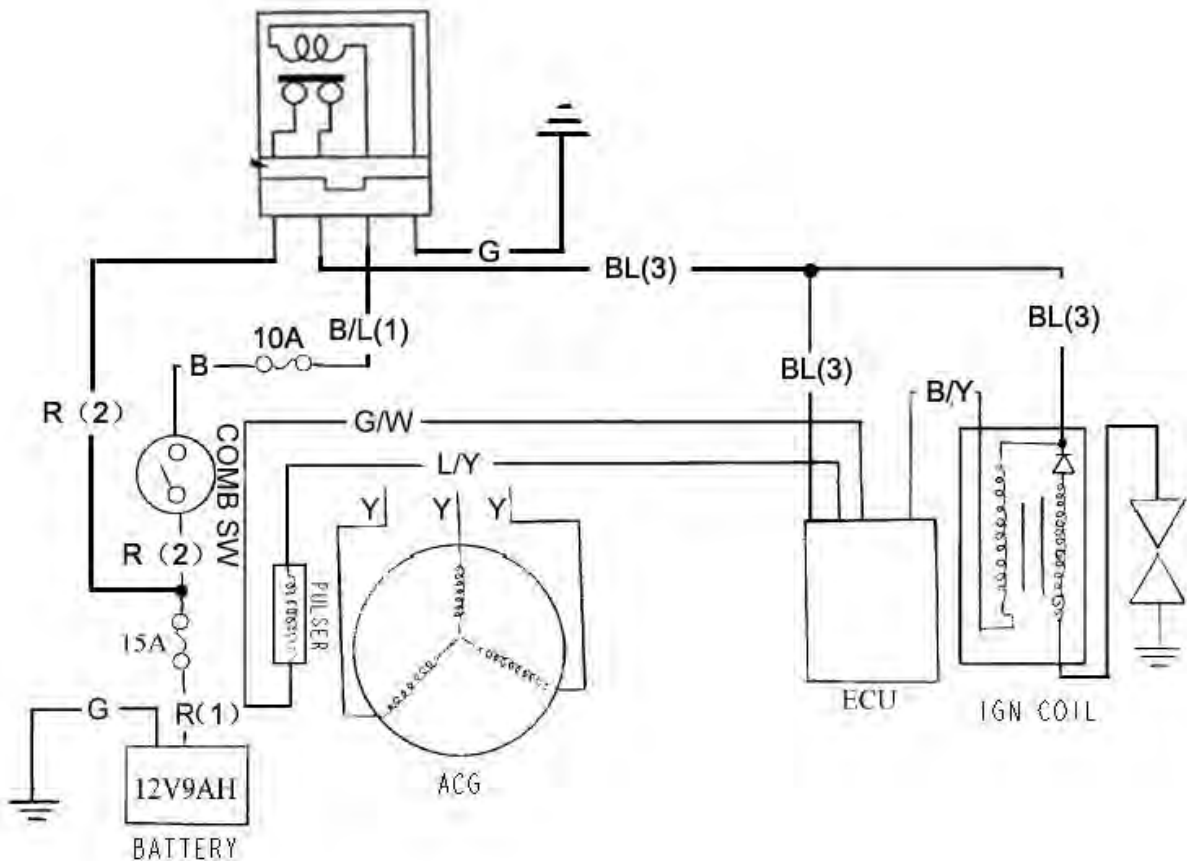
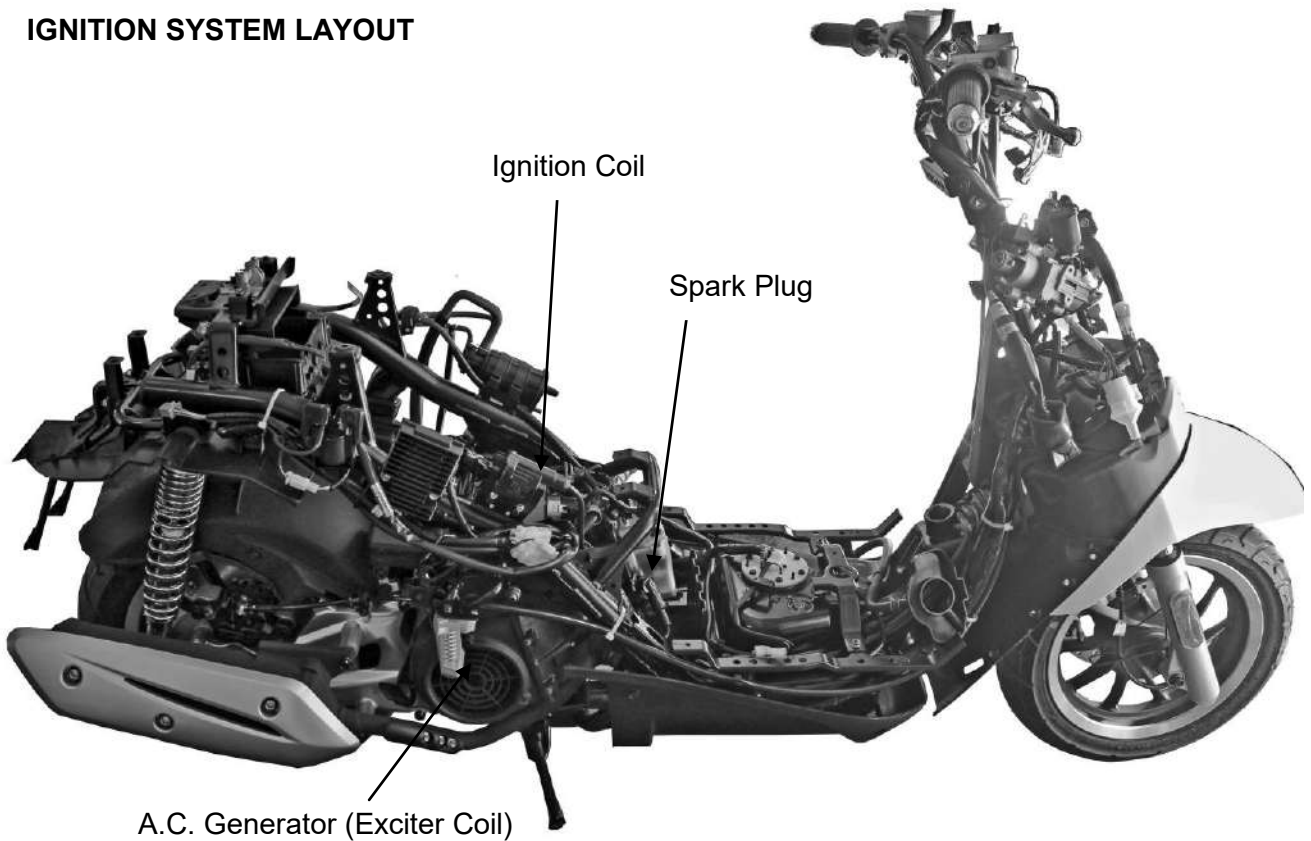

13. IGNITION SYSTEM

SERVICE INFORMATION

GENERAL INSTRUCTIONS

- Some electrical components may be damaged if terminals or connectors are connected or disconnected while the ignition switch is “ON” and current is present.
- When servicing the ignition system, always follow the steps in the troubleshooting on page 17-2.
- The ignition timing cannot be adjusted since the ignition control module is already adjusted in factory.
- The ignition control module or ECU maybe damaged if dropped or the connector is disconnected when the key is “ ON ” , the excessive voltage may damage the ignition control module or ECU. Always turn off the ignition switch before servicing.
- A faulty ignition system is often related to poor connections. Check those connections before proceeding.
- Make sure the battery is adequately charged. Using the starter motor with weak battery results in a slower engine cranking speed as well as no spark at the spark plug.
- Use a spark plug of the correct heat range. Using spark plug with an incorrect heat range can damage the engine.

SPECIFICATIONS

Item		Standard
Spark plug	Standard type	NGK CR8E
Spark plug gap		0.7 ~ 0.8 mm
Inductive Ignition Coil	Primary coil	0.55~0.75 Ω
Throttle Position Sensor Input Volt		5V±0.1
Fuel Pump		1.0 Ω ~6.0 Ω
Fuel Injector		10.6 Ω ~15.9 Ω
Engine Temperature Sensor		11.7±7.45%k Ω (25°C)
Oxygen Sensor (engine warming condition)		6.7 ~ 9.5 Ω
Crank Position Sensor		96~144 Ω
Angle Detect Sensor		0.4V~1.44V(normal) 3.7V~4.4V (fall down)

TROUBLESHOOTING

No peak voltage

- Short circuit in engine stop switch or ignition switch wire.
- Faulty engine stop switch or ignition switch.
- Loose or poorly connected ignition control module connectors.
- Open circuit or poor connection in ground wire of the ignition control module.
- Faulty crank position sensor.
- Faulty ignition control module.

Peak voltage is normal, but no spark jumps at the plug

- Faulty spark plug or leaking ignition coil secondary current.
- Faulty ignition coil.

13. IGNITION SYSTEM

IGNITION COIL INSPECTION

Remove the seat and met-in box.

Remove the ignition coil.

IGNITION COIL CONTINUITY

TEST

Inspect the continuity of the ignition coil, primary coil and secondary coil.

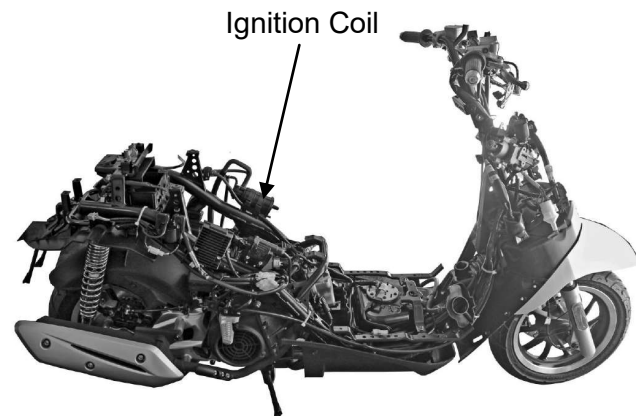

Measure the ignition coil resistances

0.55~0.75 Ω /20°C

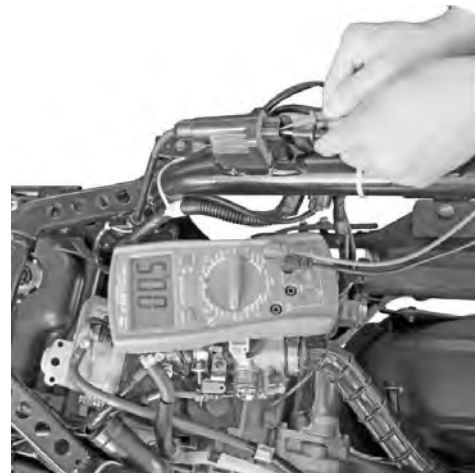

13. IGNITION SYSTEM

CRANK POSITION SENSOR INSPECTION

This test is performed with the stator installed in the engine

Remove the seat and met-in box.

Disconnect the Crank Position Sensor Wire Coupler.

Measure the resistance between the blue/white and green/white wire terminals.

Blue/Yellow~Green/White	96Ω-144Ω
-------------------------	----------

TILT SWITCH INSPECTION

Support the scooter level surface.

Put the side stand up and engine stop switch is at "RUN".

Turn the ignition switch to "OFF".

Remove the screws, washers and tilt switch.

Do not disconnect the tilt switch connector during inspection.
The capacity of battery must be fully charged.

Place the tilt switch vertical as shown at the ignition switch "ON". Measure the voltage as below.

Terminal	Standard
V/R(+)- B/W(-)+	5V(ECU voltage)
V/G(+)- B/W(-)	0.4~1.4V

Incline the tilt switch 65±10 degrees to the left or right at the ignition switch "ON". Measure the voltage as below.

Terminal	Standard
V/R(+)- B/W(-)	5V(ECU voltage)
V/G(+)- B/W(-)	3.7~4.4V

If repeat this test, first turn the ignition switch to "OFF", then turn the ignition switch to "NO".

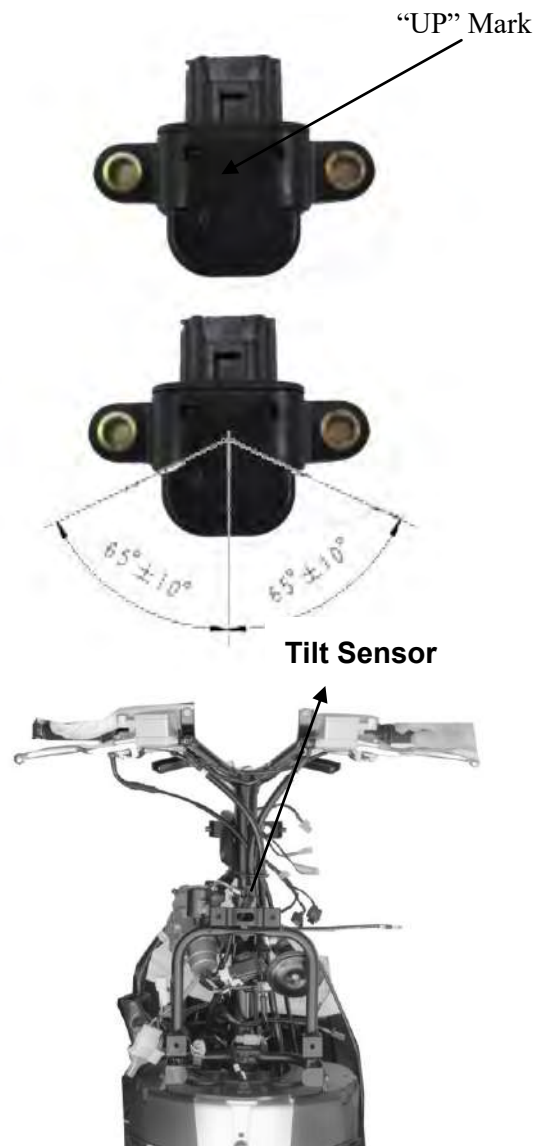

"UP" Mark

Tilt Sensor

13. IGNITION SYSTEM

REMOVAL/INSTALLATION

Disconnect the connector and remove two
Screws, then remove tilt switch.

Installation is in the reverse order of removal.

Install the tilt switch with its "up" mark
facing up.

Tighten the mounting screws securely.



Screws

14. STARTING SYSTEM

14

STARTING SYSTEM

STARTING SYSTEM LAYOUT	14-1
SERVICE INFORMATION	14-2
TROUBLESHOOTING	14-2
STARTER MOTOR	14-3
STARTER RELAY INSPECTION.....	14-4

14. STARTING SYSTEM

Like II 125

STARTING SYSTEM LAYOUT

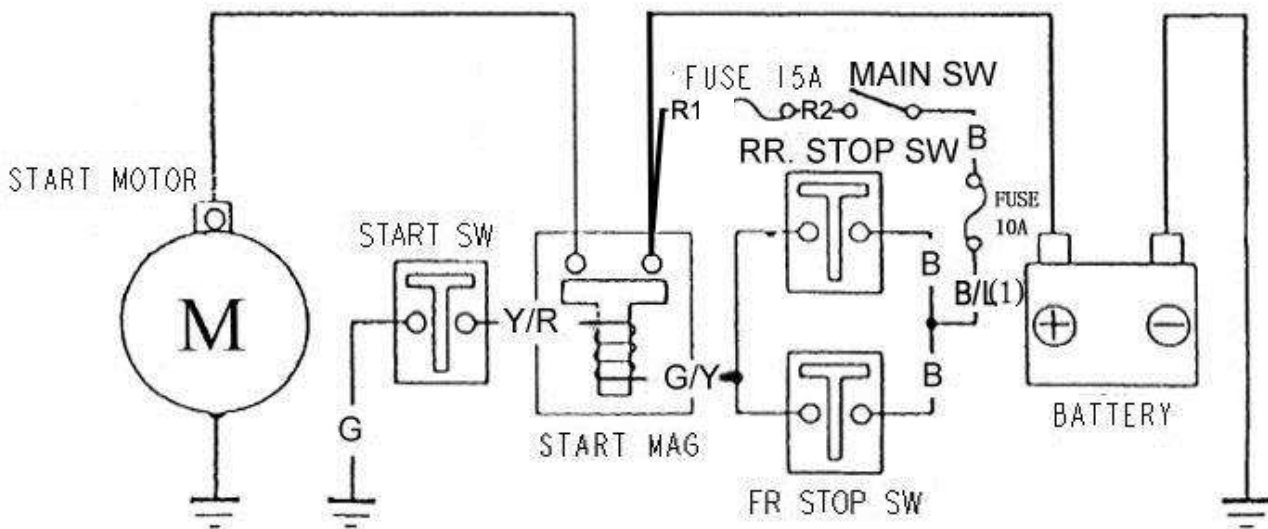
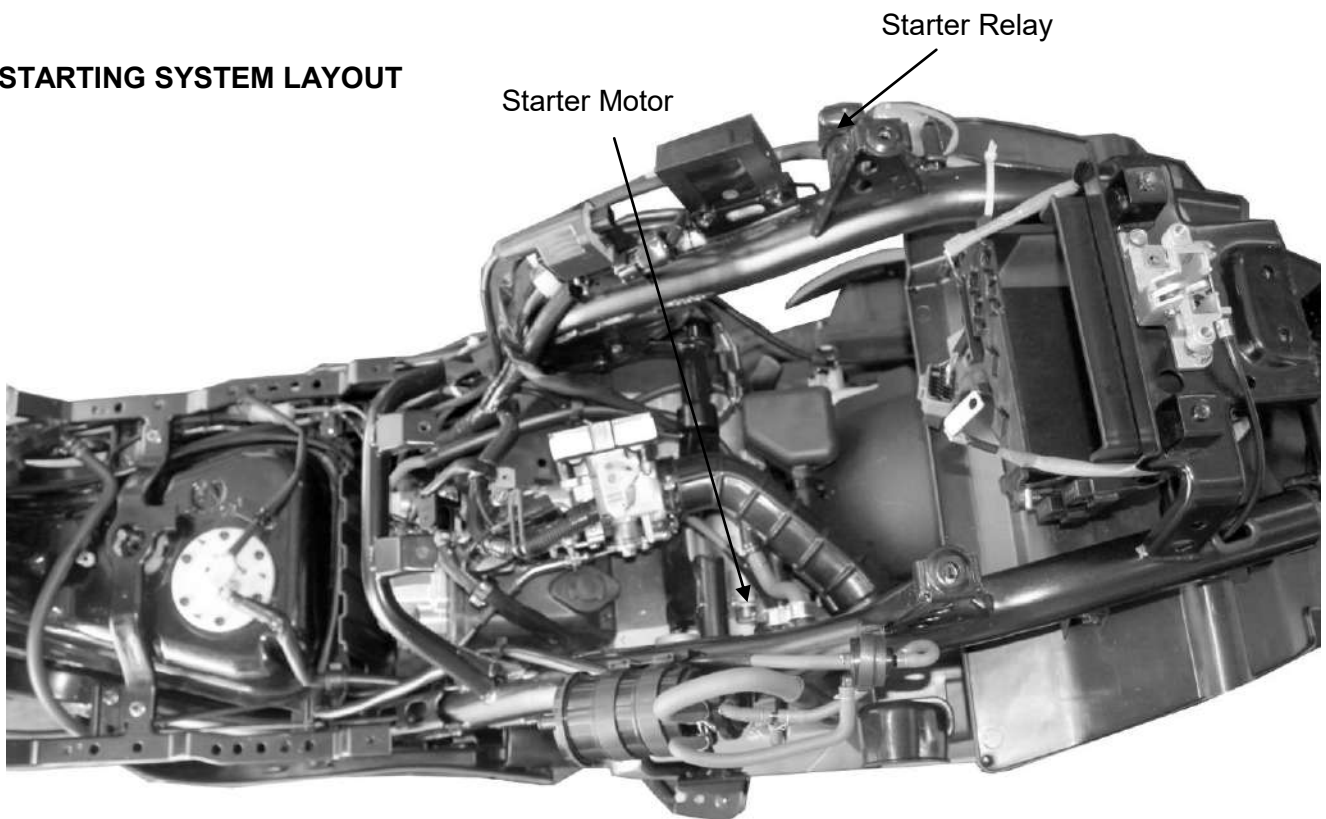

14. STARTING SYSTEM

SERVICE INFORMATION

GENERAL INSTRUCTIONS

- The removal of starter motor can be accomplished with the engine installed.
- After the starter clutch is installed, be sure to add the engine oil and coolant and then bleed air from the cooling system.

TORQUE VALUES

Starter motor mounting bolt	6.7~10.8	N-m
Starter motor case screw	2.9~4.9	N-m
Starter clutch bolt	9.8~13.7	N-m

SPECIAL TOOLS

Flywheel puller A120E00002

TROUBLESHOOTING

Starter motor won't turn

- Fuse burned out
- Weak battery
- Faulty ignition switch
- Faulty starter clutch
- Faulty front or rear stop switch
- Faulty starter relay
- Poorly connected, broken or shorted wire
- Faulty starter motor

Lack of power

- Weak battery
- Loosed wire or connection
- Foreign matter stuck in starter motor or gear

Starter motor rotates but engine does not start

- Faulty starter pinion
- Starter motor rotates reversely
- Weak battery

14. STARTING SYSTEM

STARTER MOTOR REMOVAL

Disconnect the starter motor cable.
Remove the two bolts attaching the starter motor and remove the starter motor.
The installation sequence is the reverse of removal.

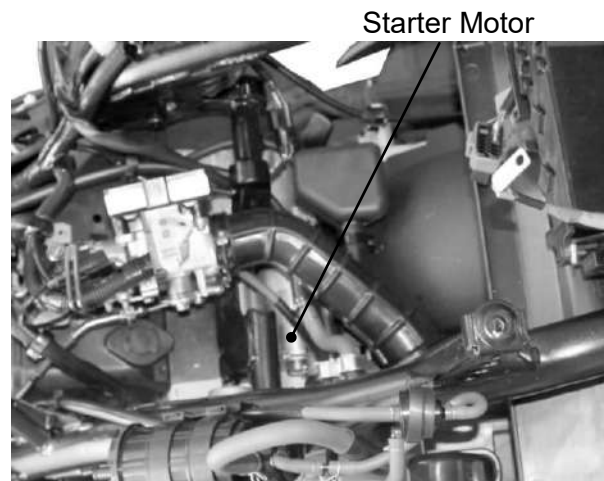

DISASSEMBLY

Remove two starter motor case screws, front cover, rear cover, motor case and other parts.



INSPECTION

Remove the airbox.
Remove the battery cover.
Turn the ignition switch to "OFF".

Remove the negative battery cable bolt with a 10mm socket or a #3 Phillips screwdriver.
Free the negative cable from the battery.

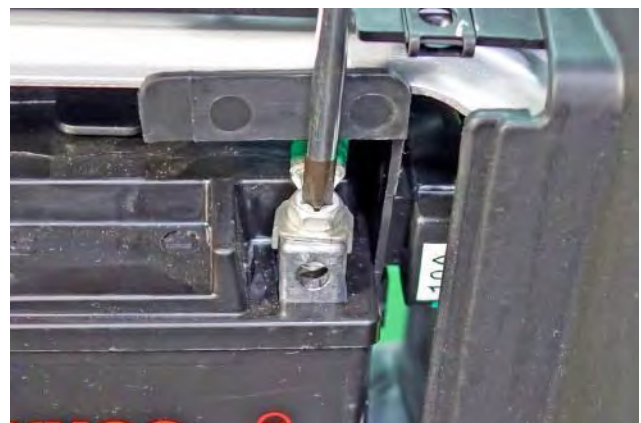

14. STARTING SYSTEM

Pull back the rubber cover.

Remove the starter motor lead screw with a #3 Phillips screwdriver.

Free the cable lead from the starter motor.

Thread the nut back on to keep track of it.



Remove the two starter motor mounting bolts with an 8mm socket.



Inspect the starter motor O-ring and replace it as needed.



O-ring

14. STARTING SYSTEM

STARTER RELAY INSPECTION

Remove the frame body cover.
Turn the ignition switch ON and the starter relay is normal if you hear a click when the starter button is depressed.
If there is no click sound:

- Inspect the starter relay voltage
- Inspect the starter relay ground circuit
- Inspect the starter relay operation



Starter Relay

STARTER RELAY VOLTAGE INSPECTION

Place the motorcycle on its main stand.
Measure the voltage between the starter relay connector green/yellow wire (-) and engine ground.
Turn the ignition switch ON and the battery voltage should be normal when the brake lever is fully applied.
If the battery has no voltage, inspect the stop switch continuity and cable.



Green/Yellow Wire

STARTER RELAY GROUND CIRCUIT INSPECTION

Disconnect the starter relay wire connector.
Check for continuity between the yellow/red wire terminal and ground.
There should be continuity when the starter button is depressed.
If there is no continuity, check the starter button for continuity and inspect the wire.



Yellow/Red Wire

OPERATION TEST

Connect the electric tester to the starter relay larger terminals that connect to the battery positive cable and the starter motor cable.
Connect a fully charged battery across the starter relay yellow/red and green/yellow wire terminals.
Check for continuity between the starter relay large terminals. The relay is normal if there is continuity.



15. INSTRUMENT/SWITCHES/LIGHTS

INSTRUMENT/SWITCHES/LIGHTS

SERVICE INFORMATION	15-1
TROUBLESHOOTING	15-1
FUEL UNIT	15-2
SWITCHES	15-4
STOP SWITCH INSPECTION/HORN	15-6
INSTRUMENT/HEADLIGHT	15-8

15. INSTRUMENT/SWITCHES/LIGHTS

SERVICE INFORMATION

GENERAL INSTRUCTIONS

- Wires should be connected to other wires of the same color. Couplers must be connected to other couplers of the same color.
- All plastic plugs have locking tabs that must be released before disconnecting, and must be aligned when reconnecting.
- After installation of each switch, a continuity check must be performed.

TROUBLESHOOTING

Lights do not come on when ignition switch is "ON"

- Burned bulb
- Faulty switch
- Broken or shorted wire
- Fuse burned out
- Weak battery
- Poorly connected wire
- Faulty winker

Light dims

- Faulty ignition coil
- Wire or switch resistance too high
- Faulty regulator/rectifier

Headlight does not change when dimmer switch is turn to Hi or Lo

- Faulty or burned bulb
- Faulty dimmer switch

Motor oil indicator light does not come on (when motor oil is insufficient)

- Fuse burned out
- Dead battery
- Faulty ignition switch
- Faulty instrument
- Faulty oil meter

Motor oil indicator light winks

- Loose wire connection
- Broken wire
- Faulty oil meter

Fuel gauge pointer does not register correctly

- Disconnected wire or connector
- Broken wire
- Faulty float
- Faulty fuel unit
- Faulty instrument

Fuel gauge pointer fluctuates or swings

- Loose wire connection
- Faulty fuel unit
- Faulty instrument

15. INSTRUMENT/SWITCHES/LIGHTS

FUEL UNIT

* No Smoking!

REMOVAL

Remove the seat.
Remove the body cover.
Disconnect the fuel unit wire connectors.

* Do not damage the fuel unit wire.

Remove the fuel unit.

* Be careful not to bend or damage the fuel unit float arm.

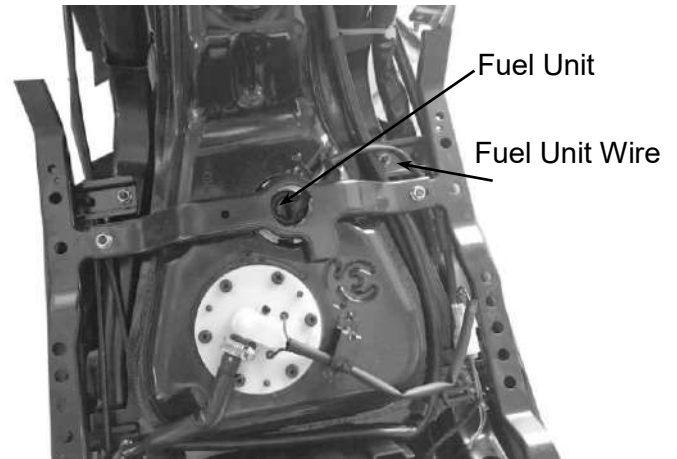

INSPECTION

Remove the fuel unit.
Measure the resistance between the fuel unit wire terminals with the float at upper and lower positions.

RESISTANCES Unit: Ω

Wire Terminals	Upper	Lower
G~Y/W	<120	>1060



FUEL GAUGE INSPECTION

Connect the fuel unit wire connectors and turn the ignition switch "ON".

* Before performing the following test, operate the turn signals to determine that the battery circuit is normal.

Check the fuel gauge needle for correct indication by moving the fuel unit float up and down.

Float Position	Needle Position
Upper	"F" (Full)
Lower	"E" (Empty)



15. INSTRUMENT/SWITCHES/LIGHTS

INSTALLATION

The installation sequence is the reverse of removal.

*

- Install the fuel unit at the connect position.

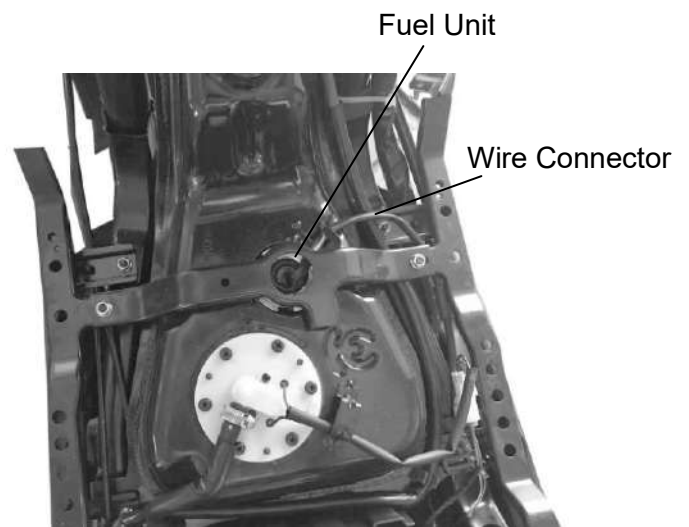

15. INSTRUMENT/SWITCHES/LIGHTS

SWITCHES

IGNITION SWITCH INSPECTION

Remove the front cover.
 Disconnect the ignition switch wire couplers and check for continuity between the wire terminals.

Color	Red		Green	Black
Symbol	BAT1	IG	E	BAT2
LOCK		○ — ○	○ — ○	
OFF		○ — ○	○ — ○	
ON	○ —			— ○



IGNITION SWITCH REPLACEMENT

Remove the front cover.
 Disconnect the ignition switch wire couplers.
 Remove the two mounting bolts and remove the ignition switch.
 The installation sequence is the reverse of removal.

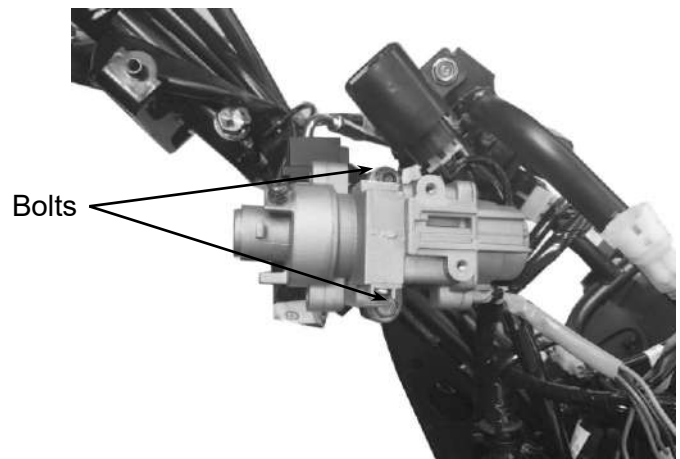

15. INSTRUMENT/SWITCHES/LIGHTS

DIMMER SWITCH INSPECTION

Check for continuity between wire terminals.

Color	W/L	L	We	Y
Symbol	HL	HI	LO	BAT
HI	○ — ○	○		
LO	○		○	
PASSING		○ — ○		○

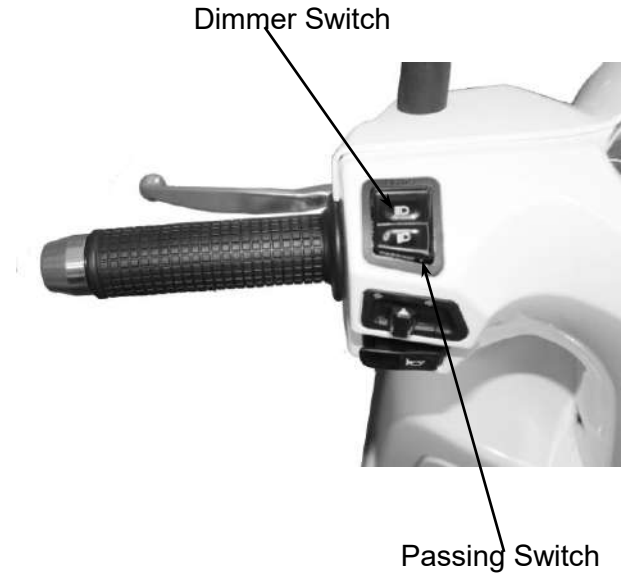

TURN SIGNAL SWITCH INSPECTION

Check for continuity between the wire terminals.

Color	SB	O	GR
Symbol	R	L	WR
R	○ — ○		○
L		○ — ○	○

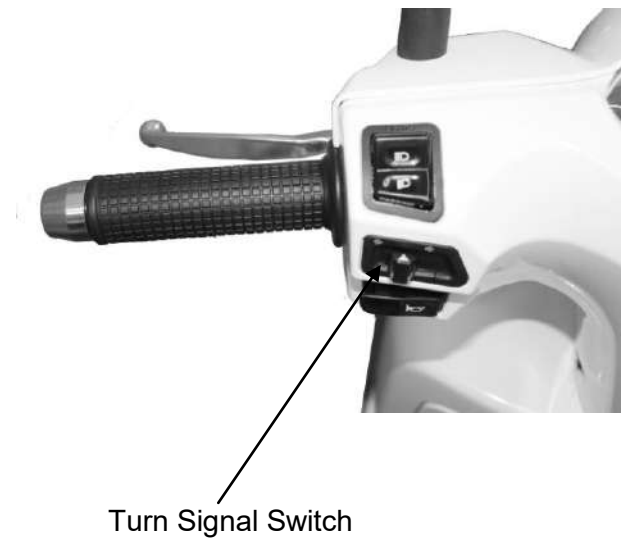

15. INSTRUMENT/SWITCHES/LIGHTS

STARTER SWITCH INSPECTION

Check for continuity between wire terminals.

Push the starter button when measuring.

Color	Y/R	G
Symbol	ST	E
FREE		
PUSH	○ ——— ○	○ ——— ○



Starter Switch

HORN SWITCH INSPECTION

Check for continuity between wire terminals.

Push the horn button when measuring.

Color	Light Green	Brown / Blue
Symbol	HO	BAT
FREE		
PUSH	○ ——— ○	○ ——— ○



Horn Switch

Stop Switch Wire

STOP SWITCH INSPECTION

Remove the handlebar front cover.

Disconnect the front and rear stop switch wire couplers.

Check for continuity between the wire terminals when the front/rear brake lever is applied.



15. INSTRUMENT/SWITCHES/LIGHTS

HORN INSPECTION

Remove the frame front cover.
Disconnect the horn wire couplers. The horn is normal if it sounds when a 12V battery is connected across the horn wire terminals.

Install a new horn in the reverse order of removal.

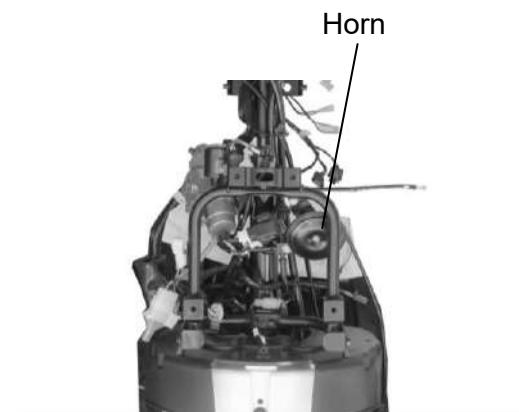

INSTRUMENTS

Remove the handlebar front cover.
Remove the handlebar rear cover.
Disconnect the handlebar switch couplers.
Remove the 5 screws to remove the instruments.

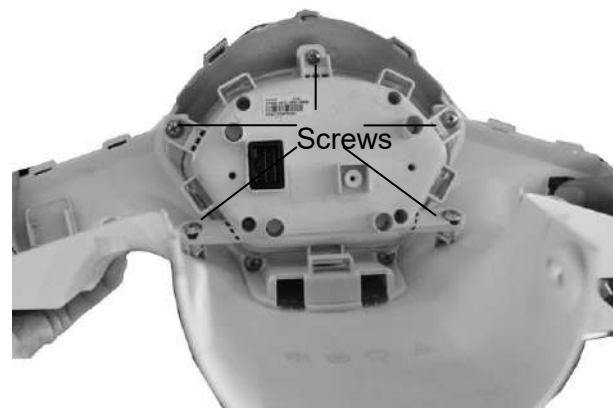

HEADLIGHT

REMOVAL/BULB REPLACEMENT

Remove the handlebar front cover.
Remove the bulb sockets and bulbs.

- Use bulbs of the same specifications for replacement.

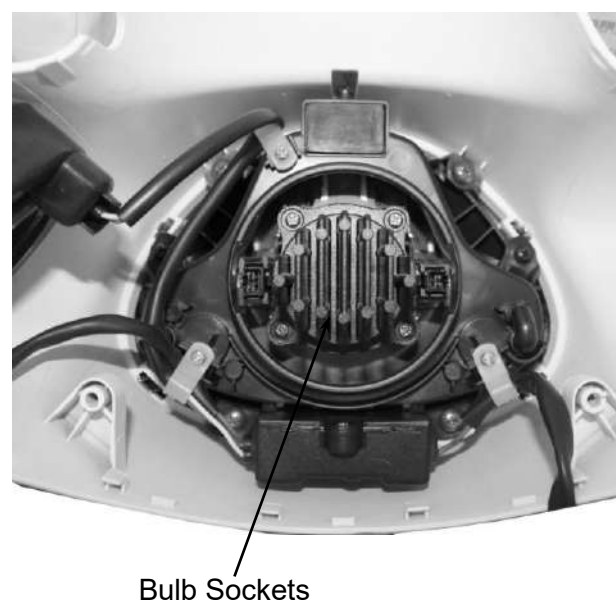

The installation sequence is the reverse of removal.