

**By KWANG YANG Motor Co., Ltd.  
1st Edition, April 2010  
All rights reserved. Any reproduction or  
unauthorized use without the written  
permission of KWANG YANG Motor Co., Ltd.  
is expressly prohibited.  
T300-LGE7-A2**

---

## PREFACE

This Service Manual describes the technical features and servicing procedures for the KYMCO **People GT 125i**.

Section 1 contains the precautions for all operations stated in this manual. Read them carefully before any operation is started.

Section 2 is the removal/installation procedures for the frame covers which are subject to removal/installation frequency during maintenance and servicing operations.

Section 3 describes the inspection/adjustment procedures, safety rules and service information for each part, starting from periodic maintenance.

Sections 5 to 12 give instructions for disassembly, assembly and adjustment of engine parts. Section 13 is the AFI system. Section 14 to 15 is the removal/ installation of chassis. Section 16 to 19 states the testing and measuring methods of electrical equipment.

Most sections start with an assembly or system illustration and troubleshooting for the section. The subsequent pages give detailed procedures for the section.

The information and contents included in this manual may be different from the motorcycle in case specifications are changed.

**KWANG YANG MOTOR CO., LTD.**  
**QUALITY TECHNOLOGY DEPT.**  
**EDUCATION SECTION**

## TABLE OF CONTENTS

ENGINE	GENERAL INFORMATION	1
	EXHAUST MUFFLER/FRAME COVERS	2
	INSPECTION/ADJUSTMENT	3
	LUBRICATION SYSTEM	4
	ENGINE REMOVAL/INSTALLATION	5
	CYLINDER HEAD/VALVES	6
	CYLINDER/PISTON	7
	DRIVE AND DRIVEN PULLEYS/V-BELT	8
	FINAL REDUCTION	9
	A.C. GENERATOR/STARTER CLUTCH	10
	CRANKCASE/CRANKSHAFT	11
	COOLING SYSTEM	12
	FUEL INJECTION SYSTEM	13
CHASSIS	STEERING HANDLEBAR/FRONT WHEEL/FRONT BRAKE/FRONT SHOCK ABSORBER/FRONT FORK	14
	REAR BRAKE/REAR FORK/REAR WHEEL/REAR SHOCK ABSORBER`	15
ELECTRICAL EQUIPMENT	BATTERY/CHARGING SYSTEM	16
	IGNITION SYSTEM	17
	STARTING SYSTEM	18
	LIGHTS SWITCHES / FUEL PUMP	19

# 1. GENERAL INFORMATION

---



---

## GENERAL INFORMATION

---

SERIAL NUMBER .....	1-1
SPECIFICATION .....	1-2
SERVICE PRECAUTIONS .....	1-5
TORQUE VALUES .....	1-9
SPECIAL TOOLS .....	1-10
LUBRICATION POINTS .....	1-11
CABLE & HARNESS ROUTING .....	1-13
TROUBLESHOOTING .....	1-14

# 1. GENERAL INFORMATION

## SERIAL NUMBER



Location of Frame Serial Number



Location of Engine Serial Number

# 1. GENERAL INFORMATION

## SPECIFICATIONS

Name	People GT 125i	
Model No.	BF25AA	
Overall length	2130 mm	
Overall width	750 mm	
Overall height	1280 mm	
Wheel base	1450 mm	
Engine type	4 stroke O.H.C.	
Displacement	124.8 cc	
Fuel Used	92# nonleaded gasoline	
Dry weight (kg)	152.2	
Ground clearance (mm)	150	
Braking distance (m)	7.9m / 40 km/hr	
Min. turning radius (mm) R/L	2250/2170	
<b>Engine part</b>		
Starting system	Starting motor	
Type	Gasoline 4-cycle	
Cylinder arrangement	Single cylinder	
Combustion chamber type	Semi-sphere	
Valve arrangement	O.H.C.-4V	
Bore x stroke (mm)	φ 54 * 54.5	
Compression ratio	11.7:1	
Compression pressure (kg/cm <sup>2</sup> -rpm)	15-570 rpm	
Max. output (ps/rpm)	<b>15 / 9000</b>	
Max. torque (kg-m/rpm)	<b>1.17 / 8500</b>	
Intake Timing	Open	-8° BTDC
	Close	31° BTDC
Exhaust Timing	Open	32° BTDC
	Close	6° BTDC
Valve clearance	Intake	0.10
	Exhaust	0.10
Idle speed (rpm)	1760±100 rpm	
Cooling Type	Liquid cooling	
Lubrication type	Forced pressure & wet sump	
Oil pump type	Inner/outer rotor	

Oil filter type	Full-flow filtration	
Oil capacity	1.2 liter	
Exchanging capacity	1.0 liter	
<b>Fi injection system</b>		
Air cleaner type & No	Paper element, wet	
Fuel capacity	9 liters	
Brand	Synerjet M3A	
Throttle Body	Butterfly type	
Venturi diameter (mm)	27	
Fuel pump pressure	2.5 bar	
<b>Electrical system</b>		
Ignition type	ECU	
Ignition timing	ECU control	
Spark plug	CR7E (NGK)	
Spark plug gap	0.6~0.7mm	
Battery Capacity	12V12AH	
<b>Transmission system</b>		
Clutch type	Dry multi-disc	
Transmission type	CVT	
Operation type	Auto centrifugal	
Reduction gear type	Two-stage reduction	
Reduction ratio	Primary	0.83~2.2
	Final	10.41
<b>Moving device</b>		
Tire type	Tubeless	
Tire spec.	Front wheel	110/70-16
	Rear wheel	140/70-16
Tire pressure (kg/cm <sup>2</sup> )	Front wheel	1.75
	Rear wheel	2.25 (with passenger)
Wheel material	Aluminium	
Turning angle	Left	45°±5
	Right	45°±5
Brake type	Front	Disk brake
	Rear	Disk brake
<b>Damping Device</b>		
Suspension type	Front	Telescope
	Rear	Swing arm
Shock absorber stroke	Front	110 mm
	Rear	100 mm

# 1. GENERAL INFORMATION

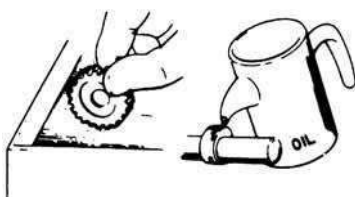
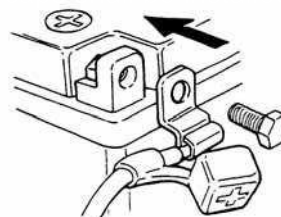
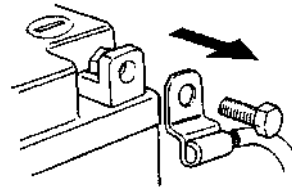
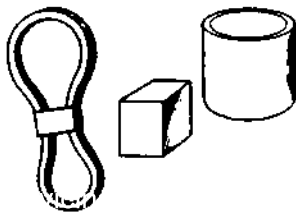
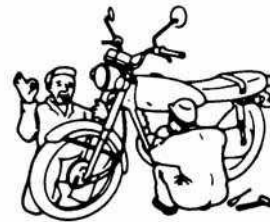
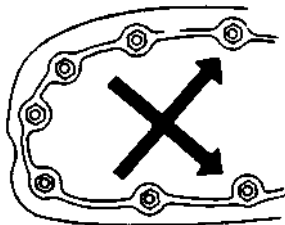
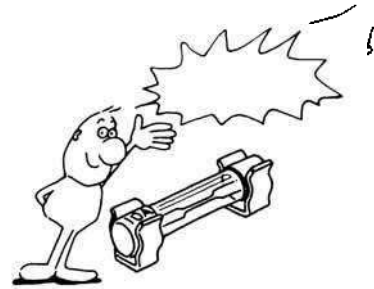
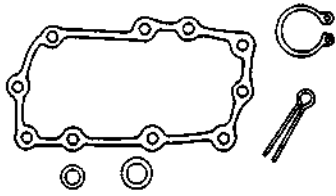

# 1. GENERAL INFORMATION

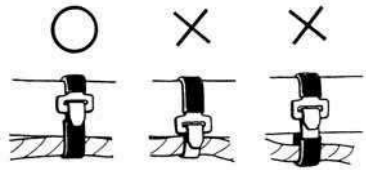
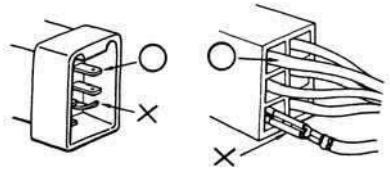
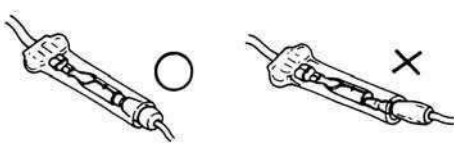
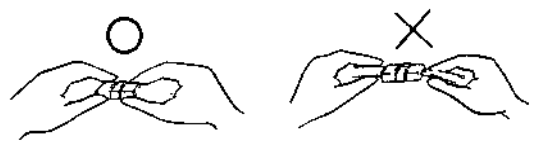
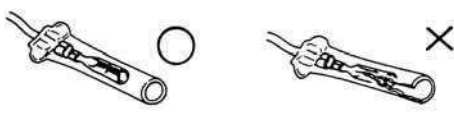
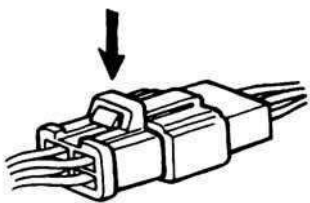
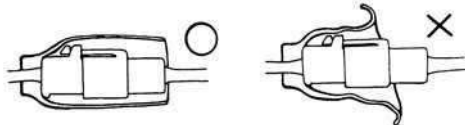
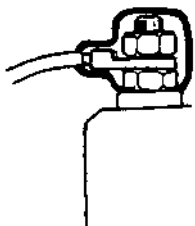
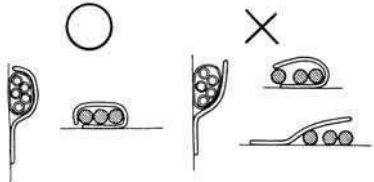
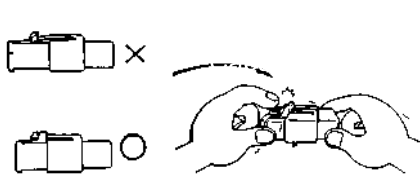

# 1. GENERAL INFORMATION

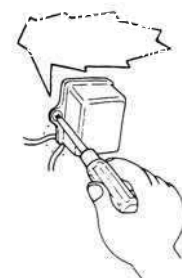
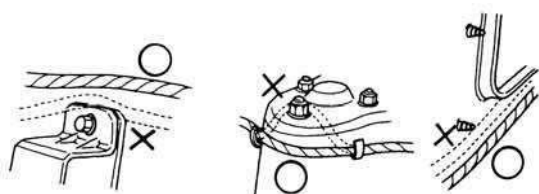
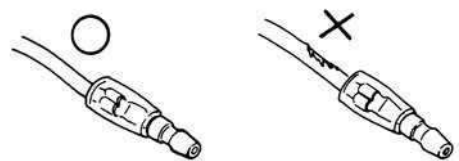
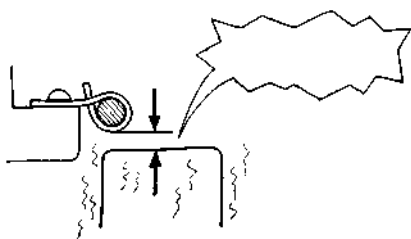
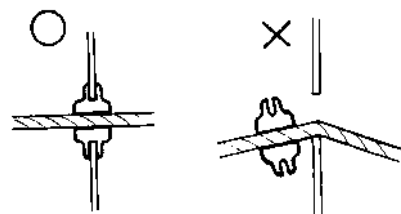
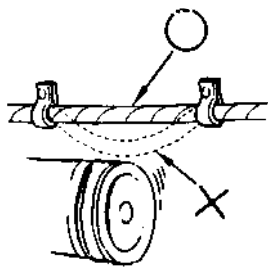
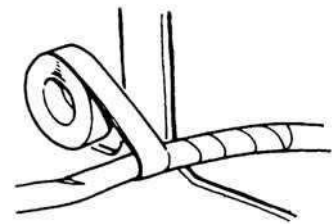
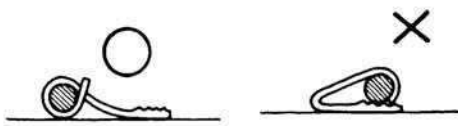
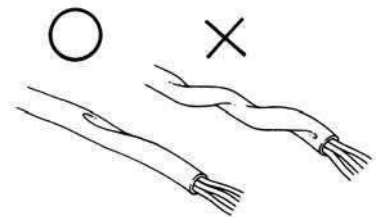
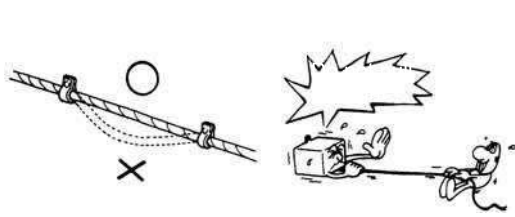



# 1. GENERAL INFORMATION

---

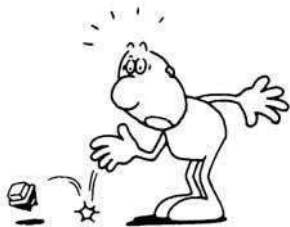
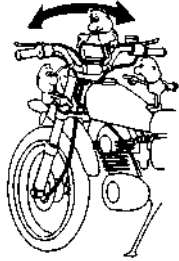

# 1. GENERAL INFORMATION



# 1. GENERAL INFORMATION

## TORQUE VALUES

### Standard Torque Values

Item	Torque (kgf-m)	Item	Torque (kgf-m)
5mm bolt, nut	0.45~0.6	5mm screw	0.45~0.6
6mm bolt, nut	0.8~1.2	6mm screw, SH bolt	0.7~1.1
8mm bolt, nut	1.8~2.5	6mm flange bolt, nut	1.0~1.4
10mm bolt, nut	3.0~4.0	8mm flange bolt, nut	2.4~3.0
12mm bolt, nut	5.0~6.0	10mm flange bolt, nut	3.0~4.5

Torque specifications listed below are for important fasteners.

### Engine

Item	Thread dia.(mm)	Torque (kgf-m)
Cylinder head bolt A	6	0.7~1.1
Cylinder head bolt B	6	0.7~1.1
Oil filter screen cap	30	2.0~3.0
O2 sensor	12	0.7~1.1
Cylinder head cover	6	0.8~0.9
Tappet adjusting hole cap	30	1.0~2.0
Cam chain set plate	6	1.0~1.4
Engine oil drain bolt	12	2.0~3.0
Clutch outer nut	12	5.0~6.0
Clutch drive plate nut	28	5.0~6.0
Starter motor mounting bolt	6	0.8~1.2
Oil pump bolt	6	0.7~1.1
Drive face nut	12	5.5~6.5
Spark plug	10	1.0~1.4
A.C. Generator flywheel	12	5.0~6.0
Cam chain tensioner pivot	6	0.8~1.2

# 1. GENERAL INFORMATION

## TORQUE VALUES

### FRAME

No.	ITEM		TORQUE			REMARK	THREAD	DWG. NO.	
			Kgf-m	N-m					
1	STEERING								
	HANDLE POST	M10x1.25	4.0~5.0	40~50	4.5	U NUT	90106-GEN5-9000	A	
	BRIDGE BOLT	M8x1.25	2.4~3.0	24~30	2.7	—	95801-08040-08	A	
	STEM LOCK	BC1	6.0~6.5	60~65	6.3	—	50306-1F96-0010	A	
	RACE NUT(HEAD)	BC1	1.8~2.2	18~22	2.0	—	53220-LBA2-E000	B	
2	WHEEL								
	FRAXLE	M14x1.5	1.5~2.5	15~25	2.0	—	44301-LLJ3-E000	A	
	RRAXLE NUT	M16x1.5	11~13	110~130	12	U NUT	90305-KKAK-9000	A	
3	SUSPENSION								
	FR FORK BOLT	M6x1.0	1.0~1.4	10~14	1.2	—	96600-06020-06	A	
	RR. CUSH. UP	M10x1.25	3.5~4.5	35~45	4.0	—	95801-10035-00	A	
	RR. CUSH. LWR.	M10x1.25	3.5~4.5	35~45	4.0	—	95801-10035-00	A	
4	BRAKE								
	FR CALIPER R	M10x1.25	3.0~4.0	30~40	3.5	—	90122-LEA7-E000	A	
	RR CALIPER	M10x1.25	3.0~4.0	30~40	3.5	—	90122-LEA7-E000	A	
	BRK OIL BOLT	M10x1.25	3.0~4.0	30~40	3.5	—	90145-MS9-6120-M1	A	
	M/C HOLDER	M6x1.0	1.0~1.4	10~14	1.2	—	96001-06028-06	C	
	M/C CAP SCREW	M4x0.7	0.12~0.2	1.2~2.0	0.16	—	96000-04012-1A	B	
	C/P BLEEDER	M8x1.25	0.4~0.7	4.0~7.0	0.55	—	43352-5H68-0040	B	
	DISK BOLT	M8x1.25	3.2~3.8	32~38	3.5	—	90105-KCR3-0010	A	
5	ENG HANGER								
	FRAME SIDE	M14x1.5	6.0~7.0	60~70	6.5	U NUT	90305-LBD4-9000	A	
	ENG SIDE	M10x1.25	4.5~5.5	45~55	5.0	U NUT	90304-GLW0-9020-M1	A	
6	MUFFLER								
	EX-H PIPE	M8x1.25	1.8~2.2	18~22	2.0	—	90033-GFY6-9000	B	
	MUFF. BRKT/RR FORK	M10x1.25	3.2~3.8	32~38	3.5	FLANGE BOLT	95801-10060-06	A	
7	RR FORK/ENG CASE	M10x1.25	3.0~4.0	30~40	3.5	—	95801-10060-06	A	
8	IGN COIL								
8	SPDWT SENSOR CABLE	M6x1.0	1.0~1.4	10~14	1.2	—	96001-06012-06	C	
	IGN COIL	M6x1.0	0.25~0.35	2.5~3.5	0.3	—	94050-06080	B	
	O2 SENSOR	M12x1.25	2.0~3.0	20~30	2.5	—	—	B	
	RR CARRIER	M8x1.25	2.0~2.8	20~28	2.4	—	90106-KKC4-9000	C	

# 1. GENERAL INFORMATION

---

## SPECIAL TOOLS

Tool Name	Tool No.	Remarks	Ref. Page
Flywheel puller	E003	A.C. generator flywheel removal	4.10
Tappet adjuster	E012	Tapper adjustment	3.7
Oil seal & bearing installer	E014	Oil seal & bearing install	9.10.11
Flywheel holder	E021	A.C. generator flywheel holding	4.10
Clutch spring compressor	E034	Clutch disassembly	9
Thread protector	E029	Protect the crankshaft's thread	10
Bearing puller 10,12,15,18mm	E037	Bearing removal	10
Valve cotter installer	E051	Valve cotter installation	7
Lock nut socket wrench	F002	Steering stem removal or install	12
Steering Stem Top Thread Wrench	F023	Steering Stem Top Thread Removal & Installation	14

# 1. GENERAL INFORMATION

---

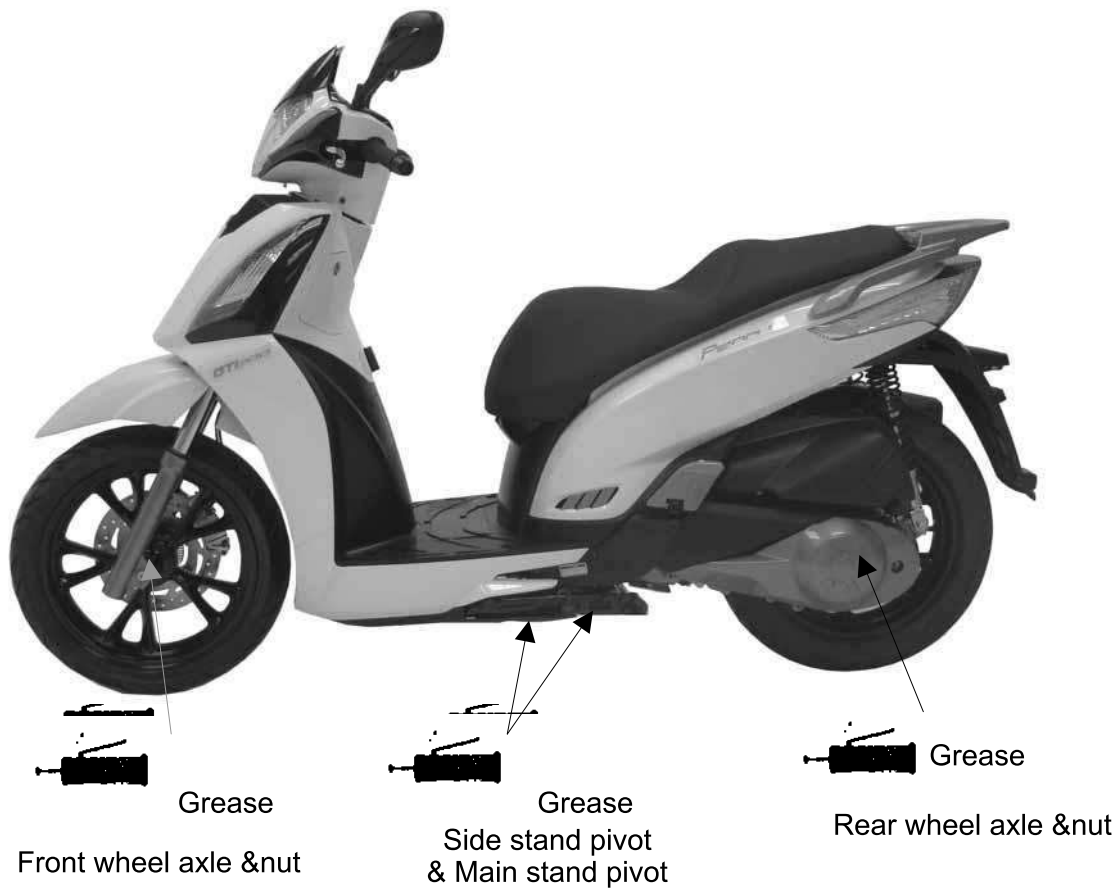

# 1. GENERAL INFORMATION

## CABLE & HARNESS ROUTING

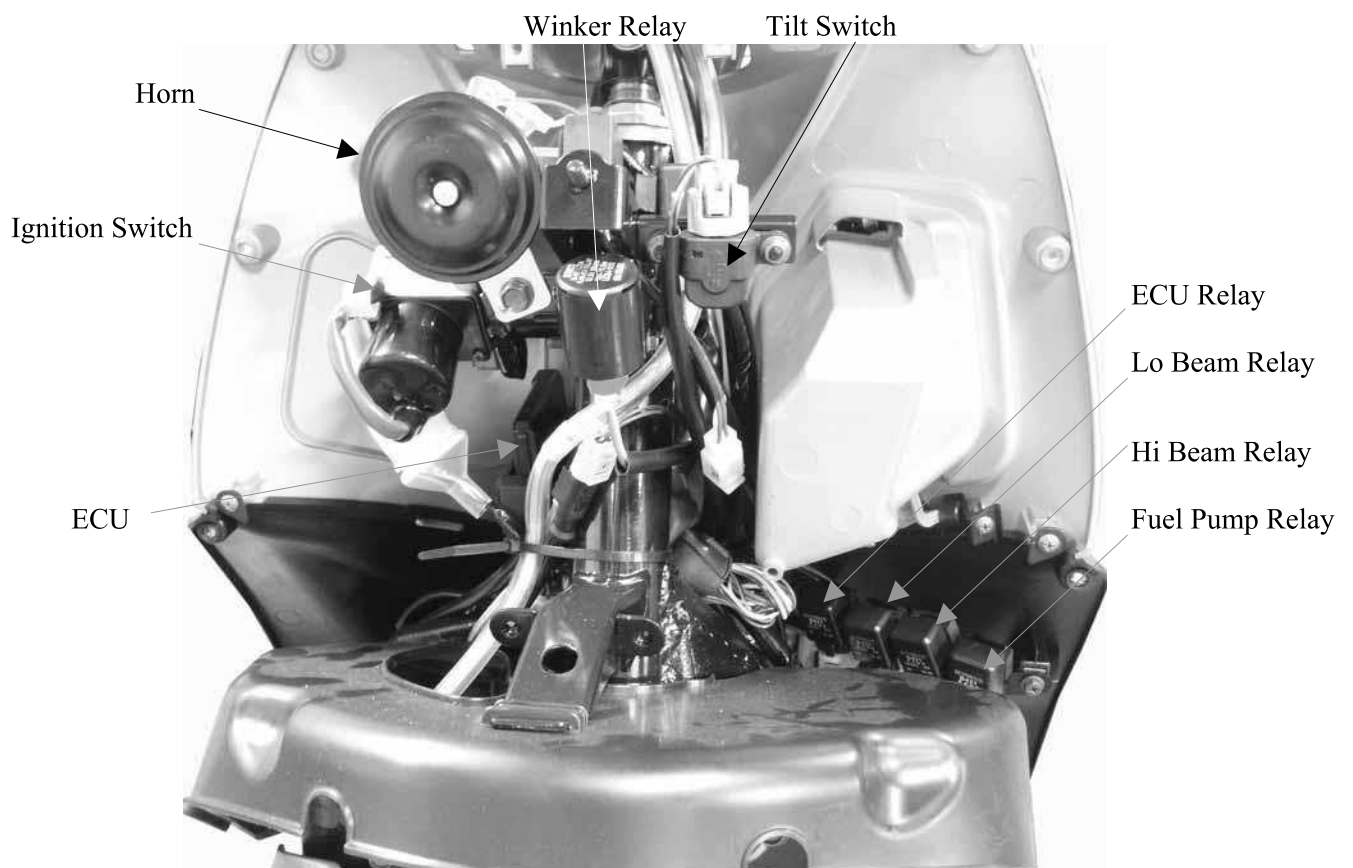

# 1. GENERAL INFORMATION

---

Oil Controller

Front Brake Hose

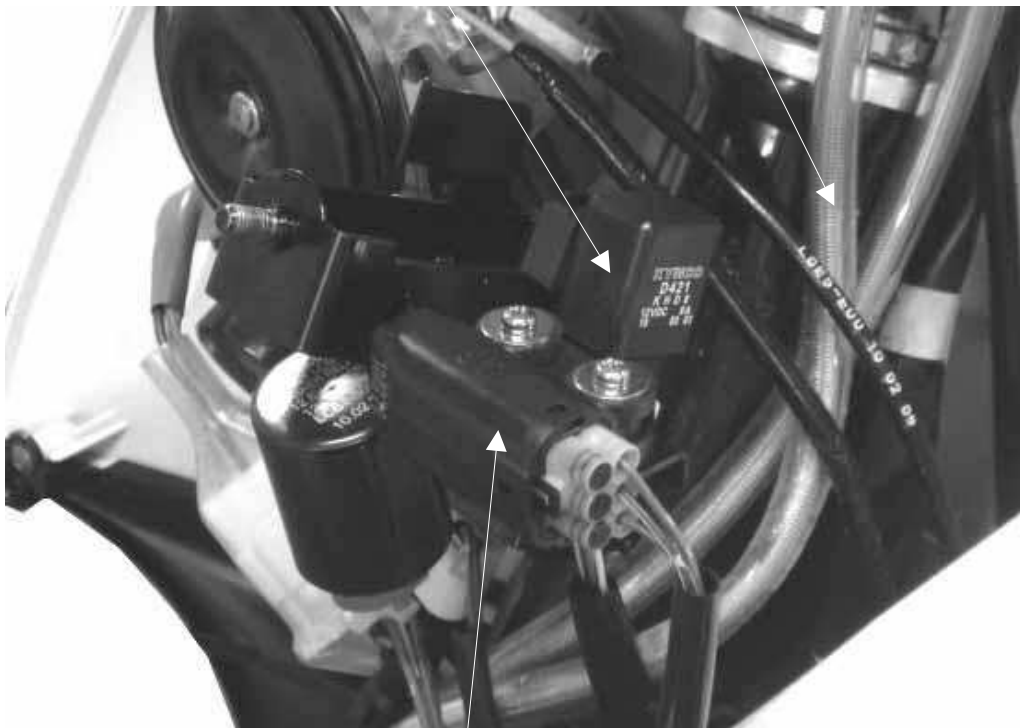

Tilt Switch



# 1. GENERAL INFORMATION

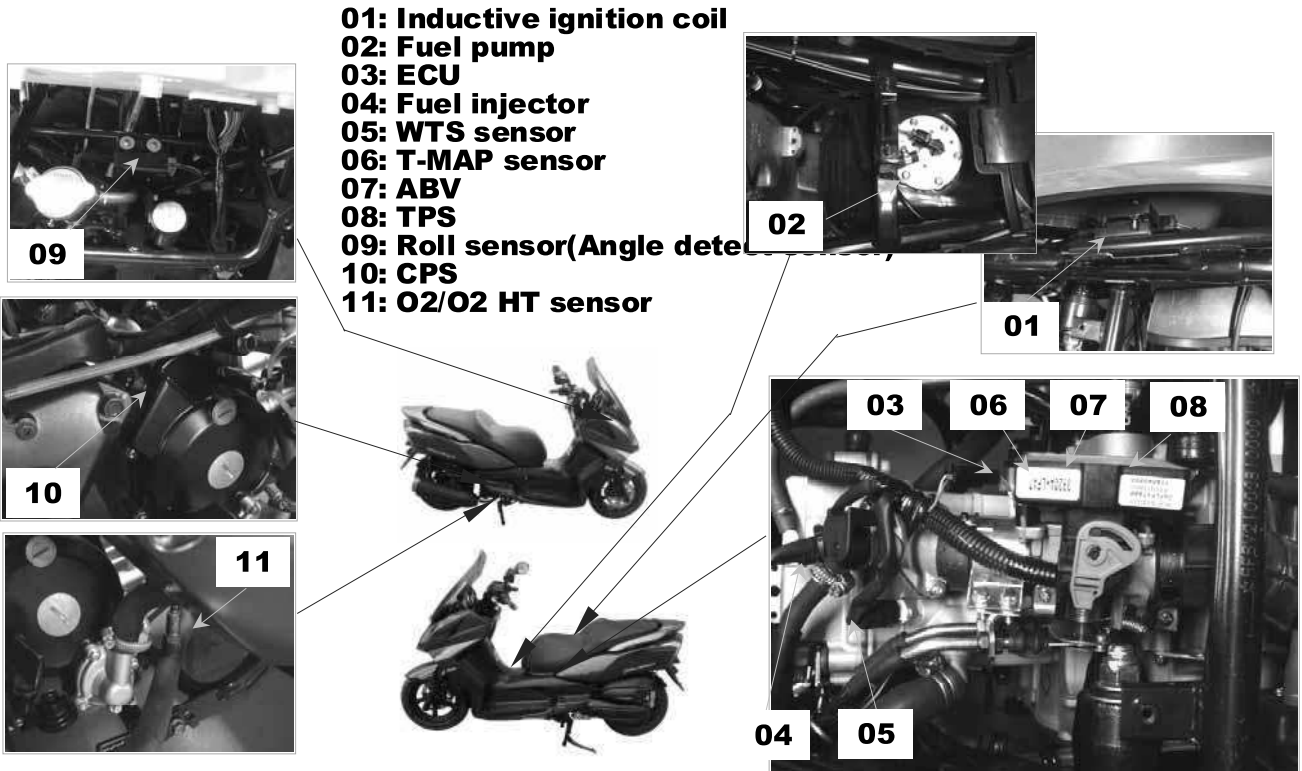

# 1. GENERAL INFORMATION

---

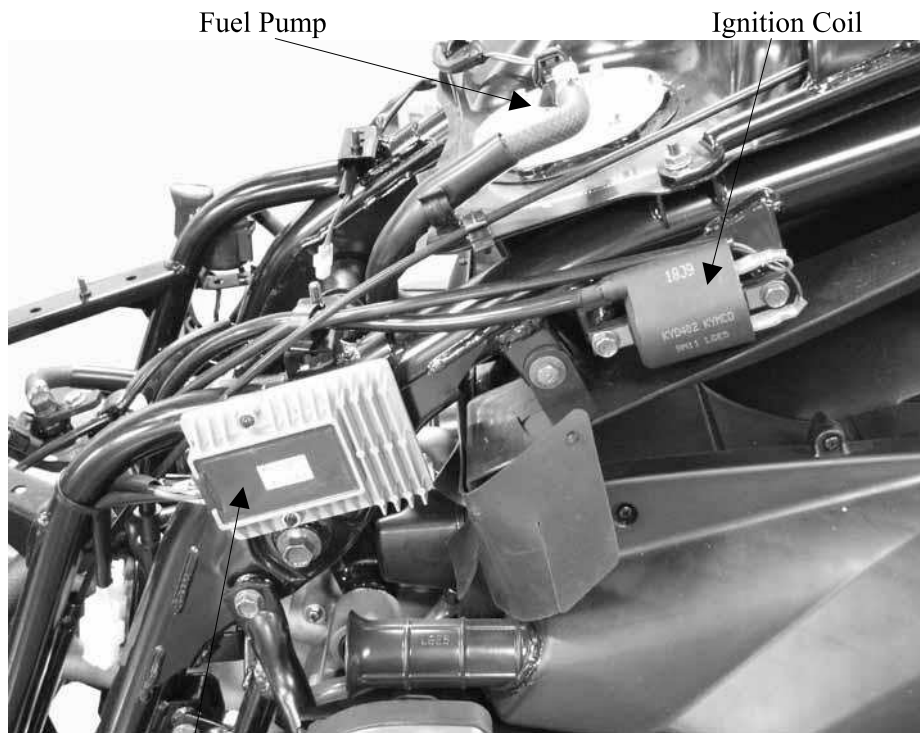

Regulator/Rectifier

# 1. GENERAL INFORMATION

## TROUBLESHOOTING

### ENGINE WILL NOT START OR IS HARD TO START

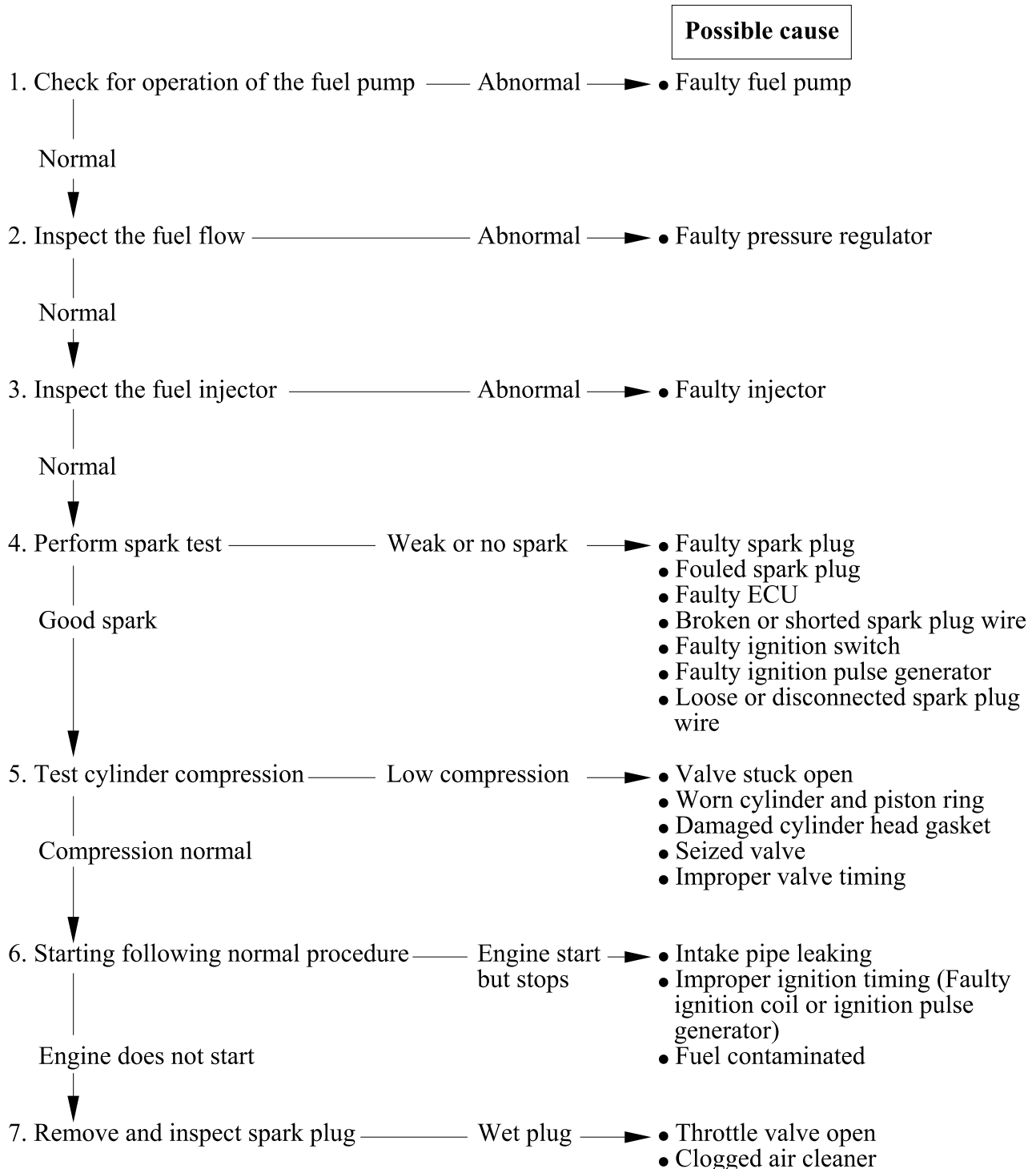

# 1. GENERAL INFORMATION

## ENGINE LACKS POWER

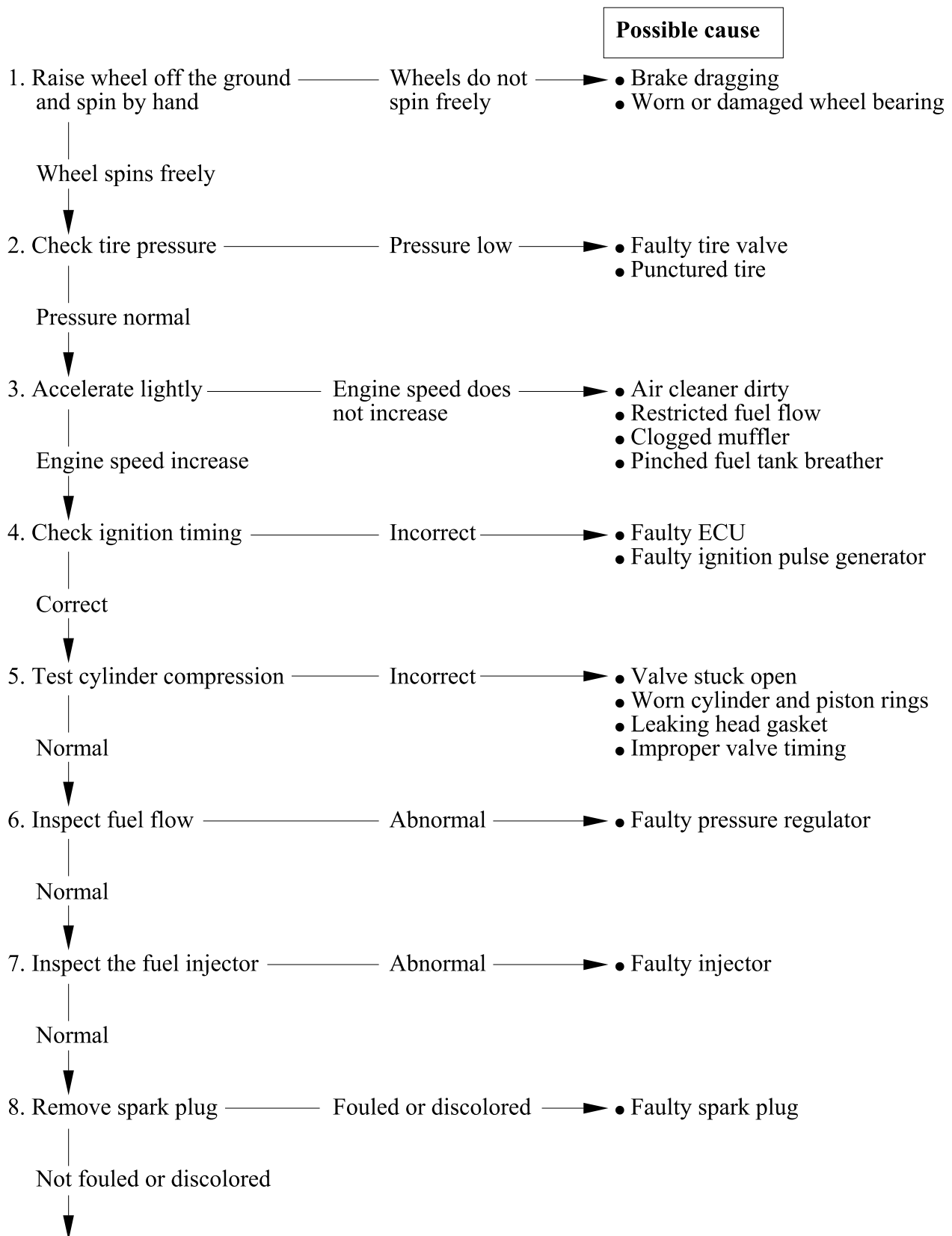

# 1. GENERAL INFORMATION

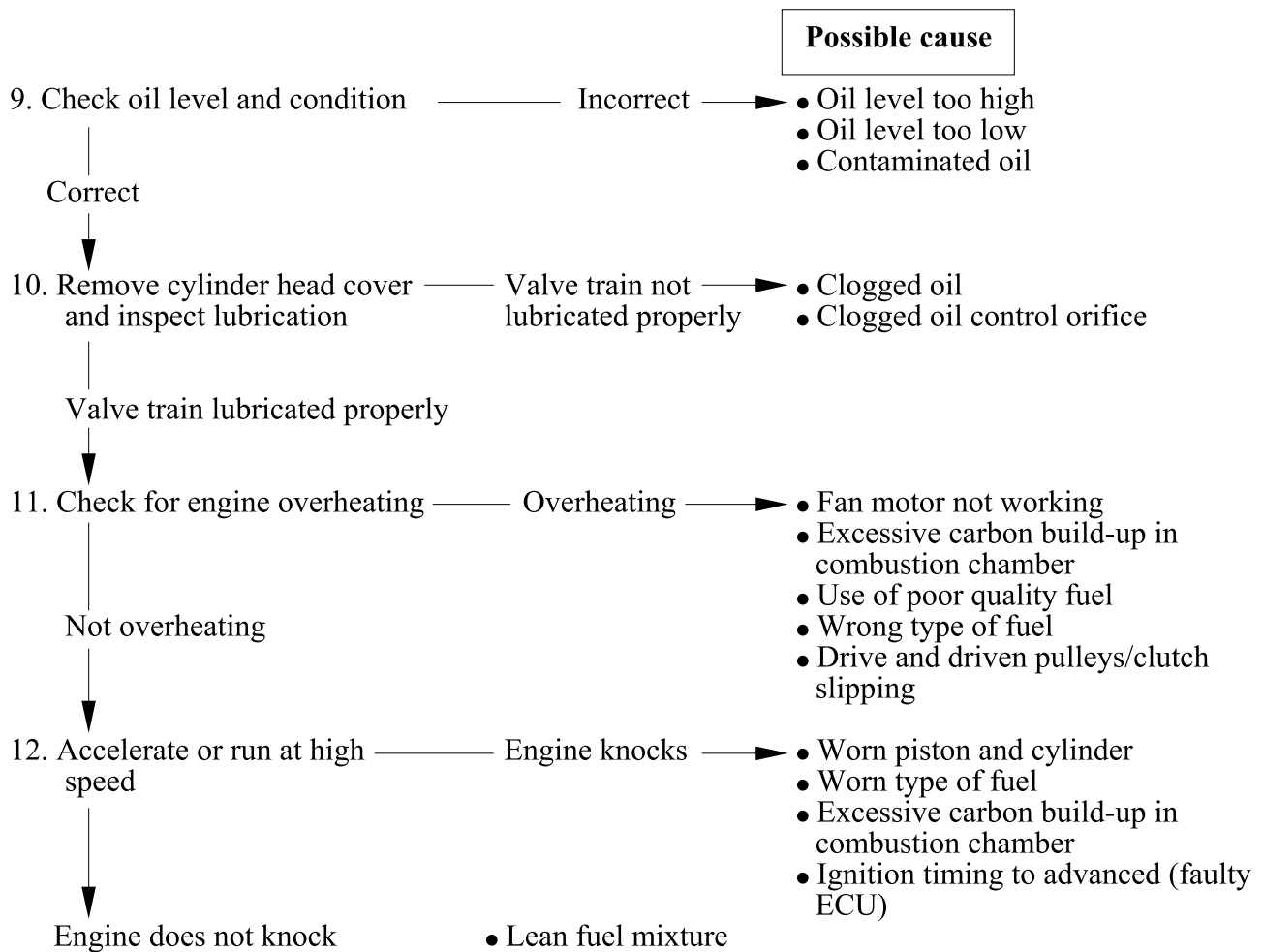

# 1. GENERAL INFORMATION

## POOR PERFORMANCE AT LOW AND IDLE SPEED

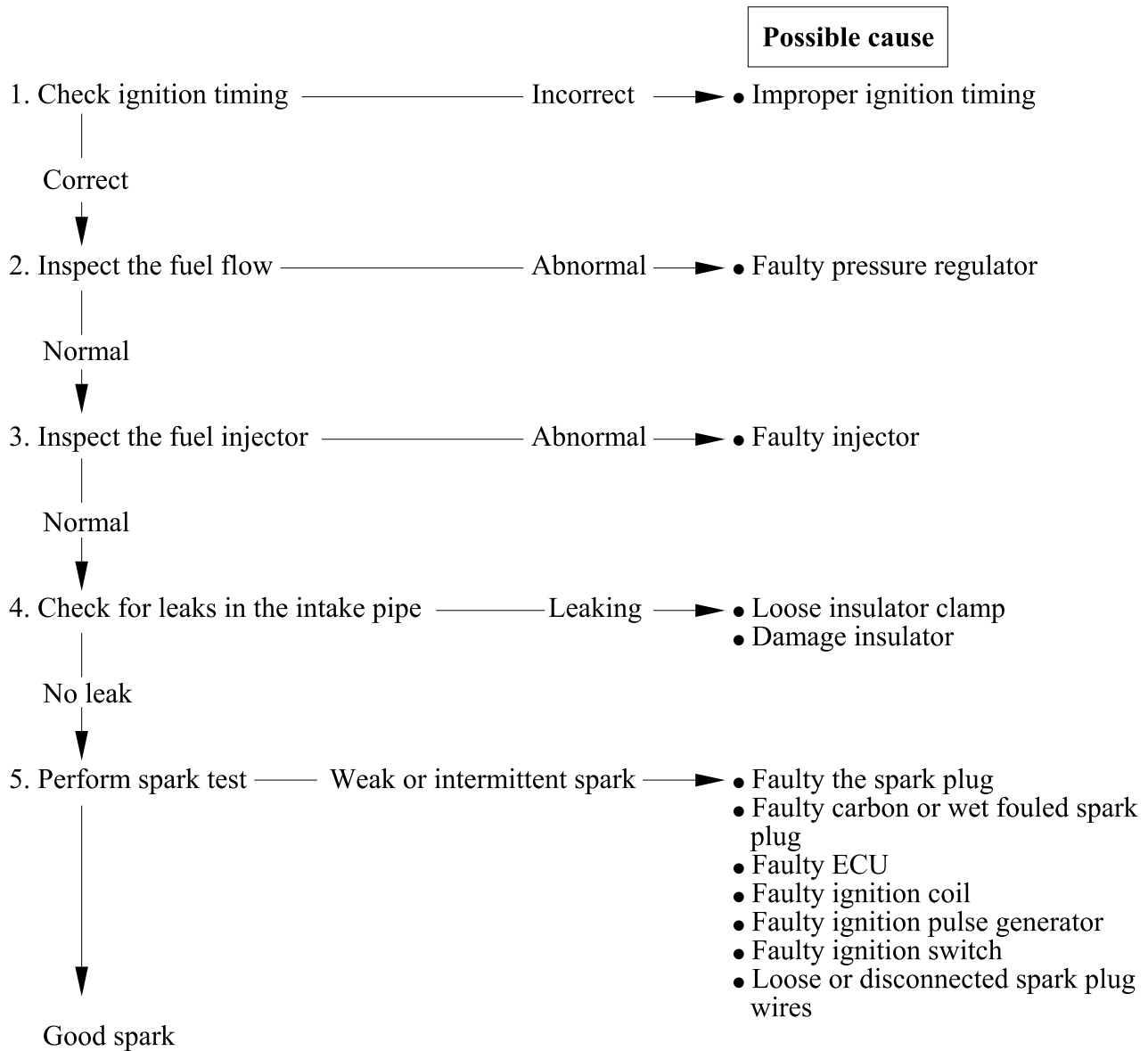

# 1. GENERAL INFORMATION

## POOR PERFORMANCE AT HIGH SPEED

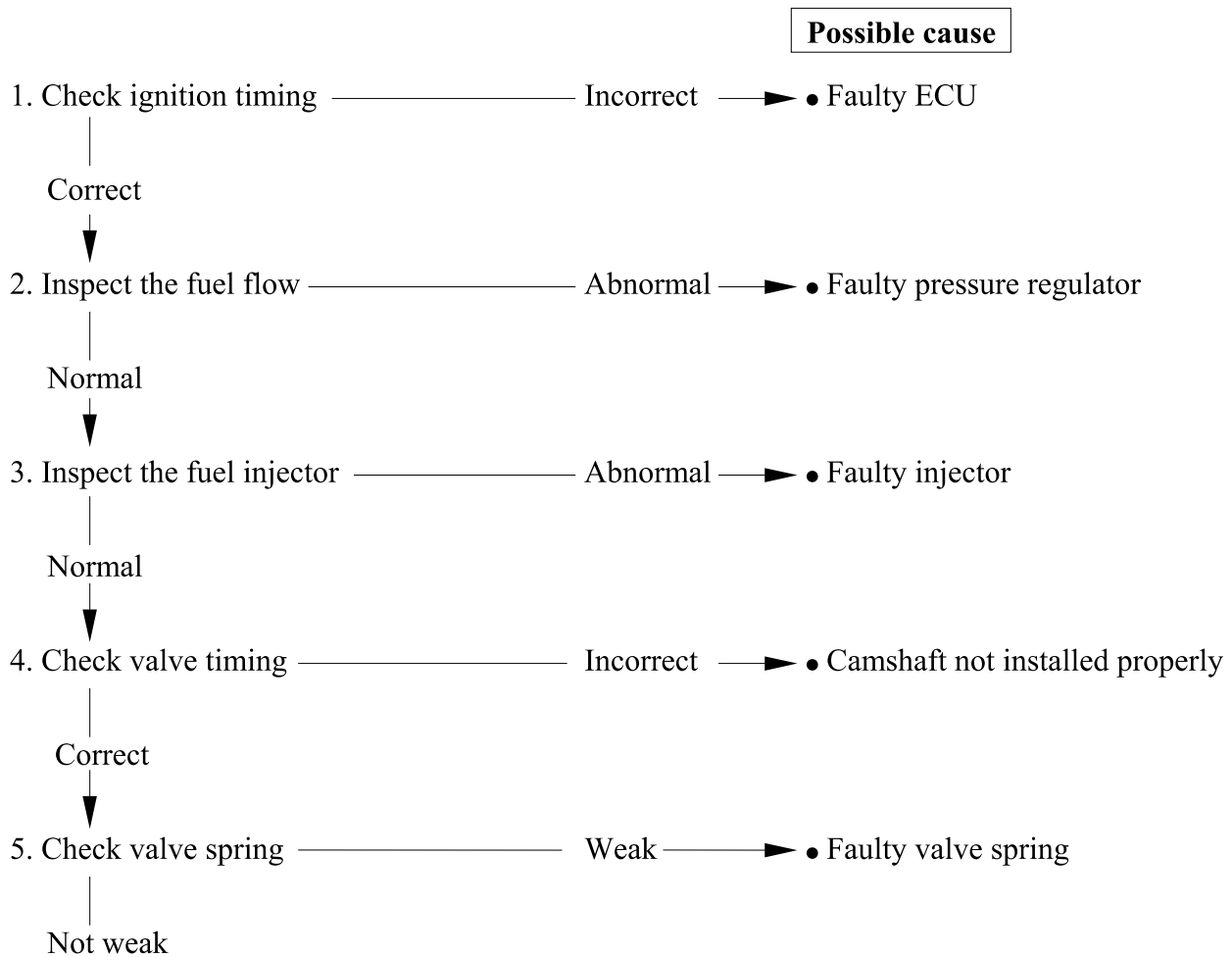

## POOR HANDLING

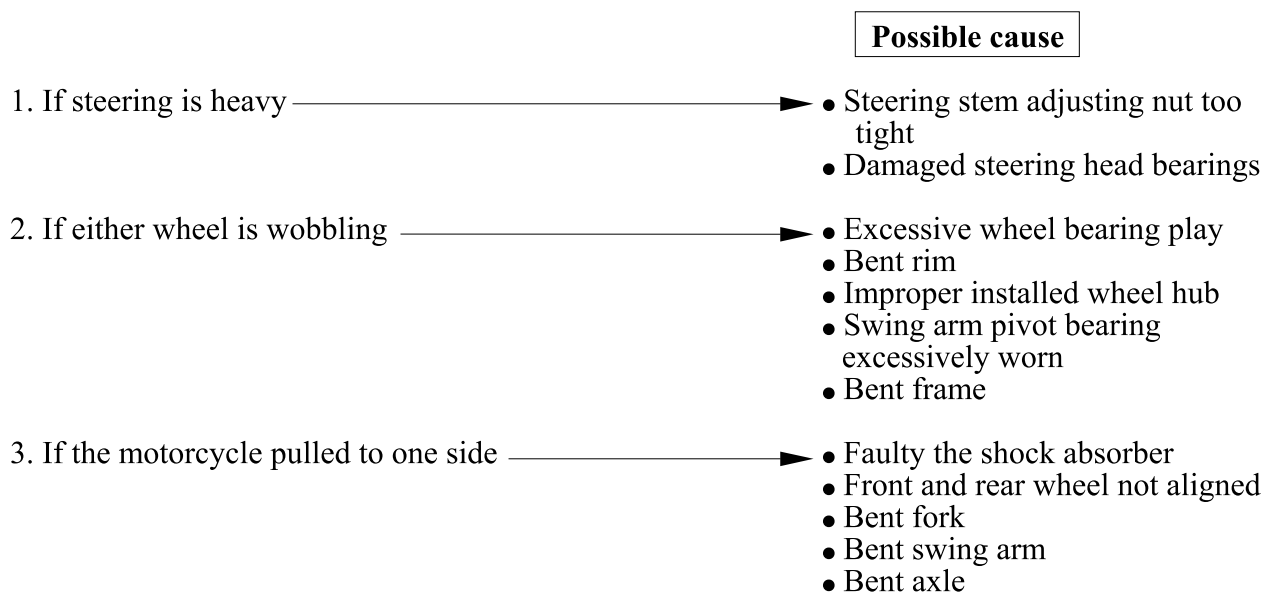

## 2. EXHAUST MUFFLER/FRAME COVERS

---

**2**

---

### EXHAUST MUFFLER/FRAME COVERS

---

SCHEMATIC DRAWING .....	2-1
SERVICE INFORMATION .....	2-2
TROUBLESHOOTING .....	2-2
FRAME COVERS REMOVAL.....	2-3
EXHAUST MUFFLER REMOVAL .....	2-6



# 2. EXHAUST MUFFLER/FRAME COVERS

## SCHEMATIC DRAWING

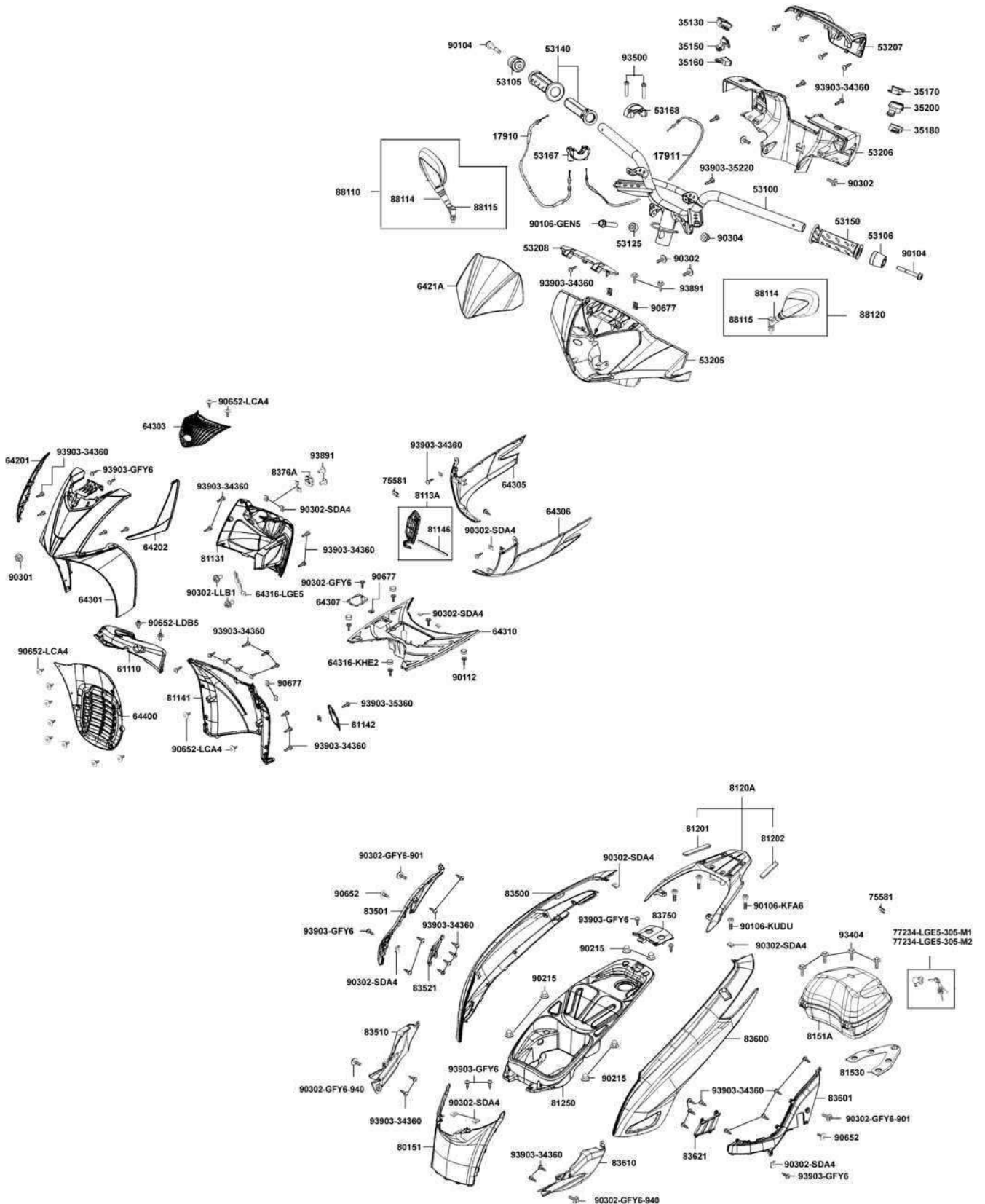

## 2. EXHAUST MUFFLER/FRAME COVERS

---

### SERVICE INFORMATION

#### GENERAL INSTRUCTIONS

- When removing frame covers, use care not to pull them by force because the cover joint claws may be damaged.
- Make sure to route cables and harnesses according to the Cable & Harness Routing.

#### TORQUE VALUES

Exhaust muffler lock bolt	35 N-m
Exhaust muffler joint lock nut	20 N-m

#### TROUBLESHOOTING

##### Noisy exhaust muffler

- Damaged exhaust muffler
- Exhaust muffler joint air leaks

##### Lack of power

- Caved exhaust muffler
- Clogged exhaust muffler
- Exhaust muffler air leaks

## 2. EXHAUST MUFFLER/FRAME COVERS

### FRAME COVERS REMOVAL

#### REAR CARRIER

Remove the met-in box.  
First remove the eight nuts attaching the met-in box.  
Remove the met-in box.

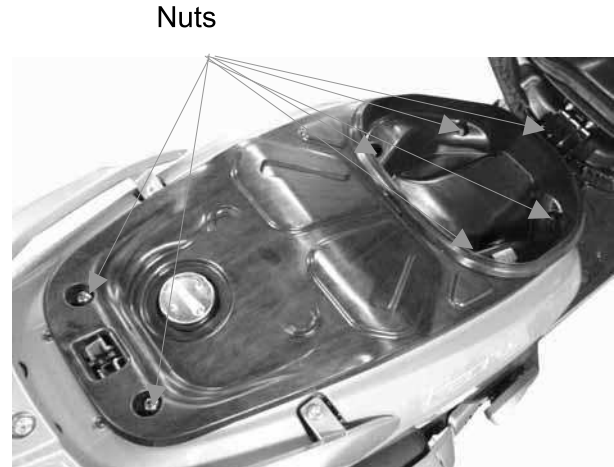

Remove the four bolts attaching the rear carrier.  
Remove the rear carrier.

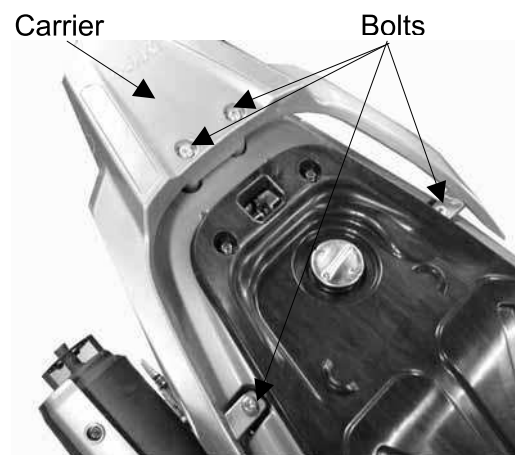

#### FRAME BODY COVER REMOVAL

Remove the two nuts attaching the rear protective cover.  
Remove the rear protective cover.

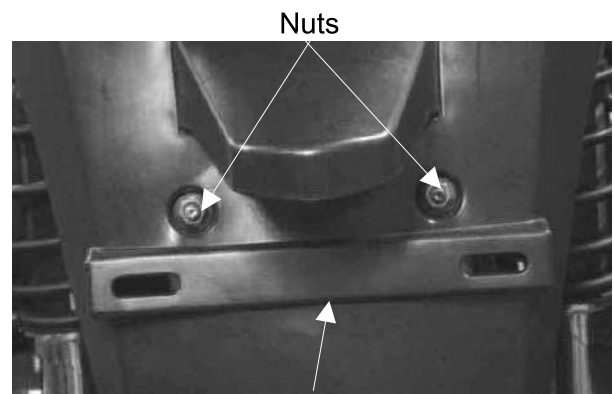

Remove the center cover.  
Remove the body cover.

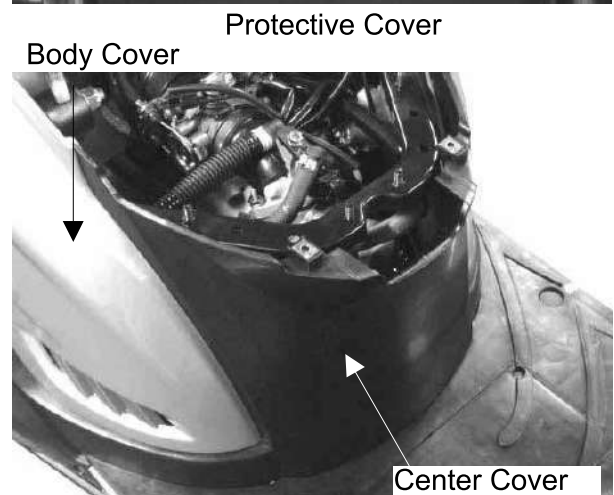

## 2. EXHAUST MUFFLER/FRAME COVERS

### FLOOR-FOOT REMOVAL

Remove the screws attaching the right and left side covers.  
Remove the right and left side covers by pulling them outward.



Side Cover

Screws

Disconnect the battery wire.  
Remove the battery.

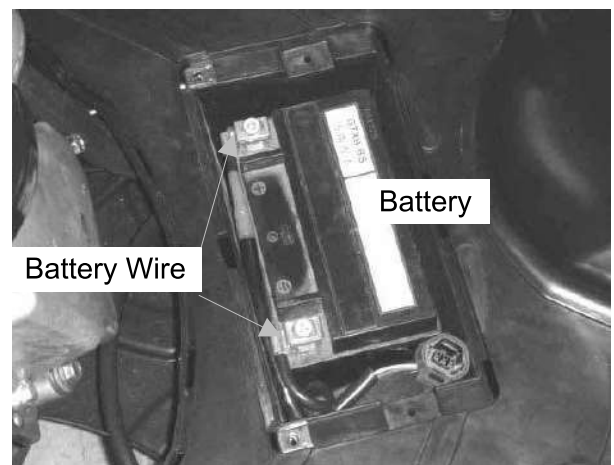

Battery

Battery Wire

Remove the floor mat.  
Remove the center cover. (⇒2-3)  
Remove the four bolts attaching the floorboard.  
Remove the floorboard.  
The installation sequence is the reverse of removal.

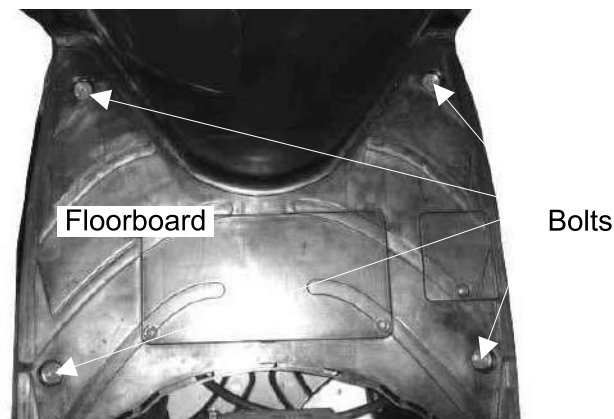

Floorboard

Bolts

### LEG SHIELD REMOVAL

Remove the met-in box.  
Remove the body cover.  
Remove the floorboard.  
Remove the front upper cover.  
Remove the screws attaching the leg shield low.  
Disconnect the leg shield low with the cowl under cover.  
The installation sequence is the reverse of removal.

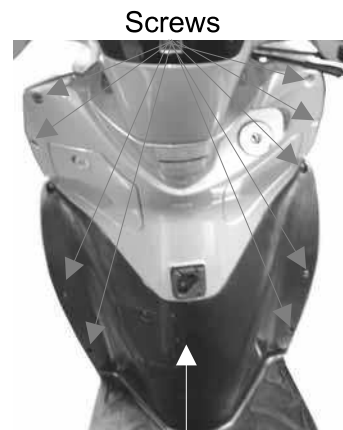

Screws

Leg Shield Low



## 2. EXHAUST MUFFLER/FRAME COVERS

### EXHAUST MUFFLER REMOVAL

Remove three lock nuts from joint in the exhaust muffler.

Remove the exhaust muffler two lock bolts to remove the exhaust muffler.

Remove the exhaust muffler joint packing collar.

The installation sequence is the reverse of removal.

#### Torque:

Exhaust muffler lock bolt	35 N-m
Exhaust muffler joint lock nut	20 N-m

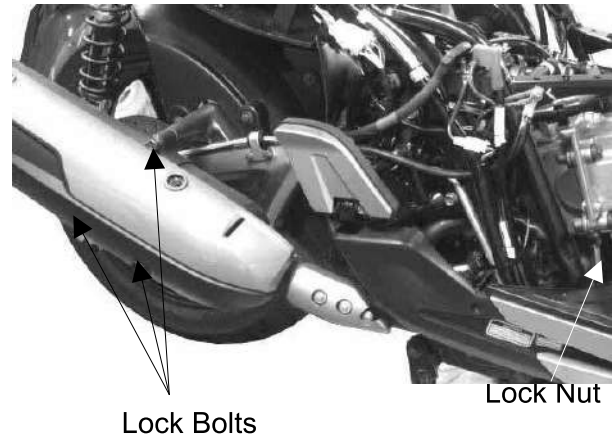



### 3. INSPECTION/ADJUSTMENT

#### SERVICE INFORMATION

##### GENERAL

 <b>WARNING</b>
--

- Before running the engine, make sure that the working area is well ventilated. Never run the engine in a closed area. The exhaust contains poisonous carbon monoxide gas, which may cause death to people.
- Gasoline is extremely flammable and is explosive under some conditions. The working area must be well ventilated and do not smoke or allow flames or sparks near the working area or fuel storage area.

##### SPECIFICATIONS

###### ENGINE

Throttle grip free play : 2~6 mm  
 Spark plug : NGK: CR7E  
 Spark plug gap : 0.6 mm ~ 0.7 mm  
 Valve clearance : IN: 0.10 mm EX: 0.10 mm  
 Idle speed : 1800±100 rpm

###### Engine oil capacity:

Cylinder compression: 15 kg/cm<sup>2</sup>  
 At disassembly : 1.2 Liter                      Ignition timing : ECU  
 At change : 1.0 Liter                              Coolant type : Liquid Cooling

###### Gear oil capacity :

At disassembly : 0.13 Liter  
 At change : 0.12 Liter

##### TIRE

	1 Rider	2 Riders
Front	1.75 kg/cm <sup>2</sup>	2.00 kg/cm <sup>2</sup>
Rear	1.75 kg/cm <sup>2</sup>	2.25 kg/cm <sup>2</sup>

##### TIRE SPECIFICATION

Front : 110/70-16  
 Rear : 140/70-16

##### TORQUE VALUES

Front axle nut : 20 N-m  
 Rear axle nut : 120 N-m

##### SPECIAL TOOL

Tappet Adjuster E012



### 3. INSPECTION/ADJUSTMENT

#### Maintenance schedule

Perform the pre-ride inspection (see page 21) at each scheduled maintenance period. This interval should be judged by odometer reading or months, whichever comes first.

#### Maintenance schedule legend

I: INSPECT AND CLEAN, ADJUST, LUBRICATE OR REPLACE IF NECESSARY

C: CLEAN    R: REPLACE    A: ADJUST    L: LUBRICATE

The maintenance schedule on the following two pages specifies the maintenance required to keep your **DOWNTOWN 300i** scooter in peak operating condition. Maintenance work should be performed in accordance with KYMCO standards and specifications by properly trained and equipped technicians. Your KYMCO dealer meets all of these requirements.

- \* Should be serviced by your KYMCO dealer, unless you have the proper tools, service data and are technically qualified.
- \*\* In the interest of safety, we recommend these items be serviced only by your KYMCO dealer. KYMCO recommends that your KYMCO dealer road test your scooter after each periodic maintenance service is completed.

ITEM		FREQUENCY	WHICHEVER COMES FIRST	ODOMETER READING							
											
		X 1000 km	1	5	10	15	20	25	30		
		X 1000 mi	0.6	3	6	9	12	15	18		
		MONTH	1	6	12	18	24	30	36		
*	AIR CLEANER			R	R	R	R	R	R	R	
	SPARK PLUGS			I	R	I	R	I	R		
*	THROTTLE OPERATION			I	I	I	I	I	I		
*	VALVE CLEARANCE			I	A	I	A	I	A		
*	FUEL LINE				I		I		I		
	CRANKCASE BREATHER		C	C	C	C	C	C	C		
*	ENGINE OIL		R	R	R	R	R	R	R		
*	ENGINE OIL SCREEN			C	R	C	R	C	R		
*	ENGINE OIL FILTER		R	R	R	R	R	R	R		
*	ENGINE IDLE SPEED				I		I		I		
*	TRANSMISSION OIL		R	R	R	R	R	R	R		
*	DRIVE BELT			I	I	I	I	I	I		
**	CLUTCH SHOE WEAR				I		I		I		
	BRAKE FLUID			I	R	I	R	I	R		
	BRAKE PAD WEAR			I	I	I	I	I	I		
	BRAKE SYSTEM			I	I	I	I	I	I		
*	BRAKE LIGHT SWITCH			I	I	I	I	I	I		
**	STEERING BEARINGS			I	I	I	I	I	I		
*	HEADLIGHT AIM			I	I	I	I	I	I		
*	NUTS, BOLTS, FASTENERS			I	I	I	I	I	I		
**	WHEELS/TIRES			I	I	I	I	I	I		
**	COOLANT			I	R	I	R	I	R		

### 3. INSPECTION/ADJUSTMENT

#### THROTTLE OPERATION

Check the throttle grip for smooth movement.  
Measure the throttle grip free play.

**Free Play:** 2~6 mm

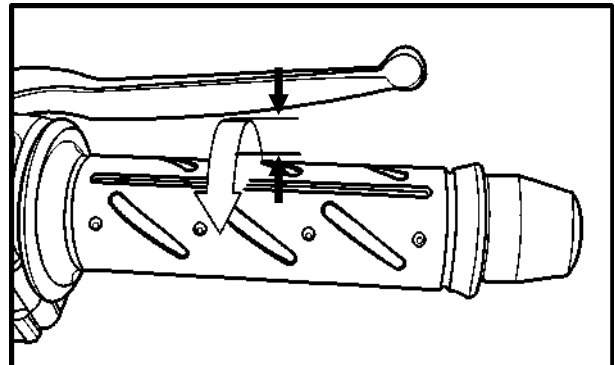

Major adjustment of the throttle grip free play is made with the adjusting nut at the throttle body side. Adjust by loosening the lock nut and turning the adjusting nut.

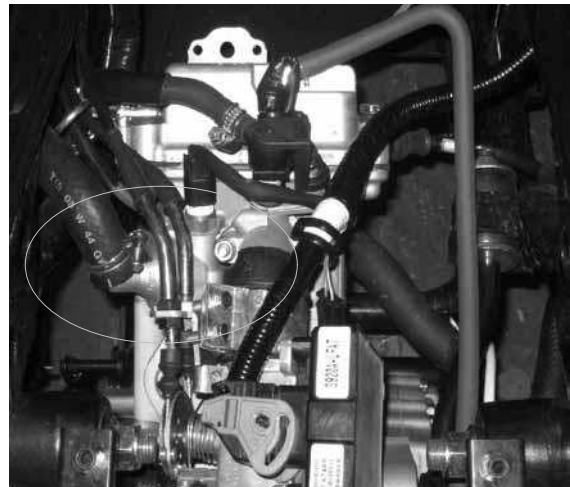

Minor adjustment is made with the adjusting nut at the throttle grip side.

Slide the rubber cover out and adjust by loosening the lock nut and turning the adjusting nut.

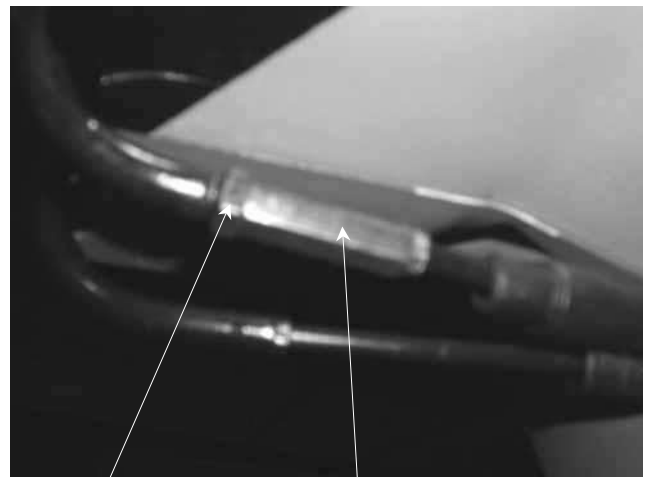

Lock Nut

Adjusting Nut

### 3. INSPECTION/ADJUSTMENT

\*



Dipstick



Oil Drain Bolt

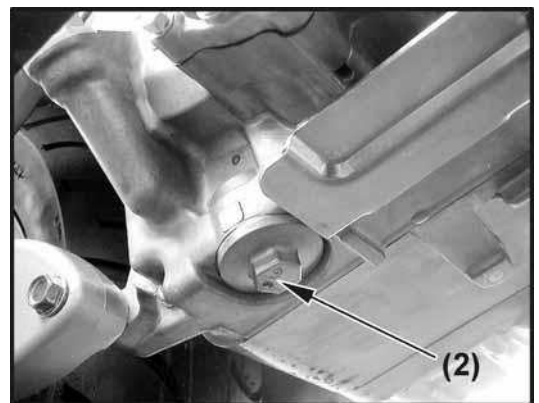

(2) Oil Filter Screen

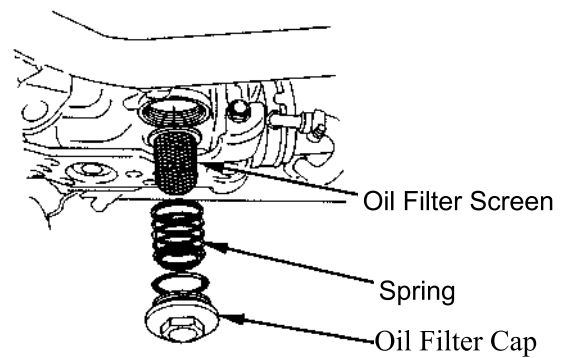

### 3. INSPECTION/ADJUSTMENT

#### OIL FILTER REPLACEMENT

Remove the oil filler cap attaching the right-under crankcase cover.

Place a drain pan under the crankcase.

Remove three bolts and then remove the oil filter cap and O-ring

The spring will come out when the filter cap is removed.

Let the engine oil drain out.

Check that the O-ring is in good condition.

Install a new oil filter.

\* Make sure the rubber seal on the oil filter facing the left crankcase.

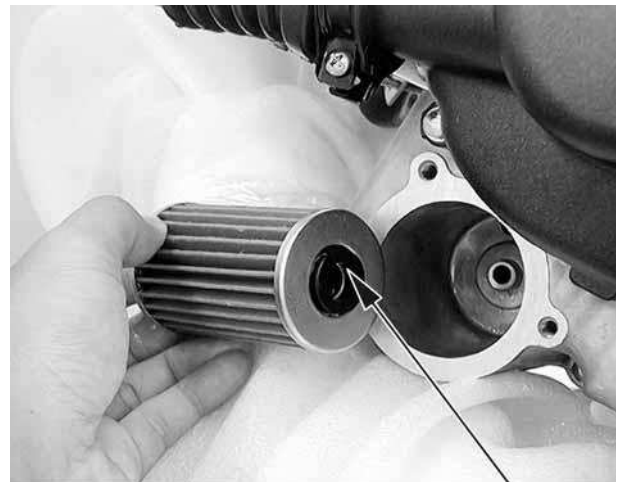

Rubber Seal

#### RESERVE TANK COOLANT LEVEL INSPECTION

The reserve tank is under left floorboard. Check the coolant level through the inspection window at the left side skirt while the engine is at the normal operating temperature, with the scooter in an upright position.

If the coolant level is below the LOWER level mark, remove the left floor mat, remove the lid screw, the reserve tank lid, and then the reserve tank cap to add coolant mixture until it reaches the upper level mark.

\* Add coolant to the reserve tank only. Do not attempt to add coolant by removing the radiator cap. Coolant in the radiator is under pressure and is very hot and can cause serious burns.

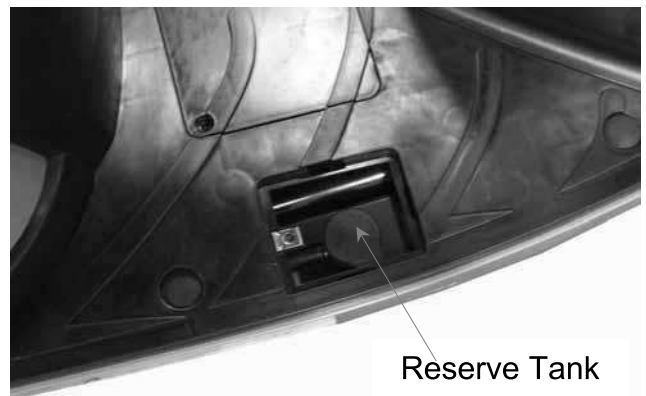

Reserve Tank



### 3. INSPECTION/ADJUSTMENT

#### AIR CLEANER

##### AIR FILTER REPLACEMENT

Remove the body cover.  
 Remove seven screws attaching to the air cleaner cover.  
 Remove six screws attaching to the filter.  
 Check the filter and replace it if it is excessively dirty or damaged.

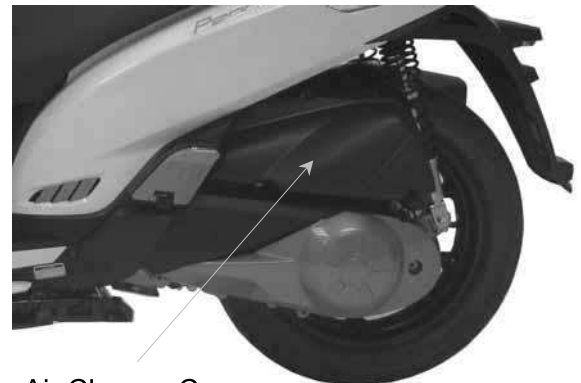

Air Cleaner Cover

##### CHANGE INTERVAL

More frequent replacement is required when riding in unusually dusty or rainy areas.

- \* 
 • The air cleaner element has a viscous type paper element. Do not clean it with compressed air.  
 • Be sure to install the air cleaner element and cover securely.



#### SPARK PLUG

Remove the spark plug cap and spark plug.  
 Check the spark plug for wear and fouling deposits.  
 Clean any fouling deposits with a spark plug cleaner or a wire brush.

**Specified Spark Plug:** NGK-CR7E

Measure the spark plug gap.

**Spark Plug Gap:** 0.6 – 0.7 mm



- \* 
 • When installing, first screw in the spark plug by hand and then tighten it with a spark plug wrench.

**Torque:** 17.2 N-m

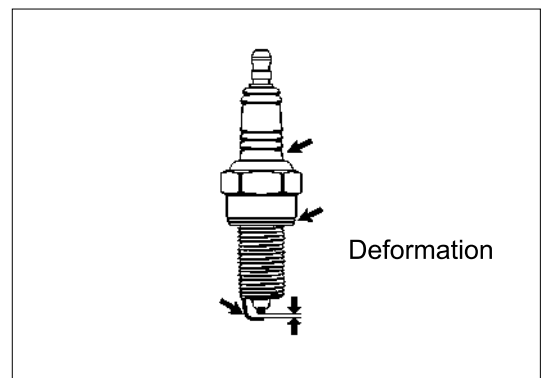

### 3. INSPECTION/ADJUSTMENT

#### VALVE CLEARANCE

- \* • Inspect and adjust valve clearance while the engine is cold (below 35°C).

Remove the seat assy and luggage box.  
Remove the four bolts and then cylinder head cover.

Top Dead Center Mark

Turn the A.C. generator flywheel to the top dead center (TDC) on the compression stroke so that the "T" mark on the flywheel aligns with the index mark on the left crankcase cover.

Inspect and adjust valve clearance.

**Valve Clearance:** IN: 0.10 mm  
EX: 0.10 mm

Loosen the lock nut and adjust by turning the adjusting nut



Valve Adjuster E012  
Feeler Gauge

- \* • Check the valve clearance again after the lock nut is tightened.



Bolts  
Timing hole cap

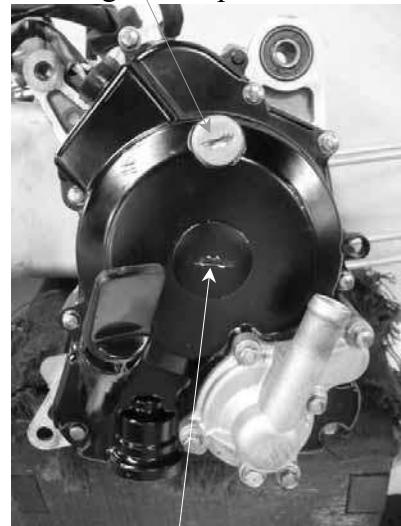

Crankshaft hole cap

#### CYLINDER COMPRESSION

Warm up the engine before compression test.

Remove the center cover and luggage box.  
Remove the spark plug.  
Insert a compression gauge.  
Open the throttle fully and push the starter button to test the compression.

**Max. Compression: 15 kg/cm<sup>2</sup> - 570 rpm**

If the compression is low, check for the following:

- Leaky valves
- Valve clearance too small
- Leaking cylinder head gasket
- Worn piston rings
- Worn piston/cylinder

If the compression is high, it indicates that carbon deposits have accumulated on the combustion chamber and the piston head.

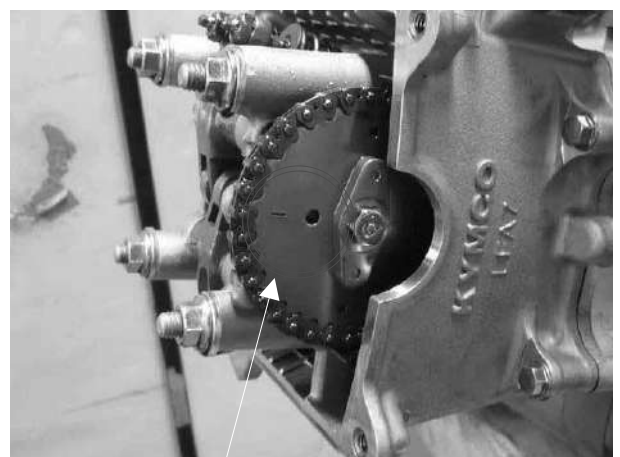

Punch Mark

### 3. INSPECTION/ADJUSTMENT

#### FINAL REDUCTION GEAR OIL

- \* • Place the scooter on its main stand on level ground.

Remove the transmission fluid drain bolt.  
Remove the transmission fluid filler bolt, then slowly rotate the rear wheel to drain the fluid.  
Fill the transmission with the recommend fluid to the capacity listed below.

**Transmission fluid type: SAE 90#**

**Transmission fluid capacity: 0.13 L**

**Transmission fluid exchanging capacity: 0.12 L**

Install the transmission filler bolt and tighten it to the specified torque.

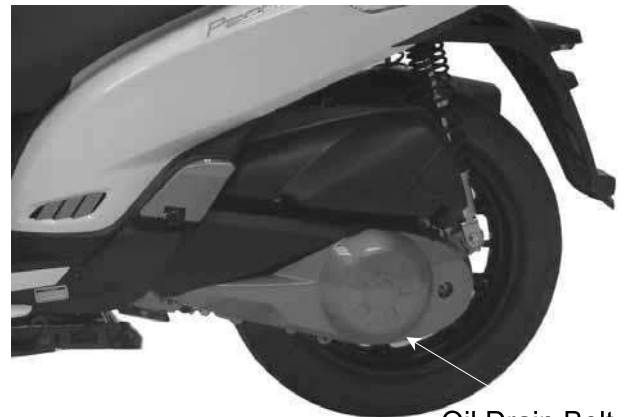

Oil Drain Bolt

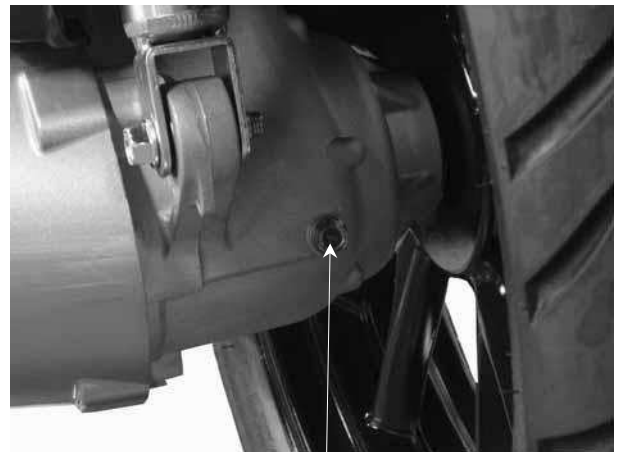

Oil Filler Bolt

#### DRIVE BELT

Remove the left crankcase cover.  
Inspect the drive belt for cracks or excessive wear.  
Replace the drive belt with a new one if necessary and in accordance with the Maintenance Schedule.

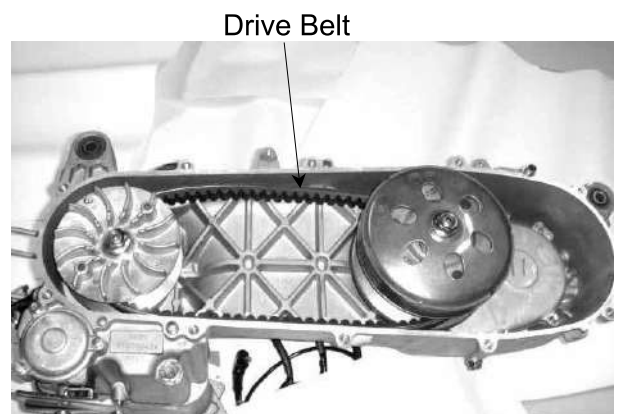

Drive Belt

## 3. INSPECTION/ADJUSTMENT

### BRAKE SYSTEM

#### BRAKE DISK/BRAKE PAD

Check the brake disk surface for scratches, unevenness or abnormal wear.

Check if the brake disk runout is within the specified service limit.

Check if the brake pad wear exceeds the wear indicator line.

\* Keep grease or oil off the brake disk to avoid brake failure.

<Front Brake>



<Rear Brake>



#### BRAKE FLUID

Turn the steering handlebar upright and check if both brake fluid levels is at the upper limit. If the brake fluid is insufficient, fill to the upper limit.

**Specified Brake Fluid: DOT-4**

\* The brake fluid level will decrease if the brake pads are worn.





## 3. INSPECTION/ADJUSTMENT

### CLUTCH SHOE WEAR

Start engine and check the clutch operation by increasing the engine speed gradually. If the motorcycle tends to creep or the engine stop, check the clutch shoes for wear and replace if necessary.



### SUSPENSION

#### FRONT

Check the action of the front shock absorbers by compressing them several times.

Check the entire shock absorber assembly for oil leaks, looseness or damage.



#### REAR

Each shock absorber(4) on your scooter has 5 spring preload adjustment positions for different load or riding conditions.

Use a pin spanner(5) to adjust the rear shock spring preload. Position 1 is for light loads and smooth road conditions. Position 3 to 5 increase spring preload for a stiffer rear suspension and can be used when the scooter is heavily loaded.

Be certain to adjust both shock absorbers to the same spring preload positions.

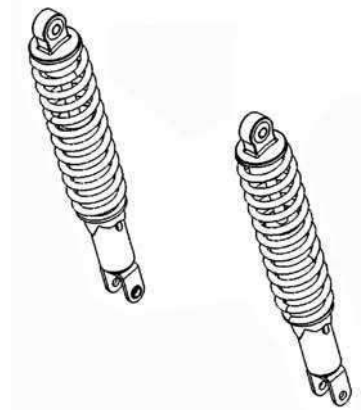

### 3. INSPECTION/ADJUSTMENT

#### NUTS/BOLTS/FASTENERS

Check all important chassis nuts and bolts for looseness.

Tighten them to their specified torque values if any looseness is found.

#### WHEELS/TIRES

Check the tires for cuts, imbedded nails or other damages.

Check the tire pressure.

- \* • Tire pressure should be checked when tires are cold.

#### Tire Pressure

	1 Rider	1 Rider (with passenger)
Front	1.75 kg/cm <sup>2</sup>	2.00 kg/cm <sup>2</sup>
Rear	1.75 kg/cm <sup>2</sup>	2.25 kg/cm <sup>2</sup>

#### Tire Size:

Front 110/70-16  
Rear 140/70-16

Check the front axle nut for looseness.

Check the rear axle nut for looseness.

If the axle nuts are loose, tighten them to the specified torques.

#### Torque:

Front axle nut 20 N-m  
Rear axle nut 120 N-m

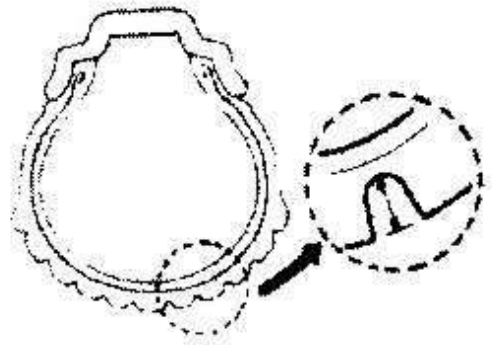

Front Axle Nut



Rear Axle Nut

#### STEERING HANDLEBAR

Raise the front wheel off the ground and check that the steering handlebar rotates freely.

If the handlebar moves unevenly, binds, or has vertical movement, adjust the steering head bearing.

## 3. INSPECTION/ADJUSTMENT

### SIDE STAND

Your scooter's side stand is not only necessary when you park, but it contains an important safety feature. This feature cuts-off the ignition if you try to ride the scooter when the side stand is down. Perform the following side stand inspection.

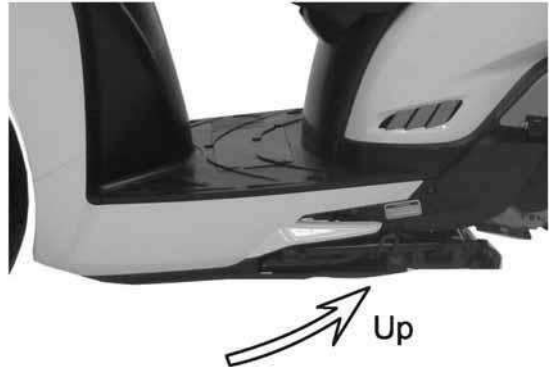

### INTERLOCK FUNCTION CHECK

Check the side stand ignition cut-off system,

1. Place the scooter on its center stand.
2. Put the side stand up and start the engine.
3. Lower the side stand. The engine should stop as you put the side stand down.



\* If the side stand system does not operate as described, see your KYMCO dealer for service.



# 4. LUBRICATION SYSTEM

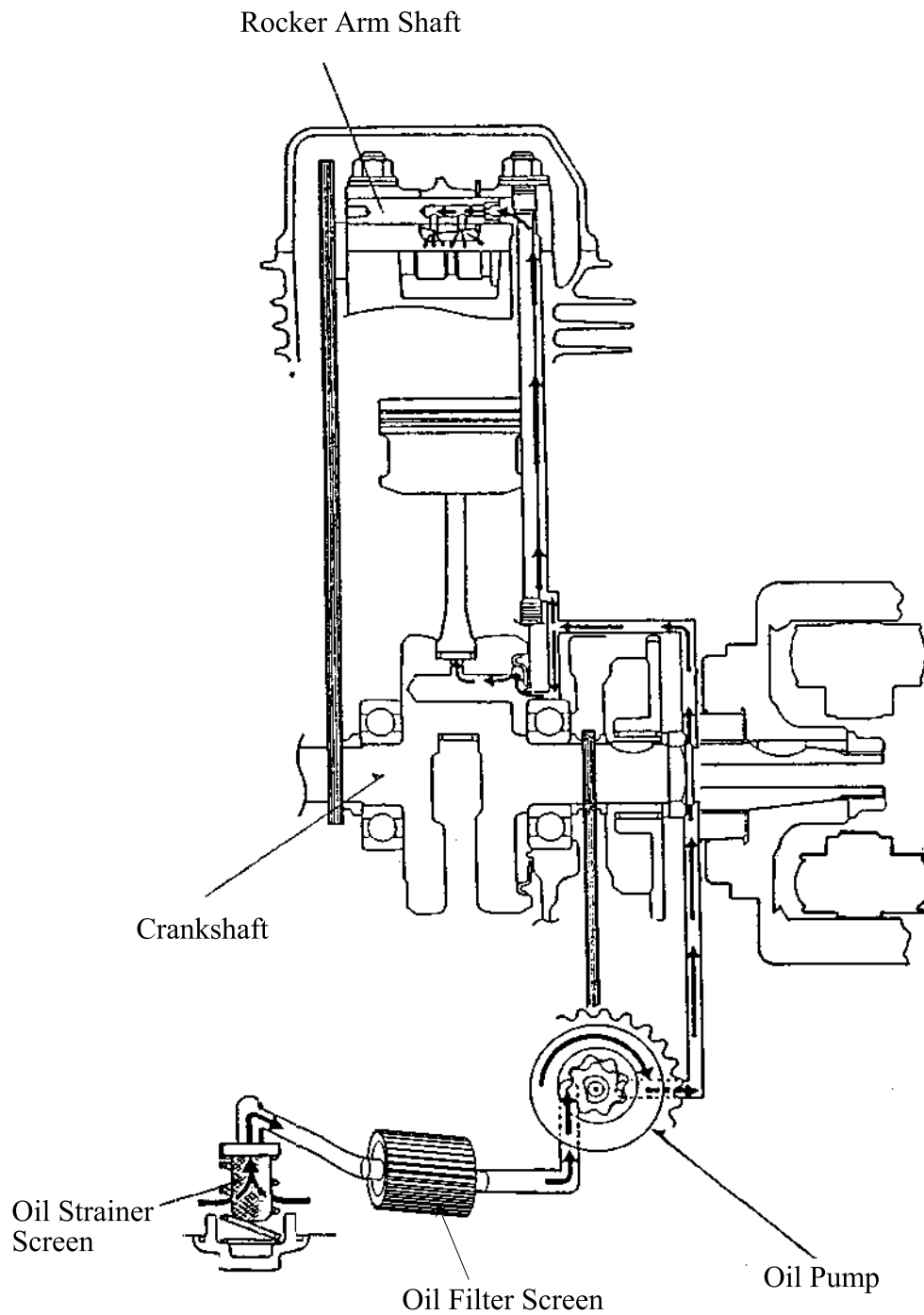

## 4. LUBRICATION SYSTEM

### SERVICE INFORMATION

#### GENERAL INSTRUCTIONS

- The maintenance of lubrication system can be performed with the engine installed in the frame.
- Drain the coolant before starting any operations.
- Be careful when removing and installing the oil pump not to allow dust and foreign matters to enter the engine and oil line.
- Do not attempt to disassemble the oil pump. The oil pump must be replaced as a set when it reaches its service limit.
- After the oil pump is installed, check each part for oil leaks.

#### SPECIFICATIONS

Item		Standard (mm)
Inner rotor-to-outer rotor clearance		0.15
Outer rotor-to-pump body clearance		0.15~0.2
Rotor end-to-pump body clearance		0.04~0.09
Engine Oil Capacity	At disassembly:	1.2 liter
	At change:	1.0 liter
Recommended Oil		SAE15W40 API: SJ

### TROUBLESHOOTING

#### Oil level too low

- Natural oil consumption
- Oil leaks
- Worn piston rings
- Worn valve guide
- Worn valve guide seal

#### Poor lubrication pressure

- Oil level too low
- Clogged oil filter or oil passage
- Faulty oil pump

#### Oil contamination

- Oil not changed often enough
- Faulty cylinder head gasket
- Loose cylinder head bolts

## 4. LUBRICATION SYSTEM

### OIL PUMP

#### REMOVAL

Remove the flywheel and driven gear (refer to the “**Starter Clutch**” section in the chapter 10).

Remove the bolt and then oil separator cover.

\* When removing and installing the oil pump, be careful not to allow dust or dirt to enter the engine.

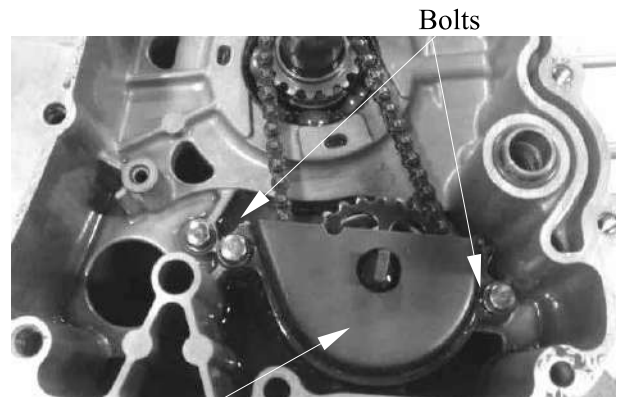

Oil Separator Cover

Pry the snap ring off and remove the oil pump driven gear, then remove the oil pump drive chain.

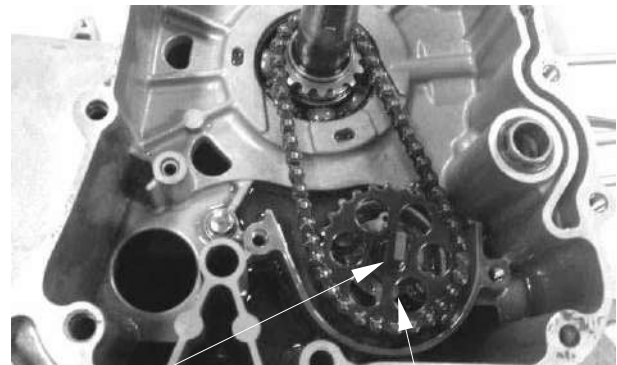

Snap Ring

Oil Pump Driven Gear

Remove the two oil separator bolts to remove the oil pump.

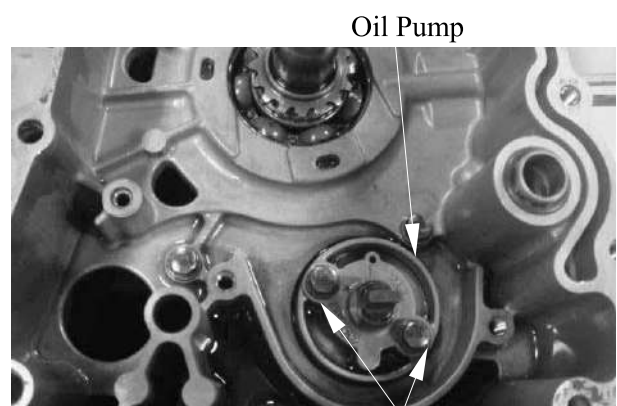

Oil Separator Bolt

# 4. LUBRICATION SYSTEM

## INSTALLATION

Install the oil pump and oil separator and tighten the two bolts.  
The arrow mark must be keep upward.

\* Make sure the pump shaft rotates freely and arrow on the oil pump is upside.

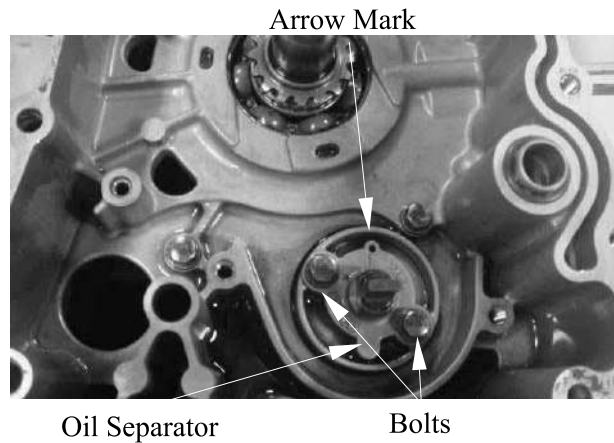

Install the pump drive chain and driven gear, then set the snap ring securely on the pump shaft.

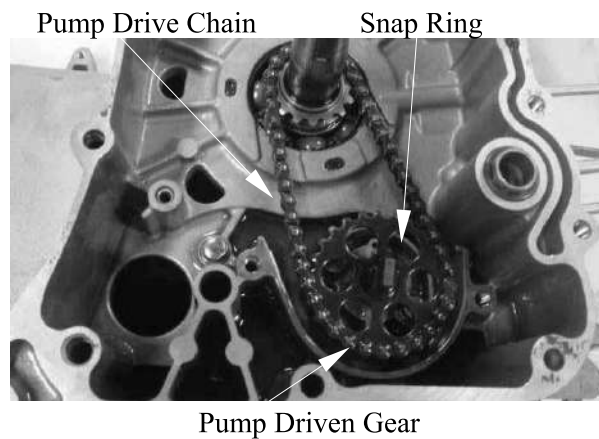

Install the oil separator cover properly.

\* Fit the tab of the separator cover into the slit in the separator.





## 4. LUBRICATION SYSTEM

### DISASSEMBLY

Remove the screw and disassemble the oil pump as shown.

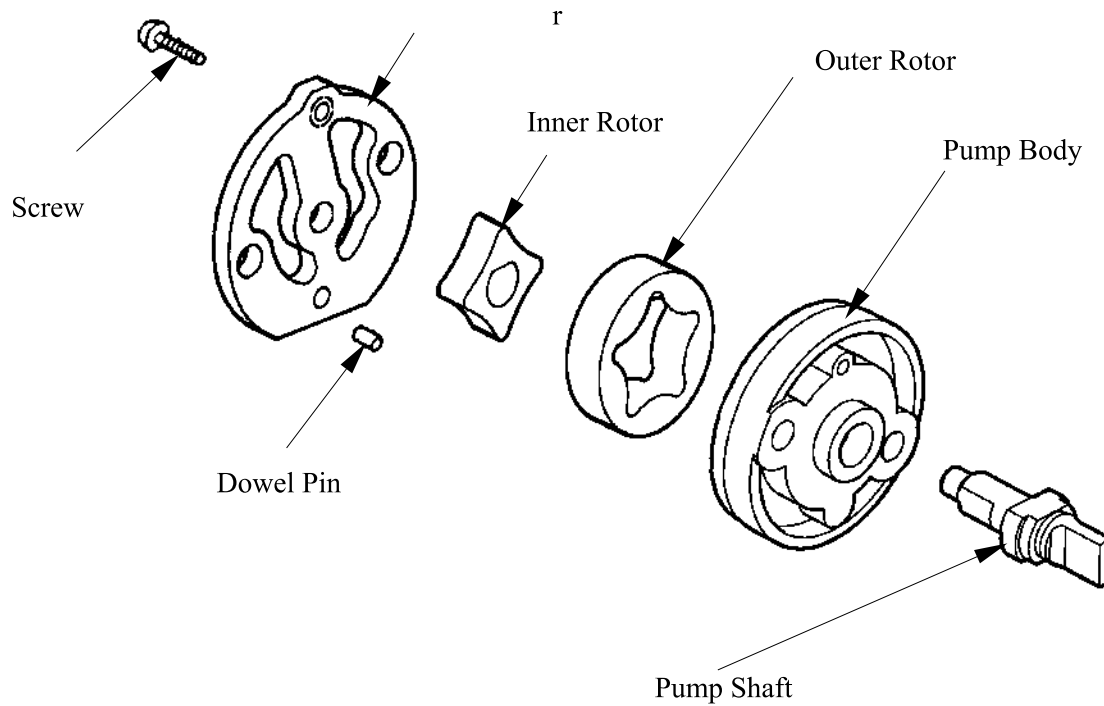

### ASSEMBLY

Install the outer rotor, inner rotor and pump shaft into the pump body.

\* Insert the pump shaft by aligning the flat on the shaft with the flat in the inner rotor. Install the dowel pin.

There is one punch mark on the surface of the inner rotor and outer rotor.

The mark is upside.

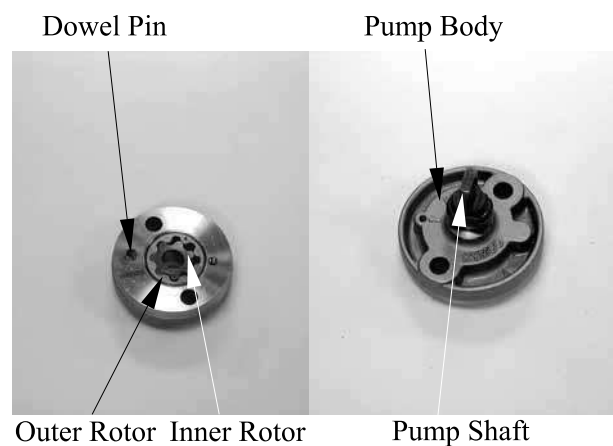



## 5. ENGINE REMOVAL/INSTALLATION

---

### SERVICE INFORMATION

#### GENERAL INSTRUCTIONS

- A floor jack or other adjustable support is required to support and maneuver the engine. Be careful not to damage the scooter body, cables and wires during engine removal.
- Use shop towels to protect the scooter body during engine removal.
- Drain the coolant before removing the engine.
- After the engine is installed, fill the cooling system with coolant and be sure to bleed air from the water jacket. Start the engine to check for coolant leaks.
- Before removing the engine, the rear brake caliper must be removed first. Be careful not to bend or twist the brake fluid tube.

#### SPECIFICATIONS

Engine oil capacity: at disassembly: 1.2 L  
: at change: 1.0 L

Coolant capacity:

Radiator capacity : 0.87 liter

Reserve tank capacity : 0.49 liter

#### TORQUE VALUES

Engine hanger (Engine side) 5.0 kgf-m (50 N-m)

Engine hanger (Frame side) 6.5 kgf-m (65 N-m)

# 5. ENGINE REMOVAL/INSTALLATION

People GT 125i

## ENGINE REMOVAL/INSTALLATION

### REMOVAL

Remove the air cleaner  
 Disconnect the ECU connector  
 Disconnect the O2 heater/O2 sensor connector  
 Disconnect the throttle cable.

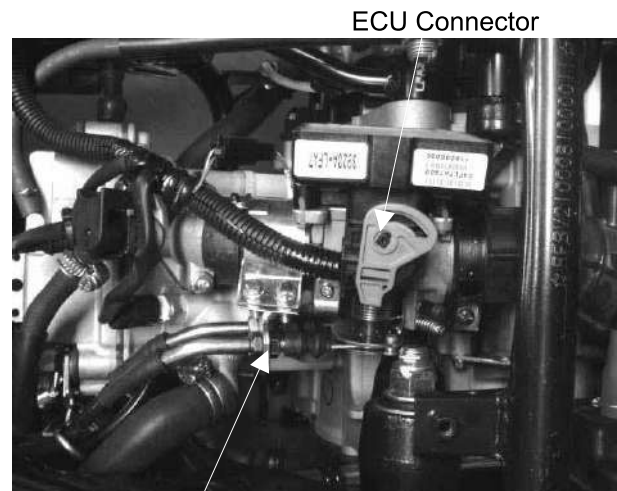

ECU Connector  
 Throttle Cable

Remove a bolt from fuel hose guide.  
 Disconnect the fuel hose from fuel injector.  
 Disconnect the WTS connector from WTS.  
 Disconnect the coolant temperature sensor connector from coolant temperature sensor.  
 Disconnect the fuel injector connector  
 Disconnect the output water hose  
 Disconnect the air bleed hose

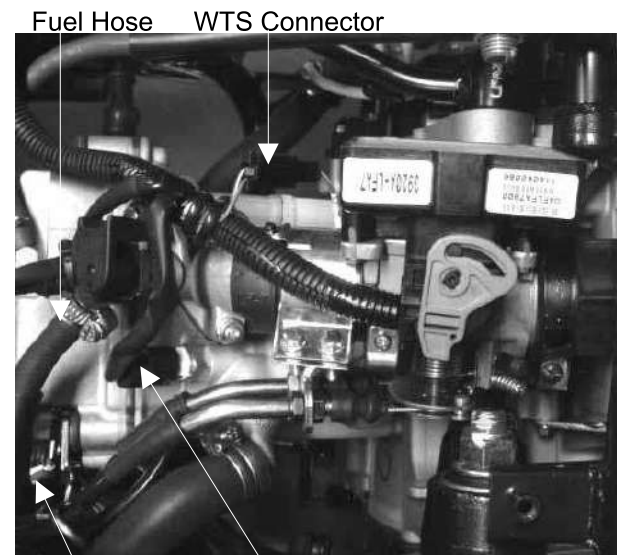

Fuel Hose WTS Connector  
 Fuel Hose Guide WTS

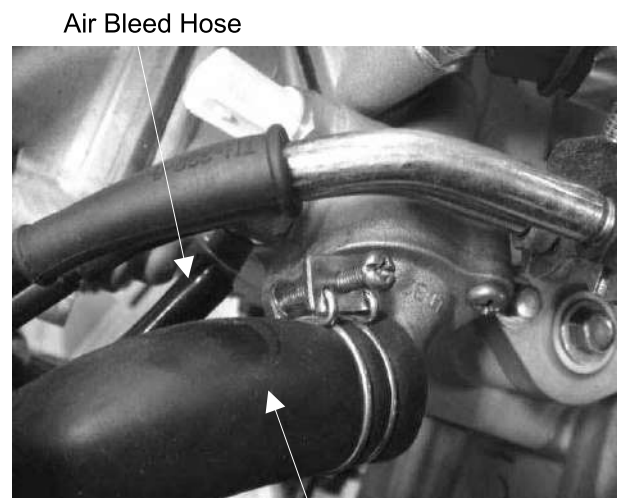

Air Bleed Hose  
 Output Water Hose

## 5. ENGINE REMOVAL/INSTALLATION

---

Loosen the rear axle nut.  
Support the scooter securely on its main stand.

Remove three bolts attaching to rear brake hose clamps.  
Remove the two bolts, then remove the rear brake caliper.

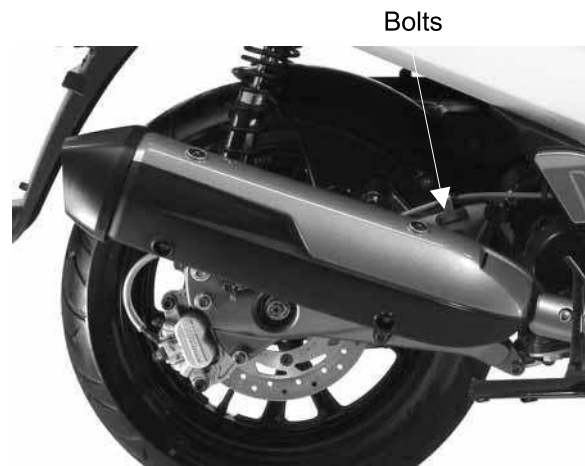

Disconnect the Regulator/Rectifier connector.  
Disconnect the ignition pulse generator connector.

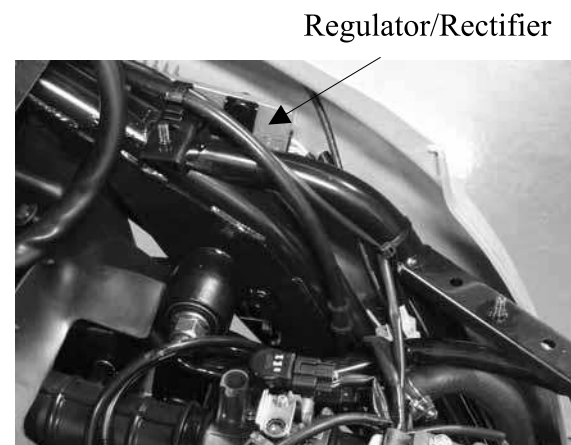

Release the rubber cap and remove the terminal screw to disconnect the start motor cable from the start motor.  
Remove the bolts and engine ground cable.

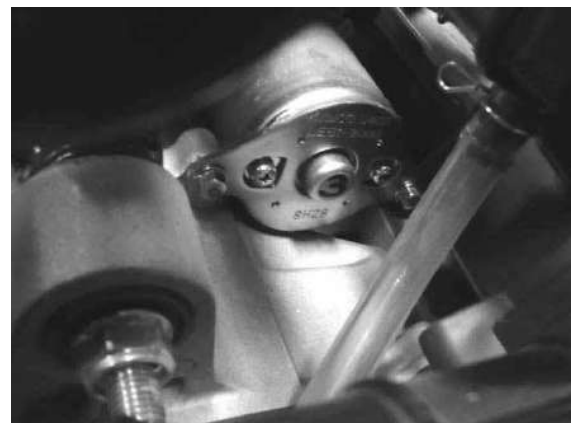

## 5. ENGINE REMOVAL/INSTALLATION

---

Remove the spark plug cap.

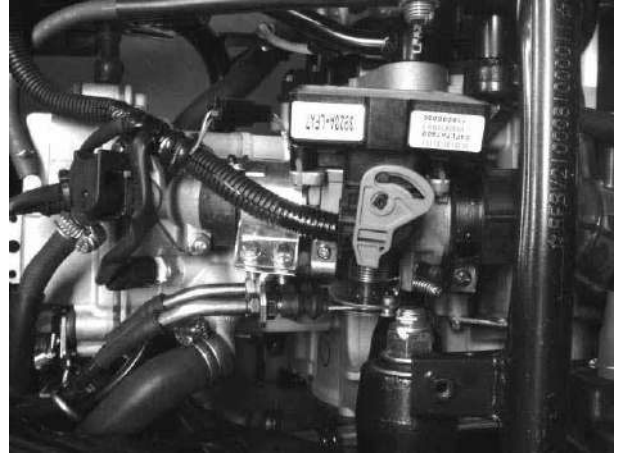

Disconnect the lower radiator hose from lower radiator pipe.



Remove the right and left rear shock absorber lower mount bolts.



## 5. ENGINE REMOVAL/INSTALLATION

---

Remove the engine mount nut  
Pull out the engine mount bolt.  
Remove the engine from the frame.

At removing the engine, be careful not to catch your hand or finger between the engine hanger and crankcase.

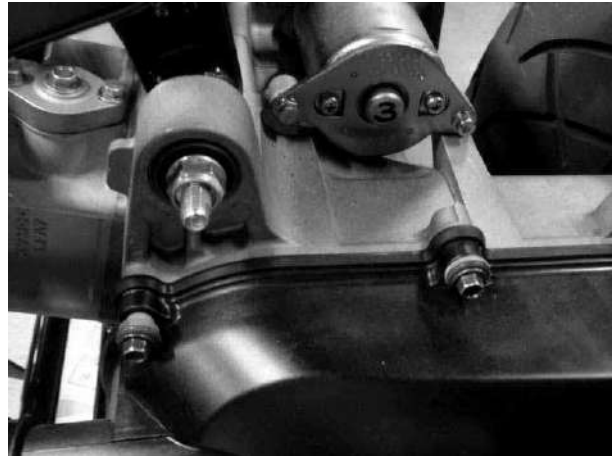

### INSTALLATION

Installation is in the reverse order of removal.

Tighten the engine mounting bolt/nut to the specified torque.

**Torque:** 5 kgf-m (50 N-m)

Tighten the right and left rear shock absorber lower mount bolts to the specified torque.

**Torque:** 4.0kgf-m (40N-m)

Install the rear brake caliper and tighten the mount bolts to the specified torque.

**Torque:** 3.2 kgf-m (32 N-m, 23 lbf-ft)

After installation, inspect and adjust the following:

- Throttle grip free play
  - Fill the cooling system with coolant and start the engine to bleed air from the system.
- API/ABV Reset(Refer to chapter14)

## 5. ENGINE REMOVAL/INSTALLATION

---

### ENGINE HANGER

#### REMOVAL

Remove the engine mount nut.  
Pull the engine mount bolt out.

Be careful to put the engine down.

Remove the left engine hanger mount bolt.  
Remove the right engine hanger mount bolt and collar.  
Remove the engine from frame.



#### INSTALLATION

Installation is in the reverse order of removal.

Tighten the engine hanger mount bolts to the specified torque (Engine side).

**Torque:** 5 kgf-m (50 N-m)

Tighten the engine mount bolt/nut to the specified torque. (Body Frame side)

**Torque:** 5 kgf-m (50 N-m, 36 lbf-ft)





**CYLINDER HEAD/VALVES**



SCHEMATIC DRAWING ----- 6- 1  
SERVICE INFORMATION----- 6- 2  
TROUBLESHOOTING----- 6- 3  
CYLINDER HEAD COVER----- 6- 4  
CAMSHAFT HOLDER----- 6- 5  
CAMSHAFT ----- 6- 8  
CYLINDER HEAD----- 6-13

# 6. CYLINDER HEAD/VALVES

People GT 125i

## SCHEMATIC DRAWING

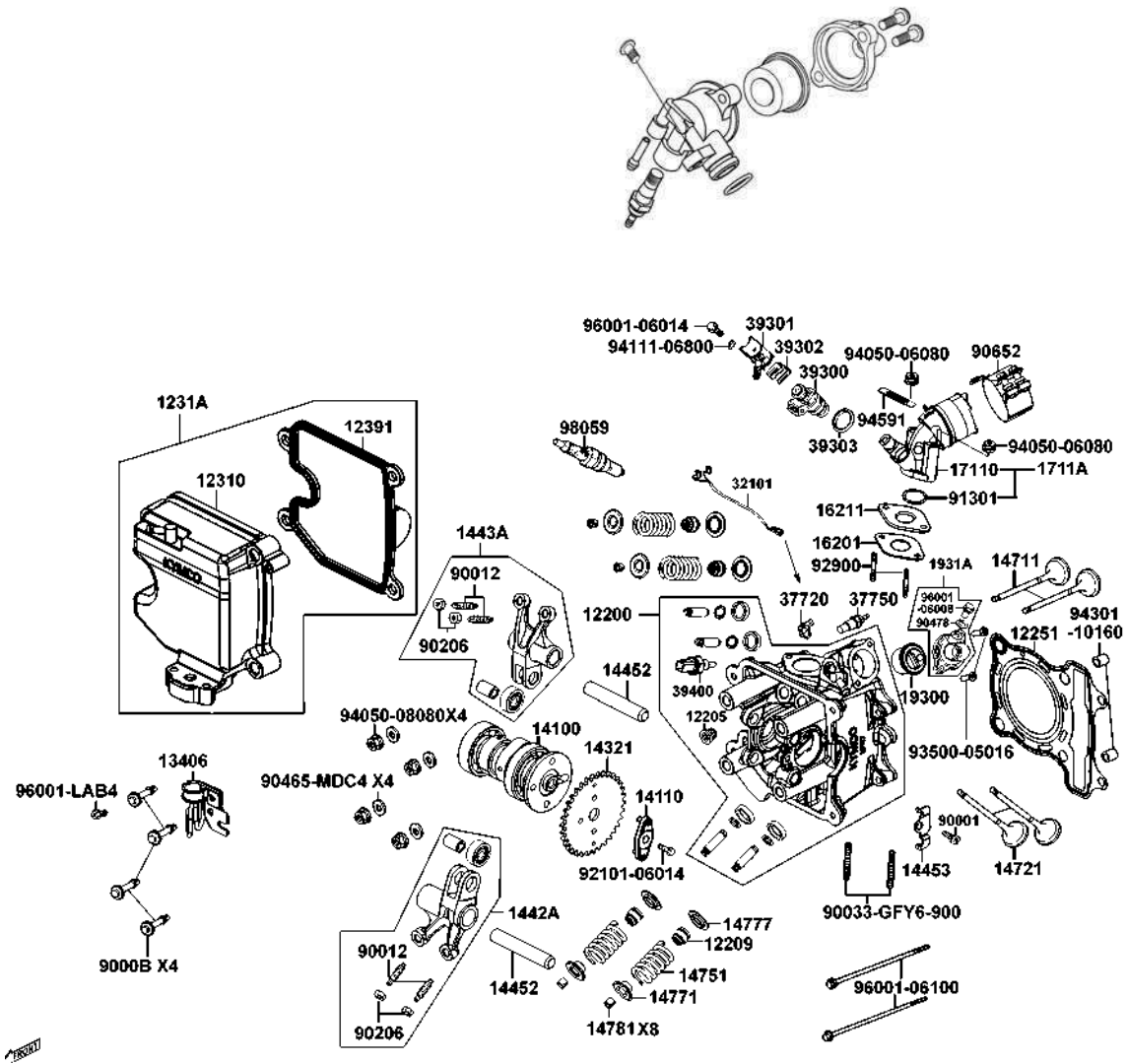

## 6. CYLINDER HEAD/VALVES

### SERVICE INFORMATION

#### GENERAL INSTRUCTIONS

- The cylinder head can be serviced with the engine installed in the frame. Coolant in the radiator and water jacket must be drained first.
- When assembling, apply molybdenum disulfide grease or engine oil to the valve guide movable parts and valve arm sliding surfaces for initial lubrication.
- The valve rocker arms are lubricated by engine oil through the cylinder head engine oil passages. Clean and unclog the oil passages before assembling the cylinder head.
- After disassembly, clean the removed parts and dry them with compressed air before inspection.
- After removal, mark and arrange the removed parts in order. When assembling, install them in the reverse order of removal.

#### SPECIFICATIONS

Item		Standard (mm)
Valve clearance (cold)	IN	0.1
	EX	0.1
Cylinder head compression pressure		15kg-cm <sup>2</sup>
Cylinder head warpage		—
Camshaft cam height	IN	25.965
	EX	25.810
Valve rocker arm I.D.	IN	10.0~10.015
	EX	10.0~10.015
Valve rocker arm shaft O.D.	IN	9.972~9.987
	EX	9.972~9.987
Valve stem O.D.	IN	4.975~4.970
	EX	4.975~4.970
Valve guide I.D.	IN	5.0~5.012
	EX	5.0~5.012
Valve stem-to-guide clearance	IN	0.010~0.037
	EX	0.030~0.057

#### TORQUE VALUES

Cylinder head cover bolt	0.8~0.9 kgf-m
Tensioner mounting bolt	0.9 kgf-m
Tensioner sealing bolt	0.9 kgf-m
Cylinder head cap nut	2.0 kgf-m
Cylinder head bolt	0.7~1.1~ kgf-m

#### SPECIAL TOOLS

Valve spring compressor	A120E00040
-------------------------	------------

## 6. CYLINDER HEAD/VALVES

### TROUBLESHOOTING

- The poor cylinder head operation can be diagnosed by a compression test or by tracing engine top-end noises.

#### **Poor performance at idle speed**

- Compression too low

#### **Compression too low**

- Incorrect valve clearance adjustment
- Burned or bent valves
- Incorrect valve timing
- Broken valve spring
- Poor valve and seat contact
- Leaking cylinder head gasket
- Warped or cracked cylinder head
- Poorly installed spark plug

#### **Compression too high**

- Excessive carbon build-up in combustion chamber

#### **White smoke from exhaust muffler**

- Worn valve stem or valve guide
- Damaged valve stem oil seal

#### **Abnormal noise**

- Incorrect valve clearance adjustment
- Sticking valve or broken valve spring
- Damaged or worn camshaft
- Worn cam chain tensioner
- Worn camshaft and rocker arm

## 6. CYLINDER HEAD/VALVES

### CYLINDER HEAD COVER

#### REMOVAL

Remove the four bolts, then remove the cylinder head cover.



#### INSTALLATION

Install a new cylinder head cover O-ring and install the cylinder head cover.

\* Be sure to install the O-ring into the groove properly.

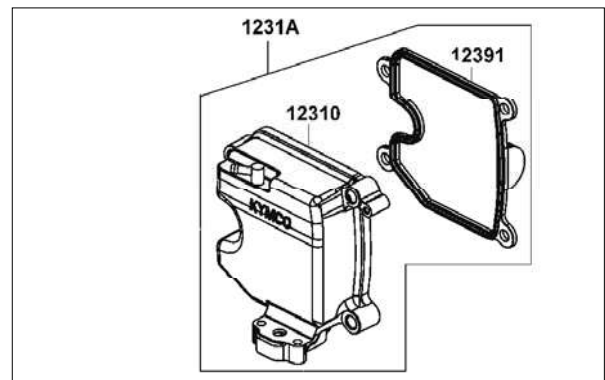

Install and tighten the cylinder head cover bolts to the specified torque in a crisscross pattern.

**Torque:** 0.8~0.9kgf-m



## 6. CYLINDER HEAD/VALVES

### CAMSHAFT HOLDER

#### REMOVAL

Turn the A.C. Generator Flywheel so that the T mark on the flywheel aligns with the index mark on the crankcase.

Hold the round hole on the camshaft gear facing up and location is the top dead center on the compression stroke.

Remove the two bolts attaching the tensioner  
 Remove the four cap nuts and cylinder two bolts washers from camshaft holder and cylinder two bolts then remove the cam shaft Bolt.



Remove the camshaft gear and holder Bolt.



#### INSTALLATION

Install the camshaft gear, Holder bolt and holder washers and nuts.  
 Tighten the four cylinder head nuts to the specified torque.

#### Torque:

- 0.7~1.1 kgf-m (Holder nuts)
- 1.0~1.4 kgf-m (Cam shaft set plate)
- 1.8~2.2 kgf-m (Cylinder head M8 \*1.25)



- \* 
 • Install the camshaft holder with the “EX” mark face exhaust valve side.  
 • Apply engine oil to the threads of the cylinder head cap nuts.  
 • Diagonally tighten the cylinder head cap nuts in 2~3 times.

## 6. CYLINDER HEAD/VALVES

### DISASSEMBLY

Take out the valve rocker arm shafts.  
Remove the valve rocker arms.



Rocker Arm Shafts

### INSPECTION

Inspect the camshaft holder, valve rocker arms and rocker arm shafts for wear or damage.

\* If the valve rocker arm contact surface is worn, check each cam lobe for wear or damage.

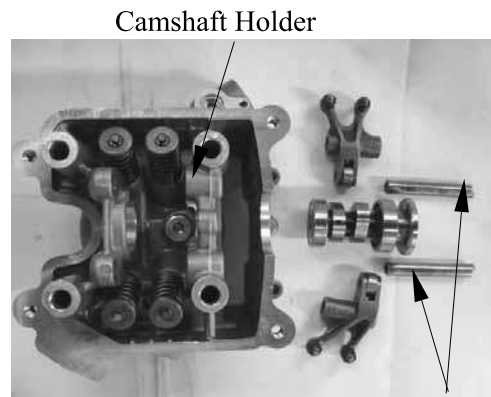

Camshaft Holder

Rocker Arm Shafts

Inspect the rocker arm bore, cam lobe contact surface and adjuster surface for wear/pitting/scratches/blue discoloration.

If any defects are found, replace the rocker arm shaft with a new one, then inspect lubrication system.

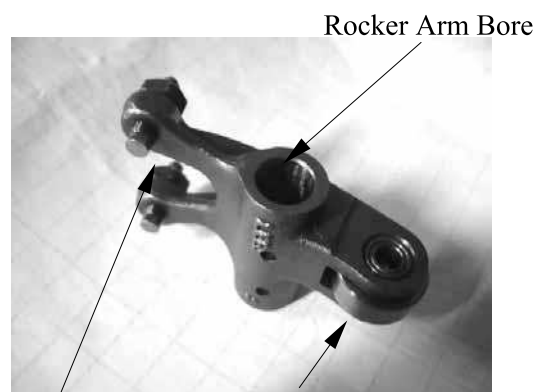

Adjuster Surface

Contact Surface

Rocker Arm Bore

## 6. CYLINDER HEAD/VALVES

Measure the I.D. of each valve rocker arm.

**Service Limits:**

IN: 10.1 mm

EX: 10.1 mm

Measure each rocker arm shaft O.D.

**Service Limits:**

IN: 9.9 mm

EX: 9.9 mm

Measure arm to shaft clearance.

Replace as a set if out of specification.

**Service limits:** 0.1 mm

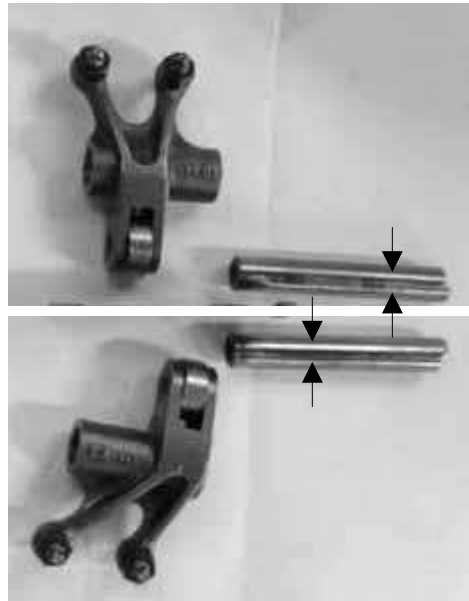

### ASSEMBLY

Apply engine oil to the rocker arms and rocker arm shafts.

Install the rocker arms and shafts into the camshaft holder.

- \*
- Install the exhaust valve rocker arm shaft on the “EX” side of the camshaft holder and the exhaust rocker arm shaft is shorter.
  - Clean the intake valve rocker arm shaft off any grease before installation.
  - Align the cutout on the exhaust valve rocker arm shaft with the bolt of the camshaft holder.

Rocker Arm Shafts

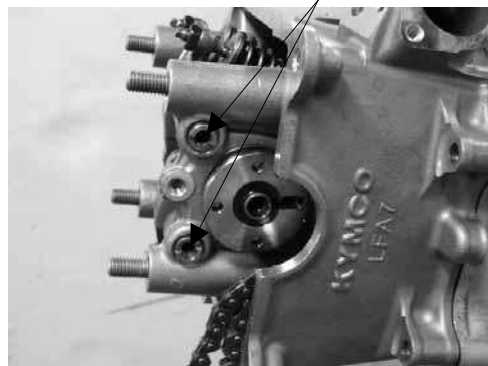



## 6. CYLINDER HEAD/VALVES

### CAMSHAFT

#### REMOVAL

Turn the A.C. Generator Flywheel so that the “T” mark on the flywheel aligns with the index mark on the crankcase.

Hold the round hole on the camshaft gear facing up and the location is the top dead center on the compression stroke.

Remove the tensioner sealing bolt and spring. Remove the two bolts from cam chain tensioner and then remove the tensioner and gasket.

Remove the camshaft holder (refer to the “**Camshaft Holder**” section in this chapter).

Remove the camshaft gear and holder bolt.

Remove the camshaft from the cam chain.

Tensioner Sealing Bolt

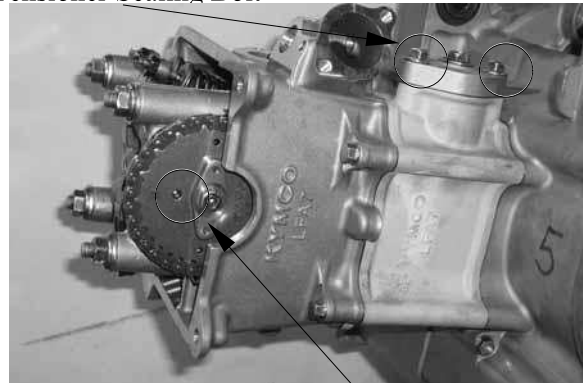

Round Hole

Camshaft

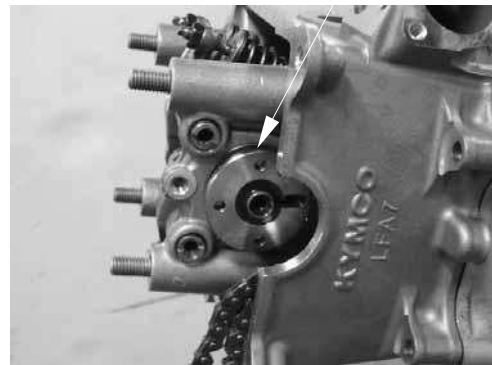

## 6. CYLINDER HEAD/VALVES

### INSPECTION

#### CAMSHAFT

Inspect camshaft lobes for pitting/scratches/blue discoloration.

Measure the cam lobe height.

#### Service Limits:

DT 125: IN : 25.57 mm

EX: 25.41 mm

If any defects are found, replace the camshaft with a new one, then inspect lubrication system.

Check each camshaft bearing for play or damage. Replace the camshaft assembly with a new one if the bearings are noisy or have excessive play.



Camshaft Bearings



## 6. CYLINDER HEAD/VALVES

### INSTALLATION

Turn the A.C. Generator Flywheel so that the “T” mark on the flywheel aligns with the index mark on the crankcase.

Keep the round hole on the camshaft gear facing up and align the punch marks on the camshaft gear with the cylinder head surface (Position the intake and exhaust cam lobes down.) and install the cam chain over the camshaft gear.

Punch Marks

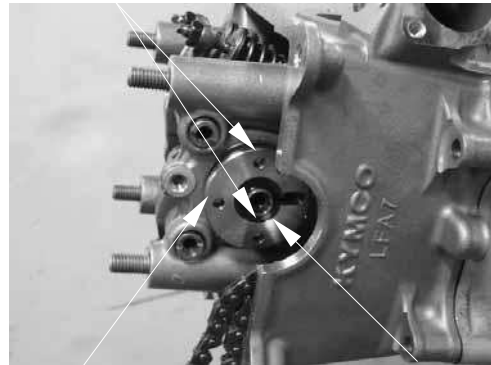

Round Hole

Cam shaft

Install the rocker arms shafts bolt .

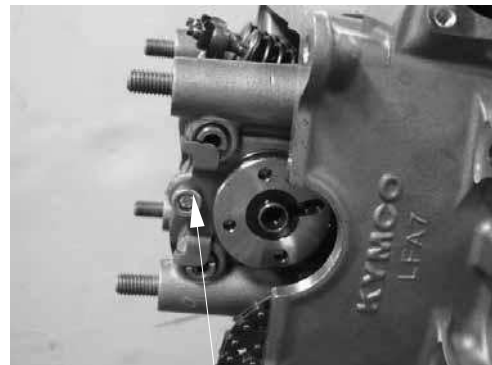

Bolt

Install the camshaft gear

Camshaft Gear



# 6. CYLINDER HEAD/VALVES

People GT 125i

## DISASSEMBLY

Remove the valve spring cotters, retainers, springs, spring seats, oil seals and valves using a valve spring compressor.

- \*
- Be sure to compress the valve springs with a valve spring compressor.
  - Mark all disassembled parts to ensure correct reassembly.

### Special tool:

Valve Spring Compressor A120E00040

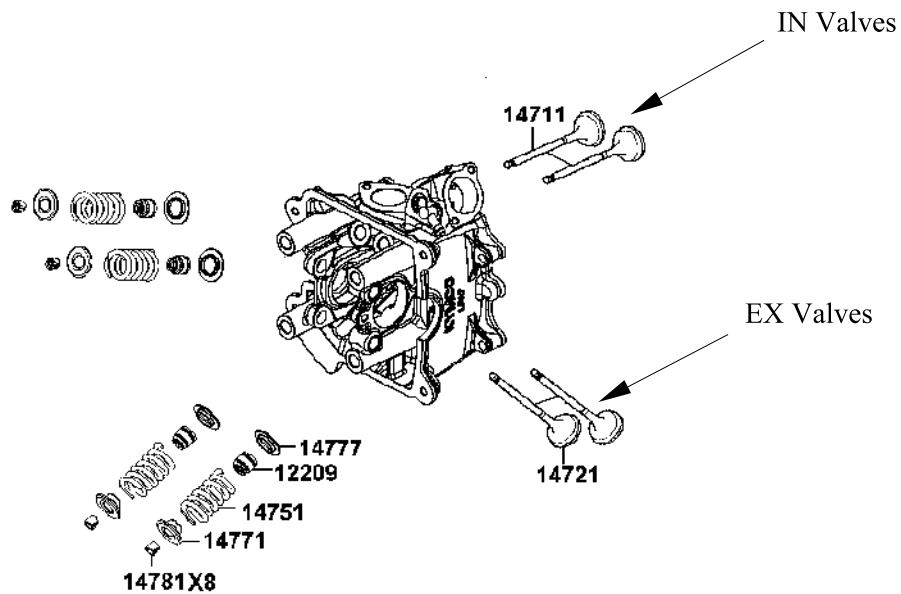
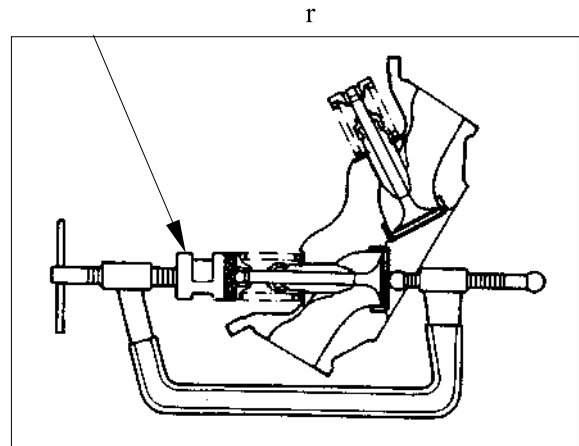

## 6. CYLINDER HEAD/VALVES

### INSPECTION

Remove carbon deposits from the exhaust port and combustion chamber.

- \* Be careful not to damage the cylinder head mating surface.

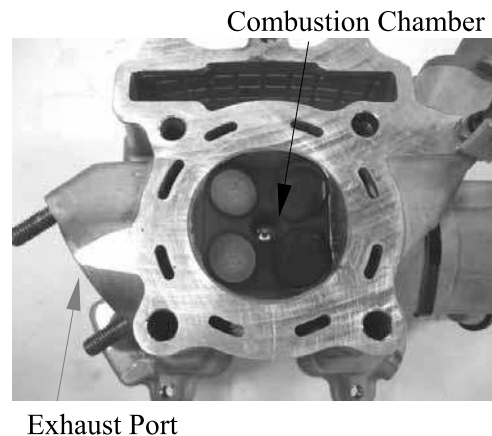

### VALVE /VALVE GUIDE

Inspect each valve for bending, burning, scratches or abnormal stem wear. If any defects are found, replace the valve with a new one.

Check valve movement in the guide.

Measure each valve stem O.D.

Measure each valve guide I.D.

Subtract each valve stem O.D. from the corresponding guide I.D. to obtain the stem-to-guide clearance.

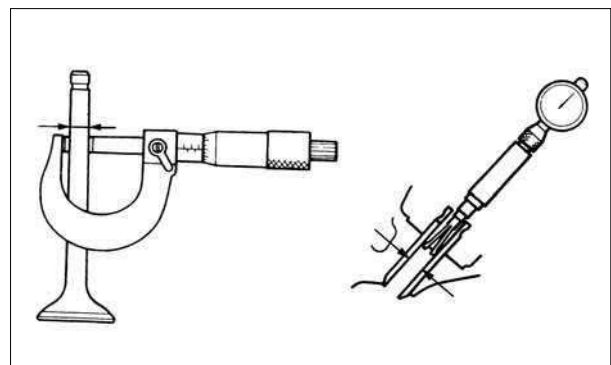

- \* If the stem-to-guide clearance exceeds the service limits, replace the cylinder head is necessary.

### Valve spring

Measure the free length of the inner and outer valve springs.

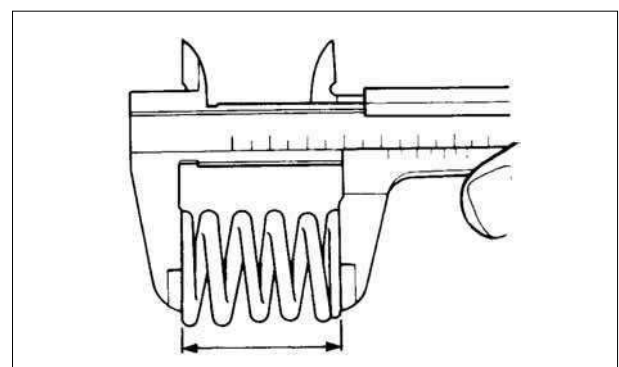

## 6. CYLINDER HEAD/VALVES

### CYLINDER HEAD

Check the spark plug hole and valve areas for cracks.

Check the cylinder head for warpage with a straight edge and feeler gauge.

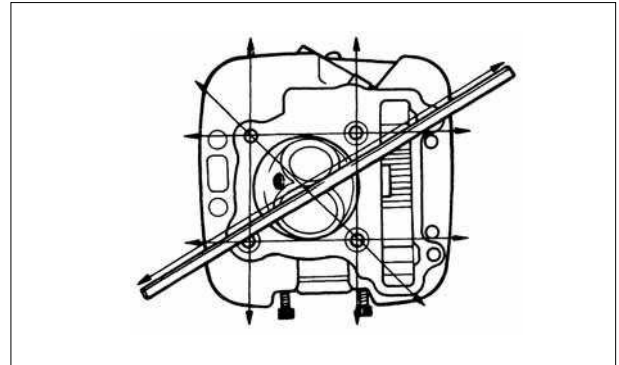

### ASSEMBLY

Install the valve spring seats and oil seal.

\* Be sure to install new oil seal.

Lubricate each valve with engine oil and insert the valves into the valve guides.

Install the valve springs and retainers.

Compress the valve springs using the valve spring compressor, then install the valve cotters.

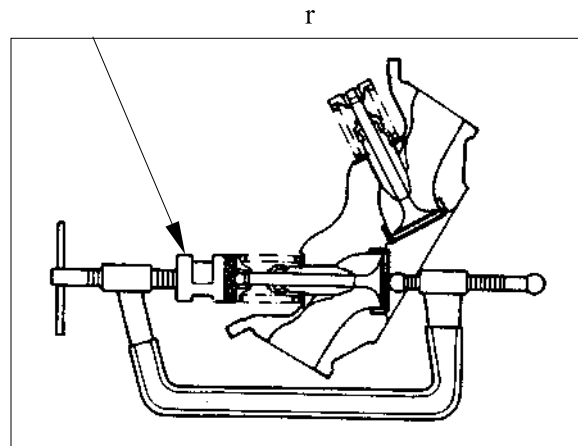

\* •When assembling, a valve spring compressor must be used.  
•Install the cotters with the pointed ends facing down from the upper side of the cylinder head.

### Special tool:

Valve Spring Compressor A120E00040

Tap the valve stems gently with a plastic hammer for 2~3 times to firmly seat the cotters.

\* Be careful not to damage the valves.



Cylinder Head

# 7. CYLINDER/PISTON

---



## CYLINDER/PISTON

---

SCHEMATIC DRAWING -----	7-1
SERVICE INFORMATION-----	7-2
TROUBLESHOOTING-----	7-3
CYLINDER AND PISTON -----	7-4



# 7. CYLINDER/PISTON

## SCHEMATIC DRAWING

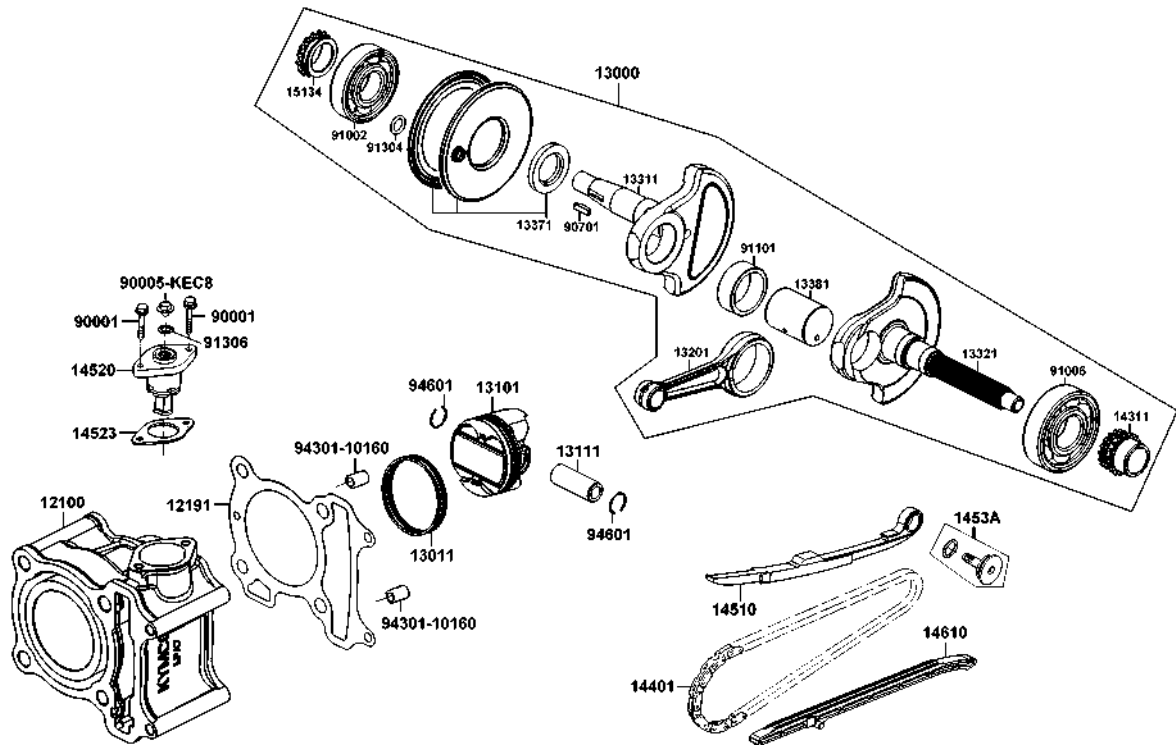



## 7. CYLINDER/PISTON

### SERVICE INFORMATION

#### GENERAL INSTRUCTIONS

- The cylinder and piston can be serviced with the engine installed in the frame.
- When installing the cylinder, use a new cylinder gasket and make sure that the dowel pins are correctly installed.
- After disassembly, clean the removed parts and dry them with compressed air before inspection.

#### SPECIFICATIONS

Item		Standard (mm)	
Cylinder	I.D.	52.4~52.41	
Piston, piston ring	Ring-to-groove clearance	Top	0.015~0.055
		Second	0.015~0.055
	Ring end gap	Top	0.10~0.25
		Second	0.10~0.25
		Oil side rail	0.2~0.7
	Piston O.D.		52.37~52.39
	Piston O.D. measuring position		9 mm from bottom of skirt
	Piston-to-cylinder clearance		0.01~0.04
	Piston pin hole I.D.		15.002~15.008
Piston pin O.D		14.994~15	
Piston-to-piston pin clearance		0.002~0.014	
Connecting rod small end I.D. bore		15.016~15.034	

## 7. CYLINDER/PISTON

### TROUBLESHOOTING

When hard starting or poor performance at low speed occurs, check the crankcase breather for white smoke. If white smoke is found, it means that the piston rings are worn, stuck or broken.

#### **Compression too low or uneven compression**

- Worn or damaged cylinder and piston rings
- Worn, stuck or broken piston rings

#### **Compression too high**

- Excessive carbon build-up in combustion chamber or on piston head

#### **Excessive smoke from exhaust muffler**

- Worn or damaged piston rings
- Worn or damaged cylinder and piston

#### **Abnormal noisy piston**

- Worn cylinder, piston and piston rings
- Worn piston pin hole and piston pin
- Incorrectly installed piston

## 7. CYLINDER/PISTON

### CYLINDER AND PISTON

#### REMOVAL

Remove the cylinder head (Refer to “Cylinder Head” section in the chapter 6).

Remove the water hose from the cylinder.  
Remove the cylinder.

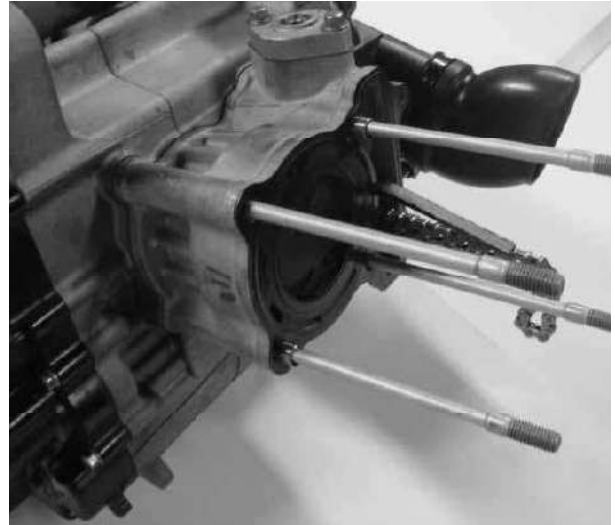

Remove the cylinder gasket and dowel pins.  
Clean any gasket material from the cylinder surface.



Remove the piston pin clip

\* Place a clean shop towel in the crankcase to keep the piston pin clip from falling into the crankcase.

Press the piston pin out of the piston and then remove the piston.



## 7. CYLINDER/PISTON

Spread each piston ring and remove it by lifting up at a point opposite the gap

\* Do not damage the piston ring by spreading the ends too far.

Clean carbon deposits from the piston ring grooves.

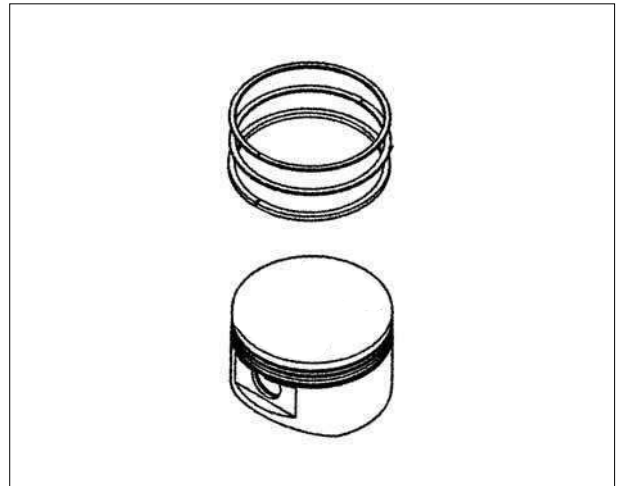

### INSPECTION PISTON RING

Inspect the piston rings for movement by rotating the rings. The rings should be able to move in their grooves without catching.

Push the ring until the outer surface of the piston ring is nearly flush with the piston and measure the ring-to-groove clearance.

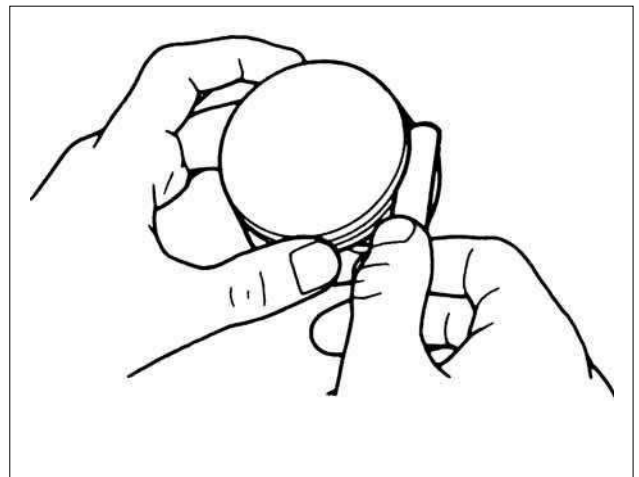

Insert each piston ring into the bottom of the cylinder squarely.

\* Use the piston head to push each piston ring into the cylinder.

Measure the piston ring end gap.

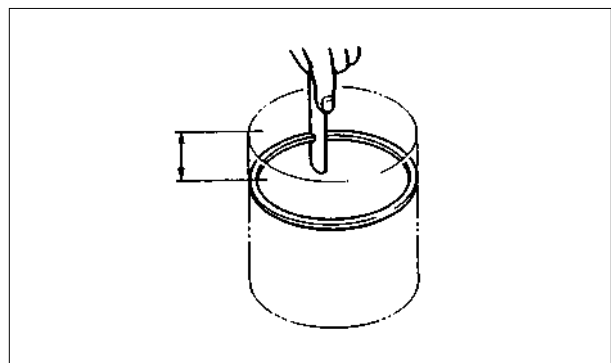

## 7. CYLINDER/PISTON

### PISTON/PISTON PIN

Measure the piston O.D. at the point (A) from the bottom and 90° to the piston pin hole.

Calculate the cylinder-to-piston clearance.

**Standard: 52.37~52.39 mm**

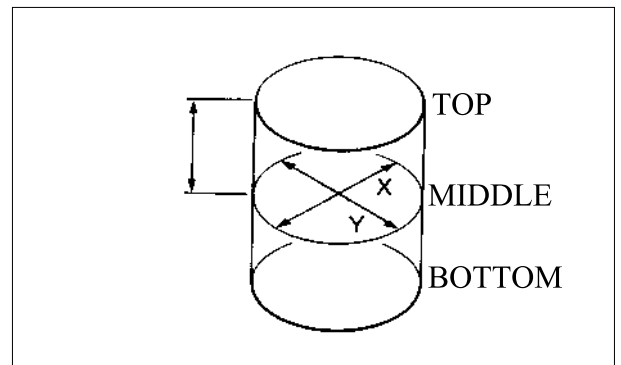

### CYLINDER

Check the cylinder for warpage with a straight edge and feeler gauge in the directions shown.

Check the cylinder wall for wear or damage. Measure and record the cylinder I.D. at three levels in an X and Y axis. Take the maximum reading to determine the cylinder wear.

Calculate the piston-to-cylinder clearance. Take a maximum reading to determine the clearance.

Calculate the taper and out-of-round at three levels in an X and Y axis. Take the maximum reading to determine them.

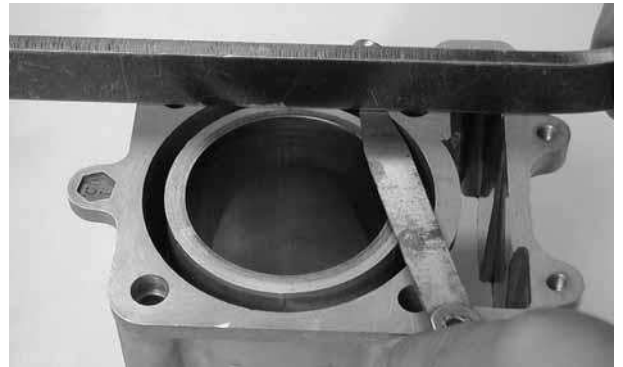

### CONNECTING ROD

Measure the connecting rod small end I.D. Calculate the connecting rod-to-piston pin clearance.

**Service Limit: 0.02 mm (0.0008 in)**



## 7. CYLINDER/PISTON

Inspect the exhaust side and intake side chain guides.

Wear/Damage → Replace.

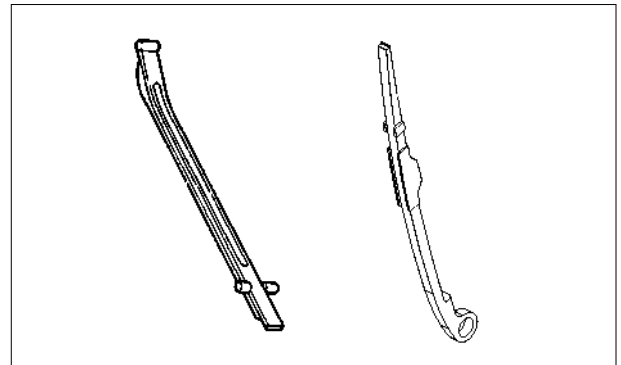

### INSTALLATION PISTON RING

Carefully install the piston rings into the piston ring grooves with the markings facing up.

\* Be careful not to damage the piston and rings.

- ♦ Do not confuse the top and second rings.
- ♦ To install the oil ring, install the oil ring and then install the side rails.

Stagger the piston ring end gaps 120° degrees apart from each other.

Stagger the side rail end gaps as shown.

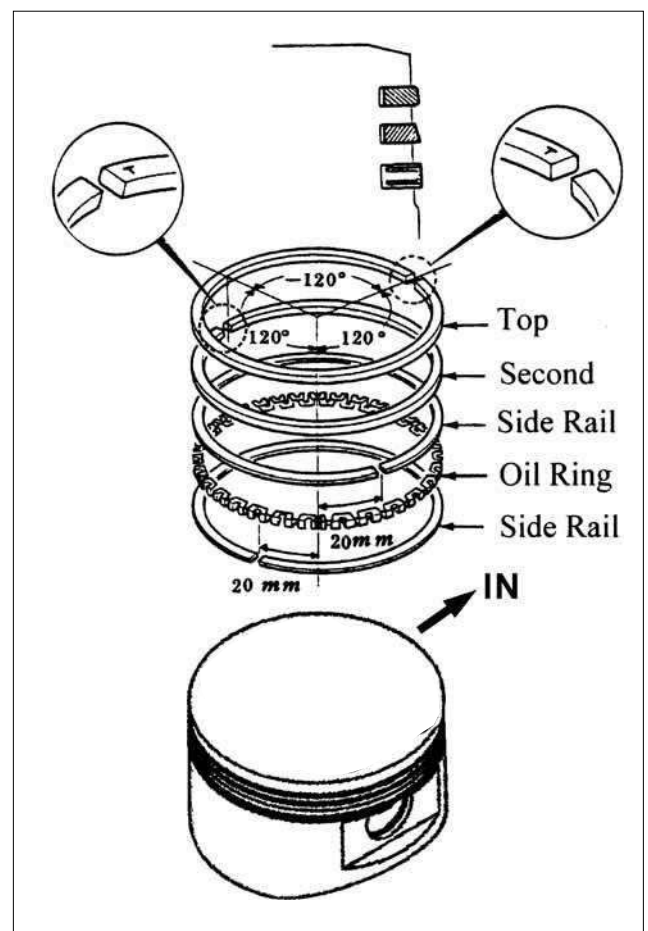

## 7. CYLINDER/PISTON

### CYLINDER/PISTON

Clean any gasket material from the cylinder mating surfaces of the crankcase and oil passage.

Apply engine oil to the piston pin.

Apply engine oil to the connecting rod small end and piston pin's hole.

Install the piston with the "IN" mark face intake side and piston pin.



Place a clean shop towel over the crankcase prevent the clip from falling into the crankcase.

Install the new pin clip.

- \* ♦Make sure that the piston pin clips are seated securely.
- ♦Do not align the piston pin clip end gap with the piston cut-out



Install the dowel pins and gasket.



## 7. CYLINDER/PISTON

---

Apply engine oil to the cylinder wall, piston and piston ring outer surfaces.

Pass the cam chain through the cylinder and install the cylinder over the piston.

\* Be careful not to damage the piston rings and cylinder walls.

Install the cylinder head and camshaft holder has installed (refer to the “**Cylinder Head**” section in the chapter 6).

Connect the water hose.

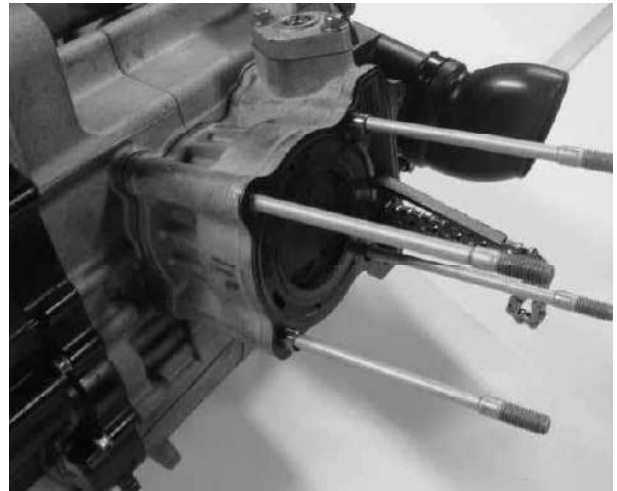



---

---

---

---

---

---

---

**DRIVE AND DRIVEN PULLEYS**

---

SCHEMATIC DRAWING -----	8- 1
SERVICE INFORMATION-----	8- 2
TROUBLESHOOTING-----	8- 3
LEFT CRANKCASE COVER -----	8- 4
DRIVE PULLEY, DRIVE BELT AND DRIVEN PULLEY -----	8- 5



# 8. DRIVE AND DRIVEN PULLEYS/ KICK STARTER



People GT 125i

## SCHEMATIC DRAWING

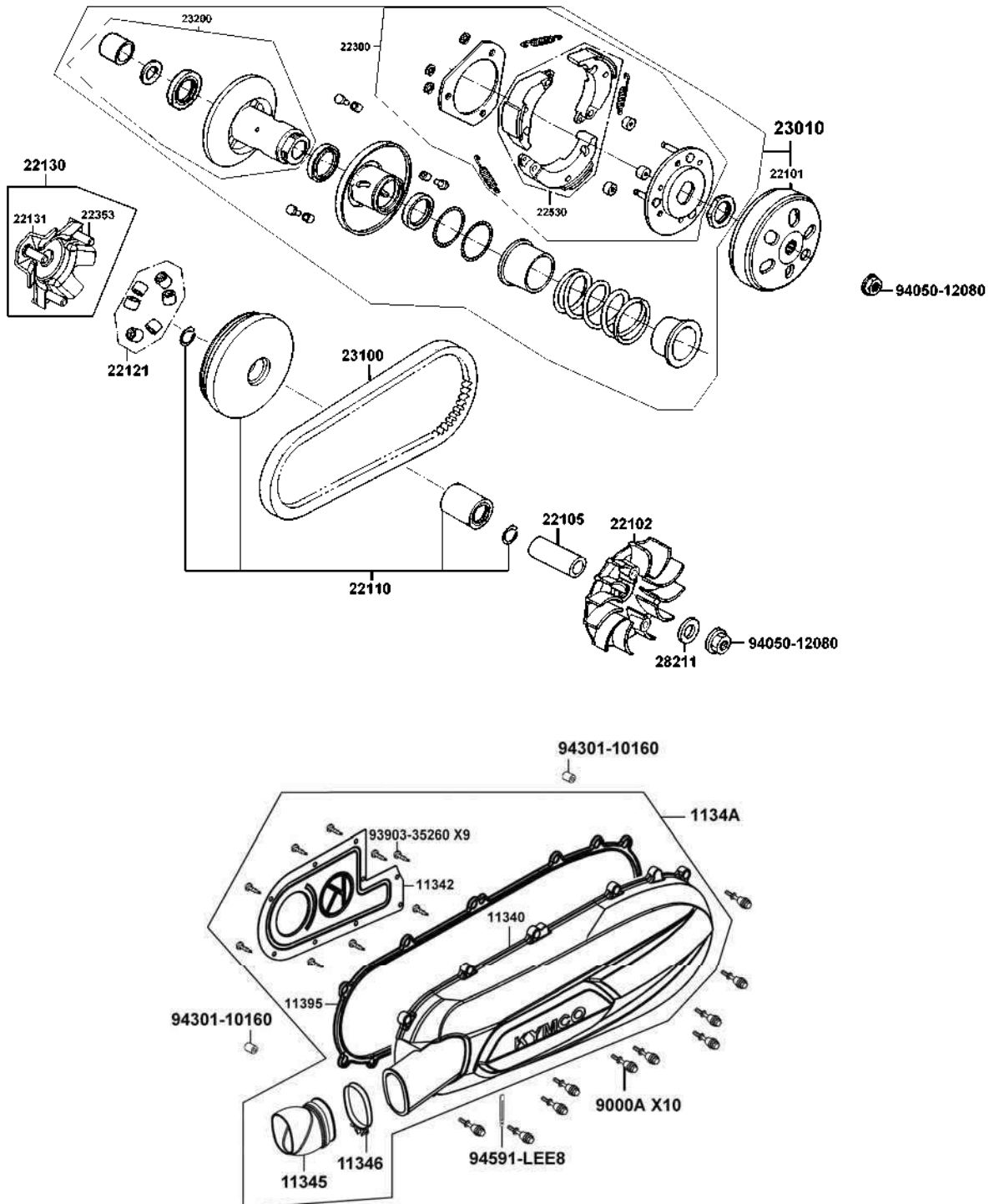

## 8. DRIVE AND DRIVEN PULLEYS/ KICK STARTER

### SERVICE INFORMATION

#### GENERAL INSTRUCTIONS

- The drive pulley, clutch and driven pulley can be serviced with the engine installed.
- Avoid getting grease and oil on the drive belt and pulley faces. Remove any oil or grease from them to minimize the slipping of drive belt and drive pulley.

#### SPECIFICATIONS

Item	Standard (mm)
Movable drive face bushing I.D.	24.011~24.052
Drive face collar O.D.	23.960~23.974
Clutch lining thickness	4.0 mm
Clutch outer I.D.	130~130.2
Driven face O.D.	33.965~33.985
Movable driven face I.D.	34~34.025
Weight roller O.D.	17.920~18.080

#### TORQUE VALUES

Drive face nut	5.5~6.5 kgf-m
Clutch outer nut	5.0~6.0 kgf-m
Clutch plate comp	5.0~6.0 kgf-m

#### SPECIAL TOOLS

Universal holder	A120E00017
Clutch spring compressor	A120E00034

## 8. DRIVE AND DRIVEN PULLEYS/ KICK STARTER

---



People GT 125i

### TROUBLESHOOTING

#### **Engine starts but motorcycle won't move**

- Worn drive belt
- Broken ramp plate
- Worn or damaged clutch lining
- Broken driven face spring

#### **Engine stalls or motorcycle creeps**

- Broken clutch weight spring

#### **Lack of power**

- Worn drive belt
- Weak driven face spring
- Worn weight roller
- Faulty driven face

## 8. DRIVE AND DRIVEN PULLEYS/ KICK STARTER

### LEFT CRANKCASE COVER

#### REMOVAL

Remove the ten left crankcase cover bolts and then remove the left crankcase cover. Remove the gasket and dowel pins.

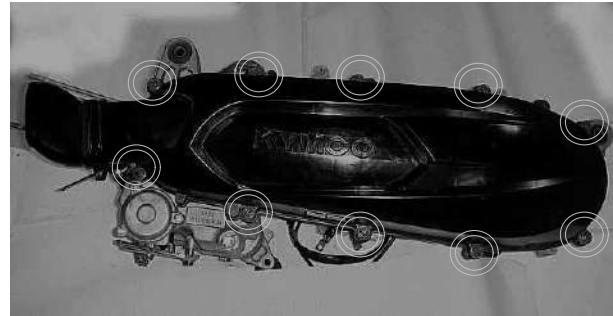

#### INSTALLATION

Install the dowel pins and gasket.

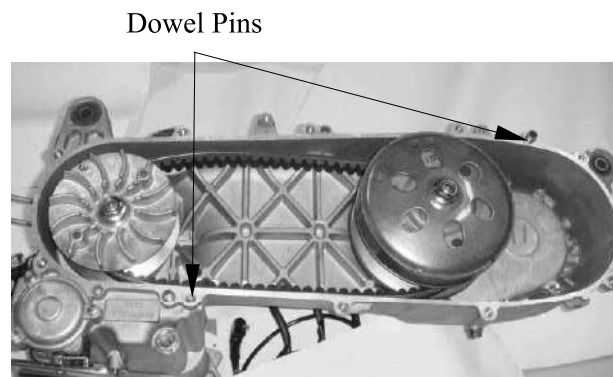

Install the left crankcase cover.

\* Do not pull out the kick starter spindle. Press in the kick starter spindle when installing the left crankcase cover.

Install and tighten the ten bolts diagonally to specified torque.



## 8. DRIVE AND DRIVEN PULLEYS/ KICK STARTER

### DRIVE PULLEY, DRIVE BELT AND DRIVEN PULLEY

#### REMOVAL

Remove the left crankcase cover (Refer to the “Left Crankcase Cover” section in this chapter).

Use the special tool to hold the drive pulley, then remove the nut and ratchet.

Nut/Ratchet

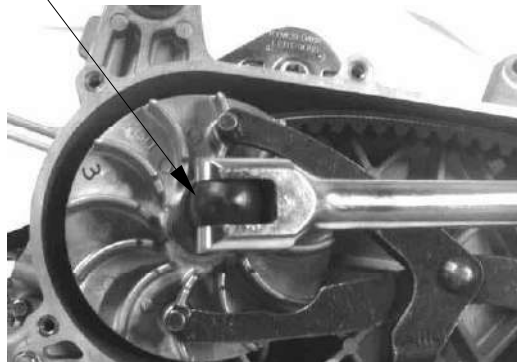

Drive Pulley Face

#### Special tool:

Universal holder                    A120E00017

Remove the drive pulley face and washer.

Hold the clutch outer with the universal holder and remove the clutch outer nut.

#### Special tool:

Universal Holder                    A120E00017

Clutch Outer/Driven Pulley Assembly

Universal Holder

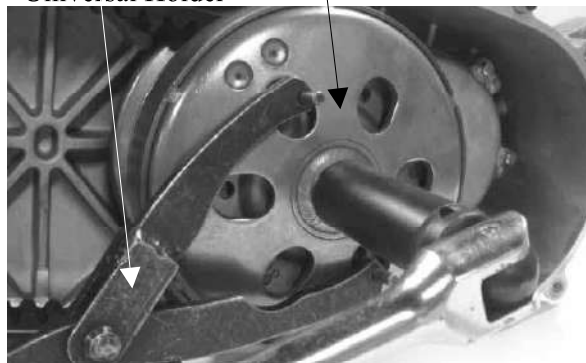

Remove the clutch outer, driven pulley assembly and drive belt together.

## 8. DRIVE AND DRIVEN PULLEYS/ KICK STARTER

Remove the movable drive face assembly.



Movable Drive Face Assembly

### DRIVE BELT INSPECTION

Check the drive belt for cracks, separation or abnormal or excessive wear.  
Measure the drive belt width.

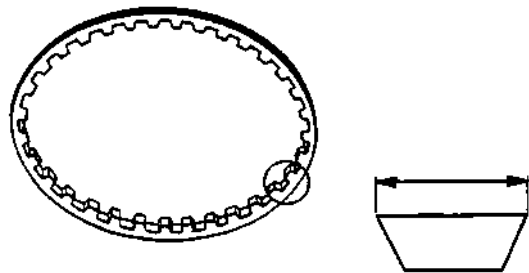

\* Use specified genuine parts for replacement.

### CLUTCH OUT INSPECTION

Inspect the clutch outer for wear or damage.  
Measure the clutch outer I.D.

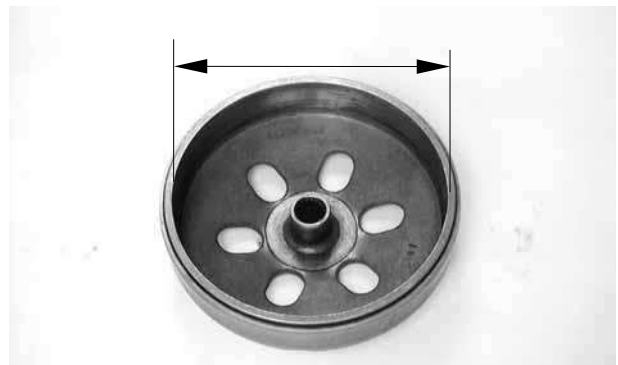

## 8. DRIVE AND DRIVEN PULLEYS/ KICK STARTER

### INSTALLATION

Apply lubricant to the drive face boss inner surface, then install the movable drive face assembly.

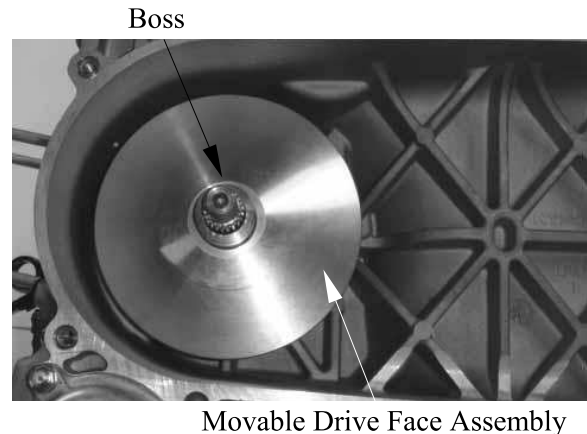

Install the clutch outer onto the driven pulley assembly.

Compress the driven pulley assembly by hand, then install the drive belt into the driven pulley assembly.

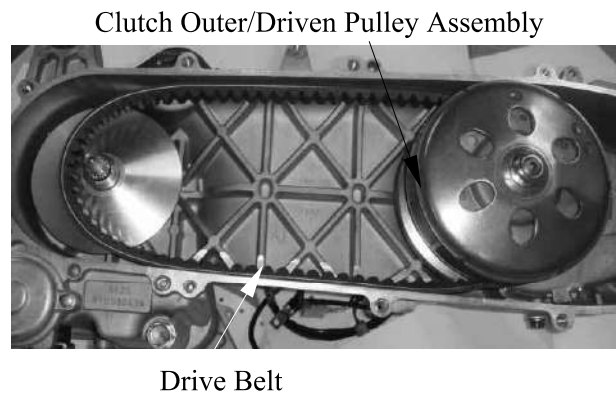

- \* ● The drive belt should be installed so that the arrows on the drive belt periphery point in the normal turning direction if the drive belt has arrow mark.
- The drive belt contact surface of the driven face should be thoroughly cleaned.

Install the driven pulley assembly/clutch outer and drive belt together.

Use the special tool to hold clutch outer, then tighten the nut to the specified torque.

**Torque:** 5.0~6.0kgf-m (50 ~60N-m)

### Special tool:

Universal holder      A120E00017

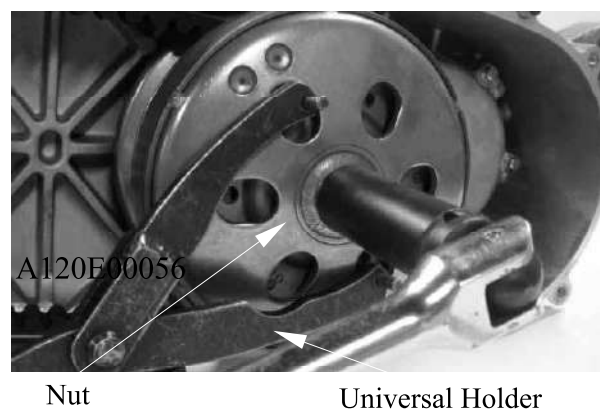



## 8. DRIVE AND DRIVEN PULLEYS/ KICK STARTER

Install the drive pulley face and ratchet.  
Use the special tool to hold drive pulley face,  
then tighten the nut to the specified torque.

**Torque: 5.5~6.5 kgf-m (55~65 N-m)**

**Special tool:**

Universal holder      A120E00017

Nut/Ratchet

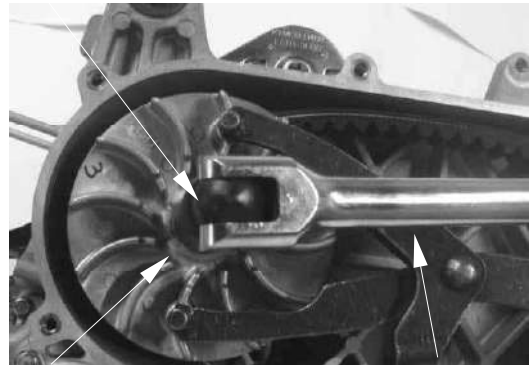

Drive Pulley Face

Universal Holder

## 8. DRIVE AND DRIVEN PULLEYS/ KICK STARTER

---

### DRIVE PULLEY DISASSEMBLY

Remove the drive face boss.



Boss

Ramp Plate

Remove the ramp plate



Remove the six weight rollers.



Weight Roller

## 8. DRIVE AND DRIVEN PULLEYS/ KICK STARTER

### DRIVE PULLEY INSPECTION

#### WEIGHT ROLLERS

Check each roller for wear or damage.  
Measure outside diameter.

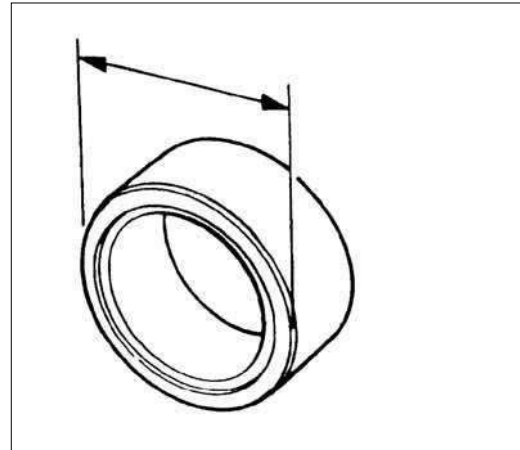

#### MOVABLE DRIVE FACE/SLIDE PIECES/DRIVE PULLEY FACE

Check the movable drive face splines for wear, cracks or damage.

Check the ramp plate for cracks or damage.

Ramp Plate



Check the movable drive face and drive pulley face cracks or damage.

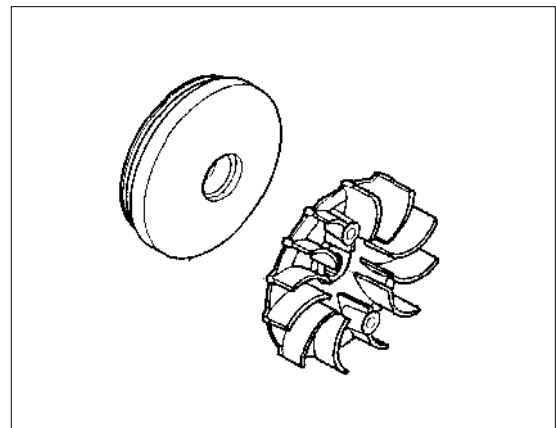

## 8. DRIVE AND DRIVEN PULLEYS/ KICK STARTER

### DRIVE PULLEY ASSEMBLY

Clean the movable drive face, drive pulley face, weight rollers, slide pieces, ramp plate and drive face boss.

- \* Remove any excess grease.



Install the weight rollers.

- \* The direction of all weight rollers is the same. The thin side is towards to clockwise.



Weight Roller

Install the slide pieces and ramp plate.

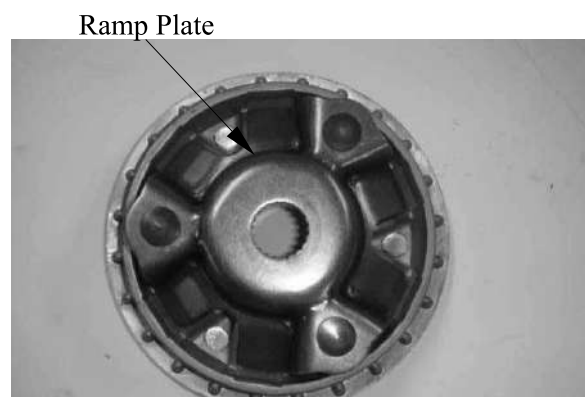

Ramp Plate

## 8. DRIVE AND DRIVEN PULLEYS/ KICK STARTER

---

Install the drive face boss.

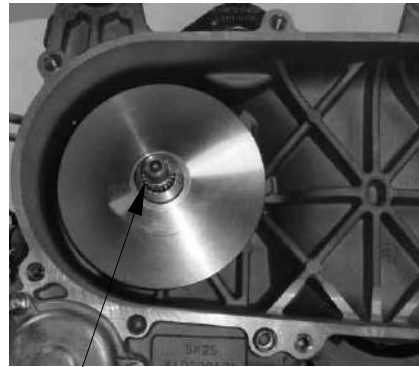

Boss

## 8. DRIVE AND DRIVEN PULLEYS/ KICK STARTER

### DRIVEN PULLEY DISASSEMBLY

Hold the clutch/driven pulley assembly with the clutch spring compressor.

\* Be sure to use a clutch spring compressor to avoid spring damage.

#### Special tool:

Clutch Spring Compressor    A120E00034

Set the tool in a vise and remove the clutch drive plate nut.

Remove the clutch.

Lock Nut Wrench

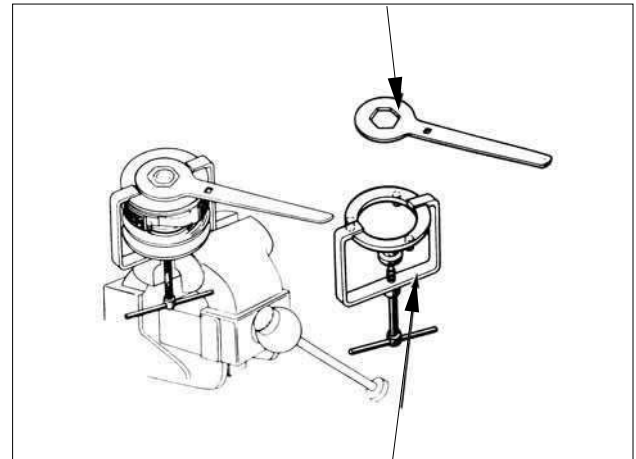

Clutch spring compressor



## 8. DRIVE AND DRIVEN PULLEYS/ KICK STARTER

Remove the spring.

Remove the spring collar on the movable driven face.

Remove the three guide pins/rollers, then remove the movable driven face.

Remove the needle bearing from driven face.

Remove the snap ring, then remove the bearing from driven face.

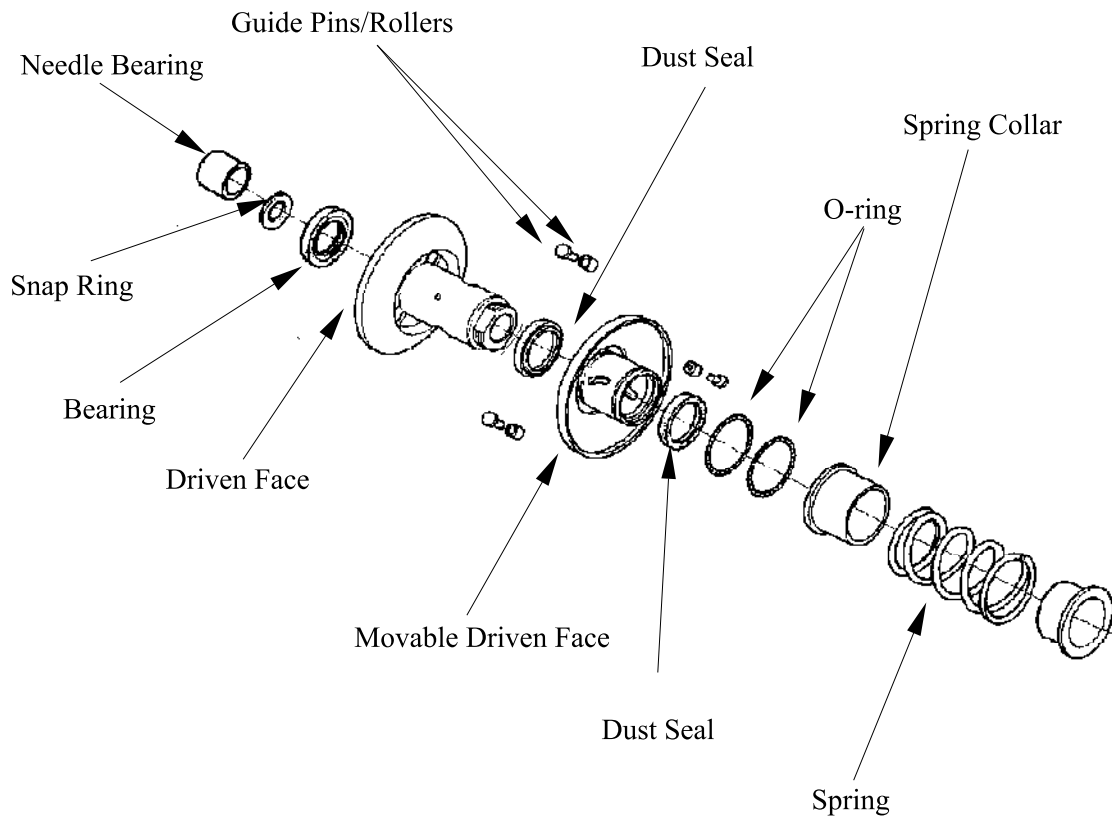

## 8. DRIVE AND DRIVEN PULLEYS/ KICK STARTER

### DRIVEN PULLEY INSPECTION

Check the driven pulley for smooth operation.

If any scratches or damage is found then replace as a set.

Check the torque cam grooves for wear or damage.

Check the guide pins and rollers for wear or damage.

If any scratches or damage is found then replace as a set.

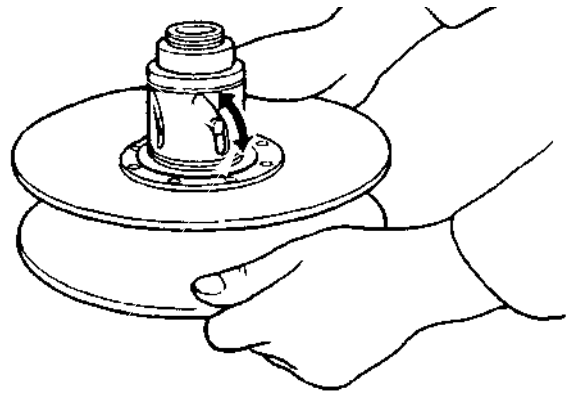

Check the spring for damage.

Measure the spring free length.

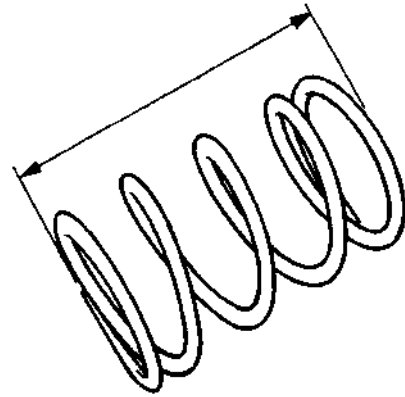

Check the clutch shoe for heat damage.

Measure the clutch shoe thickness.





## 8. DRIVE AND DRIVEN PULLEYS/ KICK STARTER

### DRIVEN PULLEY ASSEMBLY

Clean any oil from the drive belt sliding surfaces on the driven face.

Filling 12 g of grease to driven face inner side.

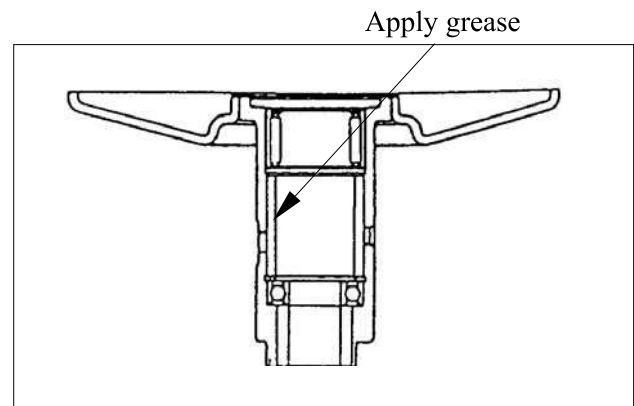

Apply grease to lips of the new dust seals and install into the movable driven face.

Coat new O-rings with grease and install them into the movable driven face grooves.

Install the movable driven face onto the driven face.

Install the guide rollers and guide roller pins.

Filling 5 g of grease to each guide groove.

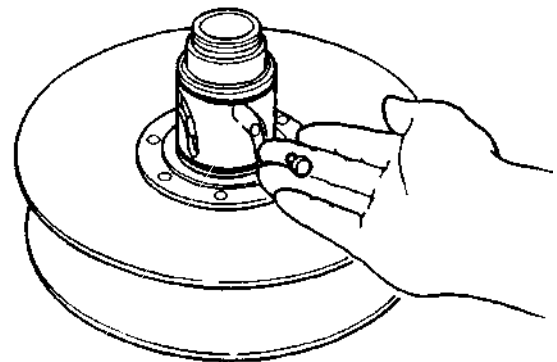

Install the guide pins/rollers.

Install spring collar.

Use the special tool to install spring and clutch, then install and tighten the nut to the specified torque.

**Torque:** 5.5 ~6.5m (55~65N-m)

**Special tool:**

Clutch Spring Compressor A120E00034

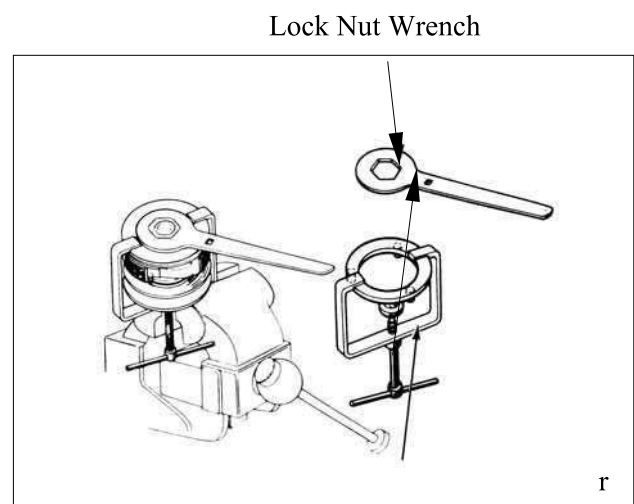

# 9. FINAL REDUCTION

---

---

---

---

---

---

---

## FINAL REDUCTION

---

SCHEMATIC DRAWING -----	9-1
SERVICE INFORMATION-----	9-2
TROUBLESHOOTING-----	9-2
FINAL REDUCTION -----	9-3
BEARING REPLACEMENT -----	9-7



# 9. FINAL REDUCTION

## SCHEMATIC DRAWING

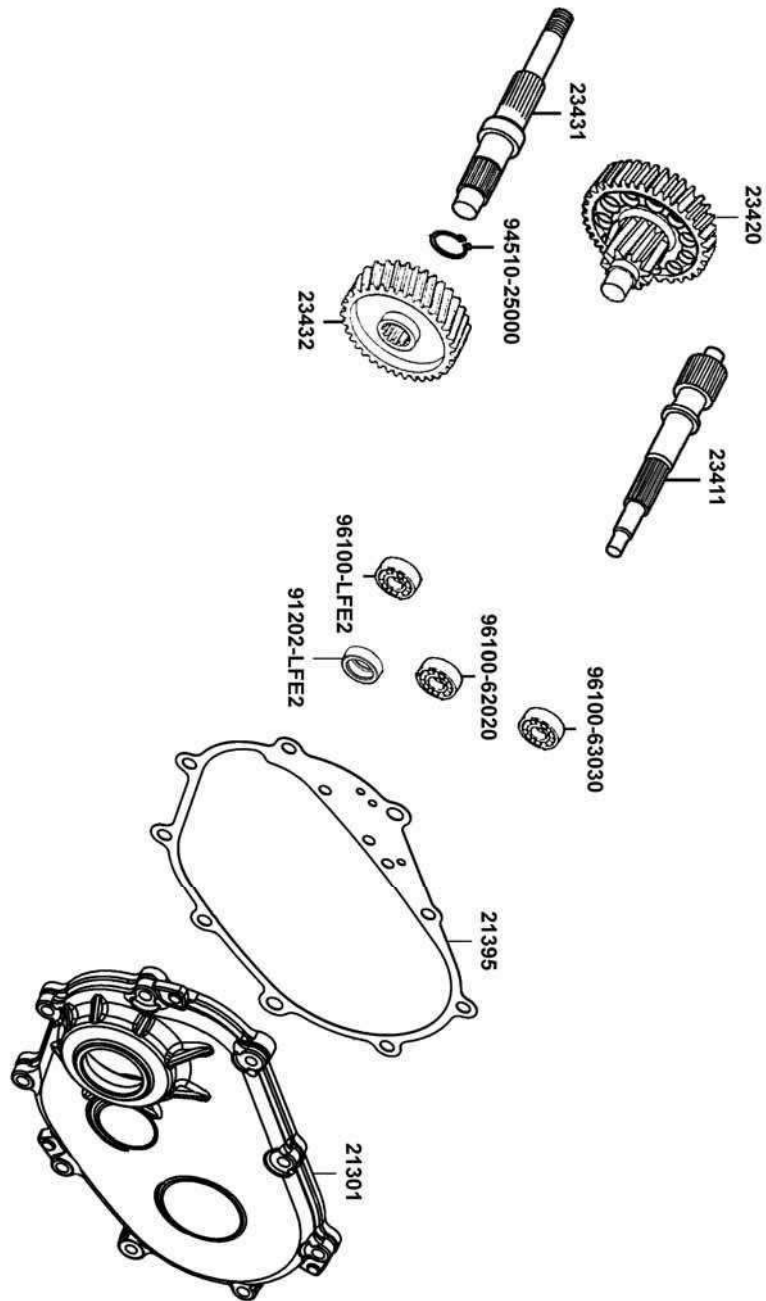

## 9. FINAL REDUCTION

---

### SERVICE INFORMATION

#### GENERAL INSTRUCTIONS

- The servicing operations of this section can be made with the engine installed.
- When replacing the drive shaft, use a special tool to hold the bearing inner race for this operation.

#### SPECIFICATIONS

Specified Oil: SAE 90#

Oil Capacity:

- At disassembly : 0.13liter
- At change : 0.12 liter

#### TORQUE VALUES

Transmission case cover bolt 1.0~1.4kgf-m

#### SPECIAL TOOLS

Oil seal and bearing installer A120E00014  
Bearing Puller A120E00037

### TROUBLESHOOTING

#### Engine starts but motorcycle won't move

- Damaged transmission
- Seized or burnt transmission

#### Abnormal noise

- Worn, seized or chipped gears
- Worn bearing

#### Oil leaks

- Oil level too high
- Worn or damaged oil seal

## 9. FINAL REDUCTION

### FINAL REDUCTION

#### REMOVAL

Drain the transmission gear oil into a clean container (refer to the “**Transmission Oil**” section in the chapter 3).

Remove the driven pulley (refer to the “**Drive Pulley, Drive Belt And Driven Pulley**” section in the chapter 8).

Remove the nine bolts from the transmission case cover, then remove the transmission case cover.

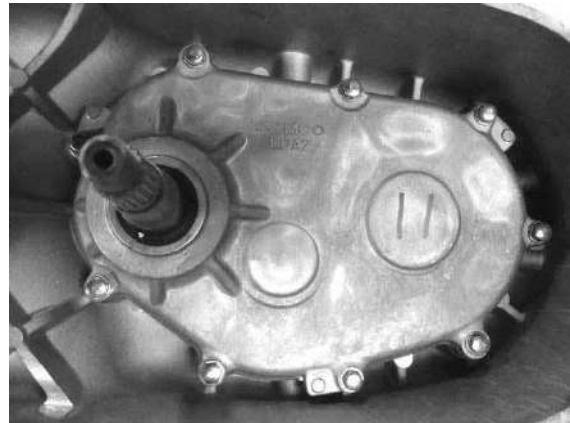

Remove the dowel pins and gasket.  
Remove the final gear and shaft, then remove the countershaft.

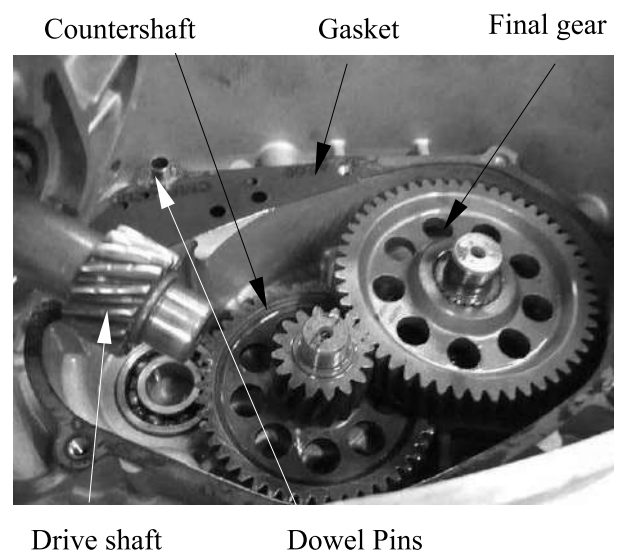

## 9. FINAL REDUCTION

---

### INSPECTION

Inspect the countershaft and gear for wear or damage.



Inspect the final gear and final gear shaft for wear, damage or seizure.



Check the driveshaft for wear or damage.

Check the left crankcase bearings for excessive play and inspect the oil seal for wear or damage.



## 9. FINAL REDUCTION

Check the transmission case cover bearings for excessive play and inspect the final shaft bearing oil seal for wear or damage.

Drive Shaft Bearing

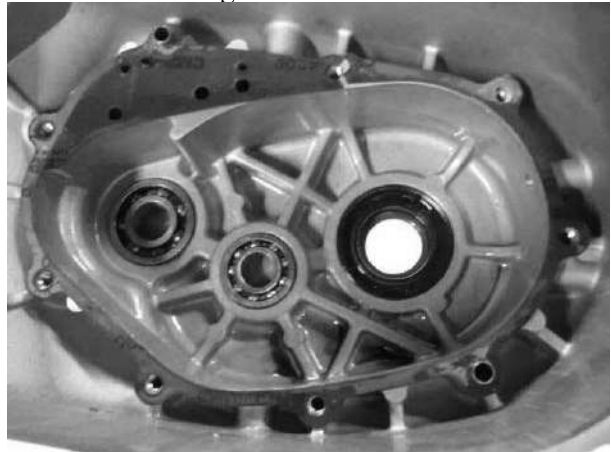

Countershaft Bearing

Final Shaft Bearing

Final Gear Shaft Bearing

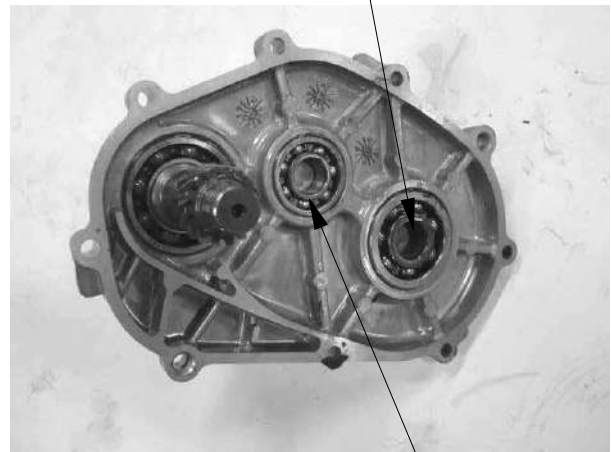

Drive Shaft Bearing

Countershaft Bearing

### INSTALLATION

Install the final gear and final gear shaft.  
 Install the Countershaft  
 Install the driveshaft.

Countershaft

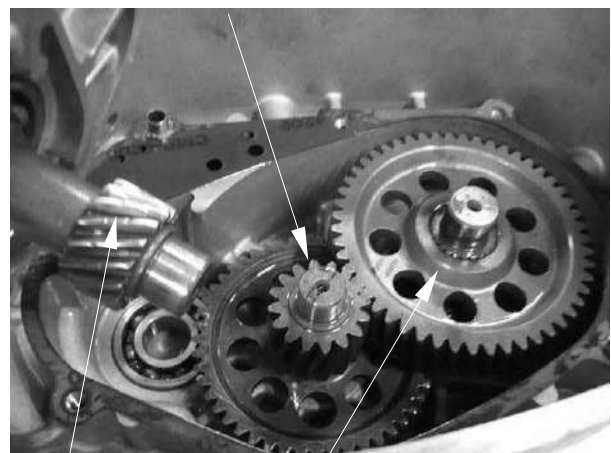

Driveshaft

Final Gear Shaft/Final Gear

## 9. FINAL REDUCTION

Install new gasket.

Install the two dowel pins.

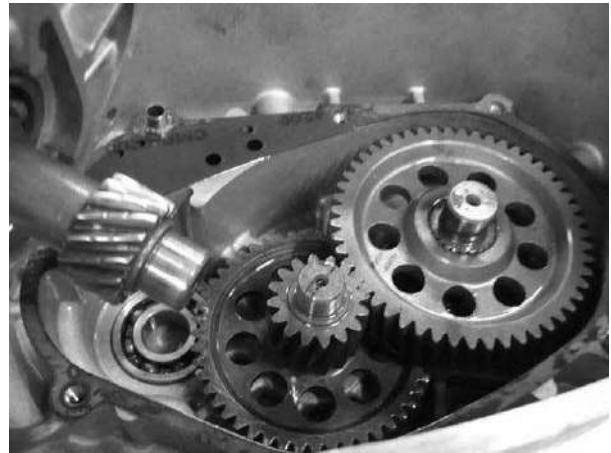

Install the transmission case cover.

Install and tighten the nine bolts to the specified torque in a crisscross pattern in 2 or 3 steps.

**Torque:** 1.0~1.4kgf-m

Fill the transmission case with the specified oil (refer to the “**Transmission Oil**” section in the chapter 3).

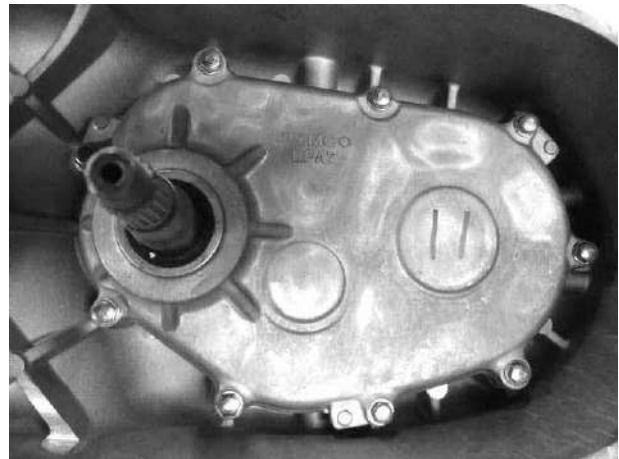



## 9. FINAL REDUCTION

### BEARING REPLACEMENT TRANSMISSION CASE COVER

Remove the transmission case cover  
Remove the transmission case cover  
bearings by using the special tool.

**Special tool:**

Bearing puller A120E00037



Install the new bearings or new oil seal into  
the transmission case cover by using the  
special tool.

**Special tool:**

Oil seal and bearing installer A120E00014



### TRANSMISSION CASE

Remove the all transmission gears (refer to  
the “**Final Reduction Removal/  
Inspection/Installation**” section in this chapter).

Remove the transmission case bearings by  
using the special tool.

**Special tool:**

Bearing puller A120E00037

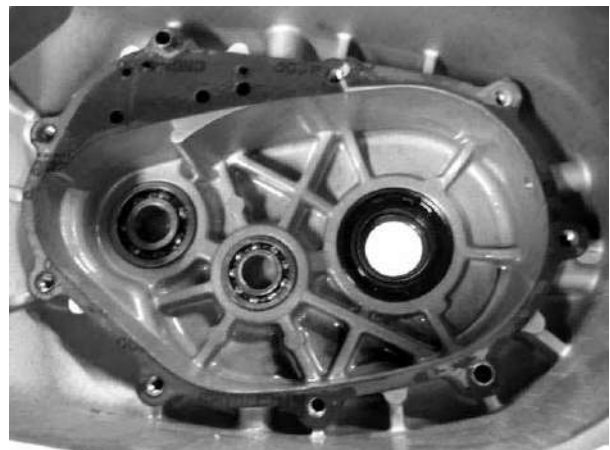

## 9. FINAL REDUCTION

Install the new bearings or new oil seal into the transmission case by using the special tool.

**Special tool:**

Oil seal and bearing installer  
A120E00014

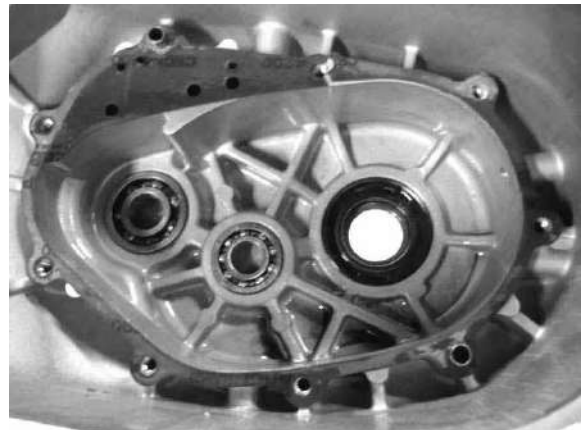

After installation, fill the transmission case with the specified oil.

**Specified gear oil** :SAE90#

**Oil capacity:**

At disassembly: 0.13 liter  
At change: 0,12 liter

Install and tighten the oil check bolt.

Torque : 0.8~1.2kgf-m

Start the engine and check for oil leaks.



Drain Bolt



Oil Filler

# **10. A.C. GENERATOR/STARTER CLUTCH**

---

---

---

---

---

---

---

---

## **A.C. GENERATOR/STARTER CLUTCH**

---

SCHEMATIC DRAWING -----	10-1
SERVICE INFORMATION-----	10-2
TROUBLESHOOTING-----	10-2
ALTERNATOR STATOR-----	10-3
STARTER CLUTCH-----	10-6

# 10. A.C. GENERATOR/STARTER CLUTCH

People GT 125i

## SCHEMATIC DRAWING

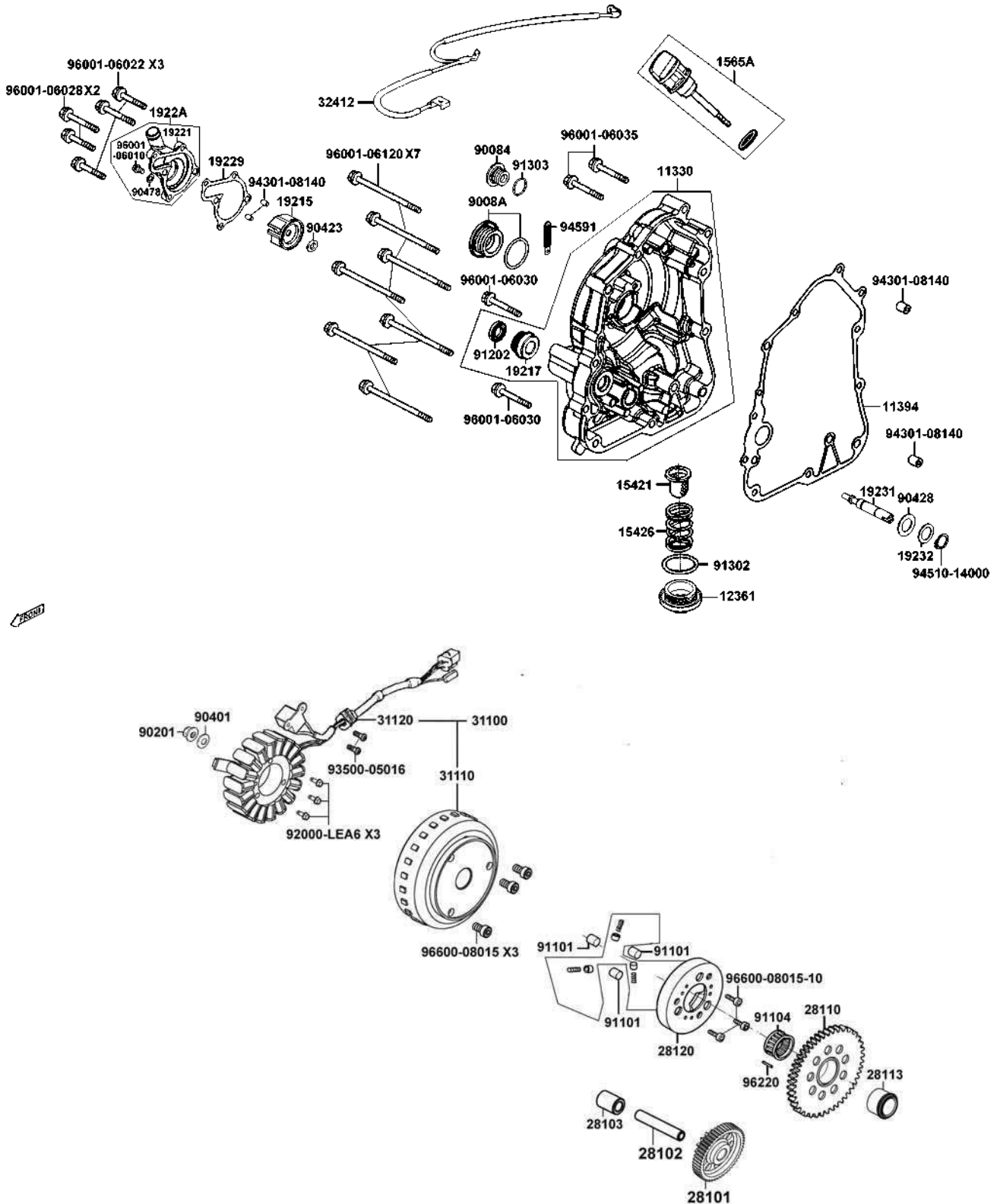

# 10. A.C. GENERATOR/STARTER CLUTCH

---

## SERVICE INFORMATION

### GENERAL INSTRUCTIONS

- All servicing operations and inspections in this section can be made with the engine installed.
- Drain the coolant before removing the right crankcase cover.
- Be careful not to drain the coolant when the engine temperature is high. (Perform this operation when the engine is cold.)
- Drain the coolant into a clean container.
- Drain the engine oil into a clean container before removing the right crankcase cover.
- When the right crankcase cover is installed, fill with the recommended engine oil and coolant. Then, bleed air from the water jacket.
- Refer to Chapter 17 for A.C. generator inspection.

### SPECIFICATIONS

Engine oil: SAE 15W/40#  
API-SJ

Oil capacity at change: 1.0 liter

Coolant: distilled water + coolant concentrate

Coolant capacity: 0.87 liter

### SPECIAL TOOLS

Flywheel puller	A120E00003
Flywheel holder	A120E00021

### TORQUE VALUES

Flywheel nut : 5.0~6.0 kgf-m

### TROUBLESHOOTING

Refer to page chapter 17 for A.C. generator troubleshooting.

#### **Starter motor rotates but engine does not start**

- Faulty starter clutch
- Starter motor rotates reversely
- Weak battery

## 10. A.C. GENERATOR/STARTER CLUTCH

### ALTERNATOR STATOR REMOVAL

Drain the engine oil (refer to the “**Engine Oil**” section in the chapter 3).

Disconnect the alternator stator connectors (refer to the chapter 17).

Remove the ten bolts from the right crankcase cover and then remove the cover.

Remove the two dowel pins and gasket.

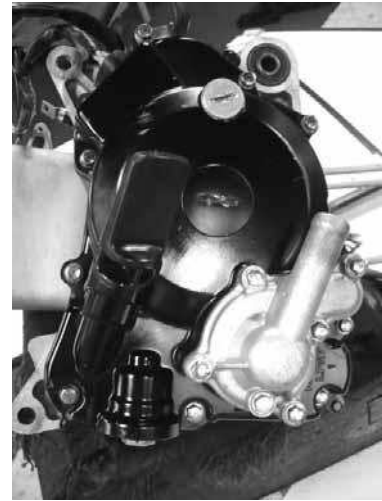

Remove the two pulse coil mount screws.  
Remove the three stator mount bolts, grommet and the stator from the right crankcase cover.

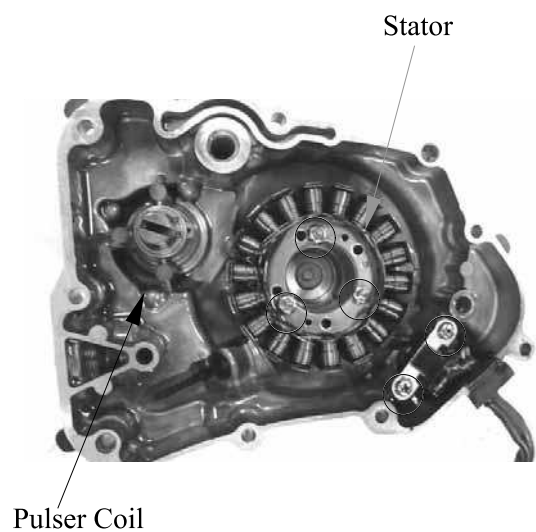

# 10. A.C. GENERATOR/STARTER CLUTCH

## INSPECTION

Check the stator and pulse coil for damage.

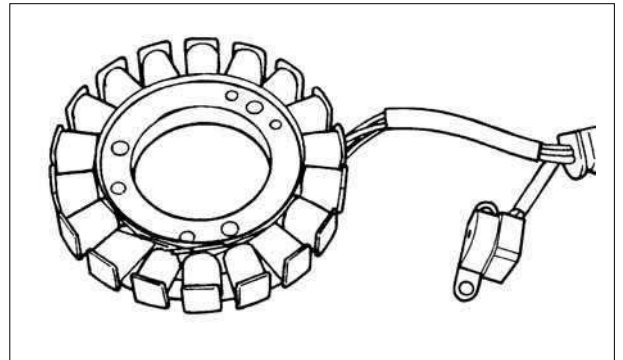

## INSTALLATION

Install the stator and tighten the stator mount bolts to the specified torque.

**Torque:** 1 kgf-m

Apply sealant to the grommet seating surface and install it to the cover groove properly.

Install the pulse coil and tighten mount screws securely.

Clean the mating surfaces of the right crankcase and cover.

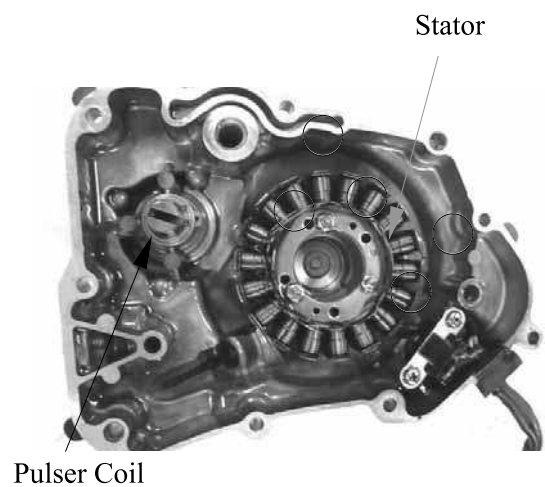

Pulser Coil

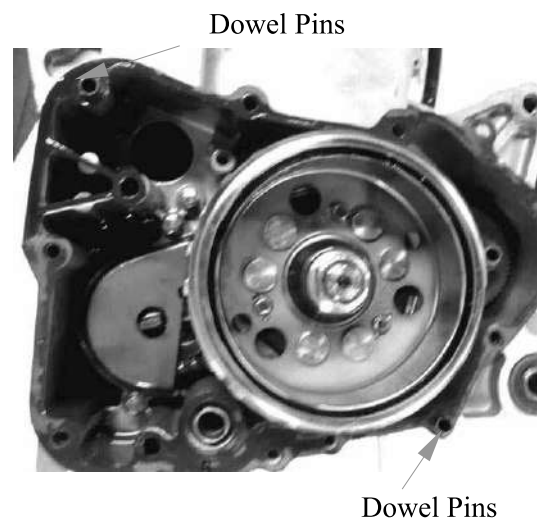

Dowel Pins

## 10. A.C. GENERATOR/STARTER CLUTCH

---

Install the dowel pins and gasket.

Install the right crankcase cover and tighten the bolts in a crisscross pattern in two or three times.

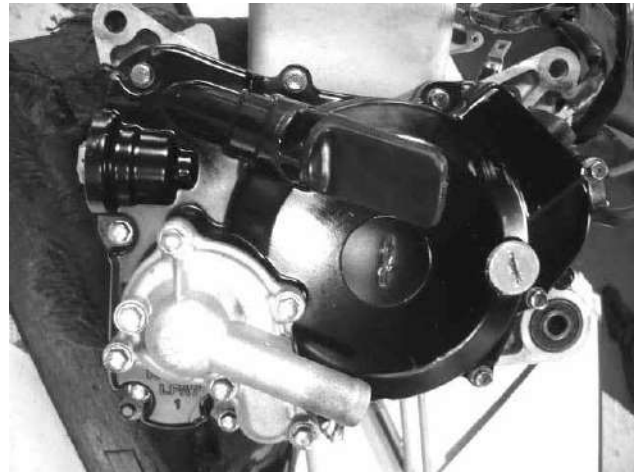



# 10. A.C. GENERATOR/STARTER CLUTCH

## STARTER CLUTCH REMOVAL

Remove the right crankcase cover (refer to the “**Alternator Stator**” section in this chapter).

Hold the flywheel with a special tool and remove the flywheel nut.

**Special tool:**

Flywheel holder                      A120E00021

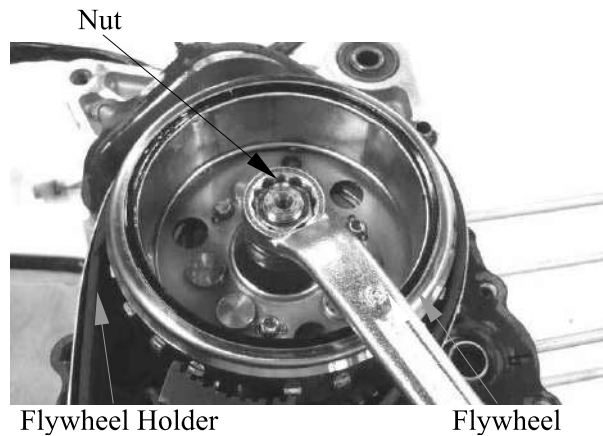

Remove the flywheel/driven gear by using the special tool.

**Special tool:**

Flywheel puller                      A120E00003

Flywheel Puller



Remove the reduction gear shaft and reduction gear.

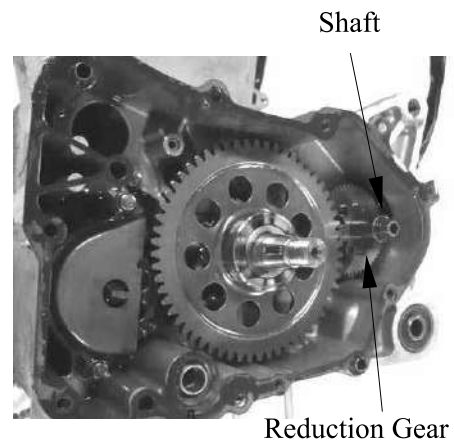

# 10. A.C. GENERATOR/STARTER CLUTCH

Remove the starter driven gear.



## INSPECTION

Install the driven gear into the flywheel.

Check the operation of the sprag clutch by turning the driven gear.

You should be able to turn the driven gear clockwise smoothly, but the gear should not turn counterclockwise.

Remove the starter driven gear by turning the driven gear.

Check the starter driven gear teeth for wear or damage.

Measure the starter driven gear boss O.D.

**Service limit:** 41 mm (1.64 in)

Measure the starter driven gear bushing I.D.

**Service limit:** 20.15 mm (0.806 in)

Check the starter reduction gear teeth and shaft for wear or damage.



Starter Driven Gear

Starter Idle Gear

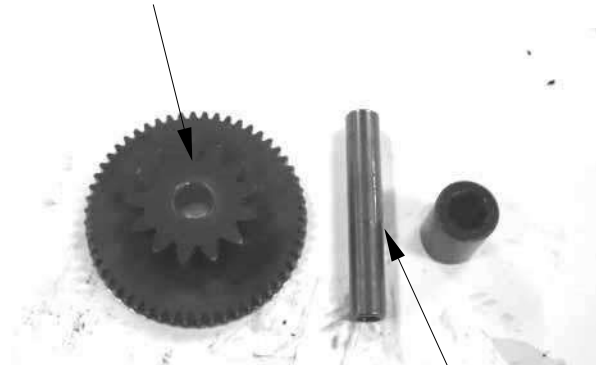

Shaft

## 10. A.C. GENERATOR/STARTER CLUTCH

### INSTALLATION

Install the starter driven gear onto the crankshaft.



Apply oil to the starter reduction gear shaft.  
Install the starter reduction gear and shaft to the right crankcase.

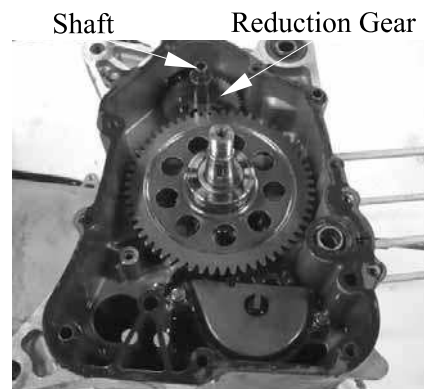

Install the flywheel onto the crankshaft by aligning the key on the crankshaft with the groove in the flywheel.

Before installation, check and make sure that the inside of the flywheel is not contaminated.

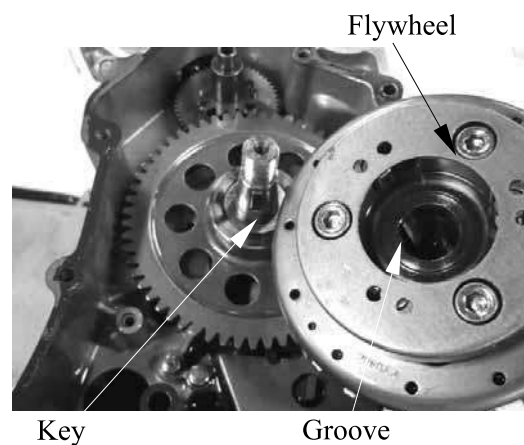

## 10. A.C. GENERATOR/STARTER CLUTCH

Hold the flywheel with the special tool and tighten the flywheel nut.

**Torque:** 5.0~6.0 kgf-m

**Special tool:**

Flywheel holder                      A120E00021

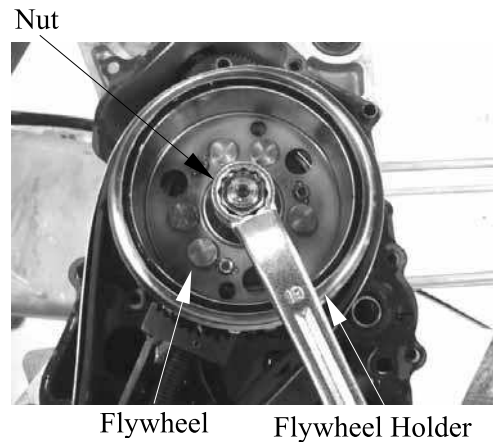

Install the dowel pins and gasket.

Install the right crankcase cover and tighten the bolts in a crisscross pattern in two or three times.



# 11. CRANKCASE/CRANKSHAFT

---

---

## CRANKCASE/CRANKSHAFT

---

SCHEMATIC DRAWING -----	11-1
SERVICE INFORMATION-----	11-2
TROUBLESHOOTING-----	11-2
CRANKCASE SEPARATION -----	11-3
CRANKSHAFT INSPECTION-----	11-4
CRANKCASE ASSEMBLY -----	11-5

# 11. CRANKCASE/CRANKSHAFT

People GT 125i

## SCHEMATIC DRAWING

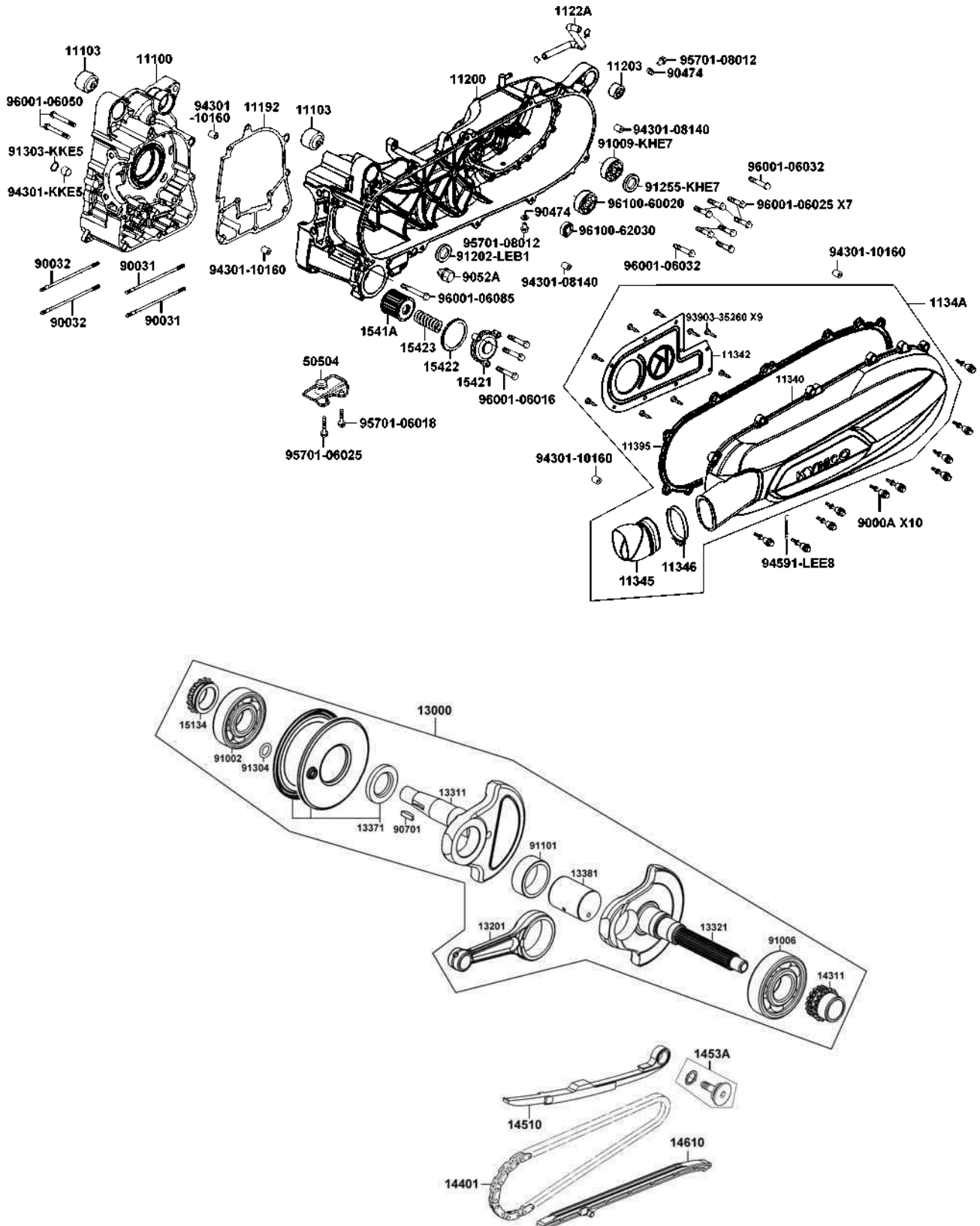

# 11. CRANKCASE/CRANKSHAFT

## SERVICE INFORMATION

### GENERAL INSTRUCTIONS

- This section covers crankcase separation to service the crankshaft. The engine must be removed for this operation.
- When separating the crankcase, never use a driver to pry the crankcase mating surfaces apart forcibly to prevent damaging the mating surfaces.
- When installing the crankcase, do not use an iron hammer to tap it.
- The following parts must be removed before separating the crankcase.

Cylinder head

Cylinder/piston

Drive and driven pulley

A.C. generator/starter clutch

Rear wheel/rear shock absorber

Starter motor

Oil pump

### SPECIFICATIONS

Part	Item	Standard (mm)
Crankshaft	Connecting rod big end side clearance	0.15~0.35
	Connecting rod big end radial clearance	0~0.008

### TORQUE VALUES

Crankcase bolt	1.0 kgf-m
Cam chain tensioner slipper bolt	1.0 kgf-m

### TROUBLESHOOTING

#### Excessive engine noise

- Excessive bearing play
- Excessive crankpin bearing play
- Worn piston pin and piston pin hole

# 11. CRANKCASE/CRANKSHAFT

## CRANKCASE SEPARATION

Remove the cam chain tensioner slipper bolt.  
 Remove the cam chain tensioner slipper and cam chain.  
 Remove the two right crankcase attaching bolts.

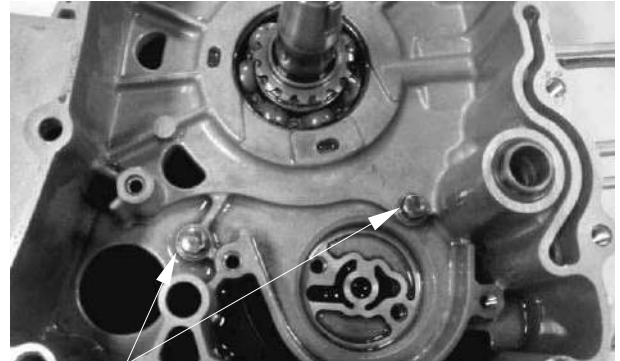

Bolt

Remove the left crankcase bolts.

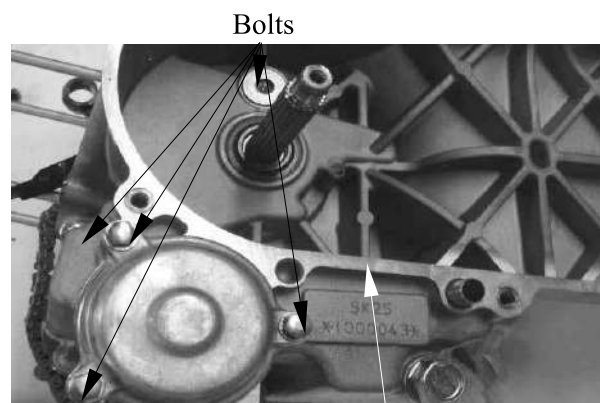

Bolts

Left Crankcase

Place the crankcase with the left crankcase down and remove the right crankcase from the left crankcase.

\* Never use a driver to pry the crankcase mating surfaces apart.

Remove the gasket and dowel pins.

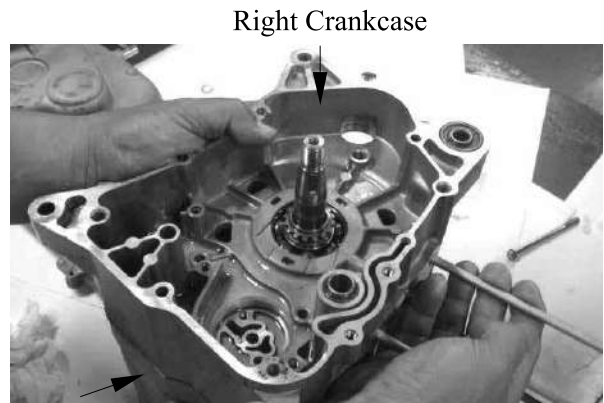

Right Crankcase

Left Crankcase

Remove the crankshaft from the left crankcase.

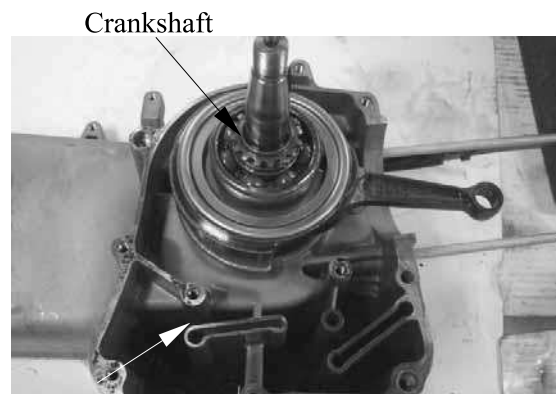

Crankshaft

Left Crankcase



# 11. CRANKCASE/CRANKSHAFT

Remove the oil seal from the left crankcase.



Left Crankcase

## CRANKSHAFT INSPECTION

Measure the connecting rod big end side clearance.

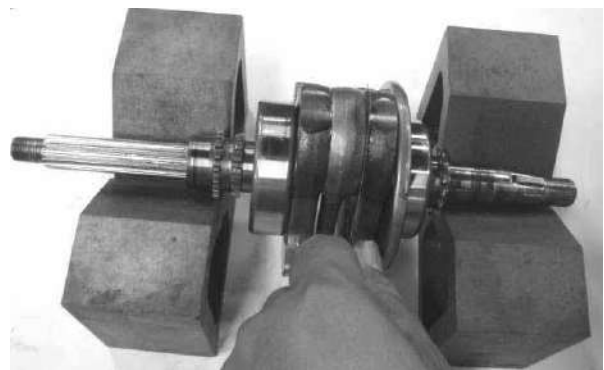

Measure the connecting rod small end I.D.

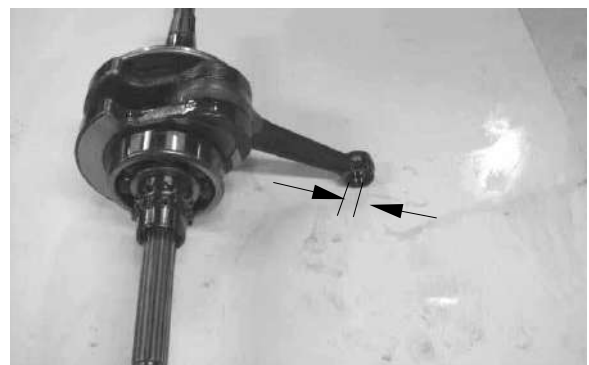

# 11. CRANKCASE/CRANKSHAFT

Measure the crankshaft runout.

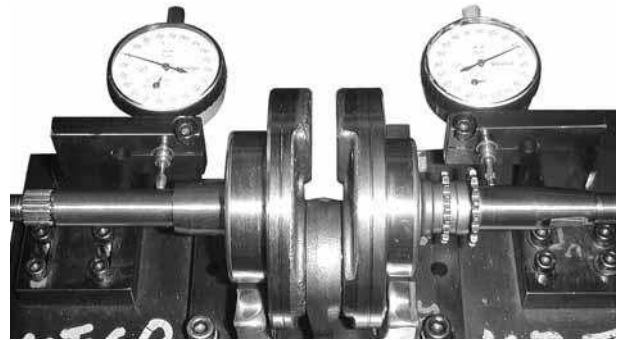

Measure the crankshaft bearing play.

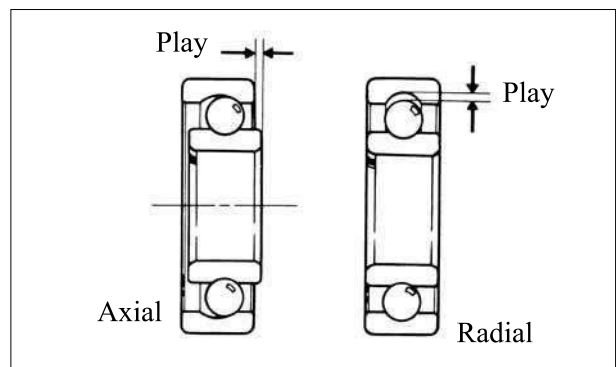

## CRANKCASE ASSEMBLY

Clean off all gasket material from the crankcase mating surfaces.

\* Avoid damaging the crankcase mating surfaces.



Install a new oil seal into the left crankcase.



Left Crankcase

# 11. CRANKCASE/CRANKSHAFT

Place the left crankcase down and install the crankshaft into the left crankcase.

- \* 
 • Avoid damaging the oil seal.  
 • Apply grease to the lip of the oil seal.

Install the two dowel pins and a new gasket.

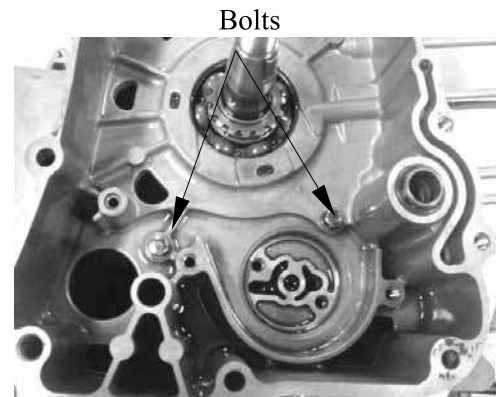

Place the right crankcase over the crankshaft and onto the left crankcase.

- \* 
 Install the right crankcase squarely and do not tap it with an iron or plastic hammer.



Install and tighten the right and left crankcase attaching bolts.

**Torque:** 1.0 kgf-m

Install the cam chain.

Install the cam chain tensioner slipper.

Install and tighten the cam chain tensioner slipper bolt.

**Torque:** 1.0kgf-m

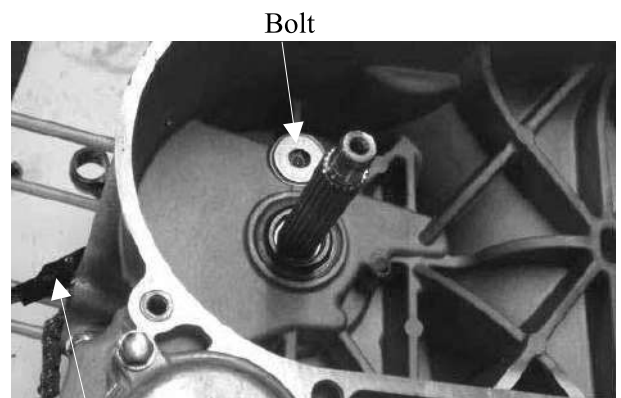

Cam Chain Tensioner Slipper

# 12. COOLING SYSTEM

---

---

## COOLING SYSTEM

---

SCHEMATIC DRAWING .....	12- 1
SERVICE INFORMATION .....	12- 2
TROUBLESHOOTING .....	12- 2
COOLING SYSTEM TESTING .....	12- 4
COOLANR REPLACEMENT .....	12- 4
RADIATOR.....	12- 6
WATER PUMP.....	12- 9
THERMOSENSOR.....	12-12
THERMOSTAT .....	12-13

# 12. COOLING SYSTEM

## SCHEMATIC DRAWING

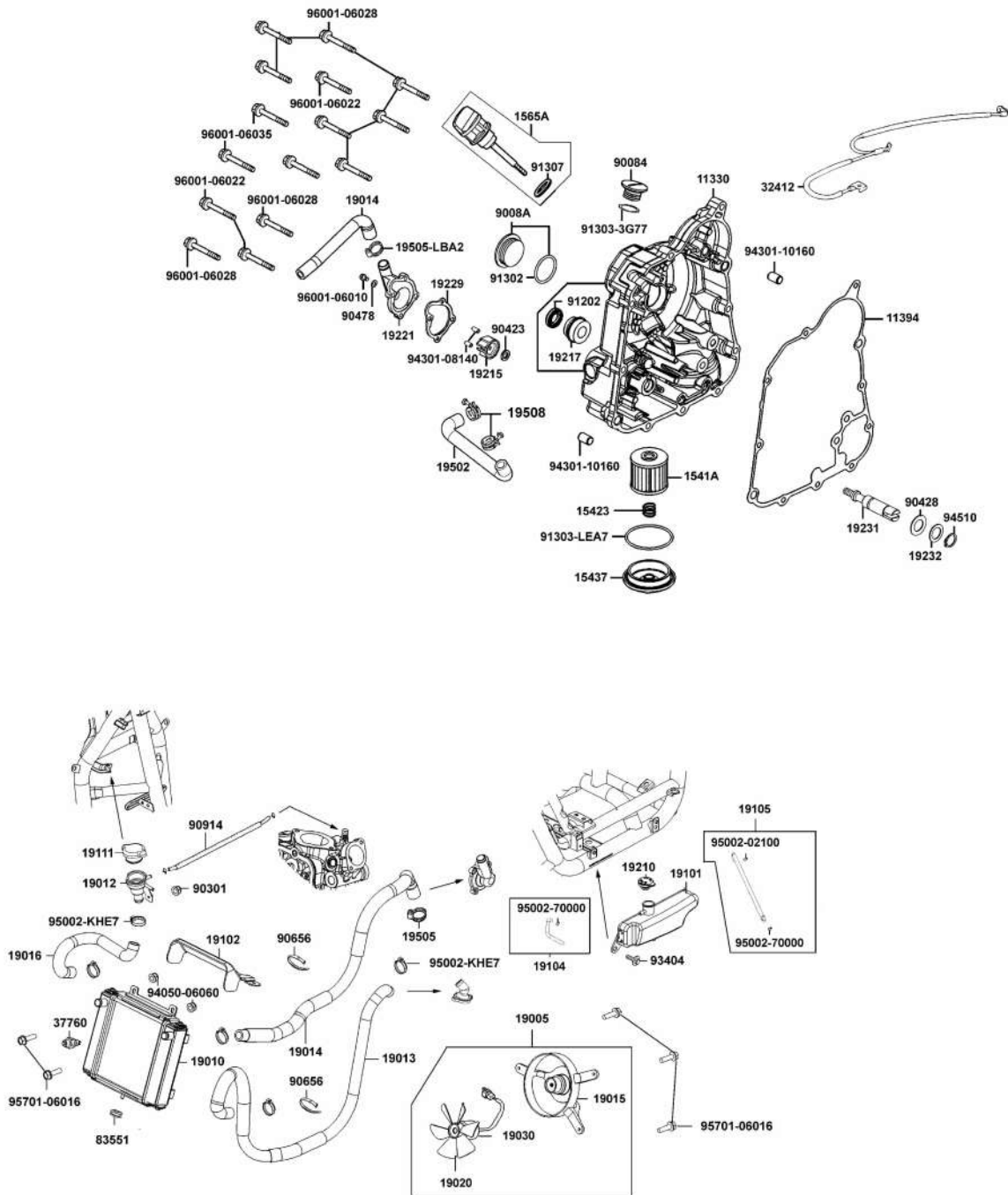

# 12. COOLING SYSTEM

---

## SERVICE INFORMATION

### GENERAL INSTRUCTIONS

- The water pump must be serviced after removing the engine. Other cooling system service can be done with the engine installed in the frame.
- The engine must be cool before servicing the cooling system.  
When the coolant temperature is over 100□, never remove the radiator cap to release the pressure because the boiling coolant may cause danger.
- Avoid spilling coolant on painted surfaces because the coolant will corrode the painted surfaces. Wash off any spilled coolant with fresh water as soon as possible.
- After servicing the system, check for leaks with a cooling system tester.

### TORQUE VALUES

Water pump impeller	1.0~1.4 kgf-m (11.8 N-m)
Water pump cover bolt	1.0~1.4 kgf-m (11.8 N-m)

### TROUBLESHOOTING

#### Engine temperature too high

- Faulty temperature gauge or thermosensor
- Faulty radiator cap
- Faulty thermostat
- Insufficient coolant
- Passages blocked in hoses or water jacket
- Clogged radiator fins
- Passages blocked in radiator
- Faulty water pump

#### Coolant leaks

- Faulty pump mechanical (water) seal
- Deteriorated O-rings
- Damaged or deteriorated water hoses

#### Temperature gauge shows the wrong temperature

- Faulty temperature gauge or thermosensor
- Faulty thermostat

### SPECIFICATIONS

Radiator cap relief pressure	0.9±0.15 kg/cm <sup>2</sup>	
Thermostat temperature	Begins to open	71 □
	Full-open	80 □
	Valve lift	3.5□4.5 mm
Coolant capacity	Total 1250 cc	Radiator & Engine: 950 cc Reserve tank: 300 cc

## 12. COOLING SYSTEM

### COOLANT GRAVITY CHART

Temp. □ Coolant concentration	0	5	10	15	20	25	30	35	40	45	50
5%	1.009	1.009	1.008	1.008	1.007	1.006	1.005	1.003	1.001	0.999	0.997
10%	1.018	1.107	1.017	1.016	1.015	1.014	0.013	1.011	1.009	1.007	1.005
15%	1.028	1.027	1.026	1.025	1.024	1.022	1.020	1.018	1.016	1.014	1.012
20%	1.036	1.035	1.034	1.033	1.031	1.029	1.027	1.025	1.023	1.021	1.019
25%	1.045	1.044	1.043	1.042	1.040	1.038	1.036	1.034	1.031	1.028	1.025
30%	1.053	1.051	1.051	1.049	1.047	1.045	1.043	1.041	1.038	1.035	1.032
35%	1.063	1.062	1.060	1.058	1.056	1.054	1.052	1.049	1.046	1.043	1.040
40%	1.072	1.070	1.068	1.066	1.064	1.062	1.059	1.056	1.053	1.050	1.047
45%	1.080	1.078	1.076	1.074	1.072	1.069	1.056	1.063	1.062	1.057	1.054
50%	1.086	1.084	1.082	1.080	1.077	1.074	1.071	1.068	1.065	1.062	1.059
55%	1.095	1.093	1.091	1.088	1.085	1.082	1.079	1.076	1.073	1.070	1.067
60%	1.100	1.098	1.095	1.092	1.089	1.086	1.083	1.080	1.077	1.074	1.071

### COOLANT MIXTURE (WITH ANTI-RUST AND ANTI-FREEZING EFFECTS)

Freezing Point	Mixing Rate	KYMCO SIGMA Coolant Concentrate	Distilled Water
-9□	20 %	250cc	1000cc
-15□	30 %	375cc	875cc
-25□	40 %	500cc	750cc
-37□	50 %	625cc	625cc
-44.5□	55 %	688cc	562cc

- 
- Use coolant of specified mixing rate 40%:60%. (The mixing rate of 500cc KYMCO SIGMA coolant concentrate + 750c distilled water)
  - Do not mix coolant concentrate of different brands.
  - Do not drink the coolant, which is poisonous.
  - The freezing point of coolant mixture shall be 5□ lower than the freezing point of the riding area.

**13. FUEL INJECTION SYSTEM**

---

**FUEL INJECTION SYSTEM**

---

SYSTEM DIAGRAM .....	13 - 1
SYSTEM LOCATION.....	13 - 2
SERVICE INFORMATION .....	13 - 3
TROUBLESHOOTING .....	13 - 4
CHECK ENGINE LAMP (CELP).....	13 - 5
HOW TO SHOW THE FAILURE CODE.....	13 - 6
FAILURE CODES CHART .....	13 - 7
ECU .....	13-11
FUEL PUMP .....	13-12
T-MAP & TPS.....	13-13
WTS.....	13-14
INJECTOR .....	13-14
O <sup>2</sup> SENSOR .....	13-15
ROLL SENSOR .....	13-16
TP SCREW.....	13-16
TPI / ABV INITIALIZATION .....	13-17
DIAGNOSTIC REPORT .....	13-18
Fi DIAGNOSTIC TOOL OPERATION INSTRUCTIONS.....	13-19



## 13. FUEL INJECTION SYSTEM

### SYSTEM DIAGRAM

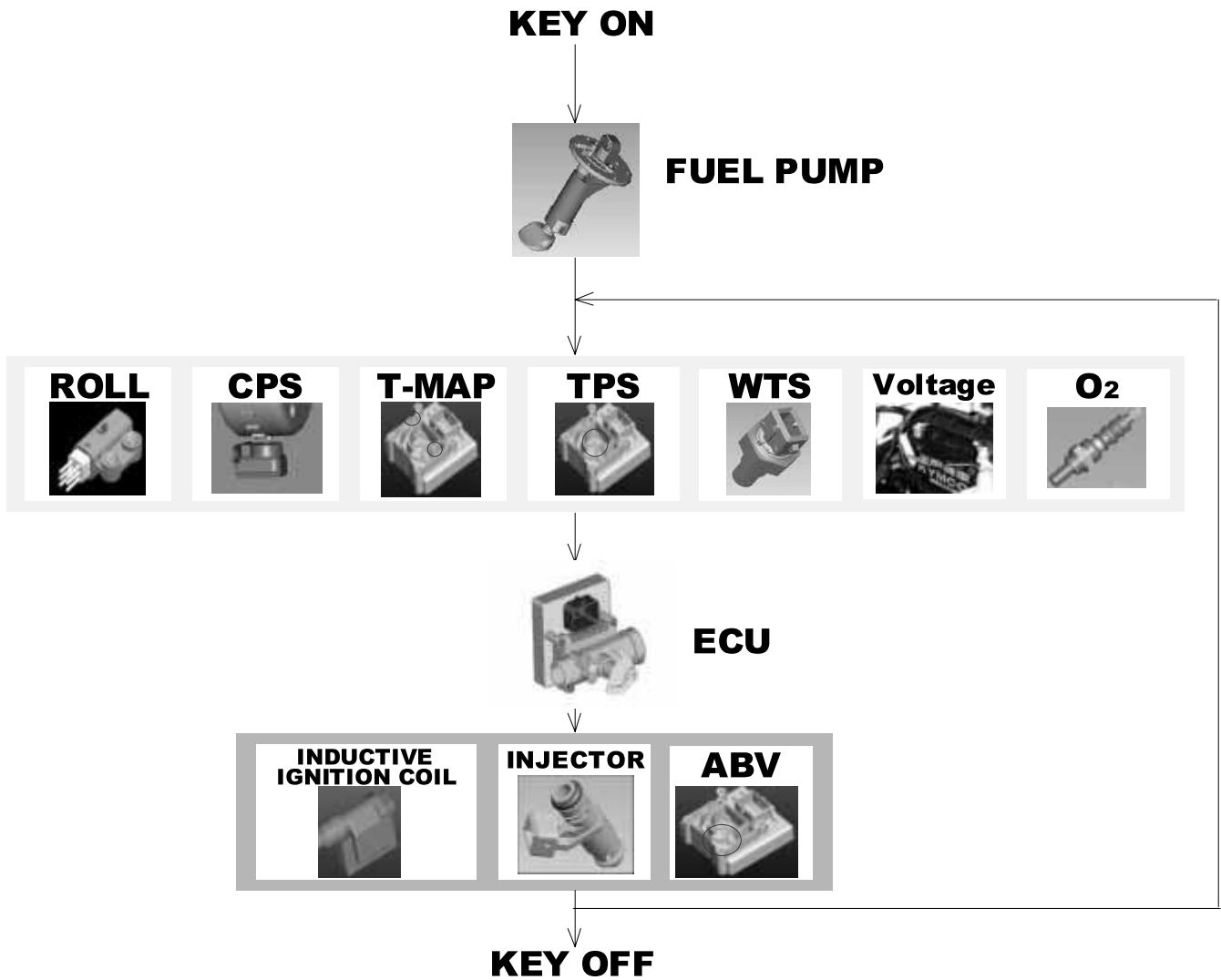

# 13. FUEL INJECTION SYSTEM

## Parts Location

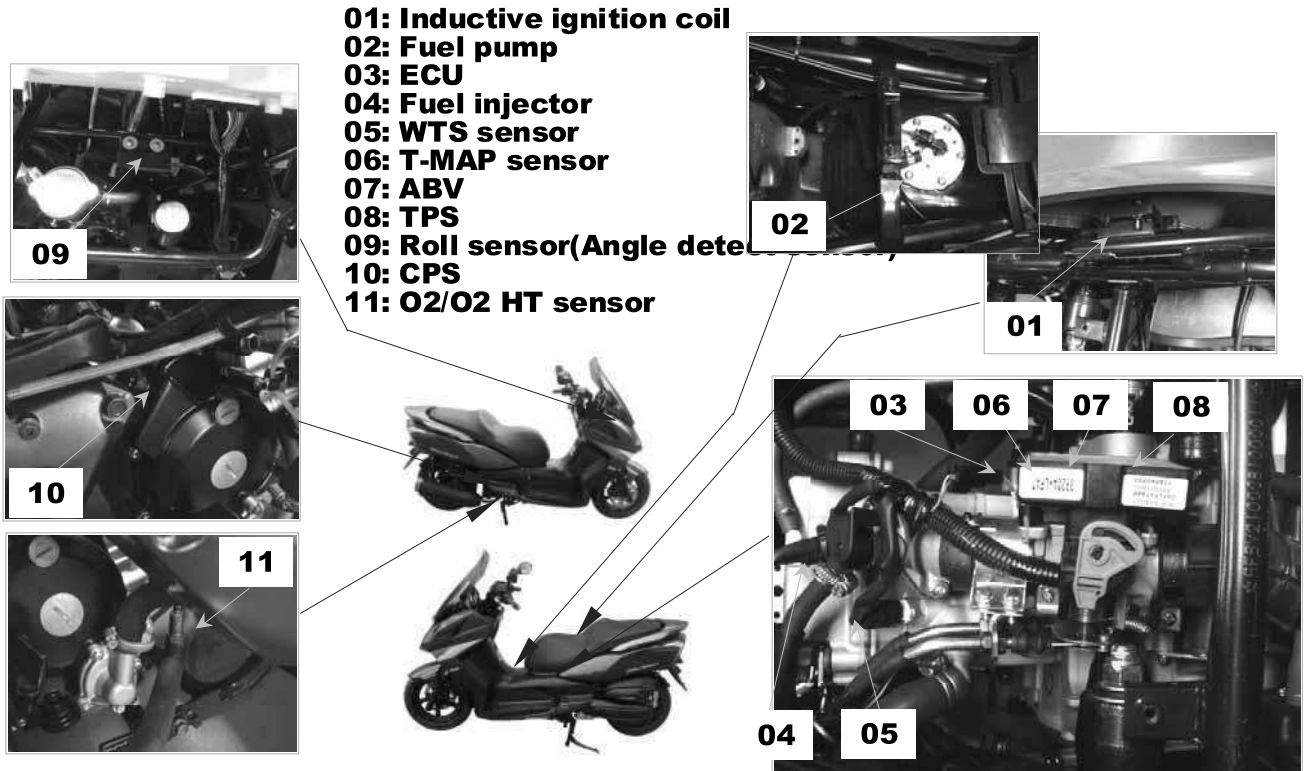

## 13. FUEL INJECTION SYSTEM

### SERVICE INFORMATION

#### GENERAL INSTRUCTIONS

Gasoline is very dangerous. When working with gasoline, keep sparks and flames away from the working area.

Gasoline is extremely flammable and is explosive under certain conditions. Be sure to work in a well-ventilated area.

- Disconnect the cables of the battery when the engine is running, which could lead to ECU damage.
- Connect the harness positive (+) cable to the battery negative (-) terminal or connect the harness negative (-) to the battery positive (+) terminal, which could lead to ECU damage.
- Always keep fuel over 750 cc in fuel tank.

#### SPECIFICATIONS

Item		Standard	
Charging voltage of battery		13.5~14.5V	
Voltage from the ECU to sensor		5±0.1V	
Fuel injector resistance (20°C/68°F)		10.6~15.9Ω	
Water temperature sensor resistance		2.075±10 KΩ (20~30°C)	
Throttle position sensor voltage		Idle (0°)=0.23±0.05V Throttle fully (90° /3.27V over)	
Fuel pump resistance (20°C/68°F)		F: about 1100Ω E: about 100Ω	
O2 sensor	O2 sensor heater resistance	6.7~9.5Ω	
	Voltage	Air/Fuel<14.7 (Rich)	>0.7V
		Air/Fuel>14.7 (Lean)	<0.18V
Crank position sensor (Pulser) resistance		95~144Ω	
Inductive ignition coil resistance (20°C/68°F)		0.55~0.75Ω	
Roll sensor voltage (diagnostics)		Normal: 0.3~1.4V Fall down (>65°): 3.5~4.7V	
Idle speed		1850±100 rpm	

## 13. FUEL INJECTION SYSTEM

### TROUBLESHOOTING

#### **Engine won't start**

- Battery voltage too low
- Fuel level too low
- Pinched or clogged fuel hose
- Faulty fuel pump operating system
- Clogged fuel filter (fuel pump)
- Clogged fuel injector
- Faulty spark plug or wrong type
- Cut by ECU due to angle detect sensor or incorrect function

#### **Backfiring or misfiring during acceleration**

- Ignition system malfunction

#### **Poor performance (drive ability) and poor fuel economy**

- Pinched or clogged fuel hose
- Faulty fuel injector

#### **Engine stall, hard to start, rough idling**

- Intake air leak
- Fuel contaminated/deteriorated
- Pinched or clogged fuel hose
- Idle speed misadjusted

# 13. FUEL INJECTION SYSTEM

## FI INJECTION INDICATOR

- When turning on the switch, the lamp will be lighted for 2 seconds then off. Let user to know the lamp is available and connect to ECU.
- But after then or during riding, if the CELP start to blink or keep lighting, it means something wrong with this vehicle, you better do the further check to find out the failure code to know which part get trouble
- There are three kinds of priority grade let user to know what kind of trouble was happened.
- Priority grade 1: CELP blinks continuously. This is the most emergent situation like engine over heat. User should be slow down the riding and go to dealer for checking.
- Priority grade 2: CELP lights all the time. It means components gets trouble or circuit something wrong. Do the further check to find out the failure code to know which part get trouble.
- Priority grade 3: CELP just blinks once suddenly and then disappear. It sometimes just warning like the RPM was too high in a short term.

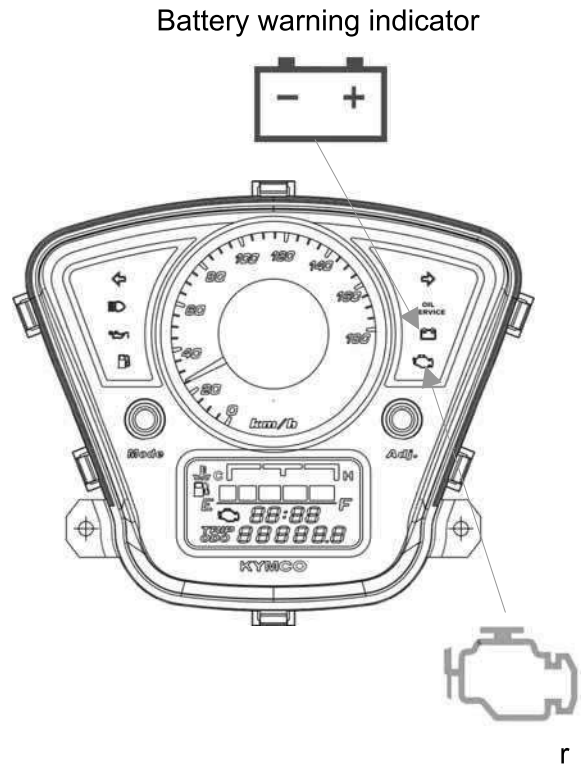

PRIORITY	LAMP ACTION
1	<p>ON</p> <p>OFF</p>
2	<p>ON</p> <p>OFF</p>
3	<p>ON</p> <p>OFF</p>

## 13. FUEL INJECTION SYSTEM

### How To Show Failure Code

- You can read the failure code by as below :
- Turn switch on. The CELP will be lighted for 2 seconds then off. The CELP start to blink to show the failure codes
- (The number of blinks from 1 to 25).
- If vehicle got more than one failure code, the CELP will be shown from lower number failure code and then show the other higher number one after four seconds. All the failure codes would be shown repeatedly.

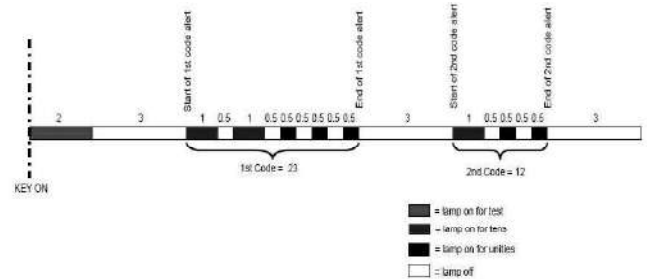

### How To Reset Failure Code

- After repairing the trouble, you should clear the failure code or it will still exist in the ECU memory. When you do a next maintain, it will show again and you get confuse.
- Turn switch on. The CELP will be lighted for two seconds then off.
- The CELP begins to blink to show the failure codes.
- The self-diagnosis memory data will be erased when all the failure codes has showed for four cycles.

## 13. FUEL INJECTION SYSTEM

### Failure Code Chart

Blink	Failure Codes	Fault description	Priority	Fault management
1	P0217	Engine temperature overheat	1	1.Slow down the vehicle and go to workshop for checking immediately. 2.Confirm if the engine temperature sensor or electric circuit is abnormality.
2	P0335	Crankshaft position sensor or circuit malfunction	2	1.Check if the connector of crankshaft position sensor is loosen. 2.Check if the Rotor is align with Crankshaft position sensor during the crankshaft running.
3	P1120	Throttle position sensor setting value problem	2	1.Make sure if the connector of Throttle position sensor is connected correctly. 2.Check if the Throttle position sensor is adjusted.
4	P1121	Throttle position sensor output range problem	2	1.Make sure if the connector of Throttle position sensor is connected correctly. 2.Check if the Throttle position sensor is adjusted.

## 13. FUEL INJECTION SYSTEM

### Failure Code

Blink	Failure Codes	Fault description	Priority	Fault management
5	P1122	Throttle position sensor movement speed problem	2	<ol style="list-style-type: none"> <li>1. Make sure if the connector of Throttle position sensor is connected correctly.</li> <li>2. Check if the Throttle position sensor is adjusted.</li> </ol>
6	P0560	Battery voltage malfunction	1	<ol style="list-style-type: none"> <li>1. Check if the battery voltage is lower or higher.</li> <li>2. Check if the charge system is malfunction.</li> </ol>
7	P0110	Inlet air temperature sensor or electric circuit malfunction	2	<ol style="list-style-type: none"> <li>1. Check if the connector of Inlet air temperature sensor loosen.</li> <li>2. Check if the resistance of sensor is normal .</li> </ol>
8	P0410	Idle air valve or electric circuit malfunction	2	<ol style="list-style-type: none"> <li>1. Check if the connector of Idle air valve loosen.</li> <li>2. Check if the resistance of valve is normal.</li> </ol>
9	P0505	Idle speed volume control range	2	<ol style="list-style-type: none"> <li>1. Check if the opening angle is over 180° for Idle air valve.</li> <li>2. Check if the opening angle is malfunction.</li> </ol>
10	P0251	Injector or electric circuit	2	<ol style="list-style-type: none"> <li>1. Check if the connector of Injector is loosen.</li> <li>2. Check if the ECU send signal to Injector.</li> <li>3. Check if the power source and resistance of Injector are malfunction.</li> </ol>



## 13. FUEL INJECTION SYSTEM

### Failure Code

Blink	Failure Codes	Fault description	Priority	Fault management
11	P0350	Ignition coil or electric circuit malfunction	2	<ol style="list-style-type: none"> <li>1. Check if the connector of ignition coil is loosen.</li> <li>2. Check if the ECU send signal to Ignition coil.</li> <li>3. Check if the power source and resistance is malfunction.</li> </ol>
12	P0230	Fuel pump relay or electric circuit malfunction	2	<ol style="list-style-type: none"> <li>1. Check if the connector of relay is loosen.</li> <li>2. Check if the ECU send signal to relay.</li> <li>3. Check the fuel pump relay resistance</li> </ol>
13	P0219	Engine speed is over than top speed	2	Check if the belt of CVT is broken.
14	P1560	Sensor don't receive power source from ECU	2	<ol style="list-style-type: none"> <li>1. Check if ECU output DC5V to sensor.</li> <li>2. Check if the power source of all sensor is DC5V.</li> <li>3. Replace a new ECU if the CELP still blinks even the output power source of ECU is normal.</li> </ol>
15	P0700	Engine starting speed exceed CVT speed limited	2	<ol style="list-style-type: none"> <li>1. Check if the throttle wire locked.</li> <li>2. Check if the position of throttle screw is correct.</li> <li>3. Check if the belt of CVT is broken.</li> </ol>
16	P0115	Engine temperature sensor or electric circuit malfunction	2	<ol style="list-style-type: none"> <li>1. Check if the connector of sensor is loosen.</li> <li>2. Check if ECU pin is broken.</li> <li>3. Check if the resistance of sensor is malfunction.</li> </ol>
17	P1561	Temperature gauge electric circuit malfunction	2	Don't use it at present.

## 13. FUEL INJECTION SYSTEM

### Failure Code

Blink	Failure Codes	Fault description	Priority	Fault management
18	P0650	CELP electric circuit malfunction	3	<ol style="list-style-type: none"> <li>1. Check if the lamp of CELP is broken.</li> <li>2. Check if wires of CELP is broken.</li> </ol>
21	P0105	Atmospheric Pressure Sensor or electric Circuit Malfunction	2	<ol style="list-style-type: none"> <li>1. Check if the connector of sensor is loosen.</li> <li>2. Check if ECU pin is broken.</li> <li>3. Check if voltage of sensor is fit in specification.</li> </ol>
22	P1110	Roll sensor or electric circuit malfunction	2	<ol style="list-style-type: none"> <li>1. Check if the sensor installation direction is correct.</li> <li>2. Check if voltage of sensor is fit in specification.</li> <li>3. Check if ECU pin is broken.</li> </ol>
23	P0136	O2 sensor malfunction	1	<ol style="list-style-type: none"> <li>1. Check if the connector of sensor is loosen.</li> <li>2. Check if ECU pin is broken.</li> </ol>
24	P0141	O2 sensor heater malfunction	1	<ol style="list-style-type: none"> <li>1. Check if the connector of sensor is loosen.</li> <li>2. Check if ECU pin is broken.</li> <li>3. Check if the resistance of sensor is malfunction.</li> </ol>
25	P0171	O2 sensor electric circuit malfunction	1	<ol style="list-style-type: none"> <li>1. Check if the connector of sensor is loosen.</li> <li>2. Check if O2 sensor is blocked.</li> <li>3. Don't follow a routine maintenance.</li> </ol>

## 13. FUEL INJECTION SYSTEM

---

### ECU

There are 36 pins attaching the ECU.

**Part number: 3620A-LFA7-E00**

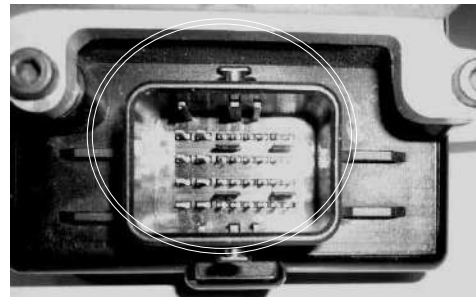

### Voltage inspection

Connect the meter (+) probe to the F4(R/W) wire and the meter (-) probe to the H4(G/B) wire to measure the voltage.



MAP content (edition issue no.)

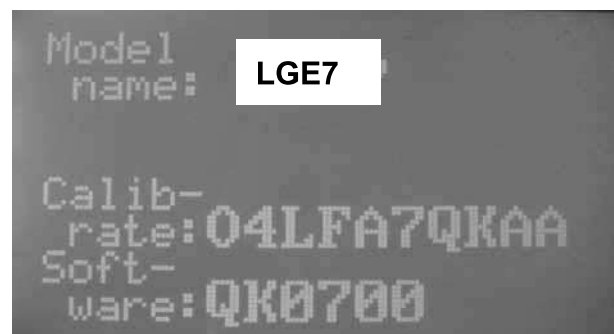

## 13. FUEL INJECTION SYSTEM

---

### FUEL PUMP

Connect the meter (+) probe to the red/black wire and the meter (-) probe to the green wire to measure the voltage from the ECU input to fuel pump unit.

Standard : 8~16 V (Battery volt)

To measure the resistance of the fuel pump to see if it is short circuit or not.

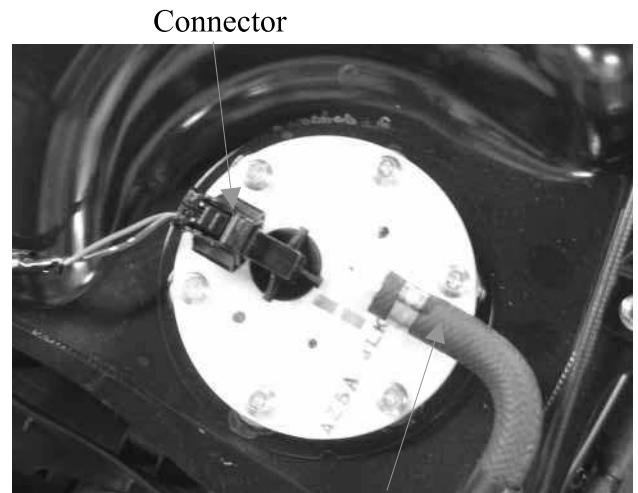

### 13. FUEL INJECTION SYSTEM

#### T-MAP(Manifold Air Temperature Pressure) Sensor

Connect the PDA or Fi diagnostic tool.  
 Enter the Data Analyze  
 Check if the manifold pressure data is malfunction.  
 Turn the ignition switch to the "ON" position.  
 If data is incorrect, and the T-map sensor is problem.

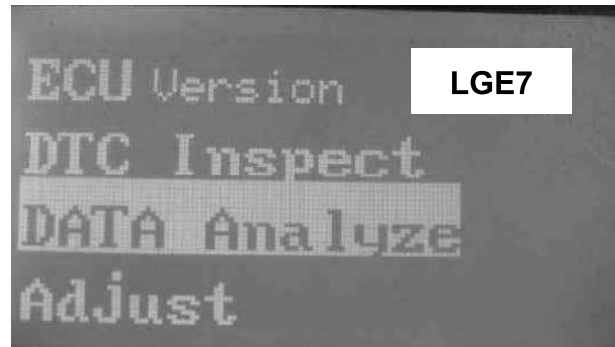

**Standard : 101.3 ±3 kpa on sea altitude**

The ambient pressure drop is about **12Kpa** according to the altitude raises.

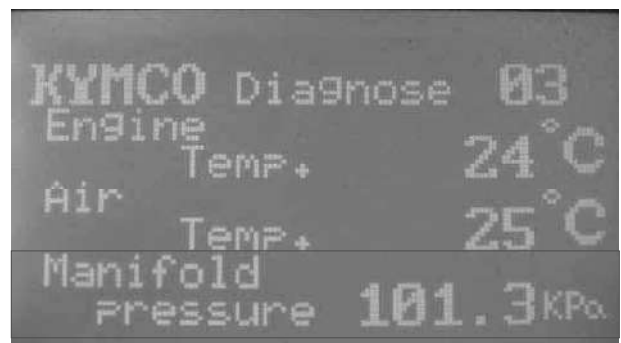

#### TPS (Throttle Position Sensor)

Enter the Data Analyze  
 Check if the TPS position data is malfunction.  
 Turn the ignition switch to the "ON" position.  
 If data is incorrect even the Idle and throttle fully, the TPS is problem.

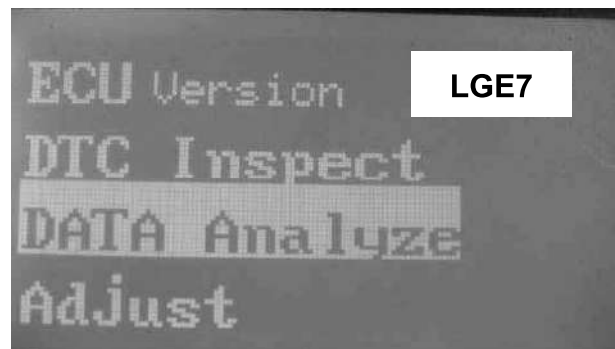

**Standard :**

**Idle ~0°                    0.23V ±0.05**  
**Throttle fully ~90°       > 3.27V**

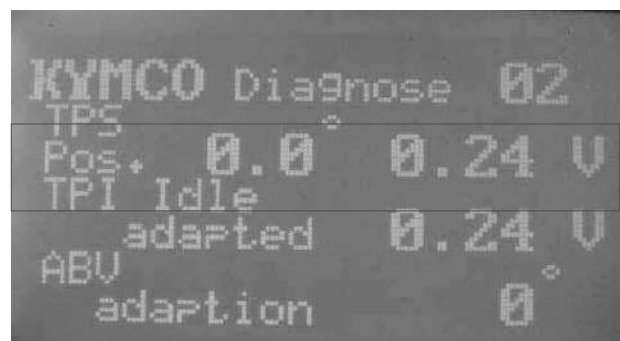

## 13. FUEL INJECTION SYSTEM

---

### WTS (Water Temperature Sensor)

Connect the meter (+) probe to the V/G wire and the meter (-) probe to the G/L wire to measure the voltage

**Standard :  $5\pm 0.25$  V**

Measure the resistance of the WTS

**Standard (20°C/68°F):  $2.075\pm 10\%$  k $\Omega$**



### INJECTOR

Measure the resistance of the Injector

**Standard (20°C/68°F ): 10.6~15.9 $\Omega$**

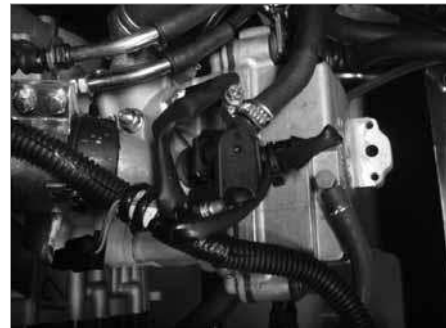

## 13. FUEL INJECTION SYSTEM

### O2 SENSOR

Measure the resistance of the O2 sensor heater.  
(2 white wire pin)

**Standard (20°C/68°F): 6.7 ~9.5Ω**



Connect the PDA or KYMCO Fi diagnostic tool.

Enter the Data Analyze

Check Page 05

Turn the ignition switch to the “ON” position.

Starting engine till the O2 heater activation is ON.

If data is incorrect, the O2 sensor is problem.



## 13. FUEL INJECTION SYSTEM

### ROLL SENSOR

The engine should be stop when the vehicle incline over 65° for safety. When you place the vehicle back to normal position, you have to key-off and key-on the switch again, then it can be restarted.

**Standard:**

Normal: 0.4~1.4V

Fall down > 65°: 3.7~4.4 V



Roll sensor

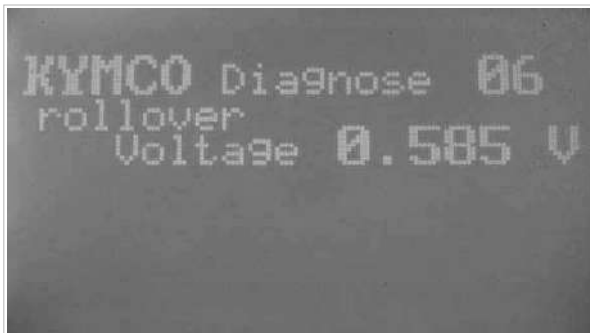

### TP SCREW

Don't adjust the TP screws, they should be adjusted by KYMCO.

If TP screw lost of the original position, it may cause to unstable problem.

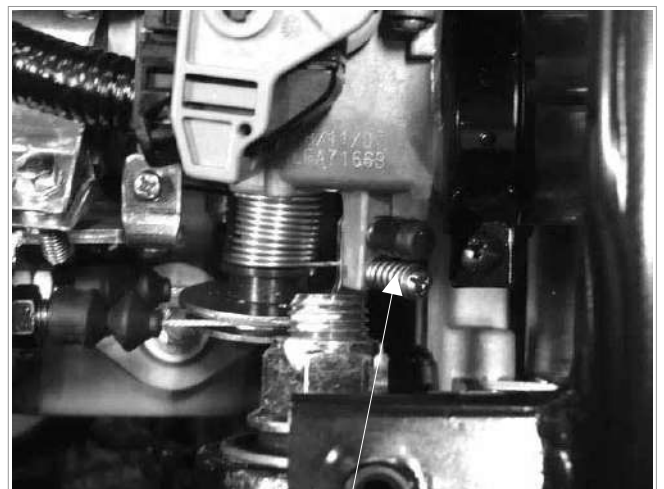

TP screws



### 13. FUEL INJECTION SYSTEM

Connect the PDA or Fi diagnostic tool.

Enter the Data Analyze

Check if the ignition advance data is malfunction.

Turn the ignition switch to the "ON" position.

Starting engine till the temperature up to 80°C.

If the figure is over **20°**, you should adjust the air bypass screw 1~1.5 turns in counterclockwise.

Don't adjust the air bypass adjustment screw over 1.5 circle.

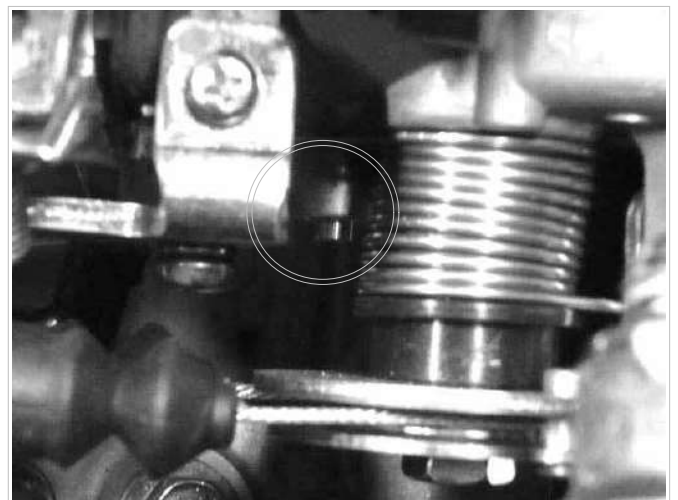
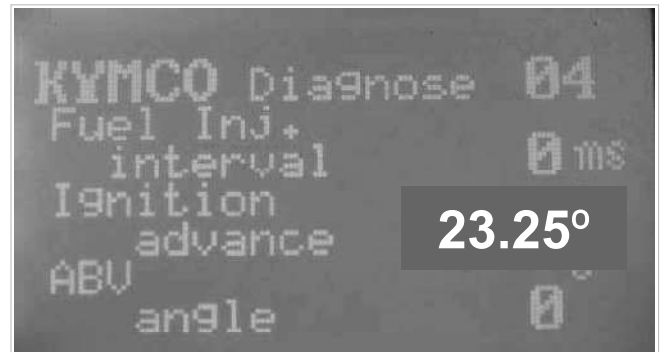

#### TPI / ABV Initialization

After replacing throttle body or engine overhauled, it cause to the efficiency of air intake be changed, so should do the TPI/ABV initialization process.

1. When the scooter is working, turn off the ignition switch and turn on again (keep the engine is off).
2. Touch this pink wire to the negative point of battery or the earth of body frame to complete TPI ABV resetting.

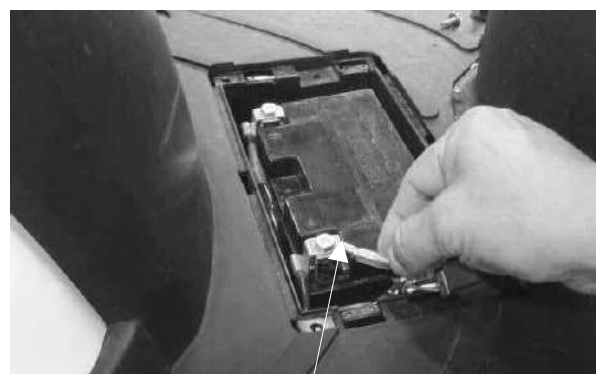

Reset wire (Pink)

#### Attention

Disconnect the pink wire immediately after shorting.



# KYMCO Diagnostic Report

# LGE7

SF :  
 Production  
 Date :

Customer :  
 Service  
 Date :

Eng. No:  
 Mileage :

Reason of repair:  maintenance  breakdown

	Item	Data	Reference	Memo
ECU Version	ECU No		---	
	Hardware Ver		---	
	Software Ver		QK0700	
	Calibration Ver		O4LGE7QKAB	
	Model Name		LGE7	
DTC	Active			
	Occurred			
	History			
(Cool Engine) EngineStop	Engine Temp.(Coiling)		environ.temp ± 2 °C	
	Air Temp.(°C)		environ.temp ± 2 °C	
	Atom. Pressure(Kpa)		101.3 ± 3 kPa	The ambient pressure drop about 12 kpa at the altitude every 1000m raised
	Throttle Position(%)		0° / 90°	Full Throttle: >90%
	Throttle Position Voltage (V)		0.23V ± 0.05 / >3.27V	Full Throttle Voltage: >3.27V
	TPI Idle Mean (V)		0.23 ± 0.05 V	
	Battery Voltage(V)		>12 V	
	Idle speed setpoint (rpm)		---	
	ABV Adap Mean (°)		---	
	Roll Sensor State		0.4 ~ 1.44 V(stand)	
	Accumulated eng. run time (hr)		---	
(Hot Engine) BeforeRepair	EngineSpeed IDLE(rpm)		1760 ± 100 rpm	Following data Engine Temp. > 80°C
	Intake Pressure(Kpa)		50~62 kpa	
	Fuel Inject Interval(ms)		1.6 ~ 2.7 ms	
	Ignition Timing (°)		5 ~ 17 BTDC	
	Ign.Dwell duration (ms)		1.9 ~ 2.6 ms	
	Air Temp.(°C)		environ.temp ± 2 °C	
	Engine Temp. (°C)		>80°C	
	O2 sensor voltage (V)		0 ~ 1 V	
	O2 sensor heater (OFF/ON)		ON	
	O2 sensor correct		± 20	
	IDLE CO(%)		0.5~1.5%	
	ABVAngDurMech (°)		140°	
(Hot Engine) AfterRepair	EngineSpeed IDLE(rpm)		1760 ± 100 rpm	Following data Engine Temp. > 80°C
	Intake Pressure(Kpa)		50~62 kpa	
	Fuel Inject Interval(ms)		1.6 ~ 2.7 ms	
	Ignition Timing (°)		5 ~ 17 BTDC	
	Ign.Dwell duration (ms)		1.9 ~ 2.6 ms	
	Air Temp.(°C)		environ.temp ± 2 °C	
	Engine Temp. (°C)		>80°C	
	O2 sensor voltage (V)		0 ~ 1 V	
	O2 sensor heater (OFF/ON)		ON	
	O2 sensor correct		± 20	
	IDLE CO(%)		0.5~1.5%	
	ABVAngDurMech (°)		140°	

Repair description	Repair Process
--------------------	----------------

## Fi Diagnostic Tool Operation Instructions Part No. 3620A-LEB2-E00



- |                                       |                |
|---------------------------------------|----------------|
| 1 Model No.                           | 8 DATA Analyze |
| 2 Down Button                         | 9 DTC Inspect  |
| 3 DTC indicator (Failure codes)       | 10 ECU Version |
| 4 Enter or Exit                       |                |
| 5 Power indicator                     |                |
| 6 UP Button                           |                |
| 7 Adjust (TPI and ABV reset function) |                |

## DTC INSPECTION

Connect Fi diagnostic tool with the connector of harness wire located beside the Battery.

Press the "Enter" button

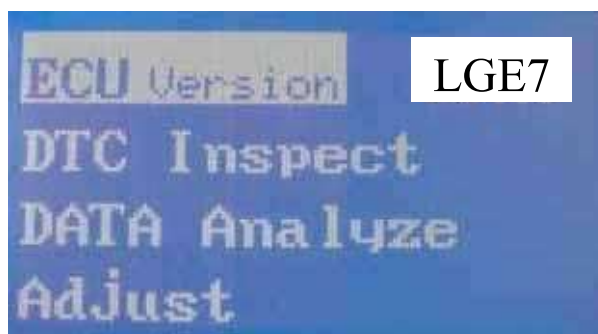

Check the software version

Press the "Enter" button and then turn to the first page.

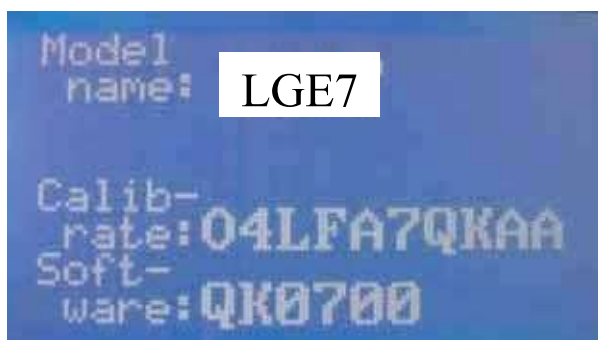

Press the "Down" button to enter the DTC Inspect.

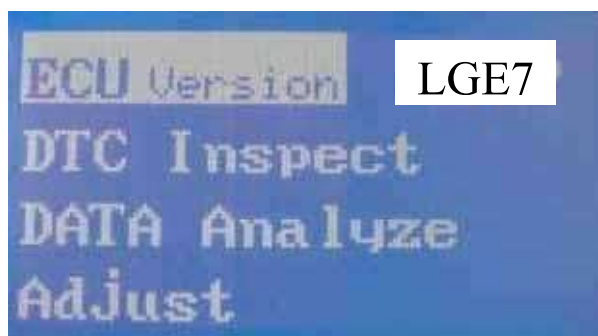

# 13. FUEL INJECTION SYSTEM

Press the "Enter" button to check the DTC number

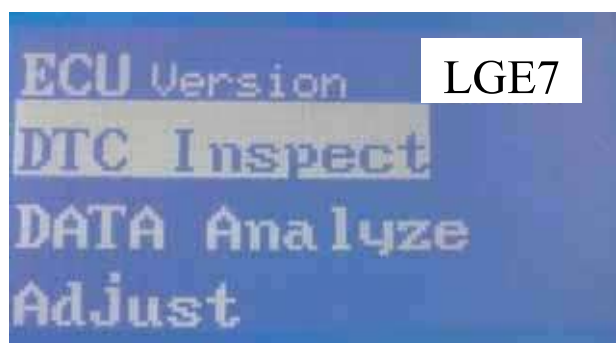

Press the "Enter" button

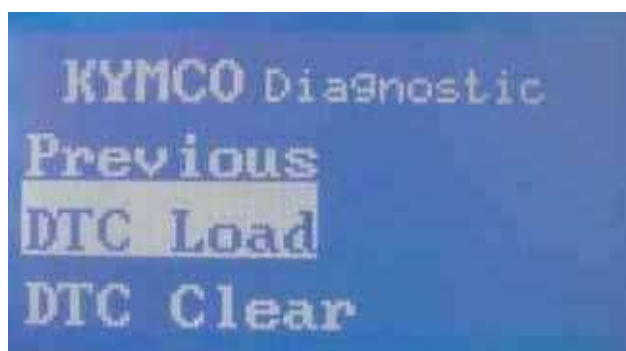

Press the "Enter" button

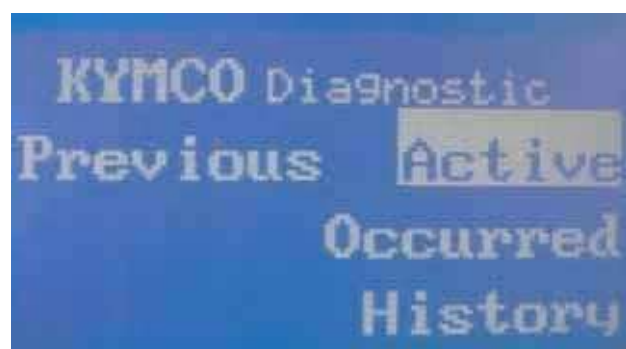

Display the DTC number of the DTC-List. Refer to DTC summary list.

Press the "Enter" button and then turn to the previous page

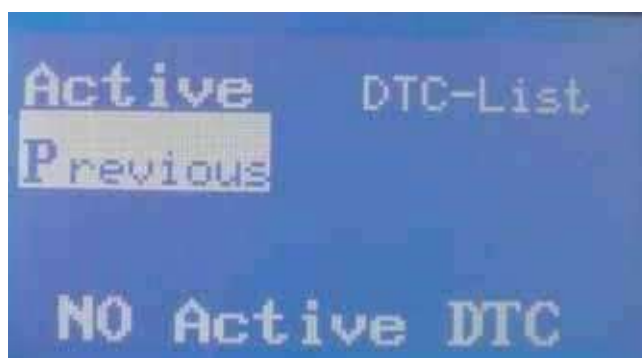

Press the "UP" button

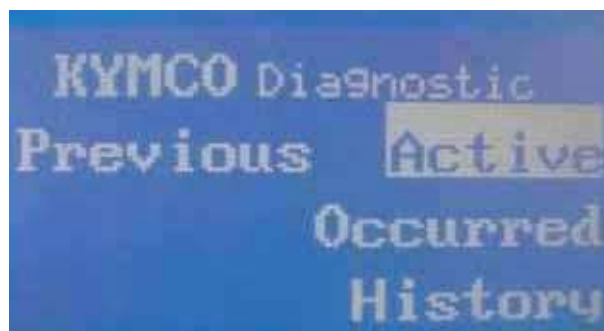

Press the "Enter" button and then turn to the previous page.

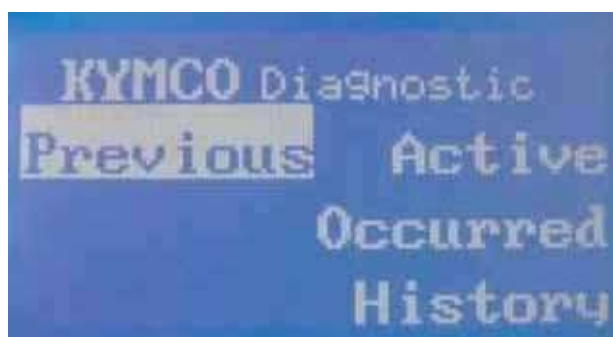

Press the "UP" button

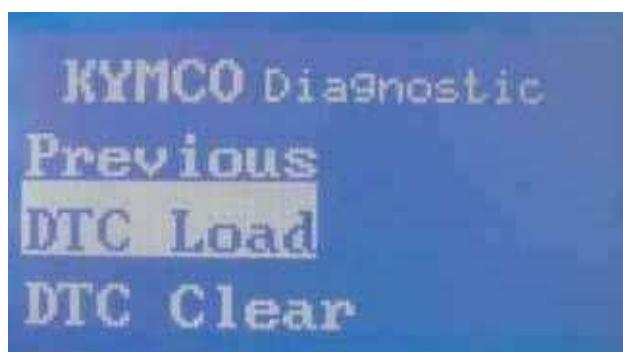

Press the "Enter" button and then turn to the first page.

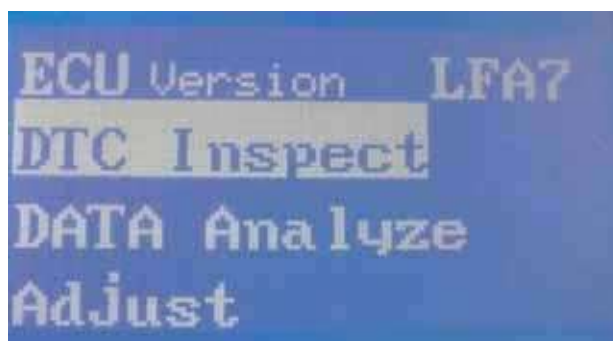

## DTC CLEAR PROCEDURE

Choose "Load DTC"

Press the "Down" button

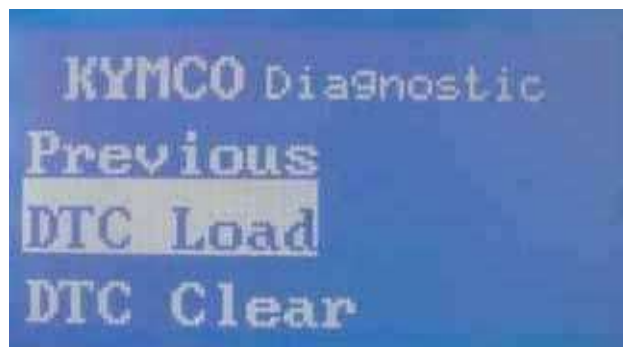

Press the "Enter" button

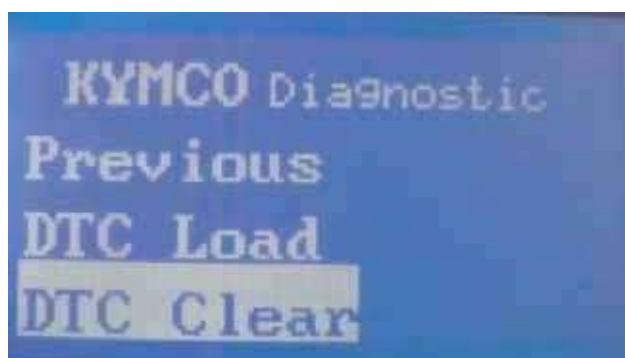

The DTC indicator is lighting at that time.



Clearing DTC until the DTC indicator is off.

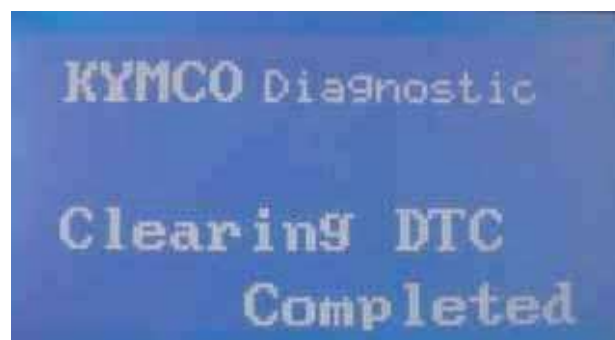



## DATA ANALYSIS

Choose "Data Analyze"

Press the "Enter" button to enter page 01.

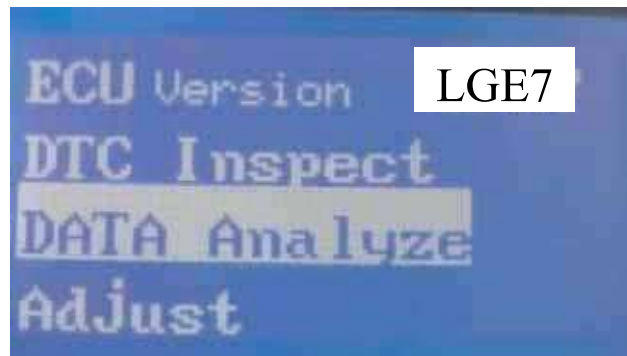

The figure includes the engine speed, idle speed and the battery voltage.

Refer to standard specification.

Press the "Down" button to enter page 02.

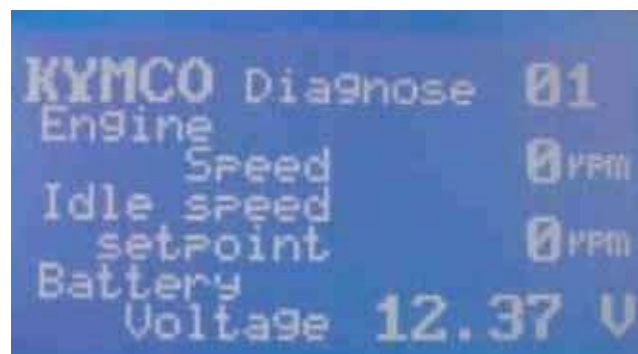

The figure includes TPS position, TPI idle adapted voltage and TPI WOT adapted (Throttle grip fully opened).

Refer to standard specification.

Press the "Down" button to enter page 03.

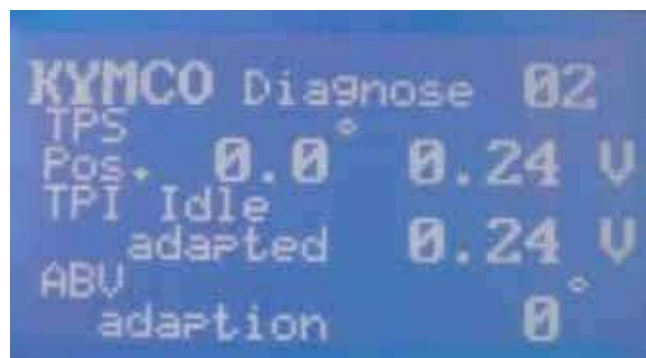

The figure includes engine working temperature, atmosphere pressure and Manifold pressure.

Refer to standard specifications on page 18-9.

Press the "Down" button to enter page 04.





## 13. FUEL INJECTION SYSTEM

The figure includes fuel injector interval, ignition advance angle and ABV angle. Refer to standard specification. Press the "Down" button to enter page 05.

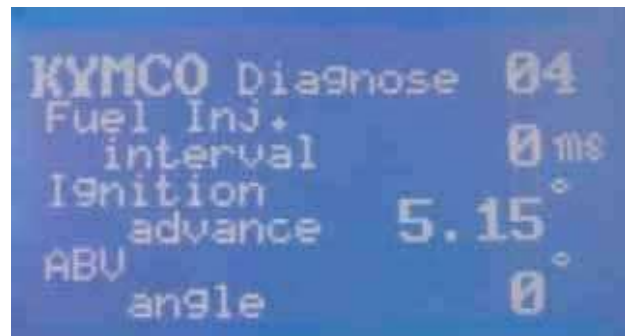

The figure includes O2 sensor voltage, O2 heater working condition and O2 correction.

Refer to standard specification.

Press the "Down" button to enter page 06.



The figure includes rollover voltage.

Refer to standard specification.

Press the "Down" button to enter page 07.



The figure includes ECU counter hours.

Press the "UP" button to the first page.

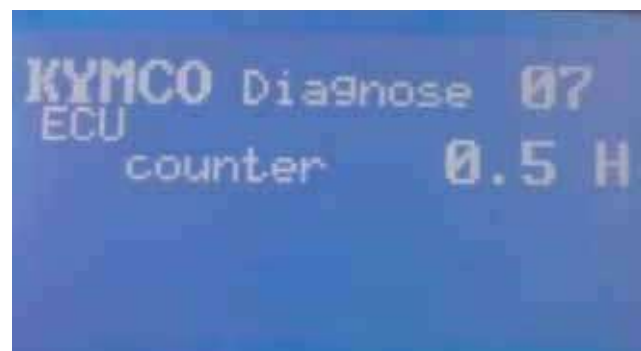

## 13. FUEL INJECTION SYSTEM

### ADJUST

Need to process the TPI/ABV reset after replacing a new ECU or clean Throttle Body.  
To make ECU set up and set up initially

Choose "Adjust"

Press the "Enter" button to TPI/ABV Reset

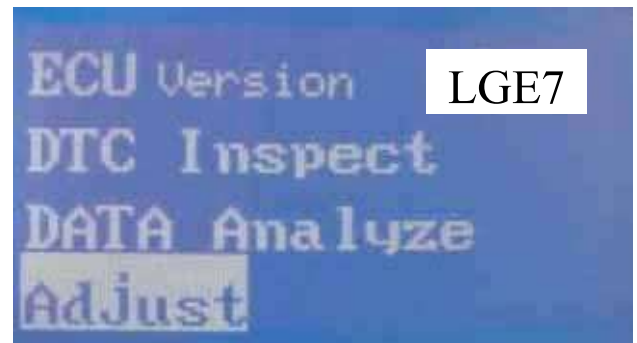

Press the "Enter" button

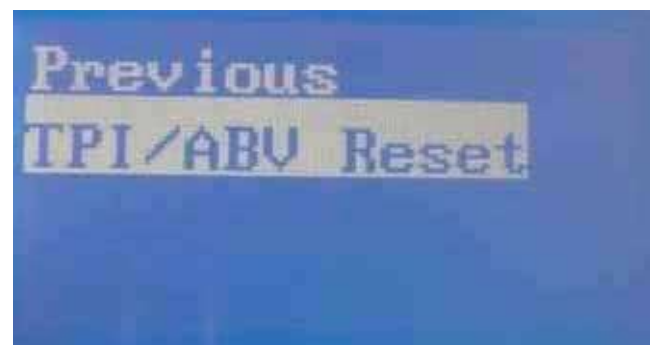

Please turn the ignition switch to the "OFF" position and then switch ON.

TPI/ABV reset is completed.

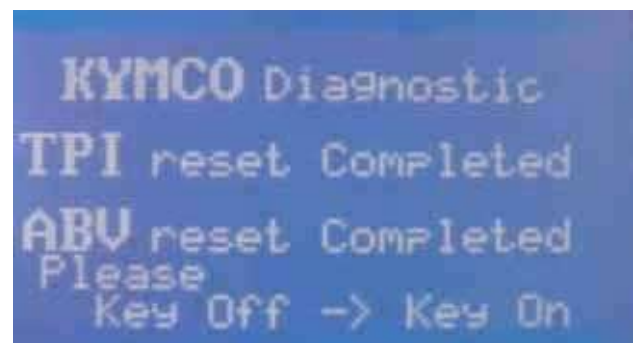

**14. STEERING HANDLEBAR/FRONT WHEEL/FRONT  
BRAKE/FRONT SHOCK ABSORBER/FRONT FORK**

---

---

---

---

---

---

---

---



People GT 125i

---

**STEERING HANDLEBAR/FRONT WHEEL/FRONT  
BRAKE/FRONT SHOCK ABSORBER/FRONT FORK**

---

SCHEMATIC DRAWING-----	14- 1
SERVICE INFORMATION-----	14- 2
TROUBLESHOOTING -----	14- 3
STEERING HANDLEBAR -----	14- 4
FRONT WHEEL-----	14- 5
FRONT BRAKE -----	14- 8
FRONT SHOCK ABSORBER -----	14-12
FRONT FORK-----	14-13

# 14. STEERING HANDLEBAR/FRONT WHEEL/FRONT BRAKE/FRONT SHOCK ABSORBER/FRONT FORK



People GT 125i

## SCHEMATIC DRAWING

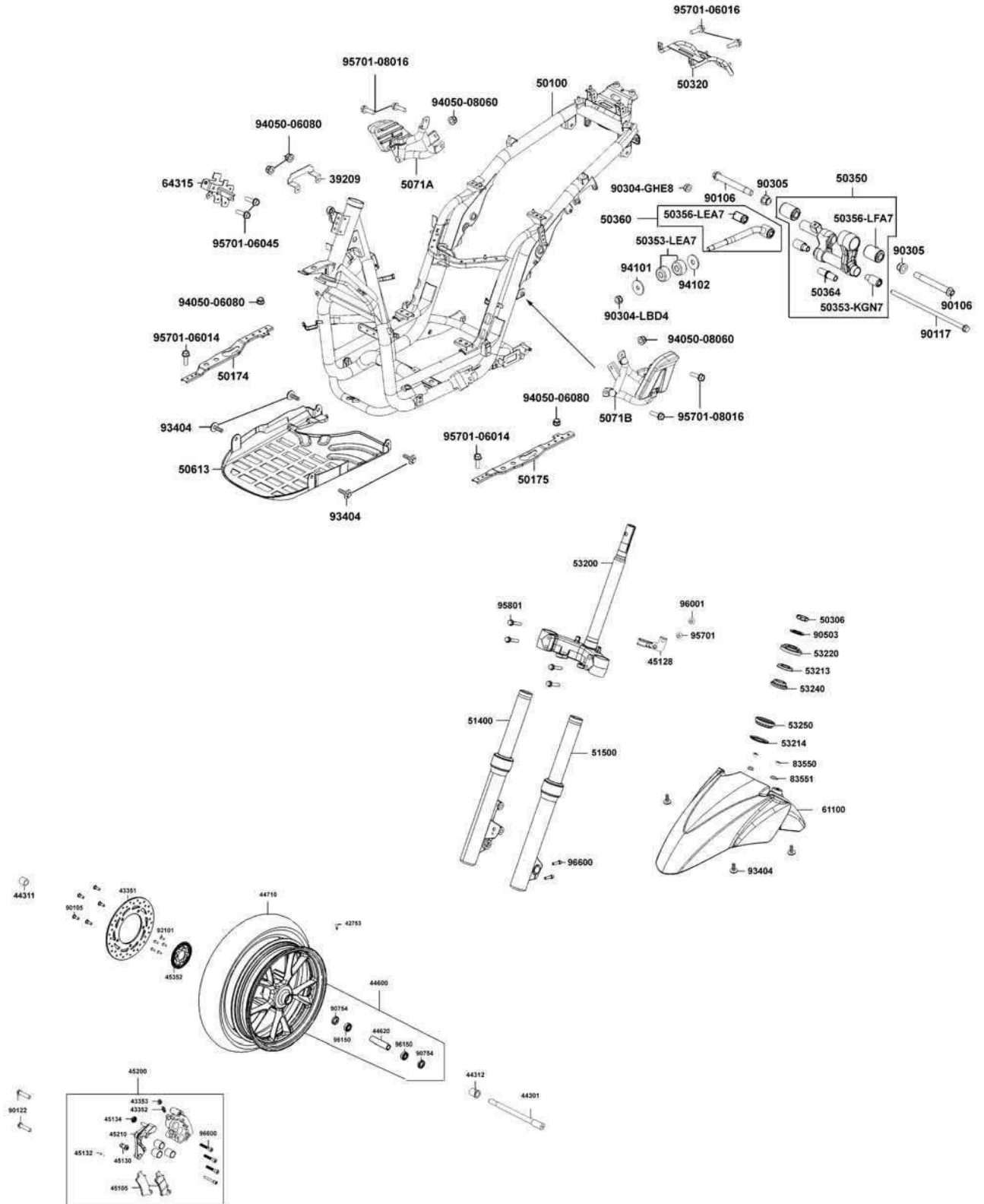

## 14. STEERING HANDLEBAR/FRONT WHEEL/FRONT BRAKE/FRONT SHOCK ABSORBER/FRONT FORK



People GT 125i

### SERVICE INFORMATION

#### GENERAL INSTRUCTIONS

- Remove the motorcycle frame covers before removing the front wheel, steering handlebar, front shock absorber and front fork. Jack the motorcycle front wheel off the ground and be careful to prevent the motorcycle from falling down.
- During servicing, keep oil or grease off the brake pads and brake disk.

#### SPECIFICATIONS

Item		Standard (mm)	Service Limit (mm)
Axle shaft runout		—	0.2
Front wheel rim runout	Radial	—	2.0
	Axial	—	2.0
Brake disk thickness		5.0	4.0
Brake disk runout		—	0.30
Brake caliper piston O.D.		25.33~25.36	25.3
Brake caliper cylinder I.D.		25.4~25.45	25.45
Brake master cylinder O.D.		13.95~13.98	13.94
Brake master cylinder I.D.		14.0~14.04	14.05

#### TORQUE VALUES

Steering Handle Post Bolt	45 N-m
Steering Stem Lock	63 N-m
Steering Head Race Nut	20 N-m
Front Suspension Bolt	27 N-m
Brake caliper holder bolt	35 N-m

#### SPECIAL TOOLS

Lock Nut Wrench	F002
Oil seal & Bearing Driver	E014

**TROUBLESHOOTING**

**Hard steering (heavy)**

- Excessively tightened steering stem top cone race
- Broken steering balls
- Insufficient tire pressure

**Steers to one side or does not track straight**

- Uneven front shock absorbers
- Bent front fork
- Bent front axle or uneven tire

**Poor brake performance**

- Worn brake pads
- Contaminated brake pad surface
- Deformed brake disk
- Air in brake system
- Deteriorated brake fluid
- Worn brake master cylinder piston oil seal
- Clogged brake fluid line
- Unevenly worn brake caliper

**Front wheel wobbling**

- Bent rim
- Loose front axle
- Bent spoke plate
- Faulty tire
- Improperly tightened axle nut

**Soft front shock absorber**

- Weak shock springs
- Insufficient damper oil

**Front shock absorber noise**

- Slider bending
- Loose fork fasteners
- Lack of lubrication

## 14. STEERING HANDLEBAR/FRONT WHEEL/FRONT BRAKE/FRONT SHOCK ABSORBER/FRONT FORK

### STEERING HANDLEBAR

#### REMOVAL

Remove the handlebar front and rear covers.  
(⇒2-3)  
Remove the front and rear brake master cylinder attaching bolts.

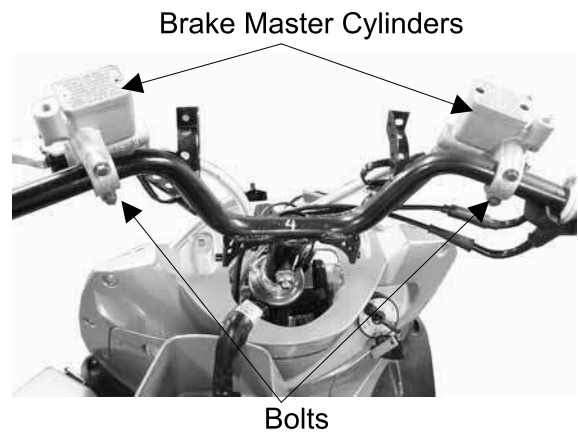

Remove the four screws attaching the right and left handlebar switches.  
Disconnect the throttle cable from the throttle grip and remove the throttle grip from the handlebar.

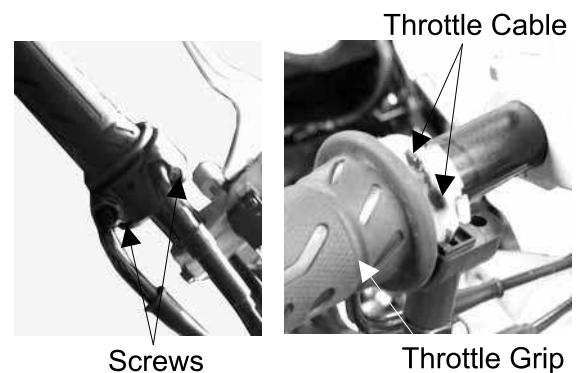

Remove the handlebar lock nut, then take out the bolt and collar.  
Remove the handlebar.

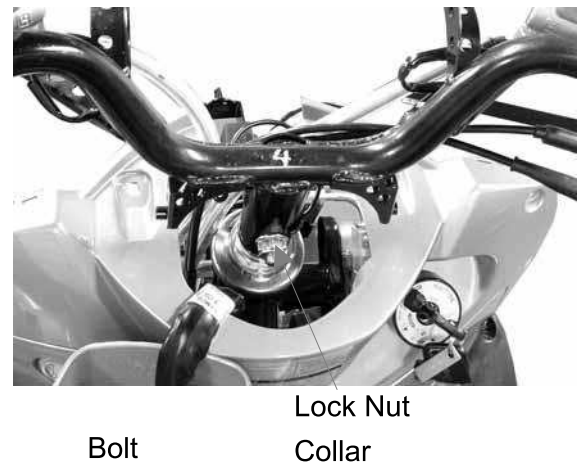

#### INSTALLATION

Install the handlebar onto the steering stem and install the handlebar collar, lock nut and bolt.  
Tighten the handle post bolt to the specified torque.

**Torque:** 45 N-m



## 14. STEERING HANDLEBAR/FRONT WHEEL/FRONT BRAKE/FRONT SHOCK ABSORBER/FRONT FORK

Lubricate the throttle grip front end with grease and then install the throttle grip. Connect the throttle cable to the throttle grip. Install the right and left handlebar switches and tighten the screws.

- \* Adjust the throttle grip free play to the specified range of 2~6mm.

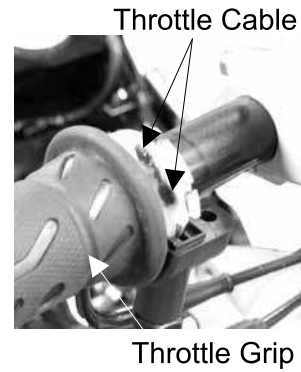

Install the front and rear brake master cylinders.

- \* Install the brake master cylinders by aligning the index marks.



### FRONT WHEEL REMOVAL

Disconnect the speed wire from the front right suspension unit. Remove the front axle to pull out the axle. Remove the front wheel.



### INSPECTION

#### AXLE RUNOUT

Set the axle in V blocks and measure the runout using a dial gauge. The actual runout is  $\frac{1}{2}$  of the total indicator reading.

**Service Limit:** 0.2 mm replace if over

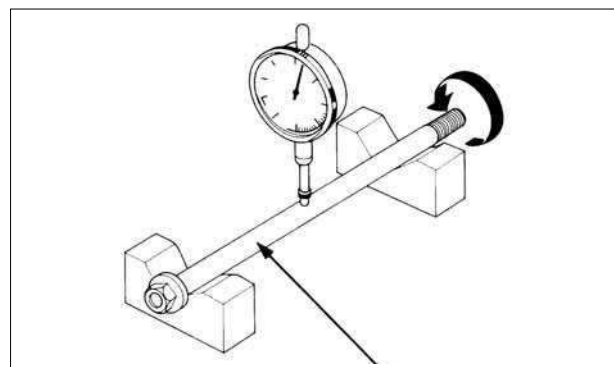



## 14. STEERING HANDLEBAR/FRONT WHEEL/FRONT BRAKE/FRONT SHOCK ABSORBER/FRONT FORK

### WHEEL RIM

Check the wheel rim runout.

#### Service Limits:

**Radial:** 2.0 mm replace if over

**Axial:** 2.0 mm replace if over

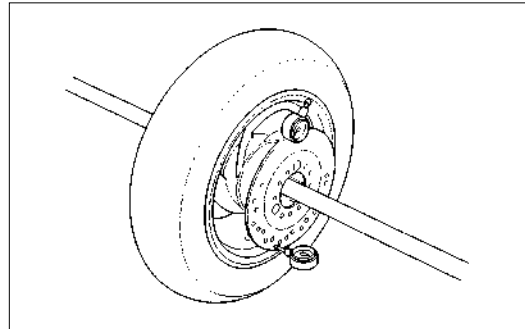

### FRONT WHEEL BEARING

Remove the side collar and dust seal.

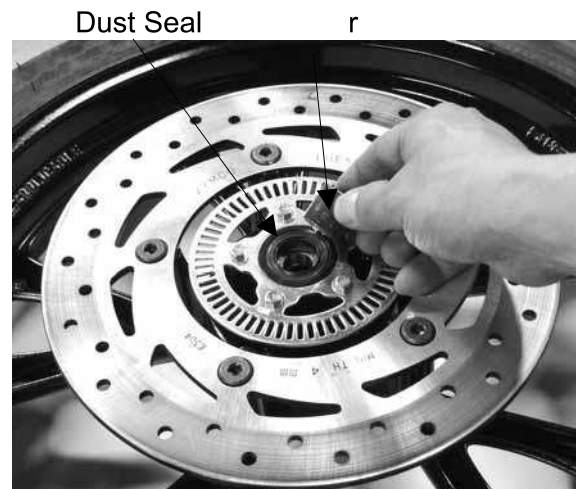

Turn the inner race of each bearing with your finger to see if they turn smoothly and quietly. Also check if the outer race fits tightly in the hub.

Replace the bearings if the races do not turn smoothly, quietly, or if they fit loosely in the hub.



### BEARING REPLACEMENT

Remove the front wheel bearings and distance collar.

## 14. STEERING HANDLEBAR/FRONT WHEEL/FRONT BRAKE/FRONT SHOCK ABSORBER/FRONT FORK

Pack all bearing cavities with grease.  
Drive in the left bearing.  
Install the distance collar.  
Drive in the right bearing.

- \* • Do not allow the bearings to tilt while driving them in.  
• Drive in the bearing squarely with the sealed end facing out.

### Special Tools

Oil seal & Bearing Driver      E014



Outer Driver

### INSTALLATION

Insert the axle and tighten the axle nut.

- \* When installing the front wheel, take the brake disk among the two brake pads.

**Torque:** 65 N-m



Axle

**FRONT BRAKE**

**BRAKE MASTER CYLINDER**

**REMOVAL**

Remove the handlebar covers. (⇒2-3)  
Drain the brake fluid from the hydraulic brake system.  
Disconnect the front stop switch wire connector.  
Remove the brake fluid tube bolt.  
Remove two bolts attaching the brake master cylinder  
Remove the brake master cylinder.



Holder

- \*
  - When servicing the brake system, use towels to cover rubber and plastic parts and coated surfaces to avoid being contaminated by brake fluid.
  - When removing the brake fluid tube bolt, be sure to plug the tube end to avoid brake fluid leakage.

**DISASSEMBLY**

Remove the brake lever bolt and the brake lever.  
Remove the piston rubber cover and snap ring from the brake master cylinder.

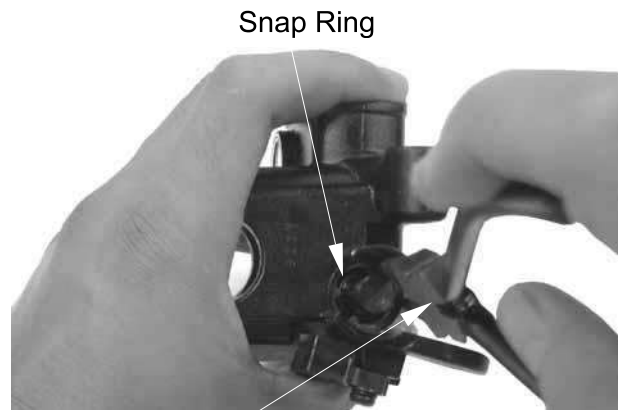

Snap Ring

Snap Ring Pliers (Close)

Master Cylinder    Spring    Main Piston

Remove the washer, main piston and spring from the brake master cylinder.  
Clean the inside of the master cylinder and brake reservoir with brake fluid.

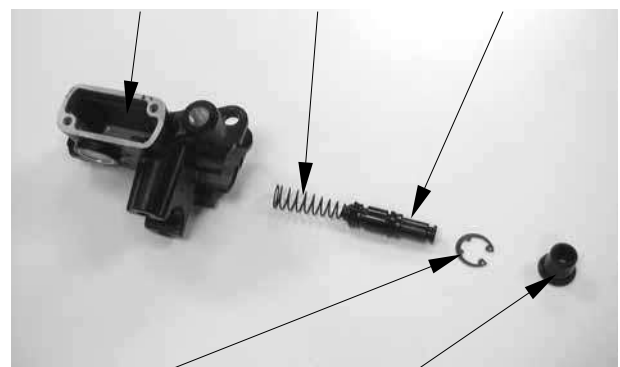

Snap Ring

Rubber Cover

## 14. STEERING HANDLEBAR/FRONT WHEEL/FRONT BRAKE/FRONT SHOCK ABSORBER/FRONT FORK

### INSPECTION

Measure the brake master cylinder I.D.  
Inspect the master cylinder for scratches or cracks.

**Service Limit:** 14.05 mm



Measure the brake master cylinder piston O.D.

**Service Limit:** 13.94 mm

Before assembly, inspect the 1st and 2nd rubber cups for wear.



### ASSEMBLY

Before assembly, apply brake fluid to all removed parts.

Install the spring together with the 1st rubber cup.

- \*
- During assembly, the main piston and spring must be installed as a unit without exchange.
  - When assembling the piston, soak the cups in brake fluid for a while.
  - Install the cups with the cup lips facing the correct direction.

Install the main piston, spring and snap ring.  
Install the rubber cover.  
Install the brake lever.

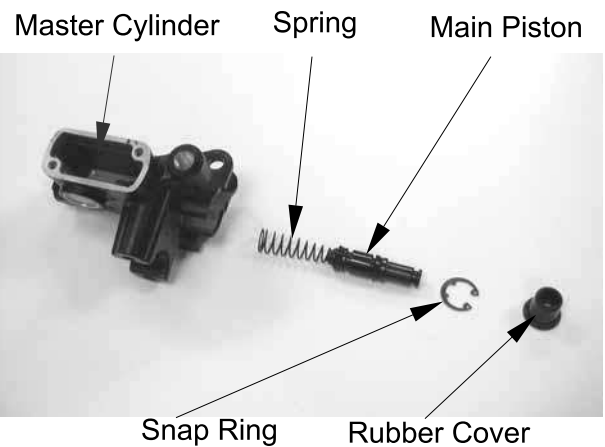

## 14. STEERING HANDLEBAR/FRONT WHEEL/FRONT BRAKE/FRONT SHOCK ABSORBER/FRONT FORK

Place the brake master cylinder on the handlebar and install the holder with the "up" mark facing up. Also align the punch mark with the holder joint seam.

First tighten the upper bolt and then tighten the lower bolt.

**Torque:** 12 N·m

Install the brake fluid tube with the attaching bolt and two sealing washers, then tighten the fluid tube bolt.

Connect the front stop switch wire connector. Install the handlebar covers. (⇒2-3)



Bolts

### BRAKE FLUID REFILLING

Keep the handlebar upright and remove the brake reservoir cover and diaphragm.

Add DOT-4 brake fluid to the brake reservoir.

- \*
  - When bleeding, be careful not to allow air in the brake reservoir flowing into the brake system.
  - When using a brake bleeder, follow the manufacturer's instructions.
  - Never use dirty or unspecified brake fluid or mix different brake fluids because it will damage the brake system.

### BRAKE FLUID BLEEDING

Keep the handlebar upright and remove the brake reservoir cover and diaphragm. Add the specified brake fluid to the upper limit.

- \*
  - Do not allow dust or water to enter the brake system during refilling.
  - When servicing the brake system, use towels to cover plastic parts and coated surfaces to avoid damage caused by splash of brake fluid.

In order to avoid spilling brake fluid, connect a transparent hose to the bleed valve.

#### Warning

Brake fluid spilled on brake pads or brake disk will reduce the braking effect. Clean the brake pads and brake disk with a high quality brake degreaser.

Fully apply the brake lever and then loosen the brake caliper bleed valve to drain the brake fluid until there is no air bubbles in the brake fluid. Then, tighten the bleed valve.

Repeat these steps until the brake system is free of air.

Stop Switch Wire Connector



Washer

Bleed Valve



### BRAKE CALIPER

#### REMOVAL

First drain the brake fluid from the hydraulic brake system.

Remove the brake fluid tube bolt.

Remove the two bolts attaching the brake caliper.

Remove the brake caliper.

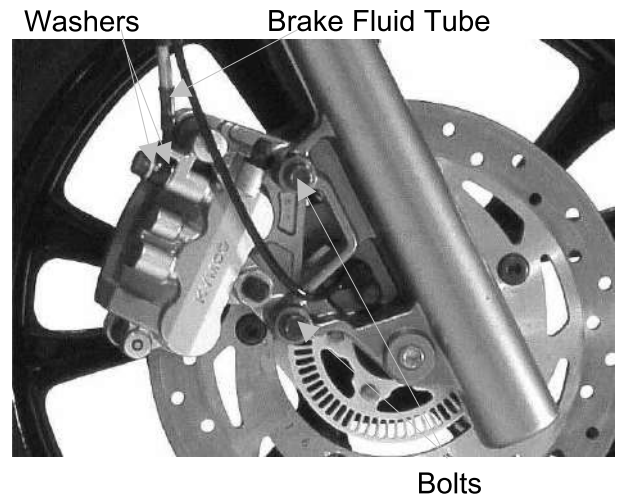

#### INSTALLATION

Install the two brake pads.

Install the two brake pad dowel pin and tighten them.

\* When installing the brake caliper, be sure to position the brake disk between the two brake pads.

Install the brake caliper to the shock absorber and tighten the two bolts.

**Torque:** 35 N-m

Connect the brake fluid tube with the attaching bolt and two sealing washers to the brake caliper and tighten the fluid tube bolt.

**Torque:** 35 N-m

Fill the brake reservoir with the specified brake fluid and bleed air from the brake system. (⇒14-10)

\* When installing the brake fluid tube, be sure to install the two sealing washers.

## 14. STEERING HANDLEBAR/FRONT WHEEL/FRONT BRAKE/FRONT SHOCK ABSORBER/FRONT FORK

### FRONT SHOCK ABSORBER

#### REMOVAL

Remove the front cover. (⇒2-5)  
Remove the front wheel. (⇒15-5)  
Remove the front brake caliper. (⇒15-11)  
Remove the front shock absorber upper mount bolts.  
Loosen the lower mount bolts to remove the front shock absorbers.

#### INSTALLATION

Install the front shock absorbers onto the front fork.  
Install and tighten the front shock absorber upper mount bolts.  
Tighten the lower mount bolts.

**Torque:** 27 N-m

\* Align the hole of upper mount bolt with the groove on the front fork.

Install the front wheel. (⇒15-7)

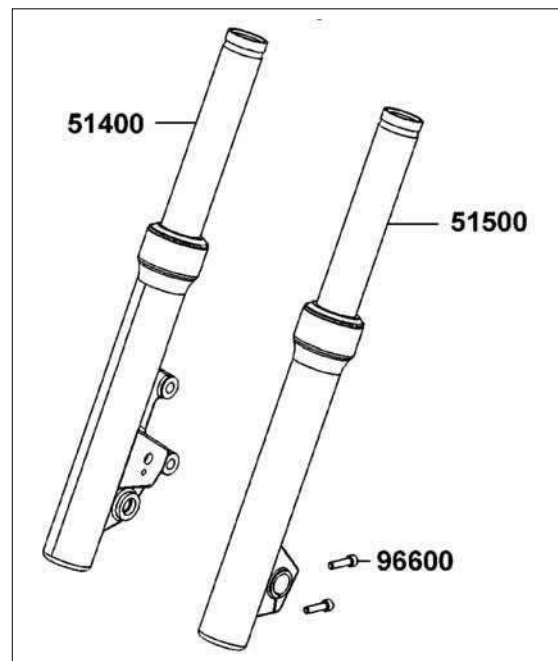
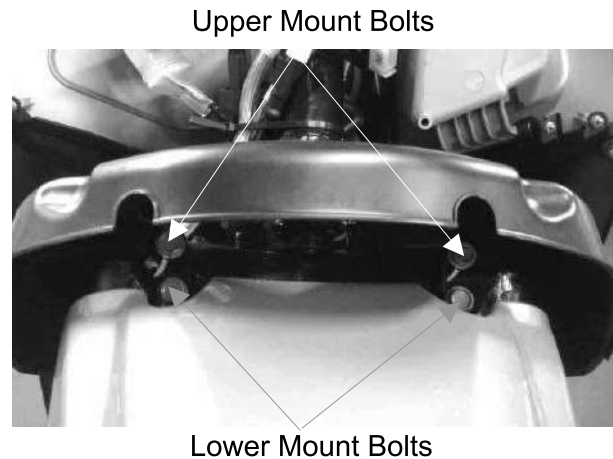

Front Shock Absorber

## 14. STEERING HANDLEBAR/FRONT WHEEL/FRONT BRAKE/FRONT SHOCK ABSORBER/FRONT FORK

### FRONT FORK

#### REMOVAL

Remove the handlebar covers. (⇒2-3)  
Remove the steering handlebar. (⇒15-4)  
Remove the front cover. (⇒2-5)  
Remove the front fender cover. (⇒2-6)  
Remove the front wheel. (⇒15-5)  
Remove the front brake caliper. (⇒15-11)  
Remove the front shock absorbers.  
Hold the steering stem top cone race and remove the steering stem lock nut.  
Remove the top cone race and remove the front fork.

\* Be careful not to lose the steel balls (26 on top race and 19 on bottom race).

Inspect the ball races, cone races and steel balls for wear or damage. Replace if necessary.

#### BOTTOM CONE RACE REPLACEMENT

Remove the bottom cone race using a chisel.

Drive a new bottom cone race into place with a proper driver.

\* Be careful not to damage the steering stem and front fork.

#### BALL RACE REPLACEMENT

Drive out the ball races.  
Drive in new ball races.

\* Be sure to drive the ball races into place completely.

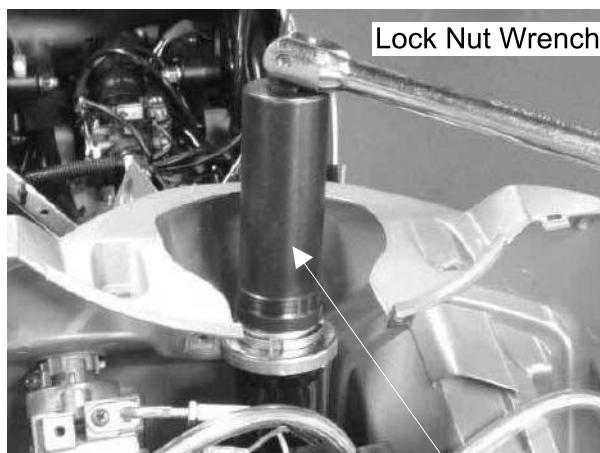

Lock Nut Wrench

Lock Nut Socket

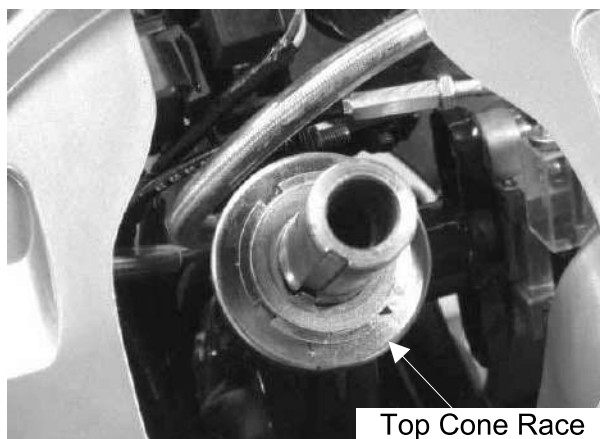

Top Cone Race

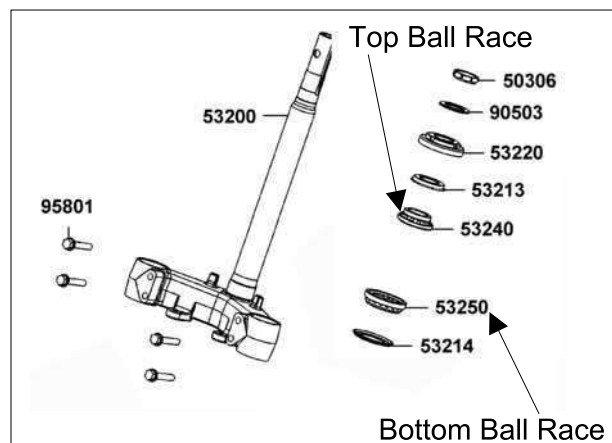

Top Ball Race

Bottom Ball Race



## 14. STEERING HANDLEBAR/FRONT WHEEL/FRONT BRAKE/FRONT SHOCK ABSORBER/FRONT FORK

### INSTALLATION

Apply grease to the top and bottom ball races and install 26 steel balls on the top ball race and 19 steel balls on the bottom ball race.  
Install the front fork.

Apply grease to the top cone race and install it.  
Tighten the top cone race and then turn the steering stem right and left several times to make steel balls contact each other closely.

\* Make sure the steering stem rotates freely without vertical play.



Install the steering stem lock nut and tighten it while holding the top cone race.

**Torque:** 63 N-m

Install the front wheel. (⇒15-7)  
Install the front brake caliper. (⇒15-12)  
Install the front fender cover. (⇒2-6)  
Install the throttle grip and the right and left handlebar switches. (⇒15-5)  
Install the right and left brake master cylinders. (⇒15-5)

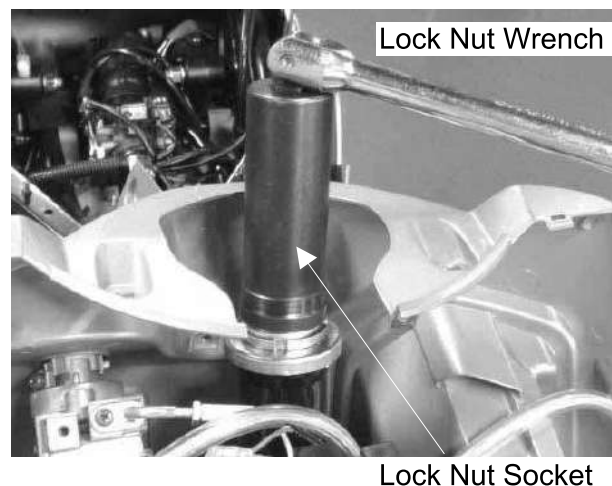

**14. STEERING HANDLEBAR/FRONT WHEEL/FRONT  
BRAKE/FRONT SHOCK ABSORBER/FRONT FORK**

---



People GT 125i

# 15. REAR BRAKE/REAR FORK/REAR WHEEL/REAR SHOCK ABSORBER



People GT 125i

---

---

---

---

---

---

---

---

## REAR BRAKE/REAR FORK/REAR WHEEL/ REAR SHOCK ABSORBER

---

SCHEMATIC DRAWING-----	15-1
SERVICE INFORMATION-----	15-2
TROUBLESHOOTING -----	15-2
REAR BRAKE -----	15-3
REAR FORK -----	15-4
REAR WHEEL-----	15-5
REAR SHOCK ABSORBER -----	15-5

# 15. REAR BRAKE/REAR FORK/REAR WHEEL/REAR SHOCK ABSORBER



People GT 125i

## SCHEMATIC DRAWING

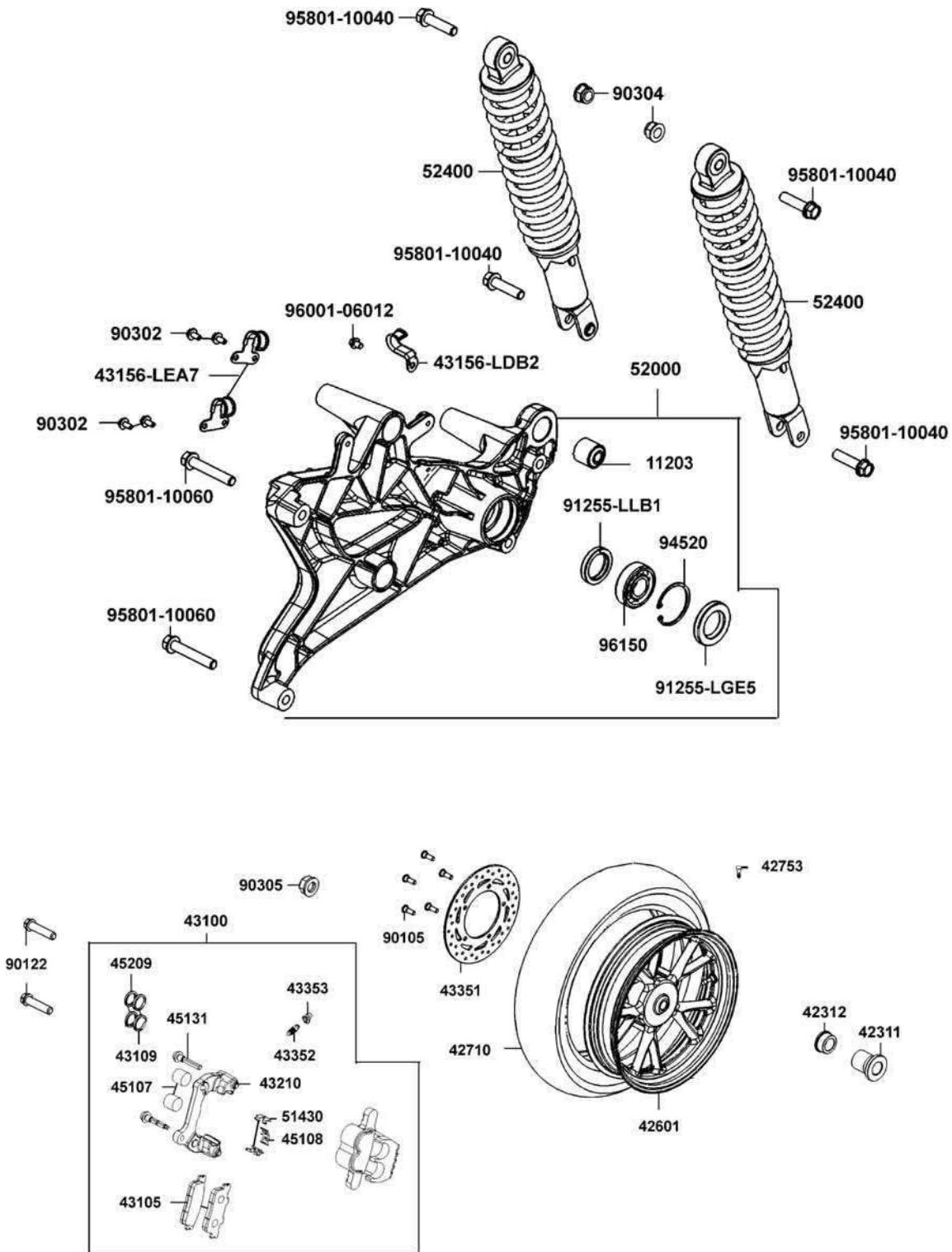

# 15. REAR BRAKE/REAR FORK/REAR WHEEL/REAR SHOCK ABSORBER



People GT 125i

## SERVICE INFORMATION

### GENERAL INSTRUCTIONS

- When performing the services stated in this section, the engine and exhaust muffler must be cold to avoid scalding.
- During servicing, keep oil or grease off the brake pads and brake disk.

### SPECIFICATIONS

Item	Standard (mm)	Service Limit (mm)
Rear wheel rim runout	—	2.0
Rear brake disk thickness	5.0	4.0
Rear brake disk runout	—	0.30
Rear brake master cylinder I.D.	27.00	27.05
Rear brake master cylinder piston O.D.	26.95	26.90

### TORQUE VALUES

Exhaust muffler lock bolt	35 N-m
Exhaust muffler pipe nut	20 N-m
Rear axle nut	140 N-m
Rear shock absorber lower mount bolt	40 N-m
Rear shock absorber upper mount bolt	40 N-m
Rear brake caliper holder bolt	35 N-m

### TROUBLESHOOTING

#### Rear wheel wobbling

- Bent rim
- Faulty tire
- Axle not tightened properly

#### Soft rear shock absorber

- Weak shock absorber spring
- Damper oil leaks

#### Rear wheel noise

- Worn rear wheel axle bearings
- Worn rear fork bearings
- Deformed rear fork

#### Poor brake performance

- Air in brake system
- Deteriorated brake fluid
- Contaminated brake pad surface
- Worn brake pads
- Clogged brake fluid line
- Deformed brake disk
- Unequal worn brake caliper

# 15. REAR BRAKE/REAR FORK/REAR WHEEL/REAR SHOCK ABSORBER

## REAR BRAKE

### REAR BRAKE CALIPER REMOVAL

First remove the exhaust muffler. (⇒2-10)  
Remove the rear brake fluid tube bolt and disconnect the brake fluid tube.  
Remove two bolts attaching the rear brake caliper.  
Remove the rear brake caliper.

When removing the brake fluid tube, use shop towels to cover plastic parts and coated surfaces to avoid damage.

Fluid Tube Bolt



Brake Caliper Bolts

Brake Disk

## INSPECTION

Inspect the brake pads and brake disk.

Measure the brake disk thickness.

**Service Limit:** 4.0 mm replace if below

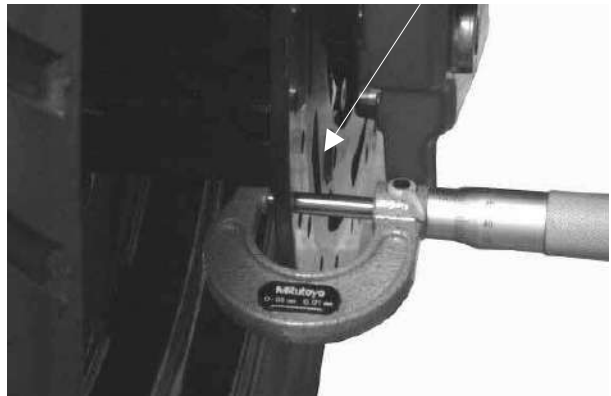

Visually check the brake pad thickness and it should not exceed the wear indicator mark.

Dowel Pin



Brake Pads

## DISASSEMBLY

Remove two brake pads dowel pins and three bolts from the brake caliper.

Remove the brake pads.

# 15. REAR BRAKE/REAR FORK/REAR WHEEL/REAR SHOCK ABSORBER

## INSTALLATION

Install the brake caliper to the rear fork and tighten the two bolts.

**Torque:** 35 N-m

Connect the brake fluid tube to the brake caliper and install fluid tube bolt, copper washers and tighten the fluid tube bolt.

Fill the brake reservoir with the specified brake fluid and bleed air from the brake system. (⇒14-10)

When installing the brake fluid tube, be sure to install the two copper sealing washers.

Fluid Tube Bolt



Brake Caliper Bolts

## REAR FORK

### REMOVAL

Remove the exhaust muffler. (⇒2-10)

Remove the rear brake caliper. (⇒16-3)

Remove the right rear shock absorber lower mount bolt.

Remove the rear axle nut and remove the collar.

Remove the rear fork.



Bolt

The installation sequence is the reverse of removal.

Turn the inner race of each bearing with your finger to see if they turn smoothly and quietly. Also check if the outer race fits tightly in the hub.

Replace the bearings if the races do not turn smoothly, quietly, or if they fit loosely in the hub.

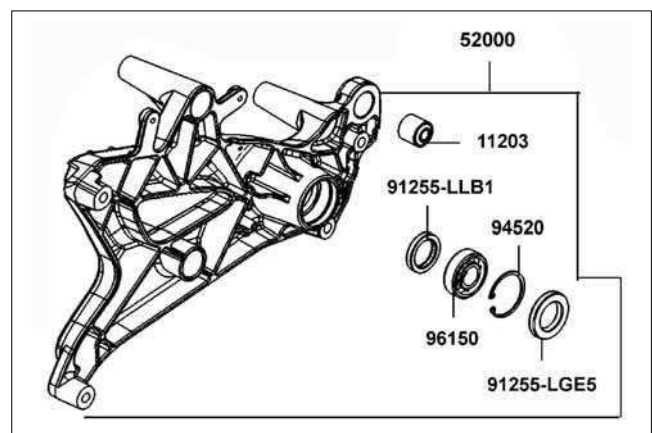

# 15. REAR BRAKE/REAR FORK/REAR WHEEL/REAR SHOCK ABSORBER



People GT 125i

## REAR WHEEL REMOVAL

- Remove the exhaust muffler. (⇒2-10)
- Remove the rear brake caliper. (⇒16-3)
- Remove the rear fork. (⇒16-6)
- Remove the rear axle collar.
- Remove the rear wheel.

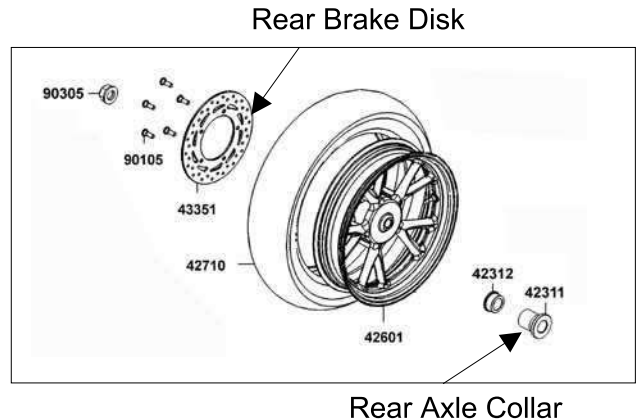

## INSPECTION

Measure the rear wheel rim runout.

### Service Limits:

- Radial:** 2.0mm replace if over
- Axial:** 2.0mm replace if over

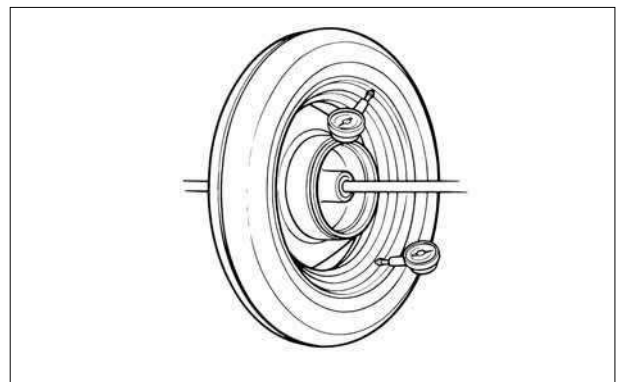

## INSTALLATION

The installation sequence is the reverse of removal.

### Torque:

- Rear shock absorber lower mount bolt: 40 N-m
- Rear axle nut: 140 N-m



Bolt

## REAR SHOCK ABSORBER REMOVAL

- Remove the met-in box and carrier. (⇒2-6)
- Remove the body cover, center cover and rear fender A together. (⇒2-6)
- Remove the right/left rear shock absorber upper and lower mount bolts.
- Remove the right and left rear shock absorbers.

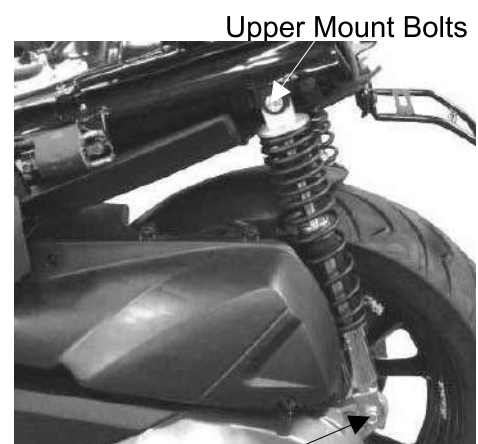

Upper Mount Bolts

Lower Mount Bolts



# 15. REAR BRAKE/REAR FORK/REAR WHEEL/REAR SHOCK ABSORBER

### INSTALLATION

Install the rear shock absorbers in the reverse order of removal.

#### Torque:

Upper Mount Bolt: 40 N-m

Lower Mount Bolt: 40 N-m

### ADJUSTABLE REAR CUSHION

To suit scooter comfortable to load condition rear cushion could be adjusted in spring preload.

It is possible to adjust rear cushion in three positions:

**A position “soft”**

**B position “medium”**

**C position “hard”**

When adjusting rear cushion, the spring preload of rear cushions must be the same.

A cushion adjust wrench is provided with new scooter.

The rear right cushion can be adjusted directly with the wrench tool.

Disconnect the breather hose from air cleaner and keep air cleaner up to adjust rear left cushion with wrench tool.

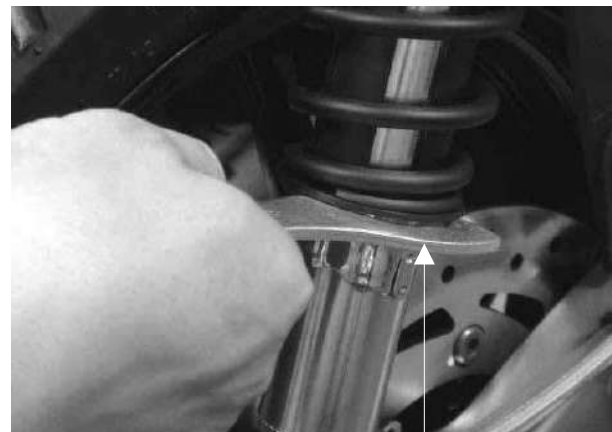
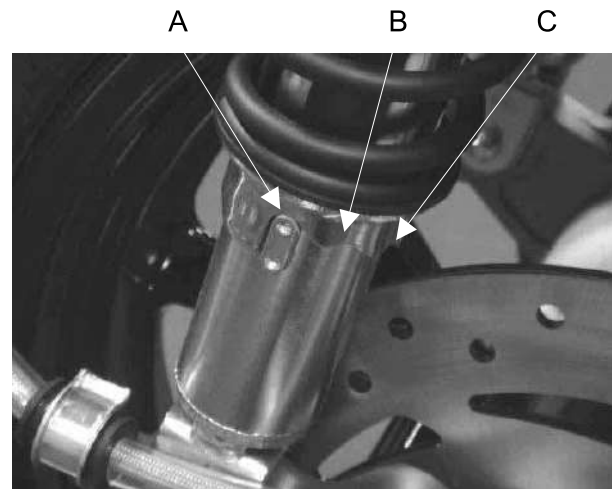

Wrench

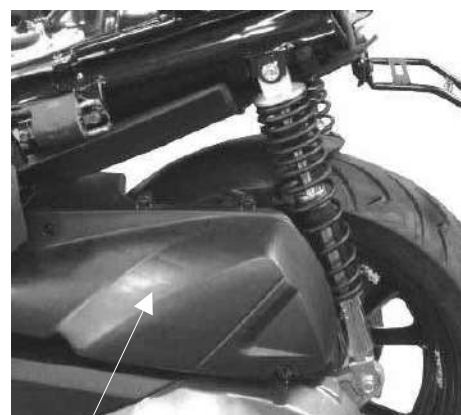

Air Cleaner

# 16. BATTERY/CHARGING SYSTEM

---

---

---

---

---

**16**

---

## BATTERY/CHARGING SYSTEM

---

CHARGING SYSTEM LAYOUT .....	16-1
CHARGING CIRCUIT .....	16-1
SERVICE INFORMATION.....	16-2
TROUBLESHOOTING.....	16-3
BATTERY CHARGING .....	16-4
CHARGING SYSTEM .....	16-6
REGULATOR/RECTIFIER .....	16-6

# 16. BATTERY/CHARGING SYSTEM

## CHARGING SYSTEM LAYOUT



Battery

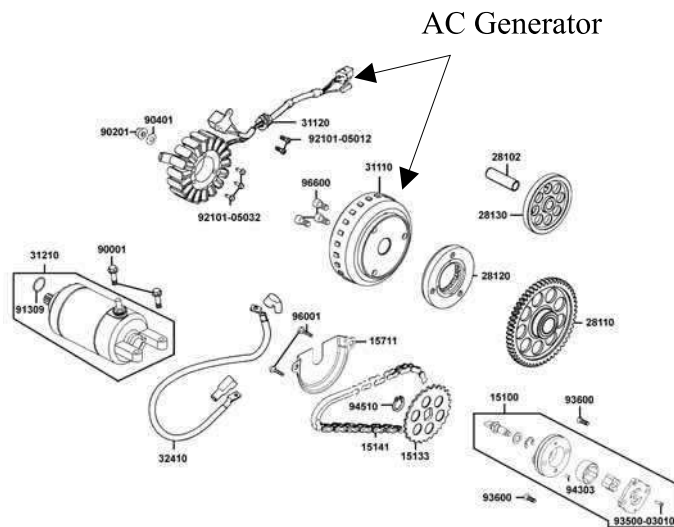

AC Generator



Regulator/Rectifier

# 16. BATTERY/CHARGING SYSTEM

## SERVICE INFORMATION

### GENERAL INSTRUCTIONS

\* The battery electrolyte (sulfuric acid) is poisonous and may seriously damage the skin and eyes. Avoid contact with skin, eyes, or clothing. In case of contact, flush with water and get prompt medical attention

- The battery can be charged and discharged repeatedly. If a discharged battery is not used for a long time, its service life will be shortened. Generally, the capacity of a battery will decrease after it is used for 2~3 years. A capacity-decreased battery will resume its voltage after it is recharged but its voltage decreases suddenly and then increases when a load is added.
- When a battery is overcharged, some symptoms can be found. If there is a short circuit inside the battery, no voltage is produced on the battery terminals. If the rectifier won't operate, the voltage will become too high and shorten the battery service life.
- If a battery is not used for a long time, it will discharge by itself and should be recharged every 3 months.
- A new battery filled with electrolyte will generate voltage within a certain time and it should be recharged when the capacity is insufficient. Recharging a new battery will prolong its service life.
- Inspect the charging system according to the sequence specified in the Troubleshooting.
- Do not disconnect and soon reconnect the power of any electrical equipment because the electronic parts in the regulator/rectifier will be damaged. Turn off the ignition switch before operation.
- It is not necessary to check the MF battery electrolyte or fill with distilled water.
- Check the load of the whole charging system.
- Do not quick charge the battery. Quick charging should only be done in an emergency.
- Remove the battery from the motorcycle for charging.
- When replacing the battery, do not use a traditional battery.
- When charging, check the voltage with an electric tester.

### SPECIFICATIONS

Item		Standard	
Battery	Capacity	12V12AH	
	Voltage (20°C)	Fully charged	13.2V
		Insufficient charged	< 12.3V
	Charging current	1.2A* 5~10H	

# 16. BATTERY/CHARGING SYSTEM

---

## TROUBLESHOOTING

### No power

- Dead battery
- Disconnected battery cable
- Fuse burned out
- Faulty ignition switch

### Low power

- Weak battery
- Loose battery connection
- Charging system failure
- Faulty regulator/rectifier

### Intermittent power

- Loose battery cable connection
- Loose charging system connection
- Loose connection or short circuit in ignition system

### Charging system failure

- Loose, broken or shorted wire or connector
- Faulty regulator/rectifier
- Faulty A.C. generator

# 16. BATTERY/CHARGING SYSTEM

## BATTERY REMOVAL

The battery is under the floorboard.  
Remove the two screws attaching the battery cover.  
Pull battery out to expose the terminal leads.  
Disconnect the negative (-) terminal lead from the battery first, then disconnect the positive (+) terminal lead.  
Remove the battery from the battery box.

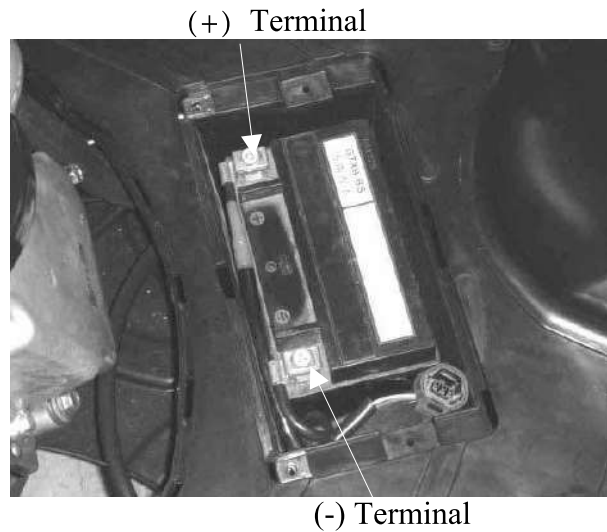

## BATTERY INSTALLATION

Install in the reverse order of the removal.

\* When install the battery, first connect the positive (+) cable and then negative (-) cable to avoid short circuit.

## VOLTAGE INSPECTION

Remove the battery cover.  
Measure the battery voltage by using a commercially available digital multimeter.

**Voltage (20°C/68°F):**

**Fully charged: 13.0 ~ 13.2 V**

**Insufficient charged: < 12.3 V**

## 16. BATTERY/CHARGING SYSTEM

---

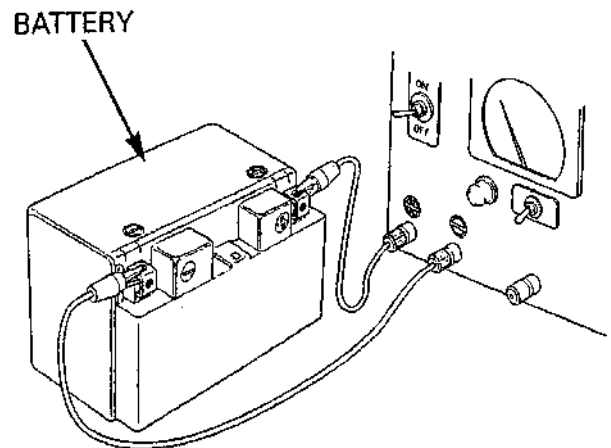

\*

\* Do not disconnect the battery or any cable in the charging system without first switching off the ignition switch. Failure to follow this precaution can damage the tester or electrical

# 16. BATTERY/CHARGING SYSTEM

## REGULATOR/RECTIFIER

### WIRE HARNESS INSPECTION

Remove the luggage box  
Disconnect the regulator/rectifier connectors.  
Check the connectors for loose contacts of corroded terminals.



Regulator/Rectifier

## BATTERY WIRE

Measure the voltage between the Red/White wire terminal and ground.  
There should be battery voltage at all times.



## GROUND WIRE

Check the continuity between the Green wire terminal and ground.  
There should be continuity at all times.





# 16. BATTERY/CHARGING SYSTEM

## CHARGING COIL WIRE

Measure the resistance between each Yellow wire terminals.

**Standard:** 0.4 ~ 0.6  $\Omega$  (20°C/68°F)

Disconnect the regulator/rectifier connector.  
Check for continuity between each Yellow wire terminal regulator/rectifier side and ground.

There should be no continuity.



## REMOVAL/INSTALLATION

Remove the side body cover.

Disconnect the regulator/rectifier connectors.

Remove the two bolts, regulator/rectifier.

Installation is in the reverse order of removal.

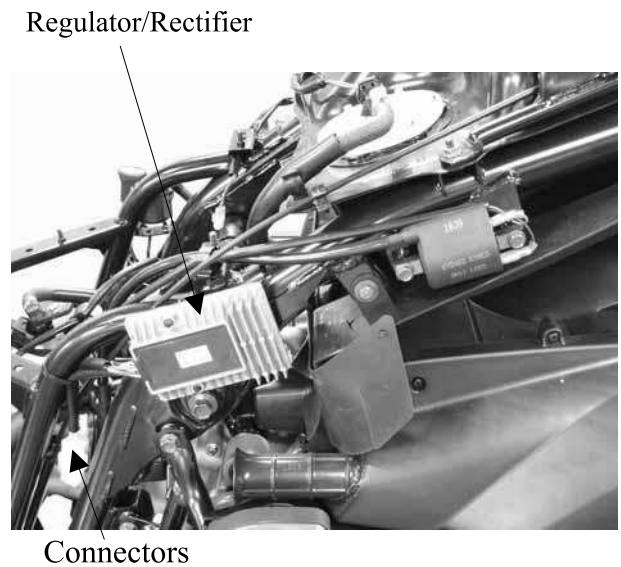



# 17. IGNITION SYSTEM

## IGNITION SYSTEM LAYOUT

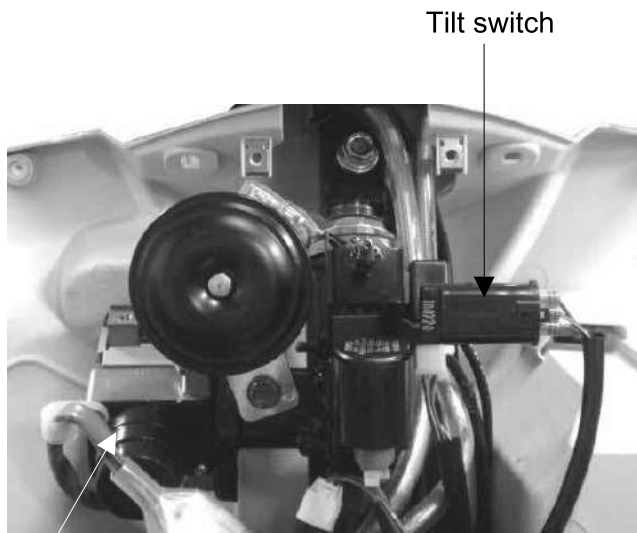

Tilt switch

Ignition Switch



Ignition Coil

## IGNITION CIRCUIT

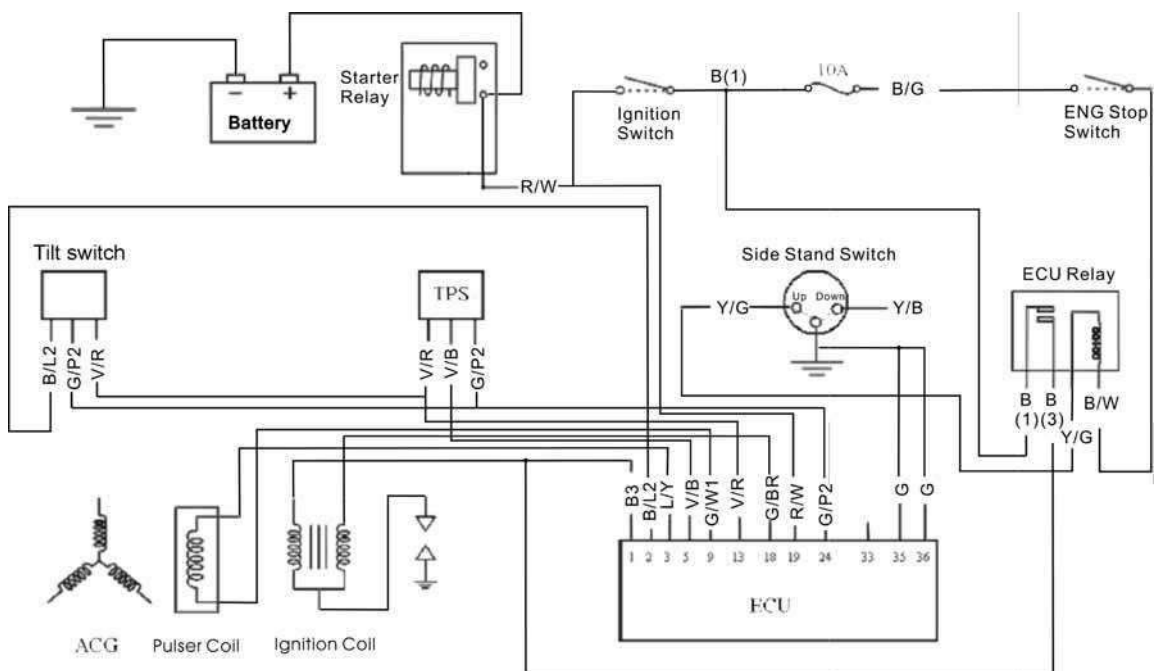

# 17. IGNITION SYSTEM

## SERVICE INFORMATION

### GENERAL INSTRUCTIONS

- Some electrical components may be damaged if terminals or connectors are connected or disconnected while the ignition switch is "ON" and current is present.
- When servicing the ignition system, always follow the steps in the troubleshooting on page 17-2.
- The ignition timing cannot be adjusted since the ignition control module is already adjusted in factory.
- The ignition control module or ECU maybe damaged if dropped or the connector is disconnected when the key is " ON " , the excessive voltage may damage the ignition control module or ECU. Always turn off the ignition switch before servicing.
- A faulty ignition system is often related to poor connections. Check those connections before proceeding.
- Make sure the battery is adequately charged. Using the starter motor with weak battery results in a slower engine cranking speed as well as no spark at the spark plug.
- Use a spark plug of the correct heat range. Using spark plug with an incorrect heat range can damage the engine.

### SPECIFICATIONS

Item		Standard
Spark plug	Standard type	NGK CR7E
Spark plug gap		0.6 ~ 0.7 mm
Inductive Ignition Coil	Primary coil	3.57~4.83 Ω
	Secondary coil without plug cap	10.42~14.49 KΩ
Throttle Position Sensor		3500~6500 Ω
Fuel Pump		1.9 Ω about
Fuel Injector		11.7±0.6 Ω
Water Temperature Sensor		2.076KΩ±10% (25°C)
Oxygen Sensor ( engine warming condition )		6.7 Ω~9.5 Ω
Crank Position Sensor		115Ω±15Ω
Tilt Switch		0.4V~1.4V(normal) 3.7V~4.4V (fall down)

### TROUBLESHOOTING

#### No peak voltage

- Short circuit in engine stop switch or ignition switch wire.
- Faulty engine stop switch or ignition switch.
- Loose or poorly connected ignition control module connectors.
- Open circuit or poor connection in ground wire of the ignition control module.
- Faulty crank position sensor.
- Faulty ignition control module.

#### Peak voltage is normal, but no spark jumps at the plug

- Faulty spark plug or leaking ignition coil secondary current.
- Faulty ignition coil.

# 17. IGNITION SYSTEM

## SPARK PLUG

For spark plug inspection and adjustment, refer to page 3-5.

## IGNITION COIL INSPECTION

Remove the seat and met-in box. (⇒2-6)  
Remove the ignition coil.

Ignition Coil

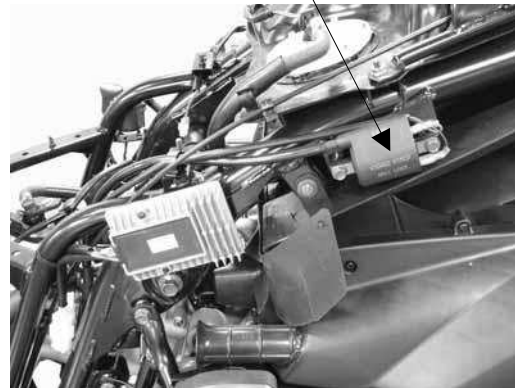

Primary Coil



## IGNITION COIL CONTINUITY TEST

Inspect the continuity of the ignition coil, primary coil and secondary coil.

\* This is a general test. Accurate ignition coil test must be performed with an ignition unit tester.

Secondary Coil with plug cap



Secondary Coil without plug cap



Measure the ignition coil resistances at 20°C.

Primary coil	3.57~4.83 Ω
Secondary coil with plug cap	15 ~ 19 KΩ
Secondary coil without plug cap	10 ~14 KΩ

# 17. IGNITION SYSTEM

## A .C. GENERATOR INSPECTION

### CRANK POSITION SENSOR INSPECTION

\* This test is performed with the stator installed in the engine.

Remove the seat and met-in box.  
 Disconnect the Crank Position Sensor Wire Coupler.  
 Measure the resistance between the blue/white and green/white wire terminals.

Blue/Yellow ~ Green/White	115Ω±15Ω
---------------------------	----------

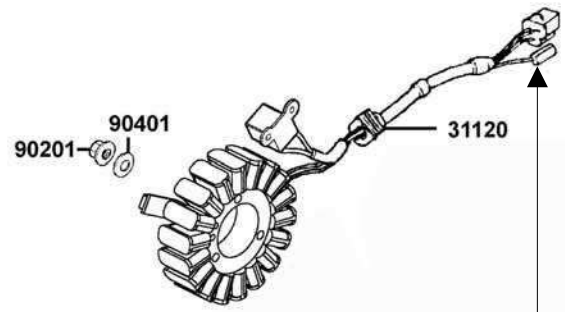

Crank Position Sensor Wire Coupler

## TILT SWITCH

### INSPECTION

Support the scooter level surface.  
 Put the side stand up and engine stop switch is at "RUN".  
 Turn the ignition switch to "OFF".  
 Remove the screws, washers and tilt switch.

\* Do not disconnect the tilt switch connector during inspection.  
 The capacity of battery must be fully charged.

Place the tilt switch vertical as shown at the ignition switch "ON". Measure the voltage as below.

Terminal	Standard
Violet/Red (+) – Green/Pink (-)	5 V (ECU voltage)
Black/Blue (+) – Green/Pink (-)	0.4 ~ 1.4 V less

Incline the tilt switch 65±10 degrees to the left or right at the ignition switch "ON". Measure the voltage as below.

Terminal	Standard
Violet/Red (+) – Green/Pink (-)	5 V (ECU voltage)
Black/Blue (+) – Green/Pink (-)	3.7 ~ 4.4 V

If repeat this test, first turn the ignition switch to "OFF", then turn the ignition switch to "ON".

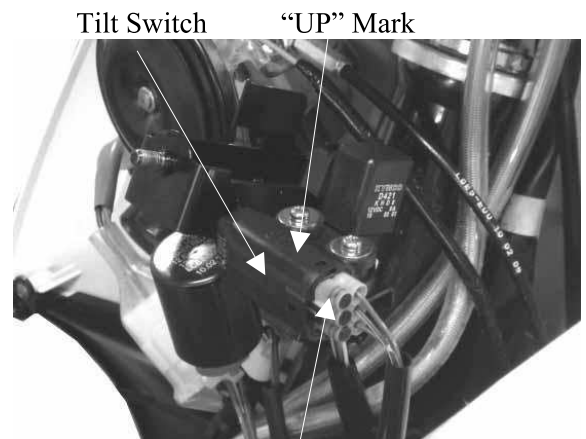

Connector

## 17. IGNITION SYSTEM

---

### REMOVAL/INSTALLATION

Disconnect the connector and remove two screws, then remove tilt switch.

Installation is in the reverse order of removal.

\* 

Install the tilt switch with its “up” mark facing up.
---

Tighten the mounting screws securely.





# 18. STARTING SYSTEM

## STARTING SYSTEM LAYOUT



Ignition Switch



Starter Relay

## STARTING CIRCUIT

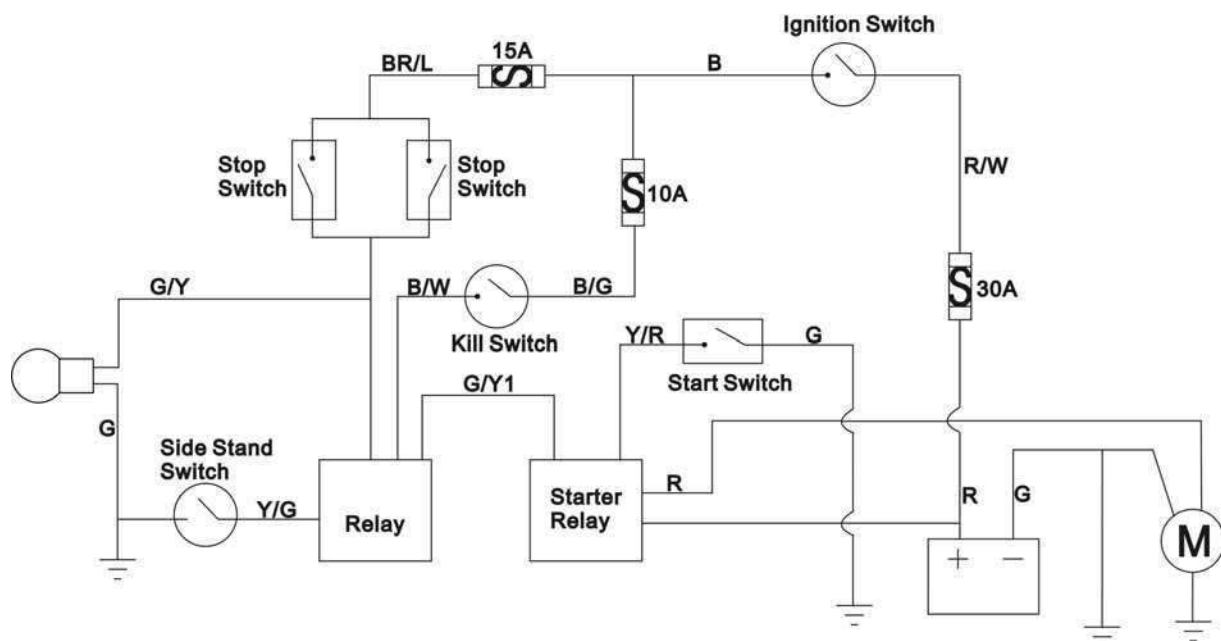

## 18. STARTING SYSTEM

### SERVICE INFORMATION

#### GENERAL INSTRUCTIONS

- The removal of starter motor can be accomplished with the engine installed.
- After the starter clutch is installed, be sure to add the engine oil and coolant and then bleed air from the cooling system.

#### SPECIFICATIONS

Item	Standard (mm)	Service Limit (mm)
Starter motor brush length	12.5mm	8.5mm

#### TORQUE VALUES

Starter motor mounting bolt	6.7~10.8	N-m
Starter motor case screw	2.9~4.9	N-m
Starter clutch bolt	9.8~13.7	N-m

#### SPECIAL TOOLS

Flywheel holder	E021
Flywheel puller	E003

#### TROUBLESHOOTING

##### Starter motor won't turn

- Fuse burned out
- Weak battery
- Faulty ignition switch
- Faulty starter clutch
- Faulty front or rear stop switch
- Faulty starter relay
- Poorly connected, broken or shorted wire
- Faulty starter motor

##### Lack of power

- Weak battery
- Loosed wire or connection
- Foreign matter stuck in starter motor or gear

##### Starter motor rotates but engine does not start

- Faulty starter pinion
- Starter motor rotates reversely
- Weak battery

## 18. STARTING SYSTEM

### STARTER MOTOR

#### REMOVAL

\* Before removing the starter motor, turn the ignition switch OFF and remove the battery ground. Then, turn on the ignition switch and push the starter button to make sure the starter motor can't operate securely.

Remove the seat, met-in box and carrier.  
Remove the body cover, center cover and rear fender together.  
Remove the nut goes to the starter relay and relax cable band to disconnect the starter motor cable.

Remove two start motor mounting bolts and the motor.

Starter Motor Cable

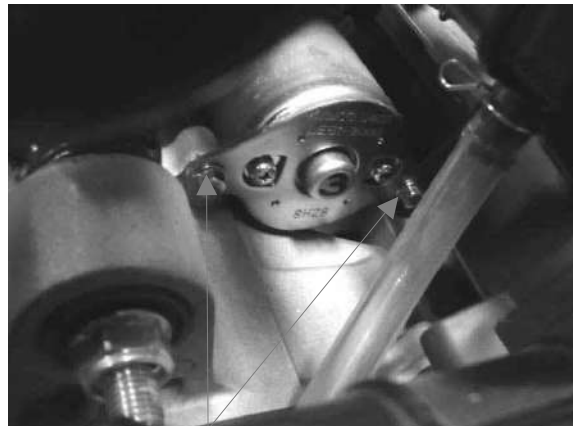
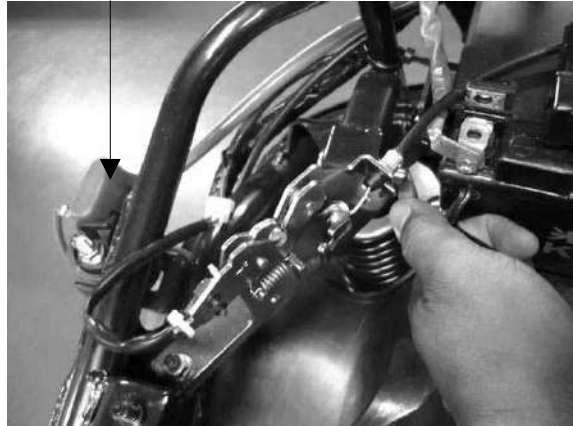

Bolts

## 18. STARTING SYSTEM

### INSTALLATION

Connect the starter motor cable.

Check the O-ring for wear or damage and replace if necessary.

Apply grease to the O-ring and install it to the starter motor.

Tighten the two mounting bolts.

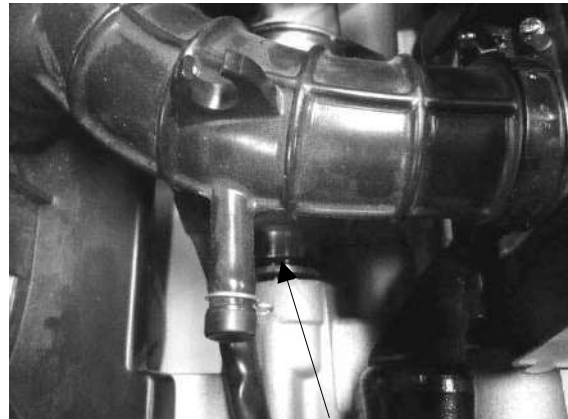

O-ring

Yellow/Red Wire And Green/Yellow Wire

### STARTER RELAY INSPECTION

Disconnect the starter relay wire connector.

Check for continuity between the yellow/red wire and green/yellow wire.

There should be continuity when the starter button is depressed.

If there is no continuity, check the starter button for continuity and inspect the wire.

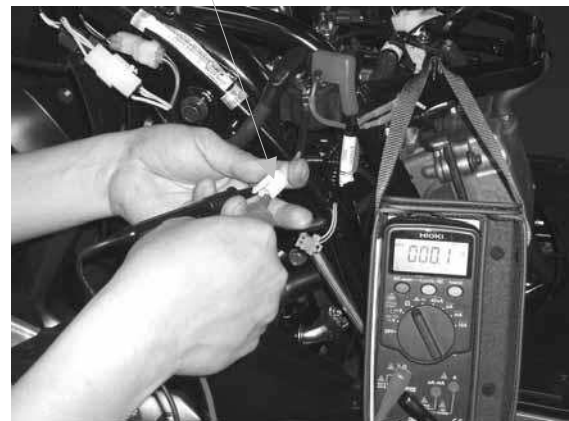

### OPERATION TEST

Connect the electric meter to the starter relay terminals that connect to the battery positive cable and the starter motor cable.

Connect a fully charged battery across the starter relay yellow/red and green/yellow wire terminals.

Check for continuity between the starter relay large terminals. The relay is normal if there is continuity and hear sounds.

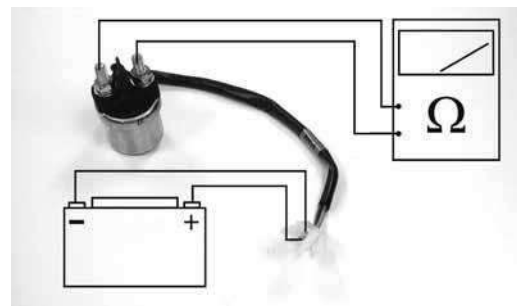

Starter Relay test chart

---

**19. LIGHTS SWITCHES/ FUEL PUMP**

---

---

**LIGHTS/METERS/SWITCHES**

---

SERVICE INFORMATION-----	19- 1
BULB REPLACEMENT -----	19- 3
BRAKE LIGHT SWITCH-----	19- 5
IGNITION SWITCH -----	19- 5
RIGHT HANDLEBAR SWITCH -----	19- 6
LEFT HANDLEBAR SWITCH -----	19- 7
AUXILIARY OUTLET-----	19- 7
FUEL PUMP -----	19- 8
SIDE STAND SWITCH -----	19-10

# 19. LIGHTS SWITCHES/ FUEL PUMP

## ELECTRICAL EQUIPMENT LAYOUT

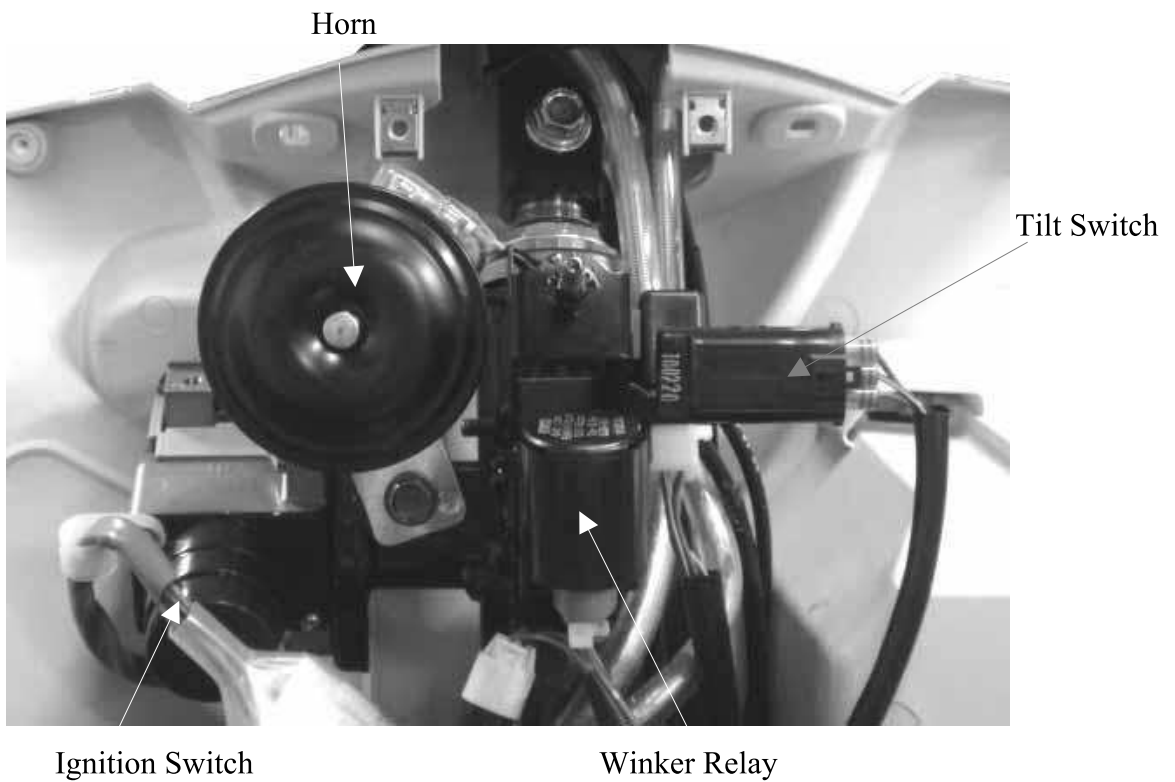
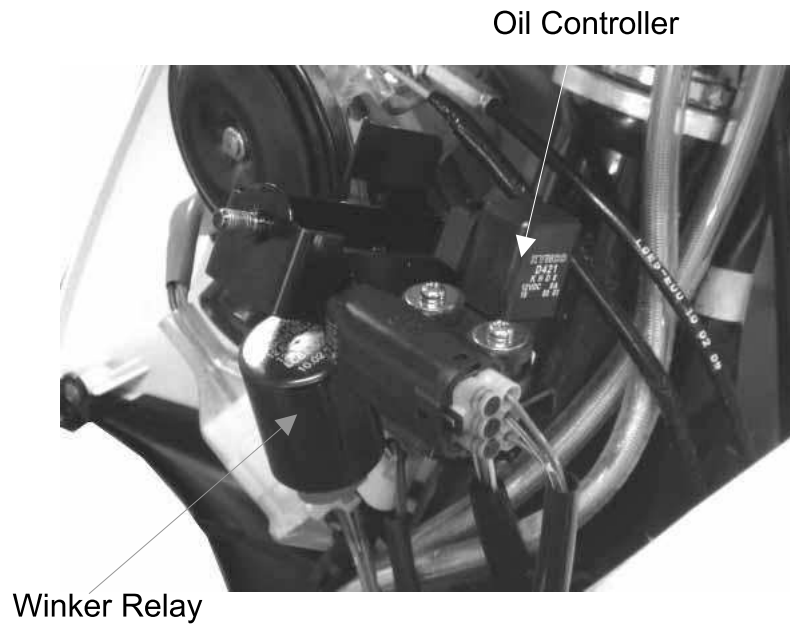

## 19. LIGHTS SWITCHES/ FUEL PUMP

### SERVICE INFORMATION

#### GENERAL

A halogen head light bulb becomes very hot while the head light is on, and remains for a while after it is turned off. Be sure to let it cool down before servicing.

- Note the following when replacing the halogen headlight bulb
  - Wear clean gloves while replacing the bulb. Do not put finger prints on the headlight bulb, as they may create hot spots on the bulb and cause it to fail.
  - If you touch the bulb with your bare hands, clean it with a cloth moistened with alcohol to prevent its early failure.
  - Be sure to install the dust cover after replacing the bulb.
- Check the battery condition before performing any inspection that requires proper battery voltage.
- A continuity test can be made with the switches installed on the scooter.
- Route the wires and cables properly after servicing each component.

#### TROUBLESHOOTING

##### Lights do not come on when ignition switch is "ON"

- Burned bulb
- Faulty switch
- Poorly connected, broken or shorted wire

##### Temperature gauge does not register correctly

- Faulty temperature gauge
- Faulty thermosensor
- Broken or shorted wire between the temperature gauge and thermosensor

##### Fuel gauge does not work or wrong show figures

- Faulty fuel gauge
- Faulty fuel unit
- Poorly connected wire between fuel gauge and fuel unit
- Fuse burned out

#### SPECIFICATIONS

Fuse	10A/15A/30A
Headlight bulb	12V 60W/55W
Turn signal light bulb	12V 10W/ 2W (LED)
Stoptlight/taillight	12V 21/5W

## 19. LIGHTS SWITCHES/ FUEL PUMP

### BULB REPLACEMENT

#### LICENSE LIGHT

Disconnect the license bulb socket.  
Remove the bulb and replace with a new one.



#### HEADLIGHT

A halogen headlight bulb becomes hot while the headlight is ON and remains for a while after it is turned OFF. Be sure to let it cool down before servicing.

#### REMOVAL

Remove the handle cover  
Disconnect the headlight connector from the headlight bulb.



#### INSTALLATION

Install a new bulb into the headlight case.  
Install the headlight and connect the headlight connector



Headlight Bulb



## 19. LIGHTS/METERS/SWITCHES

### FRONT TURN SIGNAL LIGHT

Remove the front cover.  
Turn the bulb socket and then remove the front turn signal light.  
Push and turn the bulb counterclockwise to remove it, then replace with a new one.  
Installation is in the reverse order of removal.



Socket

### TAILLIGHT/BRAKE LIGHT/REAR TURN SIGNAL LIGHT

Remove the seat and met-in.  
Remove the body covers.  
Remove the taillight bulb socket.

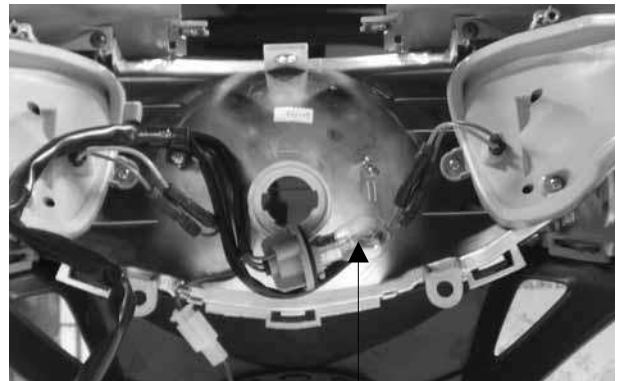

Taillight Bulb

### REAR TURN SIGNAL LIGHT

Turn the bulb counterclockwise to remove it, then replace with a new one.

Installation is in the reverse order of removal.



Rear Turn Signal Light

## 19. LIGHTS/METERS/SWITCHES

### BRAKE LIGHT SWITCH

Remove the handlebar cover.

Disconnect front or rear brake light switch connectors and check for continuity between the switch terminals.

There should be continuity with the front or rear brake lever squeezed, and there should be no continuity with the front or rear brake lever is released.



Brake Light Switch

### IGNITION SWITCH

#### INSPECTION

Remove the front cover.

Disconnect the ignition switch connector and check the ignition switch for continuity at the switch side connector terminals.

Continuity should exist between the color code wires as follows:

COMB SW

	BAT2	IG	E	BAT1	HA
LOCK		○—○			
OFF		○—○		○—○	
ON	○—			○—○	
COLOR	B	B/W	G	R	B/L



Ignition Switch

# 19. LIGHTS/METERS/SWITCHES

## RIGHT HANDLEBAR SWITCH

### INSPECTION

Remove the handle cover.

Disconnect the right handlebar switch connector and check for continuity at switch side connector terminals.

Continuity should exist between the color code wires as follows:

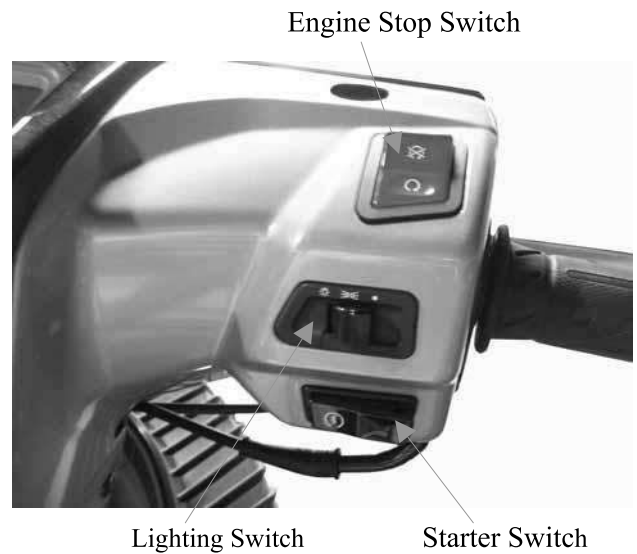

LIGHTING SW

	BAT3	PO	TL	HL
•				
(N)				
P	○	○	○	
(N)	○	○	○	○
H	○		○	○
COLOR	BR/L	BR/W	BR	W/L

STARTER SW

	E	ST
FREE		
PUSH	○	○
COLOR	G	Y/R

ENGINE STOP SW

	IG	BAT3
OFF		
RUN	○	○
COLOR	B/W	B/G

# 19. LIGHTS/METERS/SWITCHES

## LEFT HANDLEBAR SWITCH

### INSPECTION

Disconnect the left handlebar switch connector and check for continuity at switch side connector terminals.

Continuity should exist between the color code wires as follows:

WINKER SW

	WR	R	L
R	○	○	
N			
L	○		○
COLOR	GR	SB	O

HORN SW

	BAT4	HO
FREE		
PUSH	○	○
COLOR	BR/L	LG

DIMMER SW

	HL	HI	LO
LO	○		○
(N)	○	○	○
HI	○	○	
COLOR	W/L	L	W

PASSING SW

	BAT4	HI
FREE		
PUSH	○	○
COLOR	BR/L	L

Dimmer Switch



Horn Switch

Turn Signal light Switch

Passing Switch



## AUXILIARY OUTLET

### INSPECTION

Open the luggage box

Disconnect the auxiliary outlet connector and check for continuity between the switch terminals.

There should be no continuity with the luggage box light switch pushed, and there should be continuity with the luggage box light switch is released.

Auxiliary Outlet



## 19. LIGHTS/METERS/SWITCHES

### FUEL PUMP REMOVAL

Remove the seat and met-in

Remove the center cover

Remove the fuel pump connector

Be sure to relieve the fuel pressure before removing fuel pump or fuel hose.

Remove the six nuts and fuel unit connectors then remove the fuel hose.

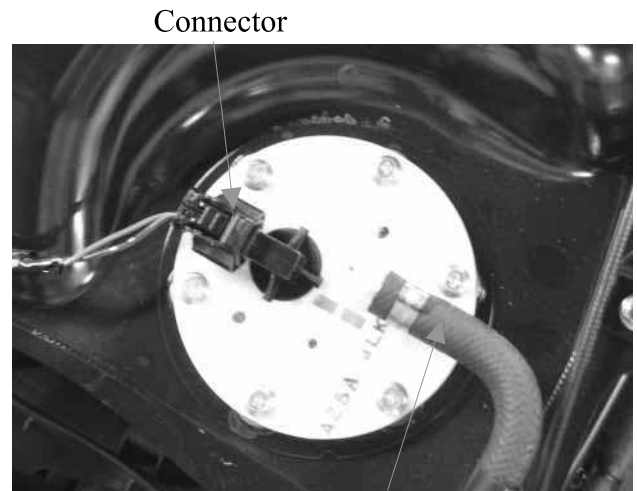

Fuel Hose

Check the fuel pump O-ring.

If was damage, replace a new one.

### INSPECTION

Connect the fuel unit wire connectors and turn the ignition switch "ON".

Before performing the following test, operate the turn signals to determine that the battery circuit is normal.

## 19. LIGHTS/METERS/SWITCHES

Measure the resistance between the Red/Black and Green wire of the fuel unit connector.

**Standard** (at 20°C/68°F):

Float at full position	About 1100 $\Omega$
Float at empty position	About 100 $\Omega$

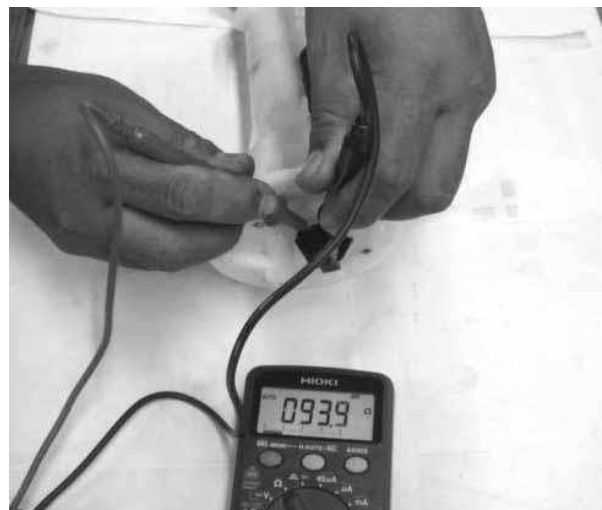
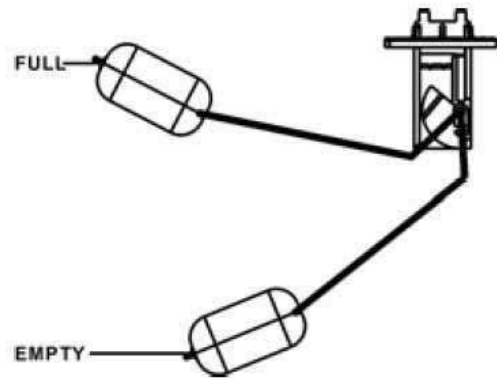

# 19. LIGHTS/METERS/SWITCHES

## SIDE STAND SWITCH INSPECTION

Remove the luggage box.

The side stand switch is located on the side stand.

Disconnect the side stand switch connector.

There should be continuity between the Yellow/Green and Green with the side stand is up.

There should be continuity between the Yellow/Black and Green with the side stand is down.

