

**KYMCO**  
**SERVICE MANUAL**  
**VENOX 250**

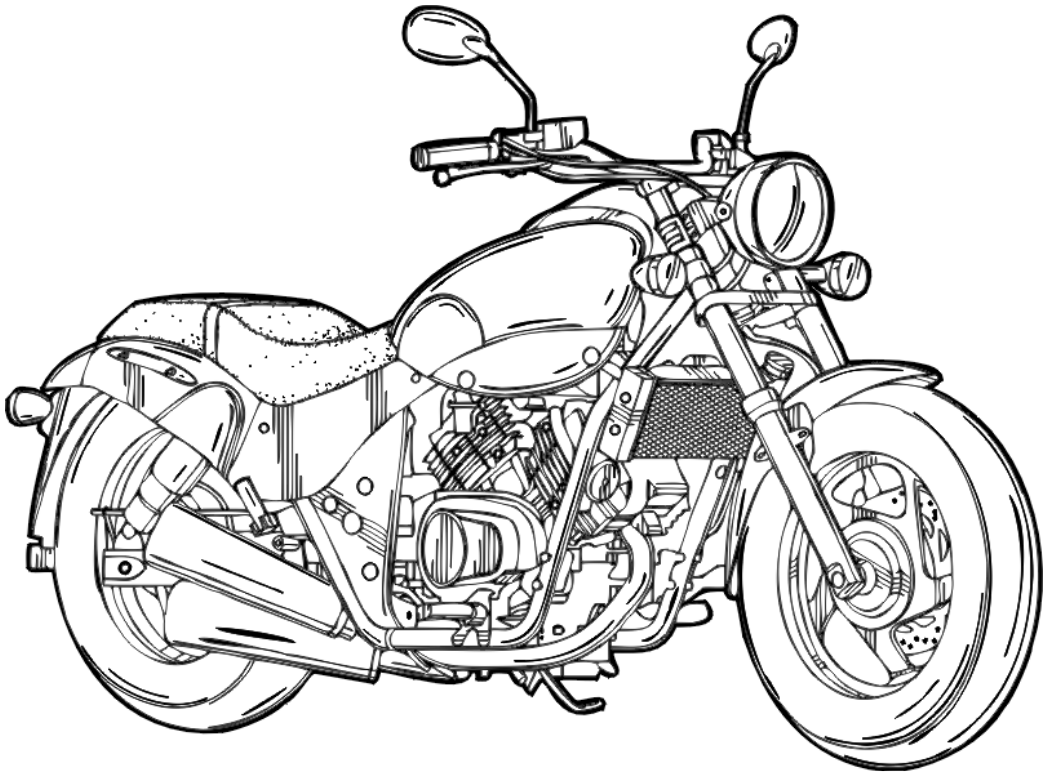

**KYMCO**  
**Overseas Sales Division**  
**Overseas Service Department**

---

# PREFACE

This Service Manual describes the technical features and servicing procedures for the KYMCO **VENOX 250**.

In this manual, many illustrations and drawings are used to help servicemen have better understanding.

Section 2 contains the service precautions for all operations and troubleshooting stated in this manual. Read them carefully before starting any operation.

Section 3 describes the inspection/adjustment procedures, safety rules and service information for each part, starting from periodic maintenance.

Sections 4 through 18 give instructions for disassembly, assembly and inspection of engine, chassis frame and electrical equipment.

Most sections start with an assembly or system illustration and troubleshooting for the section. The subsequent pages give detailed procedures for the section.

\*

The information, specifications, and illustrations included in this manual may be different from the motorcycle in case specifications are changed.
---

**KWANG YANG MOTOR CO., LTD.**  
**OVERSEAS SALES DIVISION**  
**OVERSEAS SERVICE DEPARTMENT**  
**MAR 2002**

---

---

## TABLE OF CONTENTS

<b>GENERAL INFORMATION .....</b>	<b>1</b>
<b>INSPECTION/ADJUSTMENT .....</b>	<b>2</b>
<b>LUBRICATION SYSTEM.....</b>	<b>3</b>
<b>FUEL SYSTEM.....</b>	<b>4</b>
<b>ENGINE REMOVAL/INSTALLATION .....</b>	<b>5</b>
<b>CYLINDER HEAD/VALVES.....</b>	<b>6</b>
<b>CRANKSHAFT/PISTON/CYLINDER .....</b>	<b>7</b>
<b>GENERATOR/LEFT CRANK CASE COVER.....</b>	<b>8</b>
<b>CLUTCH/GEAR SHIFT MECHANISM .....</b>	<b>9</b>
<b>TRANSMISSION SYSTEM.....</b>	<b>10</b>
<b>COOLING SYSTEM .....</b>	<b>11</b>
<b>FRONT WHEEL/SUSPENSION/STEERING.....</b>	<b>12</b>
<b>REAR WHEEL/BRAKE/SUSPENSION.....</b>	<b>13</b>
<b>HYDRAULIC BRAKE .....</b>	<b>14</b>
<b>IGNITION SYSTEM .....</b>	<b>15</b>
<b>CHARGING SYSTEM .....</b>	<b>16</b>
<b>STARTING SYSTEM.....</b>	<b>17</b>
<b>LIGHTS/INSTRUMENT/SWITCHES/HORN.....</b>	<b>18</b>

---

---

## GENERAL INFORMATION

---

ENGINE SERIAL NUMBER/IDENTIFICATION.....	1- 1
SPECIFICATIONS .....	1- 2
SERVICE PRECAUTIONS.....	1- 3
SERVICE INFORMATION .....	1-10
TORQUE VALUES .....	1-12
SPECIAL TOOLS .....	1-14
LUBRICATION POINTS .....	1-16
WIRING DIAGRAM .....	1-17
CABLE & HARNESS ROUTING.....	1-18
TROUBLESHOOTING .....	1-22

# 1. GENERAL INFORMATION

## ENGINE SERIAL NUMBER/IDENTIFICATION

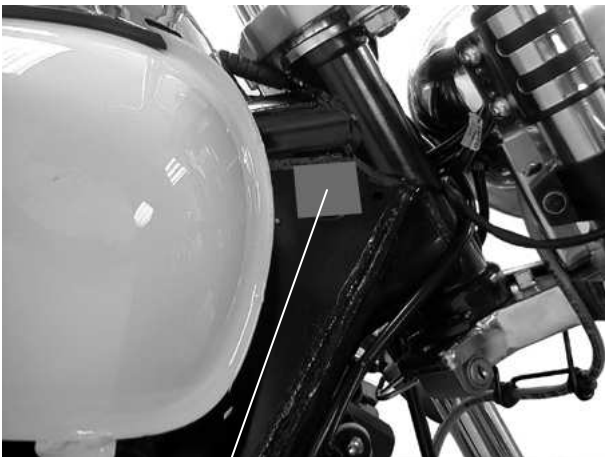

Vehicle Identification Serial Number

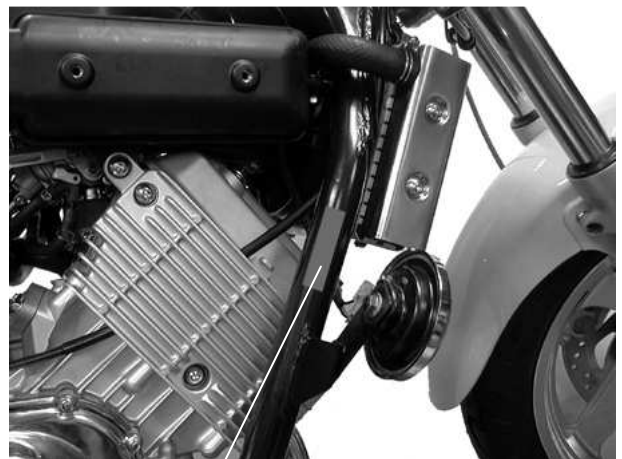

Location of Frame Serial Number

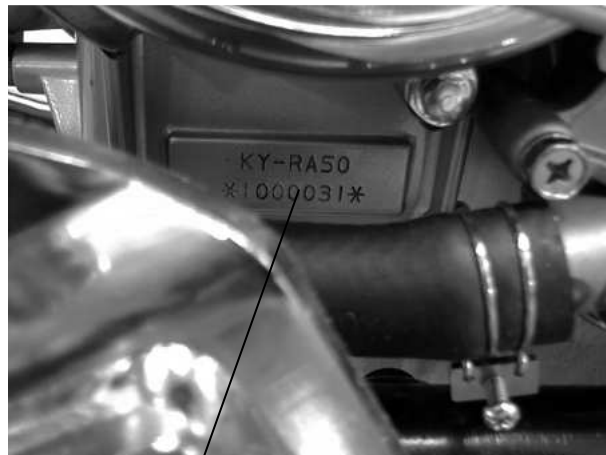

Location of Engine Serial Number

# 1. GENERAL INFORMATION

## SPECIFICATIONS

Motorcycle name & Model No.		VENOX 250		
Chassis name & Model No.		RA50AA		
Overall length (mm)		2325		
Overall width (mm)		840		
Overall height (mm)		1080		
Wheel base (mm)		1600		
Engine type		4 ∞		
Displacement (cc)		249.4		
Fuel type		Nonleaded gasoline		
Dry weight (kg)	Front	80		
	Rear	95		
	Total	175		
Gross weight (kg)	Front	90		
	Rear	100		
	Total	190		
Tires	Front	120/80-17		
	Rear	150/80-15		
Ground clearance (mm)		150		
Performance	Braking distance (m)	<6.9(40km/h)		
	Min. turning radius (m)	2.750		
Engine	Starting system		Self motor	
	Type		DOHC8V	
	Cylinder arrangement		Twin cylinder	
	Combustion chamber type		Dome head	
	Valve arrangement		DOHC	
	Bore x stroke (mm)		58.0 x 47.2	
	Compression ratio		11±0.2	
	Compression pressure (kg/cm <sup>2</sup> - rpm)		17±2	
	Max. output (ps/rpm)		27.5/10500	
	Max. torque (kg-m/rpm)		2/8500	
	Port timing	Intake (1mm)	Open	4°
			Close	35°
		Exhaust (1mm)	Open	31°
			Close	0°
	Valve clearance (Cold engine)	Intake	0.1mm	
		Exhaust	0.1mm	
	Idle speed (rpm)		1300±100	
	Lubrication System	Lubrication type		Forced pressure & wet sump
		Oil pump type		Inner/outer rotor
		Oil filter type		Wire gauze filter
		Oil capacity		2.5 liter
	Cooling Type		Air + water cooling	

Fuel System	Air cleaner type		Paper element		
	Fuel capacity		14 liter		
	Carburetor	Type	CVK		
		Main Jet NO	Front:112 Rear:108		
		Venturi dia.(mm)	φ30 equivalent		
Throttle type		Butterfly type			
Electrical Equipment	Ignition System	Type	Fully Transistor		
		Ignition timing	B.T.D.C10°/1000rpm		
		Breaker type	—		
	Spark plug	CR8E			
		Spark plug gap	0.6~0.7mm		
	Battery	Capacity	12V8AH		
Power Drive System	Clutch	Type	Wet multi-disc clutch		
		Type	5-speed transmission		
	Transmission Gear	Operating method	Foot operated		
		Type	International type		
		Reduction ratio	1st gear	2.733	
			2nd gear	1.8	
			3rd gear	1.375	
4th gear	1.111				
5th gear	0.965				
Moving Device	Front Axle	Caster angle	35°		
		Tire pressure (kg/cm <sup>2</sup> )(2 riders)	Front	2.0	
	Rear		2.25		
	Turning angle	Left	40°		
		Right	40°		
	Brake system type	Front	Disk brake		
Rear		Drum brake			
Damping Device	Suspension	Front	Telescopic fork		
		Rear	Telescopic fork		
	Shock absorber	Front	Oil damper spring		
		Rear	Oil damper spring		

# 1. GENERAL INFORMATION

## SERVICE PRECAUTIONS

- Make sure to install new gaskets, O-rings, circlips, cotter pins, etc. when reassembling.

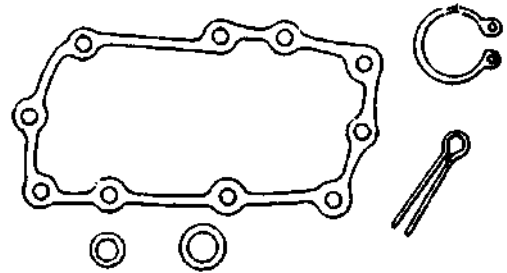

- When tightening bolts or nuts, begin with larger-diameter to smaller ones at several times, and tighten to the specified torque diagonally.

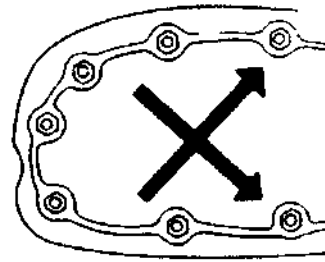

- Use genuine parts and lubricants.

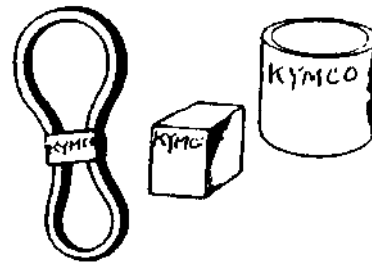

- When servicing the motorcycle, be sure to use special tools for removal and installation.



- After disassembly, clean removed parts. Lubricate sliding surfaces with engine oil before reassembly.

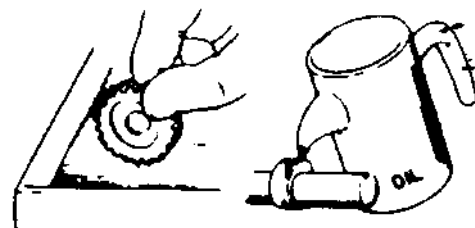

# 1. GENERAL INFORMATION

- Apply or add designated greases and lubricants to the specified lubrication points.

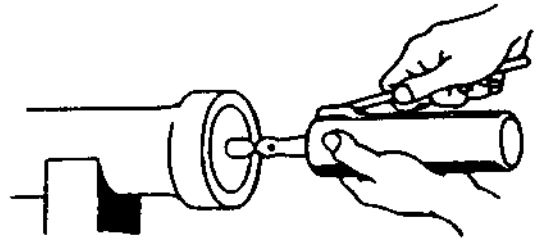

- After reassembly, check all parts for proper tightening and operation.

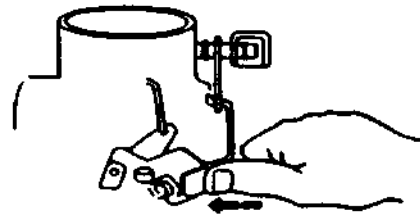

- When two persons work together, pay attention to the mutual working safety.

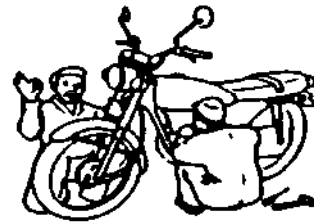

- Disconnect the battery negative (-) terminal before operation.
- When using a spanner or other tools, make sure not to damage the motorcycle surface.

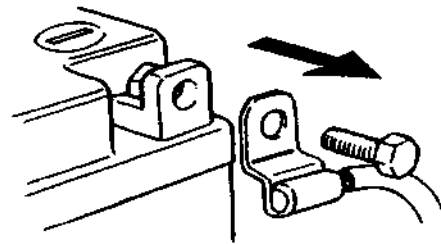

- After operation, check all connecting points, fasteners, and lines for proper connection and installation.
- When connecting the battery, the positive (+) terminal must be connected first.
- After connection, apply grease to the battery terminals.
- Terminal caps shall be installed securely.

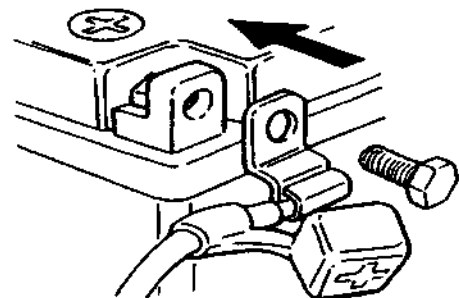



# 1. GENERAL INFORMATION

- If the fuse is burned out, find the cause and repair it. Replace it with a new one according to the specified capacity.

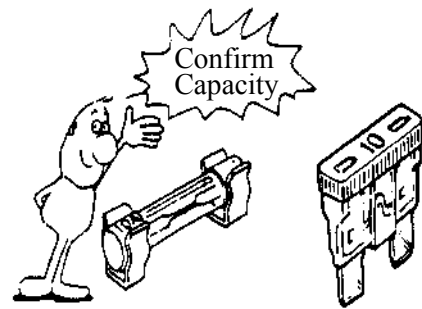

- After operation, terminal caps shall be installed securely.



- When taking out the connector, the lock on the connector shall be released before operation.

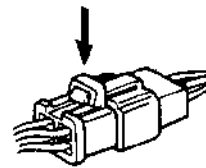

- Hold the connector body when connecting or disconnecting it.
- Do not pull the connector wire.

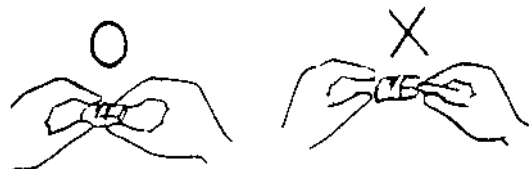

- Check if any connector terminal is bending, protruding or loose.

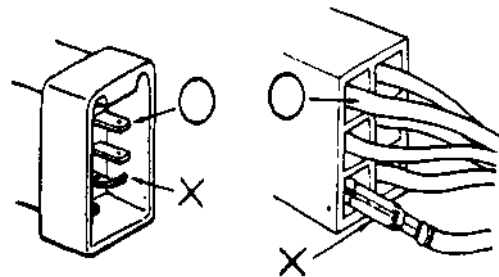

# 1. GENERAL INFORMATION

- The connector shall be inserted completely.
- If the double connector has a lock, lock it at the correct position.
- Check if there is any loose wire.

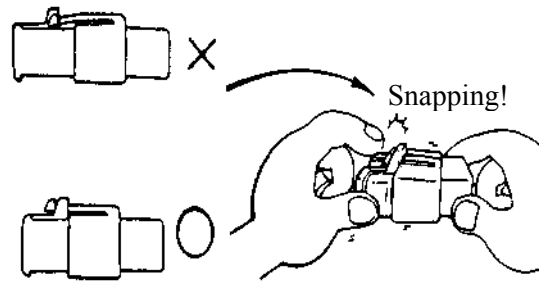

- Check the double connector cover for proper coverage and installation.

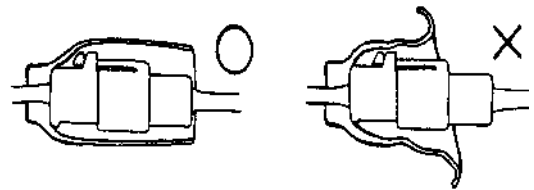

- Before connecting a terminal, check for damaged terminal cover or loose negative terminal.

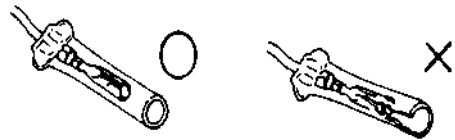

- Insert the terminal completely.
- Check the terminal cover for proper coverage.
- Do not make the terminal cover opening face up.

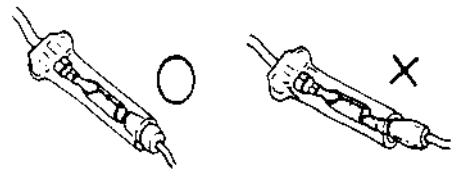

- Secure wire harnesses to the frame with their respective wire bands at the designated locations.
- Tighten the bands so that only the insulated surfaces contact the wire harnesses.

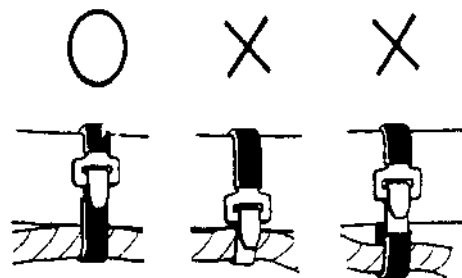

# 1. GENERAL INFORMATION

- After clamping, check each wire to make sure it is secure.

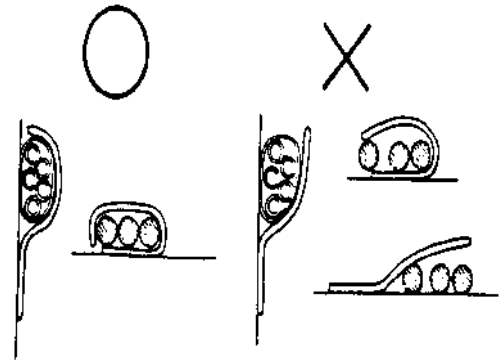

- Do not squeeze wires against the weld or its clamp.

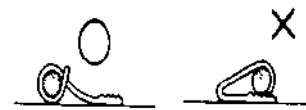

- After clamping, check each harness to make sure that it is not interfering with any moving or sliding parts.

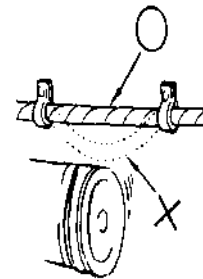

- When fixing the wire harnesses, do not make it contact the parts which will generate high heat.

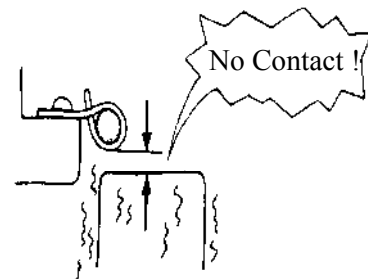

- Route wire harnesses to avoid sharp edges or corners. Avoid the projected ends of bolts and screws.
- Route wire harnesses passing through the side of bolts and screws. Avoid the projected ends of bolts and screws.

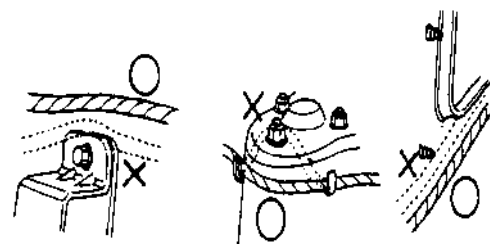

# 1. GENERAL INFORMATION

- Route harnesses so they are neither pulled tight nor have excessive slack.

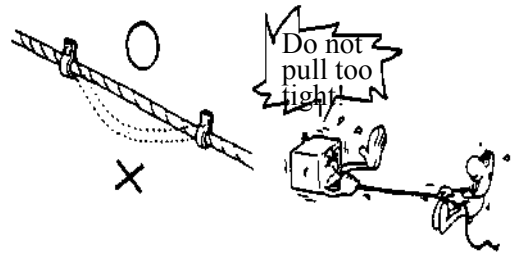

- Protect wires and harnesses with electrical tape or tube if they contact a sharp edge or corner.

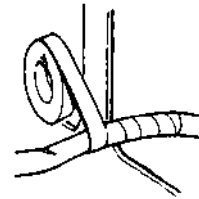

- When rubber protecting cover is used to protect the wire harnesses, it shall be installed securely.

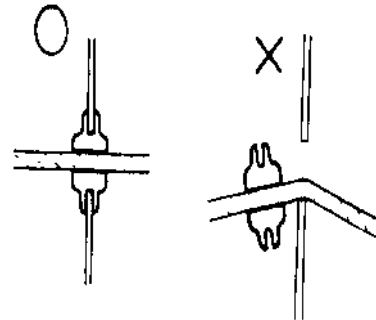

- Do not break the sheath of wire.
- If a wire or harness is with a broken sheath, repair by wrapping it with protective tape or replace it.

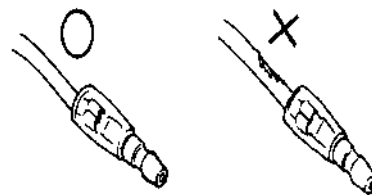

- When installing other parts, do not press or squeeze the wires.

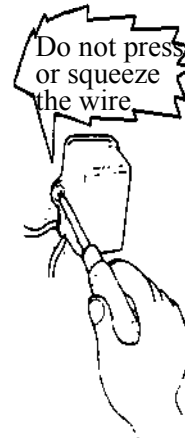

# 1. GENERAL INFORMATION

- After routing, check that the wire harnesses are not twisted or kinked.

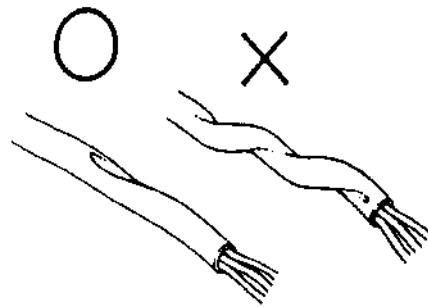

- Wire harnesses routed along with handlebar should not be pulled tight, have excessive slack or interfere with adjacent or surrounding parts in all steering positions.

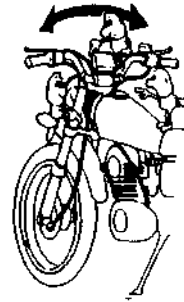

- When a testing device is used, make sure to understand the operating methods thoroughly and operate according to the operating instructions.

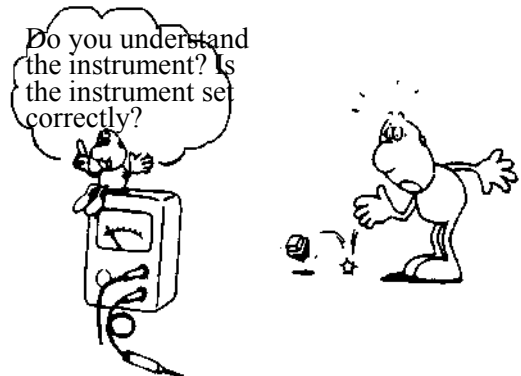

- Be careful not to drop any parts.

- When rust is found on a terminal, remove the rust with sand paper or equivalent before connecting.



- Do not bend or twist control cables. Damaged control cables will not operate smoothly and may stick or bind.

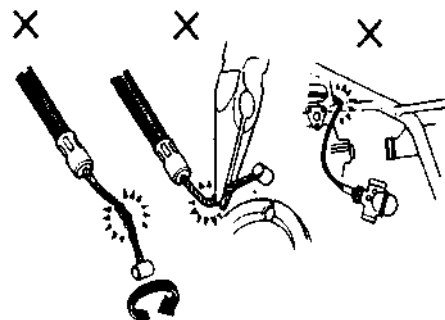

# 1. GENERAL INFORMATION

---

■ Symbols:

The following symbols represent the servicing methods and cautions included in this service manual.



: Apply engine oil to the specified points. (Use the designated engine oil for lubrication.)



: Apply grease for lubrication.



: Caution



: Use special tool.



: Warning

# 1. GENERAL INFORMATION

## SERVICE INFORMATION

ENGINE Item	Standard (mm)	Service Limit (mm)
	Venox 250	Venox 250
Cylinder head warpage	—	—
Piston O.D.(10mm from bottom of piston skirt)	57.975~57.99	57.81
Cylinder-to- piston clearance	0.01~0.35	0.35
Piston pin hole I.D.	16.000~16.006	16.06
Piston pin O.D.	15.994~15.997	15.90
Piston-to-piston pin clearance	0.003~0.012	0.10
Piston ring end gap (top/second)	No1:0.10~0.25 No2: 0.2~0.35	0.5
Connecting rod small end I.D.	16.013~16.028	16.09
Cylinder bore	58.0~58.015	58.20
Connecting rod big end side clearance	0.09~0.29	—
Connecting rod big end radial clearance	—	—
Crankshaft runout A/B	0.03	—

CARBURETOR	Venox 250
Venturi dia.	30 mm
Type	CVK
Float level	FR:17.5 mm RR:19.0mm
Main jet	FR:#110 RR:#108
Slow jet	#35
Pilot screw opening	2±½
Idle speed	1300±100 rpm
Throttle grip free play	2~6mm

# 1. GENERAL INFORMATION

FRAME		Standard (mm)	Service Limit (mm)
Item		Venox 250	Venox 250
Axle shaft runout		0.3/100mm	0.5
Front wheel rim runout	Radial	0.5	2.0
	Axial	0.5	2.0
Front shock absorber spring free length		—	—
Rear wheel rim runout		0.5	2.0
Brake drum I.D.	Rear	160	161
Brake lining thickness	Front/Rear	5.0/5.0	2.0/2.0
Rear shock absorber spring free length		—	—

ELECTRICAL EQUIPMENT		Venox 250
Battery	Capacity	12V8AH
	Voltage	13.0~13.2V
	Charging current	0.9A/5~10H
Spark plug	(NGK)	CR8E
Spark plug gap (mm)		0.6~0.7
Ignition coil resistance	Primary	3.57~4.83Ω
	Secondary (with plug cap)	14.96~20.24KΩ
Pulser coil resistance (20°C)		396~594Ω
Ignition timing		10° BTDC/1000rpm



# 1. GENERAL INFORMATION

## TORQUE VALUES

### ENGINE

Item	Thread dia. (mm)	Torque (kg-m)	Remarks
Plate oil flowby	M5×12	0.8~1.2	
Connect rod nut	M7×0.75	2.0~2.4	
Oil drain	M12×15	2.0~3.0	
Plate ball brg holder	6×12	0.8~1.2	
Drum gear shift	6×20	0.8~1.2	
Shift fork comp	6×12	0.8~1.2	
Sw assy neutral		1.0~1.4	
Crank case	8×60, 8×65, 8×75, 8×82	1.9~2.3	
	6×35, 6×85, 6×60, 6×40, 6×30, 6×90	1.0~1.4	
Case cooler tank pipe	6×20	0.8~1.2	
Oil seperator	6×20	0.8~1.2	
Sprocket oil pump nut	8	1.8~2.3	
Oil sump	6×25	0.8~1.2	
Motor assy starter	6×25	0.8~1.2	
Holder head (FR/RR)	8×151	3.0~3.4	
	8×131, 8×48, 8×65	1.9~2.3	
Tension guide pivot		1.8~2.2	
Lifter assy tensioner (FR/RR)	6×22	1.0~1.4	
Lifter assy tensioner screw pan (FR/RR)	6×6	0.35~0.5	
Guide upper tensioner	6×12	0.8~1.2	
Head cover	6×30	0.8~1.2	
Clutch nut lock	20	5.5~6.5	
Clutch	6×22	0.8~1.2	
One way clutch socket bolt	8×12	1.8~2.5	
One way clutch bolt UBS (left)	10×35	7.5~8.5	
R cover	6×30	0.8~1.2	
Cover change	6×30	0.8~1.2	
Water pump	6×55, 6×10	0.8~1.2	
A.C.G.	10×35	7.5~8.5	
L cover	6×30, 6×35	0.8~1.2	
Sprocket drive bolt special	10×30	5.5~6.5	
Spark plug	CR8E	1.0~1.4	
Head bolt stud	6×40	0.7~1.1	

# 1. GENERAL INFORMATION

## FRAME

Item	Thread dia.	Torque (kg-m)	Remarks
Strg stem nut	22×1.0	6.0~8.0	Back 90°
Thread comp strg head	26×1.0	0.15~2.5 or 1.2	
Top bridge	8×1.25	1.7~2.1	
Bottom bridge	10×1.25	2.4~3.0	
Front axle bolt	14×1.5	6.0~8.0	
Rear axle nut	16×1.5	8.0~10.0	
Front brake caliper	8×1.25	2.4~3.0	
Oil bolt	10×1.25	3.0~4.0	
Master cylinder holder	6×1.0	0.8~1.2	
Rear suspension cush bolt(upper)	6×1.0	0.8~1.2	
Rear suspension cush bolt(under)	10×1.25	3.0~4.0	
Front suspension cush bolt(axle)	8×1.25	3.0~4.0	
Rear fork pivot nut	14×1.5	6.0~8.0	
Up ENG hanger	10×1.25	3.5~4.5	
Front ENG hanger	10×1.25	3.5~4.5	
	8×1.25	2.4~3.0	
Rear ENG hanger	10×1.25	3.5~4.5	
Handle nut	12×1.25	5.0~6.0	
EXH Muffler bolt	8×1.25	3.0~3.6	
Front step bolt	10×1.25	3.0~4.0	
Rear winker	10×1.25	1.6~1.8	

Torque specifications listed above are for important fasteners. Others should be tightened to standard torque values below.

### STANDARD TORQUE VALUES

SH bolt: 8mm

Flange 6mm bolt

Item	Torque (kg-m)	Item	Torque (kg-m)
5mm bolt, nut	0.45~0.6	4,5mm screw	0.2~0.4, 0.35~0.5
6mm bolt, nut	0.8~1.2	6mm screw, SH bolt	0.7~1.1
8mm bolt, nut	1.8~2.5	6mm flange bolt, nut	1.0~1.4
10mm bolt, nut	3.0~4.0	8mm flange bolt, nut	2.4~3.0
12mm bolt, nut	5.0~6.0	10mm flange bolt, nut	3.5~4.5

# 1. GENERAL INFORMATION

## SPECIAL TOOLS

Tool Name	Tool No.	Remarks
Lock nut socket wrench	E046	9-6
Lock nut wrench	F006	12-11,12-12
Flywheel holder	E021	8-3,8-4
Flywheel puller	E042	8-4
Valve wrench	E036	2-13
Vacuum & CO adjuster	E043	2-14
Vacuum gauge	E045	2-14
Valve spring compressor	E040	6-8,6-9
Piston installer	E041	7-8
Clutch lifter holder	E047	9-6
Bearing remover	E030	10-10
Bearing driver handle	E014	12-8,13-6
Steering stem wrench	F007	12-11,12-12

# 1. GENERAL INFORMATION

## LUBRICATION POINTS

### ENGINE

NO.	Lubrication Points	Lubricant	Remarks
1	Crankcase sliding & movable parts	SAE 5W-50 SF	
2	Cylinder movable parts	SAE 5W-50 SF	
3	Drive chain	SAE 80~90	
4	Kick lever movable parts	Grease	
5	Front suspension	SAE 10W	400cc/piece
6	Rear suspension	SAE 5W	99cc/piece

### FRAME

Apply clean engine oil or grease to cables and movable parts not specified. This will avoid abnormal noise and rise the durability of the motorcycle.

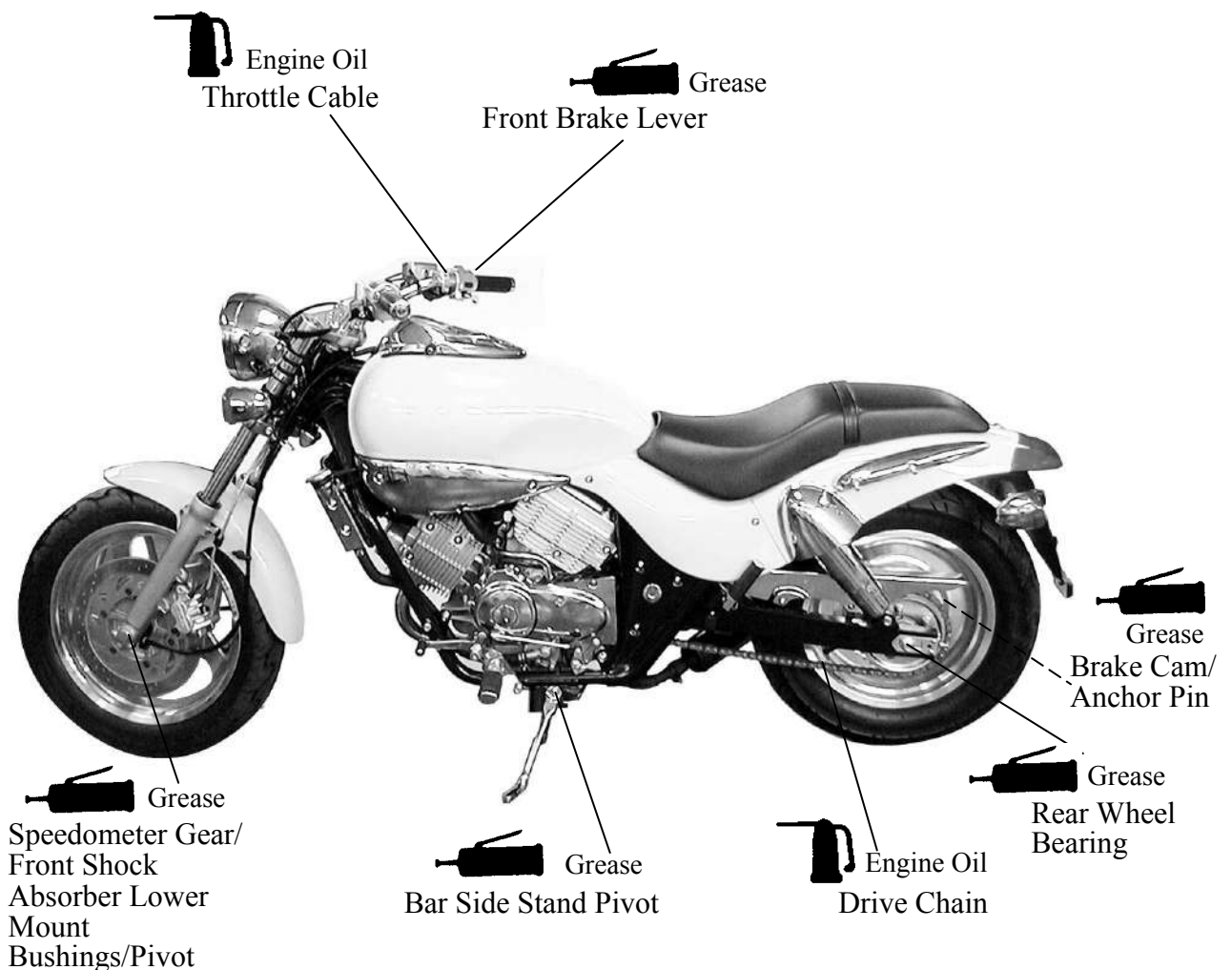

# 1. GENERAL INFORMATION

## WIRING DIAGRAM

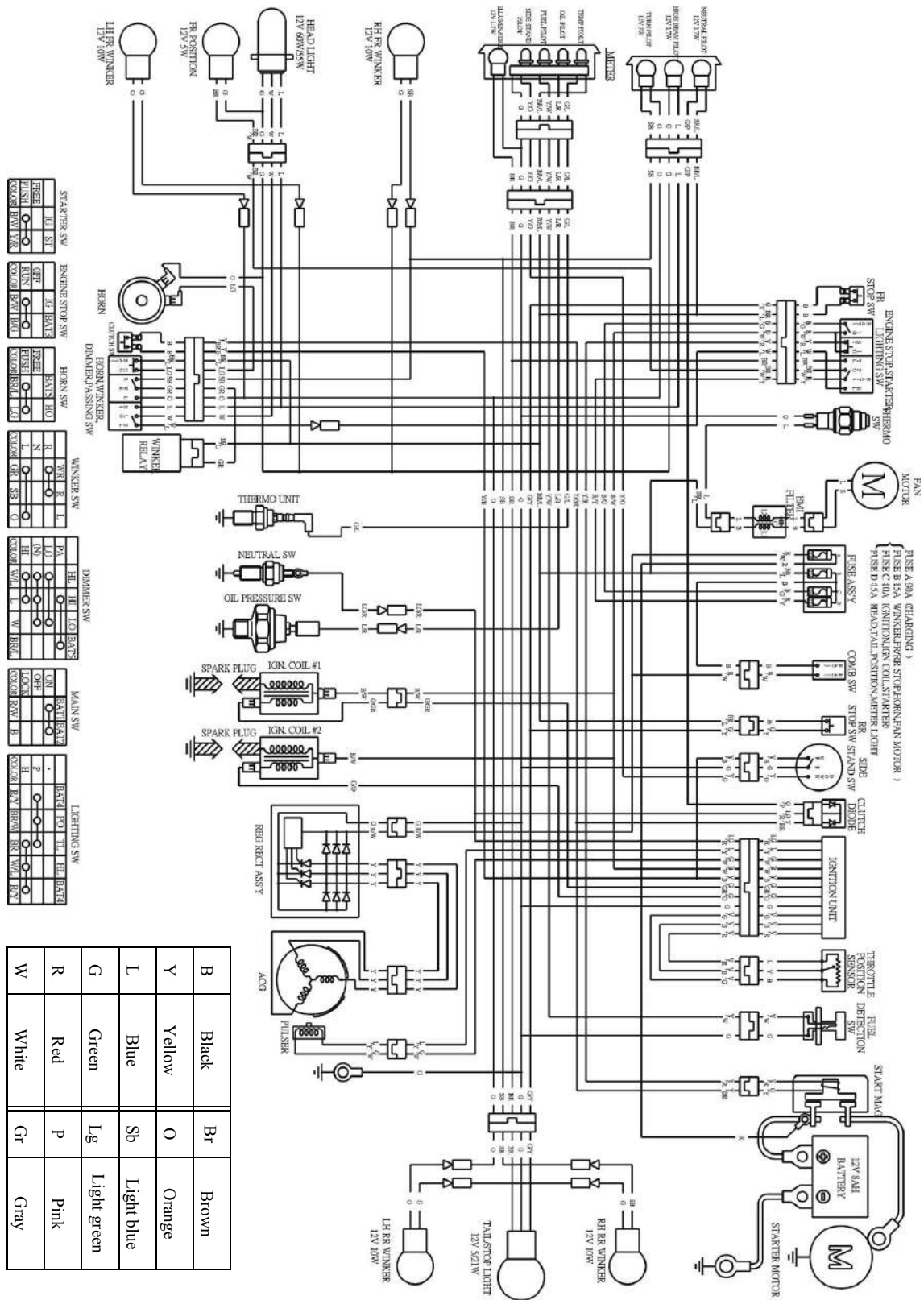

# 1. GENERAL INFORMATION

## CABLE & HARNESS ROUTING

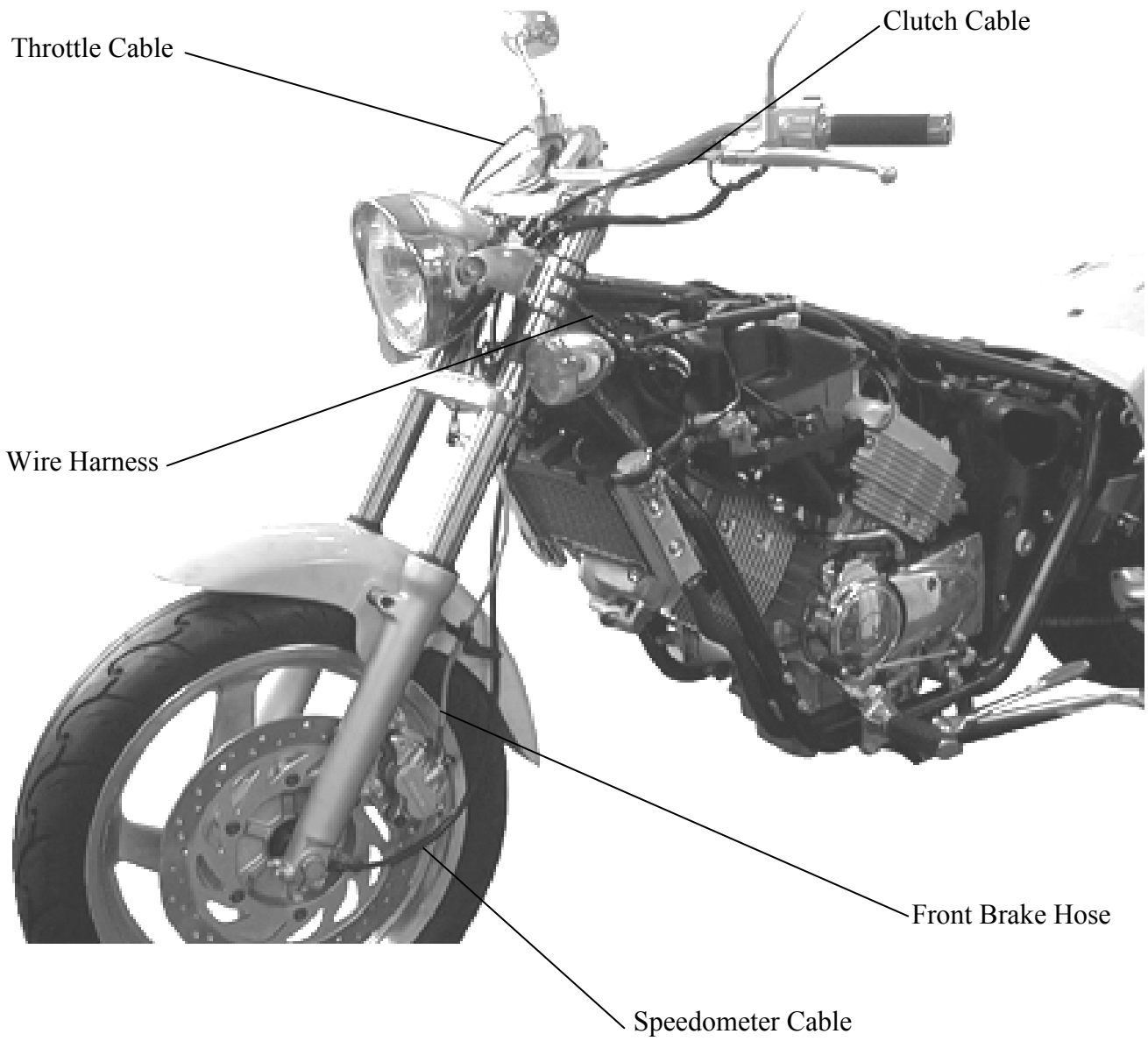

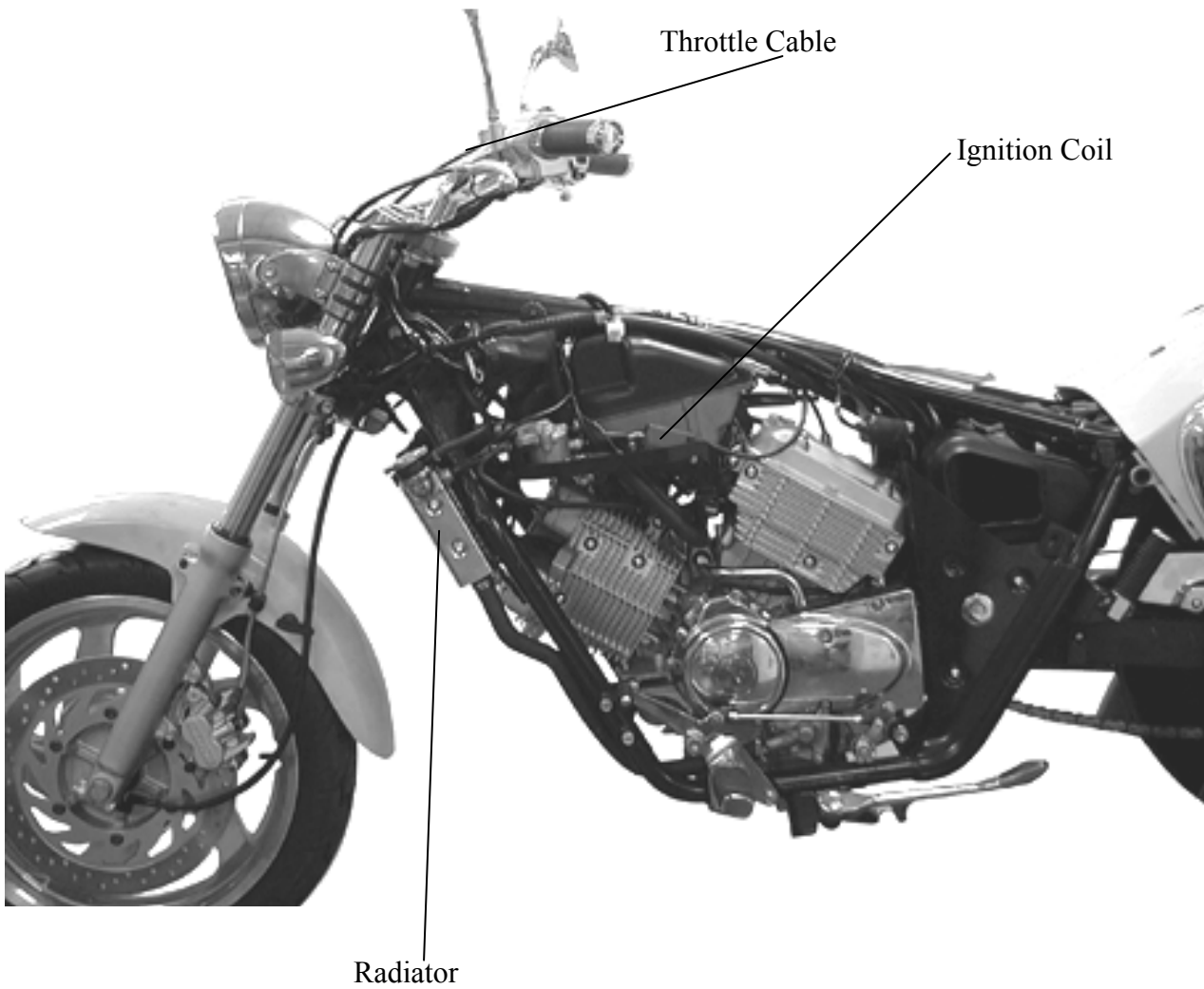

# 1. GENERAL INFORMATION

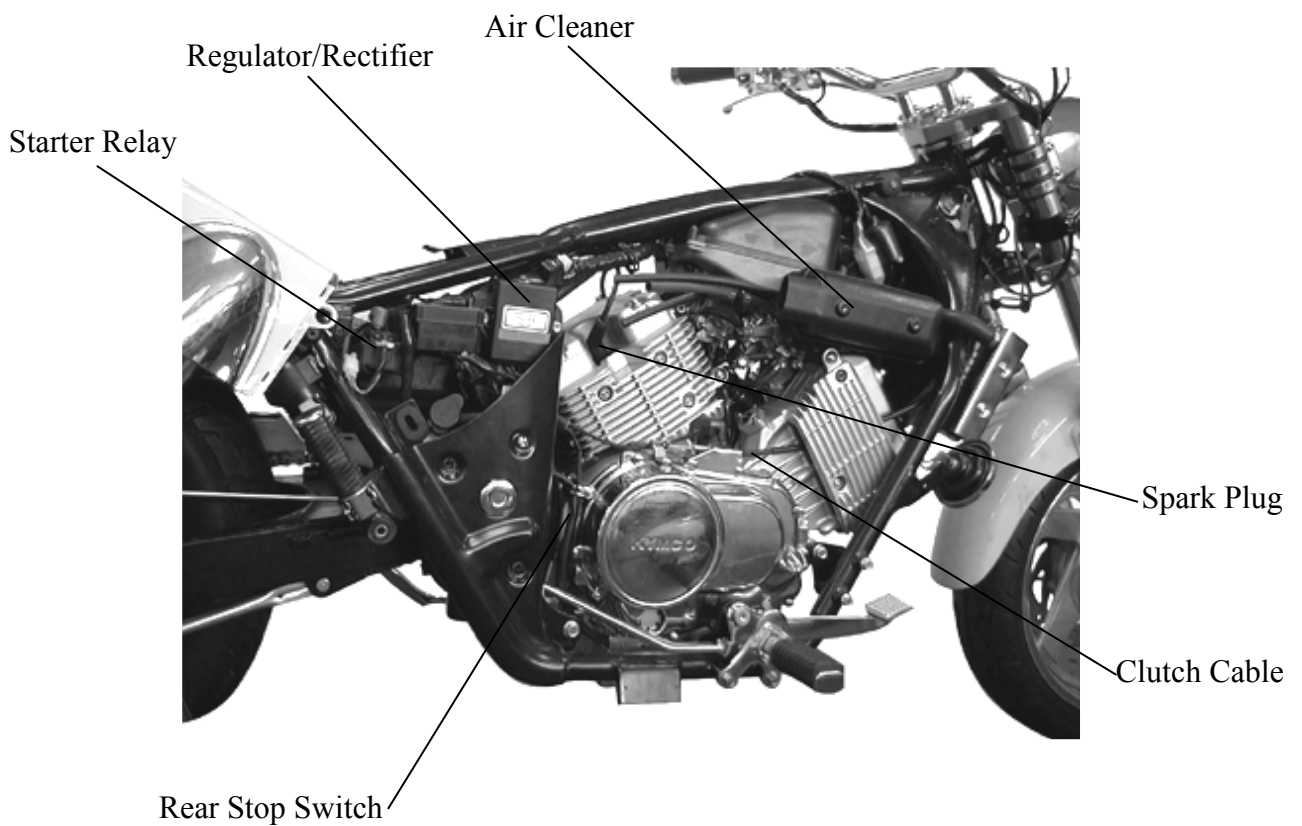
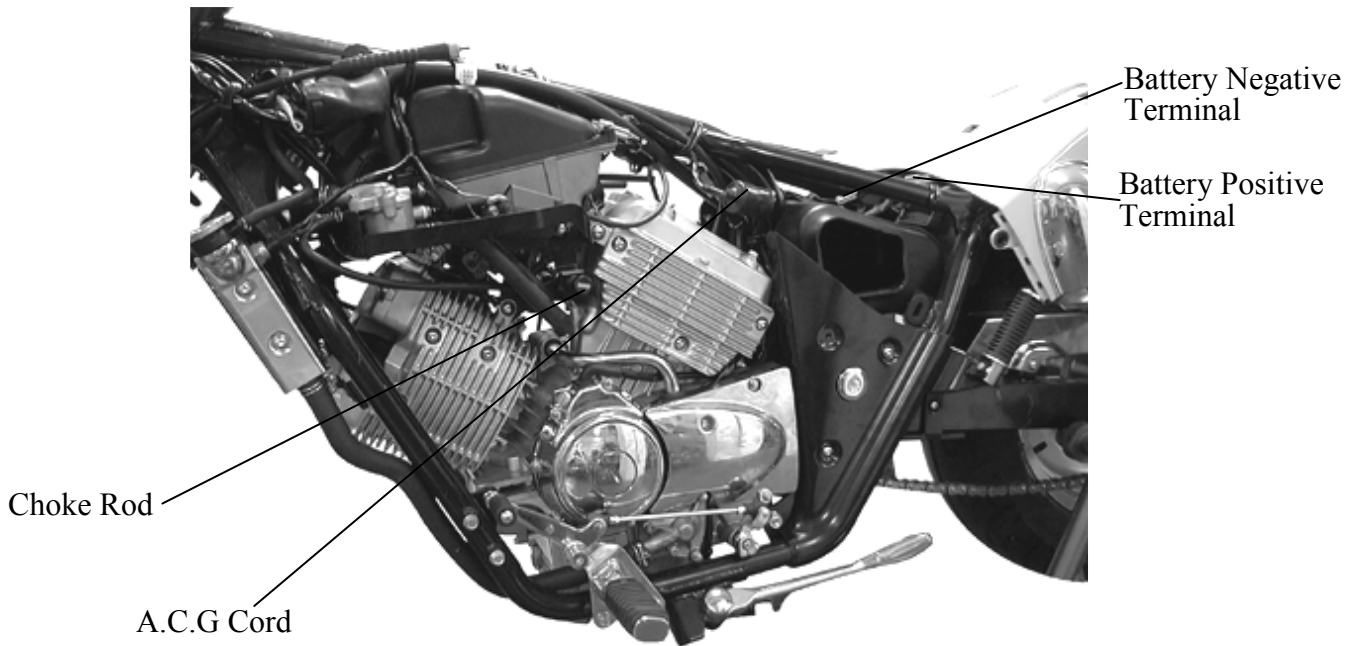



# 1. GENERAL INFORMATION

---

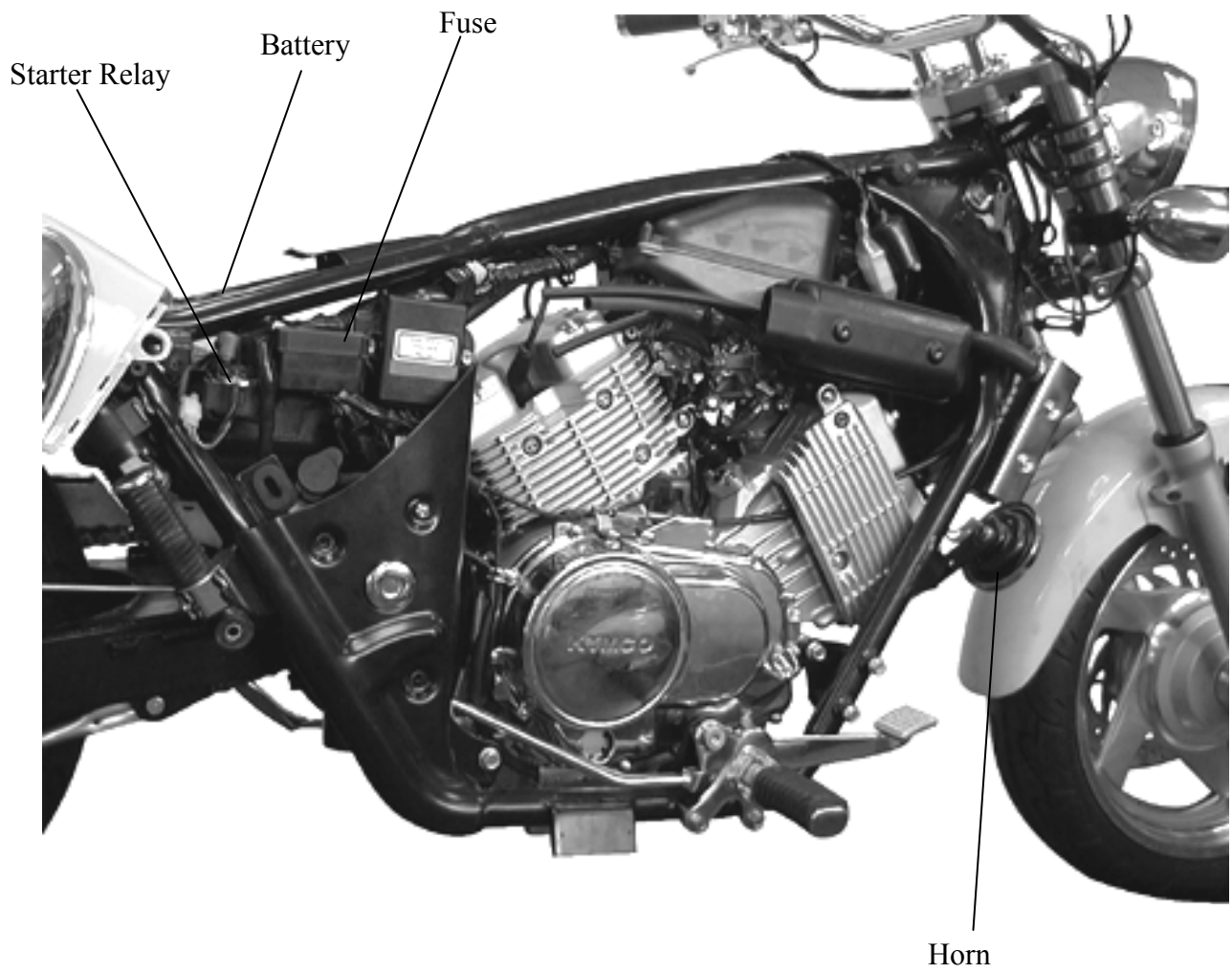

# 1. GENERAL INFORMATION

## TROUBLESHOOTING

### ENGINE WILL NOT START OR IS HARD TO START

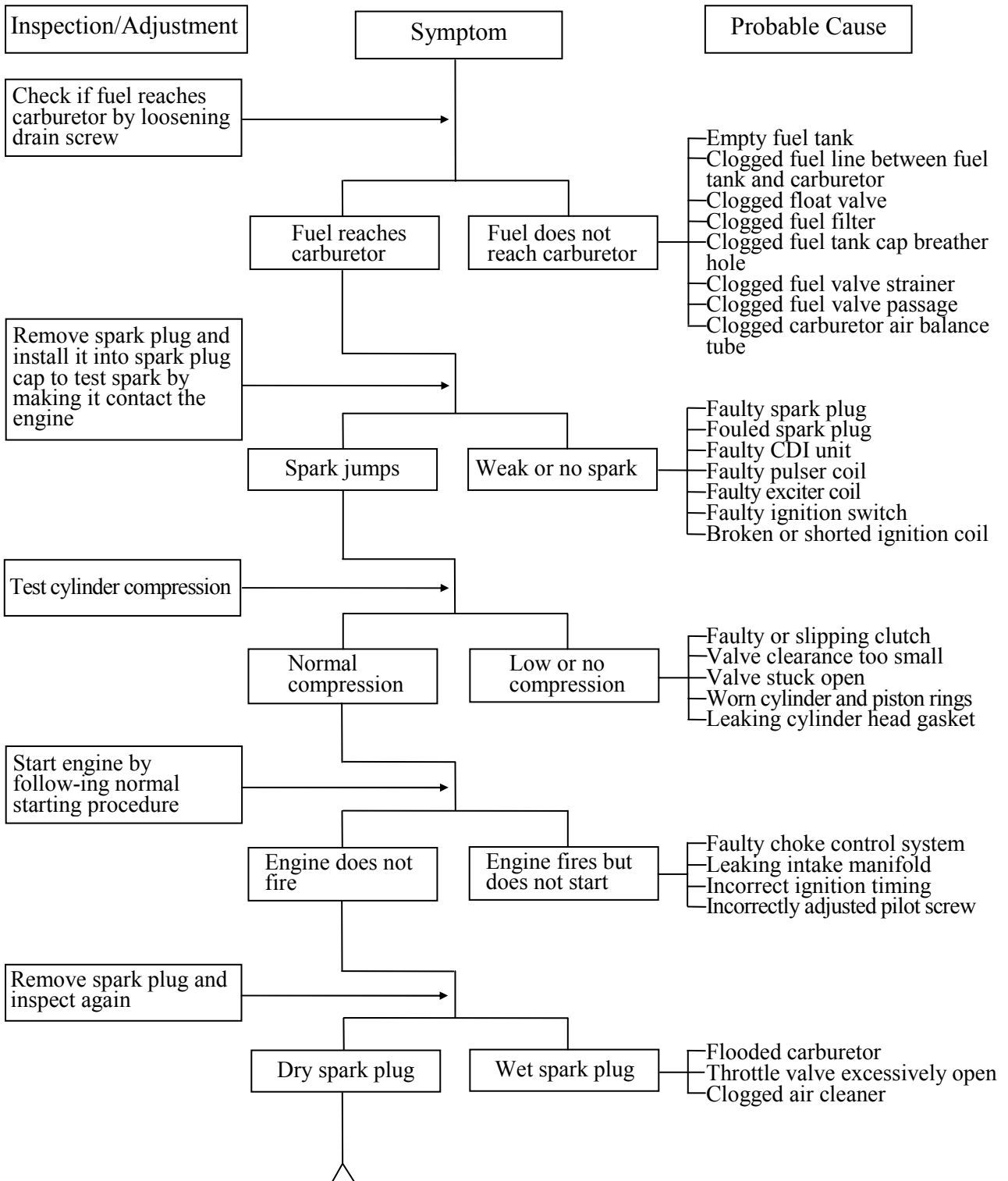

# 1. GENERAL INFORMATION

## ENGINE STOPS IMMEDIATELY AFTER IT STARTS

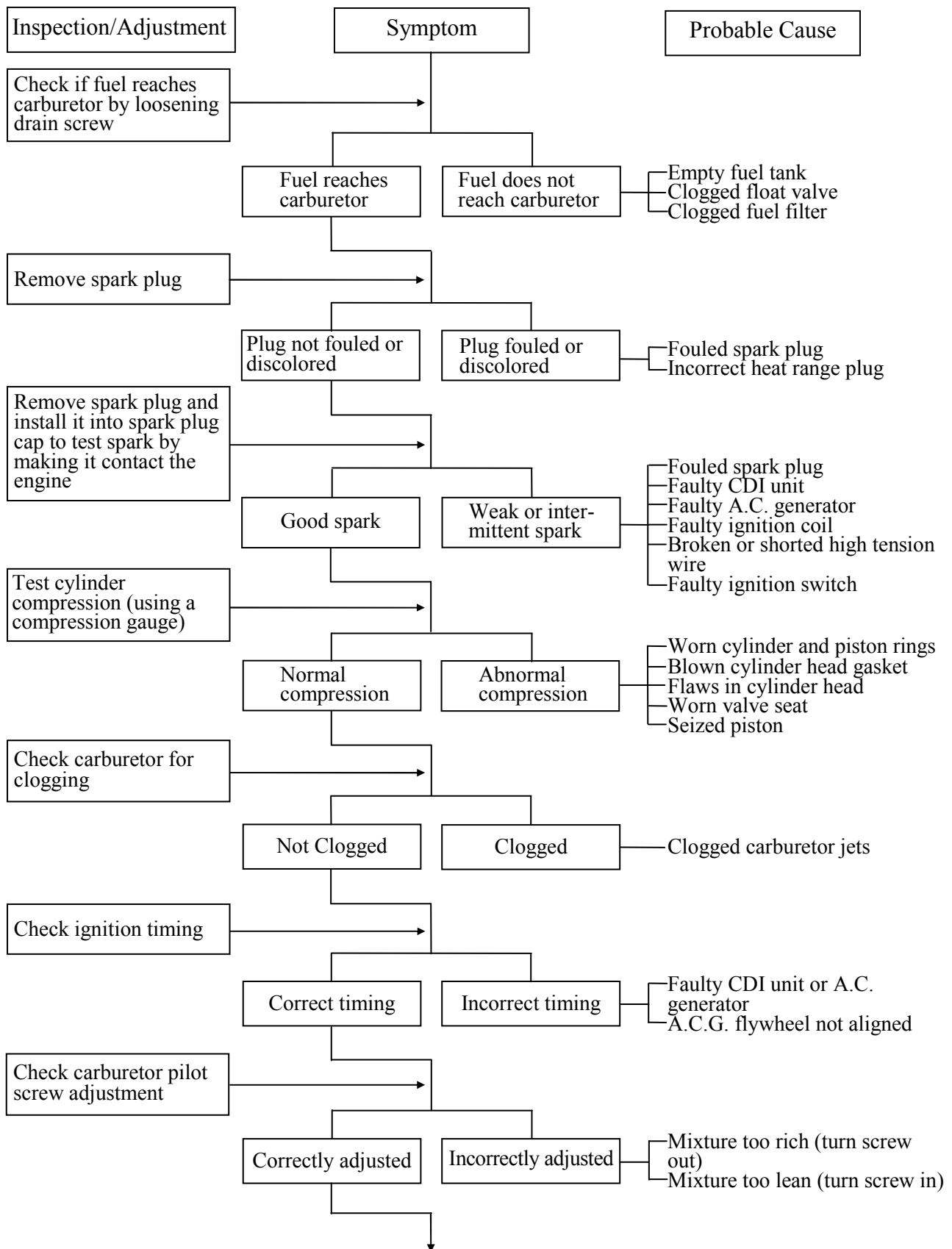

# 1. GENERAL INFORMATION

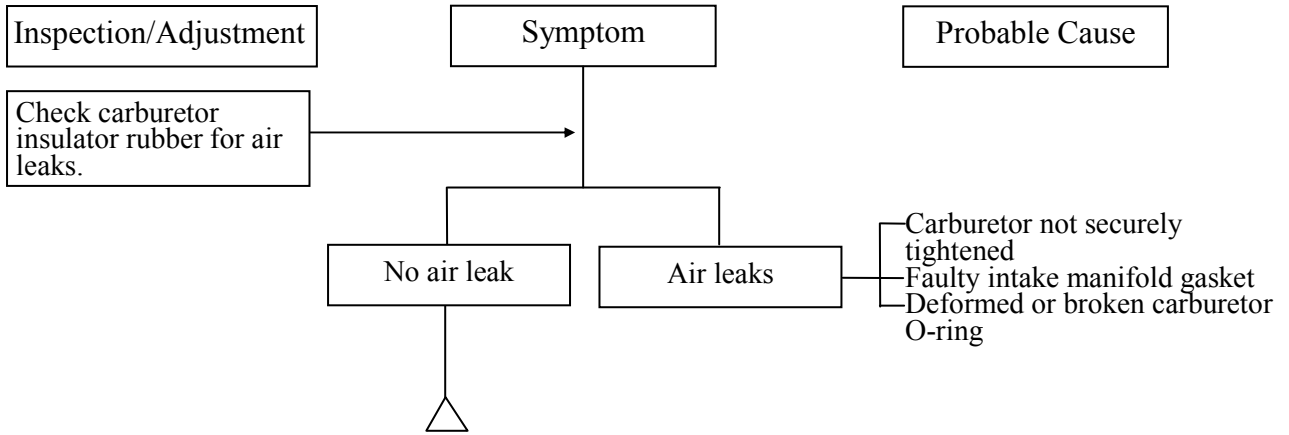

# 1. GENERAL INFORMATION

## POOR PERFORMANCE (ENGINE LACKS POWER)

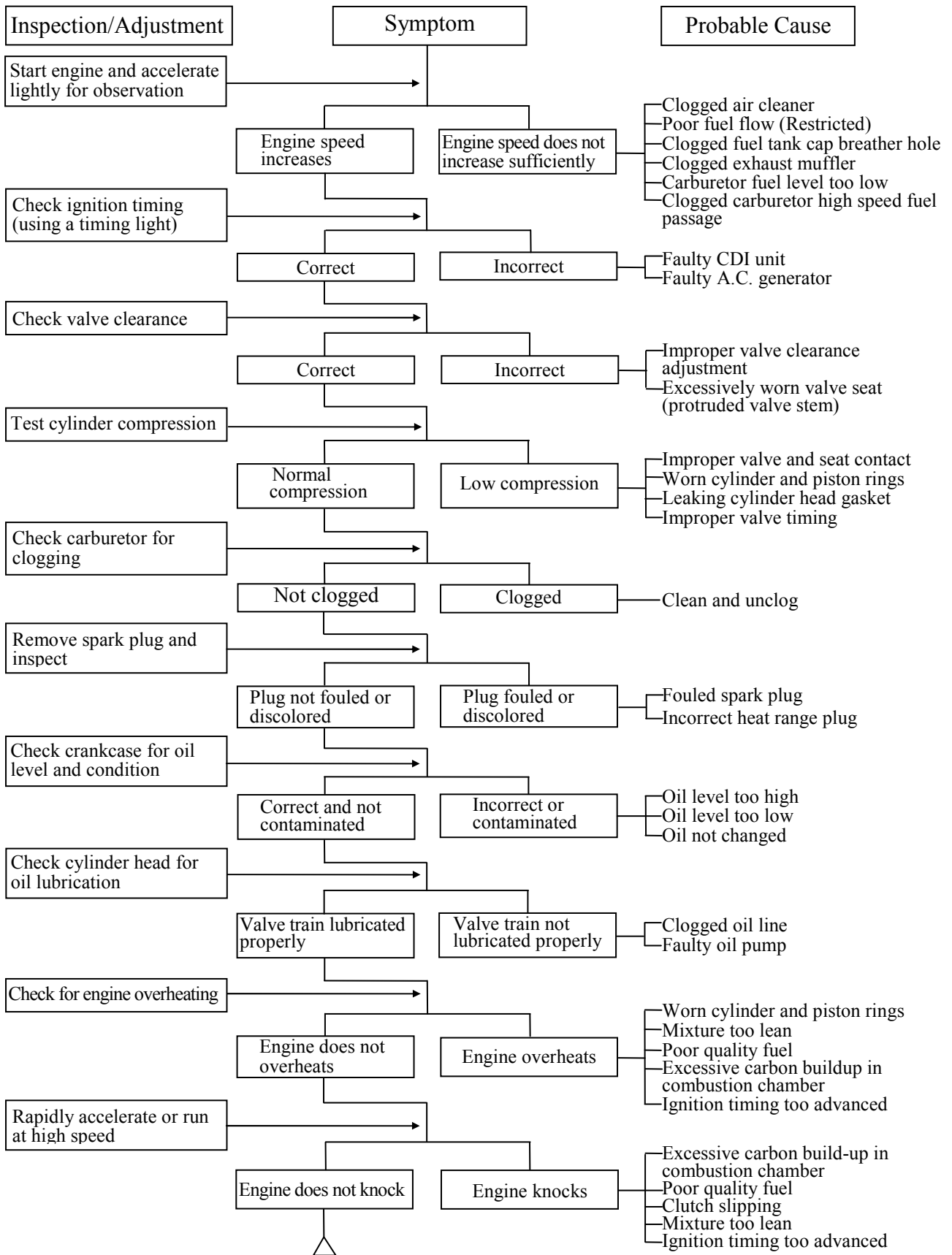

# 1. GENERAL INFORMATION

## POOR PERFORMANCE (ESPECIALLY AT IDLE AND LOW SPEEDS)

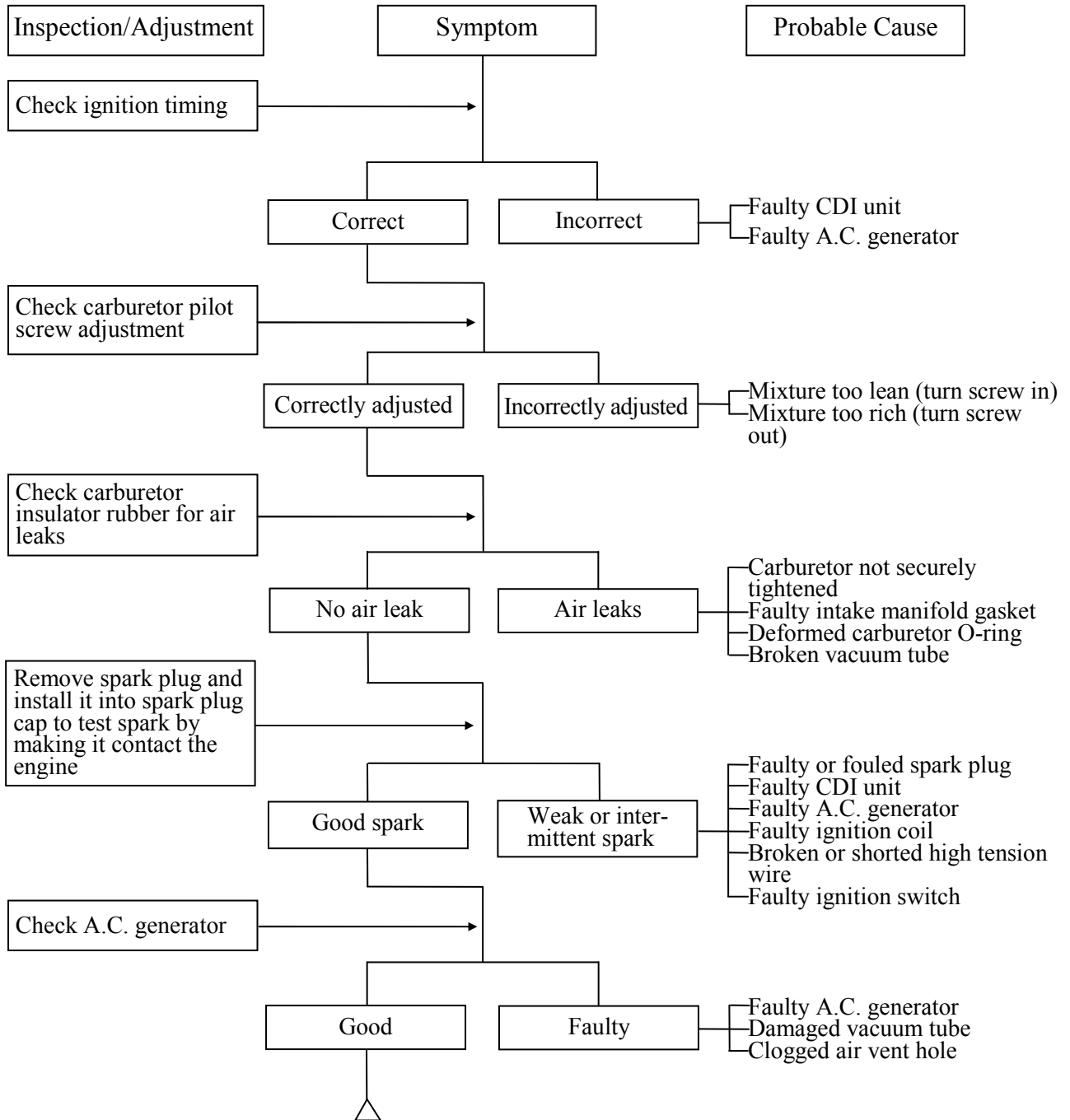

# 1. GENERAL INFORMATION

## POOR PERFORMANCE (AT HIGH SPEED)

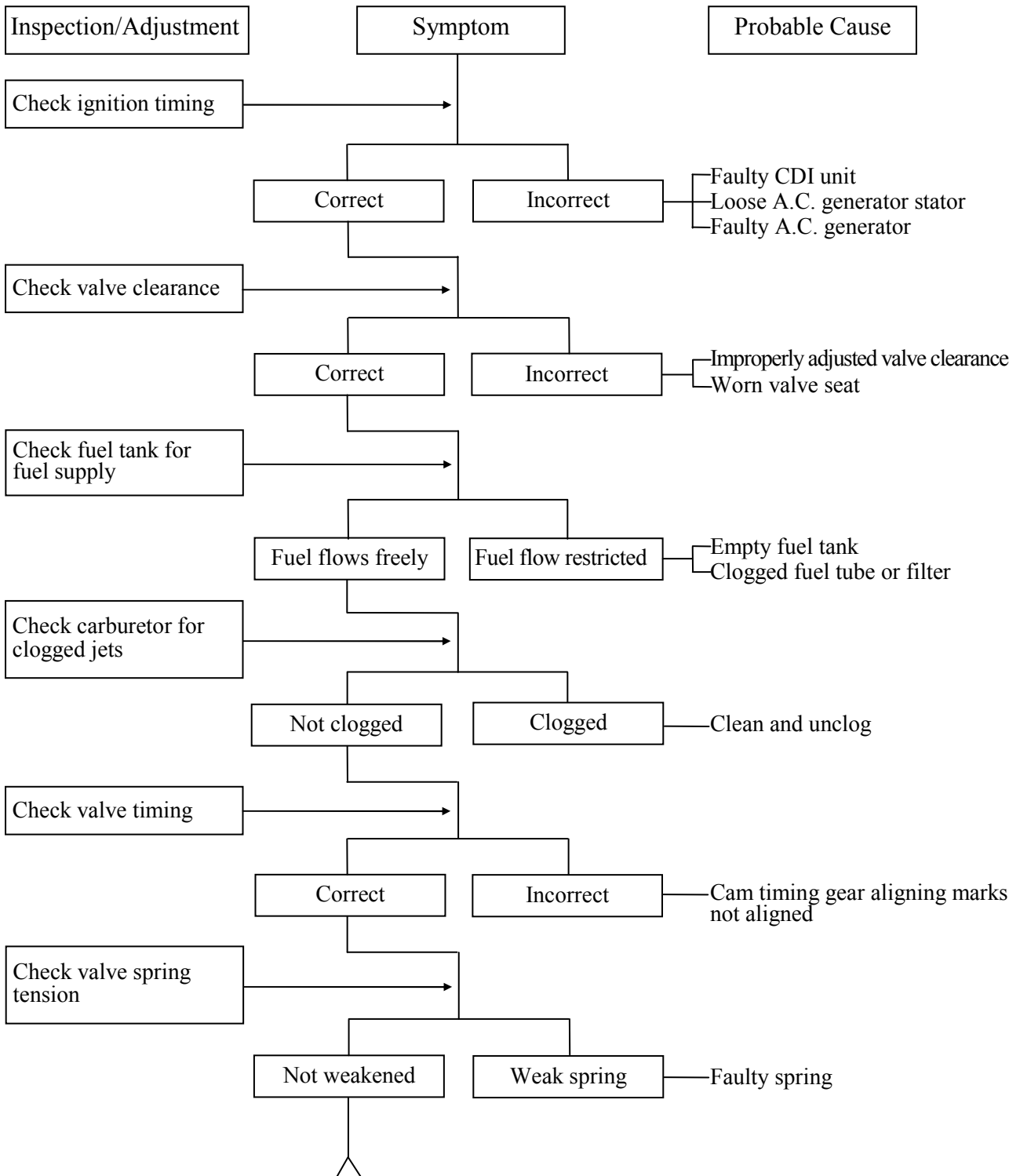

# 1. GENERAL INFORMATION

## STARTER MOTOR

### 1. Starter motor won't turn

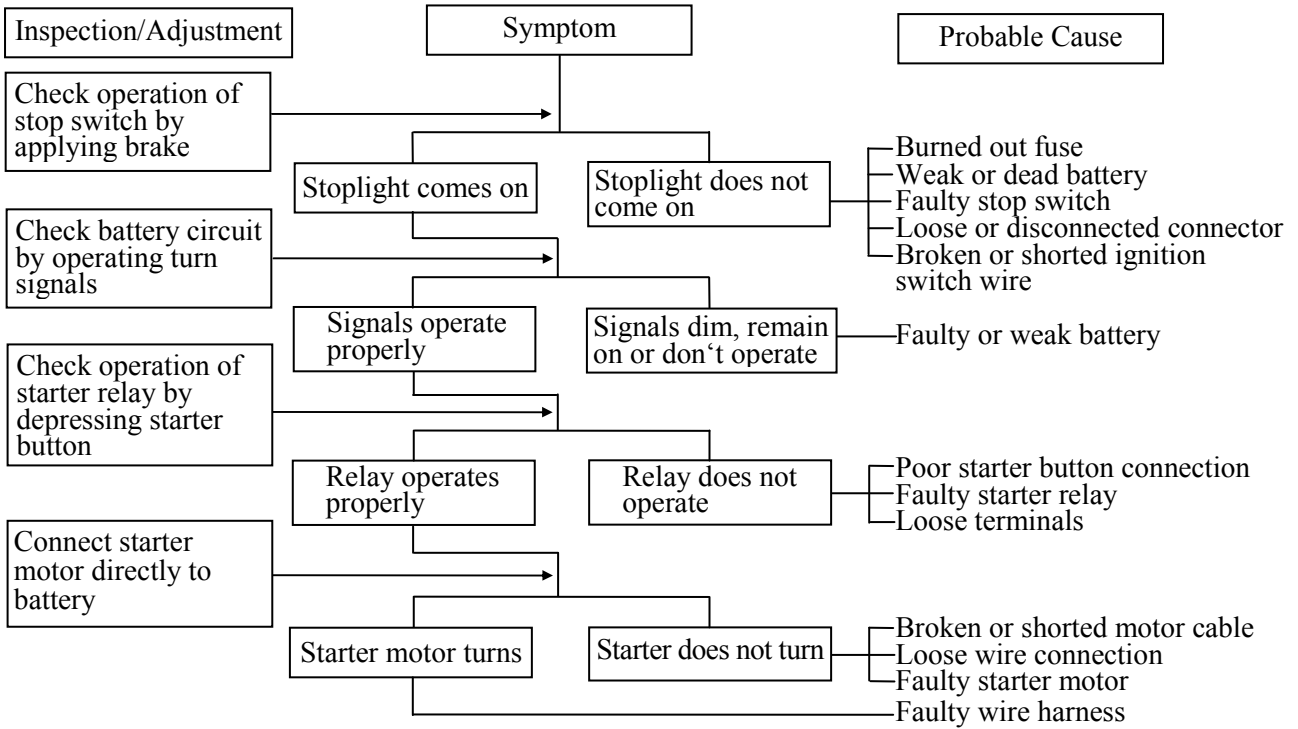

### 2. Starter motor turns slowly or idles

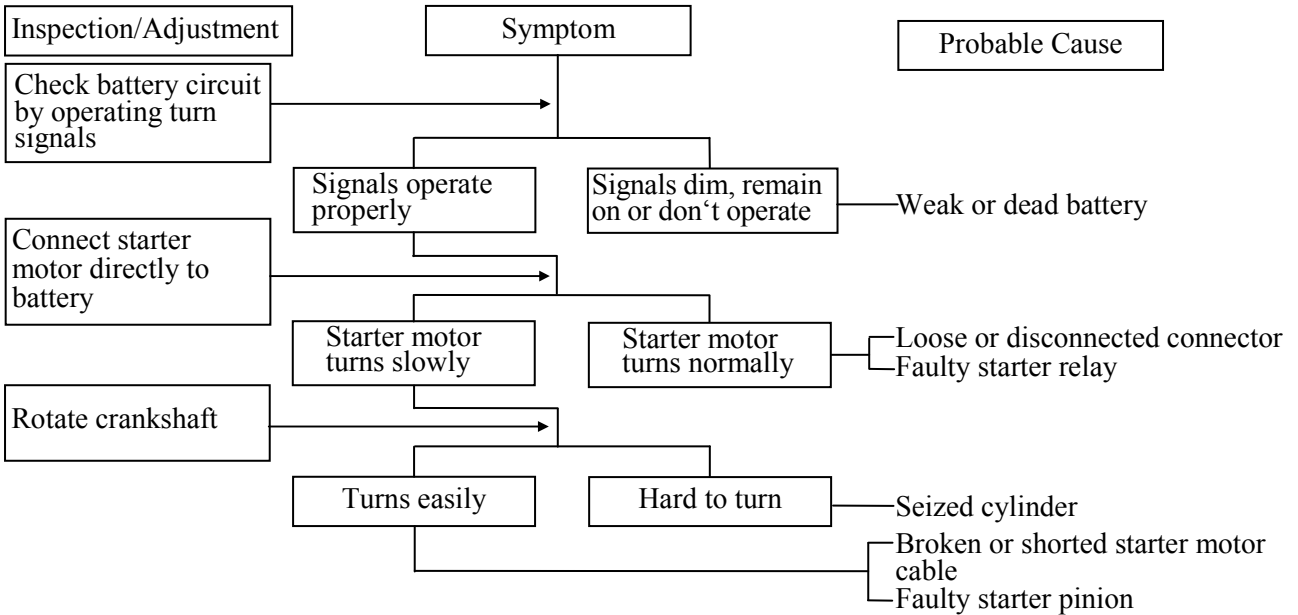

### 3. Starter motor does not stop turning

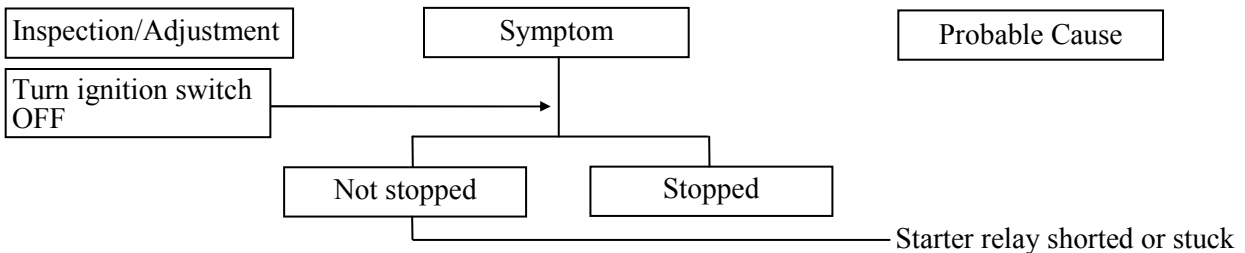



# 1. GENERAL INFORMATION

## STEERING HANDLEBAR DOES NOT TRACK STRAIGHT

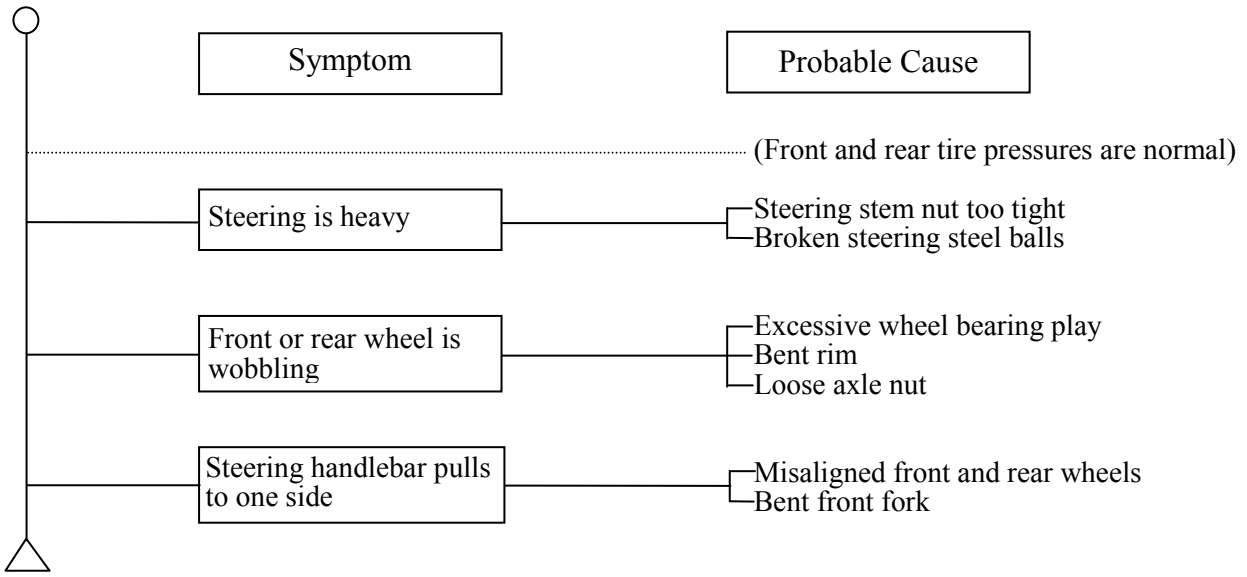

# 1. GENERAL INFORMATION

## POOR SUSPENSION PERFORMANCE

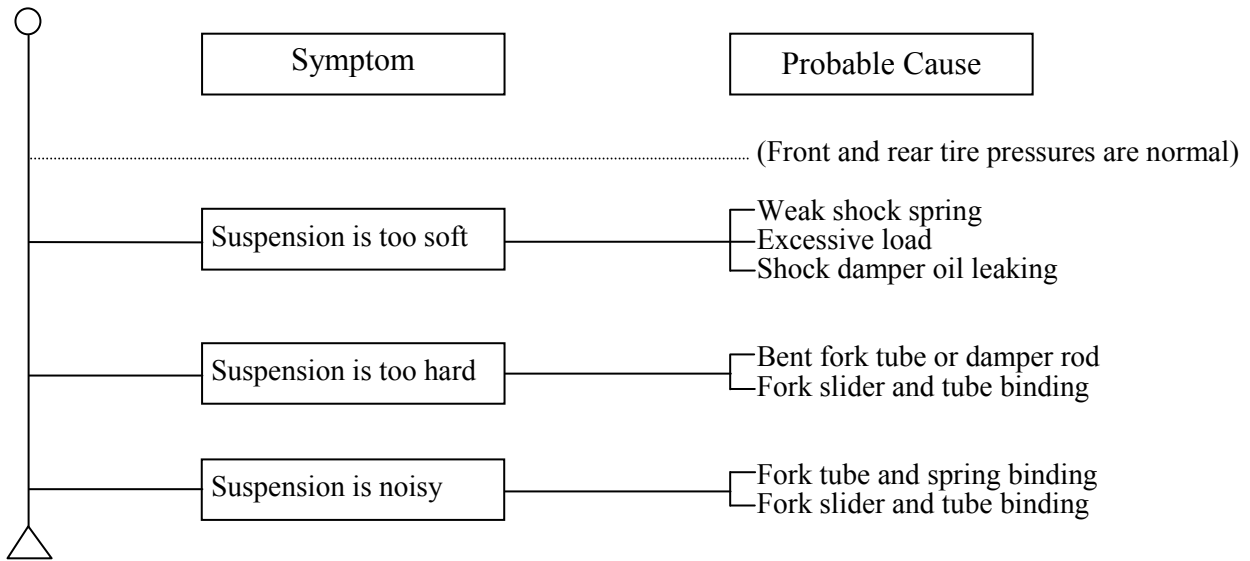

## POOR BRAKE PERFORMANCE

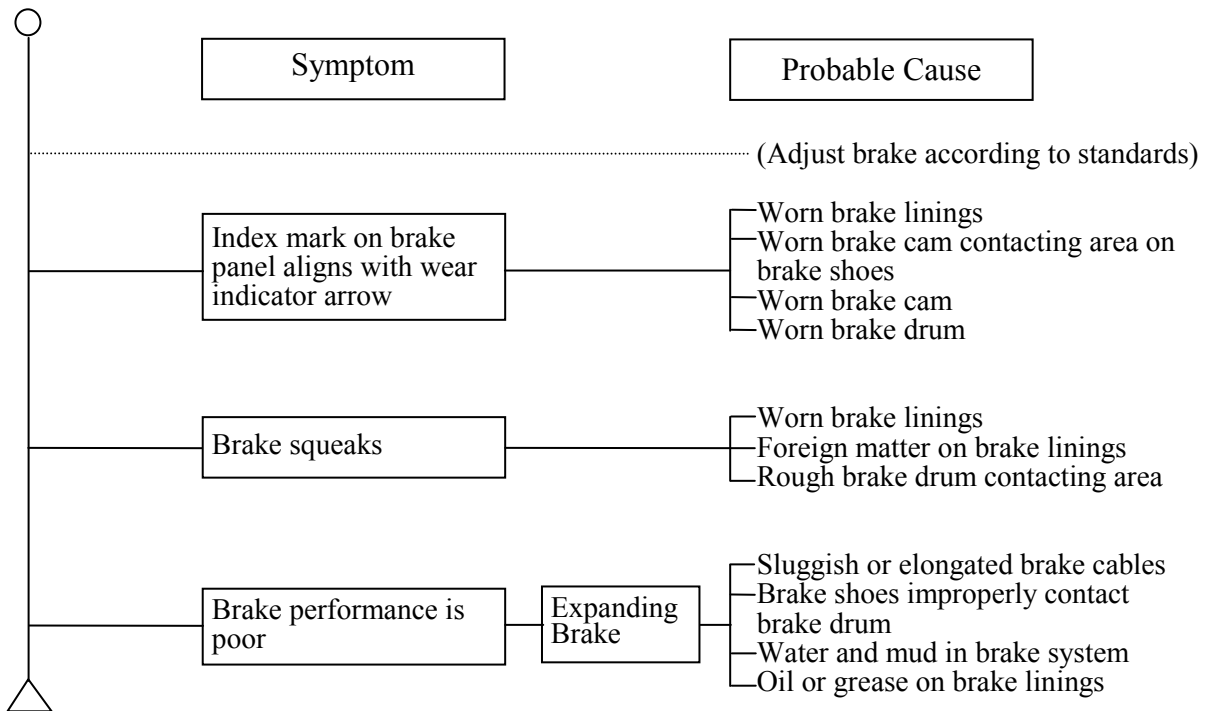

# 1. GENERAL INFORMATION

## FUEL GAUGE

### 1. Pointer does not register correctly (Ignition switch ON)

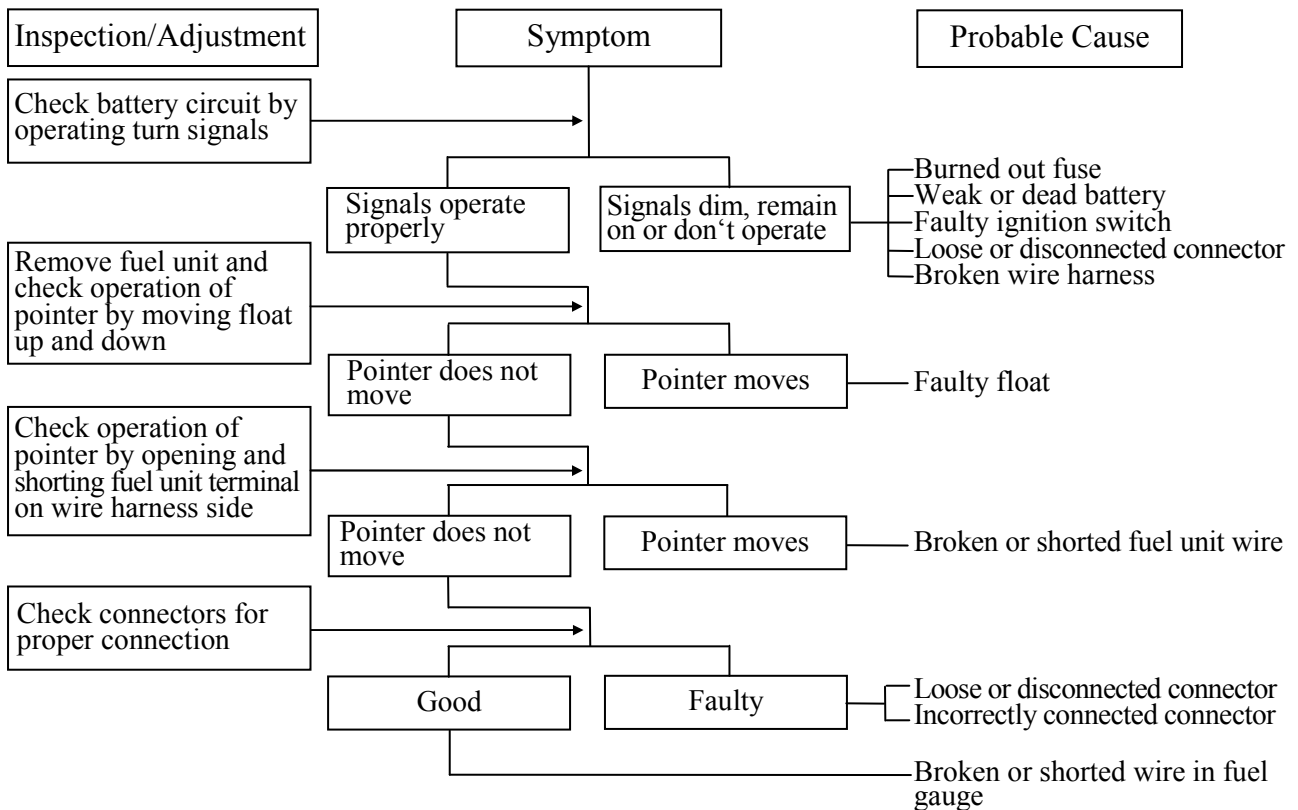

### 2. Pointer fluctuates or swings (Ignition switch ON)

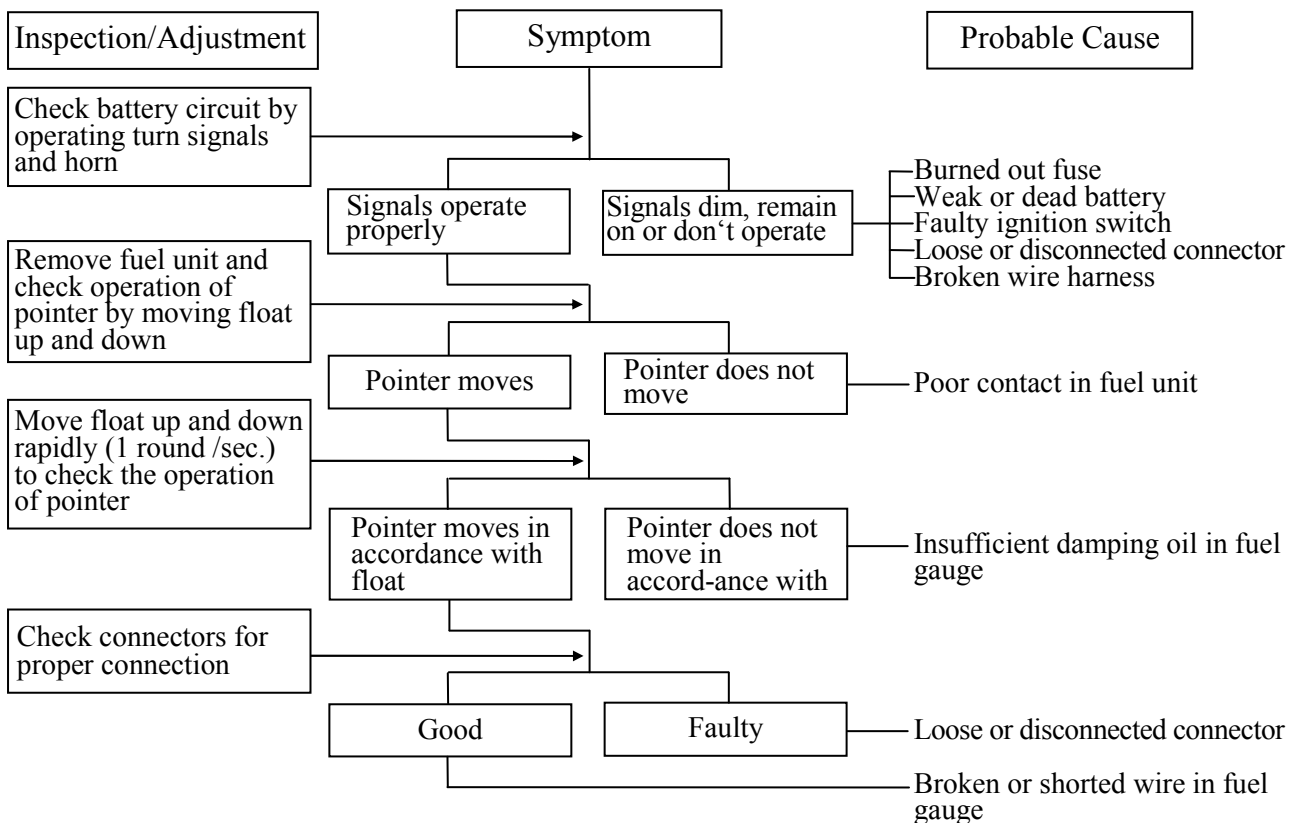

# 1. GENERAL INFORMATION

## POOR CHARGING (BATTERY OVER DISCHARGING OR OVERCHARGING)

### Undercharging

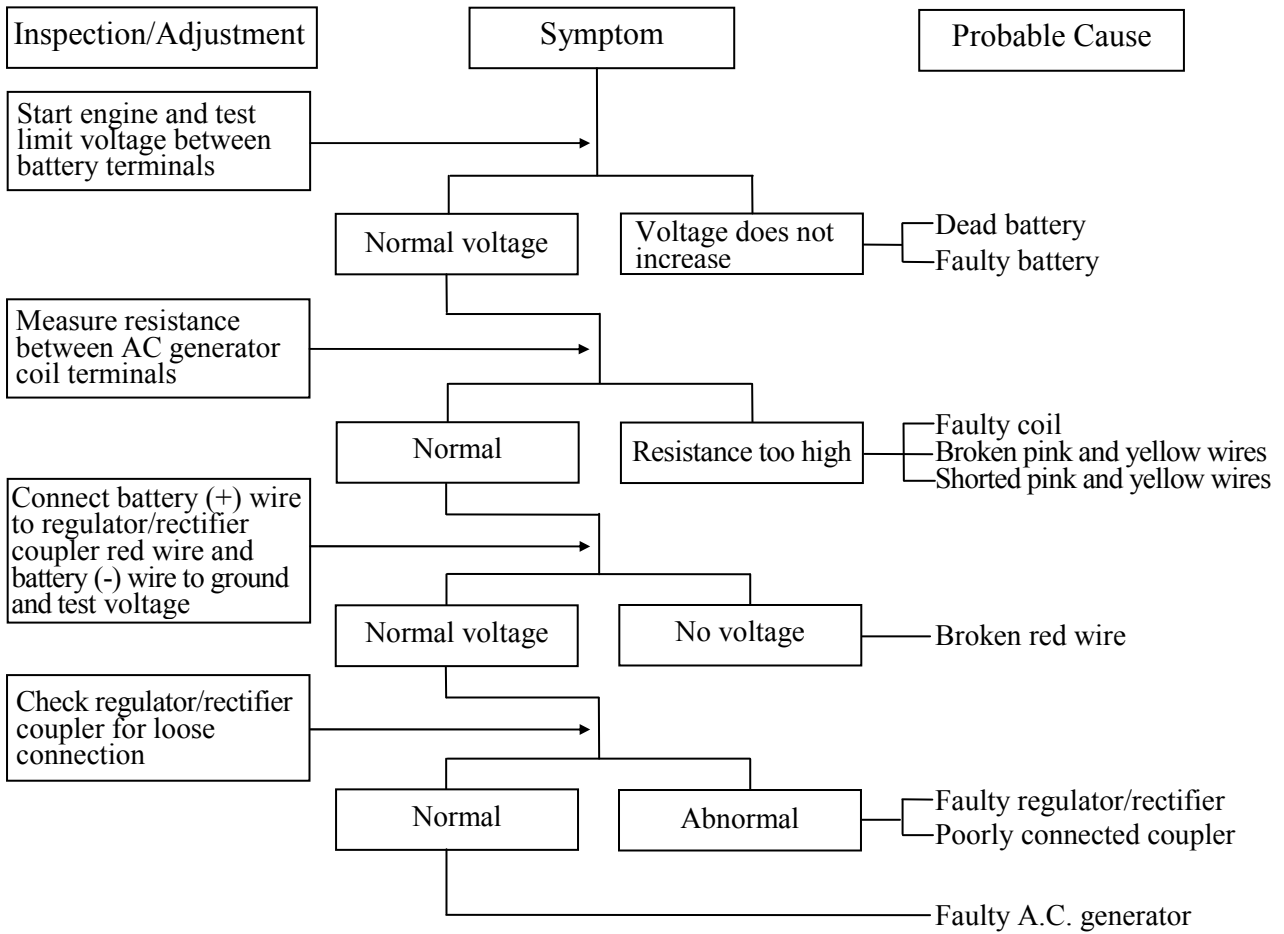

### Overcharging

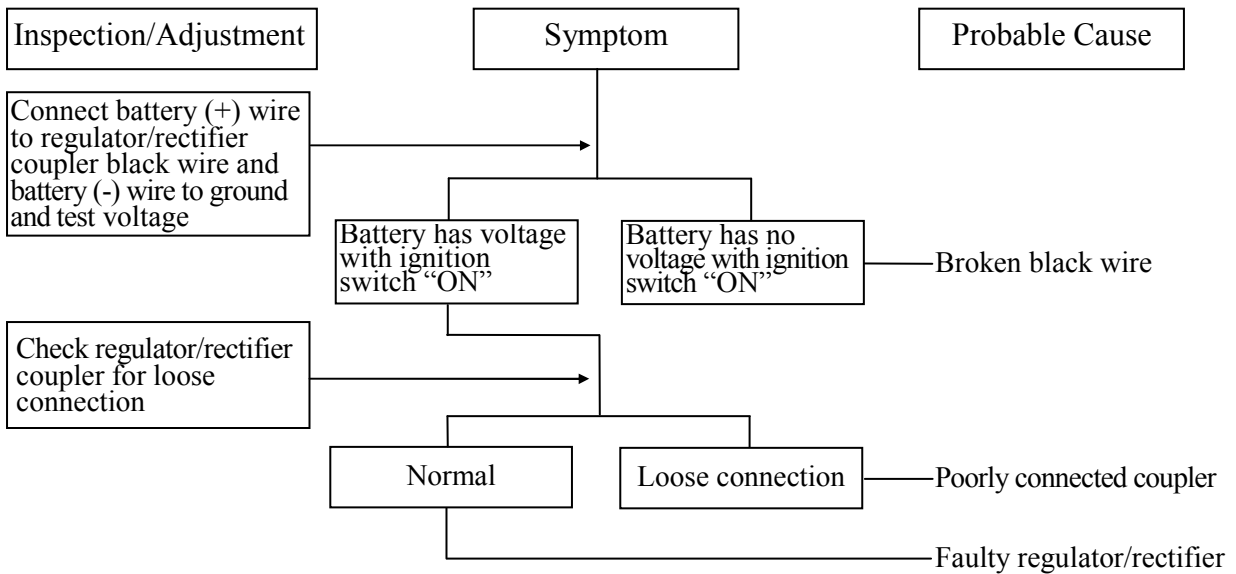

# 1. GENERAL INFORMATION

## NO SPARK AT SPARK PLUG

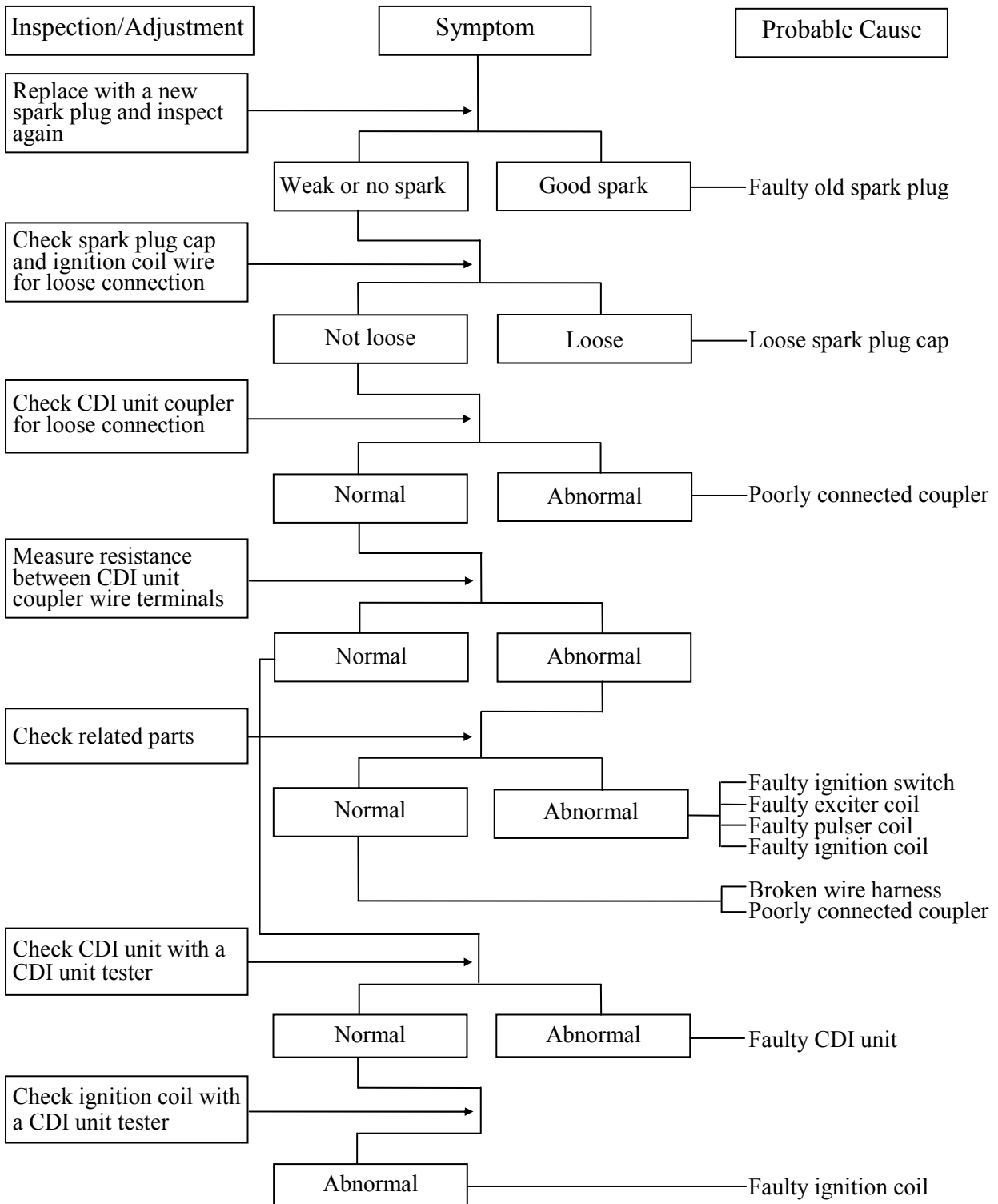

### INSPECTION/ADJUSTMENT

SERVICE INFORMATION-----	2-1
MAINTENANCE SCHEDULE-----	2-2
BRAKE SYSTEM-----	2-3
BRAKE SHOE-----	2-4
WHEELS/TIRES-----	2-4
SUSPENSION-----	2-5
CLUTCH-----	2-6
DRIVE CHAIN-----	2-7
SPARK PLUG-----	2-7
IGNITION TIMING-----	2-8
THROTTLE OPERATION-----	2-8
LUBRICATION SYSTEM-----	2-9
OIL FILTER SCREEN REPLACEMENT-----	2-10
COOLING SYSTEM-----	2-11
AIR CLEANER-----	2-12
VALVE CLEARANCE-----	2-13



## 2. INSPECTION/ADJUSTMENT

### MAINTENANCE SCHEDULE

In order to have a safe riding, maintain good performance, prolong the motorcycle service life and reduce pollution, make sure to perform the periodic inspection and maintenance.

I: Inspect and clean, lubricate, refill, repair or replace if necessary.

A: Adjust C: Clean R: Replace T: Tighten

Item	Frequency	Whichever comes first ⇔ ↓	Regular Service Mileage (km)								Daily pre-ride inspection	
			1000	7000	13000	19000	25000	31000	37000	43000		50000
Engine oil			R New motorcycle 1000 km	R	R	R	R	R	R	R	R	I
Engine oil strainer			R	C	R	C	R	C	R	C	R	
Cooling water			Clean at every 10000km or once a year								I	
Valve clearance				A		A		A		A		
Carburetor					I		I		I			
Air Cleaner			Replace(R) at every 20000km									
Spark plug			Clean(C) at every 6000km or replace(R) if necessary									
Brake system				I	I	I	I	I	I	I	I	I
Drive chain				A	A	A	A	A	A	A	A	
Battery electrolyte				I	I	I	I	I	I	I	I	I
Fuel filter screen							R					
Clutch lever free play			A		A	A	A	A	A	A	A	
Tire pressure				I	I	I	I	I	I	I	I	I
Bolts&Nuts			T			T			T			

The above items are applicable to different models. Perform suitable items for each model.  
 When exceeding the listed mileages, perform maintenance according to the listed intervals.  
 The air cleaner requires more frequent cleaning or replacing when ridden in unusually dusty areas.



## 2. INSPECTION/ADJUSTMENT

### BRAKE SYSTEM

#### BRAKE LEVER & PEDAL

##### 《Free Play》

Measure the rear brake pedal free plays.

**Free Play:** Rear: 20~30mm

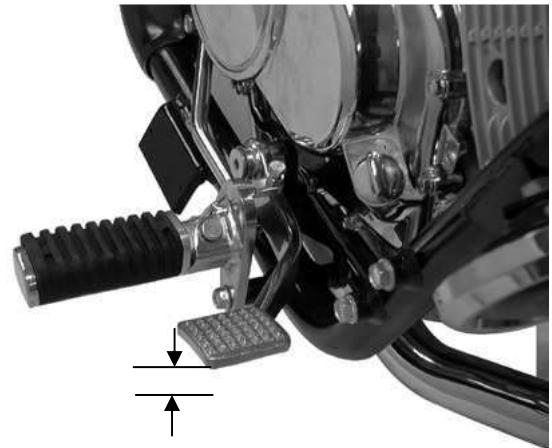

If the free plays do not fall within the limits, adjust by turning the adjusting nuts.

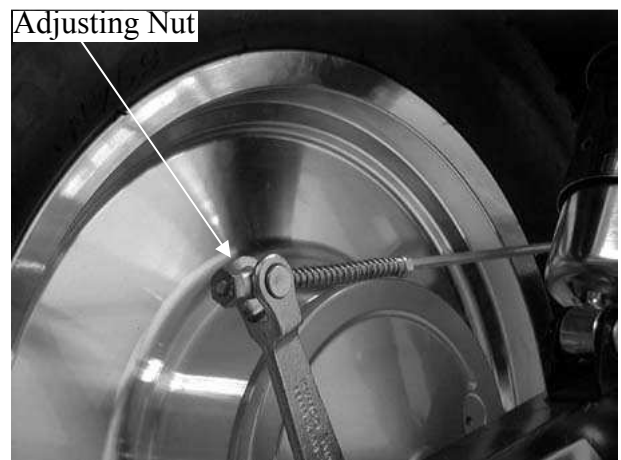

If the pedal height is unsuitable, turning the adjusting nut.

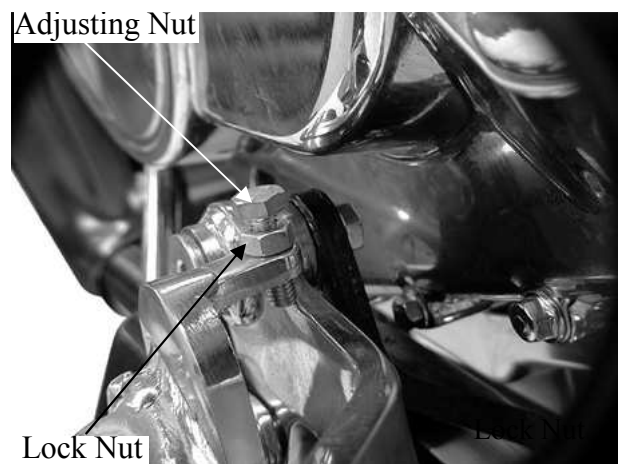

Measure the front brake lever free plays.

**Free Play:** Front: 10~20mm

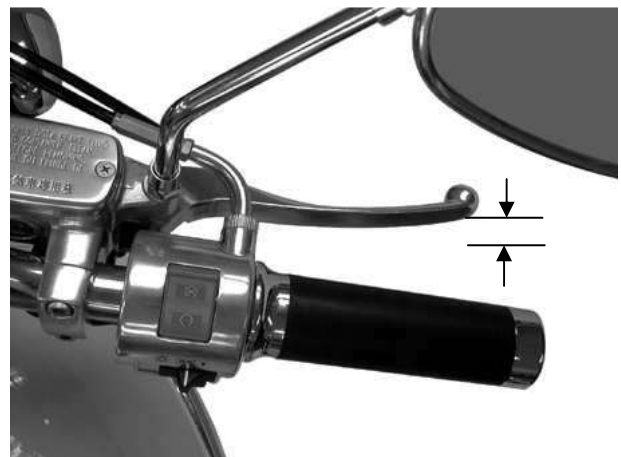

## 2. INSPECTION/ADJUSTMENT

### BRAKE FLUID

Turn the steering handlebar upright and check if the brake fluid level is between the upper and lower limits.

**Specified Brake Fluid:** DOT-4

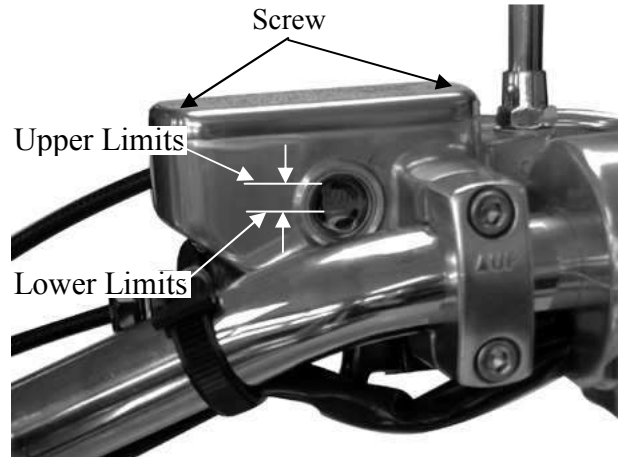

### BRAKE SHOE

Replace the brake shoes if the arrow on the brake arm aligns with the reference mark “△” on full application of the rear brake.

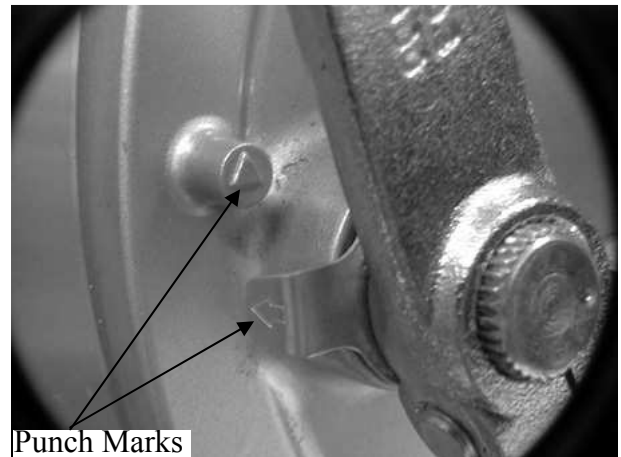

### WHEELS/TIRES

Check the tires for cuts, imbedded objects or other damages.  
Check the tire pressure.

\* Tire pressure should be checked when the tires are cold.



### TIRE PRESSURE

	1 Rider	2 Riders
Front	2.0 kg/cm <sup>2</sup>	2.0 kg/cm <sup>2</sup>
Rear	2.0 kg/cm <sup>2</sup>	2.25 kg/cm <sup>2</sup>

### TIRE SIZE

Model	VENOX 250
Front	120/80-17
Rear	150/80-15

## 2. INSPECTION/ADJUSTMENT

Check the front and rear axle nuts for looseness.  
If the axle nuts are loose, tighten them to their specified torques.

**Torques: Front** : 6.0~8.0kg-m  
**Rear** : 8.0~10.0kg-m



### SUSPENSION

#### FRONT

Fully apply the front brake lever and check the action of the front shock absorbers by compressing them several times.  
Check the entire shock absorber assembly for oil leaks, looseness or damage.

Recommended Oil: SAE 10W  
Oil Capacity: 400cc/piece



#### REAR

Check the action of the rear shock absorber by compressing it several times.  
Check the entire shock absorber assembly for oil leaks, looseness or damage.  
Jack the rear wheel off the ground and move the rear wheel sideways with force to see if the engine hanger bushings are worn.

Recommended Oil: SAE 5W  
Oil Capacity: 99cc/piece



## 2. INSPECTION/ADJUSTMENT

### STEERING HANDLEBAR

Check that the control cables do not interfere with handlebar rotation.

Raise the front wheel off the ground and check that the steering handlebar rotates freely.

If the handlebar moves unevenly, binds, or has vertical movement, adjust the steering head bearing.

**Torque:**

Steering stem nut: 6.0~8.0kg-m



### CLUTCH

Measure the clutch lever free play.

**Free Play:** 10~20mm

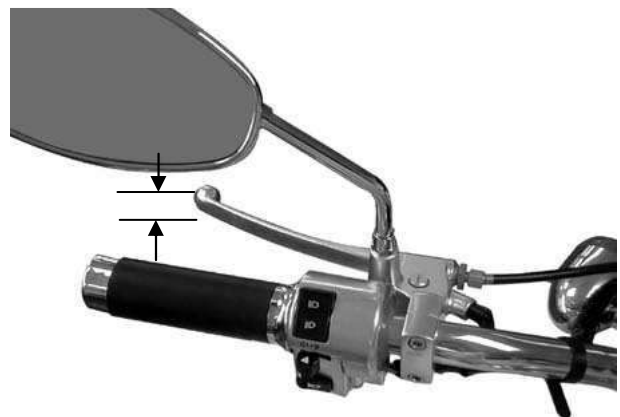

When major adjustment is required, adjust by turning the adjusting nut on the clutch cable from the right crankcase cover.

Adjust by loosening the lock nut and turning the adjusting nut. After adjustment, tighten the lock nut.

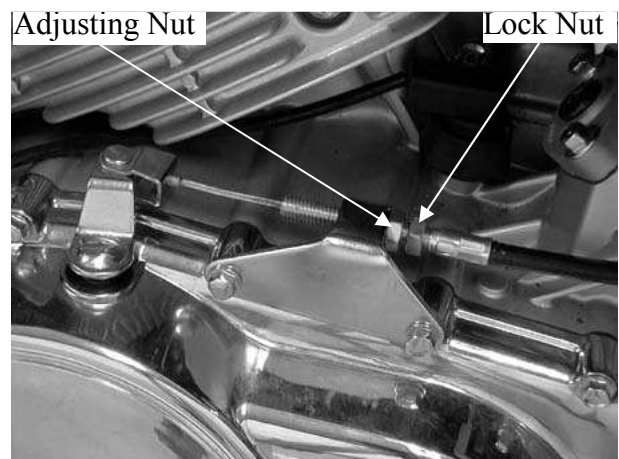

When minor adjustment is required, adjust by turning the adjusting nut on the clutch lever side.

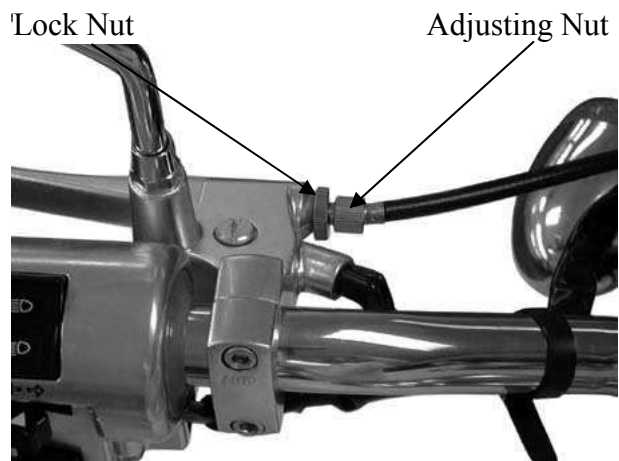

## 2. INSPECTION/ADJUSTMENT

### DRIVE CHAIN

Check the drive chain slack.  
**Specified Slack:** 10~20mm

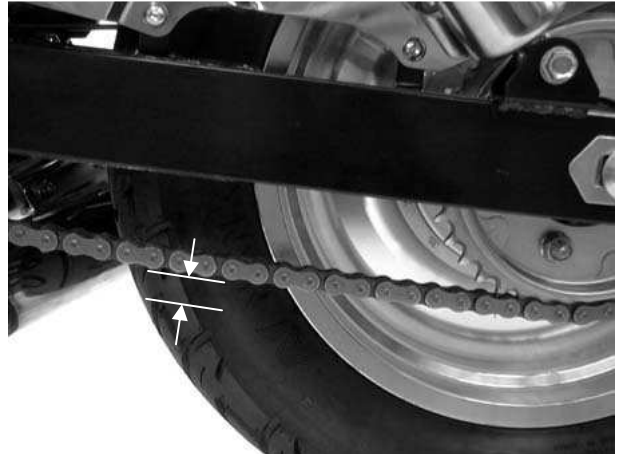

Drive Chain Adjustment:

1. First loosen the rear axle nut.
2. Adjust the right and left chain adjusting nuts to align the right and left index marks with the punch marks on the chain adjusters.
3. Turn the rear wheel to see if the drive chain slack is within the specified range.
4. Tighten the rear axle nut.

\* After drive chain adjustment, check the rear brake pedal free play and adjust if necessary.

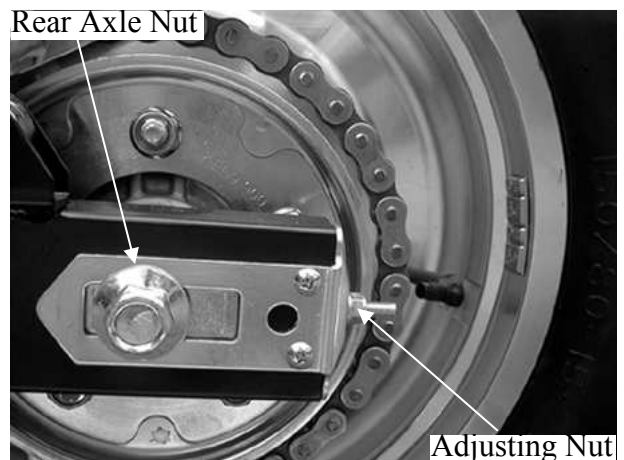

### ELECTRICAL EQUIPMENT

#### SPARK PLUG

Remove the spark plug cap and spark plug.  
Check the spark plug for wear, fouling and carbon deposits.  
Remove the fouling and carbon deposits with a spark plug cleaner or wire brush.  
**Specified Spark Plug:** CR8E



Measure the spark plug gap.  
**Spark Plug Gap:** 0.6~0.7mm

\* When installing, first screw in the spark plug by hand and then tighten it with a spark plug wrench.

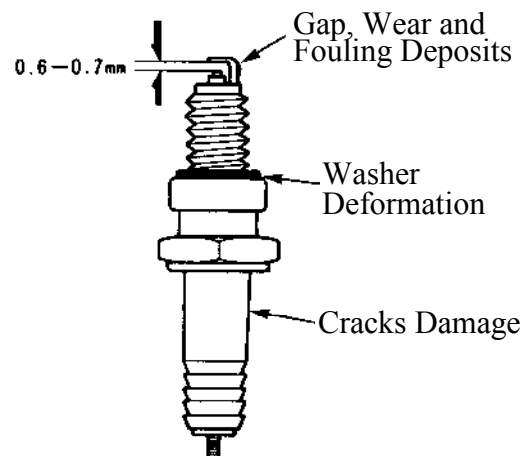

## 2. INSPECTION/ADJUSTMENT

### IGNITION TIMING

\* The CDI ignition timing is not adjustable, a kind of fully transistor ignition. If the timing is incorrect, check the CDI unit, ignition coil and A.C. generator and replace any faulty parts.

Remove the ignition timing eye hole cap on the left crankcase cover.

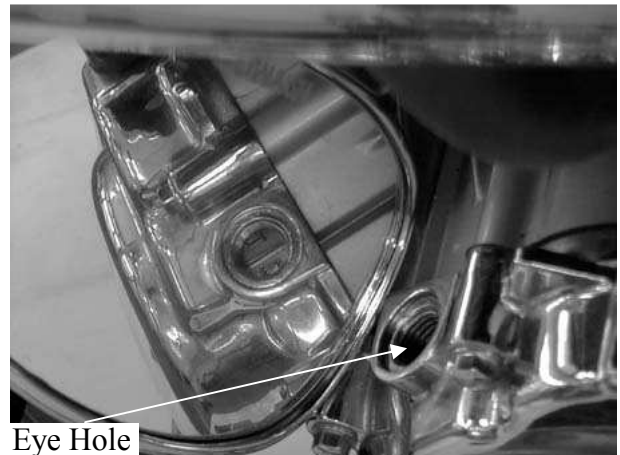

Warm up the engine and check the ignition timing with a timing light. When the engine is running at the specified rpm, the ignition timing is correct if the "F" mark aligns with the index mark on the crankcase within  $\pm 2^\circ$ .

**Ignition Timing:**  $10^\circ \pm 2^\circ$  BTDC/1000rpm



### THROTTLE OPERATION

Check for smooth throttle grip movement in all steering positions. Measure the throttle grip free play.

**Free Play:** 2~6mm



When major adjustment is required, adjust by turning the adjusting nut on the carburetor cable from the front carburetor. Adjust by loosening the lock nut and turning the adjusting nut. After adjustment, tighten the lock nut.

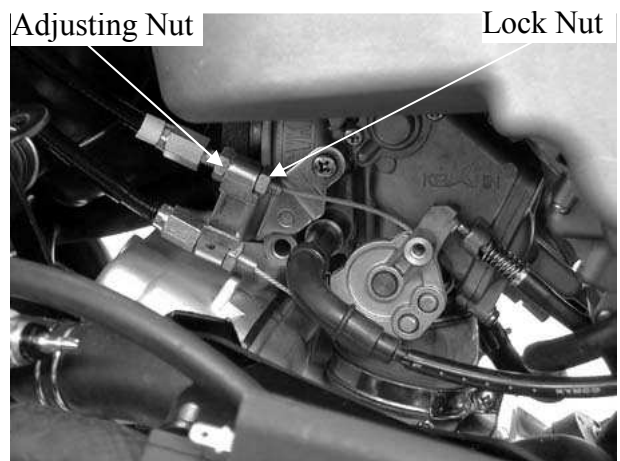

## 2. INSPECTION/ADJUSTMENT

When minor adjustment is required, adjust by turning the adjusting nut on the throttle cable.

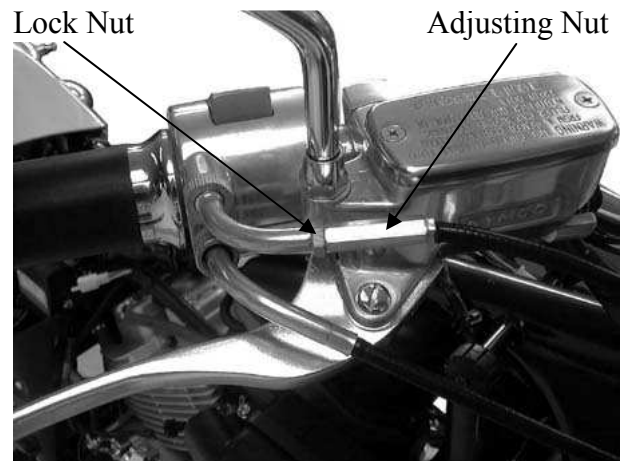

Check the choke rod operating properly if smoothly or not.

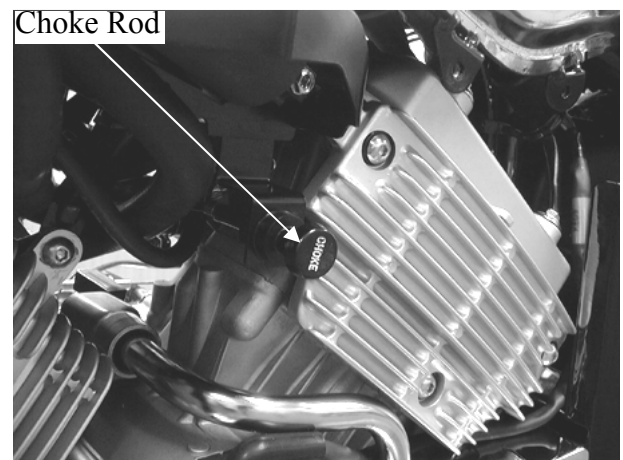

Remove the choke rod valve.  
Check the choke rod valve for wear, fouling and carbon deposits.  
Remove the fouling and carbon deposits.

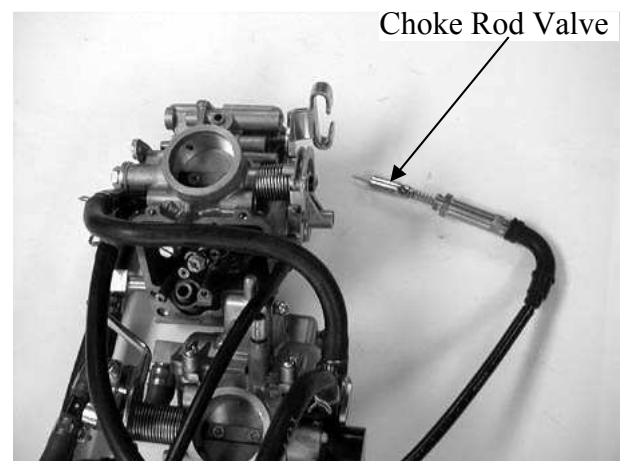

### LUBRICATION SYSTEM

#### 《Oil Filter Cleaning》

#### Oil Level Check

\* Place the motorcycle on its main stand on level ground for oil level check.

After the engine is stopped for 10 minutes, check if the oil level is between the upper and lower limits on the oil windows.

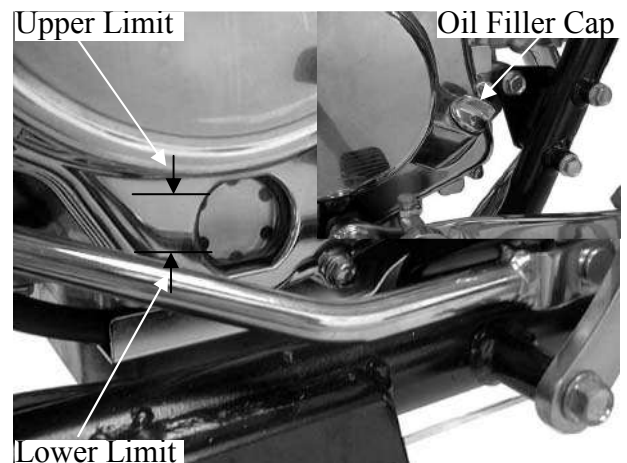

## 2. INSPECTION/ADJUSTMENT

If the oil level is low, add the recommended oil to the proper level.

**Recommended Oil:** SAE 5W-50  
API:SF

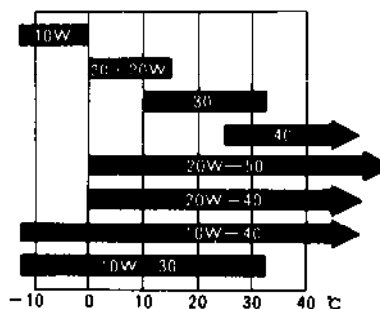

When changing engine oil, be sure to tighten the drain bolt securely.

Check the drain bolt washer for damage.

**Oil Capacity:** Full capacity : 2.5 liter  
At change with oil filter : 2.2 liter  
At change without oil filter : 2.0 liter

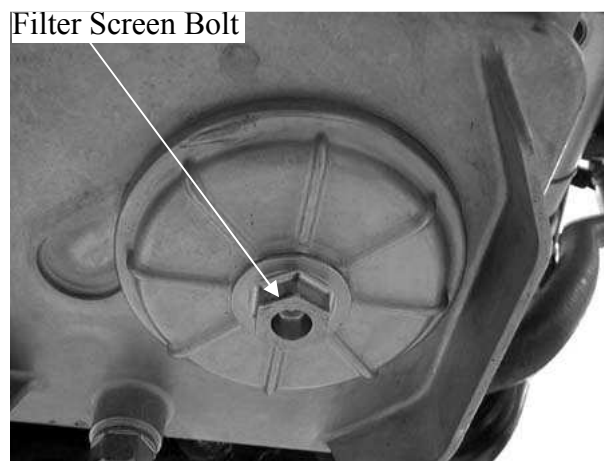
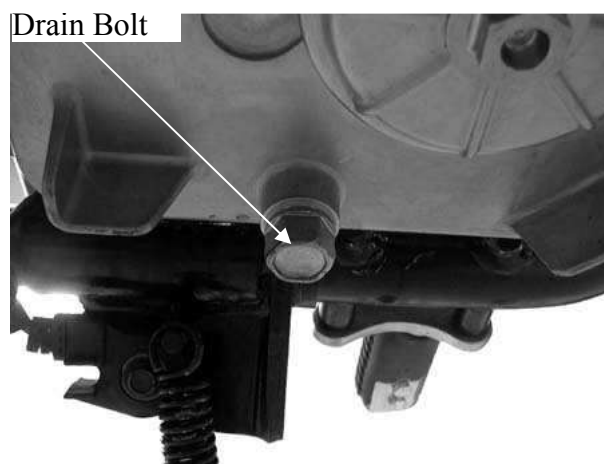

### Oil Filter Screen Replacement

Remove the oil filter screen cap.  
Remove the oil filter screen and spring.  
Then, replace the oil filter screen.

\* Be careful not to install the oil filter screen in the reverse direction to avoid engine damage.

**Change Interval:** First 1000km  
Replace the oil filter screen at every 12000km

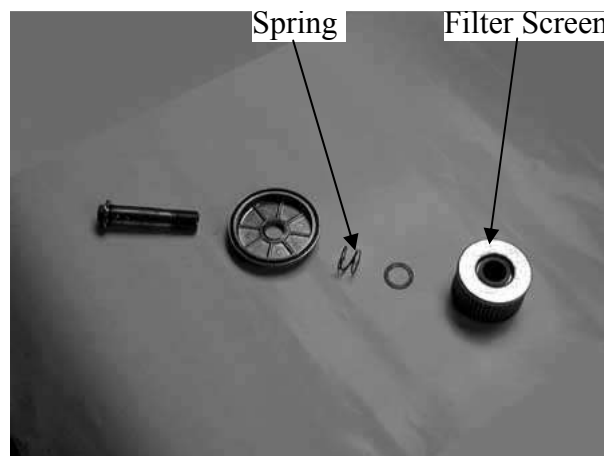



## 2. INSPECTION/ADJUSTMENT

### COOLING SYSTEM

- \* Place the motorcycle on its main stand on level ground for coolant level check.

Check if the coolant level is between the upper and lower limits on the reserve tank. If the coolant level is too low, it means that there are abnormal conditions. First fill the reserve tank with coolant to the upper level line.

- \* Start the engine and allow the cooling fan to run. Then, stop the engine. Check the coolant level in the reserve tank and fill to the upper level line if the level is under the lower level line.

Coolant concentrate specified density:30%(cold area 50%).

Inspect the telltale hole for signs of mechanical seal coolant leakage. If the mechanical seal is leaking, replace the water pump assy.

Remove the reserve tank cap and fill to the upper level line with distilled water.

Press down the reserve tank cap.  
Remove the drain bolt to drain the coolant.

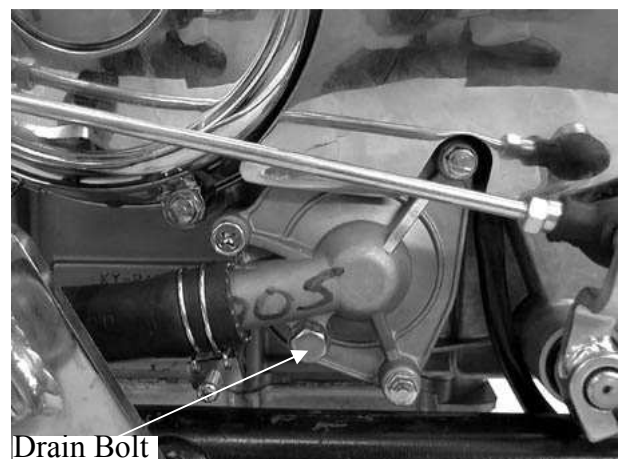
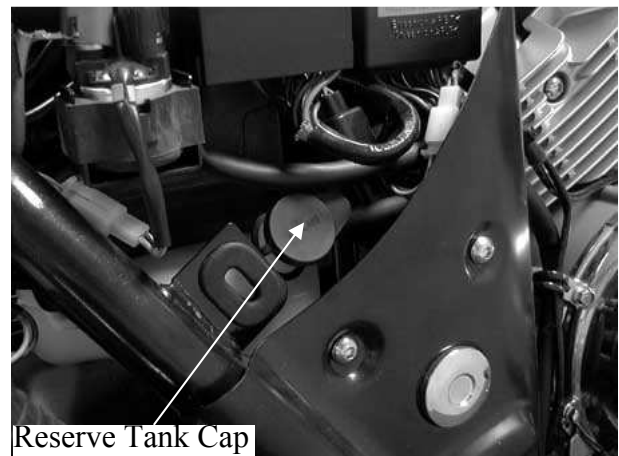
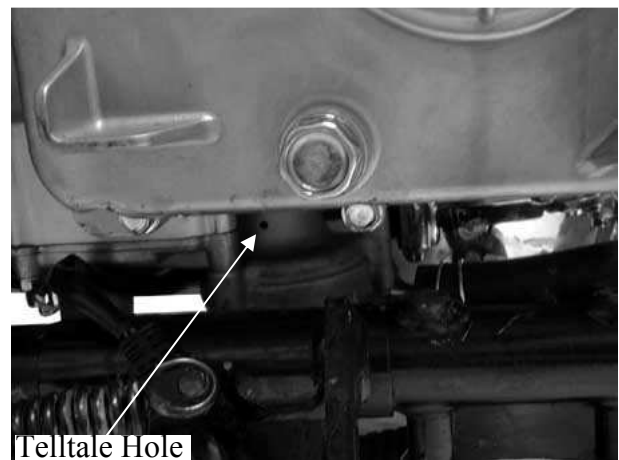
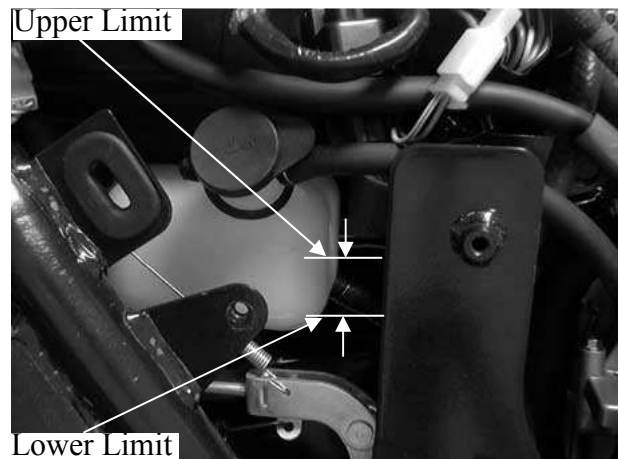

## 2. INSPECTION/ADJUSTMENT

### AIR CLEANER

#### AIR CLEANER REPLACEMENT

Remove the right side cover.

Remove the air cleaner case cover screws and the cover.

Remove the air cleaner element.

Check the element and replace it with a new one if it is excessively dirty or damaged.

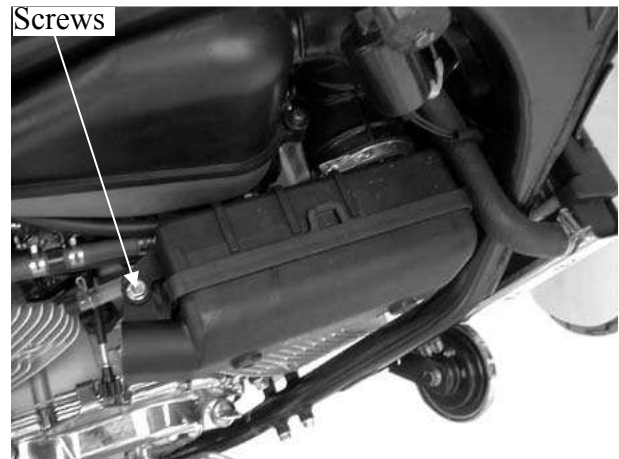

#### CHANGE INTERVAL

More frequent replacement is required if ridden in unusually dusty or rainy areas.

**Replace the element at every 20000 km.**

- \*
- If the air cleaner is installed improperly, dust may be sucked into the cylinder directly to reduce the engine horse-power and affect engine service life.
  - Pay attention to the installation direction during reassembly.



#### CYLINDER COMPRESSION

- \*
- Warm up the engine before compression test.

Remove the spark plug and insert a compression gauge.

Open the throttle valve fully and crank the engine with the starter motor or kick lever for 7~8 seconds to test the compression.

**Compression:**  $17 \pm 2 \text{ kg/cm}^2$



If the compression is low, check for the following:

- . Leaky valves
- . Valve clearance too small
- . Leaking cylinder head gasket
- . Worn piston/cylinder
- . Worn piston rings

If the compression is high, it indicates that carbon deposits have accumulated on the combustion chamber and the piston head.

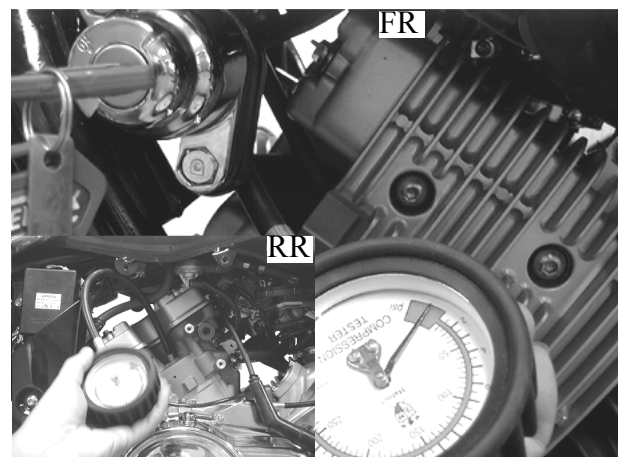

## 2. INSPECTION/ADJUSTMENT

### VALVE CLEARANCE

- \* Inspect and adjust valve clearance while the engine is cold (below 35°C).

Remove the four cylinder head cover bolts and the cylinder head cover.

#### Front cylinder:

Rotate the generator flywheel to bring the camshaft to the top dead center on the compression stroke and align the "T1" mark on the flywheel with the mark on the left crankcase cover.

#### Rear cylinder:

Rotate the generator flywheel for 270° counterclockwise to bring the camshaft to the top dead center on the compression stroke and align the "T2" mark on the flywheel with the mark on the left crankcase cover.

- \* After adjustment, rotate the crankshaft several turns to make sure that the valve clearance is correct.

Inspect and adjust the valve clearance.

**Valve Clearance:** IN : 0.1mm  
EX: 0.1mm

Loosen the lock nut and adjust by turning the adjusting bolt.

Special

Valve Wrench

- \* Check the valve clearance again after the lock nut is tightened.

### IDLE SPEED ADJUSTMENT

1. Warm the engine up to 60□.
2. Remove the engine protector cover.
3. Insert both of vacuum gauges on the both of vacuum holes.
4. Check the vacuum value of twin-cylinder separately.
5. Adjust the differential vacuum within 20mm-hg.
6. Slightly turn the throttle grip for several times and recheck if the differential vacuum is within 20mm-hg. If within and continue next step, If not within and operate the step above again.
7. Adjust the idle speed to 1300±100rpm.
8. Slightly turn the throttle grip for several times and recheck if the idle speed still stay at the specific value. If rpm is at 1300 and continue next step, If not and operate the step above again.

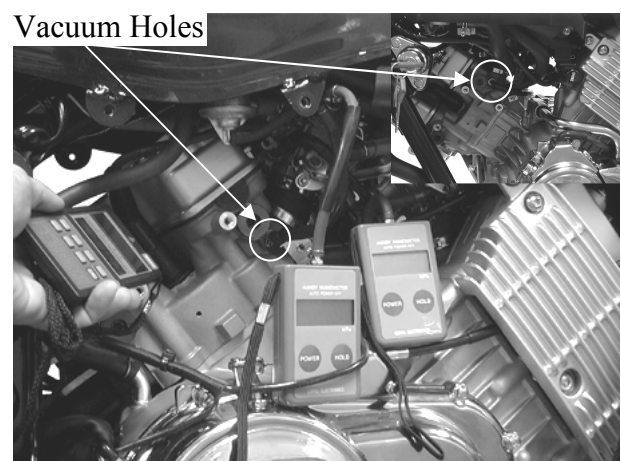
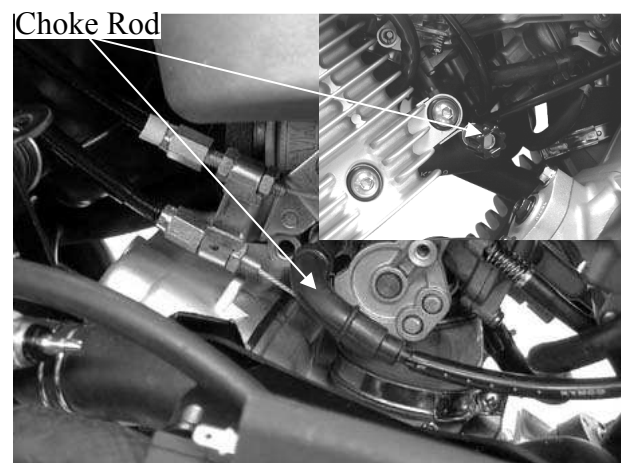
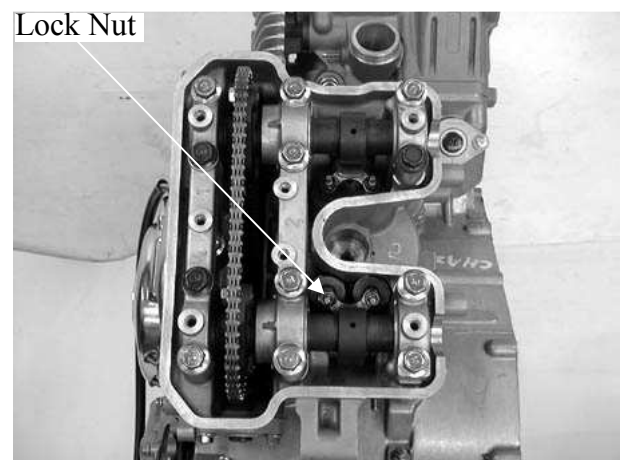

## 2. INSPECTION/ADJUSTMENT

9. Adjust the CO density of the front/rear carburetor at  $3.0 \pm 0.5\%$  by turning the pilot screw.

10. Slightly turn the throttle grip for several time again and recheck if the idle speed, vacuum value and CO density is within the specified range.

Special

Vacuum & CO Adjuster  
Vacuum Gauge

\* The front cylinder is close to the headlight side and the rear cylinder is another side.

Adjust the idle speed to the specified range by turning the throttle stop screw and pilot screw.

**Idle Speed:**  $1300 \pm 100$ rpm

**CO density:**  $3.0 \pm 0.5\%$

\* The engine must be warm for accurate idle speed adjustment.

### OTHERS

#### LIGHTS

##### 《Headlight》

Adjust the headlight beam by loosening the headlight adjusting bolts and moving the headlight upward and downward to a proper position. After adjustment, tighten the adjusting bolts.

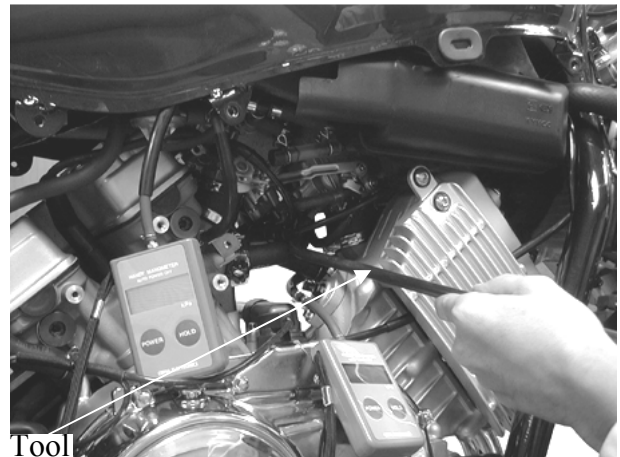

Tool

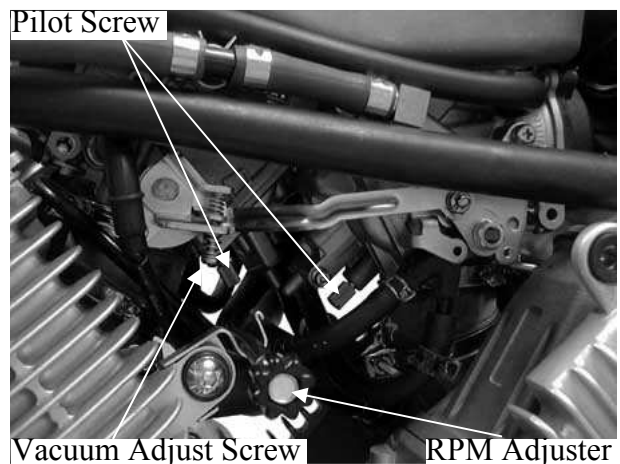

Vacuum Adjust Screw

RPM Adjuster



Bolt

# 3. LUBRICATION SYSTEM

## LUBRICATION SYSTEM

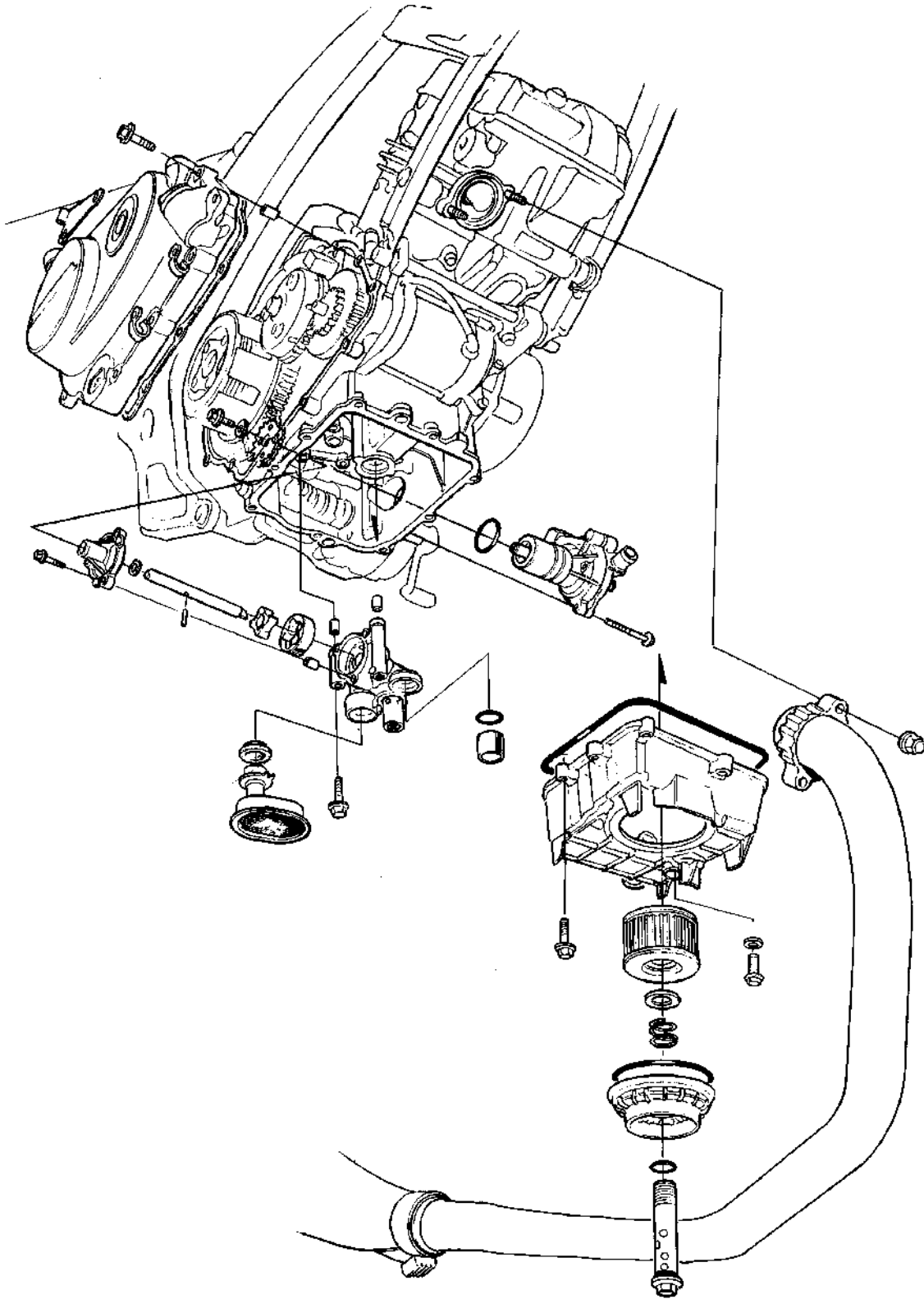

### 3. LUBRICATION SYSTEM

---

---

## LUBRICATION SYSTEM

---

SERVICE INFORMATION .....	3-2
TROUBLESHOOTING .....	3-2
ENGINE OIL/OIL FILTER .....	3-3
OIL PUMP.....	3-4

### 3. LUBRICATION SYSTEM

#### SERVICE INFORMATION

##### GENERAL INSTRUCTIONS

- The service and maintenance of this section can be accomplished with the engine installed in the frame.
- Use care when removing and installing the oil pump not to allow dust and foreign matters to enter the engine and oil line.
- After the oil pump is installed, check each part for oil leaks and improper lubrication.

##### SPECIFICATIONS

Item		Standard (mm)	Service Limit (mm)
Oil pump	Inner rotor-to-outer rotor clearance	—	0.20
	Outer rotor-to-pump body clearance	—	0.20
	Rotor end-to-pump body clearance	0.015~0.10	0.15
Oil pump output pressure		2.4kg/cm <sup>2</sup> (1000rpm)	—

##### TORQUE VALUES

- Oil drain: 2.0~3.0kg-m
- Oil separator: 0.8~1.2kg-m
- Oil pump sprocket: 1.8~2.3kg-m
- Oil sump: 0.8~1.2kg-m

##### TROUBLESHOOTING

###### Oil level too low

- Natural oil consumption
- Oil leaks
- Worn or poorly installed piston rings
- Worn valve guide or seal

###### Engine burns

- Low or no lubrication pressure
- Clogged oil passages
- Not use the specified oil

## ENGINE OIL/OIL FILTER

### OIL LEVEL

- \* Place the motorcycle upright on level ground for engine oil level check.
- \* Run the engine for 2~3 minutes and check the oil level after the engine is stopped for 2~3 minutes.

If the level is near the lower limit, fill to the upper limit with the specified engine oil.

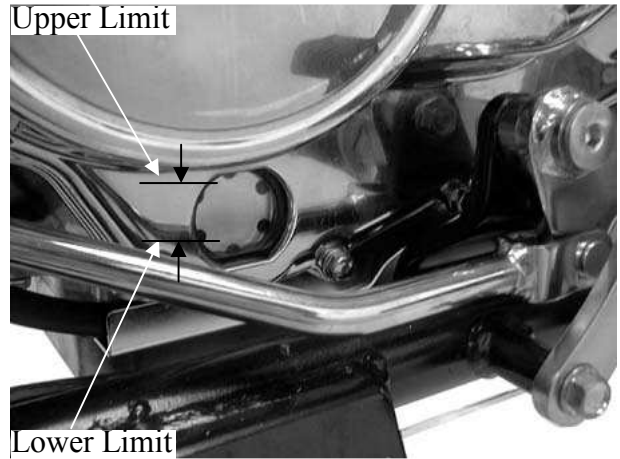

### OIL CHANGE

- \* The engine oil will drain more easily while the engine is warm.

Remove the drain bolt to drain the engine oil thoroughly.  
Check the drain bolt washer for damage or deformation and replace with a new one if necessary.

**Torque:** Oil drain 2.0~3.0kg-m

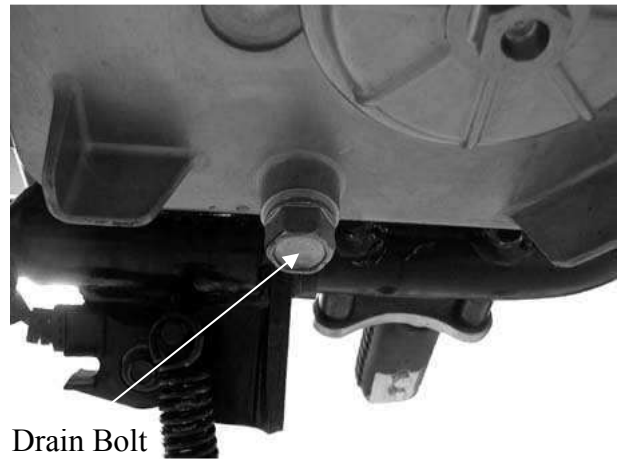

Remove the oil filter screen cap and then remove the oil filter screen and spring.  
Check the filter screen cap O-ring for damage or deformation and replace if necessary.  
Install the oil filter screen, spring and filter screen cap.

**Torque:** 2.0~3.0kg-m

- \* Do not install the oil filter screen upside down.

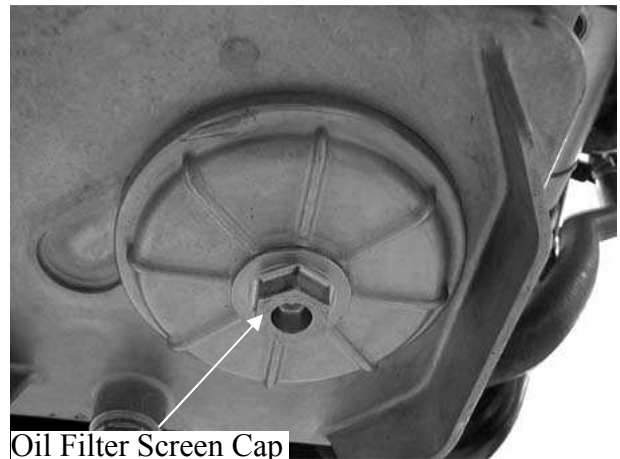

Oil Capacity:

At disassembly: 2.5 liter

At change without oil filter: 2.2 liter

At change with oil filter: 2.0 liter

Check for oil leaks and then start the engine and let it idle for few minutes.

Stop the engine and recheck the oil level.

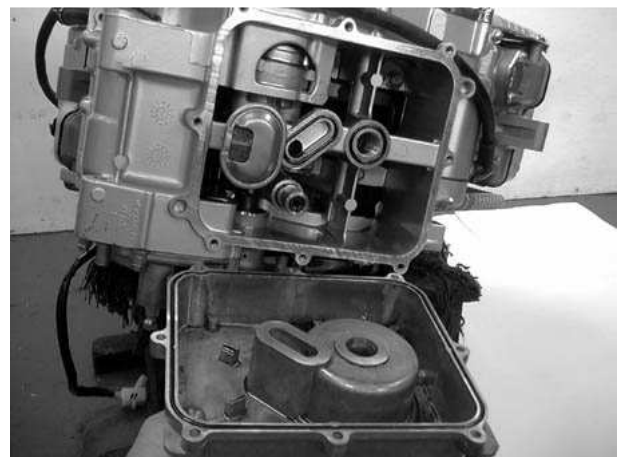



### 3. LUBRICATION SYSTEM

#### OIL PUMP

##### REMOVAL

1. Disconnect the clutch cable.
2. Remove the right crankcase cover bolts and right crankcase cover.

\* When installing, make sure to use a new right crankcase cover gasket.

Remove the bolt attaching the starter gear.  
 Remove the reduction gear, shaft and collar.  
 Remove the four clutch lifter bolts.  
 Remove the clutch lifter and four tension springs.  
 Remove the clutch filter rotor lock nut and then remove the washer and clutch filter rotor.  
 Remove the clutch center, clutch friction disks and plates.  
 Remove the thrust washer, clutch outer and outer guide.

\* During installation, install the washer with the mark facing up.

Remove the three oil pump gear cover bolts and oil pump sprocket nut to oil pump gear cover.

##### Torque:

Oil pump sprocket nut: 1.8~2.3kg-m

Disconnect the oil pump driven gear and chain.

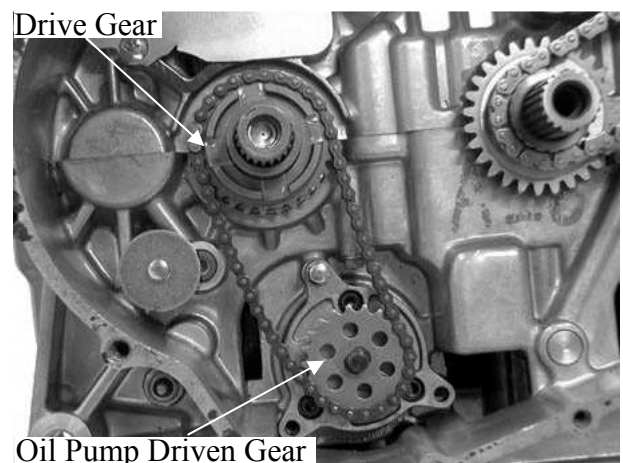
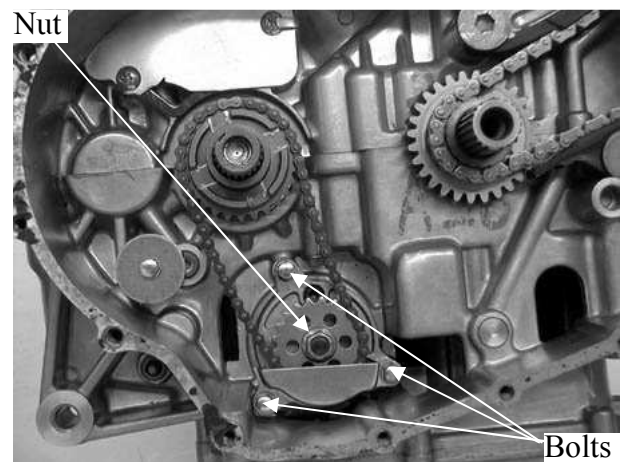
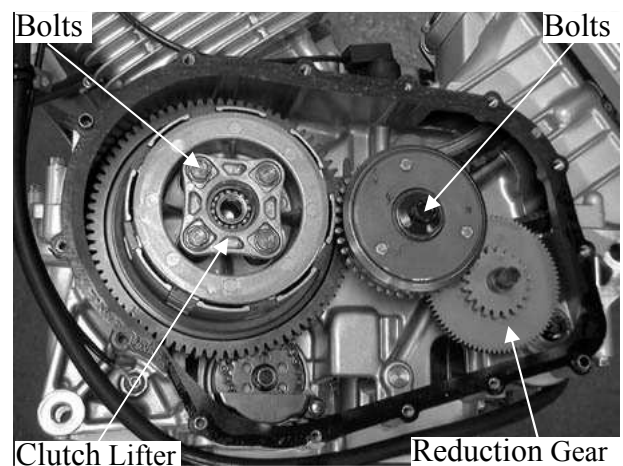
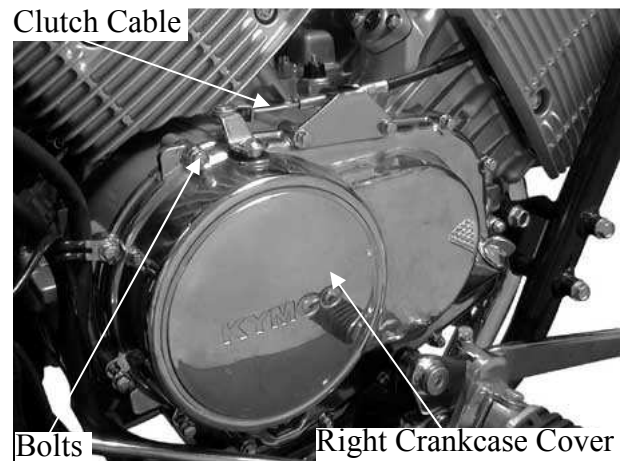

### 3. LUBRICATION SYSTEM

#### DISASSEMBLY

Remove the three oil pump mounting bolts and the oil pump body.

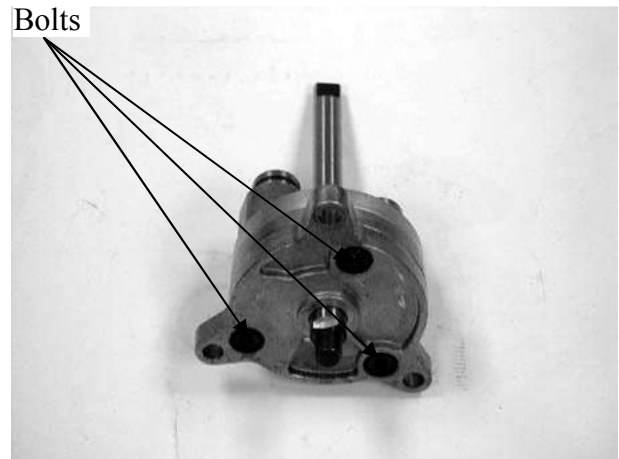

#### INSPECTION

Measure the pump body-to-outer rotor clearance.

**Service Limit:** 0.20mm

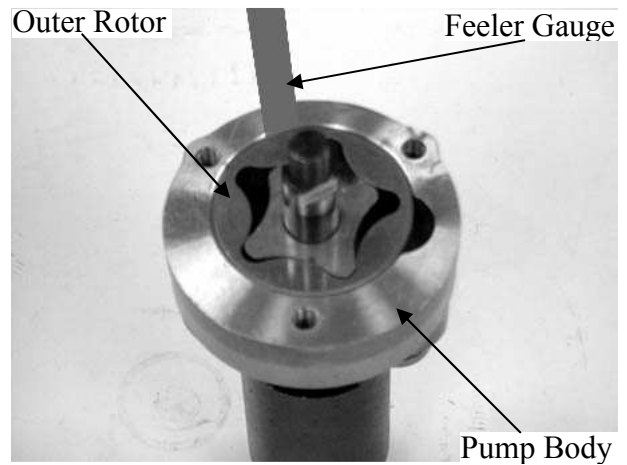

Measure the inner rotor-to-outer rotor clearance.

**Service Limit:** 0.20mm

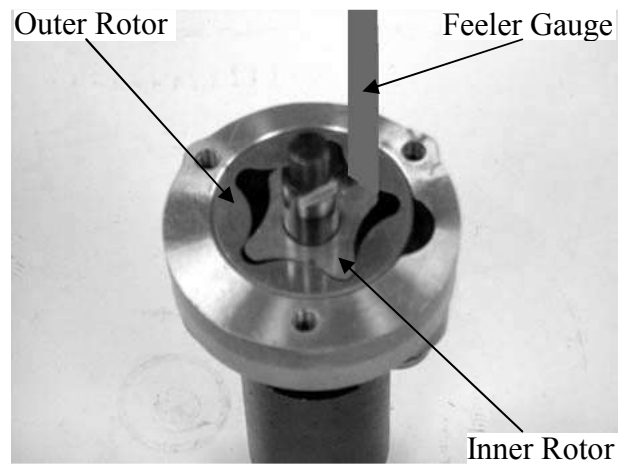

Measure the rotor end-to-pump body clearance.

**Service Limit:** 0.15mm



### 3. LUBRICATION SYSTEM

#### ASSEMBLY

Install the outer rotor and inner rotor into the pump body. Insert the pump shaft.

\* Insert the pump shaft by aligning the flat on the shaft with the flat in the inner rotor.

Install the pump cover.  
Tighten the bolts.  
After installation, make sure that the pump shaft rotates freely.

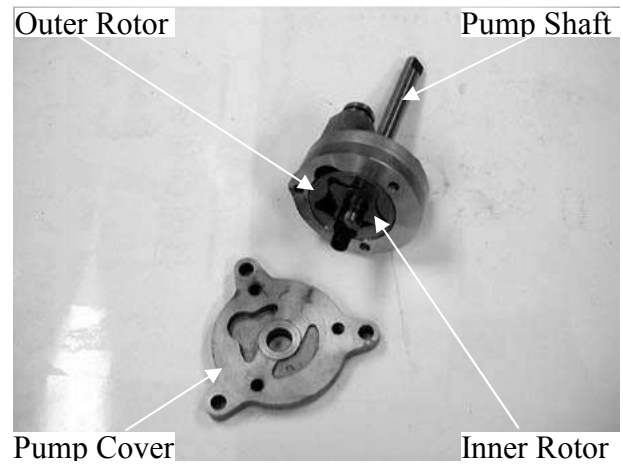

#### INSTALLATION

The installation sequence is the reverse of removal.

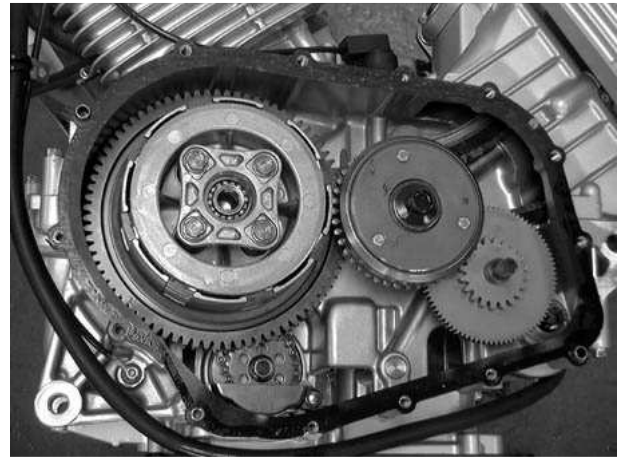



**FUEL SYSTEM**

SERVICE INFORMATION ..... 4- 2

TROUBLESHOOTING ..... 4- 3

CARBURETOR REMOVAL ..... 4- 4

VACUUM CHAMBER..... 4- 5

AIR CUT-OFF VALVE..... 4- 6

FLOAT CHAMBER ..... 4- 6

AUTO FUEL VALVE..... 4- 8

AIR CLEANER..... 4- 9

IDLE SPEED ADJUSTMENT ..... 4- 9

## 4. FUEL SYSTEM

### SERVICE INFORMATION

#### GENERAL INSTRUCTIONS



Gasoline is very dangerous. When working with gasoline, keep sparks and flames away from the working area.  
Gasoline is extremely flammable and is explosive under certain conditions. Be sure to work in a well-ventilated area.

- Do not bend or twist control cables. Damaged control cables will not operate smoothly.
- When disassembling fuel system parts, note the locations of O-rings. Replace them with new ones during reassembly.
- Before float chamber disassembly, loosen the drain screw to drain the residual gasoline into a clean container.
- After the carburetor is removed, plug the intake manifold side with a clean shop towel to prevent foreign matters from entering.
- When cleaning the carburetor air and fuel jets, the O-rings and diaphragm must be removed first to avoid damage. Then, clean with compressed air.
- When the motorcycle is not used for over one month, drain the residual gasoline from the float chamber to avoid erratic idling and clogged slow jet due to deteriorated fuel.

#### SPECIFICATIONS

	Venox250
Type	CVK
Venturi dia.	φ30
Float level	Front: 17.5 mm Rear: 19.0 mm
Main jet	Front: 110# Rear: 108#
Slow jet	35#
Idle speed	1300±100rpm
Throttle grip free play	2~6mm
Pilot screw opening	P.S. 2± $\frac{1}{2}$
CO density	3±0.5%

#### SPECIAL TOOL

Float level gauge

CO & Vacuum adjuster

## 4. FUEL SYSTEM

---

### TROUBLESHOOTING

#### **Engine cranks but won't start**

- No fuel in tank
- No fuel to carburetor
- Cylinder flooded with fuel
- No spark at plug
- Clogged air cleaner
- Intake air leak
- Improper throttle operation

#### **Engine idles roughly, stalls or runs poorly**

- Excessively used choke
- Ignition malfunction
- Faulty carburetor
- Poor quality fuel
- Lean or rich mixture
- Incorrect idle speed

#### **Misfiring during acceleration**

- Faulty ignition system
- Faulty carburetor
- Faulty accelerating pump

#### **Backfiring at deceleration**

- Float level too low
- Incorrectly adjusted carburetor
- Faulty A.C.V.
- Faulty exhaust muffler

#### **Engine lacks power**

- Clogged air cleaner
- Faulty carburetor
- Faulty ignition system

#### **Lean mixture**

- Clogged carburetor fuel jets
- Float level too low
- Intake air leak
- Clogged fuel tank cap breather hole
- Kinked or restricted fuel line

#### **Rich mixture**

- Float level too high
- Clogged air jets
- Clogged air cleaner
- Restricted A.C.V. tube

## 4. FUEL SYSTEM

### CARBURETOR REMOVAL

Remove the seat and fuel tank.

Loosen the air cleaner connecting tube band screw.



Remove the five lock bolts.  
Remove the carburetor cap.

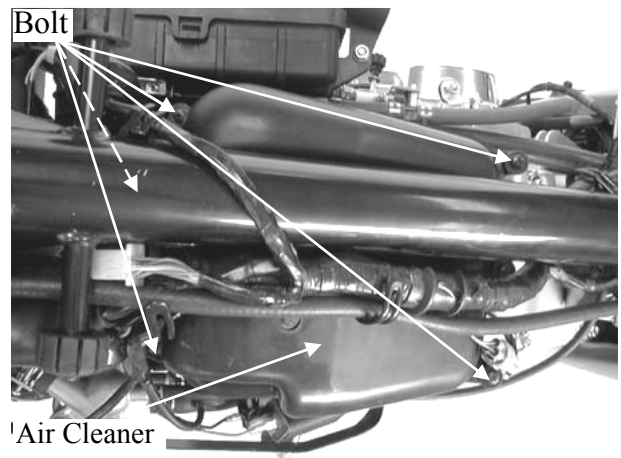

Loosen the throttle cable adjusting nut and lock nut, and disconnect the throttle cable from the carburetor.  
Loosen the carburetor intake manifold band screws and then remove the carburetor.

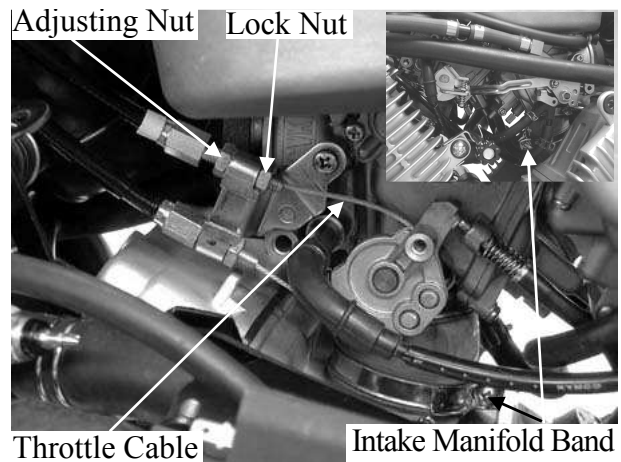

Loosen the drain screw to drain the gasoline from the float chamber.  
Remove the eight inlet duct base lock bolts.  
Remove the inlet duct and base.

- \* 
  - Keep sparks and flames away from the work area.
  - Drain gasoline into a clean container.

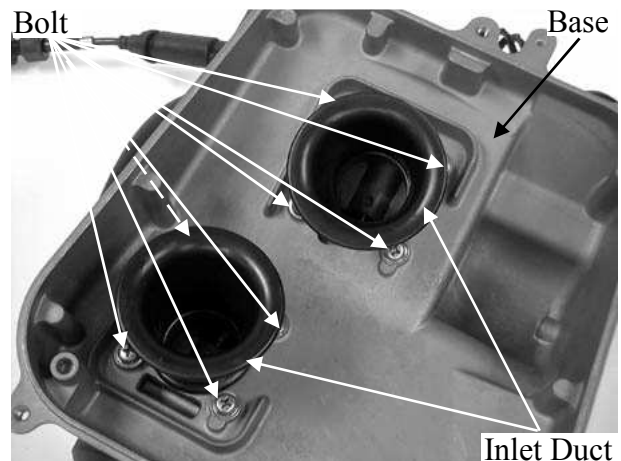



## 4. FUEL SYSTEM

### VACUUM CHAMBER DISASSEMBLY

Remove the four vacuum chamber cover screws and the cover.

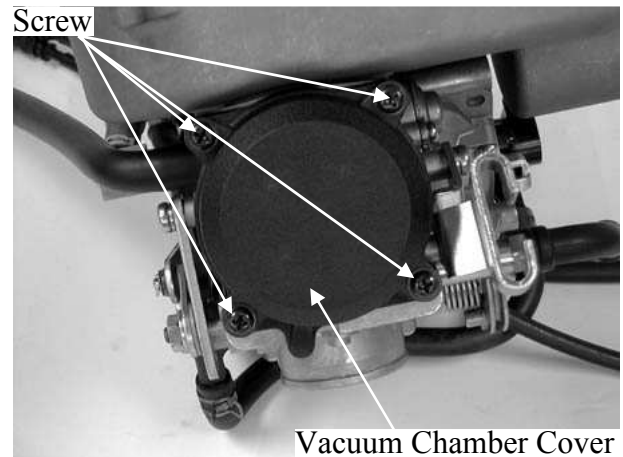

Remove the spring, vacuum diaphragm and piston.

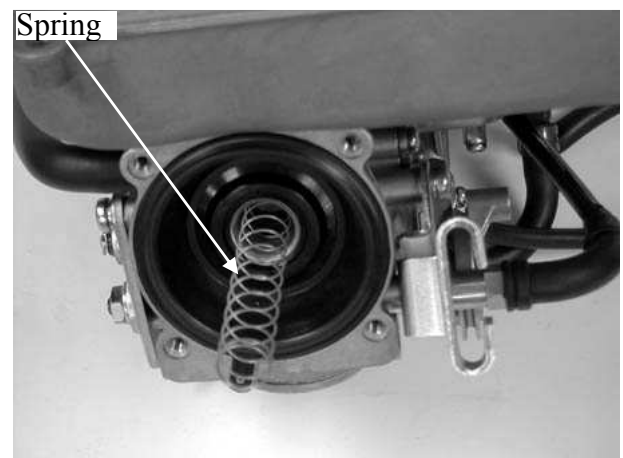

Remove the needle holder and jet needle.

\* Be careful not to damage the vacuum diaphragm.  
Don't apply the vacuum diaphragm with the carburetor cleaner.

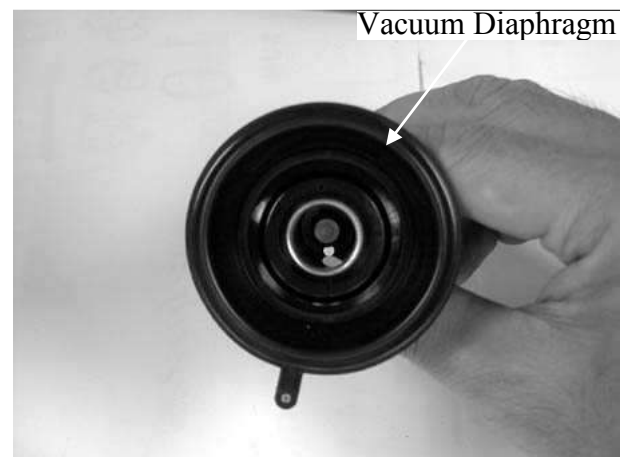

### INSPECTION

Inspect the needle for stepped wear.  
Inspect the vacuum piston for wear or damage.  
Inspect the diaphragm for deterioration and tears.

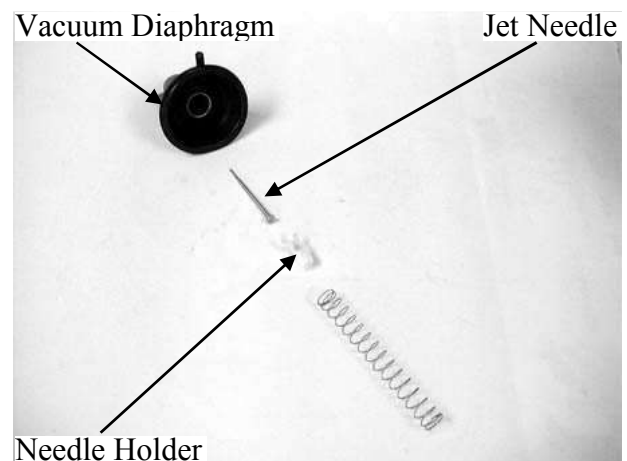

## 4. FUEL SYSTEM

### ASSEMBLY

Install the vacuum piston/diaphragm in the carburetor body.  
Install the spring and then install the vacuum chamber cover.  
Tighten the four screws.

- \* • Be careful not to damage the diaphragm.
- Hold the vacuum piston while tightening the vacuum chamber cover.



### AIR CUT-OFF VALVE

#### DISASSEMBLY

Remove the two screws attaching the air cut-off valve.  
Remove the spring and vacuum diaphragm.  
Check the vacuum diaphragm for cracks or damage and check each passage for clogging.

- \* • Be sure to set the vacuum diaphragm lip into the groove on the carburetor.
- When installing the air cut-off valve cover, make sure that the vacuum diaphragm is properly installed.
- Don't apply the vacuum diaphragm with the carburetor cleaner.

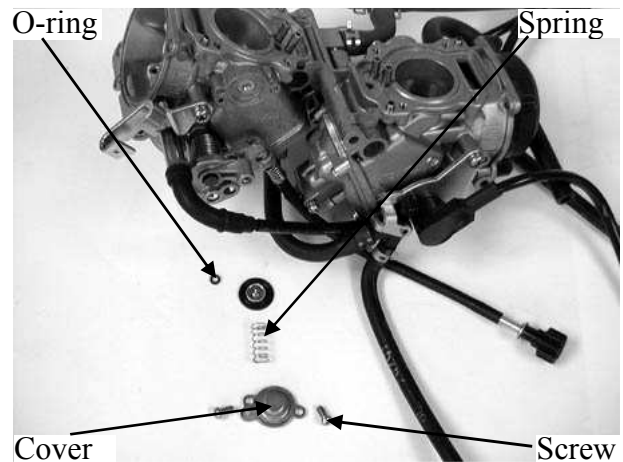

### FLOAT CHAMBER

#### DISASSEMBLY

Remove the four float chamber screws and the float chamber.

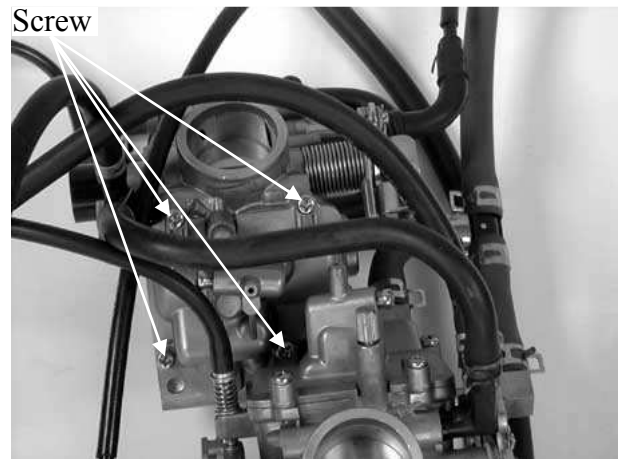

Loosen the float pin screw.  
Remove the float pin, float and float valve.

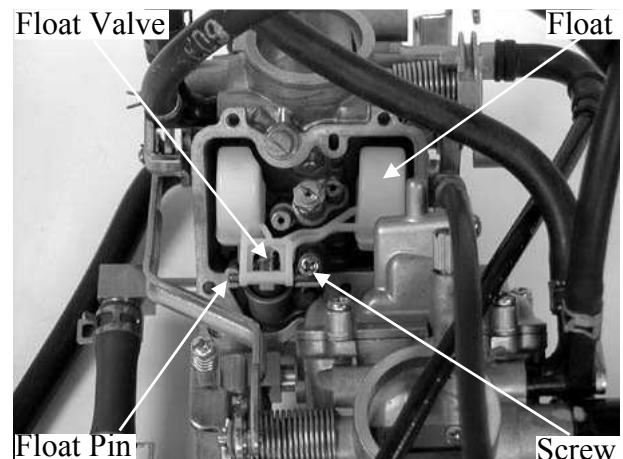

## 4. FUEL SYSTEM

Remove the main jet, needle jet holder, needle jet, slow jet and pilot screw.

- \* Be careful not to damage the fuel jets and pilot screw.
- Before removing, turn the pilot screw in and carefully count the number of turns until it seats lightly and then make a note of this.
- Do not force the pilot screw against its seat to avoid seat damage.

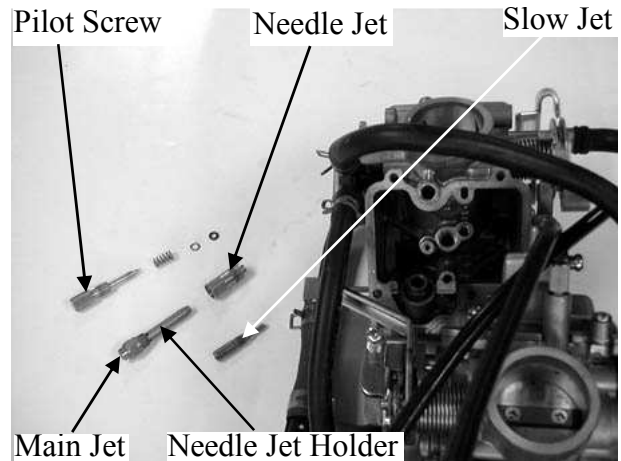

Clean the removed fuel jets with detergent oil and blow them open with compressed air. Blow compressed air through all passages of the carburetor body.

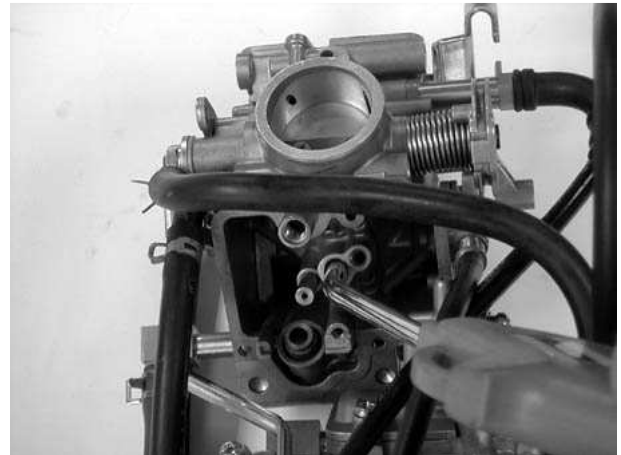

### INSPECTION

Inspect the float valve and valve seat for damage or clogging. Inspect the float valve and valve seat contact area for stepped wear or contamination.

- \* Worn or contaminated float valve and valve seat must be replaced because it will result in float level too high due to incomplete airtightness.

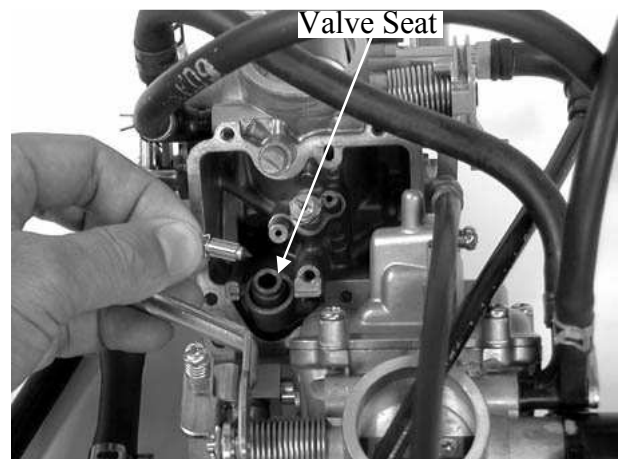

### ASSEMBLY

Install the slow jet, needle jet, needle jet holder, main jet and pilot screw.

- \* Return the pilot screw to the original position as noted during removal.

**Standard Opening:**  $2 \pm \frac{1}{2}$  turns

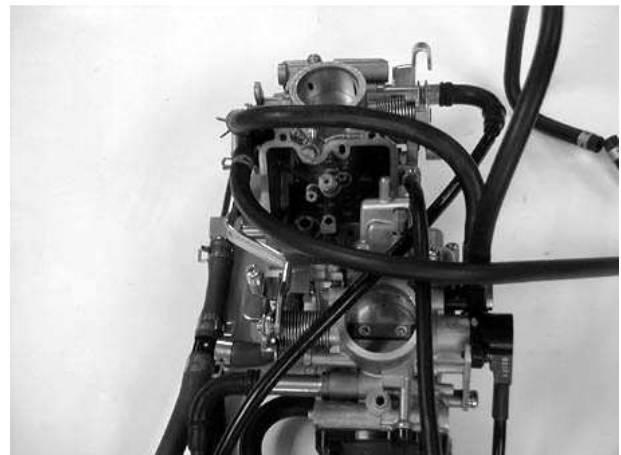

## 4. FUEL SYSTEM

Install the float valve, float and float pin.  
Secure the float pin with the screw.

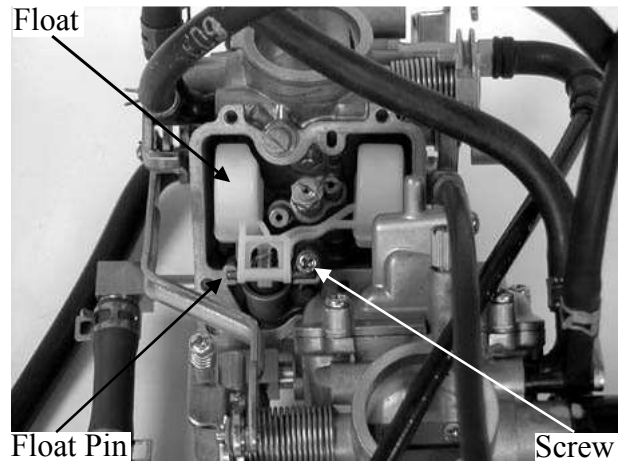

### FLOAT LEVEL INSPECTION

- \* • Check the operation of the float valve and float before this inspection.
- Measure the float level by placing the float level gauge on the float chamber face parallel with the main jet.

Measure the float level.

**Float Level:** Front: 17.5mm , Rear: 19.0mm

Special

Float Level Gauge

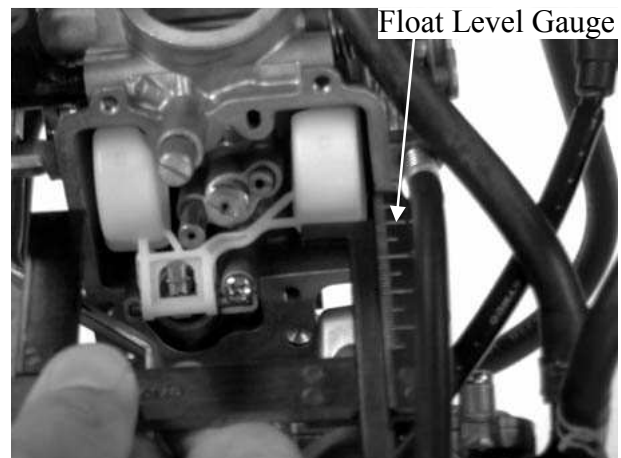

### INSTALLATION

The installation sequence is the reverse of removal.

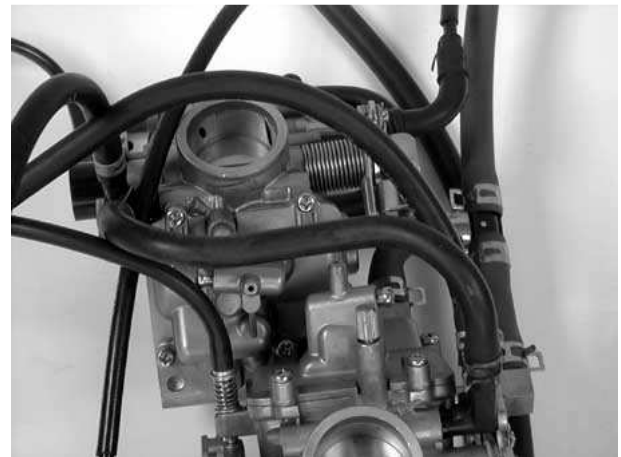

### AUTO FUEL VALVE

- \* No Smoking!

Disconnect the fuel tube and vacuum tube from the carburetor.

Connect a vacuum pump to the vacuum tube and apply vacuum. Check if fuel flows out. The valve is operating normally if fuel flows out of the fuel tube when the vacuum is applied.

The fuel shall stop flowing out when the vacuum pump is disconnected.

If the fuel valve does not operate normally, Check the vacuum diaphragm for poor installation or damage and inspect the fuel tube for clogging.

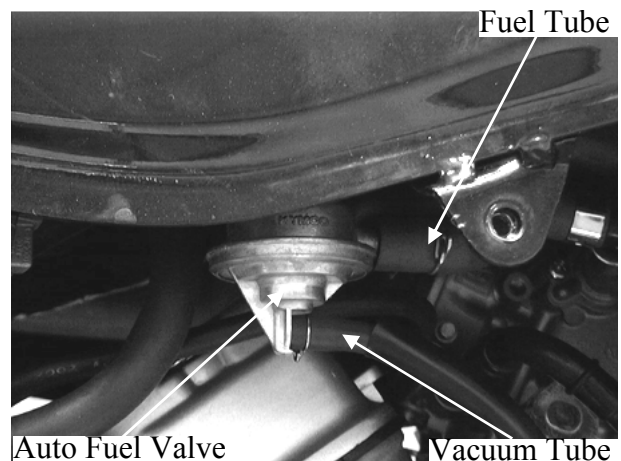

## 4. FUEL SYSTEM

### INSTALLATION

Install the fuel tank in the reverse order of removal.



### AIR CLEANER

Loosen the air cleaner connecting tube band screw.  
Disconnect the transmission case breather tube from the air cleaner.  
Remove the bolt and air cleaner case.

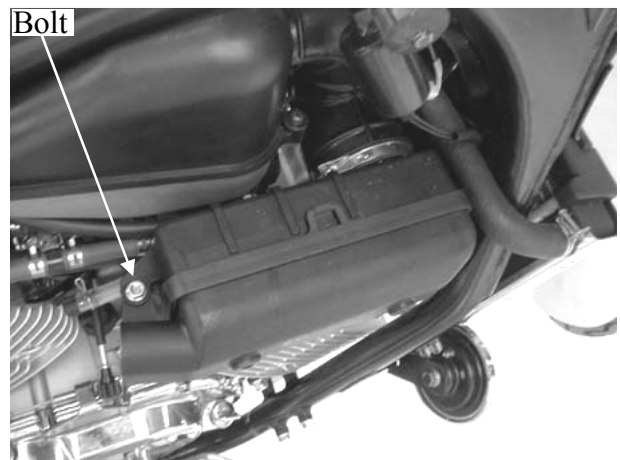

The installation sequence is the reverse of removal.

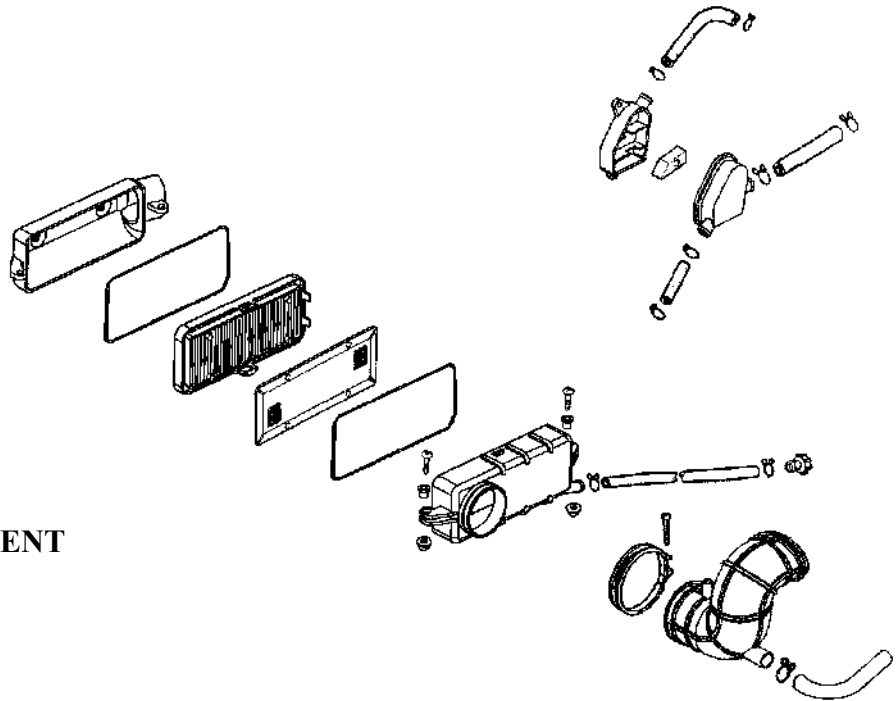

### IDLE SPEED ADJUSTMENT

Please refer to P2-13.

# 5. ENGINE REMOVAL/INSTALLATION

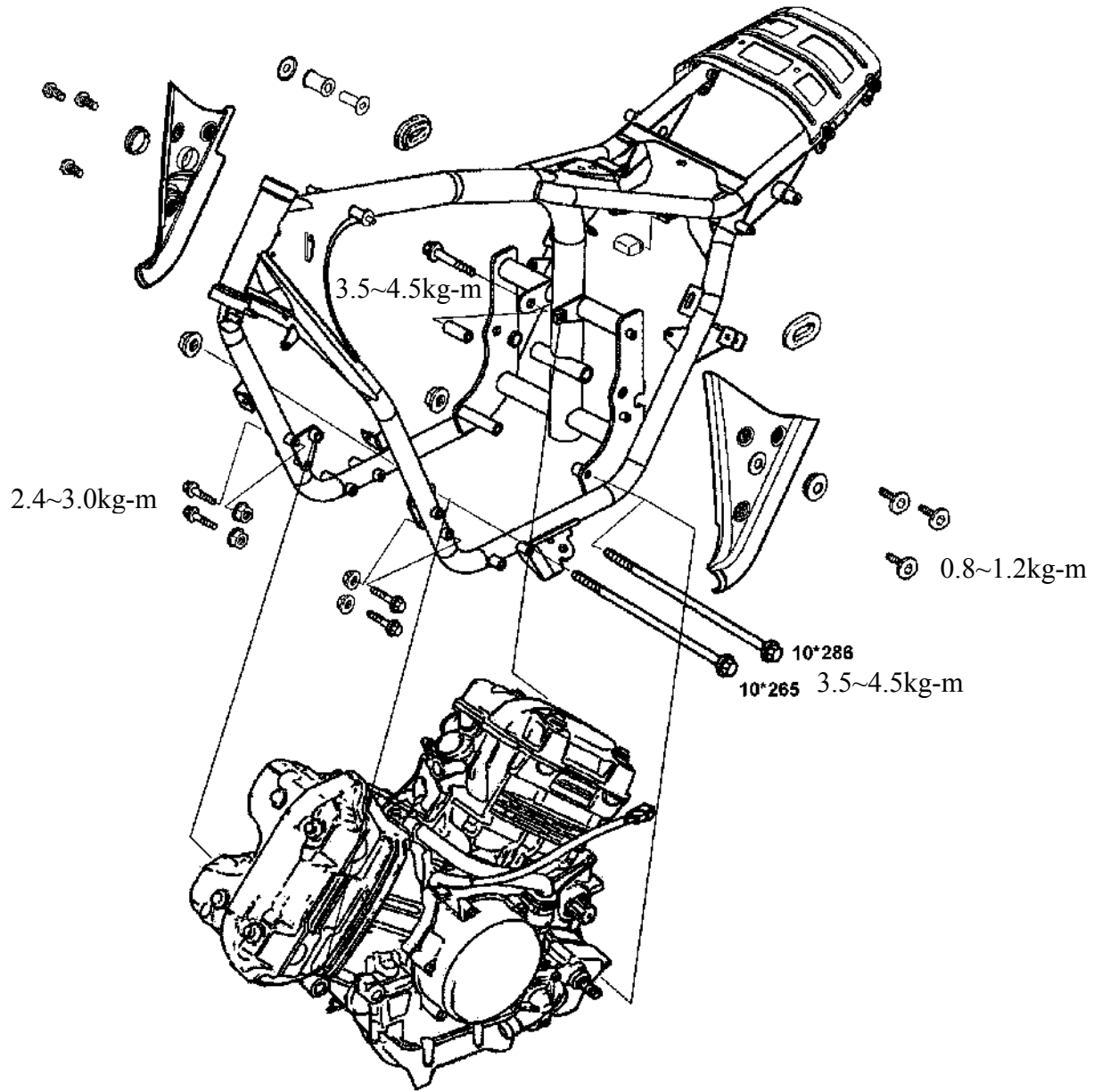



**ENGINE REMOVAL/INSTALLATION**

SERVICE INFORMATION ..... 5- 2  
ENGINE REMOVAL ..... 5- 3  
ENGINE INSTALLATION ..... 5- 6

## **5. ENGINE REMOVAL/INSTALLATION**

---

### **SERVICE INFORMATION**

#### **GENERAL INSTRUCTIONS**

- A engine stand or floor jack is required to support and maneuver the engine.
- The following parts can be serviced with the engine installed in the frame:
  - Cylinder head/valves (Section 6)
  - Cylinder/piston (Section 7)
  - Starter motor/generator/left crankcase cover/starter clutch/camshaft (Section 8)
  - Clutch/gear shift mechanism (Section 9)

#### **SPECIFICATIONS**

Recommended engine oil: SAE5W50

Engine oil capacity: Capacity: 2.5 liter

Change with oil filter: 2.2 liter

Change without oil filter: 2.0 liter

Coolant capacity: Radiator: 560cc

Reserve tank: 240cc



## 5. ENGINE REMOVAL/INSTALLATION

### ENGINE REMOVAL

Remove the seat and fuel tank.  
Remove the left and right side cover.  
Disconnect the fuel tube from the auto fuel valve.  
Disconnect the speedometer wire coupler from the hardness wire.

Fuel Tank



Disconnect the A.C. generator and starter motor wire coupler.

Generator Wire Coupler



Loosen the air cleaner connecting tube band bolt.  
Remove the carburetor.  
Remove the spark plug cap.

Bolt

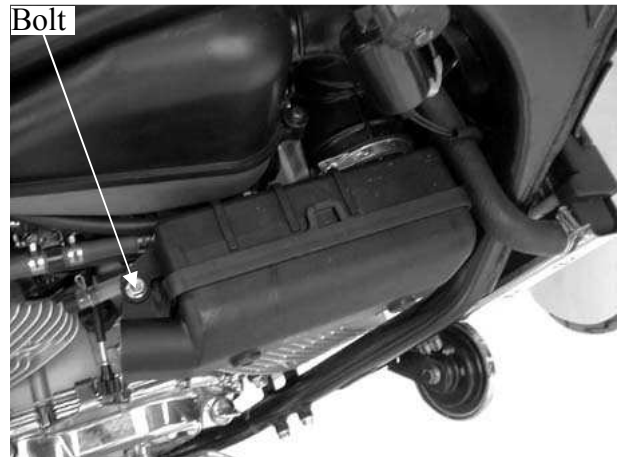

- \*
- Drain the engine oil before engine removal.
  - The exhaust muffler temperature is extremely high. Remove it when the engine is cold.

Remove the two exhaust muffler joint lock nuts.

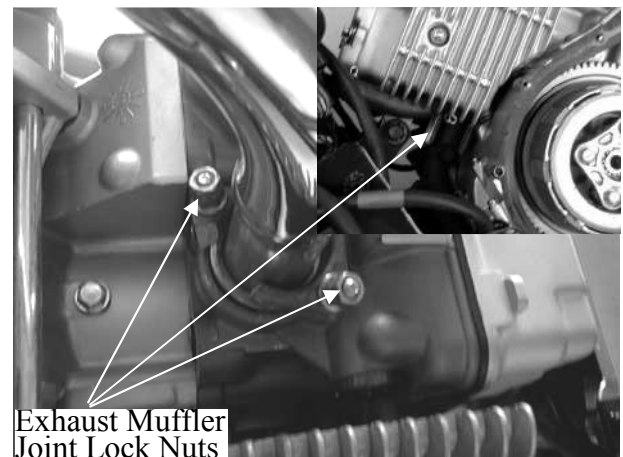

Exhaust Muffler Joint Lock Nuts

## 5. ENGINE REMOVAL/INSTALLATION

Remove the exhaust muffler brace lock bolt.

**Torgue:** 3.0~3.6kg-m



Remove the exhaust muffler hanger lock bolt.

Remove the exhaust muffler.

**Torgue:** 3.0~3.6kg-m



Disconnect the clutch cable.

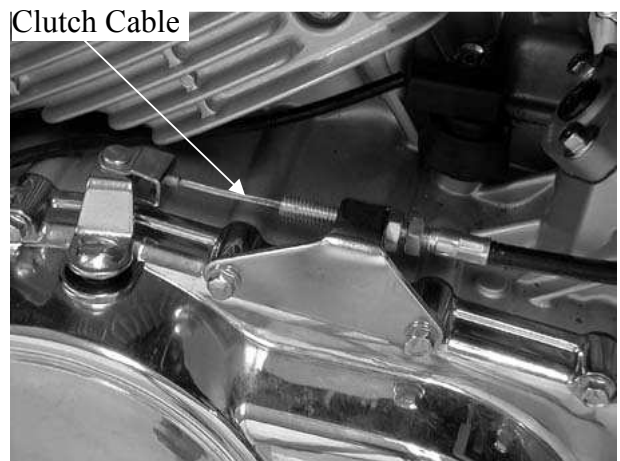

Remove the coolant hose.

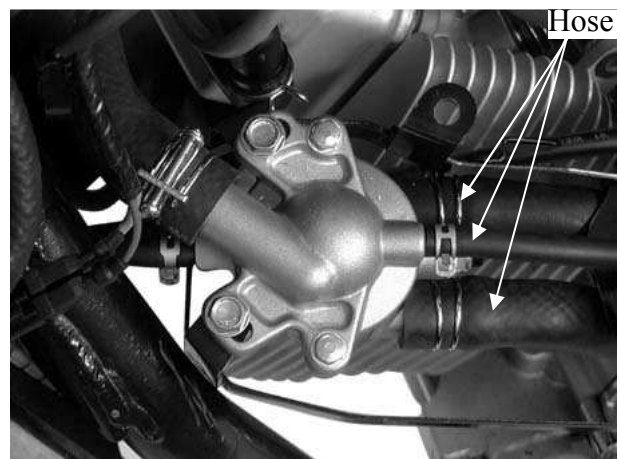

## 5. ENGINE REMOVAL/INSTALLATION

Remove the gear shift pedal attaching bolt and the gear shift pedal.

Remove the three left rear crankcase cover attaching bolts and the cover.

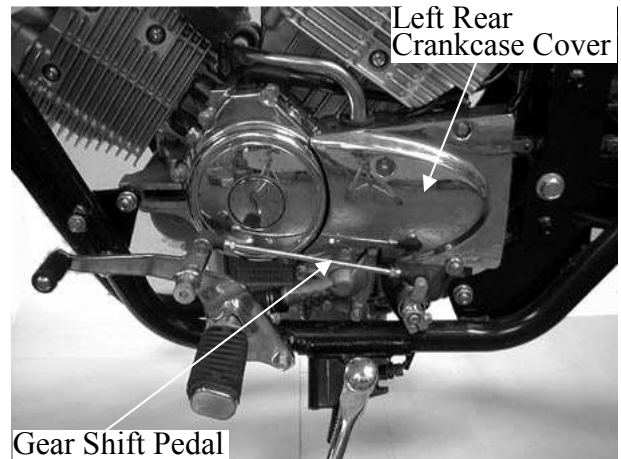

Remove the drive gear attaching bolt.  
Remove the drive gear and drive chain.

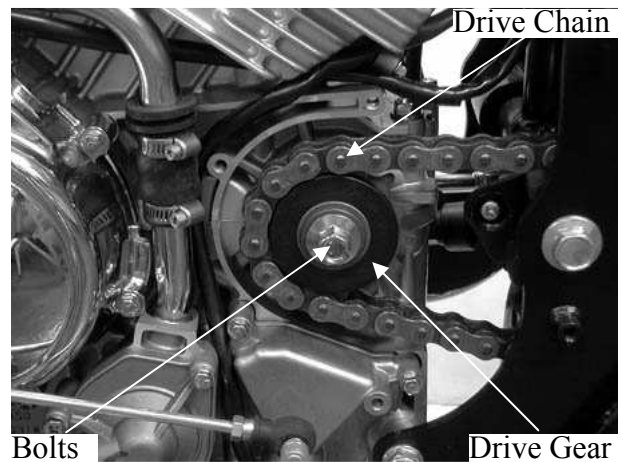

Remove the three front engine bracket lock bolts and the left/right engine bracket.  
Remove the two lock nuts attaching the engine rear end.  
Forward tilt the engine to remove the upper bolt.

**Torque:** 2.4~3.0kg-m

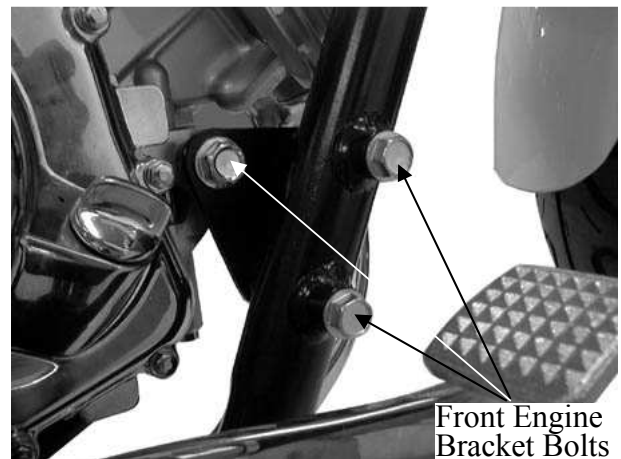

Remove the engine upper bracket nut and bolt.

**Torque:** 3.5~4.5kg-m

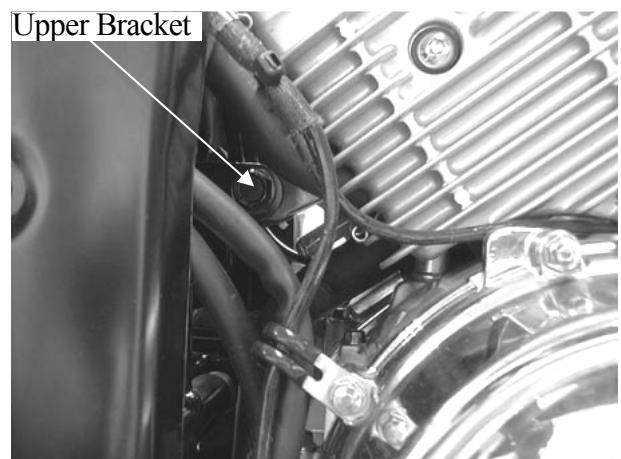

## 5. ENGINE REMOVAL/INSTALLATION

Remove the lower bracket bolt and nut.  
Tilt the engine to dismount the engine from right side.

**Torgue:** 3.5~4.5kg-m

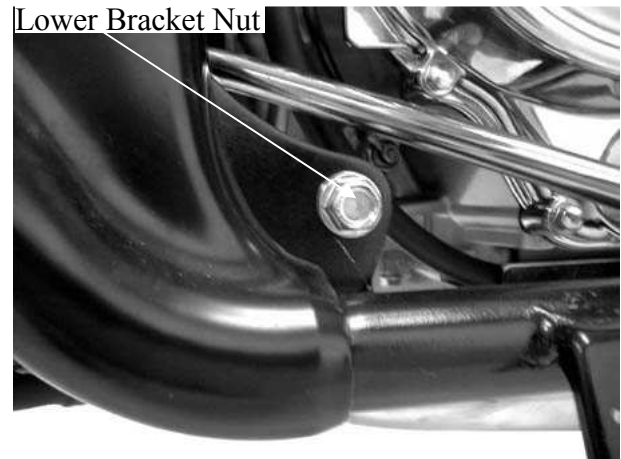

### ENGINE INSTALLATION

Install the engine in the reverse order of removal.  
Install the engine to its original position with a jack or other adjustable support.

\*

- When installing the engine, do not damage the bolt threads and route the wires and cables properly.
- Install the gear shift pedal by aligning the punch mark on the pedal with that on the spindle.
- Fill the crankcase to the proper level with the recommended engine oil.
- After installation, perform the following inspections and adjustments:
  1. Throttle operation
  2. Clutch lever free play adjustment
  3. Drive chain adjustment

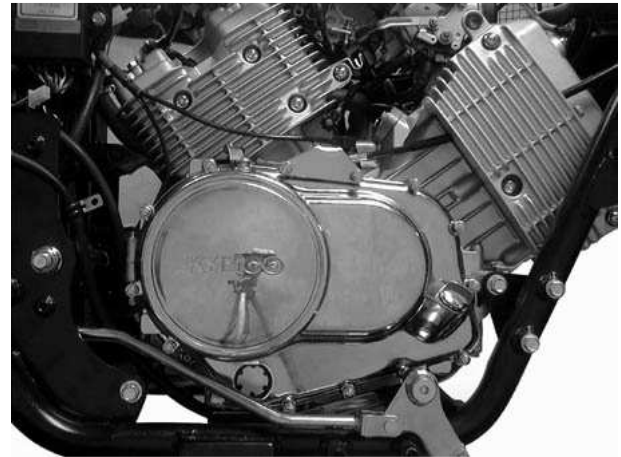

# 6. CYLINDER HEAD/VALVES

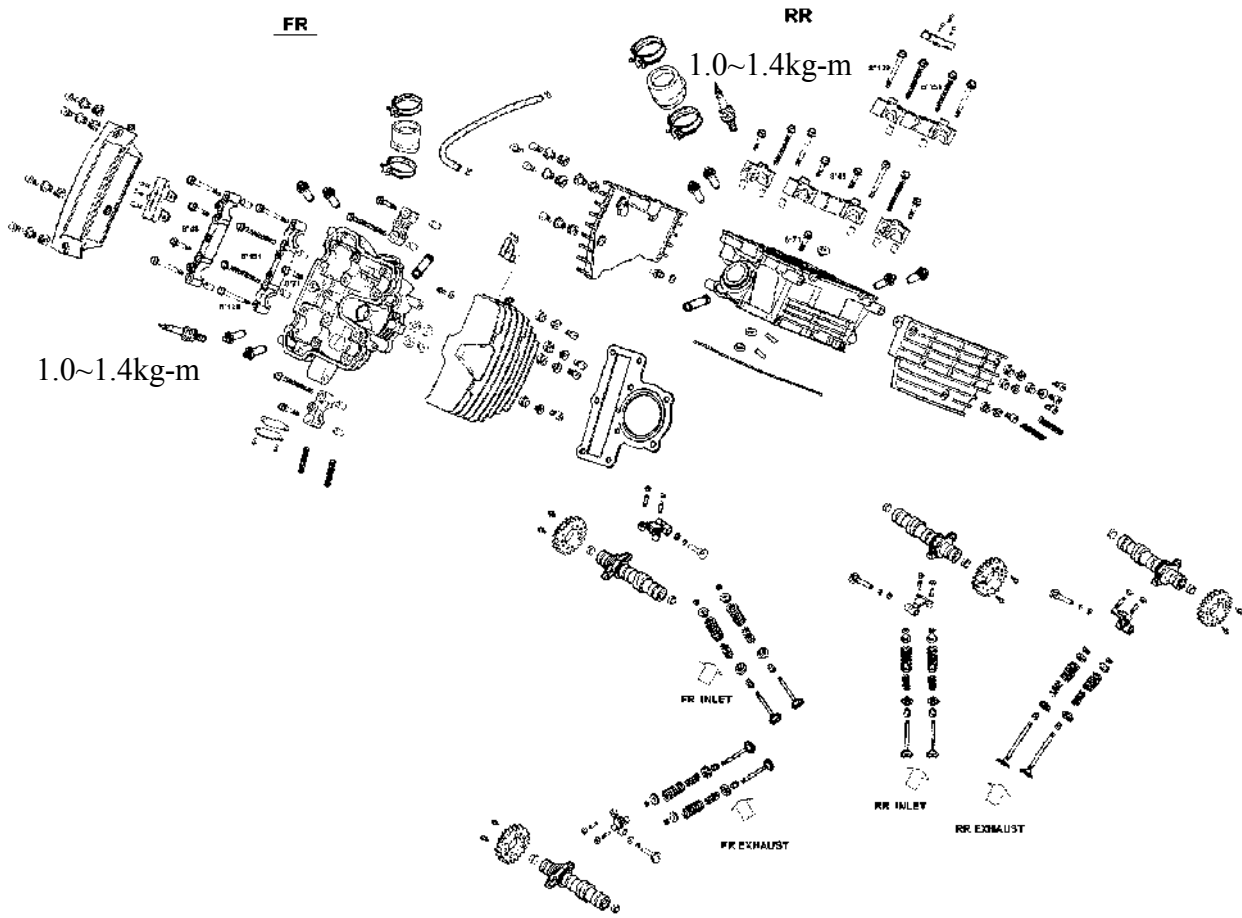

**CYLINDER HEAD/VALVES**

SERVICE INFORMATION ..... 6- 2

TROUBLESHOOTING ..... 6- 3

CYLINDER HEAD BOLTS TORQUE TABLE..... 6- 4

CYLINDER HEAD COVER REMOVAL ..... 6- 5

ROCKER ARMS DISASSEMBLY ..... 6- 7

CYLINDER HEAD ASSEMBLY ..... 6- 9

CYLINDER HEAD INSTALLATION..... 6-10

## SERVICE INFORMATION

### GENERAL INSTRUCTIONS

- When assembling, apply engine oil to the valve guide movable parts, valve arm and camshaft sliding surfaces for initial lubrication.
- The valve rocker arm is lubricated with engine oil through the cylinder head engine oil passages. Clean and unclog the oil passages before cylinder head assembly.
- After disassembly, clean the removed parts and dry them with compressed air before inspection.
- After removal, mark and arrange the removed parts in order. When assembling, install them in the reverse order of removal.
- The cylinder head and holder need to be replaced if anyone broken.

### SPECIFICATIONS

Item		Standard (mm)	Service Limit (mm)
		VENOX250	VENOX250
Valve clearance (cold)	IN	0.1mm	—
	EX	0.1mm	—
Compression pressure (kg/cm <sup>2</sup> )		17±2	—
Cylinder head warpage		—	0.1
Camshaft cam height	IN	34.40	—
	EX	34.40	—
Camshaft height	R	23.978~23.990	23.90
	C	23.90~23.920	23.80
	L	23.978~23.990	23.90
Rocker arm I.D.	IN	10.0~10.015	10.040
	EX	10.0~10.015	10.040
Rocker arm shaft O.D.	IN	9.975~9.990	9.94
	EX	9.975~9.990	9.94
Rocker arm-to-shaft clearance	IN	0.04	—
	EX	0.04	—
Valve seat angle	IN	90°+1.0	—
	EX	90°+1.0	—
Valve stem O.D.	IN	4.975~4.990	4.90
	EX	4.975~4.990	4.90
Valve guide I.D.	IN	4.95~5.0	5.05
	EX	4.95~5.0	5.05
Valve spring free length	IN	Inner:29.8 Outer:33.6	Inner:29.8 Outer:33.6
	EX	Inner:29.8 Outer:33.6	Inner:29.8 Outer:33.6
Valve stem-to-guide clearance	IN	0.175	—
	EX	0.155	—

## 6. CYLINDER HEAD/VALVES

---

### TROUBLESHOOTING

- The poor cylinder head operation can be diagnosed by a compression test or by tracing engine top-end noises.

#### **Poor performance at idle speed**

- Compression too low

#### **Compression too low**

- Incorrect valve clearance (too small)
- Burned or bent valves
- Incorrect valve timing
- Broken valve spring
- Poor valve and seat contact
- Leaking cylinder head gasket
- Warped or cracked cylinder head
- Poorly installed spark plug

#### **Compression too high**

- Excessive carbon build-up in combustion chamber or on piston head

#### **White smoke from exhaust muffler**

- Worn or broken valve stem or valve guide
- Damaged valve stem seal

#### **Abnormal noise**

- Incorrect valve clearance (too large)
- Burned valve or rocker arm
- Worn camshaft or cam follower



# 6. CYLINDER HEAD/VALVES

CYLINDER HEAD BOLTS TORQUE  
TORQUE TABLE

Sequence Torque kgf-m	{ BF 8*151 (washer) }				BF 8*71	{ BF 8*131 }			BF 8*48	{ BF 8*131 }			
	1	2	3	4	5	6	7	8	9	10	11	12	13
1 <sup>st</sup> Tightening	1.8	1.8	1.8	1.8	1.2	1.2	1.2	1.2	1.2	-	-	-	-
2 <sup>nd</sup> Tightening	3.4	3.4	3.4	3.4	2.3	2.3	2.3	2.3	2.3	-	-	-	-
3 <sup>rd</sup> Tightening	-	-	-	-	-	-	-	-	-	1.2	1.2	1.2	1.2
4 <sup>th</sup> Tightening	-	-	-	-	-	-	-	-	-	2.3	2.3	2.3	2.3

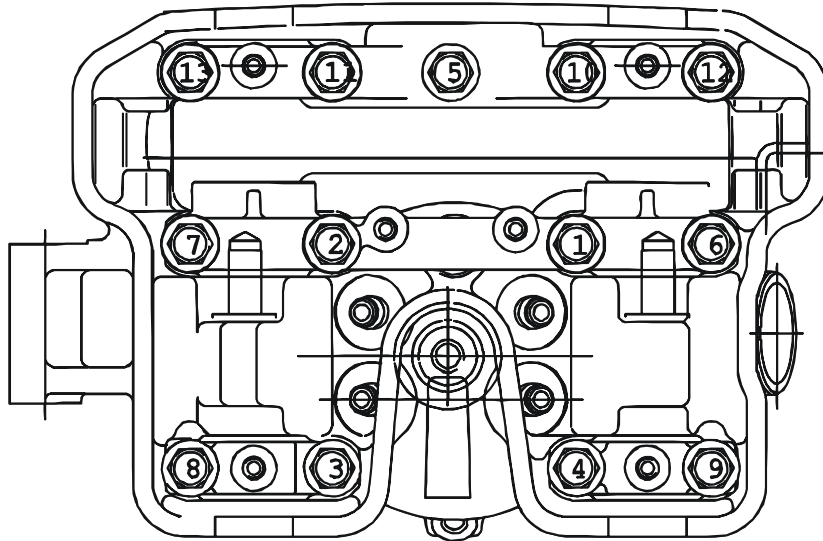

## 6. CYLINDER HEAD/VALVES

### CYLINDER HEAD COVER REMOVAL

Remove the eight cylinder head cover bolts for twin cylinder cover.  
Remove the cylinder head cover.  
Inspect the cylinder head cover O-ring for damage or deterioration and replace if necessary.

**Torque:** 0.8~1.2kg-m

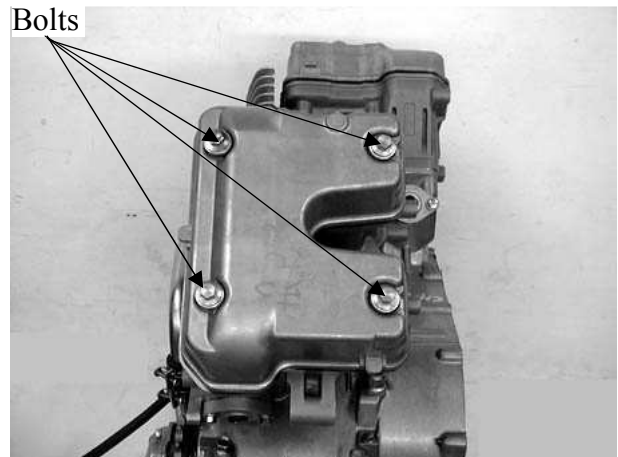

Remove the cam chain tensioner cap screw and the O-ring.  
Turn the cam chain tensioner screw clockwise to tighten it.

**Torque:** 0.35~0.5kg-m

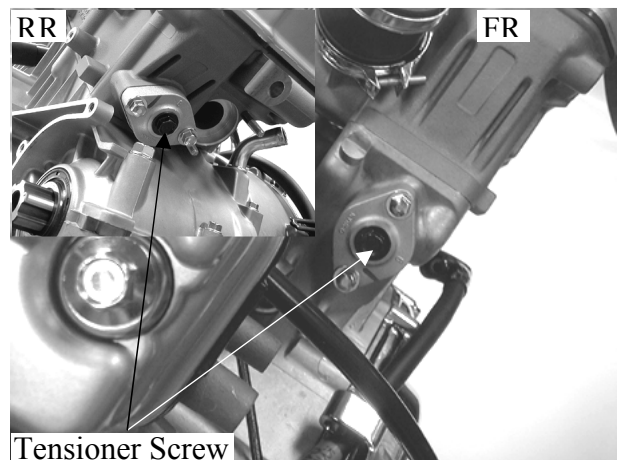

Tensioner Screw

Remove the twelve camshaft holder bolts

- \*
- Bring the piston to the top dead center on the compression stroke before removing the camshaft holder.
  - When removing the camshaft holder, first loosen the center bolt and then the left and right bolts.
  - Diagonally loosen the camshaft set bolts in 2 or 3 times.

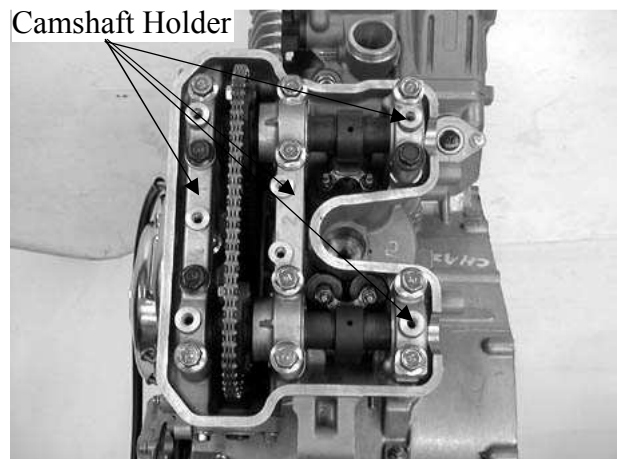

Camshaft Holder

Remove the camshaft holder and dowel pins.

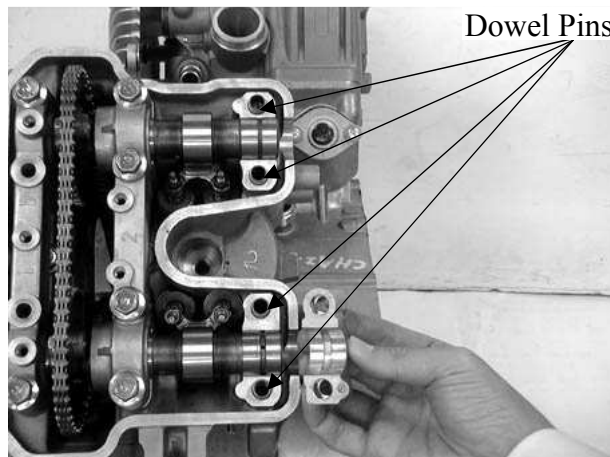

Remove the camshaft gear from the cam chain and remove the camshaft.

\* Suspend the cam chain with a piece of wire to keep it from falling into the crankcase.

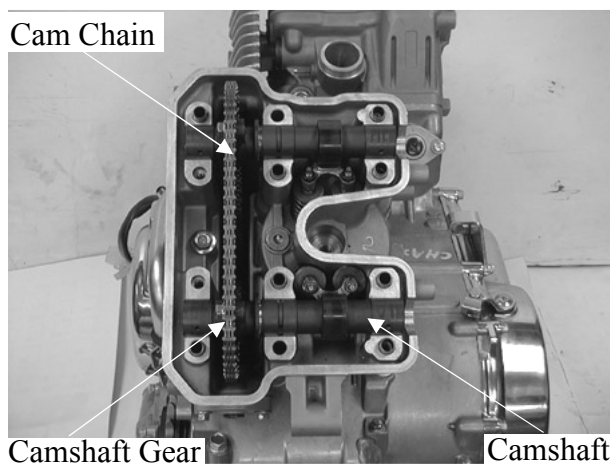

### CAMSHAFT INSPECTION

Check each cam for wear or damage.  
Measure the cam height.

**Service Limits:**

- Front IN : 34.40mm replace if below
- EX: 34.40mm replace if below
- Rear IN : 34.40mm replace if below
- EX: 34.40mm replace if below



Check each camshaft for wear or damage.  
Measure the camshaft height.

**Service Limits:**

- R camshaft: 23.90mm
- C camshaft: 23.80mm
- L camshaft: 23.90mm

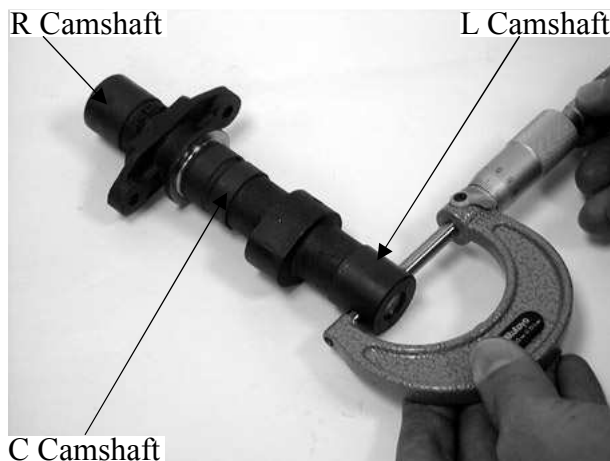

## 6. CYLINDER HEAD/VALVES

### CYLINDER HEAD REMOVAL

Remove the cylinder head bolt.  
Remove the cylinder head.

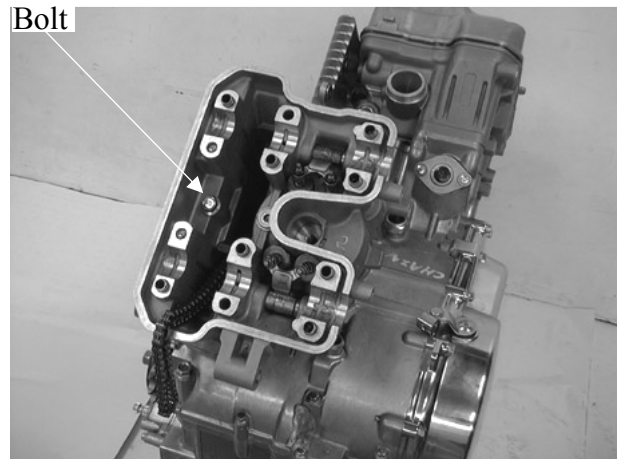

### ROCKER ARMS DISASSEMBLY

Remove the rocker arm shafts.  
Remove the rocker arm.

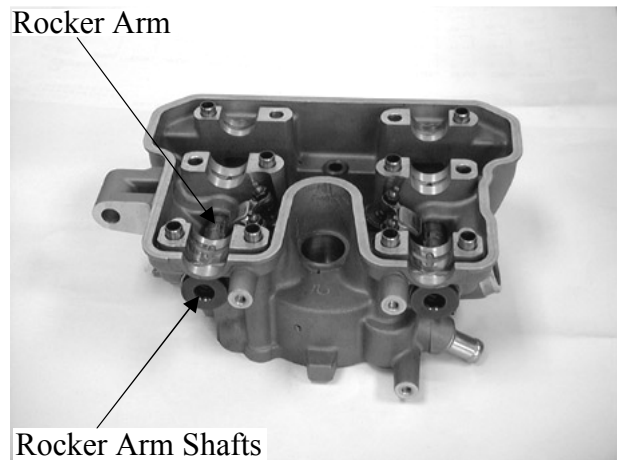

Check the rocker arm shafts washer and O-ring for damage or deformation and replace with a new one if necessary.

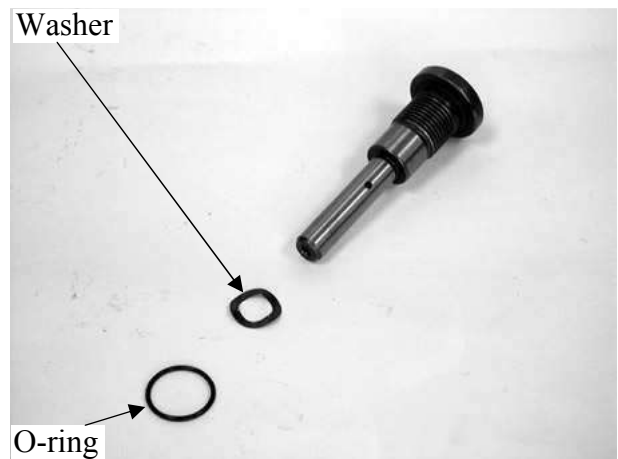

Measure the I.D. of each rocker arm.

**Service Limits:** IN: 10.04mm replace if over  
EX: 10.04mm replace if over

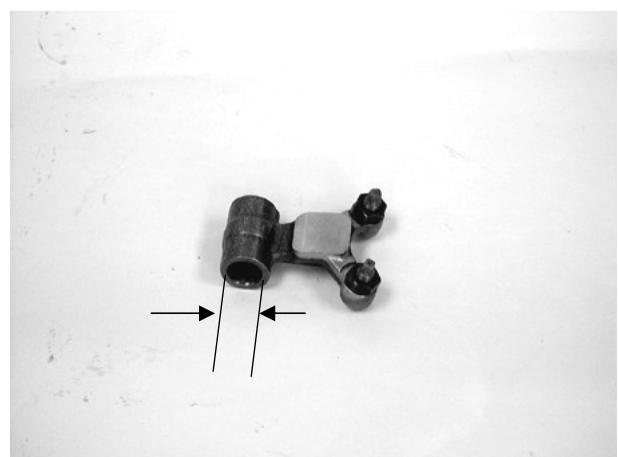

Measure the diameter of this column.  
**Service Limits:** 9.94mm replace if below



### CYLINDER HEAD DISASSEMBLY

Remove the valve spring cotters, retainers, springs, spring seats, washers and valve stem seals with a valve spring compressor.

- \* Be sure to compress the valve springs with a valve spring compressor.
- \* Mark all disassembled parts to ensure correct reassembly.

**Special**  
Valve Spring Compressor



Inspect the top of the cylinder head for plane surface.

**Service Limits:** 0.1mm repair or replace if over.

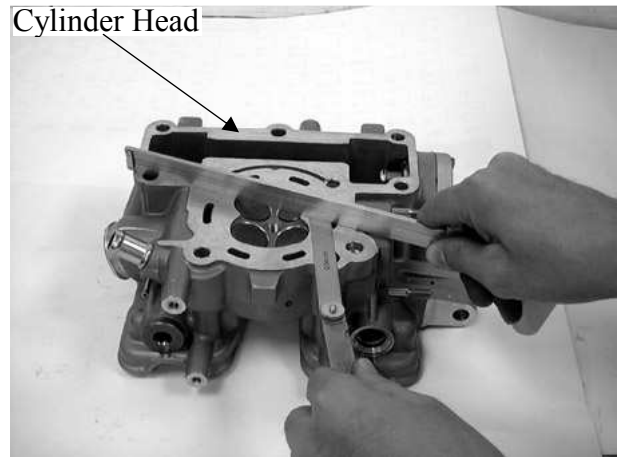

### VALVE SPRING FREE LENGTH

Measure the free length of the inner and outer valve springs.

**Service Limits:**  
Inner spring : 29.8mm replace if below  
Outer spring : 33.6mm replace if below

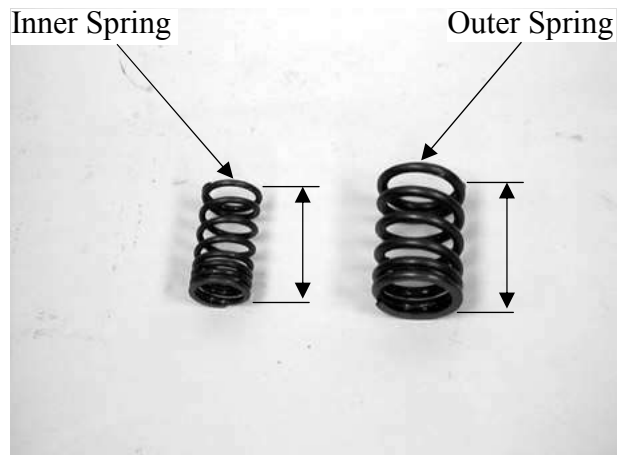

## 6. CYLINDER HEAD/VALVES

### VALVE /VALVE GUIDE

Inspect each valve for bending, burning, scratches or abnormal stem wear.  
Check valve movement in the guide.  
Measure each valve stem O.D.

#### Service Limits:

IN	4.90mm replace if below
EX	4.90mm replace if below

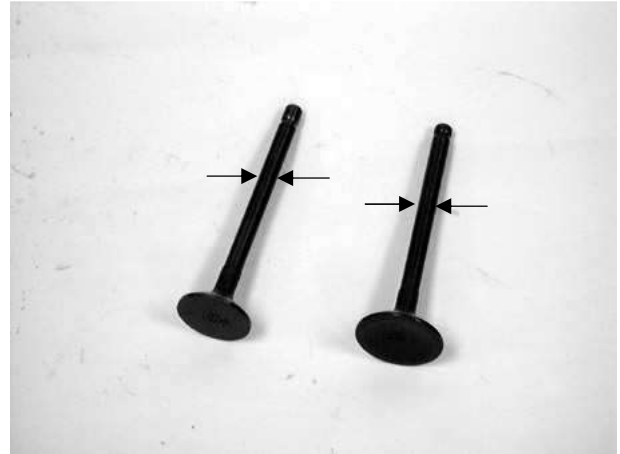

Measure each valve guide I.D.

**Service Limits:** IN: 5.05mm replace if over  
EX: 5.05mm replace if over

Subtract each valve stem O.D. from the corresponding guide I.D. to obtain the stem-to-guide clearance.

**Service Limits:** IN: 0.175mm  
EX: 0.155mm

- \* If the stem-to-guide clearance exceeds the service limits, replace the guides.
- \* Reface the valve seats whenever the valve guides are replaced.

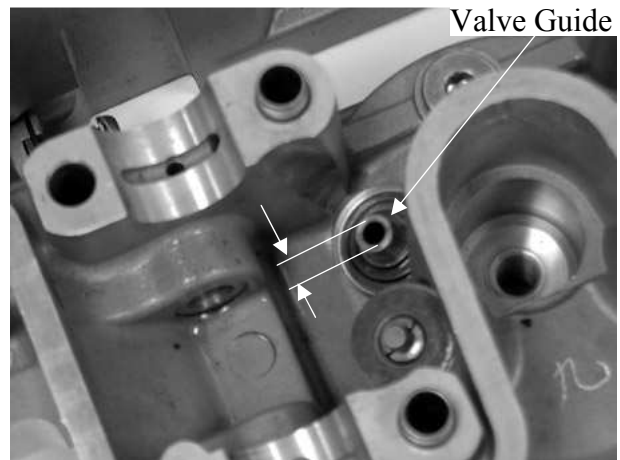

### CYLINDER HEAD ASSEMBLY

Lubricate each valve stem with engine oil and insert the valves into the valve guides.  
Apply engine oil to the valve stem seals and install them into the valve guides.

- \* Be sure to install new valve stem seals.

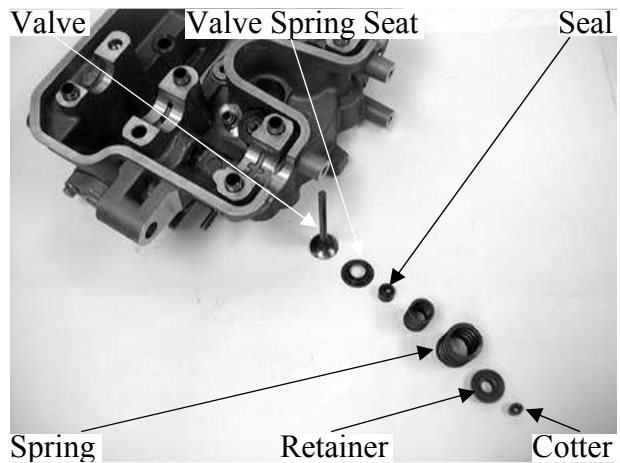

Install the valve spring seats, washers, inner and outer springs, and retainers.  
Compress the valve springs using the valve spring compressor, then install the valve cotters.

- \* Use the valve spring compressor to compress the springs and do not damage the cylinder head surface.
- \* Install the cotters with the pointed ends facing down.

Special

Valve Spring Compressor



## 6. CYLINDER HEAD/VALVES

Tap the valve stems gently with a plastic hammer for 2~3 times to firmly seat the cotters.

\* Be careful not to damage the valves.

Plastic Hammer



### ROCKER ARMS INSTALLATION

Install the rocker arm shafts bolt and the rocker arm.

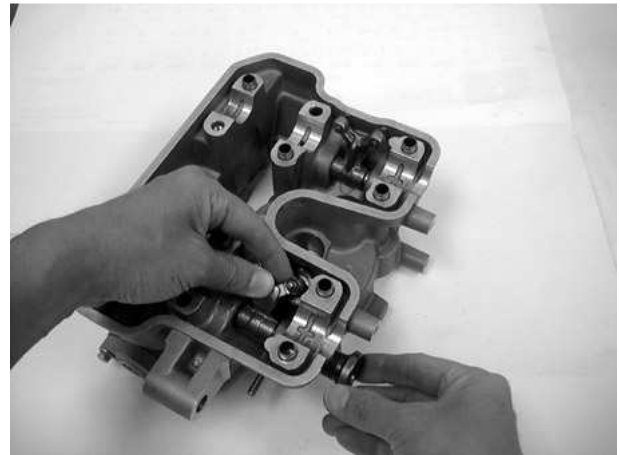

Lock the rocker arm shafts bolt.



### CYLINDER HEAD INSTALLATION

Install the cylinder head in the reverse order of removal.

Refer to P2-13

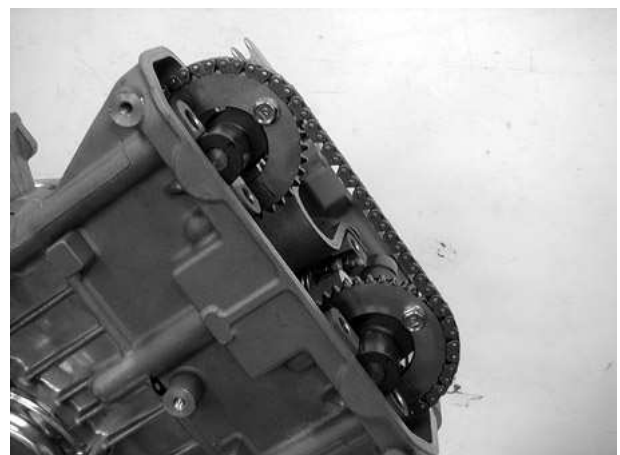

# 7. CRANKSHAFT/PISTON/CYLINDER

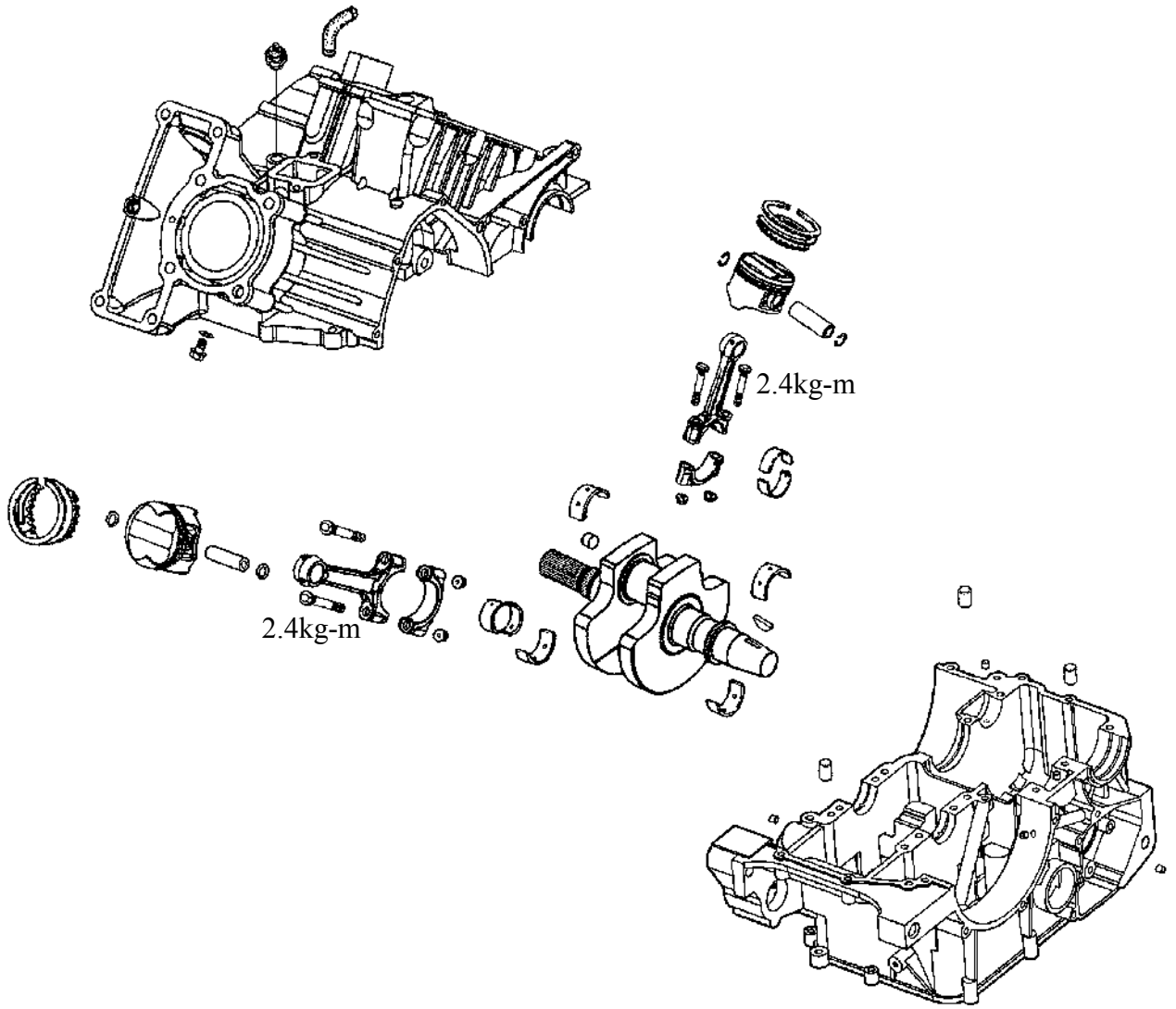



---

---

---

---

---

---

---

---

---

---

**CRANKSHAFT/PISTON/CYLINDER**

**7**

SERVICE INFORMATION ..... 7- 1

TROUBLESHOOTING ..... 7- 1

CRANKCASE REMOVAL ..... 7- 3

CRANKSHAFT REMOVAL..... 7- 4

PISTON REMOVAL ..... 7- 5

PISTON INSTALLATION ..... 7- 6

CYLINDER INSPECTION..... 7- 7

CONNECTING ROD BEARING CHOICE..... 7- 7

CRANK BEARING CHOICE ..... 7- 9

## SERVICE INFORMATION

### GENERAL INSTRUCTIONS

- Both of crankcase need to be replaced if anyone crankcase is damaged.
- After disassembly, clean the removed parts and dry them with compressed air before inspection.

### SPECIFICATIONS

Item		Standard (mm)	Service Limit (mm)	
		VENOX 250	VENOX 250	
Cylinder	I.D.	58.0~58.015	58.30	
	Warpage	—	—	
	Cylindricity	0.1	0.2	
	True roundness	0.005	0.01	
Piston/ piston ring	Ring-to-groove clearance	Top	0.02~0.06	0.09
		Second	0.02~0.06	0.09
	Ring end gap	Top	0.1~0.25	0.5
		Second	0.2~0.35	0.5
		Oil side rail	0.2~0.7	0.9
	Piston O.D.	57.975~57.99	57.80	
	Piston O.D. measuring position	10mm from bottom of skirt		
	Piston-to-cylinder clearance	0.005~0.065	0.125	
Piston pin hole I.D.	16.0~16.006	16.012		
Piston pin O.D	15.994~15.997	15.90		
Piston-to-piston pin clearance	0.001~0.007	0.01		
Connecting rod small end I.D.	16.013~16.028	16.032		
Connecting rod big end side clearance	—	0.40		
Crankshaft runout	—	0.10		
Crank-to-crankcase clearance	0.07~0.27	0.3.		

## TROUBLESHOOTING

- When hard starting or poor performance at low speed occurs, check the crankcase breather for white smoke. If white smoke is found, it means that the piston rings are worn, stuck or broken.

### Compression too low

- Worn, stuck or broken piston rings
- Worn or damaged cylinder or piston

### Compression too high

- Excessive carbon build-up in combustion chamber or on piston head

### Excessive smoke from exhaust muffler

- Worn or damaged piston rings
- Worn or damaged cylinder or piston

### Abnormal noisy piston

- Worn cylinder, piston or piston rings
- Worn piston pin hole or piston pin

# 7. CRANKSHAFT/PISTON/CYLINDER

## CRANKCASE REMOVAL

The following parts must be removed before removing the crankcase:

- Cylinder head /camshaft.
- Starter motor/generator/left and right crankcase cover/clutch.
- Clutch/gear shift mechanism.

Remove the six attaching bolts on the upper crankcase.

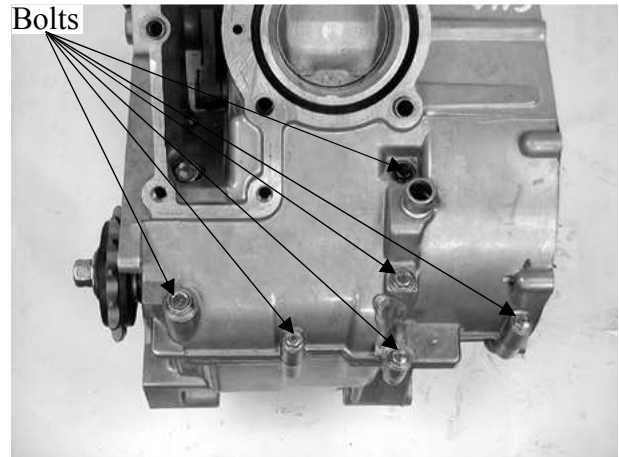

Remove the eleven attaching bolts on the lower crankcase.

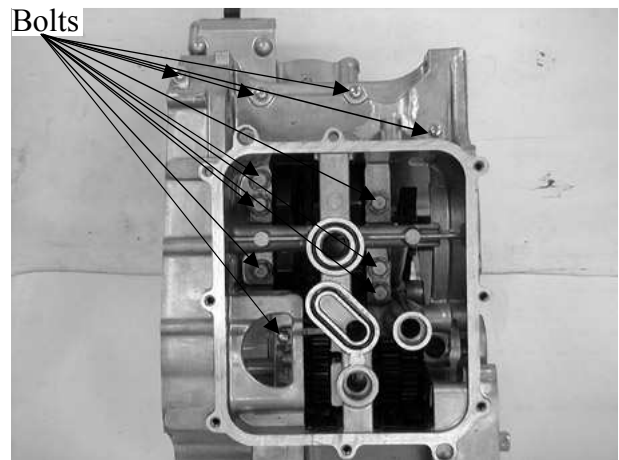

Separate the upper and lower crankcase halves.

Slightly tap the crankcase to separate the crankcase halves with a plastic hammer.

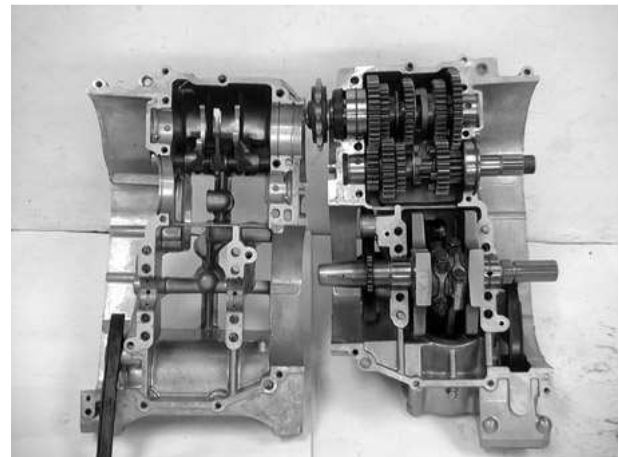

Measure the connecting rod big end side clearance.

**Service Limit:** 0.40mm replace if over

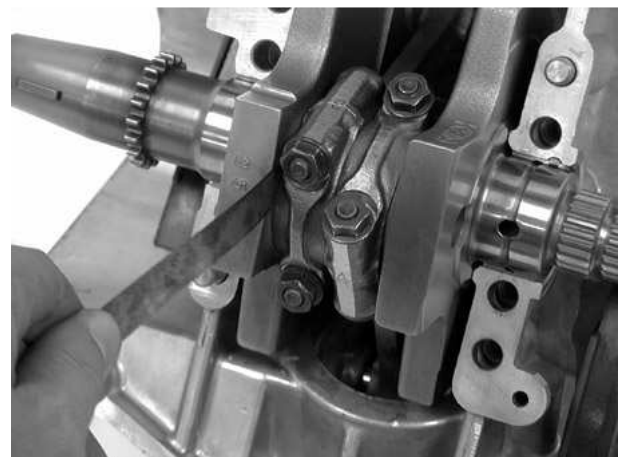

## 7. CRANKSHAFT/PISTON/CYLINDER

### CRANKSHAFT REMOVAL

Remove the four attaching nut on the connecting rod cap.  
Remove the connecting rod cap.

**Torgue:** 2.4kg-m

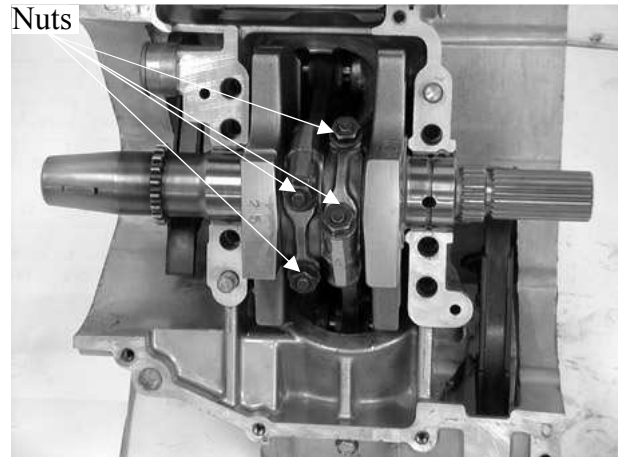

Remove the crankshaft.

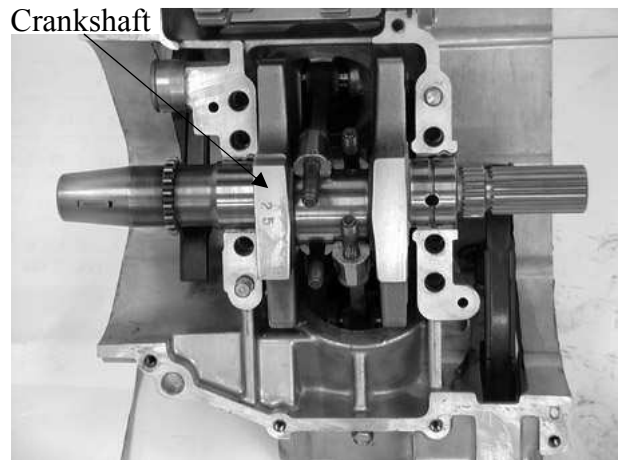

### INSPECTION

Measure the crankshaft runout.  
**Service Limit:** 0.1mm replace if over

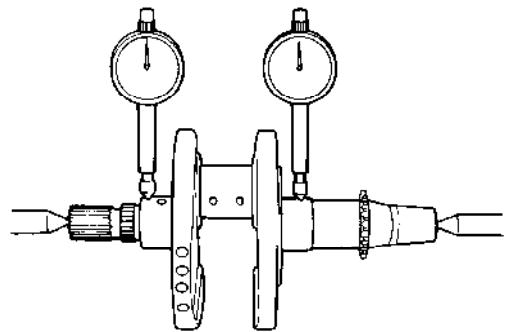

## 7. CRANKSHAFT/PISTON/CYLINDER

### PISTON REMOVAL

Remove the piston/connecting rod.

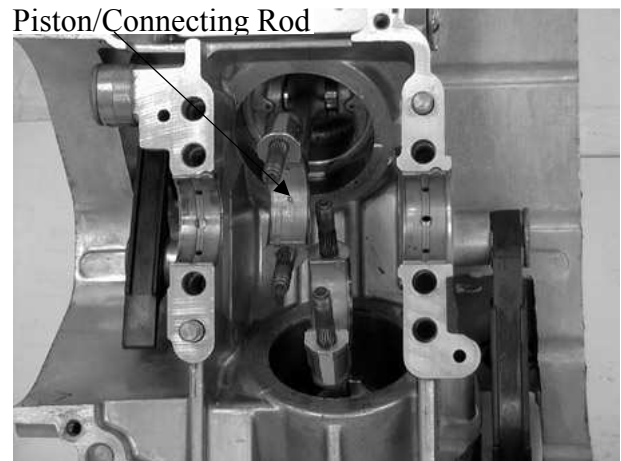

Remove the piston pin clip.  
Take out the piston pin.

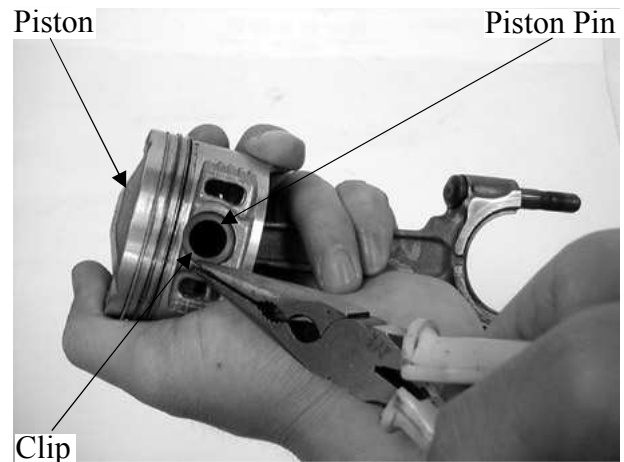

### INSPECTION

Inspect the piston, piston pin and piston rings.

Remove the piston rings.

\* Take care not to damage or break the piston rings during removal.

Remove carbon deposits from the piston ring grooves.



Install the piston rings onto the piston and measure the piston ring-to-groove clearance.

**Service Limits:** **Top:** 0.09mm replace if over  
**2nd:** 0.09mm replace if over





## 7. CRANKSHAFT/PISTON/CYLINDER

### CYLINDER INSPECTION

Inspect the cylinder bore for wear, scratches or damage.

Measure the cylinder I.D. at three levels of top, middle and bottom at 90° to the piston pin (in both X and Y directions).

**Service Limit:** 58.30mm replace if over

Measure the cylinder-to-piston clearance and take the maximum figure measured.

**Service Limit:** 0.125mm repair or replace if over

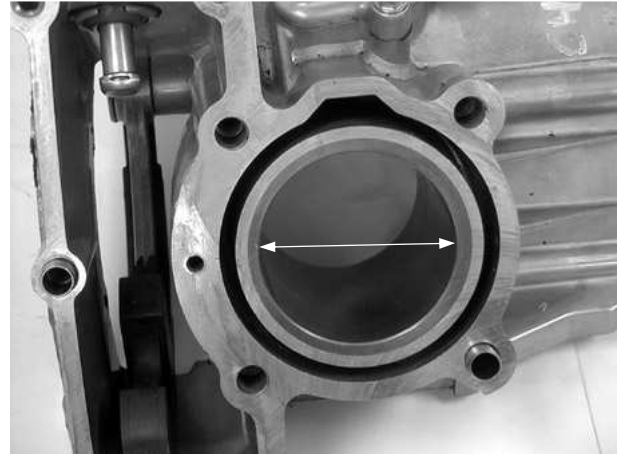

The true roundness is the difference between the values measured in X and Y directions. The cylindricity (difference between the values measured at the three levels in X or Y directions) is subject to the maximum value calculated.

**Service Limits:**

**True Roundness:** 0.01mm repair or replace if over

**Cylindricity:** 0.2mm repair or replace if over

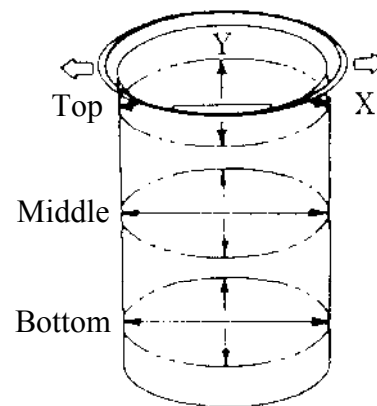

Measure the connecting rod small end I.D.

**Service Limit:** 16.032mm replace if over



### CONNECTING ROD BEARING CHOICE

Align the mark with both of plate bearing when installing the connecting rod big end.



## 7. CRANKSHAFT/PISTON/CYLINDER

There is a mark on the connecting rod big end.

Connecting Rod Big End Mark	Crank Pin Mark	Bearing Chose(Color)
A	B	A(Brown)
A	A	B(Green)
B	B	B(Green)
B	A	C(Yellow)

Crank Pin Mark



First install the plate bearings before the connecting rod big end is installed.

\* Press the flange on the plate bearing into the connecting rod groove.

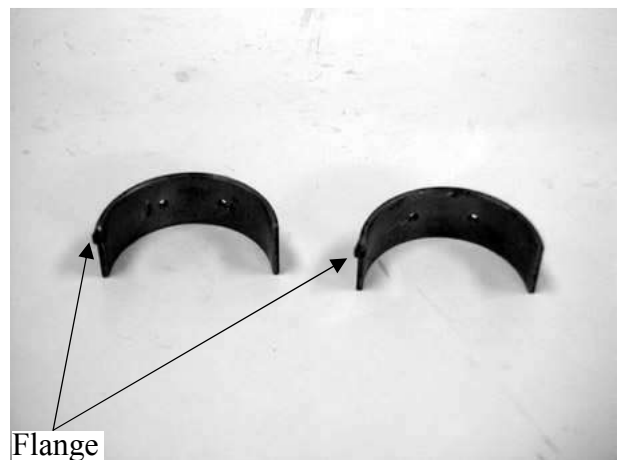

Apply engine oil to the plate bearing on the connecting rod.



Install the piston and connecting rod into the cylinder with a piston installer.

\*
 

- When fitting the piston, face the “IN” mark on the piston head to intake valve side.
- The more curve side on the connecting rod big end should face to the engine outside.

**Special**

Piston installer

More Curve

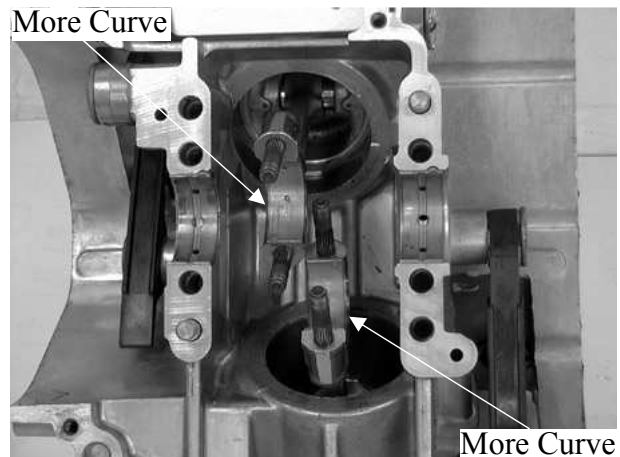

More Curve



# 7. CRANKSHAFT/PISTON/CYLINDER

## CRANK BEARING CHOICE

Crankcase Mark	Crank Pin Mark	Bearing Chose(Color)
A	B	A(Brown)
A	A	B(Green)
B	B	B(Green)
B	A	C(Yellow)

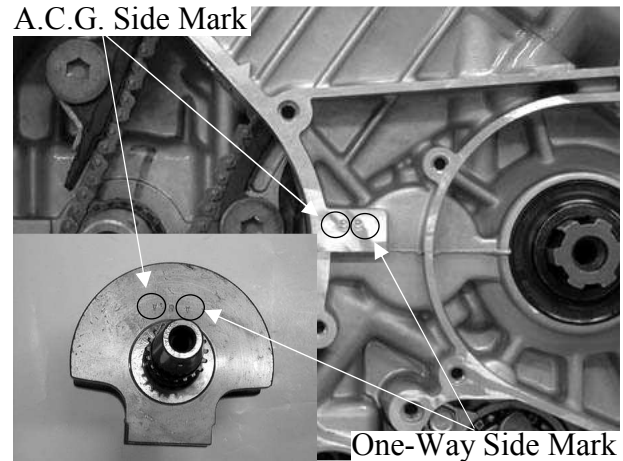

First install the plate bearings before installing the upper and lower crankcase. Apply engine oil to the plate bearing on the crankcase.

\* Press the flange on the plate bearing into the crankcase groove.

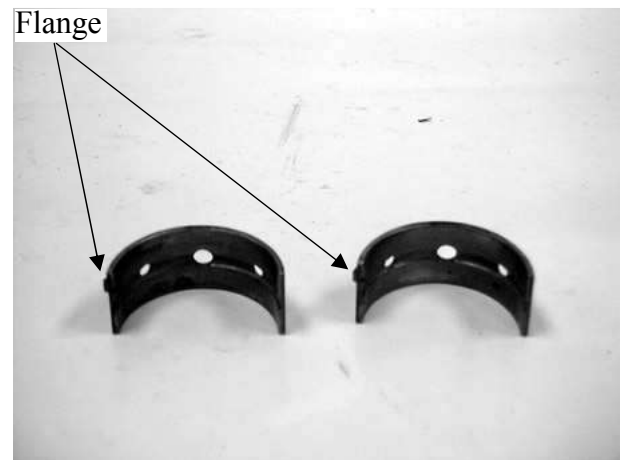

Measure the axle clearance between the crank and crankcase.

**Standard:**0.30mm replace if over

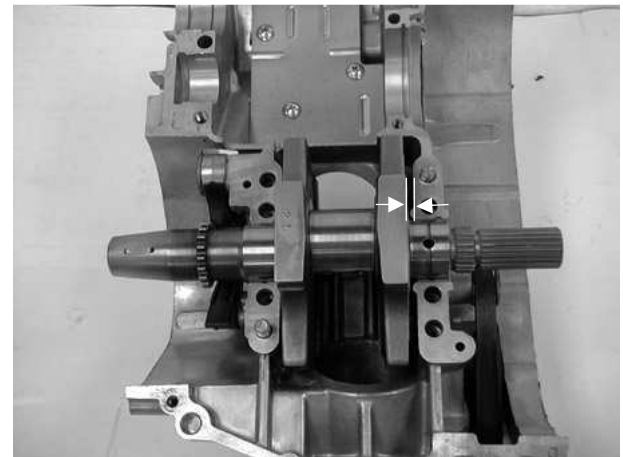

Put the piston/connecting rod comp inside the piston installer and then put it inside the cylinder.

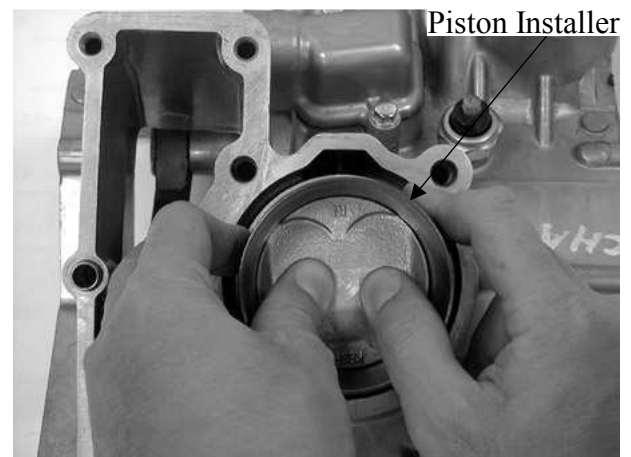

## 7. CRANKSHAFT/PISTON/CYLINDER

---

### INSTALLATION

Install other removed parts in the reverse of order of removal.

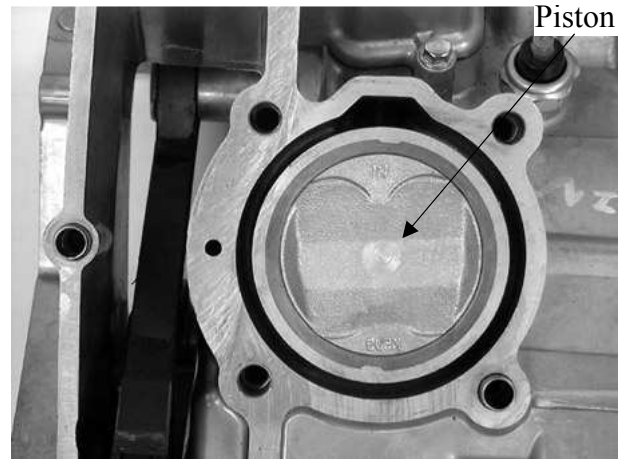

# 8. GENERATOR/LEFT CRANK CASE COVER

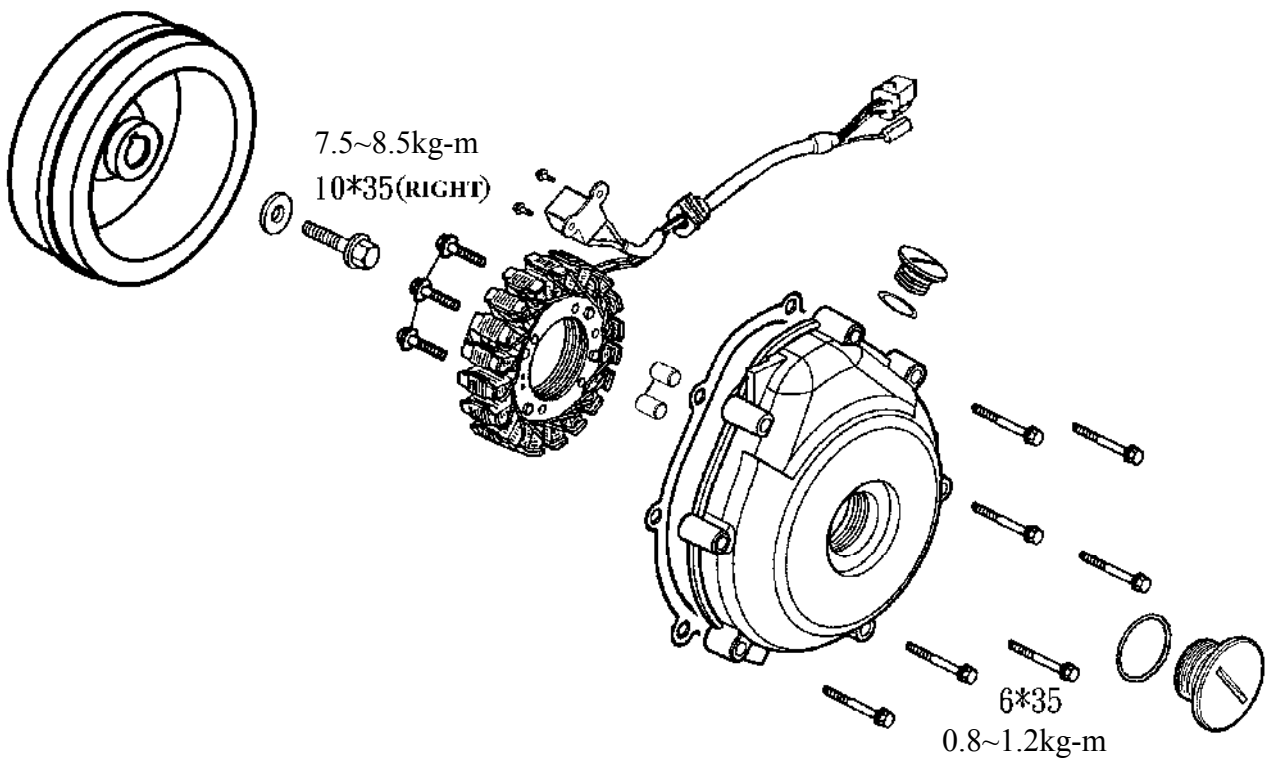

**GENERATOR/LEFT CRANK CASE COVER**

SERVICE INFORMATION ..... 8-2  
TROUBLESHOOTING ..... 8-2  
LEFT CRANKCASE COVER/GENERATOR REMOVAL ..... 8-3  
GENERATOR INSTALLATION..... 8-4

### SERVICE INFORMATION

#### GENERAL INSTRUCTIONS

- The starter motor, generator, left crankcase cover and starter clutch can be serviced in the frame.
- Do not install the starter clutch forcedly.
- Install the generator by aligning the groove in the flywheel with the key on the crankshaft.

#### TORQUE VALUE

Flywheel nut: 7.5~8.5kg-m

#### SPECIAL TOOLS

Flywheel holder

Flywheel puller

#### TROUBLESHOOTING

##### Hard starting/Poor performance at high speed

- Improperly tightened flywheel lock nut

##### Starter clutch slips

- Worn starter clutch roller
- Faulty starter clutch roller or spring
- Worn starter gear shaft O.D.

##### Starting noise

- Worn reduction gear
- Worn starter gear
- Worn starter clutch roller
- Faulty reduction gear shaft bearing

## 8. GENERATOR/LEFT CRANK CASE COVER

### LEFT CRANKCASE COVER/ GENERATOR REMOVAL

Remove the seat and fuel tank.  
Remove the left and right side cover.  
Disconnect the fuel tube from the auto fuel valve.  
Disconnect the A.C. generator and starter motor wire coupler.

Generator Wire Coupler



Remove the seven left crankcase cover bolts.  
Remove the left crankcase cover and two dowel pins.  
Clean off all gasket material from the left crankcase cover.

Bolt

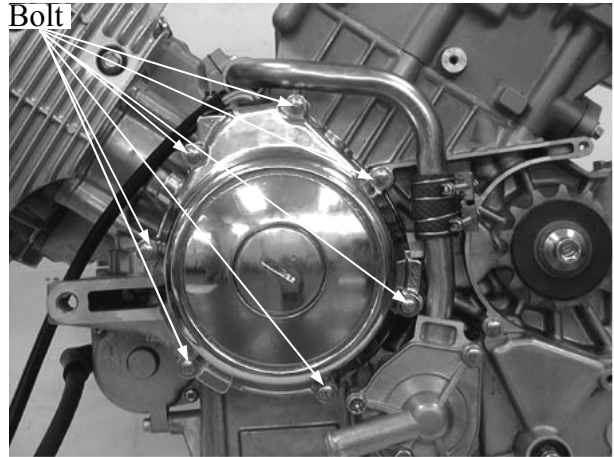

Remove the five stator mounting bolts and the stator.

Bolt

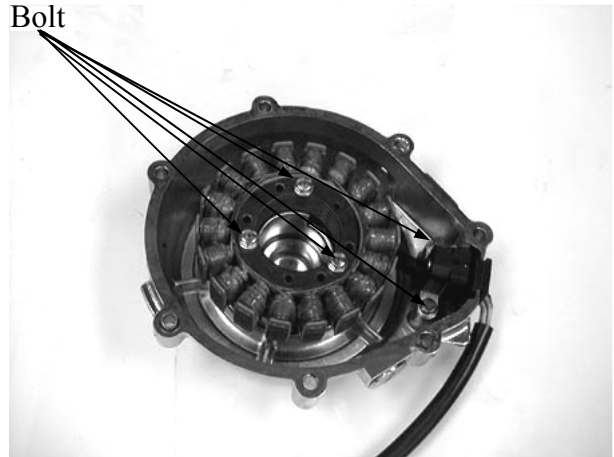

Hold the flywheel with a flywheel holder.  
Remove the flywheel lock bolt.

**Special**

Flywheel holder

Flywheel Lock Bolt

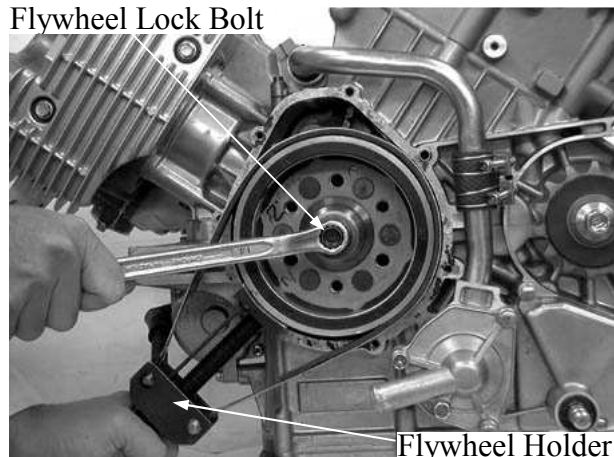

Install the flywheel puller.

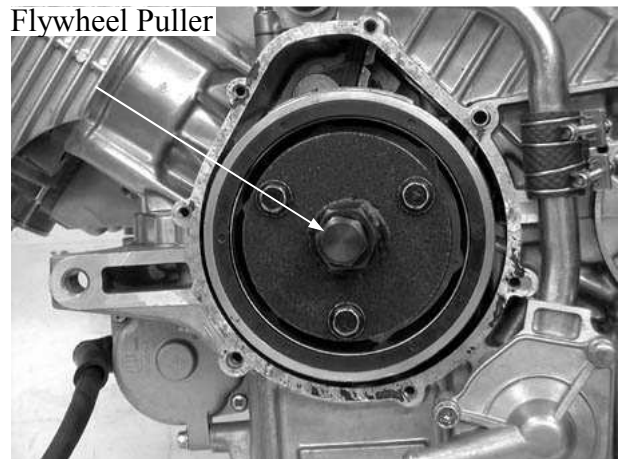

Remove the flywheel using a flywheel puller.

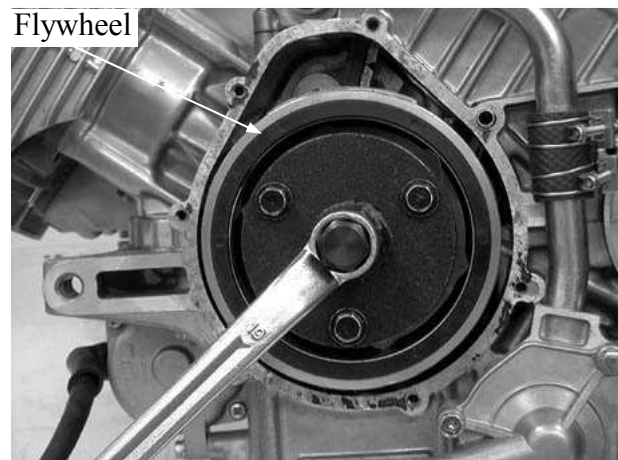

## GENERATOR INSTALLATION

Install the generator flywheel. Hold the flywheel with a flywheel holder and tighten the flywheel lock bolt.

- \*
- Install the flywheel by aligning the groove in the flywheel with the key on the crankshaft.
  - When installing, be careful not to damage the crankshaft.

**Torque:** 7.5~8.5kg-m

### **Special**

Flywheel Holder  
Flywheel Puller

## LEFT CRANKCASE COVER INSTALLATION

Install the left crankcase cover and tighten the seven bolts.

**Torque:** 0.8~1.2kg-m

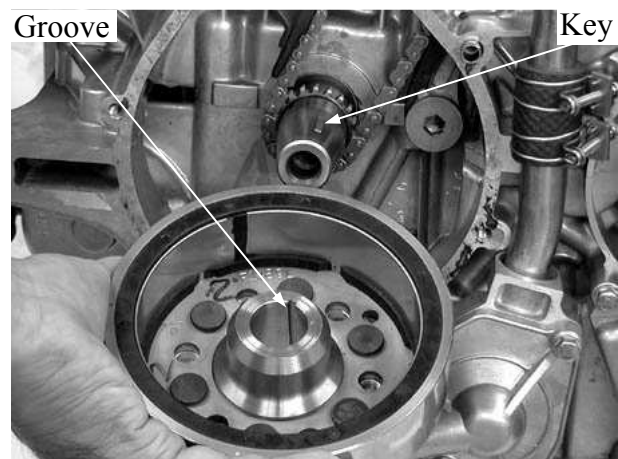

# 9. CLUTCH/GEAR SHIFT MECHANISM

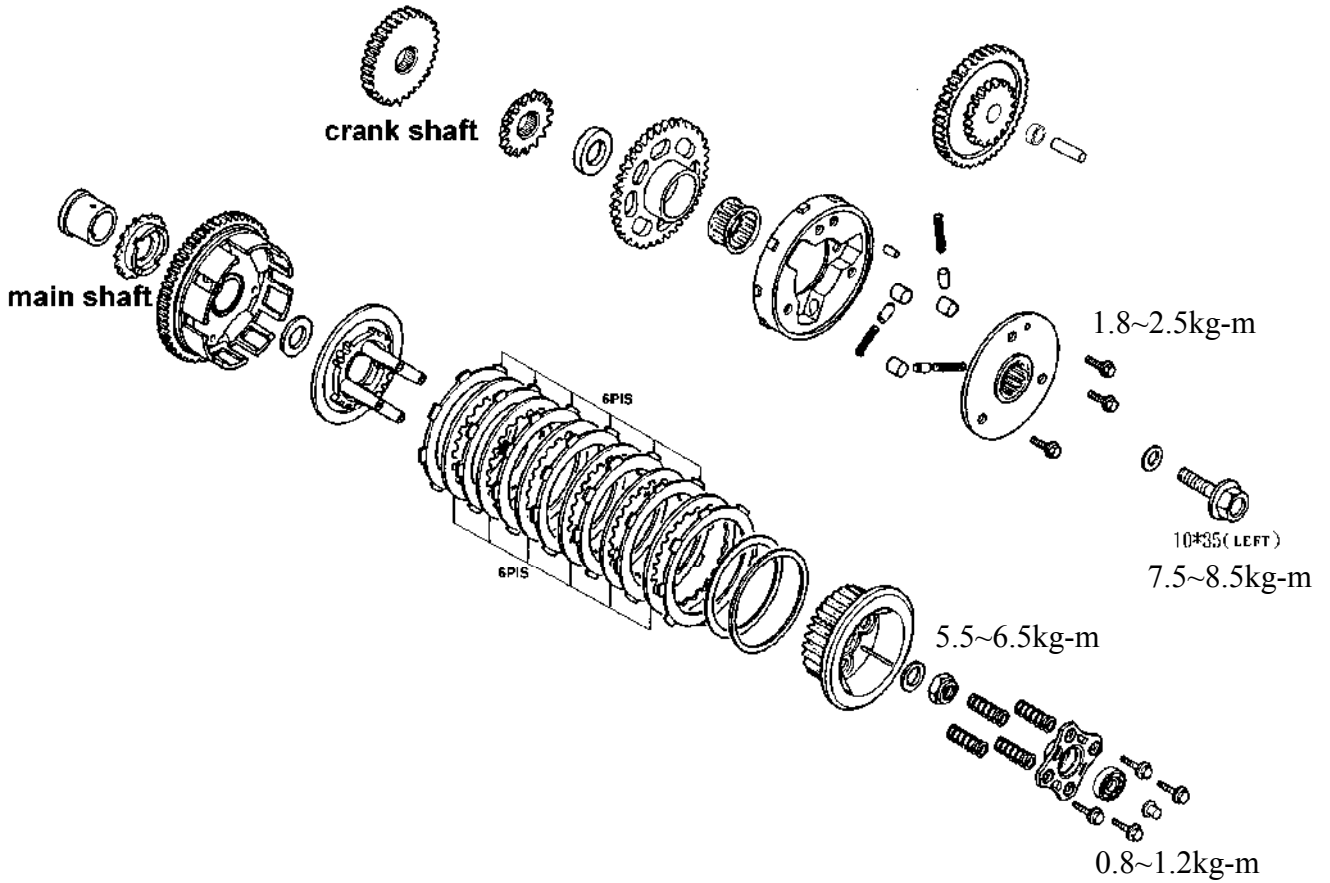



---

**CLUTCH/GEAR SHIFT MECHANISM**

---

SERVICE INFORMATION ..... 9-2  
TROUBLESHOOTING ..... 9-3  
RIGHT CRANKCASE COVER REMOVAL ..... 9-4  
ONE WAY CLUTCH REMOVAL..... 9-4  
CLUTCH REMOVAL ..... 9-6

## 9. CLUTCH/GEAR SHIFT MECHANISM

### SERVICE INFORMATION

#### GENERAL INSTRUCTIONS

- The clutch and gear shift mechanism can be serviced in the frame.
- Install the clutch plates in the same chamfer direction.
- Install the thrust washer with the chamfer facing up and the flat facing down.

#### SPECIFICATIONS

Item		Standard (mm)	Service Limit (mm)
Clutch spring free length		32.30	31.0
Clutch friction disk thickness		3.7~3.8	3.4
Clutch plate bending		0~0.05	0.1
Clutch outer I.D.		46.2~46.3	46.5
Flange starter clutch O.D.		27.95~27.97	27.80
Oil pump drive bush	O.D.	28.970~28.990	28.80
	I.D.	22.020~22.040	22.20
Starter gear shaft	O.D.	42.175~42.2	42.0
	I.D.	32.0~32.025	32.2
Oil pump drive sprocket I.D.		29.0~29.030	29.20

#### TORQUE VALUES

Clutch center lock nut	5.5~6.5kg-m
Clutch lifter bolt	0.8~1.2kg-m
One-way clutch bolt	1.8~2.5kg-m
One-way clutch mounting bolt	7.5~8.5kg-m

#### SPECIAL TOOLS

Clutch lifter holder  
Lock nut socket wrench

## 9. CLUTCH/GEAR SHIFT MECHANISM

---

### TROUBLESHOOTING

#### Clutch slips during acceleration

- No free play
- Worn friction disk
- Weak spring

#### Clutch won't operate

- Excessive free play
- Bent clutch plate

#### Improper shifting

- Excessive clutch lever free play
- Bent gear shift spindle
- Worn or deformed gear shift plate
- Damaged transmission drum grooves
- Faulty gear shift cam stopper

#### Clutch won't operate and motorcycle moves slowly

- Excessive free play
- Bent clutch plate

#### Too much pressure on clutch lever

- Kinked, twisted or damaged clutch cable
- Damaged clutch lifter

#### Clutch does not operate smoothly

- Improper clutch outer groove machining

#### Gear tripping

- Faulty gear shift cam stopper
- Bent gear shift spindle
- Worn gear teeth

## 9. CLUTCH/GEAR SHIFT MECHANISM

### RIGHT CRANKCASE COVER REMOVAL

Drain the engine oil.  
Disconnect the clutch cable.  
Remove the right crankcase cover attaching bolts and right crankcase cover.



Remove the right crankcase cover.

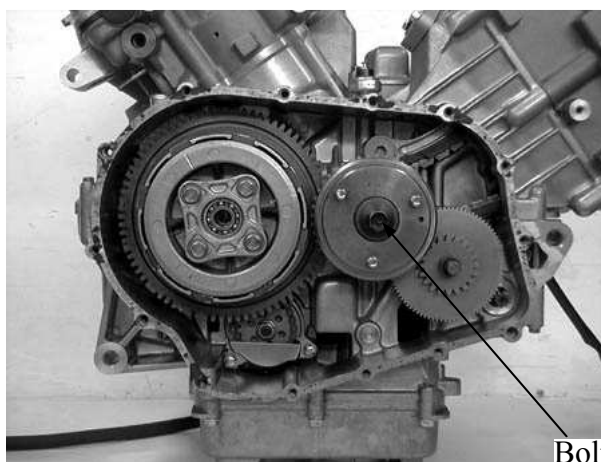

### ONE-WAY CLUTCH REMOVAL

Remove the one-way clutch mounting bolt and one-way clutch.

**Torque:** 7.5~8.5kg-m

\* The one-way clutch mounting bolt is left screw.

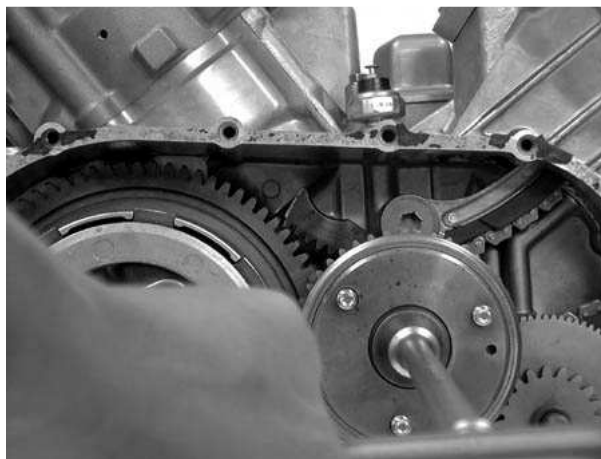

### INSPECTION

Measure the flange starter clutch O.D.  
**Service Limit:** 27.80 replace if below.

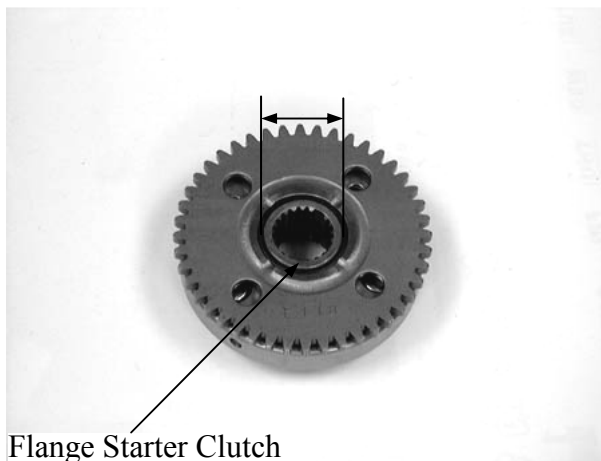

## 9. CLUTCH/GEAR SHIFT MECHANISM

Measure the starter gear shaft O.D. and I.D.

**Service Limit:** O.D. 42.0mm replace if over.  
I.D. 32.20mm replace if below.

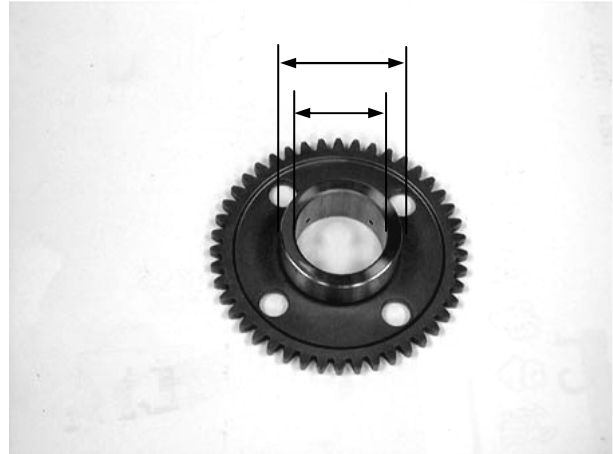

One-Way Clutch

Remove the one-way clutch rollers, plungers and springs.

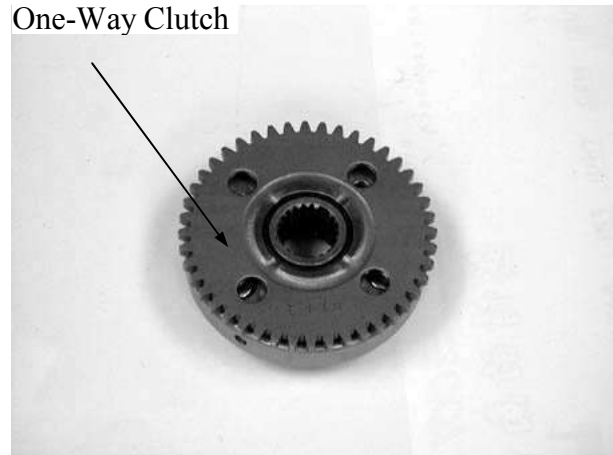

Check the one-way clutch bearing for smooth turning.  
Replace a new needle bearing if noisy or loosely.

Bearing

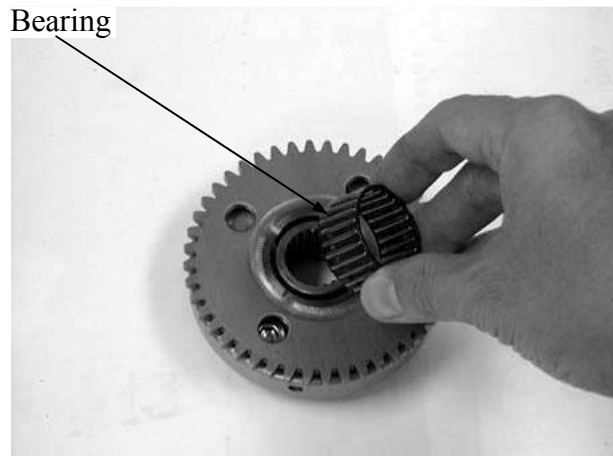

Remove the starter reduction gear.

Reduction Gear

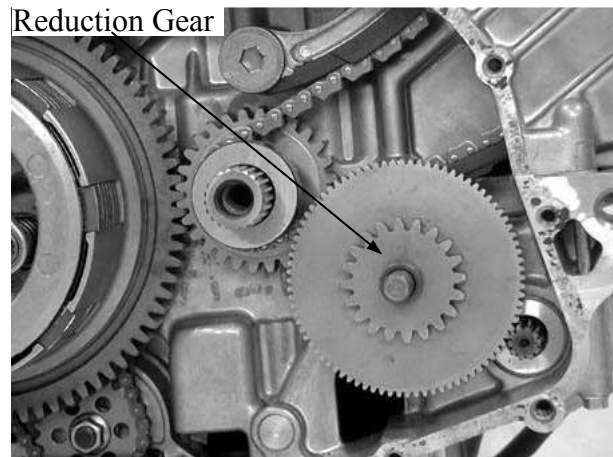

## 9. CLUTCH/GEAR SHIFT MECHANISM

### INSTALLATION

Install the one-way clutch and starter reduction gear in the reverse order of removal.

Align the flange of the one-way clutch with the crank mark.

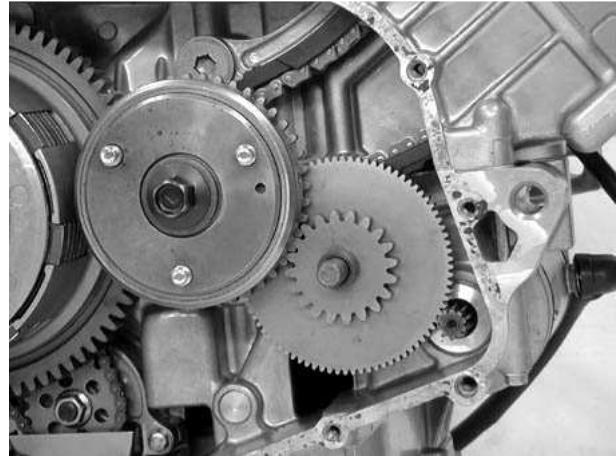

### CLUTCH REMOVAL

Remove the four clutch lifter bolts.  
Remove the clutch lifter and four tension springs.

**Torque:** 0.8~1.2kg-m

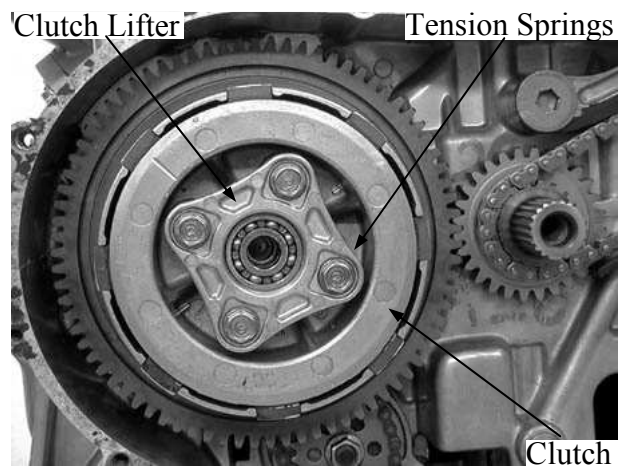

Remove the one-way clutch mounting bolt and the clutch.

**Torque:** 5.5~6.5kg-m

#### **Special**

Clutch lifter holder  
Lock nut socket wrench

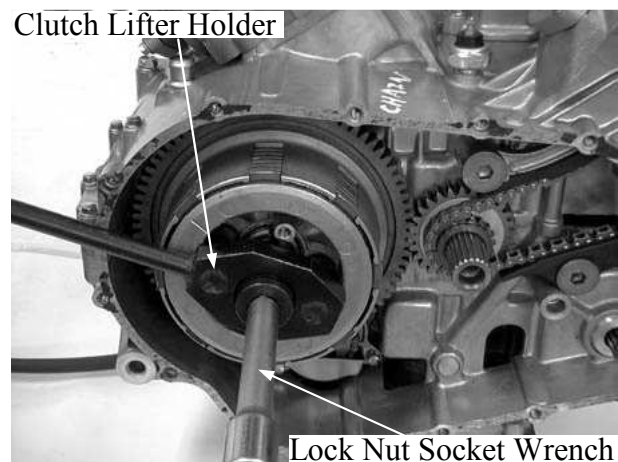

Remove the washer.

\* Install the washer with the mark facing up.



## 9. CLUTCH/GEAR SHIFT MECHANISM

Remove the clutch center, clutch friction disks and plates.



Remove the washer, clutch outer.

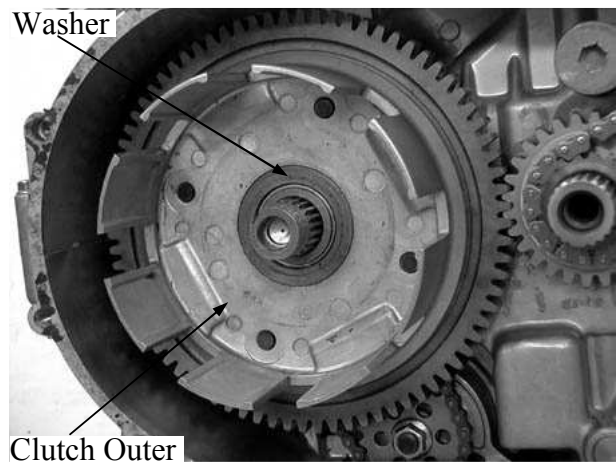

### INSPECTION

#### CLUTCH TENSION SPRING

Measure each clutch tension spring free length.

**Service Limit:** 31.0mm replace if below

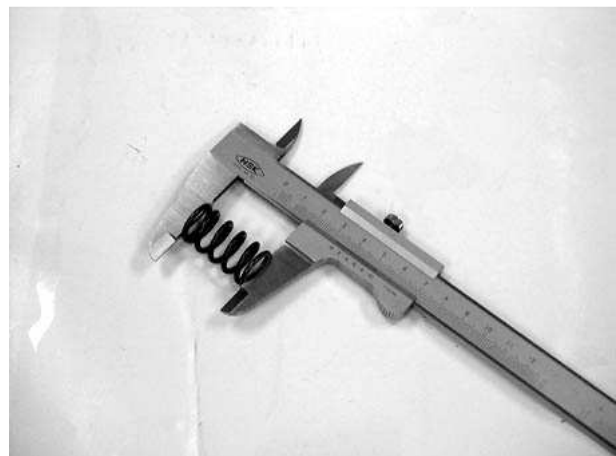

#### CLUTCH FRICTION DISK

Measure each clutch friction disk thickness.

**Service Limit:** 3.4mm replace if below

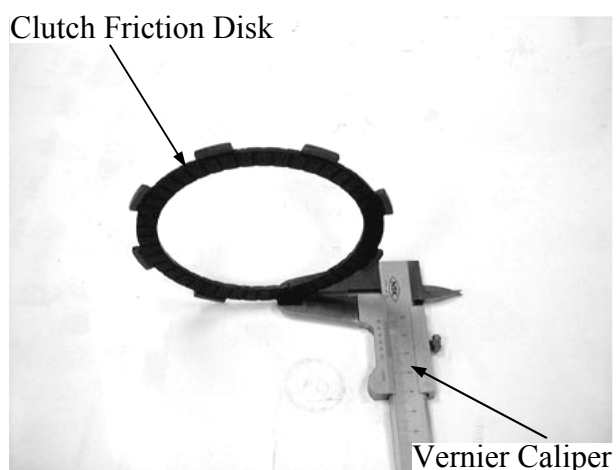

## 9. CLUTCH/GEAR SHIFT MECHANISM

### CLUTCH PLATE

Measure each clutch plate bending using a feeler gauge.

**Service Limit:** 0.10mm replace if over

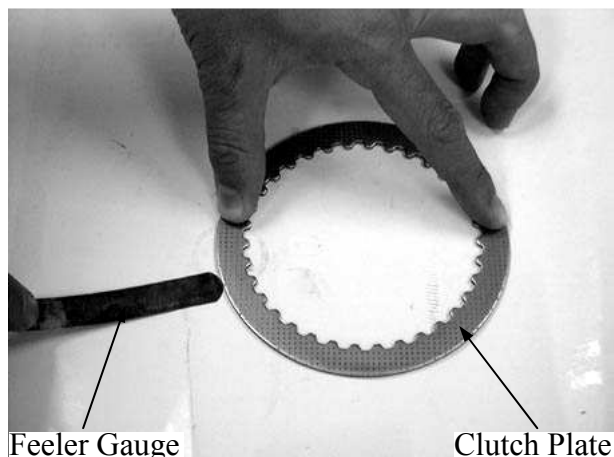

### CLUTCH OUTER

Inspect the clutch outer groove for scratches caused by the friction disks.

Measure the clutch outer I.D.

**Service Limit:** 46.5mm replace if OVER

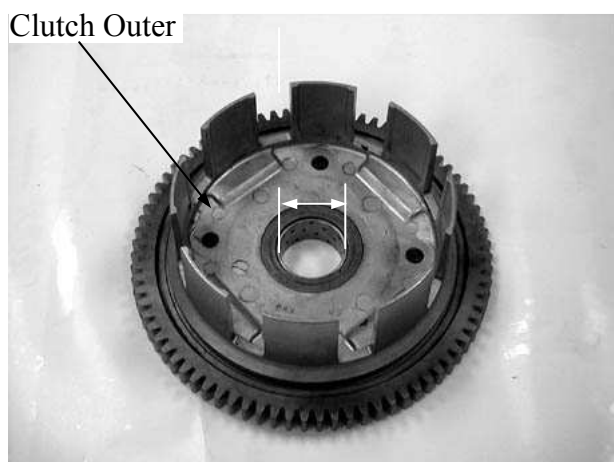

### OIL PUMP DRIVE SPROCKET/BUSH

Measure the oil pump drive bush I.D. and O.D.

**Service Limits:**

I.D. : 22.20mm replace if over

O.D. : 28.80mm replace if below

Measure the oil pump drive sprocket I.D.

**Service Limits:**

I.D. : 29.20mm replace if over



### INSTALLATION

Install other removed parts in the reverse of order of removal.

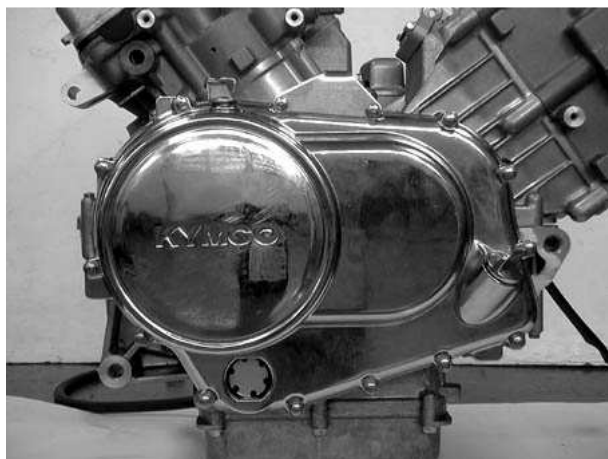



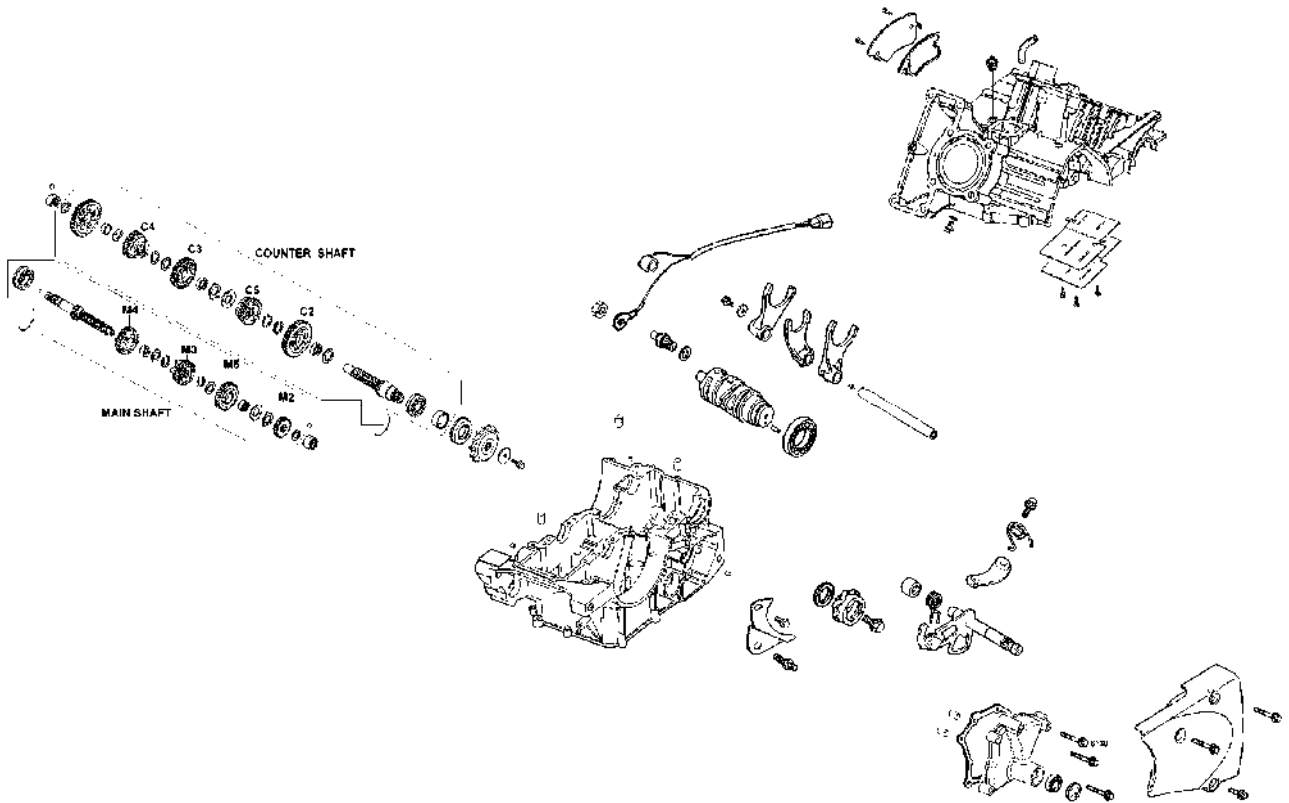

---

**TRANSMISSION SYSTEM**

---

SERVICE INFORMATION ..... 10-2  
TROUBLESHOOTING ..... 10-3  
GEAR SHIFT MECHANISM REMOVAL..... 10-4  
CRANKCASE REMOVAL ..... 10-5

## SERVICE INFORMATION

### GENERAL INSTRUCTIONS

- During crankcase separation, do not separate the crankcase halves with an iron hammer to avoid crankcase deformation or damage.
- After separation, be careful not to damage the right and left crankcase mating surfaces to avoid oil leakage.
- Replace the gasket with a new one during reassembly of the crankcase halves.
- After transmission system disassembly, make sure that the gear shifting operation is normal before reassembly of the remaining parts.
- Apply engine oil to the transmission system and crankshaft before reassembly.
- Replace both of crankcase together if anyone crankcase is problem.

### SPECIFICATIONS

Item		Standard (mm)	Service Limit (mm)	
Transmission fork	Claw thickness	5.5~5.6	5.0	
	Shaft hole I.D.	12~12.013	12.053	
Transmission fork shaft O.D.		11.96~11.98	11.92	
Transmission drum O.D.	Left	11.966~11.984	11.926	
	Right	24.95~24.97	24.90	
Transmission gear	Gear I.D.	Main shaft 4th gear	25.020~25.041	25.081
		Main shaft 5th gear	25.020~25.041	25.081
		Countershaft 1st gear	23.020~23.041	23.081
		Countershaft 2nd gear	28.020~28.041	28.081
		Countershaft 3rd gear	28.020~28.041	28.081
	Main Shaft O.D.	Left crankcase side	16.987~17.0	16.947
		2nd/3rd gear	22.002~22.015	21.962
		4th/5th gear	22.002~22.015	21.962
	Countershaft O.D.	Right crankcase	19.987~20.0	19.947
		Left crankcase	24.959~24.980	24.919
		1st gear	25.002~25.015	24.962
		2nd/3rd gear	25.002~25.015	24.962
		4th/5th gear	25.002~25.015	24.962
	Collar I.D.	1st gear	20.020~20.041	20.081
		4th gear	22.020~22.041	22.081
	Collar O.D.	1st gear	22.959~22.980	22.919
		2nd gear	27.959~27.980	27.919
		3rd gear	27.967~27.980	27.927
		4th gear	24.959~24.980	24.919
		5th gear	24.967~24.980	24.927

## TROUBLESHOOTING

### Excessive engine noise

- Worn main shaft journal bearing
- Worn crankshaft pin bearing
- Worn transmission bearings

### Transmission gear tripping

- Worn gear teeth
- Bent transmission fork
- Bent transmission fork shaft
- Damaged gear shift cam stopper

### Hard shifting

- Improperly adjusted clutch
- Bent or damaged transmission fork
- Bent transmission fork shaft
- Bent gear shift spindle
- Damaged transmission drum grooves

# 10. TRANSMISSION SYSTEM

## GEAR SHIFT MECHANISM REMOVE

Remove the gear shift pedal.  
Remove the two water pump attaching bolts and remove the water pump.

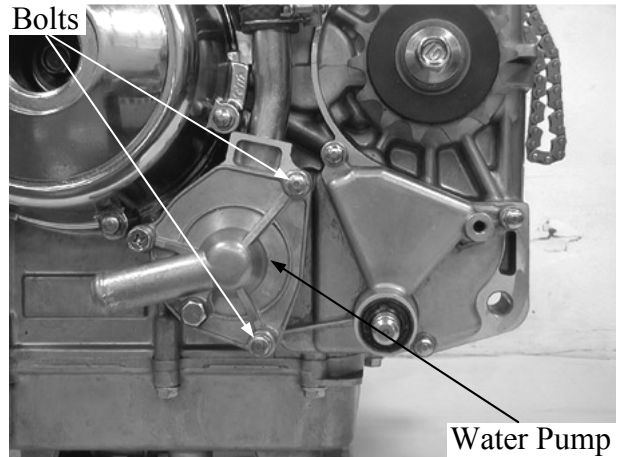

Remove the three gear shift mechanism cover attaching bolts.

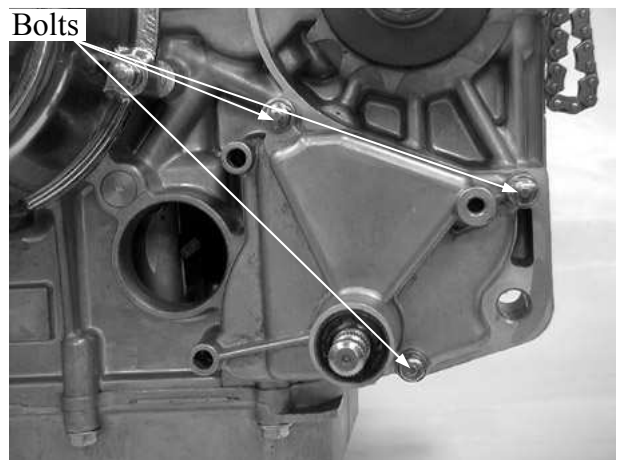

Remove the gear shift mechanism cover.

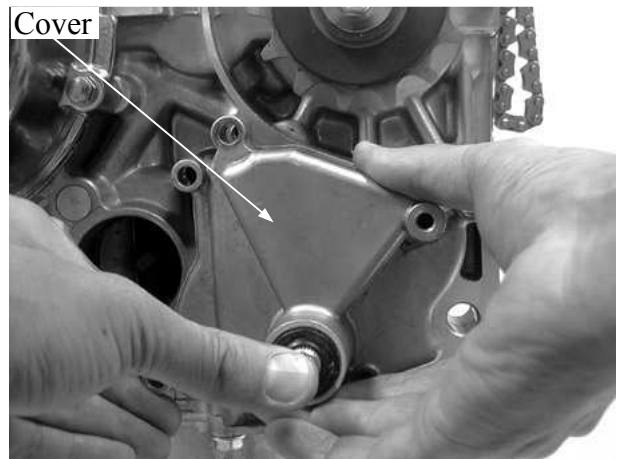

Remove the gear shift spindle.

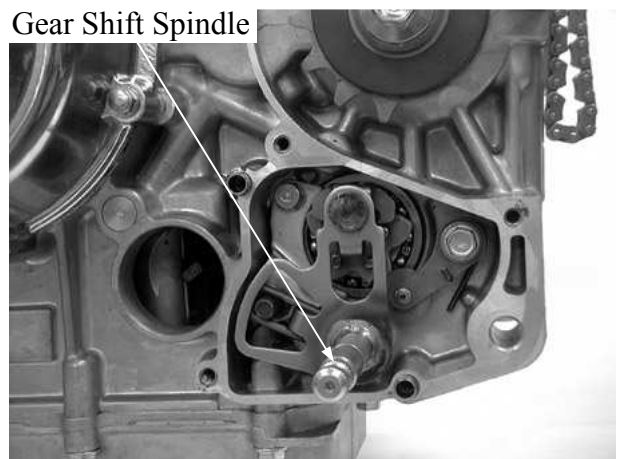

Remove the stopper and spring attaching bolts.  
 Remove the gear shift cam bolt.  
 Remove the gear shift cam and set pin.

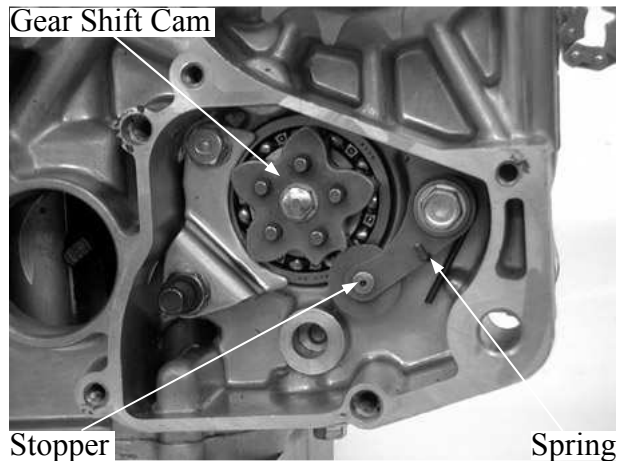

### GEAR/SHAFT COLLAR INSPECTION

Check the drum stopper and spring for damage, or change shape.  
 Check the gear shift plate and gear splindle shift, gear shift cam, washer for wear, damage, or change shape.  
 Check the change cover bearing for damage, slack or change shape.

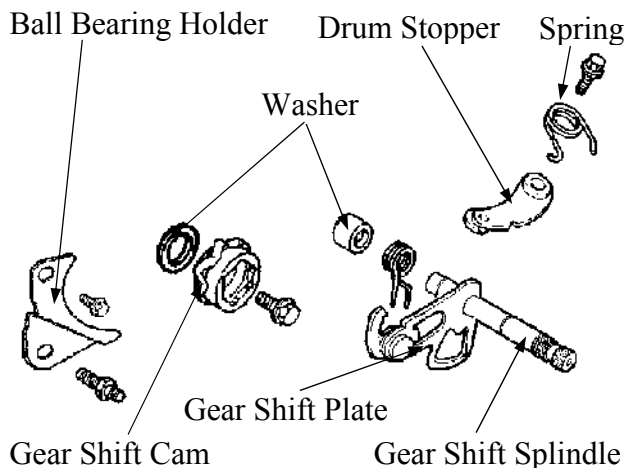

### INSTALLATION

The installation sequence is the reverse of removal.

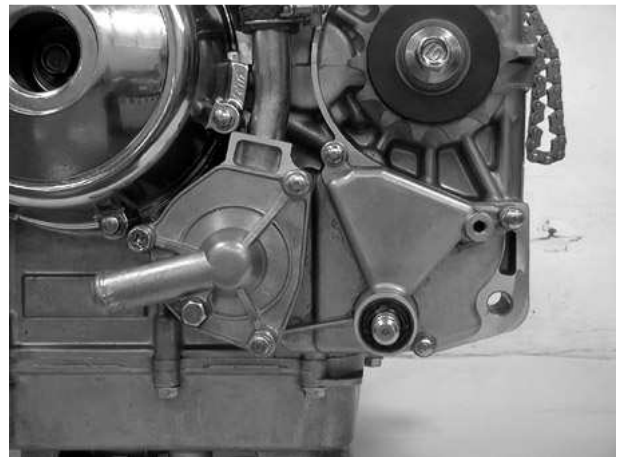

### CRANKCASE REMOVAL

The following parts must be removed before removing the crankcase:

- Cylinder head/ camshaft.
  - Starter motor/generator/left and right crankcase cover/one-way clutch.
  - Clutch/gear shift mechanism.
- Remove the six upper crankcase attaching bolts.

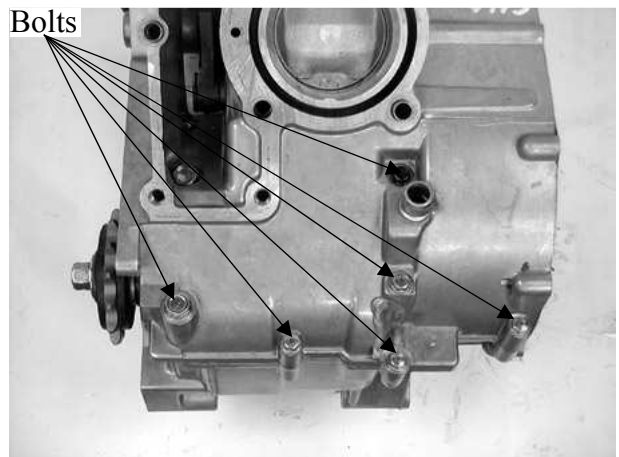

Remove the eleven lower crankcase attaching bolts.

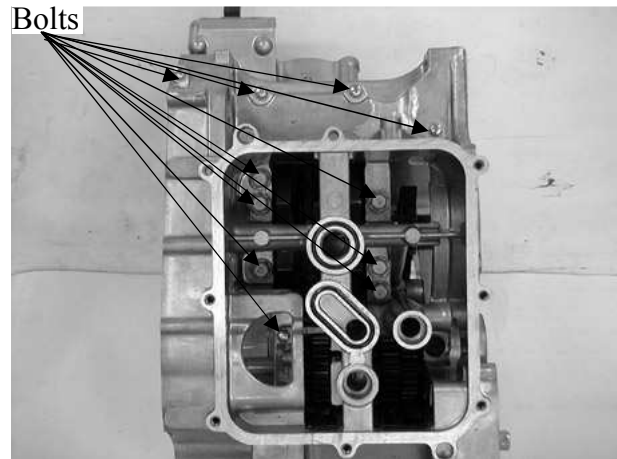

Separate the upper and lower crankcase halves.  
Slightly tap the crankcase to separate the crankcase halves using a plastic hammer.

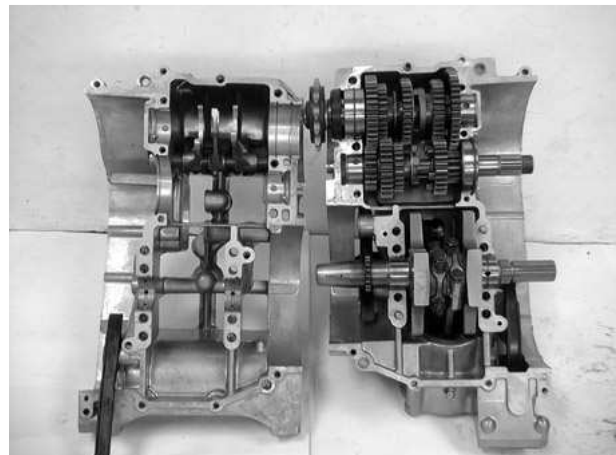

Remove the main/counter shaft ball bearing clip.

\* Be careful not to lose the ball bearing clip.

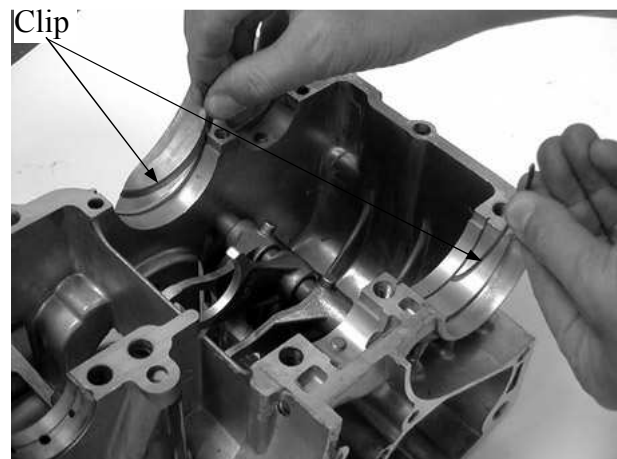

## TRANSMISSION SYSTEM REMOVAL

Remove the transmission fork shaft attaching bolt.



Remove the transmission fork shaft and transmission forks.  
Remove the transmission drum.

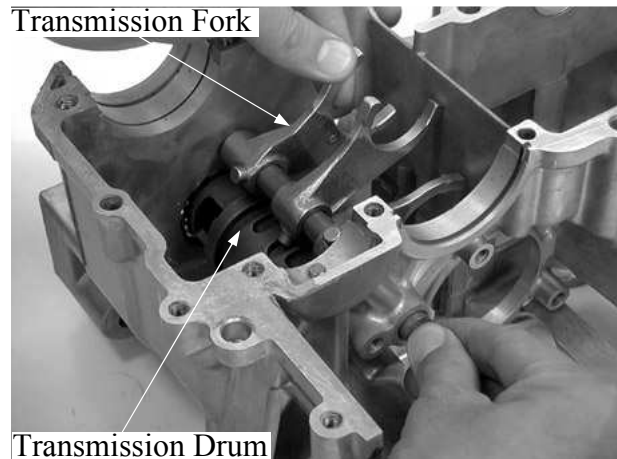

## INSPECTION

### TRANSMISSION FORK/DRUM

Inspect each transmission fork for bending or damage.

Measure each transmission fork claw thickness.

**Service Limit:** 5.0mm replace if below

Measure each transmission fork shaft hole I.D.

**Service Limit:** 12.053mm replace if over

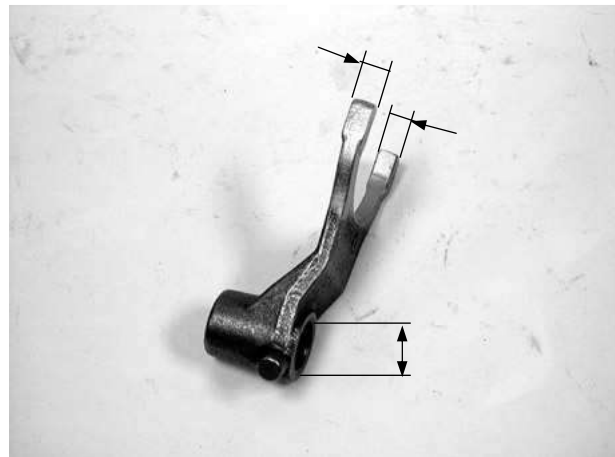

Check the transmission fork shaft for bending or damage.

Measure the transmission fork shaft O.D.

**Service Limit:** 11.92mm replace if below

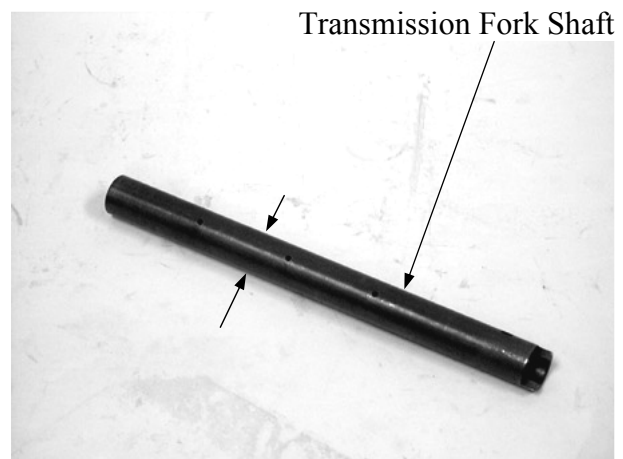

Inspect the transmission drum for scratches or poor lubrication.

Check the transmission drum grooves for damage.

Check the bearing for excessive free play.

Measure the transmission drum O.D.

### Service Limits:

Left end : 11.926mm replace if below

Right end: 24.90mm replace if below

Check the transmission drum and transmission fork shaft holes in the lower crankcase for wear or damage.

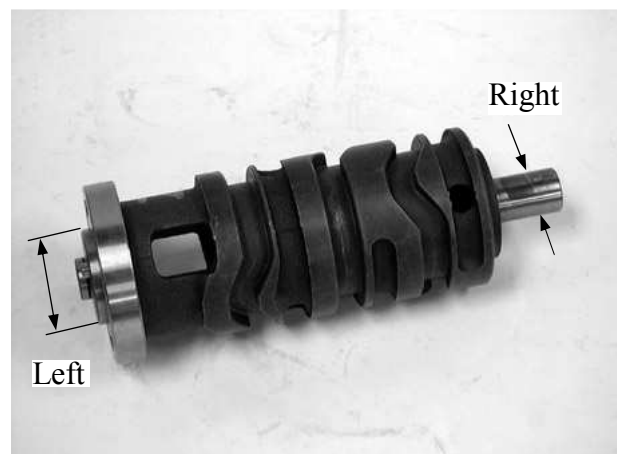



# 10. TRANSMISSION SYSTEM

## INSTALLATION

The installation sequence is the reverse of removal.

- \* Transmission fork make is as follows R(right),C(center),L(left).

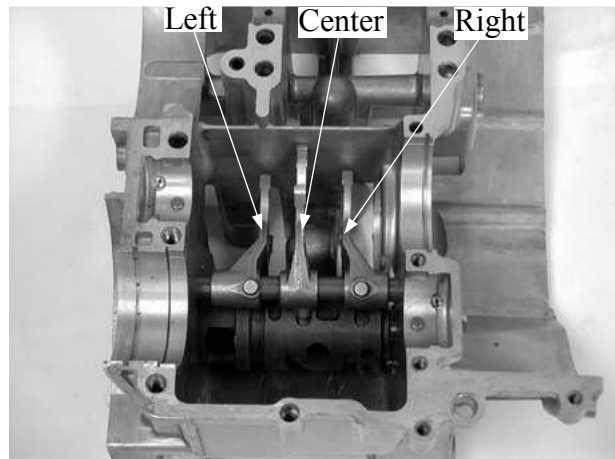

## TRANSMISSION GEARS REMOVAL

Remove the transmission main shaft and counter shaft from the upper crankcase.

- \* When removing, the transmission gears must be removed as a set.

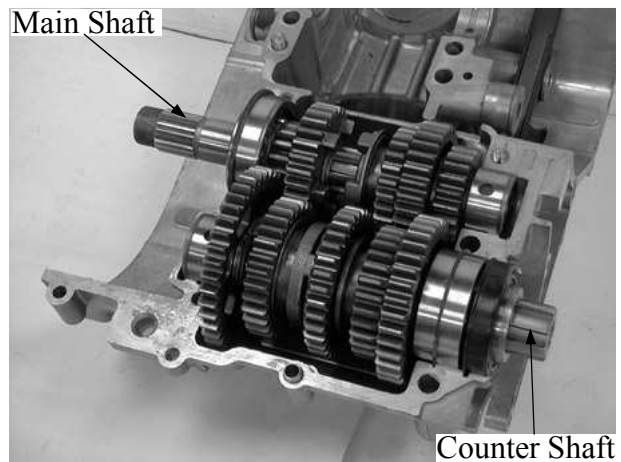

Disassemble the main shaft and counter shaft.

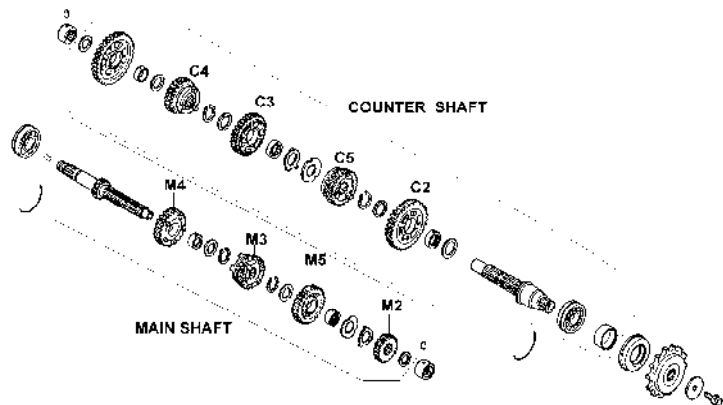

## GEAR/SHAFT COLLAR INSPECTION

Check each gear and gear teeth for wear, damage, or poor lubrication. Measure each gear I.D.

### Service Limits:

Main shaft 4th gear 25.081mm replace if over

Main shaft 5th gear 25.081mm replace if over

Countershaft 1st gear 23.081mm replace if over

Countershaft 2nd gear 28.081mm replace if over

Countershaft 3rd gear 28.081mm replace if over



Measure each shaft collar I.D./O.D.

**Service Limits:**

- Main shaft 4th gear collar I.D.22.081mm  
replace if over
- Main shaft 4th gear collar O.D.24.919mm  
replace if below
- Main shaft 5th gear collar O.D.24.927mm  
replace if below
- Countershaft 1st gear collar I.D.20.081mm  
replace if over
- Countershaft 1st gear collar O.D.22.919mm  
replace if below
- Countershaft 2nd gear collar O.D.27.919mm  
replace if below
- Countershaft 3rd gear collar O.D.27.927mm  
replace if below

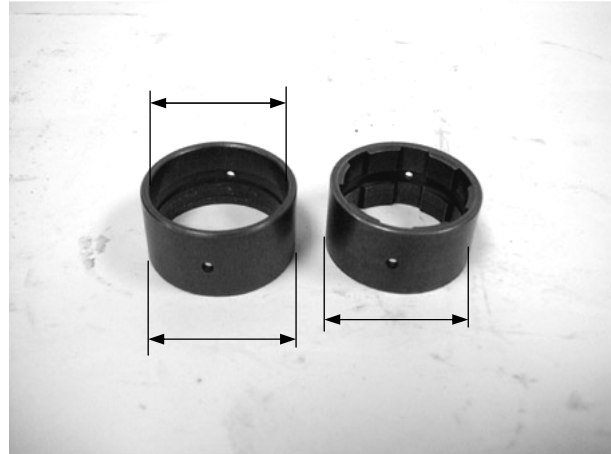

**MAIN SHAFT/COUNTERSHAFT INSPECTION**

Inspect the main shaft and countershaft for wear or damage.  
Measure the main shaft and countershaft O.D.

**Service Limits:**

**MAIN SHAFT:**

- 4th gear: 21.962mm replace if below
- 2nd/3rd/5th gear: 21.962mm replace if below

**COUNTERSHAFT:**

- 1st gear: 24.962mm replace if below
- 2nd gear: 24.962mm replace if below
- 3rd/ 4th/ 5th gear: 24.962mm replace if below

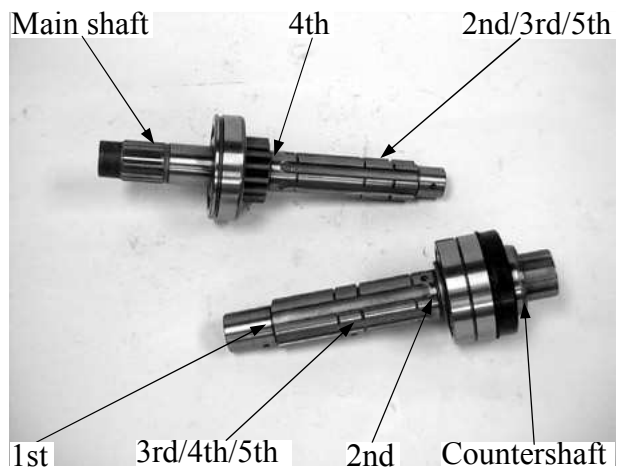

**BEARING INSPECTION**

Check the main shaft and countershaft bearings for smooth turning.  
Replace the bearings with new ones if they do not turn smoothly, quietly, or if they fit loosely in the case.

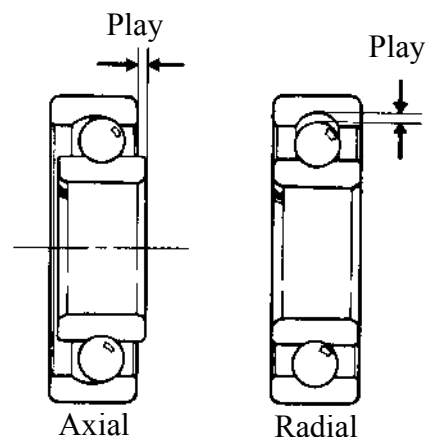

## BEARING REPLACEMENT

Remove the main shaft and countershaft bearings from the main shaft and countershaft using a bearing remover.

**Special**

Bearing Remover

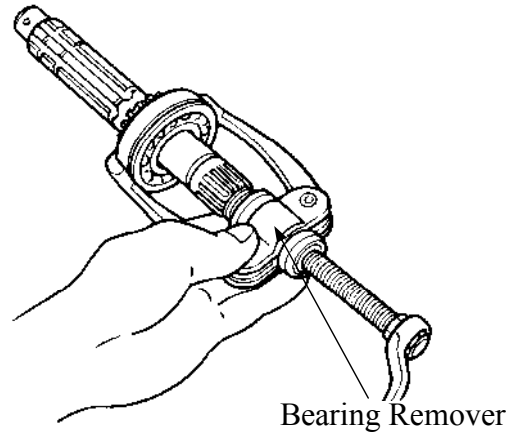

Drive the new bearing into the shaft using a bearing driver.

- \* • The flange of the oil seal should fix in the groove of the upper crankcase.
- Drive the bearing squarely.

**Special**

Bearing Remover

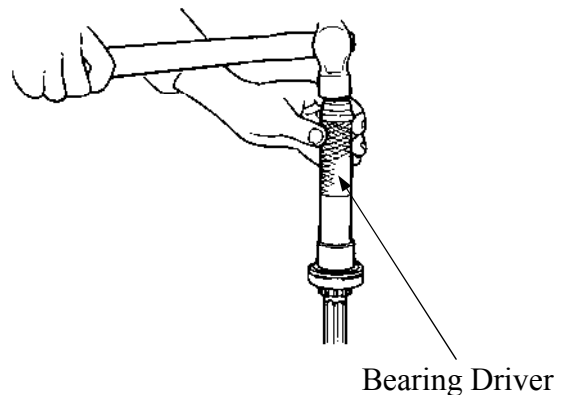

## MAIN SHAFT/COUNTERSHAFT INSTALLATION

Apply engine oil to the main shaft/countershaft before installation.

- \* • Confirm each gear for smooth drive.

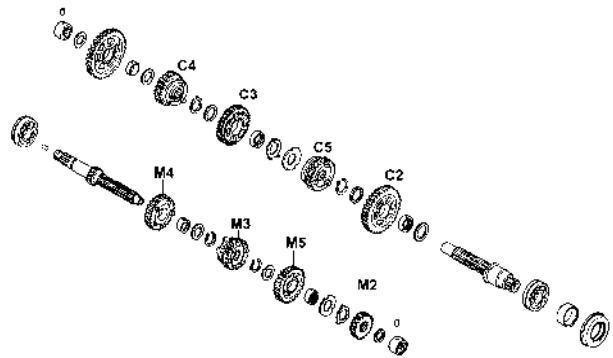

Align the hole on the collar with the hole on the each shaft.



## INSTALLATION

The installation sequence is the reverse of removal.

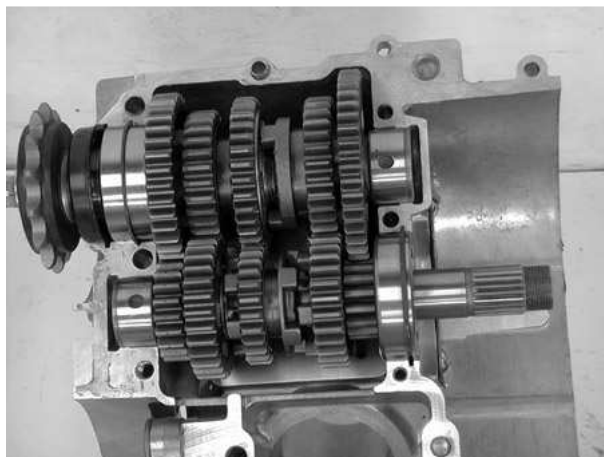

# 11. COOLING SYSTEM

## SCHEMATIC DRAWING

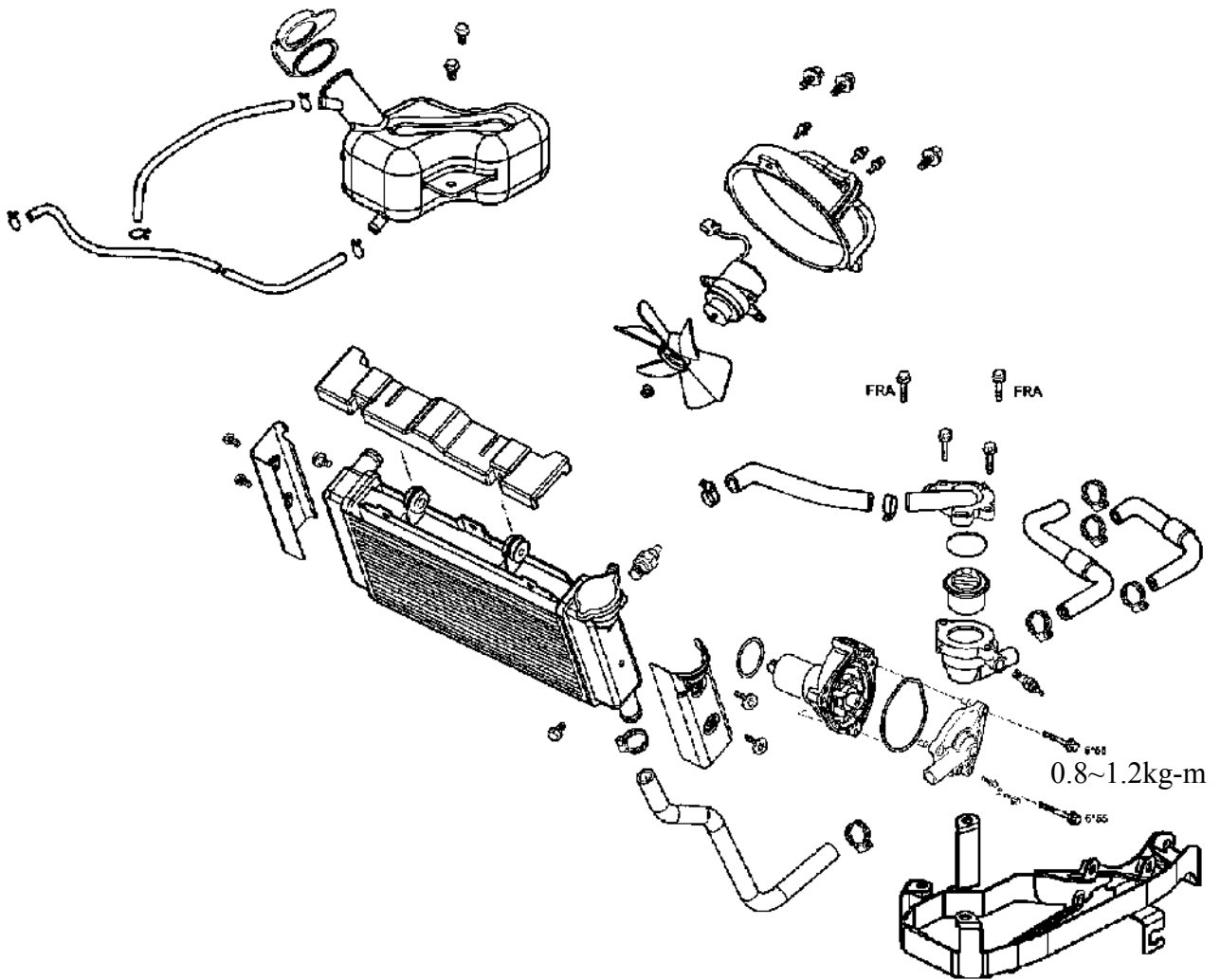

---

## COOLING SYSTEM

---

SERVICE INFORMATION-----	11- 2
TROUBLESHOOTING-----	11- 2
COOLING SYSTEM TESTING-----	11- 4
RADIATOR REMOVAL-----	11- 4
THERMOSTATIC SWITCH INSPECTMENT-----	11- 6
WATER PUMP-----	11- 7
THERMOSENSOR-----	11- 8
THERMOSTAT-----	11- 8

## SERVICE INFORMATION

### GENERAL INSTRUCTIONS

- The engine must be cool before servicing the cooling system.  
When the coolant temperature is over 100°C, never remove the radiator cap to release the pressure because the boiling coolant may cause danger.
- Avoid spilling coolant on painted surfaces because the coolant will corrode the painted surfaces.  
Wash off any spilled coolant with fresh water as soon as possible.
- After servicing the system, check for leaks with a cooling system tester.

### TORQUE VALUES

Water pump cover bolt	0.8~1.2 kg-m
Water bleeding bolt	0.8~1.2 kg-m

### TROUBLESHOOTING

#### Engine temperature too high

- Faulty temperature gauge or thermosensor
- Faulty radiator cap
- Faulty thermostat
- Insufficient coolant
- Passages blocked in hoses or water jacket
- Clogged radiator fins
- Passages blocked in radiator
- Faulty water pump

#### Temperature gauge pointer does not register the correct coolant temperature

- Faulty temperature gauge or thermosensor
- Faulty thermostat

#### Coolant leaks

- Faulty pump mechanical (water) seal
- Deteriorated O-rings
- Damaged or deteriorated water hoses

# 11. COOLING SYSTEM

## SPECIFICATIONS

Radiator cap relief pressure		0.9±0.15kg/cm <sup>2</sup>	
Thermostat temperature	Begins to open	80±2°C	
	Full-open	90°C	
	Valve lift	3.5~4.5mm	
Coolant capacity		Total system 1030cc	Radiator: 560cc Reserve tank: 240cc

## COOLANT GRAVITY

Temp. °C \ Coolant concentration	0	5	10	15	20	25	30	35	40	45	50
5%	1.009	1.009	1.008	1.008	1.007	1.006	1.005	1.003	1.001	0.009	0.997
10%	1.018	1.107	1.017	1.016	1.015	1.014	0.013	1.011	1.009	1.007	1.005
15%	1.028	1.027	1.026	1.025	1.024	1.022	1.020	1.018	1.016	1.014	1.012
20%	1.036	1.035	1.034	1.033	1.031	1.029	1.027	1.025	1.023	1.021	1.019
25%	1.045	1.044	1.043	1.042	1.040	1.038	1.036	1.034	1.031	1.028	1.025
30%	1.053	1.051	1.051	1.049	1.047	1.045	1.043	1.041	1.038	1.035	1.032
35%	1.063	1.062	1.060	1.058	1.056	1.054	1.052	1.049	1.046	1.043	1.040
40%	1.072	1.070	1.068	1.066	1.064	1.062	1.059	1.056	1.053	1.050	1.047
45%	1.080	1.078	1.076	1.074	1.072	1.069	1.056	1.063	1.062	1.057	1.054
50%	1.086	1.084	1.082	1.080	1.077	1.074	1.071	1.068	1.065	1.062	1.059
55%	1.095	1.093	1.091	1.088	1.085	1.082	1.079	1.076	1.073	1.070	1.067
60%	1.100	1.098	1.095	1.092	1.089	1.086	1.083	1.080	1.077	1.074	1.071

### Cautions for Using Coolant:

- Do not mix coolant concentrate of different brands.
- Do not drink the coolant which is poisonous.



# 11. COOLING SYSTEM

## COOLING SYSTEM TESTING

### RADIATOR CAP INSPECTION

Install the radiator cap onto the radiator tester and apply specified pressure to it. It must hold specified pressure for at least six seconds.

- \* Apply water to the cap sealing surface before testing.

### Radiator Cap Relief Pressure:

0.9±0.15kg/cm<sup>2</sup>

Check the water hoses and connectors for leaks.

- \* The test pressure should not exceed 1.05 kg/cm<sup>2</sup>. Excessive pressure can damage the radiator and its hose

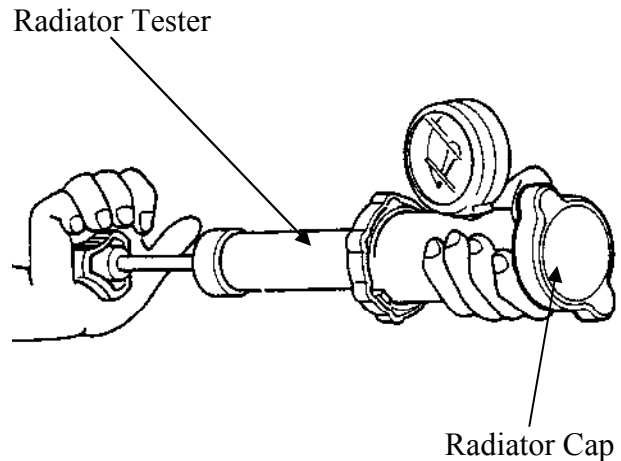

Inspect the radiator soldered joints and seams for leaks.  
Blow dirt out from between core fins with compressed air. If insects, etc., are clogging the radiator, wash them off. Carefully straighten any bent fins.



### RADIATOR REMOVAL

Drain the coolant.  
Remove the overflow tube clamp and disconnect the overflow tube.  
Loosen the hose band and disconnect the lower hose from the radiator.

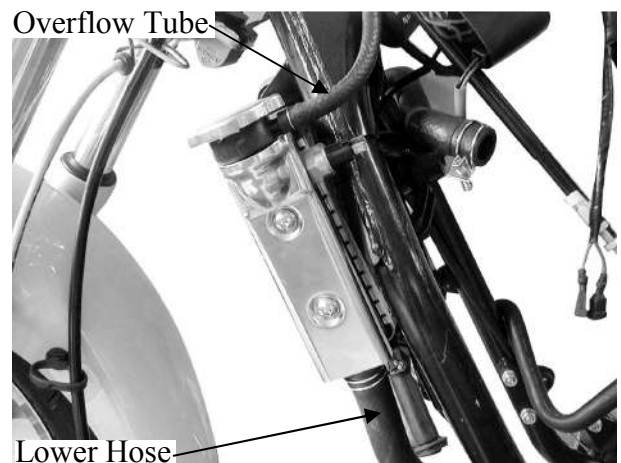

## 11. COOLING SYSTEM

Loosen the hose band and disconnect the upper hose from the radiator.



Disconnect the thermostatic switch wire coupler.  
Disconnect the fan motor wire coupler.

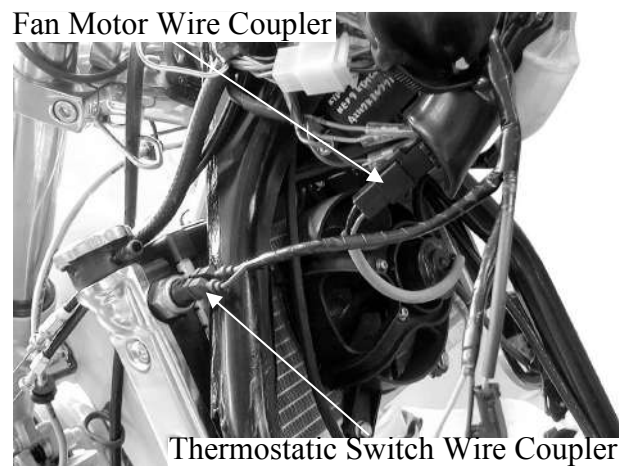

Remove the two bolts on the radiator.



### RADIATOR DISASSEMBLY

Remove the three bolts and then remove the fan/shroud from the radiator.

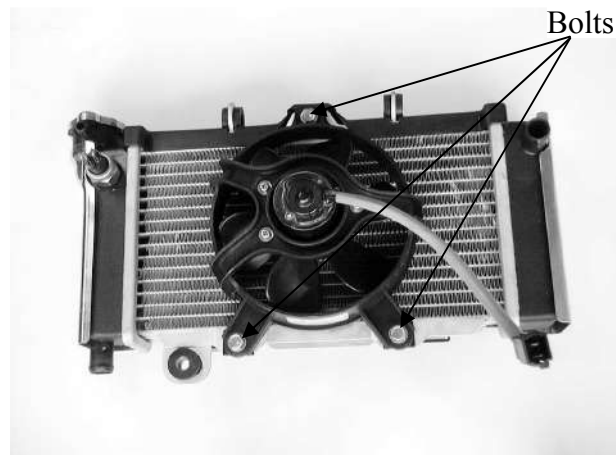

# 11. COOLING SYSTEM

## FAN MOTOR INSPECTMENT

Check fan motor by battery.



## THERMOSTATIC SWITCH INSPECTMENT

When coolant temperature lower then  $90\pm 2$  °C the thermostatic switch OFF.  
When coolant temperature over  $90\pm 2$  °C the thermostatic switch ON.



## RADIATOR INSTALLATION

The installation sequence is the reverse of removal.



Connect the overflow tube and secure with the tube clamp.  
Connect the air vent tube to the radiator filler.  
Fill the radiator with coolant.  
After installation, check for coolant leaks.

\*

- If you want to refill the coolant, the following procedure must be checked.
1. Then start the engine, filled in the coolant till the coolant flowed out from the air vent tube.
  2. Check if no bubble in the radiator filler.
  3. Put the bypass tube on.

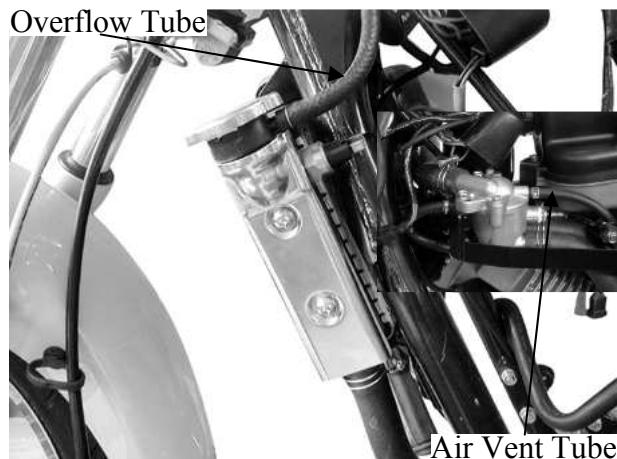

# 11. COOLING SYSTEM

## WATER PUMP

### MECHANICAL SEAL (WATER SEAL) INSPECTION

Inspect the telltale hole for signs of mechanical seal coolant leakage. If the mechanical seal is leaking, remove the water pump.

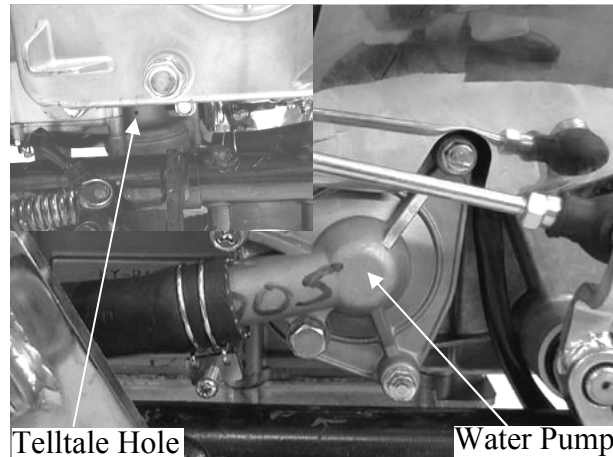

### WATER PUMP REMOVAL

Remove the coolant inlet hose and outlet cupreous iron pipe.

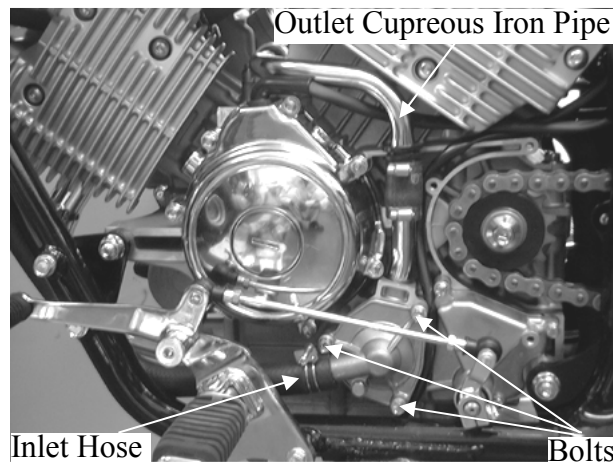

Remove the three bolts and the water pump cover, gasket and two dowel pins.

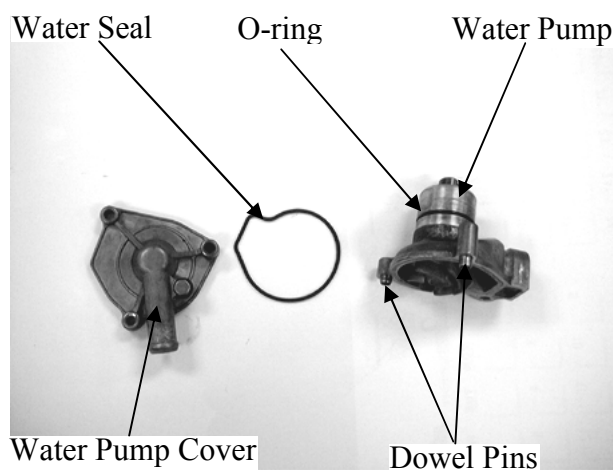

### WATER PUMP INSTALLATION

Install the dowel pins and a new gasket and then install the water pump assembly into the lower crankcase. Tighten the three bolts to secure the water pump assembly.

\* When installing the water pump assembly, aligning the groove on the water pump shaft with the tab on the oil pump shaft.

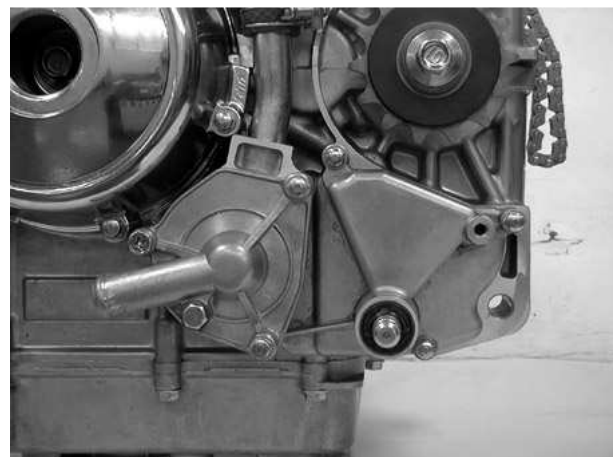

# 11. COOLING SYSTEM

## THERMOSENSOR

### THERMOSENSOR REMOVAL

Remove the seat, fuel tank and left/right side cover.  
 Drain the coolant.  
 Disconnect the thermosensor wire.  
 Remove the thermosensor.

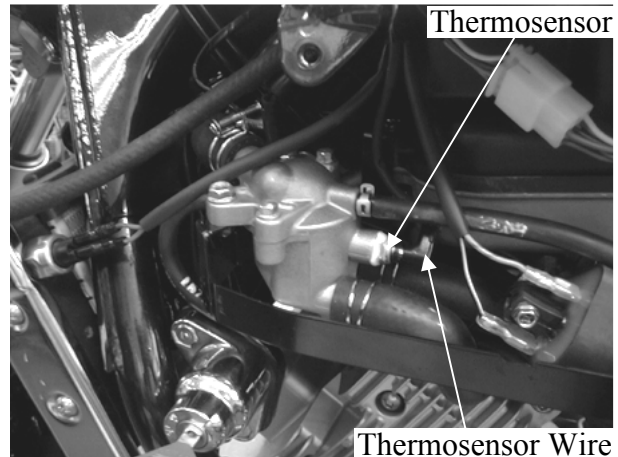

### THERMOSENSOR INSPECTION

Suspend the thermosensor in a pan of water over a burner and measure the resistance through the sensor as the water heats up.

Temperature(°C)	50	80	100	120
Resistance(Ω)	154	52	27	16

So the temperature is higher, the resistance is lower.

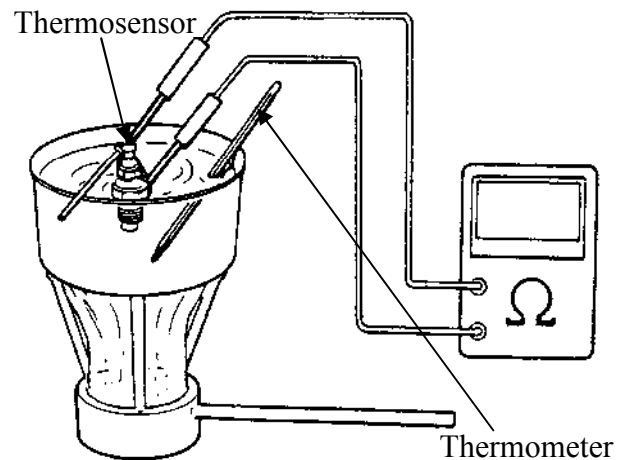

### THERMOSENSOR INSTALLATION

Apply 3-BOND No. 1212 sealant or equivalent to the thermosensor threads and install it into the thermostat housing.  
 Connect the thermosensor wire.  
 Fill the radiator with coolant.

\* Be sure to bleed air from the cooling system.

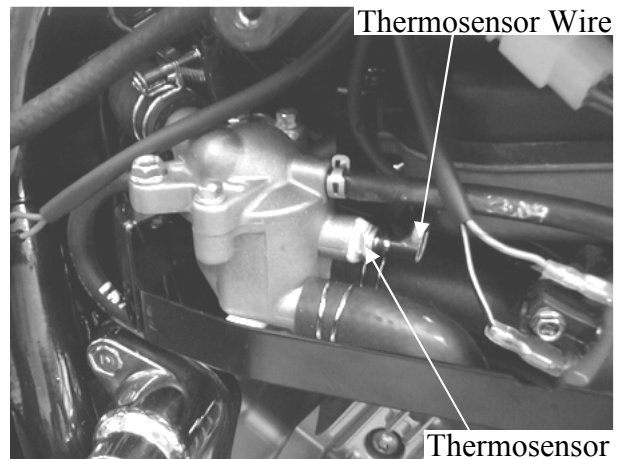

## THERMOSTAT

### THERMOSTAT REMOVAL

Drain the coolant.  
 Disconnect the thermosensor wire from the thermosensor.  
 Disconnect the water hose from the thermostat housing.  
 Disconnect the air vent tube from the thermostat housing.  
 Remove the two mounting bolts and the thermostat housing.

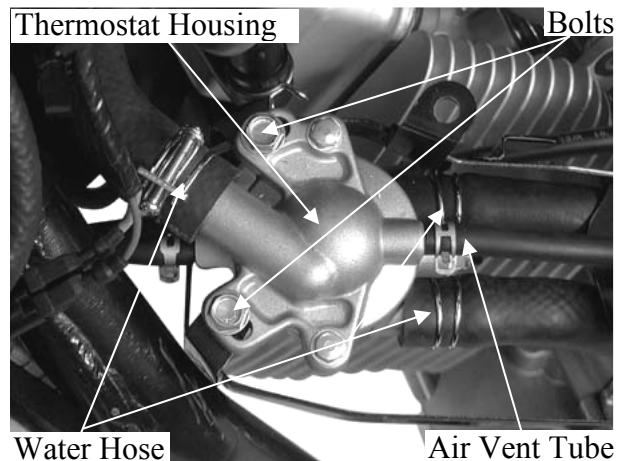

# 11. COOLING SYSTEM

Remove the two bolts and separate the thermostat housing halves.

**Torgue:** 0.8~1.2 kg-m

Remove the thermostat from the thermostat housing.

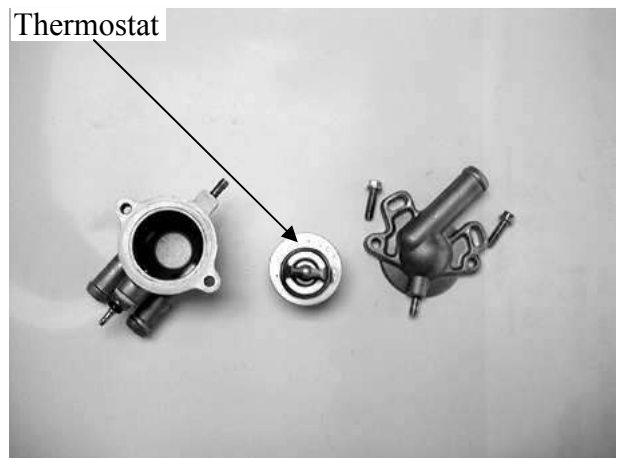
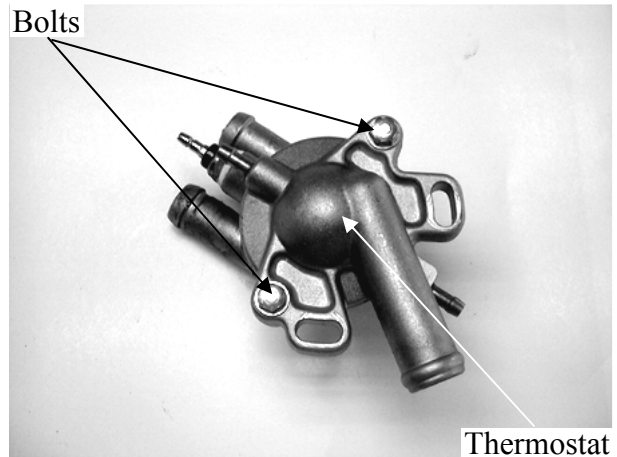

## THERMOSTAT INSPECTION

Suspend the thermostat in a pan of water over a burner and gradually raise the water temperature to check its operation.

### Technical Data

Begins to open	80±2°C
Full-open	90°C
Valve lift	3.5~4.5mm

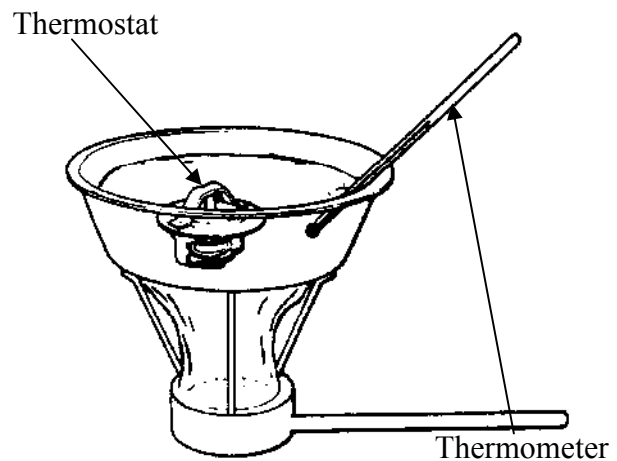

- \* Do not let the thermostat touch the pan as it will give a false reading.
- Replace the thermostat if the valve stays open at room temperature.
  - Test the thermostat after it is opened for about 5 minutes and holds the temperature at 70°C.



## 11. COOLING SYSTEM

### THERMOSTAT INSTALLATION

The installation sequence is the reverse of removal.

- \* Replace the O-ring with a new one and apply sealant to it.

Fill the radiator system with the specified coolant.

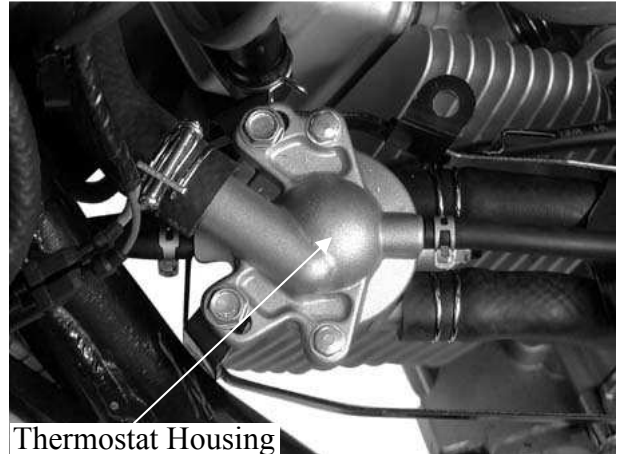

Thermostat Housing

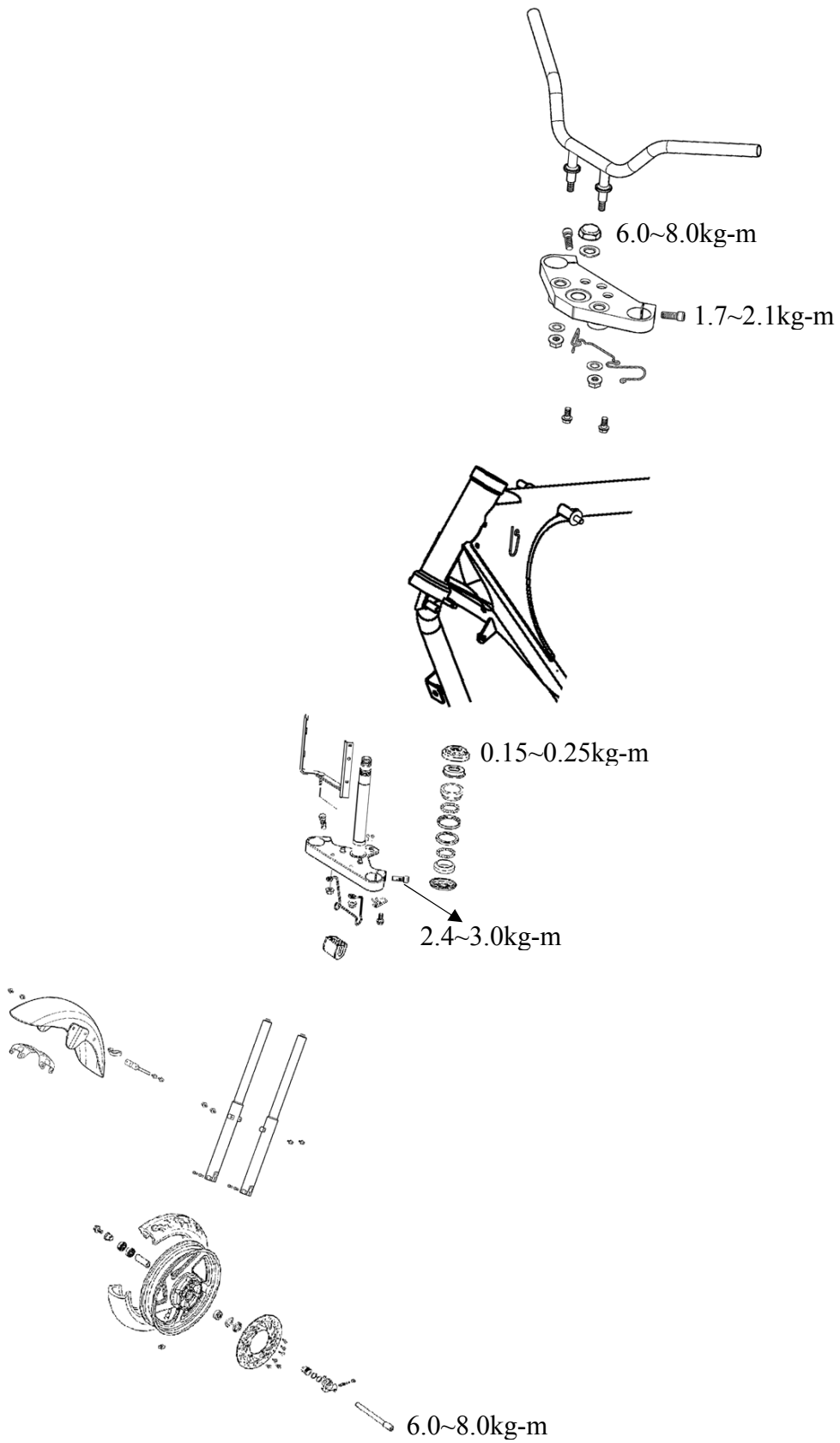



---

---

---

---

---

---

---

---

**FRONT WHEEL/SUSPENSION/STEERING**

**12**

SERVICE INFORMATION ..... 12- 2

TROUBLESHOOTING ..... 12- 3

HANDLEBAR..... 12- 4

FRONT WHEEL ..... 12- 6

FRONT FORK ..... 12-10

STEERING STEM ..... 12-11

## SERVICE INFORMATION

### GENERAL INSTRUCTIONS

### SPECIFICATIONS

Item		Standard (mm)	Service Limit (mm)
Front axle shaft runout		—	0.2
Front wheel rim runout	Axial	—	2.0
	Radial	—	2.0
Front fork spring free length		334.5	—
Front fork tube runout		—	0.2
Front fork oil capacity		400cc/SAE10W	—

### SPECIAL TOOLS

Steering stem wrench

Bearing driver handle

Bearing outer driver, 37x40mm

Lock nut wrench

## TROUBLESHOOTING

### Hard steering

- Insufficient tire pressure
- Excessively tightened steering stem nut
- Damaged steering stem bearings
- Damaged steering stem bearing races

### Steers to one side or does not track straight

- Uneven front shock absorbers
- Bent front fork
- Bent front axle or uneven tire

### Front wheel wobbling

- Improperly tightened axle nut
- Bent rim
- Worn front wheel bearing
- Faulty tire

### Soft suspension

- Weak fork springs
- Insufficient front fork oil

### Hard suspension

- Incorrect front fork oil level
- Bent front fork tube
- Clogged front fork oil passages

### Front suspension noise

- Slider bending
- Loose front fork fasteners
- Insufficient front fork oil
- Worn front fork bearing
- Insufficient speedometer gear grease

## HANDLEBAR

### REMOVAL

Remove two screws attaching the throttle housing and the throttle housing.

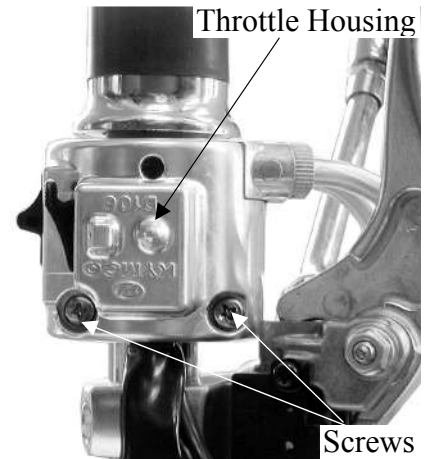

Disconnect the throttle cable from the throttle grip and then remove the throttle pipe from the handlebar.

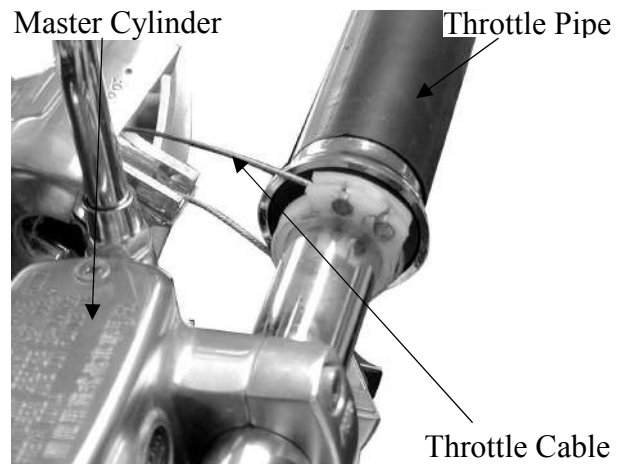

Remove the two master cylinder holder bolts and the master cylinder.



Remove the two left handlebar switch housing screws and the housing. Remove the two clutch lever holder bolts and the clutch lever holder.



Remove the four upper fork bridge bolts to remove the handlebar.

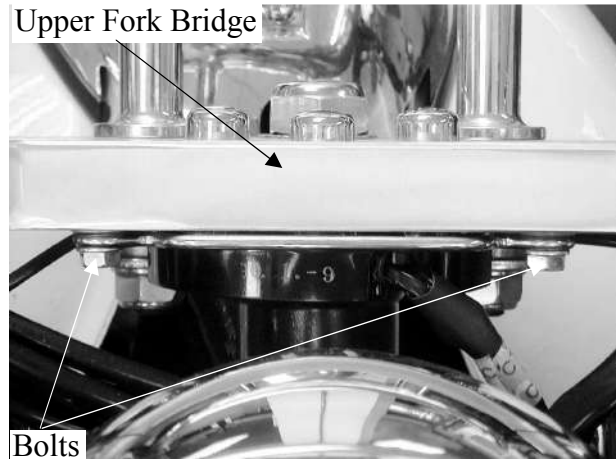

## INSTALLATION

Place the handlebar on the upper fork bridge seat.

Install the upper fork bridge set plates onto the handlebar. First tighten the front bolts and then the rear bolts.

**Torque:** 1.7~2.1kg-m

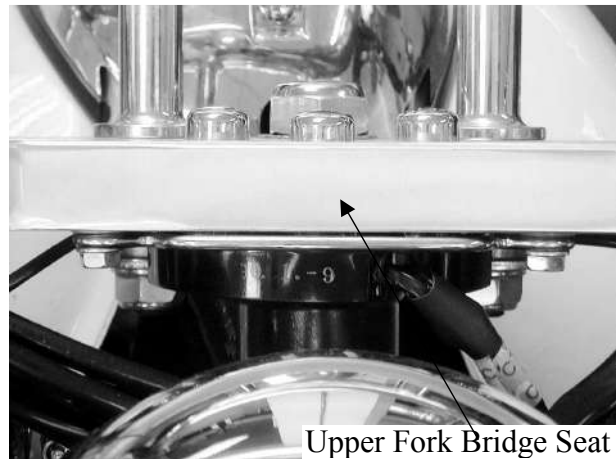

When installing the right and left handlebar switch housings. Tighten the two switch housing screws.



When installing the master cylinder and clutch lever holders, align the tab on the holder with the hole in the handlebar with the holder "UP" mark facing up. First tighten the upper bolt and then the lower bolt.



## THROTTLE PIPE INSTALLATION

Clean the handlebar surface and install the throttle pipe. Check the throttle grip for proper operation.



Connect the throttle cable to the throttle grip. Apply grease to the throttle cable. Install the throttle housing by aligning the pin on the housing with the punch hole in the handlebar. Then, tighten the two screws.

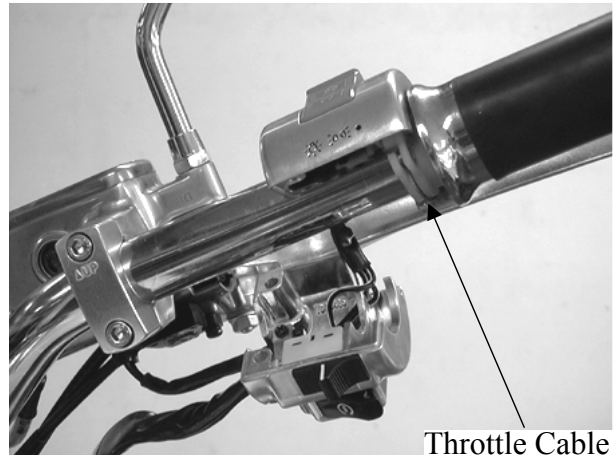

## FRONT WHEEL

### REMOVAL

Place a jack or other adjustable support under the engine to raise the front wheel off the ground. Remove the speedometer cable set screw and disconnect the speedometer cable.

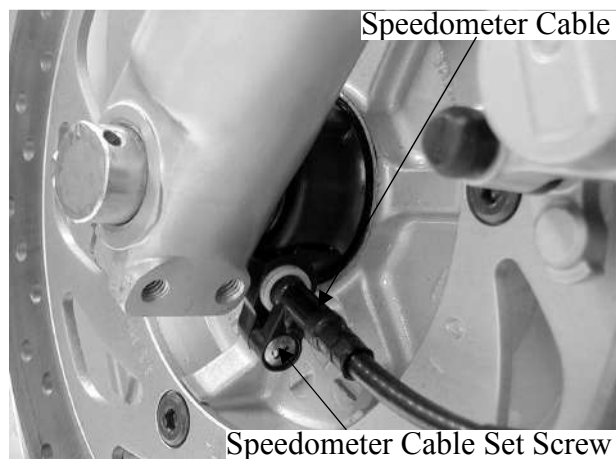

Remove the four bolts from the right and left front fork. Remove the front axle bolt and pull out the axle. Remove the front wheel.

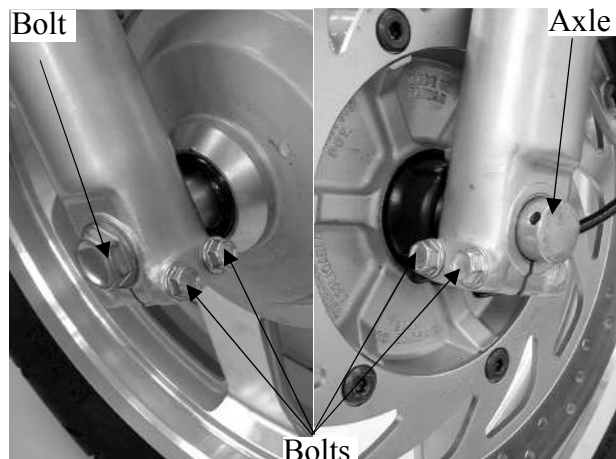

## 12. FRONT WHEEL/SUSPENSION/STEERING

### INSPECTION

Set the axle in V blocks and measure the runout.

**Service Limit:** 0.2mm replace if over

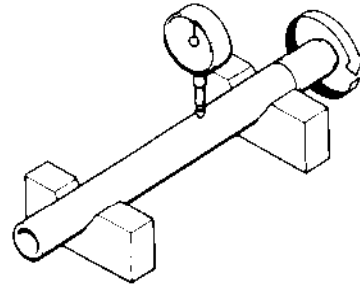

### WHEEL RIM INSPECTION

Place the front wheel in a turning stand. Spin the wheel by hand and measure the rim runout by using a dial gauge.

**Service Limits:**

**Axial** : 2.0mm replace if over

**Radial** : 2.0mm replace if over

Check the wheel spoke wires for looseness. If the wheel rim is made of aluminum alloy, replace with a new one if necessary.

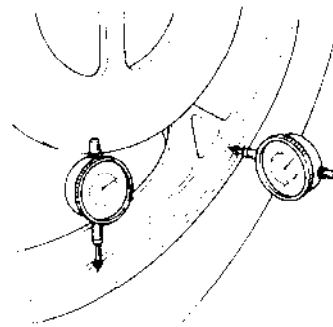

Check the wheel bearing play by placing the wheel in a turning stand and spinning the wheel by hand.

Replace the bearings with new ones if they are noisy or have excessive play.

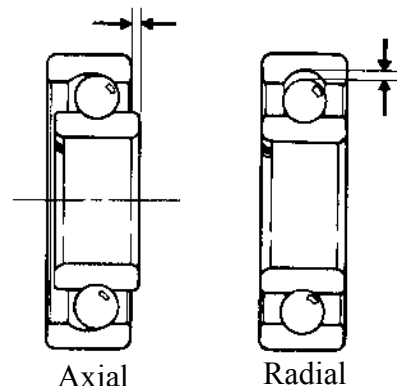

### DISASSEMBLY

Remove the speedometer gearbox and dust seal from the left side of the wheel.



## 12. FRONT WHEEL/SUSPENSION/STEERING

Remove the axle collar and dust seal from the right side of the wheel.

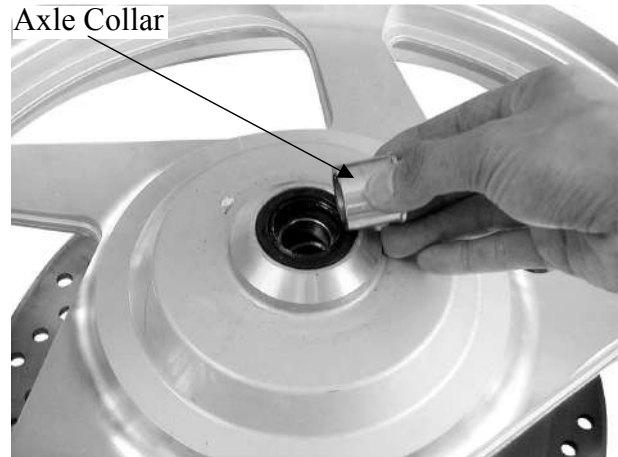

Remove the dust seal.  
Remove the six bolts and the brake disk.

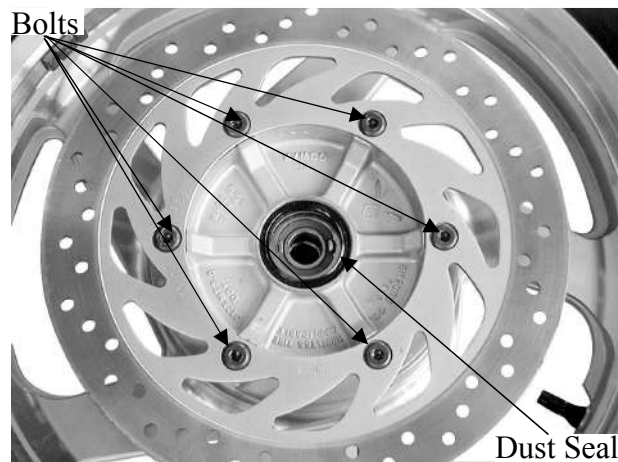

Drive out the wheel bearings and distance collar.

**Special**

Bearing remover

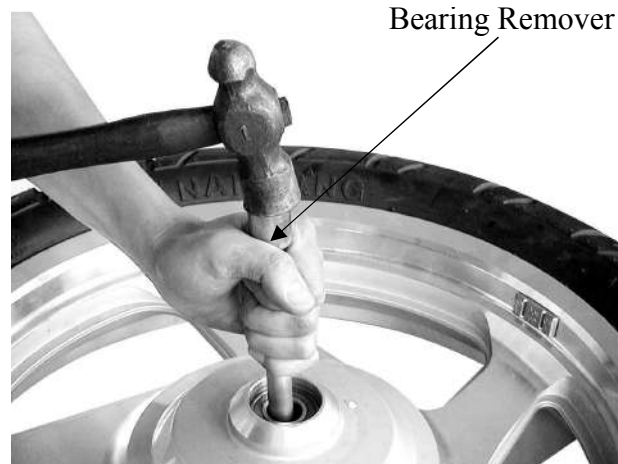

### ASSEMBLY

Pack all bearing cavities with grease. First drive in the right bearing and then install the distance collar. Finally, drive in the left bearing.

**Special**

Bearing driver handle  
Attachment, 37x40mm

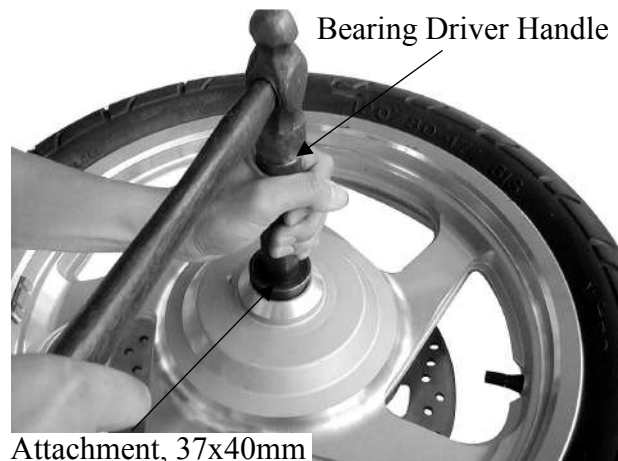



# 12. FRONT WHEEL/SUSPENSION/STEERING **VENOX 250**

Install the brake disk and tighten the six bolts.  
Apply grease to the dust seal and install it.

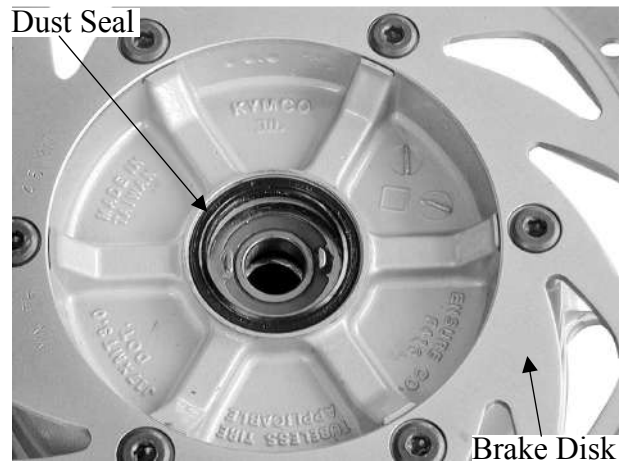

Install the speedometer gearbox by aligning the tabs with the grooves.

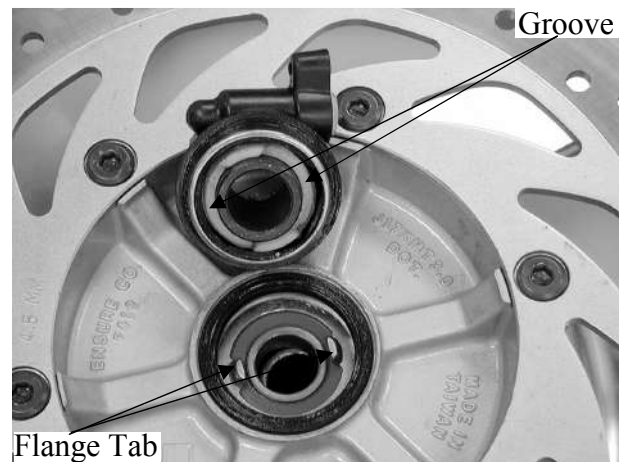

Apply grease to the speedometer gearbox and dust seal, then install them to the wheel from the left side.



Install the axle collar to the right side of the wheel.

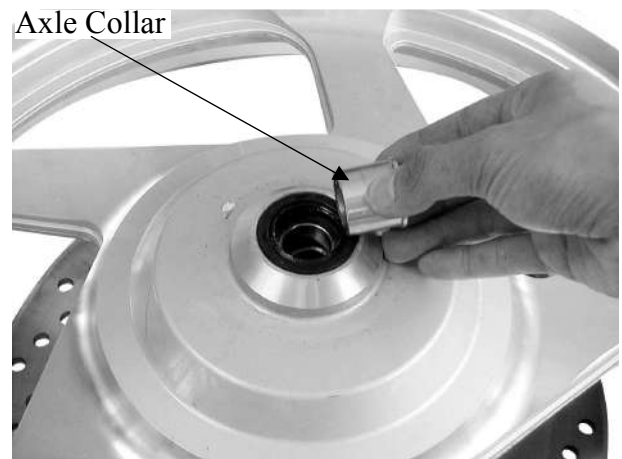

## INSTALLATION

Install the front wheel onto the front fork, aligning the tab on the front fork with the groove in the speedometer gearbox.

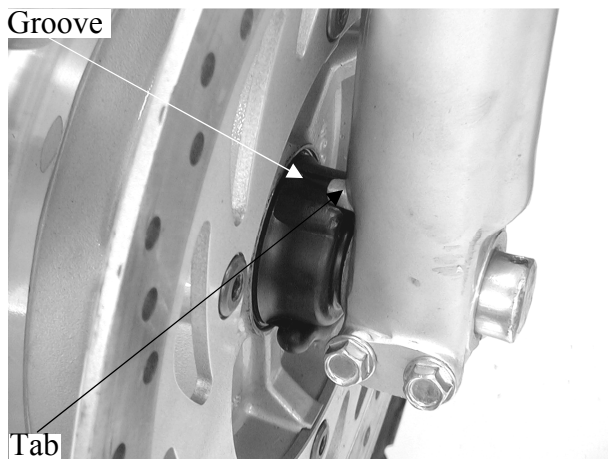

Insert the axle shaft and tighten the axle nut.

**Torque:** 6.0~8.0kg-m

Connect the speedometer cable and secure it with the screw.

\* Install the speedometer cable by aligning the groove with the tab.

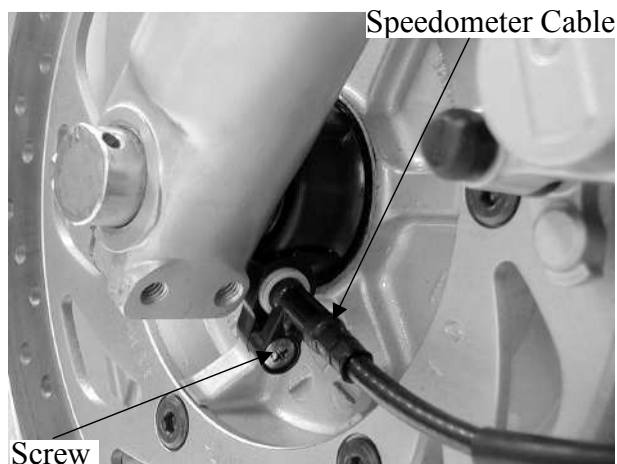

## FRONT FORK

### REMOVAL

Remove the front wheel.

Remove the four front fender bolts and the front fender.

Remove the front brake caliper.

Loosen the upper and lower fork bridge bolts and the bolts attaching the front right and left turn signal lights.

Remove the right and left front forks.



### DISASSEMBLY

Remove the four front fender bolts.

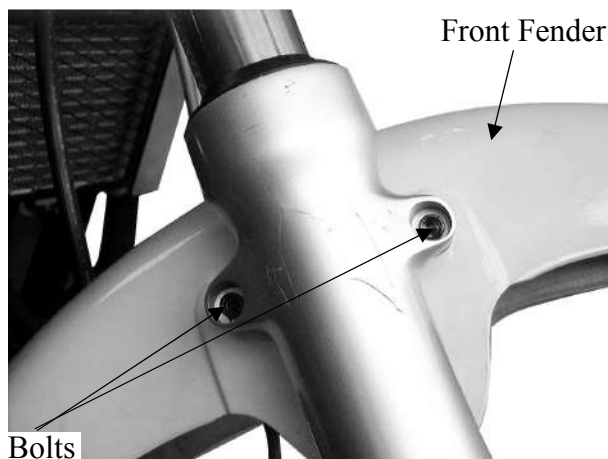

## 12. FRONT WHEEL/SUSPENSION/STEERING

Remove the two bolts attaching the brake caliper holder.

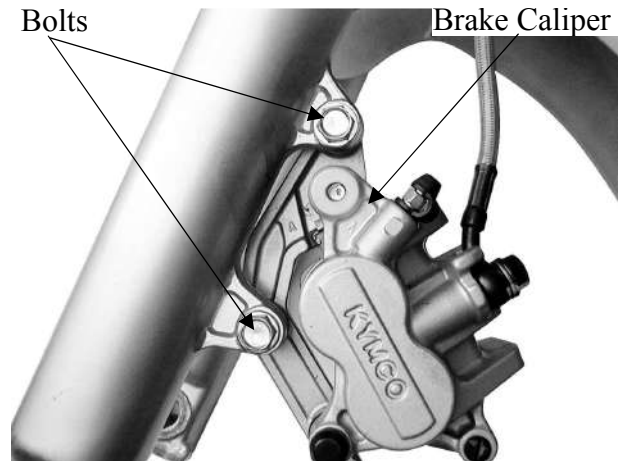

Remove the two headlight holder screws. Remove the upper fork bridge mount bolt. Remove the turn signal light holder screw. Remove the lower fork bridge mount bolt and then remove the right and left front forks.

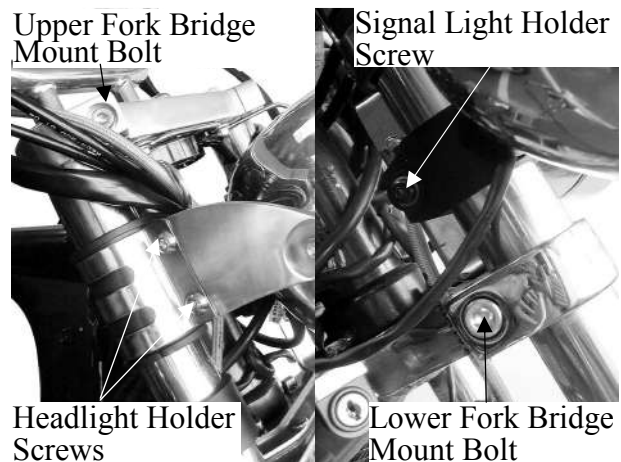

### INSTALLATION

The installation sequence is the reverse of removal.

### STEERING STEM

#### REMOVAL

Remove the handlebar. Remove the front fork tubes. Remove the steering stem nut by using the lock nut wrench.

**Special**

Lock nut wrench

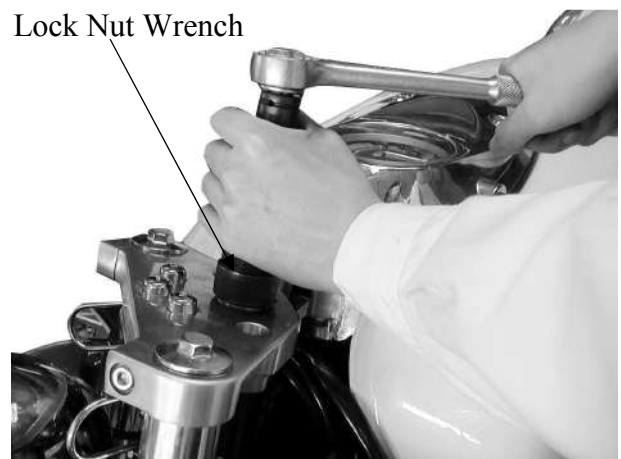

Remove the steering head top nut, top cone race, steering stem and steel balls.

**Special**

Steering stem wrench



## BOTTOM CONE RACE REPLACEMENT

Drive out the bottom cone race.  
Drive in a new bottom cone race onto the steering stem.



Bottom Cone Race

## STEERING STEM INSTALLATION

Apply grease to the top and bottom ball races and steel balls.  
Install the steering stem into the steering head pipe and then install the top cone race and the steering head nut.

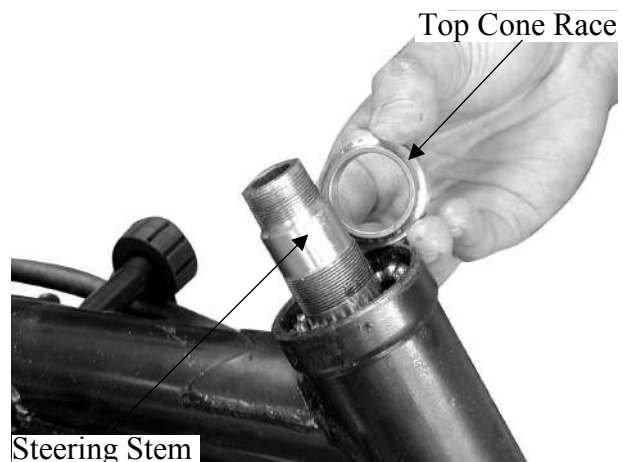

Top Cone Race

Steering Stem

Tighten the steering head nut until it seats against the top cone race, then turn it back 1/4 turn.

\* Check that the steering stem rotates freely and that there is no vertical play.

### Special

Steering stem wrench

**Torque:** 0.15~0.25kg-m



Steering Stem Wrench

Install the front fork.  
Install the upper fork bridge and steering stem nut.  
Tighten the steering stem nut.

**Torque:** 6.0~8.0kg-m

Properly adjust the installed front fork.

### Special

Lock nut wrench



Lock Nut Wrench

# 13. REAR WHEEL/BRAKE/SUSPENSION

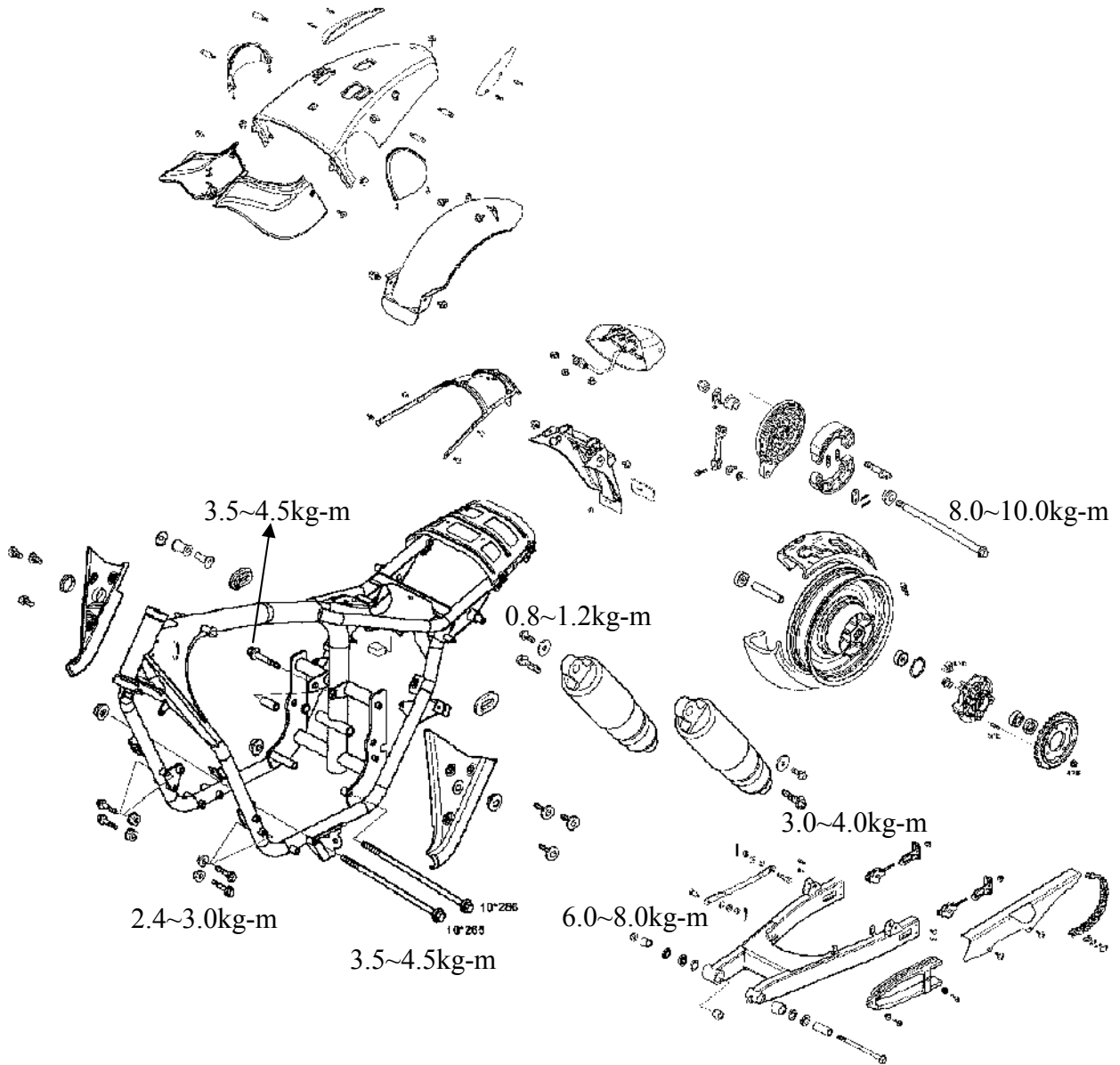

---

---

---

---

---

---

---

---

## REAR WHEEL/BRAKE/SUSPENSION

---

SERVICE INFORMATION .....	13- 2
TROUBLESHOOTING .....	13- 3
REAR WHEEL.....	13- 4
REAR BRAKE .....	13- 6
REAR SHOCK ABSORBER.....	13- 9
REAR FORK.....	13- 9
REAR Fender .....	13-10

## SERVICE INFORMATION

### GENERAL INSTRUCTIONS

- When installing the drive chain joint clip, the cutout of the clip should be opposite to the rotating direction.
- After the drive chain is adjusted, make sure that the rear brake pedal free play is normal and adjust it if necessary.

### SPECIFICATIONS

Item	Standard (mm)	Service Limit (mm)
Rear axle shaft runout	—	0.2
Rear rim runout	Axial	2.0
	Radial	2.0
Rear brake drum I.D.	160.05~160.3	161.3
Rear brake lining thickness	5.0	2.0
Rear shock absorber spring free length	194.8	—
Rear fork oil capacity	90cc/SAE5W	—

### SPECIAL TOOLS

Bearing remover

Bearing driver HANDLE

## TROUBLESHOOTING

### Rear wheel wobbling

- Bent rim
- Worn rear wheel bearing
- Loose or broken wheel spoke wires
- Faulty tire
- Improperly tightened axle nut
- Loose rear fork pivot nut

### Soft suspension

- Weak shock absorber spring
- Improperly adjusted shock absorber
- Damper oil leaks

### Hard suspension

- Improperly adjusted shock absorber

### Rear suspension noise

- Bent rear shock absorber
- Loose shock absorber fasteners
- Insufficient damper oil

### Poor brake performance

- Improperly adjusted brake
- Worn brake linings
- Contaminated or damaged brake linings
- Worn brake cam
- Worn brake drum
- Improperly installed brake linings
- Worn brake shoes at cam contacting area
- Worn camshaft



# 13. REAR WHEEL/BRAKE/SUSPENSION

## REAR WHEEL

### REMOVAL

Remove the rear axle nut.  
Remove the rear brake adjusting nut.

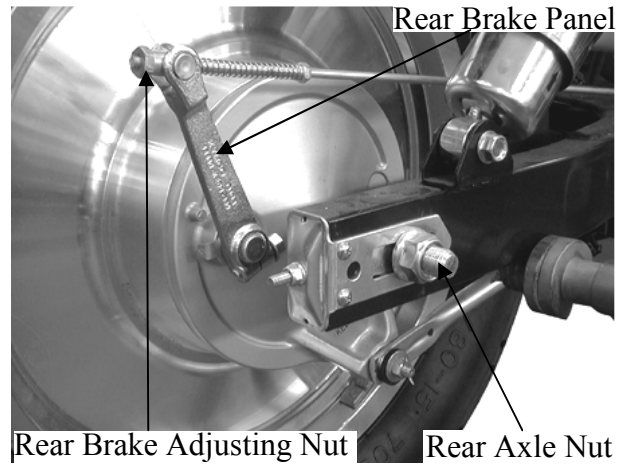

Remove the rear brake panel fixing arm bolt.  
Remove the bushing.  
Remove the rear brake panel.  
Loose both of the chain adjuster nut.  
Push the rear wheel forward.  
Disconnect the drive chain.  
Remove the rear wheel.

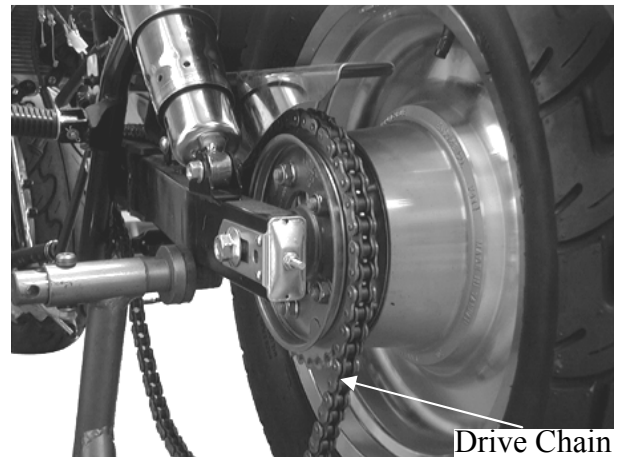

### INSPECTION

Set the rear axle in V blocks and measure the runout with a dial gauge.

**Service Limit:** 0.2mm

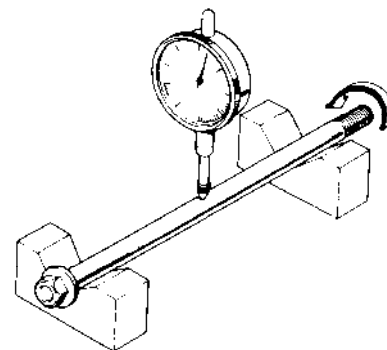

Place the rear wheel in a turning stand and measure the rim runout.

**Service Limits:**

**Axial:** 2.0mm replace if over

**Radial:** 2.0mm replace if over

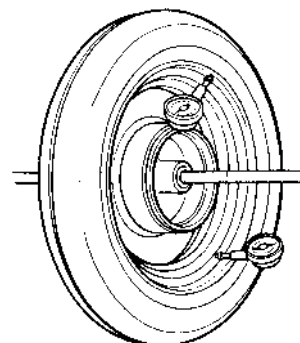

# 13. REAR WHEEL/BRAKE/SUSPENSION

Check the wheel bearing play by placing the wheel in a turning stand and spinning the wheel by hand.

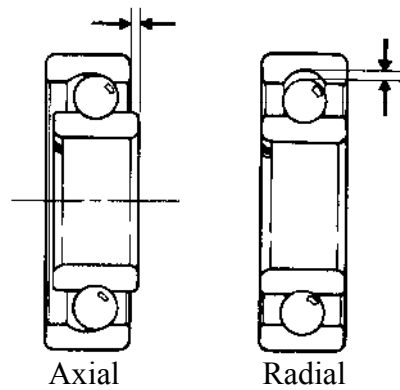

Check the drive chain gear teeth for wear or damage.  
Replace the drive chain gear if necessary.

\* If the drive chain gear teeth are worn or damaged, also check the drive chain and replace if necessary.



## DISASSEMBLY

Remove the side collar and dust seal from the left side of the rear wheel.  
Remove the five drive chain gear lock nuts.  
Remove the drive chain gear.  
Check the damping bushings for damage.

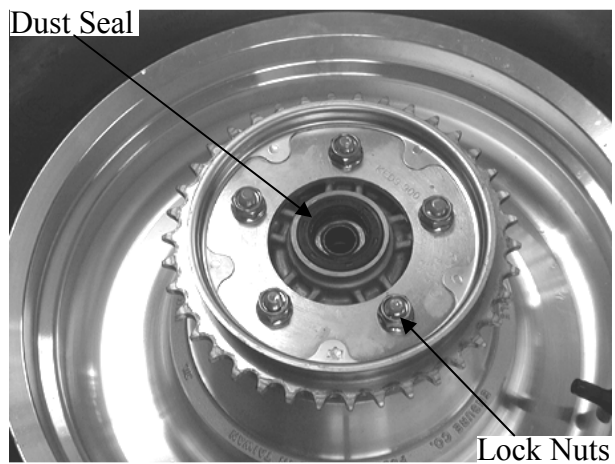

Drive out the wheel bearings and remove the distance collar by using a bearing remover.

**Special**

Bearing remover



# 13. REAR WHEEL/BRAKE/SUSPENSION

## ASSEMBLY

Pack all bearing cavities with grease.  
Drive in the left bearing.  
Install the distance collar.  
Drive in the right bearing.

- \* Drive in the bearings squarely.
- \* Install the bearings with the sealed end facing out.

### Special

Bearing driver handle  
Attachment, 37×40mm



Install the drive chain gear.  
Apply grease to the dust seal and install it to the bearing.  
Install the side collar.



## INSTALLATION

Install the rear wheel in the reverse order of removal.

**Drive Chain Slack:** 10~20mm

- \* After rear wheel installation, be sure to adjust the drive chain slack and rear brake pedal free play.

**Torque:** 8.0~10.0kg-m

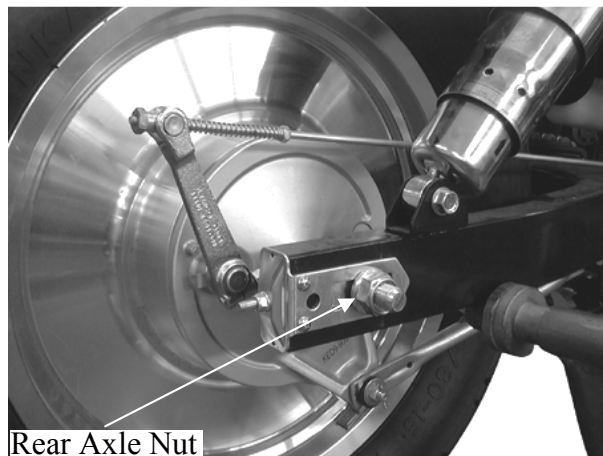

## REAR BRAKE

### REMOVAL

Remove the rear wheel and rear brake panel.

### INSPECTION

Measure the rear brake lining thickness.

**Service Limit:** 2.0mm replace if below



# 13. REAR WHEEL/BRAKE/SUSPENSION

Measure the brake drum I.D.

**Service Limit:** 161.3mm replace if over

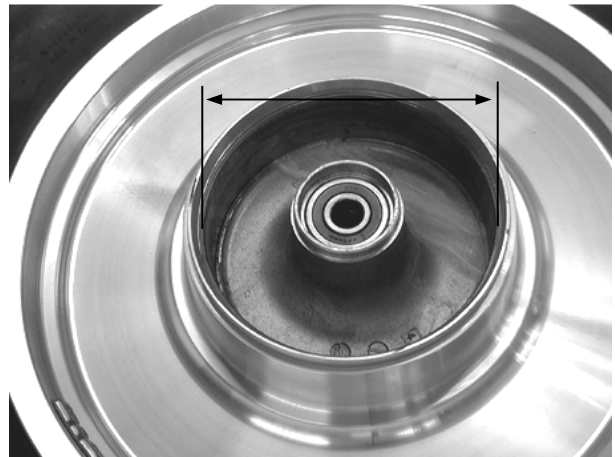

## DISASSEMBLY

Remove the springs and brake shoes.

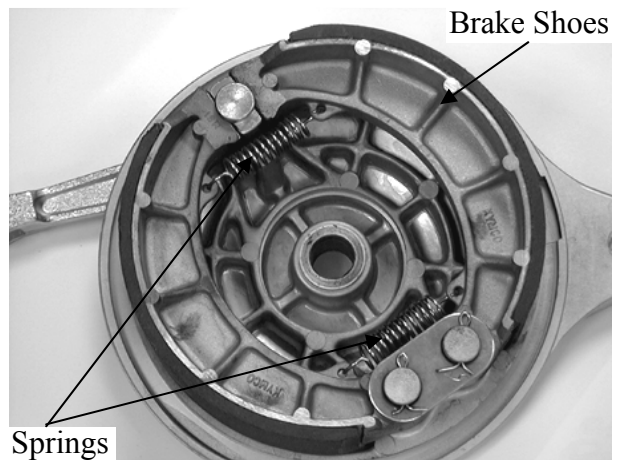

Remove the brake arm bolt to remove the brake arm.  
Remove the dust seal.  
Remove the brake cam.

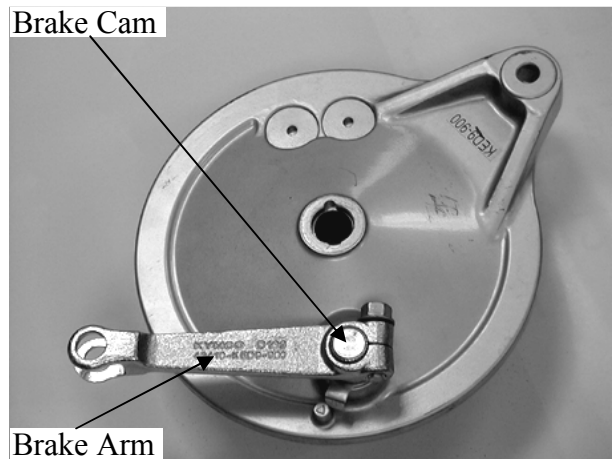

## ASSEMBLY

\*

- Keep grease off the linings because contaminated brake linings reduce stopping power.
- During installation, wipe any excess grease off the brake cam.

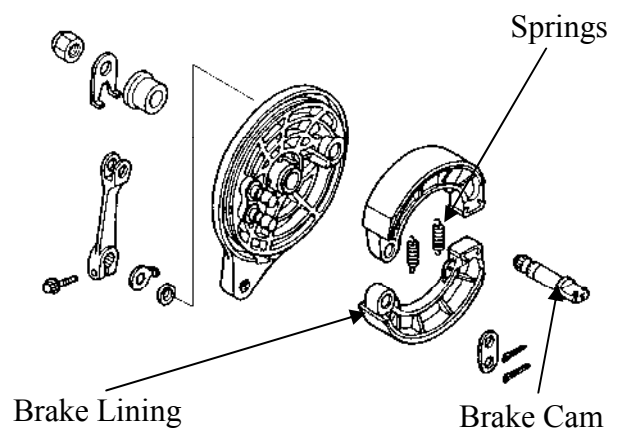

# 13. REAR WHEEL/BRAKE/SUSPENSION

Apply grease to the brake cam and anchor pin, then install the brake cam to the brake panel.

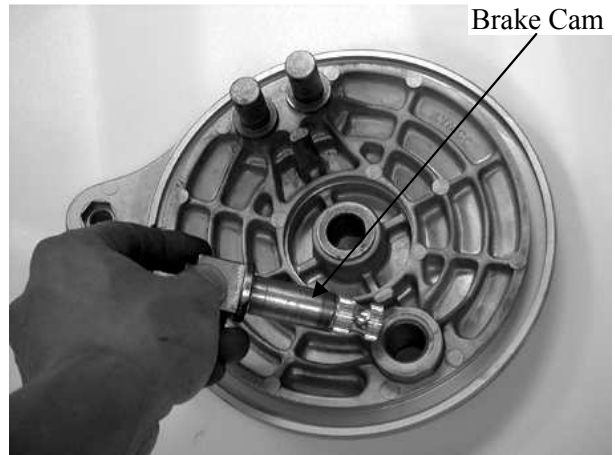

Apply engine oil to the dust seal and install it to the brake cam. Install the wear indicator plate on the brake cam, aligning the mark on the plate with the groove on the brake cam.

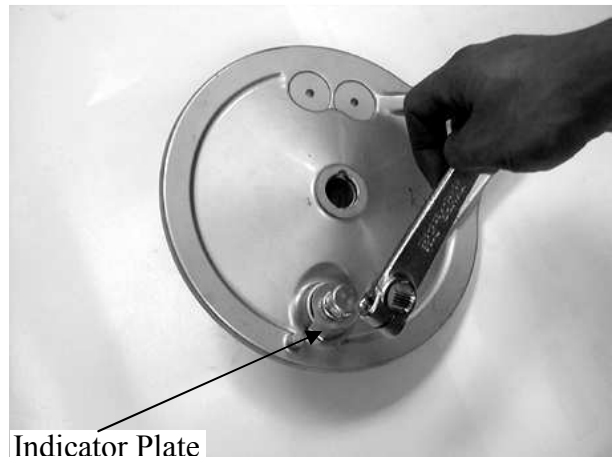

Install the brake arm onto the brake cam, aligning the punch mark on the cam with the scribed line on the arm. Install and tighten the brake arm bolt. **Torque: 0.8~1.2kg-m**



## INSTALLATION

Install the brake panel and rear wheel in the reverse order of removal.

\* After the rear wheel installation, check the drive chain slack and rear brake pedal free play.



## REAR SHOCK ABSORBER

### REMOVAL/INSTALLATION

Remove the shock absorber upper mount nuts and washers and then press down the motorcycle to pull out the shock absorbers. Remove the shock absorber lower mount bolts to remove the rear shock absorbers.

### INSTALLATION

The installation sequence is the reverse of removal.

**Torque:** Upper 0.8~1.2kg-m  
Lower 3.0~4.0kg-m

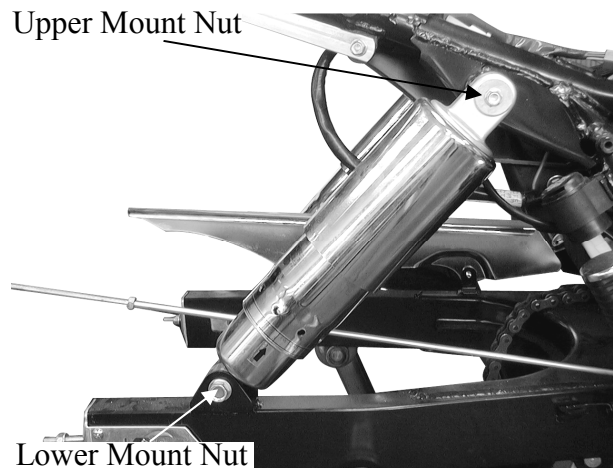

## REAR FORK

### REMOVAL

Remove the rear wheel.  
Remove the rear shock absorbers.  
Remove the rear fork pivot nut to remove the pivot and rear fork.

Remove the drive chain slider and check for wear or damage.

\* When replacing the rear fork pivot bushings, apply grease to the pivot bushing.

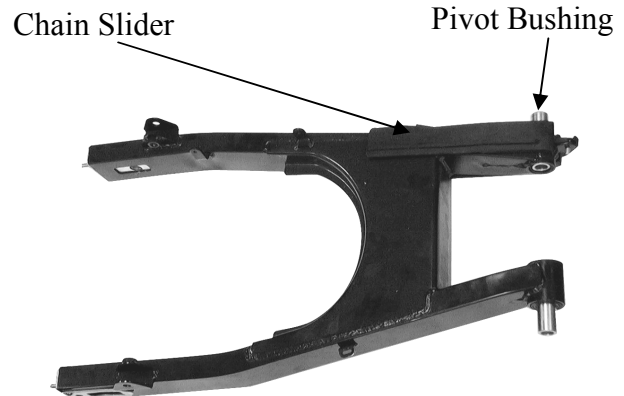
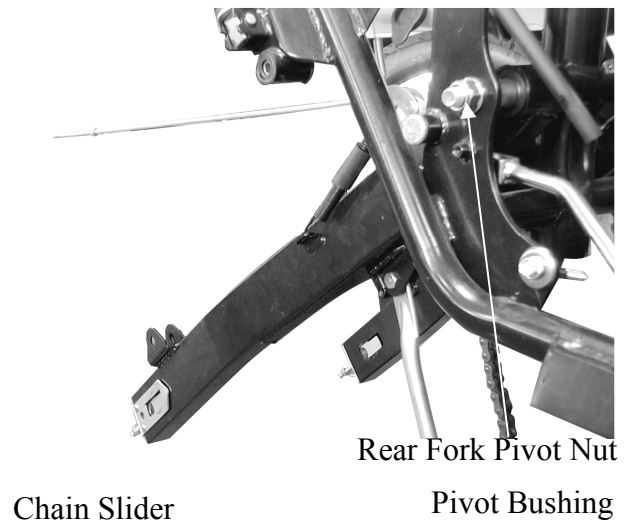

### INSTALLATION

Install the rear fork in the reverse order of removal.

Tighten the rear fork pivot nut.

**Torque:** 6.0~8.0kg-m

After the rear fork is installed, install the following parts:

Rear shock absorbers

Rear wheel

Drive chain cover

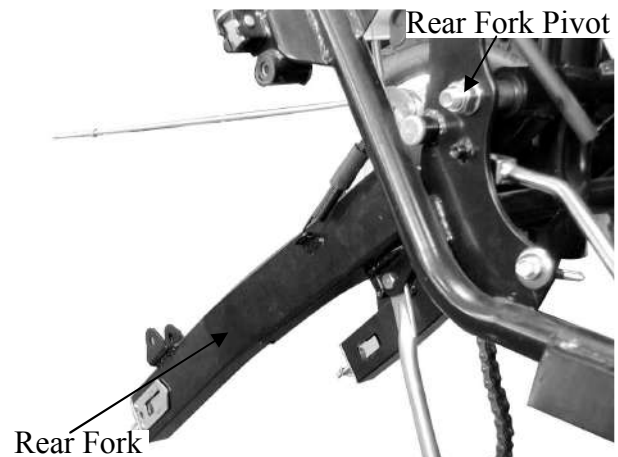

## REAR FENDER

### REMOVAL

Remove the rear carrier.  
Disconnect the turn signal light, rear stop light and taillight wires.  
Remove the right and left side cover bolts and then remove the two upper lock bolts to remove the rear fender.

\* When installing, connect and route the taillight and turn signal light wires properly.

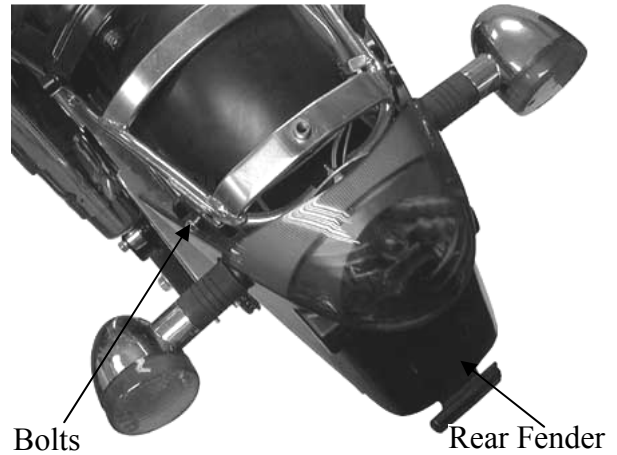

### INSTALLATION

Install the rear fender in the reverse order of removal.



# 14. HYDRAULIC BRAKE

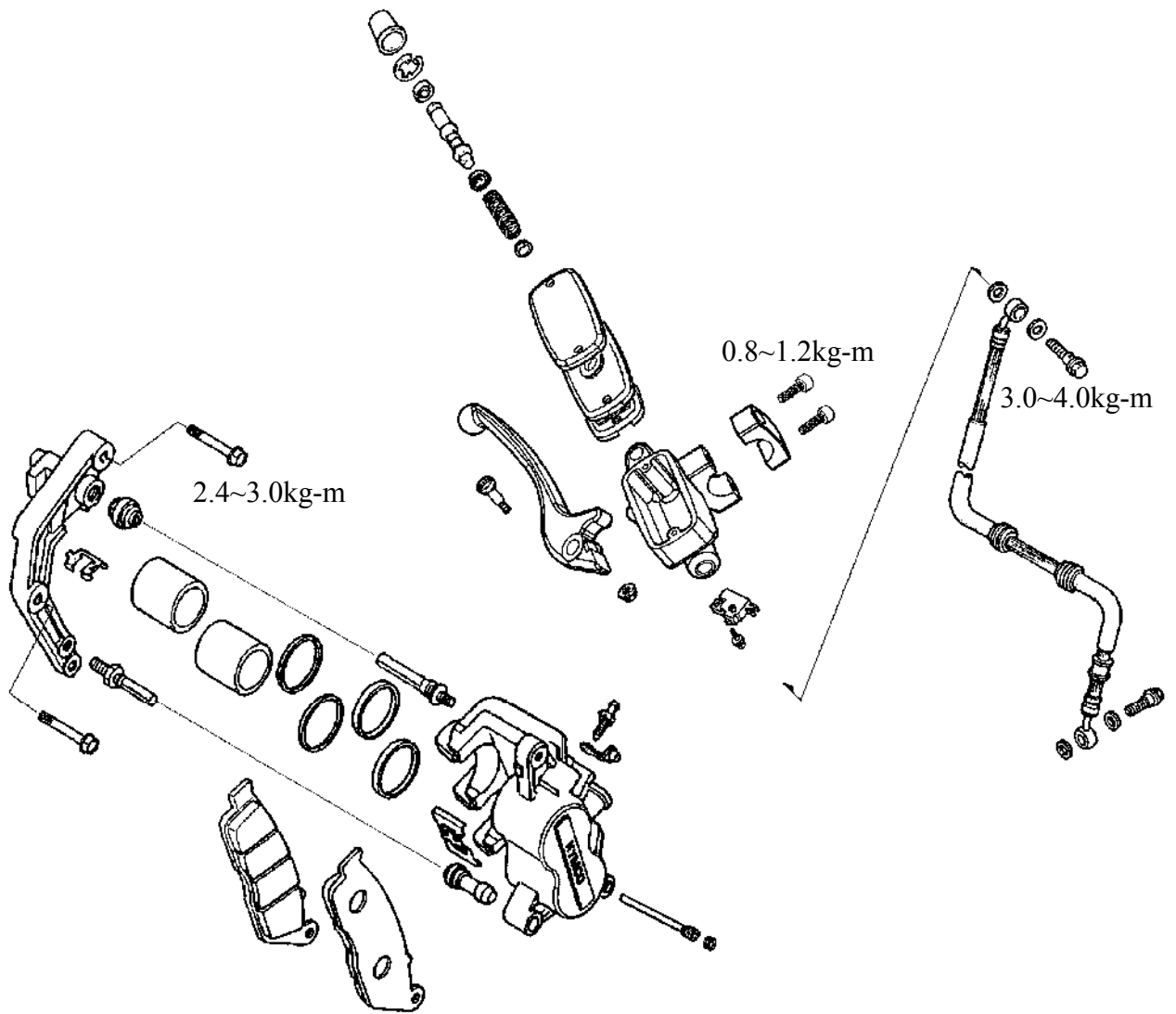





**HYDRAULIC BRAKE**

SERVICE INFORMATION ..... 14- 2

TROUBLESHOOTING ..... 14- 3

BRAKE FLUID CHANGE/AIR BLEED ..... 14- 4

BRAKE PAD/DISK ..... 14- 5

BRAKE MASTER CYLINDER ..... 14- 6

BRAKE CALIPER ..... 14- 8

## SERVICE INFORMATION

### GENERAL INSTRUCTIONS

- Drain the brake fluid from the hydraulic brake system before disassembly.
- Do not allow any foreign matters entering the brake reservoir when filling the brake reservoir with brake fluid.
- Be careful not to splash brake fluid on any coated surfaces and instrument covers to avoid damage.
- Inspect the brake operation before riding.
- Brake fluid will damage painted, coated surfaces and plastic parts. When working with brake fluid, use towel to cover and protect painted, rubber and plastic parts. Wipe off any splash of brake fluid with a clean towel. Do not wipe the motorcycle with a towel contaminated by brake fluid.
- Make sure to use recommended brake fluid DOT-4. Use of other unspecified brake fluids may cause brake failure.

### SPECIFICATIONS

Item	Standard (mm)	Service Limit (mm)
Brake disk thickness	5.0	3.0
Brake disk runout	0.15	0.3
Brake master cylinder I.D.	12.70~12.743	12.75
Brake master cylinder piston O.D.	12.657~12.684	12.64

## TROUBLESHOOTING

### Loose brake lever

- Air in hydraulic brake system
- Brake fluid level too low
- Hydraulic brake system leakage

### Tight brake lever

- Seized piston
- Clogged hydraulic brake system
- Smooth or worn brake pad

### Hard braking

- Seized hydraulic brake system
- Seized piston

### Poor brake performance

- Contaminated brake pad surface
- Brake disk or wheel not aligned

### Brake noise

- Contaminated brake pad surface
- Excessive brake disk runout
- Incorrectly installed caliper
- Brake disk or wheel not aligned

## BRAKE FLUID CHANGE/AIR BLEED

Place the motorcycle on its main stand on level ground and set the handlebar upright. Remove the two screws attaching the brake fluid reservoir cap.

- \* Use towel to cover plastic parts and coated surfaces to avoid damage caused by splash of brake fluid.

**Torque:**0.8~1.2kg-m

Connect a transparent hose to the brake caliper bleed valve and then loosen the bleed valve nut. Use a syringe to drain the brake fluid out through the hose.

## BRAKE FLUID REFILLING

Connect a transparent hose and syringe to the brake caliper bleed valve and then loosen the bleed valve nut. Fill the brake reservoir with brake fluid and use the syringe to drain brake fluid into it until there is no air bubbles in the hose. Then, tighten the bleed valve nut.

- \*
  - When draining brake fluid with the syringe, the brake fluid level should be kept over 1/2 of the brake reservoir height.
  - Use only the recommended brake fluid.

**Recommended Brake Fluid: DOT-4**

## BRAKE SYSTEM BLEEDING

Connect a transparent hose to the bleed valve and fully apply the brake lever after continuously pull it several times. Then, loosen the bleed valve nut to bleed air from the brake system. Repeat these steps until the brake system is free of air.

- \* When bleeding air from the brake system, the brake fluid level should be kept over 1/2 of the brake reservoir height.

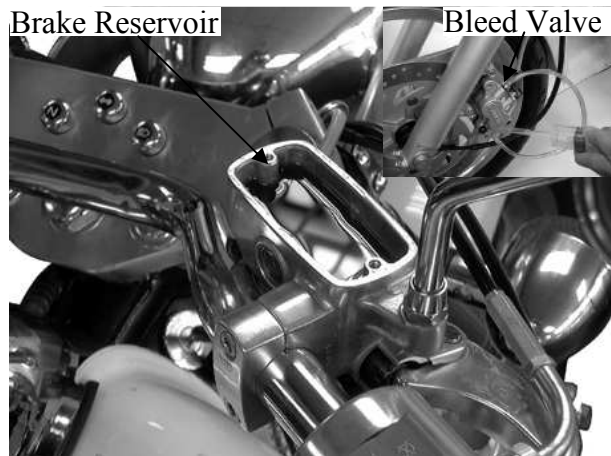
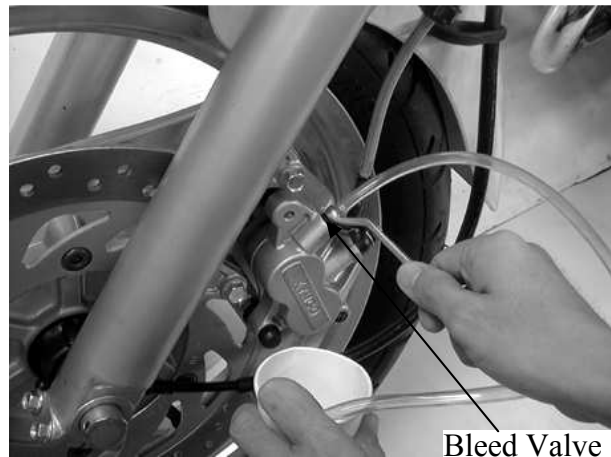

## BRAKE PAD/DISK

### BRAKE PAD REPLACEMENT

Remove the two bolts attaching the brake caliper holder.

\* The brake pads can be replaced without removing the brake fluid tube.

Remove the brake caliper.

Remove the brake pad pin bolt and then remove the pad pin bolt and brake pads.

Remove the brake pads and springs.

### ASSEMBLY

Assemble the brake pads in the reverse order of removal.

Tighten the pad pin bolt.

Tighten the pad pin bolt cap.

Tighten the brake caliper bolts.

**Torque:** 2.4~3.0kg-m

\* Do not tighten the pad pin bolt caps excessively.

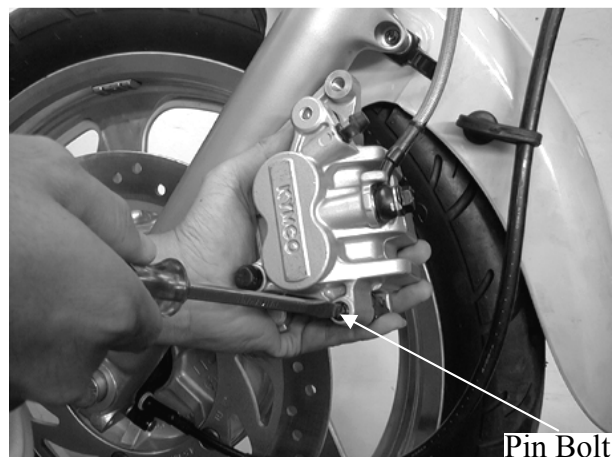
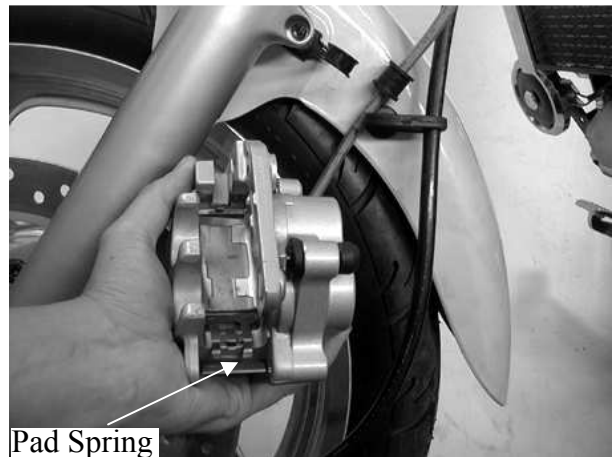
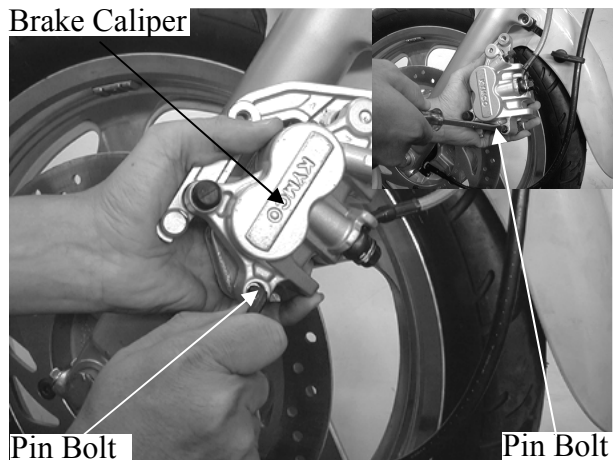

## BRAKE DISK

Measure the brake disk thickness.

**Service Limit:** 3.0mm

Measure the brake disk runout.

**Service Limit:** 0.3mm



## BRAKE MASTER CYLINDER

### REMOVAL

Drain the brake fluid from the hydraulic brake system.

\* Do not splash brake fluid onto any rubber, plastic and coated parts. When working with brake fluid, use towel to cover these parts.

Remove the two master cylinder holder bolts and remove the master cylinder.

\* When removing the brake fluid tube bolt, be sure to place towels under the tube and plug the tube end to avoid brake fluid leakage and contamination.

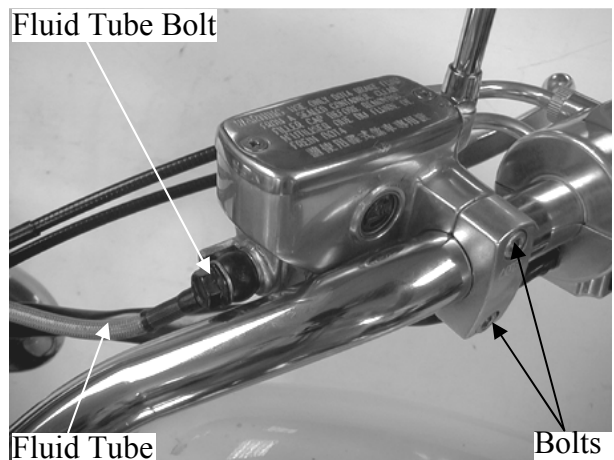

### DISASSEMBLY

Remove the piston rubber cover and snap ring from the brake master cylinder.

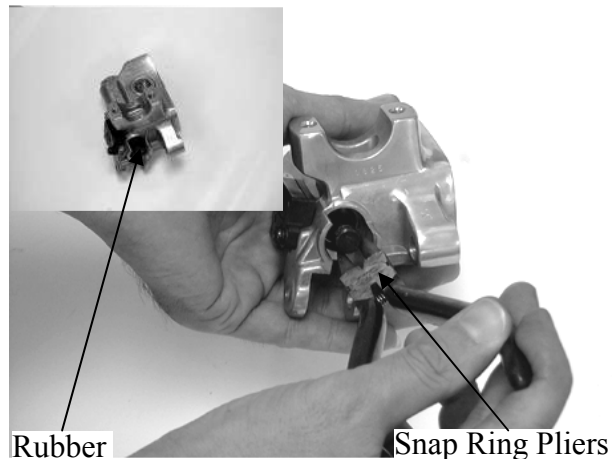

Remove the washer, main piston and spring from the brake master cylinder. Clean the inside of the master cylinder and brake reservoir with brake fluid.

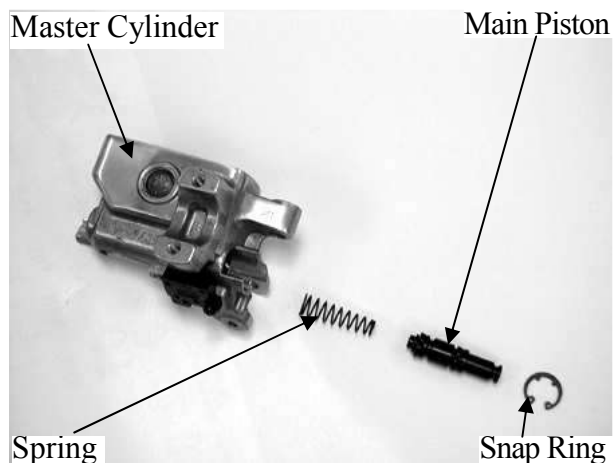

## INSPECTION

Measure the brake master cylinder I.D.  
Inspect the master cylinder for scratches or cracks.

**Service Limit:** 12.75mm replace if over



Measure the brake master cylinder piston O.D.

**Service Limit:** 12.64mm replace if below

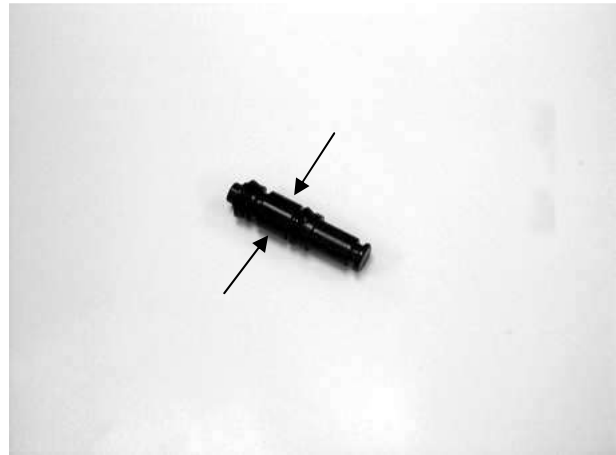

## ASSEMBLY

Before assembly, apply brake fluid to all removed parts.

Install the spring together with the 1st rubber cup.

- \* During assembly, the master cylinder, main piston and spring must be installed as a unit without exchange.
- \* When assembling the piston, soak the cups in brake fluid for a while.



Install the main piston and snap ring.  
Install the rubber cover.  
Install the brake lever.



# 14. HYDRAULIC BRAKE

Place the brake master cylinder on the handlebar and install the master cylinder holder with the “UP” mark facing up, aligning the tab on the holder with the hole in the handlebar.  
First tighten the upper bolt and then tighten the lower bolt.

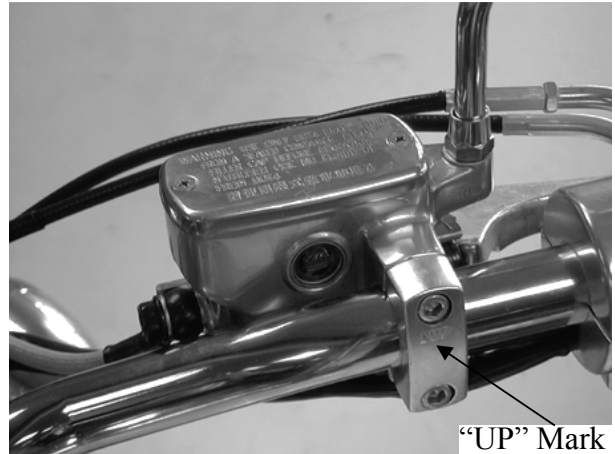

Install the brake fluid tube with the bolt and two sealing washers. Then, install the rearview mirror.  
Fill the brake reservoir with recommended brake fluid to the upper level.  
Bleed air from the hydraulic brake system. (Refer to 14 -4.)  
Recommended brake fluid:DOT-4



## BRAKE CALIPER

### REMOVAL

Remove the brake caliper and brake pad springs.  
Place a clean container under the brake caliper and disconnect the brake fluid tube from the brake caliper.

\* Be careful not to splash brake fluid on any coated surfaces.



### DISASSEMBLY

Remove the brake caliper seat from the brake caliper.

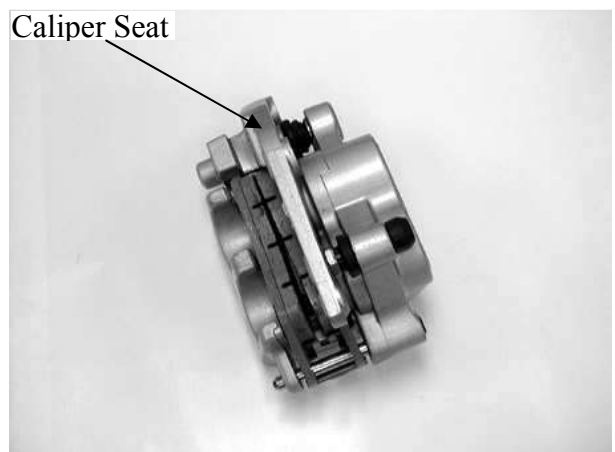



# 14. HYDRAULIC BRAKE

Remove the pistons from the brake caliper. Use compressed air to press out the pistons through the brake fluid inlet opening and place a towel under the caliper to avoid contamination caused by the removed pistons.

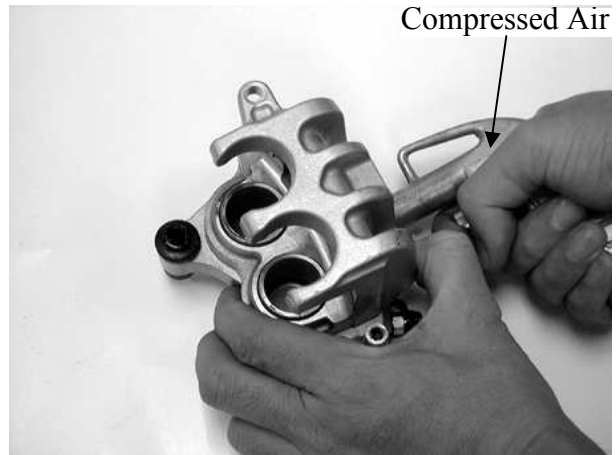

Push the piston oil seals inward to remove them. Clean each oil seal groove with brake fluid.

\* Be careful not to damage the piston surface.

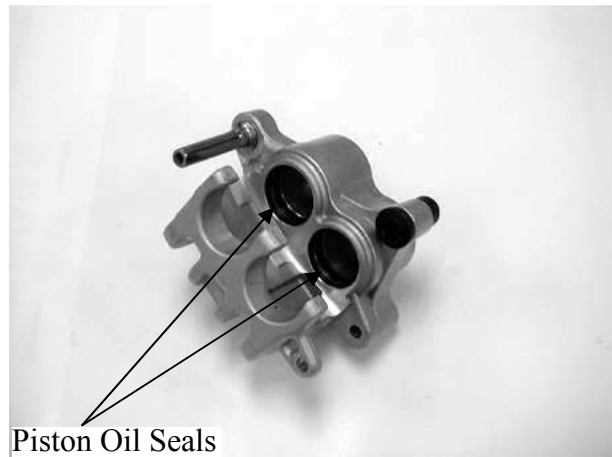

## INSPECTION

Check each piston for scratches or wear. Measure each piston O.D. with a micrometer gauge.



Check each caliper and caliper cylinder for scratches or wear and measure the caliper cylinder I.D.



## ASSEMBLY

Clean all removed parts.  
Apply silicon grease to the pistons and oil seals. Lubricate the brake caliper cylinder inside wall with brake fluid.  
Install the oil seals and then install the brake caliper pistons with the grooved side facing out.

\* Install the piston with its outer end protruding 3~5mm beyond the brake caliper.

Wipe off excessive brake fluid with a clean towel. Apply silicon grease to the brake caliper seat pin and caliper inside.  
Install the brake caliper seat.

## INSTALLATION

Install the brake caliper onto the right front fork and tighten the bolts.

**Torque:** 2.4~3.0kg-m

Connect the brake fluid tube to the brake caliper and tighten the fluid tube bolt.

Add the recommended brake fluid into the brake reservoir and bleed air from the brake system.



# 15. IGNITION SYSTEM

---

---

## IGNITION SYSTEM

---

SERVICE INFORMATION .....	15-2
TROUBLESHOOTING .....	15-3
IGNITION COIL .....	15-4
CDI UNIT .....	15-5
PULSER COIL .....	15-6

# 15. IGNITION SYSTEM

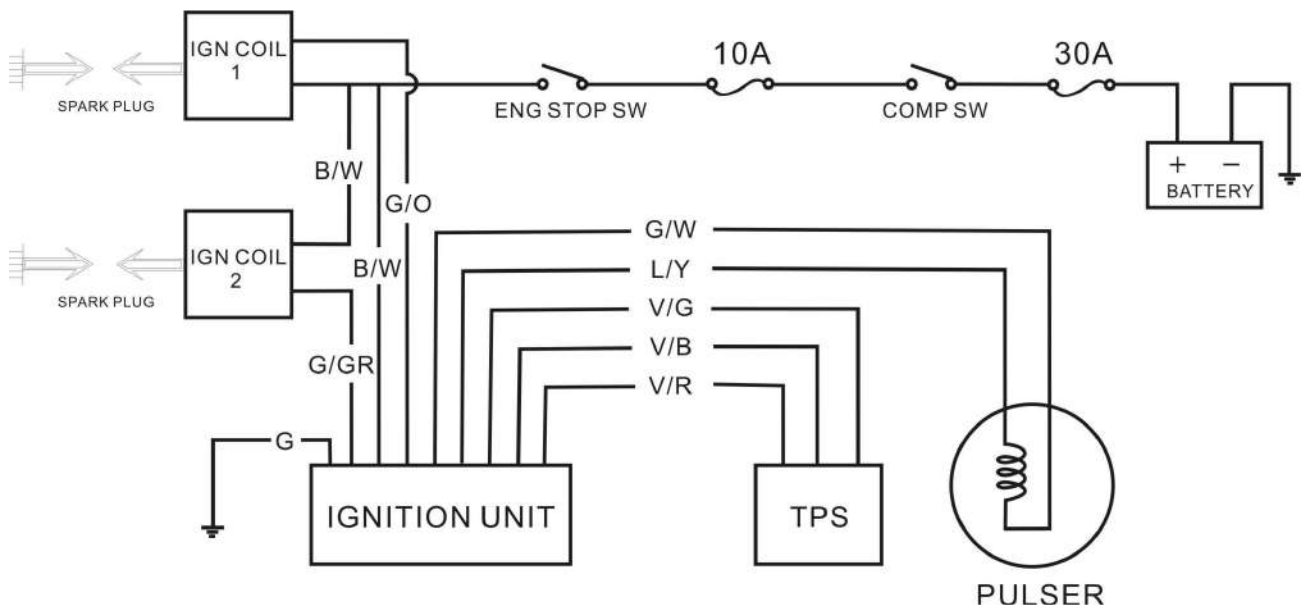
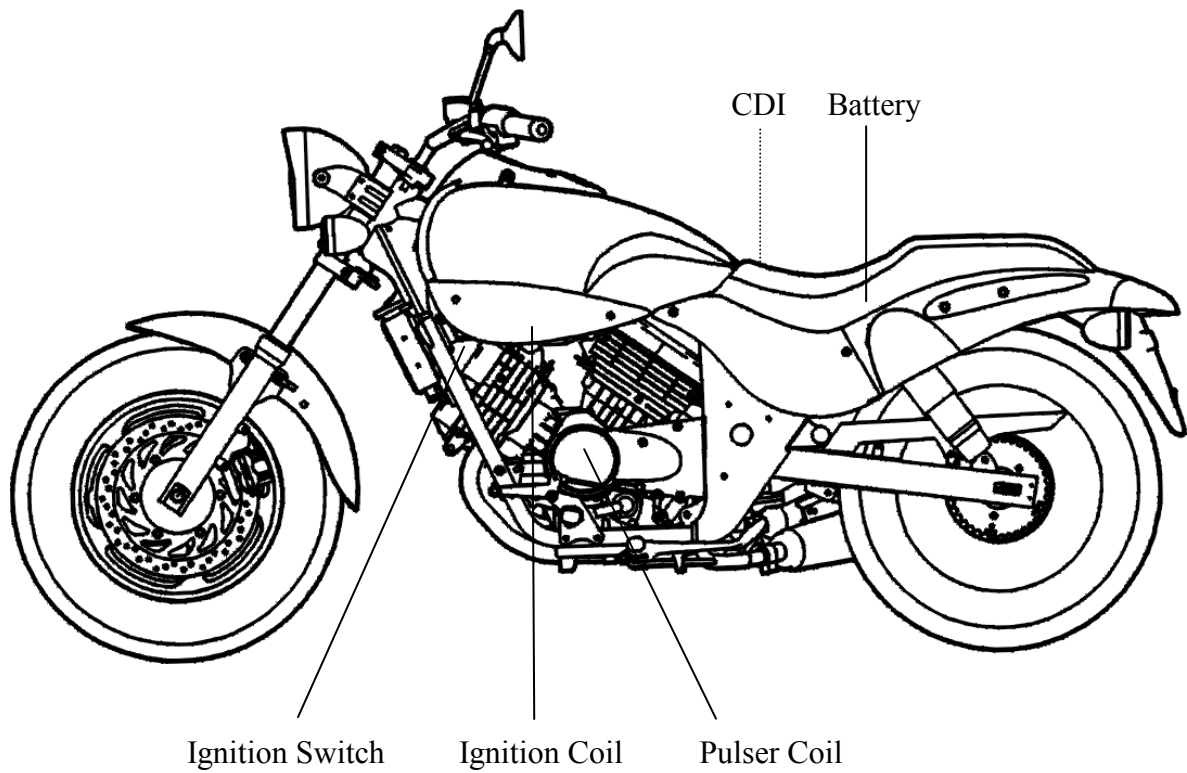

# 15. IGNITION SYSTEM

---

## SERVICE INFORMATION

### GENERAL INSTRUCTIONS

- Inspect the ignition system according to the sequence specified in the Troubleshooting 15-3.
- The ignition system has a CPU in the CDI unit, so the ignition timing is not adjustable.
- Do not drop or impact the CDI unit with strong force to avoid damage. Be careful when removing it.
- Loose connector and poor wire connection are the main causes of faulty ignition system. Check each connector before operation.
- Check the spark plug heat range. Use of spark plug with improper heat range is the main cause of poor engine performance or burned engine.
- Perform inspections according to the servicing procedures specified in each section.

### SPECIFICATIONS

Item		Standard
Spark plug	Standard type	CR8E
	Hot type	CR7E
	Cold type	CR9E
Spark plug gap		0.6~0.7mm
Ignition timing		BTDC 10° ±2° /1000rpm
Ignition type		Fully Transistor Ignition
Ignition coil resistance (20°C)	Primary coil	3.57Ω~4.83Ω
	Secondary coil with plug cap	14.96KΩ~20.24 KΩ
Pulser coil resistance (20°C)		396~594Ω

### TESTING INSTRUMENT

Electric Tester

# 15. IGNITION SYSTEM

---

## TROUBLESHOOTING

### **Engine stalls immediately after it starts**

- Weak spark
- Improper ignition timing
- Faulty CDI unit

### **No spark at plug**

- Faulty ignition switch
- Poorly connected, broken or shorted wire
  - Between pulser coil, CDI unit and ignition coil
  - Between exciter coil and CDI unit
  - Between CDI unit and ignition coil
  - Between CDI unit and ignition switch
  - Between ignition coil and spark plug

### **Engine starts but runs poorly**

- Faulty ignition coil
- Poorly connected wire
- Faulty spark plug
- Spark plug cap electricity leakage
- Faulty A.C. generator
- Stator not installed properly (Loose)
- Faulty CDI unit

# 15. IGNITION SYSTEM

---

## IGNITION COIL

### CONTINUITY TEST

Disconnect the ignition coil primary wire coupler and measure the resistance between the ignition coil primary wire terminals.

**Resistance:**  $3.57\Omega \sim 4.83\Omega$



Measure the secondary coil resistance between the spark plug wire and the primary coil terminal.

**Resistance:**  $14.96K\Omega \sim 20.24 K\Omega$

\* This test is for reference only. Accurate test should be performed with a CDI tester.



# 15. IGNITION SYSTEM

## CDI UNIT

### INSPECTION

Disconnect the CDI unit coupler.  
 Check for continuity with the coupler on the harness wire side and CDI unit.  
 Inspection table is as follows.

\* The CDI unit is fully transistorized. For accurate testing, it is necessary to use a specified tester. Use of an improper tester or measurements in an improper range may give false readings.

CDI Unit



Picture A



Picture B

Item	Terminal	Standard	Remark
Continuity from ignition switch to CDI unit	Black/white and green (ignition switch "ON", engine stop switch "RUN")	Battery voltage	Picture A
Primary coil	Black/white and green/orange Black/white and green/gray	3.57Ω~4.83Ω	Picture B
Pulser coil	Green/white and blue/yellow	396~594Ω	Picture C
Continuity for CDI unit	Green/white and green	Continuity	Picture D



# 15. IGNITION SYSTEM

---

## PULSER COIL

### INSPECTION

Disconnect the pulser coil wire coupler and measure the resistance between the blue/yellow and green/white wire terminals.

**Resistance:** 396~594Ω



Picture C



Picture D

# 16. CHARGING SYSTEM

---

---

## CHARGING SYSTEM

---

SERVICE INFORMATION .....	16-2
TROUBLESHOOTING .....	16-3
BATTERY .....	16-4
BATTERY CHARGING.....	16-4
A.C. GENERATOR .....	16-5
REGULATOR/RECTIFIER .....	16-5

# 16. CHARGING SYSTEM

---

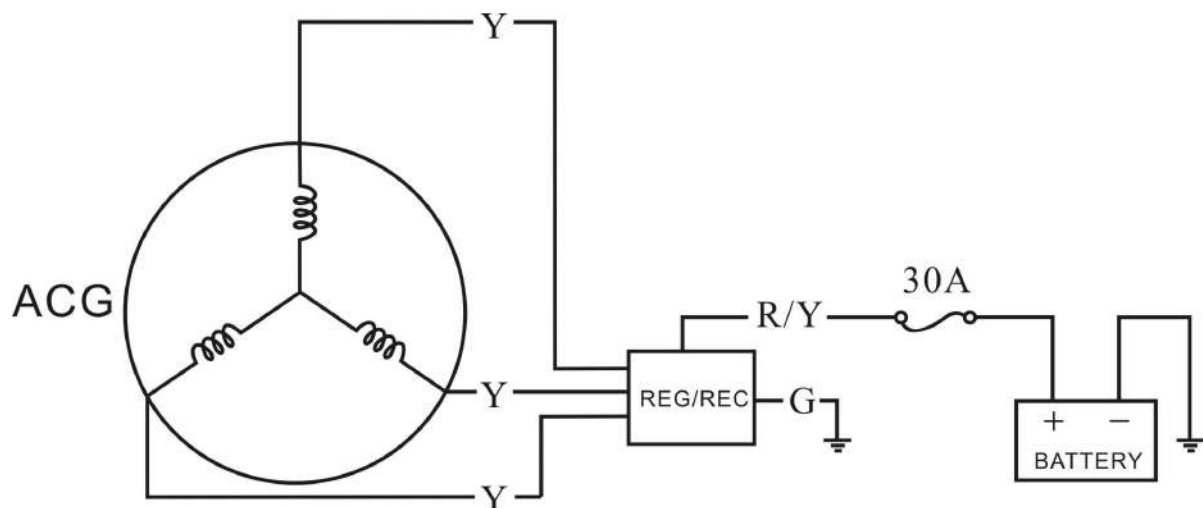
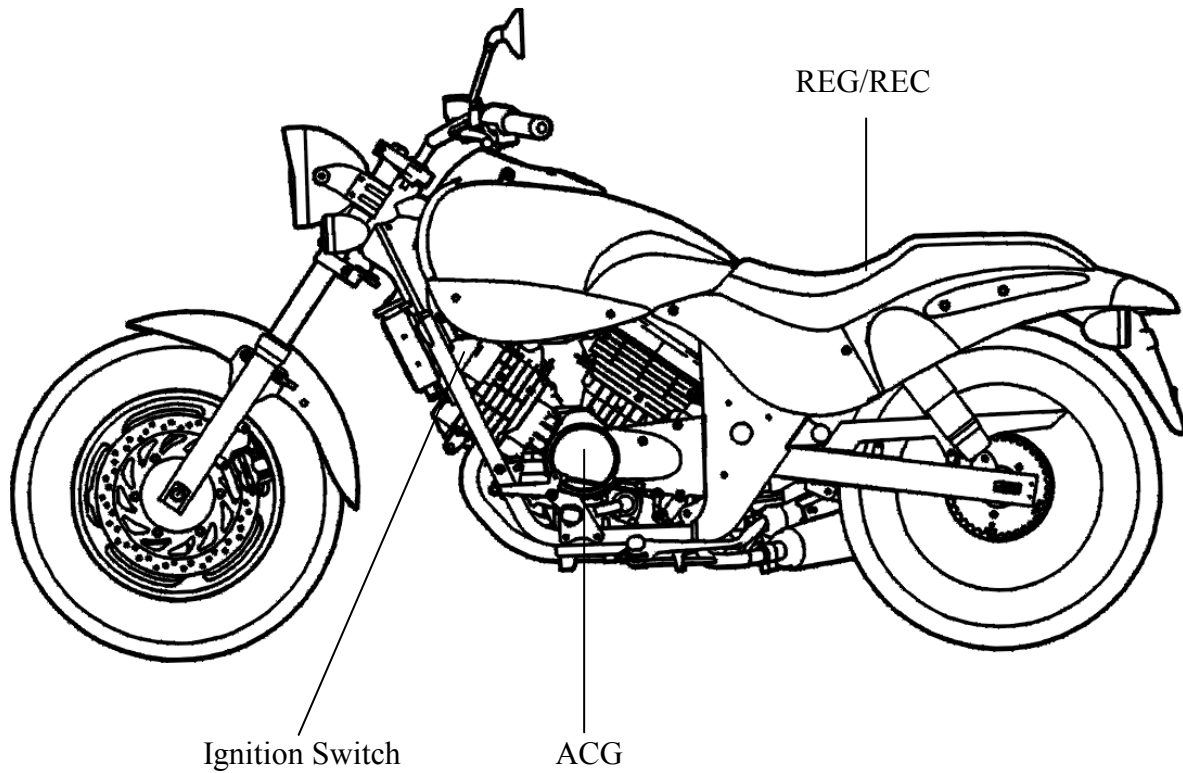

# 16. CHARGING SYSTEM

---

## SERVICE INFORMATION

### GENERAL INSTRUCTIONS

- Do not quick charge the battery. Quick charging should only be done in an emergency.
- Remove the battery from the motorcycle for charging. If the battery must be charged on the motorcycle, keep sparks and flames away from a charging battery. The hydrogen gas produced by a charging battery is very flammable and can explode.
- When inspecting the A.C. generator, use an electric tester.
- Route the charging system wires properly to avoid short-current due to wires being twisted or kinked.

### SPECIFICATIONS

		VENOX 250
Battery	Battery capacity	12V8AH
	Electrolyte specific gravity	1.32
	Charging current	Less than 0.9A
A.C. generator	Start charging rpm	900 rpm (min.)
	Charging performance	10.5A min. / 1500 rpm
		17~20A / 5000 rpm
Regulator/Rectifier	Limit voltage	14.5 ± 0.5V/5000 rpm
	Type	Three-way wave rectifier / Regulate auto in the SCR
Charging coil resistance for ACG		0.301Ω~0.559Ω

### TORQUE VALUES

A.C. generator stator screw	0.8~1.2 kg-m
A.C. generator flywheel nut	7.5~8.5 kg-m

### SPECIAL TOOLS

Flywheel holder  
Flywheel puller

### TESTING INSTRUMENTS

Electric tester

# 16. CHARGING SYSTEM

---

## TROUBLESHOOTING

### No power

- Dead battery
- Low fluid level
- Disconnected battery cable
- Faulty ignition switch

### Low power

- Weak battery
- Loose battery connection (terminal)
- Charging system failure
- Faulty regulator/rectifier

### Intermittent power

- Loose battery cable connection
- Loose charging system connection
- Loose lighting system connection

### Charging system failure

- Loose, broken or short-current or connector
- Faulty regulator/rectifier
- Faulty A.C. generator

# 16. CHARGING SYSTEM

## BATTERY

### REMOVAL

- Remove the seat.
- Remove the left side cover.
- First disconnect the battery negative cable and then the positive cable.
- Remove the two battery set plate lock nuts.

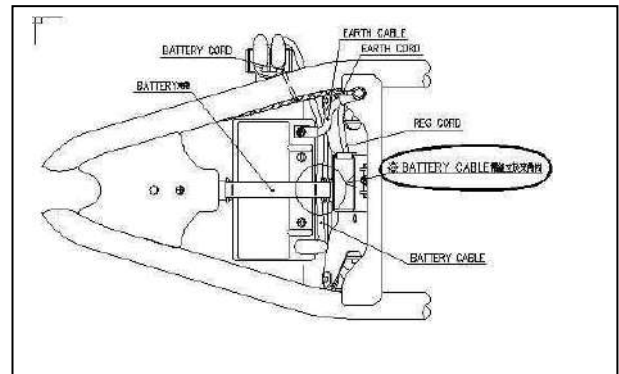

## BATTERY CHARGING

- Connect the charger positive cable to the battery positive cable.
- Connect the charger negative cable to the battery negative cable.

### CHARGING METHOD:

**Standard Charging:** Less than 0.9A/5~10hr

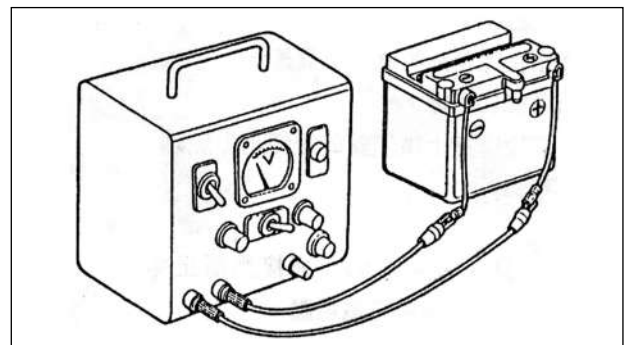

### Warning

- Keep flames and sparks away from a charging battery to prevent igniting the hydrogen gas produced by the battery.
- Turn power ON/OFF at the charger, not at the battery terminals to prevent sparks near the battery.
- Discontinue charging if the electrolyte temperature exceeds 45°C.

\* Do not quick charge the battery. Quick charging should only be done in an emergency.

# 16. CHARGING SYSTEM

## LIMIT VOLTAGE TEST:

Start the engine and gradually increase the engine speed to measure the limit voltage.

**Limit Voltage:**  $14.5 \pm 0.5V/5000rpm$

Note: Test when the battery is fully charged.

\* When testing the limit voltage, also use a tachometer for operation.

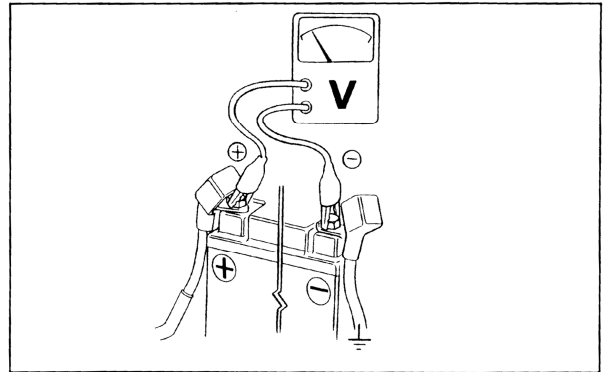

## A.C. GENERATOR

### REMOVAL

Remove the A.C. generator.

### INSPECTION

Disconnect the A.C. generator connector. Check the continuity between the yellow wires.

There should be continuity between the yellow wires and no continuity between each yellow wire and ground.

**Resistance:**

Yellow~Yellow	$0.301\Omega \sim 0.559\Omega$
---------------	--------------------------------



## REGULATOR/RECTIFIER

### REMOVAL

Remove the regulator/rectifier lock bolt and disconnect the regulator/rectifier wire coupler.



Regulator/Rectifier

# 16. CHARGING SYSTEM

## INSPECTION

Remove the regulator/rectifier wire coupler.  
Check the continuity between the wire terminals.

Normal Direction: Continuity

	(+) Probe	(-) Probe
I	Yellow	Green
II	Red/White	Yellow

Reverse Direction: No Continuity

	(+) Probe	(-) Probe
I	Green	Yellow
II	Yellow	Red/White

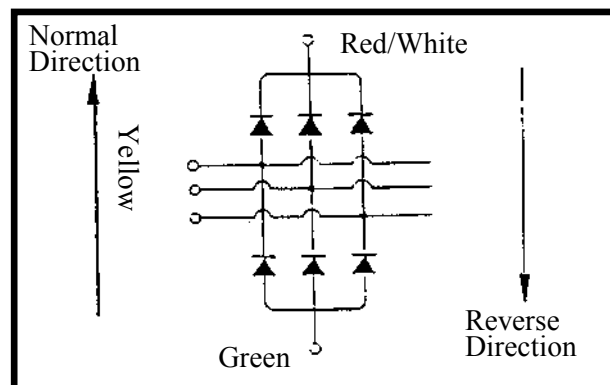



# 17. STARTING SYSTEM

---

---

## STARTING SYSTEM

---

SERVICE INFORMATION .....	17-2
TROUBLESHOOTING .....	17-2
STARTER MOTOR .....	17-3
STARTER RELAY .....	17-4
CLUTCH DIODE.....	17-4

# 17. STARTING SYSTEM

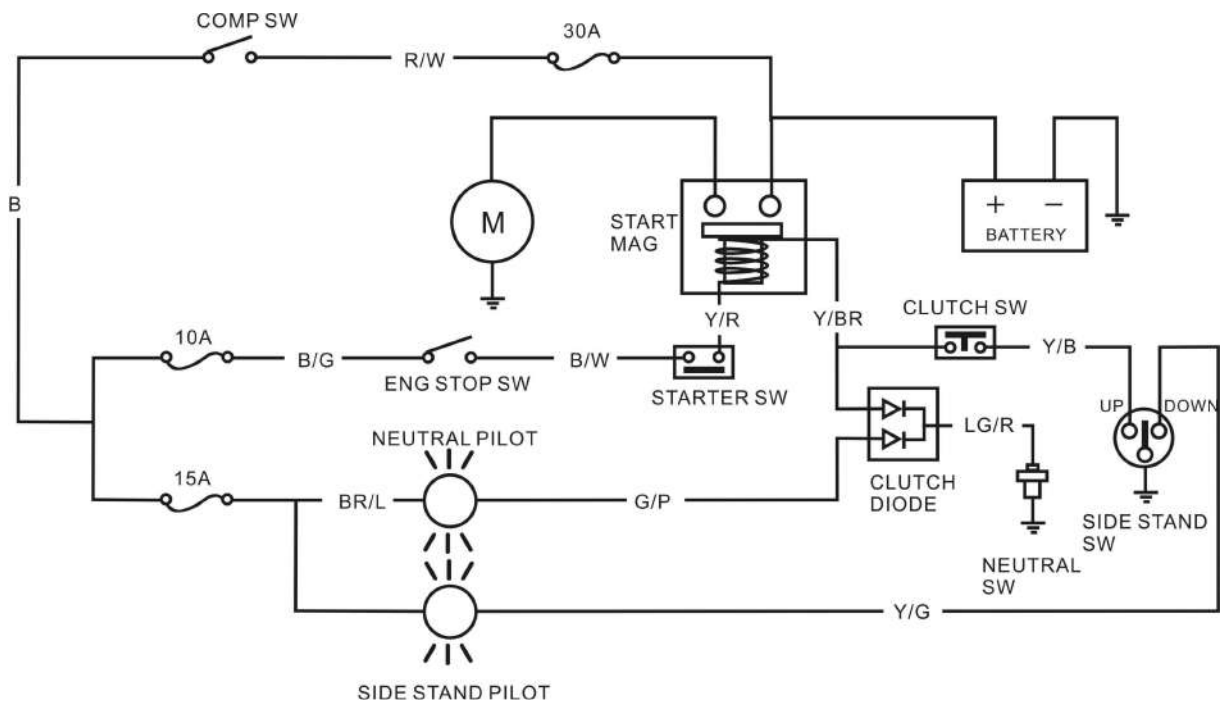
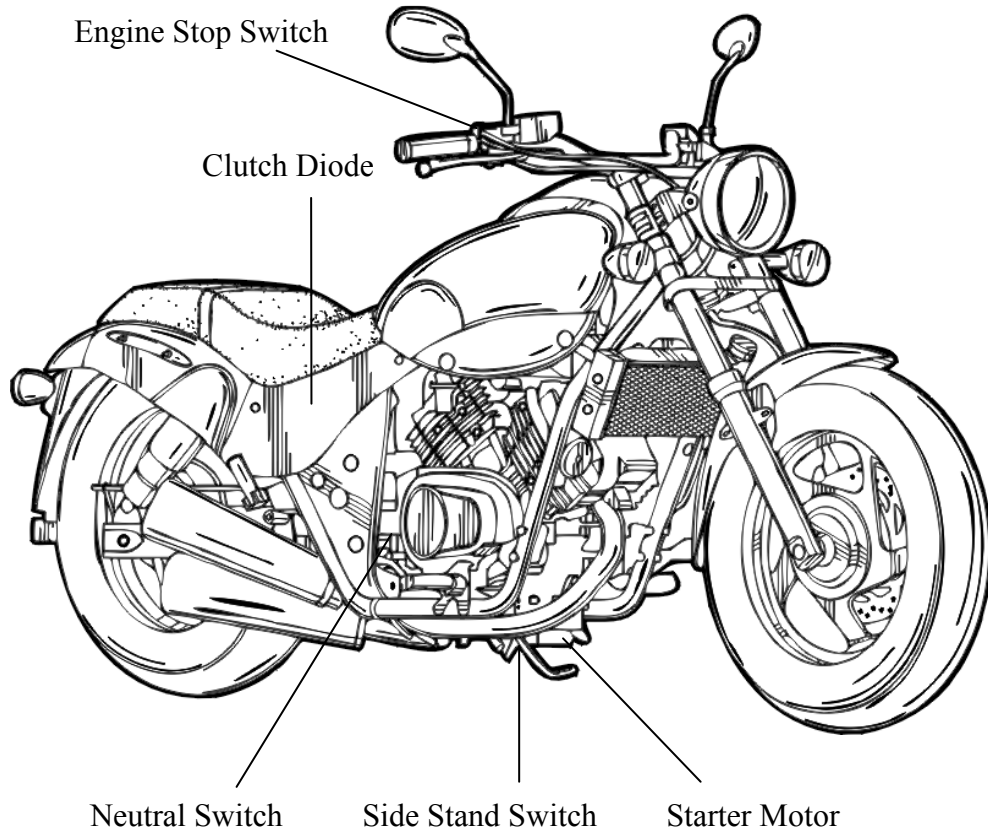

# 17. STARTING SYSTEM

---

## SERVICE INFORMATION

### GENERAL INSTRUCTIONS

- The removal of starter motor can be accomplished with the engine installed in the frame.
- When connecting the starting system wires, connect them securely to avoid hard starting due to poor connection.

### TROUBLESHOOTING

#### **Starter motor won't turn**

- Fuse burned out
- Weak battery
- Faulty ignition switch
- Faulty starter switch
- Faulty starter relay
- Poorly connected, broken or shorted wire
- Faulty starter motor
- Faulty clutch switch
- Faulty side stand switch
- Side stand is at "down" position
- Engine stop switch is at "stop" position

#### **Lack of power**

- Weak battery
- Loose wire or connection
- Foreign matter stuck in starter motor or gear

#### **Starter motor rotates but engine does not start**

- Faulty starter clutch
- Reverse rotation of starter motor
- Weak battery

# 17. STARTING SYSTEM

---

## STARTER MOTOR

### REMOVAL

Remove the two starter motor mounting bolts and the motor.

- \* Before removing the starter motor, turn the ignition switch OFF and remove the battery ground. Then, turn the ignition switch on to check if the starter motor operates properly.

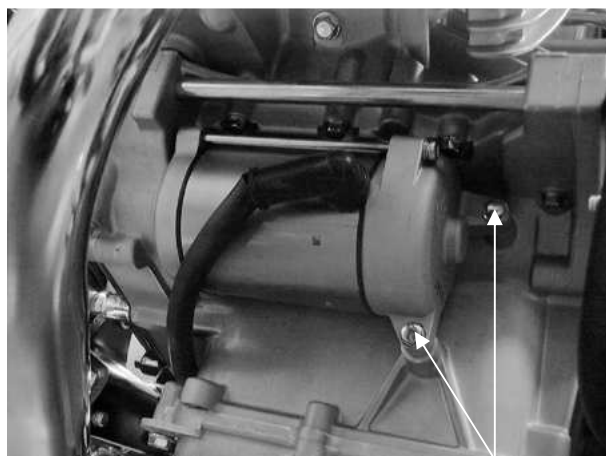

Mounting Bolts

### STARTER MOTOR INSTALLATION

Apply engine oil to the starter motor O-ring and install the starter motor onto the lower crankcase by slightly turning it left and right.

- \* Be careful not to damage the O-ring during installation.

Tighten the two starter motor mounting bolts.

Install the starter motor cable screw.  
After installation, check the starter motor for proper operation.

# 17. STARTING SYSTEM

## STARTER RELAY

### INSPECTION

Turn the ignition switch ON and the starter relay is normal if you hear a “click” when the starter button is depressed.

If there is no click sound:

- Inspect the starter relay voltage
- Inspect the starter relay ground circuit
- Check for continuity between the starter relay yellow/red and green/red wire terminals
- Check if the side stand position is up.
- Check if is neutral position. If not, directly apply the clutch lever and push the starter switch.



Starter Relay

Connect a 12V battery across the starter relay yellow/red and green/red wire terminals.

Connect an electric tester between the starter relay large terminals and check for continuity between the two terminals.

The relay is normal if there is continuity. Replace the starter relay with a new one if there is no continuity.

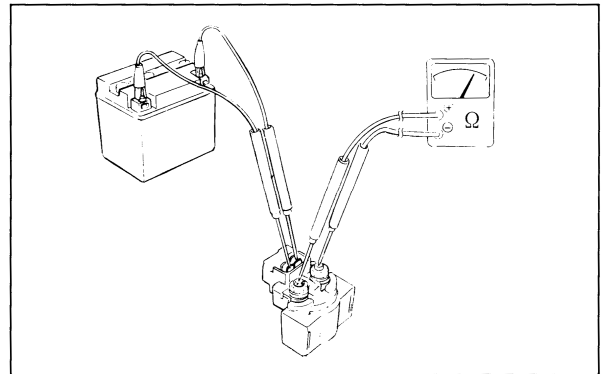

## CLUTCH DIODE

### INSPECTION

Check the continuity between the wire terminals.

Normal Direction: Continuity

Reverse Direction: No Continuity

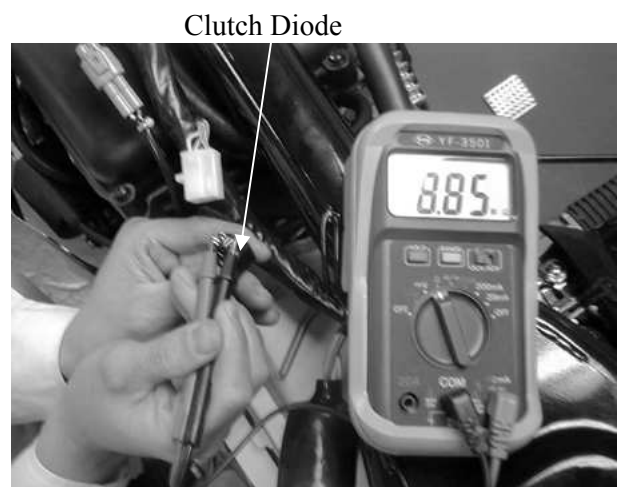

Clutch Diode

# 18. LIGHTS/INSTRUMENT/SWITCHES/HORN

---

---

## LIGHTS/INSTRUMENT/SWITCHES/HORN

---

SERVICE INFORMATION .....	18-1
TROUBLESHOOTING .....	18-1
HEADLIGHT/INSTRUMENT .....	18-2
TURN SIGNAL LIGHT.....	18-3
STOP LIGHT/TAIL LIGHT .....	18-3
IGNITION SWITCH.....	18-3
STARTER BUTTON/HORN BUTTON / FUEL GAUGE .....	18-4
HANDLEBAR SWITCHES .....	18-5
FUEL UNIT.....	18-7

# 18. LIGHTS/INSTRUMENT/SWITCHES/HORN

---

## SERVICE INFORMATION

### GENERAL INSTRUCTIONS

- All plastic plugs have locking tabs that must be released before disconnecting.
- An electric tester must be used for checking the continuity between two points. The electric tester also contains a voltmeter which can be used to measure voltage.
- Different bulbs have different specifications. When replacing, use a new bulb of the same specification to avoid burned wire.
- The continuity check of switches can be made without removing the switches from the motorcycle.

### SPECIFICATIONS

Headlight	12V 60/55W
Stoplight/Taillight	12V 21/5W
Turn signal light	12V 10W x 4
Turn signal indicator light	12V 3W
Instrument light	12V 1.7W x 1
High beam indicator light	12V 1.7W
Neutral indicator light	12V 1.7W
Fuse	15A

### TROUBLESHOOTING

#### Light does not come on when ignition switch is "ON"

- Burned bulb
- Faulty ignition or light switch
- Fuse burned out
- Dead battery or loose battery wire

#### Light comes on but dims

- Weak battery
- Wire or switch resistance too high
- Aged bulb or faulty lighting circuit

#### Headlight beam does not change when dimmer switch is operated

- Faulty or burned bulb
- Faulty dimmer switch
- Loose wire connection

# 18. LIGHTS/INSTRUMENT/SWITCHES/HORN

## HEADLIGHT

### REMOVAL

Remove the left sides of attaching bolts and screws on headlight fairing to dismantle the fairing.  
Remove the headlight unit and disconnect the headlight wire coupler.



Screws

Remove the headlight bulb and bulb socket.  
Check the bulb for damage and replace with a new one if necessary.

### INSTALLATION

Install the headlight in the reverse order of removal.

\*

After installation, adjust the headlight beam.

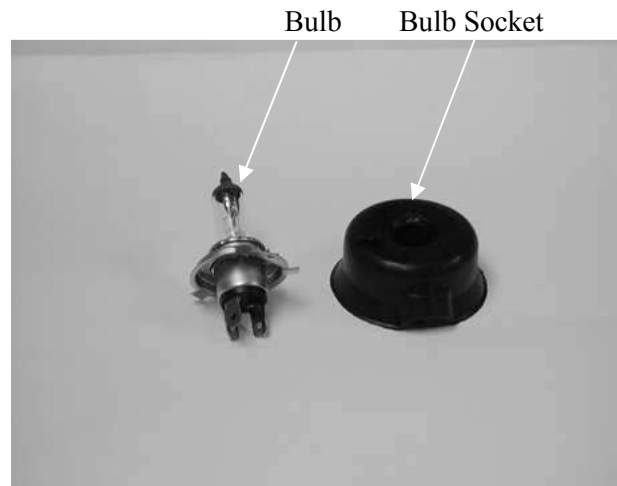

## INSTRUMENT (SPEEDOMETER)

### REMOVAL

Remove the three bolts attaching the speedometer seat.  
Disconnect the speedometer cable.  
Remove the speedometer.

### INSTALLATION

The installation sequence is the reverse of removal.



Bolts



## 18. LIGHTS/INSTRUMENT/SWITCHES/HORN

---

### TURN SIGNAL LIGHT

Remove the turn signal light shell and the bulb.  
Check the bulb for damage and replace with a new one if necessary.  
The installation sequence is the reverse of removal.

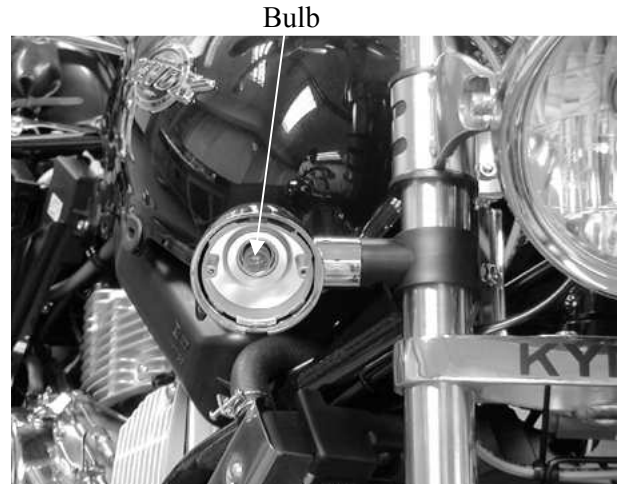

### STOP LIGHT/TAIL LIGHT

Remove the two taillight shell screws and the shell.  
Remove the bulb and check the bulb for damage. Replace with a new one if necessary.  
**Bulb Specification:** 12V 21/5W

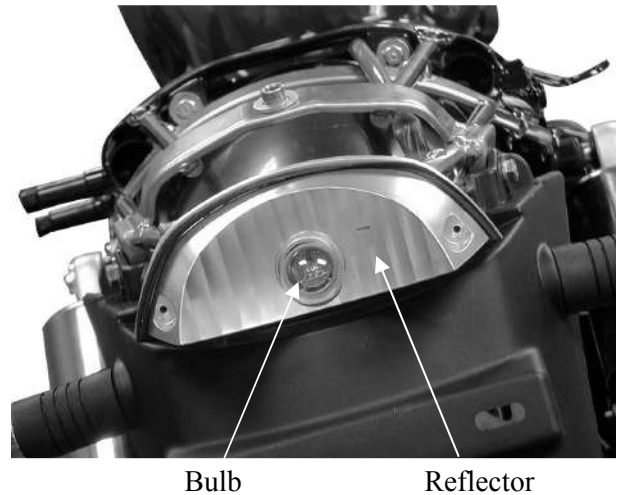

### IGNITION SWITCH

#### REMOVAL

Disconnect the ignition switch wire coupler.  
Remove the two bolts attaching the ignition switch.  
Remove the ignition switch.

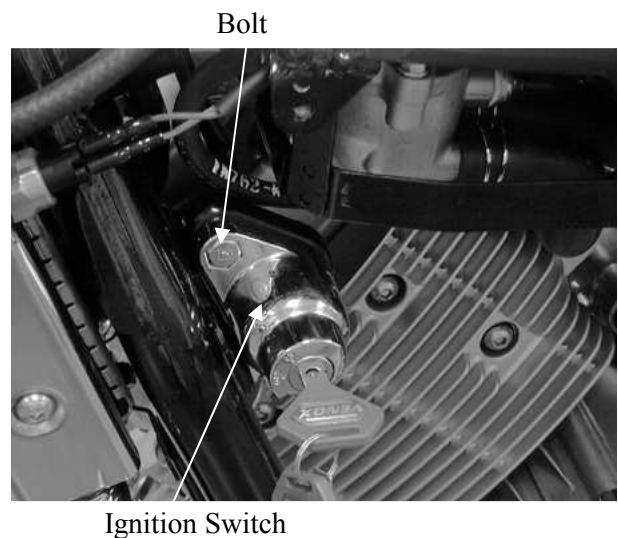

# 18. LIGHTS/INSTRUMENT/SWITCHES/HORN

## INSPECTION

Check for continuity between the wires indicated below.

Color Position	Black	Red/White
OFF		
ON	○ —	○ —



## STARTER BUTTON

Disconnect the right switch wire coupler. Check for continuity between the black/white and yellow/red wires.

Color Position	Black/White	Yellow/Red
FREE		
PUSH	○ —	○ —



Starter Switch Coupler

## HORN BUTTON

Disconnect the left switch wire coupler. Check for continuity between the brown/blue and light green wires.

Color Position	Brown/Blue	Light Green
FREE		
PUSH	○ —	○ —



Horn Switch Coupler

## 18. LIGHTS/INSTRUMENT/SWITCHES/HORN

### HORN

The horn is normal if it sounds when a 12V battery is connected across the horn wire terminals. Replace the horn if it does not sound.



Horn

### FUEL GAUGE

Disconnect the fuel gauge and fuel unit wire couplers.  
Connect the fuel gauge green wire with the yellow/white wire. Turn the ignition switch ON and the fuel gauge is normal if its indicator is light.



Fuel Indicator

### HANDLEBAR SWITCHES

#### FRONT STOP SWITCH

Disconnect the front stop switch wire coupler.  
Check for continuity between the front stop switch wires.

**Brake lever applied: Continuity.**  
**Brake lever released: No continuity.**



Front Brake

# 18. LIGHTS/INSTRUMENT/SWITCHES/HORN

## REAR STOP SWITCH

Remove the right side cover.  
 Disconnect the rear stop switch wire coupler.  
 Check for continuity between the rear stop switch wires.  
**Brake pedal depressed: Continuity.**  
**Brake pedal released: No continuity.**



Rear Brake

## TURN SIGNAL SWITCH

Disconnect the turn signal switch wire coupler.  
 Check for continuity between the turn signal switch wires.

Color \ Position	Orange	Gray	Light Blue
R		○ — ○	○
L	○ — ○	○	

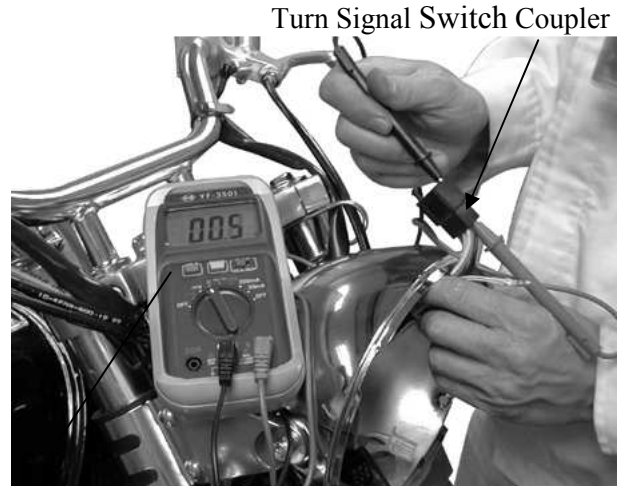

Turn Signal Switch Coupler

## HEADLIGHT SWITCH

Disconnect the headlight switch wire coupler. Check for continuity between the headlight switch wires.

Color \ Position	Red/ Yellow	Brown	Brown/ White	White/ Blue
●				
P	○ — ○ — ○	○	○	
H	○ — ○	○		○



Headlight Switch Coupler

# 18. LIGHTS/INSTRUMENT/SWITCHES/HORN

## ENGINE STOP SWITCH

Disconnect the engine stop switch wire coupler.  
Check for continuity between the engine stop switch wires.

Color Position	Black/White	Black/Green
OFF		
RUN	○ —	— ○



Engine Stop Switch Coupler

## DIMMER SWITCH

Disconnect the dimmer switch wire coupler.  
Check for continuity between the dimmer switch wires.

Color Position	White/ Blue	Blue	White	Brown/ Blue
HI	○ —	○		
LO	○ —		○	
PASSING		○ —	—	○

## FUEL UNIT

\* Keep flames and sparks away from the working area.

### REMOVAL

Remove the seat and fuel tank.  
Remove the fuel unit attaching nut.  
Remove the fuel unit.

\* Be careful not to bend or damage the fuel unit float arm.



# 18. LIGHTS/INSTRUMENT/SWITCHES/HORN

## INSPECTION

Check the fuel unit O-ring for wear, damage or deformation. Replace if necessary. Measure the continuity between the fuel unit wire terminals with the float at the upper (Full) and lower (Empty) positions.

**Resistances:** Upper (Full): No continuity

Lower (Empty): Continuity

Connect the fuel unit wire coupler to the wire harness and turn the ignition switch ON.

Check the fuel indicator for lighting. If the fuel indicator isn't light, the fuel indicator is faulty and replace it with a new one.

Empty

## INSTALLATION

Install the fuel unit in the reverse of removal.

\* Check for fuel leakage after installation.

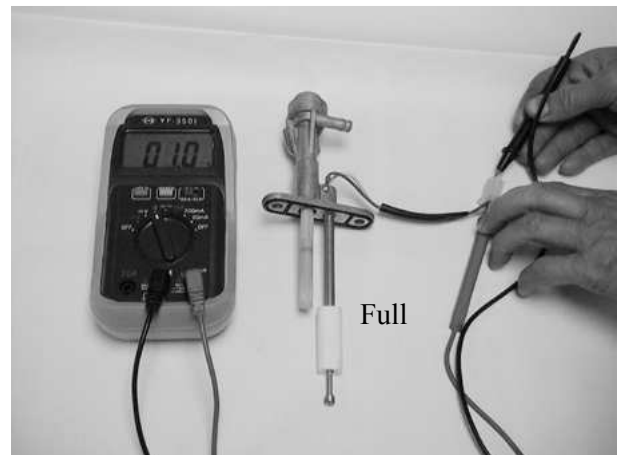

## CLUTCH SWITCH

Disconnect the clutch switch wire coupler. The clutch switch is as shown.

Check for continuity between the terminal of the clutch switch.

Clutch lever	(⊕) probe	(⊖) probe
No Apply	No continuity	
Apply	Continuity	



## THROTTLE POSITION SENSOR



# 18. LIGHTS/INSTRUMENT/SWITCHES/HORN

Disconnect the throttle position sensor wire coupler on carburetor.

Check for the resistance among three wires of the throttle position sensor.

Unit:KΩ

	V/R	V/G	V/B
V/R		4~6	∞
V/G	4~6		0~5±1
V/B	∞	0~5±1	

↑  
Throttle Position Sensor

## SIDE STAND SWITCH

Disconnect the side stand switch wire coupler. Check for continuity with the tester ⊕ probe connected to Yellow/Black lead and the ⊖ probe to Green lead.

Item	Yellow/Black (⊕) probe	Green (⊖) probe
OFF (When the side-stand is up)	No continuity	
ON (When the side-stand is down)	Continuity	

Side Stand Switch Wire Coupler

