

**By KWANG YANG Motor Co., Ltd.
First Edition, Apr 2006
All rights reserved. Any reproduction or
unauthorized use without the written permission of
KWANG YANG Motor Co., Ltd.
is expressly prohibited.
T100-SB30AA-A1**

PREFACE

This Service Manual describes the technical features and servicing procedures for the **KYMCO XCITING 500/500 AFI/250/300 AFI**.

Section 1 contains the precautions for all operations stated in this manual. Read them carefully before any operation is started.

Section 2 is the removal/installation procedures for the frame covers which are subject to higher removal/installation frequency during maintenance and servicing operations.

Section 3 describes the inspection/adjustment procedures, safety rules and service information for each part, starting from periodic maintenance.

Sections 8 through 14 give instructions for disassembly, assembly and adjustment of engine parts. Section 15 through 17 is the removal/ installation of chassis. Section 18 through 22 states the testing and measuring methods of electrical equipment.

Most sections start with an assembly or system illustration and troubleshooting for the section. The subsequent pages give detailed procedures for the section.

The information and contents included in this manual may be different from the motorcycle in case specifications are changed.
 KYMCO reserves the right to make changes at any time without notice and without incurring any obligation.

TABLE OF CONTENTS

	GENERAL INFORMATION	1
	FRAME COVERS /EXHAUST MUFFLER	2
	INSPECTION/ADJUSTMENT	3
ENGINE	LUBRICATION SYSTEM	4
	FUEL SYSTEM/FUEL PUMP/FUEL TANK/CARBURETOR	5
	AFI (AUTOMATIC FUEL INJECTION)	6
	COOLING SYSTEM	7
	ENGINE REMOVAL/INSTALLATION	8
	CYLINDER HEAD/VALVES	9
	CYLINDER/PISTON	10
	DRIVE AND DRIVEN PULLEY	11
	FINAL REDUCTION	12
	A.C. GENERATOR/STARTER CLUTCH	13
	CRANKCASE/CRANKSHAFT	14
CHASSIS	STEERING HANDLEBAR/FRONT WHEEL/FRONT SHOCK ABSORBER	15
	REAR FORK/REAR WHEEL/REAR SHOCK ABSORBER`	16
	BRAKE SYSTEM	17
ELECTRICAL EQUIPMENT	BATTERY/CHARGING SYSTEM	18
	IGNITION SYSTEM	19
	ELECTRIC STARTER	20
	LIGHTS/METERS/SWITCHES	21
	WIRING DIAGRAMS	22

KWANG YANG MOTOR CO., LTD.

OVERSEAS SERVICE DEPARTMENT

GENERAL INFORMATION

SERIAL NUMBER----- 1 - 1

SPECIFICATIONS (XCITING 500)----- 1 - 2

SPECIFICATIONS (XCITING 500 AFI) ----- 1 - 3

SPECIFICATIONS (XCITING 250)----- 1 - 4

SPECIFICATIONS (XCITING 300 AFI) ----- 1 - 5

SERVICE PRECAUTIONS ----- 1 - 6

TORQUE VALUES ----- 1-10

SPECIAL TOOLS ----- 1-14

LUBRICATION POINTS ----- 1-15

CABLE & HARNESS ROUTING (XCITING 500)----- 1-17

CABLE & HARNESS ROUTING (XCITING 500 AFI)----- 1-27

CABLE & HARNESS ROUTING (XCITING 250)----- 1-35

CABLE & HARNESS ROUTING (XCITING 300 AFI)----- 1-43

TROUBLESHOOTING (XCITING 500/250) ----- 1-51

TROUBLESHOOTING (XCITING 500 AFI/300 AFI)----- 1-62

SERIAL NUMBER

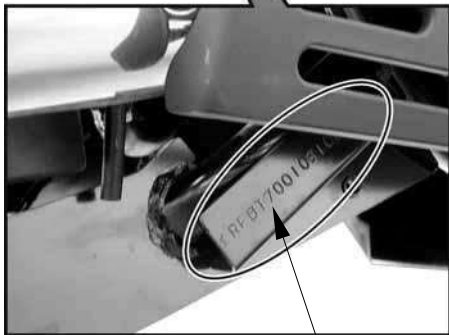
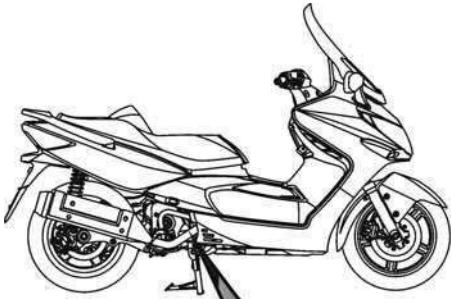

Location of Frame Serial Number

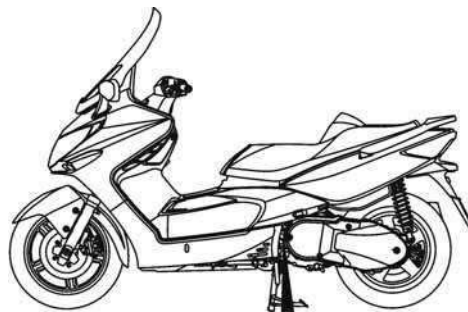

Location of Engine Serial Number

1. GENERAL INFORMATION

XCITING 500/500 AFI/250/300 AFI

SPECIFICATIONS (XCITING 500)

ITEM		SPECIFICATIONS		
Name		XCITING 500		
Overall length		2250 mm (90 in)		
Overall width		815 mm (33 in)		
Overall height		1450 mm (58 in)		
Wheel base		1570 mm (63 in)		
Engine type		O.H.C.		
Displacement		498.5 cm ³ (30.4 cu-in)		
Fuel Used		92# unleaded gasoline		
Dry weight	Front wheel	83 kg (183 lbs)		
	Rear wheel	132 kg (290 lbs)		
	Total	215 kg (473 lbs)		
Curb weight	Front wheel	90 kg (198 lbs)		
	Rear wheel	141 kg (310 lbs)		
	Total	231 kg (508 lbs)		
Tires	Front wheel	120/70-15		
	Rear wheel	150/70-14		
Ground clearance		150 mm (6 in)		
Min. turning radius		2750 mm (110 in)		
Engine	Starting system		Electric starter motor	
	Type		Gasoline, 4-stroke	
	Cylinder arrangement		Single cylinder	
	Combustion chamber type		Semi-sphere	
	Valve arrangement		O.H.C., chain drive	
	Bore x stroke		92 x 75 mm (3.7 x 3 in)	
	Compression ratio		10.5:1	
	Compression pressure		13 kgf/cm ² (1300kPa, 185 psi)	
	Intake valve	Open	2° BTDC	
		Close	45° ABDC	
	Exhaust valve	Open	45° BBDC	
		Close	5° ATDC	
	Valve clearance (cold)	Intake	0.1 mm (0.004 in)	
		Exhaust	0.1 mm (0.004 in)	
	Idle speed		1400 rpm	
	Lubrication System	Lubrication type		Forced pressure & Wet sump
		Oil pump type		Trochoid
		Oil filter type		Full-flow filtration
		Oil capacity		2.5 L (2.2 Imp qt, 2.65 Us qt)
		Final reduction oil capacity		0.55 L (0.5 Imp qt, 0.58 Us qt)
Cooling Type		Liquid cooled		

ITEM		SPECIFICATIONS	
Fuel System	Air cleaner type & No		Wet paper type element
	Fuel capacity		12.8 L (3.38 Imp gal, 2.82 US gal)
	Carburetor	Type	CVK
		Main jet NO.	98
Venturi dia.		φ36 mm (φ1.44 in)	
		Throttle type	PISTON
Electrical Equipment	Ignition System	Type	Full transistor ignition
		Spark plug	CR8E
		Ignition timing	Throttle position sensor
		Spark plug gap	0.6 ~ 0.7mm (0.002 ~ 0.003 in)
Battery	Capacity	12V12AH	
Power Drive System	Clutch	Type	Dry, centrifugal automatic
		Type	Helical gear/spur gear
	Transmission Gear Ratio	Operation	Automatic centrifugal Type
		Type	CVT
		Preliminary	2.68 – 1
Final	5.4		
Moving Device	FR/RR tire rolling circumference		1724/1778 mm (69/71 in)
	Tire pressure (rider only/60 kg)	Front	2 kg/cm ² (200 Kpa, 28 psi)
		Rear	2.5 kg/cm ² (250 Kpa, 36 psi)
	Turning angle	Left	40°
Right		40°	
Brake system type		Rear	Disk brake
		Front	Disk brake
Damping Device	Suspension type	Front	Telescopic fork
		Rear	Unit swing
Frame type		Back born	

1. GENERAL INFORMATION

XCITING 500/500 AFI/250/300 AFI

SPECIFICATIONS (XCITING 500 AFI)

ITEM		SPECIFICATIONS		
Name		XCITING 500 AFI		
Overall length		2250 mm (90 in)		
Overall width		815 mm (33 in)		
Overall height		1450 mm (58 in)		
Wheel base		1570 mm (63 in)		
Engine type		O.H.C.		
Displacement		498.5 cm ³ (30.4 cu-in)		
Fuel Used		92# unleaded gasoline		
Dry weight	Front wheel	83 kg (183 lbs)		
	Rear wheel	132 kg (290 lbs)		
	Total	215 kg (473 lbs)		
Curb weight	Front wheel	90 kg (198 lbs)		
	Rear wheel	141 kg (310 lbs)		
	Total	231 kg (508 lbs)		
Tires	Front wheel	120/70-15		
	Rear wheel	150/70-14		
Ground clearance		150 mm (6 in)		
Min. turning radius		2750 mm (110 in)		
Engine	Starting system		Electric starter motor	
	Type		Gasoline, 4-stroke	
	Cylinder arrangement		Single cylinder	
	Combustion chamber type		Semi-sphere	
	Valve arrangement		O.H.C., chain drive	
	Bore x stroke		92 x 75 mm (3.7 x 3 in)	
	Compression ratio		10.5:1	
	Compression pressure		13 kgf/cm ² (1300kPa, 185 psi)	
	Intake valve	Open	5° BTDC	
		Close	45° ABDC	
	Exhaust valve	Open	45° BBDC	
		Close	5° ATDC	
	Valve clearance (cold)	Intake	0.1 mm (0.004 in)	
		Exhaust	0.1 mm (0.004 in)	
	Idle speed		1400 rpm	
	Lubrication System	Lubrication type		Forced pressure & Wet sump
		Oil pump type		Trochoid
		Oil filter type		Full-flow filtration
		Oil capacity		2.5 L (2.2 Imp qt, 2.65 Us qt)
		Final reduction oil capacity		0.55 L (0.5 Imp qt, 0.58 Us qt)
	Cooling Type		Liquid cooled	

ITEM		SPECIFICATIONS	
Fuel System	Air cleaner type & No		Wet paper type element
	Fuel capacity		12.8 L (3.38 Imp gal, 2.82 US gal)
	Throttle Body Venturi dia		φ40 mm (φ1.6 in)
Electrical Equipment	Ignition System	Type	Full transistor ignition
		Spark plug	CR7E
		Ignition timing	ECU
		Spark plug gap	0.6~0.7mm (0.002~0.003 in)
	Battery	Capacity	12V12AH
Power Drive System	Clutch	Type	Dry, centrifugal automatic
		Transmission Gear	Type
	Ratio Reduction	Operation	Automatic centrifugal Type
		Type	CVT
		Preliminary	2.68 – 1
Final	5.4		
Moving Device	FR/RR tire rolling circumference		1724/1778 mm (69/71 in)
	Tire pressure (rider only/60 kg)	Front	2 kg/cm ² (200 Kpa, 28 psi)
		Rear	2.5 kg/cm ² (250 Kpa, 36 psi)
	Turning angle	Left	40°
Right		40°	
Brake system type		Rear	Disk brake
		Front	Disk brake
Damping Device	Suspension type	Front	Telescopic fork
		Rear	Unit swing
Frame type		Back born	

1. GENERAL INFORMATION

XCITING 500/500 AFI/250/300 AFI

SPECIFICATIONS (XCITING 250)

ITEM		SPECIFICATIONS		
Name		XCITING 250		
Overall length		2250 mm (90 in)		
Overall width		815 mm (33 in)		
Overall height		1450 mm (58 in)		
Wheel base		1570 mm (63 in)		
Engine type		O.H.C.		
Displacement		251/249.1 cm ³ (15.3/15.8 cu-in)		
Fuel Used		92# nonleaded gasoline		
Dry weight	Front wheel	75 kg (165 lbs)		
	Rear wheel	110 kg (242 lbs)		
	Total	185 kg (407 lbs)		
Curb weight	Front wheel	81 kg (178 lbs)		
	Rear wheel	119 kg (262 lbs)		
	Total	200 kg (440 lbs)		
Tires	Front wheel	120/70-15		
	Rear wheel	150/70-14		
Ground clearance		170 mm (6.8 in)		
Min. turning radius		2600 mm (104 in)		
Engine	Starting system		Electric starter motor	
	Type		Gasoline, 4-stroke	
	Cylinder arrangement		Single cylinder	
	Combustion chamber type		Semi-sphere	
	Valve arrangement		O.H.C., chain drive	
	Bore x stroke		72.7 x 60 mm (2.908 x 2.4 in)	
	Compression ratio		10.3:1	
	Compression pressure		15 kgf/cm ² (1500kPa, 213 psi)	
	Intake valve	Open	9° BTDC	
		Close	45° ABDC	
	Exhaust valve	Open	38° BBDC	
		Close	10° ATDC	
	Valve clearance (cold)	Intake	0.1 mm (0.004 in)	
		Exhaust	0.1 mm (0.004 in)	
	Idle speed		1600 rpm	
	Lubrication System	Lubrication type		Forced pressure & Wet sump
		Oil pump type		Trochoid
		Oil filter type		Full-flow filtration
		Oil capacity		1.1 L (0.97 Imp qt, 1.17 Us qt)
		Final reduction oil capacity		0.2 L (0.18 Imp qt, 0.21 Us qt)
Cooling Type		Liquid cooled		

ITEM		SPECIFICATIONS		
Fuel System	Air cleaner type & No		Wet paper type element	
	Fuel capacity		12.8 L (3.38 Imp gal, 2.82 US gal)	
	Carburetor	Type	CVK	
		Main jet NO.	94	
Venturi dia.		φ30 mm (φ1.2 in)		
		Throttle type	PISTON	
Electrical Equipment	Ignition System	Type	Full transistor ignition	
		Spark plug	DPR7EA-9	
		Ignition timing	Throttle position sensor	
		Spark plug gap	0.6~0.7mm (0.002~ 0.003 in)	
Battery		Capacity	12V10AH	
Power Drive System	Clutch	Type	Dry, centrifugal automatic	
		Transmission Gear	Type	Helical gear/spur gear
			Operation	Automatic centrifugal Type
	Reduction Ratio	Type	CVT	
Preliminary		0.83 – 2.2		
Final		8.72		
Moving Device	FR/RR tire rolling circumference		1724/1778 mm (69/71 in)	
	Tire pressure (rider only/60 kg)	Front	2 kg/cm ² (200 Kpa, 28 psi)	
		Rear	2.5 kg/cm ² (250 Kpa, 36 psi)	
	Turning angle	Left	40°	
Right		40°		
Brake system type		Rear	Disk brake	
		Front	Disk brake	
Damping Device	Suspension type	Front	Telescopic fork	
		Rear	Unit swing	
Frame type		Back born		

1. GENERAL INFORMATION

XCITING 500/500 AFI/250/300 AFI

SPECIFICATIONS (XCITING 300 AFI)

ITEM		SPECIFICATIONS		
Name		XCITING 300 AFI		
Overall length		2250 mm (90 in)		
Overall width		815 mm (33 in)		
Overall height		1450 mm (58 in)		
Wheel base		1570 mm (63 in)		
Engine type		O.H.C.		
Displacement		270 cm ³		
Fuel Used		nonleaded gasoline		
Dry weight	Front wheel	75 kg (165 lbs)		
	Rear wheel	110 kg (242 lbs)		
	Total	185 kg (407 lbs)		
Curb weight	Front wheel	81 kg (178 lbs)		
	Rear wheel	119 kg (262 lbs)		
	Total	200 kg (440 lbs)		
Tires	Front wheel	120/70-15		
	Rear wheel	150/70-14		
Ground clearance		170 mm (6.8 in)		
Min. turning radius		2600 mm (104 in)		
Engine	Starting system		Electric starter motor	
	Type		Gasoline, 4-stroke	
	Cylinder arrangement		Single cylinder	
	Combustion chamber type		Semi-sphere	
	Valve arrangement		O.H.C., chain drive	
	Bore x stroke		72.7 x 65.2 mm	
	Compression ratio		10.6:1	
	Compression pressure		15 kgf/cm ² (1500kPa, 213 psi)	
	Intake valve	Open	9° BTDC	
		Close	40° ABDC	
	Exhaust valve	Open	42° BBDC	
		Close	7° ATDC	
	Valve clearance (cold)	Intake	0.1 mm (0.004 in)	
		Exhaust	0.1 mm (0.004 in)	
	Idle speed		1600 rpm	
	Lubrication System	Lubrication type		Forced pressure & Wet sump
		Oil pump type		Trochoid
		Oil filter type		Full-flow filtration
		Oil capacity		1.1 L/0.9L
		Final reduction oil capacity		0.23 L/0.18L
	Cooling Type		Liquid cooled	

ITEM		SPECIFICATIONS	
Fuel System	Air cleaner type & No		Wet paper type element
	Fuel capacity		12.8 L (3.38 Imp gal, 2.82 US gal)
	Throttle Body Venturi dia		φ32 mm
Electrical Equipment	Ignition System	Type	Full transistor ignition
		Spark plug	DPR6EA-9
		Ignition timing	ECU
		Spark plug gap	0.8~0.9mm
	Battery	Capacity	12V12AH
Power Drive System	Clutch	Type	Dry, centrifugal automatic
		Transmission Gear Ratio	Type
	Operation		Automatic centrifugal Type
	Type		CVT
	Preliminary	0.83 – 2.2	
Final	8.26		
Moving Device	FR/RR tire rolling circumference		1724/1778 mm (69/71 in)
	Tire pressure (rider only/60 kg)	Front	2 kg/cm ² (200 Kpa, 28 psi)
		Rear	2.5 kg/cm ² (250 Kpa, 36 psi)
	Turning angle	Left	40°
Right		40°	
Brake system type		Rear	Disk brake
		Front	Disk brake
Damping Device	Suspension type	Front	Telescopic fork
		Rear	Unit swing
Frame type		Back born	

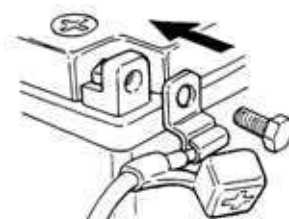
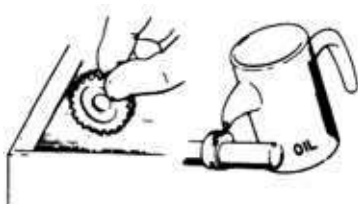
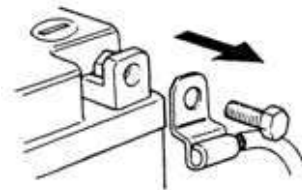
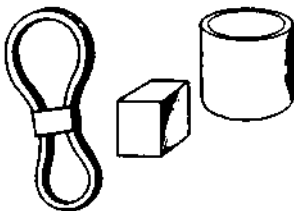
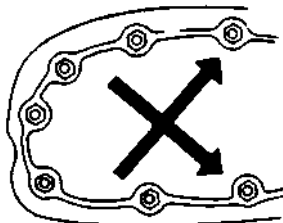
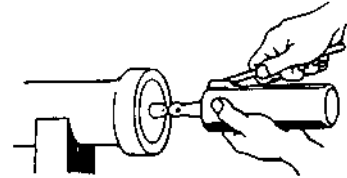
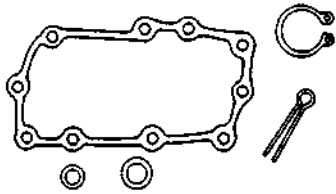

1. GENERAL INFORMATION

XCITING 500/500 AFI/250/300 AFI

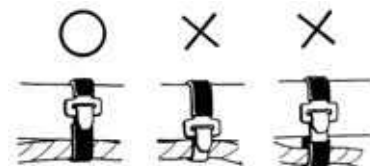
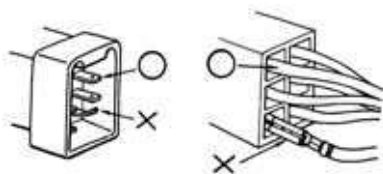
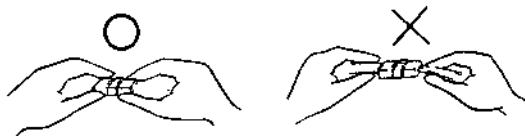
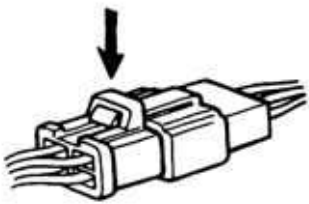
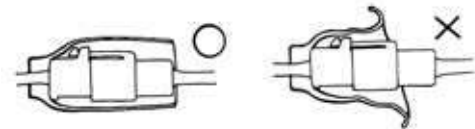
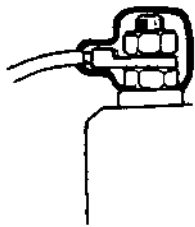
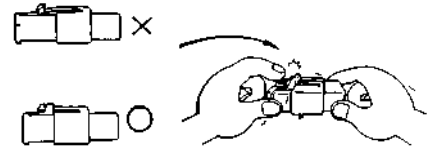
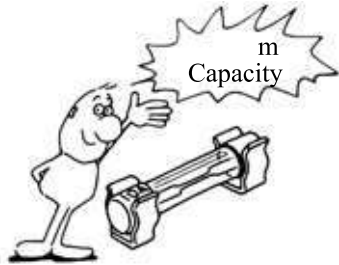

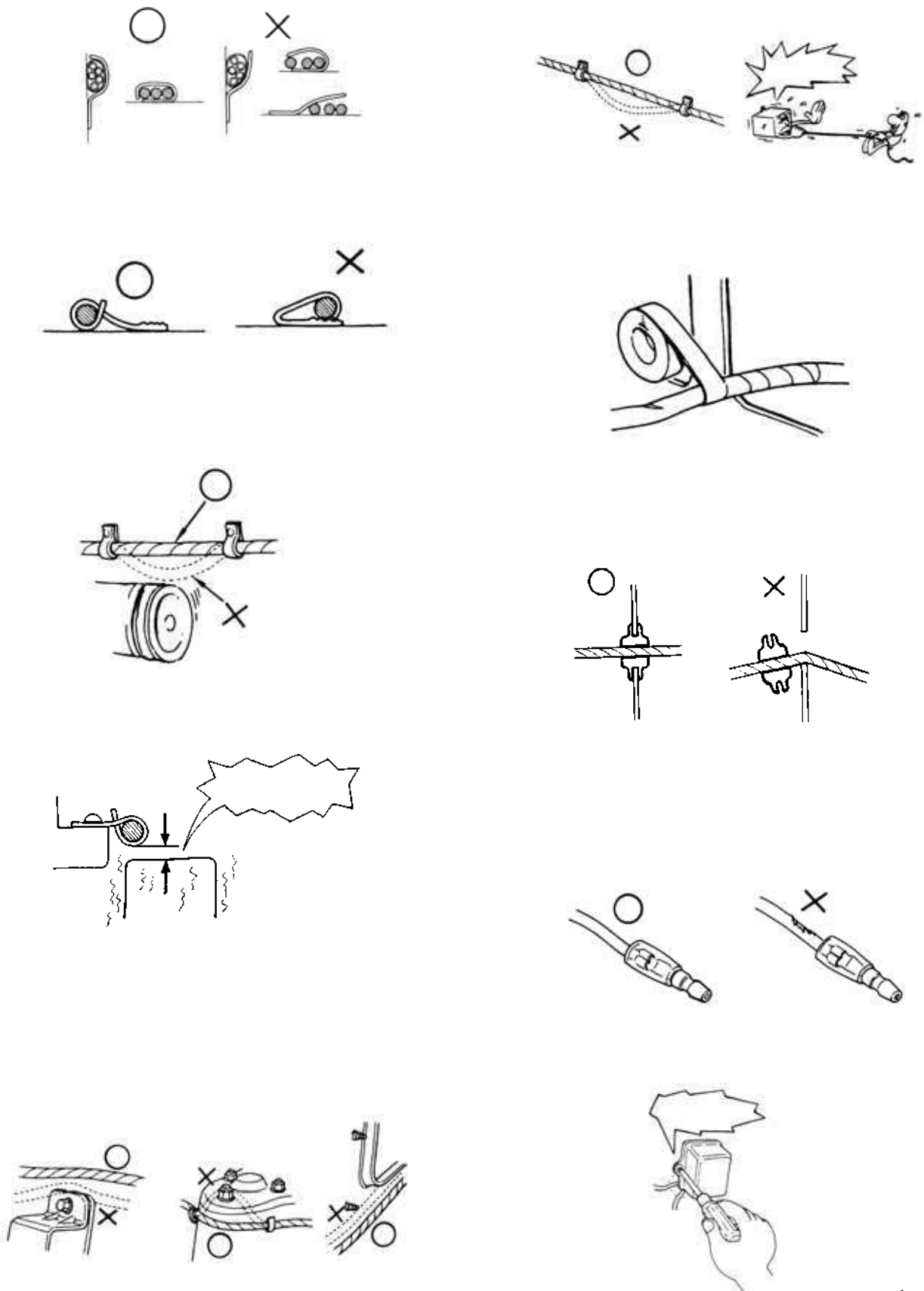

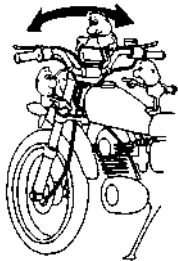
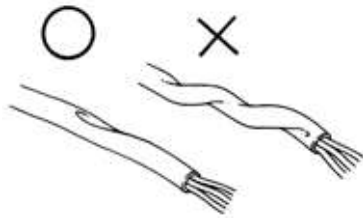

1. GENERAL INFORMATION

XCITING 500/500 AFI/250/300 AFI

TORQUE VALUES

STANDARD TORQUE VALUES

Item	Torque N•m (kgf•m, lbf•ft)	Item	Torque N•m (kgf•m, lbf•ft)
5mm bolt and nut	5(0.5, 4)	4mm screw	3 (0.3, 2)
6mm bolt and nut	10 (1, 7)	5mm screw	4 (0.4, 3)
8mm bolt and nut	22 (2.2, 16)	6mm screw, SH bolt	9 (0.9, 6.5)
10mm bolt and nut	35 (3.5, 25)	6mm flange bolt and nut	12 (1.2, 9)
12mm bolt and nut	55 (5.5, 40)	8mm flange bolt and nut	27 (2.7, 20)
14mm bolt and nut	70 (7, 50)	10mm flange bolt and nut	40 (4, 29)

Torque specifications listed below are for important fasteners.

ENGINE (XCITING 500/XCITING 500 AFI)

Item	Q'ty	Thread dia. (mm)	Torque N•m (kgf•m, lbf•ft)	Remarks
MAINTENANCE:				
Engine oil drain plug	1	12	25 (2.5, 18)	
Oil strainer screen cap	1	30	15 (1.5, 11)	
Oil filter cartridge	1	20	10 (1, 7)	
Transmission oil drain bolt	1	8	20 (2, 15)	
Transmission oil filler bolt	1	8	20 (2, 15)	
Spark plug	1	10	12 (1.2, 9)	
Tappet adjust nut	4	5	9 (0.9, 6)	
LUBRICATION SYSTEM:				
Oil pump screw	1	4	3 (0.3, 2)	
Oil cooler bolt	2	16	35 (3.5, 25)	Apply oil
COOLING SYSTEM:				
Water pump cover bolt	2	6	13 (1.3, 9)	
CYLINDER HEAD:				
Breather separator bolt	3	6	13 (1.3, 9)	Apply oil
Cylinder head bolt (1 – 4)	4	10	48 (4.8, 35)	Apply oil
Cylinder head bolt (5 – 13)	9	8	23 (2.3, 17)	Apply oil
Cylinder head cover bolt	4	6	10 (1, 7)	
Cam chain tensioner bolt	2	6	12 (1.2, 9)	
Tensioner pivot bolt	1	8	10 (1, 7)	
Rocker arm shaft	2	18	45 (4.5, 32)	
DRIVE/DRIVEN PULLEY:				
Drive face nut	1	18	135 (13.5, 97)	Apply oil
Clutch out nut	1	14	80 (8, 58)	Apply oil

1. GENERAL INFORMATION

XCITING 500/500 AFI/250/300 AFI

ENGINE (XCITING 500/XCITING 500 AFI)

(Cont'd)

Item	Q'ty	Thread dia. (mm)	Torque N•m (kgf•m, lbf•ft)	Remarks
Drive plate nut	1	28	78 (7.8, 56)	
ALTERNATOR				
ACG flywheel nut	1	14	55 (5.5, 40)	
FINAL REDUCTION:				
Transmission cover bolt	8	8	27 (2.7, 20)	
CRANKCASE:				
Crankcase bolt	13	6	12 (1.2, 9)	Apply oil
Oil pipe bolt	2	16	43 (4.3, 31)	Apply oil
Cam chain guide	2	8	20 (2, 15)	
SWITCH:				
Oil pressure switch	1	PT 1/8	22 (2.2, 16)	Apply seal

ENGINE (XCITING 250/XCITING 300 AFI)

Item	Q'ty	Thread dia.(mm)	Torque N•m (kgf•m, lbf•ft)	Remarks
MAINTENANCE:				
Valve adjusting lock nut	2	5	9 (0.9, 6.5)	Apply oil
Spark plug	1	10	12 (1.2, 9)	
Transmission oil drain bolt	1	12	20 (2, 15)	
Transmission oil check/fill bolt	1	8	20 (2, 15)	
Crank case oil drain bolt	1	12	25 (2.5, 18)	
Oil filter screen cap	1	30	15 (1.5, 10.8)	Apply oil
LUBRICATION SYSTEM:				
Oil pump screw	1	3	2 (0.2, 1.4)	
COOLING SYSTEM:				
Water pump impeller	1	7	12 (1.2, 8.6)	Left screw
CYLINDER HEAD:				
Cylinder head cap nut	4	8	25 (2.5, 18)	Apply oil
Tensioner lifter bolt	1	6	4 (0.4, 3)	
Cylinder head cover bolt	4	6	12 (1.2, 8.6)	
Cam chain tensioner bolt	2	6	12 (1.2, 8.6)	

1. GENERAL INFORMATION

XCITING 500/500 AFI/250/300 AFI
ENGINE (XCITING 250/XCITING 300 AFI)
(Cont'd)

Item	Q'ty	Thread dia. (mm)	Torque N•m (kgf•m, lbf•ft)	Remarks
DRIVE/DRIVEN PULLEY:				
Drive face nut	1	14	93 (9.3, 67)	Apply oil
Clutch outer nut	1	12	54 (5.4, 39)	
Clutch drive plate nut	1	28	54 (5.4, 39)	
Left crankcase cover bolt	6	6	12 (1.2, 8.6)	
ALTERNATOR				
A.C.G. stator	5	5	9 (0.9, 6.5)	
Flywheel nut	1	14	55 (5.5, 40)	
FINAL REDUCTION:				
Transmission case cover bolt	9	8	20 (2, 14.4)	
CRANKCASE:				
Cam chain guide bolt	1	6	10 (1, 7)	
SWITCH:				
Oil pressure switch	1	PT 1/8	22 (2.2, 16)	Apply seal

1. GENERAL INFORMATION

XCITING 500/500 AFI/250/300 AFI

FRAME

Item	Q'ty	Thread dia.(mm)	Torque N•m (kgf•m, lbf•ft)	Remarks
STEERING:				
Handlebar bolt	4	8	23 (2.3, 17)	
Upper pinch bolt	2	8	23 (2.3, 17)	
Lower pinch bolt	4	8	32 (3.2, 23)	
Bridge stem nut	1	22	62 (6.2, 45)	
Steering stem lock nut	1	25.4	55 (5.5, 40)	
Top thread	1	25.4	20 (2, 15)	
WHEEL:				
Front axle bolt	1	18	20 (2, 15)	
Front fork bolt	2	8	23 (2.3, 17)	
Rear axle nut (XCITING 500)	1	20	180 (18, 130)	
Rear axle nut (XCITING 250)	1	16	140 (14, 100)	
SUSPENSION:				
Rear shock absorber bolt	4	10	40 (4, 29)	
Rear fork	2	8	32 (3.2, 23)	
BRAKE:				
Front caliper mounting bolt	4	8	32 (3.2, 23)	Replace a new one
Rear caliper mounting bolt	2	8	32 (3.2, 23)	Replace a new one
Brake fluid bolt	6	10	35 (3.5, 25)	
Master cylinder bolt	4	6	12 (1.2, 9)	
ENGINE HANGER:				
Engine hanger bolt	4	10	50 (5, 36)	
Engine mounting bolt/nut (XCITING 500)	1	14	80 (8, 58)	
Engine mounting bolt/nut (XCITING 250)	1	10	50 (5, 36)	
Engine hanger rod nut	1	10	35 (3.5, 25)	
MUFFLER				
Exhaust pipe nut	2	8	20 (2, 14)	
Muffler mount bolt	3	10	35 (3.5, 25)	

1. GENERAL INFORMATION

XCITING 500/500 AFI/250/300 AFI

SPECIAL TOOLS

XCITING 500/XCITING 500 AFI

Tool Name	Tool No.	Remarks
Oil seal & bearing installers	A120E00014	Oil seal & bearing install
Lock nut socket wrench	A120E00015	Steering stem removal or install
Universal holder	A120E00017	Holding clutch for removal
Flywheel holder	A120E00021	A.C. generator flywheel holding
Tappet adjuster	A120E00036	Tappet adjustment
Bearing pullers	A120E00037	Bearing removal
Valve spring compressor	A120E00040	Valve removal
Oil filter cartridge wrench	A120E00052	Cartridge removal or install
Clutch spring compressor	A120E00053	Clutch disassembly
Flywheel puller	A120E00054	A.C. generator flywheel removal
Lock nut socket wrench	A120F00007	Steering stem removal or install
Steering stem top thread wrench	A120F00023	Steering stem removal or install

XCITING 250/XCITING 300 AFI

Tool Name	Tool No.	Remarks
Flywheel puller	A120E00003	A.C. generator flywheel removal
Oil seal & bearing installers	A120E00014	Oil seal & bearing install
Lock nut socket wrench	A120E00015	Steering stem removal or install
Universal holder	A120E00017	Holding clutch for removal
Flywheel holder	A120E00021	A.C. generator flywheel holding
Clutch spring compressor	A120E00034	Clutch disassembly
Tappet adjuster	A120E00036	Tappet adjustment
Bearing pullers	A120E00037	Bearing removal
Valve spring compressor	A120E00040	Valve removal
Lock nut socket wrench	A120F00007	Steering stem removal or install
Steering stem top thread wrench	A120F00023	Steering stem removal or install

LUBRICATION POINTS

ENGINE

Lubrication Points	Lubricant
Valve guide/valve stem movable part Camshaft protruding surface Valve rocker arm friction surface Camshaft drive chain Cylinder lock bolt and nut Piston surroundings and piston ring grooves Piston pin surroundings Cylinder inside wall Connecting rod/piston pin hole Connecting rod big end Crankshaft Balancer shaft Crankshaft one-way clutch movable part Oil pump drive chain Starter reduction gear engaging part O-ring face Oil seal lip	<ul style="list-style-type: none"> •Genuine KYMCO Engine Oil (SAE 5W-50) •API SJ Engine Oil
Drive gear shaft Countershaft Final gear Final gear shaft Transmission gearshaft bearing part	Transmission oil: SAE 90
A.C. generator connector	Adhesive

1. GENERAL INFORMATION

XCITING 500/500 AFI/250/300 AFI

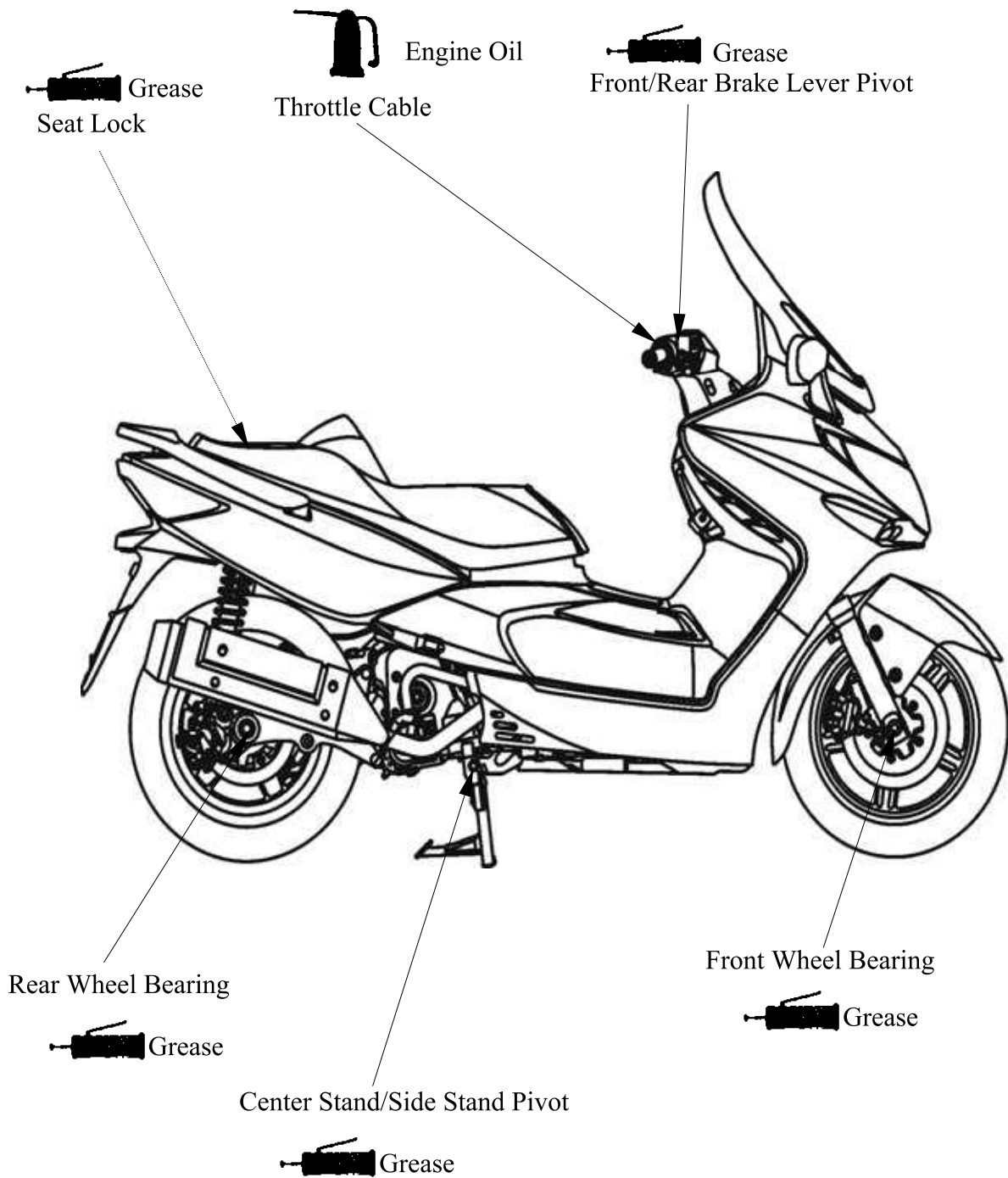

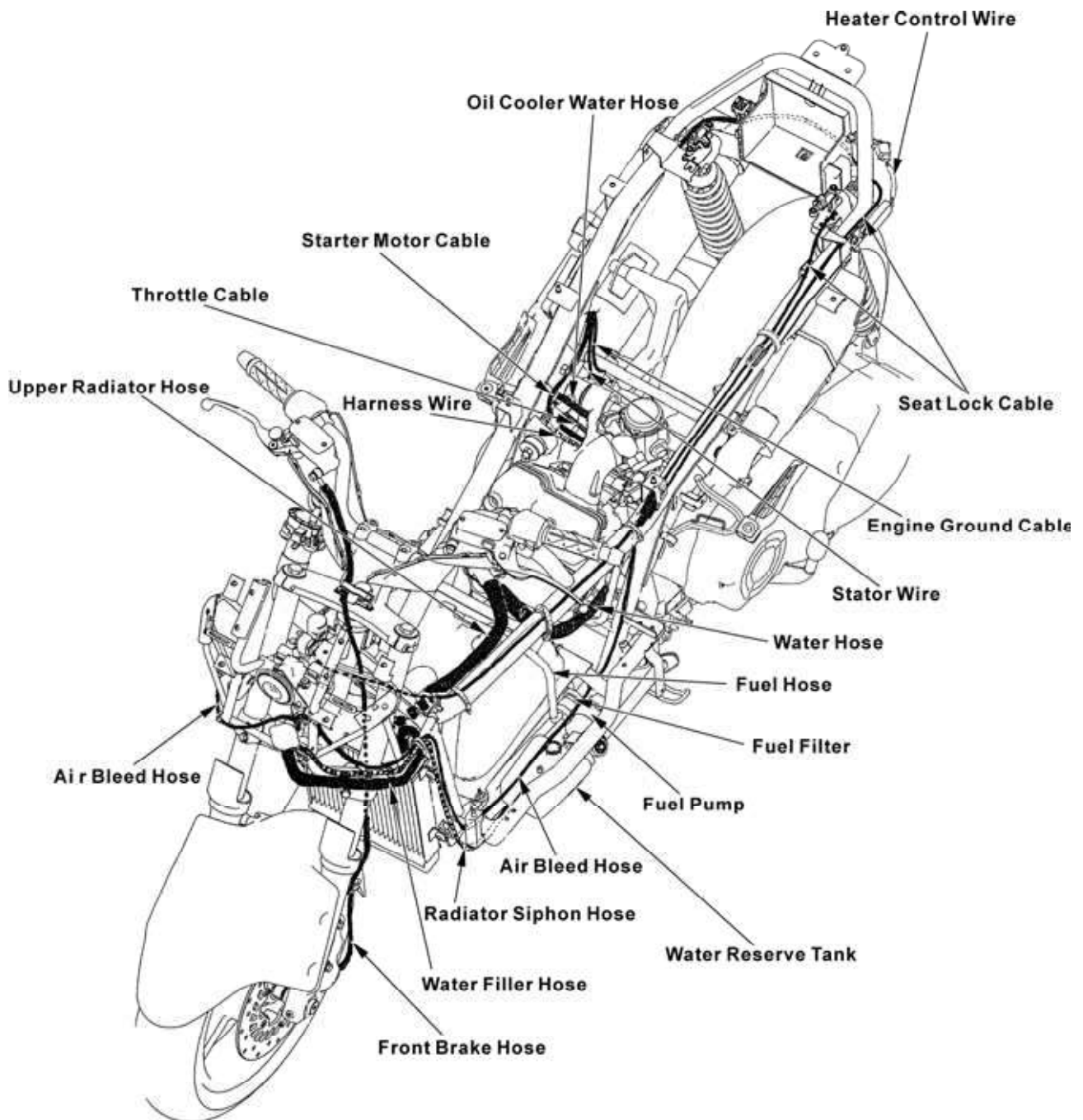
CABLE & HARNESS ROUTING (XCITING 500)

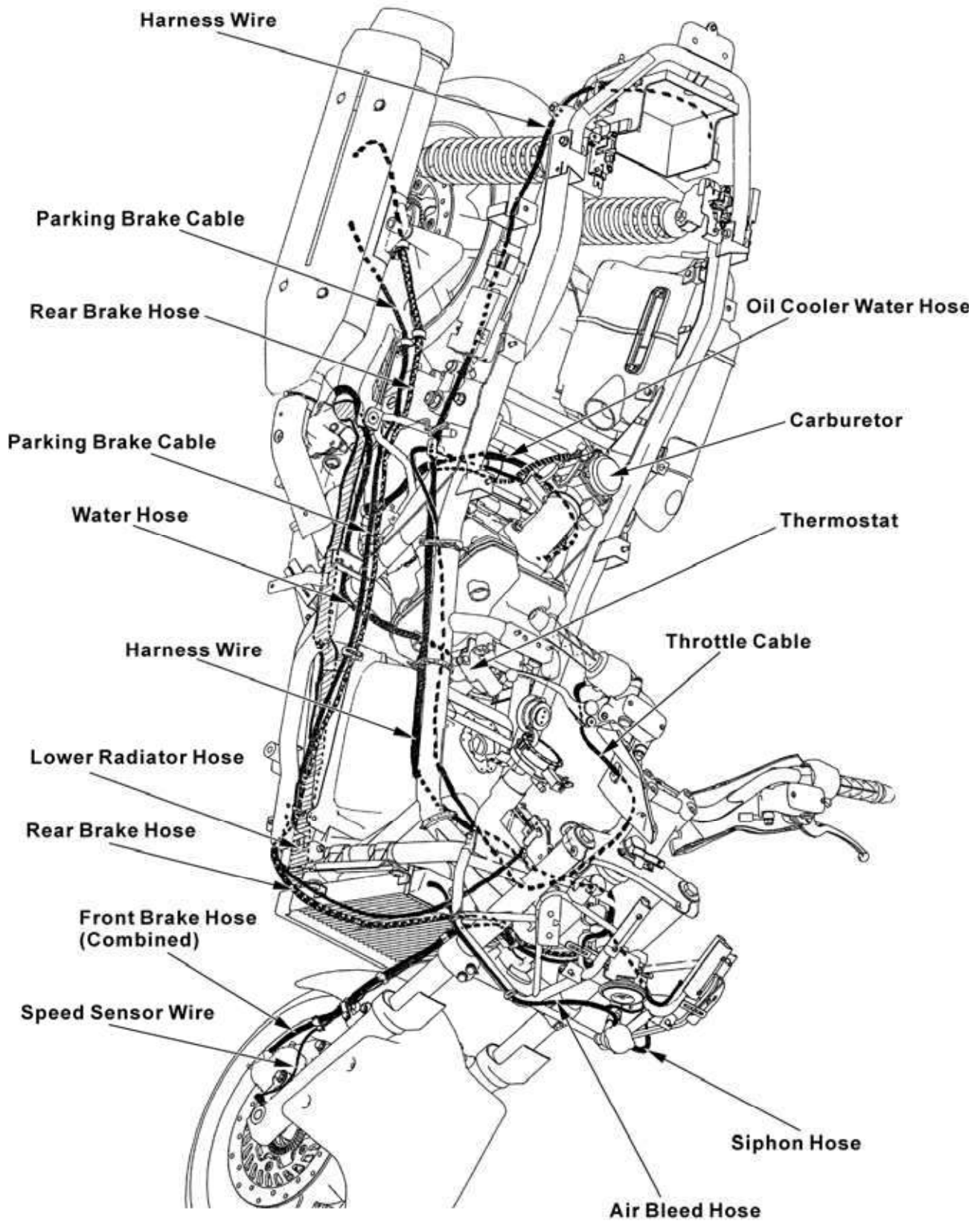

1. GENERAL INFORMATION

XCITING 500/500 AFI/250/300 AFI

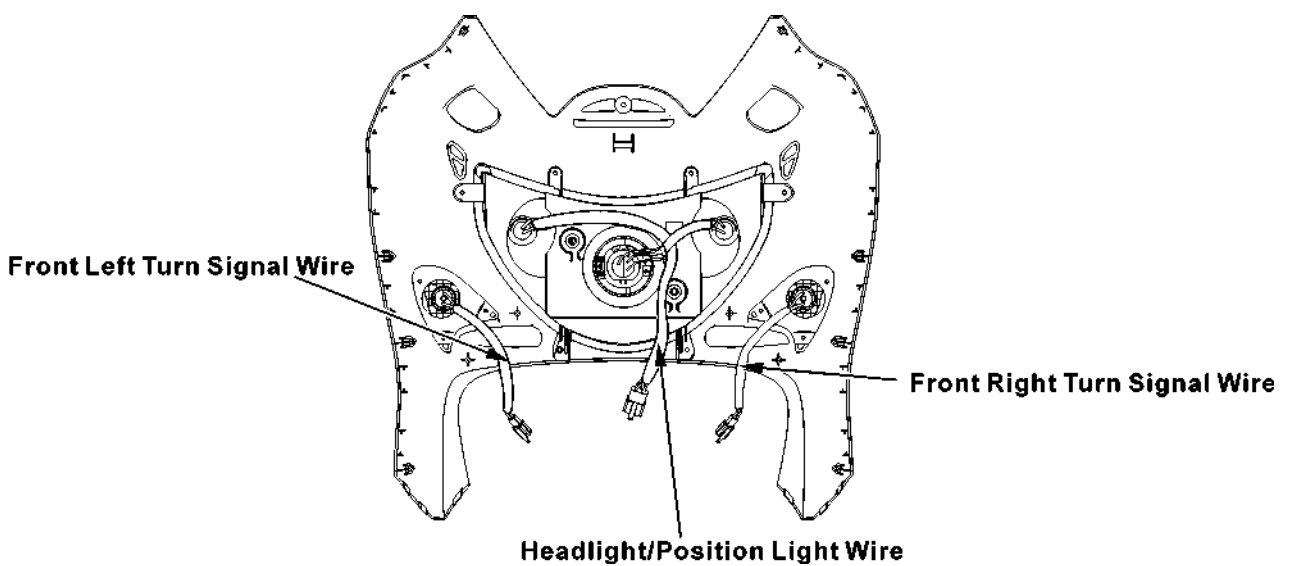
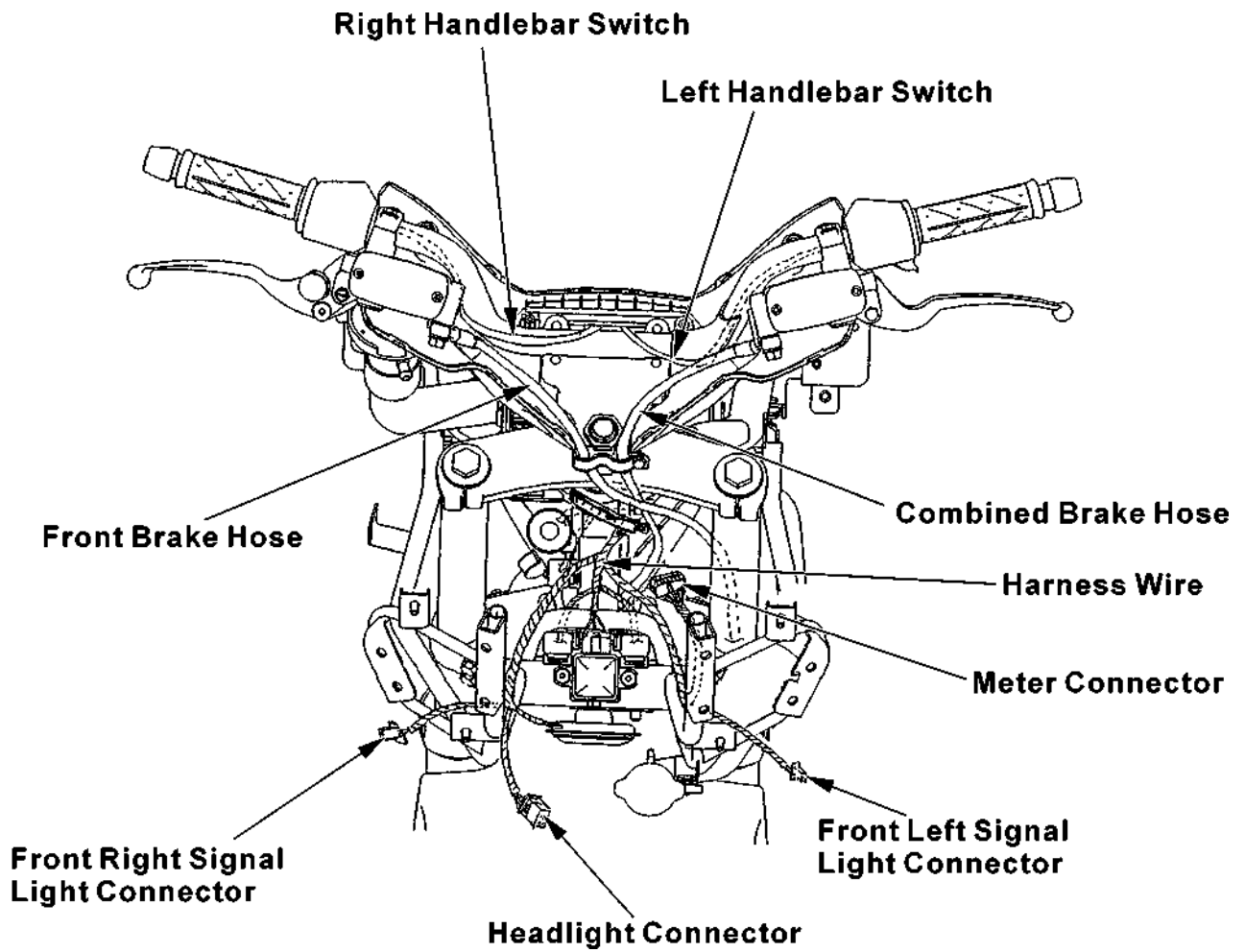

1. GENERAL INFORMATION

XCITING 500/500 AFI/250/300 AFI

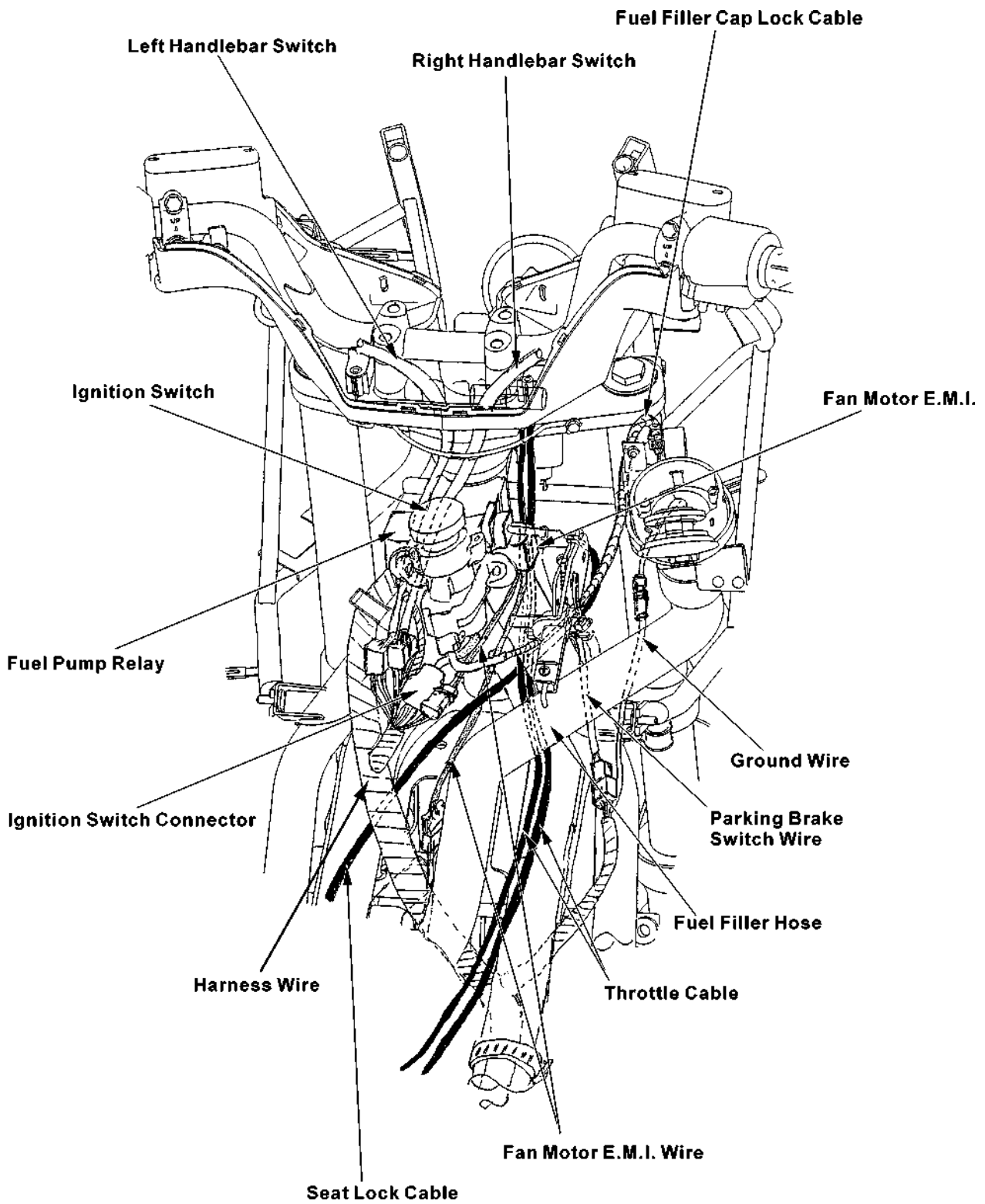

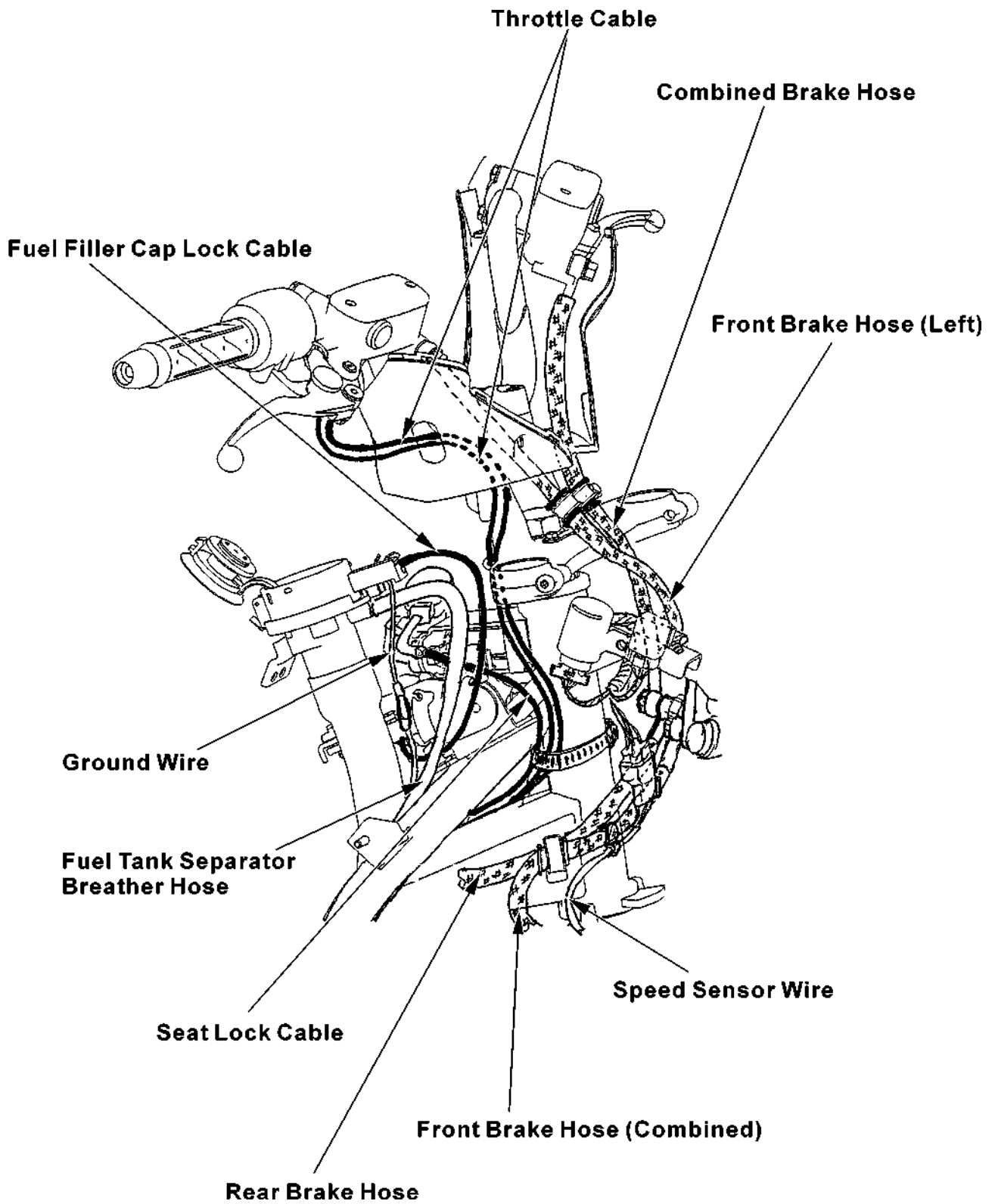

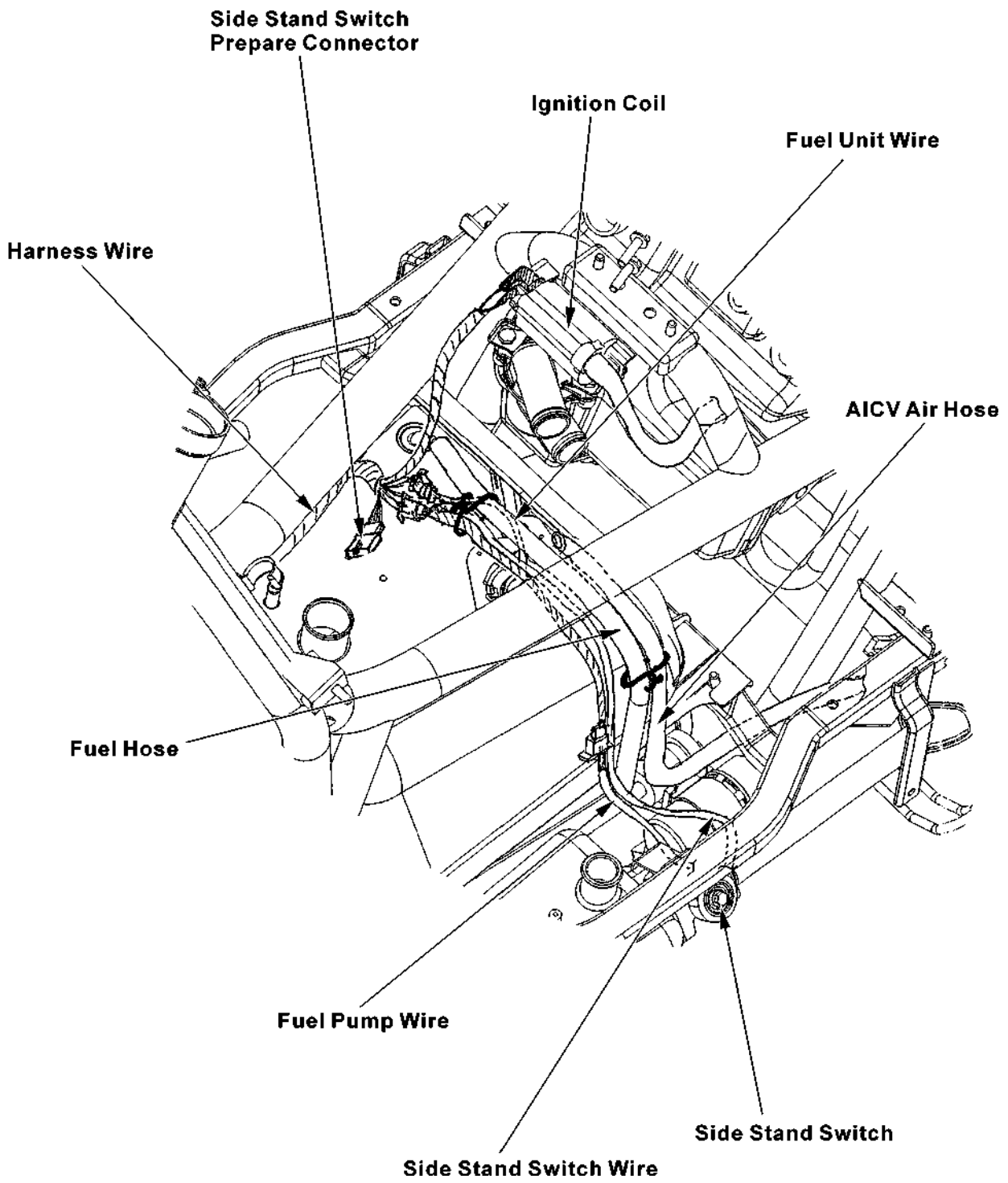

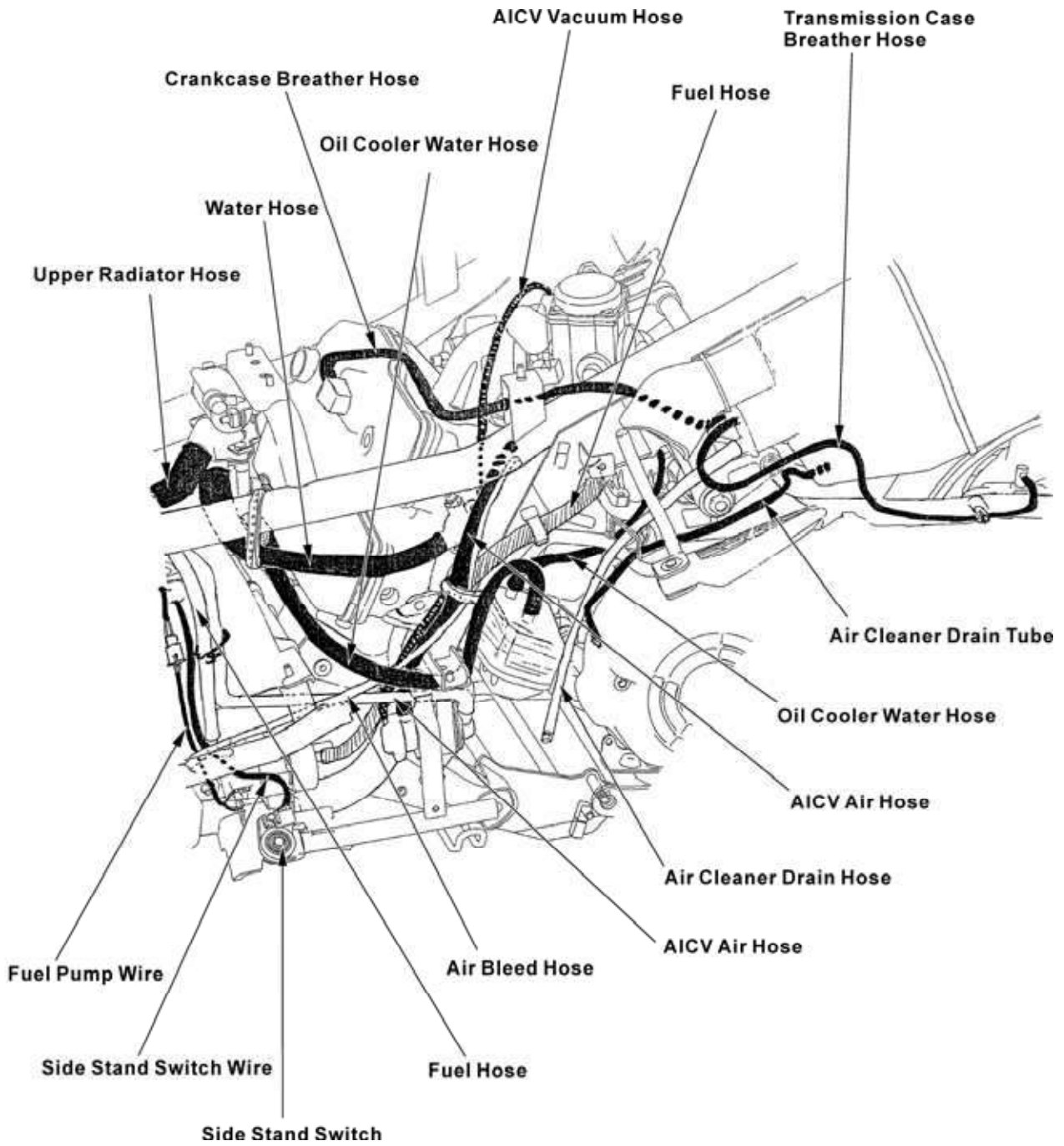

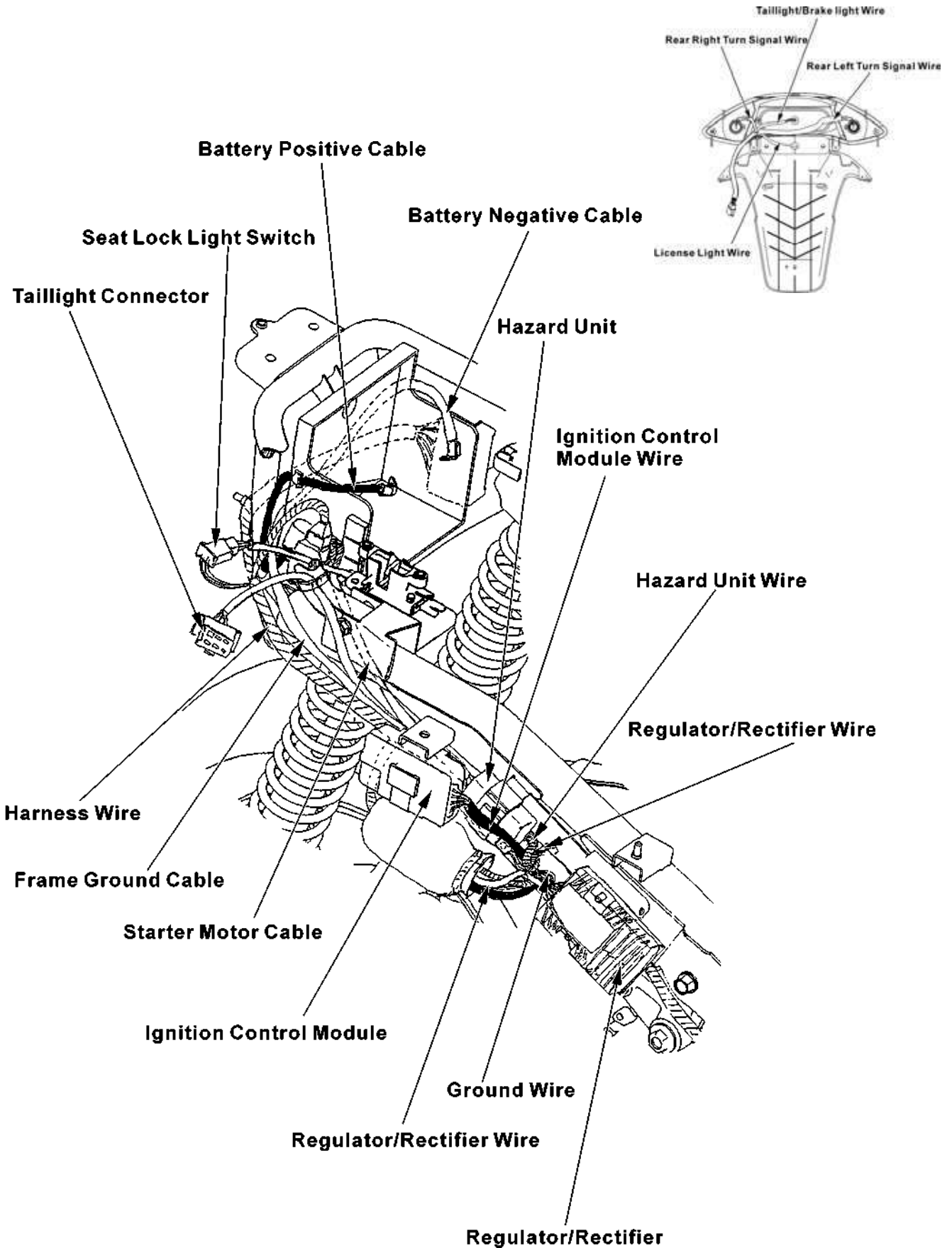

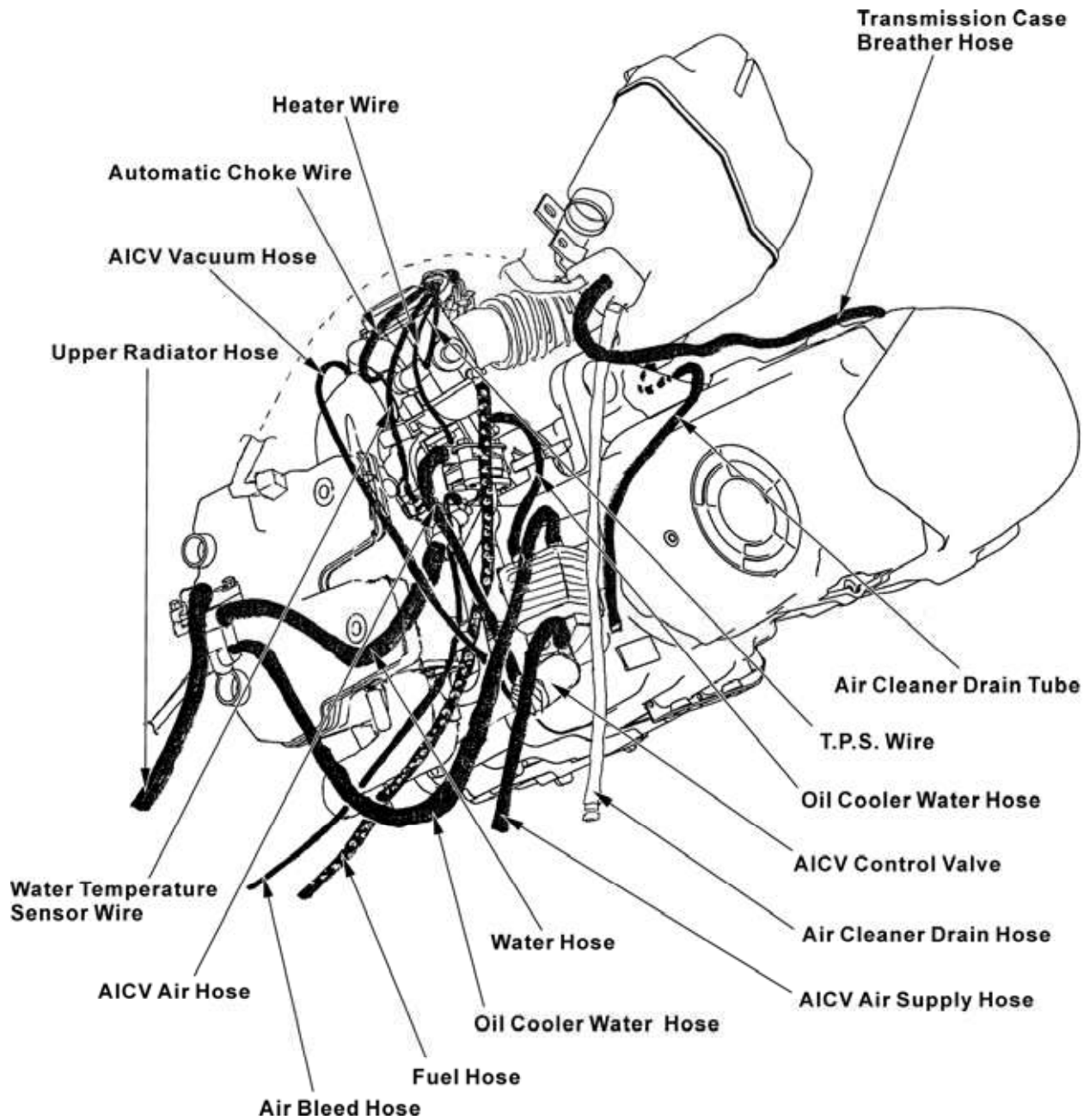

1. GENERAL INFORMATION

XCITING 500/500 AFI/250/300 AFI

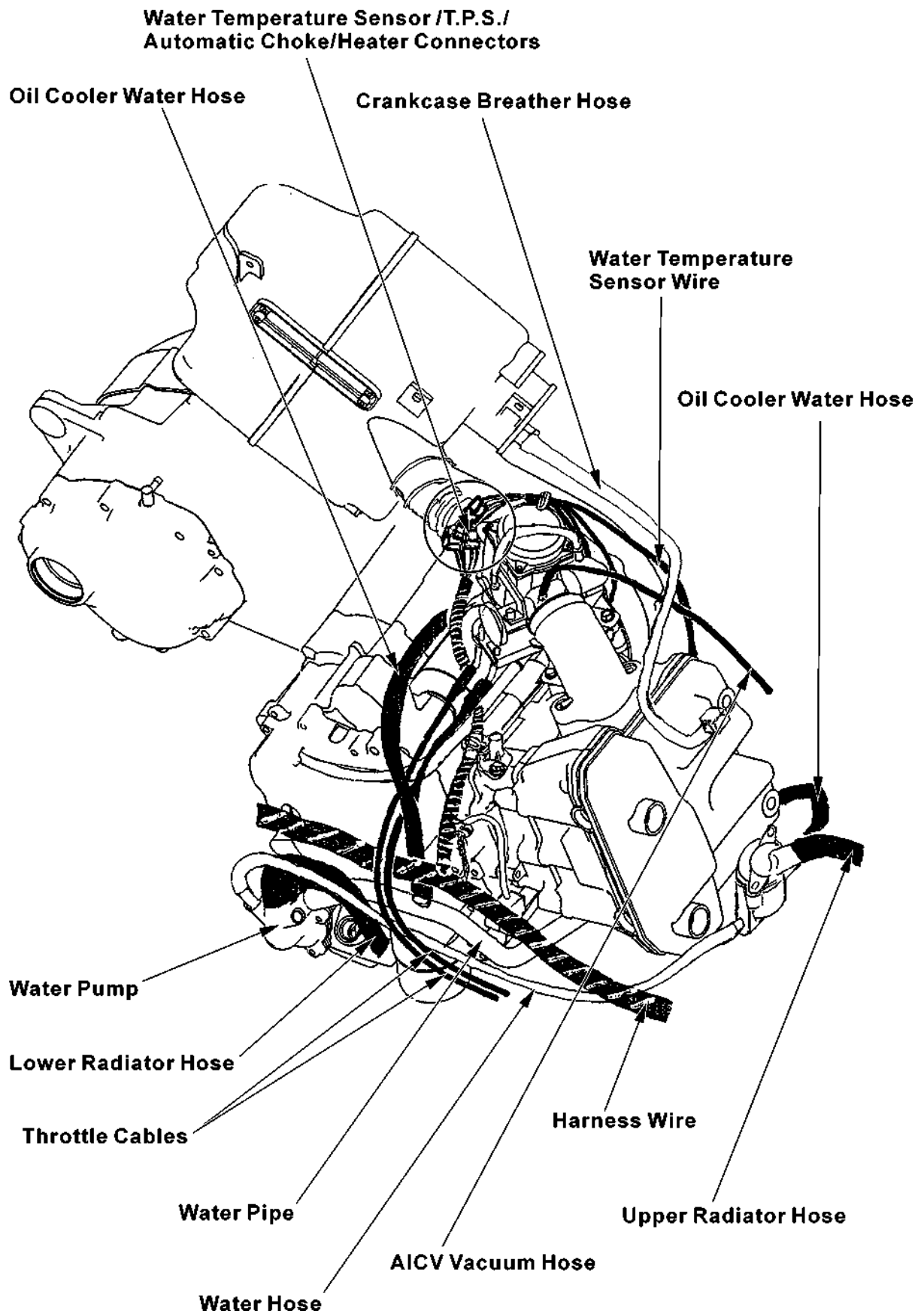

1. GENERAL INFORMATION

XCITING 500/500 AFI/250/300 AFI

CABLE & HARNESS ROUTING (XCITING 500 AFI)

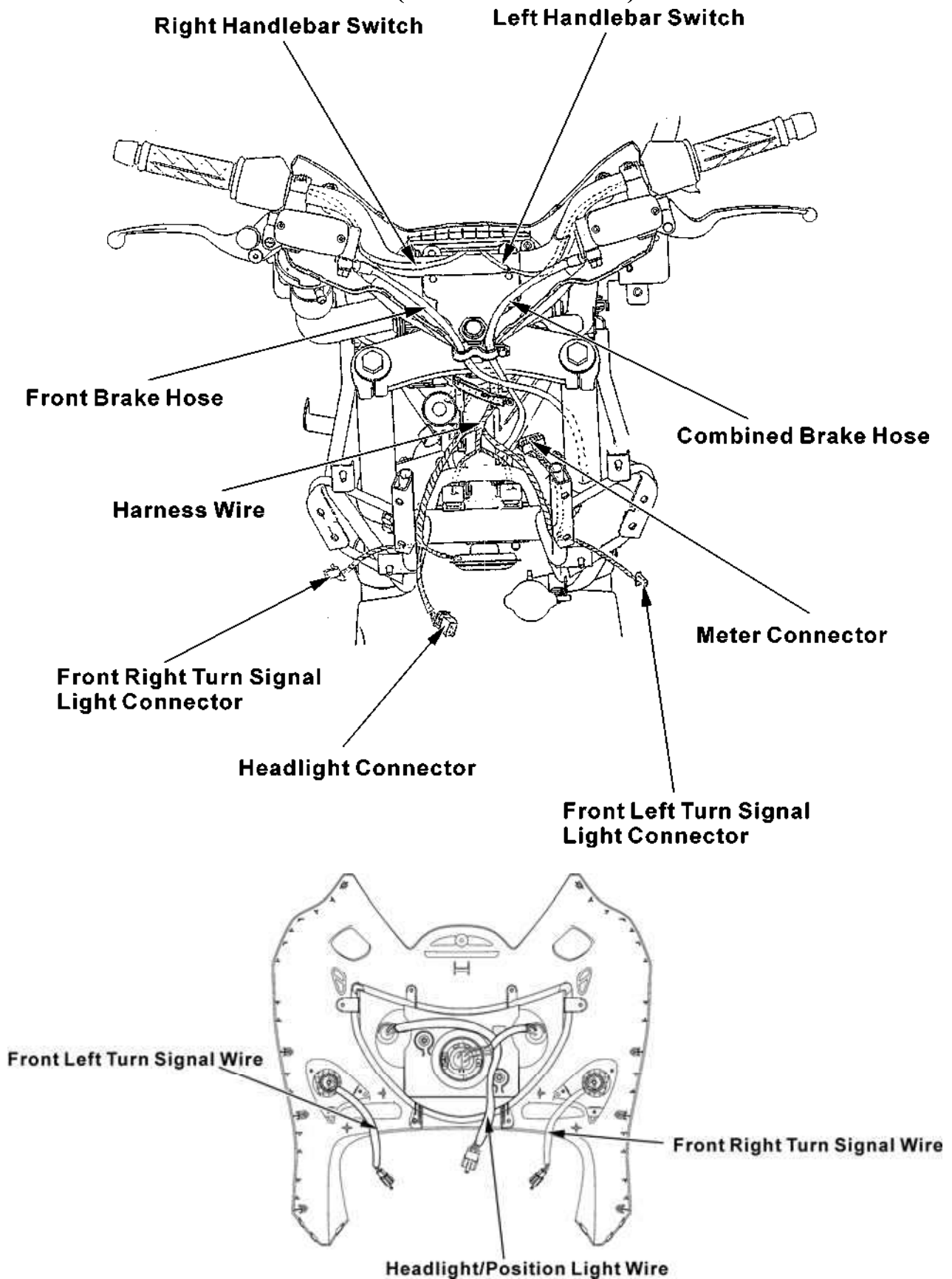

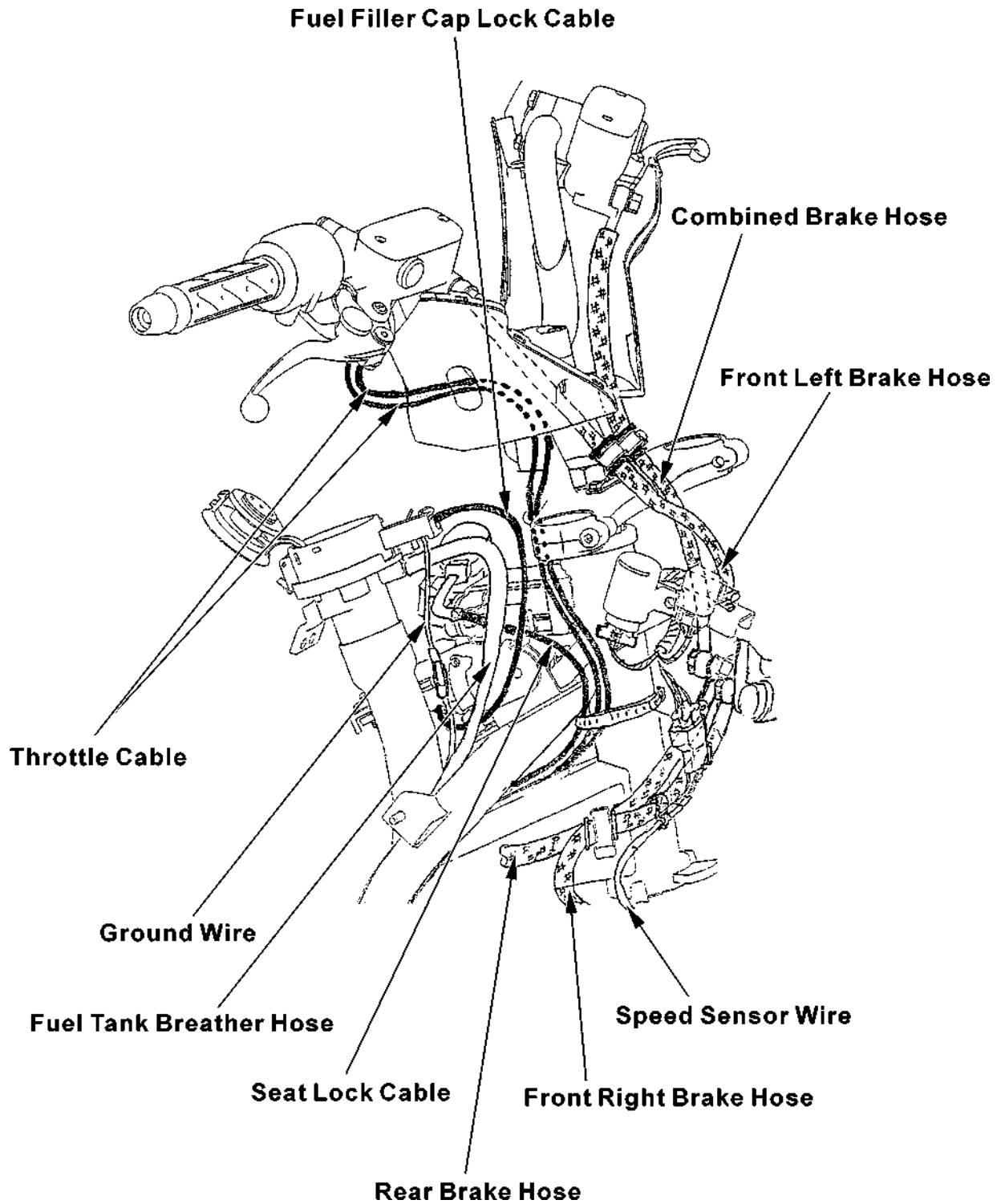

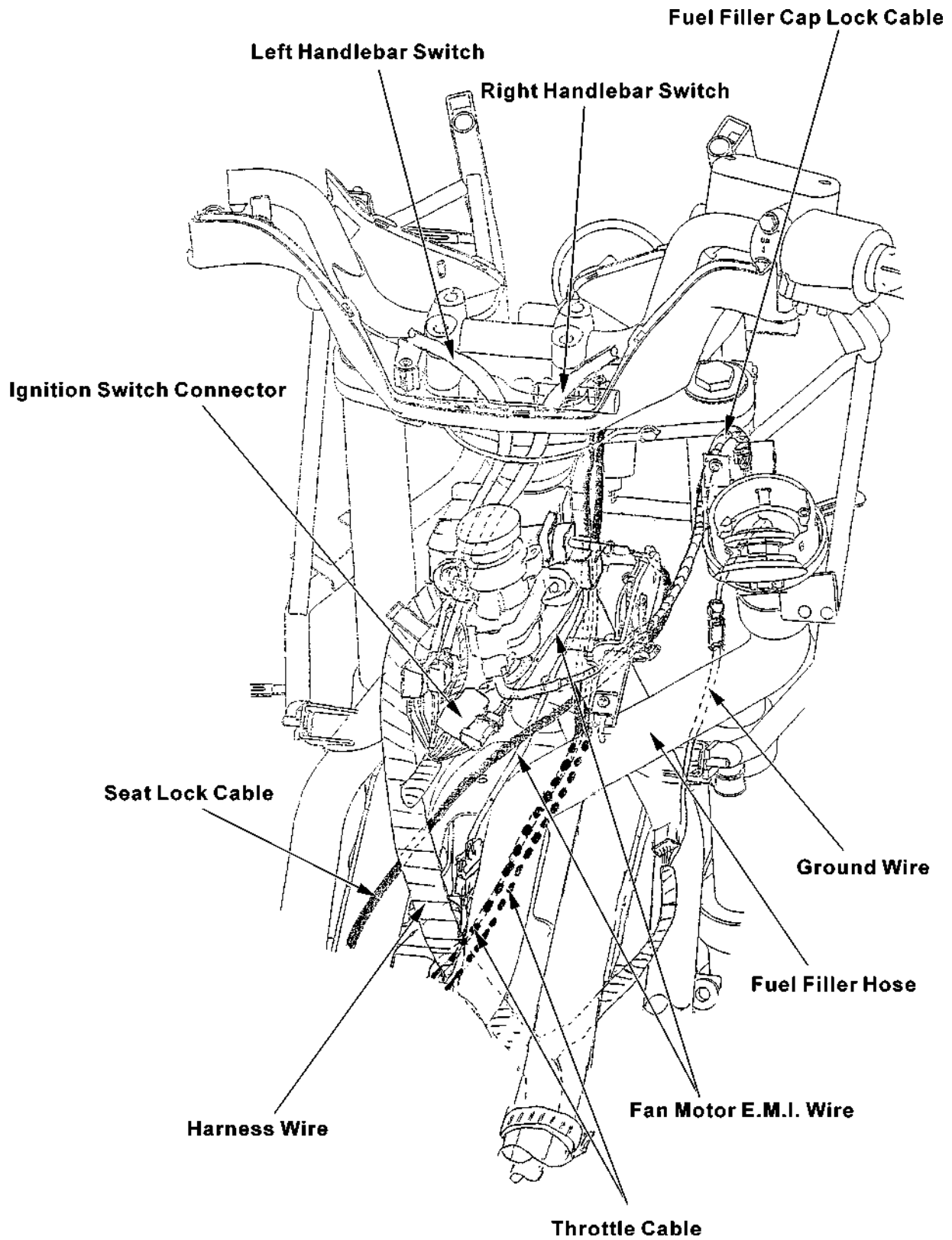

1. GENERAL INFORMATION

XCITING 500/500 AFI/250/300 AFI

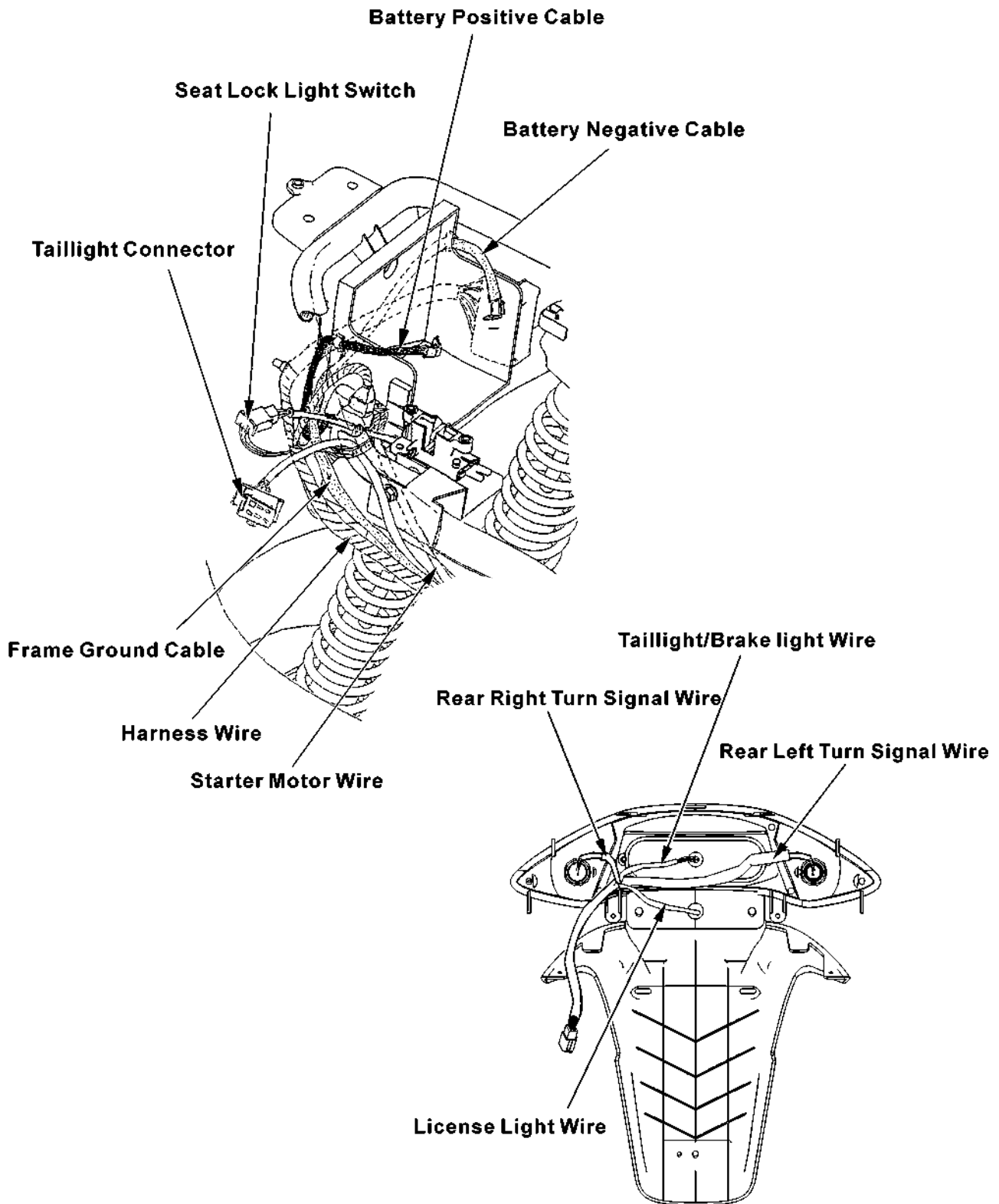

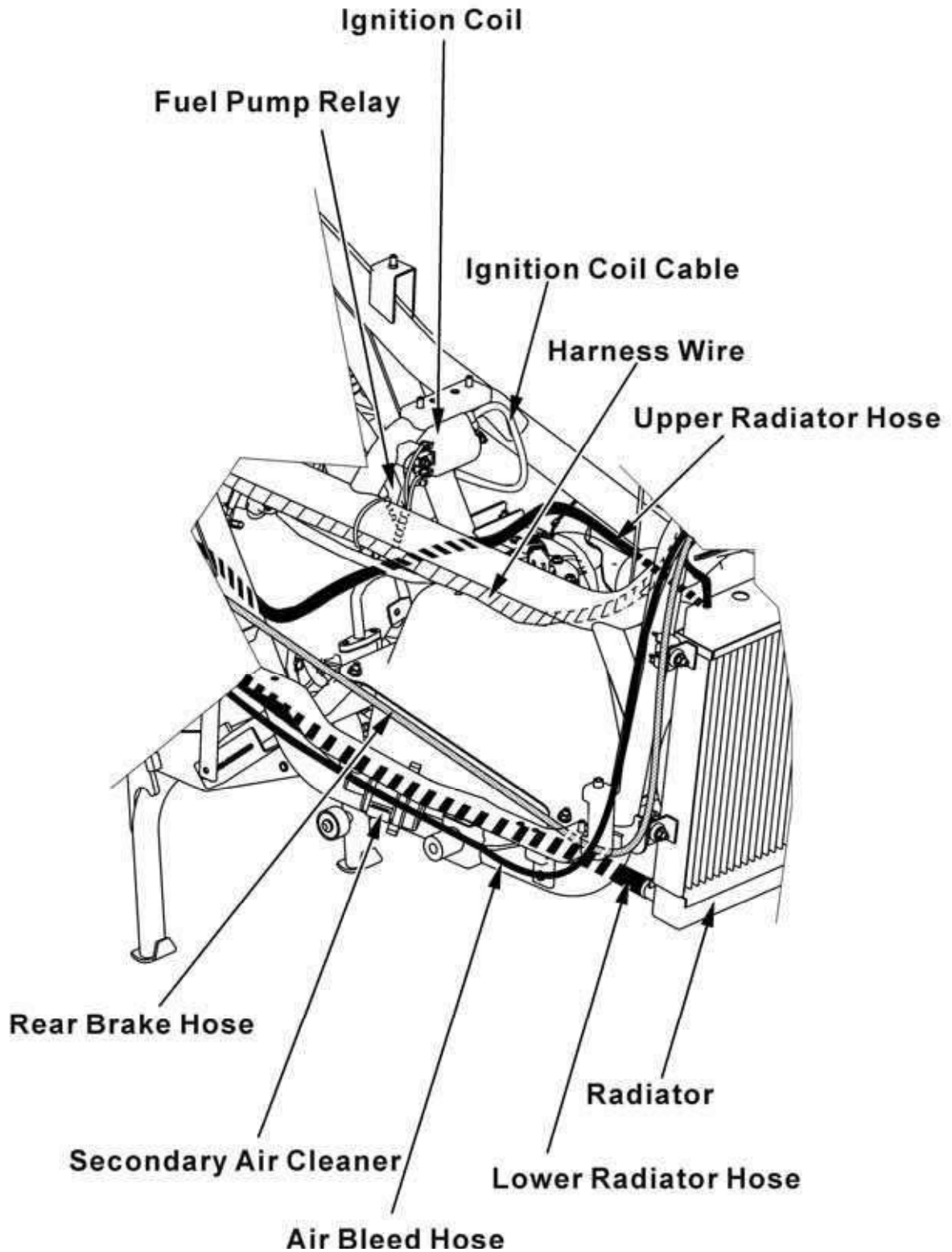

1. GENERAL INFORMATION

XCITING 500/500 AFI/250/300 AFI

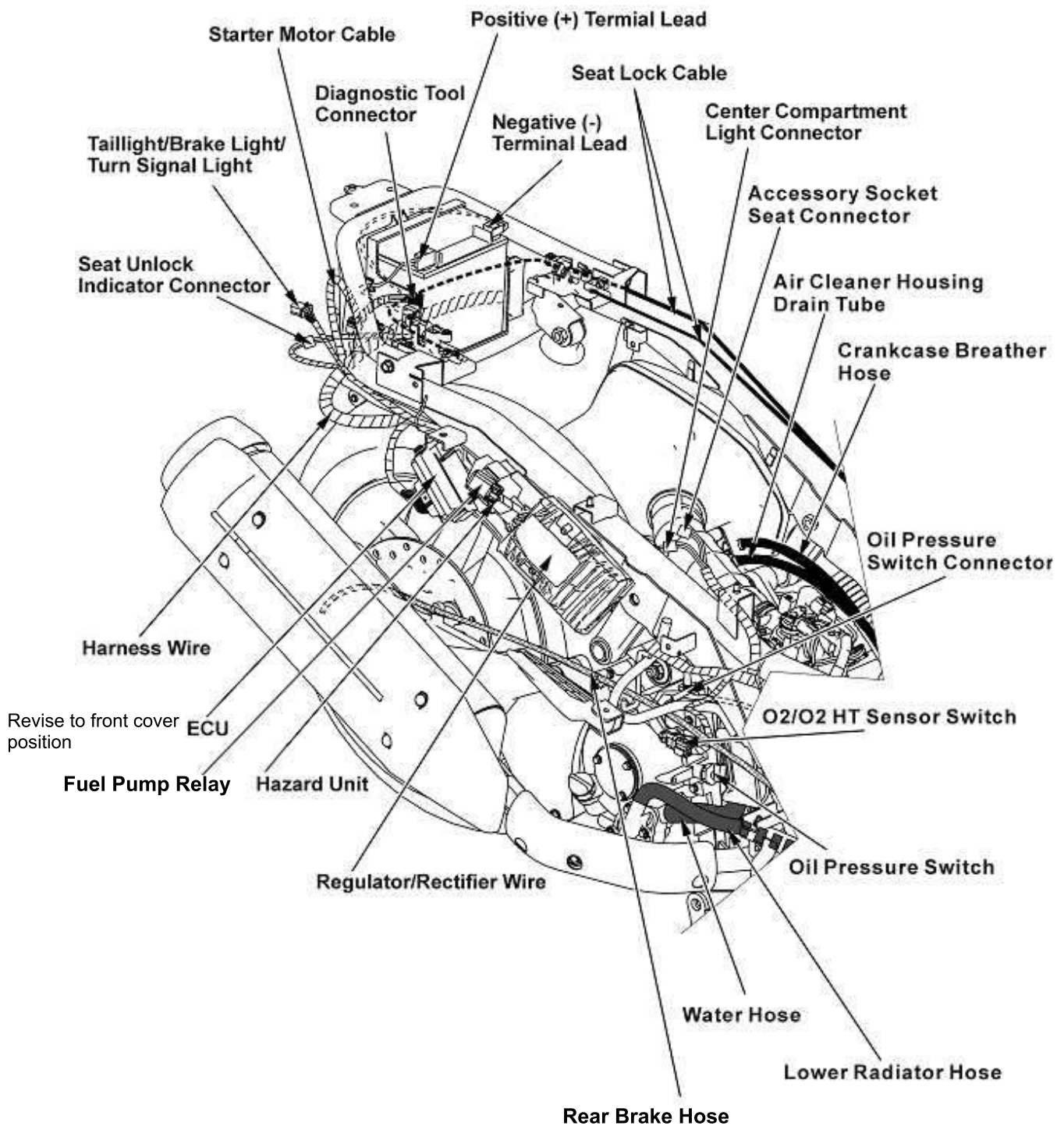

1. GENERAL INFORMATION

XCITING 500/500 AFI/250/300 AFI

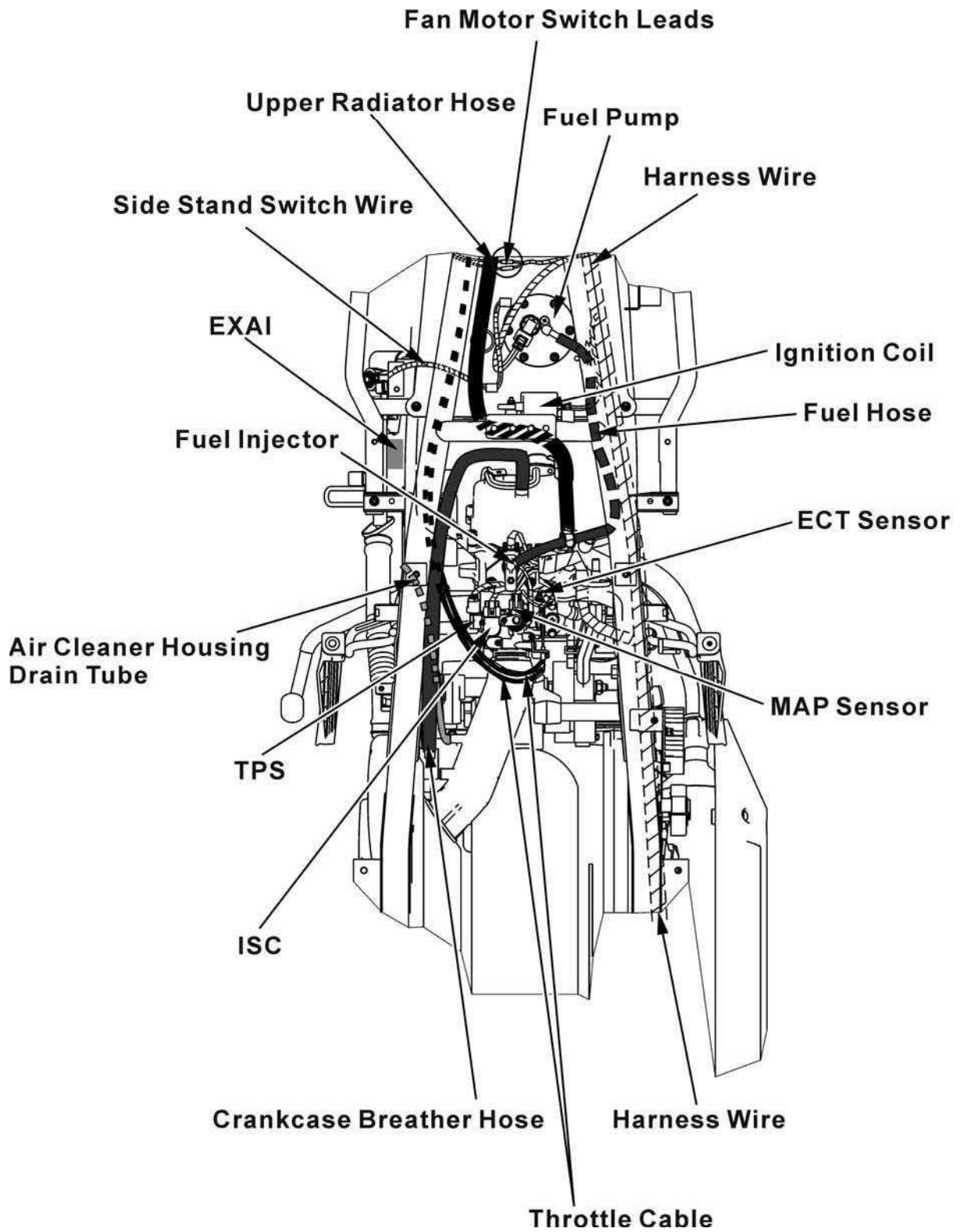

1. GENERAL INFORMATION

XCITING 500/500 AFI/250/300 AFI

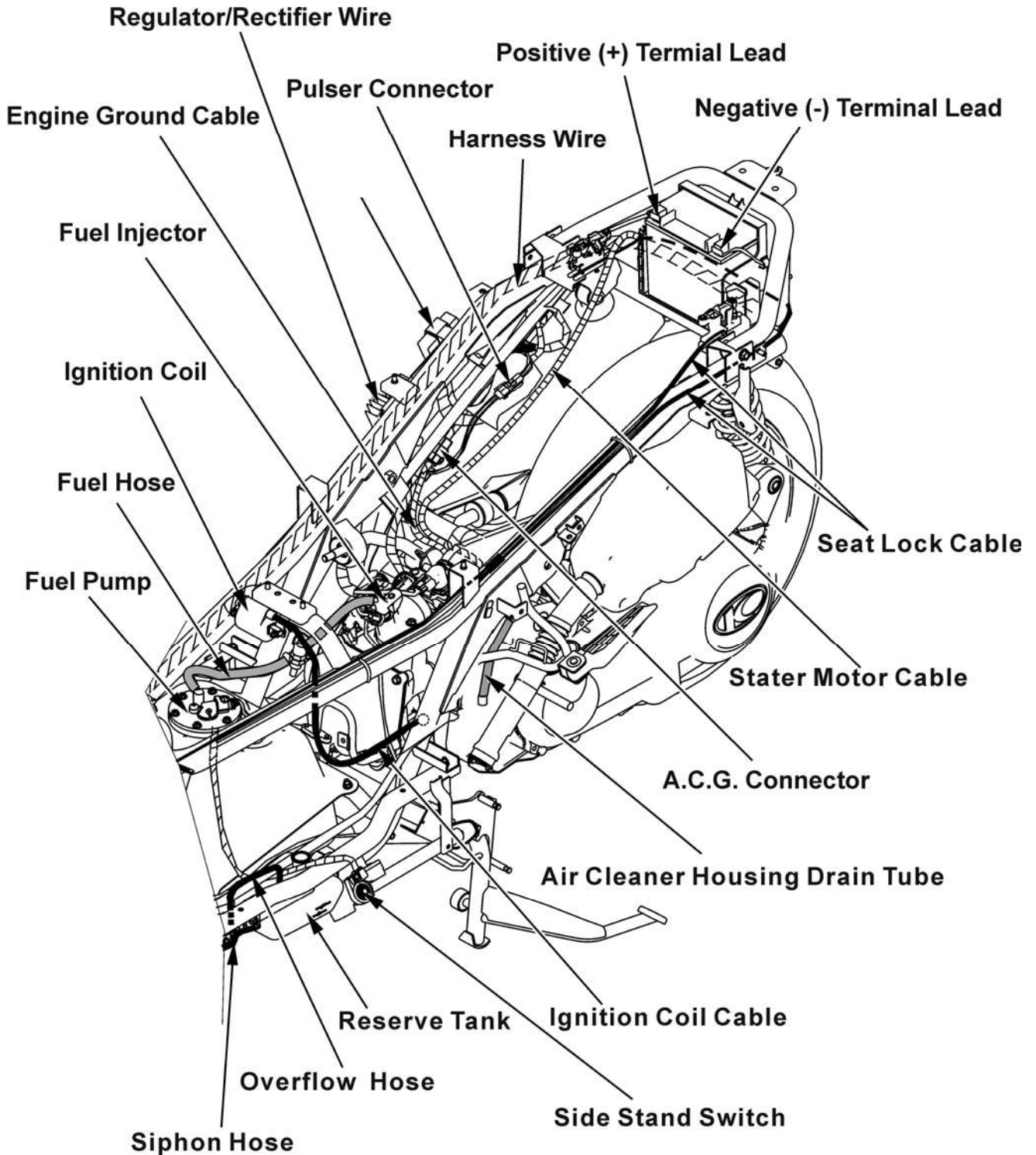

CABLE & HARNESS ROUTING (XCITING 250)

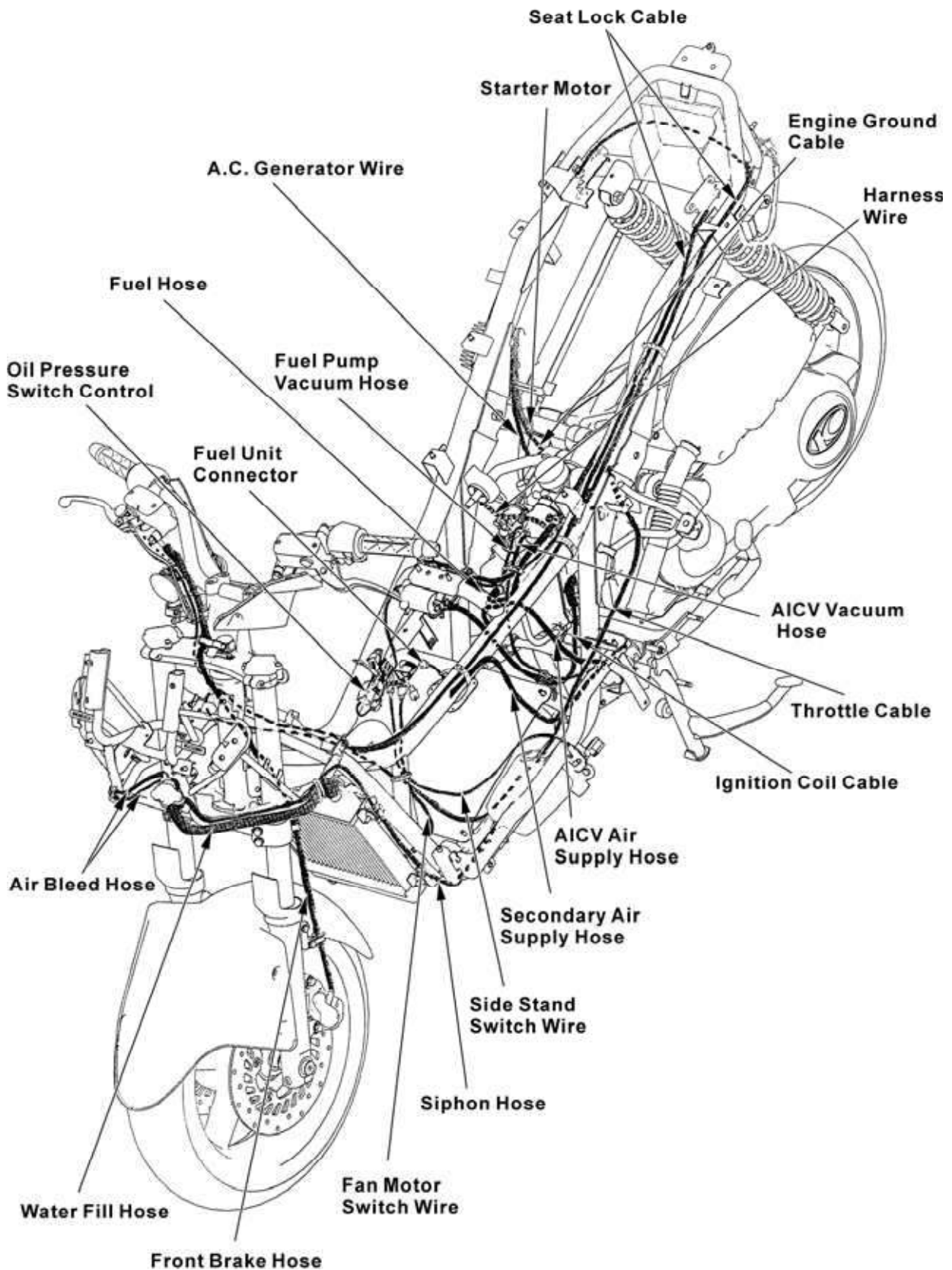

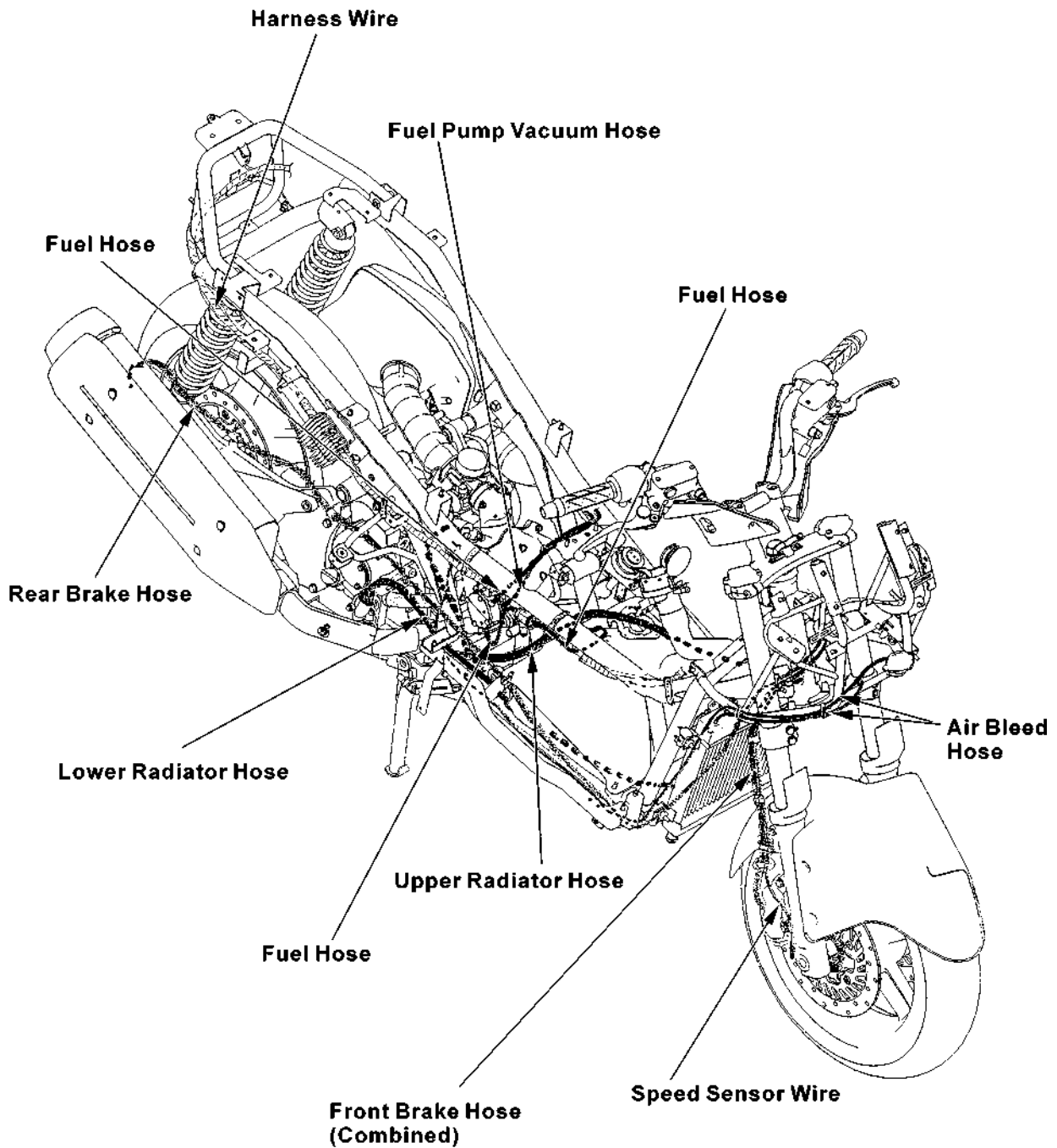

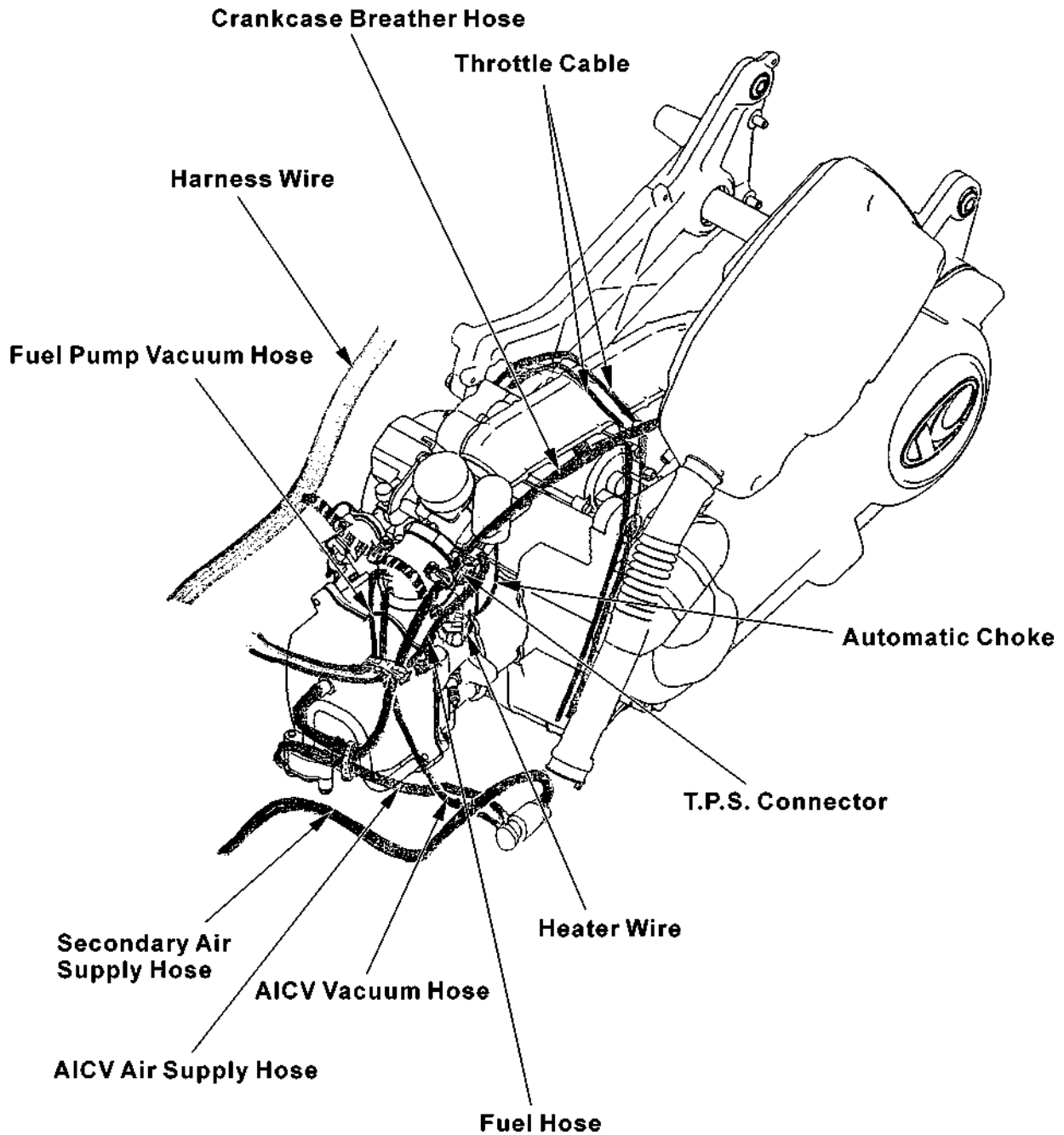

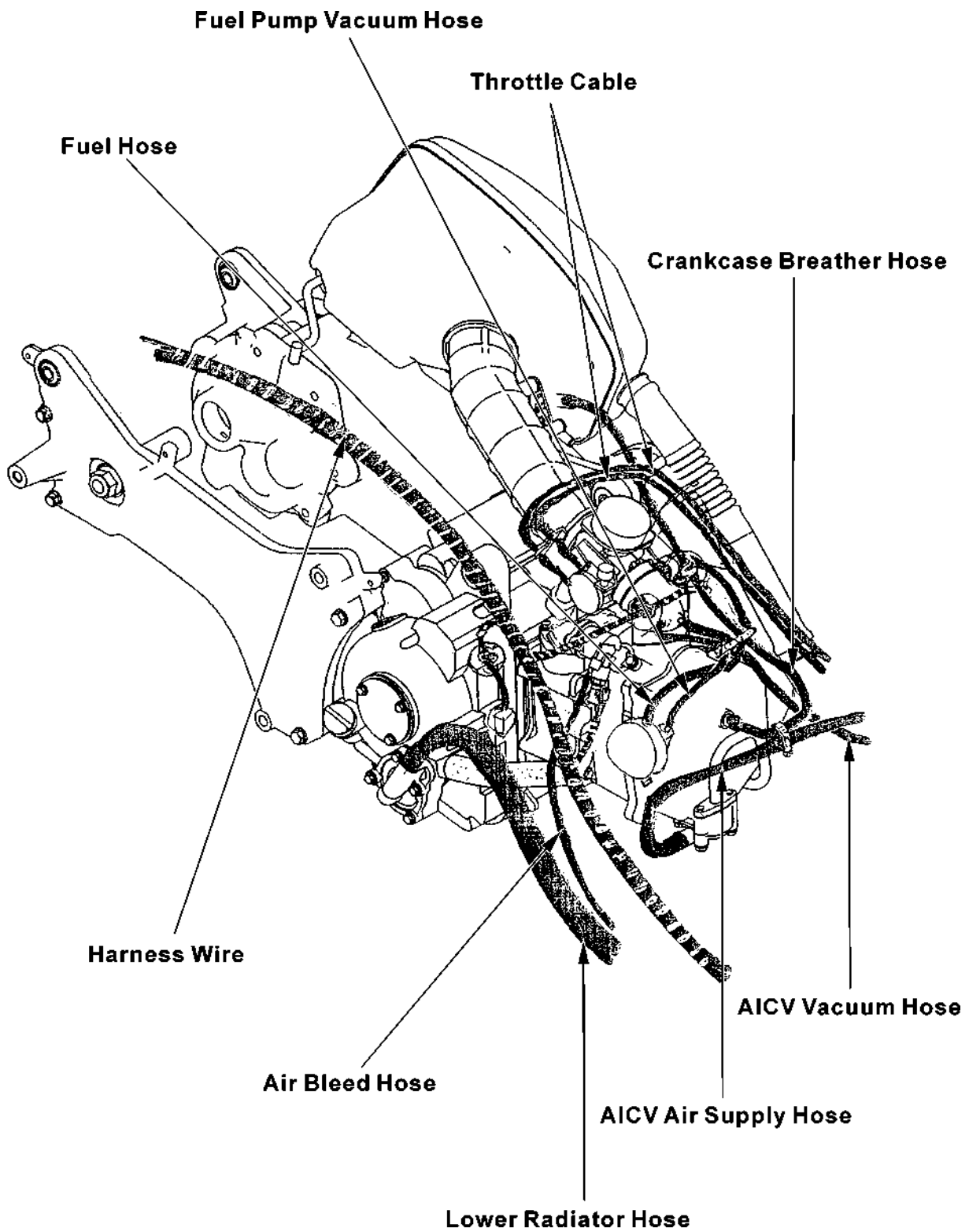

1. GENERAL INFORMATION

XCITING 500/500 AFI/250/300 AFI

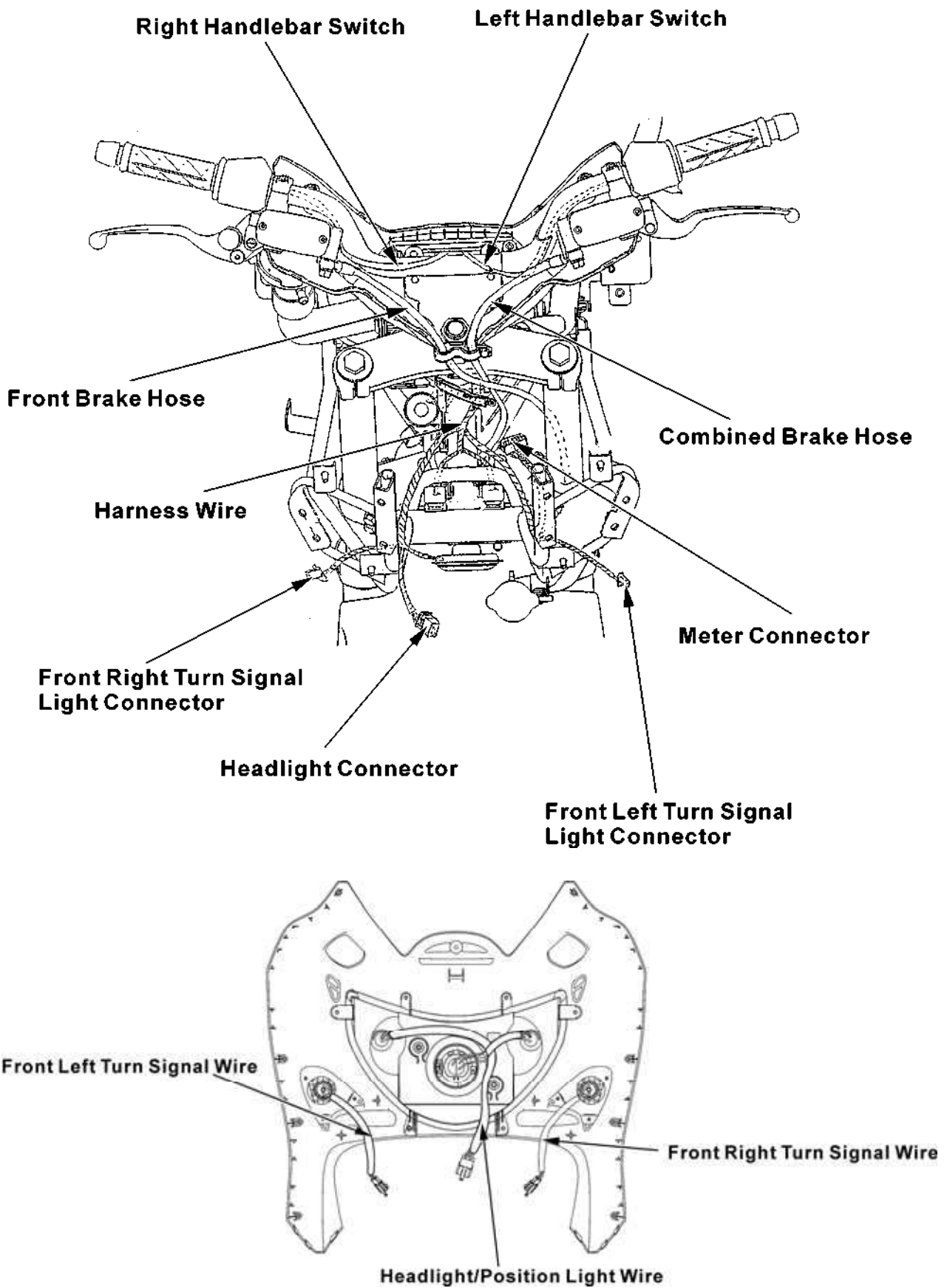

1. GENERAL INFORMATION

XCITING 500/500 AFI/250/300 AFI

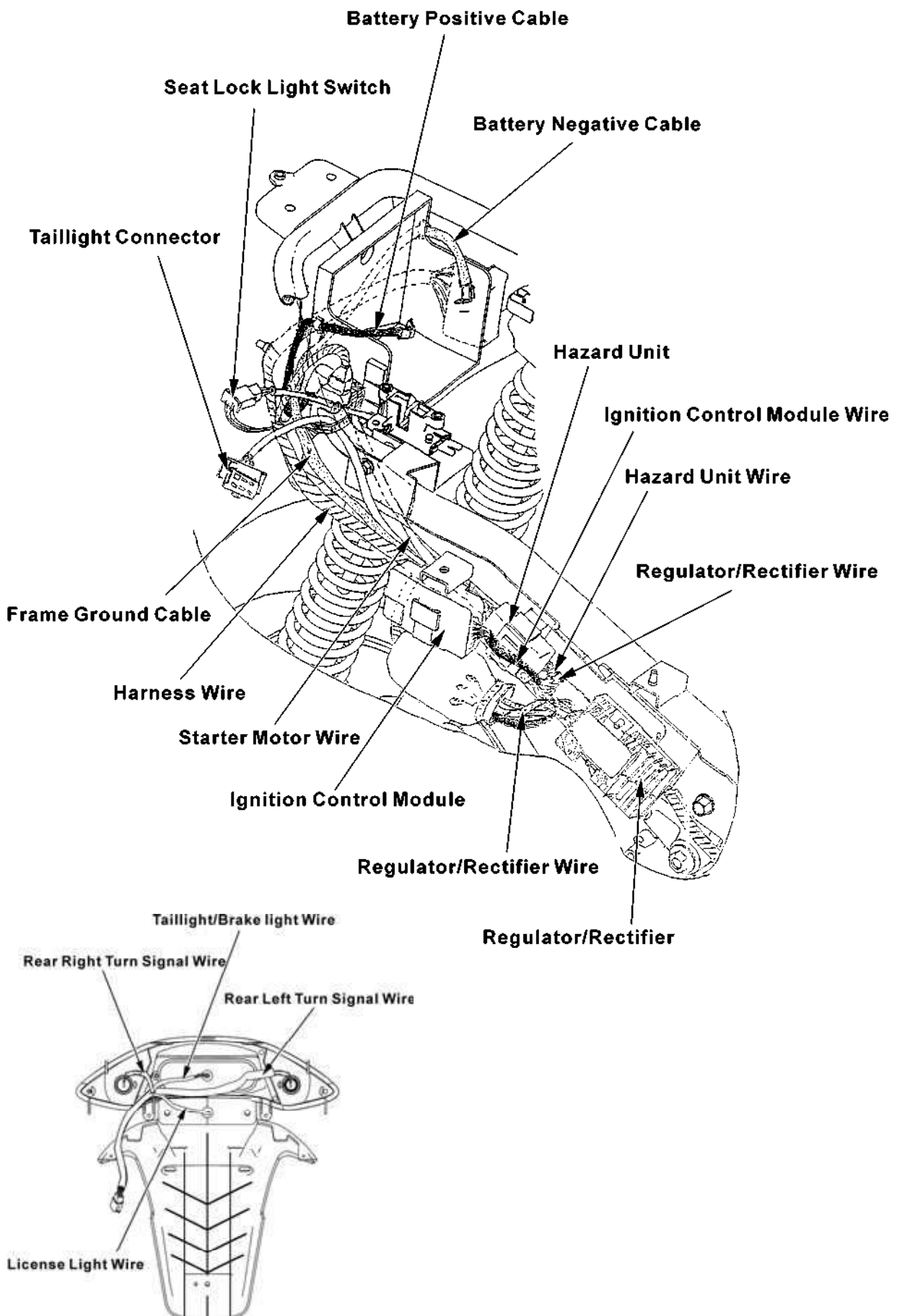

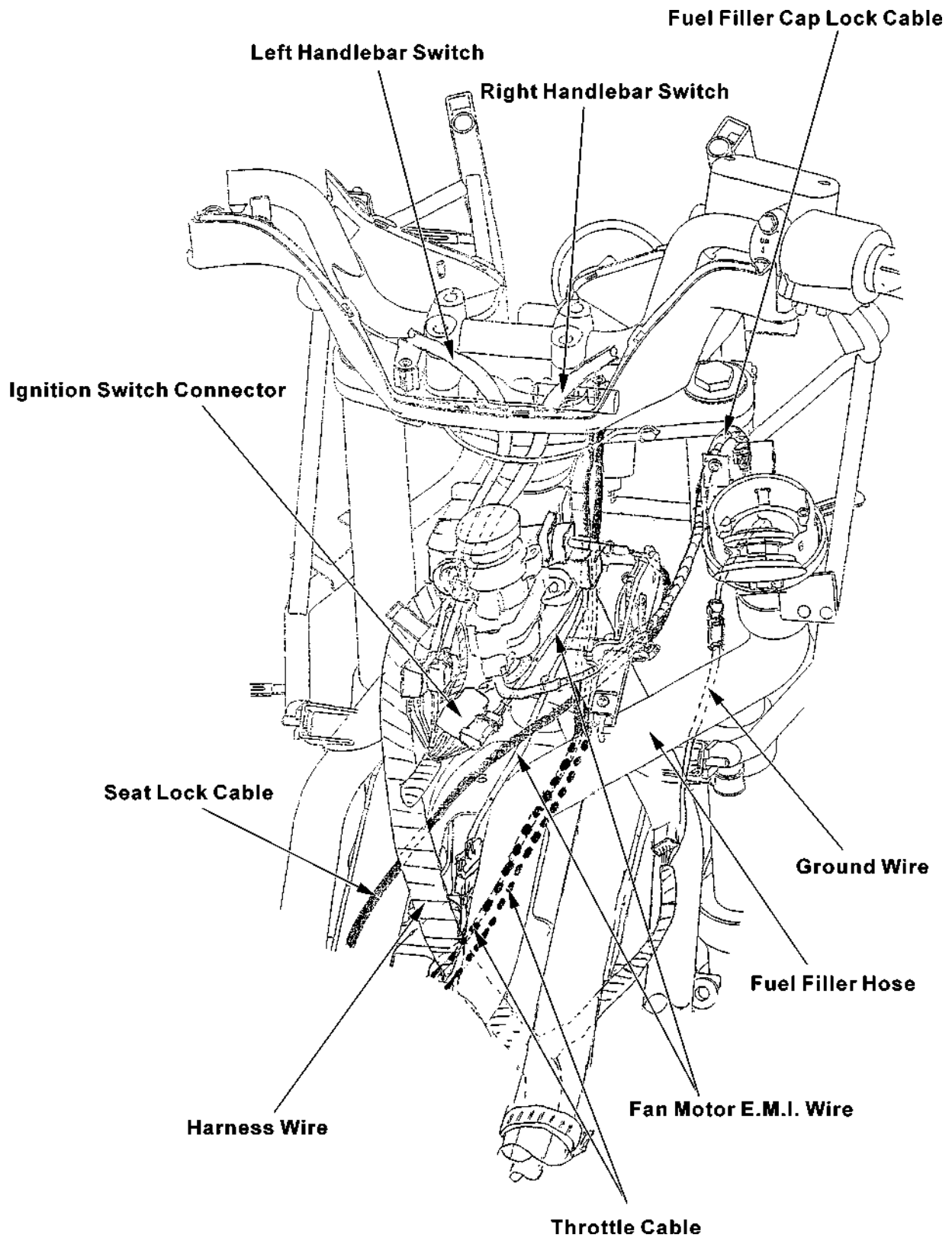

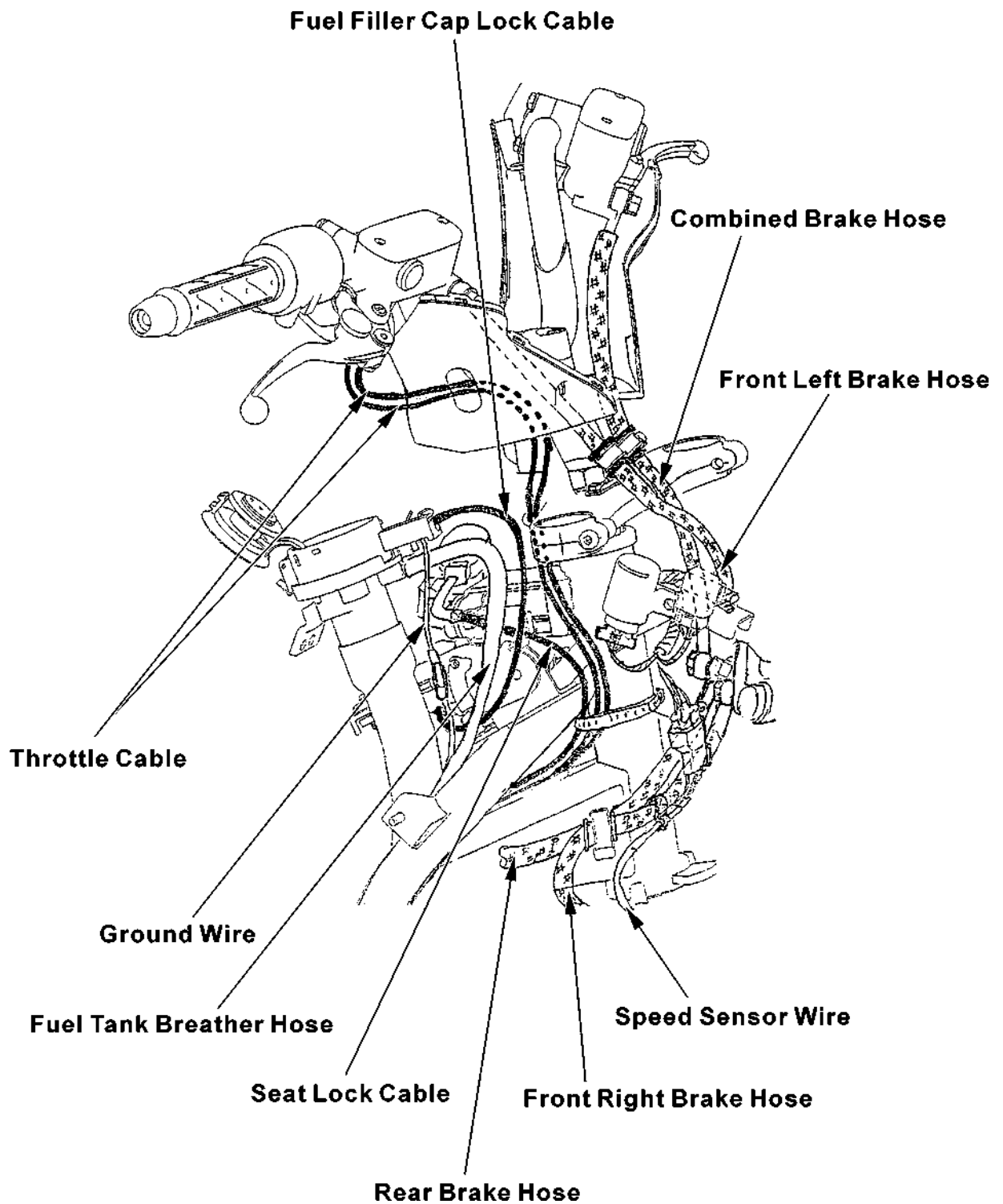

1. GENERAL INFORMATION

XCITING 500/500 AFI/250/300 AFI

CABLE & HARNESS ROUTING (XCITING 300 AFI)

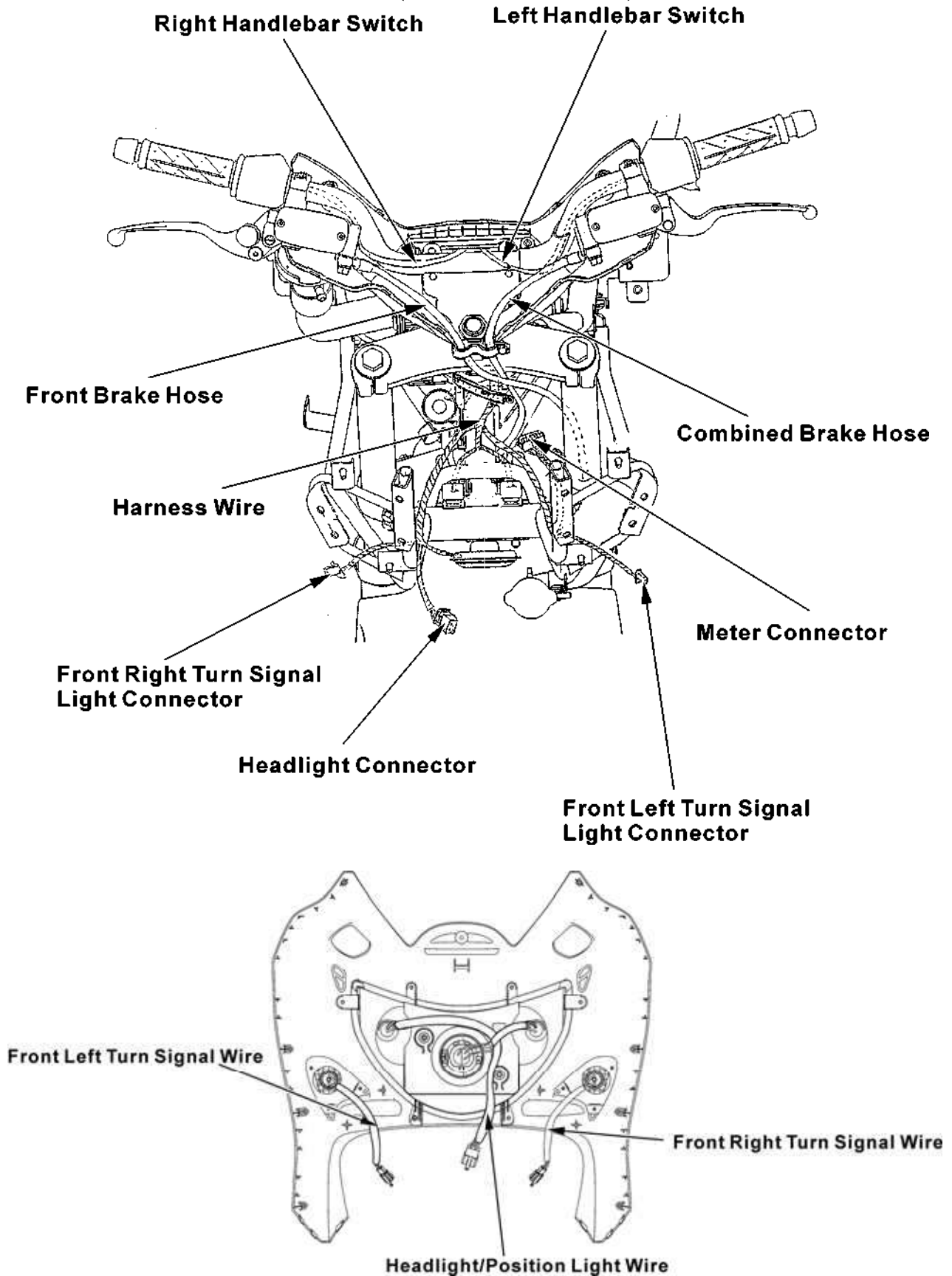

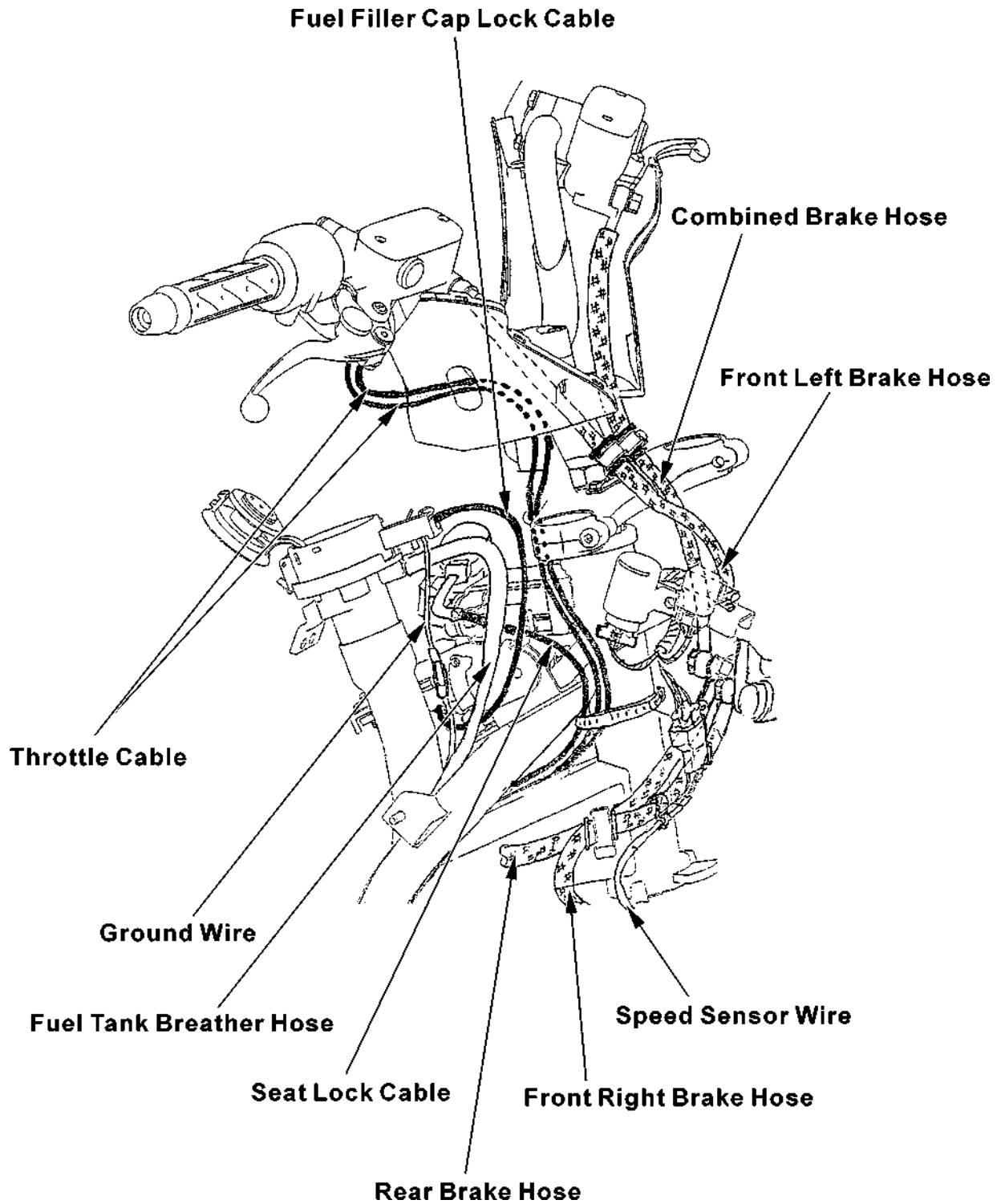

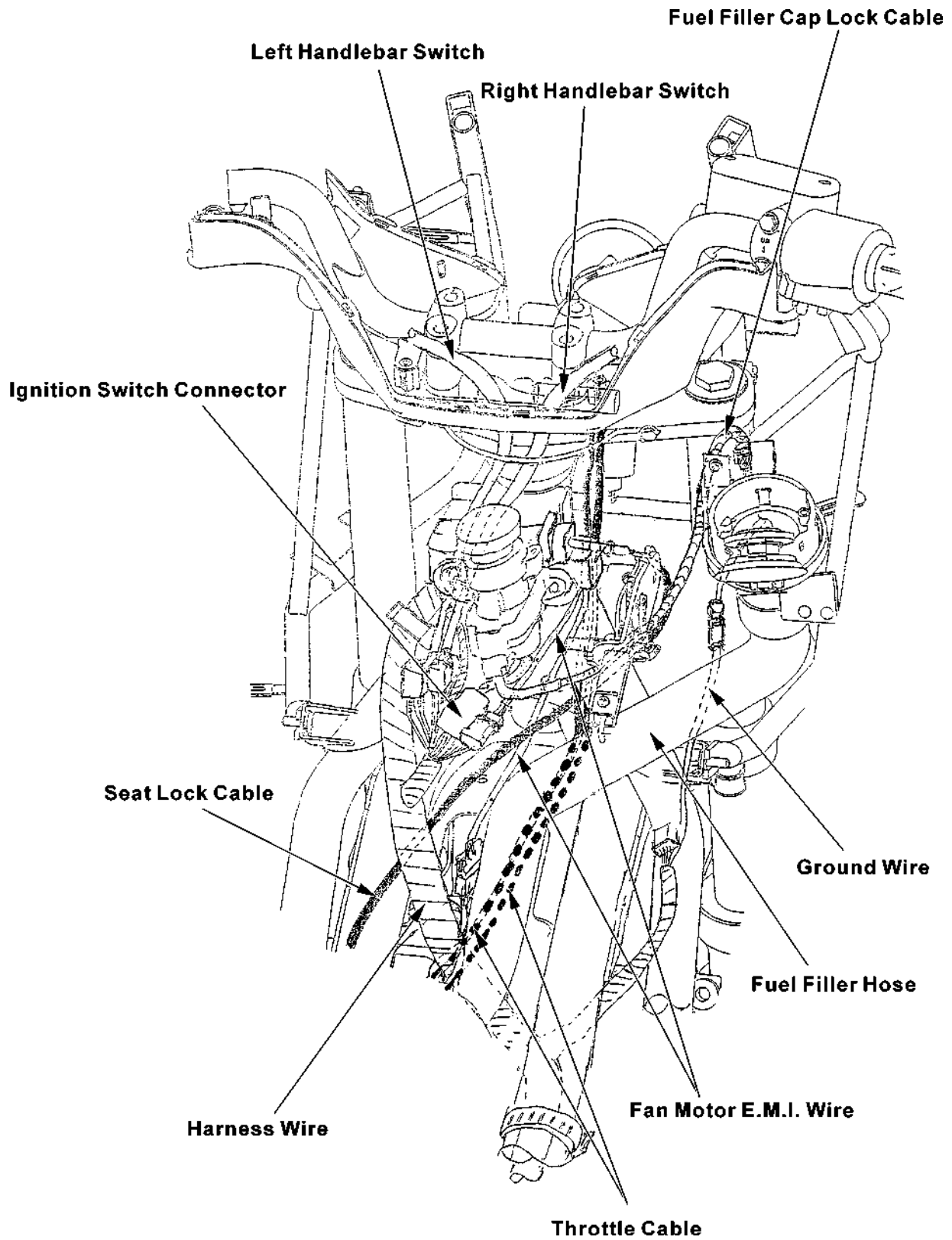

1. GENERAL INFORMATION

XCITING 500/500 AFI/250/300 AFI

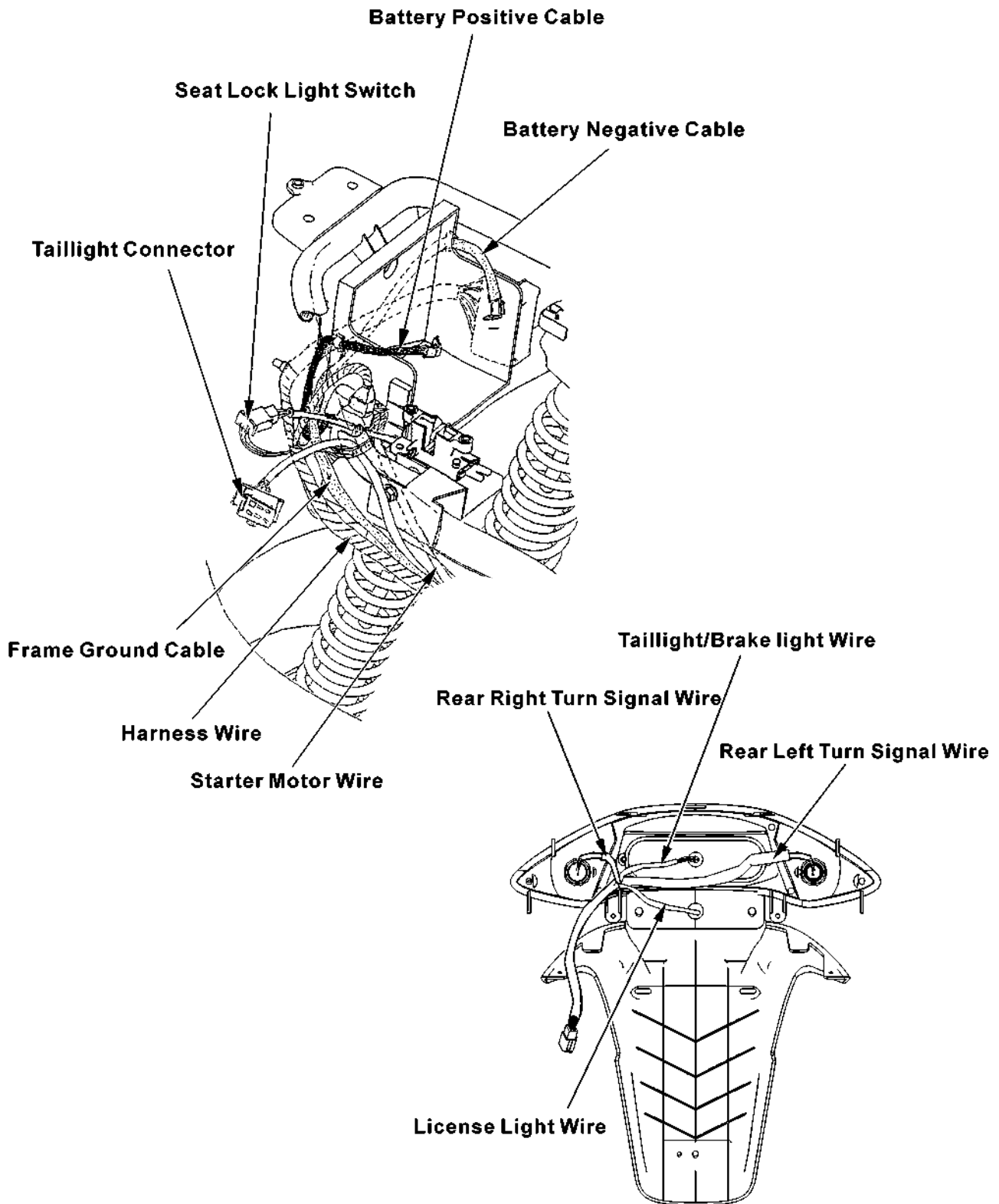

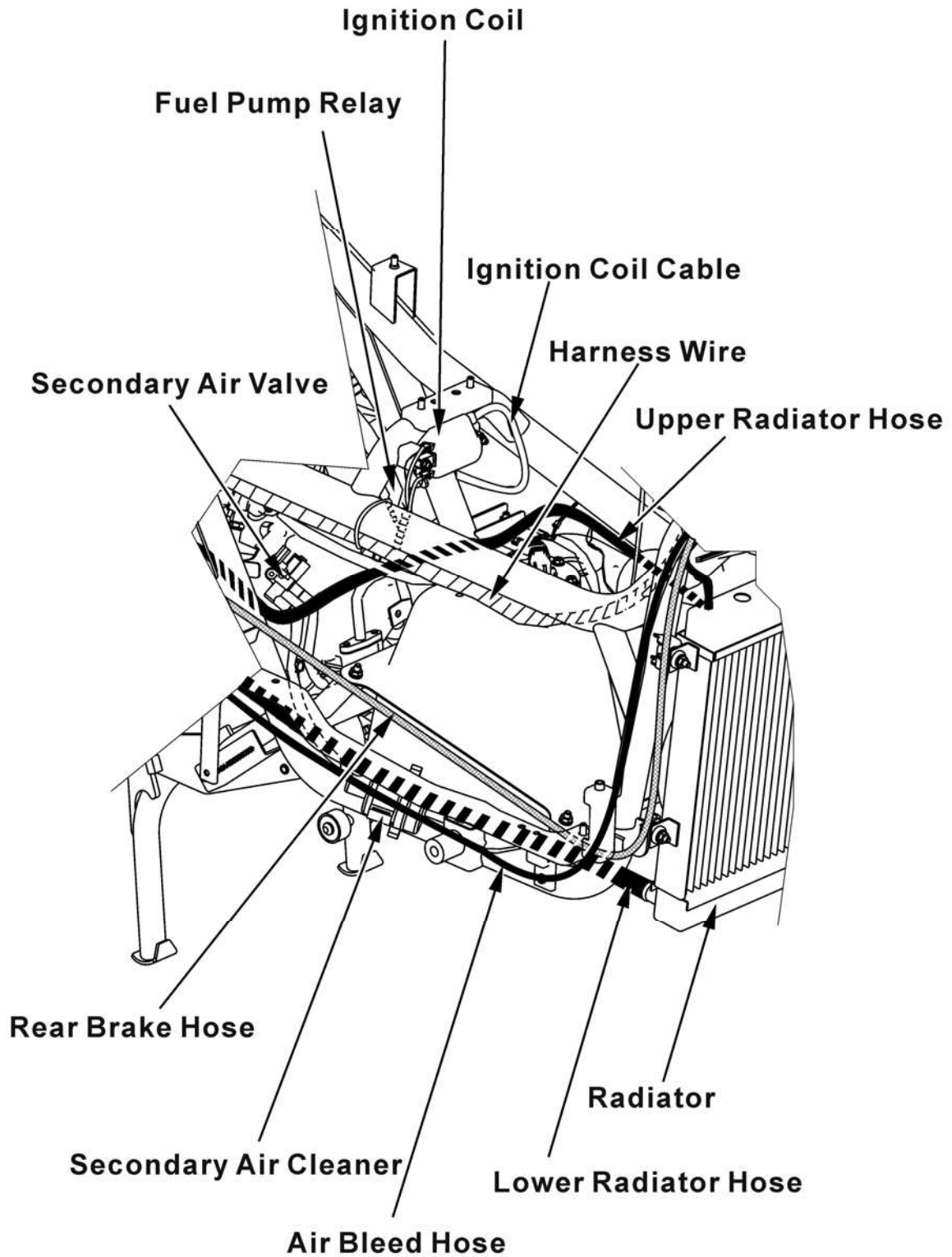

1. GENERAL INFORMATION

XCITING 500/500 AFI/250/300 AFI

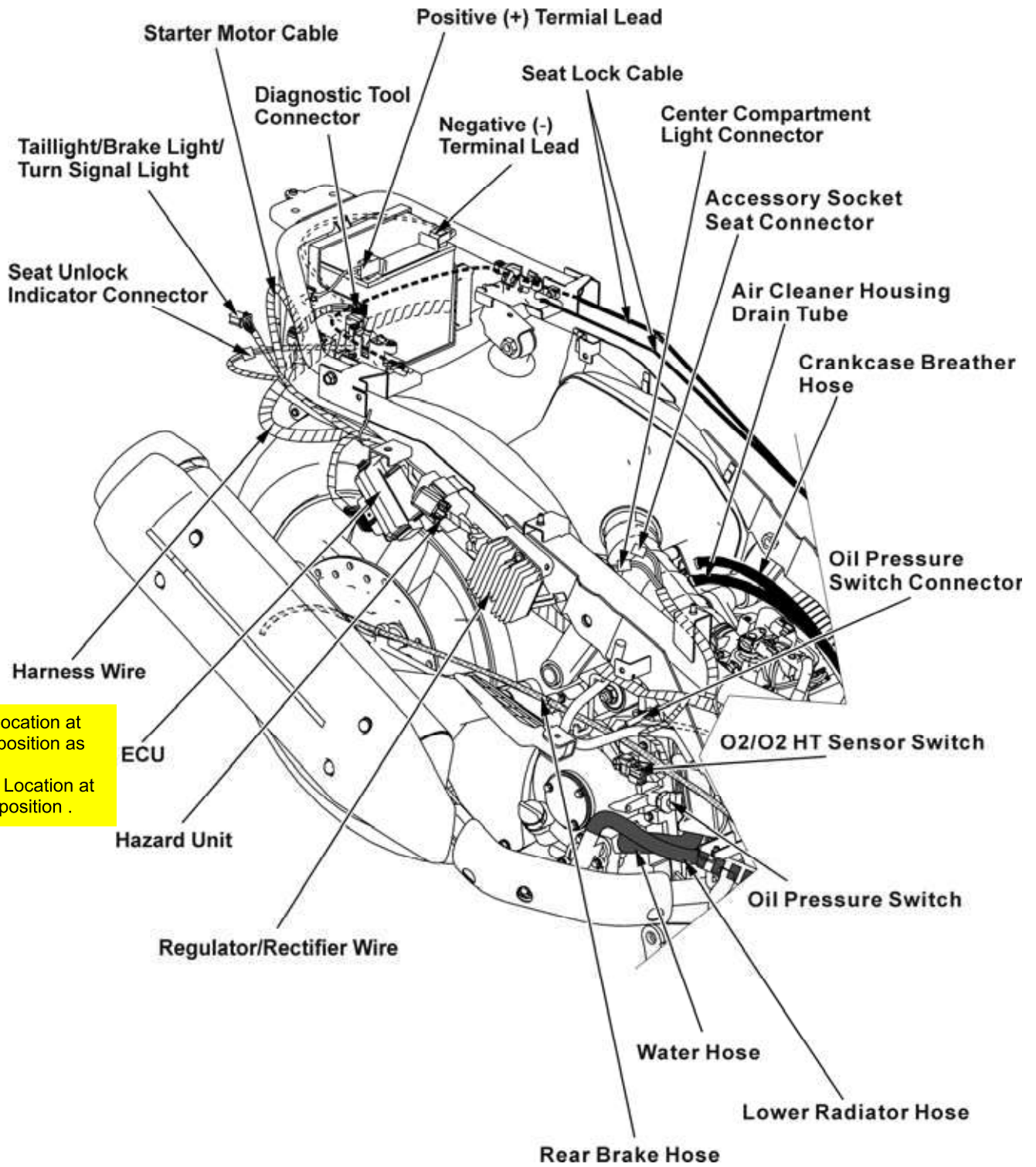

300i ECU Location at rear frame position as picture.
 300Ri ECU Location at front cover position .

1. GENERAL INFORMATION

XCITING 500/500 AFI/250/300 AFI

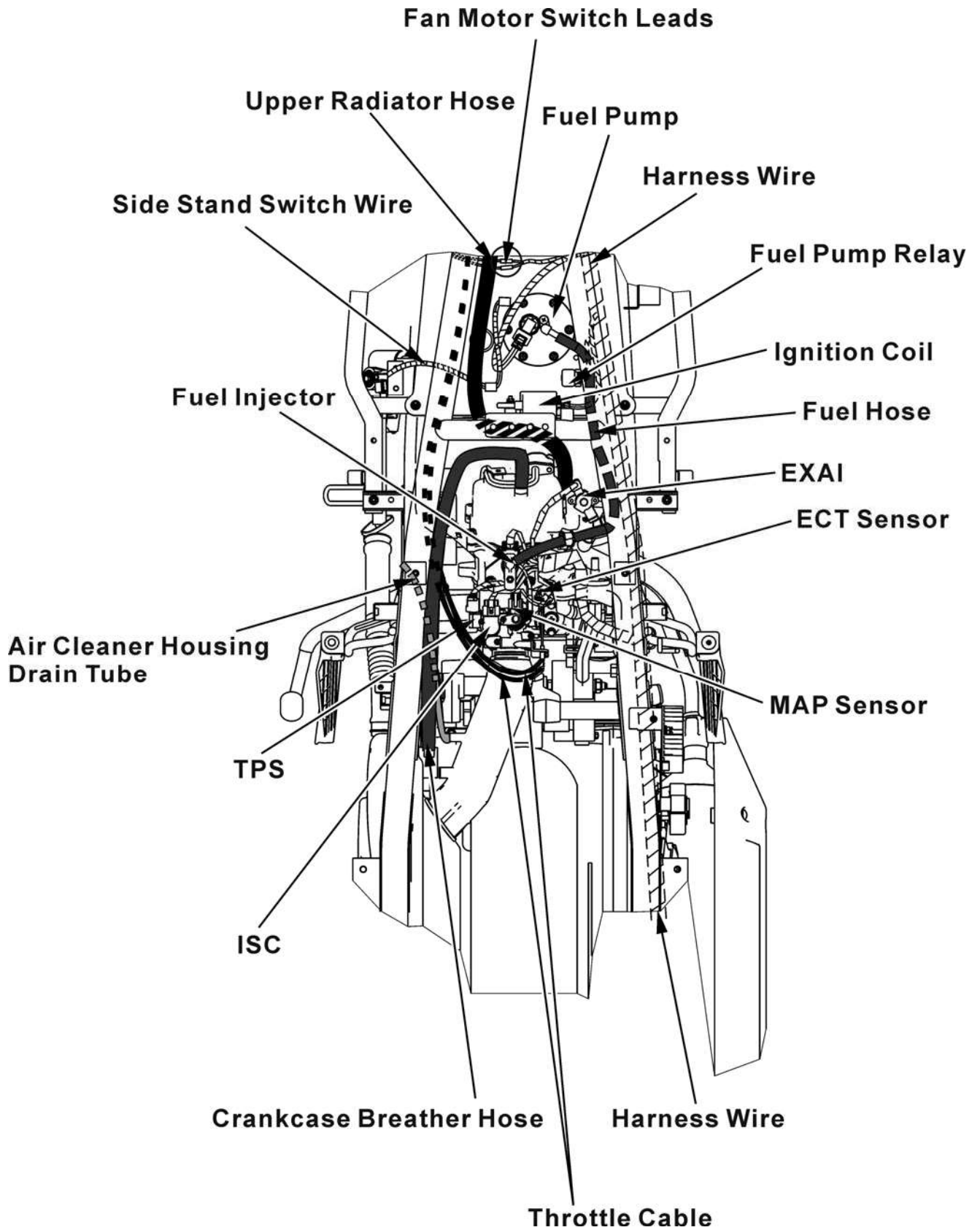

1. GENERAL INFORMATION

XCITING 500/500 AFI/250/300 AFI

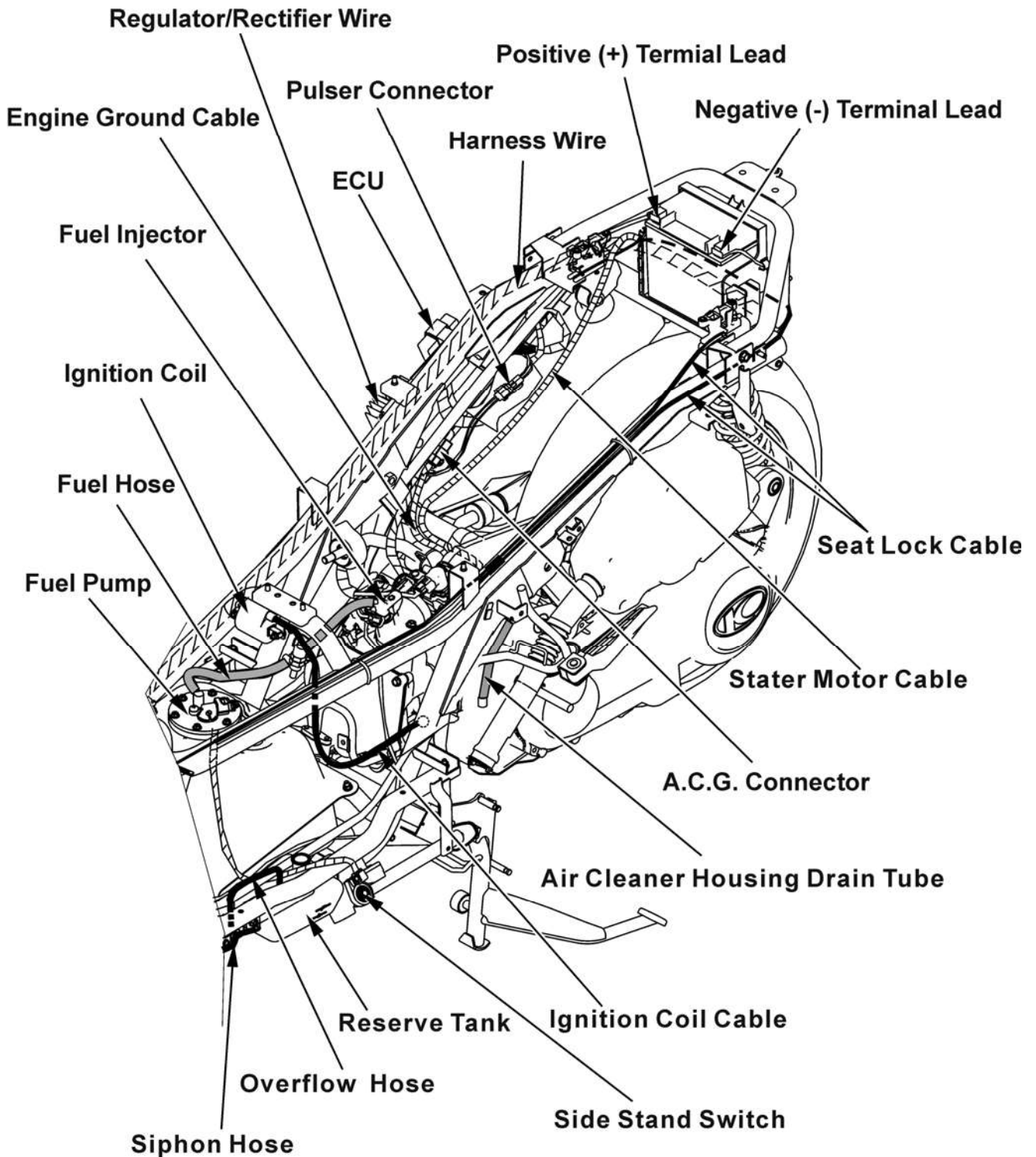

1. GENERAL INFORMATION XCITING 500/500 AFI/250/300 AFI

TROUBLESHOOTING (XCITING 500/250)

ENGINE WILL NOT START OR IS HARD TO START

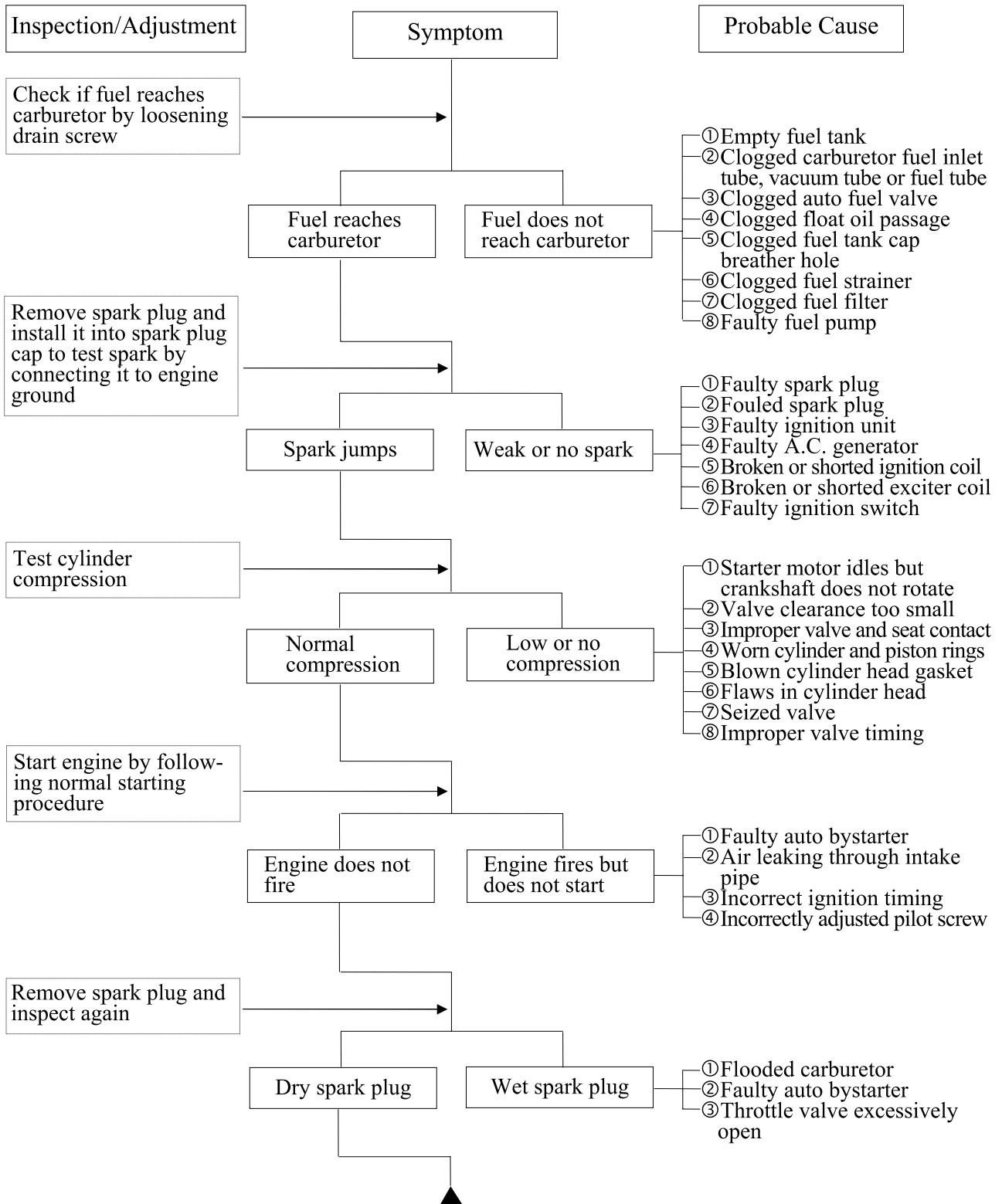

1. GENERAL INFORMATION

XCITING 500/500 AFI/250/300 AFI

ENGINE LACKS POWER

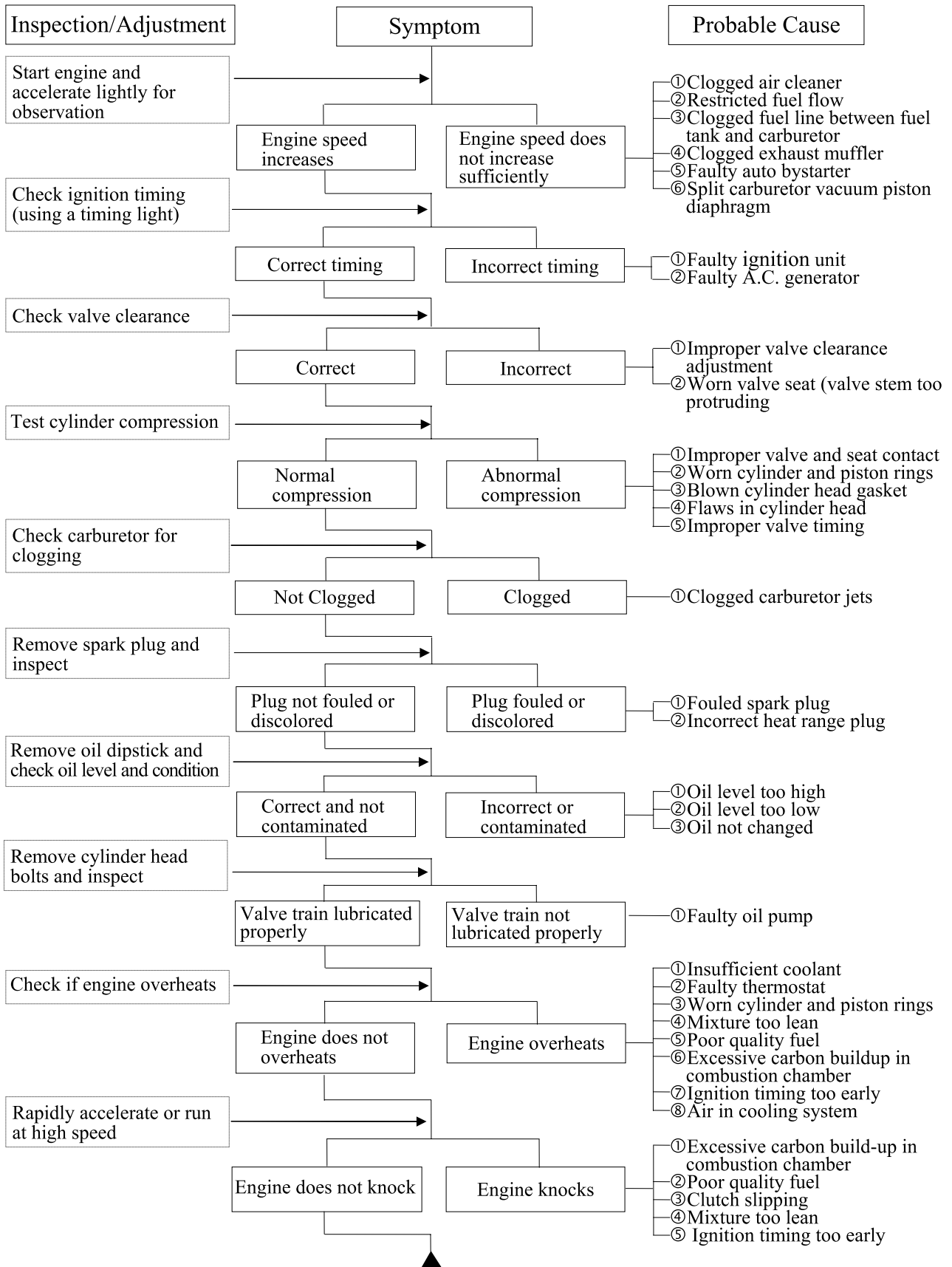

1. GENERAL INFORMATION

XCITING 500/500 AFI/250/300 AFI

POOR PERFORMANCE (ESPECIALLY AT IDLE AND LOW SPEEDS)

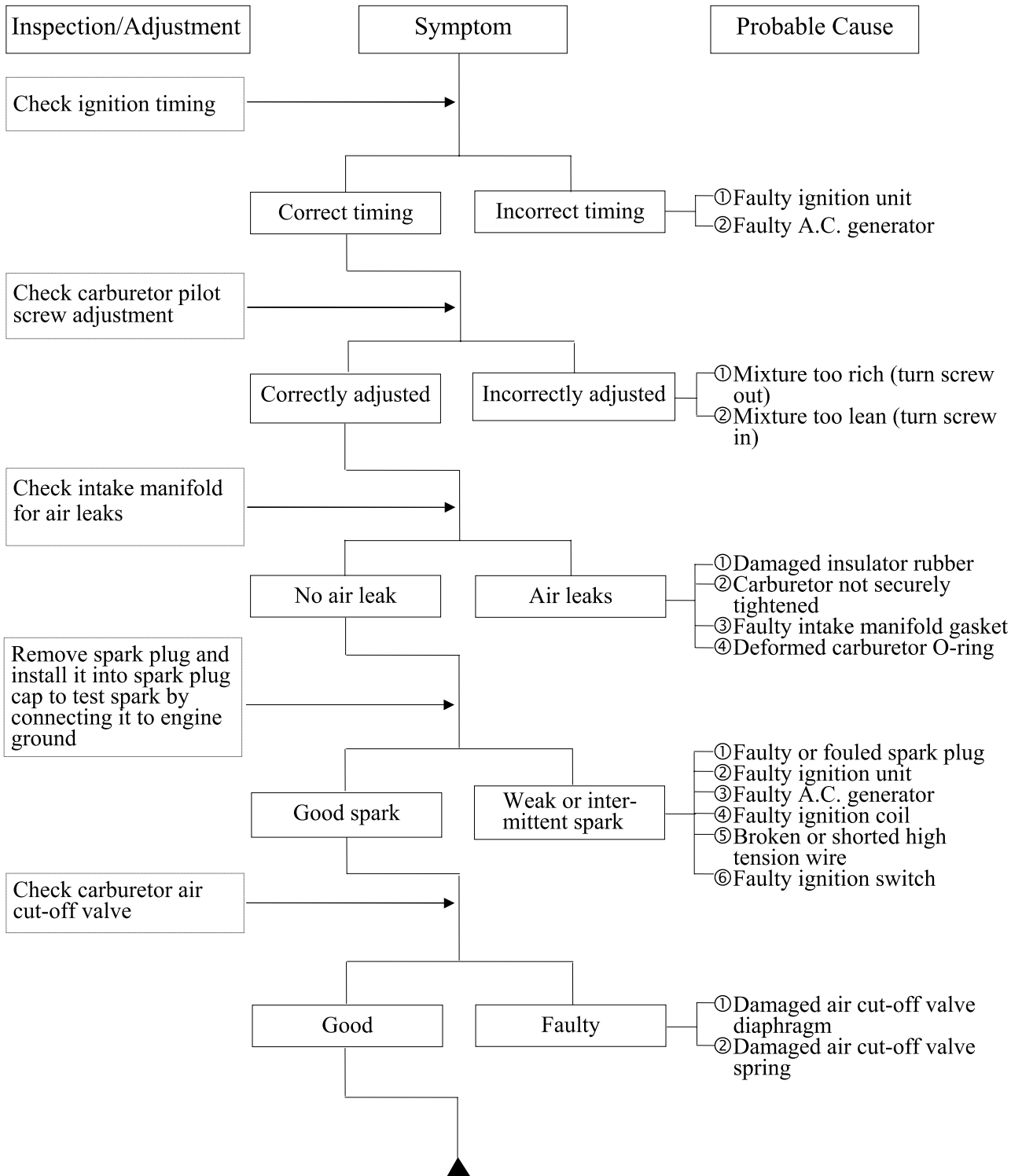

1. GENERAL INFORMATION

XCITING 500/500 AFI/250/300 AFI

POOR PERFORMANCE (AT HIGH SPEED)

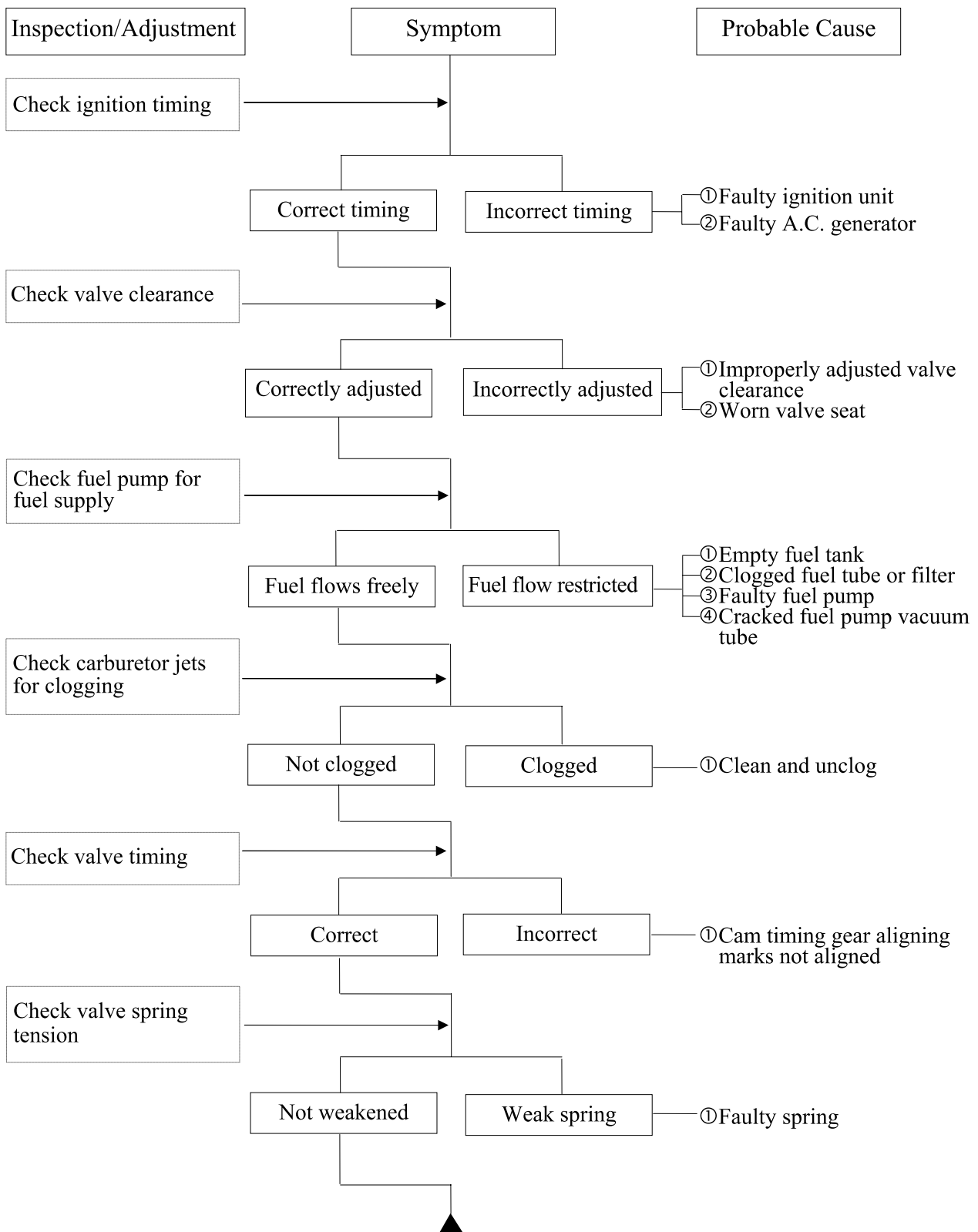

1. GENERAL INFORMATION

XCITING 500/500 AFI/250/300 AFI

ENGINE NOISE

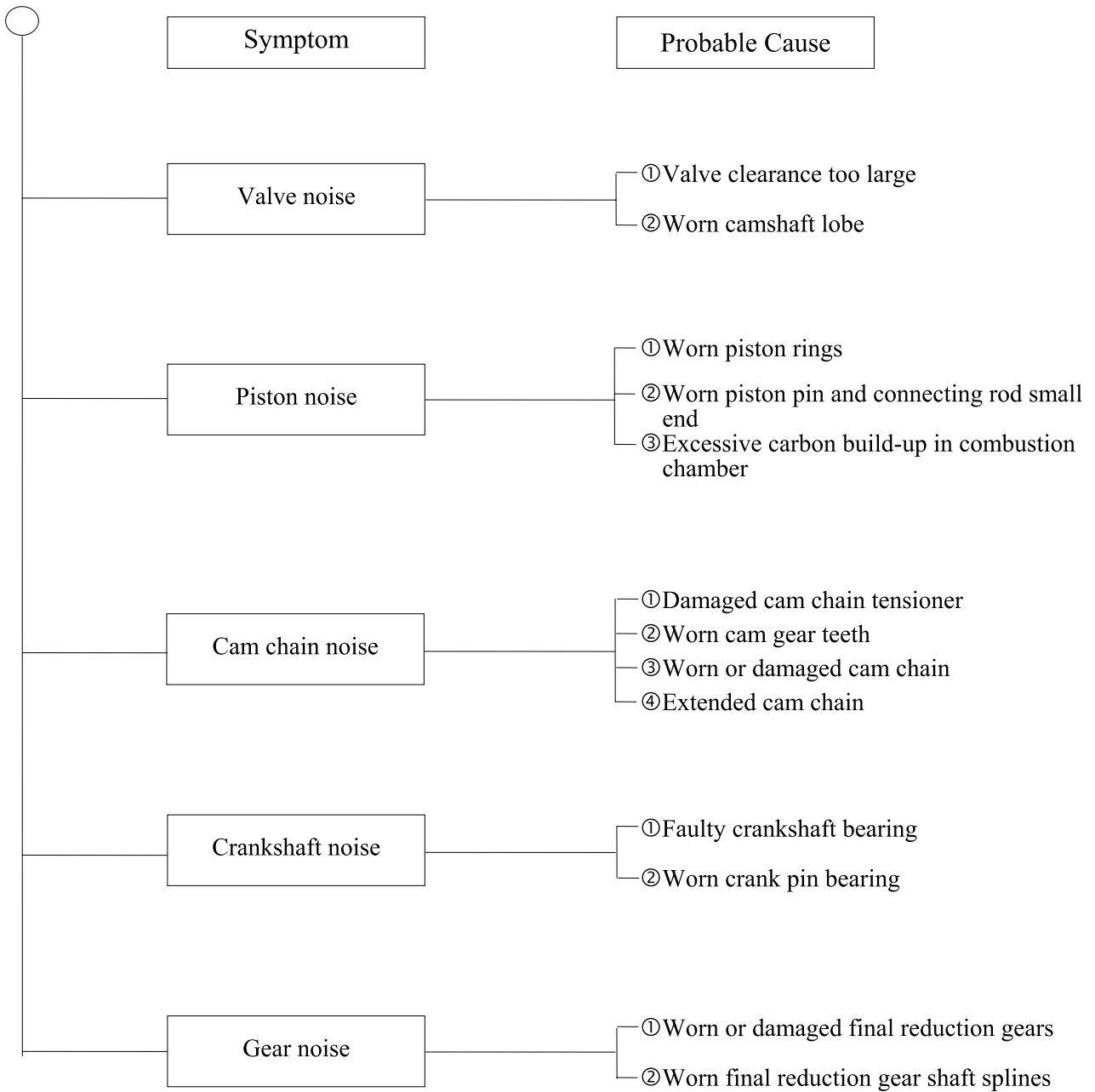

1. GENERAL INFORMATION

XCITING 500/500 AFI/250/300 AFI

CLUTCH, DRIVE AND DRIVEN PULLEYS

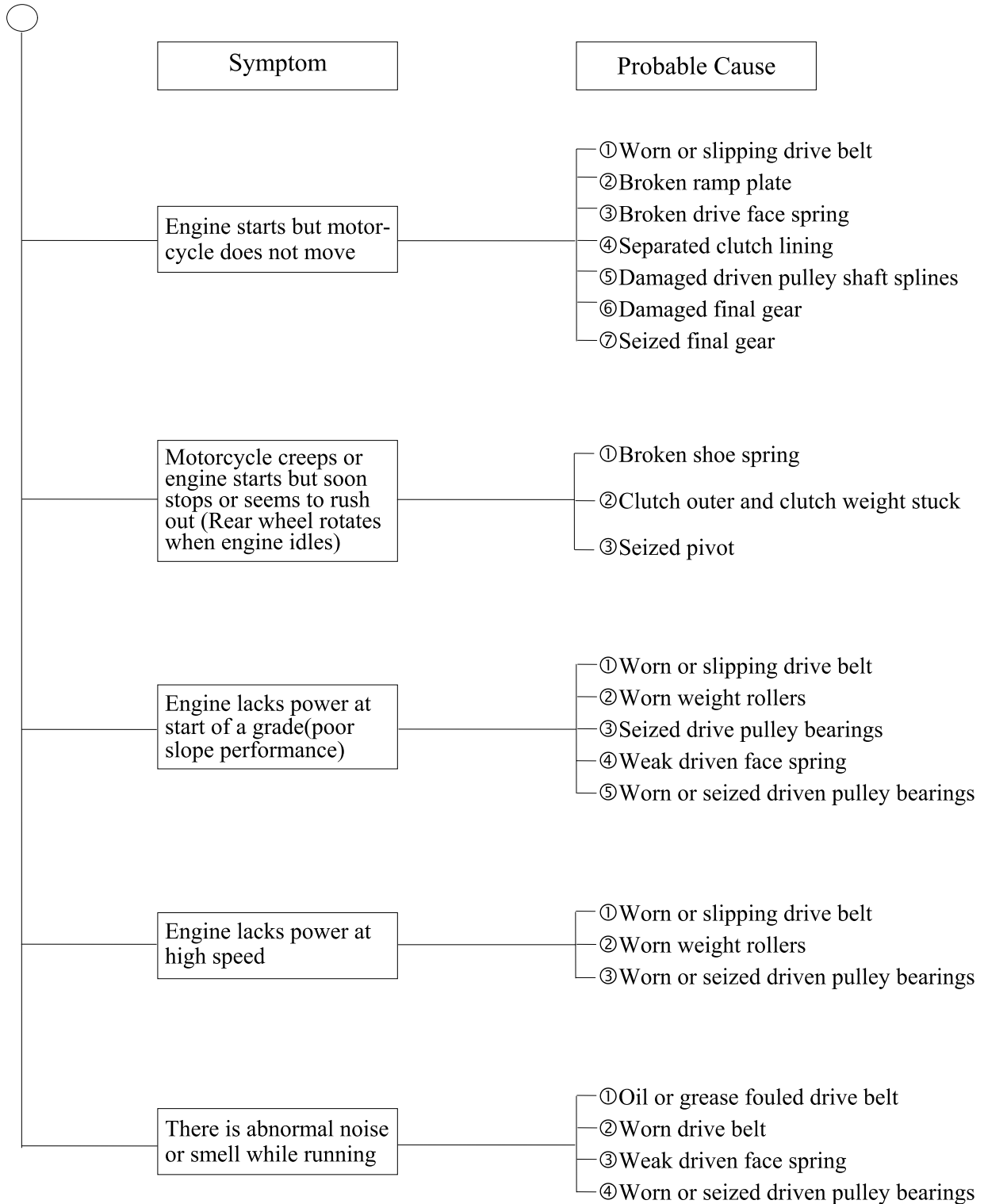

1. GENERAL INFORMATION

XCITING 500/500 AFI/250/300 AFI

STARTER MOTOR

1. Starter motor won't turn

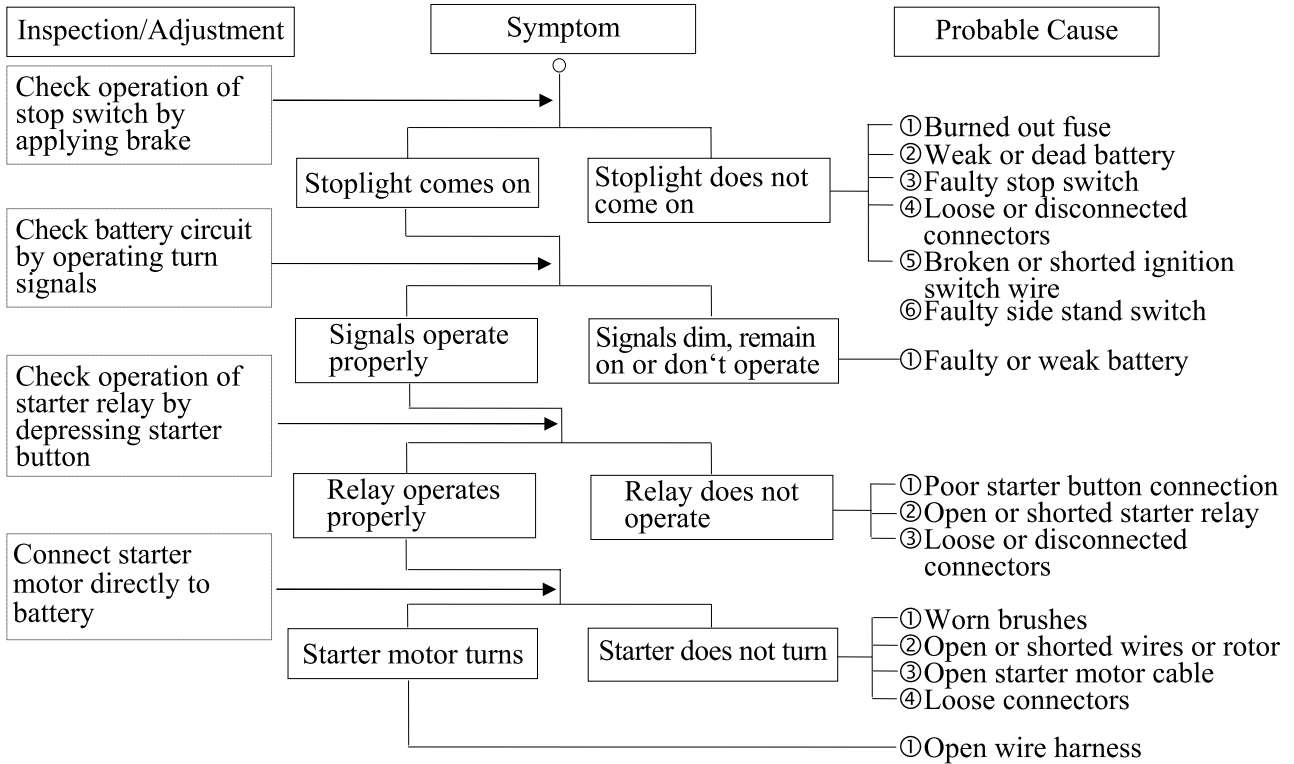

2. Starter motor turns slowly or idles

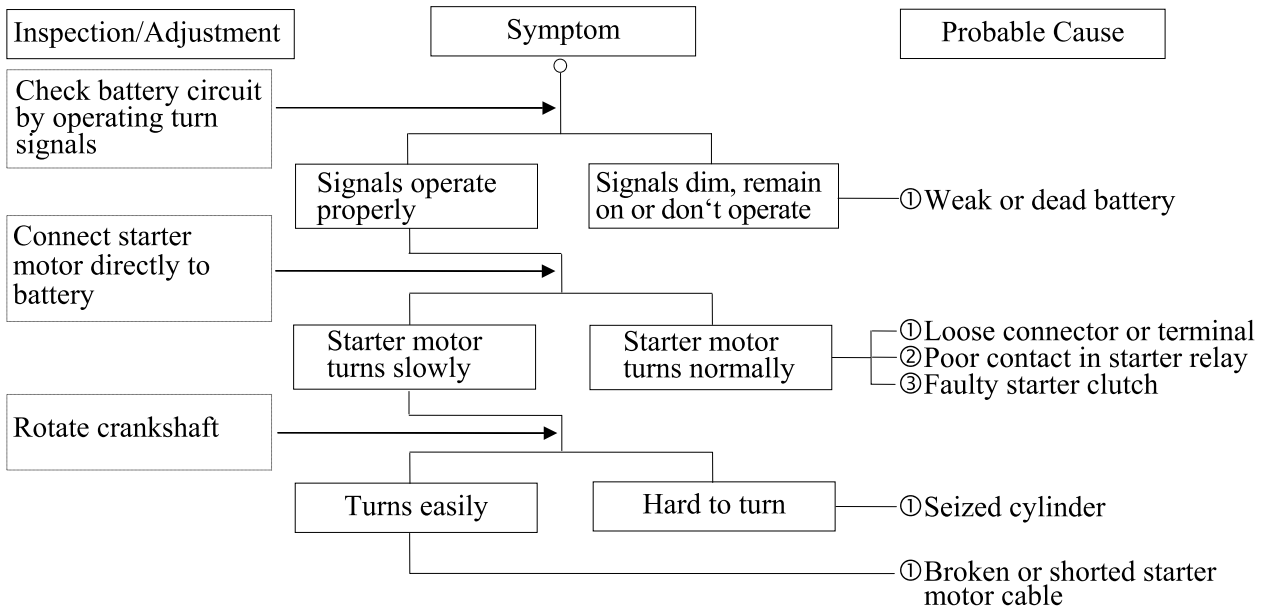

3. Starter motor does not stop turning

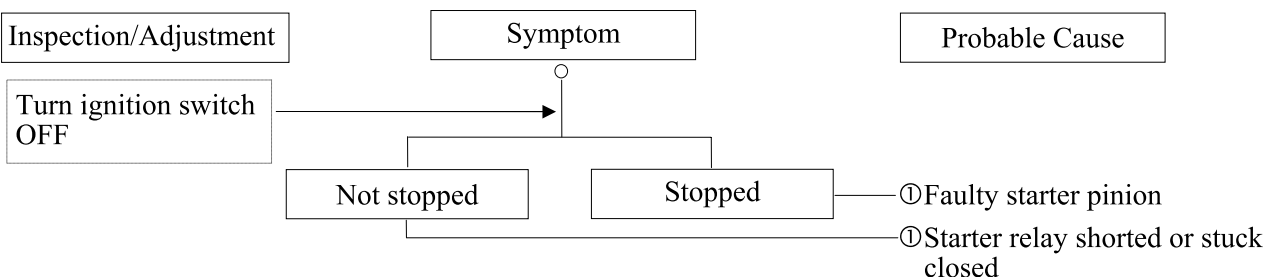

1. GENERAL INFORMATION

XCITING 500/500 AFI/250/300 AFI

NO SPARK AT SPARK PLUG

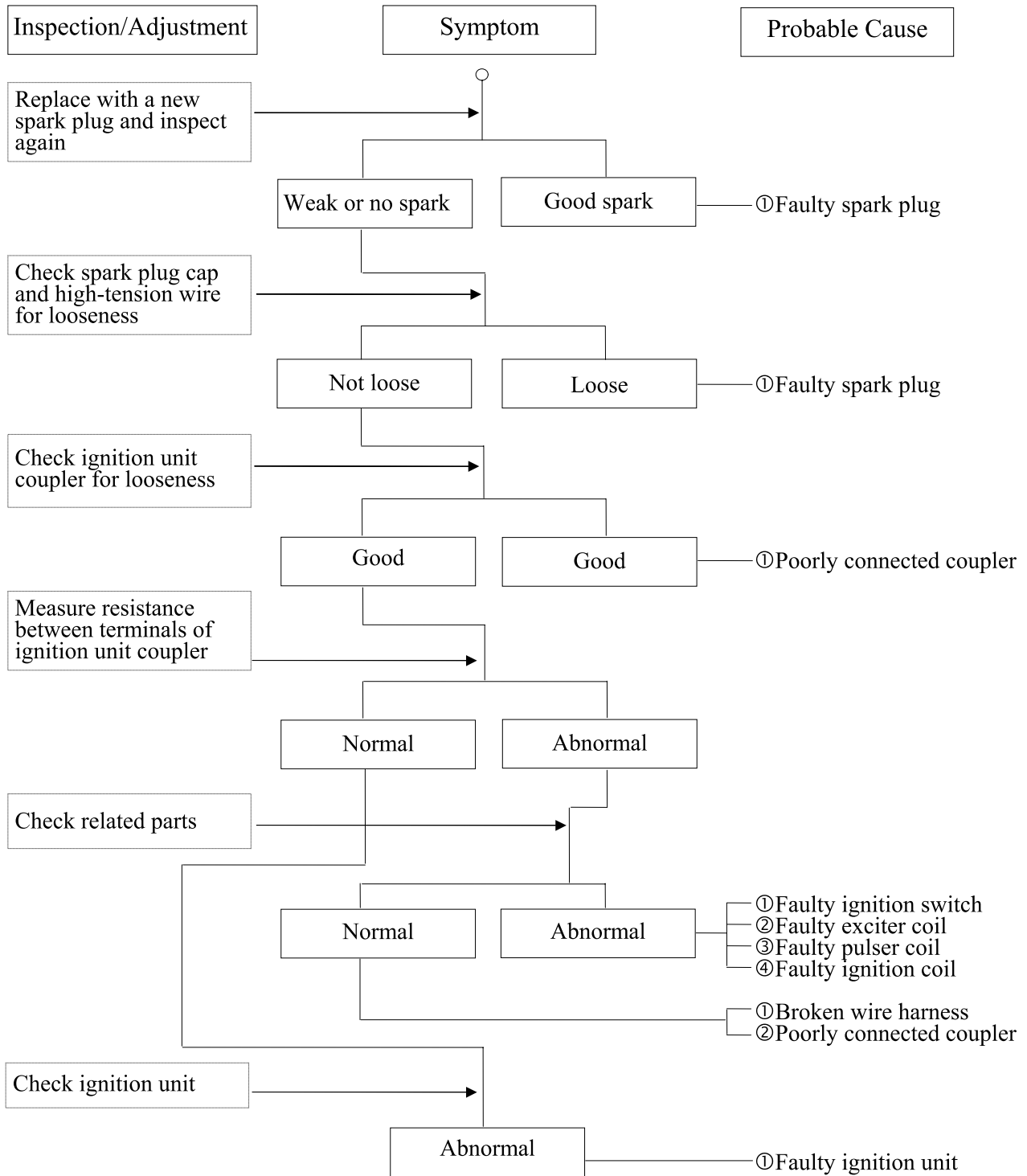

1. GENERAL INFORMATION XCITING 500/500 AFI/250/300 AFI

POOR CHARGING (BATTERY OVER DISCHARGING OR OVERCHARGING)

Undercharging

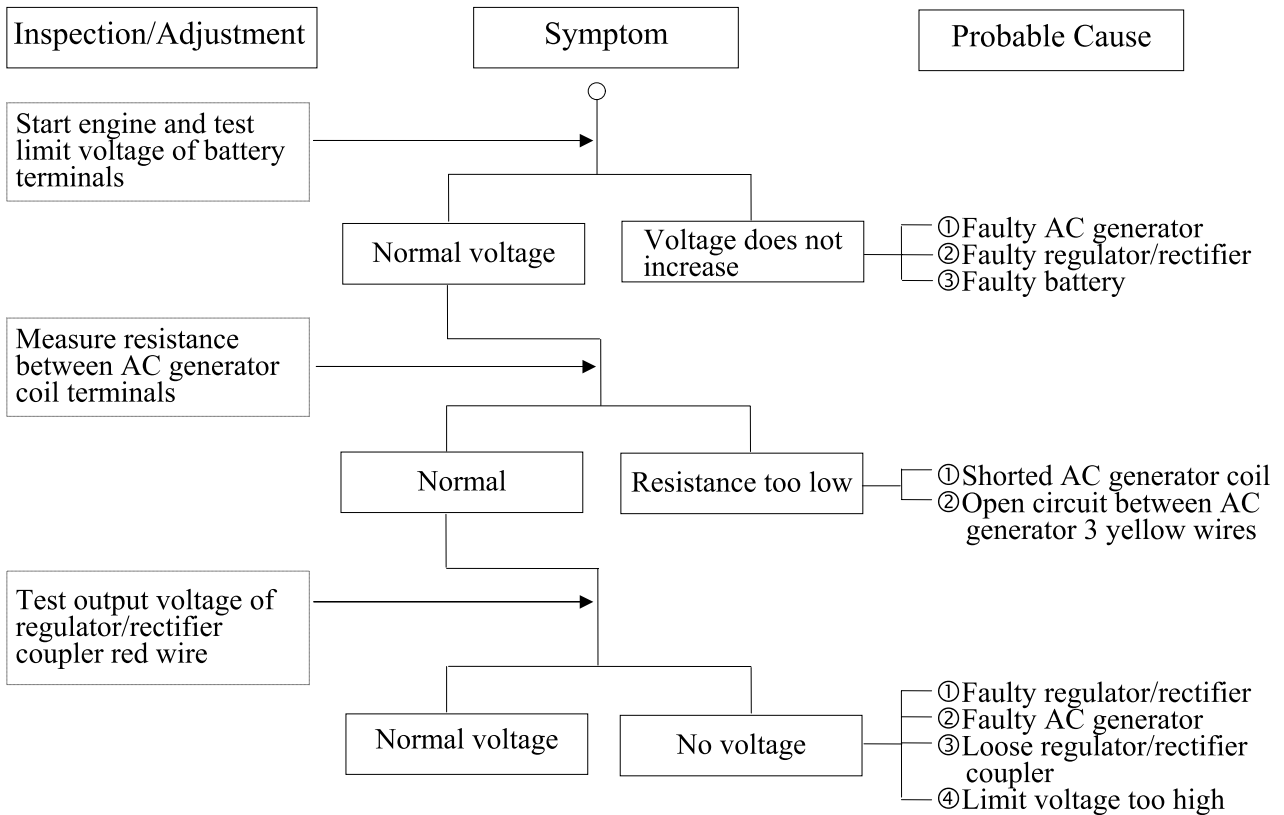

Overcharging

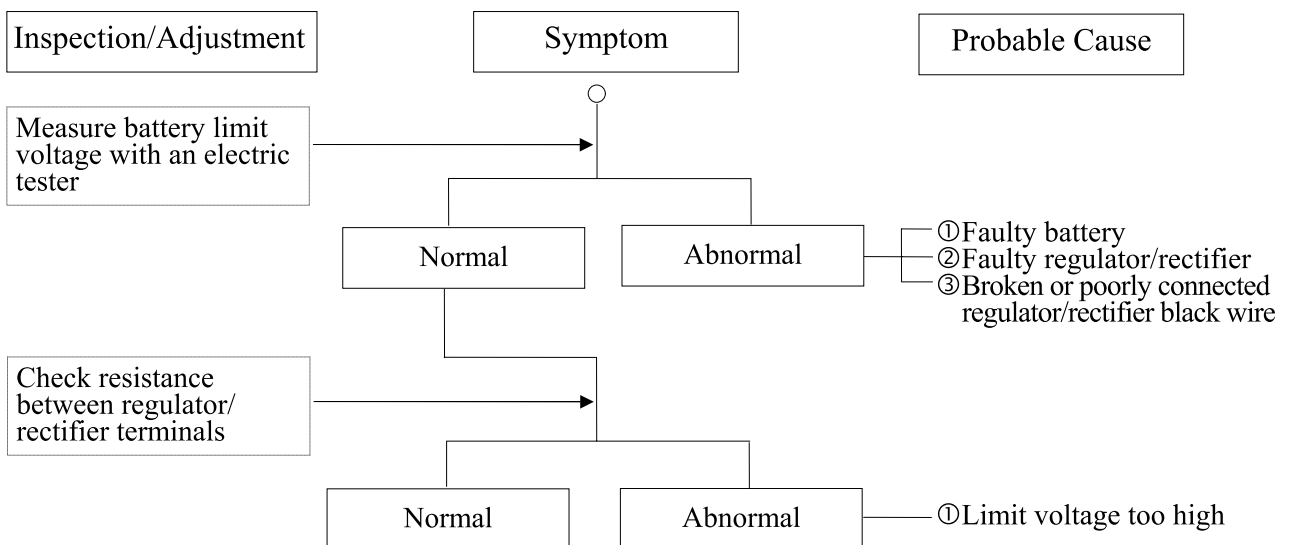

1. GENERAL INFORMATION

XCITING 500/500 AFI/250/300 AFI

FUEL GAUGE

1. Pointer does not register correctly (Ignition switch ON)

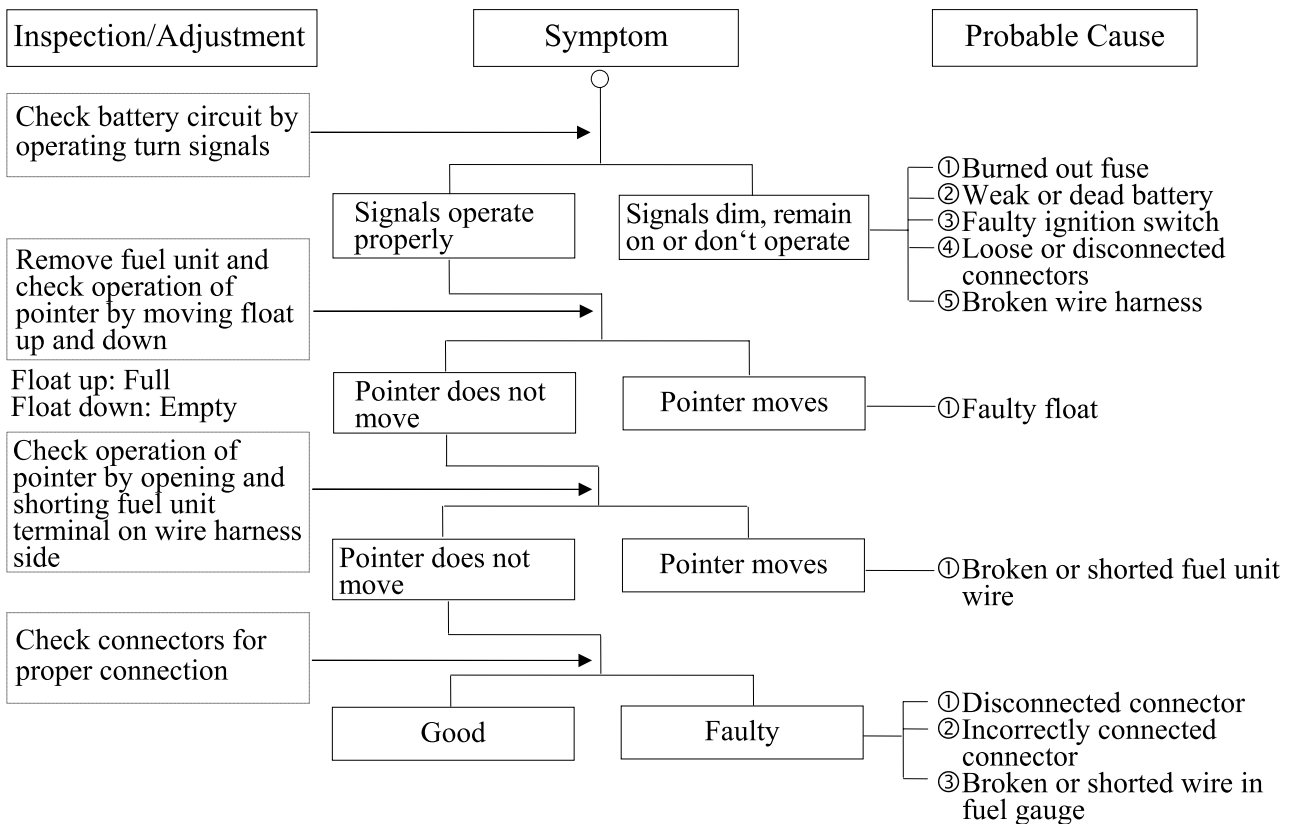

2. Pointer fluctuates or swings (Ignition switch ON)

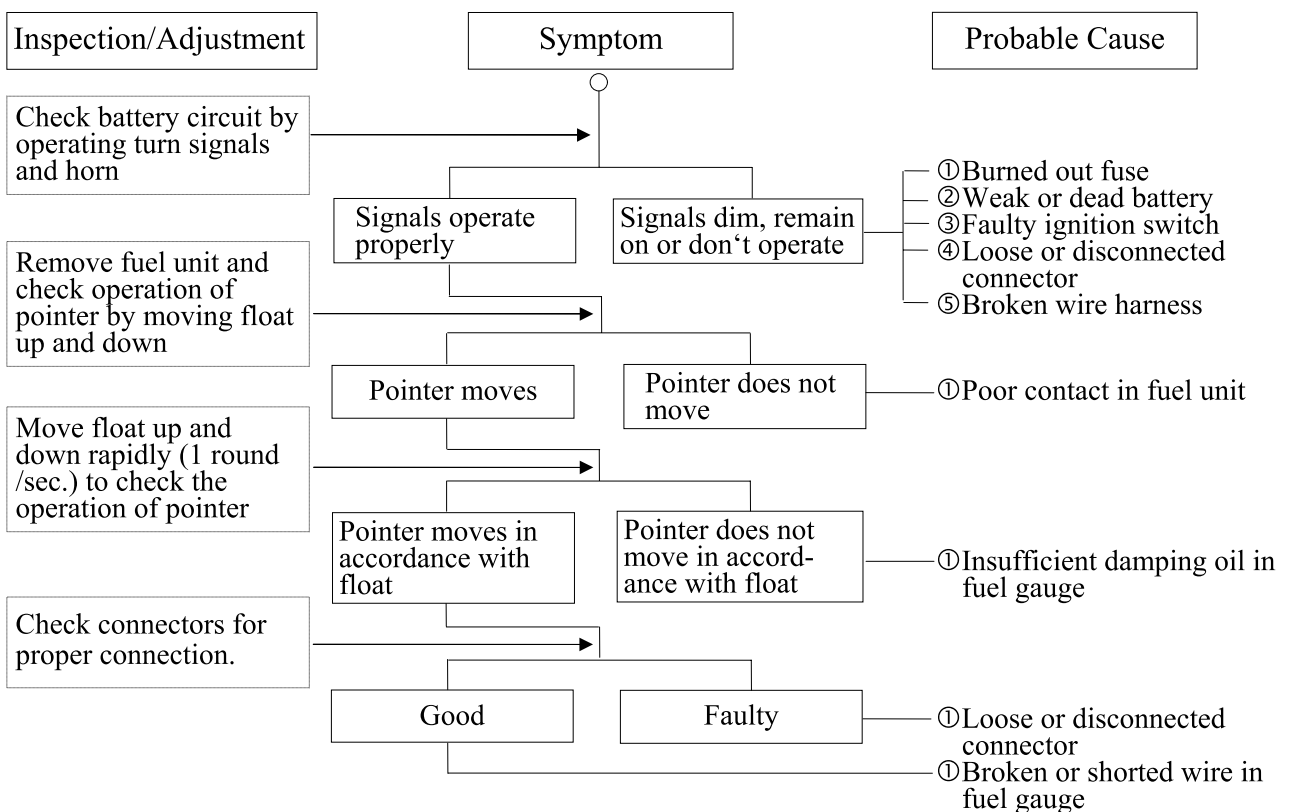

1. GENERAL INFORMATION

XCITING 500/500 AFI/250/300 AFI

STEERING HANDLEBAR DOES NOT TRACK STRAIGHT

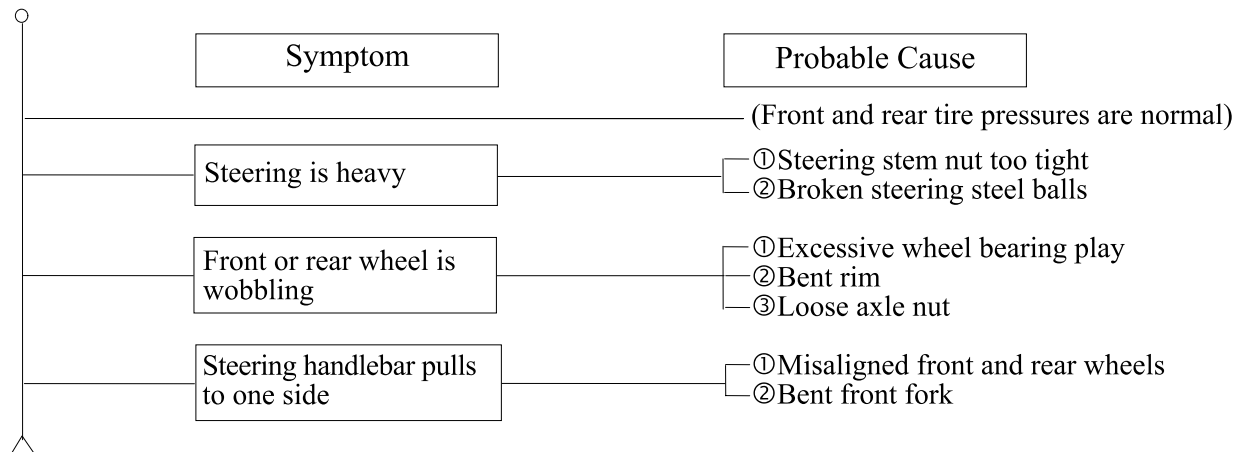

POOR SUSPENSION PERFORMANCE

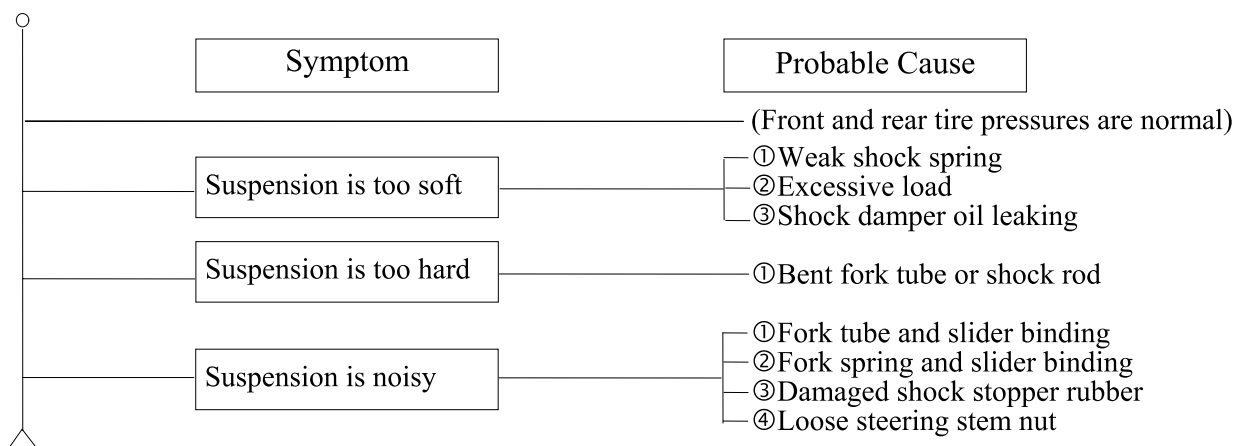

POOR BRAKE PERFORMANCE

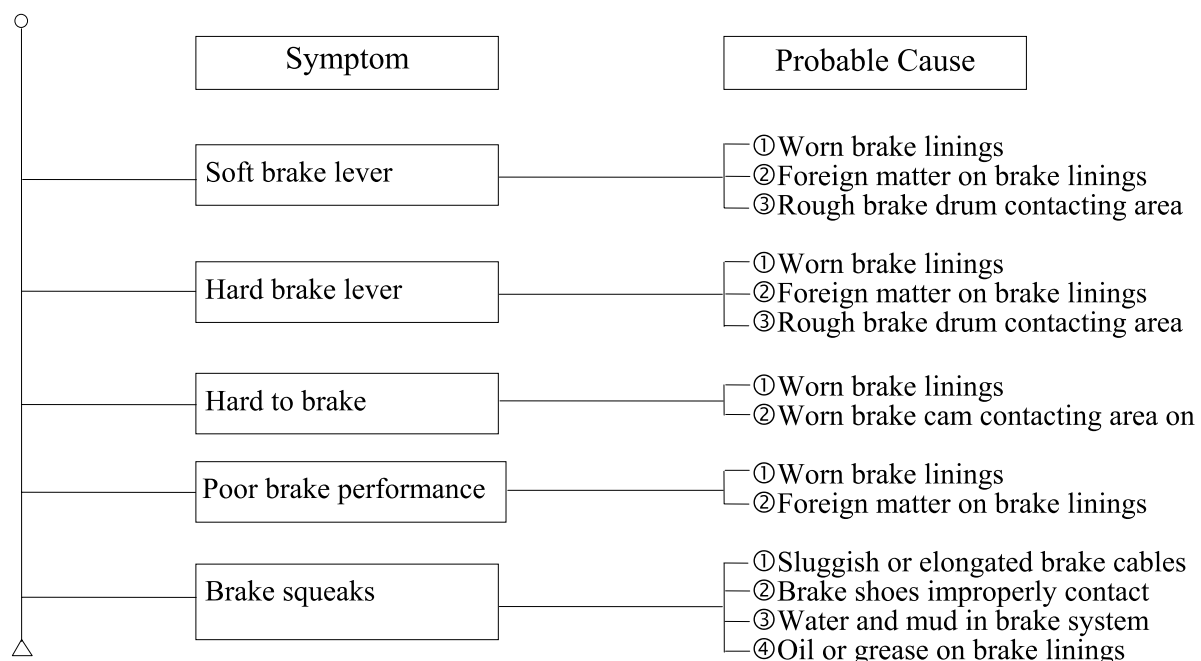

TROUBLESHOOTING (XCITING 500 AFI/300 AFI)

ENGINE WILL NOT START OR IS HARD TO START

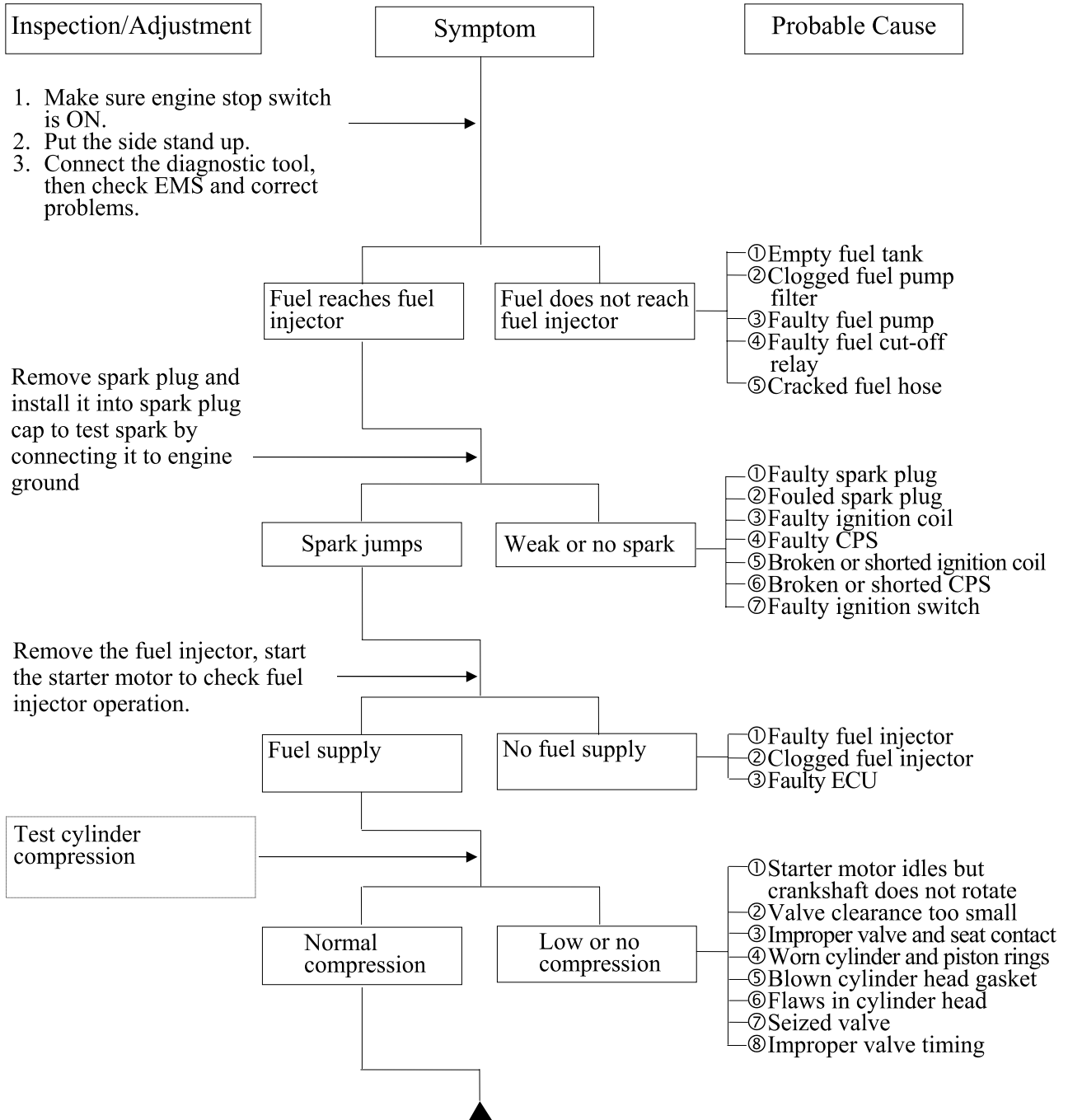

ENGINE LACKS POWER

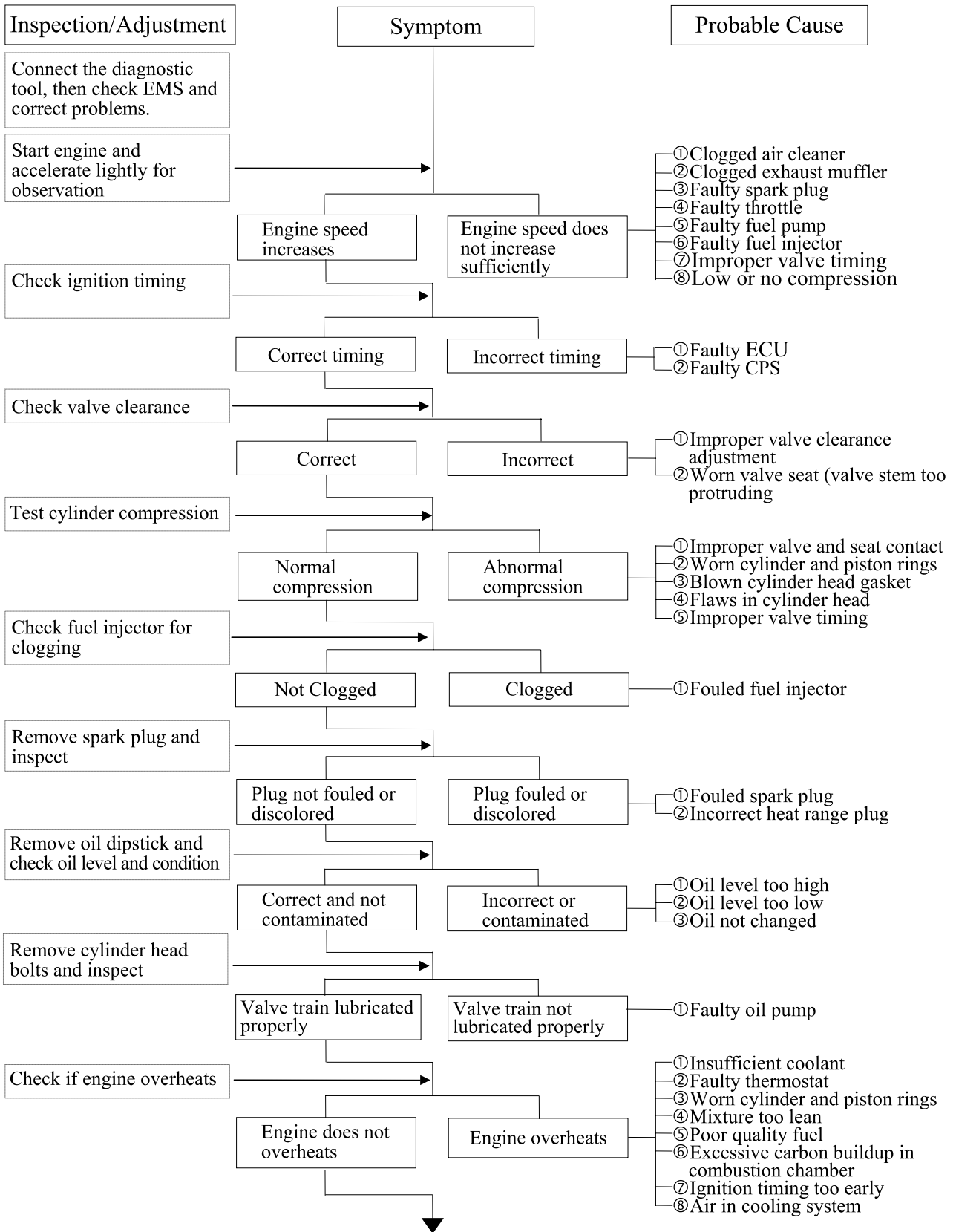

1. GENERAL INFORMATION

XCITING 500/500 AFI/250/300 AFI

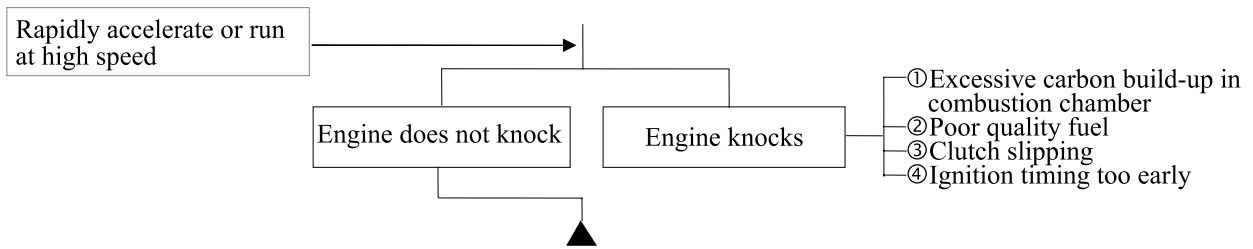

1. GENERAL INFORMATION

XCITING 500/500 AFI/250/300 AFI

POOR PERFORMANCE (ESPECIALLY AT IDLE AND LOW SPEEDS)

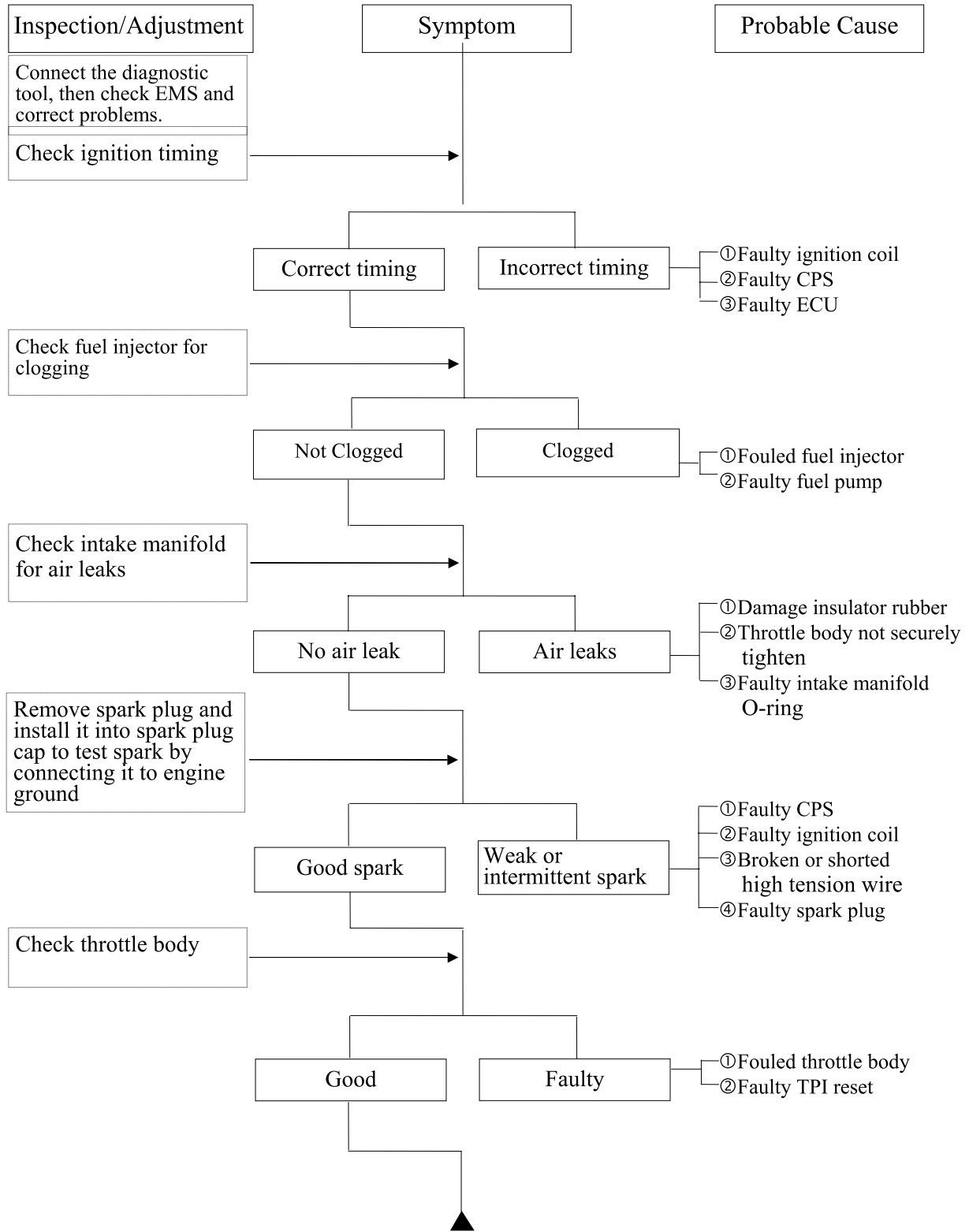

POOR PERFORMANCE (AT HIGH SPEED)

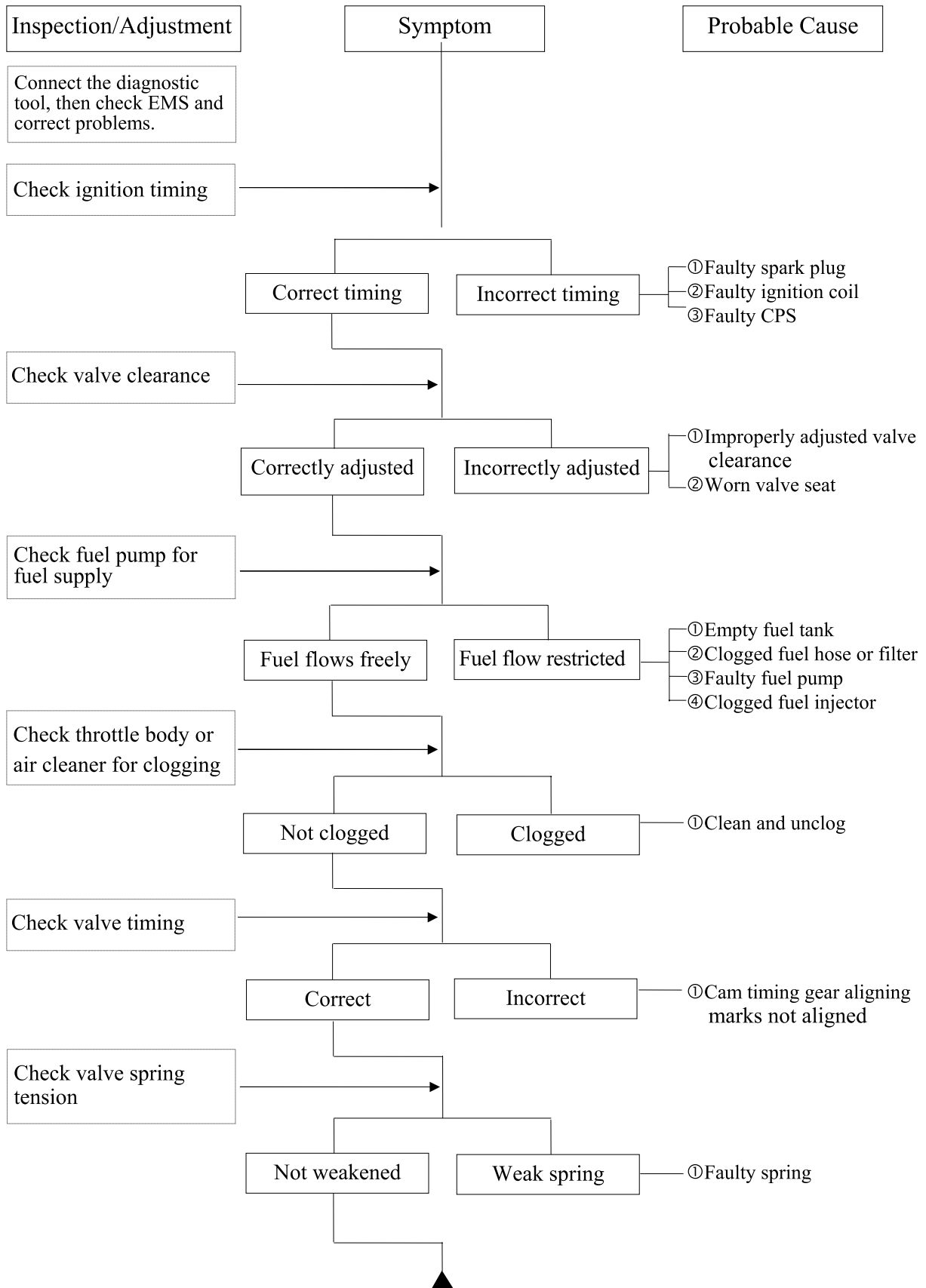

ENGINE NOISE

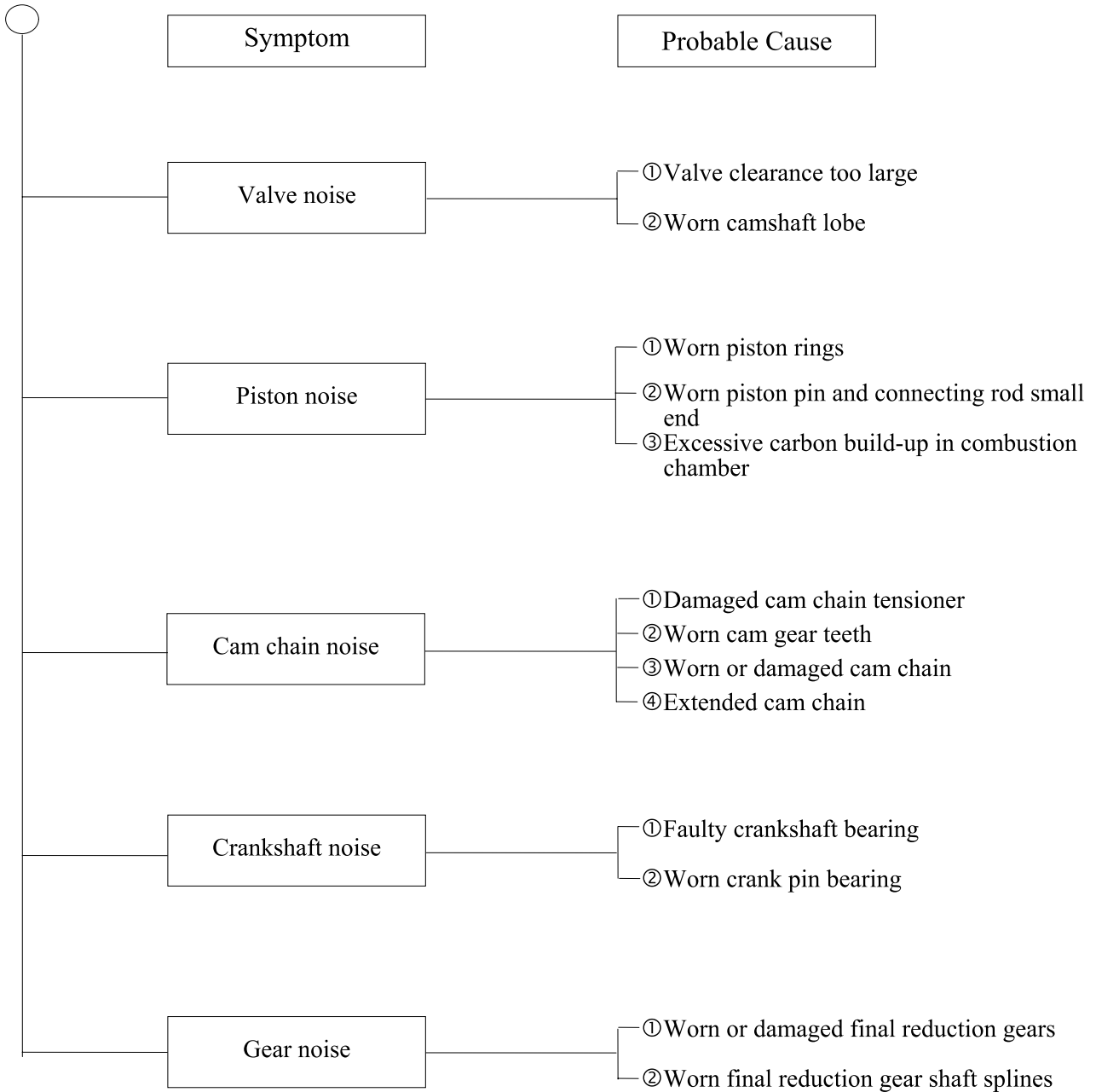

CLUTCH, DRIVE AND DRIVEN PULLEYS

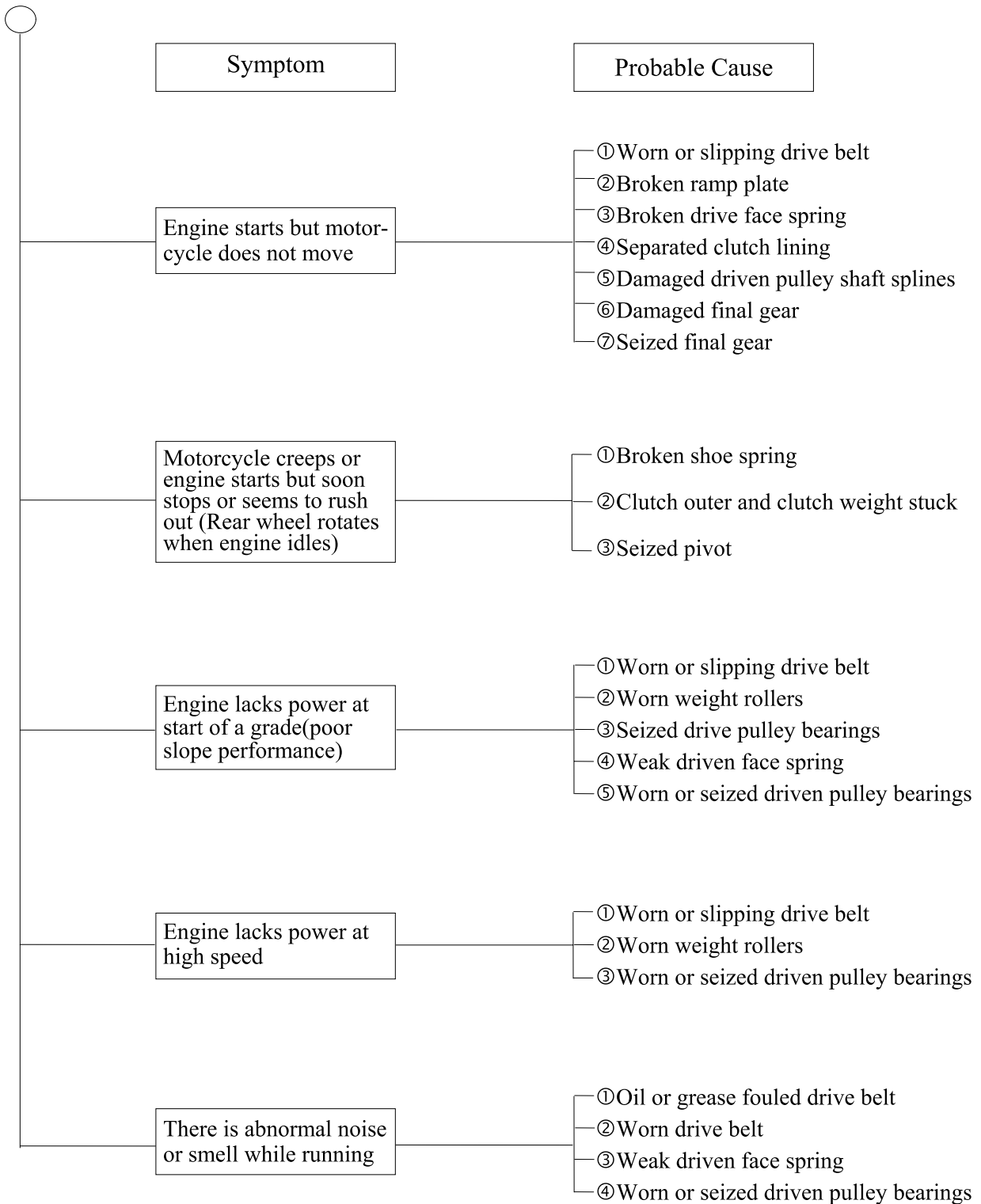

1. GENERAL INFORMATION

XCITING 500/500 AFI/250/300 AFI

STARTER MOTOR

1. Starter motor won't turn

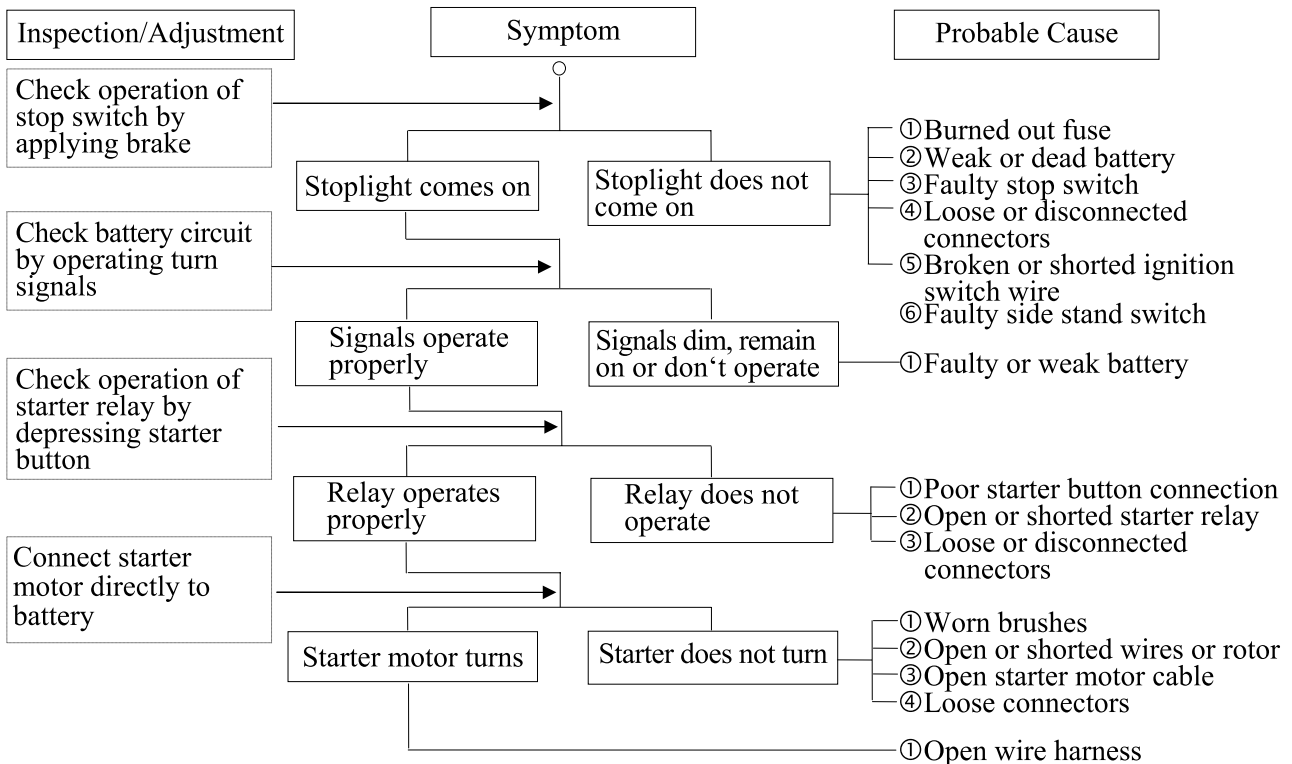

2. Starter motor turns slowly or idles

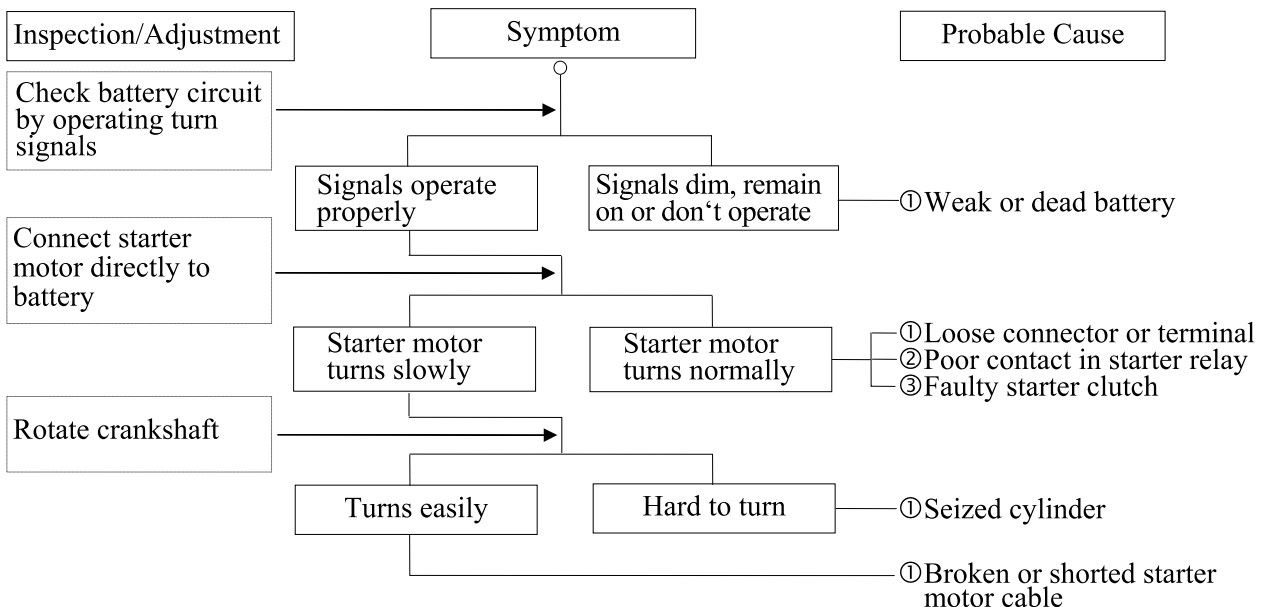

3. Starter motor does not stop turning

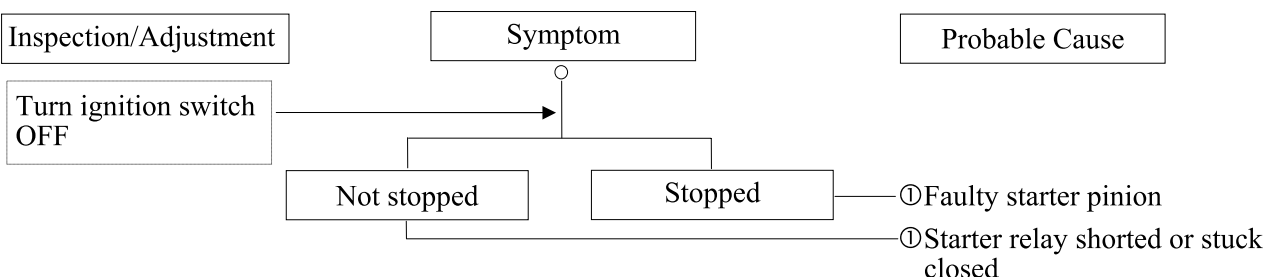

NO SPARK AT SPARK PLUG

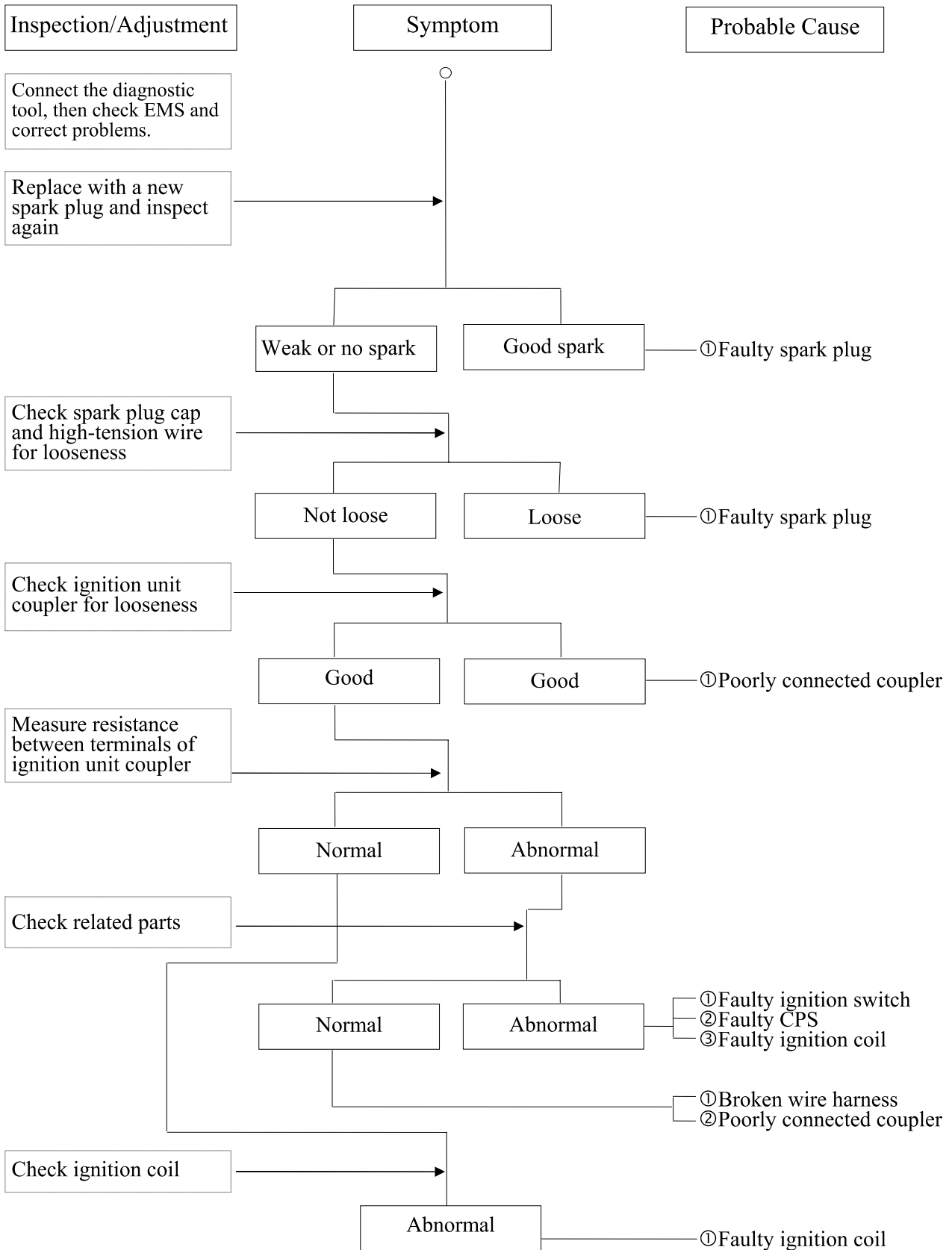

POOR CHARGING (BATTERY OVER DISCHARGING OR OVERCHARGING)

Undercharging

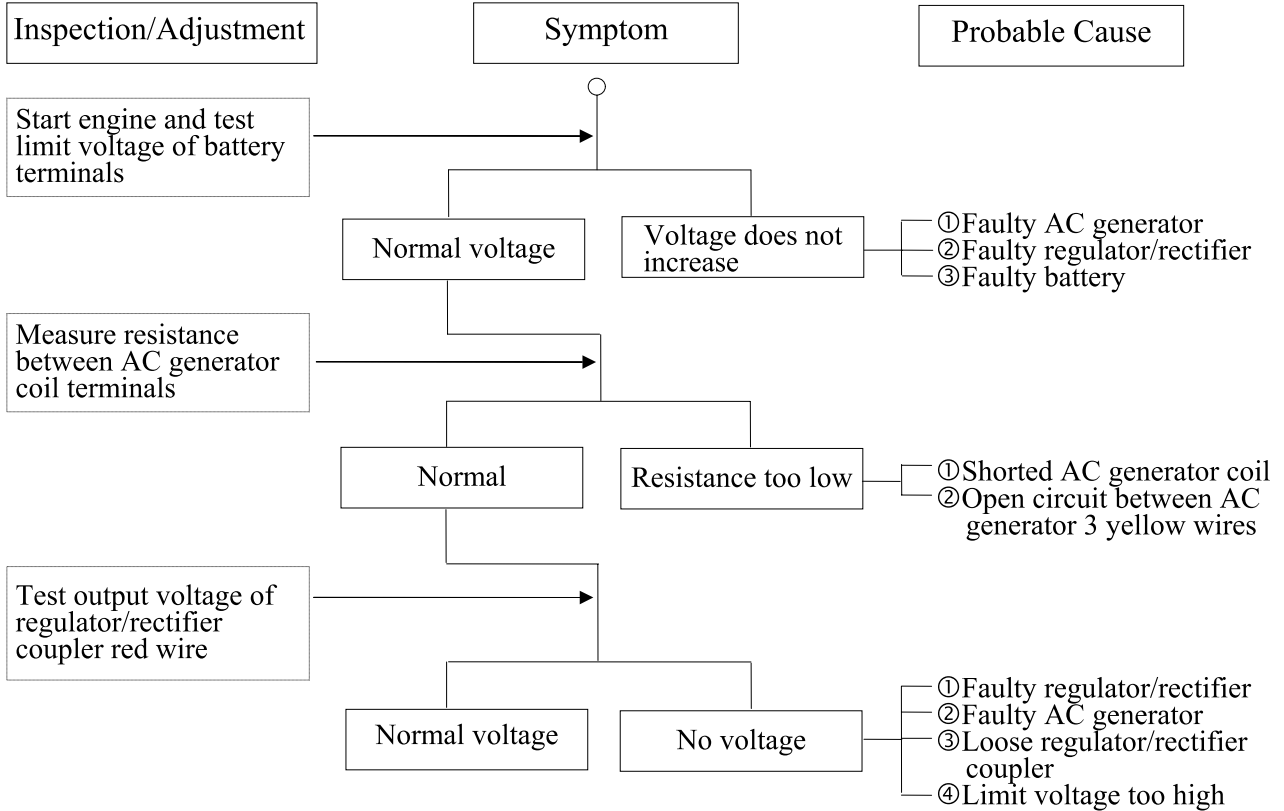

Overcharging

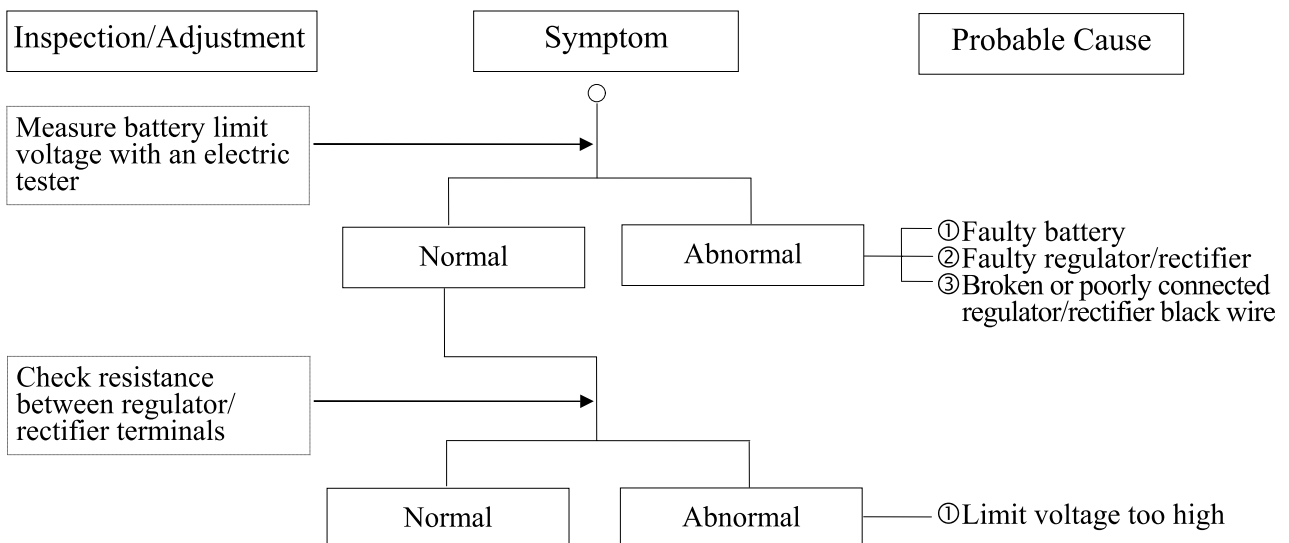

FUEL GAUGE

1. Pointer does not register correctly (Ignition switch ON)

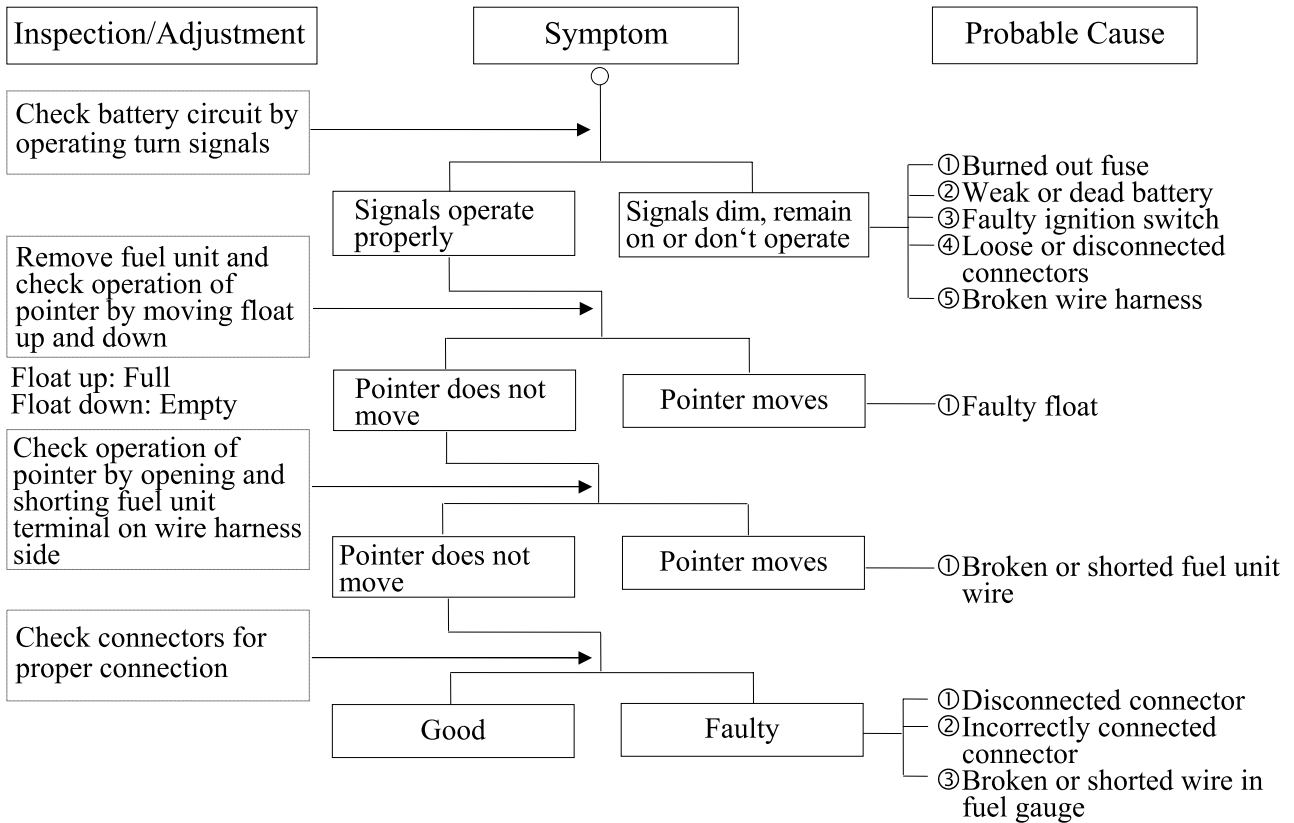

2. Pointer fluctuates or swings (Ignition switch ON)

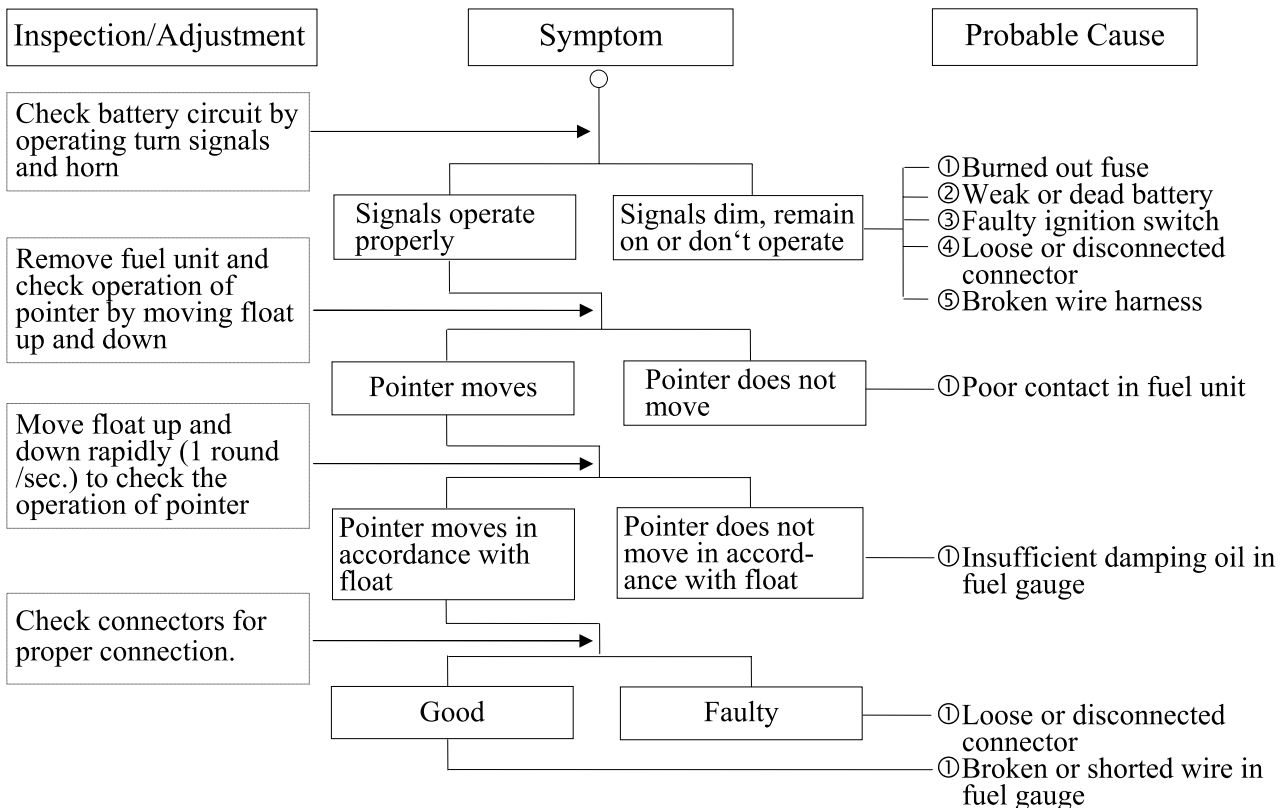

STEERING HANDLEBAR DOES NOT TRACK STRAIGHT

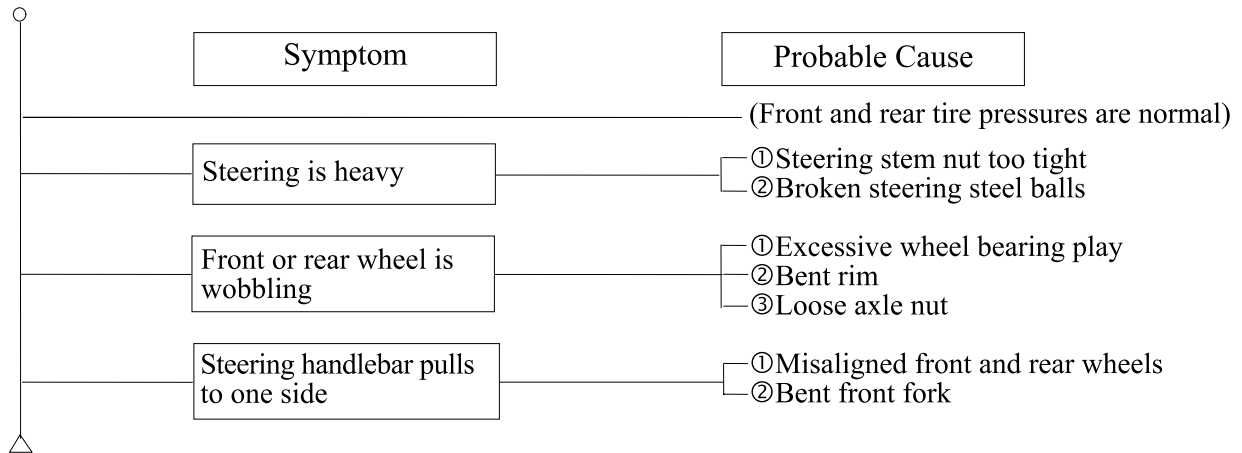

POOR SUSPENSION PERFORMANCE

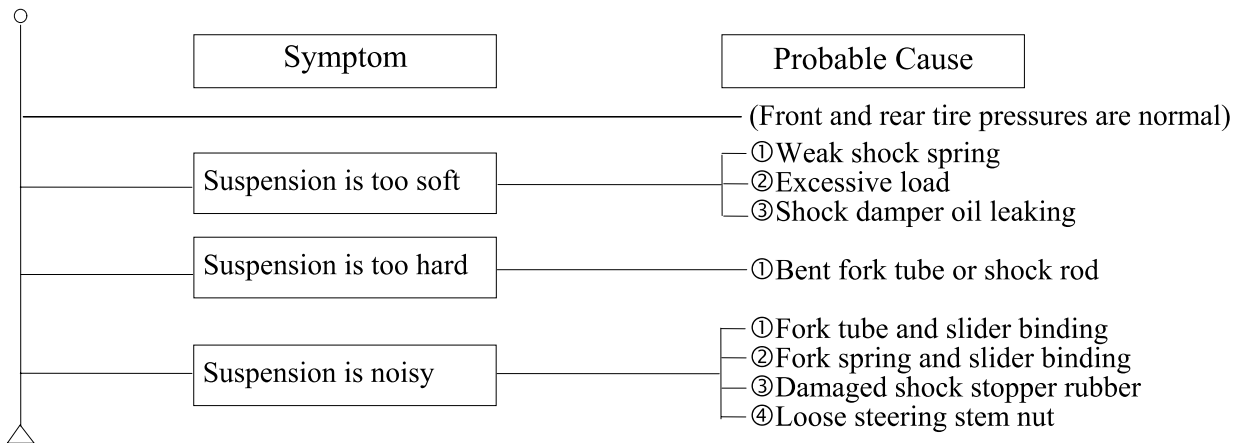

POOR BRAKE PERFORMANCE

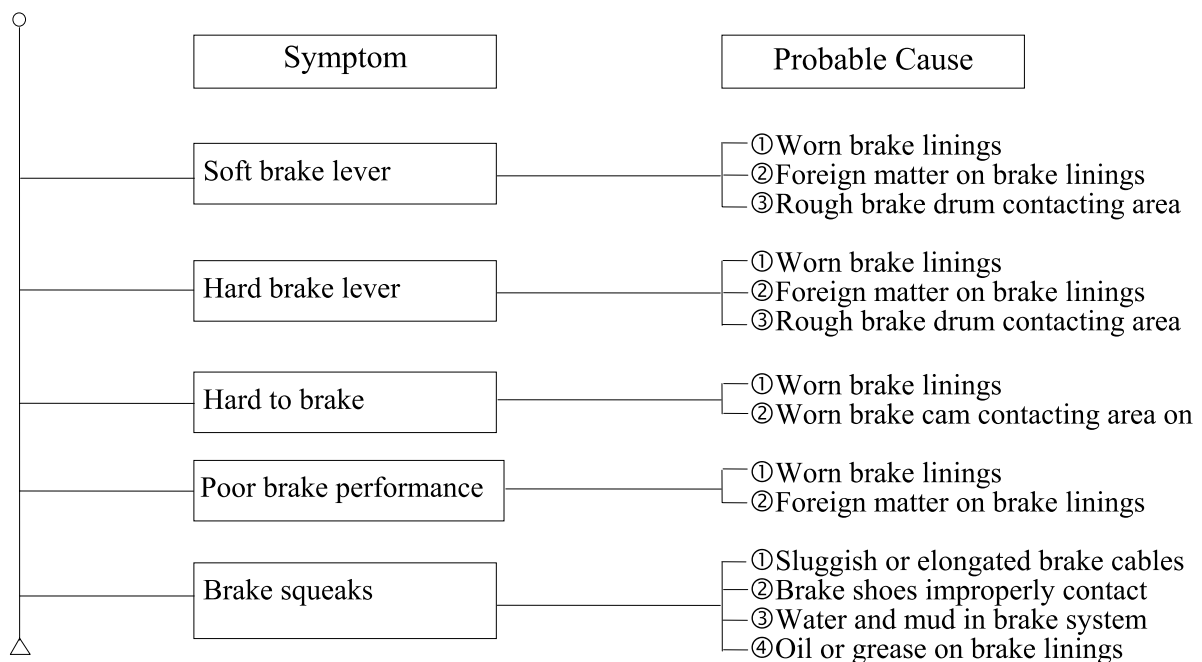

**2. FRAME COVERS/
EXHAUST MUFFLER**

XCITING 500/500 AFI/250/300 AFI

2

FRAME COVERS/EXHAUST MUFFLER

SCHEMATIC DRAWING ----- 2- 1
SERVICE INFORMATION----- 2- 2
TROUBLESHOOTING----- 2- 2
FRAME COVERS REMOVAL ----- 2- 3
EXHAUST MUFFLER ----- 2-16

2. FRAME COVERS/ EXHAUST MUFFLER

XCITING 500/500 AFI/250/300 AFI

SCHEMATIC DRAWING

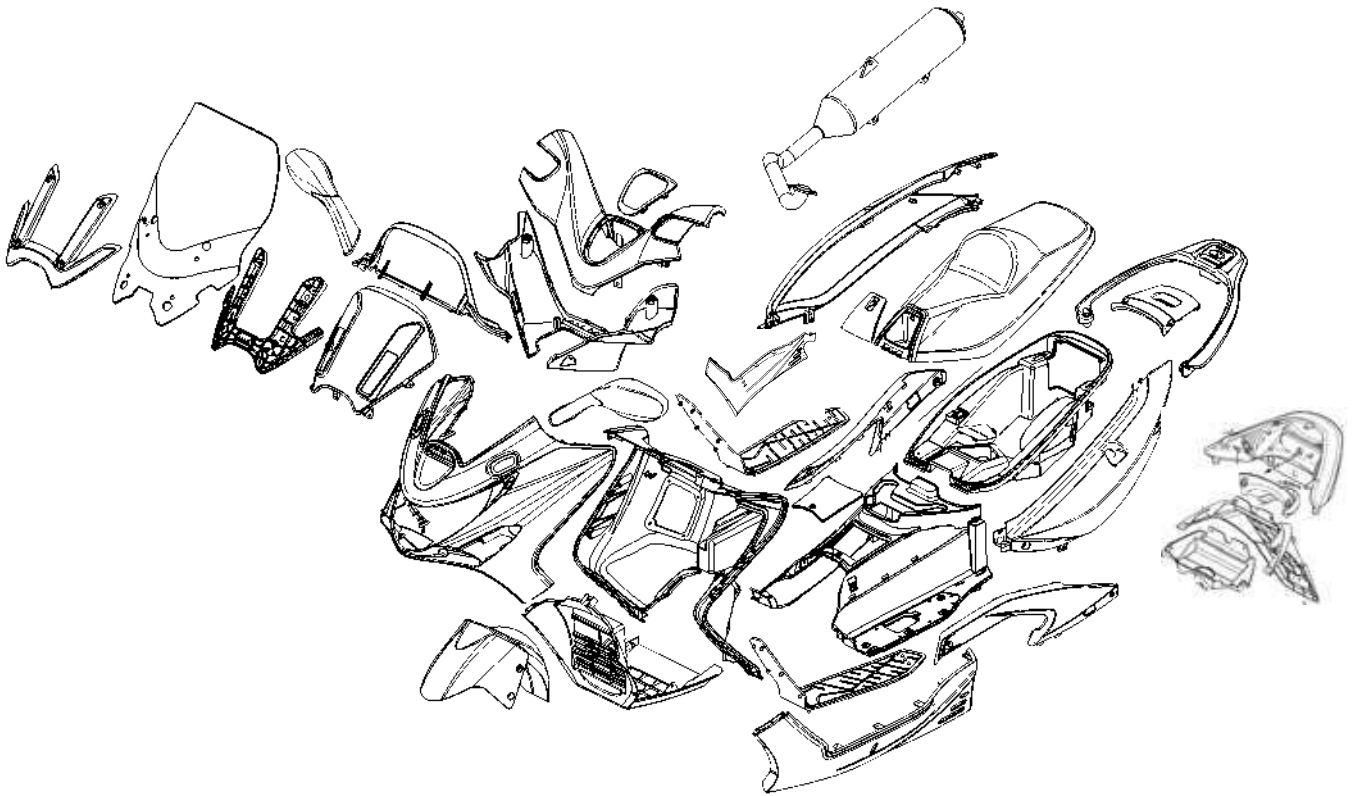

2. FRAME COVERS/ EXHAUST MUFFLER

XCITING 500/500 AFI/250/300 AFI

SERVICE INFORMATION

GENERAL INSTRUCTIONS

- When removing frame covers, use care not to pull them by force because the cover joint claws may be damaged.
- Make sure to route cables and harnesses according to the Cable & Harness Routing.

TORQUE VALUES

Muffler mount bolt	35 N•m (3.5 kgf•m, 25 lbf•ft)
Exhaust pipe joint nut	20 N•m (2 kgf•m, 14 lbf•ft)
Exhaust pipe band bolt	21 N•m (2.1 kgf•m, 15 lbf•ft)

TROUBLESHOOTING

Noisy exhaust muffler

- Damaged exhaust muffler
- Exhaust muffler joint air leaks

Lack of power

- Caved exhaust muffler
- Clogged exhaust muffler
- Exhaust muffler air leaks

2. FRAME COVERS/ EXHAUST MUFFLER

XCITING 500/500 AFI/250/300 AFI

FRAME COVERS REMOVAL

SEAT

REMOVAL

Unlock the seat with the ignition key.
Open the seat.

Remove the two nuts and seat damper unit.

Remove the two nuts and the seat.

INSTALLATION

Installation is in the reverse order of the removal.

After installation, check the seat installation by moving the seat.

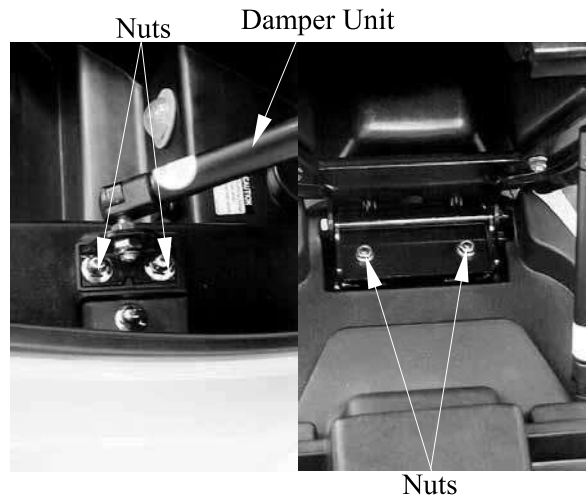

LUGGAGE BOX

REMOVAL

Remove the seat (page 2-3).

Remove the four screws and three nuts.



Raise the luggage box, disconnect the luggage box light and accessory socket connectors.

INSTALLATION

Installation is in the reverse order of removal.

Luggage Box Light Connector



Accessory Socket Connector

2. FRAME COVERS/ EXHAUST MUFFLER

XCITING 500/500 AFI/250/300 AFI

SPARK PLUG MAINTENANCE LID REMOVAL

Remove the bolt and lid.

INSTALLATION

Installation is in the reverse order of removal.

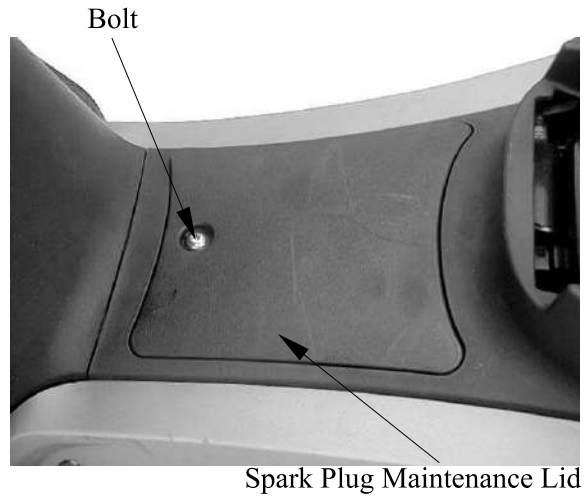

REAR SPOILER REMOVAL

Unlock the seat with the ignition key.
Open the seat.

Remove the rubber cap.

Remove four bolts and rear spoiler.

INSTALLATION

Installation is in the reverse order of removal.

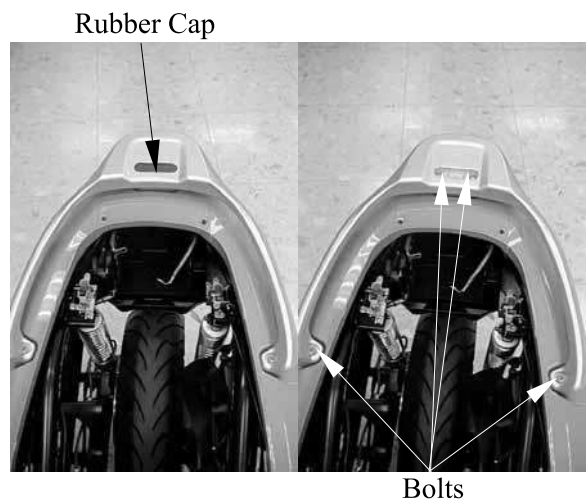

FRONT FENDER REMOVAL

Remove the six bolts and front fender.

INSTALLATION

Installation is in the reverse order of removal.

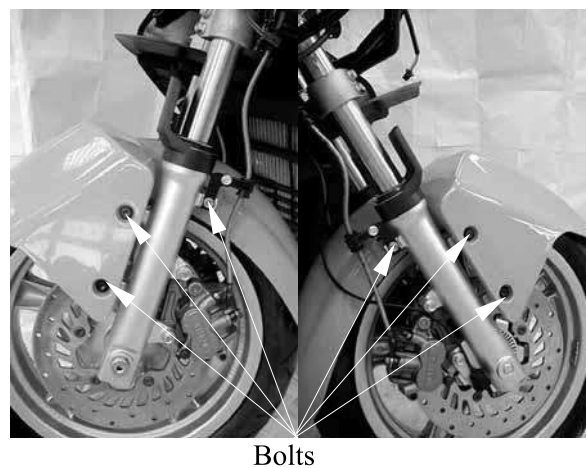

2. FRAME COVERS/ EXHAUST MUFFLER

XCITING 500/500 AFI/250/300 AFI

UPPER HANDLEBAR COVER

REMOVAL

Remove four screws and upper handlebar cover.

INSTALLATION

Installation is in the reverse order of removal.

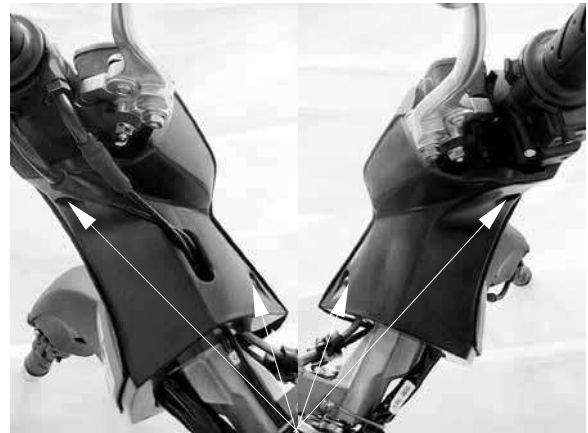

Screws

RIGHT/LEFT CENTER BODY COVER

REMOVAL

Remove the two bolts and right/left center body cover.

Be careful not to damage the tabs on the center body cover.

INSTALLATION

Installation is in the reverse order of removal.

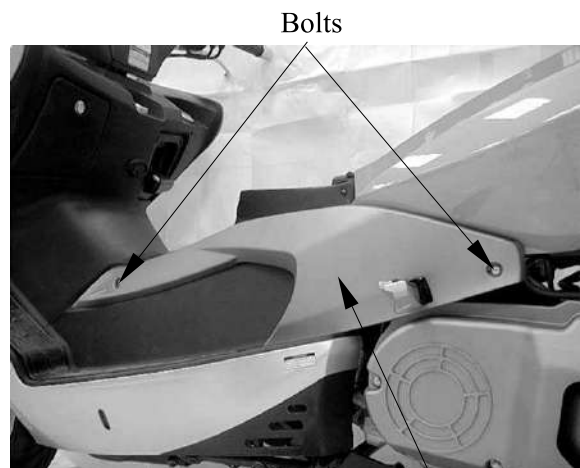

Bolts

Center Body Cover

RIGHT/LEFT FLOOR SKIRT

REMOVAL

Remove the floor mat.

Remove the right and left center body cover (page 2-5).



Floor Mat

2. FRAME COVERS/ EXHAUST MUFFLER

XCITING 500/500 AFI/250/300 AFI

Remove the seven screws.



Remove two screws.

Remove the floor skirt.

Be careful not to damage the tabs on the floor skirt.

INSTALLATION

Installation is in the reverse order of removal.

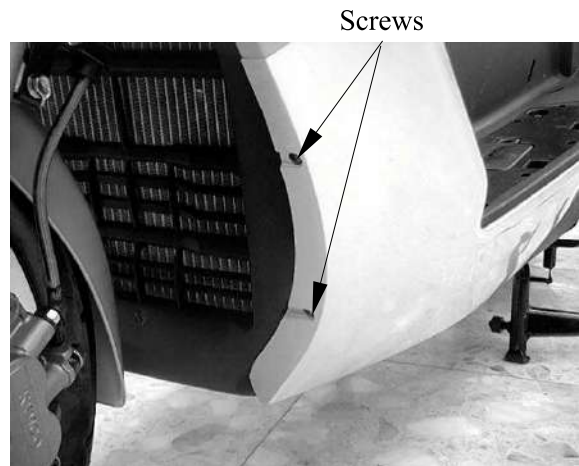

FLOORBOARD

REMOVAL

Remove right and left center body cover (page 2-5).

Remove the right and left floor skirt (page 2-5).

Remove the luggage box (page 2-3).

Remove six bolts, four screws and floorboard.

INSTALLATION

Installation is in the reverse order of removal.

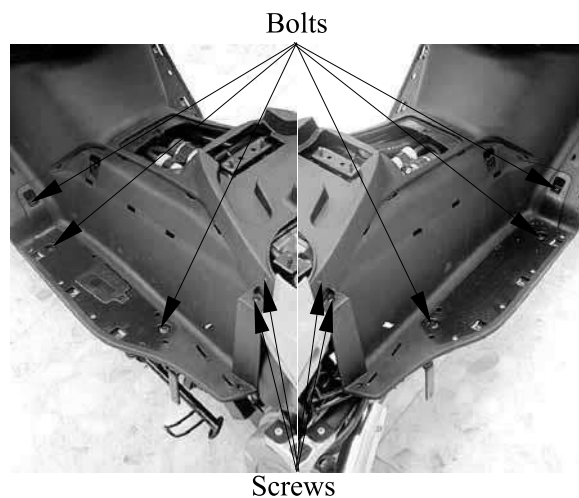

2. FRAME COVERS/ EXHAUST MUFFLER

XCITING 500/500 AFI/250/300 AFI

LICENCE LIGHT REMOVAL

Remove two screws.
Disconnect the license light connector and
remove the license light.

INSTALLATION

Installation is in the reverse order of removal.

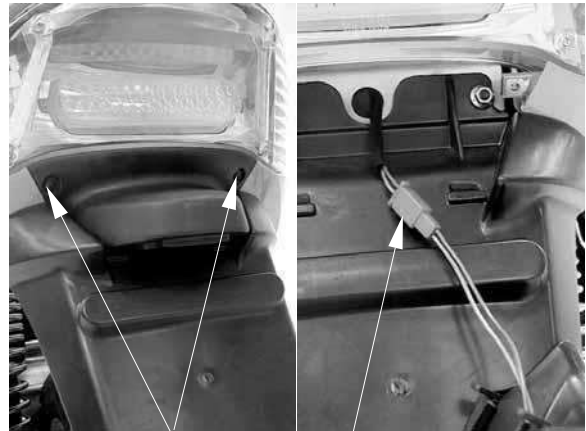

Screws

Connector

REAR FENDER REMOVAL

Remove the licence light (page 2-7).

Remove two screws.

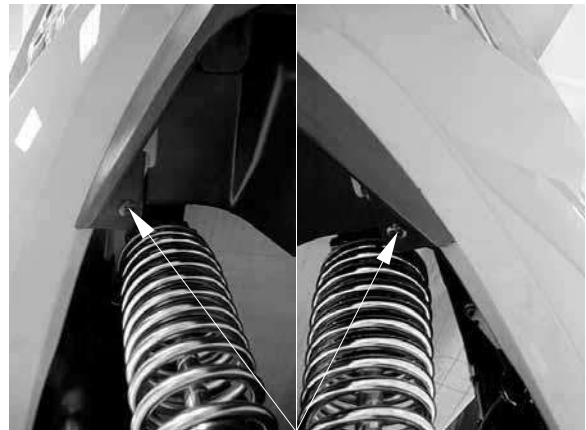

Screws

Remove two nuts and rear fender.

INSTALLATION

Installation is in the reverse order of removal.

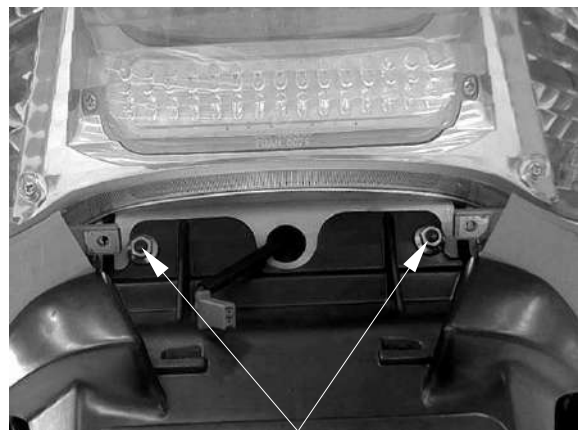

Nuts

2. FRAME COVERS/ EXHAUST MUFFLER

XCITING 500/500 AFI/250/300 AFI

RIGHT/LEFT SIDE BODY COVER REMOVAL

Remove the luggage box (page 2-3).
Remove the rear spoiler (page 2-4).

Remove two bolts.

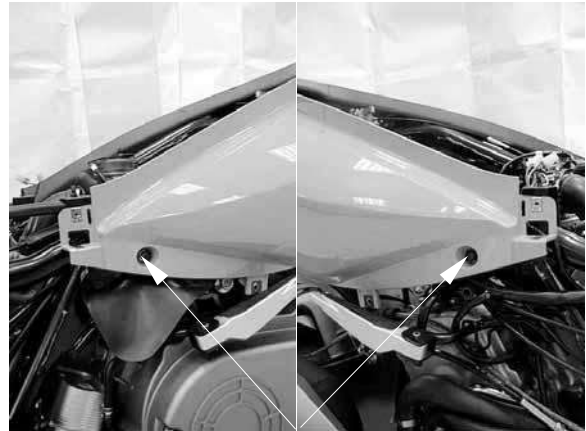

Bolts

Raise the side body cover, disconnect the taillight/rear turn signal light connector and remove the side body cover.

INSTALLATION

Installation is in the reverse order of removal



Taillight/Rear Turn Signal Light Connector

REAR BODY COVER REMOVAL

Remove the luggage box (page 2-3).
Remove the rear spoiler (page 2-4).

Remove two screws and rear body cover.

Be careful not to damage the tabs on the rear body cover.

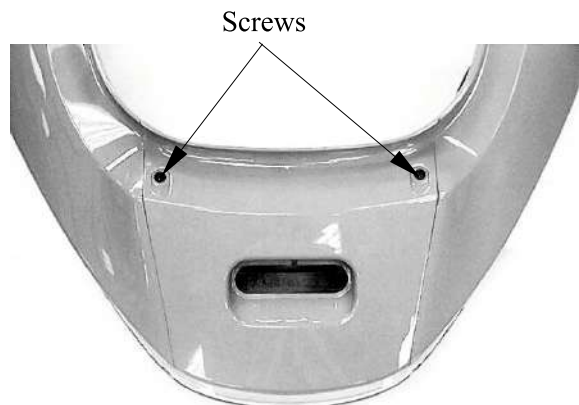

INSTALLATION

Installation is in the reverse order of removal.

2. FRAME COVERS/ EXHAUST MUFFLER

XCITING 500/500 AFI/250/300 AFI

TAILLIGHT/REAR TURN SIGNAL LIGHT

REMOVAL

Remove the side and rear body cover (page 2-8).

Remove eight screw and taillight/rear turn signal light.

INSTALLATION

Installation is in the reverse order of removal.

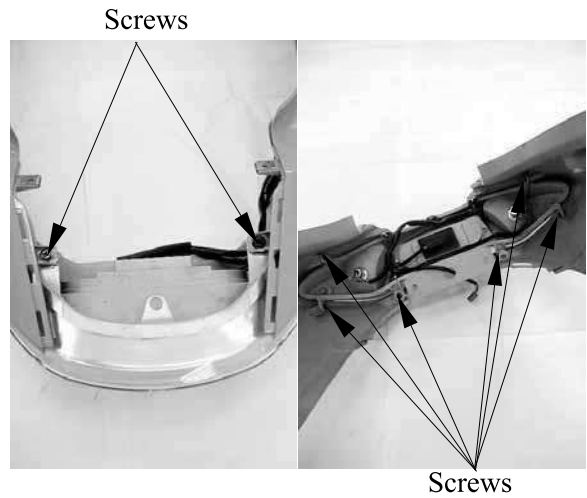

REAR LOWER COVER

REMOVAL

Remove the side body cover (page 2-8).

Remove the rear lower cover.

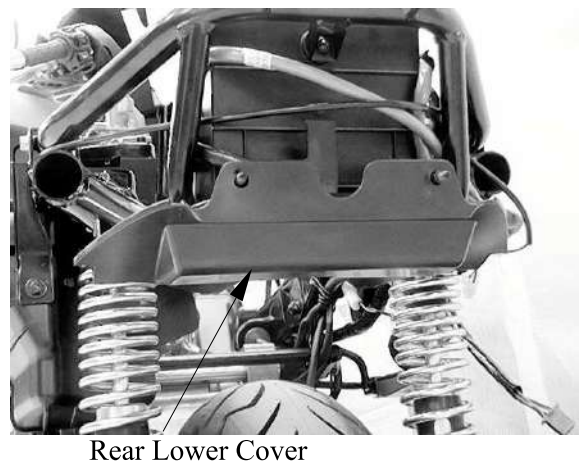

REARVIEW MIRROR(OLD TYPE)

REMOVAL

Remove bolts lid.

Remove three bolts and rearview mirror.

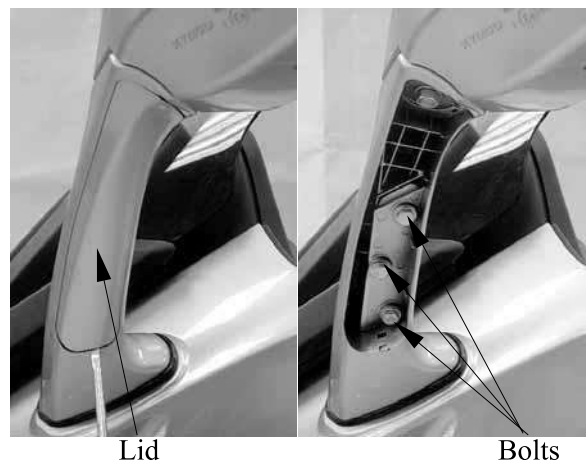

2. FRAME COVERS/ EXHAUST MUFFLER

XCITING 500/500 AFI/250/300 AFI

Remove the two bolts, rearview mirror holder and seat.

INSTALLATION

Installation is in the reverse order of removal

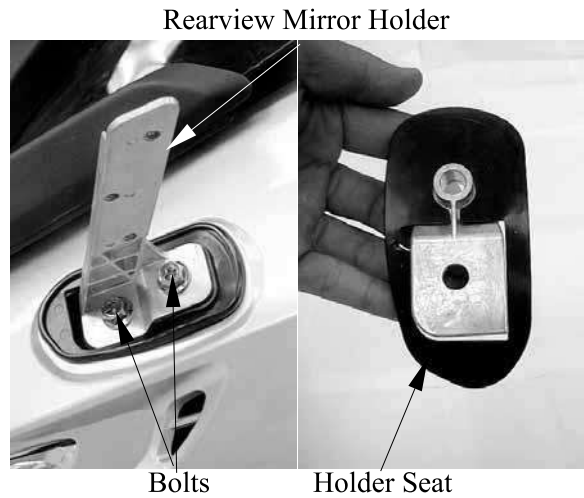

REARVIEW MIRROR (NEW TYPE '06) REMOVAL

Remove bolts and rearview mirror.

INSTALLATION

Installation is in the reverse order of removal

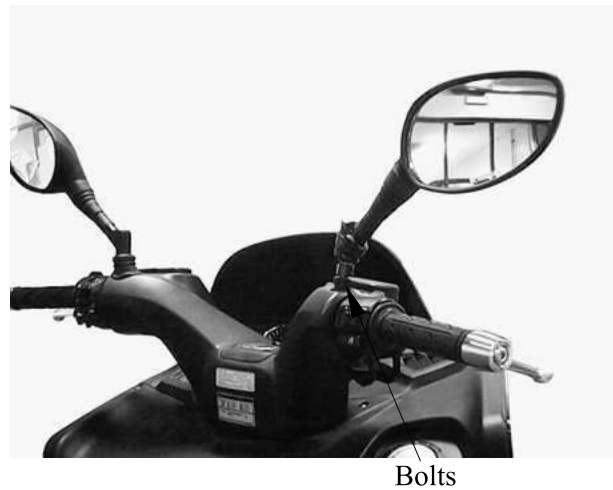

WINDSHIELD

REMOVAL

Remove four screws and windshield garnish.

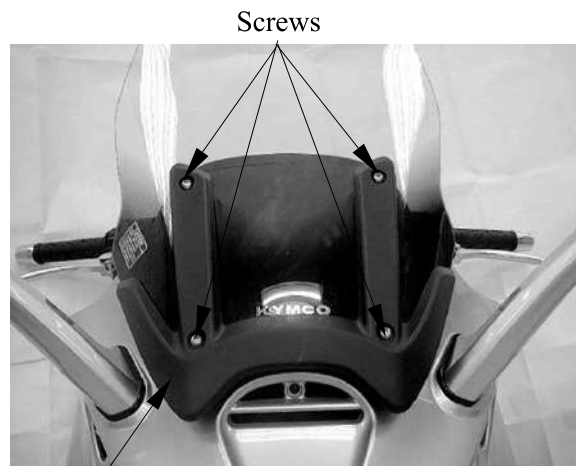

Windshield Garnish

2. FRAME COVERS/ EXHAUST MUFFLER

XCITING 500/500 AFI/250/300 AFI

Remove four bolts and windshield.

Be careful not to scratch or damage the windshield surface.

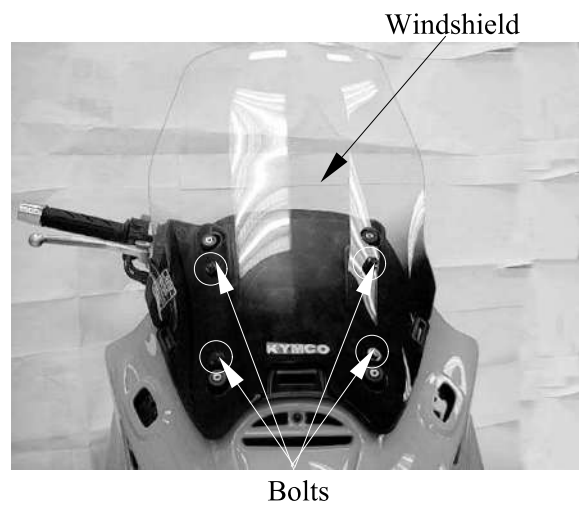

FRONT COVER REMOVAL

Remove the rearview mirrors (page 2-9).

Remove six screws.

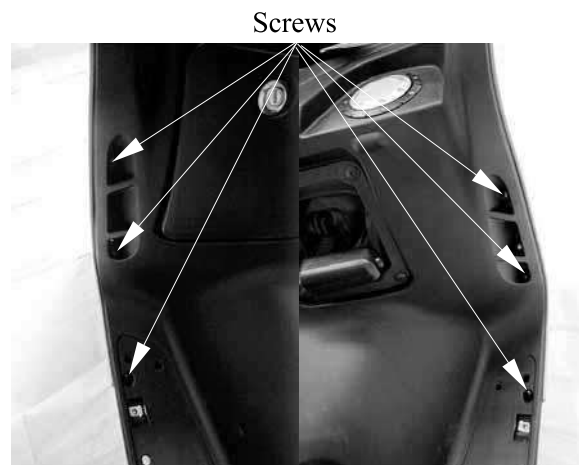

Remove two screws.

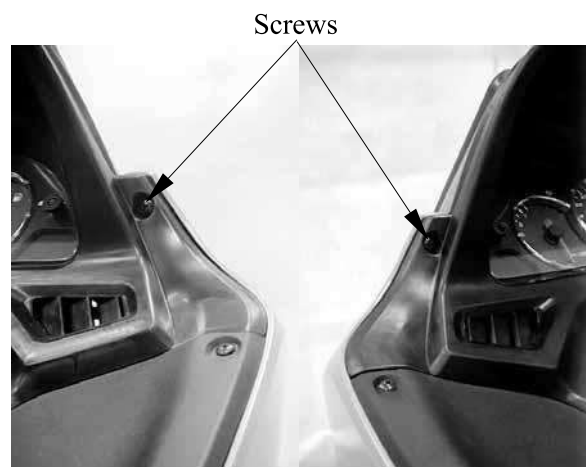

2. FRAME COVERS/ EXHAUST MUFFLER

XCITING 500/500 AFI/250/300 AFI

Remove one screw.

Disconnect headlight and turn signal light connectors.

INSTALLATION

Installation is in the reverse order of removal.

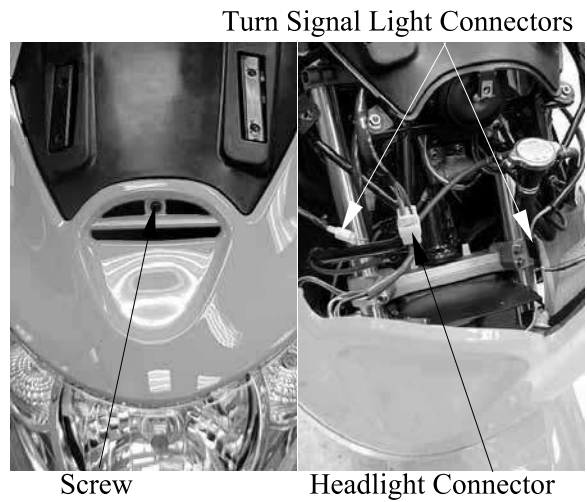

HEADLIGHT REMOVAL

Remove the front cover (page 2-11).

Remove six screws and headlight.

INSTALLATION

Installation is in the reverse order of removal.

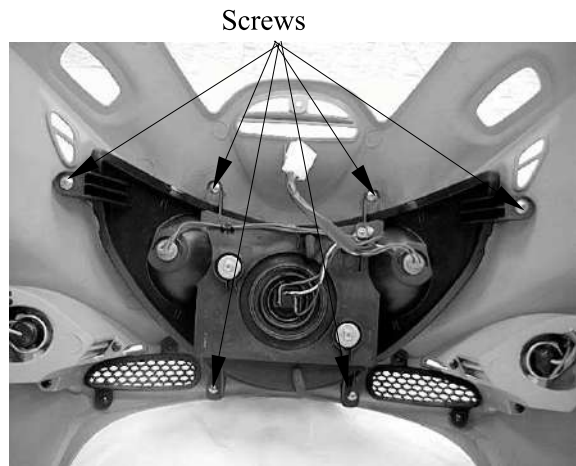

TURN SIGNAL LIGHT REMOVAL

Remove the front cover (page 2-11).

Remove three screws and turn signal light.

INSTALLATION

Installation is in the reverse order of removal.

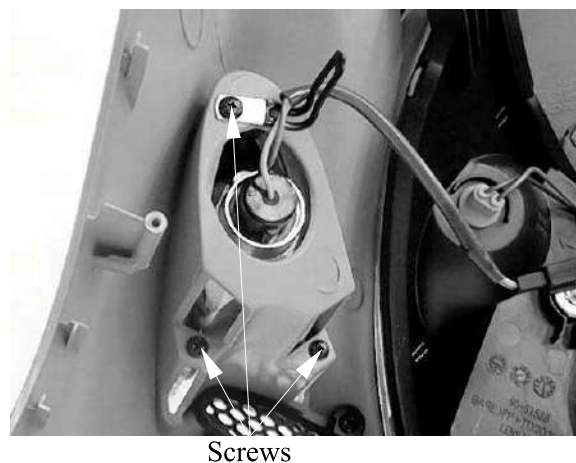

2. FRAME COVERS/ EXHAUST MUFFLER

XCITING 500/500 AFI/250/300 AFI

FRONT METER VISOR

REMOVAL

Remove the windshield (page 2-10).

Remove the front cover (page 2-11).

Remove four bolts and windshield holder.

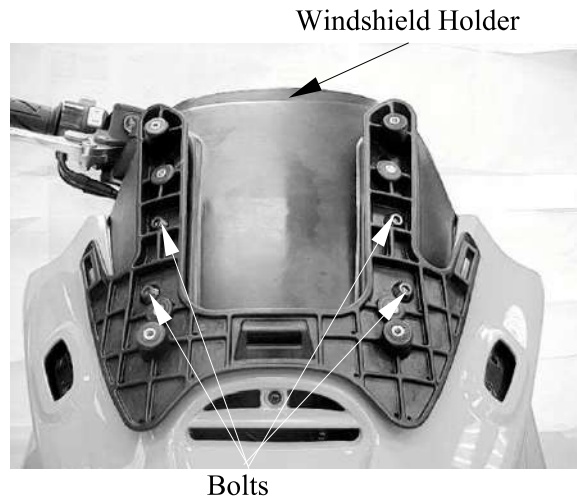

Remove two screws and front meter visor.

INSTALLATION

Installation is in the reverse order of removal.



MEER PANEL

REMOVAL

Remove the front cover (page 2-11).

Remove the front meter visor (page 2-13).

Remove four screws.



2. FRAME COVERS/ EXHAUST MUFFLER

XCITING 500/500 AFI/250/300 AFI

Disconnect the speedometer connector and remove meter panel.

INSTALLATION

Installation is in the reverse order of removal.

Speedometer Connector

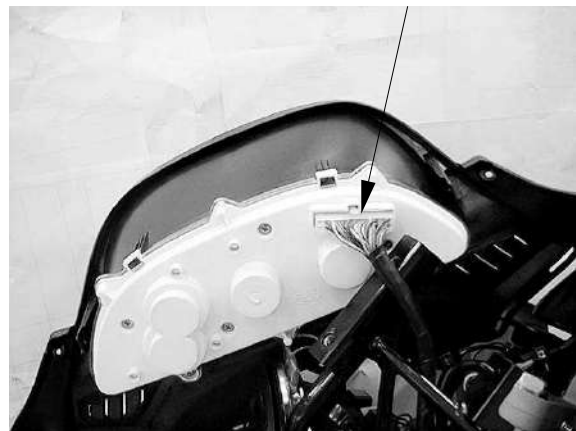

METER

REMOVAL

Remove the meter panel (page 2-13).

Remove two screws and meter.

Screws

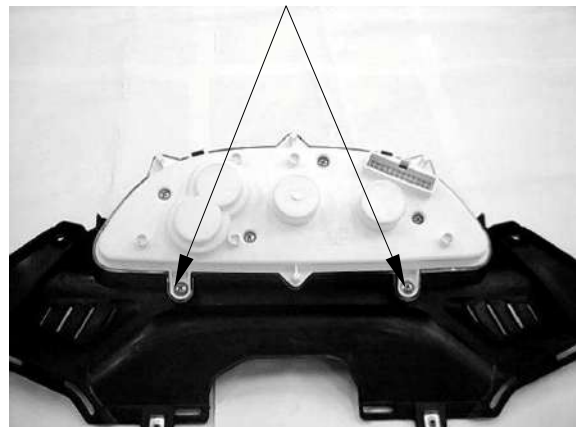

INNER COVER

REMOVAL

Remove the front cover (page 2-11).

Remove the floorboard (page 2-6).

Remove the meter panel (page 2-13).

Remove the shutter screw and shutter.

Shutter

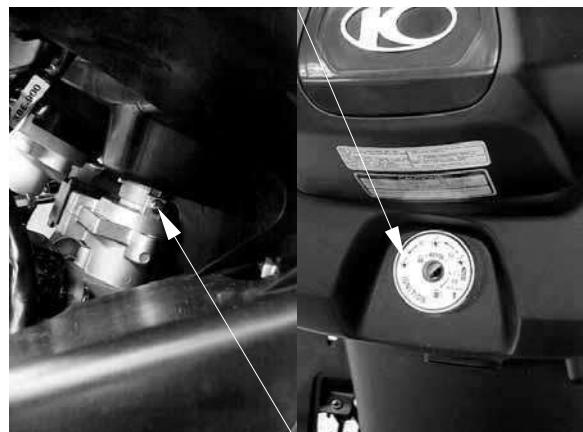

Screw

2. FRAME COVERS/ EXHAUST MUFFLER

XCITING 500/500 AFI/250/300 AFI

Turn the fuel fill cap garnish counterclockwise and remove it.
Remove three screws and disconnect the fuel fill duct.



Remove four fasteners (XCITING 500/500 AFI).
Remove the inner cover.

INSTALLATION

Installation is in the reverse order of removal.

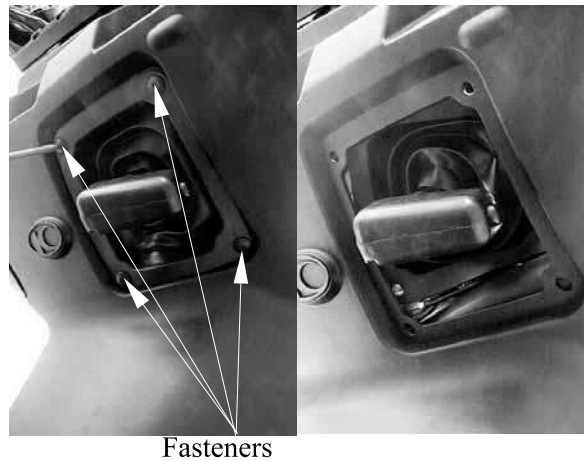

FRONT LOWER COVER

REMOVAL

Remove the front cover (page 2-11).
Remove the right and left floor skirt (page 2-5).

Remove two bolts and front lower cover.

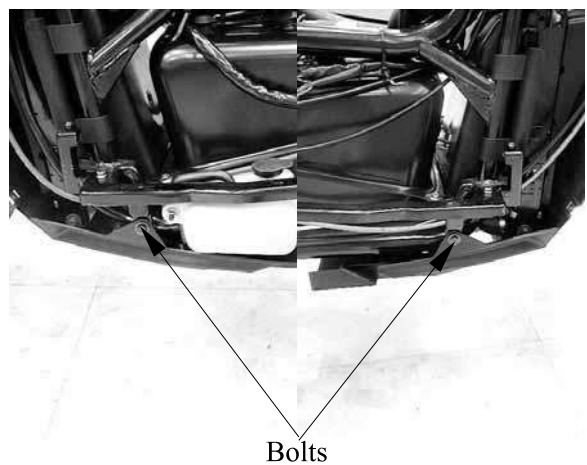

2. FRAME COVERS/ EXHAUST MUFFLER

XCITING 500/500 AFI/250/300 AFI

EXHAUST MUFFLER

REMOVAL

Disconnect the O₂/O₂ HT sensor connector (refer chapter 6).

(XCITING 500 AFI/250 AFI)

Loosen the exhaust pipe band bolt.

Remove three muffler mount bolts and muffler from the exhaust pipe.

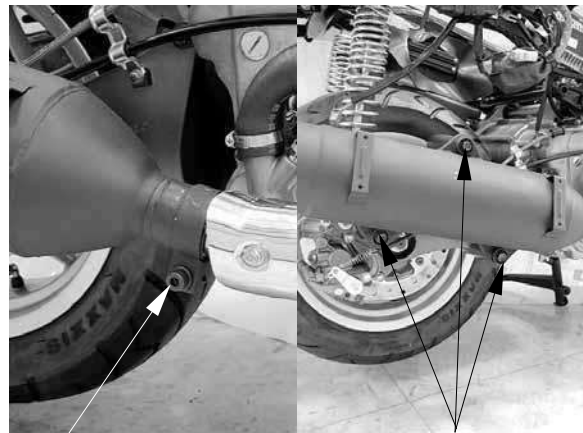

Band Bolt

Mount bolts

Remove the exhaust pipe joint nuts and exhaust pipe.

Remove the gaskets.



Joint Nuts

INSTALLATION

Replace the gaskets with new ones.

Install the exhaust pipe and tighten the joint nuts.

Torque: 20 N•m (2 kgf•m, 14 lbf•ft)

Install the muffler and tighten the mount bolts.

Torque: 35 N•m (3.5 kgf•m, 25 lbf•ft)

Install and tighten the band bolts.

Torque: 21 N•m (2.1 kgf•m, 15 lbf•ft)



Gaskets

3. INSPECTION/ADJUSTMENT XCITING 500/500 AFI/250/300 AFI

3

INSPECTION/ADJUSTMENT

SERVICE INFORMATION-----	3- 1
MAINTENANCE SCHEDULE (XCITING 500/XCITING 500 AFI) -	3- 3
MAINTENANCE SCHEDULE (XCITING 250/XCITING 300 AFI) -	3- 5
FUEL LINE-----	3- 6
THROTTLE OPERATION-----	3- 6
AIR CLEANER -----	3- 8
CRANKCASE BREATHER -----	3-10
SPARK PLUG-----	3-10
VALVE CLEARANCE -----	3-12
ENGINE OIL -----	3-14
ENGINE OIL FILTER CARTRIDGE (XCITING 500/500 AFI) -----	3-17
ENGINE IDLE SPEED -----	3-18
RADIATOR COOLANT -----	3-19
COOLING SYSTEM-----	3-20
SECONDARY AIR SUPPLY SYSTEM -----	3-21
TRANSMISSION OIL -----	3-22
BRAKE FLUED -----	3-24
BRAKE PAD WEAR -----	3-25
BRAKE SYSTEM -----	3-25
BRAKE LOCK OPERATION (XCITING 500/500 AFI) -----	3-26
HEADLIGHT AIM -----	3-27
SIDE STAND-----	3-28
SUSPENSION-----	3-28
NUTS, BOLTS, FASTENERS-----	3-29
WHEELS/TIRES-----	3-29
STEERING HEAD BEARINGS-----	3-30

3. INSPECTION/ADJUSTMENT XCITING 500/500 AFI/250/300 AFI

SERVICE INFORMATION

GENERAL

- Place the scooter on a level ground before starting any work.
- Gasoline is extremely flammable and is explosive under certain conditions.
- Work in a well ventilated area. Smoking or allowing flames or sparks in the work area or where the gasoline is stored can cause a fire or explosion.
- If the engine must be running to do some work, make sure the area is well ventilated. Never run the engine in an enclosed area.
- The exhaust contains poisonous carbon monoxide gas that may cause loss of consciousness and may lead to death. Run the engine in an open area or with an exhaust evacuation system in an enclosed area.

SPECIFICATIONS (XCITING 500/500 AFI)

ITEM		SPECIFICATIONS	
Throttle free play		2-6 mm (1/16 – 1/4 in)	
Spark plug	XCITING 500	NGK	CR8E
	XCITING 500 AFI	NGK	CR7E
Spark plug gap		0.6 – 0.7 mm (0.024 – 0.028 in)	
Valve clearance	IN	0.1 mm (0.004 in)	
	EX	0.1 mm (0.004 in)	
Engine oil capacity	At draining		2.0 liter (2.1 US pt, 1.8 Imp qt)
	At draining/oil filter change		2.1 liter (2.2 US pt, 1.9 Imp qt)
	Total amount		2.5 liter (2.6 US pt, 2.3 Imp qt)
Recommended engine oil		KYMCO 4-stroke oil or equivalent motor oil API service classification: SJ Viscosity: 5W50	
Engine idle speed		1400±100 rpm	
Final reduction oil capacity	At draining		0.45 liter (0.48 US pt, 0.4 Imp qt)
	Total amount		0.55 liter (0.57 US pt, 0.5 Imp qt)
Recommended final reduction oil		SAE 90	
Recommended brake fluid		DOT 4	
Parking brake lever stroke		3 – 6 notch	
Tire size	Front	120/70-15	
	Rear	150/70-14	
Tire air pressure	Solo riding	Front	200 kPa (2 kgf/cm ² , 29 psi)
		Rear	250 kPa (2.5 kgf/cm ² , 36 psi)
	Two up riding	Front	225 kPa (2.25 kgf/cm ² , 32 psi)
		Rear	250 kPa (2.5 kgf/cm ² , 36 psi)
Minimum tire tread depth	Front	1.6 mm (0.06 in)	
	Rear	2.0 mm (0.08 in)	

3. INSPECTION/ADJUSTMENT XCITING 500/500 AFI/250/300 AFI

SPECIFICATIONS (XCITING 250/300 AFI)

ITEM			SPECIFICATIONS
Throttle free play			2-6 mm (1/16 – 1/4 in)
Spark plug	XCITING 250	NGK	DPR7EA-9
	XCITING 300 AF	NG K	DPR6EA-9
Spark plug gap			0.6 – 0.7 mm (0.024 – 0.028 in)
Valve clearance	IN		0.1 mm (0.004 in)
	EX		0.1 mm (0.004 in)
Engine oil capacity	At draining		0.9 liter (0.95 US pt, 0.8 Imp qt)
	Total amount		1.1 liter (1.17 US pt, 0.97 Imp qt)
Recommended engine oil			KYMCO 4-stroke oil or equivalent motor oil API service classification: SJ Viscosity: 5W50
Engine idle speed			1600±100 rpm
Final reduction oil capacity	At draining		0.18 liter (0.19 US pt, 0.16 Imp qt)
	Total amount	XCITING 250	0.2 liter (0.21 US pt, 0.18 Imp qt)
		XCITING 300 AF	0.23 L (0.2 Imp qt, 0.24 Us qt)
Recommended final reduction oil			SAE 90
Recommended brake fluid			DOT 4
Tire size	Front	120/70-15	
	Rear	150/70-14	
Tire air pressure	Solo riding	Front	200 kPa (2 kgf/cm ² , 29 psi)
		Rear	250 kPa (2.5 kgf/cm ² , 36 psi)
	Two up riding	Front	225 kPa (2.25 kgf/cm ² , 32 psi)
		Rear	250 kPa (2.5 kgf/cm ² , 36 psi)
Minimum tire tread depth	Front	1.6 mm (0.06 in)	
	Rear	2.0 mm (0.08 in)	

TORQURE VALUES

Engine oil drain plug	25 N•m (2.5 kgf•m, 18 lbf•ft)
Oil strainer screen cap	15 N•m (1.5 kgf•m, 11 lbf•ft)
Oil filter cartridge (XCITING 500)	Apply oil to the threads and seating surface. 10 N•m (1 kgf•m, 7 lbf•ft) Apply oil to the threads and seating surface.
Transmission oil drain bolt	20 N•m (2 kgf•m, 15 lbf•ft)
Transmission oil filler bolt	20 N•m (2 kgf•m, 15 lbf•ft)
Spark plug	12 N•m (1.2 kgf•m, 9 lbf•ft)
Tappet adjust nut	9 N•m (0.9 kgf•m, 6 lbf•ft)

SPECIAL TOOLS

Tappet adjuster	A120E00036
Oil filter cartridge wrench	A120E00052 (XCITING 500/500 AFI)

3. INSPECTION/ADJUSTMENT XCITING 500/500 AFI/250/300 AFI

MAINTENANCE SCHEDULE (XCITING 500/500 AFI)

Perform the pre-ride inspection in the owner's manual at each scheduled maintenance period. This interval should be judged by odometer reading or months, whichever comes first.

I: INSPECT AND CLEAN, ADJUST, LUBRICATE OR REPLACE IF NECESSARY

C: CLEAN R: REPLACE A: ADJUST L: LUBRICATE

ITEM	FREQUENCY	WHICHEVER COMES FIRST	ODOMETER READING [NOTE (1)]							
			X 1000 km	1	6	12	18	24	30	36
			X 1000 mi	0.6	4	8	12	16	20	24
	NOTE	MONTH		6	12	18	24	30	36	
AIR CLEANER		NOTE 2		R	R	R	R	R	R	
SPARK PLUGS					R		R		R	
THROTTLE OPERATION					I		I		I	
VALVE CLEARANCE							I			
FUEL LINE					I		I		I	
CRANKCASE BREATHER		NOTE 3		C	C	C	C	C	C	
ENGINE OIL			R	R	R	R	R	R	R	
ENGINE OIL FILTER			R	R	R	R	R	R	R	
ENGINE OIL STRAINER SCREEN			C	C	C	C	C	C	C	
ENGINE IDLE SPEED			I	I	I	I	I	I	I	
RADIATOR COOLANT		NOTE 6			I		I		R	
COOLING SYSTEM					I		I		I	
SECONDARY AIR SUPPLY SYSTEM					I		I		I	
TRANSMISSION OIL		NOTE 5	R							
DRIVE BELT		NOTE 4				I			I	
CLUTCH SHOE WEAR				I	I	I	I	I	I	
BRAKE FLUID		NOTE 7		I	I	I	R	I	I	
BRAKE PAD WEAR				I	I	I	I	I	I	
BRAKE SYSTEM			I		I		I		I	
BRAKE LIGHT SWITCH					I		I		I	
BRAKE LOCK OPERATION			I	I	I	I	I	I	I	
SIDE STAND					I		I		I	
SUSPENSION					I		I		I	
HEADLIGHT AIM					I		I		I	
NUTS, BOLTS, FASTENERS			I		I		I		I	
WHEELS/TIRES					I		I		I	
STEERING BEARINGS			I		I		I		I	

3. INSPECTION/ADJUSTMENT XCITING 500/500 AFI/250/300 AFI

NOTE:

- 1 At higher odometer readings, repeat at the frequency interval established here.
- 2 Service more frequently if the scooter is ridden in unusually wet or dusty areas.
- 3 Service more frequently when riding in rain or at full throttle.
- 4 Inspect every 18000 km (12000 mi) after replacement.
- 5 Replace every 1 year, or every 10000km (6000mi), whichever comes first.
- 6 Replace every 2 year, or at indicated odometer interval, whichever comes first.
- 7 Replace every 2 years. Replacement requires mechanical skill.

3. INSPECTION/ADJUSTMENT XCITING 500/500 AFI/250/300 AFI

MAINTENANCE SCHEDULE (XCITING 250/XCITING 300 AFI)

Perform the periodic maintenance at each scheduled maintenance period.

I: Inspect, and Clean, Adjust, Lubricate or Replace if necessary.

A: Adjust C: Clean R: Replace T: Tighten

Item	Frequency	Whichever comes first ⇔ ↓	Regular Service Mileage (km)					
			1000	2000	4000	6000	8000	10000
Engine oil			R New scooter 300km	R	R	R	R	R
Engine oil filter screen					C		C	
Fuel filter			Replace at every 6000km					
Gear oil	Note 3		R New scooter 300km		R			R
Valve clearance				A	A		A	
Carburetor					I		I	
Air Cleaner	Note 2,3		I		R			R
Spark plug			Clean at every 3000km and replace if necessary					
Brake system			I	I	I	I	I	I
Drive belt							I	
Suspension					I		I	
Nut, bolt, fastener							I	
Tire					I		I	
Steering head bearing			I			I	I	
Brake fluid			Perform pre-ride inspection daily					
Radiator coolant			Replace every year or at every 10000km (R)					
Radiator core						I		I
Radiator cap						I		I
Brake lever					I			I
Brake shoe wear					I			I
Shock absorber					I			I

- In the interest of safety, we recommend these items be serviced only by an authorized KYMCO motorcycle dealer.

Note: 1. For higher odometer readings, repeat at the frequency interval established here.

2. Service more frequently when riding in dusty or rainy areas.

3. Service more frequently when riding in rain or at full throttle.

3. INSPECTION/ADJUSTMENT XCITING 500/500 AFI/250/300 AFI

FUEL LINE

Remove the floorboard. (page 2-6).

Check the fuel lines for deterioration, damage or leakage. Replace the fuel line if necessary.

- *
 - Do not smoke or allow flames or sparks in your working area.

FUEL FILTER

Visually check the fuel filter. If accumulation of sediment or clogging is found, replace the fuel filter with a new one.

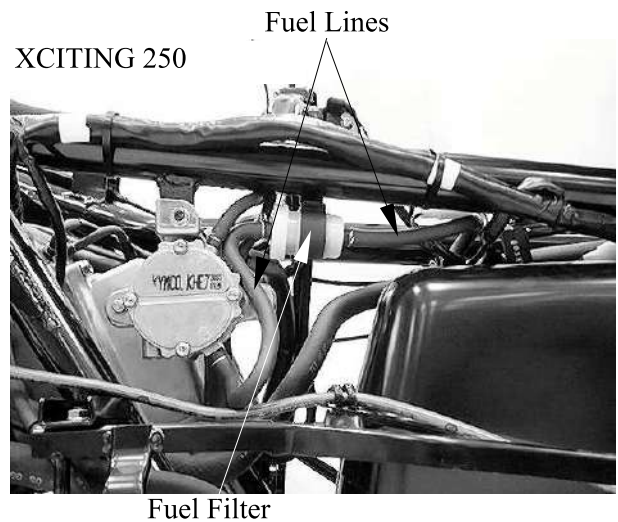
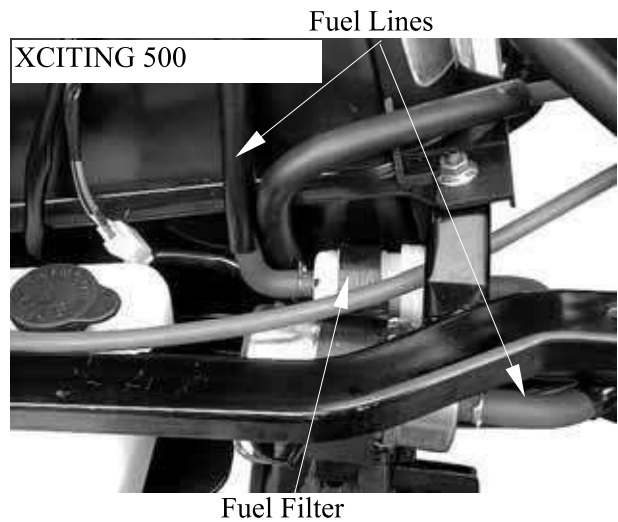

THROTTLE OPERATION

Check for smooth throttle grip full opening and automatic full closing in all steering positions.

Check the throttle cables and replace them if they are deteriorated, kinked or damaged. Lubricate the throttle cables, if throttle operation is not smooth.

Measure the throttle grip free play.

Free Play: 2~6 mm (1/16~1/4 in)

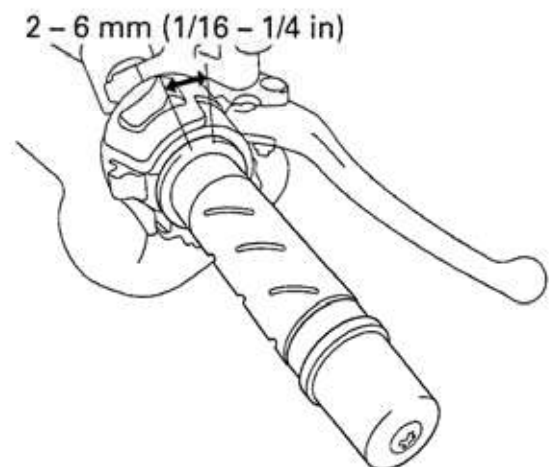

3. INSPECTION/ADJUSTMENT XCITING 500/500 AFI/250/300 AFI

Throttle grip free play can be adjusted at either end of the throttle cable.

Minor adjustment is made with the upper adjuster.
 Slide the rubber sleeve back to expose the throttle cable adjuster.
 Adjust the free play by loosening the lock nut and turning the adjuster.

Major adjustments are made with the lower adjuster.

Remove the seat luggage box (page 2-3).
 Adjust the free play by loosening the lock nut and turning the adjuster.
 After adjustment, tighten the lock nut securely.
 Recheck the throttle operation.
 Replace any damaged parts, if necessary.

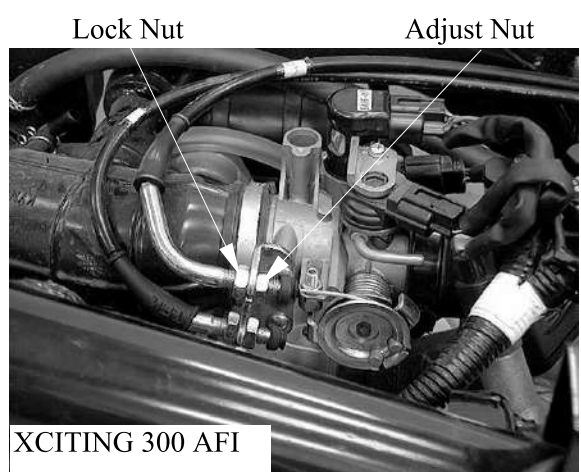
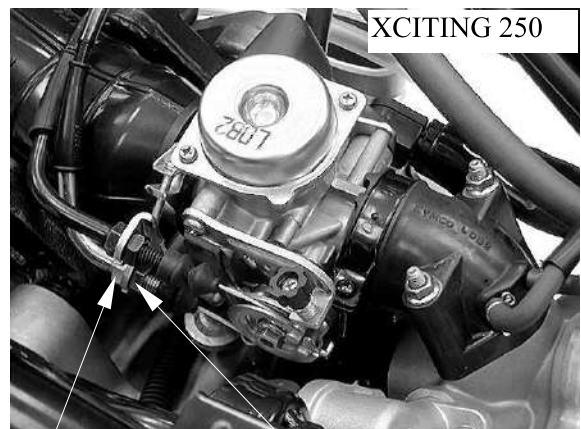
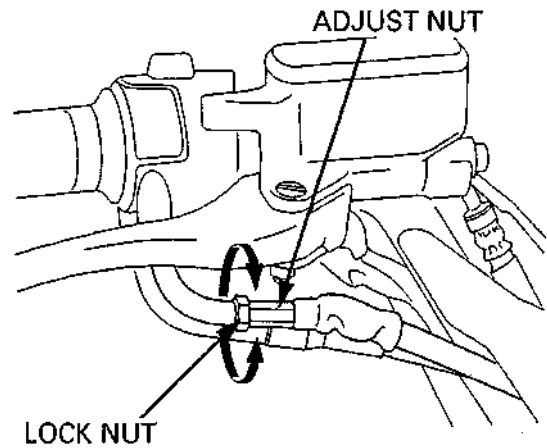

3. INSPECTION/ADJUSTMENT XCITING 500/500 AFI/250/300 AFI

AIR CLEANER

The air cleaner should be serviced at regular intervals. Service more frequently when riding in unusually wet or dusty areas.

Install a new air cleaner element. Use the KYMCO genuine air cleaner element or an equivalent air cleaner element specified for your model. Using the wrong KYMCO air cleaner element or a non-KYMCO air cleaner which is not of equivalent quality may cause premature engine wear or performance problems.

Air cleaner element removal/installation (XCITING 500/500 AFI):

Unlock the seat with the ignition key.
Open the seat.

Remove the air cleaner cover.

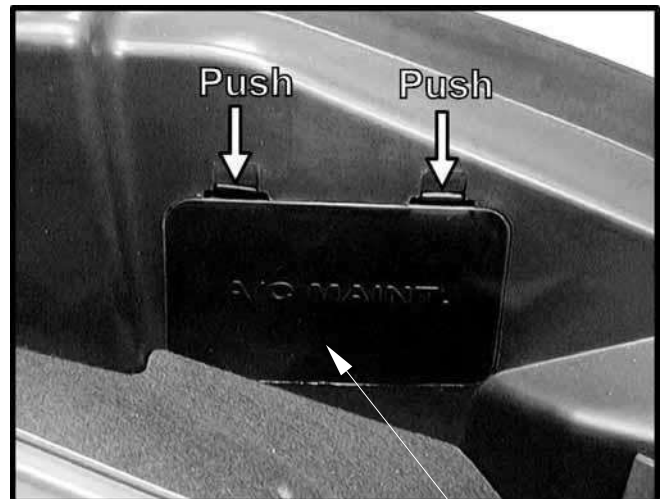

Air Cleaner Cover

Remove the screws and air cleaner housing cover

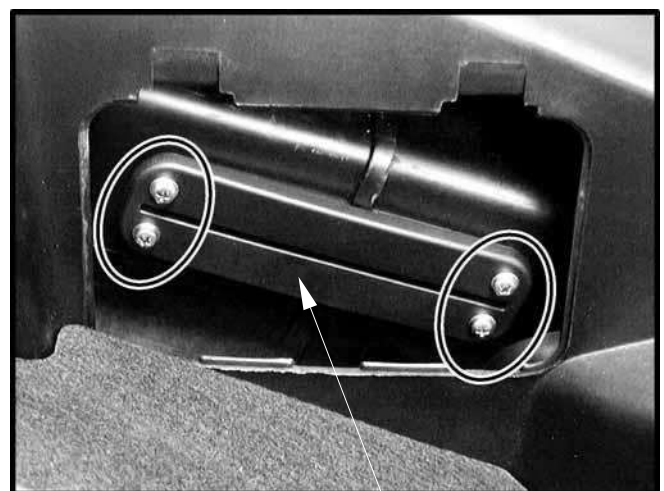

Air Cleaner Housing Cover

3. INSPECTION/ADJUSTMENT XCITING 500/500 AFI/250/300 AFI

Remove the air cleaner element by pull it out.
Discard the air cleaner element.

Install the removed parts in the reverse order of removal.

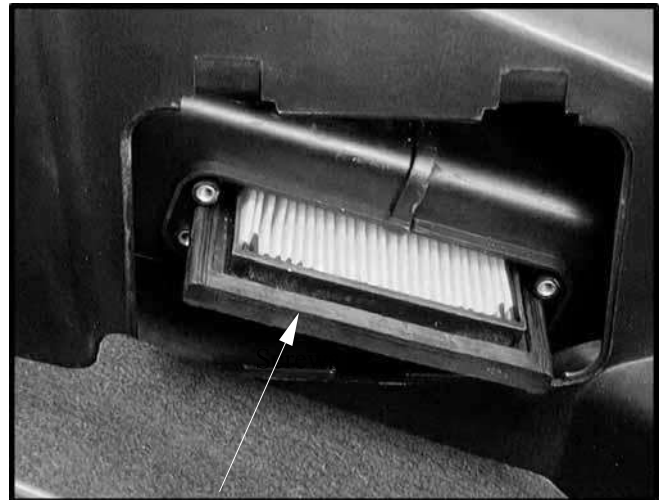

Air Cleaner Element

Air cleaner element removal/installation (XCITING 250/250 AFI):

Remove the luggage box (page 2-3).

Remove the six screws and air cleaner cover.



Air Cleaner Cover

Remove the four screws and air cleaner element from air cleaner cover.
Discard the air cleaner element.

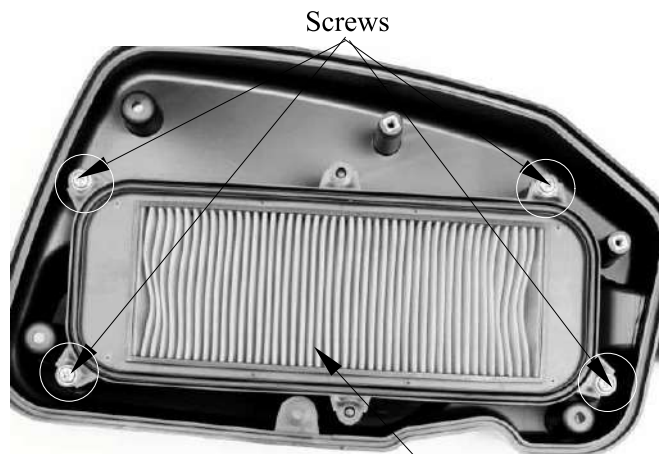

Air Cleaner Element

3. INSPECTION/ADJUSTMENT XCITING 500/500 AFI/250/300 AFI

Install the removed parts in the reverse order of removal

Tighten the screws using a diagonal pattern.

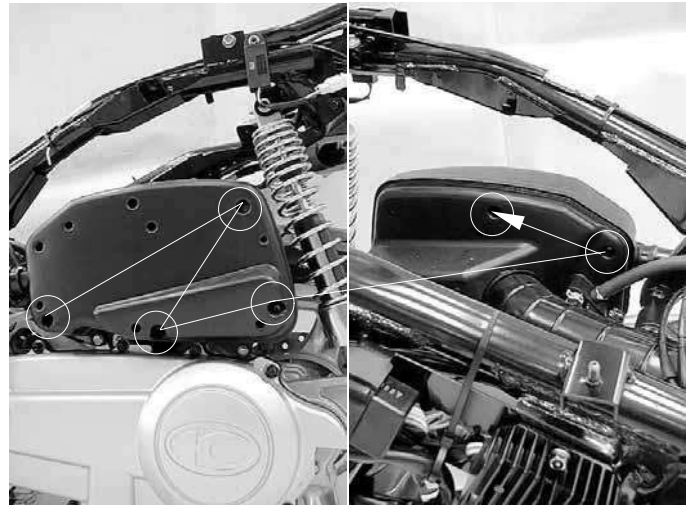

CRANKCASE BREATHER

Remove the crankcase breather tube plug from the tube and drain deposits into a suitable container.

Reinstall the crankcase breather tube plug.

Service more frequently when riding in rain, at full throttle, or after the scooter is washed or overturned. Service if the deposit level can be seen in the transparent section of the drain tube.

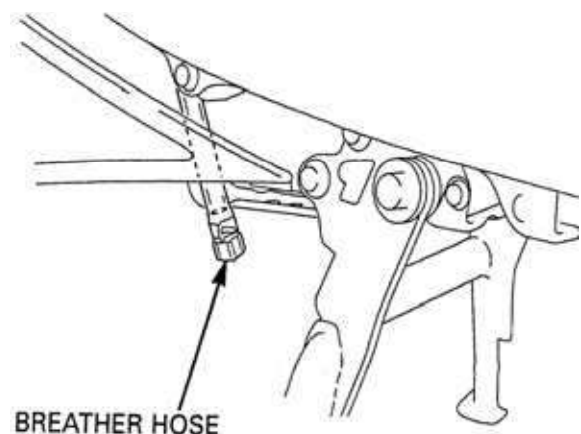

SPARK PLUG

REMOVAL

Remove the spark plug maintenance lid (XCITING 500/500 AFI) (page 2-4).

Remove the luggage box (XCITING 250 /250 AFI) (page 2-3)

Disconnect the spark plug cap and clean around the spark plug

* Clean around the spark plug base with compressed air before removing, and be sure that no debris is allowed to enter the combustion chamber.



Spark Plug Cap

3. INSPECTION/ADJUSTMENT XCITING 500/500 AFI/250/300 AFI

Remove the spark plug using a equipped spark plug wrench or an equivalent tool.

Inspect or replace as described in the maintenance schedule.



Spark Plug

INSPECTION

Remove the carbon deposits from the spark plug with a small wire brush or a spark plug cleaning machine.

The spark plug should be replaced periodically. Whenever removing the carbon deposits, be sure to observe the operational color of the spark plug's porcelain tip. This color tells you whether or not the standard spark plug is suitable for your type of usage. A normal operating spark plug should be light brown or tan color. If the spark plug is very white or glazed appearing, then it has been operating much too hot. This spark plug should be replaced with the colder plug.

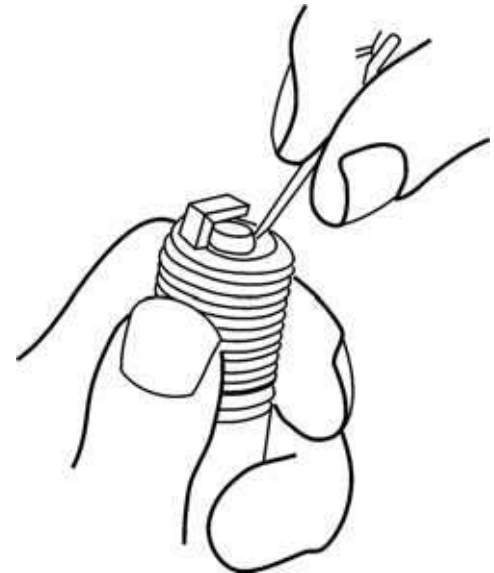

Recommended spark plug:
XCITING 500: NGK: CR8E
XCITING 500 AFI: NGK: CR7E
XCITING 250 : NGK: DPR7EA-9
XCITING 300 AFI: NGK: DPR6EA-9

Measure the spark plug gap between the center and side electrodes with the feeler gauge.
 If necessary, adjust the gap by bending the side electrode carefully.

Spark plug gap:
0.6–0.7 mm (0.024–0.028 in)

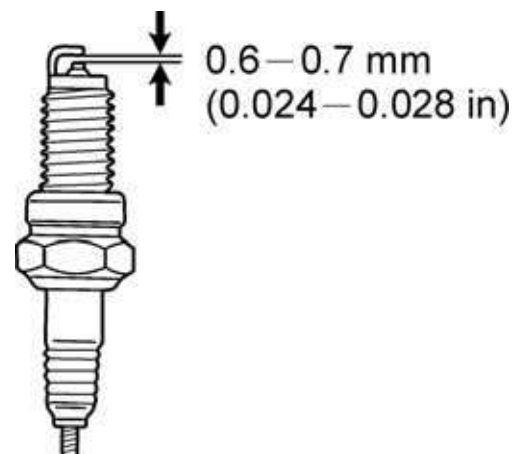

Install the spark plug in the cylinder head and hand tighten, then torque to the specification.

Torque: 12 N•m (1.2kgf•m, 9 lbf•ft)

Install the spark plug cap.

Install the removed parts in the reverse order of removal.

3. INSPECTION/ADJUSTMENT XCITING 500/500 AFI/250/300 AFI

VALVE CLEARANCE

* Inspect and adjust the valve clearance while the engine is cold (Below 35°C/95°F).

To adjust (XCITING 500/500 AFI):

Remove the floorboard (page 2-6).
Remove the cylinder head cover (page 9-7).

Remove the timing hole cap and O-ring.
Remove the crankshaft hole cap and O-ring.

Turn the crankshaft clockwise and align the "T" mark on the flywheel with the index mark on the right crankcase cover.

The punch marks on the camshaft should face upward as shown.

If the punch marks on the camshaft are facing downward, turn the crankshaft clockwise one full turn (360°) and the punch marks are facing upward.

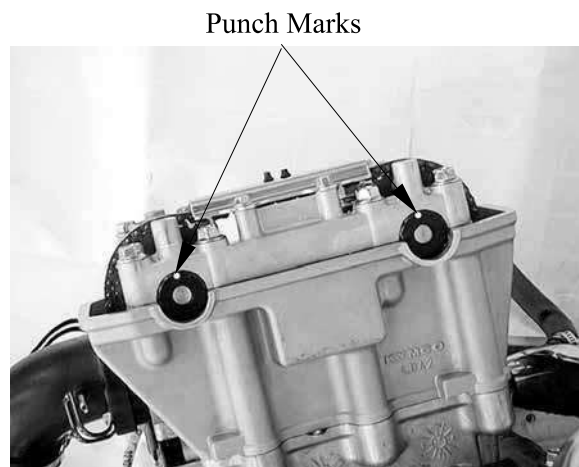
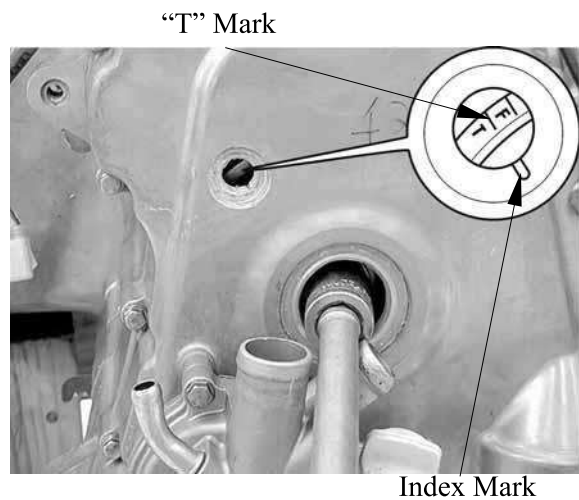
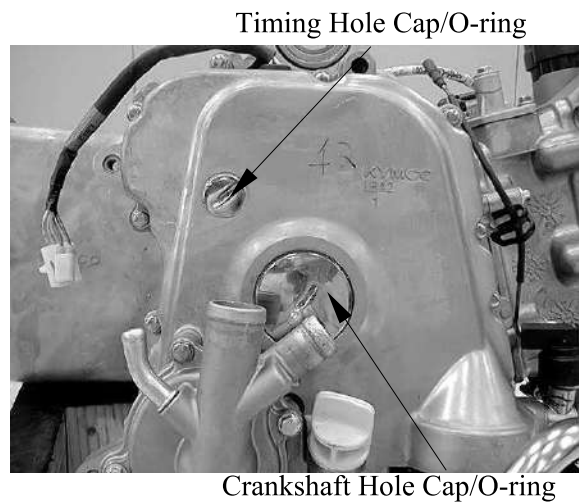

3. INSPECTION/ADJUSTMENT XCITING 500/500 AFI/250/300 AFI

Adjust by loosening the valve adjusting screw lock-nut and turning the adjusting screw until there is a slight drag on the thickness gauge.

Valve clearance (when cold):

IN.: 0.1 mm (0.004 in)

EX.: 0.1 mm (0.004 in)

Apply oil to the valve adjusting screw lock-nut threads and seating surface.
Hold the adjusting screw and tighten the lock nut.

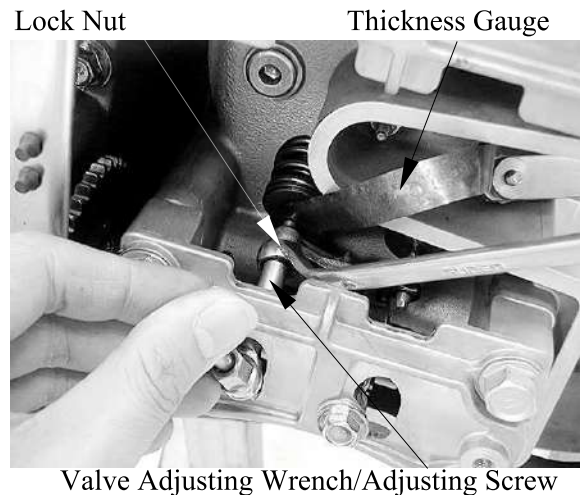

Special tool:

Valve adjusting wrench A120E00036

Torque: 9N•m (0.9 kgf•m, 6 lbf•ft)

After tightening the lock nut, recheck the valve clearance.

Install the removed parts in the reverse order of removal.

To adjust (XCITING 250/250 AFI):

Remove the floorboard (page 2-6).
Remove the cylinder head cover (page 9-8).

Remove the timing hole cap and O-ring.
Remove the crankshaft hole cap and O-ring.

Turn the crankshaft clockwise and align the "T" mark on the flywheel with the index mark on the right crankcase cover.

If the punch marks on the camshaft are facing downward, turn the crankshaft clockwise one full turn (360°) and the punch marks are facing upward.

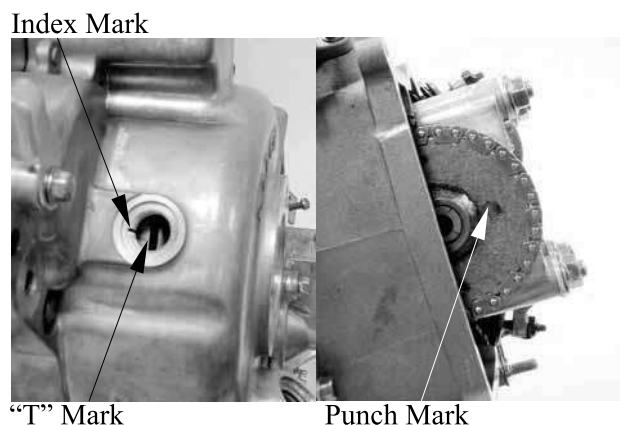

3. INSPECTION/ADJUSTMENT XCITING 500/500 AFI/250/300 AFI

Adjust by loosening the valve adjusting screw lock-nut and turning the adjusting screw until there is a slight drag on the thickness gauge.

Valve clearance (when cold):

IN.: 0.1 mm (0.004 in)

EX.: 0.1 mm (0.004 in)

Apply oil to the valve adjusting screw lock-nut threads and seating surface.

Hold the adjusting screw and tighten the lock nut.

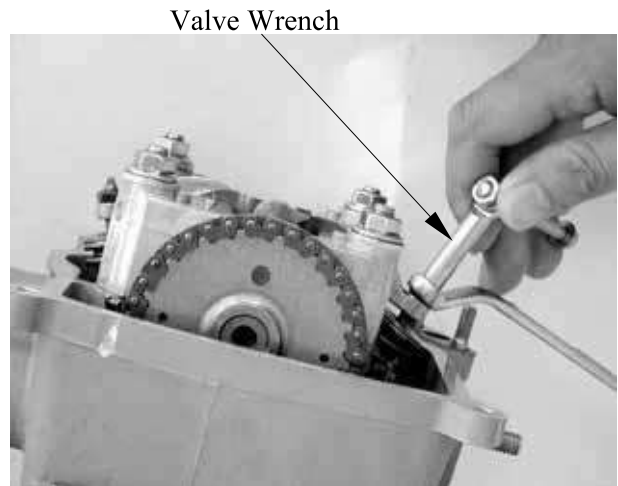

Special tool:

Valve adjusting wrench E012

Torque: 9 N•m (0.9 kgf•m, 6 lbf•ft)

After tightening the lock nut, recheck the valve clearance.

Install the removed parts in the reverse order of removal.

ENGINE OIL

OIL LEVEL INSPECTION

Start the engine and let it idle for 2–3 minutes.

Turn off the engine and support the scooter level surface.

Remove the oil filler cap/dipstick and wipe the oil from the dipstick with a clean cloth.

Insert the dipstick into the oil filler hole without screwing it in.

If the oil level is below or near the lower level line (1) on the dipstick, add the recommended engine oil until the oil level is to the upper level line (2)

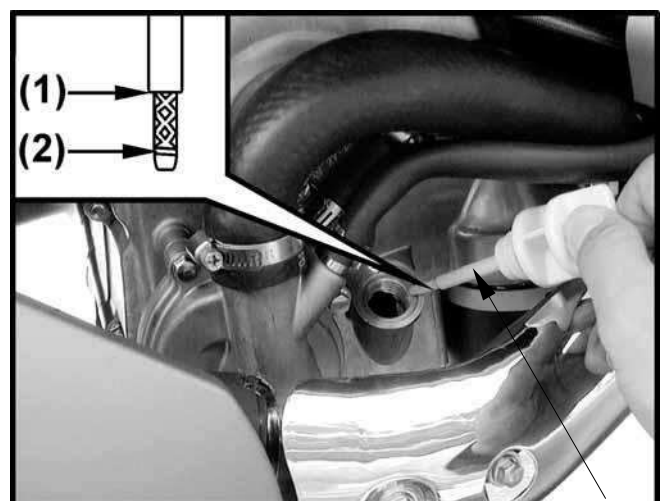

Oil Filler Cap/Dipstick

3. INSPECTION/ADJUSTMENT XCITING 500/500 AFI/250/300 AFI

Recommended engine oil:

KYMCO 4-stroke oil or equivalent motor oil API service classification: SJ

Viscosity: SAE 5W50

* Other viscosities shown in the chart may be used when the average temperature in your riding area is within the indicated range.

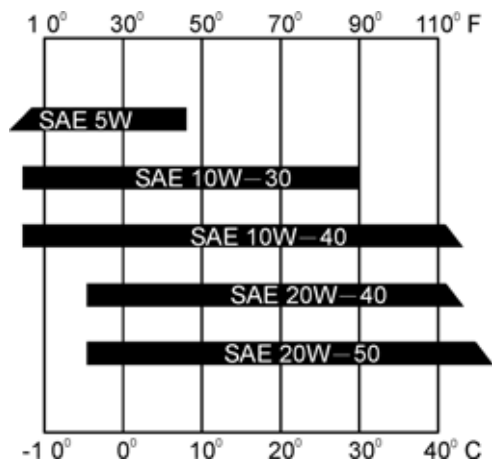

Reinstall the filler cap/dipstick.

ENGINE OIL & STARINER SCREEN

When running in very dusty conditions, oil changes should be performed more frequently than specified in the maintenance schedule.

Please dispose of used engine oil in a manner that is compatible with the environment. We suggest you take it in a sealed container to your local recycling center or service station for reclamation. Do not throw it in the trash or pour it on the ground or down a drain.

Used engine oil may cause skin cancer if repeatedly left in contact with the skin for prolonged periods. Although this is unlikely unless you handle used oil on a daily basis, it is still advisable to thoroughly wash your hands with soap and water as soon as possible after handling used oil.

Change the engine oil with the engine at normal operating temperature and the scooter on its center stand to assure complete and rapid draining.

Remove the oil filler cap/dipstick (1) from the right crankcase cover.

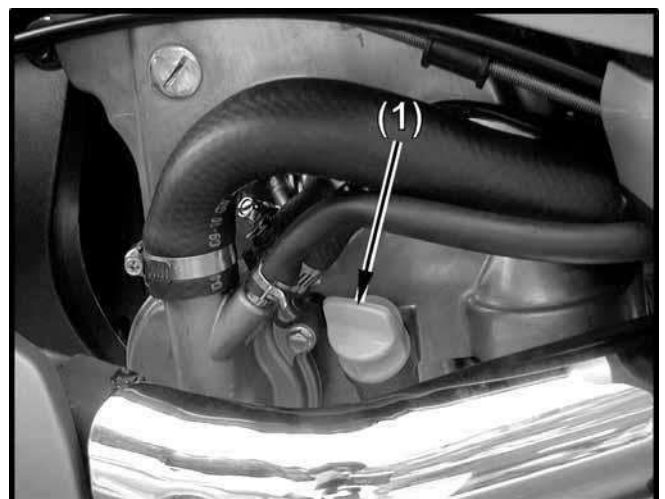

3. INSPECTION/ADJUSTMENT XCITING 500/500 AFI/250/300 AFI

Place a drain pan under the crankcase and remove the oil strainer cap.

The setting spring and oil strainer screen will come out when the oil strainer cap is removed.

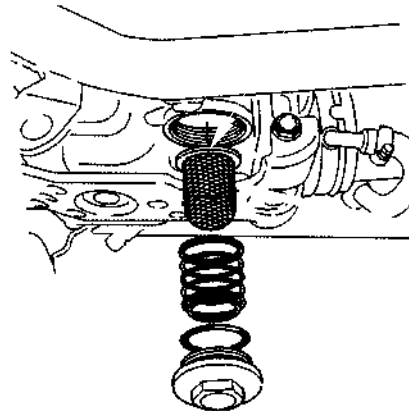

Clean the oil strainer screen.

After draining the oil completely, install the strainer screen and setting spring into the engine.

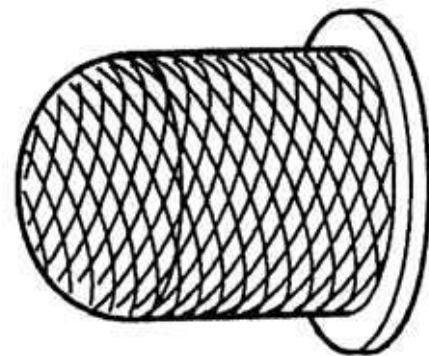

Apply clean engine oil to the strainer cap threads, flange surface and a new O-ring. Install and tighten the strainer cap with a new O-ring.

Torque: 15N•m (1.5 kgf•m, 11 lbf•ft)

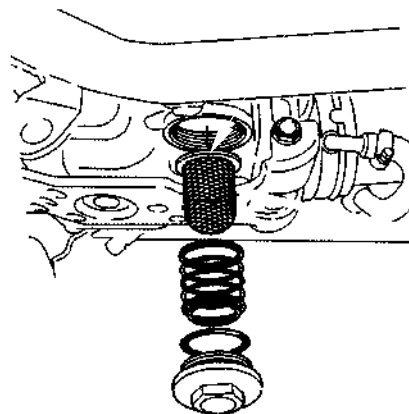

3. INSPECTION/ADJUSTMENT XCITING 500/500 AFI/250/300 AFI

Fill the crankcase with the recommended engine oil.

Oil capacity (XCITING 500/500 AFI):
2.0 liter (2.1 US qt, 1.8 Imp qt) at draining
2.1 liter (2.2 US qt, 1.9 Imp qt)
at oil filter cartridge change

Oil capacity (XCITING 250/300 AFI):
0.9 liter (0.95 US qt, 0.8 Imp qt)
at draining

Install the oil filler cap/dipstick (1).
Check the engine oil level (page 3-14).
Make sure there are no oil leaks

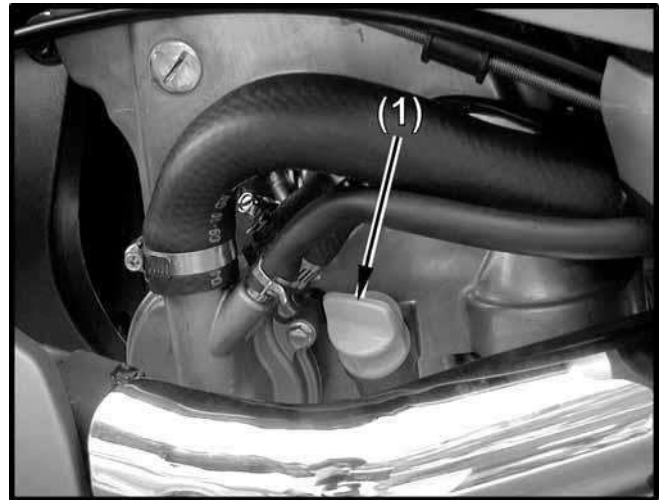

ENGINE OIL FILTER CARTRIDGE (XCITING 500/500 AFI)

REPLACEMENT

Drain the engine oil (page 3-15).

Remove the rubber sleeve (2) by removing the clip (1).



Remove and discard the oil filter cartridge (3) using the special tool.

Tool:
Oil filter wrench: A120E00052



3. INSPECTION/ADJUSTMENT XCITING 500/500 AFI/250/300 AFI

Apply clean engine oil to the new oil filter cartridge threads, flange surface and a new O-ring.

Install the new oil filter cartridge and tighten it to the specified torque.

Tool:

Oil filter cartridge wrench E052

Torque: 10N•m (1 kgf•m, 7 lbf•ft)

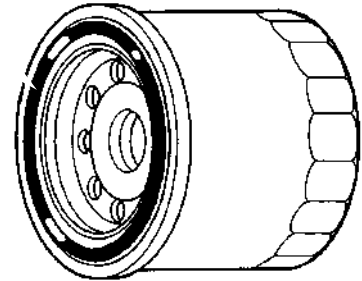

Refill the engine oil (page 3-15)

ENGINE IDLE SPEED

- ◆ Inspect and adjust the idle speed after all other engine maintenance items have been performed and are within specification.
- ◆ The engine must be warm for accurate idle speed inspection and adjustment.

Warm up the engine.

Place the scooter on its center stand.

Unlock the seat with the ignition key.

Open the seat and remove carburetor cover (1).

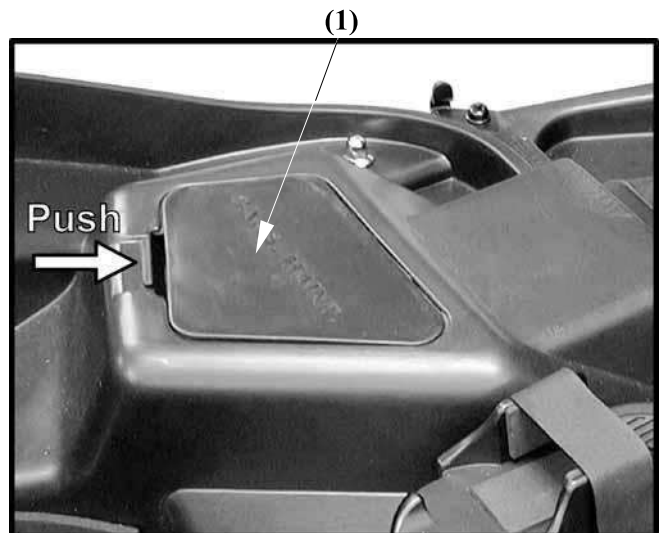

Turn the throttle stop screw (2) as required to obtain the specified idle speed.

Idle speed (XCITING 500/500 AFI):

1400±100 rpm

*** XCITING 500 AFI**

- The idle speed is not necessary to adjust.
- Do not loosen or tighten the painted bolts and screws of the throttle body. Loosening or tightening them can cause throttle and idle valve synchronization failure.

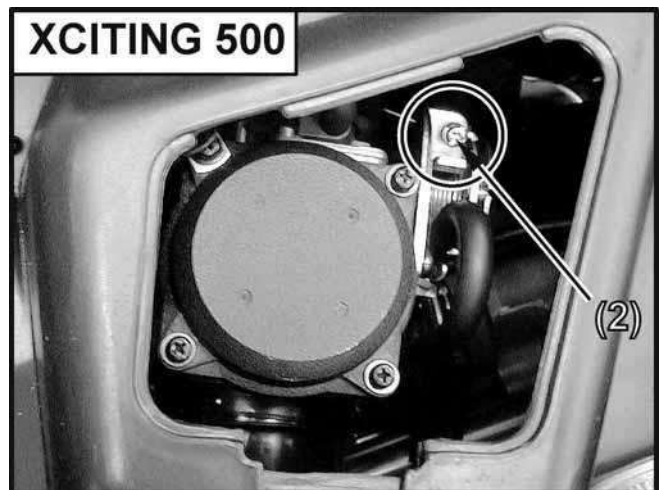

3. INSPECTION/ADJUSTMENT XCITING 500/500 AFI/250/300 AFI

Idle speed (XCITING 250/300 AFI):
1600±100 rpm

* **XCITING 300 AFI**

- The idle speed is not necessary to adjust.
- Do not loosen or tighten the painted bolts and screws of the throttle body. Loosening or tightening them can cause throttle and idle valve synchronization failure.

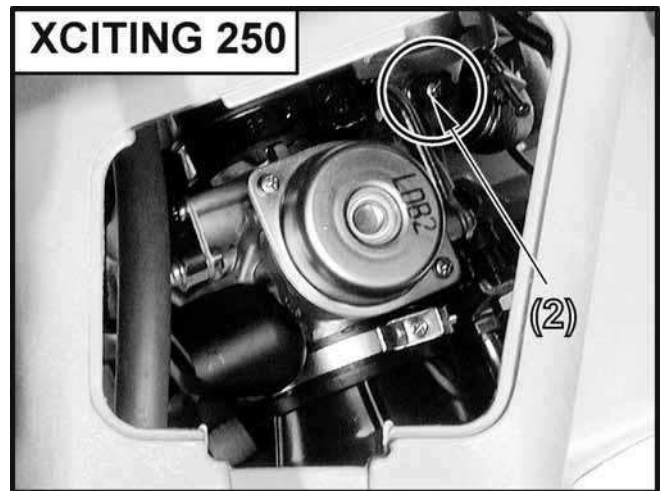

RADIATOR COOLANT

Place the scooter on its center stand.

Check the coolant level through the inspection window at the left floor skirt while the engine is at the normal operating temperature.

The level should be between the “F” and “L” level surface.

If the level is low, remove the reserve tank cap and fill the tank to the “F” level line with 1:1 mixture of distilled water and antifreeze (coolant mixture preparation: page 7-7)

- * Using coolant with silicate inhibitors may cause premature wear of water pump seals or blockage of radiator passages. Using tap water may cause engine damage.

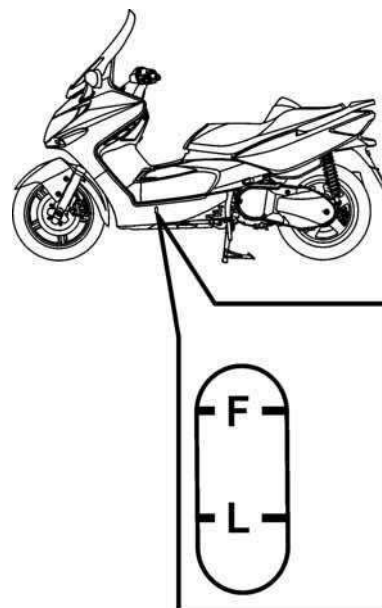

3. INSPECTION/ADJUSTMENT XCITING 500/500 AFI/250/300 AFI

Remove the left floor mat and remove screw and reserve tank lid.

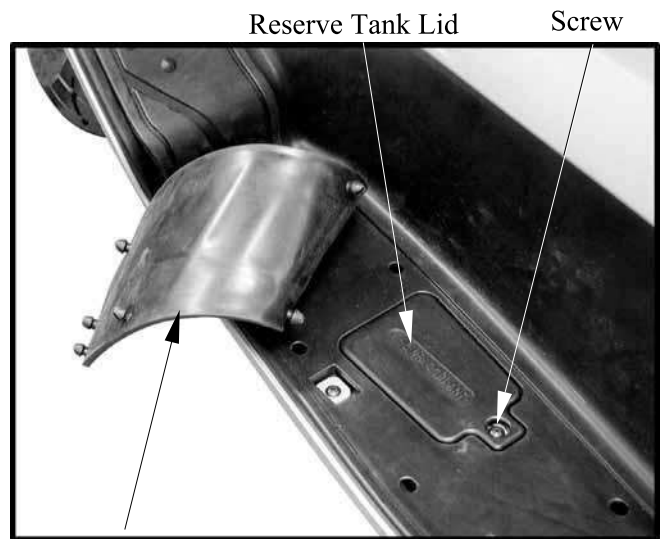

Left Floor Mat

Remove reserve tank cap.

Check to see if there are any coolant leaks when the coolant level decrease very rapidly. If reserve tank becomes completely empty, there is a possibility of air getting into the cooling system.

Be sure to remove all air from the cooling system (page 7-8).

Reinstall the filler cap.



Reserve Tank Cap

COOLING SYSTEM

Remove the floorboard (page 2-6).

Check for any coolant leakage from the water pump, radiator hoses and hose joints.

Check the radiator hoses for cracks or deterioration and replace if necessary.

Check that all hose clamps are tight.

Remove the front lower cover (page 2-15).

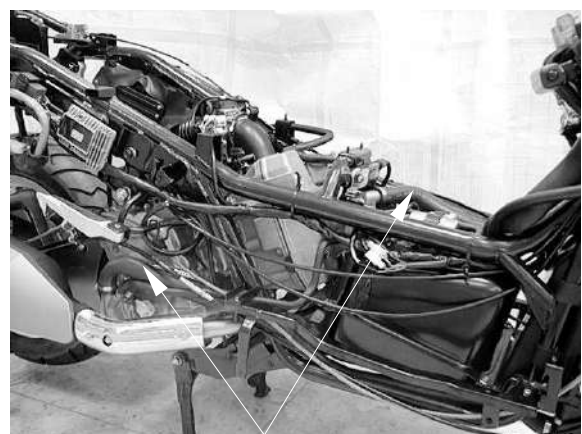

Radiator Hose

3. INSPECTION/ADJUSTMENT XCITING 500/500 AFI/250/300 AFI

Check the radiator air passages for clogs or damage.

Straighten any bent fins, and remove insects, mud or other obstructions with compressed air or low water pressure.

Replace the radiator if the air flow is restricted over more than 20% of the radiating surface.

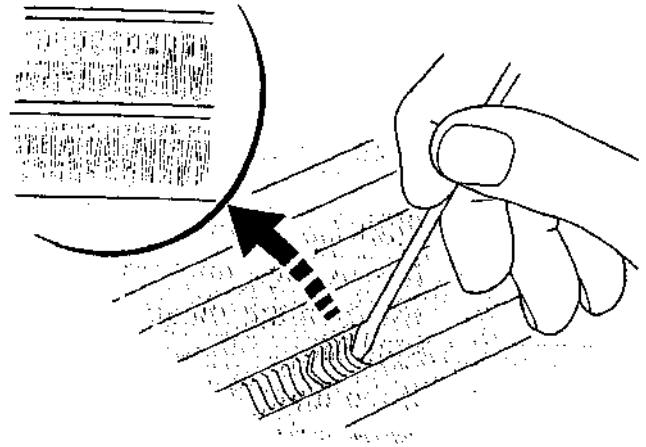

SECONDARY AIR SUPPLY SYSTEM

This model is equipped with a built-in secondary air supply system.

The secondary air supply system introduces filtered air into exhaust gases in the exhaust port. The secondary air is drawn into the exhaust port whenever there is negative pressure pulse in the exhaust system. This charged secondary air promotes burning of the unburned exhaust gases and changes a considerable amount of hydrocarbons and carbon monoxide into relatively harmless carbon dioxide and water.

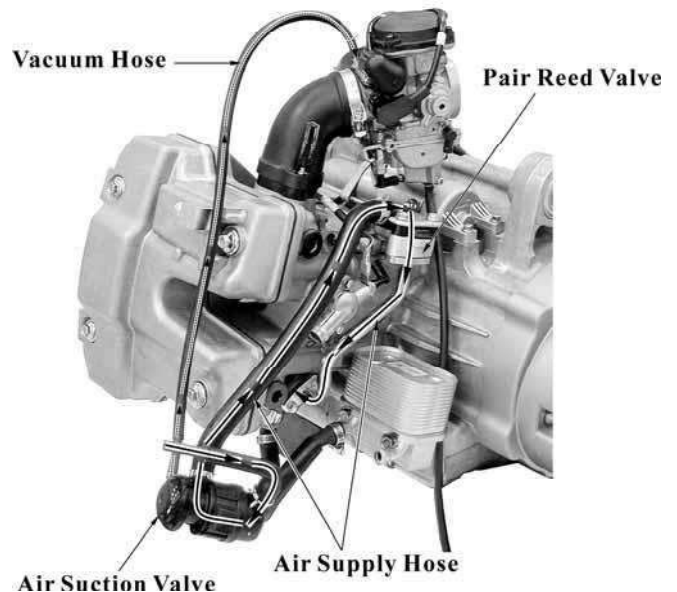

Check the AICV (air injection control valve) hoses between the AICV control solenoid valve and cylinder head cover for deterioration, damage or loose connections. Make sure the hoses are not cracked.

If the hoses show any signs of heat damage, inspect the AICV check valve in the AICV reed valve cover damage.

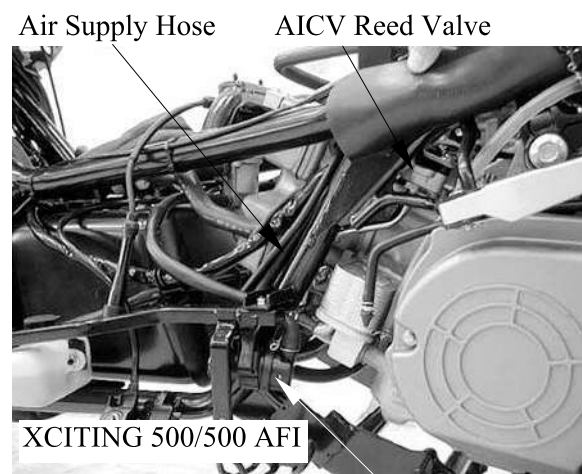

XCITING 500/500 AFI

AICV Control Solenoid Valve

3. INSPECTION/ADJUSTMENT XCITING 500/500 AFI/250/300 AFI

Air Supply Hose

AICV Reed Valve

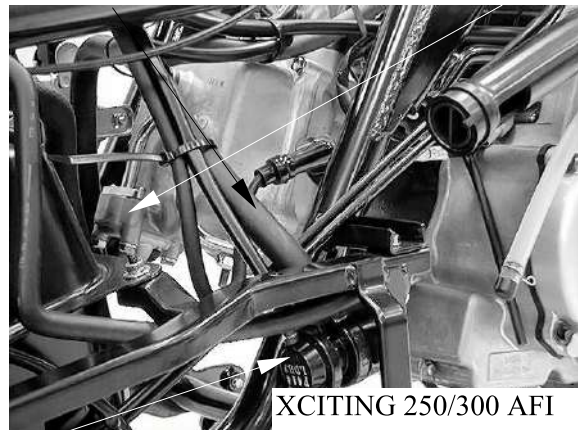

AICV Control Solenoid Valve

TRANSMISSION OIL OIL CHANGE

Place the scooter in its center stand.

Remove the transmission oil drain bolt (1) and the transmission oil filler bolt (2), slowly turn the rear wheel and drain the oil.

After draining the oil completely, install the oil drain bolt with a new sealing washer and tighten it.

Torque: 20 N•m (2 kgf•m, 15 lbf•ft)

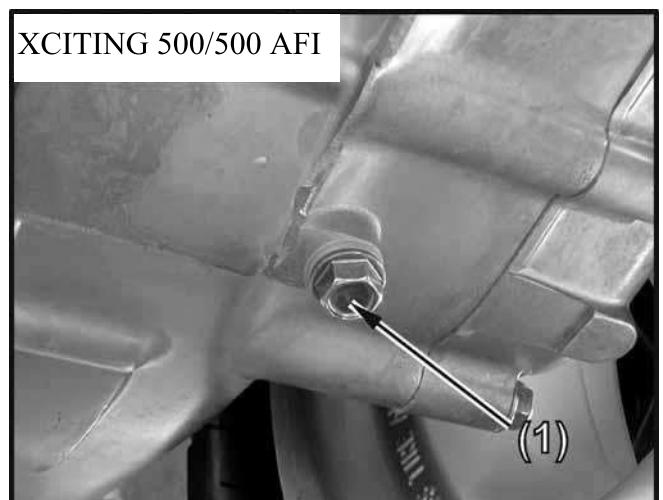

3. INSPECTION/ADJUSTMENT XCITING 500/500 AFI/250/300 AFI

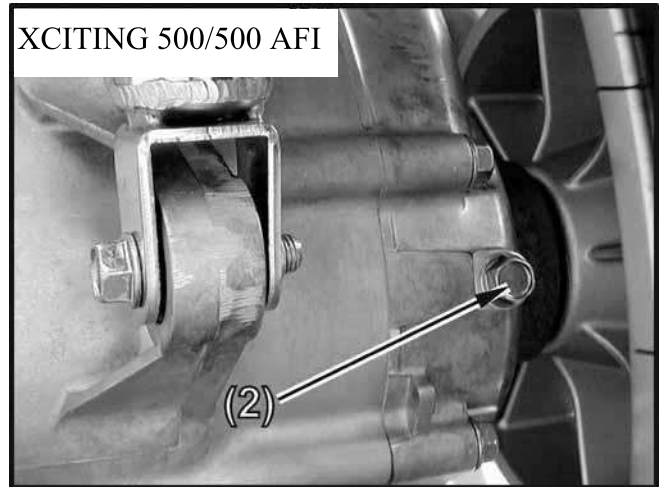

Fill the transmission case with recommended oil.

Recommended transmission oil: SAE 90

Oil capacity (at draining):

XCITING 500/500 AFI:

0.45 liter (0.48 US qt, 0.4 Imp qt)

XCITING 250/300 AFI:

0.18 liter (0.19 US qt, 0.16 Imp qt)

Install the transmission oil filler bolt with a new sealing washer and tighten it.

Torque: 20 N•m (2 kgf•m, 15 lbf•ft)

3. INSPECTION/ADJUSTMENT XCITING 500/500 AFI/250/300 AFI

BRAKE FLUID

- *
 - ◆ Do not mix different type of fluid, as they are not compatible with each other.
 - ◆ Do not allow foreign material to enter the system when filling the reservoir.
 - ◆ Avoid spilling fluid on painted, plastic or rubber parts. Place a rag over these parts whenever the system is serviced.

When the fluid level is low, check the brake pads for wear. A low fluid level may be due to wear of the brake pads. If the brake pads are worn, the caliper piston is pushed out, and this accounts for a low reservoir level. If the brake pads are not worn and the fluid level is low, check the entire system for leaks.

FRONT BRAKE

Turn the handlebar so the reservoir is level and check the front brake fluid reservoir level.

If the level is near the lower level line “L”, check brake pad wear.

REAR BRAKE

Place the scooter on a level surface and support it in an upright position.

Check the rear brake fluid reservoir level.

If the level is near the lower level line “L”, check brake pad wear.

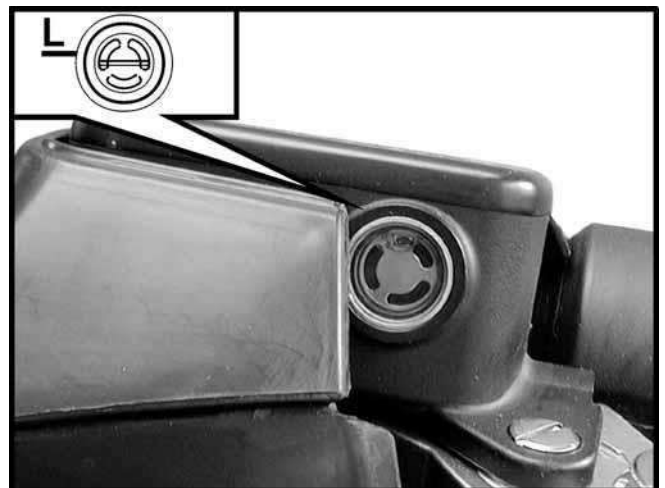

3. INSPECTION/ADJUSTMENT XCITING 500/500 AFI/250/300 AFI

BRAKE PAD WEAR

Brake pad wear depends upon the severity of usage, the type of riding, and road conditions. (Generally, the pads will wear faster on wet and dirty roads.) Inspect the pads at each regular maintenance interval.

FRONT RIGHT/LEFT BRAKE

Check the cutout in each pad.

If either pad is worn to the cutout, replace both pads as a set.

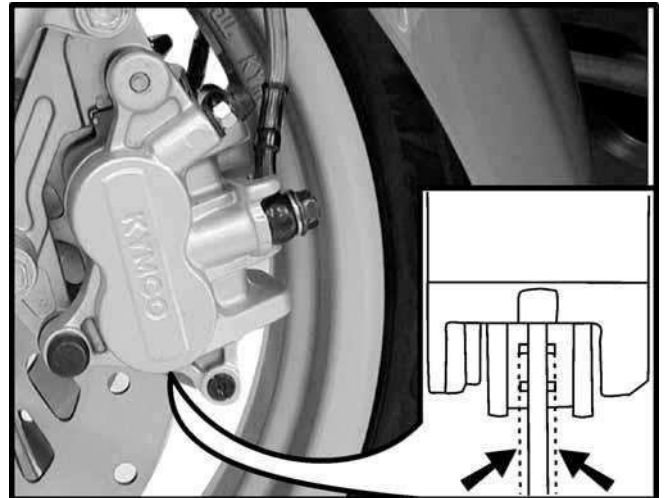

REAR BRAKE

Check the cutout in each pad.

If either pad is worn to the cutout, replace both pads as a set.

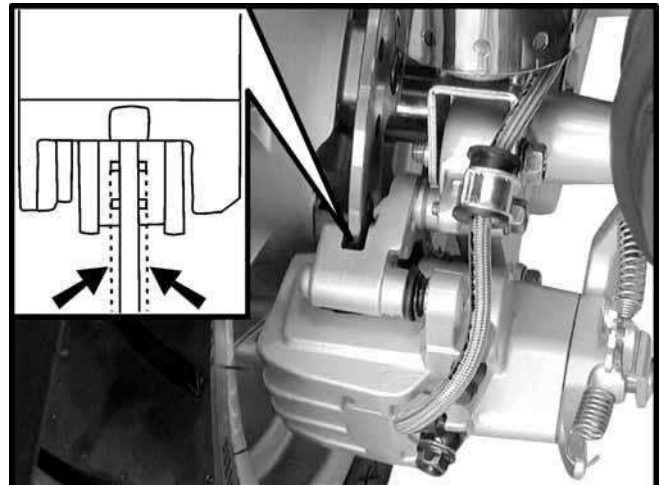

BRAKE SYSTEM

INSPECTION

This model equipped with a linked brake system.

Check the rear brake operation as follows:

Place the scooter on its center stand.

Jack-up the scooter to raise the front wheel off the ground.

* Do not use the oil filter as a jack point.

Rear Brake Lever

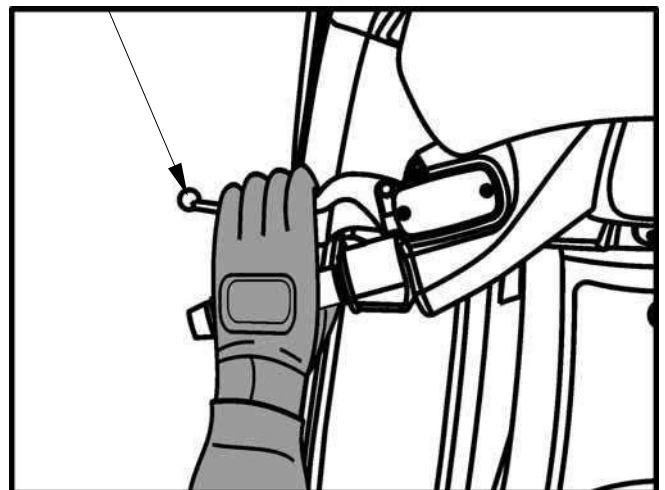

3. INSPECTION/ADJUSTMENT XCITING 500/500 AFI/250/300 AFI

Operate the rear brake lever.
 Make sure the front wheel does not turn while the rear brake lever is operated.

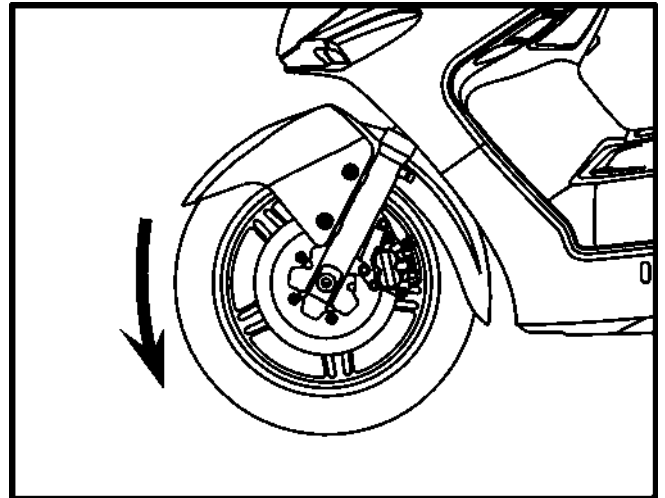

Firmly apply the brake lever and check that no air has entered the system.
 If the lever feels soft or spongy when operated, bleed the air from the system.

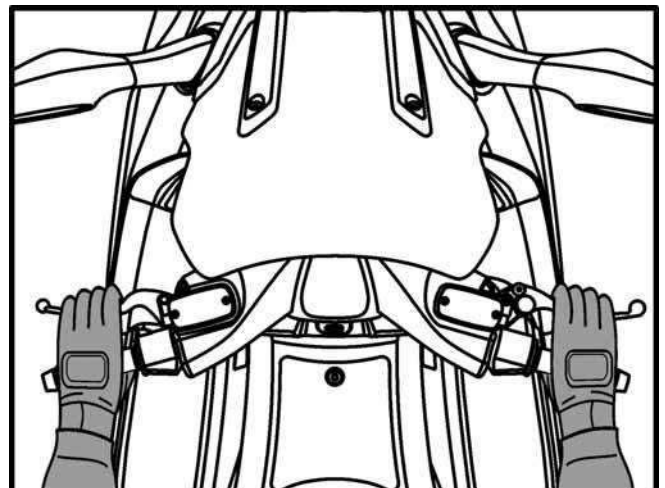

Inspect the brake hose and fittings for deterioration, cracks and signs of leakage.
 Tighten any loose fittings.
 Replace hoses and fittings as required.

BRAKE LOCK OPERATION (XCITING 500/500 AFI)

INSPECTION

Stop the engine and put the scooter on its center stand on level ground.

Pull up the parking brake lever slowly and check the parking brake lever stroke.

Parking brake lever stroke: 3 – 6 notches

If out of specification, adjust the parking brake lever.



3. INSPECTION/ADJUSTMENT XCITING 500/500 AFI/250/300 AFI

ADJUSTMENT

Place the scooter on its center stand.
Release the parking brake lever lock.
Pull up the parking brake lever until 1 notch.

Loosen the lock nut.
Turn the adjust bolt until you feel resistance when turn the rear wheel by your hand.
Hold the adjust bolt and tighten the lock nut securely.



Lock Nut

Adjust Bolt

Release the parking brake lever.
Make sure the rear wheel turns smoothly.

Pull the parking brake lever slowly and check the lever stroke.

Standard: 3 – 6 notches

All stroke: 9 notches

If there is out of specification, adjust again.

HEADLIGHT AIM

Place the scooter on a level surface.

Adjust the headlight beam vertically by turning the vertical beam adjuster.
A clockwise rotation moves the beam up and counterclockwise rotation moves the beam down.

Adjust the headlight beam horizontally by turning the horizontal beam adjuster.
A clockwise rotation moves the beam toward the right side of the rider.

Horizontally Adjusting Screw

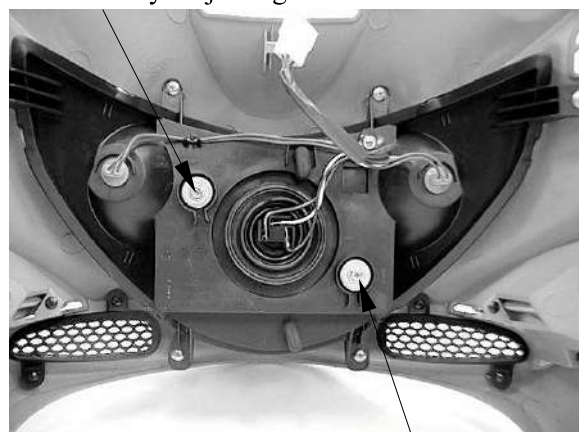

Vertically Adjusting Screw

* Adjust the headlight beam as specified by local laws and regulations.

3. INSPECTION/ADJUSTMENT XCITING 500/500 AFI/250/300 AFI

SIDE STAND

Support the scooter on a level surface.

Check the side stand spring for fatigue or damage.

Check the side stand assembly for smooth movement and lubricate the side stand pivot if necessary.

Check the side stand ignition cut-off system:

- ✓ Start the engine.
- ✓ Fully lower the side stand while running the engine.
- ✓ The engine should stop as the side stand is lowered.

If there is a problem with the system, check the side stand switch (page 21-15).

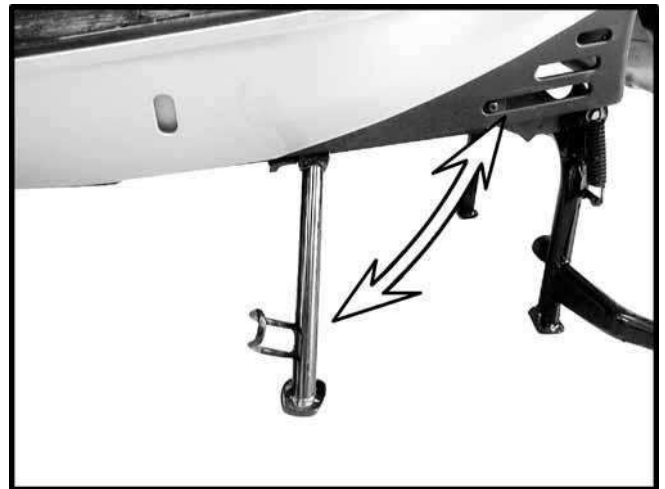

SUSPENSION

FRONT SUSPENSION INSPECTION

Check the action of the forks by operating the front brakes and compressing the front suspension several times.

Check the entire assembly for signs of leaks, damage or loose fasteners.

Replace damaged components which cannot be repaired.

Tighten all nuts and bolts.

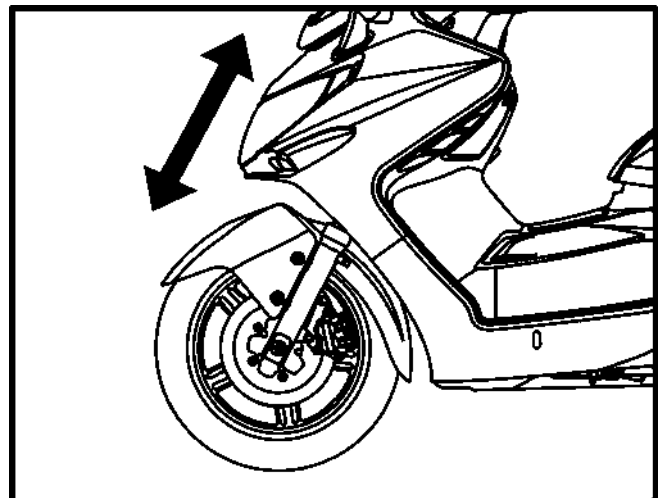

3. INSPECTION/ADJUSTMENT XCITING 500/500 AFI/250/300 AFI

REAR SUSPENSION INSPECTION

Check the action of the shock absorber by compressing it several times.

Check the entire shock absorber assembly for signs of leaks, damage or loose fasteners.

Replace damaged components which cannot be repaired.

Tighten all nuts and bolts.

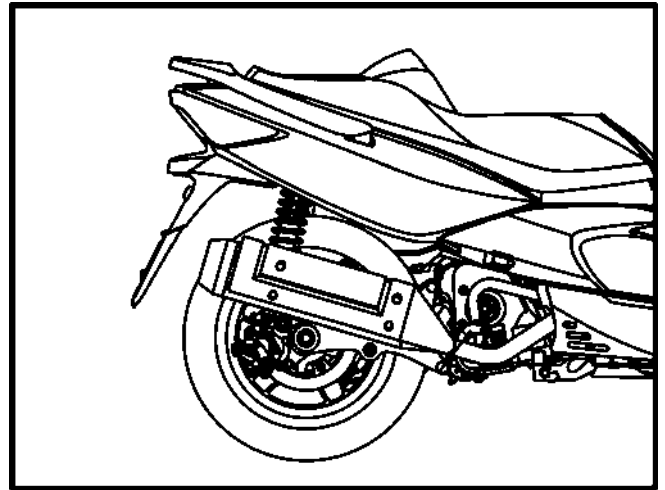

NUTS, BOLTS, FASTENERS

Check that all chassis nuts and bolts are tightened to their correct torque values (page 1-9).

Check that all safety clips, hose clamps and cable stays are in place and properly secured.

WHEELS/TIRES

Tire pressure should be checked when the tires are cold.

Recommended tire pressure:

	Solo riding	Two-up riding
Front	200 kpa (2 kgf/cm ² , 29 psi)	225 kpa (2.25 kgf/cm ² , 32 psi)
Rear	250 kpa (2.5 kgf/cm ² , 36 psi)	250 kpa (2.5 kgf/cm ² , 36 psi)

3. INSPECTION/ADJUSTMENT XCITING 500/500 AFI/250/300 AFI

Recommended tire size:

	Front	Rear
Size	120/70-15	150/70-14
Type	TUBELESS	TUBELESS

Check the tires for cuts, embedded nails, or other damage.
Check the front and rear wheels for trueness.

Measure the tread depth at the center of the tires.

Replace the tires when the tread depth reaches the following limits.

Minimum tread depth:

Front: 1.6 mm (0.06 in)

Rear: 2.0 mm (0.08 in)

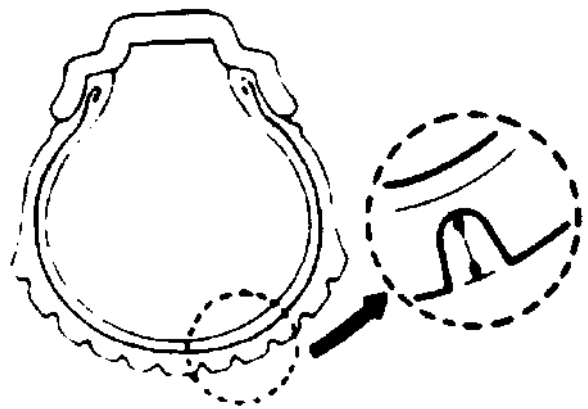

STEERING HEAD BEARINGS

Check that the control cables do not interfere with handlebar rotation.

Support the scooter securely and raise the front wheel off the ground.

Check that the handlebar moves freely from side to side.

If the handlebar moves unevenly, binds, or has vertical movement, inspect the steering head bearings.

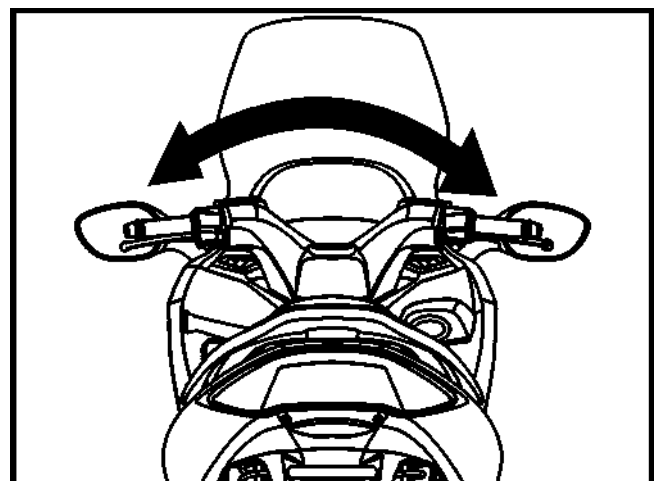

LUBRICATION SYSTEM

LUBRICATION SYSTEM DIAGRAM -----	4- 1
SERVICE INFORMATION-----	4- 3
TROUBLESHOOTING-----	4- 5
OIL PRESSURE SWITCH -----	4- 6
OIL PRESSURE RELIEF VALVE (XCITING 500/500 AFI) -----	4- 6
OIL PUMP-----	4- 7
OIL COOLER (XCITING 500/500 AFI)-----	4-12

LUBRICATION SYSTEM DIAGRAM

XCITING 500/500 AFI

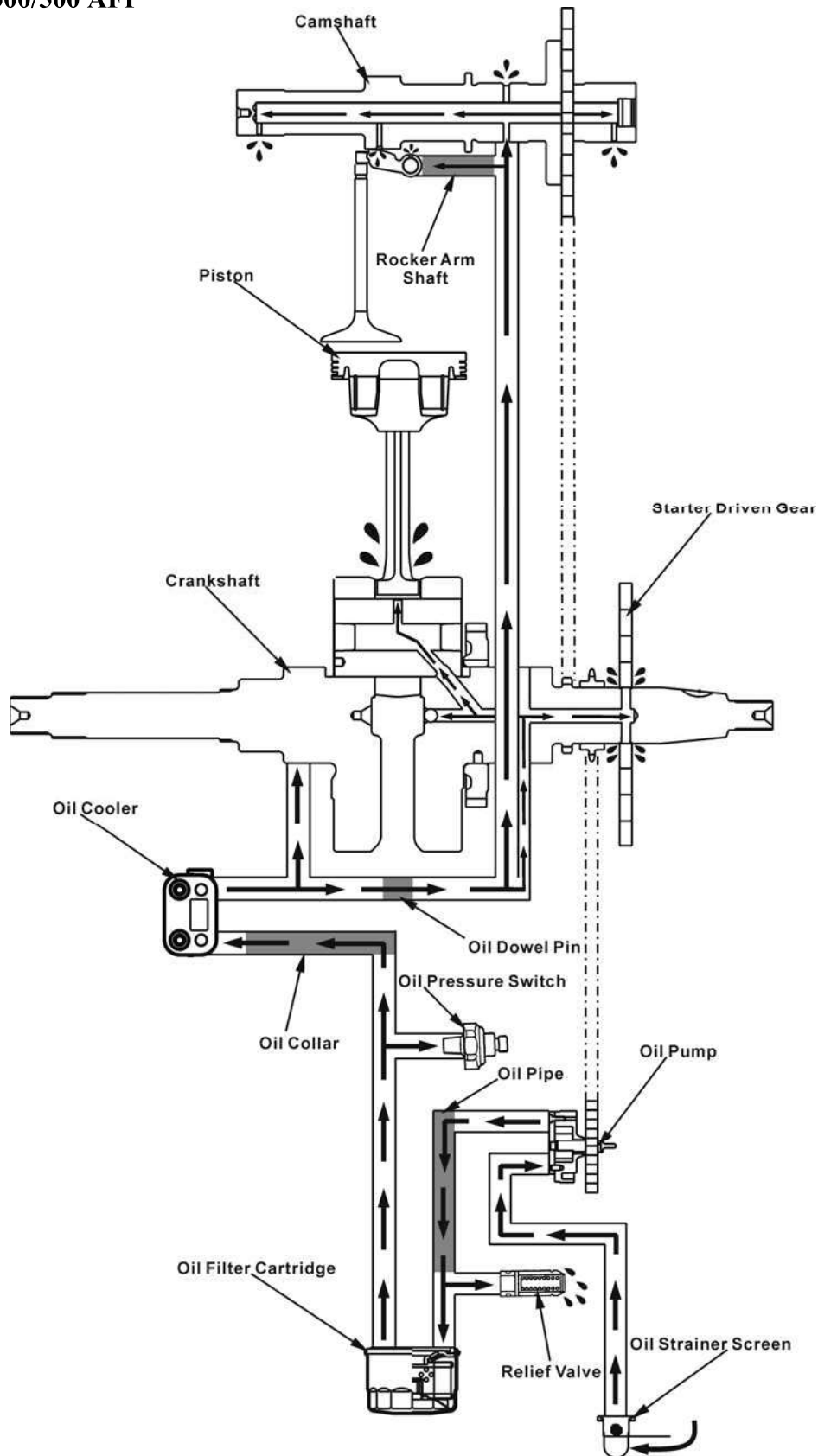

4. LUBRICATION SYSTEM

XCITING 500/500 AFI/250/300 AFI

XCITING 250/300 AFI

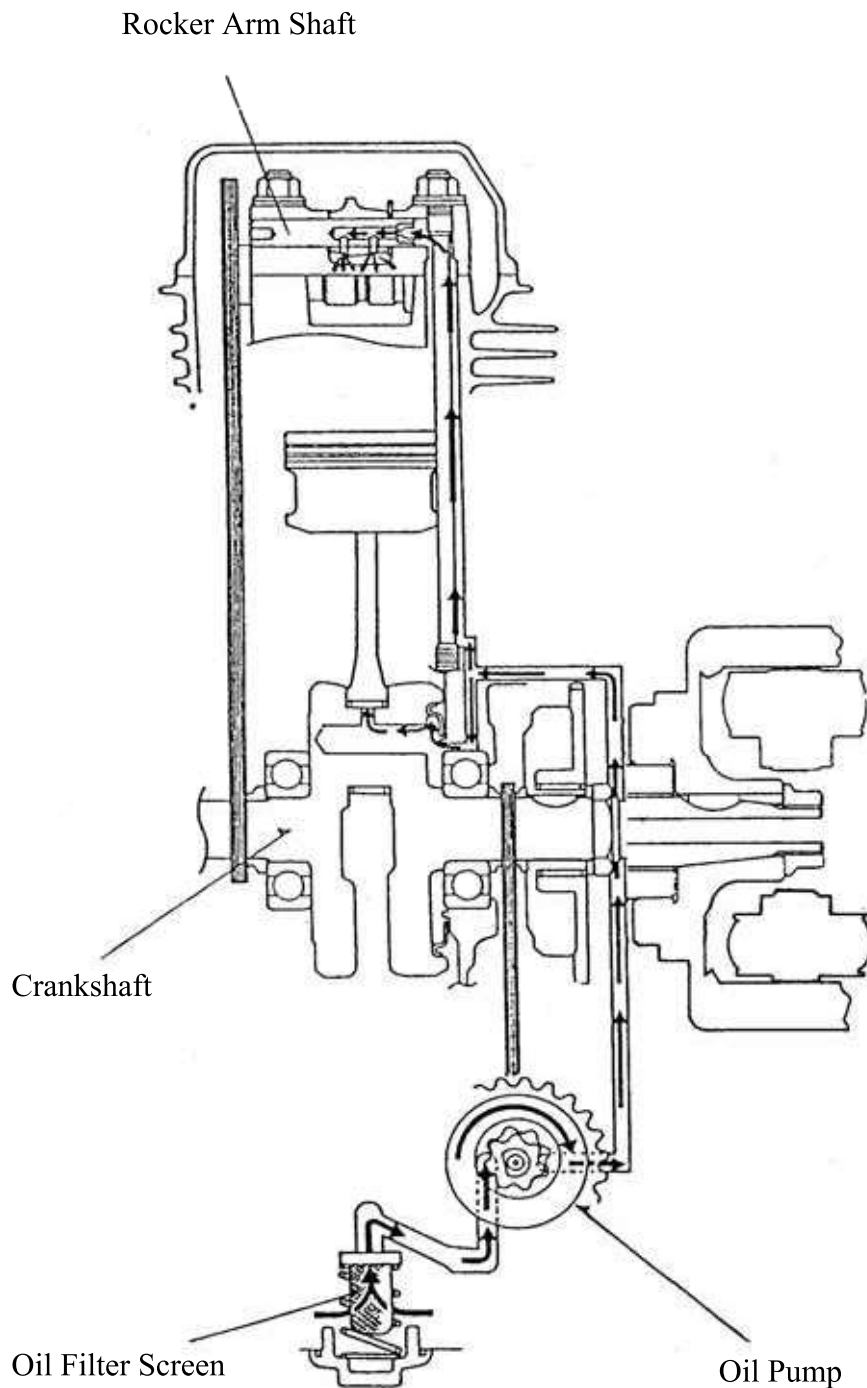

SERVICE INFORMATION

GENERAL INSTRUCTIONS

- The oil pump service may be done with the engine installed in the frame.
- When removing and installing the oil pump use care not to allow dust or dirt to enter the engine.
- If any portion of the oil pump is worn beyond the specified service limits, replace the oil pump as an assembly.
- After the engine has been installed check that there are no oil leaks and that oil pressure is correct.
- For oil pressure indicator inspection, refer to section 20 of this manual.

SPECIFICATIONS (XCITING 500/500 AFI)

Unit: mm (in)

ITEM		STANDARD	SERVICE LIMIT
Engine oil capacity	At draining	2.0 liter (2.1 US qt, 1.8 Imp qt)	—
	At disassembly	2.5 liter (2.7 US qt, 2.2 Imp qt)	—
	At oil filter change	2.1 liter (2.2 US qt, 1.9 Imp qt)	—
Recommended engine oil		KYMCO 4-stroke oil or equivalent motor oil API service classification SJ Viscosity: SAE 5W-50	—
Oil pump rotor	Tip clearance	0.15 (0.006) max	0.2 (0.008)
	Body clearance	0.15 – 0.2 (0.006 – 0.008)	0.25 (0.01)
	Side clearance	0.04 – 0.09 (0.0016 – 0.0036)	0.12 (0.0048)

SPECIFICATIONS (XCITING 250/XCITING 300 AFI)

Unit: mm (in)

ITEM		STANDARD	SERVICE LIMIT
Engine oil capacity	At draining	0.9 liter (0.95 US qt, 0.8 Imp qt)	—
	At disassembly	1.1 liter (1.17 US qt, 1 Imp qt)	—
Recommended engine oil		KYMCO 4-stroke oil or equivalent motor oil API service classification SJ Viscosity: SAE 5W-50	—
Oil pump rotor	Tip clearance	0.15 (0.006) max	0.2 (0.008)
	Body clearance	0.15 – 0.2 (0.006 – 0.008)	0.25 (0.01)
	Side clearance	0.04 – 0.09 (0.0016 – 0.0036)	0.12 (0.0048)

TORQUE VALUES (XCITING 500/500 AFI)

Oil pump screw	3 N•m (0.3kgf•m, 2 lbf•ft)	
Oil cooler bolt	35 N•m (3.5 kgf•m, 25 lbf•ft)	
Oil pressure switch	22 N•m (2.2 kgf•m, 16 lbf•ft)	Apply sealant to threads.
Oil strainer screen cap	15 N•m (1.5 kgf•m, 11 lbf•ft)	
	Apply oil to the threads and seating surface.	
Oil filter cartridge	10 N•m (1 kgf•m, 7 lbf•ft)	
	Apply oil to the threads and seating surface.	

TORQUE VALUES (XCITING 250/XCITING 300 AFI)

Oil pump screw	3 N•m (0.3kgf•m, 2 lbf•ft)	
Oil pressure switch	22 N•m (2.2 kgf•m, 16 lbf•ft)	Apply sealant to threads.
Oil strainer screen cap	15 N•m (1.5 kgf•m, 11 lbf•ft)	
	Apply oil to the threads and seating surface.	

TOOLS

Oil filter wrench A120E00052

TROUBLESHOOTING**Oil level low**

- Oil consumption
- External oil leak
- Worn piston ring
- Incorrect piston ring installation
- Worn valve guide or seal

Oil contamination (White appearance)

- From coolant mixing with oil
 - Faulty water pump mechanical seal
 - Faulty head gasket
 - Water leak in crankcase

No oil pressure

- Oil level too low
- Oil pump drive chain broken
- Oil pump drive sprocket broken
- Oil pump damaged (pump shaft)
- Internal oil leak

Low oil pressure

- Pressure relief valve stuck open
- Clogged oil filter and strainer screen
- Oil pump worn or damaged
- Internal oil leak
- Incorrect oil being used
- Oil level too low

High oil pressure

- Pressure relief valve stuck closed
- Plugged oil filter, gallery, or metering orifice
- Faulty oil pump

Seized engine

- No or low oil pressure
- Clogged oil orifice/passage
- Internal oil leak
- Non-recommended oil used

Oil contamination

- Deteriorated oil
- Faulty oil filter
- Worn piston ring (White appearance with water or moisture)
 - Damaged water pump mechanical seal
 - Damaged head gasket
 - Oil relief not frequent enough

Oil pressure warning indicator does not work

- Faulty oil pressure switch
- Short circuit in the indicator wire
- Low or no oil pressure

4. LUBRICATION SYSTEM

XCITING 500/500 AFI/250/300 AFI

OIL PRESSURE SWITCH

CHECK

Start the engine.

Check the oil pressure indicator goes out after one or two seconds. If the oil pressure indicator stay on, stop the engine immediately and determine the cause (section 21).



OIL PRESSURE RELIEF VALVE (XCITING 500/500 AFI)

REMOVAL

Remove the right crankcase cover (page 13-3).

Remove the pressure relief valve and O-ring from the right crankcase

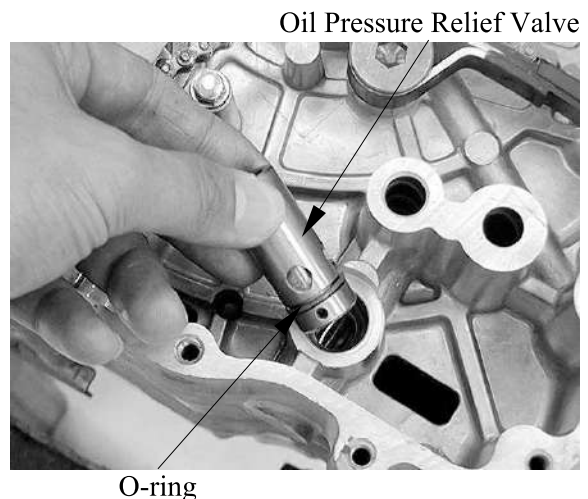

INSPECTION

Check the operation of the pressure relief valve buy pushing on the piston.

INSTALLATION

Apply oil to a new O-ring and install the pressure relief valve groove, and install the relief valve to the right crankcase.

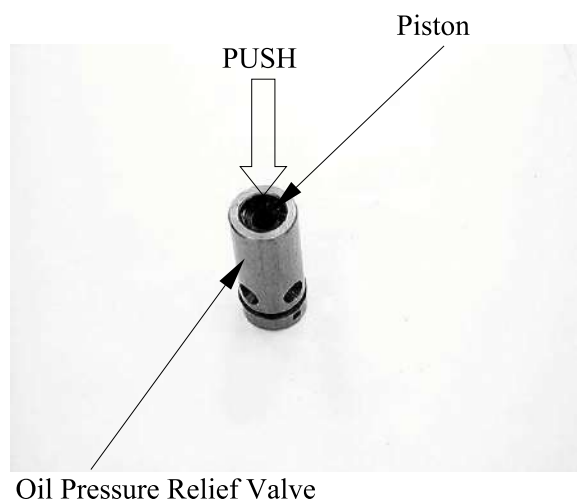

4. LUBRICATION SYSTEM

OIL PUMP

REMOVAL

Remove the flywheel (page 13-5).

Remove the attaching bolt and oil separator cover.

When removing and installing the oil pump, use care not to allow dust or dirt to enter the engine..

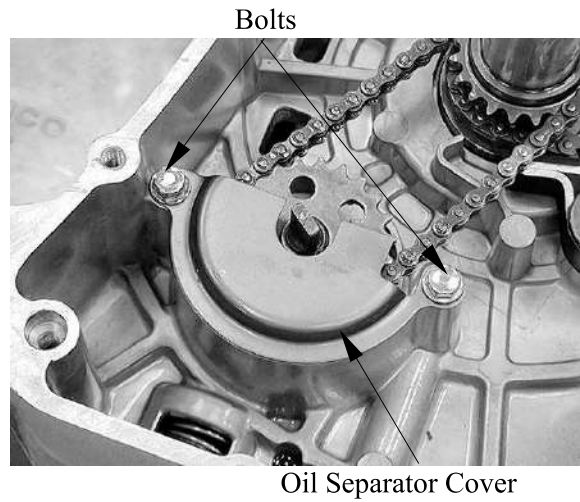

Remove snap ring.

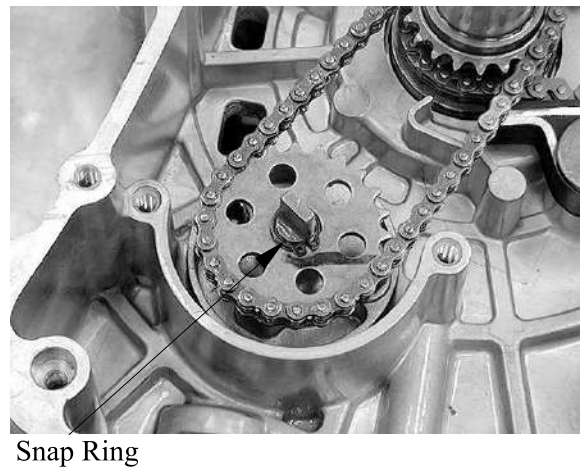

Remove the oil pump driven gear, then remove the oil pump drive chain.

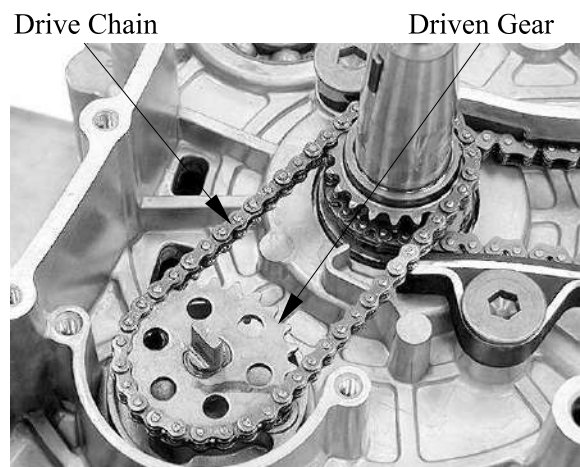

4. LUBRICATION SYSTEM

XCITING 500/500 AFI/250/300 AFI

Remove the two oil pump bolts to remove the oil pump.

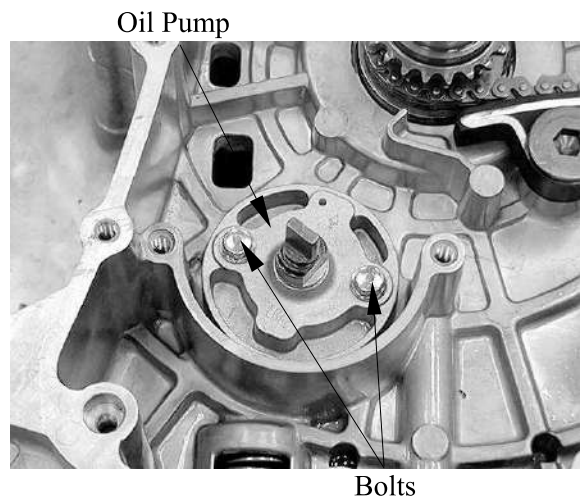

DISASSEMBLY

Remove the screw and oil pump cover.

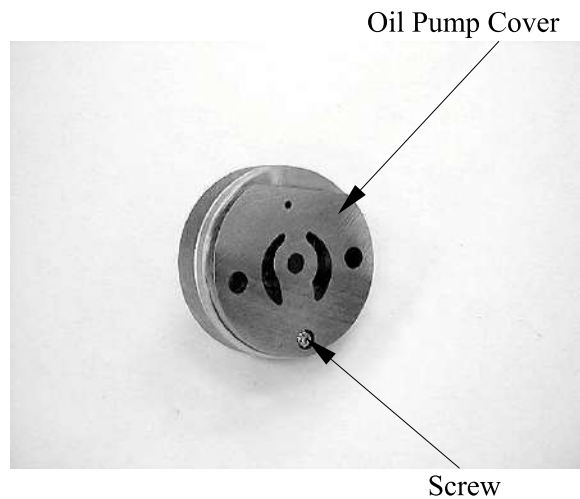

Remove the dowel pin, oil pump shaft, oil pump outer rotor and inner rotor.

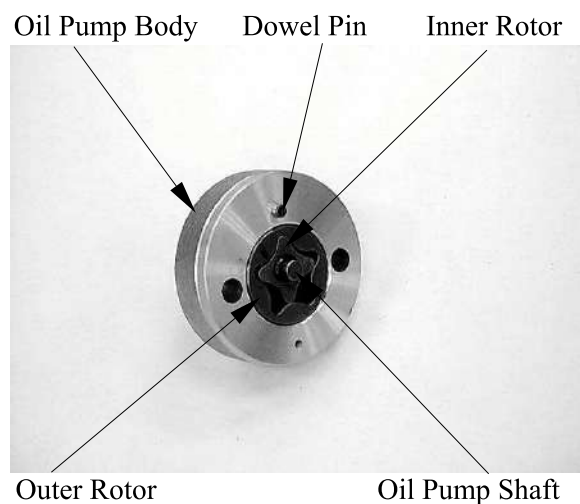

4. LUBRICATION SYSTEM

XCITING 500/500 AFI/250/300 AFI

INSPECTION

Temporarily install the oil pump shaft.
Install the outer and inner rotors into the oil pump body.

Measure the tip clearance.

Service limit: 0.2 mm (0.008 in)

Measure at several points and use the largest reading to compare the service limit.

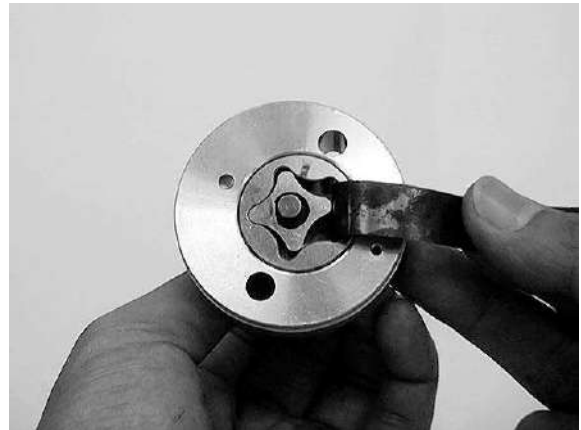

Measure the pump body clearance.

Service limit: 0.25 mm (0.01 in)

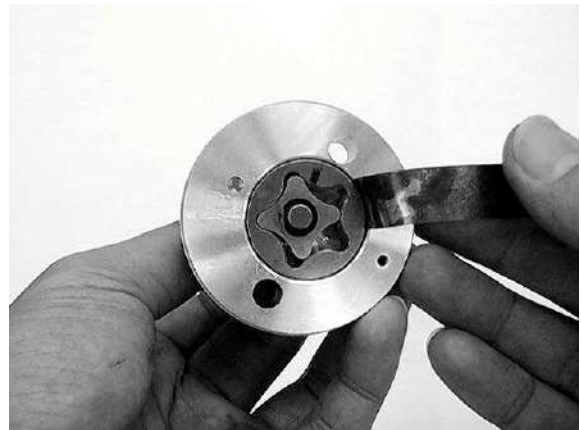

Measure the side clearance with the straight edge and feeler gauge.

Service limit: 0.12 mm (0.0048 in)

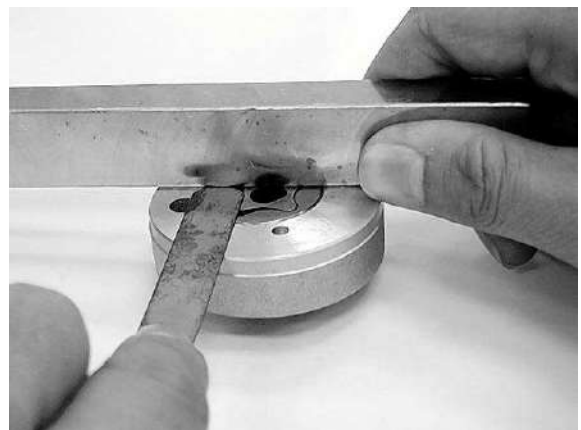

4. LUBRICATION SYSTEM

XCITING 500/500 AFI/250/300 AFI

ASSEMBLY

Dip all parts in clean engine oil.

Install the outer rotor into the oil pump body.

Install the inner rotor into the outer rotor.

Install the oil pump shaft.

Install the dowel pin onto the oil pump body.

Install the oil pump cover onto the oil pump body by aligning the dowel pin.

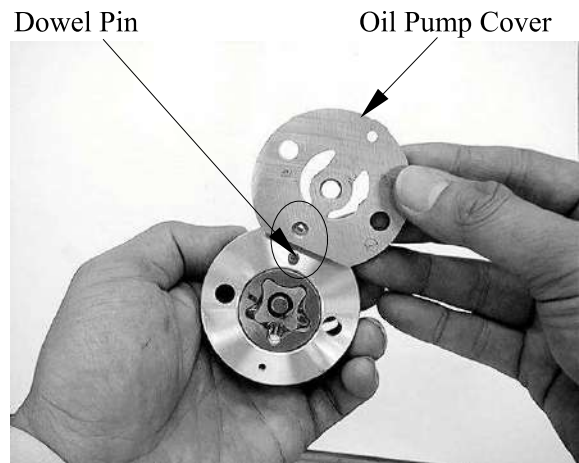

Install and tighten the screw to the specified torque.

Torqur: 3 N•m (0.3kgf•m, 2 lbf•ft)

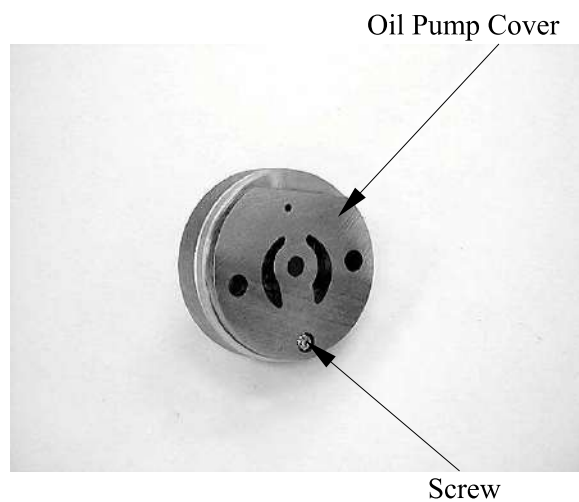

INSTALLATION

Install the oil pump and tighten the two bolts securely.

Make sure the pump shaft rotates freely and arrow on the oil pump is upside.

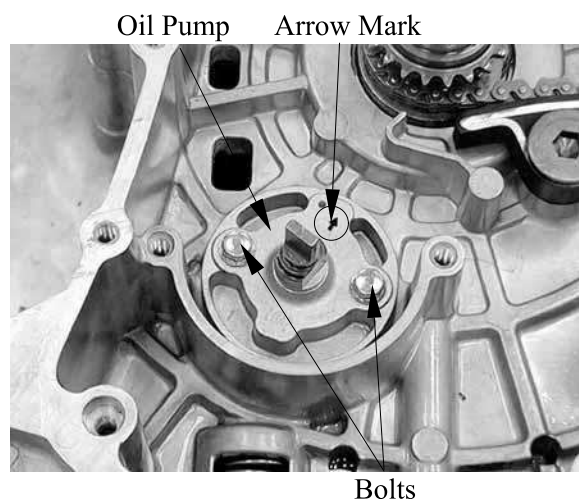

4. LUBRICATION SYSTEM

XCITING 500/500 AFI/250/300 AFI

Install the oil pump driven sprocket and drive chain.

Install the snap ring.

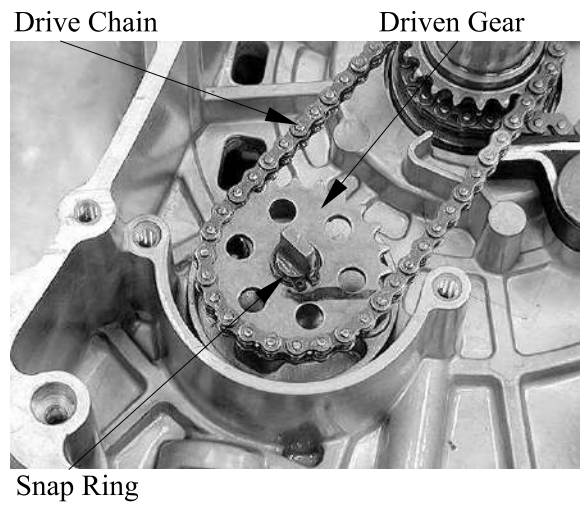

Install the oil separator cover properly and tighten two bolts securely as shown.

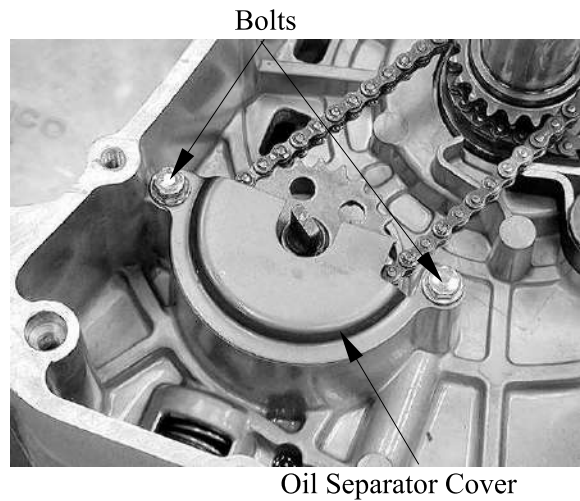

4. LUBRICATION SYSTEM

OIL COOLER (XCITING 500 /500 AFI)

REMOVAL

Drain the engine oil and remove the oil filter cartridge (page 3-17).

Drain the coolant from the system (page 7-8).

Loosen the hose bands and disconnect the oil cooler water hoses from the cooler.

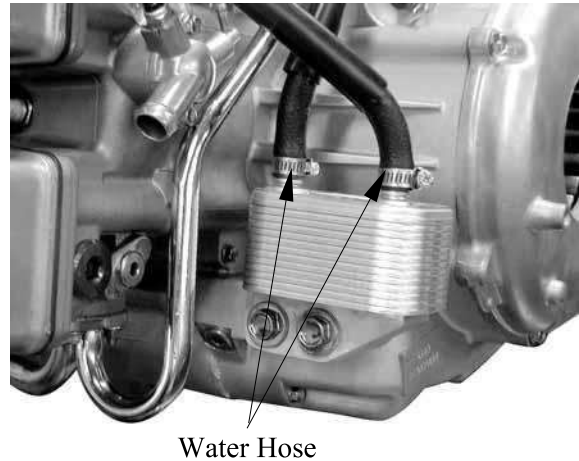

Remove the oil cooler mounting bolts, washers, oil cooler and gasket.

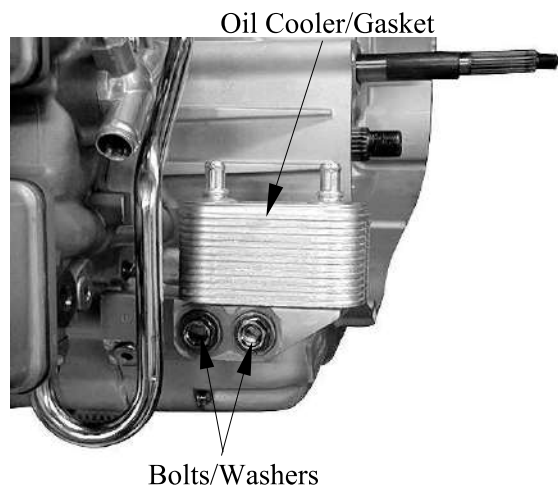

INSPECTION

Check the cooler for damage.

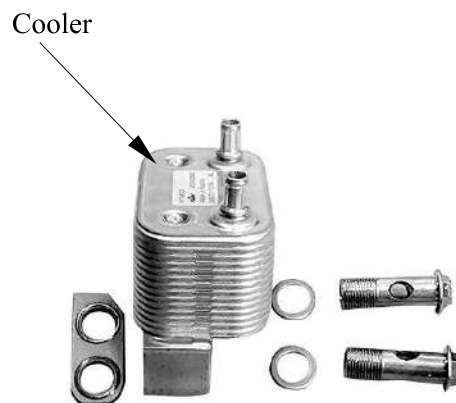

4. LUBRICATION SYSTEM

INSTALLATION

Install the gasket and oil cooler.
Install the washers and tighten the oil cooler bolts to the specified torque.

Torque: 35 N•m (3.5 kgf•m, 25 lbf•ft)

Connect the oil cooler water hoses, tighten the hose band securely.

Install the oil filter cartridge and fill the crankcase with recommended engine oil (page 3-14).

Fill the cooling system and bleed air (page 7-8).

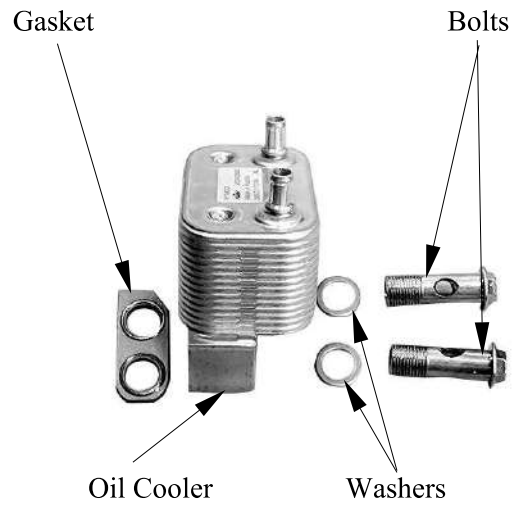

**FUEL SYSTEM/FUEL PUMP/
FUEL TANK/CARBURETOR**

5

SCHEMATIC DRAWING-----	5- 1
FUEL SYSTEM (XCITING 500)-----	5- 2
FUEL PUMP (XCITING 250) -----	5- 3
SERVICE INFORMATION -----	5- 4
TROUBLESHOOTING -----	5- 5
CARBURETOR -----	5- 6
FUEL FILTER/FUEL PUMP-----	5-23
FUEL TANK-----	5-25

5. FUEL SYSTEM/FUEL PUMP /FUEL TANK/CARBURETOR



XCITING 500/500 AFI/250/300 AFI

SCHEMATIC DRAWING

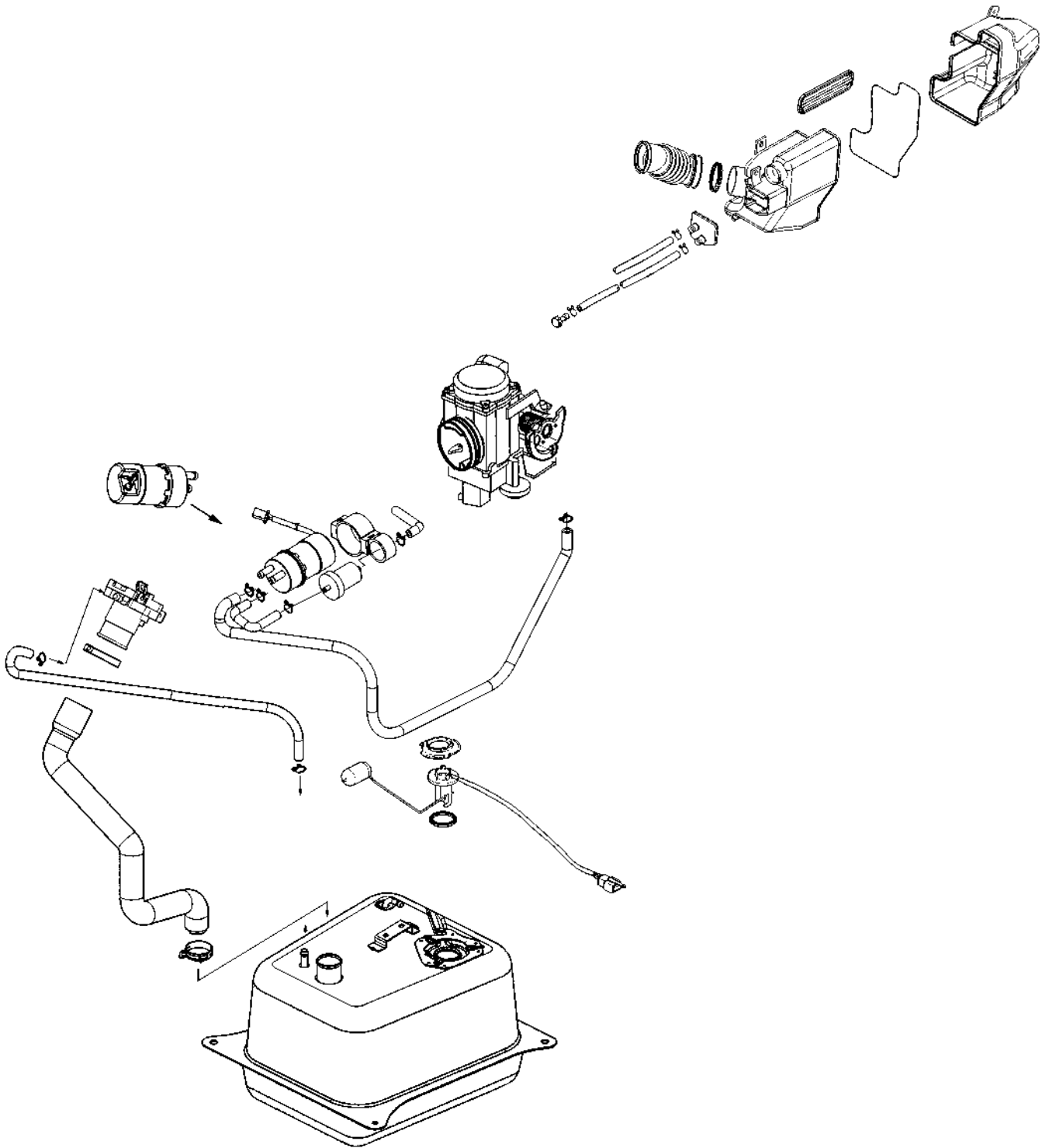

FUEL SYSTEM (XCITING 500)

The fuel pump is operated by an electromagnetic force and its electrical energy is supplied from the battery. The fuel sent under pressure by the fuel pump flows into the float chamber when the float of the carburetor has dropped and the needle valve is open. When the needle valve closes, the pressure of the fuel in the hose connecting the carburetor and the fuel pump increases, and when the set pressure is reached, the operation of the fuel pump is stopped by the fuel pressure to prevent excessive supply.

FUEL PUMP CONSTRUCTION

When voltage is applied between the fuel pump terminals, current flows into the solenoid coil which then pulls up the plunger together with the diaphragm allowing fuel to be drawn into the pump. At this time, the contact which is linked with the plunger opens and interrupts current causing the coil to be de-energized. This allows the diaphragm to go down by the spring force, thereby pressurizing and delivering fuel to the outlet. When the fuel pressure builds up and overcomes the spring force, the plunger stops at pulled up position with the contact in open position.

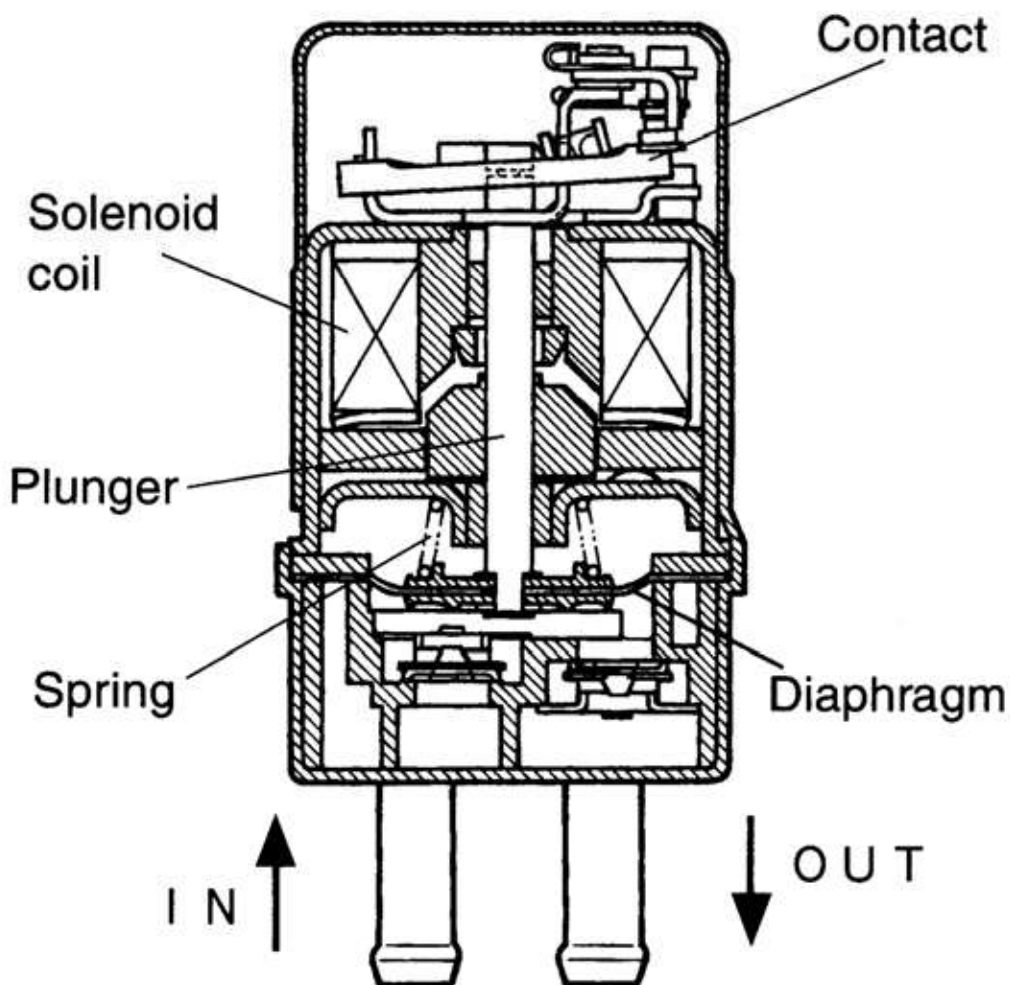

FUEL PUMP (XCITING 250)

CONSTRUCTION:

The fuel pump adopted for this model is a vacuum-type fuel pump which utilizes the positive and negative pulsating pressures produced by the engine crankcase to control the oil pump diaphragms and deliver fuel from the fuel tank to the carburetor through the suction valve and outlet valve.

FUEL PUMP CONSTRUCTION

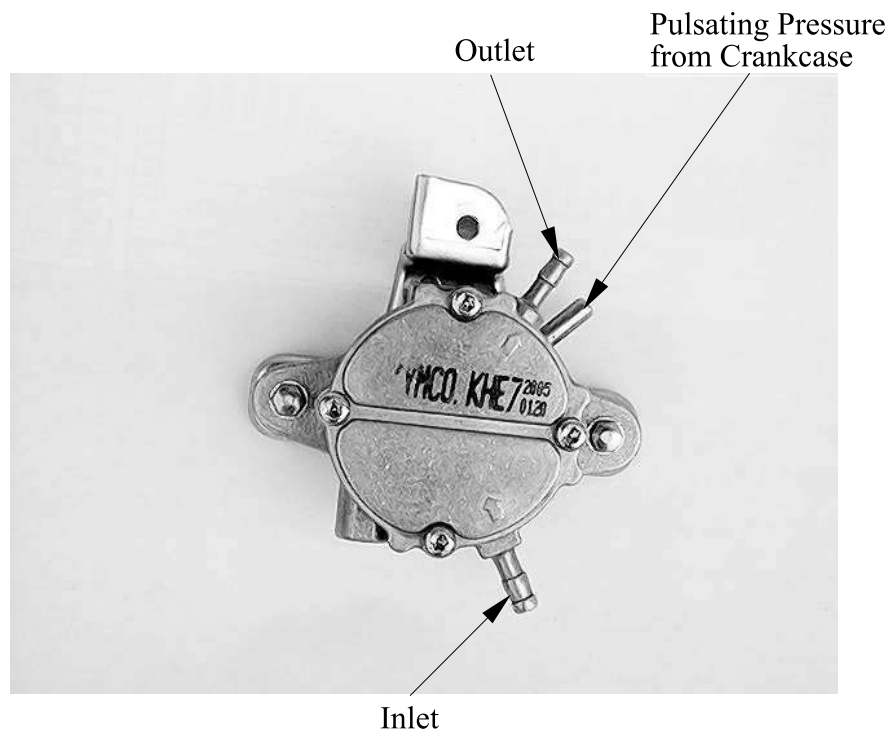

SERVICE INFORMATION

GENERAL INSTRUCTIONS

- When working with gasoline, keep away from sparks and flames.
- Note the locations of O-rings when disassembling and replace them with new ones during assembly.
- Before float chamber disassembly, drain the residual gasoline from the float chamber.
- Do not try to disassemble the automatic choke.
- When assembling the vacuum chamber and air cut-off valve, be careful not to damage the diaphragms.
- All cables, fuel lines and wires must be routed and secured at correct locations.
- When removing the fuel tank, keep sparks and flames away from the working area.
- When removing the fuel tank, the remaining fuel in the tank must be lower than 1/2 of the fuel tank capacity to avoid gasoline overflowing.
- Fuel tank capacity: 12.8 liters (3.38 Imp gal, 2.82 US gal)

SPECIFICATIONS

	XCITING 500	XCITING 250
Type	CVK	CVK
Carburetor identification number	15F8 SD8	LDB2
Size of bore (mm)	Ø36	Ø30
Main jet	#108	KY94
Slow jet	#38	KY035
Idle speed	1400±100	1600±100
Pilot screw opening	3½ ± ½ turns out	2½ ± ½ turns out
Fuel pump flow (at 12V): ml (US oz, Imp oz)/min	370 (12.6 , 13)	
Fuel pump flow (at 12V): cc/rpm/Seconds		40/1700/10

TROUBLESHOOTING

Engine does not start

- No fuel in tank
- Restricted fuel line
- Too much fuel getting to cylinder
- Clogged air cleaner
- Contaminated fuel
- Faulty fuel pump

Throttle does not open fully, so engine stalls

- Damaged vacuum piston diaphragm
- Clogged diaphragm hole

Lean mixture

- Clogged fuel jets
- Clogged fuel tank cap breather hole
- Clogged fuel filter
- Bent, kinked or restricted fuel line
- Faulty float valve
- Float level too low
- Faulty fuel pump or insufficient output

Engine is hard to start

- No fuel in tank
- Restricted fuel line
- Clogged fuel strainer
- Faulty fuel pump
- Broken or clogged vacuum tube
- Faulty or clogged charcoal canister

Lean mixture

- Clogged charcoal canister
- Bent, kinked or restricted fuel line
- Clogged fuel strainer
- Float level too low

Engine idles roughly, stalls or runs poorly

- Incorrect idle speed
- Rich mixture
- Lean mixture
- Clogged air cleaner
- Intake air leak
- Contaminated fuel
- Faulty air-cut off valve
- Damaged vacuum tube and connectors
- Damaged carburetor insulator

Rich mixture

- Automatic valve opens excessively
- Faulty float valve
- Float level too high
- Clogged air jets
- Automatic choke valve set plate installed in the wrong groove
- Clogged air cleaner

5. FUEL SYSTEM/FUEL PUMP /FUEL TANK/CARBURETOR



XCITING 500/500 AFI/250/300 AFI

CARBURETOR

REMOVAL/INSTALLATION (XCITING 500)

Remove the luggage box (page 2-3)

Loosen the air cleaner clamp screw.
Loosen the carburetor clamp screw.
Disconnect the vacuum hose from the carburetor.

Pull the carburetor out from the air cleaner and intake manifold.

Carburetor Clamp Screw



Air Cleaner Clamp Screw

Vacuum Hose

Disconnect the fuel hose from the carburetor.
Disconnect the carburetor heater connector.

Fuel Hose



Carburetor Heater Connector

Disconnect the throttle cables.
Disconnect the automatic choke connector.
Disconnect the T.P.S connector.
Remove the carburetor.

T.P.S Connector

Throttle Cables



Automatic Choke Connector

Installation is in the reverse order of the removal.

5. FUEL SYSTEM / FUEL PUMP / FUEL TANK / CARBURETOR



XCITING 500/500 AFI/250/300 AFI

REMOVAL/INSTALLATION (XCITING 250)

Remove the luggage box (page 2-3)

Disconnect the throttle cables.



Throttle Cables

Loosen the air cleaner clamp screw.
Loosen the carburetor clamp screw.

Pull the carburetor out from the air cleaner
and intake manifold.



Carburetor Clamp Screw

Disconnect the fuel hose from the
carburetor.
Disconnect the carburetor heater connector.
Disconnect the automatic choke connector.
Disconnect the T.P.S connector.
Remove the carburetor.

Installation is in the reverse order of
removal.



T.P.S Connector

Automatic Choke Connector

5. FUEL SYSTEM/FUEL PUMP /FUEL TANK/CARBURETOR



XCITING 500/500 AFI/250/300 AFI

DISASSEMBLY (XCITING 500)

With the automatic choke cover removed, remove the screw and automatic choke assembly.

The automatic choke assembly is a non-disassemblable type

Automatic Choke Assembly

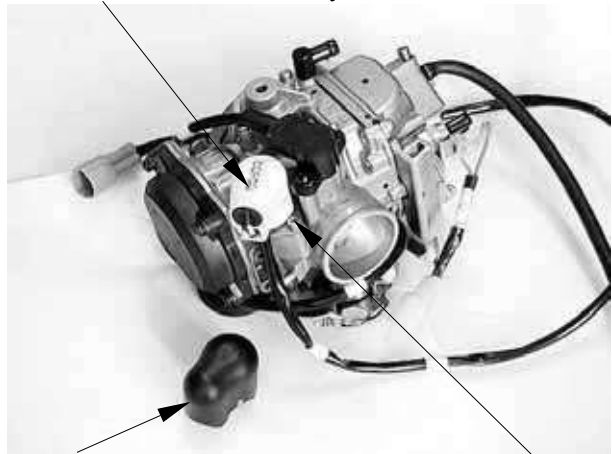

Automatic Choke Cover

Screw

Loosen the drain screw and drain the fuel from the float chamber.

Remove the carburetor heater.

Carburetor Heater



Drain Screw

Remove the four screws and top cap.

Top Cap

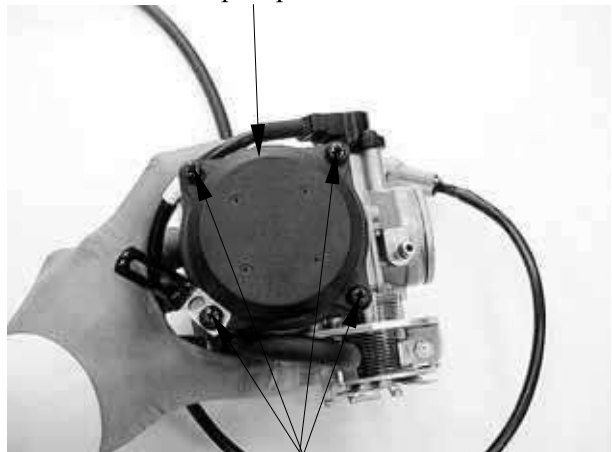

Screws

5. FUEL SYSTEM / FUEL PUMP / FUEL TANK / CARBURETOR



XCITING 500/500 AFI/250/300 AFI

Remove the spring , spring retainer, jet needle and throttle valve.

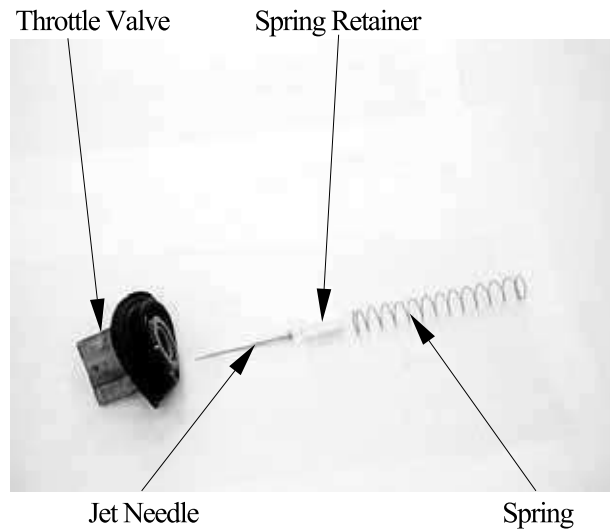

Remove the two screws and casting enrichment valve cover and then take out the spring.

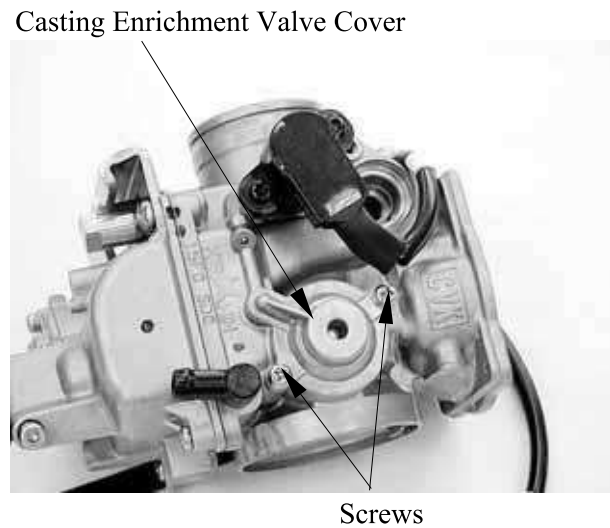

Remove the casting enrichment valve and O-ring.

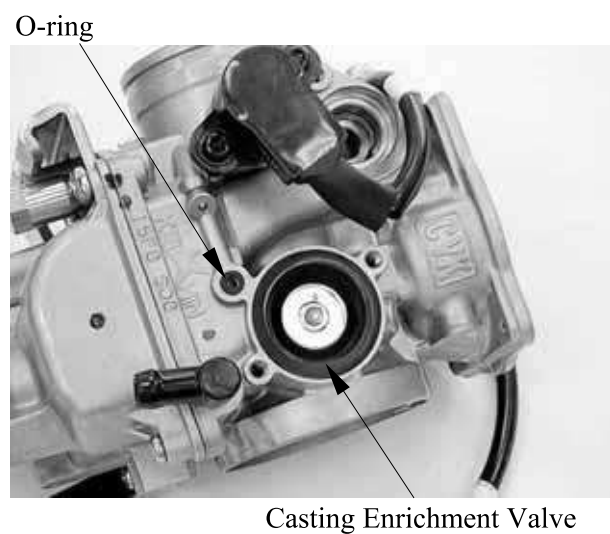

5. FUEL SYSTEM/FUEL PUMP /FUEL TANK/CARBURETOR

Remove the three screws and accelerating pump cover.



Accelerating Pump Cover

Remove the accelerating pump diaphragm and O-ring.



Accelerating Pump Diaphragm

Remove the four screws and float chamber.

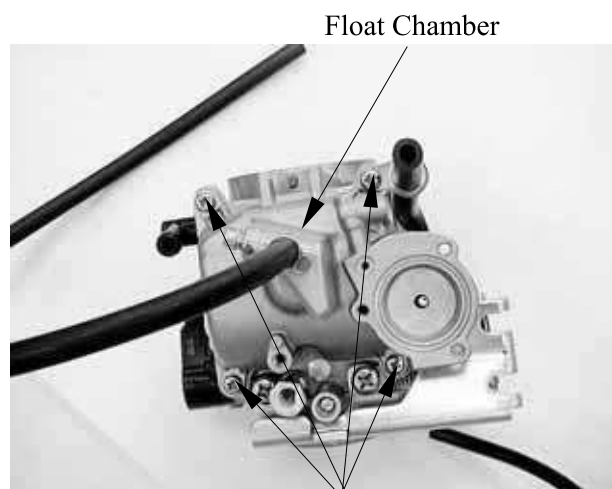

Screws

5. FUEL SYSTEM / FUEL PUMP / FUEL TANK / CARBURETOR



XCITING 500/500 AFI/250/300 AFI

Pull float pin out, then remove the float and float valve.

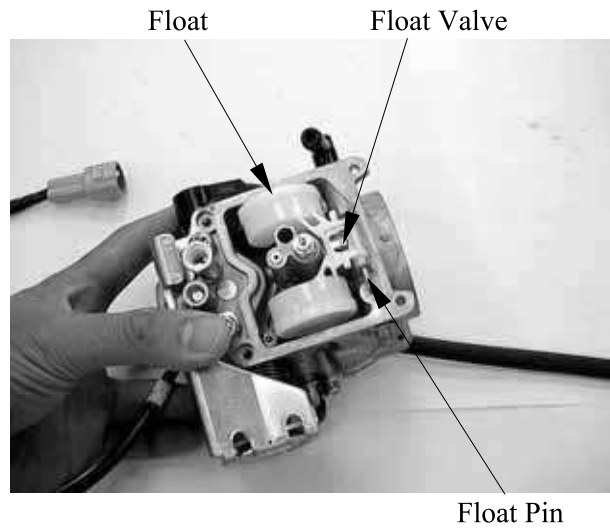

Remove the slow jet.
Remove the main jet.

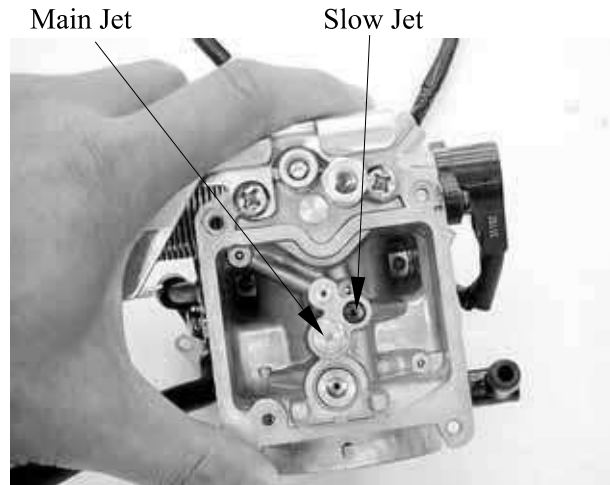

Remove the needle jet holder.

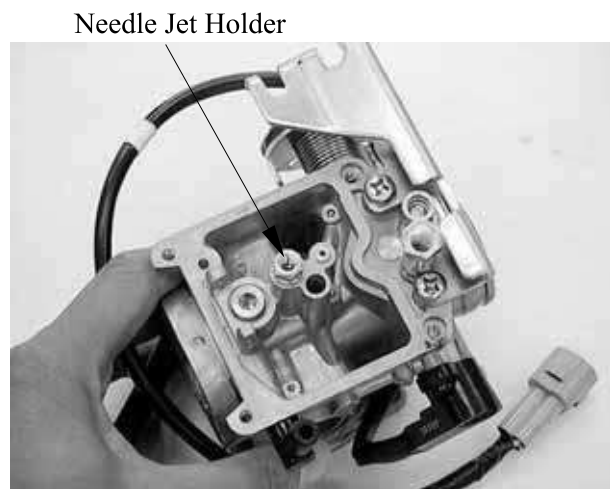

5. FUEL SYSTEM/FUEL PUMP /FUEL TANK/CARBURETOR



XCITING 500/500 AFI/250/300 AFI

Remove the needle jet.



Needle Jet

Remove the pilot screw, spring, washer and O-ring.

Before pilot screw removal, slowly turn the pilot screw clockwise and count the number of turns until the screw is lightly seated. Make a note of how many turns were made so the screw can be reset correctly.

Pilot Screw

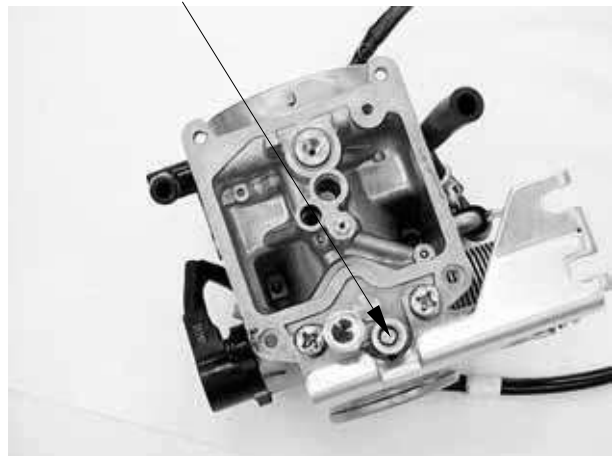

Drain Screw

DISASSEMBLY (XCITING 250)

Loosen the drain screw and drain the fuel from the float chamber.

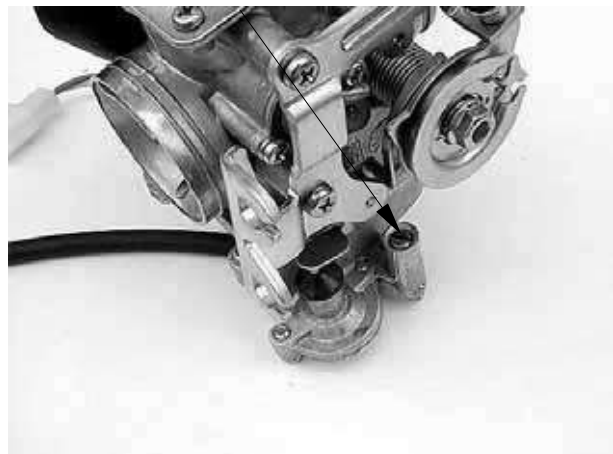

5. FUEL SYSTEM/FUEL PUMP /FUEL TANK/CARBURETOR



XCITING 500/500 AFI/250/300 AFI

With the automatic choke cover removed, remove the screw and automatic choke assembly.

The automatic choke assembly is a non-disassemblable type

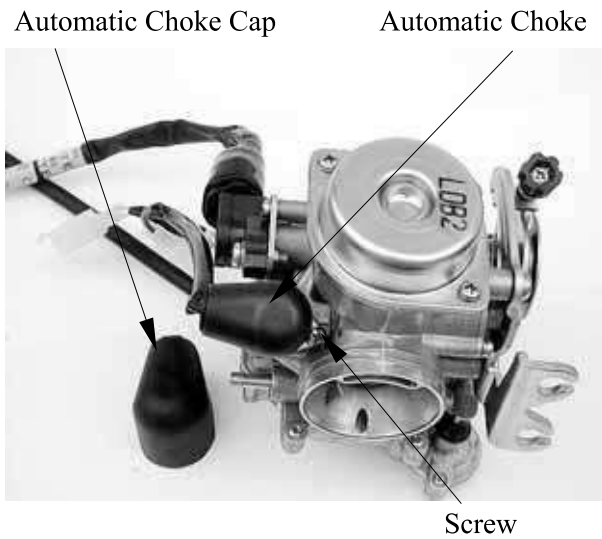

Remove the two screws and top cap.

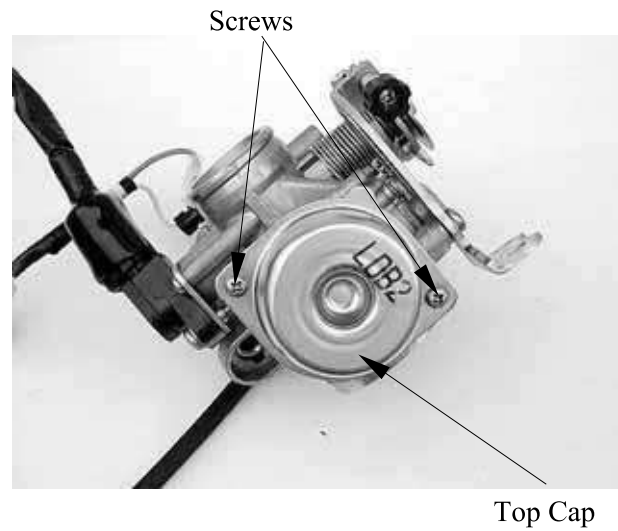

Remove the spring and throttle valve.
Remove the spring retainer/spring and jet needle from throttle valve.

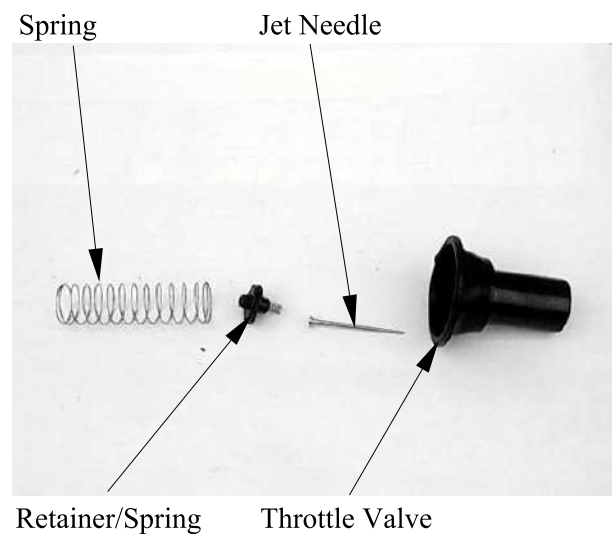

5. FUEL SYSTEM/FUEL PUMP /FUEL TANK/CARBURETOR



XCITING 500/500 AFI/250/300 AFI

Remove the two screws and throttle cable holder.

Remove the two screws and casting enrichment valve cover.

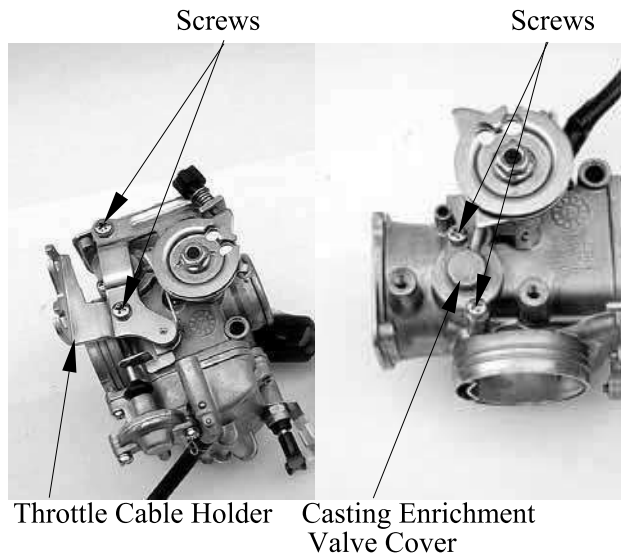

Remove the spring, casting enrichment valve and O-ring.

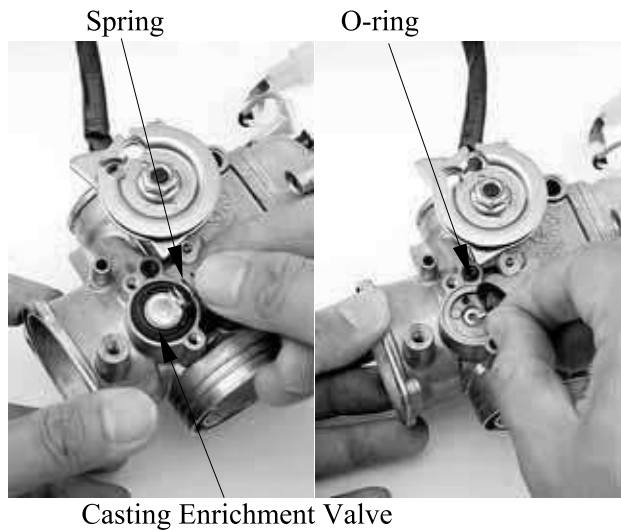

Remove the two screws and accelerating pump cover.

Remove the spring, accelerating pump diaphragm and O-ring

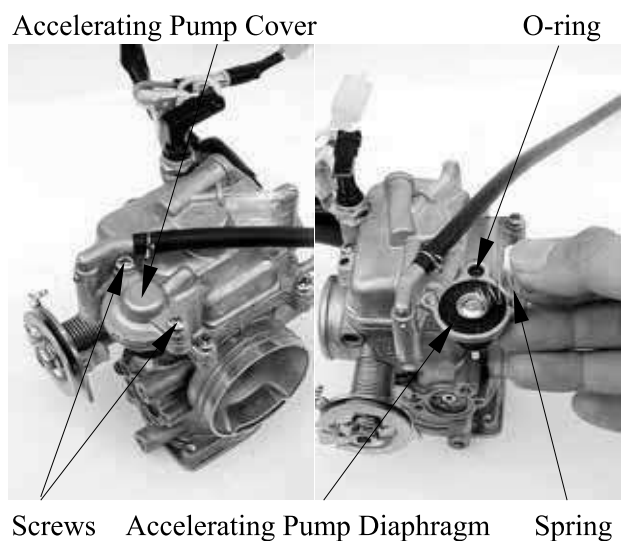

5. FUEL SYSTEM/FUEL PUMP /FUEL TANK/CARBURETOR



XCITING 500/500 AFI/250/300 AFI

Remove the three screws, then remove the float chamber and O-ring.

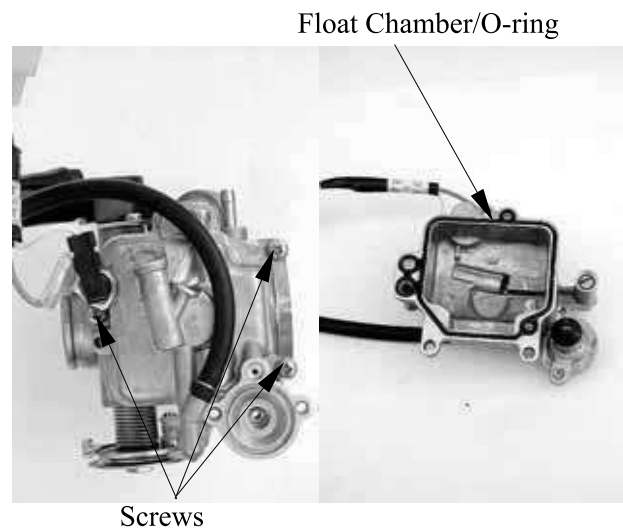

Pull float pin out, then remove the float and float valve.

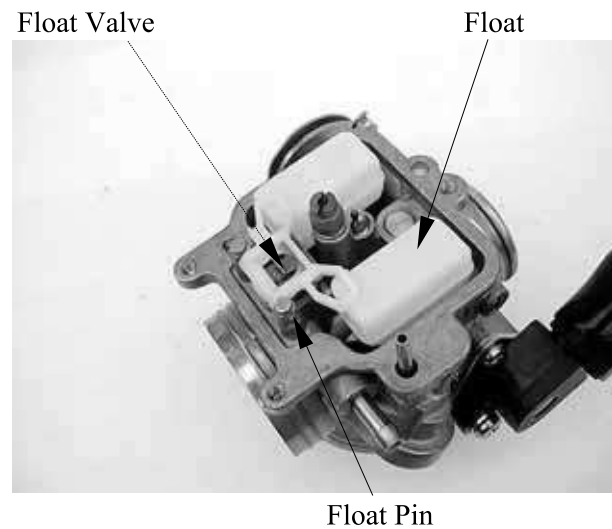

Remove the slow jet.
Remove the main jet, then remove the needle jet holder.

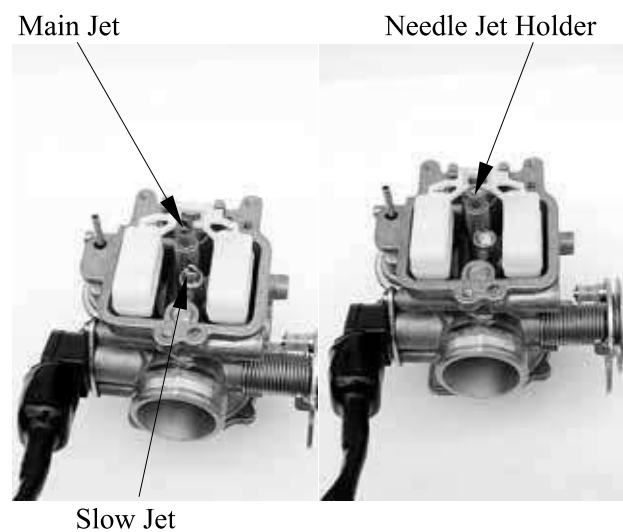

5. FUEL SYSTEM/FUEL PUMP /FUEL TANK/CARBURETOR

Remove the needle jet.

Needle Jet

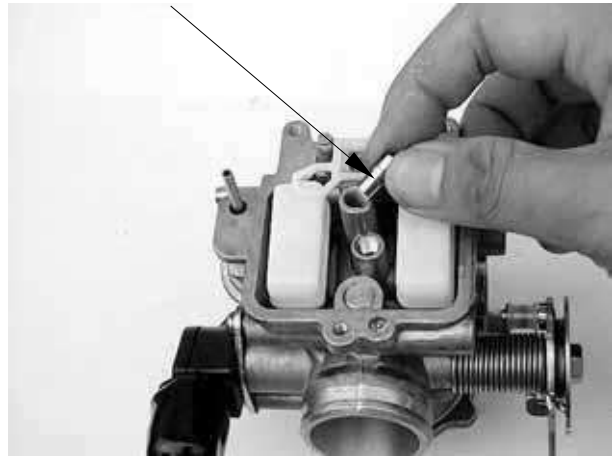

Remove the pilot screw, spring, washer and O-ring.

Before pilot screw removal, slowly turn the pilot screw clockwise and count the number of turns until the screw is lightly seated. Make a note of how many turns were made so the screw can be reset correctly.

Pilot screw

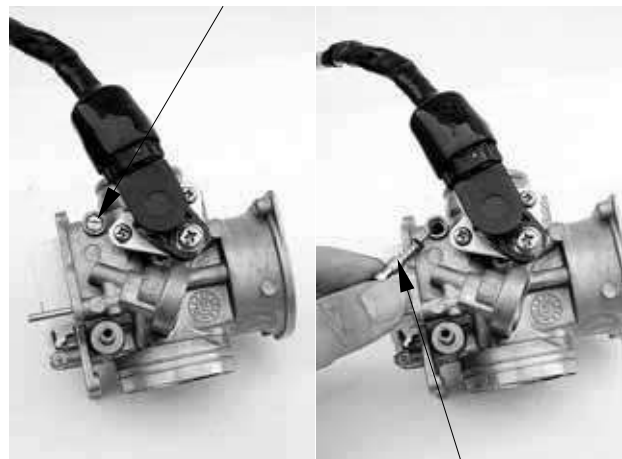

Pilot Screw/Spring/Washer/O-ring

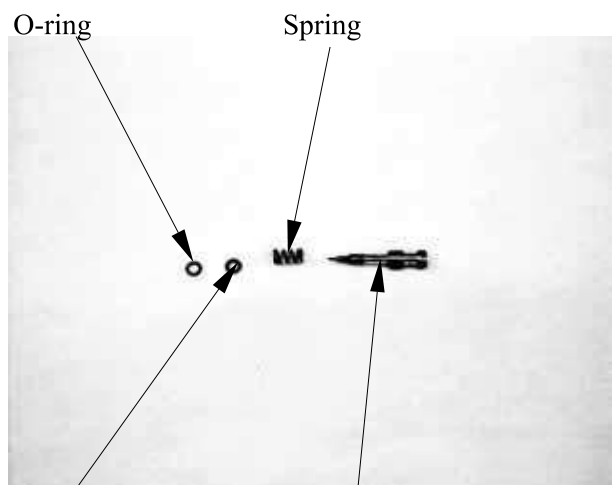

Washer

Pilot Screw

FLOAT/FLOAT VALVE INSPECTION

Inspect the float for deformation or damage.

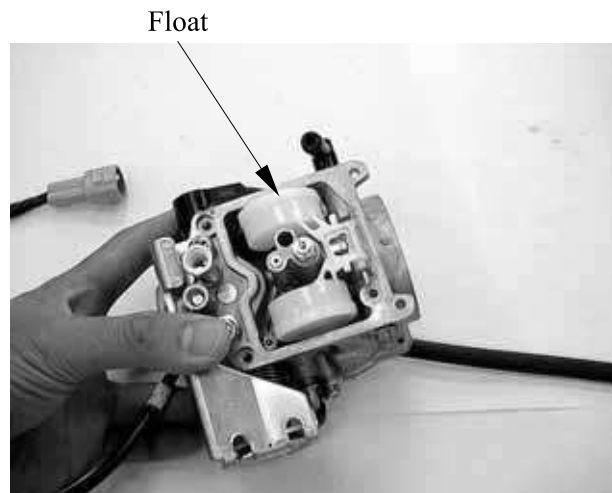

Check the float valve and valve seat for foreign substance, clogging or damage. Check the tip of the float valve, where it contacts the valve seat, for stepped wear or contamination.

Check the operation of the float valve.

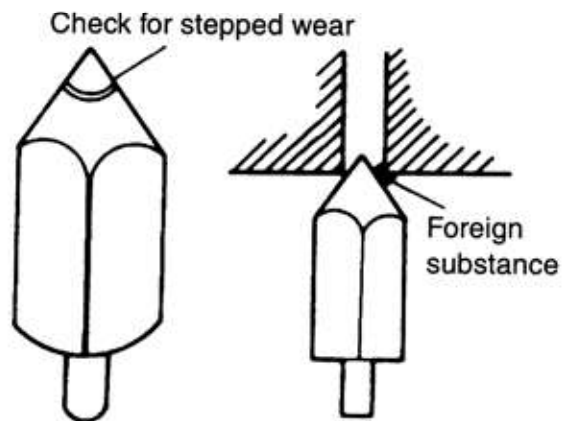

5. FUEL SYSTEM/FUEL PUMP /FUEL TANK/CARBURETOR



XCITING 500/500 AFI/250/300 AFI

CARBURETOR BODY/JETS INSPECTION AND CLEANING

Check carburetor body and each jet for wear or damage.

Clean all jets with a spray-type carburetor cleaner and dry them using compressed air. Clean all circuits of the carburetor thoroughly-not just the perceived problem area.

Clean the circuits in the carburetor body with a spray-type cleaner and allow each circuit to soak, if necessary, to loosen dirt and varnish. Blow the body dry using compressed air.

- Some carburetor cleaning chemicals, especially dip type soaking solutions, are very corrosive and must be handled carefully. Always follow the chemical manufacturer's instructions on proper use, handling and storage.
- Do not use a wire to clean the jets or passageways. A wire can damage the jets and passageways. If the components cannot be cleaned with a spray cleaner it may be necessary to use a dip-type cleaning solution and allow them to soak. Always follow the chemical manufacturer's instructions for proper use and cleaning of the carburetor components.

After cleaning, reassemble the carburetor with new seals.

Main Jet/Needle Jet Holder/Needle Jet

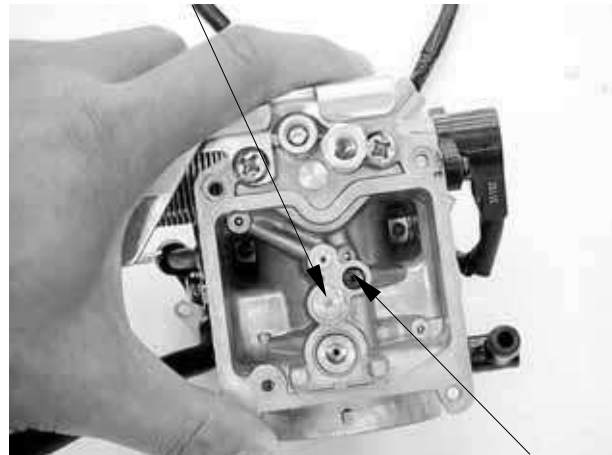

Slow Jet

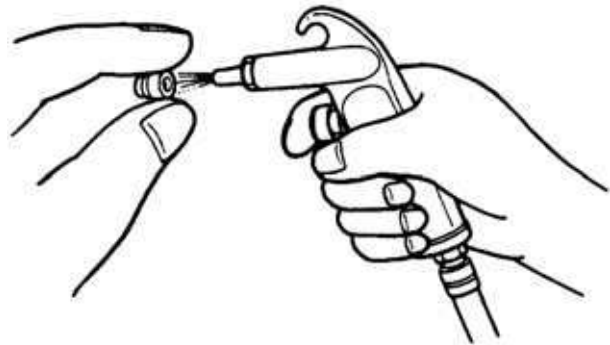

PILOT SCREW INSPECTION

Remove the O-ring from the pilot screw.

Check the pilot screw for wear or damage.

The pilot screw is factory pre-set and should not be removed unless the carburetor is overhauled.

Damage to the pilot screw is tightened against the seat.

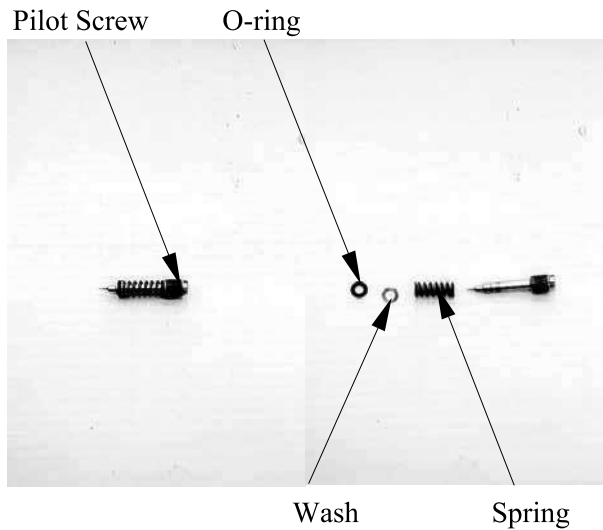

THROTTLE VALVE/JET NEEDLE INSPECTION

Check the throttle valve and jet needle for scratches, wear or damage.

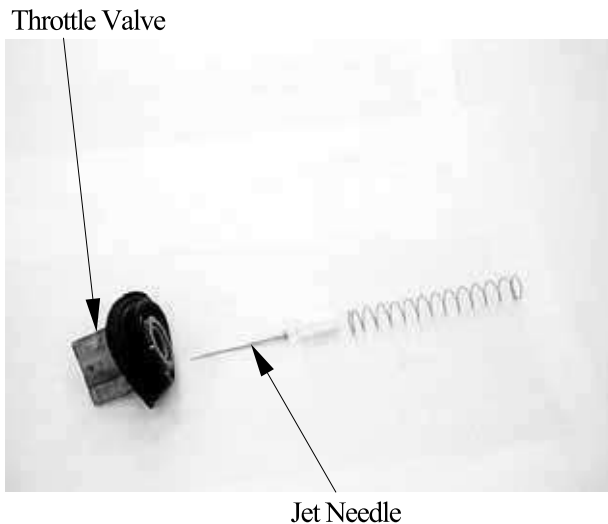

CASTING ENRICHMENT VALVE/ACCELERATING PUMP DIAPHRAGM INSPECTION

Check the casting enrichment valve/accelerating pump diaphragm for damage and clogging. If any abnormal condition is found, wash the part clean. If damage or clogging is found, replace the part with a new one.

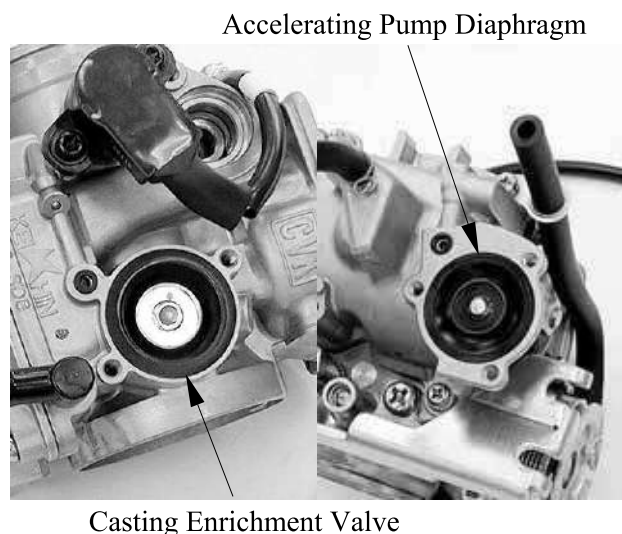

FLOAT LEVEL INSPECTION

Check the float level after checking the float valve, valve seat and float.

Set the carburetor so that the float valve end just contacts the float arm lip. Make sure the float valve tip is securely in contact with the valve seat.

Measure the float level with the float level gauge.

Float level (A):

XCITING 500: 18.5 mm (0.74 in)

XCITING 250: 18 mm (0.72 in)

The float level cannot be adjusted.

Replace the float assembly if the float level is out of specification.

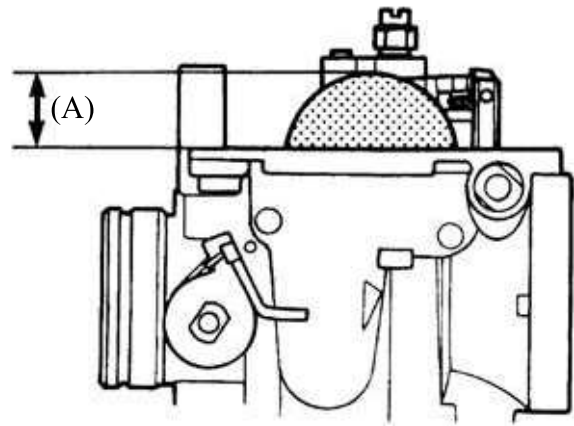

AUTO-BYSTARTER INSPECTION

Disconnect the connector.

Remove the automatic choke cover.

Connect the positive (+) terminal of a 12 V battery to Black/White lead and the negative (-) terminal to the Green/Black lead.

Check that the automatic choke section is heated in 5 minutes after the battery has been connected.

To inspect the function, check for change of temperature from the cold condition.

Do not attempt to disassemble the automatic choke for the purpose of checking temperature.

Automatic Choke

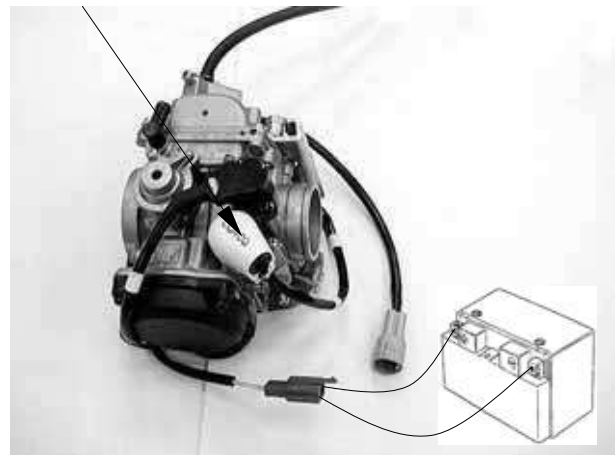

Carburetor Heater

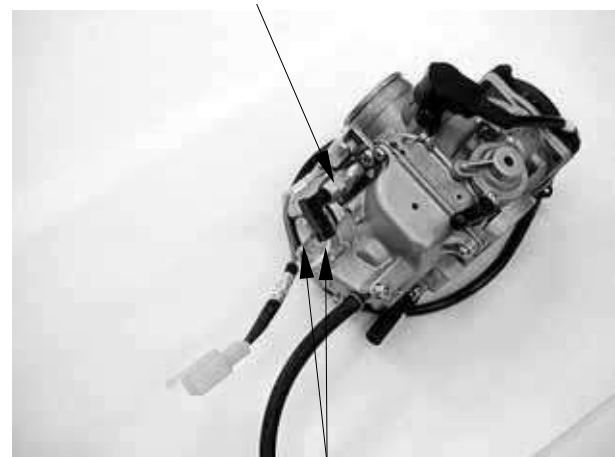

Carburetor Heater Terminal Leads

CARBURETOR HEATER INSPECTION

Disconnect the carburetor heater terminal leads.

5. FUEL SYSTEM / FUEL PUMP / FUEL TANK / CARBURETOR



XCITING 500/500 AFI/250/300 AFI

Connect the positive (+) terminal of a 12 V battery to the terminal of the carburetor heater and the battery negative (-) terminal to the terminal.
Check that the heater section is heated in 5 minutes after the battery has been connected.

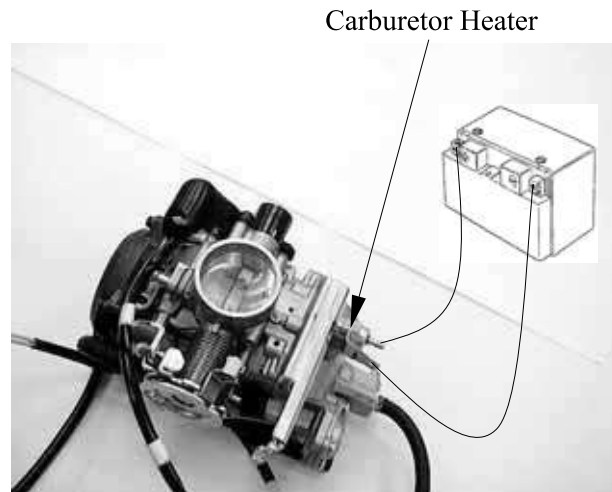

REASSEMBLY

Carburetor reassembly can be performed in the reverse order of disassembly. When reassembling, carefully observe the following instructions.

- Assemble the parts taking consideration of their function.
- Replace O-rings and seals with new ones.

Fit a new O-ring in to the float chamber groove securely.

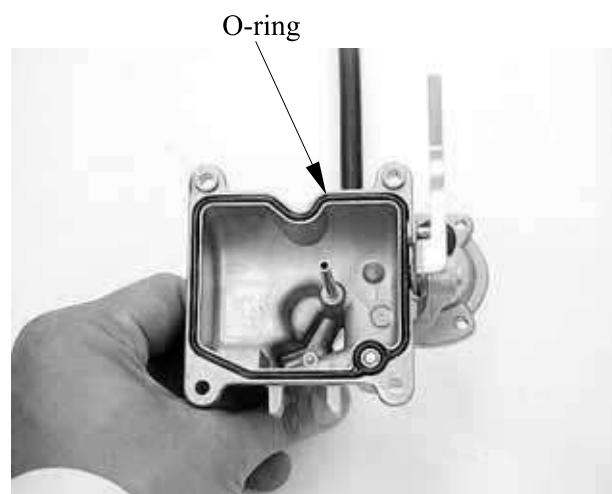

5. FUEL SYSTEM/FUEL PUMP /FUEL TANK/CARBURETOR

Assemble the accelerating pump diaphragm and new O-ring.

Install the accelerating pump diaphragm with the small convex facing up.

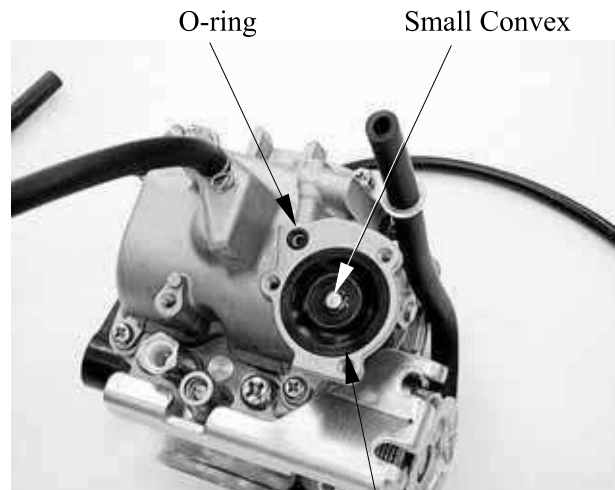

Accelerating Pump Diaphragm

Assemble the coasting enrichment valve and new O-ring.

Assemble the jet needle, spring retainer, spring and throttle valve



Casting Enrichment Valve

Apply thermo-grease to the threads and tighten the carburetor heater securely.

After cleaning, reinstall the pilot screw to the original setting by turn the screw in until it lightly seats, and then backing it out the same number of turns counted during disassembly.

Replace the O-ring with a new one.

After the assembly and installation on the engine have been completed, perform the following adjustment.

Throttle cable adjustment (page 3-6)

Idle speed adjustment (page 3-18)

FUEL FILTER/FUEL PUMP FUEL FILTER INSPECTION

Visually check the fuel filter. If accumulation of sediment or clogging is found, replace the fuel filter with a new one.

Install the fuel filter with the arrow mark facing forward.

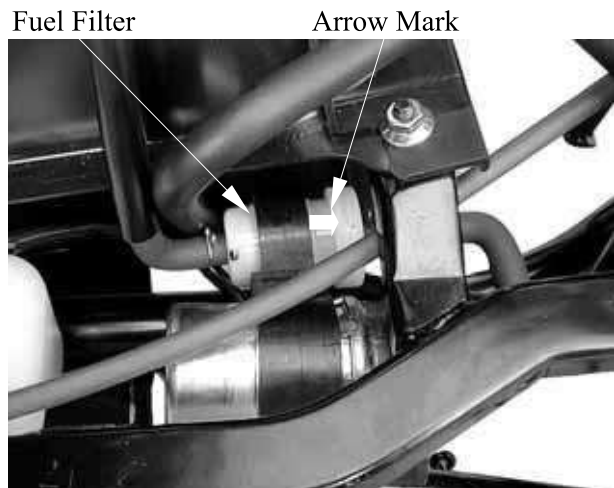

FUEL PUMP INSPECTION (XCITING 500)

Measure resistance between the terminals of fuel pump lead wire coupler.

If the measurement is out of specification replace the fuel pump.

Fuel pump resistance: 1 – 2.5Ω

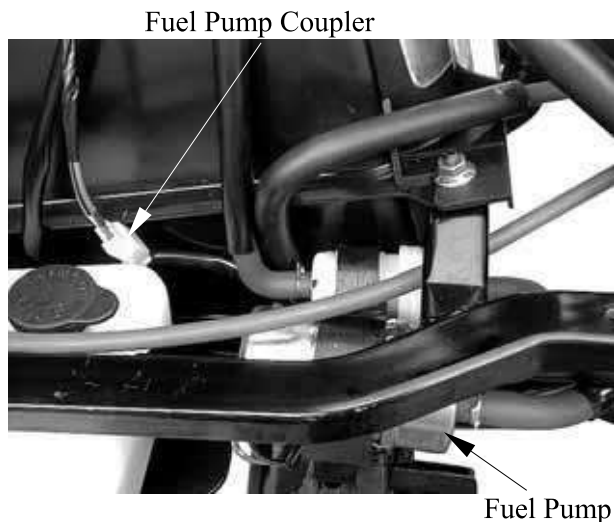

As shown in the right illustration, connect the battery to the fuel pump and measure the pump discharge amount per minute using kerosene.

Battery (+) to Black/Red

Battery (-) to Green

Discharge amount per minute:

370 ml (12.6 US oz, 13 Imp oz)

If the measurement is less than the standard value, replace the fuel pump with a new one.

Do not use gasoline in this test as its is highly combustible.

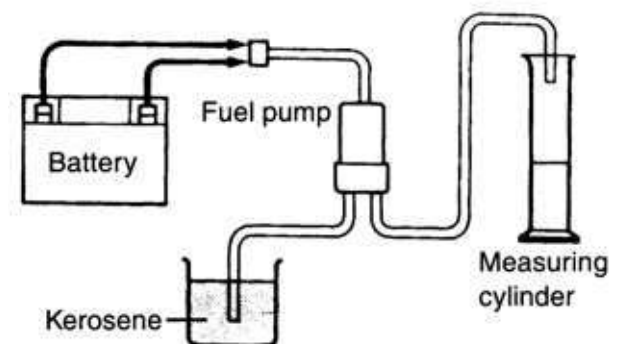

5. FUEL SYSTEM/FUEL PUMP /FUEL TANK/CARBURETOR



XCITING 500/500 AFI/250/300 AFI

FUEL PUMP REMOVAL/INSTALLATION (XCITING 500)

Remove the floorboard (page 2-6).

Disconnect the fuel hoses.
Disconnect the fuel pump connector.
Remove the fuel pump and filter.

Fuel Pump Connector Fuel Hoses

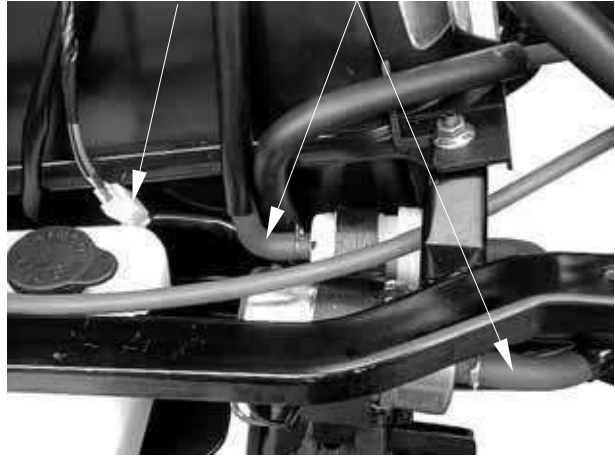

Installation is in the reverse order of removal.

- Install the fuel pump with the arrow mark facing up.
- Connect the fuel inlet hose between the inlet duct of the fuel pump and fuel filter.
- Connect the fuel outlet hose between the outlet duct of the fuel pump and carburetor.

“Arrow” Mark Inlet Duct

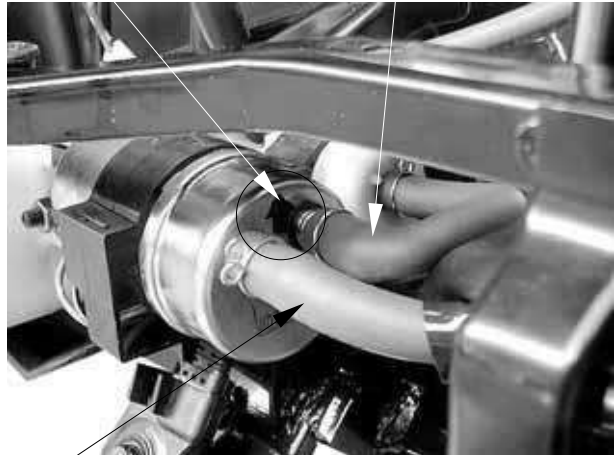

Outlet Duct

FUEL PUMP REMOVAL/INSTALLATION (XCITING 250)

Remove the floorboard (page 2-6).

Disconnect the fuel pump inlet, outlet and vacuum hose from fuel pump.
Remove the nut and fuel pump.

Nut Fuel Outlet Hose Vacuum Hose



Fuel Inlet Hose

5. FUEL SYSTEM / FUEL PUMP / FUEL TANK / CARBURETOR



XCITING 500/500 AFI/250/300 AFI

Installation is in the reverse order of removal.

- Connect the vacuum hose between the vacuum duct of the fuel pump and inlet pipe.
- Connect the fuel inlet hose between the inlet duct of the fuel pump and fuel filter.
- Connect the fuel outlet hose between the outlet duct of the fuel pump and carburetor.

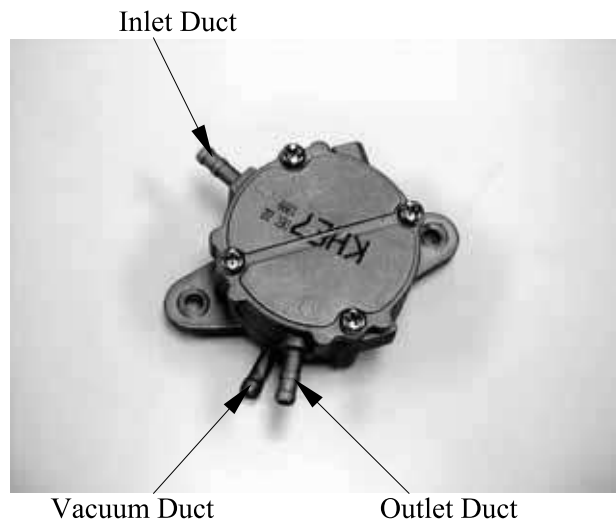

FUEL TANK REMOVAL

Remove the floorboard (page 2-6).
Remove the inner cover (page 2-14).
Remove the front lower cover (page 2-15).
Remove the fuel pump and fuel filter (page 5-24).
Remove the radiator (page 7-23).

Remove the front heat insulation cover.



Heat Insulation Cover

5. FUEL SYSTEM/FUEL PUMP /FUEL TANK/CARBURETOR



XCITING 500/500 AFI/250/300 AFI

Disconnect the fuel unit connector.

Fuel Unit Connector



Remove the four nuts from the fuel tank.

Nuts

Disconnect the ground wire connector.
Disconnect the fuel filler cap open cable.

Ground Wire Connector



Fuel Filler Cap Open Cable

Remove the two nuts and left floorboard set holder from the frame.
Remove the AICV control solenoid valve from the left floorboard set holder.

AICV Control Solenoid Valve



Nuts

5. FUEL SYSTEM / FUEL PUMP / FUEL TANK / CARBURETOR



XCITING 500/500 AFI/250/300 AFI

Remove the fuel tank from the frame left side.



Fuel Tank



Fuel Tank

INSTALLATION

Installation is in the reverse order of removal.



Fuel Tank

AFI (AUTOMATIC FUEL INJECTION)

SERVICE INFORMATION-----	.6- 1
SYSTEM DIAGRAM-----	---6- 4
SYSTEM LOCATION-----	---6- 5
TROUBLESHOOTING-----	---6- 7
SELF-DIAGNOSTIC PROCEDURES WITHOUT DIAGNOSTIC TOOL-----	.6- 8
EFI SELF-DIAGNOSIS CHECK ENGINE LAMP (CELP) FAILURE CODES-----	---6- 9
CELP FAILURE CODES CHART-----	---6-11
SELF-DIAGNOSTIC PROCEDURES USING DIAGNOSTIC TOOL (diagnostic tool)-----	.6-13
AFI SIGNAL DATA-----	.6-17
TPS/ISC RESET-----	.6-21
FUEL PUMP-----	.6-22
FUEL CUT-OFF RELAY-----	.6-24
TILT SWITCH-----	---6-25
AIR IDLE SPEED VALVE, ENGINE CONTROL UNIT (ECU)----	.6-26
FUEL INJECTOR-----	---6-29
ECT SENSOR (500 AFI)-----	.6-31
ECT SENSOR (300 AFI)-----	.6-32
O2/O2 HT SENSOR-----	.6-33
THROTTLE BODY/MAP/ISC/TPS-----	---6-34
DIAGNOSTIC TOOL CONNECTOR-----	---6-39



SERVICE INFORMATION

GENERAL INSTRUCTIONS

- This section covers service of the fuel system.
- These services can be done with the engine installed in the frame.
- Be sure to relieve the fuel pressure before fuel pump or fuel hose removal.
- Bending or twisting the control cables will impair smooth operation and could cause the cables to stick or bind, resulting in loss of vehicle control.
- Work in a well ventilated area. Smoking or allowing flames or sparks in the work area or where gasoline is stored can cause a fire or explosion.
- Do not apply commercially available carburetor cleaners to the inside of the throttle bore, which is coated with molybdenum.
- Do not snap the throttle valve from fully open to fully close after the throttle cable has been removed; it may cause incorrect idle operation.
- Do not loosen or tighten the painted bolts and screws of the throttle body. Loosening or tighten them can cause throttle and idle valve synchronization failure.
- Seal the cylinder head intake ports with tape or a clean cloth to keep dirt and debris from entering the intake ports after the throttle body has been removed.
- Do not damage the throttle body. It may cause incorrect throttle and idle valve synchronization.
- Do not push the fuel pump base under the fuel tank when the fuel tank is stored.
- Always replace the packing when the fuel pump is removed.
- The electronic fuel injection system is equipped with the self-diagnostic system described on page 6-8 (without diagnostic tool) or page 6-13 (using diagnostic tool). If the Check Engine Lamp “CELP” illuminate while riding, follow the self-diagnostic procedures to remedy the problem.
- A faulty AFI system is often related to poorly connected or corroded connectors. Check those connections before proceeding.
- When disassembling the fuel injection parts, note the location of the O-rings. Replace them with new ones upon reassembly.
- Do not disconnect the battery negative or positive cable while engine is running, it may cause ECU damage.
- Connect the battery cables mistook may cause ECU damage.
- Do not disconnect or connect the ECU connector during the ignition switch “ON”; it may cause the ECU damage.

6. AFI (AUTOMATIC FUEL INJECTION)



XCITING 500/500 AFI/250/300 AFI

SPECIFICATIONS(XCITING 500 AFI)

ITEM		SPECIFICATIONS
Throttle body identification number		
Idle speed		1400±100 rpm
Throttle grip free play		2~6 mm (1/16~1/4 in)
Fuel injector resistance (at 20°C/68°F)		11.7±0.6Ω
Fuel pump resistance (at 20°C/68°F)	Float at full position	7±3 Ω
	Float at empty position	95±5 Ω
Fuel pump standard pressure (at 40 L/H)		294±6 kPa
Fuel pump flow (at 12 V/Standard pressure)		20 L/Hr (MIN)
Engine coolant temperature sensor resistance	At -20°C/28°F	18.8 KΩ
	At 40°C/88°F	1.136 KΩ
	At 100°C/148°F	0.1553 KΩ 25C:2.076+ - 10%
Intake pressure sensor (MAP) pressure (at 1~4.2 V)		13.332 kPa (0.13332 kgf/cm ² , 1.89 psi)~ 119.99 kPa (1.1999 kgf/cm ² , 17.04 psi)
Throttle position sensor (TPS) resistance (at 20°C/68°F)		0.3~4.5 V (at throttle valve open 0~100%)
Idle air bypass A/B valve (ISC) resistance (at 20°C/68°F)		80±5 Ω
Crank position sensor voltage (at any rpm)		Over 1 mV
O2 heater sensor resistance (at 20°C/68°F)		7.7±1.2 Ω
Tilt switch voltage	Standard	0.4~1.4 V
	Over 65° position	3.7~4.4 V
Air idle speed valve (AICV) resistance (at 20°C/68°F)		35.5~40.5 Ω

SPECIFICATIONS(XCITING 300 AFI)

ITEM		SPECIFICATIONS
Throttle body identification number		
Idle speed		1600±100 rpm
Throttle grip free play		2~6 mm (1/16~1/4 in)
Fuel injector resistance (at 20°C/68°F)		11.7±0.6Ω
Fuel pump resistance (at 20°C/68°F)	Float at full position	7±3 Ω
	Float at empty position	95±5 Ω
Fuel pump standard pressure (at 40 L/H)		294±6 kPa
Fuel pump flow (at 12 V/Standard pressure)		20 L/Hr (MIN)
Engine coolant temperature sensor resistance	At -20°C/28°F	18.8 KΩ
	At 40°C/88°F	1.136 KΩ
	At 100°C/148°F	0.1553 KΩ
Intake pressure sensor (MAP) pressure (at 1~4.2 V)		13.332 kPa (0.13332 kgf/ cm ² , 1.89 psi)~ 119.99 kPa (1.1999 kgf/ cm ² , 17.04 psi)
Throttle position sensor (TPS) resistance (at 20°C/68°F)		0.3~4.5 V (at throttle valve open 0~100%)
Idle air bypass A/B valve (ISC)		
Crank position sensor voltage (at 200 rpm)		Over 1 V
O2 heater sensor resistance (at 20°C/68°F)		7.7±1.2 Ω
Tilt switch voltage	Standard	0.4~1.4 V
	Over 65° position	3.7~4.4 V
Air idle speed valve (AISV) resistance (at 20°C/68°F)		25.95~29.55 Ω

SYSTEM DIAGRAM

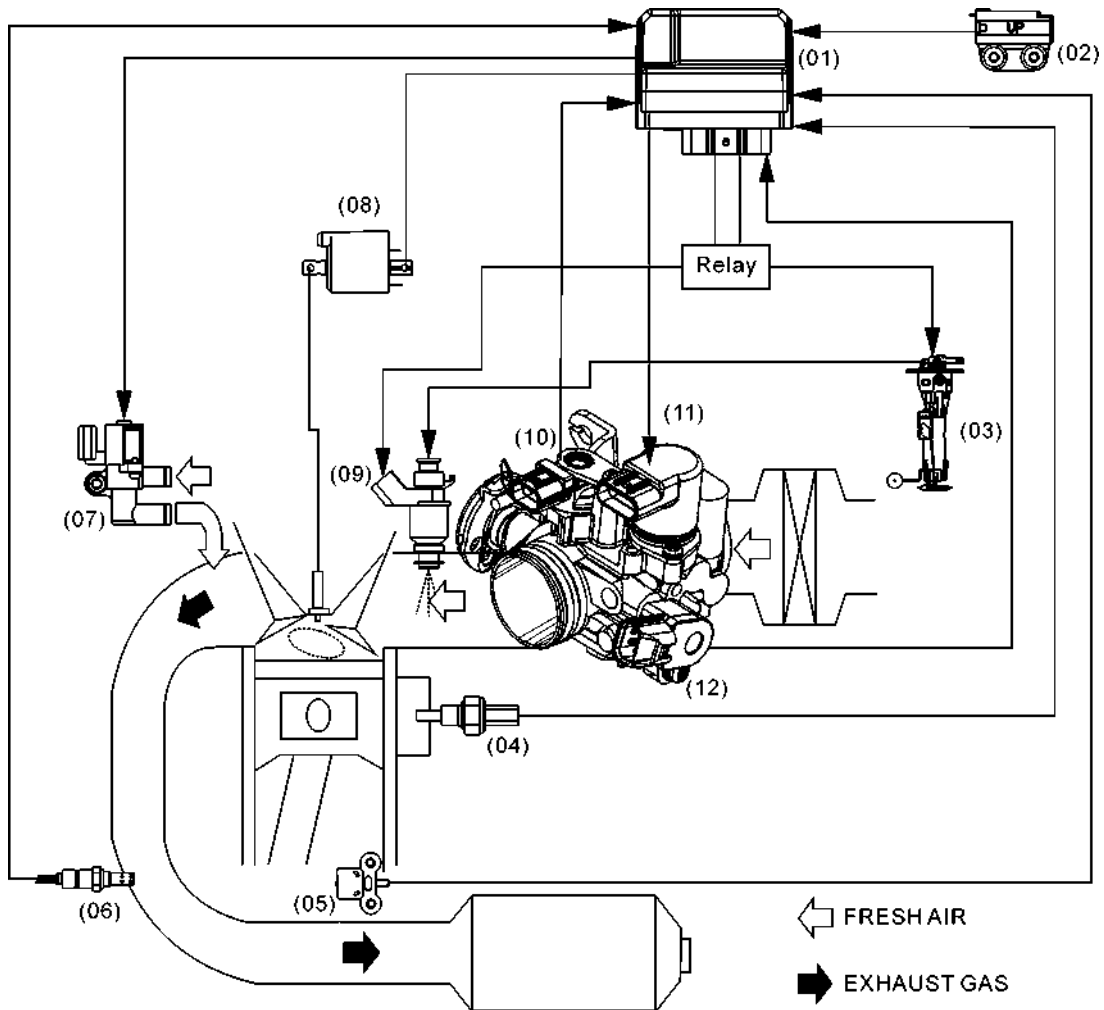

No.	FULL NAME	ABBREVIATIONS
(01)	Engine control unit	ECU
(02)	Tilt switch (Angle detect sensor)	ROLL
(03)	Fuel pump/Fuel level unit	FP
(04)	Engine coolant temperature sensor	ECT sensor
(05)	Crank position sensor (Pulser)	CPS
(06)	Oxygen/Oxygen heater sensor	O2/O2 HT sensor
(07)	Air idle speed valve (Secondary air valve)	(AISV)
(08)	Inductive ignition coil	IG
(09)	Fuel injector (Nozzle)	INJ
(10)	Intake pressure sensor	MAP sensor
(11)	Idle air bypass valve	ISC
(12)	Throttle position sensor	TPS

6. AFI (AUTOMATIC FUEL INJECTION)



XCITING 500/500 AFI/250/300 AFI

SYSTEM LOCATION(XCITING 500 AFI)

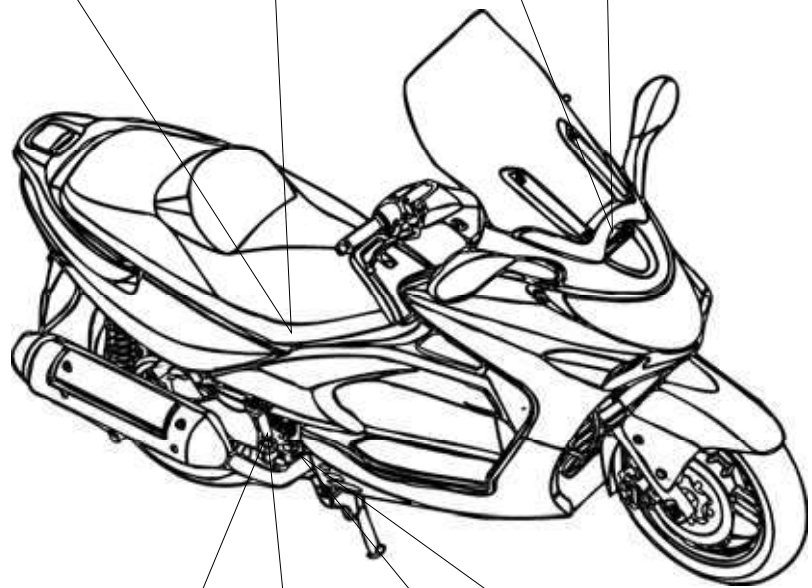
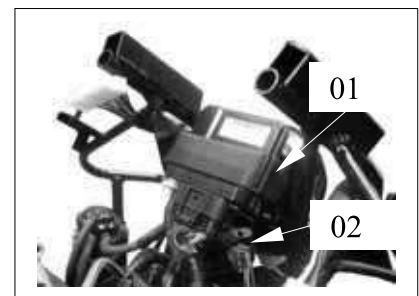
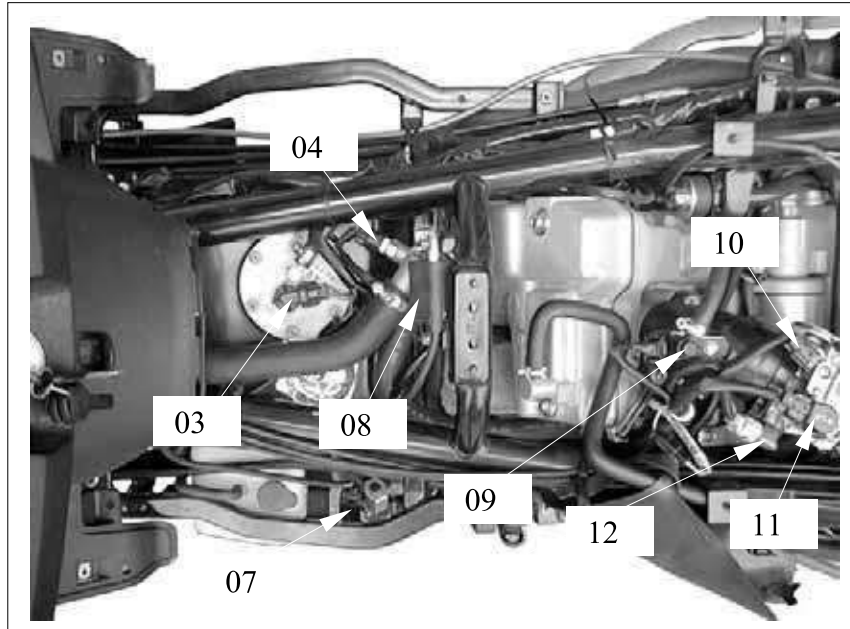

- 01: ECU
- 02: ROLL
- 03: Fuel pump/Fuel level unit
- 04: ECT sensor
- 05: CPS
- 06: O2/O2 HT sensor
- 07: EXAI
- 08: IG
- 09: INJ
- 10: MAP sensor
- 11: ISC
- 12: TPS

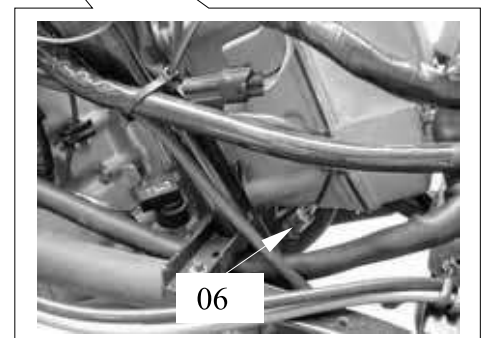
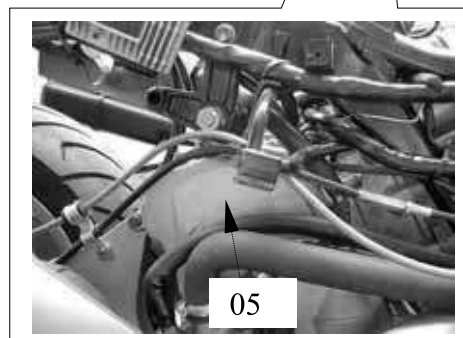

SYSTEM LOCATION (XCITING 300 AFI)

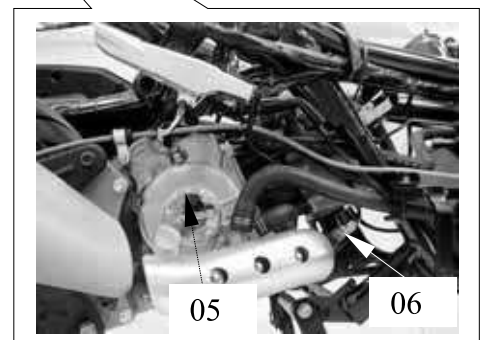
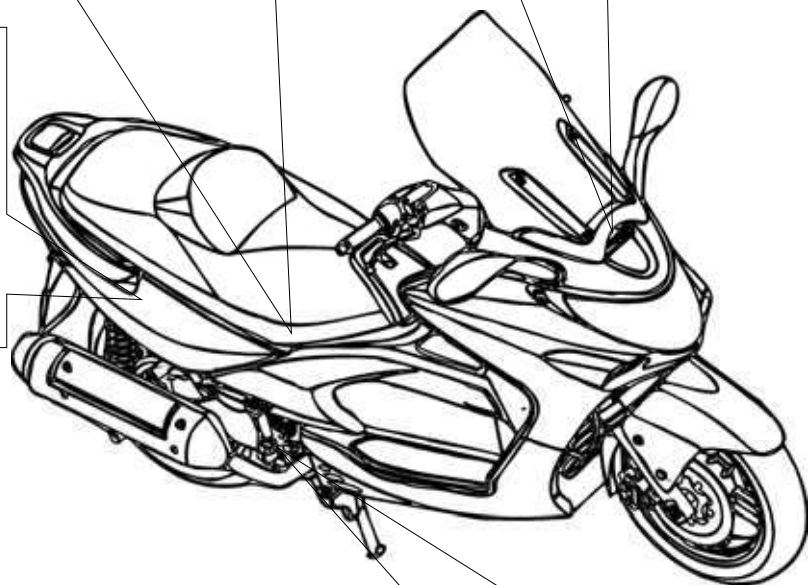
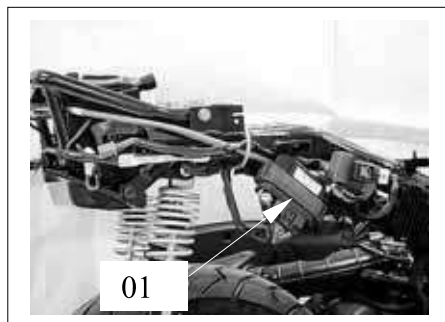
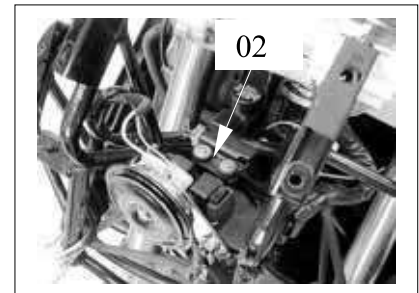
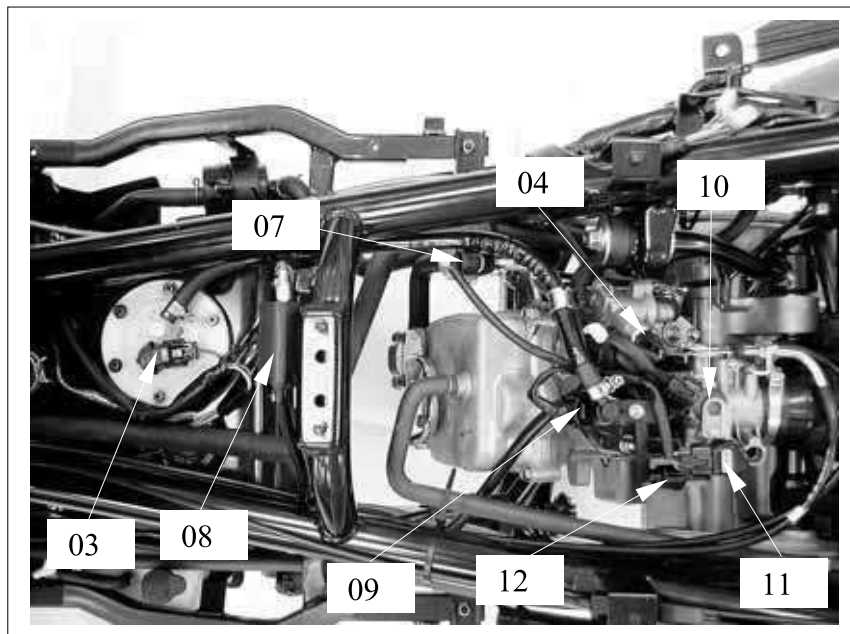

- 01: ECU
- 02: ROLL
- 03: Fuel pump/Fuel level unit
- 04: ECT sensor
- 05: CPS
- 06: O2/O2 HT sensor
- 07: AISV
- 08: IG
- 09: INJ
- 10: MAP sensor
- 11: ISC
- 12: TPS

TROUBLESHOOTING

Engine would not start

- Intake air leak
- Fuel contaminated/deteriorated
- Pinched or clogged fuel hose
- Faulty fuel pump
- Clogged fuel filter
- Sticking fuel injector needle
- Faulty fuel pump operating system

Backfiring or misfiring during acceleration

- Ignition system malfunction

Engine stall, hard to start, rough idling

- Intake air leak
- Fuel contaminated/deteriorated
- Pinched or clogged fuel hose
- Idle speed misadjustment
- Fail to perform PTS/ISC reset

Poor performance (drive ability) and poor fuel economy

- Pinched or clogged fuel hose
- faulty injector

SELF-DIAGNOSTIC PROCEDURES WITHOUT DIAGNOSTIC TOOL

SELF-DIAGNOSTIC PROCEDURES

* Without diagnostics program can be performed condition.

Place the scooter on its main stand.
Put the side stand up and the engine stop switch is at "RUN".

- Turn the ignition switch "ON" with no engine speed, the CELP will light for two second then off. It shows the lamp work normal.
- Turn the ignition switch "ON" with no engine speed, after "lamp test" illumination 2 seconds and the lamp shall turn off for 5 seconds. The "CELP" will start blinking if the ECU has self-diagnosis memory data.

Note no matter when the "CELP" illuminate while riding, and determine the cause of the problem (page 6-11 through 6-12).

SELF-DIAGNOSIS RESET (CLEAR FAILURE CODES) PROCEDURE

1. Put the side stand up and engine stop switch is at "RUN".
2. Turn the ignition switch "OFF" and close the throttle fully.
3. Disconnect the diagnostic tool (page 6-13).
4. Turn the ignition switch "ON" and wait 10 seconds.
5. Open and hold the throttle fully, after 10 seconds close the throttle fully.

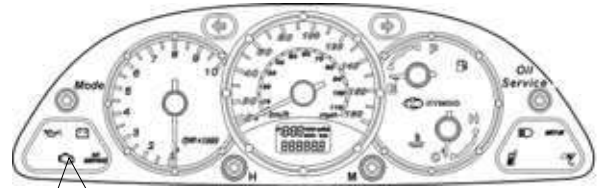

Check Engine Lamp (CELP)

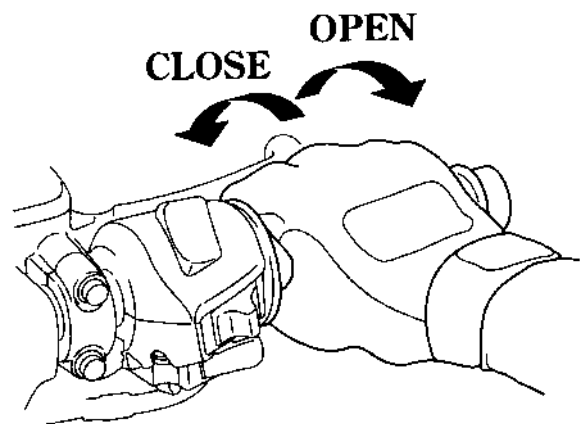

6. The CELP will blink 2 times after 5 seconds. Self-diagnosis memory data is erased if the CELP turns off.

* The self-diagnosis can not reset when there still is trouble in the system.

EFI SELF-DIAGNOSIS CHECK ENGINE LAMP (CELP) FAILURE CODES

- The “CELP” denotes the failure codes. When the indicator lights for 1 second it is equivalent 10 blinks. For example, a 1 second illumination and two blink (0.5 second x 2) of the indicator equals 12 blinks. Follow code 12.

Example 1 (procedures):

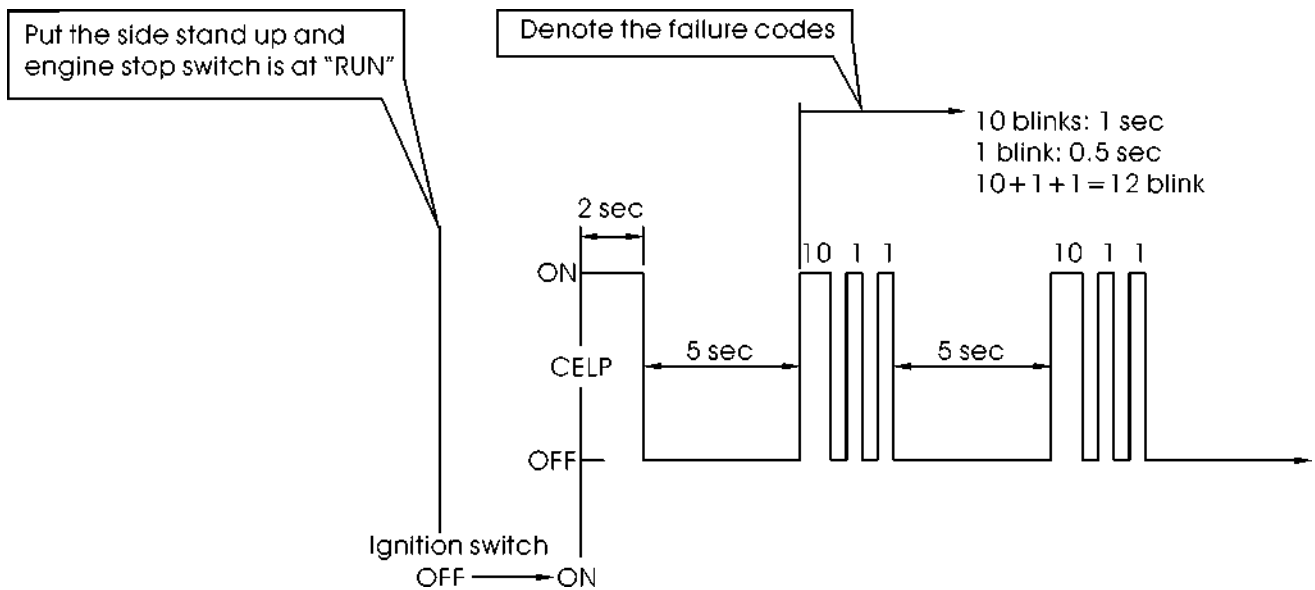

- When more than one failure occurs, the "CELP" shows the blinks in the occurred order. For example, if the indicator blinks 6 times, then 1-second illumination and two blinks, two failures have occurred. Follow code 6 and 12.

Example 2 (failure codes 6 and 12):

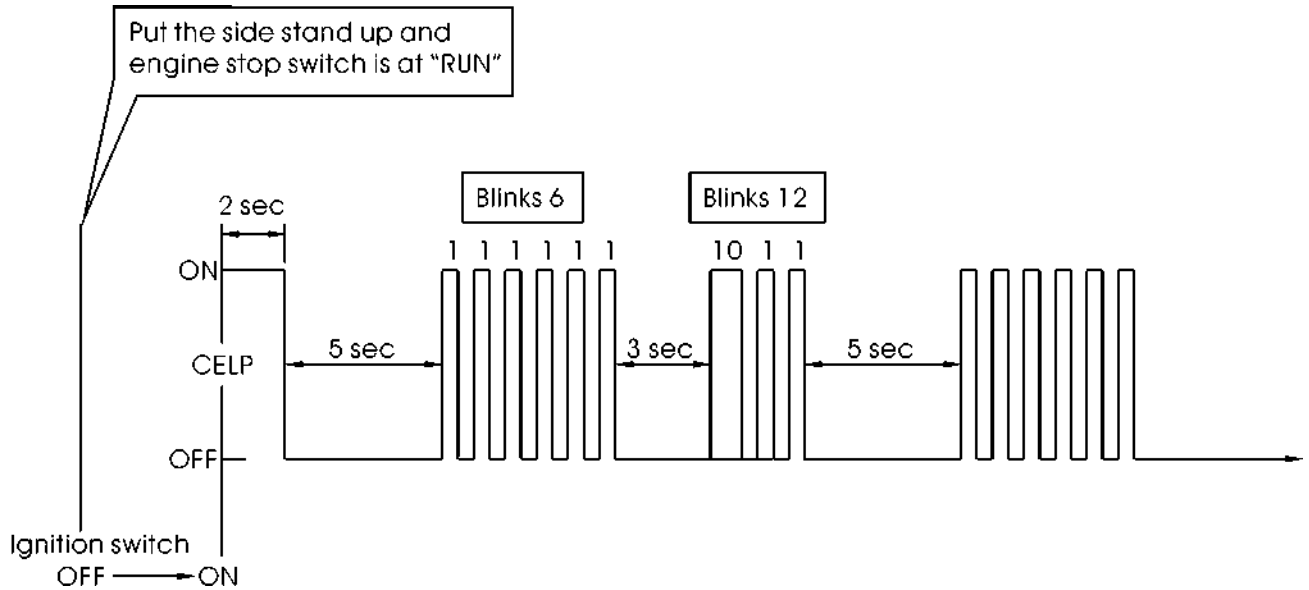

CELP FAILURE CODES CHART

Blinks	Failure Codes (diagnostic tool)	Contents	Causes	Symptoms
06	P0120	Faulty TPS	<ul style="list-style-type: none"> • TPS range fault • TPS voltage range (0.3~4.5 V) fault • Loose or poor contacts on TP Sensor • Open or short circuit in TPS wire • Faulty TPS 	<ul style="list-style-type: none"> • Engine operates normally
09	P0105	Faulty MAP	<ul style="list-style-type: none"> • MAP voltage range (1~4.2 V) fault • Loose or poor contacts on MAP • Open or short circuit in MAP wire • Faulty MAP 	<ul style="list-style-type: none"> • Engine operates normally
11	P0195	Faulty ECT (oil temperature)	<ul style="list-style-type: none"> • No this equipment 	
12	P0115	Faulty ECT (water temperature)	<ul style="list-style-type: none"> • ECT Ω range (-20°C: 18.8 Ω/40°C: 1.136 Ω/100°C: 0.1553 Ω) fault • Loose or poor contacts on ECT • Open or short circuit in ECT wire • Faulty ECT 	<ul style="list-style-type: none"> • Engine operates normally
13	P0110	Faulty IAT	<ul style="list-style-type: none"> • No this equipment 	
15	P1630	Faulty Tilt switch (Roll)	<ul style="list-style-type: none"> • Tilt switch voltage range (incline angle < 65°: 0.4~1.4 V/incline angle . 65°: 3.7~4.4 V) fault • Loose or poor contacts on tilt switch • Open or short circuit in tilt switch wire • Faulty tilt switch 	<ul style="list-style-type: none"> • Engine operates normally
17	P0130	Faulty O2 sensor	<ul style="list-style-type: none"> • O2 sensor voltage range (A/F below 14.7: > 0.7V/ A/F over 14.7: < 0.18 V) fault • Loose or poor contacts on O2 sensor • Open or short circuit in O2 sensor wire • Faulty O2 sensor 	<ul style="list-style-type: none"> • Engine operates normally
33	P0201	Faulty injector (Nozzle)	<ul style="list-style-type: none"> • Fuel injector Ω range (11.7Ω \pm 15%) fault • Loose or poor contacts on injector • Open or short circuit in injector wire • Faulty fuel injector 	<ul style="list-style-type: none"> • Engine does not start • Engine does not operate

(Cont'd)

6. AFI (AUTOMATIC FUEL INJECTION)



XCITING 500/500 AFI/250/300 AFI

Blinks	Failure Codes (diagnostic tool)	Contents	Causes	Symptoms
37	P0351	Faulty inductive ignition coil	<ul style="list-style-type: none"> ● Inductive ignition coil Ω range ($4.2 \Omega \pm 15\%$) fault ● Loose or poor contacts on inductive ignition coil ● Open or short circuit in inductive ignition coil wire ● Faulty inductive ignition coil 	<ul style="list-style-type: none"> ● Engine does not start ● Engine does not operate
41	P0230	Faulty fuel pump	<ul style="list-style-type: none"> ● Fuel pump Ω range ($11.7 \Omega \pm 15\%$) fault ● Loose or poor contacts on fuel pump ● Open or short circuit in fuel pump wire ● Faulty fuel pump 	<ul style="list-style-type: none"> ● Engine does not start ● Engine does not operate
45	P0135	Faulty O2 sensor heater	<ul style="list-style-type: none"> ● O2 sensor heater Ω range ($7.7 \Omega \pm 2 \Omega$) fault ● Loose or poor contacts on O2 sensor heater ● Open or short circuit in O2 sensor heater wire ● Faulty O2 sensor heater 	<ul style="list-style-type: none"> ● Engine starts normally ● Engine does not operate
49	P1505	Faulty ISC	<ul style="list-style-type: none"> ● Loose or poor contacts on ISC ● Open or short circuit in ISC wire ● Faulty ISC 	<ul style="list-style-type: none"> ● Engine operates normally
54	P1410	Faulty AICV (AISV)	<ul style="list-style-type: none"> ● AISV Ω range fault ● Loose or poor contacts on AISV ● Open or short circuit in AISV wire ● Faulty AISV 	<ul style="list-style-type: none"> ● Engine operates normally
66	P0335	Faulty CPS	<ul style="list-style-type: none"> ● Loose or poor contacts on CPS ● Open or short circuit in CPS wire ● Faulty CPS 	<ul style="list-style-type: none"> ● Engine does not start ● Engine does not operate

KYMCO Fi DIAGNOSTIC TOOL (Part No,3620A-LEB2-E00)

DIAGNOSTIC PROCEDURE

Connect the KYMCO Fi Diagnostic tool with this connector as picture. Upward the side stand and keep the engine stop switch is at “RUN” position. This power is from the battery.



Diagnostic Tool Connector

Main drawing introduce

Model No.



Press ENTER button



Check the ECU version

Loading DTC



Press ENTER

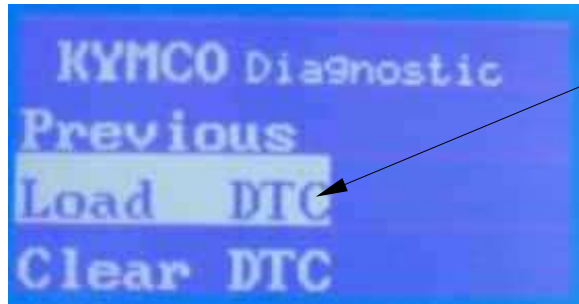

Loading DTC



Press ENTER button



Current DTC



Press ENTER button



NO Current DTC



Press ENTER button

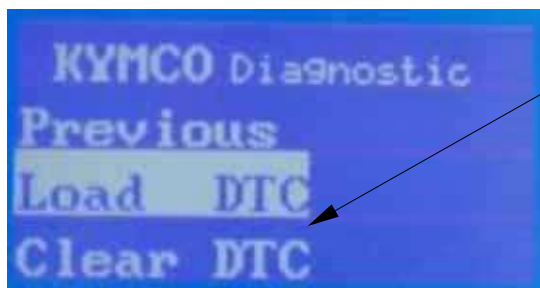

Loading DTC



Press ENTER button



Freeze DTC

6. AFI (AUTOMATIC FUEL INJECTION)



XCITING 500/500 AFI/250/300 AFI



Press ENTER button

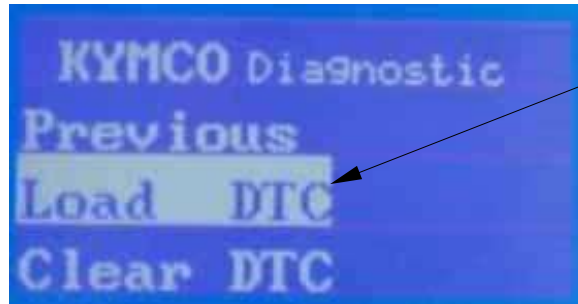

Loading DTC



Press ENTER button



All DTC

Clear DTC



Press ENTER button

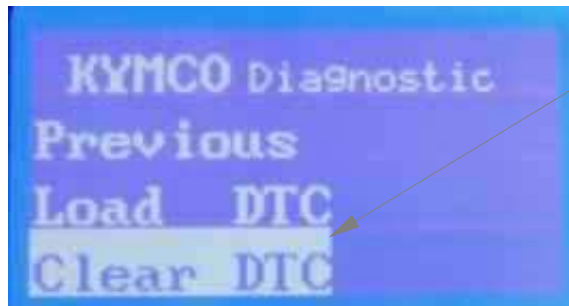

Clear DTC



Press ENTER button



Completed

6. AFI (AUTOMATIC FUEL INJECTION)



XCITING 500/500 AFI/250/300 AFI

Data Analyze(Please see XCITING 300i diagnostic report standard) to checking it. Page 20)

Page 01



Press ENTER button



Page 02



Page 03



Page 05



Page 04



Page 06



Data Analyze(Please see XCITING 300i diagnostic report standard) to checking it. page 20)



Page 07

Roll sensor is normal

CO ADJUST (Please connect E/M measure machine checking it and see XCITING 300i diagnostic report co item standard-page 20)

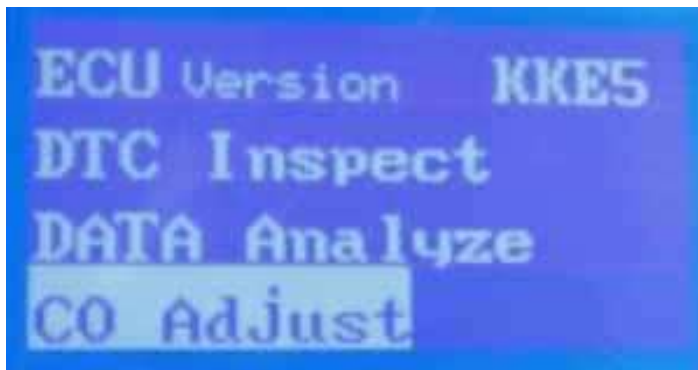

Press ENTER button



Press ENTER button



UP
button:+1

DOWN
button:-1



UP button:1



DOWN button:-1

TPS/ISC RESET

- The ECU may record incorrect TPS close fully or open fully position when the ECU or the throttle body has been reinstalled. It can cause engine stall, hard to start or rough idling.
- ISC has a motor inside. It controls ISC valve to obtain regulated idling. The ECU may record incorrect ISC position during the engine speed is 0 rpm when the ECU or the throttle body has been reinstalled. It can cause engine stall, hard to start or rough idling.

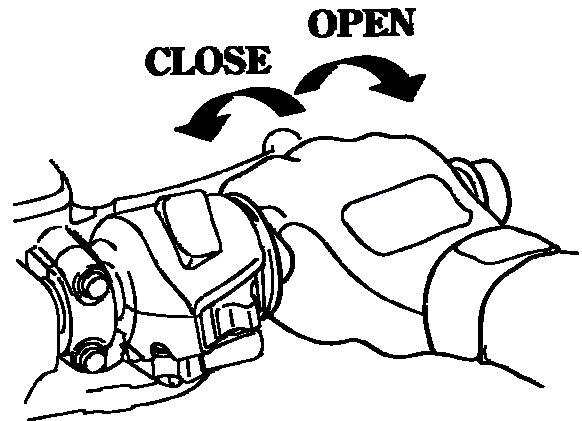

The throttle position sensor (TPS) and idle air bypass valve (ISC) have to reset when the throttle body MAP, TPS, ISC or ECU has been reinstalled.

TPS/ISC RESET PROCEDURE

1. Put the side stand up and engine stop switch is at "RUN".
2. Turn the ignition switch to "OFF".
3. Open and hold the throttle fully.
4. Turn the ignition switch to "ON", after 8 seconds close the throttle fully.
5. Turn the ignition switch to "OFF".
6. When turn the ignition switch to "ON" again, the TPS and ISC have been reset.
7. Enter EFI signal data page 02 then close the throttle fully
 Check "Throttle position (TP)" is 1.0% below and "Throttle position sensor output voltage (TPAD)" is 0.5 ± 0.10 V.
 If not repeat the steps from 1 to 6.
8. Open the throttle fully and check "Throttle position (TP)" is 94% over and "Throttle position sensor output voltage (TPAD)" is 3.5 to 3.9 V.
 If not repeat the steps from 1 to 6.

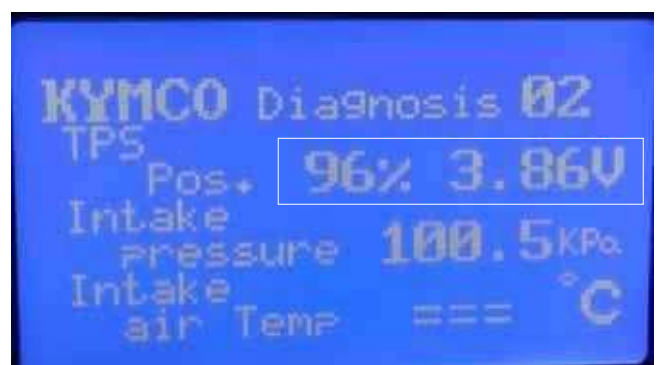

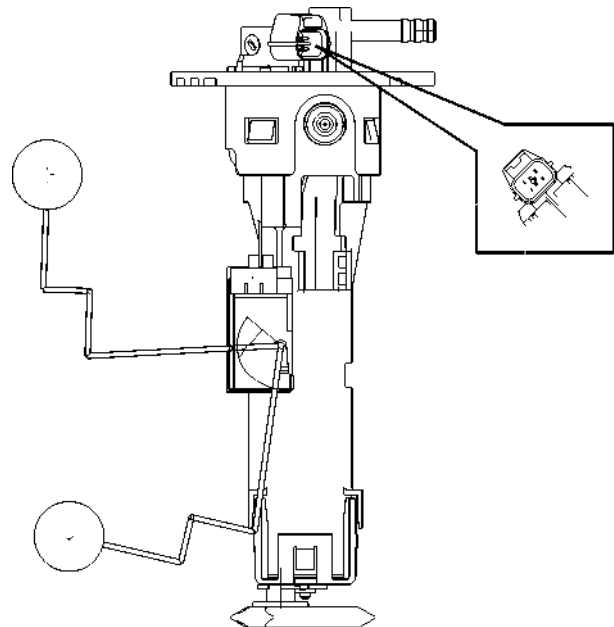

REMOVAL

Disconnect the fuel pump connector and fuel hose from fuel pump.

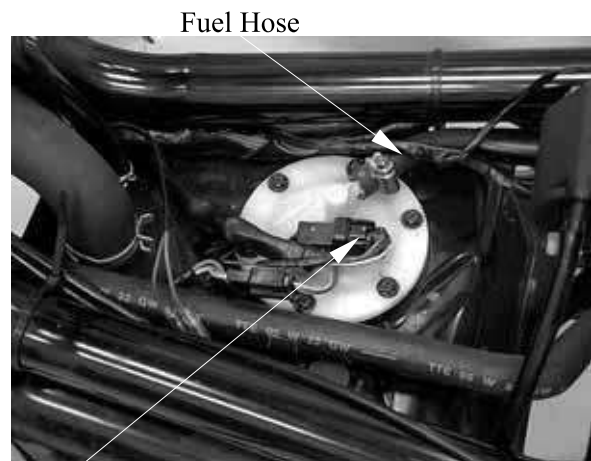

Fuel Pump Connector

Remove the six screws, then remove the fuel pump and O-ring.

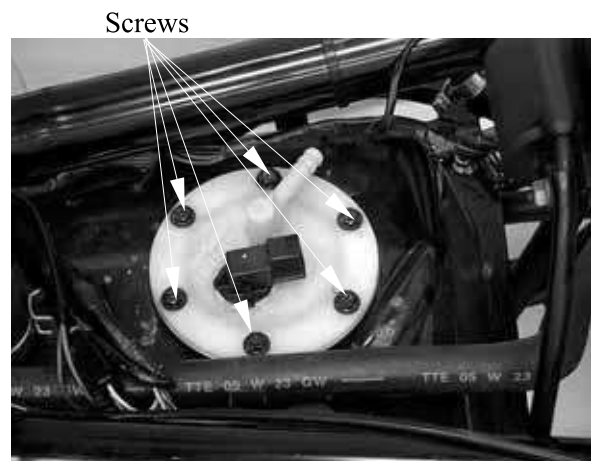

Screws

INSTALLATION

Place a new O-ring onto fuel tank.

Install the fuel pump being careful not to damage the fuel pump wire and make sure fuel connector rearward.

Install and tighten the screws using crisscross pattern to the specified torque.

Torque: 0.35 kgf-m (3.5 N-m, 2.5 lbf-ft)



O-ring

FUEL CUT-OFF RELAY

INSPECTION

Remove the fuel cut-off relay.
Connect the ohmmeter to the fuel cut-off relay connector terminals.

Connection: Black – Red/Black

Connect the 12 V battery to the following fuel cut-off relay connector terminals

Connection: Blue/Black – Black

There should be continuity only when the 12 V battery is connected.
If there is no continuity when the 12 V battery is connected, replace the fuel cut-off relay.

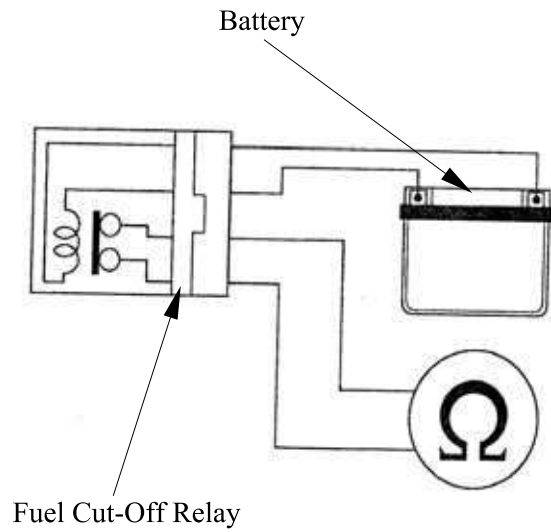

REMOVAL (500 AFI)

Disconnect the fuel cut-off relay connector, then remove it from frame.



Fuel Cut-off Relay

REMOVAL (300 AFI)

Disconnect the fuel cut-off relay connector, then remove it from frame.



Fuel Cut-off Relay

TILT SWITCH

INSPECTION

Support the scooter level surface.

Put the side stand up and engine stop switch is at "RUN".

Turn the ignition switch to "OFF"

Remove the screws, washers and tilt switch.

* Do not disconnect the tilt switch connector during inspection.

Place the tilt switch vertical as shown, and turn the ignition switch to "ON".

Measure the voltage between the following terminals of the tilt switch connector with the connector connected.

Terminal	Normal
Violet/Red (+) – Green/Pink (-)	5 V (ECU voltage)
Black/Blue (+) – Green/Pink (-)	0.4 ~ 1.4 V

Incline the tilt switch 65 ± 10 degrees to the left or right with the ignition switch turned to "ON".

Measure the voltage between the following terminals of the tilt switch connector with the connector connected.

Terminal	$65 \pm 10^\circ$
Violet/Red (+) – Green/Pink (-)	5 V (ECU voltage)
Black/Blue (+) – Green/Pink (-)	3.7 ~ 4.4 V

If you repeat this test, first turn the ignition switch to "OFF", then turn the ignition switch to "ON".

REMOVAL/INSTALLATION

Disconnect the connector and remove two screws, then remove tilt switch.

Installation is in the reverse order of removal.

* Install the tilt switch with its "UP" mark facing up.

Tighten the mounting screws securely.

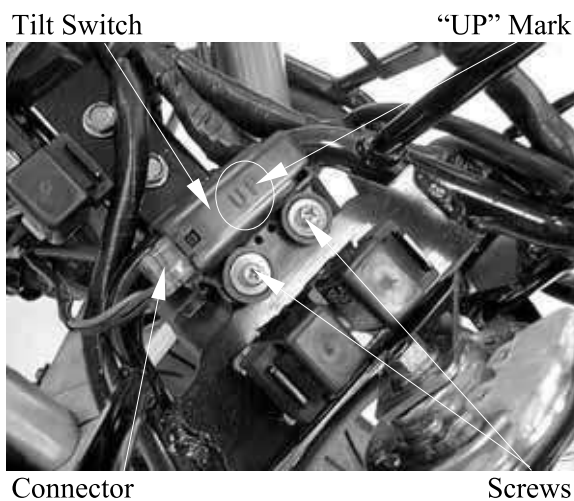
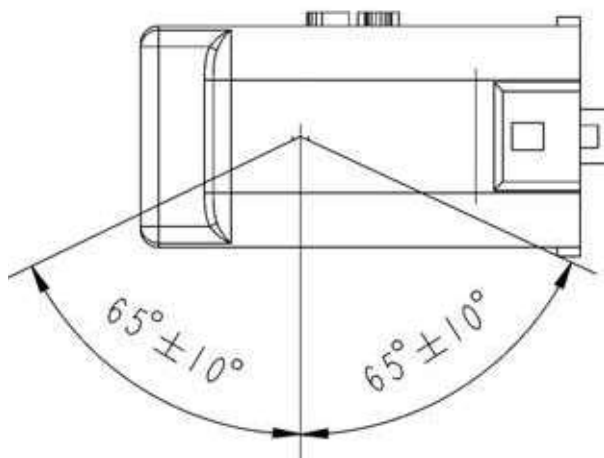
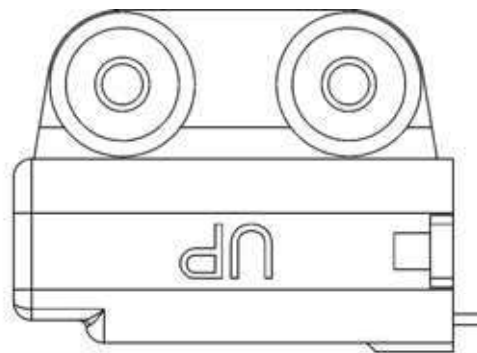

AIR IDLE SPEED VALVE (500 AFI) REMOVAL/INSTALLATION

Disconnect the air idle speed valve connector.

Remove the bolt and disconnect the air idle speed valve air suction hoses.

Installation is in the reverse order of removal.

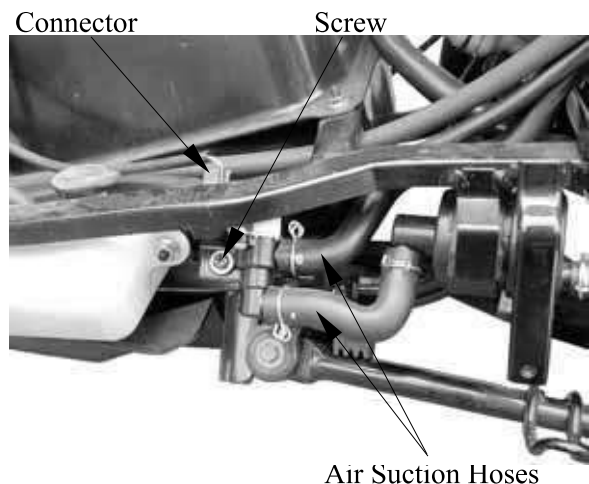

INSPECTION

Remove the air idle speed valve.

Check the resistance between the terminals of the air idle speed valve.

Standard: 25.95~29.55 Ω (at 25°C)

If the resistance is out of specification, replace the air idle speed valve.

Check that the air should not flow (A) to (B), only when the 12-V battery is connected to the air idle speed valve terminals.

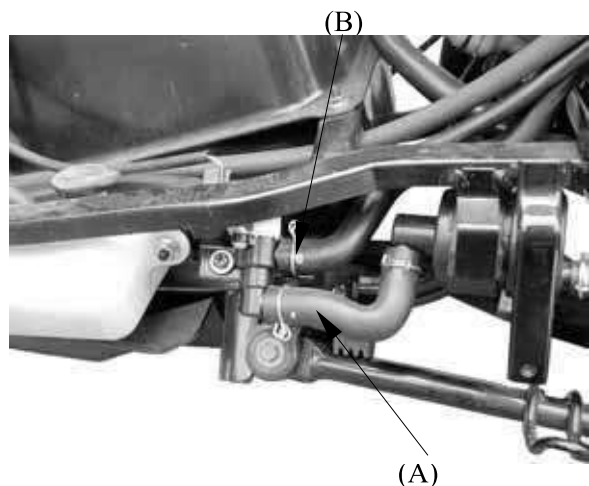

ENGINE CONTROL UNIT (ECU) (500 AFI) REMOVAL/INSTALLATION

- * Do not disconnect or connect the ECU connector during the ignition switch "ON"; it may cause the ECU damage.
- The throttle position sensor (TPS) and idle air bypass valve (ISC) have to reset when the throttle body MAP, TPS, ISC or ECU has been reinstalled (see page 6-28).

Disconnect the ECU connector, then remove the ECU from the frame.

Installation is in the reverse order of the removal.



AIR IDLE SPEED VALVE (300 AFI) REMOVAL/INSTALLATION

Disconnect the air idle speed valve connector.

Remove the bolt and disconnect the air idle speed valve air suction hoses.

Installation is in the reverse order of removal.

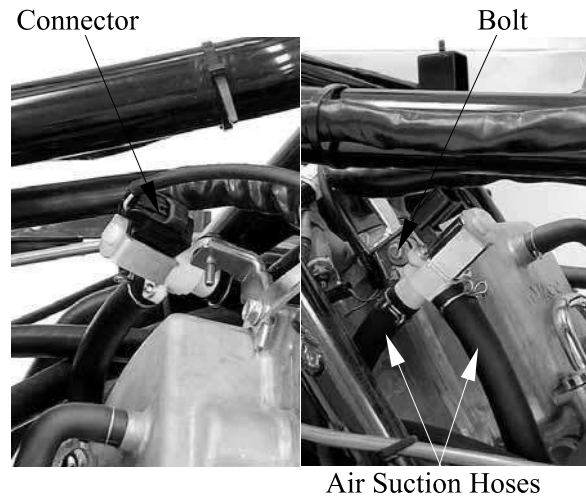

INSPECTION

Remove the air idle speed valve.

Check the resistance between the terminals of the air idle speed valve.

Standard: 25.95~29.55 (at 25°C)

If the resistance is out of specification, replace the air idle speed valve.

Check that the air should not flow (A) to (B), only when the 12-V battery is connected to the air idle speed valve terminals.

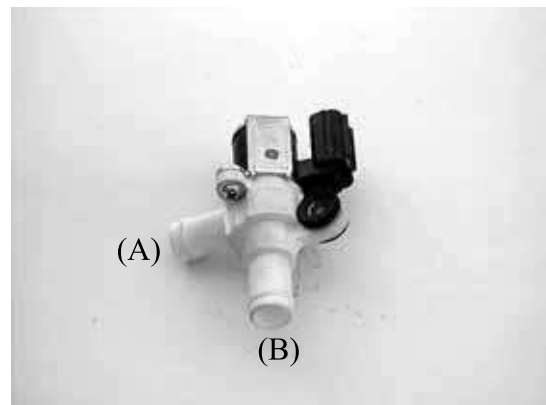

ENGINE CONTROL UNIT (ECU) (250 AFI) REMOVAL/INSTALLATION

- * Do not disconnect or connect the ECU connector during the ignition switch "ON"; it may cause the ECU damage.
- * The throttle position sensor (TPS) and idle air bypass valve (ISC) have to reset when the throttle body MAP, TPS, ISC or ECU has been reinstalled (see page 6-28).

Disconnect the ECU connector, then remove the ECU from the frame.

Installation is in the reverse order of the removal.



6. AFI (AUTOMATIC FUEL INJECTION)



XCITING 500/500 AFI/250/300 AFI

INSPECTION

Disconnect and remove the ECU from the frame.

Check for continuity between pins 35 and 36 of the ECU side connector.

There should be continuity at all times.

Check for continuity between each pins 8, 9 and 24 of the ECU side connector.

There should be continuity at all times.

Check for continuity between pins 24 and 36 of the ECU side connector.

There should be no continuity at all times.

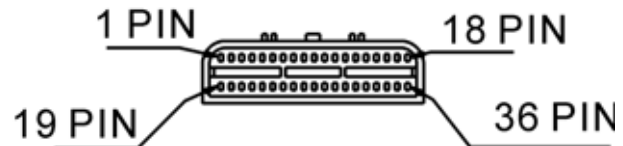
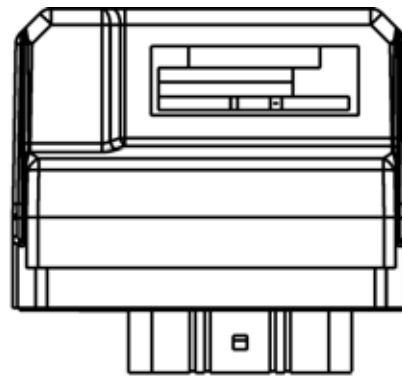

ECU PIN FUNCTION

PIN NO.	NAME	FUNCTION	PIN NO.	NAME	FUNCTION
1	IGP	Ignition power	19	BATT	Battery
2	ROLL	Roll sensor (Tilt switch)	20	—	—
3	CRK-P	Crank pulse sensor	21	MIL	Multi indicator lamp (ECLP)
4	—	—	22	TW	Water temperature sensor (ECT)
5	TH	Throttle position sensor	23	—	—
6	PM	Manifold pressure sensor (Intake pressure sensor)	24	SG	Sensor ground
7	HEGO	HEGO sensor (O ₂ sensor)	25	—	—
8	LG	Logic ground	26	—	—
9	CRK-M	Crank pulse sensor ground	27	—	—
10	K-LINE	Diagnostic tool	28	—	—
11	FLPR	Fuel pump relay	29	—	—
12	SOL	Solenoid (air idle speed valve) output	30	—	—
13	VCC	Sensor power output (+5V)	31	ISCAN	Idle speed control (ISC) / A (-)
14	ISCBP	Idle speed control (ISC) B (+)	32	ISCBN	Idle speed control (ISC) / B (-)
15	ISCAP	Idle speed control (ISC) A (+)	33	NE	Meter
16	INJ	Injection	34	—	—
17	HEGO HT	HEGO HT sensor (O ₂ HT sensor)	35	PG1	Power ground
18	IG	Ignition coil	36	PG2	Power ground

FUEL INJECTOR

INSPECTION

Disconnect the fuel injector connector.

Measure the resistance between 2 pins of the fuel injector connector.

Standard: 9.945~13.5 Ω (at 20°C/68°F)

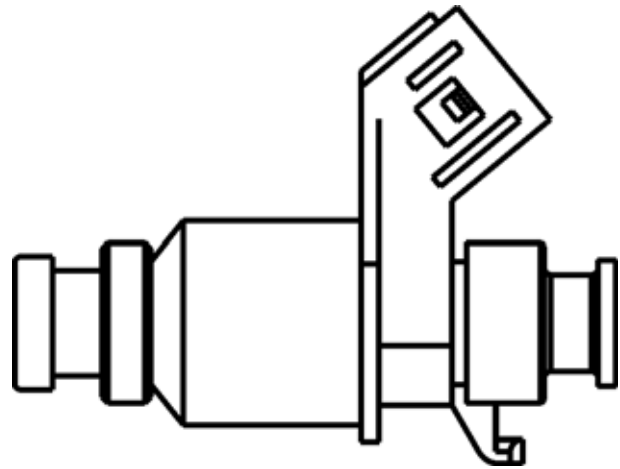

REMOVAL

Disconnect the fuel injector connector and from fuel injector.

Remove the bolt, then pull fuel pipe and fuel injector as assembly out from intake manifold.



Connector

Bolt

Remove the fuel injector from the fuel pipe.



Fuel Pipe

Fuel Injector

INSTALLATION

Apply oil to new O-ring.

Install the fuel injector into the fuel pipe, being careful not to damage the O-ring and cushion ring.

Cushion Ring



O-ring

Make sure the tab on the fuel injector into the groove on the fuel pipe.

Groove



Tab

Install the fuel pipe assembly onto intake manifold by aligning the dowel pin, being careful not to damage the seal ring.

Install and tighten the fuel pipe mounting bolt.



O-ring

Dowel Pin

ECT SENSOR (500 AFI) REMOVAL /INSTALLATION

* Replace the ECT sensor while the engine is cold.

Drain the coolant from the cooling system (refer to chapter 7)

Disconnect the ECT sensor connector from the sensor.

Remove the ECT sensor and O-ring



Connector

Install the new O-ring and ECT sensor.

* Always replace an O-ring with a new

Tighten the ECT sensor to specified torque.

Torque: 1.2 kgf-m (12 N-m, 8.6 lbf-ft)

Connect the ECT sensor connector.

Fill the cooling system with the recommended coolant (refer to chapter 7)

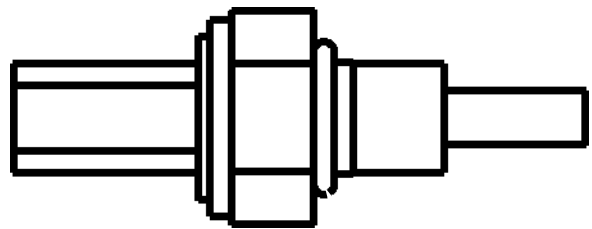

INSPECTION

Measure the resistance at the ECT sensor terminals

STANDARD

°C	-20	40	100
KΩ	18.8	1.136	0.1553



ECT SENSOR(300 AFI) REMOVAL /INSTALLATION

* Replace the ECT sensor while the engine is cold.

Drain the coolant from the cooling system (refer to chapter 7)

Disconnect the ECT sensor connector from the sensor.

Remove the ECT sensor and O-ring

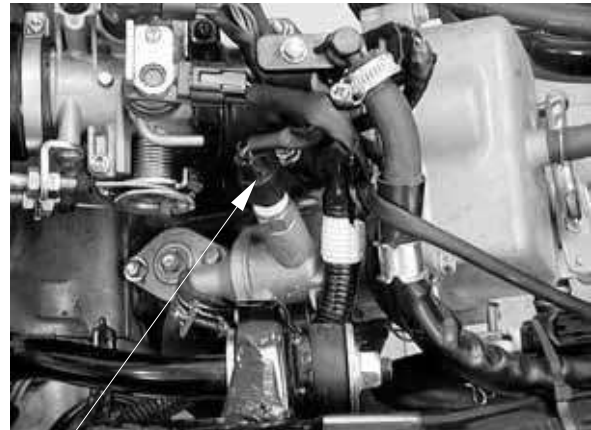

Connector

Install the new O-ring and ECT sensor.

*

Tighten the ECT sensor to specified torque.

Torque: 1.2 kgf-m (12 N-m, 8.6 lbf-ft)

Connect the ECT sensor connector.

Fill the cooling system with the recommended coolant (refer to chapter 7)

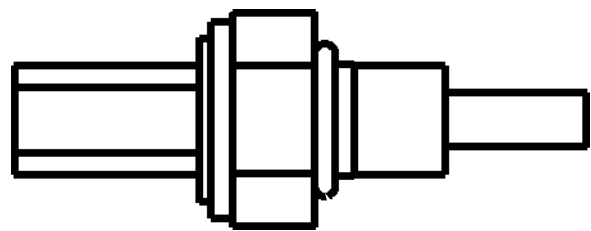

INSPECTION

Measure the resistance at the ECT sensor terminals

STANDARD

°C	-20	40	100
KΩ	18.8	1.136	0.1553



6. AFI (AUTOMATIC FUEL INJECTION)



XCITING 500/500 AFI/250/300 AFI

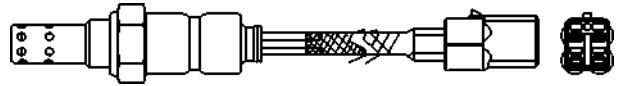

*
Apply anti-seize compound on circumference of thread area before O₂/O₂ HT sensor installation.

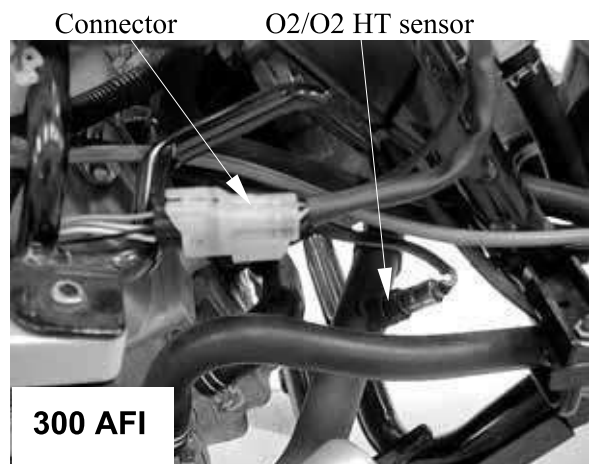
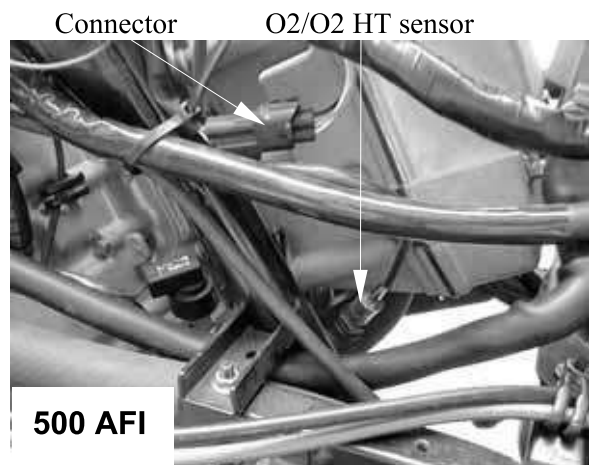

THROTTLE BODY/MAP/ISC/TPS

- Turn ignition switch off and set up center stand when do the replacement.
- Check and confirm the voltage above 12V by a voltmeter after replacement.
- Check and confirm the other connectors are assembled correctly after replacement.
- Do not damage the throttle body, this may cause incorrect throttle and idle valve synchronization.
- The throttle body is factory pre-set, do not disassemble it in a way other than shown in this manual.
- Do not loosen or tighten the painted bolts and screws of the throttle body. Loosening or tightening them can cause throttle and idle valve synchronization failure.

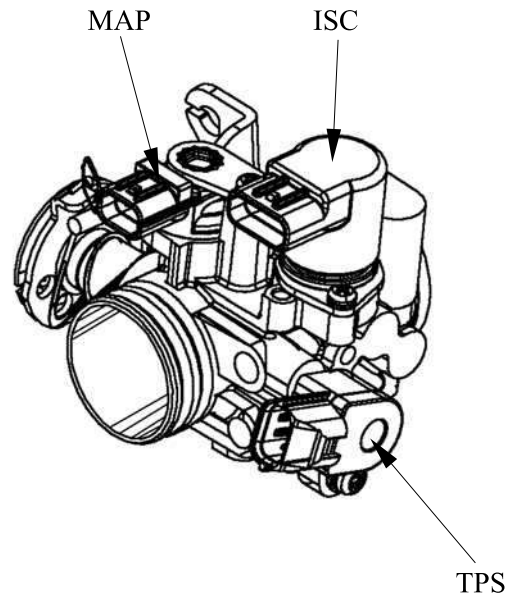

MAP INSPECTION

Support the scooter level surface.
Put the side stand up and engine stop switch is at "RUN".

Turn the ignition switch to "ON"

Measure the ECU voltage between the following terminals of the MAP connector.

Terminal	Normal
Violet/Red (+) – Green/Pink (-)	5 V

TPS INSPECTION

Support the scooter level surface.
Put the side stand up and engine stop switch is at "RUN".

Turn the ignition switch to "ON"

Measure the ECU voltage between the following terminals of the PTS connector with.

Terminal	Normal
Violet/Red (+) – Green/Pink (-)	5 V

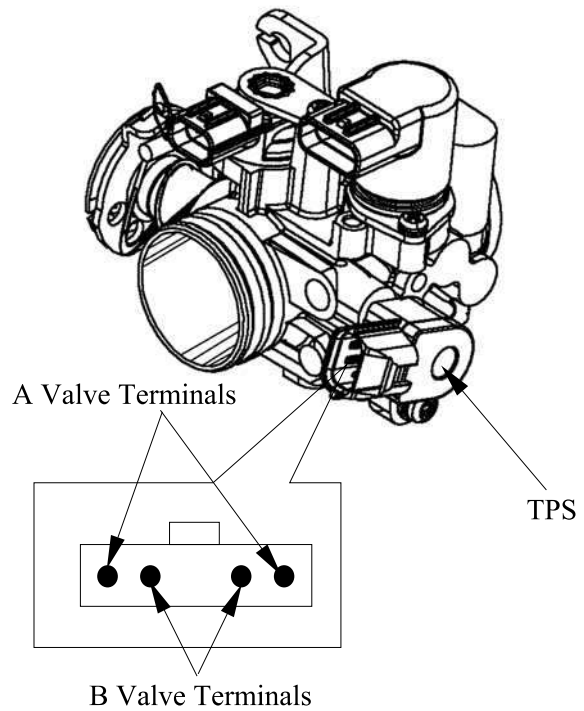

REMOVAL

Loosen the throttle cables free play with the adjusting nuts.
Disconnect the throttle cable ends from throttle drum.

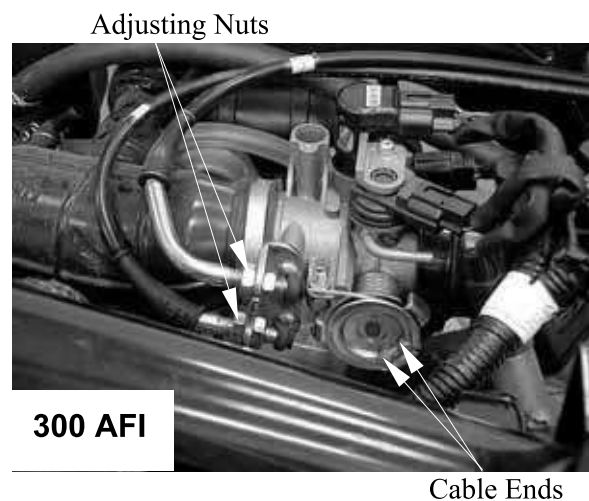
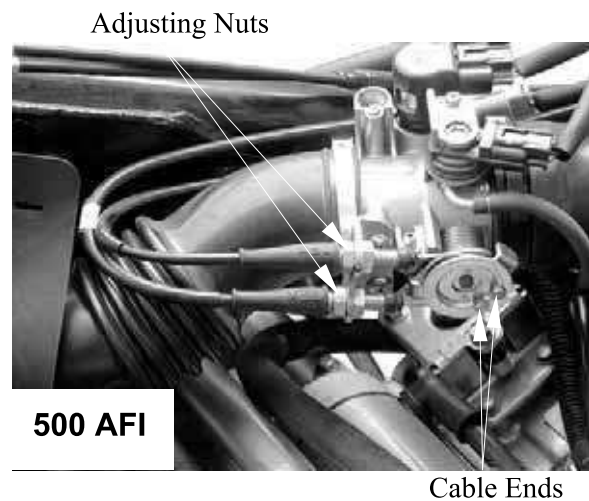

6. AFI (AUTOMATIC FUEL INJECTION)



XCITING 500/500 AFI/250/300 AFI

Disconnect the TPS, ISC and MAP sensor connectors.

ISC Sensor Connector/MAP Sensor Connector

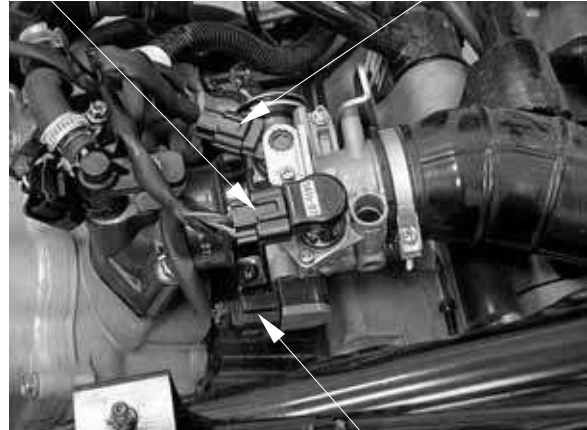

TPS Sensor Connector

Loosen the air cleaner chamber connecting hose band screw.
Loosen the intake manifold band screw.
Remove the throttle body, MAP sensor, TPS sensor and ISC sensor as assembly.

Connecting Hose Band Screw



Intake Manifold Band Screw

DISASSEMBLY

* The throttle position sensor (TPS) and idle air bypass valve (ISC) have to reset when the throttle body MAP, TPS, ISC or ECU has been reinstalled (see page 6-28).

Remove the screw, then remove the ISC and set plate.

Remove the screw and set plate, remove the MAP

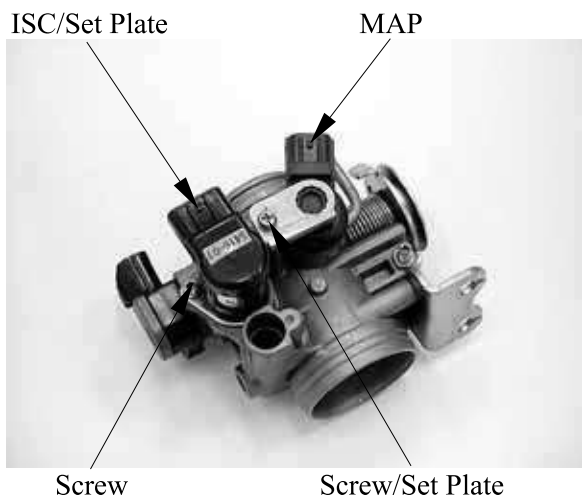

6. AFI (AUTOMATIC FUEL INJECTION)

Remove the screw, then remove the TPS.

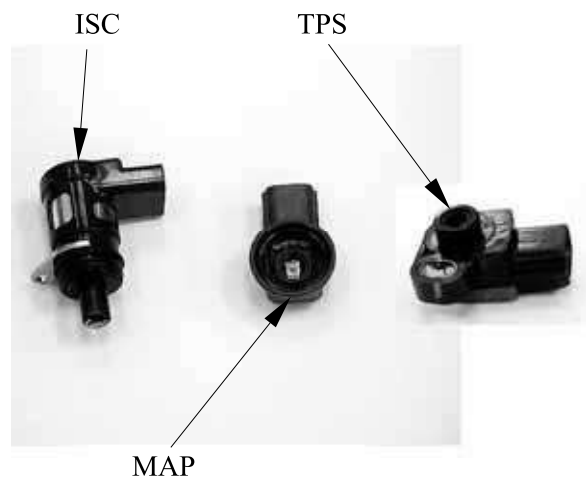
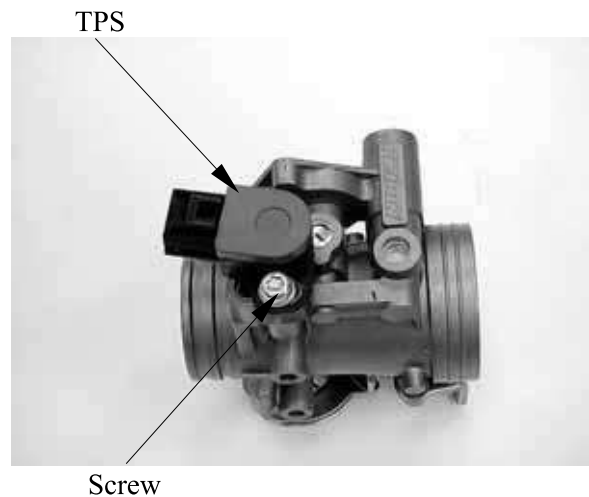

ASSEMBLY

*

The throttle position sensor (TPS) and idle air bypass valve (ISC) have to reset when the throttle body MAP, TPS, ISC or ECU has been reinstalled (see page 6-28).

Apply oil to new O-ring.

Install the TPS onto the throttle body, being careful not to damage the O-ring.

Install and tighten the screw securely.

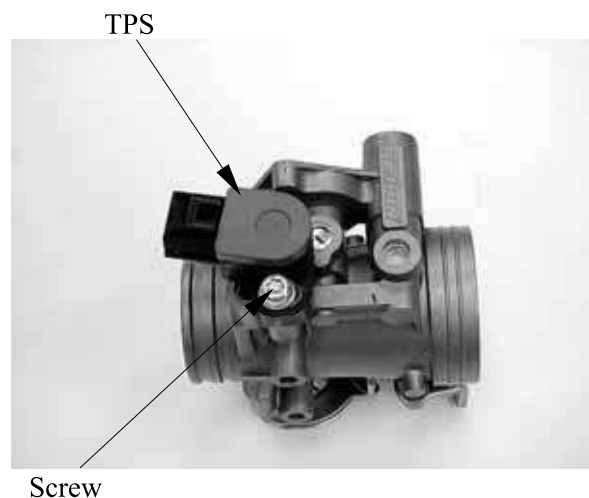

6. AFI (AUTOMATIC FUEL INJECTION)



XCITING 500/500 AFI/250/300 AFI

* Always replace an O-ring with a new

Apply oil to new O-ring.

Install the MAP onto the throttle body, being careful not to damage the O-ring.

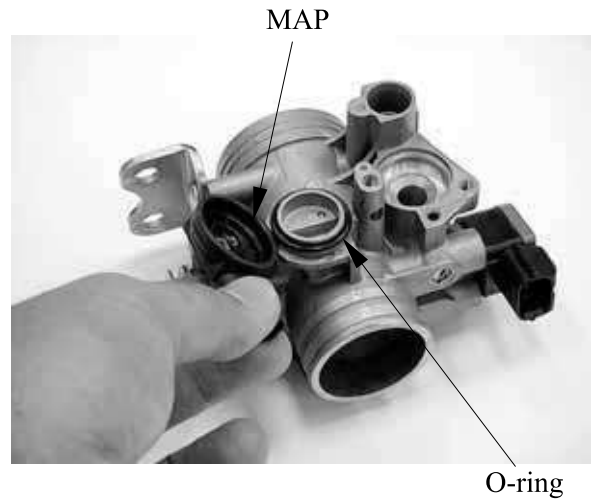

Install the set plate and tighten the screw securely.

Apply oil to new O-ring.

Install the ISC and set plate onto the throttle body, being careful not to damage the O-ring.

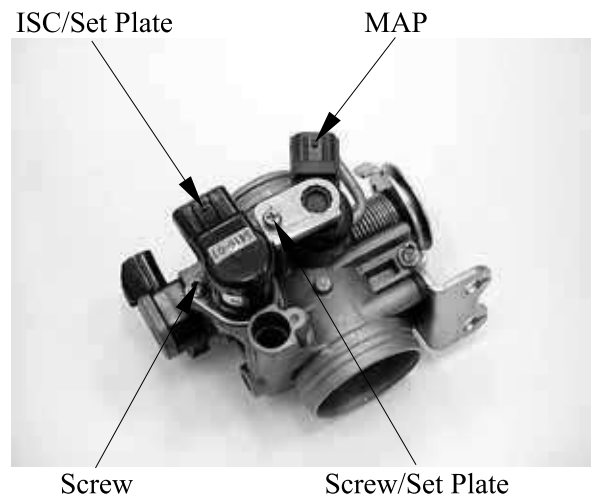

DIAGNOSTIC TOOL CONNECTOR

INSPECTION

Put the side stand up and engine stop switch is at "RUN".

Turn the ignition switch to "ON"

Measure the voltage between the following terminals of the diagnostic tool connector with.

Terminal	Normal
Black (+) – Green (-)	Battery voltage
White/Yellow (+) – Green (-)	Battery voltage – 1 V

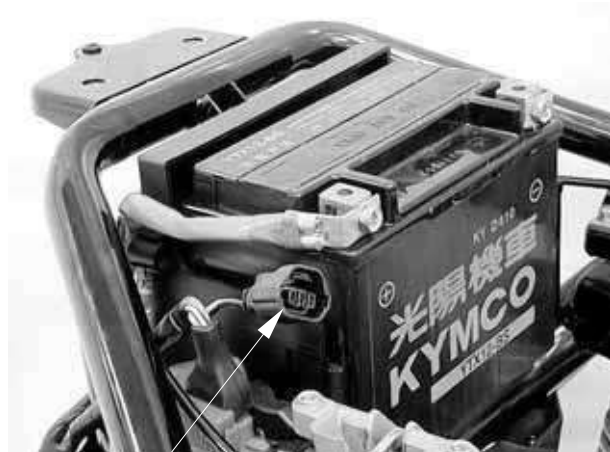

Diagnostic Tool Connector

COOLING SYSTEM

SYSTEM FLOW PATTERN (XCITING 500/500 AFI) -----	7- 1
SYSTEM FLOW PATTERN (XCITING 250/300 AFI) -----	7- 2
SERVICE INFORMATION-----	7- 3
TROUBLESHOOTING-----	7- 6
COOLING SYSTEM TESTING-----	7- 7
COOLANT REPLACEMENT -----	7- 7
THERMOSTAT-----	7-10
WATER PUMP -----	7-15
RADIATOR -----	7-23
FAN MOTOR SWITCH -----	7-26
WATER TEMPERATURE SENSOR -----	7-27
RAIDATOR RESERVE TANK -----	7-29

7. COOLING SYSTEM

XCITING 500/500 AFI/250/300 AFI

SYSTEM FLOW PATTERN (XCITING 500/500 AFI)

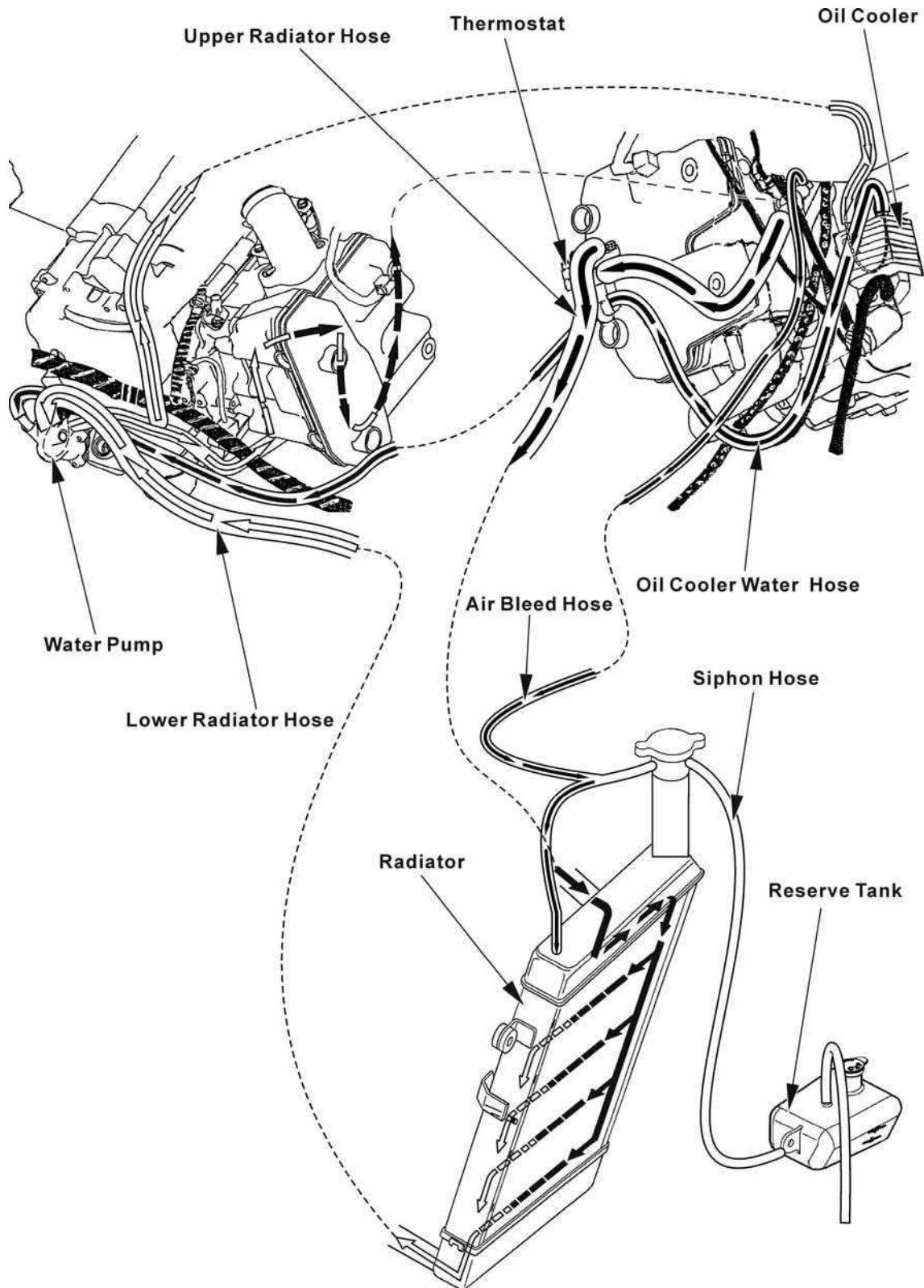

7. COOLING SYSTEM

XCITING 500/500 AFI/250/300 AFI

SYSTEM FLOW PATTERN (XCITING 250/XCITING 300 AFI)

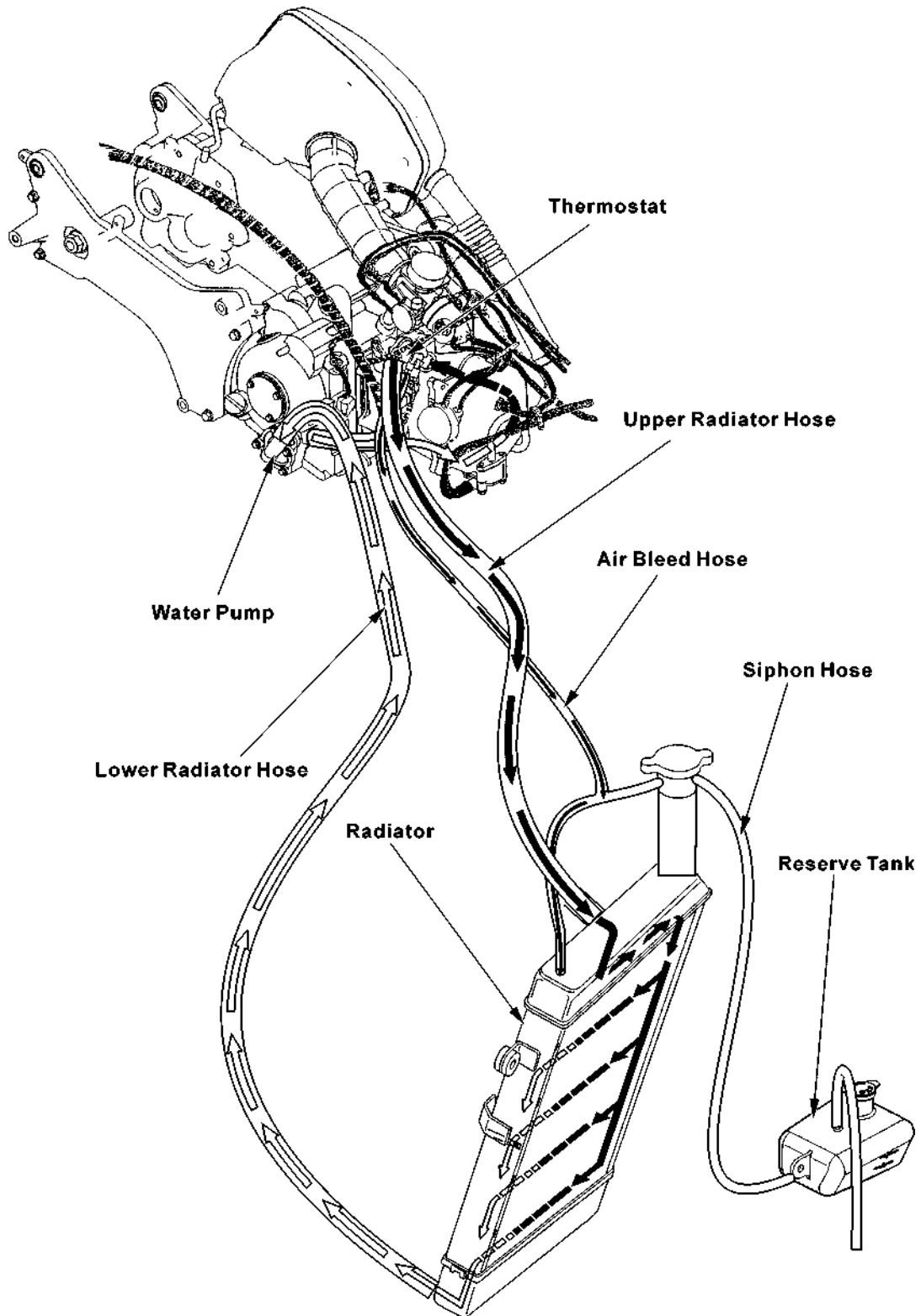

SERVICE INFORMATION**GENERAL INSTRUCTIONS****WARNING:**

Removing the radiator cap while the engine is hot can allow the coolant to spray out, seriously scalding you. Always let the engine and radiator cool down before removing the radiator cap.

CAUTION:

Radiator coolant is toxic. Keep it away from eyes, mouth, skin and clothes.

- If any coolant gets in your eyes, rinse them with water and consult a physician immediately.
- If any coolant is swallowed, induce vomiting, gargle and consult a physician immediately.
- If any coolant gets on your skin or clothes, rinse thoroughly with plenty of water.

NOTE:

Use coolant with silicate inhibitors may cause premature wear of water pump seals or blockage of radiator passages. Using tap water may cause engine damage.

- This section covers service of the cooling system.
- These services can be done with the engine installed in the frame.
- Add coolant at the reserve tank. Do not remove the radiator cap except to refill or drain the system.
- All cooling system services can be done with the engine in the frame.
- Avoid spilling coolant on painted surfaces.
- After servicing the system, check for leaks with a cooling system tester.

7. COOLING SYSTEM

XCITING 500/500 AFI/250/300 AFI

SPECIFICATIONS (XCITING 500/500 AFI)

ITEM		SPECIFICATIONS
Coolant capacity	Radiator and engine	2 liter (2.1 US qt, 1.76 Imp qt)
	Reserve tank	0.37 liter (0.4 US qt, 0.33 Imp qt)
Radiator cap relief pressure		90 kPa (0.9 kgf/cm ² , 12.8 psi)
Thermostat	Begin to open	80 - 84°C (176 - 183°F)
	Fully open	95°C (203°F)
	Valve lift	8 mm (0.3 in) minimum
Standard coolant concentration		1:1 mixture with soft water

SPECIFICATIONS (XCITING 250/XCITING 300 AFI)

ITEM		SPECIFICATIONS
Coolant capacity	Radiator and engine	1 liter (1.1 US qt, 0.88 Imp qt)
	Reserve tank	0.37 liter (0.4 US qt, 0.33 Imp qt)
Radiator cap relief pressure		90 kPa (0.9 kgf/cm ² , 12.8 psi)
Thermostat	Begin to open	80 - 82°C (176 - 180°F)
	Fully open	90°C (198°F)
	Valve lift	3.5 mm (0.14 in) minimum
Standard coolant concentration		1:1 mixture with soft water

7. COOLING SYSTEM

XCITING 500/500 AFI/250/300 AFI

COOLANT GRAVITY CHART

Temp. Coolant concentration	0	5	10	15	20	25	30	35	40	45	50
5%	1.009	1.009	1.008	1.008	1.007	1.006	1.005	1.003	1.001	0.009	0.997
10%	1.018	1.107	1.017	1.016	1.015	1.014	0.013	1.011	1.009	1.007	1.005
15%	1.028	1.027	1.026	1.025	1.024	1.022	1.020	1.018	1.016	1.014	1.012
20%	1.036	1.035	1.034	1.033	1.031	1.029	1.027	1.025	1.023	1.021	1.019
25%	1.045	1.044	1.043	1.042	1.040	1.038	1.036	1.034	1.031	1.028	1.025
30%	1.053	1.051	1.051	1.049	1.047	1.045	1.043	1.041	1.038	1.035	1.032
35%	1.063	1.062	1.060	1.058	1.056	1.054	1.052	1.049	1.046	1.043	1.040
40%	1.072	1.070	1.068	1.066	1.064	1.062	1.059	1.056	1.053	1.050	1.047
45%	1.080	1.078	1.076	1.074	1.072	1.069	1.056	1.063	1.062	1.057	1.054
50%	1.086	1.084	1.082	1.080	1.077	1.074	1.071	1.068	1.065	1.062	1.059
55%	1.095	1.093	1.091	1.088	1.085	1.082	1.079	1.076	1.073	1.070	1.067
60%	1.100	1.098	1.095	1.092	1.089	1.086	1.083	1.080	1.077	1.074	1.071

COOLANT MIXTURE (WITH ANTI-RUST AND ANTI-FREEZING EFFECTS)

Freezing Point	Mixing Rate	KYMCO SIGMA Coolant Concentrate	Distilled Water
-9	20%		
-15	30%	425cc	975cc
-25	40%		
-37	50%		
-44.5	55%		

Cautions for Using Coolant:

- Use coolant of specified mixing rate. (The mixing rate of 425cc KYMCO SIGMA coolant concentrate + 975cc distilled water is 30%.)
- Do not mix coolant concentrate of different brands.
- Do not drink the coolant which is poisonous.
- The freezing point of coolant mixture shall be 5 ° lower than the freezing point of the riding area.

TORQUE VALUES

Water pump cover bolt (XCITING 500/500 AFI)	13 N•m (1.3 kgf•m, 9 lbf•ft)
Water pump cover bolt (XCITING 250/300 AFI)	10 N•m (1 kgf•m, 7 lbf•ft)
Fan motor bolt	5 N•m (0.53 kgf•m, 3.8 lbf•ft)
Radiator shroud mounting nut	9 N•m (0.9 kgf•m, 6.5 lbf•ft)
Water pump impeller (XCITING 250/250 AFI) screw)	12 N•m (1.2 kgf•m, 8.6 lbf•ft) (Left

TROUBLESHOOTING**Engine temperature too high**

- Faulty radiator cap
- Faulty temperature gauge or thermosensor
- Air in system
- Thermostat stuck closed
- Insufficient coolant
- Passages blocked in radiator, hoses or water jacket
- Faulty cooling fan motor
- Faulty fan motor switch
- Faulty water pump

Engine temperature too low

- Faulty temperature gauge or thermosensor
- Thermostat stuck open
- Faulty fan motor switch

Coolant leak

- Faulty water pump mechanical seal
- Deteriorated O-rings
- Faulty radiator cap
- Damaged or deteriorated cylinder head gasket
- Loose hose connection or clamp
- Damaged or deteriorated hoses

7. COOLING SYSTEM

XCITING 500/500 AFI/250/300 AFI

Before installing the cap in the tester, wet the sealing surface.

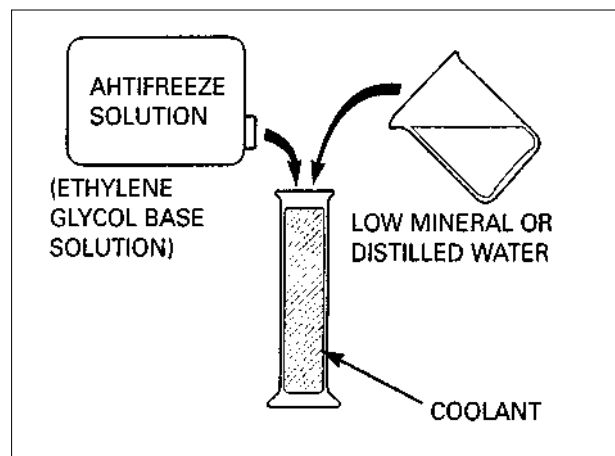
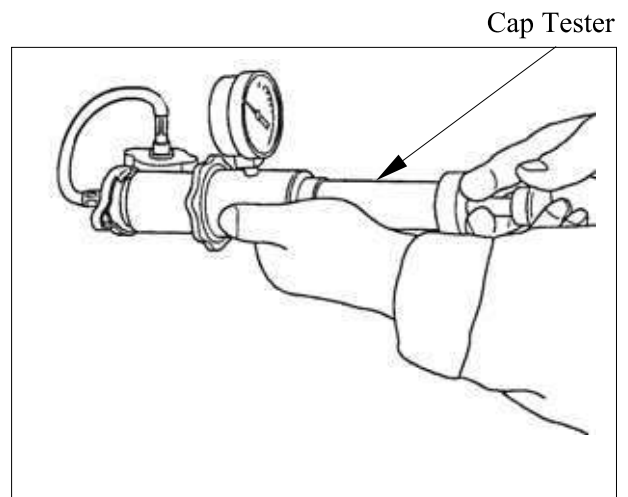
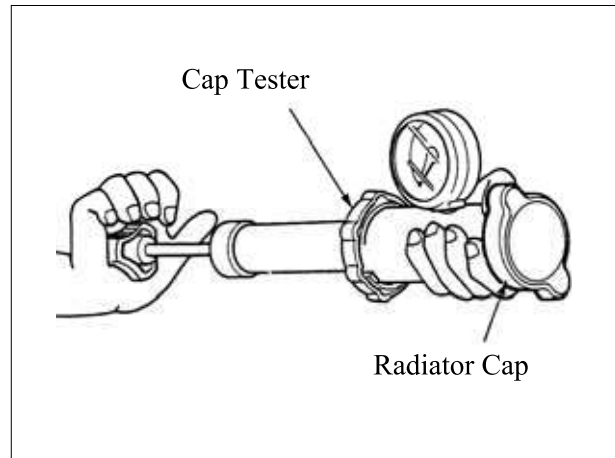

7. COOLING SYSTEM

REPLACEMENT/AIR BLEEDING

Remove the front cover (page 2-11).

Remove the front lower cover (page 2-15).

When filling the system or reserve tank with coolant (checking the coolant level), place the scooter in a vertical position on a flat, level surface.

Remove the radiator cap.



Disconnect the water lower hose and drain the coolant from the system.

XCITING 250/XCITING 250 AFI:
Remove the water drain bolt and drain the coolant from the system (page 7-17).

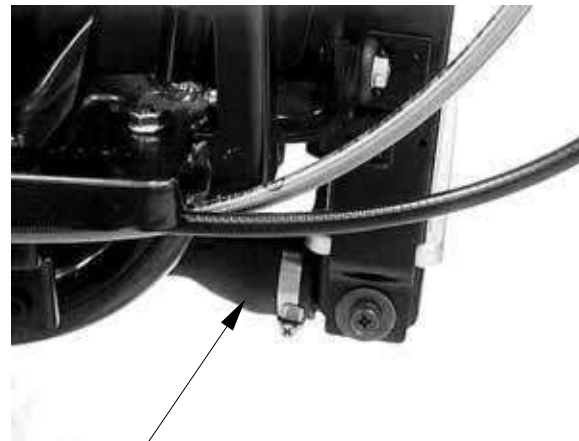

Water Lower Hose

Remove the floor mat.

Remove the screw and reserve tank lid.

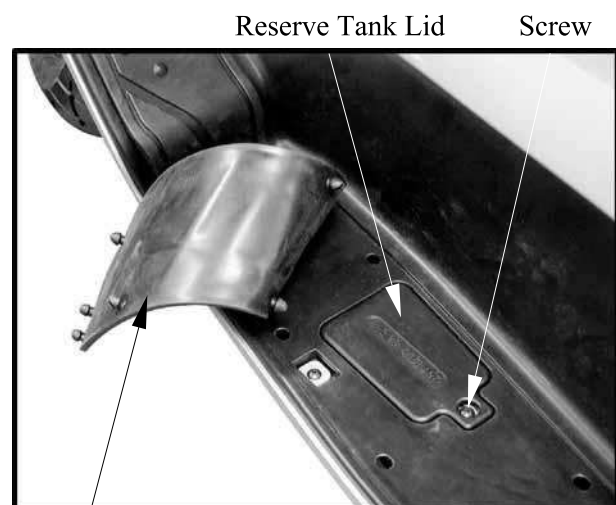

Floor Mat

7. COOLING SYSTEM

Remove the reserve tank cap and drain the coolant from the reserve tank.

Reconnect the water lower hose securely.

Reserve Tank Cap

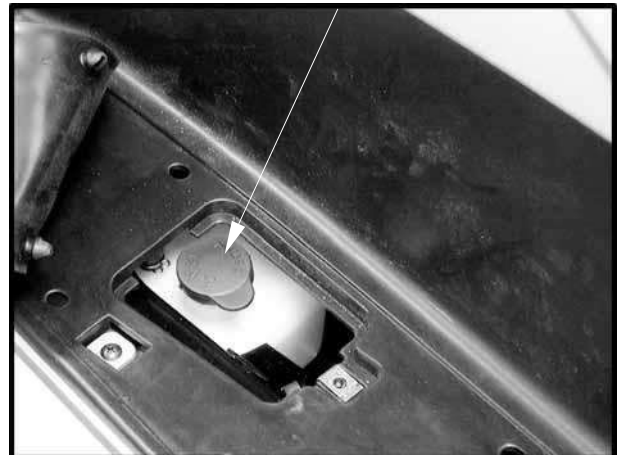

Place the scooter on its center stand on a flat, level surface.
Fill the reserve tank to the upper level line.

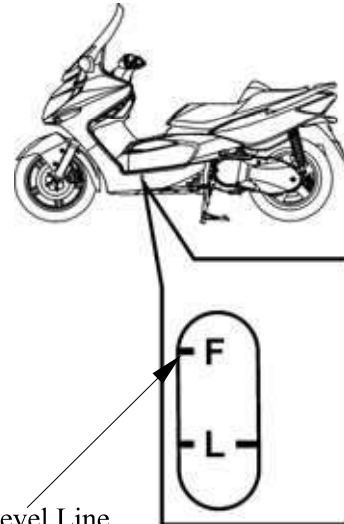

Upper Level Line

Fill the system with the recommended coolant through the filler opening up to the filler neck.

Filler Neck

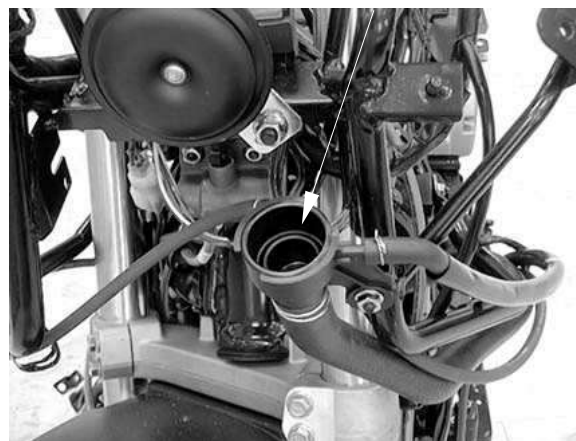

7. COOLING SYSTEM

XCITING 500/500 AFI/250/300 AFI

Bleed air from the system as follow:

1. Start the engine and let it idle for 2–3 minutes.
2. Snap the throttle three to four times to bleed air from the system.
3. Stop the engine and add coolant to the proper level if necessary. Reinstall the radiator cap.
4. Check the level of coolant in the reserve tank and fill to the upper level if it is low.

THERMOSTAT REMOVAL (XCITING 500/500 AFI)

Remove the floorboard (page 2-6).
Remove the ignition coil (page 19-5).

Remove the nut and thermostat housing stay from the frame.

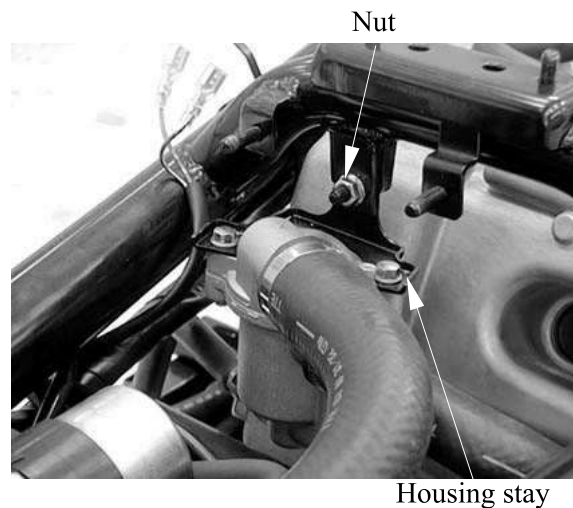

Housing stay

Remove the bolts, housing stay and thermostat housing cover.

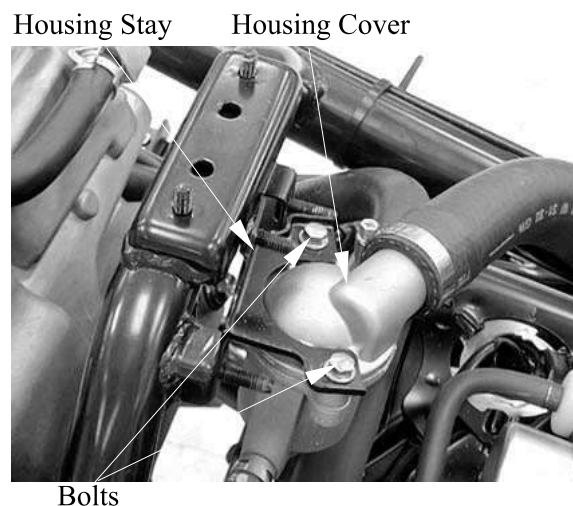

Bolts

7. COOLING SYSTEM

Remove the O-ring from the housing cover.
Remove the thermostat.

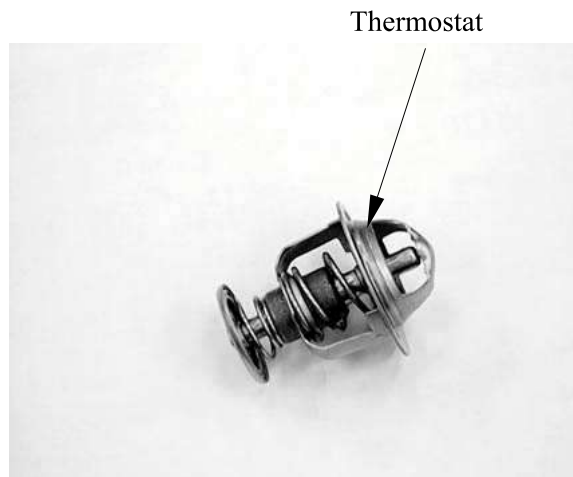

REMOVAL (XCITING 250/300 AFI)

Remove the luggage box (page 2-3).
Drain the coolant (page 7-17).

Disconnect ECT sensor connector from the sensor (XCITING 300 AFI).

Disconnect the water temperature sensor connectors from the sensor.

Disconnect the water hose from the thermostat housing.

Disconnect the air bleed hose from the thermostat housing.

Remove the mounting bolt and the thermostat housing from the cylinder head.

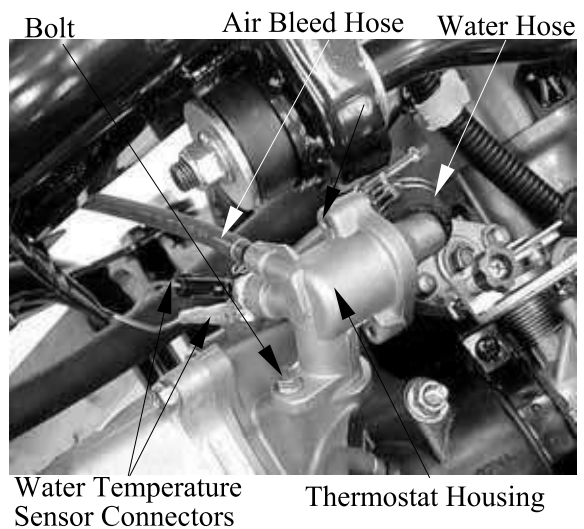

7. COOLING SYSTEM

XCITING 500/500 AFI/250/300 AFI

Remove the two bolts and thermostat housing cover.

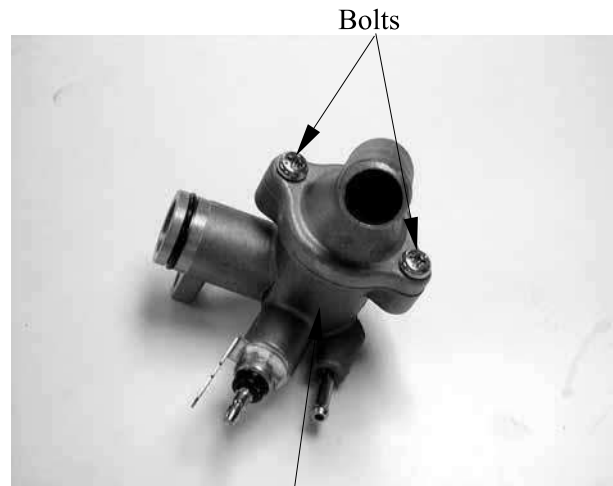

Thermostat Housing

Remove the thermostat from the thermostat housing.

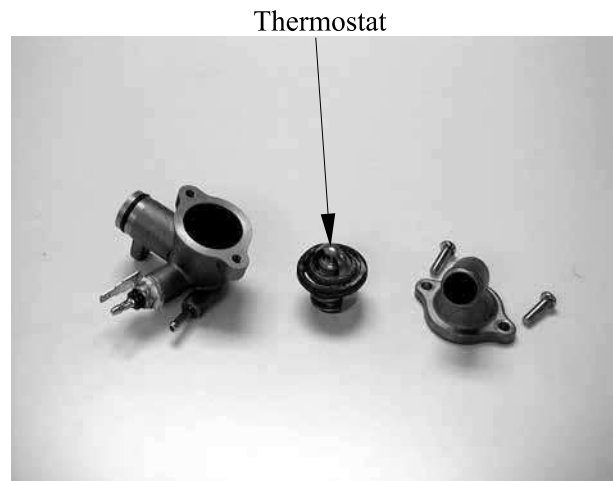

7. COOLING SYSTEM

XCITING 500/500 AFI/250/300 AFI

INSPECTION

Visually inspect the thermostat for damage.

Heat the water with an electric heating element to operating temperature for five minutes.

Suspend the thermostat in heated water to check its operation.

- Keep flammable materials away from the electric heating element.
- Do not let the thermostat or thermometer touch the pan, or you will get false readings.

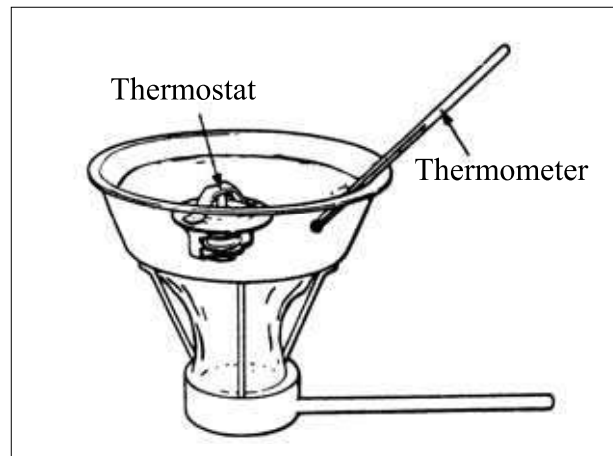

Replace the thermostat if the valve stays open at room temperature, or if it respond at temperatures other than those specified.

Thermostat begin to open:

XCITING 500/500 AFI:

80–84°C (176–183°F)

XCITING 250/300 AFI:

80–82°C (176–180°F)

Valve lift:

XCITING 500/500 AFI:

8 mm (0.3 in) minimum at 95°C (203°F)

XCITING 250/300 AFI:

**3.5 mm (0.14 in) minimum at 90°C
(198°F)**

7. COOLING SYSTEM

INSTALLATION (XCITING 500/500 AFI)

Install the thermostat into the housing with its air bleed hole facing up and aligning bleed hole with the tab in the housing.

Air Bleed Hole

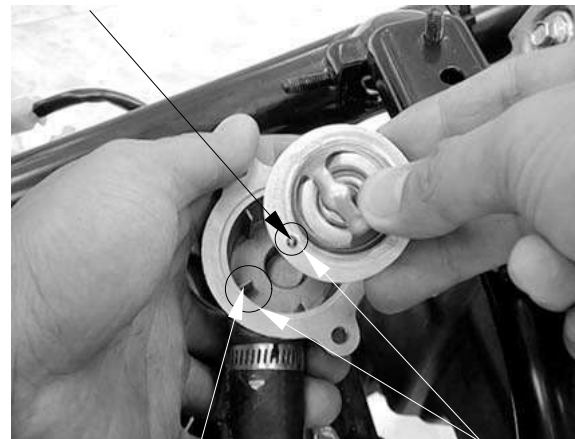

Tab

Align

Install a new O-ring into the housing cover groove.

Install the housing cover and housing stay to the housing.
Tighten the bolts securely.

Install the housing stay to the frame.
Tighten the nut securely.

Fill the system with recommended coolant and bleed the air (page 7-8).



O-ring

INSTALLATION (XCITING 250/300 AFI)

The installation sequence is the reverse of removal.

Replace the O-ring with a new one and apply grease to it.

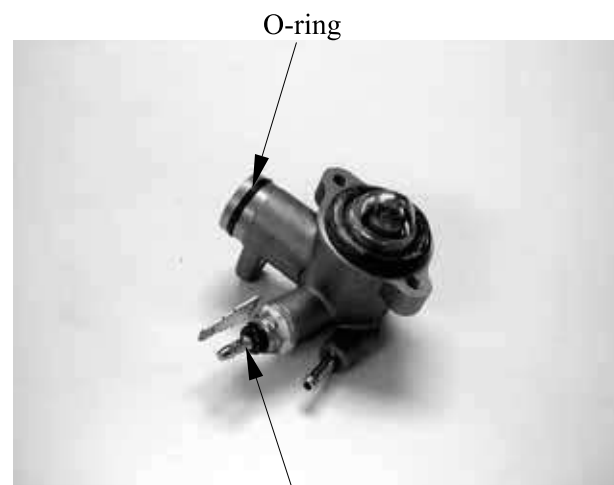

Water Temperature Sensor

7. COOLING SYSTEM

XCITING 500/500 AFI/250/300 AFI

WATER PUMP

MECHANICAL SEAL INSPECTION

Inspect the telltale hole for sign of coolant leakage.

If there is leakage, the mechanical seal is defective, and water pump should be replaced

XCITING 500/500 AFI

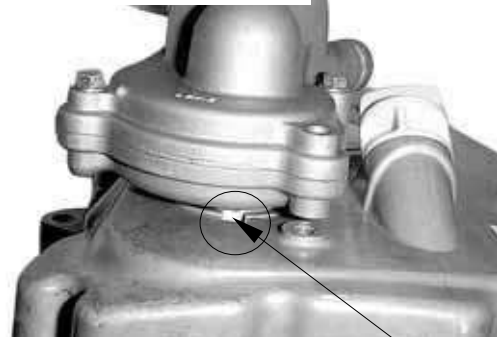

Telltale Hole

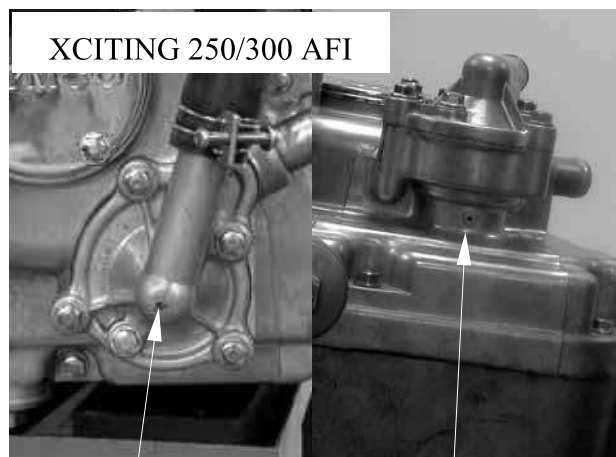

XCITING 250/300 AFI

Water Pump

Telltale Hole

REMOVAL (XCITING 500/500 AFI)

Remove the exhaust muffler (page 2-16)

Drain the coolant (page 7-8).

Loosen the hose bands and disconnect the water hoses and bypass hose from the water pump.

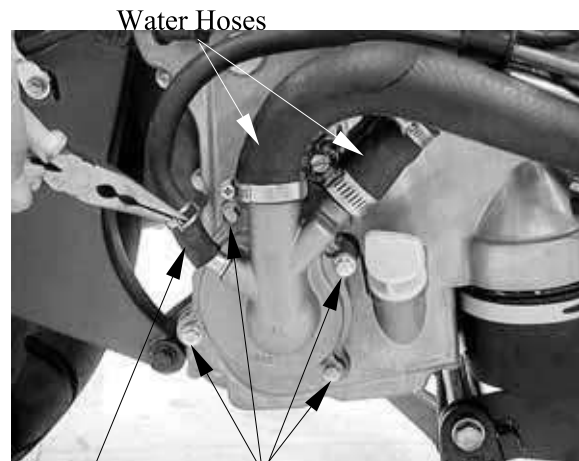

Bypass Hose

Bolts

7. COOLING SYSTEM

XCITING 500/500 AFI/250/300 AFI

Remove the bolts and water pump cover.

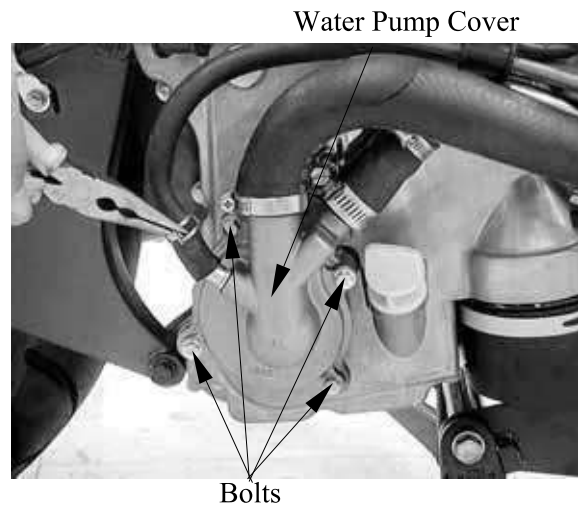

Remove the O-ring from the water pump cover.

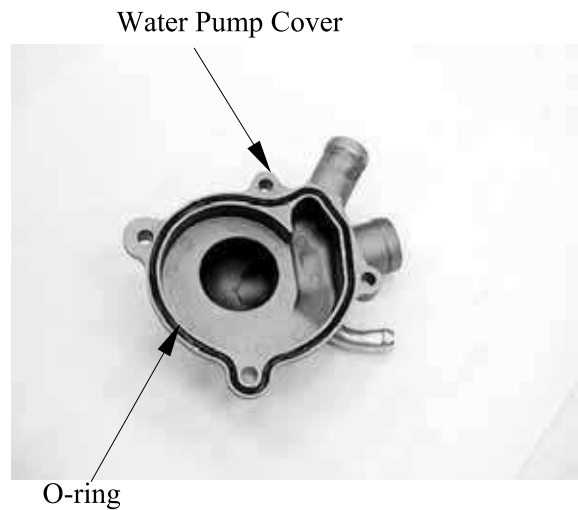

Remove the water pump body from the crankcase.



7. COOLING SYSTEM

XCITING 500/500 AFI/250/300 AFI

INSTALLATION (XCITING 500/500 AFI)

Apply engine oil to a new O-ring and install it onto the stepped portion of the water pump.

Install the water pump into the crankcase while aligning the water pump shaft groove with oil pump shaft end.

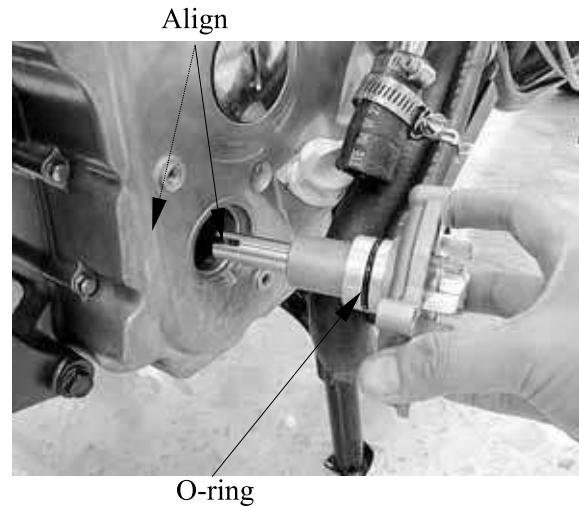

Align the mounting bolt holes in the water pump and crankcase and make sure the water pump is securely installed.

Install a new O-ring into the groove in the water pump cover.

Install the water pump cover and tighten the bolts to the specified torque.

Torque: 13 N•m (1.3 kgf•m, 9 lbf•ft)

Connect the water hoses and bypass hose, then tighten the hose bands.



Fill the system with recommended coolant and bleed the air (page 7-8).

REMOVAL (XCITING 250/300 AFI)

Remove the drain bolt to drain coolant.

Loosen the hose band screw and disconnect the water hoses from the water pump.

Remove the four bolts and the water pump cover, gasket and 2 dowel pins.

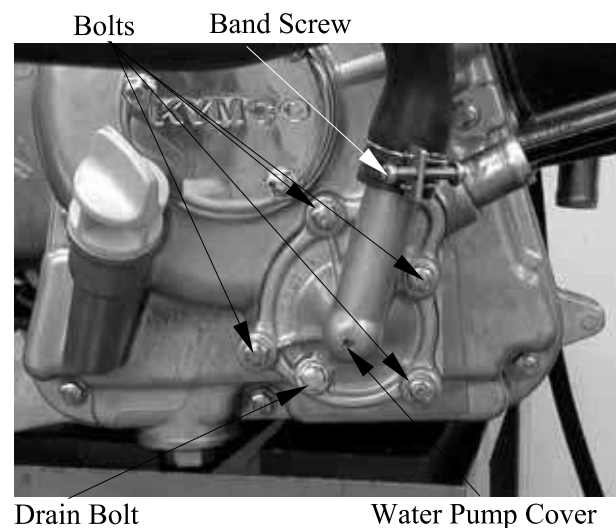

7. COOLING SYSTEM

Remove the water pump impeller.

The impeller has left hand threads.

Impeller (Left Hand Threads)



Inspect the mechanical (water) seal and seal washer for wear or damage.

The mechanical seal and seal washer must be replaced as a set.

Mechanical Seal

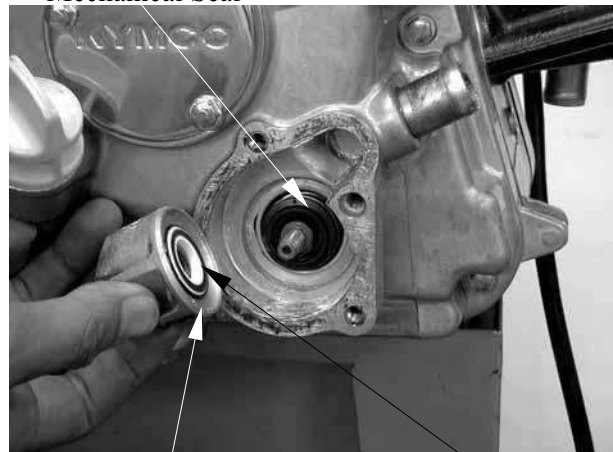

Impeller

Seal Washer (Porcelain)

Disconnect the water hose from the right crankcase cover.

Remove the eight bolts attaching the right crankcase cover.

Bolts

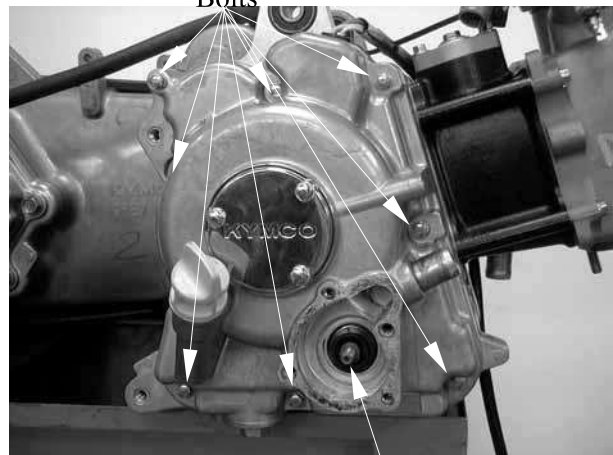

Water Pump Assembly

7. COOLING SYSTEM

Remove the water pump bearing snap ring from the water pump assembly.
Remove the water pump shaft and inner bearing.

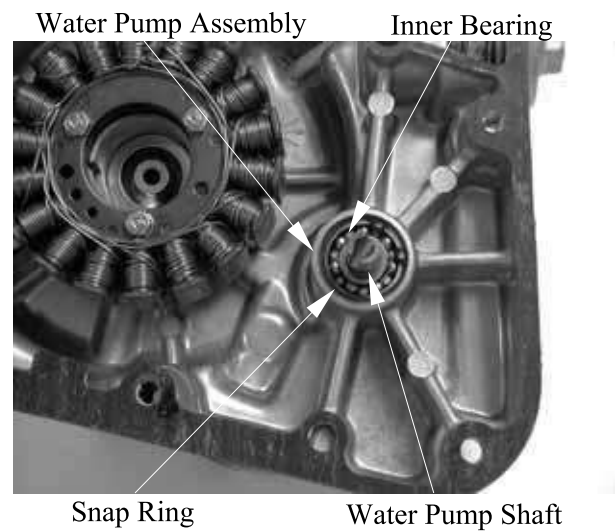

Remove the water pump shaft outer bearing.

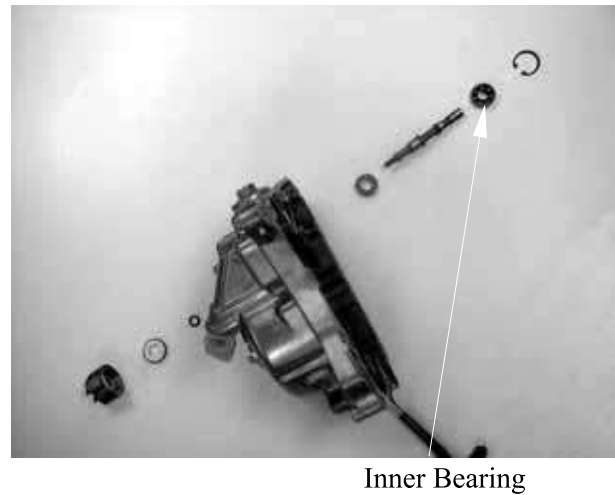

Drive the mechanical seal out of the water pump assembly from the inside.



7. COOLING SYSTEM

Drive in a new mechanical seal using a mechanical seal driver.

Apply sealant to the right crankcase cover fitting surface of a new mechanical seal and then drive in the mechanical seal.

Mechanical Seal Driver



INSTALLATION (XCITING 250/300 AFI)

Drive a new water pump shaft outer bearing into the water pump assembly from the inside.

Outer Bearing



Water Pump Assembly

Install the water pump shaft and shaft inner bearing into the water pump assembly. Install the snap ring to secure the inner bearing properly.

Snap Ring

Water Pump Shaft



Inner Bearing

7. COOLING SYSTEM

XCITING 500/500 AFI/250/300 AFI

Install the dowel pins and a new gasket and then install the water pump assembly to the right crankcase cover. Tighten the eight bolts to secure the right crankcase cover.

When installing the water pump assembly, aligning the groove on the water pump shaft with the tab on the oil pump shaft.

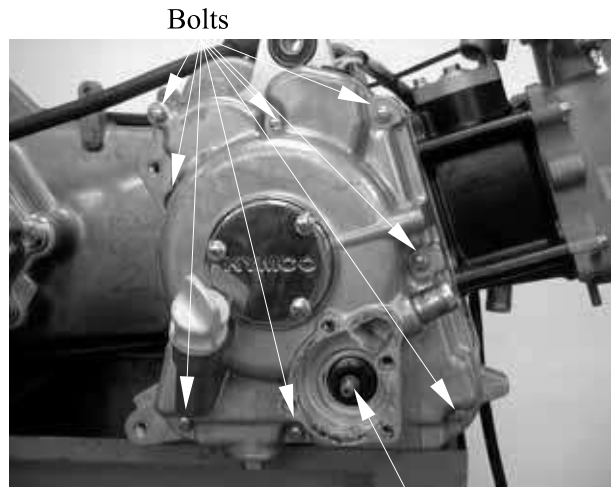

Water Pump Assembly

When the mechanical seal is replaced, a new seal washer must be installed to the impeller.

Mechanical Seal

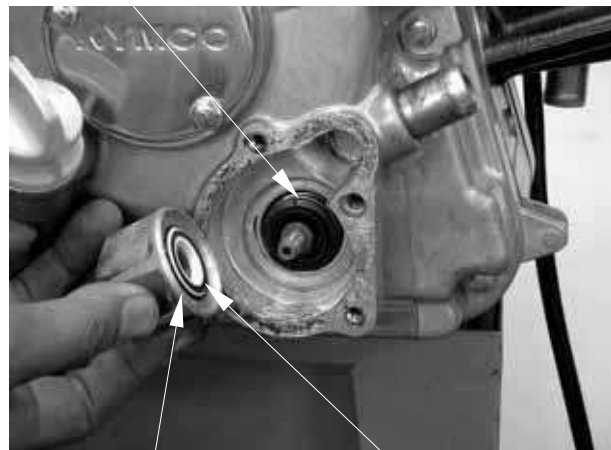

Impeller Seal Washer (Porcelain)

Install the impeller onto the water pump shaft.

Torque:

12 N•m (1.2 kgf•m, 8.6 lbf•ft) (Left screw)

The impeller has left hand threads.

Impeller (Left Hand Threads)

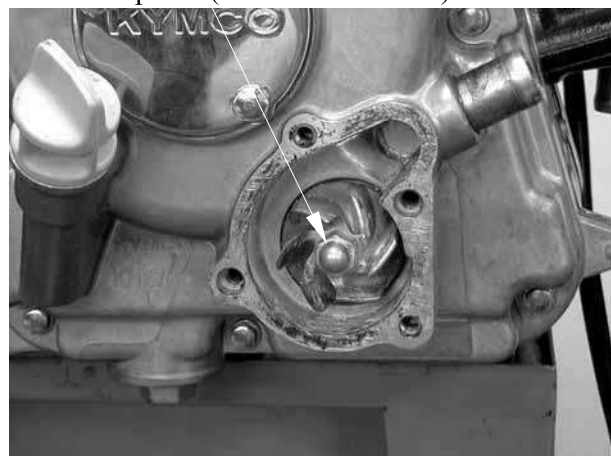

7. COOLING SYSTEM

XCITING 500/500 AFI/250/300 AFI

Install the two dowel pins and a new gasket.

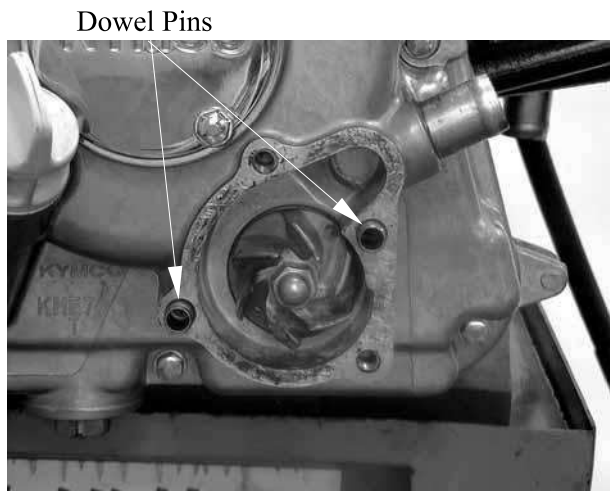

Install the water pump cover and tighten the 4 bolts.

Torque: 10 N•m (1 kgf•m, 7 lbf•ft)

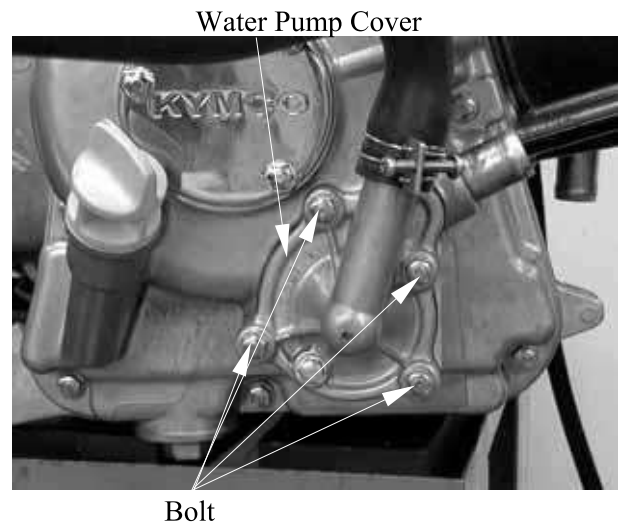

7. COOLING SYSTEM

RADIATOR REMOVAL

Drain the coolant (page 7-8).
Remove the inner cover (page 2-14).
Remove the front lower cover (page 2-15)

Disconnect the fan motor connector.



Fan Motor Connector

Loosen the hose band and disconnect the radiator lower hose from the radiator.

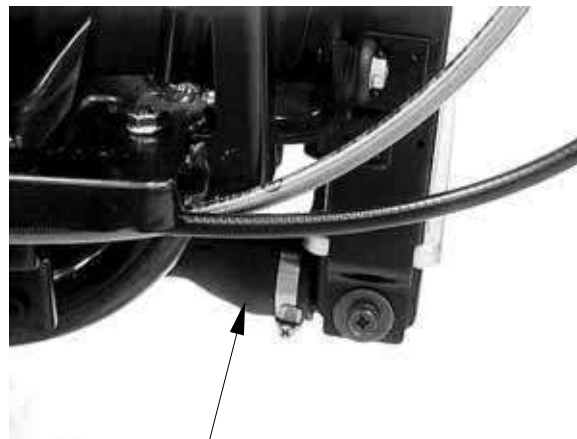

Lower Hose

Loosen the hose band and disconnect the coolant filler hose from the radiator.

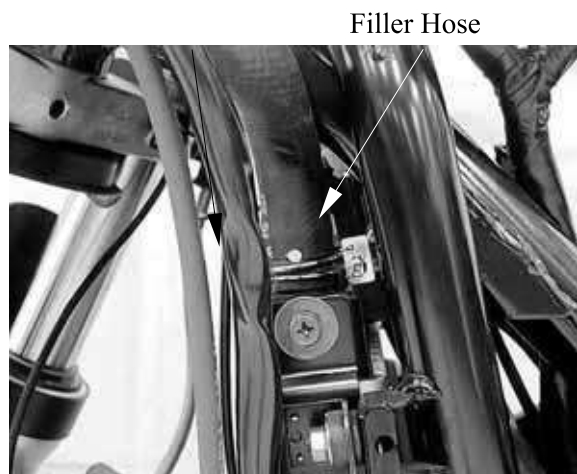

Filler Hose

7. COOLING SYSTEM

Disconnect the fan motor switch connectors.
Disconnect the air bleed hose.

Fan Motor Switch Connectors



Air Bleed Hose

Remove the four nuts and radiator from the frame.

Be careful not to damage the radiator core.

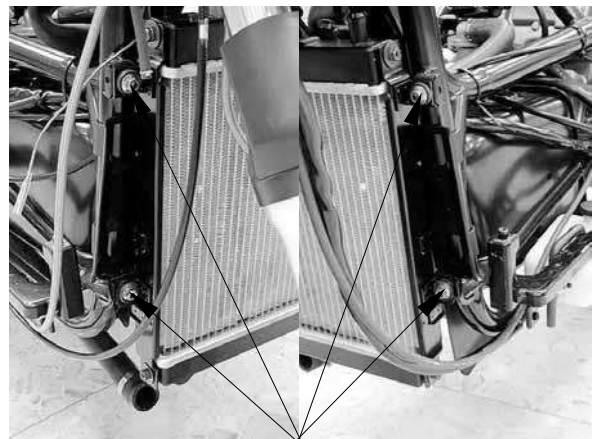

Nuts

Loosen the hose band and disconnect the radiator upper hose from the radiator.

Upper Hose



7. COOLING SYSTEM

DISSASSEMBLY

Remove the four bolts and fan motor/shroud assembly.

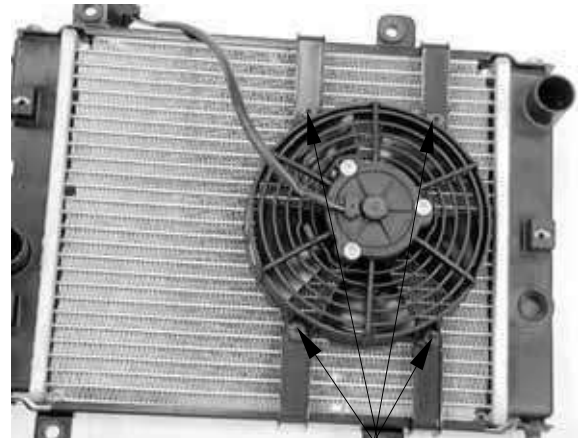

Bolts

Check the fan motor to operate using an available battery.

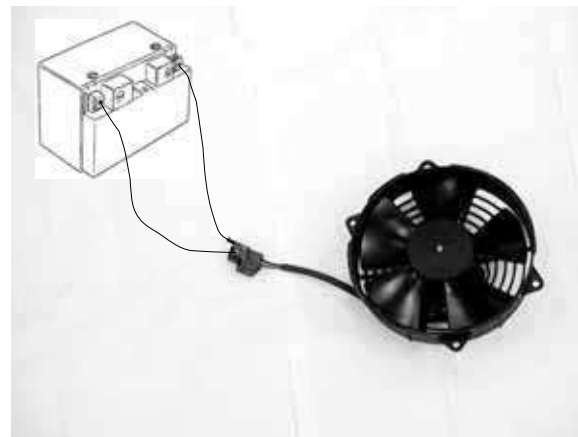

ASSEMBLY

Install the fan motor/shroud assembly to the radiator with the fan motor wire facing up.
Install and tighten the bolts securely.

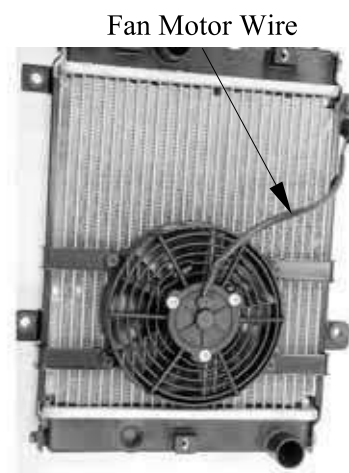

Fan Motor Wire

7. COOLING SYSTEM

XCITING 500/500 AFI/250/300 AFI

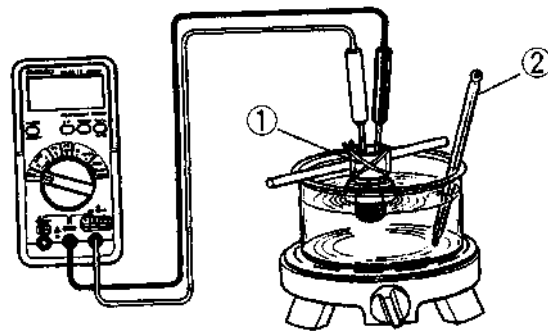
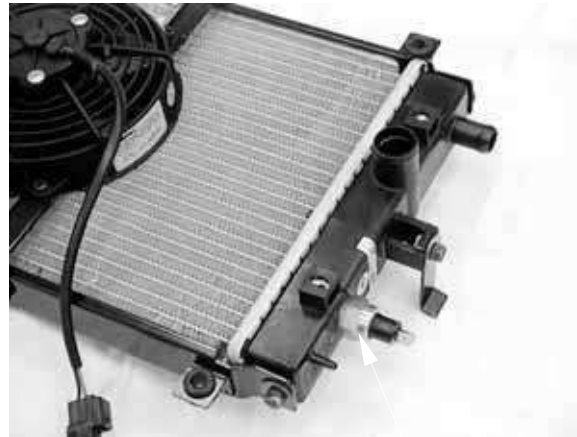

- Replace the O-ring a new one.
- Do not coat grease to the O-ring.



7. COOLING SYSTEM

WATER TEMPERATURE SENSOR

REMOVAL (XCITING 500/500 AFI)

Remove the side body cover (page 2-8)

Disconnect the water temperature sensor connector.

Remove the water temperature sensor from the water joint.



Water Temperature Sensor

REMOVAL (XCITING 250/300 AFI)

Remove the luggage box (page 2-3).

Disconnect the water temperature sensor connectors.

Remove the water temperature sensor from the thermostat housing.

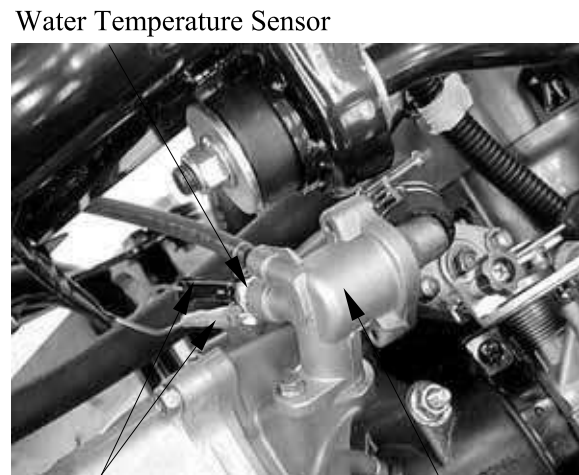

Water Temperature Sensor Connectors

Thermostat Housing

7. COOLING SYSTEM

XCITING 500/500 AFI/250/300 AFI

INSPECTION

Connect the water temperature sensor to the ohmmeter and dip it in oil contained in a pan which is placed on an electric heater.

Gradually raise oil temperature while reading the thermometer in the pan and the ohmmeter connected. If the resistance measured is out of specification, replace the temperature gauge with a new one.

Temperature	Standard resistance
50	123.9– 478.9 Ω
100	26– 29.3 Ω

- Handle the water temperature sensor carefully as it is vulnerable to impact.
- Do not allow the water temperature sensor and the thermometer to come in contact with the bottom of the pan.

After the water temperature sensor has been installed, fill coolant and perform air bleeding (page 7-8).

INSTALLATION

With thread lock applied to the threaded part, tighten the water temperature sensor.

Torque: 8 N•m (0.8 kgf•m, 5.8 lbf•ft)

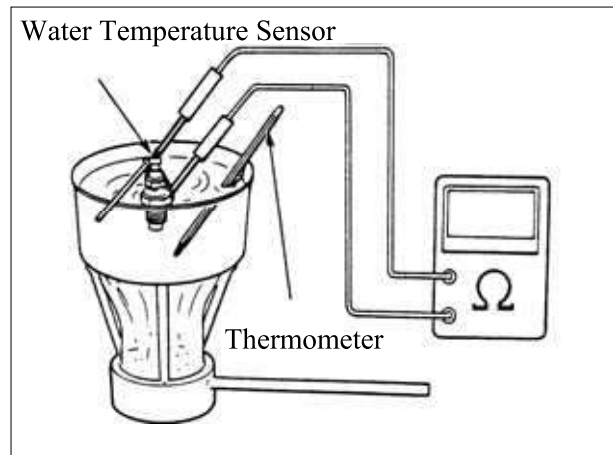

7. COOLING SYSTEM

RADIATOR RESERVE TANK

REMOVAL

Remove the floorboard (page 2-6).

Remove the two nuts and radiator reserve tank from the frame.



Nuts

Open the reserve tank cap and drain the coolant from the reserve tank.

Disconnect the siphon hose.

INSTALLATION

Installation is in the reverse order of removal.

Pour the recommended coolant to the upper level line with the center stand applied



Siphon Hose

**8.ENGINE REMOVAL/
INSTALLATION**

XCITING 500/500 AFI/250/300 AFI

ENGINE REMOVAL/INSTALLATION

SERVICE INFORMATION----- 8- 1
ENGINE REMOVAL (XCITING 500/500 AFI)----- 8- 2
ENGINE REMOVAL (XCITING 250/300 AFI)----- 8-11
ENGINE HANGER ----- 8-16



8.ENGINE REMOVAL/ INSTALLATION

XCITING 500/500 AFI/250/300 AFI

SERVICE INFORMATION

GENERAL INSTRUCTIONS

- During engine removal and installation, support the scooter on its main stand.
- Support the frame using a jack or other adjustable support to ease of engine hanger bolt removal.
- The following components require engine removal for serviced with the engine installed in the frame.

™ Oil pump (Section 4)

™ Water pump (Section 7)

™ Cylinder head (Section 9)

™ Cylinder/Piston (Section 10)

™ Drive and driven pulleys/clutch (Section 11)

™ Final reduction (Section 12)

™ Alternator/Starter clutch (Section 13)

- The following components require engine removal for service.

™ Crankshaft/Crankcase/Balancer (Section 14)

SPECIFICATIONS

ITEM		SPECIFICATIONS	
Engine dry weight		XCITING 500/500 AFI	66 kg (145.2 lbs)
		XCITING 250/300 AFI	37.5 kg (82.5 lbs)
Engine oil capacity	At draining	XCITING 500/500 AFI	2 liter (2.1 US qt, 1.8 lmp qt)
		XCITING 250/300 AFI	0.9 liter (0.95 US qt, 0.8 lmp qt)
	At disassembly	XCITING 500/500 AFI	2.5 liter (2.7 US qt, 2.2 lmp qt)
		XCITING 250/300 AFI	1.1 liter (0.97 US qt, 1.17 lmp qt)
	At oil filter cartridge change (XCITING 500/500 AFI)		2.1 liter (2.2 US qt, 1.9 lmp qt)

TORQUE VALUES

Engine mounting bolt/nut (XCITING 500/500 AFI)	80 N•m (8 kgf•m, 58 lbf•ft)
Engine mounting bolt/nut (XCITING 250/300 AFI)	50 N•m (5 kgf•m, 36 lbf•ft)
Rear shock absorber lower mounting bolt	40 N•m (4 kgf•m, 29 lbf•ft)
Rear/parking brake caliper mounting bolt	32 N•m (3.2 kgf•m, 23 lbf•ft)
	ALOCK bolt: replace with a new one
Engine hanger mounting bolt	50 N•m (5 kgf•m, 36 lbf•ft)
Engine hanger rod nut	35 N•m (3.5 kgf•m, 25 lbf•ft)

8.ENGINE REMOVAL/ INSTALLATION

XCITING 500/500 AFI/250/300 AFI

ENGINE REMOVAL (XCITING 500/500 AFI)

Remove the following:

Luggage box (page 2-3)

Floorboard (page 2-6)

Rear fender (page 2-7)

Side/rear body cover (page 2-8)

Exhaust muffler (page 2-16)

Drain the coolant from the system (page 7-8).

Support the scooter on its main stand.

Loosen the air cleaner clamp screw.

Loosen the carburetor clamp screw.

Remove the carburetor.

Throttle body (page 6-42)

Air Cleaner Clamp Screw



Carburetor Clamp Screw

Disconnect the fuel hose from the carburetor.

Remove fuel injector pipe and disconnect the fuel injector connector (page 6-36).

Fuel Hose

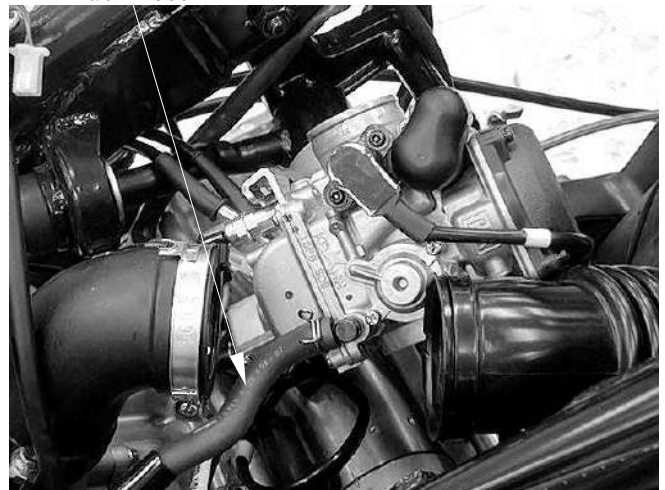

8.ENGINE REMOVAL/ INSTALLATION

XCITING 500/500 AFI/250/300 AFI

Disconnect the water temperature sensor connector.
Disconnect AICV air supply hose from the AICV check valve.

AICV air Supply Hose



Water Temperature Sensor Connector

Disconnect the spark plug cap from the cylinder head.
Disconnect the crankcase breather hose from the cylinder head cover.

Crankcase Breather Hose

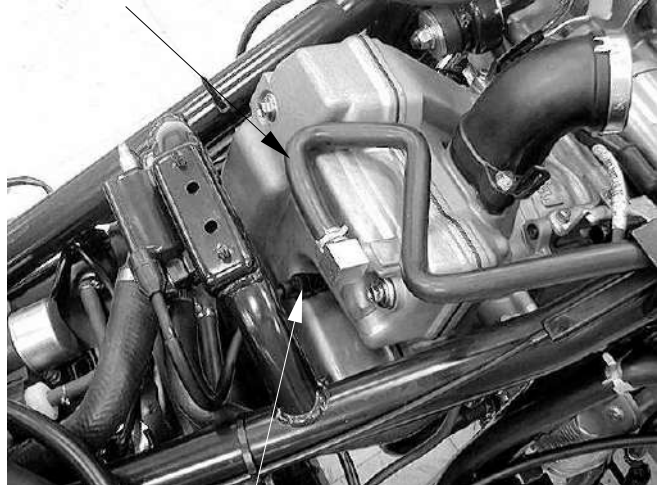

Spark Plug Cap

Release the rubber cap and remove the terminal nut to disconnect the starter motor cable.

Rubber Cap

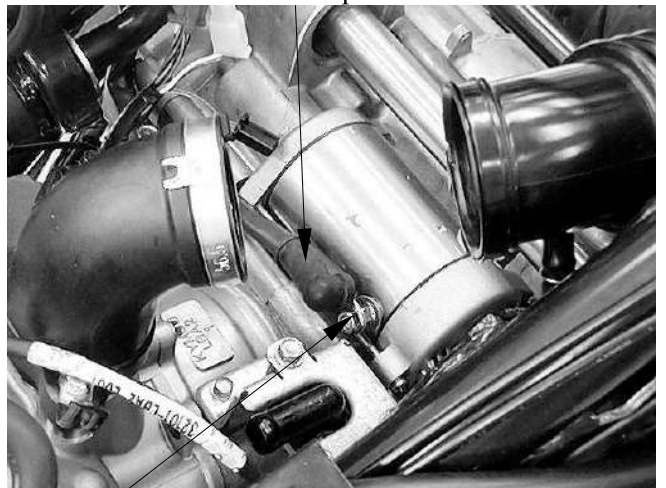

Nut

8.ENGINE REMOVAL/ INSTALLATION

XCITING 500/500 AFI/250/300 AFI

Disconnect the air bleed hose and water hose from the water joint.

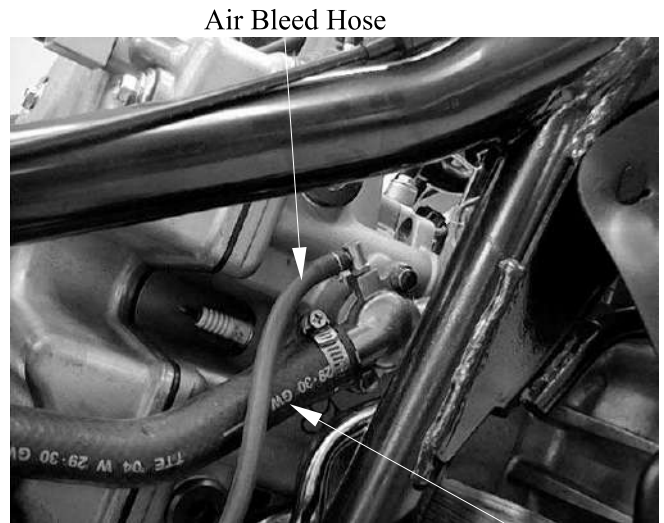

Disconnect the outer water hose from the oil cooler.

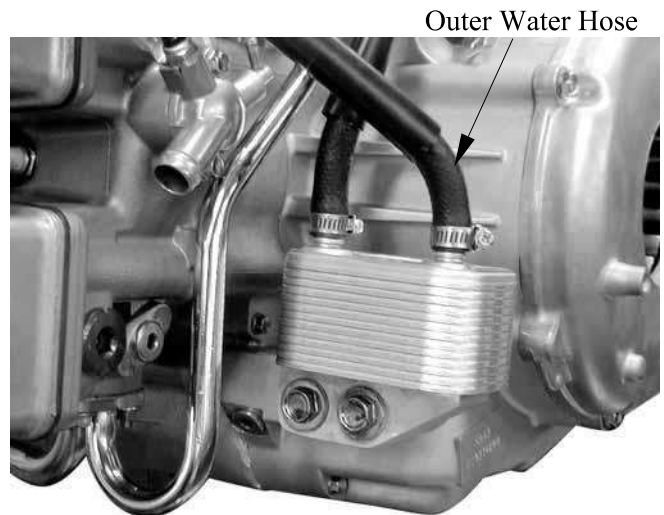

Loosen the wire bands and disconnect the alternator connectors.



8.ENGINE REMOVAL/ INSTALLATION

XCITING 500/500 AFI/250/300 AFI

Remove the bolt and engine ground cable.

Engine Ground Cable

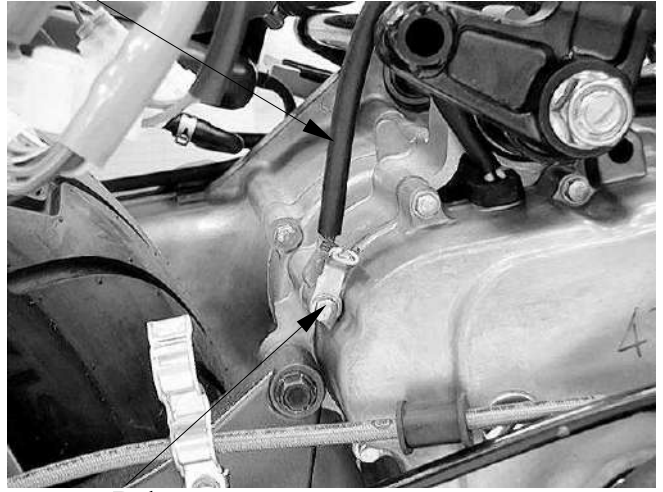

Bolt

Loosen the hose bands and disconnect the
bypass hose and water hose

Bypass Hose

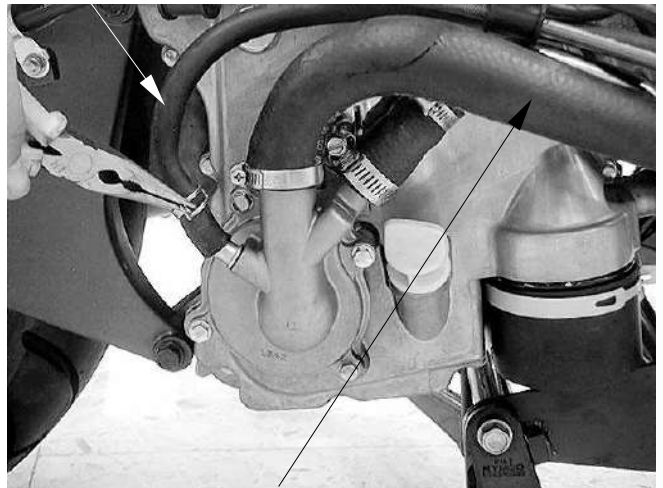

Water Hose

Disconnect the oil pressure switch connector.

Oil Pressure Switch



Oil Pressure Switch Connector

8.ENGINE REMOVAL/ INSTALLATION

XCITING 500/500 AFI/250/300 AFI

Remove the bolts and rear/parking brake caliper.

Remove the brake hose from clamps.

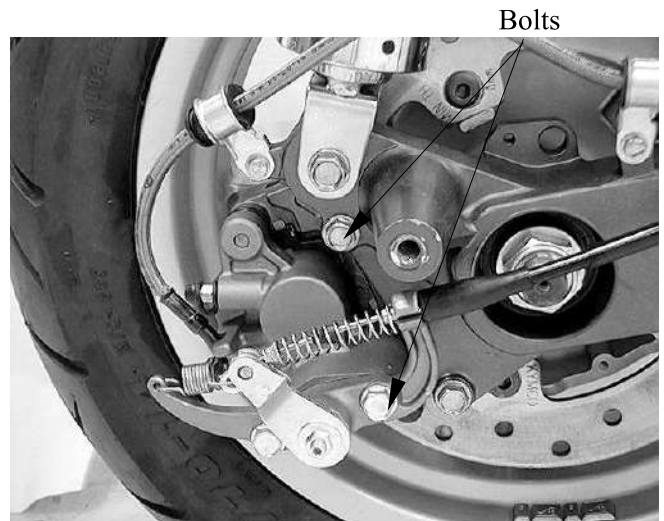

Disconnect the transmission case breather hose from transmission case.

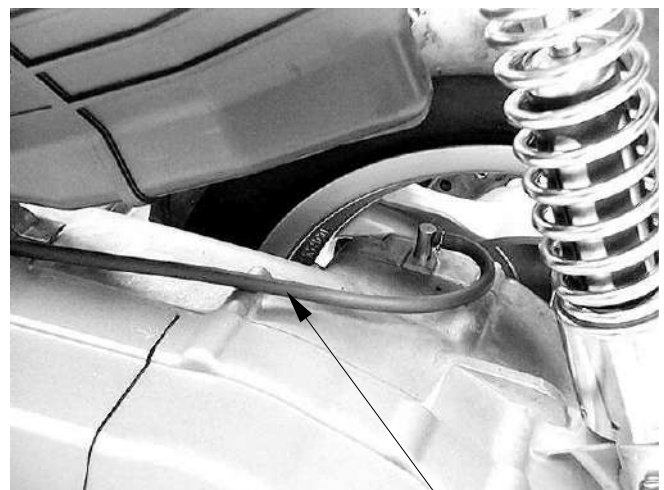

Remove the bolts and air cleaner.

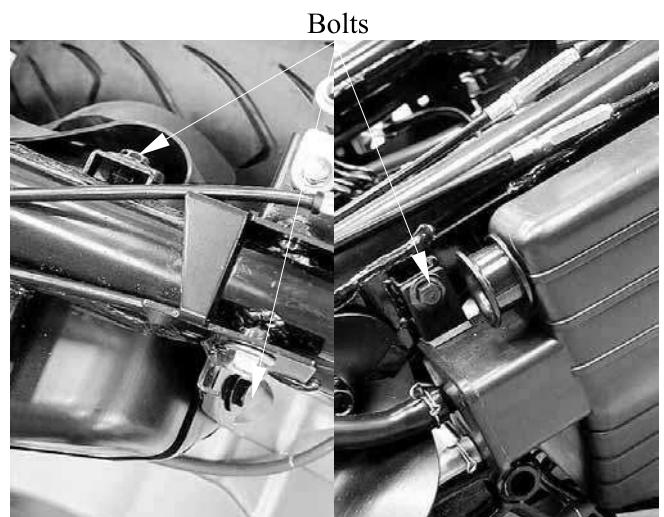

8.ENGINE REMOVAL/ INSTALLATION

XCITING 500/500 AFI/250/300 AFI

Remove the rear cushion lower mount bolts

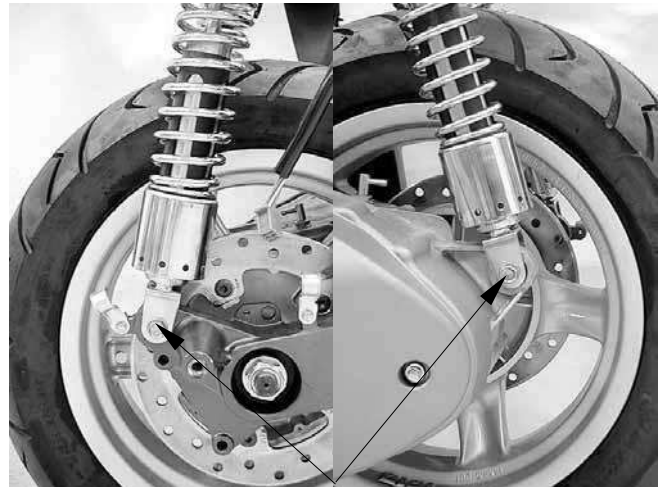

Lower Mount Bolts

Remove the engine mount nut.

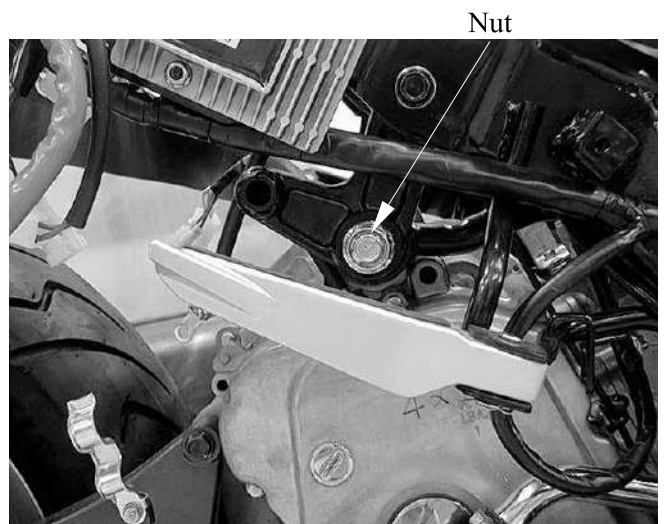

Nut

Turn the engine mount bolt counterclockwise and loosen it.

Pull out the engine mount bolt then removes the engine from the frame.

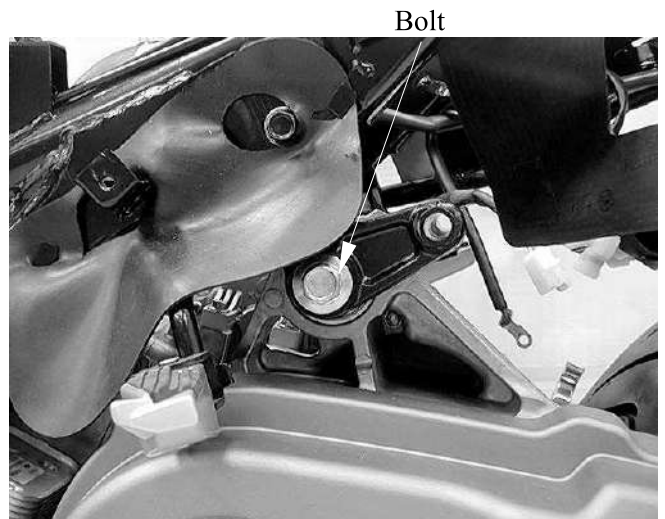

Bolt

8.ENGINE REMOVAL/ INSTALLATION

XCITING 500/500 AFI/250/300 AFI

At removing the engine, be careful not to catch your hand or finger between the engine hanger and crankcase.

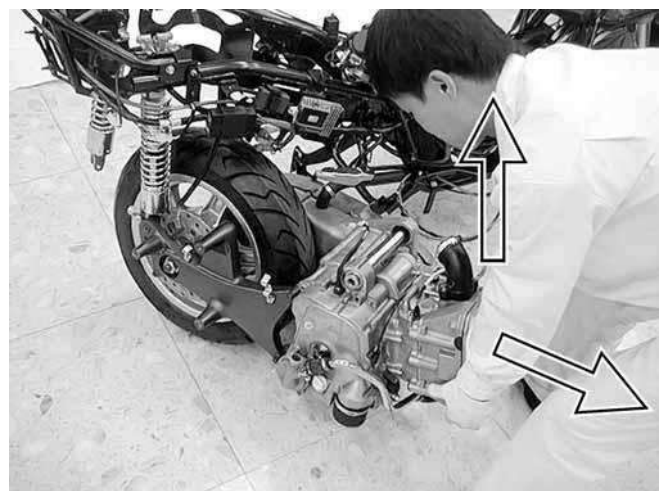
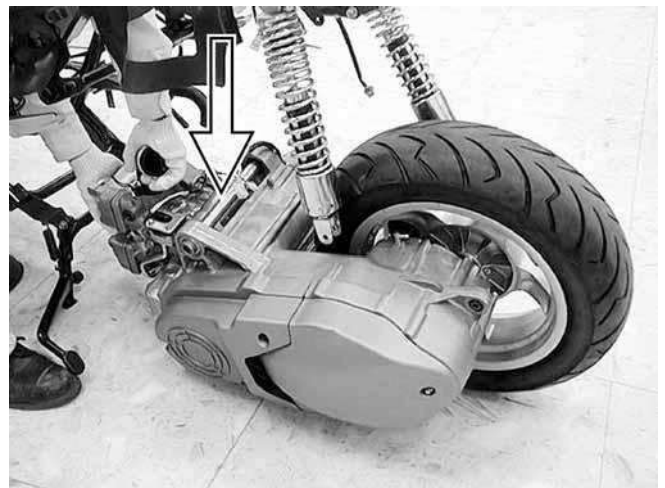
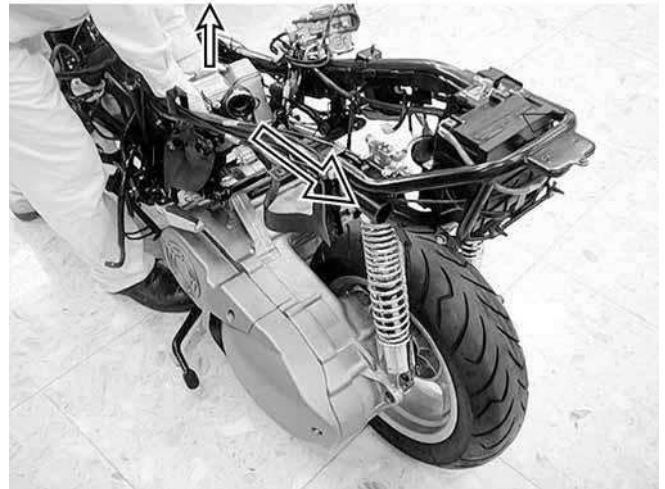

8.ENGINE REMOVAL/ INSTALLATION

XCITING 500/500 AFI/250/300 AFI

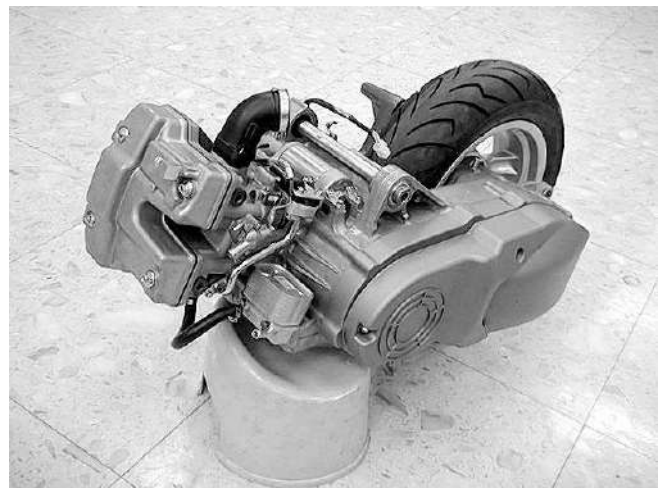

Remove the collar.

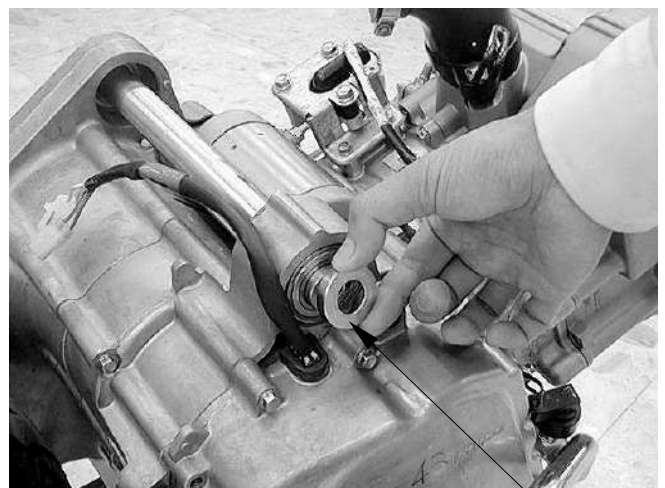

Collar

8.ENGINE REMOVAL/ INSTALLATION

XCITING 500/500 AFI/250/300 AFI

Pull out the long engine collar.

INSTALLATION

Installation is in the reverse order of removal.

- At installing the engine, be careful not to catch your hand or finger between the engine hanger and crankcase.
- Check for leakage of the engine oil and engine coolant.

Torque:

Engine mounting bolt/nut:

80 N•m (8 kgf•m, 58 lbf•ft)

Route the brake hoses and wires properly
(page 1-16).

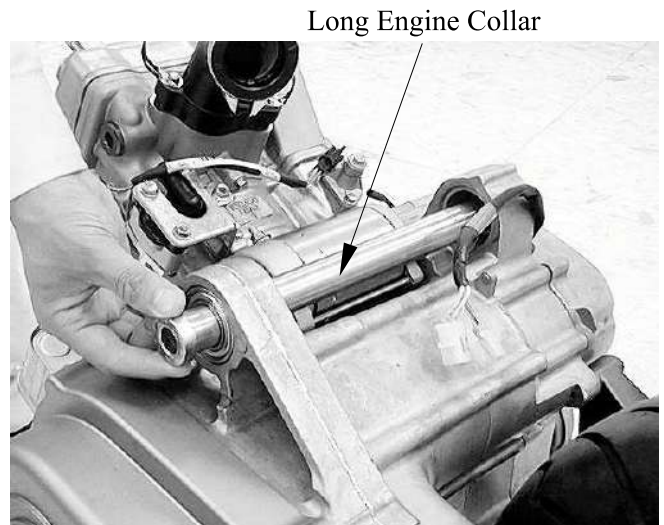

8.ENGINE REMOVAL/ INSTALLATION

XCITING 500/500 AFI/250/300 AFI

ENGINE REMOVAL (XCITING 250/250 AFI)

Remove the following:

Luggage box (page 2-3)

Floorboard (page 2-6)

Rear fender (page 2-7)

Side/rear body cover (page 2-8)

Exhaust muffler (page 2-16)

Carburetor (page 5-6) (XCITING 250)

Throttle body (page 6-42)

Drain the coolant from the system (page 7-8). Support the scooter on its main stand. Disconnect the crankcase breather and AICV air supply hoses from the cylinder head cover.

Disconnect the fuel pump and AICV vacuum hoses from the inlet pipe (XCITING 250).

Remove fuel injector pipe and disconnect the fuel injector connector (page 6-36).

Remove the two air cleaner mounting bolts and disconnect the transmission case breather hose from air cleaner case, then remove the air cleaner.

Crankcase Breather Hose

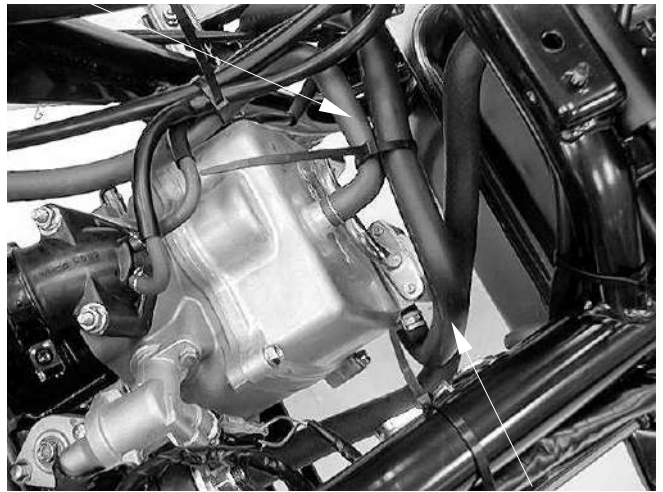

AICV Air Supply Hose

Fuel Pump Vacuum Hose



AICV Vacuum Hose

Air Cleaner

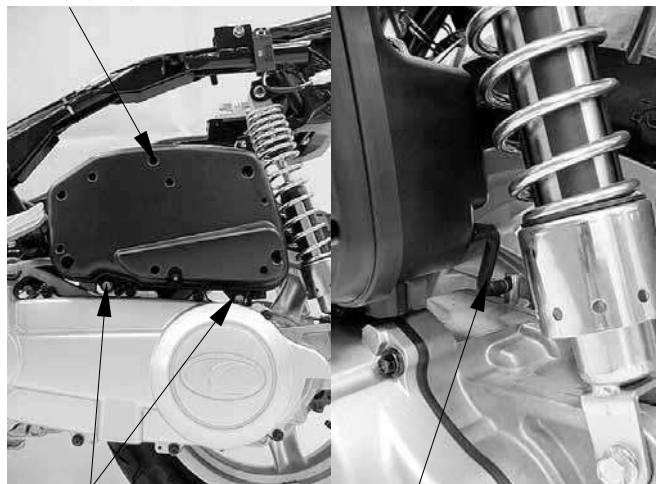

Bolts

Transmission Case Breather Hose

8.ENGINE REMOVAL/ INSTALLATION

XCITING 500/500 AFI/250/300 AFI

Disconnect the ECT sensor connector (page 6-39). (XCITING 250 AFI)

Remove the bolt and thermostat housing.

Release the rubber cap and remove the terminal nut to disconnect the starter motor cable.

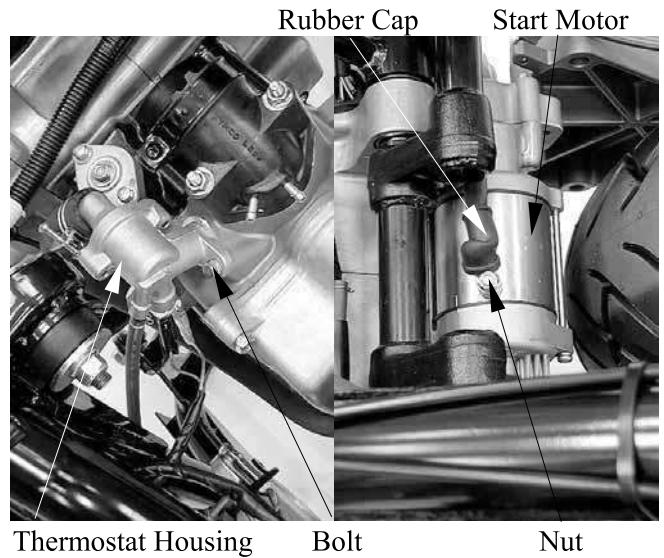

Disconnect the alternator connectors.



Remove the bolt and disconnect the engine ground cable from the right crankcase cover.

Loosen the band screw and disconnect the water hose from the water pump.

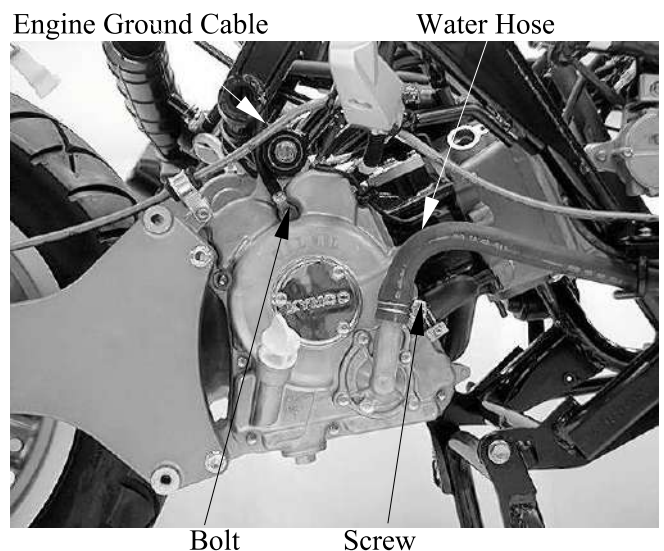

8.ENGINE REMOVAL/ INSTALLATION

XCITING 500/500 AFI/250/300 AFI

Remove the two rear brake caliper mounting bolts and three rear brake hose bands/bolts from rear fork, then remove the rear brake caliper.

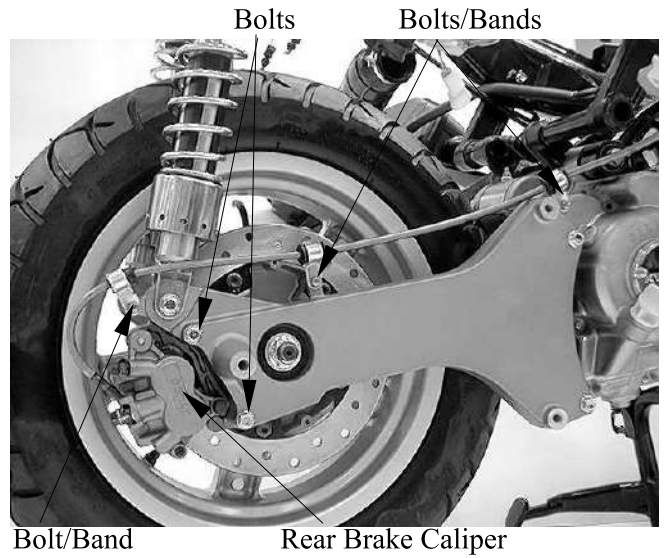

Disconnect the oil pressure switch connector .

Remove the spark plug cap.

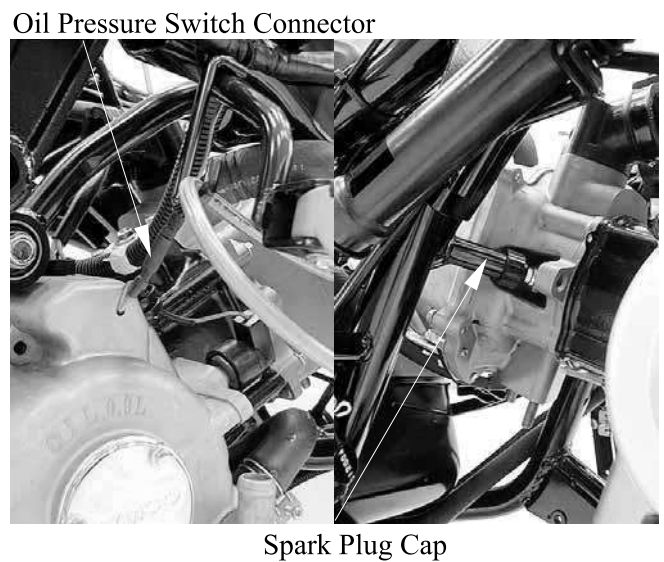

Remove the rear cushion lower mounting bolts.

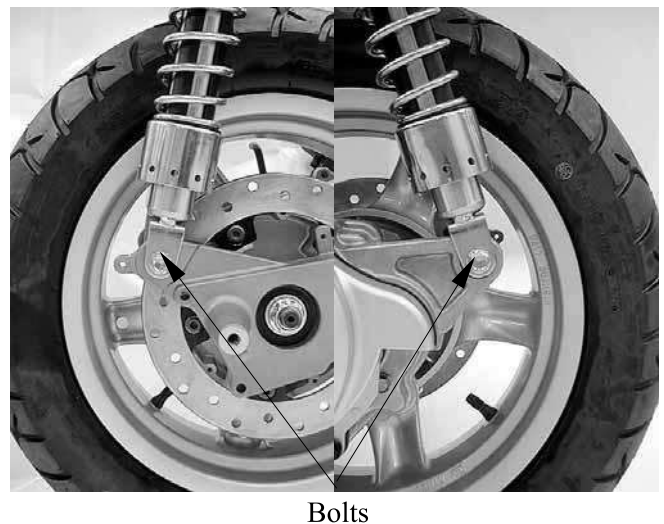

8.ENGINE REMOVAL/ INSTALLATION

XCITING 500/500 AFI/250/300 AFI

Remove the nut.

Pull out the engine mounting bolt, then removes the engine from the frame.

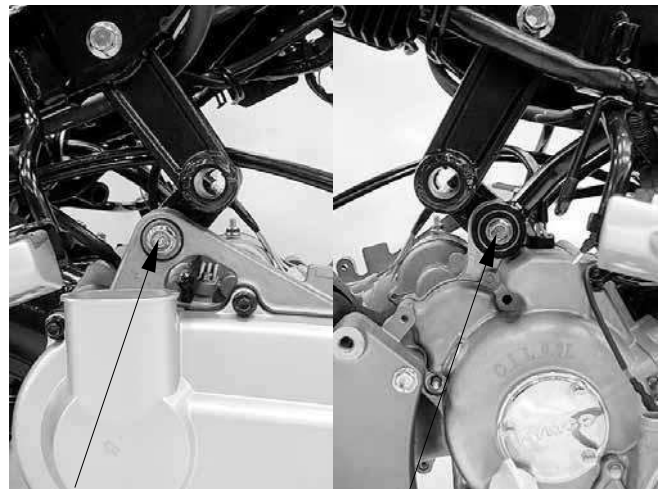

Nut

Bolt

At removing the engine, be careful not to catch your hand or finger between the engine hanger and crankcase.



INSTALLATION

Installation is in the reverse order of removal.

- At installing the engine, be careful not to catch your hand or finger between the engine hanger and crankcase.
- Check for leakage of the engine oil and engine coolant.

Torque:

Engine mounting bolt/nut:
50 N•m (5 kgf•m, 36 lbf•ft)

Route the brake hoses and wires properly (XCITING 250: page 1-26/XCITING 250 AFI: page 1-34).



8.ENGINE REMOVAL/ INSTALLATION

XCITING 500/500 AFI/250/300 AFI

INSPECTION

Inspect the bearing (XCITING 500/500 AFI):
Bearings allow play in the right/left crankcase
or the bearing turns roughly → Replace.

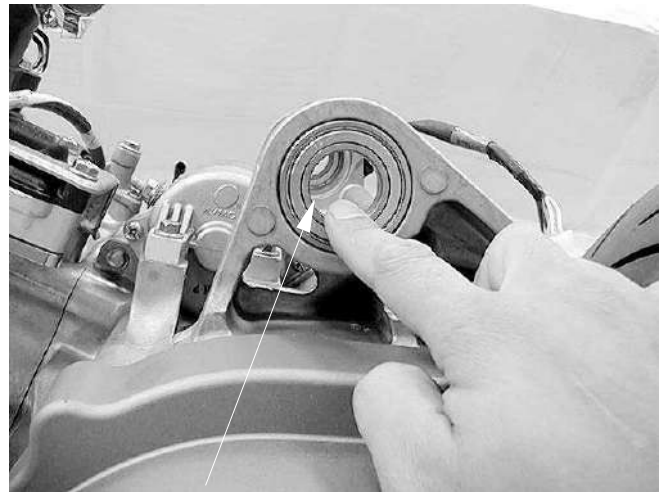

Bearing

Inspect the bushes (XCITING 250/250 AFI):
Bushes allow play in the right/left crankcase
or the wear/damage → Replace.

Inspect the inner collars (XCITING 250/250
AFI):
Wear/Damage → Replace.

Replace the new O-rings and apply grease to
the inner collars outside when the inner
collars are installation.



Bush

Inner Collar

Bush

Inspect the engine mount bolt:
Band/Damage → Replace

Do not attempt to straighten a bent
engine mount bolt.

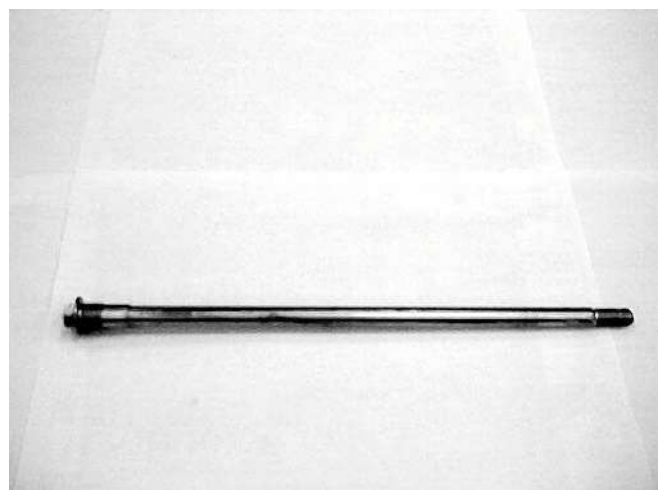

8.ENGINE REMOVAL/ INSTALLATION

XCITING 500/500 AFI/250/300 AFI

ENGINE HANGER REMOVAL

Loosen and remove the engine mount nut (page 8-7).

Loosen and remove the engine mount bolt (page 8-7).

Remove the engine hanger mount bolts.

Remove the outer collars (XCITING 500/500 AFI).

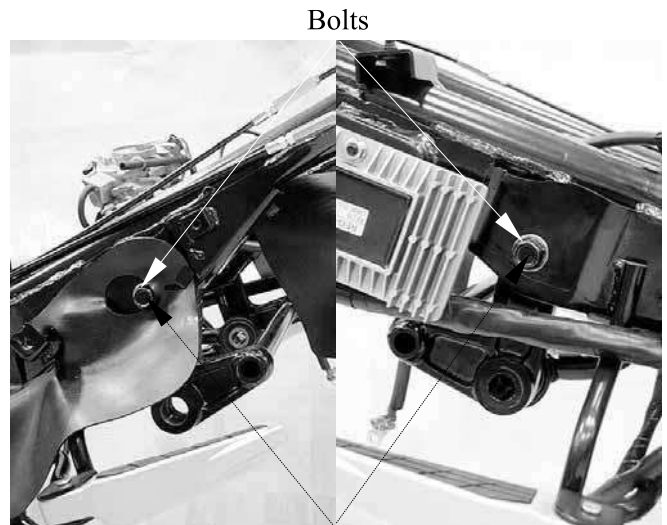

Outer Collars (XCITING 500)

Remove the engine hanger

Remove the inner collars.



Remove the nut, washers, rubber washers and engine hanger rod.

INSTALLATION

Installation is in the reverse order of removal.

Torque:

Engine hanger mounting bolt:

50 N•m (5 kgf•m, 36 lbf•ft)

Engine hanger rod nut:

35 N•m (3.5 kgf•m, 25 lbf•ft)

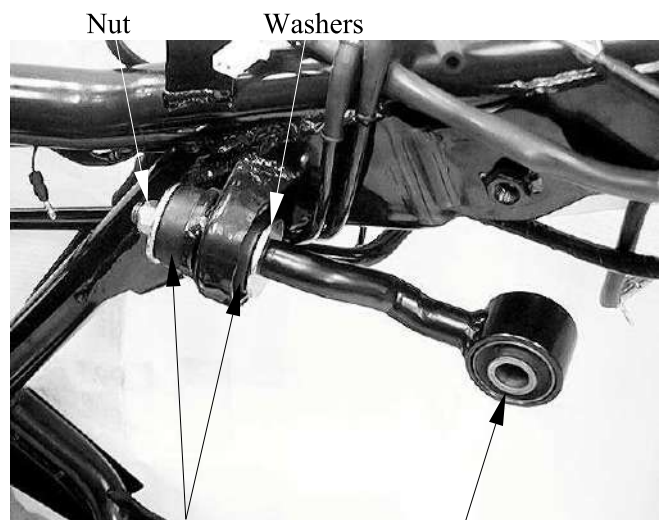

Rubber Washers

Engine Hanger rod

8.ENGINE REMOVAL/ INSTALLATION

XCITING 500/500 AFI/250/300 AFI

INSPECTION

Inspect the bearings in the engine hanger
(XCITING 500/500 AFI):

Bearings allow play in the engine hanger or
the bearing turns roughly → Replace.

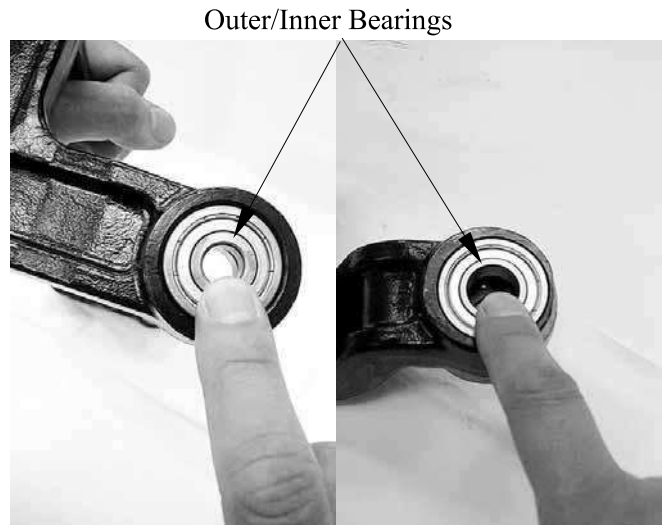

Inspect the bushes in the engine hanger
(XCITING 250/250 AFI):

Wear/Damage → Replace.

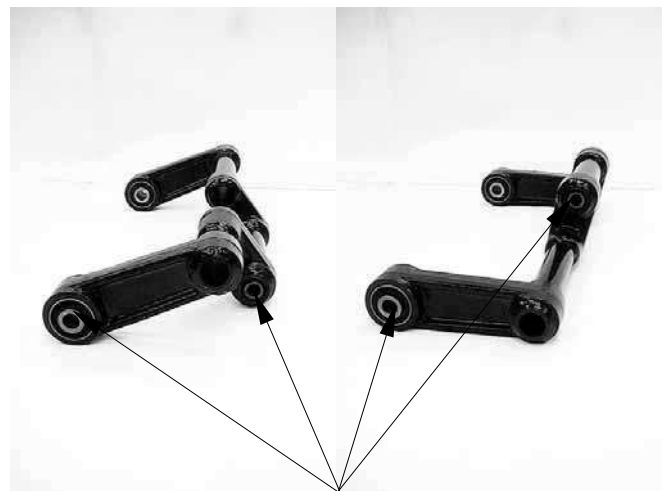

Bushes

Inspect the bush in the engine hanger rod:
Wear/Damage → Replace.



CYLINDER HEAD/VALVES

SCHEMATIC DRAWING (XCITING 500/500 AFI) -----	9- 1
SCHEMATIC DRAWING (XCITING 250/300 AFI) -----	9- 2
SERVICE INFORMATION-----	9- 3
TROUBLESHOOTING-----	9- 5
CYLINDER COMPRESSION TEST -----	9- 6
CYLINDER HEAD COVER (XCITING 500/500 AFI)-----	9- 7
CYLINDER HEAD COVER (XCITING 250/300 AFI)-----	9- 8
CAMSHAFT (XCITING 500/500 AFI) -----	9- 9
CAMSHAFT (XCITING 250/300 AFI) -----	9-14
ROCKER ARMS (XCITING 500/500 AFI) -----	9-17
ROCKER ARMS (XCITING 250/300 AFI) -----	9-18
CYLINDER HEAD-----	9-19

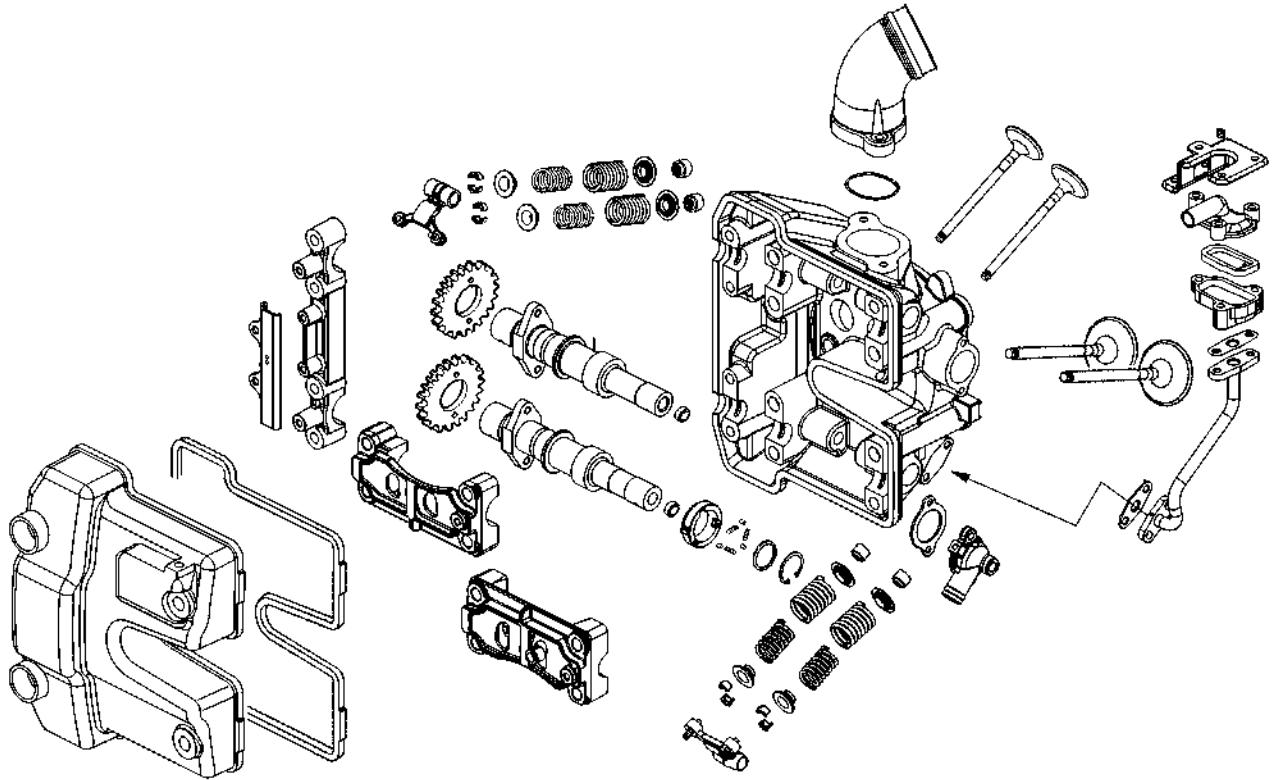

9. CYLINDER HEAD/VALVES XCITING 500/500 AFI/250/300 AFI

SCHEMATIC DRAWING (XCITING 500/500 AFI)

9. CYLINDER HEAD/VALVES

XCITING 500/500 AFI/250/300AFI

SCHEMATIC DRAWING (XCITING 250/XCITING 300 AFI)

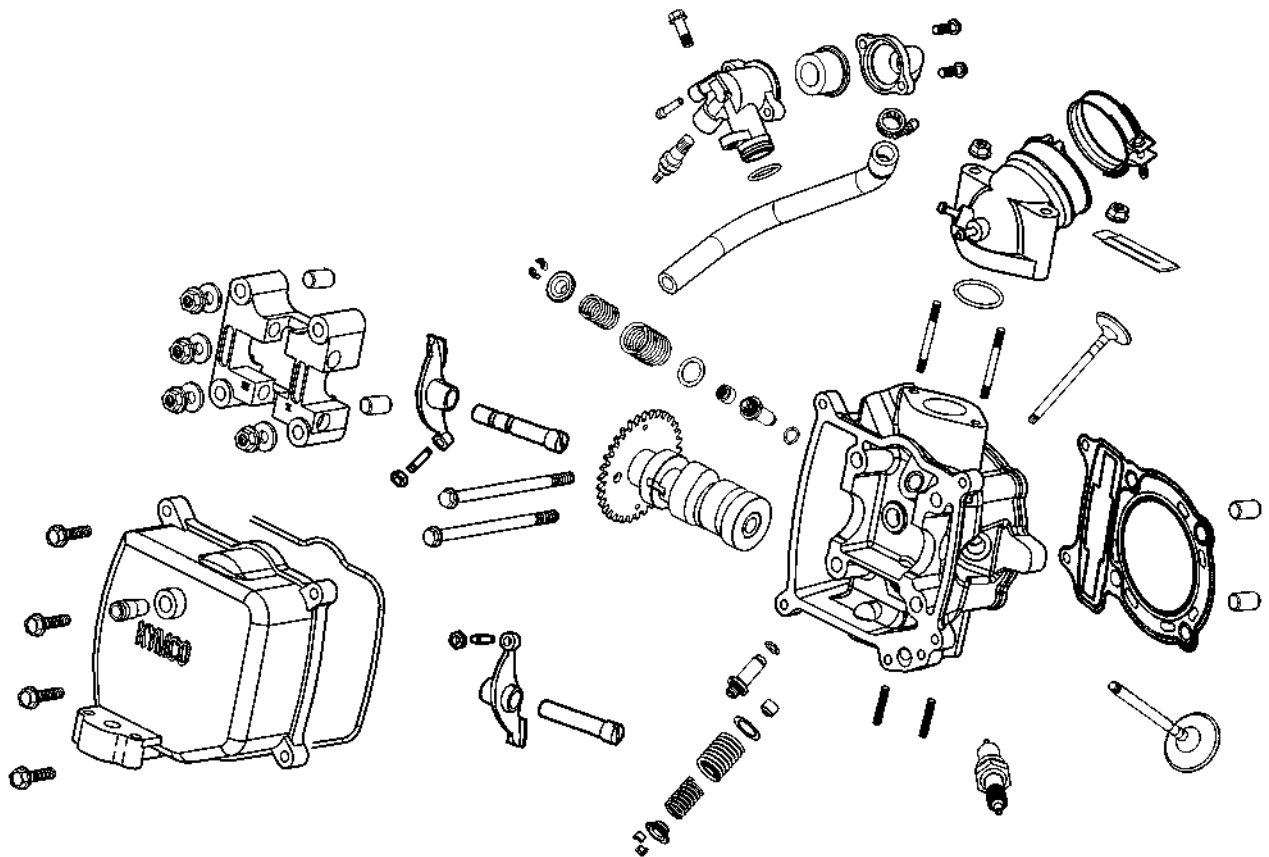

9. CYLINDER HEAD/VALVES XCITING 500/500 AFI/250/300 AFI

SERVICE INFORMATION

GENERAL INSTRUCTIONS

- The cylinder head can be serviced with the engine installed in the frame. Coolant in the radiator and water jacket must be drained first.
- When assembling, apply molybdenum disulfide grease or engine oil to the valve guide movable parts and valve arm sliding surfaces for initial lubrication.
- The valve rocker arms are lubricated by engine oil through the cylinder head engine oil passages. Clean and unclog the oil passages before assembling the cylinder head.
- After disassembly, clean the removed parts and dry them with compressed air before inspection.
- After removal, mark and arrange the removed parts in order. When assembling, install them in the reverse order of removal.

SPECIFICATIONS (XCITING 500/500 AFI)

Unit: mm (in)

Item		Standard	Service Limit
Valve clearance (cold)	IN	0.1 mm (0.004 in)	—
	EX	0.1 mm (0.004 in)	—
Cylinder head compression pressure		13 kg/cm ² (185 psi, 1300 kPa)	—
Cylinder head warpage		—	0.05 (0.002)
Camshaft cam height	IN	37.2614 (1.4905)	37.11 (1.4844)
	EX	37.0084 (1.4803)	36.86 (1.4744)
Valve rocker arm I.D.	IN	10 (0.4)~10.015 (0.4006)	10.1 (0.404)
	EX	10 (0.4)~10.015 (0.4006)	10.1 (0.404)
Valve rocker arm shaft O.D.	IN	9.975 (0.399)~9.99 (0.3996)	9.9 (0.396)
	EX	9.975 (0.399)~9.99 (0.3996)	9.9 (0.396)
Valve stem O.D.	IN	4.975 (0.199)~4.99 (0.1996)	4.925 (0.197)
	EX	4.955 (0.1982)~4.97 (0.1988)	4.915 (0.1966)
Valve guide I.D.	IN	5 (0.2)~5.015 (0.2006)	5.03 (0.2012)
	EX	5 (0.2)~5.015 (0.2006)	5.03 (0.2012)
Valve stem-to-guide clearance	IN	0.01 (0.004)~0.037 (0.0015)	0.08 (0.0032)
	EX	0.03 (0.0012)~0.057 (0.0023)	0.1 (0.004)

9. CYLINDER HEAD/VALVES

XCITING 500/500 AFI/250/300AFI

SPECIFICATIONS (XCITING 250/XCITING 300 AFI)

Unit: mm (in)

Item		Standard	Service Limit
Valve clearance (cold)	IN	0.1 mm (0.004 in)	—
	EX	0.1 mm (0.004 in)	—
Cylinder head compression pressure		15 kg/cm ² (213 psi, 1500 kPa)	—
Cylinder head warpage		—	0.05 (0.002)
Camshaft cam height	IN	34.2987 (1.371948)	34.14 (1.3656)
	EX	34.1721 (1.366884)	34.02 (1.3608)
Valve rocker arm I.D.	IN	10 (0.4)~10.015 (0.4006)	10.1 (0.404)
	EX	10 (0.4)~10.015 (0.4006)	10.1 (0.404)
Valve rocker arm shaft O.D.	IN	9.972 (0.399)~9.987 (0.3995)	9.9 (0.396)
	EX	9.972 (0.399)~9.987 (0.3995)	9.9 (0.396)
Valve stem O.D.	IN	4.975 (0.199)~4.99 (0.1996)	4.925 (0.197)
	EX	4.955 (0.1982)~4.97 (0.1988)	4.915 (0.1966)
Valve guide I.D.	IN	5 (0.2)~5.012 (0.2005)	5.03 (0.2012)
	EX	5 (0.2)~5.012 (0.2005)	5.03 (0.2012)
Valve stem-to-guide clearance	IN	0.01 (0.004)~0.037 (0.0015)	0.08 (0.0032)
	EX	0.03 (0.0012)~0.057 (0.0023)	0.1 (0.004)

TORQUE VALUES (XCITING 500/500 AFI)

Cylinder head bolt (13)	13 N•m (1.3 kgf•m, 9 lbf•ft)	Apply engine oil to threads
Cylinder head bolt (1 – 4)	48 N•m (4.8 kgf•m, 35 lbf•ft)	Apply engine oil to threads
Cylinder head bolt (5 – 12)	23 N•m (2.3 kgf•m, 17 lbf•ft)	Apply engine oil to threads
Cylinder head cover bolt	10 N•m (1 kgf•m, 7 lbf•ft)	
Cylinder head cover bolt	10 N•m (1 kgf•m, 7 lbf•ft)	
Breather separator bolt	13 N•m (1.3 kgf•m, 9 lbf•ft)	
Cam chain tensioner bolt	12 N•m (1.2 kgf•m, 9 lbf•ft)	
Tensioner pivot bolt	10 N•m (1 kgf•m, 7 lbf•ft)	
Rocker arm shaft	45 N•m (4.5 kgf•m, 32 lbf•ft)	

TORQUE VALUES (XCITING 250/XCITING 250 AFI)

Cylinder head cap nut	25 N•m (2.5 kgf•m, 18 lbf•ft)	Apply engine oil to threads
Valve clearance adjusting nut	9 N•m (0.9 kgf•m, 6.5 lbf•ft)	Apply engine oil to threads
Cylinder head cover bolt	12 N•m (1.2 kgf•m, 8.6 lbf•ft)	

SPECIAL TOOLS

Valve spring compressor	A120E00040
-------------------------	------------

TROUBLESHOOTING

- The poor cylinder head operation can be diagnosed by a compression test or by tracing engine top-end noises.

Poor performance at idle speed

- Compression too low

Compression too low

- Incorrect valve clearance adjustment
- Burned or bent valves
- Incorrect valve timing
- Broken valve spring
- Poor valve and seat contact
- Leaking cylinder head gasket
- Warped or cracked cylinder head
- Poorly installed spark plug

Compression too high

- Excessive carbon build-up in combustion chamber

White smoke from exhaust muffler

- Worn valve stem or valve guide
- Damaged valve stem oil seal

Abnormal noise

- Incorrect valve clearance adjustment
- Sticking valve or broken valve spring
- Damaged or worn camshaft
- Worn cam chain tensioner
- Worn camshaft and rocker arm

9. CYLINDER HEAD/VALVES

XCITING 500/500 AFI/250/300AFI

CYLINDER COMPRESSION TEST

Warm up the engine to normal operating temperature.
Stop the engine and remove the spark plug cap and remove the spark plug (page 3-10).



Spark Plug Cap

Install a compression gauge into the spark plug hole.

Open the throttle all the way and crank the engine with the starter motor until the gauge reading stops rising.

The maximum reading is usually reached 4 – 7 seconds.

* To avoid discharging the battery, do not operate the starter motor for more than seven seconds.

Compression Gauge



Compression pressure:

XCITING 500/500 AFI:

13 kg/cm² (185 psi, 1300 kPa)

XCITING 250/300 AFI:

15 kg/cm² (213 psi, 1500 kPa)

Low compression can be caused by:

- ♦ Blown cylinder head gasket
- ♦ Improper valve adjustment
- ♦ Valve leakage
- ♦ Worn piston ring or cylinder

High compression can be caused by:

- ♦ Carbon deposits in combustion chamber or on piston head

9. CYLINDER HEAD/VALVES XCITING 500/500 AFI/250/300 AFI

CYLINDER HEAD COVER (XCITING 500/500 AFI)

DISASSEMBLY

Remove the floorboard (page 2-6).
Remove the spark plug caps (page 9-6)
Disconnect the crankcase breather hose from the cylinder head cover (page 8-3).

Remove the four bolts and cylinder head cover.

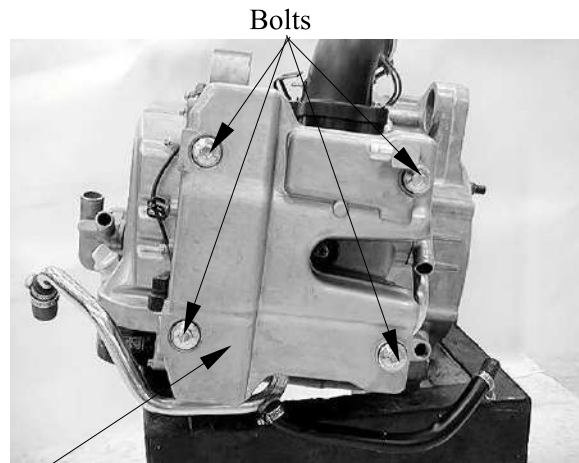

Cylinder Head Cover

Remove the cylinder head cover packing.

Cylinder Head Cover Packing



Remove the bolts and breather separator.

Bolts

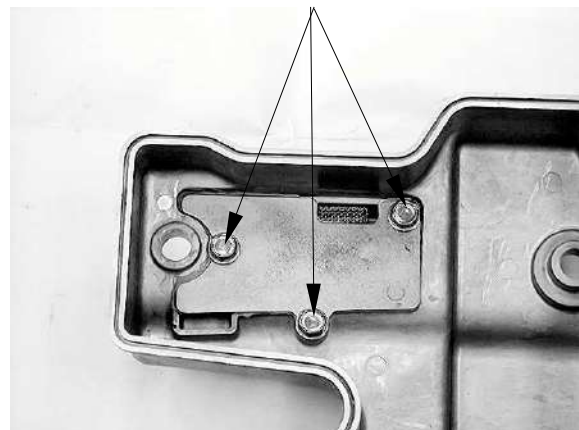

9. CYLINDER HEAD/VALVES

Remove the gasket.

ASSEMBLY

Assembly is in the reverse order of disassembly.

Torque:

Breather separator bolt:

13 N•m (1.3 kgf•m, 9 lbf•ft)

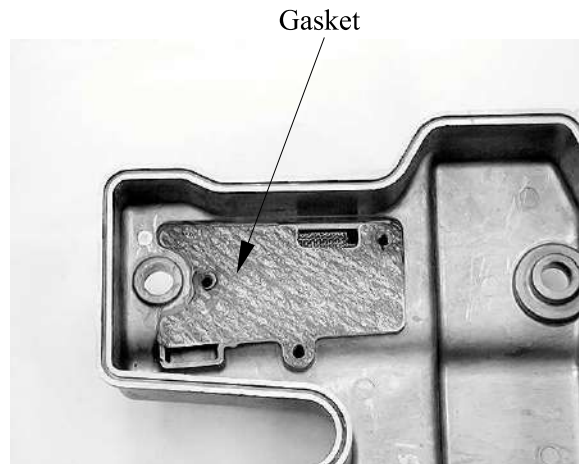

CYLINDER HEAD COVER (XCITING 250/300 AFI)

DISASSEMBLY

Remove the floorboard (page 2-6).
Disconnect the crankcase breather hose from the cylinder head cover (page 8-11).

Remove the four bolts and two nuts, then remove cylinder head cover.

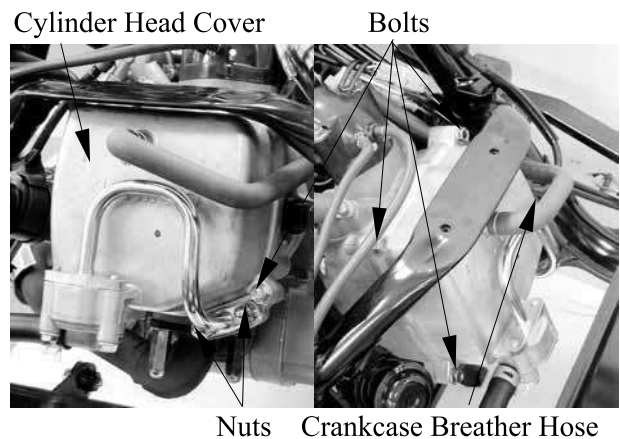

Remove the cylinder head cover O-ring.

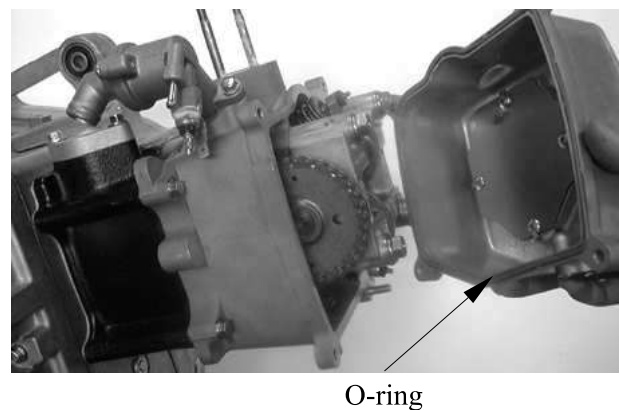

9. CYLINDER HEAD/VALVES

XCITING 500/500 AFI/250/300 AFI

CAMSHAFT (XCITING 500/500 AFI)

REMOVAL

Remove the cylinder head cover (page 9-6).
Turn the crankshaft clockwise and align the "T" mark on the flywheel with the index mark on the right crankcase cover (page 3-12).

Remove the cam chain tensioner lifter sealing bolt, spring and sealing washer.

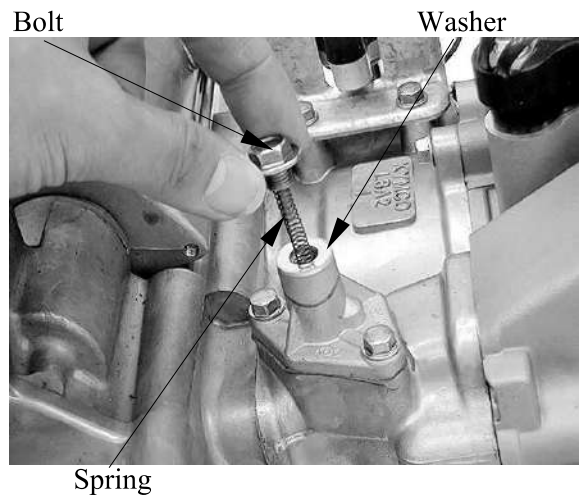

Remove the two bolts, cam chain tensioner and gasket.

Cam Chain Tensioner/Gasket

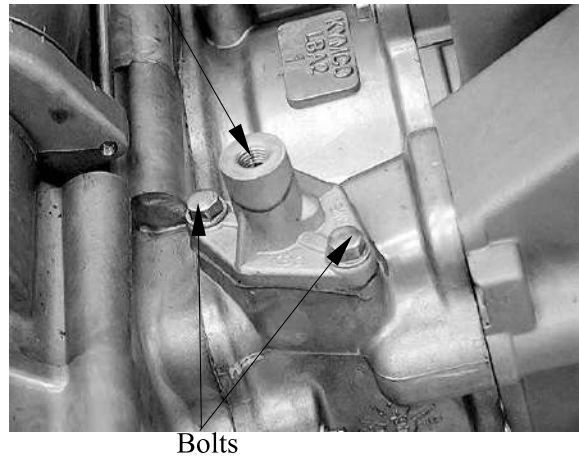

Remove the two bolts and cam chain guide.

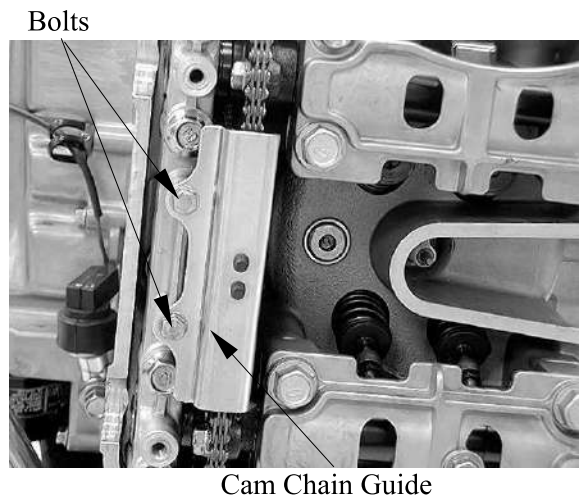

9. CYLINDER HEAD/VALVES

XCITING 500/500 AFI/250/300AFI

Loosen and remove the twelve camshaft holder bolts in a crisscross pattern in several steps, then remove the camshaft holders.

* Suspend the cam chain with a piece of wire to prevent the chain from falling into the crankcase.

Camshaft Holders Bolts

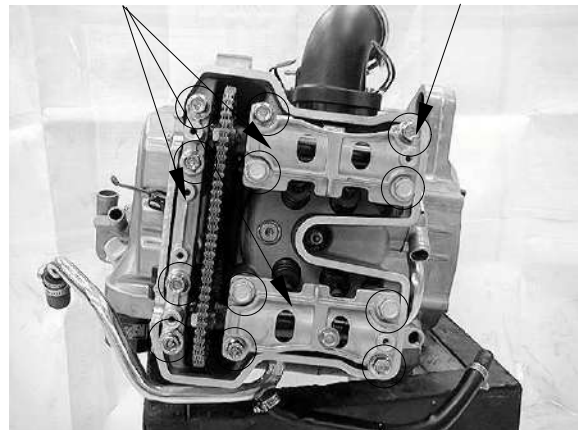

Remove the camshafts.

Camshafts

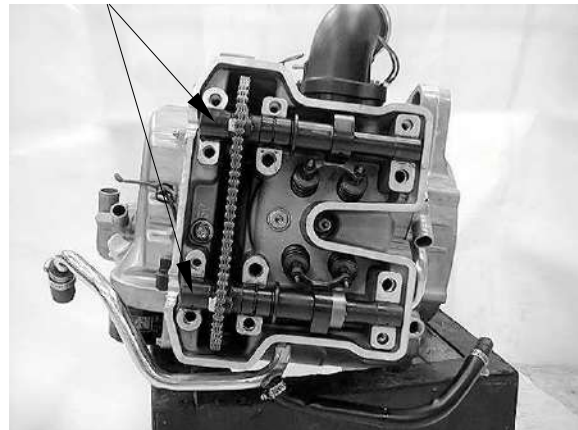

Refer to the page 9-28 to install the camshafts.

9. CYLINDER HEAD/VALVES XCITING 500/500 AFI/250/300 AFI

INSPECTION

Cam chain guide

Inspect the cam chain slipper surface of the cam chain guide for wear or damage.



Camshaft holder

* Always replace the camshaft holder and cylinder head in pairs

Inspect the bearing surface of each camshaft holder for scoring, scratches, or evidence of insufficient lubrication.

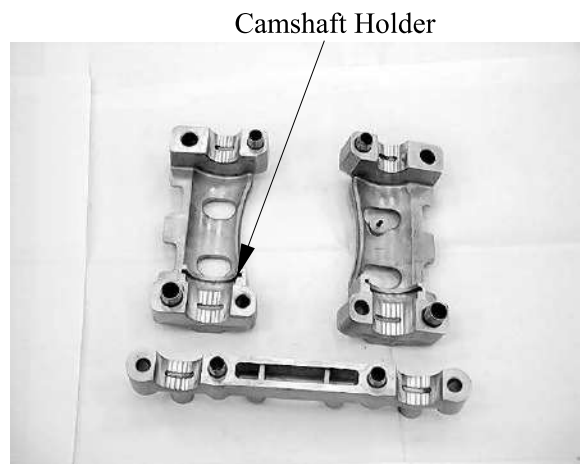

Check the stop pin spring on the exhaust camshaft holder for damage.

Replace the stop pin assembly with a new one if the spring is damaged.

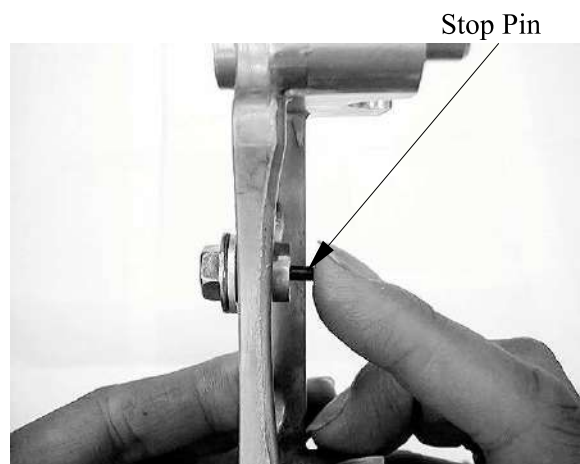

9. CYLINDER HEAD/VALVES

Camshaft

Support both ends of the camshaft with V-blocks and check the camshaft runout with a dial gauge.

Service limit: 0.05 mm (0.002 in)

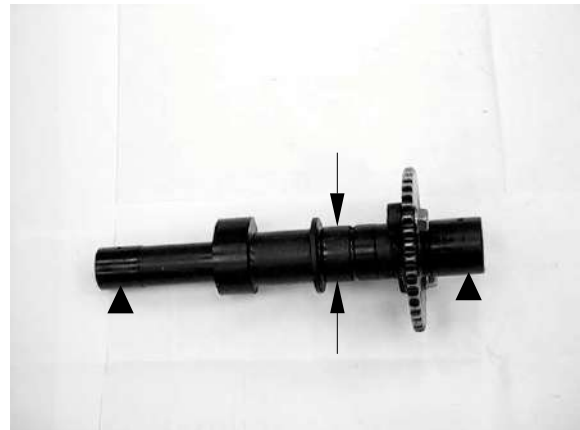

Inspect camshaft lobes for pitting/scratches/blue discoloration.

Measure the cam lobe height.

Service Limits: IN : 37.11 mm (1.4844 in)

EX: 36.86 mm (1.4744 in)

If any defects are found, replace the camshaft with a new one, then inspect lubrication system.

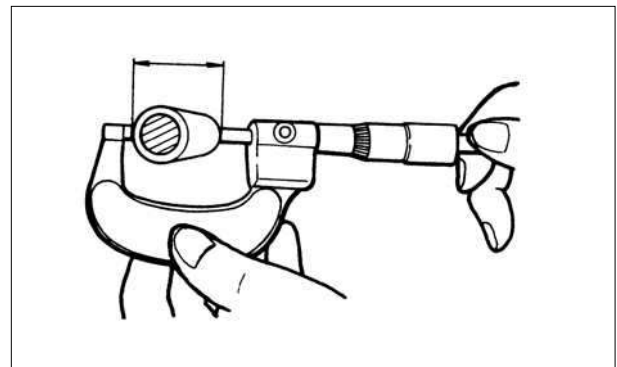

Check the decompression system by turning the decompressor cam on the exhaust camshaft.

You should be able to turn the decompressor cam clockwise smoothly, but the decompressor should not turn counterclockwise.



Cam chain tensioner

Check the one-way cam operation (tensioner)

Unsmooth operation → Replace.



9. CYLINDER HEAD/VALVES

XCITING 500/500 AFI/250/300AFI

CAMSHAFT (XCITING 250/300 AFI)

REMOVAL

Turn the A.C. generator flywheel so that the "T" mark on the flywheel aligns with the index mark on the right crankcase cover (page 3-13).

Hold the round hole on the camshaft gear facing up and the location is the top dead center on the compression stroke.

Remove the cam chain tensioner lifter sealing bolt.

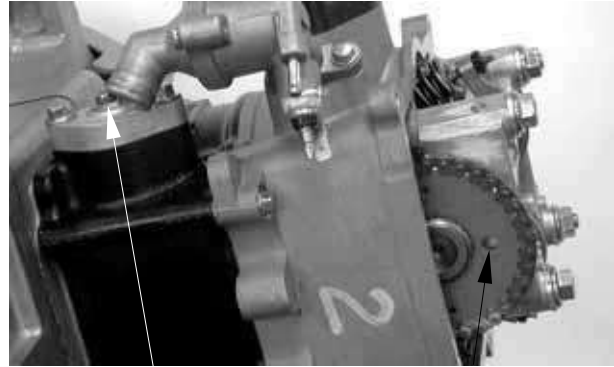

Cam Chain Tensioner

Round Hole

Turn the cam chain tensioner screw clockwise to pull the tensioner rod all the way in.

Tensioner Screw

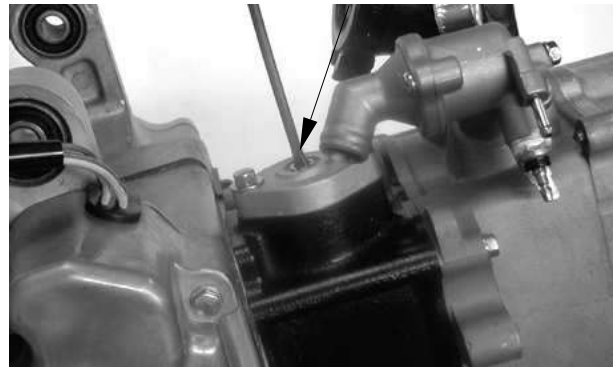

Remove the four cap nuts attaching the camshaft holder.

- * • Diagonally loosen the cylinder head cap nuts in 2 or 3 times.

Camshaft Holder

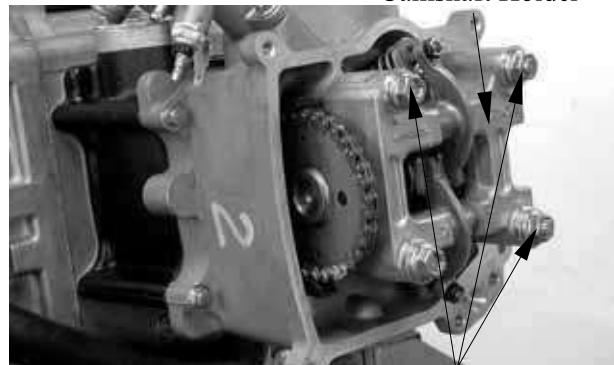

Cap Nuts

9. CYLINDER HEAD/VALVES XCITING 500/500 AFI/250/300 AFI

Remove the camshaft holder and dowel pins.

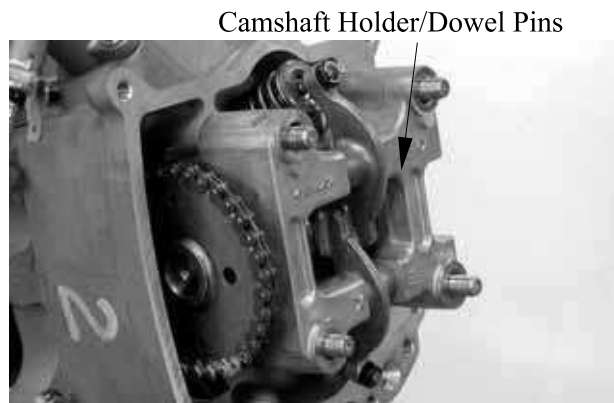

Remove the camshaft gear from the cam chain to remove the camshaft.

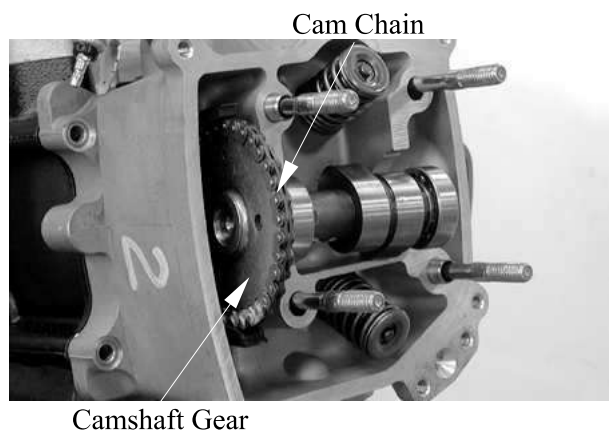

INSPECTION

Camshaft

Check each cam lobe for wear or damage.
Measure the cam lobe height.

Service Limits: IN : 34.14 mm (1.3656 in)
EX: 34.02 mm (1.3608 in)

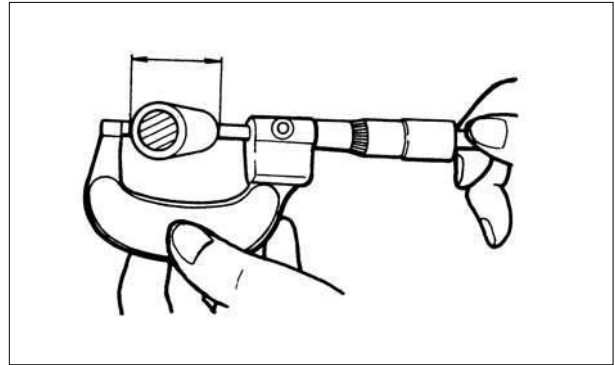

Check each camshaft bearing for play or damage. Replace the camshaft assembly with a new one if the bearings are noisy or have excessive play.

Camshaft Bearings

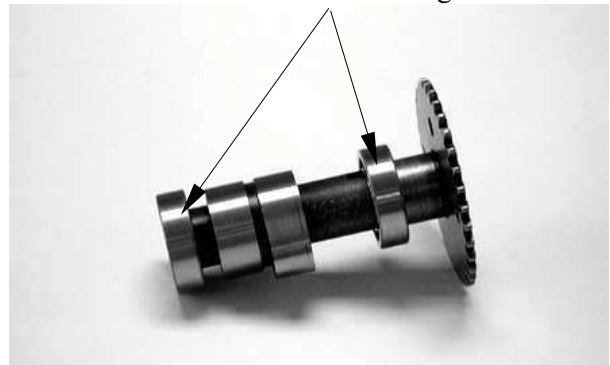

9. CYLINDER HEAD/VALVES XCITING 500/500 AFI/250/300 AFI

ROCKER ARMS (XCITING 500/500 AFI)

REMOVAL

Remove the camshaft (page 9-9).

Remove the rocker arm shafts and washers, then remove the rocker arms.

Refer to page 9-27 to install the rocker arms.

Rocker Arms

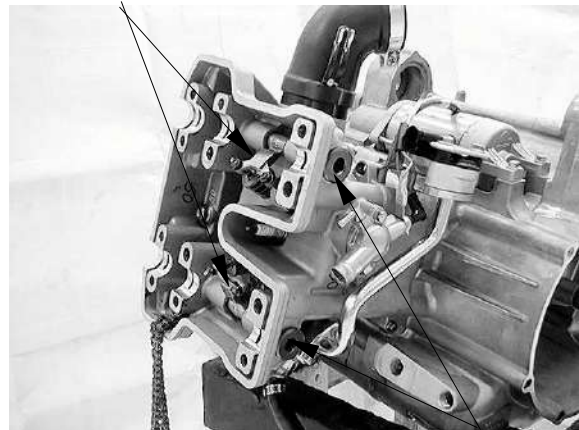

Rocker Arm Shafts/Washers

INSPECTION

Rocker arm shaft

Inspect the rocker arm shaft for blue discoloration or grooves.

If any defects are found, replace the rocker arm shaft with a new one, then inspect lubrication system.

Measure each rocker arm shaft O.D.

Measure the I.D. of each rocker arm.

Measure arm to shaft clearance.

Replace as a set if out of specification.

Service limits: 0.1 mm (0.004 in)

Rocker Arm Shaft



Inspect the rocker arm bore, cam lobe contact surface and adjuster surface for wear/pitting/scratches/blue discoloration.

If any defects are found, replace the rocker arm shaft with a new one, then inspect lubrication system.

Measure each rocker arm shaft O.D.

Measure the I.D. of each rocker arm.

Measure arm to shaft clearance.

Replace as a set if out of specification.

Service limits: 0.1 mm (0.004 in)

Rock Arm

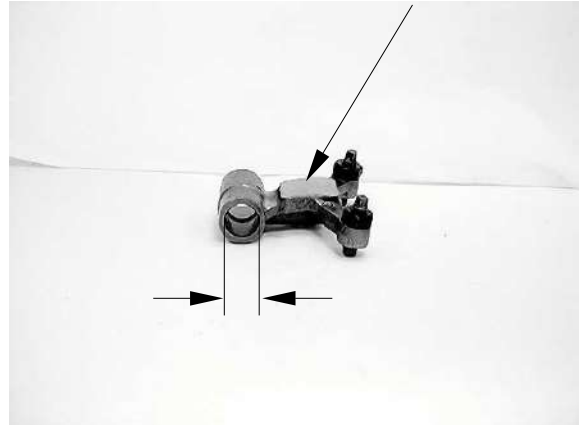

9. CYLINDER HEAD/VALVES

XCITING 500/500 AFI/250/300AFI

ROCKER ARMS (XCITING 250/300 AFI)

REMOVAL

Remove the camshaft (page 9-14).

Remove the rocker arm shafts and then remove the rocker arms.

INSPECTION

Camshaft holder

Inspect the bearing surface of camshaft holder for scoring, scratches, or evidence of insufficient lubrication.

Rocker arm shaft

Inspect the rocker arm shaft for blue discoloration or grooves.

If any defects are found, replace the rocker arm shaft with a new one, then inspect lubrication system.

Measure each rocker arm shaft O.D.
 Measure the I.D. of each rocker arm.
 Measure arm to shaft clearance.
 Replace as a set if out of specification.

Service limits: 0.1 mm (0.004 in)

Inspect the rocker arm bore, cam lobe contact surface and adjuster surface for wear/pitting/scratches/blue discoloration.

If any defects are found, replace the rocker arm shaft with a new one, then inspect lubrication system.

Measure each rocker arm shaft O.D.
 Measure the I.D. of each rocker arm.
 Measure arm to shaft clearance.
 Replace as a set if out of specification.

Service limits: 0.1 mm (0.004 in)

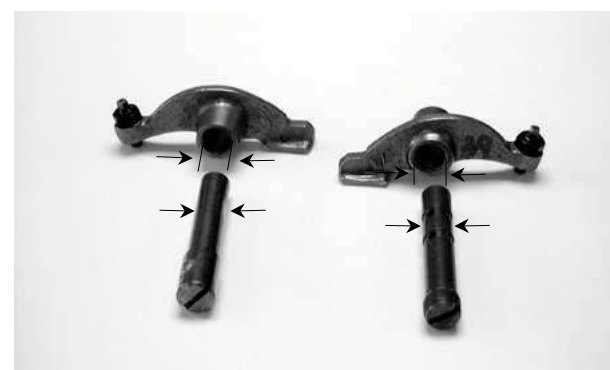
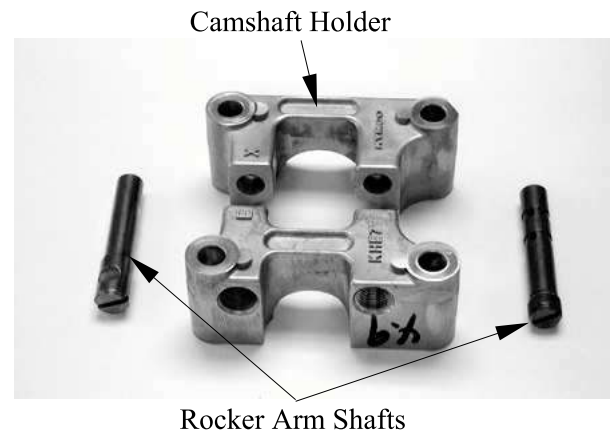
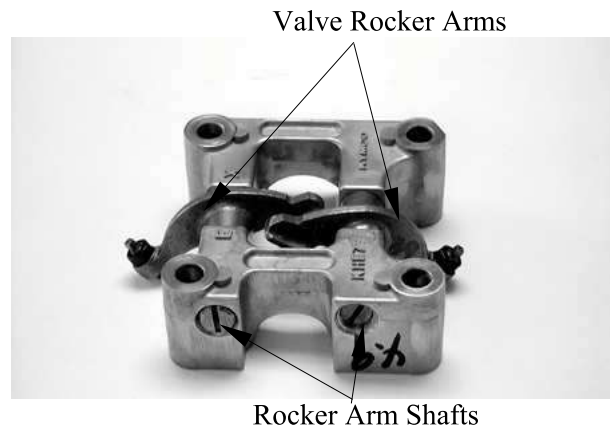

9. CYLINDER HEAD/VALVES XCITING 500/500 AFI/250/300 AFI

CYLINDER HEAD

REMOVAL (XCITING 500/500 AFI)

* Always replace the camshaft holder and cylinder head in pairs

Remove the rock arms (page 9-17).

Remove the two bolts, intake pipe and insulator.

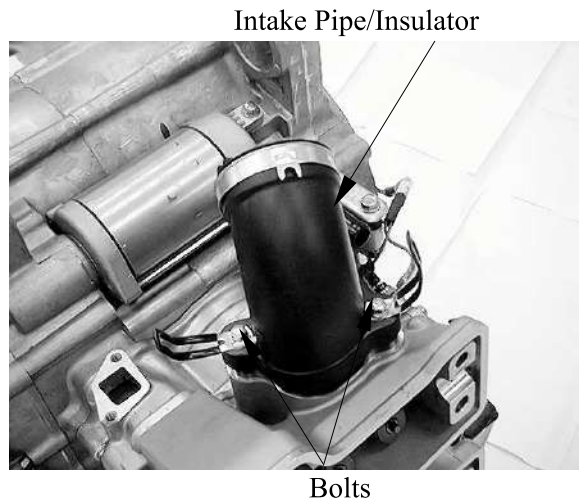

Remove the two bolts, two nuts, pair reed valve and gasket.

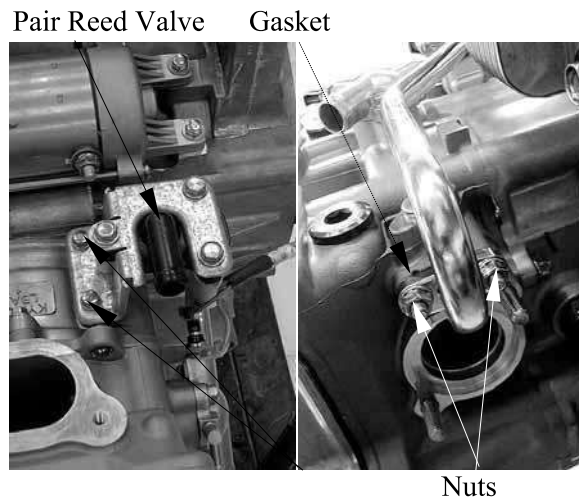

Remove the two bolts, water joint, gasket and water stop collar.

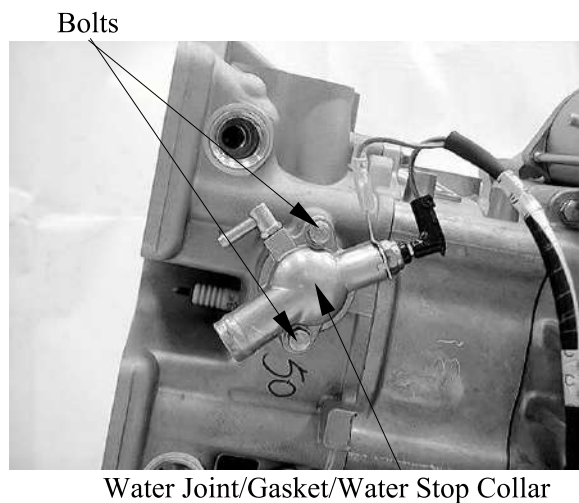

9. CYLINDER HEAD/VALVES

Remove the three bolts and cylinder head.

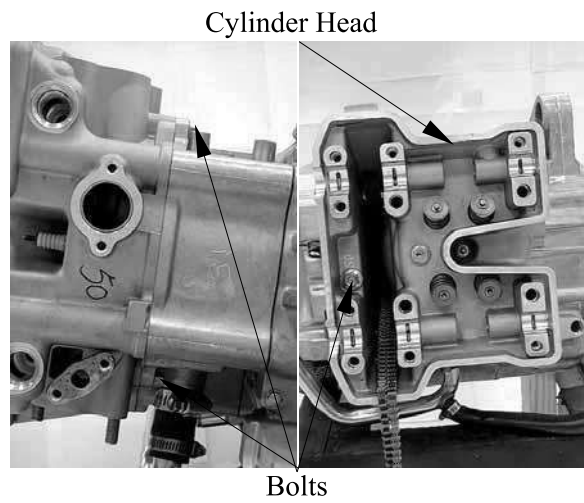

Remove the dowel pins and cylinder head gasket.

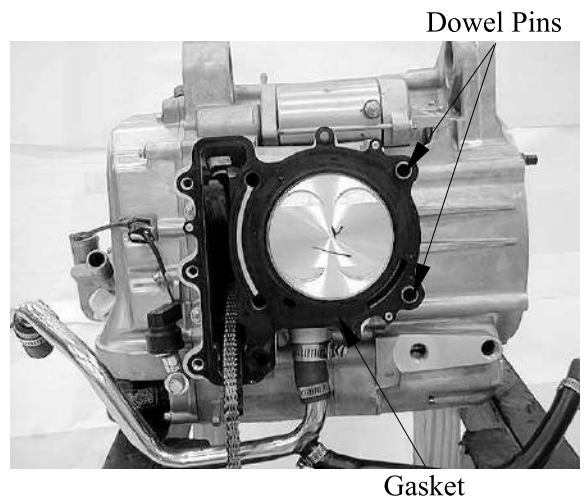

9. CYLINDER HEAD/VALVES XCITING 500/500 AFI/250/300 AFI

REMOVAL (XCITING 250/300 AFI)

First drain the coolant from the radiator and water jacket, then remove the thermostat water hose.

Remove the camshaft. (page 9-14).

Remove the carburetor and intake pipe.

Remove the two cylinder bolts.

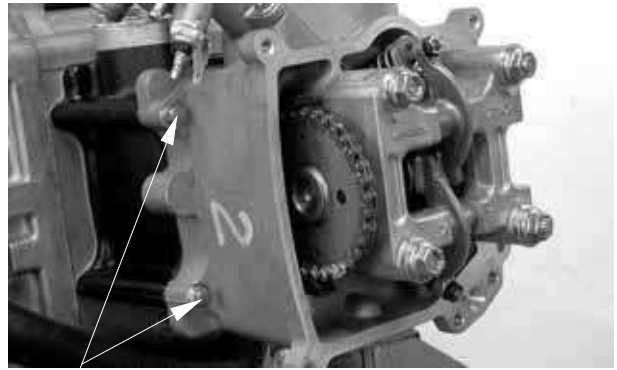

Cylinder Bolts

Remove the bolt attaching the thermostat housing and the thermostat housing.
Remove the cylinder head.



Bolt

Remove the dowel pins and cylinder head gasket.
Remove the cam chain guide.
Remove all gasket material from the cylinder head mating surface.

* Be careful not to drop any gasket material into the engine.

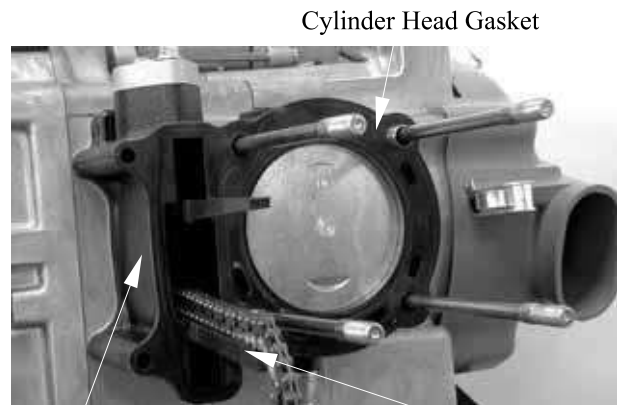

Cylinder

Cam Chain Tensioner Slipper

9. CYLINDER HEAD/VALVES

XCITING 500/500 AFI/250/300AFI

CYLINDER HEAD DISASSEMBLY

Remove the valve spring cotters, retainers, springs, spring seats, oil seals and valves using a valve spring compressor.

*

- Be sure to compress the valve springs with a valve spring compressor.
- Mark all disassembled parts to ensure correct reassembly.

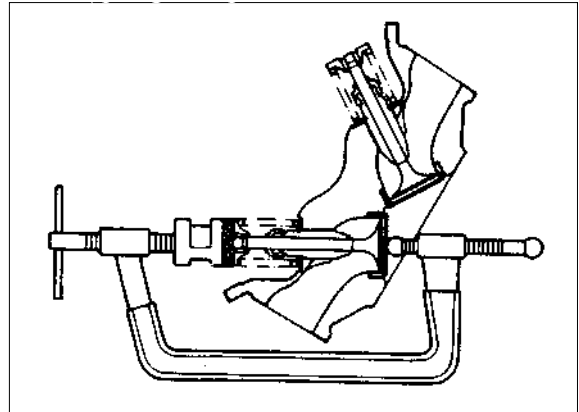

Special tool:

Valve Spring Compressor A120E00040

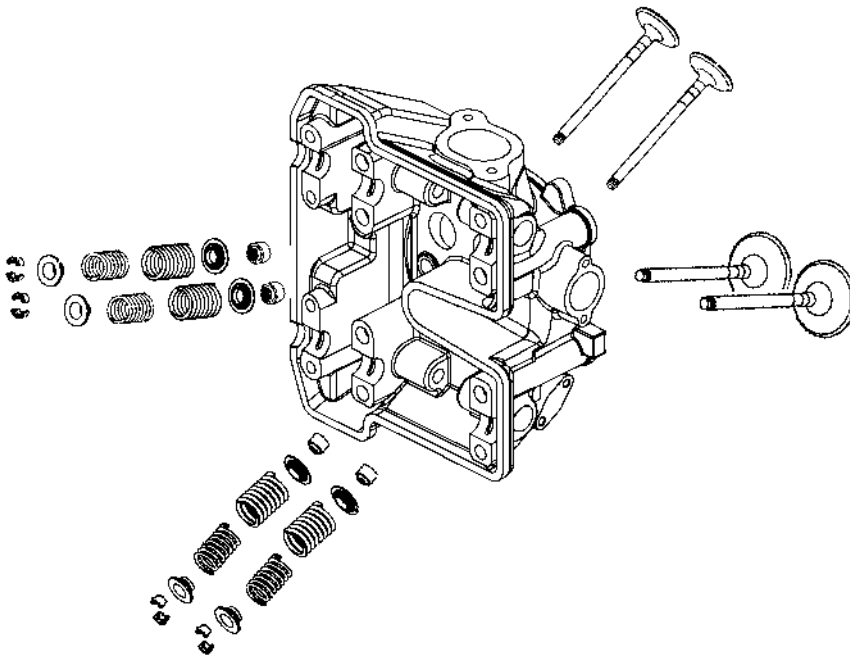

9. CYLINDER HEAD/VALVES XCITING 500/500 AFI/250/300 AFI

VALVE /VALVE GUIDE INSPECTION

Inspect each valve for bending, burning, scratches or abnormal stem wear.
If any defects are found, replace the valve with a new one.

Check valve movement in the guide.

Measure each valve stem O.D.

Measure each valve guide I.D.

Subtract each valve stem O.D. from the corresponding guide I.D. to obtain the stem-to-guide clearance.

Service limits:

IN: 0.08 mm (0.0032 in)

EX: 0.1 mm (0.004 in)

* If the stem-to-guide clearance exceeds the service limits, replace the cylinder head is necessary.

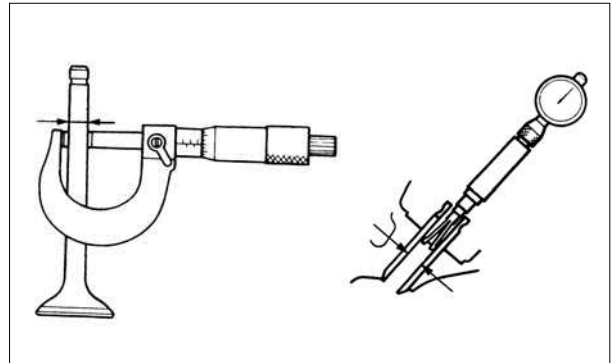

CYLINDER HEAD INPECTION

Check the spark plug hole and valve areas for cracks.

Check the cylinder head for warpage with a straight edge and feeler gauge.

Service Limit: 0.05 mm (0.002 in)

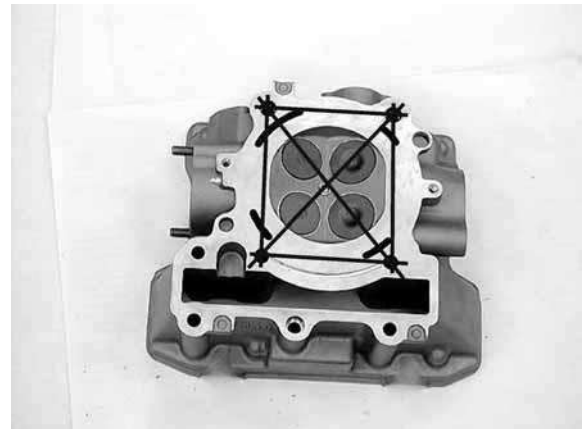

VALVE SPRING INSPECTION

Measure the free length of the inner and outer valve springs.

Service Limit:

XCITING 500/500 AFI:

Inner: 33.4 mm (1.336 in)

Outer: 38 mm (1.52 in)

XCITING 250/300 AFI:

Inner: 29.1 mm (1.164 in)

Outer: 39.2 mm (1.568 in)

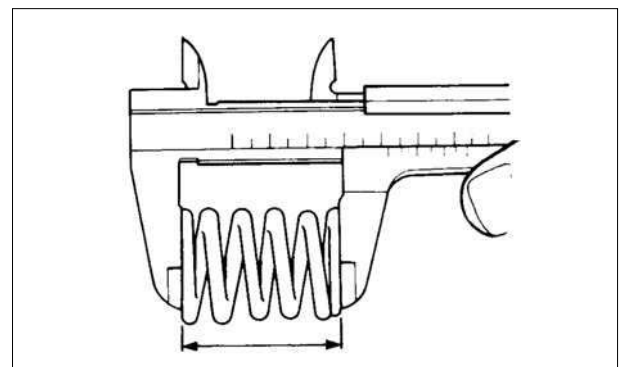

9. CYLINDER HEAD/VALVES

XCITING 500/500 AFI/250/300AFI

Measure compressed force (valve spring) and installed length.

Replace if out of specification.

Standard (XCITING 500/500 AFI):

Inner: 3.5 kg (at 28.7 mm, 1.148 in)

Outer: 13 kg (at 31.43 mm, 1.2572 in)

Standard (XCITING 250/300 AFI):

Inner: 2.95 kg (at 26.6 mm, 1.064 in)

Outer: 10.45 kg (at 29.6 mm, 1.184 in)

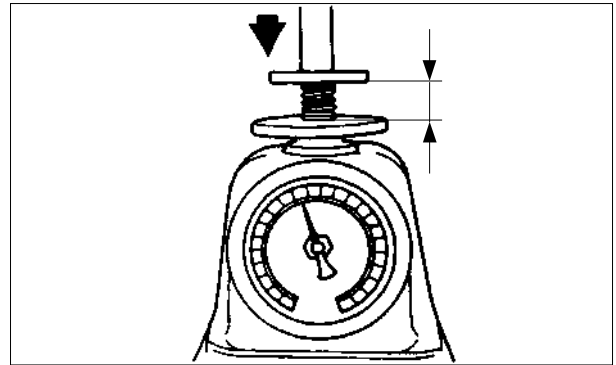

Measure the spring tilt.

Replace if out of specification.

Standard (XCITING 500/500 AFI):

Inner: 1.2 mm (0.048)

Outer: 1.2 mm (0.048)

Standard (XCITING 250/300 AFI):

Inner: 0.81 mm (0.0324 in)

Outer: 1.07 mm (0.0428 in)

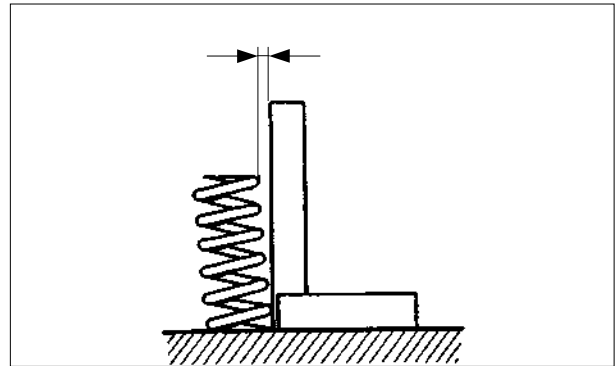

ASSEMBLY

Install the valve spring seats and oil seal.

*

Lubricate each valve with engine oil and insert the valves into the valve guides.
Install the valve springs and retainers.
Compress the valve springs using the valve spring compressor, then install the valve cotters.

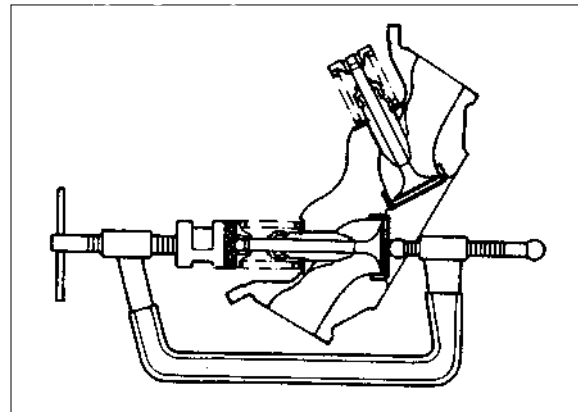

- * • When assembling, a valve spring compressor must be used.
• Install the cotters with the pointed ends facing down from the upper side of the cylinder head.

Special tool:

Valve Spring Compressor A120E00040

9. CYLINDER HEAD/VALVES XCITING 500/500 AFI/250/300 AFI

Tap the valve stems gently with a plastic hammer for 2~3 times to firmly seat the cotters.

* Be careful not to damage the valves.

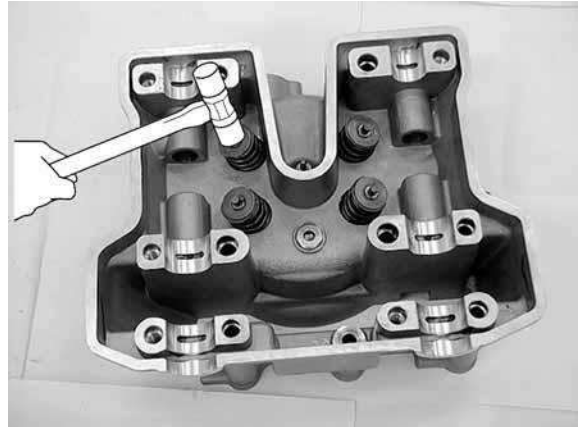

INSTALLATION (XCITING 500/500 AFI)

Install the dowel pins and new cylinder head gasket as shown.

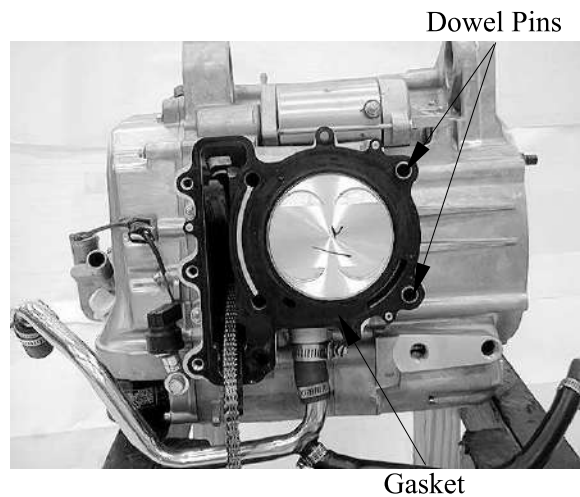

Install the cylinder head.

Apply engine oil to the cylinder head bolt (9) threads.

Install the two cylinder bolts and cylinder head bolt (9) but do not tighten them.

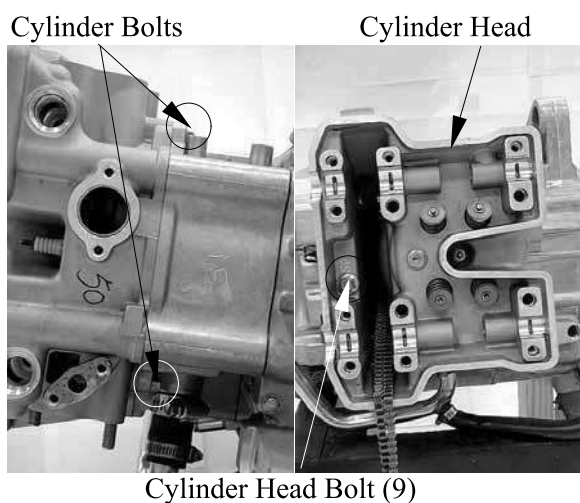

9. CYLINDER HEAD/VALVES

Install the water stop collar, gasket and water joint.

Install and tighten the two bolts to the specified torque.

Torque: 12 N•m (1.2 kgf•m, 9 lbf•ft)

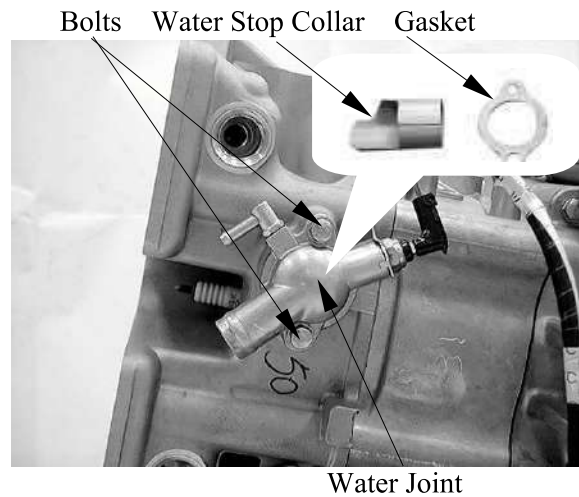

Install gasket and pair reed valve.
Install and tighten the four bolts securely.

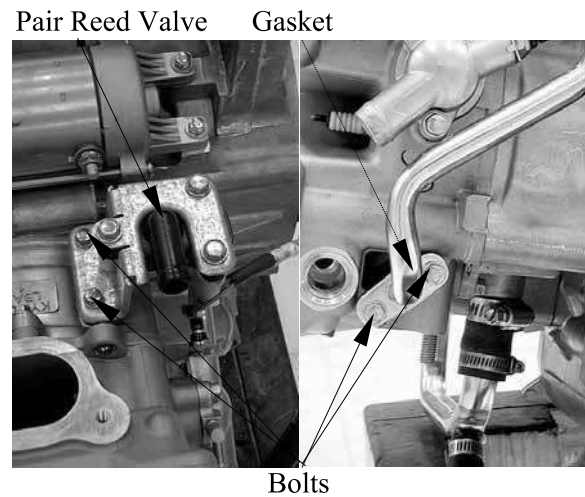

Install the new O-rings onto the insulator and intake pipe.

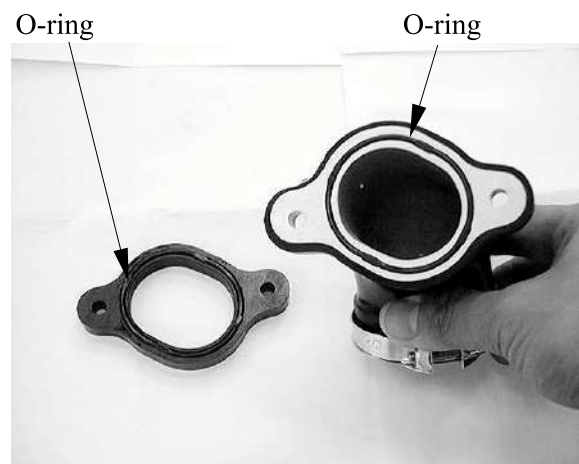

9. CYLINDER HEAD/VALVES XCITING 500/500 AFI/250/300 AFI

Install the insulator with the O-ring face the cylinder head.

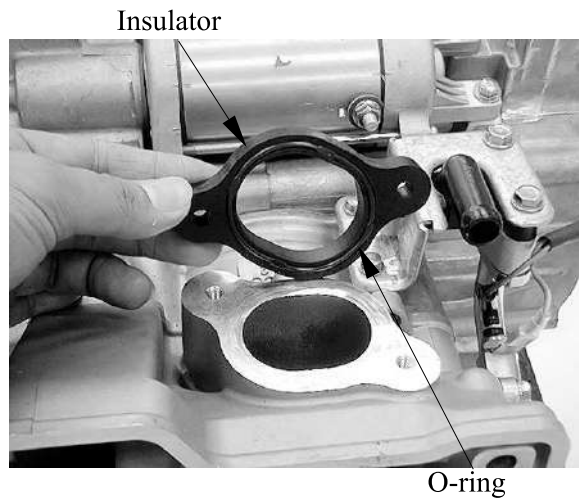

Install the intake pipe and tighten the two bolts securely.

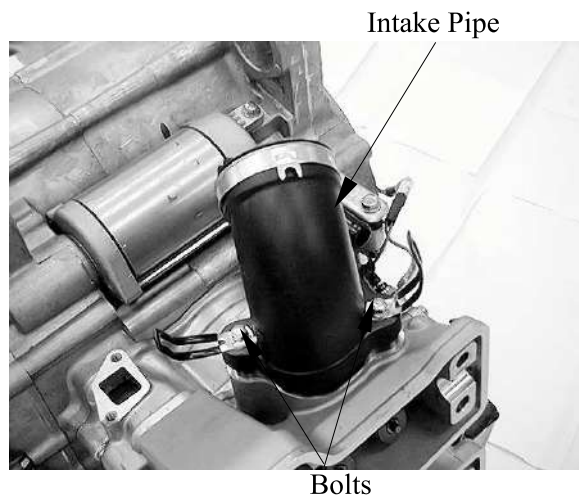

ROCKER ARM INSTALLATION (XCITING 500/500 AFI)

Apply engine oil to the rocker arms and rocker arm shafts

Install the rocker arms, rocker arm shafts and washers.
Tighten the rocker arm shaft to the specified torque.

Torque: 45 N•m (4.5 kgf•m, 32 lbf•ft)

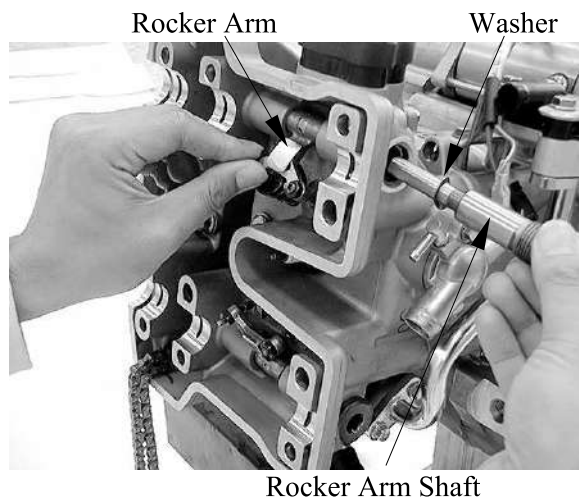

9. CYLINDER HEAD/VALVES

CAMSHAFT INSTALLATION (XCITING 500/500 AFI)

Turn the crankshaft clockwise, align the “T” mark on the flywheel with the index mark on the right crankcase cover (page 3-12).

Apply molybdenum disulfide oil to the camshaft journals of the camshaft holder.

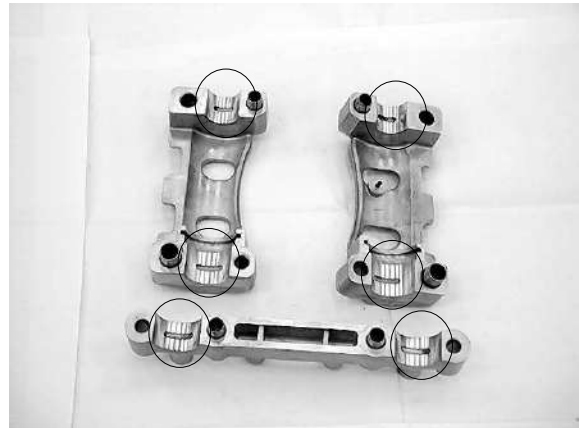

Apply molybdenum disulfide oil to the camshaft journals of the cylinder head.

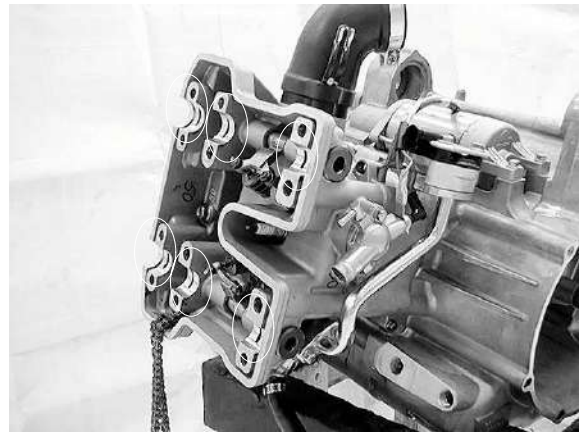

Install the cam chain over the cam sprockets and then install the intake and exhaust camshafts.

*

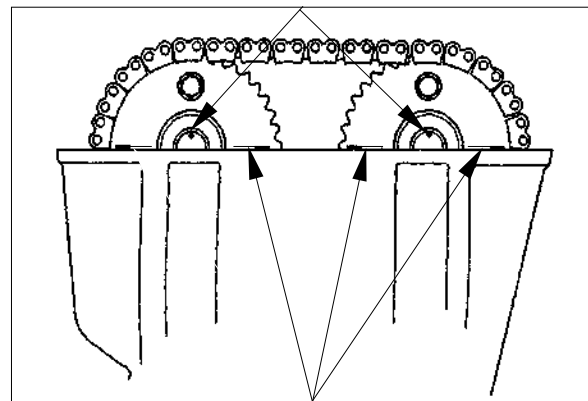

9. CYLINDER HEAD/VALVES XCITING 500/500 AFI/250/300 AFI

Install intake and exhaust camshaft holders to the correct locations.

- * Install each camshaft holders to the correct locations.
 - “IN”: no stop pin.
 - “EX”: has a stop pin.

Apply engine oil to cylinder head bolt (No. 1 – 9) threads.

Install and tighten the holder bolts (No. 1 – 9) in a crisscross pattern in four steps to the specified torque as follow diagram.

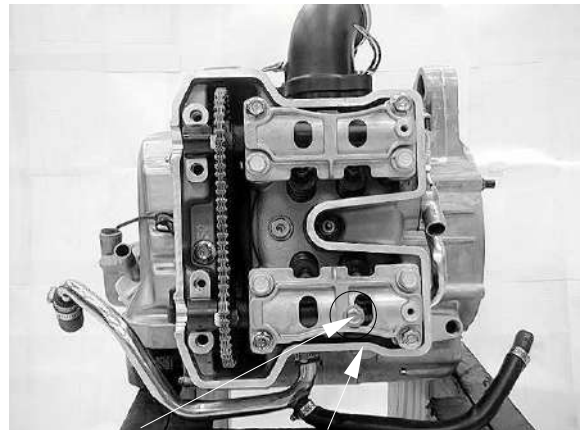

Stop Pin Exhaust Camshaft Holder

Tighten the bolts to the specified torque in sequence									
N•m (kgf•m, lbf•ft)									
	(1)	(2)	(3)	(4)	(5)	(6)	(7)	(8)	(9)
Step 1	18 (1.8, 13)	←	←	←	12 (1.2, 9)	←	←	←	←
Step 2	48 (4.8, 35)	←	←	←	23 (2.3, 17)	←	←	←	←

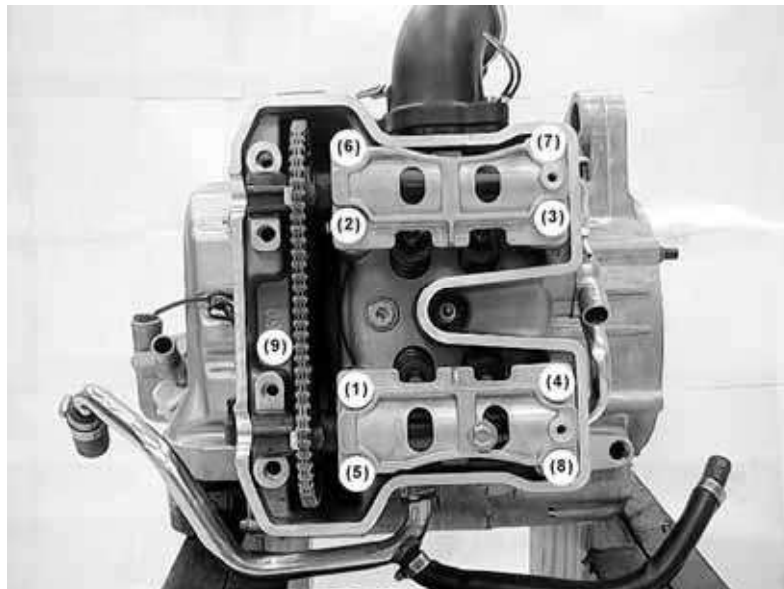

9. CYLINDER HEAD/VALVES

XCITING 500/500 AFI/250/300AFI

Install the common camshaft holder by arrow mark facing outside.

Install and tighten the holder bolts (No. 10 – 13) in a crisscross pattern in four steps to the specified torque as follow diagram.

* Apply engine oil to cylinder head bolt (No. 10 – 13) threads.

Tighten the bolts to the specified torque in sequence								
N•m (kgf•m, lbf•ft)								
	(10)	(11)	(12)	(13)				
Step 1	12 (1.2, 9)	←	←	←				
Step 2	23 (2.3, 17)	←	←	←				

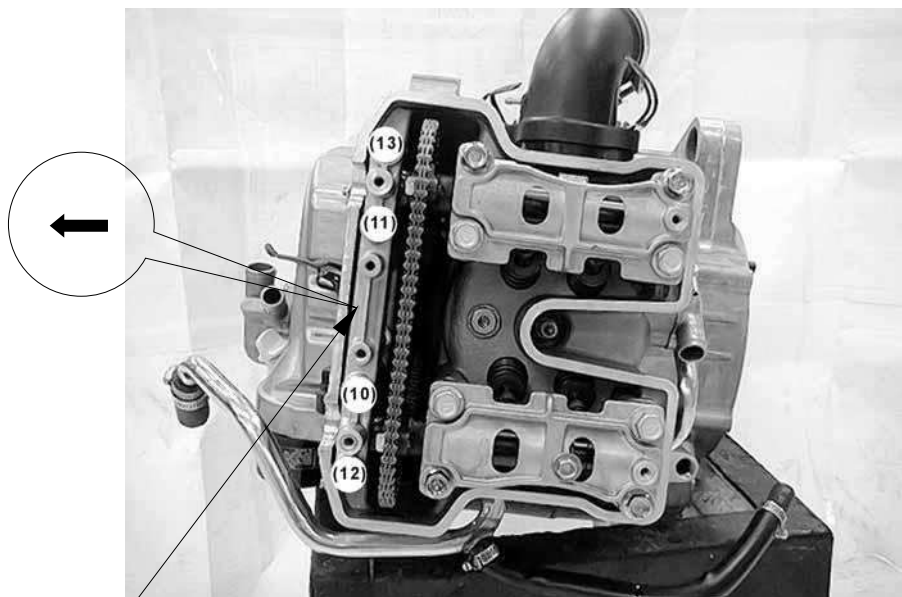

“Arrow” Mark

Tighten the two cylinder bolts to the specified torque.

Torque: 10 N•m (1 kgf•m, 7 lbf•ft)

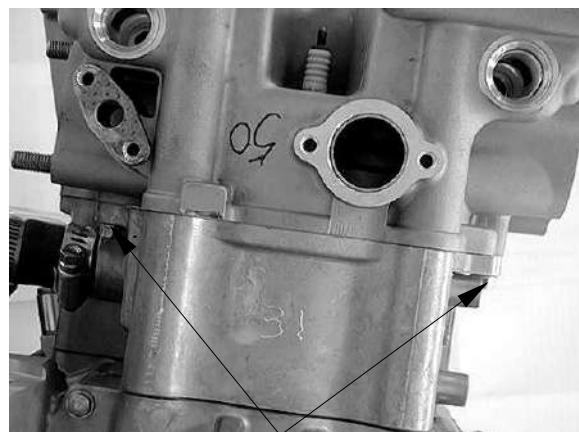

Cylinder Bolts

9. CYLINDER HEAD/VALVES XCITING 500/500 AFI/250/300 AFI

Install the cam chain guide and tighten the two bolts securely.

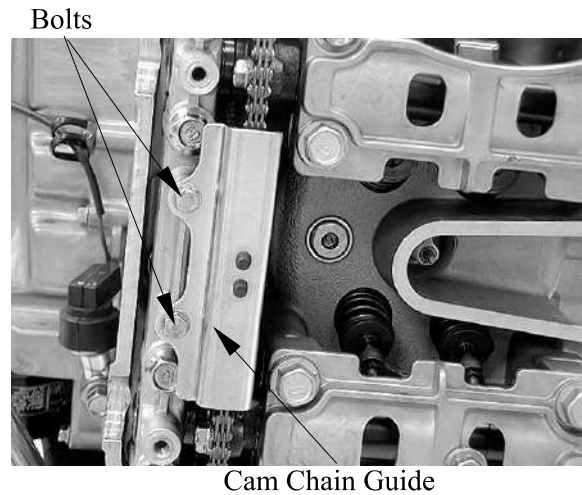

Release the timing chain tensioner one-way cam and push the tensioner rod all the way in.



Install the tensioner with a new gasket onto the cylinder.
Install and tighten the tensioner bolts to specified torque.

Torque: 12 N•m (1.2 kgf•m, 9 lbf•ft)

Install the spring, washer and timing chain tensioner cap bolt to specified torque.

Torque: 10 N•m (1 kgf•m, 9 lbf•ft)

Adjust the valve clearance (page 3-12).

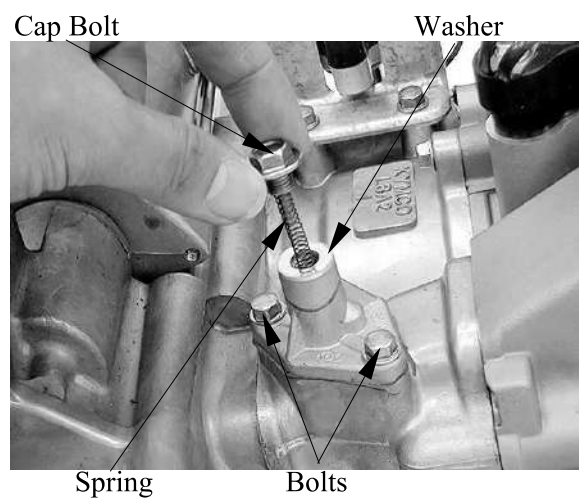

9. CYLINDER HEAD/VALVES

Install the cylinder head packing into the groove of the cylinder head cover.

Cylinder Head Cover Packing



Install the cylinder head cover onto the cylinder head and tighten the cylinder head cover bolts to the specified torque.

Torque: 10 N•m (1 kgf•m, 7 lbf•ft)

Bolts

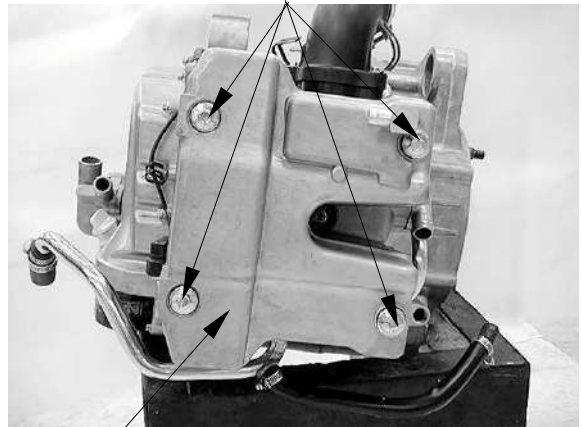

Cylinder Head Cover

9. CYLINDER HEAD/VALVES XCITING 500/500 AFI/250/300 AFI

INSTALLATION (XCITING 250/250 AFI)

Install the cam chain guide.
Install the dowel pins and a new cylinder head gasket.

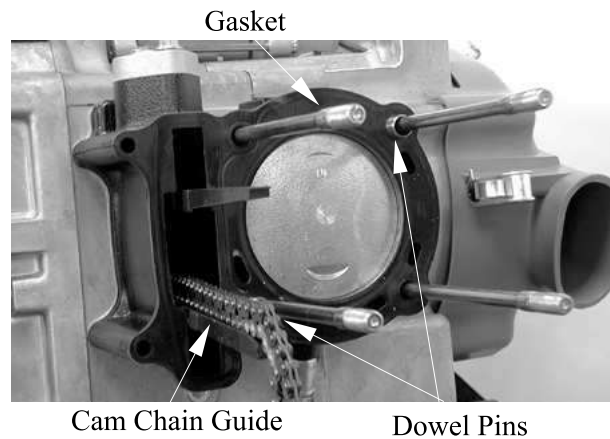

Install the cylinder head and take out the cam chain

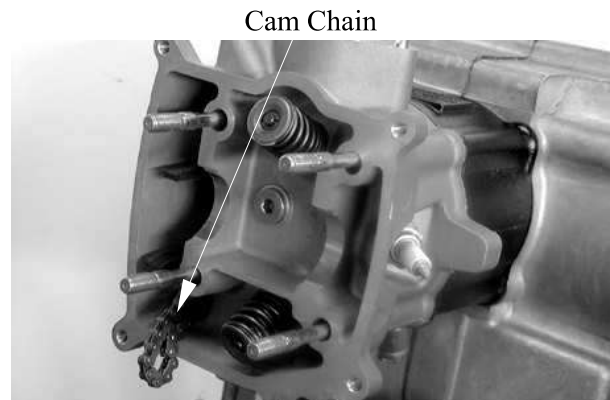

Assemble the camshaft holder.
First install the intake and exhaust valve rocker arms; then install the rocker arm shafts.

- * • Install the exhaust valve rocker arm shaft on the “EX” side of the camshaft holder and the exhaust rocker arm shaft is shorter.
• Clean the intake valve rocker arm shaft off any grease before installation.
• Align the cutout on the exhaust valve rocker arm shaft with the bolt of the camshaft holder.

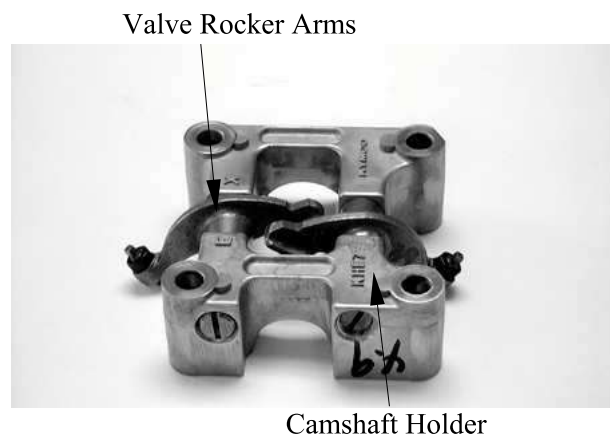

9. CYLINDER HEAD/VALVES

Turn the A.C. generator flywheel so that the “T” mark on the flywheel aligns with the index mark on the right crankcase cover. Keep the round hole on the camshaft gear facing up and align the punch marks on the camshaft gear with the cylinder head surface (Position the intake and exhaust cam lobes down.) and install the cam chain over the camshaft gear.

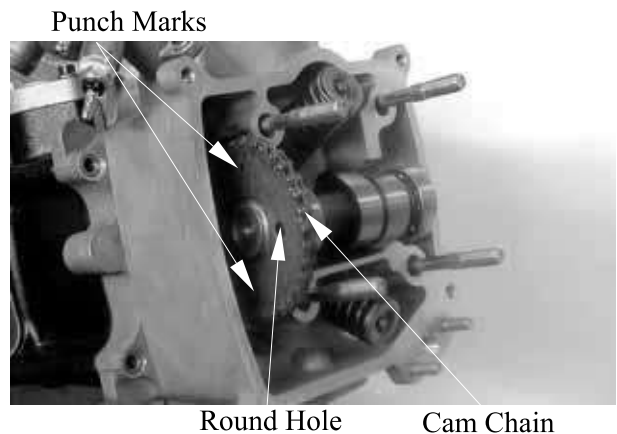

Install the dowel pins.

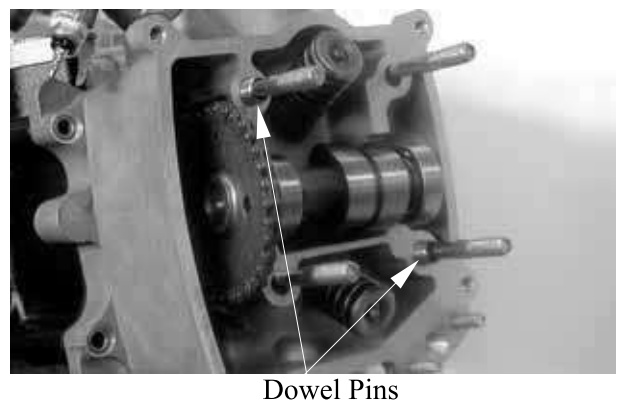

Install the camshaft holder, washers and nuts on the cylinder head. Tighten the four cylinder head cap nuts and two cylinder bolts to the specified torque.

Torque:

Cylinder head cap nut:

25 N•m (2.5 kgf•m, 18 lbf•ft)

Apply engine oil to threads

Cylinder bolt: 10 N•m (1 kgf•m, 7 lbf•ft)

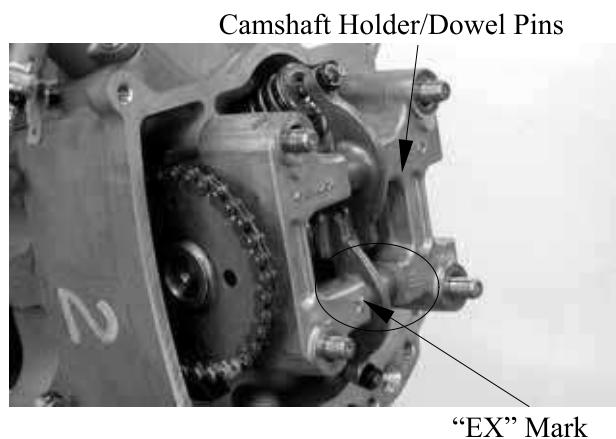

“EX” Mark

- *
- Install the camshaft holder with the “EX” mark face exhaust valve side.
 - Apply engine oil to the threads of the cylinder head cap nuts.
 - Diagonally tighten the cylinder head cap nuts in 2~3 times.
 - First tighten the cylinder head cap nuts and then tighten the cylinder bolts to avoid cracks.

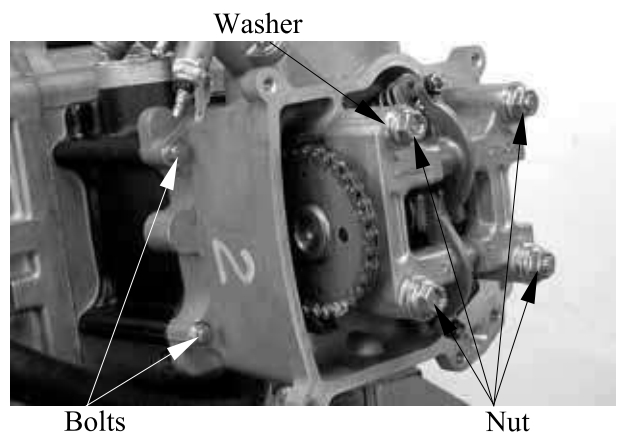

9. CYLINDER HEAD/VALVES XCITING 500/500 AFI/250/300 AFI

Turn the cam chain tension screw counterclockwise to release it.

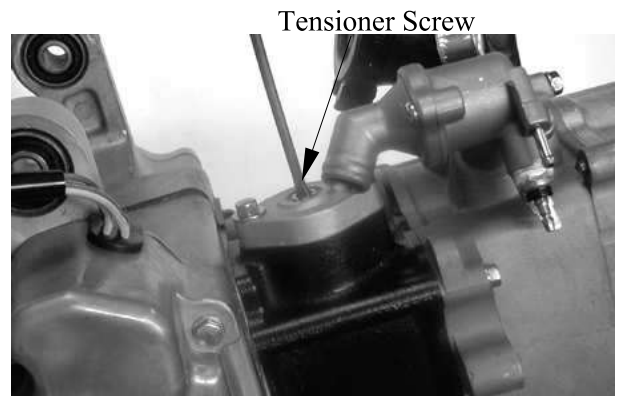

Apply engine oil to a new O-ring and install it.
Tighten the cam chain tension cap screw.

* Be sure to install the gasket into the groove properly.

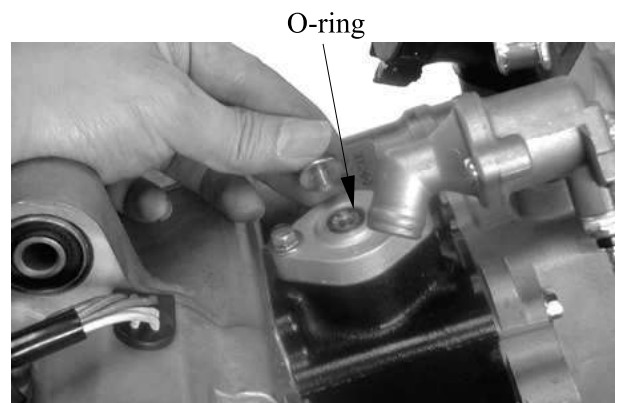

Adjust the valve clearance. (page 3-13).

Install a new cylinder head cover O-ring and install the cylinder head cover.

* Be sure to install the O-ring into the groove properly.

Install and tighten the cylinder head cover bolts.

Torque: 10 N•m (1 kgf•m, 7 lbf•ft)

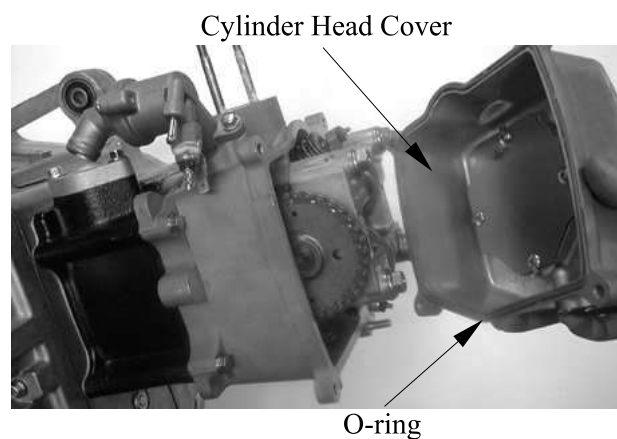

CYLINDER/PISTON

SCHEMATIC DRAWING ----- 10-1
SERVICE INFORMATION----- 10-2
TROUBLESHOOTING----- 10-3
CYLINDER/PISTON ----- 10-4

10. CYLINDER/PISTON

XCITING 500/500 AFI/250/300 AFI

SCHEMATIC DRAWING

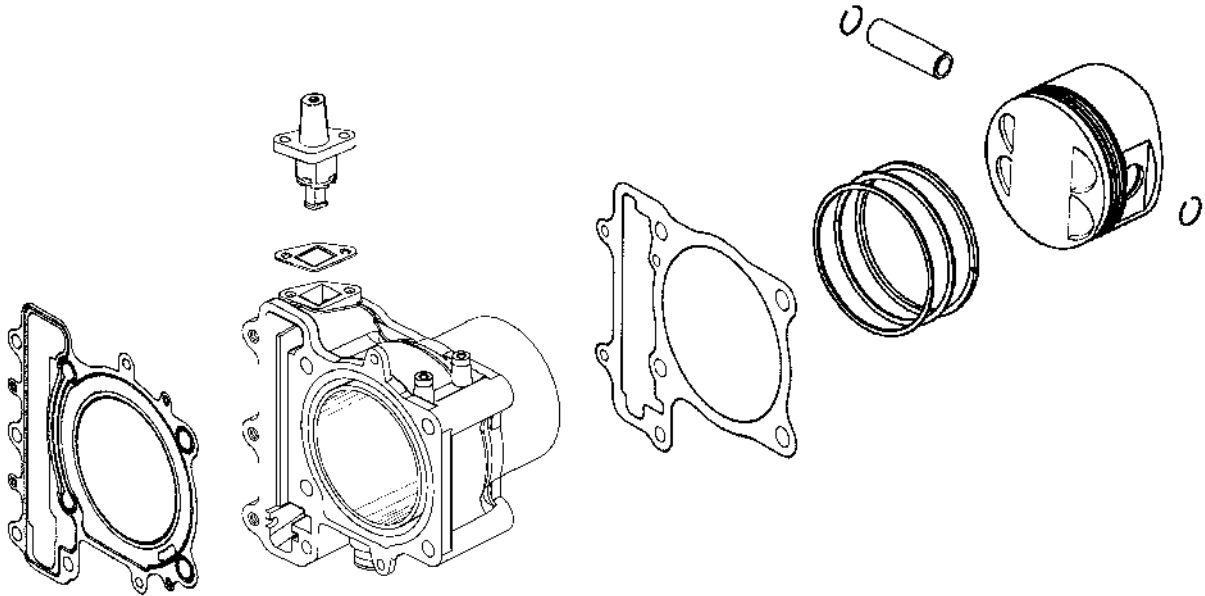

10. CYLINDER/PISTON

XCITING 500/500 AFI/250/300 AFI

SERVICE INFORMATION

GENERAL INSTRUCTIONS

- The cylinder and piston can be serviced with the engine installed in the frame.
- When installing the cylinder, use a new cylinder gasket and make sure that the dowel pins are correctly installed.
- After disassembly, clean the removed parts and dry them with compressed air before inspection.

SPECIFICATIONS (XCITING 500/500 AFI)

Unit: mm (in)

Item		Standard	Service Limit	
Cylinder	I.D.	92.005 (3.6802)~92.015 (3.6806)	92.1 (3.684)	
	Warpage	0.01 (0.0004)	0.05 (0.002)	
	Cylindricity	0.01 (0.0004)	0.1 (0.004)	
	True roundness	0.01 (0.0004)	0.1 (0.004)	
Piston, piston ring	Ring-to-groove clearance	top	0.03 (0.0012)~0.065 (0.0026)	0.08 (0.003)
		Second	0.015 (0.0006)~0.05 (0.002)	0.65 (0.0026)
	Ring end gap	top	0.15 (0.006)~0.3 (0.012)	0.5 (0.02)
		Second	0.03 (0.012)~0.45 (0.018)	0.65 (0.026)
		Oil side rail	0.2 (0.008)~0.7 (0.028)	1 (0.04)
	Piston O.D.	91.96 (3.6784)~91.98 (3.6793)	91.9 (3.676)	
	Piston O.D. measuring position	10 mm from bottom of skirt	—	
	Piston-to-cylinder clearance	0.01 (0.0004)~0.045 (0.0018)	0.1 (0.004)	
Piston pin hole I.D.	22.002 (0.8801)~22.008 (0.8803)	22.04 (0.8816)		
Piston pin O.D		21.994 (0.8798)~22 (0.88)	21.96 (0.8784)	
Piston-to-piston pin clearance		0.002 (0.0001)~0.014 (0.0006)	0.02 (0.001)	
Connecting rod small end I.D. bore		22.016 (0.8806)~22.034 (0.8814)	22.06 (0.8824)	

SPECIFICATIONS (XCITING 250/300 AFI)

Unit: mm (in)

Item		Standard	Service Limit	
Cylinder	I.D.	72.75 (2.91)~72.7015 (2.90806)	72.8 (2.912)	
	Warpage	0.01 (0.0004)	0.05 (0.002)	
	Cylindricity	0.01 (0.0004)	0.1 (0.004)	
	True roundness	0.01 (0.0004)	0.1 (0.004)	
Piston, piston ring	Ring-to-groove clearance	top	0.03 (0.0012)~0.065 (0.0026)	0.08 (0.003)
		Second	0.015 (0.0006)~0.05 (0.002)	0.65 (0.0026)
	Ring end gap	top	0.15 (0.006)~0.3 (0.012)	0.5 (0.02)
		Second	0.03 (0.012)~0.45 (0.018)	0.65 (0.026)
		Oil side rail	0.2 (0.008)~0.7 (0.028)	1 (0.04)
	Piston O.D.	72.67 (2.9068)~72.69 (2.9076)	72.6 (2.904)	
	Piston O.D. measuring position	9 mm from bottom of skirt	—	
	Piston-to-cylinder clearance	0.01 (0.0004)~0.045 (0.0018)	0.1 (0.004)	
Piston pin hole I.D.	17.002 (0.68008)~17.008 (0.68032)	17.04 (0.6816)		
Piston pin O.D		16.994 (0.67976)~17 (0.68)	16.96 (0.6784)	
Piston-to-piston pin clearance		0.002 (0.0001)~0.014 (0.0006)	0.02 (0.001)	
Connecting rod small end I.D. bore		17.016 (0.68064)~17.034 (0.68136)	17.06 (0.6824)	

TROUBLESHOOTING

- When hard starting or poor performance at low speed occurs, check the crankcase breather for white smoke. If white smoke is found, it means that the piston rings are worn, stuck or broken.

Compression too low or uneven compression

- Worn or damaged cylinder and piston rings
- Worn, stuck or broken piston rings

Compression too high

- Excessive carbon build-up in combustion chamber or on piston head

Excessive smoke from exhaust muffler

- Worn or damaged piston rings
- Worn or damaged cylinder and piston

Abnormal noisy piston

- Worn cylinder, piston and piston rings
- Worn piston pin hole and piston pin
- Incorrectly installed piston

10. CYLINDER/PISTON

CYLINDER/PISTON

REMOVAL (XCITING 500/500 AFI)

Remove the cylinder head (page 9-19).

- Take the block pin out.
- Remove the water hose from the cylinder.
- Remove the two cylinder bolts.
- Remove the cylinder and gasket.

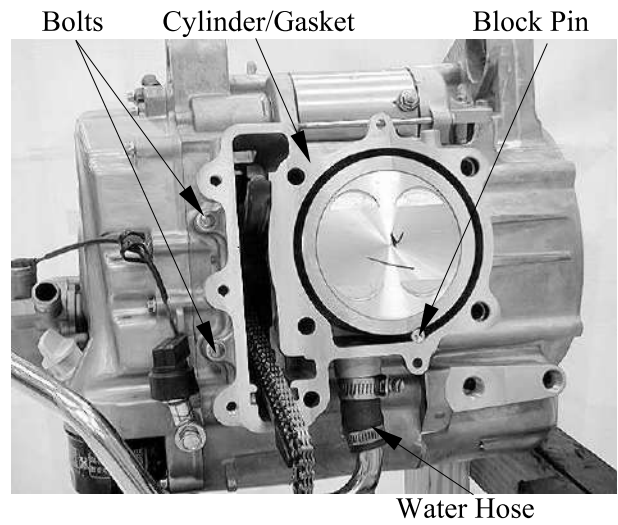

Remove the dowel pins

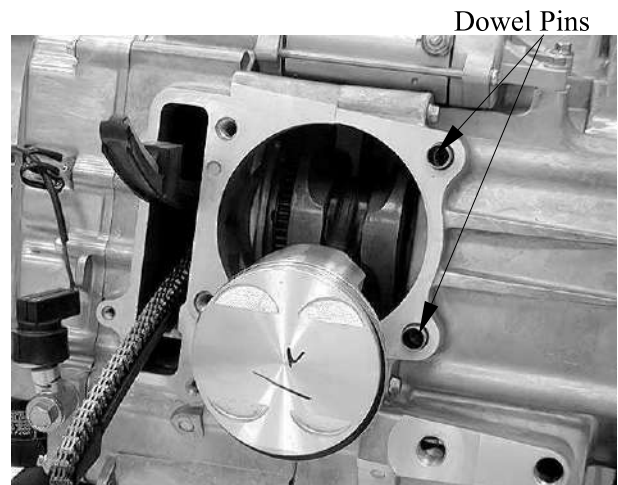

Remove the piston pin clip.

* Place a clean shop towel in the crankcase to keep the piston pin clip from falling into the crankcase.

Press the piston pin out of the piston and remove the piston.

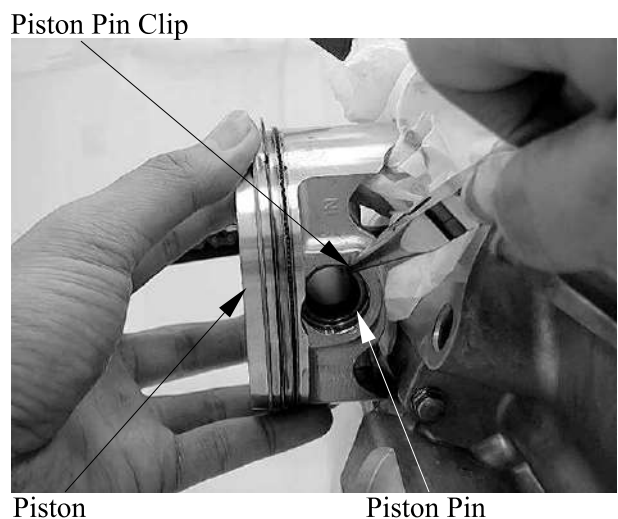

10. CYLINDER/PISTON

XCITING 500/500 AFI/250/300 AFI

REMOVAL (XCITING 250/300 AFI)

Remove the cylinder head (page 9-21).

Remove the water hose from the cylinder.
Remove the cylinder head gasket and dowel pins.

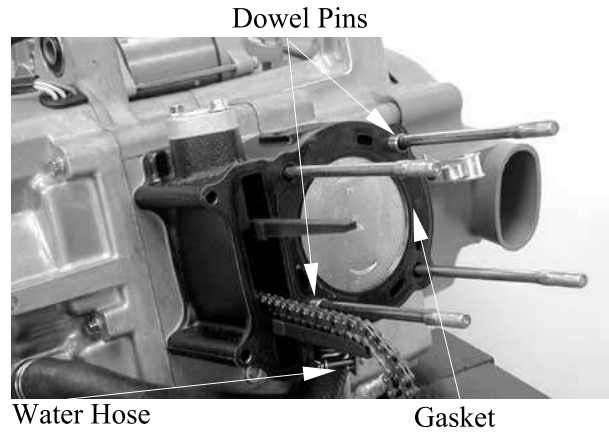

Remove the cam chain guide.
Remove the cylinder.

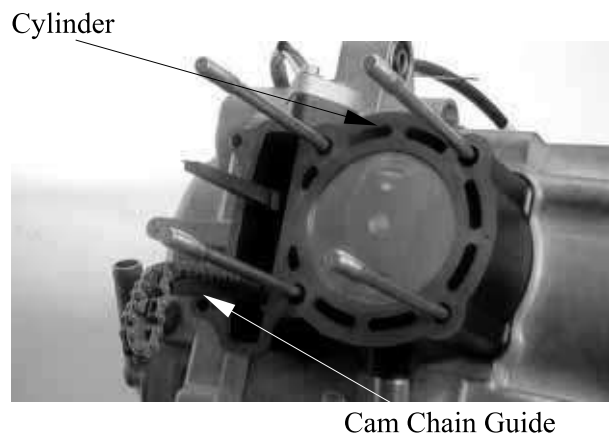

Remove the cylinder gasket and dowel pins.
Clean any gasket material from the cylinder surface.

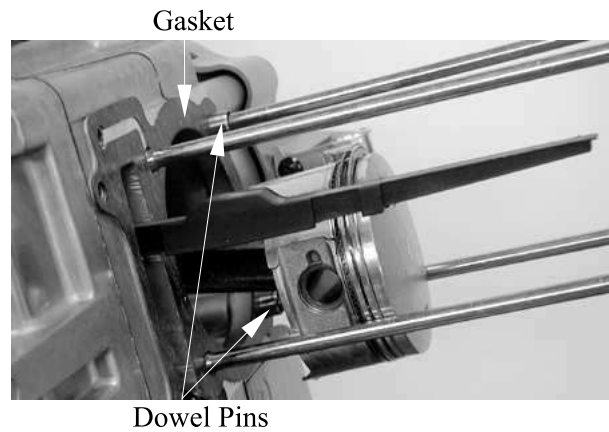

Remove the piston pin clip.

* Place a clean shop towel in the crankcase to keep the piston pin clip from falling into the crankcase.

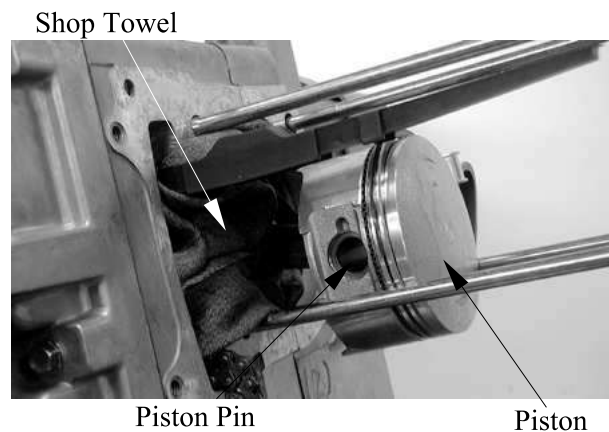

Press the piston pin out of the piston and remove the piston.

10. CYLINDER/PISTON

XCITING 500/500 AFI/250/300 AFI

PISTON RING REMOVAL

Spread each piston ring and remove it by lifting up at a point opposite the gap

- * Do not damage the piston ring by spreading the ends too far.

Clean carbon deposits from the piston ring grooves.

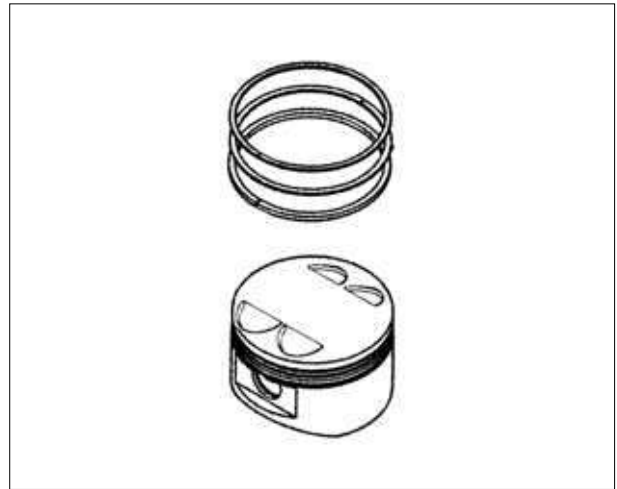

INSPECTION

Piston ring

Inspect the piston rings for movement by rotating the rings. The rings should be able to move in their grooves without catching.

Push the ring until the outer surface of the piston ring is nearly flush with the piston and measure the ring-to-groove clearance.

Service Limits: Top: 0.08 mm (0.003 in)
2nd: 0.065 mm (0.0026 in)

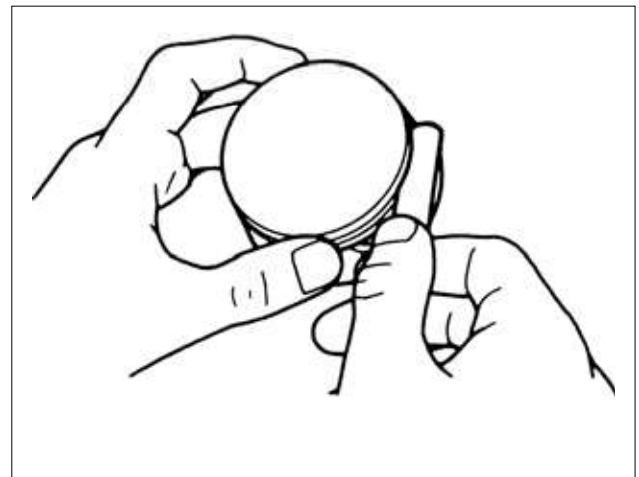

Insert each piston ring into the bottom of the cylinder squarely.

- * Use the piston head to push each piston ring into the cylinder.

Measure the piston ring end gap.

Service Limit:

Top: 0.5 mm (0.02 in)
2nd: 0.65 mm (0.026 in)
Oil ring: 1 mm (0.04 in)

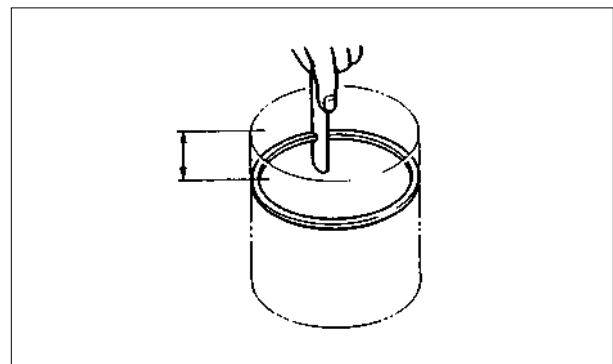

10. CYLINDER/PISTON

XCITING 500/500 AFI/250/300 AFI

Piston/Piston pin

Measure the piston O.D. at the point (A) from the bottom and 90° to the piston pin hole.

Service Limit (XCITING 500/500 AFI):

91.9 mm (3.676 in) at (A): 10 mm

Service Limit (XCITING 250/300 AFI):

72.6 mm (2.904 in) at (A): 9 mm-250

Calculate the cylinder-to-piston clearance (cylinder I.D.: page 10-8)

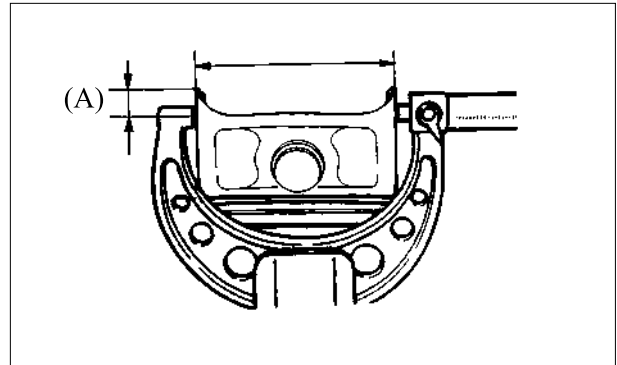

Measure the piston pin hole. Take the maximum reading to determine the I.D..

Service Limit:

XCITING 500/500 AFI:

22.04 mm (0.8816 in)

XCITING 250/300 AFI:

17.04 mm (0.6816 in)

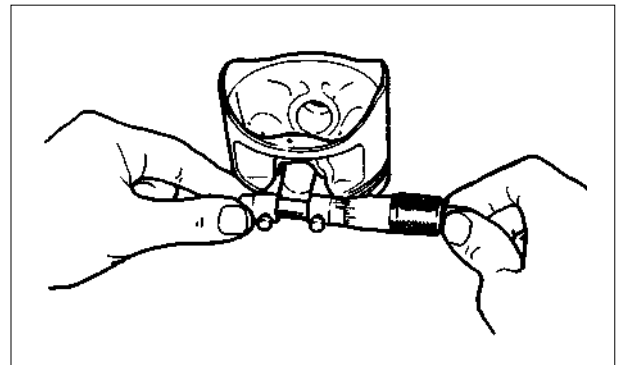

Measure the piston pin O.D. at piston and connecting rod sliding areas.

Service Limit:

XCITING 500/500 AFI:

21.96 mm (0.8784 in)

XCITING 250/300 AFI:

16.96 mm (0.6784 in)

Measure the piston-to-piston pin clearance.

Service Limit: 0.002 mm (0.0001 in)

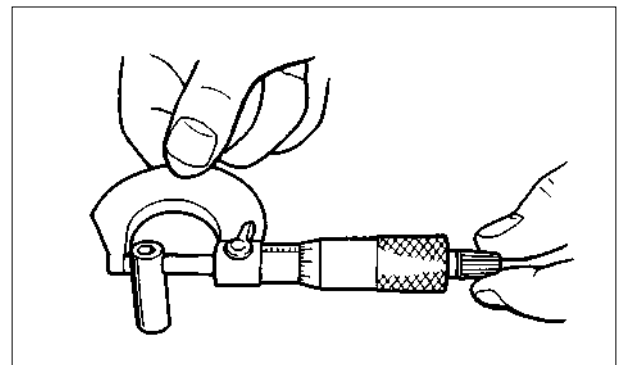

10. CYLINDER/PISTON

XCITING 500/500 AFI/250/300 AFI

Cylinder

Check the cylinder for warpage with a straight edge and feeler gauge in the directions shown.

Service Limit: 0.05 mm (0.002 in)

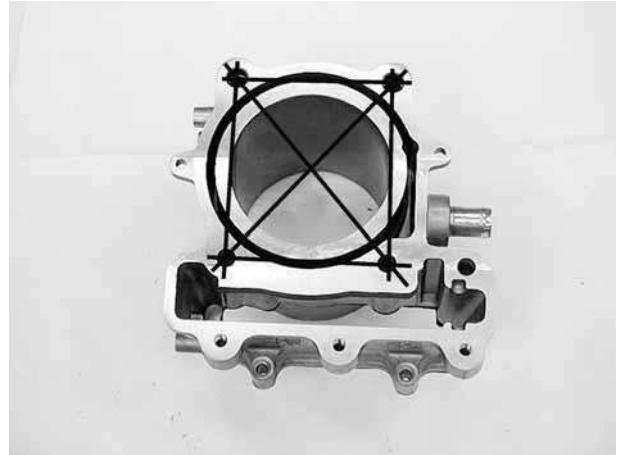

Check the cylinder wall for wear or damage. Measure and record the cylinder I.D. at three levels in an X and Y axis. Take the maximum reading to determine the cylinder wear.

Service Limit:

XCITING 500/500 AFI: 92.1 mm (3.684 in)

XCITING 250/250 AFI: 72.8 mm (2.912 in)

Calculate the piston-to-cylinder clearance. Take a maximum reading to determine the clearance. Refer to page 10-7 for measurement of the piston O.D..

Service Limit: 0.1 mm (0.004 in)

Calculate the taper and out-of-round at three levels in an X and Y axis. Take the maximum reading to determine them.

Service Limit:

Taper: 0.1 mm (0.004 in)

Out-of-round: 0.1 mm (0.004 in)

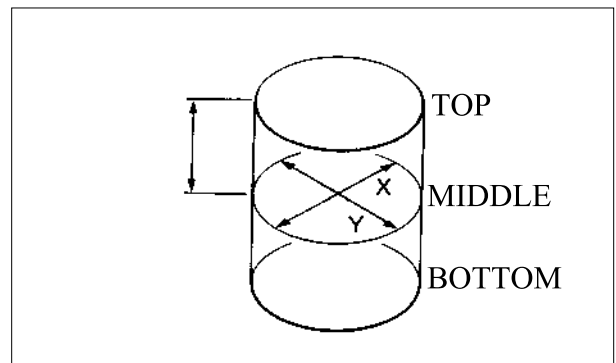

10. CYLINDER/PISTON

XCITING 500/500 AFI/250/300 AFI

Measure the connecting rod small end I.D..

Service Limit:

XCITING 500/500 AFI: 22.06 mm (0.8824 in)

XCITING 250/300 AFI: 17.06 mm (0.6824 in)

Calculate the connecting rod-to-piston pin clearance.

Service Limit: 0.06 mm (0.002 in)

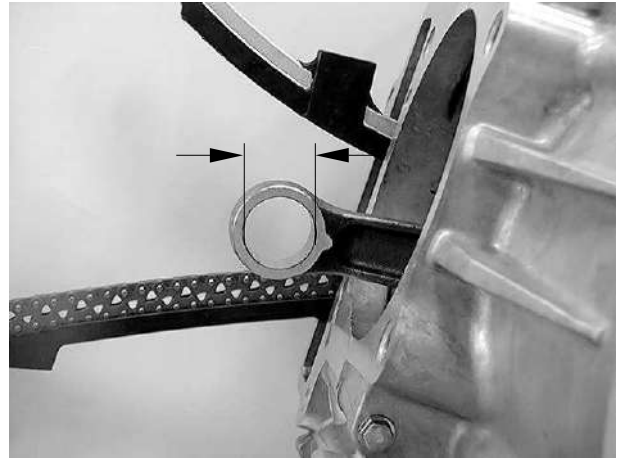

PISTON RING INSTALLATION

Carefully install the piston rings into the piston ring grooves with the markings facing up.

* Be careful not to damage the piston and rings.

- ♦ Do not confuse the top and second rings.
- ♦ To install the oil ring, install the oil ring, then install the side rails.

Stagger the piston ring end gaps 120° degrees apart from each other.

Stagger the side rail end gaps as shown.

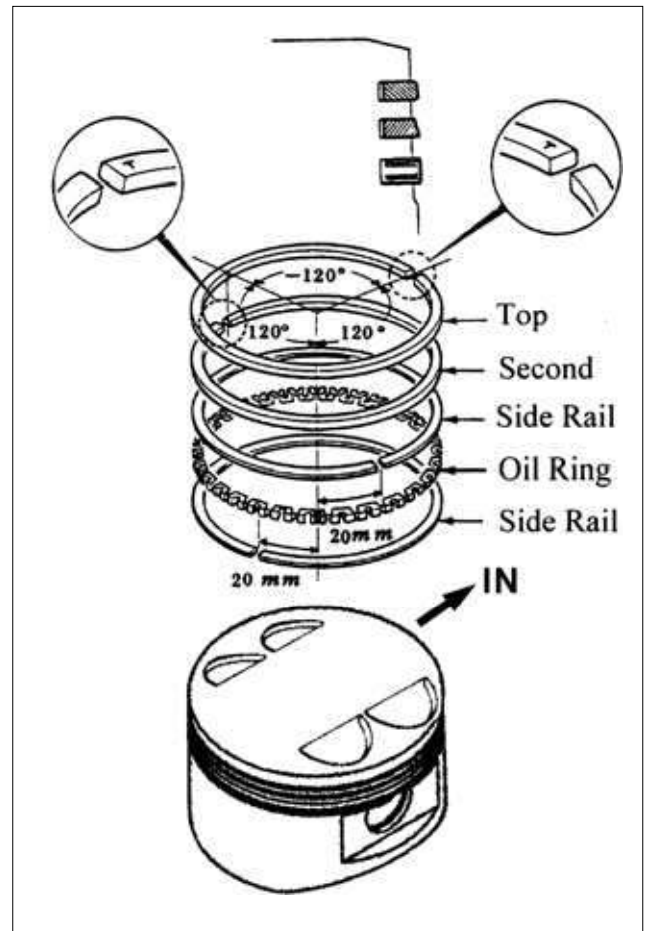

10. CYLINDER/PISTON

XCITING 500/500 AFI/250/300 AFI

CYLINDER/PISTON INSTALLATION (XCITING 500/500 AFI)

Clean any gasket material from the cylinder mating surfaces of the crankcase and oil passage.

Apply engine oil to the piston pin.
Apply engine oil to the connecting rod small end and piston pin hole.

Install the piston with the "IN" mark face intake side and piston pin.

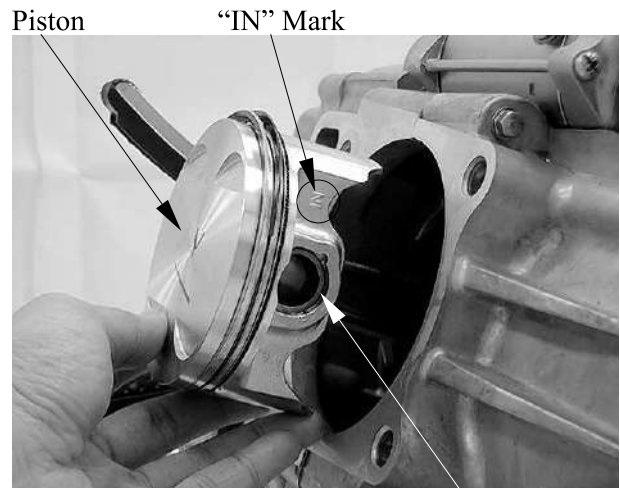

Piston Pin

Place a clean shop towel over the crankcase prevent the clip from falling into the crankcase.

Install the new pin clip.

- * ♦Make sure that the piston pin clips are seated securely.
- ♦Do not align the piston pin clip end gap with the piston cut-out

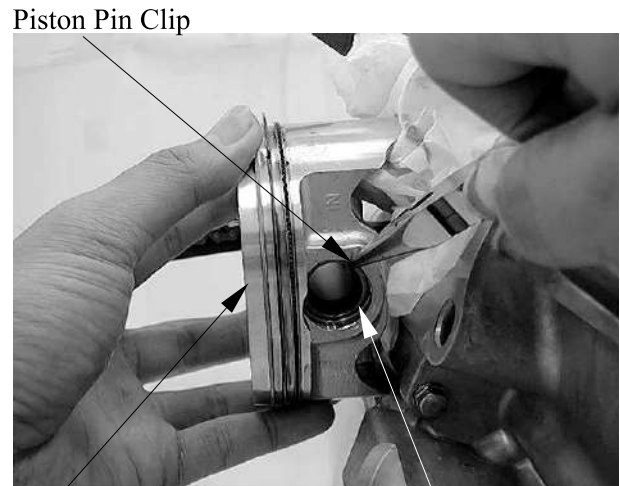

Piston

Piston Pin

Install the dowel pins.

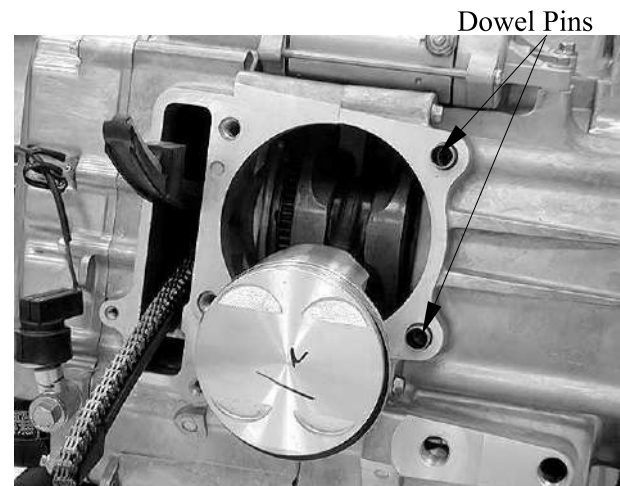

10. CYLINDER/PISTON

XCITING 500/500 AFI/250/300AFI

Install the gasket.

Apply engine oil to the cylinder wall, piston and piston ring outer surfaces.

Pass the cam chain through the cylinder and install the cylinder over the piston.

* Be careful not to damage the piston rings and cylinder walls.

Install the two cylinder bolts and after the cylinder head and holders has installed (page 9-25), then tighten the two cylinder bolts to specified torque.

Torque: 10 N•m (1 kgf•m, 7 lbf•ft)

Install the block pin.

Connect the water hose.

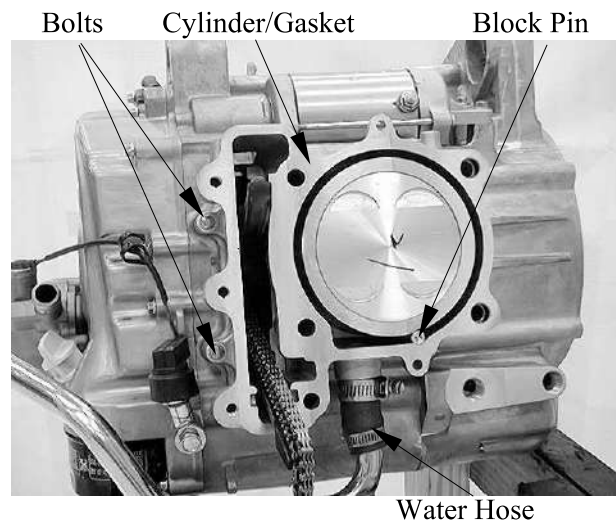

10. CYLINDER/PISTON

XCITING 500/500 AFI/250/300 AFI

CYLINDER/PISTON INSTALLATION (XCITING 250/300 AFI)

Remove any gasket material from the crankcase surface.

- * • Be careful not to drop foreign matters into the crankcase.

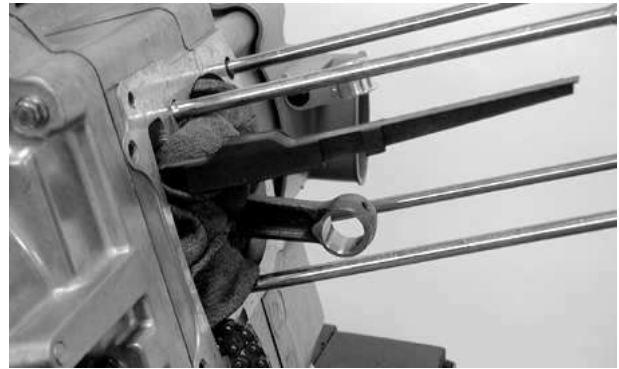

Install the piston, piston pin and a new piston pin clip.

- * • Position the piston "IN" mark on the intake valve side.
- Place a clean shop towel in the crankcase to keep the piston pin clip from falling into the crankcase.

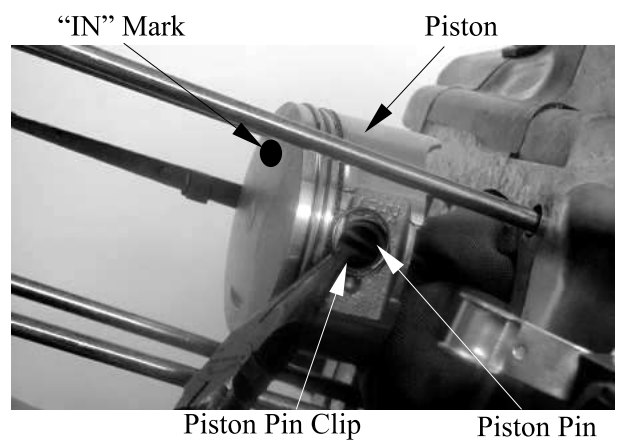

Install the dowel pins and a new cylinder gasket on the crankcase.

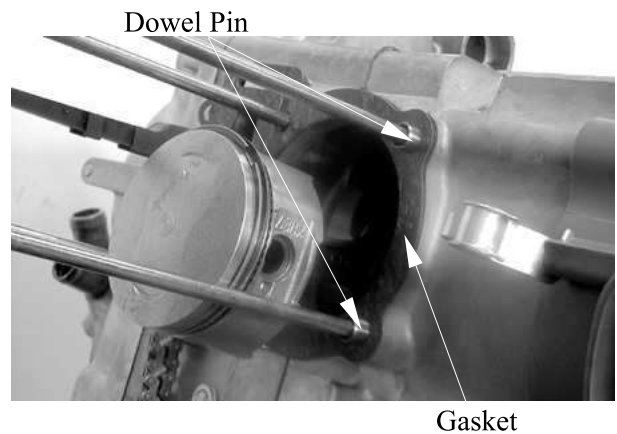

Coat the cylinder bore, piston and piston rings with clean engine oil. Carefully lower the cylinder over the piston by compressing the piston rings.

- * • Be careful not to damage or break the piston rings.
- The piston ring end gaps should not be parallel with or at 90° to the piston pin.

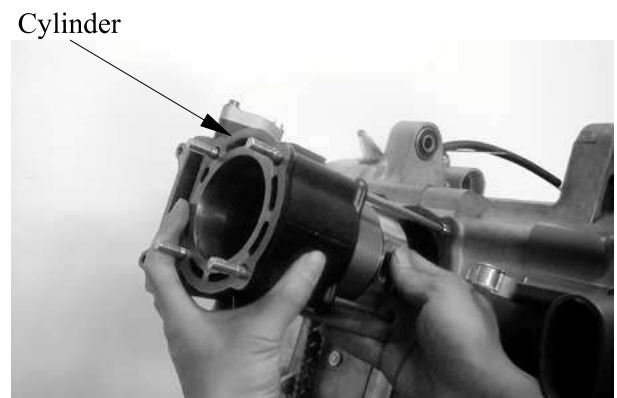

10. CYLINDER/PISTON

XCITING 500/500 AFI/250/300 AFI

Install the cam chain guide.

- * • Insert the tab on the cam chain guide into the cylinder groove.

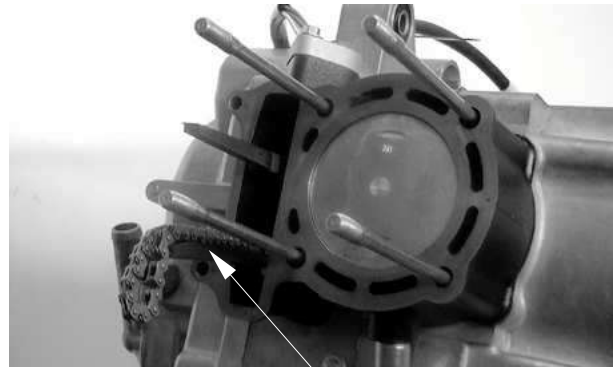

Cam Chain Guide

Install the cylinder gasket and dowel pins.
Connect the water hose to the cylinder.

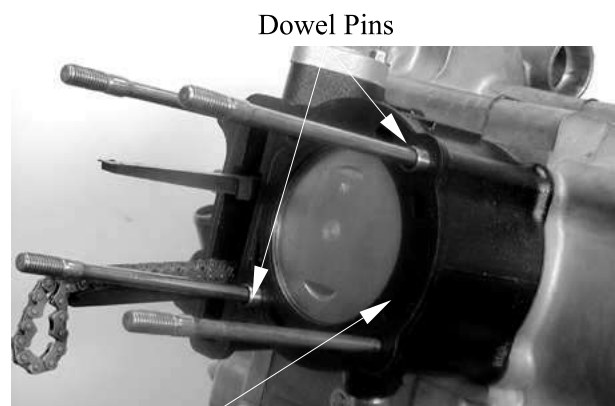

Dowel Pins

Gasket

DRIVE AND DRIVEN PULLEY

SCHEMATIC DRAWING -----	11- 1
SERVICE INFORMATION-----	11- 2
TROUBLESHOOTING-----	11- 3
LEFT CRANKCASE COVER-----	11- 4
DRIVE PULLEY -----	11- 7
CLUTCH/DRIVEN PULLEY-----	11-14

11. DRIVE AND DRIVEN PULLEY



XCITING 500/500 AFI/250/300 AFI

SCHEMATIC DRAWING



11. DRIVE AND DRIVEN PULLEY

SERVICE INFORMATION

GENERAL INSTRUCTIONS

- The drive pulley, clutch and driven pulley can be serviced with the engine installed.
- Avoid getting grease and oil on the drive belt and pulley faces. Remove any oil or grease from them to minimize the slipping of drive belt and drive pulley.
- Do not apply grease to the movable drive face and weight rollers.

SPECIFICATIONS (XCITING 500/500 AFI)

Unit: mm (in)

Item	Standard	Service Limit
Movable driven face bushing I.D.	48 (1.92)~48.025 (1.921)	48.06 (1.9224)
Driven face collar O.D.	47.965 (1.9186)~47.985 (1.9194)	47.94 (1.9176)
Drive belt width	28.9 (1.156)	
Clutch lining thickness	4 (0.16)	1 (0.04)
Clutch outer I.D.	160 (6.3)~160.2 (6.31)	160.5 (6.32)
Drive pulley collar O.D.	28.96 (1.158)~28.974 (1.159)	28.9 (1.156)
Weight roller O.D.	29.98 (1.1992)~30.08 (1.203)	29.5 (1.18)

SPECIFICATIONS (XCITING 250/300 AFI)

Unit: mm (in)

Item	Standard	Service Limit
Movable driven face bushing I.D.	40 (1.6)~40.025 (1.601)	40.06 (1.6024)
Driven face collar O.D.	39.965 (1.5986)~39.985 (1.5994)	39.94 (1.5976)
Drive belt width	23.6 (0.944)~24.4 (0.976)	
Clutch lining thickness	4 (0.16)	1 (0.04)
Clutch outer I.D.	153 (6.12)~153.2 (6.128)	153.5 (6.14)
Drive pulley collar O.D.	26.96 (1.0784)~26.974 (1.07896)	26.9 (1.076)
Weight roller O.D.	22.92 (0.9168)~23.08 (0.9232)	22 (0.88)

11. DRIVE AND DRIVEN PULLEY



XCITING 500/500 AFI/250/300 AFI

TORQUE VALUES (XCITING 500/500 AFI)

Drive face nut	135 N•m (13.5 kgf•m, 97 lbf•ft)	Apply oil to the threads
Clutch outer nut	80 N•m (8 kgf•m, 58 lbf•ft)	
Clutch drive plate nut	78 N•m (7.8 kgf•m, 56 lbf•ft)	

TORQUE VALUES (XCITING 250/250 AFI)

Drive face nut	93 N•m (9.3 kgf•m, 67 lbf•ft)	Apply oil to the threads
Clutch outer nut	54 N•m (5.4 kgf•m, 39 lbf•ft)	
Clutch drive plate nut	54 N•m (5.4 kgf•m, 39 lbf•ft)	

SPECIAL TOOLS (XCITING 500/500 AFI)

Universal holder	A120E00017
Clutch spring compressor	A120E00053
Oil seal & bearing install	A120E00014

SPECIAL TOOLS (XCITING 250/250 AFI)

Universal holder	A120E00017
Clutch spring compressor	A120E00034
Oil seal & bearing install	A120E00014

TROUBLESHOOTING

Engine starts but motorcycle won't move

- Worn drive belt
- Broken ramp plate
- Worn or damaged clutch lining
- Broken driven face spring

Engine stalls or motorcycle creeps

- Broken clutch weight spring

Lack of power

- Worn drive belt
- Weak driven face spring
- Worn weight roller
- Faulty driven face

11. DRIVE AND DRIVEN PULLEY

LEFT CRANKCASE COVER

REMOVAL (XCITING 500/500 AFI)

Remove the left center body cover (page 2-5).

Remove the three bolts and the left front cover.

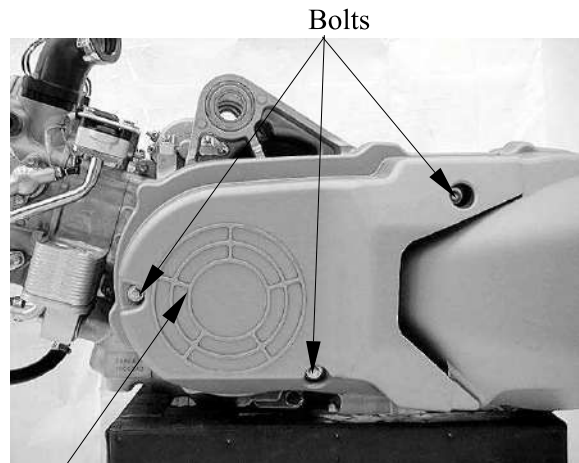

Left Front Cover

Remove the two bolts and left rear cover

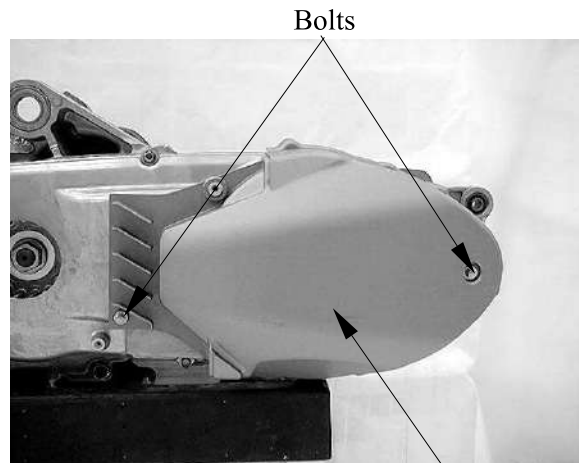

Left Rear Cover

Remove the eight bolts and left crankcase cover.

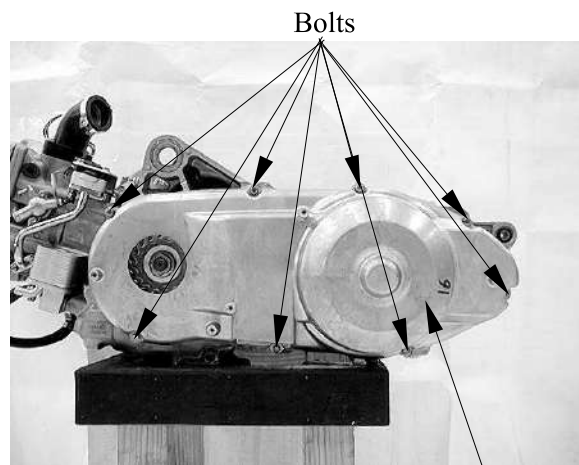

Crankcase

11. DRIVE AND DRIVEN PULLEY



XCITING 500/500 AFI/250/300 AFI

Remove the dowel pins and gasket.

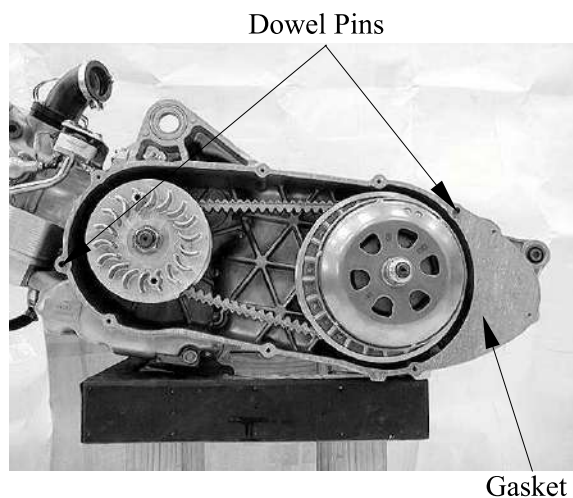

REMOVAL (XCITING 250/250 AFI)

Remove the left crankcase cover bolts and left crankcase covers.

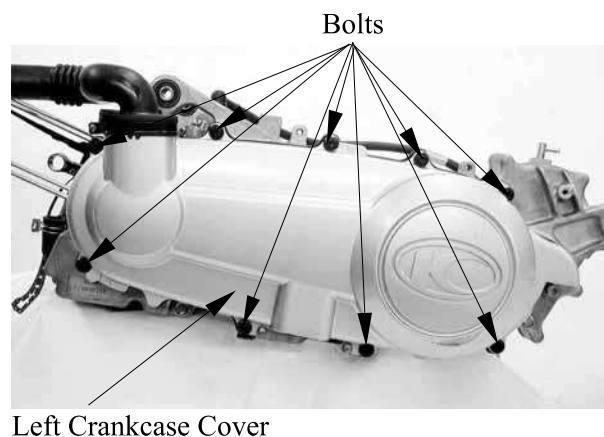

Remove the seal rubber and dowel pins.

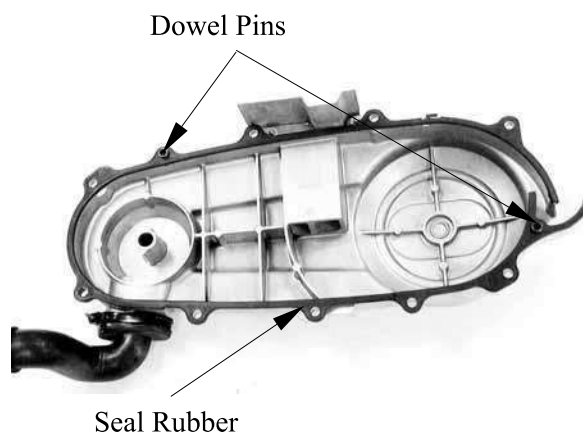

11. DRIVE AND DRIVEN PULLEY



XCITING 500/500 AFI/250/300 AFI

DRIVESHAFT BEARING REPLACEMENT (XCITING 500/500 AFI)

Remove the snap ring.



Clip

Heat the left crankcase cover around the driveshaft bearing with industrial dryer. Remove the driveshaft bearing from the left crankcase cover.

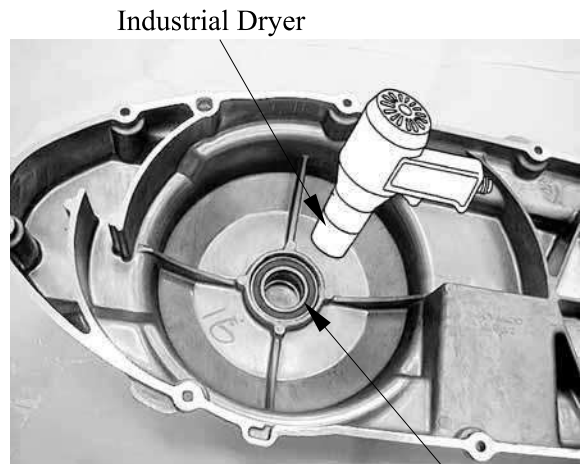

Industrial Dryer

Bearing

Install the new driveshaft bearing into the left crankcase cover using a special tool.

Special tool:

Oil seal & bearing install A120E00014

INSTALLATION

Installation is in the reverse order of removal.

* Clean the gasket on the left crankcase before installation.



Bearing Install

11. DRIVE AND DRIVEN PULLEY



XCITING 500/500 AFI/250/300 AFI

DRIVE PULLEY REMOVAL

Remove the left crankcase cover (XCITING 500/500 AFI: page 11-4, XCITING 250/250 AFI: 11-5).

Hold the drive pulley face with the special tool and loosen the drive pulley face nut.

Special tool:

Universal holder A120E00017

Remove the nut, washer and drive pulley face.

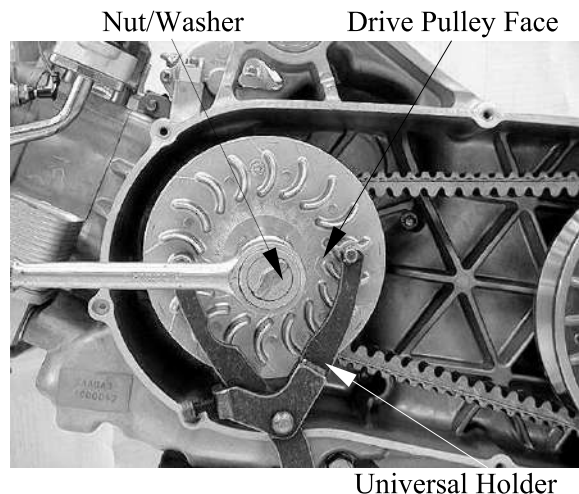

Hold the clutch outer with the special tool as shown.

Special tool:

Universal holder A120E00017

Remove the nut, collar (XCITING 500/500 AFI) and clutch outer.

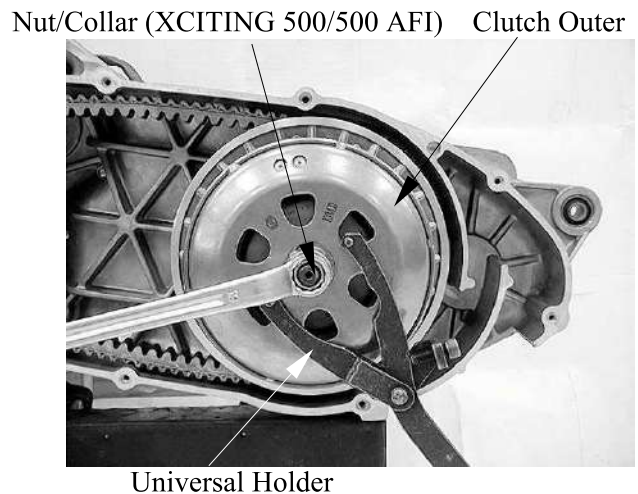

Remove the clutch/driven pulley assembly and drive belt.

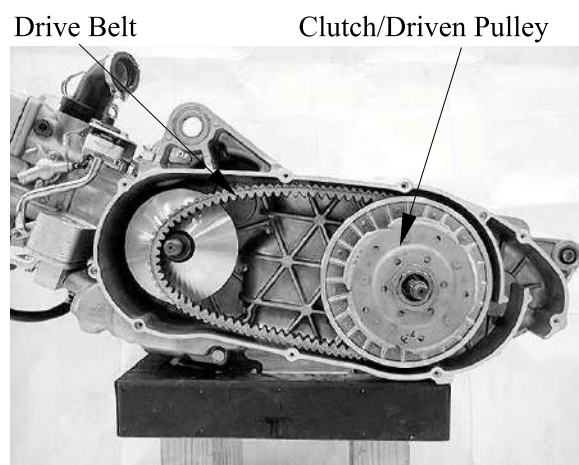

11. DRIVE AND DRIVEN PULLEY

Remove the washer (XCITING 500/500 AFI).



Remove the movable drive face assembly while holding the back of the face (ramp plate).

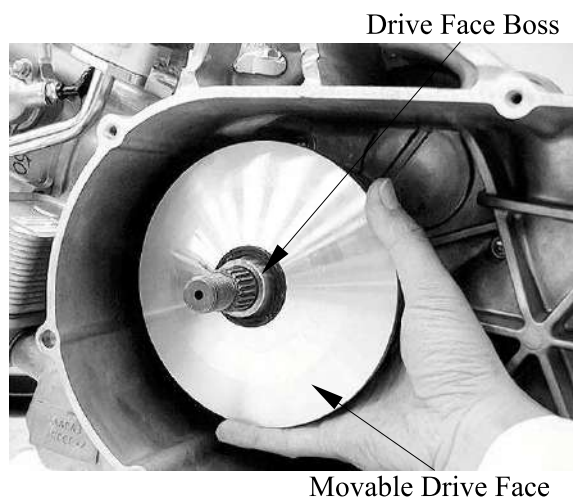

Remove the washer (XCITING 500/500 AFI).



11. DRIVE AND DRIVEN PULLEY



XCITING 500/500 AFI/250/300 AFI

DISASSEMBLY

Drive pulley

Remove the ramp plate and slide pieces.

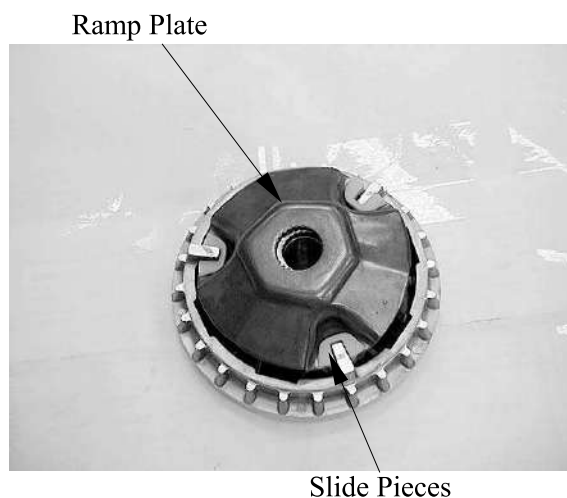

Remove the weight rollers.



Remove the drive face boss from the movable drive face.

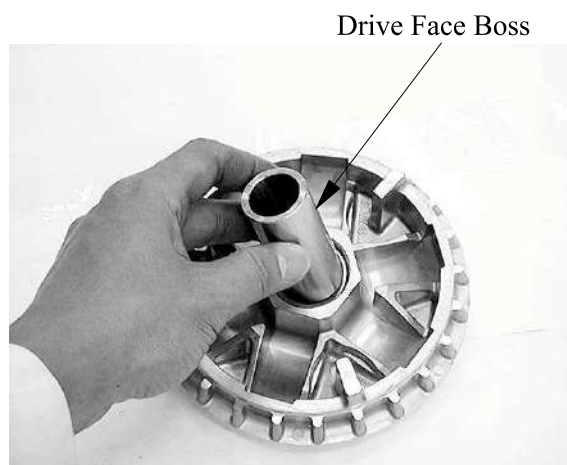

11. DRIVE AND DRIVEN PULLEY



XCITING 500/500 AFI/250/300 AFI

INSPECTION

Movable Drive Face

Check the drive face boss for wear or damage.

Measure the boss O.D..

Service limit:

XCITING 500/500 AFI: 28.9 mm (1.156 in)

XCITING 250/250 AFI: 26.9 mm (1.076 in)

Measure the face bushing I.D..

Service limit:

XCITING 500/500 AFI: 29.1 mm (1.164 in)

**XCITING 250/250 AFI:
27.13 mm (1.058 in)**

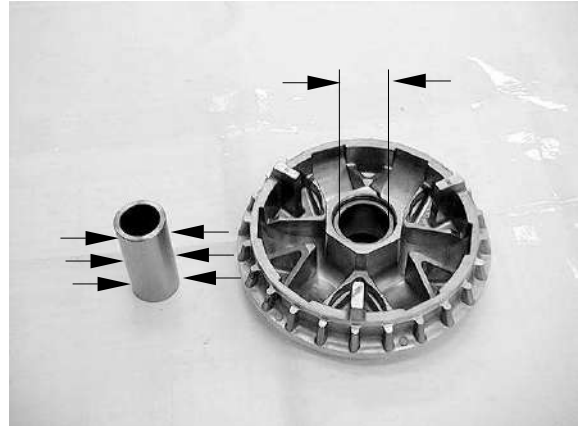

Weight Roller

Check each roller for wear or damage.

Measure the weight roller O.D..

Service limit:

XCITING 500/500 AFI: 29.5 mm (1.18 in)

XCITING 250/250 AFI: 22 mm (0.888 in)

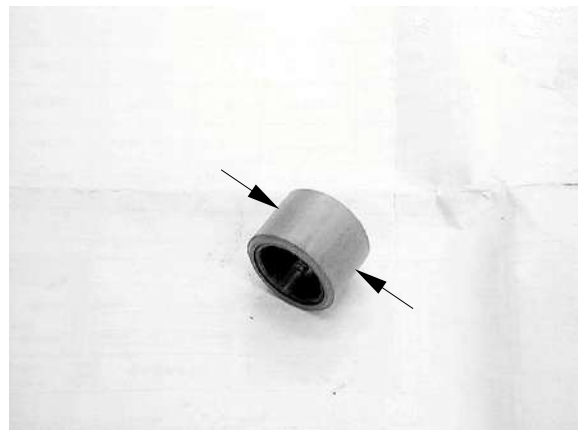

Movable Drive Face

Check the dust seal (XCITING 500/500 AFI) for wear or damage.

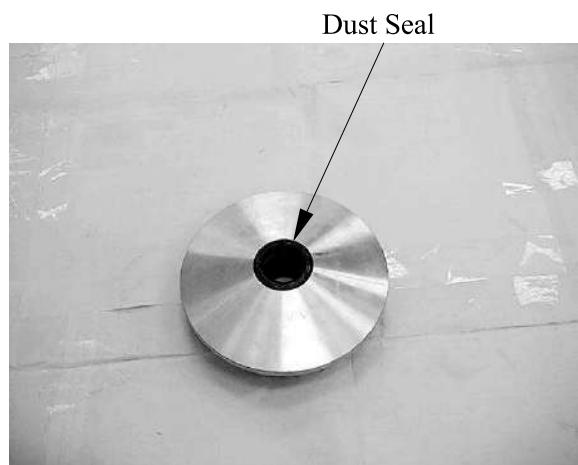

11. DRIVE AND DRIVEN PULLEY



XCITING 500/500 AFI/250/300 AFI

ASSEMBLY

Clean any oil and grease from the pulley faces and weight rollers.

Install the drive face boss into the movable drive face.



Install the weight rollers to the movable drive face.

* The direction of all weight rolls is the same. The thin side is towards to clockwise.

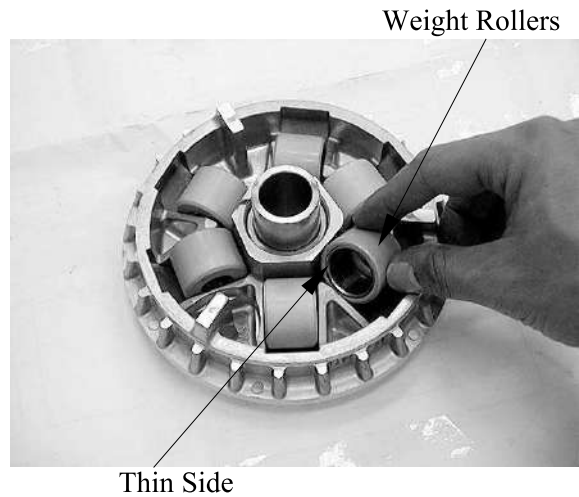

Install the slide pieces to ramp plate.
Install the ramp plate to the movable drive face.

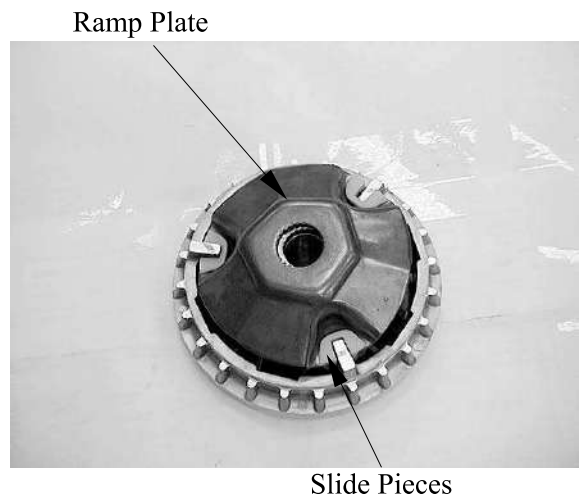

11. DRIVE AND DRIVEN PULLEY

INSTALLATION

Install the washer (XCITING 500/500 AFI).

* The inner indentation side on the washer faces the left crankcase.

Inner Indentation Side (XCITING 500/500 AFI)



Washer

Clean any oil and grease from the pulley faces and the drive belt.

Install the movable drive face assembly onto the crankshaft while holding the ramp plate.

Install the washer (XCITING 500/500 AFI).

Washer (XCITING 500/500 AFI)

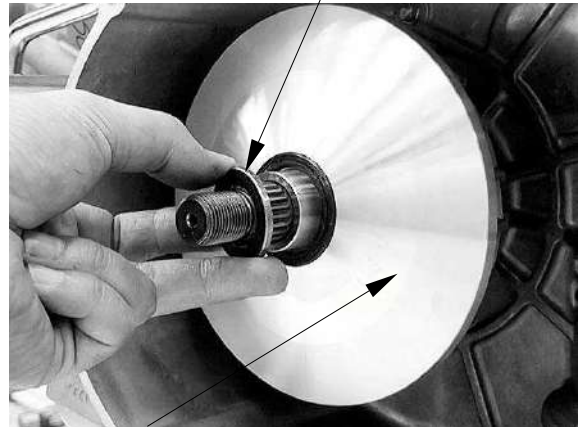

Movable Drive Face Assembly

Install the drive belt and clutch/driven pulley assembly.

* Install the drive belt with the arrow mark facing the direction of travel.

Drive Belt

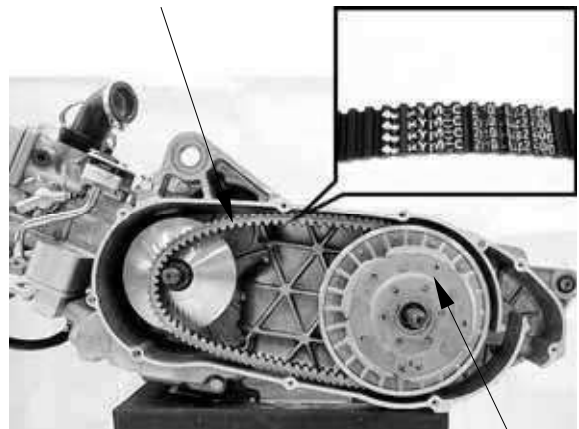

Clutch/Driven Pulley Assembly

11. DRIVE AND DRIVEN PULLEY



XCITING 500/500 AFI/250/300 AFI

Hold the clutch outer with the special tool as shown.

Special tool:

Universal holder A120E00017

Install the collar (XCITING 500/500 AFI) and nut.

Tighten the nut to the specified torque.

Torque:

XCITING 500/500 AFI:

80 N•m (8 kgf•m, 58 lbf•ft)

XCITING 250/250 AFI:

54 N•m (5.4 kgf•m, 36 lbf•ft)

Clutch Outer Collar (XCITING 500/500 AFI)/Nut

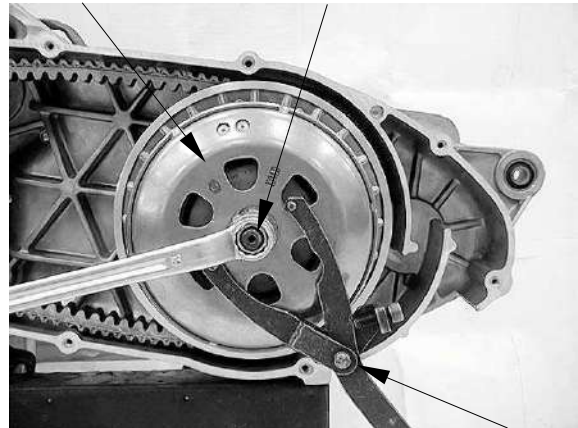

Universal Holder

Install the drive pulley face and washer.

Apply oil to the drive pulley face nut threads and seating surface and install the nut.

Hold the drive face with the special tool and tighten the bolt to the specified torque.

Special tool:

Universal holder A120E00017

Torque:

XCITING 500/500 AFI:

135 N•m (13.5 kgf•m, 97 lbf•ft)

XCITING 250/250 AFI:

93 N•m (9.3 kgf•m, 67 lbf•ft)

Washer/Nut Drive Pulley Face

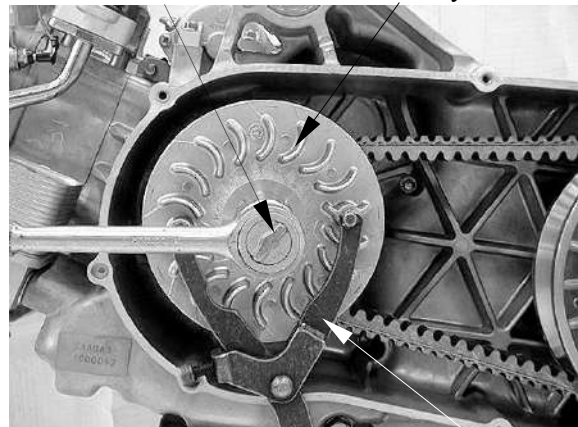

Universal Holder

11. DRIVE AND DRIVEN PULLEY



XCITING 500/500 AFI/250/300 AFI

CLUTCH/DRIVEN PULLEY

REMOVAL

Remove the left crankcase cover (XCITING 500/500 AFI: page 11-4, XCITING 250/250 AFI: 11-5).

Hold the drive pulley face with the special tool and loosen the drive pulley face nut.

Special tool:

Universal holder **A120E00017**

Remove the nut, washer and drive pulley face.

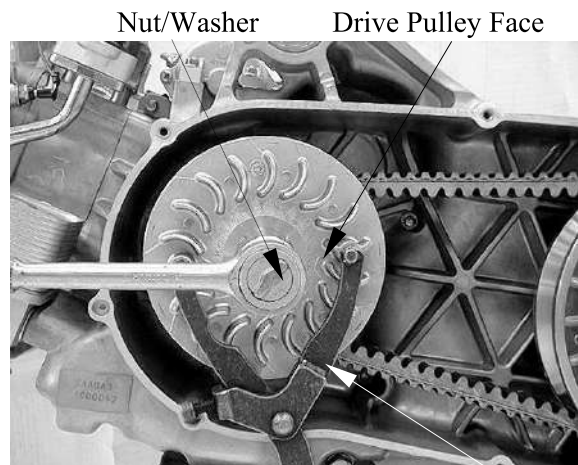

Universal Holder

Hold the clutch outer with the special tool as shown.

Special tool:

Universal holder **A120E00017**

Remove the nut, collar (XCITING 500/500 AFI) and clutch outer.

Nut/Collar (XCITING 500/500 AFI) Clutch Outer

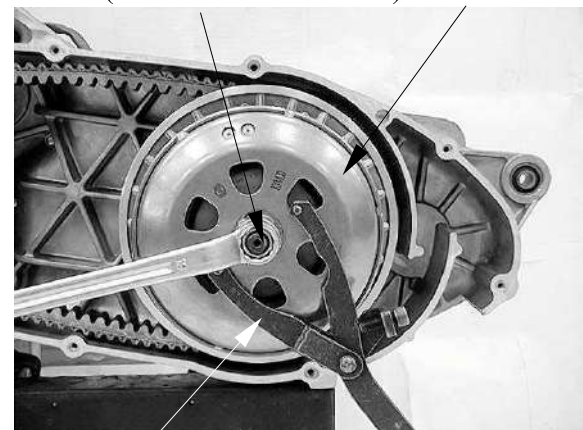

Universal Holder

Remove the clutch/driven pulley assembly and drive belt.

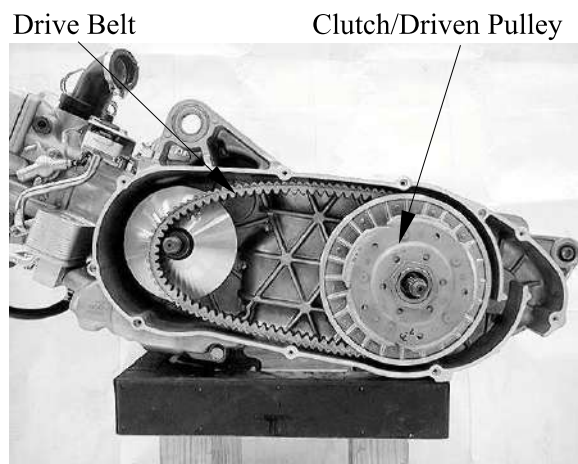

11. DRIVE AND DRIVEN PULLEY



XCITING 500/500 AFI/250/300 AFI

DISASSEMBLY Clutch/Driven Pulley

Hold the clutch/driven pulley assembly with the clutch spring compressor.

* Be sure to use a clutch spring compressor to avoid spring damage.

Special tool:

XCITING 500/500 AFI:

Clutch Spring Compressor A120E00053

XCITING 250/300 AFI:

Clutch Spring Compressor A120E00034

Set the tool in a vise and remove the clutch drive plate nut.

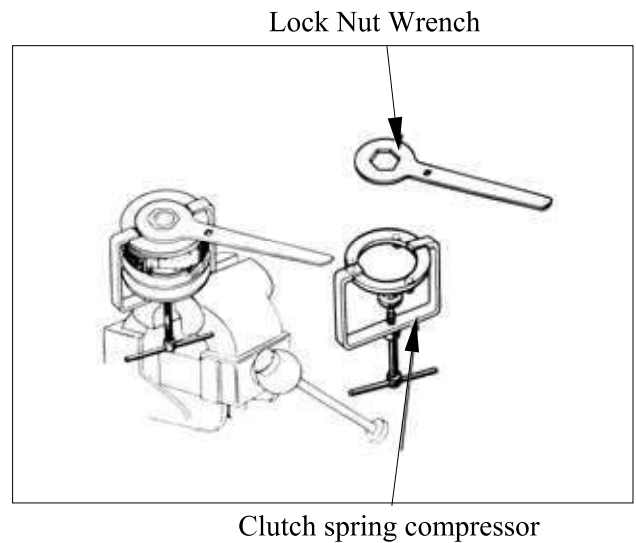

Remove the spring compressor and disassemble the following:

- Clutch assembly
- Driven face spring
- Driven pulley

Remove the washer (XCITING 500/500 AFI).

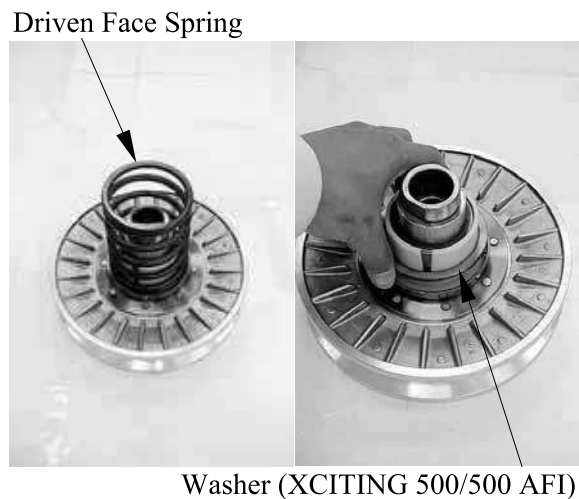

Remove the spring collar (XCITING 500/500 AFI).

Remove the seal collar.

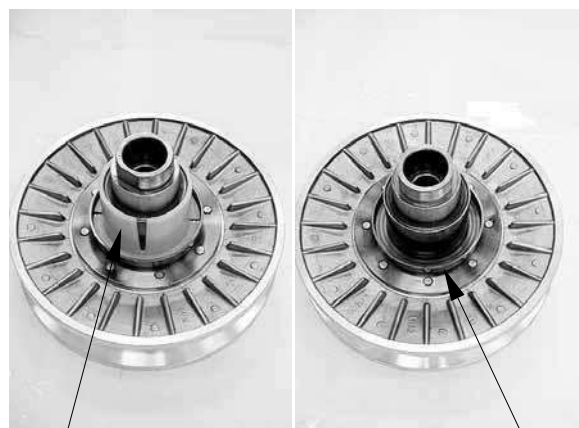

11. DRIVE AND DRIVEN PULLEY



XCITING 500/500 AFI/250/300 AFI

Remove the guide roller pins, guide rollers and the movable driven face.

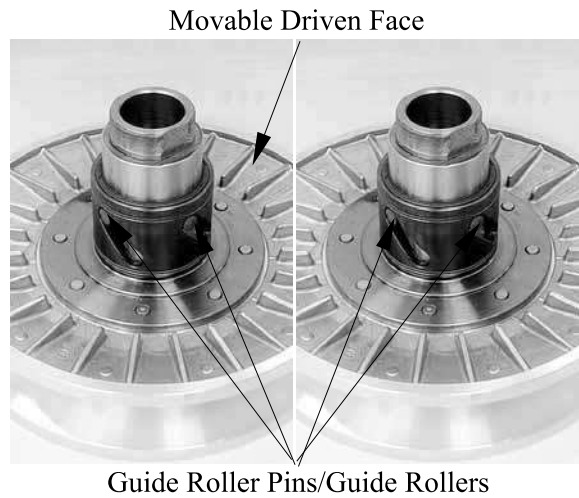

Remove the O-rings and oil seals from the movable driven face.

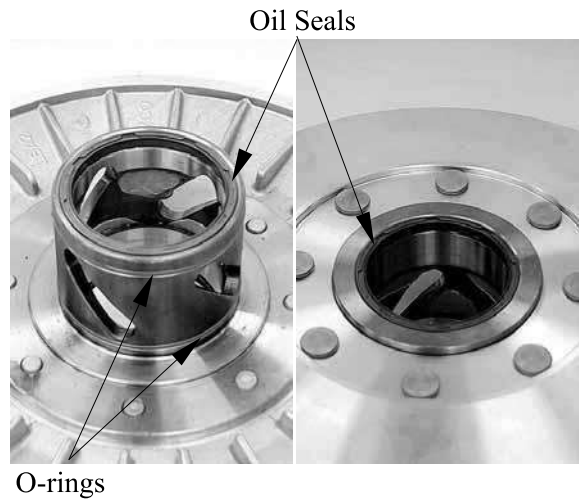

Driven Face Bearing Replacement

Remove the driven face needle bearing.

Remove the snap ring, then remove the ball bearing.

Apply grease to new ball bearing.

Install the ball bearing into the driven face. Install the snap ring to groove in the driven face securely.

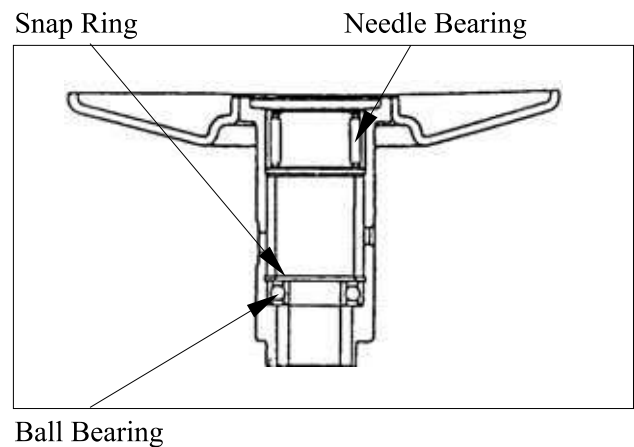

11. DRIVE AND DRIVEN PULLEY



XCITING 500/500 AFI/250/300 AFI

Filling 25 g of grease to the driven face inner surface.

Apply grease to new needle bearing.
Press the needle bearing into the driven.

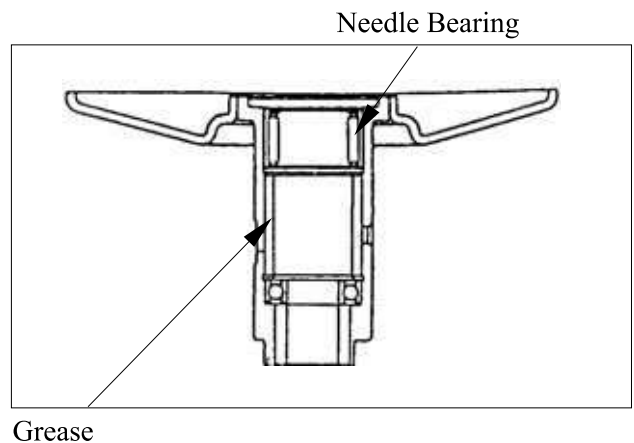

INSPECTION

Clutch Outer

Check the clutch outer for wear or damage.
Measure the clutch outer I.D..

Service limit:

XCITING 500/500 AFI: 160.5 mm (6.32 in)

XCITING 250/250 AFI: 153.5 mm (6.14 in)

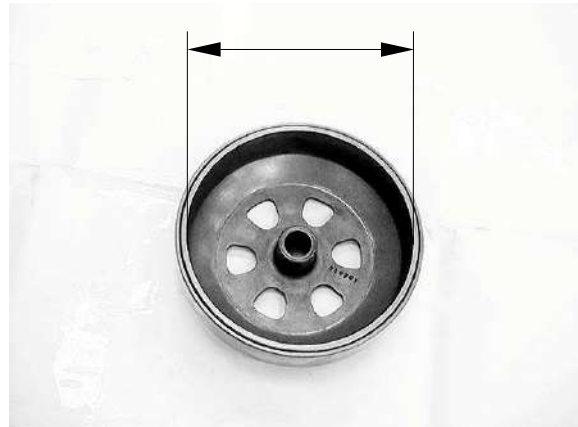

Clutch Shoe Lining

Check the clutch shoe for wear or damage.
Measure the thickness of each shoe.

Service limit: 1 mm (0.04 in)

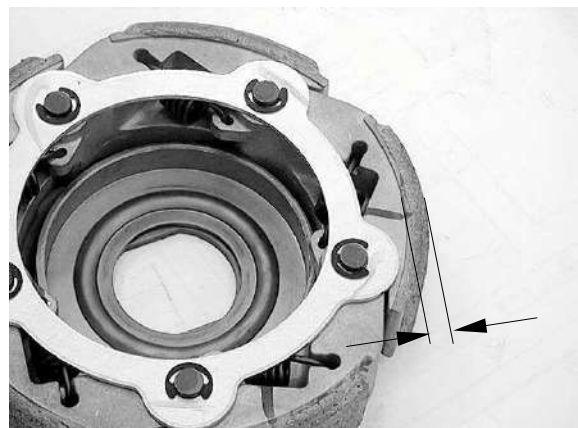

11. DRIVE AND DRIVEN PULLEY



XCITING 500/500 AFI/250/300 AFI

Driven Face Spring

Measure the driven face spring free length.

Service limit:

XCITING 500/500 AFI:

100.7 mm (4.028 in)

XCITING 250/250 AFI:

130.5 mm (5.22 in)

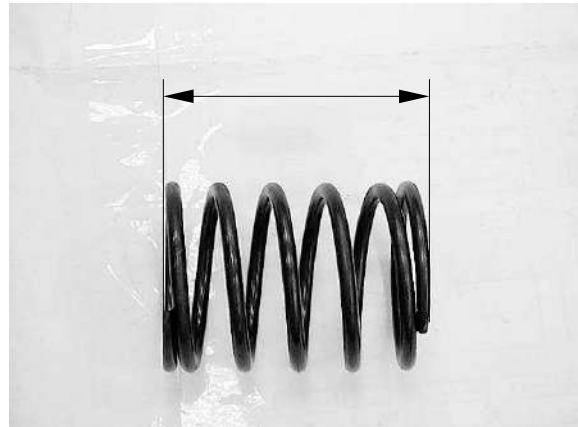

Driven Face

Check the driven face for scratches, scoring or damage.

Measure the driven face boss O.D..

Service limit:

XCITING 500/500 AFI:

47.94 mm (1.9176 in)

XCITING 250/250 AFI:

39.94 mm (1.5976 in)



Movable Driven Face

Check the movable driven face for scratches, scoring or damage.

Check the guide grooves for stepped wear or damage.

Measure the movable driven face I.D..

Service limit:

XCITING 500/500 AFI:

48.06 mm (1.9224 in)

XCITING 250/250 AFI:

40.06 mm (1.6024 in)

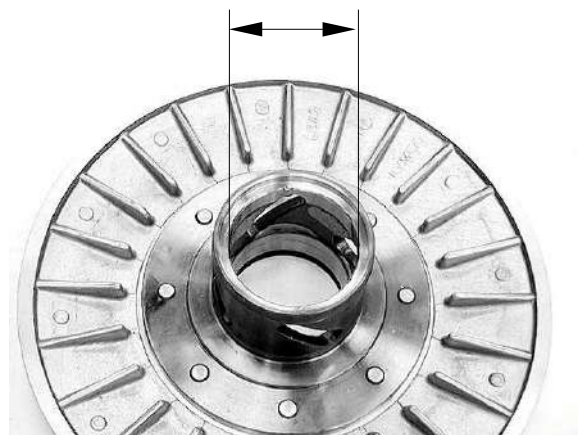

11. DRIVE AND DRIVEN PULLEY



XCITING 500/500 AFI/250/300 AFI

Drive Belt

Check the drive belt for cracks, separation or abnormal or excessive wear.

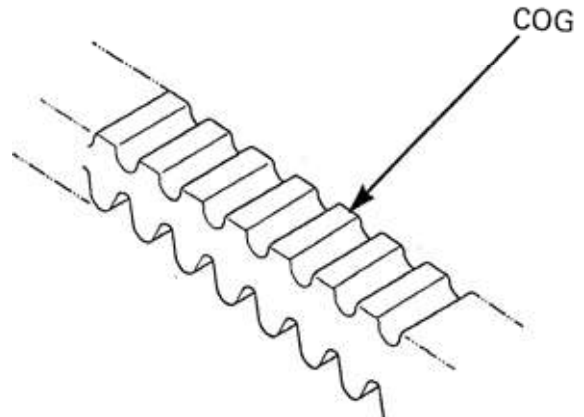

Attach the suitable plates as shown.
Measure the drive belt width.

Service limit: 20000KM replace new one

Every 5000KM inspection

Remove the clutch/driven pulley, then replace the drive belt if necessary.

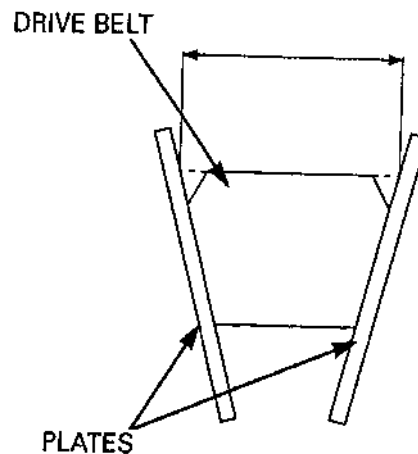

ASSEMBLY

Clean any oil from the drive belt sliding surfaces on the driven face.

Apply grease to new oil seal lips and install into the movable driven face.

Coat new O-rings with grease and install them into the movable driven face grooves.



11. DRIVE AND DRIVEN PULLEY

Install the movable driven face onto the driven face.
Install the guide rollers and guide roller pins.
Filling 8 g of grease to each guide groove.

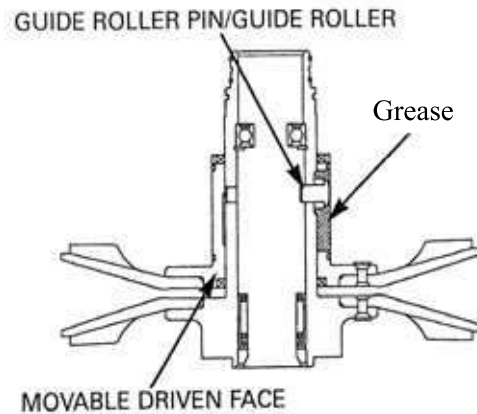

Install the seal collar.
Install spring collar (XCITING 500/500 AFI).
Install washer (XCITING 500/500 AFI).
Install driven face spring.

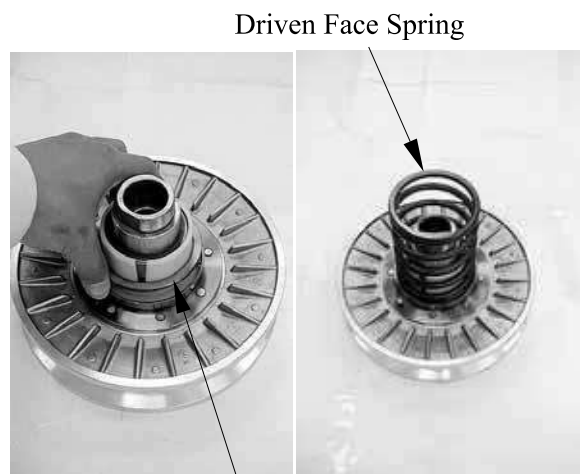

Install the drive belt into the driven pulley.
Squeeze and hold the drive belt by your hand.

Set the clutch spring compressor over the clutch/driven pulley assembly and hold the spring compressor in a vice.

Special tool:

XCITING 500/500 AFI:

Clutch Spring Compressor A120E00053

XCITING 500/500 AFI:

Clutch Spring Compressor A120E00034

Compress the driven face spring.
Install and tighten the clutch drive plate nut to the specified torque.

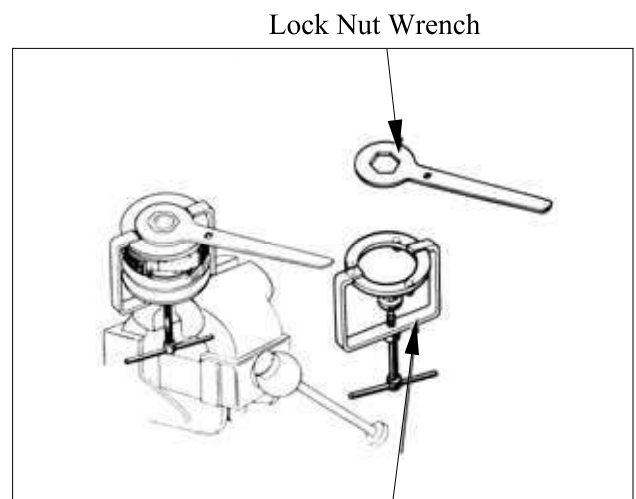

Torque:

XCITING 500/500 AFI:

78 N•m (7.8 kgf•m, 56 lbf•ft)

XCITING 250/250 AFI:

54 N•m (5.4 kgf•m, 39 lbf•ft)

11. DRIVE AND DRIVEN PULLEY



XCITING 500/500 AFI/250/300 AFI

* Install the drive belt with the arrow mark facing the direction of travel.

Install the drive belt and clutch/driven pulley assembly.

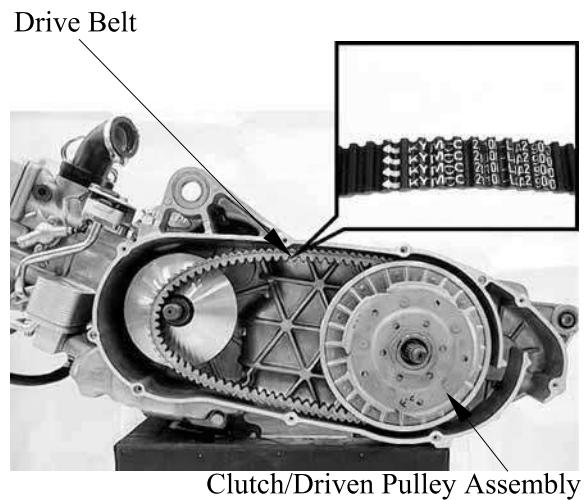

Hold the clutch outer with the special tool as shown.

Special tool:
Universal holder **A120E00017**

Install the collar and nut.
Tighten the nut to the specified torque.

Torque:
XCITING 500/500 AFI:
 80 N•m (8 kgf•m, 58 lbf•ft)
XCITING 250/300 AFI:
 54 N•m (5.4 kgf•m, 39 lbf•ft)

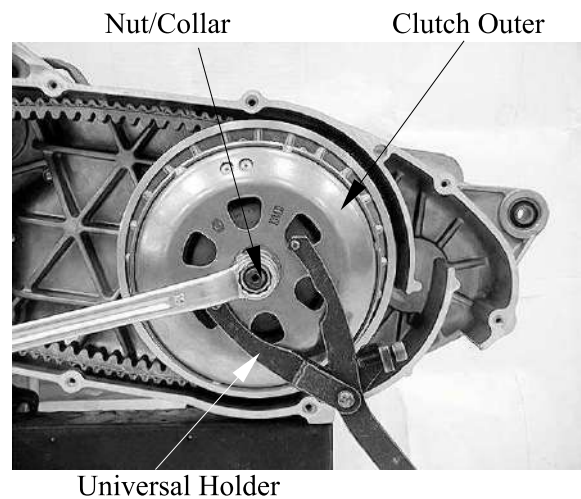

Install the drive pulley face and washer.
Apply oil to the drive pulley face nut threads and seating surface and install the nut.

Hold the drive face with the special tool and tighten the bolt to the specified torque.

Special tool:
Universal holder **A120E00017**

Torque:
XCITING 500/500 AFI:
 135 N•m (13.5 kgf•m, 97 lbf•ft)
XCITING 250/300 AFI:
 93 N•m (9.3 kgf•m, 67 lbf•ft)

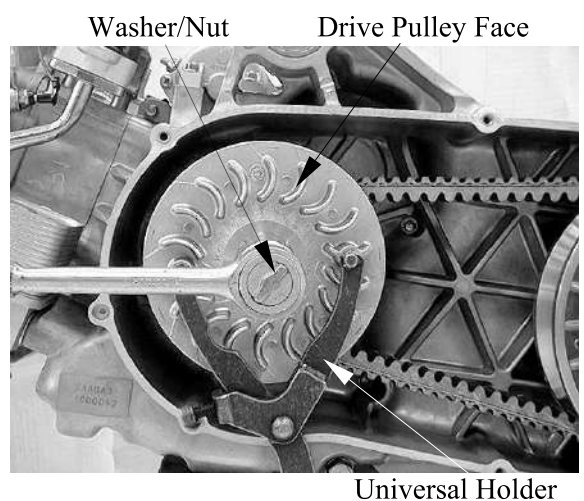

FINAL REDUCTION

SCHEMATIC DRAWING -----	12-1
SERVICE INFORMATION-----	12-2
TROUBLESHOOTING-----	12-2
FINAL REDUCTION DISASSEMBLY -----	12-3
FINAL REDUCTION INSPECTION-----	12-5
FINAL REDUCTION ASSEMBLY -----	12-9

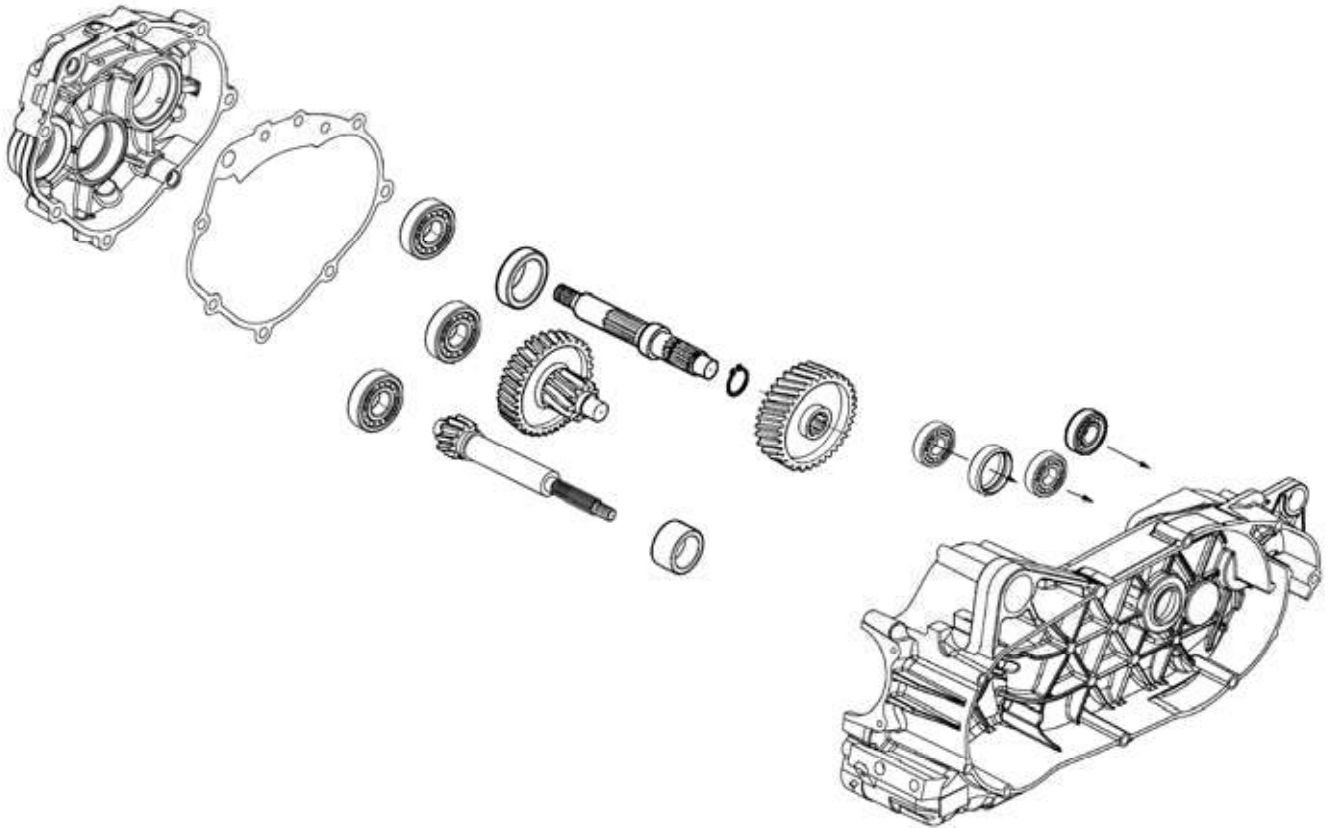
SCHEMATIC DRAWING

SERVICE INFORMATION**GENERAL INSTRUCTIONS**

- The servicing operations of this section can be made with the engine installed.
- When replacing the drive shaft, use a special tool to hold the bearing inner race for this operation.

SPECIFICATIONS

Specified Oil: SAE 90#

Oil Capacity:

XCITING 500/500 AFI:

At disassembly: 0.55 L (0.57 US qt, 0.5 Imp qt)

At change: 0.45 L (0.48 US qt, 0.4 Imp qt)

XCITING 250:

At disassembly: 0.2 L (0.21 US qt, 0.18 Imp qt)

At change: 0.18 L (0.19 US qt, 0.16 Imp qt)

XCITING 250 AFI:

At disassembly: 0.23 L (0.2 Imp qt, 0.24 US qt)

At change: 0.18 L (0.19 US qt, 0.16 Imp qt)

TORQUE VALUES

Transmission case cover bolt 27 N•m (2.7 kgf•m, 20 lbf•ft)

Oil drain bolt 20 N•m (2 kgf•m, 15 lbf•ft)

Oil filler bolt 20 N•m (2 kgf•m, 15 lbf•ft)

SPECIAL TOOLS

Bearing puller A120E00037

Oil seal & bearing driver A120E00014

Universal bearing puller A120E00030

TROUBLESHOOTING**Engine starts but motorcycle won't move**

- Damaged transmission
- Seized or burnt transmission
- Faulty drive and driven pulleys/clutch

Abnormal noise

- Worn, seized or chipped gears
- Worn bearing

Oil leaks

- Oil level too high
- Worn or damaged oil seal
- Cracked crankcase

12. FINAL REDUCTION

FINAL REDUCTION DISASSEMBLY

Remove the exhaust muffler (page 2-16).
Remove the rear brake caliper (page 17-26).
Remove the right rear shock absorber (page 16-10).
Remove the rear fork (page 16-4).
Remove the rear wheel (page 16-4).

Drain the transmission gear oil into a clean container.

Remove the eight bolts and transmission cover.

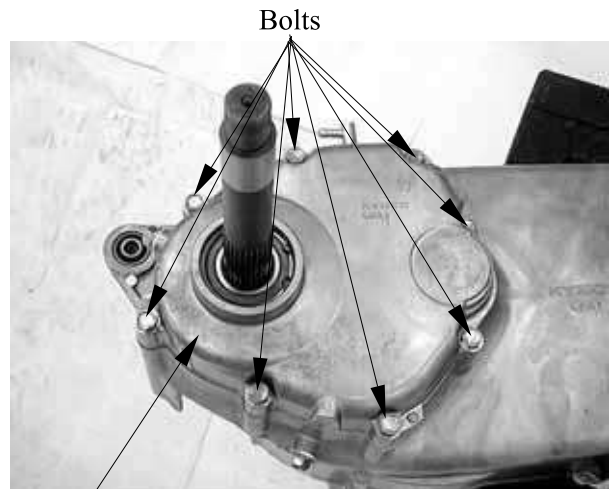

Transmission Cover

Remove the gasket and dowel pins.

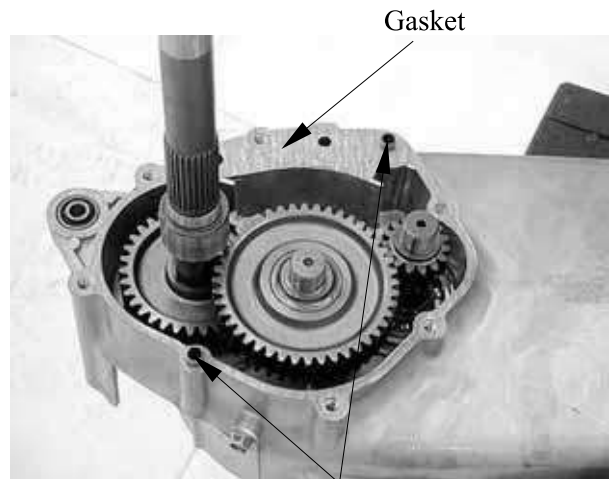

Dowel Pin

Remove the final gear shaft.

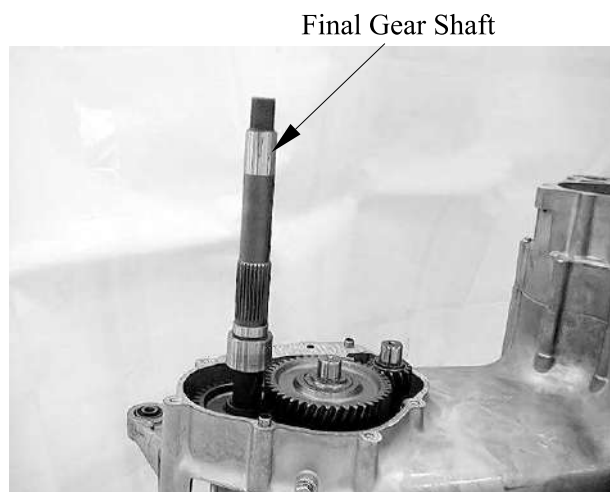

12. FINAL REDUCTION

XCITING 500/500 AFI/250/300 AFI

Remove the countershaft.



Remove the final gear.



Remove the driven pulley (page 11-14).

Press the driveshaft out of the left crankcase.

Check the drive shaft for wear or damage.

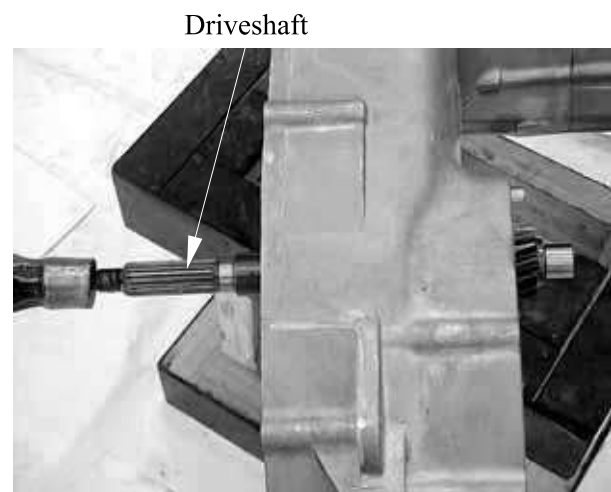

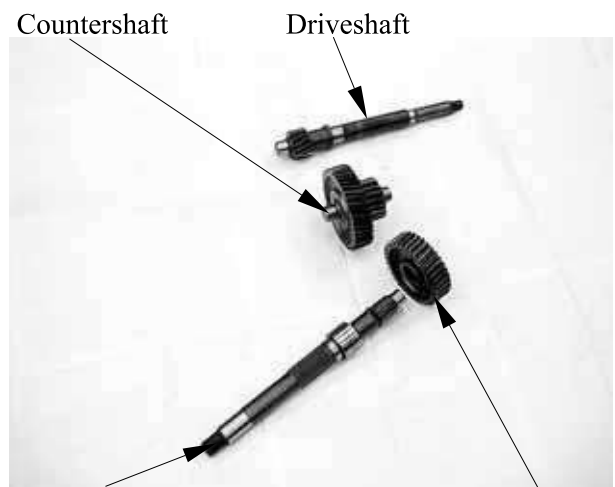
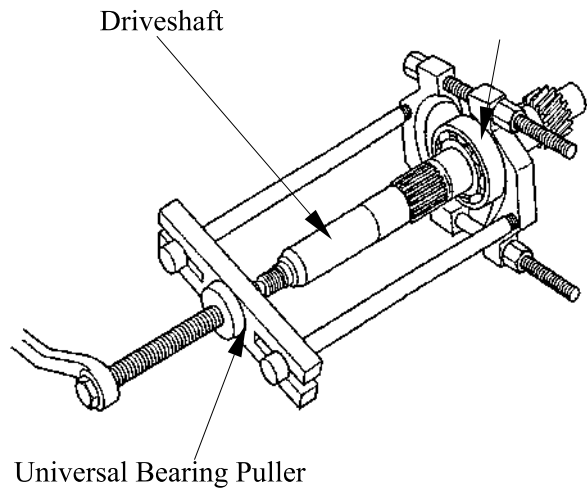
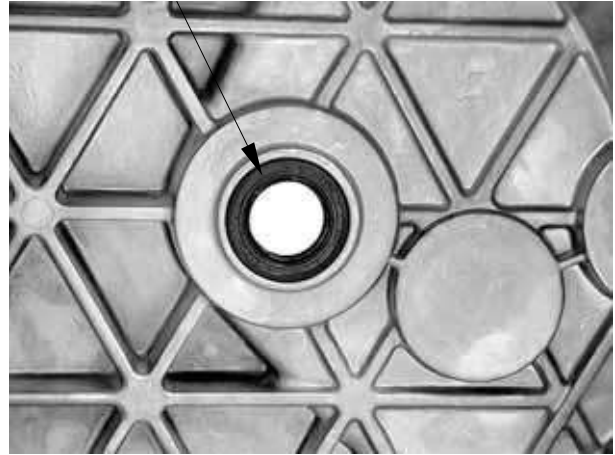

r

12. FINAL REDUCTION

XCITING 500/500 AFI/250/300 AFI

Check the oil seal and bearings in the left crankcase for wear or damage.

BEARING REPLACEMENT (TRANSMISSION CASE)

Remove the countershaft or final gear shaft bearing using the special tool.

Special tool:

Bearing puller A120E00037

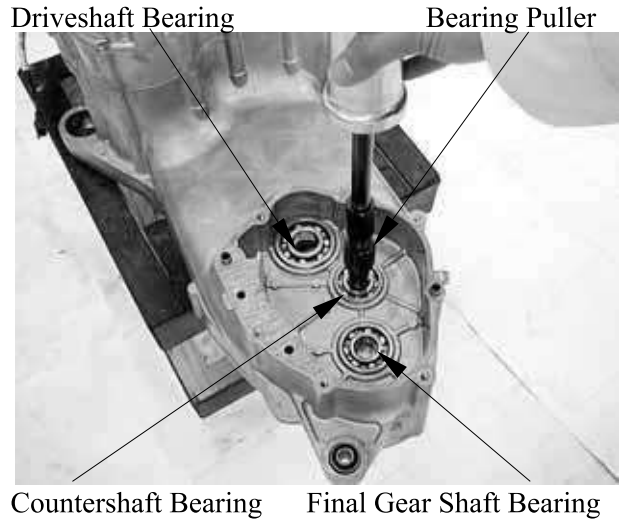

Apply engine oil to new bearings cavities.
Drive new bearings into the transmission case.

Special tool:

Oil seal & bearing driver A120E00014



BEARING REPLACEMENT (TRANSMISSION COVER)

Remove the final gear shaft oil seal.



12. FINAL REDUCTION

XCITING 500/500 AFI/250/300 AFI

Remove the bearing snap ring (XCITING 500/500 AFI).



Remove the final gear shaft bearing.



Remove the countershaft or drive shaft bearing using the special tool.

Special tool:

Bearing puller A120E00037



12. FINAL REDUCTION

Apply engine oil to new bearings cavities.
Drive new bearings into the transmission cover.

Special tool:

Oil seal & bearing driver A120E00014

Oil Seal & Bearing Driver



Apply engine oil to new final gear shaft bearing cavity.
Drive new bearing into the transmission cover.

Special tool:

Oil seal & bearing driver A120E00014



Oil Seal & Bearing Driver

Install the bearing snap ring.

Snap Ring

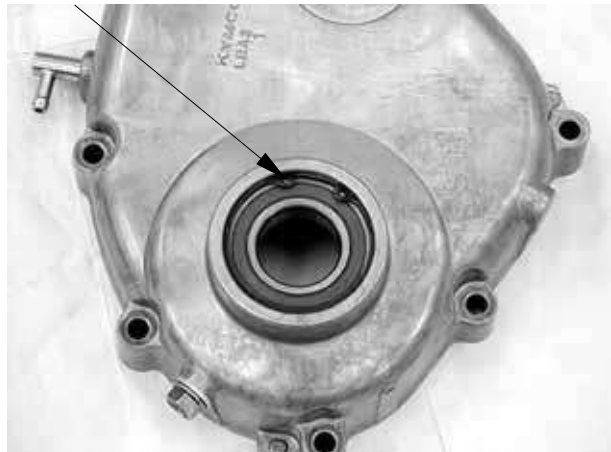

12. FINAL REDUCTION

Apply oil to a new final gear shaft oil seal lip and outer surface.

Install the final gear shaft oil seal.



FINAL REDUCTION ASSEMBLY

Install the final gear to the transmission case.



Install the countershaft to the transmission case.

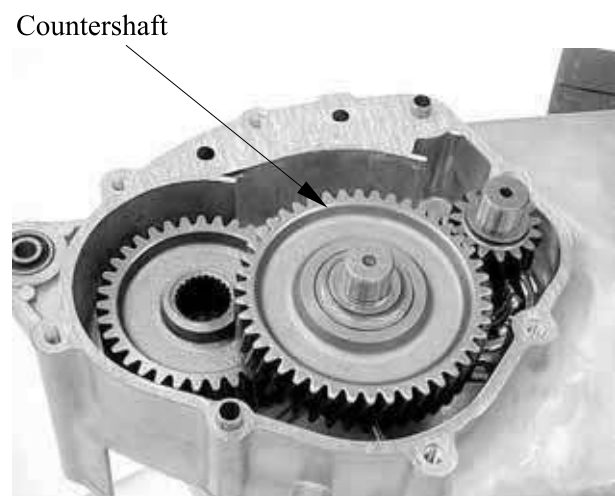

12. FINAL REDUCTION

Install the final gear shaft to transmission case.

Install the dowel pins.

Clean the mating surfaces of the left crankcase and transmission cover.

Install the new gasket.

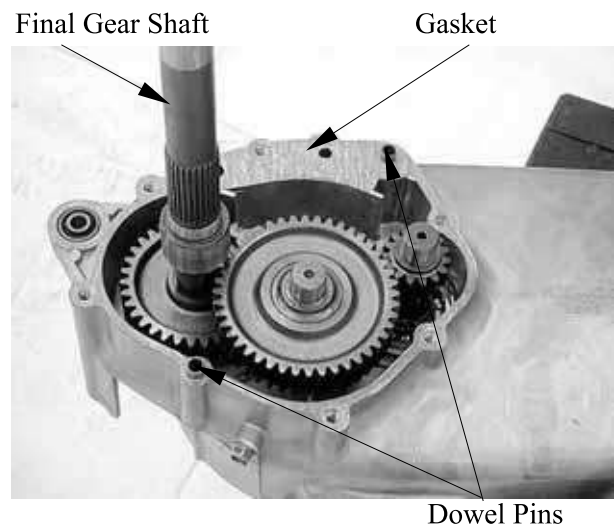

Install the transmission cover and tighten the eight bolts in a crisscross pattern in 2 – 3 steps to the specified torque.

Torque: 27 N•m (2.7 kgf•m, 20 lbf•ft)

Fill the transmission case with the recommended oil (page 3-22).

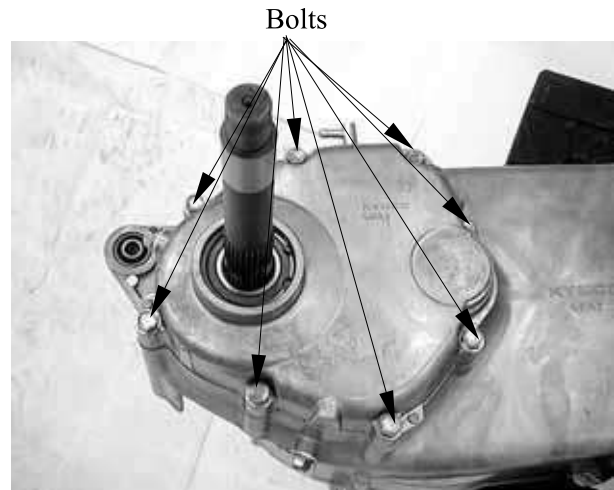

A.C. G/STARTER CLUTCH

SCHEMATIC DRAWING -----	13-1
SERVICE INFORMATION-----	13-2
TROUBLESHOOTING-----	13-2
ALTERANTOR STATOR-----	13-3
FLYWHEEL/STARTER CLUTCH-----	13-5

13. A.C. G/STARTER CLUTCH

XCITING 500/500 AFI/250/300 AFI

SCHEMATIC DRAWING

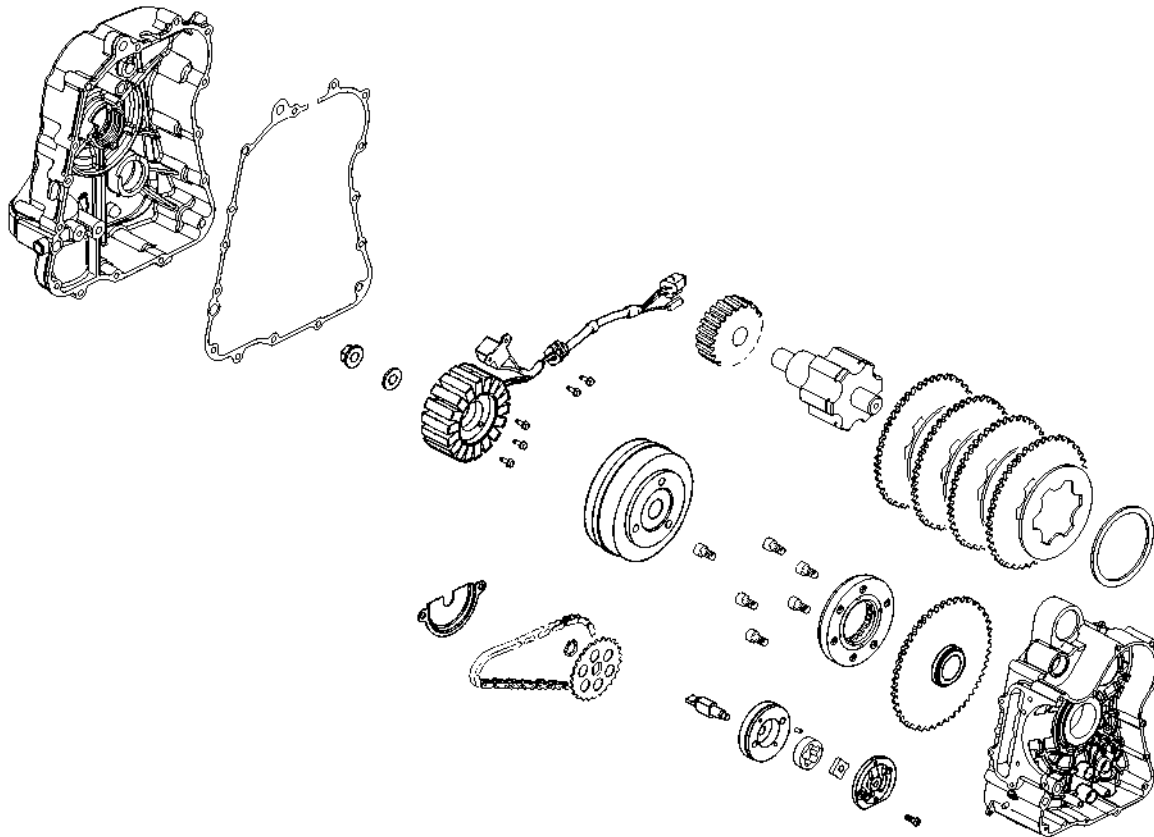

SERVICE INFORMATION

GENERAL INSTRUCTIONS

- All servicing operations and inspections in this section can be made with the engine installed.
- Drain the coolant before removing the right crankcase cover.
- Be careful not to drain the coolant when the engine temperature is high. (Perform this operation when the engine is cold.)
- Drain the coolant into a clean container.
- Drain the engine oil into a clean container before removing the right crankcase cover.
- When the right crankcase cover is installed, fill with the recommended engine oil and coolant. Then, bleed air from the water jacket.
- Refer to section 18 for alternator inspection, and to section 19 for ignition pulse generator inspection.

SPECIFICATIONS (XCITING 500/500 AFI)

Unit: mm (in)

Item	Standard	Service Limit
Starter driven gear I.D.	27.026 (1.081)~27.045 (1.0818)	27.1 (1.084)
Starter driven gear O.D.	45.66 (1.8264)~45.673 (1.8292)	45.6 (1.824)

SPECIFICATIONS (XCITING 250/250 AFI)

Unit: mm (in)

Item	Standard	Service Limit
Starter driven gear I.D.	22.026 (0.88104)~22.045 (0.8818)	22.1 (0.884)
Starter driven gear O.D.	42.195 (1.6878)~42.208 (1.68832)	41.5 (1.66)

SPECIAL TOOLS (XCITING 500/500 AFI)

Flywheel puller A120E00054
 Flywheel holder A120E00021

SPECIAL TOOLS (XCITING 250/250 AFI)

Flywheel puller A120E00003
 Flywheel holder A120E00021

TORQUE VALUES

Flywheel nut: 55 N•m (5.5 kgf•m, 40 lbf•ft)

TROUBLESHOOTING

Starter motor turns, but engine does not turn

- Faulty starter clutch
- Damaged starter reduction gear

ALTERNATOR STATOR

REMOVAL (XCITING 500/500 AFI)

Remove the right center body cover (page 2-5).

Remove the exhaust muffler (page 2-16).

Remove water pump (page 7-15).

Remove the fifteen bolts and right crankcase cover, dowel pins and gasket.

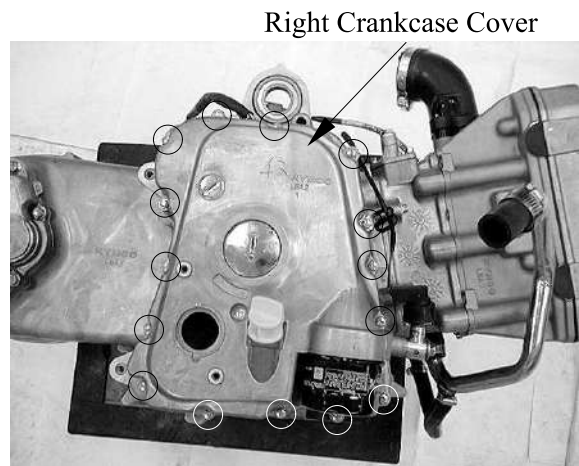

Remove the two pulse coil mount bolts. Remove the three stator mount bolts, grommet and the stator from the right crankcase cover.

INSTALLATION

Install the stator and tighten the stator mount bolts to the specified torque.

Torque: 12 N•m (1.2 kgf•m, 9 lbf•ft)

Apply sealant to the grommet seating surface and install it to the cover groove properly.

Install the pulse coil and tighten mount bolts to the specified torque.

Torque: 12 N•m (1.2 kgf•m, 9 lbf•ft)

Clean the mating surfaces of the right crankcase and cover.

Install the dowel pins and gasket.

Install the right crankcase cover and tighten the bolts in a crisscross pattern in 2 or 3 steps.

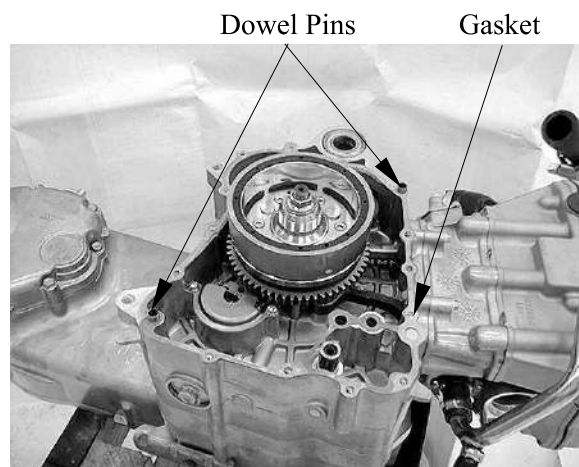
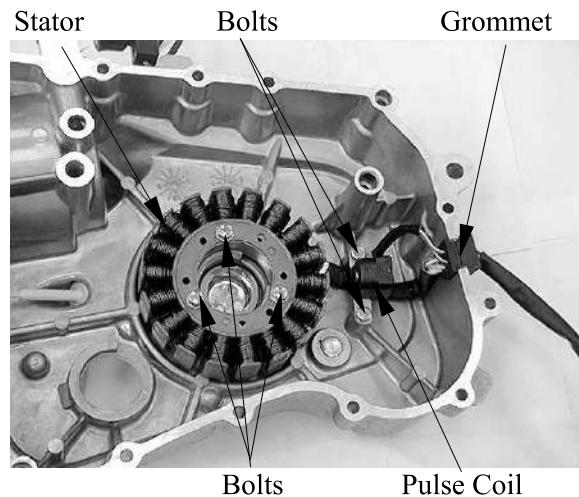

13. A.C. G/STARTER CLUTCH

ALTERNATOR STATOR

REMOVAL (XCITING 250/300 AFI)

Remove the right center body cover (page 2-5).

Remove the exhaust muffler (page 2-16).

Disconnect the water hoses from the right crankcase cover.

Remove the nine bolts attaching the right crankcase cover and the cover.

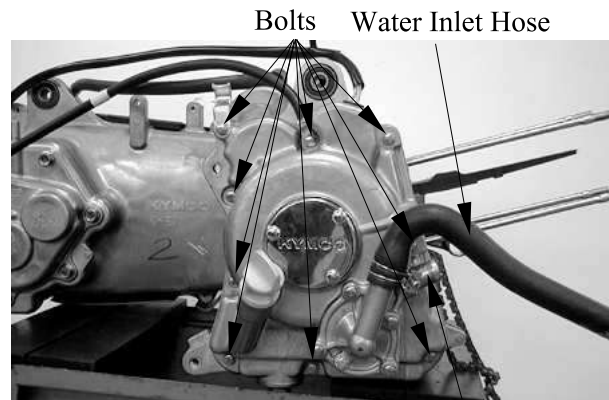

Water Outlet Hose

Remove the two pulse coil mount screws.
Remove the three stator mount bolts, grommet and the stator from the right crankcase cover.

A.C. Generator Stator Screws

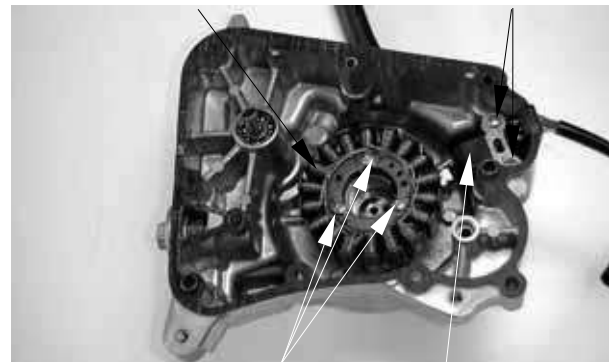

Bolts Pulser Coil

INSTALLATION

Install the stator and tighten the stator mount bolts to the specified torque.

Torque: 12 N•m (1.2 kgf•m, 9 lbf•ft)

Apply sealant to the grommet seating surface and install it to the cover groove properly.

Install the pulse coil and tighten mount bolts to the specified torque.

Torque: 12 N•m (1.2 kgf•m, 9 lbf•ft)

Clean the mating surfaces of the right crankcase and cover.

Install the dowel pins and gasket.

Install the right crankcase cover and tighten the bolts in a crisscross pattern in 2 or 3 steps.

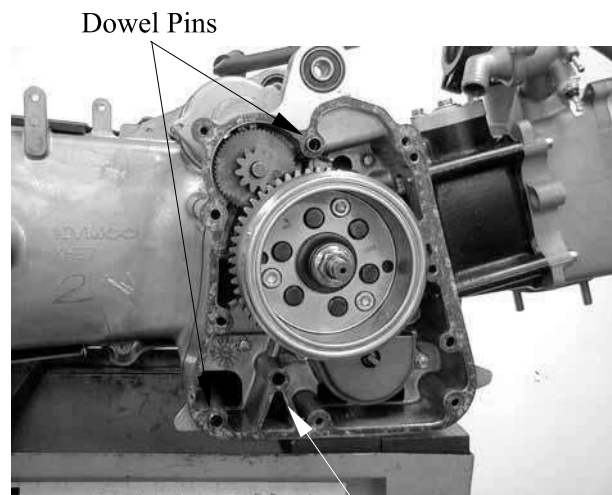

Gasket

FLYWHEEL/STARTER CLUTCH REMOVAL

Remove the right crankcase cover (page 13-3).

Hold the flywheel with the special tool and loosen the flywheel nut.

Special tool:

Flywheel holder A120E00021

Remove the flywheel nut and washer.

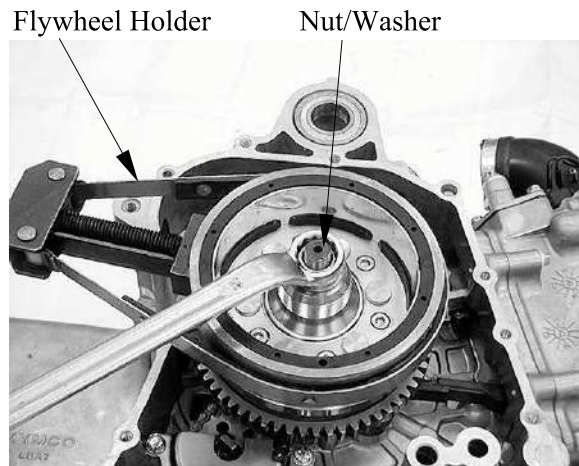

Remove the flywheel/starter driven gear assembly using the special tool.

Special tool:

XCITING 500/500 AFI:

Flywheel puller A120E00054

XCITING 250/250 AFI:

Flywheel puller A120E00003

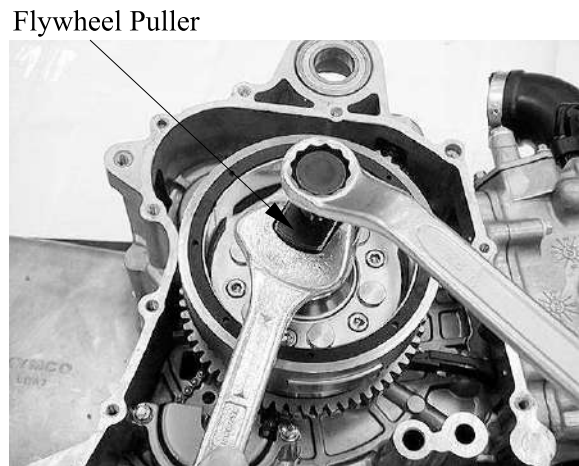

Remove the woodruff key.

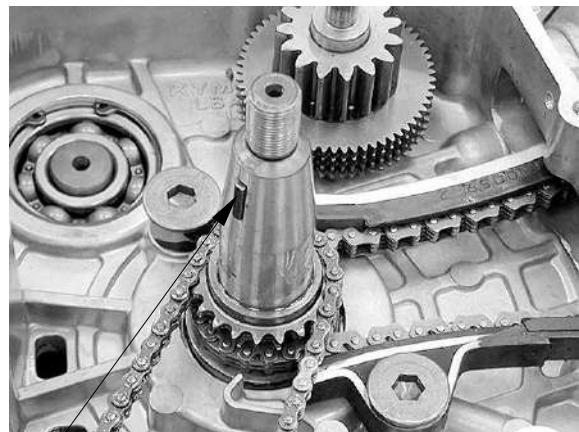

13. A.C. G/STARTER CLUTCH

XCITING 500/500 AFI/250/300AFI

Remove the reduction gear
(XCITING 500/500 AFI).

Reduction Gear

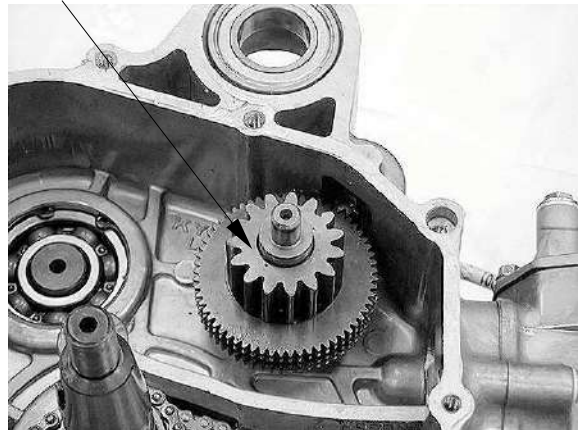

Remove the reduction gear and shaft
(XCITING 250/250 AFI).

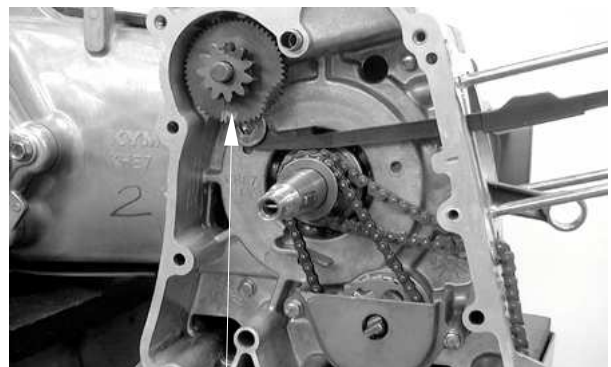

Starter Idle Gear

Check the starter reduction gear teeth and
shaft for wear or damage
(XCITING 500/500 AFI).

Reduction Gear

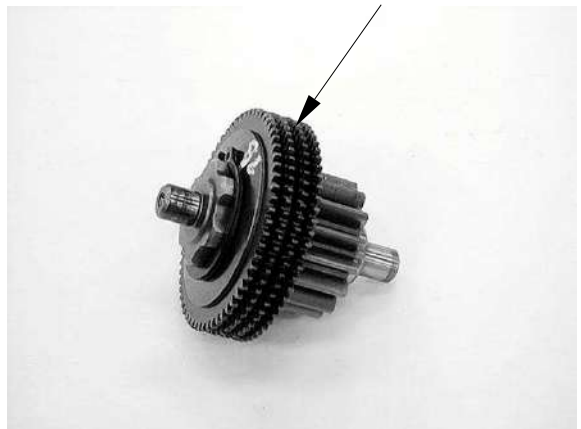

13. A.C. G/STARTER CLUTCH

XCITING 500/500 AFI/250/300 AFI

Inspect the reduction gear and shaft for wear or damage (XCITING 250/250 AFI).

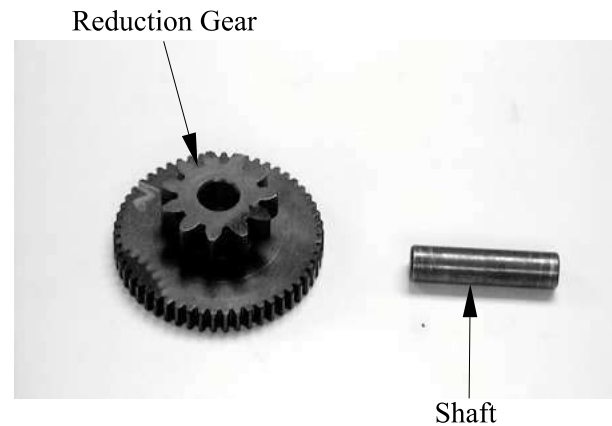

INSPECTION

Check the operation of the sprag clutch by turning the driven gear. You should be able to turn the driven gear clockwise smoothly, but the gear should not turn counterclockwise.

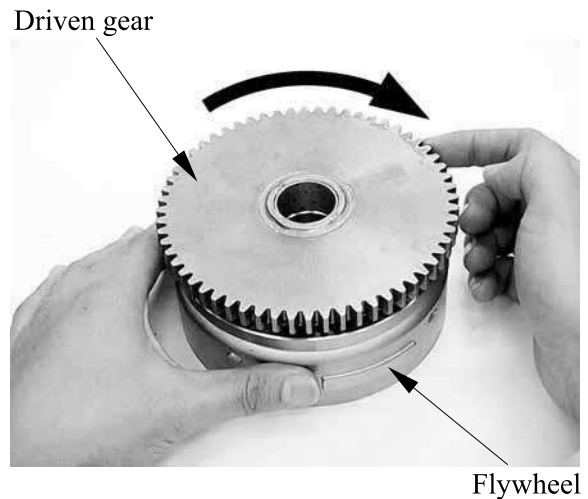

Remove the starter driven gear by turning the driven gear.

Check the starter driven gear teeth for wear or damage.

Measure the starter driven gear boss O.D..

Service limit:

XCITING 500/500 AFI: 45.6 mm (1.824 in)

XCITING 250/250 AFI:

41.5.6 mm (1.66 in)

Measure the starter driven gear bushing I.D..

Service limit:

XCITING 500/500 AFI: 27.1 mm (1.084 in)

XCITING 250/250 AFI: 22.1 mm (0.884 in)

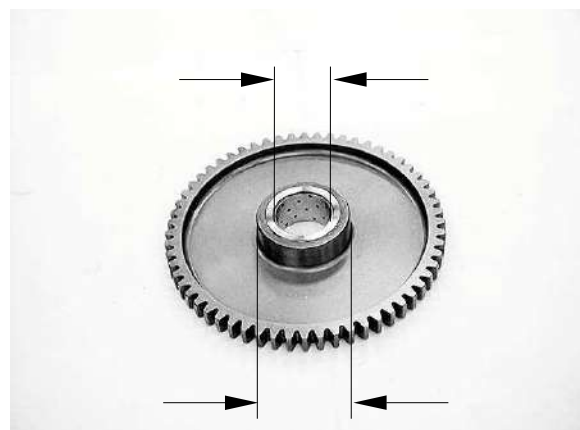

13. A.C. G/STARTER CLUTCH

Apply oil to the starter reduction gear.
Install the starter reduction gear to the right crankcase.

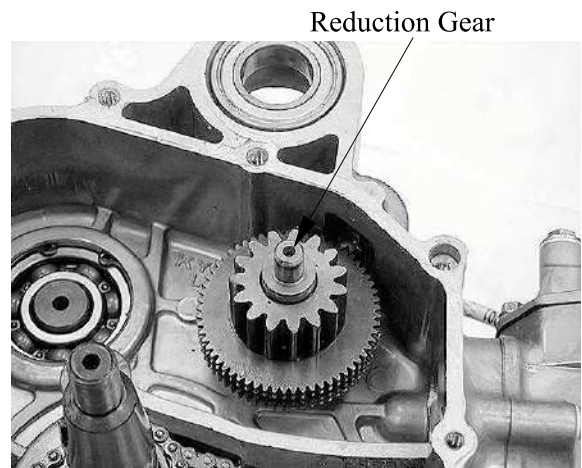

Apply oil to the starter reduction gear and shaft (XCITING 250/250 AFI).
Install the starter reduction gear and shaft (XCITING 250/250 AFI) to the right crankcase.

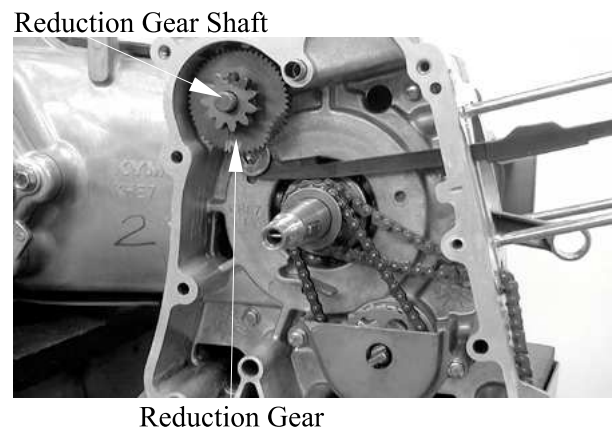

Apply molybdenum oil solution to the starter driven gear bushing.
Install the starter driven gear by turning the driven gear clockwise.

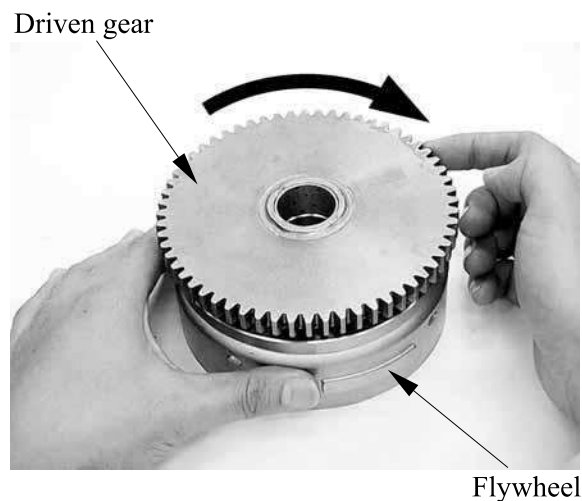

13. A.C. G/STARTER CLUTCH

XCITING 500/500 AFI/250/300 AFI

Clean any oil from tapered portion of the crankshaft.

Install the woodruff key in the crankshaft key groove.

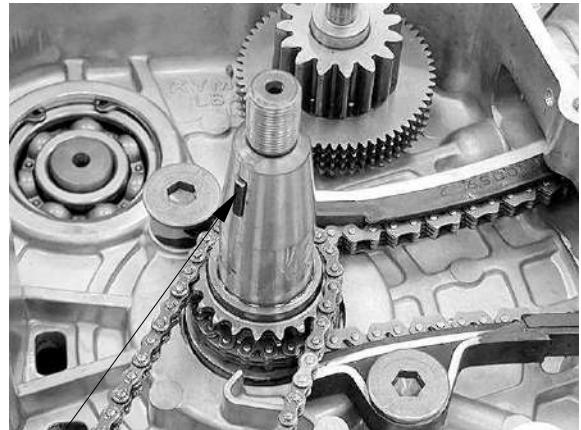

Woodruff Key

Clean any oil from the tapered portion of the flywheel I.D..

Install the flywheel/driven gear onto the crankshaft, aligning the key way with woodruff key.

Apply oil to the washer and flywheel nut threads and seating surface.

Install the washer and flywheel nut to the crankshaft.

Hold the flywheel with the special tool and tighten the flywheel nut to the specified torque.

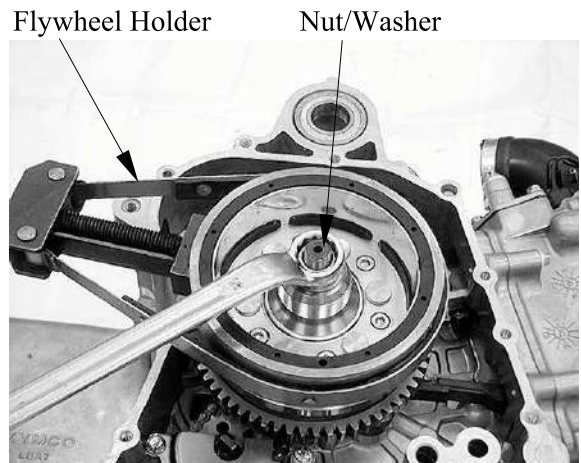

Special tool:

Flywheel holder A120E00021

Torque: 55 N•m (5.5 kgf•m, 40 lbf•ft)

14. CRANKCASE/CRANKSHAFT

XCITING 500/500 AFI/250/300 AFI

14

CRANKCASE/CRANKSHAFT

SCHEMATIC DRAWING (XCITING 500/500 AFI) -----	14- 1
SCHEMATIC DRAWING (XCITING 250/300 AFI) -----	14- 2
SERVICE INFORMATION-----	14- 3
TROUBLESHOOTING-----	14- 4
CAM CHAIN/CAM CHAIN GUIDE -----	14- 5
CRANKCASE-----	14- 6
CRANKCASE ASSEMBLY (XCITING 500/500 AFI)-----	14-16
CRANKCASE ASSEMBLY (XCITING 250/300 AFI)-----	14-18

14. CRANKCASE/CRANKSHAFT

XCITING 500/500 AFI/250/300 AFI

SCHEMATIC DRAWING (XCITING 500/500 AFI)

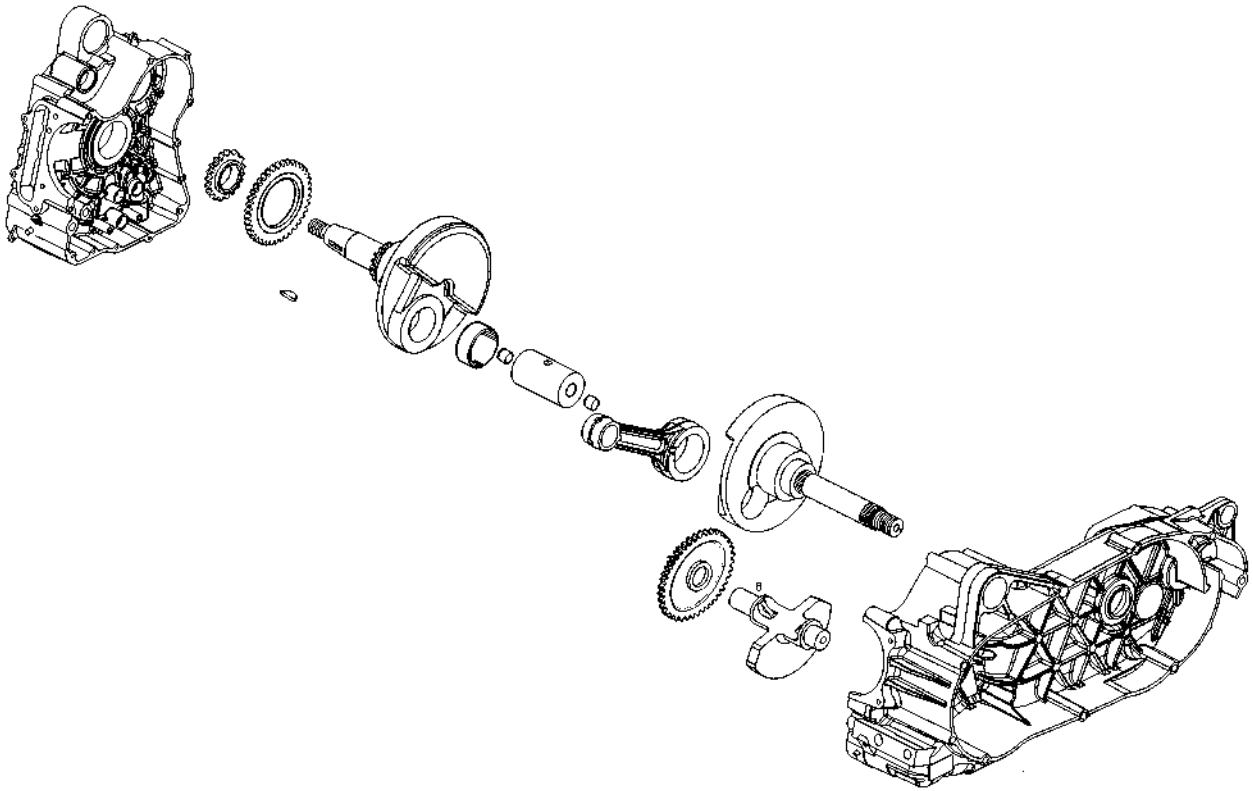

14. CRANKCASE/CRANKSHAFT

XCITING 500/500 AFI/250/300 AFI

SCHEMATIC DRAWING (XCITING 250/250 AFI)

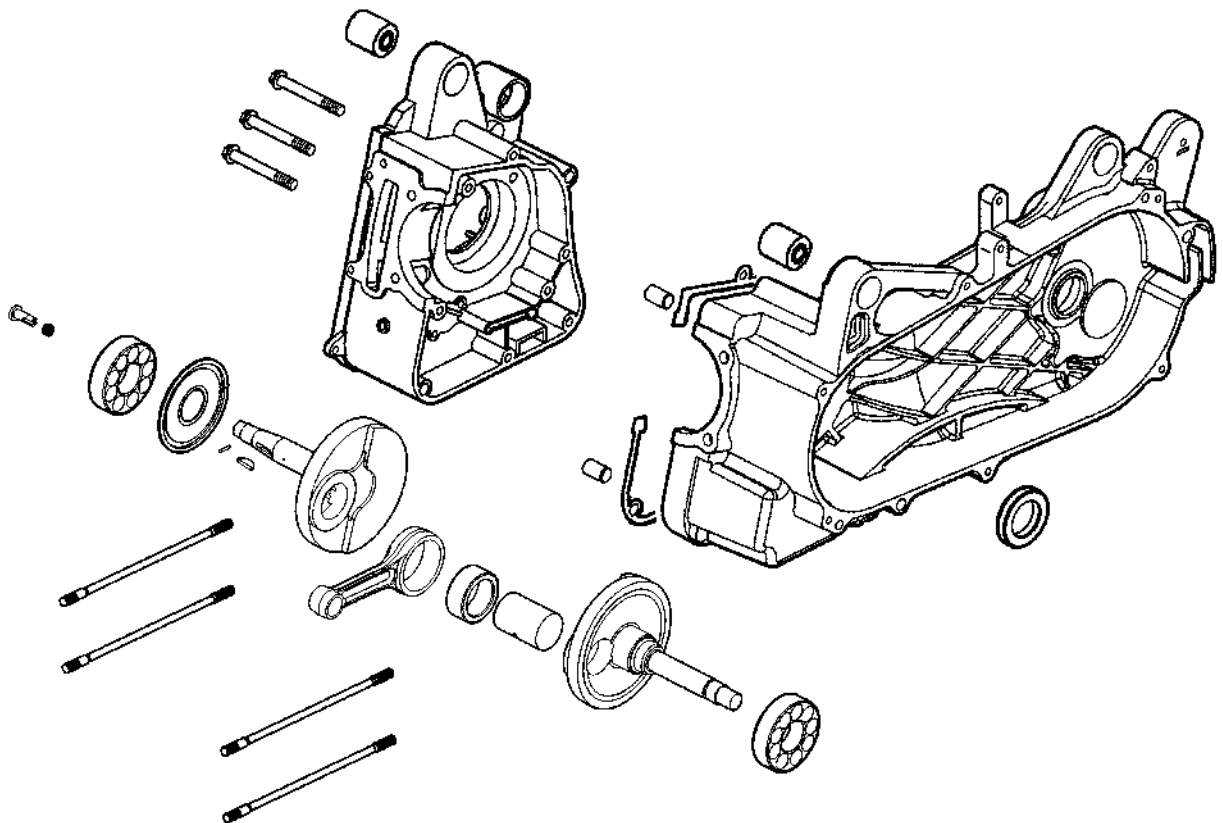

14. CRANKCASE/CRANKSHAFT

XCITING 500/500 AFI/250/300 AFI

SERVICE INFORMATION

GENERAL INSTRUCTIONS

- This section covers crankcase separation to service the crankshaft and balancer. The engine must be removed for this operation.
- When separating the crankcase, never use a driver to pry the crankcase mating surfaces apart forcedly to prevent damaging the mating surfaces.
- When installing the crankcase, do not use an iron hammer to tap it.
- The following parts must be removed before separating the crankcase.
 - Cylinder head (section 9)
 - Cylinder/piston (section 10)
 - Drive and driven pulley (section 11)
 - A.C. generator/starter clutch (section 13)
 - Starter motor (section 20)
 - Oil pump (section 4)

SPECIFICATIONS (XCITING 500/500 AFI)

Unit: mm (in)

	Item	Standard	Service Limit
Crankshaft	Main bearing oil clearance	0.025 (0.001)~0.041 (0.0016)	0.7 (0.003)
	Connecting rod big end side clearance	0.05 (0.002)~0.5 (0.02)	0.8 (0.031)
	Runout	—	0.06 (0.002)

SPECIFICATIONS (XCITING 250/250 AFI)

Unit: mm (in)

	Item	Standard	Service
Crankshaft	Connecting rod big end side clearance	0.15~0.35 (0.006~0.014)	0.6 (0.024)
	Connecting rod big end radial clearance	0.004~0.008 (0.00016~0.0032)	0.05 (0.002)
	Runout	—	0.1 (0.004)

14. CRANKCASE/CRANKSHAFT

XCITING 500/500 AFI/250/300 AFI

TORQUE VALUES (XCITING 500/500 AFI)

Crankcase bolt	12 N•m (1.2 kgf•m, 9 lbf•ft)
Cam chain guide bolt	20 N•m (2 kgf•m, 15 lbf•ft)
Oil pipe bolt	43 N•m (4.3 kgf•m, 31 lbf•ft)

TORQUE VALUES (XCITING 250/250 AFI)

Crankcase bolt	12 N•m (1.2 kgf•m, 9 lbf•ft)
Cam chain guide bolt	10 N•m (1 kgf•m, 10 lbf•ft)

SPECIAL TOOLS

Bearing puller	A120E00037
Oil seal & bearing driver	A120E00014

TROUBLESHOOTING

Excessive engine noise

- Worn connecting to small end
- Worn or damaged crankshaft bearings

14. CRANKCASE/CRANKSHAFT

XCITING 500/500 AFI/250/300 AFI

CAM CHAIN/CAM CHAIN GUIDE REMOVAL (XCITING 500/500 AFI)

Remove the starter driven gear (page 13-5).
Remove the cylinder (page 10-4).

Remove the cam chain from the right crankcase.

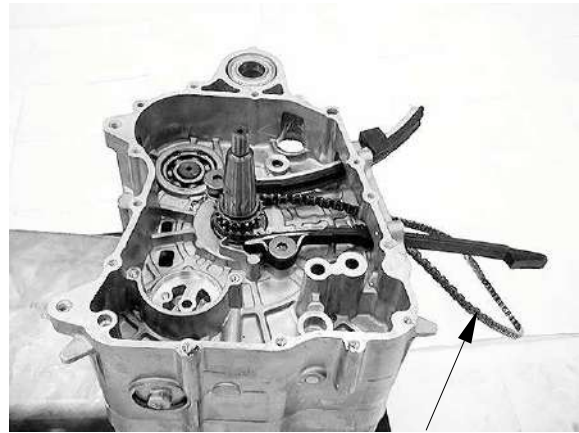

Cam Chain

Remove the bolts and cam chain guides.

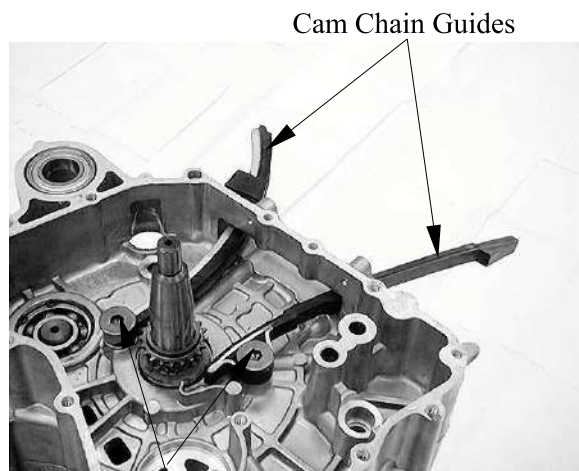

Bolts

REMOVAL (XCITING 250/250 AFI)
Remove the cam chain guide bolt.
Remove the cam chain guide and cam chain.

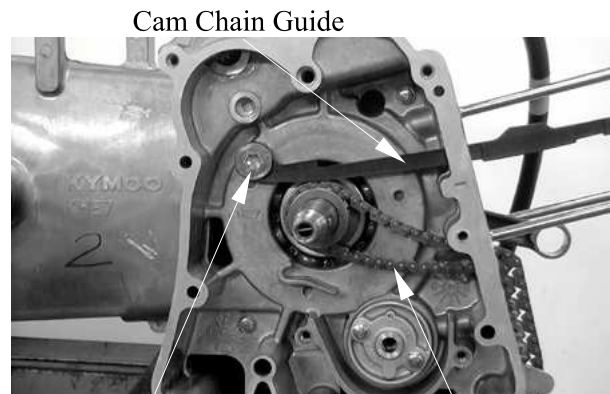

Bolt

Cam Chain

14. CRANKCASE/CRANKSHAFT

XCITING 500/500 AFI/250/300 AFI

INSPECTION

Cam chain guide

Inspect the cam chain slipper surface of the cam chain guide for wear or damage.



Slipper Surface

Cam chain

Inspect the cam chain for cracks or stiff.

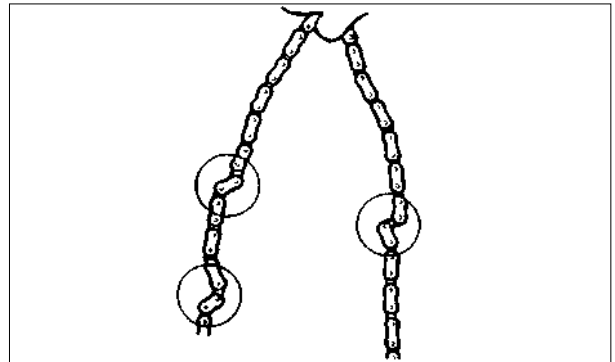

CRANKCASE

SEPARATION (XCITING 500/500 AFI)

Remove the parts required for crankcase separation (page 14-3).

Remove the twelve bolts from left crankcase.

* Loosen the bolts in a crisscross pattern in several steps.

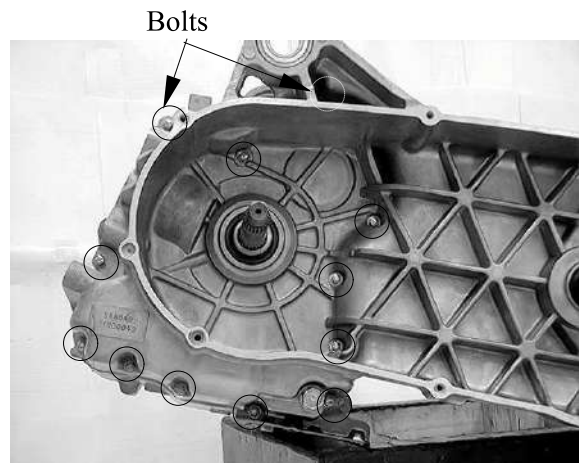

14. CRANKCASE/CRANKSHAFT

XCITING 500/500 AFI/250/300 AFI

Remove the bolt from right crankcase.

Place the crankcase assembly with the left side down and separate the right crankcase from the left crankcase.

* Separate the right crankcase from the left crankcase while tapping them at several locations with a soft hammer.

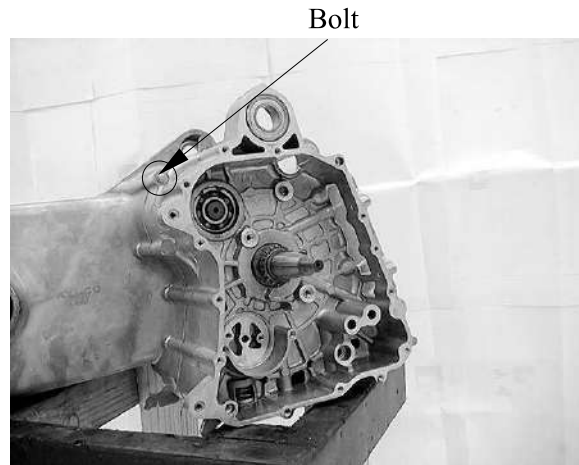

Remove the dowel pins and O-ring.
Remove the oil collar and O-rings from the left crankcase.
Clean of the sealant from the left and right crankcase mating surfaces.

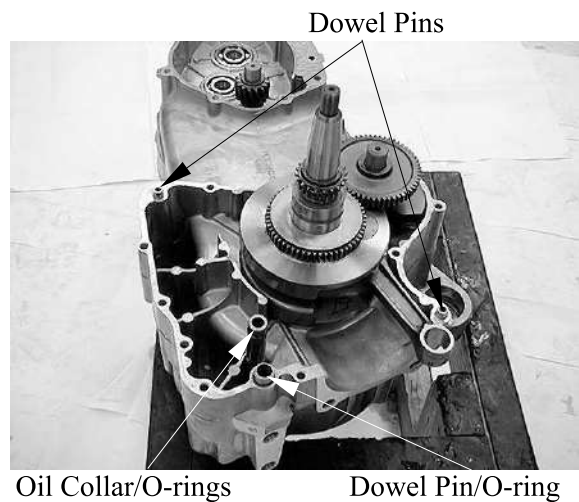

Remove the washer from the crankshaft.
Remove the balancer shaft from the left crankcase.

* Always replace the crankshaft and balancer shaft in pairs



14. CRANKCASE/CRANKSHAFT

XCITING 500/500 AFI/250/300 AFI

Remove the crankshaft from the left crankcase.

- * Always replace the crankshaft and balancer shaft in pairs

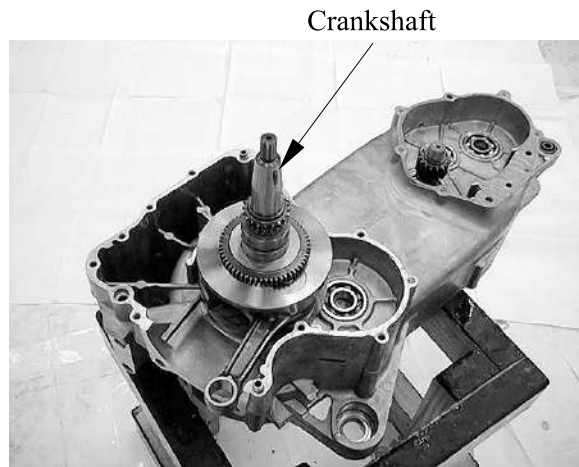

SEPARATION (XCITING 250/250 AFI)

Place the crankcase with the left crankcase down and remove the right crankcase from the left crankcase.

- * Never use a driver to pry the crankcase mating surfaces apart.

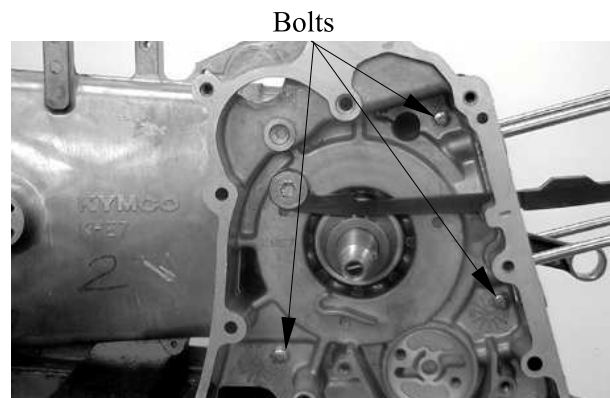

Remove the gasket and dowel pins.

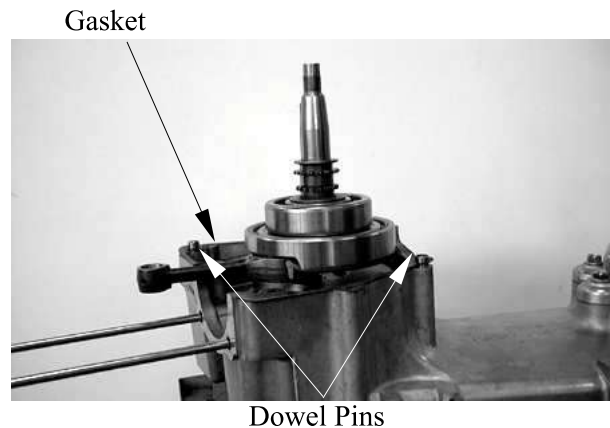

14. CRANKCASE/CRANKSHAFT

XCITING 500/500 AFI/250/300 AFI

Remove the crankshaft from the left crankcase.

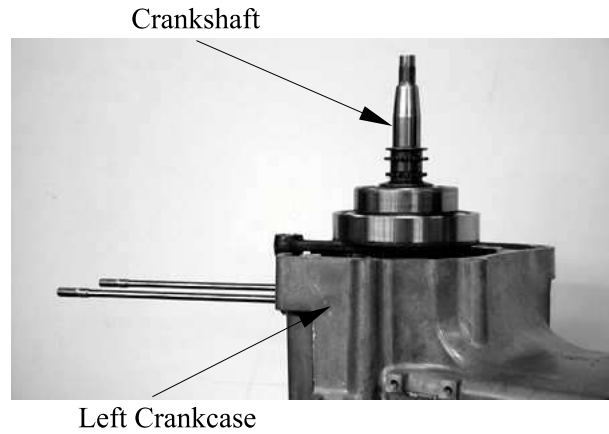

RIGHT CRANKCASE DISASSEMBLY (XCITING 500/500 AFI)

Remove the two bolts, outer washer, oil pipe and inner washers.

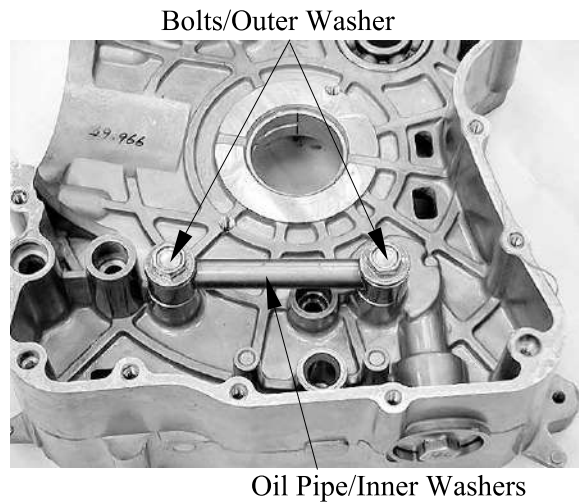

RIGHT CRANKCASE ASSEMBLY

Install the inner washers onto the right crankcase.

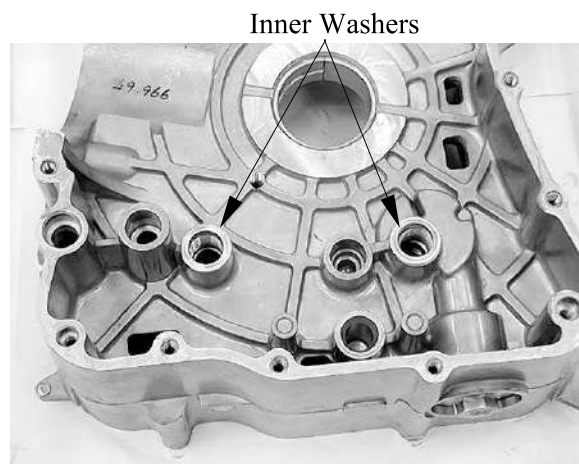

14. CRANKCASE/CRANKSHAFT

XCITING 500/500 AFI/250/300 AFI

Install the oil pipe with the thick side face upward.

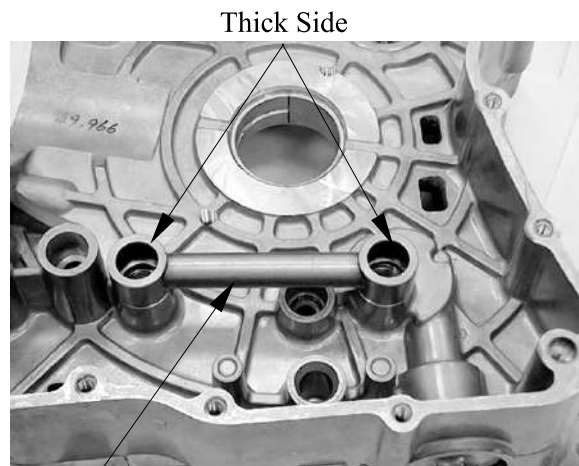

Oil Pipe

Install the outer washers and two bolts.
Tighten the two bolts to the specified torque.

Torque: 43 N•m (4.3 kgf•m, 31 lbf•ft)

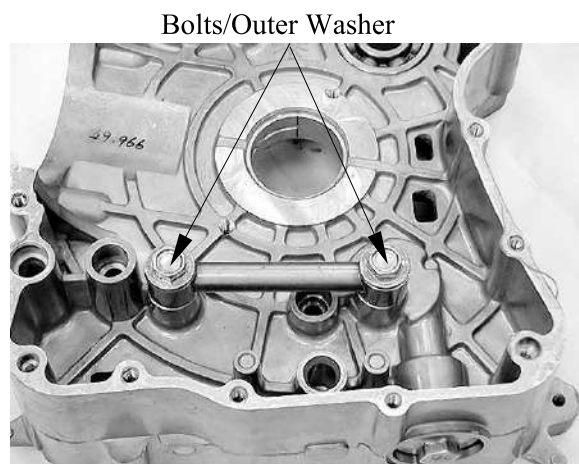

Bolts/Outer Washer

14. CRANKCASE/CRANKSHAFT

XCITING 500/500 AFI/250/300 AFI

CRANKSHAFT/CRANKCASE SELECTION (XCITING 500/500 AFI)

Crankcase and crankshaft are select fitted.

Record the main journal O.D. code (– or +)

Record the main journal bearing I.D. color code (green, brown or yellow).

Record the right or left crankcase main journal I.D. code (A or B).

If the crankcase and/or crankshaft are replaced, select them with the following fitting table.

The “Y” mark in the table indicates that mating is possible in the crossed code.

Main journal O.D. code \ Main journal bearing I.D. color code / Crankcase main journal I.D. code	+	–
	Green/A	Y
Green/B		Y
Brown/A		Y
Yellow/B	Y	

* Always replace the crankcase in pairs.

Main Journal Bearing I.D. Color Code

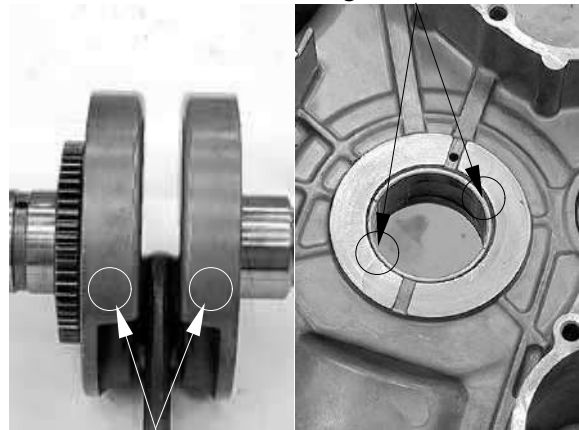

Main Journal O.D. Code

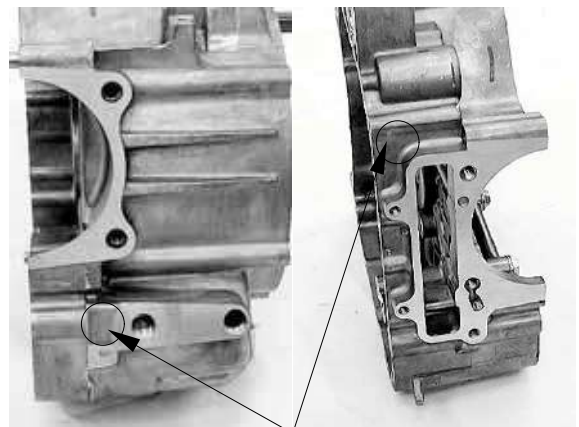

Crankcase Main Journal I.D. Code

14. CRANKCASE/CRANKSHAFT

XCITING 500/500 AFI/250/300 AFI

MAIN BEARING INSPECTION (XCITING 500/500 AFI)

Inspect the bearing inserts for unusual wear, damage or peeling and replace the crankcase if necessary.

Main bearing oil clearance

Clean off any oil from the main bearing inserts and crankshaft journals.

Measure and record the crankshaft main journal O.D..

Measure and record the main bearing I.D..

Calculate the oil clearance by subtracting the journal O.D. from bearing I.D..

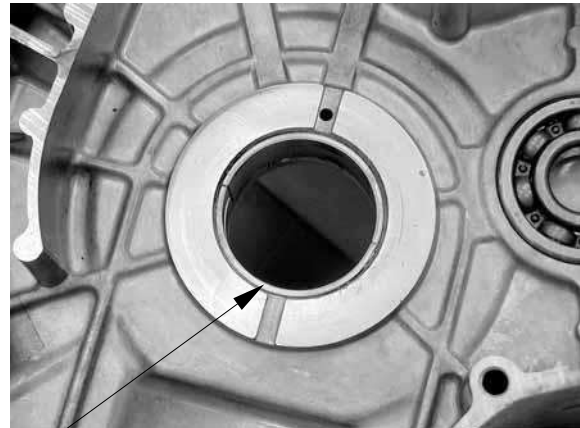

Bearing

Standard:

0.025 – 0.041 mm (0.001 – 0.0016 in)

Service limit: 0.07 mm (0.003 in)

Replace the crankcase if the service limit is exceeded.

Select the replacement crankcase (page 14-11).

CRANKSHAFT INSPECTION (XCITING 500/500 AFI)

Measure the connecting rod big end side clearance.

Service limit: 0.8 mm (0.031 in)

Measure the crankshaft runout.

Service limit: 0.06 mm (0.002 in)

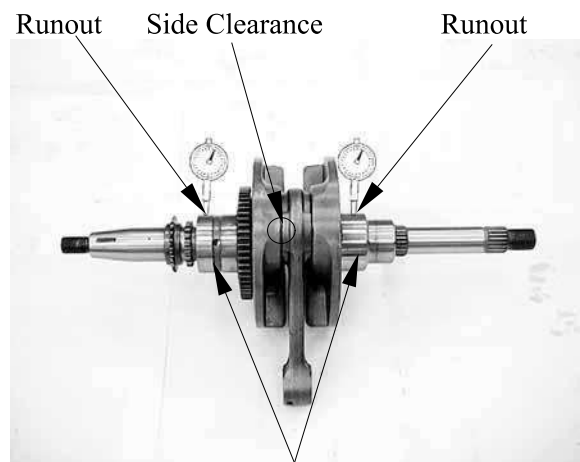

Journals

CRANKSHAFT INSPECTION (XCITING 250/250 AFI)

Measure the crankshaft runout.

Service Limit: 0.1 mm (0.004 in)



14. CRANKCASE/CRANKSHAFT

XCITING 500/500 AFI/250/300 AFI

Measure the connecting rod big end side clearance.

Service Limit: 0.6 mm (0.024 in)

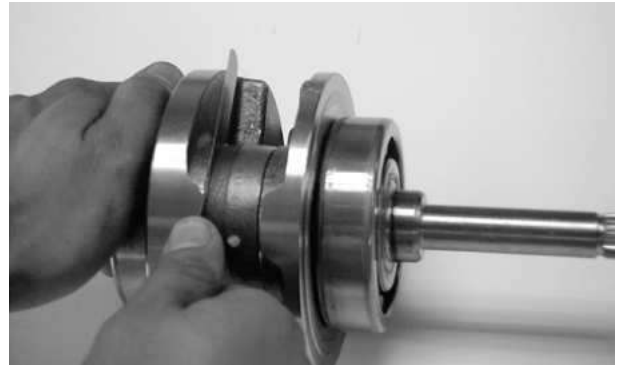

Measure the connecting rod small end I.D.

Service Limit: 17.06 mm (0.6824 in)



BALANCER SHAFT INSPECTION (XCITING 500/500 AFI)

Inspect the balance shaft gear teeth.
Burrs/chips/roughness/wear → Replace.



Balancer Shaft

14. CRANKCASE/CRANKSHAFT

XCITING 500/500 AFI/250/300 AFI

BALANCER SHAFT BEARING REPLACEMENT (XCITING 500/500 AFI)

Remove the crankshaft and balancer shaft (page 14-7).

Turn the inner race of each bearing with your finger.

The bearings should turn smoothly and quietly. Also check that the bearing outer race fits tightly in the crankcase.

Replace the bearings if the races does not turn smoothly and quietly, or if they fit loosely in the crankcase.

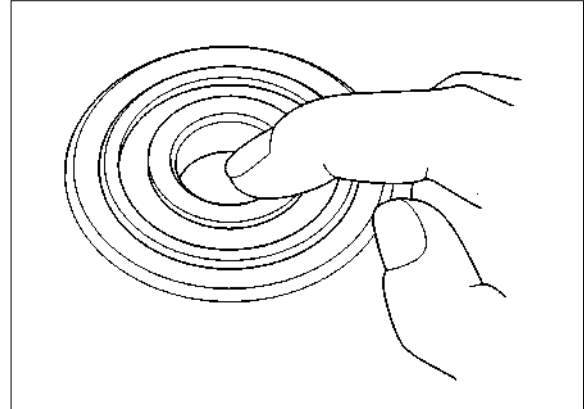

Remove the balancer shaft bearing from the left crankcase using the special tool.

Special tool: Bearing puller A120E00037

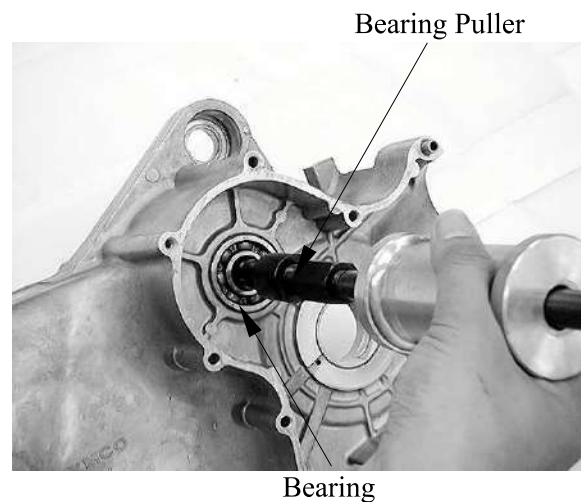

Remove the bearing snap ring from right crankcase.



14. CRANKCASE/CRANKSHAFT

XCITING 500/500 AFI/250/300 AFI

Remove the balancer shaft bearing from the right crankcase.

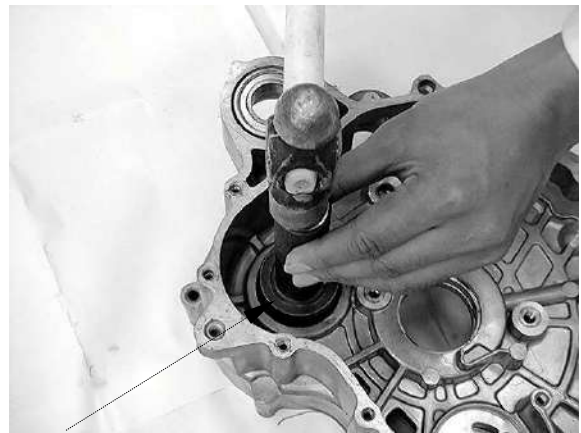

Bearing

Install the snap ring into the right crankcase.

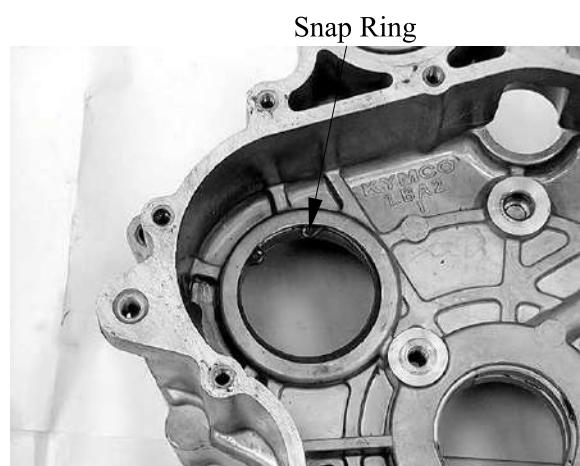

Snap Ring

Install the new bearings to the right and left crankcase using special tool.

Special tool:

Oil seal & bearing driver A120E00014



Bearing

14. CRANKCASE/CRANKSHAFT

XCITING 500/500 AFI/250/300 AFI

CRANKCASE ASSEMBLY (XCITING 500/500 AFI)

Install the crankshaft to the left crankcase.

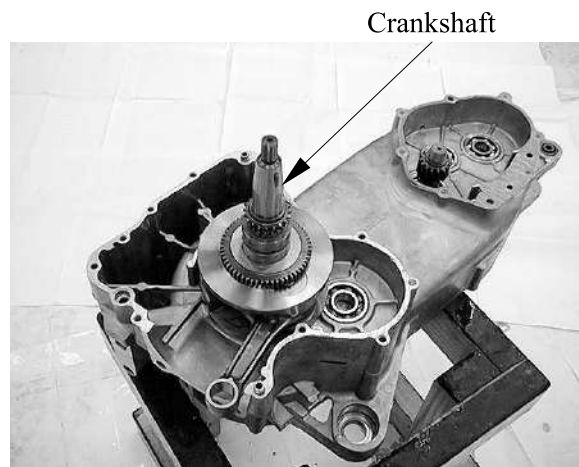

Install the balancer shaft to align the punch mark with the "O" mark on the crankshaft.



Install the washer onto the crankshaft.



14. CRANKCASE/CRANKSHAFT

XCITING 500/500 AFI/250/300 AFI

Install the oil collar and O-rings

Clean the right and left crankcase mating surface thoroughly, being careful not to damage them.

Install the dowel pins and O-ring.

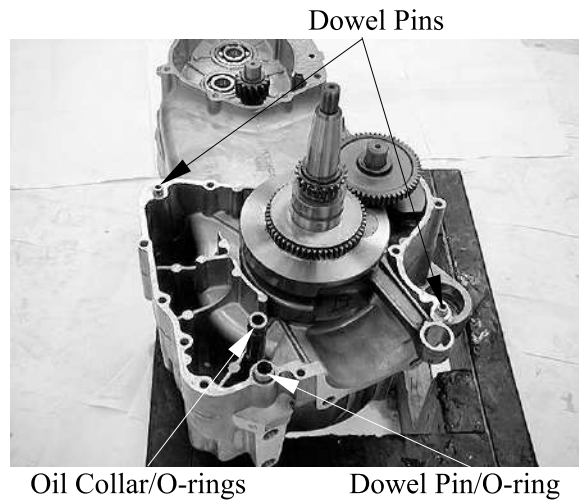

Apply a light but thorough coating of sealant (Threebond 1215 or equivalent) to all crankcase mating surfaces except the oil passage area.

Install the right crankcase over the left crankcase.

Install and turn in the right crankcase bolt but do not tighten it.

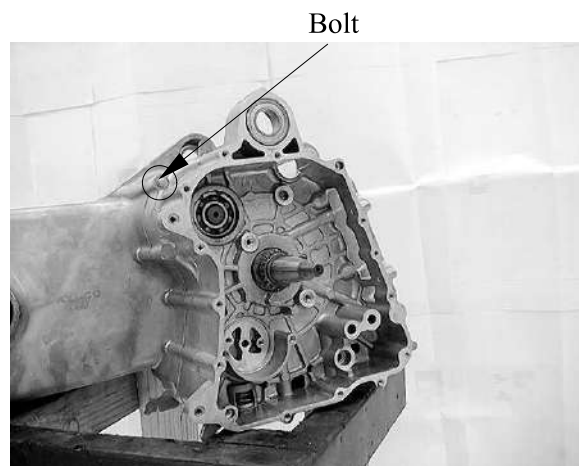

Install and tighten the left crankcase bolts in a crisscross pattern in 2 – 3 steps to the specified torque.

Torque: 12 N•m (1.2 kgf•m, 9 lbf•ft)

Tighten the right crankcase bolt to the specified torque.

Torque: 12 N•m (1.2 kgf•m, 9 lbf•ft)

Make sure that the crankshaft turns smoothly.

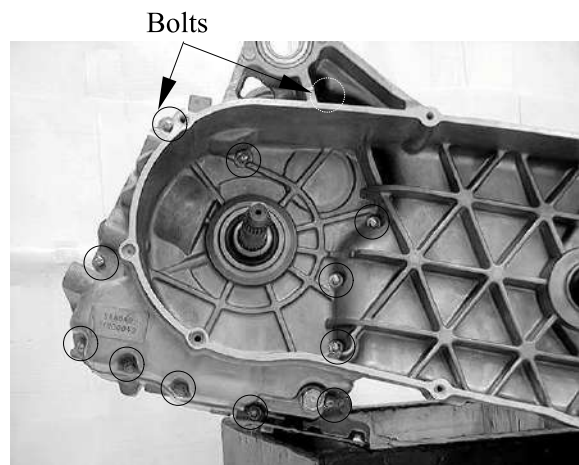

14. CRANKCASE/CRANKSHAFT

XCITING 500/500 AFI/250/300 AFI

Install the cam chain guides to the right crankcase and tighten the bolts to the specified torque.

Torque: 20 N•m (2 kgf•m, 15 lbf•ft)

Install the cam chain to right crankcase.

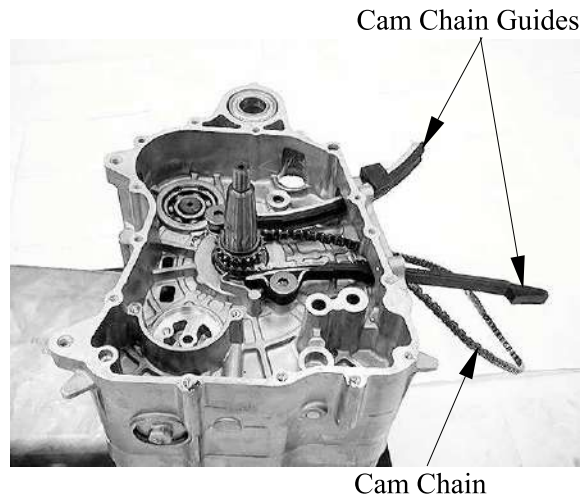

CRANKCASE ASSEMBLY (XCITING 250/250 AFI)

Clean off all gasket material from the crankcase mating surfaces.

- * Avoid damaging the crankcase mating surfaces.



Install a new oil seal into the left crankcase.

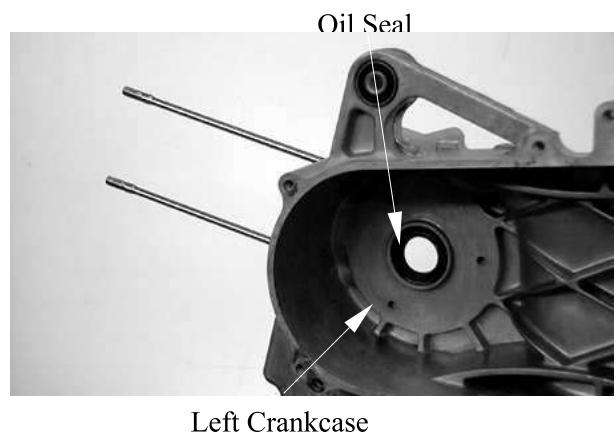

14. CRANKCASE/CRANKSHAFT

XCITING 500/500 AFI/250/300 AFI

Place the left crankcase down and install the crankshaft into the left crankcase.

- * • Avoid damaging the oil seal.
- Apply grease to the lip of the oil seal.



Install the two dowel pins and a new gasket.

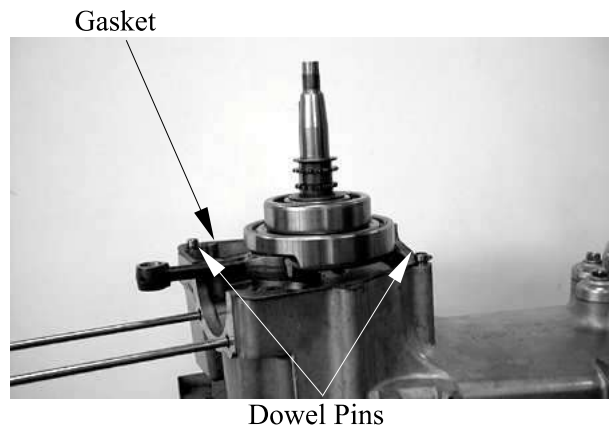

Place the right crankcase over the crankshaft and onto the left crankcase.

- * • Install the right crankcase squarely and do not tap it with an iron or plastic hammer.

Install and tighten the right and left crankcase attaching bolts.

Torque: 12 N•m (1.2 kgf•m, 9 lbf•ft)

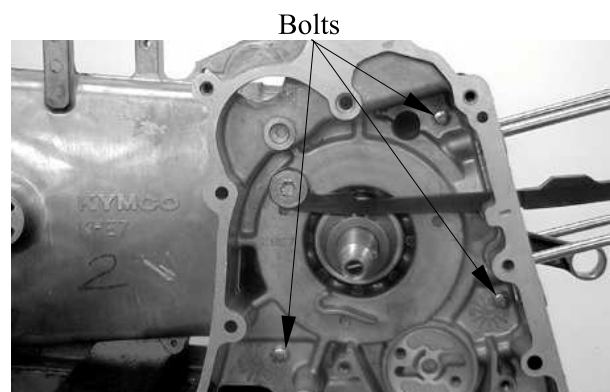

14. CRANKCASE/CRANKSHAFT

XCITING 500/500 AFI/250/300 AFI

Install the cam chain.
Install the cam chain tensioner slipper.
Install and tighten the cam chain tensioner slipper bolt.

Torque: 10 N•m (1 kgf•m, 10 lbf•ft)

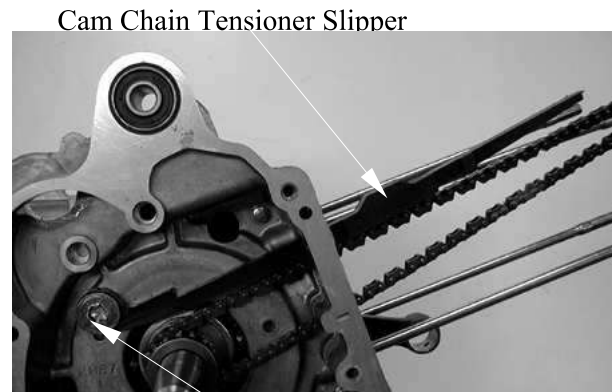

Bolt

**STEERING HANDLEBAR/FRONT WHEEL/
FRONT SHOCK ABSORBER**

SCHEMATIC DRAWING -----	15- 1
SERVICE INFORMATION-----	15- 2
TROUBLESHOOTING-----	15- 3
FRONT WHEEL -----	15- 4
FORK-----	15-12
STEERING HANDLEBAR -----	15-14
STEERING STEM-----	15-20

**15. STEERING HANDLEBAR/FRONT WHEEL/
FRONT SHOCK ABSORBER**



XCITING 500/500 AFI/250/300 AFI

SCHEMATIC DRAWING

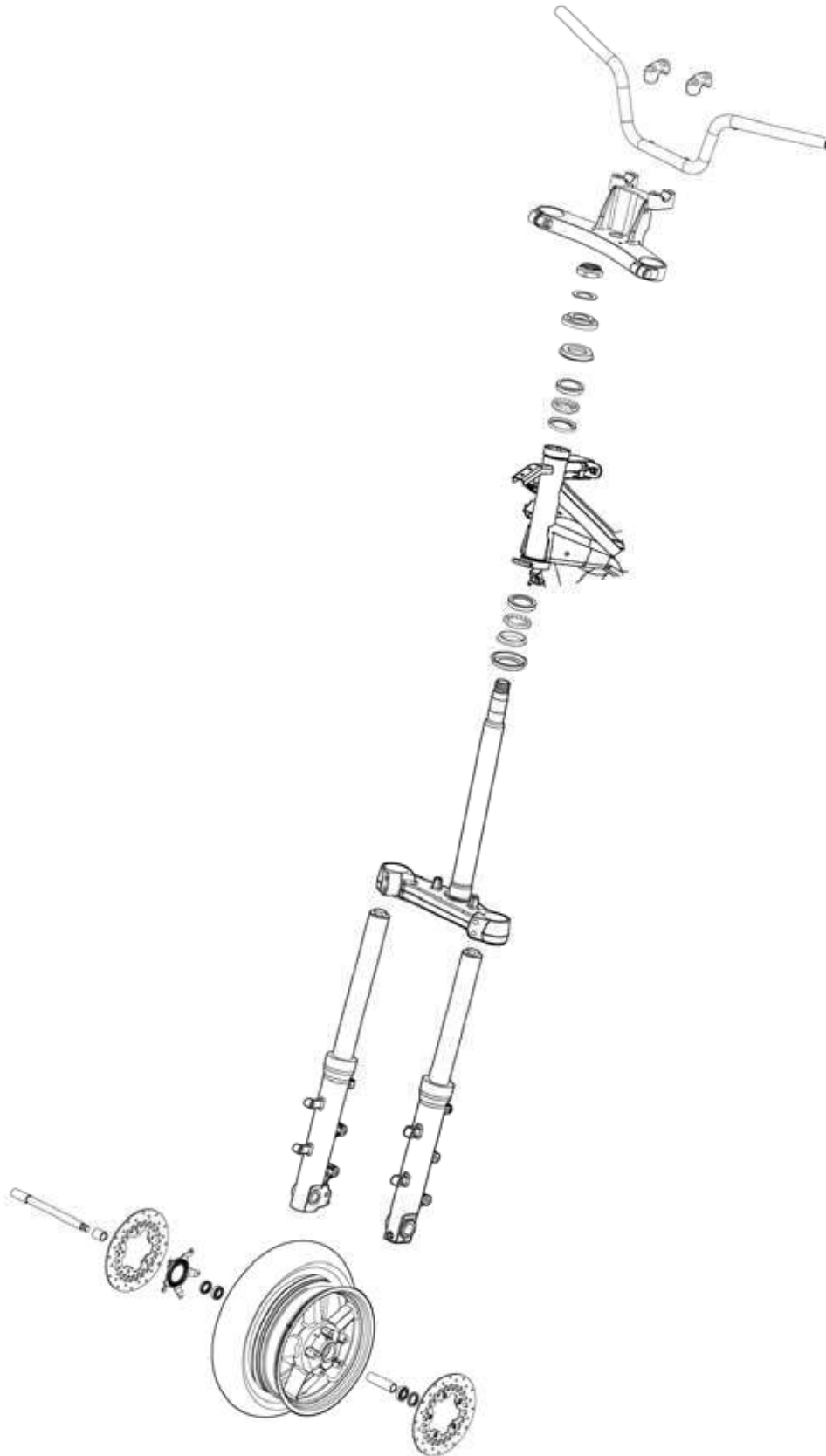

SERVICE INFORMATION

GENERAL INSTRUCTIONS

- A contaminated brake disc or pad reduces stopping power. Discard contaminated parts and clean a contaminated disc with a high quality brake degreasing agent.
- This section covers of the front wheel , fork, handlebar, and steering.
- A jack or other support is required to support the vehicle.
- Do not twist or bend the brake hose and pipe when servicing.
- Use genuine KYMCO replacement bolts and nuts for all suspension pivots and mounting points
- Refer to section 17 for brake system information.

SPECIFICATIONS

Unit: mm (in)

ITEM		STANDARD	SERVICE LIMIT
Minimum tire tread depth		—	1.6 (0.06)
Cold tire pressure	Driver only	200 kPa (2.00 kgf/cm ² , 29 psi)	—
	Driver and passenger	225 kPa (2.25kgf/cm ² , 32 psi)	—
Axle runout		—	0.2 (0.008)
Wheel rim runout	Radial	—	2 (0.08)
	Axial	—	2 (0.08)

TORQUE VALUES

Handlebar bolt	23 N•m (2.3 kgf•m, 17 lbf•ft)
Steering stem nut	62 N•m (6.2 kgf•m, 45 lbf•ft)
Steering stem lock nut	55 N•m (5.5 kgf•m, 40 lbf•ft)
Steering top thread	20 N•m (2 kgf•m, 15 lbf•ft)
Steering stem pinch bolt	23 N•m (2.3 kgf•m, 17 lbf•ft)
Front axle bolt	20 N•m (2 kgf•m, 15 lbf•ft)
Front brake disc bolt	42 N•m (4.3 kgf•m, 31 lbf•ft)
	Lock bolt: replace with a new one.
Front fork bolt	23 N•m (2.3 kgf•m, 17 lbf•ft)

SPECIAL TOOLS

Oil seal & bearing install driver	A120E00014
Lock nut socket wrench	A120E00015
Bearing remover	A120E00037
Long socket wrench	A120F00007
Steering stem top thread wrench	A120F00023

TROUBLESHOOTING

Hard steering

- Steering stem top thread too tight
- Worn or damaged steering bearings
- Worn or damaged steering bearing races
- Bent steering stem
- Insufficient tire pressure
- Faulty front tire

Steers to one side or does not track straight

- Damaged or loose steering bearings
- Bent fork
- Bent front axle: wheel installed incorrectly
- Bent frame
- Faulty front tire
- Worn or damaged front wheel bearings
- Worn or damaged engine mounting bushings

Front wheel wobbling

- Bent rim
- Worn or damaged front wheel bearings
- Faulty front tire
- Loose front axle fasteners

Wheel turns hard

- Faulty front wheel bearings
- Bent front axle
- Brake drag

Soft suspension

- Weak fork spring
- Insufficient fluid in fork
- Deteriorated fork fluid
- Incorrect fork fluid weight
- Low tire pressure

Hard suspension

- Bent fork tube
- Too much fluid in fork
- Incorrect fork fluid weight
- Clogged fork fluid passage
- High tire pressure

Front suspension noise

- Worn slider or fork tube bushing
- Insufficient fluid in fork
- Loose fork fastener

15. STEERING HANDLEBAR/FRONT WHEEL/ FRONT SHOCK ABSORBER



XCITING 500/500 AFI/250/300 AFI

FRONT WHEEL

REMOVAL

Loosen the front axle holder bolt.

Holder bolt



Loosen the front axle bolt.

Support the scooter securely using a hoist or equivalent and raise the front wheel off the ground.

Front Axle



Remove the right and left mount bolts and front brake calipers.

Pull off the front axle out and remove the front wheel.

NOTE:

Do not operate the front and rear brake lever after removing the front wheel.

Bolts

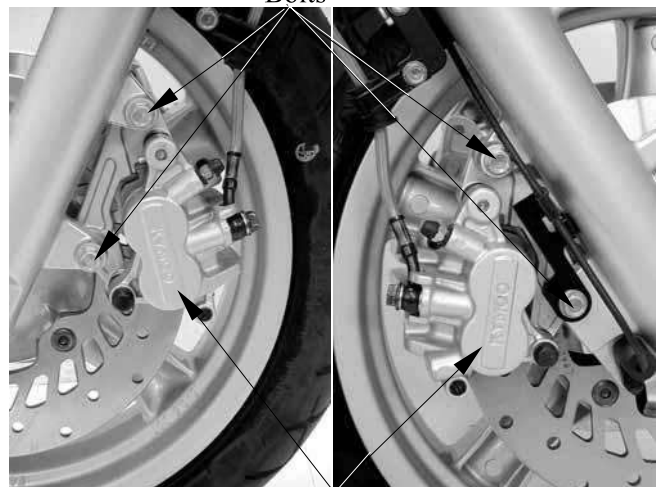

Calipers

15. STEERING HANDLEBAR/FRONT WHEEL/ FRONT SHOCK ABSORBER



XCITING 500/500 AFI/250/300 AFI

Remove the right and left side collar from the wheel hub.

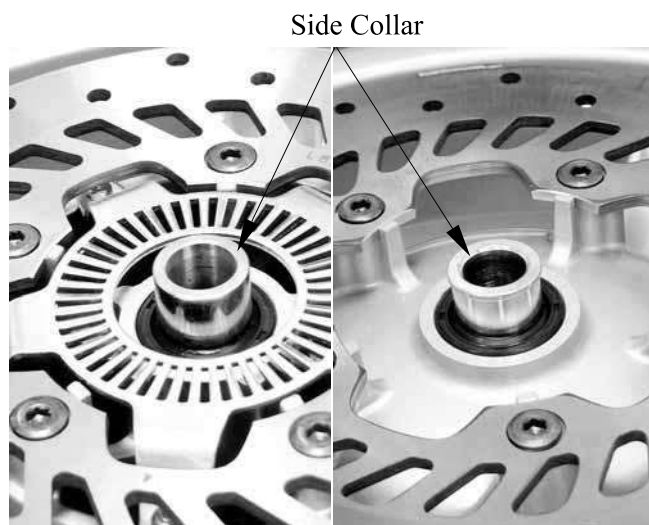

INSPECTION

Axle

Place the axle in V-blocks and measure the runout.

Actual runout is 1/2 the total indicator reading.

Service limit: 0.20 mm (0.008 in)

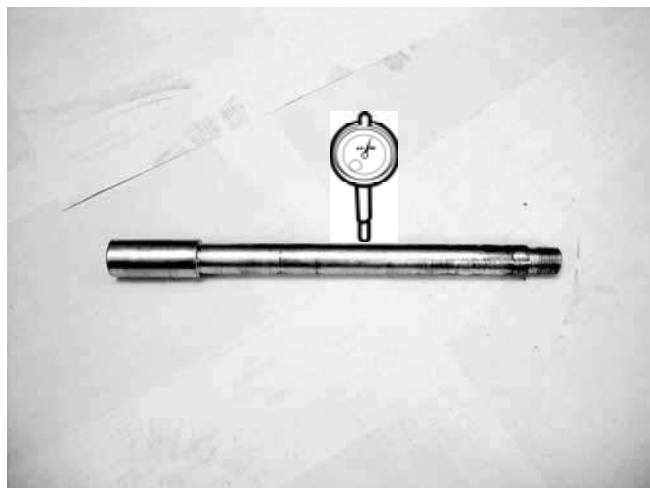

Wheel

Check the rim runout by placing the wheel in a truing stand.

Spin the wheel slowly and read the runout using a dial indicator.

Actual runout is 1/2 the total indicator reading.

Service limit: Radial: 2 mm (0.08 in)

Axial: 2 mm (0.08 in)

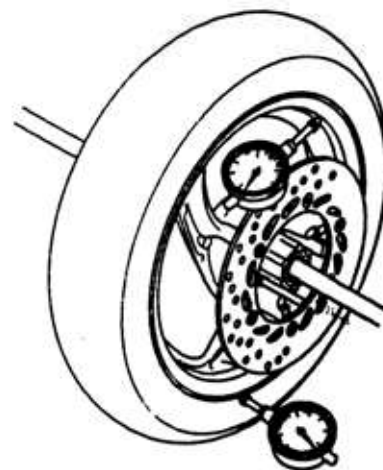

15. STEERING HANDLEBAR/FRONT WHEEL/ FRONT SHOCK ABSORBER



XCITING 500/500 AFI/250/300 AFI

Wheel Bearing

Turn the inner race of each bearing with your finger.

The bearings should turn smoothly and quietly. Also check that the bearing outer race fits tightly in the hub.

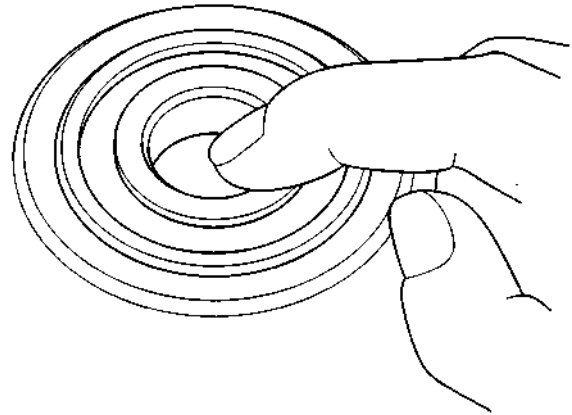

DIASSEMBLY

Remove the right and left disc bolts and brake discs.



Discs

Remove the bolts and speed sensor guide.

Speed Sensor Guide



15. STEERING HANDLEBAR/FRONT WHEEL/ FRONT SHOCK ABSORBER



XCITING 500/500 AFI/250/300 AFI

Remove the dust seals

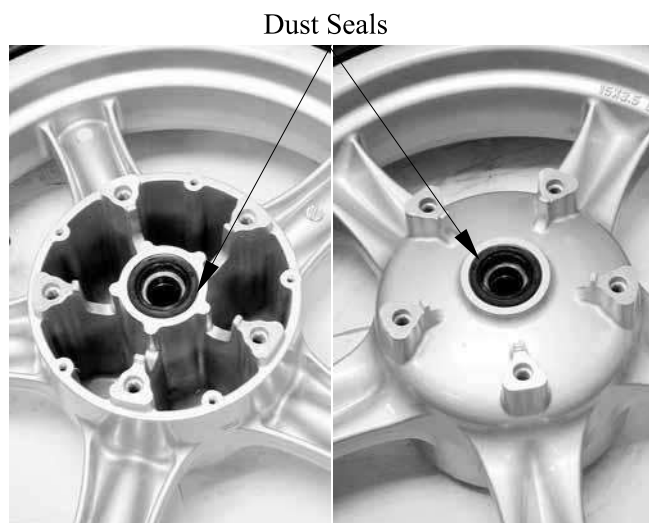

Install the bearing remover into the bearing.
Drive the bearing out of the wheel hub.
Remove the distance collar and drive out the
other bearing.

Special tool:

Bearing remover A120E00037

NOTE:

**Replace the wheel bearings in pairs.
Do not reuse old bearings.**



ASSEMBLY

Pack a new bearing cavities with grease.
Drive the new left bearing squarely with the
sealed side facing up until it is fully seated.

Special tool:

Oil seal & bearing install driver

A120E00014



15. STEERING HANDLEBAR/FRONT WHEEL/ FRONT SHOCK ABSORBER

Install the distance collar.

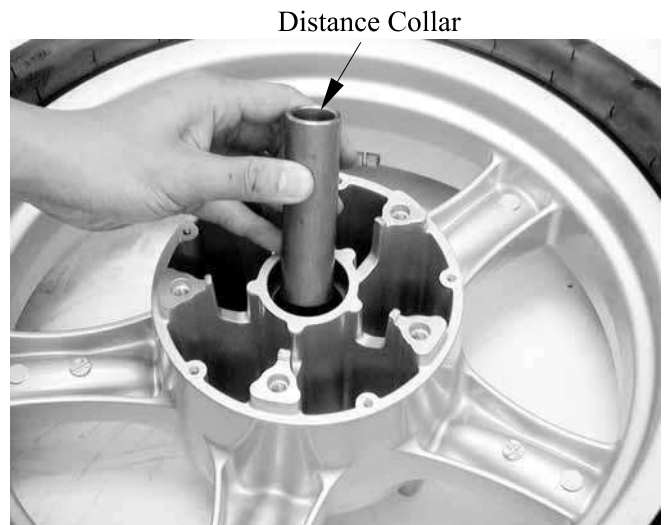

Pack a new bearing cavities with grease.
Drive the new right bearing squarely with the
sealed side facing up until it is fully seated.

Special tool:

Oil seal & bearing install driver

A120E00014



Apply grease to the new dust seal lips.
Install the dust seals into the wheel hub until
there are flush with the wheel hubs.

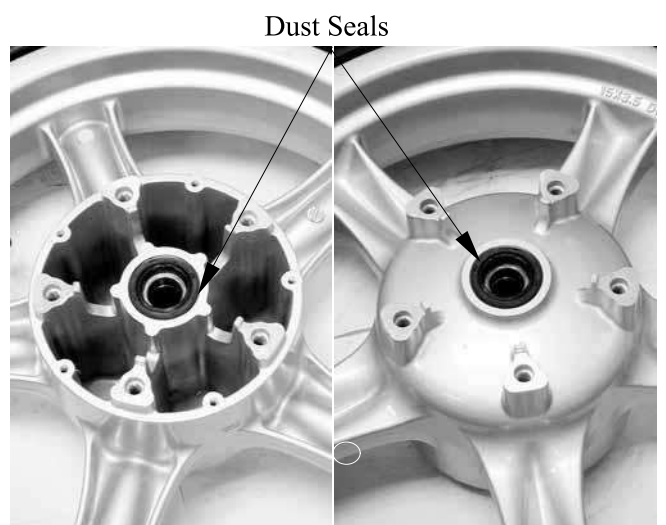

15. STEERING HANDLEBAR/FRONT WHEEL/ FRONT SHOCK ABSORBER



XCITING 500/500 AFI/250/300 AFI

Install the speed sensor guide.
Install the plate bolts and tighten them to the specified torque.

Torque: 10 N•m (1.0 kgf•m, 7 lbf•ft)

Speed sensor guide



Install the brake discs into wheel hub.
Install new disc bolts and tighten them to the specified torque.

Torque: 42 N•m (4.3 kgf•m, 31 lbf•ft)



Discs

INSTALLATION

Install the side collars into the wheel hub.

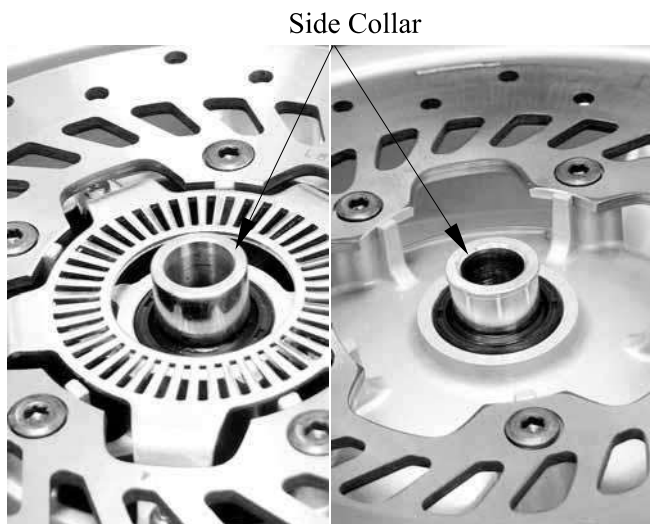

Side Collar

15. STEERING HANDLEBAR/FRONT WHEEL/ FRONT SHOCK ABSORBER

Install the front wheel between the fork leg.
Install the front axle front left side.
Tighten the axle bolt to the specified torque.

Torque: 20 N•m (2 kgf•m, 15 lbf•ft)



Tighten the front axle holder bolt to the specified torque.

Torque: 23 N•m (2.3 kgf•m, 17 lbf•ft)



Install the right and left front calipers onto the fork leg.

Install and tighten the new front caliper mount bolts to the specified torque.

Torque: 32 N•m (3.2 kgf•m, 23 lbf•ft)

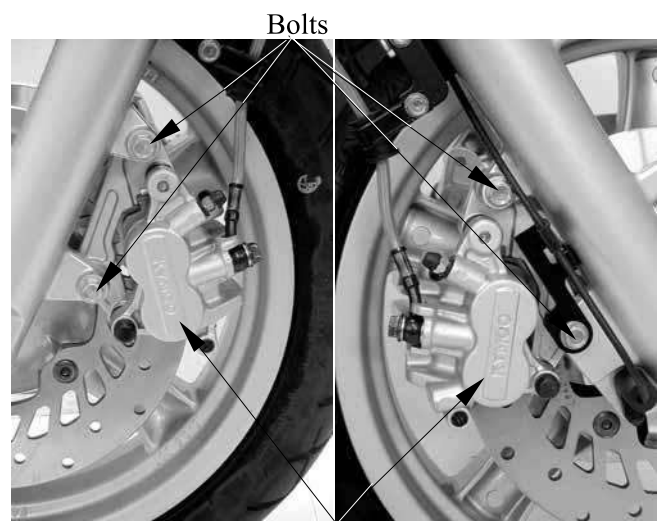

Calipers

15. STEERING HANDLEBAR/FRONT WHEEL/ FRONT SHOCK ABSORBER



XCITING 500/500 AFI/250/300 AFI

With the front brake applied, pump the fork up and down several times to seat the axle and check brake operation.

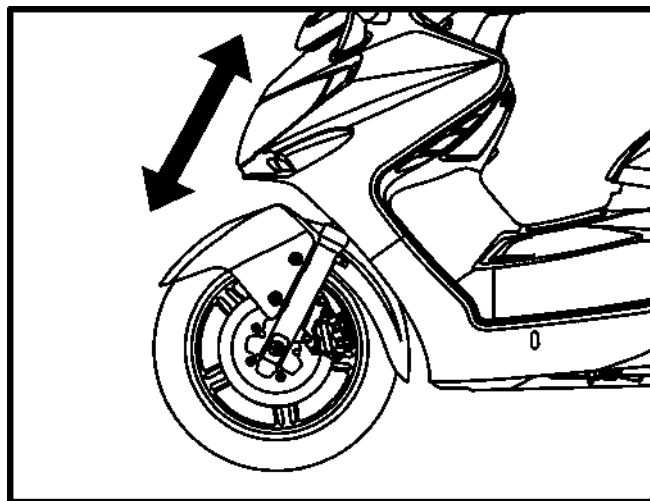

Check the brake operation by applying the brake lever.

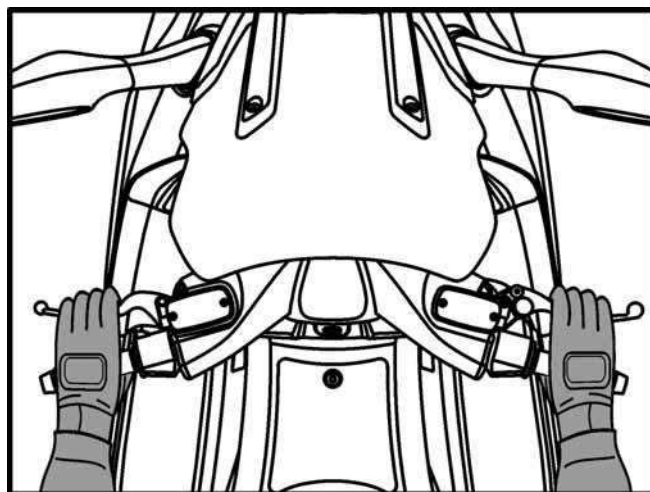

Measure the speed sensor to speed sensor guide clearance.

Standard (A): 0.3 – 1.2 mm (0.0012 – 0.048 in)

Adjust it if necessary (page 21-5).

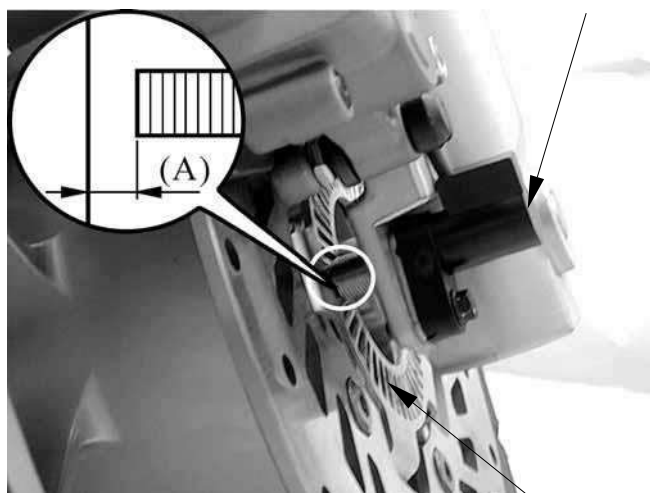

Speed Sensor Guide

15. STEERING HANDLEBAR/FRONT WHEEL/ FRONT SHOCK ABSORBER

FORK

REMOVAL

Remove the front wheel (page 15-4).

Remove the front fender (page 2-4).

Remove the bolt and hose clamp.

Remove the bolt and speed sensor (only right fork).

Remove the upper fork pinch bolt.

Remove the lower fork pinch bolts.

Remove the fork from the handlebar post and steering stem.

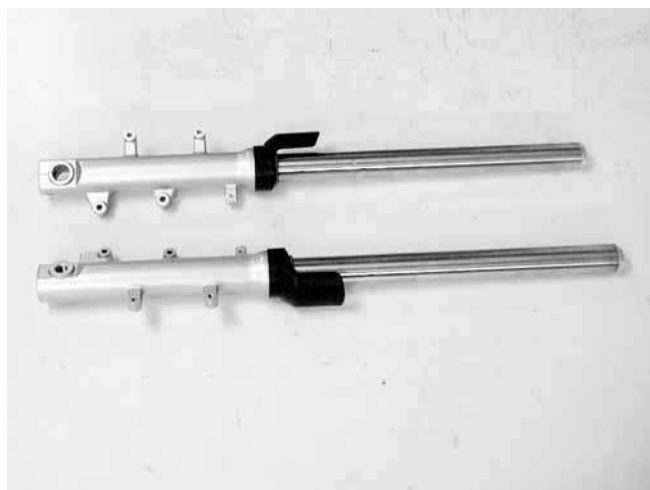
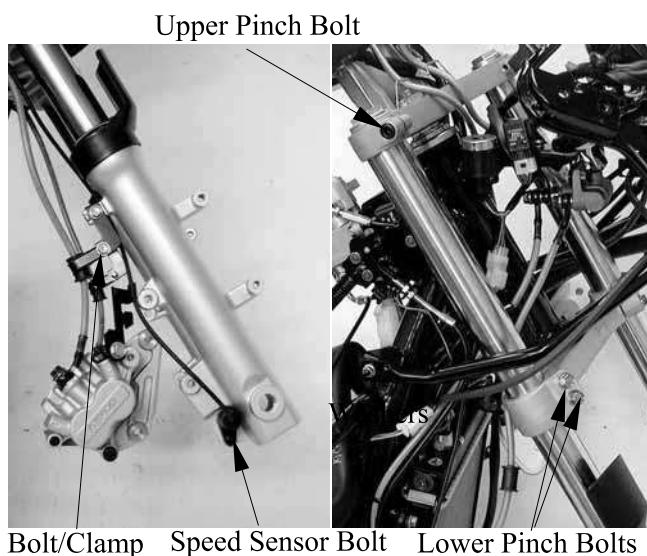

INSTALLATION

Install the fork tube into steering stem and handlebar post and align the mark on the fork tube with the handlebar post surface as shown.

Install and tighten the upper pinch bolt to the specified.

Torque: 23 N•m (2.3 kgf•m, 17 lbf•ft)

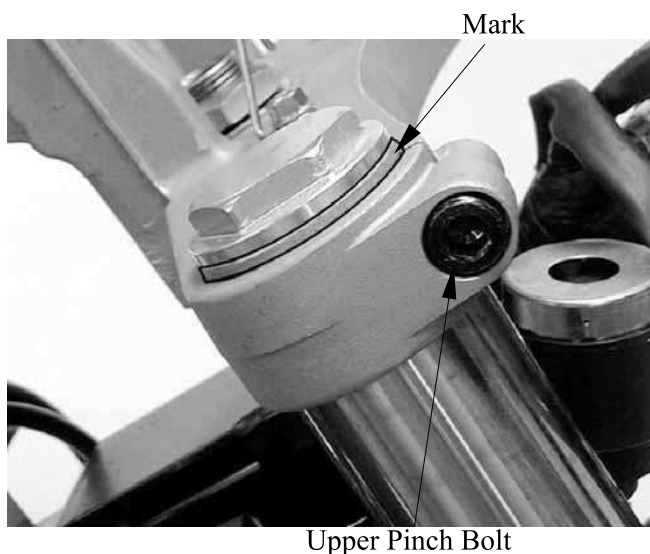

15. STEERING HANDLEBAR/FRONT WHEEL/ FRONT SHOCK ABSORBER



XCITING 500/500 AFI/250/300 AFI

Tighten the lower pinch bolts to specified torque.

Torque: 23 N•m (2.3 kgf•m, 17 lbf•ft)

Install the brake caliper onto the fork leg with new mount bolts.

Torque: 32 N•m (3.2 kgf•m, 23 lbf•ft)

Install the brake hose clamp onto the fork leg with the bolt.

Install the speed sensor onto the right fork leg and tighten the bolt.

Install the front fender.

Install the front wheel.

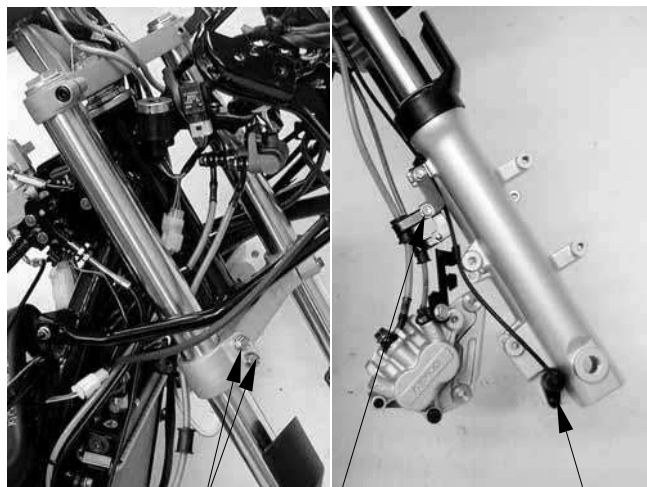

Lower Pinch Bolts

Bolt/Clamp

Speed Sensor Bolt

15. STEERING HANDLEBAR/FRONT WHEEL/ FRONT SHOCK ABSORBER



XCITING 500/500 AFI/250/300 AFI

STEERING HANDLEBAR

REMOVAL

Remove the front cover (page 2-11).
Remove the upper handlebar cover (page 2-5).

Remove the band bolt and disconnect the left handlebar switch connector.

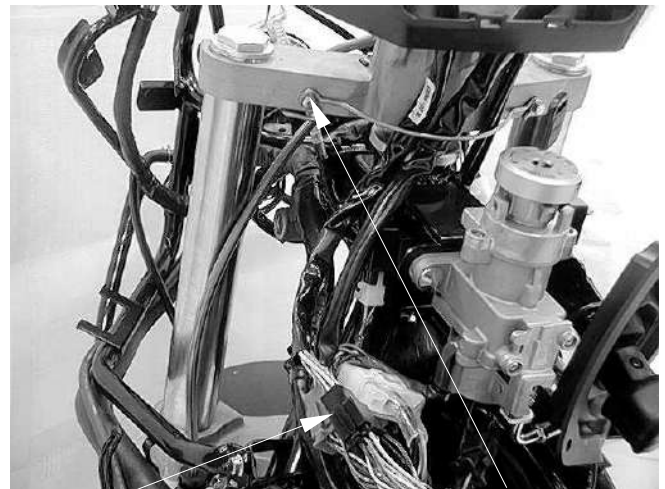

Left Handlebar Switch Connector Bolt

Remove the two screws and lower handlebar cover.

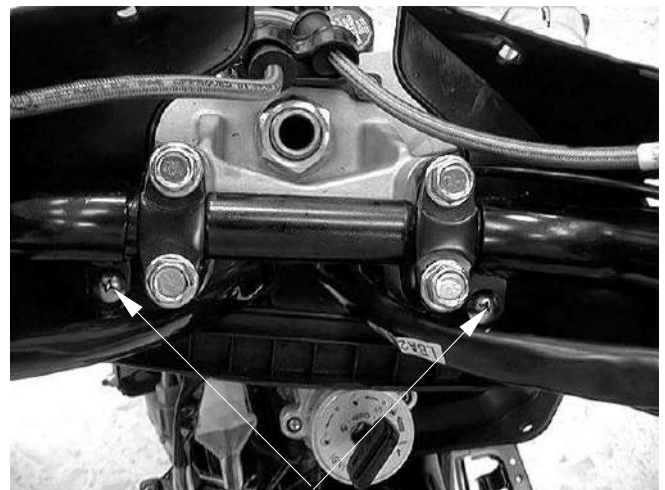

Screws

Remove the bolts, master cylinder holders and rear master cylinders.
Disconnect the left brake light switch connectors.

NOTE:

Keep the master cylinder upright to prevent air from entering the hydraulic system.

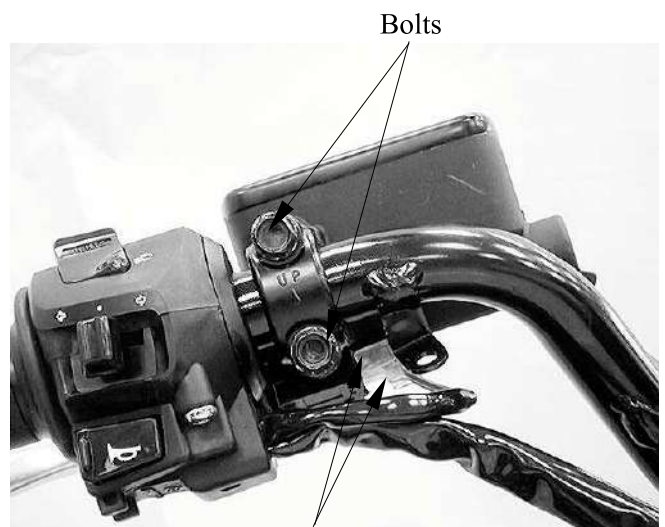

Brake Light Switch Connectors

15. STEERING HANDLEBAR/FRONT WHEEL/ FRONT SHOCK ABSORBER



XCITING 500/500 AFI/250/300 AFI

Remove the bolts, master cylinder holders and front master cylinders.

NOTE:

Keep the master cylinder upright to prevent air from entering the hydraulic system.

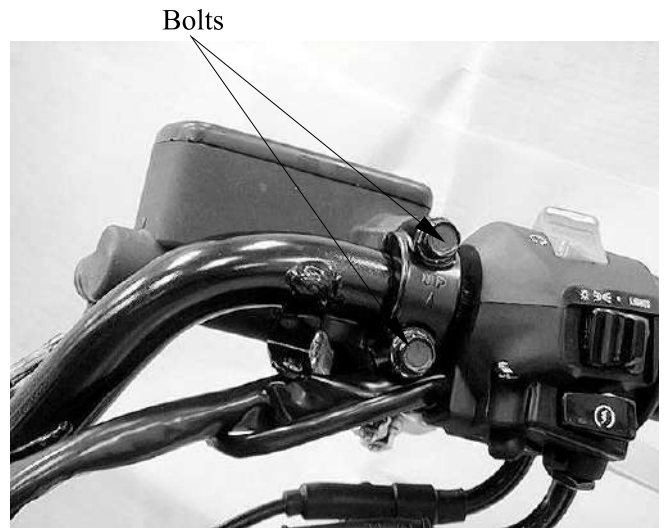

Remove the screws and right handlebar switch housing.



Remove the bolt/right handlebar weight.



15. STEERING HANDLEBAR/FRONT WHEEL/ FRONT SHOCK ABSORBER

Remove the bolts and upper holders.

Holder Bolts

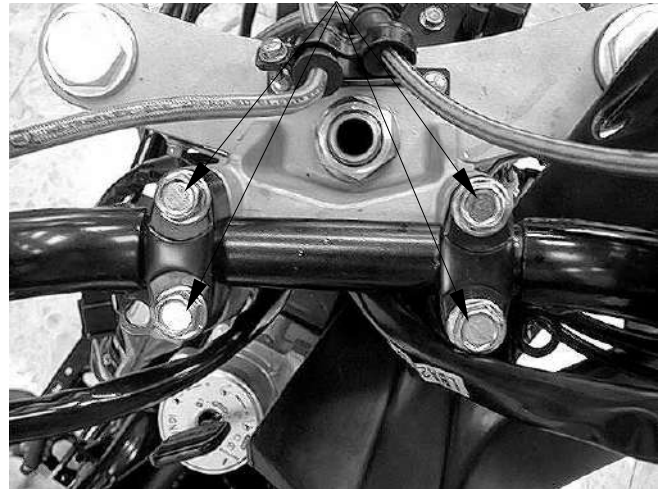

Remove the handlebar from the handlebar post and right handlebar switch housing.

Switch Housing

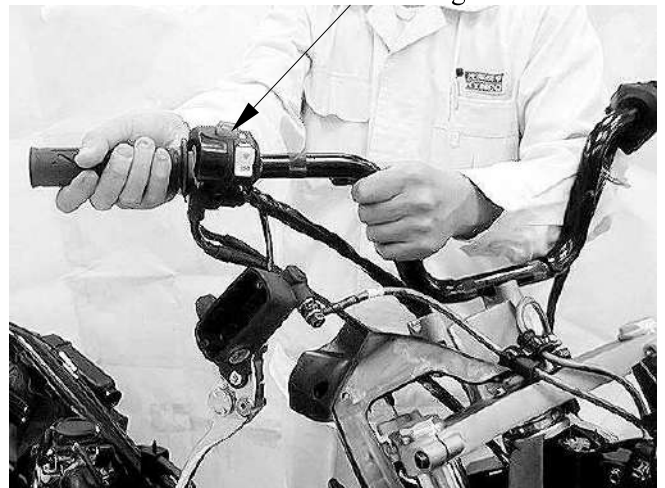

INSTALLATION

Pass the handlebar through the right handlebar switch housing.

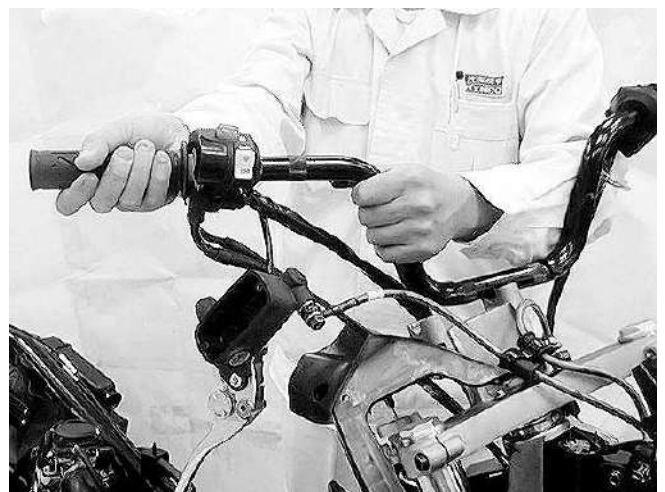

15. STEERING HANDLEBAR/FRONT WHEEL/ FRONT SHOCK ABSORBER



XCITING 500/500 AFI/250/300 AFI

Align the holes on the handlebar with the pins on the handle post.

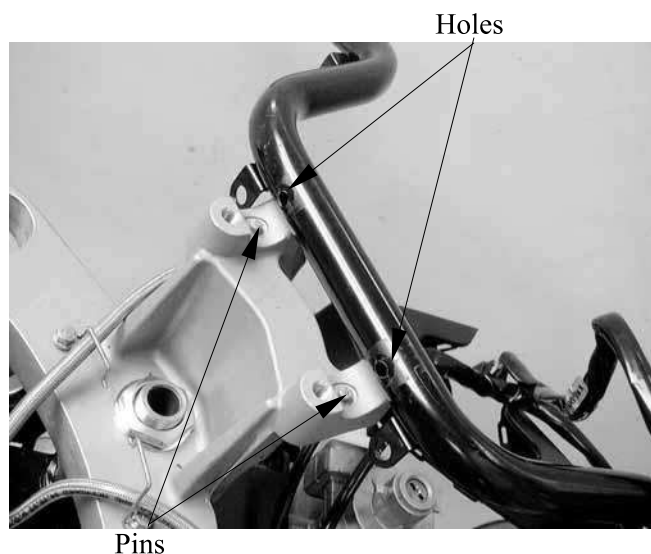

Install the handlebar to the handle post.

Install the upper holders with its punch marks facing toward.

Install the upper holder bolts.

Tighten the front bolts first, then tighten the rear bolts.

Torque: 23 N•m (2.3 kgf•m, 17 lbf•ft)

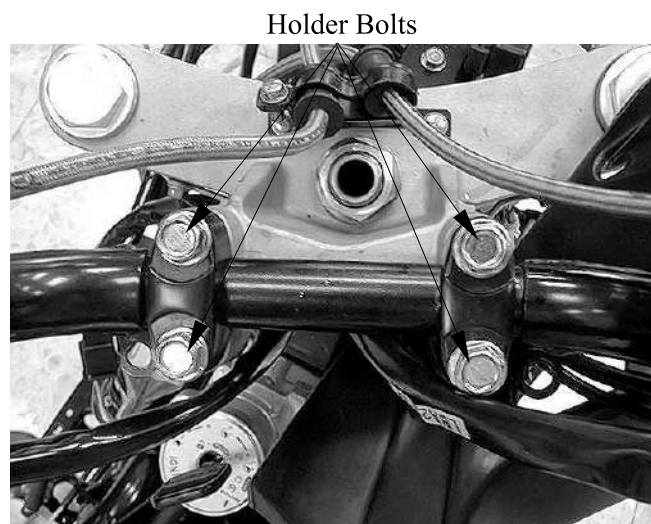

Install the throttle grip and bolt/right handlebar weight and tighten the bolt.



15. STEERING HANDLEBAR/FRONT WHEEL/ FRONT SHOCK ABSORBER



XCITING 500/500 AFI/250/300 AFI

Align the pin on the right handlebar switch housing with the hole on the steering handle.

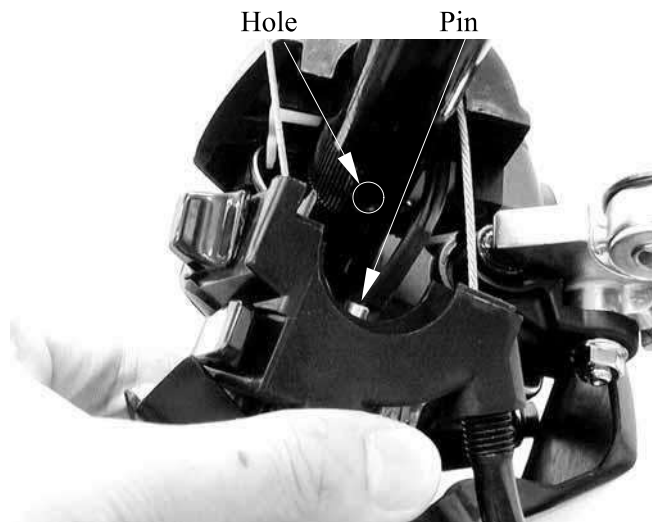

Install the screws and tighten the forward screw first, then tighten the rear screw.



Align the pin on the rear master cylinder holder with the hole on the handlebar.

Install the front master cylinders and holder with the "UP" mark facing up.

Install the bolts and tighten the upper bolt first then tighten the lower bolt to the specified torque.

Torque: 12 N•m (1.2 kgf•m, 9 lbf•ft)

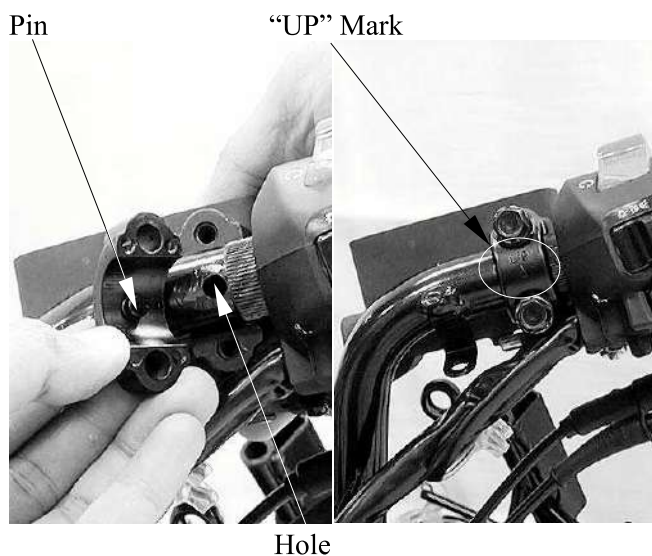

15. STEERING HANDLEBAR/FRONT WHEEL/ FRONT SHOCK ABSORBER



XCITING 500/500 AFI/250/300 AFI

Align the pin on the rear master cylinder holder with the hole on the handlebar.



Install the rear master cylinders and holder with the “UP” mark facing up.

Install the bolts and tighten the upper bolt first then tighten the lower bolt to the specified torque.

Torque: 12 N•m (1.2 kgf•m, 9 lbf•ft)

Connect the brake light switch connectors.



Connect the left handlebar switch connector and tighten the band bolt.

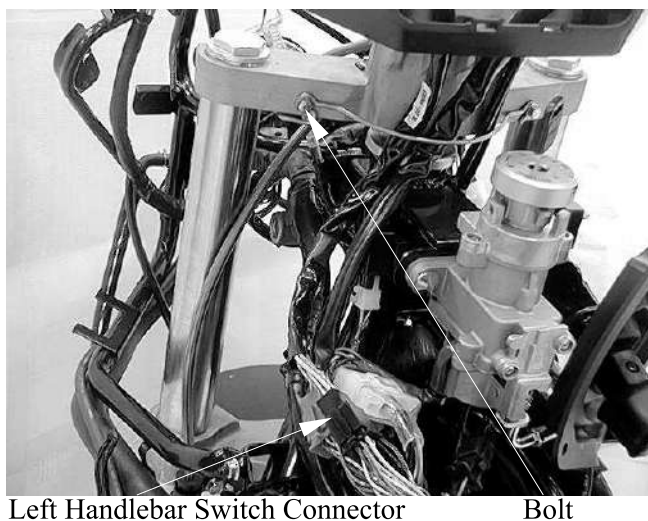

15. STEERING HANDLEBAR/FRONT WHEEL/ FRONT SHOCK ABSORBER



XCITING 500/500 AFI/250/300 AFI

STEERING STEM

REMOVAL

Remove the front fork (page 15-12).
Remove the steering handle (page 15-14).

Remove the bolts and brake hoses clamp.

Clamp Bolts

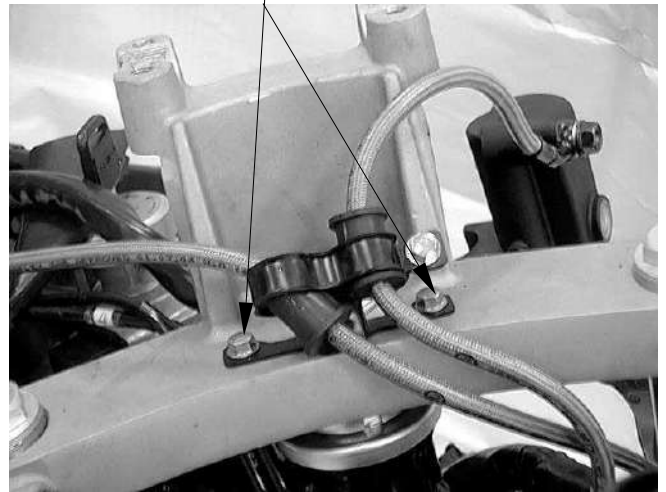

Remove the nut, washer and handle post.

Special tool:

Long socket wrench A120E00015

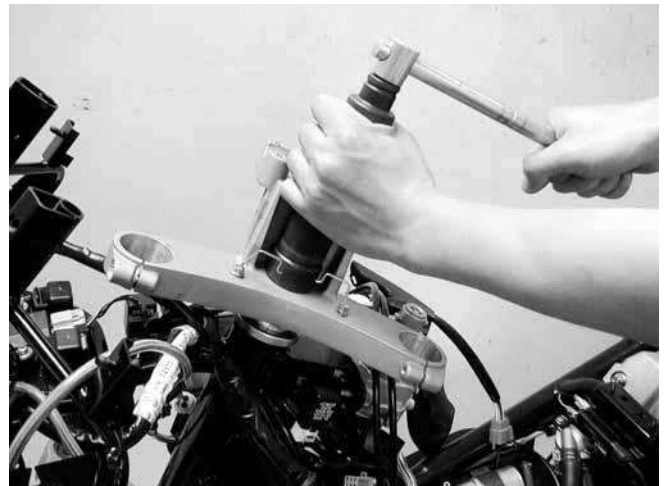

Remove the brake hoses from the clamps on the steering stem.



Brake Hoses

15. STEERING HANDLEBAR/FRONT WHEEL/ FRONT SHOCK ABSORBER



XCITING 500/500 AFI/250/300 AFI

Remove the steering stem lock nut.

Special tool:

Long socket wrench A120F00007



Remove the lock washer.



Loosen the steering top thread by using a special tool.

Hold the steering stem and remove the steering stem top thread.

Special tool:

Steering stem top thread wrench

A120F00023

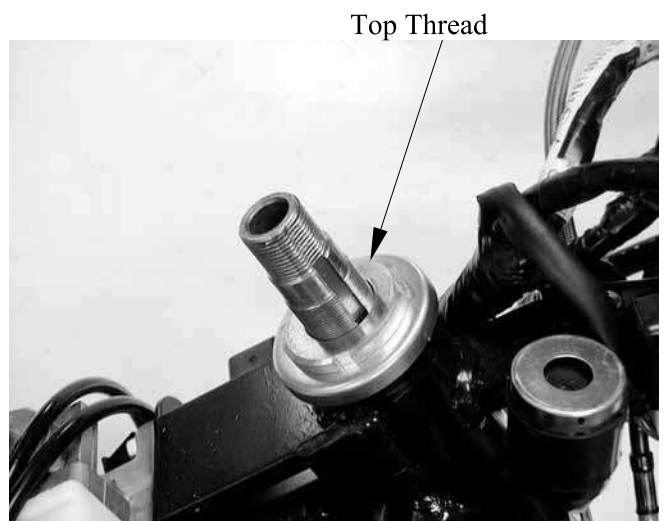

15. STEERING HANDLEBAR/FRONT WHEEL/ FRONT SHOCK ABSORBER

Remove the steering stem and lower bearing.

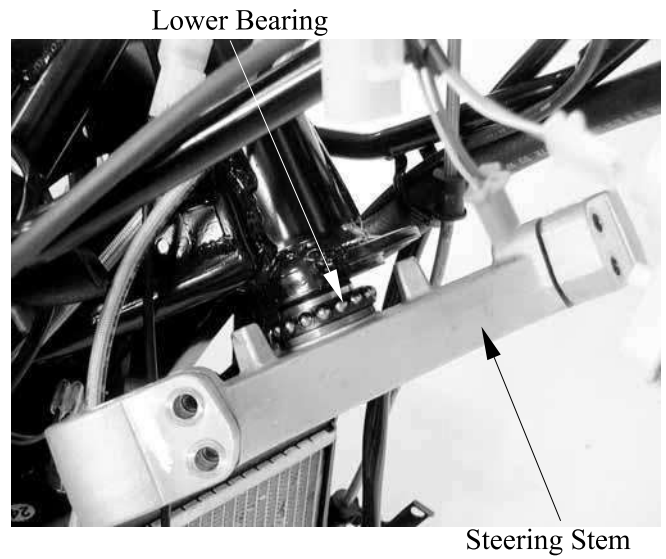

Remove the dust seal, upper inner race and upper bearing

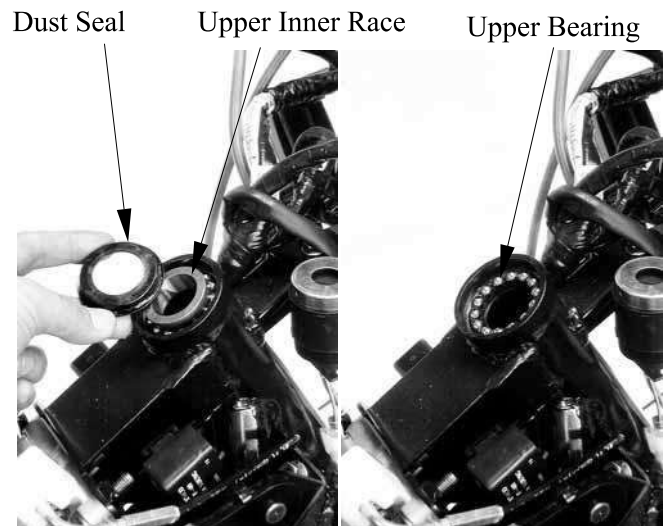

BEARING REPLACEMENT

Remove the upper bearing outer race.

NOTE:

Always replace the bearings and races as a set.

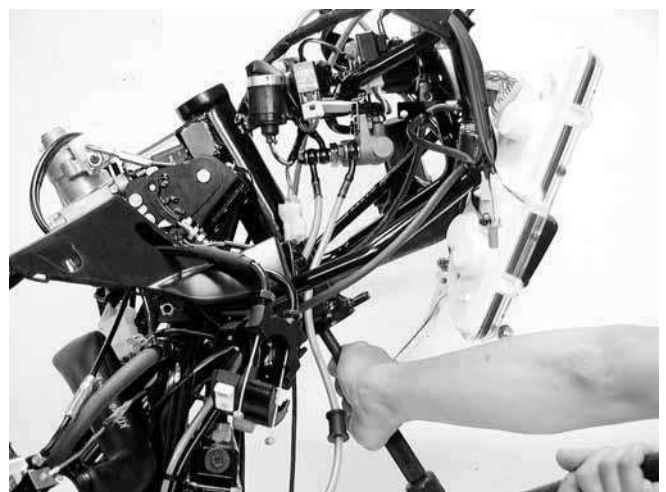

15. STEERING HANDLEBAR/FRONT WHEEL/ FRONT SHOCK ABSORBER



XCITING 500/500 AFI/250/300 AFI

Remove the lower bearing outer race.



Lower Outer Race

Drive a new upper bearing race into the steering head pipe.



Upper Outer Race

Drive a new lower bearing race into the steering head pipe.



Lower Outer Race

15. STEERING HANDLEBAR/FRONT WHEEL/ FRONT SHOCK ABSORBER

Install the steering stem lock nut onto the steering to prevent the threads from being damaged when removing the lower bearing inner race from the steering stem.

Remove the lower bearing inner race with a chisel or equivalent tool, being careful not to damage the steering stem.

Remove the dust seal.

Lower Inner Race

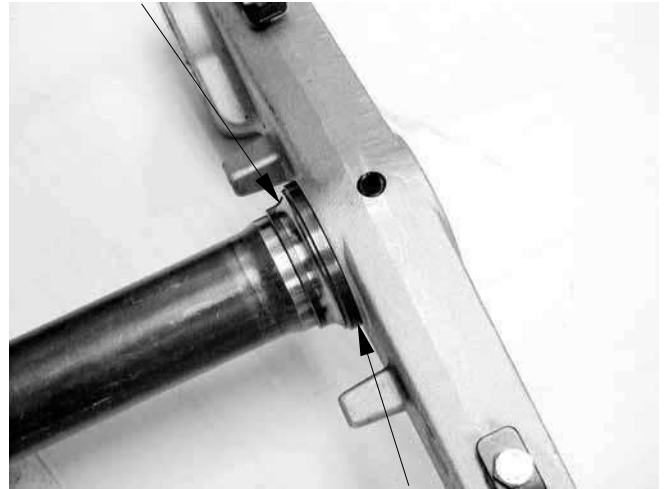

Dust Seal

Install the dust seal.

Apply grease to a new lower bearing inner race using a hydraulic press.

INSTALLATION

Apply grease to each new bearings and inner races.

Install the upper bearing, upper inner race and dust seal.

Dust Seal Upper Inner Race Upper Bearing

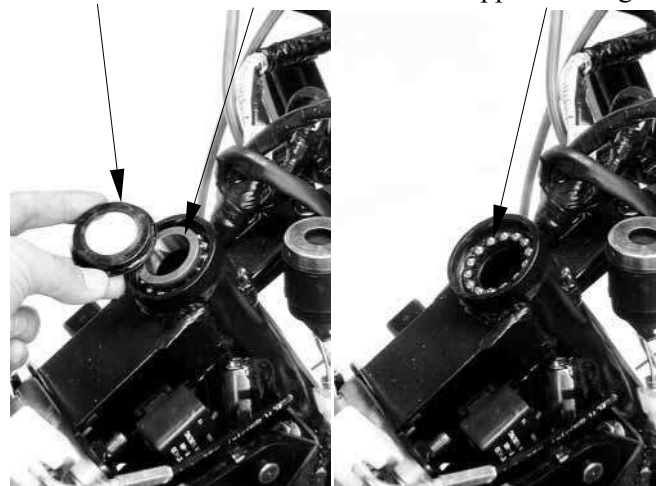

15. STEERING HANDLEBAR/FRONT WHEEL/ FRONT SHOCK ABSORBER



XCITING 500/500 AFI/250/300 AFI

Install the lower bearing onto the stem.
Insert the steering stem into the steering head pipe.

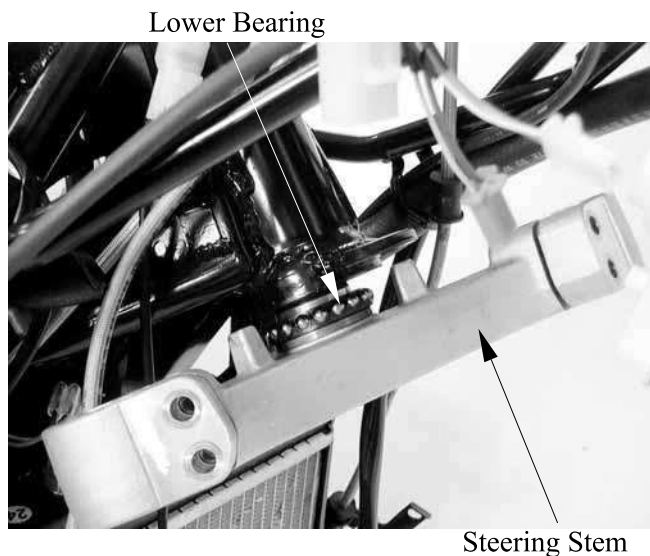

Install the steering top thread.

Steering top thread tightening step by using a special tool:

Special tool:

Steering stem top thread wrench

A120F00023

- Tighten the steering top thread to specified torque.

Torque: 52 N•m (5.2 kgf•m, 37 lbf•ft)

- Temporarily loosen the steering stem top thread, then retighten it to specified torque.

Torque: 20 N•m (2 kgf•m, 15 lbf•ft)

- Turn the steering stem lock-to-lock several times to seat the bearings.

Temporarily loosen the steering stem top thread.

Install the fork (page 15-12).

Install the front wheel (page 15-9).

Install the steering top thread to the specified torque with the front wheel grounded.

Torque: 20 N•m (2 kgf•m, 15 lbf•ft)

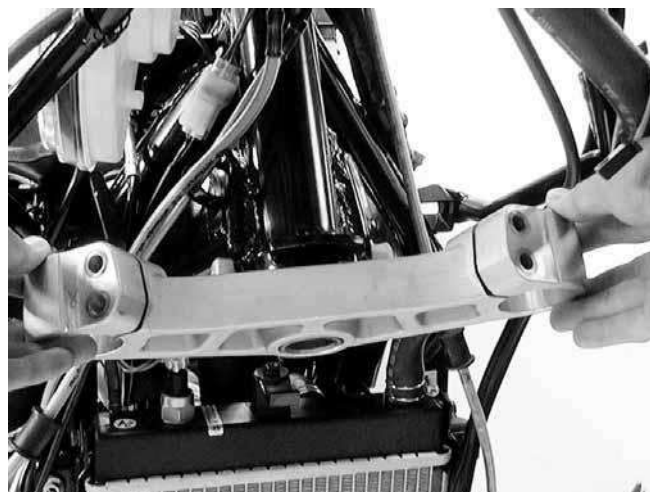

15. STEERING HANDLEBAR/FRONT WHEEL/ FRONT SHOCK ABSORBER

Install the lock washer aligning its tab into the groove on the steering stem.

Install the steering stem lock nut.
Hold the steering stem top thread and tighten the steering stem lock nut to the specified torque.

Special tool:

Long socket wrench A120F00007

Torque: 55 N•m (5.5 kgf•m, 40 lbf•ft)

Make sure that the steering stem moves smoothly without play or binding.



Install the handle post to the steering stem and front forks.

Install the washer and nut.

Tighten the handle post nut to the specified torque.

Special tool:

Long socket wrench A120E00015

Torque: 62 N•m (6.2 kgf•m, 45 lbf•ft)

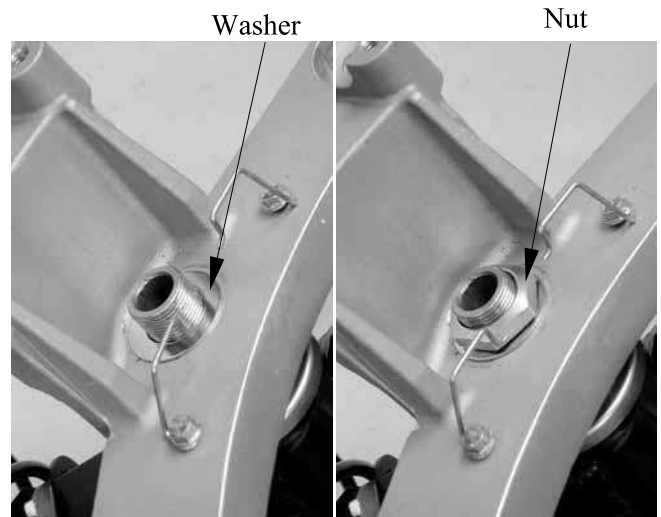

Install the brake hose clamp and tighten the bolts securely.

Route the brake hoses and wires properly (page 1-16).

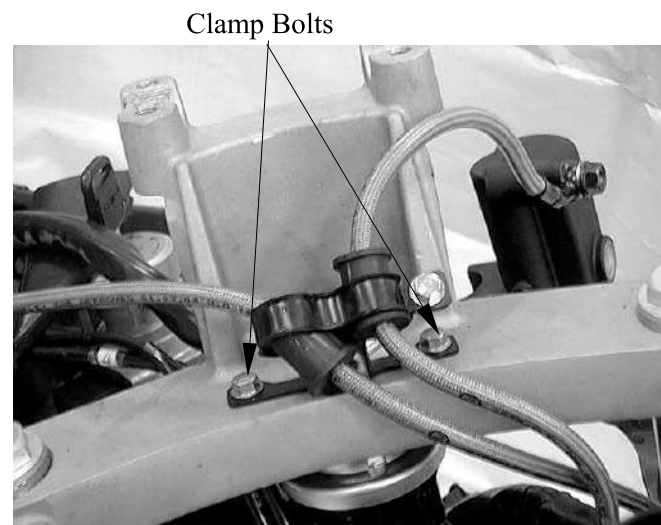

**16. REAR FORK/REAR WHEEL/
REAR SHOCK ABSORBER**



XCITING 500/500 AFI/250/300 AFI

**REAR FORK/REAR WHEEL/
REAR SHOCK ABSORBER**

16

SCHEMATIC DRAWING ----- 16- 1
SERVICE INFORMATION----- 16- 2
TROUBLESHOOTING----- 16- 3
REAR WHEEL/REAR FORK ----- 16- 4
REAR SHOCK ABSORBER ----- 16-10

16. REAR FORK/REAR WHEEL/ REAR SHOCK ABSORBER



XCITING 500/500 AFI/250/300 AFI

SCHEMATIC DRAWING

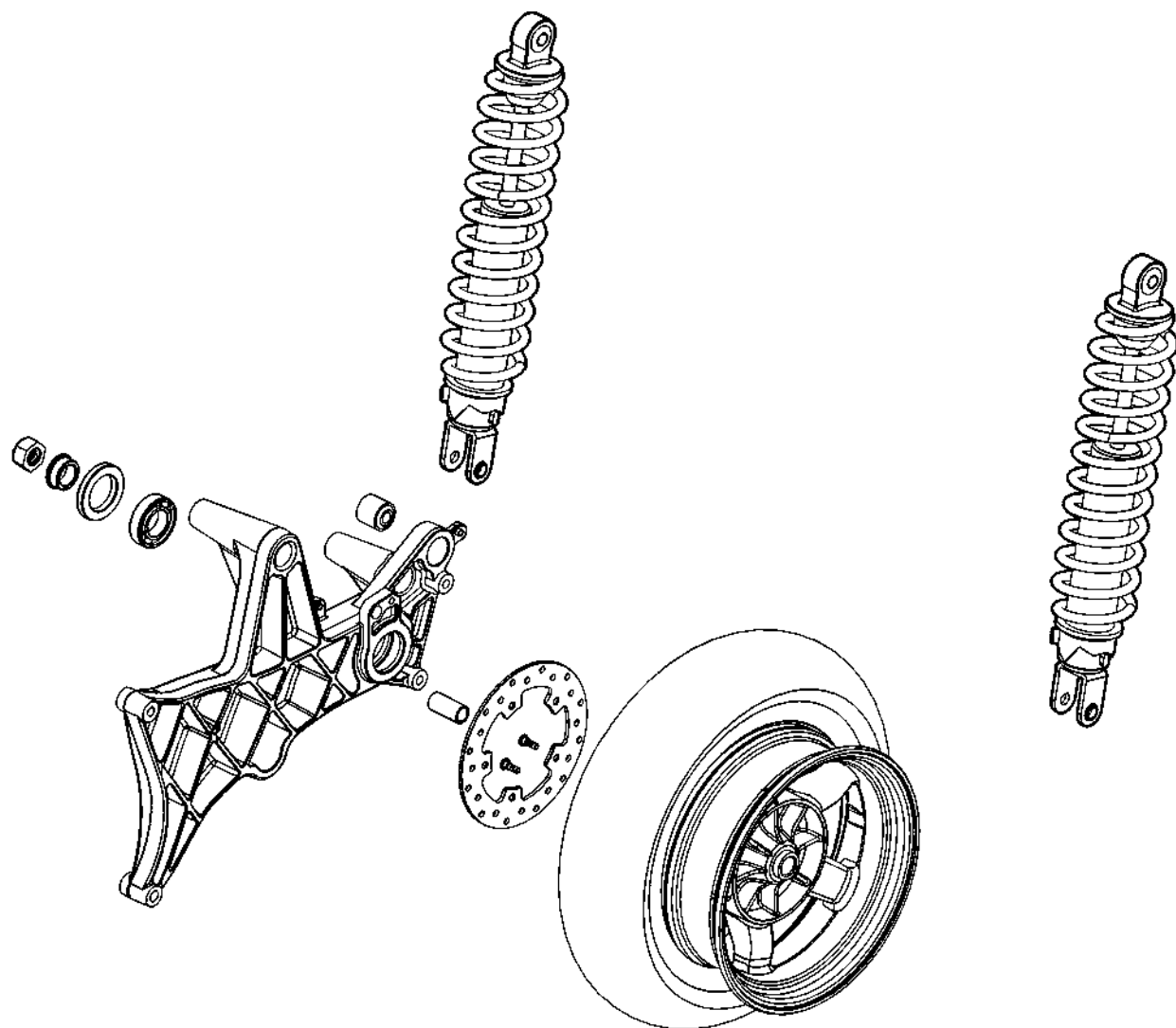

16. REAR FORK/REAR WHEEL/ REAR SHOCK ABSORBER



XCITING 500/500 AFI/250/300 AFI

SERVICE INFORMATION

GENERAL INSTRUCTIONS

- A contaminated brake disc or pad reduces stopping power. Discard contaminated parts and clean a contaminated disc with a high quality brake degreasing agent.
- Riding on damaged rims impairs safe operation of the vehicle.
- This section covers of the rear wheel and rear suspension.
- A jack or other support is required to support the vehicle.
- Do not twist or bend the brake hose when servicing.
- Use genuine KYMCO replacement bolts and nuts for all suspension pivots and mounting points.
- Refer to section 17 for brake system information.

SPECIFICATIONS

Unit: mm (in)

ITEM		STANDARD	SERVICE LIMIT
Minimum tire tread depth		—	2 (0.08)
Cold tire pressure	Rider only	250 kPa (2.5 kgf/cm ² , 36 psi)	—
	Rider and passenger		—
Wheel rim runout	Radial	—	2 (0.08)
	Axial	—	2 (0.08)

TORQUE VALUES

Rear brake disc bolt	42 N•m (4.3 kgf•m, 31 lbf•ft)
	ALOC bolt: replace with a new one.
Rear axle nut (XCITING 500/500 AFI)	180 N•m (18 kgf•m, 130 lbf•ft)
Rear axle nut (XCITING 250/250 AFI)	140 N•m (14 kgf•m, 100 lbf•ft)
Rear shock absorber upper mounting bolt	40 N•m (4 kgf•m, 29 lbf•ft)
Rear shock absorber lower mounting bolt	40 N•m (4 kgf•m, 29 lbf•ft)
Final shaft holder bolt	32 N•m (3.2 kgf•m, 23 lbf•ft)
Right/parking brake caliper mounting bolt	32 N•m (3.2 kgf•m, 23 lbf•ft)
	ALOC bolt: replace with a new one.

TROUBLESHOOTING

Rear wheel wobbling

- Bent rim
- Faulty tire
- Axle not tightened properly
- Engine mount bolt not tightened properly
- Loose or worn final gear shaft bearing
- Insufficient tire pressure
- Unbalanced tire and wheel

Soft suspension

- Weak rear shock absorber spring
- Oil leakage from damper unit

Rear wheel noise

- Worn rear wheel axle bearings
- Worn rear fork bearings
- Deformed rear fork

Hard suspension

- Bent damper rod
- Worn or damaged engine mount bushings
- High tire pressure

Rear suspension noisy

- Loose mounting fasteners
- Faulty shock absorber
- Weak rear suspension mount bushings

16. REAR FORK/REAR WHEEL/ REAR SHOCK ABSORBER

REAR WHEEL/REAR FORK

REMOVAL

Remove the muffler (page 2-16).
Remove the rear/parking brake caliper (page 17-26).

Loosen the rear axle nut.
Support the scooter securely on its main stand.



Remove the bolts and brake hose/cable clamps from the rear fork.
Remove the rear shock absorber lower mount bolt.
Remove the rear axle nut.



Remove the rear fork mount bolts and rear fork.



16. REAR FORK/REAR WHEEL/ REAR SHOCK ABSORBER



XCITING 500/500 AFI/250/300 AFI

Remove the inner side collar.



Inner Side Collar

Remove the rear wheel.



Rear Wheel

INSTECTION

Wheel

Check the wheel rim runout using dial indicator.

Actual urnout is 1/2 the total indicator reading.

Service Limits:

Radial: 2 mm (0.08 in)

Axial: 2mm (0.08 in)

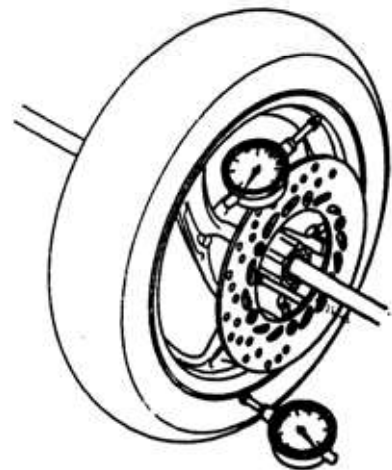

16. REAR FORK/REAR WHEEL/ REAR SHOCK ABSORBER

DISASSEMBLY

Wheel

Remove the brake disc bolts and rear brake disc.



REAR FORK BEARING REPLACEMENT

Remove the outer side collar from the rear fork.



Remove the dust seal from the rear fork.



16. REAR FORK/REAR WHEEL/ REAR SHOCK ABSORBER

Remove the snap ring.

Turn the inner race of the bearing with your finger.

The bearing should turn smoothly and quietly. Also check that the bearing outer race fits tightly in the rear fork.

Remove and discard the bearing if the race does not turn smoothly and quietly, or if it fits loosely in the rear fork.

Remove the bearing from the rear fork.

Drive in a new bearing squarely until it is fully seated, using the special tools.

Special tool:

Oil seal & bearing install A120E00014

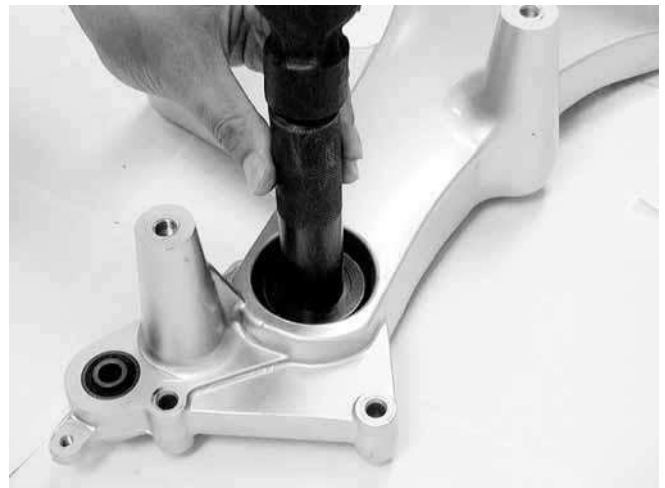
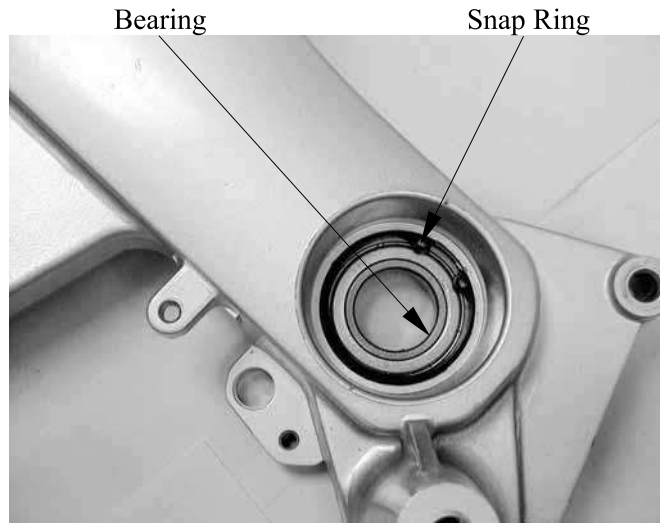

Install the snap ring to the groove of the rear fork securely.



16. REAR FORK/REAR WHEEL/ REAR SHOCK ABSORBER

Apply grease to the new dust seal lip and install it to the rear fork.



Dust Seal

Check the bushing for wear or damage.

Bushing



ASSEMBLY

Wheel

Install the brake disc onto the wheel hub.

Install the new brake disc bolts and tighten them to the specified torque.

Torque: 42 N•m (4.3 kgf•m, 31 lbf•ft)

Brake Disc



16. REAR FORK/REAR WHEEL/ REAR SHOCK ABSORBER



XCITING 500/500 AFI/250/300 AFI

INSTALLATION

Install the rear wheel onto the final gear shaft, aligning the spline.



Rear Wheel

Install the inner side collar.
Apply grease to the final gear shaft.



Inner Side Collar

Install the rear fork and tighten the bolts to the specified torque.

Torque: 32 N•m (3.2 kgf•m, 23 lbf•ft)



Rear Fork

Mount Bolts

16. REAR FORK/REAR WHEEL/ REAR SHOCK ABSORBER

Install and tighten the rear axle nut to temporarily.
Install and tighten the rear shock absorber lower mount bolt to the specified torque.

Torque: 40 N•m (4.0 kgf•m, 29 lbf•ft)

Install the brake hose/cable clamps to the rear fork and tighten the bolts securely.



Mount Bolt

Release the main stand and support the scooter securely on its side stand.

Tighten the rear axle nut to the specified torque.

Torque:

XCITING 500/500 AFI:

180 N•m (18 kgf•m, 130 lbf•ft)

XCITING 250/250 AFI:

140 N•m (14 kgf•m, 100 lbf•ft)

Install the rear/parking brake caliper (page 17-30).

Install the muffler (page 2-16).



Axle Nut

REAR SHOCK ABSORBER

REMOVAL

Remove the luggage box (page 2-3).

Support the scooter securely on its center stand.

Support the engine securely with a hoist or equivalent.

Remove the rear shock absorber lower mount bolt.

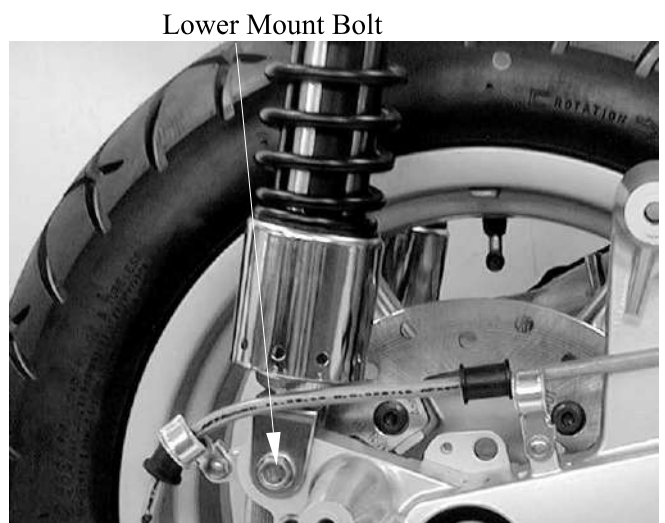

Lower Mount Bolt

16. REAR FORK/REAR WHEEL/ REAR SHOCK ABSORBER

Remove the rear shock absorber upper mount bolt and shock absorber.

Upper Mount Bolt



INSPECTION

Check the damper unit for leakage or other damage.

Check the upper joint bushing for wear or damage.

Replace the shock absorber assembly if necessary.

Bushing

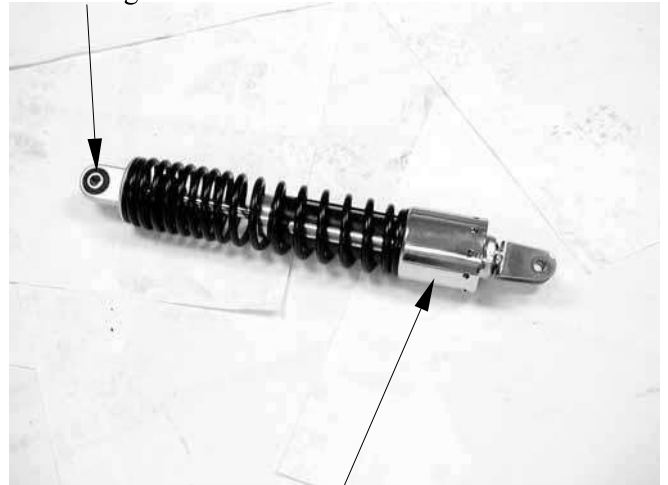

Damper Unit

INSTALLATION

Install the rear shock absorber tighten the upper mount bolt to the specified torque.

Torque: 40 N•m (4 kgf•m, 29 lbf•ft)

Upper Mount Bolt



16. REAR FORK/REAR WHEEL/ REAR SHOCK ABSORBER



XCITING 500/500 AFI/250/300 AFI

Install and tighten the lower mount bolt to the specified torque.

Torque: 40 N•m (4 kgf•m, 29 lbf•ft)

Lower Mount Bolt



BRAKE SYSTEM

SCHEMATIC DRAWING -----	17- 1
SERVICE INFORMATION -----	17- 2
TROUBLESHOOTING-----	17- 3
BRAKE FLUID -----	17- 4
BRAKE PAD-----	17-10
BRAKE DISC INSPECTION-----	17-13
FRONT MASTER CYLINDER -----	17-14
REAR MASTER CYLINDER -----	17-18
DELAY VALVE-----	17-22
FRONT BRAKE CALIPER -----	17-24
REAR/PARKING BRAKE CALIPER -----	17-26
PARKING BRAKE LEVER LINK (XCITING 500/500 AFI) -----	17-31

17. BRAKE SYSTEM

XCITING 500/500 AFI/250/300 AFI

SCHEMATIC DRAWING

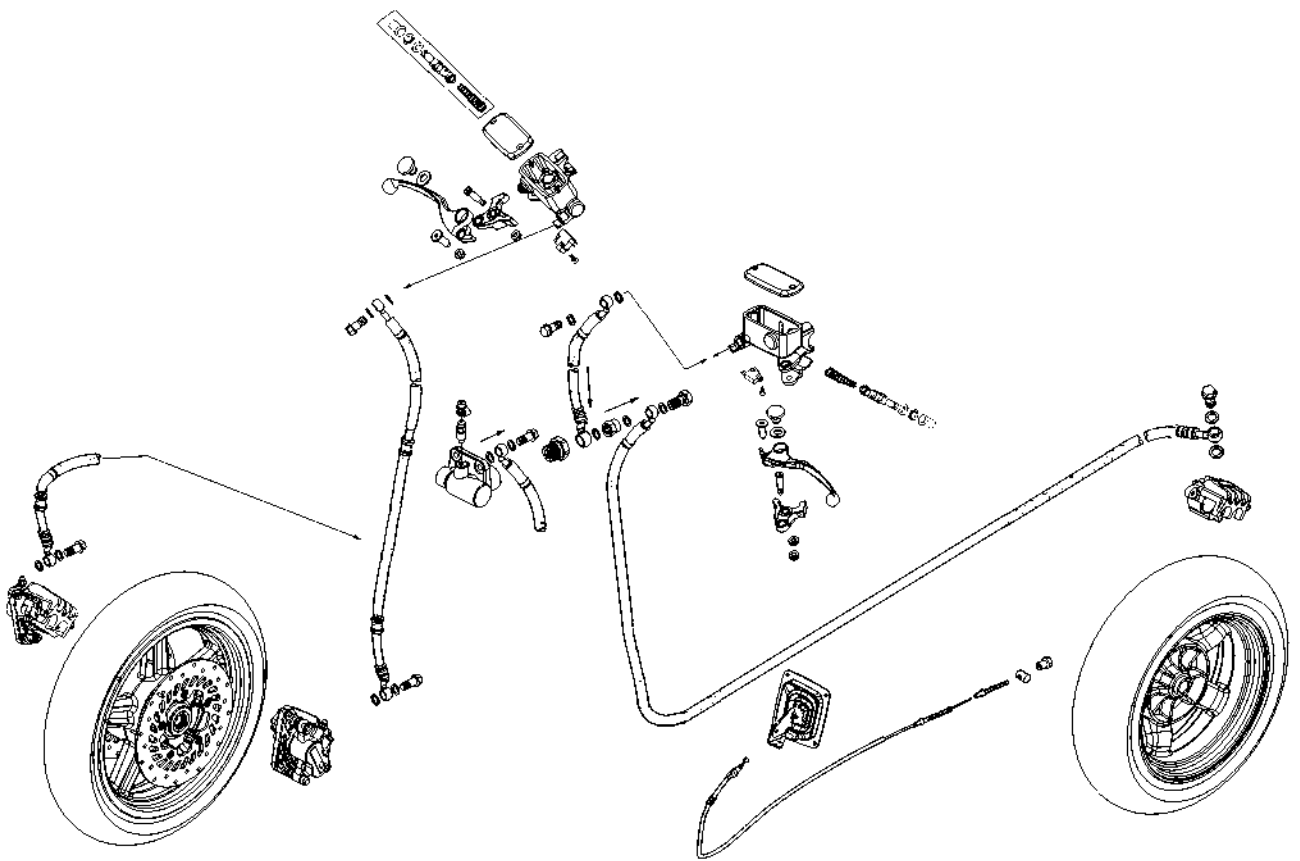

SERVICE INFORMATION

GENERAL

Frequent inhalation of brake pad dust, regardless of material composition could be hazardous to your health.

Avoid breathing dust particles.

- A contaminated brake disc or pad reduces stopping power. Discard contaminated parts and clean a contaminated disc with high quality brake degreasing agent.
- Avoid spilling brake fluid on painted, plastic or rubber parts. Place a rag over these parts whenever the system is serviced.
- This section covers maintenance of the front and rear hydraulic brake system.
- Never allow contamination (dirt, water, etc.) to get into and open reservoir.
- Once the hydraulic system has been opened, or if the brake feel spongy, the system must be bled.
- Always use fresh DOT 4 brake fluid from a sealed container when servicing the system. Do not mix different types of fluid as they may not be compatible.
- Always check brake operation before riding the vehicle.

SPECIFICATIONS

Unit: mm (in)

	ITEM	STANDARD	SERVICE LIMIT
Front	Specified brake fluid	DOT 4	—
	Brake disc thickness	4.8 – 5.2 (0.19 – 0.20)	4 (0.16)
	Brake disc runout	—	0.03 (0.012)
Rear	Specified brake fluid	DOT 4	—
	Brake disc thickness	4.8 – 5.2 (0.19 – 0.20)	4 (0.16)
	Brake disc warpage	—	0.03 (0.012)

TORQUE VALUES

Master cylinder reservoir cover screw	2 N•m (0.2 kgf•m, 1.4 lbf•ft)
Master cylinder holder bolt	12 N•m (1.2 kgf•m, 9 lbf•ft)
Brake lever pivot bolt	2 N•m (0.2 kgf•m, 1.4 lbf•ft)
Brake lever pivot nut	10 N•m (1 kgf•m, 7.2 lbf•ft)
Brake light switch screw	1 N•m (0.1 kgf•m, 0.7 lbf•ft)
Brake caliper mounting bolt	32 N•m (3.2 kgf•m, 23 lbf•ft)
	ALOC bolt: replace with a new one.
Brake caliper bleed screw	6 N•m (0.6 kgf•m, 4.3 lbf•ft)
Brake pad pin	18 N•m (1.8 kgf•m, 13 lbf•ft)
Front/Rear caliper pad pin plug	2 N•m (0.2 kgf•m, 1.4 lbf•ft)
Brake hose oil bolt	35 N•m (3.5 kgf•m, 25 lbf•ft)
Delay valve bleed screw	6 N•m (0.6 kgf•m, 4.3 lbf•ft)

TROUBLESHOOTING

Brake lever soft or spongy

- Air in the hydraulic system
- Low brake fluid level
- Clogged fluid passage
- Contaminated brake disc/pad
- Warped/deformed brake disc
- Worn brake disc/pad
- Sticking/worn master cylinder piston
- Contaminated master cylinder
- Contaminated caliper
- Caliper not sliding properly
- Leaking hydraulic system
- Worn caliper piston seal
- Worn master cylinder piston cups
- Bent brake lever

Brake lever hard

- Clogged/restricted brake system
- Sticking/worn caliper piston
- Caliper not sliding properly
- Clogged/restricted fluid passage
- Worn caliper piston seal
- Sticking/worn master cylinder piston
- Bent brake lever

Brake drag

- Contaminated brake disc/pad
- Worn brake disc/pad
- Warped/deformed brake disc
- Caliper not sliding properly

17. BRAKE SYSTEM

XCITING 500/500 AFI/250/300 AFI

BRAKE FLUID

Check

Brake fluid: (page 3-24)

Brake hose:

Cracks/wear/damage → Replace.

Apply the brake lever several times.

Fluid leakage → Replace.

Brake hose clamp:

Loosen → Tighten

FLUID REPLACEMENT

Front brake

Avoid spilling brake fluid on painted, plastic or rubber parts and so on. Place a rag over these parts whenever the system is serviced.

Place the scooter on a level surface and keep the handlebar straight.

Remove the master cylinder reservoir cap and diaphragm.

Suck up the old brake fluid as much as possible.

Fill the reservoir with new brake fluid.

Specification and classification: DOT 4



17. BRAKE SYSTEM

XCITING 500/500 AFI/250/300 AFI

Connect a clear hose to the left front caliper air bleed screw and insert the other end of the hose into a receptacle.

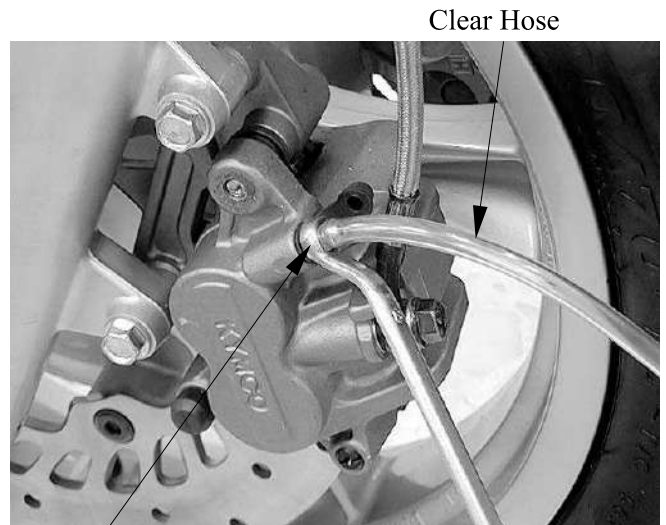

Left Front Caliper Air Bleed Screw

Loosen the air bleed screw and pump the brake lever until the old brake fluid is completely out of the brake system.

Close the air bleed screw and disconnect the clear hose. Fill the reservoir with new brake fluid to the upper end of the inspection window.

Tighten the bleed screw to the specified torque.

Torque: 6 N•m (0.6 kgf•m, 4.3 lbf•ft)

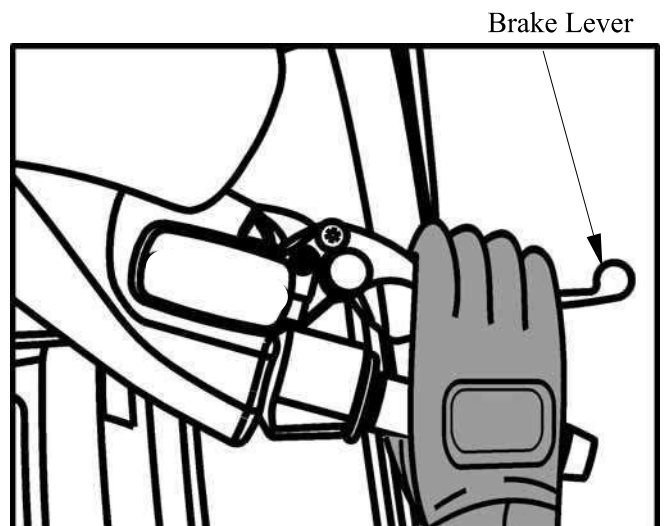

Combination brake

Avoid spilling brake fluid on painted, plastic or rubber parts and so on. Place a rag over these parts whenever the system is serviced.

Place the scooter on a level surface and keep the handlebar straight.

17. BRAKE SYSTEM

XCITING 500/500 AFI/250/300 AFI

Remove the master cylinder reservoir cap and diaphragm.

Suck up the old brake fluid as much as possible.

Fill the reservoir with new brake fluid.

Specification and classification: DOT 4

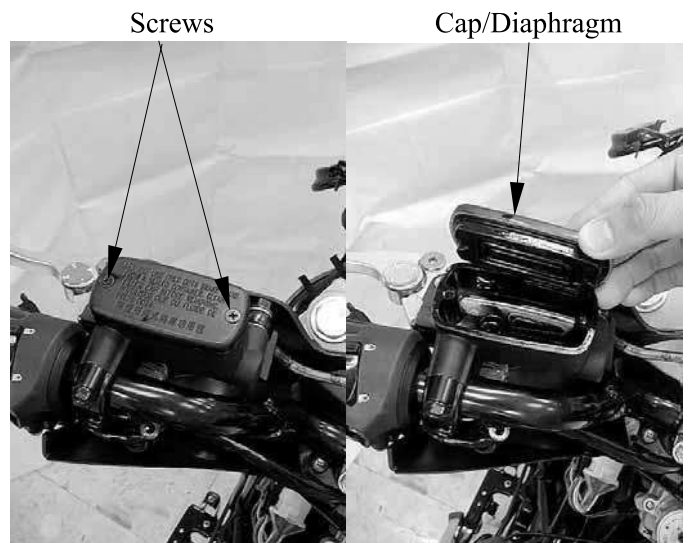

Step 1:

Connect a clear hose to the delay valve air bleed screw and insert the other end of the hose into a receptacle.

Loosen the air bleed screw and pump the brake lever until the old brake fluid is completely out of the brake system. Close the air bleed screw and disconnect the clear hose. Fill the reservoir with new brake fluid to the upper end of the inspection window.

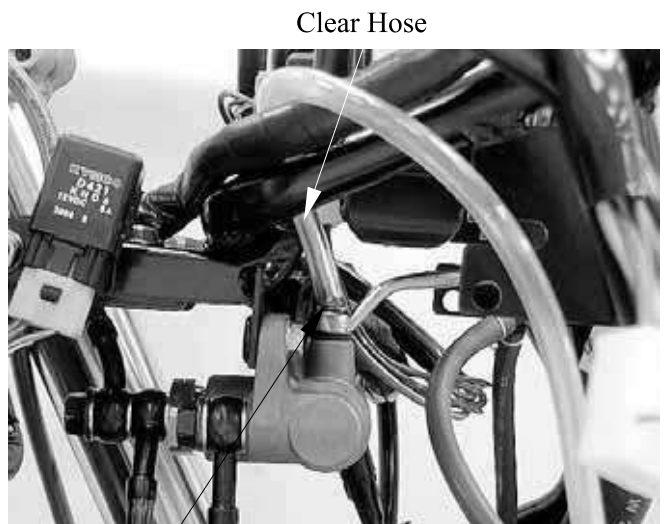

Relay Valve Air Bleed Screw

Step 2:

Connect a clear hose to the right front caliper air bleed screw. The right brake fluid replacement is the same way as that of the step 1.

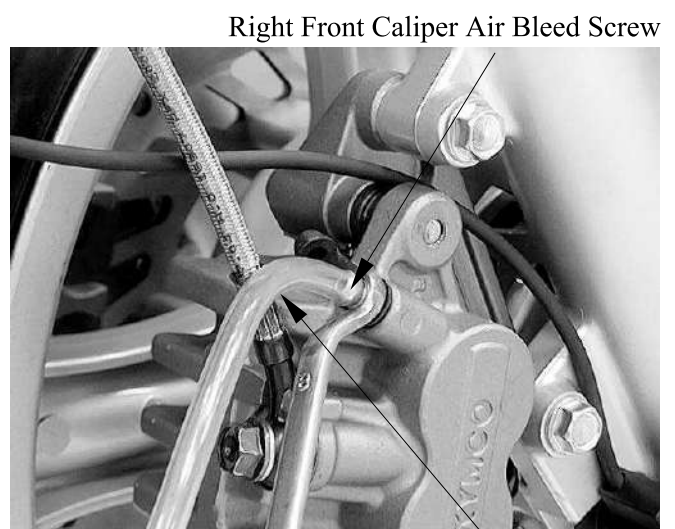

Clear Hose

17. BRAKE SYSTEM

XCITING 500/500 AFI/250/300 AFI

Step 3:

Connect a clear hose to the rear caliper air bleed screw. The rear brake fluid replacement is the same way as that of the step 1.

Rear Caliper Air Bleed Screw

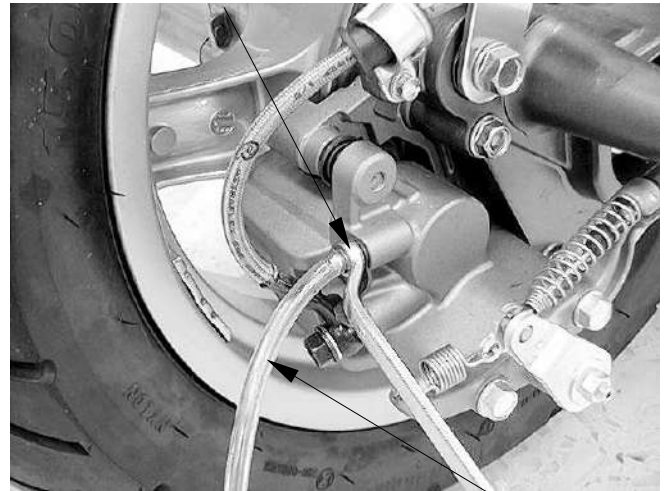

Clear Hose

BLEEDING THE HYDRAULIC BRAKE SYSTEM

Bleed the brake fluid circuit:

- The system has been disassembled.
- A brake hose or brake pipe have been loosened or removed.
- The brake fluid has been very low.
- The brake operation has been faulty.

A loss of braking performance may occur if the brake system is not properly bled.

Air bleeding steps (Front brake):

1. Add the proper brake fluid to the reservoir.
2. Install the diaphragm. Be careful not to spill any fluid or allow the reservoir to overflow.
3. Connect the clear plastic hose tightly to the left front caliper air bleed screw.
4. Place the other end of the hose into a container.
5. Slowly apply the brake lever several times.
6. Pull the lever in and hold it.
7. Loosen the bleed screw and allow the lever to travel towards its limit.

Clear Hose

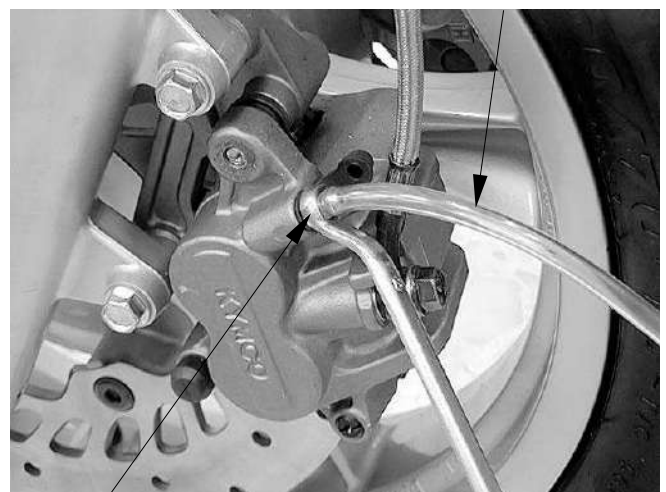

Left Front Caliper Air Bleed Screw

17. BRAKE SYSTEM

8. Tighten the bleed screw when the lever limit has been reached, then release the lever.
9. Repeat steps (5) to (7) until all the air bubbles have disappeared from the fluid.
10. Tighten the bleed screw.

Torque: 6 N•m (0.6 kgf•m, 4.3 lbf•ft)

If bleeding is difficult, it may be necessary to let the brake fluid settle for a few hours.

Repeat the bleeding procedure when the tiny bubbles in the system have disappeared.

12. Add brake fluid to the proper level and install the master cylinder reservoir cap and diaphragm.

Check the operation of the brake after bleeding the brake system.

Air bleeding steps (combination brake):

The combination brake system air bleeding is the same manner as that of the front brake one.

Bleed the air from the rear side (rear caliper) and then the front side (right front caliper and delay valve).

Tighten the bleed screw.

Torque: 6 N•m (0.6 kgf•m, 4.3 lbf•ft)

If bleeding is difficult, it may be necessary to let the brake fluid settle for a few hours.

Repeat the bleeding procedure when the tiny bubbles in the system have disappeared.

Rear Caliper Air Bleed Screw

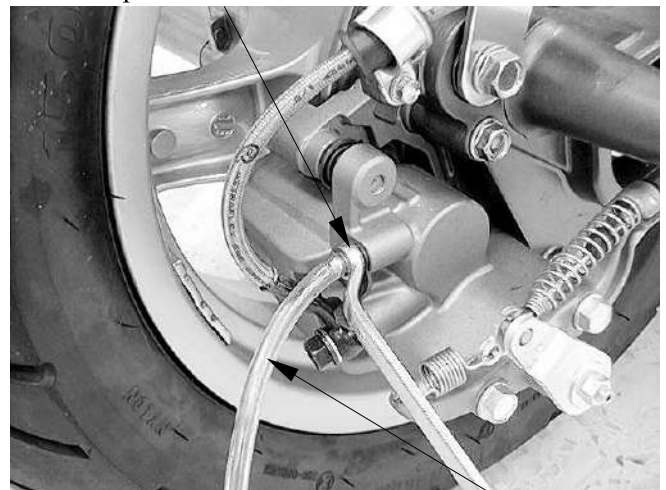

Clear Hose

17. BRAKE SYSTEM

Add brake fluid to the proper level.

Check the operation of the brake after bleeding the brake system.

Install the master cylinder reservoir cap and diaphragm.

Right Front Caliper Air Bleed Screw

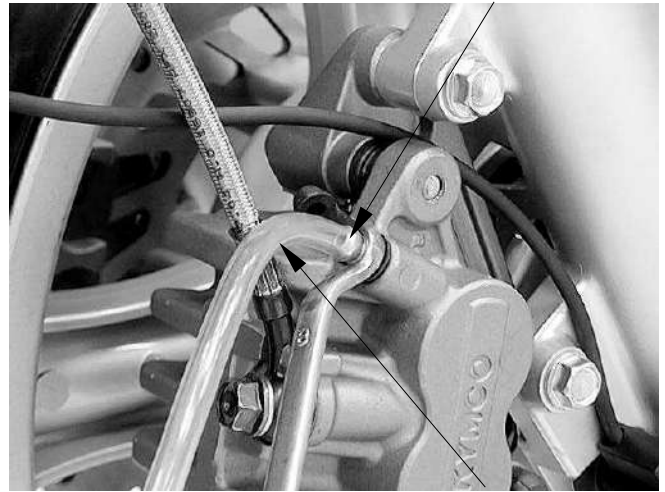

Clear Hose

Clear Hose



Relay Valve Air Bleed Screw

17. BRAKE SYSTEM

XCITING 500/500 AFI/250/300 AFI

BRAKE PAD

BRAKE PAD REPLACEMENT

Front brake:

Push the caliper pistons all the way in by pushing the caliper body inward to provide clearance for new pads.

Always replace the brake pads in pairs to ensure even disc pressure.



Caliper body

Remove the pad pin plug and loosen the pad pin.

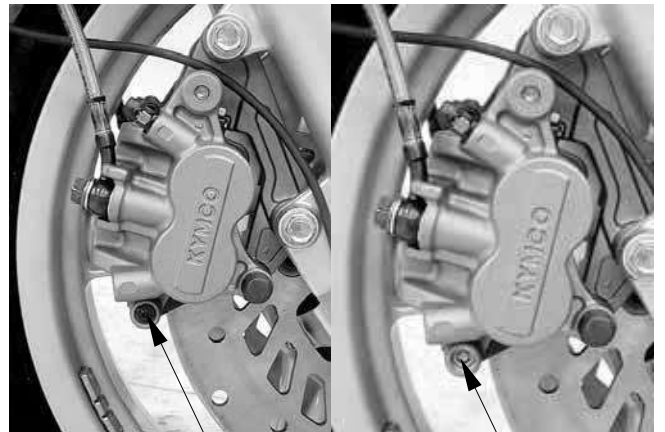

Pad Pin Plug

Pad Pin

Remove the pad pin and the brake pads.

Make sure that the pad spring is installed in original position.

Install new pads so that their ends rest on the pad retainer on the bracket properly.

Install the pad pin by pushing the pads against the pad spring to align the pad pin holes in the pads and caliper.

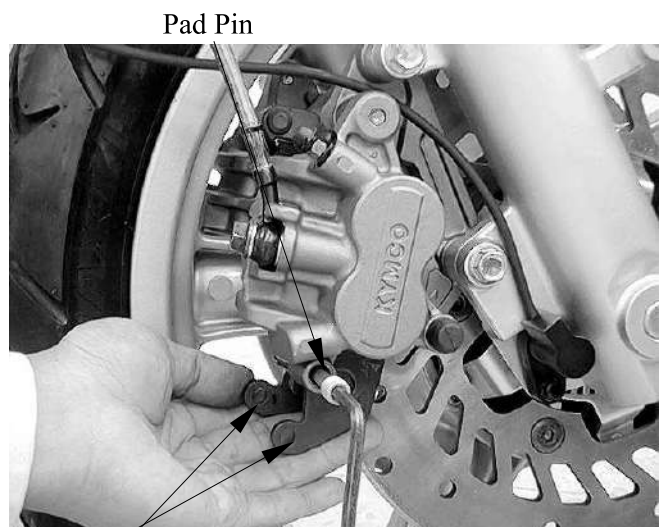

Brake Pads

17. BRAKE SYSTEM

XCITING 500/500 AFI/250/300 AFI

Tighten the pad pin to the specified torque.

Torque: 18 N•m (1.8 kgf•m, 13 lbf•ft)

Install the pad pin plug to the specified torque.

Torque: 3 N•m (0.3 kgf•m, 2.2 lbf•ft)

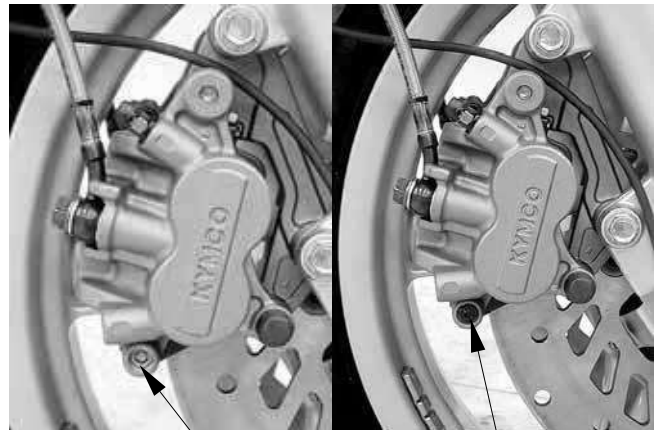

Pad Pin

Pad Pin Plug

Rear/Parking brake (XCITING 500/500 AFI):

Remove the pad pin plug and loosen the pad pin.

Always replace the brake pads in pairs to ensure even disc pressure.

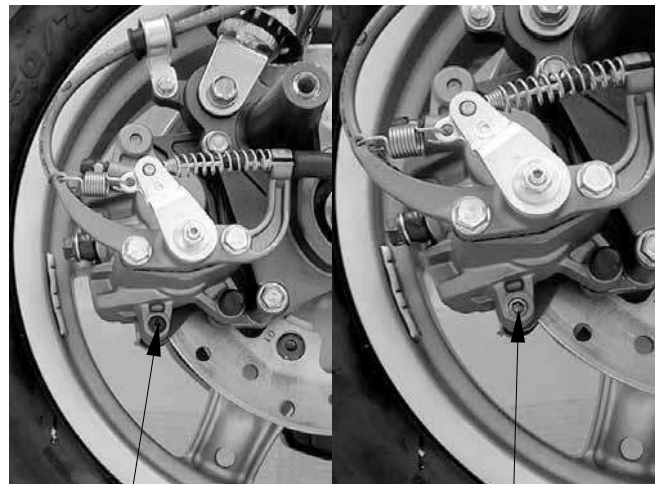

Pad Pin Plug

Pad Pin

Remove the mount bolts and rear/parking brake caliper from the rear fork.

Remove the pad pin and brake pads.

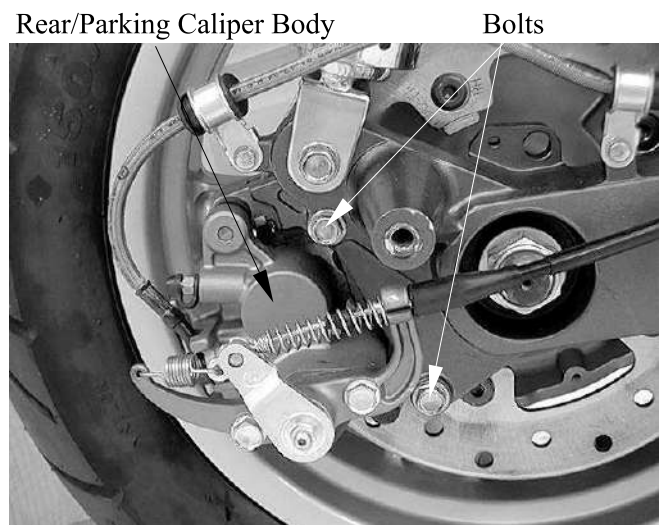

Rear/Parking Caliper Body

Bolts

17. BRAKE SYSTEM

XCITING 500/500 AFI/250/300 AFI

Installation steps:

Turn the parking brake caliper piston clockwise and push it into the parking brake caliper.

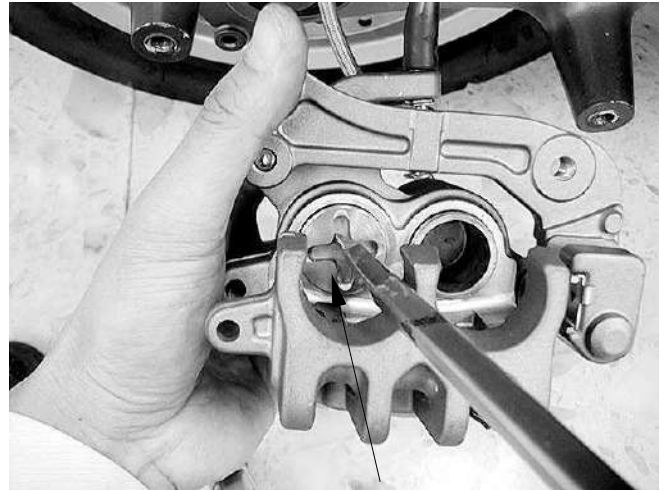

Parking Brake Caliper Piston

Install the pad pin by pushing the pads against the pad spring to align the pad pin holes in the pads and caliper.

Align the pin on the pad with the groove on the parking brake caliper piston.

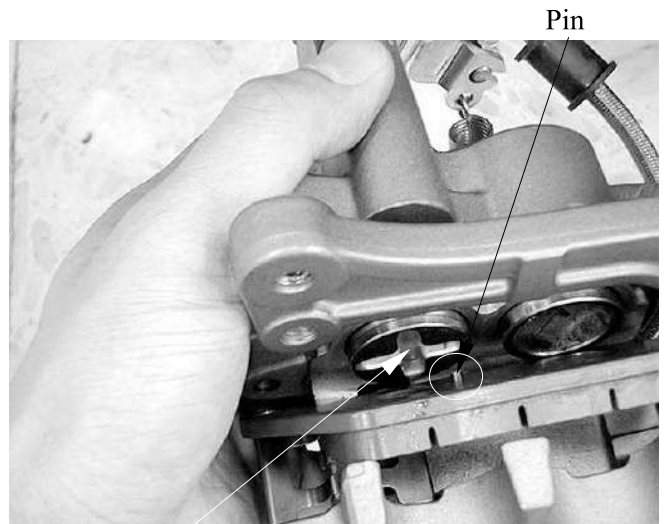

Groove

Install the rear/parking brake caliper to the rear fork.

Install and tighten the new rear/parking brake caliper mounting bolts to the specified torque.

Torque: 32 N•m (3.2 kgf•m, 23 lbf•ft)

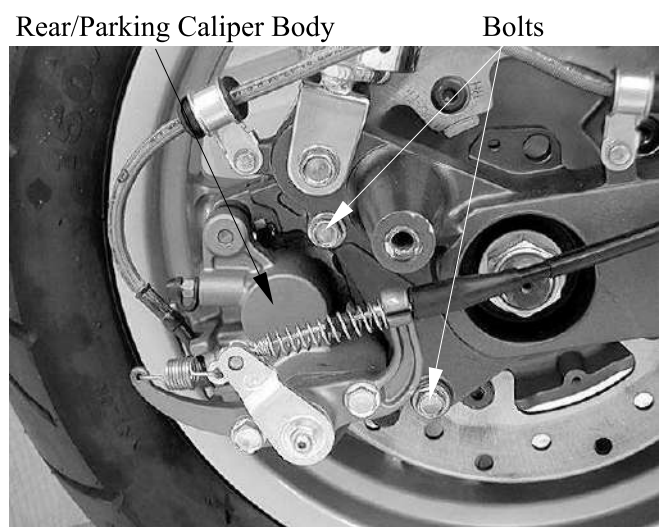

17. BRAKE SYSTEM

XCITING 500/500 AFI/250/300 AFI

Tighten the pad pin to the specified torque.

Torque: 18 N•m (1.8 kgf•m, 13 lbf•ft)

Install the pad pin plug to the specified torque.

Torque: 3 N•m (0.3 kgf•m, 2.2 lbf•ft)

Rear brake (XCITING 250/250 AFI):

The rear brake pads and front brake pads replacement are all the same.

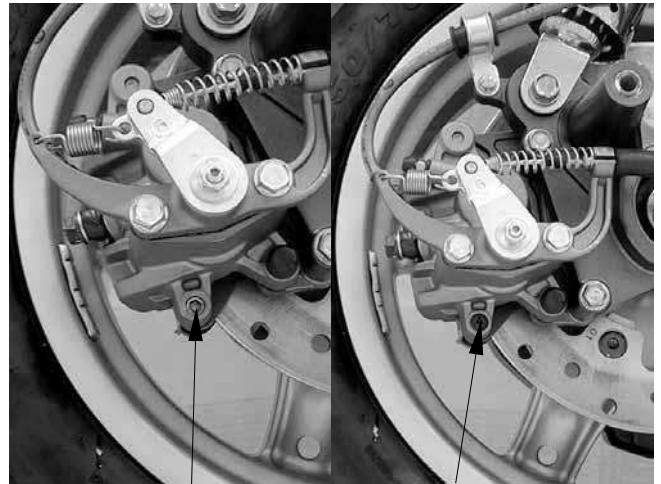

Pad Pin

Pad Pin Plug

BRAKE DISC INSPECTION

Visually inspect the brake disc for damage or cracks.

Measure the brake disc thickness.

Service limits: Front: 4mm (0.16 in)

Rear: 4mm (0.16 in)

Replace the brake disc if the smallest measurement is less than the service limit.

Measure the brake disc warpage.

Service limits: 0.3 mm (0.012 in)



17. BRAKE SYSTEM

XCITING 500/500 AFI/250/300 AFI

FRONT MASTER CYLINDER REMOVAL

When removing the brake hose bolt, cover the end of the hose to prevent contamination. Secure the hose to prevent fluid from leaking out.

Remove the upper handlebar cover (page 2-5).

Drain the front brake hydraulic system (page 17-4).

Remove the two screws and lower handlebar cover.

Disconnect the brake light connectors from front master cylinder.

Remove the brake hose oil bolt, sealing washers and brake hose eyelet.

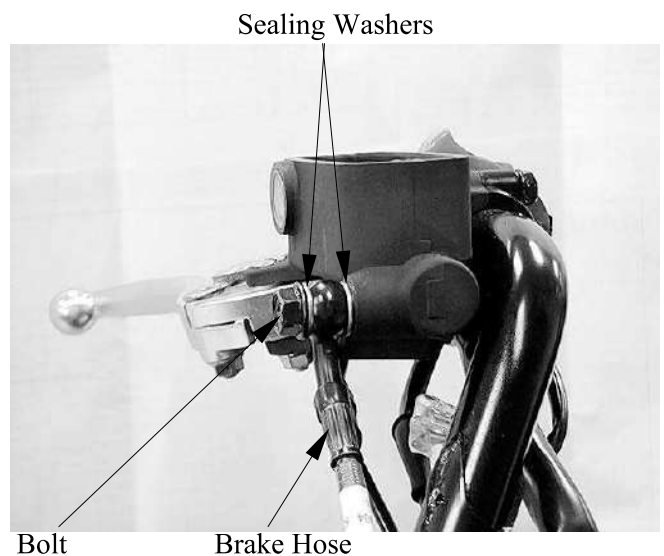
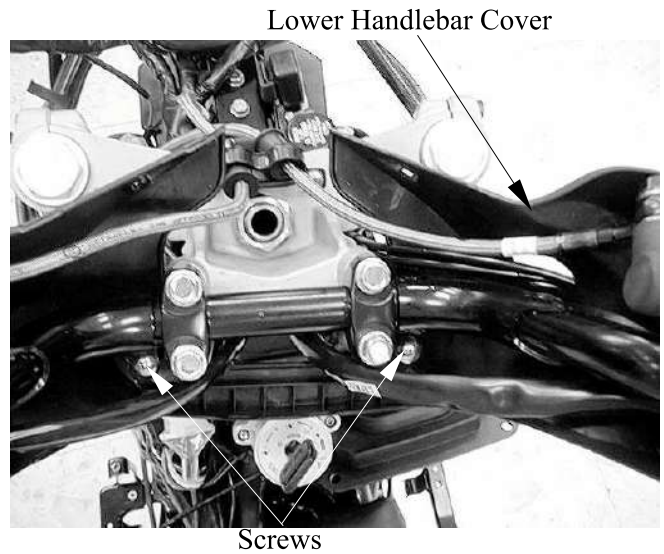

17. BRAKE SYSTEM

XCITING 500/500 AFI/250/300 AFI

Remove the bolts from the master cylinder holder and remove the master cylinder assembly.

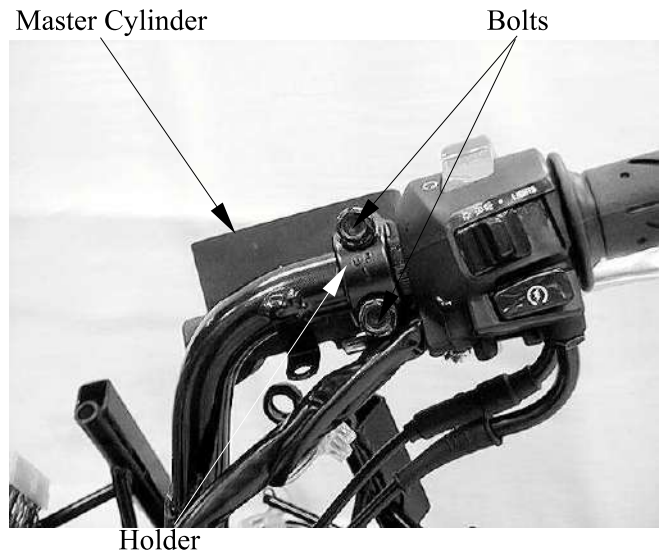

DISASSEMBLY

Remove the brake lever pivot bolt and nut.
Remove the brake lever.

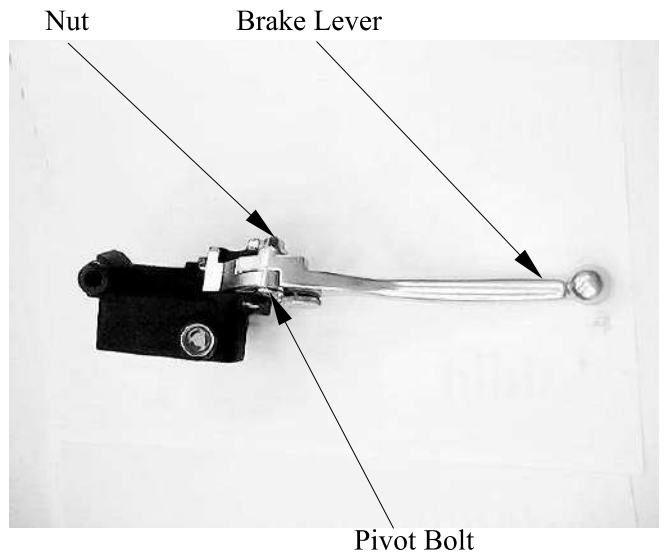

Remove the screw and brake light switch.

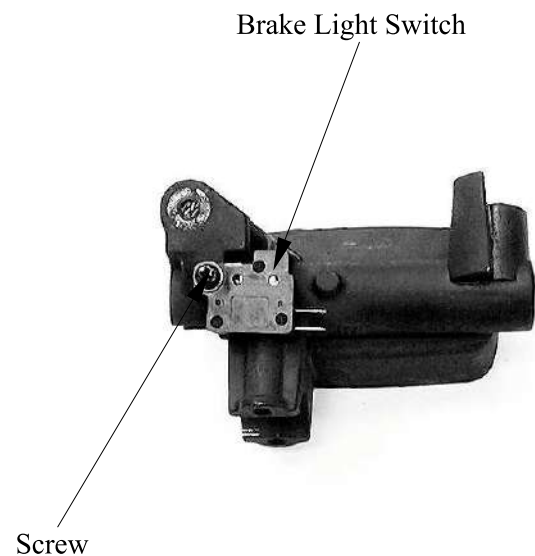

17. BRAKE SYSTEM

XCITING 500/500 AFI/250/300 AFI

ASSEMBLY

Install the brake light switch and tighten the screw to the specified torque.

Torque: 1 N•m (0.1 kgf•m, 0.7 lbf•ft)

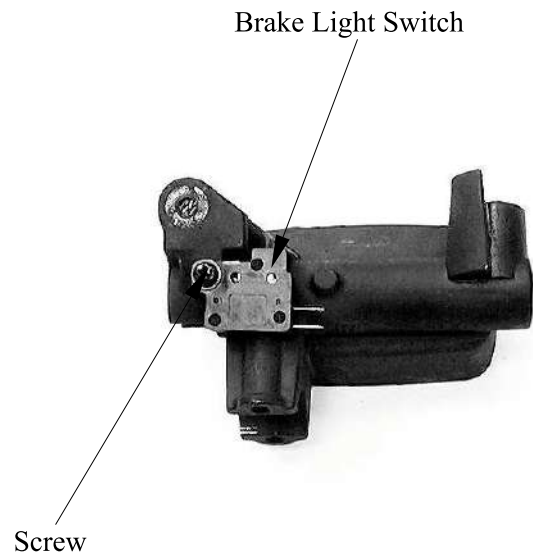

Apply silicone grease to the master piston tip. Install the brake lever.

Apply silicone grease to the brake lever pivot bolt sliding surface.

Install and tighten the pivot bolt to the specified torque.

Torque: 2 N•m (0.2 kgf•m, 1.4 lbf•ft)

Install and tighten the pivot nut to the specified torque.

Torque: 10 N•m (1 kgf•m, 7.2 lbf•ft)

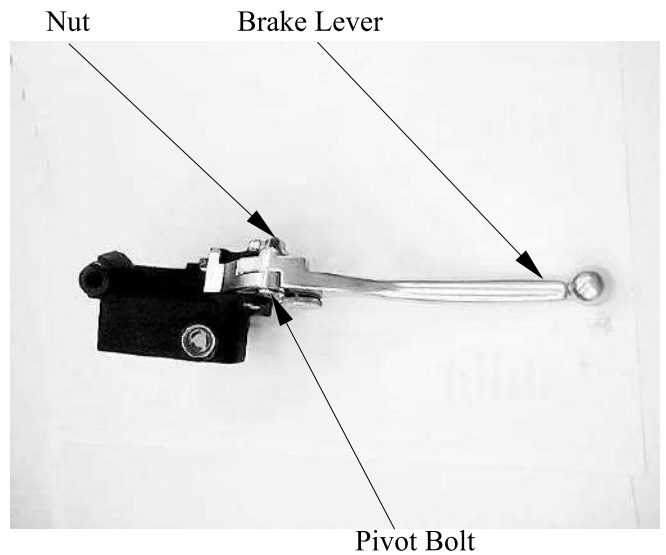

INSTALLATION

Align the pin on the master cylinder holder with the hole on the handlebar.

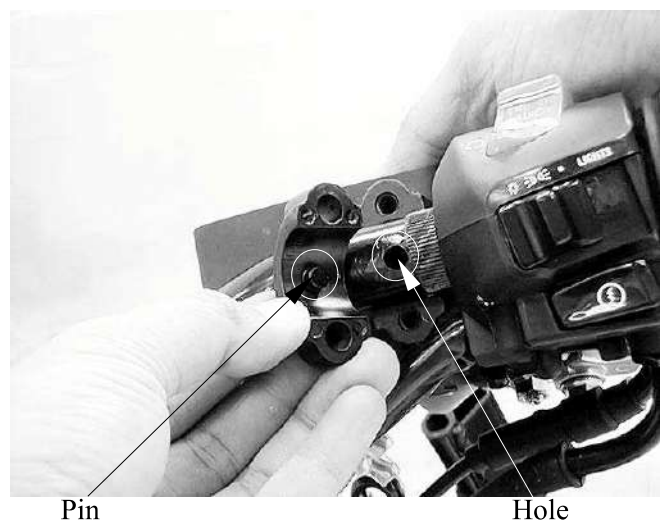

17. BRAKE SYSTEM

XCITING 500/500 AFI/250/300 AFI

Install the front master cylinders and holders with the “UP” mark facing up.

Install the bolts and tighten the upper bolt first then tighten the lower bolt to the specified torque.

Torque: 12 N•m (1.2 kgf•m, 9 lbf•ft)

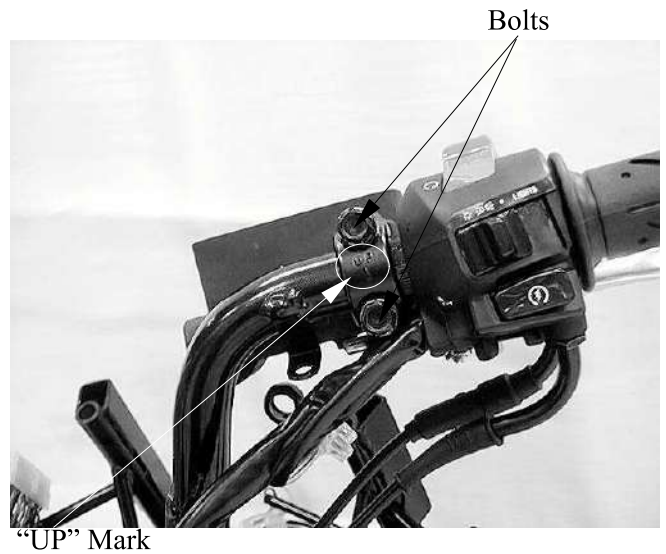

Rest the brake hose eyelet against the stopper.

Install the brake hose eyelet with the oil bolt and new sealing washers.

Tighten the oil bolt to the specified torque.

Torque: 35 N•m (3.5 kgf•m, 25 lbf•ft)

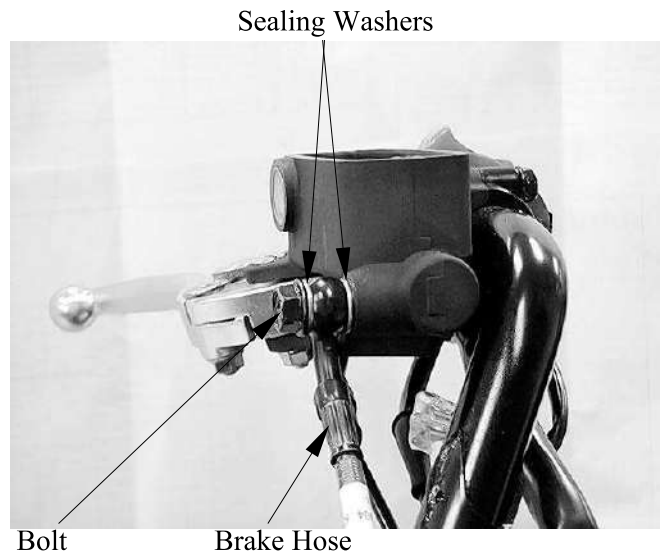

Connect the brake light switch connectors.

Fill the reservoir to the upper level and bleed the brake system (page 17-7).



17. BRAKE SYSTEM

REAR MASTER CYLINDER REMOVAL

When removing the brake hose bolt, cover the end of the hose to prevent contamination. Secure the hose to prevent fluid from leaking out.

Remove the upper handlebar cover (page 2-5).

Drain the combination brake hydraulic system (page 17-5).

Remove the two screws and lower handlebar cover.

Disconnect the brake light switch connectors from master cylinder.

Remove the brake hose oil bolt, sealing washers and brake hose eyelet.

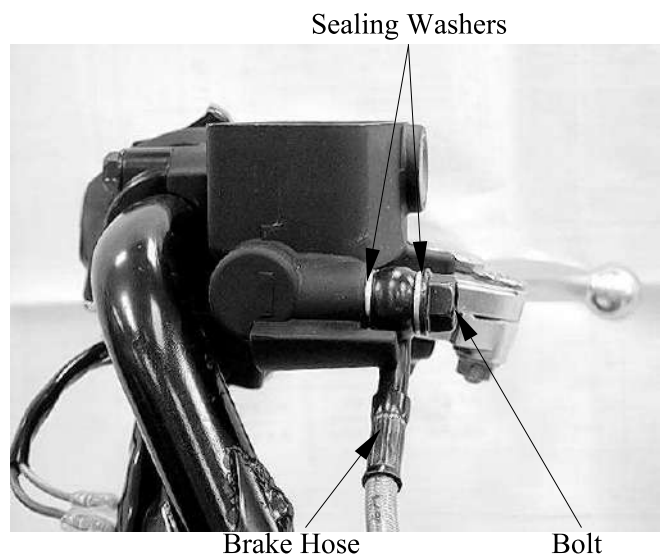
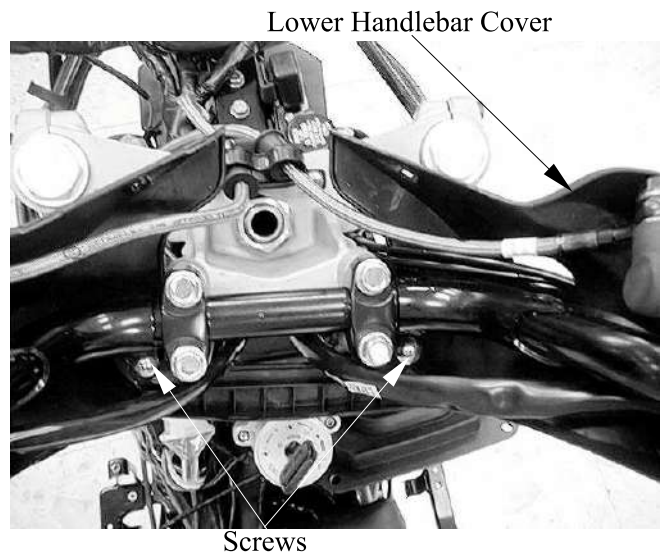

17. BRAKE SYSTEM

XCITING 500/500 AFI/250/300 AFI

Remove the bolts from the master cylinder holder and remove the master cylinder assembly.

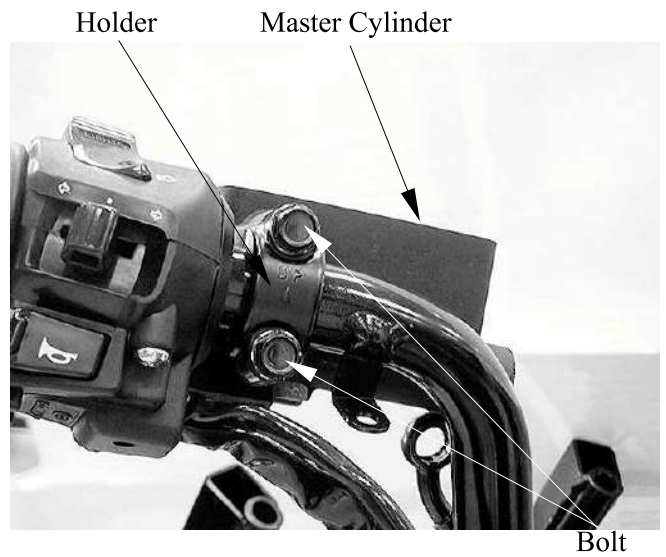

DISASSEMBLY

Remove the brake lever pivot bolt and nut.
Remove the brake lever.

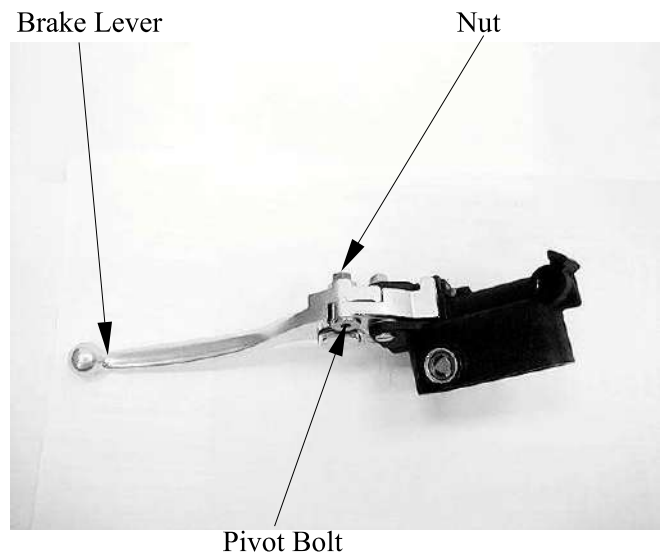

Remove the screw and brake light switch.

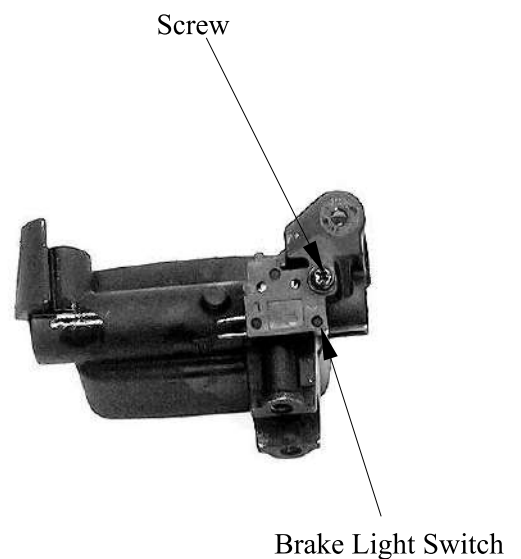

17. BRAKE SYSTEM

XCITING 500/500 AFI/250/300 AFI

ASSEMBLY

Install the brake light switch and tighten the screw to the specified torque.

Torque: 1 N•m (0.1 kgf•m, 0.7 lbf•ft)

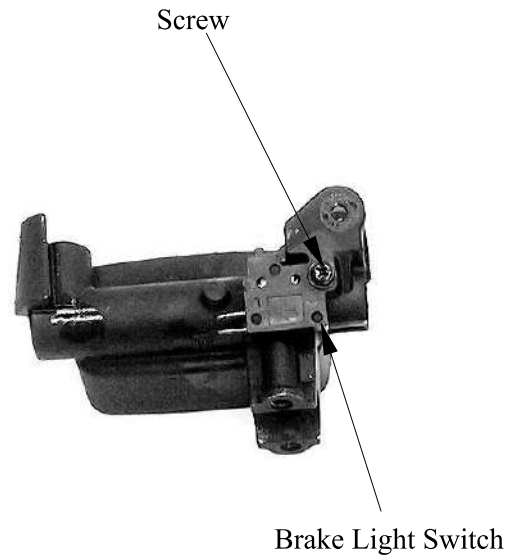

Apply silicone grease to the master piston tip.
Install the brake lever.

Apply silicone grease to the brake lever pivot bolt sliding surface.

Install and tighten the pivot bolt to the specified torque.

Torque: 2 N•m (0.2 kgf•m, 1.4 lbf•ft)

Install and tighten the pivot nut to the specified torque.

Torque: 10 N•m (1 kgf•m, 7.2 lbf•ft)

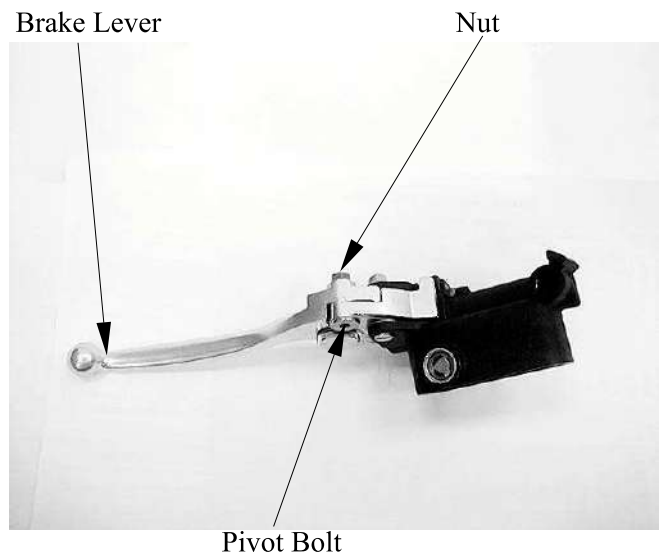

INSTALLATION

Align the pin on the master cylinder holder with the hole on the handlebar.

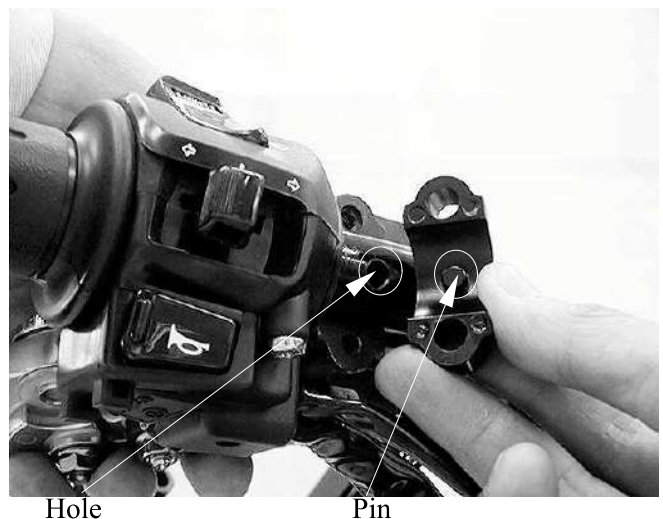

17. BRAKE SYSTEM

Install the rear master cylinders and holders with the “UP” mark facing up.

Install the bolts and tighten the upper bolt first then tighten the lower bolt to the specified torque.

Torque: 12 N•m (1.2 kgf•m, 9 lbf•ft)

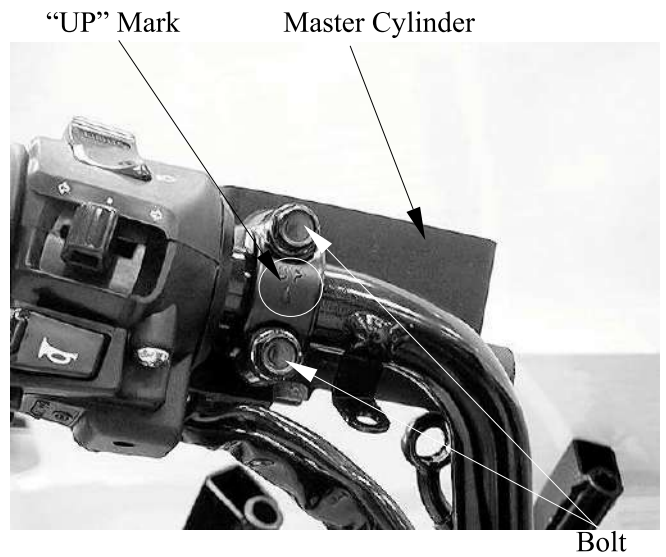

Rest the brake hose eyelet against the stopper.

Install the brake hose eyelet with the oil bolt and new sealing washers.

Tighten the oil bolt to the specified torque.

Torque: 35 N•m (3.5 kgf•m, 25 lbf•ft)

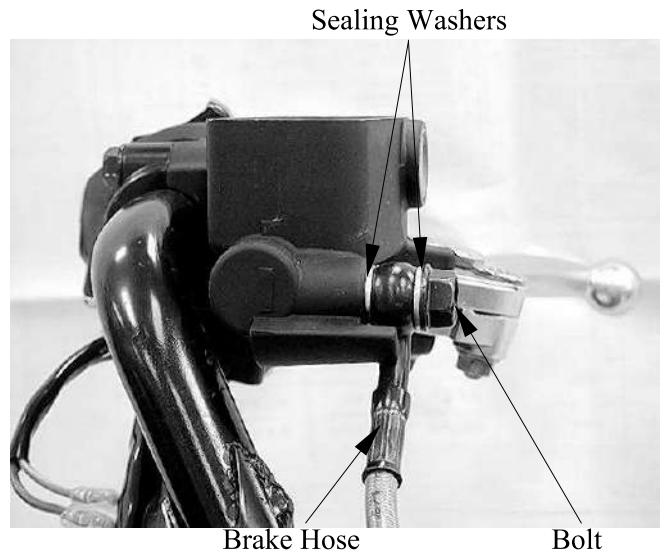

Connect the brake light switch connectors.

Fill the reservoir to the upper level and bleed the brake system (page 17-8).



17. BRAKE SYSTEM

DELAY VALVE

REMOVAL

When removing the brake hose bolt, cover the end of the hose to prevent contamination. Secure the hose to prevent fluid from leaking out.

Remove the front cover (page 2-11).
 Drain the combination brake hydraulic system (page 17-5).

Remove the brake hose oil bolt, sealing washers and brake hose eyelets.

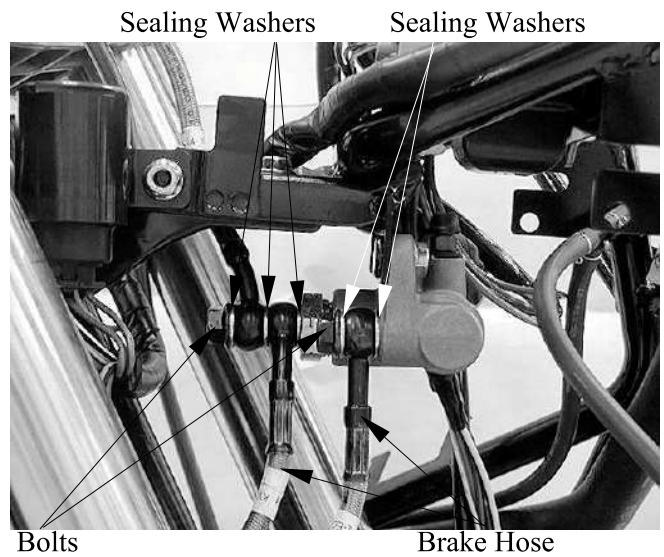

Remove the two nuts and delay valve.

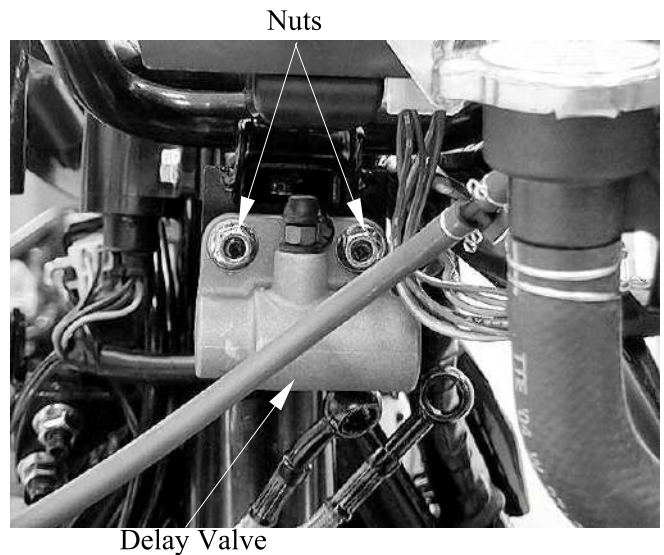

17. BRAKE SYSTEM

XCITING 500/500 AFI/250/300 AFI

INSTALLATION

Install the delay valve and tighten the nuts securely.

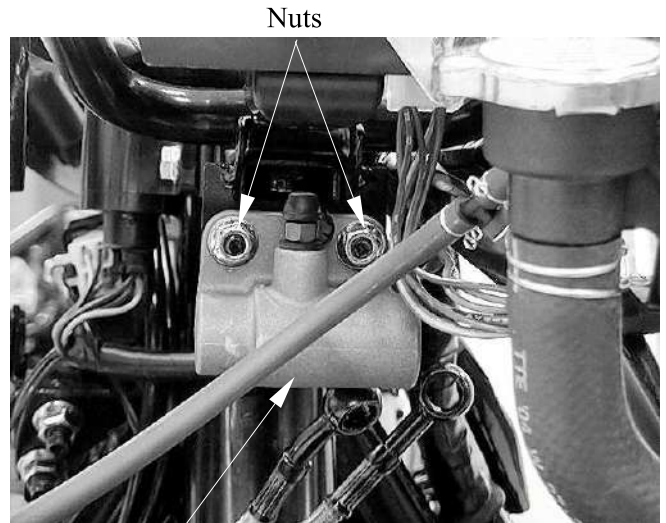

Nuts

Delay Valve

Install the brake hose eyelets and new sealing washers.

Tighten the brake hose bolt to the specified torque while rest the brake hose eyelet against the stopper on the delay valve.

Torque: 35 N•m (3.5 kgf•m, 25 lbf•ft)

Fill the reservoir to the upper level and bleed the brake system (page 17-8).

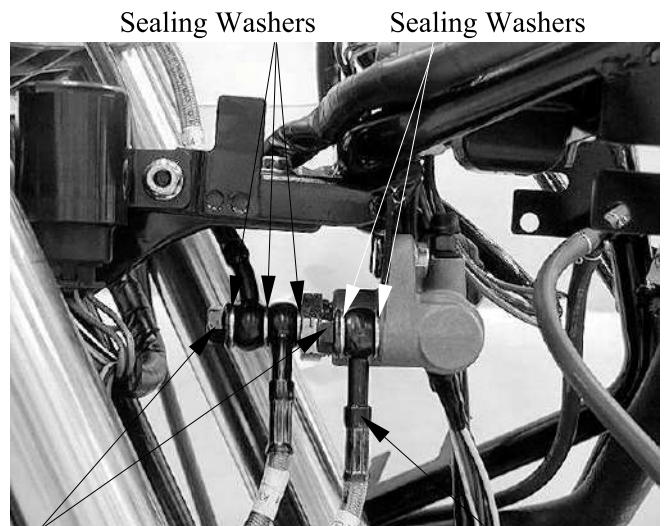

Sealing Washers

Sealing Washers

Bolts

Brake Hose

17. BRAKE SYSTEM

FRONT BRAKE CALIPER

REMOVAL

Drain the front brake hydraulic system (left front brake caliper: page 17-4) or combination brake hydraulic system (right front brake caliper: page 17-5).

Remove the brake pads (page 17-10).

Remove the oil bolts, sealing washers and brake hose from the brake caliper.

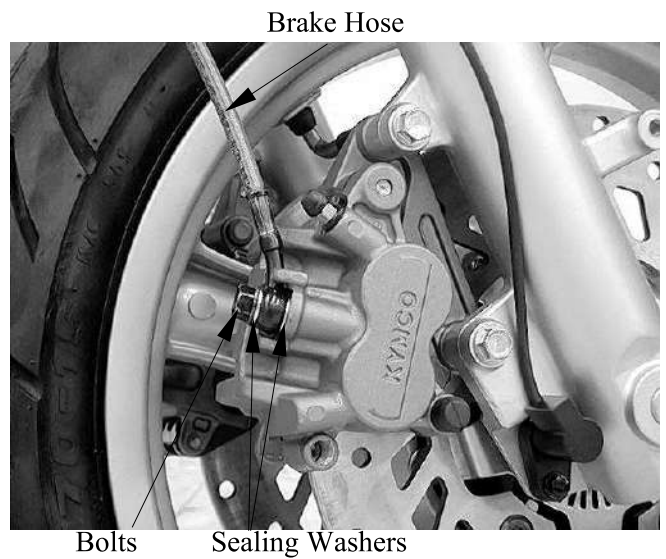

Remove the mount bolts and front brake caliper.

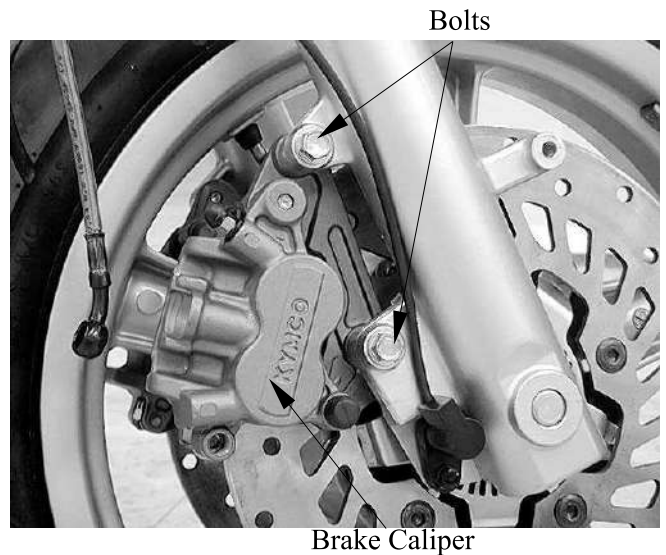

DISASSEMBLY

Remove pad spring from the caliper body.

Do not remove the retainer from the bracket unless replacement.

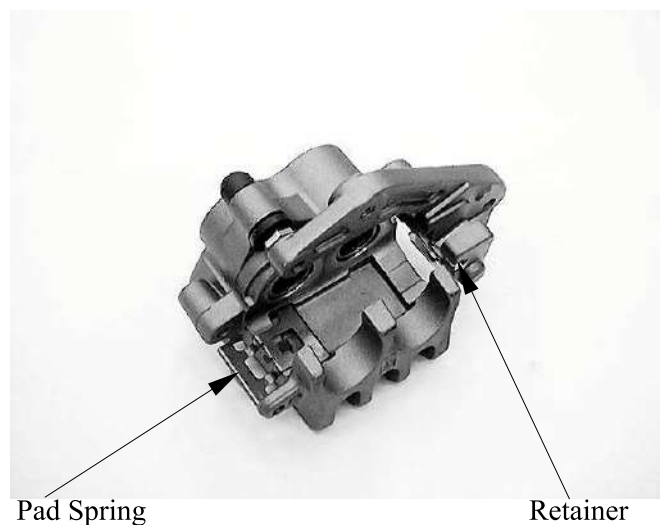

17. BRAKE SYSTEM

XCITING 500/500 AFI/250/300 AFI

Remove the caliper bracket from the caliper body.

Do not remove the caliper and bracket pins unless replacement.

ASSEMBLY

Apply silicone grease to the boots inside.
Install the caliper bracket to the caliper.

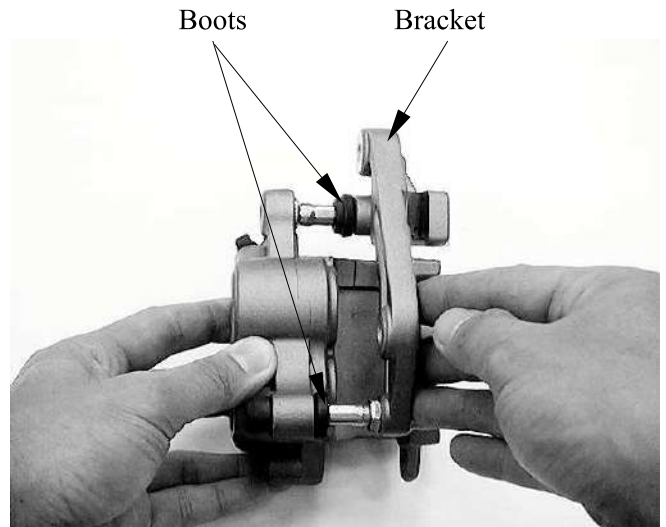

Install the pad spring into the caliper body as shown.

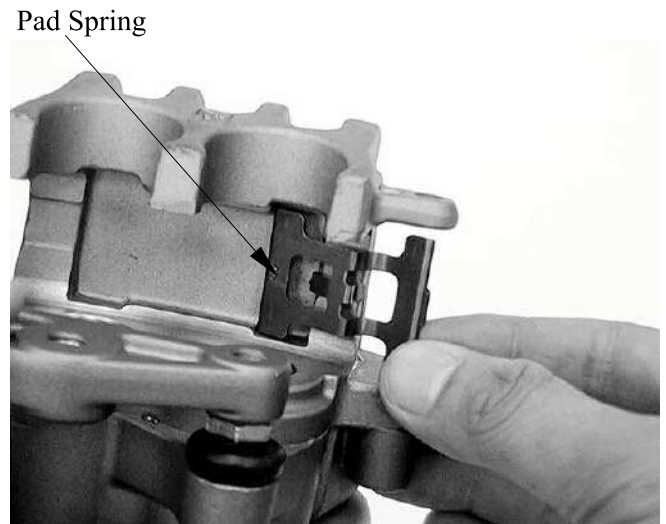

INSTALLATION

Install the front caliper onto the fork leg.
Install and tighten the new front caliper mount bolts to the specified torque.

Torque: 32 N•m (3.2 kgf•m, 23 lbf•ft)

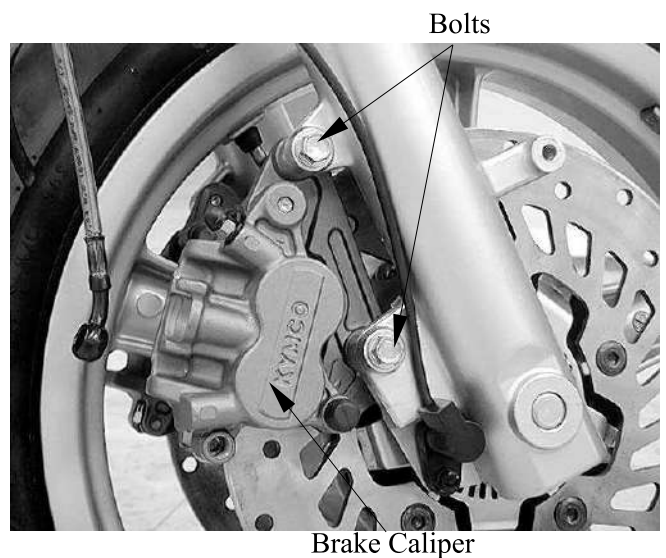

17. BRAKE SYSTEM

XCITING 500/500 AFI/250/300 AFI

Install the brake hose eyelet to the caliper body with new sealing washers and oil bolts. Push the brake hose eyelet to the stopper on the caliper, then tighten the oil bolts to the specified torque.

Torque: 35 N•m (3.5 kgf•m, 25 lbf•ft)

Install the brake pads (page 17-10).
Fill and bleed the hydraulic system (page 17-7 or page 17-8).

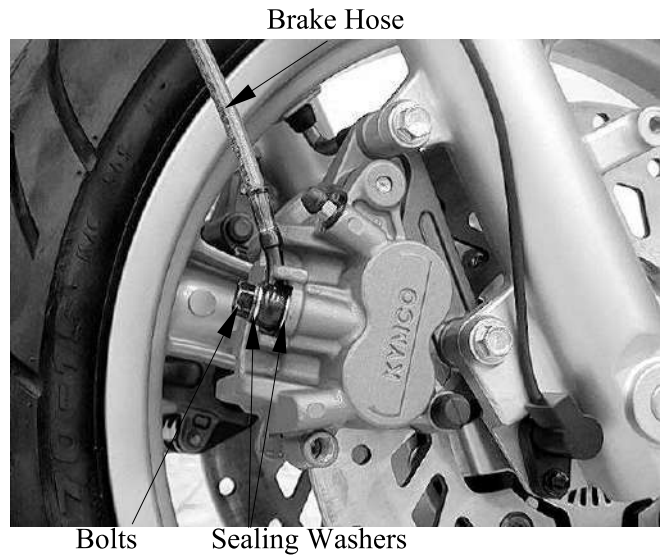

REAR/PARKING BRAKE CALIPER

REMOVAL (XCITING 500/500 AFI)

Remove the muffler (page 2-16).
Drain the rear brake hydraulic system (page 17-5).

Disconnect the parking brake cable from the brake arm.

Remove the pad pin plug and loosen the pad pin.

Remove the brake pad (XCITING 500/500 AFI: page 17-11, XCITING 250/250 AFI: page 17-13).

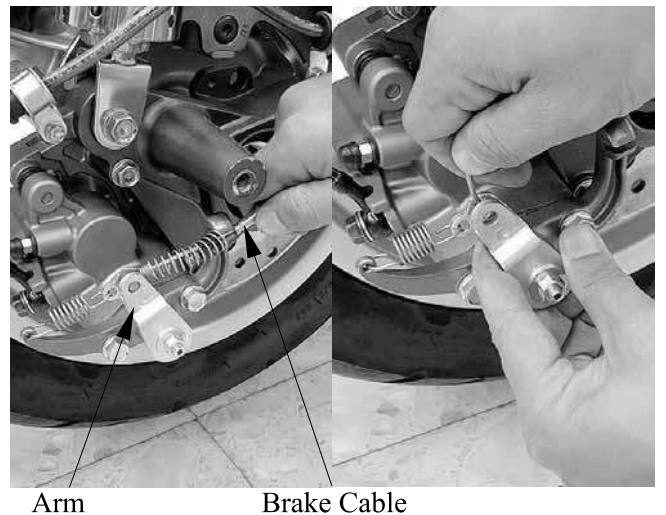

Remove the oil bolt, sealing washers and brake hose from the brake caliper.

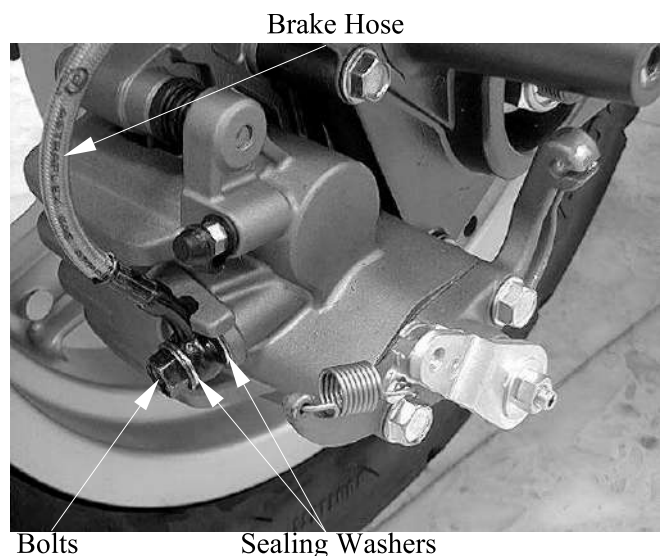

17. BRAKE SYSTEM

XCITING 500/500 AFI/250/300 AFI

Remove the mount bolts and rear/parking brake caliper from the rear fork.

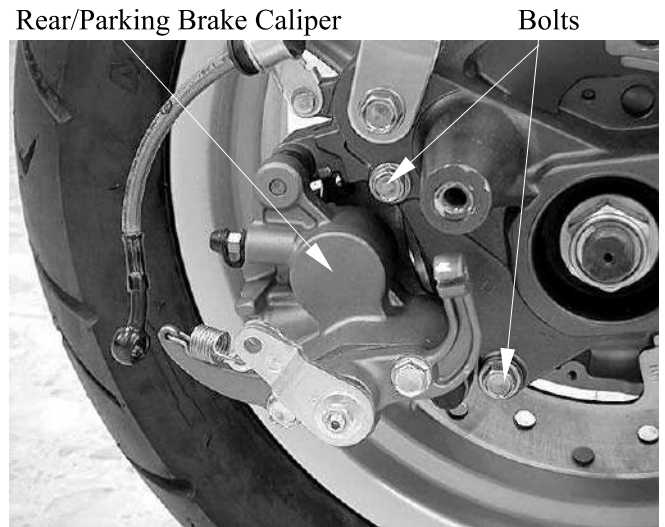

DISASSEMBLY (XCITING 500/500 AFI)

Remove the pad spring from the caliper body.

Do not remove the retainer from the bracket unless replacement.

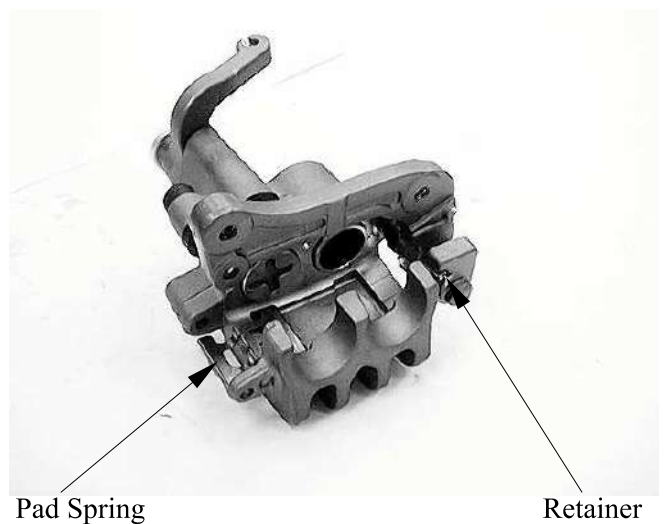

Remove the caliper bracket from the caliper body.

Do not remove the caliper and bracket pins unless replacement.

ASSEMBLY (XCITING 500/500 AFI)

Apply silicone grease to the boot inside.
Apply silicone grease to the boot inside.
Install the caliper bracket to the caliper.

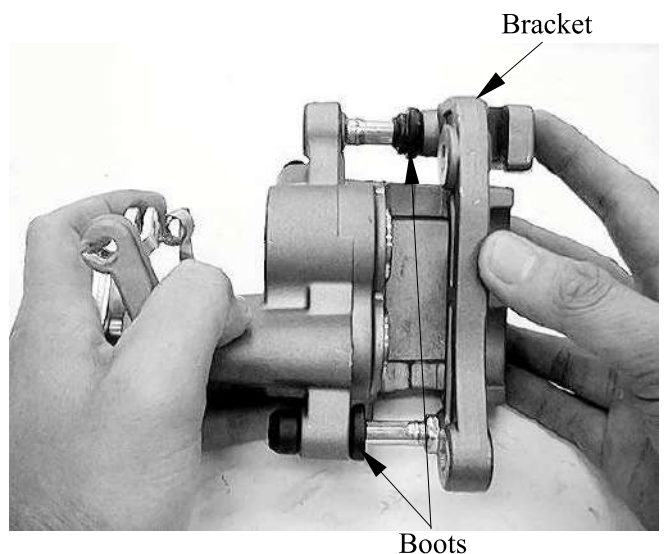

17. BRAKE SYSTEM

XCITING 500/500 AFI/250/300 AFI

Install the pad spring into the caliper body as shown.

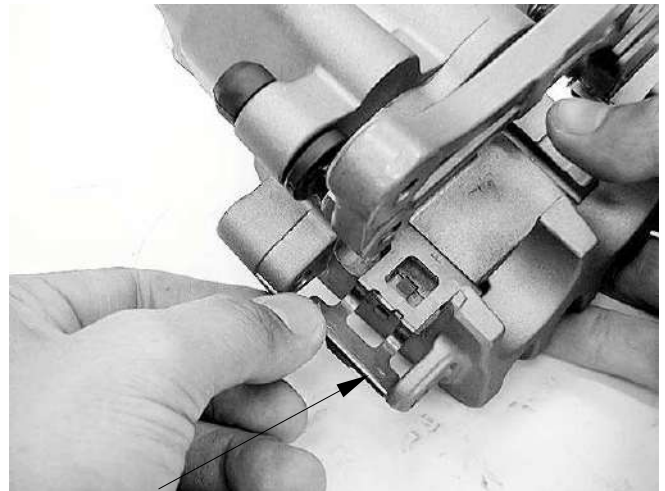

Pad Spring

PARKING BRAKE DISASSEMBLY (XCITING 500/500 AFI)

Remove the lock nut and parking brake arm.

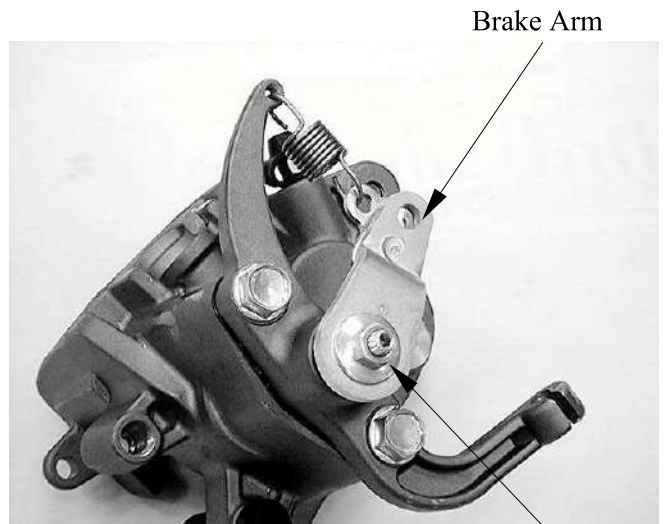

Brake Arm

Lock Nut

Remove the parking brake shaft and push rod.

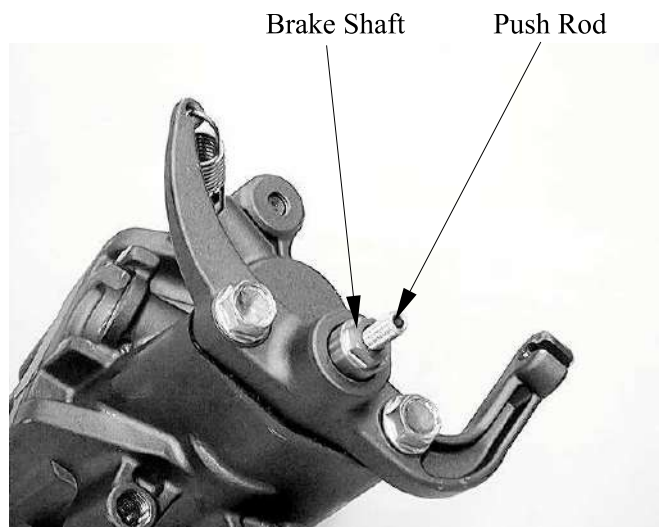

Brake Shaft

Push Rod

17. BRAKE SYSTEM

XCITING 500/500 AFI/250/300 AFI

Removed the two bolts, gasket and parking brake bracket.

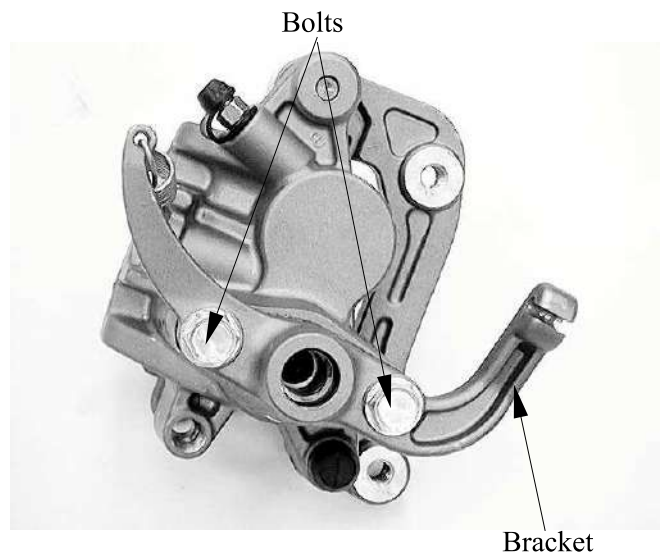

PARKING BRAKE ASSEMBLY (XCITING 500/500 AFI)

Install the gasket.

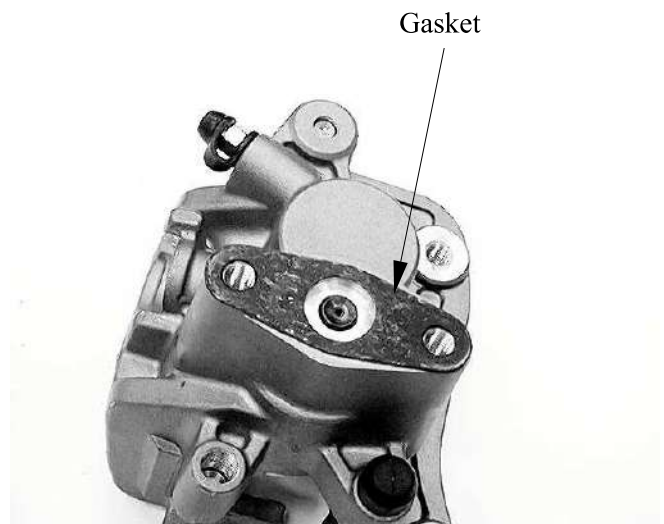

Install the parking brake bracket and tighten the bolts to the specified torque.

Torque: 32 N•m (3.2 kgf•m, 23 lbf•ft)

Apply silicone grease to the parking brake shaft rolling surface.

Install the parking brake shaft.

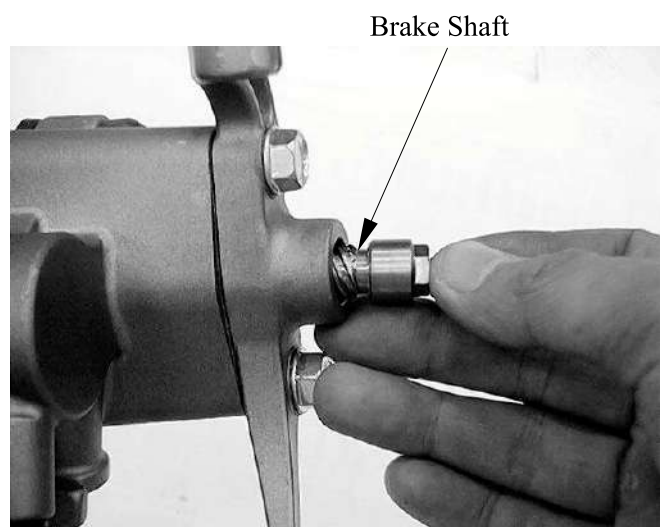

17. BRAKE SYSTEM

XCITING 500/500 AFI/250/300 AFI

Temporarily install the brake arm and the lock nut.

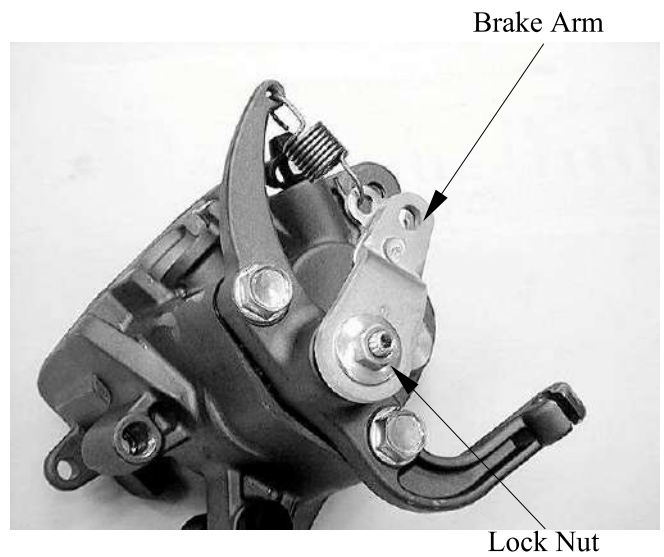

INSTALLATION (XCITING 500/500 AFI)

Install the brake pads (page 17-12).

Install the rear/parking brake caliper to the rear fork and tighten the new mount bolts to specified torque.

Torque: 32 N•m (3.2 kgf•m, 23 lbf•ft)



Install the brake hose eyelet to the caliper body with new sealing washers and oil bolts. Push the brake hose eyelet to the stopper on the caliper, then tighten the oil bolts to the specified torque.

Torque: 35 N•m (3.5 kgf•m, 25 lbf•ft)

Fill and bleed the hydraulic system (page 17-8).

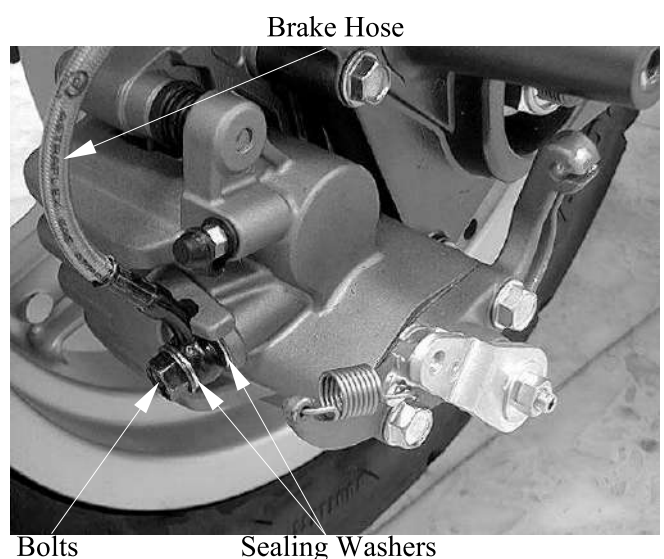

17. BRAKE SYSTEM

XCITING 500/500 AFI/250/300 AFI

Connect the parking brake cable.

Adjust the parking brake (page 3- 26).

REMOVAL/INSTALLATION/ DISASSEMBLY/ASSEMBLY (XCITING 250/250 AFI)

The rear caliper and front caliper
removal/installation/disassembly/assembly
are all the same.

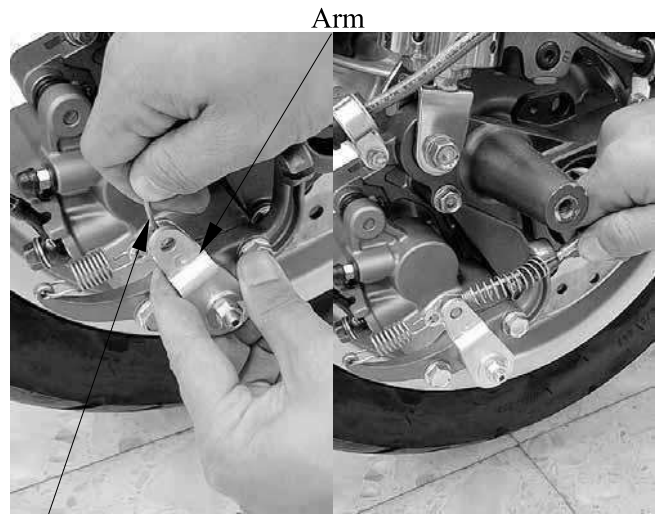

Brake Cable

PARKING BRAKE LEVER LINK (XCITING 500/500 AFI)

REMOVAL

Remove the inner cover (page 2-14).

Loosen the lock nut and disconnect the
parking brake cable from the parking braking
lever link.

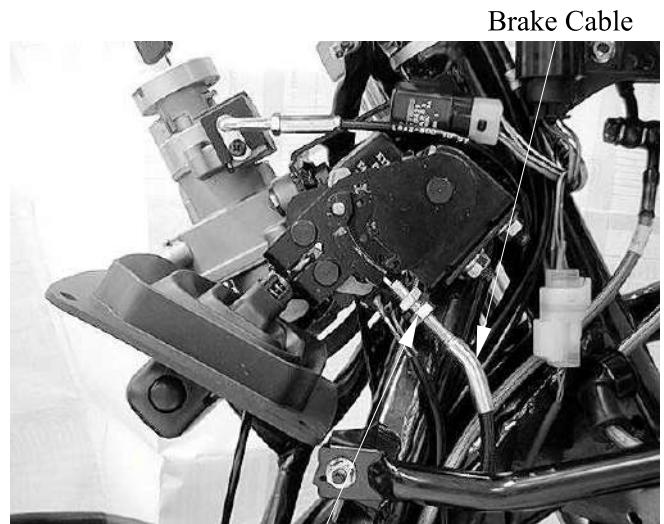

Lock Nut

Disconnect the parking brake switch
connector.

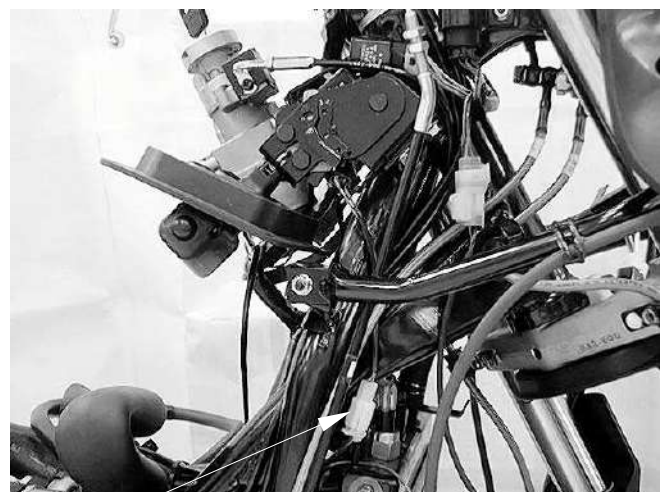

Parking Brake Switch Connector

17. BRAKE SYSTEM

XCITING 500/500 AFI/250/300 AFI

Remove the two nuts and parking brake lever link.



DISASSEMBLY

Remove the two screws and parking brake switch.

ASSEMBLY

Assembly is in the reverse order of disassembly.

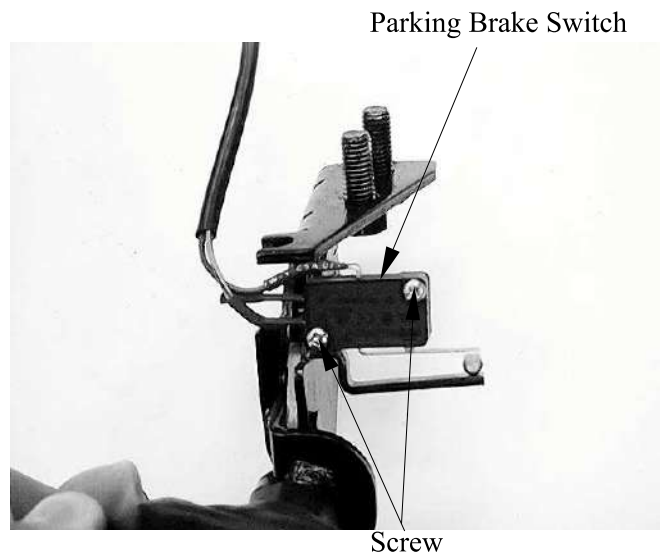

INSTALLATION

Installation is in the reverse order of removal.

18. BATTERY/CHARGING SYSTEM

XCITING 500/500 AFI/250/300 AFI

BATTERY/CHARGING SYSTEM

CHARGING SYSTEM LAYOUT -----	18-1
SERVICE INFORMATION-----	18-2
TROUBLESHOOTING-----	18-4
BATTERY -----	18-5
CHARGING SYSTEM INSPECTION -----	18-6
ALTERNATOR CHARGING COIL-----	18-7
REGULATOR/RECTIFIER-----	18-8

18. BATTERY/CHARGING SYSTEM

XCITING 500/500 AFI/250/300 AFI

CHARGING SYSTEM LAYOUT

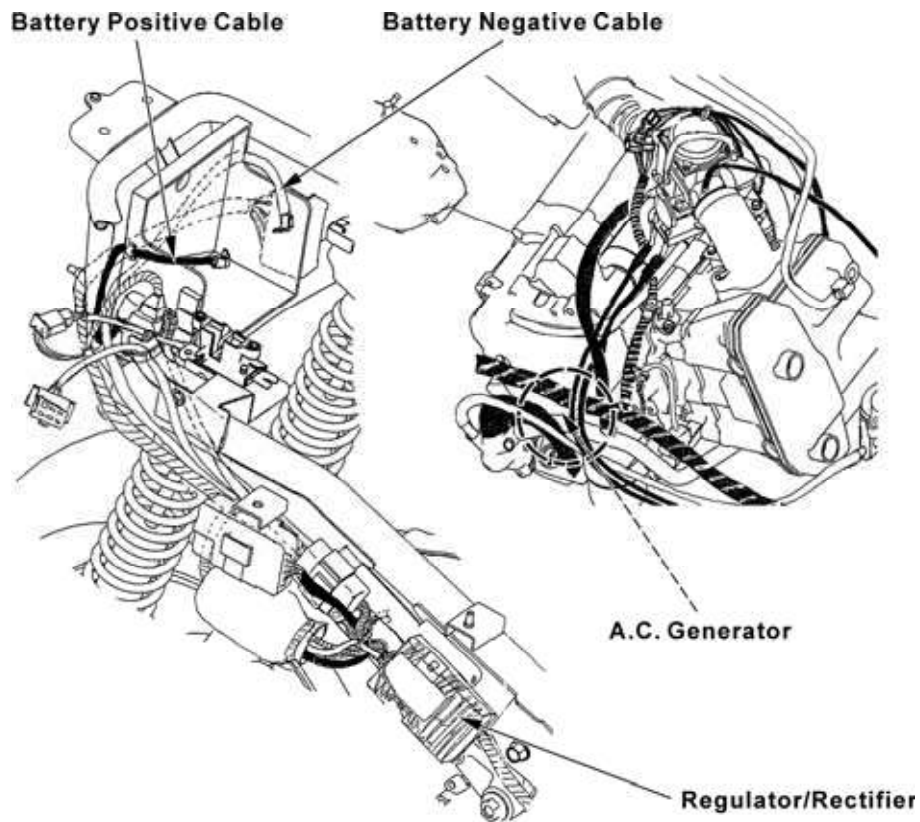

CHARGING CIRCUIT

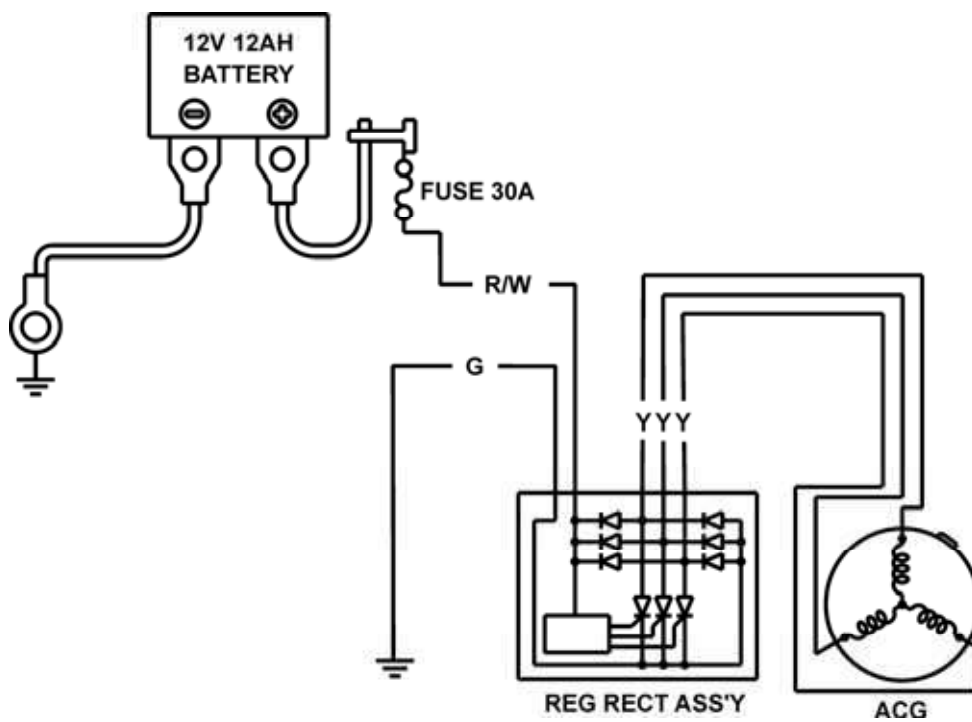

18. BATTERY/CHARGING SYSTEM

XCITING 500/500 AFI/250/300 AFI

SERVICE INFORMATION

GENERAL

CAUTION

- The battery gives off explosive gases; keep sparks, flames and cigarettes away. Provide adequate ventilation when charging.
- The battery contains sulfuric acid (electrolyte). Contact with skin or eyes may cause severe burns. Wear protective clothing and a face shield.
 - If electrolyte gets on your skin, flush with water.
 - If electrolyte gets in your eyes, flush with water for at least 15 minutes and call a physician immediately.
- Electrolyte is poisonous.
 - If swallowed, drink large quantities of water or milk and call your local Poison Control Center or physician immediately, **KEEP OUT OF REACH OF CHILDREN.**

- Always turn off the ignition switch before disconnecting any electrical component.
- Some electrical components may be damaged if terminals or connectors are connected or disconnected while the ignition switch is turned to “ON” and current is present.
- For extended storage, remove the battery, give it a full charge, and store it in a cool, dry place.
- For a battery remaining in a shorted vehicle, disconnect the negative battery cable from the battery.
- The battery caps should not be removed. Attempting to remove the sealing caps from the cells may damage the battery.
- The maintenance free battery must be replaced when it reaches the end of its service life.
- The battery can be damaged if overcharged or undercharged, or if left to discharge for long period. These same conditions contribute to shortening the “life span” of the battery. Even under normal use, the performance of the battery deteriorates after 2-3 years.
- Battery voltage may recover after battery charging, but under heavy load, the battery voltage will drop quickly and eventually die out. For this reason, the charging system is often suspected as the problem. Battery overcharge often results from problems in the battery itself, which may appear to be an overcharging symptom. If one of the battery cells is shorted and battery voltage does not increase, the regulator/rectifier supplies excess voltage to the battery. Under these conditions, the electrolyte level goes down quickly.
- Before troubleshooting the charging system, check for proper use and maintenance of the battery. Check if the battery is frequently under heavy load, such as having the headlight and taillight on for long periods of time without riding the vehicle.
- The battery self-discharge when the vehicle is not in use, for this reason, charge the battery every 2 weeks to prevent sulfate from occurring.
- Filling a new battery with electrolyte will produce some voltage, but in order to achieve its maximum performance, always charge the battery. Also, the battery life is lengthened when it is initially charged.
- When checking the charging system, always follow the steps in the troubleshooting flow chart (page 18-4)
- For alternator service, refer to chapter 13

18. BATTERY/CHARGING SYSTEM

XCITING 500/500 AFI/250/300 AFI

BATTERY CHARGING

- This model comes with a maintenance free (MF) battery. Remember the following about MF batteries.
 - Use only the electrolyte that comes with the battery.
 - Use all of the electrolyte
 - Seal the battery properly
 - Never open the seals again
- For battery charging, do not exceed the charging current and time specified on the battery. Using excessive current or extending the charging time may damage the battery.

SPECIFICATIONS

ITEM		SPECIFICATIONS	
Battery	Capacity	XCITING 500	12V – 12 Ah
		XCITING 500 AFI	12V – 12 Ah
		XCITING 250	12V – 10 Ah
		XCITING 250 AFI	12V – 10 Ah
	Current leakage		0.5 Ma max.
	Voltage (20°C/68°F)	Full charged	13.0 – 13.2 V
		Needs charging	Below 12.3 V
Charging current	Normal	1.4 A/5 – 10 h	
	Quick	5.5 A/0.5 h	
Alternator	Capacity	240 W/5000 rpm	
	Charging coil resistance (20°C/68°F)		0.1 – 0.5Ω

18. BATTERY/CHARGING SYSTEM

XCITING 500/500 AFI/250/300 AFI

TROUBLESHOOTING

Battery is damaged or weak

Remove the battery.
Check the battery condition.

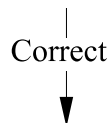

Install the battery.
Check the battery current leakage.

Specified current leakage: 0.5 Ma max

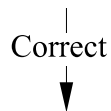

Check the alternator charging coil.

Standard: 0.1 – 0.5 Ω (20°C/68°F)

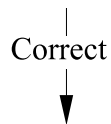

Measure and record the battery voltage using a digital multimeter.
Start the engine.
Measure the charging voltage.
Compare the measurements to result of the following calculation.

Measured voltage < measured charging voltage < 15.5 V

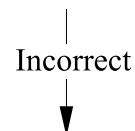

Perform the regulator/rectifier wire harness inspection.

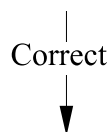

•Faulty regulator/rectifier

— Incorrect —▶ •Faulty battery

— Incorrect —▶ Disconnect the regulator/rectifier connectors and recheck the battery current leakage.

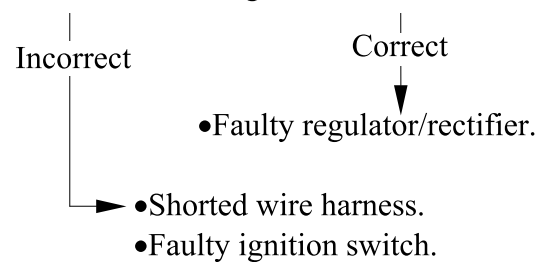

— Incorrect —▶ •Faulty charging coil.

— Correct —▶ •Faulty battery.

— Incorrect —▶ •Open circuit in related wire.
•Loose or poor contacts of related terminal.
•Shorted wire harness

18. BATTERY/CHARGING SYSTEM

XCITING 500/500 AFI/250/300 AFI

BATTERY

REMOVAL/INSTALLATION

Unlock and open the seat (page 2-3).
Turn ignition switch OFF.
Remove the screws and battery box cover.

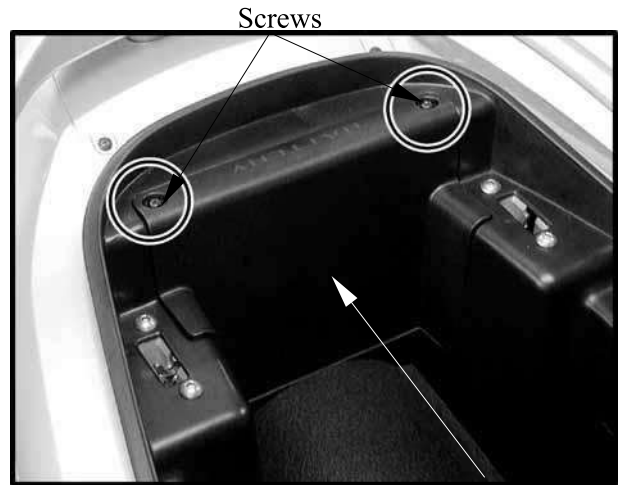

Battery Box Cover

Remove the battery retainer.
With the ignition switch to "OFF" disconnect the negative (-) terminal lead from the battery first, then disconnect the positive (+) terminal lead.
Pull out the battery from the battery box.

Installation is in the reverse order of removal.

After connecting the battery cables, coat the terminals with grease.

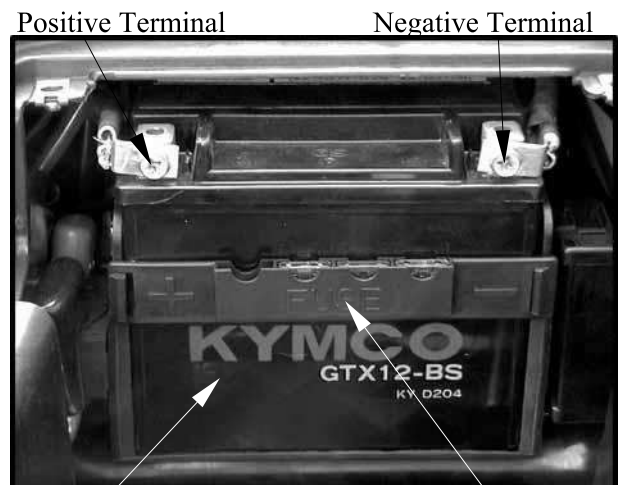

Battery

Battery Retainer

VOLTAGE INSPECTION

Remove the battery cover (see above).

Measure the battery voltage using a commercially available digital multimeter.

Voltage (20°C/68°C):

Fully charged: 13.0 13.2 V

Under charged: below 12.3 V

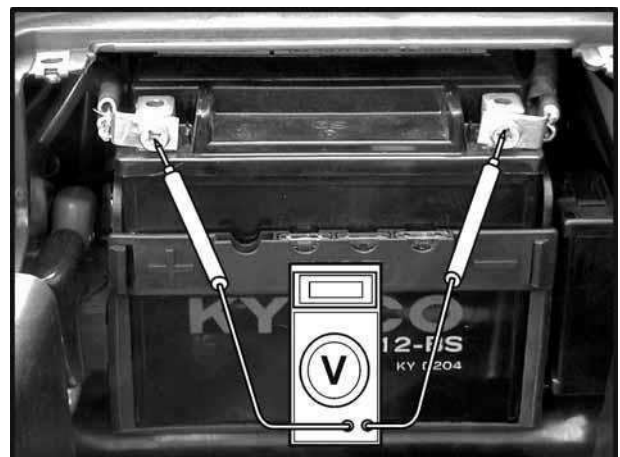

18. BATTERY/CHARGING SYSTEM

XCITING 500/500 AFI/250/300AFI

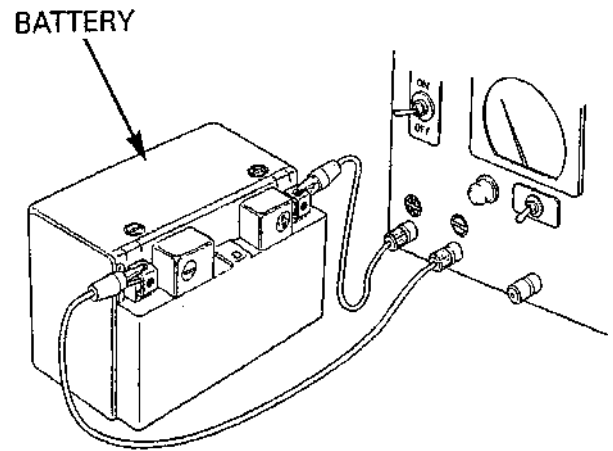

18. BATTERY/CHARGING SYSTEM

XCITING 500/500 AFI/250/300 AFI

CHARGING VOLTAGE INSPECTION

Be sure that the battery is in good condition before performing this test.

Do not disconnect the battery or any cable in the charging system without first switching off the ignition switch. Failure to follow this precaution can damage the tester or electrical components.

Start the engine and warm it up to the operating temperature; stop the engine. Connect the multimeter between the positive and negative terminals of the battery.



To prevent short, make absolutely certain which are the positive and negative terminals or cable.

With the headlight on and turned to the high beam position, restart the engine.

Measure the voltage on the multimeter when the engine runs at 5000 min⁻¹ (rpm).

Standard:

Measured battery voltage (page 18-5) <
Measure charging voltage (see above)
<15.5 V

ALTERNATOR CHARGING COIL INSPECTION

Remove the luggage box (page 2-3).

Disconnect the alternator connector.

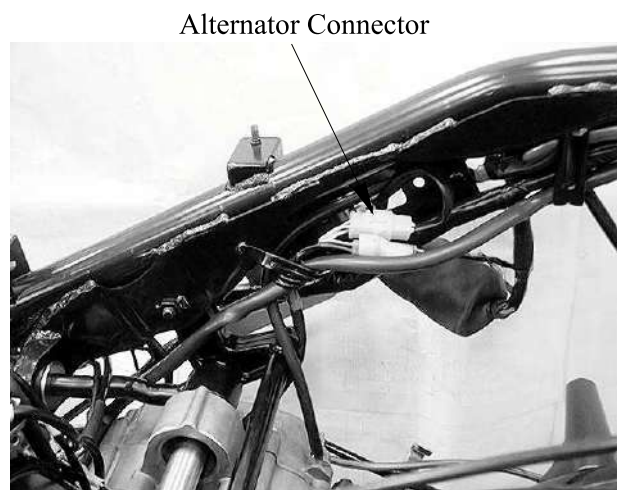

18. BATTERY/CHARGING SYSTEM

XCITING 500/500 AFI/250/300 AFI

Measure the resistance between each Yellow wire terminals.

Standard: 0.1 0.5 Ω (20°C/68°F)

Check for continuity between each Yellow wire terminal of the alternator side connector and ground.

There should be continuity.

Replace the alternator stator if resistance is out of specification, or if any wire has continuity to ground.

Refer to chapter 13 for alternator stator replacement.

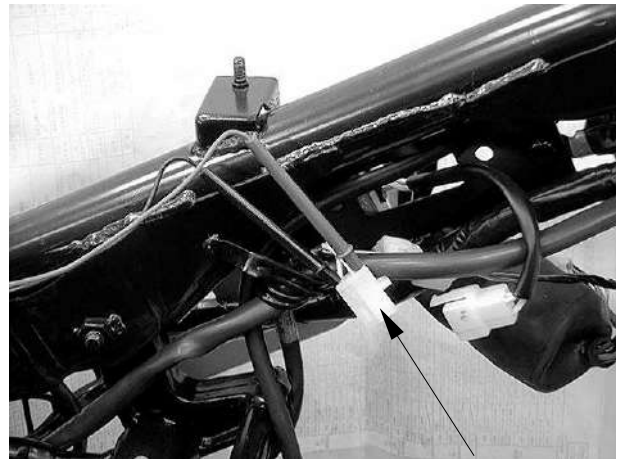

Alternator Connector

REGULATOR/RECTIFIER WIRE HARNESS INSPECTION

Remove the luggage box (page 2-3).

Disconnect the regulator/rectifier connectors. Check the connectors for loose contacts of corroded terminals.

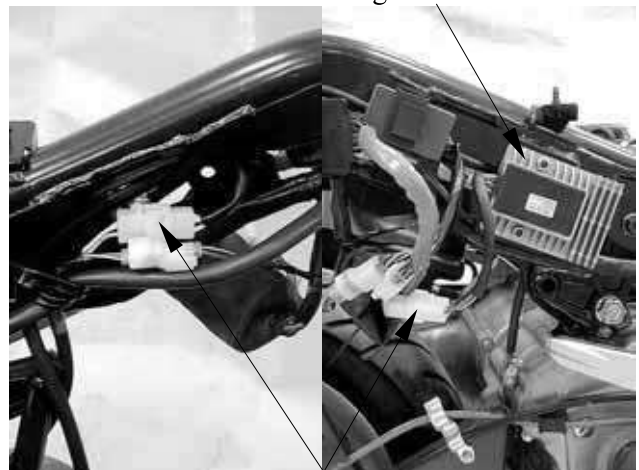

Regulator/Rectifier Connectors

Battery line

Measure the voltage between the Red/White wire terminal and ground.

There should be battery voltage at all times.



Regulator/Rectifier Connector

18. BATTERY/CHARGING SYSTEM

XCITING 500/500 AFI/250/300 AFI

Ground line

Check the continuity between the Green wire terminal and ground.

There should be continuity at all times.



Regulator/Rectifier Connector

Charging coil line

Measure the resistance between each Yellow wire terminals.

Standard: 0.1 - 0.5 Ω (20°C/68°F)



Regulator/Rectifier Connector

Regulator/Rectifier Connector

Check for continuity between each Yellow wire terminal and ground.

There should be no continuity.

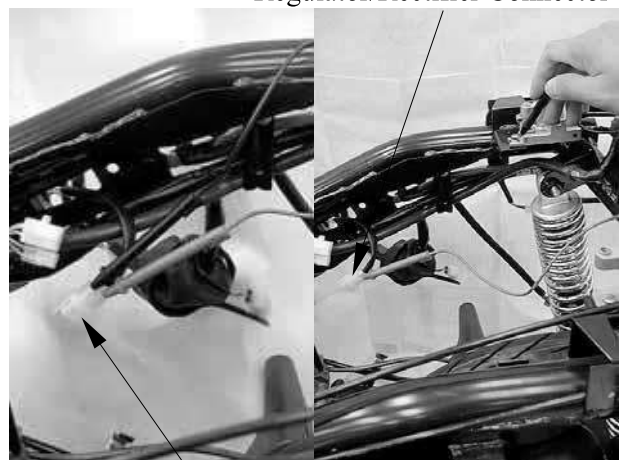

Regulator/Rectifier Connector

18. BATTERY/CHARGING SYSTEM

XCITING 500/500 AFI/250/300 AFI

REMOVAL/INSTALLATION

Remove the side body cover (page 2-8).

Disconnect the regulator/rectifier connectors.

Remove the two bolts, regulator/rectifier and stay.

Installation is in the reverse order of removal.

Regulator/Rectifier (XCITING 500/500 AFI)



Bolts

Regulator/Rectifier (XCITING 250/300 AFI)



Bolts

IGNITION SYSTEM

IGNITION SYSTEM LAYOUT-----	19-1
IGNITION CIRCUIT (XCITING 500) -----	19-2
IGNITION CIRCUIT (XCITING 500 AFI)-----	19-3
IGNITION CIRCUIT (XCITING 250) -----	19-4
IGNITION CIRCUIT (XCITING 300 AFI)-----	19-5
SERVICE INFORMATION-----	19-6
TROUBLESHOOTING-----	19-6
IGNITION COIL INSPECTION -----	19-7
IGNITION CONTROL MODULE (XCITING 500/250) -----	19-8

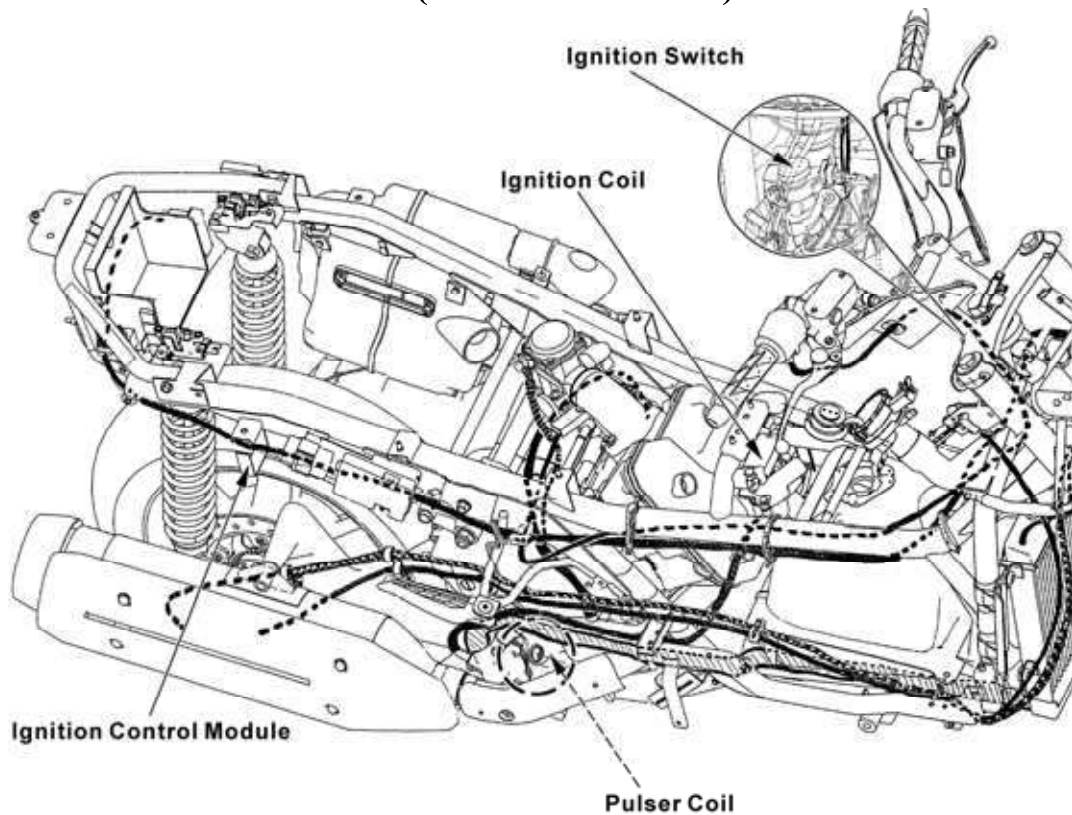
IGNITION SYSTEM LAYOUT (XCITING 500/250)**IGNITION SYSTEM LAYOUT (XCITING 500 AFI/300 AFI)**

Refer to the “SYSTEM LOCATION” section in the chapter 6.

19. IGNITION SYSTEM

XCITING 500/500 AFI/250/300 AFI

IGNITION CIRCUIT (XCITING 500)

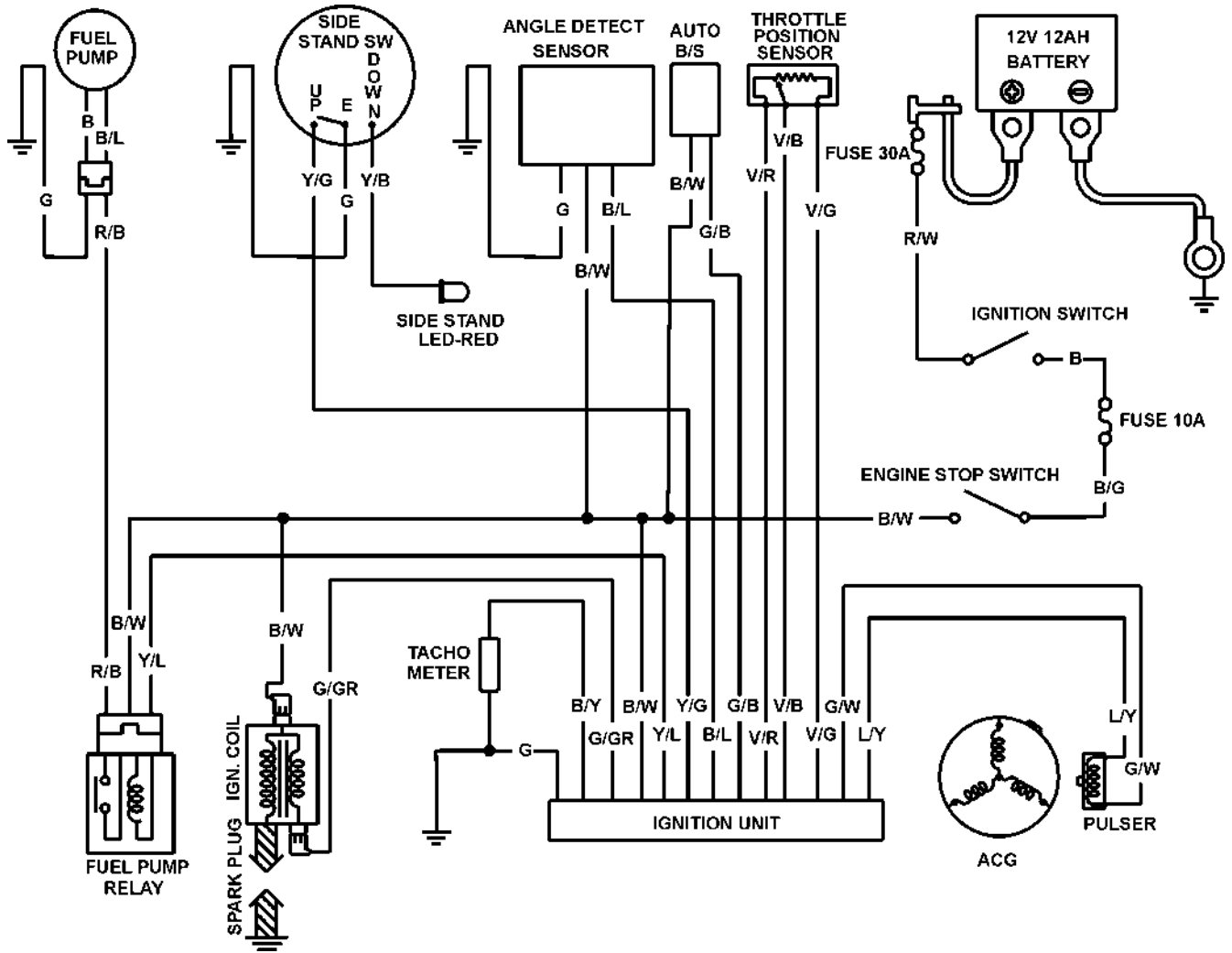

19. IGNITION SYSTEM

XCITING 500/500 AFI/250/300 AFI

IGNITION CIRCUIT (XCITING 500 AFI)

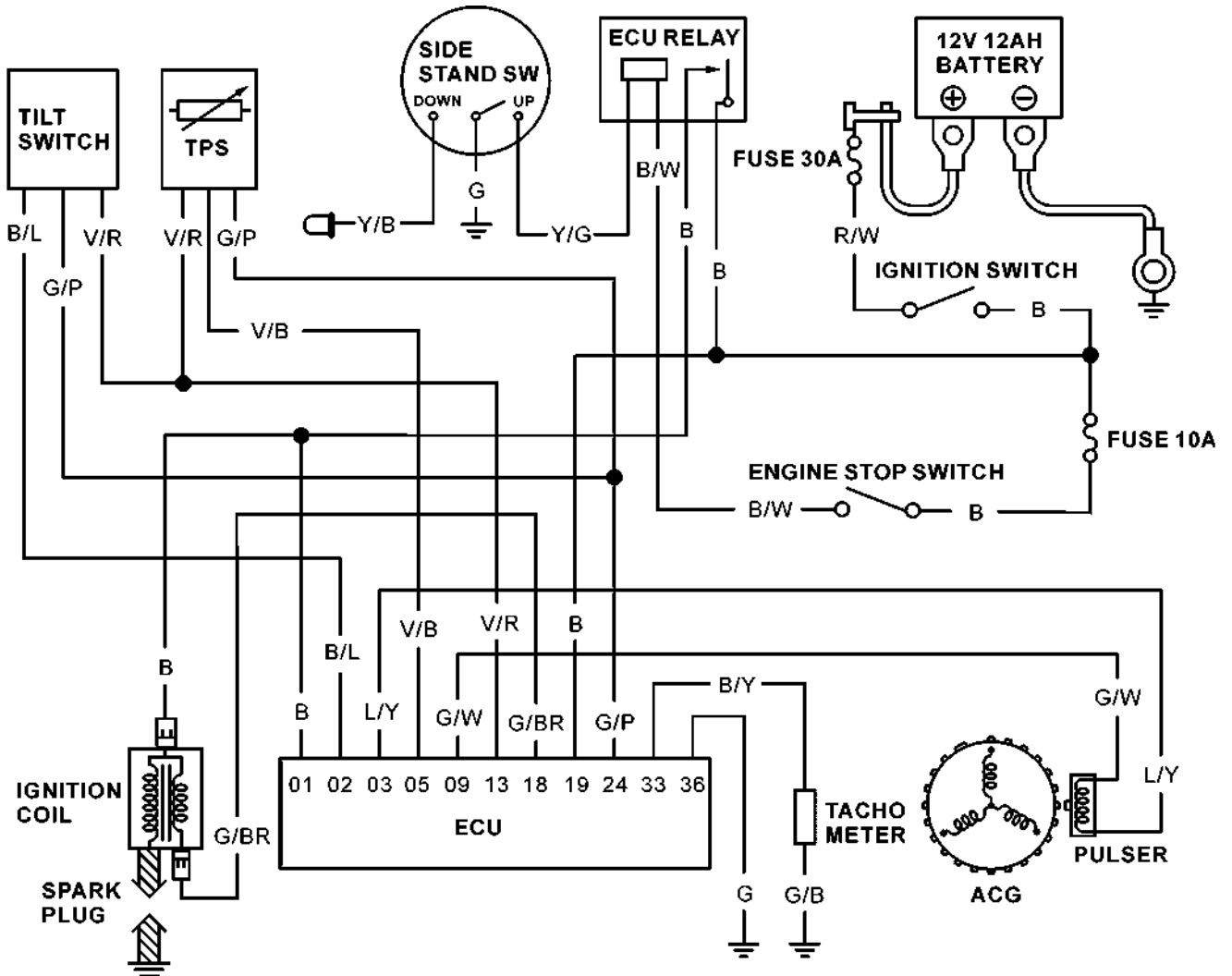

19. IGNITION SYSTEM

XCITING 500/500 AFI/250/300 AFI

IGNITION CIRCUIT (XCITING 250)

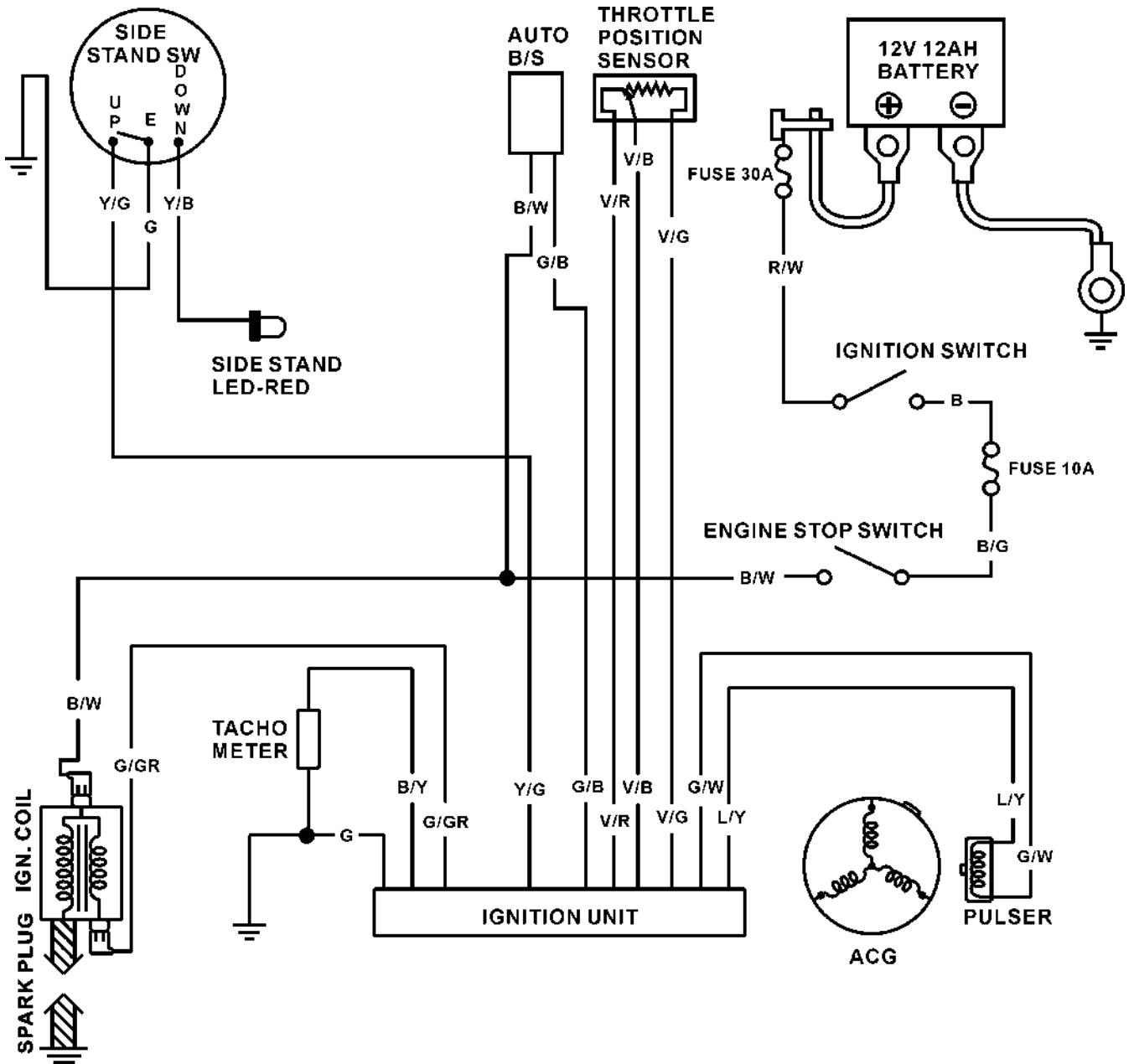

19. IGNITION SYSTEM

XCITING 500/500 AFI/250/300 AFI

IGNITION CIRCUIT (XCITING 300 AFI)

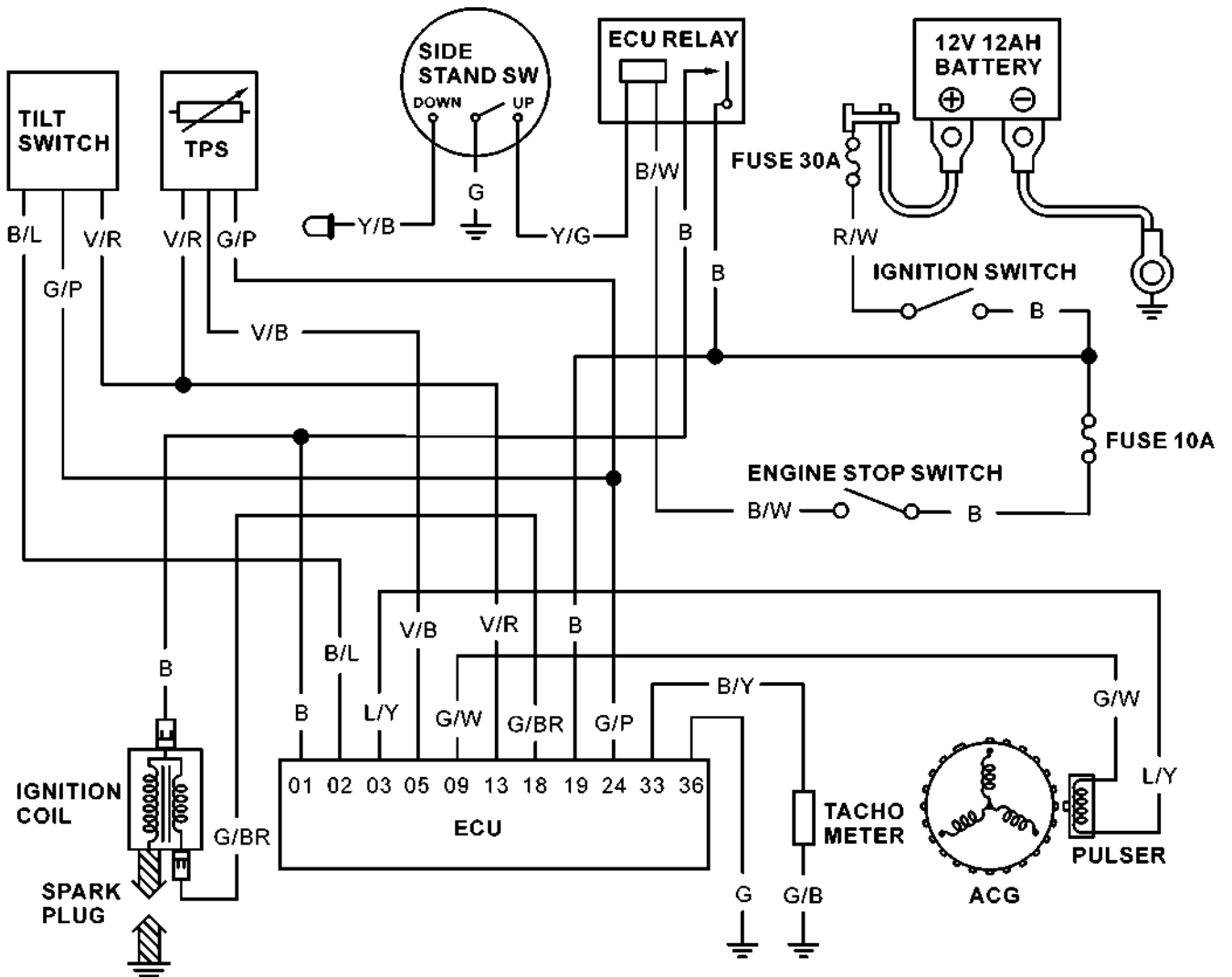

SERVICE INFORMATION

GENERAL INSTRUCTIONS

- Some electrical components may be damaged if terminals or connectors are connected or disconnected while the ignition switch is “ON” and current is present.
- When servicing the ignition system, always follow the steps in the troubleshooting on page 19-5.
- The ignition timing cannot be adjusted since the ignition control module is factory preset.
- The ignition control module or ECU may be damaged if dropped. Also, if the connector is disconnected when current is flowing, the excessive voltage may damage the ignition control module or ECU. Always turn off the ignition switch before servicing.
- A faulty ignition system is often related to poor connections. Check those connections before proceeding.
- Make sure the battery is adequately charged. Using the starter motor with a weak battery results in a slower engine cranking speed as well as no spark at the spark plug.
- Use a spark plug of the correct heat range. Using spark plug with an incorrect heat range can damage the engine.
- See section 13 for ignition pulse generator removal/installation.
- See section 6 for ECU removal/installation/inspection.
- See section 21 for those components: Ignition switch, Engine stop switch

SPECIFICATIONS

Item	Standard
Spark plug	XCITING 500/500 AFI NGK-CR8E/NGK-CR7E
	XCITING 250/300 AFI NGK-DPR7EA-9/NGK-DPR6EA
Spark plug gap	0.7 mm (0.028 in)
Ignition system	Full transistor digital ignition
Ignition timing	Throttle position sensor

TROUBLESHOOTING

LOW PEAK VOLTAGE

- Cranking speed is too low (battery is undercharged).
- Poorly connected connectors or an open circuit in the ignition system.
- Faulty ignition-coil.
- Faulty ignition control module.

NO PEAK VOLTAGE

- Short circuit in engine stop switch or ignition switch wire.
- Faulty engine stop switch or ignition switch.
- Loose or poorly connected ignition control module connectors.
- Open circuit or poor connection in ground wire of the ignition control module.
- Faulty ignition pulse generator.
- Faulty ignition control module.

PEAK VOLTAGE IS NORMAL, BUT NO SPARK JUMPS AT THE PLUG

- Faulty spark plug or leaking ignition coil secondary current.
- Faulty ignition coil.

19. IGNITION SYSTEM

IGNITION COIL INSPECTION

IGNITION COIL PRIMARY PEAK VOLTAGE

Remove the floorboard (page 2-6).

Check cylinder compression and check that the spark plug is installed correctly in the cylinder. Disconnect the spark plug cap from the spark plug.



Spark Plug Cap

Connect known good spark plug to the spark plug cap and ground the spark plugs to the cylinder as done in the spark test.

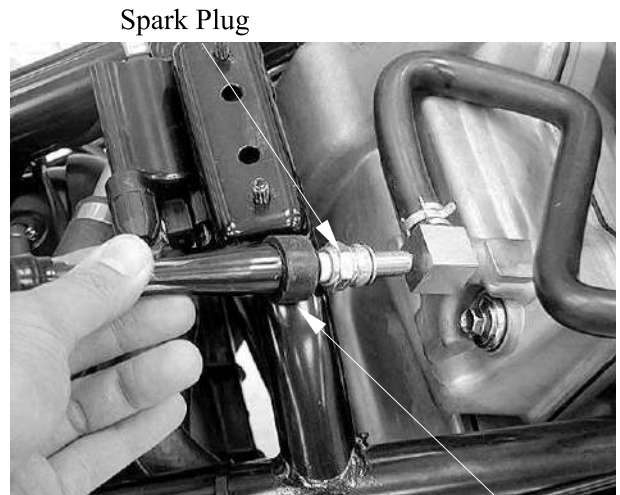

Spark Plug Cap

Turn the ignition switch to “ON” and engine stop switch ON.
Connect the multimeter (+) probe to the Black/White wire and the multimeter (-) to the body ground.
Check for initial voltage at this time.
The battery voltage should be measured.
If the initial voltage cannot be measured, check the power supply circuit.

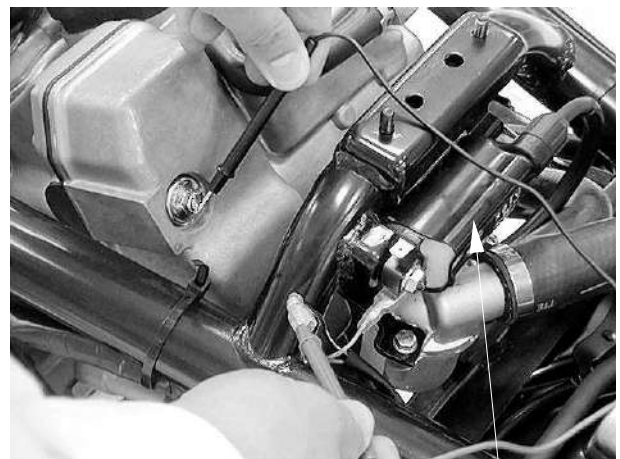

Ignition Coil

19. IGNITION SYSTEM

XCITING 500/500 AFI/250/300 AFI

IGNITION PULSE GENERATOR INSPECTION

Remove the luggage box (page 2-3).
 Disconnect the ignition pulse generator connector.
 Measure the ignition pulse generator resistance between the Green/White wire and Blue/Yellow wire.

Standard: 516Ω (20°C/68°F)

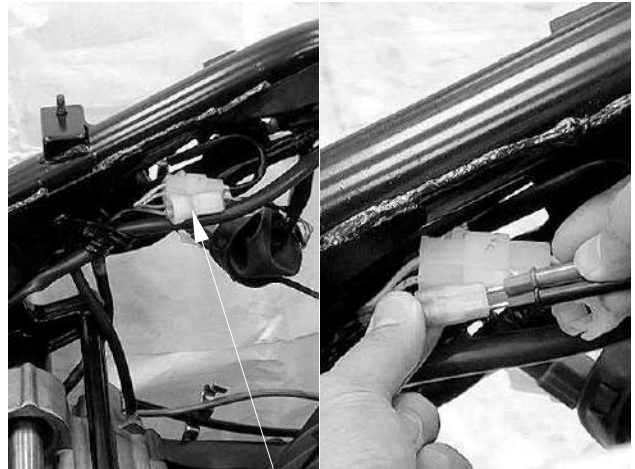

Ignition Pulse Generator Connector

IGNITION COIL REMOVAL/INSTALLATION

Remove the floorboard (page 2-6).
 Disconnect the spark plug cap from the spark plug (page 19-7).

Disconnect the ignition coil primary connectors.
 Remove the two nuts and the ignition coil.

Installation is in the reverse order of removal.



Ignition Coil

IGNITION CONTROL MODULE (XCITING 500/250)

REMOVAL/INSTALLATION

Remove the side body cover (page 2-8).

Disconnect the ignition control module connectors and remove the ignition control module.

Ignition Control Module Connectors



Ignition Control Module

19. IGNITION SYSTEM

XCITING 500/500 AFI/250/300 AFI

RESISTANCE INSPECTION

(XCITING 500)

Measure the resistance between the terminals.

Due to the semiconductor in circuit, it is necessary to use a specified tester for accurate testing. Use of an improper tester in an improper range may give false readings.

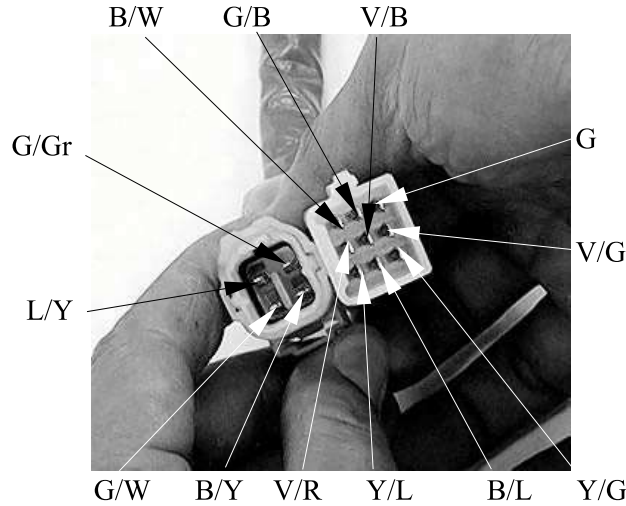

Unit: Ω

(+) / (-)	L/Y	G/GR	G/W	B/Y	B/W	G/B	G	V/R	V/B	V/G	Y/L	B/L	Y/G
L/Y			91.6K	6.67M	6.68M		46.2K	49.5K	150K	46.2K	12.59M	49.7K	
G/GR	9.5M		9.3M		←	↑	9.23M	9M	9.16M	8.97M		8.96M	↑
G/W	91.8K			6.67M	6.68M	↑	47K	50.3K	150.9K	47K	12.59M	50.3K	↑
B/Y	15.96M	↑	15.6M		994	↑	15.33M	14.88M	15.04M	14.74M	3.35M	14.7M	↑
B/W	15.96M	↑	15.6M	994		↑	14.96M	14.88M	15.02M	14.74M	3.35M	14.7M	↑
G/B		↑		←	←		←	←	←	←	←	←	↑
G	44.3K	↑	44.9K	6.62M	6.63M	↑		3.54K	103.9K	∞	12.51M	3.54K	↑
V/R	47.5K	↑	48.4K	6.62M	6.63M	↑	3.53K		100.2K	3.54K	12.51M	1.99K	↑
V/B	148.5K	↑	149.4K	6.75M	6.76M	↑	102.8K	99.3K		102.7K	12.67M	101.2K	↑
V/G	44.3K	↑	44.9K	6.62M	6.63M	↑	∞	3.55K	103.9K		12.51M	3.55K	↑
Y/L	8.13M	↑	8.1M		←	↑	7.81M	7.77M	7.91M	7.72M		7.72M	↑
B/L	47.5K	↑	48.4K	6.62M	6.62M	↑	3.53K	1.99K	102.2K	3.53K	12.51M		↑
Y/G		↑		←	←	←	←	←	←	←	←	←	

19. IGNITION SYSTEM

XCITING 500/500 AFI/250/300 AFI

RESISTANCE INSPECTION

(XCITING 250)

Measure the resistance between the terminals.

Due to the semiconductor in circuit, it is necessary to use a specified tester for accurate testing. Use of an improper tester in an improper range may give false readings.

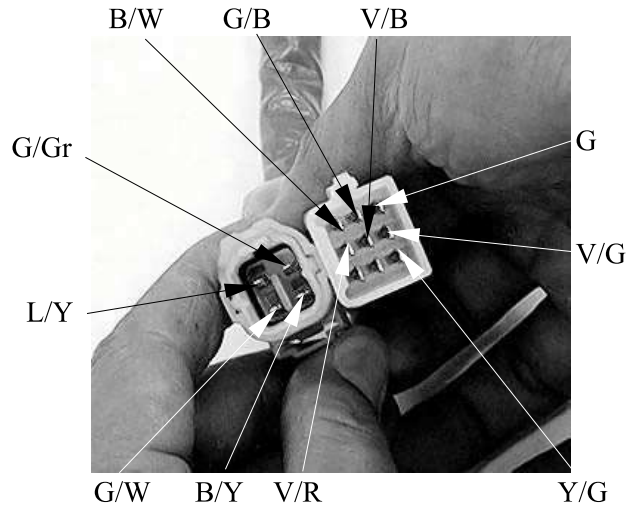

Unit: Ω

(+) (-)	L/Y	G/GR	G/W	B/Y	B/W	G/B	G	V/R	V/B	V/G	Y/G
L/Y			91.6K	6.67M	6.68M		46.2K	49.5K	150K	46.2K	
G/GR	9.5M		9.3M		←	↑	9.23M	9M	9.16M	8.97M	↑
G/W	91.8K			6.67M	6.68M	↑	47K	50.3K	150.9K	47K	↑
B/Y	15.96M	↑	15.6M		994	↑	15.33M	14.88M	15.04M	14.74M	↑
B/W	15.96M	↑	15.6M	994		↑	14.96M	14.88M	15.02M	14.74M	↑
G/B		↑		←	←		←	←	←	←	↑
G	44.3K	↑	44.9K	6.62M	6.63M	↑		3.54K	103.9K	∞	↑
V/R	47.5K	↑	48.4K	6.62M	6.63M	↑	3.53K		100.2K	3.54K	↑
V/B	148.5K	↑	149.4K	6.75M	6.76M	↑	102.8K	99.3K		102.7K	↑
V/G	44.3K	↑	44.9K	6.62M	6.63M	↑	∞	3.55K	103.9K		↑
Y/G		↑		←	←	←	←	←	←	←	

ELECTRIC STARTER

STARTING SYSTEM LAYOUT	20-1
SERVICE INFORMATION.....	20-2
TROUBLESHOOTING.....	20-2
STARTER MOTOR	20-5
STARTER RELAY SWITCH.....	20-7

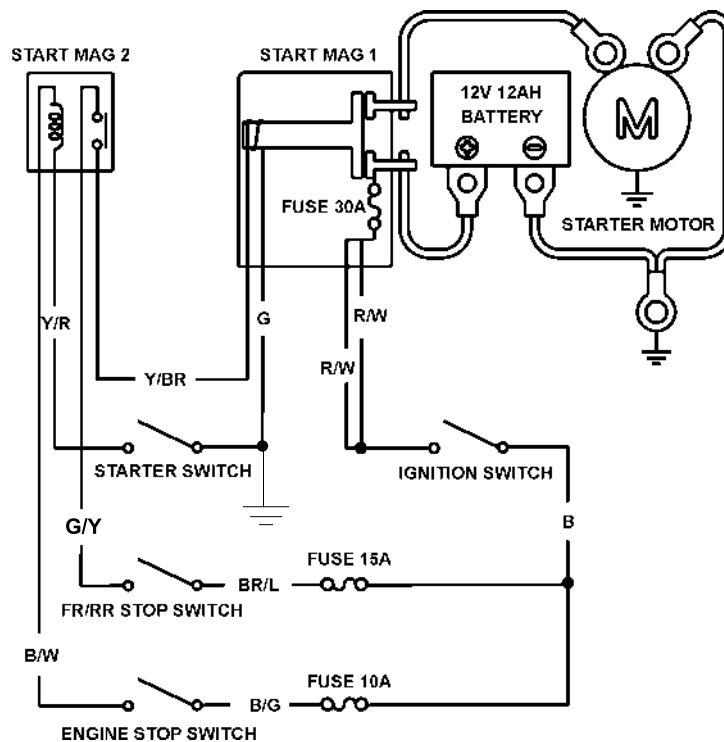
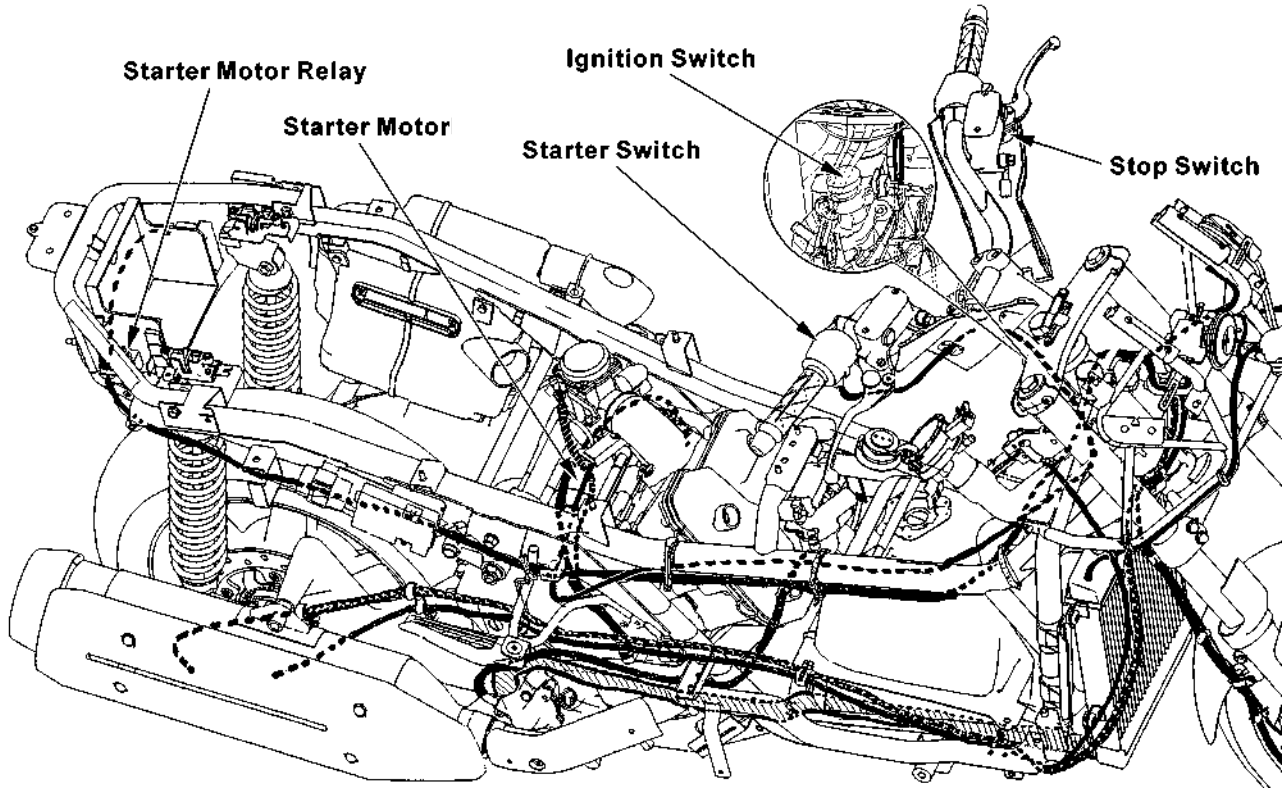

SERVICE INFORMATION

GENERAL

- Always turn the ignition switch to “OFF” before servicing the starter motor. The motor could suddenly start, causing serious injury.
- The starter motor can be serviced with the engine in the frame.
- When checking the starter system, always follow the steps in the troubleshooting flow chart (page 20-2).
- A weak battery may be unable to turn the starter motor quickly enough, or supply adequate ignition current.
- If the current is kept flowing through the starter motor to turn it while the engine is not cranking over, the starter motor may be damaged.
- See section 13 for starter clutch servicing.
- See section 21 for following components:
 - ™ Ignition switch
 - ™ Starter switch
 - ™ Brake light switch

TROUBLESHOOTING

- Check for the following before troubleshooting:
 - Blown main fuse (30A) and sub fuse (10 A)
 - Loose battery and starter motor cable
 - Discharged battery
- The starter motor can turn with the following conditions:
 - Ignition switch ON
 - Engine stop switch in RUN
 - Rear brake lever fully squeezed
 - Side stand retracted
 - Starter switch pushed

Starter motor will not turn

Check for loose or poorly connected battery terminals and opened or shorted battery cable.

— Abnormal —▶ • Poorly connected battery terminals.
• Open or short circuit in battery.

Normal
↓

(Go to following page)

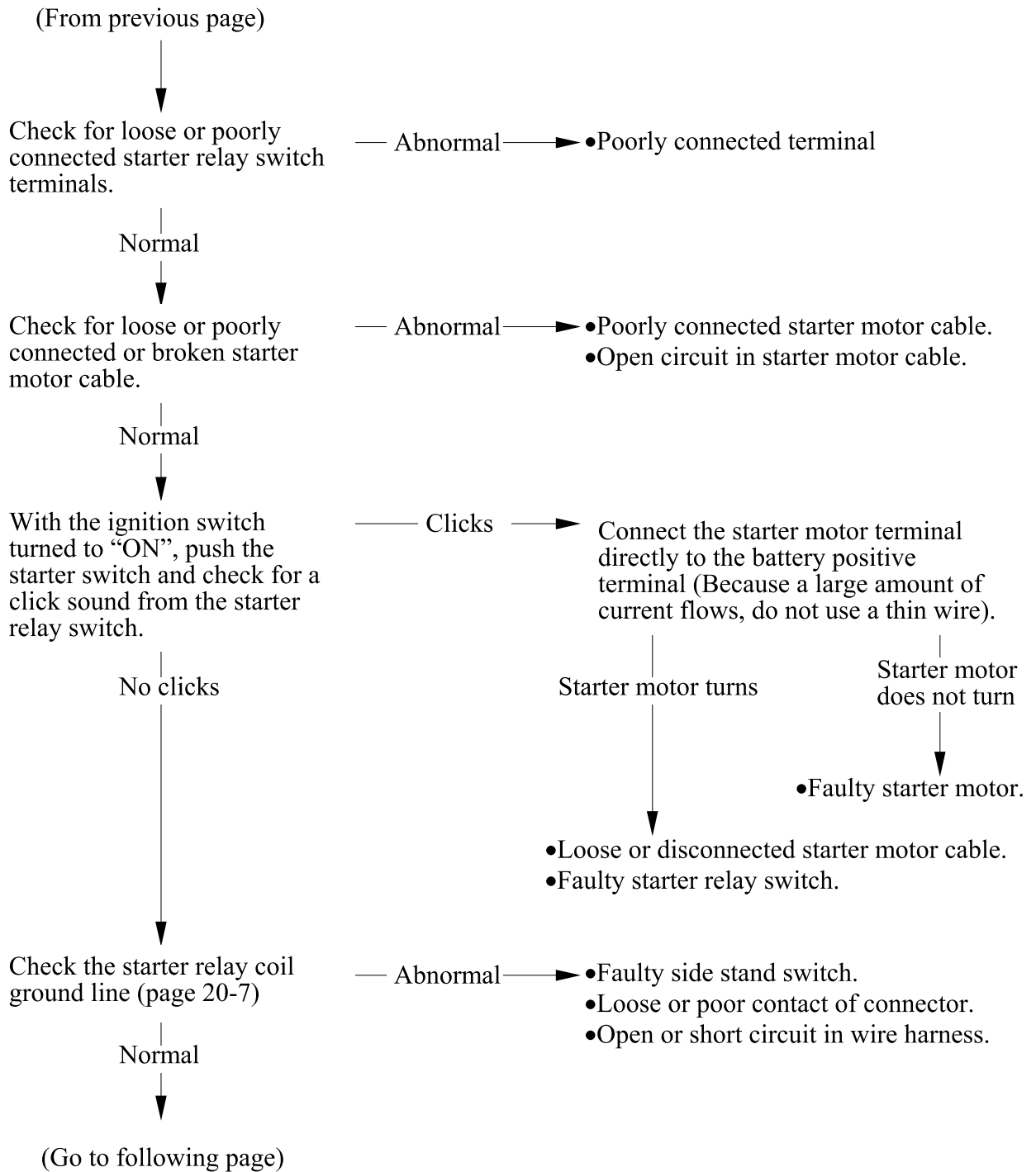

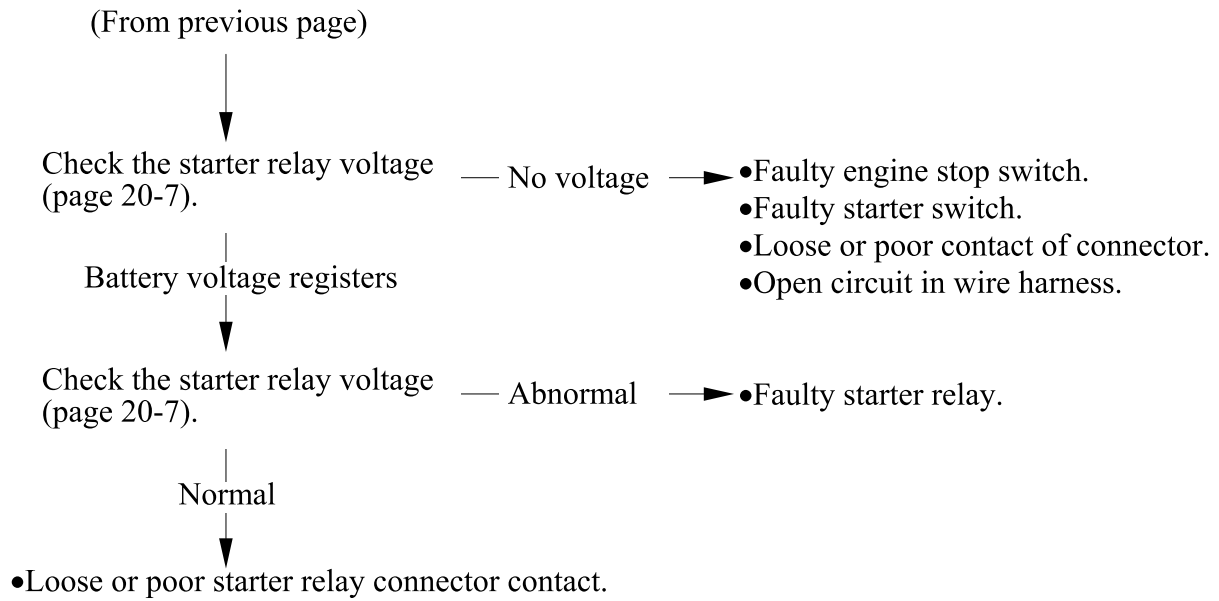

20. ELECTRIC STARTER

STARTER MOTOR

INSPECTION

Remove the luggage box (page 2-3).

Disconnect the starter motor cable from the starter relay switch.
Turn the ignition switch to “ON”.
Connect the starter motor cable directly to the battery positive terminal.
If the starter motor does not turn, the starter motor is faulty.

Starter Motor Cable



REMOVAL

Remove the carburetor (page 5-6) or throttle body (page 6-30).

Turn the ignition switch turned to “OFF”

Release the rubber cap and remove the terminal nut to disconnect the starter motor cable from the starter motor.

Nut



Rubber Cap

Remove the two bolts and starter motor.

Starter Motor



Bolts

20. ELECTRIC STARTER

INSTALLATION

Coat a new O-ring with engine oil and install it into the starter motor groove.

Install the starter motor into the crankcase.

O-ring



Install the two bolts and tighten them securely.

Starter Motor



Bolts

Connect the starter motor cable to motor terminal with the terminal nut and tighten it.

Starter Motor Cable



Nut

20. ELECTRIC STARTER

STARTER RELAY SWITCH

INSPECTION

Remove the luggage box (page 2-3).

Retracted the side stand.

Turn the ignition switch to “ON” and engine stop switch on.

Squeeze the rear brake lever fully and push the starter switch.

The coil is normal if the starter relay switch clicks.

If you do not hear the switch click. Inspect the relay switch using the procedure below.

Starter Relay Switch



GROUND LINE INSPECTION

Disconnect the starter relay switch connector. Check for continuity between the Green wire terminal and ground.

There should be continuity.

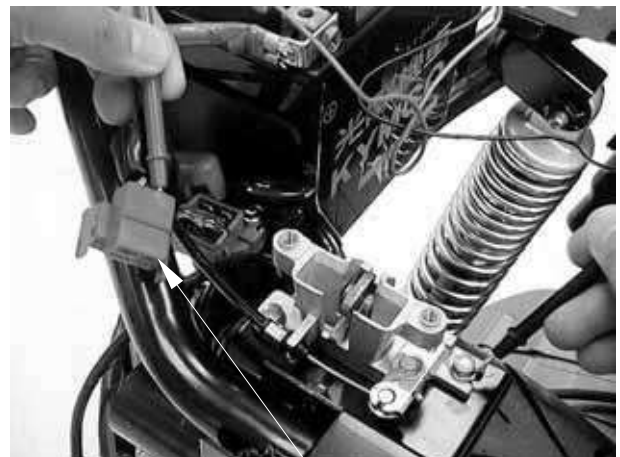

Starter Relay Connector

VOLTAGE INSPECTION

Connect the starter relay switch connector. Turn the ignition switch ON and engine stop switch to RUN.

Measure the starter relay switch Yellow/Red wire terminal and ground.

If the battery voltage appears only when the rear brake lever is squeezed fully and starter switch is pushed, the circuit is normal.



Starter Relay Switch

20. ELECTRIC STARTER

XCITING 500/500 AFI/250/300 AFI

CONTINUITY INSPECTION

Disconnect the starter relay switch connector and cables.

Connect a fully charged 12 V battery positive wire to the relay switch Yellow/Red wire terminal and negative wire to the Green wire terminal.

There should be continuity between the cable terminals while the battery is connected, and no continuity when the battery is disconnected.

Starter Relay Switch

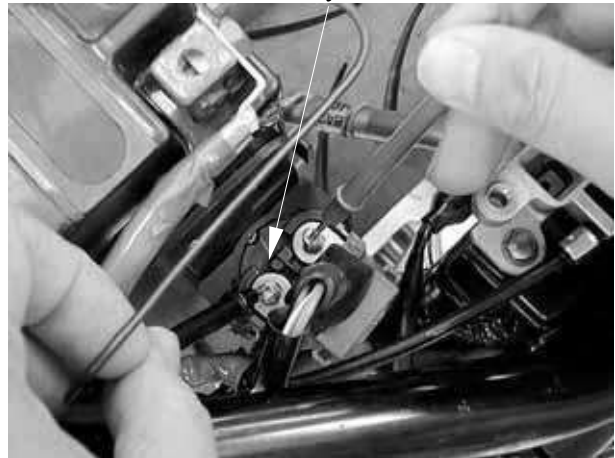

ELECTRIC STARTER

STARTING SYSTEM LAYOUT -----	20-1
SERVICE INFORMATION-----	20-2
TROUBLESHOOTING-----	20-2
STARTER MOTOR -----	20-5
STARTER RELAY SWITCH-----	20-7

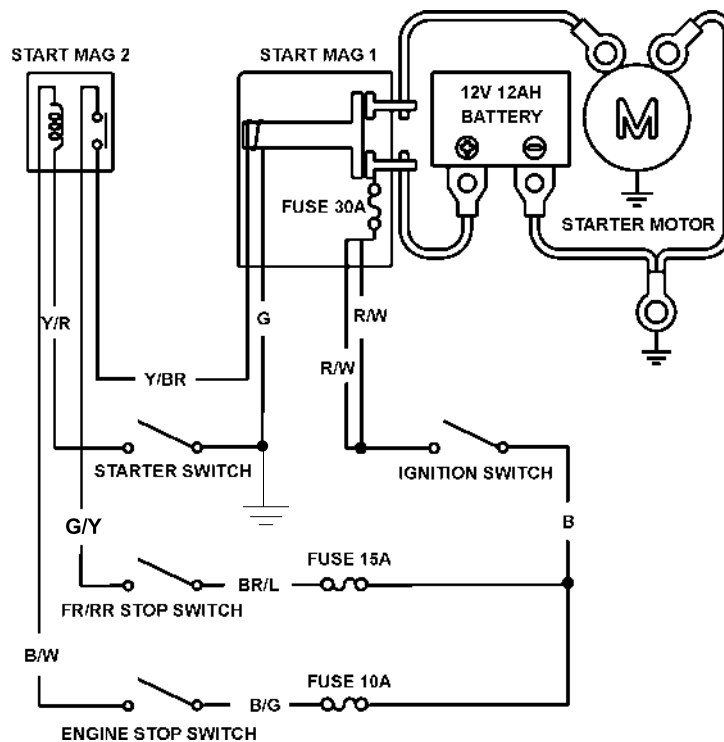
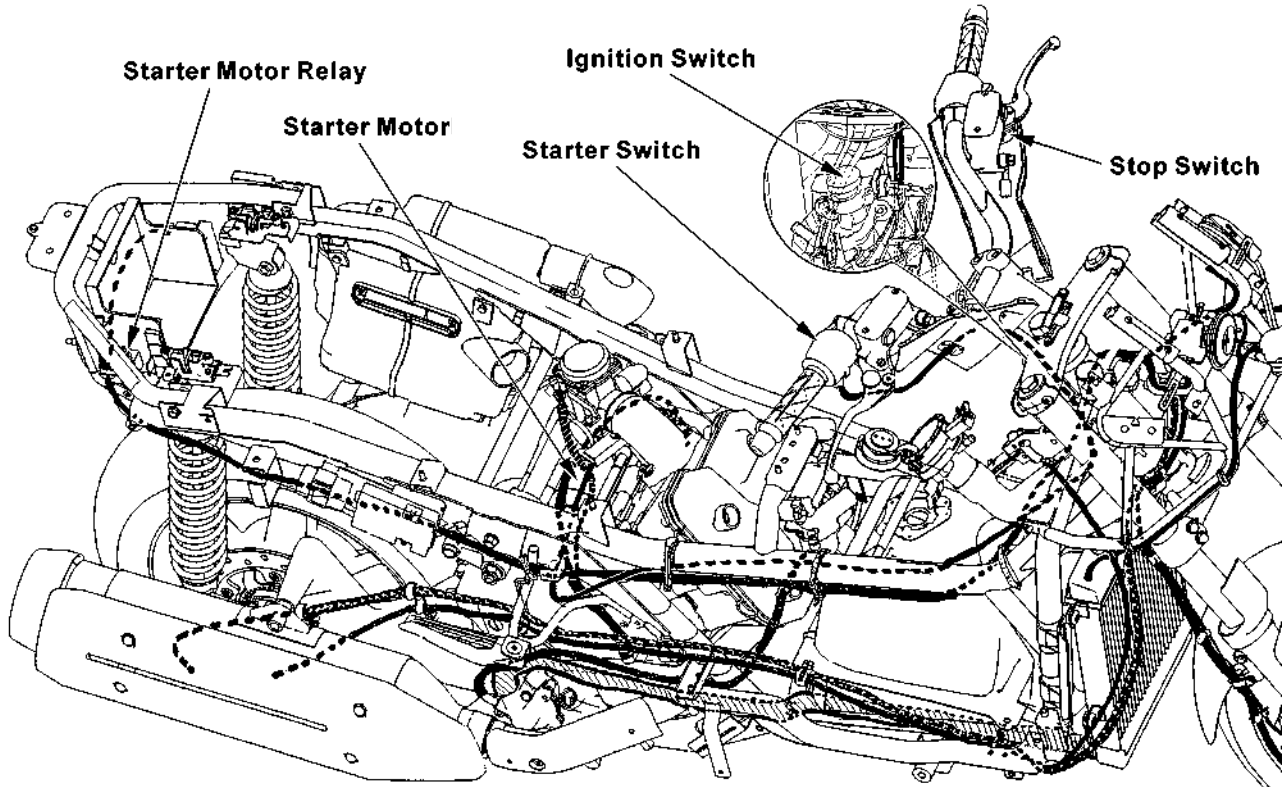

SERVICE INFORMATION**GENERAL**

- Always turn the ignition switch to “OFF” before servicing the starter motor. The motor could suddenly start, causing serious injury.
- The starter motor can be serviced with the engine in the frame.
- When checking the starter system, always follow the steps in the troubleshooting flow chart (page 20-2).
- A weak battery may be unable to turn the starter motor quickly enough, or supply adequate ignition current.
- If the current is kept flowing through the starter motor to turn it while the engine is not cranking over, the starter motor may be damaged.
- See section 13 for starter clutch servicing.
- See section 21 for following components:
 - ™ Ignition switch
 - ™ Starter switch
 - ™ Brake light switch

TROUBLESHOOTING

- Check for the following before troubleshooting:
 - Blown main fuse (30A) and sub fuse (10 A)
 - Loose battery and starter motor cable
 - Discharged battery
- The starter motor can turn with the following conditions:
 - Ignition switch ON
 - Engine stop switch in RUN
 - Rear brake lever fully squeezed
 - Side stand retracted
 - Starter switch pushed

Starter motor will not turn

Check for loose or poorly connected battery terminals and opened or shorted battery cable.

— Abnormal —► • Poorly connected battery terminals.
• Open or short circuit in battery.

Normal
↓

(Go to following page)

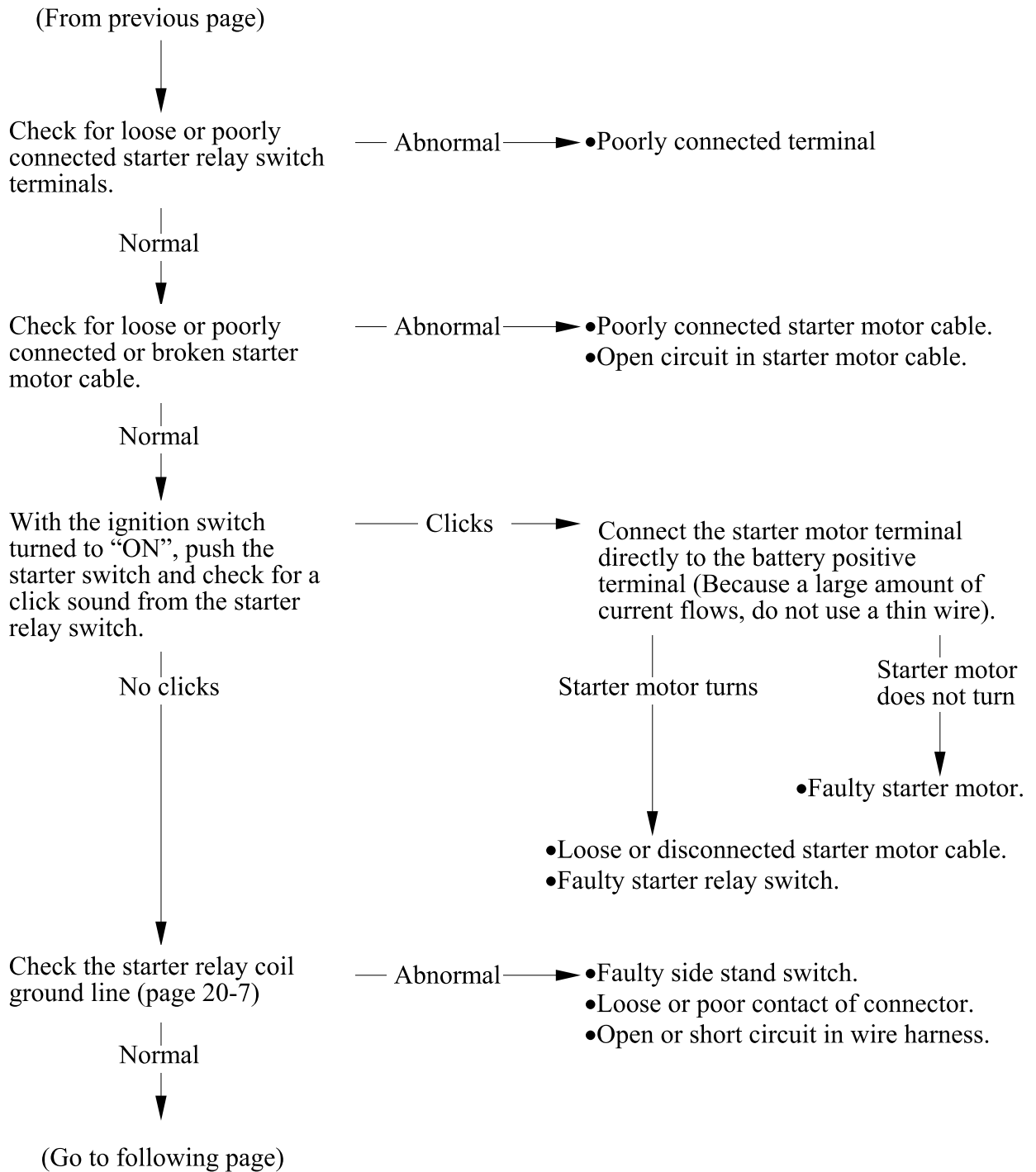

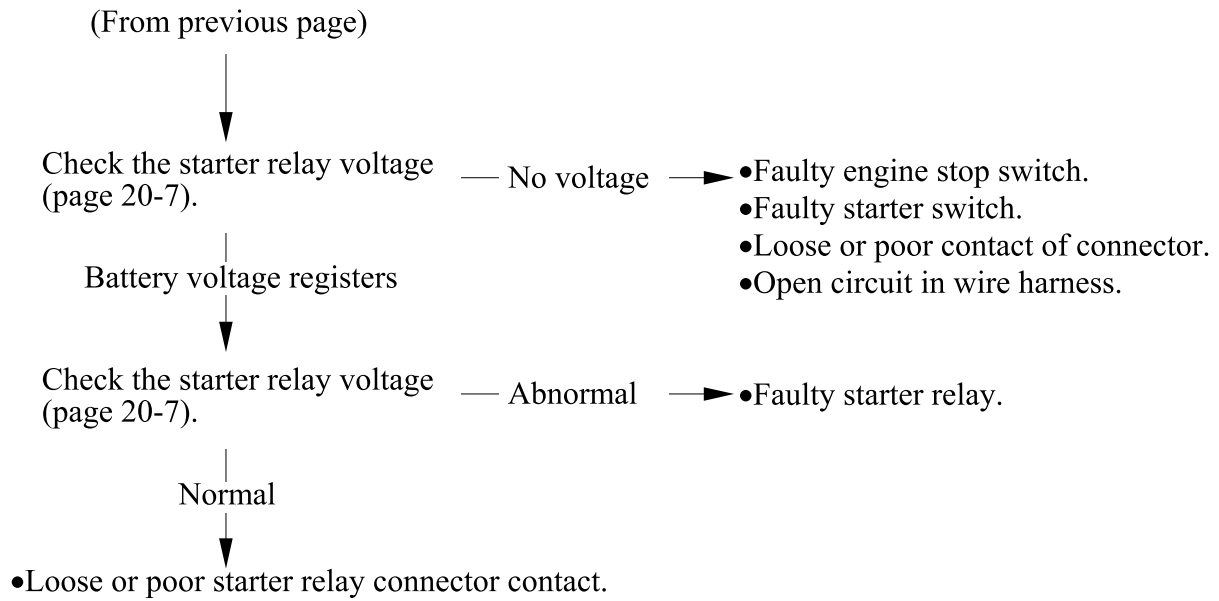

20. ELECTRIC STARTER

STARTER MOTOR

INSPECTION

Remove the luggage box (page 2-3).

Disconnect the starter motor cable from the starter relay switch.
Turn the ignition switch to “ON”.
Connect the starter motor cable directly to the battery positive terminal.
If the starter motor does not turn, the starter motor is faulty.

Starter Motor Cable



REMOVAL

Remove the carburetor (page 5-6) or throttle body (page 6-30).

Turn the ignition switch turned to “OFF”

Release the rubber cap and remove the terminal nut to disconnect the starter motor cable from the starter motor.

Nut



Rubber Cap

Remove the two bolts and starter motor.

Starter Motor



Bolts

20. ELECTRIC STARTER

INSTALLATION

Coat a new O-ring with engine oil and install it into the starter motor groove.

Install the starter motor into the crankcase.



Install the two bolts and tighten them securely.

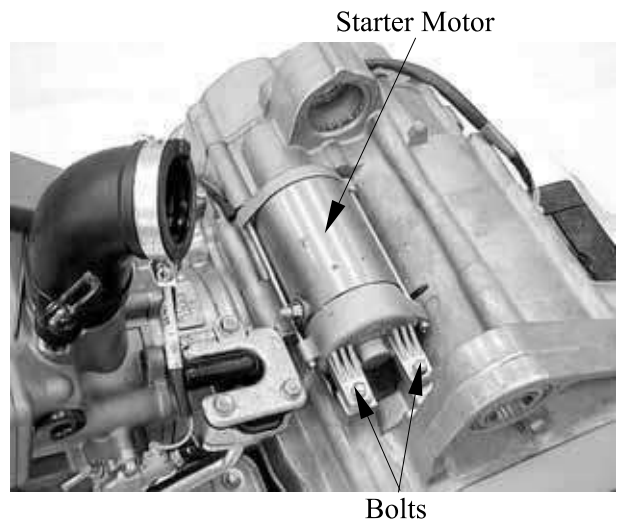

Connect the starter motor cable to motor terminal with the terminal nut and tighten it.

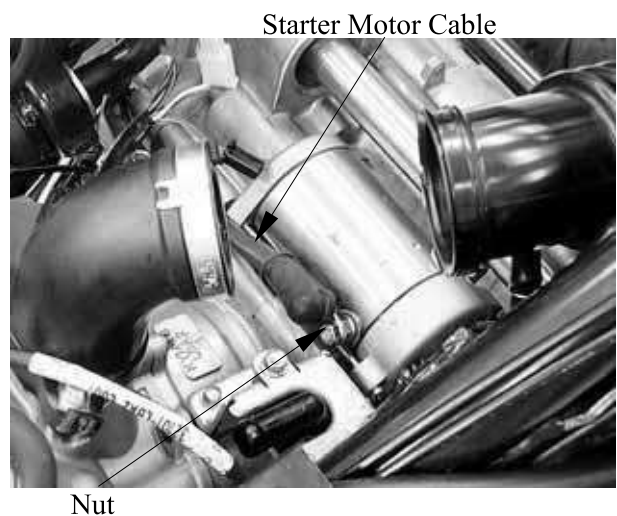

20. ELECTRIC STARTER

STARTER RELAY SWITCH

INSPECTION

Remove the luggage box (page 2-3).

Retracted the side stand.

Turn the ignition switch to “ON” and engine stop switch on.

Squeeze the rear brake lever fully and push the starter switch.

The coil is normal if the starter relay switch clicks.

If you do not hear the switch click. Inspect the relay switch using the procedure below.

Starter Relay Switch



GROUND LINE INSPECTION

Disconnect the starter relay switch connector. Check for continuity between the Green wire terminal and ground.

There should be continuity.

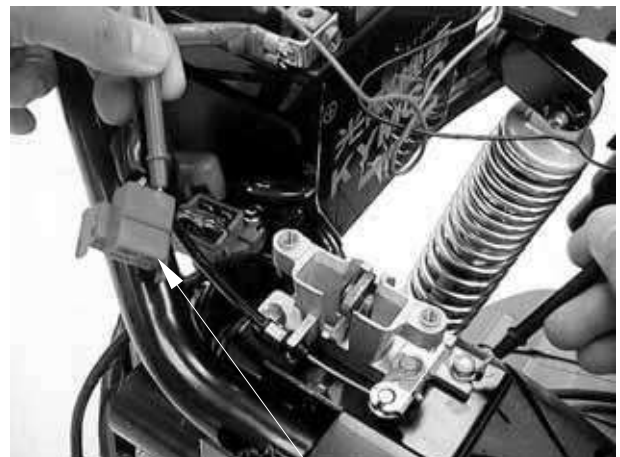

Starter Relay Connector

VOLTAGE INSPECTION

Connect the starter relay switch connector. Turn the ignition switch ON and engine stop switch to RUN.

Measure the starter relay switch Yellow/Red wire terminal and ground.

If the battery voltage appears only when the rear brake lever is squeezed fully and starter switch is pushed, the circuit is normal.



Starter Relay Switch

20. ELECTRIC STARTER

XCITING 500/500 AFI/250/300 AFI

CONTINUITY INSPECTION

Disconnect the starter relay switch connector and cables.

Connect a fully charged 12 V battery positive wire to the relay switch Yellow/Red wire terminal and negative wire to the Green wire terminal.

There should be continuity between the cable terminals while the battery is connected, and no continuity when the battery is disconnected.

Starter Relay Switch

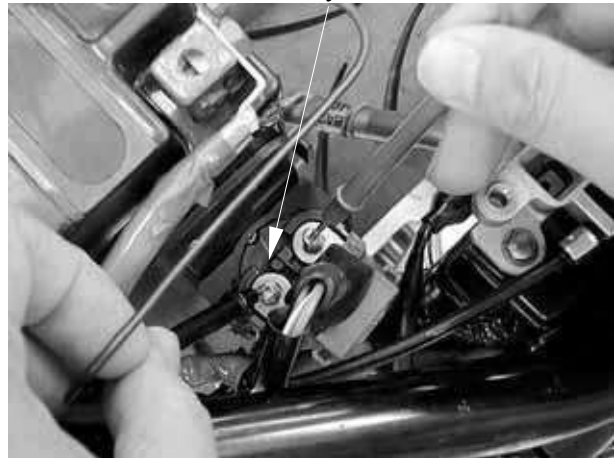

21. LIGHTS/METERS/SWITCHES

XCITING 500/500 AFI/250/300 AFI

LIGHTS/METERS/SWITCHES

SERVICE INFORMATION-----	21- 1
BULB REPLACEMENT -----	21- 2
SPEED SENSOR -----	21- 5
BRAKE LIGHT SWITCH-----	21- 7
IGNITION SWITCH -----	21- 7
HANDLEBAR SWITCH -----	21- 8
PARKING SWITCH (XCITING 500/500 AFI) -----	21-10
LUGGAGE BOX LIGHT SWITCH -----	21-10
OIL PRESSURE SWITCH -----	21-10
FUEL UNIT (XCITING 500/250)-----	21-13
SIDE STAND SWITCH -----	21-15
HORN -----	21-16
BANK ANGLE SENSOR (XCITING 500)-----	21-17
HEATER CONTROL UNIT (XCITING 500/250)-----	21-18

21. LIGHTS/METERS/SWITCHES

XCITING 500/500 AFI/250/300 AFI

SERVICE INFORMATION

GENERAL

A halogen head light bulb becomes very hot while the head light is on, and remains for a while after it is turned off. Be sure to let it cool down before servicing.

- Note the following when replacing the halogen headlight bulb
 - ™ Wear clean gloves while replacing the bulb. Do not put finger prints on the headlight bulb, as they may create hot spots on the bulb and cause it to fail.
 - ™ If you touch the bulb with your bare hands, clean it with a cloth moistened with alcohol to prevent its early failure.
 - ™ Be sure to install the dust cover after replacing the bulb.
- Check the battery condition before performing any inspection that requires proper battery voltage.
- A continuity test can be made with the switches installed on the scooter.
- Route the wires and cables properly after servicing each component.

21. LIGHTS/METERS/SWITCHES

XCITING 500/500 AFI/250/300 AFI

BULB REPLACEMENT

HEADLIGHT

A halogen headlight bulb becomes very hot while the headlight is ON, and remain for a while after it is turned OFF. Be sure to let it cool down before servicing.

Remove the front cover (page 2-11)

Disconnect the headlight connector from the headlight bulb and remove the dust cover.

Unhook the retainer and remove the bulb from the headlight case.

Avoid touching the halogen headlight bulb. Finger prints can create hot spots that cause a bulb to break.

Install a new bulb in the headlight case, by aligning the bulb tab with the case groove.

Hook the retainer.

Install the dust cover properly on to the headlight and connect the headlight connector

Headlight Connector

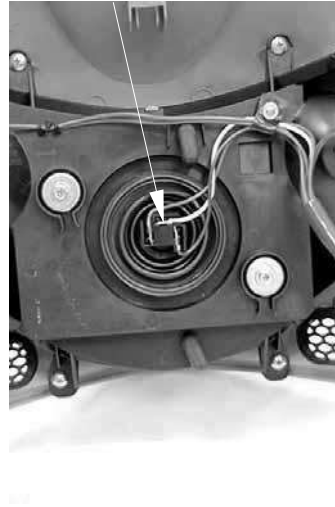

Dust Cover

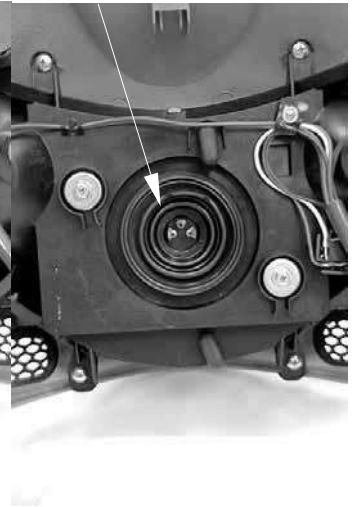

Retainer



Bulb

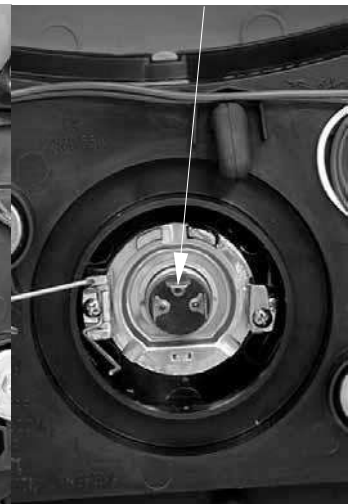

Socket

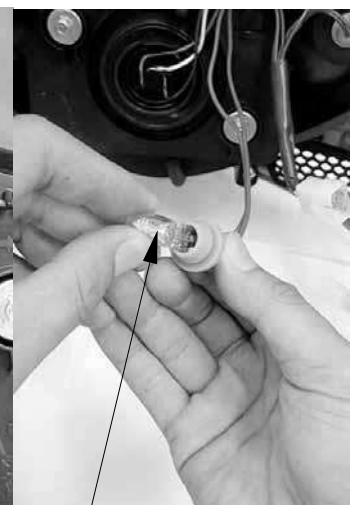

Bulb

POSITION LIGHT

Remove the front cover (page 2-11).

Remove the bulb socket and position light bulb. Remove the bulb and replace with a new one.

Installation is in the reverse order of removal.

21. LIGHTS/METERS/SWITCHES

XCITING 500/500 AFI/250/300 AFI

FRONT TURN SIGNAL

Remove the front cover (page 2-11).

Turn the bulb socket counterclockwise to remove it.

Remove the bulb and replace with a new one.

Installation is in the reverse order of removal.

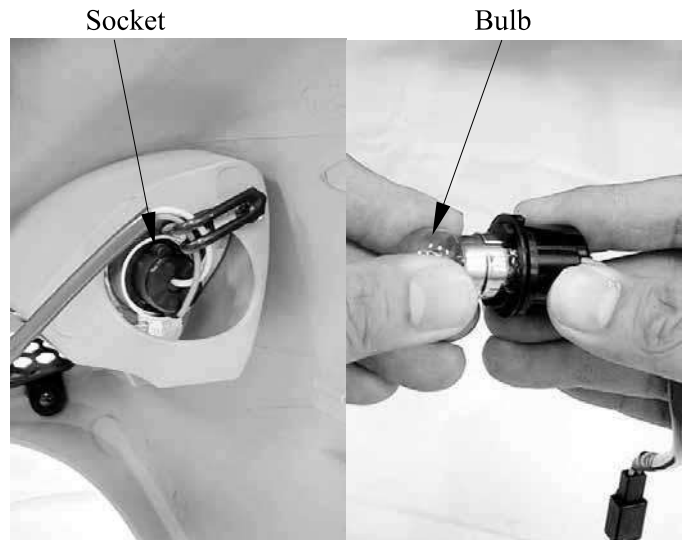

TAILLIGHT/BRAKE LIGHT, REAR TURN SIGNAL

Remove the six screws and lens.

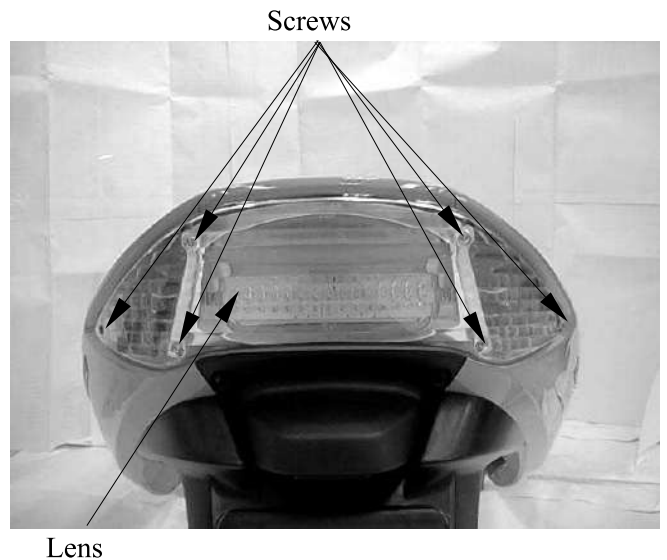

Taillight/Brake light

Remove the two screws and remove the taillight/brake light.

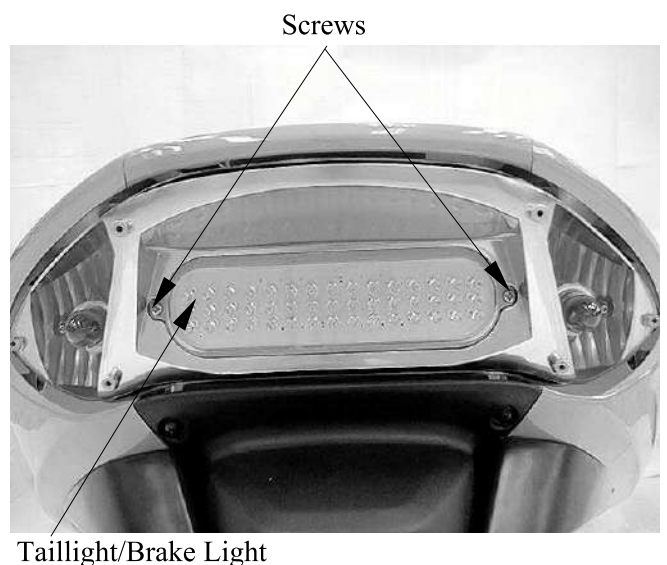

21. LIGHTS/METERS/SWITCHES

XCITING 500/500 AFI/250/300 AFI

Disconnect the taillight/brake light connectors.

Installation is in the reverse order of removal.

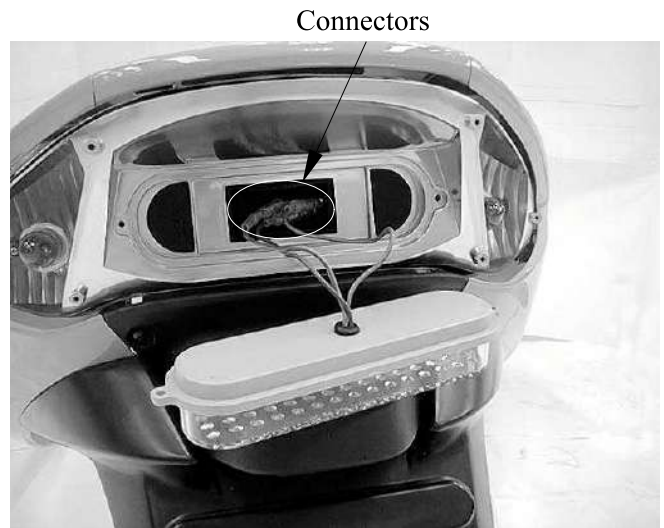

Rear turn signal

Remove the screw and bulb cap.

Remove the bulb and replace with a new one.

Installation is in the reverse order of removal.

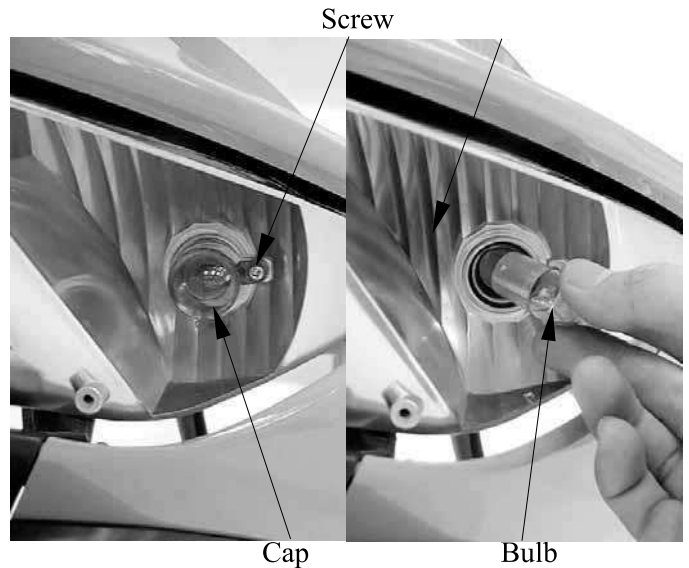

LICENSE LIGHT

Remove two screws.

Disconnect the license light connector and remove the license light.

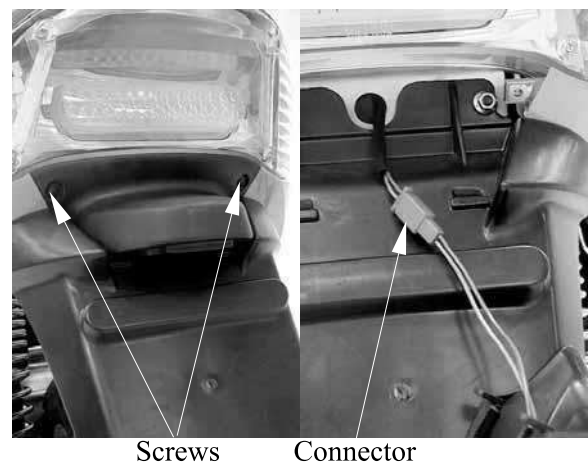

21. LIGHTS/METERS/SWITCHES

XCITING 500/500 AFI/250/300 AFI

Remove the bulb socket and license light bulb.
Remove the bulb and replace with a new one.

Installation is in the reverse order of removal.

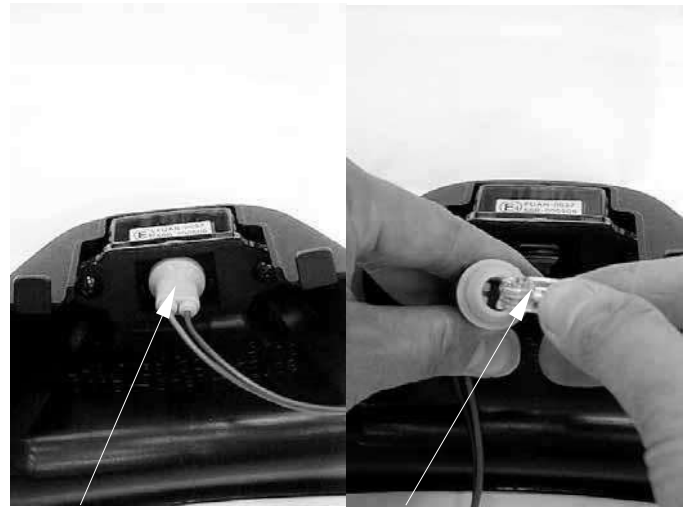

Socket

Bulb

SPEED SENSOR REMOVAL/INSTALLATION

Remove the front cover (page 2-11).

Disconnect the speed sensor connector.
Remove the bolt and speed sensor.

Installation is in the reverse order of removal.



Speed Sensor connector

Bolt

Speed Sensor

INSPECTION

Measure the speed sensor to speed sensor guide clearance.

Standard (A): 0.3 – 1.2 mm (0.0012 – 0.048 in)

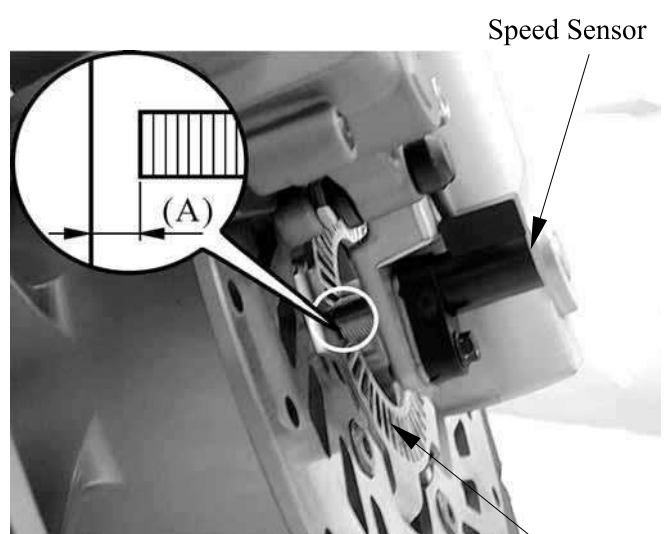

Speed Sensor

Speed Sensor Guide

21. LIGHTS/METERS/SWITCHES

XCITING 500/500 AFI/250/300 AFI

ADJUSTMENT

Remove the bolt and speed sensor.

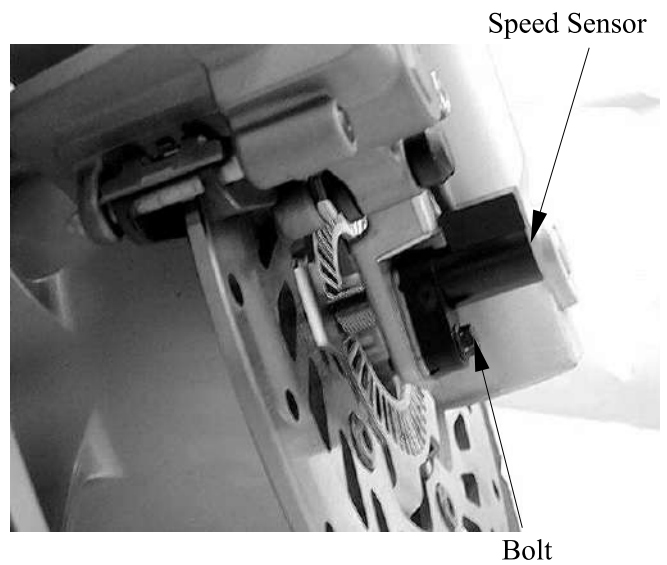

Remove the speed sensor cap.

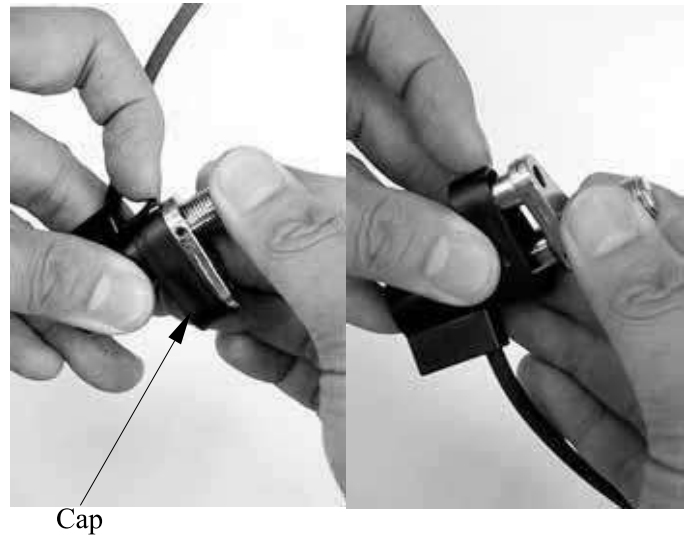

Loosen the lock screws and adjust speed sensor to the standard clearance.

Standard: 0.3 – 1.2 mm (0.0012 – 0.048 in)

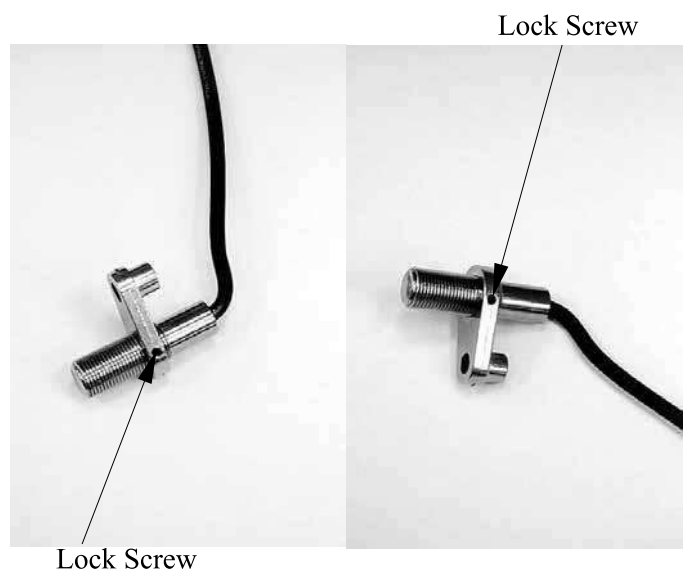

21. LIGHTS/METERS/SWITCHES

XCITING 500/500 AFI/250/300 AFI

BRAKE LIGHT SWITCH

Remove the upper handlebar cover (page 2-5).

Disconnect front or rear light switch connector and check for continuity between the switch terminals.

There should be continuity with the front or rear brake lever squeezed, and there should be no continuity with the front or rear brake lever is released.



Brake Light Switch

IGNITION SWITCH INSPECTION

Remove the front cover (page 2-11).

Disconnect the ignition switch connector and check for continuity at the switch side connector terminals.

Continuity should exist between the color code wires as follows:

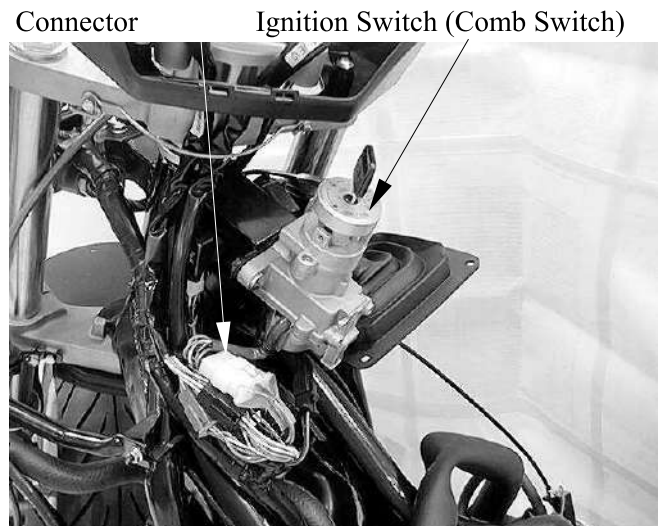

Connector

Ignition Switch (Comb Switch)

COMB SW

	BAT2	IG	E	BAT1	HA
LOCK		○—○			
OFF		○—○		○—○	
ON	○			○—○	
COLOR	B	B/W	G	R	B/L

21. LIGHTS/METERS/SWITCHES

XCITING 500/500 AFI/250/300 AFI

HANDLEBAR SWITCH INSPECTION

Remove the front cover (page 2-11).

Right handlebar switch

Disconnect the right handlebar switch connector and check for continuity at switch side connector terminals.

Continuity should exist between the color code wires as follows:

LIGHTING SW

	BAT4	PO	TL	HL
•				
(N)				
P	○—○	○—○	○	
(N)	○—○	○—○	○—○	○
H	○—○		○—○	○
COLOR	BR/L	BR/W	BR	W/L

STARTER SW

	E	ST
FREE		
PUSH	○—○	○
COLOR	G	Y/R

HAZARD SW

	WR	HA
△	○—○	○
OFF	○—○	○
COLOR	B/L	Y/B

ENGINE STOP SW

	IG	BAT3
OFF		
RUN	○—○	○
COLOR	B/W	B/G

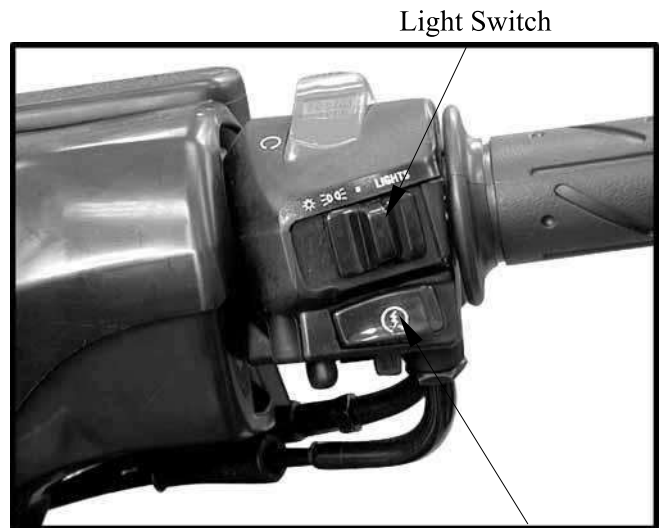

Light Switch

Starter Switch

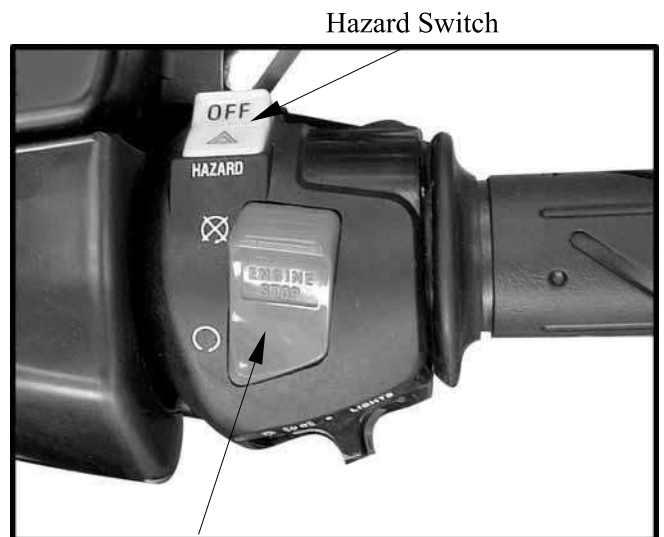

Hazard Switch

Engine Stop Switch

21. LIGHTS/METERS/SWITCHES

XCITING 500/500 AFI/250/300 AFI

Left handlebar switch

Disconnect the left handlebar switch connector and check for continuity at switch side connector terminals.

Continuity should exist between the color code wires as follows:

WINKER SW

	WR	R	L
R	○—○		
N			
L	○—○		
COLOR	GR	SB	O

HORN SW

	BAT4	HO
FREE		
PUSH	○—○	
COLOR	BR/L	LG

PASSING SW

	BAT4	HI
FREE		
PUSH	○—○	
COLOR	BR/L	L

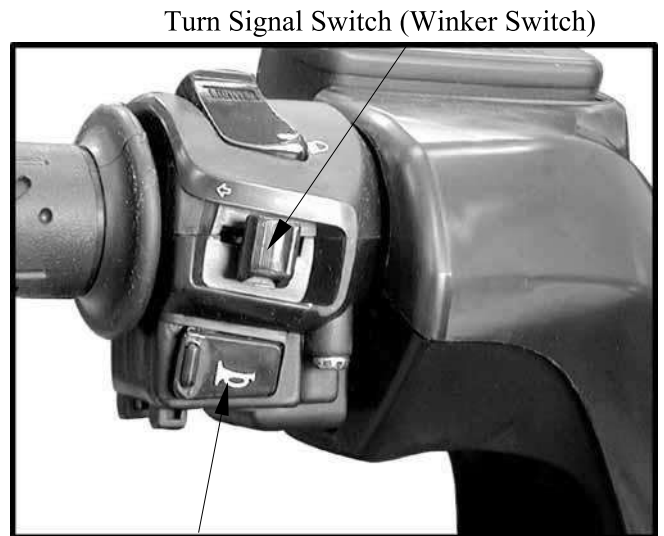

Turn Signal Switch (Winker Switch)

Horn Switch

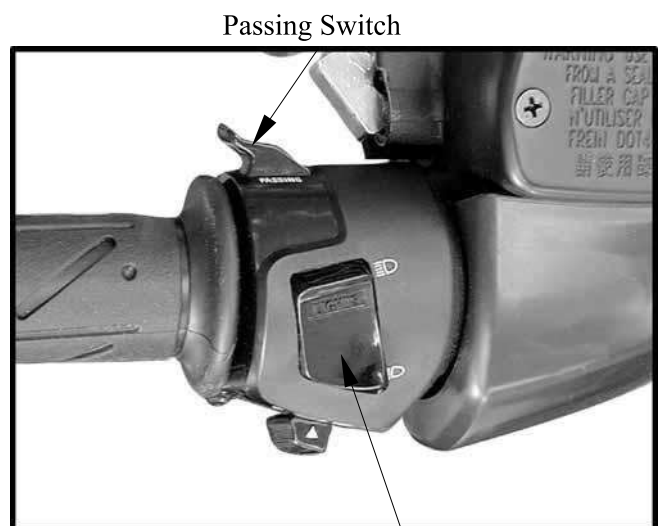

Passing Switch

Dimmer Switch

DIMMER SW

	HL	HI	LO
LO	○—○		
(N)	○—○	○—○	
HI	○—○		
COLOR	W/L	L	W

21. LIGHTS/METERS/SWITCHES

XCITING 500/500 AFI/250/300 AFI

PARKING SWITCH (XCITING 500/500 AFI)

INSPECTION

Remove the front cover (page 2-11).

Disconnect the parking switch connector and check for continuity between the switch terminals.

There should be continuity with the parking lever pull up, and there should be no continuity with the front brake lever is push down.

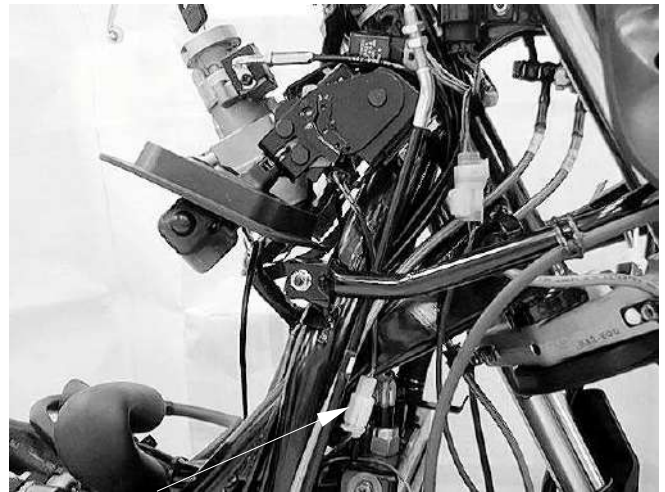

Parking Brake Switch Connector

LUGGAGE BOX LIGHT SWITCH

INSPECTION

Remove the luggage box (page 2-3).

Disconnect the luggage box light switch connector and check for continuity between the switch terminals.

There should be no continuity with the luggage box light switch pushed, and there should be continuity with the luggage box light switch is released.



OIL PRESSURE SWITCH

INSPECTION

If the oil pressure warning indicator stays on while the engine running, check the engine oil level before inspection.

Make sure that the oil pressure warning indicator come on with the ignition switch ON.

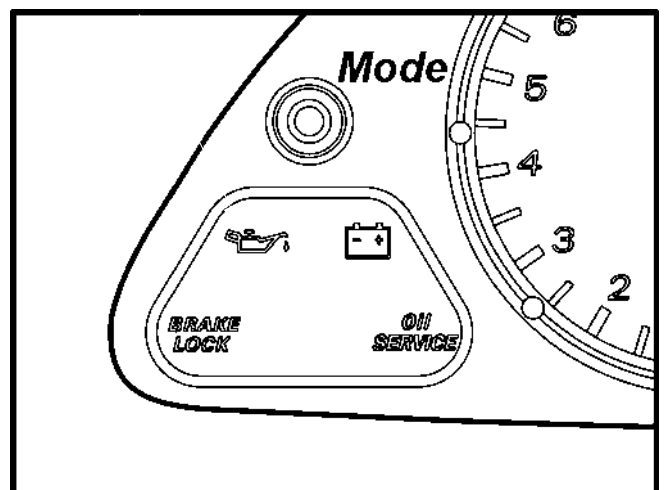

21. LIGHTS/METERS/SWITCHES

XCITING 500/500 AFI/250/300 AFI

If the indicator does not come on, inspect as follow:

Remove the dust cover and disconnect oil pressure switch terminal.

Dust Cover



Short the oil pressure switch wire terminal with the ground using a jumper wire.

The oil pressure warning indicator comes on with the ignition switch is ON.

If the light does not comes on, check the fuse and wires for a loose connection or an open circuit.

Start the engine and make sure that the light goes out.

If the light does not go out, check the internal oil for leak.

If the engine oil does not leak, replace the oil pressure switch (see below).

Oil Pressure Switch Terminal



Oil Pressure Switch

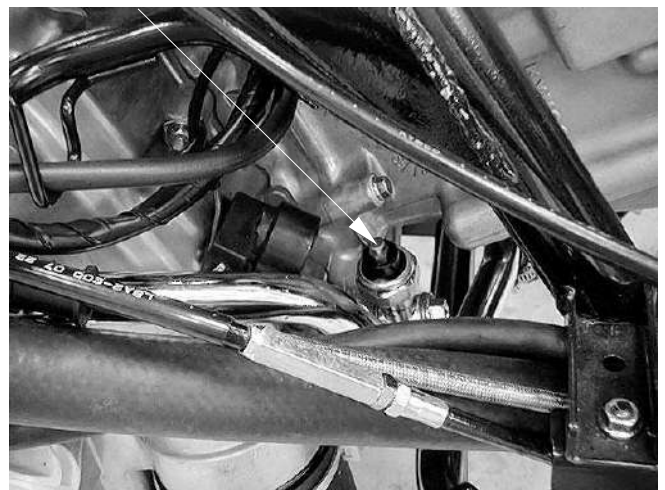

REMOVAL/INSTALLATION

Remove the dust cover and disconnect oil pressure switch terminal.

Remove the oil pressure switch from the crankcase.

21. LIGHTS/METERS/SWITCHES

XCITING 500/500 AFI/250/300 AFI

Apply sealant to the oil pressure switch threads as shown.

Install the oil pressure switch onto the crankcase, tighten it to the specified torque.

Torque: 22 N•m (2.2 kgf•m, 16 lbf•ft)

Do not apply sealant to the thread head 3 – 4 mm (0.1 – 0.2 in)

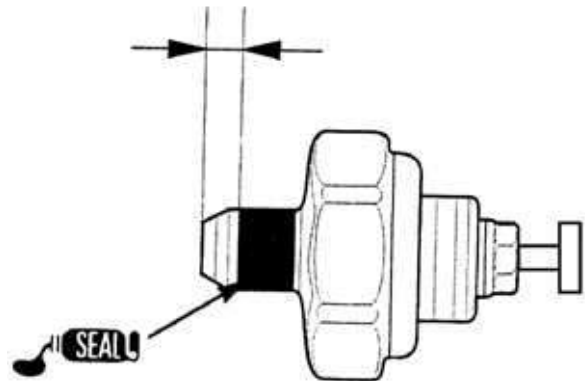

Oil Pressure Switch Terminal

Connect the oil pressure switch terminal to the switch.



Dust Cover

Install the dust cover.



21. LIGHTS/METERS/SWITCHES

XCITING 500/500 AFI/250/300 AFI

FUEL UNIT (XCITING 500/250)

REMOVAL

Remove the floorboard (page 2-6).

Disconnect the fuel unit connector.

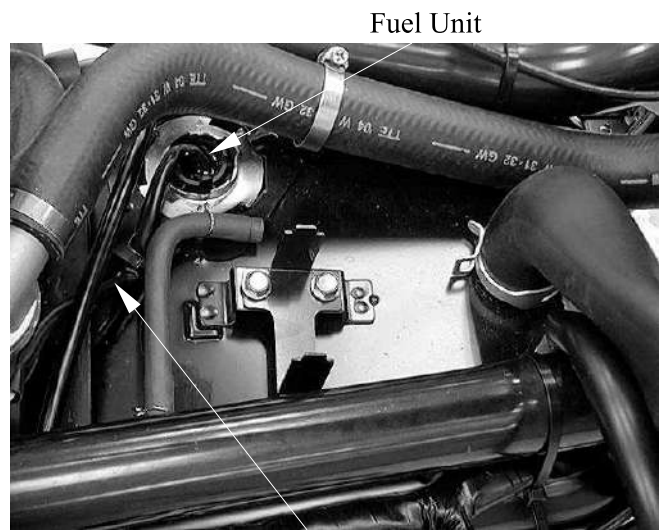

Fuel Unit

Fuel Unit Wire

Turn the fuel unit retainer counterclockwise and remove it.

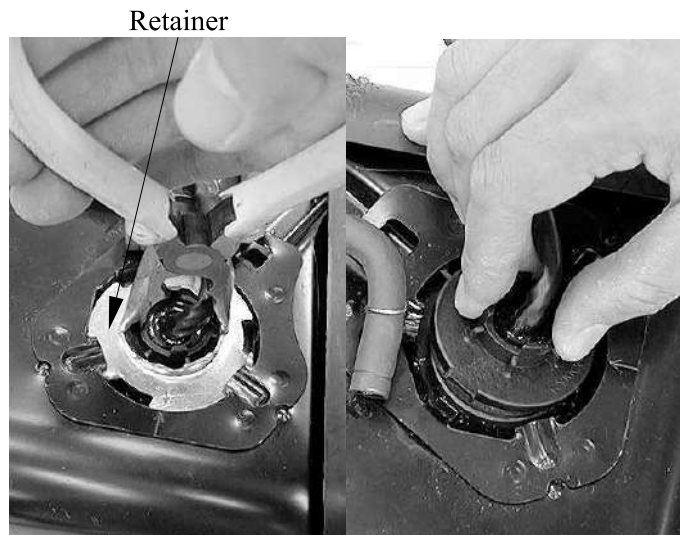

Retainer

Remove the fuel unit.

Be careful not to bend or damage the fuel unit float arm.

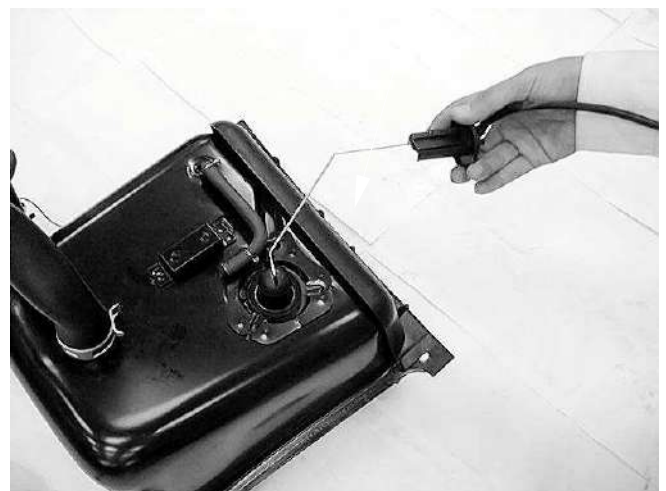

21. LIGHTS/METERS/SWITCHES

XCITING 500/500 AFI/250/300 AFI

INSPECTION

Connect the fuel unit wire connectors and turn the ignition switch "ON".

Check the fuel meter for correct indication by moving the fuel unit float up and down.

Float Position	Display
Upper	Much (Full)
Lower	Less (Empty)

Wire Terminals	Display
Free	From Much to Less
Apply	From Less to Much

The fuel meter is normal if it operates as above indicated. If not, check for poorly connected terminals or shorted wires.

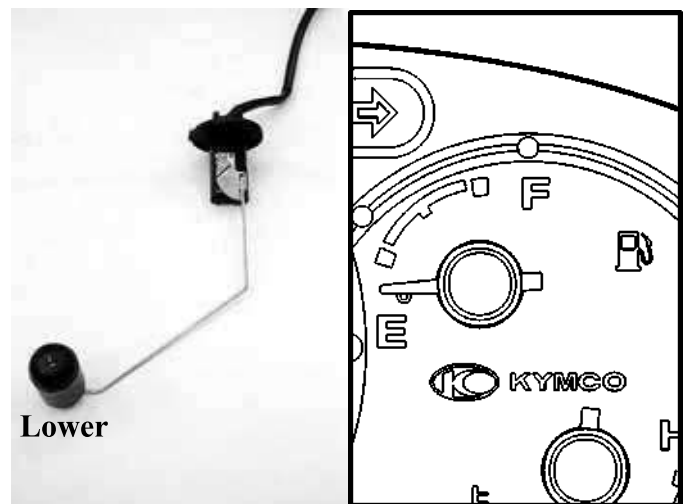
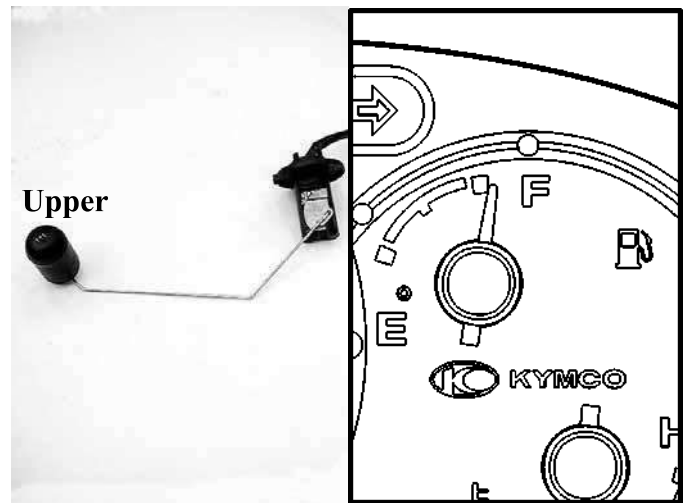

INSTALLATION

Install the O-ring and fuel unit.

Align the groove on the fuel unit with the flange on the fuel tank.

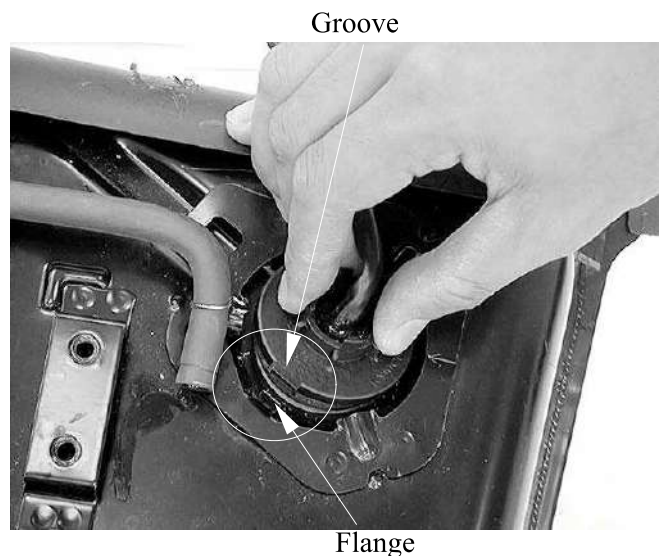

21. LIGHTS/METERS/SWITCHES

XCITING 500/500 AFI/250/300 AFI

Install the fuel unit retainer.

Align the arrow mark on the fuel unit retainer with the arrow mark on the fuel tank.

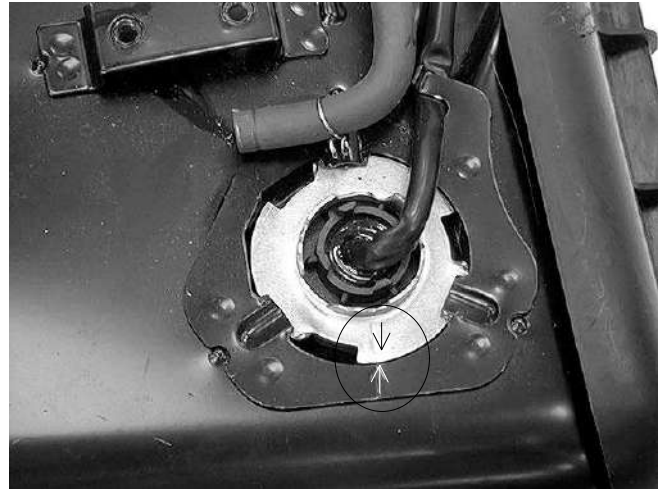

SIDE STAND SWITCH INSPECTION

Remove the left floor skirt (page 2-5).

Disconnect the side stand switch connector. There should be continuity between the Yellow/Green and Green with the side stand retracted.

There should be continuity between the Yellow/Black and Green with the side stand applied.

Side Stand Switch Connector

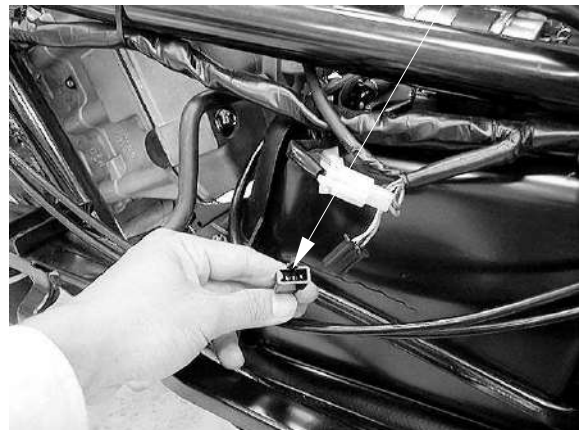

REMOVAL

Remove the left floor skirt (page 2-5).

Disconnect the side stand switch connector. Remove the bolt and side stand switch from the side stand.

Luggage Box Light Connector

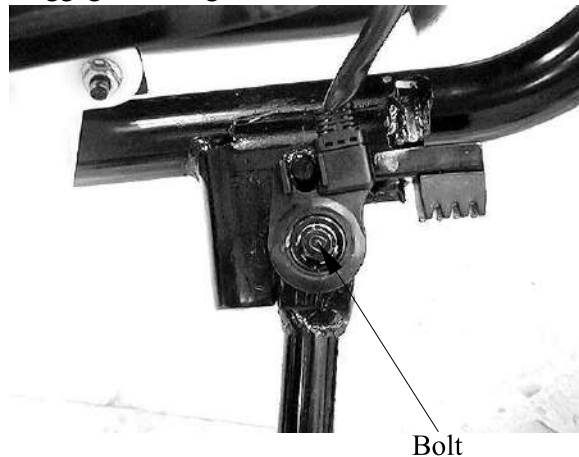

21. LIGHTS/METERS/SWITCHES

XCITING 500/500 AFI/250/300 AFI

Installs the side stand switch aligning the switch pin with the side stand hole.

Install and tighten the side stand switch bolt securely.

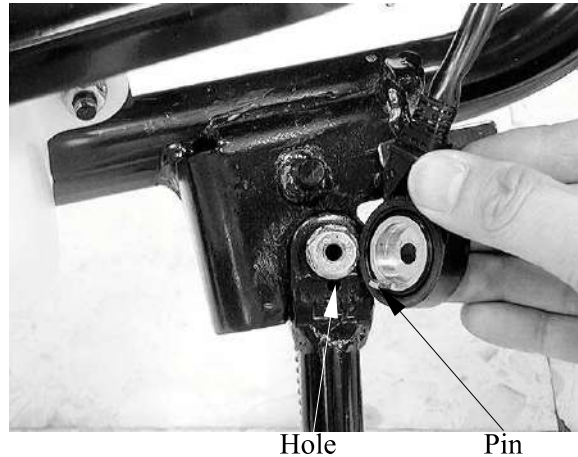

HORN INSPECTION

Remove the front cover (page 2-11)

Disconnect the horn connectors from the horn.

Connect a 12 V battery to the horn terminals.
The horn is normal if it sounds when the 12 V battery is connected across the horn terminals.

Connector

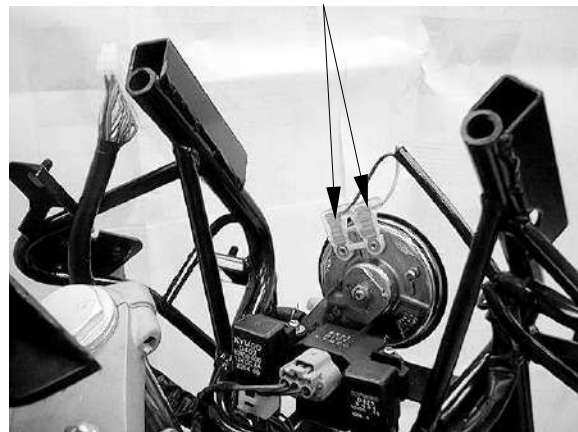

REMOVAL/INSTALLATION

Remove the front cover (page 2-11)

Disconnect the horn connectors from the horn.
Remove the nut and horn.

Installation is in the reverse order of removal.

Horn

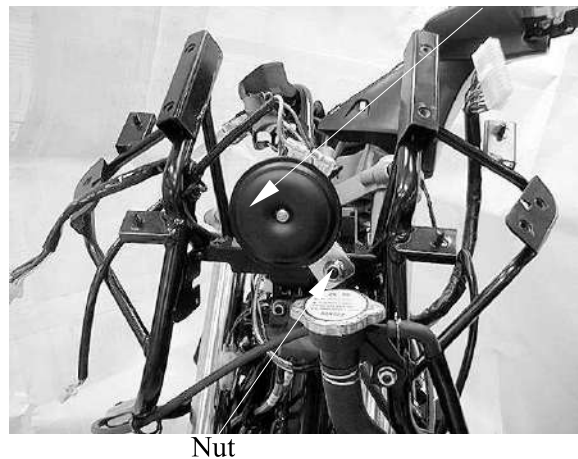

Nut

21. LIGHTS/METERS/SWITCHES

XCITING 500/500 AFI/250/300 AFI

BANK ANGLE SENSOR (XCITING 500)

INSPECTION

Support the scooter level surface.

Remove the meter panel (page 2-13).

Turn the ignition switch to “ON” and measure the voltage between the following terminals of the bank angle sensor connector with the connector connected.

TERMINAL	STANDARD
Black/Blue	Battery voltage
Black/White	Battery voltage – (0-1 V)



Bank Angle Sensor

The engine should stop as you incline the bank angle sensor approximately degrees to the left or right.

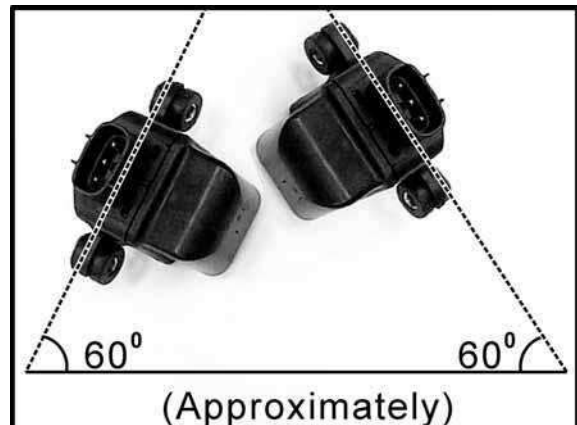

REMOVAL/INSTALLATION

Disconnect the bank angle sensor connector.

Remove the two screws, washers and bank angle sensor.



Bank Angle

Sensor Screws/Washers

21. LIGHTS/METERS/SWITCHES

XCITING 500/500 AFI/250/300 AFI

Installation is in the reverse order of removal.

Install the bank angle sensor with its “UP” mark facing up.

Tighten the mounting screws securely.



HEATER CONTROL UNIT (XCITING 500/250)

INSPECTION

Heater control unit inspection

1. Open ignition switch to check if the brown /blue wire of it is enough voltage.
2. Put the heater controller unit in refrigerator. Start engine after keeping the temperature under 10 ± 4 .
3. Check if the yellow wire of heater controller unit has output voltage.

Start engine and if the temperature of heater controller unit is under 10 ± 4 . Check if the white/yellow wire of heater controller unit has output voltage. If it has not any voltage. It is damaged.

REMOVAL/INSTALLATION

Remove the side body cover (page 2-8).

Remove the nut and heater control unit.

Installation is in the reverse order of removal.

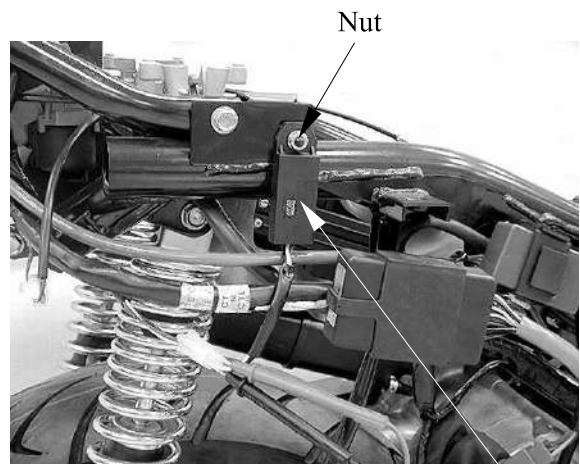

Heater Control Unit