



**DIRT BIKE  
MOTOCROSS  
MOTARD**

**XB31** ○

**XB37** ○

**XB39** ○

**XB85** ○

**XB88** ○



**ENGINE DISPLACEMENT**

**200 250**

**OWNER'S MANUAL**

**XB31-250**



**XB37-250**



**XB39-250**



**XB85-250**



**XB88-250**



**XB31-200**



**XB37-200**



**XB39-200**



**XB85-200**



**XB88-200**



## **Owner's Manual**

This manual should be considered a permanent part of the motorcycle and should remain if it is resold.

This manual contains the latest product information available before printing. XGroup Corporation reserves the right to make changes at any time without notice and without incurring any obligation.

No part of this publication may be reproduced without written permission.

© 2013 - 2014 XGroup Corporation



# IMPORTANT

**PLEASE READ THIS MANUAL CAREFULLY AND COMPLETELY BEFORE GOING ON YOUR FIRST RIDE. IT CONTAINS A GREAT DEAL OF INFORMATION AND ADVICE WHICH WILL HELP YOU USE AND HANDLE YOUR BIKE PROPERLY.**

**Please write the serial numbers of your motorcycle in the boxes below**

Chassis (VIN) Number

Engine Number

Key Number (If Available)

Dealer Stamp

## CONSUMER INFORMATION FOR UNITED STATES

### **Tampering with noise & emissions control systems is prohibited**

Owners are warned that the law prohibits:

- A.** The removal or rendering inoperative by any person other than for purposes of maintenance, repair or replacement, of any device or element of design incorporated into any new vehicle for the purpose of noise and/or emissions control prior to its sale or delivery to the ultimate purchaser or while it is in use; and
- B.** The use of the vehicle after such device or element of design has been removed or rendered inoperative by any person.

XGroup Corporation reserves the right to modify any equipment, technical specifications, colors, materials, services offered and rendered, and the like so as to adapt them to local conditions without previous announcement and without giving reasons, or to cancel any of the above items without substituting them with others. It shall be acceptable to stop manufacturing a certain

model without prior notice. In the event of such modifications, please ask your local Xmosos dealer for information.



## LIMITED WARRANTY

**WHAT IS COVERED:** Please check your “Warranty and Service Record” booklet.

**WHAT IS NOT COVERED:** This warranty does not cover any conditions caused by misuse, neglect, negligence, accident operation in any way contrary to the operating instructions in the owner’s manual, normal wear, alteration, modification, improper or inadequate maintenance, use of unauthorized replacement parts, or service provided by anyone other than an authorized Xmosos service center and/or dealer. This warranty does not cover transportation costs for warranty service. Without limiting the above, this warranty is Voided with respect to any product that has been used for rental or commercial purposes or that sustained the following damage:

- Bent or broken frame or swing-arm due to abuse
- Bent or broken wheels due to abuse
- Bent or broken plastic shrouds due to abuse
- Any sign of impact, accident, spin-outs or roll over not caused by the condition for which the warranty coverage is sought.

**TO GET SERVICE:** Contact your nearest Xmosos service center and/or dealer. The cost of transportation of the product to and from the service center and/or dealer must be paid by the owner.

Xmosos obligation under this warranty is strictly and exclusively limited to the repair or replacement of defective parts and Xmosos does not assume or authorize anyone to assume for them any other obligation. No service center and/or dealer is authorized to modify this warranty.

All implied warranties are limited in duration to the stated warranty period, and are hereby expressly disclaimed in their entirety after the expiration of the warranty period.

# CONTENTS



IMPORTANT WARRANTY INFORMATION	04	<b>SUSPENSION SYSTEM</b>	48 - 51
INTRODUCTION	06	FRONT SUSPENSION INSPECTION	48
IMPORTANT SAFETY INFORMATION	07, 08	FRONT SUSPENSION ADJUSTMENT	48 - 49
SAFETY INFORMATION FOR PARENTS	09	REAR SUSPENSION INSPECTION	49
SAFETY LABEL INFORMATION	10, 11	REAR SUSPENSION ADJUSTMENT	50, 51
COMPONENT LOCATIONS	12 - 15	<b>RIMS, TIRES &amp; SPOKES</b>	52 - 54
SERIAL NUMBER LOCATIONS	16	TIRE AIR PRESSURE	52
HANDLE BAR LEVER CONTROLS	17	TIRE INSPECTION	53
OPERATING CONTROLS	17 - 21	TIRE AND TUBE REPLACEMENT	53
GUAGES, INDICATORS & DISPLAY	22	NEW TIRE BREAK-IN PERIOD	54
BEFORE RIDING	23	<b>DRIVE CHAIN SYSTEM</b>	54 - 58
PROTECTIVE GEAR & APPAREL	23	DRIVE CHAIN INSPECTION	54
IS THE MOTORCYCLE READY TO RIDE	24	DRIVE SPROCKET INSPECTION	55
PRE-RIDE INSPECTION	24	CHAIN ROLLER INSPECTION	55
BASIC OPERATION & RIDING	25 - 27	CHAIN SLIDER INSPECTION	56
BREAK-IN PERIOD	25	CHAIN ADJUSTMENT	57
SAFE RIDE PRECAUTIONS	25	CHAIN LUBRICATION	57
ENGINE STARTING PROCEDURE	26	CHAIN REMOVAL & REPLACEMENT	58
FLOODED ENGINE	27	TROUBLESHOOTING	59 - 63
STOPPING THE ENGINE	27	RESOLVING THE UNEXPECTED	64, 65
SHIFTING GEARS	28	TORQUE SPECIFICATIONS	66 - 70
BRAKING TECHNIQUE	29	SPECIFICATIONS	71, 72
PARKING & POST RIDE INSPECTION	29	WIRING SCHEMATICS	73 - 75
MAINTAINING YOUR DIRT BIKE	30	MAINTENANCE RECORDS	76
IMPORTANT SAFETY PRECAUTIONS	30	NOTES	77, 78
MAINTENANCE SCHEDULE	31 - 33		
<b>BASIC MAINTENANCE PRECEDURES</b>	34 - 58		
FUEL, GASOLINE	34		
REFUELING & INSPECTION	34		
COOLING SYSTEM	35		
ENGINE OIL	36		
CHECKING & ADDING OIL	36, 37		
CHANGING OIL & FILTER	38		
CHANGING AIR FILTER	39		
THROTTLE SYSTEM	40		
ENGINE IDLE SPEED	41		
CLUTCH SYSTEM	42, 43		
SPARK PLUG	44		
BRAKING SYSTEM	45 - 47		
BRAKE LEVER ADJUSTMENT	45		
BRAKE FLUID CHECK	45		
ADDING BRAKE FLUID	46		
BRAKE PADS	47		
BRAKE SYSTEM BLEEDING	47		



## INTRODUCTION

Congratulations on choosing your Xmotos motorcycle.

Your Xmotos motorcycle was designed as a recreational motorcycle for off-road use only by a single rider. This motorcycle is ideal for riders with basic experience. (Off-Road)

Your Xmotos motorcycle was designed as an on road motorcycle and to be used only by a single rider. (On-Road)

**This manual has information regarding four (4) different types of models. Please read and understand each section before riding and/or performing maintenance. Each section and/or picture will have information about the type of model that you have with a model number or name as LC/ZS/M/RM/V4. You must be certain that you are following the instruction(s) and/or information pertaining to the particular model that you own.**

Before riding, take plenty of time to get acquainted with your motorcycle and how it works. To protect your investment, we urge you to keep your motorcycle well maintained. In addition to regular maintenance, it is just as important to observe and perform all pre-ride and periodic checks detailed in this manual. We also recommend that you read this manual before you begin riding. In this manual you will find safety information, facts, instructions, helpful tips and illustrations. To make it easy to use, the manual contains a table of contents at the beginning of the manual.

As you read through this manual, you will find information that is preceded by a **NOTICE** symbol. This information is intended to help you avoid damage to your motorcycle and/or property around you. This manual covers basic maintenance procedures. A detailed parts diagram manual is available and it can be purchased separately from Xmotos. The parts manual will be helpful to those with the mechanical skills and tools required to service their own motorcycle.

Whenever you ride, tread lightly. By staying on established trails and riding in approved areas, you will help protect the environment and keep off-road riding areas open for future use. (Off-Road)

If you have any questions or you need any special service or repair, remember that your Xmotos dealer knows your motorcycle best and will be dedicated to your complete satisfaction. Replacement parts and technical support can be obtained through your Xmotos dealer. Please be sure to register your motorcycle with Xmotos and report any address changes so that we may contact you in the future concerning important product information.





Your personal safety, and the safety of those around you, is extremely important. Operating this motorcycle safely is an important responsibility. XGroup Corporation has provided operating procedures and other information on labels and in this manual to help you make informed decisions about safety. This information will alert you to potential hazards that could harm you or others.

It is understood that it is not practical or possible to warn you about all possible hazards associated with operating and maintaining a motorcycle. You must use your own good judgment.

Safety information will come in a variety of different forms, including:

- ❖ Safety Labels on the Motorcycle.
- ❖ Safety Messages preceded by a safety symbol  and one of these signal words:

Below are the definitions of these three words:

 **DANGER** You WILL be KILLED or SERIOUSLY INJURED if you do not follow instructions.

 **WARNING** You CAN be KILLED or SERIOUSLY INJURED if you do not follow instructions.

 **CAUTION** You CAN be INJURED if you do not follow instructions.

- ❖ Safety Headings such as important safety reminders and/or precautions.
- ❖ Safety Section such as motorcycle safety.
- ❖ Instructions how to use the motorcycle safely and correctly.

This entire manual is filled with important safety information - please read it carefully.





## IMPORTANT SAFETY INFORMATION

A motorcycle can provide many years of service and pleasure, provided you take responsibility for safety, properly maintain your motorcycle and understand the challenges you may encounter while riding. Listed below are some of the most important safety measures one should take when riding.

### **⚠ DANGER**

Never Ride Without a Helmet. The following statement is a proven fact: “Helmets significantly reduce the number and severity of head injuries.” Never ride your motorcycle without a helmet. Even a crash at slow speed can result in a fatal head injury if you are not wearing a helmet. Xmosos strongly recommends wearing helmets that have been certified for safety by helmet testing organizations that are independent from the helmet manufacturer. We also recommend that you wear eye protection, boots, gloves, and other protective gear such as riding pants.

### **⚠ WARNING**

Never Carry a Passenger. This motorcycle has been designed for ONE rider only. There are no passenger pegs, footrests, handles or seat room for a passenger. Riding with a passenger can interfere with your ability to operate and/or control the motorcycle and may result in serious injury or death.

### **⚠ WARNING**

Ride Off-Road Only. This motorcycle has been designed and manufactured for off-road use only. The motorcycle is not equipped with lights, turn signals, horn and other features required to drive a motorcycle on public roads. The tires are not designed for pavement and will make the motorcycle unstable if it is ridden on pavement. If you have to cross a paved road, dismount and walk the motorcycle across the road.

### **⚠ WARNING**

Ride Within Your Limits. Never attempt to ride your motorcycle in a manner that is beyond your skill level. It takes time to learn riding skills. Learn to ride your motorcycle step by step. Start by practicing in safe areas at slow speeds and gradually build your skill level. Instruction from an experienced rider(s) is highly recommended. Remember that alcohol, drug use, fatigue and ignorance can reduce your ability to make good decisions and ride safely.

### **⚠ WARNING**

Be Alert for Hazards. The terrain or road in which you ride can present many hazards. Always “scan” the terrain or road ahead of you continually. Watch for un-expected turns, drop-offs, ditches, rocks and other hazards. Always maintain a speed slow enough to allow you enough time to see and react to hazards.

### **⚠ DANGER**

Do Not Drink and Ride. Even one drink can impair your ability to ride a motorcycle safely. Each drink afterward will make the impairment worse. Do not drink and ride. Do not let your friend’s drink and ride. Remember, in most states throughout the United States, you can be arrested and charged with Driving Under the Influence (DUI) if you are riding a motorcycle while intoxicated. This applies to off-road motorcycles as well.





As a parent, your child's safety is your first priority. Riding an off-road motorcycle is very fun. However, just like riding a bicycle, bad decisions can result in injury. As a parent, you can greatly prevent accidents by making informed decisions about if, when and how your child will ride. Always supervise your child when he/she is riding.

Before you allow your child to ride, you need to decide if he/she is capable of riding. Riding readiness can vary tremendously from one person to another. Age and size are not being the only factors that help determine one's riding readiness. There are three other factors that you should also consider before deciding if your child is ready to ride.

First, consider the **physical ability** of your child. Riders must be able to hold the motorcycle up, get on, and sit comfortably with both feet on the ground. The rider must also be able to reach all of the controls on the handlebars and work the brakes and clutch. Second, consider your child's **athletic ability**. Your child should be good at riding a bicycle before riding a motorcycle. Determine if your child can judge speeds and distances while riding a bicycle and react with the proper hand and foot actions. Any person who does not have good coordination, balance, and agility should not ride this motorcycle.

Finally, determine your child's level of **mental maturity**. It is imperative that you are honest with yourself when you ask yourself the following questions: Does your child think through problems and come to logical conclusions? Does your child obey your rules when they ride their bicycle? If your child makes bad judgments, takes un-warranted risks and/or does not obey your rules, they should not ride this motorcycle.

If you have decided that your child is ready to ride, please remember the following points and never let your child ride without a helmet. It is up to you (parent) to ensure your child's safety, even if they learn to ride from another experienced adult. Never push your child to try things faster than they are willing or capable. Always supervise your child when they are riding and regularly remind them about safety rules. As a parent it is your responsibility to be sure that the motorcycle is properly maintained and kept in safe operating condition.

Modifying this motorcycle or using parts not manufactured by Xmotos can make your motorcycle unsafe. Before you consider making any modifications or adding an accessory, please read the following information carefully.

**⚠ WARNING** Improper accessories or modifications can cause a crash in which you can be seriously hurt or killed. Follow all instructions in this owner's manual regarding and accessories.

Xmotos strongly recommends that you do not remove any original equipment or modify your motorcycle in any way that may alter the design and/or operation. Such a change could drastically impair the stability, handling, acceleration, and braking capabilities of the motorcycle and cause a crash. We also strongly suggest that you do not make any modifications to the exhaust system, noise control system or emission control components.



# SAFETY LABEL INFORMATION (LC / ZS / V4)

This page will show you where to find the safety labels on your motorcycle. You will find that some labels warn you of potential hazards. Others will provide important safety and maintenance information. Please read them carefully and do not remove them. If your label wears off from riding or becomes hard to read, contact your Xmotos dealer for a replacement.

**WARNING / AVERTISSEMENT / ADVERTENCIA**  
 Improper use of this motorcycle can result in serious injury or death. L'utilisation incorrecte de cette moto peut causer des blessures graves ou la mort. El uso incorrecto de esta motocicleta puede provocar lesiones graves o la muerte.  
 Always use an approved helmet and protective gear. Toujours utiliser un casque approuvé et un équipement de protection. Siempre utilizar con cuidado un casco y el equipo de protección.  
 Never ride on public roads. Ne conduisez jamais sur des voies publiques. Nunca rida en las vías públicas.  
 Never carry passengers. Ne transportez jamais deux ou plusieurs. Nunca lleve pasajeros.  
 Never use side stands or chocks. Ne jamais utiliser les supports latéraux ou l'éclair. Nunca utilice los pegas o alfileres.

**WARNING**  
 Never operate over speeds too fast for your skill or road conditions. Ne circulez jamais en vitesses trop excessives pour vos compétences et selon les conditions de route. Nunca conduzca a velocidad excesivamente rápida para su nivel de conducción.

**WARNING**  
 This vehicle is an off-road motorcycle and is not intended for use on public highways. Ce véhicule est une motocyclette hors route qui n'est pas destinée sur les voies publiques. Este vehículo es una moto callejera y no es para uso en autopistas públicas.

**WARNING**  
 Operating this vehicle if you are under the age of 16 increases your chance of serious injury or death. MCRDT interdit d'utiliser avant age 16 si opérez this vehicle. L'utilisation de ce véhicule par des enfants de moins de 16 ans augmente le risque de blessures graves ou de mort. No permitir JAMAIS un véhicule de moins de 16 ans d'utiliser ce véhicule. Operar este vehículo cuando es menor de 16 años aumenta la posibilidad de lesiones graves o la muerte. NUNCA permita a los niños menores de 16 años operar esta vehículo.

**UNDER 16**  
**MONS DE 16**  
**MINORES DE 16 AÑOS**

**WARNING**  
 Improper tire pressure or overloading can cause loss of control. Loss of control can result in serious injury or death. COLD TIRE PRESSURE: Recommended: Front and Rear: 15-16 psi (103-124 kpa) Never set tire pressure below the recommended level. It could cause the tire to dislodge from the rim.

**WARNING**  
 • Keep hands clear.  
 • Do not operate with guard removed.  
 • Moving parts can throw and cut.

<b>WARNING</b> LOADING: Maximum vehicle capacity is: 245 lbs. (111 kg). Maximum capacity includes the weight of the operator and accessories.	<b>AVERTISSEMENT</b> CHARGEMENT DU VEHICULE: Charge maximale autorisée: 111 kg (245 livres). La charge maximale autorisée inclut le poids combiné de l'utilisateur et des accessoires.	<b>ADVERTENCIA</b> CARGA: La capacidad máxima del vehículo es: 111 kg (245 lbs). La capacidad máxima incluye el peso del operador y los accesorios.
--	---	--

# SAFETY LABEL INFORMATION (RM)



This page will show you where to find the safety labels on your motorcycle. You will find that some labels warn you of potential hazards. Others will provide important safety and maintenance information. Please read them carefully and do not remove them. If your label wears off from riding or becomes hard to read, contact your Xmotos dealer for a replacement.

**WARNING**  
Never operate over speeds too fast for your skill or road conditions.  
**AVERTISSEMENT** Ne circuler jamais en vitesses trop excessives pour vos compétences et selon les conditions de route.  
**ADVERTENCIA** Nunca conduzca a velocidad excesivamente rápida para su nivel de conducción.

**WARNING**  
Always use the correct procedure for refueling. Do not use open flames or smoking materials near the fuel tank. Do not use the motorcycle as a stove or heater. Do not use the motorcycle as a power source for electrical equipment. Do not use the motorcycle as a generator. Do not use the motorcycle as a power source for electrical equipment. Do not use the motorcycle as a power source for electrical equipment. Do not use the motorcycle as a power source for electrical equipment.

**WARNING**  
Operating this vehicle if you are under the age of 16 increases your chance of serious injury or death.  
**UNDER 16**  
**NEVER permit children under age 16 to operate this vehicle.**  
**AVERTISSEMENT**  
L'utilisation de ce véhicule par des enfants de moins de 16 ans augmente le risque de blessures graves ou de mort.  
**MONS DE 16**  
**Ne permettez JAMAIS aux enfants de moins de 16 ans d'utiliser ce véhicule.**  
**ADVERTENCIA**  
Operar este vehículo cuando es menor de 16 años aumenta la posibilidad de lesiones graves o la muerte.  
**NIUNCA permita a los niños menores de 16 años operar este vehículo.**

**WARNING**  
Improper use of this motorcycle can result in serious injury or death. L'utilisation inadéquate de cette moto peut causer des blessures graves ou la mort. El uso incorrecto de esta motocicleta puede provocar lesiones graves o la muerte.  
Always use an approved helmet and protective gear. Porter toujours un casque approuvé et un équipement de protection. Siempre use casco aprobado y equipo de protección. Nunca use de casco usado. No conducir jamás en las vías públicas. Nunca use el vehículo en la vía pública. Never carry passengers. Ne transportez jamais deux ou plusieurs. Nunca lleve pasajeros. Never use with drugs or alcohol. Ne prenez jamais avec les substances ou l'alcool. Nunca utilice con drogas o alcohol.

**WARNING**  
Improper tire pressure or overloading can cause loss of control. Loss of control can result in serious injury or death. COLD TIRE PRESSURE: Recommended: Front: 25-28 psi (175-195 kPa) Rear: 29-31 psi (200-215 kPa) Never set tire pressure below the recommended level. It could cause the tire to dislodge from the rim.

**WARNING**  
Keep hands clear. Do not operate with guard removed. Moving parts can crush and cut.

**WARNING**  
**AVERTISSEMENT**  
**ADVERTENCIA**  
LOADING: Maximum vehicle capacity is: 245 lbs. (111 kg). Maximum capacity includes the weight of the operator and accessories. CHARGEMENT DU VEHICULE: Charge maximale autorisée: 111 kg (245 livres). La charge maximale autorisée inclut le poids combiné de l'utilisateur et des accessoires. CARGA: La capacidad máxima del vehículo es: 111 kg (245 lbs). La capacidad máxima incluye el peso del operador y los accesorios.



## COMPONENT LOCATIONS

When you ride a motorcycle off-road, you need to be able to operate the throttle, clutch, brakes, and other controls without stopping to look at them. Please read this section carefully before you ride your motorcycle. This section of the manual will show the location and operation of all the basic controls of your motorcycle.

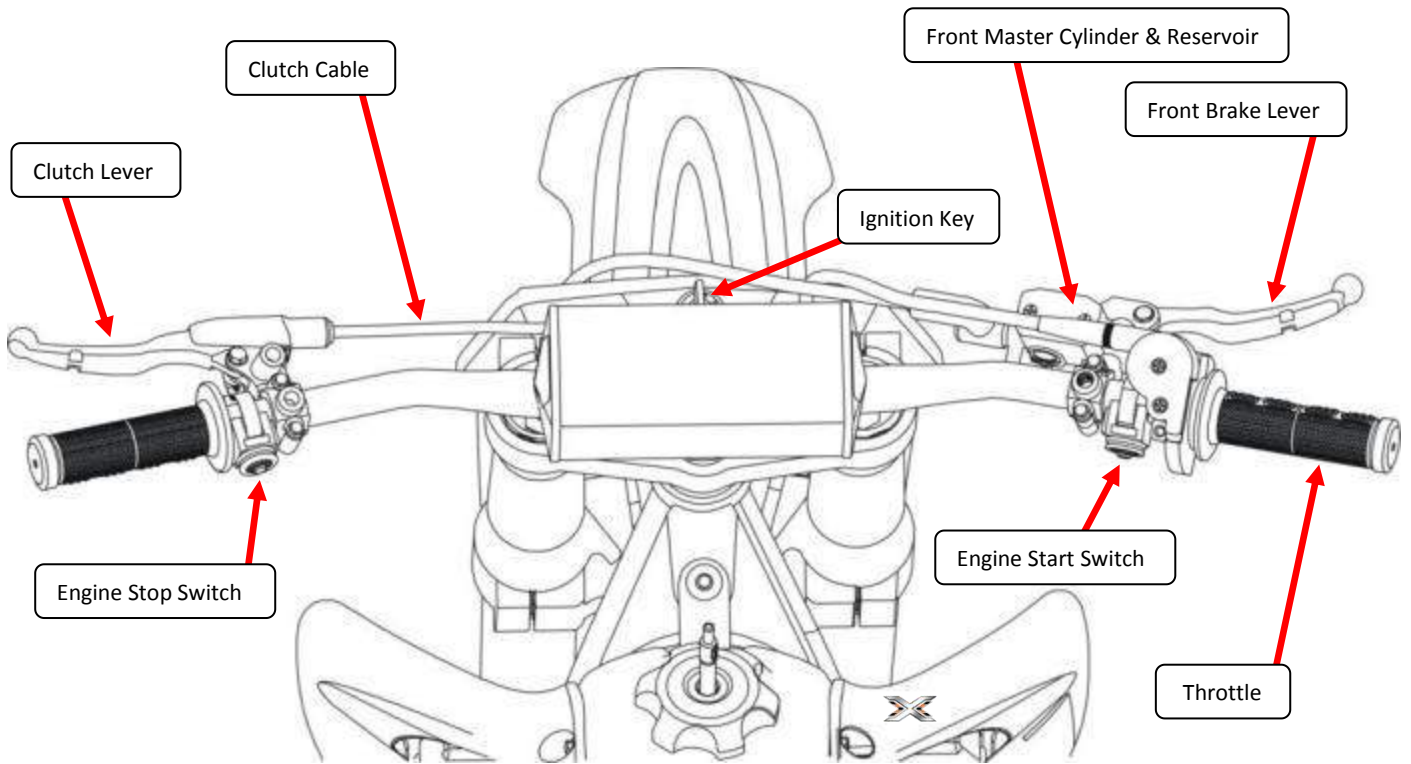

LC / ZS Models

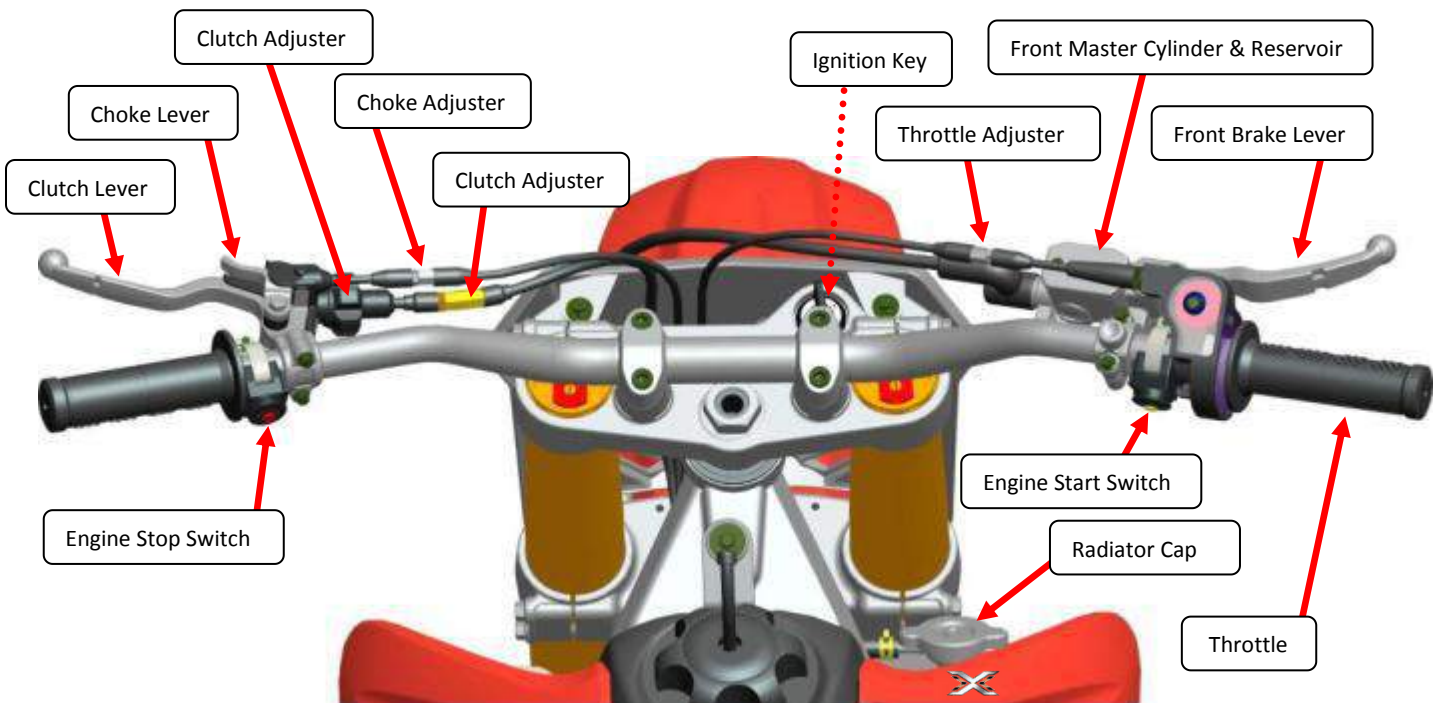

V4 Model



When you ride a motorcycle on-road, you need to be able to operate the throttle, clutch, brakes, and other controls without stopping to look at them. Please read this section carefully before you ride your motorcycle. This section of the manual will show the location and operation of all the basic controls of your motorcycle.

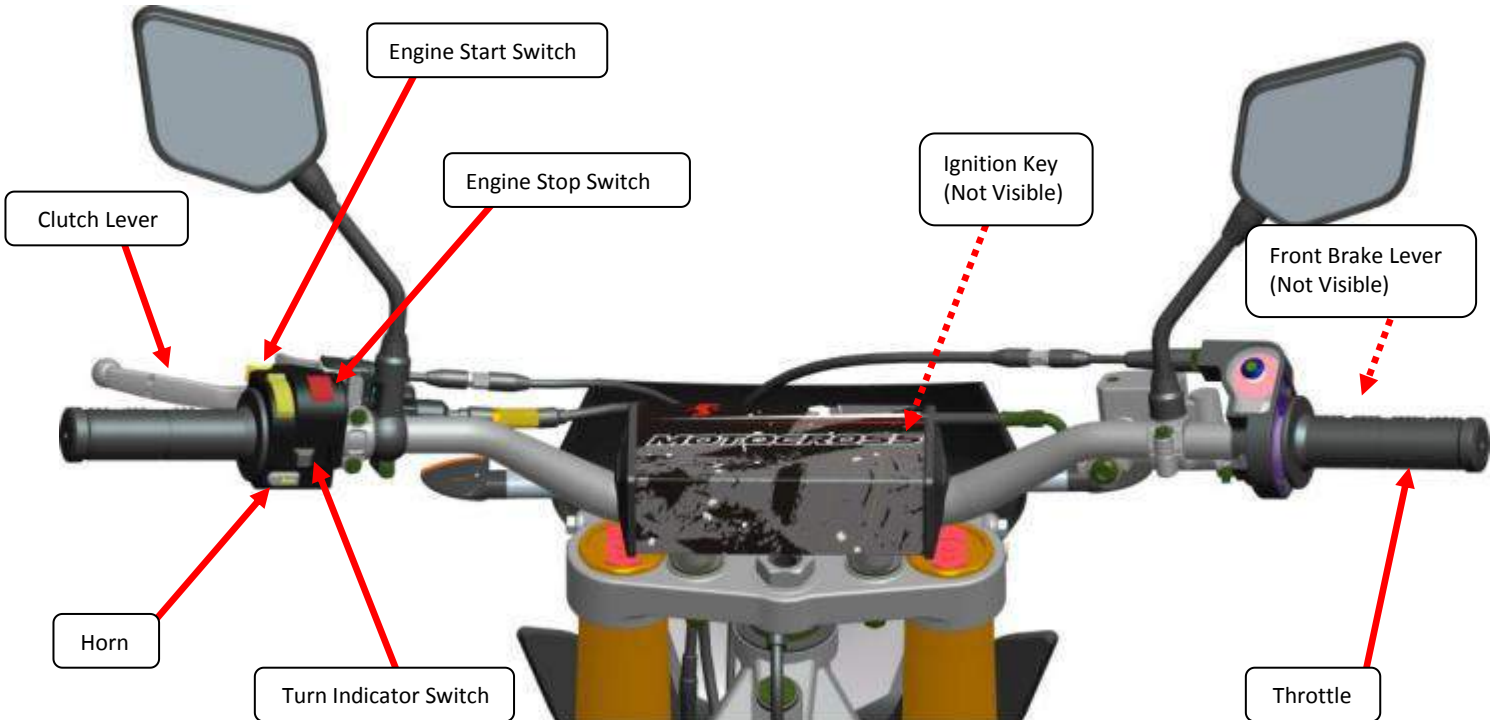



## COMPONENT LOCATIONS (OFF-ROAD)

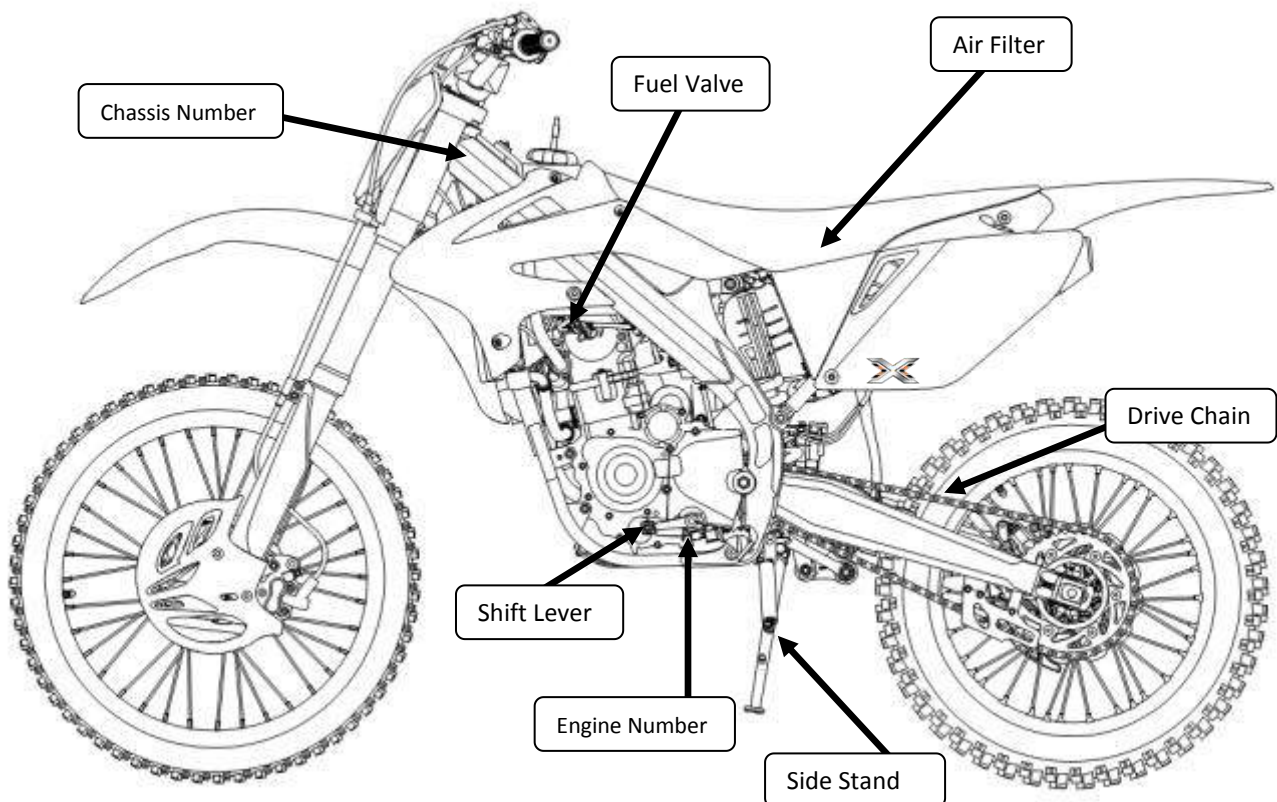
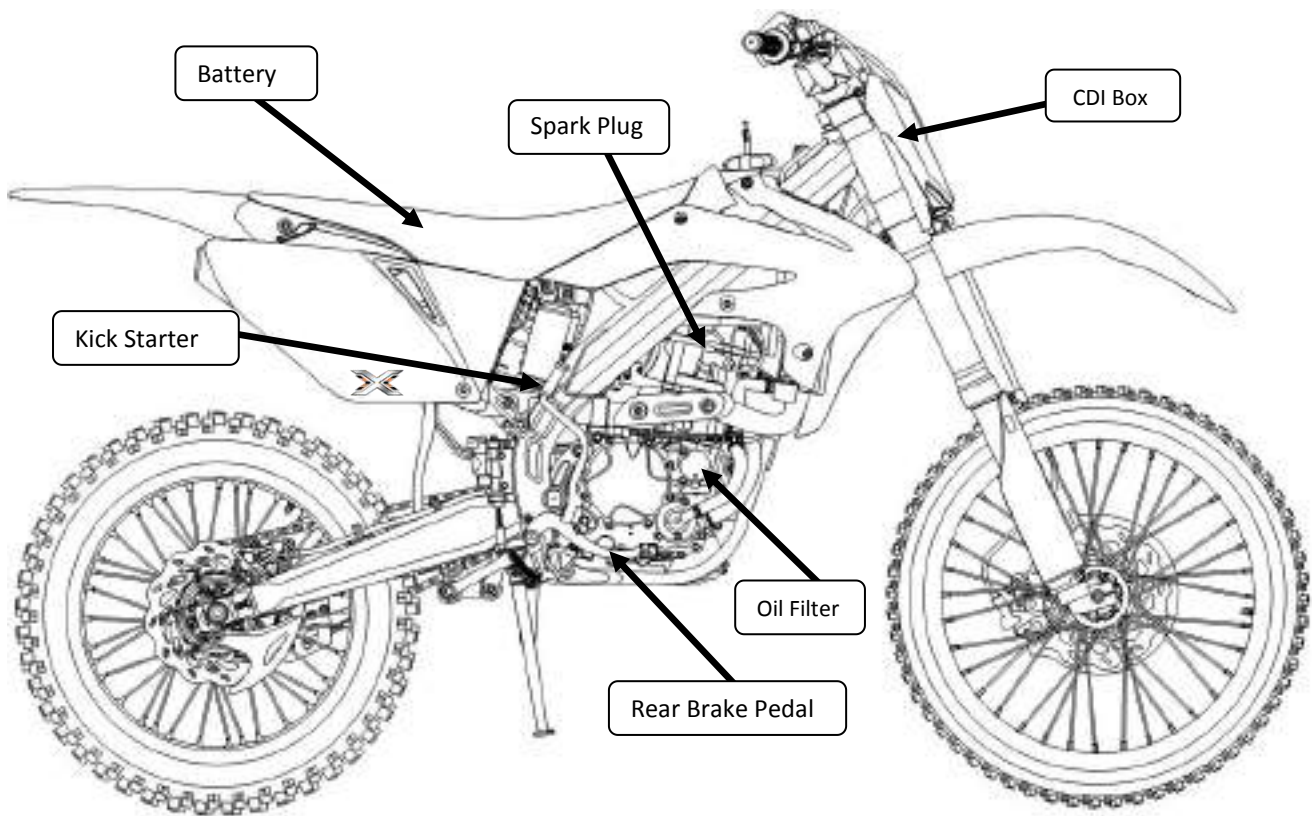

# COMPONENT LOCATIONS (ON-ROAD)

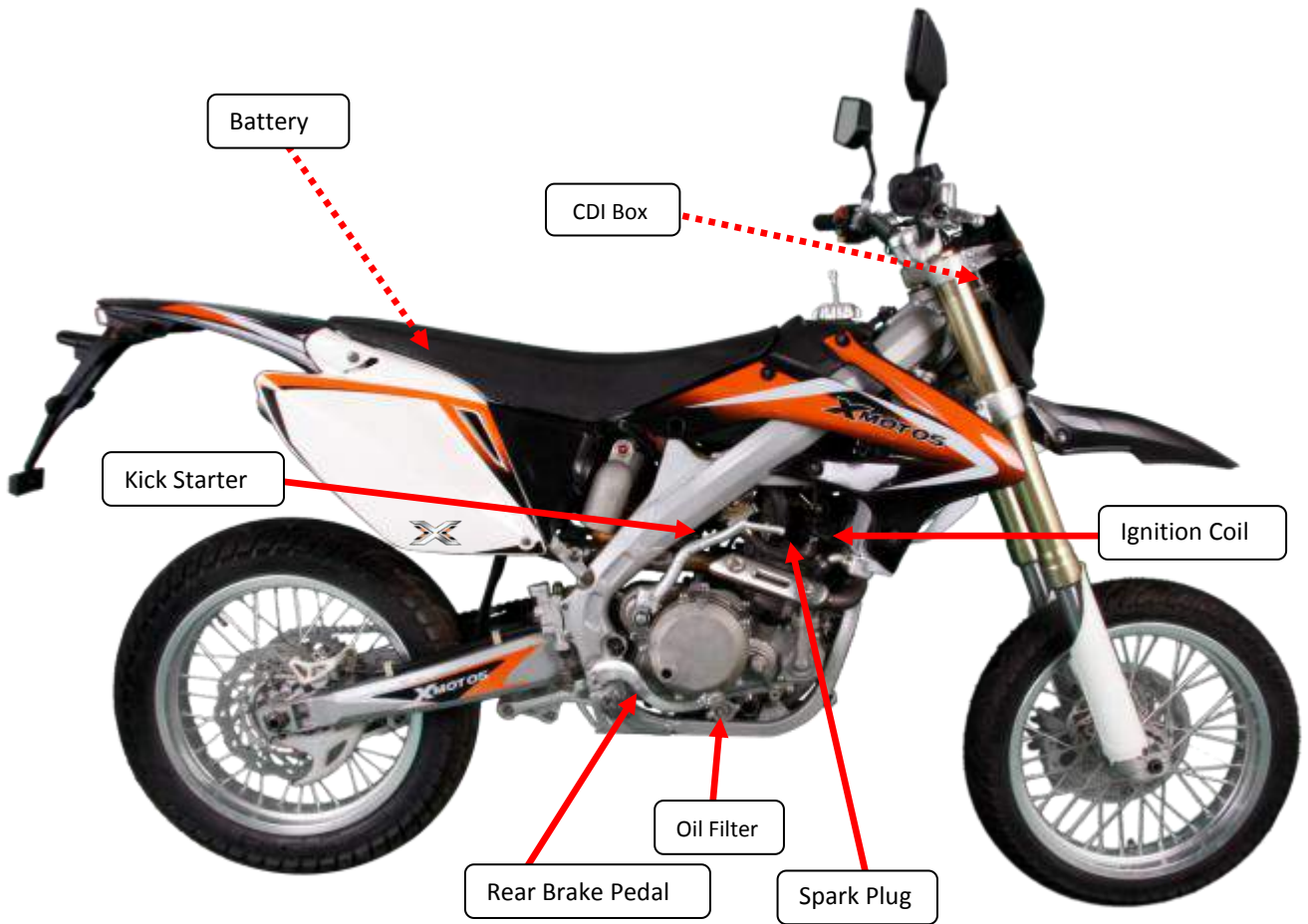



## SERIAL NUMBER LOCATIONS



### VIN – Chassis Number

The VIN number is located in one of three places on the chassis.

1. Right Side of frame.
2. Left side of frame.
3. Steering head tube.

Write this number in the VIN box on page 3.



### Engine Model & Serial Number

The engine model number and serial number is stamped on the left side of the engine under the countershaft sprocket.

Write this number in the Engine Number box on page 3.

LC / ZS SERIES



V4 / RM SERIES





## HANDLEBAR LEVER CONTROLS

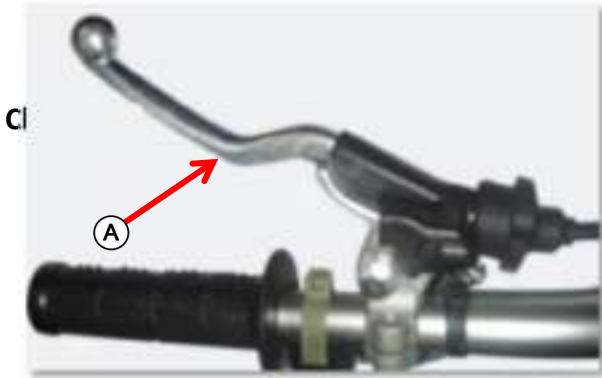

The clutch lever **A** is located on the left side of the handlebar.

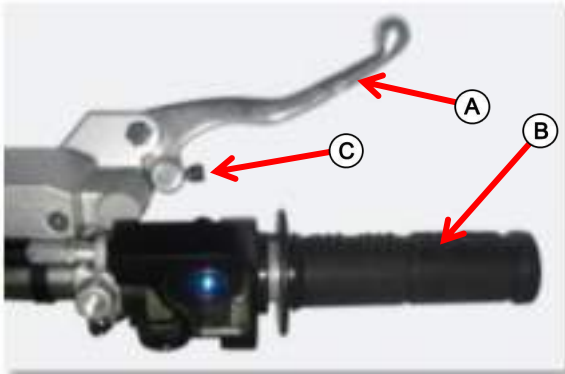

### Hand Brake Lever & Throttle

The hand brake lever **A** and throttle **B** is mounted on the right side of the handlebar. The adjusting screw **C** can be used to change the basic position of the brake lever.

## OPERATING CONTROLS (OFF-ROAD)



### Stop Switch

The stop switch **A** turns off the engine. When this button is pressed, the ignition circuit is turned off.



### Start Switch

The start switch **A** turns on the engine. When this button is pressed, the engine will start. Once started, release the button.



## OPERATING CONTROLS (ON-ROAD)

### Left Handlebar Switches

#### Electric Start Button **A**

Use this button to operate the starter motor. With the key ignition switch in the "ON" position, the engine stop switch **C** in the "RUN" position **1**, and the transmission in the neutral position, pull the clutch lever and push the electric start button to start the engine.

#### Engine Stop Switch **C**

In position **2** the ignition circuit is off. The engine cannot start or run.

In position **1** the ignition circuit is on and the engine can start or run.

#### Headlight / Dimmer Switch **B**

In position **3** the headlight low beam and tail-light turn on.

In position **4** the headlight high beam and tail-light turn on. The high beam indicator light also turn on.

#### Turn Signal Light Switch **E**

Moving the switch to the "←" position will flash the left turn signals. Moving the switch to the "→" position will flash the right turn signals. The indicator light will also flash intermittently. To cancel turn signal operation, push the switch in.

#### Horn Switch **D**

Press the horn switch to sound the horn.

## FUEL FILL CAP

### Fuel Fill Cap

**To Open:** Turn the cap **A** counter-clockwise.

**To Close:** Turn the cap clockwise, make sure the breather tube **B** is installed.

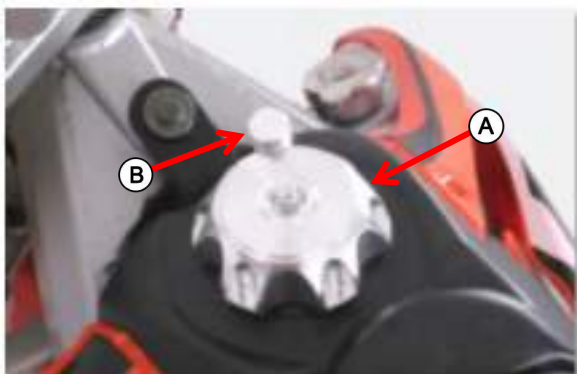
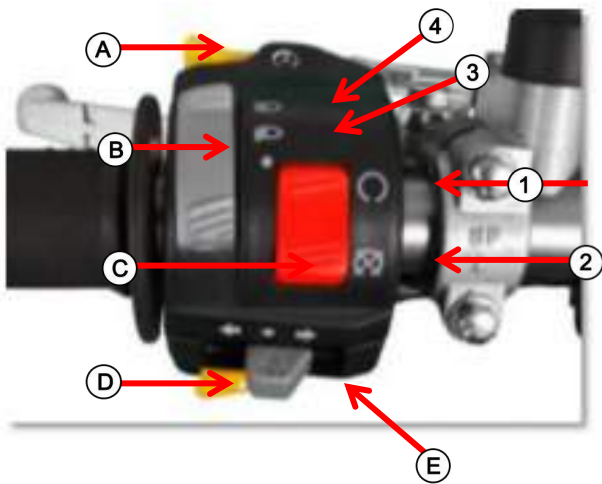



## OPERATING CONTROLS

### Key Ignition Switch

The ignition key **A** is used to supply power from the battery to the electrical components of the motorcycle in the “ON” position **B**. Turn the switch to the “OFF” position **C** when you are finished riding, or if you wish to stop the engine.

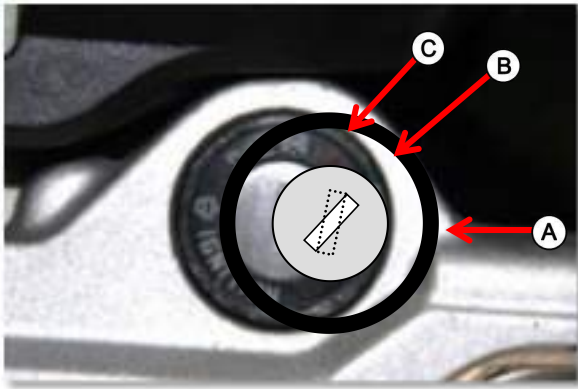

### Steering Lock

To lock the steering system, turn the key to the “OFF” position **A**, push and release the key, then rotate it to the “LOCK” position **B**.

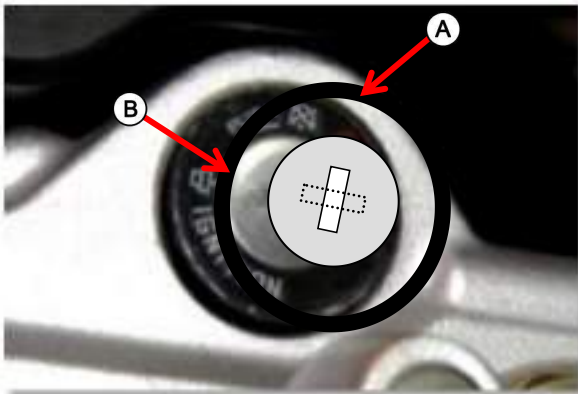

### Fuel Tap

**OFF** - In this position, the fuel tap is closed. No fuel can flow to the carburetor.

**ON** - In this position, the fuel tap is open. This means fuel can flow to the carburetor. With the lever in this position, the tank will be emptied.

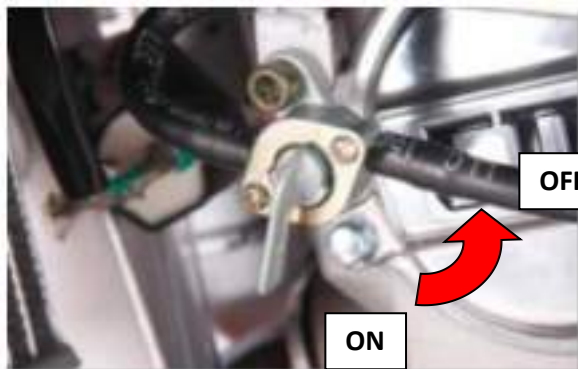

### Choke Lever (XZ250R – V4 / RM)

When pulling the choke lever **A** toward you, a cylinder in the carburetor is opened. Through this cylinder, the engine can take in additional fuel. This results in a rich fuel and air mixture, which is needed for a cold start. When releasing the choke lever, the cylinder is closed again.

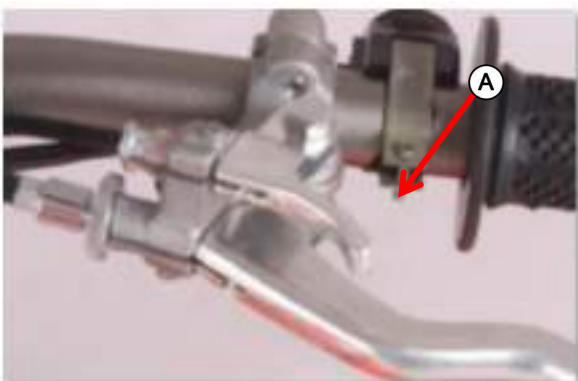



## OPERATING CONTROLS

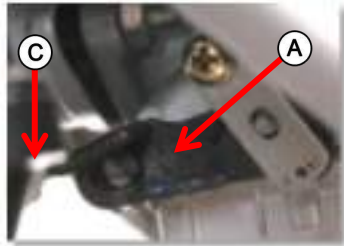
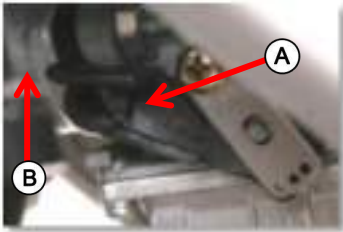

### Choke Lever (XZ250R – LC / ZS / M)

When pulling the choke lever **A** fully toward the top **B**, a cylinder in the carburetor is opened. Through this cylinder, the engine can take in additional fuel. This results in a rich fuel and air mixture, which is needed for a cold start. When pushing down **C** the choke lever, the cylinder is closed again.

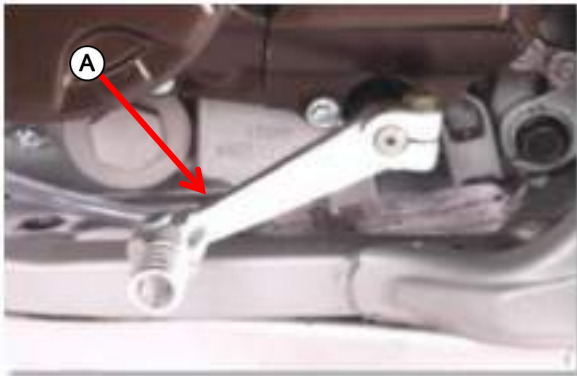

### Shift Lever (LC / ZS / M)

The shift lever **A** is on the left side of the engine. The gear positions are shown in the illustration on page 28.

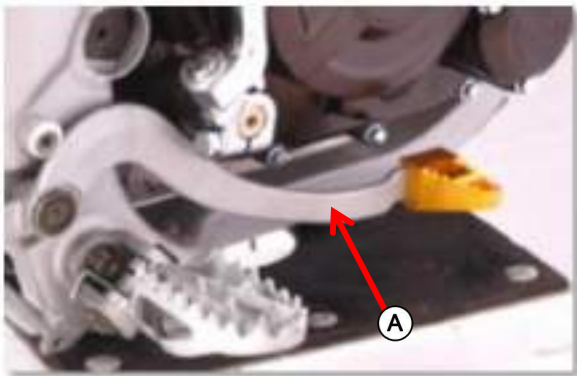

### Foot Brake Lever (LC / ZS / M)

The brake lever **A** is located on the right side of the engine. Its basic operation is to apply the rear brake to slow or stop the motorcycle.

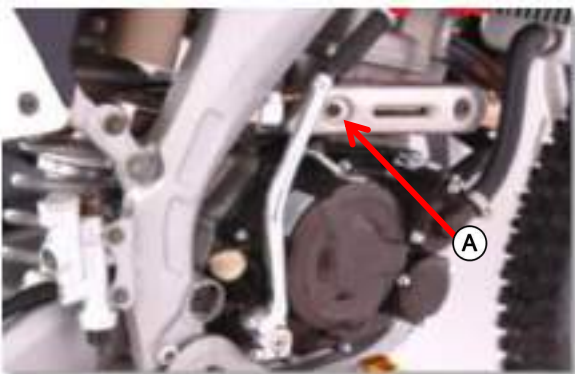

### Kick Start Lever (LC / ZS / M)

The kick start lever **A** is mounted on the right side of the engine. It is used to start the engine in case the electrical starter system is non-functional.



## OPERATING CONTROLS

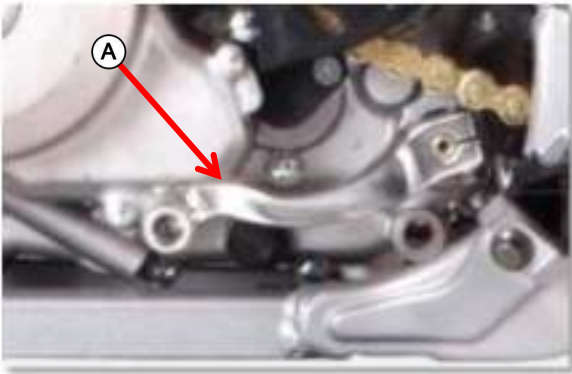

### Shift Lever (V4 / RM)

The shift lever **A** is on the left side of the engine. The gear positions are shown in the illustration on page 28.

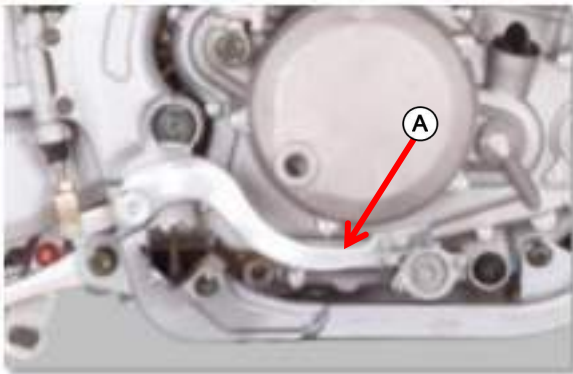

### Foot Brake Lever (V4 / RM)

The brake lever **A** is located on the right side of the engine. Its basic operation is to apply the rear brake to slow or stop the motorcycle.

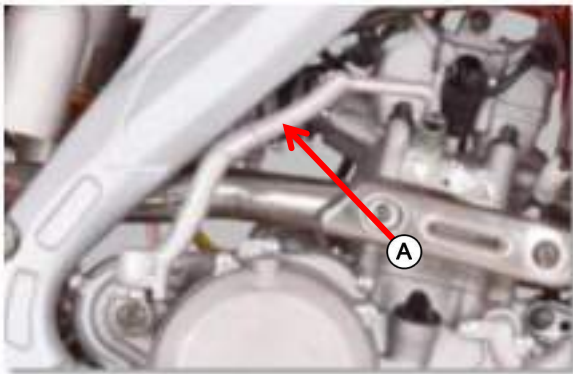

### Kick Start Lever (V4 / RM)

The kick start lever **A** is mounted on the right side of the engine. It is used to start the engine in case the electrical starter system is non-functional.

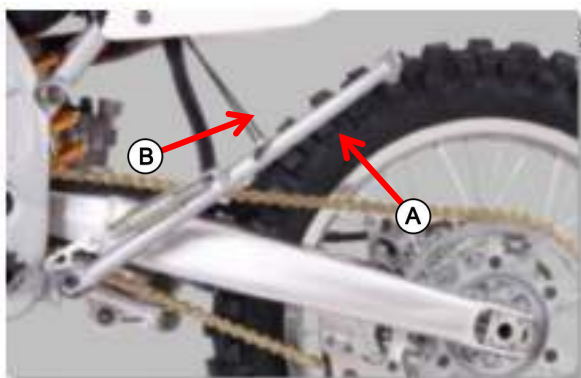

### Side Stand

Push the side stand **A** to the ground and tilt the motorcycle to the left. Make sure the bike is on solid ground and the position is secure. You can use the band **B** to secure the stand when riding off-road.

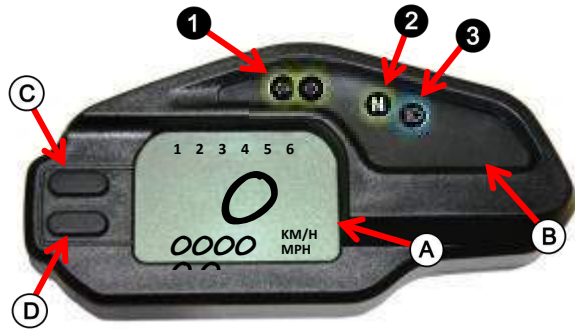

## Speedometer and Odometer

The digital speedometer indicates the road speed of the motorcycle. The read-out displays the motorcycle road speed in increments of one kilometer (or mile) per hour. In the speedometer face is the electronic odometer and one trip meter.

- (A) Multi-Function Display
- (B) Indicator Lights
- (C) Odometer/Trip Button
- (D) Mph/Km-h Button

- (1) Turn Signal Indicator Lights
- (2) Neutral Indicator Light
- (3) High Beam Indicator Light

### Turn Signal Indicator Lights ①

When either the right or left turn signals are being operated, the indicator light will flash intermittently. NOTE: If a turn signal light is not operating properly due to bulb filament or circuit failure, the indicator light flickers more quickly to notify the rider of the existence of the failure.

### Neutral Indicator Light ②

The green indicator light will come on when the transmission is in neutral. The light will go out when you shift into any gear other than neutral.

### High Beam Indicator Light ③

This blue indicator light will be lit when the headlight high beam is turned on.

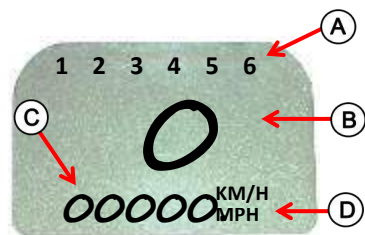

### Gear Position Indicator ① (LC/ZS/M/V4 – 5 Gears) (RM – Optional 6)

The gear position indicator displays the gear position. When the Transmission is in gear, the relevant gear number 1 to 6 will be displayed.

### Speedometer ②

The speedometer indicates the road speed in kilometers per hour and miles per hour. (Note: Select km/h or mph as appropriate, to comply with traffic regulations. Press button ③ to switch between km/h or mph.)

### Odometer ④

The odometer registers the total distance that the motorcycle has been ridden.

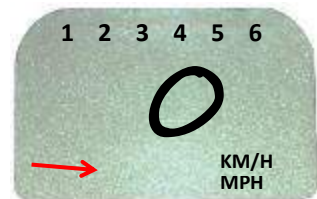

### Trip Meter

To reset the trip meter to zero, push the odometer/trip button ④ for 3 seconds. The display will show “000.0” after reset.



Before you ride, you must be absolutely sure that you and your motorcycle are ready to ride. To help you get prepared, this section of the manual will discuss how to evaluate your riding readiness and how to perform our recommended pre-ride inspection of your motorcycle. If you are a parent, please be sure you have read the section “Important Safety Information for Parents” on page 9.

## Are You Ready to Ride?

**Before you ride your motorcycle for the first time, we strongly recommend the following:**

1. Completely read this manual.
2. Be sure you have read and understand all the safety messages and labels.
3. You know how to operate all of the motorcycle’s controls.

**Before each ride, we strongly recommend that you:**

1. Are in good physical and mental condition.
2. Are free of alcohol and other drugs.
3. Are wearing an approved motorcycle helmet with a tight chin strap, eye protection and other protective clothing.

## PROTECTIVE GEAR & APPAREL

For your safety, we strongly recommend that you always wear an approved helmet, eye protection, boots, gloves, long pants and a long sleeved jersey, shirt or jacket whenever you ride. Although complete protection is not possible, wearing the proper gear can reduce the chance of and severity of injuries when you ride.

**Helmets & Eye Protection** – Your helmet is your most important piece of riding gear because it offers the best protection against head injuries. A good helmet will be approved by a testing organization independent of the helmet manufacturer and will have a chin strap that can be tightened securely. Open-face helmets offer some protection, but a full-face helmet offers the most protection. When purchasing a helmet, regardless of style, look for DOT (Department of Transportation) sticker (USA only). If the helmet has been tested by an independent organization such as the Snell Institute, you will usually find their logo on a tag inside the padding of the helmet.

**Additional Riding Gear** – In addition to your helmet and eye protection, we also recommend:

1. Sturdy off-road motorcycle boots to help protect your feet, ankles and lower legs.
2. Good quality motorcycle gloves to protect your hands.
3. Riding pants with knee and hip pads, a riding jersey with elbow pads and a chest/shoulder protector.



### WARNING

NOT WEARING A HELMET INCREASES THE CHANCE OF SERIOUS INJURY OR DEATH IN A CRASH. BE SURE YOU ALWAYS WEAR YOUR HELMET AND OTHER PROTECTIVE APPAREL WHEN YOU RIDE.



## IS THE MOTORCYCLE READY TO RIDE?

Before each and every ride you take, it is extremely important that you inspect the motorcycle and make sure any problems you find are corrected. A pre-ride inspection is a must because off-road riding can be very tough on a motorcycle and you do not want to have a breakdown for from help.



### WARNING

Improperly maintaining your motorcycle or failing to correct a problem before riding can cause a crash in which you can be seriously hurt or killed. Always perform a pre-ride inspection before any ride and correct any problems.



### NOTICE TO PARENTS

If a youngster will be performing any of the following pre-ride inspection procedures, it is your responsibility to provide careful supervision and make sure they are performed safely.

## PRE-RIDE INSPECTION

Check the following items before you get on the motorcycle:

**Tires** – Use a tire pressure gauge to check the air pressure. Inflate or deflate as needed. Also check for signs of damage or excessive wear.

**Spokes & Rims** – Make sure all of the spokes are tight. Inspect the rim to be sure it is not bent.

**Leaks** – Look under the motorcycle for signs of leaking fluids such as engine oil or gasoline.

**Engine Oil** – Check the level of engine oil and add if needed.

**Fuel** – Check the level of fuel in the gas tank. Add if needed. Be sure the gas cap is tightened securely.

**Drive Chain** – Inspect the drive chain condition and slack. Adjust and lubricate if needed. Also check the chain guide(s) and roller(s) for wear and replace if and when it is worn. For detailed instructions on drive chain slack adjustment, see the Servicing section of this manual.

**Brake Hoses** – Inspect the brake hoses for leaks and replace if needed.

**Nuts & Bolts** – Inspect all accessible nuts and bolts. Tighten then if it is needed.

**Spark Plug & Cap** – Check the spark plug for looseness. Tighten if needed. Be sure the cap is pushed on the spark plug and it is tight properly.

Check the following items after you get on the motorcycle:

**Throttle** – Check the throttle free-play and adjust if needed. Rotate the throttle to be sure it moves easily and freely. Make sure that it snaps back to its closed position automatically when you release it in all steering positions.

**Brakes** – Step on the rear brake lever and squeeze the front brake lever to be sure the brakes are working properly.

Remember, be sure to take care of any problems you find or have your Xmotos dealer correct it before you ride.





This section of the manual gives basic information on how to begin riding your motorcycle. In this section we will cover how to start and stop the engine, how to use the throttle and brakes, how to use the clutch and shift gears, and things you need to do when you are finished riding.

### Break-In Period

The first 800 km (500 miles) is the most important in the life of your motorcycle. Proper operation during this break-in period will help assure maximum life and performance from your new motorcycle. The following guidelines explain proper break-in procedures.

### Maximum Engine Speed Recommendation

The table below shows the maximum engine speed recommendation during the break-in period.

<b>Initial 80 KM (50 MILES)</b>	<b>Below 3000 rpm</b>
<b>Up to 160 KM (100 MILES)</b>	<b>Below 5500 rpm</b>

### Vary the Engine Speed

Vary the engine speed during the break-in period. This allows the parts to “load” (aiding the mating process) and the “unload” (allowing the parts to cool). Although it is essential to place some stress on the engine components during break-in, you must be careful not to load the engine too much.

## SAFE RIDE PRECAUTIONS

Before riding this motorcycle, be sure you have read this entire manual up to this point including the section titled “Important Safety Information (Pg. 7, 8 & 9) & Before Riding”.

Even if you have ridden other motorcycles in the past, take time to get familiar with the way the motorcycle works and handles. Always practice in a safe area until you have built your skill level to a point at which it is safe to ride.

### CAUTION

For your safety, avoid starting or operating the motorcycle in an enclosed area with poor ventilation, such as a garage. The motorcycle’s exhaust gas contains poisonous carbon monoxide which can collect rapidly in an enclosed area and result in illness or death.

### WARNING

Only the RM series is equipped with lights. DO NOT ride LC-ZS-V4 off road series of motorcycle(s) at night, they are not equipped with lights.



### STARTING & STOPPING THE ENGINE

Always follow the proper starting procedure as described below.

#### STARTING PROCEDURE (ELECTRIC START)

##### Starting When the Engine Is Cold

1. Turn the key switch to the “ON” position.
2. Make sure the transmission is in the neutral position.
3. Turn the fuel tap to the “ON” position.
4. Pull and hold the choke lever. (V4 - RM)
5. Lift the choke lever up. (LC – ZS - M)
6. Press and hold the brake lever on the right side of the handle bar.
7. Open the throttle no more than 1/4 of the way.
8. Press the start “yellow” button until the engine starts.
9. Release the button as soon as the engine starts.
10. After about 1 minute after the engine starts, release the choke lever. (V4 - RM)
11. After about 1 minute after the engine starts, push the choke lever down. (LC – ZS - M)
12. Wait until the engine warms up for approximately 5 minutes. After the 5 minute warm up, you are ready to go.

##### Starting When the Engine Is Warm

1. Repeat steps 1, 2, 3, 6, 7, and 8 in section “Starting when the engine is cold”.

#### STARTING PROCEDURE (KICK START)

##### Starting When the Engine Is Cold

1. Turn the key switch to the “ON” position.
2. Make sure the transmission is in the neutral position.
3. Turn the fuel tap to the “ON” position.
4. Pull and hold the choke lever. (V4 - RM)
5. Lift the choke lever up. (LC – ZS - M)
6. Press and hold the brake lever on the right side of the handle bar.
7. Open the throttle no more than 1/4 of the way.
8. Open the kick start lever and from the top of the kick starter stroke, kick through to the bottom with a rapid continuous motion.
9. After about 1 minute after the engine starts, release the choke lever. (V4 - RM)
10. After about 1 minute after the engine starts, push the choke lever down. (LC – ZS - M)
11. Wait until the engine warms up for approximately 5 minutes. After the 5 minute warm up, you are ready to go.

##### Starting When the Engine Is Warm

1. Repeat steps 1, 2, 3, 6, 7, and 8 in section “Starting when the engine is cold”



## FLOODED ENGINE

If the engine fails to start after repeated attempts, it may be flooded with excess fuel. Follow the steps below to clear a flooded engine.

1. Press the engine stop switch and hold it.
2. Open the throttle completely.
3. Press the engine start switch and hold it for 5 seconds. (Electric Start)
4. Kick start the engine several time. (Kick Start)
5. If necessary remove the spark plug and let it dry.
6. Once the engine starts, open the throttle  $\frac{1}{4}$  for a few times.

## STOPPING THE ENGINE

To stop the engine, shift into neutral and push the engine stop switch **A** on the left side of the handle bar.

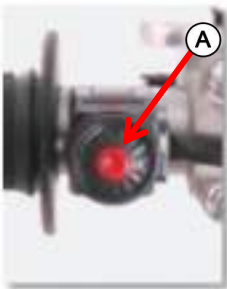

LC / ZS / V4 SERIES



RM SERIES

### CAUTION

DO NOT ride your motorcycle with full load and DO NOT rev up the engine when cold. Since the piston warms up and expands faster than the water cooled cylinder, this might cause engine damage. Always let the engine idle until warm or ride it warm at low RPM speeds.

### CAUTION

For your safety, avoid starting or operating the motorcycle in an enclosed area with poor ventilation, such as a garage. The motorcycle's exhaust gas contains poisonous carbon monoxide which can collect rapidly in an enclosed area and result in illness or death.



## SHIFTING GEARS

This motorcycle has five (5) forward gears for LC / ZS / M / V4 series and six (6) forward gears for RM – (V4 – Optional) series.

To start riding, after the engine has been warmed up and the side stand raised:

1. Close the throttle and squeeze the clutch lever all the way in.
2. Depress the shift lever from neutral down to first gear. Once the transmission clicks into gear, the shift lever will return back to the neutral “N” position once you remove your foot.
3. Slowly and gradually open the throttle and release the clutch lever in a simultaneous motion. When you feel the clutch begin to grab and the motorcycle starts to ease forward, you have reached the “friction zone” of the clutch. Gradually open the throttle more and release the clutch lever completely as the motorcycle moves forward.
4. When you attain moderate speed, close the throttle and squeeze the clutch lever at the same time. Raise the shift lever until it clicks into second gear. After shifting, re-open the throttle and release the clutch lever.
5. To continue shifting up to each higher gear, repeat step 4.
6. To shift down to a lower gear, close the throttle and pull the clutch. Depress the shift lever until you feel it click into gear. After shifting, re-apply the throttle and release the clutch lever smoothly.

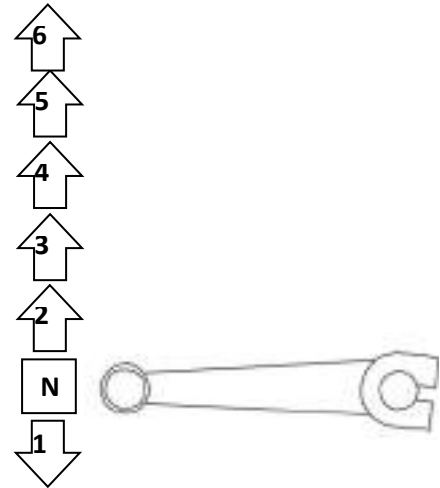

### NOTICE

Remember to close the throttle before shifting gears. Improper shifting may damage the engine, transmission, and drive train.

Learning when to shift gears will come with riding experience. Up-shift into a higher gear when you hear the engine speed (rpm) get too high. When the engine rpm gets too high in a gear, you will feel the motorcycle stop accelerating. This is another way to know when to up-shift.

Downshift to a lower gear when you feel the engine lugging at a low rpm. Downshifting is usually done when you slow down for a turn or when you stop the motorcycle. Downshifting into a lower gear can help slow down your motorcycle, especially when going down-hill. However, down shifting when the engine rpm is too high can cause engine damage.

The neutral position of the transmission is located between the first and second gear positions. To shift into neutral, pull the clutch lever in and depress the shift lever as many times as needed to get into first gear. Once you are in first gear, pull up on the shift lever  $\frac{1}{2}$  the distance required to up-shift into second gear. You can also shift into neutral from second gear by depressing the shift lever  $\frac{1}{2}$  the distance required to downshift into first gear.

To prevent transmission damage, do not coast or tow the motorcycle for long distances with engine off.

### WARNING

Never attempt to start the engine in gear. Doing so may cause a crash that could result in serious injury or death.



This section will cover basic braking technique for your motorcycle. To slow or stop the motorcycle, squeeze and hold the clutch lever and apply the front brake lever and rear brake pedal firmly and smoothly. If your speed is reduced a significant amount, you may need to downshift to a lower gear. Gradually increase your braking pressure as you feel it is needed. When you come to a stop, put your left foot down first, then the right foot. Do this so that your brake pedal foot remains on the brake pedal until you come to a complete stop. To prevent the engine from stalling, always pull and hold the clutch lever when slowing to a complete stop unless you are in neutral.

For maximum braking, close the throttle and firmly apply both the front and rear brake. On a motorcycle, the front brake accounts for 70% of the total stopping power of the motorcycle. The rear brake only accounts for 30%. This is because of the weight transfer that occurs when you apply the brakes. When you must stop quickly, you must use the front brake together with the rear brake.

Remember that you can apply more brake to the front wheel than you can to the rear wheel before it will lock up and cause a skid. Finding the proper balance between the amount of front and rear brake pressure you use will come with experience. Attempting an abrupt stop with only the rear brake will likely cause a skid.

Applying the brakes too hard or too fast can cause the wheels to lock and cause a skid, reducing your control of the motorcycle. If this happens, release the brake controls and steer straight ahead until you regain control of the motorcycle. Once you have control, reapply the brakes with less force.

Generally, reduce your speed and complete your braking before you begin a turn. Avoid braking or closing the throttle quickly while turning. Either of these actions may cause one or both of the wheels to slip. Any wheel slip will reduce your control over the motorcycle and could cause a crash.

When riding in wet or rainy conditions, or on loose surfaces such as mud or sand, your ability to maneuver and stop the motorcycle will be reduced. All of your actions should be done in a smooth and steady manner under these conditions. Rapid acceleration, braking, or turning can cause you to lose control of the motorcycle. For your safety, exercise extreme caution when riding under wet, rainy, and/or muddy conditions.

When descending a long, steep grade, use engine compression braking by downshifting with intermittent use of both brakes.

## **PARKING & POST RIDE INSPECTION**

Lower the side stand, to support your motorcycle. Press and hold the red stop switch on the left side of the handle bar until your engine stops. If you are through riding for the day, turn the fuel valve to the “OFF” position. Always park the motorcycle on a flat level surface. If you will be storing the motorcycle for a long period of time, turn the fuel valve to the “OFF” position while the engine is still running. Open and close the throttle repeatedly until the engine stops running on its own. Do this to use up any fuel that still remains in the carburetor. This will help you avoid carburetor problems that can occur when your motorcycle is stored for long periods of time with gasoline left in the carburetor.



## MAINTAINING YOUR XMOTOS MOTORCYCLE

Keeping your motorcycle in perfect operating condition is absolutely essential to your safety. It is also the best way to protect your investment, get maximum performance, avoid breakdowns, and have more fun. To help keep your motorcycle well maintained, this section includes a maintenance schedule for required servicing and step-by-step instructions on how to perform specific maintenance tasks. In this section you will also find important safety precautions, information on oils, and tips for keeping your Xmotos motorcycle looking good.

Careful pre-ride inspections and good maintenance are invaluable. To help you properly care for your motorcycle, this section provides you with a maintenance schedule. The service intervals in this section are based on average riding conditions. More frequent service is needed if you subject your motorcycle to severe use, such as competition, or ride in unusually wet and dusty areas. Frequent checks of the air cleaner are very important to help you avoid engine damage.

Remember, proper maintenance is the responsibility of the owner. Be sure to inspect your motorcycle before each ride and follow the maintenance schedule in this section.



### WARNING

Improperly maintaining this motorcycle or failing to correct a problem before you ride can cause a crash in which you can be seriously injured or killed. Always follow the inspection and maintenance recommendations and schedules in this manual.



### NOTICE TO PARENTS

As a parent, it is up to you to make sure the motorcycle is properly maintained and kept in safe operating condition. For youngsters, learning how to take care of a motorcycle and perform basic maintenance can be an important part of their riding experience. However, if you allow a youngster to perform or assist in any maintenance task(s), such as filling the fuel tank with gasoline, you need to provide close supervision and make sure the task is performed safely.



### WARNING

Failure to properly follow maintenance instructions and precautions can cause you to be seriously hurt or killed. Always follow the procedures and precautions in this manual.

## IMPORTANT SAFETY PRECAUTIONS

Make sure the engine is off before you begin any maintenance or repairs. This will help eliminate the following hazards:

1. **Carbon Monoxide Poisoning From Engine Exhaust** – Be sure you have adequate ventilation whenever you operate the engine.
2. **Burns From Hot Motorcycle Parts** – Let the engine and exhaust system cool off before you touch them.
3. **Injury From Moving Parts** – Do not run the engine unless instructed to do so.

Read all instructions before you begin a procedure. Make sure you have all of the tools and skills required. To help prevent the motorcycle from falling over, park it on a firm, level surface, using the side stand or a maintenance stand to provide support. To reduce the chance of a fire or explosion, be careful when working around gasoline. Use only a non-flammable (high flash point) solvent such as kerosene to clean parts. Keep cigarettes, sparks, and flames away from all fuel related parts.



To keep your motorcycle safe and reliable when you ride, regular inspections and service is required. Below you will find a maintenance schedule that describes when components need to be inspected or serviced. The maintenance schedule lists item that can be performed with basic mechanical skills and hand tools. In addition, the maintenance schedule will list items that involve more extensive procedures and could require special training, tools and/or equipment.

Because this motorcycle does not have an odometer, service intervals in the maintenance schedule are expressed in terms of riding days. To avoid missing required maintenance, we suggest that you develop a good way to record the amount of time you spend riding your motorcycle. If you do not feel capable of performing any of the procedures described in this manual or if you need assistance, please contact your nearest Xmotos dealer. If you decide to do your own maintenance, use only genuine replacement parts that you have purchased from an Xmotos dealer or parts purchased directly from Xmotos. This will ensure the best quality and reliability for your motorcycle.

Always perform the pre-ride inspection described on page 24 at each scheduled maintenance interval.

Each item on the maintenance schedule requires some mechanical knowledge. You will find that some items in the table (marked \* and \*\*) may require a higher level of mechanical skill and special tools. If you do not feel capable of performing any procedure, please consult your nearest Xmotos dealer.

\* Indicates items that require a moderate to high level of mechanical skill. We recommend service by an Xmotos dealer if the owner is not mechanically qualified.

\*\* Indicates items and procedures that require special tools.

Note: Service your motorcycle more frequently when you ride in wet or dusty conditions.

Maintenance Procedures: I = Inspect (clean, adjust or replace if needed), C = Clean, A = Adjust, L = Lubricate, R = Replace

<b>PERIODIC MAINTENANCE SCHEDULE (off-road)</b>						
Frequency		Month(s)				
Items		1	6	12	18	24
❖	Fuel Filter			I		I
❖	Fuel Line		I	R	I	R
❖	Throttle Operation			I		
	Air Filter		C	C	C	C
	Spark Plug		I	I	I	I
	Engine Oil		R	R	R	R
❖	Engine Idle Speed		I	I	I	I
	Drive Chain	INSPECT & LUBRICATE EVERY 3 MONTHS OR 300 MILES				
	Drive Chain Sliders		I	I	I	I
	Brake Pad Wear		I	I	I	I
	Brake System	I	I	I	I	I
❖❖	Clutch System	I	I	I	I	I
	Side Stand			I		
❖❖	Suspension			I		
	Nuts, Bolts, Fasteners	I		I		I
❖	Wheels & Tires	I	I	I	I	I
❖	Steering Head Bearings	I		I		I



<b>PERIODIC MAINTENANCE SCHEDULE</b>				
<b>A clean and maintained motorcycle saves time and money!</b>		<b>After 10 Hours or 1000 KM</b>	<b>After 25 Hours or 2500 KM</b>	<b>Service After 5000 KM</b>
<b>EN GI NE</b>	Check engine oil level	❖	❖	❖
	Change engine oil and oil, SEE Pg. 71	❖	❖	❖
	Check, clean engine oil screens (2)	❖	❖	❖
	Change engine oil screens (2)	❖	❖	
	Check and adjust spark plug, replace every 10,000 km			❖
	Check and adjust valve clearance	❖		❖
	Check engine bolts for tightness	❖	❖	❖
	Make sure all engine screws accessible from the outside are tight	❖		❖
<b>CA RB UR ET OR</b>	Check carburetor connection boots for cracks and leaks		❖	❖
	Check idle setting	❖	❖	❖
	Check over flow hoses for damage and kink-free arrangement	❖	❖	❖
	Check fuel hoses for damage and replace if necessary	❖	❖	❖
	Change fuel filter insert	❖	❖	❖
<b>A D D O N P A R T</b>	Check cooling system for leaks, add coolant if necessary	❖	❖	❖
	Check exhaust system for leaks	❖	❖	❖
	Check front suspension for leaks and proper operation	❖	❖	❖
	Clean air filter and filter box		❖	❖
	Check cables for damage and kink-less arrangement			❖
	Check headlamp adjustment		❖	❖
	Check all electrical system for function	❖		❖
<b>BR AK ES</b>	Check brake fluid level, brake pads and brake discs		❖	❖
	Check brake lines for damage and leaks		❖	❖
	Check and adjust the smooth operation and free travel of handbrake and foot brake levers		❖	❖
	Check brake system bolts for tightness	❖	❖	❖
<b>C H A S S I S</b>	Check front and rear suspension for leaks and proper operation		❖	❖
	Clean and/or replace fork dust seals			❖
	Bleed the air from the front forks		❖	❖
	Check and/or replace the swing-arm bearings		❖	❖
	Check/adjust/replace steering head bearings		❖	❖
	Lubricate rear suspension pivot bearings		❖	❖
	Check all chassis screws and bolts for tightness		❖	❖
<b>W H E E L S</b>	Check spoke tension and tighten if necessary	❖	❖	❖
	Check tire condition and air pressure	❖	❖	❖
	Check chain tension and chain guides for wear, replace if necessary		❖	❖
	Check bolts on chain sprocket and brake disc for tightness		❖	❖
	Lubricate chain	❖	❖	❖
	Check wheel bearings		❖	❖





**PERIODIC MAINTENANCE SCHEDULE**

<b>VITAL CHECKS &amp; CARE PROCEDURES TO BE CONDUCTED BY THE OWNER OR THE TECHNICIAN(S)</b>	<b>Before Each Start</b>	<b>After Every Cleaning</b>	<b>For Cross Country Use</b>	<b>Once a year</b>
Check oil level	❖			
Check brake fluid level	❖			
Check brake pads for wear	❖			
Check lighting system for proper operation	❖			
Check horn for proper operation	❖			
Lubricate and adjust cables		❖		
Bleed the air from forks in regular intervals			❖	
Remove and clean fork dust seals at regular intervals			❖	
Clean and lubricate chain as necessary		❖	❖	
Check chain tension	❖	❖	❖	
Clean air filter and filter box (depending on the dirt accumulation)			❖	
Check tire pressure and wear	❖			
Check coolant level	❖			
Check fuel lines for leaks	❖			
Drain fuel bowl chamber		❖		
Check all controls for smooth operation	❖			
Check brake performance	❖	❖		
Treat exposed metal components (except brake and exhaust system) with wax-based anti-corrosion agents		❖		
Treat ignition, steering lock and electrical switches with contact spray		❖		
Check all screws, nuts, bolts and hose clamps for tightness			❖	❖

**PERIODIC MAINTENANCE SCHEDULE**

<b>IMPORTANT RECOMMENDED MAINTENANCE PROCEDURES TO BE PERFORMED BASED ON A SEPARATE SUPPLEMENTARY ORDER</b>	<b>At Least Once a Year</b>	<b>Every 2 Years or 20,000 km</b>
Perform a complete front suspension maintenance	❖	
Perform a complete rear suspension maintenance		❖
Clean and lubricate steering head bearings and seals	❖	
Clean and adjust the carburetor	❖	
Treat the electrical contacts and switches with contact spray	❖	
Treat battery connections with contact grease	❖	
Change the front and rear brake fluid	❖	



## BASIC MAINTENANCE PROCEDURES

### FUEL (GASOLINE)

**Fuel Recommendation** – Any unleaded gasoline with an octane rating of **90** or higher.

The engine in your motorcycle has been designed to run on any gasoline with a pump octane rating of **90** or higher. Most service stations will display the octane rating above each pump. Although it is not required, Xmotors recommends use of gasoline with a **90** octane rating or higher to ensure maximum performance and reliability.

Use of a lower octane gasoline can cause pre-detonation in the engine. When this occurs, you will hear a persistent “pinging” or “spark knock” which, if severe, can cause engine damage. It is however no cause for concern if you hear light pinging while the engine is under hard acceleration, such as climbing up a hill. If pinging occurs under normal load and a steady engine speed, switch brands of gasoline and be sure you are using the proper octane rating. Use of unleaded fuel is recommended because it produces fewer engine deposits and extends the life of the engine and exhaust components.

**Never use stale or contaminated gasoline. Never use gasoline that has been mixed with oil. Avoid getting dust, dirt and water into the fuel tank.**

### INSPECTION & REFUELING PROCEDURE

1. Before refueling your motorcycle, check the fuel hoses **A** for leaks, damage, cracks, or deterioration.
2. Replace the fuel hose if you feel it is necessary.
3. Inspect the fuel filter **B**, replace if necessary.
4. Twist the fuel tank cap **1** counter-clockwise **C** and remove the cap from the tank.
5. Using a funnel, add fuel to the tank until the level reaches about 2 inches from the top of the tank.
6. Twist the fuel cap clockwise **D** until it is securely tight.
7. Be sure that you have the breather tube **2** connected to the gas tank cap.

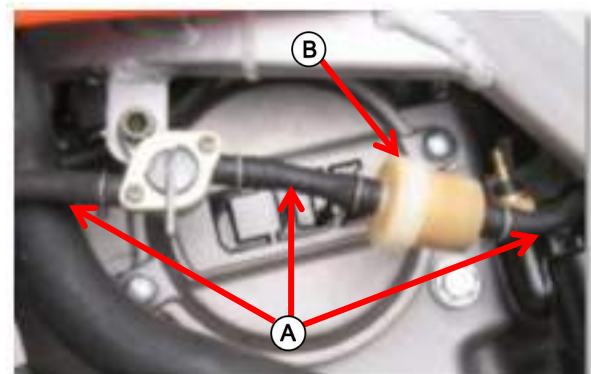
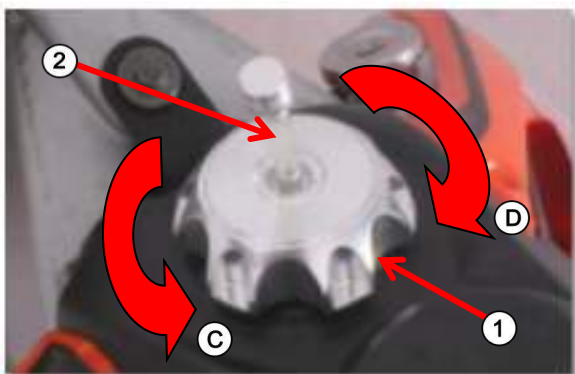

#### WARNING

Gasoline is highly flammable and explosive. You can be burned or seriously injured when handling gasoline. Always stop the engine. Only handle gasoline outdoors. Clean all spills immediately.



## COOLING SYSTEM

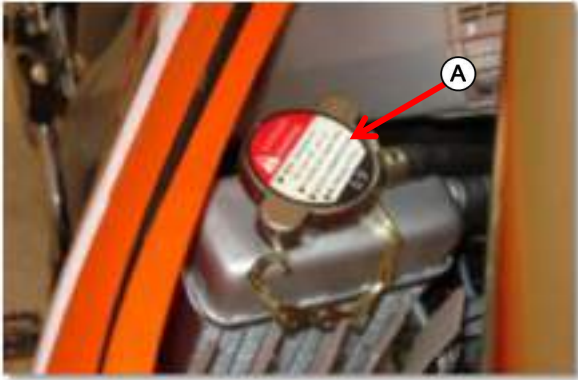

### Checking & Adding Coolant.

1. With the engine cold, remove the radiator cap **A**, and check the coolant level. The level of coolant is correct when it is at the bottom of the filler neck **B**. If the level is below the filler neck, you must add more coolant.

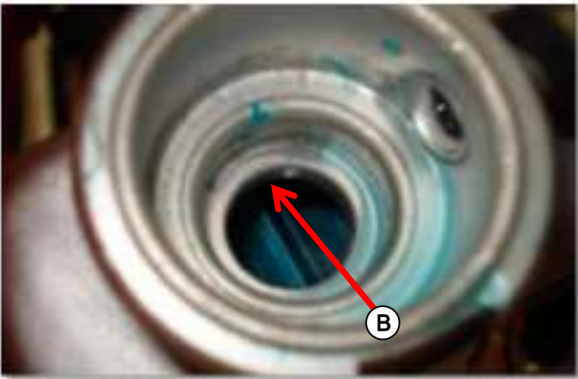

Xmotos recommends using high quality ethylene glycol antifreeze which contains corrosion protection inhibitors specifically recommended for use in aluminum engines. Use only distilled water as a part of the coolant solution. Water with high levels of minerals and salt will be harmful to aluminum engines. The factory provides a 50/50 mixed solution of antifreeze and water in the motorcycle. This is recommended for most operating temperatures and provides good corrosion protection.

Decreasing the antifreeze volume to less than 40% will not provide proper corrosion protection.

Increasing the concentration of antifreeze is not recommended because it decreases cooling system performance. Higher volumes of antifreeze up to 60%, should only be used to provide additional protection against freezing.

### NOTICE

Using coolant with silicate inhibitors may cause premature wear of seals and/or blockage of radiator passages.  
Using tap water may cause engine damage.

### Checking & Adding Coolant - Cont.

2. Add coolant up to the filler neck if you notice the level is low. Inspect the coolant level before each ride. Coolant loss through the overflow tube is normal. But if loss is more than normal, inspect the cooling system.

### Cooling System Inspection

1. Check the cooling system for leaks.
2. Check the water hoses for cracks, deterioration & hose clamps for looseness.
3. Check the radiator mounts for looseness.
4. Make sure the overflow tube is connected and not clogged.
5. Check the radiator fins to make sure they are not clogged.
6. If you do notice any leaks at any time, consult your nearest Xmotos dealer.

### NOTICE

Improper disposal of drained fluids is harmful to the environment.

### Coolant Replacement

Coolant should be replaced by your Xmotos dealer, unless you have the proper tools and service data and are mechanically qualified.

### NOTICE

If the radiator cap is not installed properly, it will cause excessive coolant loss and may result in overheating and engine damage.

### WARNING

REMOVING THE RADIATOR CAP WHILE THE ENGINE IS HOT WILL CAUSE COOLANT TO SPRAY OUT, SERIOUSLY SCALDING YOU. ALWAYS LET THE ENGINE AND RADIATOR COOL DOWN BEFORE REMOVING THE RADIATOR CAP.



## ENGINE OIL

Using proper oil, and regularly checking, adding and changing oil will help extend the service life of your engine. Even the best oil wears out and becomes thinner. Changing oil helps get rid of dirt and deposits in the engine. Operating the engine with old or dirty oil may and may damage your engine. Running the engine with not enough oil can cause serious damage to your engine.

**Engine Oil Recommended:** (See Also Page 71)

The chart below indicates oil for regular air temperatures. Please see the oil/air temperature chart to help you choose the best oil for your climate.

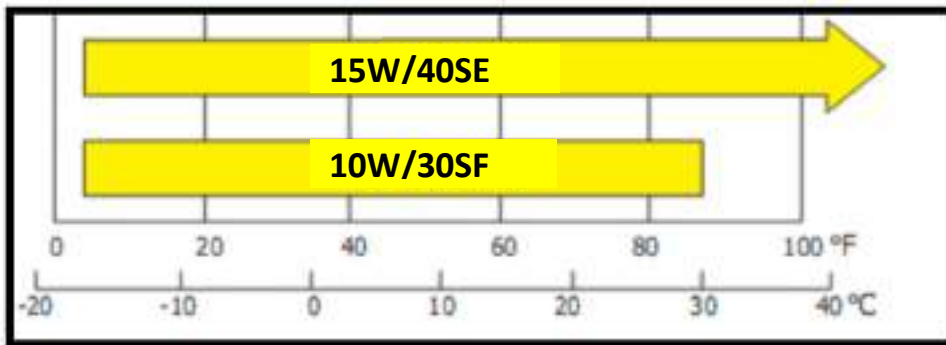

### CAUTION

Your motorcycle does not need oil additives. ONLY use the recommended oil. DO NOT use oil with graphite or molybdenum additives, they may adversely affect the clutch operation. DO NOT use motor oils that display the API circular logo that is labeled "energy conserving", they may affect the lubrication and clutch performance.

## CHECKING & ADDING OIL



XZ250R - LC

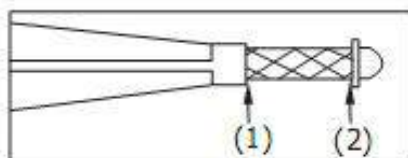

Fig. 1

1. Start and run the engine at idle for 3-5 minutes, then stop it.
2. Wait about 2-3 minutes to allow the oil to properly distribute itself in the engine.
3. Stand the motorcycle on a support stand so that it is not leaning to either the right or left.
4. Remove the oil filler cap **A**, wipe it clean, and insert it back in to its place but DO NOT screw it back in.
5. Check that the oil level is within the (1) & (2) hash-marks on the dip stick as in Fig. 1
6. If the oil level is at or near the upper mark (1), you do not need to add oil.
7. If the oil level is at or near the lower mark (2), you need to add oil.
8. Add the recommended oil until the upper mark (1), is reached. (DO NOT OVERFILL)
9. You can also check the oil level through the sight glass **B**
10. Repeat steps 1 through 5.
11. Reinstall the dipstick and check for any leaks.



## ENGINE OIL Cont.

### CHECKING & ADDING OIL

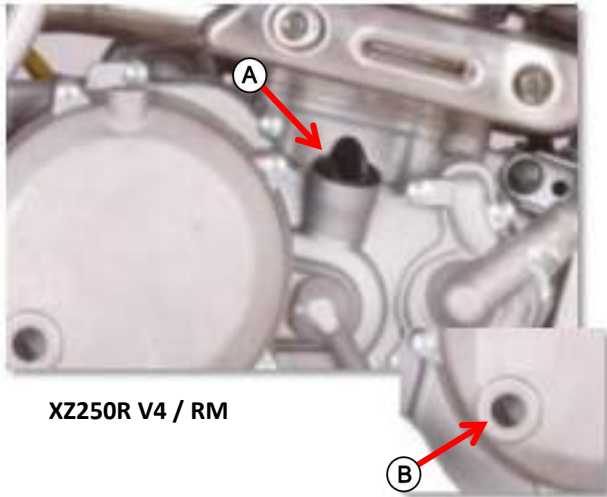

XZ250R V4 / RM

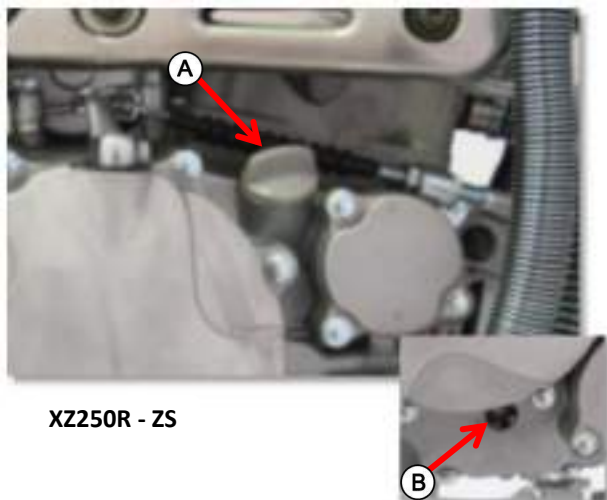

XZ250R - ZS

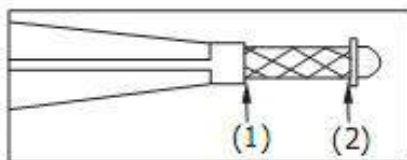

Fig. 1

1. Start and run the engine at idle for 3-5 minutes, then stop it.
2. Wait about 2-3 minutes to allow the oil to properly distribute itself in the engine.
3. Stand the motorcycle on a support stand so that it is not leaning to either the right or left.
4. Remove the oil filler cap **A**, wipe it clean, and insert it back in to its place but **DO NOT** screw it back in.
5. Check that the oil level is within the (1) & (2) hash-marks on the dip stick as in Fig. 1
6. If the oil level is at or near the upper mark (1), you do not need to add oil.
7. If the oil level is at or near the lower mark (2), you need to add oil.
8. Add the recommended oil until the upper mark (1), is reached. (**DO NOT OVERFILL**)
9. You can also check the oil level through the sight glass **B**
10. Repeat steps 1 through 5.
11. Reinstall the dipstick and check for any leaks.
12. The V4/RM model do not have a dipstick, please make sure the oil level is accurate by viewing the level in the sight glass on the V4/RM model shown above.

#### NOTICE

Allow the engine oil to circulate in the engine for 2 – 3 minutes before riding at start up. This will give enough time for the oil to lubricate all critical engine components. Failure to do so, will cause engine damage.

#### NOTICE

If the oil filter and cap are not installed correctly, it will cause serious engine damage.

#### NOTICE

Improper disposal of drained fluids is harmful to the environment.

#### NOTICE

Do Not dispose of drained oil in an appropriate manner. Most parts stores or auto shops do take used oil.



## BASIC MAINTENANCE PROCEDURES

### CHANGING OIL & OIL FILTER

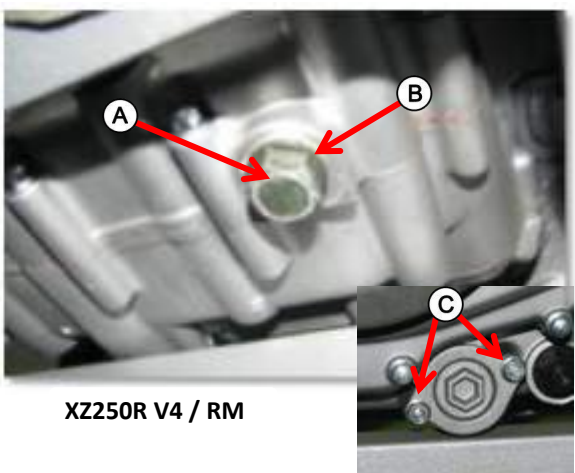
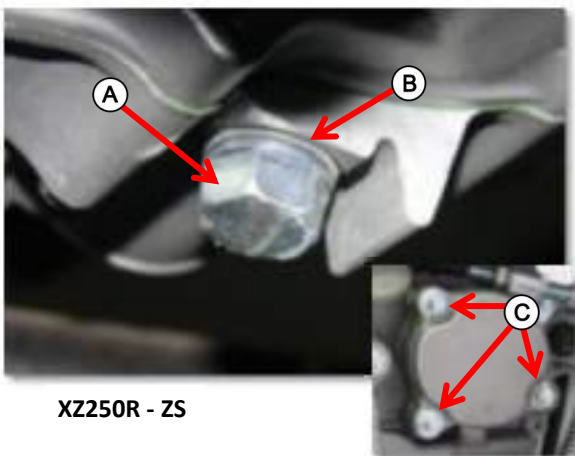
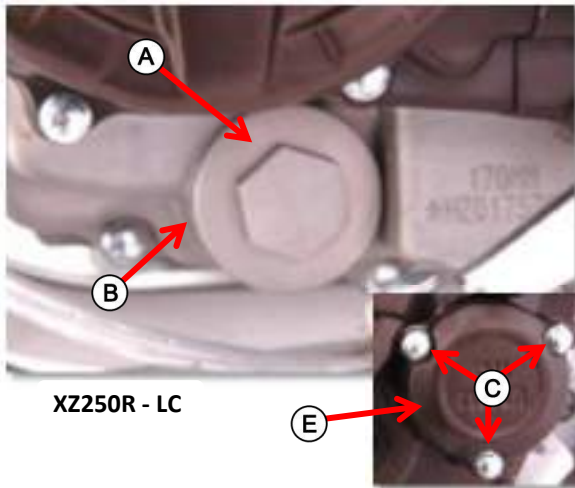

Fig. 1

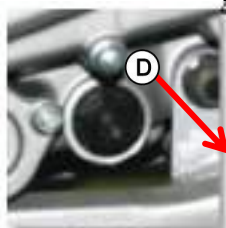

Fig. 2

1. Start and run the engine at idle for 3-5 minutes, then stop it.
2. Stand the motorcycle on a straight level surface so that it is not leaning to either the right or left & support it.
3. Remove the oil filler cap. (Pg. 36) **A**
4. Place the oil drain pan under the engine.
5. Remove the oil drain bolt **A** and sealing washer **B**.
6. As the oil is draining out, press and hold the engine stop button and the starter button. The engine will turn but will not start. This will allow all the oil to be drained from the engine. (ONLY FOR 5 SECONDS)
7. After the oil has drained, apply fresh engine oil to the drain bolt threads.
8. Install and tighten the drain bolt with a new sealing washer to 11ft lbs. (15Nm)
9. It is recommended to replace the oil and filter after every 15 hours of riding.
10. Remove the oil filter cover bolts **C** and the oil filter cover **E**
11. Remove the filter from the filter cover.
12. Remove the spring in the filter.
13. Check and see if the cover O-ring is in good condition.
14. After the oil is drained out of the filter chamber, install a new filter back in to the filter chamber.
15. Make sure the rubber seal is facing out toward the filter cover. You will see the "OUT-SIDE" words on the filter body, near the rubber seal.
16. Install the spring in to the new oil filter.
17. Apply clean engine oil to the O-ring and install it to the oil filter cover.
18. Install the filter cover, be careful not to damage the O-ring, tighten the filter cover bolts to 9ft lbs. (12 Nm).
19. For the XZ250R V4 & RM engine series, there are 2 screen filters that also need to be cleaned and/or replaced when doing an oil change.  
Fig. 1 **C** & Fig. 2 **D**
20. Fill the crankcase with the recommended oil only. Pg. 71
21. Install the oil filler cap.
22. Check the oil level by following the steps in "Checking & Adding Oil".



## AIR FILTER

Proper air filter maintenance is extremely important for off-road vehicles. A dirty, water-soaked, worn-out air filter will allow dirt, dust, mud or other impurities to pass into the engine. If you are riding in wet and/or muddy areas, you should service the air filter more often. Always replace the air filter with a genuine Xmotors filter specifically designed for your model or a filter of equal quality.

Failure to maintain the filter can/may cause engine wear or damage, expensive repairs, low engine power, low fuel mileage, carbon build up on valves and foul the spark plug.

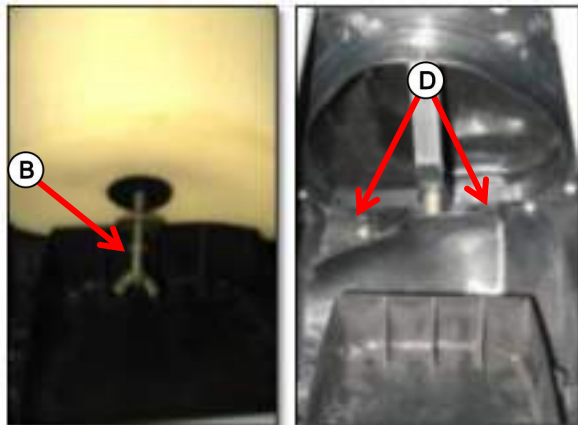
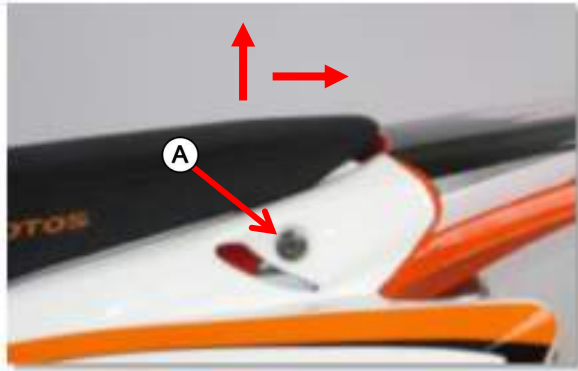
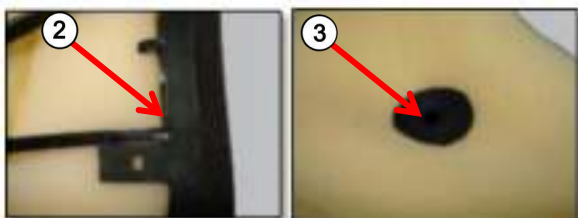
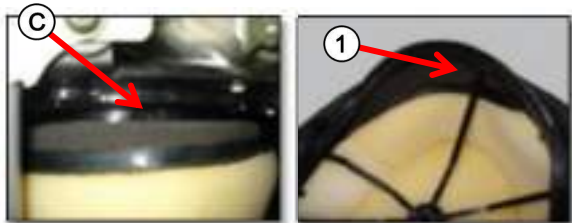

Fig. 1



### CHANGING THE AIR FILTER

1. Remove the seat. Loosen & take out the seat bolts **A** on both sides.
2. Once you have taken out the bolts, raise and pull back on the seat.
3. When the seat is removed, place it in a safe place so not to damage it.
4. Remove the wing bolt **B** holding the air filter in place
5. Pull back on the filter **C** & rotate it counter-clockwise.
6. Pull it out of the filter housing (Fig. 1).
7. Once you remove the filter from the housing, make sure there is no dirt or debris in the housing **D**
8. Remove the filter from the filter holder **1**, starting at either end.
9. Once the filter is removed, wash it clean with a non-flammable cleaning solvent. Then wash in hot, soapy water, rinse well. Then allow the filter to dry well.
10. If the filter is damaged, replace it with a new filter.
11. When the filter is thoroughly dry, spray the filter with a good quality air filter oil. Saturate the filter with the oil rubbing it with both hands. Squeeze out any excess.
12. Assemble the filter back in to the filter holder **1** being careful not to tear the filter.
13. Make sure the holder is correctly in place and the filter is hugging the filter holder **2**
14. Also pay attention to the middle section of the filter, making sure the filter is correctly in place **3**
15. Install the filter assembly back in to the filter housing, again being careful not to tear the filter.
16. Push the bottom of the filter in to place and then the top.
17. Once securely in place, install and tighten the wing bolt.
18. Re-attach the seat and make sure it is securely fastened.

#### NOTICE

Improper or lack of proper air filter maintenance can cause poor performance.

#### NOTICE

Improper installation of the air filter assembly can/may allow dirt to enter the engine and cause rapid wear of the piston rings and cylinder.



### THROTTLE

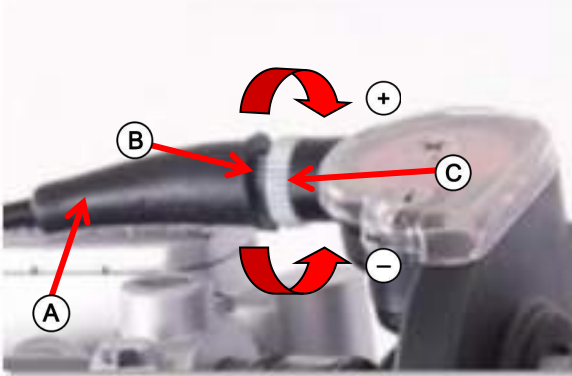

#### THROTTLE FREEPLAY

- A. Throttle free-play should be 3 – 5 mm (0.10 – 0.20 in)
- B. If your throttle has more play than specified, adjustments need to be made. Follow the steps below:
- C. Minor adjustments are generally made with the upper adjuster.
1. Pull back the dust cover **A**.
  2. Loosen the lock nut **C**
  3. Turn the adjuster **B**
  4. Turning the adjuster in the **+** direction will decrease free-play. Turning the adjuster in the **-** direction will increase free-play.
  5. Operate the throttle to ensure that it is functioning smoothly, and when released, it returns completely from fully open to fully closed in all steering positions.
  6. Inspect the condition of the throttle cable from the throttle down to the carburetor. If the cable is kinked or chafed, it must be replaced.
  7. Lubricate the cable with a commercially available cable lubricant to prevent premature rust and/or corrosion.
  8. Check the cable for tension or stress in all steering positions.





## ENGINE IDLE SPEED

### ENGINE IDLE SPEED ADJUSTMENT

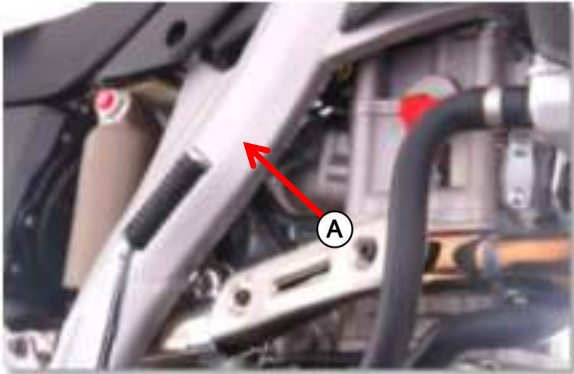

Fig. 1

LC / ZS

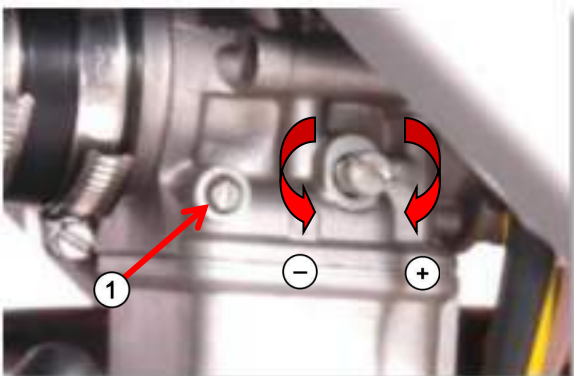

Fig. 2

V4 / RM

Remember, idle adjustment is not a real cure for other problems in your engines' fuel delivery system. Adjusting the idle will not solve or compensate for a fault elsewhere in the engine. If you are having trouble, please contact your Xmotos dealer.

The engine must be at normal operating temperature for an accurate adjustment.

1. If the engine is cold, start it up and let it warm up for 3-5 minutes then shut it off.
2. Connect a tachometer to the engine.
3. Make sure the transmission is in neutral gear.
4. Keep the motorcycle in an upright position.
5. Adjust the idle speed with the stop screw **A**
6. To increase the idle, turn the screw to **+**
7. To decrease the idle, turn the screw to **-**
8. The idle screw looks just like the adjusting screw in Fig. 2. Only in different locations
9. The idle must be at  $1500 \pm 100$  Rpm.
10. **DO NOT** adjust the air/fuel mixture screw **1**. It has been set from the factory. This should only be adjusted by an Xmotos dealer.



### CLUTCH SYSTEM

In order to ensure the best performance and durability from the clutch, always be sure you have proper clutch free-play. Free-play is needed to ensure that the clutch has room for wear. A clutch with no free-play will begin to slip as the discs wear down. Failure to fix a slipping clutch can cause clutch damage. To check the free-play, simply pull on the clutch lever. The lever should move very easily within the free-play range before you feel the clutch begin to engage. If too much or too little free-play exists, adjustments are needed.

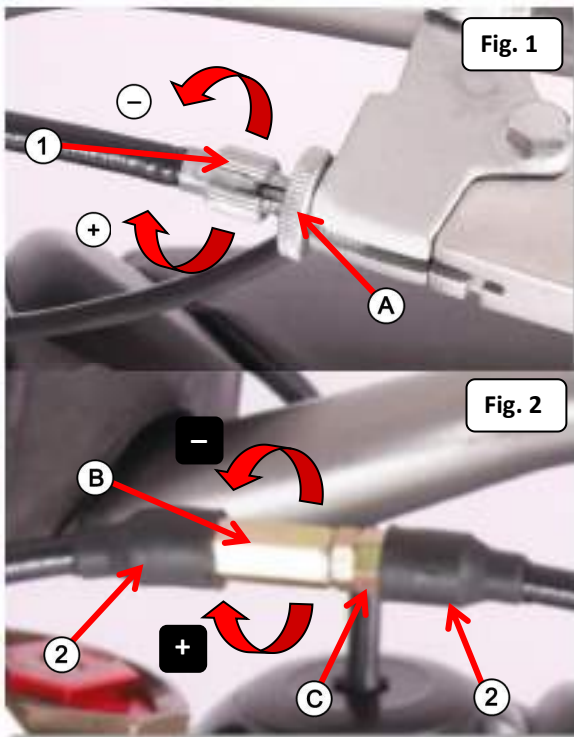

#### CLUTCH LEVER ADJUSTMENT

The distance between the clutch lever and the grip may be adjusted.

1. Loosen the clutch adjuster lock nut **A**
2. Turn the adjuster **1** clockwise **-** to add free-play and counterclockwise **+** to remove free-play. Fig. 1
3. Pull back the boot covers **2**, loosen the lock nut **C** and turn the internal cable adjuster **B** to adjust free-play.
4. Once you are satisfied with the adjustment, tighten the lock nut **C**
5. If the adjuster is threaded out near its limit or the correct free-play cannot be reached, turn the adjuster all the way in to direction **-**, and then turn it in to direction **+** one full turn, and then make the adjustment with the integral cable adjuster.
6. All models with LC – ZS – V4 engines are the same adjustment for the clutch lever on the handlebar.

A second adjustment may be needed if the clutch is slipping or if the clutch will not engage. Follow the steps below carefully to perform the adjustment. If the clutch is slipping, you will need to decrease the amount of clutch engagement. If you squeeze the clutch lever all the way and the clutch still will not engage, you need to increase the engagement. **(Clutch Free-play 7 – 10 mm)**



## CLUTCH SYSTEM Cont.

### INTEGRAL CABLE ADJUSTMENT

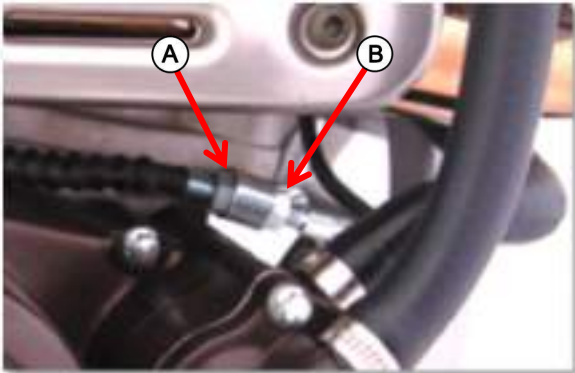

XZ250R - LC

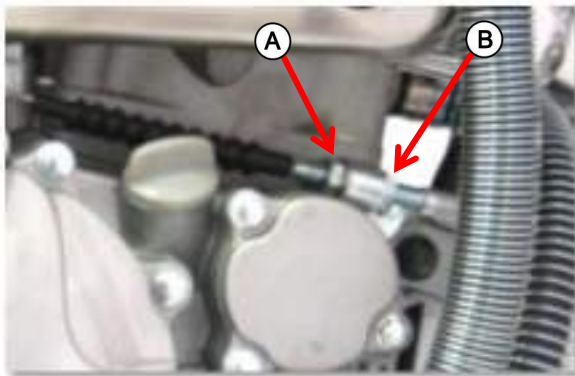

XZ250R - ZS

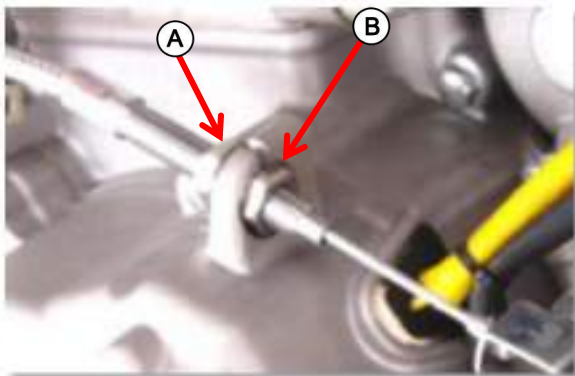

XZ250R V4 / RM

1. Loosen the lock nut **A**
2. Move the integral cable adjuster and lock in to place with the adjuster nut **B** to obtain the specified free-play.
3. Tighten the lock nut **A** and check the adjustment.
4. Start the engine and pull the clutch lever in and shift into gear. Make sure the engine does not stall and the motorcycle does not creep forward.
5. Gradually release the clutch lever and open the throttle. The motorcycle should move smoothly and accelerate gradually.
6. If you cannot get the proper adjustment, see you Xmotors dealer or service center.



## SPARK PLUG

The recommended standard spark plug will work very well in most riding condition. However, if you plan on riding for extended periods of time at high speed or high engine rpm in hot climates, or plan extended riding in cold climates, a different plug may be recommended.

A fouled (dirty) spark plug can cause your motorcycle to run poorly and lose performance. Follow the steps below to inspect, clean and/or replace the spark plug if needed.

1. Clean any dust and dirt from around the spark plug base.
2. Disconnect the spark plug cap.
3. Remove the spark plug.
4. Using the photos below for reference, examine the plug to determine its cleanliness. If the plug is a normal color, go on to step 6. If the plug is fouled (dirty), go to step 5.
5. Using moderate grit sandpaper (220-400), sand between the center electrode and the side electrode until all carbon and oil deposits are removed. Xmotos recommends that you use a spark plug cleaner or a new spark plug if the plug is very dirty.
6. Inspect the spark plug electrodes for wear. The center electrode should have square edges. The side electrode should not be eroded at all. The insulator should not be cracked or chipped. Replace the plug if any electrode wear and/or cracks are present.
7. Check the spark plug gap using a spark plug gaper. Gapers can be purchased at your local auto parts store. The spark plug gap should be .02 - .03 in (0.6 - 0.7mm). Always check the gap of a new spark plug before you install it.
8. Be sure all dirt has been cleaned from the threads. Install the spark plug by hand. This will prevent stripping and/or cross threading of the threads. Use a 5/8 in socket or wrench to securely tighten the spark plug. Do not over or under tighten the spark plug.

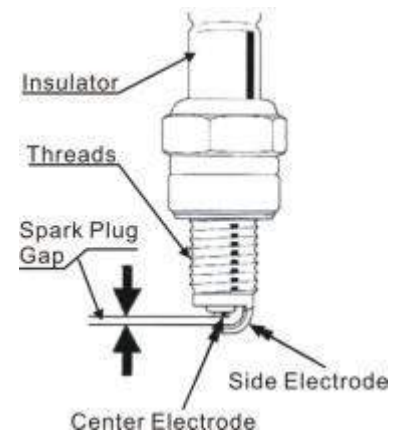

When you inspect the spark plug, generally it will fit into one of the four categories shown above. A normal/clean spark plug will have a light brown center and displays no wear around the electrodes. A spark plug with a bright white center indicates a lean condition in the engine. If your plug looks like this, have your motorcycle serviced by your Xmotos dealer immediately. A carbon fouled plug will be completely black with no gloss. An oil fouled plug will appear a dark shiny brown or shiny black as shown above. An oil fouled plug is caused when the engine oil seeps by the piston ring and is burned with the fuel. Oil fouled plugs are not uncommon, however, if your motorcycle is consistently oil fouling spark plugs, have it serviced by your local Xmotos dealer immediately.



### NOTICE

Using a spark plug with an improper heat range or incorrect reach, can cause engine damage. Using a non-resistor spark plug may cause ignition problems.



### NOTICE

An improperly tightened spark plug can damage the engine. If a plug is too loose, a piston may be damaged. If a plug is too tight, the threads may be damaged.

## BRAKING SYSTEM

Your motorcycle is equipped with hydraulic disc brakes on both the front and rear wheels. Hydraulic brakes require brake fluid for its operation. Both front and rear brakes have a brake fluid reservoir built into the master cylinders. Follow the procedures below to adjust the brake levers to the specified ranges and check fluid levels.

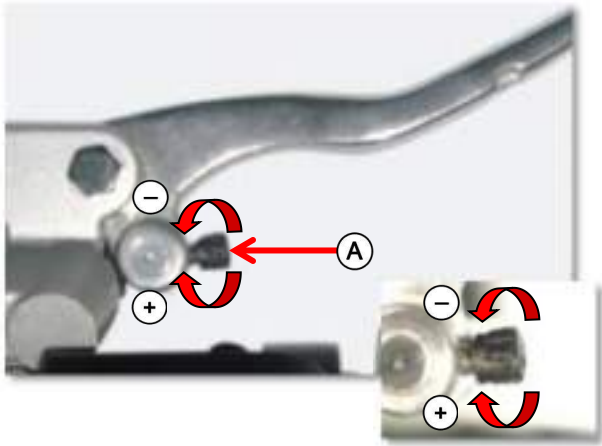

### BRAKE LEVER ADJUSTMENT (FRONT)

1. To position the brake lever away from the grip, turn the adjuster **+** clockwise until the desired position is reached.
2. To position the brake lever closer to the grip, turn the adjuster **A** counter-clockwise **-**.
3. Pull in the brake lever slowly until the brake starts to engage. The free-play should be 10-15 mm.
4. If the free-play is less or more, you need to adjust the lever again, until the specification is reached.

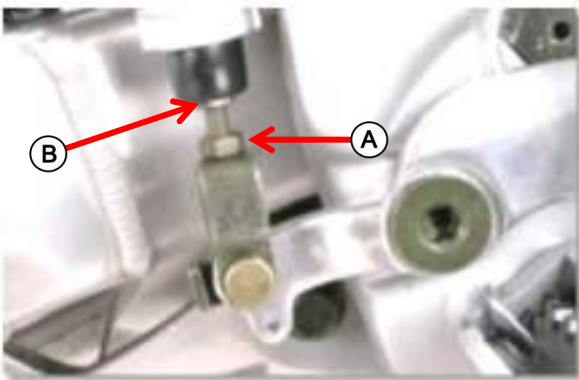

### BRAKE LEVER ADJUSTMENT (REAR)

1. Loosen the nut **A** and turn the adjuster **B** to either direction for the desired height.
2. The height of the lever should approximately be level with the height of the foot rest.

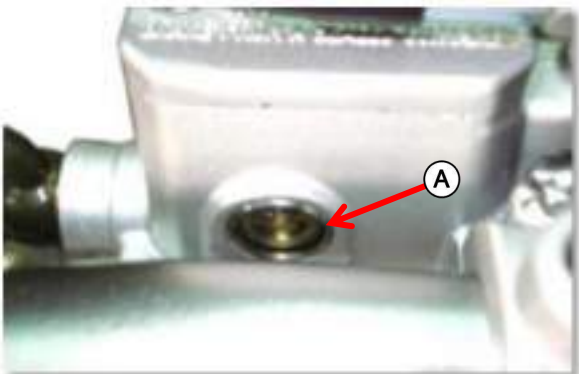

### BRAKE FLUID LEVEL CHECK (FRONT)

1. Check the level of the brake fluid by looking in the sight glass **A** periodically with the motorcycle in the upright position.
2. The fluid level should not be lower than half way.
3. If the level is lower than half way, check the brake pads for wear and the system for leaks. (Pg. 47)

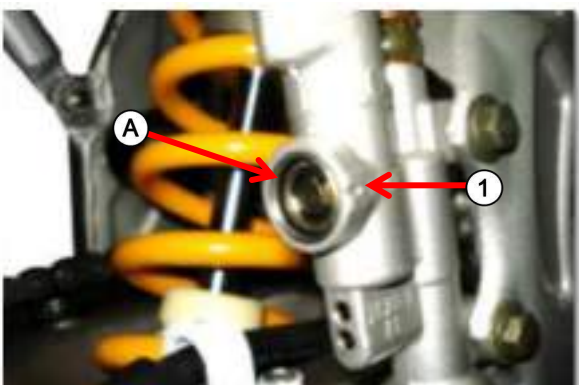

### BRAKE FLUID LEVEL CHECK (REAR)

1. Check the level of the brake fluid by looking in the sight glass **A** periodically with the motorcycle in the upright position.
2. The fluid level should not be lower than half way **1**.
3. If the level is lower than half way, check the brake pads for wear and the system for leaks. (Pg. 47)



### BRAKING SYSTEM Cont.

Hydraulic brakes require brake fluid for its operation. Both front and rear brakes have a brake fluid reservoir built into the master cylinders. Follow the procedures below to check and fill the cylinders with the specified brake fluid.

#### RECOMMENDED BRAKE FLUID – DOT 4

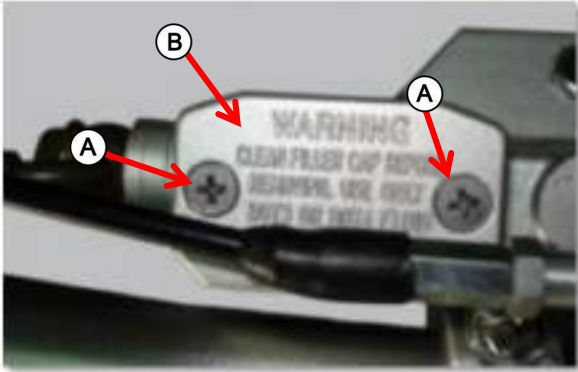

#### NOTICE

**USE ONLY DOT 4 BRAKE FLUID.**

#### ADDING BRAKE FLUID PROCEDURE (FRONT)

1. Clean all dirt and dust from the master cylinder cap **B**
2. Remove the cap screws **A** with a Phillips head screwdriver.
3. Remove the cap. Be careful not to damage the diaphragm gasket that is seated under the cap.
4. Add the required amount in to the master cylinder. (DO NOT OVERFILL) (Always use fresh fluid sealed bottle)
5. Replace the cap and tighten the screws securely.
6. Squeeze the brake lever to be sure the brakes are working properly.
7. Check the brake hose and brake caliper for leaks.

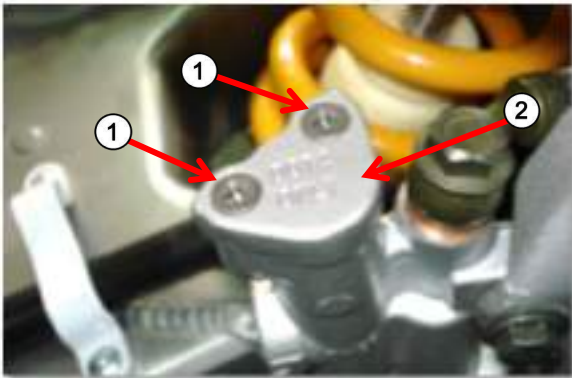

#### ADDING BRAKE FLUID PROCEDURE (REAR)

1. Clean all dirt and dust from the master cylinder cap **2**
2. Remove the cap screws **1** with a Phillips head screwdriver.
3. Remove the cap. Be careful not to damage the diaphragm gasket that is seated under the cap.
4. Add the required amount in to the master cylinder. (DO NOT OVERFILL) (Always use fresh fluid sealed bottle)
5. Replace the cap and tighten the screws securely.
6. Press the foot brake lever to be sure the brakes are working properly.
7. Check the brake hose and brake caliper for leaks.

If you are unsure how to re-assemble a part, contact your Xmos dealer for servicing information and/or servicing.



#### NOTICE

Be very careful not to spill brake fluid on painted surfaces or it will damage the paint. It will also be harmful to some rubber parts. Be careful when you remove the master cylinder cap, make sure the motorcycle is in an upright position.



## BRAKING SYSTEM Cont.

Hydraulic disc brake systems use a brake caliper to squeeze the rotors (brake disc) which causes the motorcycle to stop. Inside the brake caliper are brake pads. The brake pads are the part of the brake system that makes contact with the brake rotor. The pads must be checked in accordance with the maintenance schedule for the brake system as described on page(s) 31, 32, 33. Follow the procedure below to check the brake pad wear.

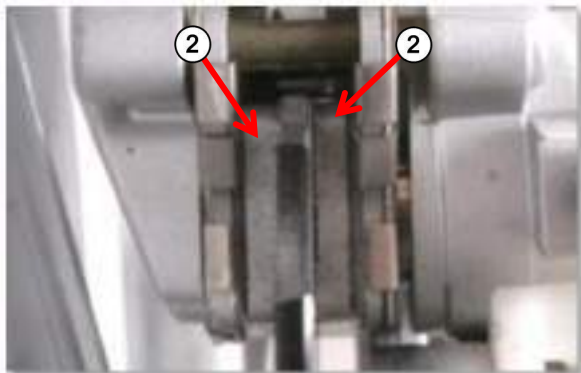

### BRAKE PAD WEAR

1. Inspect the brake pads ② at each maintenance interval. (more frequently if you do a lot of riding)
2. If the pads are worn down to a thickness of 1 mm, both pads need to be replaced. (Never replace only one pad).
3. If you find that both pads on either front or rear caliper are not wearing down evenly, you may need to replace the brake pads. If one side has worn down more extensive than the other, consult your Xmotos dealer for a possible bad brake caliper.

4. If you are unsure how to replace the brake pads, please contact your nearest Xmotos dealer for assistance, or schedule your motorcycle for servicing.



## BLEEDING THE BRAKE SYSTEM

Because the brake system utilizes fluid, any air bubbles inside the brake system will cause you to lose braking efficiency. Air generally enters the brake system when the motorcycle sits unused for long periods of time. Air will also enter the system if you have a leaking brake hose, brake caliper or master cylinder. A brake system with air will cause the brake lever and pedal to feel soft and spongy. Use the procedure below to bleed air from both the front and rear brake system.

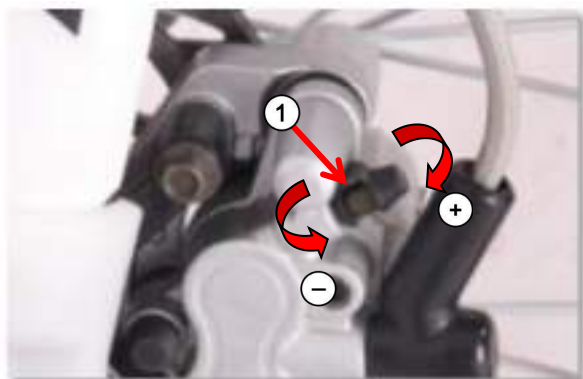

### BRAKE BLEEDING PROCEDURE

1. Clean all dust and dirt from the master cylinder and remove the master cylinder cap.
2. Pump the brake lever or pedal slowly and firmly 4-6 times and then hold it.
3. Using an 8mm wrench, loosen  $\ominus$  the bleeder valve ① located on the brake caliper. You will see brake fluid, and possibly some air bubbles exit out the bleeder valve.
4. Tighten  $\oplus$  the bleeder valve and then release the lever or pedal slowly.
5. Repeat steps 1 – 4 until all air bubbles have stopped flowing from the bleeder valve. The lever/pedal should feel hard and firm when you are complete.

### NOTICE

**USE ONLY DOT 4 BRAKE FLUID.**



## FRONT SUSPENSION

Loose, worn or damaged suspension components may affect the stability and handling of your motorcycle. If any of the suspension components seem to be worn or damaged, see your Xmotos dealer for service and/or inspection. Your Xmotos dealer is the most qualified to determine whether or not replacement parts or service is required.

Your motorcycle is new. Break it in for about 2 hours with the original settings before attempting adjustments.

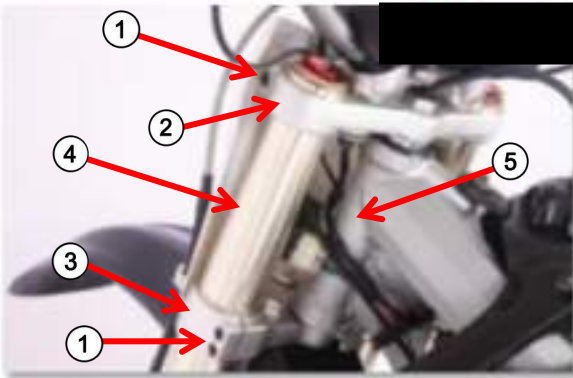

### SUSPENSION INSPECTION (FRONT)

1. Check the fork **4** operation by pulling in the front brake lever and holding it to lock the front wheel.
2. Next, pump down on the handle bars several times. The suspension should feel clean and smooth.
3. Check the lower end of the forks (near the wheel) for oil leaks.
4. Inspect the upper **2** and lower triple clamps **3** for tightness.
5. Be sure all the triple clamp bolts **1** are tight.
6. Examine the metal for any cracks, wear or other damage.
7. Be sure there is no free-play in the steering head **5**.

### SUSPENSION ADJUSTMENT (FRONT)

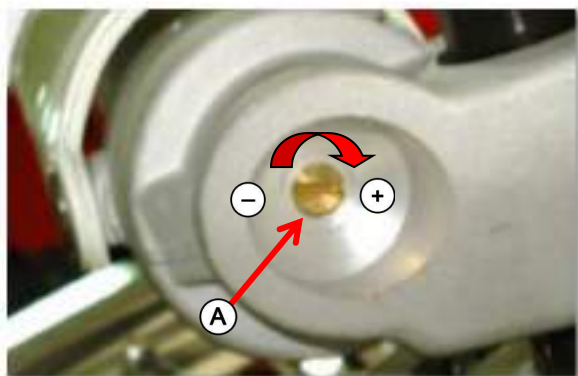

1. On the top of the fork, you will find a screw head **1** (or a clicker).
2. It will have the writing S – H, meaning Soft & Hard or the marks { + } or { - }. This is the Rebound Adjuster.
3. If you turn the screw **1** toward the “H” { + }, the downward action of the fork will harden. Alternatively, if you turn the screw toward the “S” { - }, the downward action of the fork will soften.
4. To get a good feel for the difference this can make, try turning both screws all the way to the “H” { + } position, then go for a ride. Don’t try and set any new records though. Once you have a good feel for the ride, try turning the screws all the way to the “S” { - } position and compare the difference.
5. Now, on the bottom of the forks you will find the compression adjuster **A**. This determines how quickly the forks return to its extended position after being compressed. Turning the screw clockwise towards (+) “Hard” will slow the compression speed, making it better for larger, rolling terrain or bumps.
6. Turning the screw counter clockwise (-) “Soft” will increase the compression speed making it better for smaller, rougher bumps.

#### NOTICE

DO NOT TRY TO REPAIR THE FORKS.  
IF REPAIR IS NECESSARY, TAKE THE  
MOTORCYCLE TO AN XMOTOS DEALER.





## FRONT SUSPENSION

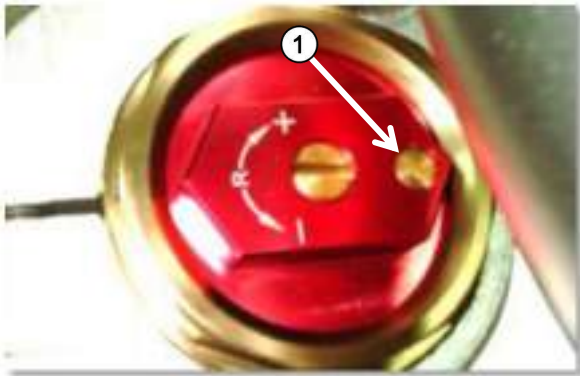

### SUSPENSION ADJUSTMENT (FRONT) Cont.

Over time, the forks suck in air, creating a build-up that will have a bad effect on the performance of the forks.

1. Put a support on the bottom of the bike so that the front tire is off the ground.
2. Turn the air bleeder screw **1** on the top of the fork counter-clockwise to release the air.
3. Make sure you do this with the weight off the front forks and be sure to tighten it back before placing the bike back on the ground.

## REAR SUSPENSION

Loose, worn or damaged suspension components may affect the stability and handling of your motorcycle. If any of the suspension components seem to be worn or damaged, see your Xmotos dealer for service and/or inspection. Your Xmotos dealer is the most qualified to determine whether or not replacement parts or service is required.

Your motorcycle is new. Break it in for about 2 hours with the original settings before attempting adjustments.

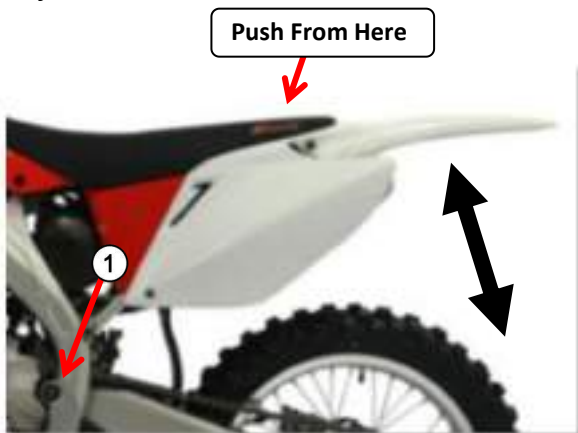

### SUSPENSION INSPECTION (REAR)

1. Move the motorcycle by bouncing it up and down to check for smooth suspension action.
2. Check for a broken or damaged spring.
3. Check the shock absorber for a bent center shaft or any oil leaks.
4. Check nuts and bolts of shock for tightness.
5. Check the spring adjuster(s) ring for tightness.
6. Check the swing-arm bolts for tightness.
7. Push the rear wheel from side to side feeling for any loose or worn swing-arm bearings **1**. If there is movement, have the motorcycle serviced by your Xmotos dealer.



### NOTICE

DO NOT TRY TO REPAIR THE SHOCK.  
IF REPAIR IS NECESSARY, TAKE THE  
MOTORCYCLE TO AN XMOTOS DEALER.



### REAR SUSPENSION Cont.

The rear suspension of your motorcycle has 3 different adjustment points. It comes from the factory set to the softest setting. If you wish to make the rear suspension harder, follow the procedure below. Adjusting the rear shock is not hard, but like the front forks, changes should be made one at a time to gain an accurate understanding of how they affect the bike.

Once you are familiar with the settings on your suspension, you can quickly and easily adjust them to suit different terrain. For example, you make know the setting position for when you ride in the sand dunes. But when you are riding on your local motocross track you know to tune them to a different setting.

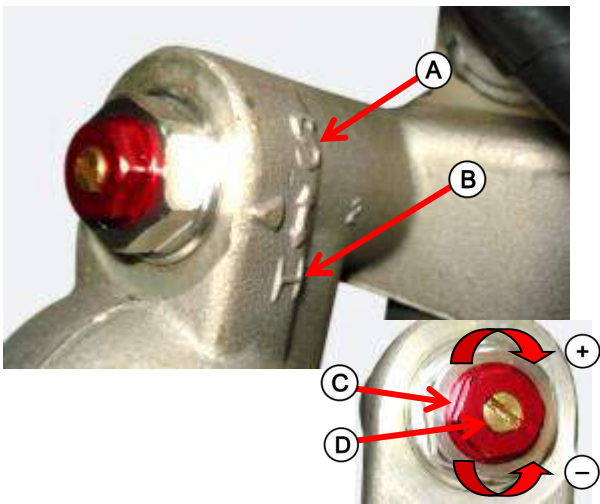

#### SUSPENSION ADJUSTMENT (REAR)

- A. The high speed damping adjuster **C** is effective when damping adjustment is desired for high speed operation.
- B. The low speed damping adjuster **D** should be used when damping adjustment is desired at relatively low speeds.

1. Both the high and low speed damping can be increased by turning the appropriate adjuster clockwise.
2. Adjust the high speed adjuster in 1/12<sup>th</sup> turn increments.
3. The first thing we'll look at is the high-speed compression adjuster. Using a wrench, turn the nut **C** clockwise or counter-clockwise to make changes. This affects how quickly or how slowly the shock works during compression over small, rough, bumpy terrain.
4. Softening the nut **C** can help make the bike ride more smoothly over choppy land.
5. The low-speed compression adjuster **D** can be turned clockwise to make the overall feel of the shock firmer. Or, turn it counter-clockwise to soften it. Your preferred settings will depend on what style of riding you do. If you prefer riding trails then you may want to set it towards soft. If you are on high jumps and whoops, you will definitely want to make it harder. Remember, having the screw turned all the way too hard puts more pressure on the shock, so keep it a few clicks out.
6. Next, you'll find the rebound adjuster at the bottom of the shock under the swing-arm. This works much the same as the rebound screw on the front forks. It controls how quickly or slowly the shock returns to its extended position after being compressed.
7. Try turning it clockwise to allow the rear wheel to stay in contact with the ground over larger rolling terrain.
8. If you turn the screw counter-clockwise this should give you a better ride over rough bumps that are close together by allowing the shock to rebound faster and 'hug' the flow of the terrain.



REAR SUSPENSION Cont.

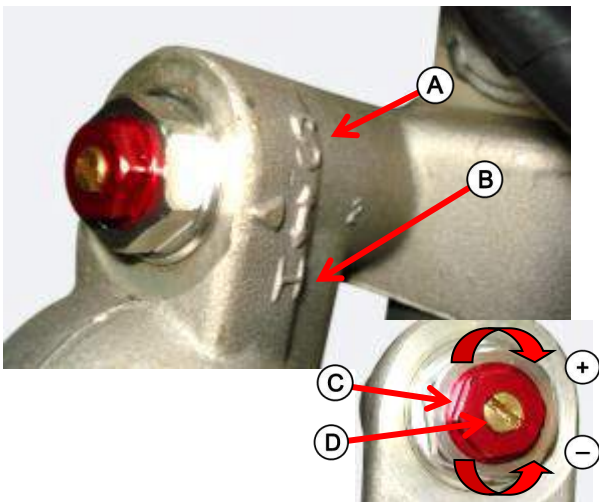

HIGH SPEED DAMPING ADJUSTMENT (REAR)

1. The high speed damping can be adjusted by turning the hexagonal portion of the compression adjuster **C**
2. The high speed damping adjuster has 3 ½ turns or more.
3. To adjust to the standard position, turn the adjuster **C** clockwise until it will no longer turn (DO NOT FORCE). This is the full hard **B** setting
4. Turn the adjuster **C** counter-clockwise 1 5/6<sup>th</sup> - 2 1/3<sup>rd</sup> turns. Slow setting **A**

LOW SPEED DAMPING ADJUSTMENT (REAR)

1. The low speed damping can be adjusted by turning the center screw **D** of the compression adjuster.
2. The low speed adjuster has 9 positions. Turning the adjuster one full turn clockwise advances the adjuster 4 positions.
3. To adjust to the standard position, turn the adjuster clockwise until it will no longer turn (DO NOT FORCE). This is the full hard **B** setting.
4. Turn the adjuster **D** counter-clockwise 6 to 9 clicks. Slow setting **A**

**NOTICE**

DO NOT TRY TO REPAIR THE SHOCK.  
IF REPAIR IS NECESSARY, TAKE THE  
MOTORCYCLE TO AN XMOTOS DEALER.

REBOUND DAMPING ADJUSTMENT (REAR)

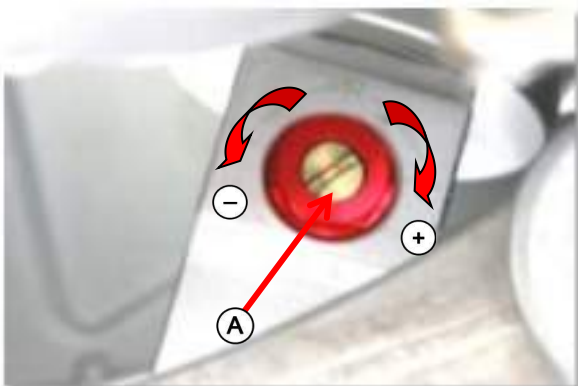

1. The rebound damping adjuster **A** is located at the lower end of the shock absorber.
2. It has 12 positions. Turning the adjuster one full turn advances the adjuster 4 positions.
3. Rebound damping can be increased by turning the adjuster clockwise **-**
4. To adjust to the standard position, turn the adjuster clockwise until it will no longer turn (DO NOT FORCE). This is the full hard **+** setting.
5. Turn the adjuster counter-clockwise 9-12 clicks.



## BASIC MAINTENANCE PROCEDURES

### RIMS & SPOKES

Maintenance of spoke tension and wheel trueness (roundness) is critical to safe motorcycle operation. During the first 100 miles of riding, spokes will loosen faster due to the initial seating of the parts. Excessively loose spokes will cause the motorcycle to become unstable at high speed and could cause you to lose control. Loose spokes can also cause rim and spoke damage (not covered in the warranty).

It is not necessary to remove the wheels for regular maintenance. However, information on wheel removal is available from Xmotos.



#### WHEEL INSPECTION (FRONT & REAR)

1. Inspect the wheel rims **A** and spokes **B** for damage. Feel all of the spokes with your fingers to make sure none are loose.
2. Tighten any loose spokes with a small adjustable wrench or spoke wrench from the spoke nut **C**
3. Elevate each wheel off the ground, one at a time, and spin the wheel slowly. Look for a wobble in the wheel. If a wobble is evident, the wheel is not “true”. See your Xmotos dealer or local motorcycle shop for inspection.

### TIRE AIR PRESSURE

Properly inflated tires will provide you with the best combination of handling, tread life, and riding comfort. Generally speaking, underinflated tires will wear unevenly and adversely affect handling. Underinflated tires are also more likely to fail from being overheated and can cause wheel damage on rocky terrain.

Overinflated tires will cause the motorcycle to ride harshly, are prone to failure from surface hazards and wear unevenly.

Make sure the valve stem caps are secure, if needed, install a new cap. Always check air pressure when your tires are cold. If you check the air pressure when the tires are warm, you will get higher readings. If you let air out of warm tires to match the recommended cold tire pressure, the tires will be underinflated. The correct cold tire pressures are listed below. If you replace the tire, inflate the tire to the following tire pressure amount marked below.

TIRE PRESSURE (off-road)	
Front Tire	15-18Psi (104-124 kPa)
Rear Tire	15-18Psi (104-124 kPa)

TIRE PRESSURE (on-road-RM)	
Front Tire	25-28Psi (175-195 kPa)
Rear Tire	29-31Psi (200-215 kPa)

#### WARNING

USING TIRES THAT ARE EXCESSIVELY WORN OR IMPROPERLY INFLATED CAN CAUSE A CRASH IN WHICH YOU CAN BE SERIOUSLY INJURED OR KILLED. FOLLOW ALL INSTRUCTIONS IN THIS OWNER'S MANUAL REGARDING TIRE INFLATION AND MAINTENANCE.



## TIRE INSPECTION

A flat tire or tire blowout can be very inconvenient and can even cause you to have an accident. Take the time to inspect your tires and wheels before you ride. For more information about handling a flat tire, refer to the section of this manual titled, Resolving the Unexpected.

- Inspect the tire carefully for bumps or bulges in the sidewall of the tire and inside of the treads. replace any tires that have bumps or bulges in them.
- Look closely for cuts, slits or cracks in the tires. Replace any tire if you can see a fabric or cord showing through.
- Check for rocks or other objects embedded in the tires or tread. Remove any foreign objects. Be sure there are no screws or nails in the tires.
- Measure the tread depth of the tires. Replace all tires before the read depth gets below 0.12in (3mm) or anytime you notice a reduction in your traction.
- Check the position of both valve stems. A tilted valve stem indicates that the tube is slipping inside of the tire or the tire is slipping on the rim. See your Xmotos dealer for assistance.

## TIRE & TUBE REPLACEMENT

If a tube has been punctured or damaged, it should be replaced immediately. You may repair the tube using a tube patch kit. However, a repaired tube may not have the same reliability as a new one and could fail while riding. For more information on a temporary repair, see the section titled Resolving the Unexpected.

Always use replacement tubes that are the same size as the original. We recommend that you have tubes changed at your local Xmotos dealer or your local motorcycle shop. Replacing a tube requires removal and installation of the wheel. Anytime you have a tube replaced, perform the tire inspection listed at the top of this page. The tires that came on your motorcycle were designed to provide a good combination of handling, braking, durability and comfort across a broad range of riding conditions.

- Use a replacement tire equivalent in size and type to the original tire.
- Replace the tube anytime you replace a tire. Old tubes are usually stretched and, if installed in a new tire, could fail.
- Have the wheel balanced after a new tire has been installed.
- We recommend that tires be replaced by your Xmotos dealer or a local motorcycle shop.

TIRE SIZE (off-road)	
Front Tire	80/100-21
Rear Tire	110/100-18
Type	Bias Ply, Tube Type

TIRE SIZE (on-road-RM)	
Front Tire	110/70-17
Rear Tire	130/70-17
Type	Bias Ply, Tube Type

**WARNING**

INSTALLING IMPROPER TIRE ON YOUR MOTORCYCLE CAN AFFECT HANDLING AND STABILITY. WHICH, IF SEVERE, CAN CAUSE A CRASH IN WHICH YOU CAN BE SERIOUSLY HURT OR KILLED. ALWAYS USE THE SIZE AND TYPE OF TIRES RECOMMENDED IN THIS OWNER'S MANUAL.



## BASIC MAINTENANCE PROCEDURES

### BREAKING IN NEW TIRES (ON-ROAD)

New tires need proper break-in to assure maximum performance, just as the engine does. Wear-in the tread surface by gradually increasing your cornering lean angles over the first 160km (100 miles) before attempting maximum performance. Avoid hard acceleration, hard cornering, and hard braking for the first 160 km (100 miles).



#### WARNING

FAILURE TO PERFORM BREAK-IN OF NEW TIRES COULD CAUSE TIRE SLIP AND LOSS OF CONTROL. USE EXTRA CARE WHEN RIDING ON NEW TIRES. PERFORM PROPER BREAK-IN OF THE TIRES AS DESCRIBED IN THIS SECTION.

### DRIVE CHAIN

The service life of your drive chain will depend on several factors including proper lubrication, adjustment, and riding style. If you are an experienced rider and tend to ride in a more intense manner, or you ride in muddy/dusty areas, you will need to check the drive chain more frequently. Poor maintenance will cause pre-mature wear and/or damage to the drive chain and sprockets.

Before you service your drive chain, be sure you are parked on a level surface and you turn the engine OFF. Be sure the transmission is in neutral. It is not necessary to remove or replace the chain to perform recommended maintenance service.

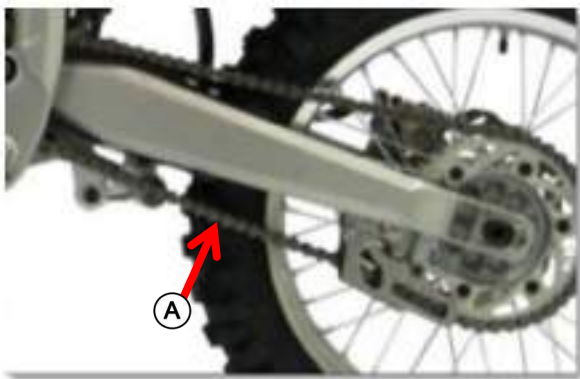

#### CHAIN INSPECTION

1. Check the slack in the lower drive chain midway between the sprockets **A**. Push upward on the chain with your finger. The vertical movement should measure between 08 – 10 mm.
2. Repeat step 1 along several points of the drive chain. The slack should remain constant through-out. If it is not, some links may be kinked and binding. Lubricating the chain will often stop this.
3. Inspect the drive chain for the following: damaged rollers, loose pins, dry or rusted links, kinked or binding links and excessive wear. Replace the chain, loose pins, or kinks that cannot be freed. Lubricate the drive chain if it appears dry or shows signs of rust. Lubricate any kinked or binding links and work them free.
4. You should replace the drive chain once the rear axle is moved as far back as possible and slack still remains. This indicates that the chain is worn beyond its service limit.
5. Inspect the front and rear sprockets for excessive wear or damage. Refer to the illustration at the top of page 42. If needed, replace any worn or damaged sprockets. See your Xmotos dealer for assistance.



#### NOTICE

EXCESSIVE DRIVE CHAIN SLACK MAY ALLOW THE DRIVE CHAIN TO DAMAGE THE ENGINE CASES..



#### NOTICE

ALWAYS USE HIGH QUALITY LUBRICANT FOR THE DRIVE CHAIN.



**DRIVE CHAIN Cont.**

Use the diagram below to determine if the sprockets need to be replaced. Never use a new chain with a damaged or worn sprocket.

**NOTICE**  
 THE USE OF A NEW CHAIN ON A WORN SPROCKET WILL CAUSE RAPID CHAIN WEAR.

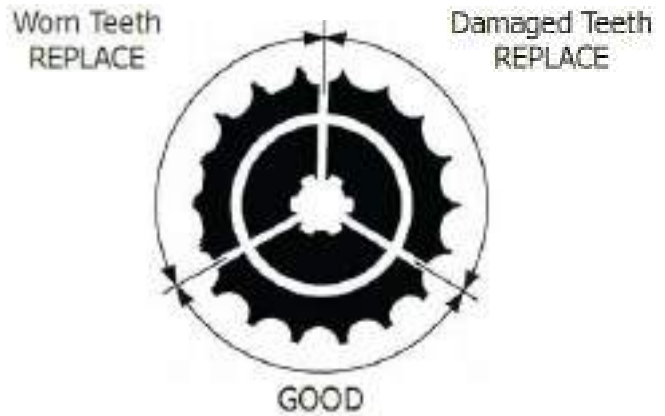

**CHAIN ROLLERS**

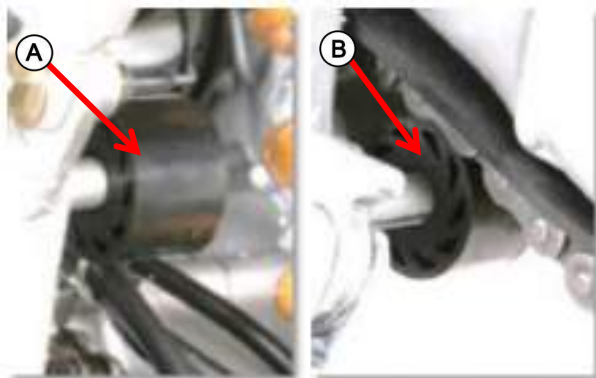

**CHAIN ROLLER INSPECTION**

1. Check the upper **A** and lower **B** rollers for wear and damage.
2. If the rollers are worn or damaged, they must be replaced before your next ride.
3. If the roller has been worn down beyond the two points marked in Fig. 1, then the roller(s) must be replaced.
4. If you cannot or do not know how, take the motorcycle to a Xmotors dealer for service.



Fig. 1

**CAUTION**  
 NEVER RIDE YOUR MOTORCYCLE IF THE ROLLERS ARE WORN EXCESSIVELY.

**NOTICE**  
 ALWAYS USE HIGH QUALITY LUBRICANT FOR THE DRIVE CHAIN.



## CHAIN SLIDERS

### CHAIN SLIDER INSPECTION

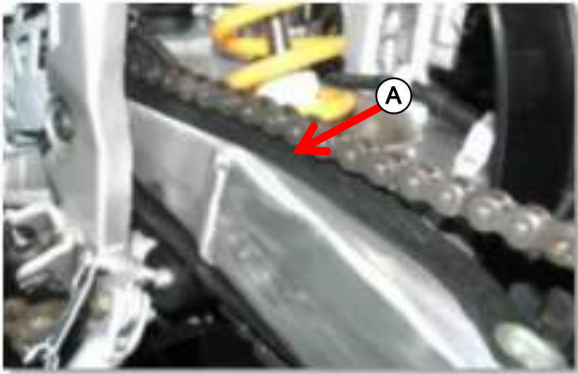

Fig. 1

1. Check the slider **A** for wear Fig. 1
2. If the wear limit **1** has been reached Fig. 3, it must be replaced.

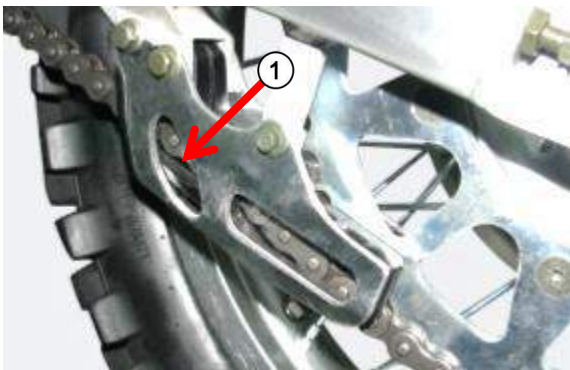

Fig. 2

1. Check the guide slider **1** for wear Fig 2.
2. Replace the guide slider if it is worn to the bottom of the wear limit. Fig. 3 - **A**



Fig. 3



### NOTICE

THE SLIDERS MUST BE REPLACED IF WORN DOWN TOO FAR.





**CHAIN ADJUSTMENT**

Follow the procedure below to adjust the drive chain slack. Be sure that you are parked on a level surface and the engine is turned OFF.

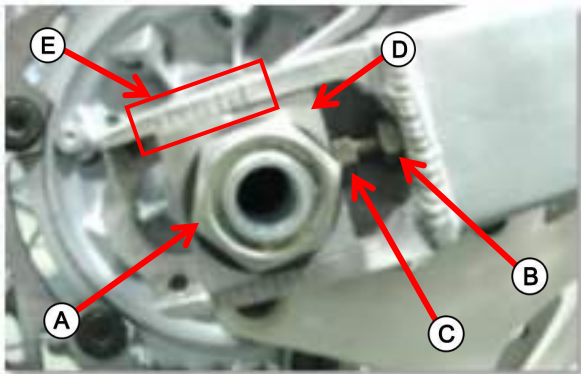

Fig. 1

**CHAIN ADJUSTMENT**

1. Loosen the rear axle nut **A**
2. Loosen the lock nut **B** on both right and left side.
3. Turn the adjusting bolts **C** counter-clockwise to decrease slack in the chain, or clockwise to increase slack.
4. Align the marks **1** in Fig. 1 of the adjusting plate **D** with the same reference marks **E** on both sides of the swing-arm.
5. Tighten the axle nut **A** to 85ft-lbs. (115 Nm)
6. Re-check chain slack and readjust if necessary.

**CHAIN LUBRICATION**

Commercially prepared chain lubricants may be purchased at most motorcycle shops and should be used instead of motor oil. Chain lube or gear oil (80w or 90w) is recommended.

Saturate each joint so that the lubricant penetrates the space between each surface of the link plates and rollers.





### DRIVE CHAIN Cont.

If you have been riding in extremely muddy or dusty conditions, the drive chain should be removed and cleaned before you apply lubricant. Follow the procedure below to remove and clean or replace the drive chain with a new one.

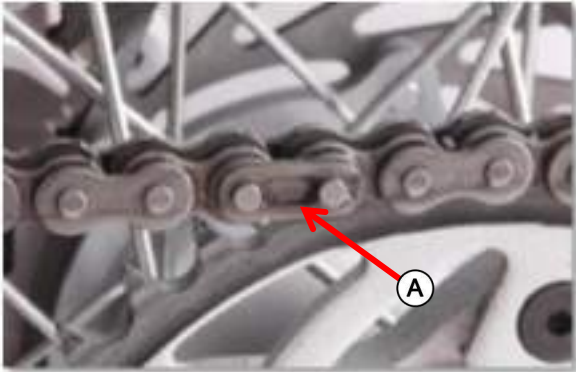

### CHAIN REMOVAL, CLEANING & REPLACEMENT

1. Remove the master link retaining clip **A** with needle nose pliers. Do not bend or twist the clip. Remove the master link and remove the drive chain.
2. Clean the drive chain with a non-flammable solvent such as kerosene - NOT gasoline – and allow it to dry.
3. Inspect the drive chain for possible wear or damage. Replace the drive chain if it has any damaged rollers, loose fitting links, or otherwise appear unserviceable.
4. Inspect the sprockets for wear or damage. Xmotors recommends that you replace the sprockets when you install a new drive chain.
5. Pass the chain over the sprockets and join the ends of the chain with the master link. For ease of assembly, hold the chain ends against adjacent rear sprocket teeth while inserting the master link. Install the master link retaining clip so that the closed end of the retaining clip will face the direction of forward wheel rotation.
6. Lubricate the chain.

The master link is the most critical element of drive chain security. Master links are reusable, as long as they are in excellent condition. We recommend installing a new master link when you install a new drive chain. You may find it easier to install a new chain by connecting it to the old chain using a master link and pulling the old chain to position the new chain on the sprockets.

### APPEARANCE CARE.

To clean the motorcycle you can use any of the following: water, mild neutral detergents, mild spray and wipe cleaner, mild spray and rinse cleaner/degreaser. Avoid products that contain harsh detergents or chemical solvents that can damage the metal, paint and plastic on your motorcycle.

We recommend that you use a garden hose to wash your motorcycle. High pressure washers (like coin operated car washers) can damage certain parts of the motorcycle. If you must use a high pressure washer, avoid spraying the following areas: Wheel hubs, muffler outlet, underneath the seat, engine stop switch, underneath the gas tank, drive chain and carburetor.

#### NOTICE

HIGH PRESSURE WATER OR AIR CAN DAMAGE CERTAIN PARTS OF THE MOTORCYCLE. NEVER WAS THE MOTORCYCLE WHILE THE ENGINE IS RUNNING. ALWAYS LUBRICATE THE DRIVE CHAIN AFTER YOU ARE FINISHED WASHING AND THE MOTORCYCLE IS DRY.



## ENGINE DOES NOT START OR IS HARD TO START

### 1. *Examine the Carburetor* - Be sure there is fuel flowing into the carburetor.

Is there fuel flowing into the carburetor?

- No**
- Clogged fuel hose/line or clogged fuel filter
  - Clogged Fuel Valve
  - Clogged fuel tank breather hose
  - Sticking or stuck carburetor float

**Yes** - SEE STEP 2

### 2. *Examine the Spark Plug* - Remove the spark plug and inspect.

Is the spark plug in good working condition?

- No**
- Flooded engine and/or carburetor
  - Choke valve is closed
  - Throttle is stuck open
  - Dirty or clogged air filter
  - Excessively worn piston rings (replace engine)

**Yes** - SEE STEP 3

### 3. *Spark Test* - Test for ignition spark by removing the spark plug and inserting it into the spark plug cap. Place the open end of the spark plug on a metal part of the engine and kick start the engine. You should see a nice blue spark on the end of the spark plug. A faint spark will not start the engine.

Is there a good spark?

- No**
- Fouled or faulty spark plug
  - Broken or shorted spark plug wire or spark plug cap
  - Broken or shorted ignition coil
  - Faulty ignition CDI Box
  - Faulty or shorted magneto assembly
  - Broken or shorted engine stop switch
  - Loose or corroded wires and/or connectors (always clean bad electrical connections)

**Yes** - SEE STEP 4

 <b>NOTICE</b>
<p><b>DO NOT TOUCH THE SPARK PLUG OR PLUG CAP WHILE TRYING TO START THE ENGINE. YOU WILL RECEIVE AND ELECTRICAL SHOCK WHICH COULD RESULT IN SERIOUS INJURY OR DEATH.</b></p>

### 4. *Cylinder Compression Test* - Perform a simple compression test by kick starting the engine slowly. Be sure you have the spark plug installed. While pushing down on the kick starter slowly, you should feel a very hard firmness that will abruptly soften as the kick start lever moves further down. No hard firmness in the kick start lever means you have poor compression.

Is the compression normal?

- No**
- Valve stuck open/seized or improper valve timing (see your Xmotos dealer)
  - Worn cylinder wall and/or piston rings (replace engine)
  - Leaking or damaged cylinder head gasket (see your Xmotos dealer)

**Yes** - SEE STEP 5

### 5. *Engine Start Condition* - Start the engine by using the normal starting procedure

Does the engine start but then stop quickly afterward?

- Yes**
- Improper choke operation
    - Dirty or improperly adjusted carburetor (Contact your Xmotos Dealer)
    - Intake manifold/pipe leak
    - Improper ignition timing (see your Xmotos Dealer)
    - Dirty or contaminated gasoline



## ENGINE LACKS POWER

### **1. Examine the Drive-train** - Raise the wheel of the ground and spin by hand.

Does the wheel spin freely?

- No** - Brake dragging, improperly mounted brake pads  
- Worn or damaged wheel bearings  
- Bent axle

**Yes** - SEE STEP 2

### **2. Check the Tire Pressure** - Use a tire pressure gauge to check the tire pressure of each tire

Is the tire pressure correct?

- No** - Faulty tire valve  
- Punctured tire and/or inner tube

**Yes** - SEE STEP 3

### **3. Clutch Inspection** - Accelerate rapidly through first and second gears.

Does the engine speed/RPM decrease properly when you shift from first gear to second gear?

- No** - Slipping clutch, adjust  
- Worn out clutch discs and/or plates  
- Weak clutch springs  
- Contaminating additive in the engine oil

**Yes** - SEE STEP 4

### **4. Engine Performance Inspection** - Accelerate lightly.

Does the engine speed increase?

- No** - Clogged air filter  
- Restricted or clogged fuel line and/or fuel filter  
- Clogged muffler/spark arrester  
- Choke valve is closed  
- Clogged fuel tank breather hose

**Yes** - SEE STEP 5

### **5. Spark Plug inspection** - Remove the spark plug and inspect

Is the spark plug in good working condition?

- No** - Spark plug is not serviced frequently enough  
- Incorrect spark plug heat range  
- Incorrect spark plug gap

**Yes** - SEE STEP 6

### **6. Engine Oil Inspection** - Check the oil level and the condition of the oil

Is the engine oil level correct and in clean condition?

- No** - Oil level too high  
- Oil level too low  
- Contaminated oil

**Yes** - SEE STEP 7

### **7. Cylinder Compression Inspection** - Check the cylinder compression.

Is the engine compression normal?

- No** - Valve stuck open/seized or improper valve timing (see your Xmos dealer)  
- Worn cylinder wall and/or piston rings (replace engine)  
- Leaking or damaged cylinder head gasket (see your Xmos dealer)

**Yes** - SEE STEP 8



## ENGINE LACKS POWER Cont.

### 8. *Carburetor Inspection* - Disassemble the carburetor and check for clogs

Was the carburetor clogged and dirty?

- No** - SEE STEP 9
- Yes** - Carburetor is not serviced frequently enough
- Contaminated fuel

### 9. *Over Heating Inspection* - Check the engine for overheating

Is the engine overheating?

- No** - GO TO STEP 10
- Yes** - Excessive carbon buildup in the combustion chamber
- Use of poor quality fuel
  - Clutch slipping
  - Lean fuel mixture or improper octane rating of fuel

### 10. *Engine Condition Inspection* - Accelerate rapidly through all gears and ride at high speed.

Does the engine knock?

- No** - SEE STEP 11
- Yes** - Worn piston and cylinder (replace engine)
- Wrong type of fuel (octane rating)
  - Lean fuel mixture
  - Excessive carbon buildup in the combustion chamber

### 11. *Ignition Timing Inspection* - See your local Xmotos dealer or motorcycle repair shop to have the ignition timing and engine lubrication system inspected. Only attempt these procedures if you are qualified and have the proper tools needed.

Is the ignition timing normal? (Timing is non-adjustable)

- No** - Faulty CDI ignition box
- Faulty ignition pulse generator
- Yes** - SEE STEP 12

### 12. *Lubrication Inspection* - Remove the valve adjuster hole cap on the cylinder head and inspect for lubrication.

Is the valve train lubricated properly?

- No** - Clogged oil passage (replace engine)
- Dirty and/or contaminated engine oil
- Yes** - See your Xmotos dealer to have your motorcycle serviced.

## POOR PERFORMANCE AT IDLE & LOW SPEED

### 1. *Intake Manifold Inspection* - Check the intake manifold for leaks

Is there a leak in the manifold?

- No** - SEE STEP 2
- Yes** - Loose carburetor mounting bolts
- Damaged insulator/spacer
  - Damaged intake manifold gasket
  - Cracked or broken intake manifold/pipe



## POOR PERFORMANCE AT IDLE & LOW SPEED Cont.

**2. Spark Test** - Test for ignition spark by removing the spark plug and inserting it into the spark plug cap. Place the open end of the spark plug on a metal part of the engine and kick start the engine. You should see a nice blue spark on the end of the spark plug. A faint spark will not start the engine.

Is there a good spark?

- No**
- Fouled or faulty spark plug
  - Broken or shorted spark plug wire or spark plug cap
  - Broken or shorted ignition coil
  - Faulty ignition CDI Box
  - Faulty or shorted magneto assembly
  - Broken or shorted engine stop switch
  - Loose or corroded wires and/or connectors (always clean bad electrical connections)
- Yes** - SEE STEP 3



### NOTICE

DO NOT TOUCH THE SPARK PLUG OR PLUG CAP WHILE TRYING TO START THE ENGINE. YOU WILL RECEIVE AN ELECTRICAL SHOCK WHICH COULD RESULT IN SERIOUS INJURY OR DEATH.

**3. Carburetor Air Screw Inspection** - Check the carburetor air screw. Turn the screw clockwise until you feel it stop. Do not tighten. Back out the screw counter clockwise 1.5 turns.

Is the air screw setting correct?

- No** - Adjust using the procedure above.
- Yes** - SEE STEP 4

**4. Ignition Timing Inspection** - See your local Xmos dealer or motorcycle repair shop to have the ignition timing inspected. Only attempt these procedures if you are qualified and have the proper tools needed.

Is the ignition timing normal? (Timing is non-adjustable)

- No**
- Faulty CDI ignition box
  - Faulty ignition pulse generator
- Yes** - See your Xmos dealer to have your motorcycle serviced

## POOR PERFORMANCE AT HIGH SPEED

**1. Examine the Fuel Line** - Disconnect the fuel hose at the carburetor.

Is there fuel flowing freely?

- No**
- Clogged fuel hose/line or clogged fuel filter
  - Clogged Fuel Valve
  - Clogged fuel tank breather hose
- Yes** - SEE STEP 2

**2. Carburetor Inspection** - Disassemble the carburetor and check for clogs.

Was the carburetor clogged and dirty?

- No** - SEE STEP 3
- Yes** - Carburetor is not serviced frequently enough, contaminated fuel

**3. Ignition Timing & Valve train Inspection** - See your local Xmos dealer or motorcycle repair shop to have the ignition timing inspected. Only attempt these procedures if you are qualified and have the proper tools needed.

Are the ignition timing, valve timing and valve springs normal? (Timing is non-adjustable)

- No**
- Faulty CDI ignition box
  - Faulty ignition pulse generator
  - Broken valve spring
  - Broken or damaged camshaft sprocket
- Yes** - See your Xmos dealer to have your motorcycle serviced

**POOR HANDLING****Steering is heavy**

- Steering stem nut too tight
- Damaged steering head bearings
- Check tire pressure

**Either wheel has a Wobble**

- Excessive wheel bearing play
- Bent Rim
- Improperly installed wheel hub
- Damaged swing-arm
- Bent frame
- Loose or broken spokes
- Old tires with “dry-rot”

**The motorcycle pulls to one side**

- Front and rear wheels out of alignment
- Faulty shock absorber
- Damaged fork(s)
- Bent Swing-arm
- Damaged axel
- Damaged frame
- Damaged upper or lower triple clamp



### GENERAL GUIDELINES

If you encounter trouble during a ride, the first thing you should do is stop as soon as it is safely possible. Do not continue to ride if you have a flat tire, if you hear an unusual noise, or if your motorcycle just does not feel right. If you continue to ride, you will cause more damage to the motorcycle and endanger your own safety.

After you stop, take time to carefully look over your motorcycle and identify the problem. Always consider all of your options before you make a decision. Sometimes a problem can be relatively minor and can be permanently repaired on the trail provided you have the tools, supplies and skills needed to do so. In addition, you may be able to make a temporary repair and ride slowly back to your base where you can get further help and/or supplies.

When a problem appears to be more serious; or you do not have the tools, supplies and skills needed to make a repair, you will need to choose a safe way to get yourself and the motorcycle back to your base. If you are close enough, you can often push the motorcycle back.

Whatever the problem may be, always follow the instructions below:

1. Always put safety first.
2. If the problem is minor and you have the tools, supplies and skills needed to make a temporary repair, be sure to make permanent repairs as soon as possible.
3. Do not continue riding if you are hurt or if your motorcycle is not in safe riding condition.

Recommendations for specific problems follow.

### IF THE ENGINE QUILTS or WILL NOT START

If the engine was not making unusual noises before it quit running, and it feels normal when you operate the kick starter, you can probably rule out a major mechanical problem.

First, check the fuel system:

1. Make sure you have fuel in the gas tank and the fuel valve is set to the “ON” position.
2. Check the fuel tank cap breather hose to be sure it is not pinched or clogged.
3. Turn the fuel valve to the “OFF” position. Disconnect the fuel line from the carburetor and momentarily turn the fuel valve to “ON”. If fuel does not flow out, there is an obstruction in the fuel tank, fuel filter, or in the fuel line.

If the fuel system appears to be okay, check the ignition system.

1. Check the spark plug cap. Be sure that it is not loose or disconnected.
2. Disconnect the spark plug cap and remove the spark plug. Connect the spark plug to the plug cap and place the threaded end of the spark plug on a metal part of the engine.
3. Kick the kick starter while you watch the spark plug. If it sparks, the ignition system is probably working. If there is no spark, replace the spark plug with a new one. If there is still no spark, there is a problem with the ignition system.

If you cannot identify or correct a problem, you will have to push your motorcycle back to your base or get some help.



**IF YOU HAVE A FLAT TIRE**

How you handle a flat tire on the trail will depend on the severity of the damage to the tire and/or the inner tube and what tools and supplies you keep with you. If you have a slow leak or a minor puncture, there are two ways you can try to make a temporary repair:

1. Use an aerosol tire sealer to seal the puncture and inflate the tube. You can do this without removing the wheel.
2. Use a tube repair kit to patch the hole in the inner tube. This requires removal of the wheel and tire.

If the leak is more severe, or a temporary repair does not hold up, you will need to replace the inner tube.

If the tire is also severely damaged, you will need to replace the tire as well.

If you cannot repair the flat tire on the trail, you will need to push the motorcycle back to your base or send for help. Do not ride on a flat tire. The motorcycle will be hard to handle, and if the tire comes off the rim, it can lock up the wheel and cause you to crash.

**IF YOU CRASH**

Personal safety is the first priority after an accident. If you or anyone else has been injured, take plenty of time to assess the severity of the injuries and determine if it is safe to continue riding. If you cannot ride safely, send someone for help. Do not ride if you will risk further injury or if your motorcycle has been damaged too severely.

If you decide you are capable of riding safely, carefully inspect the motorcycle for damage. Check the tightness of critical nuts and bolts such as the handle bars, control levers, brakes and wheels. If there is minor damage, or you are not sure about possible damage but decide to ride back to your base, ride slowly and cautiously.

Sometimes crash damage is hidden or not immediately apparent. Once you get home, go over your motorcycle thoroughly and fix any problems that you find. Also, be sure to have your Xmos dealer inspect the frame and suspension after a serious crash.

**IF A COMPONENT FAILS**

The drive chain, master link, control cables, brake controls, and other components can be damaged if you ride in dense brush or over rocky terrain. As mentioned earlier, making the repair on the trail will depend on the severity of the damage, tools, supplies, and skills that you have.

1. If the drive chain comes off because the master link clip has been knocked off, you may be able to repair the chain with a new master link. However, if the chain is broken or causes damage when it comes off, you may not be able to make a trailside repair.
2. If any component of the front braking system is damaged, you may be able to ride back to your base carefully using the rear brake for slowing and stopping. Likewise, if a component of the rear braking system fails, you can use the front brake for slowing and stopping.
3. If you damage the throttle cable or some other critical component, the motorcycle may be unsafe to ride. Carefully assess the damage and make any repairs that you can. But if you have any doubts, it is best to be conservative and safe.



# TORQUE SPECIFICATIONS

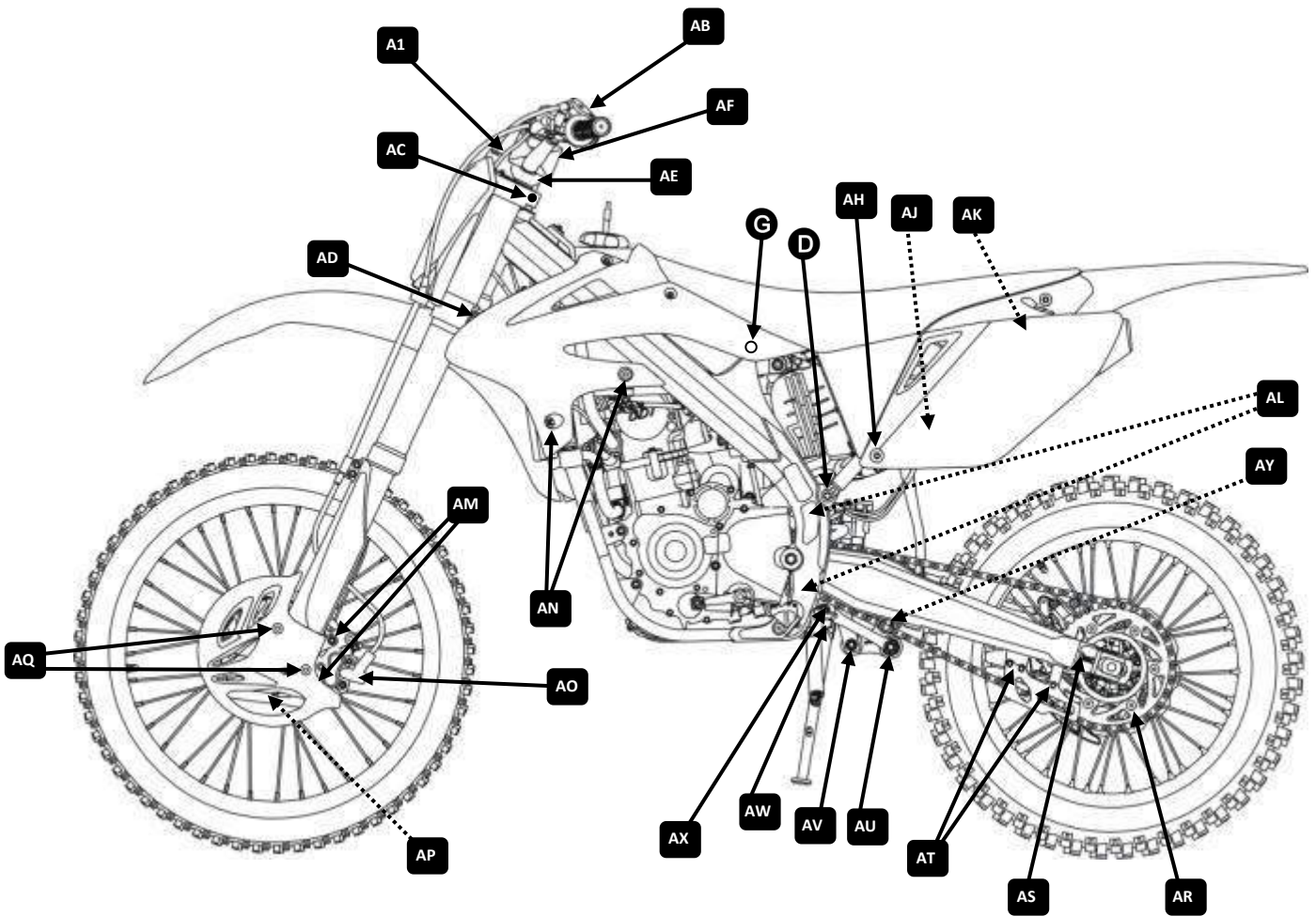
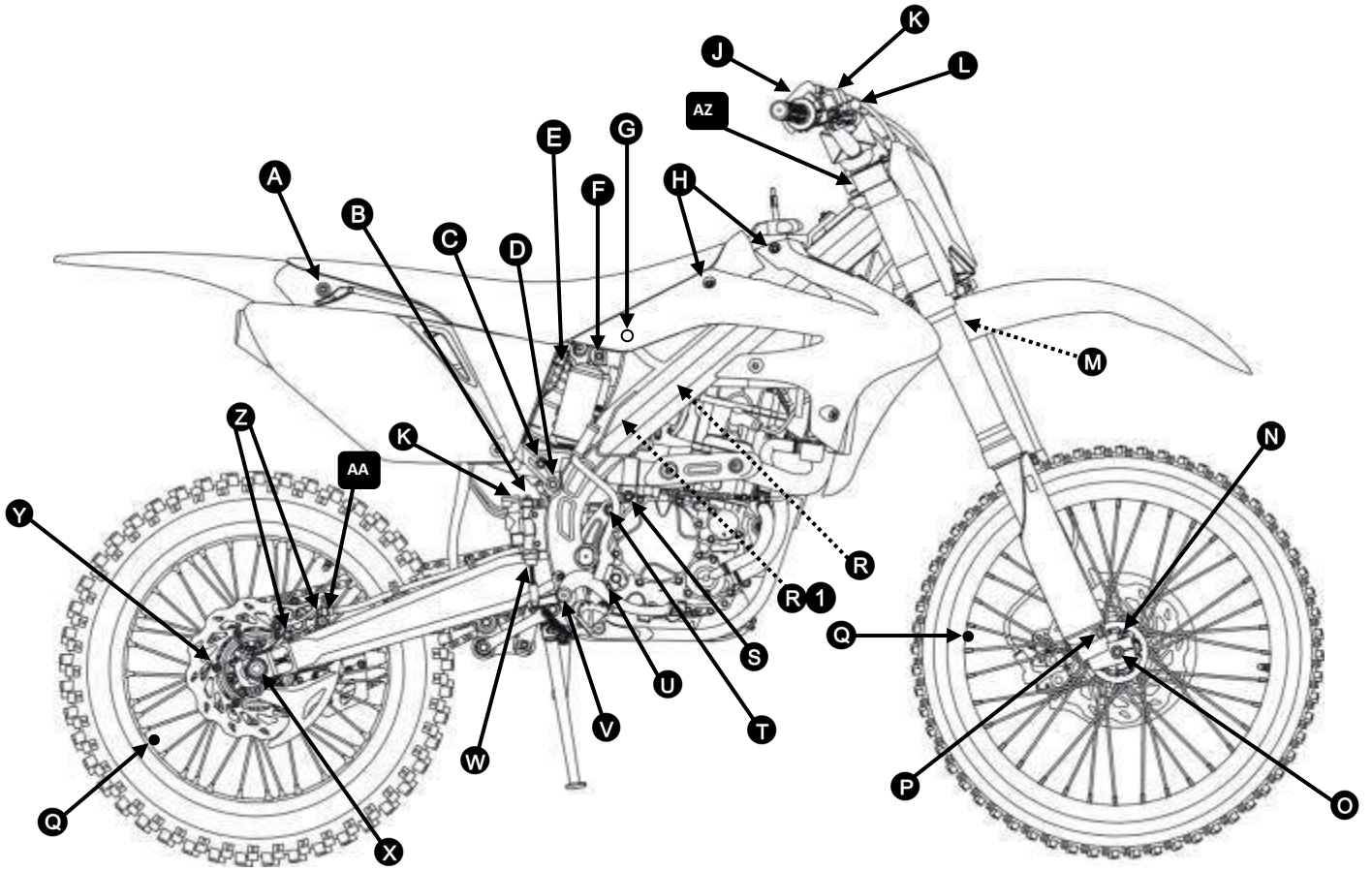

# TORQUE SPECIFICATIONS



Name		Torque		Notes	Name		Torque		Notes
		N•m	ft•lbs				N•m	ft•lbs	
A	Seat bolts	25	18.5	3	AA	Brake hose bolt	28	20	
B	Brake hose bolt	28	20.6		AB	Clutch holder	9.7	7.15	
C	Exhaust mounting bolt	26	19.2	3	AC	Triple clamp (upper)	27	20	3
D	Sub-frame bolt (lower)	38	28	3	AD	Triple clamp (lower)	27	20	3
E	Shock spring lock nut	46	34		AE	Handlebar riser (lower)	34	25	3
F	Shock nut	50	36.8	3	AF	Handlebar riser (upper)	28	20	3
G	Sub-frame bolt (upper)	35	25.8		AH	Cover bolt	10	7.3	2
H	Shroud bolts	7	5.10		AJ	Muffler clamp (LT / RT)	23	17	
J	Master cylinder holder	9.7	7.15		AK	Muffler mount (LT / RT)	27	20	3
K	Brake reservoir cap bolt	1.3	1		AL	Chain roller bolt (top/btm)	15	11	3
L	Brake hose bolt	28	20.6		AM	Brake caliper bolts	27	20	3
M	Fender bolts	7	5.16	3	AN	Shroud bolts	7	5	
N	Axle pinch bolts	25	18.4	3	AO	Brake hose bolt	28	20	
O	Axle nut	75	55	3	AP	Brake disc bolts	22	16	3
P	Fork guard bolts	8	5.9	3	AQ	Disc cover bolts	8	6	2
Q	Rim lock	12	8.8	3	AR	Drive sprocket bolts	26	19	3
R	Engine mounting bolt	30	22	3	AS	Chain adjuster nut	15	11	
S	Exhaust joint clamp	23	17		AT	Chain guide bolts	15	11	3
T	Engine mount (upper)	30	22	3	AU	Connecting rod (rear)	65	48	3
U	Kick starter bolt	22	16	3	AV	Shock mount (lower)	50	37	3
V	Brake lever pivot bolt	30	22	3	AW	Kick stand bolt	25	18	3
W	Brake lever adjuster nut	10	7.3		AX	Connecting rod (front)	50	37	3
X	Axle nut	95	70	3	AY	Linkage connection	55	40	3
Y	Brake disc bolts	22	16	3	AZ	Steering stem nut (btm)	40/15	29/11	
Z	Brake caliper bolts	27	19	3	R1	Engine bracket bolt	28	20.6	3
A1	Steering stem nut (top)	145	107	3					

**Notes:**

1. Apply oil to threads.
2. Apply Loctite 241/242 to threads.
3. Apply Loctite 243 liquid to threads.
4. Apply grease to bolt, NOT threads.
5. Bottom (btm)
6. AZ – Torque to specified amount, turn counterclockwise ½ turn, torque again to second specified amount.

Specific engine torque specifications on pages 68, 69, 70.

For a complete detailed list of torque specifications, please contact XGroup Corporation.



# TORQUE SPECIFICATIONS (LC)

## XZ250R - LC

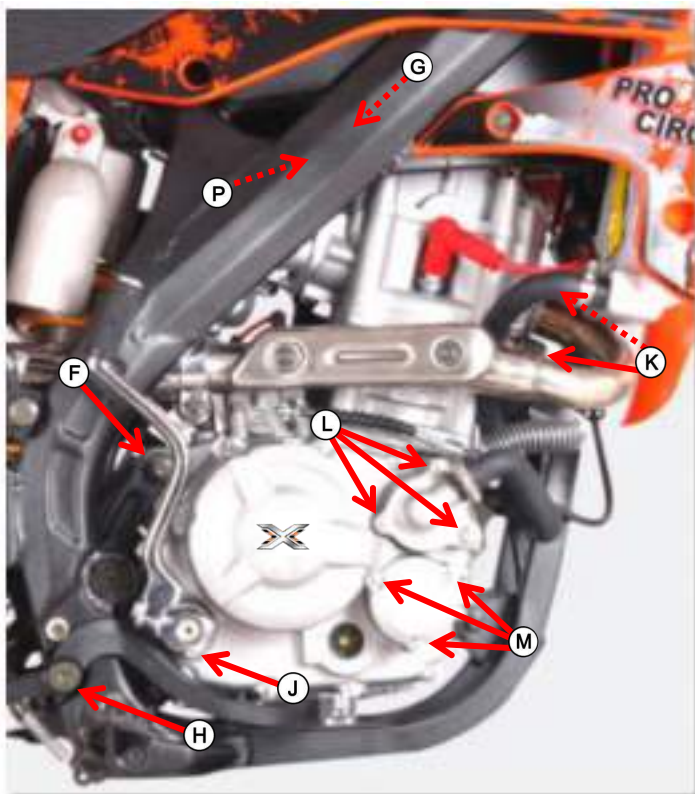
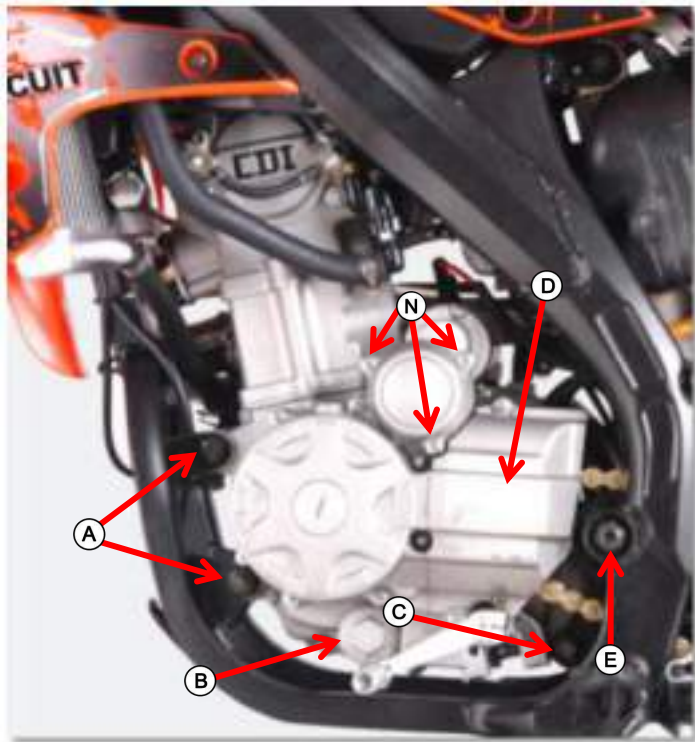

	Name	Torque		Notes
		N•m	ft•lbs	
A	Engine mount (front)	35	26	3
B	Oil drain cap	17.5	13	1
C	Engine mount (lower)	30	22	3
D	Sprocket bolts	15	11	3
E	Swing arm nut	85	63	3
F	Engine mount (upper)	30	22	3
G	Engine mount (top)	30	22	3
H	Brake lever pivot bolt	30	22	3-4
J	Kick starter bolt	22	16	3
K	Exhaust nut	22	16	
L	Water pump bolts	9.4	7	
M	Oil filter cover bolts	9.4	7	
N	Starter gear cover bolts	9.4	7	
P	Engine mount bracket	28	20	3

### Notes

1. Apply oil to threads.
2. Apply Locktite 241/242 to threads.
3. Apply Locktite 243 to threads.
4. Apply grease to bolt, NOT threads.



## XZ250R / M - ZS

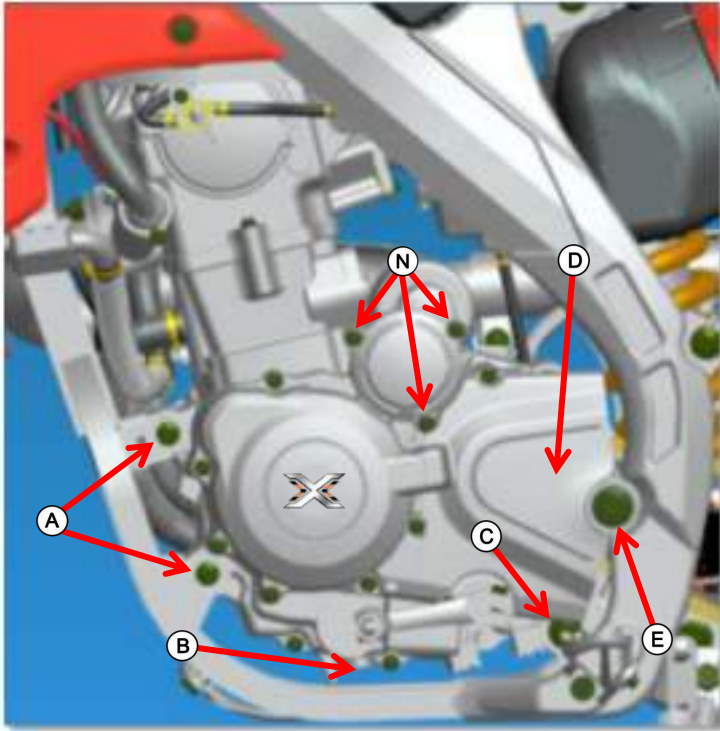

Name		Torque		Notes
		N•m	ft•lbs	
A	Engine mount (front)	35	26	2
B	Oil drain bolt	17.5	13	1
C	Engine mount (lower)	40.5	30	2
D	Sprocket bolts	16.2	12	3
E	Swing arm nut	81	60	3
F	Engine mount (upper)	54	40	2
G	Engine mount (top)	51	38	3
H	Brake lever pivot bolt	29.7	22	3-4
J	Kick starter bolt	33.7	25	3
K	Exhaust nut	20.2	15	
L	Oil filter cover bolts	10.8	8	
M	Water pump bolts	9.4	7	
N	Starter gear cover bolts	9.4	7	
P	Clutch cover bolts	10.8	8	
R	Engine mount bracket	28	20	3

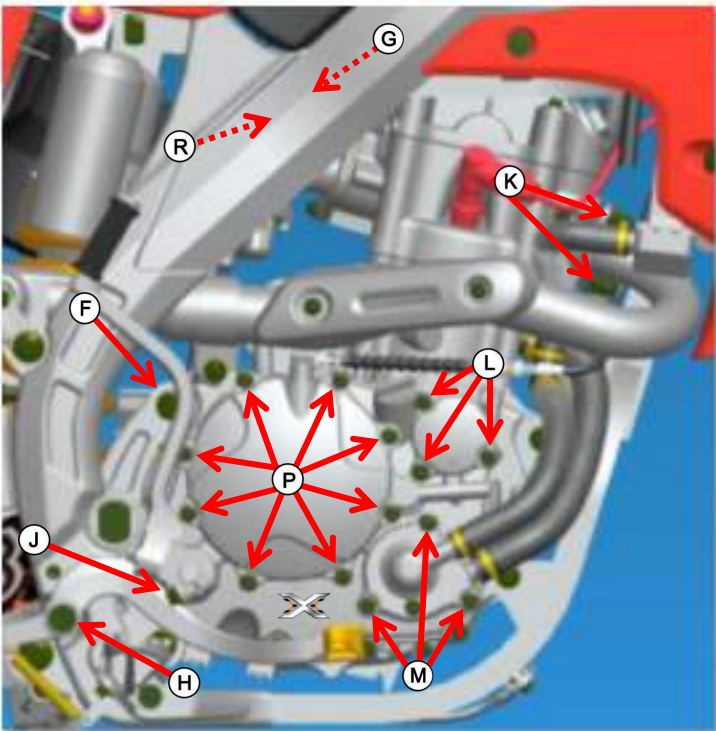

### Notes

1. Apply oil to threads.
2. Apply Loctite 241/242 to threads.
3. Apply Loctite 243 to threads.
4. Apply grease to bolt, NOT threads.



# TORQUE SPECIFICATIONS (V4 - RM)

## XZ250R – V4 / RM

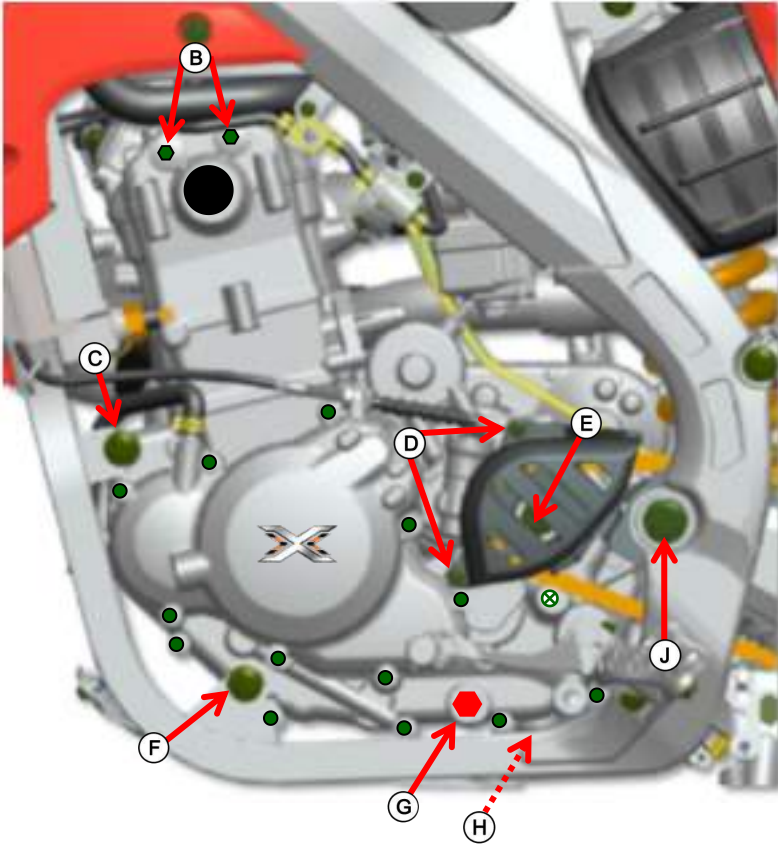

Name		Torque		Notes
		N•m	ft•lbs	
A	Engine mount (top)	30	20	3
B	DO NOT REMOVE	////	////	////
C	Engine mount (upper)	45	33	3
D	Sprocket cover bolts	10	7.3	
E	Sprocket bolt	48.6	36	3
F	Engine mount (lower)	40	29.5	3
G	Oil filter screen	13.5	10	
H	Oil drain bolt	15	11	1
J	Swing arm nut	85	63	3
K	Kick starter bolt	32	23	3
L	Clutch cover bolts	10.8	8	
M	Oil filter cover bolts	10.8	8	
N	Oil filter screen	13.5	10	
Q	Water pump bolts	9.4	7	
P	Exhaust nut	20.2	15	
R	Brake lever pivot bolt	35	26	3-4

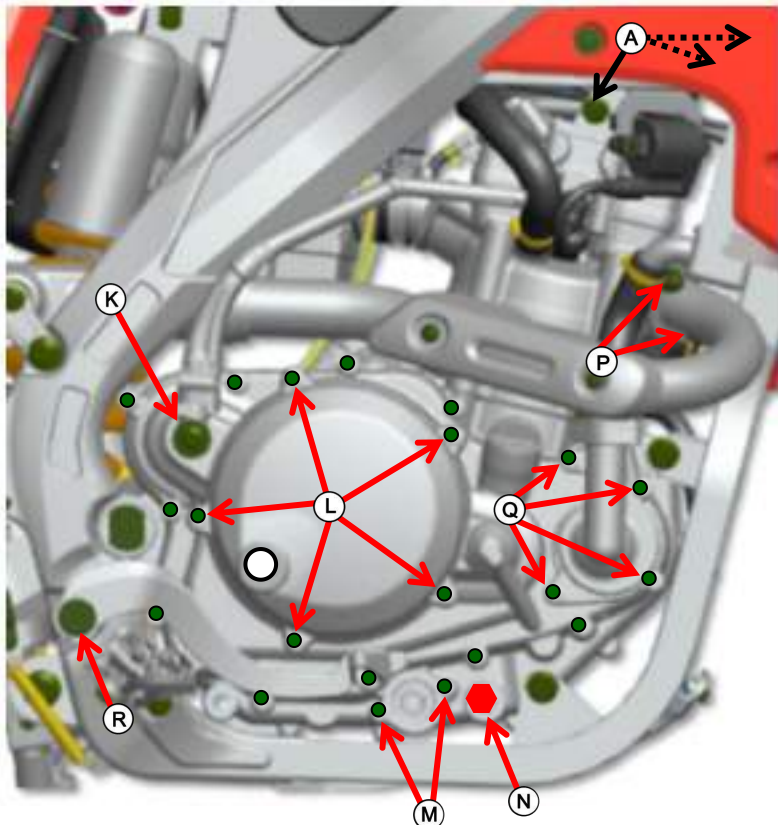

### Notes:

1. Apply oil to threads.
2. Apply Loctite 241/242 to threads.
3. Apply Loctite 243 to threads.
4. Apply grease to bolt, NOT threads.

# SPECIFICATIONS



	XZ250R - LC	XZ250R - ZS	XZ250R V4 / RM
Engine	LC170MM-2A	ZS169FMM	ZS177MM
Design	4 - Stroke Water Cooled / 2 Valve / Single Camshaft		4 - Stroke Water Cooled / 4 Valve / Single Camshaft
Displacement	249.4 mL	222.6 mL	249.6 mL
Bore / Stroke	70 x 64.8 mm	65 x 66 mm	77 x 53.6 mm
Power Max.	12.5 kW / 7500 Rpm (17 Hp)	12 kW / 7000 Rpm (16.3 Hp)	19 kW / 9000 Rpm (26 Hp)
Torque Max.	18.5 N.m / 5000 Rpm	18 N.m / 5500 Rpm	23 N.m / 7000 Rpm
Idle Speed	1500 ± 100 Rpm		
Compression Ratio	9.5 : 1	10.5 :1	11.5 : 1
Fuel	91 Octane or Higher	91 Octane or Higher	91 Octane or Higher (Required)
Oil	15w40SE - 10w30SF 1.3 – 1.5L Capacity		
Ignition Timing	11° BTDC @ 2000 Rpm	15° BTDC @ 2000 Rpm	8° BTDC @ 2000 Rpm
Ignition Type	Contactless DC - CDI Ignition		
Spark Plug	NGK - D8RTC	NGK - D8EA	DENSO – U22ESR-N
Drive	Chain		
Clutch	Wet Multi-Plate Disc		
Transmission	5 Speed, Claw Actuated		5 Speed, (6 Opt.) Claw Actuated
Gear Ratio			
1st Gear	2.667	2.909	2.589
2nd Gear	1.867	1.867	1.801
3rd Gear	1.471	1.389	1.338
4th Gear	1.150	1.150	1.131
5th Gear	0.955	0.955	0.966
6th Gear	//	//	0.882
Coolant	Antifreeze / Coolant Only		
Generator Output	12V - 14V	12V - 14V	12V - 14V
Carburetor	KF 30 mm	KF 30 mm	Dellorto 34mm (Italy)
Air Filter	Foam type air filter insert		



## SPECIFICATIONS

	XZ250R - LC	XZ250R - ZS	XZ250R V4 / RM
Frame	High Strength Tensile Steel		
Forks	Xmotos T7 (S) Series, Inverted, Dual Adjustable 910mm		Xmotos T8 (Z) Series, Dual Adjustable
Wheel Travel			
Front	Xmotos T7 (S) Series Dual Adjustable 246 mm // T8 (Z) Series 275 mm		
Rear	Xmotos T8 (Z) Series 102 mm		
Rear Suspension	Xmotos T8 (Z) Series, Dual Adjustable with Piggyback Reservoir 485mm with Linkage		
Front Brake	Disc Brakes with 240mm disc, floating dual piston caliper		
Rear Brake	Disc Brakes with 240mm disc, floating single piston caliper		
Front Tire	80/100-21 (off-road) 110/70-17 (on-road)		
Air Pressure	15 - 18 Psi {104 - 124 kPa} (off-road) 28 - 32 Psi {193 - 220 kPa} (on-road)		
Rear Tire	110/100-18 (off-road) 130/70-17 (on-road)		
Air Pressure	15 - 18 Psi {104 - 124 kPa} (off-road) 28 - 32 Psi {193 - 220 kPa} (on-road)		
Fuel Tank Capacity	6.7 liters (1.77 US gallons)		
Final Drive Ratio	FT: 13T / RR: 51T (off-road) FT: 13T / RR: 39T (on-road)		
Chain	KMC 520 - 116 links (off-road) KMC 520 - 110 links (on-road)		
Lighting (if applicable)	Head Light - 12V 55W // Front Position Light - 12V 5W		
	Rear Brake Light - 12V 10W		
	Rear Parking Light - 12V 5W		
	Directional Flasher Lights - 12V 10W		
	Rear License Plate light - 12V 10W		
Wheel base	1440 mm (59.69 in)		
Seat Height	920 mm (36.22 in)		
Ground Clearance	320 mm (12.59 in)		
Dry Weight	124 kg		



# WIRING SCHEMATIC (OFF-ROAD / LC-ZS-V4)

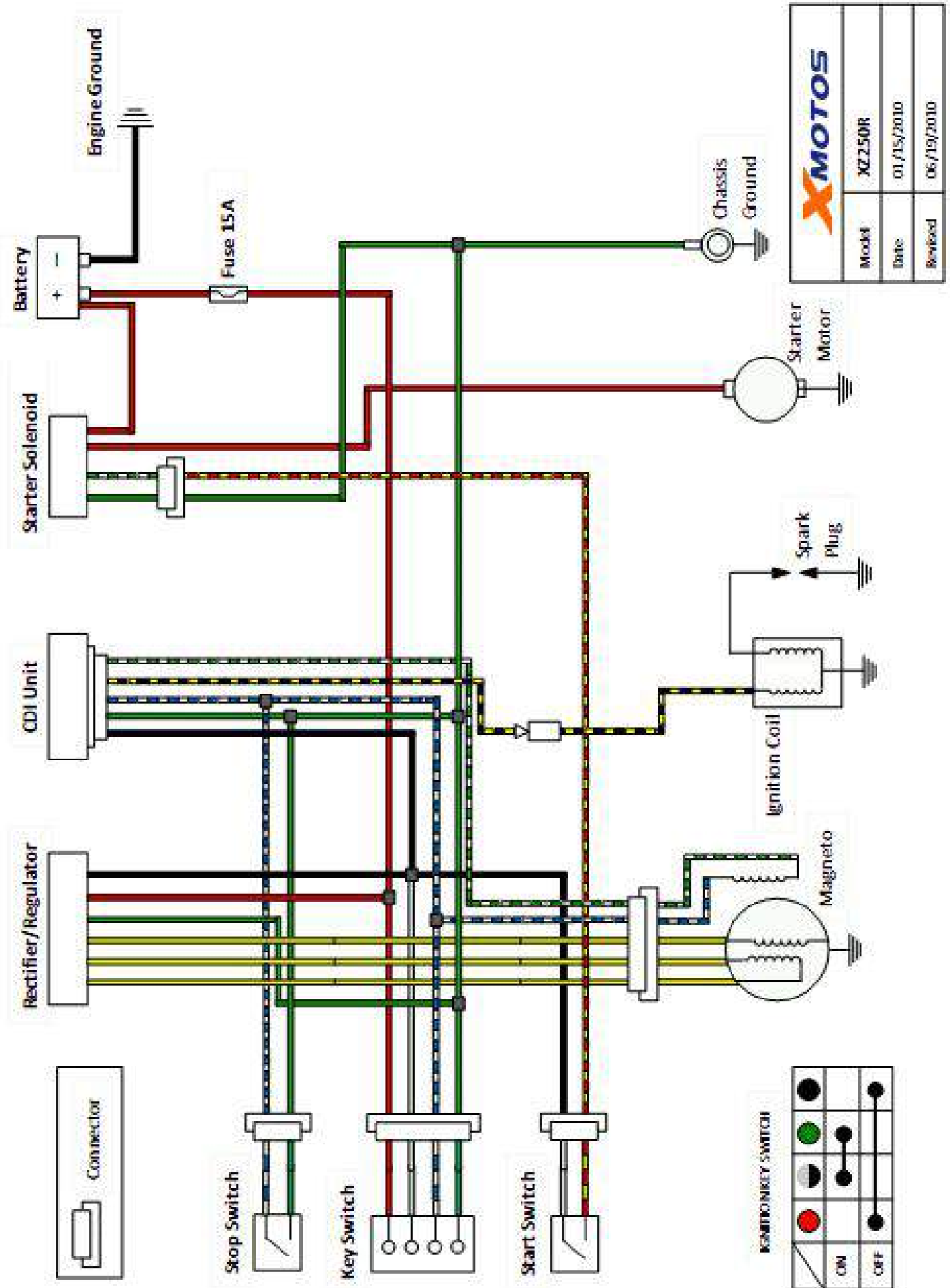

<b>XMOTOS</b>	
Model	XZ250R
Date	01/15/2010
Revised	06/19/2010



# WIRING SCHEMATIC (ON-ROAD / RM)

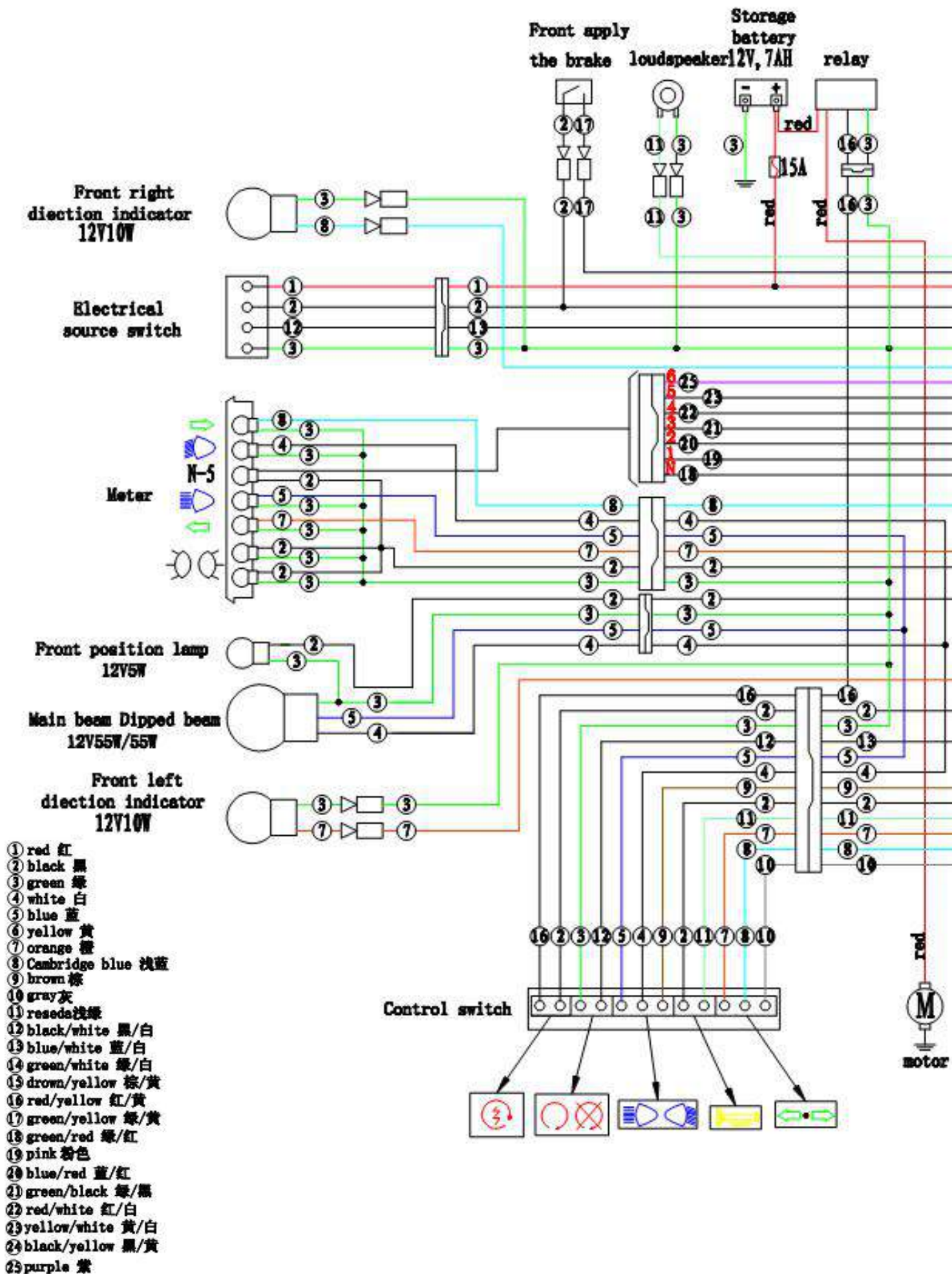

# WIRING SCHEMATIC (ON-ROAD / RM)

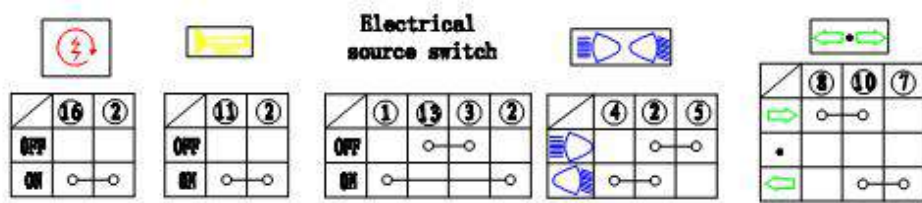
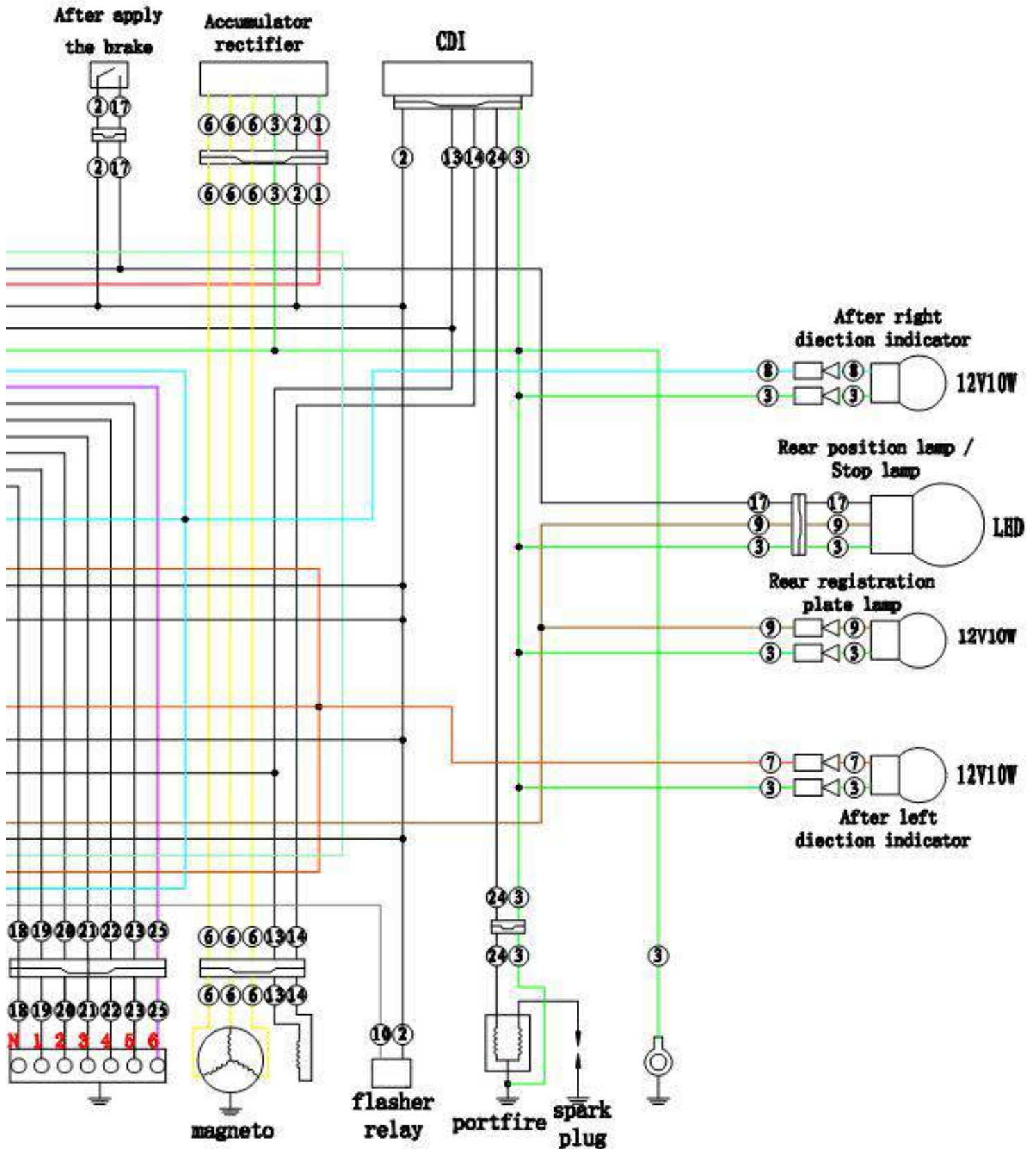

<b>X-MOTOS</b>	
Model	XZ250M/RM/RL
Revised	03/2011



# MAINTENANCE SCHEDULE RECORD

<p><b>Odometer or Hour Reading</b></p> <p style="text-align: right;">00,000      km hr.</p> <hr/> <p><b>Dealer Stamp</b></p> <p>Date _____</p> <p>Signature _____</p>	<p><b>Odometer or Hour Reading</b></p> <p style="text-align: right;">                 km hr.</p> <hr/> <p><b>Dealer Stamp</b></p> <p>Date _____</p> <p>Signature _____</p>	<p><b>Odometer or Hour Reading</b></p> <p style="text-align: right;">                 km hr.</p> <hr/> <p><b>Dealer Stamp</b></p> <p>Date _____</p> <p>Signature _____</p>
--	---	---

<p><b>Odometer or Hour Reading</b></p> <p style="text-align: right;">                 km hr.</p> <hr/> <p><b>Dealer Stamp</b></p> <p>Date _____</p> <p>Signature _____</p>	<p><b>Odometer or Hour Reading</b></p> <p style="text-align: right;">                 km hr.</p> <hr/> <p><b>Dealer Stamp</b></p> <p>Date _____</p> <p>Signature _____</p>	<p><b>Odometer or Hour Reading</b></p> <p style="text-align: right;">                 km hr.</p> <hr/> <p><b>Dealer Stamp</b></p> <p>Date _____</p> <p>Signature _____</p>
---	---	---

<p><b>Odometer or Hour Reading</b></p> <p style="text-align: right;">                 km hr.</p> <hr/> <p><b>Dealer Stamp</b></p> <p>Date _____</p> <p>Signature _____</p>	<p><b>Odometer or Hour Reading</b></p> <p style="text-align: right;">                 km hr.</p> <hr/> <p><b>Dealer Stamp</b></p> <p>Date _____</p> <p>Signature _____</p>	<p><b>Odometer or Hour Reading</b></p> <p style="text-align: right;">                 km hr.</p> <hr/> <p><b>Dealer Stamp</b></p> <p>Date _____</p> <p>Signature _____</p>
---	---	---

**NOTICE**

THE FIRST OIL CHANGE MUST BE DONE BEFORE THE FIRST INITIAL RIDE.





XGroup Corporation (Xmotos)  
No.2 Jinniu Rd. Baiyang Industrial Zone  
Wuyi City, Zhejiang Province, China

Book #: Y370501a  
Ver.4 - 08/2013 AH