



ZS200GY-2(EC)

**MOTORCYCLE
MAINTENANCE MANUAL**

ZONGSHEN MOTORCYCLE

Foreward

Since its establishment, Zongshen Industry Group, which has obtained the **ISO9001:2000** Certification, has developed numerous well-received motorcycles with the emission reached Euro II standard. **ZONGSHEN** brand has been authorized as Chinese Famous Brand. This manual is to help our service personnel and customers know more about the service of this motorcycle.

ZS200GY-2 motorcycle is a newly developed motorcycle with outstanding style and easily operation. The engine installed on this model is **ZS167FML** which is an air cooling, one cylinder and 4-stroke one with advantages of strong power and good acceleration performance. The spoke wheel installed, front brake is disc and rear is drum respectively, with a feature of strong reliability.

This book lays stress on the disassembly/assembly, removal/installation, inspection, troubleshooting and service methods of **ZS200GY-2** motorcycle. It also introduces the general knowledge of service tools. With both the descriptions and pictures, you may have a comprehensive understanding of the configuration as well as the service and repair skill.

When reading this book, the users are suggested to make reference to User's Manual and Parts Breakdown & Catalogue of **ZS200GY-2** motorcycle for better understanding. This book is based on this model only. To ensure the book is always consistent with the ever updating products, Zongshen Industry Group reserves the right to make changes to the specifications of its vehicles without notification.

This book is prepared by Zuo Zongshen(editor-in-chief), Wu Jian, Lei Ting, Li Heping(subeditor), Hu Zhiping, Wang Chong (executive editor), Liu Fubo, Zhongxueliang, Zhang Qiaoli (editor). All people involved in the preparation of this book are employees of Zongshen group who have long been devoted to the development and management of the generator. Due to our limited knowledge and urgent time, it is very possible to have errors in this book. And we welcome your comments.

Editor
Aug. 2006



CONTENT

Chapter 1 General	1
1.1 Vehicle introduction	1
1.2 Specification	2
Chapter 2 Maintenance Knowledge	3
2.1 Maintenance and adjustment data	3
2.2 Maintenance Tool	7
Chapter 3 Maintenance of Engine	9
3.1 Maintenance of Body	9
3.2 Maintenance of Crankshaft Connecting Rod	23
3.3 Maintenance of Valve Mechanism	29
3.4 Maintenance of Fuel System	35
3.5 Maintenance of Intake and Exhaust System	42
3.5.1 Dismantle, Mount and Maintain Intake System	42
3.5.2 Dismantle, Mount and Maintain Exhaust system	44
3.5.3 Dismantle, Mount and Maintain Environmental Protection Device	46
3.6 Maintenance of Lubricant System	48
3.7 Maintenance of Cooling System	51
Chapter 4 Maintenance of Transmission	52
4.1 Maintenance of Starter	52
4.2 Maintenance of Clutch	58
4.3 Maintenance of Transmission	63
4.4 Maintenance of Rear Drive system	69
Chapter 5 Maintenance of Riding System	73
5.1 Maintenance of Frame and Accessories	73
5.2 Maintenance of Suspension system	77
5.3 Maintenance of Wheel	84
Chapter 6 Maintenance of Controls and Brakes System	88
6.1 Maintenance of Controls System	88
6.2 Maintenance of Brakes System	91
Chapter 7 Maintenance of Electrical Parts and Meter System	96
7.1 Maintenance of Charging System	96
7.2 Maintenance of Ignition System	99
7.3 Maintenance of Signal System	102
7.4 Maintenance of Illuminating System	106
7.5 Maintenance of Electrical Starter control system	110
7.6 Maintenance of Meter	114
Chapter 8 Analyze of Motorcycle Troubles	116
8.1 Analyze of Engine Trouble	116
8.2 Analyze of Electric System Trouble	124
Circuit Diagram	131

Chapter1 General

Vehicle introduction

ZS200GY-2 motorcycle is a newly developed product with outstanding style and easily operation. The engine installed on this model is ZS67FML, which is 4-stroke, air-cooling engine with advantages of strong power and good acceleration performance.

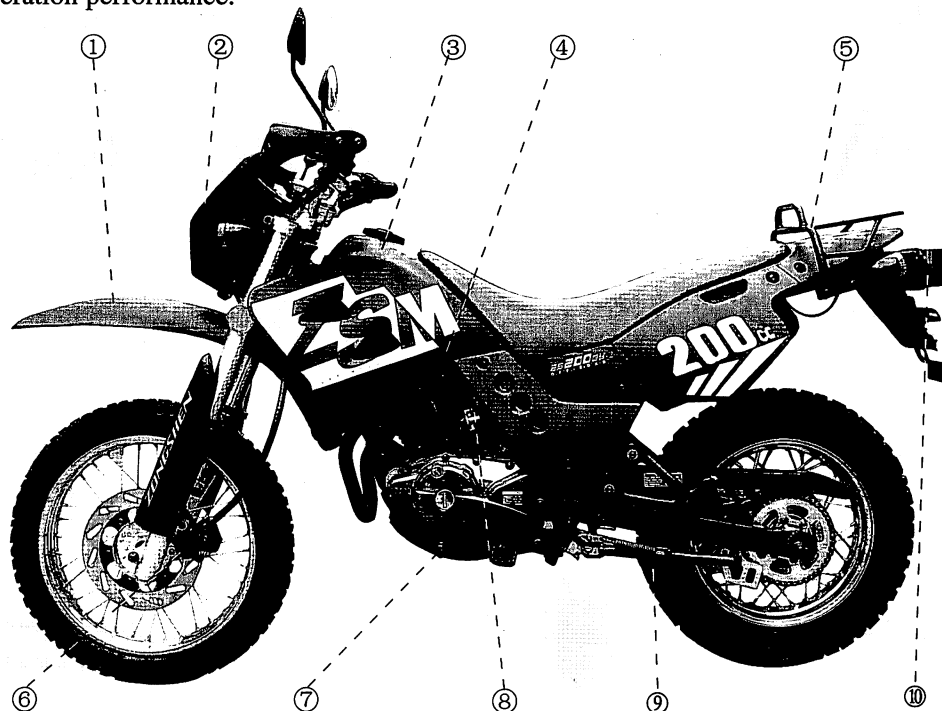

Fig.1-1 left view of ZS200GY-2

- ① front fender ② headlamp ③ fuel tank lock ④ fuel supply valve
- ⑤ rear carrier ⑥ front brake ⑦ gear shifting pedal ⑧ carburetor ⑨ side stand ⑩ tail light

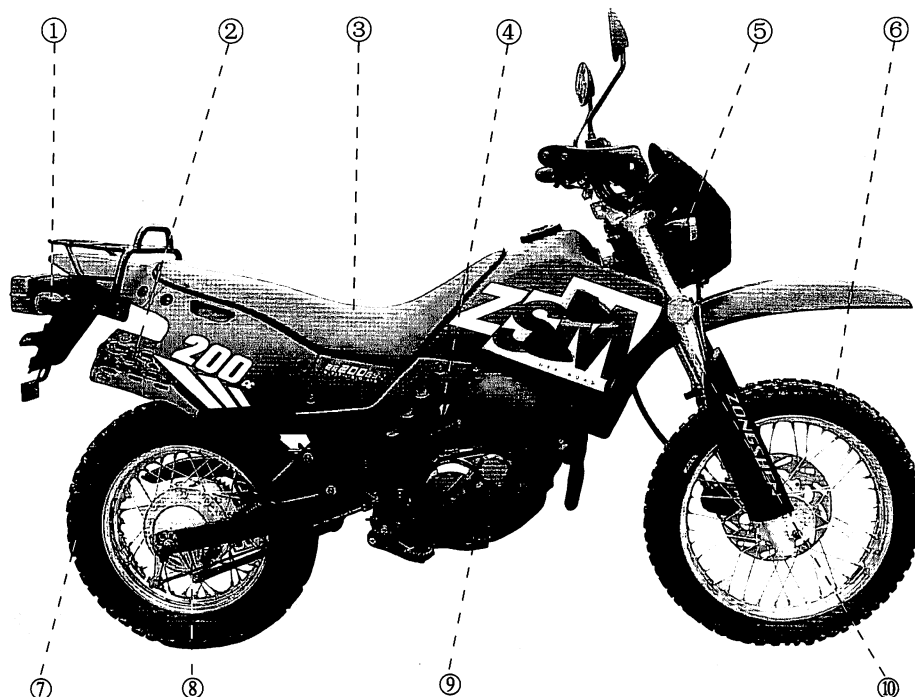

Fig.1-2 right view of ZS200GY-2

- ① right rear turning lamp ② muffler ③ seat ④ kick starter
- ⑤ right front turning lamp ⑥ front wheel ⑦ rear wheel ⑧ brake ⑨ rear brake pedal ⑩ front shock absorber

1-1

Specification

Description		Specification		
Size and net weight	Length × width × height	2180mm × 810mm × 1200mm		
	Wheelbase	1375mm		
	Min ground clearance	250mm		
	Net weight	135kg		
	Max load	150kg		
Engine	Engine model	ZS167FML		
	Engine type	single, 4-strok, air cooling		
	bore × stroke	67.0mm × 55.7mm		
	total capacity	196.0mL *		
	compression ratio	9.5:1		
	craburetor type	vacuum film		
	air cleaner	foam combined with plastic		
	lubrication way	pressure and splash		
	starting type	electric starter / kick starter		
	max.power/corresponding rev	10.5kW/ (7500 ± 500) r/min		
	max.power/corresponding rev	11.0kW/ (7500 ± 500) r/min		
	max.torque/corresponding rev	14.5N • m/ (6500 ± 500) r/min		
	idle speed	(1400 ± 140) r/min		
Riding system	front shock absorber	hydraulic spring		
	rear shock absorber	hydraulic spring		
	angle of steering handlebar	≤ 48°		
Riding system	tyre standard/ pressure	front wheel	100 / 90-18 ≥ 225kPa	
		rear wheel	130/90-15/ ≥ 250kPa	
	drive way	chain		
	min.turning diameter	4200mm		
Transmission	Clutch	multiple,wet and manual		
	Transmission	mesh with 5-speed		
	Transmission way	return spring with left control		
	Primary decelerate ratio	3.318		
	Final decelerate ratio	3.286		
	Gear speed ratio	1-speed	2.833	
		2-speed	1.789	
		3-speed	1.318	
		4 -speed	1.040	
		5 -speed	0.821	
driven chain	model	428H		
	number	122		
control and brake	front brake	disc brakes		
	rear brake	drum brakes		

Description		Specification	
electrical system	ignition way	C·D·I	
	igniiton timing	20° before top dead center (1200r/min)	
	Spark plug	D8EA	
	Clearance of spark plug	0.6mm~0.7mm	
	Capacity of battery	12V7Ah	
	Fuse	10A	
	headlamp	12V35W/35W	
	Tail light/Brake light	12V5W/21W	
	Turn signal light	12V10W × 4	
	Turn signal indicator	12V1.7W × 2	
	Meter light	12V1.7W × 2	
	Neutral indicating light	12V1.7W	
Fuel	position light	12V3W	
	fuel brand	≥ 90 (GB 17930-1999)	
	fuel tank	Capacity(including spare)	≥ 8.0L
		spare	1L
	engine oil	fuel brand	SF 15W/40 (GB 11121-1995)
		Capacity	1.1L
	damping oil	brand	HQ-10
		capacity	(200 ± 5)mL

Chapter 2 Maintenance Knowledge

Maintenance and adjustment data

Engine System

2-1 Cylinder, piston crankshaft and connecting rod

Description	Standard (mm)	Limitation (mm)
clearance of piston and cylinder	0.02	0.06
cylinder internal diameter	67	67.045
piston diameter	66.955	66.825
cylinder head end surface is deformed	—————	0.05
cylinder end surface is bend	—————	0.05
end clearance of piston ring	0.35	0.10
side clearance of piston ring	0.05	0.10
clearance of piston pin and pin hole	0.02	0.08
internal diameter of piston pin	16 + 0.013	16.05
external diameter of piston pin	16.00 - 0.009	15.855
hole diameter of connecting rod small end	16.00 + 0.015	16.045
radial clearance of connecting rod small end	0.02	0.05
radial clearance of connecting rod big end	0.01	0.05
axial clearance of connecting rod big end	0.40	0.60
axial jumping of crankshaft	0.02	0.05

2-2

valve mechanism

Description		Standard (mm)	Limitation (mm)
cam height	intake	36.588 ± 0.05	36.550
	exhaust	36.63 ± 0.05	36.50
valve spring length	inner	36.17	36.00
	outer	36.63	36.50
valve gap		0.06-0.08	0.09-0.10
width of valve seat		1.6~2.0	2.20
valve guide / valve	outernal diameter of valve guide	intake	6.00~5.985
		exhaust	6.00~5.955
	internal diameter of valve guide	intake	6.00~6.012
		exhaust	6.00~6.012
	gap between valve stem and guide	intake	0.015~0.04
		exhaust	0.03~0.057

Transmission

2-3

clutch, starting gear, gearbox

Description		Standard (mm)	Limitation (mm)	
clutch	friction disc height	3.00~3.10	2.60	
	deformation of friction disc	2.800~2.825	0.20	
	free length of clutch spring	37.30	36.50	
starting gear	internal diameter of gear hole	tr26 × 136	—————	
	axial diameter of shifting fork	tr26 × 136	—————	
	internal diameter of shifting fork	19	18.985	
	height of shifting fork claw	7.5	7.485	
gearbox	outer diameter of drum	—————	—————	
	outer diameter of pricipal shaft	15.02	14.94	
	outer diameter of countershaft	25.021	24.96	
	internal diameter of gear	C1	19.50	19.45
		M2	20.041	19.98
		C3	20.021	19.96
		M4	20.02	19.95
C5		25.021	24.98	

2-4

Oil pump

Description	Standard (mm)	Limitation (mm)
gap of pump top		0.20
radial gap between outer rotor and pump		0.25
gap between outer rotor and inner rotor		0.25

Ride system

2-5

wheel and shock absorber

Description		Standard (mm)	Limitation (mm)
depth of tire surface		4.0	2.0
stroke of front absorber shock		108	_____
free length of front absorber shock spring		185.9	180.00
stroke of rear absorber shock		70	_____
free length of rear absorber shock spring		125.00	120.00
jumping of rim	axial	_____	2.00
	radial	_____	2.00
jumping of axle	front	_____	2.00
	rear	_____	2.00

Controls System

2-6

Controls system

Description	Standard (mm)	Limitation (mm)
free stroke of front brake lever	10~20	20~30
free stroke of rear brake pedal	20~30	30~40
thickness of rear brake shoe	3.9~4.0	2.0

Assembly requirement and tools

2-7

Tighten torque

	Description	Standard value	Torque value(N.m)
Engine	Cylinder head bolt	M6	8-12
	Cinnecting bolt of cylinder head	M6	10-12
	Cylinder head nut	M8	20-30
	Bolt of left crankcase cover	M6	8-12
	Bolt of generator rotor	M10	50-60
	Bolt of starting motor	M6	8-12
	Bolt of timing gear	M6	8-12
	right crankcase cover bolt	M6	8-12
	lock nut of clutch and drive gear	M18	40-50
	oil pump gear bolt	M5	6-9
	clutch cover boad bolt	M6	8-12
	fixing bolt of gear change drum cam	M6	8-12
	crankcase bolt	M6	8-12
	Locking nut of vertical tube	M6	8-12
Vehicle	fixing bolt of handlebar	M24	50-60
	fixing bolt of upper connecting block	M6	25-30
	fixing bolt of lower connecting block	M8	30-35
	Nut of front axle	M8	30-35
	nut of rear axle	M14	60-70
	Engine suspension bolt	M16	70-90
	fixing nut of rear shock absorber	M10	30-40
	Sprocket retainer nut	M12	60-70
	steering stem bolt	M8	20-25
	Nut of rear rocker arm	M12	25-30
		M14	60-70

Assemble location

- a.The top mark “↓” should be toward intake position when fitting piston.
- b.The mark “A” on the first and second ring should be upside,and be 120 degree each other.
- c.The dense end of the valve spring should be downside.
- d.The T line of magneto,timing gear mark O and crankshaft gear mark O should be aimed.
- e O mark of balance shaft drive gear should aim to O mark of balance shaft pinion.

Maintenance Tool

2-8

Special Tools and Gauge

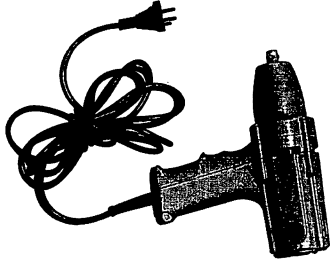
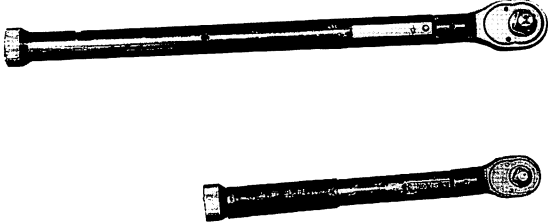
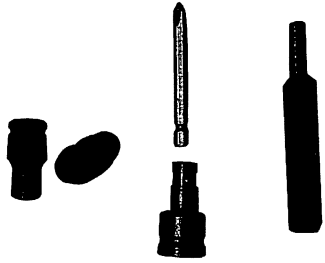
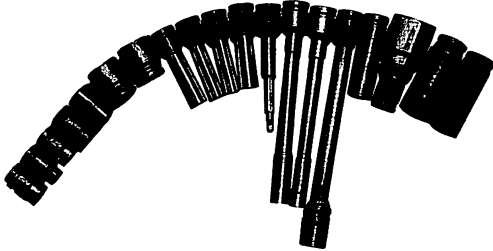
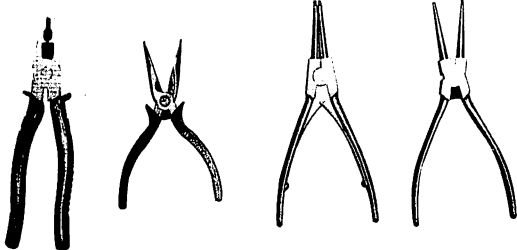
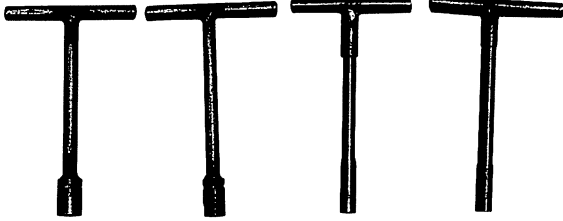
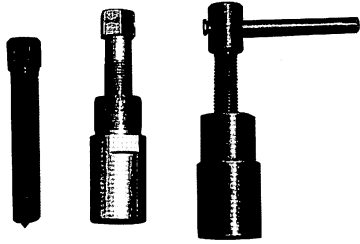
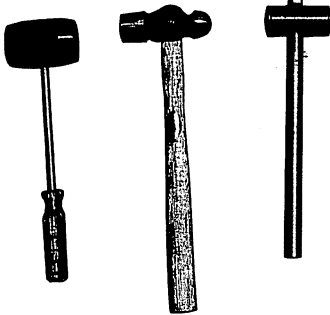
	
<p>Motorized gun: special power tool for mantling/dismantling and clutch nut</p>	<p>wrench: special tool used with socket</p>
	
<p>A, B bolt socket: for mantling/dismantling A, B bolt and exhaust muffler bolt; Adaptor: electric special tool for cross, hexagon gun tip; Valve adjusting socket: for valve clearance adjustment</p>	<p>Socket: for mantling/dismantling nuts, bolts</p>
	
<p>Cutting plier, nipper plier, expansion plier for mantling/dismantling flexible retainer</p>	<p>T- socket wrench</p>
	
<p>rotor puller : for dismantling magneto rotor</p>	<p>Rubber hammer, iron hammer, copper hammer</p>

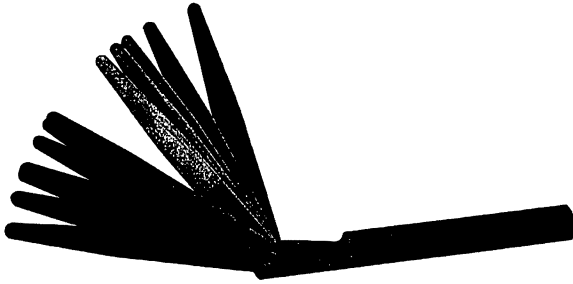

Feeler gauge: to measure the clearance of piston, cylinder, valve, etc.

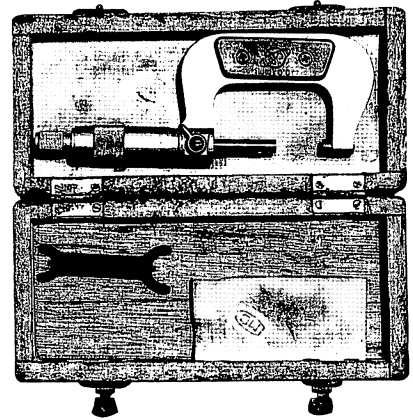

Micrometer: to measure the dimensions of piston, piston pin, etc.

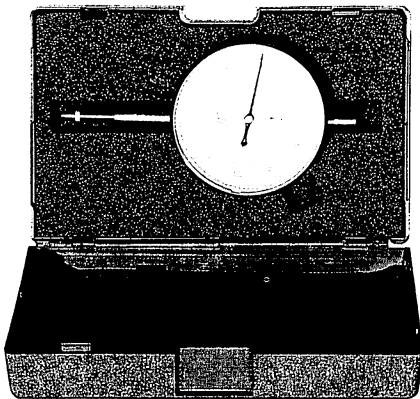

Dial gauge: to measure the wheel bouncing, cylinder inner diameter, etc.

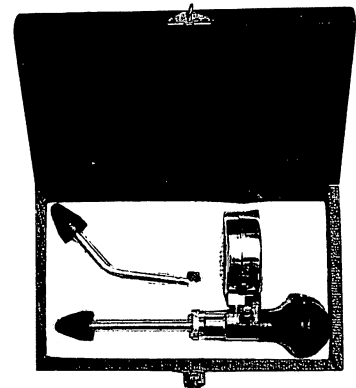

Cylinder barometer: to measure the cylinder pressure

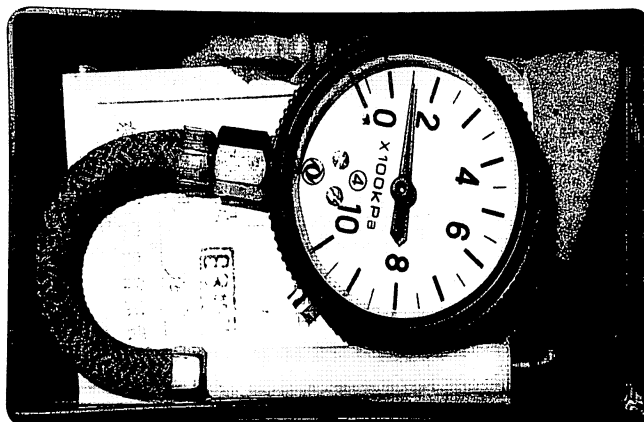

Tire barometer: to measure the tire pressure

Chapter 3 Maintenance of Engine

3.1 Maintenance of engine body

Dismantle, mount and maintain cylinder head

Cnfiguration of engine is shown in fig. Check engine surface and rinse sand or dirt on engine surface if necessary.

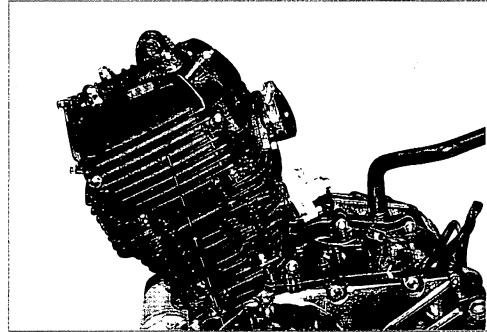

cylinder head

Cnfiguration of engine is shown in fig. Check leakage from engine and repair engine if necessary.
remove cylinder head cover.

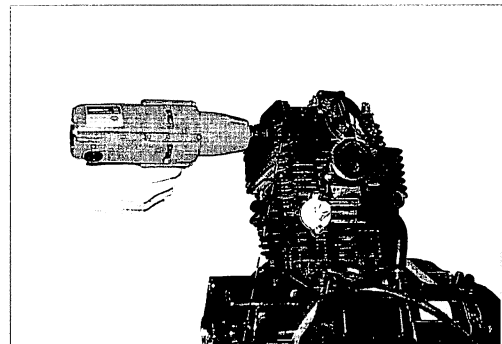

bolt

remove C.D.I cap.

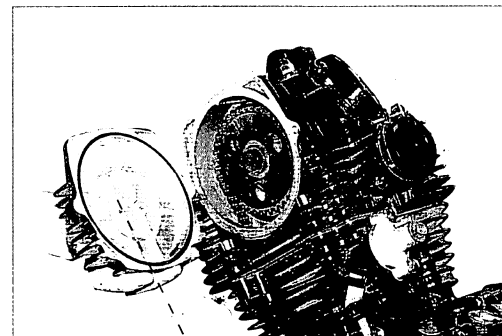

C.D.I cap

check seal ring of C.D.I. cap and replace seal ring if necessary.

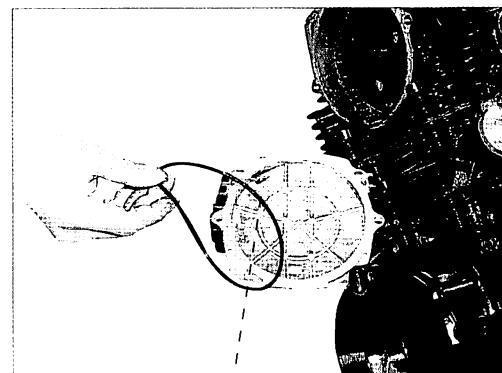

seal ring

unscrew cylinder head nut.

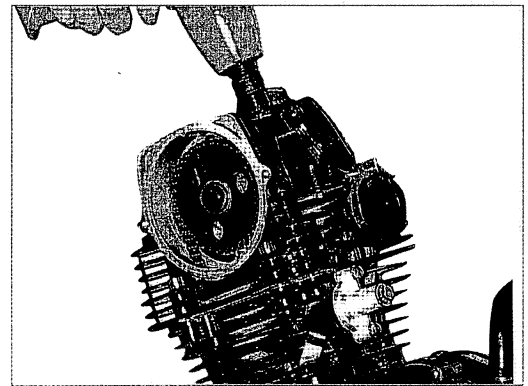

nut

remove cylinder head nut washer.

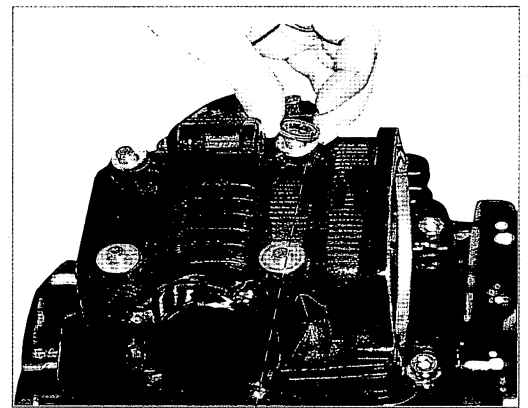

washer

unscrew bolt of intake and exhaust valve cover.

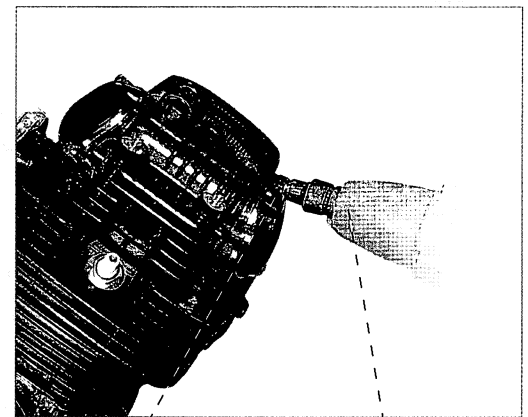

bolt

tool

check intake and exhaust valve, change seal ring of valve if necessary.

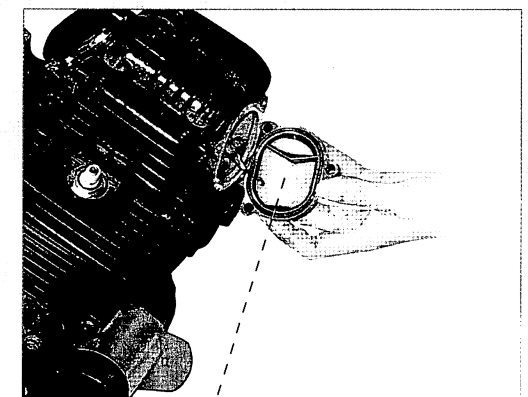

valve cover

unscrew bolt of chain tensioner.

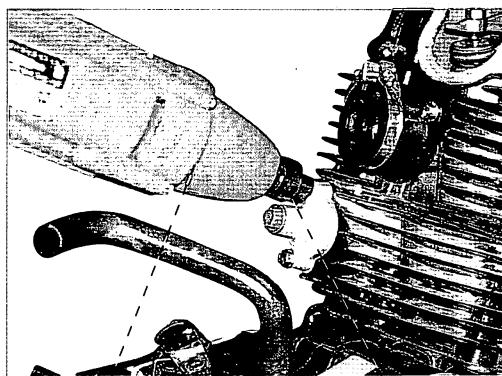

tool

bolt

remove tensioner and check wear of tensioner, change if necessary.

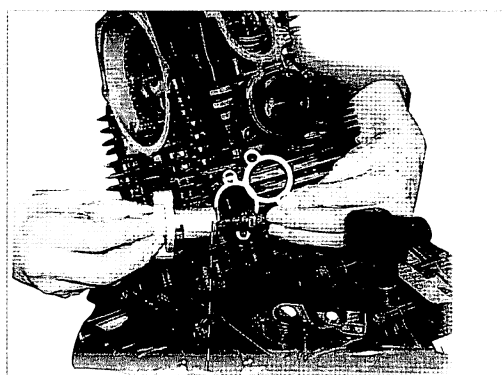

tensioner

unscrew connecting bolt of cylinder head crankcase.

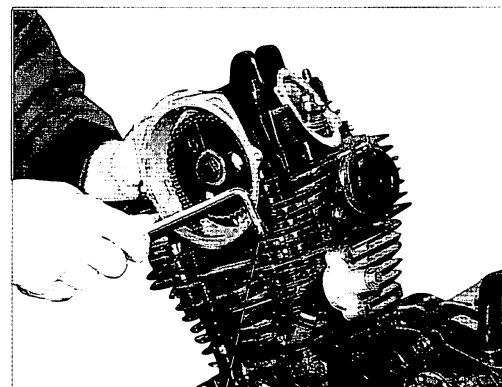

bolt

unscrewlock bolt of sprocket.

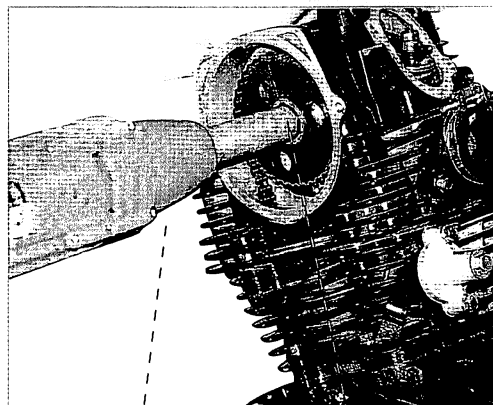

tool

bolt

remove driven sprocket and check wear of sprocket, change sprocket if necessary.

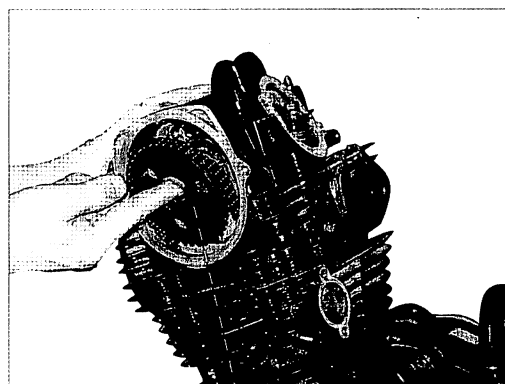

sprocket

remove cylinder head.

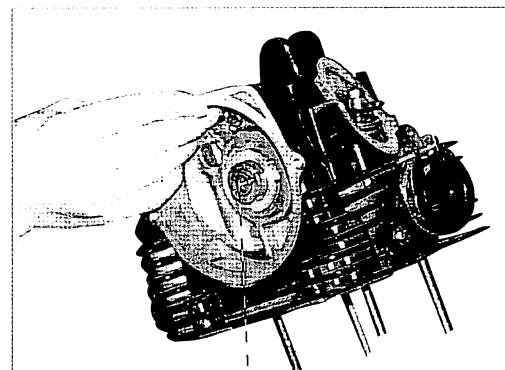

cylinder head

check end surface and change cylinder head if necessary. the limitation of deformation should be 0.05mm.

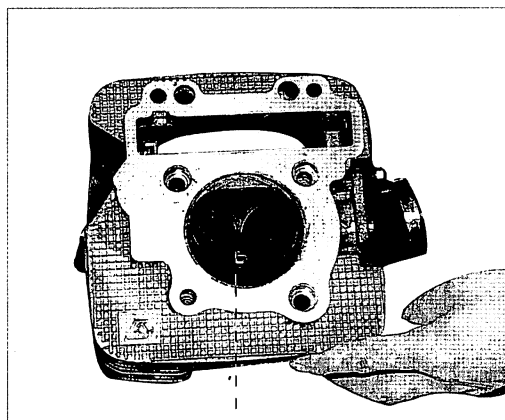

end surface

check carbon deposit in combustion chamber and remove carbon deposit.

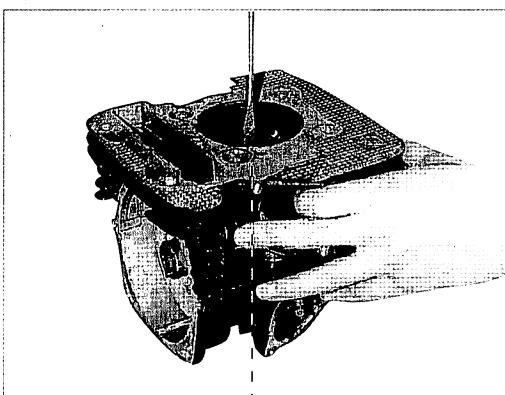

combustion chamber

remove camshaft, rocker shaft and rocker to check wear. change camshaft, rocker shaft and rocker if necessary.

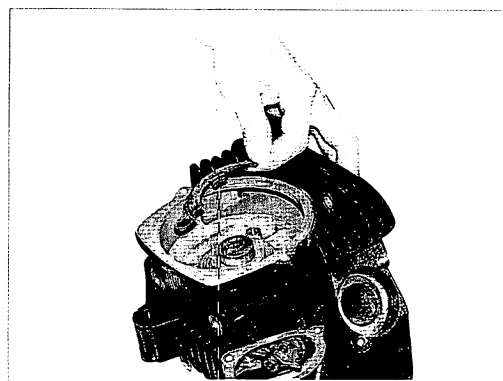

camshaft

fill petrol into intake and exhaust pipe of cylinder head and check. grind valve if necessary. Check valve seat and grind valve seat if necessary. width of valve seat should be 1.6mm-2.0mm

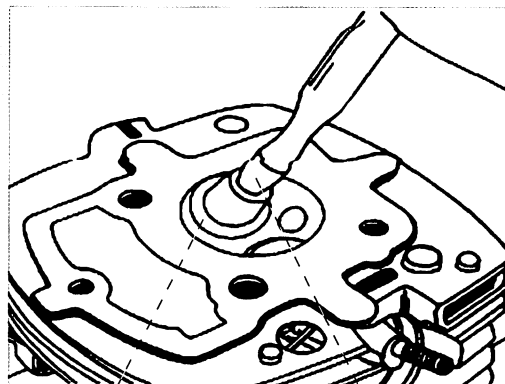

valve

tool

measure guide pipe inside diameter of valve and change guide pipe if necessary. the limitation of guide pipe should be 6.045mm.

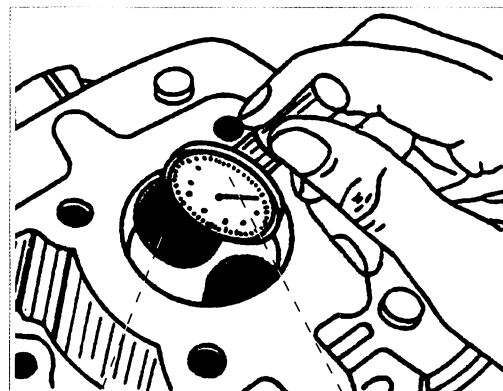

guide pipe

micrometer

check carbon deposit and remove carbon deposit and clean spark plug if necessary. adjust spark plug clearance, it should be 0.6mm-0.8mm.

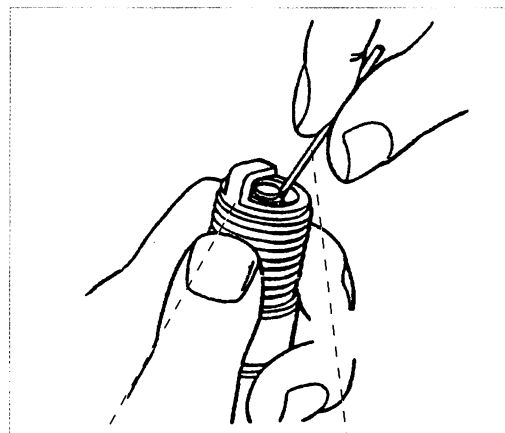

spark plug

tool

3 - 1

Maintenance of Cylinder Head

Component description	Damage form	Trouble symptom of component	Trouble symptom of motorcycle	Repair method
Cylinder head	Too much oil dirt or sand on the radiating fins.	Poor heat radiation of the fins on cylinder head	The engine overheats.	Remove the oil dirt or sand on the radiating fins.
	Carbon de posit in the combustion chamber.	—————	The engine overheats.	Remove the carbon deposit
	Failure of sparking plug threaded hole	Air leakage between the sparking plug and cylinder head.	The engine is difficult or impossible to start.	Repair the threaded hole or replace the cylinder head
	Serious deformation of cylinder head end surface (i.e. the deformation is beyond the limit of 0.05mm).	Air leakage between the cylinder head and cylinder.	The engine is difficult or impossible to start. Insufficient engine output; Engine speed changes during idle run.	Grind the cylinder head end surface or replace the cylinder head
	There are pits, ablation or pock marks, damages on the working surface of valve seat.	Air leakage between the valve and valve seat due to improper tightness.	The engine is difficult or impossible to start. Insufficient engine output; Engine speed changes during idle run.	Repair the valve seat
	The inner hole of valve guide is over worn (i.e. the inner diameter of the valve guide is beyond the limit of 6.045mm).	The fitting clearance between the valve and the valve guide is too large.	Thick blue and white fume from the exhaust muffler pipe.	Replace the valve guide
	The cylinder gasket is broken.	Air leakage between the cylinder head and cylinder.	The engine is difficult or impossible to start. Insufficient engine output; Engine speed changes during idle run.	Replace the cylinder head gasket.
	The retainer nut is not properly tightened.	Air leakage between the cylinder head and cylinder.	The engine is difficult or impossible to start. Insufficient engine output; Engine changes speed during idle run.	To screw up the retainer nut.
Spark plug	Improper clearance between electrodes	Weak or no sparking from the spark plug electrodes.	Oil leakage between the cylinder and crankcase.	Adjust by slightly pulling the side electrode till the clearance is 0.6~0.7mm.
	The spark plug electrodes are jointed by carbon deposit.	No sparking from the spark plug electrodes.	The engine is impossible to start.	Remove the carbon deposit between the electrodes.
	Excessive carbon deposit or oil dirt in the spark plug.	Weak or no sparking from the spark plug electrodes.	The engine is difficult or impossible to start. Insufficient engine output; Engine changes speed during idle run.	Remove the carbon deposit or oil dirt
	The spark plug insulat is damaged.	Weak or no sparking from the spark plug electrodes.	The engine is difficult or impossible to start. Insufficient engine output; Engine changes speed during idle run.	Replace with a new spark plug of the same type.
	The spark plug is not properly tightened.	Air leakage between the spark plug and cylinder head.	The engine is difficult to start. Engine changes speed during idle run.	Tighten the spark plug.

Dismantle, mount and maintain cylinder

configuration of cylinder is shown in fig and remove dowel pin to check deformation and change dowel pin.

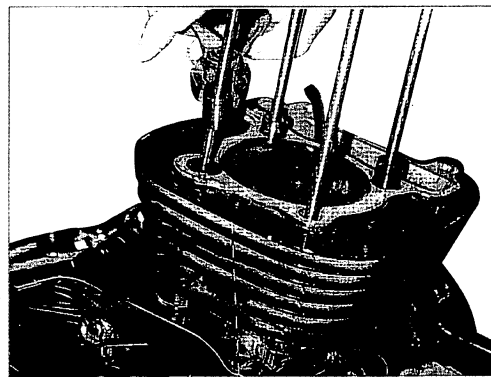

cylinder

remove cylinder gasket to check gasket, change gasket if necessary.

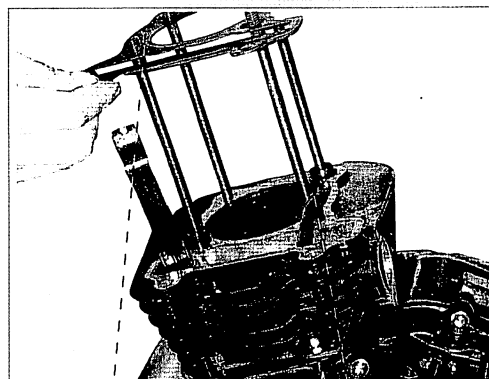

gasket

dowel pin

remove tension strip to check wear and change if necessary.

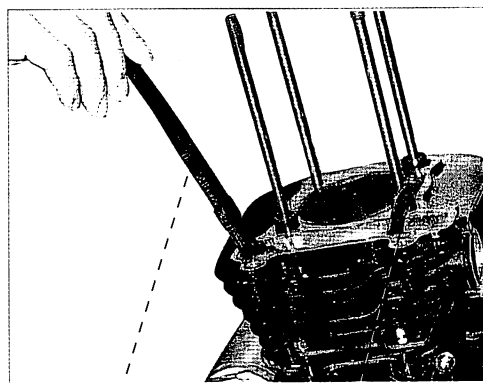

guide strip

tension strip

unscrew connecting bolt and remove cylinder to check wear, change cylinder if necessary.

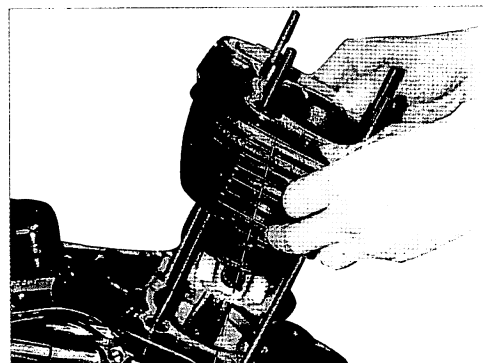

cylinder

remove baffle ring of piston pin to check baffle ring.

Never fall baffle ring into crankcase.

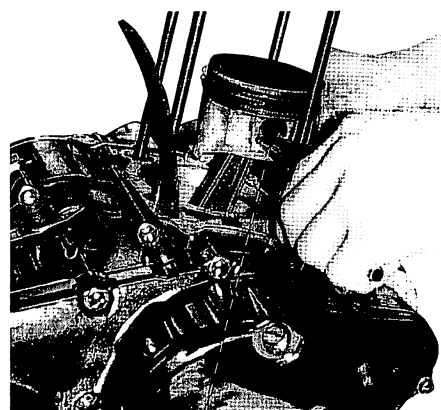

baffle ring

remove piston pin to check wear, the use limitation of piston pin external diameter should be 15.855mm.

Never fall baffle ring into crankcase.

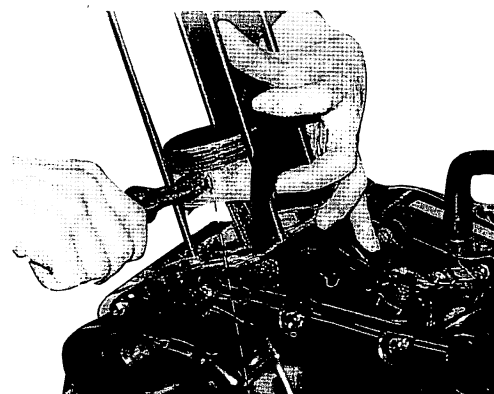

piston pin

remove piston to check wear. the maximum limitation of external diameter should be 66.825mm and the minimum limitation of piston pin hole internal diameter should be 16.05mm.

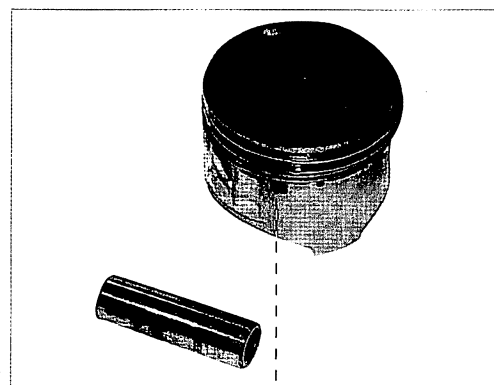

piston

check wear of connecting rod small end and the maximum limitation should be 16.045mm.

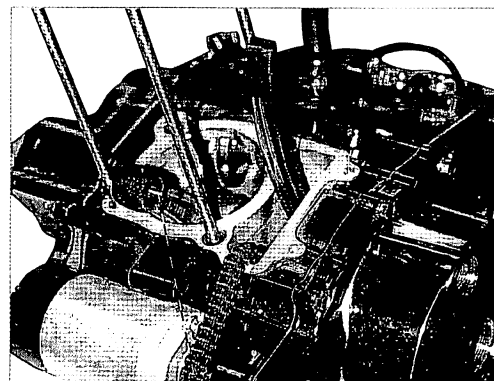

small end

remove residual gasket on cylinder surface and check deformation of cylinder, change if necessary.

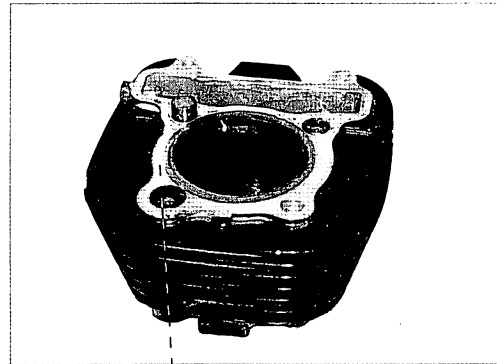

residual gasket

remove cylinder and check wear of cylinder, change if necessary.

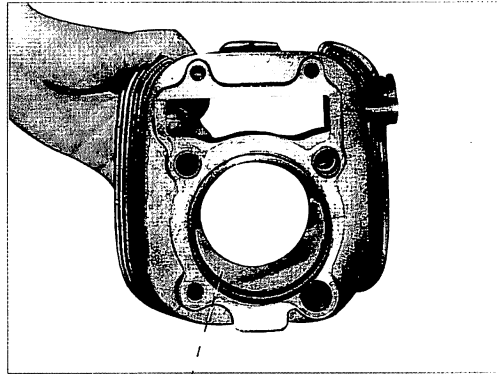

inside

check deformation of cylinder end face and the deformation limitation is 0.05mm.

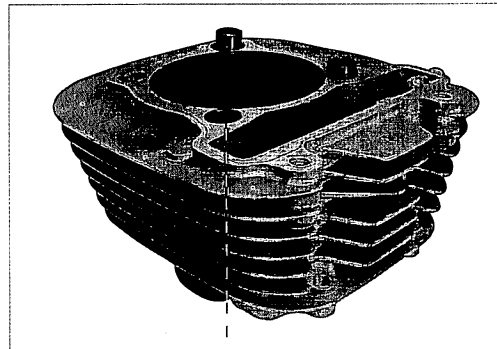

end face

measure internal diameter of cylinder from upper, mid and lower, the max. limitation is 67.045mm.

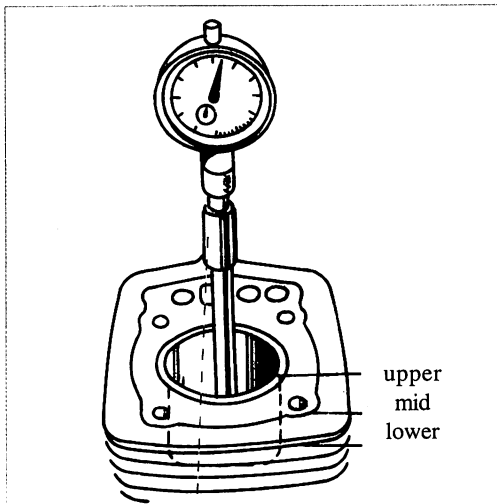

micrometer

3-2

Maintenance of Cylinder body

Component description	Damage form	Trouble symptom of component	Trouble symptom of motorcycle	Repair method
Cylinder	Too much oil dirt or sand on the radiating fins.	Poor heat radiation of the fins on cylinder head	The engine overheats.	Remove the oil dirt or sand on the radiating fins.
	Serious deformation of cylinder end surface (larger than limitation of 0.05mm)	Air leakage between the cylinder head and cylinder.	The engine is difficult or impossible to start. Insufficient engine output; Engine changes speed during idle run.	Grind the cylinder head end surface or replace the cylinder head.
	The cylinder is worn (larger than 67.045mm)	The fitting clearance between the cylinder and piston, piston ring is too wide.	The engine is difficult or impossible to start. Insufficient engine output; Engine changes speed during idle run. Thick blue and white fume from the exhaust muffler pipe.	Repair with boring machine or replace the cylinder
	The cylinder gasket is broken.		Oil leakage between the cylinder and crankcase.	Replace the cylinder gasket.

Dismantle, mount and maintain crankcase

Unscrew engine oil plug and check oil to check oil and oil level.

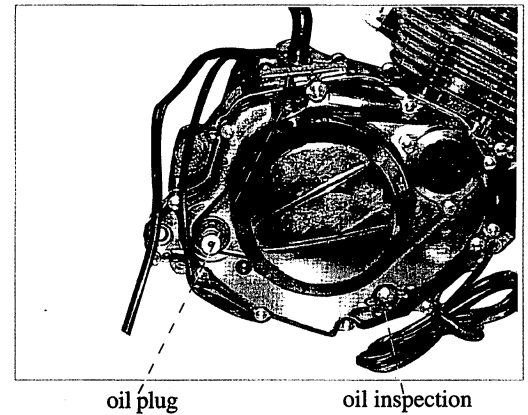

remove clutch rod and steel ball, check wear of rod. change clutch rod and steel ball if necessary.

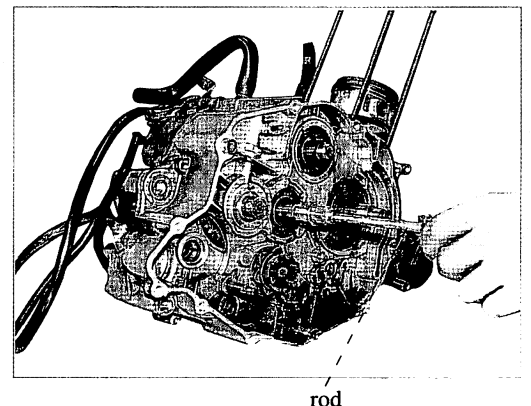

view of right crankcase is shown in fig, and check wear of balance shaft bearing, crankshaft bearing, principal and countershaft.

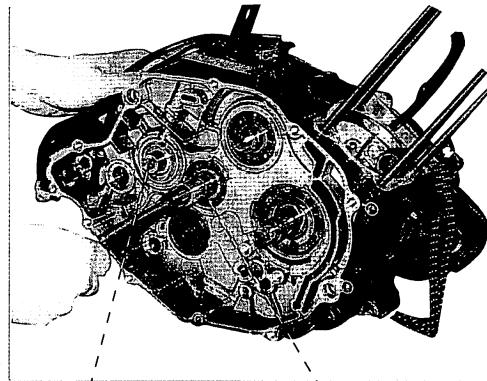

countershaft bearing principal shaft bearing

view of right crankcase is shown in fig, and check wear of balance shaft bearing, crankshaft bearing, principal and countershaft, change if necessary.

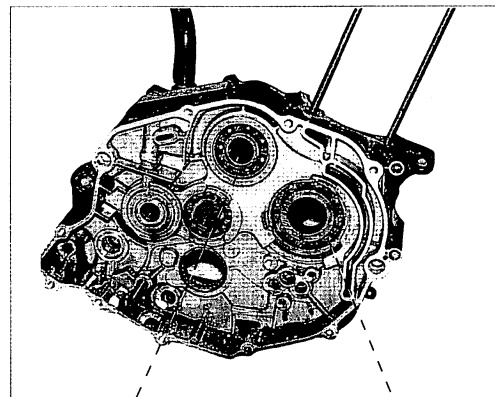

balancershaft bearing crankshaft bearing

view of left crankcase is shown in fig and check wear of countershaft oil seal, gear change lever oil seal. change if necessary.

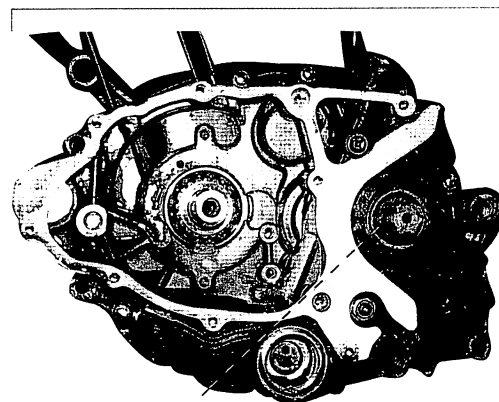

countershaft oil seal gear change lever oil seal

view of left crankcase is shown in fig and check wear of balance shaft bearing, principal shaft bearing and countershaft bearing. change if necessary.

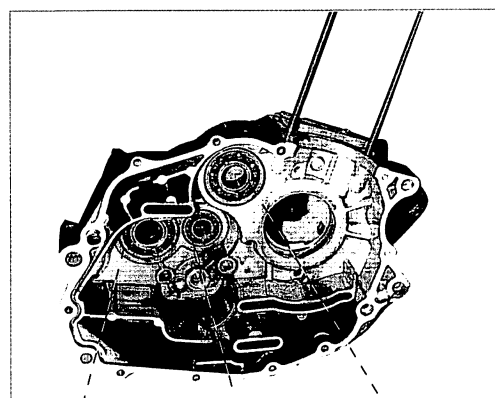

balancershaft bearing principal shaft bearing balancershaft bearing

engine number is stamped on right crankcase and remove oil plug and check oil quality.

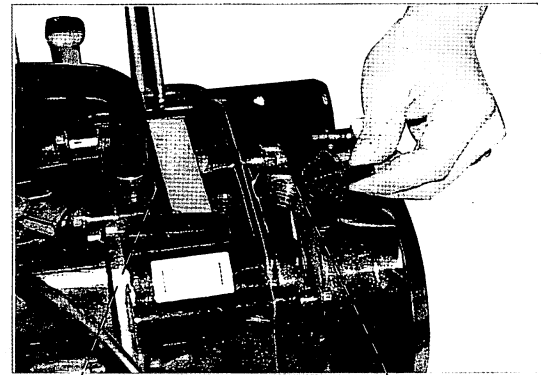

engine number

oil plug

check lubricant level and add if below lower line.

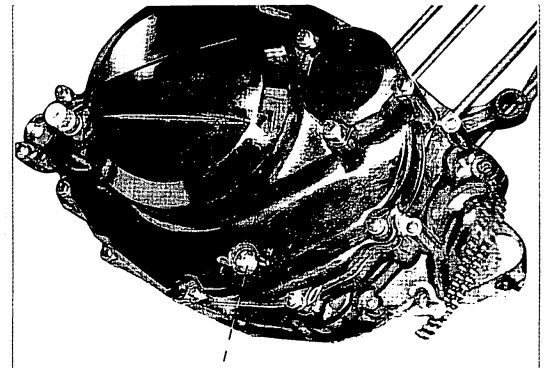

oil inspection

unscrew filter net cap bolt of right crankcase cover and remove filter cap.

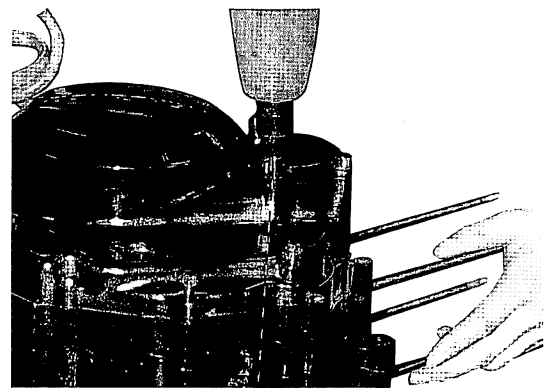

bolt

remove filter net cap to check rubber ring and remove filter net to clean.

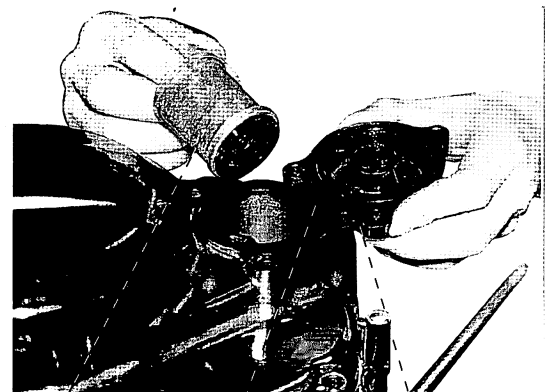

filter net

O ring

filter net cap

remove right crankcase cover and check oil line,
clean right crankcase cover oil line

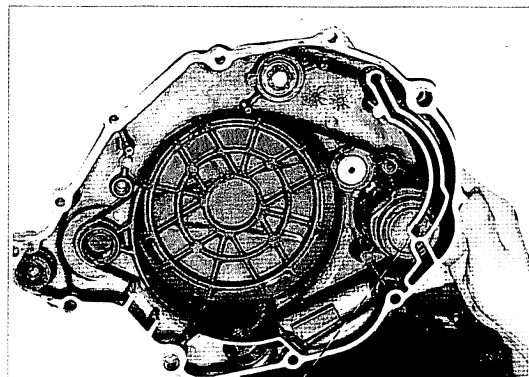

oil line

remove fuel inspection cap and check seal ring
of fuel inspection cap. change seal ring if necessary.

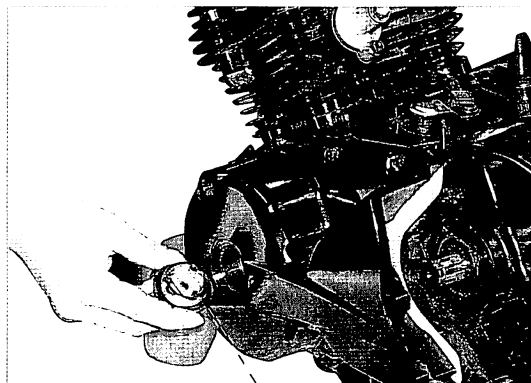

inspection cap

unscrew bolt of left crankcase cover and re-
move crankcase cover to check. change gasket.

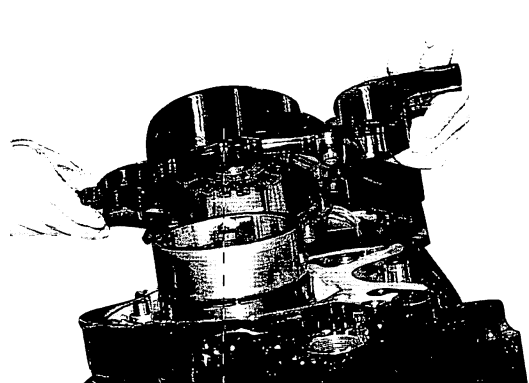

left crankcase cover

check bolt of stator and trigger coil, check wear
of roller needle bearing of electrical starter. change
stator if necessary.

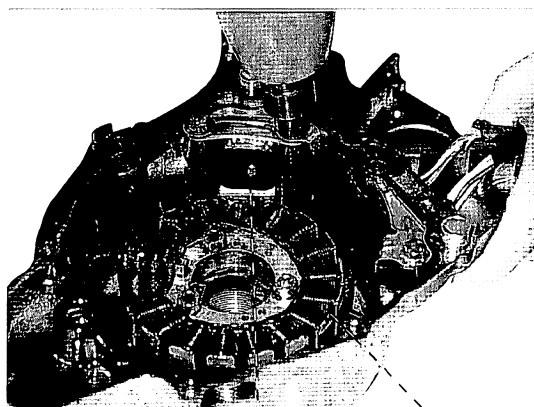

stator

trigger coil

bearing

Take off the residual bolt in crankcase as shown in fig. and remove broken bolt.

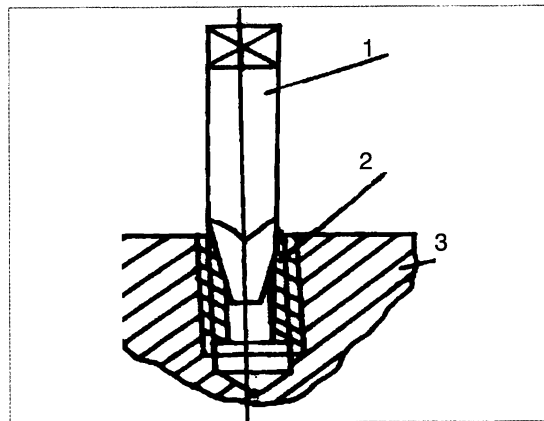

1.Triangle taper of wedge
2.Residual bolt 3.Crankcase

3-3

Maintenance of crankcase

Component description	Damage form	Trouble symptom of component	Trouble symptom of motorcycle	Repair method
Crankcase	Crack in the crankcase.	_____	Oil leakage from the crankcase.	Repair or replace
	threaded hole of oil drain plug screw is ineffective.	_____	Oil leakage from the joint of left and right crankcase.	replace crankcase
	threaded holes of cylinder bolt are ineffective.	cylinder head fasten nut is impossible to screw firmly so that air leakage between head and cylinder	engine is difficult or impossible to start. Insufficient power; unstable idle speed	Repair the threaded hole or replace the crankcase.
	bolt of the cylinder is broken.	cylinder head fasten nut is impossible to screw firmly so that air leakage between head and cylinder	engine is difficult or impossible to start. Insufficient power; unstable idle speed	Replace the cylinder bolt.
	oil seal is damaged or oil seal edge is damaged	_____	Oil leakage from the oil seal	Replace the oil seal.
Right crankcase cover	crankcase cover is worn or cracked.	_____	Oil leakage from the case cover	Replace or repair the case cover.
	gasket is broken.	_____	Oil leakage between case cover and the case.	Replace the gasket
Left crankcase cover	crankcase cover is worn or cracked.	_____	Oil leakage from the case cover	Replace or repair the case cover.
	gasket of left crankcase is broken.	_____	Oil leakage between the case cover and the case.	Replace the gasket

Maintenance of crankshaft connecting rod

Dismantle, mount and maintain crankshaft connecting rod

Unscrew fixing bolt of crankcase.

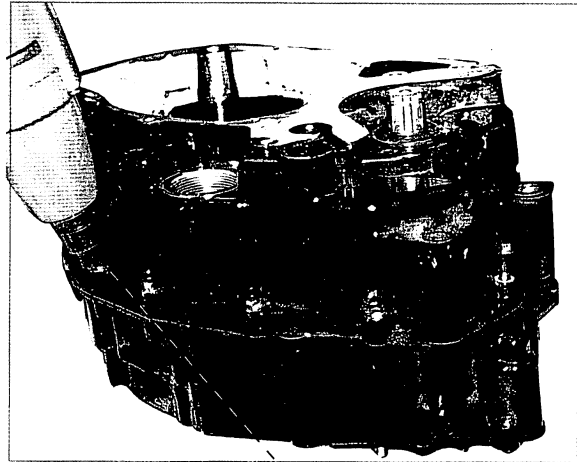

bolt

remove left crankcase. never fall principal shaft, countershaft and starting shaft washer into crankcase.

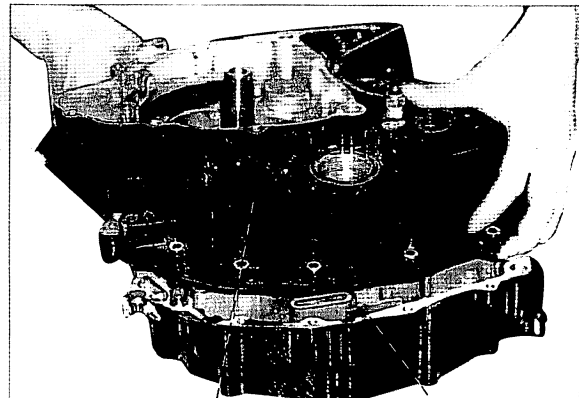

left crankcase right crankcase

remove crankshaft connecting rod and check wear of bearing, change if necessary.

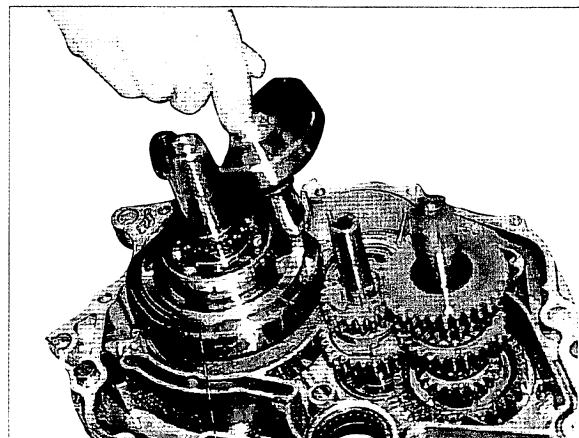

connecting rod

remove balance shaft and check wear of balance shaft neck. change balance shaft if necessary.

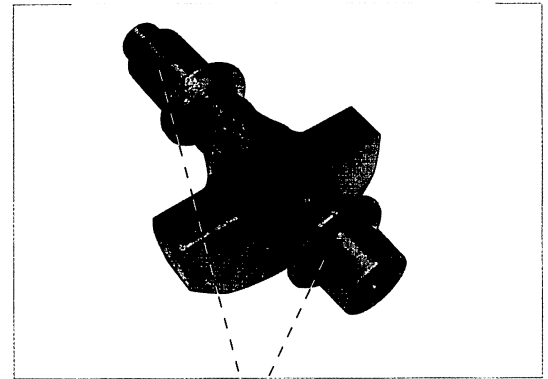

balance shaft neck

check clearance of connecting rod big end and change connecting rod if necessary.

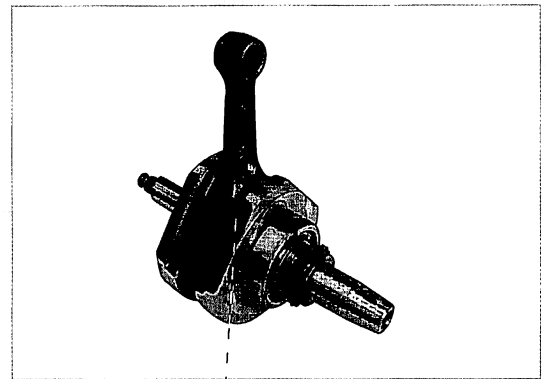

big end

measure external diameter of piston and check wear of piston, the minimum limitation should be 15.95mm.

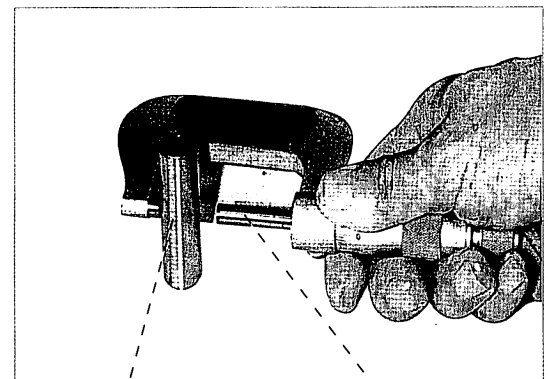

piston pin

micrometer

measure side gap between piston ring and piston groove. the maximum limitation is 0.08mm.

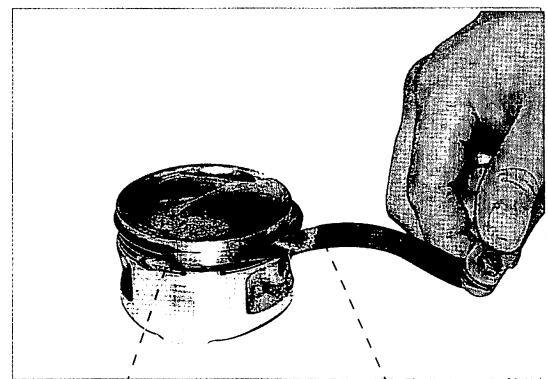

groove

feeler gauge

check baffle ring of piston pin and change baffle ring if necessary.

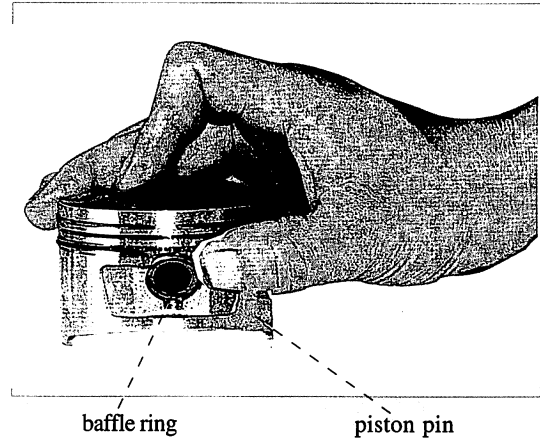

measure piston skirt diameter to check and the use limitation should be 66.825mm. change piston if necessary.

measure diameter by moved 15mm upwards from piston bottom.

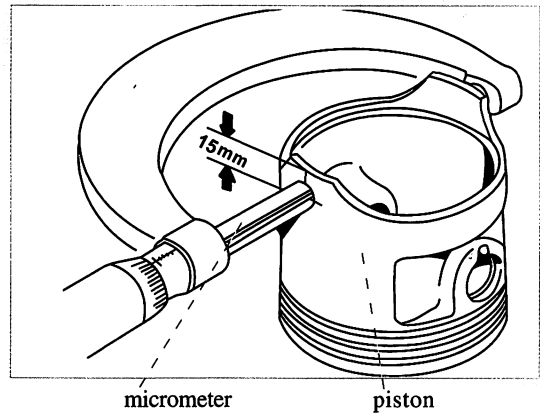

change piston ring if necessary and the fixing process is shown in fig.

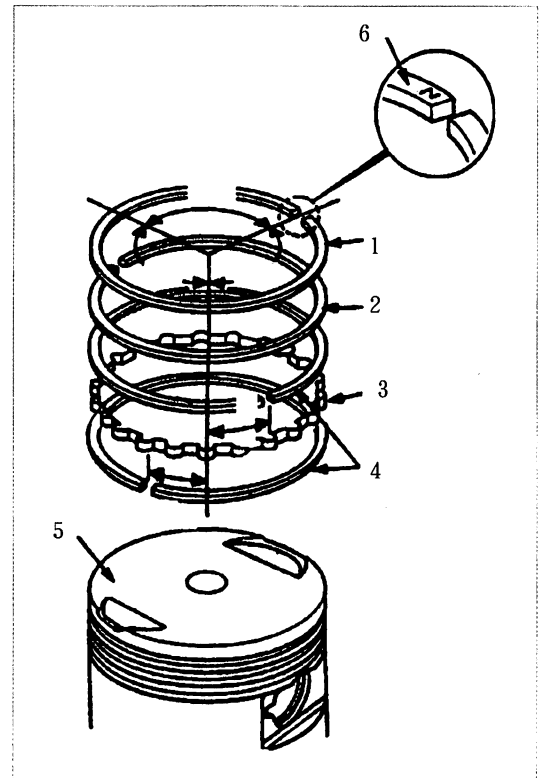

1. 1st ring 2. 2nd ring 3. oil ring
4. scraper 5. oil ring 6. mark

Measure radial jumping of crankshaft and check both ends of crankshaft, the limitation is 0.05mm.

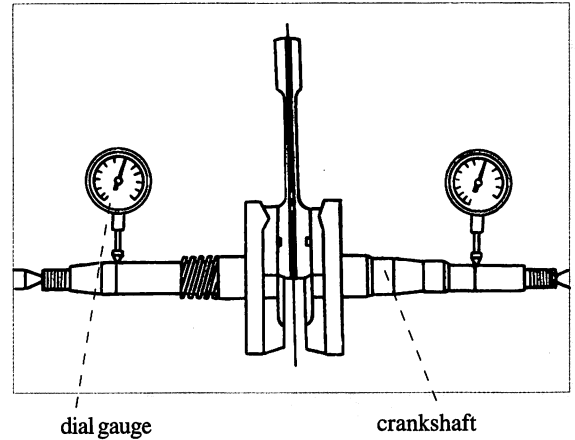

Measure axial jumping of connecting rod and check needle bearing, the limitation is 0.05mm.

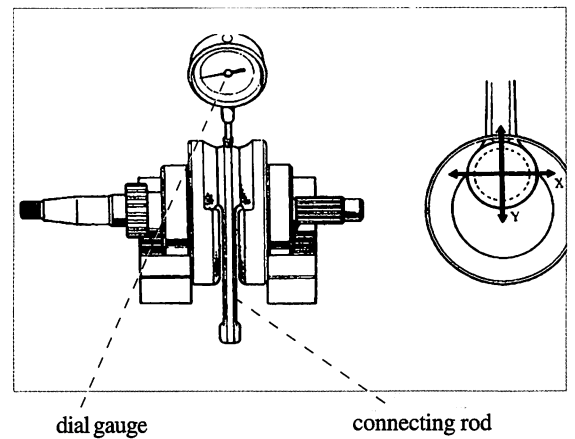

Measure connecting rod big end gap and check gap. the limitation is 0.60mm. change connecting rod if necessary.

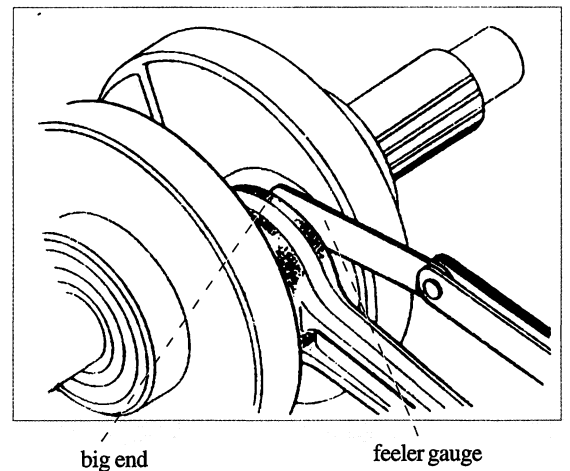

check axial jumping of crankshaft and the limitation is 0.05mm.

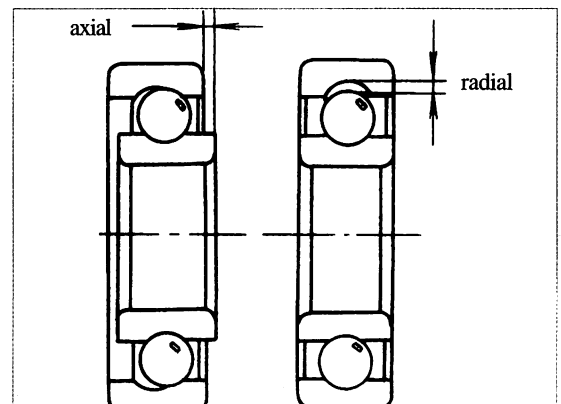

3-4

Maintenance of Crankshaft Connecting Rod

description	Damage form	Trouble symptom of component	Trouble symptom of vehicle	maintenance method
Piston	Carbon deposit on piston top.	_____	The engine overheats.	remove carbon deposit.
	Carbon deposit in the ring groove	The piston ring is seized in ring groove.	The engine is difficult or impossible to start. Insufficient engine output; thick blue and white fume from the exhaust muffle pipe.	remove carbon deposit.
	Scuffing or scratches on the surface of piston skirt.	Scuffing or scratches on the surface of piston skirt.	The engine is difficult or impossible to start. Insufficient engine output; thick blue and white fume from the exhaust muffle pipe.	Replace the piston.
	excessive wear of piston (diameter is less than limitation of 66.825mm)	fitting clearance between the piston and the cylinder is over large	engine is difficult or impossible to start. Insufficient engine output; thick blue and white fume from the exhaust muffle pipe.	Replace the piston.
	excessive wear of groove	fitting clearance between piston ring and groove is over large	thick blue and white fume from the exhaust muffle pipe.	Replace the piston.
	excessive wear of piston pin hole(inter diameter is more than limitation of 16.045mm)	fitting clearance between the piston ring and the hole is over large.	Striking sound of the piston pin and of the cylinder.	Replace the piston.
Crank pin	excessive worn.	Radial and axes gap is too large.	Striking sound of the big-end bearing	Replace crankshaft connecting rod.
Bearing	needle bearing is over worn.	Radial and axes gap is too large.	Striking sound of the big-end bearing	Replace crankshaft connecting rod.
	The crankshaft bearing is over worn or damaged.	_____	Abnormal sound during the crankshaft bearing	Replace crankshaft bearing
Piston ring set	piston ring is fractured.	piston ring is fractured.	The engine is difficult or impossible to start. Insufficient engine output; thick blue and white fume from the exhaust muffle pipe.	Replace piston set.
	piston ring is over worn.	end or side gap is over large	The engine is difficult or impossible to start. Insufficient engine output; thick blue and white fume from the exhaust muffle pipe.	Replace piston set.

Maintenance of Crankshaft Connecting Rod

description	Damage form	Trouble symptom of component	Trouble symptom of vehicle	maintenance method
Piston ring set	Insufficient elasticity of piston ring.	contact of piston ring and cylinder is not close	The engine is difficult or impossible to start. Insufficient engine output; thick blue and white fume from the exhaust muffle pipe.	Replace piston set.
	Improper fixing	piston ring gap is not staggered	blue and white fume from muffle pipe.	Refitting
Piston pin	excessive wear (external diameter is less than limitation of 15.095mm)	fitting clearance between piston ring and hole is over large.	Striking sound of piston pin	Replace piston pin
Connecting rod	excessive wear of small-end hole (iner diamter is more than limitation of 16.045mm)	fitting clearance between small-end and piston pin is over large.	Striking sound of piston pin	Replace crankshaft connecting rod.
	connecting rod is bend	connecting rod is bend	Striking sound of cylinder	Replace crankshaft connecting rod.
	big-end hole is over worn.	Radial and axes gap is too large.	Striking sound of the big-end bearing	Replace crankshaft connecting rod.
Timing sprocket	The gear is over worn or damaged.	_____	Abormal sound from drive chain	Replacet timing sprocket

Maintenace of valve mechanism

Dismantle, mount and maintain crankshaft connecting rod

remove cylinder head assembly and remove valve clip and spring, valve by tool to check wear, change if necessary.

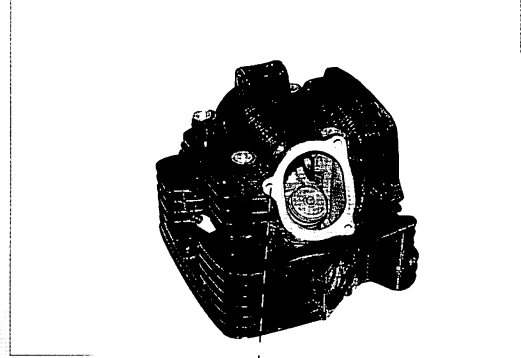

cylinder head

unscrew bolt of cylinder head cam shaft.

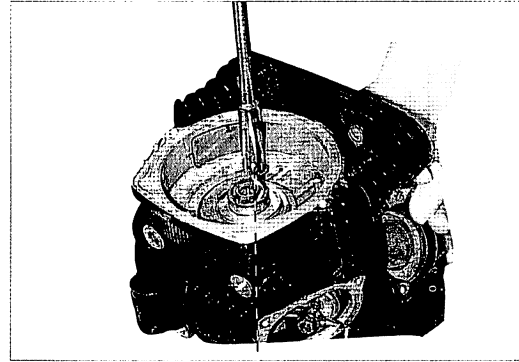

bolt

remove cam shaft baffle to check and change if necessary.

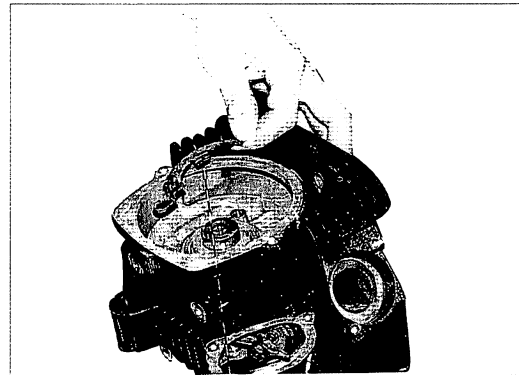

baffle

remove valve rocker shaft, rocker and camshaft to check wear, change if necessary.

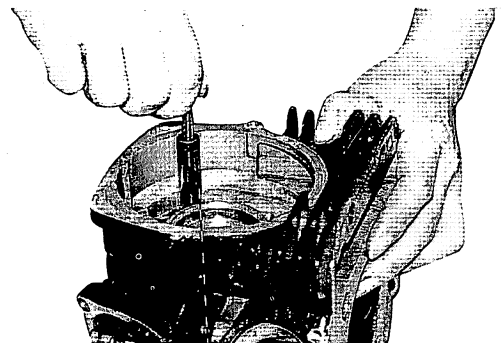

rocker shaft

remove rocker, rocker shaft and timing cam to check wear, change if necessary.

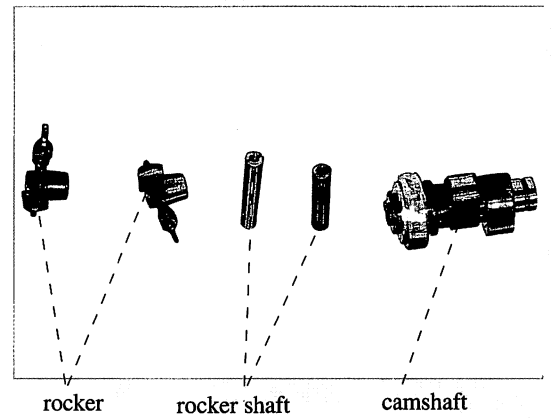

measure valve spring length and check wear of valve spring, the minimum limitation of inner spring is 36.00mm, the minimum limitation of outer spring is 36.50mm.

Caution: the end with dense spring should be downwards when fitting.

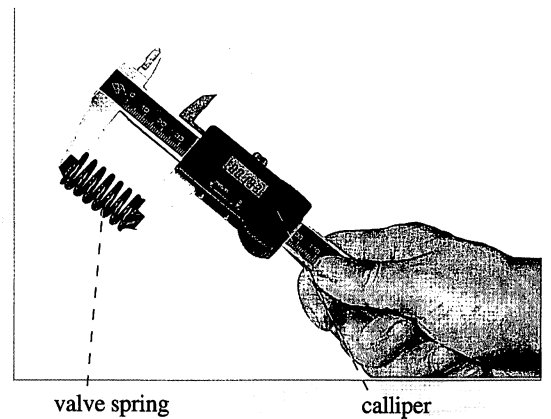

measure minimum limitation of outer diameter is 5.955mm and check carbon deposit on valve stem.

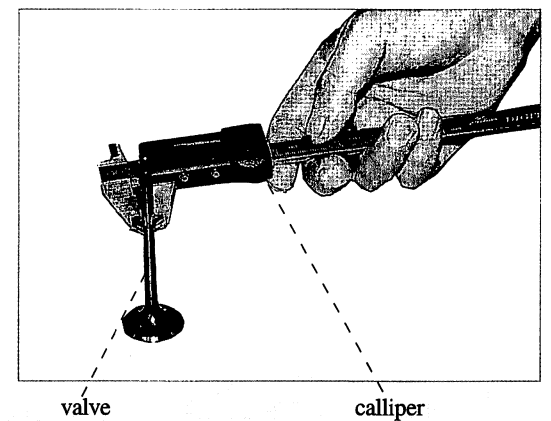

measure valve interface width and the limitation is 2.20mm. change valve if necessary.

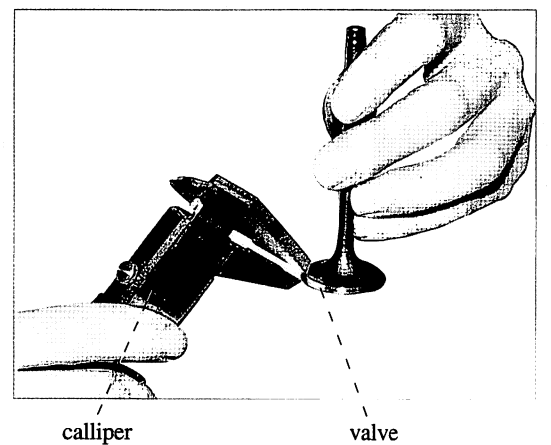

Check deformation of valve stem and measure the limitation of roundness is 0.05mm. change valve stem if necessary.

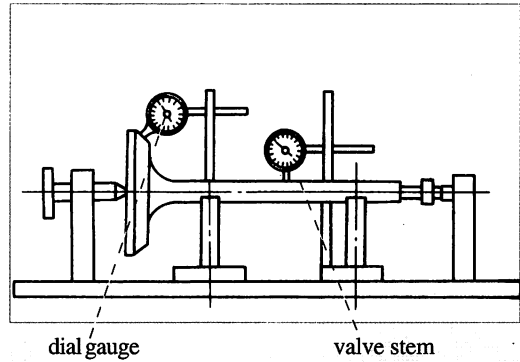

check cam lift and the minimum limitation of cam lift is 36.50mm. change camshaft if necessary.

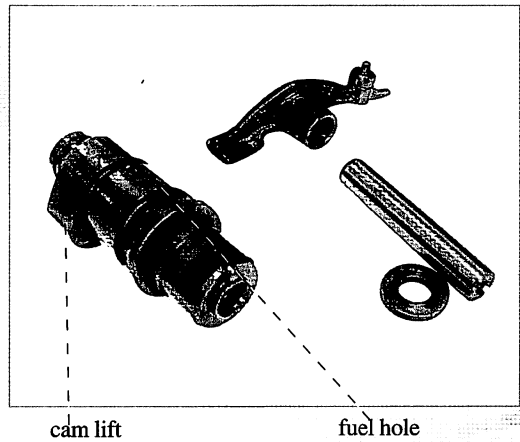

check wear of camshaft neck and gap between camshaft and bush. change camshaft or bush if necessary.

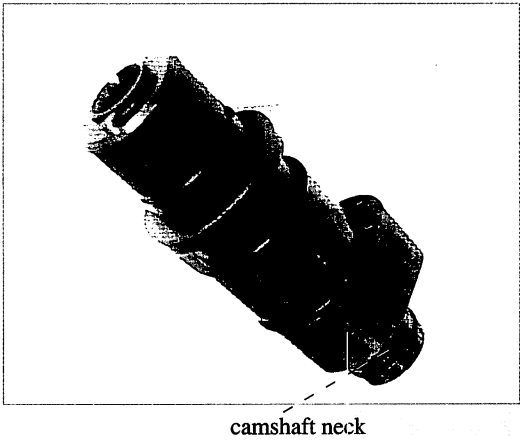

check wear of rocker interface and gap between rocker shaft and rocker. change rocker shaft or rocker if necessary.

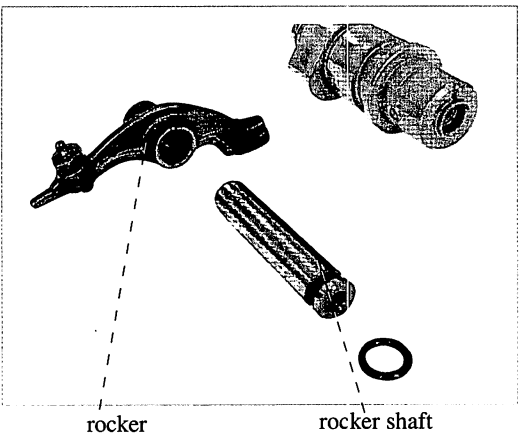

Measure external diameter of rocker by micrometer and the minimum limitation is 11.93mm.

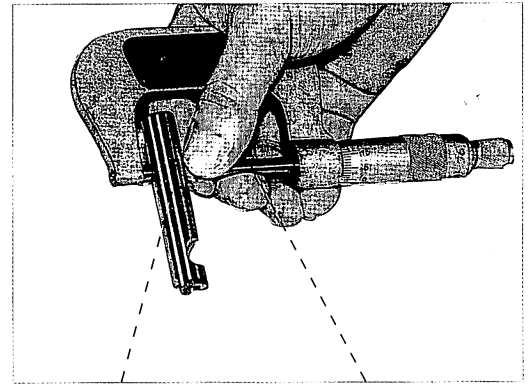

rocker shaft

micrometer

check wear of drive sprocket and change drive sprocket if necessary.

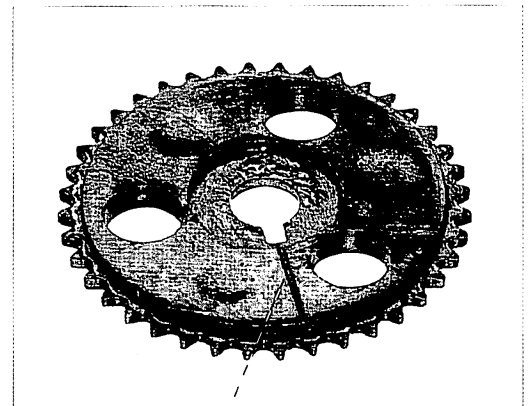

sprocket

check wear of timing chain, tension strip and chain guide and change if necessary

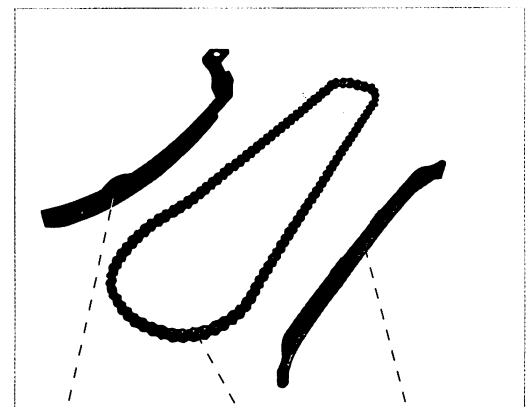

tension strip

chain

chain guide

check wear of tension strip and change tensioner if necessary.

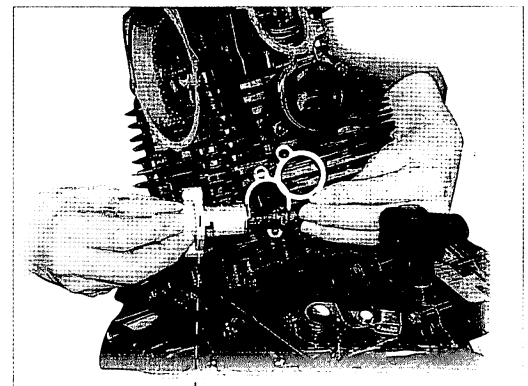

chain tensioner

remove valve cover firstly when adjusting engine timing position.

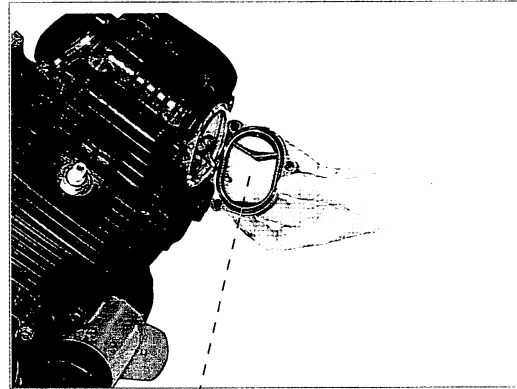

valve cover

remove fuel inspection cap and rotate magneto to make piston locate at top dead center and make T aim to mark of left crankcase cover.

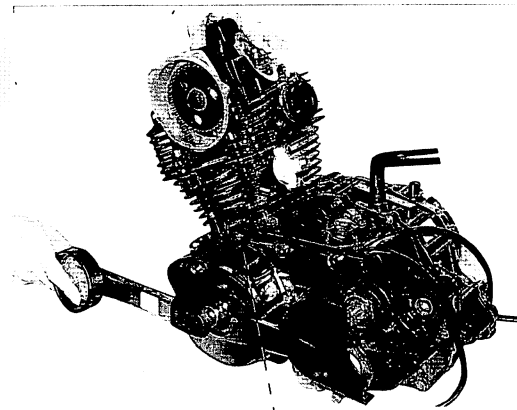

T mark

Lineal mark of timing sprocket should be aimed to lineal mark of cylinder head plane when T mark aimed to mark on left crankcase fuel inspection cap. adjust sprocket location if necessary.

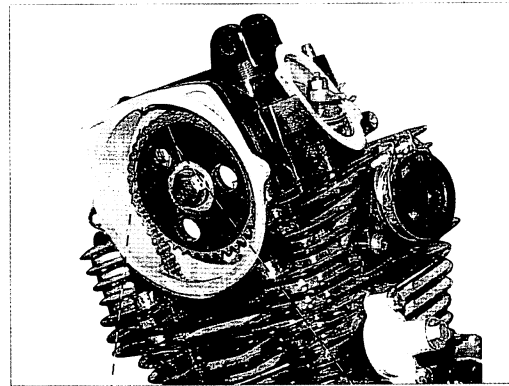

cylinder head mark

lineal mark

adjust valve gap.

intake gap should be 0.06-0.08mm

exhaust gap should be 0.08-0.10mm.

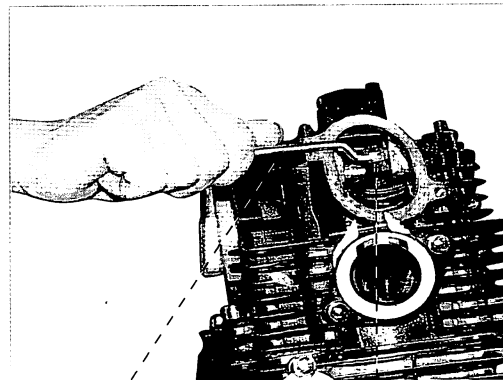

wrench

adjustment nut

Maintenance of Valve Mechanism

Description	Damage form	Trouble symptom of component	Trouble symptom of vehicle	Maintenance method
valve oil seal	edge of valve oil seal is worn, aged or damaged.	_____	Thick blue and white fume from the exhaust muffle pipe.	Replace valve oil seal.
camshaft	excessive wear(lifting is less than min. limitation- 36.50mm)	_____	Insufficient engine output.	Replace the camshaft.
	excessive wear of interface of camshaft and bearing or damaged	axial or radial clearance of the bearing is too wide. Ineffective bearing swiveling or abnormal sound during swiveling.	Abnormal sound heard during camshaft transmission.	Replace camshaft.
Rocker arm	working surface is scratched or excessive wear.	_____	Valve striking sound.	Replace rocker arm.
	excessive wear of rocker arm shaft hole (inner diameter is more than limitation-12.05mm)	Big gap between rocker arm and rocker arm shaft.	Valve striking sound.	Replace rocker arm.
	excessive wear of rocker shaft (external diameter is less than limitation-11.93mm)	Big gap between rocker arm and rocker arm shaft.	Valve striking sound.	Replace rocker shaft
Valve	Carbon deposit on surface.	It is impossible to fit valve and valve seat tightly.	engine is difficult or impossible to start. Insufficient engine output; unsteady idle	Remove carbon deposit.
	working surface is over worn or has pits, pock marks, ablation or damage.	It is impossible to fit valve and valve seat tightly.	engine is difficult or impossible to start. Insufficient engine output; unsteady idle	Replace valve.
	excessive wear of vave stem (external diamter of intake stem is less than limitation- ϕ 5.955mm, exhaust diameter is less than limitation-5.955mm)	gap between valve stem and guide tube is over large	Sound from valve, thick blue and white fume from muffle pipe.	Replace valve.
	valve stem is deformed.	valve an not close completely.	engine can not start.	Replace valve.
	excessive wear of valve stem	gap between valve stem and guide tube is over large	thick blue and white fume from muffle pipe.	Replace valve.
	valve stem is deformed.	valve an not close completely.	engine can not start.	Replace valve.
valve spring	insufficient elasticity or spring is broken	It is impossible to fit the valve and the valve seat tightly.	engine is difficult or impossible to start. Insufficient engine output; unsteady idle	replace valve spring
timing driving sprocket	excessive wear of sprocket teeth	_____	abnormal sound from sprocket	replace sprocket
timing chain	excessive wear or elongated	_____	abnormal sound from chain	replace chain
	improper fitting of valve timing	improper of valve timing	engine can not start.	refit
chain tensioner	excessive wear of tension strip and guide roller	insufficient tension force of chain	abnormal sound from chain	replace tension strip and guide strip
	tensioner failure	insufficient tension force of chain	abnormal sound from chain	replace tensioner

Maintenance of fuel system

Dismantle, mount and maintain fuel system

shut off fuel shut-off and remove fuel line, drain off fuel in fuel tank.

Caution: keep away from fire to avoid accident while drain fuel.

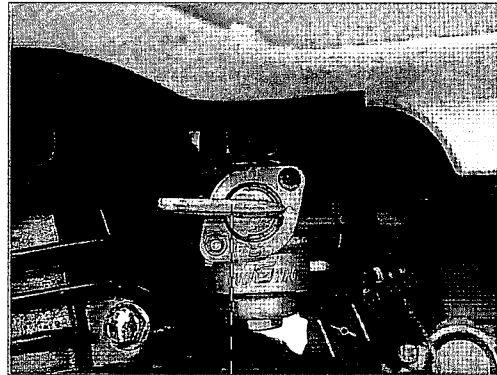

fuel shut-off

shut off fuel tank key and check gasket.

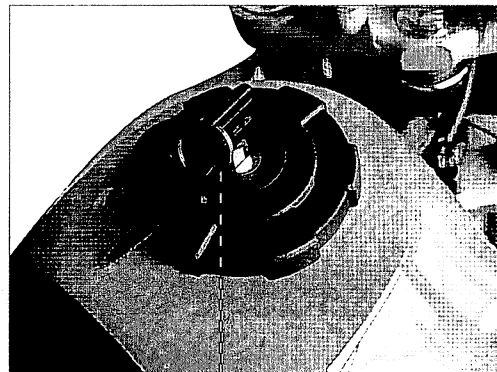

fuel tank key

unscrew bolt of fuel tank protective cover and remove cover.

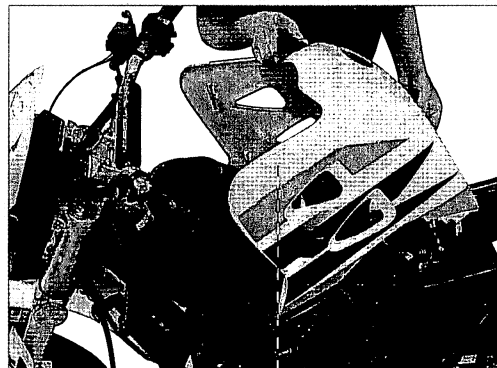

protective cover

unscrew bolt of seat and remove seat and then unscrew bolt of fuel tank.

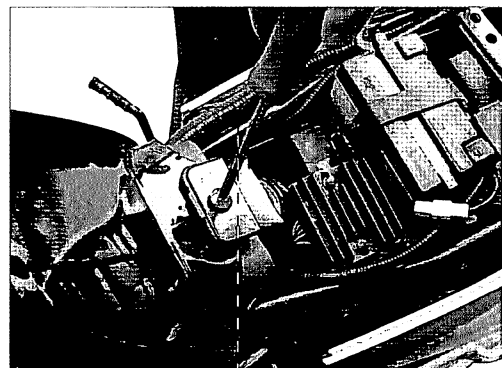

bolt

remove fuel tank and check inside of fuel tank.



fuel tank cover

unscrew bolt of fuel shut-off and check inside of fuel tank. clean inside with petrol if necessary.

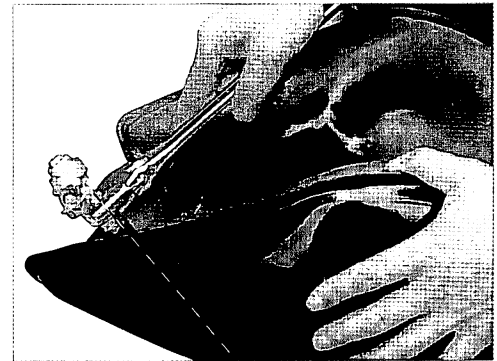

fuel shut-off

remove fuel filter to check and clean filter net if necessary.

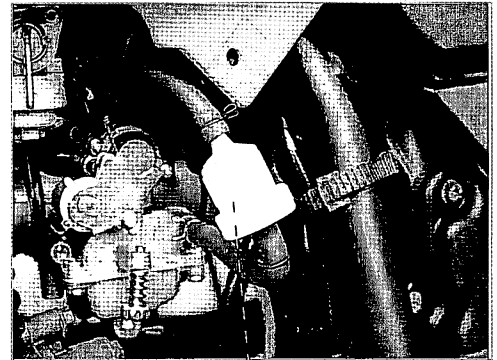

fuel filter

Table 3-6 Maintenance of Fuel Tank

Component description	Damage form	Trouble symptom of component	Trouble symptom of motorcycle	Repair method
Fuel tank	The tank is broken due to corrosion.	Oil leakage from the tank.	_____	Repair or replace the fuel tank.
	The venting holes of fuel tank cap are clogged.	Impeded fuel supply.	The engine is impossible to start.	Clean the venting holes.
Fuel switch assembly	The fuel filtering tube is fouled or choked.	Impeded fuel supply.	The engine is difficult or impossible to start. Insufficient engine output; The engine changes speed during idle run.	Clean the fuel switch.
	The switch is clogged or damaged.	Impeded fuel supply.	The engine is impossible to start.	Replace the fuel switch.

Dismantle, mount and maintain carburetor

unscrew intake pipe clip screw and air filter joint clip screw.

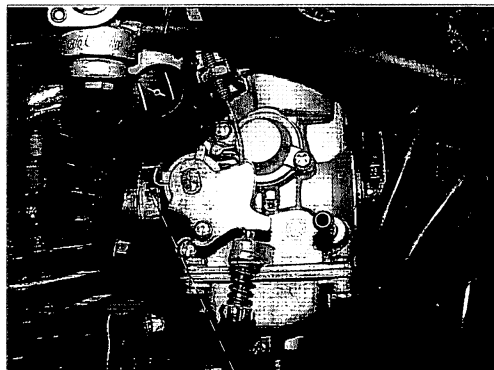

screw

shut off fuel shut-off and remove fuel pipe.

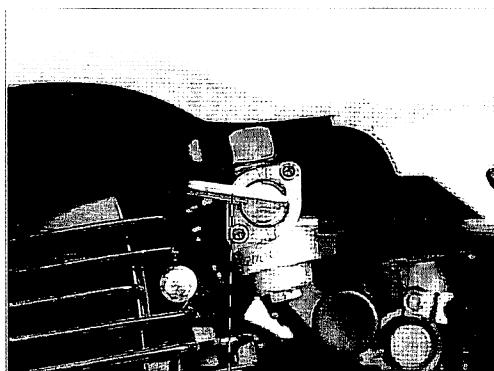

fuel shut-off

remove carburetor assembly.

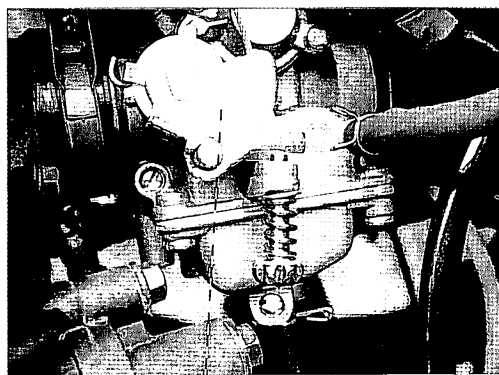

carburetor assembly

unscrew throttle cap screw of carburetor.

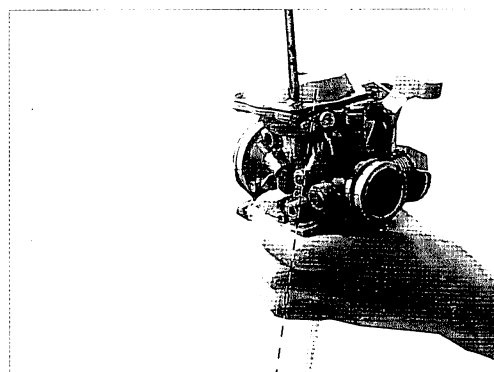

throttle cap

remove throttle cap and check throttle ring and spring.

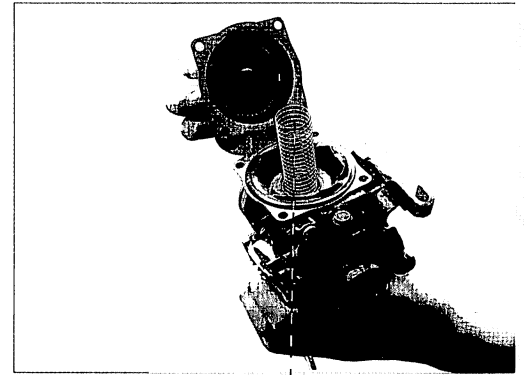

spring

remove throttle and check wear of throttle and oil needle.

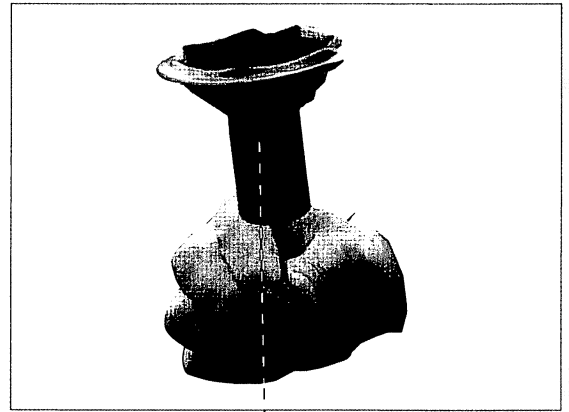

throttle

check oil needle clip and clip should be at the third layer.

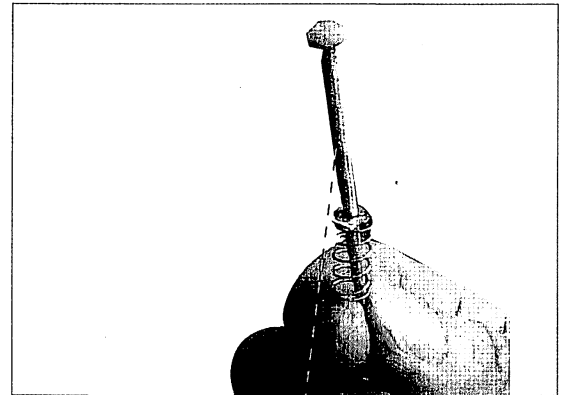

clip

clean carburetor surface and unscrew float chamber screw.

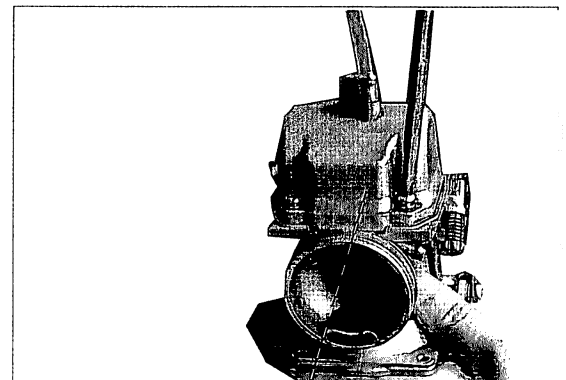

float chamber cover

open float chamber cover and check inside of float chamber, clean float chamber.

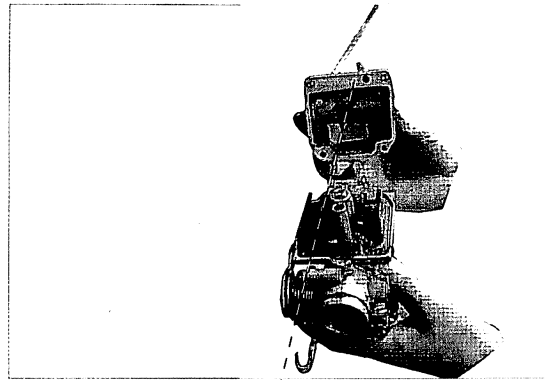

float chamber cover

dismantle main jet to check and clean jet if necessary.

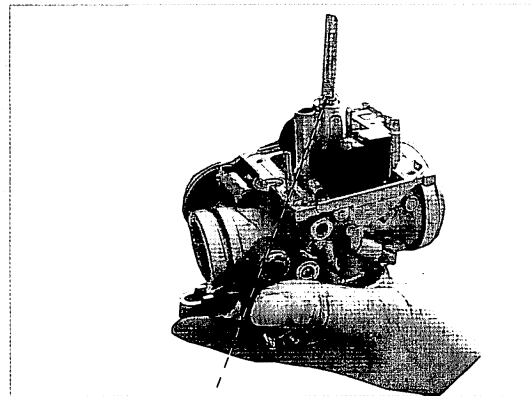

main jet

Dismantle idle jet and check is jet is smooth.

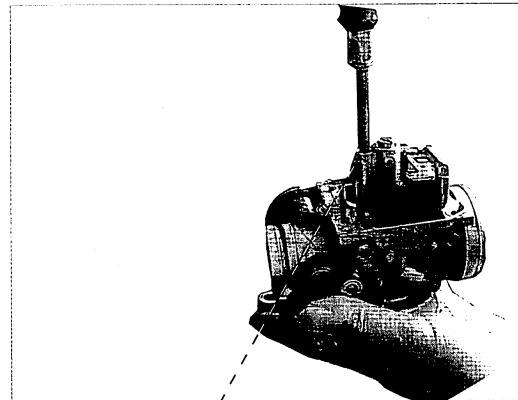

idle jet

check float cylinder or float needle if fuel leakage from carburetor.

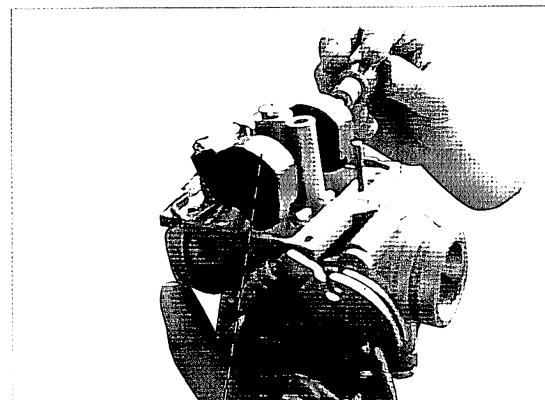

float cylinder

clean carburetor by petrol and blow all line then fit carburetor.

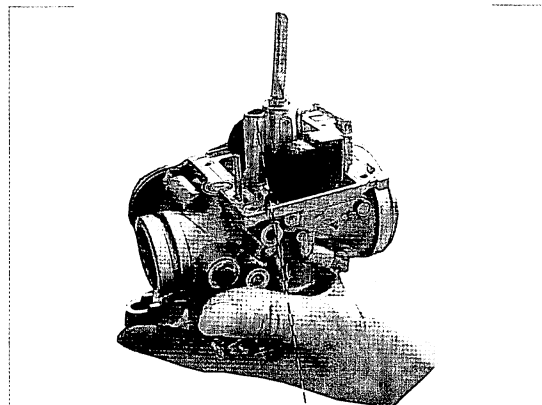

intake or exhaust

unscrew bolt of mixture jet and clean jet. tighten mixture screw and screw 2 circlces backwards while fit mixture jet.

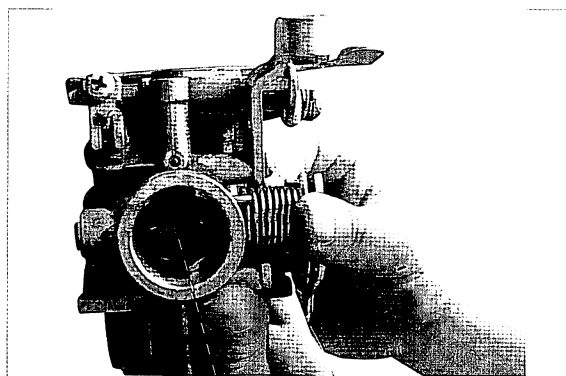

choke

measure float cylinder height and adjsut height if out of the range of 15mm-16mm.

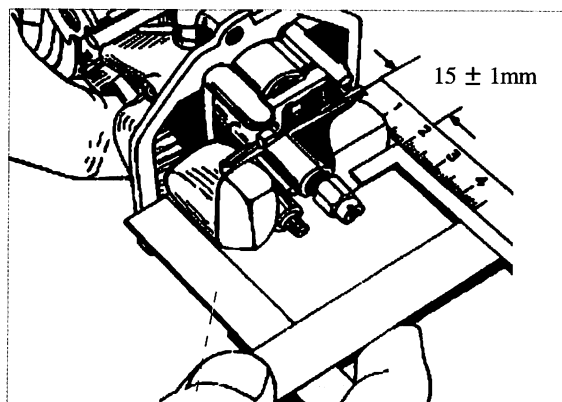

gauge

check abrasion of oil needle valve surface and if wear, fuel leakage from carburetor.

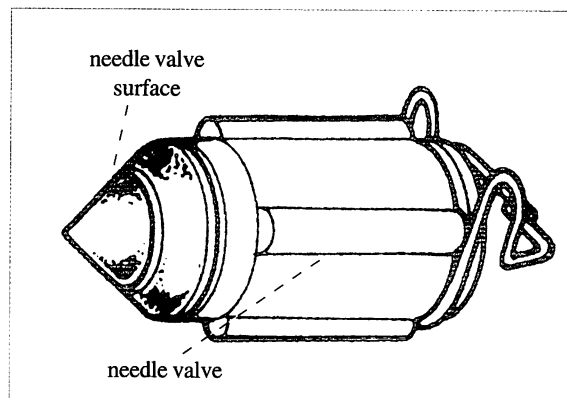

check fitting of carburetor oil needle and adjust oil needle if necessary, clip should be at third layer.

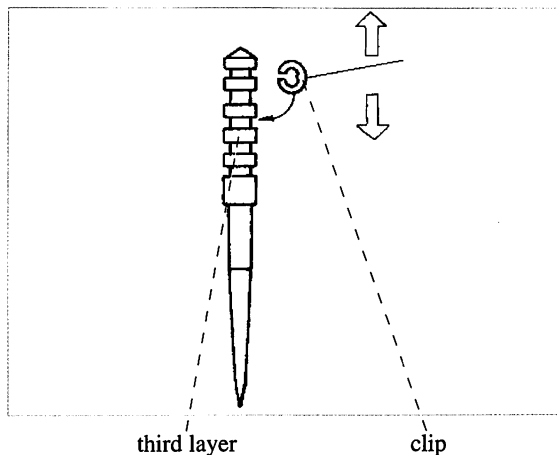

3-7

Maintenance of Carburetor

Component description	Damage form	Trouble symptom of component	Trouble symptom of motorcycle	Repair method
Idle speed air adjusting screw	Improper adjustment	_____	Insufficient engine output; The engine changes speed during idle run. Excessive fuel consumption.	Readjust.
Jet needle set	The clip is improperly adjusted.	_____	Insufficient engine output; Excessive fuel consumption.	Readjust the clip position in the jet needle.
Float set	The float level is too high (i.e. the float level is over 16mm).	The oil level in float chamber of carburetor is too low.	engine is difficult or impossible to start. engine overheats. Insufficient engine output; engine changes speed during idle run. Excessive fuel	Replace the float set.
	The float level is too low (i.e. the float level is below 15mm)	Oil spilled out of the carburetor.	The engine is difficult or impossible to start. Insufficient engine output; Excessive fuel consumption.	Repair or replace the float set.
	The float set is broken or deformed.	Oil spilled out of the carburetor.	The engine is difficult or impossible to start. Insufficient engine output; Excessive fuel consumption.	Replace the float set.
Needle valve of float	The cone of the needle valve is damaged or worn into terrace shape.	Oil spilled out of the carburetor.	The engine is difficult or impossible to start. Insufficient engine output; Excessive fuel consumption.	Replace the needle valve of float.
Main jet	The jet diameter is too large.	_____	Excessive fuel consumption.	Replace the main jet.
idle speed jet	The slow jet is clogged.	_____	The engine is difficult or impossible to start. The engine changes speed during idle run.	Replace the slow jet.
	The jet diameter is too large.	_____	Excessive fuel consumption.	Replace the slow jet.
Air jet	The air jet is clogged.	_____	The engine is difficult or impossible to start. Insufficient engine output; the engine changes speed during idle run.	Clean the air jet.

Maintenance of intake system and exhaust system

Dismantle, mount and maintain intake system

unscrew bolt of left cover and then remove left cover.

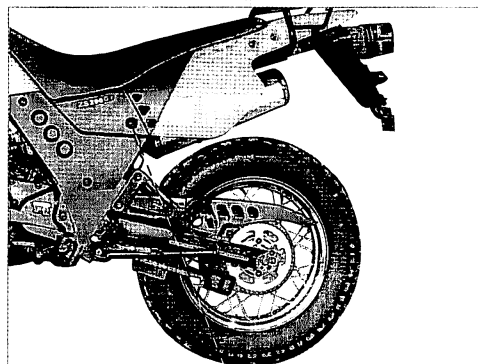

left cover

unscrew bolt of air cleaner cover.



screw

remove air filter cover to check broken and change cover if necessary.



air filter cover

foam element

remove foam element of air filter to check and clean element if necessary.

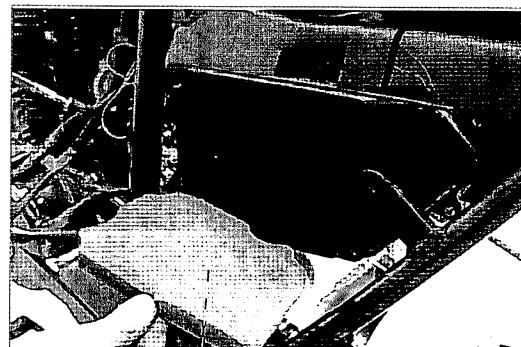

foam element

remove air cleaner element bracket to check air cleaner and remove dust in air cleaner.

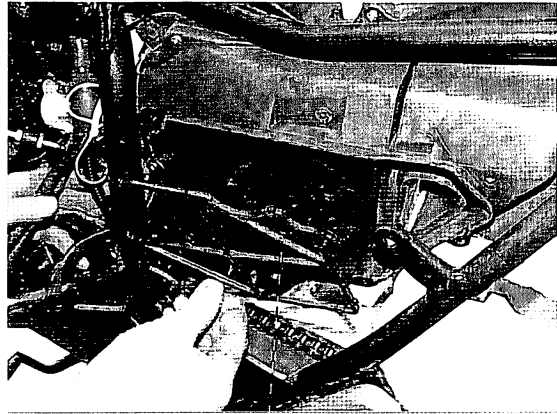

air filter

Clean foam element as follows:

- put foam element into detergent to wash.
- then squeeze foam element
- drop proper lubricant on foam element.
- extrude excessive lubricant from foam element and then fit foam element.

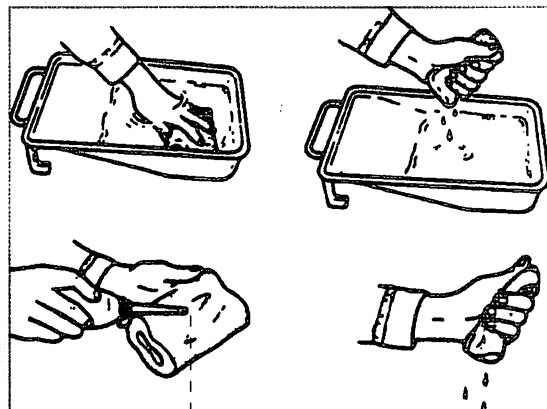

clean process

3-8

Maintenance of Air filter

Component description	Damage form	Trouble symptom of component	Trouble symptom of motorcycle	Repair method
Air cleaner	Too much dust deposit on the filtering element.	_____	The engine is difficult to start. Insufficient engine output; Poor performance of engine during idle run. Excessive fuel consumption. The exhaust muffler pipe fumes strongly (black).	Clean the filtering element.
	The filtering element is fractured or chaped.	_____	Engine air suction noise is too loud	Replace the filtering element.

Dismantle, mount and maintain exhaust system

unscrew connecting nut of muffler.

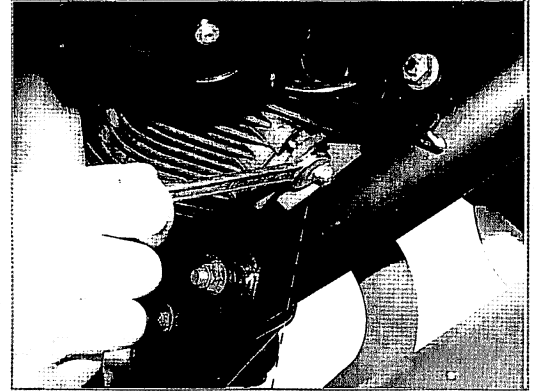

nut

unscrew connecting bolt of exhaust pipe to check washer. change washer if necessary.

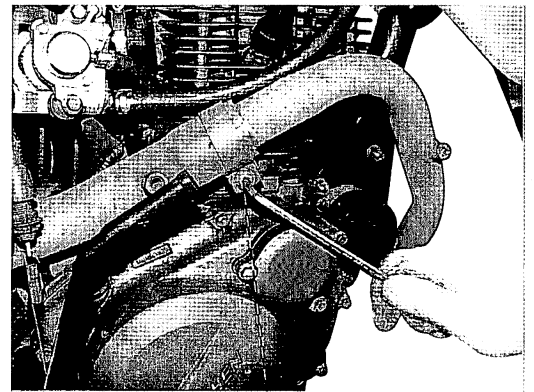

bolt

unscrew suspension bolt to check suspension bracket and change muffler if bracket broken..

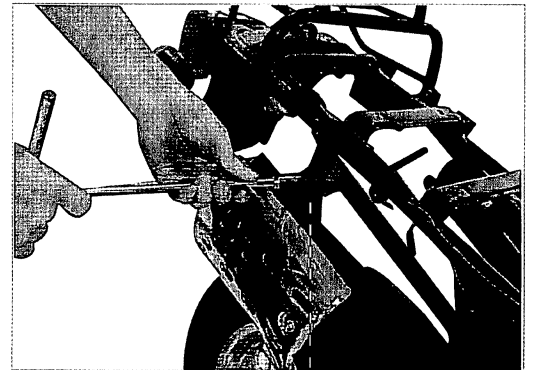

bolt

remove muffler and check break of exhaust pipe, change exhaust pipe if necessary.

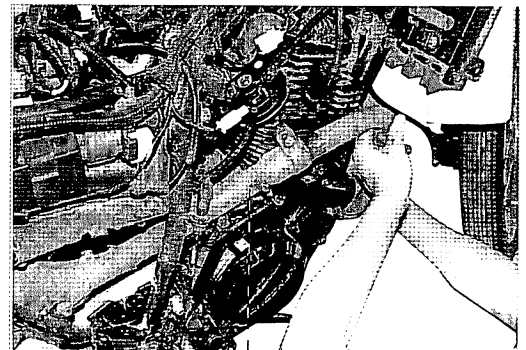

muffler

remove muffler and check break of washer, change washer if necessary.

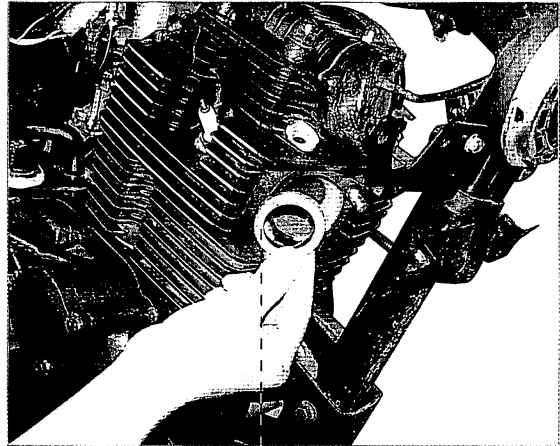

washer

check carbon deposit in exhaust pipe and remove carbon deposit, change air pump filter, air pump and exhaust pipe if pollution can not be reached requirement.

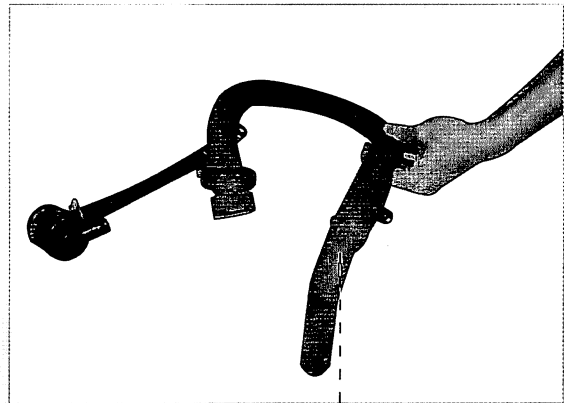

exhaust pipe

check rear section of muffler and change muffler if rear section broken.

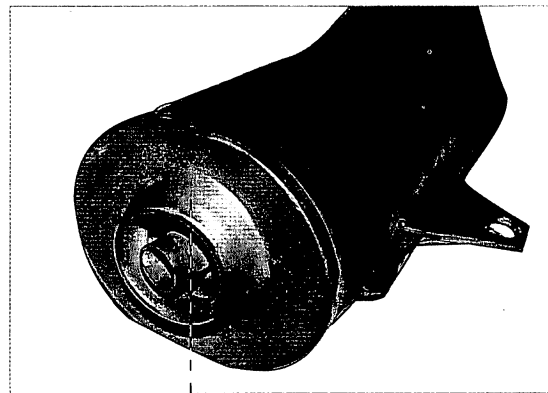

rear section

3-9

Maintenance of Exhaust Muffler

Description	Damage form	Trouble symptom of component	Trouble symptom of motorcycle	Repair method
Exhaust pipe gasket	gasket is broken.	air leakage from exhaust pipe.	Engine exhaust noise is too loud.	change exhaust pipe gasket.
muffler	muffler case is broken.	muffler case is broken	Engine exhaust noise is too loud.	change muffler.
environment protection device	environment protection device failure	environment protection device damage or position	emission pollution exceeds standard	change exhaust pipe, air pump and air filter

Dismantle, mount and maintain environmental protection device

check nut of environmental protection device and tighten nut if necessary.

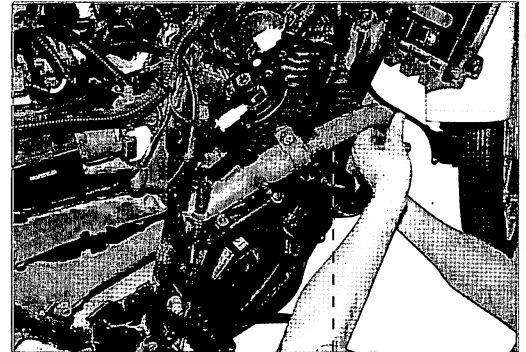

bolt

check connecting clip of air pump when pulltion exceed standard and tighten or change clip.

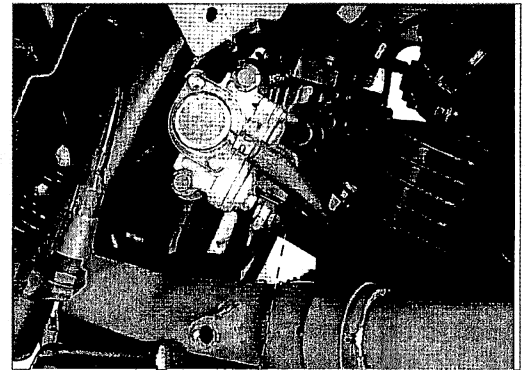

intake

unscrew fixing bolt of air pump when pollution exceeds standard and check air pump, change if necessary.

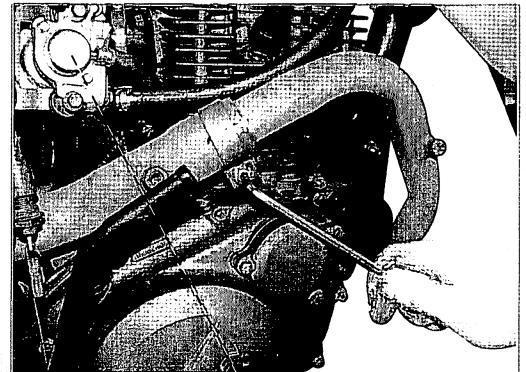

air pump

dismantle hose of air pump to check and tighten or change hose if necessary.



hose

dismantle secondary intake air filter to check and change air filter if necessary.

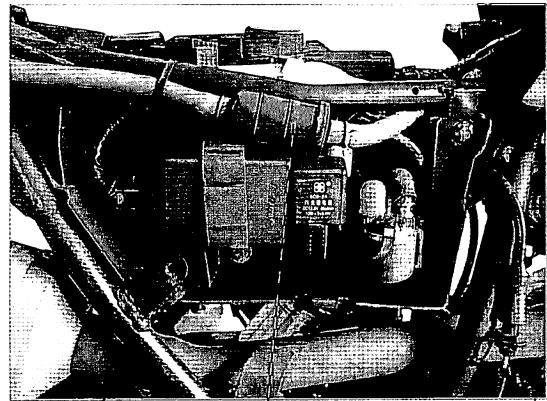

air filter

remove connecting hose of air pump to check loose or aging, tighten or change hose if necessary.

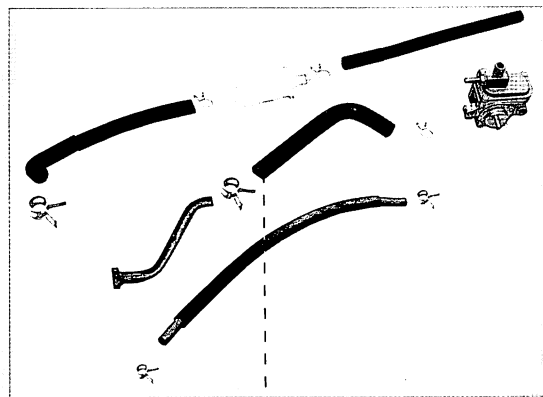

disassembly

ensure seal of environmental protection device connection.

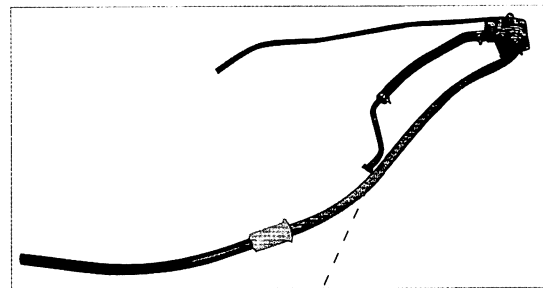

environmental protection device

3-10

Maintenance of Environmental Protection Device

Description	Damage form	Trouble symptom of component	Trouble symptom of motorcycle	Repair method
air pump	jamed or damaged	out of action	emission pollution exceeds standard	change air pump
air filter	jamed or damaged	out of actiob	emission pollution exceeds standard	change air filter
connecting hose	loose	noise from environment protection device	emission pollution exceeds standard	change connecting hose
air pump gakset	noise from secondary intake	air leakage from secondary intake	emission pollution exceeds standard	change gasket
muffler exhaust	carbon deposit on exhaust	incomplete combustion	emission pollution exceeds standard	remove carbon deposit

Maintenance of Lubricant System

Dismantle, mount and maintain lubricating system

remove valve cap to inspect inside of cylinder head and if no lubricant, check oil line of cylinder head and clean oil line if necessary.

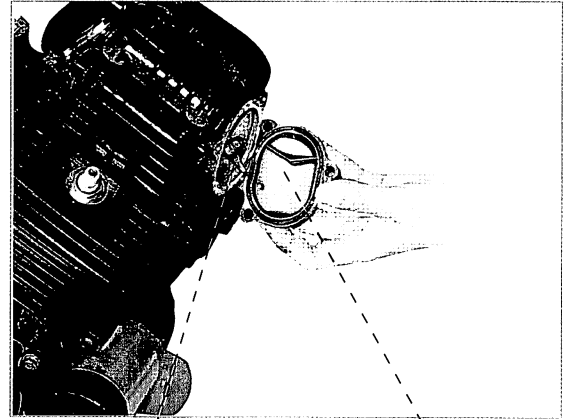

lubricant

valve cap

then dismantle fuel filter to check filter element and clean element if necessary.

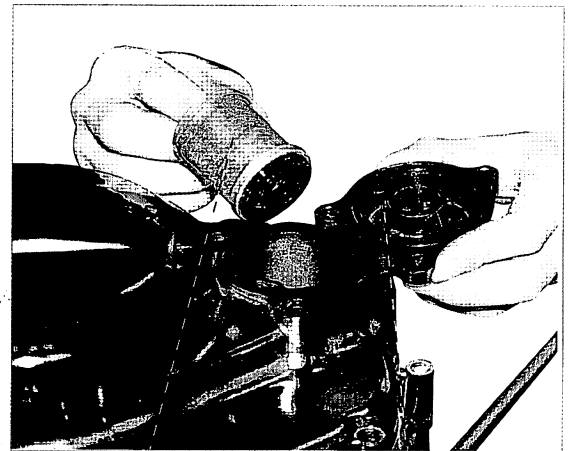

filter net

filter cap

check oil line and remove impurity if necessary to keep smooth.

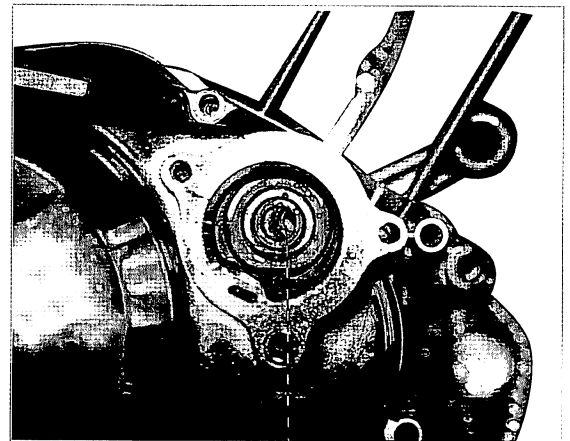

oil line

unscrew drain bolt and drain oil to check fuel line and fuel.

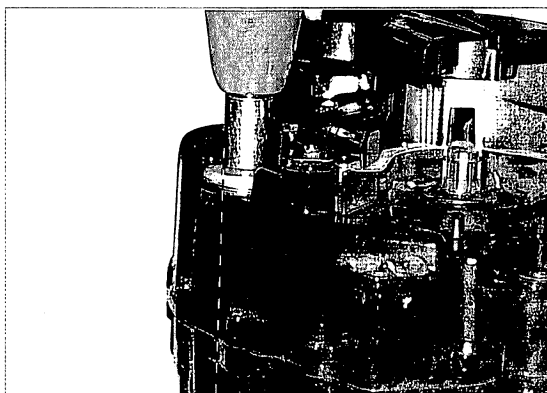

drain bolt

remove right crankcase and clutch, unscrew oil pump screw and remove oil pump.

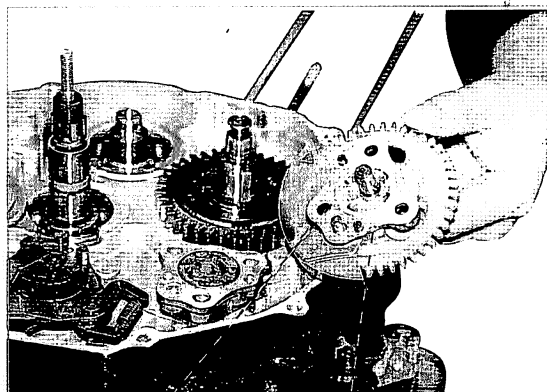

oil pump cover

gear

check break of oil pump gasket and check smooth of fuel line. clean fuel line and change gasket if necessary.

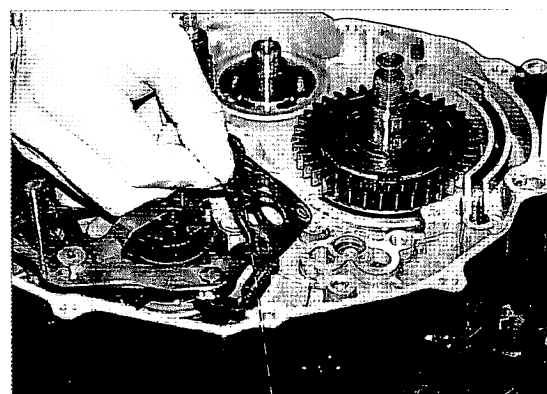

gasket

check inlet and outlet of oil pump to keep oil line smooth.

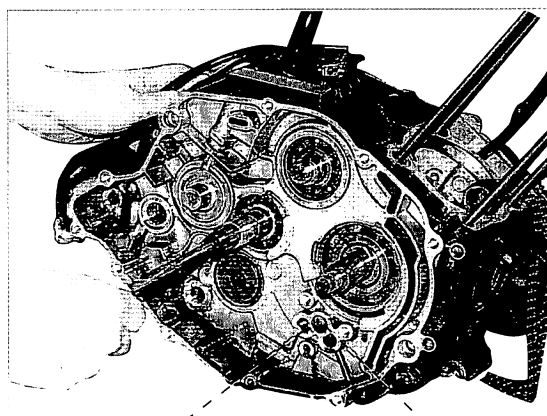

inlet

outlet

check wear of fuel pump gear when fitting fuel upmp.

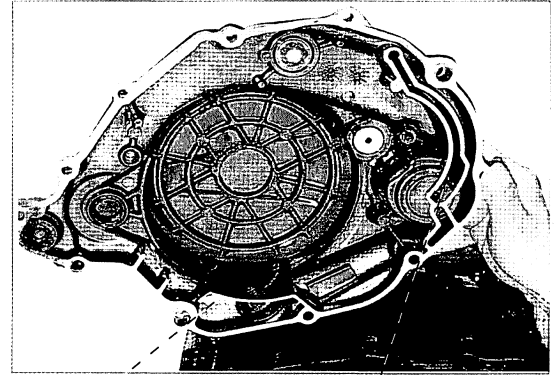

outlet line

cylinder head oil line

check cylinder head oil line, oil line of main shaft and countershaft and outlet to keep smooth.

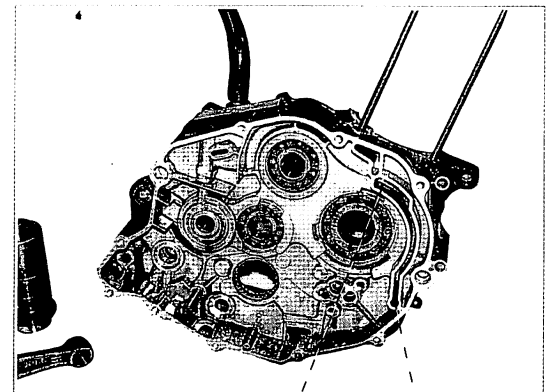

cylinder oil line

outlet

check oil line of cylinder head, crankshaft and outlet to keep smooth.

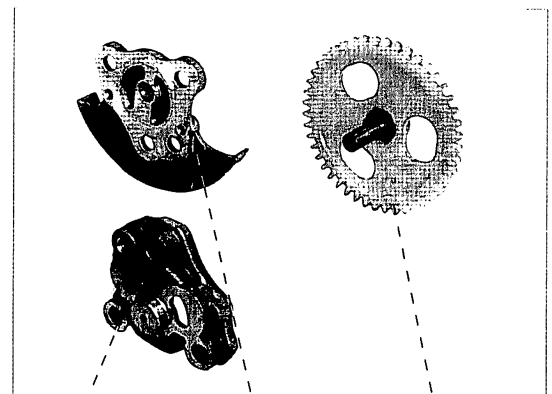

oil pump case

oil pump cover

oil pump gear

check wear of inner rotor, outer rotoe and gear, change if necessary.

the useage limitation of external diameter of rotor gap should be 0.25mm.

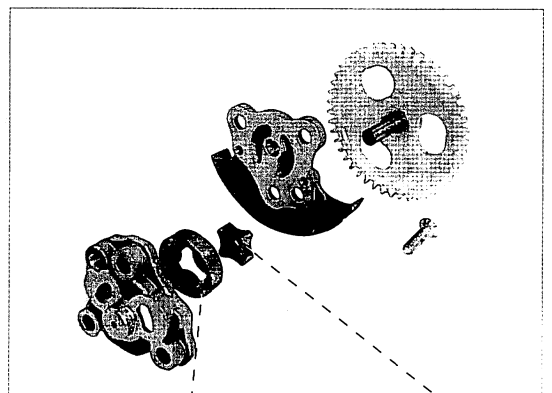

outer rotor

inner rotor

fit oil pump and keep seal and oil line smooth.

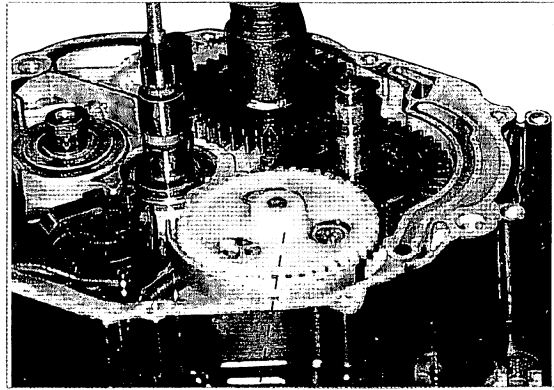

oil pump component

3-11

Maintenance of Lubrication System

Component description	Damage form	Trouble symptom of component	Trouble symptom of motorcycle	Repair method
Oil pump	The inner and outer rotator of the pump is over worn	No or insufficient oil is delivered by the oil pump.	Insufficient engine output. The engine overheats.	Replace the oil pump
Oil strainer	The strainer is clogged.	Impeded oil supply causing insufficient or no oil delivery from the pump.	Insufficient engine output. The engine overheats.	Clean the oil strainer.
Oil filter	The inside of rotor is foul	—————	The engine overheats.	Clean the inside of rotor.
Lubrication system	Oil channel is clogged.	Insufficient of oil supply.	Insufficient engine output. The engine overheats.	Clean the oil channel.

Maintenance of Cooling System

Dismantle, assemble and maintain cooling system

Check if there are dirt on cylinder head, cylinder and crankcase surface, clean radiating blade and crankcase.

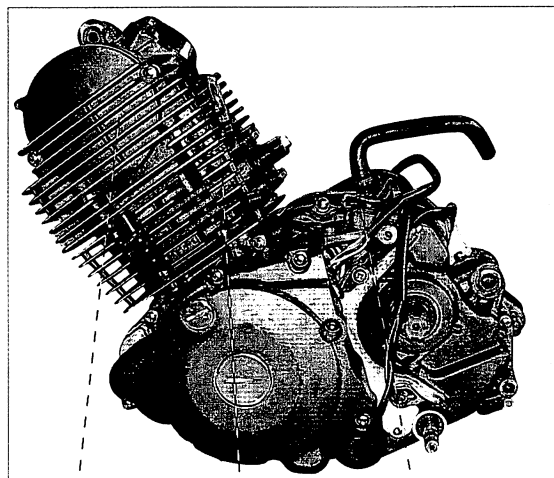

cylinder head

cylinder

crankcase cover

Chapter 4 Maintenance of Drive System

Maintenance of Kick Starter

Disassemble, assemble and maintain kick starter

remove clutch and remove starting shaft.

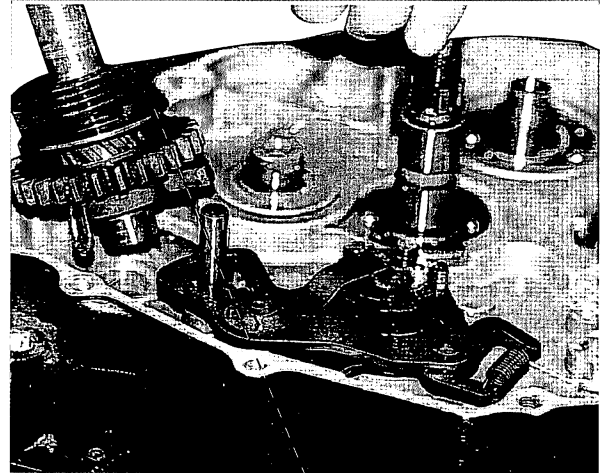

starting shaft

remove starting shaft gear to check wear of gear and change gear if necessary .

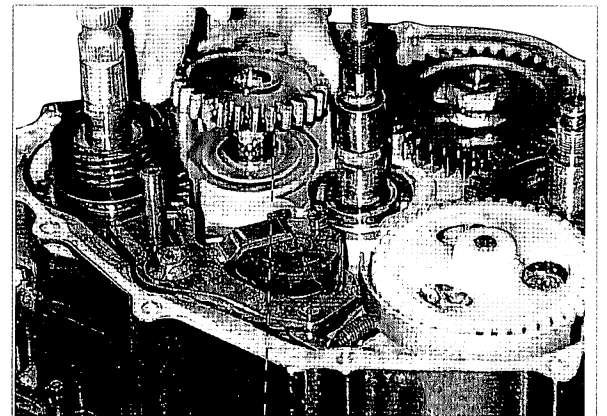

gear

remove starting shaft and check wear of starting shaft and change whole set starting shaft if necessary.

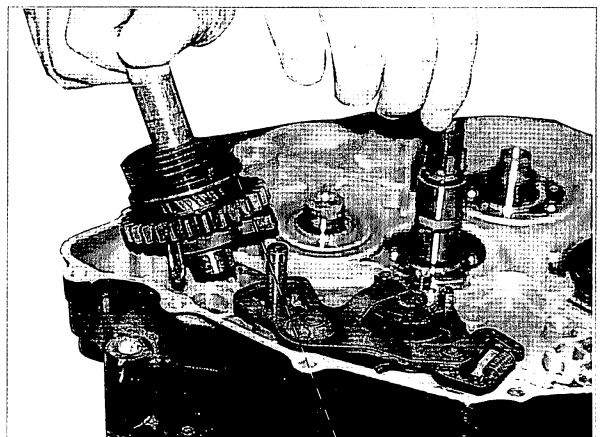

starting shaft

remove starting shaft spring to check spring and change spring if necessary .

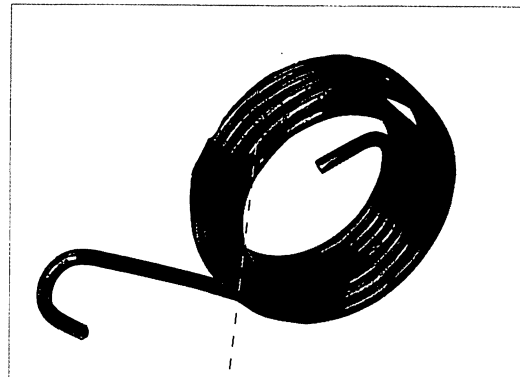

spring

remove starting ratchet and check wear of ratchet. change ratchet if necessary.

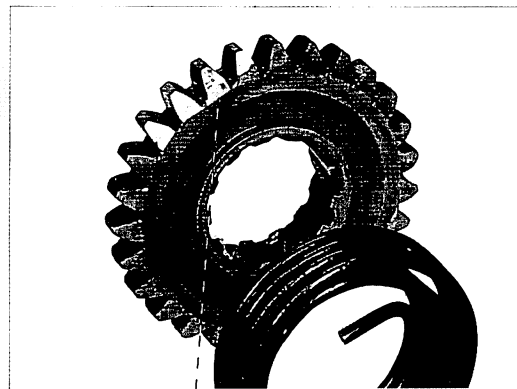

starting ratchet

check wear of starting shaft surface and change starting shaft if necessary.

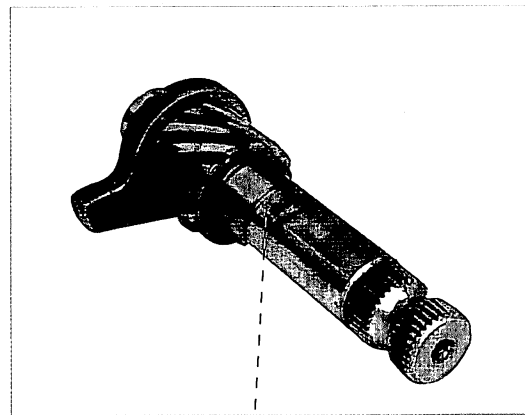

starting shaft

check wear of starting assembly and change if necessary.

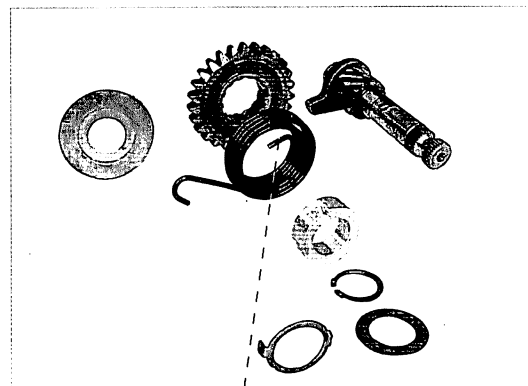

starting shaft assembly

4-1

Maintenance of Kick Starter

Component description	Damage form	Trouble symptom of component	Trouble symptom of motorcycle	Repair method
starting lever	spine connected with starting lever slipping	starting lever slip	start skidding	change starting lever
starting gear	wear of ratchet	start skidding	start skidding	change starting gear
	damage or wear of gear teeth	—————	difficult to start	change starting gear
starting ratchet	wear of ratchet	start skidding	start skidding	change starting ratchet
	ratchet spring broke	start skidding	start skidding	change ratchet spring
starting shaft	spine connected with starting lever and starting shaft slipping	start skidding	start skidding	change starting shaft
	return spring broke	starting lever can not return	—————	change spring

Disassemble, assemble and maintain electric starter

unscrew motor bolt and remove motor.

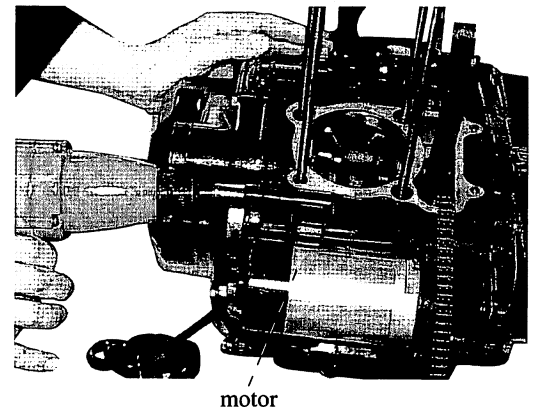

check wear of motor gear and change motor assembly if necessary.

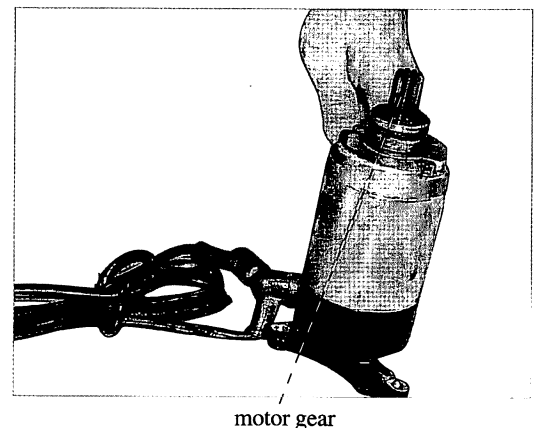

unscrew left crankcase cover bolt and check left crankcase cover.

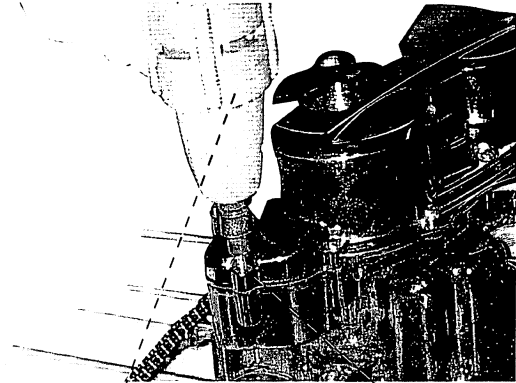

tool

bolt

remove left crankcase cover to check gasket and change gasket if necessary.

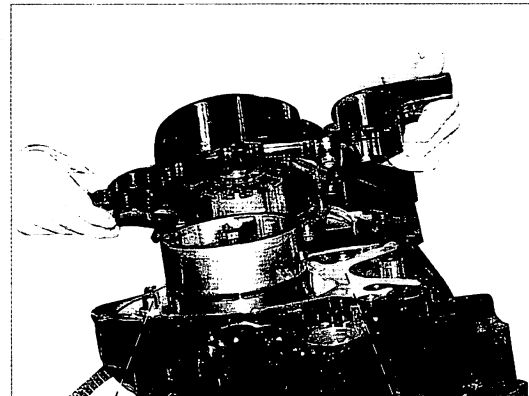

dowel pin

gasket

unscrew stator bolt and trigger coil bolt.

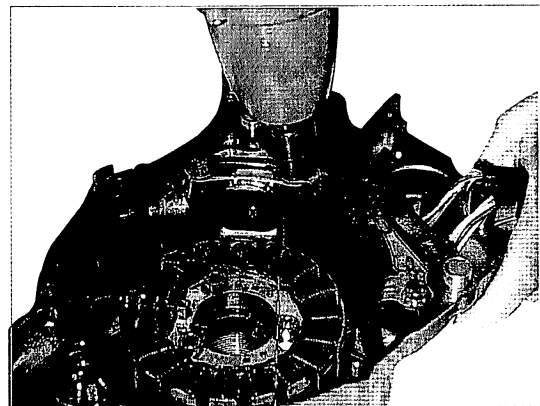

stator

check wear of trigger coil, ignition loop and illuminating loop. change stator if necessary.

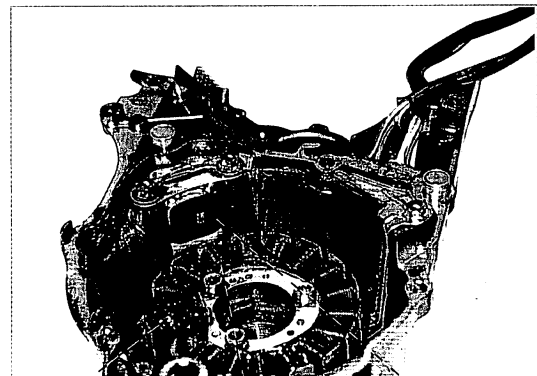

ignition loop

illuminating loop

trigger coil

unscrew fixing bolt of magneto rotor.

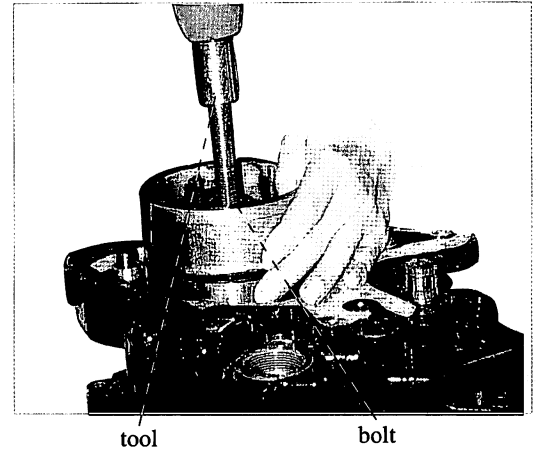

pull rotor by special tool to check wear of rotor and change rotor if necessary.

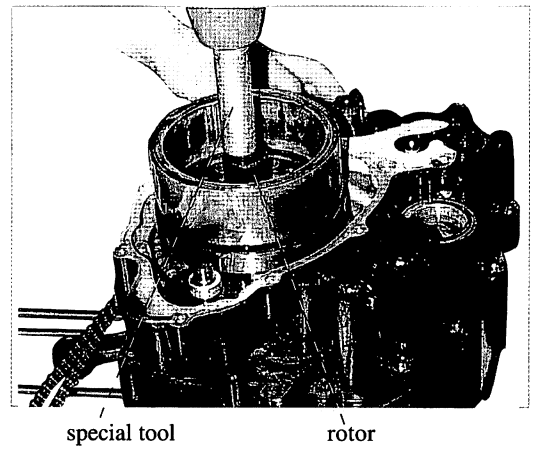

remove reduction gear and check wear of reduction gear and change gear if necessary.

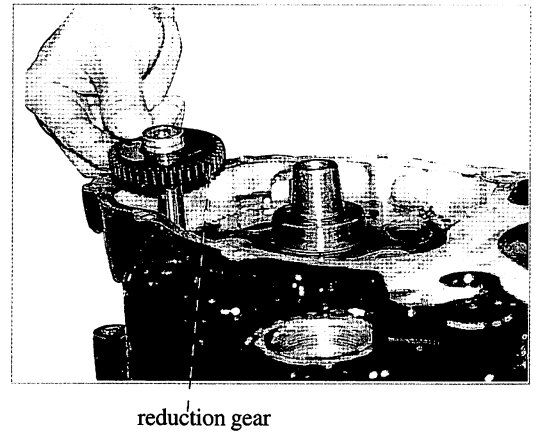

remove overrun clutch gear and check wear of overrun clutch gear and change if necessary.

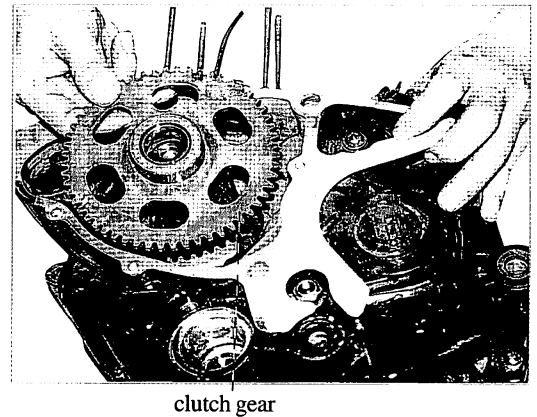

remove overrun clutch holder and roller to check wear and change clutch holder and roller if necessary.

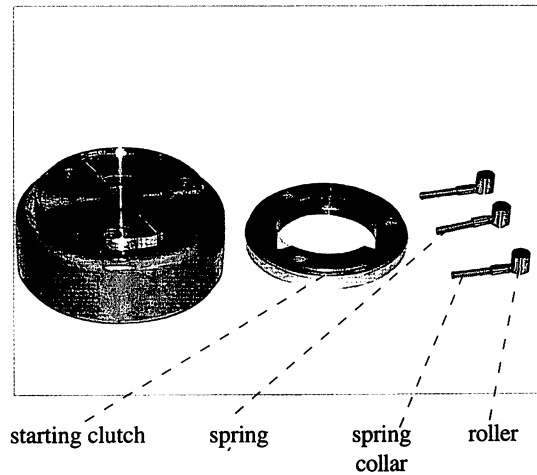

4-2

Maintenance of Starting Clutch

Description	Damage form	Trouble symptom of component	Trouble symptom of motorcycle	Repair method
starting motor	excessive wear of carbon brush(length is less than 8.5mm)	_____	motor run without power or failure	change starting motor
	carbon brush spring is broken	_____	Starter motor run without force	change carbon brush
	Armature commutator surface is fouled.	_____	Starter motor run without force	Clean the commutator surface with gasoline or alcohol
	Armature commutator surface is spotted, burnt or damaged.	_____	Starter motor run without force	Polish the surface against the commutator with fine abrasive paper. Make the cut on the mica plate between each commutator piece with broken saw bit 0.5~0.8mm deeper than the commutator surface. Remove the chip and burr between each commutator.
	Armature commutator surface is ablation or over worn.	_____	Starter motor run without force or failure	Replace starter motor
	Broken circuit or short circuit of armature coil	_____	Starter motor failure	Replace starter motor
starting clutch	contact surface of starter clutch gear and roller is over worn or damaged.	Starter clutch is slipping or has abnormal sound	start slipping or has abnormal sound	Replace starter clutch gear
	contact surface of starter clutch and roller is damage or worn out into concave groove.	Starter clutch is slipping or has abnormal sound	start slipping or has abnormal sound	Replace starter clutch
	roller is over worn or damaged.	Starter clutch is slipping or has abnormal sound	start slipping or has abnormal sound	Replace starter clutch

Maintenance of Clutch

Disassemble, assemble and maintain clutch

unscrew right crankcase cover bolt.

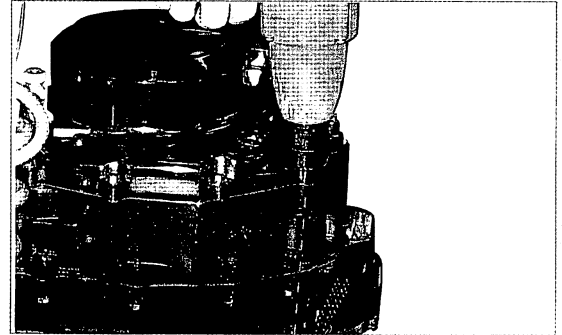

bolt

remove right crankcase cover.

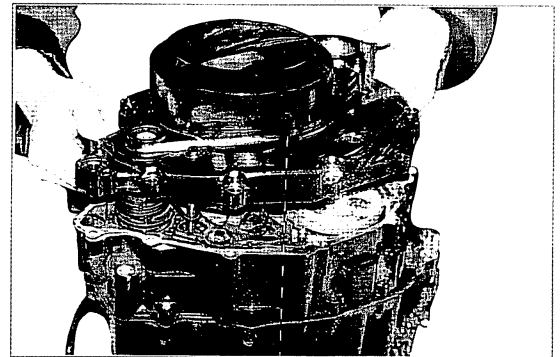

right crankcase cover

remove gasket of right crankcase cover and change gasket if necessary.

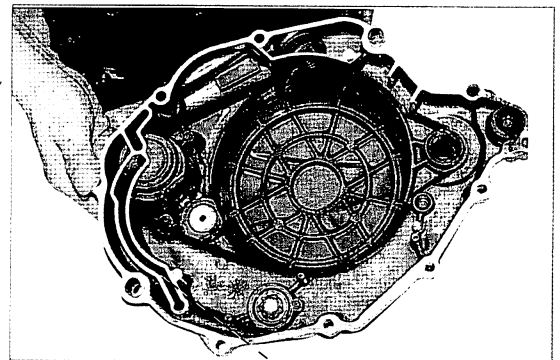

gasket

unscrew adjustment nut of clutch and check wear of connecting rod jet.

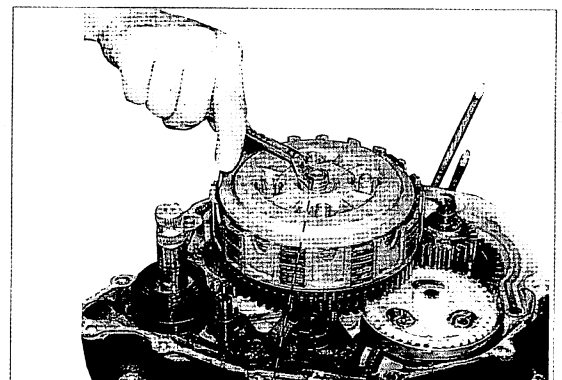

adjustment nut

unscrew clutch cover plate bolt and remove clutch spring to check wear of spring, change spring if necessary.

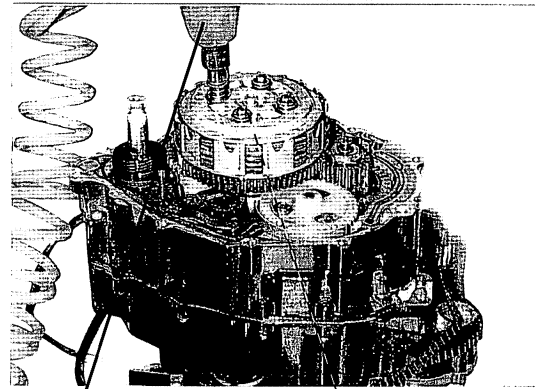

tool

clutch cover plate

remove clutch cover plate and check wear of clutch cover plate, change cover if necessary.

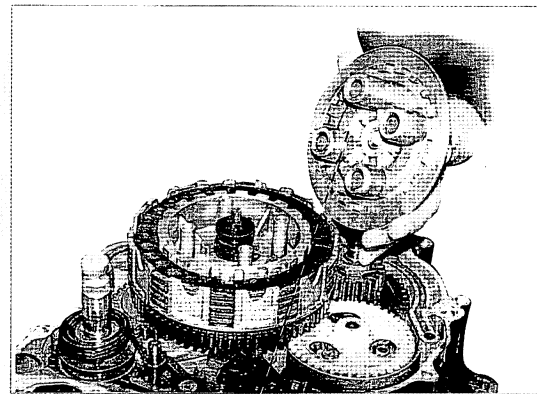

clutch cover plate

unscrew lock nut of clutch and remove driving disc.

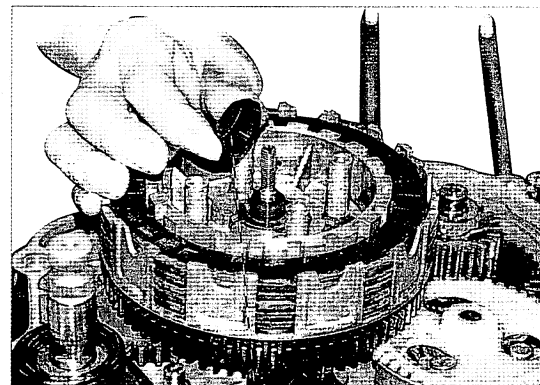

nut

remove driving piece and driven piece to check wear. change if necessary.

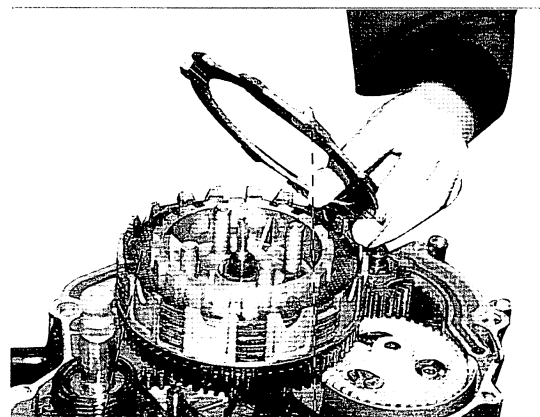

driven piece

driving piece

remove driving disc and check wear of driving disc, change driving disc if necessary.

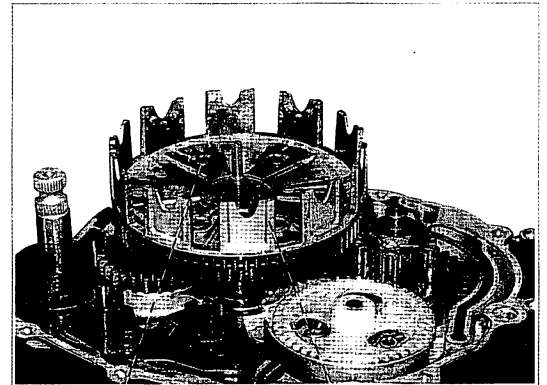

rivet driving disc

remove clutch spline washer and check wear of spline washer. change spline if necessary.

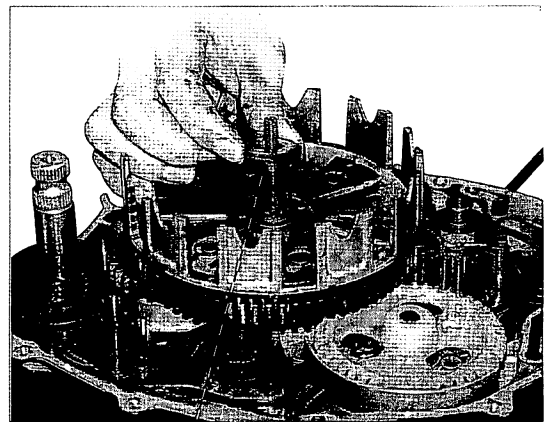

spline washer

check wear of clutch driven disc and change driven disc if necessary.

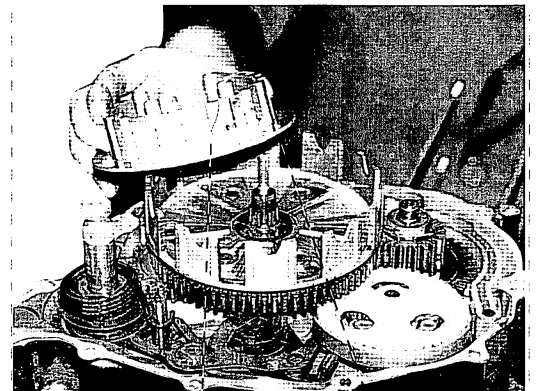

driven hub groove

check wear of driven hub spline slot and check wear of groove of clutch friction disc. change driven disc if necessary.

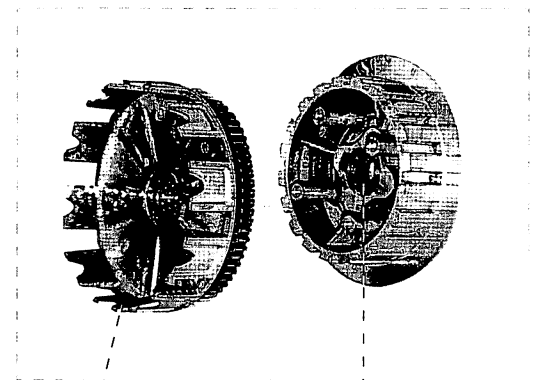

groove spline slot

unscrew nut of drive gear and check wear of drive gear. change drive gear if necessary.

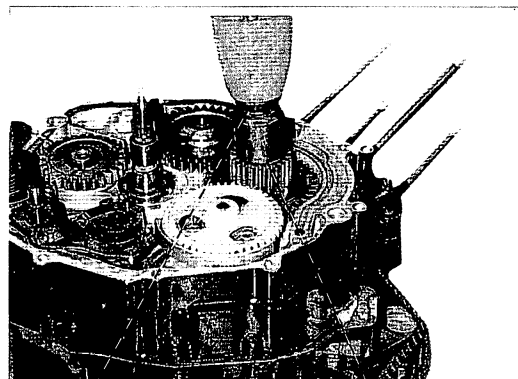

tool

nut

unscrew pinion nut and check wear of balance shaft pinion. change pinion if necessary.

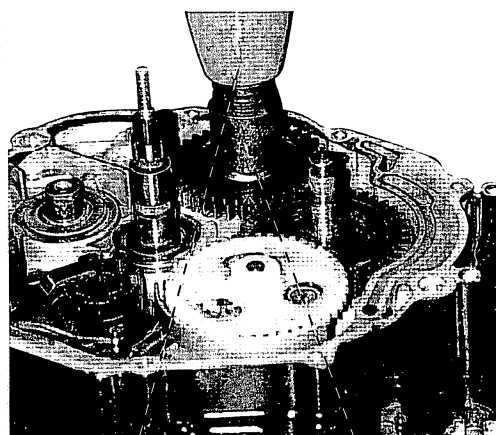

tool

nut

measure thickness of clutch driving friction plate and the minimum limitation is 2.60mm.

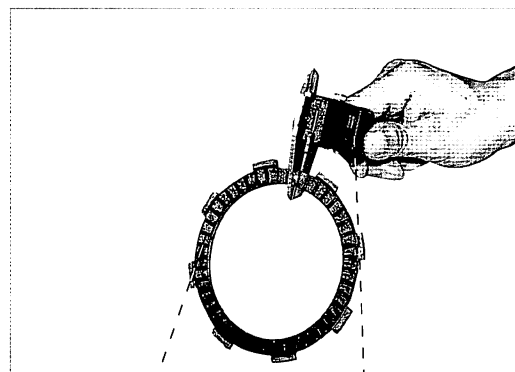

friction plate

calliper

check thickness of clutch iron plate and the minimum limitation is 2.80mm. the usage limitation of plane deformation is less than 0.05mm. check wear of groove.

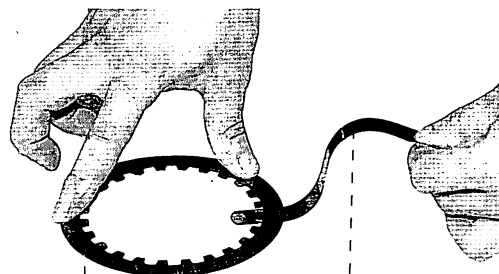

iron plate

feeler gauge

measure clutch spring length and the minimum usage limitation is 36.50mm.

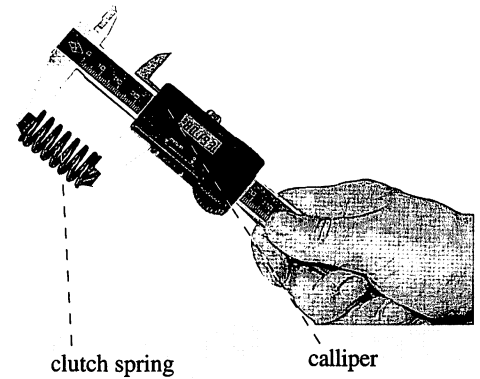

4-3

Maintenance of Clutch

Component description	Damage form	Trouble symptom of component	Trouble symptom of motorcycle	Repair method
Clutch drive hub	The drive hub groove is worn into sawteeth groove	The friction disc is impossible to move freely in the drive hub gear groove.	Clutch slippage, incomplete disconnection.	Cut the clutch groove with saw or replace the drive hub
Clutch driven hub	The driven clutch gear groove is worn into sawteeth groove	The clutch plate is impossible to move freely in the driven clutch gear groove.	Clutch slippage, incomplete disconnection.	Cut the clutch cover groove with saw or replace the center clutch
	The contact surface end with clutch friction disc is over worn.	_____	Clutch slippage	Replace center clutch
Clutch friction plate	Ablation or over worn (i.e. the thickness is less than the allowed limit 2.6mm)	_____	Clutch slippage or incomplete disconnection.	Replace the complete set of clutch friction plate.
Friction iron plate	It is seriously deformed.	_____	Clutch slippage	Replace the complete set of friction iron plate
Clutch spring pressing plate	The contact surface end with clutch friction disc is over worn.	_____	Clutch slippage	Replace complete clutch spring pressing plate
Clutch spring	It has insufficient elastic force or broken	_____	Clutch slippage	Replace complete clutch spring

Maintenance of Transmission

Disassemble, assemble and maintain transmission

remove gear shift lever to check wear and change gear shift lever assembly.

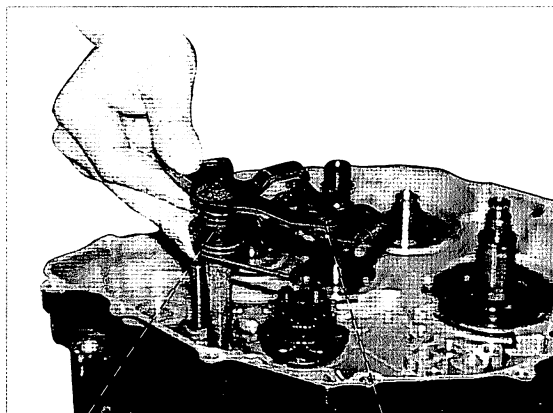

return spring

gear shift lever

check deformation of gear change shaft and change if necessary.

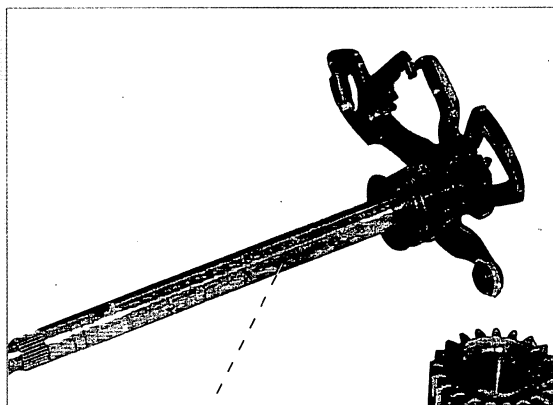

gear change shaft

unscrew shifting cam screw to check wear of cam and change cam if necessary.

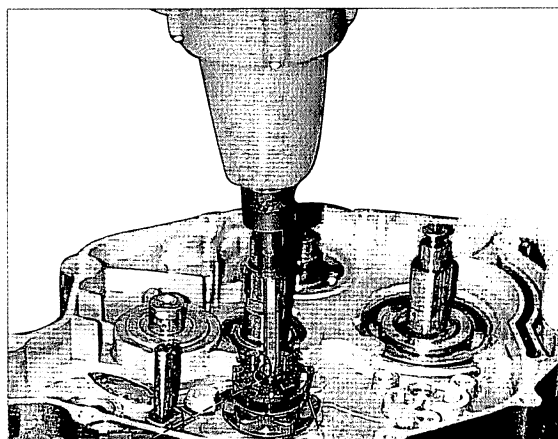

screw

shifting cam

remove shifting cam and check dowel pin.

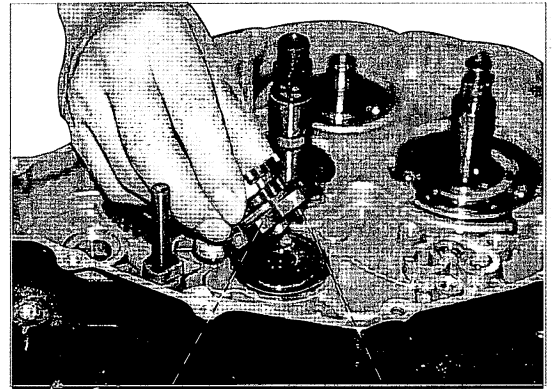

shifting cam

dowel pin

Disassembly gear shift lever and check wear of assembly, change if necessary.

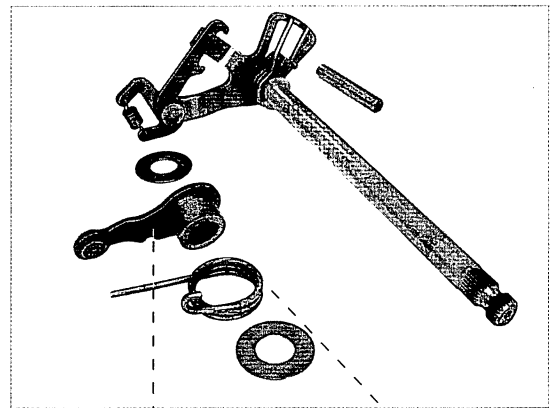

retainer

spring

remove crankcase and check gasket, change gasket if necessary.

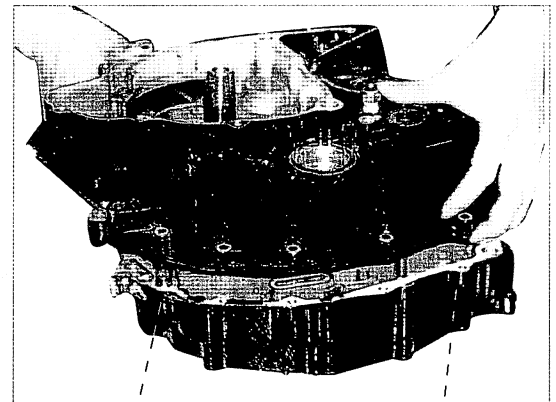

dowel pin

gasket

check wear of shifting drum groove.
check the gap between fork and shifting drum groove.

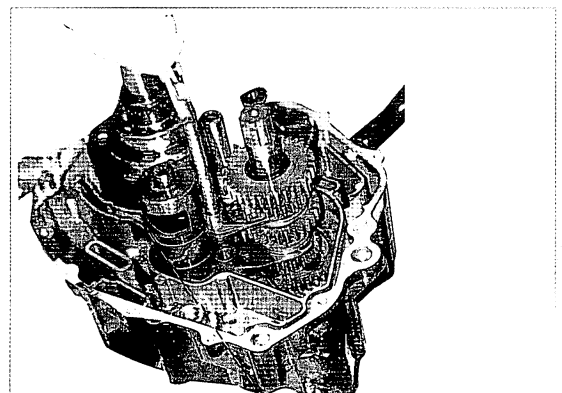

shifting drum

configuration of shifting drum, fork and fork shaft is shown in fig.

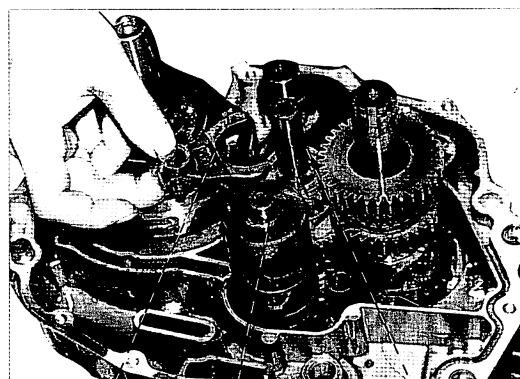

fork shifting drum fork shaft

remove fork shaft and check wear of fork shaft.

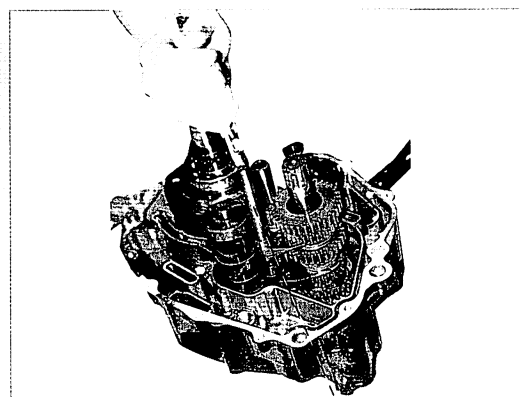

fork shaft

dismantle fork1 and check wear of fork, change fork 1 if necessary.

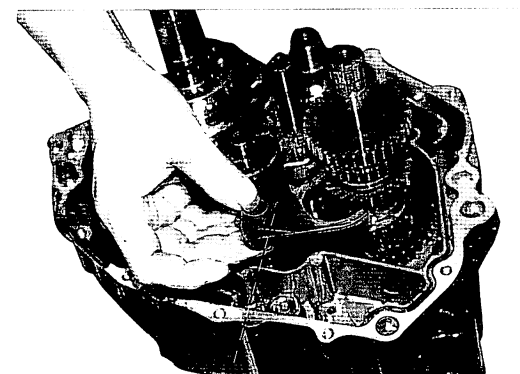

fork1

dismantle fork 2 to check wear and change fork 2 if necessary.

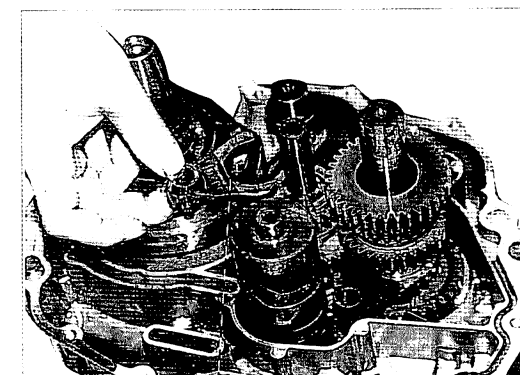

fork 2

Dismantle fork 3 to check wear and change fork 3 if necessary.

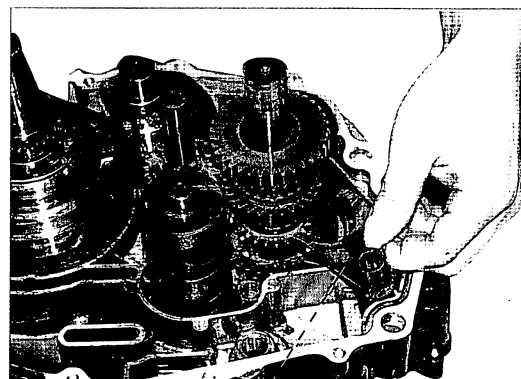

fork3

Remove shifting drum and check gear indicator contact.

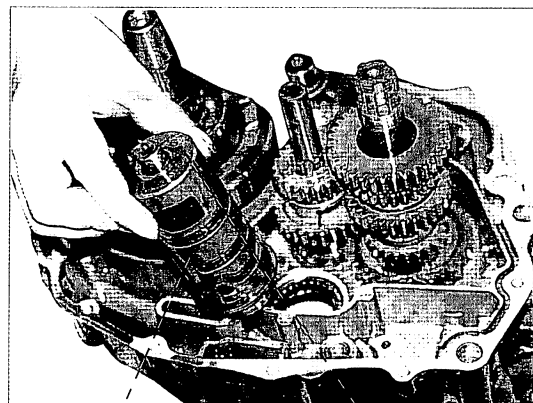

shifting drum

contact

Measure external diameter of fork shaft and the minimum limitation is 11.96mm.

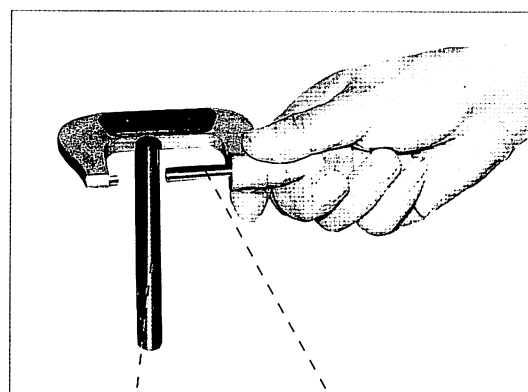

fork shaft

micrometer

measure fork thickness and the minimum limitation is 4.5mm. change fork if necessary.

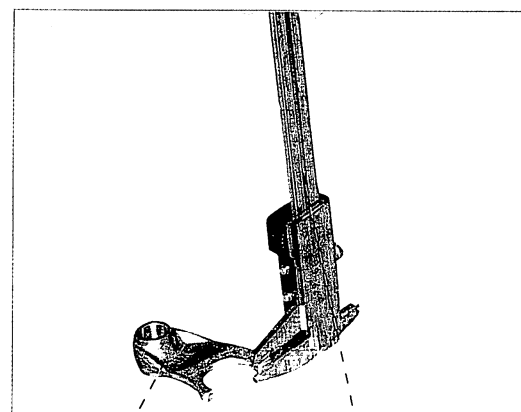

shifting fork

calliper

Measure internal diameter of fork hole and the maximum limitation is 12.05mm. change fork if necessary.

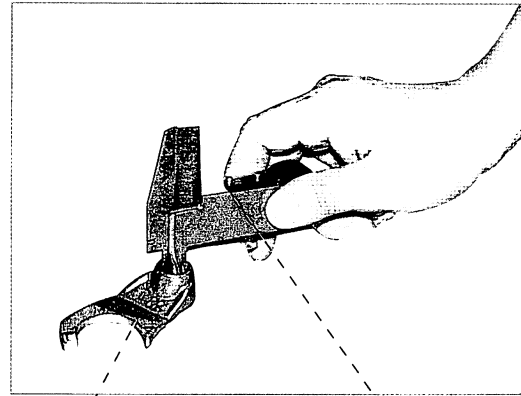

shifting fork

calliper

check gap between main shaft and countershaft, remove main shaft and countershaft.

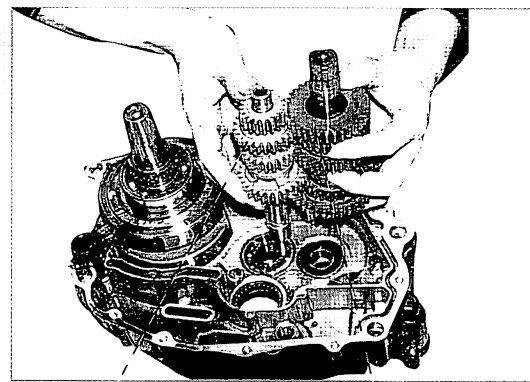

main shaft

countershaft

check wear of main shaft and countershaft groove, change main shaft and countershaft if necessary.

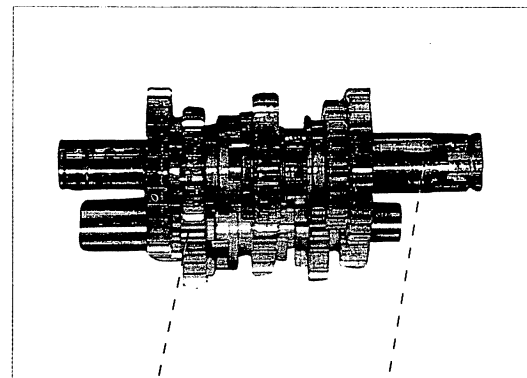

main shaft

countershaft

Dismantle gear of main shaft and countershaft to check wear of gear, change gear if necessary.

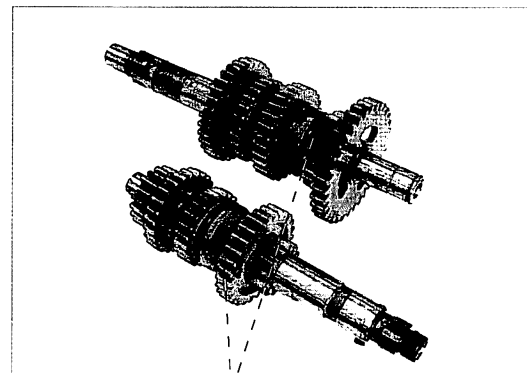

gear

4-4

Maintenance of transmission

description	Damage form	Trouble symptom of component	Trouble symptom of motorcycle	Maintenance method
Each gear	Gear tooth surface or gear are over worn or damaged	oil leakage from gear change drive shaft	Abnormal sound during gear-box driving, gear shifting with difficulty	Replace gear.
	Gear end face engagement claw edge is worn into arc	_____	transmission is easy to disengage	Replace gear.
	Gear engagement hole is worn into trumpet shape.	gap of shaft hole and shaft is over large	transmission is easy to disengage	Replace gear.
	fork slot is over worn	gap of fork and gear slot is over large	easy to disengage	Replace gear.
Fork	claw thickness is over worn (less than use limitation of 4.5mm)	gap of fork and gear slot is over large	transmission is easy to disengage	Replace fork
	The fork is deformed.	The fork is deformed.	transmission is difficult to gear change	Replace fork
	Fork shaft hole is over worn (more than use limitation of 12.05mm)	gap of fork and gear change drum is over large	transmission is difficult to gear change	Replace fork
Gearshift drum	gearshift slot is over worn (less than use limitation of 11.96mm)	_____	transmission is difficult to gear change	Replace gearshift drum
retaining wheel	over worn or damaged	_____	transmission is difficult to gear change	Replace retaining wheel
	weak elasticity or spring is broken	_____	transmission is easy to disengage	Replace spring
gear change lever	spline is damaged	gear change pedal slipping	transmission can not engage	Replace gear change lever
	gear change lever is deformed	gear change lever is deformed	difficult to gear shift for gear change lever	Replace gear change lever
	gear change lever is worn or broken	gear change lever is worn or broken	difficult to gear shift for gear change drum	Replace gear change lever
	insufficient elasticity or spring is broken.	insufficient elasticity or spring is broken.	gear change lever is impossible to gear shift and pedal is impossible to return	Replace return spring
Oil seal	Oil seal is worn out or the edge is damaged, worn or aged.	_____	Oil leakagess	Replace oil seal

Maintenance of rear drive system

Disassemble, assemble and maintain rear drive system

Unscrew bolt of left front connecting plate and remove gear change lever to check wear and change gear change lever if necessary..

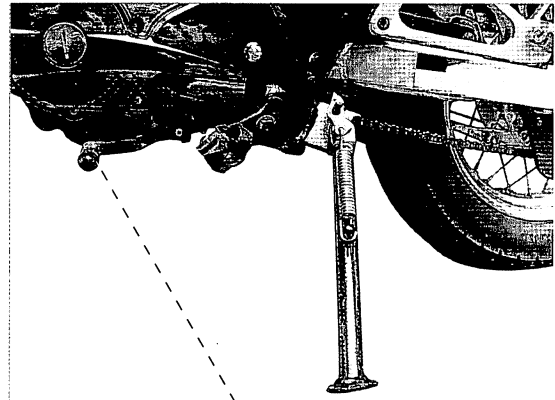

gear lever lever

unscrew left crankcase cover bolt and remove left crankcase cover to check wear, change rear cover if necessary.

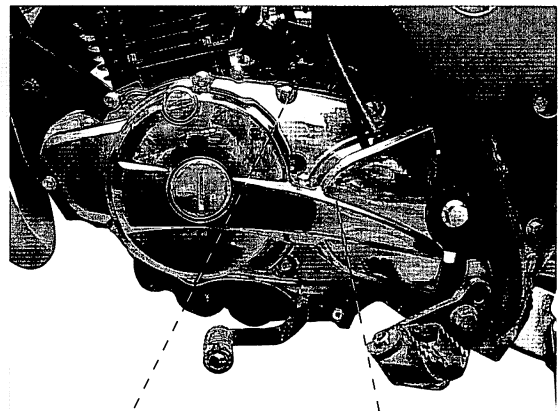

bolt

left crankcase cover

unscrew half chain case bolt and remove half chain case to check.

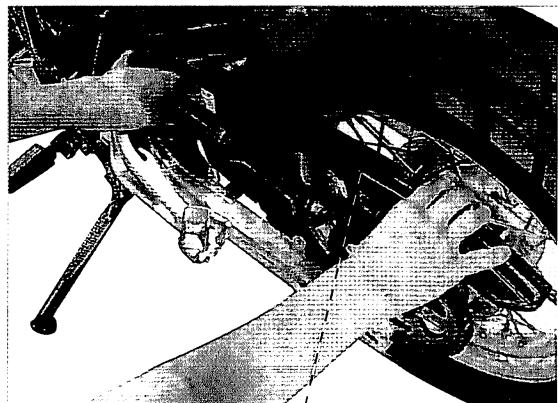

half chain case

unscrew sprocket bolt and remove small sprocket,
check wear of sprocket and change sprocket and chain
if necessary.

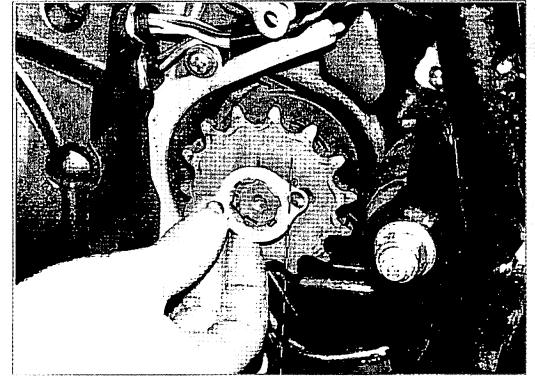

sprocket

Dismantle chain clip and chain to check wear
and deformation of chain.

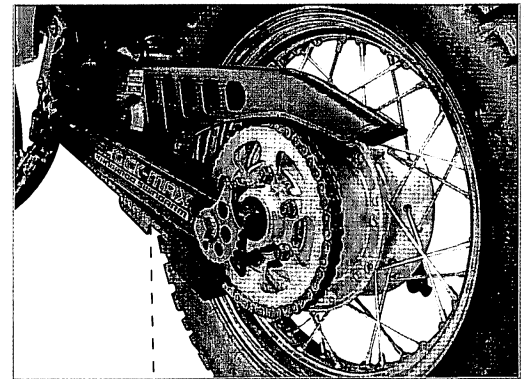

clip

check wear of rear driven chain and change chain
if necessary.

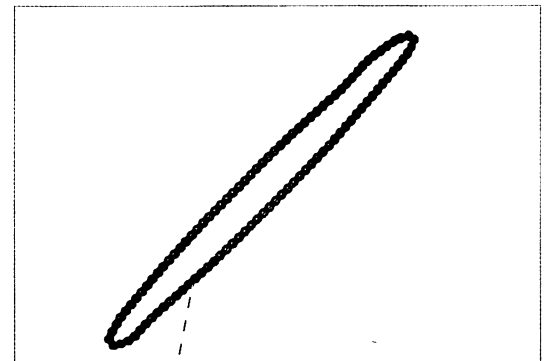

chain

check deformation of chain connector and
change connector if necessary.

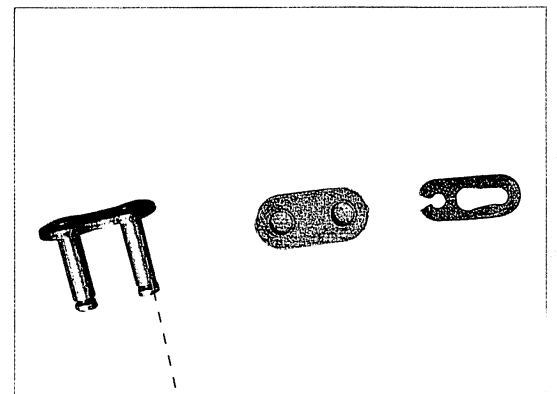

chain connector

unscrew rear axle nut.

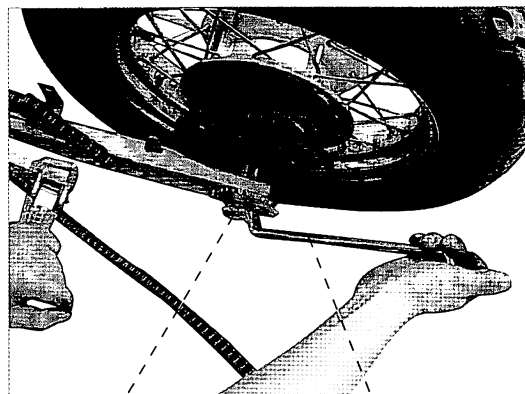

nut

tool

Dismantle nut connected rear brake disc with limit lever and remove adjustment nut of rear brake.

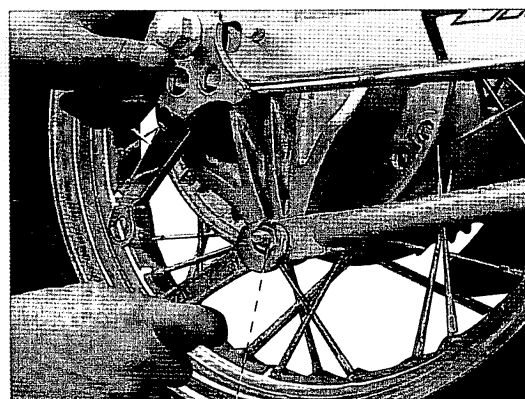

nut

Remove rear axle to check wear and remove rear wheel assembly.

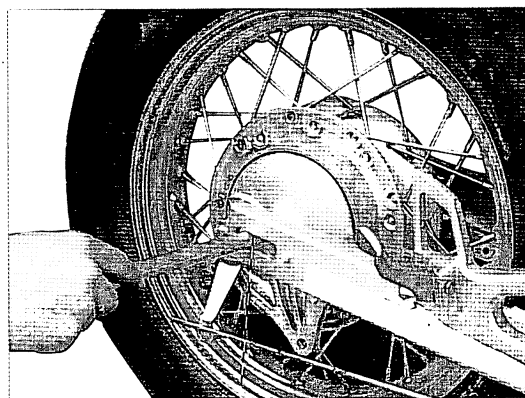

rear axle

unscrew rear sprocket bolt and remove rear sprocket.

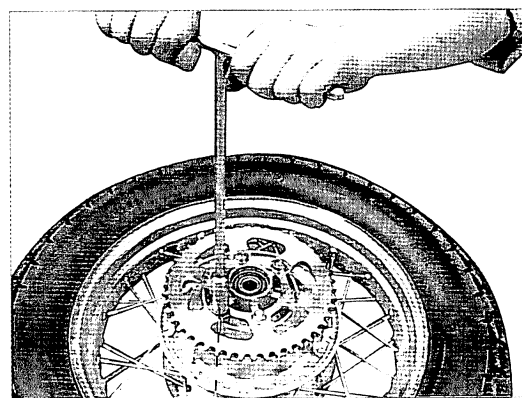

bolt

remove rear drive sprocket to check wear of rear drive sprocket and remove drive chain and sprocket.

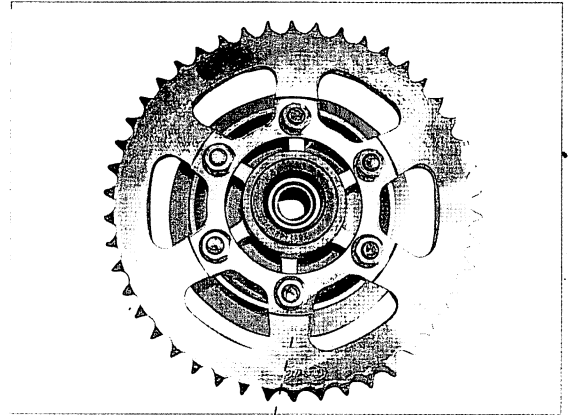

drive sprocket

Check wear of rear rocker bush and check swing of rear rocker.

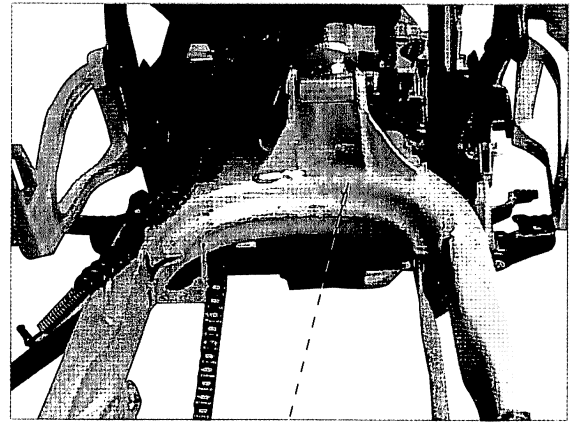

rear rocker assembly

4-5

Maintenance of Rear drive system

Component description	Damage form	Trouble symptom of component	Trouble symptom of motorcycle	Maintenance method
Sprocket and cam sprocket	Gear is over worn	—————	Drive chain has abnormal sound, drive chain is easy to fall out.	Replace sprocket and cam sprocket
Drive chain	Too dirty or poor lubrication	—————	Drive chain has abnormal sound	Clean and lubricate the chain.
	Improper chain tightness.	Chain is over tight	Drive chain has abnormal sound	Adjust the chain tightness to 15~25mm
		Chain is over loose	Drive chain is easy to fall out.	Adjust the chain tightness to 15~25mm
	Over worn	—————	Drive chain has abnormal sound, and is easy to fall.	Replace drive chain

Chapter 5 Maintenance of Riding System

Maintenance of frame and accessory

Disassemble, assemble and maintain frame and accessory

Structure of frame is shown in fig, check weld part and frame.

weld or correct frame if deformation or necessary.

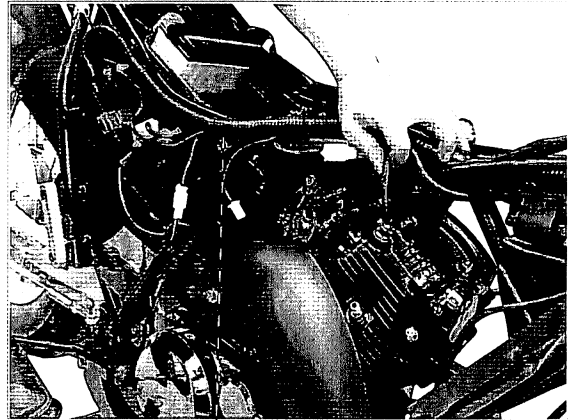

frame

check rear view mirror and fix it if loose. keep mirror clean.

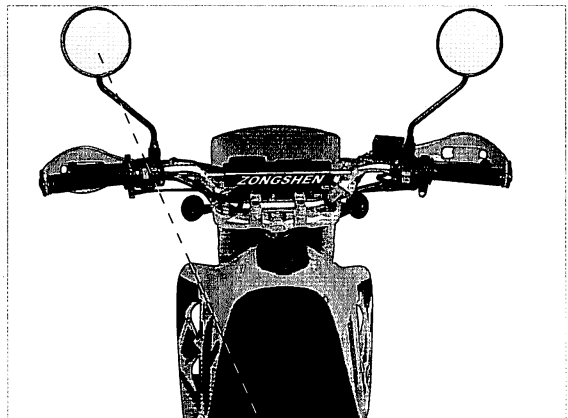

rear mirror

Structure of side stand is shown in fig and check side stand bend.

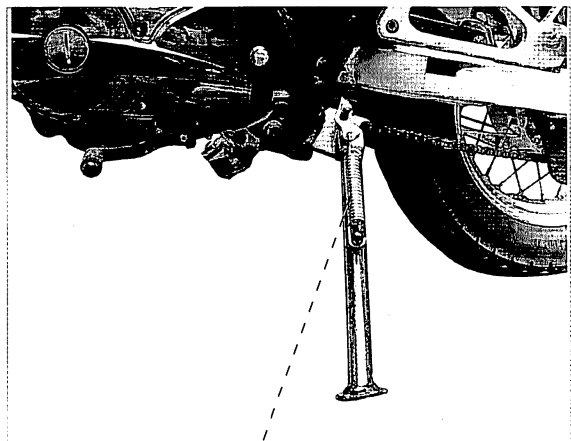

side stand

unscrew front footrest bolt and check welding part of footrest.

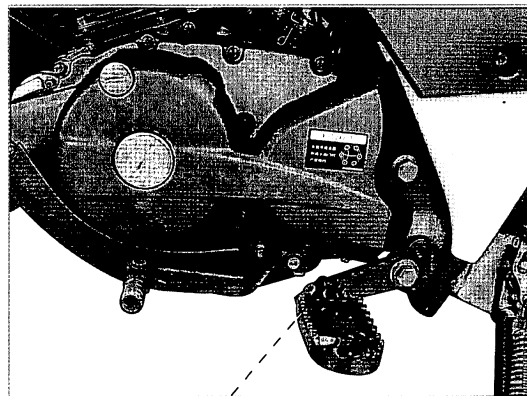

front footrest

check welding part broken and change footrest if necessary.

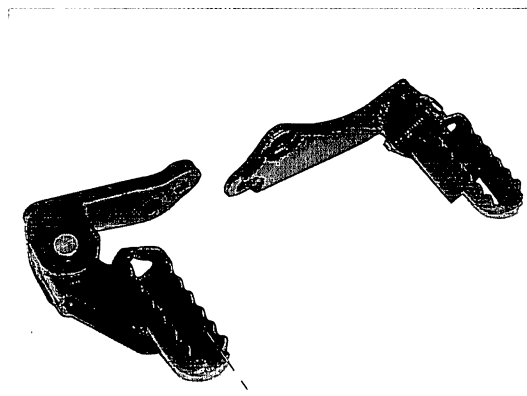

front footrest

unscrew front footrest bolt and remove front footrest.

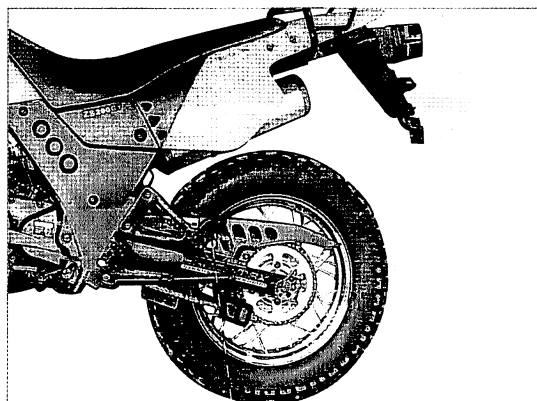

rear footrest

check rear footrest bracket broken and change bracket if necessary.

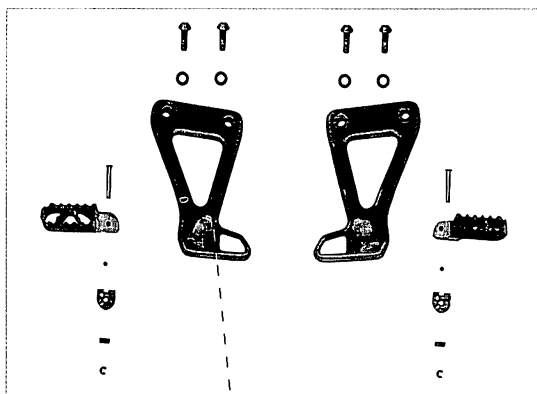

rear footrest

check front fender broken and change front fender if necessary.



front fender

check rear fender broken and change rear fender if necessary.

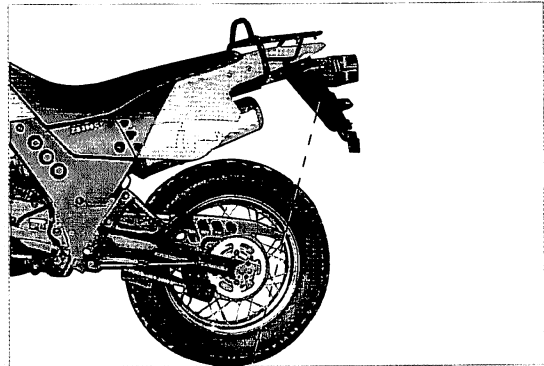

rear fender

unscrew rear fender bolt and check broken.

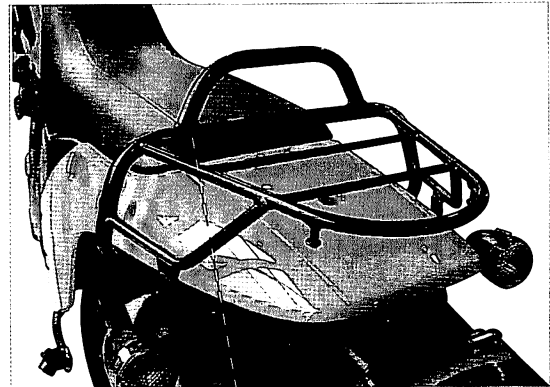

rear carrier

check left side cover broken and change cover if necessary.

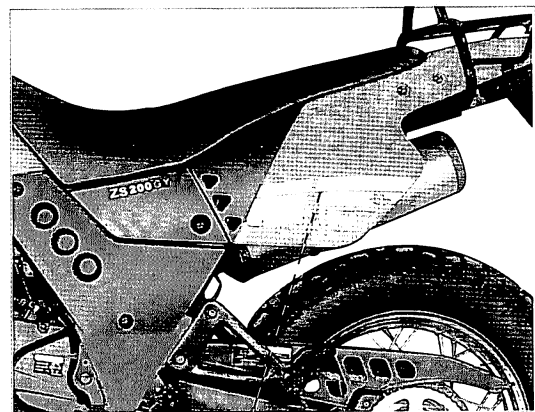

left side cover

check right side cover broken and change cover if necessary.

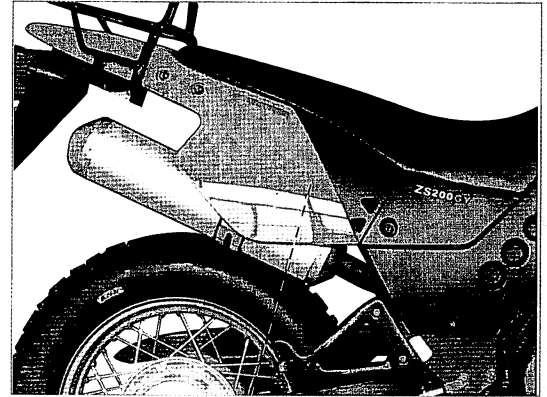

right side cover

unscrew seat bolt and check seat leather.

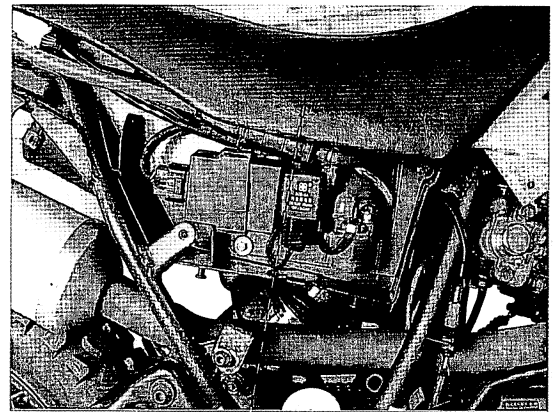

seat

check front bossing broken and change bossing if broken.

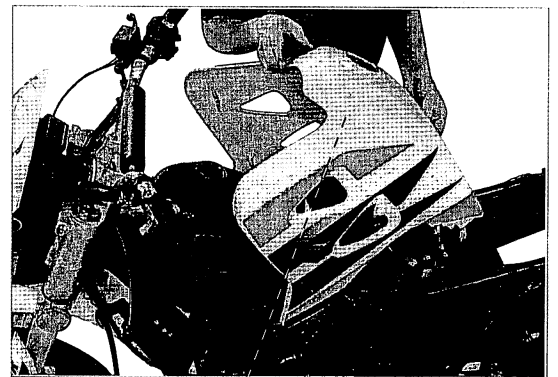

bossing

5-1

Maintenance of Frame and Accessories

Component description	Damage form	Trouble symptom of component	Trouble symptom of motorcycle	Repair method
Frame	The frame is deformed or broken.	The frame is deformed or broken.	Running off-tracking	Calibrate or replace frame
Side stand	Deformation or fractured	—————	Effect of parking	Replace the main stand
	Return spring is fractured	side stand can not return	Effect of parking	Replace the return spring
body cover	Broken	Broken	Effect the apperance	Replace or repair sidecover
Fender	Damaged	Broken	Effect the fend result	Replace the fender
Seat	Broken	Broken	Decrease of the comfortable	Replace the seat
footrest	Broken and deformation	Broken and deformation	—————	Replace the footrest

Maintenance of Suspension System

Disassemble,assemble and maintain steering handlebar

Turn steering handlebar to check operation and check wear of beafing.

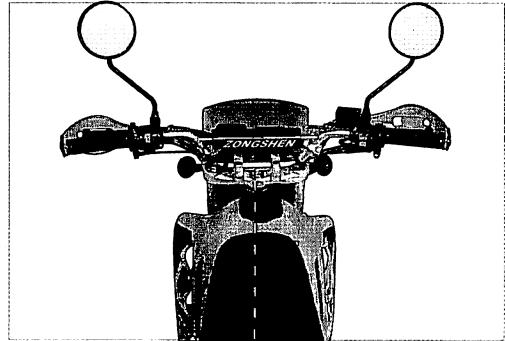

steering handlebar

remove steering handlebar to check bend or deformation, correct or change steering handlebar if necessary.

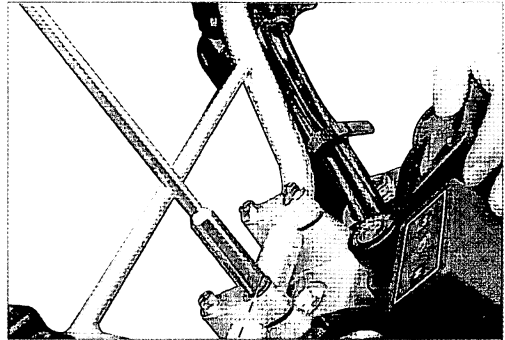

lock bolt

dismantle steering system if necessary. unscrew fixing bolt and lock bolt of steering stem firstly.

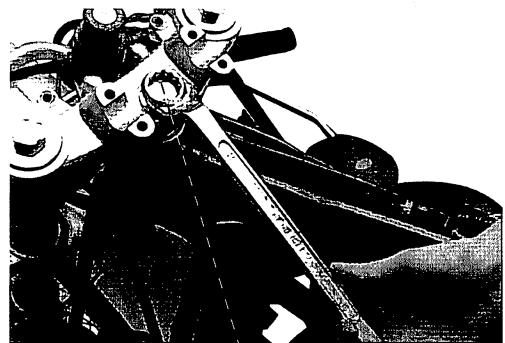

lock bolt

unscrew adjustment nut.

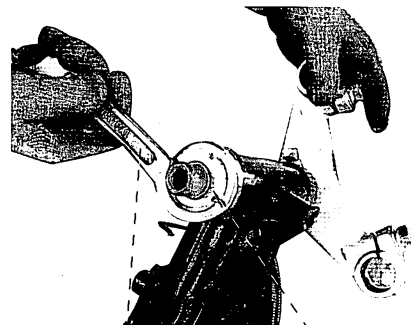

tool

adjustment nut

check wear of steering stem holder ring, retaining ring and steel ball, change if necessary.

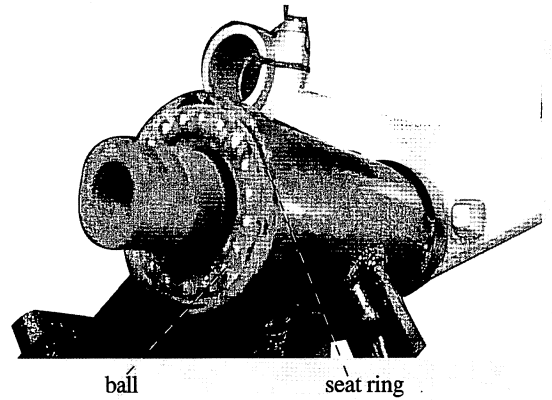

dismantle steering stem to check wear or deformation and change steering stem if necessary.

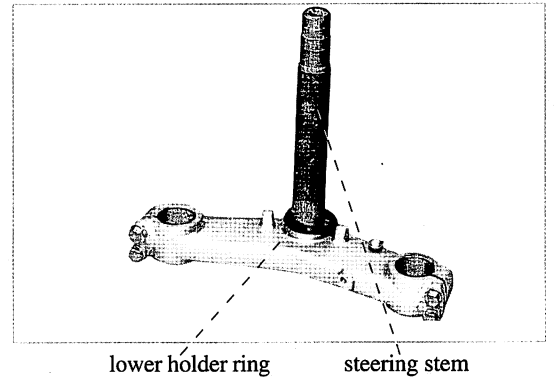

Smear lubricant on upper and lower housing washer when fitting steering stem, then fit steel ball.

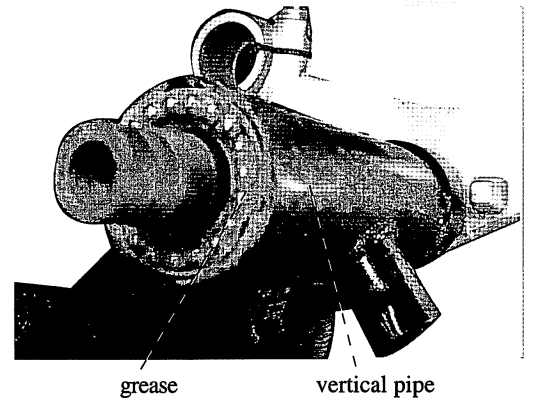

5-2

Maintenance of steering stem

Component description	Damage form	Trouble symptom of component	Trouble symptom of motorcycle	Repair method
Steel ball socket	Over tight of steering stem screw	Too small gap between steel ball and steel ball steering ring	Steering handle is ineffective.	Adjust the steering post screw by tighten wrench till the steering post moves left and right flexibly and no axial shifting between steering post and frame stand pipe
	Over worn, pockmark, indentation, crack and damage of steel ball steering ring ball track	_____	Ineffective steering handle or handle shakes or vibrates during running	Replace complete steel ball steering ring
Steel ball	The steel ball is worn, deformed and damaged.	_____	Ineffective handle steering or handle shakes or vibrates during running	Replace all steel balls
Steering stem	The steering stem is deformed.	The steering stem is deformed.	The steering stem is deformed.	Replace steering stem

unscrew lock bolt of upper connecting plate and check upper connecting plate.

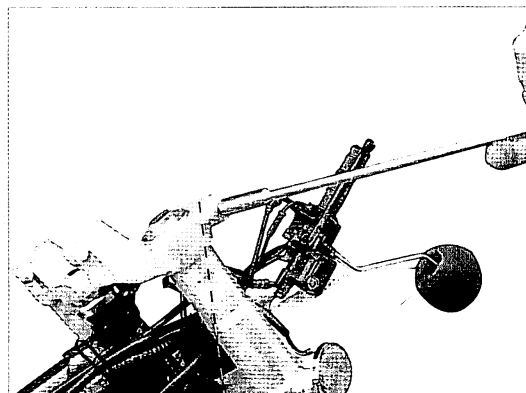

bolt

unscrew lock bolt of lower connecting plate and check lower connecting plate.

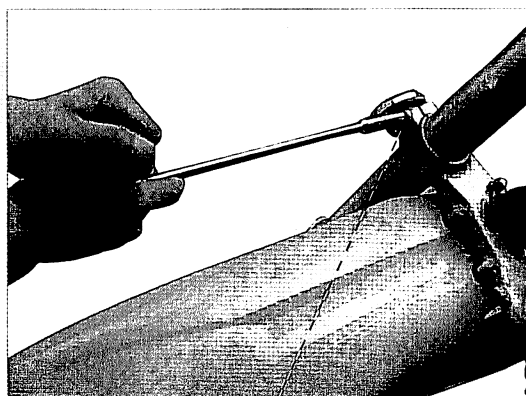

bolt

unscrew fixing bolt of front fender.

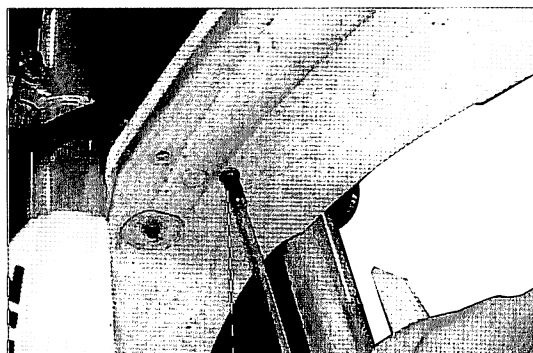

bolt

unscrew fixing nut of front axle and remove front wheel. unscrew front brake plier bolt and remove brake plier.

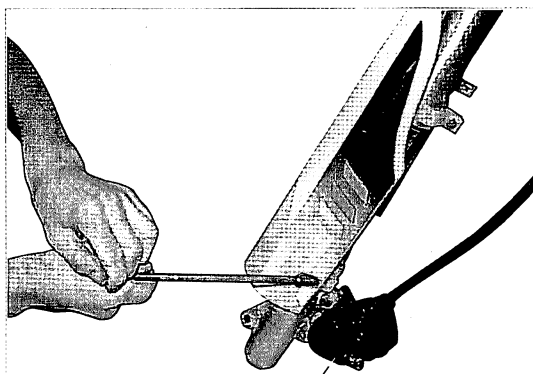

brake plier

remove front shock absorber assembly.

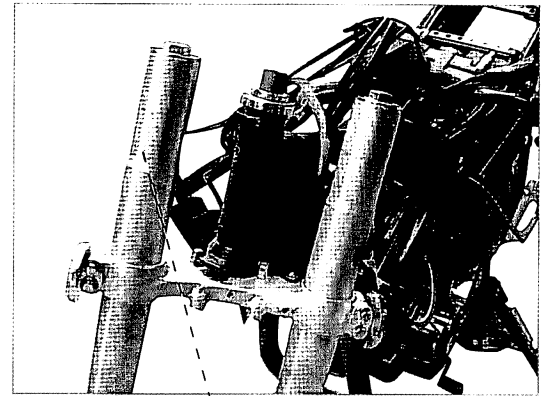

front shock absorber

unscrew oil filling bolt of front shock absorber.

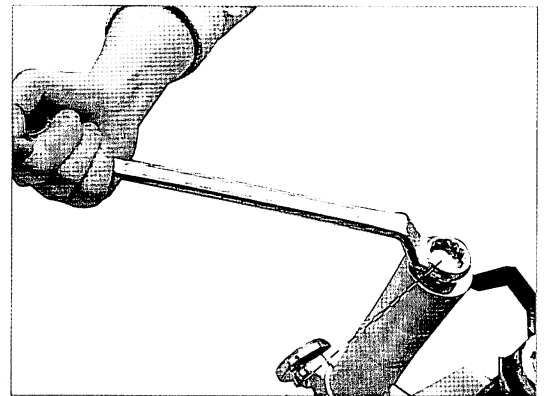

oil filling bolt

drain damping oil to check lubricant and change lubricant if necessary.

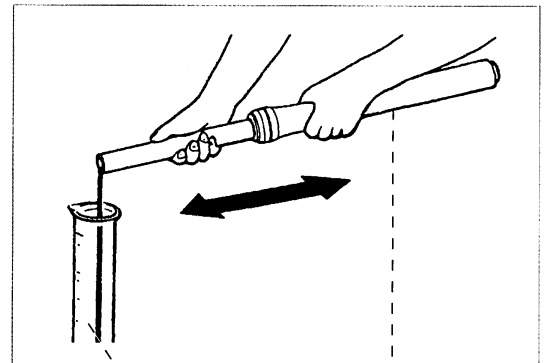

gauge

shock absorber

remove dustproof cover, circlip and oil seal to check wear of oil seal blade and deformation of circlip.

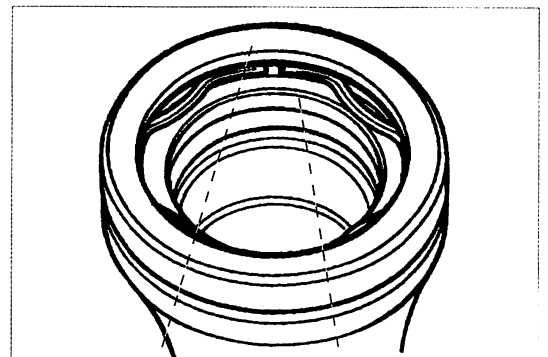

oil seal

circlip

Measure length of shock absorber spring and check bend or deformation of spring. change spring if necessary.

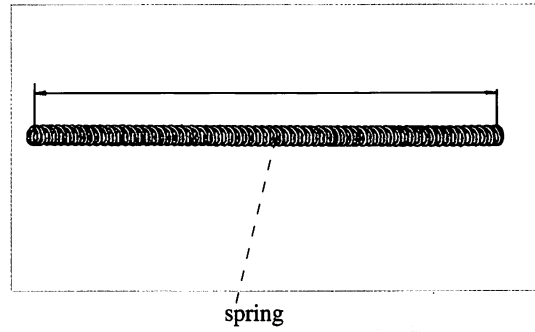

remove return spring to check wear and change return spring if necessary.

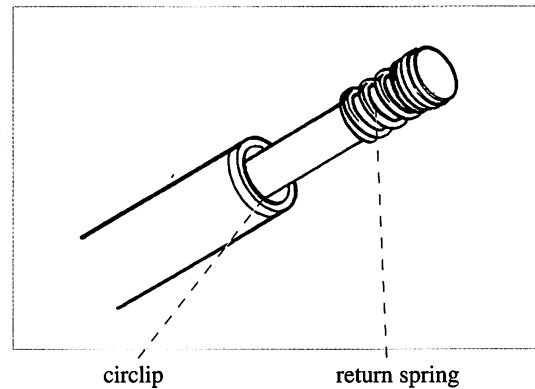

Measure length of return spring and check bend or deformation of spring.

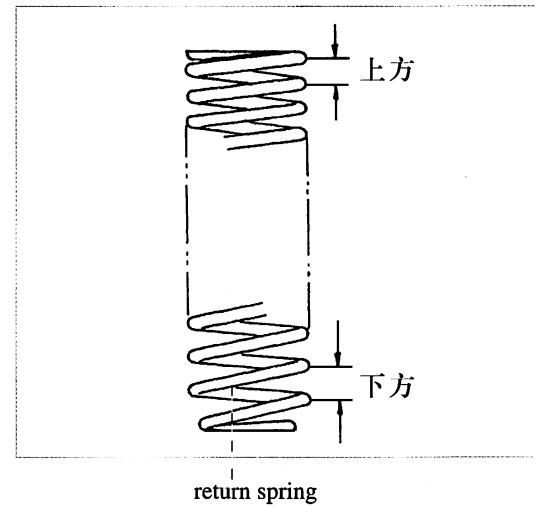

Add oil (200 ± 10)ml based on standard.

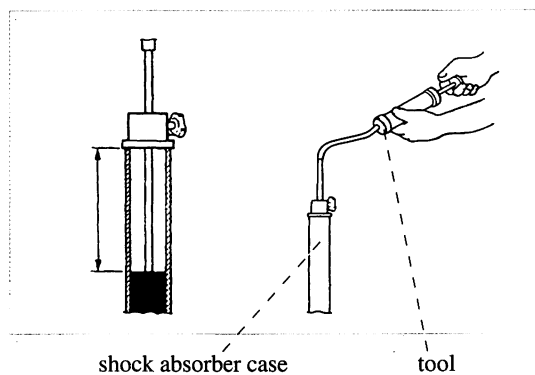

Maintenance of Front Shock Absorber

Component description	Damage form	Trouble symptom of component	Trouble symptom of motorcycle	Repair method
Front shock absorber spring	The elastic force is Insufficient or broken	The elastic force of shock absorber is Insufficient or broken	Front shock absorber is over soft, abnormal sound comes out in case of front absorber working	Replace front shock absorber spring
Front shock strut	Bending and deformation	Front shock strut is bent and deformed	Off-track in running	Correct or replace front shock strut
	Working stroke surface is damaged or scratched	Leakage from oil seal	Leakage at front shock cylinder	Replace front shock strut
	Working stroke surface Cr coating partial is worn out to expose the substrate	Leakage from oil seal	Leakage at front shock cylinder	Replace front shock cylinder
Front shock cylinder	Broken deformed and damaged	Leakage at front shock cylinder	Leakage at front shock cylinder	Replace piston rod
Piston rod	Over worn or damaged	—————	Over soft at front shock cylinder	Replace piston ring
	Piston ring is over worn or damaged	—————	Over soft at front shock cylinder	Replace piston ring
Oil sealing	Cut edge is over worn or damaged or aged	Leakage from oil seal	Leakage at front shock absorber	Replace oil seal
Shock oil	Insufficient oil amount or too little	Insufficient shock oil or too little	Over soft of front shock absorber	Fill shock oil as per the specified stipulat(120 ± 5ml)

Disassemble, disassemble and maintain rear shock absorber

unscrew rear rocker lever nut and check wear of rear rocker lever bush. change bush if necessary.

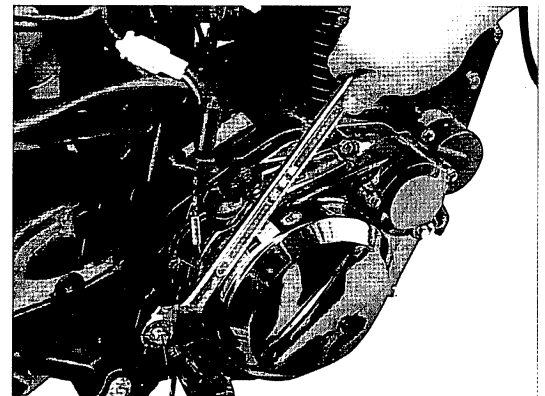

nut

unscrew rear shock absorber bolt and check wear of rear shock absorber bush. change bush if necessary.

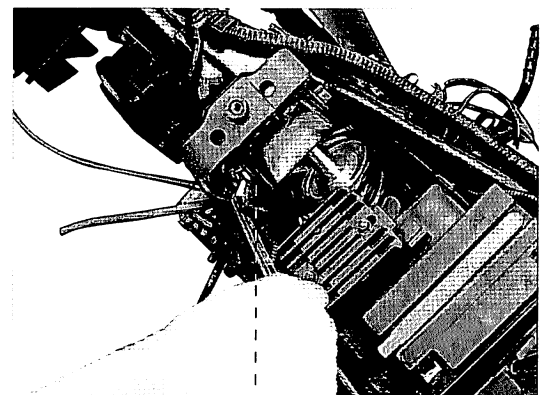

bolt

remove dowel pin and remove bush.

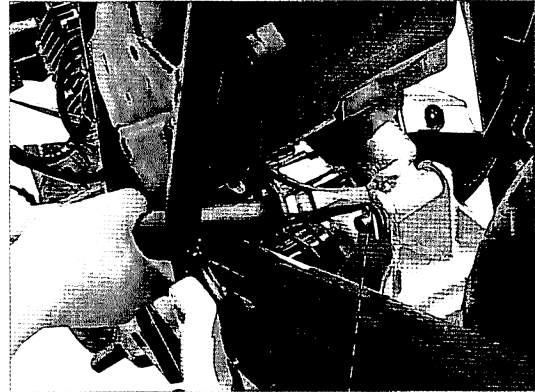

pin

remove rear shock absorber assembly and change rear shocker absorber if necessary.

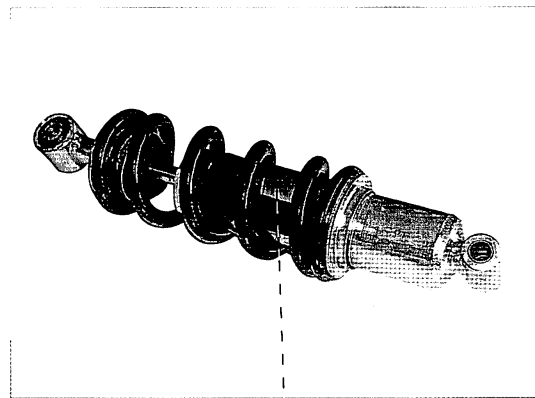

rear shocker absorber

check rear shock absorber and change rear shock absorber if necessary.

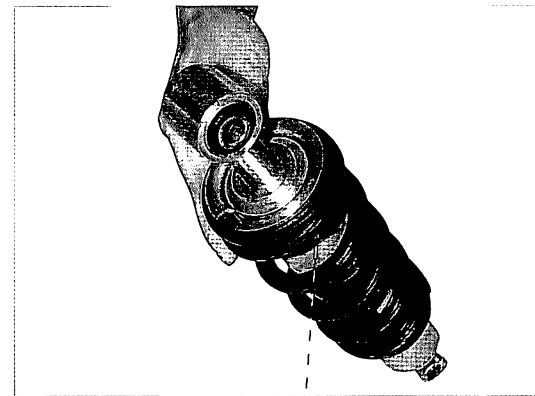

spring

5-4

Maintenance of Rear Shock Absorber

Component description	Damage form	Trouble symptom of component	Trouble symptom of motorcycle	Repair method
Rear shock absorber assembly	Rear shock absorber spring is broken or with insufficient elastic force	Rear shock absorber spring is broken or with insufficient elastic force	Rear shock absorber is over soft or over hard	Replace rear shock absorber spring
	Leakage at rear damper	Leakage at rear damper	Leakage at rear shock absorber, rear shock absorber is over soft	Replace rear damper
	Piston rod on rear damper is bent, deformed or broken	Piston rod on rear damper is bent, deformed or broken	Rear shock absorber is over hard	Replace rear damper
Rear rocker arm	Deformation	The rear rocker arm is deformed	Off-tracking in running	Corect or replace rear rocker arm
	Breakage	The rear rocker is broken	It is impossible to run	Weld or replace rear rocker arm

Maintenance of Wheel

Disassemble, assemble and maintain wheel

Unscrew lock nut of front axle and remove front axle.

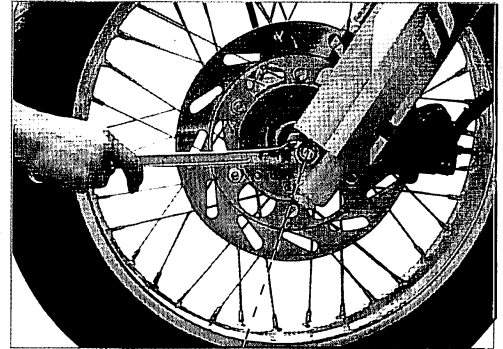

front axle

remove front wheel assembly to check front spoke broken and change spoke then correct rim.

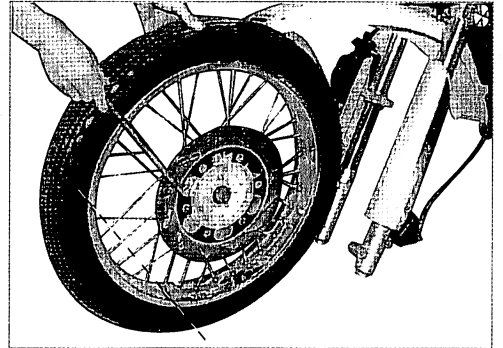

front wheel

remove front axle bush.

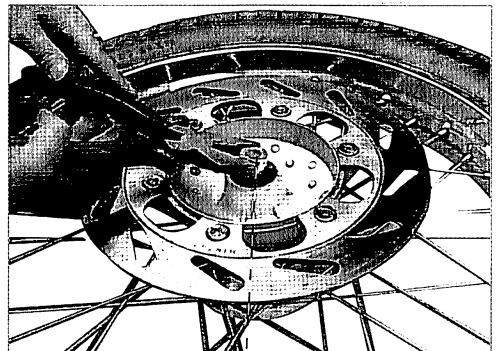

bush

remove oil seal and check wear of oil seal change oil seal if necessary.

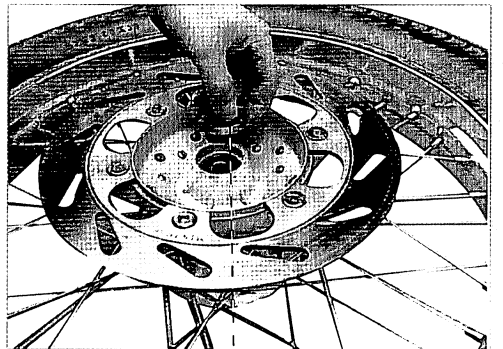

oil seal

check wear of bearing and change front axle bearing if necessary.

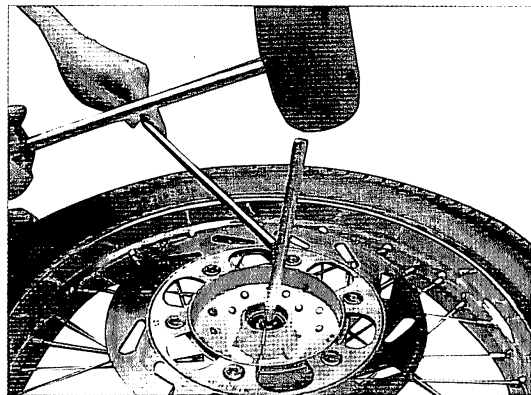

bearing

check wear of speedometer gear and lubricate gear if necessary.

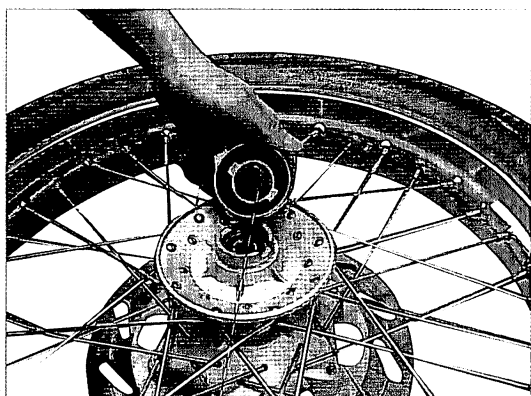

speedometer

unscrew lock nut of rear axle to check rear axle and nut.

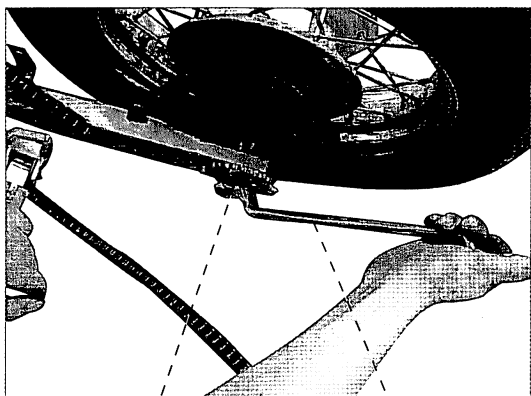

rear axle

tool

remove rear axle and check bend of rear axle, remove rear wheel assembly.

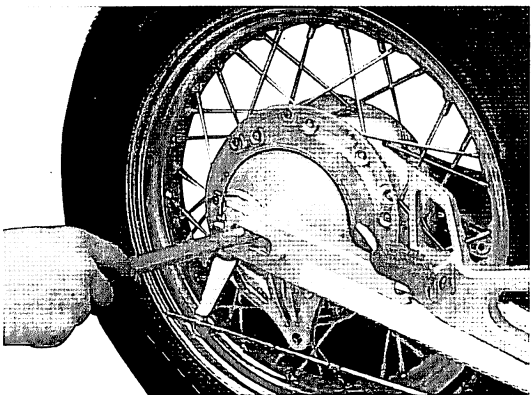

rear wheel

remove rear axle bush and check wear of bush, change bush if necessary.

remove oil seal to check wear and change oil seal if necessary.

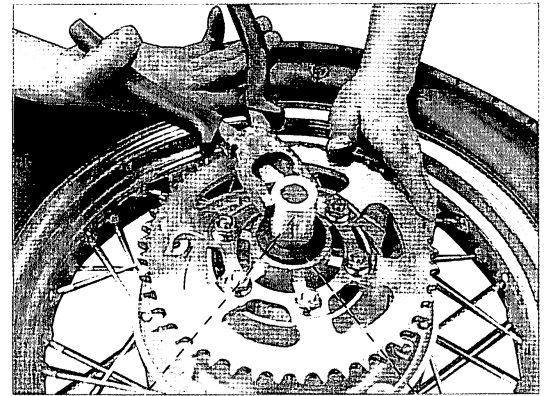

rear axle

oil seal

check wear of rear axle bearing and change rear axle bearing if necessary.

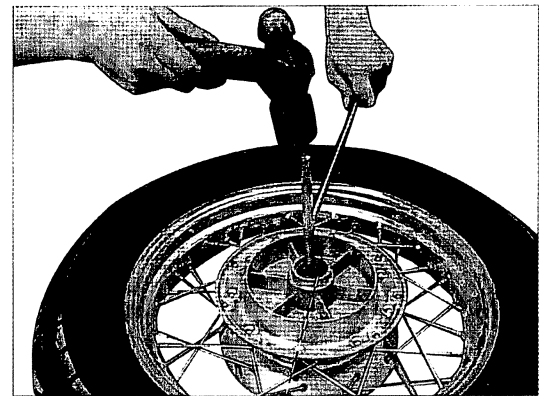

bearing

unscrew rear chain disc bolt and remove sprocket.

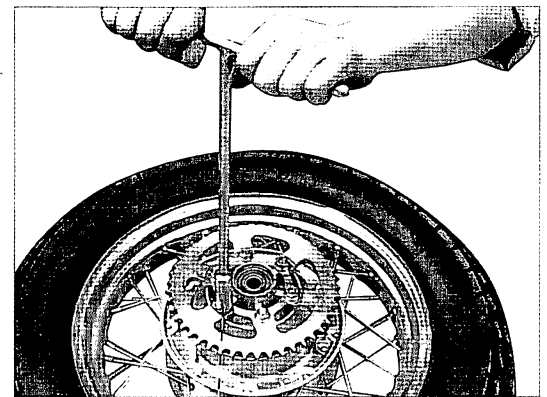

nut

remove rear chain disc bush to check wear and change bush if necessary.

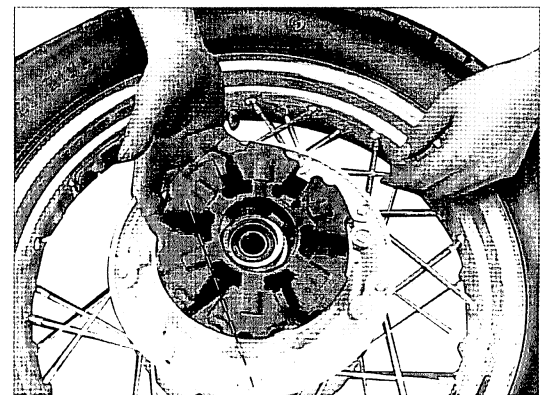

damping rubber

check wear of tire and change rear outer tire if limitation of 2mm is exceeded.

check rear brake hub and remove dirt and sand in rear hub.

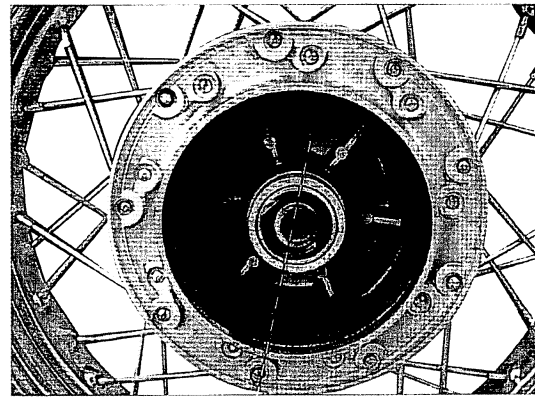

rear hub

5-5

Maintenance of Front and Rear Wheels

Component description	Damage form	Trouble symptom of component	Trouble symptom of motorcycle	Repair method
Front wheel	Front wheel rim is deformed	Front wheel rim is deformed.	Off-tracking in running, steering handle vibrates or shakes in running	Replace front hub
	The hub bearing hole is over worn	The bearing block hole has a loose match with the bearing.	Off-tracking in running, steering handle vibrates or shakes in running	Replace front rim
	Bearing is over worn or damaged.	The axial and radial gaps of bearing inner and outer rings are too big or is insufficient rotation.	Off-tracking in running, steering handle vibrates or shakes in running	Replace bearing
Front tire	The inner tire is pricked or broken	Front tire has very low pressure	Inflexible of direction handle, insufficient engine output	Repair or replace inner tire
	The tire is over worn	_____	It is possible to slip and has a poor slip proof function	Replace outer tire
Speedometer gear box	Gear is damaged.	_____	The indicator of the speedometer fails to move	Replace speedometer gear box
	The gear drive ring is damaged.	_____	The indicator of the speedometer fails to move	Replace speedometer gear box
Rear wheel	Rear rim is twisted and deformed.	Rear rim is twisted and deformed.	Off-tracking in running, rear wheel wobbles in running	Replace rear rim
	Rear brake drum is over worn	_____	Misfunction of rear brake	Replace rear rim
	The hub bearing hole is over worn	The bearing block hole has a loose match with the bearing.	Off-tracking in running, rear wheel wobbles in running	Replace rear rim
	The bearing is over worn and damaged	The axial and radial gaps of bearing inner and outer rings are too big or is insufficient rotation.	Off-tracking in running, rear wheel wobbles in running	Replace bearing
Rear tire	The inner tire is pricked or broken	Rear tire has very low pressure	Inflexible of direction handle, insufficient engine output	Repair or replace inner tire
	The tire is over worn	_____	It is possible to slip and has a poor slip proof function	Replace outer tire

Chapter 6 Maintenance of Control and Brake System

Disassemble, assemble and maintain control system

dismantle right controls and check throttle lever.
clean or change if necessary.

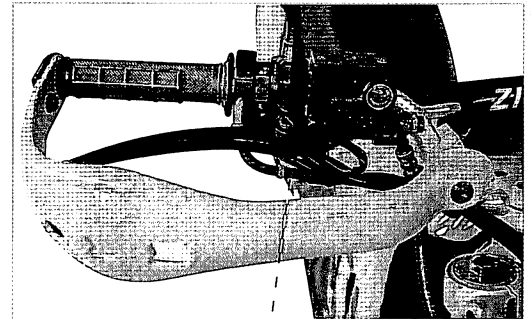

nut

remove throttle cable to check wear and lubricate it.

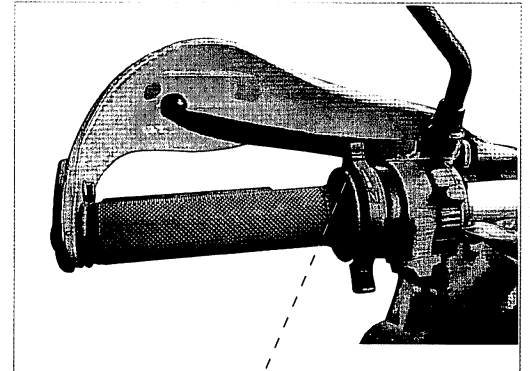

throttle cable

remove throttle cable to check wear of core and clean or lubricate it.

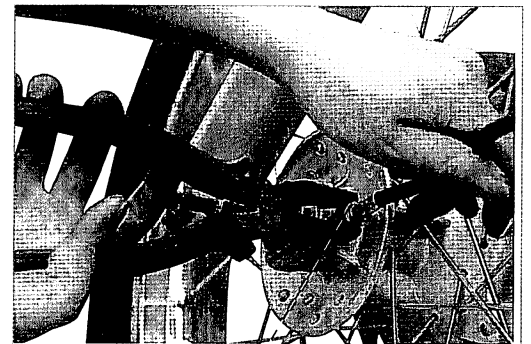

cable

remove clutch cable, throttle cable and odometer cable to clean and lubricate cable.

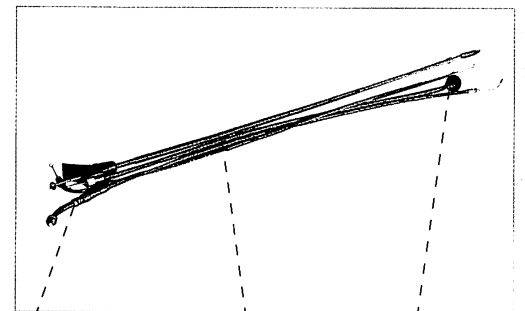

clutch cable

throttle cable

odometer cable

check free stroke of front brake lever and adjust free stroke by professional if stroke is out of range. the stroke should be 10mm-20mm.

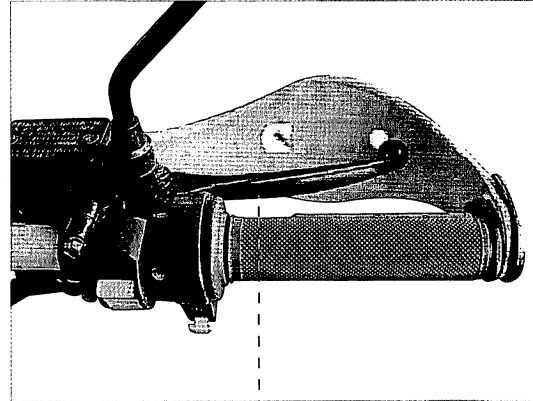

front brake lever

check front brake oil cup and add brake oil if below lower line. check oil leakage from oil tube and change brakes system if necessary.

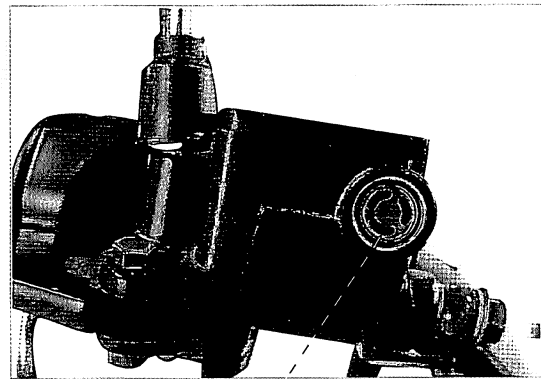

oil cup

adjust clutch cable and check clutch disengagement.

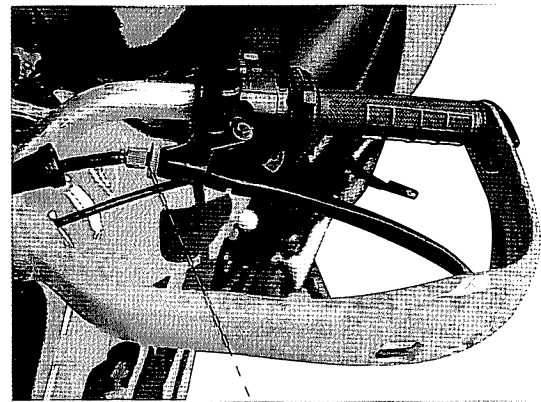

adjustment nut

adjust clutch free stroke at clutch cable bracket if can not be adjusted at clutch lever.

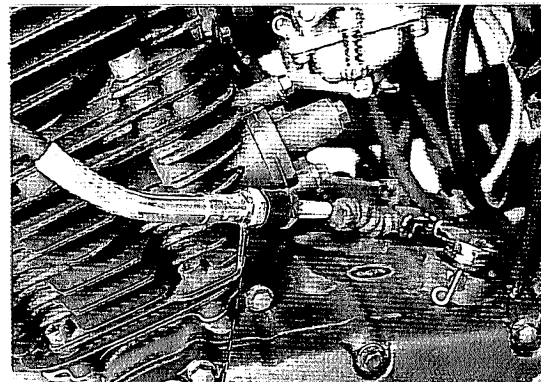

adjustment nut

check disengagement and engagement of clutch,
adjust free stroke to 10mm-20mm.

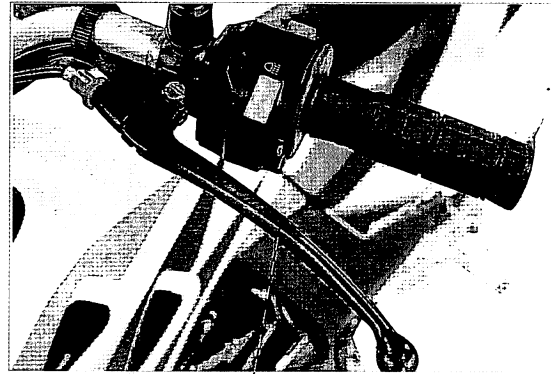

clutch lever

check free stroke of rear brake pedal and adjust
rear free stroke if necessary.

free stroke of rear brakes pedal should be 20mm-
30mm.

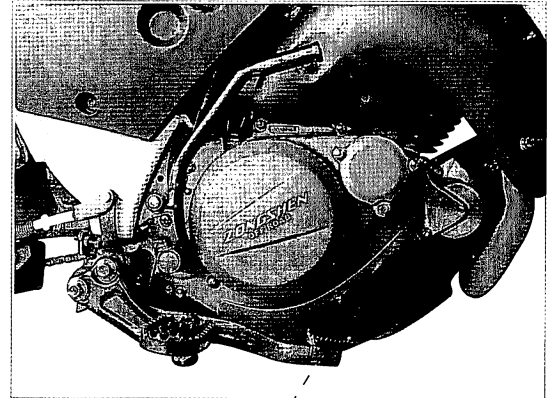

rear brake pedal

free stroke of rear brake pedal can be adjusted
by adjustment nut

rear brake light switch also be adjusted while
adjusting free stroke of rear brake pedal.

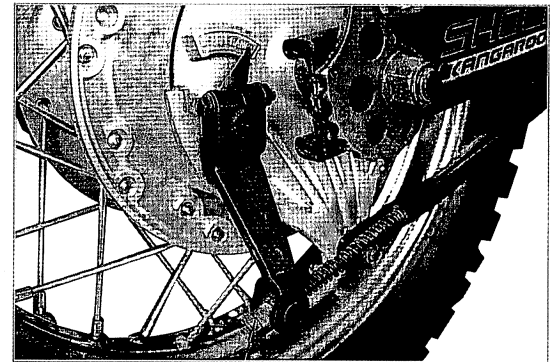

adjustment nut

6-1

Maintenance of Control system

Component description	Damage form	Trouble symptom of component	Trouble symptom of motorcycle	Repair method
Steering handle	The steering handle is deformed.	The steering handle is bent and	Off-tracking in running,	Correct or replace steering handlebar
	Over small of the free stroke	—————		Readjust the free stroke
	Over big of the free stroke	—————	failure of rear	Readjust the free stroke
front brake con	The steel cable is ineffective	cable is impossible to control	Clutch slipping or is not	Clean, lubricate or replace control steel cable
choke and throttle	The steel cable is ineffective	choke and throttle are impossible to control or return to the	The clutch is slipping or not	Clean, lubricate or replace
	control cable is broken	—————	The clutch is not fully discon	Readjust the free stroke
Rear brake pedal	The free stroke is over small.	—————	Misfunction of rear brake	replace control cable
	The free stroke is over large	—————	Misfunction of rear brake	Readjust the free stroke

Maintenance of Brake System

Disassemble, assemble and maintain brake system

Check brake oil if front brake oil cup and add brake oil if below lower line.

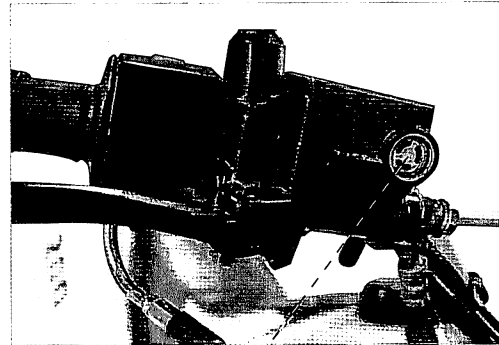

brake oil cup

unscrew front brake piler bolt and remove front brake piler assembly.

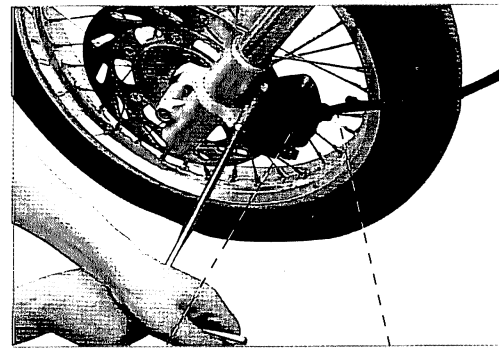

front brake

oil hose

check wear of front brake shoe and change brake shoe if necessary.

the limitation of brake shoe should be 2mm.

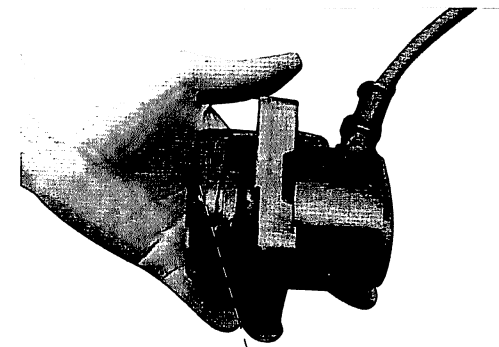

front brake disc

check oil leakage from front brake oil pipe and change oil pipe if necessary.

Caution: maintenance of front brake oil pipe should be done by professional.

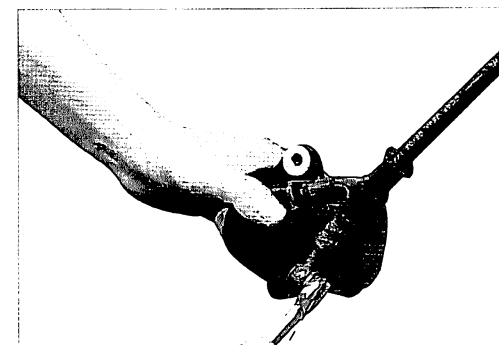

bolt

unscrew front axle nut and remove front wheel assembly.

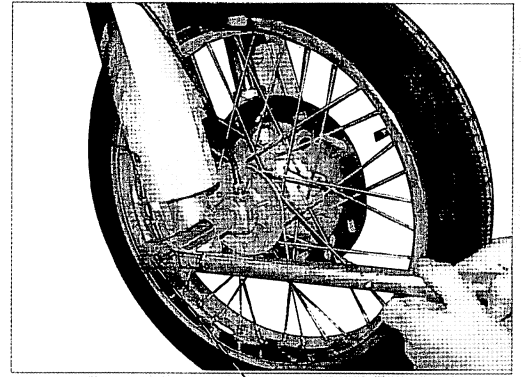

nut

unscrew front brake disc bolt and remove front brake disc.

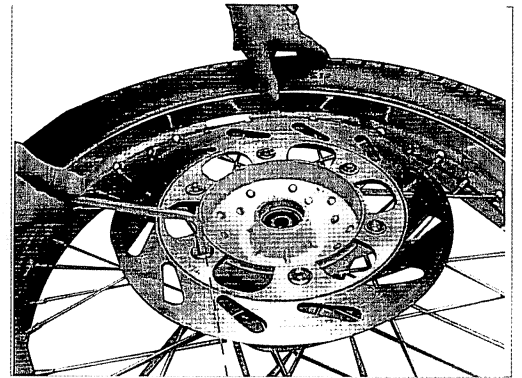

bolt

check deformation of front brake disc and measure thickness of front brake disc, the limitation is -0.3mm .

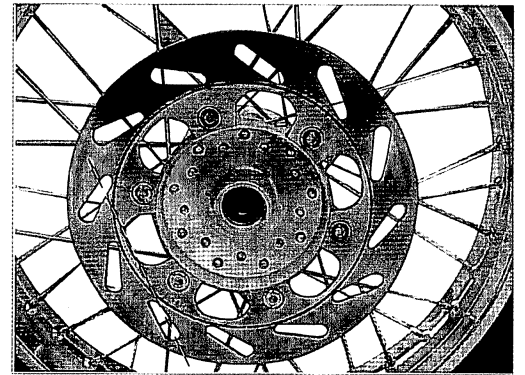

front brake disc

remove drive chain and dismantle rear axlenut.

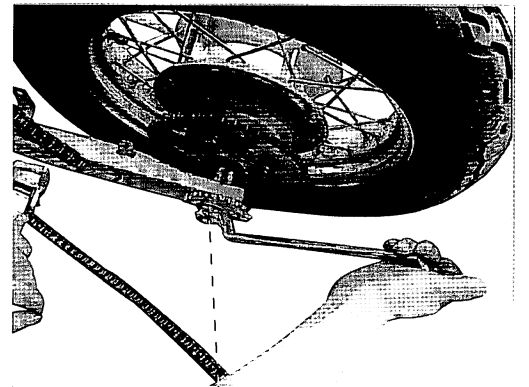

rear axle nut

unscrew rear brake disc fixing nut and adjustment nut, remove rear axle assembly.

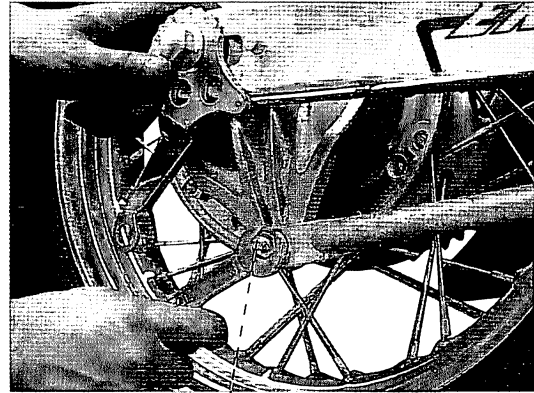

nut

remove rear wheel assembly and remove rear brake disc.

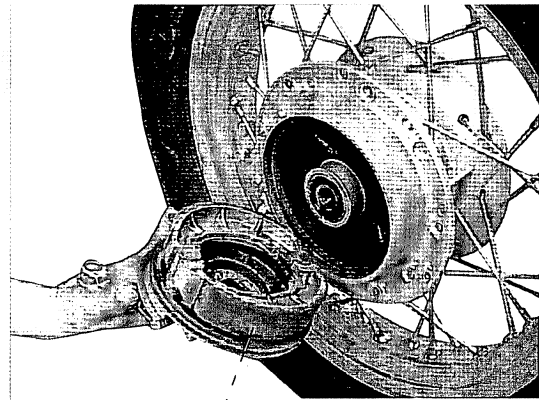

rear brakes

remove rear brake shoe.

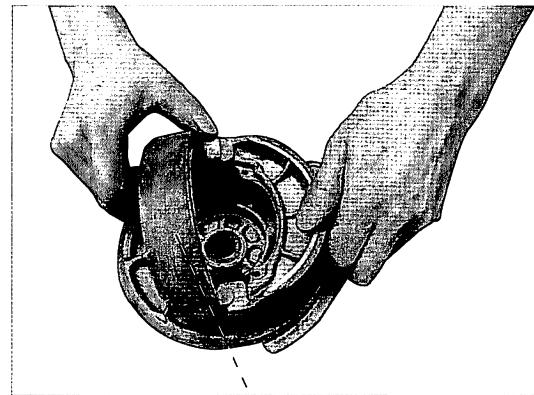

rear brake shoe

check rear brake shoe and the limitation is 2.0mm. change rear brake shoe if necessary.

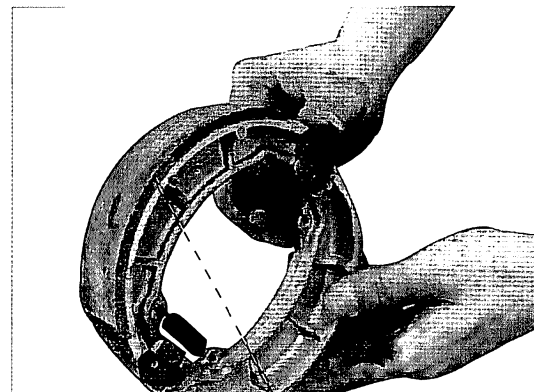

rear brake shoe

check wear of rear brake cam and change rear brake cam if necessary.

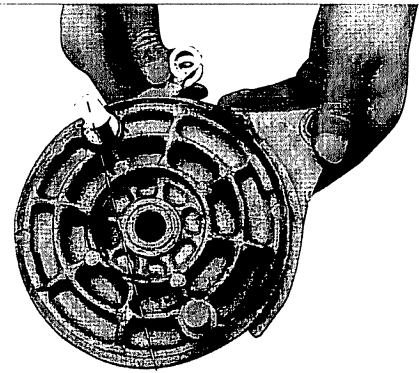

rear brake cam

check operation of rear swing lever and remove swing lever and rear brake cam, then lubricate cam.

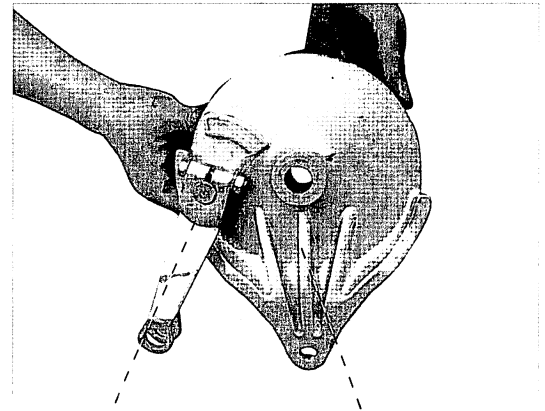

rear brake swing lever

rear brake cover

6-2

Maintenance of front and rear brake

Component	Damage form	Trouble symptom of component	Trouble symptom of motorcycle	Maintenace method
front brake main pump assembly	brake liquid is insuffeicient	brake liquid is insuffeicient	lose effect	fill DOT3 or DOT4 to upper limit mark
	dirty brake liquid	_____	lose effect	replace brake liquid
	surface of wall is damaged	_____	lose effect	repalce main pump
	wall was over worn	_____	lose effect	repalce main pump
	oil case is cracked	oil leakage	lose effect	repalce main pump
	piston surface is cracked	_____	lose effect	repalce main pump piston
	piston is damaged	_____	lose effect	repalce main pump piston

Maintenance of front and rear brake

Component	Damage form	Trouble symptom of component	Trouble symptom of motorcycle	Maintenace method
front brake calliper assembly	air entry into oil pipe	_____	brakes lose effect	exhaust front brakes pipe
	oil pipe is broken	oil leakage brakes pipe	brakes lose effect	replace brake oil tube
	front brake oil pipe is clogged	oil leakage brakes pipe	brakes lose effect	clean or replace brake oil tube
	wall is broken or cacked	_____	brakes lose effect	replace front brake calliper
	wall is over worn	_____	brakes lose effect	replace front brake calliper
	front brake caliper is broken	oil leakage from front brakes	brakes lose effect	replace front brake calliper
	seal ring is broken or worn	oil leakage	brakes lose effect	replace front brake calliper
	friction plate is over worn	_____	brakes lose effect	replace brake fritction disc
	surface of piston is dmgaged or worn	_____	brakes lose effect	replace brake caliiper piston
	guid pin is clipped	_____	brakes lose effect or fric-tion disc can not return	clean and lubricate guide pin
front brake disc	over worn	_____	brakes lose effect	replace front brake disc
	deformed	_____	brakes lose effect	replace front brake disc
rear brake shoe	friction disc is over worn	_____	lose effect	replace brake shoe
	brake shoe surface is worn	_____	lose effect	replace brake shoe
	interface of brake shoe and brake dum is small	_____	lose effect	replace brake shoe friction disc
	shoe spring is broken	_____	brakes show can not re-tur	replace return spring
brake cam	local rusted	operate inflexible	brakes lose effect or brakes show can not return	clean and lubricate brake cam
	brake cam	over worn	brakes lose effect	replace brake cam

Chapter 7 Maintenance of Electrical Part and Meter

Maintenance of Charging System

Disassemble, disassemble and maintain charging system

turn on ignition switch and check signal indicators operation, check charge system if necessary.

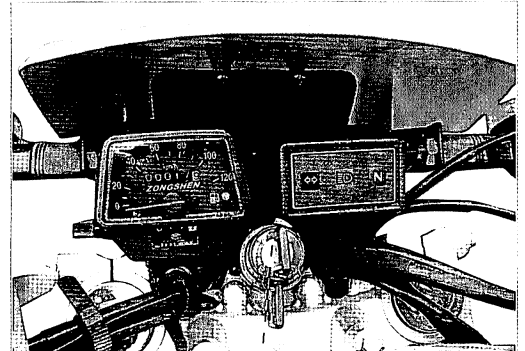

ignition switch

remove fuse to check and change same type fuse.

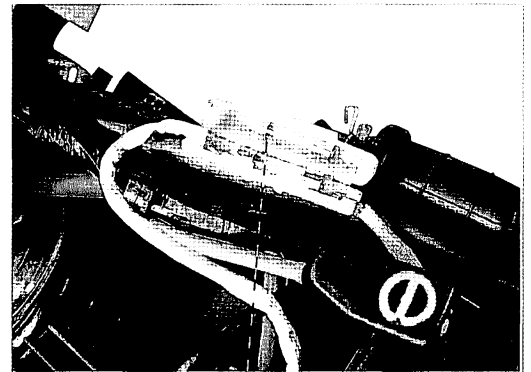

fuse

dismantle battery and measure voltage, remove battery to charge if below 12V.

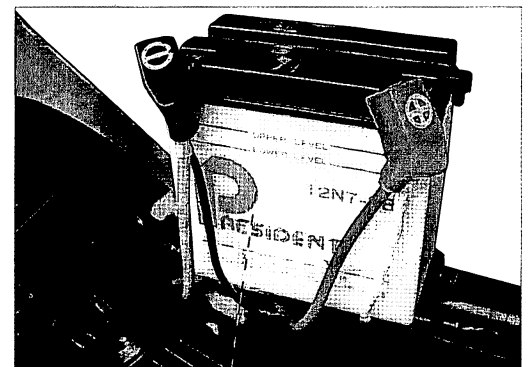

battery

dismantle magneto charging loop socket and measure short circuit of charge loop, change charge loop if necessary.

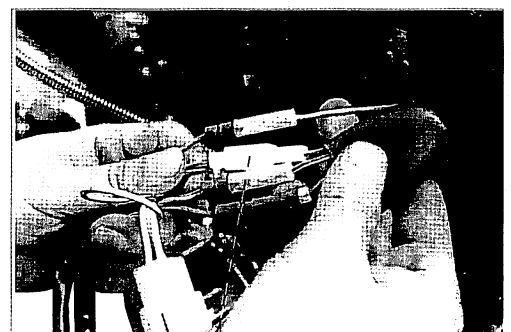

charge loop connector

measure output voltage of rectifier and change rectifier if below 13.0V. the output voltage should be 13.0V-14.5V.

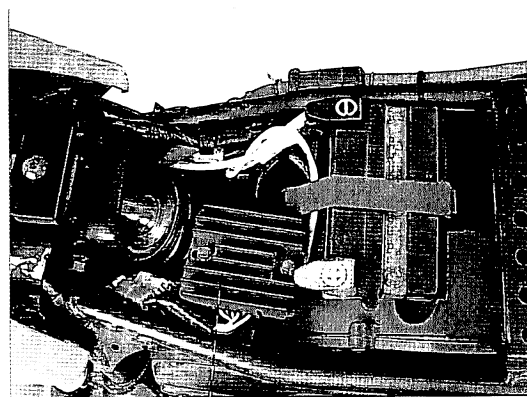

rectifier

check loose or rust of charge circuit cathode and tighten or maintain circuit if necessary.

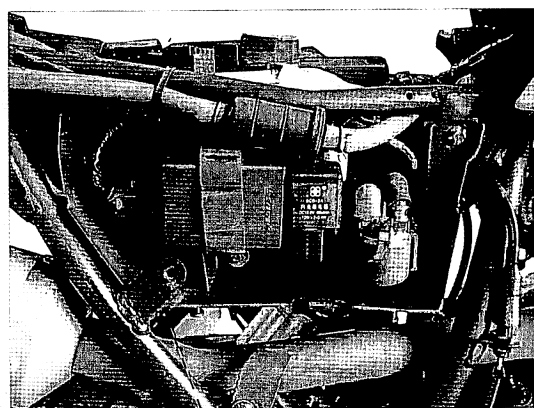

cathode

unscrew left crankcase cover bolt and remove left crankcase cover.

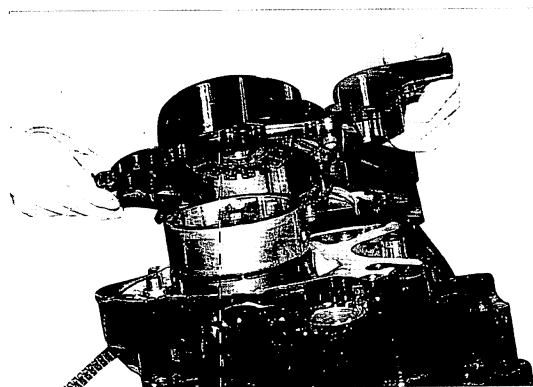

left crankcase cover

remove left crankcase cover and check wear of magneto stator, change stator if necessary.

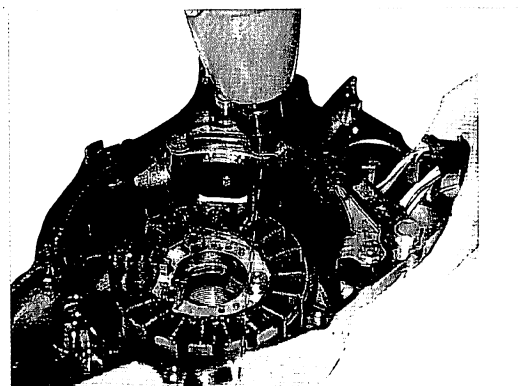

bolt

Check if magnetic rotor demagnetize and dismantle starting clutch, replace magnetic rotor.

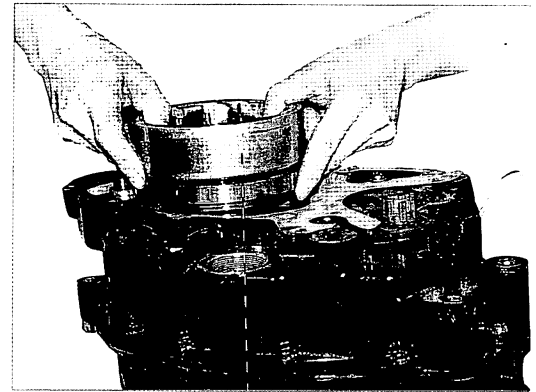

magneto rotor

7-1

Maintenance of Charging System

Component description	Damage form	Trouble symptom of component	Trouble symptom of motorcycle	Repair method
Magnetic generator	Lighting coil is short circuit.	The lighting coil has insufficient output voltage	Insufficient battery charging	Replace lighting coil
	Lighting coil circuit is broken. (the resistance value is ∞).	The lighting coil has no output voltage	Insufficient battery charging, malfunction of signal system	Replace lighting coil
Rectifying regulator	Damaged.	Rectifying regulator is broken circuit or short circuit	Not charging or insufficient battery charging, the illuminating light is dim or out of service, illuminating light is easy to burn out	Replace rectifying regulator
Battery	The battery is damaged.	No power output.	The starter motor is not running	Replace battery
	The storage time is too long and insufficient electrolyte	There is insufficient power or the voltage is too low.	The starter motor is not running or running insufficiently, the signal system is out of work	Complement charging or replace battery.

Maintenance of Ignition System

Disassemble, assemble and maintain ignition system

Turn on ignition switch to check operation of vehicle and check charge system if vehicle can not be started.

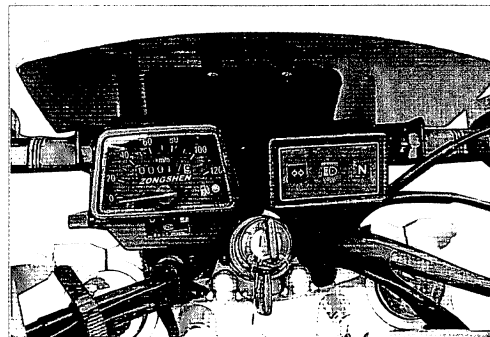

ignition switch

Start motorcycle by kick lever or press electric starter and run engine.

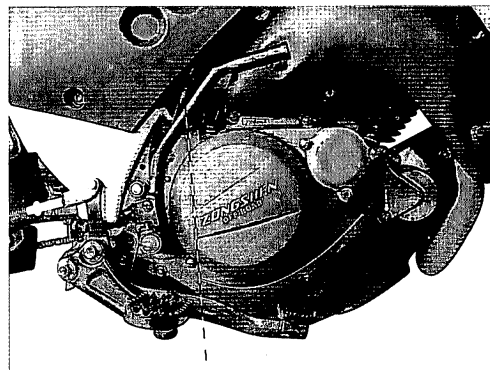

kick lever

check sparking of high tension ignition coil and check ignition system if abnormal.

the output voltage should be above 10,000 volt, spark should be in blue.

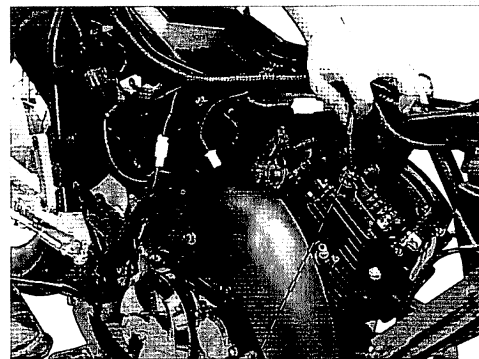

sparkling experiment

Remove spark plug and check cylinder pressure dismantle engine to check if insufficient pressure.



spark plug

check short circuit of spark plug cap electrode if normal and change spark plug cap if necessary.

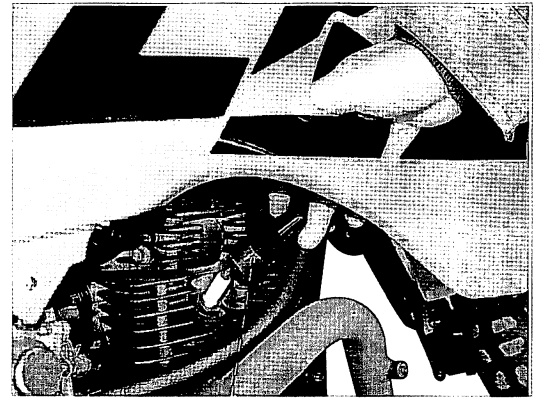

spark plug cap

check if there are carbon deposit on spark plug or spark plug clearance is over large, adjust clearance to 0.6mm-0.7mm.

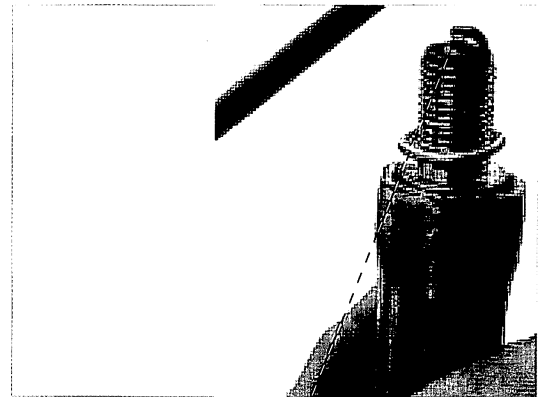

spark plug

remove connector of ignition coil and trigger coil, check ignition loop and trigger coil by multimeter.

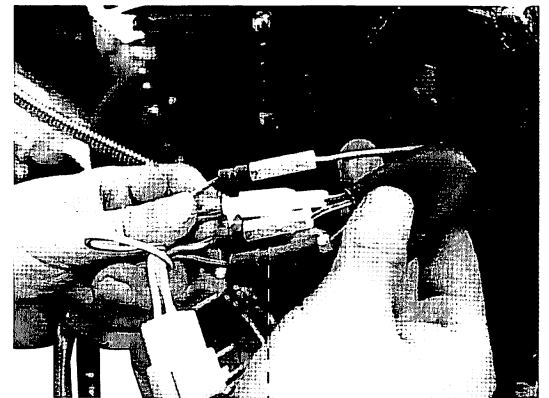

connector

remove C.D.I. connector and check resistance between Black and Red wire of ignition switch. change if abnormal.

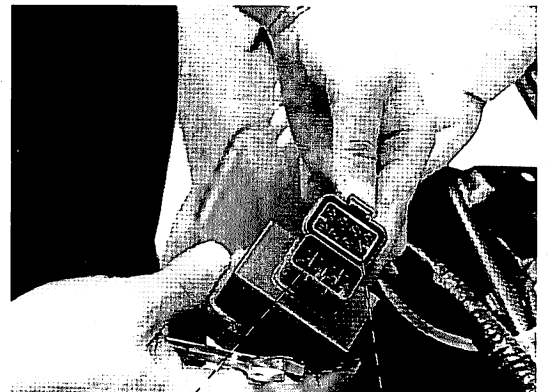

C.D.I

connector

dismantle C.D.I.outlet and check high tension loop. change high tension loop if necessary.

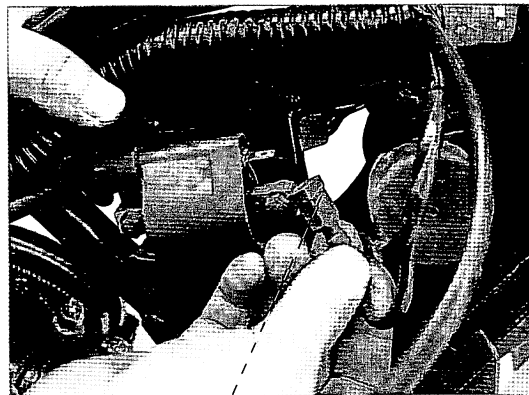

C.D.I outlet

dismantle left crankcase cover to change ignition loop and trigger loop if abnormal.

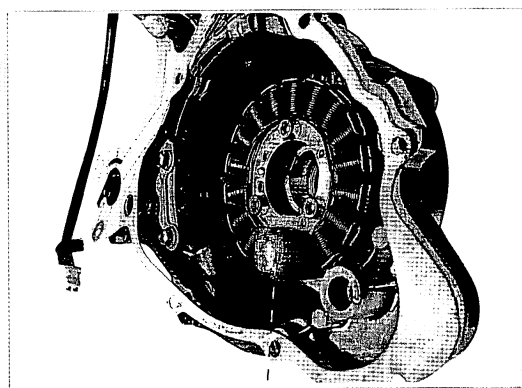

ignition loop

7-2

Maintenance of ignition system

description	Damage form	Trouble symptom of component	Trouble symptom of motorcycle	Maintenance method
ignition power loop	short circuit	Weak or no sparkover of the spark plug electrodes	difficult to start or can't start , insufficient engine power and unstable idle speed	change ignition power loop
	broken circuit (∞)	No sparkover of the spark plug electrode.	The engine does not start.	change ignition power loop
Trigger coil	Short circuit	Weak or no sparkover of the spark plug electrodes	difficult to start or can't start , insufficient engine power and unstable idle speed	Replace trigger coil
	Broken circuit (resistance value ∞)	No sparkover of the spark plug electrode.	The engine does not start.	Replace trigger coil
Ignition switch	Short circuit	No sparkover of the spark plug electrode.	The engine does not start.	Replace ignition switch
	Broken circuit (resistance value ∞)	_____	The engine does not stop.	Replace ignition switch
CDI ignition unit	Damage	No sparkover of the spark plug electrode.	The engine does not start.	Replace CDI ignition unit
Ignition coil	Short circuit	Weak or no sparkover of the spark plug electrodes	difficult to start or can't start , insufficient engine power and unstable idle speed	Replace ignition coil
	Broken circuit (resistance value ∞)	No sparkover of the spark plug electrode.	The engine does not start.	Replace ignition coil

Maintenance of signal system

turn on ignition switch to check indicator and check signale system as follows.

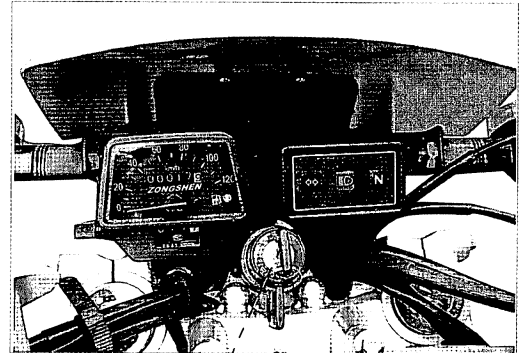

ignition switch

dismantle battery and measure voltage, remove battery to charge if below 12V.

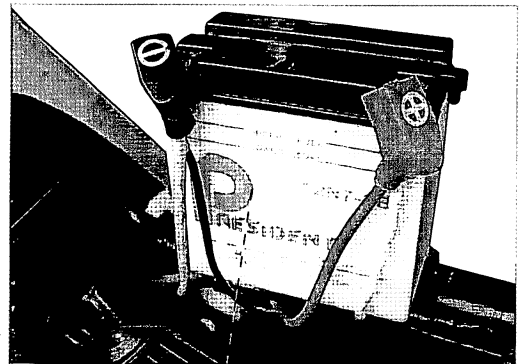

battery

dismantle charging loop socket and check short circuit of charging loop. change magneto charge loop.

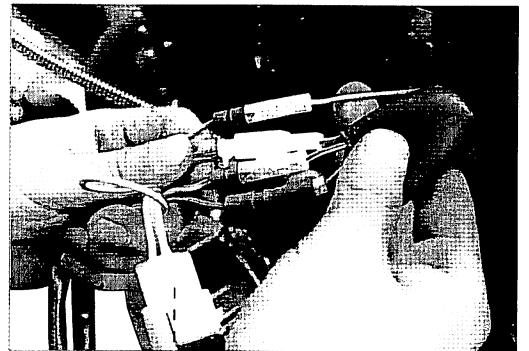

socket

check rectifier by multimeter.

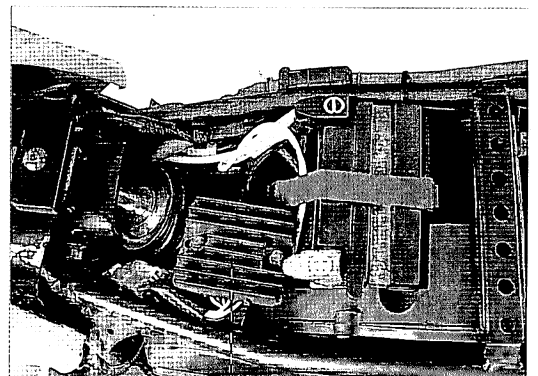

rectifier

dismantle fuse to check and change same type fuse if necessary.

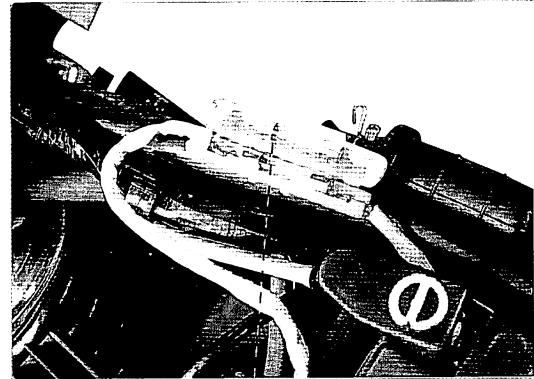

fuse

dismantle signale system falsher socket and check short circuit of falsher, change falsher if necessary.

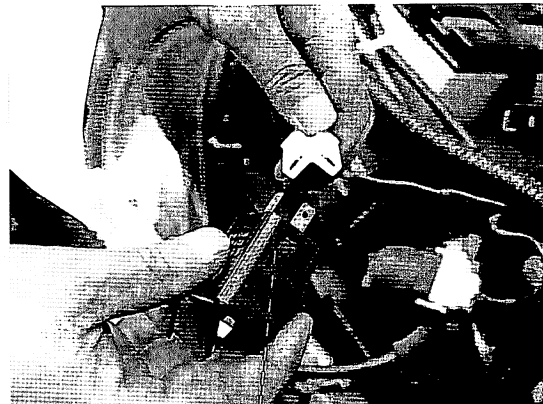

flasher

dismantle left controls switch and check rust or contact of turn indicator switchm repair or change left controls switch if necessary.

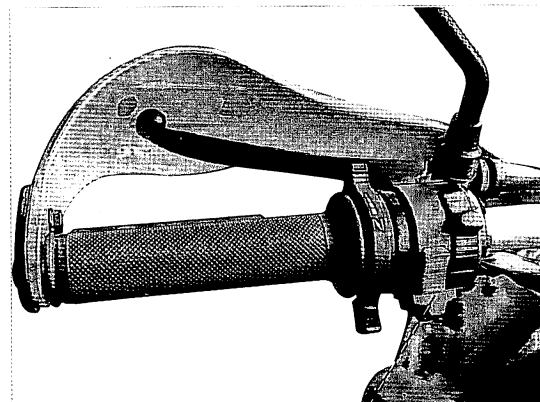

signale indicator switch

check turn light bulb and change bulb if necessary.

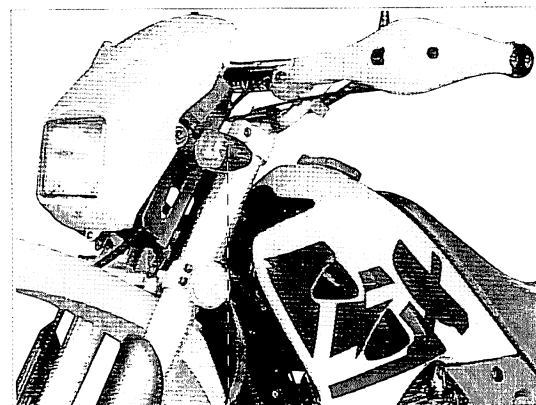

bulb

check contact of brake light socket and tail light socket, tighten socket if necessary.

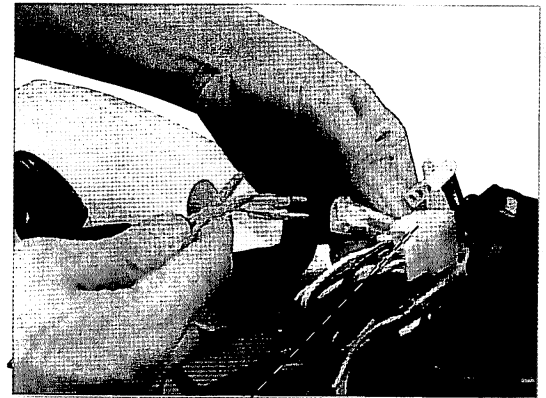

socket

check operation of brake light and adjust or change brake light switch if necessary.

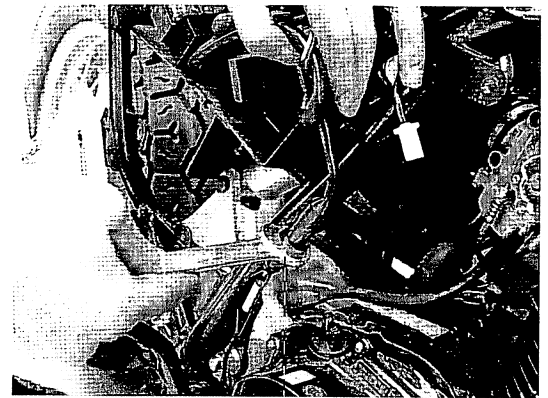

rear brake light

check tail light bulb and brake light bulb, change bulb if necessary.

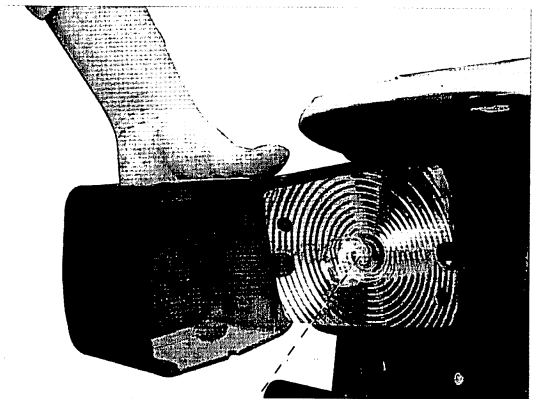

bulb

check rust or contact of horn switch and repair or change left controls holder if necessary.

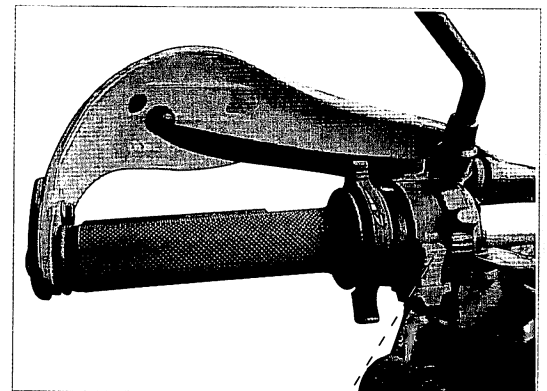

horn switch

adjust horn sound or change same type horn if necessary.

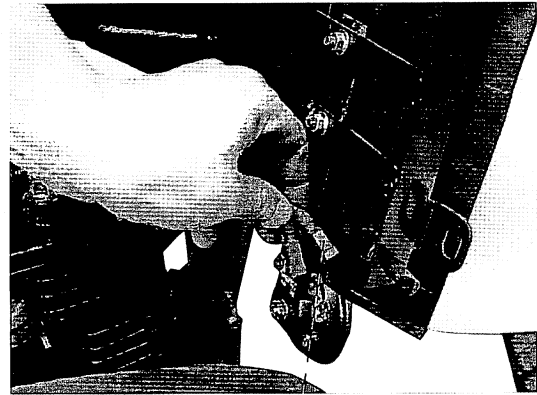

horn socket

check contact of neutral indicator socket.

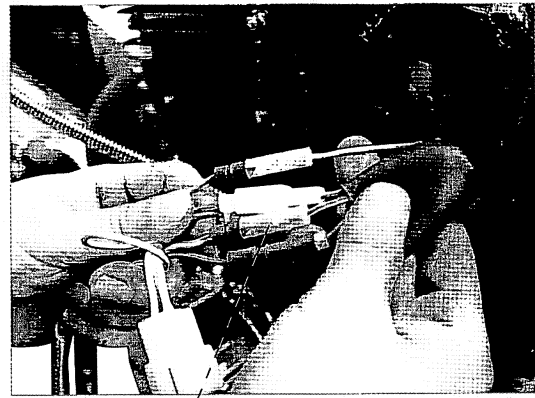

neutral indicator socket

7-3

Maintenance of Signal System

Component description	Damage form	Trouble symptom of component	Trouble symptom of motorcycle	Repair method
Winker	Filament is burnt out	Winker bulb filament is burnt out	Winker is out of work	Replace winker bulb
Winker switch	Poor connection of inner contact	Poor connection of winker switch inner contact	Winker is out of work	Repair or replace winker switch
Flasher	Inner burn out	Flasher inner part is burnt out	Winker is out of work or not flashing	Replace flasher
Brake light switch	Inner contact is not to return to the position or damaged	Inner contact is not to return to the position or damaged	Braking light is on all the time or out of work	Replace braking light switch
Rear light/brake light	The light filaments of rear light and braking light are burnt out	The light filaments of rear light and braking light are burnt out	Rear light/braking light is out of work	Replace rear light/braking light
Horn button	Poor connection of inner contact or damaged	Poor connection of horn button inner contact or damaged	Electric horn is out of work or has abnormal sound	Repair or replace horn button
Electric horn	Inner ablation or damaged	Electric horn inner part is burn out or damaged	Electric horn is out of work or has abnormal sound	Replace electric horn
Neutral switch	Poor connection of switch	The neutral indicator switch has poor connection.	The neutral indicator is out of work.	Replace neutral switch
Neutral indicator	The filament is burnt out.	The neutral indicator filament is burn out or damaged	The neutral indicator is out of work.	Replace neutral indicator

Maintenance of Illuminating System

Disassemble, assemble and maintain illuminating system

turn on ignition switch to check headlight.

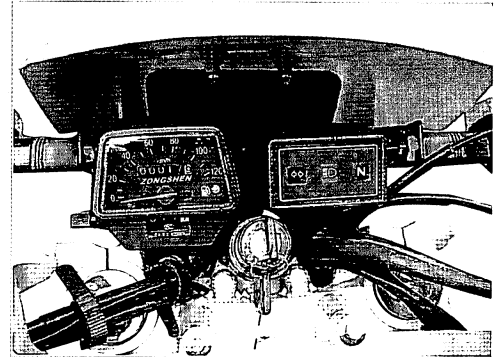

ignition switch

Check battery electrolyte and add electrolyte then charge if below lower line.

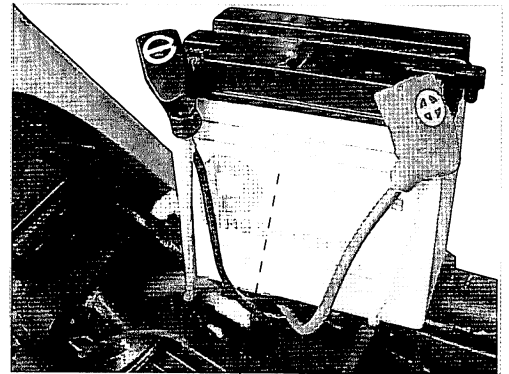

battery

measure output voltage of rectifier and change rectifier if below 13.0V. the output voltage should be 13.0V-14.5V.

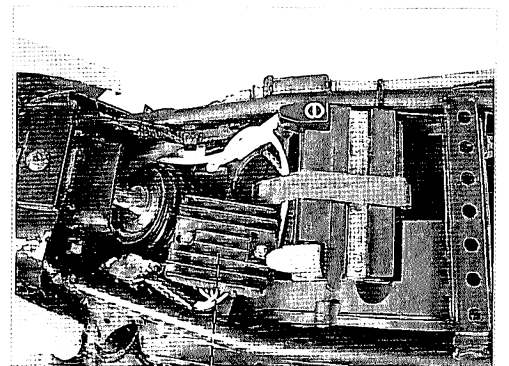

rectifier

remove charge loop socket and measure short circuit of charge loop, change charge loop.

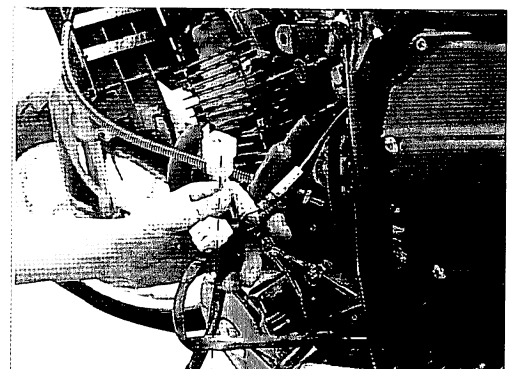

socket

dismantle battery and measure voltage, remove battery to charge if below 12V.

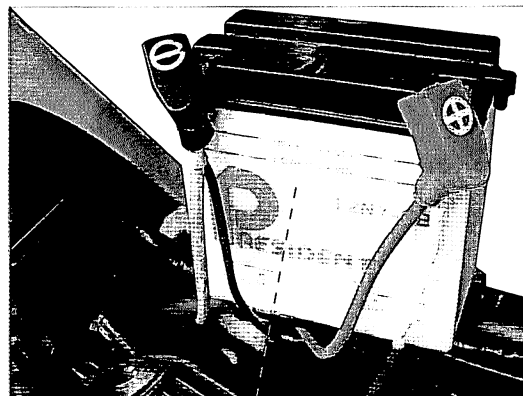

battery

remove fuse to check and change same type fuse.

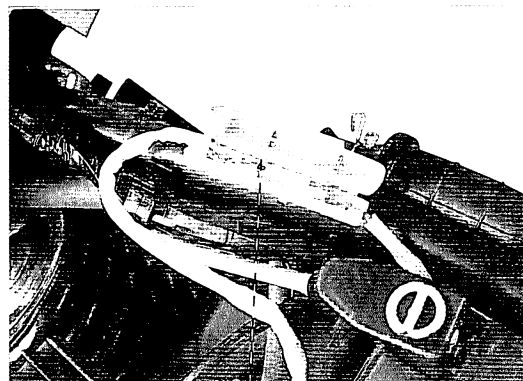

fuse

dismantle left controls switch and check rust or contact of headlamp, change left controls switch if necessary.

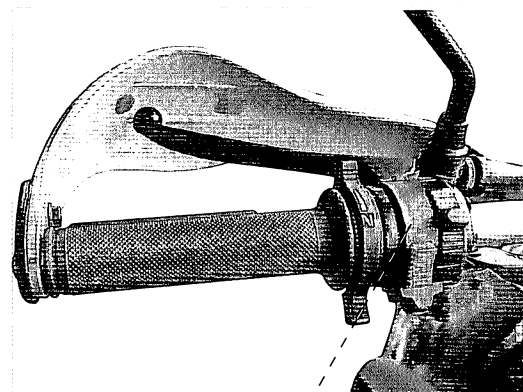

left controls switch

unscrew fixing bolt of headlamp mask and remove headlamp.

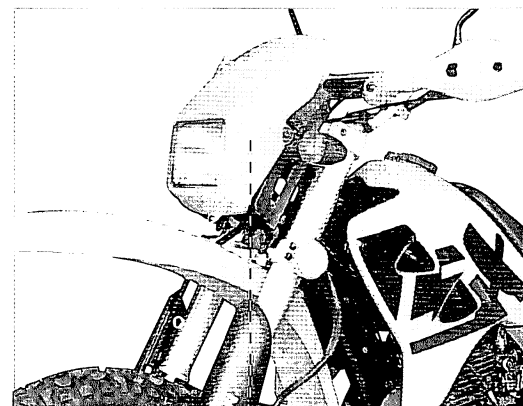

headlamp mask

remove headlamp switch socket to check socket.

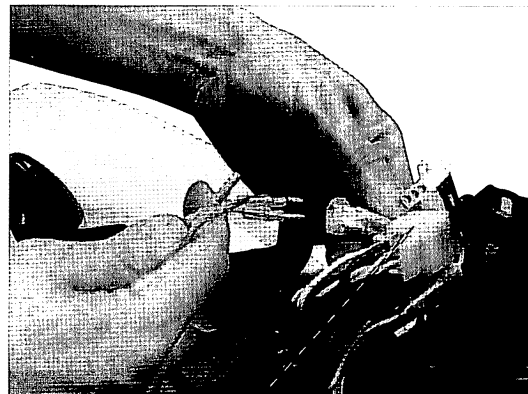

socket

remove headlamp socket to check contact of socket.

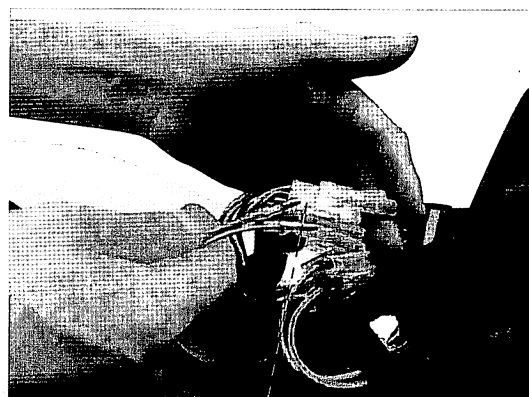

socket

remove high beam socket, low beam socket and passign light socket to check.

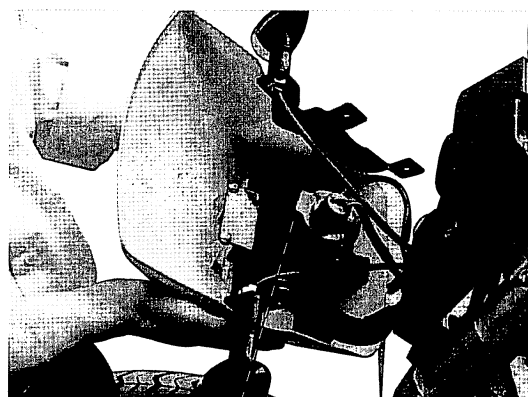

bolt

remove headlamp socket to check contact between headlamp socket and headlamp bulb.

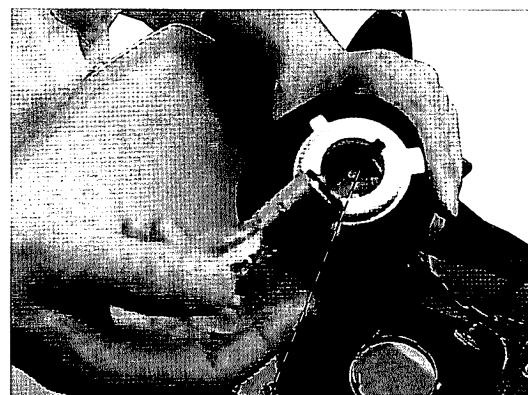

socket

remove headlamp bulb to check burn and change same type bulb of 12V35W/35W.

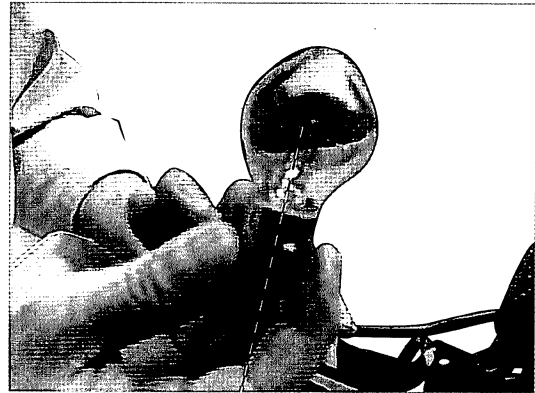

bulb

fit headlamp bulb and socket then check operation of headlamp.

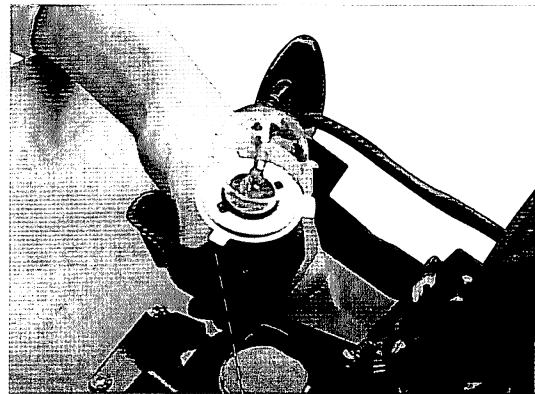

check bulb

7-4

Maintenance of Illuminating System

Component description	Damage form	Trouble symptom of component	Trouble symptom of motorcycle	Repair method
magneto illuminating coil	Coil circuit is short.	Insufficient output voltage of illuminating coil	Head light is in defective level.	Replace coil
	Coil circuit is broken.	No output of illuminating coil	Head light is in defective level.	Replace coil
Head light assembly	Light bundle is not properly adjusted.	The head light bundle is too near or too far.	—————	Adjust the head light bundle
	The filament of head light is burnt out.	The filament of head light is burnt out.	Head light is in defective level.	Replace head light bulb
Rear light/brake light	The filament of rear light and brake light is burnt out.	The filament of rear light and brake light is burnt out,	The filament of rear light and brake light is burnt out,	Repair rear light/brake bulb
Illuminating light and dimmer switch	Poor connection of inner contact or it is damaged.	Poor connection of inner contact or it is damaged.	Illuminating light is abnormal or out of work	Repair or replace illuminating/high-low light switch

Maintenance of electric start control system

Diassemble, assemble and maintain electric start control system

turn on ignition switch and check electric start.

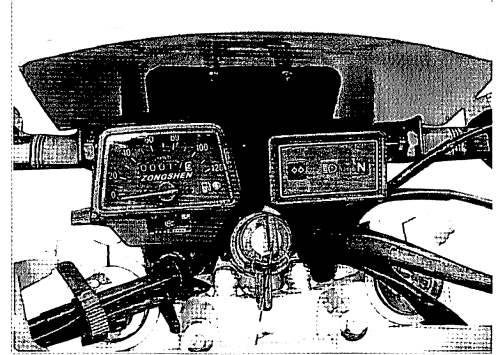

ignition switch

remove fuse to check and change same type fuse.

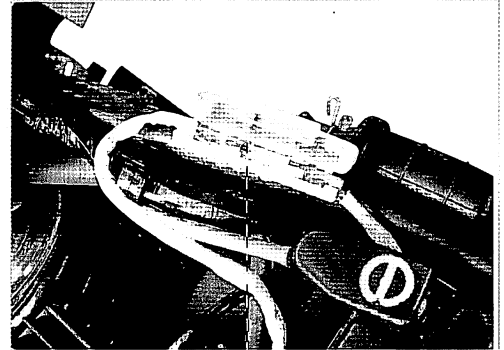

fuse

dismantle battery and measure voltage, remove battery to charge if below 12V.

check electrode plate and change battery or add electrolyte.

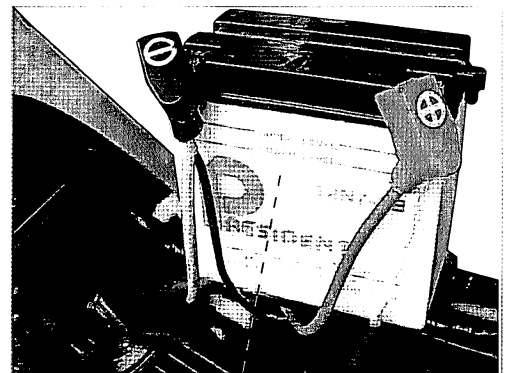

battery

unscrew fixing bolt of electrical start button to check short circuit of electrical start switch, change electrical start if necessary.

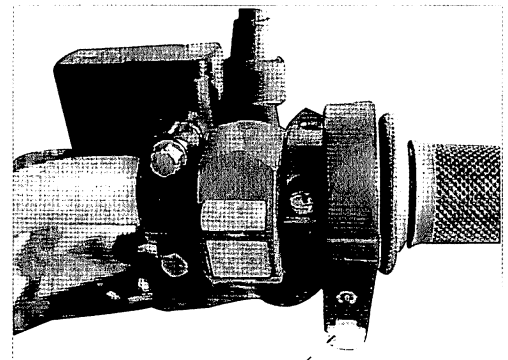

electrical start button

check connector of battery anode and cathode,
tighten connector immediately if necessary.

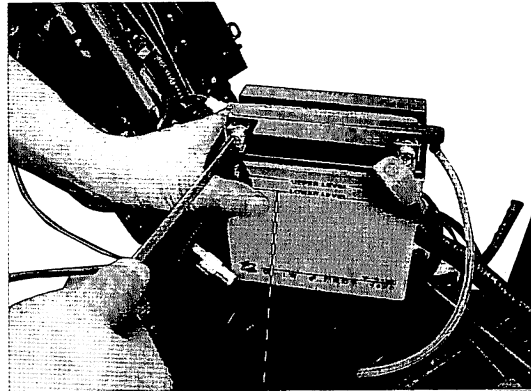

battery

measure output voltage of rectifier and change
rectifier if below 13.0V. the output voltage should be
13.0V-14.5V.

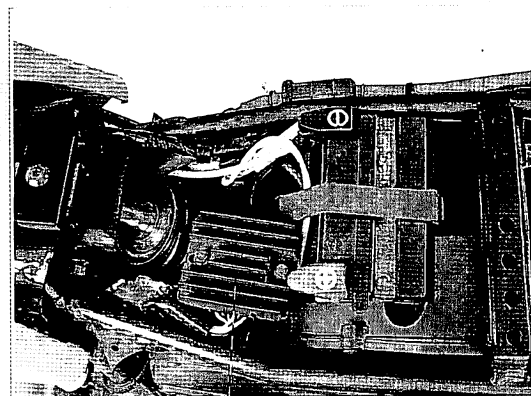

rectifier

remove charge loop socket and measure short
circuit of charge loop, change loop if necessary.

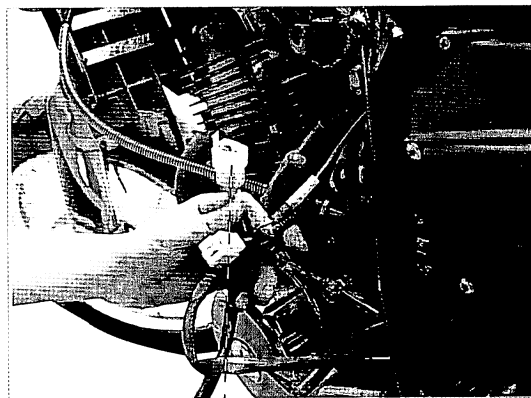

socket

remove relay and measure short circuit of relay,
change same type relay if necessary.

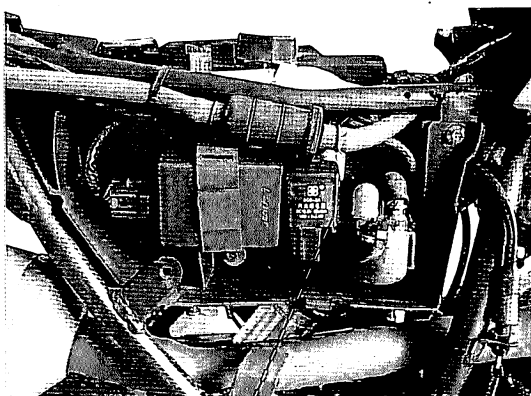

relay

check connector of relay wire and tighten connector.

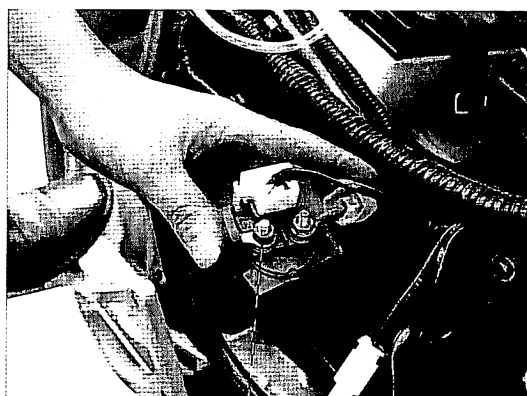

relay

check operation of motor and dismantle motor to repair or change if necessary.

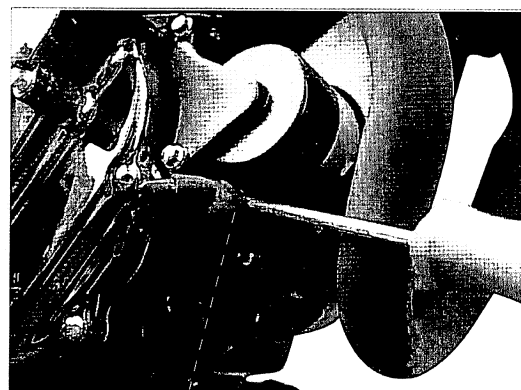

motor

turn on flameout switch and press electrical start button

change flameout switch if vehicle can not be started by electrical start button.

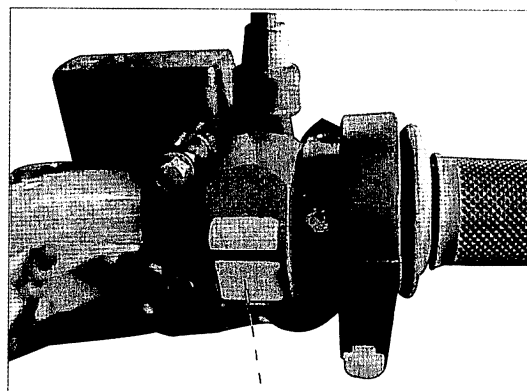

electrical start button

check short circuit of clutch electrical start control switch and change if necessary.

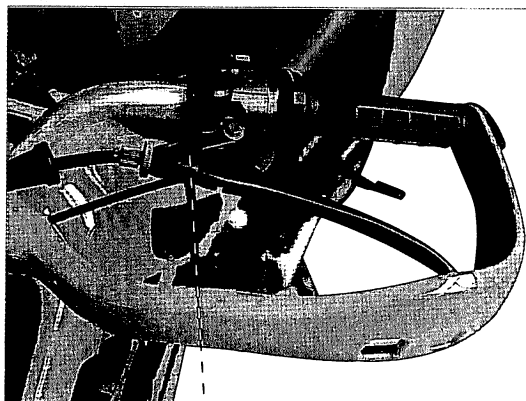

electrical start control switch

remove side stand switch and measure short circuit, change if necessary.

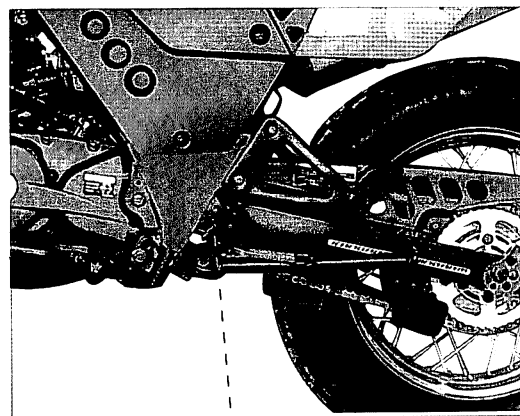

start switch

7-5

Maintenance of Electric Starting Control System

Component description	Damage form	Trouble symptom	Trouble symptom of motorcycle	Repair method
Starter relay	Inner coil circuit is short or broken.	Starter motor is out of work	Motorcycle is impossible to start up	Replace starting relay
	Inner contact is ablation	Starter motor rotation is ineffective	Motorcycle is impossible to start up	Replace starting relay
Starting pushbutton	Poor connection of inner contact or damaged	Starter motor is out of work	Motorcycle is impossible to start up	Replace button
Battery	No output or insufficient output	Starter motor is out of work or rotation is ineffective	Motorcycle is impossible to start up	Inspect battery

Maintenance of meter

Dismantle, fit and maintain meter

turn on ignition switch to check neutral indicator and operation.

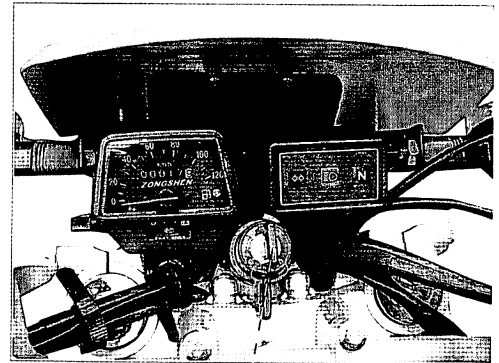

ignition switch

remove fuse to check and change same type fuse.

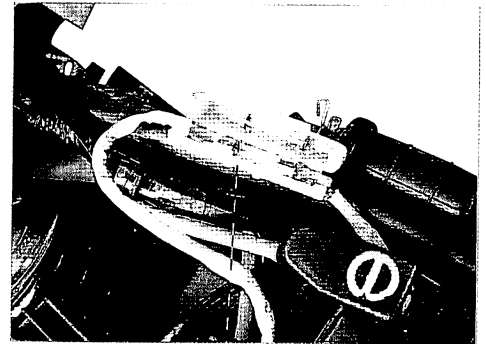

fuse

dismantle battery and measure voltage, remove battery to charge if below 12V.

check electrode plate and change battery or add electrolyte.

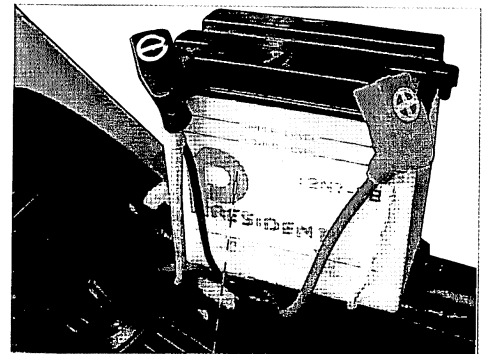

battery

dismantle odometer cable firstly then unscrew fixing bolt of meter and remove meter.

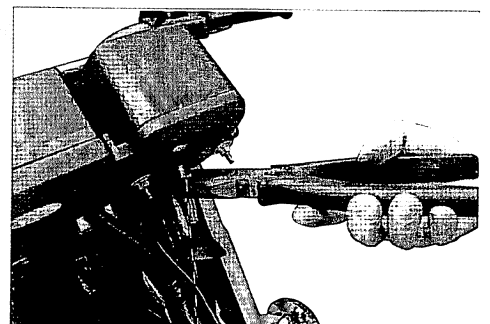

odometer cable

dismantle meter cover to check indicator bulb and change bulb if necessary.

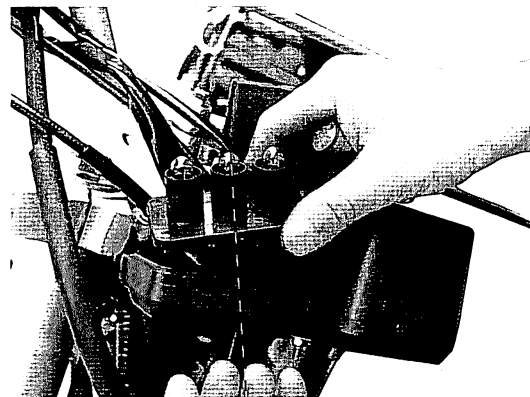

bulb

check operation of odometer, tachmeter and fuel gauge, and check if indicator bulb is burned, change bulb if necessary.

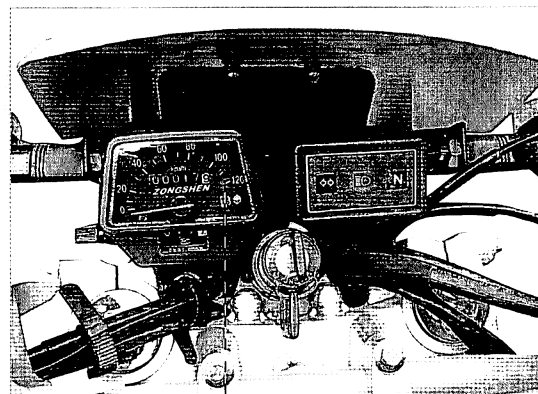

meter

remove meter core to check odometer core, tachmeter core broken, change meter assembly if necessary.

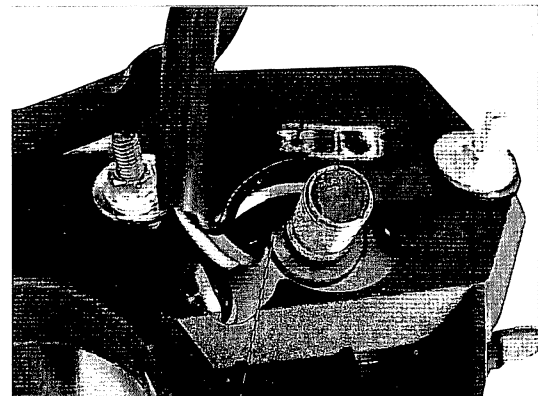

core

7-6

Maintenance of meter

Component description	Damage form	Trouble symptom of component	Trouble symptom of motorcycle	Maintenance method
Meter assembly	winker indicator filament is burnt out	winker indicator filament is burnt out	Winker indicator is out of work	Replace winker indicator
	meter illuminator filament is burnt out	meter illuminator filament is burnt out	illuminator is out of work	Replace meter illuminator bulb
	speedometer is damaged.	speedometer is damaged.	Speedometer is out of work	Replace speedometer
	Tachometer is damaged.	Tachometer is damaged.	Tachometer is out of work	Replace tachometer

Chapter 8 Analyze of Motorcycle Troubles

8.1 Analyze of Engine Trouble

8.1.1 Analyze of engine idle speed failure

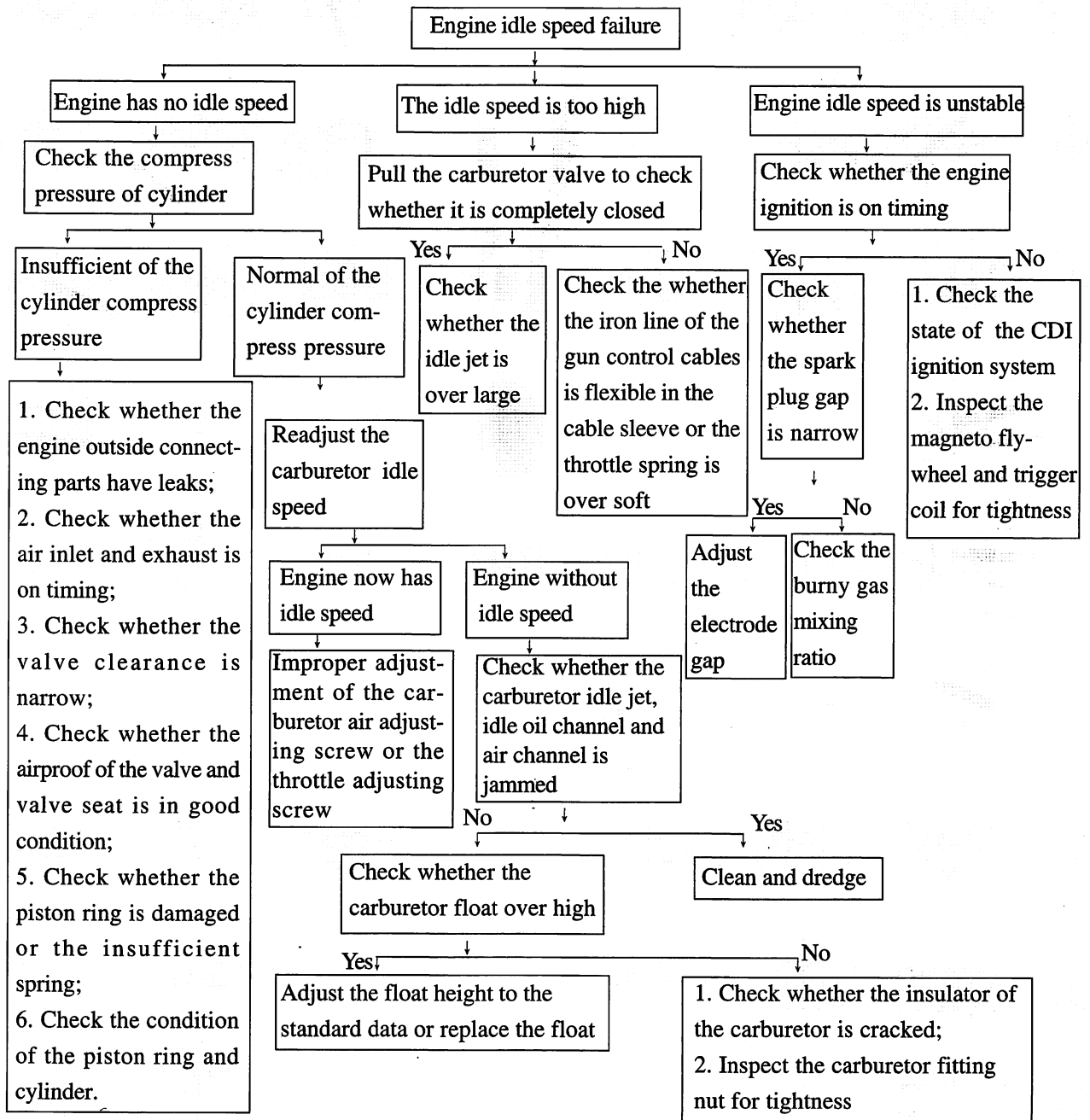

8.1.2 Analyze of engine power insufficient

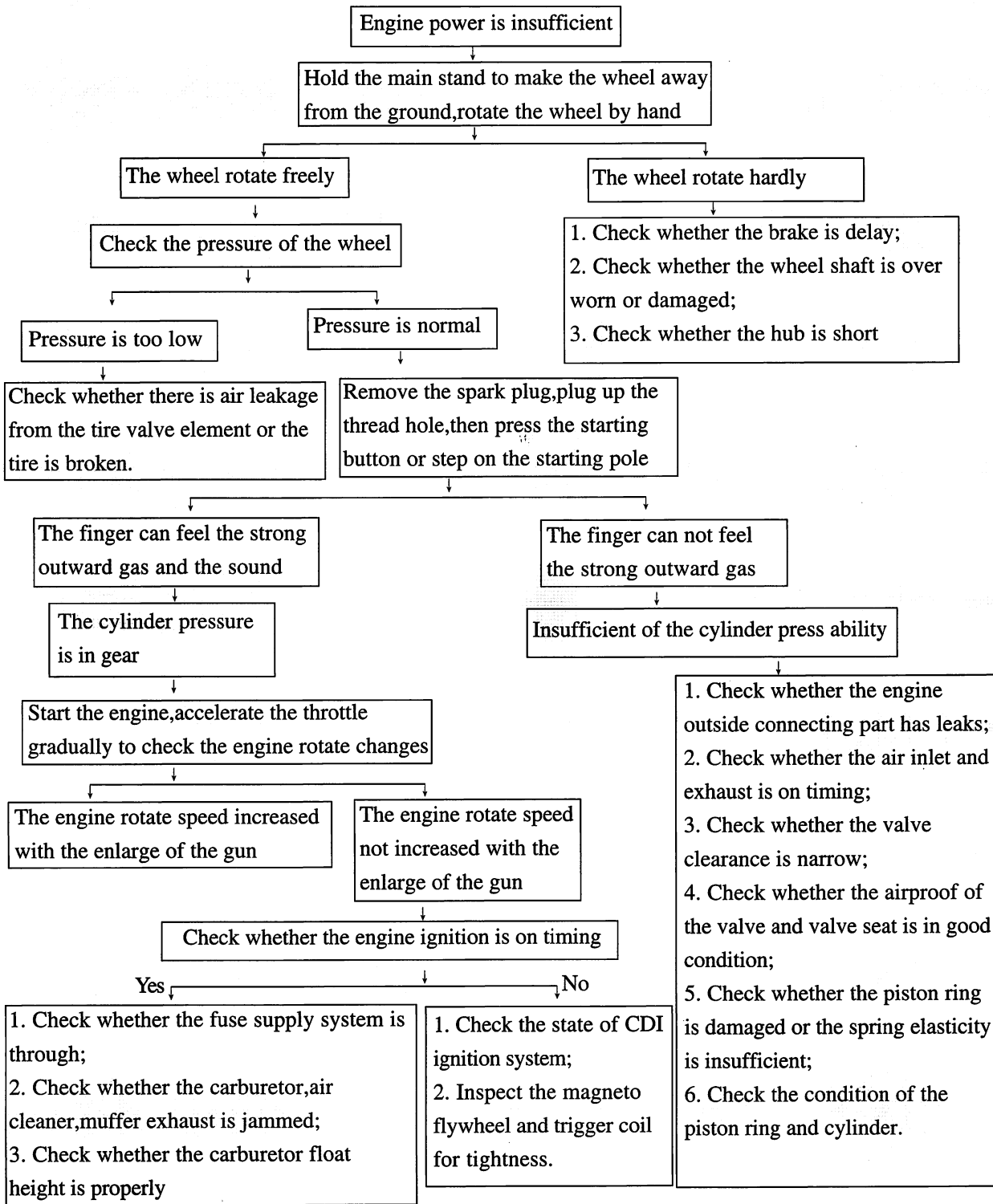

8.1.3 Analyze of engine starts hard or fails to start

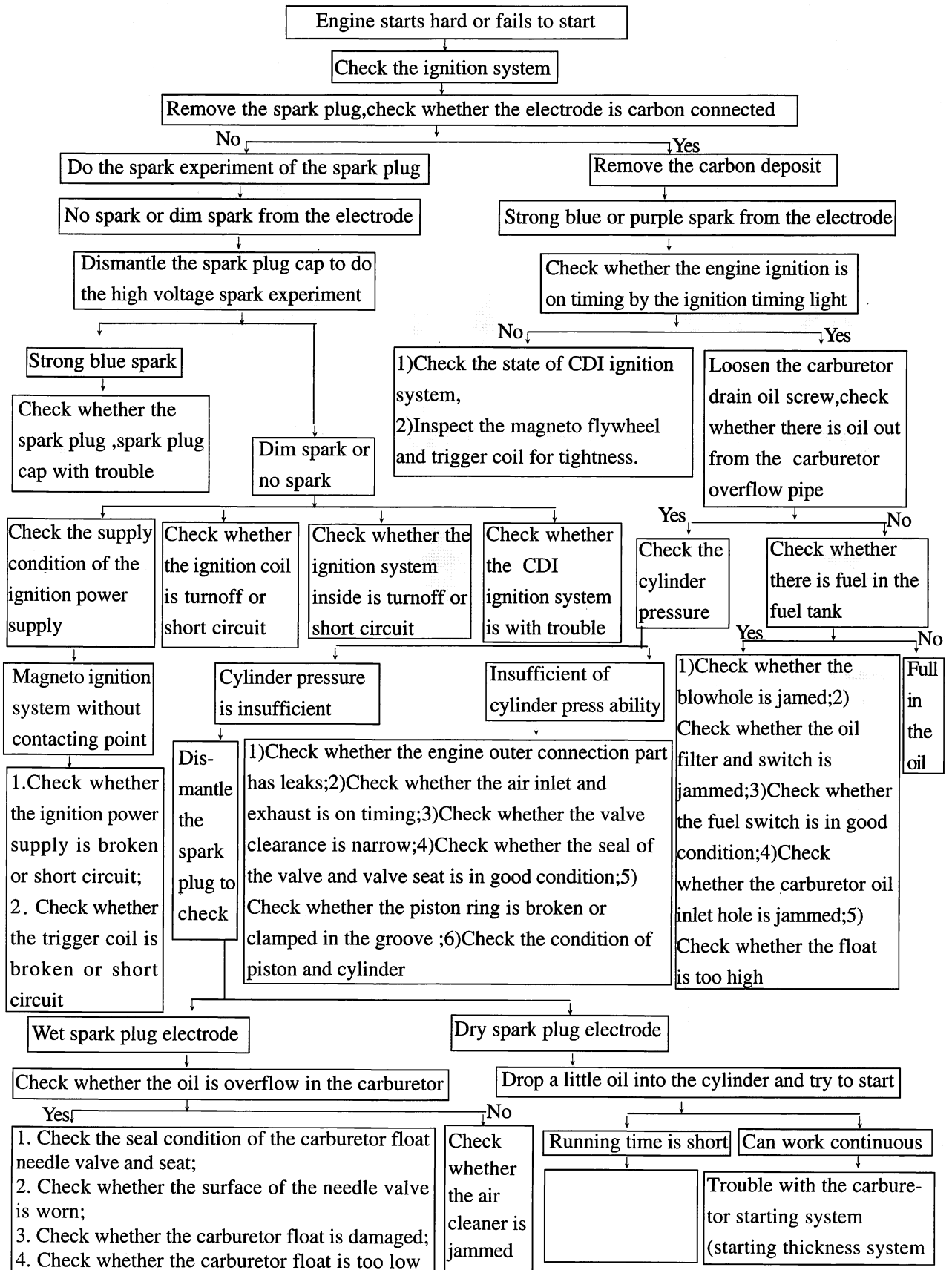

8.1.4 Analyze of engine overheat

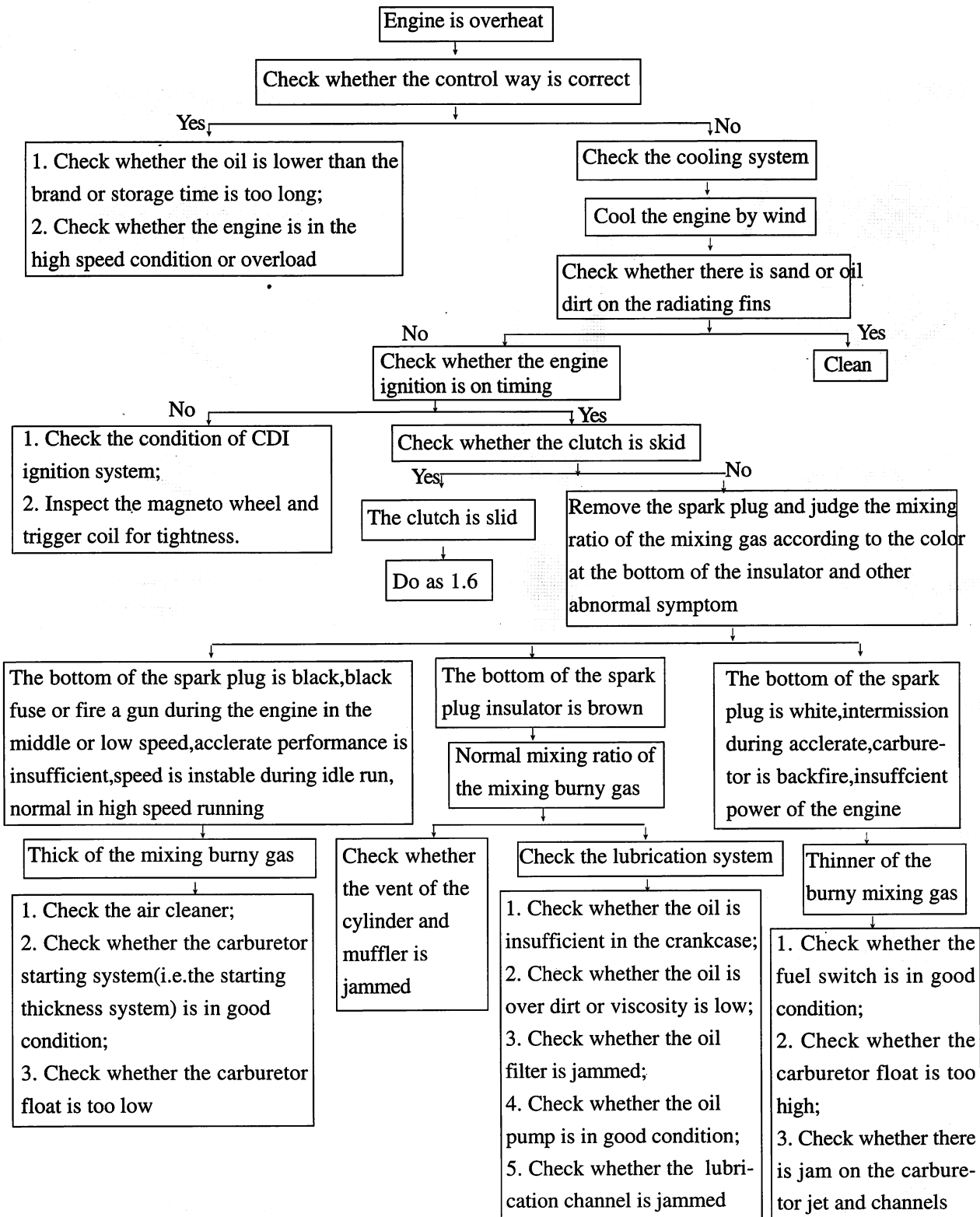

8.1.5 Analyze of engine oil over consumption

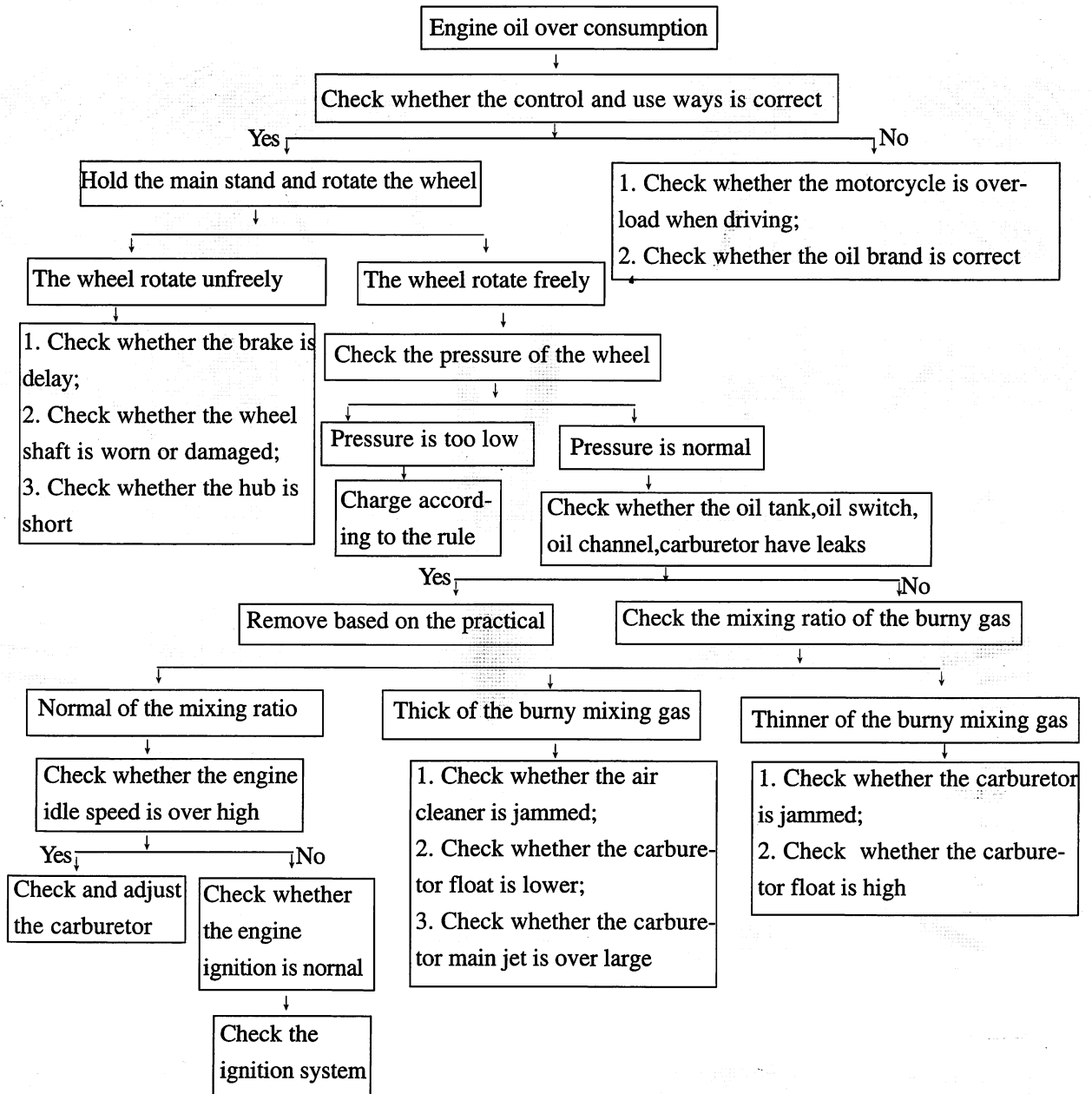

8.6 Analyze process of clutch skid

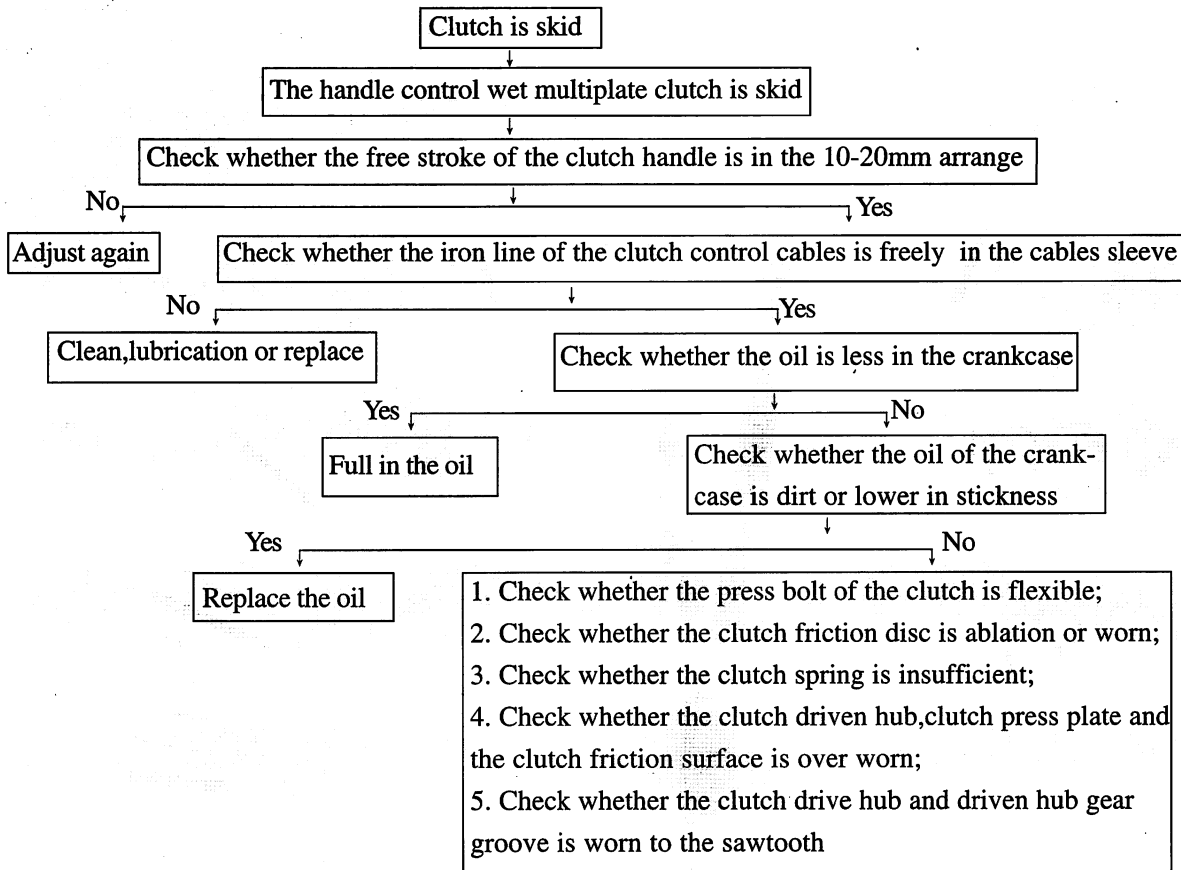

8.7 Analyze process of blue white thick fuse of the exhaust muffler

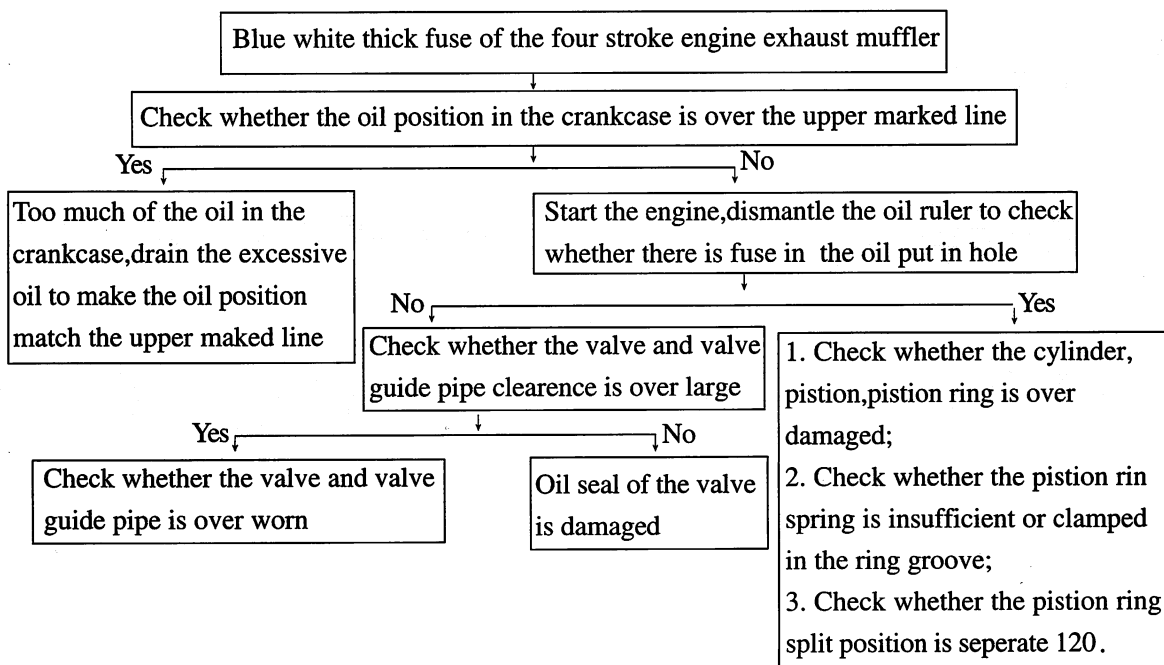

8.8 Analyze process of clutch disengage incompletely

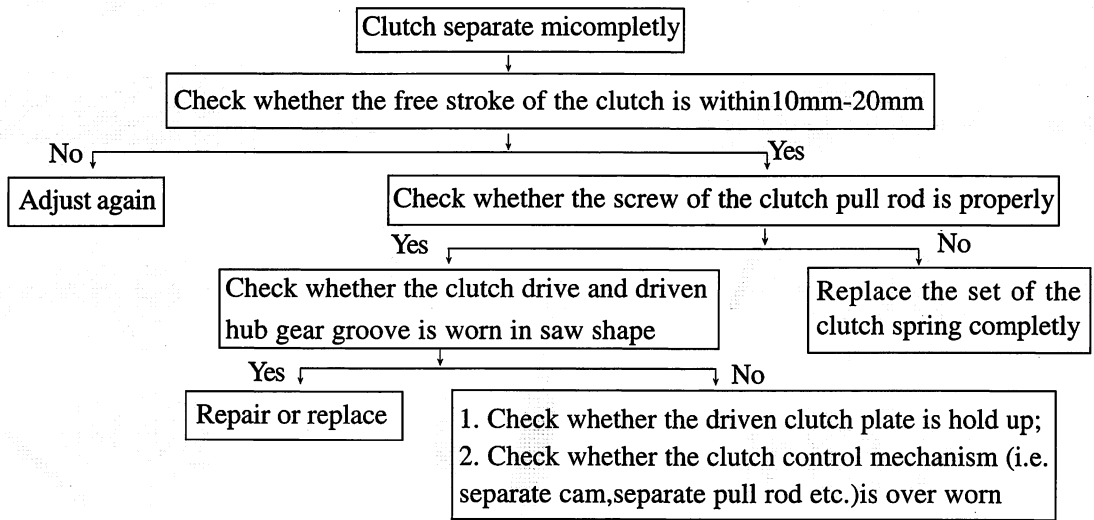

8.9 Analyze process of difficult to gear change

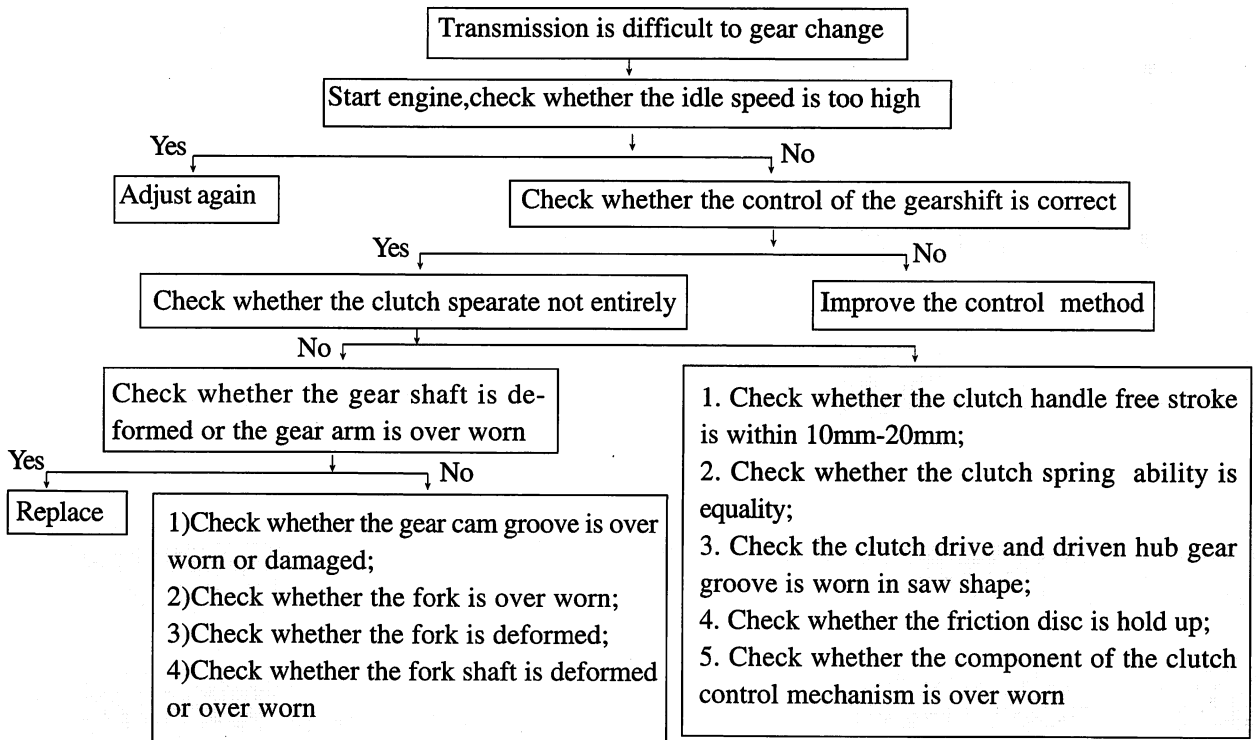

8.10 Analyze process of transmission shift

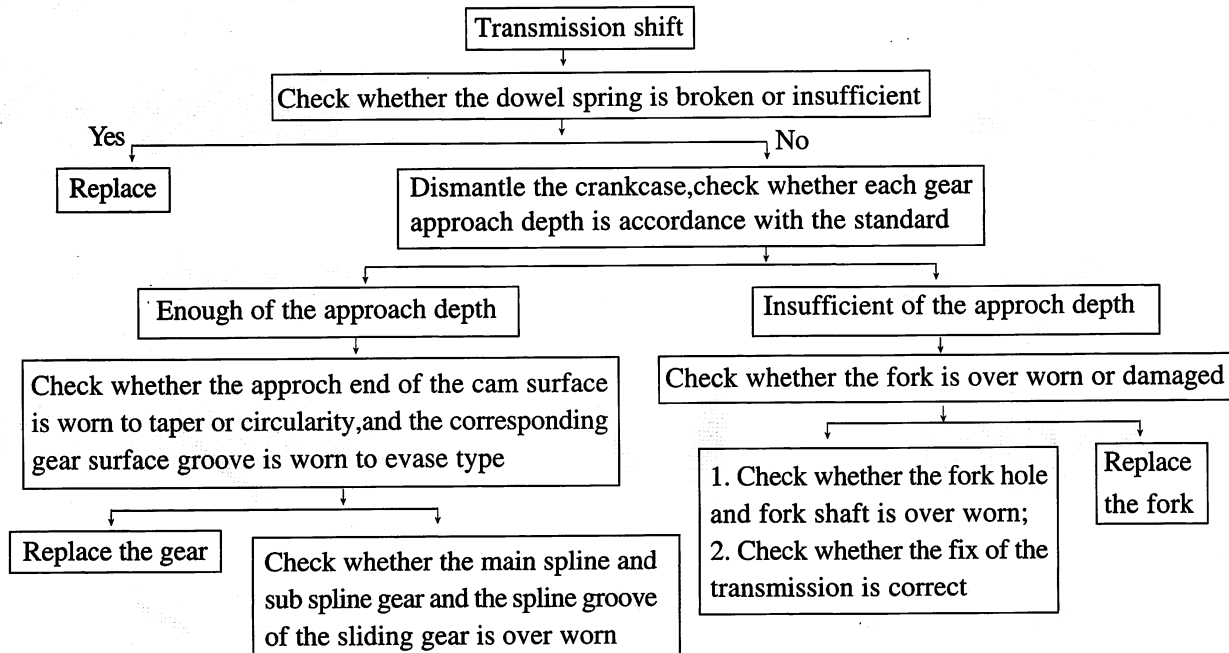

8.2 Analyze of Electric System Trouble

8.11 Analyze process of battery discharge

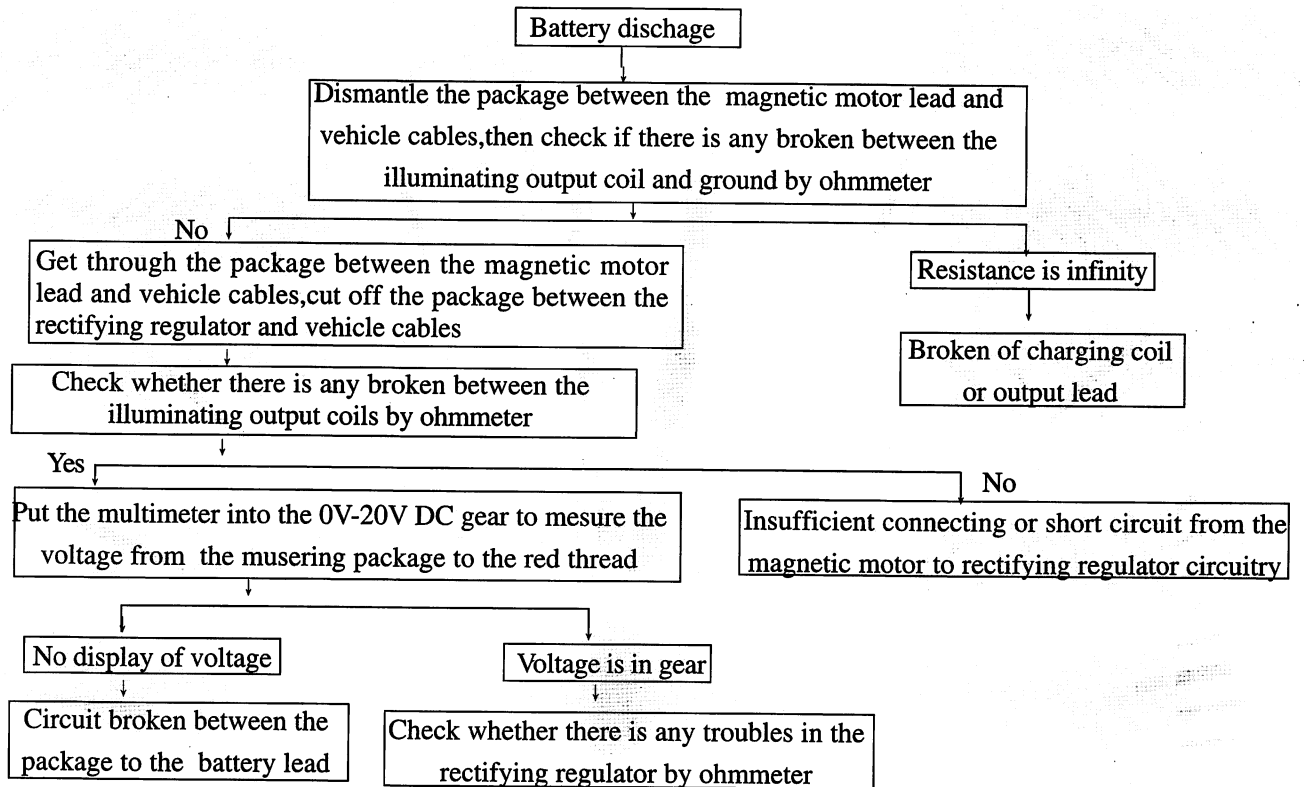

8.12 Analyze process of battery insufficient charge

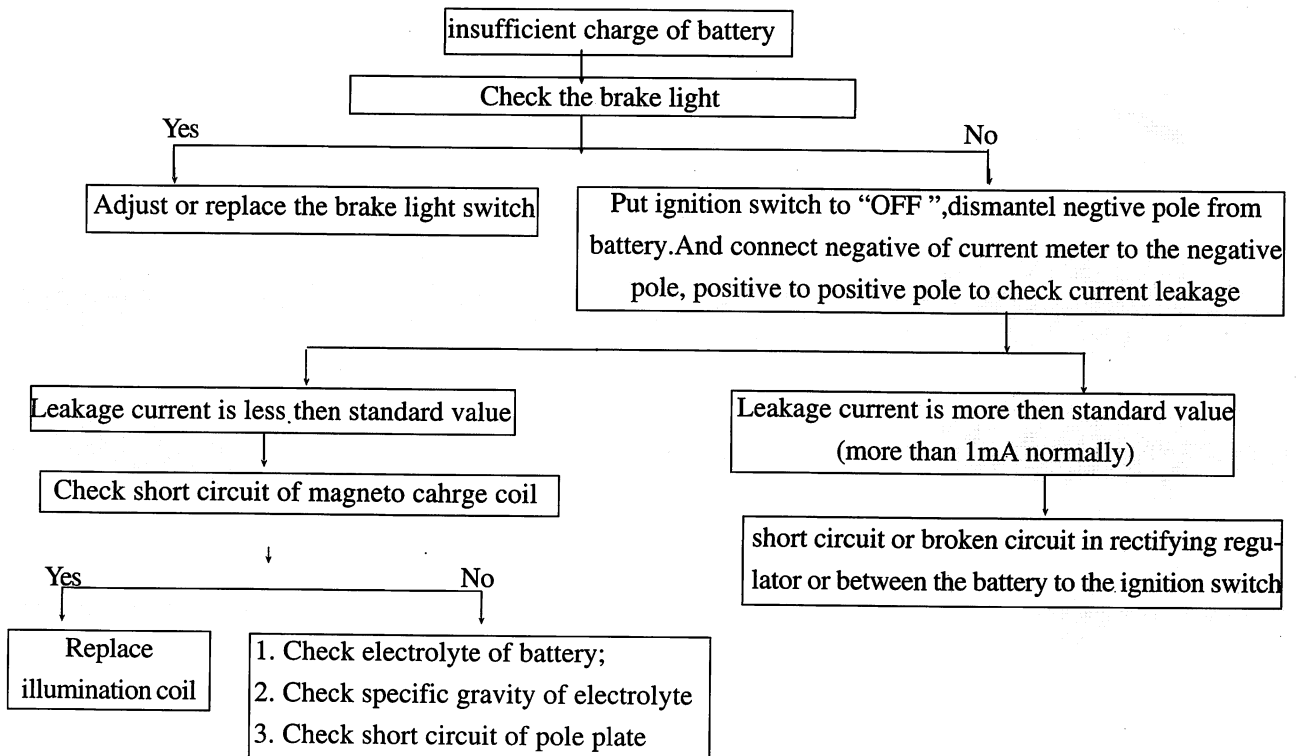

8.13 Analyze process of starting motor without rotate

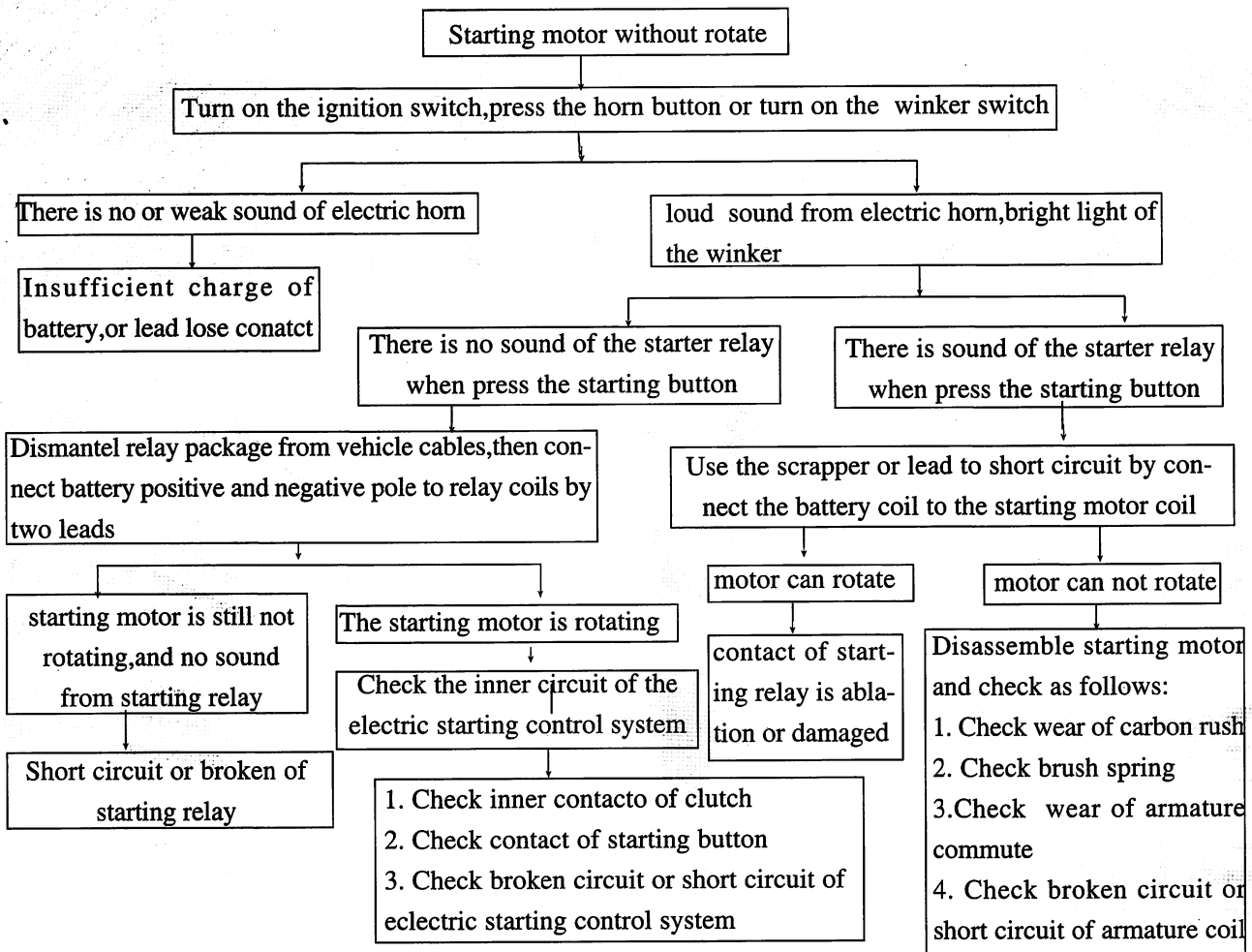

8.14 Analyze process of motor rotate with disability

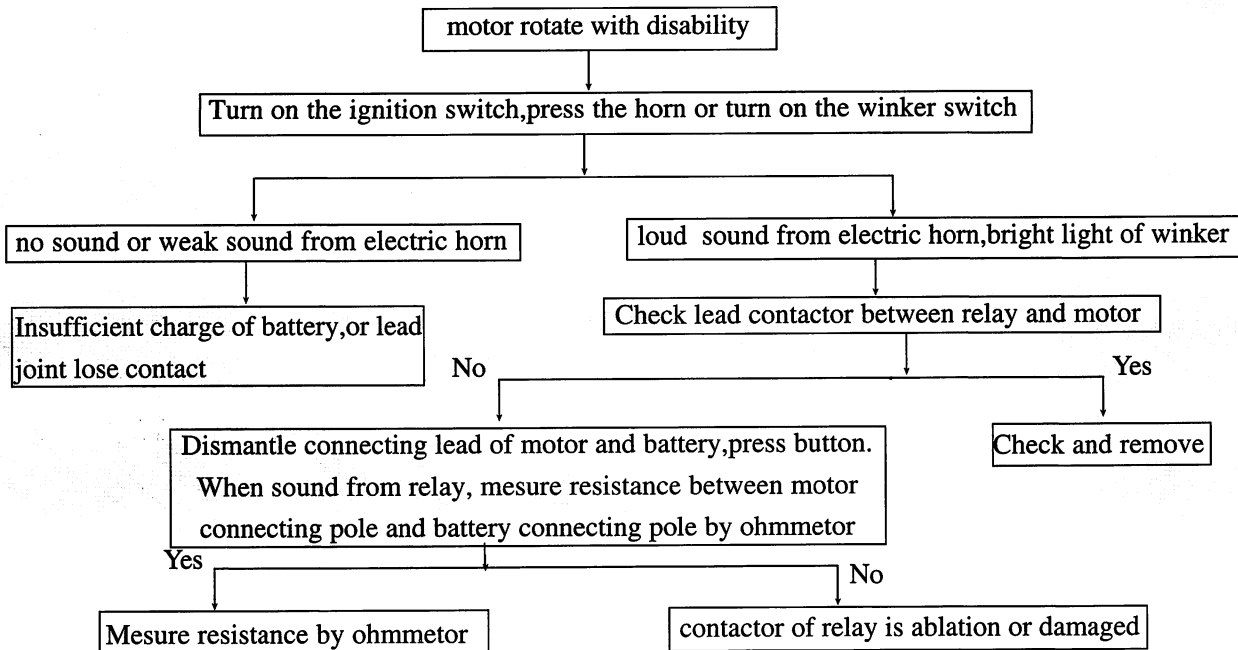

8.15 Analyze process of illuminating lights all out of work

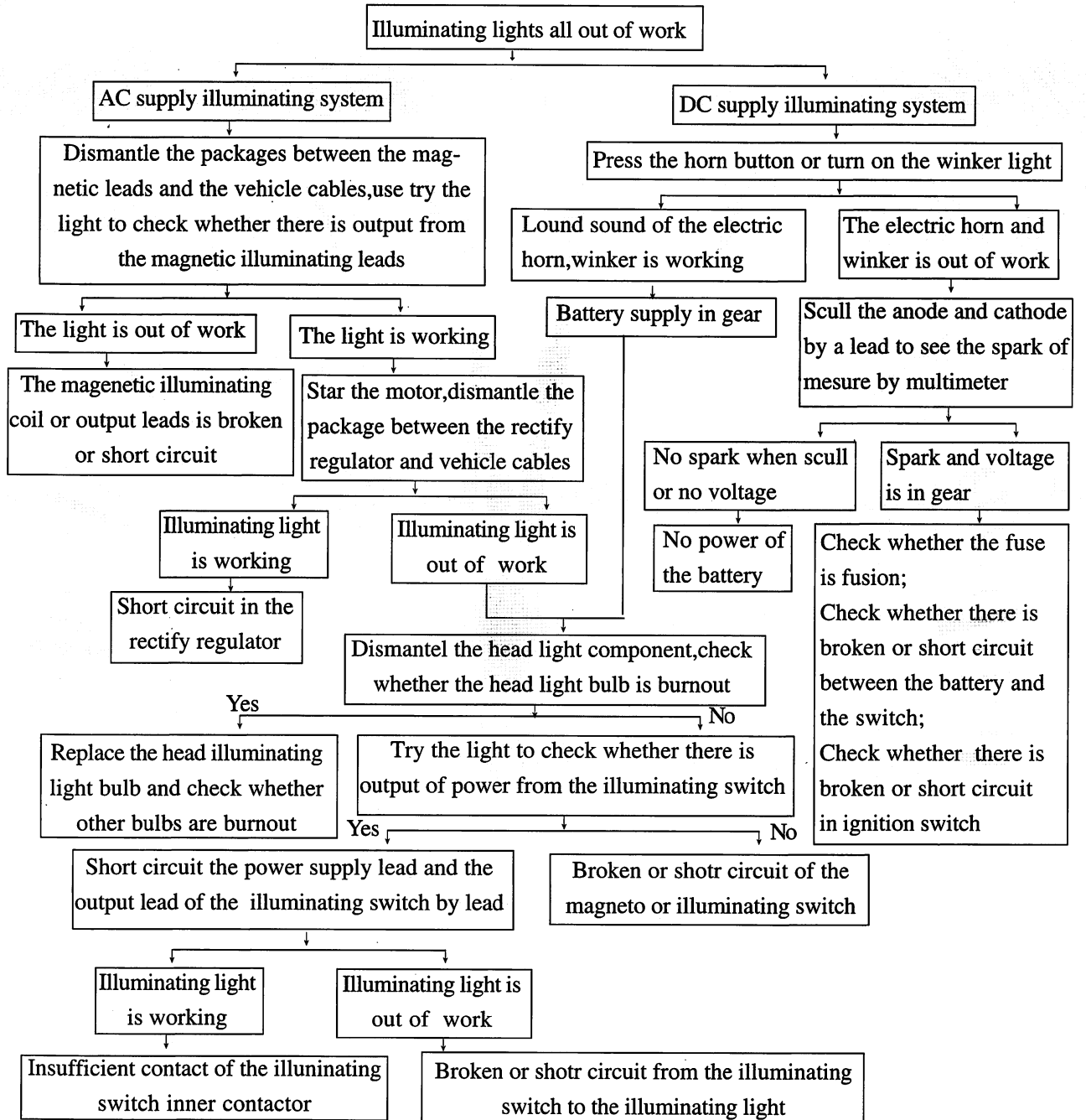

8.16 Analyze process of illuminating lights easy to burnout

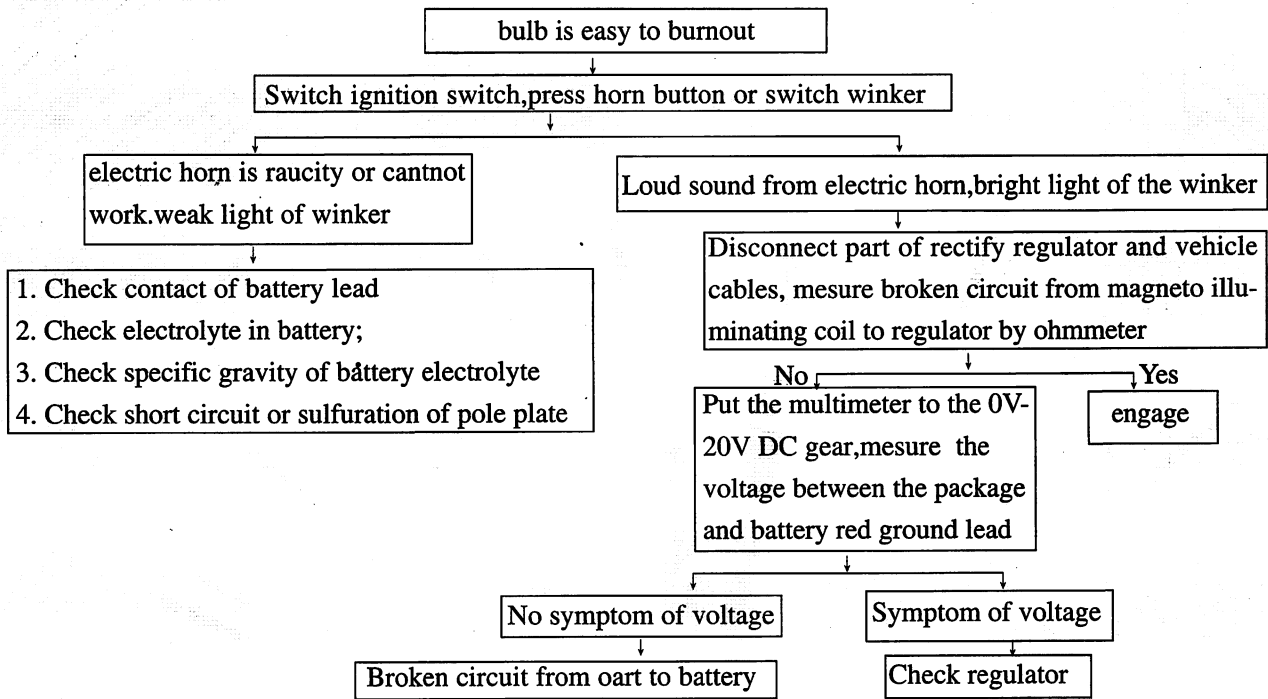

8.17 Analyze process of illuminating lights dim light

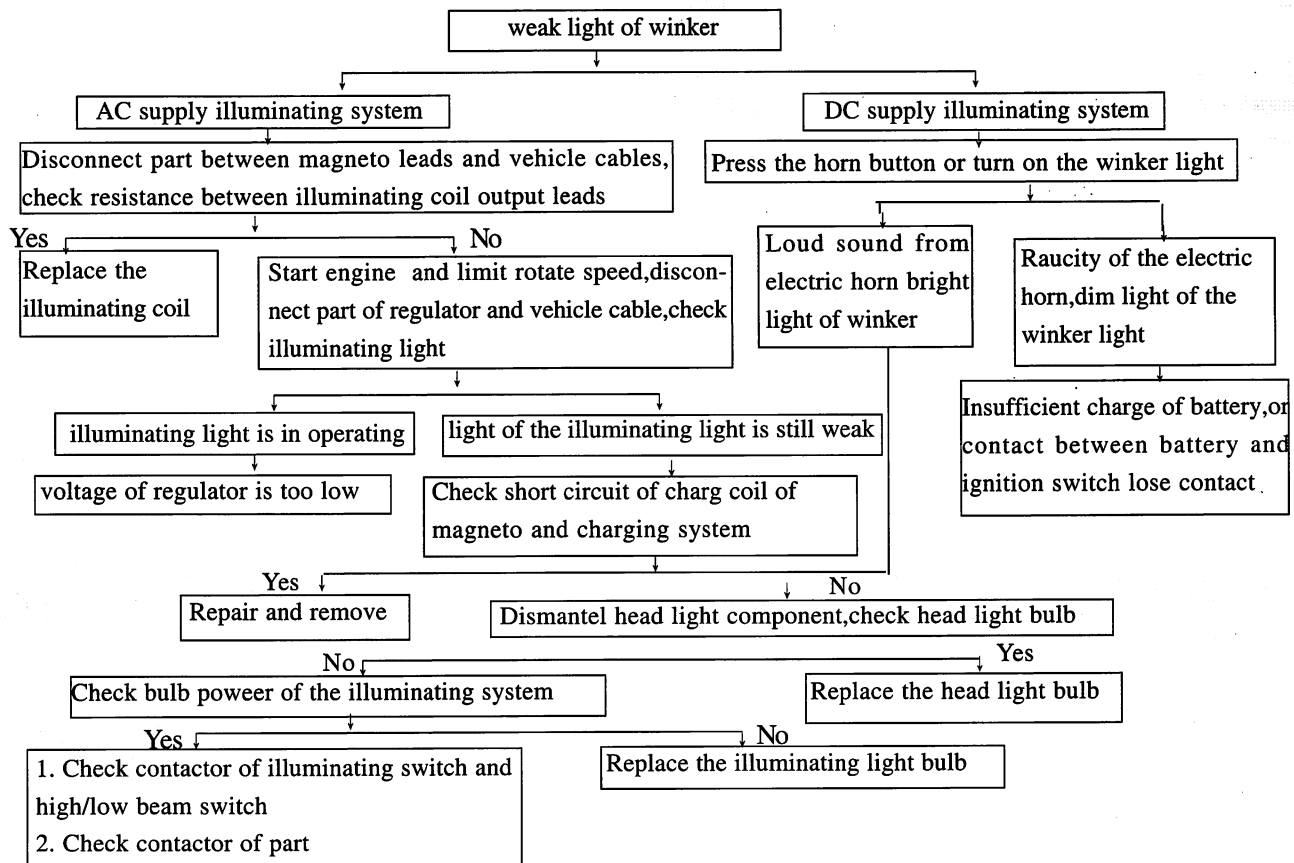

8.18 Analyze process of winker out of work

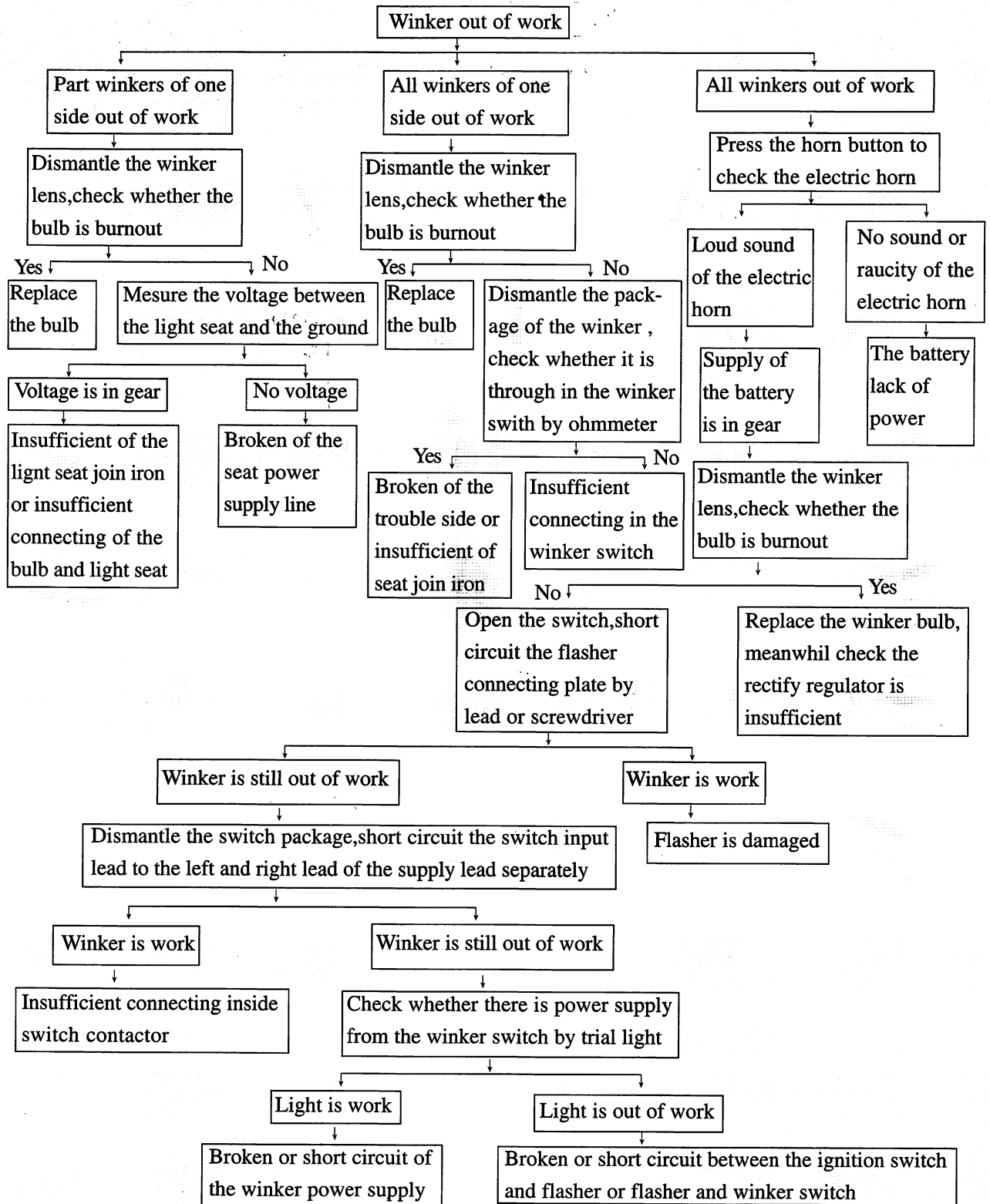

8.19 Analyze process of electric horn out of work

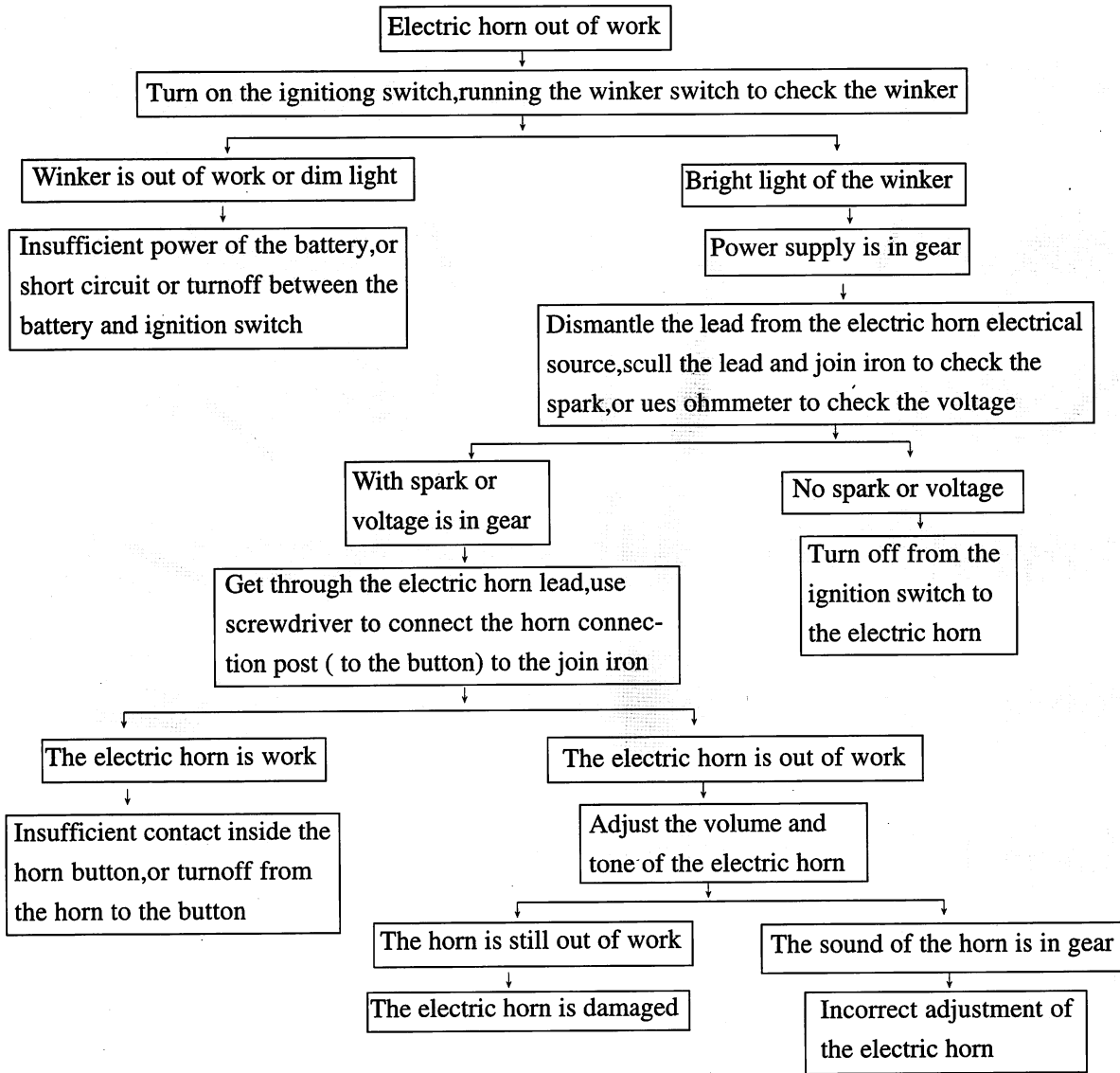

8.20 Analyze process of brake light

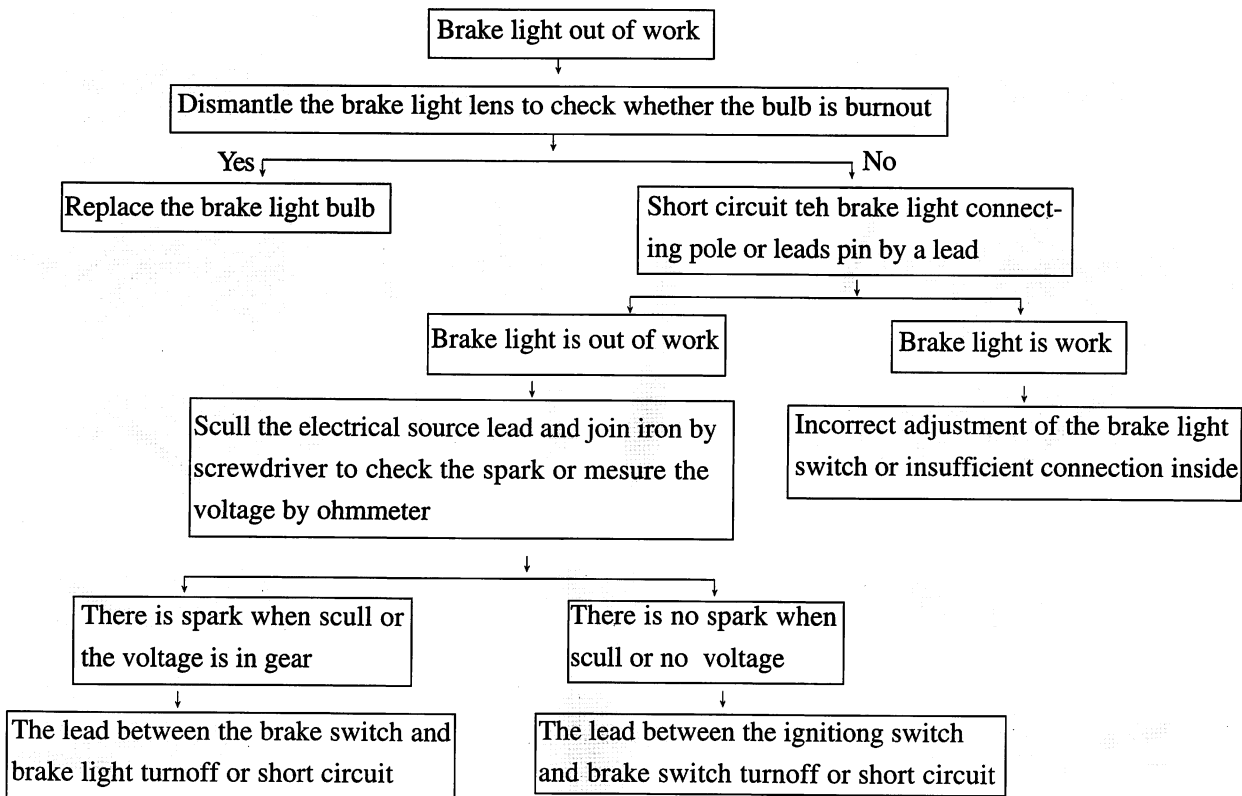

8.21 Analyze process of ignition system electric trouble

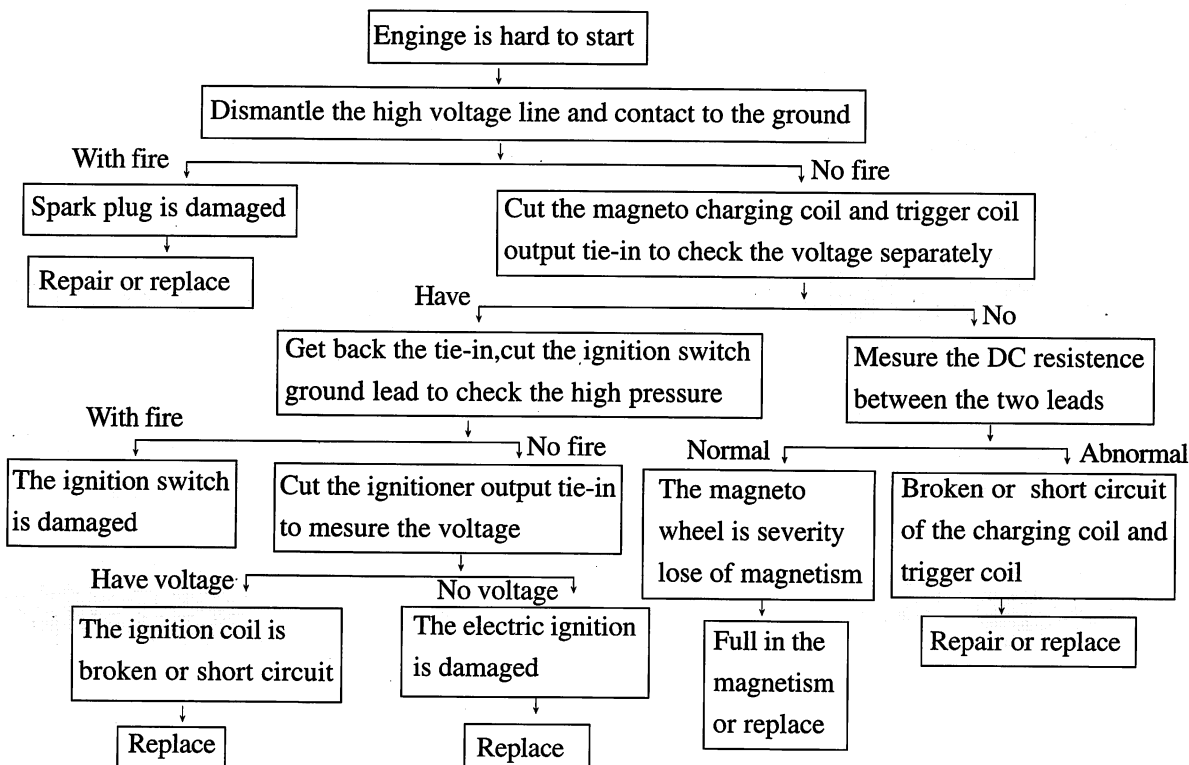

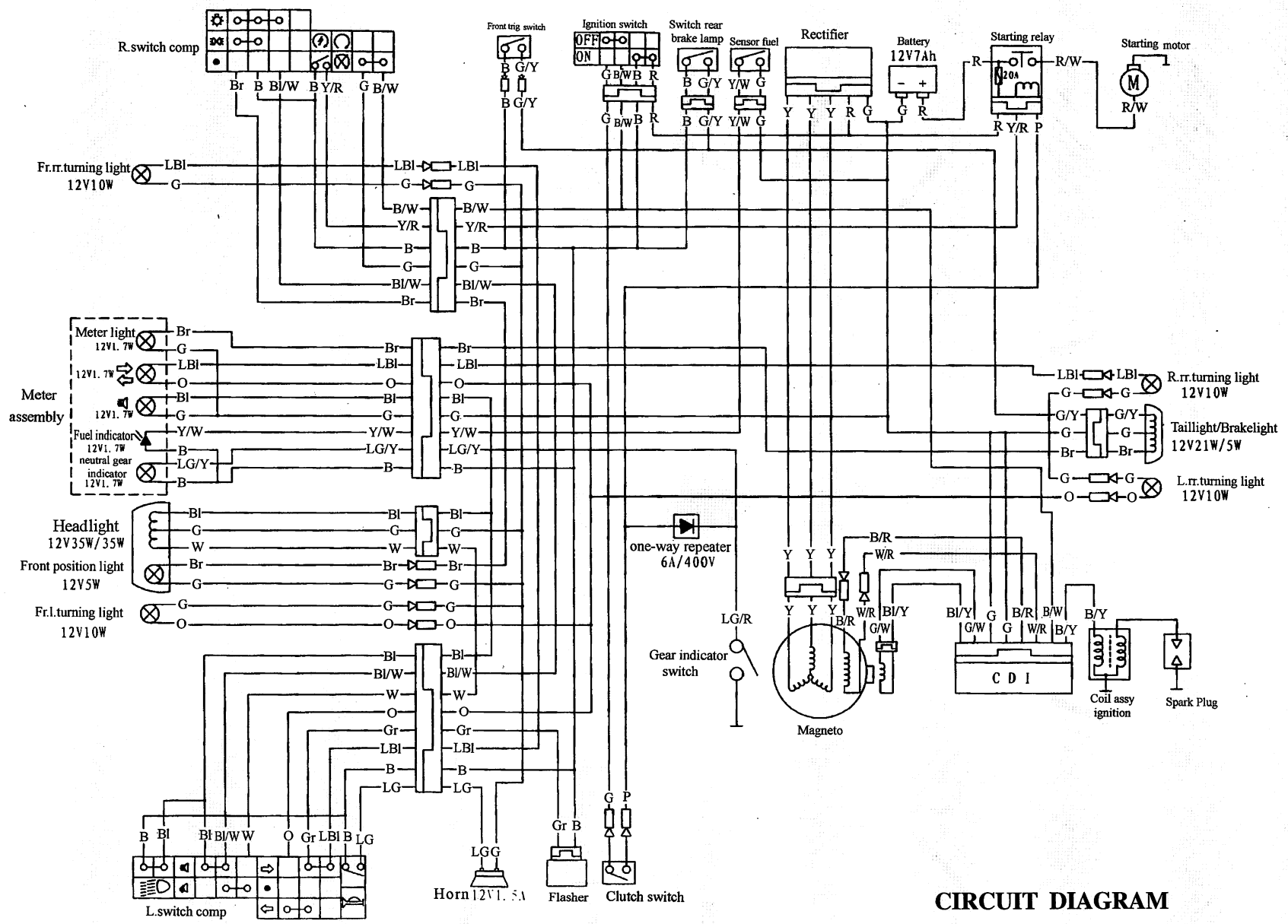

CIRCUIT DIAGRAM



ZS200GY-2(EC)Maintenance Manual

Copyright reserved by Zongshen Group

Format 210mm × 285mm

Edition 1st edition Aug.2006

Print 1st print Aug.2006



CHONGQING ZONGSHEN MOTORCYCLE INDUSTRY MANUFACTURE CO.,LTD.
ADDRESS:25,ERLANG ROAD,SHIOIAOPU,CHONGQING,CHINA
TEL:0827-69534477 FAX:862388460487 TOLL-FREE PHONE:8508070036 8508070040 8508070041