

Repair-works on 2-stroke engine for engines up to 100 cc

ZUNDAPP

**Servicing Manual
for Two-Stroke Engines
up to 100 cc**

Issued February, 1966

Subjekt to alterations

ZUNDAPP-WERKE GMBH MÜNCHEN

8 München 8, Anzinger Straße 1-3

Printed in Germany

FOREWORD

Advances in the design of motorised two-wheelers during the last few years, particularly for the lower cubic capacities, have greatly stepped up engine output as well as riding comfort. ZUNDAPP machines, in particular, have led the way and gained an enviable reputation for good engineering design and solid construction.

Each new ZUNDAPP model will always make its contribution towards justifying our excellent reputation, so as to maintain and increase the popularity of ZUNDAPP machines. One of the most important factors in ensuring our continuing success is a first class after-sales service. That is why we are anxious to acquaint all our distributors and appointed service stations with the latest developments. Throughout the winter months, our ZUNDAPP training centres are holding courses for service mechanics. This manual is designed to save students at these courses the time-wasting trouble of taking copious notes and to be a permanent record which they can consult at any time to refresh their memory.

The descriptions of dismantling and assembly operations have been compiled with clarity and simplicity in view and are accompanied by numerous illustrations. We trust that every distributor who has not yet had the opportunity to attend a training course will find the manual a useful aid and reference book.

Reproduction, in whole or in parts, prohibited, except by prior authorisation.

Table of Contents

	Page
Introductory Notes	7
 1. Dismantling Engine	
a) Taking off Gear Change Pedal and Fan Casing . .	8
b) Taking off Casing Cover, left, and Kickstarter Assembly	9
c) Dismantling Ignition System	9
d) Taking off Clutch Cover, Cover for Clutch and Gear Change Setting Controls	10
e) Taking off Pedal Gear Change Spindle and Selector Slide	11
f) Dismantling Clutch	11
g) Taking off Chain Sprocket	12
h) Taking off Cylinder and Piston	12
i) Taking off Crank Casing	13
k) Taking off Bearings, Bushes and Clutch Gear	15
l) Taking off Steel Ball Selector, on engines with manual gear change	16
 2. Engine Assembly	
a) Setting Steel Ball Selector, on engines with manual gear change	18
b) Measuring Axial Play of Crankshaft	18
c) Fitting Crankshaft into Right Casing	19
d) Measuring Axial Play of Selector Shaft	20
e) Measuring Selector Gears	21
f) Measuring Starter Spindle	22
g) Assembling Engine Block	23
h) Fitting Selector Shaft to Bearing on Left Casing . .	25
i) Mounting Sealing Rings	25
k) Inspecting Connecting Rod	26
l) Assembling Piston and Cylinder	26
m) Mounting Chain Sprocket	27
n) Measuring Main Drive Shaft Position	27
o) Mounting Clutch	28
p) Setting Clutch Tongue and Clutch	30

q) Taking off and Mounting Gear Change Spindle	30
r) Mounting Clutch Bell Cover	33
s) Setting Pedal Gear Change Spindle	34
t) Mounting Cover over Clutch and Gear Selector Assembly (Connector Cap)	34
u) Mounting Ignition System	34
v) Setting Ignition Timing	35
w) Taking off and Mounting Kickstarter Spring and Sleeve	35
x) Mounting Fan, Left Casing Cover with Kickstarter and Fan Casing	36
3. Special Service Tools	38
4. Bing Carburetors	41
5. Troubles and their Causes	48
6. Technical Data	49

Introductory Notes

The comprehensive text of this extensively illustrated manual on engine dismantling and assembly applies with appropriate modifications to all models with manual or pedal gear change and kickstarter. Where the assembly sequence differs in a few respects, or where different tools are needed, special reference is made to the changes in the relevant chapters. The manual covers the following engine models:

Type	Model Description	Starting System	Gear Change System	No. of Gears
267	Scooter R 50	Kickstarter	Manual	3
267	Super-Combinette	Kickstarter	Manual	3
267	Sport-Combinette	Kickstarter	Pedal	3
276	Scooter RS 50	Kickstarter	Manual	4
276	KS 50 Super	Kickstarter	Pedal	4
276	Scooter RS 50	Kickstarter	Pedal	4
281	Motorcycle KS 100	Kickstarter	Pedal	4

The instructions take account of all modifications introduced on engines supplied as from 1965.

Complete dismantling of an engine is only called for in cases of damage to the gearbox, crank drive, kickstarter assembly (except for kickstarter spring) or the manual gear-change assembly.

Defects of the gear selector mechanism — steel-ball selector mechanism for pedal-change engines — clutch, crankshaft drive gear of engines with either manual or pedal gear change, can be remedied after taking off the clutch housing cover. Consequently, the engine need not be taken off the frame. But in all these cases, the gearbox oil must be drained off through the drain plug in the bottom of the housing. This is preferably done while the engine is still warm.

Gear-change pedal, kickstarter pedal with return spring, chain sprocket, flywheel magneto (wheel and baseplate), cylinder with piston, cylinder head and fan assembly can all be taken off and fitted without dismantling the engine. Here, of course, the oil need not be drained from the gearbox.

For air-cooled engines, consult the assembly instructions on model KS 100, and disregard all references to the fan system.

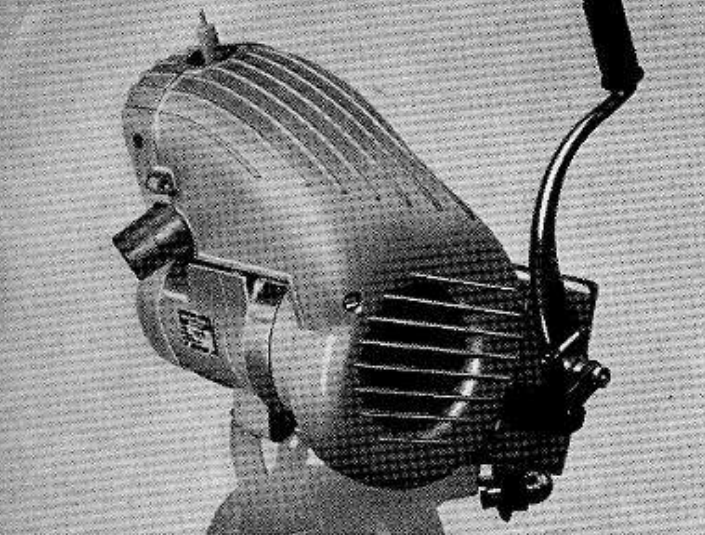

Fig. 1

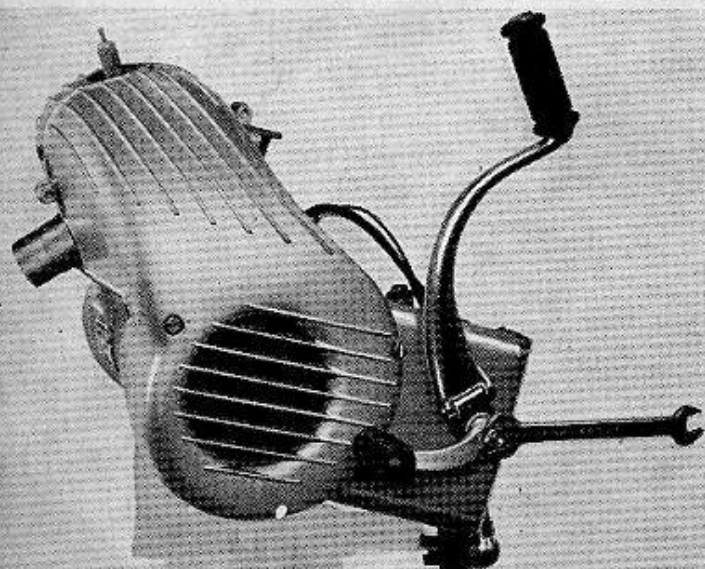

Fig. 2

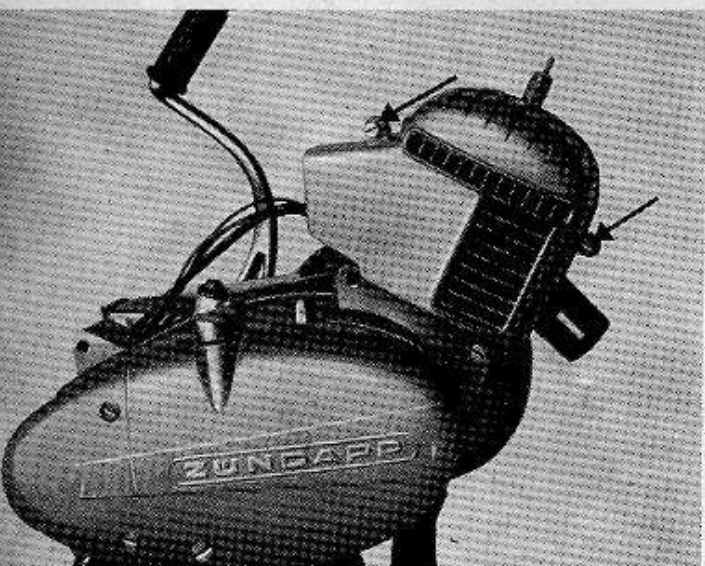

Fig. 3

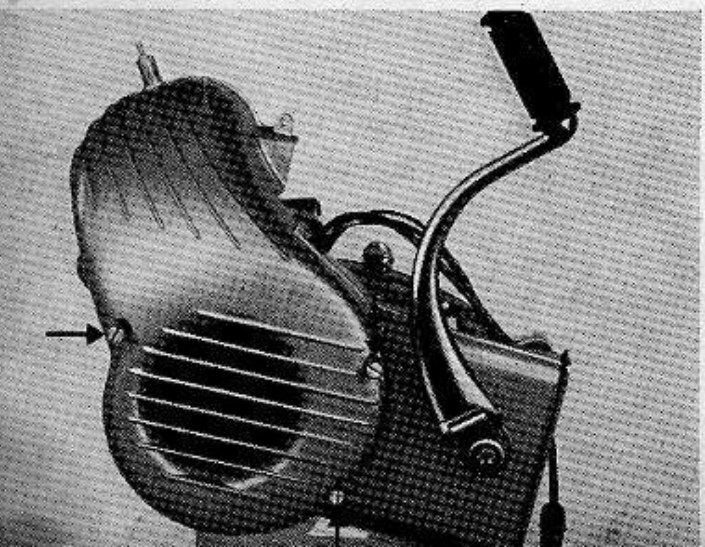

Fig. 4

1. Dismantling Engines

a) Taking off Gear Change Pedal and Fan Casing

Fit engine into service fixture SK-A 1926, draw off spark plug connector (fig. 1).

Take off gear change pedal. With the 14 mm open-ended spanner or socket spanner, slacken hexagon nut. Remove serrated washer; draw pedal and spacer ring from gear change spindle (fig. 2).

Not applicable to engines with manual gear change

Take off fan casing cap, first removing two cylindrical screws, M 5 x 15 (fig. 3).

Remove 3 cylindrical screws, M 6 x 45, from the left side of the fan casing, then take casing off (fig. 4).

b) Taking off Casing Cover, left, and Kickstarter Assembly

With a 10 mm socket key, take off 2 hexagon screws, M 6 x 35, then remove left-hand casing cover, complete with kickstarter, kickstarter spring and cover plate which also acts as the kickstarter stop (fig. 5). On air-cooled engines, slacken 2 cylindrical screws, M 6 x 45, instead of the hexagon screws mentioned above.

Take the 4 cylindrical screws, M 5 x 20, off the flywheel magneto, then remove fan.

c) Dismantling Ignition System

Holding the flywheel firmly with service tool SK-A 251, take off the wheel nut with the 14 mm socket spanner (fig. 7).

Fit press-off bolt SK-A 263 to wheel, hold assembly firmly in position with tool SK-A 251 and press wheel off the magneto spindle on the crankshaft. Remember the key which secures the wheel to the crankshaft (fig. 8).

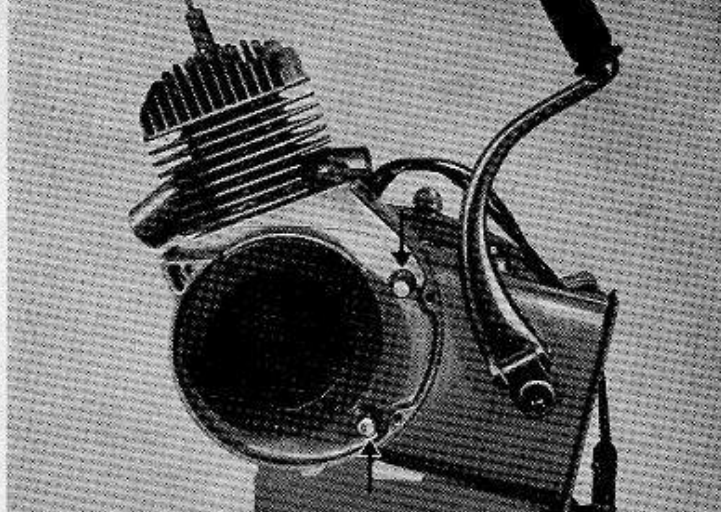

Fig. 5

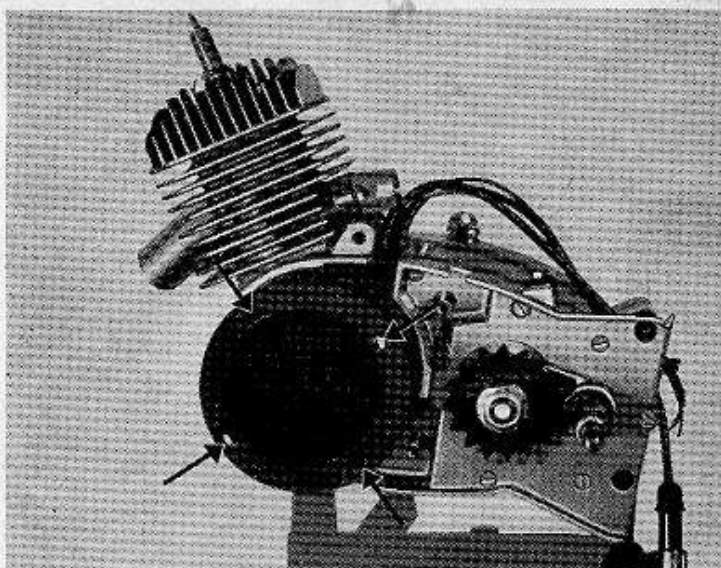

Fig. 6

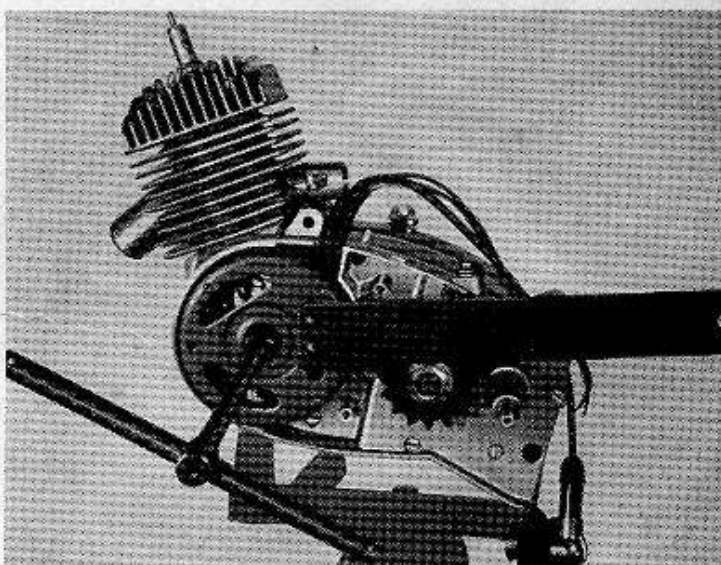

Fig. 7

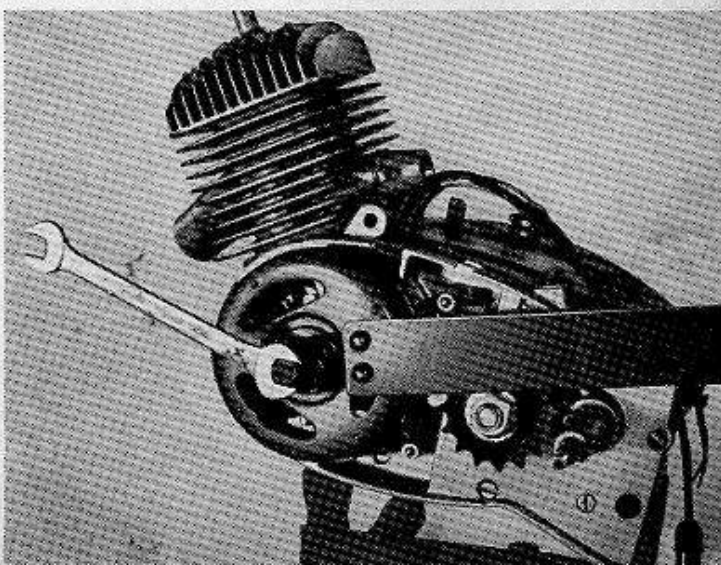

Fig. 8

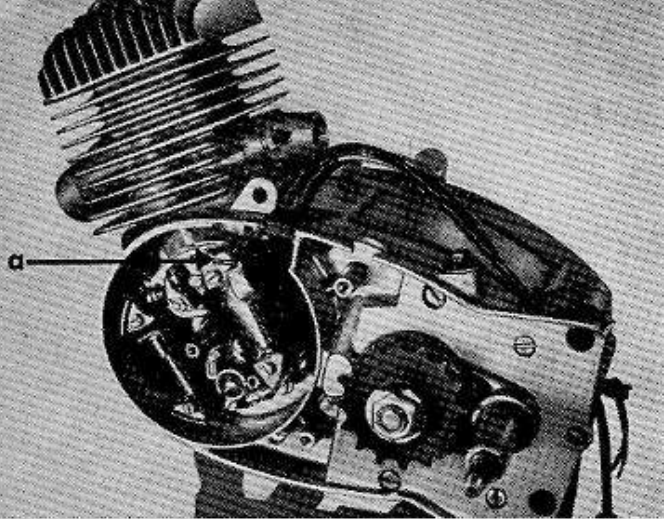

Fig. 9

If the work described in the following passages is confined to a repair of clutch and pedal gear change system, the baseplate can remain on the left casing. If the engine must be completely dismantled, take the plate off now, first removing the 2 cylindrical screws, M 4 x 15, and the casing screws, M 6 x 92, complete with cable clip (fig. 9).

On engine model 281, the baseplate is fixed with three screws, M 4 x 15.

d) Taking off Clutch Cover, Cover for Clutch and Gear Change Setting Controls.

Take the following screws off the left-hand casing cover:

	267	276	281
a)	M 6 x 92*	M 6 x 92*	M 6 x 92*
b)	M 6 x 98	M 6 x 98	M 6 x 98
c)	M 6 x 98	M 6 x 120	M 6 x 120
d)	M 6 x 120	M 6 x 120	M 6 x 120
e)	M 6 x 120	M 6 x 120	M 6 x 120
f)	M 6 x 120	M 6 x 120	M 6 x 120
g)	M 6 x 98	M 6 x 98	M 6 x 98
h)	M 6 x 98	M 6 x 98	M 6 x 98
i)	M 6 x 98	M 6 x 98	M 6 x 98

*) with cable clip (fig. 9)

Fig. 10

Three screws remain on the casing, 2 at the magneto and 1 below the starter spindle (fig. 10).

On engines, type 281, additionally take off 1 screw, M 6 x 98, above screw (i).

Remove connector cover closing off the clutch re-setting and gear change setting controls for pedal gear change engines. The cover is fixed with two countersunk fillister-head screws, M 5 x 15, to the right-hand casing cover (fig. 11).

On engines with manual gear change, the setting dome for adjusting the gear change assembly is not provided.

Slacken 2 fixing screws, M 6 x 12, on the setting dome (fig. 12).

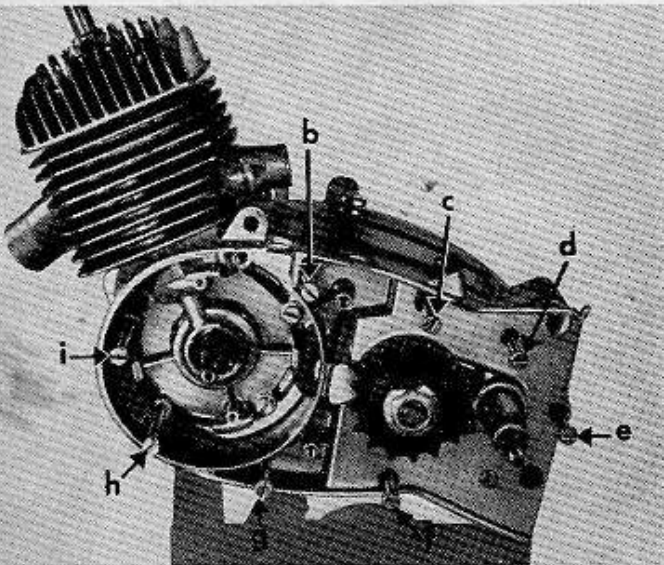

Fig. 11

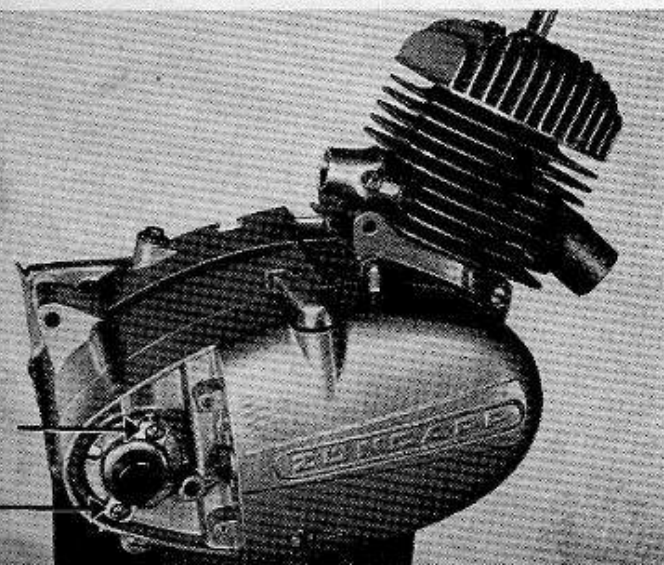
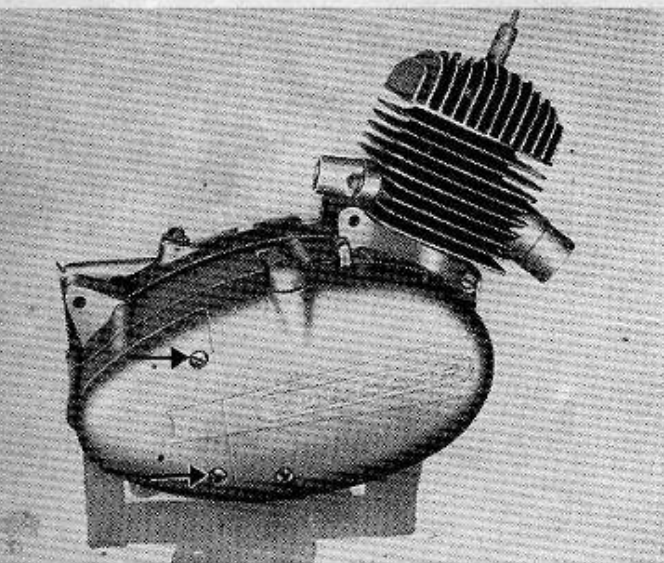

Fig. 12

Take off setting dome, remove cylindrical screw, M 6 x 45, underneath starter spindle (fig. 13).

Operate the clutch lever to press off the clutch housing cover.

Located inside the clutch housing cover are:

- Clutch spindle with lever
- Clutch dog
- 2 leaf springs for clutch dog
- Ball-headed threaded pin for re-setting clutch dog
- Bush for starter spindle
- Gearbox oil level checking screw
- Guide pin for selector slide (pedal gear change engines only)

On engines of type 276 and 281, the third crankshaft bearing is needle bush 277-01.135; engine 267 has no third crankshaft bearing (fig. 14).

e) Taking off Pedal Gear Change Spindle and Selector Slide

Take off pedal gear change spindle and selector slide (fig. 15).

Only on engines with pedal gear change

f) Dismantling Clutch

Fit service tool SK-A 235 to clutch with 2 studbolts, SK-A 237, and 1 stud, SK-A 265. Take off 5 or 10 nuts, M 4, with the 7 mm socket key. Slacken the clamping bolt, and clutch thrust plate; springs and spring bushes can now be taken off. On engines of type 267, fit the clamp with 3 studs, SK-A.237 (fig. 16).

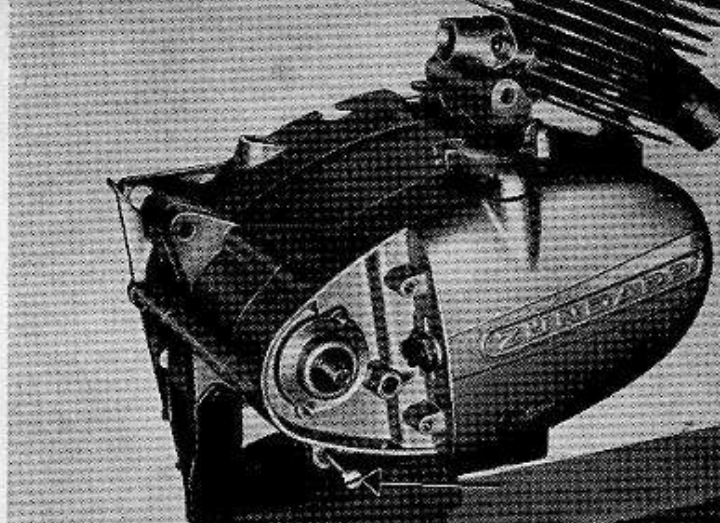

Fig. 13

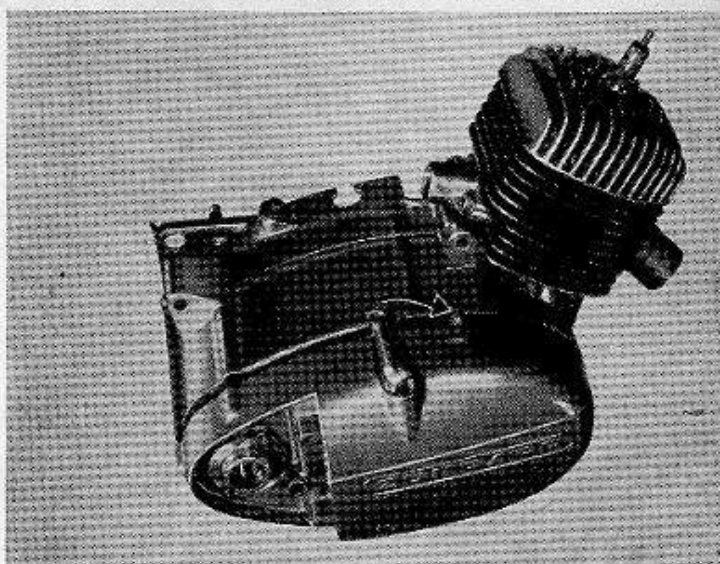

Fig. 14

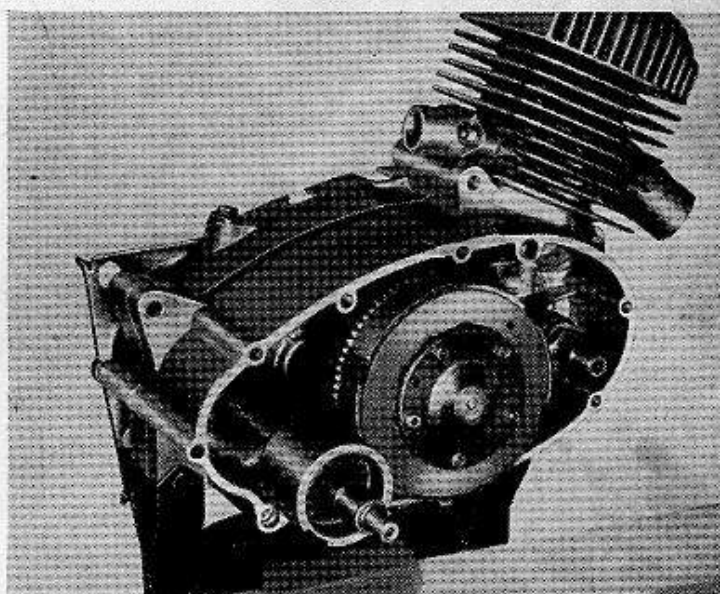

Fig. 15

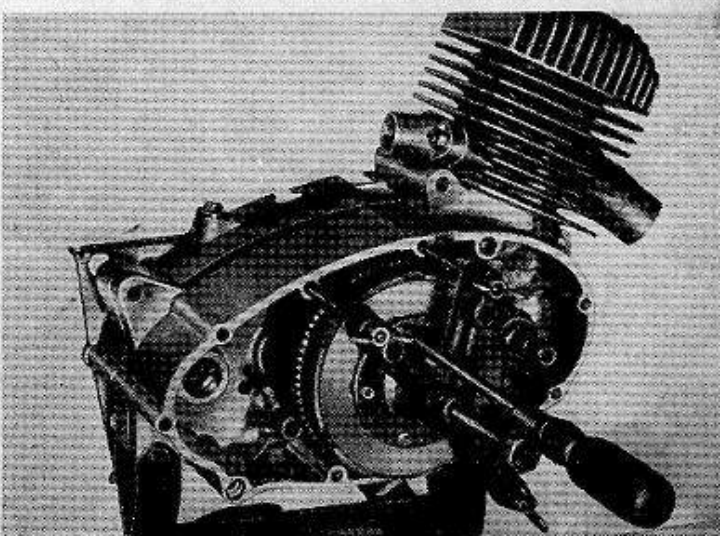

Fig. 16

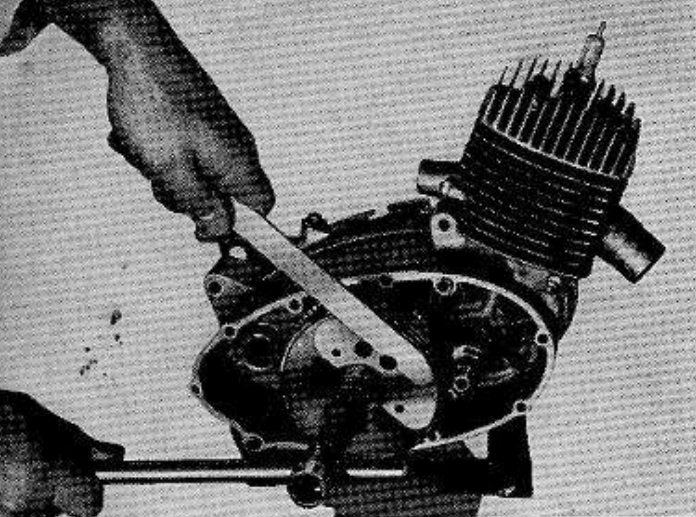

Fig. 17

Fit hold-down tool SK-A 279 to clutch thrust plate, then release clutch nut with the socket ke (fig. 17).

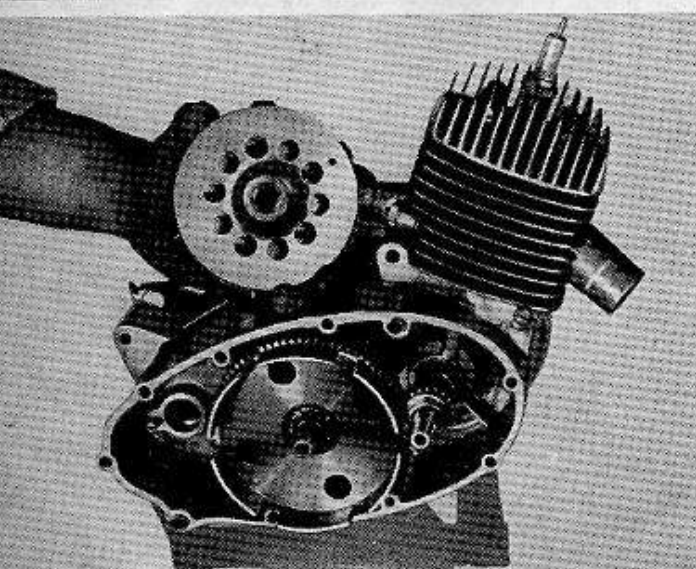

Fig. 18

Take off clutch complete with hub and the packing washers behind the hub (fig. 18).

The clutch gear remains inside the right-hand casing, held by a snap ring on the inside (gear-box).

On engines with pedal gear change, you can now draw out the steel-ball selector through one of the openings in the clutch. On engines with manual gear change, the steelball selector assembly can only be taken off after the engine has been completely dismantled.

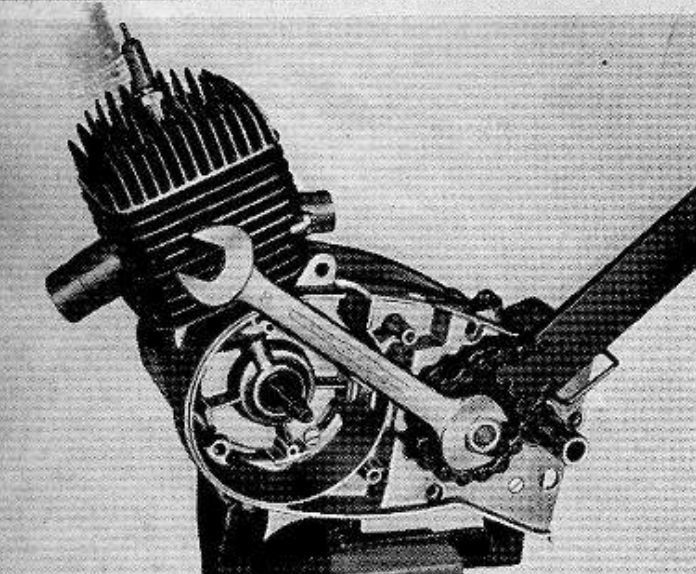

Fig. 19

g) Taking off Chain Sprocket

Bend open the locking tab washer and with an open-ended spanner take off the hexagon nut (if necessary, use a two-arm puller tool, fig. 19).

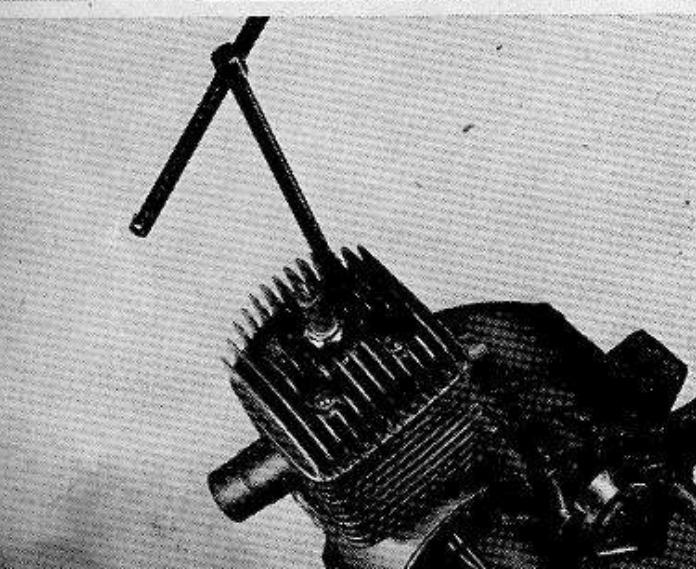

Fig. 20

h) Taking off Cylinder and Piston

Take off cylinder head and cylinder. Remove the 4 nuts, M7, with the 11 mm socket key, take off the washers underneath, then lift away cylinder head, head gasket, cylinder and base gasket; take off piston rings (fig. 20).

On engines, type 281, no head gasket is fitted as from engine No. 4600937.

Press off crank casing, then with pointed-nosed pliers draw off the retaining ring for the gudgeon pin (do not use a screw driver, fig. 21).

Fig. 21

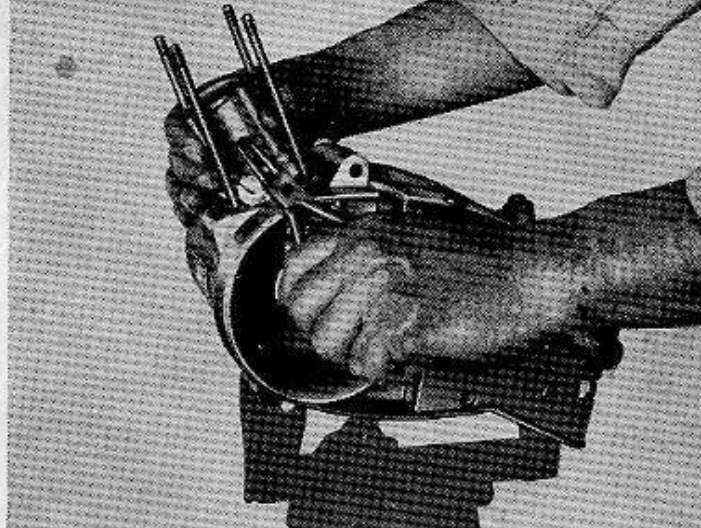

Fit gudgeon-pin press-off tool SK-A 64 and press off the gudgeon pin (fig. 22).

For engines of type 281, use press-off tool SK-A 268.

Note

Remove gudgeon pin needle bearing from connecting rod and put it away well protected from dust and dirt.

Fig. 22

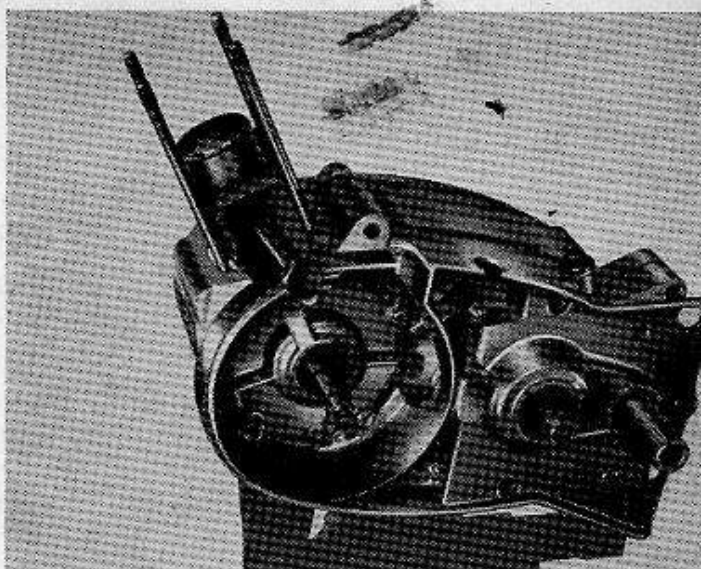

i) Taking off Crank Casing

To take the main clutch drive gear off the crankshaft, first bend up the locking tab washers. Hold assembly steady with the 11 mm spanner applied to the crankshaft flats, then with the 19 mm spanner take off the hexagon nut and pull off the wheel.

Note

Take care not to loose the two 5 mm balls underneath the gear (fig. 23).

Fig. 23

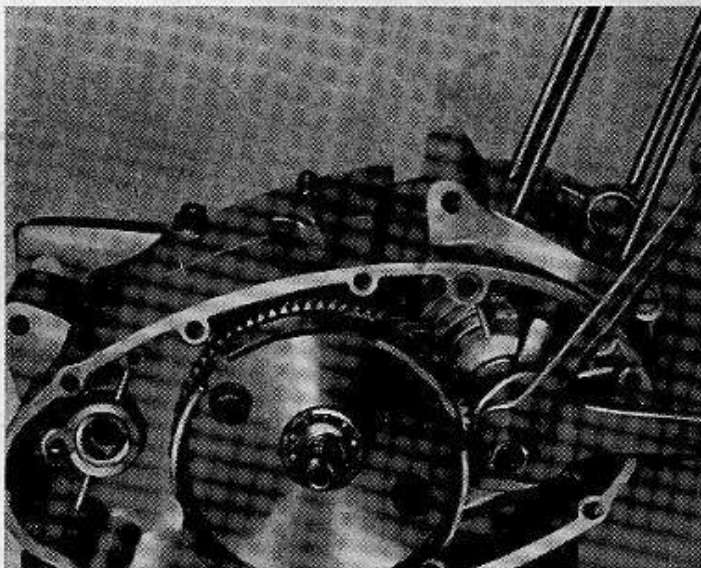

If the drive gear cannot be pulled off by hand, use a standard two-arm puller tool (fig. 24).

Fig. 24

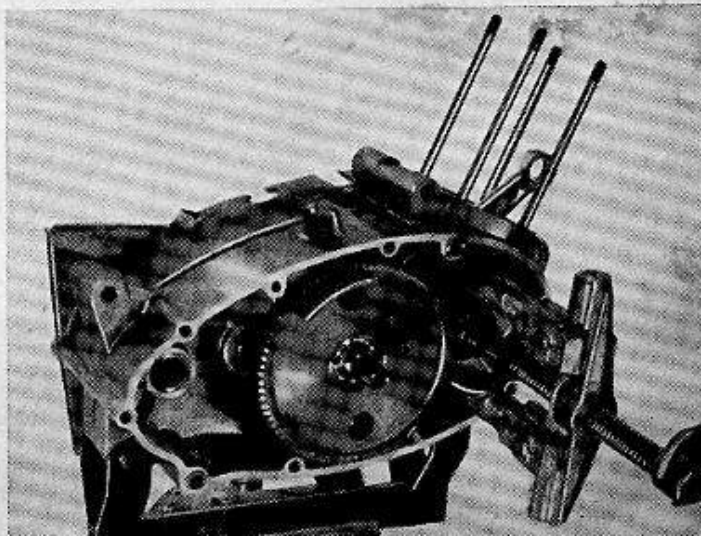

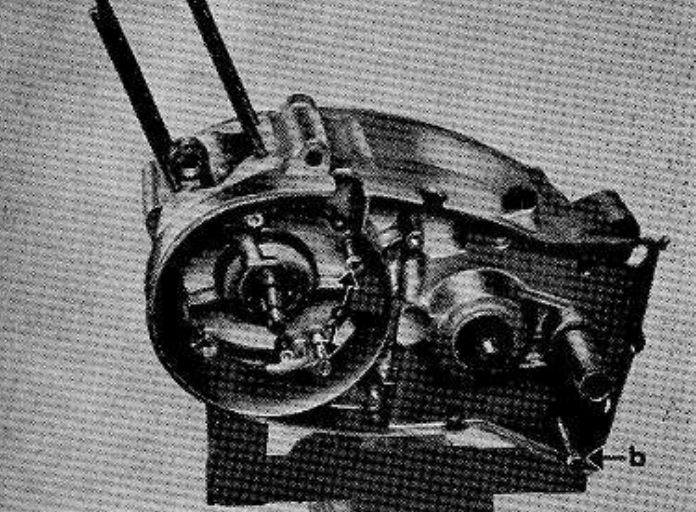

Fig. 25

Take the remaining screws from left-hand casing, 2 in magneto section, M 6 x 35 (a) and 1 under starter spindle, M 6 x 65 (b) (fig. 25).

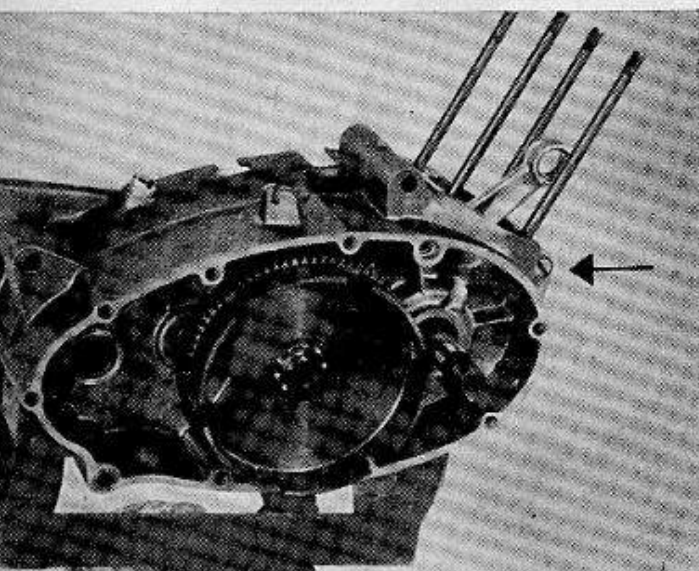

Fig. 26

On the right-hand side, take one screw, M 6 x 50, off the base of the cylinder (fig. 26).

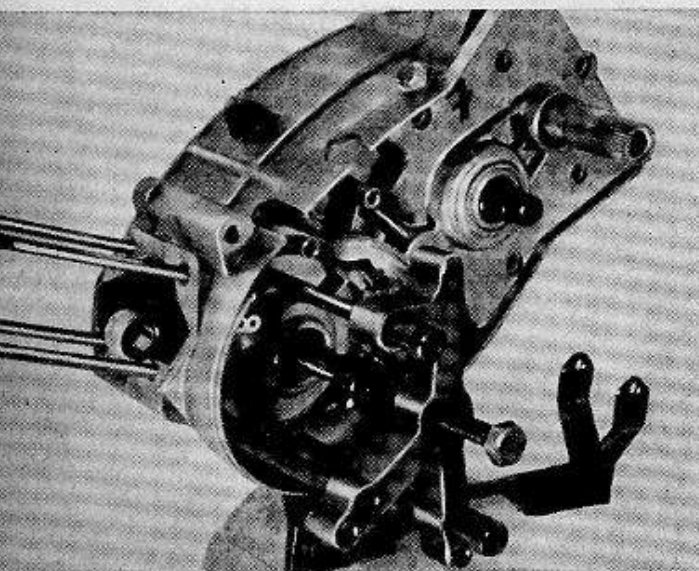

Fig. 27

Engines 267 and 276

Fit service clamp SK-A 234 by 2 stud-bolts, M 8 (SK-A 246), and 1 locating bolt (SK-A 123) on the left-hand side above the magneto spindle (fig. 27).

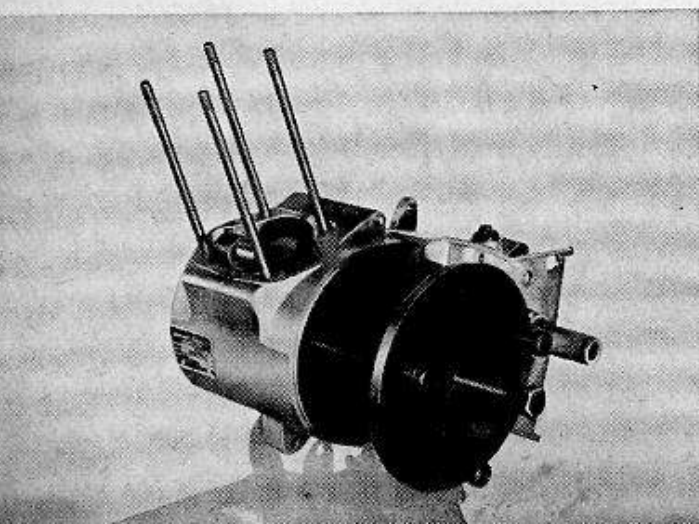

Fig. 28

For engines 281, make your own press-off fixture and secure it with three 8 mm screws SK-A 246 to the left-hand casing above the magneto spindle.

(The diameter should be 6 in. (150 mm), thickness 7 mm, bore 9 mm to take the 8 mm bolts, (see special tools, fig. 28.)

Take the gearbox block from its mounting frame and place it, right-hand side facing down, on two wooden blocks. Turn the press-off bolt and at the same time press on selector and starter shafts to prize the two gearbox halves apart. Then carefully lift off the top half (left) (fig. 29).

Fig. 29

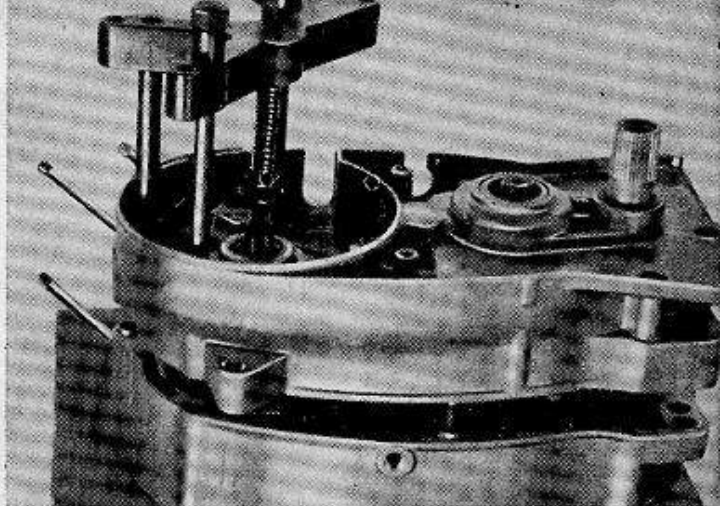

Before taking out the various shafts, note the position and number of washers and spacer rings fitted, as well as the correct meshing position of gears (and mark these with a reference line for preference). Careful attention to correct fit before starting to dismantle may save you considerable gauging and setting work when the engine is re-assembled.

Take out shafts in this sequence:

1. Gear selector shaft with selector gears and steel-ball assembly
 2. Starter shaft
 3. Main drive shaft
 4. Crankshaft
- (fig. 30).

Fig. 30

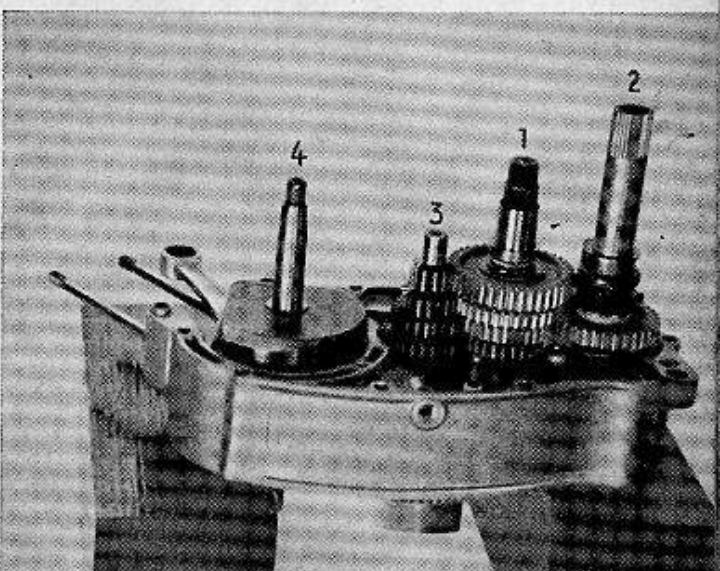

For engines with manual gear selection, the steel-ball selector remains in the selector fork on the right-hand casing.

Carefully inspect all shafts and gears for traces of wear and proper alignment as soon as you have taken them off (fig. 31).

Fig. 31

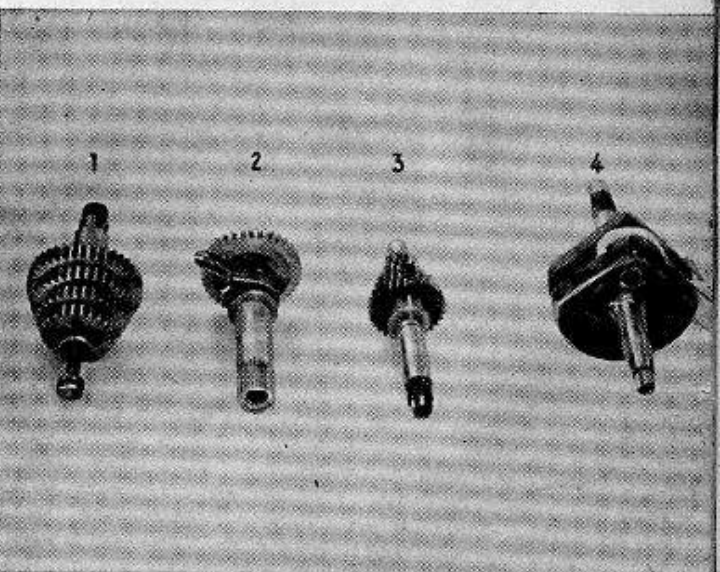

k) Taking off Bearings, Bushes and Clutch Gear

On engines of type 281, the 19 rollers, 5x3.5 dia., can be taken out after removing spacer ring 281.05.110 (fig. 32).

Fig. 32

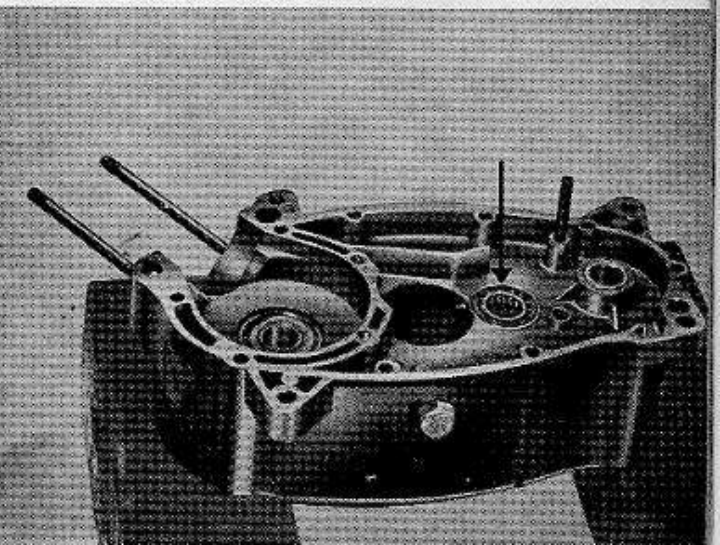

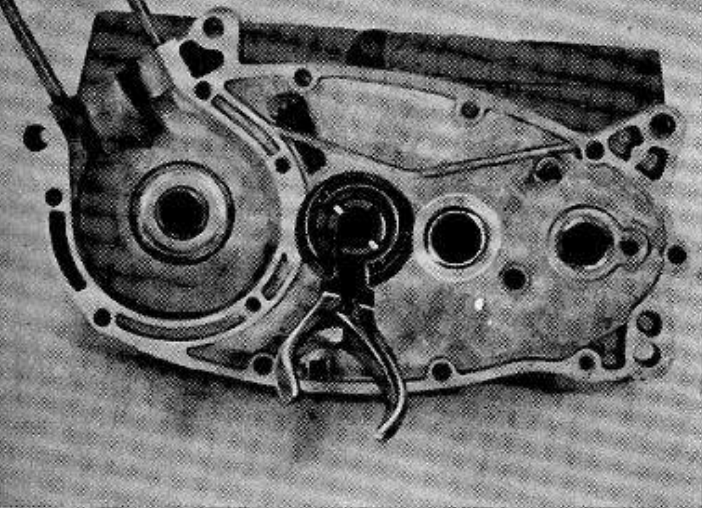

Fig. 33

The clutch gear can only be pressed off after taking the circlip in the casing behind the ball bearing from its seat with a pair of pointed pliers.

If clutch gear and both ball bearings are in perfect condition, they need not be taken off (fig. 33).



Fig. 34

If necessary, pull the ball bearing from the clutch gear with a standard bearing puller tool (fig. 34).

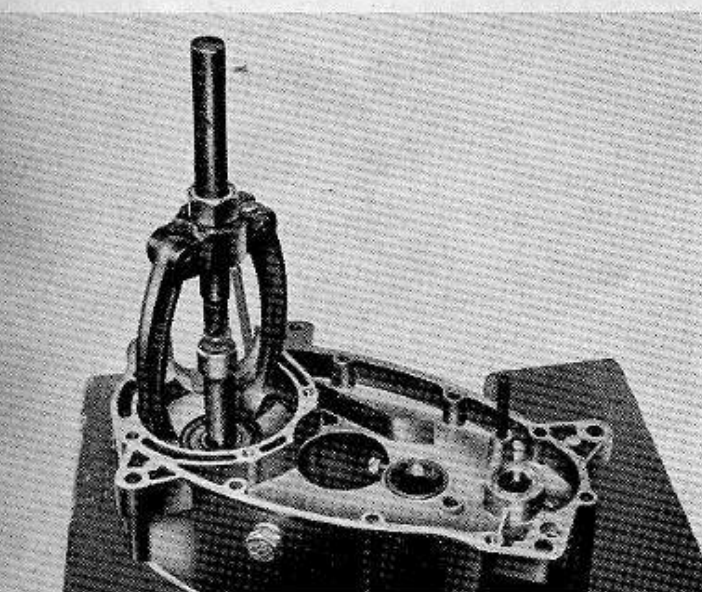

Fig. 35

Casings should be warmed first for easy withdrawal of ball bearings and bushes. Or use the puller tool to remove them (fig. 35).

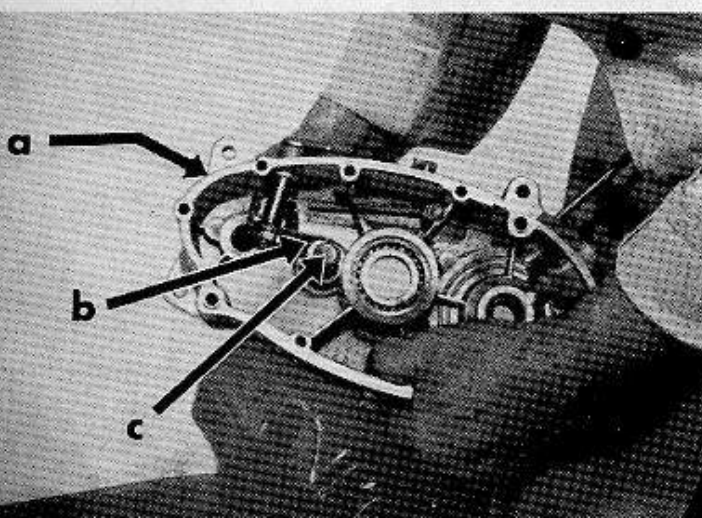

Fig. 36

l) Taking off Steel Ball Selector on engines with manual gear change

Bend up the tab of the washer securing the locknut of setscrew (a). Slacken nut, turn setscrew until selector fork (b) can be swung away and selector (c) can be taken out (fig. 36).

2. Engine Assembly

Before assembling the engine, first clean all parts thoroughly, remove the sealing compound from casing rim surfaces and check that all parts and sealing faces are in perfect condition. Replace defective or damaged parts with **Original ZUNDAPP Spare Parts**. Gaskets and sealing rings must always be replaced by new ones.

Make sure that all parts, such as spindles, shafts and bearings, are pressed home all the way to the stop in their locating bores, seats, etc. To fit a ball bearing, always heat its housing to approx. 85° C. Coat the sliding and stop faces of all moving parts with a generous film of oil, using only the grade and type specified by us.

Clean all metal filings off the magnetic plug in the right-hand casing.

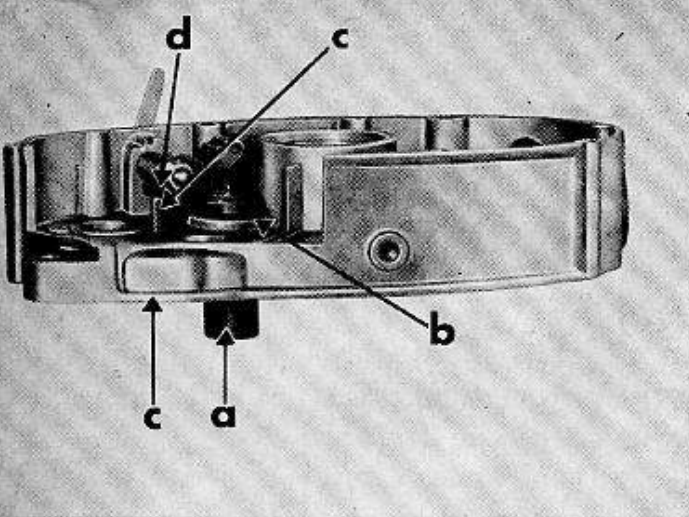

Fig. 37

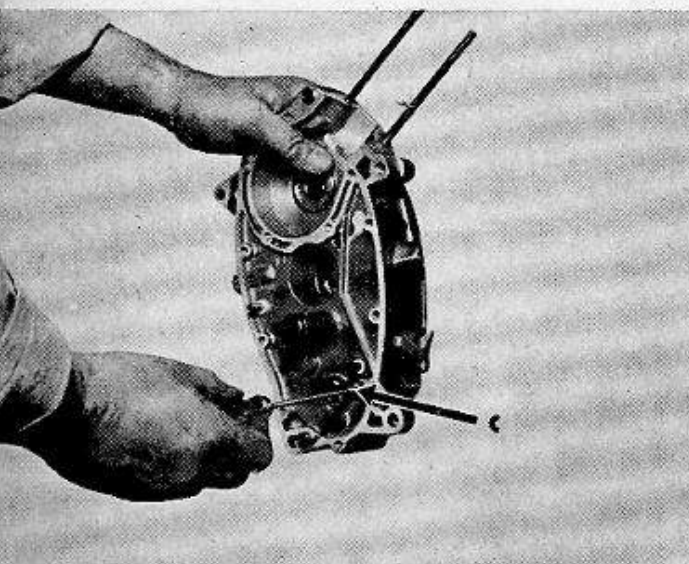

Fig. 38

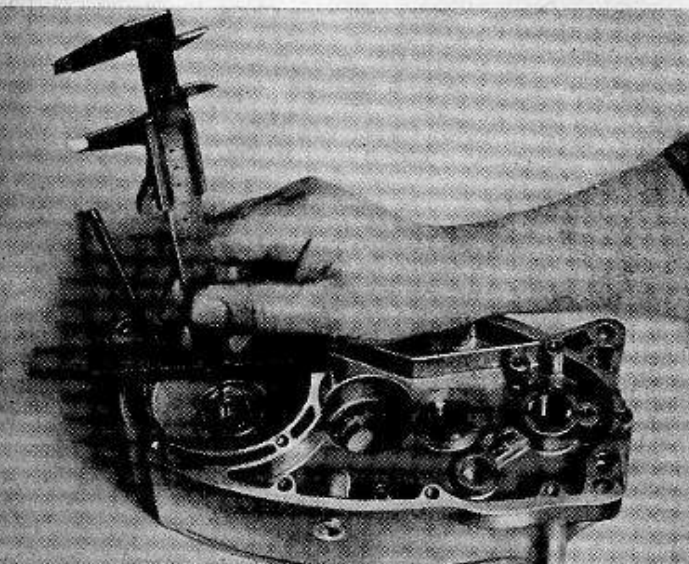

Fig. 39

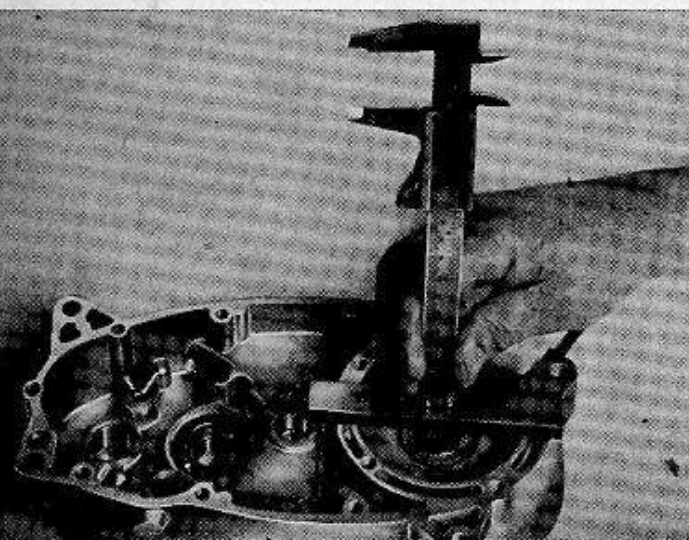

Fig. 40

a) Setting Steel Ball Selector on engines with manual gear change

On engines with manual gear change, set the steel ball selector with the setscrew so that the spherical part sits exactly in the centre of the selector shaft bore corresponding to the highest gear (3rd or 4th).

Use setting gauge SK-A 232 (3-speed /a) to carry out the adjustment, fitting it into the bearing bush of the right-hand casing in place of the selector shaft and securing it with locking washer SK-A 233 (b).

Now press the inner face of the selector at the selector lever guide against the end of the setting gauge. Turn in threaded pin (c) until all play in stop bracket (d) and thereby in the selector is reliably eliminated. Tighten locknut and secure setting with the tab washer. Slacken nut on gauge and take gauge off.

On 4-speed manual gear change engines, first fit a bush of 11.5 mm length, 14 mm o. d. and 12 mm i. d. (made in your own workshop), then fit gauge SK-A 232 (figs. 37 and 38).

b) Measuring Axial Play of Crankshaft

Permissible play is 0.1 mm. To measure it you need a gauging bar and a caliper gauge with depth scale. Measure from the contact face of the right-hand casing to the inner ball bearing race (fig. 39).

Then carry out the same check on the left-hand casing and add the two values obtained (fig. 40).

Prepare crankshaft for gauging. Fit a washer with 2 mm bevel on to the crankshaft drive shaft (bevel facing crank web).

Fit a washer with 2 mm bevel on to the flywheel magneto shaft (bevel facing crank web, fig. 41).

Now measure crankshaft over both webs, including special bevelled washers (fig. 42), then deduct the value obtained from the sum obtained by the two gauging operations shown in fig. 39 and 40. Fit packing washers to eliminate all but the permissible play of 0.1 mm, as shown in the following example.

Example:

Left casing	18,4 mm
Right casing	24,5 mm
	<hr/>
	42,9 mm
Crankshaft	- 41,7 mm
	<hr/>
	1,2 mm
Axial play	- 0,1 mm
	<hr/>
	1,1 mm
Standard washer on drive shaft	- 0,5 mm
Remainder flywheel magneto shaft	0,6 mm

On engines of type 281, the standard washer is 0.2 mm thick.

c) Fitting Crankshaft into Right Casing

Heat up inner race of ball bearing with a hot mandrel, then fit crankshaft (fig. 43).

Fit sealing ring for crankshaft drive shaft, using special assembly sleeve MV 6-339 to prevent damage to the sealing lips by the drive shaft thread. Drive sealing ring home with light taps of hollow punch MV 6-347 (fig. 44).

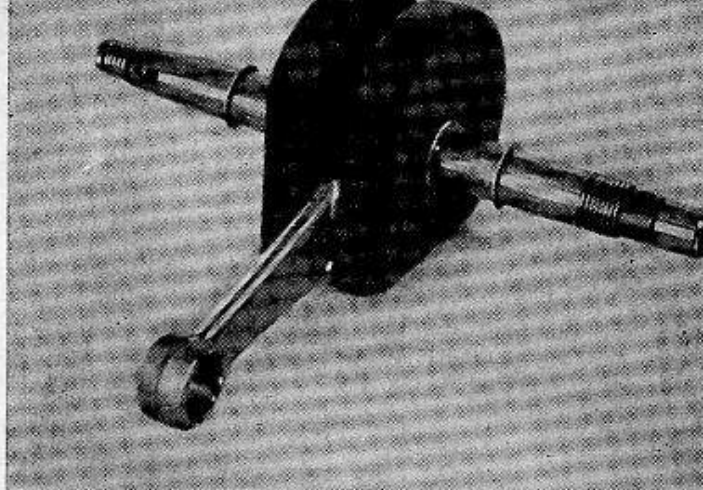

Fig. 41

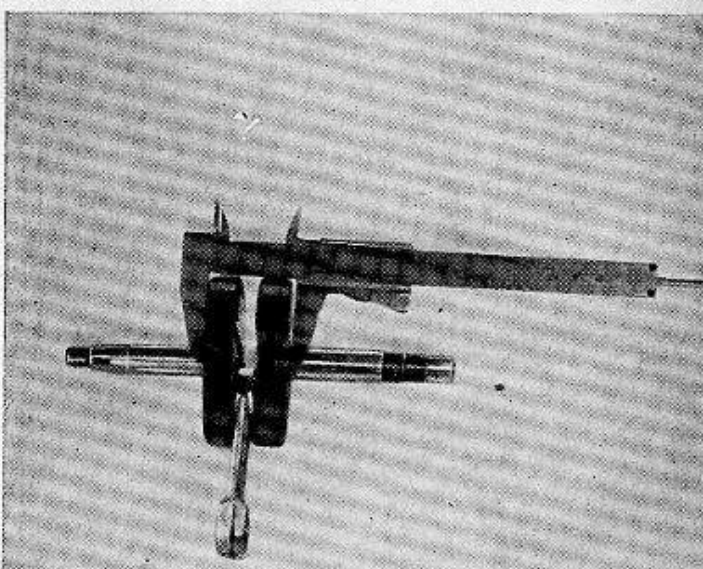

Fig. 42

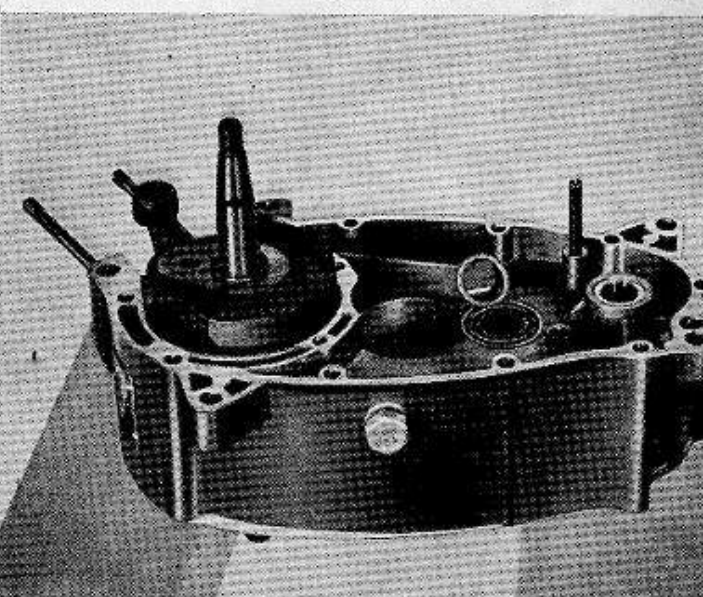

Fig. 43

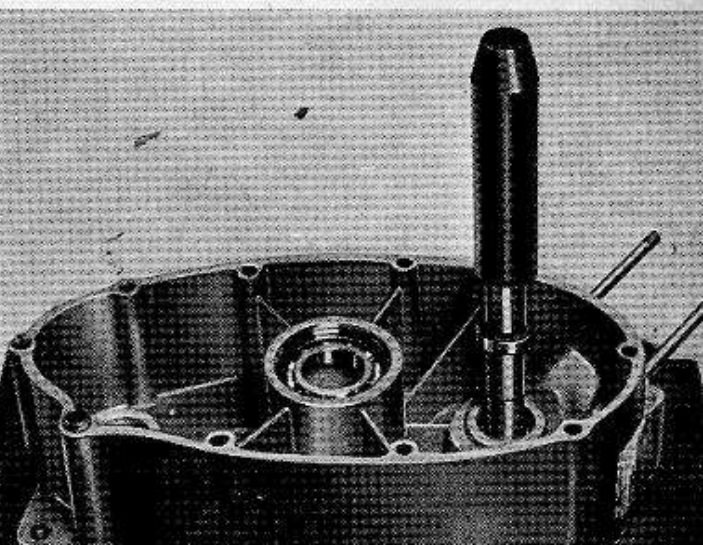

Fig. 44

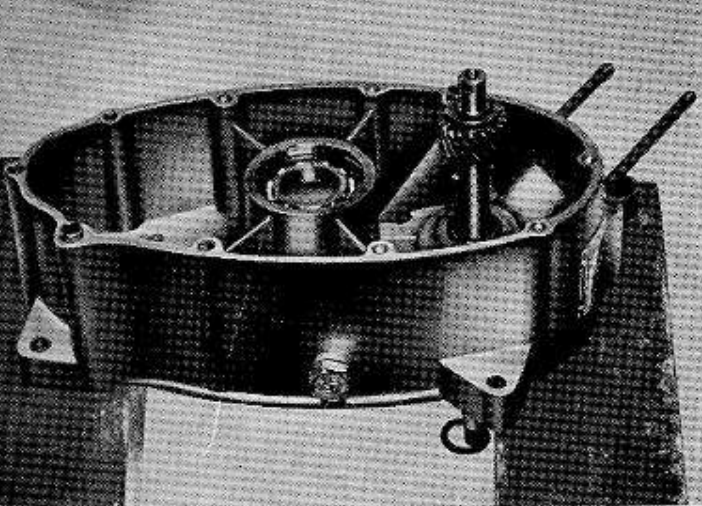

Fig. 45

For engines of type 281, use assembly sleeve SK-A 217, first expanding the bore to 13.5 mm.

Fit two 5-mm steel balls with a little grease into the ball seats of the drive shaft (crankshaft) then slide on the primary drive gear. Finally, secure assembly with locking washer and hex nut (fig. 45).

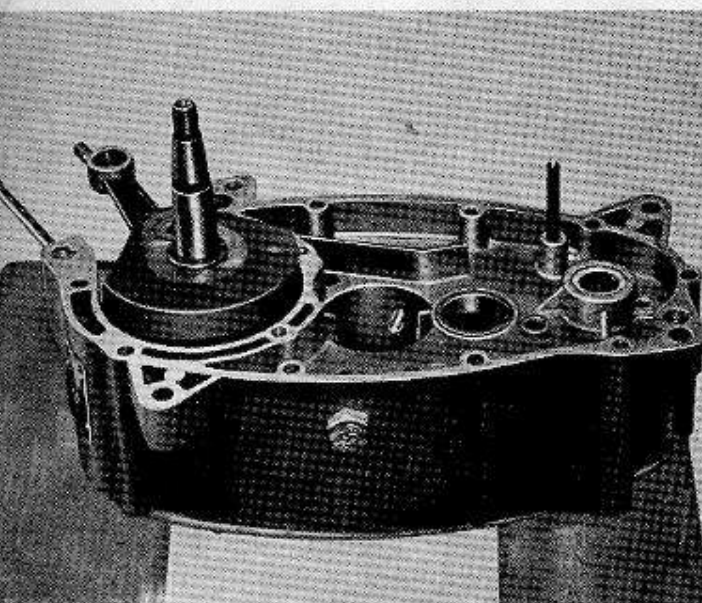

Fig. 46

Remember to secure the nut

On engines, type 281, stick 19 rollers, 5 x 3.5 dia., with a generous grease coating into the bearing race of the right casing, then slide spacer ring 281-05.110 on to the roller assembly (fig. 46).

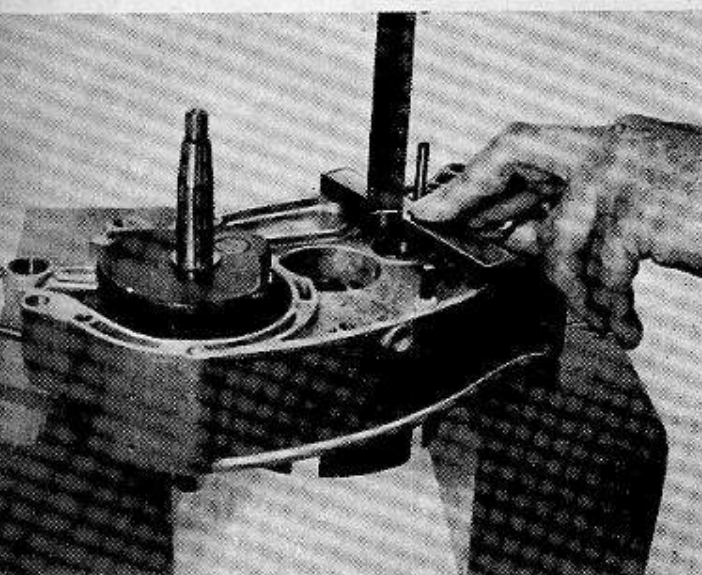

Fig. 47

d) Measuring Axial Play of Selector Shaft

Place gauging bar or the yoke over the right-hand casing, so that you can measure with the depth scale right to the stop face for the selector shaft inside the casing. Note the value measured, remembering to allow for the thickness of the scale bar (fig. 47).

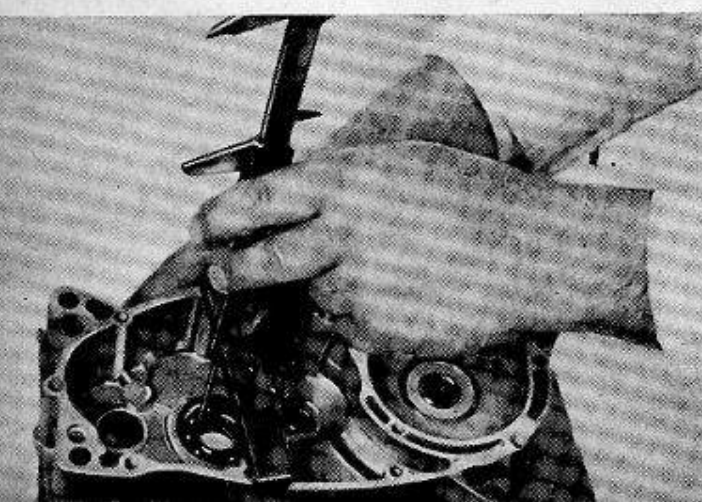

Fig. 48

Place the bar on the contact face of the left casing and measure distance to the ball bearing inner race (stop face for selector shaft, fig. 48). Add the value read off to the one already noted.

Note: Remember to allow for thickness of bar.

Now measure selector shaft between the two stop faces (fig. 49). This value will always be smaller than the sum of the two obtained to fig. 47 and 48.

Fit washers on the shaft between ball bearing and speedometer drive until only a play of 0.1 mm remains (for swinging fork machines).

Fig. 49

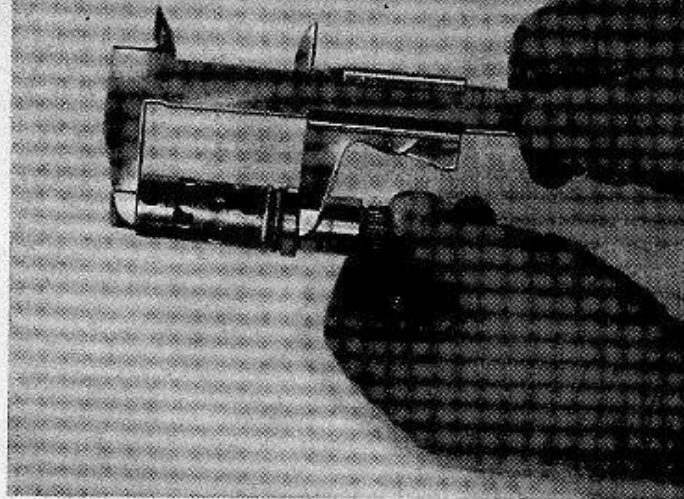

Example:

Measurement obtained to fig. 47	22,7 mm
Measurement obtained to fig. 48	+ 34,9 mm
Sum	<hr/> 57,6 mm
Dimensions, fig. 37	- 56,9 mm
	<hr/> 0,7 mm
Axial play	- 0,1 mm
Packing washers required	<hr/> 0,6 mm

For engines of machines with telescopic fork, a spacer bush is fitted to the collar of the selector shaft, since the speedometer drive is taken from the front hub.

e) Measuring Selector Gears

Fit the selector shaft with the number of packing washers calculated into the left casing, then fit selector gears in sequence in such a way that the larger collar faces down, i. e. towards the larger gear. Gears are correctly fitted if only one oil groove lies between each two gears, and the arrow at the side points to the next larger gear. Next, with the depth gauge, measure distance from end face of selector shaft to stop face of selector gear (fig. 50).

Fig. 50

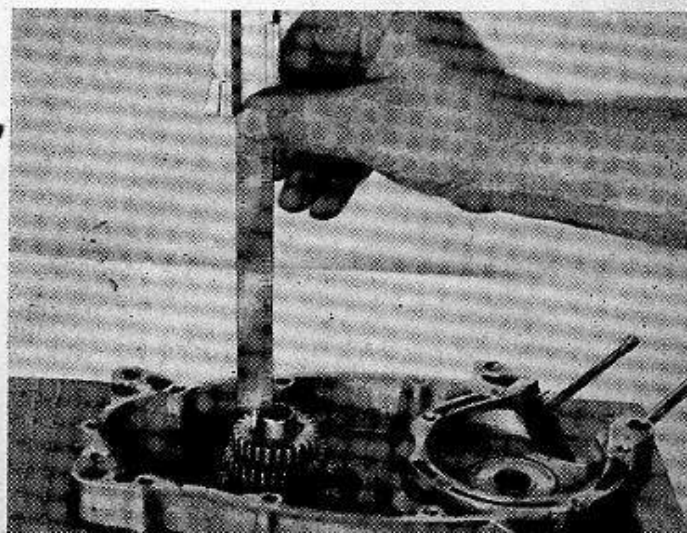

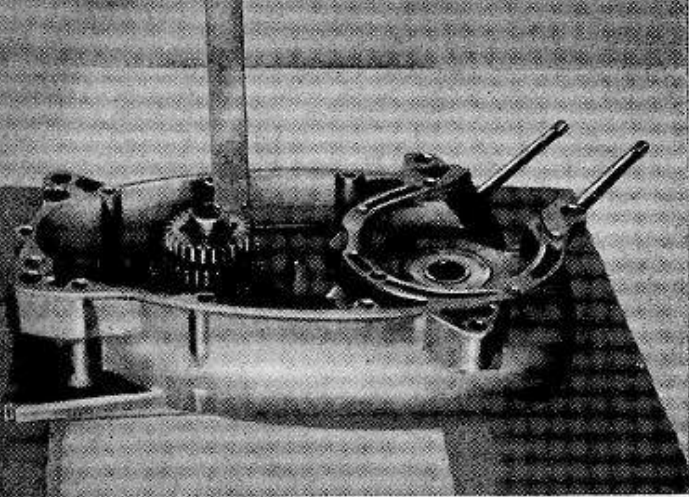

Fig. 51

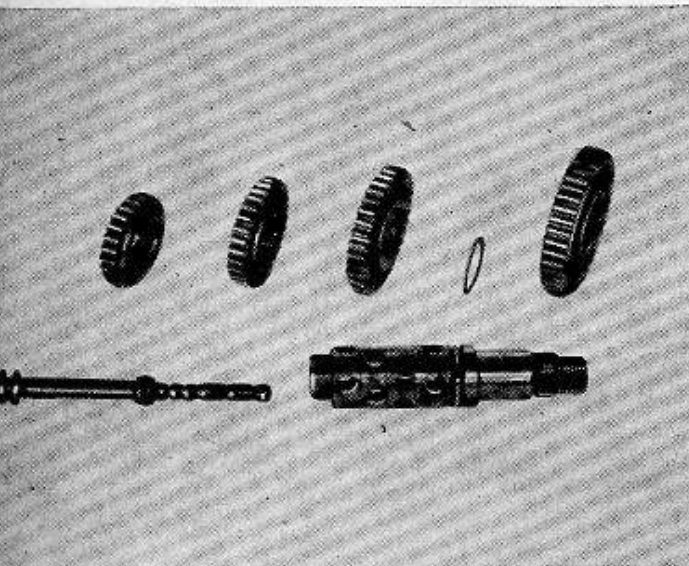

Fig. 52

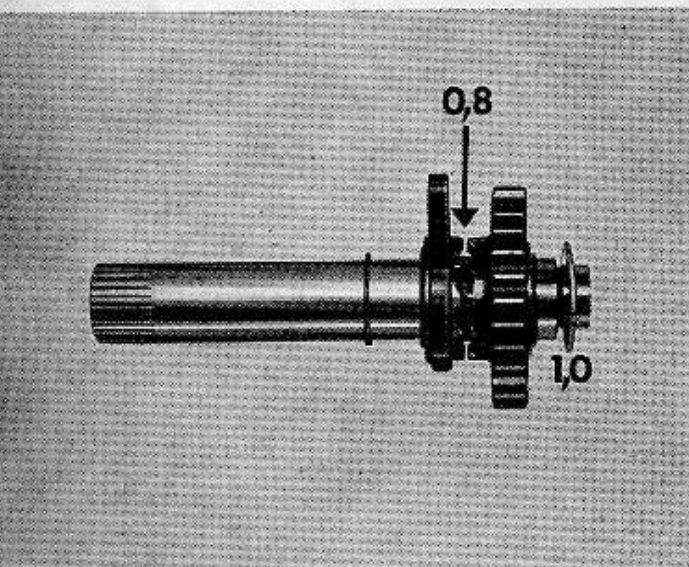

Fig. 53

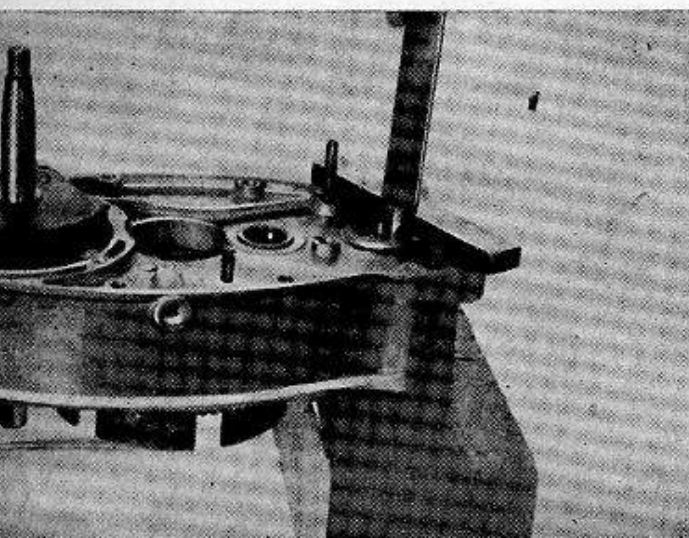

Fig. 54

Then measure from the same point to the stop collar of selector shaft (fig. 51).

The distance must not be larger than the value obtained to fig. 50. Correct any backlash in gears by fitting packing washers between 1st and 2nd speed gear; play must be eliminated to 0 (fig. 52).

Note: The balls for the selector gears should be coated with oil, not with grease, to stick them into position. Before fitting selector shaft, check that stop pins of selector shaft are correctly mounted, complete with their annular springs.

f) Measuring Starter Spindle

Check distance of opposing teeth between driver and kickstarter gear on kickstarter spindle. This should not exceed 0.8 mm. If it does, fit packing washers between shap ring and driver. A washer of 1 mm is fitted to the short shaft stub as standard (fig. 53).

With gauging bar and depth gauge, measure distance between contact face of right casing and stop collar for starter spindle (fig. 54). Note down the reading.

On the left casing measure the same distance with the same instruments (fig. 55).

Next, measure distance between the two stop faces on the starter spindle (fig. 56), then make up the difference from the sum of the two measurements just described by fitting packing washers, until only a play of maximum 0.3 mm remains.

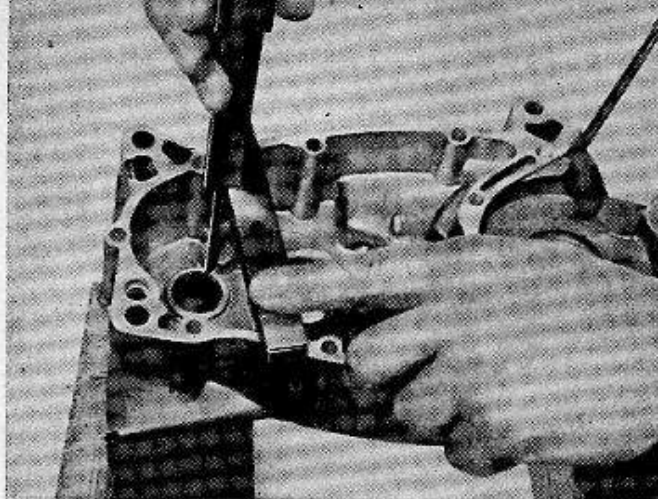

Fig. 55

g) Assembling Engine Block

Fit selector shaft and kickstarter spindle together with the packing washers determined by gauging, and the main gearbox drive shaft with a standard 1 mm washer into the left casing. Set brake spring so that when the two casing halves are fitted together, the stop pin in the right casing can be introduced into the spring. Locating stop on starter spindle must face bore marked x on housing (fig. 57).

The assembly notes on the locating stop of the starter spindle apply only up to the engine numbers listed below:

Typ 267	Nr. 3525493
Typ 267 (R 50)	Nr. 8000639
Typ 276 (KS 50 Super)	Nr. 4056928
Typ 281 (KS 100)	Nr. 4601353

As from the succeeding engine numbers of the types listed and on all RS 50 models right from the start, the kickstarter stop has been transferred to the outside and is now located in the left casing cover. Consequently, the assembly notes accompanying figs. 93—95 apply.

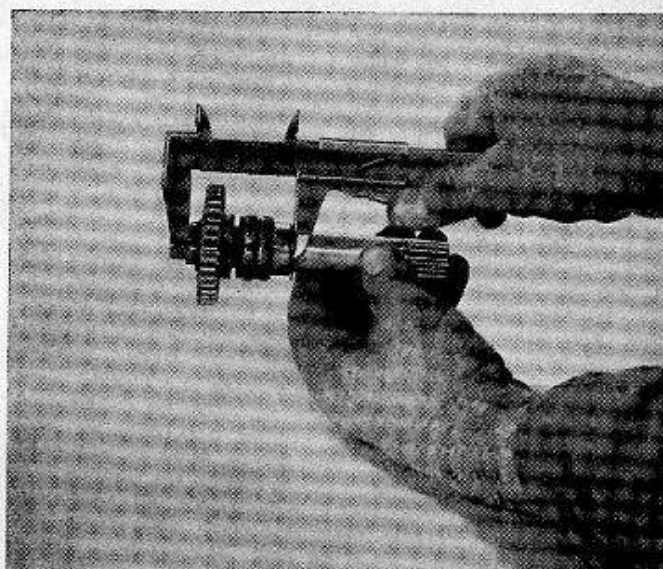

Fig. 56

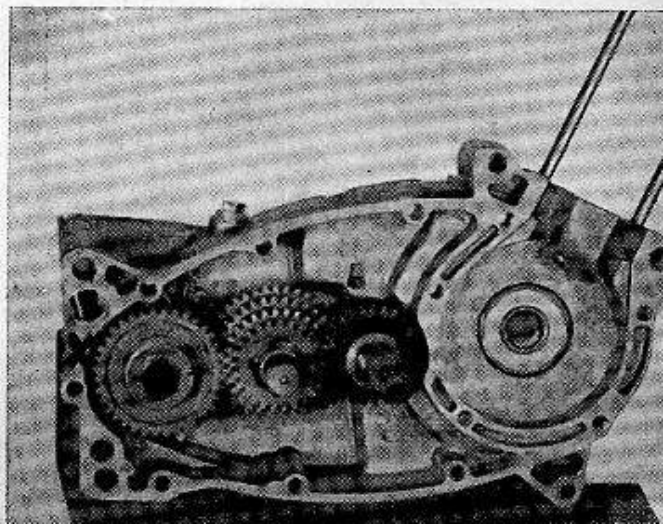

Fig. 57

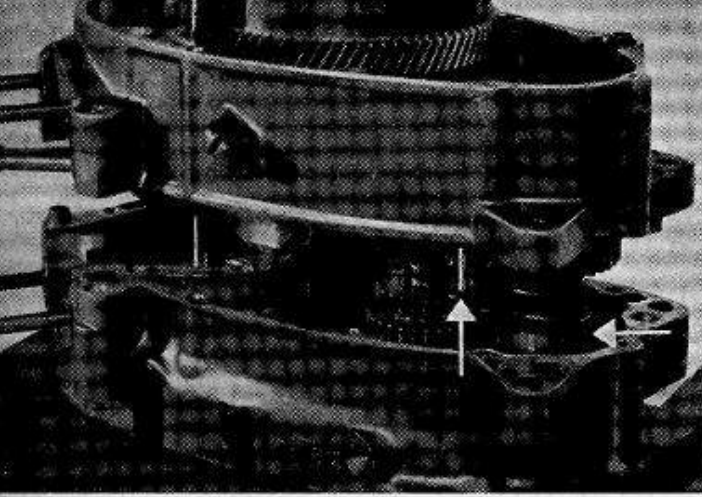

Fig. 58

Press clutch gear (if earlier taken off) into right casing, then secure it from inside with the snap ring (see fig. 33); the pre-assembled right casing is shown in figs. 24 and 26.

Mount two press-fit bushes, coat casing contact faces with compound, such as Teroson Atmosit, oil shafts and bearings, then carefully fit both casings together, taking care to position the brake spring correctly. It is advisable to lift the starter spindle up from underneath until the stop pin engages with the brake spring, so that the spring cannot shift out of position as the two casing halves are fitted together (fig. 58).

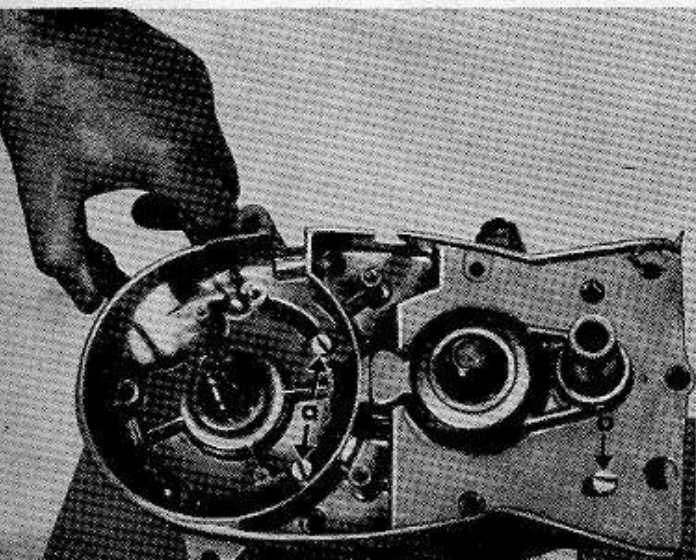

Fig. 59

Bolt casing halves together on the left with 2 bolts, M 6 x 35, at the fly-wheel magneto side (a) and below the starter spindle (b, fig. 59).

On the right hand, fit 1 bolt, M 6x50, at the cylinder base (shown by arrow on fig. 26).

h) Fitting Selector Shaft to Bearing on Left Casing

Fit 1 ring (made in your shop) of the following dimensions:

Height	6 mm
Outer dia.	36 mm
Inner dia.	31 mm

on to selector shaft, flush against the casing. Fit chain gear and tighten gear nut to shift shaft upwards bringing its collar all the way against the inner race of the ball bearing.

Take off nut, chain gear and ring again (fig. 60).

On engines of type 267, use spacer ring SK-A 138 for driver in place of the ring just mentioned. Having fitted the ring, fit and run down chain gear nut only.

Check that all shafts move smoothly.

i) Mounting Sealing Rings

Fit engine into service fixture SK-A 126 and clamp the whole assembly into the vice.

Fit sealing ring to left casing; fit sealing ring for crankshaft with punch MV 6-961.

Fit sealing ring for selector shaft with assembly socket sleeve SK-A 217 and drive it home by tapping with punch MV 6-734.

On engines of type 267 (manual and pedal gear change), use socket sleeve MV 6-960 together with punch MV 6-961.

Fit sealing ring for kickstarter spindle with hollow punch MV 6-734, noting that chamfered side of ring must face casing (fig. 61).

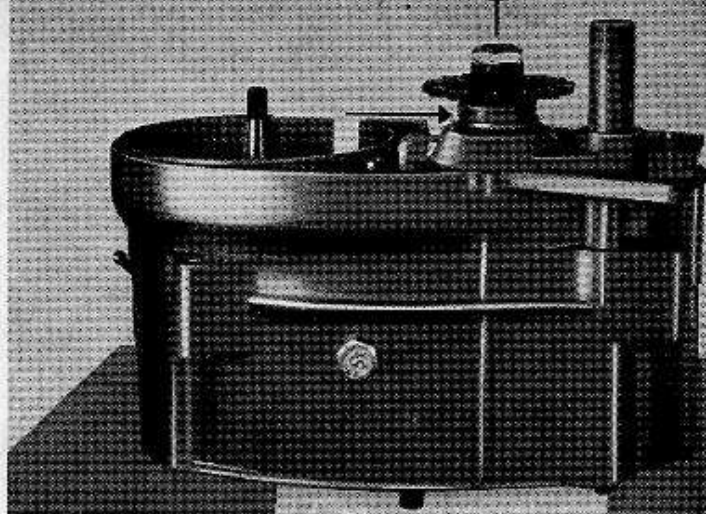

Fig. 60

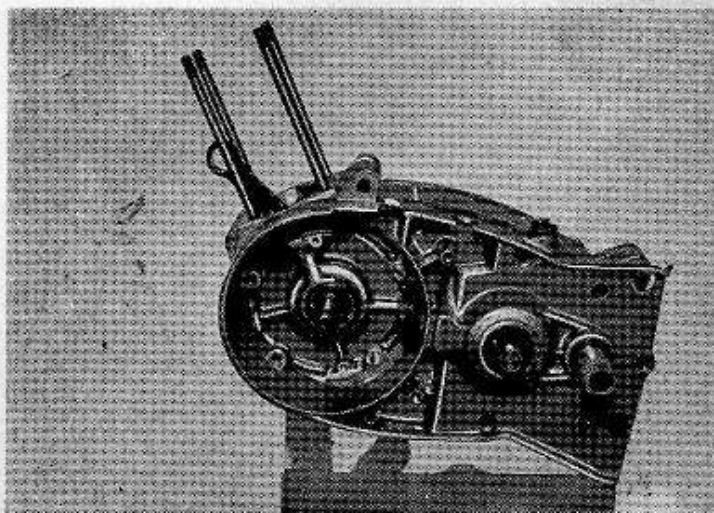

Fig. 61

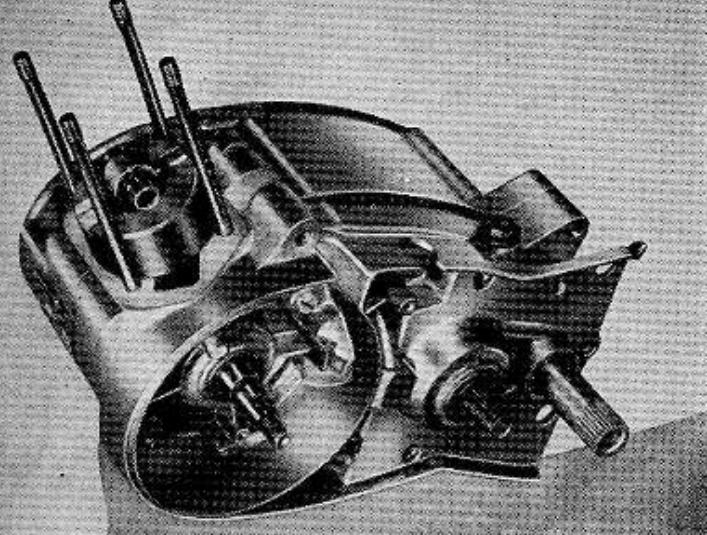

Fig. 62

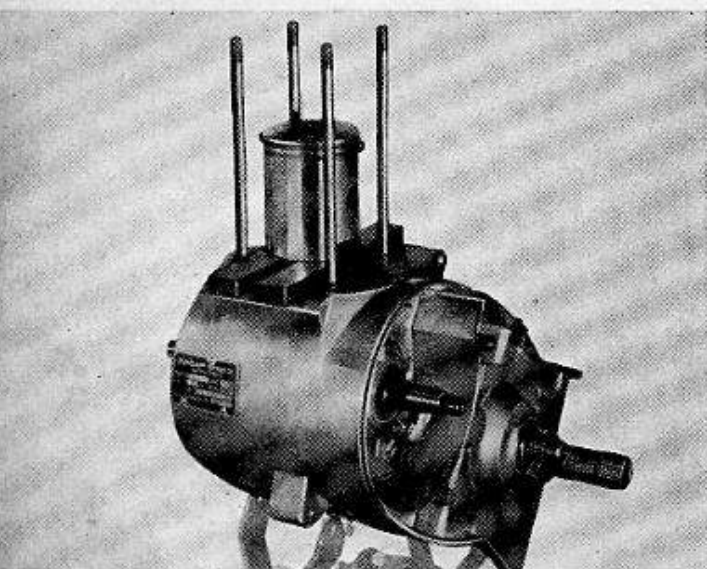

Fig. 63

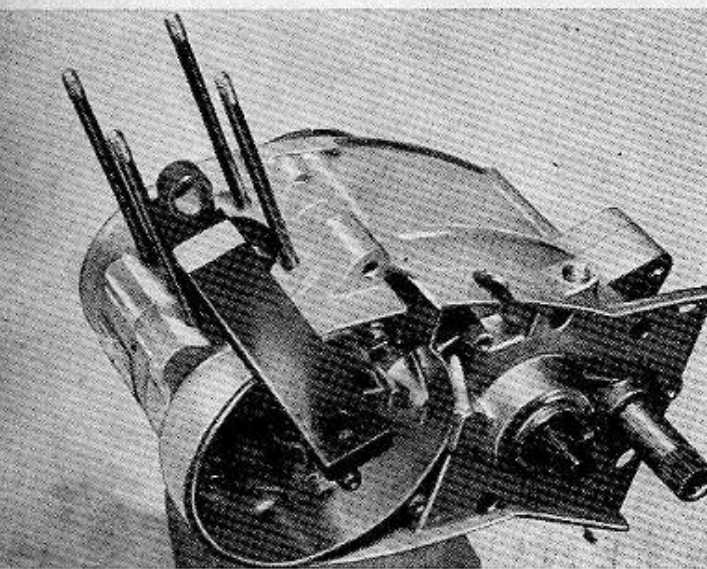

Fig. 64

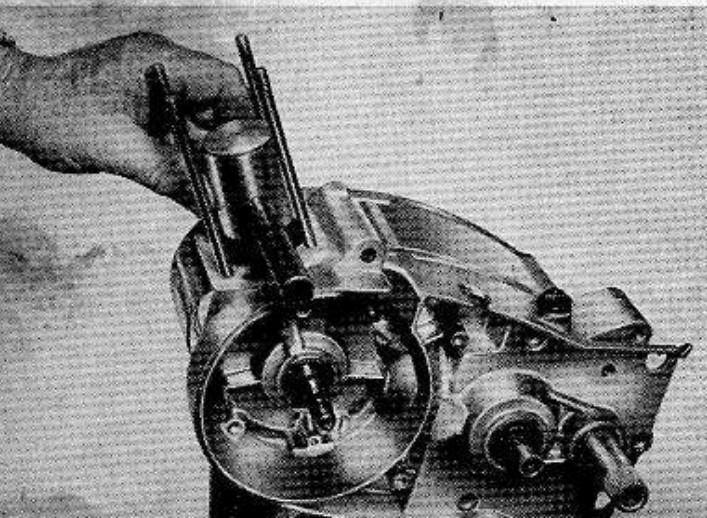

Fig. 65

k) Inspecting Connecting Rod

Fit gauging ring SK-A 125, needle bearing and gudgeon pin into connecting rod. Turn crankshaft down until gudgeon pin lies against gauging ring. Check that it contacts flush on both sides (fig. 62).

Gauge in turned-over position and compare results.

Adjust connecting rod as shown in fig. 64.

On engines of type 281, place two gauging bars SK-A 161 on both sides of the connecting rod on the casing face accommodating the cylinder base gasket. Turn the crankshaft until the piston rod edge lies against the bars. Then repeat the gauging in the opposite position. Adjust the connecting rod as shown in fig. 63.

Carry out final connecting rod setting with the setting bar MV 6-116 (fig. 64).

l) Assembling Piston and Cylinder

Fit the piston; the mark "Auslass" (exhaust port) must face towards the exhaust. Introduce gudgeon pin with service tool SK-A 163, fit crankshaft cover, then fit retaining rings. Position cylinder base gasket, but without sealing compound (fig. 65).

On engines of type 281, use tool SK-A 272 to fit the gudgeon pin.

Fit piston ring and support piston with a special fork tool, made in your workshop (fig. 66).

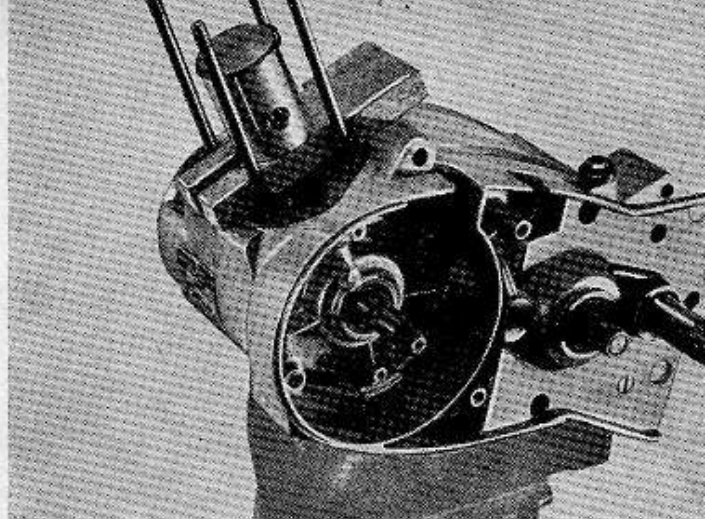

Fig. 66

Fit cylinder (introduce piston carefully and gently into cylinder to prevent fracture of piston ring).

Note: The locating pin in the piston ring groove must sit inside the ring joint. Fit cylinder head gasket and cylinder head. Fit 4 packing washers, then tighten the 4 nuts, M7, with 11-mm socket wrench, working always on diagonally opposite nuts in turn; torque 10.6 lb-ft. (1.5 mkg., see fig. 67).

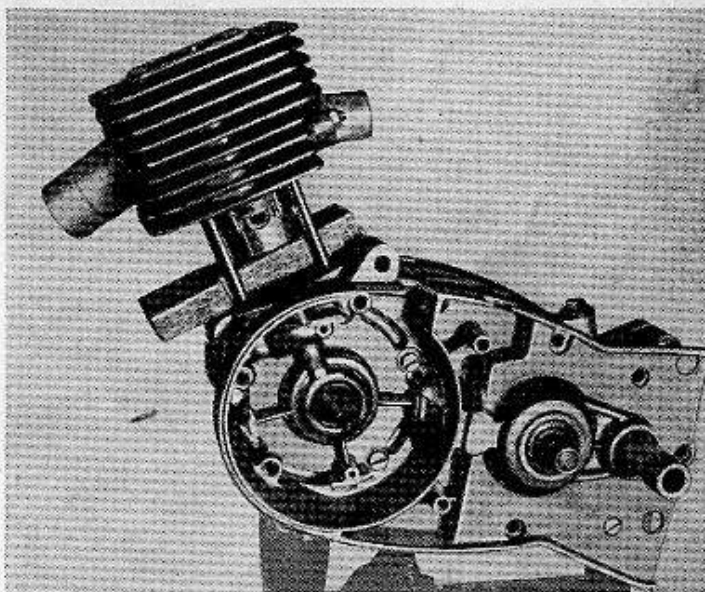

Fig. 67

Engines of type 267, 276 (without fan) and 281 have two piston rings.

m) Mounting Chain Sprocket

Fit the sprocket and secure with washer and hexagon nut; use the chain assembly tool to hold assembly firmly in place. Secure nut with tab washer (fig. 68).

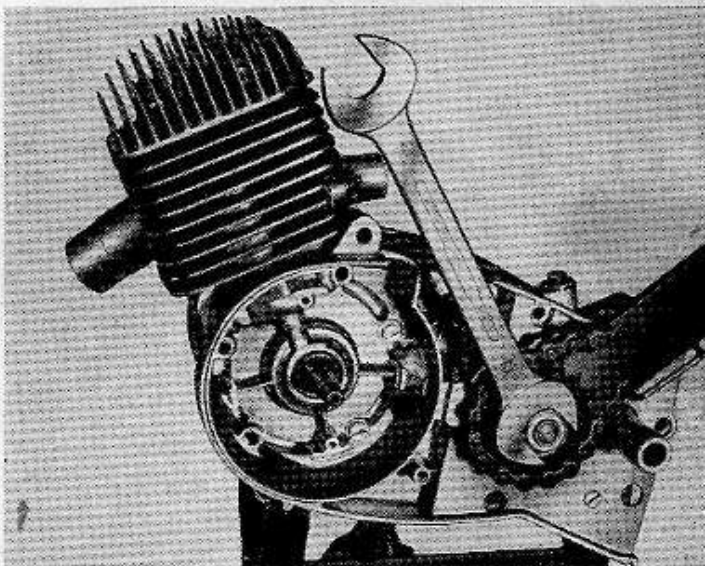

Fig. 68

n) Measuring Main Drive Shaft Position

Fit the clutch hub, cover plate and clutch nut. With a wooden spatula or other tool, shift the cover plate to the top position, then with the depth gauge inserted through the marking bore measure distance to the clutch gear – it should be 22.5 mm (fig. 69).

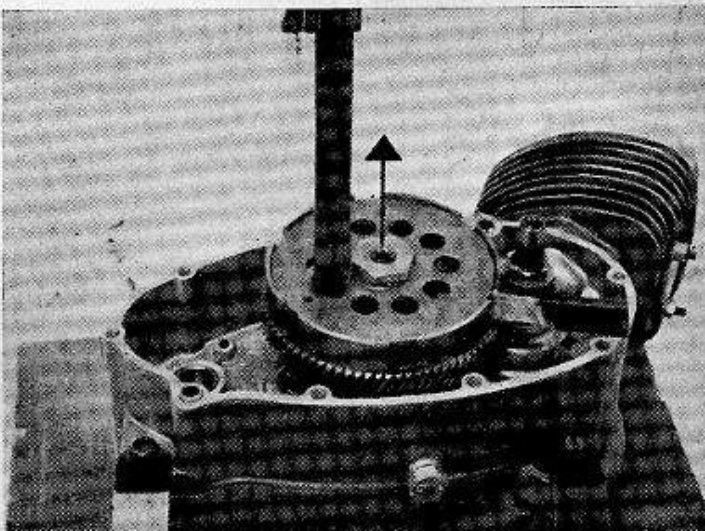

Fig. 69

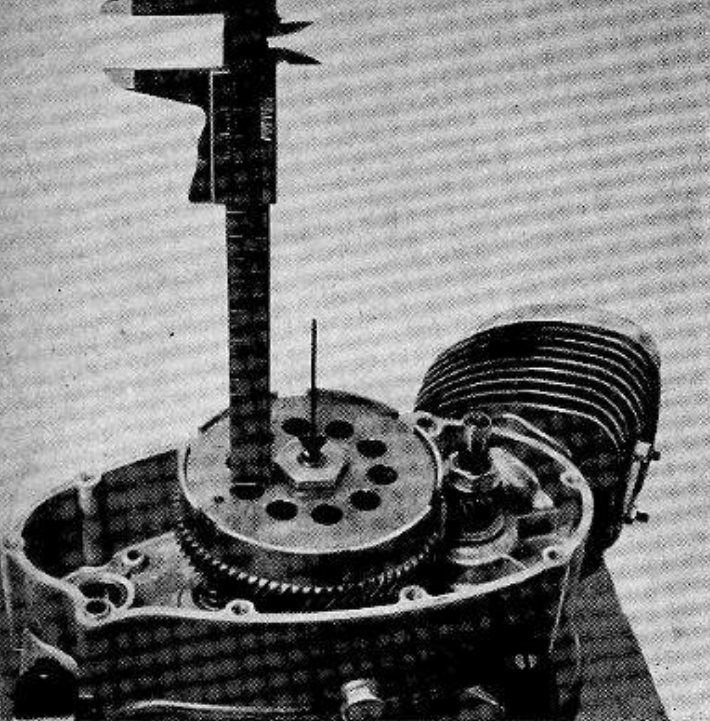

Fig. 70

Take the tool away from the cover plate and press main drive shaft down all the way to the stop, then measure distance again – it should be 21.8 mm.

$$\begin{array}{r}
 \text{Example:} \quad 22,5 \text{ mm} \\
 \quad \quad \quad - 21,8 \text{ mm} \\
 \hline
 \quad \quad \quad 0,7 \text{ mm}
 \end{array}$$

The values and final clearance listed are only given as examples (fig. 70).

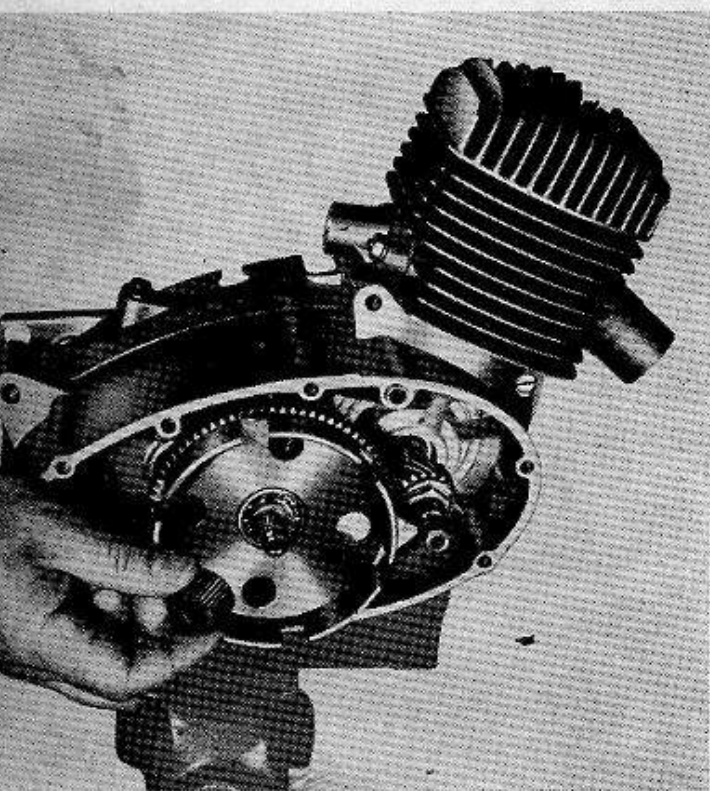

Fig. 71

To obtain the required axial play of 0.1 mm, fit 0.6 mm packing washers between ball bearing in clutch gear and clutch shifter hub (fig. 71).

o) Mounting Clutch

The clutch shown in fig. 72 is fitted to the following engines:

Type 267 up to No. 3484 123

Type 276 up to No. 4045 406

Type 281 up to No. 4600 606

Fit retaining, lining and outer steel plates, then fit cover plate. To align bores for the spring sleeves correctly, the clutch shifter hub is marked with a reference line and all plates with internal splines have a special aligning bore. Make sure that all these bores are accurately aligned on the line mark (fig. 72).

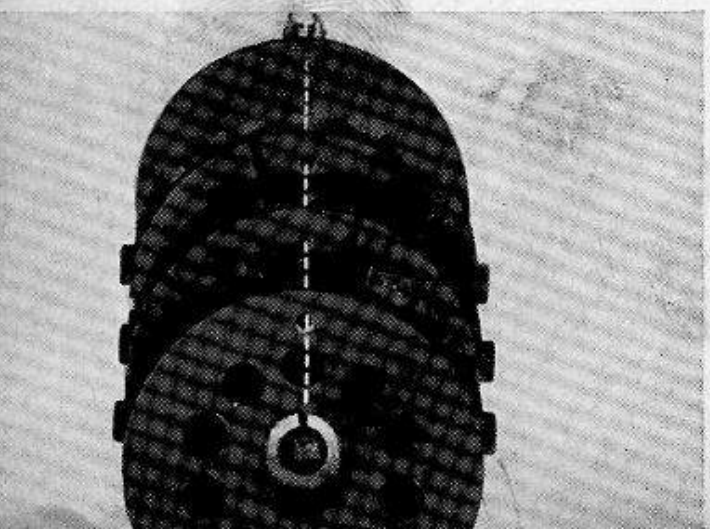

Fig. 72

Having fitted the cover plate, run down the nut and tighten it firmly, holding the assembly steady with tool SK-A 279.

Clutches with 4 plates (fig. 73) are fitted to:

Type 267 as from No. 3484124

Type 276 as from No. 4045407

Type 281 as from No. 4600607

All scooter engines are fitted with 4-plate clutches. Assemble as follows:

Fit retaining plates, lining and outer steel plates, then fit cover plate. Here again, the clutch hub has a reference line and all plates an aligning bore.

Fig. 73

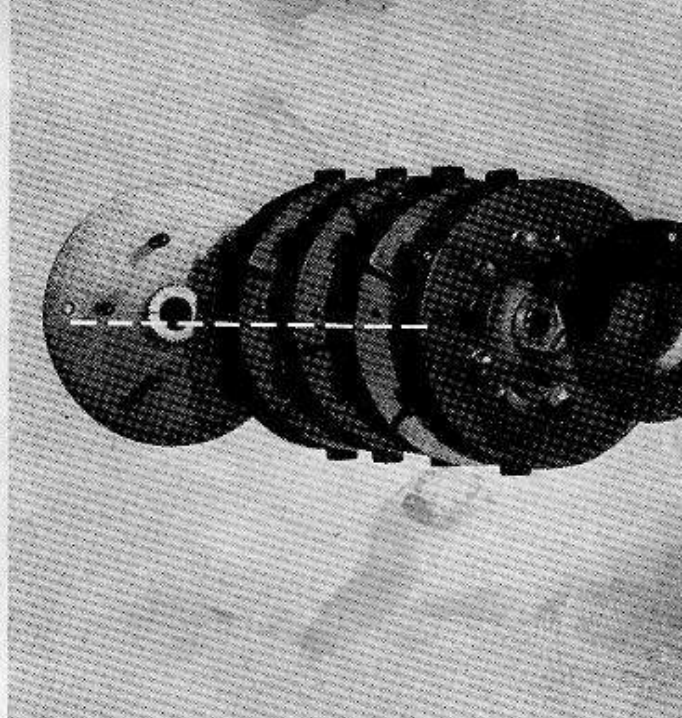

Underneath the reference bore on the cover plate, an arrow is additionally marked which must be in line with the mark on the hub. Also note that the dished side of the upper steel plate must face the gearbox. Having placed the fourth plate in position, fit the cover plate so that the dished side faces the gearbox.

Having fitted the cover plate, run down the nut, hold the assembly tightly with tool SK-A 279 and tighten nut firmly (fig. 73).

Next, insert the spring sleeves, complete with springs, fit special service tool SK-A 234 (as shown on fig. 16) and insert thrust plate between clamping bolt of the tool and the clutch springs. Press clutch springs together, and you can then fit and tighten the 5 or 10 nuts, M5. Take off the service tool, fit thrust pin with the required packing washers to the thrust plate (fig. 74).

Fig. 74

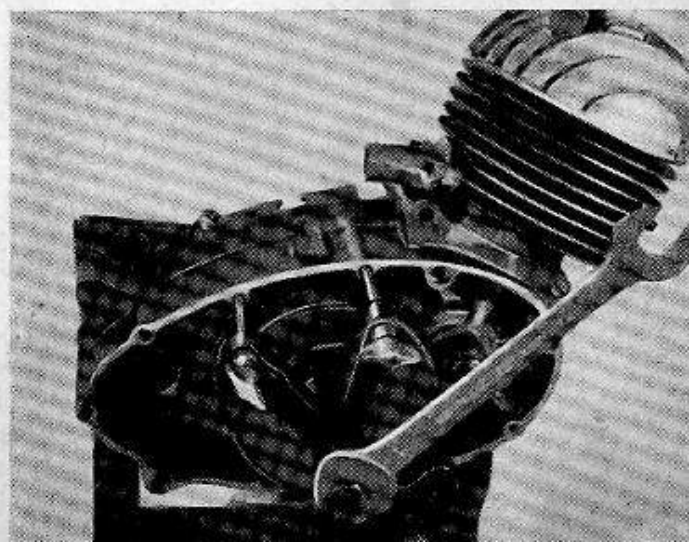

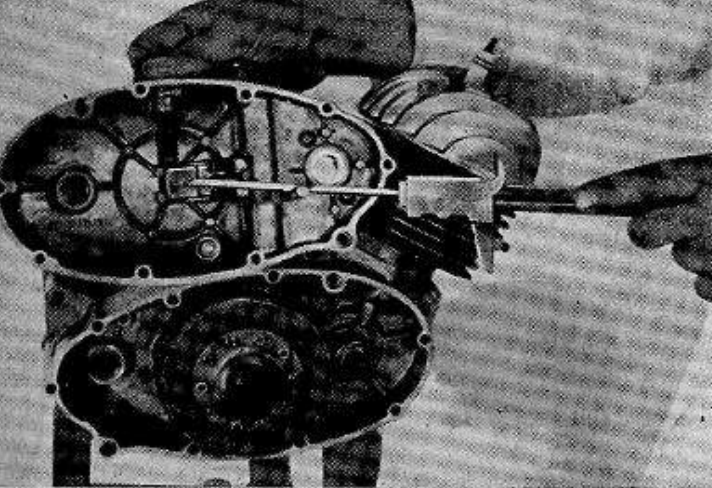

Fig. 75

p) Setting Clutch Tongue and Clutch

To obtain the largest possible re-setting range, the clutch tongue must be set to the mushroom-shaped thrust pad. To do this, first coat the pad with chalk, then fit the clutch bell cover and operate the clutch lever on the housing.

Take the bell cover off again, check whether the thrust pad contacts the tongue roughly at the centre. If it does not re-set with the setscrew for the thrust plate on the bell cover, then secure the new setting.

Next, check the clutch lever play at the housing. In its rest position, it should be possible to move the lever by hand about 2–3 mm in its bearing at the clutch tongue. If the play is too large or too small, correct by fitting or removing the appropriate number of washers under the thrust pad (fig. 75).

The following notes, up to fig. 85, apply only to engines with pedal gear change.

q) Taking off and Mounting Pedal Gear Change Spindle

The assembly is shown in fig. 76. Inside the pawl mount C are the two gear-change pawls D with spring. Selector drum B engages over the pawls; above the drum sits pawl deflector A with return spring. The whole assembly is held by snap ring F. In case of damage to the selector spindle, we supply the complete assembly for replacement, but the return spring is available as a separate repair part (fig. 76).

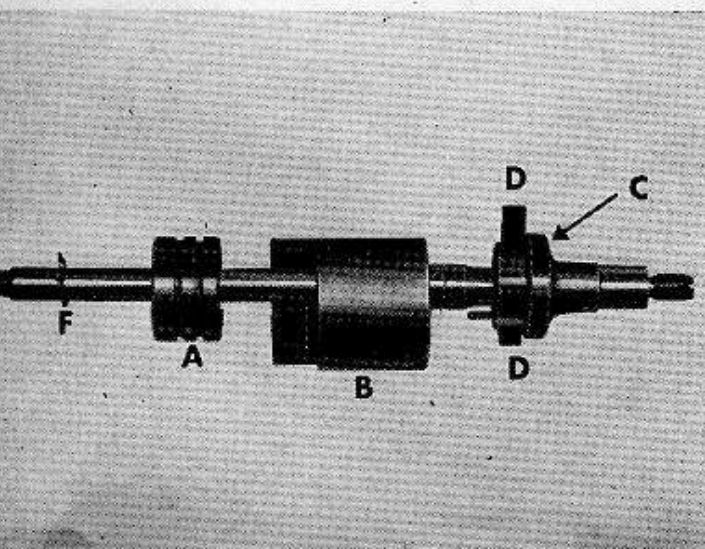

Fig. 76

The selector spindle comprises the following separate parts:

- A) Pawl deflector
 - B) Selector drum
 - C) Pedal selector spindle
 - D) Selector pawl
 - E) Return spring
 - F) Snap ring
 - G) Spring
 - H) Oval-head rivet
 - I) Compression spring
 - J) Stop pin
- (fig. 77)

Clamp pedal selector spindle by the thread for the selector drum into a vice between a pair of soft-metal pads, then remove top snap ring (fig. 78).

Span the selector drum with your hands from underneath, so that as you lift it off together with the pawl deflector, you will prevent the pawls from dropping out under spring pressure (fig. 79).

Fit selector pawls and pawl springs into the groove on the selector spindle. Note that the large side faces on the tapered pawls should face the cylindrical pin in the pawl mount on the spindle (fig. 80).

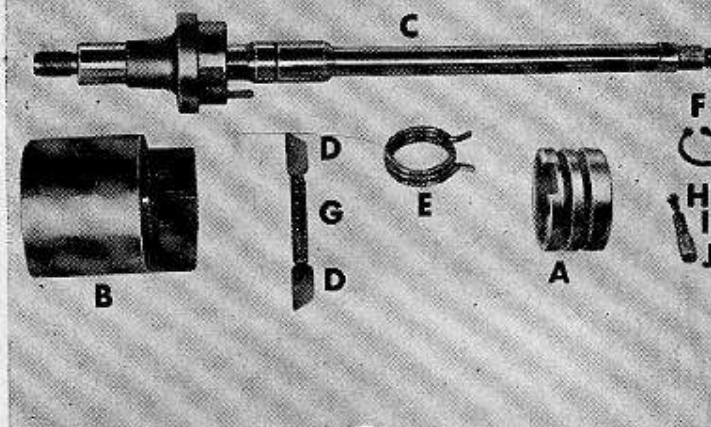

Fig. 77

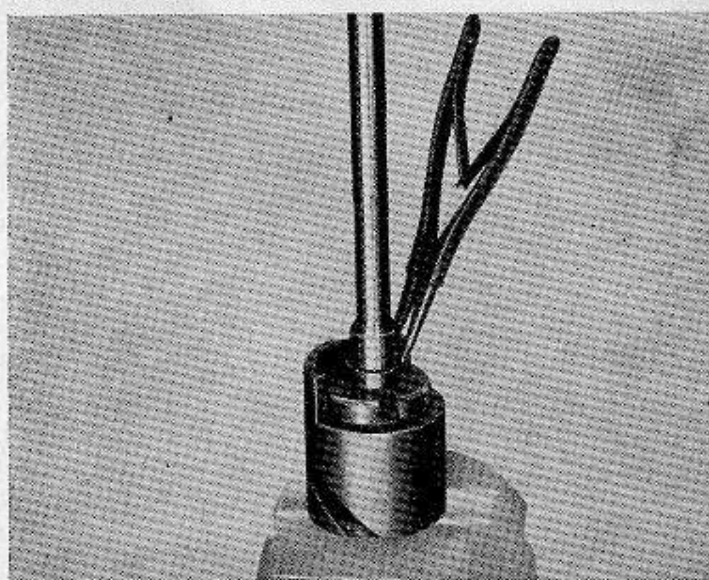

Fig. 78

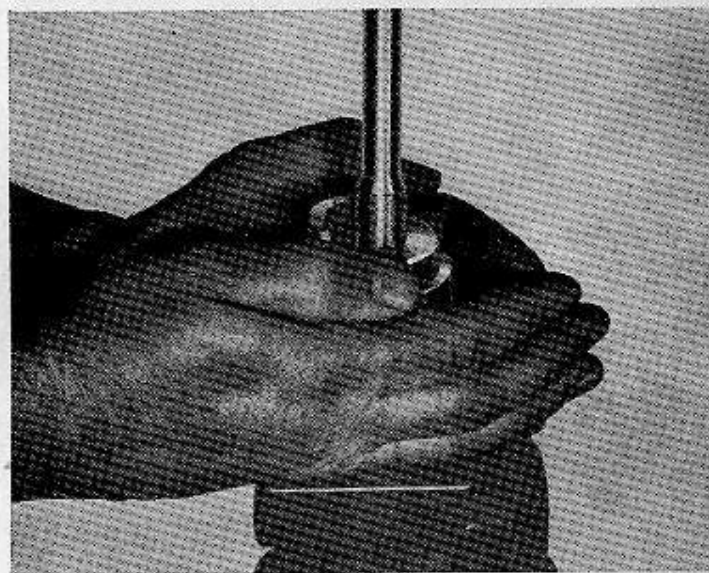

Fig. 79

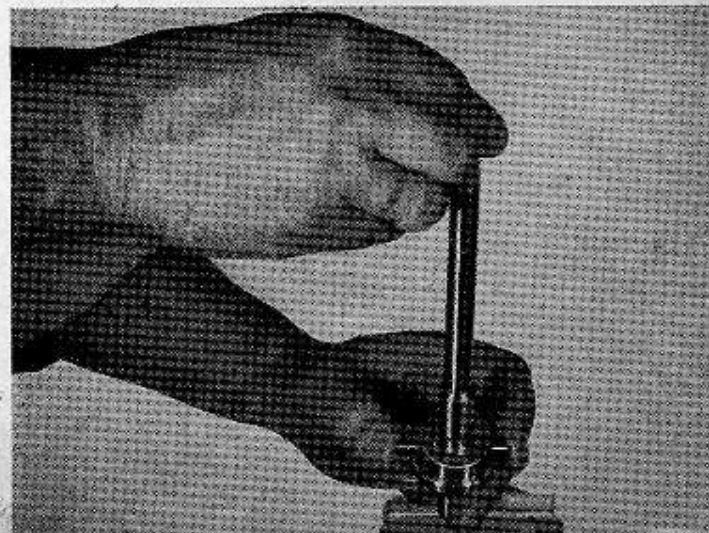

Fig. 80



Fig. 81

Fit the selector drum on to the pedal selector spindle, pressing the pawls inwards as you do so. The collar with the recesses acting as internal stops must face the cylindrical pin on the spindle. Tilt the drum at a slight angle to make it easier to fit (fig. 81).



Fig. 82

To fit the return spring to the pawl deflector, insert it with its top stop into the lower recess and with the bottom stop into the top recess of the pawl deflector. The spring should be unloaded.

It is advisable to ease the spring into position with a pair of flat pliers to ensure that the stops enter the recesses far enough. To turn the spring, use only a screw driver, pliers or similar tool. To make the fitting easier, you can use a second screw driver to press the spring against the recesses in the pawl deflector as you coil and ease it into position (fig. 82).

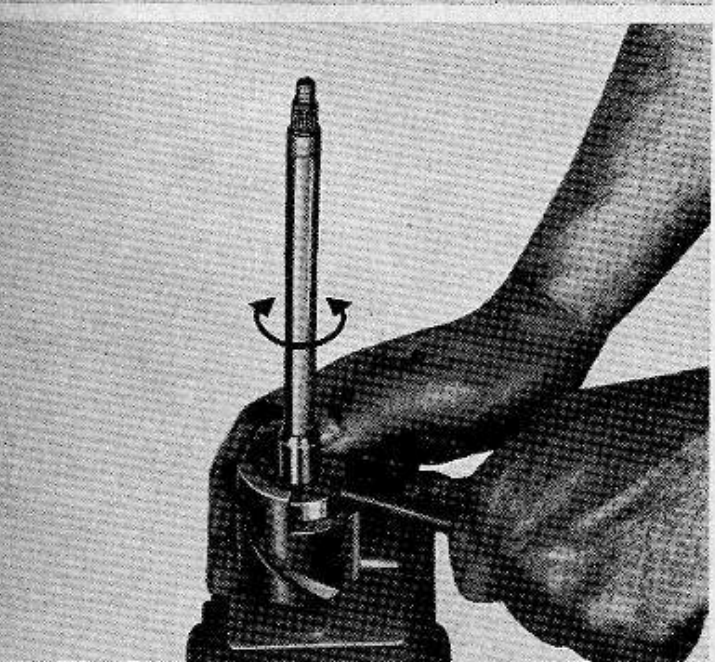

Fig. 83

Next, fit the pawl deflector, complete with return spring, to the pedal gear selector spindle. Note that the cylindrical pin in the pawl mount must be fitted through both arms of the return spring. To check correct assembly, fit assembly pin SK-A 213 into the recess of the pawl deflector, when you should be able to move the deflector to both sides under spring loading (fig. 83).

Fit the snap ring into the groove on the spindle, then turn the pawl deflector to expose the bore into which oval-head rivet (H), compression spring (I) and stop (J) are fitted.

Having fitted these parts in the sequence listed, turn the deflector again until the stop engages in the recesses providing the internal stops for the selector drum. To mount the pedal selector spindle, set the transmission to 2nd gear (fig. 84).

Fit selector slide and pedal gear change spindle. Note that the taper groove on the selector drum engages with the mating piece on the selector slide, while the recess on the pawl deflector engages over the pin on the right-hand casing. Oil all moving parts (fig. 85).

r) Mounting Clutch Bell Cover

Insert two press-fit bushes into the right casing, coat the joint faces with sealing compound, then fit clutch bell housing cover.

Introduce one bolt, M 6 x 45, from the right under the pedal gear change spindle and run it down firmly (fig. 86).

On the left-hand side, fit the following screws:

	267	276	281
A)	M 6 x 120	M 6 x 120	M 6 x 120
B)	M 6 x 120	M 6 x 120	M 6 x 120
C)	M 6 x 98	M 6 x 120	M 6 x 120
D)	M 6 x 120	M 6 x 120	M 6 x 120
E)	M 6 x 98	M 6 x 98	M 6 x 98
F)	M 6 x 98	M 6 x 98	M 6 x 98
G)*	M 6 x 92	*M 6 x 92	*M 6 x 92
H)	M 6 x 98	M 6 x 98	M 6 x 98
I)	M 6 x 98	M 6 x 98	M 6 x 98
			**M 6 x 98

*) Screw with cable clip to be fitted only after base plate has been mounted

***) Only fitted to engines of type 281, where it is located between I and G (fig. 87).

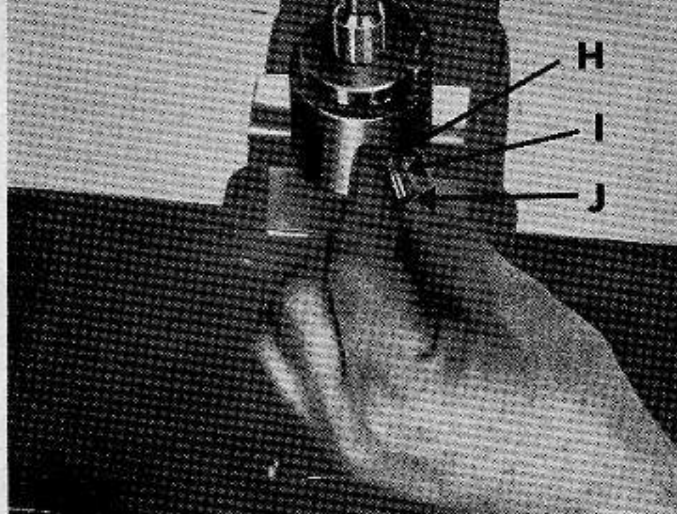

Fig. 84

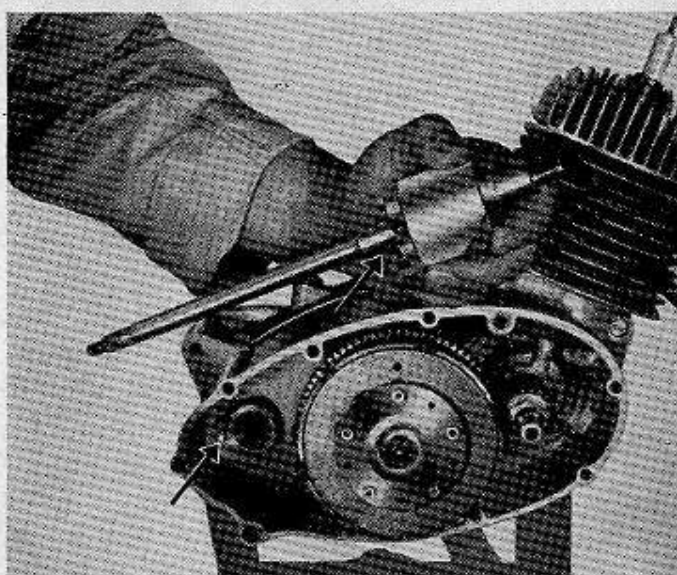

Fig. 85

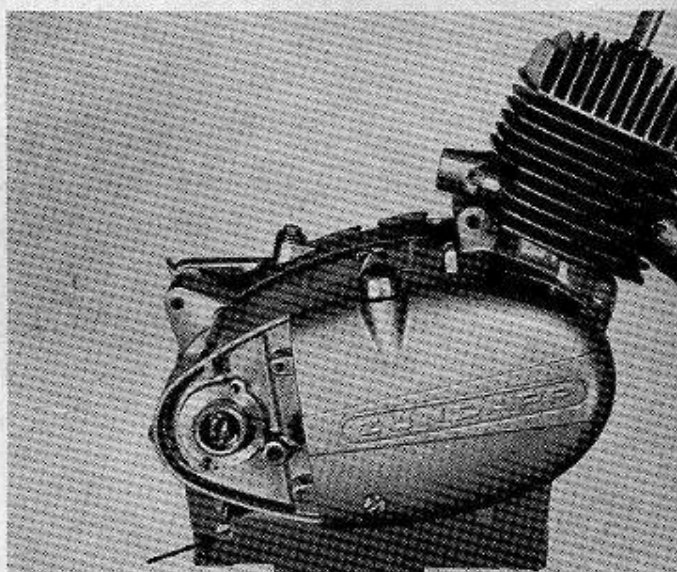

Fig. 86

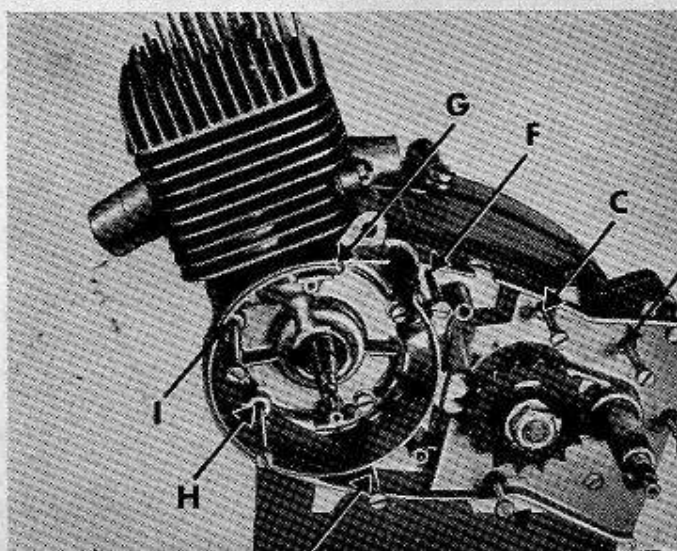

Fig. 87

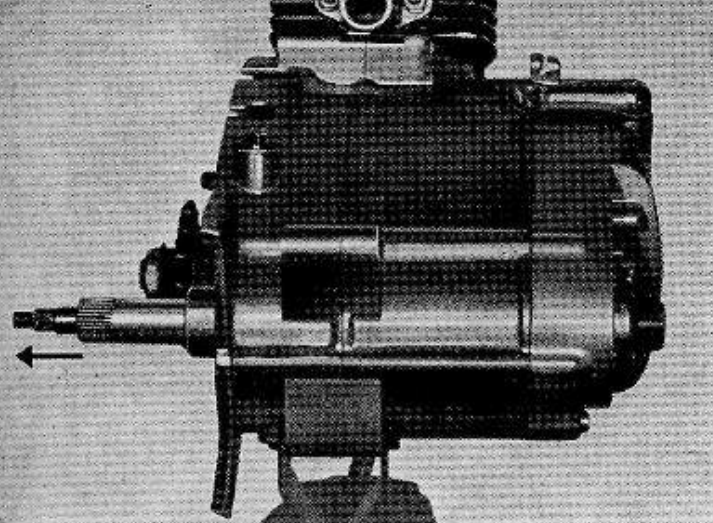

Fig. 88

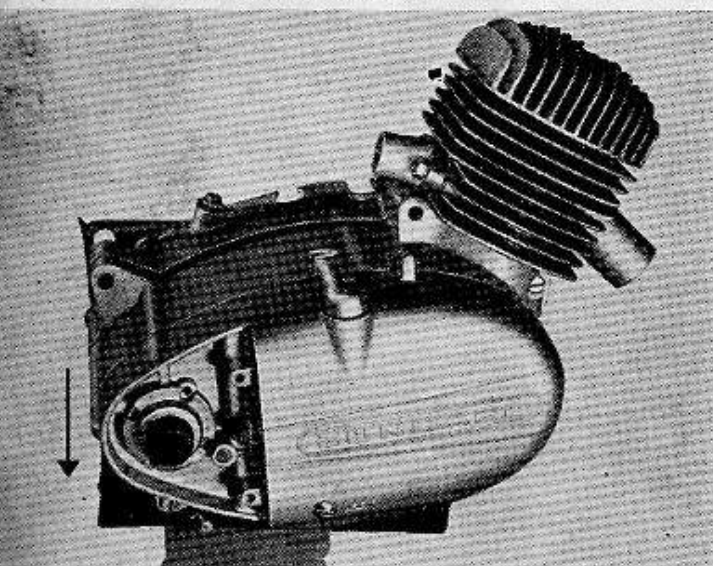

Fig. 89

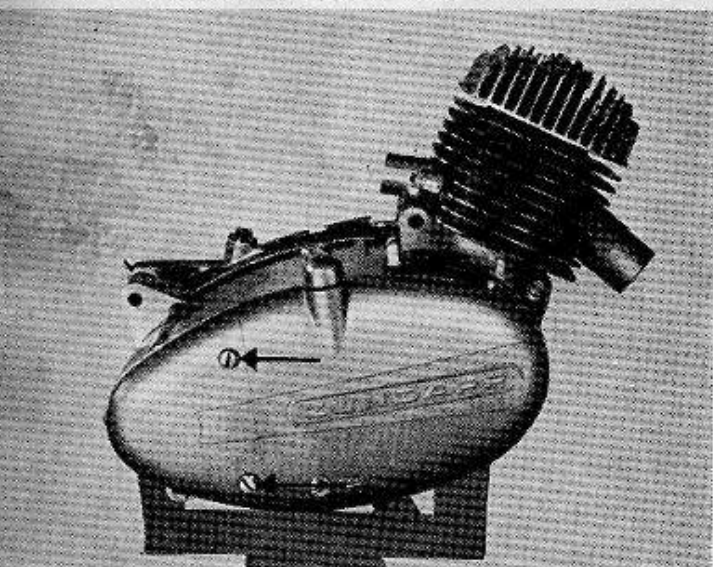

Fig. 90

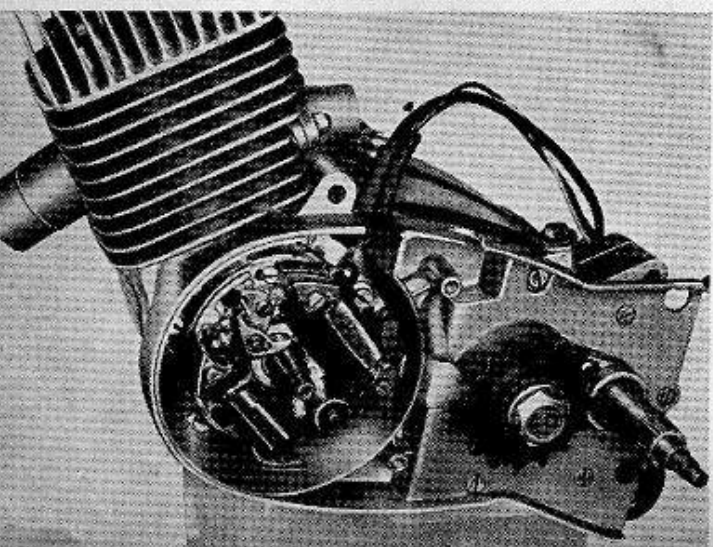

Fig. 91

s) Setting Pedal Gear Change Spindle

The spindle must be fitted with slight play. Press it lightly to the left (seen in direction of travel) all the way to the stop.

Screw on the setting dome, running it down until it lightly contacts the face of the casing, but without altering the axial location of the spindle (fig. 88).

Now, draw the spindle to the right and turn the setting dome further all the way against the casing, counting the quarter turns as you go. Then turn the dome back by half the number of quarter turns counted and fix it to the casing with the screws provided (fig. 89).

t) Mounting Cover over Clutch and Gear Selector Assembly (Connector Cap)

Fit the cover and secure with the two countersunk fillister-head screws, M 5 x 15 (fig. 90).

u) Mounting Ignition System

Fit baseplate and run down screws M 4 x 15, lightly only, since these have to be slackened again when setting the ignition.

Then slide cable with rubber grommet into the opening provided on the casing, remembering the ignition cable clip. Fit Woodruff key into its slot on the crankshaft, then slide on the flywheel magneto.

Note: Take care not to push the key out of its slot again.

Run down fixing nut and firmly tighten it with socket key, holding the flywheel in position with service tool SK-A 251.

On engines of type 281, the baseplate is fixed with 3 screws (fig. 91).

v) Setting Ignition Timing

Set contact breaker gap to 0.35 — 0.45 mm, then, with a dial gauge or similar instrument, determine top dead centre.

Next, turn flywheel magneto back in opposite direction to engine rotation until piston has reached the position matching the specified ignition point. Check the setting with a standard ignition tester or control lamp. It is advisable to carry out a second check of the timing after baseplate screws have been tightened (fig. 92).

For specified ignition timing, see technical data.

Fig. 92

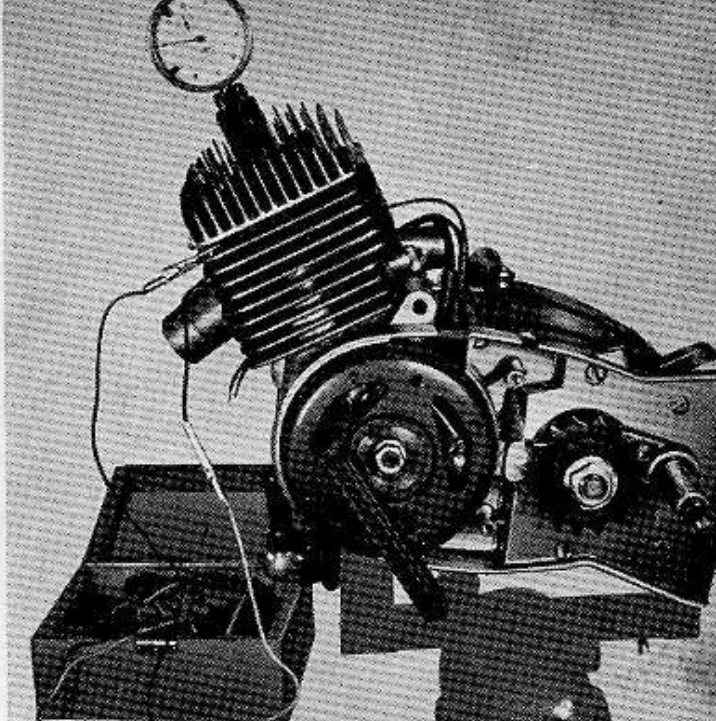

w) Taking off and Mounting Kickstarter Spring and Sleeve

Take off snap ring, lift cover plate on one side at the stop nose. Gripping the kickstarter pedal lever firmly, you can now release the kickstarter spring from load (fig. 93).

Fig. 93

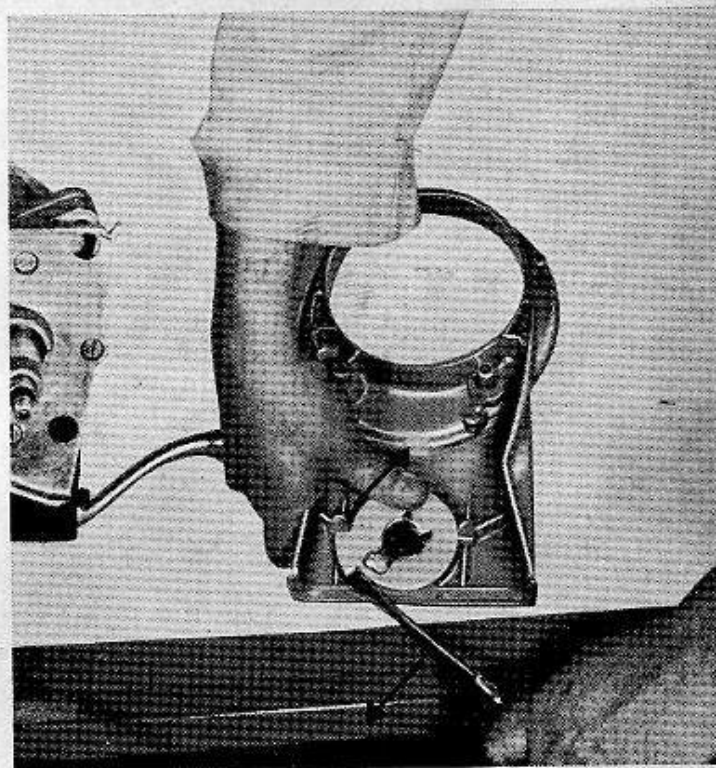

Take off lever, complete with sleeve and sealing ring from below, lift cover plate with stop up and off. The kickstarter spring can now be replaced (fig. 94).

Fig. 94

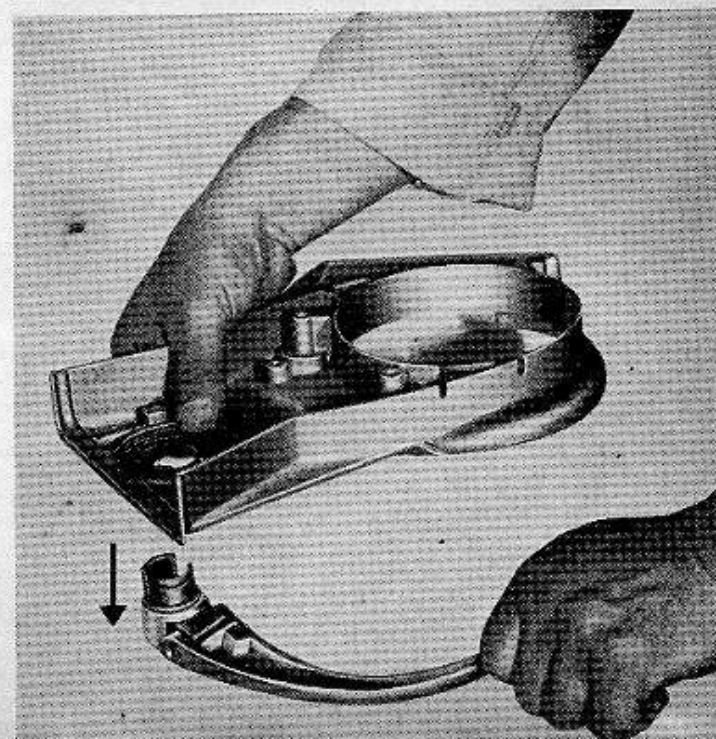

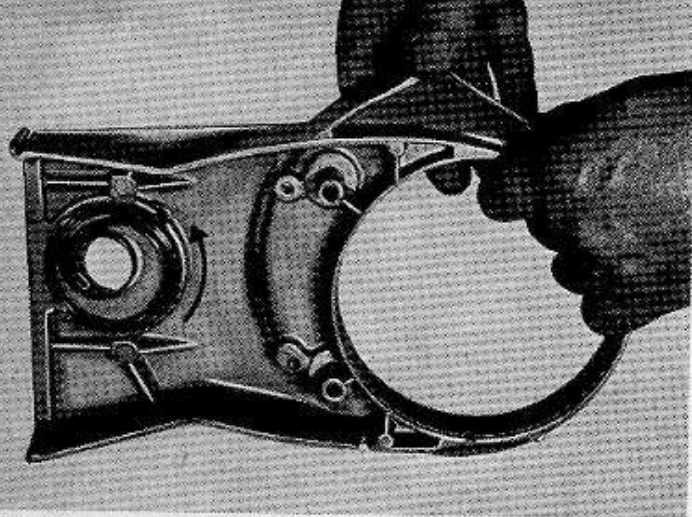

Fig. 95

Assembly of Kickstarter.

If the left-hand casing cover had been completely dismantled, first fit starter spring in such a way that, seen towards the inside of the cover, the spring can be tensioned anti-clockwise. Grease the spring well. Then introduce the small stop nose of the cover plate into the inner spring loop, and fit the sleeve, kickstarter pedal lever facing up, through the plate from the other side; remember checkplate between casing cover and sleeve. Hold the casing cover with one hand, then pre-tension kickstarter spring by turning kickstarter pedal lever through about 1 revolution, until the stop nose lies just in front of the top stop on the casing. Finally, fit the snap ring (fig. 95).

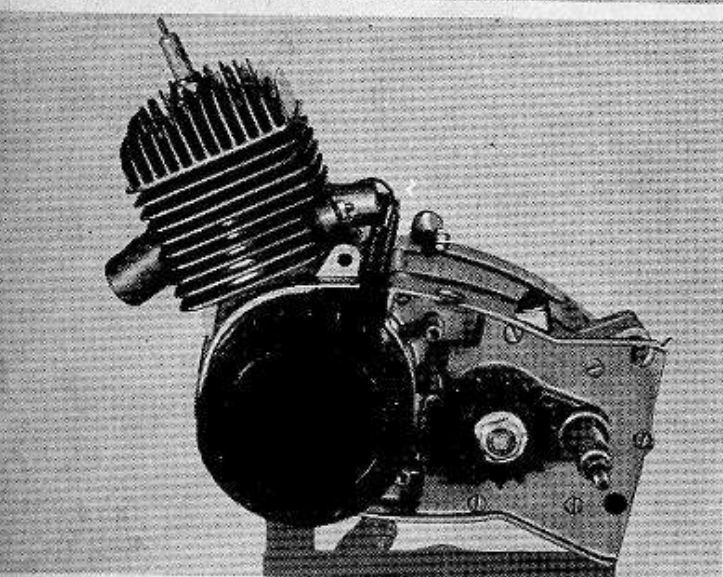

Fig. 96

x) Mounting Fan, Left Casing Cover with Kickstarter and Fan Casing

Fit and bolt fan to flywheel magnet with 4 cylindrical screws, M 5 x 20 (fig. 96).

The following can only be carried out after engine has been fitted into frame:

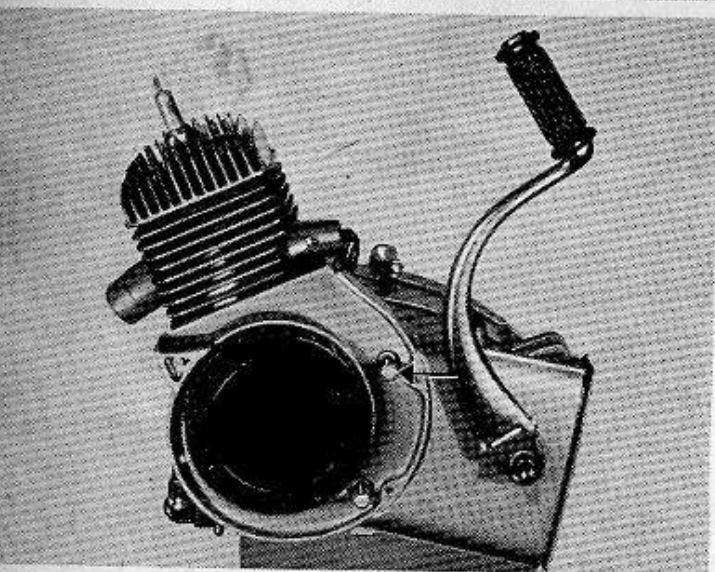

Fig. 97

Fit casing cover on left and bolt down with two hexagon bolts, M 6 x 35 (fig. 97).

On air-cooled engines, fit 2 cylindrical bolts, M 6 x 45.

Fit sealing ring of pedal gear change spindle into sleeve of kickstarter, using sleeve MV 6-1563 and hollow punch MV 6-347 (fig. 98).

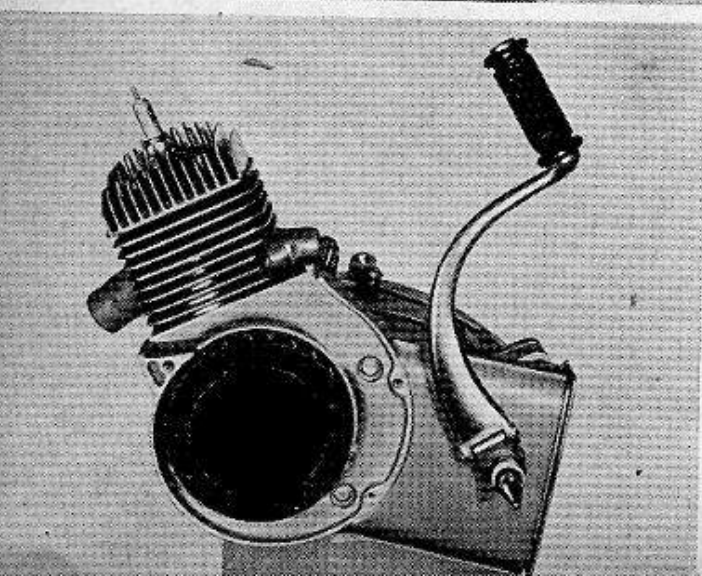

Fig. 98

Mount fan casing, bolting it to the left casing cover with 3 cylindrical screws, M 6 x 45 (fig. 99).

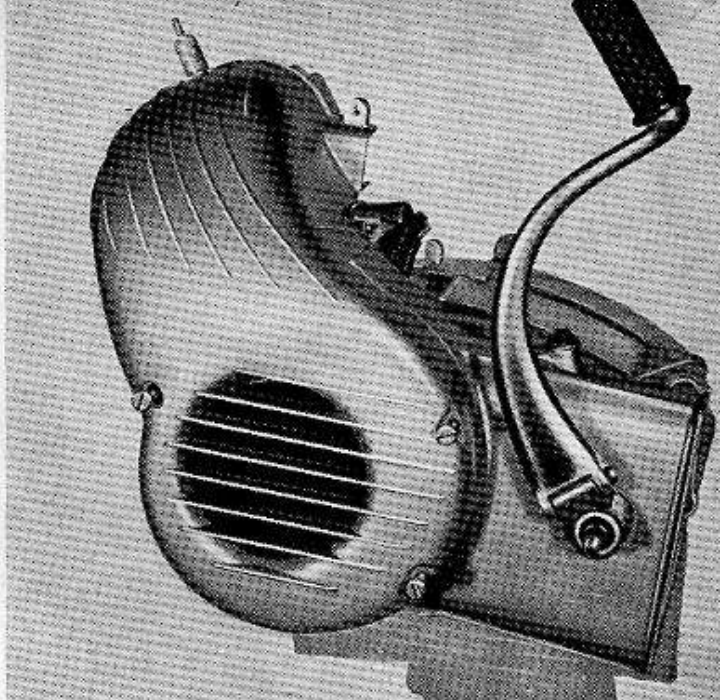

Fig. 99

Bolt on fan cap with 2 cylindrical screws, M 5 x 14.

Note: Check that the 2 rubber buffers are fitted inside the fan cap (fig. 100).

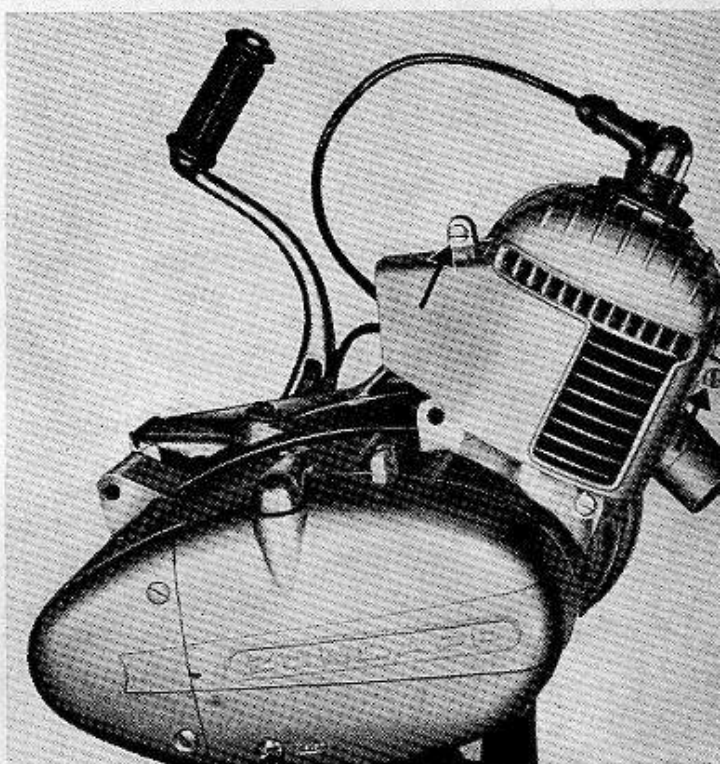

Fig. 100

Fit gear change pedal in this sequence:

Bush (spacer ring)
Lever with pedal
Serrated washer
Hexagon nut
Plastic pedal cover sleeve
(fig. 101).

Refill gearbox with oil, see technical data.

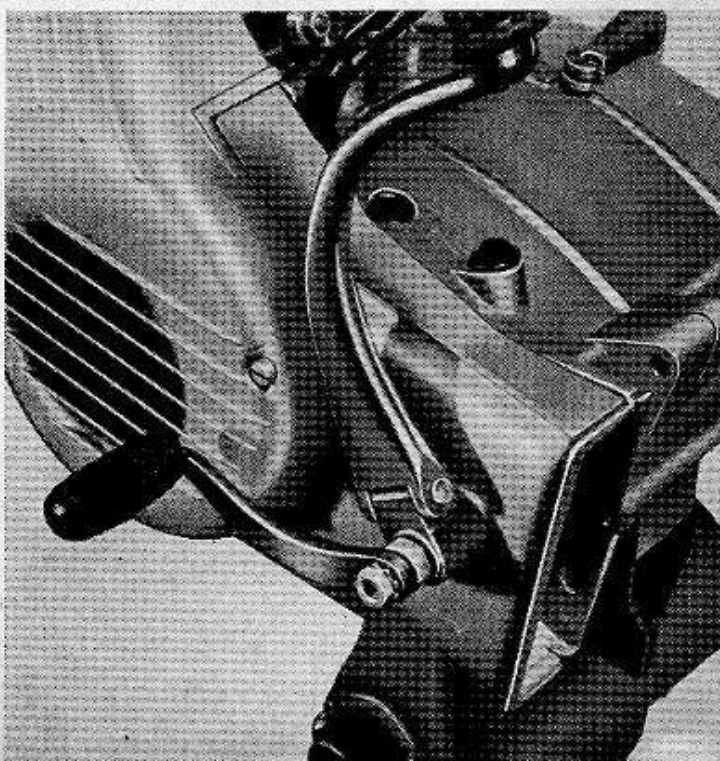
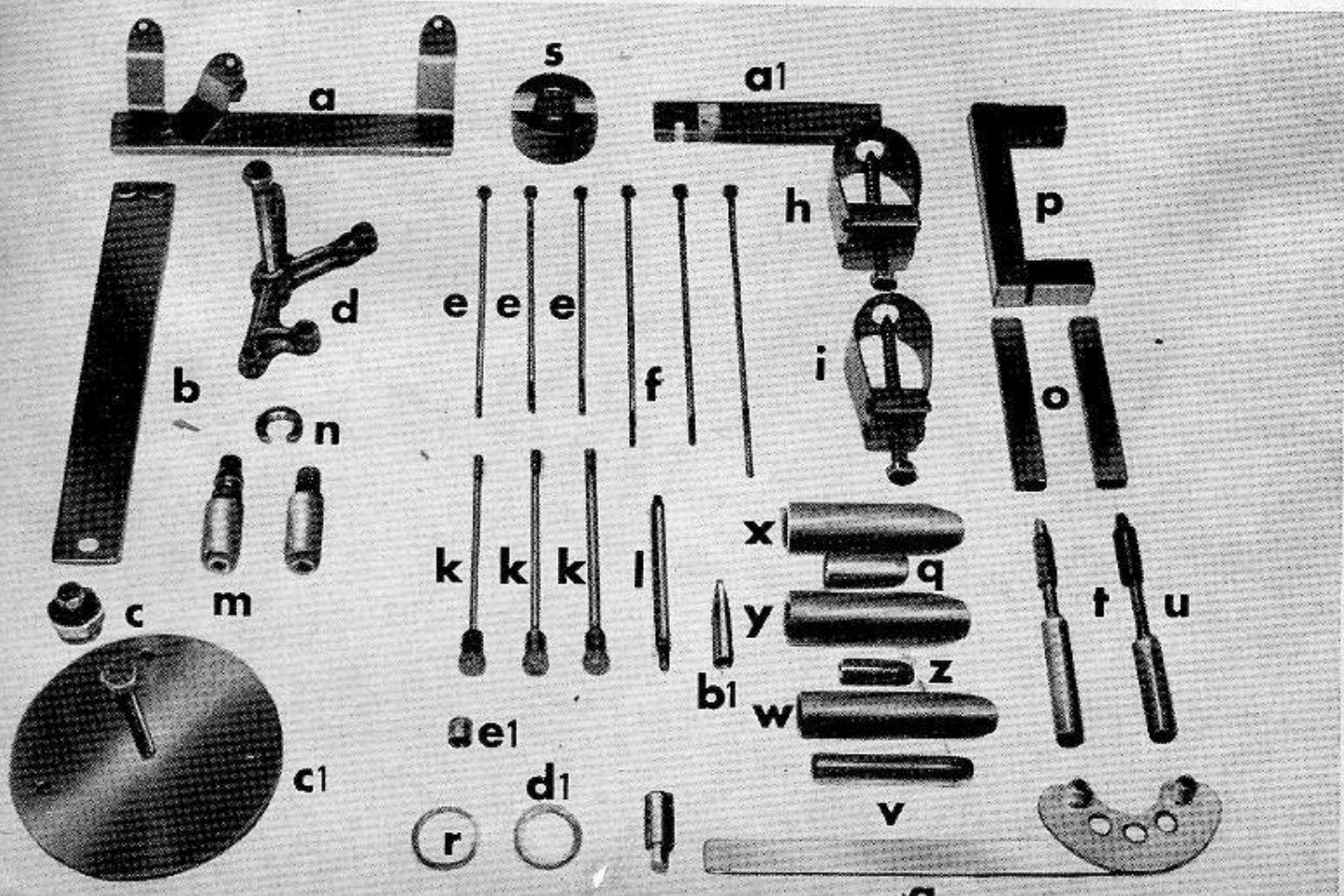

Fig. 101

3. Special Service Tools

Illustr.	Order No.	Description	For use, see fig. No.
a	SK-A 126	Engine clamping fixture	1-28, 61-96
b	SK-A 251	Flywheel magneto key	7, 8, 91
c	SK-A 263	Press-off bolt	8
d	SK-A 234	Clamp	16, 27, 74
e	SK-A 237	Studs	16, 74
f	SK-A 265	Clamping stud, 8" long	16, 74
g	SK-A 279	Assembly key	17, 73
h	SK-A 64	Press-off tool for gudgeon pin	22
i	SK-A 268	Press-off tool for gudgeon pin, 75 and 100 cc	22
k	SK-A 246	Stud	27, 28, 29
l	SK-A 213	Supporting pin	27, 29, 83
m	SK-A 232	Setting sleeve, 3-speed engines	37, 38
n	SK-A 233	Clamping snap ring	37, 38
o	SK-A 161	Gauging bar	39, 40, 63
p	SK-A 206	Gauging yoke, in place of SK-A 161	39, 40, 63
q	SK-A 217	Assembly socket sleeve for selector shaft	44, 61
r	SK-A 138	Spacer ring for driver	60
s	SK-A 125	Ring gauge	62
t	SK-A 163	Mandrel	65
u	SK-A 275	Mandrel, 100 cc	65
v	MV-6-339	Assembly sleeve	44
w	MV-6-347	Hollow punch	34, 98
x	MV-6-961	Hollow punch	61
y	MV-6-734	Hollow punch	61
z	MV-6-960	Mounting sleeve	61
a1	MV-6-115	Aligning bar	64
b1	MV-6-1563	Sleeve	98
c1	to be made in own workshop	Press-off plate	28, sketch on p. 39
d1	to be made in own workshop	Ring for selector shaft	60, sketch on p. 40
e1	to be made in own workshop	Spacer sleeve	37, 38, sketch on p. 40



Press-off Plate

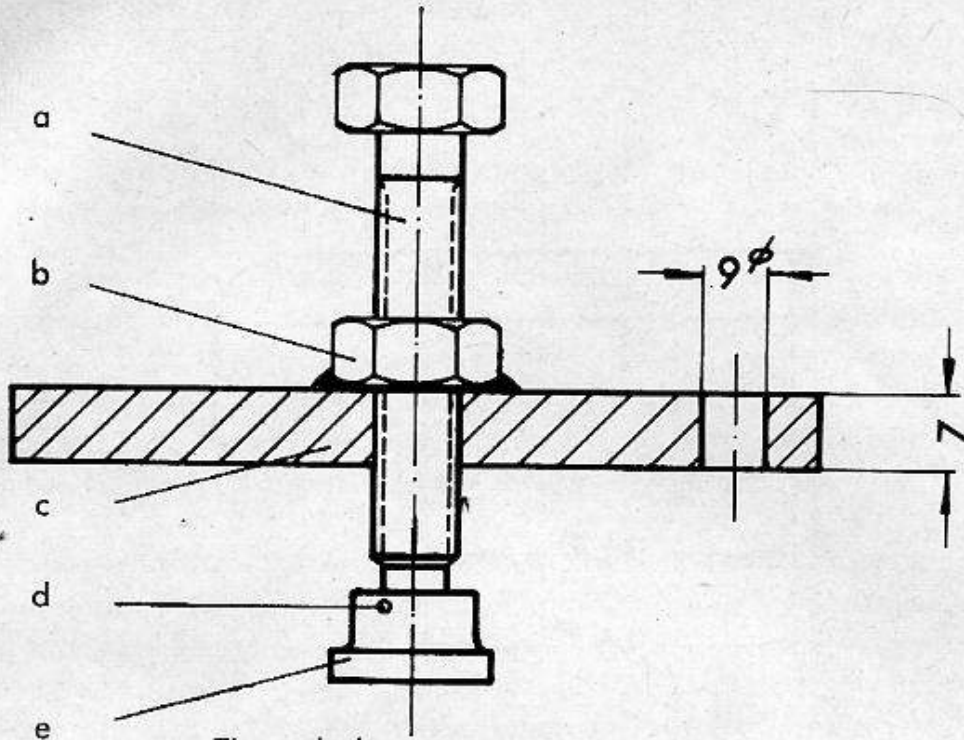

- a = Thrust bolt
- b = Hexagon nut (welded on)
- c = Steel grade 37 K
- d = Cylindrical pin
- e = Pressure pad

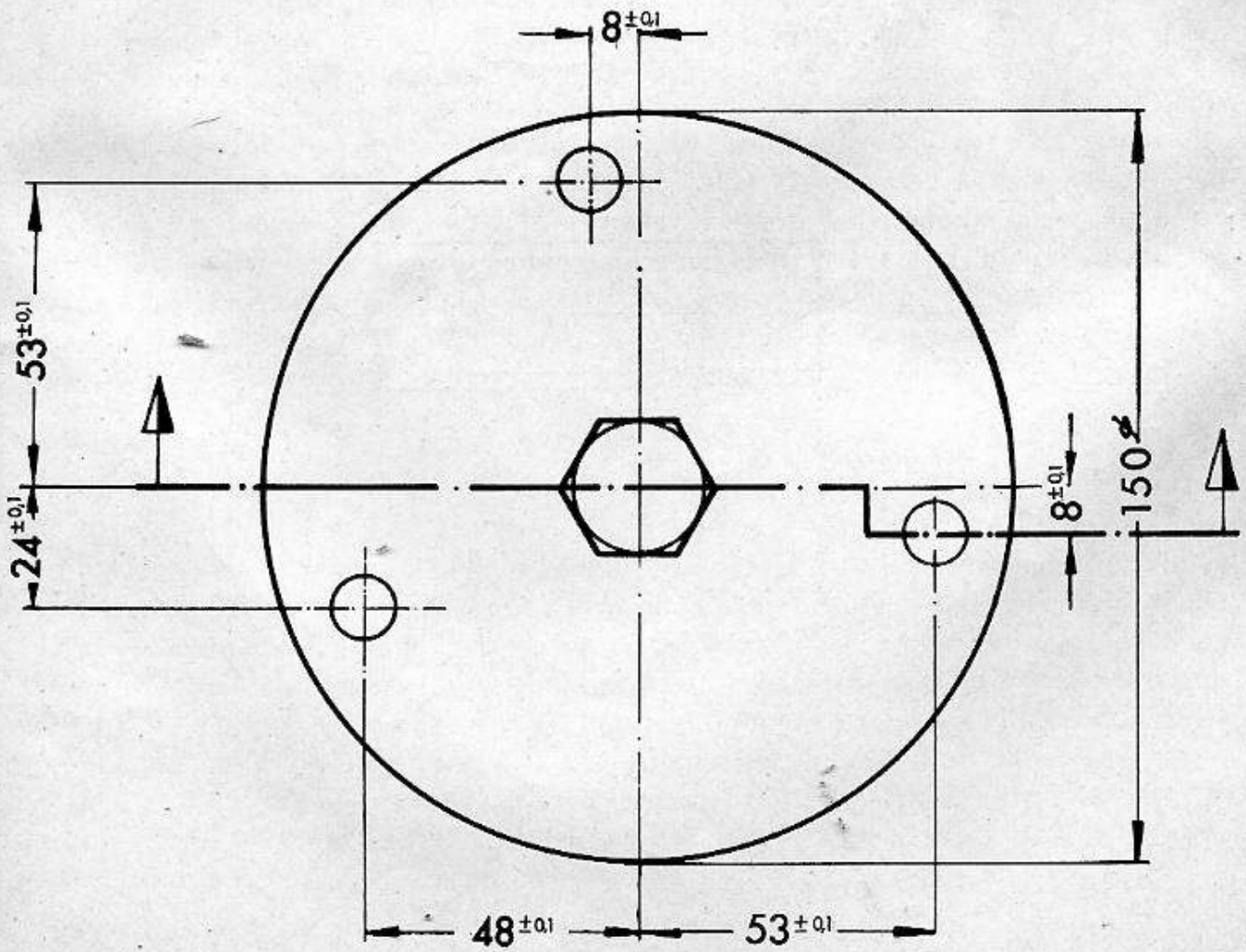

Ring for Selector Shaft

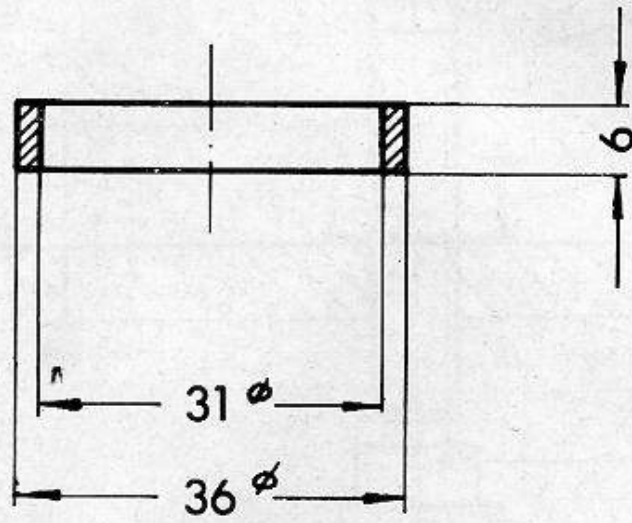

Spacer Sleeve

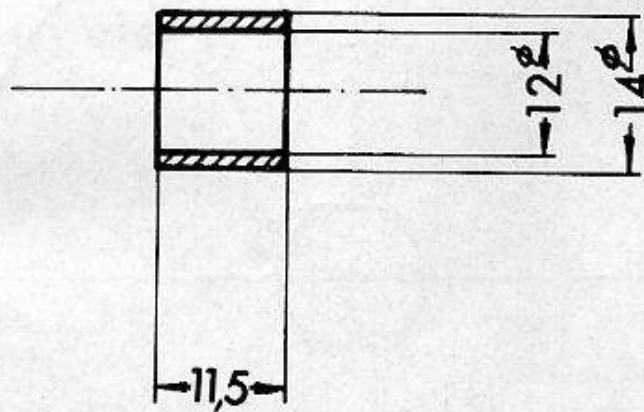

4. BING Carburettors

Operation

The carburettor is designed to supply the engine with the correctly proportioned and thoroughly mixed fuel/air mixture to match any load.

The mixture is prepared in one idling and one main jet system. The idling jet system supplies the engine at the lower speed stages. It consists of the idling fuel jet, the idling air jet and the air adjuster screw. If the air inlet is partially throttled with the adjuster screw, the idling mixture becomes richer, if more air is admitted the mixture becomes leaner. Carburettors on small engines have no separate idling jet system; instead the needle jet system provides the mixtures at all stages.

As engine speed increases, the main jet system comes into action, consisting of main jet, mixing chamber insert or fixed atomiser and needle jet. The exchangeable main jet sits in the nozzle block, screwed from below — or from the side on inclined-jet carburettor designs — into the carburettor housing. On carburettors with fixed atomisers, the main jet is screwed to the lower end of the needle jet. As the main jet system comes into action, the fuel flows via the main jet to the needle jet. The outlet bore of the needle jet is located in the mixing chamber where the preliminary mixing of fuel and air takes place. Here, little fuel, air bubbles form which are then mixed with the main air flow stream and drawn into the engine combustion chamber. A tapered needle, fixed to the throttle slide, controls the available needle jet cross section. Operation of the throttle slide drives the needle further into the jet, thus narrowing the free cross section between needle jet bore and needle, or, vice versa, draws the needle further out and thus increases the cross section.

The needle shank has several grooves, so that the needle can be re-set in relation to the throttle slide. If the setting is altered so as to drive the needle deeper into the bore, the engine is supplied with a leaner mixture. If the needle is set higher on the throttle slide, the available flow cross section increases and, consequently, the mixture becomes richer. The needle setting will only influence fuel consumption under throttle control. With the throttle fully open, fuel consumption is exclusively governed by the main jet.

Fitting Carburettor.

Carburettors must be mounted with special care. They must be positioned accurately vertical and fitted flush and precisely on their connecting socket. The slots of the clamping connecting fitting must on no account admit secondary intake air, otherwise a steady, quiet idling speed cannot be set. Where connecting flanges are provided, use only gaskets in perfect condition and tighten nuts evenly. Fix Bowden cable sleeves without any sharp bend or kinks. Check that throttle slide opens and closes all the way as you operate either lever or twist grip. On carburettors with starter jets, the Bowden cable hooked to the starter piston should have a little play to ensure that the piston provides a reliable seal.

Carburettor Maintenance

From time to time, the carburettor should be rinsed out with petrol and thoroughly cleaned. While this is done, check that all parts are in perfect condition. Replace worn float needles, needle jets and jet needles, as well as throttle slides, since these govern engine performance and fuel consumption. On carburettors with separate starter jet assembly, test that starter piston has tight seal. The air filter should also be rinsed at regular intervals in either kerosene or petrol. After cleaning, coat the filter mesh with oil.

Where a screwed hose union is fitted, take this off, draw out the filter element and clean it, slacken the connector nut and take off float cap. On carburettors with side-mounted float housing, slaken the two screws on the cover, take off the cover, then take float from housing. The float should drop by its own weight from its suspension on to the bottom of the float cap, so that it can readily be lifted out. The float needle can then be removed after taking off the spring-loaded retaining clip. On some versions, the float lies loosely in the cap. The forked part which prevents the float needle from dropping out can be taken off after its fixing pin has been drawn off. Do not bend the fork piece and check that it lies horizontally in its top position. Never use a sharp, hard tool to clean the needle seat or the jet bores, but merely rinse them out carefully, then blow them out to remove all liquid. Do not tighten the locknut too hard, but run it down by hand only. Use only the original sealing rings for the float cap seal. Take care not to bend the float sealing edge, otherwise the float may become displaced up or down and no longer seal off the float needle. This would lead either to fuel leaks or to a partial or total fuel blockage.

Use only absolutely clean fuel and fill it through a filter into the tank to prevent trouble with the feed system. Before fitting the fuel hose, first allow a little fuel to run through it to drive out all the air and prevent the formation of bubbles and an airlock in the system.

Special Hints

1. The carburettor is one of the most delicate parts of the engine. Handle all parts with great care, run down all threaded connections lightly, never use force to fit any parts of the float into position.
2. Do not use hard, sharp tools to clean the jets. **On no account, enlarge nozzle bores with a reamer or by any other means.**
3. Fit only Original BING spare parts to ensure troublefree operation and a long service life.
4. In all your spare part orders, quote part No. accurately and in full. If the number is not known, quote the carburettor type code, stamped into the casing, or send old part as a sample.
5. BING carburettors will give excellent service at all times, provided standard good-quality branded fuels are used, carburettors are kept clean and only Original BING spare parts are fitted.

Carburettor Setting

Manufacturers of carburettors work out the most suitable design and select the jet sizes in close collaboration with the engine makers. They also specify the setting which tests have shown to give best performance and maximum economy. It is, therefore, inadvisable to depart from their specifications

Idling

Idling speed should always be set or regulated while the engine is warm. With the adjuster screw, close the throttle slide until the engine just ticks over slowly and steadily. On carburettors without separate idling speed system, the needle jet assembly supplies the amount of fuel required for idling speed. Carburettors with separate idling speed system work as follows:

The air adjuster screw controls the ratio of the fuel/air mixture supplied by the idling speed system. By turning the adjuster clockwise, the mixture becomes richer, by turning anti-clockwise, it becomes leaner. The setting is correct when the engine ticks over quietly and evenly. As soon as it does, do not alter the air adjuster setting again, since this also governs the lower and medium speed range, so that any further adjustment might increase fuel consumption.

When the throttle is slowly opened out, the engine should steadily rev up. It should neither splutter nor should the speed drop back again at any throttle setting. If the engine splutters or speed rises in surges, or if black fumes escape from the exhaust silencer, the mixture has been made too rich. If the engine coughs or cuts out for brief moments, if a blue flame blows back from the carburettor, or if the engine is difficult to start, the mixture has been set too lean.

Driving Speed Range

In order to determine the most suitable main jet for a carburettor, first take the machine on a straight, level road and find out its maximum speed by the speedometer or with a stop watch. Generally, the main jet which will produce the highest speed on a level road will be the most suitable for any machine. But if on long continuous runs at full throttle the engine starts knocking due to overheating, select the next larger jet size.

In the medium speed range, carry out fine settings between two needle jet sizes by means of the needle. By setting the needle higher, the mixture will become richer and vice versa.

Note that needle position only affects the mixture ratio in the lower and medium speed ranges, not for driving at full throttle. If the carburettor is correctly set, the insulator of the spark plug will show an even brown combustion coating. A spark plug coated with black coking residues or wet to the touch is a sure sign that the mixture is too rich, a white insulator shows that it is too lean.

Always remember that only correct carburettor setting guarantees maximum running economy.

Starter Systems

To start a cold engine needs a specially enriched fuel mixture. To supply this, many carburettors have a separate starting system.

Starter Air Shutter (see carburettor for R 50 and RS 50)

On some carburettor types, the starting aid consists of a pivoted shutter in the filter chamber, operated by Bowden cable. When the starter knob is pulled, the shutter substantially narrows the carburettor cross section, so that the mixture will become rich enough to start a cold engine.

Starter Air Slide (see carburettors for KS 50 Super, Sport-Combinette and Super-Combinette 433)

With these designs, the engine is started from cold as follows: Close throttle slide all the way, and with the pressure pin and knob, press the starter slide down. As you start, pull out throttle about one-third to one-half of the way to a clearly perceptible stop. Once the engine has come to life, leave the throttle in this intermediate position, until the engine has run itself warm. Then open throttle all the way, and this will also raise the starter slide to its end position where it engages. If on starting you inadvertently pull out the throttle too far so that it overrides the stop and takes the starter slide with it, so that the knob jumps back again, press the starter knob once more.

Starter-Jet Carburettors (see carburettor for KS 100)

On these designs, a cylindrical starter-jet housing is arranged next to the main housing, whose piston is operated by Bowden cable. In its top position, the piston uncovers the port which admits starting air from the filter socket and the starting fuel mixture port leading to the carburettor intake socket. Fuel enters from below through the starter jet into this housing, which generally also has a storage chamber.

When the engine is started from cold, the piston is raised, while the throttle slide remains closed. The fuel is first drawn from the storage chamber and when this is empty, through the starter jet. It is then mixed with the starting intake air to produce at first a very rich mixture which becomes gradually leaner as it flows directly into the intake socket of the carburettor and from there to the engine. Once the engine has run itself warm, shut off the starter piston.

Carburettor for Engines 267, 276 (R 50, RS 50)

- a) Carburettor housing
- b) Cover plate
- c) Hose union with sealing ring
- d) Adjuster screw with spring
- e) Collared screw with spring
- f) Starter shutter
- g) Float
- h) Float cap
- i) Pin
- k) Float needle
- l) Slide spring
- m) Throttle slide
- n) Needle jet
- o) Main jet
- p) Washer
- q) Jet needle with locating plate

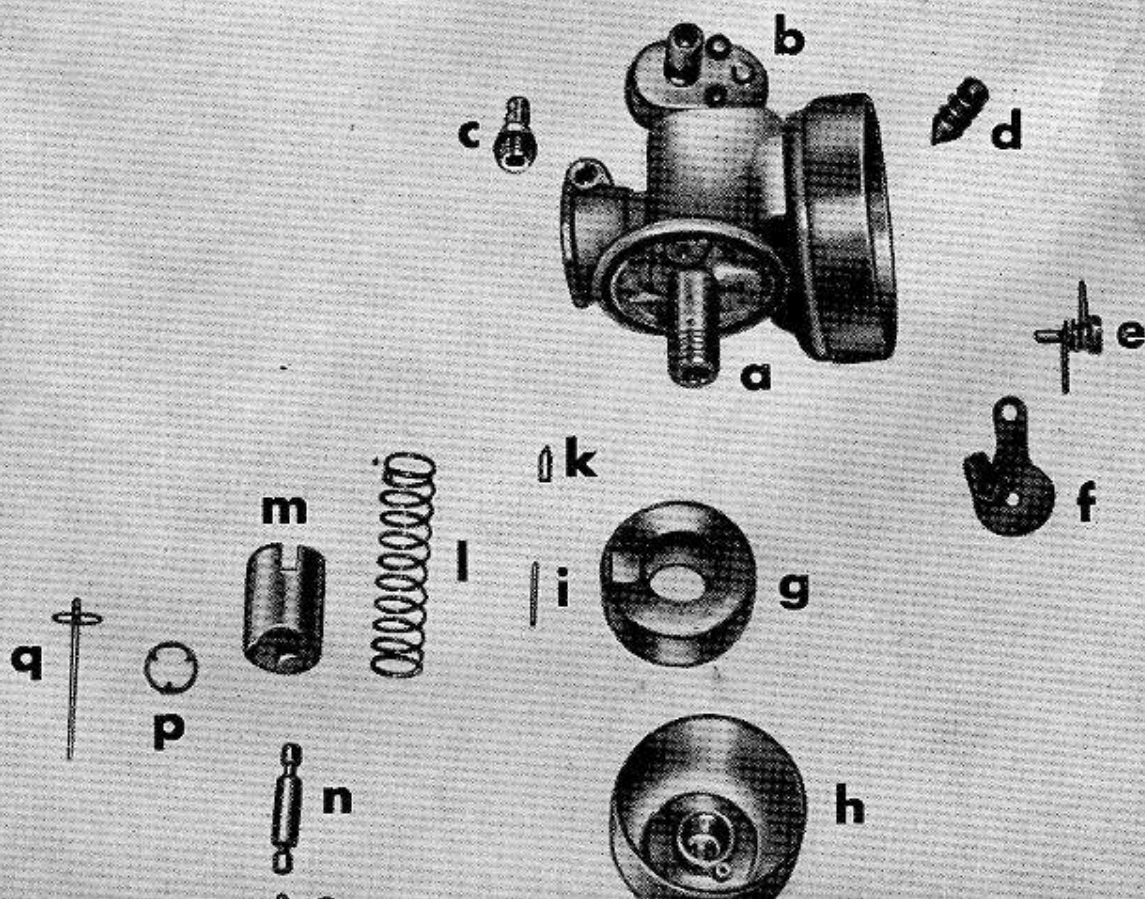

Carburetors for Engines 267, 276

(KS 50 Super, Sport-Combinette and Super-Combinette 433)

- a) Carburettor housing
- b) Starter slide
- c) Cover plate
- d) Throttle slide
- e) Slide spring
- f) Washer
- g) Jetneedle with locating plate
- h) End plug with sealing ring
- i) Needle jet
- k) Main jet
- l) Adjuster screw with spring
- m) Float with float needle
- n) Float housing cover

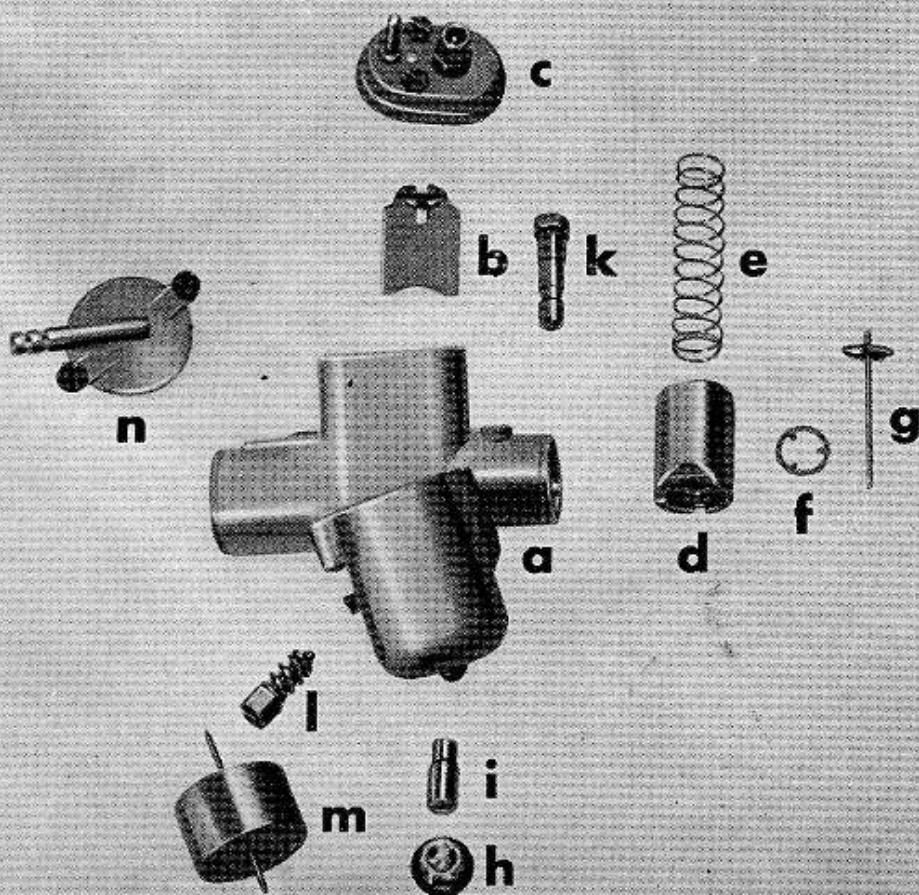

Carburettors for Engines 281 (KS 100)

- a) Cover plug
- b) Float housing cover
- c) Carburettor housing
- d) Float with float needle
- e) Slide spring
- f) Throttle slide
- g) Jet needle
- h) Adjuster screw with spring
- i) End plug with sealing ring
- k) Needle jet
- l) Main jet
- m) Screw with sealing ring
- n) Starter piston
- o) Spring
- p) Adjuster screw with nut
- q) Air control screw with spring
- r) Screw with sealing ring
- s) Idling jet

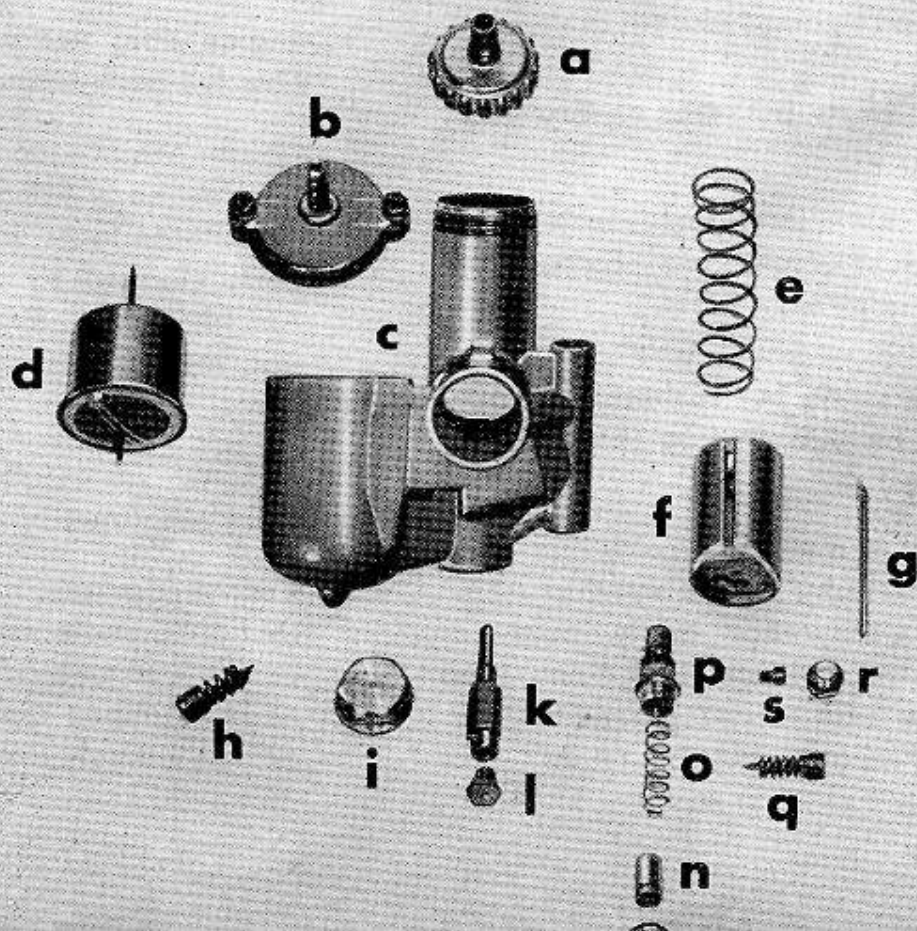

Troubles, and their Causes

1. Engine will not start

Cause: Fuel tap not opened, starter aid not operated when starting from cold. Jets clogged. Carburettor flooded (engine drowned). Ignition not switched on. Spark plug defective, spark too weak. Spark (electrode) gap on plug too large, spark plug short-circuited, gap clogged by dirt water or oil.

2. Engine chokes back on starting

Cause: Ignition timing set too early

3. Engine starts badly

Cause: Mixture too lean (operate starting aid). Idling jet clogged. Spark plug dirty or oily; spark gap too large or too small (weak spark). Water in fuel.

4. Engine starts, but stops again after short run

Cause: Carburettor empty, because fuel tap remained closed

5. Engine starts, but stops on throttling up

Cause: Main jet or fuel line clogged, engine still too cold, carburettor badly adjusted.

6. Engine starts, but carburettor "spits back" on throttling up (coughs and sneezes)

Cause: engine very cold, fuel mixture too lean. Jet too small or clogged. Carburettor badly adjusted (poor transitions). Too many late firings. Suction intake line leaks or air enters at carburettor union.

7. Engine starts, but runs irregularly and splutters on throttling up

Cause: Mixture too rich (fit smaller jets, alter needle setting of throttle slide). Air filter dirty. Float overflows. Ignition cuts out. Spark plug oily or coked up. Starter piston not completely closed (high fuel consumption).

8. Engine runs properly, but exhaust backfires

Cause: Ignition cuts out. Mixture too lean.

9. Engine knocks or pinks

Cause: Too many early firings, fuel is not of anti-knock grade. Excessive compression. Glowing coke deposits or parts of overheated spark plug produce faulty ignition. Main jet too small.

10. Engine does not pull or does not give full performance

Cause: Mixture too lean or too rich. Too few early firings. Exhaust clogged. Piston leaks. Intake or exhaust ports clogged by coking deposits. Air filter dirty. Brakes drag. Friction losses in transmission components.

11. Float overflows

Cause: Foreign body carried in fuel to float needle seat and obstructs needle operation. Float leaks. Float needle jumped out of float spring or was wrongly mounted.

Port-Co.	KS 50 Super	KS 50 Super	KS 50 Super	KS 100	Scooter R 50	Scooter RS 50
041	515-002	515-061	515-061	514-320	561-003	561-004/06
032	276-002	276-026	276-026	281-320	267-020	276-010 276-44
9	50	49,9	49,9	98	49,9	49,9
41,8	39/41,8	39/41,8	39/41,8	50/50	39/41,8	39/41,8
1	8,5:1	9:1	9:1	9:1	9:1	9:1
	4,2	4,6	4,8	8,2	2,6	4,6
0	7200	6900	7500	6340	4500	7000
stroke	2-stroke	2-stroke	2-stroke	2-stroke	2-stroke	2-stroke
E 80	SAE 80	SAE 80	SAE 80	SAE 80	SAE 80	SAE 80
	350	350	350	450	350	350
5	1:25	1:25	1:25	1:25	1:25	1:25
stroke oil or E 40 engine oil	2-stroke oil or SAE 40 engine oil	2-stroke oil or SAE 40 engine oil	2-stroke oil or SAE 40 engine oil	2-stroke oil or SAE 40 engine oil	2-stroke oil or SAE 40 engine oil	2-stroke oil or SAE 40 engine oil
1	2,3 l	2,6 l	2,6 l	2,7 l	2,3 l	2,5 l
6/60	1/17/61	1/17/64	1/17/76	1/22/41	1/16/63	1/17/62
	17	17	17	22	16	17
	82	84	82	100	68	70
0	2,24	2,24	2,15 A	2,64	2,20	2,15 A
	2	3	2	3	3	2
	-	-	-	35	-	35
	-	-	-	1 1/2-2 1/2 U.	-	-
sch /23 W	Bosch 6 V/34 W	Bosch 6 V/34 W	Bosch 6 V/34 W	Bosch 6 V/34 W	Bosch 6 V/18+5 W	Bosch 6 V/29+5 W
mm	1,8 mm	1,1 mm	1,1 mm	1,8-2,0 mm .07-.08	1,8 mm	1,1 mm
5-0,45	0,35-0,45	0,35-0,45	0,35-0,45	0,35-0,45 .015	0,35-0,45	0,35-0,45

