

aprilia

RS 125



aprilia part# 8104468

use+maintenancebook

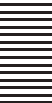

SAFETY WARNINGS

The following precautionary warnings are used throughout this manual in order to convey the following messages:



Safety warning. When you find this symbol on the vehicle or in the manual, be careful to the potential risk of personal injury. Non-compliance with the indications given in the messages preceded by this symbol may result in grave risks for your and other people's safety and for the vehicle!



Indications to make the operations easier. Technical information.

TECHNICAL INFORMATION

★ The operations preceded by this symbol must be repeated also on the opposite side of the vehicle.

If not expressly indicated otherwise, for the reassembly of the units repeat the disassembly operations in reverse order.

The terms "right" and "left" are referred to the rider seated on the vehicle in the normal riding position.

WARNINGS - PRECAUTIONS - GENERAL ADVICE

Before starting the engine, carefully read this manual and in particular the section "SAFE DRIVE".

Your and other people's safety depends not only on your quickness of reflexes and on your agility, but also on what you know about the vehicle, on its efficiency and on your knowledge of the basic information for "SAFE DRIVE".

Therefore, get a thorough knowledge of the vehicle, in such a way as to be able to drive in the traffic safely.

First edition: november 2002

Reprint:

Produced and printed by:
stp editing division
Soave (VERONA) - Italy
Tel. +39 - 045 76 11 911
Fax +39 - 045 76 12 241
E-mail: customer@stp.it
www.stp.it

On behalf of:
aprilia s.p.a.
via G. Galilei, 1 - 30033 Noale (VE) - Italy
Tel. +39 - 041 58 29 111
Fax +39 - 041 44 10 54
www.aprilia.com



This manual must be considered as an integral part of the vehicle and must always accompany it, even in case of resale.

aprilia has carried out this manual with the maximum attention, in order to supply the user with correct and updated information. However, since **aprilia** constantly improves the design of its products, there may be slight discrepancies between the characteristics of your vehicle and those described in this manual.

For any clarification concerning the information contained in this manual, do not hesitate to contact your **aprilia** Official Dealer.

For control and repair operations not expressly described in this publication, for the purchase of **aprilia** genuine spare parts, accessories and other products, as well as for specific advice, contact exclusively **aprilia** Official Dealers and Service Centers, which guarantee prompt and accurate assistance.

Thank you for choosing **aprilia**. We wish you a nice ride.

All rights as to electronic storage, reproduction and total or partial adaptation, with any means, are reserved for all Countries.



In some countries the antipollution and noise regulations in force require periodical inspections.

The user of the vehicle in these countries must:

- contact an **aprilia** Official Dealer to have the non-homologated components replaced with others homologated for use in the country in question;
- carry out the required periodical inspections.



Soon after purchasing the vehicle, write down the identification data indicated on the SPARE PARTS IDENTIFICATION LABEL in the table here below. The label is positioned under the rider saddle, see p. 56 (REMOVING THE RIDER SADDLE).

aprilia		YEAR				Y	1	2	3	4
SPARE PARTS IDENTIFICATION					I.M.	A	B	C	D	E
I	UK	A	P	SF	B	D	F	E	GR	
NL	CH	DK	J	SGP	SLO	IL	ROK	MAL	RCH	
HR	AUS	USA	BR	RSA	NZ	CDN				

These data indicate:

- YEAR = year of manufacture (Y, 1, 2, ...);
- I.M. = modification code (A, B, C, ...);
- COUNTRY CODES = homologation country (I, UK, A, ...).

and are to be supplied to the **aprilia** Official Dealer as reference data for the purchase of spare parts or specific accessories of the model you have acquired.

In this manual the various versions are indicated by the following symbols:

- ASD** automatic light switching version (Automatic Switch-on Device)
- OPT** optional
- FP** Free Power version
-  catalytic version

VERSION:

- I** Italy
- UK** United Kingdom
- A** Austria
- P** Portugal
- SF** Finland
- B** Belgium
- D** Germany
- F** France
- E** Spain
- GR** Greece
- NL** Holland
- CH** Switzerland
- DK** Denmark
- J** Japan
- SGP** Singapore
- SLO** Slovenia
- IL** Israel
- ROK** South Korea
- MAL** Malaysia
- RCH** Chile
- HR** Croatia
- AUS** Australia
- USA** United States of America
- BR** Brazil
- RSA** South Africa
- NZ** New Zealand
- CDN** Canada

TABLE OF CONTENTS

SAFE DRIVE	5	AUTOMATIC		SPARK PLUGS	64
BASIC SAFETY RULES	6	LIGHT SWITCHING VERSION ASD	34	BATTERY	65
CLOTHING	9	CATALYTIC SILENCER	34	LONG INACTIVITY	
ACCESSORIES	10	EXHAUST SILENCER AUS	34	OF THE BATTERY	65
LOAD	10	INSTRUCTIONS FOR USE	35	CHECKING AND CLEANING	
ARRANGEMENT OF THE		PRELIMINARY CHECKING OPERATIONS	35	THE TERMINALS	66
MAIN ELEMENTS	12	STARTING	36	REMOVING THE BATTERY	66
ARRANGEMENT OF THE		DEPARTURE AND DRIVE	38	CHECKING	
INSTRUMENTS/CONTROLS	14	RUNNING-IN	41	THE ELECTROLYTE LEVEL	67
INSTRUMENTS AND INDICATORS	15	STOPPING	41	RECHARGING THE BATTERY	67
INSTRUMENTS AND		PARKING	42	INSTALLING THE BATTERY	67
INDICATORS TABLE	16	SUGGESTIONS		CHANGING THE FUSES	68
MULTIFUNCTION COMPUTER	17	TO PREVENT THEFT	42	CHECKING THE SIDE STAND	
MAIN INDEPENDENT CONTROLS	20	MAINTENANCE	43	AND THE SAFETY SWITCH	69
CONTROLS ON THE LEFT PART		REGULAR SERVICE INTERVALS		CHECKING THE SWITCHES	70
OF THE HANDLEBAR	20	CHART	44	ADJUSTING THE VERTICAL	
CONTROLS ON THE RIGHT PART		IDENTIFICATION DATA	46	HEADLIGHT BEAM	71
OF THE HANDLEBAR	21	POSITIONING THE VEHICLE ON THE		BULBS	71
IGNITION SWITCH	22	REAR SUPPORT STAND OPT	47	CHANGING	
STEERING LOCK	22	POSITIONING THE VEHICLE ON THE		THE HEADLIGHT BULBS	72
AUXILIARY EQUIPMENT	23	FRONT SUPPORT STAND OPT	47	CHANGING	
CRASH HELMET HOOK	23	CHECKING THE TRANSMISSION		THE FRONT AND REAR	
GLOVE/TOOL KIT COMPARTMENT	23	OIL LEVEL AND TOPPING UP	48	DIRECTION INDICATOR BULBS	73
REAR MUDGUARD EXTENSION		CHANGING THE TRANSMISSION OIL	49	CHANGING	
(in the countries where required)	23	FRONT WHEEL	50	THE REAR LIGHT BULB	74
SPECIAL TOOLS OPT	24	REAR WHEEL	52	TRANSPORT	75
MAIN COMPONENTS	25	DRIVE CHAIN	54	DRAINING THE FUEL TANK	75
FUEL	25	REMOVING THE RIDER SADDLE	56	CLEANING	76
TRANSMISSION OIL	25	REMOVING THE SIDE FAIRINGS	56	LONG PERIODS OF INACTIVITY	77
BRAKE FLUID-recommendations	26	LIFTING THE FUEL TANK	57	TECHNICAL DATA	78
DISC BRAKES	26	AIR CLEANER	58	LUBRICANT CHART	81
FRONT BRAKE	27	INSPECTING THE FRONT		Importers	82
REAR BRAKE	28	AND REAR SUSPENSIONS	59	Importers	83
2 STROKE OIL TANK	29	REAR SUSPENSION	60	WIRING DIAGRAM - RS 125	84
ADJUSTING THE SHIFTING LEVER	29	CHECKING THE BRAKE PAD WEAR	61	WIRING DIAGRAM KEY - RS 125	85
ADJUSTING THE REAR BRAKE	30	IDLING ADJUSTMENT	62		
ADJUSTING THE CLUTCH	30	ADJUSTING			
COOLANT	32	THE ACCELERATOR CONTROL	62		
TYRES	33	ADJUSTING			
		THE COLD START CONTROL (I\I)	63		

aprilia



safe drive

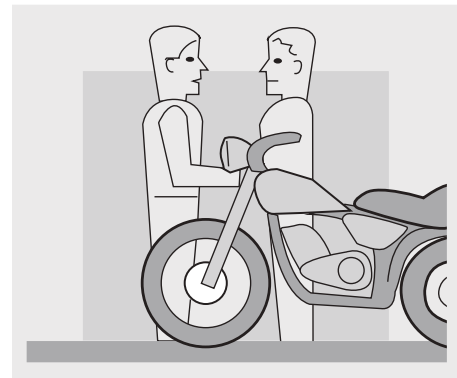
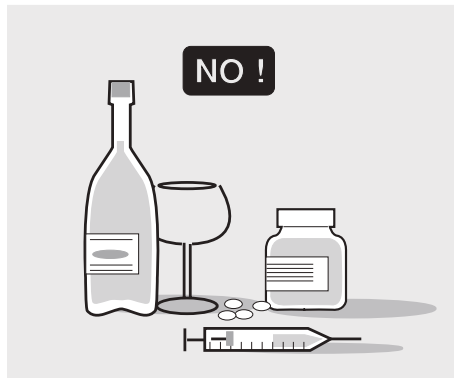

BASIC SAFETY RULES

To drive the vehicle it is necessary to be in possession of all the requirements prescribed by law (driving licence, minimum age, psychophysical ability, insurance, state taxes, vehicle registration, number plate, etc.).

Gradually get to know the vehicle by driving it first in areas with low traffic and/or private areas.

The use of medicines, alcohol and drugs or psychotropic substances notably increases the risk of accidents.

Be sure that you are in good psychophysical conditions and fit for driving and pay particular attention to physical weariness and drowsiness.

Most road accidents are caused by the driver's lack of experience.

NEVER lend the vehicle to beginners and, in any case, make sure that the driver has all the requirements for driving.

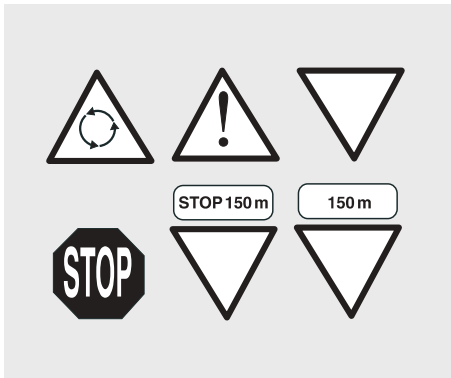

Rigorously observe all road signs and national and local road regulations.

Avoid abrupt movements that can be dangerous for yourself and other people (for example: rearing up on the back wheel, speeding, etc.), and give due consideration to the road surface, visibility and other driving conditions.

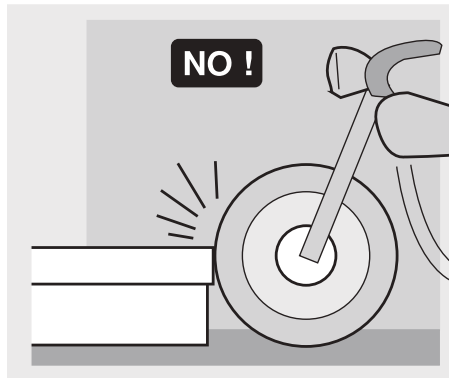

Avoid obstacles that could damage the vehicle or make you lose control.

Avoid riding in the slipstream created by preceding vehicles in order to increase your speed.

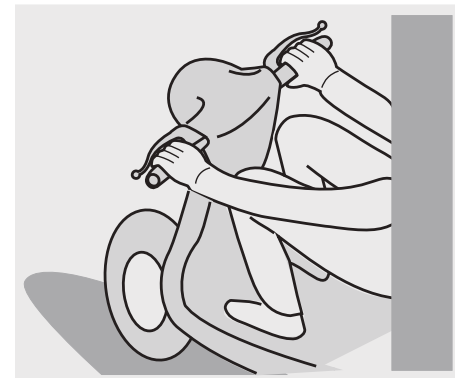

Always drive with both hands on the handlebars and both feet on the footrests (or on the rider's footboards), in the correct driving posture.

Avoid standing up or stretching your limbs while driving.



The driver should pay attention and avoid distractions caused by people, things and movements (never smoke, eat, drink, read, etc.) while driving.

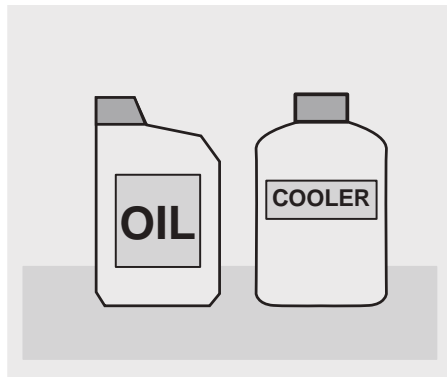

Use only the vehicle's specific fuels and lubricants indicated in the "LUBRICANT CHART"; check the oil, fuel and coolant levels regularly.

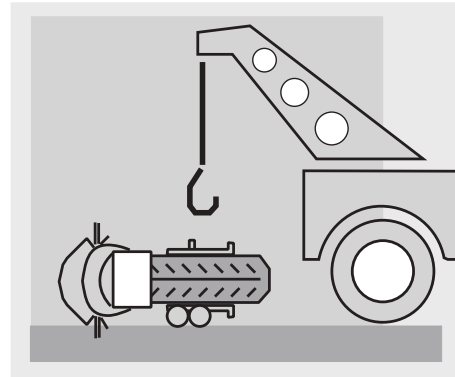

If the vehicle has been involved in an accident, make sure that no damage has occurred to the control levers, pipes, wires, braking system and vital parts.

If necessary, have the vehicle inspected by an **aprilia** Official Dealer, who should carefully check the frame, handlebars, suspensions, safety parts and all the devices that you cannot check by yourself.

Always remember to report any malfunction to the technicians to help them in their work.

Never use the vehicle when the amount of damage it has suffered endangers your safety.

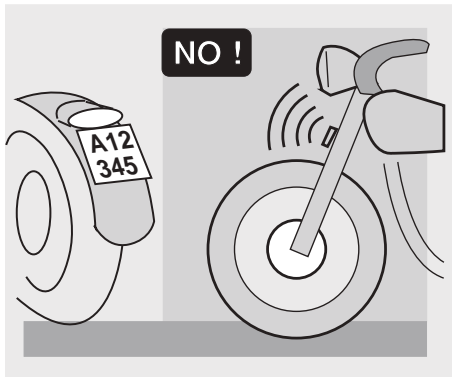

Never change the position, inclination or colour of: number plate, direction indicators, lights and horns.

Any modification of the vehicle will result in the invalidity of the guarantee.

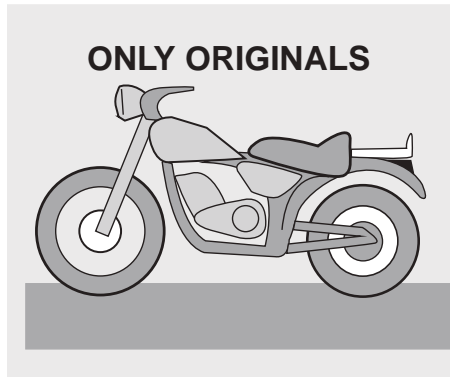

Any modification of the vehicle and/or the removal of original components can compromise vehicle performance levels and safety or even make it illegal.

We recommend respecting all regulations and national and local provisions regarding the equipment of the vehicle.

In particular, avoid all modifications that increase the vehicle's performance levels or alter its original characteristics.

Never race with other vehicles.

Avoid off-road driving.

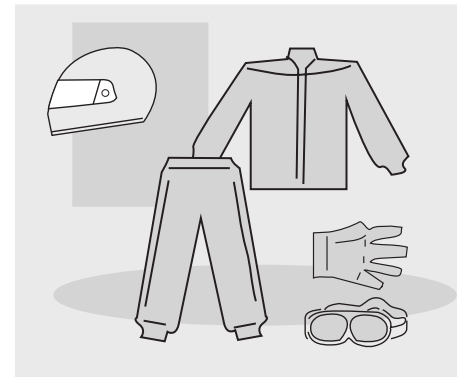

CLOTHING

Before starting, always wear a correctly fastened crash helmet. Make sure that it is homologated, in good shape, of the right size and that the visor is clean.

Wear protective clothing, preferably in light and/or reflecting colours. In this way you will make yourself more visible to the other drivers, thus notably reducing the risk of being knocked down, and you will be more protected in case of fall.

This clothing should be very tight-fitting and fastened at the wrists and ankles. Strings, belts and ties should not be hanging loose; prevent these and other objects from interfering with driving by getting entangled with moving parts or driving mechanisms.

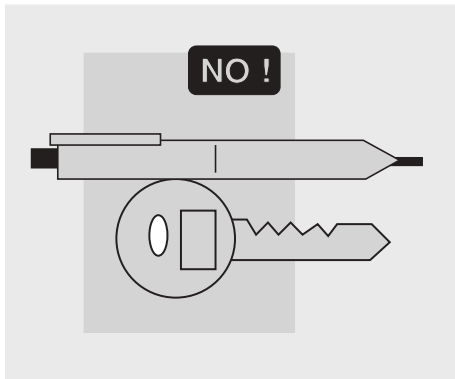

Do not keep objects that can be dangerous in case of fall, for example pointed objects like keys, pens, glass vials etc. in your pockets (the same recommendations also apply to passengers).

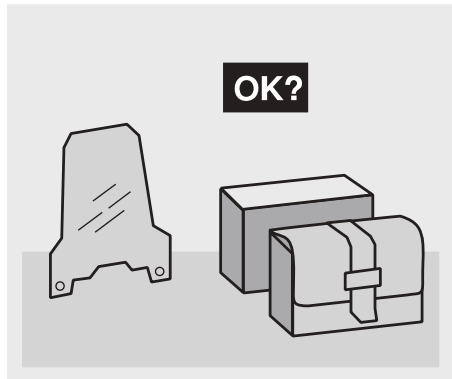

ACCESSORIES

The owner of the vehicle is responsible for the choice, installation and use of any accessory.

Avoid installing accessories that cover horns or lights or that could impair their functions, limit the suspension stroke and the steering angle, hamper the operation of the controls and reduce the distance from the ground and the angle of inclination in turns.

Avoid using accessories that hamper access to the controls, since this can prolong reaction times during an emergency.

Large fairings and windscreens assembled on the vehicle can produce aerodynamic forces capable of compromising the stability of the vehicle while driving.

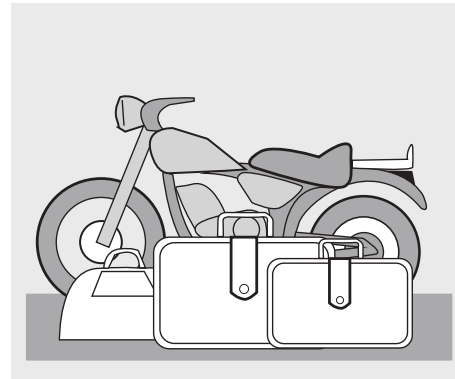

Make sure that the equipment is well fastened to the vehicle and not dangerous during driving. Do not install electrical devices and do not modify those already existing to avoid electrical overloads, because the vehicle could suddenly stop or there could be a dangerous current shortage in the horn and in the lights. **aprilia** recommends the use of genuine accessories (**aprilia** genuine accessories).

LOAD

Be careful and moderate when loading your luggage. Keep any luggage loaded as close as possible to the centre of the vehicle and distribute the load uniformly on both sides, in order to reduce imbalance to the minimum. Furthermore, make sure that the load is firmly secured to the vehicle, especially during long trips.

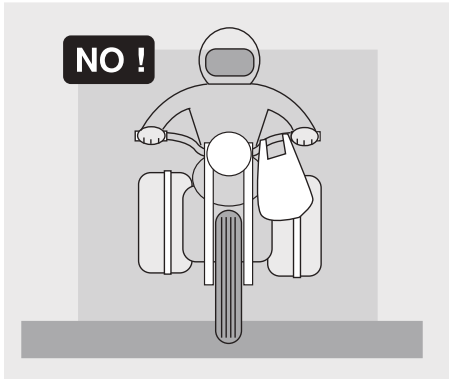

Avoid hanging bulky, heavy and/or dangerous objects on the handlebars, mudguards and forks, because the vehicle might respond more slowly in turns and its manoeuvrability could be unavoidably impaired.

Do not place bags that are too bulky on the vehicle sides and do not ride with the crash helmet hanging from its string, because it could hit people or obstacles making you lose control of the vehicle.



Do not carry any bag if it is not tightly secured to the vehicle.

Do not carry bags which protrude too much from the luggage rack or which cover the lights, horn or indicators.

Do not carry animals or children on the glove compartment or on the luggage rack.

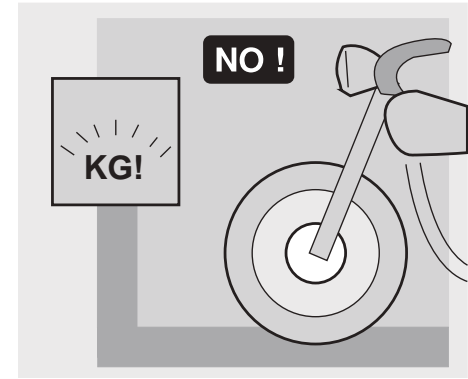

Do not exceed the maximum load allowed for each side-bag.

When the vehicle is overloaded, its stability and its manoeuvrability can be compromised.

ARRANGEMENT OF THE MAIN ELEMENTS

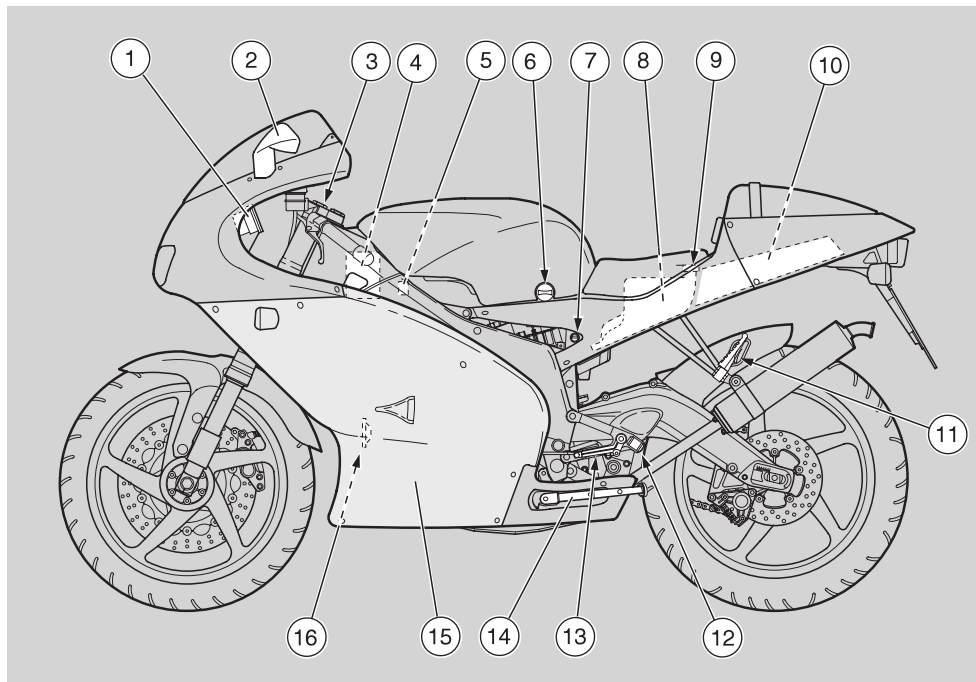

KEY

- | | | |
|----------------------------------|--|---|
| 1) Dashboard | 8) 2 stroke oil tank | 12) Rider left footrest
(with spring, always open) |
| 2) Left rear-view mirror | 9) 2 stroke oil tank plug | 13) Shifting lever |
| 3) Ignition switch/steering lock | 10) Glove/tool kit compartment | 14) Side stand |
| 4) Battery | 11) Passenger left footrest
(snapping, closed/open) | 15) Left fairing |
| 5) Fuse carrier | | 16) Horn |
| 6) Fuel tap | | |
| 7) Saddle lock | | |

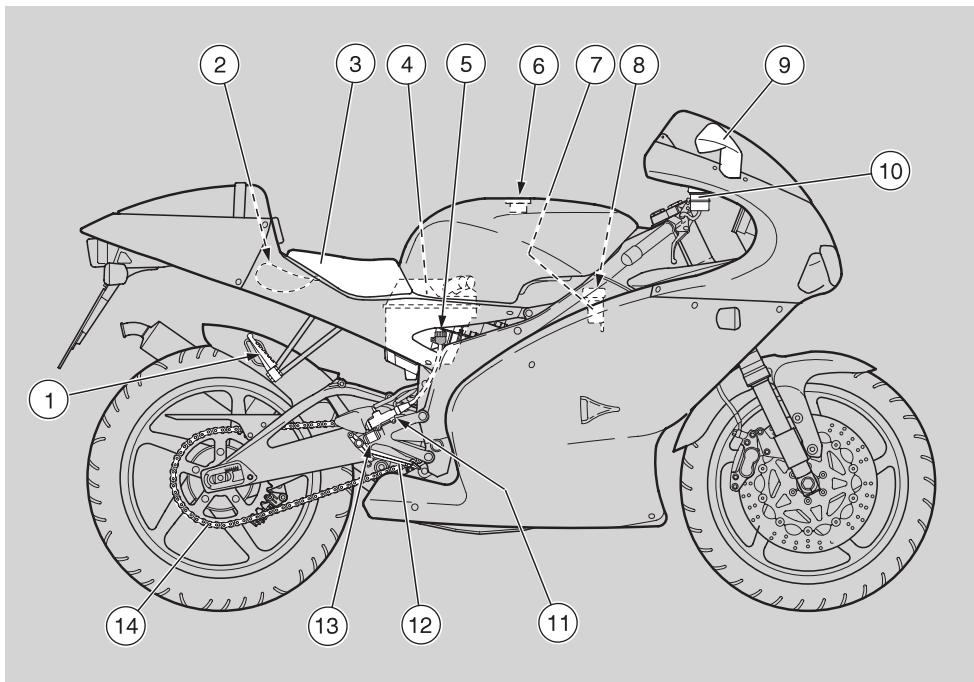



KEY

- | | | |
|--|--------------------------------|--|
| 1) Passenger right footrest
(snapping, closed/open) | 6) Fuel tank plug | 12) Rear brake control lever |
| 2) Crash helmet cable | 7) Expansion tank | 13) Rider right footrest
(with spring, always open) |
| 3) Rider saddle | 8) Coolant expansion tank plug | 14) Drive chain |
| 4) Air cleaner | 9) Right rear-view mirror | |
| 5) Rear brake fluid tank | 10) Front fairing | |
| | 11) Rear brake pump | |

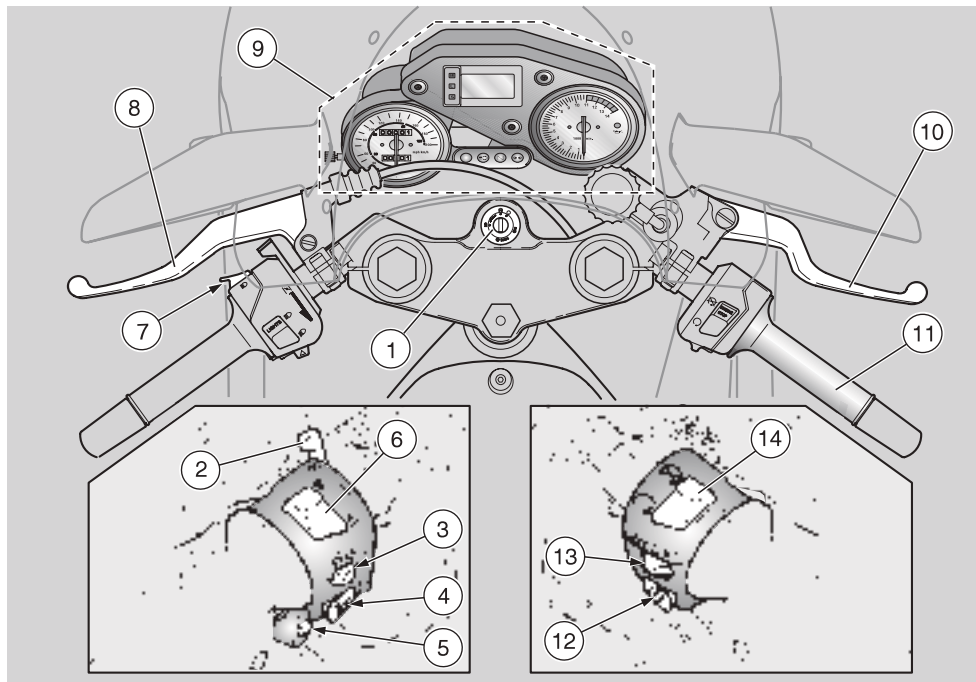
ARRANGEMENT OF THE INSTRUMENTS/CONTROLS



KEY

- | | |
|--|---|
| 1) Ignition switch/steering lock ( -  - ) | 8) Clutch lever |
| 2) Cold start lever () | 9) Instruments and indicators |
| 3) Direction indicator switch () | 10) Front brake lever |
| 4) Horn push button () | 11) Throttle grip |
| 5) LAP push button (chronometer) () | 12) Start push button () |
| 6) Dimmer switch ( - ) | 13) Light switch ( -  - ) (not provided for ASD) |
| 7) High beam signalling push button () | 14) Engine stop switch ( - ) |



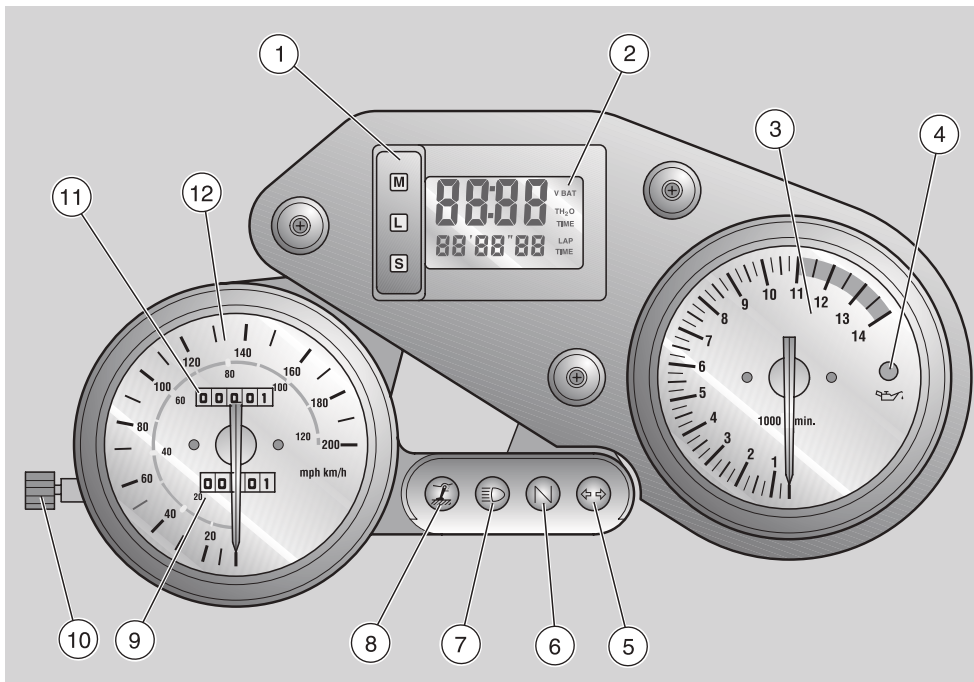





INSTRUMENTS AND INDICATORS



KEY

- | | |
|---|--|
| 1) Multifunction computer programming push buttons | 7) Blue high beam warning light (≡) |
| 2) Multifunction digital display
(coolant temperature - clock - battery voltage - chronometer) | 8) Amber "side stand down" warning light (🛞) |
| 3) Revolution counter | 9) Partial kilometres odometer |
| 4) Red 2 stroke oil reserve warning light LED (🛢️) | 10) Odometer trip control |
| 5) Green direction indicator warning light (↔) | 11) Total kilometres odometer |
| 6) Green neutral indicator warning light (N) | 12) Speedometer |
| | 12) Speedometer - only km/h scale AUS |

INSTRUMENTS AND INDICATORS TABLE

Description	Function		
Direction indicator warning light 	Blinks when the direction indicators are on.		
High beam warning light 	Comes on when the headlight is in "high beam" position or when the high beam signalling is operated.		
Revolution counter (<i>rpm</i>)	Indicates the number of revolutions of the engine per minute.  Never exceed the engine max. speed rate, see p. 41 (RUNNING-IN).		
Side stand down warning light 	Comes on when the side stand is down.		
2 stroke oil reserve warning light LED 	It comes on when the quantity of 2 stroke oil left in the tank is equal to 0.35 ℓ.  If the warning light LED comes on, this means that the 2 stroke oil reserve is being used; in this case, provide for topping up, see p. 29 (2 STROKE OIL TANK).		
Neutral indicator warning light 	Comes on when the gear is in neutral.		
Partial kilometres odometer	It indicates the partial number of kilometres covered. To set it to zero, use the odometer trip control.		
Odometer trip control	Rotate it anticlockwise to set the partial kilometres odometer to zero.		
Total kilometres odometer	It indicates the total number of kilometres covered.		
Speedometer	It indicates the driving speed.		
Multifunction digital display	Coolant temperature (°C)  Indicates the temperature of the coolant in the engine, see p. 17 (MULTIFUNCTION COMPUTER). If a temperature of 115°C±130°C is indicated, stop the engine and check the coolant level, see p. 32 (COOLANT).  If the maximum allowed temperature (130°C) is exceeded, the engine may be seriously damaged. If the writing " L L L " appears on the display, contact an aprilia Official Dealer, who will check the coolant thermistor and/or the electrical connection circuit.	To alternate the data displayed, see p. 17 (MULTIFUNCTION COMPUTER).	
	Clock		Indicates the hour and minutes according to the presetting, see p. 17 (MULTIFUNCTION COMPUTER).
	Battery voltage (V BAT)		Indicates the battery voltage, see p. 17 (MULTIFUNCTION COMPUTER).
	Chronometer		Indicates the various timings according to the presetting, see p. 17 (MULTIFUNCTION COMPUTER).

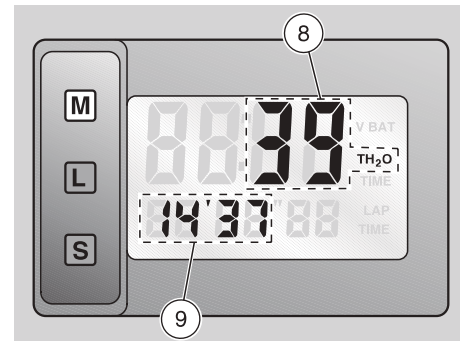
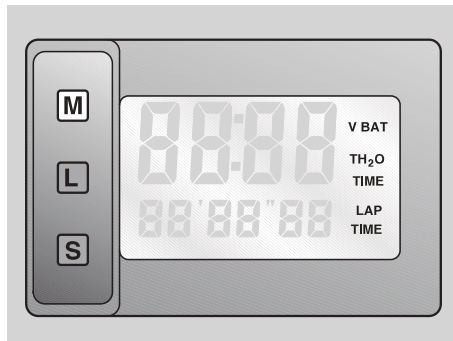
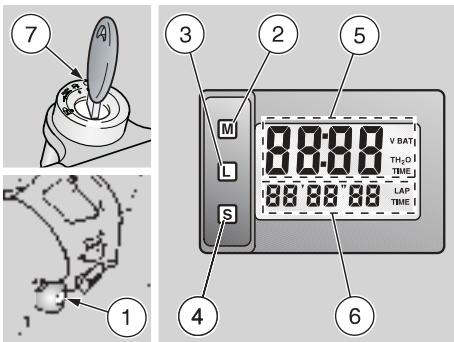

MULTIFUNCTION COMPUTER

KEY

- 1) LAP push button
- 2) MODE push button (**M**)
- 3) LOCK push button (**L**)
- 4) START push button (**S**)
- 5) Upper display
- 6) Lower display

FUNCTION DESCRIPTION

- ◆ Turn the ignition switch (7) to position "O".
- ◆ By pressing the **M** push button once and more than once in succession, the following functions are operated, in their respective order:

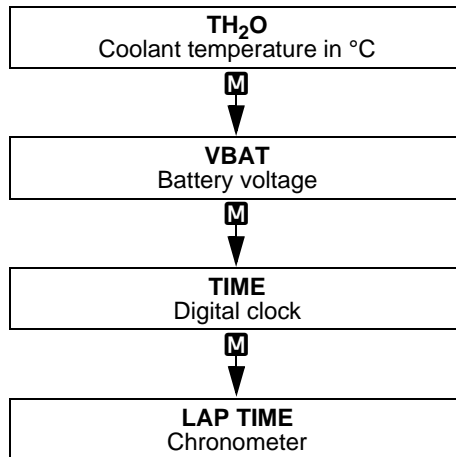

TH₂O (coolant temperature)

- ◆ By pressing the **M** function push button once, the coolant temperature (8) in centigrade degrees (°C) is indicated on the

upper part of the display, while the current time (9) is displayed on its lower part.

- If the temperature exceeds 100°C, the upper part of the display blinks, even if the set function is different from "TH₂O".
- If the temperature is lower than 30°C, the writing "e b l d" appears on the display.

Reading range: 0 ÷ 130°C.

! If the maximum allowed temperature (130°C) is exceeded, the engine may be seriously damaged.

If the writing " L L L " appears on the display, contact an **aprilia** Official Dealer, who will check the coolant thermistor and/or the electrical connection circuit.

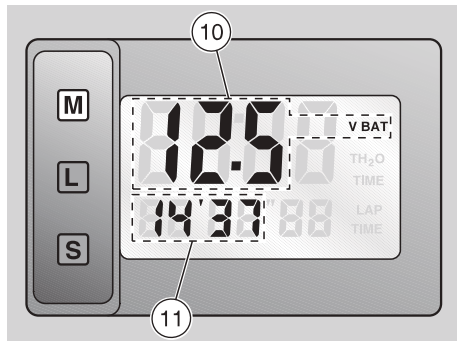

VBAT (battery voltage)

- ◆ By pressing the **M** push button for the second time, the battery voltage (10), expressed in volt, is indicated on the display.

The recharge system functions properly if at 4000 rpm the battery voltage, with low beam on, is included between 13 and 15 V.

The current time (11) appears in the lower part of the display.

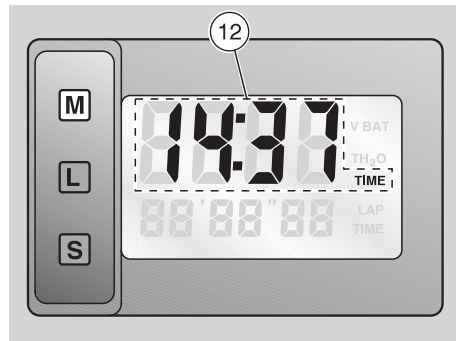

TIME (setting hour/minutes)

- ◆ By pressing the **M** push button for the third time, the hour and minutes (12) are displayed.

To change the time data, proceed as follows:

- ◆ Press the **L** push button and the number indicating the hours will start blinking.
- ◆ To increase the value, press the **S** push button.
- ◆ To set the minutes, press the **M** push button and the number indicating the minutes will start blinking.
- ◆ To increase the value, press the **S** push button.

Now, to store the setting of the hour and minutes.

- ◆ Press the central **L** push button.

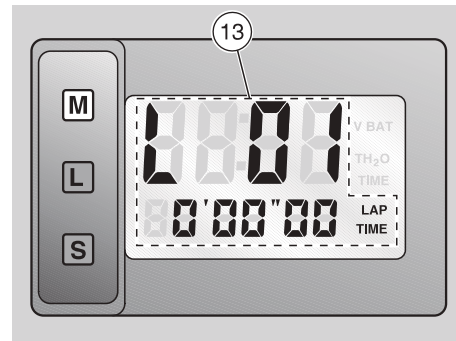

LAP TIME (chronometer)

- ◆ By pressing the **M** push button for the fourth time, the "LAP TIME" (13) function is displayed, which makes it possible to time each lap with the vehicle on the track and to store the data in order to be able to consult them successively.

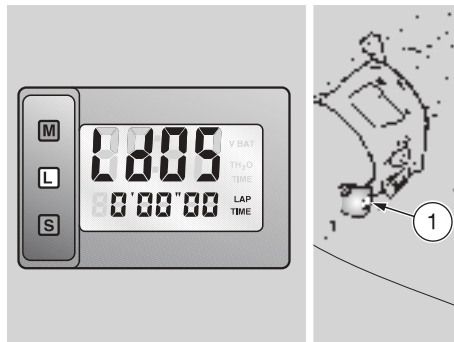
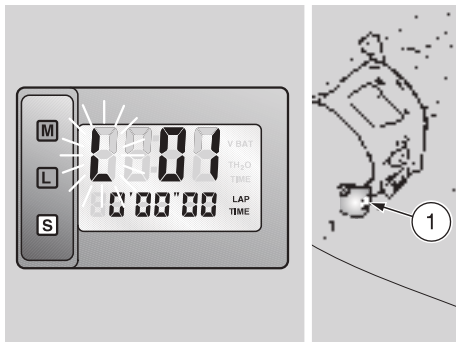

How to use the “LAP TIME” function (only for races in places that are closed to traffic).

- ◆ To initialize the computer for the timing function, press the **S** push button. The letter “L” (Lap) will blink on the display.
- ◆ To start the stop-watch, press the “LAP” (1) push button, positioned on the left half of the handlebars.
- ◆ To display the time taken for one lap, press the “LAP” (1) push button again.
After pressing the “LAP” (1) push button, the time obtained in the previous lap is displayed for about 15 seconds, after which the current time is displayed again.
- ◆ To end the timing, press the **S** push button.

It is possible to carry out up to 10 timings.

At the last timing, the writing “L 10” will appear on the display.

How to recall the time per lap (LAP MEMORY).

- ◆ To recall the time per lap, press the **L**.
The writing “Ld” will appear on the display.
- ◆ To run through the stored times per lap, press the “LAP” (1) push button.
The writing “Ld 01” corresponds to lap no. 1, “Ld 02” corresponds to lap no. 2 and so on.

How to delete the stored data.

- ◆ To delete the stored data, press the **L** push button.
The writing “L 10”, “L 09” or “L 08”, etc. will appear on the display.
- ◆ Now, press the **S** push button and, keeping it pressed, press also the “LAP” (1) push button on the left half of the handlebars.

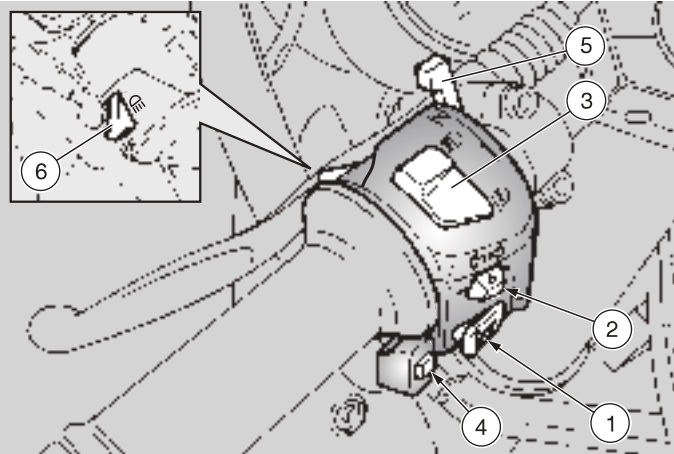

In this way the stored data will be definitively deleted.

MAIN INDEPENDENT CONTROLS





CONTROLS ON THE LEFT PART OF THE HANDLEBAR



 The electrical parts work only when the ignition switch is in position "O".

- 1) HORN PUSH BUTTON ()**
The horn is activated when the push button is pressed.
- 2) DIRECTION INDICATOR SWITCH ()**
To indicate the turn to the left, move the switch to the left; to indicate the turn to the right, move the switch to the right.
To turn off the direction indicator, press the switch.

3) DIMMER SWITCH (-)

When the light switch is in position "", see p. 21 (CONTROLS ON THE RIGHT PART OF THE HANDLEBAR): if the dimmer switch is in position "", the high beam comes on, while if it is in position "", the low beam comes on.

3) DIMMER SWITCH (-) **ASD**

When it is in position "" the parking lights, the dashboard light and the low beam are always on.
When it is in position "", the high beam comes on.



4) LAP PUSH BUTTON (chronometer)

This button makes it possible to use the multifunction computer chronometer.



For the setting of the functions, see p. 17 (MULTI-FUNCTION COMPUTER).

5) COLD START LEVER ()

The starter for the cold start of the engine is operated by rotating the lever "" downwards.
To disconnect the starter, move the lever "" to its initial position.

6) HIGH BEAM SIGNALLING PUSH BUTTON ()

It makes it possible to use the high beam for signalling to forthcoming vehicles while overtaking and in case of peril and/or emergency.

CONTROLS ON THE RIGHT PART OF THE HANDLEBAR

 The electrical parts work only when the ignition switch is in position "○".

1) ENGINE STOP SWITCH (○ - ☒)

 **Do not operate the engine stop switch "○ - ☒" in running conditions.**

This is a safety or emergency switch. With the switch in position "○", it is possible to start the engine; the engine can be stopped by moving the switch to position "☒".

 **With stopped engine and ignition switch in position "○", the battery may discharge. When the vehicle has come to rest, after stopping the engine, move the ignition switch to position "☒".**

2) HEADLIGHT SWITCH (☼ - ☼☼ - ●)

(not provided in the **ASD** version)

When the light switch is in position "●", the lights are off; when the switch is in position "☼☼", the parking lights and the dashboard light are on; when the switch is in position "☼", the parking lights, the dashboard light and the low beam are on. The high beam can be operated by means of the dimmer switch, see p. 20 (CONTROLS ON THE LEFT PART OF THE HANDLEBAR).

3) START PUSH BUTTON (Ⓢ)

When the start push button "Ⓢ" is pressed, the starter makes the engine run. For the starting, see p. 36 (STARTING).

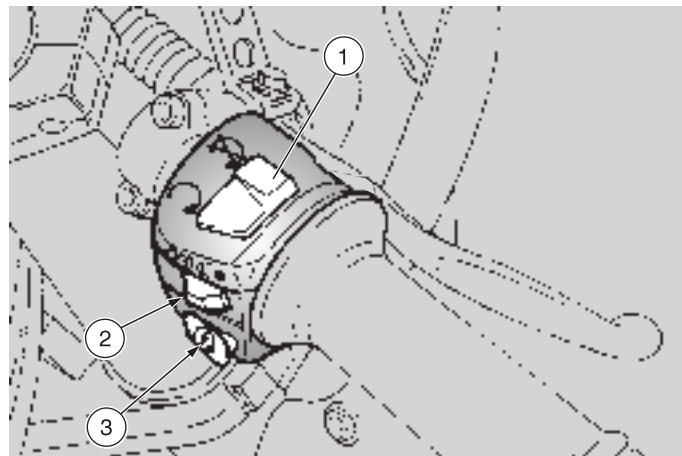

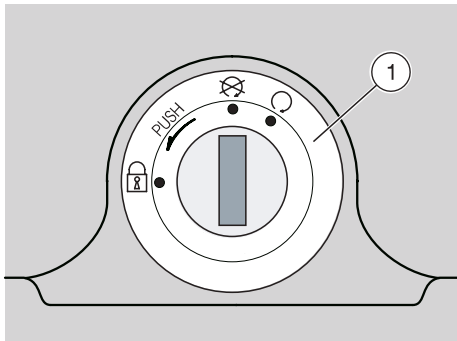

IGNITION SWITCH

The ignition switch (1) is positioned on the upper plate of the steering column.



The key operates the ignition switch/steering lock, the saddle lock and the fuel tank lock. Two keys are supplied together with the vehicle (one spare key).

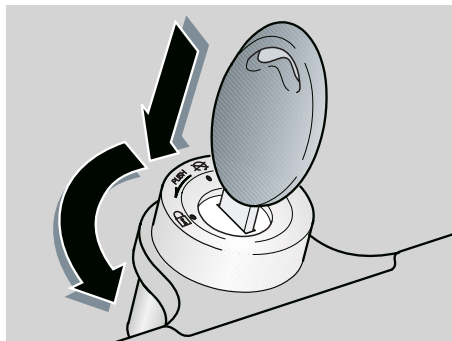

STEERING LOCK





Never turn the key to position "⊗" in running conditions, in order to avoid losing control of the vehicle.

OPERATION

To lock the steering:

- ◆ Turn the handlebar completely leftwards.
- ◆ Turn the key to position "⊗".
- ◆ Press the key and rotate it to position "⊗".
- ◆ Extract the key.

Position	Function	Key removal
 Steering lock	The steering is locked. It is neither possible to start the engine, nor to switch on the lights.	It is possible to remove the key.
	Neither the engine, nor the lights can be switched on.	It is possible to remove the key.
	The engine and the lights can be switched on.	It is not possible to remove the key.

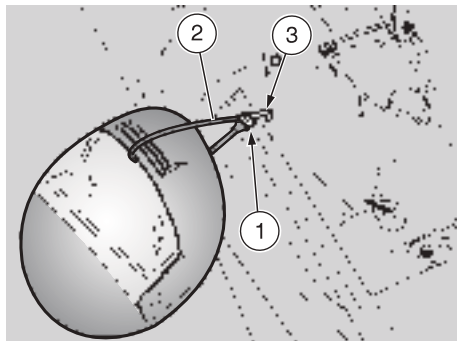

CRASH HELMET HOOK

Thanks to the crash helmet hook, you no longer have to carry the crash helmet with you every time you park the vehicle.



Do not ride with the crash helmet hanging from the hook, as this may seriously compromise your safety.

To hang the crash helmet:

- ◆ Remove the rider saddle, see p. 56 (REMOVING THE RIDER SADDLE).
- ◆ Withdraw the eyelet (1) of the cable (2) from the hook (3).
- ◆ Pass the cable (2) through the visor opening or through the appropriate loop on the crash helmet.
- ◆ Insert the eyelet (1) completely in the hook (3).
- ◆ Put back the rider saddle and lock it.

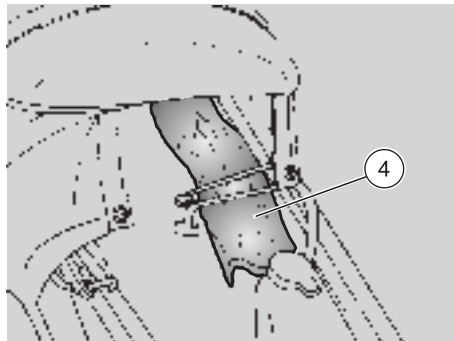

GLOVE/TOOL KIT COMPARTMENT

The glove/tool kit compartment is positioned under the rider saddle; to reach it:

- ◆ Position the vehicle on the stand.
- ◆ Remove the rider saddle, see p. 56 (REMOVING THE RIDER SADDLE).

The tool kit (4) includes:

- 3, 5 mm Allen spanners
- 10-13 mm double fork spanner
- 17-21 mm spark plug socket spanner
- Double-ended, cross-/4 mm hexagon spanner-headed screwdriver.
- Tool case

Max. allowed weight: 1.5 kg

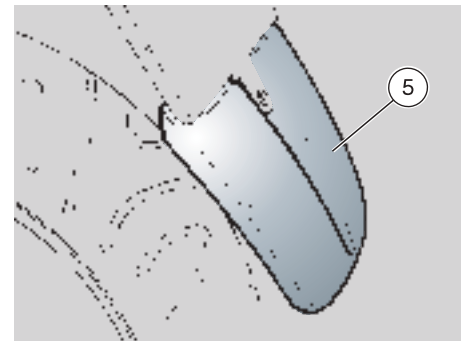

REAR MUDGUARD EXTENSION (in the countries where required)

The extension of the rear mudguard (5) is extremely useful when the road surface is wet, in fact it reduces the reach of the water spray caused by the rear wheel.



The rear mudguard extension (5) is supplied as standard component in the countries where this is required for the homologation.

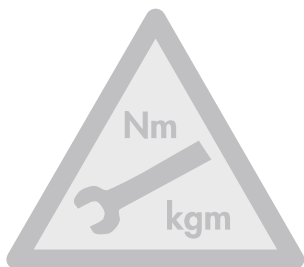

SPECIAL TOOLS OPT

To perform some specific operations, it is advisable to use the following special tools (to be requested to an **aprilia** Official Dealer):

Tool	Operations	Page
Special socket spanner (1)	Clutch clearance adjustment.	30
Rear support stand (2)	Rear wheel disassembly. Drive chain adjustment.	50 52
Front support stand (3)	Front wheel disassembly.	48
Rear support stand coupling pins (4)	Positioning of the vehicle on the rear stand.	45

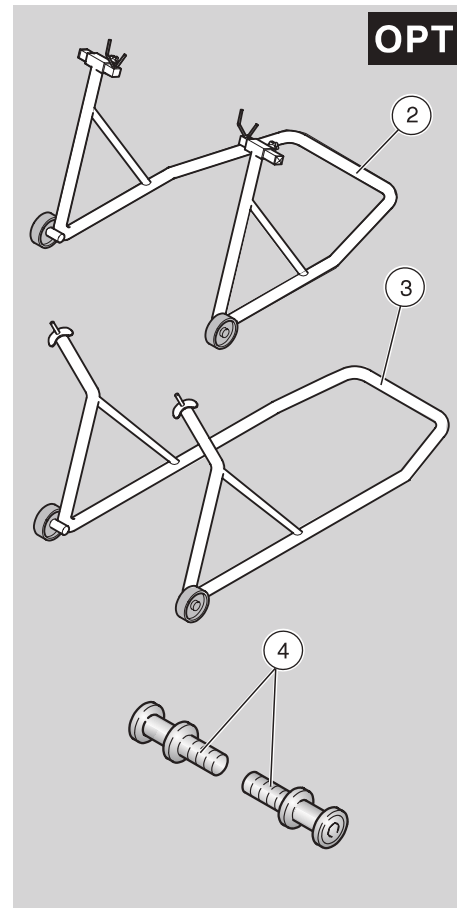
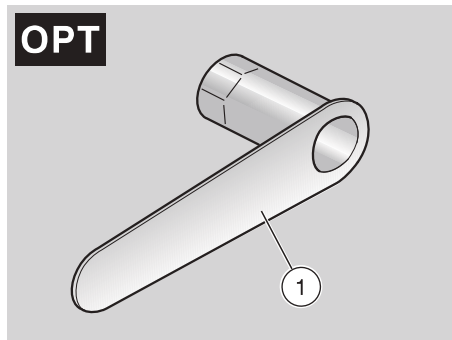

MAIN COMPONENTS

FUEL



The fuel used for internal combustion engines is extremely inflammable and in particular conditions it can become explosive. It is important to carry out the refuelling and the maintenance operations in a well-ventilated area, with the engine off. Do not smoke while refuelling or near fuel vapours, in any case avoid any contact with naked flames, sparks and any other heat source to prevent the fuel from catching fire or from exploding. Further, prevent fuel from flowing out of the fuel filler, as it could catch fire when getting in contact with the red-hot surfaces of the engine.

In case some fuel has accidentally been spilled, make sure that the area has completely dried and before starting the vehicle verify that there is no fuel inside the fuel filler neck.

Since petrol expands under the heat of the sun and due to the effects of sun radiation, never fill the tank to the brim. Screw the plug up carefully after refuelling. Avoid any contact of the fuel with the skin and the inhalation of vapours; do not swallow fuel or pour it from a receptacle into another by means of a tube.

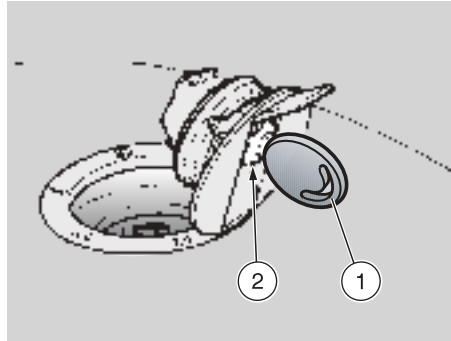

DO NOT DISPOSE OF FUEL IN THE ENVIRONMENT.

KEEP AWAY FROM CHILDREN.

Use only unleaded petrol, in conformity with the DIN 51607 standard, min. O.N. 95 (N.O.R.M.) and 85 (N.O.M.M.).

FUEL TANK CAPACITY
(reserve included): 13 ℓ

TANK RESERVE: 3.5 ℓ (mechanical reserve)

To refuel, proceed as follows:

- ◆ Insert the key (1) in the tank plug lock (2).
- ◆ Turn the key clockwise, pull and open the fuel flap.

TRANSMISSION OIL

Check the transmission oil level every 4000 km (2500 mi), see p. 48 (CHECKING THE TRANSMISSION OIL LEVEL AND TOPPING UP).

Change the transmission oil after the first 1000 km (625 mi) and successively every 12000 km (7500 mi), see p. 49 (CHANGING THE TRANSMISSION OIL).



Use high-quality 75W-90 oil, see p. 81 (LUBRICANT CHART).



Engine oil can cause serious damage to the skin if handled every day and for long periods. Wash your hands carefully after using the oil.

Do not dispose of the oil in the environment.

Put it in a sealed container and take it to the filling station where you usually buy it or to an oil salvage center.

In case any maintenance operation has to be carried out, it is advisable to use latex gloves.



BRAKE FLUID-recommendations

 This vehicle is provided with front and rear disc brakes, with separate hydraulic circuits. The following information refers to a single braking system, but is valid for both.

 Sudden resistance or clearance problems on the brake lever may be due to troubles in the hydraulic system. For any doubt regarding the perfect functioning of the braking system and in case you are not able to carry out the usual checking operations, contact your **aprilia** Official Dealer.

 Make sure that the brake discs are neither oily nor greasy, especially after maintenance or checking operations. Check that the brake cables are neither twisted nor worn out. Prevent water or dust from accidentally getting into the circuit.

In case maintenance operations are to be performed on the hydraulic circuit, it is advisable to use latex gloves.

If the brake fluid gets in contact with the skin or the eyes, it can cause serious irritations. Carefully wash the parts of your body that get in contact with the liquid. Consult a doctor or an oculist if the liquid gets in contact with your eyes.

Do not dispose of the brake fluid in the environment.

KEEP AWAY FROM CHILDREN.

 When using the brake fluid, take care not to spill it on the plastic or painted parts, since it can damage them.

DISC BRAKES

 The brakes are the parts that most ensure your safety and for this reason they must always be perfectly working; check them before every trip.

The brake fluid must be changed once a year by an **aprilia** Official Dealer.

Use brake fluid of the type specified in the lubricant chart, see p. 81 (LUBRICANT CHART).

This vehicle is provided with front and rear hydraulic disc brakes. When the disc pads wear out, the level of the fluid decreases to automatically compensate for their wear.

The front brake fluid tank is positioned on the right part of the handlebar, near the front brake lever coupling.

The rear brake fluid tank is positioned under the upper part of the fairing, on the right side of the vehicle.

Periodically check the brake fluid level in the tanks, see p. 27 (FRONT BRAKE), p. 28 (REAR BRAKE) and the wear of the pads, see p. 61 (CHECKING THE BRAKE PAD WEAR).

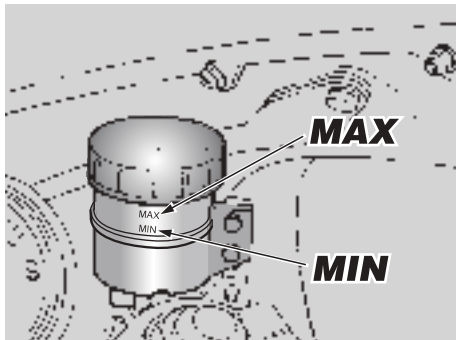

FRONT BRAKE

CHECKING



Position the vehicle on firm and flat ground.

- ◆ Position the vehicle on the stand, and rotate the handlebar completely rightwards.
- ◆ Make sure that the fluid level exceeds the "MIN" mark.
- ◆ If the fluid does not reach the "MIN" mark, provide for topping up.

TOPPING UP



The brake fluid may flow out of the tank. Do not operate the front brake lever if the brake fluid tank plug is loose or has been removed.

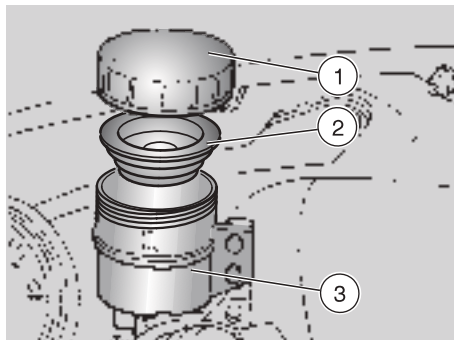

- ◆ Unscrew and remove the plug (1).



Avoid any prolonged exposure of the brake fluid to the air. The brake fluid is hygroscopic and when in contact with the air it absorbs its humidity.

Leave the brake fluid tank open ONLY for the time necessary for topping up.

- ◆ Remove the gasket (2).



In order not to spill the brake fluid while topping up, do not shake the vehicle.

- ◆ Fill the tank (3) with brake fluid, see p. 81 (LUBRICANT CHART), until reaching the correct level between the "MIN" and "MAX" marks.



When topping up, never exceed the "MAX" level. It is advisable to top up until reaching the "MAX" level only with new pads.

When the disc pads wear out, the level of the fluid decreases progressively to compensate for their wear.

Do not reach the "MAX" level with worn out pads, since this will cause a fluid outflow when the pads are changed.

- ◆ To reassemble the components, follow the reverse order.



Check the braking efficiency. If necessary, contact your **aprilia** Official Dealer.

In case of excessive stroke of the brake lever, of excessive elasticity or in case there is air in the circuit, contact your **aprilia** Official Dealer, since it may be necessary to bleed the system.

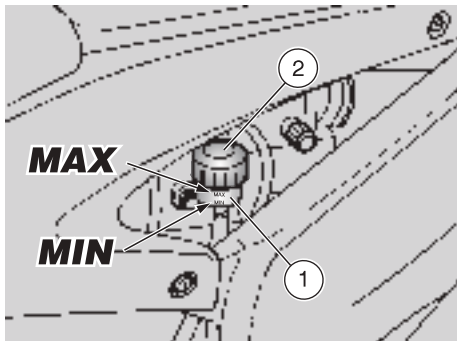

REAR BRAKE

CHECKING

 Position the vehicle on firm and flat ground.

- ◆ Keep the vehicle in vertical position, so that the fluid contained in the tank (1) is parallel to the plug (2).
- ◆ Make sure that the fluid level exceeds the “MIN” mark.
- ◆ If the fluid does not reach the “MIN” mark, provide for topping up.

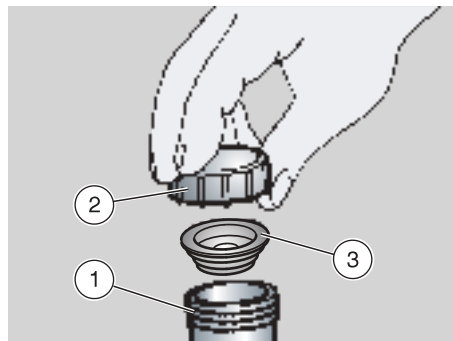

TOPPING UP

 The brake fluid may flow out of the tank. Do not operate the rear brake lever if the brake fluid tank plug is loose or has been removed.

- ◆ Unscrew and remove the plug (2).

 Avoid any prolonged exposure of the brake fluid to the air. The brake fluid is hygroscopic and when in contact with the air it absorbs its humidity. Leave the brake fluid tank open **ONLY** for the time necessary for topping up.

 In order not to spill the brake fluid while topping up, keep the fluid in the tank parallel to the tank rim (in horizontal position).

- ◆ Remove the gasket (3).
- ◆ By means of a syringe, top up the brake fluid tank (1), see p. 81 (LUBRICANT CHART) until reaching the correct level between the “MIN” and “MAX” marks.

 It is advisable to top up until reaching the “MAX” level only with new pads.

When the disc pads wear out, the level of the fluid decreases progressively to compensate for their wear. Do not reach the “MAX” level with worn out pads, since this will cause a fluid outflow when the pads are changed.

- ◆ To reassemble the components, follow the reverse order.

 Check the braking efficiency. If necessary, contact your **aprilia** Official Dealer.

In case of excessive stroke of the brake lever, of excessive elasticity or in case there is air in the circuit, contact your **aprilia** Official Dealer, since it may be necessary to bleed the system.

2 STROKE OIL TANK

Top up the 2 stroke oil tank every 500 km (312 mm).

The vehicle is provided with a separate mixer that ensures the mixing of petrol and oil for the engine lubrication, see p. 81 (LUBRICANT CHART).

The 2 stroke oil reserve is indicated by the coming on of the 2 stroke oil reserve warning light LED “

The use of the vehicle without 2 stroke oil causes serious damages to the engine.

If you run out of oil in the 2 stroke oil tank or if the mixer oil pipe has been removed, contact an **aprilia Official Dealer, who will provide for bleeding the system.**

This operation is indispensable, since the running of the engine with air in the mixer oil system may result in serious damage to the engine.

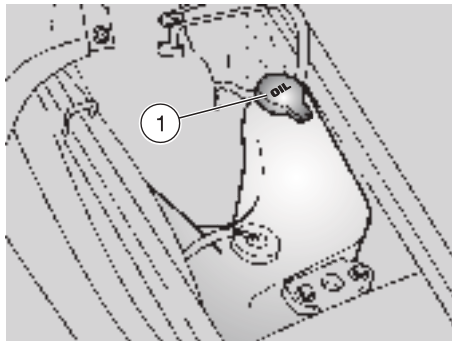

To introduce the 2 stroke oil in the tank, proceed as follows:

- ◆ Remove the rider saddle, see p. 56 (REMOVING THE RIDER SADDLE).
- ◆ Remove the plug (1).

TANK CAPACITY: 1.4 ℓ

TANK RESERVE: 0.35 ℓ



Carefully wash your hands after handling the oil. Do not dispose of the 2 stroke oil in the environment.

KEEP AWAY FROM CHILDREN.

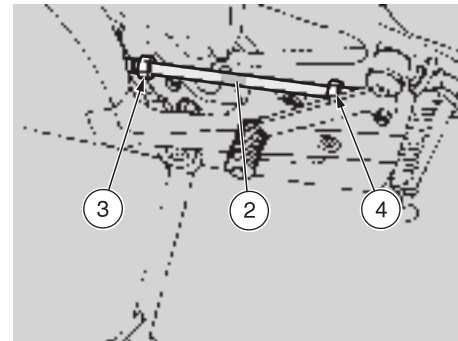

ADJUSTING THE SHIFTING LEVER

It is possible to adjust the position of the shifting lever by means of the rod (2), proceeding as follows:

- ◆ Loosen the nuts (3, 4).
- ◆ Rotate the rod and adjust the shifting lever height.
- ◆ Tighten the nuts (3, 4).

The shifting lever pin is kept greased thanks to the appropriate recess and to the two sealing rings.

In case of disassembly, lubricate it and avoid damaging the sealing rings.

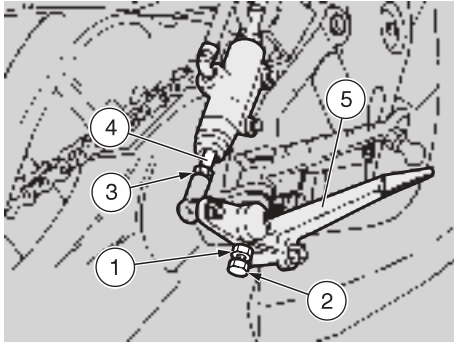

ADJUSTING THE REAR BRAKE

The brake pedal is positioned ergonomically during the assembly of the vehicle. If necessary, it is possible to adjust the height of the brake pedal:

- ◆ Loosen the lock nut (1).
- ◆ Unscrew the brake adjuster (2) completely.
- ◆ Screw the lock nut (3) completely on the pump control rod (4).
- ◆ Screw the pump control rod (4) completely, then unscrew it by giving 3-4 turns.
- ◆ Screw the brake adjuster (2) until the brake pedal (5) reaches the desired height.
- ◆ Lock the brake adjuster (2) by means of the lock nut (1).
- ◆ Unscrew the pump control rod (4) and bring it in contact with the pump piston.
- ◆ Screw the rod in order to ensure a minimum clearance of $0.5 \div 1$ mm between the pump control rod (4) and the pump piston.

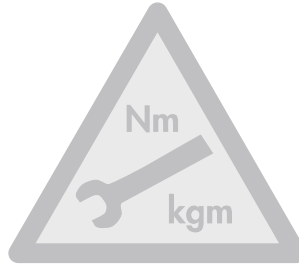

⚠ Make sure that there is a certain clearance between the brake adjuster and the point of contact, to prevent the brake from remaining operated and the consequent untimely wear of the braking elements.

Clearance between brake adjuster and point of contact: $0.5 \div 1$ mm.

- ◆ Lock the pump control rod by means of the lock nut (3).

⚠ Check the braking efficiency. If necessary, contact an **aprilia Official Dealer.**

After the adjustment, make sure that the wheel rotates freely with released brake.

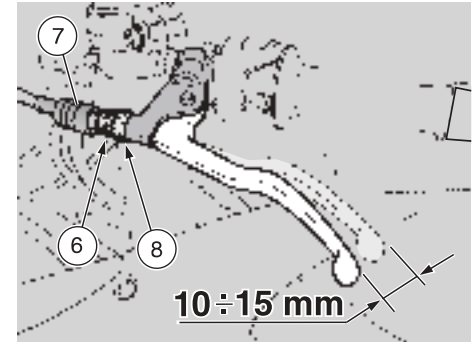

ADJUSTING THE CLUTCH

Adjust the clutch and if the engine stops or tends to advance when the clutch lever is pulled and the gears are engaged, or if the clutch slips causing a delay in the acceleration in comparison with the engine speed.

Minor adjustments can be carried out by means of the adjuster (6):

- ◆ Withdraw the protection element (7).
- ◆ Loosen the nut (8) (by screwing it).
- ◆ Rotate the adjuster (6), until the idle stroke at the end of the clutch lever is about $10 \div 15$ mm (see figure).
- ◆ Tighten the nut (8) (by unscrewing it) and lock the adjuster (6).
- ◆ Check the idle stroke at the end of the clutch lever.
- ◆ Put back the protection element (7).

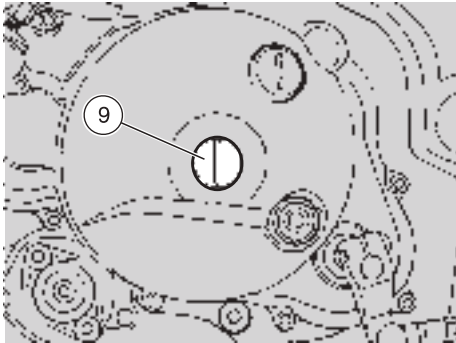

If the adjuster (6) is completely screwed or unscrewed, or if it is not possible to obtain the correct idle stroke:

- ◆ Withdraw the protection element (7).
- ◆ Tighten the nut (8) completely on the adjuster (6).
- ◆ Tighten the adjuster (6) completely.
- ◆ Remove the left fairing, see p. 56 (REMOVING THE SIDE FAIRINGS).
- ◆ Unscrew and remove the plug (9) by means of a cut-headed screwdriver (or a coin).

 **The special spanner (10) is available at any *aprilia* Official Dealer.**

- ◆ Insert the special spanner (10) and loosen the inner nut (11).
- ◆ Insert a cut-headed screwdriver (12) in the special spanner (10) and tighten the adjusting screw (13) completely.

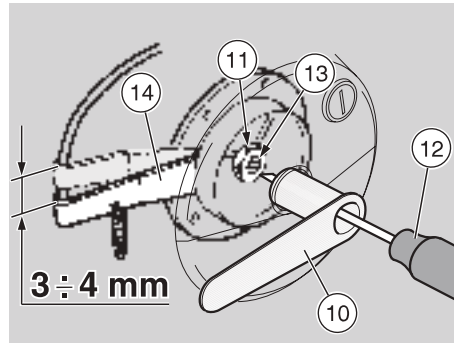

- ◆ Loosen the adjusting screw (13) by giving it half a turn, which corresponds to **3 ÷ 4 mm** of the lever (14) stroke.
- ◆ Keep the adjusting screw (12) locked by means of the screwdriver (13), act on the special spanner (10) and tighten the inner nut (11).
- ◆ Tighten the plug (9) again.
- ◆ Check the idle stroke at the end of the clutch lever (**10 ÷ 15 mm**).
- ◆ Put back the left fairing.
- ◆ Start the engine, see p. 36 (STARTING).
- ◆ Operate the clutch completely and engage the 1st gear.
Make sure that the engine does not stop, that the vehicle does not tend to advance or that the clutch does not slip during the acceleration phase or while the vehicle is running.

 If it is not possible to obtain a correct adjustment or if the clutch does not function properly, contact your *aprilia* Official Dealer.

 **Make sure that the clutch cable is intact: it must not present flattened parts and the sheath must not be worn out in any point.**

- ◆ Periodically lubricate the clutch cable with a suitable lubricant, see p. 81 (LUBRICANT CHART), in order to avoid its untimely wear and corrosion.

COOLANT



Do not use the vehicle if the coolant is below the minimum prescribed level.

Check the coolant level every 1500 km (935 mi) and after long rides; change it every 24 months.



The coolant is noxious: do not swallow it; if the coolant gets in contact with the skin or the eyes, it can cause serious irritations.

If the coolant gets in contact with your skin or eyes, rinse with plenty of water and consult a doctor. If it is swallowed, induce vomit, rinse mouth and throat with plenty of water and consult a doctor without delay.

DO NOT DISPOSE OF THE BRAKE FLUID IN THE ENVIRONMENT.

KEEP AWAY FROM CHILDREN.

Be careful not to spill the coolant on the red-hot parts of the engine: it may catch fire and send out invisible flames.

In case maintenance operations are to be performed, it is advisable to use latex gloves.



Have the coolant changed by an **aprilia Official Dealer.**

The coolant is made up of 50% water and 50% antifreeze.

This mixture is ideal for most running temperatures and ensures good protection against corrosion.

It is advisable to keep the same mixture also in the hot season, since in this way losses due to evaporation are reduced and it is not necessary to top up very frequently.

The mineral salt deposits left in the radiator by evaporated water are thus reduced and the efficiency of the cooling system remains unchanged.

If the outdoor temperature is below 0°, check the cooling circuit frequently and if necessary increase the antifreeze concentration (up to maximum 60%).

For the cooling solution use distilled water, in order not to damage the engine.



Do not remove the expansion tank cap when the engine is hot, since the coolant is under pressure and its temperature is high.



CHECKING AND TOPPING UP



Check the coolant level and top up the expansion tank with cold engine.

◆ Stop the engine and wait until it has cooled down.



Position the vehicle on firm and flat ground.

◆ Lift the fuel tank, see p. 57 (LIFTING THE FUEL TANK).

◆ Keep the vehicle in vertical position, with the two wheels resting on the ground.

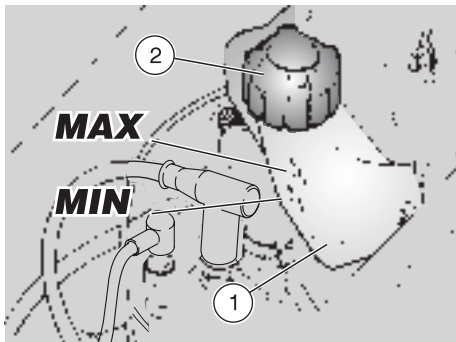

- ◆ Make sure that the level of the fluid contained in the expansion tank (1) is included between the “MIN” and “MAX” marks (see figure).
- ◆ If not, unscrew and remove the filling plug (2).
- ◆ Top up the expansion tank by adding coolant, see p. 81 (LUBRICANT CHART), until this almost reaches the “MAX” level. Do not exceed this level, otherwise the coolant will flow out while the engine is running.
- ◆ Put back the filling plug (2).



In case of excessive consumption of coolant and in case the tank remains empty, make sure that there are no leaks in the circuit. Have it repaired by an **aprilia** Official Dealer.

TYRES

This vehicle is provided with tubeless tyres.



Periodically check the tyre inflation pressure at room temperature, see p. 78 (TECHNICAL DATA).

If the tyres are hot, the measurement is not correct. Carry out the measurement especially before and after long rides.

If the inflation pressure is too high, the ground unevenness cannot be dampened and is therefore transmitted to the handlebar, thus compromising the driving comfort and reducing the road holding during turns.

If, on the contrary, the inflation pressure is too low, the tyre sides are under greater stress and the tyre itself may slip on the rim or it may become loose, with consequent loss of control of the vehicle.

In case of sudden braking the tyres could even get out of the rims. Further, the vehicle could skid while turning.

Check the surface and the wear of the tyres, since tyres in bad conditions can impair both the grip and the controllability of the vehicle.

Change the tyre when it is worn out or in case of puncture on the tread side, if the puncture is larger than 5 mm.

After repairing a tyre, have the wheels balanced. Use only tyres in the size suggested by aprilia, see p. 78 (TECHNICAL DATA).

Make sure that the tyres always have their valve sealing caps on, to prevent them from suddenly going flat.

Change, repair, maintenance and balancing operations are very important and should be carried out by qualified technicians with appropriate tools.

For this reason, it is advisable to have the above mentioned operations carried out by an **aprilia** Official Dealer or by a qualified tyre repairer.

If the tyres are new, they may still be covered with a slippery film: drive carefully for the first miles. Do not oil the tyres with unsuitable fluids.

If the tyres are old, even if not completely worn out, they may become hard and may not ensure good road holding. In this case, replace them.

MINIMUM TREAD DEPTH LIMIT

front: 2 mm
 rear: 2 mm



AUTOMATIC LIGHT SWITCHING VERSION ASD

The vehicles provided with this device can be immediately recognized, since the lights come automatically on as soon as the ignition switch is turned to position "○".

For this reason, no light switch is provided.

The lights can be switched off only by turning the ignition switch to position "⊗".

Before starting the vehicle, make sure that the dimmer switch is in position "☞" (front low beam).

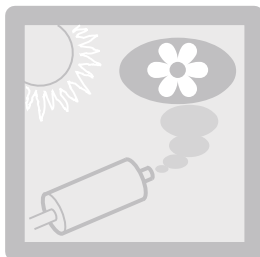

CATALYTIC SILENCER



Avoid parking the vehicle catalytic version near dry brush wood or in places easily accessible to children, as the catalytic silencer becomes extremely hot during use; be very careful and avoid any kind of contact before it has completely cooled down.

The catalytic vehicle is fitted with a silencer with metal catalytic converter of the "platinum-rhodium bivalent" type.

This device provides for the oxidation of the CO (carbon monoxide) and of the HC (unburned hydrocarbons) contained in the exhaust gases, changing them into carbon dioxide and steam, respectively.



Do not use leaded petrol, since it causes the destruction of the catalytic converter.

EXHAUST SILENCER AUS



Tampering with noise control system prohibited.

Owner's are warned that the law may prohibit:

- ◆ The removal or rendering inoperative by any person other than for purposes of maintenance, repair or replacement, of any device or element of design incorporated into any new vehicle for the purpose of noise control prior to its sale or delivery to the ultimate purchaser or while it is in use; and
- ◆ The use of the vehicle after such device or element of design has been removed or rendered inoperative by any person.

Check the exhaust silencer and the silencer pipes, making sure that there are neither signs of rust, nor holes and that the exhaust system can work effectively.

If the noise produced by the exhaust system increases, immediately contact your **aprilia** Official Dealer.

INSTRUCTIONS FOR USE



Before departure, always carry out a preliminary checking of the vehicle to make sure that it functions correctly and safely, see the following table (PRELIMINARY CHECKING OPERATIONS). The non-performance of these checking operations can cause severe personal injuries or damages to the vehicle.

Do not hesitate to consult your **aprilia** Official Dealer in case there is something you do not understand about the functioning of some controls or in case you suspect or discover some irregularities.

It does not take long to carry out a check-up and this operation ensures you much more safety.

PRELIMINARY CHECKING OPERATIONS

Component	Check	Page
Front and rear disc brakes	Check the functioning, the idle stroke of the control levers, the fluid level and make sure there are no leaks. Check the wear of the pads. If necessary, top up the fluid tank.	26, 27 28, 59
Accelerator	Make sure that it works smoothly and that it is possible to open and close it completely, in all steering positions. If necessary, adjust and/or lubricate it.	60
2 stroke oil/ transmission oil	Check and/or top up if necessary.	29, 46, 47
Wheel/tyres	Check the tyre surface, the inflation pressure, wear and tear and any damage.	33
Brake levers	Make sure that they work smoothly. If necessary, lubricate the articulations and adjust the stroke.	30
Steering	Make sure that the steering rotates smoothly, without any clearance or slackening.	–
Clutch	The idle stroke at the end of the clutch lever must be about 10÷15 mm; the clutch must operate without jerking and/or slipping.	30, 31
Side stand	Make sure that it works smoothly and that the spring tension brings it back to its normal position. If necessary, lubricate joints and hinges. Make sure that the safety switch on the side stand operates correctly.	67, 68
Fastening elements	Make sure that the fastening elements are not loose. If necessary, adjust or tighten them.	–
Drive chain	Check the slack.	52, 53
Fuel tank	Check the fuel level and top up, if necessary. Make sure there are no leaks or air bubbles in the circuit.	25, 55, 73
Coolant	The coolant level in the expansion tank must be included between the "MIN" and "MAX" marks.	32, 33
Lights, warning lights, horn and electric devices	Check the proper functioning of the acoustic and visual devices. Change the bulbs or intervene in case of failure.	63÷72

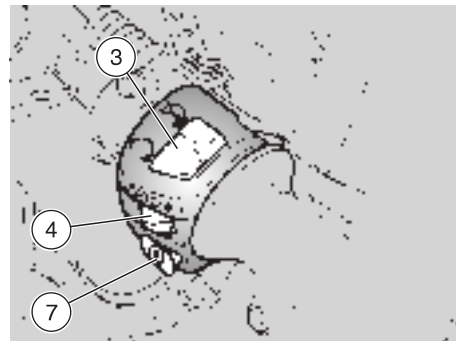
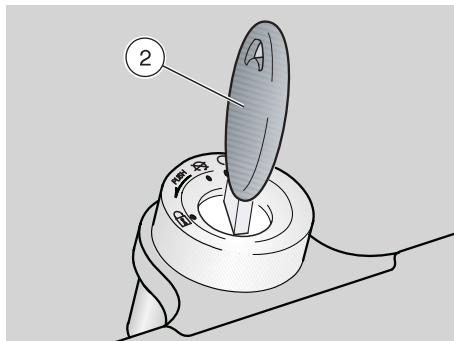
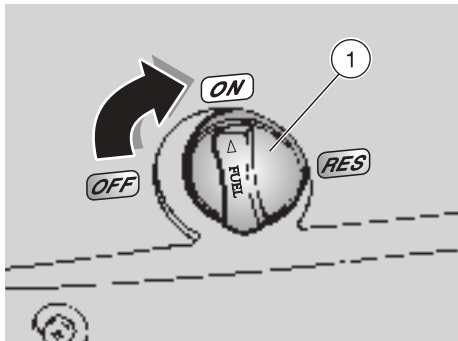

STARTING

! Exhaust gases contain carbon monoxide, which is extremely noxious if inhaled.

Avoid starting the engine in closed or badly-ventilated rooms.

The non-observance of this warning may cause loss of consciousness or even lead to death by asphyxia.

! With the side stand down, the engine can be started only if the gears are in neutral; in this case, if you try to engage the gears, the engine stops.

With the side stand up, it is possible to start the engine either in neutral gear or with engaged gears and pulled in clutch lever.

- ◆ Let the stand up.
- ◆ Get on the vehicle.
- ◆ Move the fuel tap lever (1) to position "ON".
- ◆ Rotate the key (2) and move the ignition switch to position "O".
- ◆ Lock at least one wheel, by pulling a brake lever.
- ◆ Position the shifting lever in neutral (green warning light "N" on).
- ◆ Move the engine stop switch (3) to position "O".
- ◆ Make sure that the light switch (4) is in position "•".
- ◆ **ASD** Make sure that the dimmer switch (5) is in position "☺".
- ◆ If the vehicle is started with cold engine, rotate the cold start lever "L" (6) downwards.

! To avoid excessive consumption of the battery, do not keep the start push button "Ⓢ" pressed for more than fifteen seconds.

If the engine does not start in this lapse of time, wait ten seconds and press the start push button "Ⓢ" again.

- ◆ Press the start push button "Ⓢ" (7) without accelerating and release it as soon as the engine starts.

! If the 2 stroke oil warning light LED "Ⓢ" comes on, this means that the 2 stroke oil reserve is being used; in this case, provide for topping up, see p. 29 (2 STROKE OIL TANK).

! Avoid pressing the start push button "Ⓢ" (7) when the engine is running, since you may damage the starter.



- ◆ Keep at least one brake lever pulled and do not accelerate until you start.



Never leave abruptly with cold engine.

To reduce the emission of polluting substances and the consumption of fuel, warm the engine up by proceeding at low speed for the first miles.

- ◆ Rotate the cold start lever “|↘|” (6) upwards after the engine has warmed up.

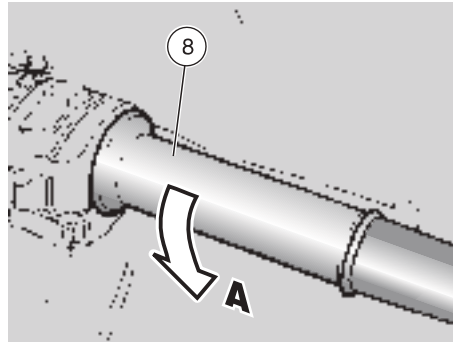

STARTING WITH FLOODED ENGINE

If the starting is not carried out properly or if there is too much fuel in the intake ducts and in the carburettor, the engine may get flooded.

To clean a flooded engine:

- ◆ Carry out the first nine operations described for the starting procedure.
- ◆ Rotate the cold start lever “|↘|” (6) upwards.
- ◆ Press the start push button “Ⓢ” (7) for a few seconds (letting the engine spin over) with completely open throttle (**Pos. A**).

STARTING WITH COLD ENGINE

When the room temperature is low (about 0 °C), it may be difficult to start the engine at the first attempt.

In this case:

- ◆ Rotate the cold start lever “|↘|” (6) downwards.
- ◆ Press the start button “Ⓢ” (7) for at least ten seconds and at the same time rotate the throttle grip slightly.

If the engine starts.

- ◆ Release the throttle grip (8).
- ◆ Rotate the cold start lever “|↘|” (6) upwards.
If the idling is unstable, twist the throttle grip (8) slightly and frequently.

If the engine does not start.

Wait for a few seconds and then repeat the starting procedure.

STARTING AFTER A LONG PERIOD OF INACTIVITY

After a long period of inactivity, make the starter run for about ten seconds without accelerating, in order to ensure the filling of the float chamber.

To start the engine, slightly open the throttle and carry out the starting procedure.

DEPARTURE AND DRIVE



This vehicle is considerably powerful and must be used gradually and with the greatest care. Do not place objects behind the front part of the fairing.



Before departure, carefully read the "safe drive" chapter, see p. 5 (SAFE DRIVE).

If you run out of the "standard" fuel quantity while riding, move the fuel tap lever (1) to position "RES", in order to use the fuel reserve.

Fuel reserve: 3.5 ℓ (mechanical reserve).



If you drive without passenger, make sure that the passenger footrests are folded.

While riding, keep your hands on the grips and your feet on the footrests.

NEVER RIDE IN ANY POSITION OTHER THAN THOSE INDICATED.

If you drive with a passenger, instruct him/her so that he/she does not create problems during manouevres.

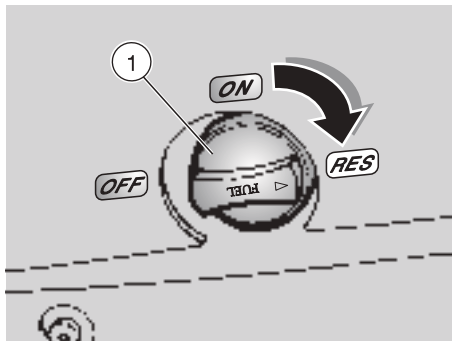

To leave:

- ◆ Adjust the inclination of the rear-view mirrors correctly.



With the vehicle at rest, try to get acquainted with the use of the rear-view mirrors. The reflecting surface is convex, therefore the objects seem to be farther away than they actually are. These mirrors offer a "wide-angle" view and only experience will allow you to evaluate the distance of the following vehicles correctly.

- ◆ Ride at reduced speed for the first miles, in order to warm the engine up.

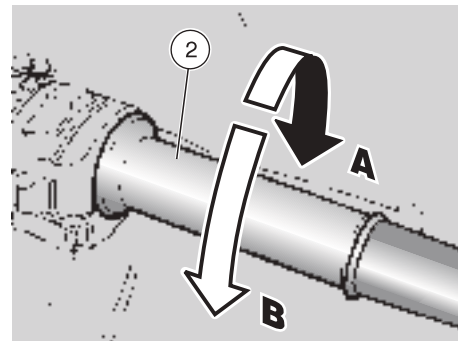

- ◆ With released throttle grip (2) (Pos. A) and engine idling, pull the clutch lever (3) completely.
- ◆ Engage the first gear, by pressing the shifting lever (4) downwards.
- ◆ Release the brake lever (pulled on the starting).



On departure, the abrupt release of the clutch lever may cause the engine to stall or the vehicle to jerk forwards.

Never accelerate abruptly or excessively when releasing the clutch lever, in order to prevent the clutch from "slipping" (slow release) or the front wheel from raising (rearing up) (quick release).

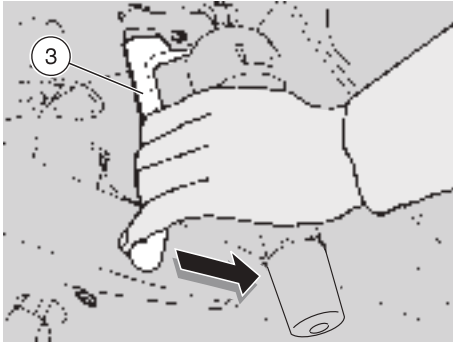

- ◆ Slowly release the clutch lever (3) and at the same time accelerate by rotating the throttle grip moderately (2) (Pos. B). The vehicle will start moving.

⚠ Never exceed the recommended rpm, see p. 41 (RUNNING-IN).

- ◆ Increase the speed by gradually rotating the throttle grip (2) (Pos. B), without exceeding the recommended rpm, see p. 41 (RUNNING-IN).

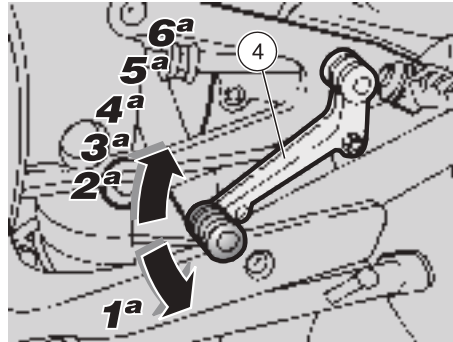

To engage the second gear:

⚠ Proceed quickly. Never ride the vehicle at too low rpm.

- ◆ Release the throttle grip (2) (Pos. A), pull the clutch lever (3) and lift the shifting lever (4). Release the clutch lever (3) and accelerate.
- ◆ Repeat the last two operations and shift up.

⚠ If the 2 stroke oil warning light LED “” comes on, this means that the 2 stroke oil reserve is being used; in this case, provide for topping up, see p. 29 (2 STROKE OIL TANK).

The downshifting should be carried out in the following situations:

- ◆ When riding downhill or when braking, in order to increase the braking action by using the compression of the engine.
- ◆ When riding uphill, if the gear engaged is not suitable to the speed (high gear, moderate speed) and the engine rpm decreases.

⚠ Shift the gears one by one; the simultaneous downshifting of more than one gear may make you exceed the maximum rpm (red line). Before and during the downshifting, release the throttle grip and decelerate, in order to avoid the “red line”.

To shift down, proceed as follows:

- ◆ Release the throttle grip (2) (Pos. A).
- ◆ If necessary, pull the brake levers moderately and decrease the speed of the vehicle.
- ◆ Pull the clutch lever (3) and lower the shifting lever (4) to shift down.
- ◆ If the brake levers are pulled, release them.
- ◆ Release the clutch lever and accelerate moderately.



Avoid opening and closing the throttle grip repeatedly and continuously, so that you do not accidentally lose control of the vehicle. If you have to brake, close the throttle and put on both brakes in order to obtain uniform deceleration, properly exerting pressure on the braking parts.

By putting on the front brake only or the rear brake only, you reduce the braking force considerably, thus running the risk of locking one wheel and consequently losing grip.

If you stop uphill, decelerate completely and use the brakes only to keep the vehicle steady. The use of the engine to keep the vehicle steady may cause the overheating of the clutch.



Before beginning to turn, slow down or brake driving at moderate and constant speed or accelerating slightly; avoid braking at the last moment: it would be very easy to skid.

If the brakes are operated continuously on downhill stretches, the friction surfaces may overheat, thus reducing the braking efficiency. Exploit the engine compression and shift down by putting on both brakes intermittently. Never drive downhill with the engine off!

In case of wet ground or scarce wheel grip (snow, ice, mud, etc.), drive slowly, avoiding sudden brakings or manoeuvres that could make you lose grip and fall down.



Pay the utmost attention to any obstacle or variation of the ground. Uneven roads, rails, manhole covers, indications painted on the road surface, building site metal plates become rather slippery by rain. For this reason all these obstacles have to be carefully avoided, driving smoothly and bending the vehicle as little as possible.

Always use the turn indicators in time when you intend to change lane or direction, avoiding sharp and dangerous movements. Switch off the direction indicators as soon as you have changed direction.

Be extremely careful when you overtake other vehicles or are overtaken.

In case of rain, the water cloud created by big vehicles reduces visibility; the air shift may make you lose control of the vehicle.

RUNNING-IN

The running-in of the engine is important to ensure its correct functioning.

If possible, drive on hilly roads and/or roads with many bends, so that the engine, the suspensions and the brakes undergo a more effective running-in.

During running-in, change speed. In this way the components are first loaded and then relieved and the engine parts can thus cool down. Even if it is important to stress the engine components during running-in, take care not to exceed.

 **Only after the first 1500 km (937 mi) of running-in you can expect the best performance levels from the vehicle.**

Keep to the following indications:

- ◆ Do not open the throttle completely if the speed is low, both during and after the running-in.
- ◆ During the first 100 km (62 mi) put on the brakes with caution, avoiding sharp and prolonged brakings. This ensures a correct bedding-in of the pads on the brake disc.
- ◆ During the first 800 km (500 mi) never exceed 6000 rpm.



After the first 1000 km (625 mi) , carry out the checking operations indicated in the column "After running-in" of the REGULAR SERVICE INTERVALS CHART, see p. 44 (REGULAR SERVICE INTERVALS CHART), in order to avoid hurting yourself or other people and/or damaging the vehicle.

- ◆ Between the first 800 km (500 mi) and 1600 km (1000 mi) drive more briskly, change speed and use the maximum acceleration only for a few seconds, in order to ensure better coupling of the components; never exceed 9000 rpm (see table).
- ◆ After the first 1600 km (1000 mi) you can expect better performance from the engine, however, without exceeding the max 11000 rpm.

Engine maximum rpm for the running-in	
Mileage km (mi)	Max. (rpm)
0÷800 (0÷500)	6000
800÷1600 (500÷1000)	9000
over 1600 (1000)	11000

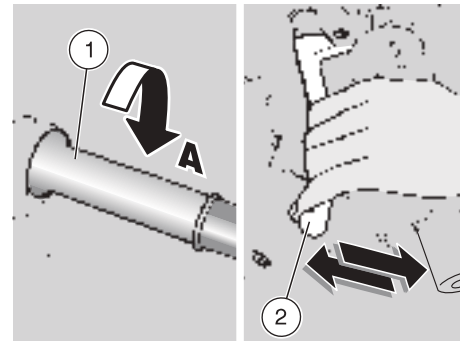

STOPPING



If possible, avoid stopping abruptly, slowing down suddenly and braking at the last moment.

- ◆ Release the throttle grip (1) (Pos. A), gradually put on the brakes and at the same time shift down in order to decrease the speed, see p. 38 (DEPARTURE AND DRIVE).

Once the speed has decreased, before stopping the vehicle:

- ◆ Pull the clutch lever (2) in order to prevent the stopping of the engine.

When the vehicle has come to rest:

- ◆ Position the shifting lever in neutral (green warning light "N" on).
- ◆ Release the clutch lever.
- ◆ In case of a brief stop, keep at least one brake on.

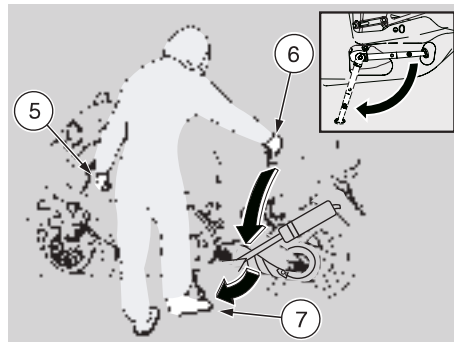
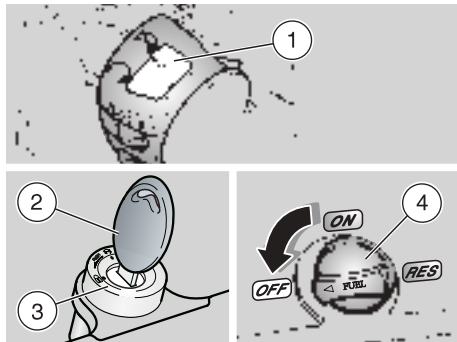

PARKING



Park the vehicle on firm and flat ground, to prevent it from falling down.

Neither lean the vehicle against walls, nor lay it on the ground.

Make sure that the vehicle and especially its red-hot parts do not represent a danger for persons and children. Do not leave the vehicle unattended when the engine is on or the key is inserted into the ignition switch.

Do not sit on the vehicle when the stand is down.

- ◆ Stop the vehicle, see p. 41 (STOPPING).
- ◆ Move the engine stop switch (1) to position "OFF".
- ◆ Rotate the key (2) and move the ignition switch (3) to position "OFF".
- ◆ Move the fuel tap lever (4) to position "OFF".



Never leave the key in the ignition switch.

- ◆ Lock the steering, see p. 22 (STEERING LOCK) and extract the key.

POSITIONING THE VEHICLE ON THE STAND

- ◆ Seize the left grip (5) and the passenger grab strap (6).
- ◆ Press the side stand with your right foot and extend it completely (7).
- ◆ Incline the vehicle until the stand rests on the ground.
- ◆ Steer the handlebar completely leftwards.



Make sure that the vehicle is stable.

SUGGESTIONS TO PREVENT THEFT

NEVER leave the ignition key inserted and always use the steering lock.

Park the vehicle in a safe place, possibly in a garage or a protected place.

When possible, use an additional anti-theft device.

Make sure that all documents are in order and the road tax has been paid.

Write down your personal data and telephone number in this page, to facilitate the identification of the owner in case of finding after theft.

SURNAME:

NAME:

ADDRESS:

TELEPHONE NO.:



Very often stolen vehicles are identified thanks to the data written in the use/maintenance manual.



 **Risk of fire.**
Keep fuel and other flammable substances away from the electrical components.

Before beginning any service operations or inspection of the vehicle, switch off the engine and remove the key, wait until the engine and the exhaust system have cooled down and, if possible, lift the vehicles with the proper equipment onto firm and flat ground.

Before proceeding, make sure that the room in which you are working is properly ventilated.

Keep away from the red-hot parts of the engine and of the exhaust system, in order to avoid burns.



 **Do not hold any mechanical piece or other parts of the vehicle with your mouth: the components are not edible and some of them are noxious or even toxic.**

 **If not expressly indicated otherwise, for the reassembly of the units repeat the disassembly operations in reverse order.**

In case any maintenance operation should be required, it is advisable to use latex gloves.



Routine maintenance operations can usually be carried out by the user, but sometimes specific tools and specific technical skills may be required.

In case periodic maintenance operations, assistance or technical advice are needed, contact an **aprilia** Official Dealer, who will ensure you prompt and accurate servicing.

Ask your **aprilia** Official Dealer to test the vehicle on the road after a repair or periodic maintenance operation.

In any case, personally carry out the "Preliminary checking operations" after any maintenance operation, see p. 35 (PRELIMINARY CHECKING OPERATIONS).

REGULAR SERVICE INTERVALS CHART

OPERATIONS TO BE CARRIED OUT BY THE **aprilia** Official Dealer (WHICH CAN BE CARRIED OUT EVEN BY THE USER).

Key

- ① = check and clean, adjust, lubricate or change, if necessary;
- ② = clean;
- ③ = change;
- ④ = adjust.

 Carry out the maintenance operations more frequently if you use the vehicle in rainy and dusty areas or on uneven ground.

Component	After running-in [1000 km (625 mi)]	Every 4000 km (2500 mi) or 12 months	Every 8000 km (5000 mi) or 24 months
Battery - Terminal fastening - Electrolyte level	①	①	–
Spark plug	①	①	③
Air cleaner		②	③
Clutch clearance	④	④	–
Light system	①	①	–
Brake fluid	①	①	–
Coolant	every 1500 km (935 mi): ①		
Mixer oil level	every 500 km (312 mi): ①		
Transmission oil	③	①	every 12000 km (7500 mi): ③
Headlight beam direction - operation	–	①	–
Engine idling rpm	④	④	–
Wheels/Tyres and inflation pressure	every 1000 km (625 mi): ①		
Drive chain tension and lubrication	every 500 km (312 mi): ①		
Front and rear brake pad wear	①	every 2000 km (1250 mi): ①	

OPERATIONS TO BE CARRIED OUT BY THE *aprilia* Official Dealer.

Key

- ① = check and clean, adjust, lubricate or change, if necessary;
- ② = clean;
- ③ = change;
- ④ = adjust.

 **Carry out the maintenance operations more frequently if you use the vehicle in rainy and dusty areas or on uneven ground.**

Component	After running-in [1000 km (625 mi)]	Every 4000 km (2500 mi) or 12 months	Every 8000 km (5000 mi) or 24 months
Rear shock absorber	–	–	①
Carburettor	①	②	–
Transmission cables and controls	①	①	–
Unit RAVE FP	①	–	④
Wheel centering	–	①	–
Steering bearings and steering clearance	①	①	–
Wheel bearings	–	①	–
Brake discs	①	①	–
General running of the vehicle	①	①	–
Braking systems	①	①	–
Cooling system	①	①	–
Brake fluid	every year: ③		
Coolant	every 2 years: ③		
Fork oil and oil seal	every 12000 km (7500 mi): ③		
Piston and linings	every 8000 km (5000 mi): ① / every 16000 km (10000 mi): ③		
Odometer transmission cable	–	–	①
Wheels/Tyres and inflation pressure	①	①	–
Nut, bolt, screw tightening	①	①	–
Mixer oil reserve warning light LED	①	①	–
Final transmission (chain, crown, pinion)	–	①	–
Fuel pipe	–	①	every 4 years: ③
Braking system pipe	–	①	every 4 years: ③
Mixer oil pipe	–	①	every 4 years: ③
Clutch wear	–	①	–
Exhaust valve FP	①	② + ④	–



IDENTIFICATION DATA

It is a good rule to write down the frame and engine numbers in the space provided in this manual.

The frame number can be used for the purchase of spare parts.

 **Do not alter the identification numbers if you do not want to incur severe penal and administrative sanctions. In particular, the alteration of the frame number results in the immediate invalidity of the guarantee.**



ENGINE NUMBER

The engine number is stamped on the upper part of the crankcase, on the left side.

Engine no. _____



FRAME NUMBER

The frame number is stamped on the right side of the steering column.

Frame no. _____

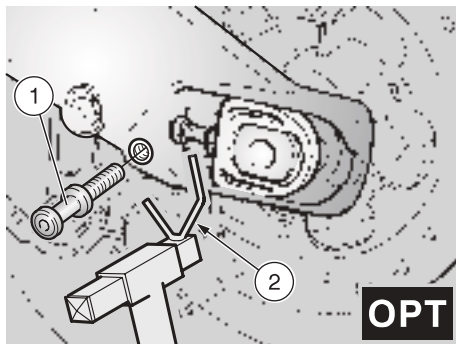

OPT

POSITIONING THE VEHICLE ON THE REAR SUPPORT STAND **OPT**

- ◆ ★ Screw and tighten the pin (1) **OPT** in the appropriate seat on the rear fork.
- ◆  **Have someone help you keep the vehicle in vertical position with the two wheels on the ground.**
- ◆ Make the two housings on the stand (2) coincide with the two pins (1) provided on the vehicle.
- ◆ Rest one foot on the rear part of the stand (3).
- ◆ Push the stand (3) downwards until it reaches the end of its stroke (see figure).

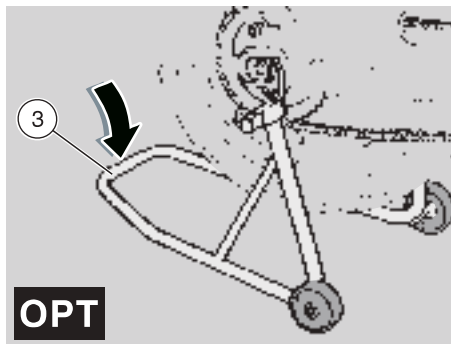

OPT

POSITIONING THE VEHICLE ON THE FRONT SUPPORT STAND **OPT**

- ◆ Position the vehicle on the appropriate rear support stand **OPT**, see beside (POSITIONING THE VEHICLE ON THE REAR SUPPORT STAND **OPT**).
- ◆ Insert the two ends of the stand (4) in the two holes (5) positioned on the lower ends of the front fork.
- ◆ Rest one foot on the front part of the stand (6).
- ◆ Push the stand (6) downwards until it reaches the end of its stroke (see figure).

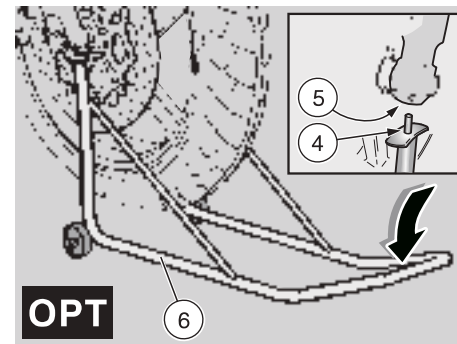

OPT

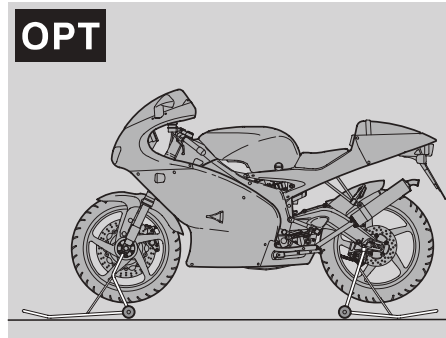

OPT

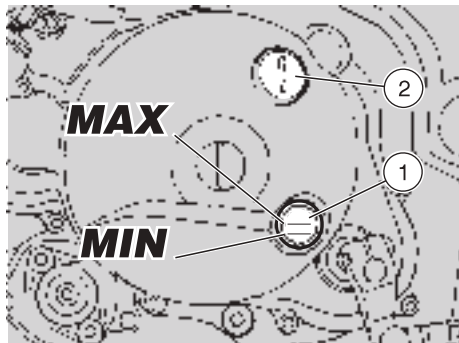

CHECKING THE TRANSMISSION OIL LEVEL AND TOPPING UP

Carefully read p. 25 (TRANSMISSION OIL) and p. 43 (MAINTENANCE).

Check the transmission oil level every 4000 km (2500 mi), change it after the first 1000 km (625 mi) and successively every 12000 km (7500 mi), see p. 49 (CHANGING THE TRANSMISSION OIL).

CHECKING



Position the vehicle on firm and flat ground.

- ◆ Stop the engine and let it cool down for at least ten minutes, in order to allow the oil to flow back to the oil pan and to cool down.
- ◆ Remove the left fairing, see p. 56 (REMOVING THE SIDE FAIRINGS).
- ◆ Keep the vehicle in vertical position, with the two wheels resting on the ground.



The non-performance of the operations described above may result in a wrong measurement of the level.

- ◆ Make sure that the oil level is included between one fourth (**MIN**) and a half (**MAX**) of the height of the glass (1).



The oil level must neither exceed a half of the height of the glass, nor fall below one fourth. In the first case the excess oil would flow out of the oil pan; in the second case the engine may get seriously damaged.

TOPPING UP

If it were necessary to top up, proceed as follows:

- ◆ Unscrew and remove the filling cap (2).
- ◆ Pour a small quantity of oil and wait about one minute, to allow the oil to flow uniformly inside the pan.
- ◆ Make sure that the oil level is included between one fourth (**MIN**) and a half (**MAX**) of the height of the glass (1).
- ◆ If this is not the case, top up again with small quantities of oil and repeat the check through the glass (1), until reaching the prescribed level (**MAX**).
- ◆ At the end of the operation, screw and tighten the filling cap (2).



Tighten the filling cap thoroughly and make sure that there are no oil leaks.

Periodically check that there are no leaks in correspondence with the oil pan cover seal.

Do not use the vehicle with insufficient lubrication or with contaminated or unsuitable lubricants, since this would accelerate the wear of the moving parts and may also cause irreparable failures.

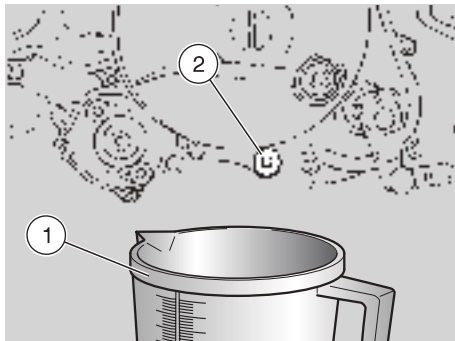

CHANGING THE TRANSMISSION OIL

Carefully read p. 25 (TRANSMISSION OIL) and p. 43 (MAINTENANCE).

Check the transmission oil level every 4000 km (2500 mi), change it after the first 1000 km (625 mi) and successively every 12000 km (7500 mi).

CHANGING

- ◆ Start the engine, see p. 36 (STARTING) and let it idle for a few minutes, in order to facilitate the outflow of the oil during the draining phase.



Position the vehicle on firm and flat ground.

- ◆ Stop the engine and let it cool down for at least ten minutes, in order to allow the oil to flow back to the oil pan and to cool down.

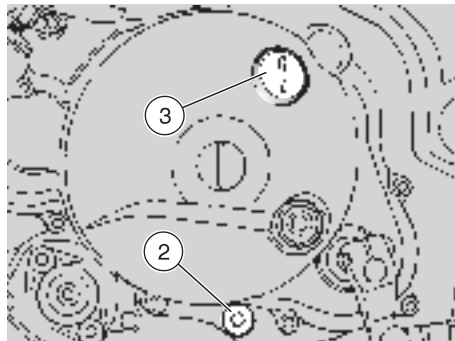

When warmed up, the engine contains hot oil; therefore, while carrying out the operations described here below be particularly careful, in order to avoid burns.

- ◆ Remove the left fairing, see p. 56 (REMOVING THE SIDE FAIRINGS).
- ◆ Keep the vehicle in vertical position, with the two wheels resting on the ground.
- ◆ Put a container (1) with at least 700 cm³ capacity in correspondence with the drain plug (2).
- ◆ Unscrew and remove the drain plug (2).
- ◆ Unscrew and remove the filling plug (3).
- ◆ Drain the oil and let it drip into the container (1) for a few minutes.
- ◆ Remove the metal residues from the drain plug (2) magnet.
- ◆ Check and if necessary replace the sealing washer of the drain plug (2).

- ◆ Screw and tighten the drain plug (2).

Drain plug (2) driving torque: 27 Nm (2.7 kgm).

- ◆ Pour about 600 cm³ of transmission oil through the filling opening (3), see p. 81 (LUBRICANT CHART).
- ◆ Tighten the filling plug (3).
- ◆ Start the engine, see p. 36 (STARTING) and let it idle for about one minute, in order to ensure the filling up of the transmission oil circuit.

Check the oil level and top up if necessary, see p. 48 (CHECKING THE TRANSMISSION OIL LEVEL AND TOPPING UP).



Tighten the filling plug and the drain plug thoroughly and make sure that there are no oil leaks.

Periodically check that there are no leaks in correspondence with the oil pan cover seal.

Do not use the vehicle with insufficient lubrication or with contaminated or unsuitable lubricants, since this would accelerate the wear of the moving parts and may also cause irreparable failures.

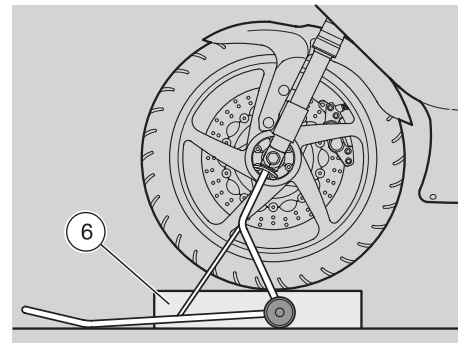
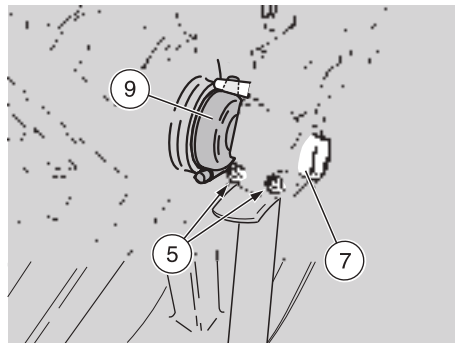

FRONT WHEEL



The disassembly and reassembly of the front wheel may be difficult for unskilled operators. If necessary, contact an **aprilia** Official Dealer.

If you want to perform these operations personally, keep to the following instructions.

Carefully read p. 43 (MAINTENANCE).

While disassembling and reassembling the wheel, be careful not to damage the brake pipes, the discs and the pads.



To remove the front wheel it is necessary to use the appropriate front and rear support stands **OPT**.

DISASSEMBLY

- ◆ Position the vehicle on the appropriate rear support stand, see p. 47 (POSITIONING THE VEHICLE ON THE REAR SUPPORT STAND **OPT**).
- ◆ Position the vehicle on the appropriate front support stand, see p. 47 (POSITIONING THE VEHICLE ON THE FRONT SUPPORT STAND **OPT**).



Make sure that the vehicle is stable.

- ◆ Have someone keep the handlebar steady in running position, so that the steering is locked.

Brake caliper screw (1) driving torque: 22 Nm (2.2 kgm).

- ◆ Unscrew and remove the two screws (1) that fasten the front brake caliper (2).
- ◆ Withdraw the brake caliper (2) from the disc, leaving it attached to the pipe (3).



Never pull the front brake lever after removing the brake caliper, otherwise the caliper pistons may go out of their seats, thus causing the outflow of the brake fluid. In this case consult your **aprilia Official Dealer, who will carry out the proper maintenance operation.**

Screw (4) driving torque: 80 Nm (8 kgm).

- ◆ Loosen and remove the screw (4), taking the washer.
- ◆ ★ Partially unscrew the two screws (5) of the wheel pin clamp.
- ◆ Put a support (6) under the tyre, in such a way as to keep the wheel in its position after loosening it.
- ◆ Withdraw the wheel pin (7) from the left side.
- ◆ Remove the wheel by withdrawing it from the front and take the spacer ring (8).
- ◆ Disconnect the odometer control (9).

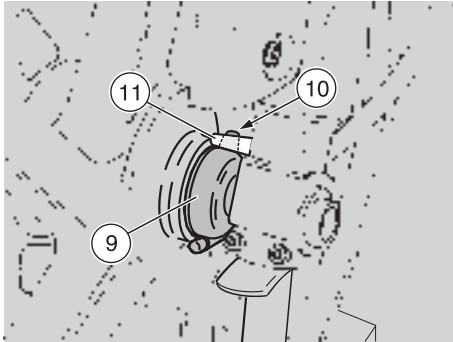

REASSEMBLY

Carefully read p. 43 (MAINTENANCE).

- ◆ Spread a film of lubricating grease on the whole length of the wheel pin (7), see p. 81 (LUBRICANT CHART).



While reassembling the wheel, be careful not to damage the brake pipe, the disc and the pads.

- ◆ Correctly position the odometer control seat (10) in correspondence with the special antirotation pin (11).



The spacer ring (8) must be positioned with the side having longer diameter facing the fork right rod.

- ◆ Position the spacer ring (8) in its seat on the wheel.

- ◆ Position the wheel between the fork rods on the support (6).



**Danger of injury.
Do not introduce your fingers to align the holes.**

- ◆ Move the wheel until its central hole and the holes on the fork are aligned.
- ◆ Introduce the wheel pin (7) completely.
- ◆ Position the washer and tighten the screw (4) manually.
- ◆ Lock the rotation of the wheel pin (7).
- ◆ Tighten the screw (4) definitively.

**Screw (4) driving torque:
80 Nm (8 kgm).**



Proceed with care, in order not to damage the brake pads.

- ◆ Insert the brake caliper (2) on the disc and position it so that its fastening holes and the holes on the support are aligned.



Upon reassembly of the brake caliper, replace the caliper fastening screws (1) with two new screws of the same type.

- ◆ Screw and tighten the two screws (1) that fasten the brake caliper.

**Brake caliper screw (1) driving torque:
22 Nm (2.2 kgm).**

- ◆ With pulled front brake lever, press the handlebar repeatedly, thrusting the fork downwards. In this way the fork rods will settle properly.

- ◆ ★ Tighten the two screws (5) of the wheel pin clamp.

Wheel pin clamp screw (5) driving torque: 12 Nm (1,2 kgm)

- ◆ Remove the front support stand **OPT**, see p. 47 (POSITIONING THE VEHICLE ON THE FRONT SUPPORT STAND **OPT**).
- ◆ Remove the rear support stand **OPT**, see p. 47 (POSITIONING THE VEHICLE ON THE REAR SUPPORT STAND **OPT**).



After reassembly, pull the front brake lever repeatedly and check the correct functioning of the braking system.

Check the wheel centering.

Have the driving torques, centering and balancing of the wheel checked by your **aprilia Official Dealer, in order to avoid accidents that may be harmful for you and/or other people.**

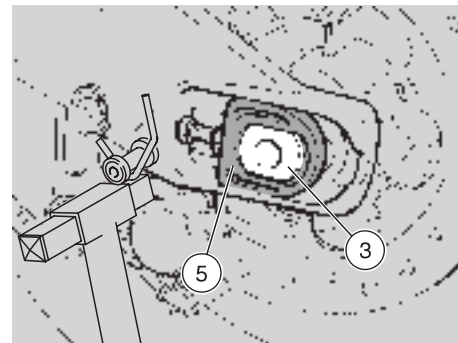
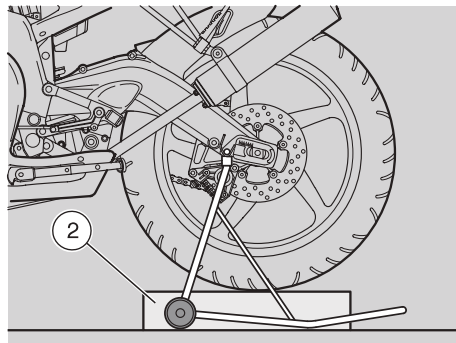
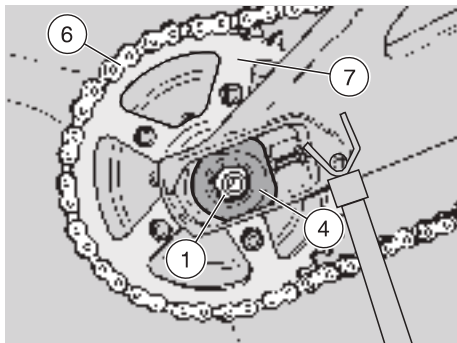

REAR WHEEL



The disassembly and reassembly of the rear wheel may be difficult for unskilled operators. If necessary, contact an **aprilia** Official Dealer.

If you want to perform these operations personally, keep to the following instructions.

Carefully read p. 43 (MAINTENANCE).

Before carrying out the following operations, let the engine and the silencer cool down until they reach room temperature, in order to avoid burns.



While disassembling and reassembling the wheel, be careful not to damage the brake pipe, the disc and the pads.



To remove the rear wheel it is necessary to use the appropriate rear support stand **OPT**.

DISASSEMBLY

◆ Position the vehicle on the appropriate rear support stand, see p. 47 (POSITIONING THE VEHICLE ON THE REAR SUPPORT STAND **OPT**).

Wheel nut (1) driving torque:
100 Nm (10 kgm).

- ◆ Loosen and remove the nut (1), taking the washer.
- ◆ Put a support (2) under the tyre, in such a way as to keep the wheel in its position after loosening it.
- ◆ Withdraw the wheel pin (3) from the right side.



Check the arrangement of the right (4) and left (5) chain tighteners, in order to be able to reassemble them correctly.



◆ Take the right (4) and left (5) chain tighteners.



Lower the drive chain (6) outside the crown gear (7).

- ◆ Make the wheel advance and release the drive chain (6) from the crown gear (7).
- ◆ Withdraw the wheel from the rear fork from behind, carefully withdrawing the disc from the brake caliper.



Never pull the rear brake lever after removing the wheel, otherwise the caliper pistons may go out of their seats, thus causing the outflow of the brake fluid. In this case consult your **aprilia** Official Dealer, who will carry out the proper maintenance operation.



Check the arrangement of the spacer rings (8) and (9), in order to be able to reassemble them correctly.

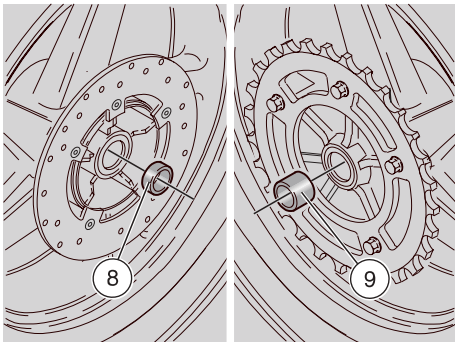

- ◆ Take the left spacer ring (8).
- ◆ Take the right spacer ring (9).

REASSEMBLY

- ◆ Moderately grease the outer seats of the wheel hub.

 **Do not invert the left (8) and right (9) spacer rings.**

- ◆ Insert the left (8) and right (9) spacer rings in their seats on the wheel hub

 **Before proceeding with the reassembly, make sure that support plate (10) of the brake caliper (11) is positioned correctly; the plate slot must be inserted in the appropriate stop pin (12) in the inner part of the rear fork left rod.**

Insert the disc in the brake caliper carefully.

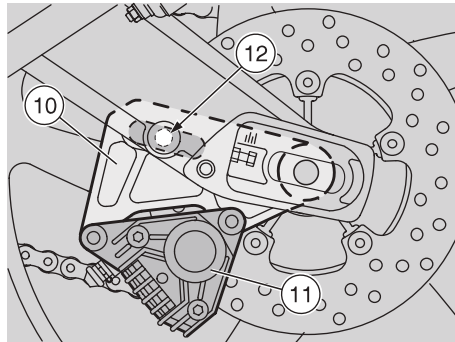

- ◆ Position the wheel between the rear fork rods on the support (2).

 **Do not introduce your fingers between the chain and the crown gear.**

- ◆ Make the wheel advance and position the drive chain (6) on the crown gear (7).

 **Danger of injury. Do not introduce your fingers to align the holes.**

- ◆ Move the wheel backwards, until its central hole and the holes on the rear fork are aligned.
- ◆ Rotate the support plate (10), complete with brake caliper (11) and with fulcrum on the stop pin (12), until it is aligned with the holes.

 **Do not invert the right (4) and left (5) chain tighteners.**

- ◆ Correctly insert the right (4) and left (5) chain tighteners in their seats on the fork.
- ◆ Uniformly apply a moderate quantity of grease on the wheel pin (3).
- ◆ Introduce the wheel pin (3) completely on the left side.

 **Make sure that the wheel pin (3) is completely inserted, with the head in the relevant seat on the left chain tightener (5).**

- ◆ Position the washer and tighten the nut (1) manually.
- ◆ Check the chain tension, see p. 54 (DRIVE CHAIN).
- ◆ Tighten the nut (1).

**Wheel nut (1) driving torque:
100 Nm (10 kgm).**

 **After reassembly, pull the rear brake lever repeatedly and check the correct functioning of the braking system.**

Check the wheel centering. Have the driving torques, centering and balancing of the wheel checked by your **aprilia Official Dealer, in order to avoid accidents that may be harmful for you and/or other people.**

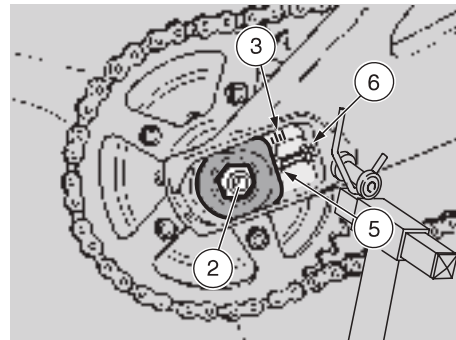
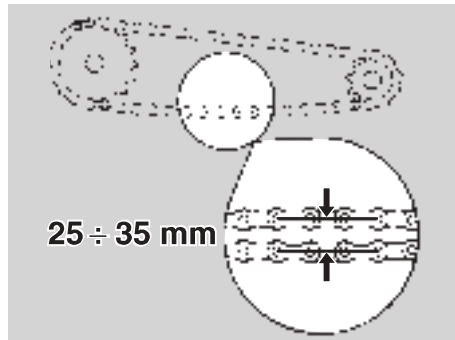
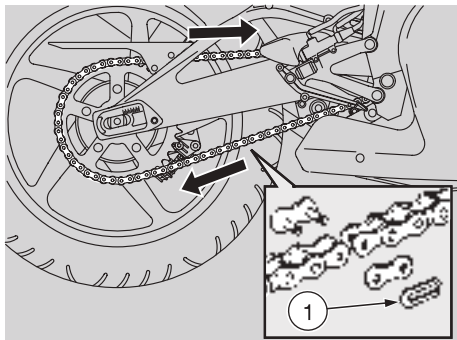

DRIVE CHAIN

Carefully read p. 43 (MAINTENANCE).

The vehicle is equipped with a chain with ring link joint.

In case of disassembly and reassembly of the chain, make sure that the clip (1) of the ring link joint has its open side opposite the travelling direction (see figure).



An excessive slackening of the chain can cause it to come off of the sprockets, which often results in accidents or serious damage to the vehicle.

Periodically check the slack and adjust it if necessary, see beside (ADJUSTMENT). To change the chain, contact an **aprilia Official Dealer, who will ensure you prompt and accurate servicing.**



Incorrect maintenance may cause the untimely wear of the chain and/or damages to the pinion and/or the crown.

Carry out the maintenance operations more frequently if you use the vehicle in difficult conditions or on dusty and/or muddy roads.

CHECKING THE SLACK

To check the slack, proceed as follows:

- ◆ Stop the engine.
- ◆ Position the vehicle on the stand.
- ◆ Position the shifting lever in neutral.
- ◆ Make sure that the vertical oscillation, in an intermediate point between pinion and crown in the lower part of the chain, is about **25 ÷ 35 mm**.
- ◆ Move the vehicle forwards, or turn the wheel, in order to be able to check the vertical oscillation of the chain even when the wheel turns; the slack must be constant in all the rotation phases of the wheel.



If in some positions the slack is higher than in others, this means that there are crushed or seized links; in this case, contact an **aprilia Official Dealer. To prevent the risk of seizures, lubricate the chain frequently, see p. 55 (CLEANING AND LUBRICATION).**

If the slack is uniform, but higher or lower than **25 ÷ 35 mm**, adjust it, see below (ADJUSTMENT).

ADJUSTMENT



To adjust the chain it is necessary to use the appropriate rear support stand **OPT.**

If after the check it is necessary to adjust the chain tension, proceed as follows:

- ◆ Position the vehicle on the appropriate rear support stand **OPT**, see p. 47 (POSITIONING THE VEHICLE ON THE REAR SUPPORT STAND **OPT**).

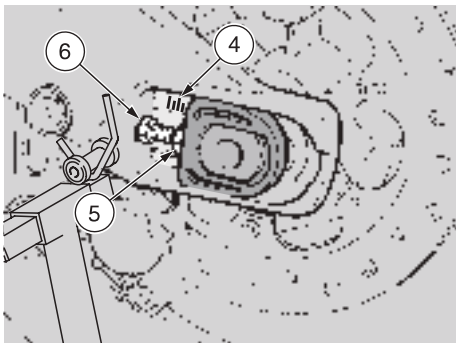

- ◆ Loosen the nut (2) completely.

For the wheel centering fixed reference marks (3-4) are provided, which can be seen inside the chain tightener seats on the rear fork arms, before the wheel pin.

- ◆ Loosen the two lock nuts (5).
- ◆ Act on the adjusters (6) and adjust the chain slack, making sure that the reference marks (3-4) are correctly positioned on both sides of the vehicle.
- ◆ Tighten the two lock nuts (5).
- ◆ Tighten the nut (2).

**Wheel nut driving torque:
100 Nm (10 kgm).**

- ◆ Check the chain slack, see p. 54 (CHECKING THE SLACK).

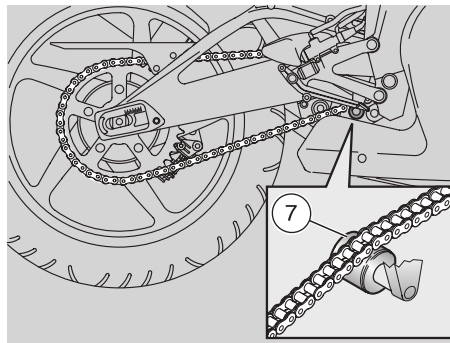

CHECKING THE WEAR OF CHAIN, PINION AND CROWN

Further, check the chain and sprockets and make sure that they do not present:

- ◆ Damaged rollers.
- ◆ Loose pins.
- ◆ Dry, rusty, crushed or seized links.
- ◆ Excessive wear.
- ◆ Sprocket or teeth excessively worn or damaged.

! If the chain rollers are damaged and/or the pins are loose, it is necessary to change the whole chain unit (both sprockets and chain).



Lubricate the chain frequently, especially if there are dry or rusty parts. The crushed or seized links must be lubricated and made work again.

If this is not possible, contact an **aprilia** Official Dealer, who will provide for changing the chain.

- ◆ Check the wear of the chain tightener roller (7).
- ◆ Finally, check the wear of the rear fork protection shoe.

CLEANING AND LUBRICATION



Carry out the adjustment, lubrication, cleaning and change of the chain with great care.

Lubricate the chain every 500 km (312 mi) or whenever necessary.

Lubricate the chain with spray grease for chains or with SAE 80W-90 oil.

Never wash the chain with water jets, steam jets, high-pressure water jets and highly inflammable solvents.

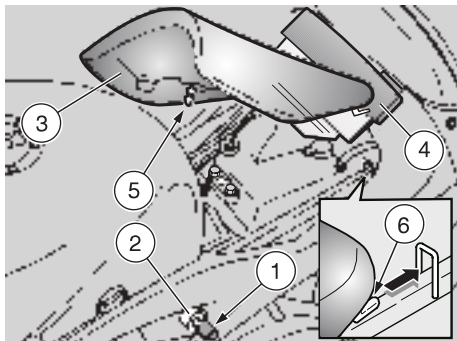

REMOVING THE RIDER SADDLE

- ◆ Position the vehicle on the stand.
- ◆ Insert the key (1) in the lock (2).
- ◆ Rotate the key (1) anticlockwise.
- ◆ Raise and remove the saddle (3).
- ◆ Remove the flap (4).

Upon reassembly:



Before lowering and locking the saddle, make sure that you have not left the key in the glove / tool kit compartment.

- ◆ Position the flap (4) correctly.
- ◆ Insert the rear tangs (6) of the saddle in the appropriate seats (see figure).
- ◆ Position the coupling (5) in its seat, lower and press the saddle, making the lock snap.



Before leaving, make sure that the saddle (3) is properly positioned and locked.

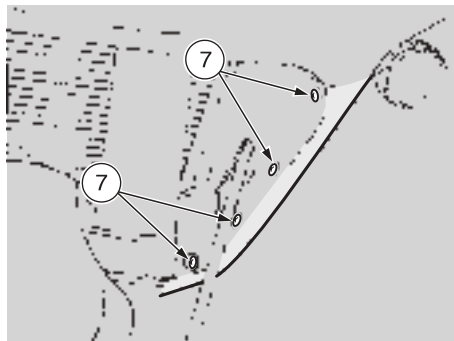

REMOVING THE SIDE FAIRINGS

Carefully read p. 43 (MAINTENANCE).



Wait until the engine and the exhaust silencer have completely cooled down.

- ◆ Position the vehicle on the stand.
- ◆ Unscrew and remove the four screws (7).
- ◆ Disconnect the two electric terminals (8) of the direction indicator.
- ◆ Unscrew and remove the two lower screws (9).
- ◆ **For the left fairing:** unscrew and remove the two rear screws (10).
- ◆ **For the right fairing:** unscrew and remove the rear screw (11).
- ◆ Unscrew and remove the four screws (12).

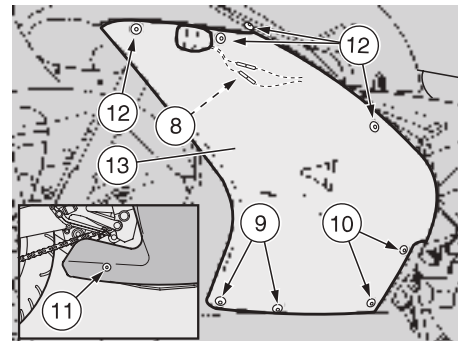

Handle the plastic and painted components with care and avoid scraping or damaging them.

- ◆ Remove the side fairing (13).

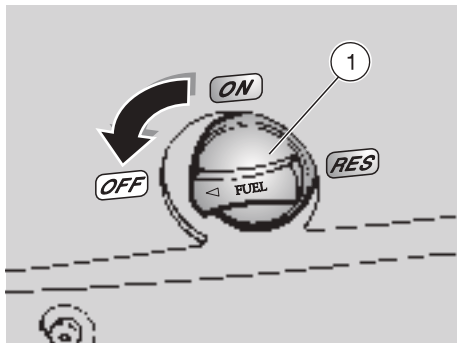

LIFTING THE FUEL TANK

Carefully read p. 25 (FUEL) and p. 43 (MAINTENANCE).

 **Risk of fire.**
Wait until the engine and the exhaust silencer have completely cooled down.

Fuel vapours are noxious for your health.

Before proceeding, make sure that the room in which you are working is properly ventilated.

Do not inhale fuel vapours.

Do not smoke and do not use naked flames.

DO NOT DISPOSE OF FUEL IN THE ENVIRONMENT.

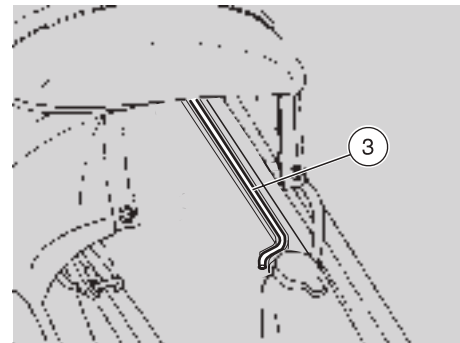
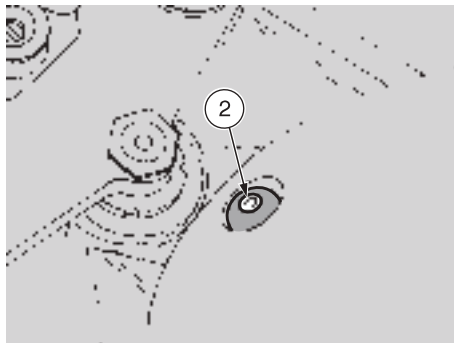

- ◆ Move the fuel tap lever (1) to position "OFF".
- ◆ Remove the rider saddle, see p. 56 (REMOVING THE RIDER SADDLE).
- ◆ Unscrew and remove the screw (2) and take the bushing.
- ◆ Remove the fuel tank support rod (3) from the relevant anchorage seats.
- ◆ Lift the front part of the fuel tank (4) and introduce the rod (3) as indicated in the figure.

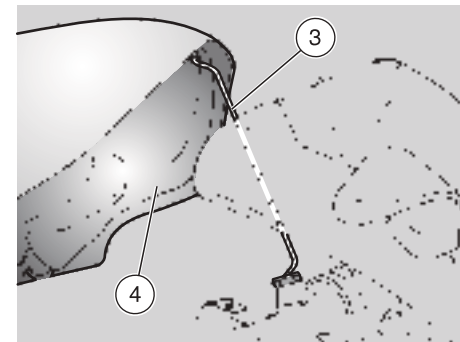



AIR CLEANER

Clean the air cleaner every 4000 km (2500 mi) or 12 months, change it every 8000 km (5000 mi) or more frequently if the vehicle is used on dusty or wet roads.

It is possible to clean the air cleaner partially after using the vehicle on this kind of roads.



The partial cleaning of the filter does not exclude or postpone the replacement of the filter itself.



REMOVAL

- ◆ Lift the fuel tank, see p. 57 (LIFTING THE FUEL TANK).
- ◆ Unscrew and remove the two screws (1).
- ◆ Unscrew and remove the two screws (2) and take the nuts positioned under them.
- ◆ Remove the filter case cover (3).
- ◆ Remove the filtering element (4) together with the grids (5).



Plug the opening with a clean cloth, to prevent any foreign matters from entering the suction pipes.

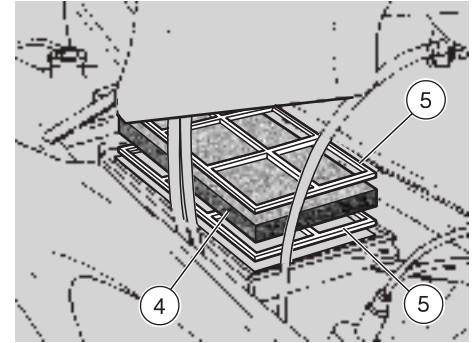

CLEANING

- ◆ Clean the filtering element (4) with clean, non-inflammable solvents or solvents with high volatility point, then let it dry thoroughly.
- ◆ Apply a filter oil or a thick oil (SAE 80W-90) on the whole surface of the filtering element, then squeeze it to eliminate the oil in excess.



The filtering element (4) must be well impregnated, though not dripping.

CHANGING

- ◆ Replace the filtering element (4) with a new one of the same type.

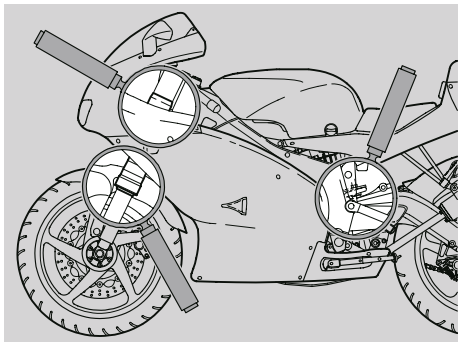

INSPECTING THE FRONT AND REAR SUSPENSIONS



Have the front fork oil changed by an **aprilia** Official Dealer, who will ensure you prompt and accurate servicing.

Carefully read p. 43 (MAINTENANCE).

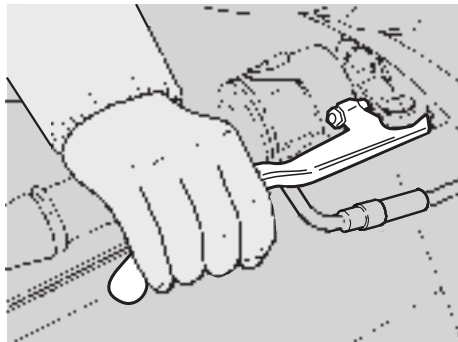

Have the front fork oil changed after the every 12000 km (7500 mi).

Every 8000 km (5000 mi), carry out the following checking operations:

- ◆ With pulled front brake lever, press the handlebar repeatedly, thrusting the fork downwards.
The stroke must be gentle and there must be no trace of oil on the rods.
- ◆ Check the fastening of all the components and the functionality of the front and rear suspension joints.

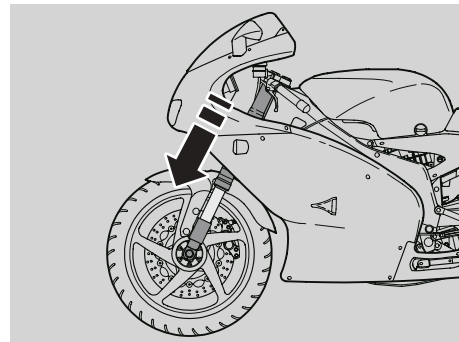

If you notice irregularities in the operation or if the help of a qualified technician is necessary, contact your **aprilia** Official Dealer.



REAR SUSPENSION

The rear suspension consists of a spring-shock absorber unit, fixed to the frame by means of silent-blocks and to the rear fork by means of lever systems. For the setting of the vehicle attitude, the shock absorber is provided with a nut (1) for the adjustment of the spring preload (2).

 **It is possible to adjust the shock absorber axis distance to personalize the vehicle attitude. For this kind of adjustment, contact an aprilia Official Dealer.**

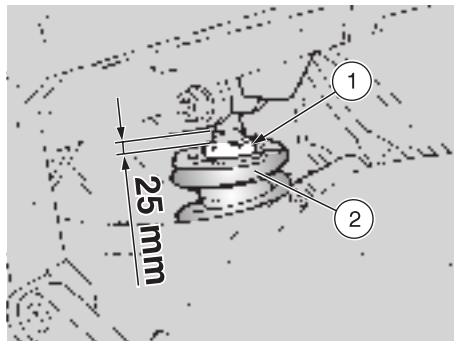

ADJUSTING THE REAR SHOCK ABSORBER

The standard setting of the rear shock absorber is such as to satisfy most driving conditions at low and high speed, either with reduced load and full load. However, it is also possible to adjust the setting according to the intended use of the vehicle.

 **The adjusting nut must not be screwed for more than 25 mm from the beginning of the thread (see figure). If this measure is exceeded, even the slightest unevenness on the road surface will cause sudden jerks.**

- ◆ Act on the adjusting nut (1) (shock absorber spring preload adjustment) (see figure).



Turn the adjusting nut (1) one turn at a time. Test the vehicle repeatedly on the road, until obtaining the optimal adjustment.

Adjusting nut (1)	By screwing it (clockwise)	By unscrewing it (anticlockwise)
Function	Spring preload increase	Spring preload decrease
Attitude	The vehicle is more rigid	The vehicle is less rigid
Recommended kind of road	Smooth or normal roads	Roads with uneven surface
Notes	Rider and passenger	Solo rider

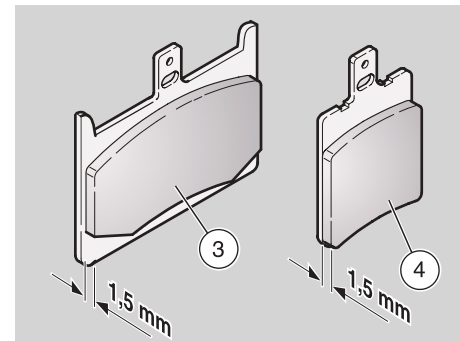
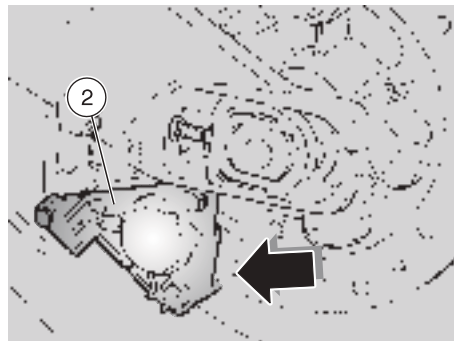
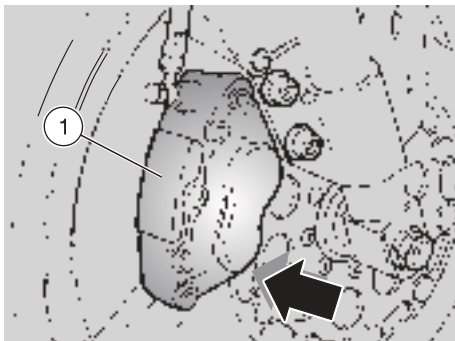

CHECKING THE BRAKE PAD WEAR

Carefully read p. 26 (BRAKE FLUID-recommendations), p. 26 (DISC BRAKES) and p. 43 (MAINTENANCE).

The following information refer to a single braking system, but are valid for both.

Check the brake pad wear after the first 1000 km (625 mi) and successively every 2000 km (1250 mi).

The wear of the brake pads depends on the use, on the kind of drive and on the road. The wear will be greater when the vehicle is driven on dirty or wet roads.



Check the wear of the brake pads, especially before every trip.

To carry out a rapid checking of the wear of the pads, proceed as follows:

- ◆ Position the vehicle on the stand.
- ◆ Carry out a visual checking of the friction material thickness by looking between the brake caliper and the pads. Proceed:
 - from below, on the front part, for the front brake caliper (1);
 - from below, on the rear part, for the rear brake caliper (2).



The excessive wear of the friction material would cause the contact of the pad metal support with the disc, with consequent metallic noise and production of sparks from the caliper; braking efficiency, safety and soundness of the disc would thus be negatively affected.

- ◆ If the thickness of the friction material (even of one pad only) has reduced to about 1 mm, replace both pads.
 - Front pad (3).
 - Rear pad (4).



Have the pads changed by your aprilia Official Dealer.

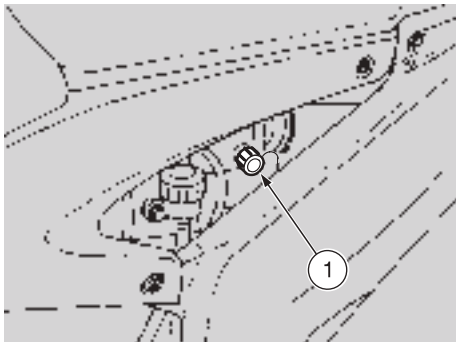

IDLING ADJUSTMENT

Carefully read p. 43 (MAINTENANCE).

Adjust the idling every time it is irregular.

To carry out this operation, proceed as follows:

- ◆ Ride for a few miles until reaching the normal running temperature, see p. 17 (Coolant temperature indicator $\frac{E}{L}$).
- ◆ Position the gear lever in neutral (green warning light "N" on).
- ◆ Check the engine idling rpm on the revolution counter.

The engine idling speed must be about 1250 ± 100 rpm.

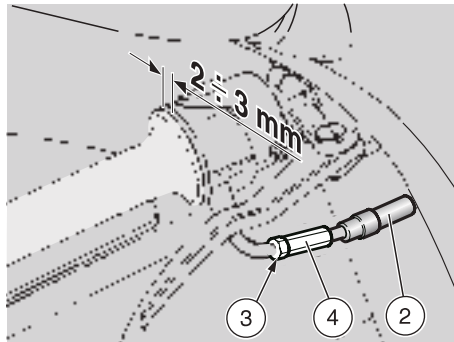

If necessary:

- ◆ Position the vehicle on the stand.
- ◆ Adjust the knob (1).

By **SCREWING IT** (clockwise), you increase the engine rpm.

By **UNSCREWING IT** (anticlockwise), you decrease the engine rpm.

- ◆ Twist the throttle grip, accelerating and decelerating a few times to make sure that it functions correctly and to check if the idling speed is constant.



If necessary, contact your Aprilia Official Dealer.

ADJUSTING THE ACCELERATOR CONTROL

Carefully read p. 43 (MAINTENANCE).

The idle stroke of the throttle grip must be 2 ± 3 mm, measured on the edge of the grip itself.

If this is not the case, proceed as follows:

- ◆ Position the vehicle on the stand.
- ◆ Withdraw the protection element (2).
- ◆ Loosen the lock nut (3).
- ◆ Rotate the adjuster (4) in such a way as to restore the prescribed value.
- ◆ After the adjustment, tighten the lock nut (3) and check the idle stroke again.
- ◆ Put back the protection element (2).



After the adjustment, make sure that the rotation of the handlebar does not modify the engine idling rpm and that the throttle grip returns smoothly and automatically to its original position after being released.

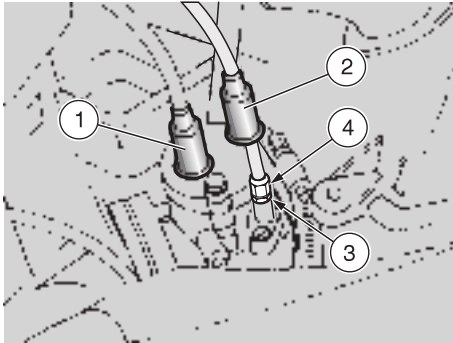

ADJUSTING THE COLD START CONTROL (I\N)

Carefully read p. 43 (MAINTENANCE).

The ideal slack of the cold start control should be about 2 ÷ 3 mm.

To adjust the slack, proceed as follows:

- ◆ Position the vehicle on the stand.
- ◆ Lift the fuel tank, see p. 57 (LIFTING THE FUEL TANK).
- ◆ Move to the left side of the vehicle.



DO NOT withdraw the accelerator cable protection element (1).

- ◆ Withdraw the protection element (2).
- ◆ Loosen the nut (3).
- ◆ Act on the adjuster (4) positioned on the carburettor.

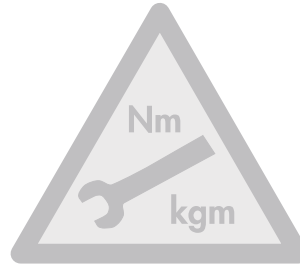

After the adjustment:

- ◆ Tighten the nut (3), thus locking the adjuster (4) and put back the protection element (2).

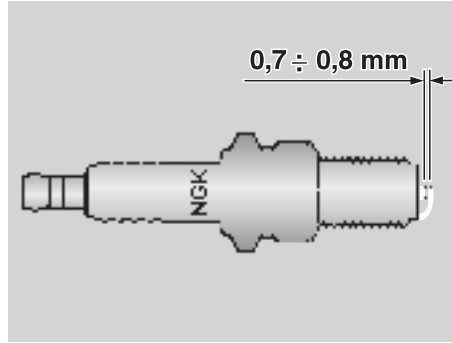
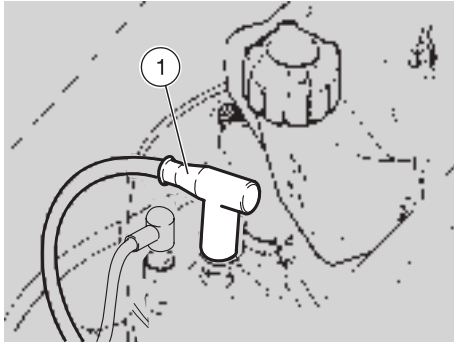

SPARK PLUGS

Carefully read p. 43 (MAINTENANCE).

Check the spark plug after the first 1000 km (625 mi) and successively every 4000 km (2500 mi); change it every 8000 km (5000 mi).

Periodically remove the spark plug and clean it carefully, removing carbon deposits; change it if necessary.

To reach the spark plug:

- ◆ Lift the fuel tank, see p. 57 (LIFTING THE FUEL TANK).

To remove and clean the spark plug:

- ◆ Take off the spark plug cap (1).
- ◆ Remove all the dirt from the base of the spark plug, then unscrew it with the spanner you will find in the tool kit and extract it from its seat, taking care that neither dust nor other substances enter the cylinder.
- ◆ Make sure that there are neither carbon deposits, nor corrosion marks on the electrode and on the central porcelain part; if necessary, clean them with the special cleaners for spark plugs, with an iron wire and/or a metal brush.
- ◆ Energetically blow some air, in order to prevent the removed residues from getting into the engine.
If the spark plug has crackings on the insulating material, corroded electrodes or excessive deposits, it must be changed.

- ◆ Check the spark plug gap with a thickness gauge.
The gap must be **0.7 ÷ 0.8 mm**; if necessary adjust it, carefully bending the earth electrode.
- ◆ Make sure that the washer is in good conditions. With the washer on, screw the spark plug by hand in order not to damage the thread.
- ◆ Tighten the spark plug by means of the spanner you will find in the tool kit, giving it half a turn to compress the washer.

Spark plug driving torque:
20 Nm (2 kgm).



The spark plug must be well tightened, otherwise the engine may overheat and be seriously damaged.

Use the recommended type of spark plug only, see p. 78 (TECHNICAL DATA), in order not to compromise the life and performance of the engine.

- ◆ Position the spark plug cap properly, so that it does not come off due to the vibrations of the engine.
- ◆ Put back the fuel tank.

BATTERY

Carefully read p. 43 (MAINTENANCE).

Check the electrolyte level and the tightening of the terminals after the first 1000 km (625 mi) and successively every 4000 km (2500 mi) or 12 months.



The electrolyte in the battery is toxic and caustic and if it gets in contact with the skin it can cause burns, since it contains sulphuric acid. Wear protection clothes, a face mask and/or goggles during maintenance operations.

In case of contact with the skin, rinse with plenty of water.

In case of contact with the eyes, rinse with plenty of water for fifteen minutes, then consult an oculist without delay.

If the electrolyte is accidentally swallowed, drink a lot of water or milk, then continue drinking milk of magnesia or vegetable oil and consult a doctor without delay.

The battery gives off explosive gases; keep it away from flames, sparks, cigarettes and any other source of heat.

During the recharging or the use, make sure that the room is properly ventilated and avoid inhaling the gases released during the recharging.

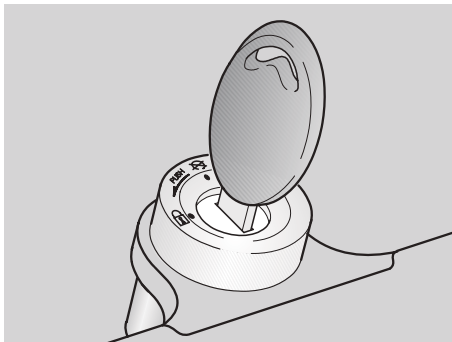

KEEP AWAY FROM CHILDREN.

Do not incline the vehicle too much, in order to avoid dangerous leaks of the battery fluid.



Never invert the connection of the battery cables.

Connect and disconnect the battery with the ignition switch in position "X". Connect first the positive cable (+) and then the negative cable (-). Disconnect following the reverse order.

LONG INACTIVITY OF THE BATTERY



If the vehicle remains unused for more than 20 days, disconnect the 20A fuse, in order to avoid the battery deterioration resulting from the current consumption due to the multi-function computer.

To remove the 20A fuse it is necessary to set the digital clock function to zero. To reset the digital clock, see p. 17 (MULTIFUNCTION COMPUTER).

If the vehicle remains unused for more than fifteen days, it is necessary to recharge the battery, in order to prevent its sulphation, see p. 67 (RECHARGING THE BATTERY).

◆ Remove the battery, see p. 66 (REMOVING THE BATTERY) and put it in a cool and dry place.

It is important to check the charge periodically (about once a month), during the winter or when the vehicle remains unused, in order to prevent the deterioration of the battery.

◆ Recharge it completely with a normal charge, see p. 67 (RECHARGING THE BATTERY).

If the battery remains on the vehicle, disconnect the cables from the terminals.

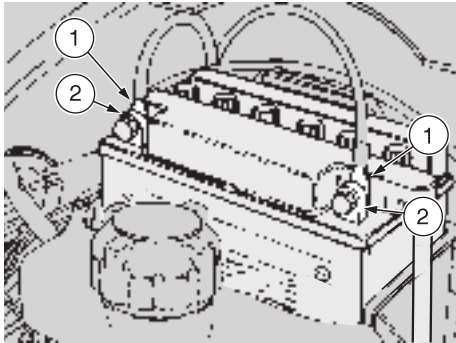

CHECKING AND CLEANING THE TERMINALS

Carefully read p. 65 (BATTERY).

- ◆ Lift the fuel tank, see p. 57 (LIFTING THE FUEL TANK).
- ◆ Make sure that the cable terminals (1) and the battery terminals (2) are:
 - in good conditions (and not corroded or covered with deposits);
 - covered with neutral grease or Vaseline.

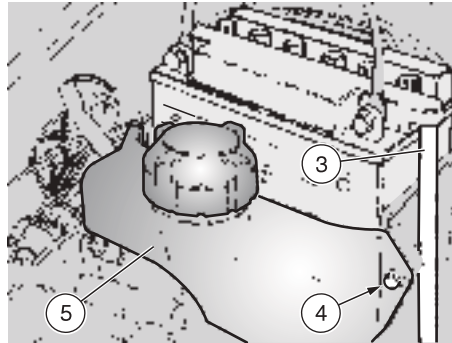

If necessary:

- ◆ Make sure that the ignition switch is in position "⊗".
- ◆ Disconnect first the negative (-) and then the positive cable (+).
- ◆ Brush with a wire brush to eliminate any sign of corrosion.
- ◆ Reconnect first the positive (+) and then the negative cable (-).
- ◆ Cover the terminals of the cables and of the battery with neutral grease or Vaseline.

REMOVING THE BATTERY

 To remove the battery it is necessary to set the digital clock function to zero. To reset the digital clock, see p. 17 (MULTIFUNCTION COMPUTER).

Carefully read p. 65 (BATTERY).

- ◆ Make sure that the ignition switch is in position "⊗".
- ◆ Lift the fuel tank, see p. 57 (LIFTING THE FUEL TANK).
- ◆ Disconnect first the negative (-) and then the positive cable (+).
- ◆ Remove the battery breather pipe (3).
- ◆ Unscrew and remove the screw (4).
- ◆ Move the coolant expansion tank (5).
- ◆ Remove the battery from its compartment and put it on a flat surface, in a cool and dry place.



Once it has been removed, the battery must be stored in a safe place and kept away from children.

CHECKING THE ELECTROLYTE LEVEL

Carefully read p. 65 (BATTERY).

To check the electrolyte level, proceed as follows:

- ◆ Lift the fuel tank, see p. 57 (LIFTING THE FUEL TANK).
- ◆ Keep the vehicle in vertical position, with the two wheels resting on the ground.
- ◆ Make sure that the fluid level is included between the two "MIN" and "MAX" notches stamped on the battery side. Otherwise:
- ◆ Remove the battery, see p. 66 (CHECKING AND CLEANING THE TERMINALS).
- ◆ Remove the element plugs.



Top up with distilled water only. Do not exceed the "MAX" mark, since the electrolyte level increases during the recharge.

- ◆ Top up by adding distilled water.

RECHARGING THE BATTERY

Carefully read p. 65 (BATTERY).

- ◆ Remove the battery, see p. 66 (REMOVING THE BATTERY).
- ◆ Remove the element plugs.

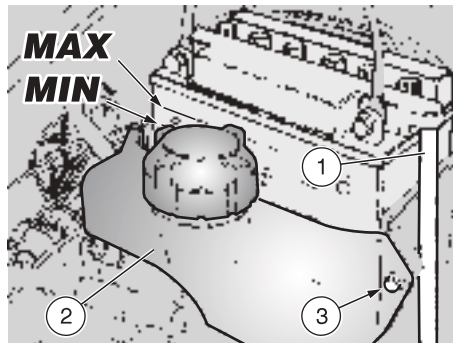

- ◆ Check the electrolyte level, see beside (CHECKING THE ELECTROLYTE LEVEL).
- ◆ Connect the battery with a battery charger.
- ◆ A recharge with an amperage equal to 1/10th of the battery capacity is recommended.
- ◆ After the recharging operation, check the electrolyte level again and if necessary top up with distilled water.
- ◆ Put back the element plugs.



Reassemble the battery only 5-10 minutes after disconnecting the recharge apparatus, since the battery continues to produce gas for a short lapse of time.

INSTALLING THE BATTERY

Carefully read p. 65 (BATTERY).

- ◆ Make sure that the ignition switch is in position "⊗".
- ◆ Lift the fuel tank, see p. 57 (LIFTING THE FUEL TANK).
- ◆ Put the battery in its container.
- ◆ Connect the breather pipe.



Always connect the battery breather pipe, to prevent the sulphuric acid vapours from corroding the electric system, painted parts, rubber elements or gaskets when they exit the breather pipe itself.

- ◆ Connect, in order, the positive (+) and negative (-) cable.
- ◆ Cover the terminals of the cables and of the battery with neutral grease or Vaseline.
- ◆ Position the coolant expansion tank (2) correctly.
- ◆ Tighten the screw (3).
- ◆ Lower and lock the fuel tank.

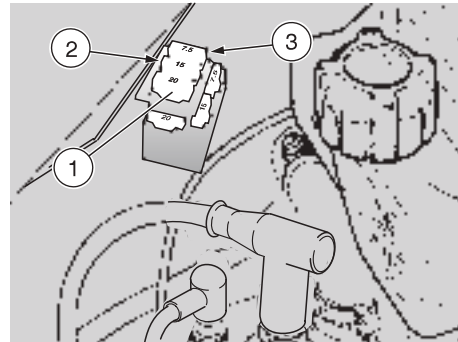
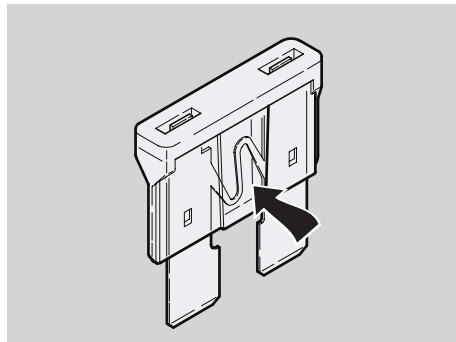
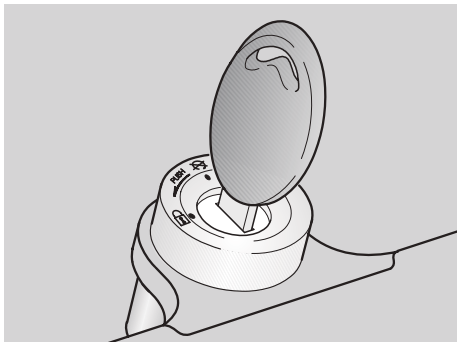

CHANGING THE FUSES

Carefully read p. 43 (MAINTENANCE).



Do not repair faulty fuses.

Never use fuses different from the recommended ones.

The use of unsuitable fuses may cause damages to the electric system or, in case of short circuit, even a fire.



If a fuse blows frequently, there probably is a short circuit or an overload in the electric system. In this case it is advisable to consult an **aprilia** Official Dealer.

If an electric component does not work or works irregularly, or if the vehicle fails to start, it is necessary to check the fuses.

- ◆ Turn the ignition switch to position "⊗", to avoid any accidental short circuit.
- ◆ Lift the fuel tank, see p. 57 (LIFTING THE FUEL TANK).



To remove the 20A fuse it is necessary to set the digital clock function to zero. To reset the digital clock, see p. 17 (MULTIFUNCTION COMPUTER).

- ◆ Extract the fuses one by one and check if the filament is broken.
- ◆ Before replacing a fuse, try to find out the cause of the trouble, if possible.

- ◆ Replace the damaged fuse with a new one having the same amperage.



If you use one of the spare fuses, put a new fuse in the proper seat.

ARRANGEMENT OF THE FUSES

- 1) **20A fuse**
From the battery to key switch, voltage regulator, clock.
- 2) **15A fuse**
From the key switch to all light loads and horn, solenoid valves **FP**, RAVE motor **FP**.
- 3) **7.5A fuse**
From the key switch to ignition, start safety device.



CHECKING THE SIDE STAND AND THE SAFETY SWITCH

Carefully read p. 43 (MAINTENANCE) and p. 70 (CHECKING THE SWITCHES).

The side stand (1) must rotate without hindrances.

Carry out the following checks:

- ◆ The springs (2) must not be damaged, worn, rusty or weakened.
- ◆ The side stand must rotate freely, if necessary grease the joint, see p. 81 (LUBRICANT CHART).

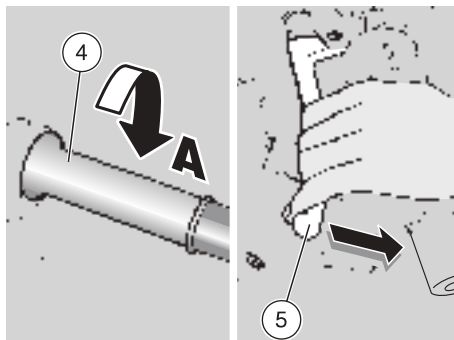

The side stand (1) is provided with a safety switch (3) that has the function to prevent or interrupt the operation of the engine with the gears on and the side stand (1) down. To check the proper functioning of the safety switch (3), proceed as follows:

- ◆ Seat on the vehicle in driving position.
- ◆ Fold the side stand (1).
- ◆ Start the engine, see p. 36 (STARTING).
- ◆ With released throttle grip (4) (Pos. A) and engine idling, pull the clutch lever (5) completely.

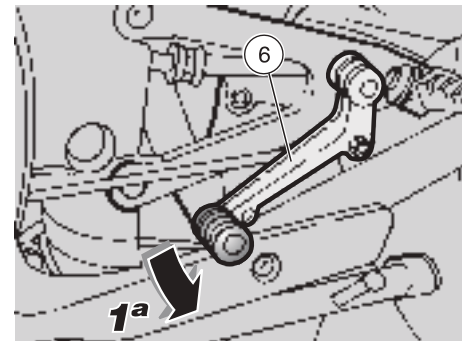

- ◆ Engage the first gear, pushing the shifting lever (6) downwards.
- ◆ Lower the side stand (1), thus operating the safety switch (3).

At this point:

- the engine must stop;
- the "side stand down" warning light  must come on.



If the engine does not stop, contact an aprilia Official Dealer.

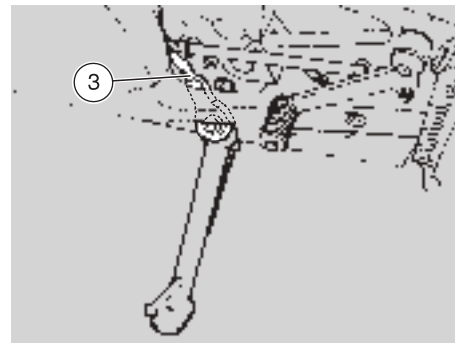
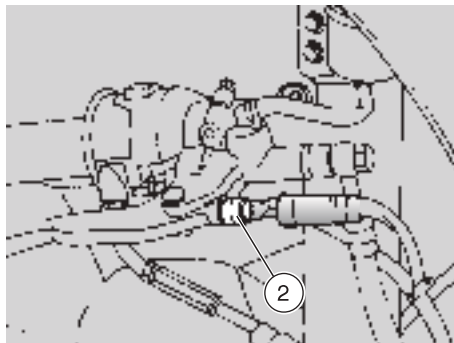
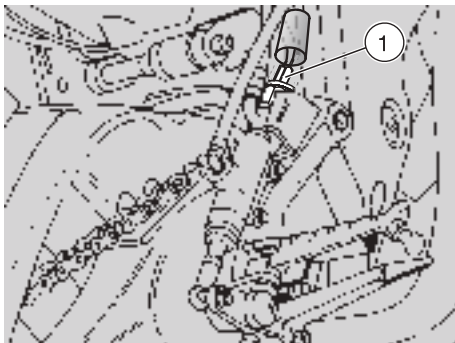

CHECKING THE SWITCHES

Carefully read p. 43 (MAINTENANCE).

The vehicle is provided with three switches:

- Stoplight switch on the rear brake control lever (1);
- Stoplight switch on the front brake control lever (2);
- Safety switch on the side stand (3).

- ◆ Make sure that there are no dirt or mud deposits on the switch; the pin must be able to move without interferences, returning automatically to its initial position.
- ◆ Make sure that the cables are connected correctly.
- ◆ Check the spring (4): it must not be damaged, worn or weakened.

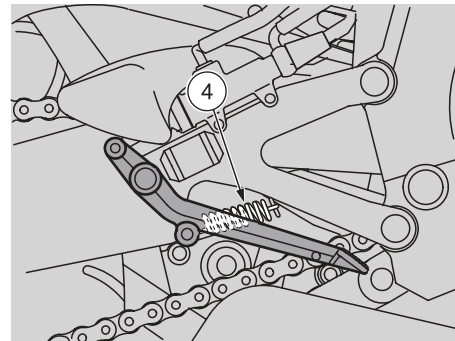

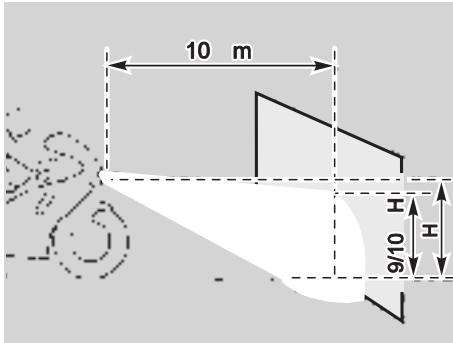

ADJUSTING THE VERTICAL HEADLIGHT BEAM

To rapidly check the correct direction of the beam, place the vehicle on flat ground, 10 m away from a wall.

Turn on the low beam, sit on the vehicle and make sure that the beam projected on the wall is slightly under the horizontal line of the headlight (about 9/10th of the total height).

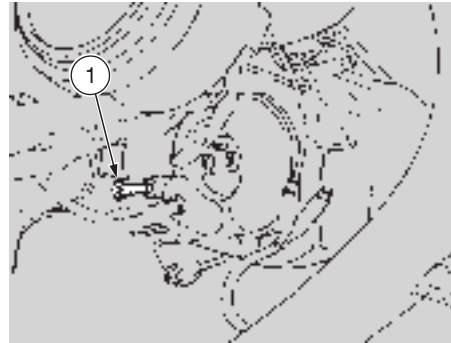

To adjust the headlight beam:

- ◆ Working on the rear left side of the front part of the fairing, adjust the appropriate screw (1) by means of a short cross-tip screwdriver.

By **SCREWING IT** (clockwise), you set the beam upwards.

By **UNSCREWING IT** (anticlockwise), you set the beam downwards.

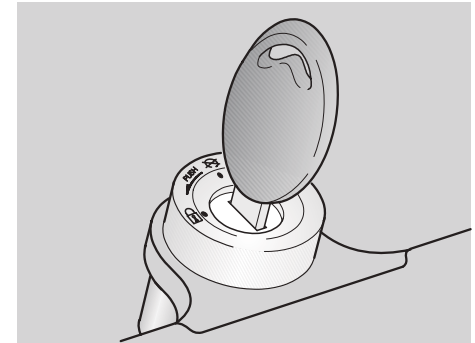

BULBS

Carefully read p. 43 (MAINTENANCE).



Before changing a bulb, turn the ignition switch to position "⊗". Change the bulb wearing clean gloves or using a clean and dry cloth.

Do not leave fingerprints on the bulb, since these may cause its overheating and consequent breakage.

If you touch the bulb with bare hands, remove any fingerprint with alcohol, in order to prevent it from blowing.

DO NOT FORCE THE ELECTRIC CABLES.

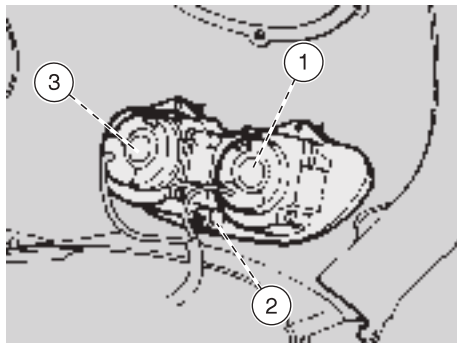

CHANGING THE HEADLIGHT BULBS

Carefully read p. 71 (BULBS).

- ◆ Position the vehicle on the stand.

 **Before changing a bulb, check the fuses, see p. 68 (CHANGING THE FUSES).**

The headlight contains:

- ◆ One high beam bulb (1) (right side).
- ◆ One parking light bulb (2) (lower side).
- ◆ One low beam bulb (3) (left side).

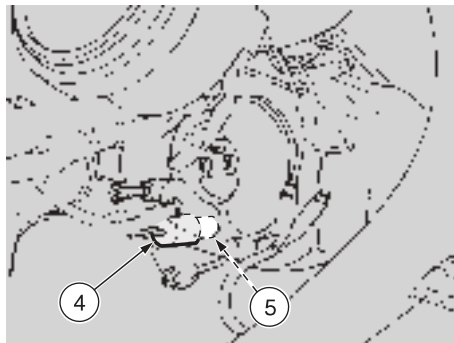

To change the bulbs, proceed as follows:

PARKING LIGHT BULB



To extract the bulb socket, do not pull the electric wires.

- ◆ Working on the rear side of the front part of the fairing, seize the bulb socket (4), pull it and remove it from its seat.
- ◆ Withdraw the parking light bulb (5) and replace it with one of the same type.

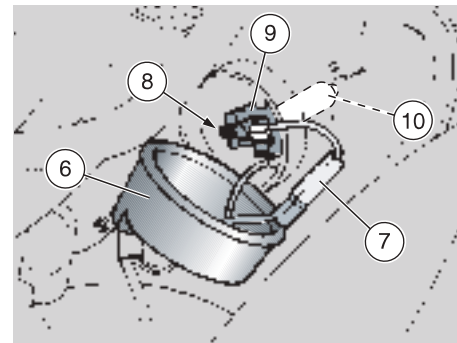

HIGH BEAM BULBS

- ◆ Working on the rear right side of the front part of the fairing, move the protection element (6) with your hands.
- ◆ Withdraw the electric terminal (7).
- ◆ Release the check spring (8) positioned at the rear of the bulb socket (9).
- ◆ Extract the bulb (10) from its seat.



Insert the bulb in the bulb socket, making the relevant positioning seats coincide.

- ◆ Correctly install a new bulb of the same type.

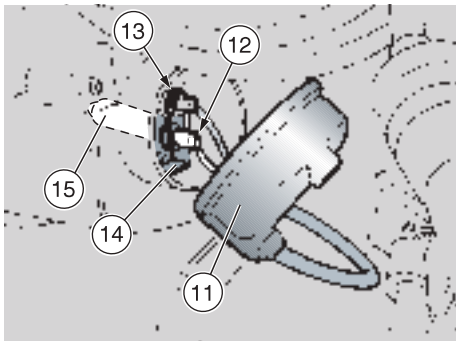

LOW BEAM BULB

- ◆ Working on the rear left side of the front part of the fairing, move the protection element (11) with your hands.
- ◆ Withdraw the connector (12).
- ◆ Release the check spring (13) positioned at the rear of the bulb socket (14).
- ◆ Extract the bulb (15) from its seat.

 **Insert the bulb in the bulb socket, making the relevant positioning seats coincide.**

- ◆ Correctly install a new bulb of the same type.

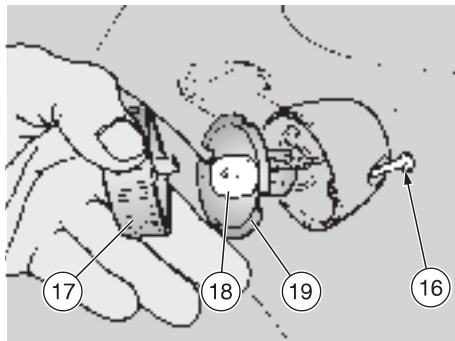

CHANGING THE FRONT AND REAR DIRECTION INDICATOR BULBS

Carefully read p. 71 (BULBS).

 **Before changing a bulb, check the fuses, see p. 68 (CHANGING THE FUSES).**

- ◆ Position the vehicle on the stand.
- ◆ Unscrew and remove the screw (16).

 **While removing the protection screen, proceed carefully in order not to break the cog.**

- ◆ Remove the protection screen (17).

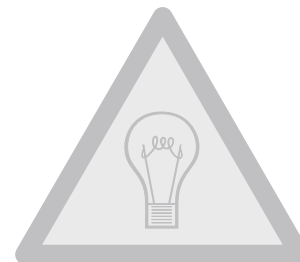

 Upon reassembly, correctly position the protection screen in its seat.

Tighten the screw (16) moderately and carefully, to avoid damaging the protection screen.

- ◆ Press the bulb (18) slightly and rotate it anticlockwise.
- ◆ Extract the bulb from its seat.

 **Insert the bulb in the bulb socket, making the two bulb pins coincide with the relevant guides on the socket.**

- ◆ Correctly install a new bulb of the same type.

 **If the bulb socket (19) goes out of its seat, insert it correctly, making the bulb socket opening coincide with the screw seat.**

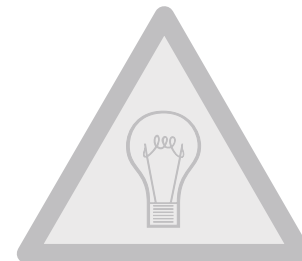
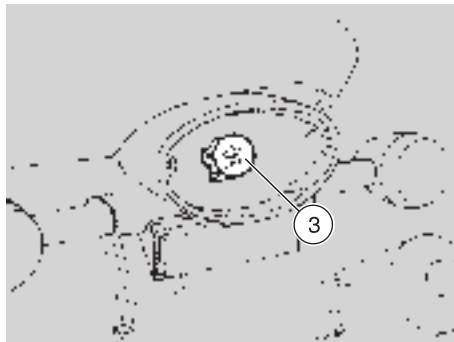
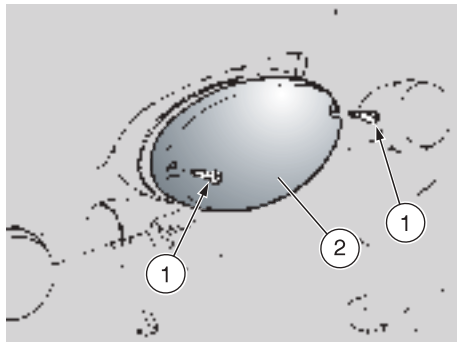

CHANGING THE REAR LIGHT BULB

Carefully read p. 71 (BULBS).

 Before changing a bulb, check the fuses, see p. 68 (CHANGING THE FUSES) and the effective operation of the stoplight switches, see p. 70 (CHECKING THE SWITCHES).

- ◆ Position the vehicle on the stand.
- ◆ Unscrew and remove the two screws (1).
- ◆ Remove the protection screen (2).

 Upon reassembly, correctly position the protection screen in its seat.

Tighten the screw (1) carefully, without exerting too much pressure, in order to avoid damaging the protection screen.

- ◆ Press the bulb (3) slightly and rotate it anticlockwise.
- ◆ Extract the bulb from its seat.

 Insert the bulb in the bulb socket, making the two bulb pins coincide with the relevant guides on the socket.

- ◆ Correctly install a new bulb of the same type.

 Upon reassembly, tighten the two screws (1) moderately and carefully, to avoid damaging the protection screen.



 Before transporting the vehicle, it is necessary to empty the fuel tank and the carburettor completely, see beside (DRAINING THE FUEL TANK) making sure that both are completely dry.

During transport, the vehicle must be kept in vertical position, it must be firmly anchored and the 1st gear must be engaged, in order to avoid any leak of fuel, oil, coolant.



In case of failure, do not tow the vehicle, but ask for assistance.

DRAINING THE FUEL TANK

Carefully read p. 25 (FUEL).



Risk of fire.
Wait until the engine and the exhaust silencers have completely cooled down. Fuel vapours are noxious for your health.

Before proceeding, make sure that the room in which you are working is properly ventilated.

Do not inhale fuel vapours.

Do not smoke, nor use free flames.

DO NOT DISPOSE OF FUEL IN THE ENVIRONMENT.

- ◆ Position the vehicle on the stand.
- ◆ Stop the engine and wait until it has cooled down.
- ◆ Prepare a container with capacity exceeding the fuel quantity present in the tank and put it on the ground on the left side of the vehicle.
- ◆ Remove the filler cap.
- ◆ Empty the fuel tank by means of a manual pump or a similar system.

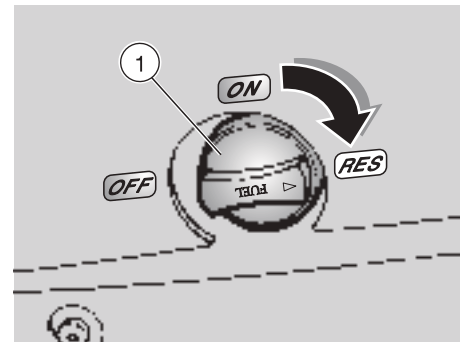

After draining the tank, tighten the filler cap.

To drain the carburettor completely, proceed as follows:

- ◆ Position the fuel tap (1) on "RES".
- ◆ Start the vehicle, see p. 36 (STARTING).
- ◆ Accelerate a few times, until the engine stops due to lack of fuel.

If necessary, contact an aprilia Official Dealer.



Clean the vehicle frequently if it used in particular areas or conditions, such as:

- ◆ Polluted areas (cities and industrial areas).
- ◆ Areas characterized by an high percentage of salinity and humidity (sea areas, hot and humid climates).
- ◆ Particular conditions (use of salt and anti-ice chemical products on the roads during the winter).
- ◆ Avoid leaving deposits of industrial and polluting powders, tar spots, dead insects, bird droppings, etc. on the body.
- ◆ Avoid parking the vehicle under trees, since in some seasons residues, resins, fruits or leaves fall down, which contain substances that may damage the paint.



After the vehicle has been washed, its braking functions could be temporarily impaired because of the presence of water on the grip surfaces. Calculate long braking distances to avoid accidents. Brake repeatedly to restore normal conditions.

Carry out the preliminary checking operations, see p. 35 (PRELIMINARY CHECKING OPERATIONS).

To remove dirt and mud from the painted surfaces use a low- pressure water jet, carefully wet the dirty parts, remove mud and filth with a soft car sponge impregnated with a lot of water and shampoo (2 ÷ 4% parts of shampoo in water). Then rinse with plenty of water and dry with chamois leather.

To clean the outer parts of the engine use a degreaser, brushes and wipers.



Polish with silicone wax only after having carefully washed the vehicle.

Do not use polishing pastes on matt paints.

Do not wash the vehicle under the sun, especially during the summer, when the body is still warm, since if the shampoo dries before being rinsed away, it can damage the paint.

Do not use water (or liquids) at a temperature exceeding 40°C to clean the plastic components of the vehicle.

Use neither high pressure water/air jets, nor vapour jets on the following parts: wheel hubs, controls on the right and on the left side of the handlebar, bearings, brake pumps, instruments and indicators, silencer exhaust, glove/tool kit compartment, ignition switch/steering lock.

Do not use alcohol, petrol or solvents to clean the rubber and plastic parts and the saddle: use only water and mild soap.



Do not apply protection waxes onto the saddle, in order not to make it too slippery.

LONG PERIODS OF INACTIVITY

 If the vehicle remains unused for more than 20 days, disconnect the 20A fuse, in order to avoid the battery deterioration resulting from the current consumption due to the multi-function computer.

After a long period of inactivity of the vehicle some precautions are necessary to avoid any problem.

Further, it is important to carry out the necessary repairs and a general check up before the period of inactivity, since you could forget to carry them out later.

Proceed as follows:

- ◆ Empty the fuel tank and the carburettor, see p. 75 (DRAINING THE FUEL TANK).
- ◆ Extract the spark plug and pour a teaspoon (5-10 cm³) of two-stroke engine oil into the cylinder.
Move the ignition switch to position “○”, press the start push button “Ⓢ” for a few seconds, to distribute the oil evenly on the cylinder surfaces.
Put back the spark plug.

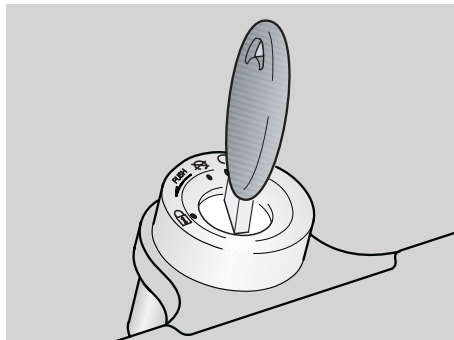

- ◆ Remove the battery, see p. 66 (REMOVING THE BATTERY) and p. 65 (LONG INACTIVITY OF THE BATTERY).
- ◆ Wash and dry the vehicle, see p. 76 (CLEANING).
- ◆ Polish the painted surfaces with wax.
- ◆ Inflate the tyres, see p. 33 (TYRES).
- ◆ By means of a suitable support, position the vehicle so that both tyres are raised from the ground.
- ◆ Place the vehicle in an unheated, not-humid room, away from sunlight, with minimum temperature variations.
- ◆ Cover the vehicle avoiding the use of plastic or waterproof materials.

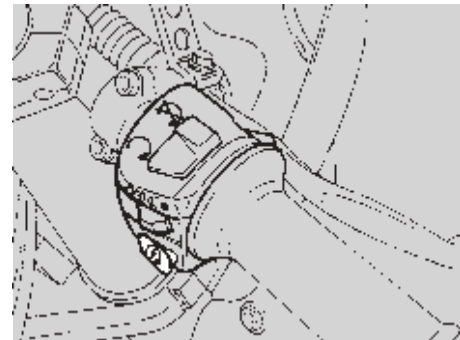

AFTER A PERIOD OF INACTIVITY

- ◆ Uncover and clean the vehicle, see p. 76 (CLEANING).
- ◆ Check the charge of the battery, see p. 67 (RECHARGING THE BATTERY) and install it, see p. 67 (INSTALLING THE BATTERY).
- ◆ Refill the fuel tank, see p. 25 (FUEL).
- ◆ Carry out the preliminary checking operations, see p. 35 (PRELIMINARY CHECKING OPERATIONS).



Have a test ride at moderate speed in a low-traffic area.

TECHNICAL DATA

DIMENSIONS	Max. length.....	1950 mm
	Max. length (rear mudguard extension included).....	2005 mm
	Max. width.....	720 mm
	Max. height (front part of the fairing included).....	1135 mm
	Seat height.....	805 mm
	Distance between centres.....	1345 mm
	Min. ground clearance.....	163 mm
	Weight ready for starting.....	139 kg
ENGINE	Type.....	one-cylinder, 2-stroke with laminar suction. Separate lubrication with variable strength automatic mixer (1.0 - 3.0 %).
	Number of cylinders.....	1
	Total displacement.....	124.82 cm ³
	Bore / stroke.....	54 mm / 54.5 mm
	Compression ratio.....	12.5 ± 0.5 : 1
	Starting.....	electric
	Engine idling rpm.....	1250 ± 100 rpm
	Clutch.....	multidisc in oil bath, with manual control on the left side of the handlebar.
	Cooling.....	liquid-cooled
CAPACITY	Fuel (reserve included).....	13 ℓ
	Fuel reserve.....	3.5 ℓ (mechanical reserve)
	Transmission oil.....	600 cm ³
	Transmission oil FP	600 cm ³
	Coolant.....	0.8 ℓ (50% water + 50% antifreeze with ethylene glycol)
	2 stroke oil (reserve included).....	1.4 ℓ
	2 stroke oil reserve.....	0.35 ℓ
	Front fork oil.....	430 cm ³ (for each rod)
	Seats.....	2
	Vehicle max. load (driver + passenger + luggage).....	180 kg

TRANSMISSION	Type.....	mechanical, 6 gears with foot control on the left side of the engine			
GEAR RATIOS	Ratio	Primary	Secondary	Final ratio	Total ratio
	1st	19/63 = 1 : 3.315	10 / 30 = 1: 3.000	17 / 40 = 1 : 2.353	1 : 23.406
	2nd		14 / 29 = 1: 2.071		1 : 16.161
	3rd		17 / 27 = 1: 1.588		1 : 12.391
	4th		19 / 25 = 1: 1.316		1 : 10.266
	5th		21 / 24 = 1: 1.143		1 : 8.916
	6th		22 / 23 = 1: 1.045		1 : 8.156
CARBURETTOR	Number.....	1			
	Model.....	DELL'ORTO PHBH 28			
FUEL SUPPLY	Fuel.....	unleaded petrol according to the DIN 51607 standard, min. O.N. 95 (N.O.R.M.) and 85 (N.O.M.M.)			
FRAME	Type.....	two-beam, with cast and stamped sheet elements			
	Steering inclination angle	25° 30'			
	Fore stroke	102 mm			
SUSPENSIONS	Front.....	hydraulically operated telescopic fork			
	Stroke	120 mm			
	Rear.....	hydraulic adjustable mono-shock absorber			
	Stroke	44.5 mm			
BRAKES	Front.....	disc brake - Ø 320 mm - with hydraulic transmission			
	Rear.....	disc brake - Ø 220 mm - with hydraulic transmission			
WHEEL RIMS	Type.....	light alloy			
	Front.....	3.00 x 17"			
	Rear.....	4.00 x 17"			

TYRES	FRONT.....	100/80 17" 52S; 110/70 R 17" 54T; 100/80 ZR 17"
	- Inflation pressure for solo rider	180 kPa (1.8 bar)
	- Inflation pressure for rider and passenger	180 ± 10 kPa (1.8 ± 0.1 bar)
	REAR	130/70 17" 62S; 140/60 ZR 17"; 150 / 60 ZR 17"
	- Inflation pressure for solo rider	200 kPa (2.0 bar)
	- Inflation pressure for rider and passenger	230 ± 10 kPa (2.3 ± 0.1 bar)
IGNITION	Type	CDI
	Spark advance	12° ± 2° to 2000 rpm
SPARK PLUG	Standard	NGK R BR8ES
	Standard FP	NGK BR10EG
	Spark plug gap.....	0.7 ÷ 0.8 mm
ELECTRIC SYSTEM	Battery.....	12 V - 9 Ah
	Fuses	20 - 15 - 7.5 A
	Generator	12 V - 180 W
BULBS	Low beam (halogen)	12 V - 55 W H1
	High beam (halogen)	12 V - 55 W H3
	Parking light	12 V - 5 W
	Direction indicators	12 V - 10 W
	Rear parking light/ number plate light/stoplight	12 V - 5 / 21 W
	Revolution counter	12 V - 2 W
	Speedometer	12 V - 2 W
	Multifunction display.....	12 V - 3 W
WARNING LIGHTS	Neutral	12 V - 2 W
	Direction indicators	12 V - 2 W
	High beam.....	12 V - 2 W
	Stand down	12 V - 2 W
	2 stroke oil reserve	LED

LUBRICANT CHART

Gearbox oil (recommended):  F.C., SAE 75W - 90 or  GEAR SYNTH, SAE 75W - 90.





As an alternative to the recommended oil, it is possible to use high-quality oils with characteristics in compliance with or superior to the A.P.I. GL-4 specifications.

Mixer oil (recommended):  MAX 2T COMPETITION or  SPEED 2T.

As an alternative to the recommended oil, use high-quality oils with characteristics in compliance with or superior to the ISO-L-ETC++, A.P.I. TC++ specifications.

Fork oil (recommended):  F.A. 5W or  F.A. 20W fork oil;

an alternative  FORK 5W or  FORK 20W fork oil.

If you need an oil with intermediate characteristics in comparison with the  F.A. 5W and  F.A. 20W or  FORK 5W and  FORK 20W, these can be mixed as indicated below:

SAE 10W =  F.A. 5W 67% of the volume +  F.A. 20W 33% of the volume, or
 FORK 5W 67% of the volume +  FORK 20W 33% of the volume;

SAE 15W =  F.A. 5W 33% of the volume +  F.A. 20W 67% of the volume, or
 FORK 5W 33% of the volume +  FORK 20W 67% of the volume.

Bearings and other lubrication points (recommended):  AUTOGREASE MP or  GREASE 30.

As an alternative to the recommended product, use high-quality grease for rolling bearings, working temperature range -30°C.... +140°C, dripping point 150°C... 230°C, high protection against corrosion, good resistance to water and oxidation.

Protection of the battery poles: neutral grease or vaseline.

Spray grease for chains (recommended):  CHAIN SPRAY or  CHAIN LUBE.

WARNING

Use new brake fluid only.

Brake fluid (recommended):  F.F., DOT 5 (DOT 4 compatible) or  BRAKE 5.1, DOT 5 (DOT 4 compatible).

WARNING

Use only antifreeze and anticorrosive without nitrite, ensuring protection at -35°C at least.

Engine coolant (recommended):  ECOBLU - 40°C or  COOL.

- I APRILIA s.p.a.** via G. Galilei, 1 - 30033 Noale (VE) Italy
Tel. +39(0)41 5829111 - Fax +39(0)41 441054 - Servizio Clienti **aprilia** +39(0)41 5786269
- F APRILIA WORLD SERVICE B.V.** Z.A. Central Parc - 255 BLD Robert Ballanger
B.P. 77- 93421 Villepinte (F) - Tel. (0) 149634747 - Fax (0) 149638750
- D MOTORRAD GmbH** Am Seestern 3 D-40547 Düsseldorf (D)
Tel. (211) 59018-00 - Fax (211) 5901819
- E APRILIA WORLD SERVICE B.V. ESPAÑA** Avda. de Aragón, 334 - Edificio América - 28022 - Madrid (E)
Tel. 91 7460066 - Fax 91 7460062
- NL APRILIA NEDERLAND** Nikkelstraat 1 - 4823 AE Breda (NL)
Tel. (076) 5431640 - Fax (076) 5431649
- UK APRILIA MOTO U.K. LTD.** Dunragit - Stranraer - Wigtownshire DG9 8PN - Scotland (UK)
Tel. (01776) 888670 - Fax (01581) 400661 - E-mail: aprilia@aol.com
- USA APRILIA USA Inc.** 110 Londonderry Court, Suite 130 - Woodstock, GA 30188 (USA)
Tel. 770 592 2261 - Fax 770 592 4878
- A GINZINGER IMPORT GmbH & CO** Frankenburgerstrasse 19 - 4910 Ried im Innkreis (A)
Tel. (7752) 88077 - Fax (7752) 70684 - E-mail: elke.ginzinger@ivnet.co.at
- P MILFA IMPORTAÇÃO EXPORTAÇÃO LDA.** Avenida da Republica 692 - 4450-238 Matosinhos (P)
Tel. 229382450 - Fax 229371305 - E-mail: milfa@meganet.pt
- SF TUONTI NAKKILA OY** P.o.B. 18 - 29250 Nakkila (SF)
Puh. (02) 5352500 - Fax (02) 5372793 - E-mail: varaosat@npm.fi
- B RAD n.v. / s.a.** Industriegebied - Landegemstraat 4 - B - 9031 Drongen-Baarle
Tel. (09) 2829410 - Fax (09) 2829433 - E-mail: aprilia@rad.be
- GR MOBILITY S.A.** Lahana 12 N. Filadelfia - 143 42 Athens (GR)
Tel. (1) 2723552 - Fax (1) 271478 - E-mail: mobility@internet.gr
- GR MOBILITY A.E.** Λασανα 12 Ν. Φιλαδέλφια - 143 42 Αθήνα - Ελλάδα
Τηλ. (1) 2723552 - Φαξ (1) 271478 - E-mail: mobility@internet.gr
- CH MOHAG AG** Bernerstrasse Nord 202 - 8064 Zurich (CH)
Tel. (1) 4348686 - Fax (1) 4348606 - E-mail: info@mohag.ch
- DK S T.M.P.** Islandsvej 3 - 7900 Nykøbing Mors (DK)
Tel 97722233 - Fax 97722133 - E-mail: t_m_p@post4.tele.dk
- J BOSCO MOTO CO. LTD.** 22-25 Hakunoshima 2 Chome Minoo-Shi 562 Osaka
562-0012 OSAKA (J) - Tel. (0727) 253311 - Fax (0727) 253322
- J 株式会社ボスコモーター** 〒562-0012大阪府箕面市白鳥2丁目22番2号
電話：0727253311・FAX：0727253322
- SGP IDEAL MOTOR SPORT PTE. LTD.** 20 Mactaggart Road, #01-01 Khong Guan Industrial Building 368079 Singapore (SGP)
Tel. 2820082 - Fax 2821012 - E-mail: idealmtr@mbox4.singnet.com.sg
- H MILLE MOTOR KFT.** H-1054 - Budapest - Hold u. 23. (H)
Tel. +36 1 301 0021 - Fax +36 1 301 0021 - E-mail: aprilia@apriliamotor.hu

Importers

PL MOTO SP. ZOO Ul. Trakt Lubelski 298 B - 04-667 Warszawa (PL)
Tel. (22) 121183 - Fax (22) 121183

IL METRO MOTOR MARKETING LTD. 12, Tushia Street - P.O. BOX 57266 - 61572 - Israel - Tel-Aviv (IL)
Tel. (3) 5623951 - Fax (3) 5623950 - E-mail: metro@inter.net.il

ROK BIKE KOREA CO., LTD. YeungSoo BLDG 302 #206-25, Ohjang-dong, Chung-ku, Seoul (ROK)
Tel. (02) 2275-6130/1 - Fax. (02) 2275-6132 - E-mail: kukbike@yahoo.co.kr

MAL GENTALI MALAYSIA SDN BHD Unit B-1-8 Megan Phileo Promenade 189 Jalan Tun Razak - 50400 - Kuala Lumpur (MAL)
Tel.(603) 21649800 - Fax. (603) 21649700

RCH HARLEY DAVIDSON SANTIAGO Isidora Goyenechea 2926 - Santiago (RCH)
Tel. (2) 2321667 - Fax (2) 2321894

BM EVE'S CYCLES LTD. 114, Middle Road - PG BX Paget (BM)
Tel. (441) 2366247 - Fax (441) 2366996

BR APRILIA-BRASIL Av. Europa, 352 - Jardim Europa - 01449-001 Sao Paulo-SP (BR)
Tel. (11) 30691220 - Fax. (11) 30691221 - E-mail: hjdeki@aprilia.com.br

AUS JOHN SAMPLE GROUP PTY LTD. 8, Sheridan Close - NSW 2214 - Milperra - Sydney (AUS)
Tel. (2) 97722666 - Fax (2) 97742321 - E-mail: jcaruso@jsg.com.au

RSA MOTOVELO S.A. Old Pretoria Road - Wynberg - Johannesburg (RSA)
Tel. (11) 7868486 - Fax (11) 7868482 - E-mail: motovelo@betech.co.za

NZ MOTORCYCLING DOWNUNDER LTD. 35, Manchester Street - P.o.B. 22416 - Christchurch (NZ)
Tel. (3) 3660129 - Fax (3) 3667580 - E-mail: guzzi@motorcycling-nz.co.nz

HR ING-KART, d.o.o. Miroslava Magdalenica, 1 - 10000 Zagreb (HR)
Tel. (1) 3491107 / 3491091 - Fax (1) 3491555 - E-mail: ing-kart@zg.tel.hr

SLO AVTO TRIGLAV, d.o.o. Baragova 5 - 1113 Ljubljana (SLO)
Tel. (61) 1883420 - Fax (61) 1883465 - E-mail: ziga.martincic@avto-triglav.si

M BIKES & COMPANY LTD. 178, Marina Street, Pieta. MSD 08. (M) - Tel. (+356) 236 665 - Fax (+356) 239 368

TR METRO MOTORLU ARACLAR TICARET A.S. Mıhrabat Caddesi Akbey Sokak Yetimoglu Is Merkezi - 81640 - Kavacik-Istanbul (TR) - Tel. (0216) 4251565 - Fax (0216) 3312606

CZ A. SPIRIT a.s. Sluzeb 5 - 10800 Praha 10 (CZ)
Tel. +420-2-72703049 - Fax. +420-2-72702156 - E-mail: office@aspirit.cz

IRL K.D.I. KAWASAKI DISTRIBUTOR IRL. LTD. 17 Wood Street - Dublin 8 (IRL)
Tel. (1) 4756046 - Fax. (1) 4756461

N HARO SKANDINAVIA A.S. Kjørbekkdalen 6 - 3735 - Skien, Norway (N)
Tel. 35506780 - Fax. 35506781 - E-mail: post@aprilia.no

MEX APRILIA DE MEXICO, SA. de CV. San Jeronimo - 64640 - 552 Monterrey N.L. (MEX)
Tel. 8333-4493 - Fax. 8348-9398 - E-mail: javier@aprilia.com.mx

WIRING DIAGRAM - RS 125

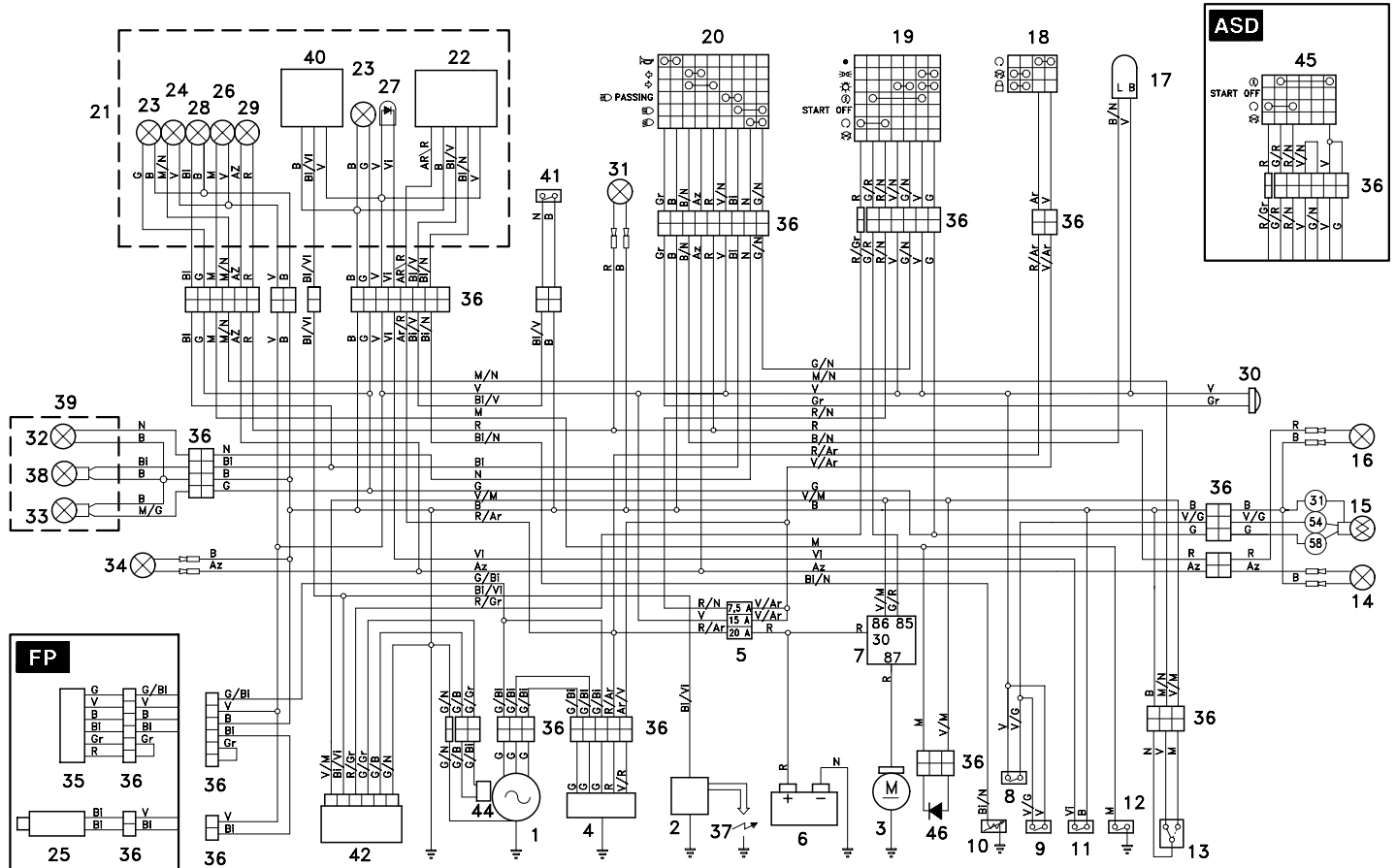

WIRING DIAGRAM KEY - RS 125

- 1) Generator
- 2) Ignition coil
- 3) Starter
- 4) Voltage regulator
- 5) Fuses
- 6) Battery
- 7) Start relay
- 8) Front stoplight switch
- 9) Rear stoplight switch
- 10) Coolant temperature thermistor
- 11) 2 stroke oil reserve sensor
- 12) Neutral switch sensor
- 13) Side stand switch
- 14) Rear left direction indicator
- 15) Rear light
- 16) Rear right direction indicator
- 17) Blinking
- 18) Ignition switch
- 19) Right dimmer switch
- 20) Left dimmer switch
- 21) Complete dashboard
- 22) Multifunction display
- 23) Dashboard bulbs
- 24) Side stand down warning light
- 25) Solenoid **FP**
- 26) Neutral warning light
- 27) 2 stroke oil reserve warning light LED
- 28) High beam warning light
- 29) Direction indicator warning light
- 30) Horn
- 31) Front right direction indicator
- 32) Low beam bulb
- 33) Front parking light
- 34) Front left direction indicator
- 35) RAVE unit **FP**
- 36) Multiple connectors
- 37) Spark plug
- 38) High beam bulb
- 39) Headlight
- 40) Electronic revolution counter
- 41) LAP push button
- 42) CDI
- 44) Pick up
- 45) Right dimmer switch **ASD**
- 46) Diode

CABLE COLOURS

- Ar** Orange
Az Light blue
B Blue
BI White
G Yellow
Gr Grey
M Brown
N Black
R Red
V Green
Vi Violet

NOTE

aprilia

ASK FOR GENUINE SPARE PARTS ONLY

NOTE

aprilia

ASK FOR GENUINE SPARE PARTS ONLY

aprilia s.p.a. wishes to thank its customers for the purchase of this vehicle.

- Do not dispose of oil, fuel, polluting substances and components in the environment.
- Do not keep the engine running if it isn't necessary.
- Avoid disturbing noises.
- Respect nature.