

# aprilia

## RALLY 50



aprilia part# 8202351

# use+maintenancebook



© 2002 **aprilia SpA** - Noale (VE)

This manual is to be considered an integral part of the vehicle, which must be delivered complete with it also in case of resale.

**aprilia s.p.a.** reserves the right to modify its models at any time, without prejudice to the main characteristics here described.

All rights as to electronic storage, reproduction and total or partial adaptation, with any means, are reserved for all Countries.

The mention to products or services supplied by third parties is made only for information purposes and is not binding in any case.

**aprilia s.p.a** takes no responsibility as to the performance or the use of said products.

First edition: december 2002

Reprint:

Produced and printed by:

**stp** editing division  
Soave (VERONA) - Italy  
Tel. +39 - 045 76 11 911  
Fax +39 - 045 76 12 241  
E-mail: customer@stp.it  
www.stp.it

On behalf of:

**aprilia s.p.a.**  
via G. Galilei, 1 - 30033 Noale (VE) - Italy  
Tel. +39 - 041 58 29 111  
Fax +39 - 041 44 10 54  
www.aprilia.com

## FOREWORD

Before starting the engine, carefully read this manual, paying particular attention to the chapter "RIDING SAFELY". Your and other people's safety depends not only on your quickness of reflexes and on your agility, but also on what you know about the vehicle, on its efficiency and on your knowledge of the basic information for RIDING SAFELY.

Therefore, get a thorough knowledge of the vehicle, in such a way as to be able to drive in the traffic safely.

For the controls and repairs not expressly described in this manual, for the purchase of **aprilia** Genuine Spare Parts, accessories and other products, as well as for specific technical advice, contact only **aprilia** Authorized Outlets and Official Dealers, who can ensure you reliable and prompt servicing.

Thank you for choosing **aprilia**. We wish you a nice ride.

Carefully observe the instructions preceded by the following warning signs:



**Safety norms and regulations to protect the driver and other people from severe injuries or grave risks.**



**Indications to make the operations easier. Technical information.**

★ **The operations preceded by this symbol must be repeated on the opposite side of the vehicle.**

**IMPORTANT:**

When asking your Dealer for spare parts, specify the spare parts code indicated on the SPARE PARTS IDENTIFICATION LABEL.

Write down the identification code in the space here below, in order to remember it also in case of loss or deterioration of the label.

The label is positioned under the saddle.

<b>aprilia</b>		YEAR		Y	1	2	3	4	
<b>SPARE PARTS IDENTIFICATION</b>		I.M.		A	B	C	D	E	
I	UK	A	P	SF	B	D	F	E	GR
NL	CH	DK	J	SGP	SLO	IL	ROK	MAL	RCH
HR	AUS	USA	BR	RSA	NZ	CDN			

In this manual the various versions are indicated by the following symbols:

**VERSION:**

- |            |                |            |                          |
|------------|----------------|------------|--------------------------|
| <b>I</b>   | Italy          | <b>SLO</b> | Slovenia                 |
| <b>UK</b>  | United Kingdom | <b>IL</b>  | Israel                   |
| <b>A</b>   | Austria        | <b>ROK</b> | South Korea              |
| <b>P</b>   | Portugal       | <b>MAL</b> | Malaysia                 |
| <b>SF</b>  | Finland        | <b>RCH</b> | Chile                    |
| <b>B</b>   | Belgium        | <b>HR</b>  | Croatia                  |
| <b>D</b>   | Germany        | <b>AUS</b> | Australia                |
| <b>F</b>   | France         | <b>USA</b> | United States of America |
| <b>E</b>   | Spain          | <b>BR</b>  | Brazil                   |
| <b>GR</b>  | Greece         | <b>RSA</b> | South Africa             |
| <b>NL</b>  | Holland        | <b>NZ</b>  | New Zealand              |
| <b>CH</b>  | Switzerland    | <b>CDN</b> | Canada                   |
| <b>DK</b>  | Denmark        |            |                          |
| <b>J</b>   | Japan          |            |                          |
| <b>SGP</b> | Singapore      |            |                          |

# TABLE OF CONTENTS

<b>SAFE DRIVE</b> .....	5	<b>REGULAR SERVICE</b>	
BASIC SAFETY RULES .....	6	INTERVALS CHART .....	42
CLOTHING .....	12	IDENTIFICATION DATA .....	44
ACCESSORIES .....	13	AIR CLEANER .....	46
LOAD .....	14	CHECKING THE TRANSMISSION OIL LEVEL .....	48
<b>ARRANGEMENT OF THE MAIN ELEMENTS</b> .....	16	CHANGING THE TRANSMISSION OIL .....	49
<b>ARRANGEMENT OF THE INSTRUMENTS</b> .....	17	FRONT WHEEL .....	50
<b>INSTRUMENTS AND INDICATORS</b> .....	18	EXHAUST SILENCER .....	52
INSTRUMENT AND INDICATOR TABLE .....	19	REAR WHEEL .....	54
<b>MAIN INDEPENDENT CONTROLS</b> .....	20	GREASING THE REAR BRAKE CAM PIN .....	55
CONTROLS ON THE LEFT SIDE OF THE HANDLEBAR .....	20	CHECKING THE BRAKE PAD WEAR .....	57
CONTROLS ON THE RIGHT SIDE OF THE HANDLEBAR .....	21	CHECKING THE BRAKE SHOE WEAR .....	58
IGNITION SWITCH .....	22	CHECKING THE STEERING .....	59
STEERING LOCK .....	22	CHECKING THE ENGINE FULCRUM AXIS .....	59
<b>AUXILIARY EQUIPMENT</b> .....	23	REMOVING THE INSPECTION COVER .....	60
UNLOCKING/LOCKING THE SADDLE .....	23	REMOVING THE FRONT HANDLEBAR COVER .....	61
CRASH HELMET / GLOVE COMPARTMENT .....	23	IDLING ADJUSTMENT .....	62
BATTERY / TOOL KIT COMPARTMENT .....	24	ADJUSTING THE ACCELERATOR CONTROL .....	63
BAG HOOK .....	24	SPARK PLUG .....	64
<b>MAIN COMPONENTS</b> .....	25	BATTERY .....	65
FUEL .....	25	LONG INACTIVITY OF THE BATTERY .....	66
MIXER OIL TANK .....	26	CHECKING THE ELECTROLYTE LEVEL .....	67
BRAKE FLUID (recommendations) .....	27	CHANGING THE FUSE .....	68
FRONT BRAKE .....	27	ADJUSTING THE HEADLIGHT BEAM .....	69
TOPPING UP .....	28	BULBS .....	69
REAR BRAKE .....	29	CHANGING THE HEADLIGHT BULBS .....	70
TYRES .....	30	CHANGING THE FRONT DIRECTION INDICATOR BULBS .....	72
AUTOMATIC LIGHT SWITCHING VERSION .....	31	CHANGING THE REAR DIRECTION INDICATOR BULBS .....	73
CATALYTIC SILENCER .....	31	CHANGING THE DASHBOARD BULBS .....	74
<b>INSTRUCTIONS FOR USE</b> .....	32	CHANGING THE REAR LIGHT BULBS .....	75
PRELIMINARY CHECKING OPERATIONS .....	33	<b>TRANSPORT</b> .....	76
STARTING .....	34	DRAINING THE FUEL TANK .....	76
DEPARTURE AND DRIVE .....	36	<b>CLEANING</b> .....	77
RUNNING-IN .....	37	LONG PERIODS OF INACTIVITY .....	78
STOPPING AND PARKING .....	38	AFTER A PERIOD OF INACTIVITY .....	78
POSITIONING THE VEHICLE		<b>TECHNICAL DATA</b> .....	79
ON THE STAND .....	38	LUBRICANT CHART .....	81
SUGGESTIONS TO PREVENT THEFT .....	39	Importers .....	82-83
ANTI-THEFT HOOK .....	40	WIRING DIAGRAM - Rally 50 .....	84
<b>MAINTENANCE</b> .....	41	WIRING DIAGRAM KEY - Rally 50 .....	85

# aprilia



safe drive

## BASIC SAFETY RULES

To drive the vehicle it is necessary to be in possession of all the requirements prescribed by law (driving licence, minimum age, psychophysical ability, insurance, state taxes, vehicle registration, number plate, etc.).

Gradually get to know the vehicle by driving it first in areas with low traffic and/or private areas.

The use of medicines, alcohol and drugs or psychotropic substances notably increases the risk of accidents.

Be sure that you are in good psychophysical conditions and fit for driving and pay particular attention to physical weariness and drowsiness.

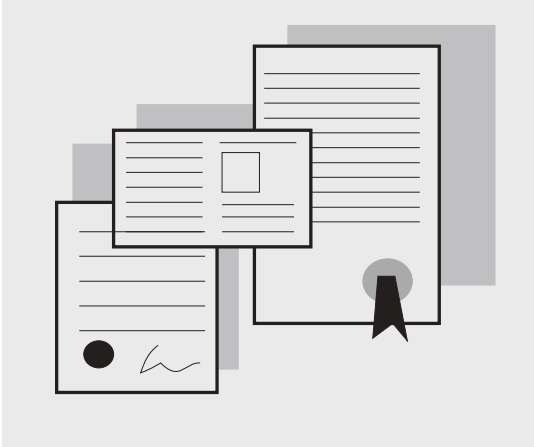

Most road accidents are caused by the driver's lack of experience.

**NEVER** lend the vehicle to beginners and, in any case, make sure that the driver has all the requirements for driving.

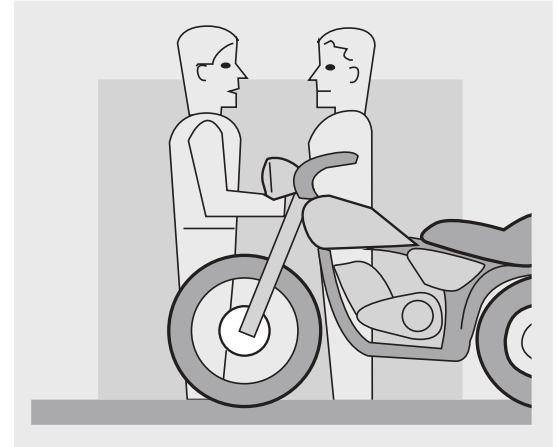

Rigorously observe all road signs and national and local road regulations.

Avoid abrupt movements that can be dangerous for yourself and other people (for example: rearing up on the back wheel, speeding, etc.), and give due consideration to the road surface, visibility and other driving conditions.

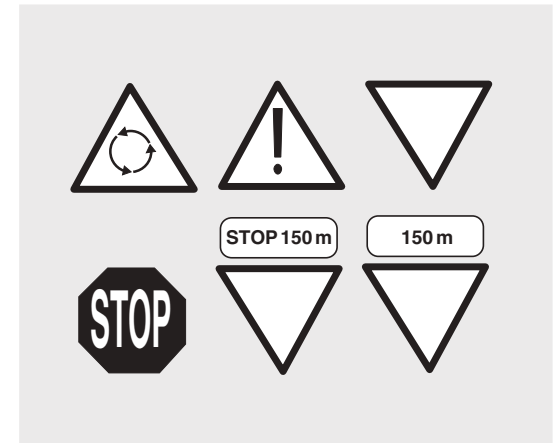

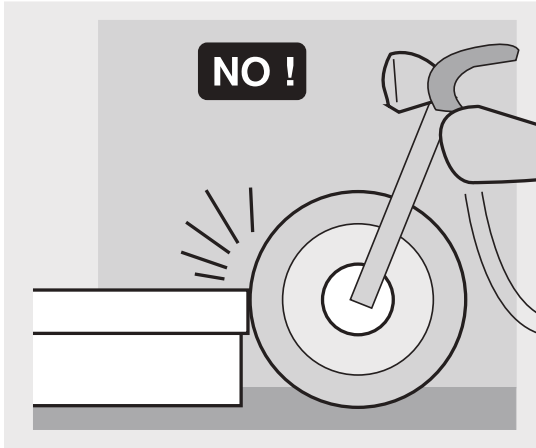

Avoid obstacles that could damage the vehicle or make you lose control.

Avoid riding in the slipstream created by preceding vehicles in order to increase your speed.

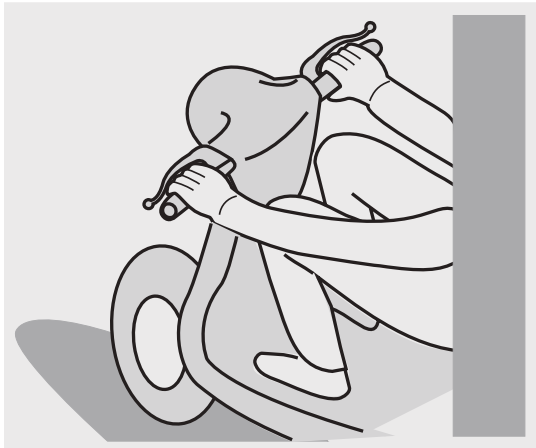

Always drive with both hands on the handlebars and both feet on the footrests, in the correct driving posture.

Avoid standing up or stretching your limbs while driving.



The driver should pay attention and avoid distractions caused by people, things and movements (never smoke, eat, drink, read, etc.) while driving.



Use only the vehicle's specific fuels and lubricants (indicated in the "LUBRICANT CHART"); check all oil, fuel and coolant levels regularly.

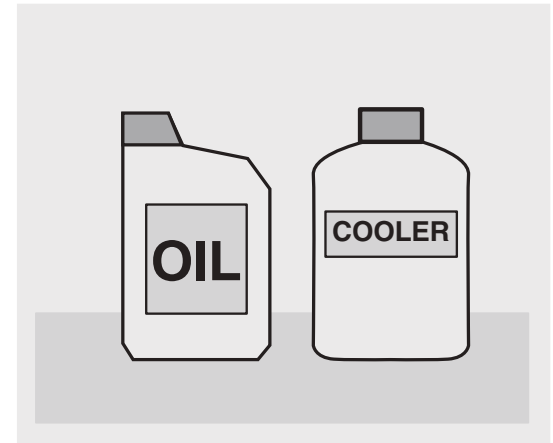

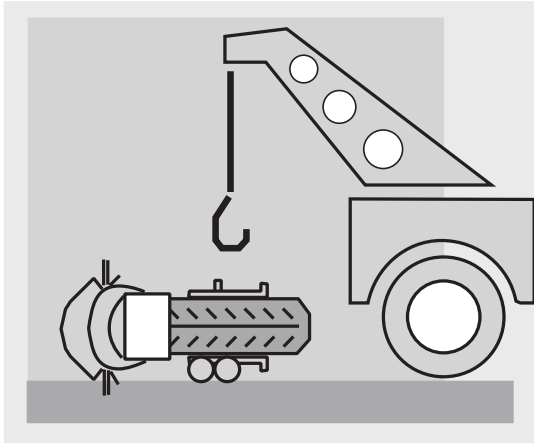

If the vehicle has been involved in an accident, make sure that no damage has occurred to the control levers, pipes, wires, braking system and vital parts.

If necessary, have the vehicle inspected by an **aprilia** Official Dealer, who should carefully check the frame, handlebars, suspensions, safety parts and all the devices that you cannot check by yourself.

Always remember to report any malfunction to the technicians to help them in their work.

Never use the vehicle when the amount of damage it has suffered endangers your safety.

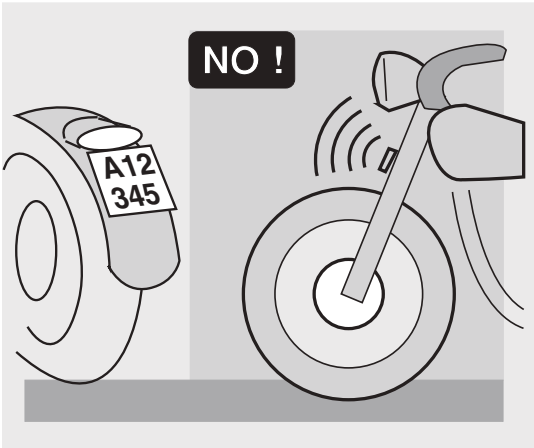

Never change the position, inclination or colour of: number plate, direction indicators, lights and horns.

Any modification of the engine or of other members which is aimed at increasing the speed or the power of the vehicle is prohibited by the law; in fact, any modification resulting in an increase of the maximum speed or of the engine displacement would change the scooter into a motorcycle, which implies the following obligations for the owner:

- new homologation;
- new registration;
- appropriate driving license.

Further, said modifications cause the loss of the insurance cover, since insurance policies expressly prohibit to make technical changes aimed at increasing the vehicle performance levels.

For the reasons stated above, the failure to comply with the tampering prohibition is punished by law with apposite sanctions (including the confiscation of the vehicle), which, according to the case, can be combined with the sanctions provided for not using the crash helmet and/or the number plate, for the violation of fiscal obligations (ownership tax) and with penal sanctions provided for using the vehicle without driving license.

Never race with other vehicles.

Avoid off-road driving.

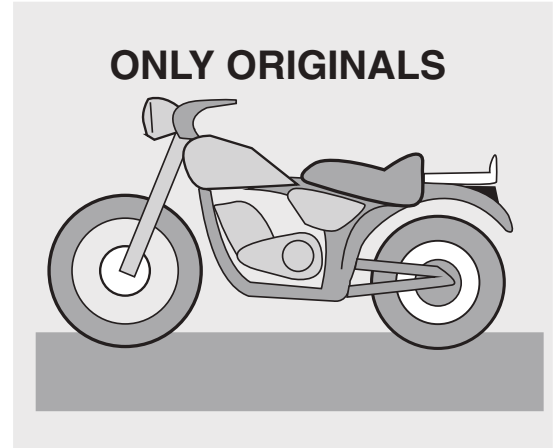

## CLOTHING

Before starting, always wear a correctly fastened crash helmet. Make sure that it is homologated, in good shape, of the right size and that the visor is clean.

Wear protective clothing, preferably in light and/or reflecting colours. In this way you will make yourself more visible to the other drivers, thus notably reducing the risk of being knocked down, and you will be more protected in case of fall.

This clothing should be very tight-fitting and fastened at the wrists and ankles. Strings, belts and ties should not be hanging loose; prevent these and other objects from interfering with driving by getting entangled with moving parts or driving mechanisms.

Do not keep objects that can be dangerous in case of fall, for example pointed objects like keys, pens, glass vials etc. in your pockets (the same recommendations also apply to passengers).

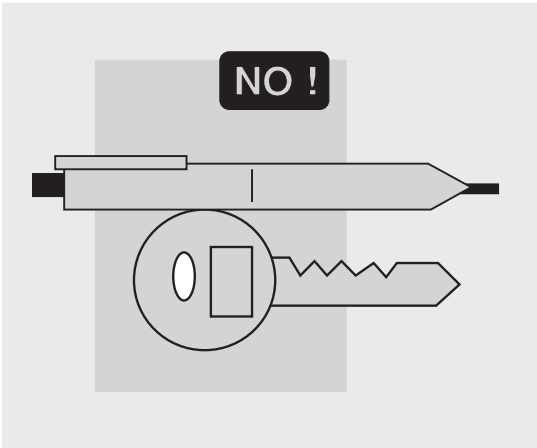
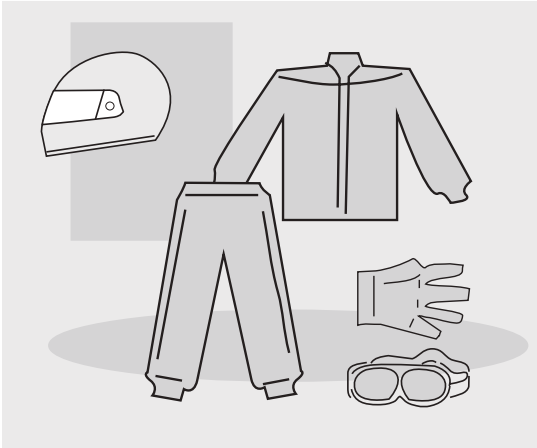

## ACCESSORIES

The owner of the vehicle is responsible for the choice, installation and use of any accessory.

Avoid installing accessories that cover horns or lights or that could impair their functions, limit the suspension stroke and the steering angle, hamper the operation of the controls and reduce the distance from the ground and the angle of inclination in turns.

Avoid using accessories that hamper access to the controls, since this can prolong reaction times during an emergency.

Large fairings and windscreens assembled on the vehicle can produce aerodynamic forces capable of compromising the stability of the vehicle while driving.

Make sure that the equipment is well fastened to the vehicle and not dangerous during driving.

Do not install electrical devices and do not modify those already existing to avoid electrical overloads, because the vehicle could suddenly stop or there could be a dangerous current shortage in the horn and in the lights. **aprilia** recommends the use of “**aprilia** genuine accessories”.

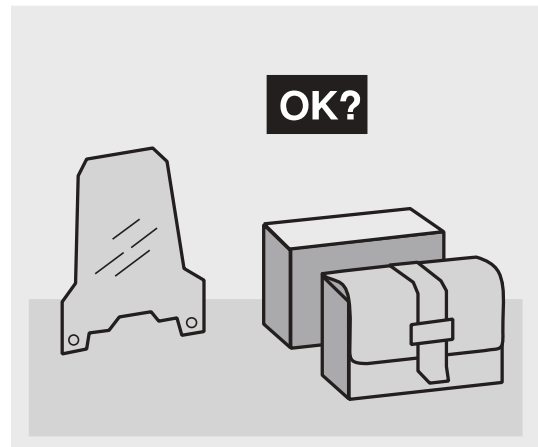

## LOAD

Be careful and moderate when loading your luggage.

Keep any luggage loaded as close as possible to the centre of the vehicle and distribute the load uniformly on both sides, in order to reduce imbalance to the minimum.

Furthermore, make sure that the load is firmly secured to the vehicle, especially during long trips.

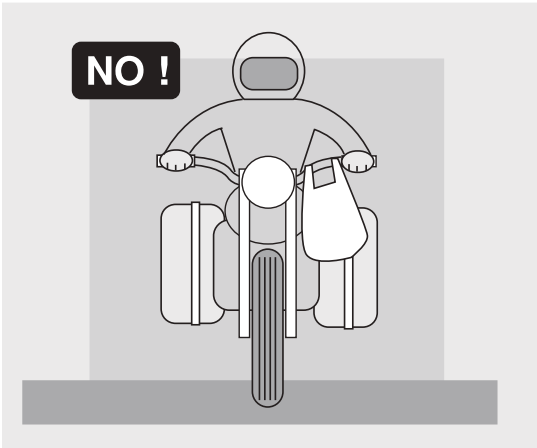
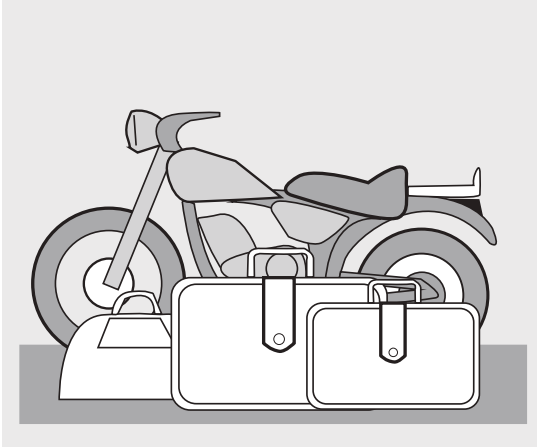

Avoid hanging bulky, heavy and/or dangerous objects on the handlebars, mudguards and forks, because the vehicle might respond more slowly in turns and its manoeuvrability could be unavoidably impaired.

Do not place bags that are too bulky on the vehicle sides and do not ride with the crash helmet hanging from its string, because it could hit people or obstacles making you lose control of the vehicle.

Do not carry any bag if it is not tightly secured to the vehicle.

Do not carry bags which protrude too much from the luggage-rack or which cover the lights, horn or indicators.

Do not carry animals or children on the glove compartment or on the luggage-rack.

Do not exceed the maximum load allowed for each side-bag.

When the vehicle is overloaded, its stability and its manoeuvrability can be compromised.

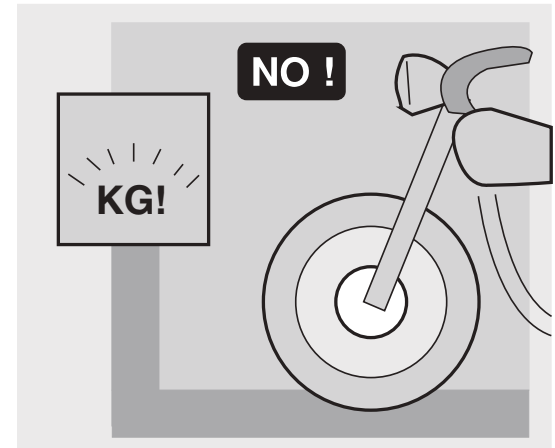
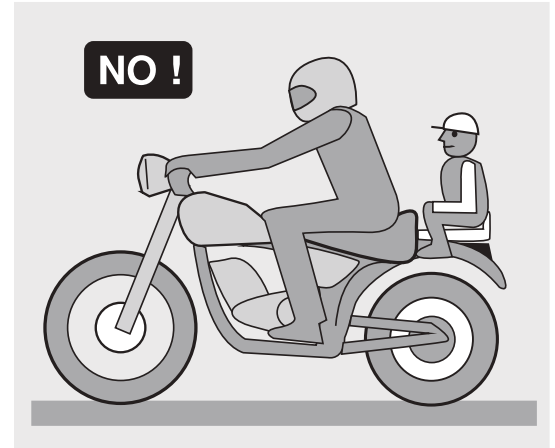

## ARRANGEMENT OF THE MAIN ELEMENTS

### KEY Fig. 1

- 1) Mixer oil tank plug
- 2) Ignition switch/steering lock
- 3) Front brake fluid reservoir
- 4) Bag hook
- 5) Battery/tool kit compartment
- 6) Inspection cover
- 7) Anti-theft hook

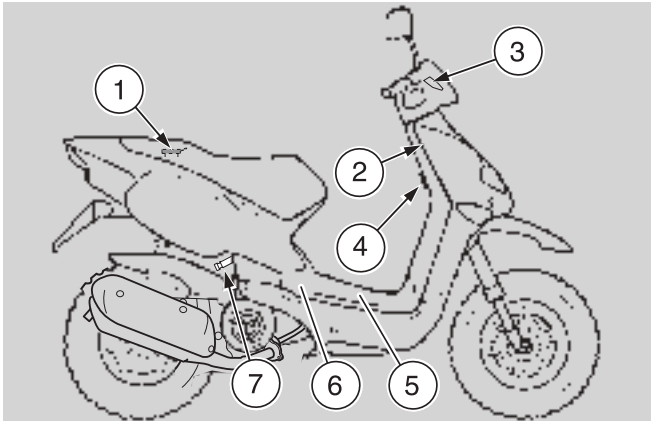

Fig. 1

### KEY Fig. 2

- 1) Fuel tank plug
- 2) Saddle lock
- 3) Transmission oil filling cap
- 4) Kick starter
- 5) Centre stand

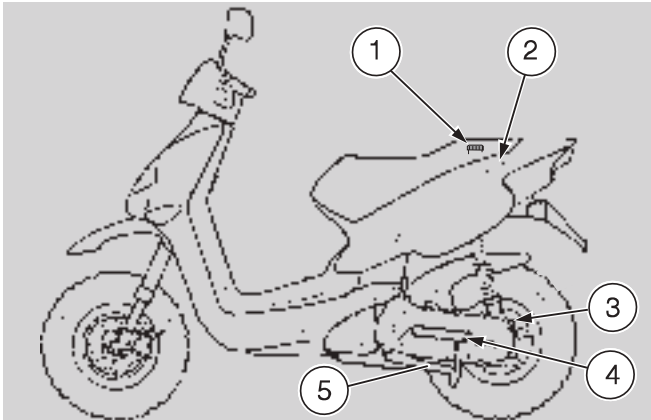

Fig. 2



## ARRANGEMENT OF THE INSTRUMENTS

### KEY Fig. 3

- 1) Horn push button (📢)
- 2) Cold start lever (|↘|)
- 3) Rear brake lever
- 4) Rear-view mirror
- 5) Direction indicator switch (↔↔)
- 6) Instruments and indicators
- 7) Front brake lever
- 8) Throttle grip
- 9) Start push button (🔌)
- 10) Ignition switch/steering lock (○ - 🔒 - 🚪)

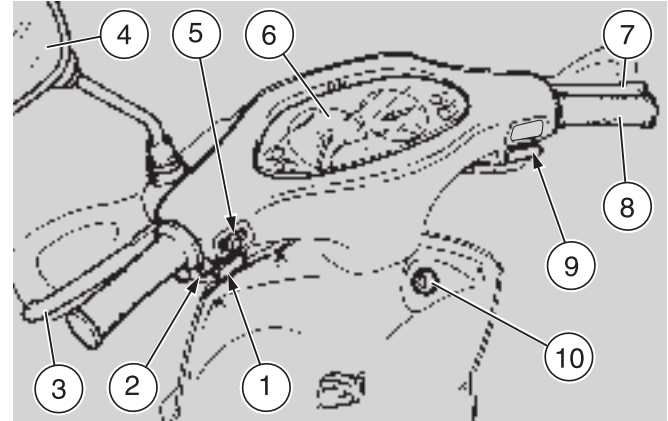
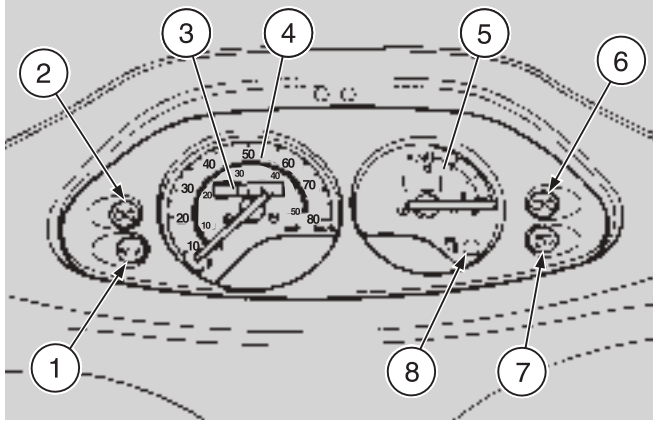

Fig. 3







**Fig. 4**

## **INSTRUMENTS AND INDICATORS**

### **KEY (Fig. 4)**

- 1) Red mixer oil reserve warning light (⚠)
- 2) Green left direction indicator warning light (↔)
- 3) Total kilometres odometer
- 4) Speedometer
- 5) Amber low fuel warning light (⚠)
- 6) Green right direction indicator warning light (↔)
- 7) Green low beam warning light (⚠)
- 8) Fuel level indicator (⚠)

## INSTRUMENT AND INDICATOR TABLE

Description	Function
<b>Mixer oil reserve warning light</b> 	<p>It comes on when the ignition switch is in position "○" and the start push button "⊗" is pressed, thus checking the proper functioning of the bulb.</p> <p>If the light does not come on during the starting, provide for replacing the bulb.</p> <p> <b>If the warning light comes on and does not go out after the start push button "⊗" has been released, or if it comes on during normal functioning, this means that the mixer oil reserve is being used; in this case, top up the mixer oil tank, see p. 26 (MIXER OIL TANK).</b></p>
<b>Direction indicator warning light</b> 	<p>It blinks when the direction indicators are on.</p>
<b>Total kilometres odometer</b>	<p>It indicates the total number of kilometres covered.</p>
<b>Speedometer</b>	<p>It indicates the driving speed.</p>
<b>Fuel level indicator</b>	<p>It indicates the approximate fuel level in the tank.</p>
<b>Low beam warning light</b> 	<p>It comes on whenever the ignition switch is turned to position "○".</p>
<b>Low fuel warning light</b> 	<p>It comes on when the quantity of fuel left in the tank is about 1,5 ℓ.</p>

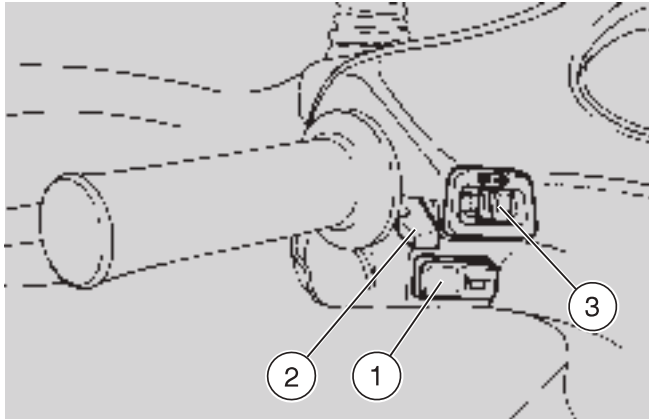

**Fig. 5**

## **MAIN INDEPENDENT CONTROLS**

### **CONTROLS ON THE LEFT SIDE OF THE HANDLEBAR (Fig. 5)**

 The electrical parts work only when the ignition switch is in position “O”.

- 1) **HORN PUSH BUTTON** (🔊)  
The horn is activated when the push button is pressed.
- 2) **COLD START LEVER** (⏴)  
The starter for the cold start of the engine is operated by rotating the lever downwards.  
To disconnect the cold start, bring the lever to its initial position.
- 3) **DIRECTION INDICATOR SWITCH** (⬅️ ➡️)  
To indicate the turn to the left, move the switch to the left; to indicate the turn to the right, move the switch to the right.  
To turn off the direction indicator, press the switch.

## CONTROLS ON THE RIGHT SIDE OF THE HANDLEBAR (Fig. 6)

 The electrical parts work only when the ignition switch is in position “○”.

### 1) START PUSH BUTTON (⊗)

When the start push button is pressed and one of the brake levers (front or rear) is activated at the same time, the starter makes the engine run.  
For the starting procedure, see p. 34 (STARTING).

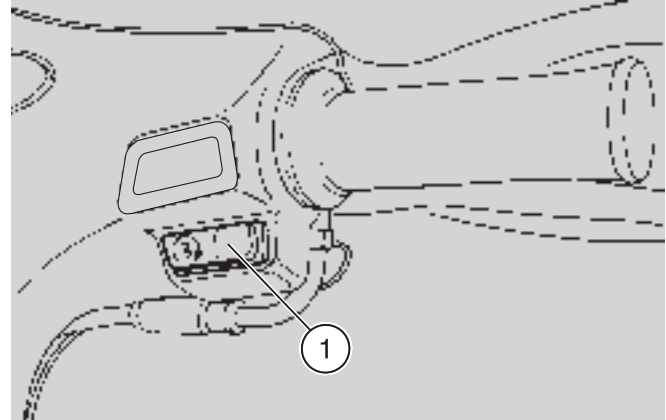

Fig. 6

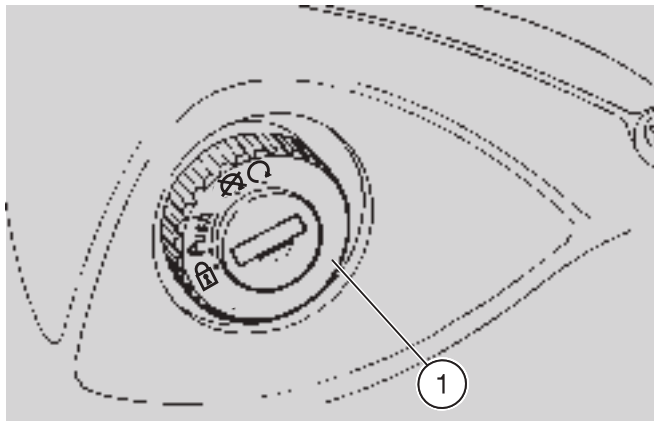

Fig. 7

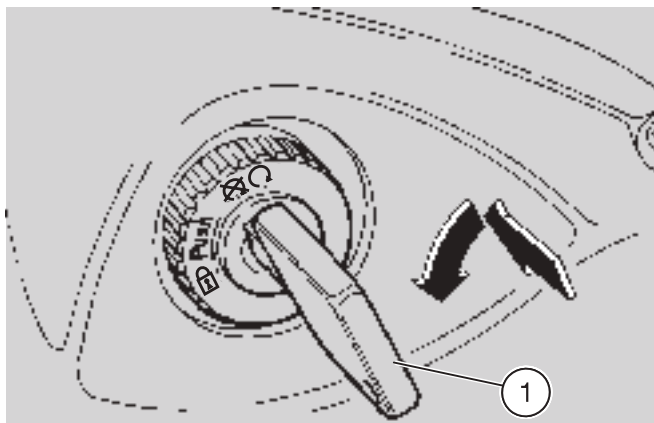



Fig. 8

## IGNITION SWITCH (Fig. 7)

The ignition switch is positioned on the right side, near the steering column.



 The key (1-Fig. 8) operates the ignition switch/steering lock, the battery/tool kit compartment and the saddle lock. Two keys are supplied together with the vehicle (one spare key).



## STEERING LOCK (Fig. 8)

Never turn the key to position “” in running conditions, in order to avoid losing control of the vehicle.

## OPERATION

To lock the steering:

- ◆ Turn the handlebar completely leftwards.
- ◆ Turn the key (1) to position “” and press it.
- ◆ Release the key and turn it to position “”.
- ◆ Extract the key.

Position	Function	Key removal
 Steering lock	The steering is locked. It is neither possible to start the engine, nor to switch on the lights.	It is possible to remove the key.
	Neither the engine, nor the lights can be switched on.	It is possible to remove the key.
	The engine and the lights can be switched on.	It is not possible to remove the key.

## AUXILIARY EQUIPMENT

### UNLOCKING/LOCKING THE SADDLE (Fig. 9)

To unlock and lift the saddle:

- ◆ Insert the key in the saddle lock (1).
- ◆ Turn the key clockwise and raise the saddle (2).

 **Before lowering and locking the saddle, make sure that you have not left the key in the crash helmet/glove compartment.**

- ◆ To lock the saddle, lower and press it (without exerting too much pressure), thus making the lock snap shut.



**Before leaving, make sure that the saddle is properly locked.**

### CRASH HELMET / GLOVE COMPARTMENT (Fig. 10)

Thanks to the crash helmet/glove compartment, you no longer have to carry the crash helmet or other objects with you every time you park the vehicle. The compartment is positioned under the saddle. To reach it:

- ◆ Raise the saddle, see (UNLOCKING/LOCKING THE SADDLE).



**Do not load the crash helmet/glove compartment too much.**

**Maximum allowed weight: 2.5 kg.**

 **Special hooks for the positioning of a lock have been provided under the saddle.**

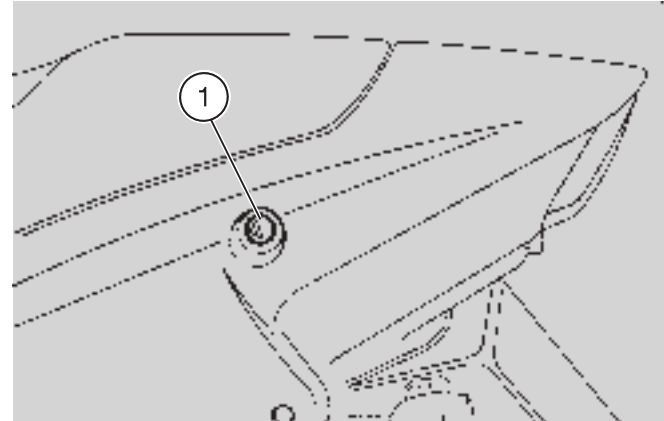

Fig. 9

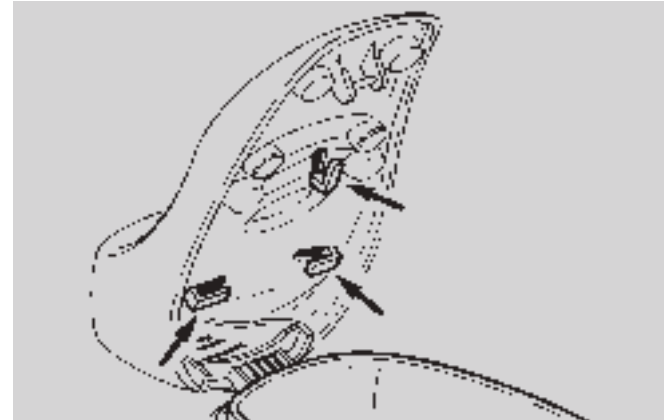
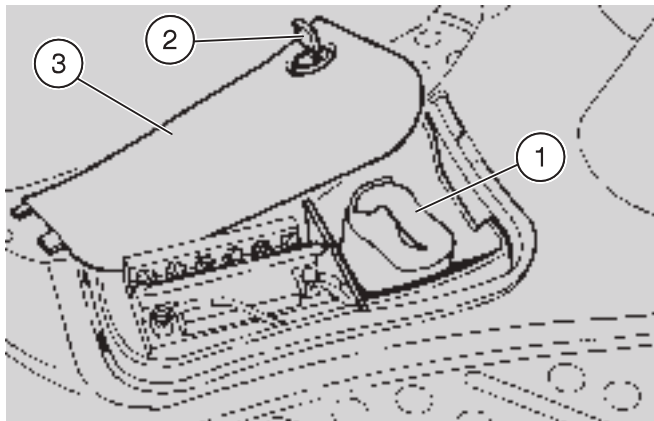
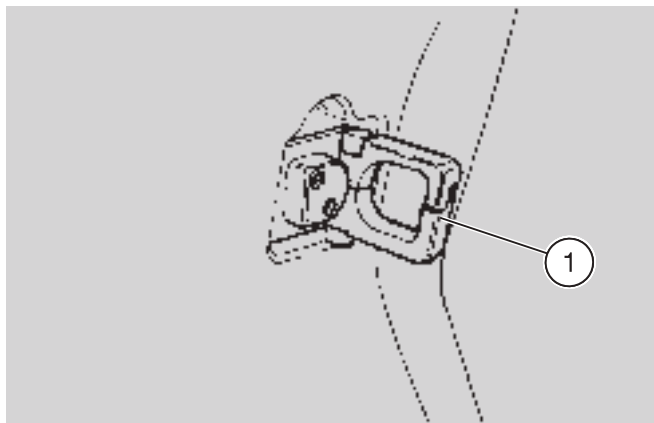

Fig. 10



**Fig. 11**



**Fig. 12**

## **BATTERY / TOOL KIT COMPARTMENT (Fig. 11)**

This compartment is positioned in the lower part of the vehicle, between the footrests.

To reach it, proceed as follows:

- ◆ Insert the key (2) in the lock.
- ◆ Rotate the key (2) clockwise, pull it and remove the cover (3).

The tool kit (1) includes:

- n. 1 tool case
- n. 1 25 mm spark plug socket spanner
- n. 1 socket spanner rod
- n. 1 8/10 mm socket spanner
- n. 1 double-ended, cross-/cut-headed screwdriver
- n. 1 screwdriver handle

To lock the cover (3), lower it and rotate the key anti-clockwise.

**Maximum allowed weight: 1.5 kg.**

## **BAG HOOK (Fig. 12)**



**Do not hang excessively bulky bags or parcels to the hook, as this may seriously compromise the manoeuvrability of the vehicle or the movement of your feet.**

The bag hook (1) is positioned on the front part of the inner shield.

**Max. allowed weight: 1.5 kg.**



## MAIN COMPONENTS

### FUEL (Fig. 13)



The fuel used for internal combustion engines is extremely inflammable and in particular conditions it can become explosive.

It is important to carry out the refuelling and the maintenance operations in a well-ventilated area, with the engine off.

Do not smoke while refuelling or near fuel vapours, in any case avoid any contact with naked flames, sparks and any other heat source to prevent the fuel from catching fire or from exploding. Further, prevent fuel from flowing out of the fuel filler, as it could catch fire when getting in contact with the red-hot surfaces of the engine.

In case some fuel has accidentally been spilt, make sure that the area has completely dried and before starting the vehicle verify that there is no fuel inside the fuel filler neck.

Since petrol expands under the heat of the sun and due to the effects of sun radiation, never fill the tank to the brim.

Screw the plug (1) up carefully after refuelling.

Avoid any contact of the fuel with the skin and the inhalation of vapours; do not swallow fuel or pour it from a receptacle into another by means of a tube.

**KEEP AWAY FROM CHILDREN**

Use only unleaded petrol, in conformity with the DIN 51607 standard, min. O.N. 95 (N.O.R.M.) and 85 (N.O.M.M.).

FUEL TANK CAPACITY (reserve included): 6 ℓ

TANK RESERVE: 1,5 ℓ

To refuel, proceed as follows:

- ◆ Lift the saddle, see p. 23 (UNLOKKING/LOCKING THE SADDLE).
- ◆ Unscrew and remove the fuel tank plug (1).
- ◆ Refuel.

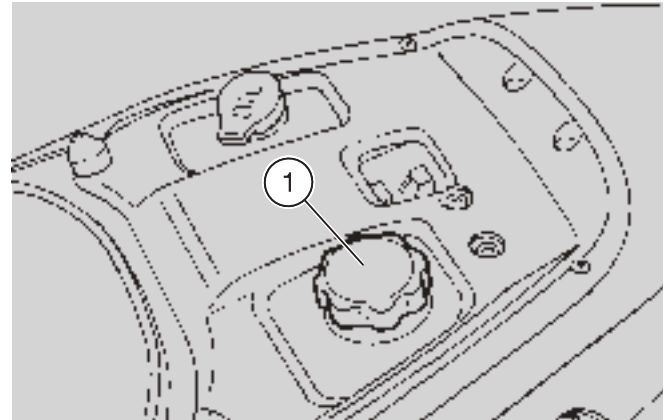

Fig. 13

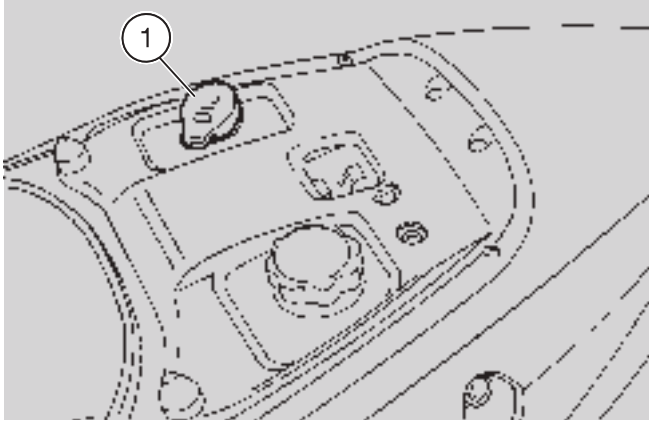

Fig. 14

### MIXER OIL TANK (Fig. 14)

The vehicle is provided with a separate mixer that makes it possible to mix petrol with oil for the lubrication of the engine, see p. 81 (LUBRICANT CHART).

The reserve is indicated by the coming on of the mixer oil reserve warning light "سعة:" positioned on the dashboard, see p. 18 and 19 (INSTRUMENTS AND INDICATORS).



The use of the vehicle without mixer oil causes serious damages to the engine. If you run out of oil in the mixer oil tank or if the mixer oil pipe has been removed, it is necessary to contact an **aprilia** Official Dealer, who will provide for bleeding the system.

This operation is indispensable, since the operation of the engine with air in the mixer oil system may cause serious damages to the engine itself.

To top up the mixer oil tank, proceed as follows:

- ◆ Lift the saddle, see p. 23 (UNLOCKING/LOCKING THE SADDLE).
- ◆ Remove the plug (1).

MIXER OIL TANK CAPACITY: 1.3 ℓ

TANK RESERVE: 0.35 ℓ



Wash your hands carefully after using the oil. Do not dispose of the oil in the environment.

**KEEP AWAY FROM CHILDREN.**

## **BRAKE FLUID (recommendations)**



Sudden resistance or clearance problems on the brake lever may be due to problems in the hydraulic system.

For any doubt regarding the perfect functioning of the braking system and in case you are not able to carry out the usual checking operations, contact your **aprilia** Official Dealer.

Make sure that the brake disc and the friction elements are neither oily nor greasy, especially after maintenance or checking operations.

Check that the brake cable is neither twisted nor worn out.

Prevent water or dust from accidentally getting into the circuit.

If the brake fluid gets in contact with the skin or the eyes, it can cause serious irritations.

Carefully wash the parts of your body that get in contact with the liquid.

Consult a doctor or an oculist if the liquid gets in contact with your eyes.

Do not dispose of the brake fluid in the environment.

### **KEEP AWAY FROM CHILDREN**



When using the brake fluid, take care not to spill it on the plastic or painted parts, since it irreparably damages them.

## **FRONT BRAKE**



The brakes are the parts that most ensure your safety and for this reason they must always be perfectly working.

The brake fluid must be changed once a year by an **aprilia** Official Dealer.

This vehicle is provided with front hydraulic disc brake.

When the disc pads wear out, the level of the fluid decreases to automatically compensate for their wear.

The brake fluid reservoir is positioned under the handlebar cover, near the brake lever coupling.

Periodically check the brake fluid level in the reservoir and the wear of the pads, see p. 57 (CHECKING THE BRAKE PAD WEAR).

To check the brake fluid level, proceed as follows:

- ◆ Incline the vehicle, so that the fluid contained in the tank is parallel to the "MIN" mark stamped on the glass (1-Fig. 15).
- ◆ Make sure that the level of the brake fluid contained in the tank exceeds the "MIN" mark stamped on the glass.
- ◆ If not, provide for topping up, see p. 28 (TOPPING UP).

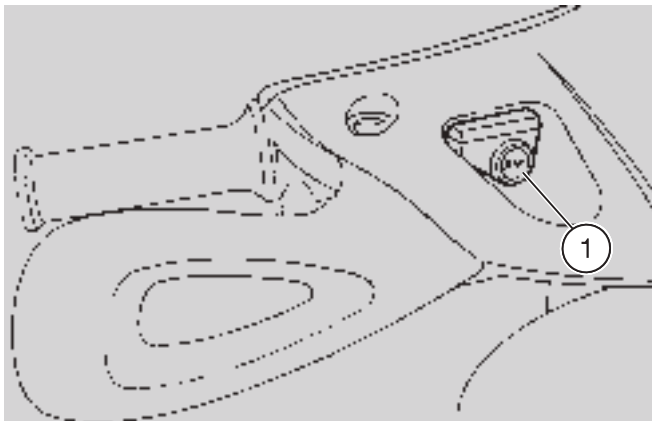

Fig. 15

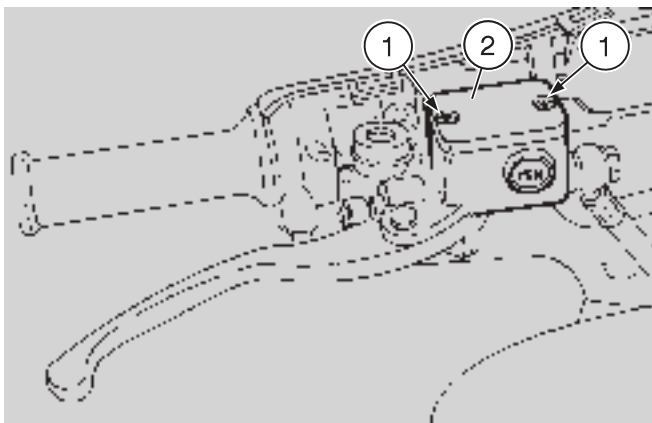

Fig. 16

## TOPPING UP

- ◆ Remove the handlebar cover, see p. 61 (REMOVING THE FRONT HANDLEBAR COVER).
- ◆ Unscrew the two screws (1-Fig. 16).
- ◆ Remove the cover (2-Fig. 16).



**In order not to spill the brake fluid while topping up, keep the fluid in the reservoir parallel to the reservoir rim.**

- ◆ Remove the gasket.
- ◆ Fill the tank with brake fluid, see p. 81 (LUBRICANT CHART), until it covers the glass (1-Fig. 15) completely.
- ◆ Put back the gasket in its seat.
- ◆ Put back the cover (2-Fig. 16).
- ◆ Screw and tighten the two screws (1-Fig. 16).
- ◆ Put back the handlebar cover.



**Check the braking efficiency. If necessary, contact your **aprilia** Official Dealer. In case of excessive movement of the brake lever, of excessive elasticity or in case there is air in the circuit, contact your **aprilia** Official Dealer, since it may be necessary to bleed the system.**

**In any case, the bleeding must be carried out after the first 500 km.**



**Remember: 1 mile = 1.6 km  
1 km = 0.625 miles**

## REAR BRAKE



The brakes are the parts that most ensure your safety and for this reason they must always be perfectly working.

For any doubt regarding the perfect functioning of the braking system and in case you are not able to carry out the usual checking operations, contact your **aprilia** Official Dealer.

### ADJUSTING THE BRAKE

- ◆ Measure the distance covered by the lever before the brake starts its braking action.  
The idle stroke at the end of the brake lever must be about 10 mm (Fig. 17).
- ◆ Adjust the clearance by acting on the adjuster (1-Fig. 18).
- ◆ Put on the brake repeatedly and make sure that the wheel turns freely after the brake has been released.
- ◆ Check the braking efficiency.



If the adjuster (1-Fig. 18) can be screwed up completely, this means that the brake shoes are worn out.

In this case, see p. 58 (CHECKING THE BRAKE SHOE WEAR).

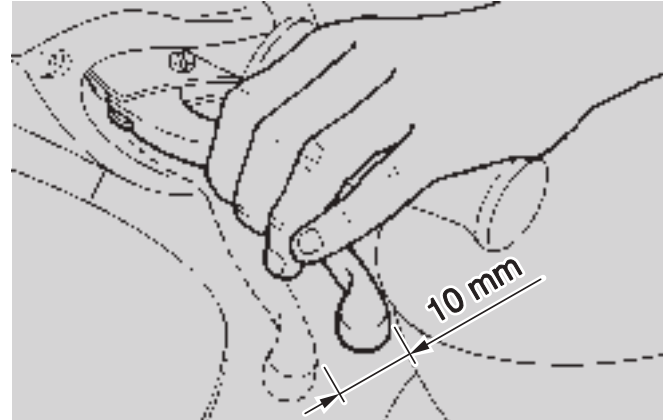

Fig. 17

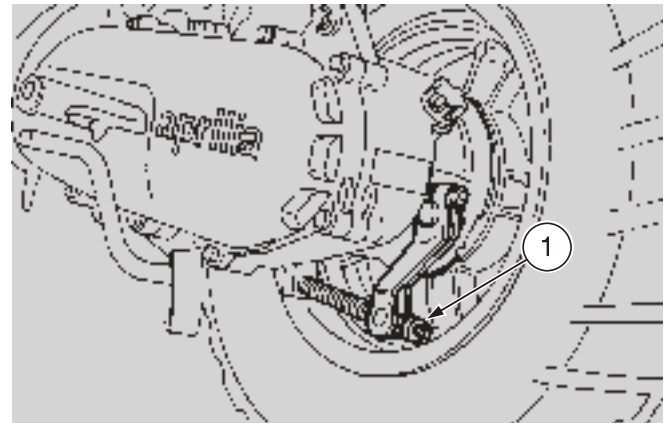

Fig. 18

## TYRES

This vehicle is provided with tubeless tyres.



Periodically check the tyre inflation pressure at room temperature. If the tyres are hot, the measurement is not correct.

Carry out the measurement especially after long rides.

If the inflation pressure is too high, the ground unevenness cannot be dampened and is therefore transmitted to the handlebar, thus compromising the driving comfort and reducing the road holding during turns.

If, on the contrary, the inflation pressure is too low, the tyre sides are under greater stress and the tyre itself may slip on the rim or it may become loose, with consequent loss of control of the vehicle.

In case of sudden braking the tyres could even get out of the rims. Further, the vehicle could skid while turning.

Check the surface and the wear of the tyres, since tyres in bad conditions can impair both the grip and the controllability of the vehicle.

Change the tyre when it is worn out or in case of puncture on the tread side, if the puncture is larger than 5 mm.

Use only tyres in the size suggested by **aprilia**, see p. 79 (TECHNICAL DATA).

Do not install tyres with air tube on rims for tubeless tyres and viceversa.

Make sure that the tyres always have their valve sealing caps on, to prevent them from suddenly going flat.

Change, reparation, maintenance and balancing operations are very important and should be carried out by qualified technicians with appropriate tools.

For this reason, it is advisable to have the above mentioned operations carried out by an **aprilia** Official Dealer or by a qualified tyre repairer.



If the tyres are new, they may still be covered with a slippery film: drive carefully for the first miles.

Do not oil the tyres with unsuitable fluids.

TYRE PRESSURE		
CONDITION	FRONT	REAR
To obtain the best grip and manoeuvrability on dry and wet road surface.	130 kPa (1,3 bar)	170 kPa (1,7 bar)
To obtain greater smoothness, with satisfying grip on dry road surface and sufficient grip on wet road surface.	190 kPa (1,9 bar)	210 kPa (2,1 bar)

## **AUTOMATIC LIGHT SWITCHING VERSION**

This vehicle is equipped with a device that switches the lights on automatically when the engine is started.

For this reason, no light switch is provided.

The lights can be switched off only by stopping the engine.

## **CATALYTIC SILENCER**



**Avoid parking the Rally 50 catalytic version near dry brush wood or in places easily accessible to children, as the catalytic silencer becomes extremely hot during use; be very careful and avoid any kind of contact before it has completely cooled down.**

The catalytic vehicle is fitted with a silencer with metal catalytic converter of the "platinum-rhodium bivalent" type.

This device provides for the oxidation of the CO (carbon monoxide) and of the HC (unburned hydrocarbons) contained in the exhaust gases, changing them into carbon dioxide and steam, respectively.

Due to the catalytic reaction, the high temperature reached by the exhaust gases makes for the burning

of the oil particles, thus keeping the silencer clean and eliminating the exhaust fumes.

To have the catalytic converter function correctly and for long and to reduce possible problems regarding the soiling of the thermal unit and of the exhaust, it is necessary to avoid covering long distances with the engine running at constantly low rpm.

It is sufficient to alternate these periods with periods in which the engine runs at relatively high rpm, even if only for a few seconds, but rather frequently.

What has been stated above assumes particular importance for the cold starting of the engine: in this case, in order to reach a rpm regime sufficient to enable the "priming" of the catalytic reaction, just make sure that the temperature of the thermal unit has reached at least 50°C, which generally occurs a few seconds after starting the engine.



**Do not use leaded petrol, since it causes the destruction of the catalytic converter.**

## INSTRUCTIONS FOR USE



Before departure, always carry out a preliminary checking of the vehicle, to make sure that it functions correctly and safely, see p. 33 (PRELIMINARY CHECKING OPERATIONS).

The non-performance of these checking operations can cause severe personal injuries or damages to the vehicle.



Do not hesitate to consult your **aprilia** Official Dealer in case there is something you do not understand about the functioning of some controls or in case you suspect or discover some irregularities.

It does not take long to carry out a check-up and this operation ensures you much more safety.



## PRELIMINARY CHECKING OPERATIONS

Component	Check	Page
Front disc brake	Check the functioning, the fluid level and make sure there are no leaks. Check the wear of the pads. Top up, if necessary.	27, 28, 55
Rear drum brake	Check the functioning, the idle stroke and the control lever conditions. If the clearance is not correct, adjust it.	29, 54, 56
Accelerator	Make sure that it works smoothly and that it is possible to open and close it completely, in all steering positions. If necessary, adjust and/or lubricate it.	61
Mixer oil	Check and/or top up, if necessary.	26, 48, 49
Wheel/tyres	Check the tyre surface, the inflation pressure, wear and tear and any damage.	30
Brake levers	Make sure that they work smoothly. If necessary, lubricate the articulations.	27, 28, 29
Stand	Make sure that they work smoothly and that the spring tension brings it back to its normal position. If necessary, lubricate joints and hinges.	—
Fastening elements	Make sure that the fastening elements are not loose. If necessary, adjust or tighten them.	—
Fuel tank	Check the fuel level and top up, if necessary. Make sure there are no leaks or occlusions in the circuit.	25
Lights, warning lights, horn and electric devices	Check the proper functioning of all the devices. Change the bulbs or intervene in case of failure.	65 ÷ 75

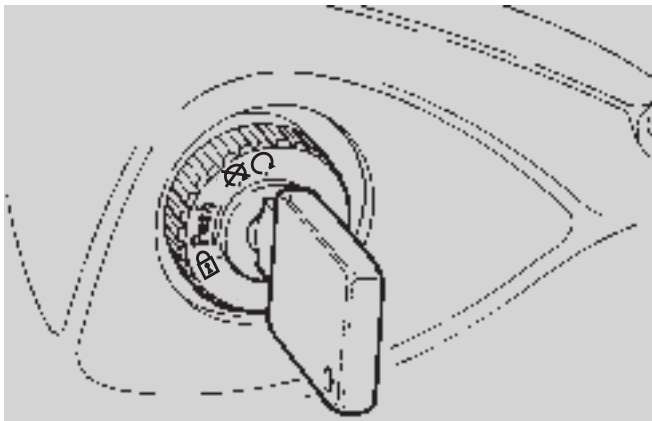

Fig. 19

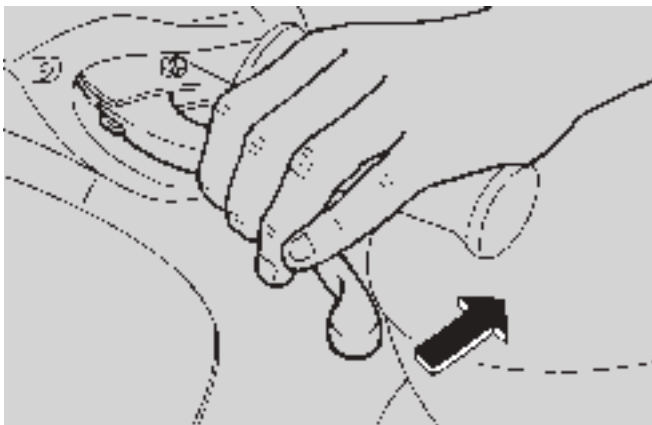

Fig. 20

## STARTING



Exhaust gases contain carbon monoxide, which is extremely noxious if inhaled.

Avoid starting the vehicle in closed or badly-ventilated rooms. The non-observance of this warning may cause loss of consciousness or even lead to death by asphyxia.

Do not get on the vehicle for the starting.

## ELECTRIC STARTING

- ◆ Position the vehicle on the centre stand.
- ◆ Turn the ignition switch (Fig. 19) to position "○".
- ◆ Lock at least one wheel, by pulling a brake lever (Fig. 20). If this operation is not carried out, the start relay receives no current and therefore the engine does not start.
- ◆ Press the start push button "Ⓢ" (1-Fig. 21) without accelerating, then release it as soon as the engine starts.



When the start push button "Ⓢ" is pressed, the mixer oil reserve warning light "⚡" comes on. With the engine in running condition, when the start push button "Ⓢ" is released, the mixer oil reserve warning light "⚡" must go out; if this does not occur, top up the mixer oil tank, see p. 26 (MIXER OIL TANK).

- ◆ If the starting is carried out with cold engine, rotate the cold start lever "⌵" (1-Fig. 22) downwards.



**Avoid pressing the start push button "Ⓝ" (1-Fig. 21) when the engine is running: this may damage the starter.**

- ◆ Do not accelerate and pull the brake levers at the same time until you move off.
- ◆ Warm the engine up before leaving.
- ◆ Once the engine has warmed up, rotate the cold start lever "↖" (1-Fig. 22) upwards.

### **KICK START**

For the kick start, proceed as follows:

- ◆ Position the vehicle on the centre stand.
- ◆ Move to the left side of the vehicle.
- ◆ Turn the ignition switch (Fig. 19) to position "○".
- ◆ To avoid losing control of the vehicle during the starting, lock both wheels by putting on the brake levers (Fig. 20).



**Do not push down the kick starter with the engine on.**

- ◆ Push down the kick starter with your right foot, releasing it immediately. If necessary, repeat the operation until the engine starts.

### **STARTING AFTER A LONG PERIOD OF INACTIVITY**

After a long period of inactivity, proceed as follows:

- ◆ Move the ignition switch (Fig. 19) to position "○".
- ◆ Make the starter run for about ten seconds, in order to ensure the filling up of the float chamber.

To start the engine:

- ◆ Rotate the cold start lever "↖" (1-Fig. 22) downwards.
- ◆ Slightly open the throttle, then carry out the electric starting procedure (or KICK START).

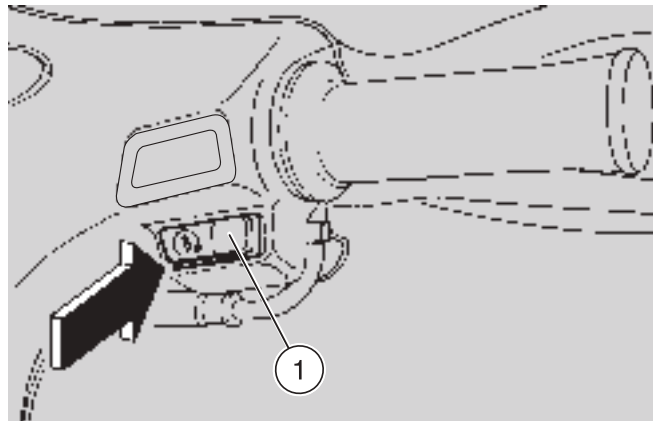

**Fig. 21**

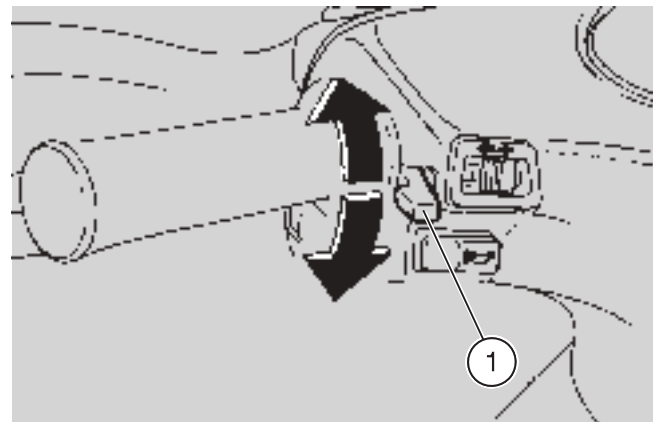

**Fig. 22**

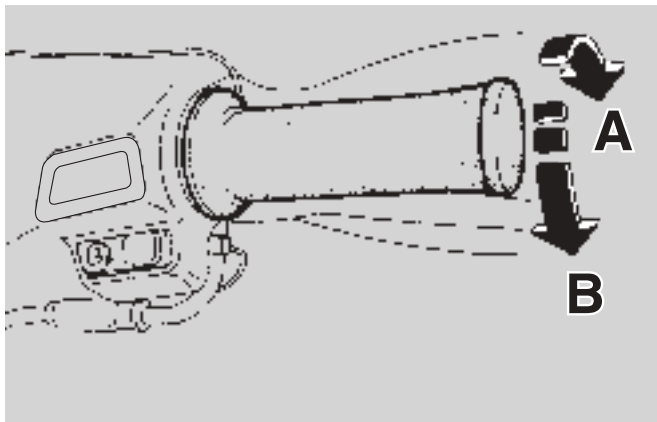

Fig. 23

## DEPARTURE AND DRIVE

Release the throttle grip (Fig. 23 - **pos. A**), put on the rear brake, then move the vehicle down the stand. Get on the vehicle, keeping at least one foot on the ground in order not to lose balance.



**Properly adjust the inclination of the rear-view mirrors.**

To leave, release the brake lever and accelerate by gently rotating the throttle grip (Fig. 23 - **pos. B**); the vehicle will start moving.



**Avoid opening and closing the throttle grip repeatedly and continuously, so that you do not accidentally lose control of the vehicle.**

**If you have to brake, close the throttle and put on both brakes in order to obtain uniform deceleration, properly exerting pressure on the braking parts.**

**By putting on the front brake only or the rear brake only, you reduce the braking force considerably, thus running the risk of locking one wheel and consequently losing grip.**

**Before beginning to turn, slow down or brake driving at moderate and constant speed or accelerating slightly; avoid braking at the last moment: it would be very easy to skid.**

**If the brakes are operated continuously on downhill stretches, the friction surfaces can overheat, thus reducing the braking efficiency. Never drive with the engine off!**

**In case of wet ground or scarce wheel grip (snow, ice, mud, etc.), drive slowly, avoiding sudden brakings or manoeuvres that could make you lose grip and fall down.**



Pay the utmost attention to any obstacle or variation of the ground.

Uneven roads, rails, manhole covers, indications painted on the road surface, building site metal plates become rather slippery by rain. For this reason all these obstacles have to be carefully avoided, driving smoothly and bending the vehicle as little as possible.

Always use the turn indicators timely when you intend to change lane or direction, avoiding sharp and dangerous movements.



If the mixer oil reserve warning light "⚠" comes on during the normal functioning of the engine, this means that the mixer oil reserve is being used; in this case, top up the mixer oil tank, see p. 26 (MIXER OIL TANK).

## **RUNNING-IN**



Remember: 1 mile = 1.6 km  
1 km = 0.625 miles



After the first 500 kilometres, carry out the checking operations indicated in the column "After running-in" of the **REGULAR SERVICE INTERVALS CHART**, see p. 42, in order to avoid hurting yourself or other people and/or damaging the vehicle.

The running-in of the engine is primary to ensure its correct functioning and its correct functioning. If possible, drive on hilly roads and/or roads with many bends, so that the engine, the suspensions and the brakes undergo a more effective running-in.

For the first 500 km, keep to the following indications:

### **0-100 km**

During the first 100 km put on the brakes with caution, avoiding sharp and prolonged brakings. This ensures a correct bedding-in of the pads on the brake disc.

### **0-300 km**

Do not keep the throttle grip open more than one half for long stretches.

### **300-500 km**

Do not keep the throttle grip open more than three-fourths for long stretches.

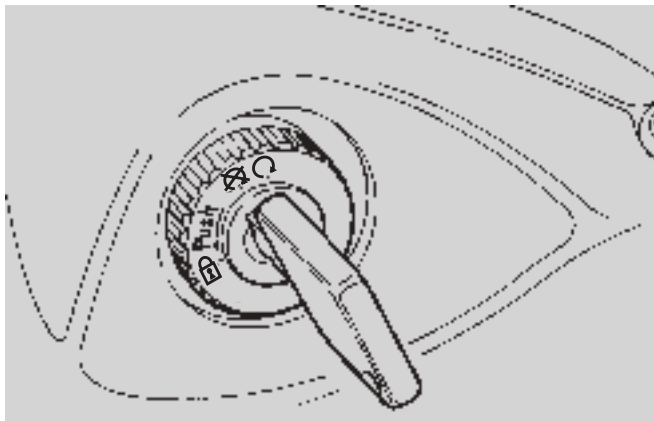

Fig. 24

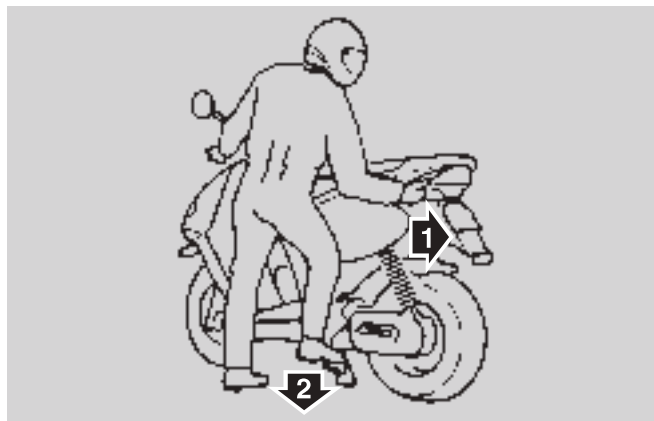

Fig. 25

## STOPPING AND PARKING

- ◆ Release the throttle grip and stop the vehicle by putting on the brakes.
- ◆ Move the ignition switch (Fig. 24) to position "⊗".

 It is not necessary to close the fuel tap when the engine is off, since it is equipped with an automatic closing system.

## POSITIONING THE VEHICLE ON THE STAND (Fig. 25)



Park the vehicle on firm and flat ground, to prevent it from falling down.

Neither lean the vehicle against walls, nor lay it on the ground.

Make sure that the vehicle and especially its red-hot parts do not represent a danger for persons and children.

Do not leave the vehicle unattended when the engine is on or the key is inserted into the ignition switch.

Do not sit on the vehicle when the stand is down.

Seize the vehicle using the rear grab rail (1) and at the same time push the stand lever (2) downwards (see figure).

Make sure that the vehicle is resting firmly.

## **SUGGESTIONS TO PREVENT THEFT**

NEVER leave the ignition key inserted and always use the steering lock.

Park the vehicle in a safe place, possibly in a garage or a protected place.

When possible, use an additional anti-theft device.

Make sure that all documents are in order and the road tax has been paid.

Write down your personal data and telephone number in the space provided in this page, to facilitate the identification of the owner in case of finding after theft.

SURNAME: .....

NAME: .....

ADDRESS: .....

.....

TELEPHONE NO.: .....



**Very often stolen vehicles are identified thanks to the data written on the use/maintenance manual.**

## **ANTI-THEFT HOOK (Fig. 25A)**

The anti-theft hook (1) is positioned on the right side of the vehicle, near the rider's footboard.

To prevent the vehicle from being stolen, it is advisable to secure it with a lock, which can be easily found on the market.



**Do not use the hook to lift the vehicle or for any purpose other than securing the vehicle once it has been parked.**

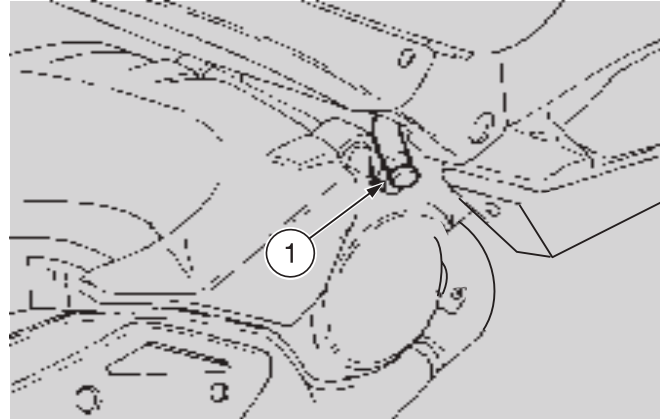

**Fig. 25A**



## MAINTENANCE



Before beginning any maintenance operation or any inspection of the vehicle, stop the engine, extract the key from the ignition block, wait until the engine and the exhaust system have cooled down and if possible lift the vehicle by means of the proper equipment, on firm and flat ground.

Keep away from the red-hot parts of the engine and of the exhaust system, in order to avoid burns.

Do not hold any mechanical piece or other parts of the vehicle with your mouth: the components are not edible and some of them are noxious or even toxic.



If not expressly indicated otherwise, for the reassembly of the units repeat the disassembly operations in reverse order.

In case any maintenance operation should be required, it is advisable to use latex gloves.

Ordinary maintenance operations can usually be carried out by the user, but sometimes a basic knowledge of mechanics and specific tools are required.

If you need assistance or technical advice, consult your **aprilia** Official Dealer, who can ensure you prompt and accurate servicing. After any maintenance operation, carry out the "Preliminary checking operations", see p. 33 (PRELIMINARY CHECKING OPERATIONS).



**Remember: 1 mile = 1.6 km**  
**1 km = 0.625 miles**

## REGULAR SERVICE INTERVALS CHART

OPERATIONS TO BE CARRIED OUT BY THE **aprilia** Official Dealer (WHICH CAN BE CARRIED OUT EVEN BY THE USER).

### Key

- ① = check and clean, adjust, lubricate or change, if necessary;
- ② = clean;
- ③ = change;
- ④ = adjust.

 **Perform the maintenance operations with doubled frequency if the vehicle is used in rainy or dusty areas, on uneven surfaces or on racetracks**

Component	After running-in [500 km (312 mi)]	Every 4000 km (2500 mi) or 12 months	Every 8000 km (5000 mi) or 24 months
Battery - Terminal fastening - Electrolyte level	①	①	–
Spark plug	①	③	–
Carburettor - idle speed	④	①	–
Air cleaner	①	②	–
Accelerator operation	①	①	–
Brake locking operation	①	①	–
Light system	①	①	–
Cylinder cooling system	every 20.000 km (12500 mi): ② (outside cleaning)		
Stop light switches	–	①	–
Brake fluid	–	①	–
2 stroke oil	every 500 km (312 mi): ①		
Light direction - operation	–	①	–
Wheels/tyres and inflation pressure	every month: ①		
Rear brake shoe wear 	①	①	–
Front brake pad wear	①	every 2000 km (1250 mi): ①	

**OPERATIONS TO BE CARRIED OUT BY THE *aprilia* Official Dealer.**

**Key**

- ① = check and clean, adjust, lubricate or change, if necessary;
- ② = clean;
- ③ = change;
- ④ = adjust.

 **Perform the maintenance operations with doubled frequency if the vehicle is used in rainy or dusty areas, on uneven surfaces or on racetracks**

Component	After running-in [500 km (312 mi)]	Every 4000 km (2500 mi) or 12 months	Every 8000 km (5000 mi) or 24 months
Rear shock absorber	–	–	①
Battery - Terminal fastening	①	–	–
Transmission cables and controls	①	①	–
Variator belt	every 6000 km (3750 mi): ③		
Steering tube bearings and steering slack	①	①	–
Wheel bearings	–	①	–
Brake discs	①	①	–
Piston rings	every 12000 km (7500 mi): ①		
Accelerator operation - Mixer	①	①	–
General running of the vehicle	①	①	–
Braking systems/brake discs	①	①	–
Rear brake cap pin greasing 	–	①	–
Brake fluid	every 2 years: ③		
Fork oil and oil seal	every 12000 km (7500 mi): ①		
2 stroke oil	③	①	every 12000 km (7500 mi) or 2 years: ③
Rear pulley pins	every 12000 km (7500 mi): ③		
Movable/fixed front pulley	every 6000 km (3750 mi): ③		
Variator front pins and guides	every 6000 km (3750 mi): ③		
Wheels/tyres and inflation pressure	①	①	–
Nut, bolt, screw tightening	①	①	–
Fuel pipe	every 4000 km (2500 mi): ① / every 4 years: ③		
Braking system pipe	–	①	every 4 years: ③
Mixer oil pipes	①	①	every 2 years: ③
Clutch wear	–	–	①

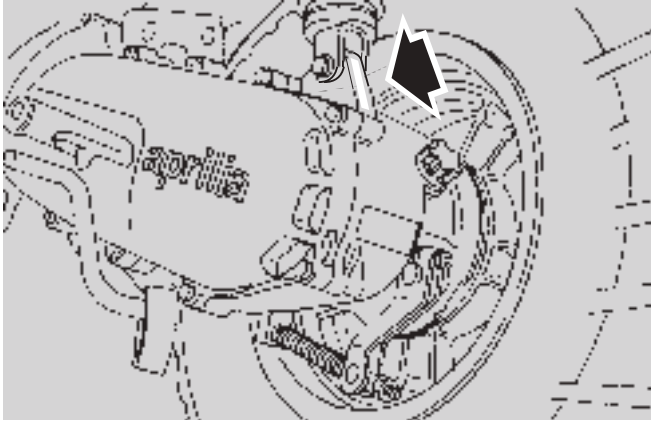



Fig. 26

## IDENTIFICATION DATA

It is a good rule to write down the frame and engine numbers in the space provided in this manual.

 **Do not alter the identification numbers if you do not want to incur severe penal and administrative sanctions. In particular, the alteration of the frame number results in the immediate invalidity of the guarantee.**

### ENGINE NUMBER (Fig. 26)

The engine number is stamped on the lower support of the rear shock absorber.

Engine no. \_\_\_\_\_

## FRAME NUMBER (Fig. 27)

The frame number is stamped on the central tube of the frame. To be able to read it, it is necessary to remove the cover (1).

Frame no. \_\_\_\_\_

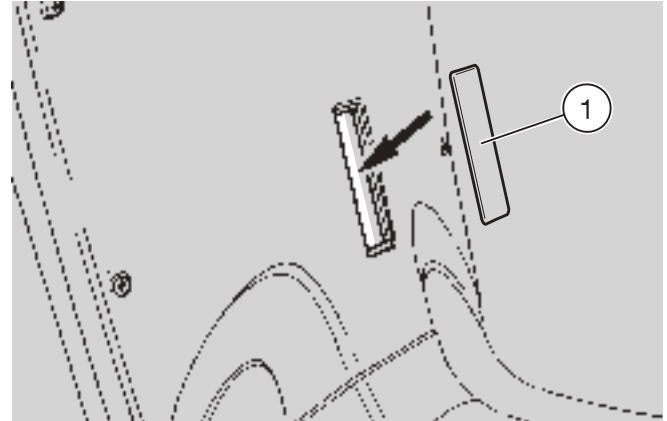

**Fig. 27**

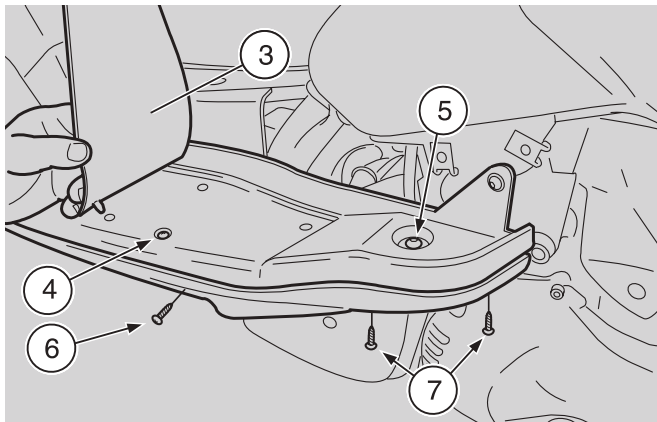

Fig. 28

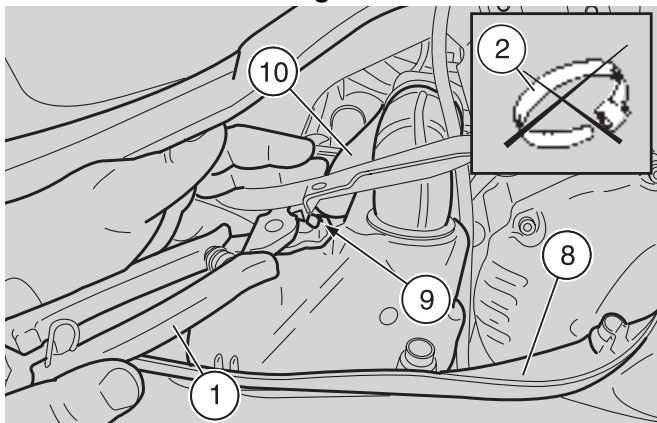

Fig. 28A

## AIR CLEANER (Fig. 28-28A-28B)

Carefully read p. 41 (MAINTENANCE).



**Do not use petrol or inflammable solvents to wash the air cleaner, in order to avoid fires or explosions.**

Check the conditions of the air cleaner and clean it monthly or every 4000 km, depending on the conditions in which the vehicle is used.

If the vehicle is used on dusty or wet roads, the cleaning operations and any replacement should be carried out more frequently.

## REMOVAL



Have the appropriate special tool **OPT** (to be requested to **aprilia** Official Dealer):  
– clamp installation pliers (1).



Upon installation, replace the hose clamp that has been removed with a new one having the same dimensions, to be requested to an **aprilia** Official Dealer.

**Do not attempt to reinstall the removed hose clamp, since it is unusable.**

**Do not replace the removed hose clamp with a screw clamp (2) or with other types of clamp.**

- ◆ Position the vehicle on the stand.
- ◆ Remove the inspection cover, see p. 60 (REMOVING THE INSPECTION COVER).

- ◆ Lift the rubber mat (3).
- ◆ Unscrew and remove the screw (4), taking the washer.
- ◆ Unscrew and remove the screw (5), taking the bushing.
- ◆ Unscrew and remove the screw (6).
- ◆ Unscrew and remove the two screws (7).



**Handle the plastic and painted components with care to avoid scraping or damaging them.**

- ◆ Slightly move the rear part (8) of the lower shield.
- ◆ Release the hose clamp (9).
- ◆ Disconnect the pipe (10).



**Upon reassembly, position the pipe (10) correctly.**

- ◆ Unscrew and remove the screw (11), taking the washer and the breather pipe ring (12).
- ◆ Unscrew and remove the screw (13) with the relevant washer.
- ◆ Loosen the screw (14) of the air manifold clamp.
- ◆ Seize the air manifold in correspondence with the clamp and pull it, thus removing the whole air cleaner.

### CLEANING THE AIR FILTER

- ◆ Unscrew the three screws (15).
- ◆ Remove the filter case cover (16) and extract the

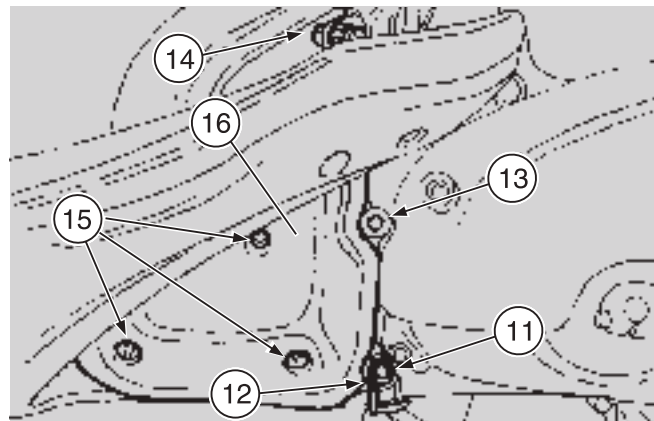

**Fig. 28B**

filtering element.

- ◆ To clean the filtering element use clean, non-flammable solvents or solvents with high volatility point, then let it dry thoroughly.
- ◆ Apply a filter oil or a thick oil (SAE 80W-90) on the whole surface of the filtering element, then squeeze it to eliminate the oil in excess.



**The filter must be well impregnated, though not dripping.**

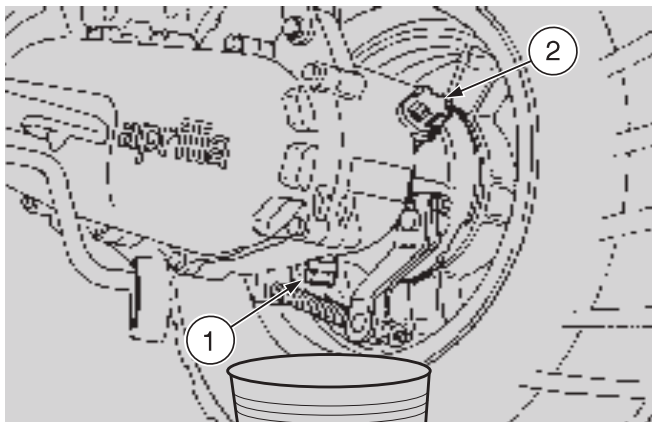

Fig. 29

## CHECKING THE TRANSMISSION OIL LEVEL (Fig. 29)



In case of oil leaks or malfunctions, contact your **aprilia** Official Dealer.

**DO NOT DISPOSE OF THE TRANSMISSION OIL IN THE ENVIRONMENT.**

Carefully read p. 41 (MAINTENANCE).



Remember: 1 mile = 1.6 km  
1 km = 0.625 miles

To check the transmission oil level, carry out the following operations every 4000 km or every 12 months:

- ◆ Drive for a few miles until the engine reaches the normal running temperature, then stop it.
- ◆ Position the vehicle on the stand.
- ◆ Put a graduated container with at least 120 cm<sup>3</sup> capacity under the drain plug (1).
- ◆ Unscrew the filling cap (2) and the oil drain plug (1).
- ◆ Let all the oil flow out of the oil pan, measure the quantity and if it is less than 110 cm<sup>3</sup>, top up by adding the lacking quantity, see p. 81 (LUBRICANT CHART).
- ◆ Tighten the drain plug (1).
- ◆ Provide for filling up, using the oil collected into the graduated container.
- ◆ Tighten the filling cap (2).



**Tighten the filling cap and the drain plug thoroughly and make sure that there are no oil leaks.**

Periodically check that there are no leaks in correspondence with the oil pan cover seal.

Do not use the vehicle with insufficient lubrication or with contaminated or unsuitable lubricants, since this would accelerate the wear of the moving parts and may also cause irreparable failures.



## **CHANGING THE TRANSMISSION OIL (Fig. 29)**



In case of oil leaks or malfunctions, contact your **aprilia** Official Dealer.

**DO NOT DISPOSE OF THE TRANSMISSION OIL IN THE ENVIRONMENT.**

Put it in a sealed container and take it to the filling station where you usually buy it or to an oil salvage center.

Carefully read p. 41 (MAINTENANCE).



**Remember: 1 mile = 1.6 km  
1 km = 0.625 miles**

To ensure the efficiency and long life of the vehicle, it is necessary to change the oil after the first 500 km and successively every 12000 km or every 2 years.

Proceed as follows:

- ◆ Drive for a few miles until the engine reaches the normal running temperature, then stop the engine.
- ◆ Position the vehicle on the stand.
- ◆ Put a graduated container with at least 120 cm<sup>3</sup> capacity under the drain plug (1).
- ◆ Unscrew the filling cap (2) and the oil drain plug (1).
- ◆ Let all the oil flow out of the oil pan.

- ◆ Tighten the drain plug and add 110 cm<sup>3</sup> of oil, see p. 81 (LUBRICANT CHART).
- ◆ Tighten the filling cap (2).



**Tighten the filling cap and the drain plug thoroughly and make sure that there are no oil leaks.**

**Periodically check that there are no leaks in correspondence with the oil pan cover seal.**

**Do not use the vehicle with insufficient lubrication or with contaminated or unsuitable lubricants, since this would accelerate the wear of the moving parts and may also cause irreparable failures.**

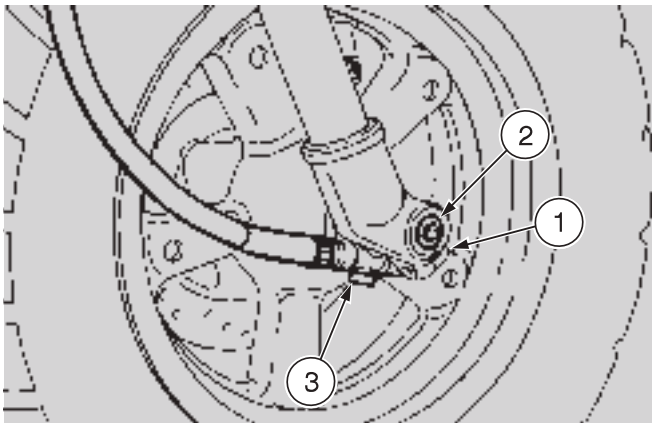

Fig. 30

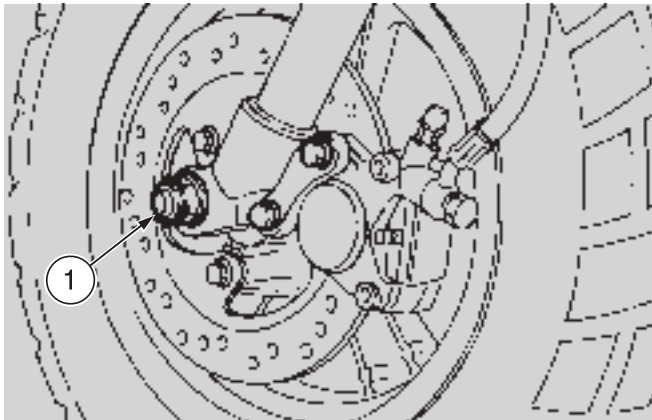

Fig. 31

## FRONT WHEEL

### DISASSEMBLY

Carefully read p. 41 (MAINTENANCE).



While disassembling the wheel, be careful not to damage the brake pipe, the disc and the pads.

To disassemble the front wheel, proceed as follows:

- ◆ Position the vehicle on the centre stand.



Place a support under the vehicle, so that the front wheel has enough space to move and the vehicle cannot fall down.

- ◆ Loosen the screw of the wheel pin clamp (1-Fig. 30).
- ◆ Lock the wheel pin (2-Fig. 30) by means of an hexagon spanner.
- ◆ Remove the nut (1-Fig. 31), taking the washer.
- ◆ Push the wheel pin (2-Fig. 30), by carefully acting on the threaded end and using a rubber hammer if necessary.



Check the arrangement of the odometer control and spacer ring, in order to be able to reassemble them correctly.

- ◆ Support the front wheel and extract the wheel pin manually.
- ◆ Remove the wheel, carefully withdrawing the disc from the brake calliper.

- ◆ Disconnect the odometer control (3-Fig. 30).



**Never pull the front brake lever after removing the wheel, otherwise the calliper pistons may go out of their seats, thus causing the outflow of the brake fluid.**

**In this case consult your **aprilia** Official Dealer, who will carry out the proper maintenance operation.**

- ◆ Take the washer and the spacer ring.

## REASSEMBLY

**Carefully read p. 41 (MAINTENANCE).**



**While reassembling the wheel, be careful not to damage the brake pipe, the disc and the pads.**

To reassemble the front wheel, proceed as follows:

- ◆ Position the wheel between the fork rods, carefully inserting the disc in the brake calliper.
- ◆ Position the odometer control tang (3-Fig. 30) in the apposite seat in the wheel hub.
- ◆ Position the odometer control seat in correspondence with the special antirotation pin.
- ◆ Place the washer between the odometer control and the right fork rod.

- ◆ Insert the pin (2-Fig. 30) from the right side of the vehicle (direction of travel).
- ◆ Insert the spacer ring between the hub and the left fork rod.
- ◆ Insert the washer, lock the rotation of the wheel pin (2-Fig. 30) by means of an hexagon spanner and screw and tighten the nut (1-Fig. 31).

**Wheel pin nut driving torque:  
50 Nm (5 kgm).**

- ◆ With pulled front brake lever, press the handlebar repeatedly, thrusting the fork downwards. In this way the fork rods will properly bed in.
- ◆ Tighten the wheel pin clamp screw (1-Fig. 30).



**After reassembly, pull the front brake lever repeatedly and check the correct functioning of the braking system.**

**Check the wheel centering.**

**Have the driving torques, centering and balancing of the wheel checked by your **aprilia** Official Dealer, in order to avoid accidents that may be harmful for you and/or other people.**

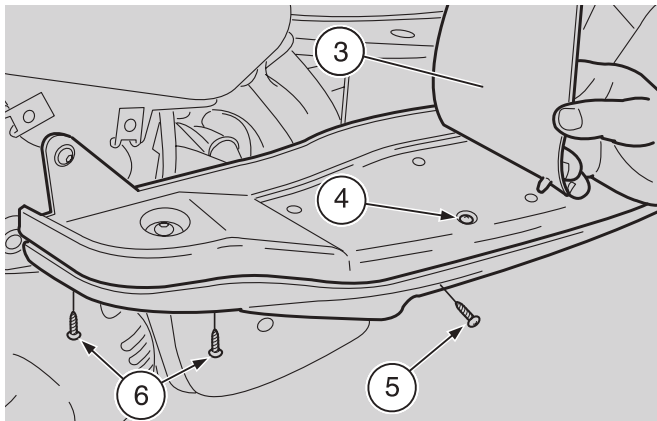

Fig. 32

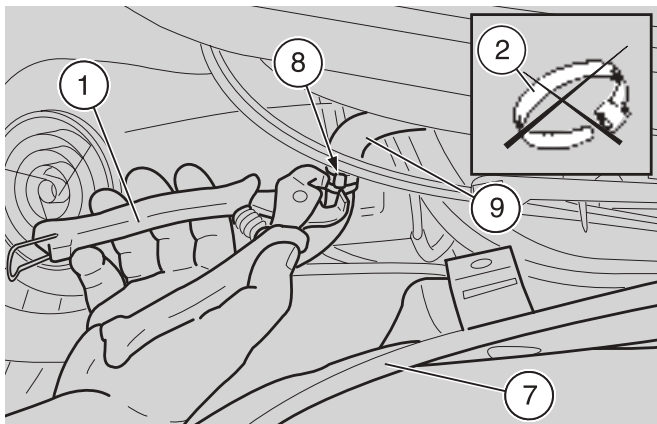



Fig. 33

## EXHAUST SILENCER (Fig.32-33-33 A-33 B)

### DISASSEMBLY

Carefully read p. 41 (MAINTENANCE).

 Have the appropriate special tool **03T** (to be requested to **aprilia** Official Dealer):  
– clamp installation pliers (1).

 Upon installation, replace the hose clamp that has been removed with a new one having the same dimensions, to be requested to an **aprilia** Official Dealer.  
Do not attempt to reinstall the removed hose clamp, since it is unusable.

Do not replace the removed hose clamp with a screw clamp (2) or with other types of clamp.

 Before carrying out the following operations, let the engine and the silencer cool down until they reach room temperature, in order to avoid burns.

- ◆ Position the vehicle on the stand.
- ◆ Lift the rubber mat (3).
- ◆ Unscrew and remove the screw (4), taking the washer.
- ◆ Unscrew and remove the screw (5).
- ◆ Unscrew and remove the two screws (6).



**Handle the plastic and painted components with care to avoid scraping or damaging them.**

- ◆ Slightly move the rear part (7) of the lower shield.
- ◆ Release the hose clamp (8).
- ◆ Disconnect the pipe (9).



**DO NOT adjust the nuts (10) of the flange (11), but follow the procedure described below**

- ◆ Unscrew and remove the screws (12-13-Fig. 32).

**Screws (12-13-Fig. 32) driving torque:  
12 Nm (1,2 kgm).**

- ◆ Unscrew and remove the two screws (14-15-Fig. 32) that fasten the silencer to the engine, taking the two bushings of the upper screw (15-Fig. 32).

**Screws (14-15-Fig. 32) driving torque:  
25 Nm (2,5 kgm).**

- ◆ Remove the silencer.



**Upon reassembly, change the exhaust manifold-silencer seal.**

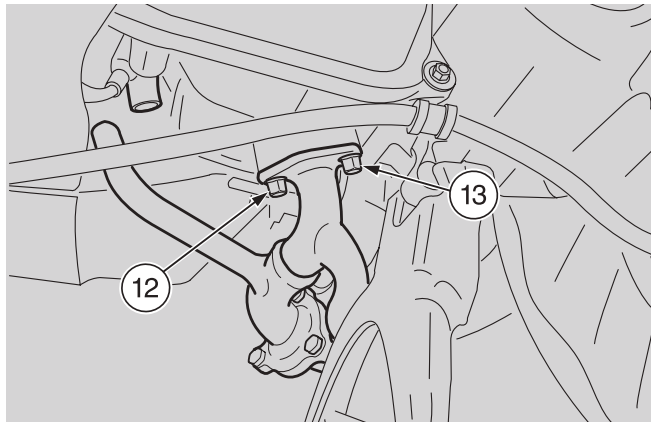

**Fig. 33A**

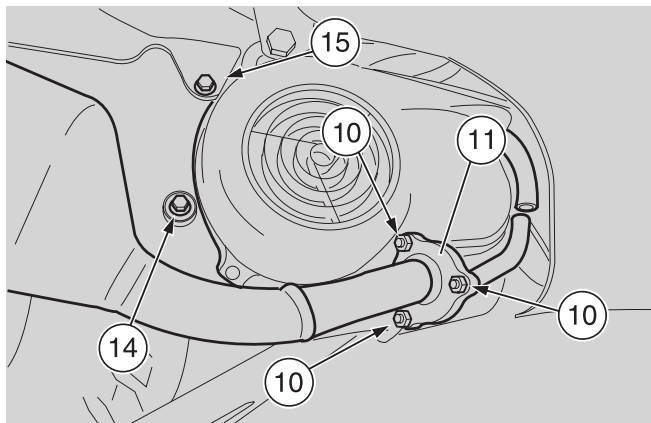

**Fig. 33B**

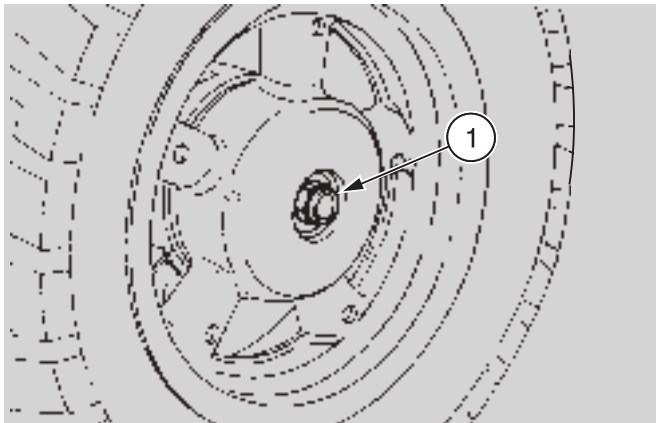

Fig. 33C

## REAR WHEEL

### DISASSEMBLY

Carefully read p. 41 (MAINTENANCE).

- ◆ Remove the exhaust silencer, see p. 52 (EXHAUST SILENCER).
- ◆ Put on the rear brake to lock the wheel.
- ◆ Unscrew and remove the wheel nut (1-Fig. 33C) and the washer.



Upon reassembly, change the wheel nut (special type).

Wheel nut (1-Fig. 33C) driving torque:  
110 Nm (11 kgm).



Use **aprilia** Genuine Spare Parts only.



After reassembly, pull the rear brake lever repeatedly and check the correct functioning of the braking system.

Check the wheel centering.

Have the driving torques, centering and balancing of the wheel checked by your **aprilia** Official Dealer, in order to avoid accidents that may be harmful for you and/or other people.

## GREASING THE REAR BRAKE CAM PIN (Fig. 34)

Carefully read p. 41 (MAINTENANCE).

 Remember: 1 mile = 1.6 km  
1 km = 0.625 miles

 Grease the rear brake cam pin every 4000 km. If the vehicle is used on dusty roads, this operation must be carried out more frequently.

 The greasing of the rear brake cam pin can be difficult or complicated for an unskilled operator.

If necessary, contact your **aprilia** Official Dealer. If you want to carry out this operation by yourself, keep to the following instructions:

- ◆ Disassemble the rear wheel, see p. 54 (REAR WHEEL).
- ◆ Unscrew and remove the adjuster (1).

 Do not dirt the shoes and the friction material with grease, to avoid compromising the braking efficiency of the vehicle.

 This operation may be difficult because the springs (2) resist considerably to the removal of the shoes. Be careful not to crush or bruise your hands and fingers.

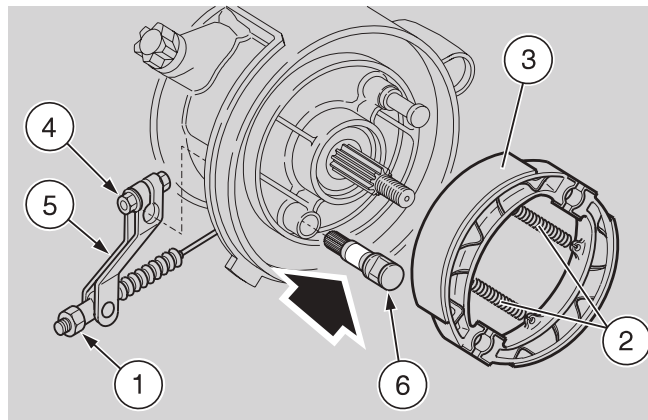

Fig. 34

- ◆ Grasp the inner edge of the two friction elements (3) at its centre and, pulling toward yourself, shake the two shoes, thus releasing them.
- ◆ Loosen the nut (4) and remove the pin lever (5).
- ◆ Withdraw the cam pin (6).



**Moderately grease only the central part of the pin.**

**Avoid dirtying the cam or the areas around the pin seat with grease.**

- ◆ Grease the central part of the pin by using grease for kinematic motions, see p. 81 (LUBRICANT CHART).

Upon reassembly:



**Neither strike, nor force the cam pin (6) with hammers or others tools, in order not to damage the two O-rings.**

- ◆ Manually insert the cam pin (6), rotating and pushing it slightly.



**Make sure that the springs (2) are correctly coupled.**



## CHECKING THE BRAKE PAD WEAR (Fig. 35)

Carefully read p. 27 (BRAKE FLUID (recommendations)), p. 27 (FRONT BRAKE), p. 41 (MAINTENANCE).

 **Remember: 1 mile = 1.6 km  
1 km = 0.625 miles**

Check the brake pad wear after the first 500 km and successively every 2000 km.

The wear of the brake pads depends on the use, on the kind of drive and on the road. The wear will be greater when the vehicle is driven on dirty or wet roads.

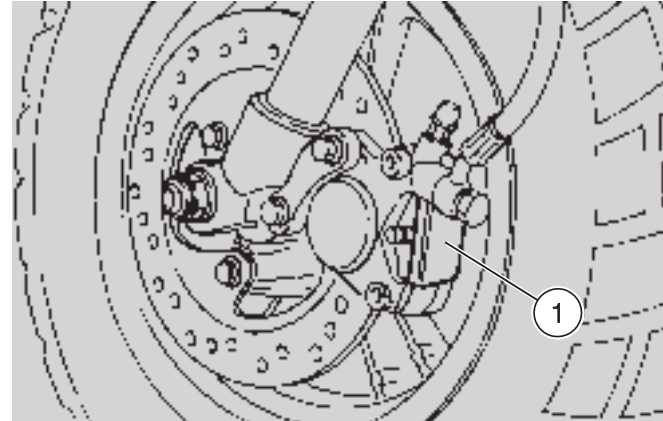

**Fig. 35**

To carry out a rapid checking of the wear of the front pads, proceed as follows:

- ◆ Position the vehicle on the centre stand.
- ◆ Remove the brake caliper cover (1).
- ◆ Carry out a visual checking of the friction material thickness by looking between the brake caliper and the pads.

If the thickness of the friction material (even of one pad only) has reduced to about 1 mm, replace both pads.

 **Have the pads changed by your **aprilia** Official Dealer.**

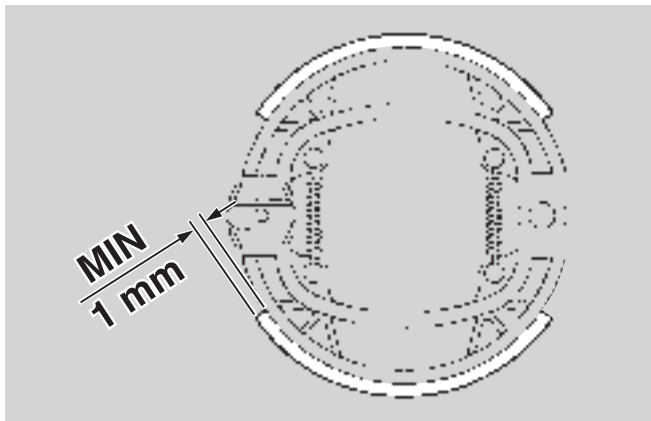

Fig. 36

## CHECKING THE BRAKE SHOE WEAR (Fig. 36)

Carefully read p. 29 (REAR BRAKE) and p. 41 (MAINTENANCE).

Check the wear of the rear brake shoes after the first 500 km and successively every 4000 km.

To check the wear of the rear brake shoes, proceed as follows:

- ◆ Remove the rear wheel, see p. 54 (REAR WHEEL).
- ◆ At this point it is possible to check the thickness of the friction material, which must never be less than 1 mm.

If the minimum allowed limit has been reached, if you notice any irregularity in the operation or if any part is damaged, contact your **aprilia** Official Dealer, who will provide for changing the brake shoes.

## CHECKING THE STEERING (Fig. 37)

Carefully read p. 41 (MAINTENANCE).

Every now and then it is advisable to check the steering, in order to verify if there are slacks.

To check the steering it is necessary to:

- ◆ Position the vehicle on the centre stand.



**Place a support under the vehicle, so that the front wheel has enough space to move and the vehicle cannot fall down.**

- ◆ Shake the fork in the direction of travel (see figure).



**Do not shake the fork excessively, otherwise you may take in consideration the movement of the stand, thus observing an incorrect slack. Repeat the previous operation more than once.**

- ◆ If you find that there is a considerable slack, contact your **aprilia** Official Dealer to restore the optimal steering conditions.

## CHECKING THE ENGINE FULCRUM AXIS (Fig. 38)

Carefully read p. 41 (MAINTENANCE).

Periodically check the slack existing between the engine pin bushings.

To carry out this operation, proceed as follows:

- ◆ Position the vehicle on the centre stand.
- ◆ Shake the wheel perpendicularly to the direction of travel (see figure).
- ◆ If you find any slack, make sure that all the fastening elements of the fulcrum axis are well tightened.



**If the slack persists, contact your **aprilia** Official Dealer.**

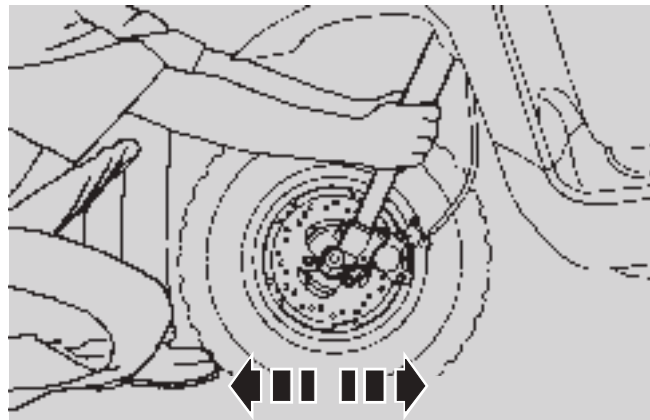

Fig. 37

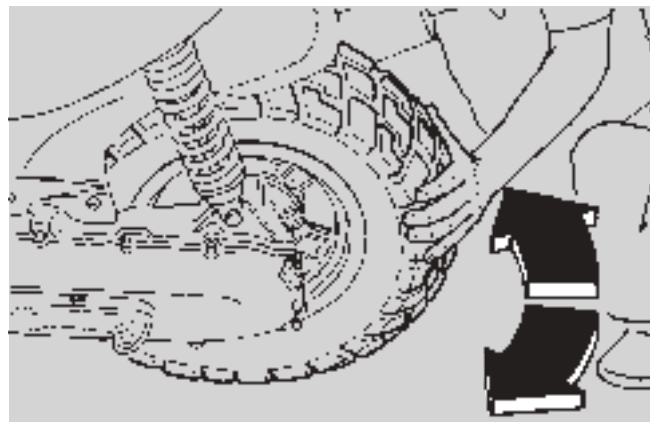

Fig. 38

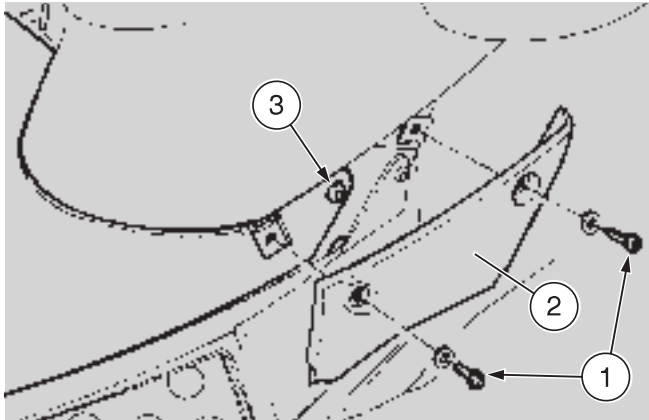

Fig. 39

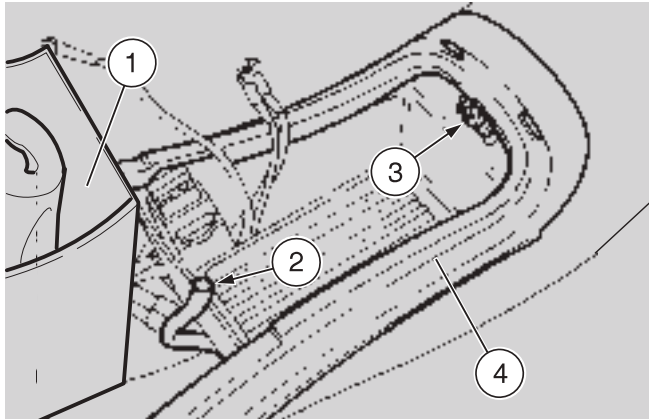

Fig. 40

## REMOVING THE INSPECTION COVER

Carefully read p. 41 (MAINTENANCE).

 Handle the painted components with care and avoid scraping or damaging them.

◆ Position the vehicle on the stand.

 The operations marked with the symbol ★ must be carried out on both sides of the vehicle.

- ◆ ★ Unscrew and remove the two screws (1-Fig. 39).
- ◆ ★ Remove the cover (2-Fig. 39).
- ◆ ★ Unscrew and remove the screw (3-Fig. 39).

 Handle with care. During the removal, take care not to damage the two tangs of the battery/tool kit compartment cover (opposite side of the lock).

- ◆ Remove the battery/tool kit compartment cover.
- ◆ Remove the tool kit compartment (1-Fig. 40).
- ◆ Disconnect the battery breather pipe (2-Fig. 40).

 Always connect the battery breather pipe, to prevent the sulphuric acid vapours from corroding the electric system, painted parts, rubber elements or gaskets when they exit the breather pipe itself. Handle the battery with care. Neither overturn the battery, nor spill the electrolyte.

- ◆ Extract the battery.
- ◆ Unscrew and remove the screw (3-Fig. 40), taking the washer.



**Handle with care.**

**During the removal, do not damage the inspection cover tangs.**

- ◆ Remove the inspection cover (4-Fig. 40) from its seat, pulling it in the direction of travel.

## REMOVING THE FRONT HANDLEBAR COVER (Abb. 41)

Carefully read p. 41 (MAINTENANCE).



**Handle the painted components with care and avoid scraping or damaging them.**

- ◆ Position the vehicle on the stand.



**The operations marked with the symbol ★ must be carried out on both sides of the vehicle.**

- ◆ ★ Raise the rubber protection of the rear-view mirror (1).
- ◆ ★ Unscrew the mirror-holder pin (2) and remove it, together with the rear-view mirror.
- ◆ ★ Take the spacer(3).
- ◆ Unscrew and remove the two screws (4) on the dashboard.
- ◆ Unscrew and remove the front screw (5), under the front part of the fairing.

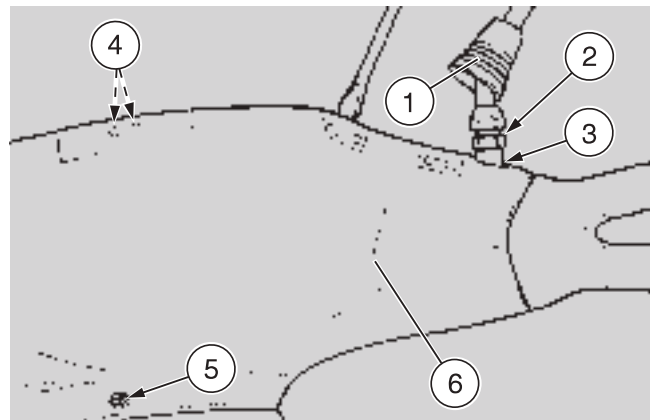

Fig. 41



**Handle with care. During removal, be careful and avoid damaging the tangs.**

- ◆ Insert a small-tip screwdriver in the joint of the two handlebar covers (front and rear), in correspondence with one of the side tangs. Lever moderately, by raising the edge of the front handlebar cover (6) and releasing the tang.
- ◆ Repeat the operation for the other tangs (four upper and four lower tangs), acting first on the side ones and then on the central ones.
- ◆ Remove the front handlebar cover.

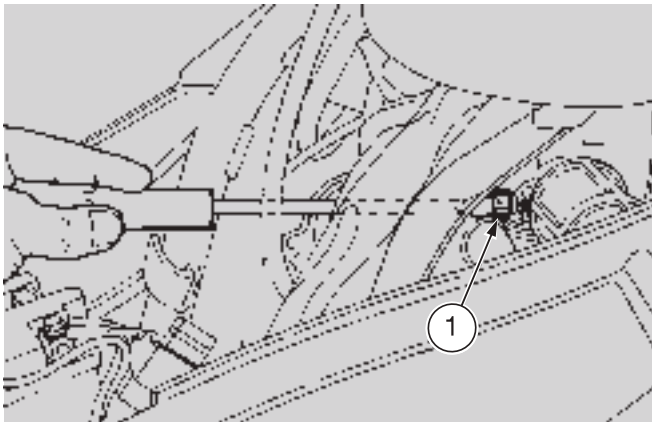

Fig. 42

## IDLING ADJUSTMENT (Fig. 42)

Carefully read p. 41 (MAINTENANCE).



**Remember: 1 mile = 1.6 km  
1 km = 0.625 miles**

Adjust the idling after the first 500 km and every time it is irregular.

To carry out this operation, proceed as follows:

- ◆ Drive for a few miles until the engine reaches the normal running temperature, then stop the engine.
- ◆ Position the vehicle on the centre stand.

- ◆ Remove the inspection cover, see p. 60 (REMOVING THE INSPECTION COVER).
- ◆ Connect an electronic revolution counter to the spark plug cable.
- ◆ Start the engine.

The minimum speed of the engine (idling) must be about  $1800 \pm 100$  rpm; in this case the engine does not make the rear wheel rotate.

If necessary:

- ◆ Act on the adjusting screw (1) positioned on the carburettor.

By **SCREWING IT** (clockwise), you increase the engine rpm.

By **UNSCREWING IT** (anticlockwise), you decrease the engine rpm.

- ◆ Twist the throttle grip, accelerating and decelerating a few times to make sure that it functions correctly and to check if the idling speed is constant.
- ◆ Close the inspection cover.



**Do not act on the air adjusting screw, to avoid variations of the carburation setting.**



**If necessary, contact your aprilia Official Dealer.**

## **ADJUSTING THE ACCELERATOR CONTROL (Fig. 43)**

**Carefully read p. 41 (MAINTENANCE).**

The ideal slack of the accelerator control should be about 2-3 mm.

To adjust the slack, proceed as follows:

- ◆ Position the vehicle on the centre stand.
- ◆ Remove the protection element (1).
- ◆ Loosen the nut (2) (by turning it clockwise).
- ◆ Act on the adjuster (3), positioned at the beginning of the accelerator control cable.

After the adjustment:

- ◆ Tighten the nut (2) (by turning it anticlockwise), thus locking the adjuster (3) and put back the protection element (1).

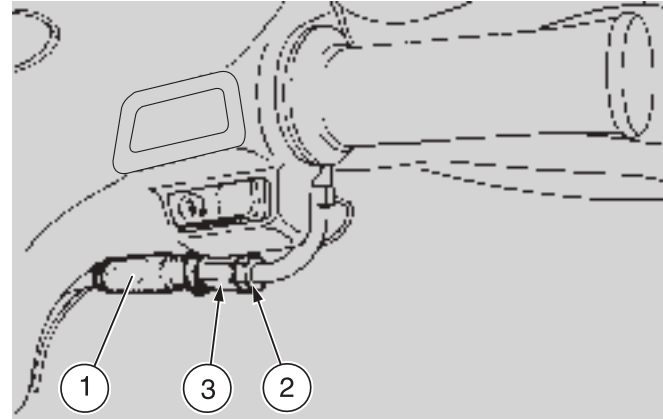

**Fig. 43**

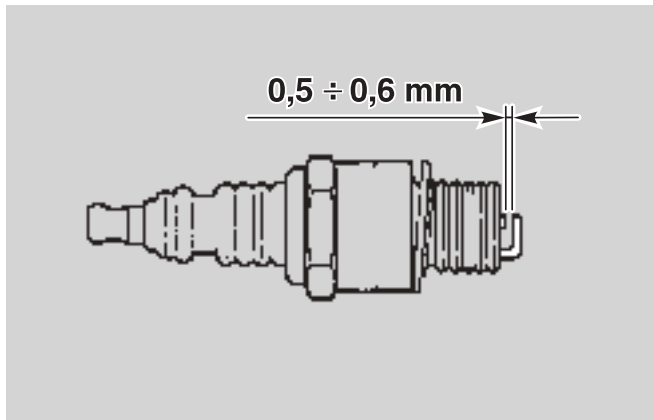

Fig. 44

## SPARK PLUG (Fig. 44)

Carefully read p. 41 (MAINTENANCE).



**Remember: 1 mile = 1.6 km**  
**1 km = 0.625 miles**

Check the spark plug after the first 500 km; change it every 4000 km.

Periodically remove the spark plug and clean it carefully, removing carbon deposits; change it if necessary.

To reach the spark plug:

- ◆ Remove the inspection cover, see p. 60 (REMOVING THE INSPECTION COVER).

To remove and clean the spark plug:

- ◆ Take off the spark plug cap (1).
- ◆ Remove all the dirt from the base of the spark plug, then unscrew it with the spanner you will find in the tool kit and extract it from its seat, taking care that neither dust nor other substances enter the cylinder.
- ◆ Make sure that there are neither carbon deposits, nor corrosion marks on the electrode and on the central porcelain part; if necessary, clean them with the special cleaners for spark plugs, with an iron wire and/ or a metal brush.
- ◆ Energetically blow some air, in order to prevent the removed residues from getting into the engine. If the spark plug has crackings on the insulating material, corroded electrodes or excessive deposits, it must be changed.
- ◆ Check the spark plug gap with a thickness gauge. The gap must be  $0,5 \div 0,6$  mm; if necessary adjust it, carefully bending the earth electrode.
- ◆ Make sure that the washer is in good conditions. With the washer on, screw the spark plug by hand in order not to damage the thread.
- ◆ Tighten the spark plug by means of the spanner you will find in the tool kit, giving it half a turn to compress the washer.





The spark plug must be well tightened, otherwise the engine may overheat and be seriously damaged.

Use the recommended type of spark plug only, see p. 79 (TECHNICAL DATA), in order not to compromise the life and performance of the engine.

- ◆ Position the spark plug cap (1).
- ◆ Put back the inspection cover.

## BATTERY

Carefully read p. 41 (MAINTENANCE).



Remember: 1 mile = 1.6 km  
1 km = 0.625 miles

Check the electrolyte level and the tightening of the terminals after the first 500 km and successively every 4000 km or 12 months.



The electrolyte in the battery is toxic and caustic and if it gets in contact with the skin it can cause burns, since it contains sulphuric acid.

Wear protection clothes, a face mask and/or goggles during maintenance operations.



In case of contact with the skin, rinse with plenty of water.  
In case of contact with the eyes, rinse with plenty of water for 15 minutes, then consult an oculist without delay.

If the electrolyte is accidentally swallowed, drink a lot of water or milk, then continue drinking milk of magnesia or vegetable oil and consult a doctor without delay.

The battery gives off explosive gases; keep it away from flames, sparks, cigarettes and any other source of heat.

During the recharging or the use, make sure that the room is properly ventilated and avoid inhaling the gases released during the recharging.

### KEEP AWAY FROM CHILDREN



Never invert the connection of the battery cables.



Do not incline the vehicle too much, in order to avoid dangerous leaks of the battery fluid.



Connect and disconnect the battery with the ignition switch in position “⊗”.

Connect first the positive cable (+) and then the negative cable (-).

Disconnect following the reverse order.

The electrolyte is corrosive.

Do not pour or spill it, especially on the plastic parts.

### LONG INACTIVITY OF THE BATTERY

If the vehicle remains unused for a long period, remove the battery and place it in a cool and dry place. Recharge it completely, by using a trickle charge.

If the battery remains on the vehicle, disconnect the cables from the terminals.

It is important to check the charge periodically (about once a month), during the winter or when the vehicle remains unused, in order to prevent the deterioration of the battery.

## CHECKING THE ELECTROLYTE LEVEL (Fig. 45)

To check the electrolyte level, proceed as follows:

- ◆ Make sure that the ignition switch is in position "⊗".
- ◆ Remove the battery/tool kit compartment cover, see p. 24 (BATTERY/ TOOL KIT COMPARTMENT).
- ◆ Remove the tool kit compartment.
- ◆ Disconnect the negative cable (-) and then the positive cable (+) of the battery.

 **Upon reassembly, connect first the positive cable (+) and then the negative cable (-).**

- ◆ Disconnect the breather pipe (1).
- ◆ Extract the battery and put it on a plane surface.
- ◆ Make sure that the fluid level is included between the two "MIN" and "MAX" notches stamped on the battery side.

Otherwise:

- ◆ Unscrew and remove the element plugs.

 **Never exceed the "MAX" notch, since the electrolyte level increases during the recharge.**

- ◆ Top up by adding distilled water.

## RECHARGING THE BATTERY

Check the electrolyte level, top up if necessary, then proceed as follows:

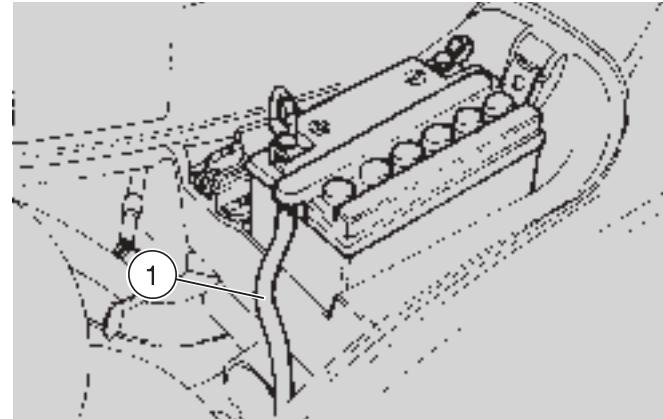



Fig. 45

- ◆ Put the battery in a cool and dry place.
- ◆ Unscrew and remove the element plugs.
- ◆ Connect the battery with a battery charger.
- ◆ A recharge with an amperage equal to 1/10th of the battery capacity is recommended.
- ◆ After the recharging operation, check the electrolyte level again and if necessary top up with distilled water.

 **Upon reassembly, always connect the battery breather pipe, to prevent the sulphuric acid vapours from corroding the electric system, painted parts, rubber elements or gaskets when they exit the breather pipe itself.**

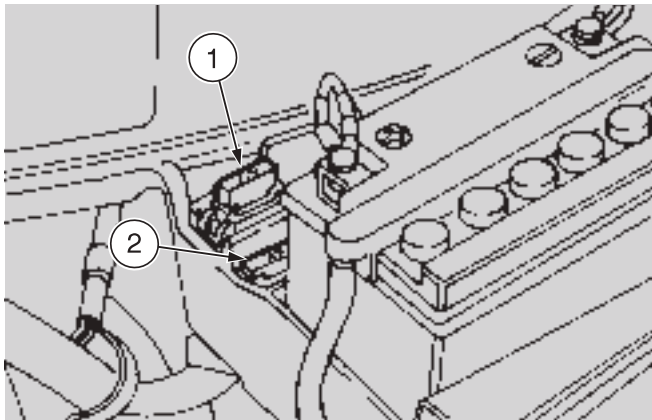

Fig. 46

## CHANGING THE FUSE (Fig. 46)



Do not repair faulty fuses.  
Never use fuses different from the recommended ones.

The use of unsuitable fuses may cause damages to the electric system or, in case of short circuit, even a fire.



If a fuse blows frequently, there probably is a short circuit or an overload in the electric system.

In this case it is advisable to consult an **aprilia** Official Dealer.

Carefully read p. 41 (MAINTENANCE).

If an electric component does not work or works irregularly, or if the vehicle fails to start, it is necessary to check the fuse (1):

- ◆ Turn the ignition switch to position “”, to avoid any accidental short circuit.
- ◆ Remove the battery/tool kit compartment cover, see p. 24 (BATTERY/ TOOL KIT COMPARTMENT).
- ◆ Extract the fuse and check if the filament is broken.
- ◆ Before replacing the fuse, try to find out the cause of the trouble, if possible.
- ◆ Then replace the damaged fuse with the spare fuse (2) or with a new one having the same amperage.



If you use one of the spare fuse (2), put a new fuse in the suitable seat.

## ARRANGEMENT OF THE FUSE

### 7.5 A fuse from the battery to:

all the electric loads, excluding the light circuit, which is fed with alternate current.

## ADJUSTING THE HEADLIGHT BEAM

To rapidly check the correct direction of the beam, place the vehicle on flat ground, 10 m away from a wall. Turn on the low beam, sit on the vehicle and make sure that the beam projected on the wall is slightly under the horizontal line of the headlight (about 9/10th of the total height) (Fig. 47).

To adjust the headlight beam:

- ◆ Act on the suitable screw (1-Fig. 48) by means of a screwdriver.

By TURNING IT CLOCKWISE, you set the beam upwards.

By TURNING IT ANTICLOCKWISE, you set the beam downwards.

## BULBS



Before changing a bulb, turn the ignition switch to position “”.

Change the bulb wearing clean gloves or using a clean and dry cloth.



Do not leave fingerprints on the bulb, since these may cause its overheating and consequent breakage. If you touch the bulb with bare hands, remove any fingerprint with alcohol, in order to prevent it from blowing frequently.

Carefully read p. 41 (MAINTENANCE).

DO NOT FORCE THE ELECTRIC CABLES

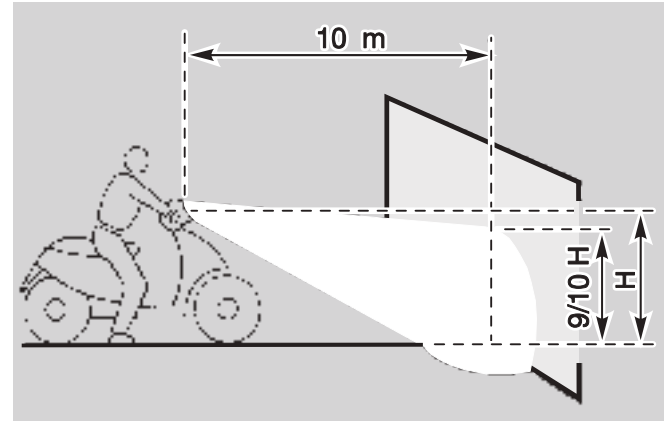

Fig. 47

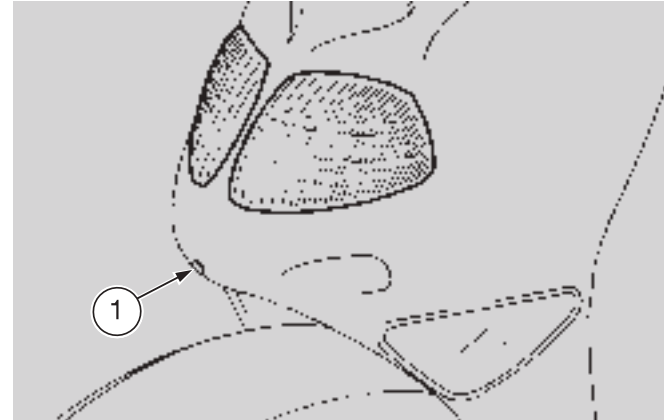

Fig. 48

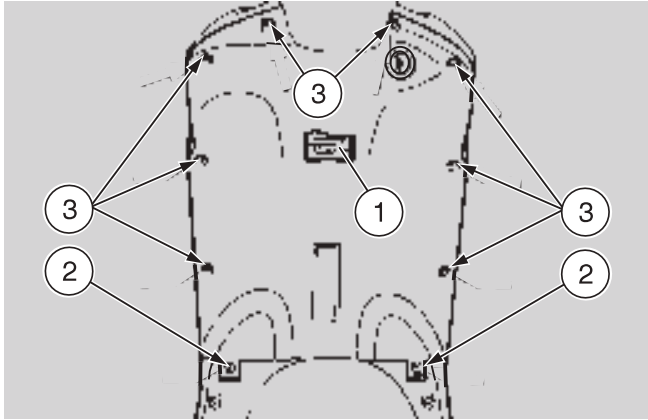

Fig. 49

## CHANGING THE HEADLIGHT BULBS

Carefully read p. 69 (BULBS).



Remove the key from the ignition switch.

◆ Position the vehicle on the centre stand.



**The operations marked with the symbol ★ must be carried out on both sides of the vehicle.**

- ◆ ★ Remove the footrest mat.
- ◆ Unscrew and remove the two fastening screws of the bag hook (1-Fig. 49).
- ◆ Remove the bag hook (1-Fig. 49).
- ◆ Unscrew and remove the screw (with the relevant washer) positioned in the seat of the bag hook.
- ◆ Unscrew and remove the two screws (2-Fig. 49).
- ◆ Unscrew and remove the eight screws (3-Fig. 49).



**Proceed with care.**

**Do not damage the tangs and/or their seats.**

**Handle the painted components with care and avoid scraping or damaging them.**

- ◆ Withdraw and remove the front inner shield, rotating it toward the saddle.

- ◆ Manually move the protection element (1-Fig. 50) of the bulb to be changed.
- ◆ Rotate the check tang positioned at the rear of the bulb socket anticlockwise.
- ◆ Extract the bulb and replace it with a new one of the same kind.

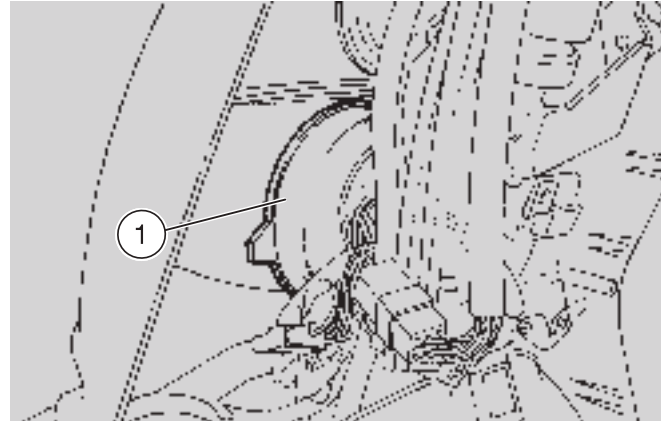

**Fig. 50**

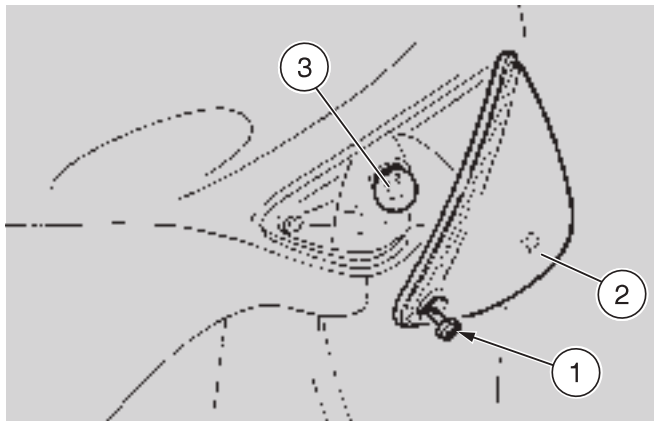

**Fig. 51**

## **CHANGING THE FRONT DIRECTION INDICATOR BULBS (Fig. 51)**

**Carefully read p. 69 (BULBS).**

To change the bulbs, proceed as follows:

- ◆ Unscrew and remove the screw (1).



**Upon reassembly, tighten the screw (1) carefully, in order not to damage the protection screen.**



**While removing the protection screen (2), proceed carefully in order not to break it.**

- ◆ Remove the protection screen (2).
- ◆ Press the bulb (3) slightly and turn it anticlockwise.
- ◆ Remove the bulb from its seat.



**Insert the bulb in the socket making the two bulb pins coincide with the relevant guides on the socket.**

- ◆ Correctly install a bulb of the same type.



## CHANGING THE REAR DIRECTION INDICATOR BULBS (Fig. 52)

Carefully read p. 69 (BULBS).

To change the bulb:

- ◆ Unscrew and remove the screw (1).



**While removing the indicator lens, proceed carefully in order not to break it.**

- ◆ Remove the indicator lens (2).
- ◆ Press the bulb (3) slightly and turn it anticlockwise.
- ◆ Remove the bulb from its seat.
- ◆ Correctly install a new bulb of the same type.



**If the bulb socket (4) has gone out of its seat, insert it again correctly, making the opening of the bulb socket itself coincide with the seat of the screw.**



**Upon reassembly, correctly position the indicator lens in its seat.**

**Tighten the screw (1) carefully, without exerting too much pressure, in order to avoid damaging the indicator lens.**

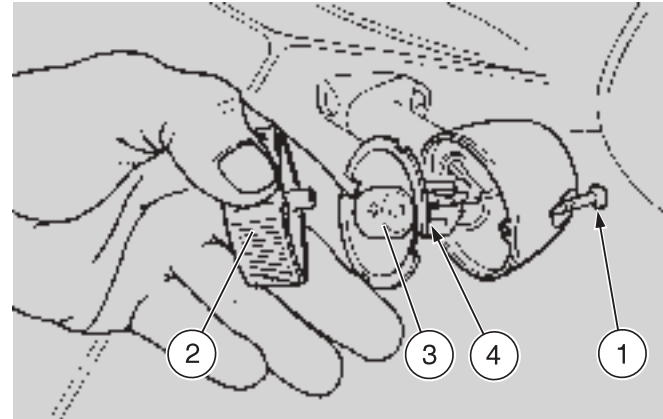

Fig. 52

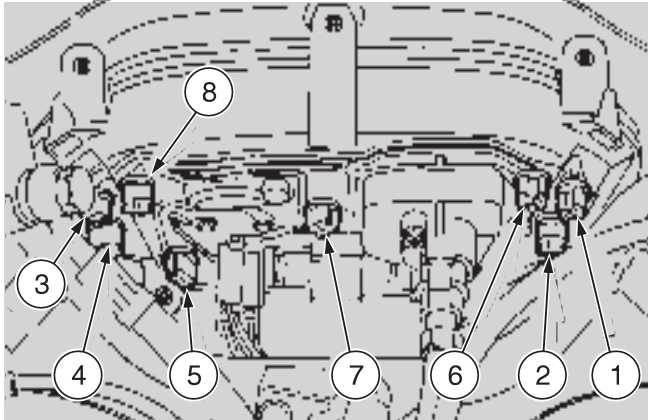

Fig. 53

## CHANGING THE DASHBOARD BULBS (Fig. 53)

Carefully read p. 69 (BULBS).

The dashboard contains:

- ◆ The warning light bulbs.
- ◆ The dashboard lighting bulbs.

To change the bulbs, proceed as follows:

- ◆ Remove the handlebar cover, see p. 61 (REMOVING THE FRONT HANDLEBAR COVER), without disconnecting it from the electric wires and from the speedometer cable.

## WARNING LIGHT BULBS

- ◆ Extract the relative bulb socket:

Pos.	Warning light	Colour
1	Left direction indicators (↔)	green
2	Mixer oil reserve (⚙)	red
3	Right direction indicators (↔)	green
4	Low beam (⚡)	green
5	Low fuel (⛽)	amber

- ◆ Extract the bulb and replace it with one of the same type.

## DASHBOARD LIGHTING BULBS

- ◆ Extract the bulb socket of the dashboard part in which there has been a light decrease:

Pos.	Lit part
6	left part
7	centre part
8	right part

- ◆ Extract the bulb and replace it with one of the same type.

## **CHANGING THE REAR LIGHT BULBS (Fig. 54)**

Carefully read p. 69 (BULBS).

To change them, proceed as follows:

- ◆ Unscrew and remove the two screws (1).

 **While removing the protection screen, proceed carefully in order not to break the cog.**

- ◆ Remove the protection screen (2).
- ◆ Slightly press the bulb and rotate it anticlockwise.
- ◆ Remove the bulb from its seat.

 **Insert the bulb in the socket, making the two bulb pins coincide with the relevant guides on the socket.**

- ◆ Correctly install a new bulb of the same type.

 **Upon reassembly, correctly position the protection screen in its seat.**

**Tighten the screws (1) carefully, without exerting too much pressure, in order to avoid damaging the protection screen (2).**

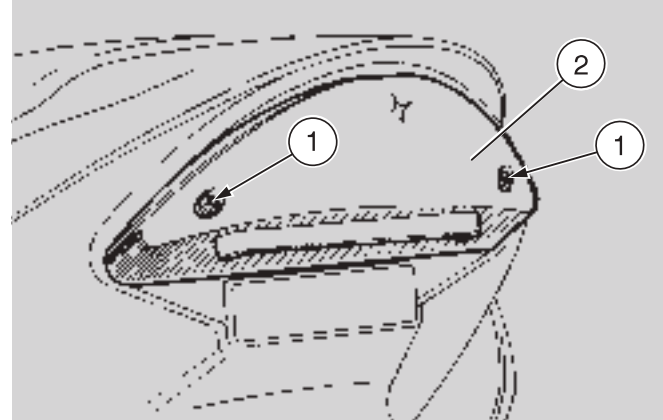

**Fig. 54**

## TRANSPORT

 Before transporting the vehicle, it is necessary to empty the fuel tank and the carburettor completely, making sure that both are completely dry. During transport, the vehicle must be held upright, in its normal use position, to avoid any oil and battery fluid leakage.

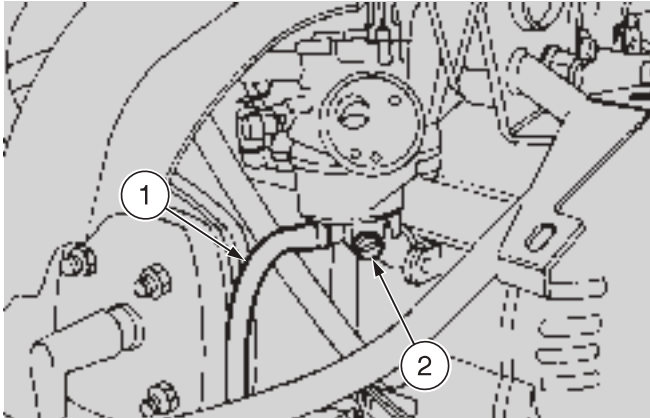

Fig. 55

## DRAINING THE FUEL TANK (Fig. 55)

Carefully read p. 25 (FUEL).

- ◆ Stop the engine and wait until it has cooled down.
- ◆ Empty the fuel tank by means of a manual pump or a similar system.

To empty the carburettor completely, proceed as follows:

- ◆ Remove the inspection cover, see p. 60 (REMOVING THE INSPECTION COVER).
- ◆ Remove the filter casing, see p. 46 (AIR CLEANER - REMOVAL).
- ◆ Put the free end of the pipe (1) into a receptacle.
- ◆ Open the carburettor breather by loosening the drain screw (2) positioned under the float chamber.

When all the fuel has flowed out:

- ◆ Tighten the drain screw (2) until the breather shuts.



**Tighten the drain screw (2) carefully, to avoid fuel leaks from the carburettor breather pipe during the refuelling.**

## CLEANING

Clean the vehicle frequently if it used in particular areas or conditions, such as:

- ◆ Polluted areas (cities and industrial areas).
- ◆ Areas characterized by an high percentage of salinity and humidity (sea areas, hot and humid climates).
- ◆ Particular conditions (use of salt and anti-ice chemical products on the roads during the winter).
- ◆ Avoid leaving deposits of industrial and polluting powders, tar spots, dead insects, bird droppings, etc. on the body.
- ◆ Avoid parking the vehicle under trees, since in some seasons residues, resins, fruits or leaves fall down, which contain substances that may damage the paint.



**After the vehicle has been washed, its braking functions could be temporarily impaired because of the presence of water on the grip surfaces. Calculate long braking distances to avoid accidents. Brake repeatedly to restore normal conditions.**

**Carry out the preliminary checking operations, see p. 33 (PRELIMINARY CHECKING OPERATIONS).**

To remove dirt and mud from the painted surfaces use a low- pressure water jet, carefully wet the dirty parts, remove mud and filth with a soft car sponge impregnated with a lot of water and shampoo (2 ÷ 4% parts of shampoo in water).

Then rinse with plenty of water and dry with chamois leather.

To clean the outer parts of the engine use a degreaser, brushes and wipers.



**Polish with silicone wax only after having carefully washed the vehicle.**

**Do not use polishing pastes on matt paints. Do not wash the vehicle under the sun, especially during the summer, when the body is still warm, since if the shampoo dries before being rinsed away, it can damage the paint.**

**Do not use water (or liquids) at a temperature exceeding 40°C to clean the plastic components of the vehicle.**

**Use neither high pressure water/air jets, nor vapour jets on the following parts: wheel hubs, controls on the right and on the left side of the handlebar, bearings, brake pumps, instruments and indicators, silencer exhaust, glove/tool kit compartment, ignition switch/steering lock.**

**Do not use alcohol or solvents to clean the rubber and plastic parts and the saddle: use water and mild soap.**

**Do not apply protection waxes onto the saddle, in order not to make it too slippery.**

## LONG PERIODS OF INACTIVITY

After a long period of inactivity of the vehicle some precautions are necessary to avoid any problem.

Further, it is important to carry out the necessary repairs and a general check up before the period of inactivity, since you could forget to carry them out later.

Proceed as follows:

- ◆ Empty the fuel tank and the carburettor, see p. 76 (DRAINING THE FUEL TANK).  
Put back the tank plug.
- ◆ Extract the spark plug and pour a teaspoon (5-10 cm<sup>3</sup>) of two-stroke engine oil into the cylinder.  
Move the ignition switch to position “○”, press the start push button “⊗” for a few seconds, to distribute the oil evenly on the cylinder surfaces.  
Put back the spark plug.
- ◆ Remove the battery, see p. 65 (BATTERY).
- ◆ Wash and dry the vehicle, see p. 77 (CLEANING).
- ◆ Polish the painted surfaces with wax.
- ◆ Inflate the tyres, see p. 30 (TYRES).
- ◆ By means of a suitable support, position the vehicle so that both tyres are raised from the ground.

- ◆ Place the vehicle in an unheated, not-humid room, away from sunlight, with minimum temperature variations.
- ◆ Cover the vehicle avoiding the use of plastic or waterproof materials.

## AFTER A PERIOD OF INACTIVITY

- ◆ Uncover and clean the vehicle, see p. 77 (CLEANING).
- ◆ Check the electrolyte level in the battery and install it, see p. 65 (BATTERY).
- ◆ Make sure that the fuel drain screw is thoroughly screwed (breather pipe closing index), see p. 76 (DRAINING THE FUEL TANK).
- ◆ Refuel, see p. 25 (FUEL).
- ◆ Carry out the preliminary checking operations, see p. 33 (PRELIMINARY CHECKING OPERATIONS).



**Have a test ride at moderate speed in a low-traffic area.**



## TECHNICAL DATA

DIMENSIONS	Max. length .....	1750 mm
	Max. width .....	800 mm
	Max. height (rear-view mirror included) .....	1310 mm
	Seat height .....	770 mm
	Distance between centres .....	1250 mm
	Min. ground clearance .....	155 mm
	Weight without driver (ready for starting) .....	91 kg
ENGINE	Type .....	MINARELLI, 2-stroke with controlled ignition
	Number of cylinders .....	1
	Total displacement .....	49.26 cm <sup>3</sup>
	Bore/stroke .....	40 mm / 39.2 mm
	Compression ratio .....	12.5 ± 0.5:1
	Starting .....	electric + kick starter
	Clutch .....	centrifugal
	Change gear .....	automatic stepless variator
CAPACITY	Cooling .....	with forced air
	Fuel (reserve included) .....	6 ℓ
	Fuel reserve .....	1.5 ℓ
	Transmission oil .....	110 cm <sup>3</sup>
	Mixer oil (reserve included) .....	1.3 ℓ
	Mixer oil reserve .....	0.35 ℓ
	Seats .....	1 (2 in the countries where this is allowed)
	Vehicle max. load (driver + luggage) .....	105 kg
	(driver+passenger+luggage) .....	180 kg (in the countries where this is allowed)
TRANSMISSION	Speed change gear .....	automatic and stepless
	Primary .....	V-belt
	Ratios .....	minimum for stepless change: 2.6 - maximum for stepless change: 0.88
	Secondary .....	with gears
CARBURETTOR	Model .....	DELL'ORTO PHBN 12
	Choke tube .....	Ø12 mm
FUEL SUPPLY	Fuel .....	unleaded petrol according to the DIN 51607 standard, min. O.N. 95 (N.O.R.M.) and 85 (N.O.M.M.)
FRAME	Type .....	one-beam, split in two cradles

SUSPENSIONS	Front .....	hydraulically operated telescopic fork
	Stroke .....	75 mm
	Rear .....	hydraulic mono-shock absorber
	Stroke .....	75 mm
BRAKES	Front .....	disc brake, Ø190 mm with hydraulic transmission
	Rear .....	drum brake, Ø110 mm, with mechanic transmission
WHEELS	Front .....	3.50 x 10"
	Rear .....	3.50 x 10"
TYRES	Front .....	tubeless
	Rear .....	120/90 - 10"
STANDARD INFLATION PRESSURE	Front .....	130 kPa (1.3 bar)
	Rear .....	170 kPa (1.7 bar)
INFLATION PRESSURE WITH PASSENGER (where drive with passenger is allowed)	Front .....	190 kPa (1.9 bar)
	Rear .....	210 kPa (2.1 bar)
IGNITION	Type .....	CDI
	Spark advance .....	14° before T.D.C.
	Standard spark plug .....	NGK BR7 HS
	Spark plug gap .....	0.5 ÷ 0.6 mm
	Engine idle rpm .....	1800 ± 100 rpm
ELECTRIC SYSTEM	Battery .....	12 V - 4 Ah
	Fuse .....	7.5 A
	Generator (with permanent magnet) .....	12 V - 85 W
	Low beam bulbs .....	12 V - 15 W
	Front parking light bulb .....	12 V - 5 W
	Direction indicator bulbs .....	12 V - 10 W
	Rear parking/stoplight bulbs .....	12 V - 5/21 W
	Dashboard bulbs .....	12 V - 1.2 W
	Low beam warning light .....	12 V - 1.2 W
	Direction indicator warning light .....	12 V - 1.2 W
	Mixer oil reserve warning light .....	12 V - 1.2 W
	Low fuel warning light .....	12 V - 1.2 W



## LUBRICANT CHART





**Transmission oil (recommended):**  F.C., SAE 75W - 90 or  GEAR SYNTH, SAE 75W - 90.

As an alternative to the recommended oil, it is possible to use high-quality oils with characteristics in compliance with or superior to the A.P.I. GL-4 specifications.

**Mixer oil (recommended):**  GREEN HIT 2 or  CITY 2T.

As an alternative to the recommended oil, use high-quality oils with characteristics in compliance with or superior to the ISO-L-ETC++, A.P.I. TC++ specifications.

**Fork oil (recommended):**  F.A. 5W or  F.A. 20W fork oil;  
an alternative  FORK 5W or  FORK 20W fork oil.

If you need an oil with intermediate characteristics in comparison with the  F.A. 5W and  F.A. 20W or  FORK 5W and  FORK 20W, these can be mixed as indicated below:

SAE 10W =  F.A. 5W 67% of the volume +  F.A. 20W 33% of the volume, or  
 FORK 5W 67% of the volume +  FORK 20W 33% of the volume;

SAE 15W =  F.A. 5W 33% of the volume +  F.A. 20W 67% of the volume, or  
 FORK 5W 33% of the volume +  FORK 20W 67% of the volume.

**Bearings and other lubrication points (recommended):**  AUTOGREASE MP or  GREASE 30.

As an alternative to the recommended product, use high-quality grease for rolling bearings, working temperature range -30°C.... +140°C, dripping point 150°C... 230°C, high protection against corrosion, good resistance to water and oxidation.

**Protection of the battery poles:** neutral grease or vaseline.

### WARNING

Use new brake fluid only.

**Brake fluid (recommended):**  F.F., DOT 5 (DOT 4 compatible) or  BRAKE 5.1, DOT 5 (DOT 4 compatible).

### WARNING

Use only antifreeze and anticorrosive without nitrite, ensuring protection at -35°C at least.

**Engine coolant (recommended):**  ECOBLU - 40°C or  COOL.

- I** APRILIA s.p.a. via G. Galilei, 1 - 30033 Noale (VE) Italy  
Tel. +39(0)41 5829111 - Fax +39(0)41 441054 - Servizio Clienti **aprilia** +39(0)41 5786269
- F** APRILIA WORLD SERVICE B.V. Z.A. Central Parc - 255 BLD Robert Ballanger  
B.P. 77- 93421 Villepinte (F) - Tel. (0) 149634747 - Fax (0) 149638750
- D** MOTORRAD GmbH Am Seestern 3 D-40547 Düsseldorf (D)  
Tel. (211) 59018-00 - Fax (211) 5901819
- E** APRILIA WORLD SERVICE B.V. ESPAÑA Avda. de Aragón, 334 - Edificio América - 28022 - Madrid (E)  
Tel. 91 7460066 - Fax 91 7460062
- NL** APRILIA NEDERLAND Nikkelstraat 1 - 4823 AE Breda (NL)  
Tel. (076) 5431640 - Fax (076) 5431649
- UK** APRILIA MOTO U.K. LTD. Dunragit - Stranraer - Wigtownshire DG9 8PN - Scotland (UK)  
Tel. (01776) 888670 - Fax (01581) 400661 - E-mail: aprilia@aol.com
- USA** APRILIA USA Inc. 110 Londonderry Court, Suite 130 - Woodstock, GA 30188 (USA)  
Tel. 770 592 2261 - Fax 770 592 4878
- A** GINZINGER IMPORT GmbH & CO Frankfurterstrasse 19 - 4910 Ried im Innkreis (A)  
Tel. (7752) 88077 - Fax (7752) 70684 - E-mail: elke.ginzinger@ivnet.co.at
- P** MILFA IMPORTAÇÃO EXPORTAÇÃO LDA. Avenida da Republica 692 - 4450-238 Matosinhos (P)  
Tel. 229382450 - Fax 229371305 - E-mail: milfa@meganet.pt
- SF** TUONTI NAKKILA OY P.o.B. 18 - 29250 Nakkila (SF)  
Puh. (02) 5352500 - Fax (02) 5372793 - E-mail: varaosat@npm.fi
- B** RAD n.v. / s.a. Industriegebied - Landegemstraat 4 - B - 9031 Drogen-Baarle  
Tel. (09) 2829410 - Fax (09) 2829433 - E-mail: aprilia@rad.be
- GR** MOBILITY S.A. Lahana 12 N. Filadelfia - 143 42 Athens (GR)  
Tel. (1) 2723552 - Fax (1) 271478 - E-mail: mobility@internet.gr
- GR** MOBILITY A.E. Λασινα 12 Ν. Φιλαδέλφεια - 143 42 Αθήνα - Ελλάδα  
Τηλ. (1) 2723552 - Φαξ (1) 271478 - E-mail: mobility@internet.gr
- CH** MOHAG AG Bernerstrasse Nord 202 - 8064 Zurich (CH)  
Tel. (1) 4348686 - Fax (1) 4348606 - E-mail: info@mohag.ch
- DK** **S** T.M.P. Islandsvej 3 - 7900 Nykøbing Mors (DK)  
Tel 97722233 - Fax 97722133 - E-mail: t\_m\_p@post4.tele.dk
- J** BOSCO MOTO CO. LTD. 22-25 Hakunoshima 2 Chome Minoo-Shi 562 Osaka  
562-0012 OSAKA (J) - Tel. (0727) 253311 - Fax (0727) 253322
- J** 株式会社ボスコ・モト 大阪府吹上区本町2丁目22番  
〒562-0012 吹上区本町2丁目22番
- SGP** IDEAL MOTOR SPORT PTE. LTD. 20 Mactaggart Road, #01-01 Khong Guan Industrial Building 368079 Singapore (SGP)  
Tel. 2820082 - Fax 2821012 - E-mail: idealmtr@mbox4.singnet.com.sg
- H** MILLE MOTOR KFT. H-1054 - Budapest - Hold u. 23. (H)  
Tel. +36 1 301 0021 - Fax +36 1 301 0021 - E-mail: aprilia@apriliamotor.hu

**PL** MOTO SP. ZOO  
Ul. Trakt Lubelski 298 B - 04-667 Warszawa (PL)  
Tel. (22) 121183 - Fax (22) 121183

**IL** METRO MOTOR-MARKETING LTD.  
12, Tushia Street - P.O. BOX 57266 - 61572 - Israel - Tel-Aviv (IL)  
Tel. (3) 5623951 - Fax (3) 5623950 - E-mail: metro@inter.net.il

**ROK** BIKE KOREA CO., LTD.  
YeungSoo BLDG 302 #206-25, Ohjang-dong, Chung-ku, Seoul (ROK)  
Tel. (02) 2275-6130/1 - Fax. (02) 2275-6132 - E-mail: kukbike@yahoo.co.kr

**MAL** GENTALI MALAYSIA SDN BHD  
Unit B-1-8 Megan Phileo Promenade 189 Jalan Tun Razak - 50400 - Kuala Lumpur (MAL)  
Tel.(603) 21649800 - Fax. (603) 21649700

**RCH** HARLEY DAVIDSON SANTIAGO  
Isidora Goyenechea 2926 - Santiago (RCH)  
Tel. (2) 2321667 - Fax (2) 2321894

**BM** EVE'S CYCLES LTD.  
114, Middle Road - PG BX Paget (BM)  
Tel. (441) 2366247 - Fax (441) 2366996

**BR** APRILIA-BRASIL  
Av. Europa, 352 - Jardim Europa - 01449-001 Sao Paulo-SP (BR)  
Tel. (11) 30691220 - Fax. (11) 30691221 - E-mail: hjdeki@aprilia.com.br

**AUS** JOHN SAMPLE GROUP PTY LTD.  
8, Sheridan Close - NSW 2214 - Milperra - Sydney (AUS)  
Tel. (2) 97722666 - Fax (2) 97742321 - E-mail: jcaruso@jsg.com.au

**RSA** MOTOVELO S.A.  
Old Pretoria Road - Wynberg - Johannesburg (RSA)  
Tel. (11) 7868486 - Fax (11) 7868482 - E-mail: motovelo@beteoh.co.za

**NZ** MOTORCYCLING DOWNUNDER LTD.  
35, Manchester Street - P.o.B. 22416 - Christchurch (NZ)  
Tel. (3) 3660129 - Fax (3) 3667580 - E-mail: guzzi@motorcycling-nz.co.nz

**HR** ING-KART, d.o.o.  
Miroslava Magdalenica, 1 - 10000 Zagreb (HR)  
Tel. (1) 3491107 / 3491091 - Fax (1) 3491555 - E-mail: ing-kart@zg.tel.hr

**SLO** AVTO TRIGLAV, d.o.o.  
Baragova 5 - 1113 Ljubljana (SLO)  
Tel. (61) 1883420 - Fax (61) 1883465 - E-mail: ziga.martincic@avto-triglav.si

**M** BIKES & COMPANY LTD.  
178, Marina Street, Pieta. MSD 08. (M) - Tel. (+356) 236 665 - Fax (+356) 239 368

**TR** METRO MOTORLU ARACLAR TICARET A.S.  
Mihrabat Caddesi Akbeysoyak Yetimoglu Is Merkezi -  
81640 - Kavacik-Istanbul (TR) - Tel. (0216) 4251565 - Fax (0216) 3312606

**CZ** A. SPIRIT a.s.  
Sluzeb 5 - 10800 Praha 10 (CZ)  
Tel. +420-2-72703049 - Fax. +420-2-72702156 - E-mail: office@aspirit.cz

**IRL** K.D.I. KAWASAKI DISTRIBUTOR IRL. LTD.  
17 Wood Street - Dublin 8 (IRL)  
Tel. (1) 4756046 - Fax. (1) 4756461

**N** HARO SKANDINAVIA A.S.  
Kjørbekkdalen 6 - 3735 - Skien, Norway (N)  
Tel. 35506780 - Fax. 35506781 - E-mail: post@aprilia.no

**MEX** APRILIA DE MEXICO, SA. de CV.  
San Jeromino - 64640 - 552 Monterrey N.L. (MEX)  
Tel. 8333-4493 - Fax. 8348-9398 - E-mail: javier@aprilia.com.mx



## WIRING DIAGRAM KEY - Rally 50

- 1) Generator
- 2) CDI
- 3) Spark plug
- 4) H.T. coil
- 5) Voltage regulator
- 6) Battery
- 7) Starter
- 8) Start relay
- 9) Front stoplight switch
- 10) Rear stoplight switch
- 11) Mixer oil reserve switch
- 13) Fuel level sensor
- 14) Rear right direction indicator
- 15) Rear light
- 16) Rear left direction indicator
- 17) Bridge
- 18) Direction indicator switch
- 19) Key switch
- 20) Control diode
- 22) Blinking
- 23) Dashboard
- 24) Left direction indicator warning light
- 25) Mixer oil reserve warning light
- 26) Dashboard light
- 27) Fuel level instrument
- 28) Low fuel warning light
- 29) Low beam warning light
- 30) Right direction indicator warning light

- 31) Front right direction indicator
- 32) Front left direction indicator
- 33) Front parking light
- 34) Low beam bulb
- 35) Horn
- 36) Pick up
- 37) Fuse
- 38) Multiple connectors
- 39) Start push button
- 40) Horn push button

## CABLE COLOURS

- Ar** Orange  
**Az** Light blue  
**B** Blue  
**Bi** White  
**G** Yellow  
**Gr** Grey  
**M** Brown  
**N** Black  
**R** Red  
**V** Green  
**Vi** Violet

## **NOTE**

---

**aprilia**

**ASK FOR GENUINE SPARE PARTS ONLY**

## **NOTE**

---

**aprilia**

**ASK FOR GENUINE SPARE PARTS ONLY**

**aprilia s.p.a.** wishes to thank its customers for the purchase of this vehicle:

- Do not dispose of oil, fuel, polluting substances and components in the environment.
- Do not keep the engine running if it is not necessary.
- Avoid disturbing noises.
- Respect nature.